



# **Mandatory VA Policy Signs by Directive**

- **Consent to Inspection**
- **No Smoking**
- **No Weapons Permitted**
- **Business Hours**
- **Notice of Weapons Search**
- **Parking Notice**
- **Patient Rights and Responsibilities**
- **Policies and Directives**
- **No Weapons**
- **Security Notice**

This page is intentionally left blank.

This section of the Sign and Graphic Design Guide is comprised of signs that are **REQUIRED** to be posted by VA Policy Directive.

The text on each sign is specific and is not open to modification or revisions. Placement of the signs is also specifically directed in the Policy Directive.

This page is intentionally left blank.

**MANDATORY POLICY SIGN DESIGNATIONS**

Each sign in the program guide has been given a specific sign type number designation. This designation provides a common description that can be referenced when programming a site and ordering signs. The following explains how the sign type designations are derived:

# IN - 02.03 A

**I** Designates an interior sign.

**N** Identifies the sign is non-illuminated.

**02** Two digit number identifies a particular sign type family.

**.03** The two digit number, following the period, identifies a specific sign within the sign family.

**A** The letter designates a specific sign configuration, version and/or layout for graphics.

**Sign Type IN-02**  
Policy Signs

**IN-02.01**  
"Consent to Inspection" sign

**IN-02.02**  
"No Smoking" sign

**IN-02.03**  
"No Weapons" sign

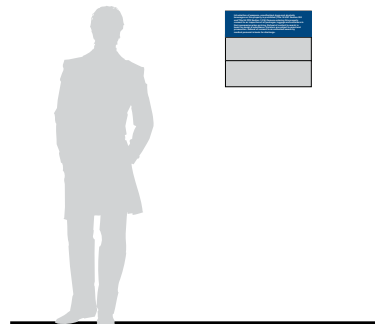

**IN-02.01**



**IN-02.02**



**IN-02.03**

**Sign Type IN-02**

"Policy" Signs

**IN-02.04**

"Hours of Operation" sign

**IN-02.05**

"Notice of Weapons Search" sign

**IN-02.06**

"Parking Restriction" sign

**IN-02.07**

"Patient Rights and Responsibilities" sign

**IN-02.08**

"Policies and Directives" sign



**IN-02.04**



**IN-02.05**

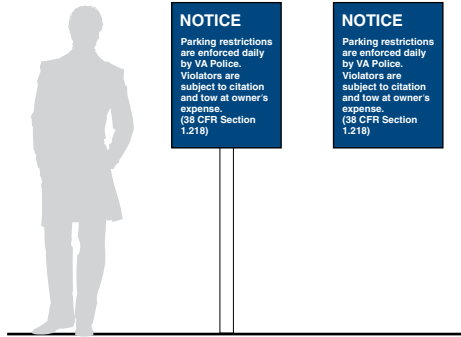

**IN-02.06**

**single post option**

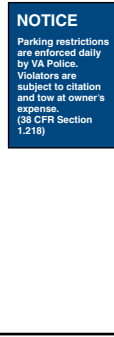

**wall mounted option**

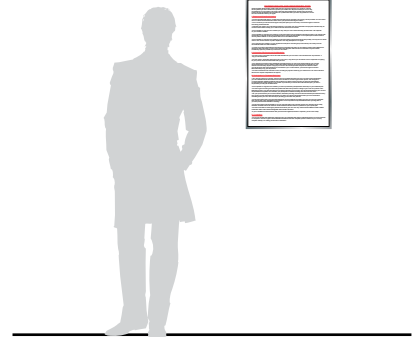

**IN-02.07**

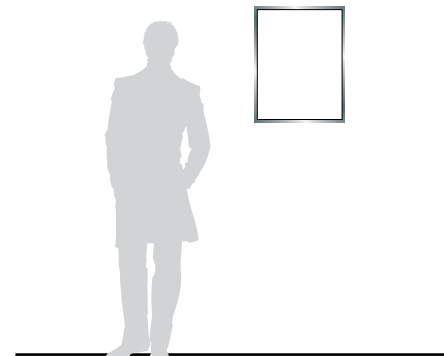

**IN-02.08**

**Sign Type IN-02**

"Policy" Signs

**IN-02.10**

"No Weapons" sign – small

**IN-02.11**

"No Weapons" sign – large

**IN-02.12**

"Security Notice" sign

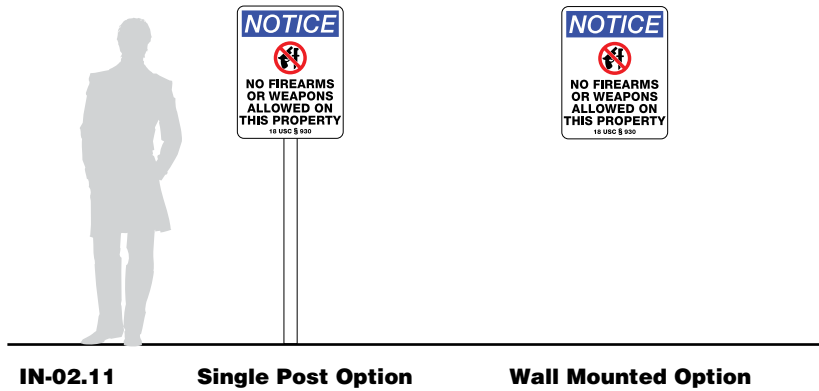
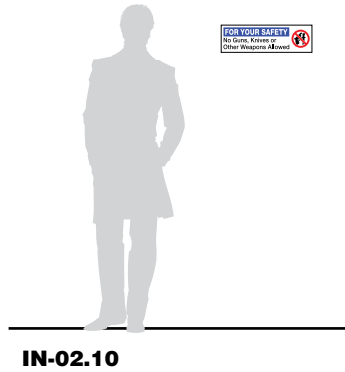

This page is intentionally left blank.



**Consent to Inspection****Size**

Sign Face:  
152 mm H x 508 mm W  
(6" H x 20" W)

**Description**

"Consent to Inspection" sign is required to be placed at the entrance of a building.

**Message Configuration**

(Refer to message layout drawing for dimensions).

**Sign Components**

Acrylic plaque

**Graphic Process**

Silk-screened

**Colors**

For background and type colors, refer to VA color chart.

**Typography**

Helvetica Bold

**Mounting**

Double sided foam tape or silastic adhesive

**Installation**

Sign can be coordinated to be placed with other policy signs, IN-02.2 and IN-02.3 that are required at the entrance.

Introduction of weapons, unauthorized drugs and alcoholic beverages on this property is prohibited (Title 18 USC Section 930 and Title 38 CFR Section 1.218). Persons entering this property consent to an inspection of all packages, luggage and containers in their possession when arriving. Refusal of content to search is basis for denial of admittance. Violators are subject to arrest and prosecution. Refusal of consent to an authorized search by medical personnel is basis for discharge.

Introduction of weapons, unauthorized drugs and alcoholic beverages on this property is prohibited (Title 18 USC Section 930 and Title 38 CFR Section 1.218). Persons entering this property consent to an inspection of all packages, luggage and containers in their possession when arriving. Refusal of content to search is basis for denial of admittance. Violators are subject to arrest and prosecution. Refusal of consent to an authorized search by medical personnel is basis for discharge.

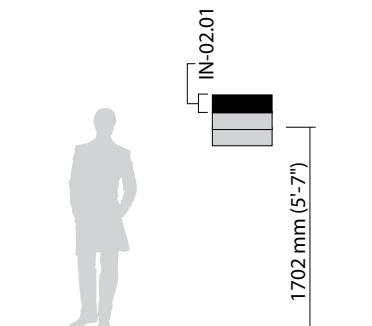

**Consent to Inspection**

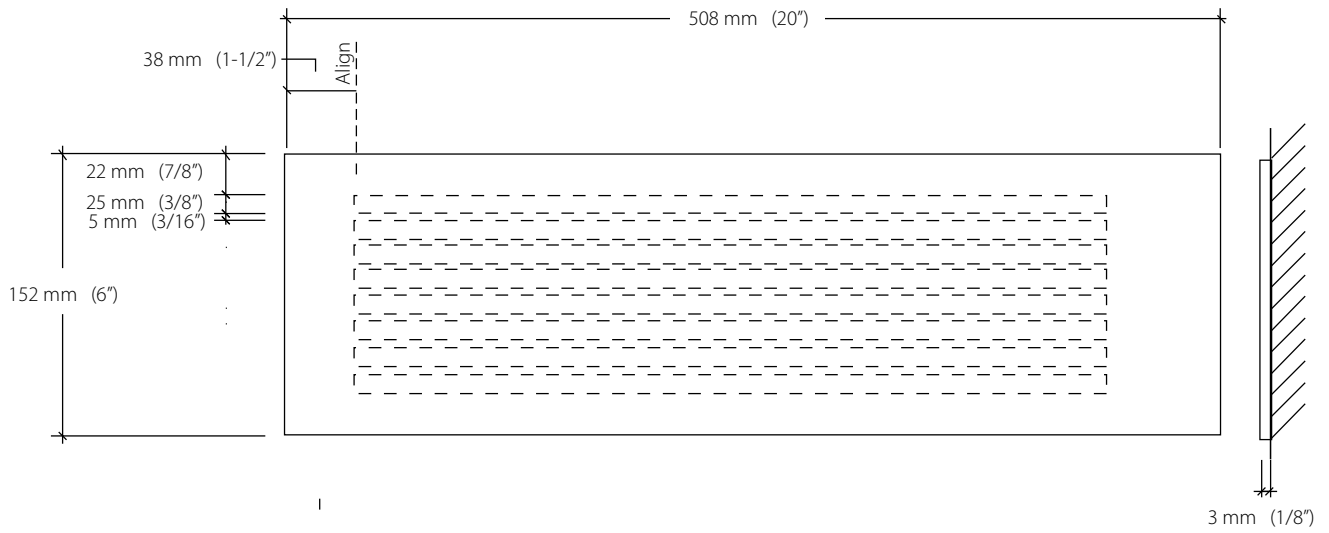

## No Smoking

**Size**

Sign Face:  
152 mm H x 508 mm W  
(6" H x 20" W)

**Description**

"No Smoking" sign is required to be placed at the entrance of a building.

**Message Configuration**

(Refer to message layout drawing for dimensions).

**Sign Components**

Acrylic plaque

**Graphic Process**

Silk-screened

**Colors**

For background and type colors, refer to VA color chart.

**Typography**

Helvetica Bold

**Mounting**

Double sided foam tape or silastic adhesive

**Installation**

Sign can be coordinated to be placed with other policy signs, IN-02.01 and IN-02.03 that are required at the entrance.

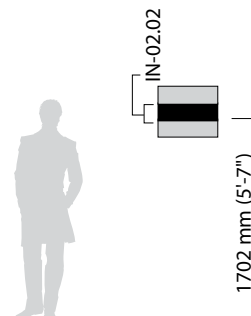
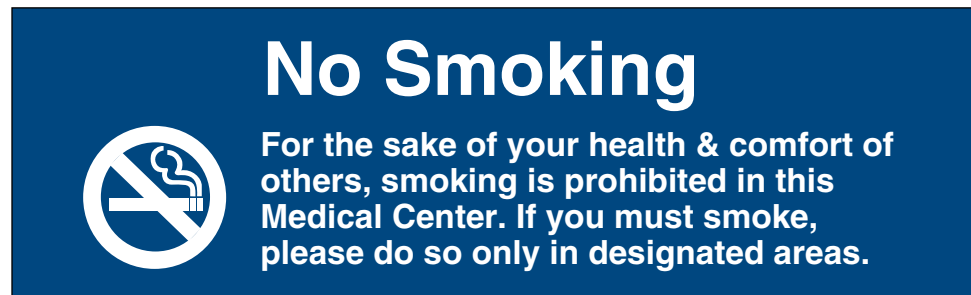
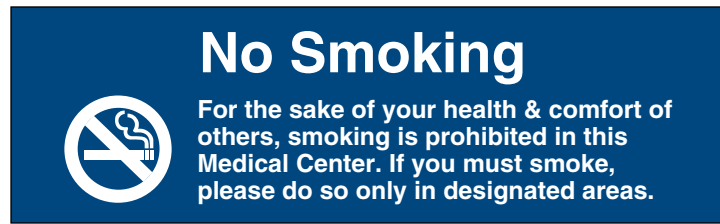

**No Smoking**

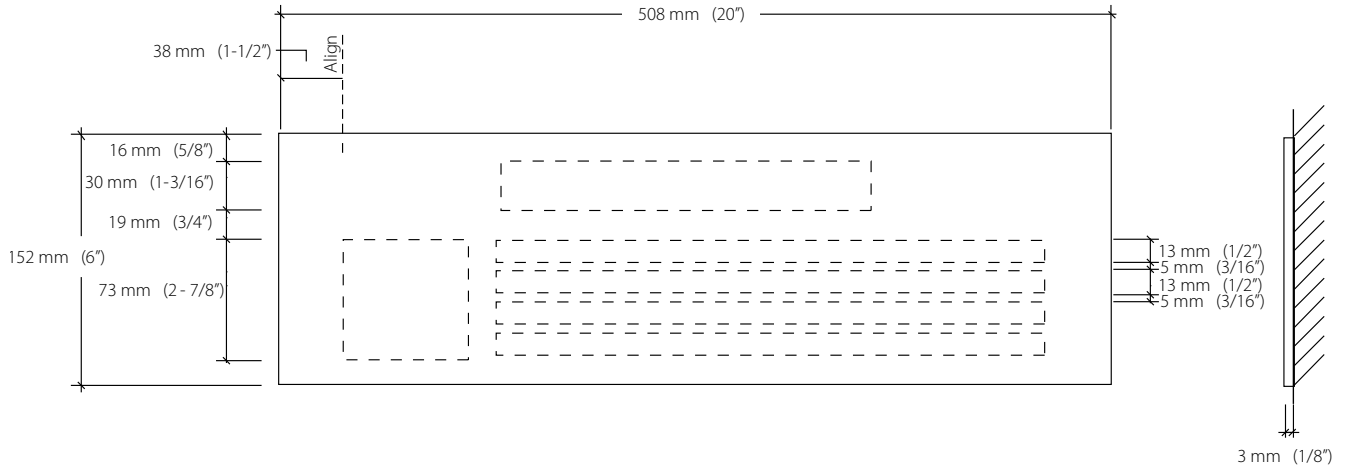

**No Weapons Permitted****Size**

Sign Face:  
152 mm H x 508 mm W  
(6" H x 20" W)

**Description**

"No Weapons" sign is required to be placed at the entrance of a building.

**Message Configuration**

(Refer to message layout drawing for dimensions).

**Sign Components**

Acrylic Plaque

**Graphic Process**

Silk-screened

**Colors**

For background and type colors, refer to VA color chart.

**Typography**

Helvetica Bold

**Mounting**

Double sided foam tape or silastic adhesive

**Installation**

Sign can be coordinated to be placed with other policy signs, IN-02.01 and IN-02.02 that are required at the entrance.

Whoever knowingly possesses or causes the presence of a firearm or other dangerous weapon on the grounds or buildings of this facility, or attempts to do so, is subject to fine or imprisonment of not more than one year, or both. 18 U.S.C. Section 930a. Whoever intends that a firearm or other dangerous weapon be used in the commission of a crime and knowingly possesses or causes the presence of a firearm or other dangerous weapon on the grounds or buildings of this facility, or attempts to do so, is subject to fine or imprisonment of not more than five years, or both. 18 U.S.C. Section 930b.

Whoever knowingly possesses or causes the presence of a firearm or other dangerous weapon on the grounds or buildings of this facility, or attempts to do so, is subject to fine or imprisonment of not more than one year, or both. 18 U.S.C. Section 930a. Whoever intends that a firearm or other dangerous weapon be used in the commission of a crime and knowingly possesses or causes the presence of a firearm or other dangerous weapon on the grounds or buildings of this facility, or attempts to do so, is subject to fine or imprisonment of not more than five years, or both. 18 U.S.C. Section 930b.

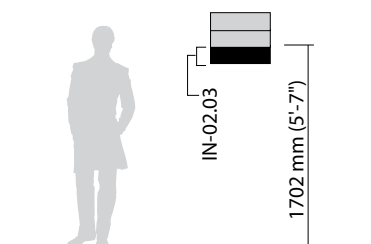

**No Weapons Permitted**

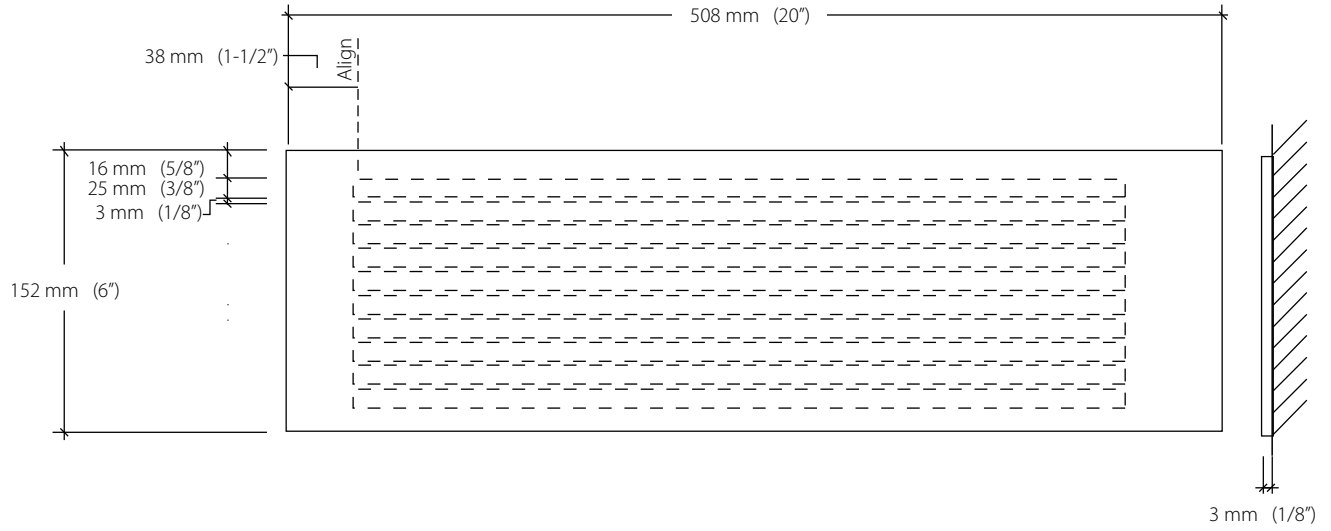

## Business Hours

**Size**

Sign Face:  
229 mm H x 229 mm W  
(9" H x 9" W)

**Description**

"Hours of Operation" sign is required to be placed at the entrance of a building.

**Message Configuration**

(Refer to message layout drawing for dimensions).

**NOTE:**

Hours and days of operation are to be established on a facility by facility basis.

**Sign Components**

Acrylic plaque

**Graphic Process**

Surface applied vinyl

**Colors**

For background and type colors, refer to VA color chart.

**Typography**

Helvetica Bold

**Mounting**

Double sided foam tape or silastic adhesive

**Installation**

On wall, 1600 mm (63") to top of sign, at the entrance.

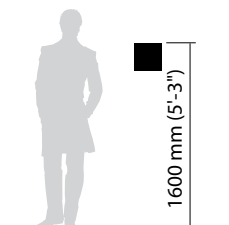

Business Hours

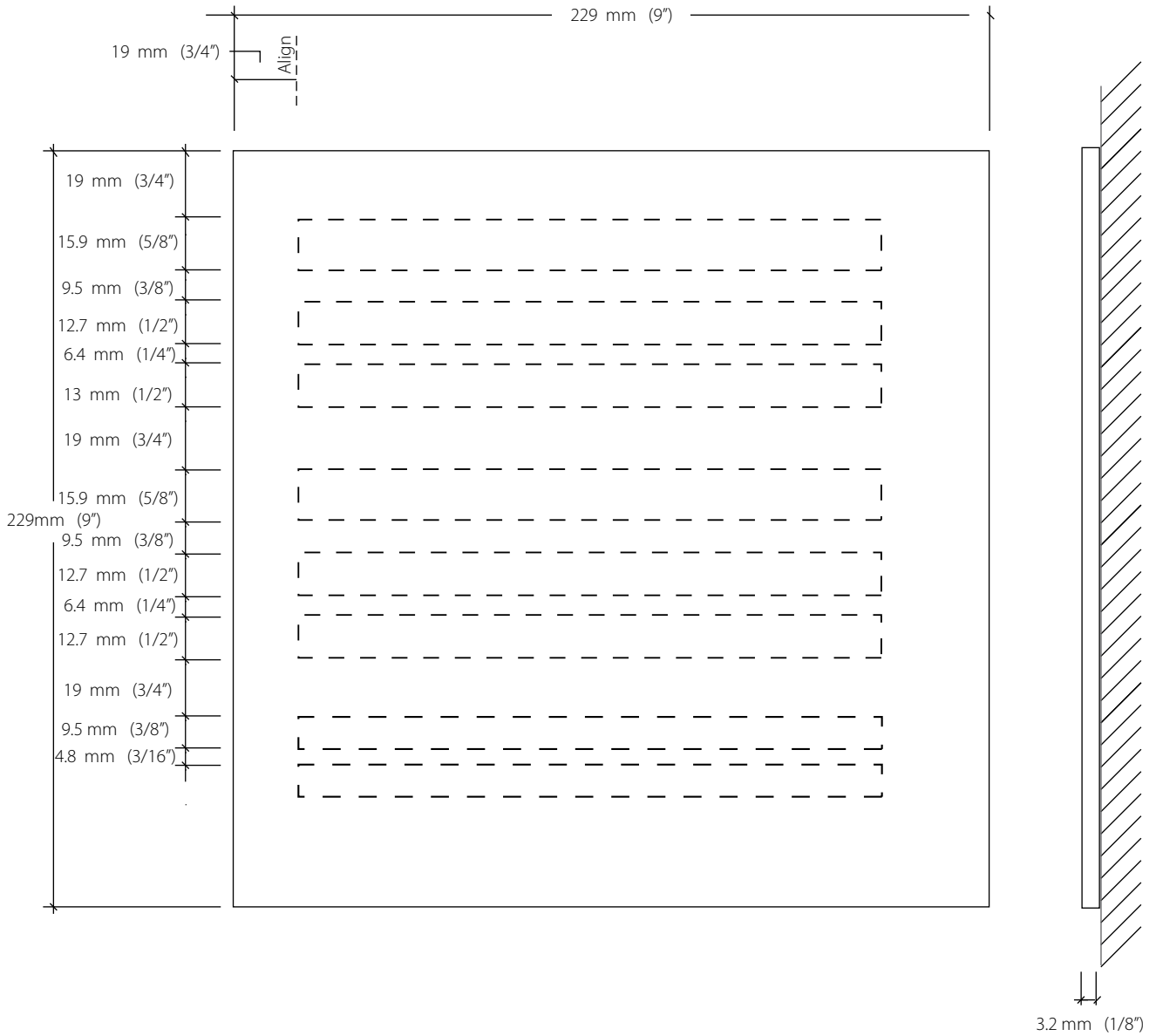



## Notice of Weapons Search

**Size**

Sign Face:  
381 mm H x 381 mm W  
(15" H x 15" W)

**Description**

This is only required at metal detector screening devices and is to be installed next to the detector and in a location that is visible before passing through the machine.

**Message Configuration**

(Refer to message layout drawing for dimensions).

**Sign Components**

Acrylic plaque

**Graphic Process**

Silk-screened

**Colors**

For background and type colors, refer to VA color chart.

**Typography**

Helvetica Bold

**Mounting**

Double sided foam tape or silastic adhesive

**Installation**

On wall, adjacent to metal detector/ screening device, 1702 mm (67") to top of sign

# NOTICE OF WEAPONS SEARCH

The possession of any weapon by persons entering this building is prohibited by law (38 cfr & 1.218 (a)(13)). Persons entering the building consent to a personal search by metal detector and to the inspection of all packages, luggage and all containers in their possession. Metal detector cannot harm you and will not affect pacemakers, hearing aids, or film. Refusal of consent to search is basis for denial of admittance. Person legally authorized to possess firearms must report to the center police. Medical Center Director.

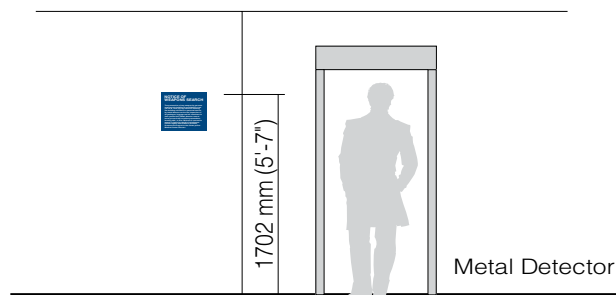

**Notice of Weapons Search**

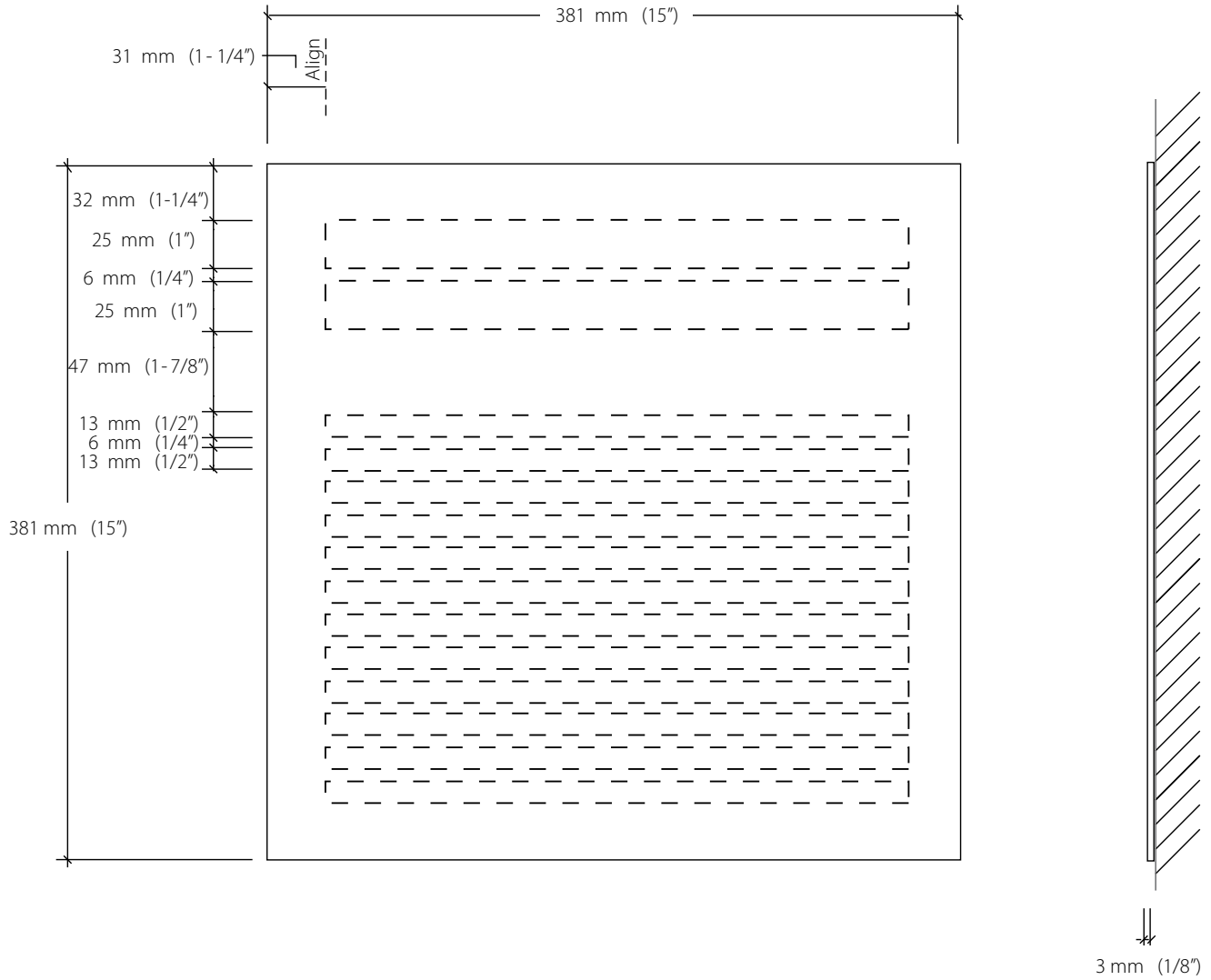

## Single Post Parking Notice

**Size**

Sign Face:  
762 mm H x 610 mm W  
(30" H x 24" W)

**Description**

Large, non-illuminated single post or wall mounted tow away informational sign.

Sign is similar to sign type EN-05.01. See exterior sign section for construction and installation details.

**Message Configuration**

(Refer to message layout drawing for dimensions).

**Graphic Process**

Surface applied reflective vinyl

**Colors**

Text: white  
Background: refer to color chart.  
Post: refer to color chart.

**Installation**

It is recommended that this sign be placed at the entrance drive to the VA site.

Position sign so drivers have a clear, unobstructed view of the sign.

When placing this type of sign near curbs or parking places, be sure the sign is set far enough back that over hanging front and rear of automobiles do not come in contact with the sign post.

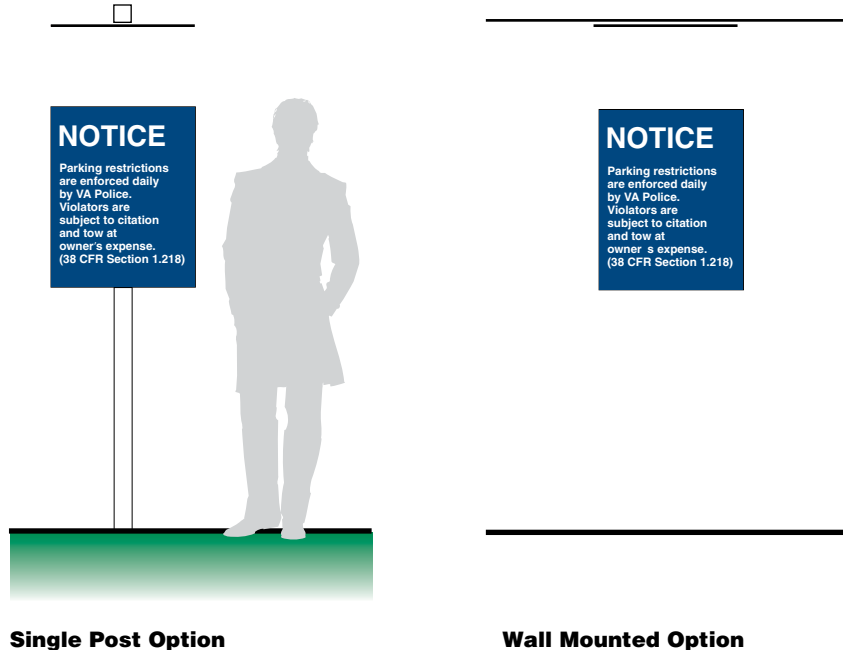

Single Post Option

Wall Mounted Option

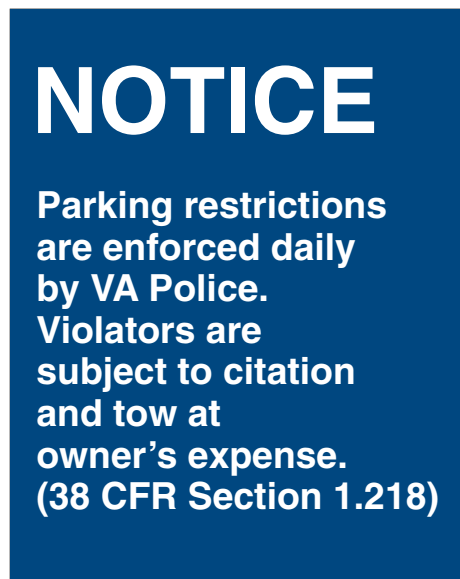
**Message Layout**

Parking Notice Sign: Single Post and Wall Mounted Options

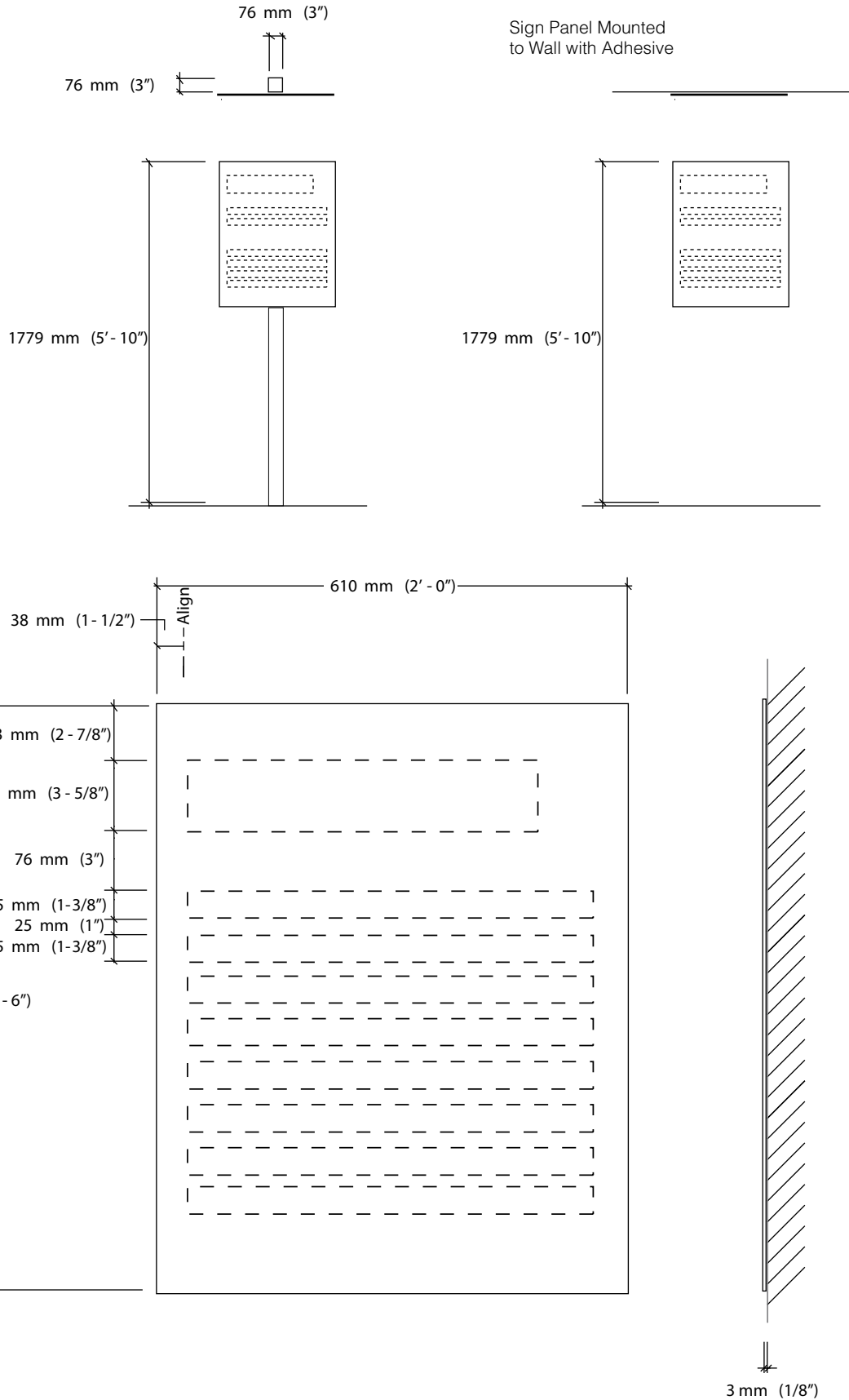

**Size**

Display Window:  
Minimum size to fit graphic insert:  
914 mm H x 610 mm W  
(36" H x 24" W )

Frame Size / Outer Dimensions:  
to vary.

**Description**

Non-illuminated enclosed display case / frame to accommodate foam core mounted paper print behind glass or acrylic.

**Options to include:**

Swing frame (frame/case with hinged glass door) or front loading snap/clip frame.

**Sign Components**

Non-illuminated

**Graphic Process**

VA provided poster

**Colors**

Finish and colors: To match or complement any existing or designated color and material palette.

**Mounting**

Wall mounted with bolts into heavy duty wall anchors.

**Installation**

It is recommended that this sign be placed at building entrances or in lobbies.

Position display so visitors have a clear, unobstructed view of the sign.

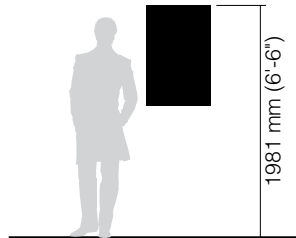
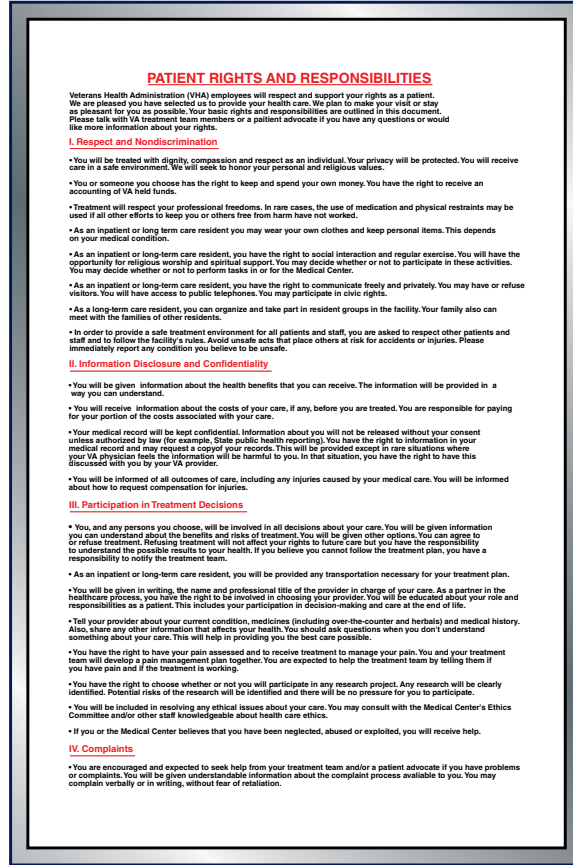

**Patient Rights and Responsibilities**

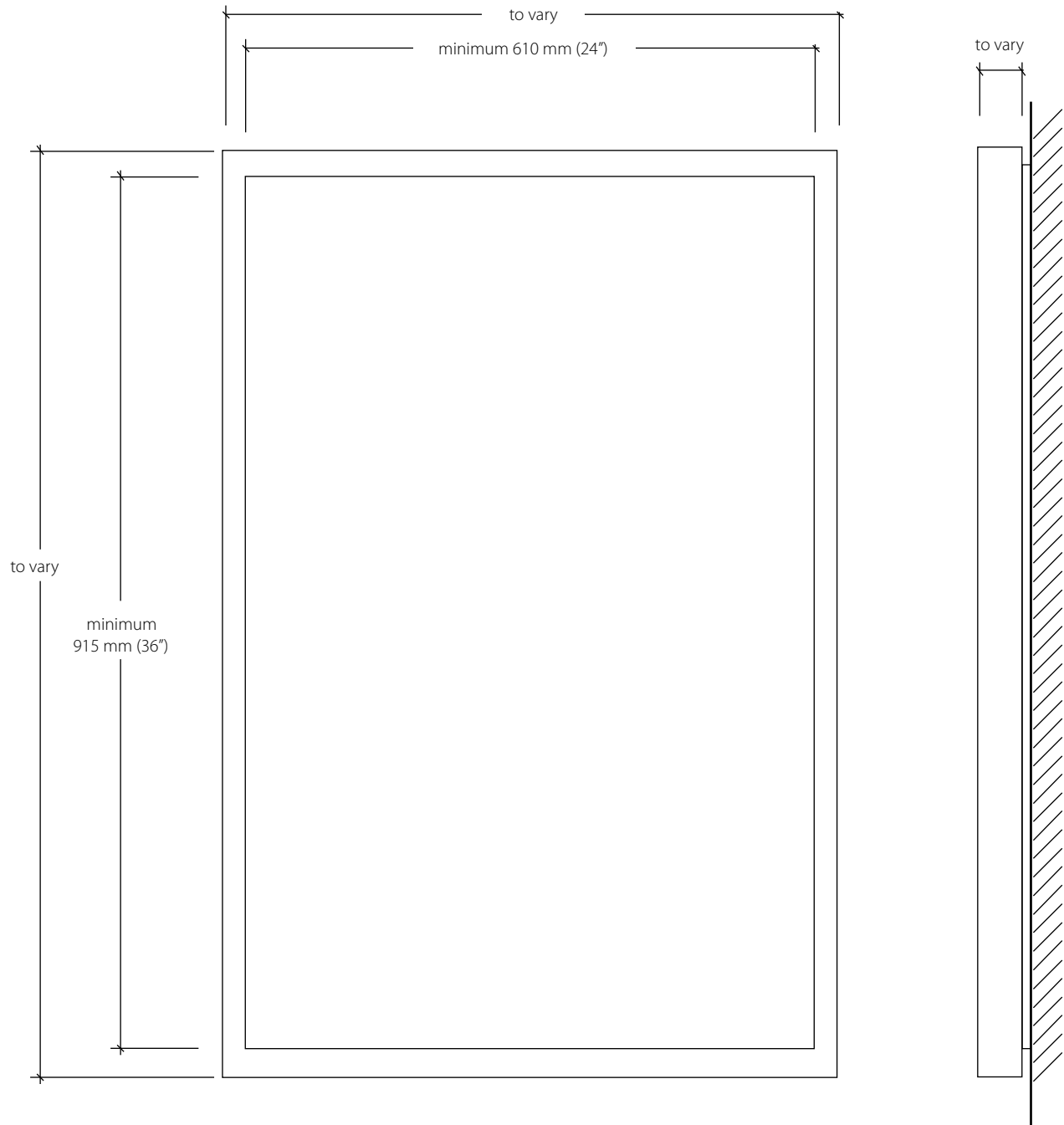

**Size**

Display Window:  
Minimum size to fit graphic insert:  
610 mm H x 457 mm W  
(24" H x 18" W )

Frame Size / Outer Dimensions:  
to vary

**Description**

Non-illuminated enclosed display case / frame to accommodate foam core mounted paper print behind glass or acrylic.

**Options to include:**

Swing frame (frame/case with hinged glass door) or front loading snap/clip frame.

**Sign Components**

Non-illuminated

**Graphic Process**

VA provided poster

**Colors**

Finish and Colors: To match or complement any existing or designated color and material palette.

**Mounting**

Wall mounted with bolts into heavy duty wall anchors.

**Installation**

It is recommended that this sign be placed at building entrances or in lobbies.

Position display so visitors have a clear, unobstructed view of the sign.

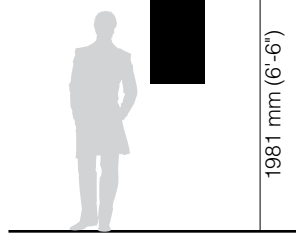

**Policies and Directives**

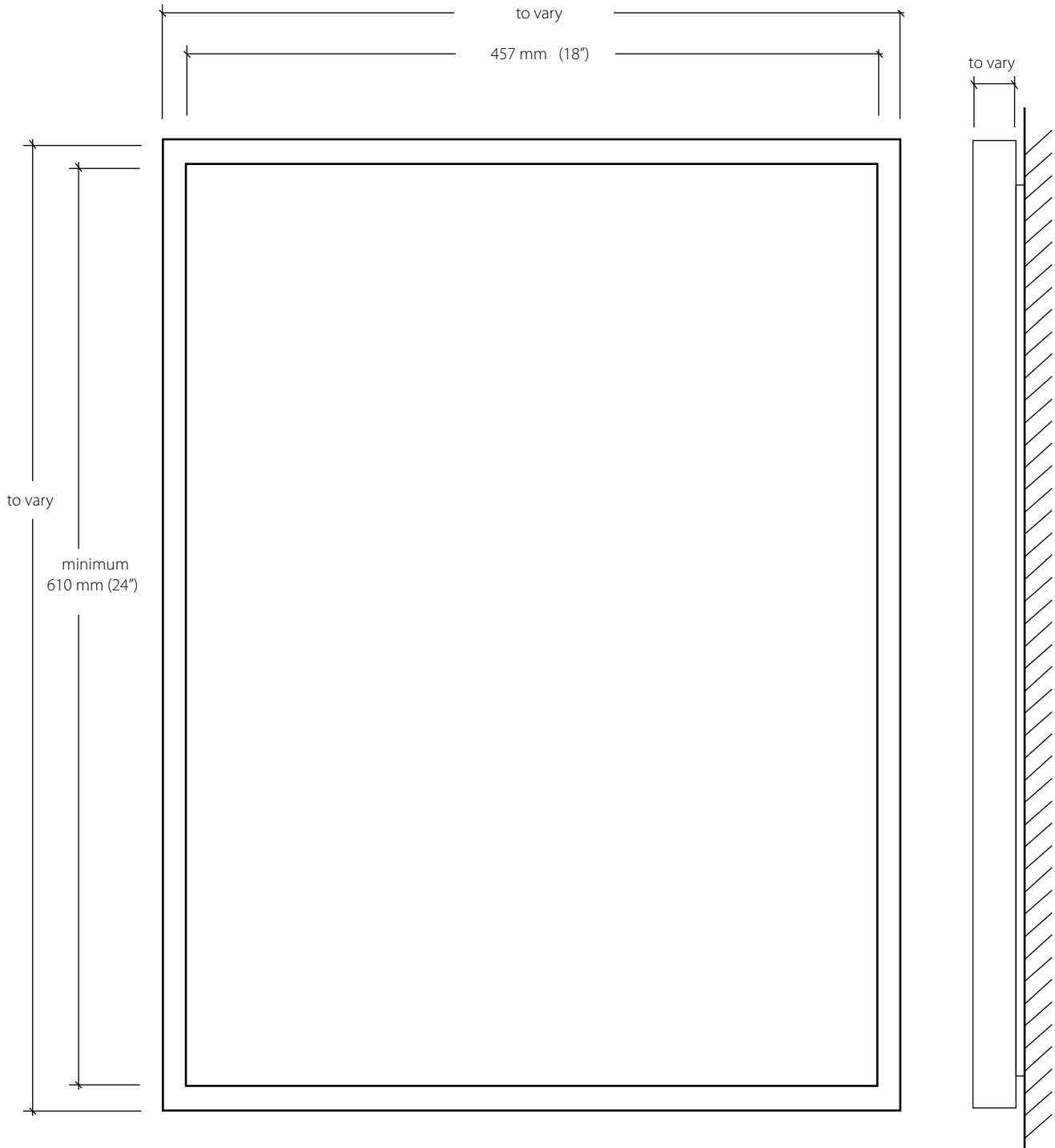



**No Weapons Sign: Small**

**Size**

152 mm H x 508 mm W  
(6" H x 20" W)

**Description**

"No Weapons" sign to be placed at all public building entrances.

**Message Configuration**

Refer to message layout drawing for dimensions.

**Sign Components**

Acrylic plaque

**Graphic Process**

Silk-screened

**Colors**

Background: white  
Graphics: red, white, blue, and black

**Typography**

Helvetica Medium Condensed:  
Regular Condensed

**Mounting**

Double sided foam tape or silastic adhesive.

**Installation**

On wall, 1676 mm (66") to top of top sign. When placed adjacent to door, sign should be mounted on hinged side of door.



**English Version**

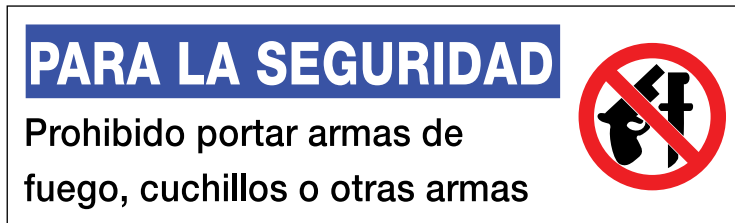

**Spanish Version**

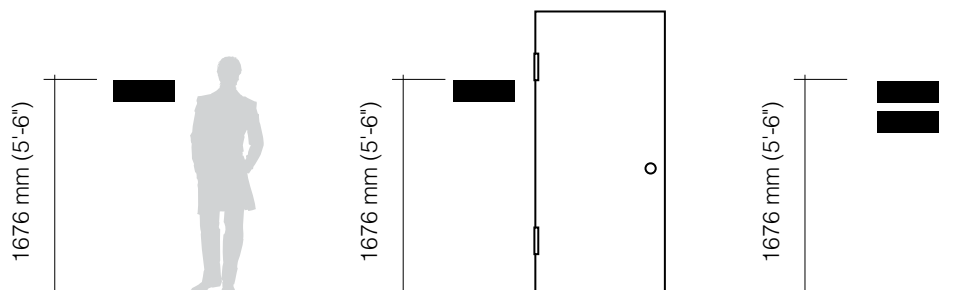

**No Weapons Sign: Small**

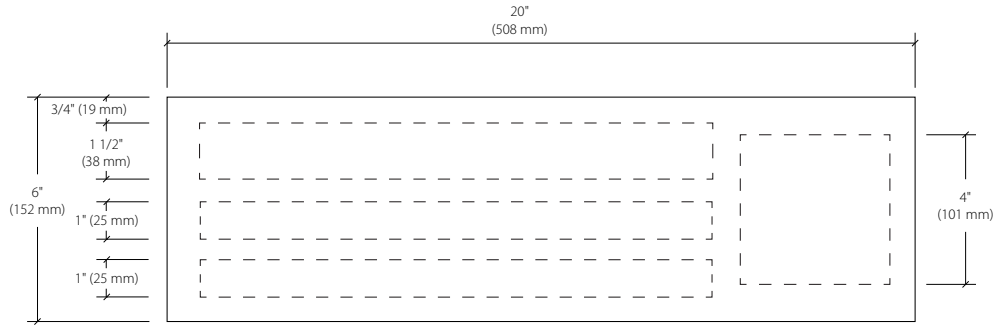

**No Weapons Sign: Large**

**Size**

762 mm H x 610 mm W  
(30" H x 24" W)

**Description**

Non-illuminated wall mounted or single post "No Weapons" sign. To be placed at all public drive entrances to site.

**Message Configuration**

Refer to message layout drawing for dimensions.

**Sign Components**

Aluminum sign panel

**Graphic Process**

Silk-screened or surface applied vinyl

**Colors**

Background: white  
Graphics: red, white, blue, and black

**Typography**

Helvetica Medium  
Helvetica Regular Italic

**Installation**

It is recommended that this sign be placed at all public drive entrances to site.

Position signs so drivers have a clear, unobstructed view of the sign.

When placing this type of sign near curbs or parking places, be sure the sign is set far enough back that over hanging front and rear of automobiles do not come in contact with the sign post.



**Single Post Option**



**Wall Mounted Option**



**Message Layout: English Version**



**Message Layout: Spanish Version**

No Weapons Sign: Large

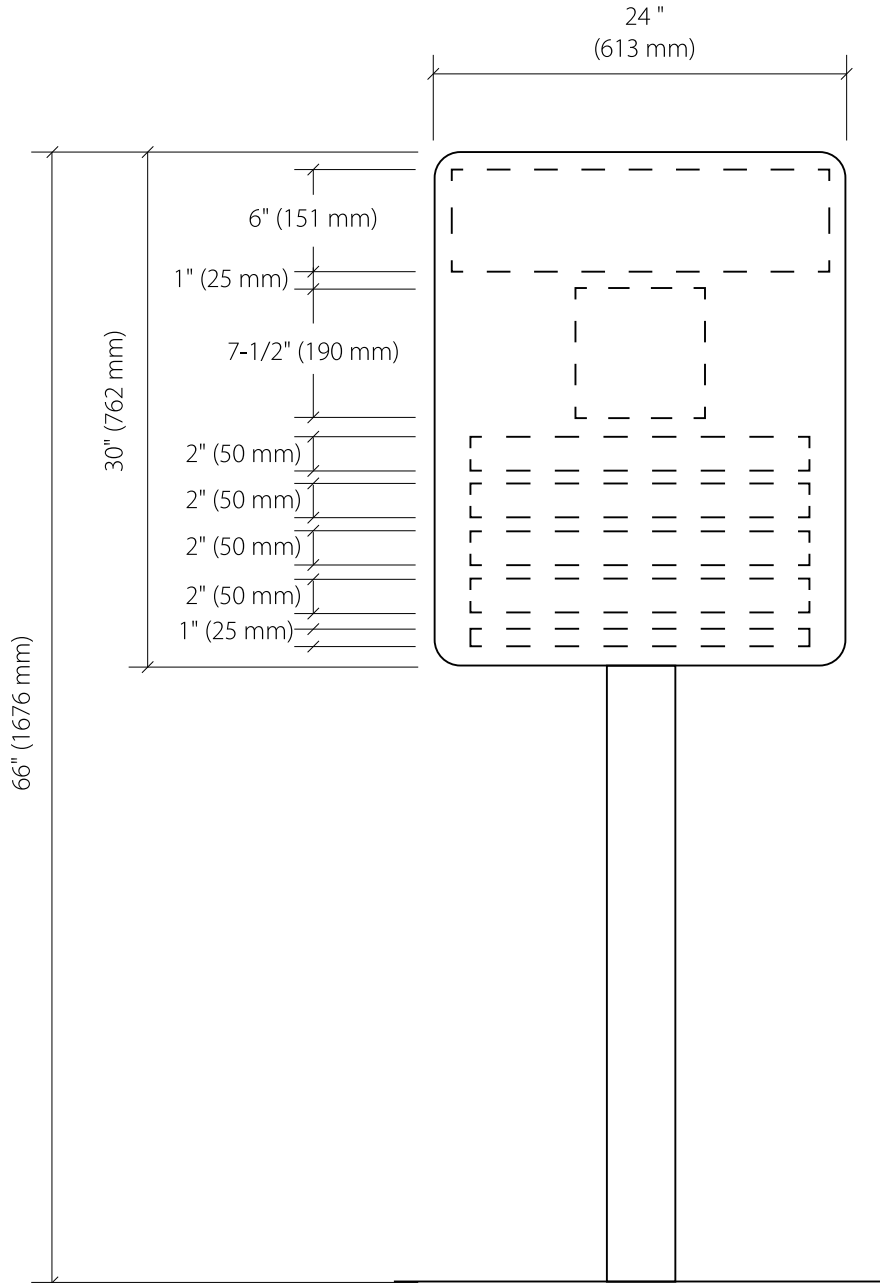

## Security Notice Sign

**Size**

Sign Face:  
610 mm H x 457 mm W  
(24" H x 18" W)

**Description**

Large, non-illuminated single post or informational sign

Sign is similar to sign type EN-05.01. See exterior sign section for construction and installation details.

**Message Configuration**

Refer to message layout drawing for dimensions.

**Graphic Process**

Surface applied vinyl

**Colors**

Text: white  
Background: refer to color chart.  
Post: refer to color chart.

**Installation**

It is recommended that this sign be placed at hospital entrances, exits, and building ventilation intakes.

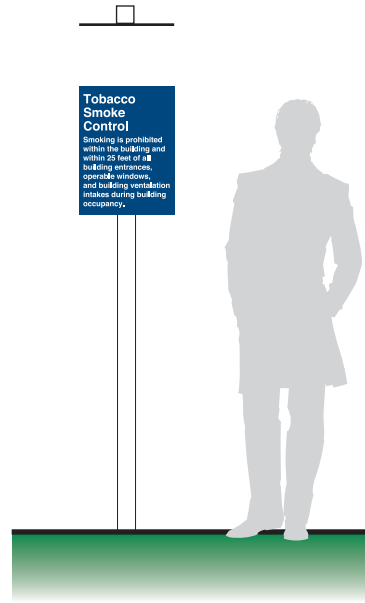

Single Post Option

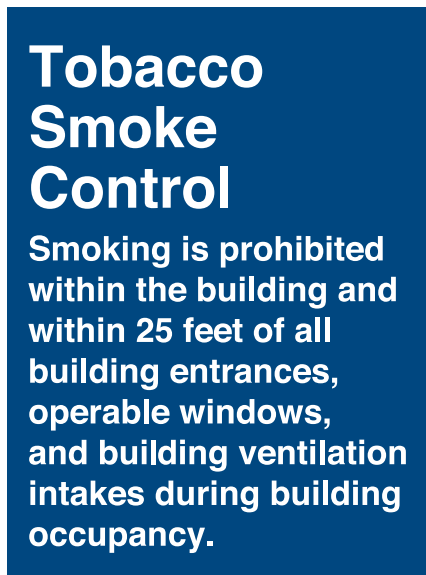
**Message Layout**

Security Notice Sign

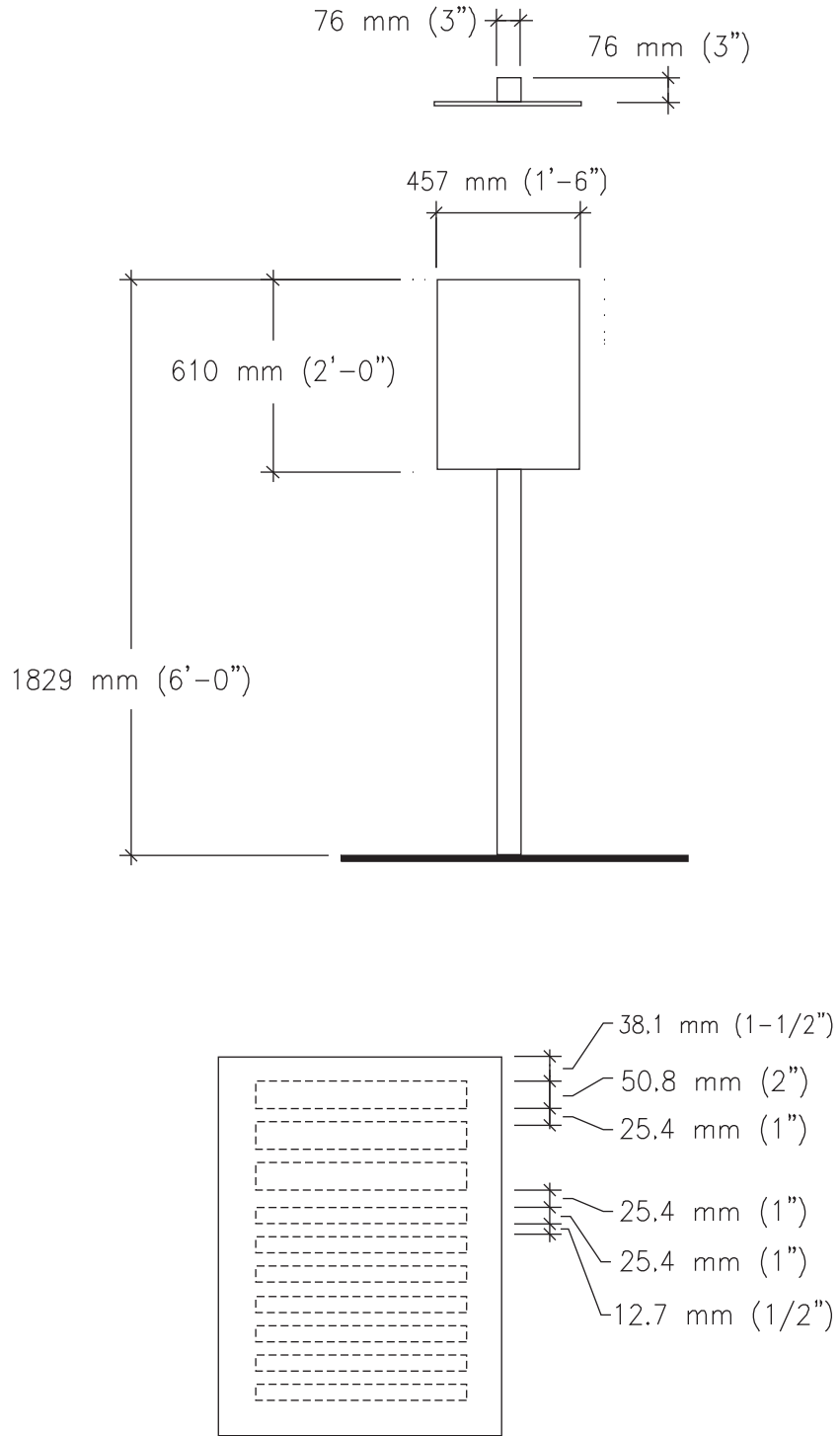

The VA Policy required sign types, for both the interior and exterior, are to be installed in a standard manner as shown in the interior and exterior sign section of the Signage Design Guide. Refer to the installation drawings pages for specific placement for each type of sign.

**Interior**

The interior policy required signs are acrylic and are to be installed using the same techniques as described in the interior sign installation section of the Signage Design Guide.

**Exterior**

The details showing the construction and installation of the exterior policy required signs are covered in the exterior sign construction section of the Signage Design Guide.

This page is intentionally left blank.



The VA Policy required sign types, for both the interior and exterior, are constructed in a standard manner with the only variable being color. This section provides an overview of the construction criteria.

**Interior**

The interior signs are acrylic with silk-screened text.

**Detail 1: Hinged Swing Frame**

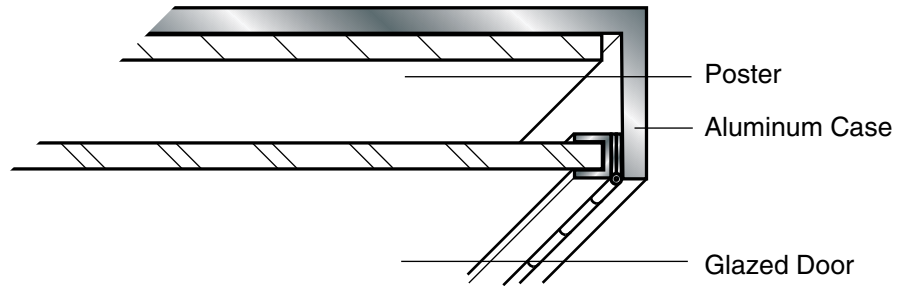

**Detail 2: Snap/Clip Frame**

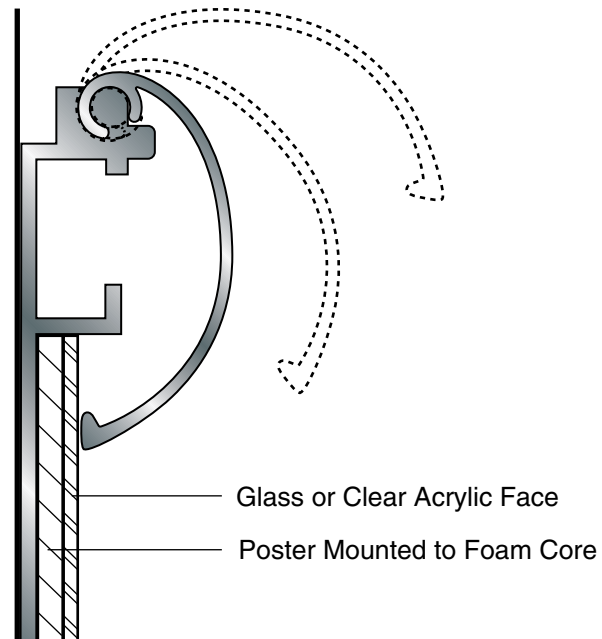

**Exterior**

The details showing the construction of the Policy signs are based on a concept of an aluminum sign system. Refer to the Exterior Sign Section of the Signage Design Guide. The illustrations are intended to show the desired configuration and intent of the sign type.