



Exterior Signs

- **Directional**
- **Building Identification**
- **Wall Mounted**
- **Letters**
- **Traffic**

This page is intentionally left blank

Section 4: Exterior Signs

• Planning	4-2-1 – 4-2-8
• Helpful Hints	4-3-1 – 4-3-2
• Names	4-4-1 – 4-4-2
• Overview	4-5-1 – 4-5-9
• Illuminated Sign Types	4-6-1 – 4-6-44
• Non-illuminated Sign Types	4-7-1 – 4-7-62
• Specification	4-8-1
• Construction	4-9-1 – 4-9-17
• Installation	4-10-1 – 4-10-11

This page is intentionally left blank

Planning an Exterior Sign Program

An effective working exterior sign program includes different categories of signs; Building Identification, Vehicular, and Pedestrian signs. Signage for those visitors approaching a site in a vehicle and first seeing the site from a great distance is different in appearance and design than those signs on the sidewalks and pathways designed for pedestrians. The differing signage needs are to be carefully considered in developing an effective exterior sign program. The objective of all exterior signage is to clearly direct visitors to their destination.

To begin a site evaluation, obtain a site plan of the campus. The plan needs to be to scale with a notation of direction such as north.

The plan needs to identify all major and minor roadways, driveways, alleys and access roads. The plan also needs to show accurate parking lot & parking structure locations. The plan need to include landscape layout which indicates sidewalks, pathways, cross walks, ramps and stairways. Obtain photographs of the site to give an indication of building height, sight lines, landscape, and tree coverage.

Visit the site and drive and walk all major roads and pathways. Identify all major building entrances. Approaching the site by private vehicle is vastly different than stepping off the bus. Stairs, ramps, and changes in elevations are all critical pieces of information in planning an exterior sign program.

While performing an evaluation, take into account the following elements associated with the site:

Character and configuration of the roadway system.

1. How do visitors currently drive around the site?
2. Where will visitors park?
3. What is the desired path of travel on the roadway system for visitors?
4. What is the desired path of travel on the roadway system for employees and deliveries?
5. Location of buildings on the facility campus in relation to roads, parking, and walkways.
6. Location of building entrances.
7. Parking plan for visitors, disabled, and employees.
8. Weather conditions like wind and snow.
9. Tree growth including the canopy height; in the summer and spring, do plants and trees cover the building(s)?
10. Location of electricity, its availability and voltage.
11. Landscaping and the irrigation system.
12. Adequate light on and around directional signs.
13. Placement of signs in locations where people are expecting them to be.
14. Which signs can have permanent messages and which ones need to be changeable.

These elements help establish the basis of a clear sign program that communicates and informs in a direct and simple manner.

An effective sign program for a campus is one that has been planned as an integrated whole. To include the main identification sign, directional signs, building and building entrance identification through to the parking lot signs.

Wayfinding

“Wayfinding” is a term that in recent years has been used to describe the process of finding a destination in the built environment. Signs play an active role in this process by providing the primary form of communication in wayfinding.

In developing a wayfinding system for the exterior of a medical center campus or the interior of a building, some common guidelines must be followed.

The paths of travel from originating points to destinations must be identified.

On the exterior of a campus this involves the roadway system from the main drive entry to the campus to the main entrance of the building to which patients and visitors are seeking a service. While this is a primary path, a secondary path is from the visitor parking lot to the main entrance or the entrance with services which the individual is seeking.

Identifying destinations people drive to, where they park, and where they walk to is the process of identifying the paths of travel. Wayfinding is then communicating to people along this pathway with appropriate directional signs.

The intersections along the vehicle roadway and pedestrian pathway system need to be identified in their importance for communication. Major high traffic intersections will require more communication than smaller secondary intersections. The environments in which these intersections present themselves also effects the wayfinding program.

The path of travel and the decision points that are necessary to reach the end point and where these decision points are located must be considered. At these decision points, information must be communicated to the driver in a priority of need.

The priority of need is defined as those departments or services that have the highest percentage of people seeking them. This high demand information then needs to be communicated with the highest priority on exterior directional signs.

Secondary information or information that applies to a small percentage of individuals that visit a campus also needs to be evaluated in regard to its importance. Typically a driver can only read 2 to 4 messages on a directional sign. Any information that is beyond or greater than this is simply not read. Prioritization of communication of information would then, in most cases, cause the secondary or minor information to be left off the sign because it is not useful.

In planning a directional sign program for pedestrians, take into account similar objectives that are done for a roadway directional sign program. Major walkways need to be identified in their respective intersections where the paths of travel split to reach various services and entrances.

Types of Signs

The main identification sign for a medical center should be a large scale illuminated sign. This can be an internally illuminated monolith sign or a masonry wall with letters that are illuminated with floodlights. Urban facilities main identification sign or letters may be directly on the building and should be directly illuminated as well.

Internally illuminated signs should be considered for those locations where important information and directions need to be communicated at night as well as during the day. This would typically be the main identification sign, the main directional signs at the entrance to the site and along the primary path of travel, buildings

and entrances that have public activity in the early morning, late afternoon, and evening.

A sign that is illuminated with floodlights can be effective at night. Typically this is a less expensive way to obtain an illuminated sign, but the ongoing maintenance will be considerably higher as ground based lights frequently get damaged.

Non-illuminated signs with reflective letters will function quite well for secondary signs at night. It is a good practice to make all the exterior signs have reflective letters as that will ensure the best possibility of being read regardless of a sign's importance.

Every site has different climate conditions that effect an exterior sign program. Considerations for snowfall and frost line will have an impact on post length and footing depth. For areas where there is a lot of snow, the posts on signs should be taller so the sign panels do not become covered with snow. How much taller should be evaluated by site locations' typical snow fall. Tree growth and the canopy of trees, both winter and summer, need to be considered. A sign obscured by plants has little to no value.

Monument signs should be typically reserved for use at the main entrance and along the principal drive to the main entrance at the medical center. Monument signs are more expensive than post and panel signs, but provide a more professional appearance at the main entrance. Use of post and panel signs throughout the remaining campus for directional signs and building identification is the most practical approach to signing.

Sizes of Signs

Signs that are to be read from a moving car need to be larger than signs that are read by a driver who is stopped or parked. As the speed of a car increases, the size of a sign needs to increase. Signs with important messages also need to be larger. Additionally, the further the distance the sign needs to be read, the larger it needs to be.

A simple explanation on the importance of size. A sign that is too small is an annoyance to everyone, because they can't read it. A sign that is too large will never be an annoyance because everyone can read it.

Signs directed to pedestrians can be smaller, but they still have to be large enough to be read. Signs placed close to a walkway can be smaller in scale, but care must be taken to not make them so small that people don't notice them.

If in doubt regarding a size decision, choose the next larger size.

Size of Lettering

Signs that are to be read from a moving car need to have larger lettering than signs that are read by a driver that is stopped or parked. As the speed of a car increases, the size of the lettering on a sign also needs to increase. Signs with important messages need to have larger lettering.

Additionally, the further the distance the sign needs to be read, the larger the lettering needs to be. Remember, lettering on a sign that is too small is an annoyance, because it can't be read.

Signs directed to pedestrians can have smaller text. But, the lettering still has to be large enough to be read.

If in doubt regarding the size of lettering to use, choose the next larger size.

Viewing Distance Guide

The following charts provide assistance in determining the size of lettering to be used in relation to the distance that a sign is going to be read.

These charts are general and there may be situations that would require lettering larger than what is indicated in the chart for a given distance of viewing.

Figure 1
Viewing Distance Chart

Text					Symbols			
Viewing Distance Up To:		Letter Height		Application	Viewing Distance Up To:		Letter Height	
7.5 M	25'	25 mm	1"		7.5 M	25'	75 mm	3"
12 M	40'	40 mm	1 1/2"		10.5 M	35'	100 mm	4"
15 M	50'	50 mm	2"		15 M	50'	125 mm	5"
24 M	80'	75 mm	3"		18 M	60'	150 mm	6"
33 M	110'	100 mm	4"		30 M	100'	200 mm	8"
48 M	160'	150 mm	6"		34.5 M	115'	225 mm	9"
75 M	250'	225 mm	9"		39 M	130'	250 mm	10"
97.5 M	325'	300 mm	12"		45 M	150'	300 mm	12"
150 M	500'	450 mm	18"					
195 M	650'	600 mm	24"					

Arrows

The proper use of arrows on directional signs are important to ensure the reader quickly understands the correct directional information. Grouping all the information together that is in one direction and using one arrow is preferred. Using an arrow for each message makes the sign difficult to read.

Figure 2
Sign Face Layout Illustration

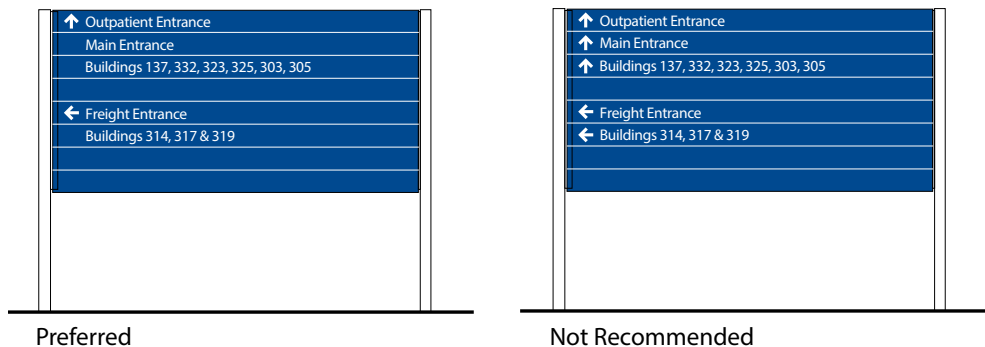

Arrows should be placed in such a manner that they precede the message. This allows the reader to understand direction first and information second. It also allows the arrows to be visually separated from text.

Arrows should always be larger in size than the text they are affiliated with. For example, a 4-1/2" arrow is what would be used with a 3" capital letter size text.

Figure 3
Arrow Direction Illustration

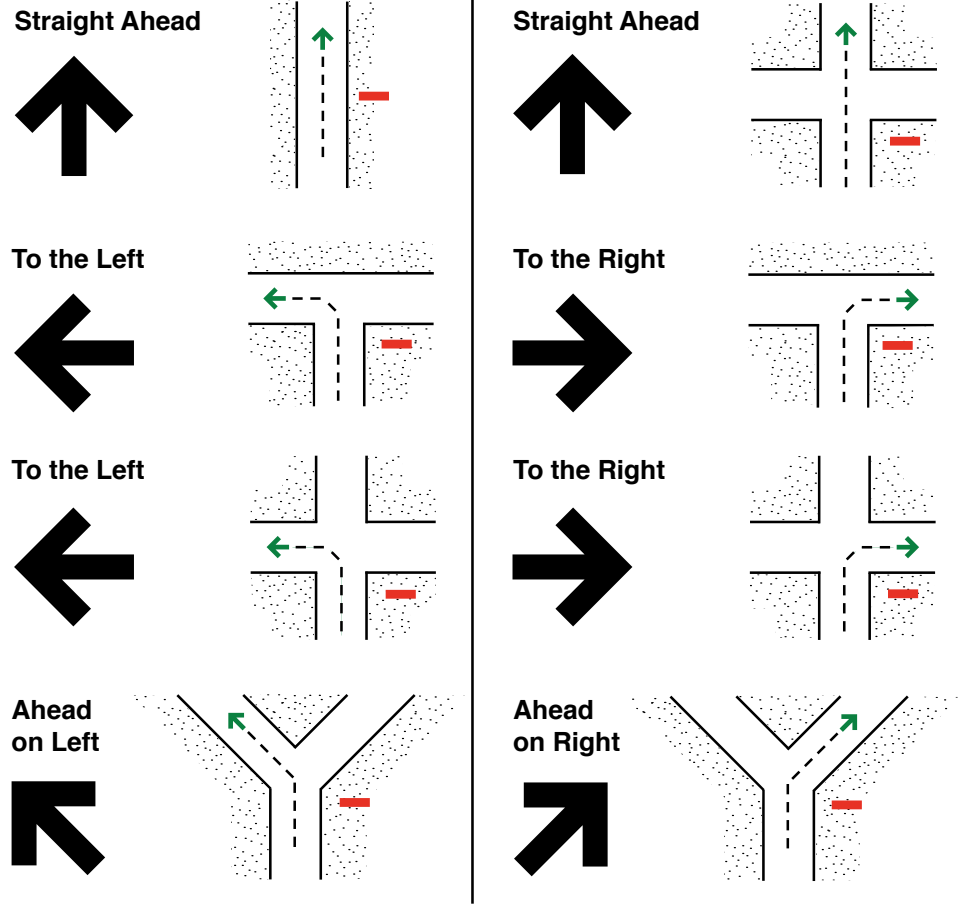

Sign Placement

Exterior signs function to communicate to both drivers and pedestrians and their placement needs to be planned relative to the intended viewer. Sign visibility to the user is a principal objective and that is the basis of correct sign placement.

Signs that are to be read from a car moving down a road need to be large and clearly visible. Poorly placed signs, that are intended to communicate to drivers, can actually create traffic hazards. Also, remember that if a sign has too much information, the placement will have to allow for a driver to stop or slow to a very low speed.

A sign that is directing pedestrians can be placed close to a walkway. Major pathway intersections are important locations to assist people who are new to a site and are trying to find their way around.

Correct placement of signs will usually mean fewer signs are required. Too many signs can create a cluttered appearance and increase the difficulty for a viewer to find the particular information they are seeking. Colors and material finish of buildings need to be taken into consideration as this impacts the visibility of signs.

Care also needs to be taken to place signs in a manner that allow clear viewing. Placement of signs so trees and shrubs do not obscure them is critical. It is also critical that signs are not placed in locations that obscure a driver's visibility of vehicular traffic and pedestrians.

Coordination needs to take place with things like irrigation systems, electrical service, and other underground utilities. Proper placement is an important part of a well-planned program.

Placement Guidelines

The following are general guidelines for placing signs to viewed from an approaching vehicle as well as for mounting signs for pedestrian viewing. Guidelines for specific sign types are shown in their respective sections.

Straight Ahead: Sign placement must be within the approaching driver's immediate cone-of-vision. Drivers cannot be expected to turn their heads to read a sign. Signs mounted more than 12 M (40 feet) off the roadway because of special circumstances may require use of a larger panel to increase readability because the sign is outside the normal cone-of-vision.

Perpendicular: The sign face should be perpendicular to the approaching viewer. Never place a sign parallel to passing traffic.

Right Side: Place signs on the right side of the roadway whenever possible. Drivers are not conditioned to look to the left side of the road for driving information. An exception to this rule is the use of a double-face Standard Identification sign mounted perpendicular to a facility entrance roadway sign should be sized and placed with clear target value and readability from both directions.

Distance Legibility: All signs must be clearly legible from the distance at which they are to be read. The viewing distance guide delineates the appropriate text size.

Advance Warning: Signs on roadways that communicate a desired reaction, must be placed in advance of the intersection to afford a safe distance for reaction to and execution of the maneuver.

Viewing Angle: Mount signs at eye level. The height of the average viewer's eye-level is 1650 mm (5'-6") standing, and 1350 mm (4'-6") driving a car. Signs placed for viewing from long distances will be mounted higher than those in the immediate foreground. Mounting height is measured from the ground level to the bottom edge of the sign panel.

For signs mounted along roadways, the grade of the road is considered ground level. When ground mounted signs on two posts are placed on sloping or inclined grades, adjustments must be made to the post lengths and mounting heights. Extreme differences between post lengths should be minimized whenever possible.

Spacing: Signs must be located with respect to other signs. Mounting sites should be carefully selected so that groups of signs are placed without creating a cluttered appearance. Also, drivers must be given time to read and react to one sign before another is presented.

Figure 4
Placement / Roadway Illustration

Site Preparation: Placement must be carefully considered to ensure that the sign fits the location without major regrading. It may be necessary to clear some shrubs or bushes or relocate an obstruction.

Field Test: An effective way to determine a sign placement location is to place the actual sign in the proposed location for verification. This is relatively simple for pedestrian signs; they are viewed from relatively short distances. For signs viewed from a moving vehicle, testing should include driving the approach from which it is viewed to verify the appropriateness of the proposed location. A cardboard or brown paper banner (which is the same size as the proposed sign) can be used instead of the sign to check placement against the criteria listed above.

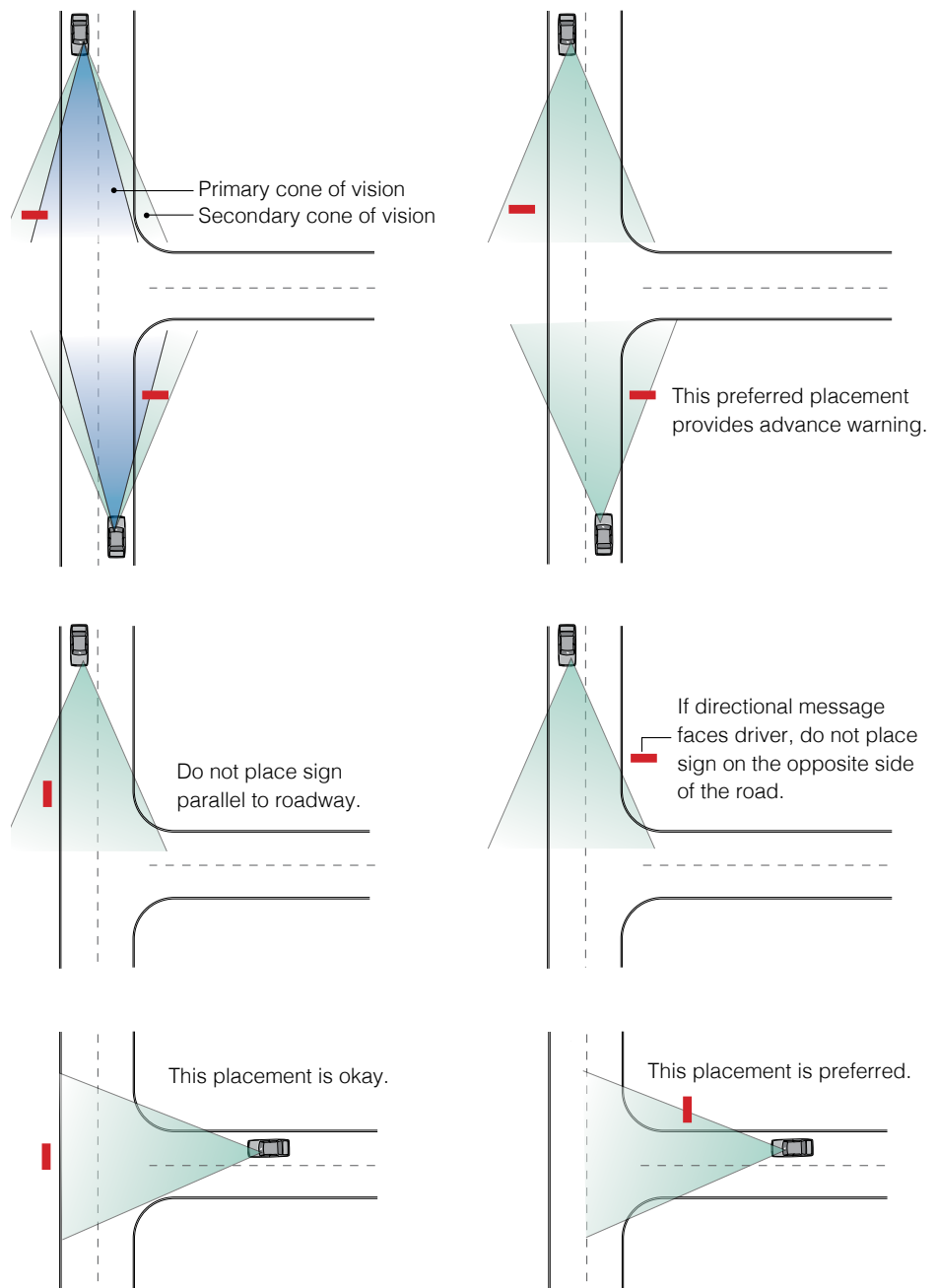
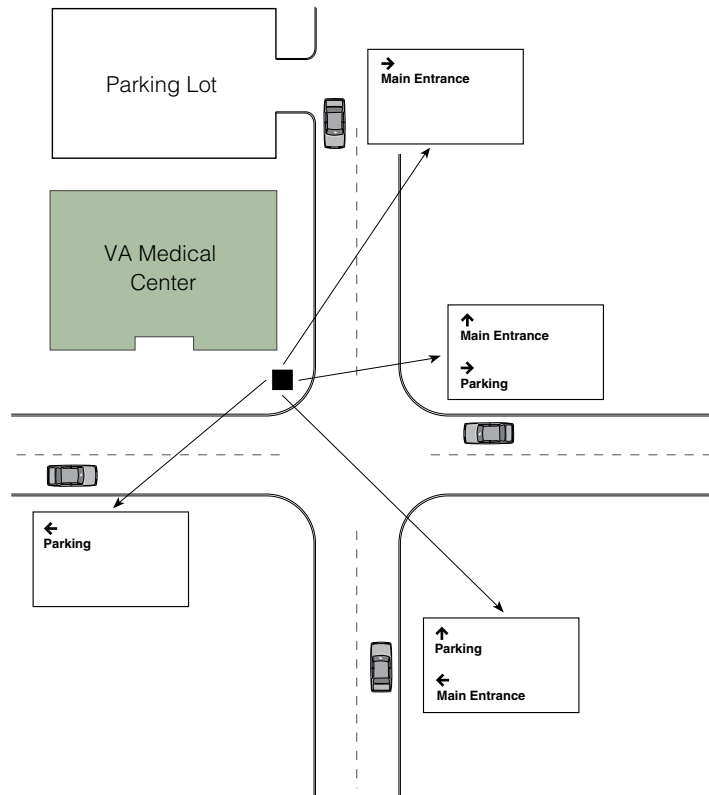

Figure 5
Building / Roadway Illustration



Existing Sign Program

Before implementing a new sign program, perform a thorough evaluation of the demolition requirements of the current sign program and the effects and impact on the facilities landscaping and irrigation system.

Old sign footings do not typically have to be totally removed. They should however be demolished to at least 1 foot below grade.

Check to see what is required to patch, seal and repair building penetrations and surfaces exposed as a result of removal of signs or letters. Repairs should be planned to match adjoining surface.

Make sure the sign demolition scope of work requires the contractor to close off any live electrical connections. Remove existing conductors and conduit to the nearest junction box and make it safe.

Be sure to clearly identify signs that are supposed to remain. It is especially important to identify markers and signs that relate to special objects or displays that may be on the medical center campus or on a building.

DO NOT remove any traffic signs without having the replacement signs available and installed at the same time the old signs are removed.

The following are some general “Do’s and Don’ts” guidelines that should be referred to when developing a exterior sign program. This is not intended to be a training section of the guide, but to provide key information or instructions that will hopefully reduce common errors that are made when planning and programming an exterior sign program.

General Guidelines

- Never use text smaller than 3” capital letter height when a sign is intended to be read from a moving car.
 - Text intended to be read by pedestrians should be a minimum of 1-1/2” capital letter height.
 - Signs do require maintenance. Cleaning and waxing will extend the life of a sign program.
 - Use text (words) which are familiar, easy to understand, and comfortable to the viewer.
 - Always use the same words throughout the sign program.
 - All sign messages need to be a minimum of 24” above grade.
 - When selecting a background color for the signs, seek a complementary color to the buildings on campus.
 - If overhead signs are used, make sure they have adequate clearance for trucks. Adequate clearance can be interpreted to be 15’-0”
-

Type of Sign to Use

- Always consider the landscaping surrounding a sign when determining a sign’s size. It is important that shrubs and other plants do not hide or obscure the sign.
 - Stacking bar signs should always have a blank bar between two different sets of directional information.
 - Lettering and sign panel size should be appropriate for the distance and speed at which a sign is viewed.
-

Size of Sign to Use

- Signs intended to be seen from a moving vehicle need to be larger and require larger text than a sign intended for pedestrians.
 - Consideration should be given to the use of a facility (i.e., whether a department or building offers night time services) when determining if a sign should be illuminated or not.
-

Message Content

- Keep sign messages brief.
- Unnecessary information on signs will confuse the viewer.
- Typically, all signs, with the exception of directional signs, should convey no more than one concept or thought.
- Use text (words) that can be quickly read by the viewer. Use the same words throughout the sign program.
- On directional and informational signs only provide information necessary to make a decision at that particular location.
- When possible, messages should present positive information.

- On directional signs, do not anticipate decisions that can be made later. Unnecessary or premature information will confuse the reader.
 - Messages placed on signs should be concise, preferably with no more than seven to ten words.
 - For signs to be read from a moving vehicle, take into account the speed of the vehicle. At a slow speed the driver may be able to read 7 or 8 words. At a faster speed they will only be able to read 4 or 5.
-

Message Layout

- Use upper and lower case text whenever possible. Upper and lower case text is easier to read and understood faster than text in all capital letters.
 - Line-spacing between two different messages should be greater than line-spacing between lines of the same multiple-line message group.
 - Text should not be run right up to the edge of the sign.
 - If a line text needs to be reduced in order to fit on a sign, use only commonly recognized abbreviations, reduce the number of words or reduce the size of the type for the entire message. DO NOT condense the type face.
 - The most important message should appear as the first line text and the most important directional information should be at the top of the sign.
-

Placement of Signs

- Signs should always be perpendicular to the intended viewer.
- Position signs with a clear line of sight from the viewing point to the sign face.
- Typically a driver gathers visual information by viewing to the right first.
- Keep directional signs on the same side of the street that the driver is driving.
- Always evaluate a sign's location at night as well as in the daylight. Lighting conditions and visibility may change at night making a particular location unsuitable.
- All signs should be placed in a manner that will be clearly visible to a driver at all times of the year. For example, make sure that snow or removal piles do not bury signs.
- Signs that receive spray from irrigation sprinklers will show oxidation from the minerals in the water resulting in a poor appearance. The life of the sign will also be considerably shortened.
- Always consider the landscaping surrounding a sign when determining a sign's location. It is important that trees, shrubs and other plants do not obscure the sign.
- Do not place signs in locations where people may walk into them. Don't place signs any closer than 12" to a walkway.
- Do not place signs too close to curbs. Car overhangs and door swings should be taken into account.

Description & Use

The following layouts depict the various ways that facility names are to be shown on the main identification sign. In all cases, note that there is a hierarchy in the presentation. The “VA Logo” and “Department of Veteran Affairs” is always on the top of the sign and in larger letters than the rest of the name. VISN identification is always at the bottom of the sign and has the smallest letters.

Message Layout A depicts Consolidated Medical Center locations.

Message Layout B depicts congressionally mandated named facilities.

Message Layout C depicts the typical facility naming practice.

Message Layout D depicts the combined VHA and VBA locations.

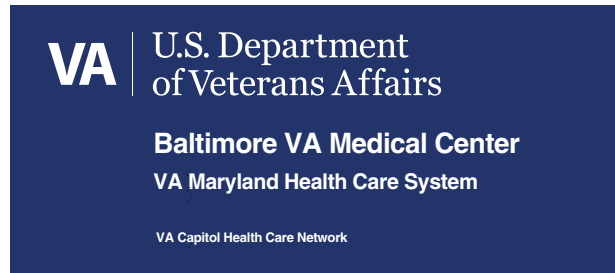
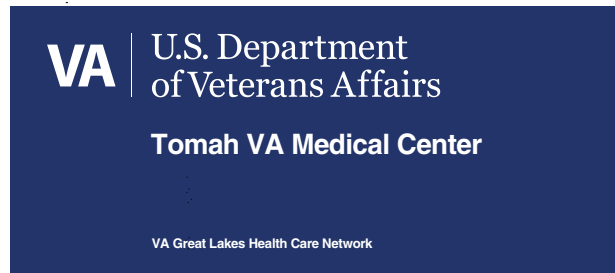
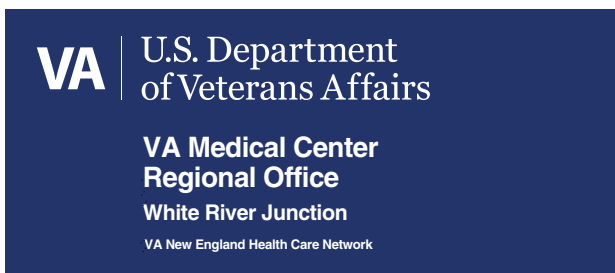
Message Layout A**Message Layout B****Message Layout C****Message Layout D**

Names

Message Layout E depicts the independent VBA Regional Office locations.

Message Layout F depicts the large Outpatient Clinic locations.

Message Layout G depicts the Community Based Outpatient Clinic locations.

Exterior Signs

Message Layout E



Message Layout F

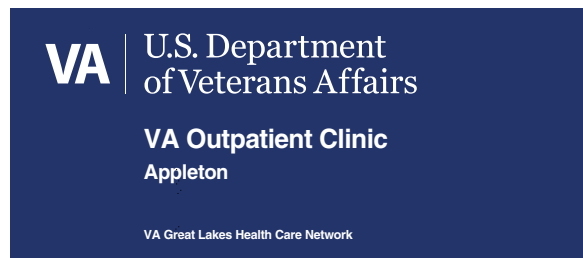

Message Layout G



New Logo/Signature

The VA has developed a new logo/signature for use in signage. It replaces the old logo and name presentation.

The old logo may remain in use on existing signs, but all new signs shall incorporate the new logo/signature.

Adjacent are its application in a horizontal format and a vertical format.

The master art is available as an electronic file, for downloading, in the Technical Information Library. www.cfm.va.gov/ti/

The master art and typography shall not be altered. The font, the size relationship between the elements, and the letter spacing for the VA and name, shall remain as presented in the master art .

The VA logo followed by a vertical line and the text "U.S. Department of Veterans Affairs".

Horizontal Sign Format

The VA logo in a large, bold font.

U.S. Department
of Veterans Affairs

Vertical Sign Format

This section of the VA Signage Guide covers the types of exterior signs that would be necessary to sign a medical center campus or single building.

Included are illuminated and non-illuminated signs for identification and direction as well as signs for traffic control and parking.

The following Overview illustrates the various types of signs in this section. The individual pages on each Sign Type provide more specific information and detailed layouts.

Illuminated Exterior Sign Designations

Each sign in the program guide has been given a specific sign type number designation. This designation provides a common description that can be referenced when programming a site and ordering signs. The following explains how the sign type designations are derived.

EI - 03 .01 A

E Designates an exterior sign.

I Identifies that the sign is internally illuminated.

03 Two digit numbers identify a particular sign type family.

.01 The two digit number following the period identifies a specific sign within the sign family.

A The letter designates a specific sign configuration, version, or layout for graphics.

Non-Illuminated Exterior Sign Designations

Each sign in the program has been given a specific sign type number designation. This designation provides a common description that can be referenced when programming a site and ordering signs. The following explains how the sign type designations are derived.

EN - 12 .01 A

E Designates an exterior sign.

N Identifies that the sign is non-illuminated.

12 Two digit numbers identify a particular sign type family.

.01 The two digit number following the period identifies a specific sign within the sign family.

A The letter designates a specific sign configuration, version, or layout for graphics.

Sign Type EI-01

Illuminated Monument Sign for Medical Center Identification

EI-01.01

Large horizontal monument sign

EI-01.02

Standard horizontal monument sign

EI-01.03

Small horizontal monument sign

EI-01.04

Standard vertical monument sign

EI-01.05

Small vertical monument sign

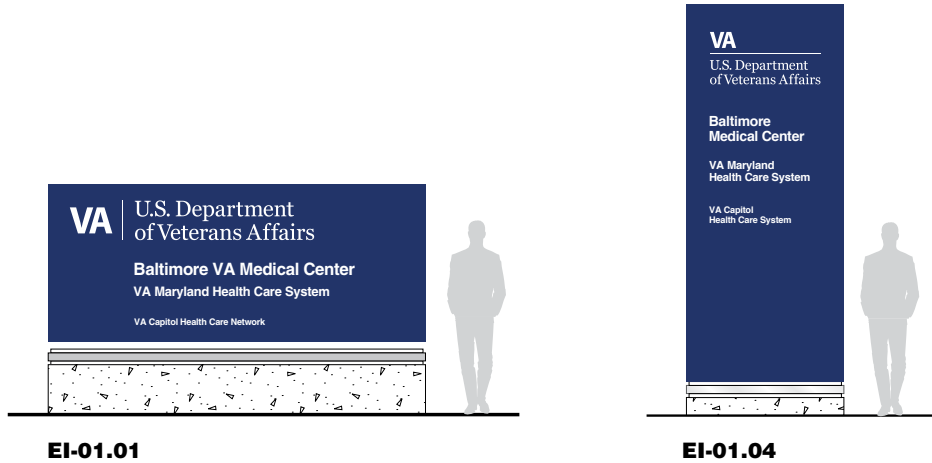

Sign Type EI-02

Illuminated Directional Monument Sign with Stacking Text Modules

EI-02.01

Large directional monument sign with stacking strips - 10 strips

EI-02.02

Small directional monument sign with stacking strips - 10 strips

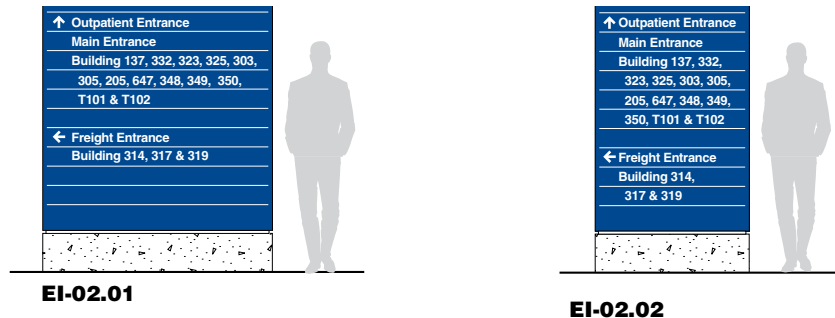

Sign Type EI-03

Illuminated Post and Panel Sign for Identification and Information

EI-03.01

Post and panel sign for medical center identification

EI-03.02

Standard auto oriented post and panel sign

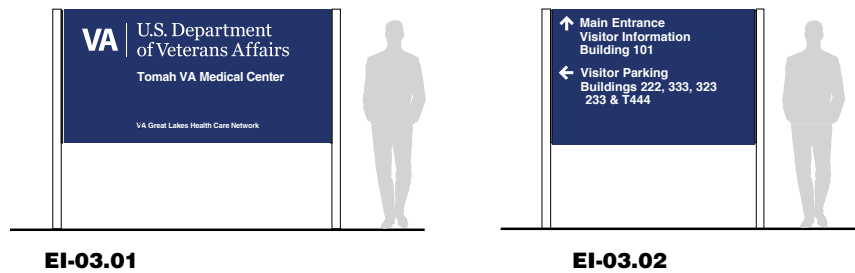

Sign Type EI-04

Illuminated Post and Stacking Bar Sign for Directional Information

EI-04.01

Large/long auto oriented stacking bar directional sign - 6 to 8 bars

EI-04.02

Standard auto oriented stacking bar directional sign - 5 to 8 bars

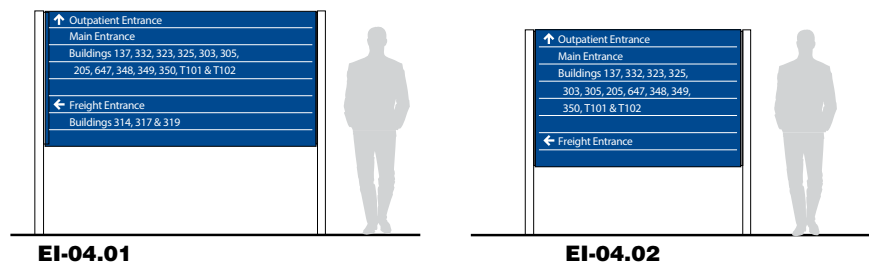

Sign Type EI-06

Illuminated Wall Mounted Signs

Nursing Home Care

EI-06.01

Overhead wall mounted sign



EI-06.01



EI-06.02

Sign Type EI-08

Ambulance Entrance Signs



EI-08.01

Overhead wall mounted sign



EI-08.01



EI-08.02



EI-08.03

Sign Type EI-09

Dimensional Letters and Logo

Outpatient Entrance

EI-09.06

Logo and dimensional letter

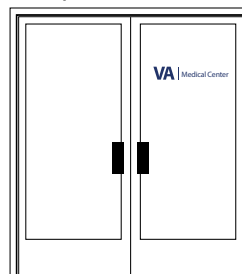

EI-09.06



EI-09.07

Logo and dimensional letter

EI-09.08

Logo and dimensional letter

EI-09.09

Logo and dimensional letter

Sign Type EI-14

4 Sided Monument Sign for Medical Center Identification

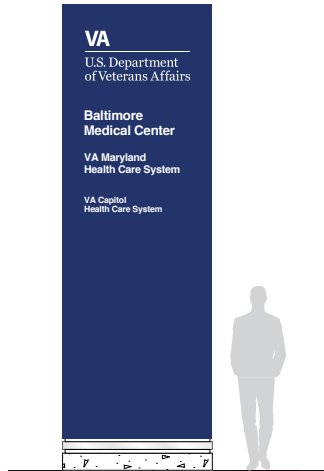

EI-14

Sign Type EI-15

4 Sided Monument Sign with Directional Information for Medical Center Identification

EI-15.01

Large 4-sided monument sign with stacking directional panels

EI-15.02

Standard 4-sided monument sign with stacking directional panels

EI-15.03

Small 4-sided monument sign with stacking directional panels

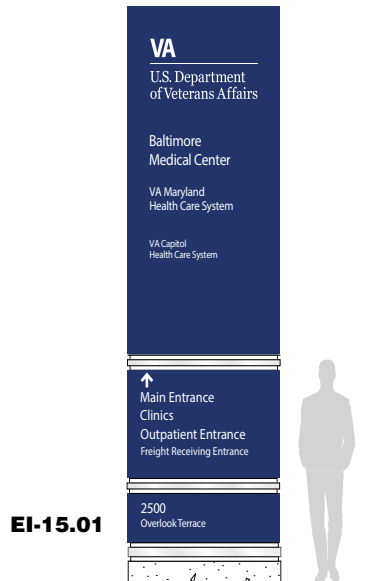

EI-15.01

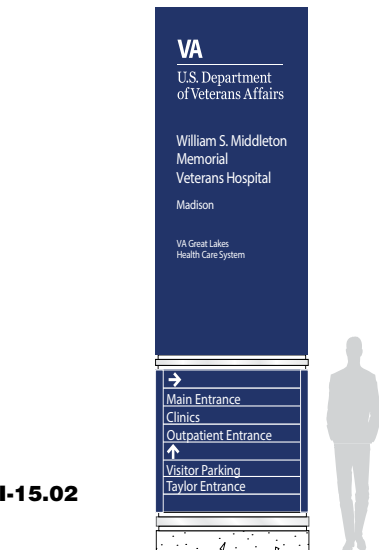

EI-15.02

Sign Type EI-16

Monument Sign for Medical Center Identification with Electronic Message Center

EI-16.01

Large monument sign with Electronic Message Center

EI-16.02

Standard monument sign with Electronic Message Center

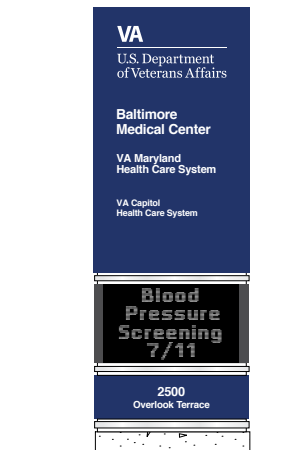

EI-16.01

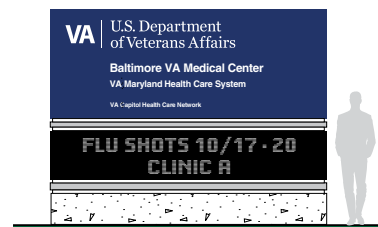

EI-16.02

Sign Type EN-02

Directional Monument Sign with Stacking Text Modules

EN-02.01

Large directional monument sign with stacking strips - 10 strips

EN-02.02

Small directional monument sign with stacking strips - 10 strips

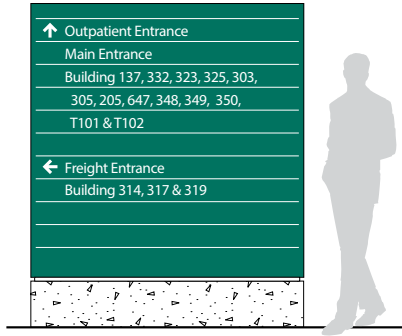

EN-02.01

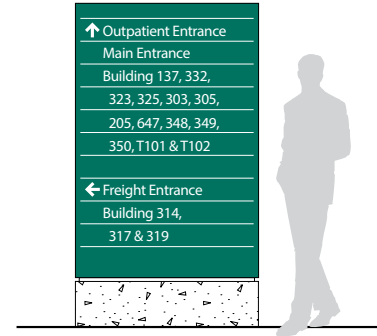

EN-02.02

Sign Type EN-03

Post and Panel Sign for Identification and Information

EN-03.02

Standard auto oriented post and panel sign

EN-03.03

Small auto oriented post and panel sign

EN-03.04

Pedestrian oriented post and panel sign

EN-03.05

Large auto oriented building number / identification post and panel sign

EN-03.06

Pedestrian oriented building number / identification post and panel sign



EN-03.02

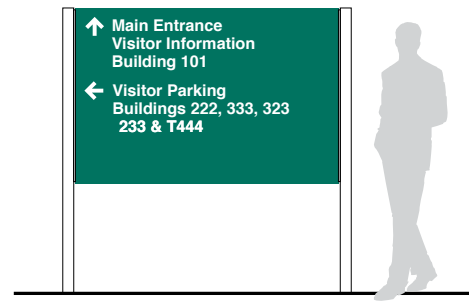

EN-03.03

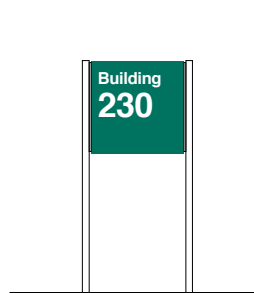

EN-03.04

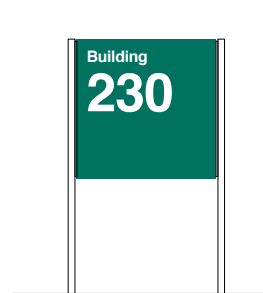

EN-03.05



EN-03.06

Sign Type EN-04

Post and Stacking Bar Sign for Directional Information

EN-04.01

Large/long auto oriented stacking bar directional sign - 6 to 8 bars

EN-04.02

Standard auto oriented stacking bar directional sign - 5 to 8 bars

EN-04.03

Small auto oriented stacking bar directional sign - 4 to 6 bars

EN-04.04

Pedestrian oriented stacking bar directional sign - 2 to 4 bars

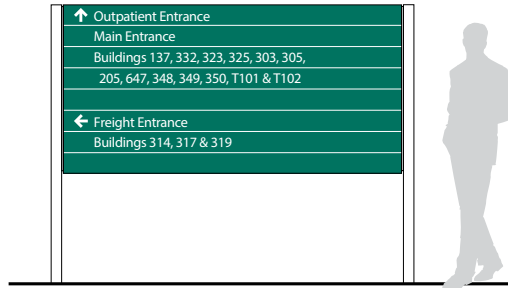

EN-04.01

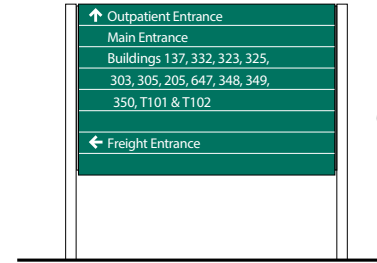

EN-04.02

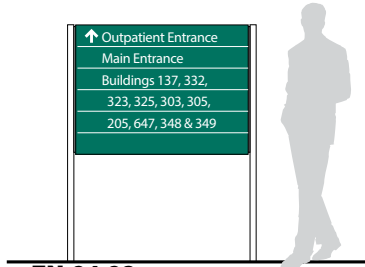

EN-04.03

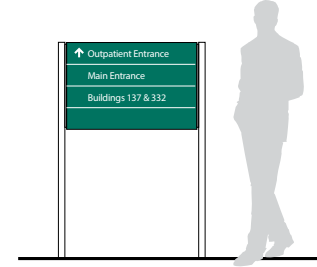

EN-04.04

Sign Type EN-05

Single Post Identification, Informational and Directional Sign

EN-05.01

Large single post identification, informational and directional sign

EN-05.02

Standard single post identification, informational and directional sign

EN-05.03

Small single post identification, informational and directional sign



EN-05.01

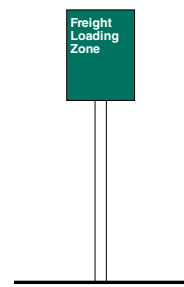

EN-05.02

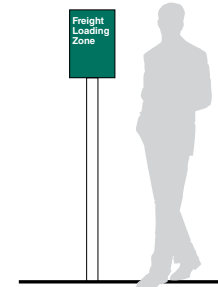

EN-05.03

Sign Type EN-06

Wall Mounted Signs

EN-06.01

Overhead wall mounted sign

EN-06.02

Large size wall mounted sign

EN-06.03

Large size wall mounted sign with stacking strips

EN-06.04

Medium size wall mounted sign

EN-06.05

Medium size wall mounted sign with stacking strips

EN-06.06

Regular size wall mounted sign

EN-06.07

Small size wall mounted sign

EN-06.08

Minor informational wall mounted sign

EN-06.09

Minor informational wall mounted sign

Spinal Rehabilitation
Clinic Entrance

EN-06.01

Building
230
Admissions
Outpatient
Rehabilitation

EN-06.02

Building
230
Admissions
Outpatient
Rehabilitation
Dental Clinic

EN-06.03

Building
230

EN-06.04

Building
230
Admissions
Outpatient
Rehabilitation
Dental Clinic

EN-06.05

Building
230

EN-06.06

Freight &
Delivery
Entrance

EN-06.07

Freight &
Delivery
Entrance

EN-06.08

Visitor
Parking

EN-06.09

Sign Type EN-08

Ambulance Entrance Signs

EN-08.01

Overhead wall mounted sign



EN-08.02

Wall mounted sign



EN-08.03

Post and panel sign



EN-08.01

EN-08.02

EN-08.03

Sign Type EN-09

Dimensional Letters and Logo

EN-09.01

Dimensional letter

EN-09.02

Dimensional letter

EN-09.03

Dimensional letter

EN-09.04

Logo and dimensional letter

EN-09.05

Logo and dimensional letter

Outpatient Entrance

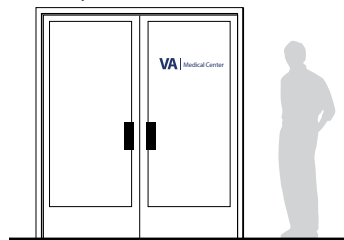

EN-09



Sign Type EN-10

Traffic Regulatory Signs

EN-10.01

Stop (R1-1)



EN-10.02

Do Not Enter (R5-1)

EN10.1



EN10.2



EN10.3



EN-10.03

Yield (R1-2)

EN-10.04

Speed Limit (R2-8)

EN10.4



EN10.5



EN10.6



EN-10.05

Keep Right (R4-7A)

EN-10.06

One Way (R6-2L, R6-2R)

EN-10.07

No Right/Left Turn (R3-1R, R3-2L)

EN-10.08

No U Turn (R3-4)

EN-10.09

Pedestrian Crossing (W11-2A)

EN10.7



EN10.8



EN10.9



EN-10.01

Sign Type EN-11

Street Signs

EN-11.01

Tall double blade

EN-11.02

Tall single blade

EN-11.03

Pylon

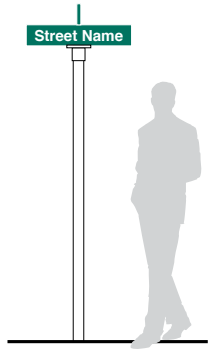

EN-11.01

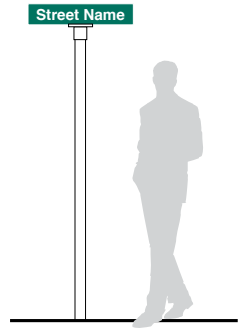

EN-11.02



EN-11.03

Sign Type EN-14

Building Entrance Door Identification



This page is intentionally left blank

Illuminated Exterior Signs

This page is intentionally left blank

Site Monument

Size

Sign Face:
1524 mm H x 3658 mm W x
305mm D
(5' 0" H x 12' 0" W x 1' 0" D)

Description & Use

Internally illuminated large horizontal free standing monument sign for identifying a medical center or the medical center's main entrance drive.

The base can be constructed of concrete or other masonry material in a color and texture that will provide a coordinated architectural look with the building finishes of the medical center.

Message Configuration

(Refer to message layout drawing for dimensions)

Specific message configuration will vary depending on the particular name of a facility. Variations to the presentation of a facility's name will need special approval from Washington DC.

Graphic Process

Illuminated, routed out copy backed with white translucent acrylic.

Colors

Text: White
Background: Refer to color chart
Accent: Refer to color chart

Recommendations

Position sign so drivers have a clear, unobstructed view of the sign. Keep landscaping around the sign low and position sprinklers so they project away from the sign.

On-off illumination of sign can be controlled through the use of a timer, manual or photoelectric switch. Consult with sign fabricator at time of order for appropriate method to use.

On-off illumination of sign can be controlled through the use of a timer, manual or photoelectric switch. Consult with sign fabricator at time of order for appropriate method to use.

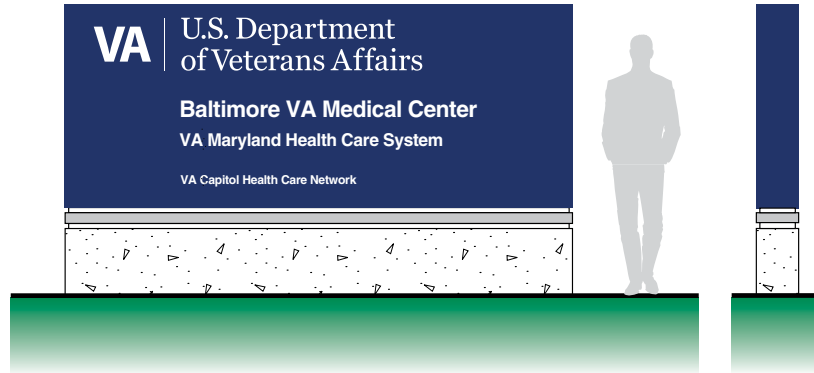

Message Layout A



Message Layout B



Message Layout C



Message Layout D



Message Layout E



Message Layout F



Site Monument

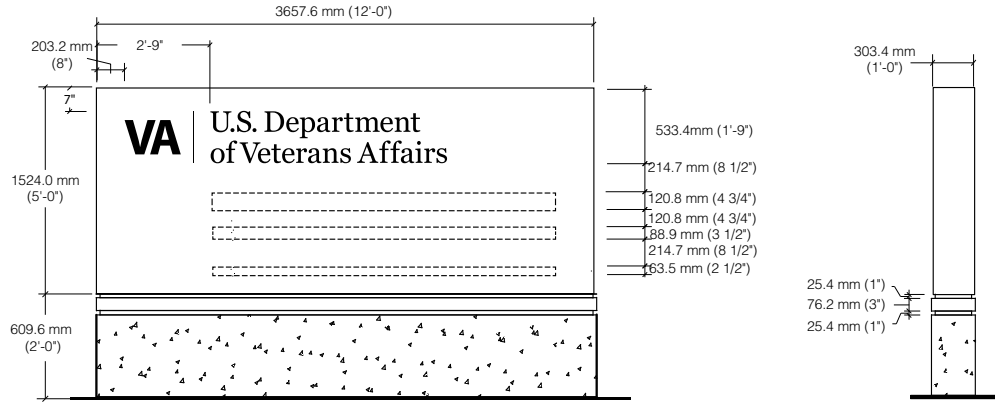

Message Layout A & F

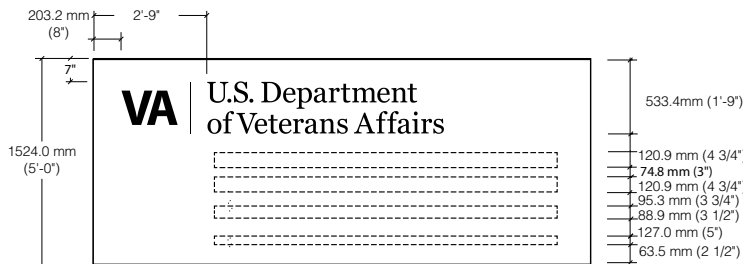

Message Layout B & D

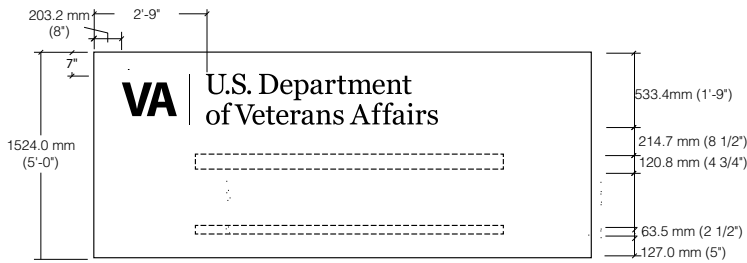

Message Layout C

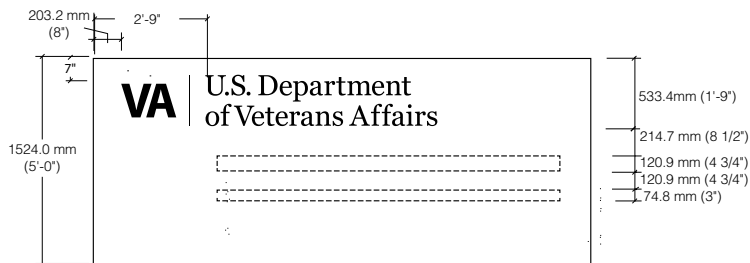

Message Layout E

Site Monument

Size

Sign Face:
1219 mm H x 3048 mm W x
305mm D
(4' 0" H x 10' 0" W x 1' 0" D)

Description & Use

Internally illuminated horizontal free standing monument sign for identifying a medical center or the medical center's main entrance drive.

The base can be constructed of concrete or other masonry material in a color and texture that will provide a coordinated architectural look with the building finishes of the medical center.

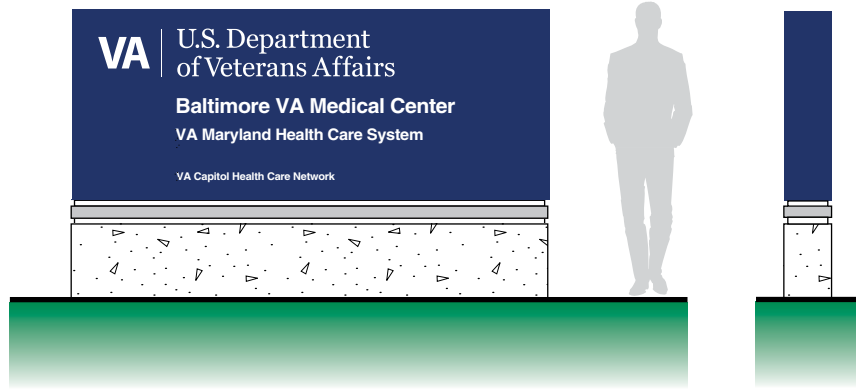

Message Configuration

(Refer to message layout drawing for dimensions)

Specific message configuration will vary depending on the particular name of a facility. Variations to the presentation of a facility's name will need special approval from Washington DC.

Graphic Process

Illuminated, routed out copy backed with white translucent acrylic.

Colors

Text: White
Background: Refer to color chart.
Accent: Refer to color chart.

Recommendations

Position sign so drivers have a clear, unobstructed view of the sign. Keep landscaping around the sign low and position sprinklers so they project away from the sign.

Message Layout A



Message Layout B



Message Layout C



Message Layout D



Message Layout E



Message Layout F



Site Monument

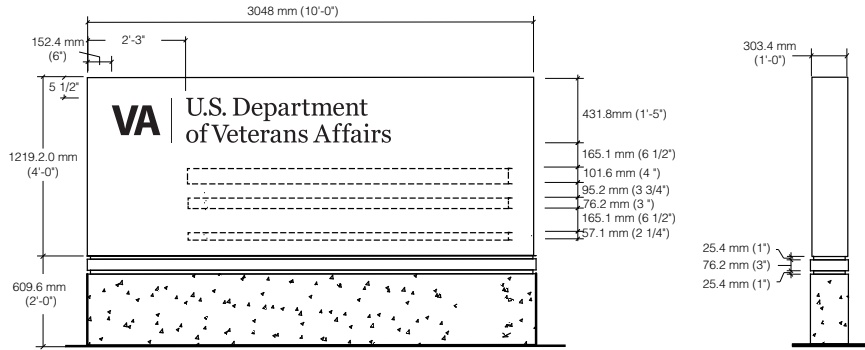

Message Layout A & F

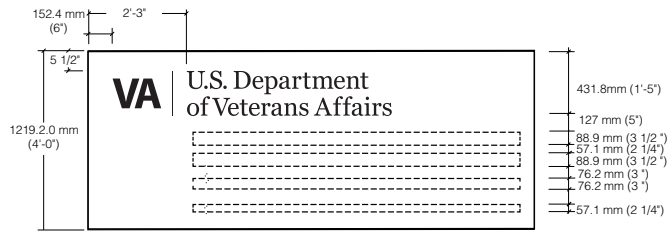

Message Layout B & D

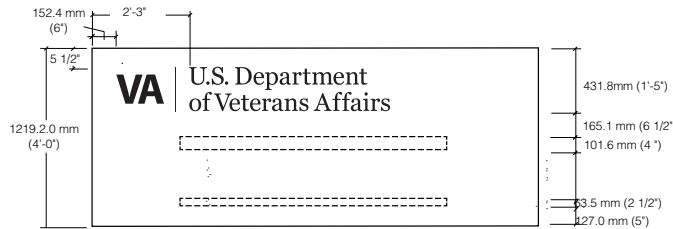

Message Layout C

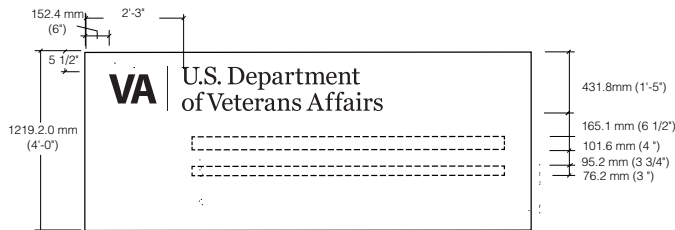

Message Layout E

Site Monument

Size

Sign Face:
1219 mm H x 2438 mm W x 305 mm D
(4' 0" H x 8' 0" W x 1' 0" D)

Description & Use

Internally illuminated small horizontal free standing monument sign for identifying a medical center where there is a space limitation. This sign can also be used to identify secondary drive entrances to the medical center.

The base can be constructed of concrete or other masonry material in a color and texture that will provide a coordinated architectural look with the building finishes of the medical center.

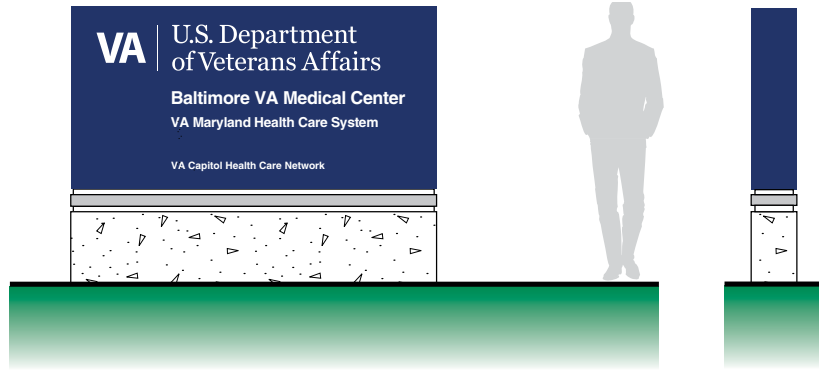

Message Configuration

(Refer to message layout drawing for dimensions)

Specific message configuration will vary depending on the particular name of a facility. Variations to the presentation of a facility's name will need special approval from Washington DC.

Graphic Process

Illuminated, routed out copy backed with white translucent acrylic.

Colors

Text: White
Background: Refer to color chart
Accent: Refer to color chart

Recommendations

Position sign so drivers have a clear, unobstructed view of the sign. Keep landscaping around the sign low and position sprinklers so they project away from the sign.

On-off illumination of sign can be controlled through the use of a timer, manual or photoelectric switch. Consult with sign fabricator at time of order for appropriate method to use.

Message Layout A



Message Layout B



Message Layout C



Message Layout D

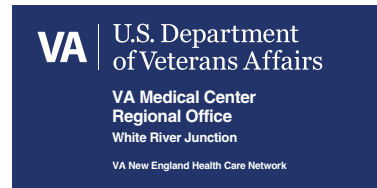

Message Layout E



Message Layout F



Site Monument

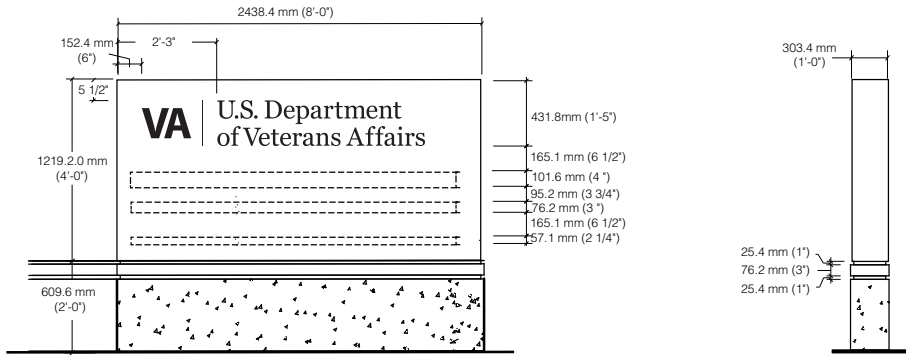

Message Layout A & F

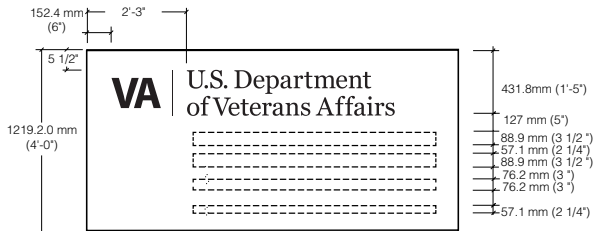

Message Layout B & D

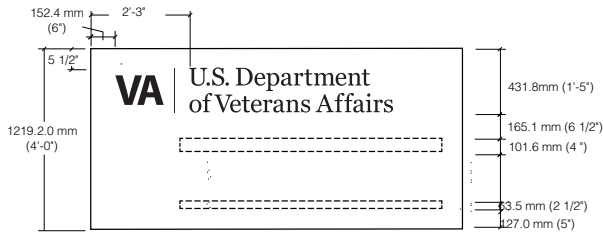

Message Layout C

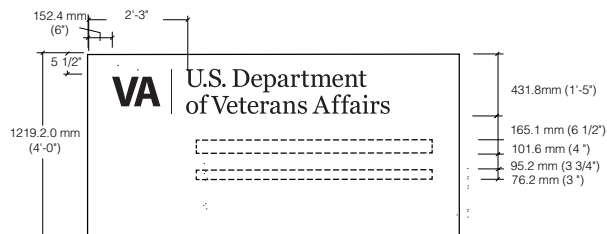

Message Layout E

Vertical Site Monument

Size

Sign Face:
3658 mm H x 1524 mm W x 305 mm D
(12' 0" H x 5' 0" W x 1' 0")

Description & Use

Internally illuminated vertical free standing monument sign for identifying a medical center or the medical center's main entrance drive.

The base can be constructed of concrete or other masonry material in a color and texture that will provide a coordinated architectural look with the building finishes of the medical center.

Message Configuration

(Refer to message layout drawing for dimensions)

Specific message configuration will vary depending on the particular name of a facility. Variations to the presentation of a facility's name will need special approval from Washington DC.

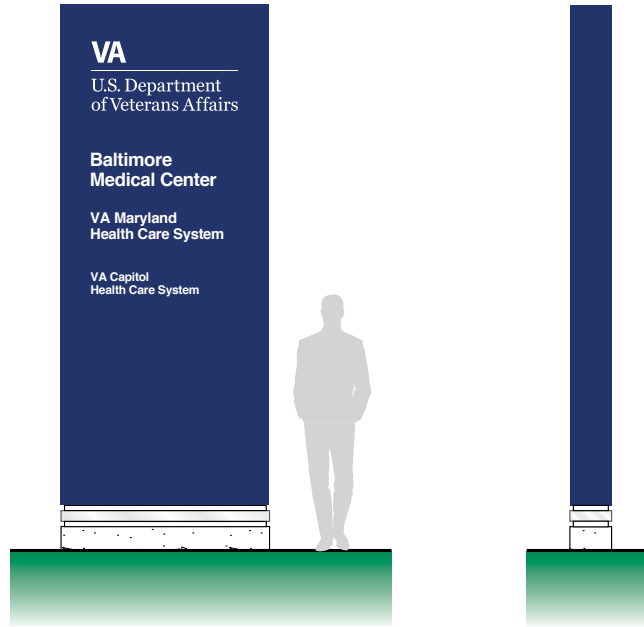

Graphic Process

Illuminated, routed out copy backed with white translucent acrylic.

Colors

Text: White
Background: Refer to color chart
Accent: Refer to color chart

Recommendations

Position sign so drivers have a clear, unobstructed view of the sign. Keep landscaping around the sign low and position sprinklers so they project away from the sign.

On-off illumination of sign can be controlled through the use of a timer, manual or photoelectric switch. Consult with sign fabricator at time of order for appropriate method to use.

Message Layout A

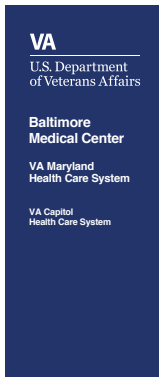

Message Layout B

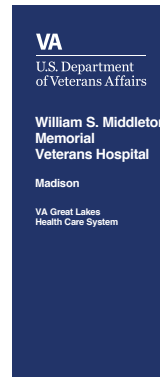

Message Layout C

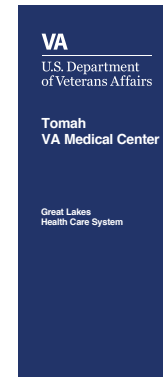

Message Layout D

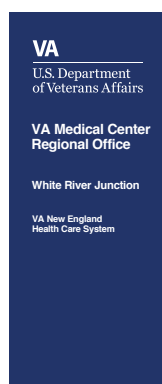

Message Layout E

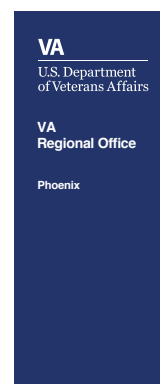

Message Layout F

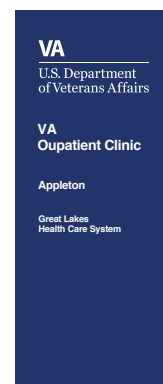

Vertical Site Monument

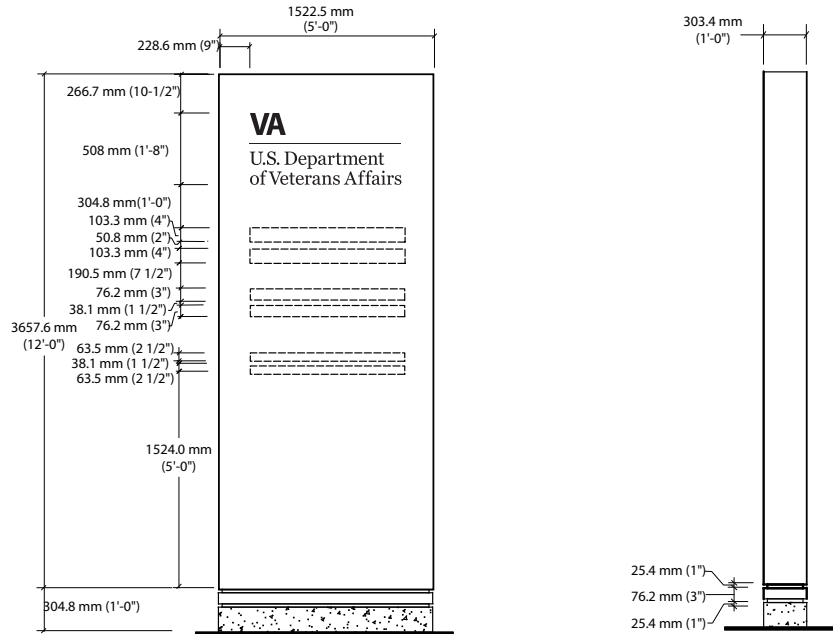

Message Layout A

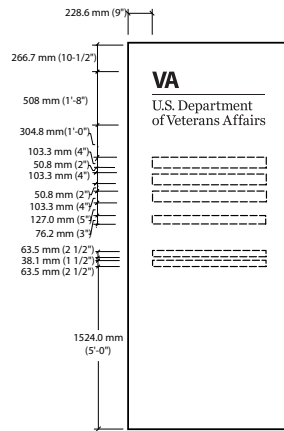

Message Layout B

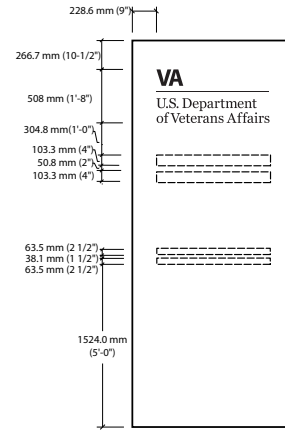

Message Layout C

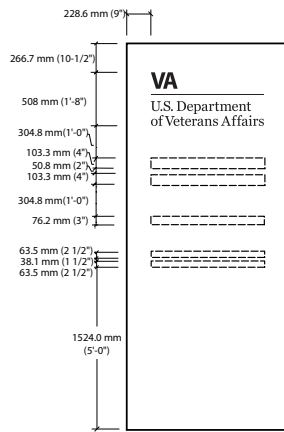

Message Layout D & F

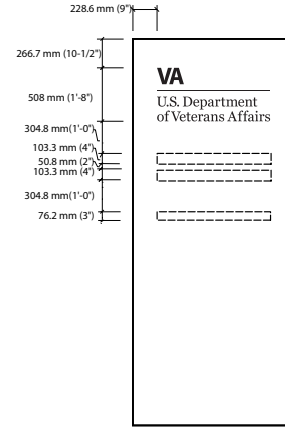

Message Layout E

Vertical Site Monument

Size

Sign Face:
2440 mm H x 1220 mm W
x 305 mm D
(8' 0" H x 4' 0" W x 1'-0" D)

Description & Use

Internally illuminated small free standing vertical monument sign for identifying a medical center where there is a space limitation. This sign can also be used to identify secondary drive entrances to the medical center.

The base can be constructed of concrete or other masonry material in a color and texture that will provide a coordinated architectural look with the building finishes of the medical center.

Message Configuration

(Refer to message layout drawing for dimensions)

Specific message configuration will vary depending on the particular name of a facility. Variations to the presentation of a facility's name will need special approval from Washington DC.

Graphic Process

Illuminated, routed out copy backed with white translucent acrylic.

Colors

Text: White
Background: Refer to color chart
Accent: Refer to color chart

Recommendations

Position sign so drivers have a clear, unobstructed view of the sign. Keep landscaping around the sign low and position sprinklers so they project away from the sign.

On-off illumination of sign can be controlled through the use of a timer, manual or photoelectric switch. Consult with sign fabricator at time of order for appropriate method to use.

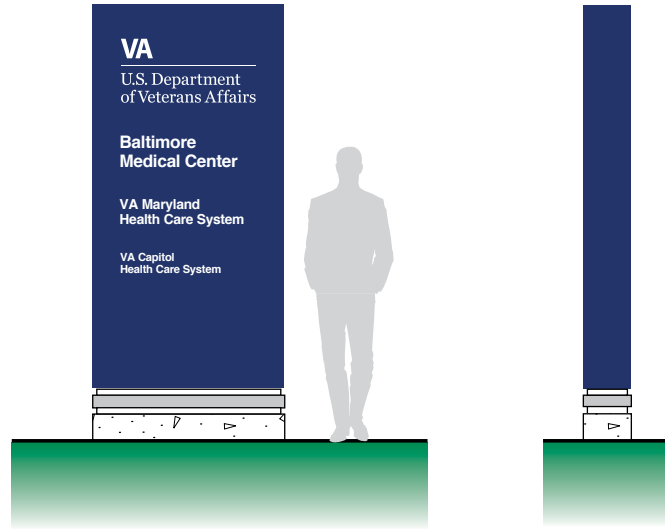

Message Layout A

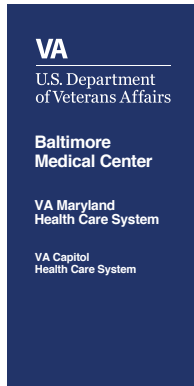

Message Layout B

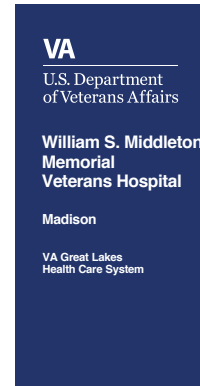

Message Layout C

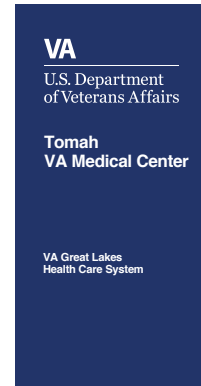

Message Layout D

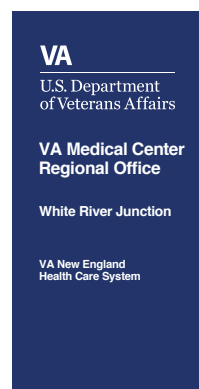

Message Layout E

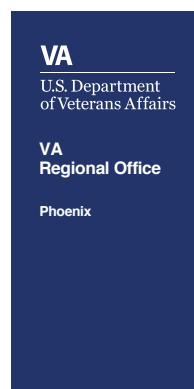

Message Layout F

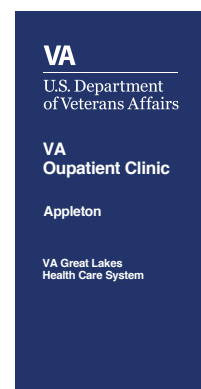

Vertical Site Monument

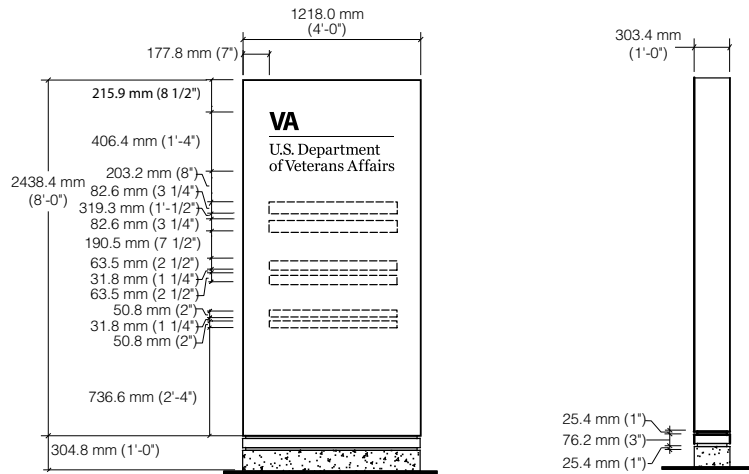

Message Layout A

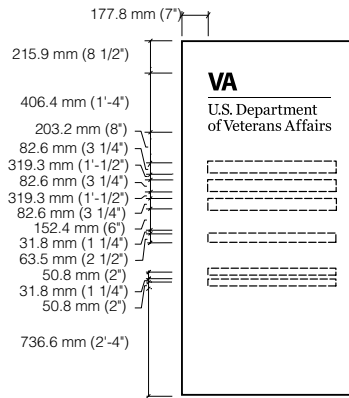

Message Layout B

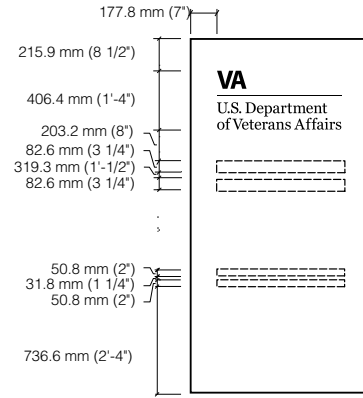

Message Layout C

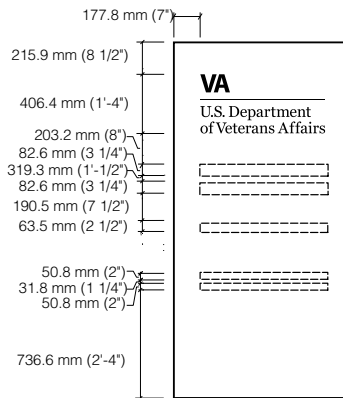

Message Layout D & F

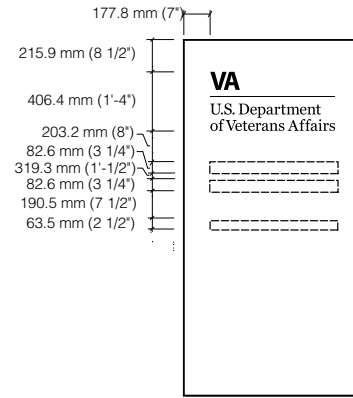

Message Layout E

Monument Primary Directional

Size

Sign Face
1829 mm H x 1829 mm W x 305 mm D
(6' 0" H x 6' 0" W x 1' 0" D)

Description & Use

Internally Illuminated Large directional monument sign with 10 stacking strips. Directional sign with messages directed specifically to drivers.

Internally illuminated sign should be used only in locations where there is a heavy night time driver need for directional information. Monument type directional signs should only be used on the main entrance drive and in front of the medical center.

Message Configuration

(Refer to message layout drawing for dimensions)

Layout A is for the first line of text with an arrow of direction.

Layout B is for message with no arrow which is located immediately under a copy bar with an arrow.

Layout C is for indented text. This is for situations where the message has to run over onto a second copy bar.

Graphic Process

Illuminated, routed out copy backed with white translucent acrylic.

Colors

Text: White
Background: Refer to color chart

Recommendations

Position sign so drivers have a clear, unobstructed view of the sign.

Directional information for services ahead should always be at the top of the sign.

Always leave a blank copy strip between groups of directional information. This will aid in the ability of the driver to quickly read grouped directional information.

Always leave a blank strip at the top of the sign. This strip is smaller than the text strips.

Configure a sign with at least one blank copy strip at the bottom of the sign. This will aid in the ability of the driver to read the sign.

On-off illumination of sign can be controlled through the use of a timer, manual or photoelectric switch. Consult with sign fabricator at time of order for appropriate method to use.

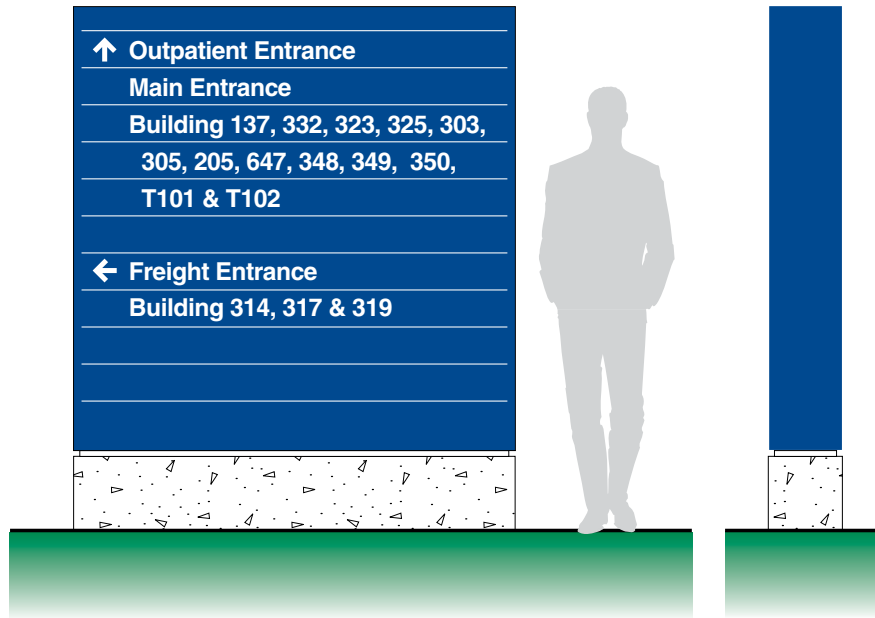

Message Layout A



Message Layout B



Message Layout C



Monument Secondary Directional

Size

Sign Face:
1829 mm H x 1219 mm W x 305 mm D
(6' 0" H x 4' 0" W x 1' 0" D)

Description & Use

Internally illuminated small directional monument sign with 10 stacking strips. Directional sign with messages directed specifically to drivers.

Internally illuminated sign should be used only in locations where there is a heavy night time driver need for directional information. Monument type directional signs should only be used on the main entrance drive and in front of the medical center.

Message Configuration

(Refer to message layout drawing for dimensions)

Layout A is for the first line of text with an arrow of direction.

Layout B is for message with no arrow which is located immediately under a copy bar with an arrow.

Layout C is for indented text. This is for situations where the message has to run over onto a second copy bar.

Graphic Process

Illuminated, routed out copy backed with white translucent acrylic.

Colors

Text: White
Background: Refer to color chart

Recommendations

Position sign so drivers have a clear, unobstructed view of the sign.

Directional information for services ahead should always be at the top of the sign.

Always leave a blank copy strip between groups of directional information. This will aid in the ability of the driver to read grouped directional information more quickly.

Always leave a blank strip at the top of the sign. This strip is smaller than the text strips.

Configure a sign with at least one blank copy strip at the bottom of the sign. This will aid in the ability of the driver to read the sign.

On-off illumination of sign can be controlled through the use of a timer, manual or photoelectric switch. Consult with sign fabricator at time of order for appropriate method to use.

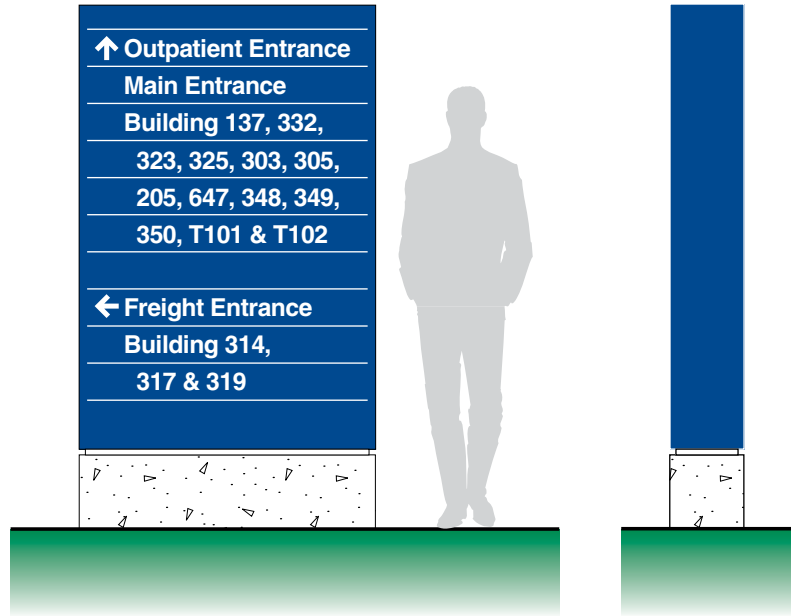

Message Layout A



Message Layout B

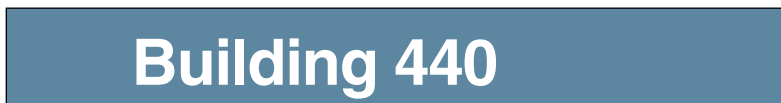

Message Layout C



Monument Secondary Directional

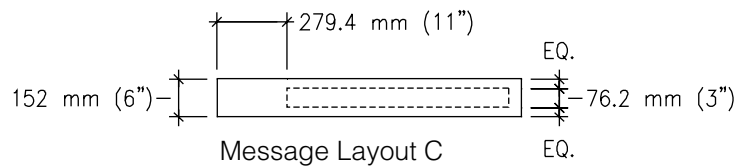
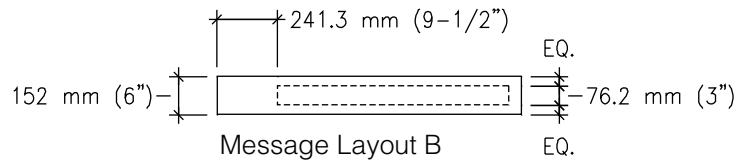
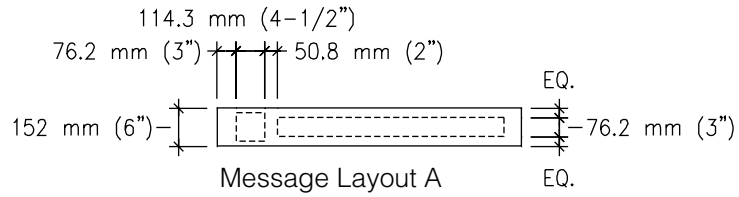
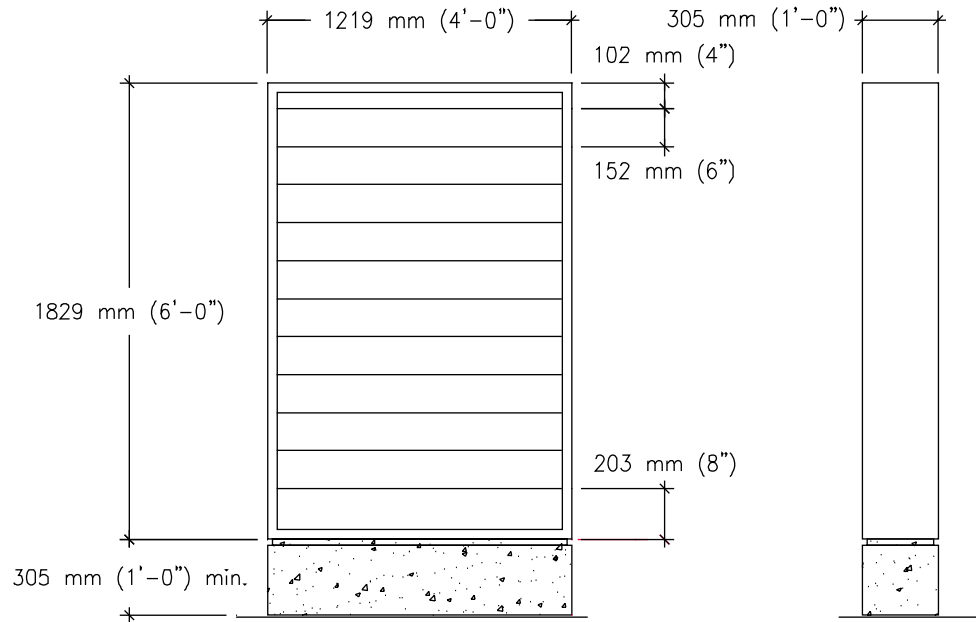

Post and Panel Building Identification

Size

Sign Face:
1219 mm H x 2438 mm W
(4' 0" H x 8' 0" W)

Overall Sign Height:
1981 mm (6' 6")

Description & Use

Internally illuminated large post and panel sign for identifying a medical center where there is a space limitation or there are other physical restraints that prevent a monument sign from being installed. This sign, in a non-illuminated version, can also be used to identify secondary drive entrances to the medical center.

Message Configuration

(Refer to message layout drawing for dimensions)

The specific message configuration will vary depending on the particular name of a facility. Variations to the presentation of a facility's name will need special approval from Washington DC.

Graphic Process

Illuminated, routed out copy backed with white translucent acrylic.

Colors

Text: White
Background: Refer to color chart
Posts: Refer to color chart

Recommendations

Position sign so drivers have a clear, unobstructed view of the sign.

On-off illumination of sign can be controlled through the use of a timer, manual or photoelectric switch. Consult with sign fabricator at time of order for appropriate method to use.

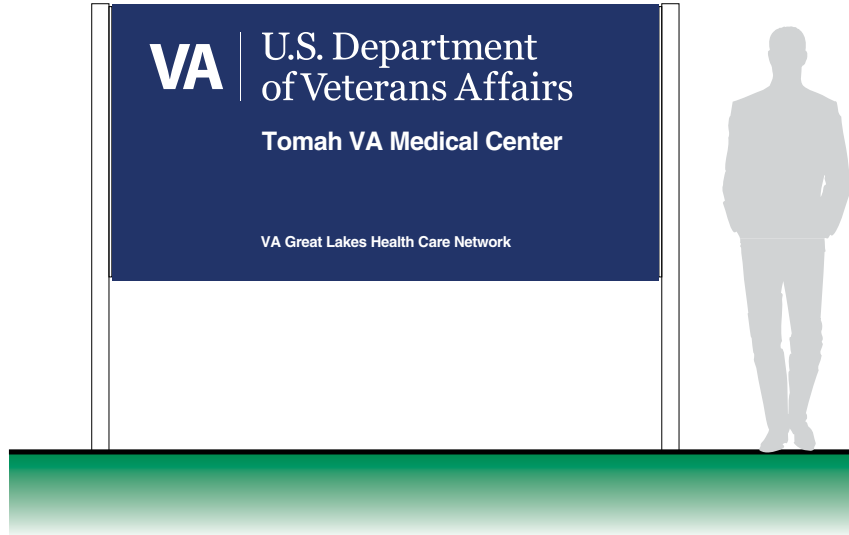

Message Layout C



Message Layout D

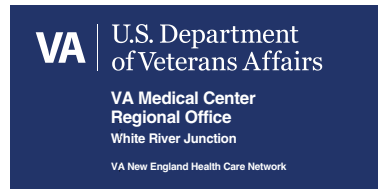

Message Layout E



Message Layout F



Post and Panel Building Identification

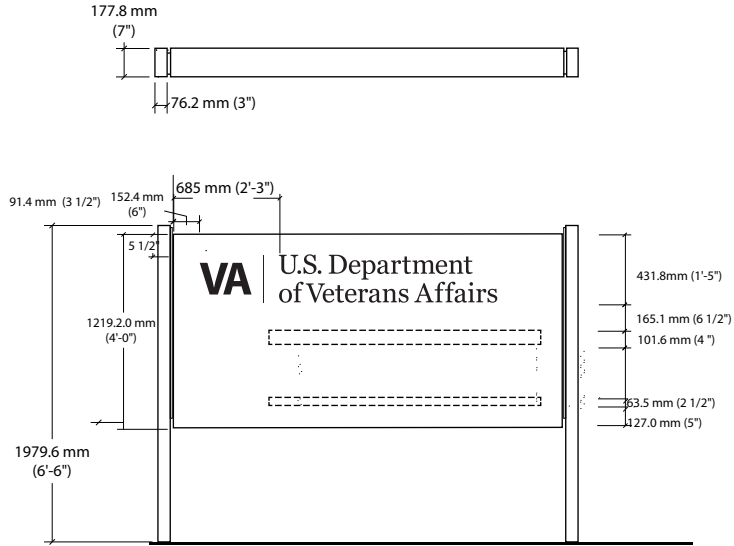

Message Layout C

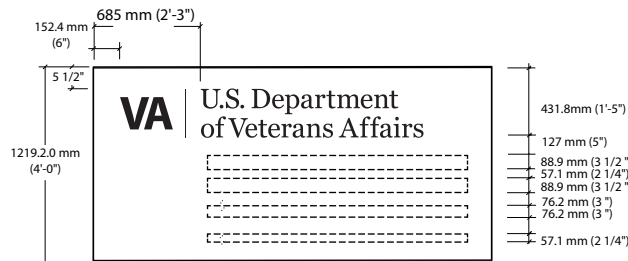

Message Layout D

685 mm (2'-3")

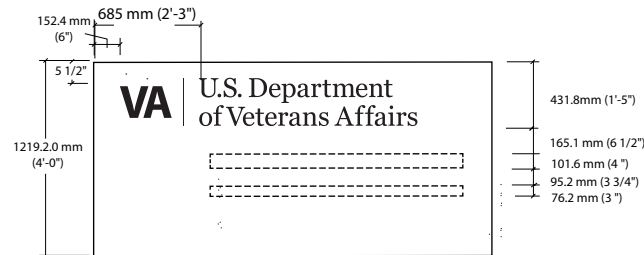

Message Layout E

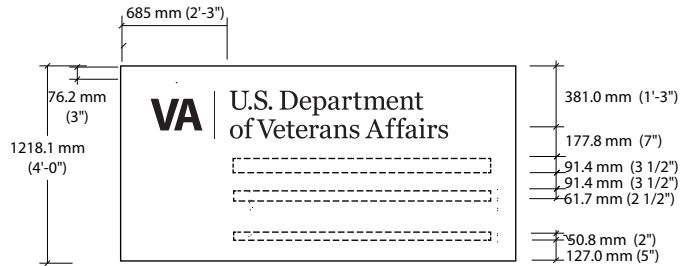

Message Layout F

Primary Directional Post and Panel

Size

Sign Face:
1220 mm H x 1830 mm W
(4' 0" H x 6' 0" W)

Overall Sign Height:
1981 mm (6' 6")

Description & Use

Internally Illuminated post and panel directional sign with messages directed specifically to drivers.

Message Configuration

(Refer to message layout drawing for dimensions)

Message size and layout should adjust to the volume of information being presented. Layouts illustrated show small, medium and large size text. Smaller text than shown should not be used as the messages will be unreadable to drivers. Larger text than shown will result in words that may not fit on the sign.

Graphic Process

Illuminated, routed out copy backed with white translucent acrylic.

Colors

Text: White
Background: Refer to color chart
Posts: Refer to color chart

Recommendations

This type of directional sign should be used only when the particular message that it will contain is not likely to change.

Directional information for services ahead should always be at the top of the sign.

Always leave space between groups of directional information. This will aid in the ability of the driver to read grouped directional information more quickly.

Generally, configure a sign with blank space at the bottom of the sign. This will aid in the ability of the driver to read the sign.

Position sign so drivers have a clear, unobstructed view of the sign.

On-off illumination of sign can be controlled through the use of a timer, manual or photoelectric switch. Consult with sign fabricator at time of order for appropriate method to use.

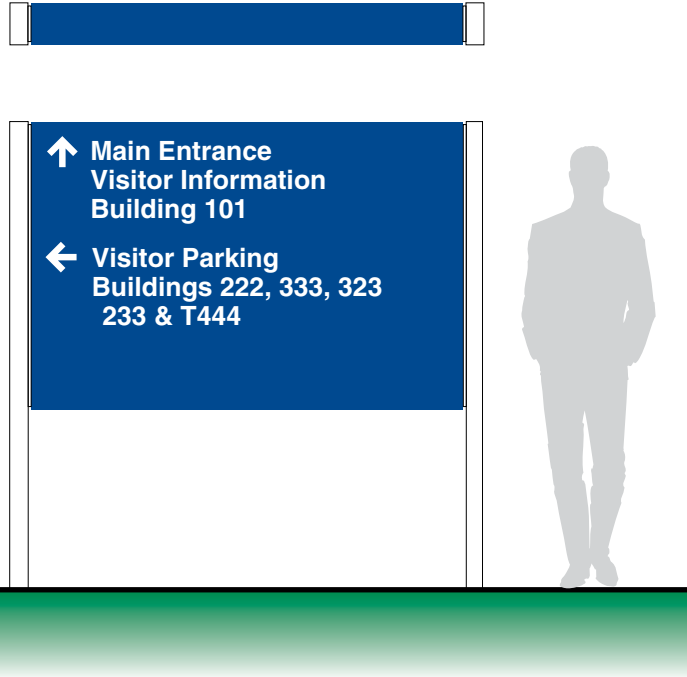

Message Layout A

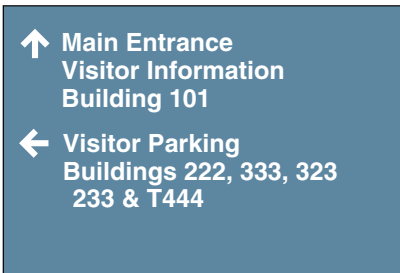

Message Layout B

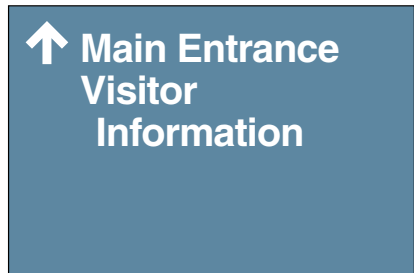

Message Layout C

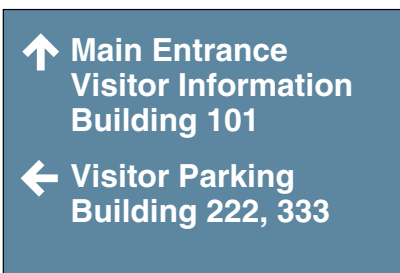

Primary Directional Post and Panel

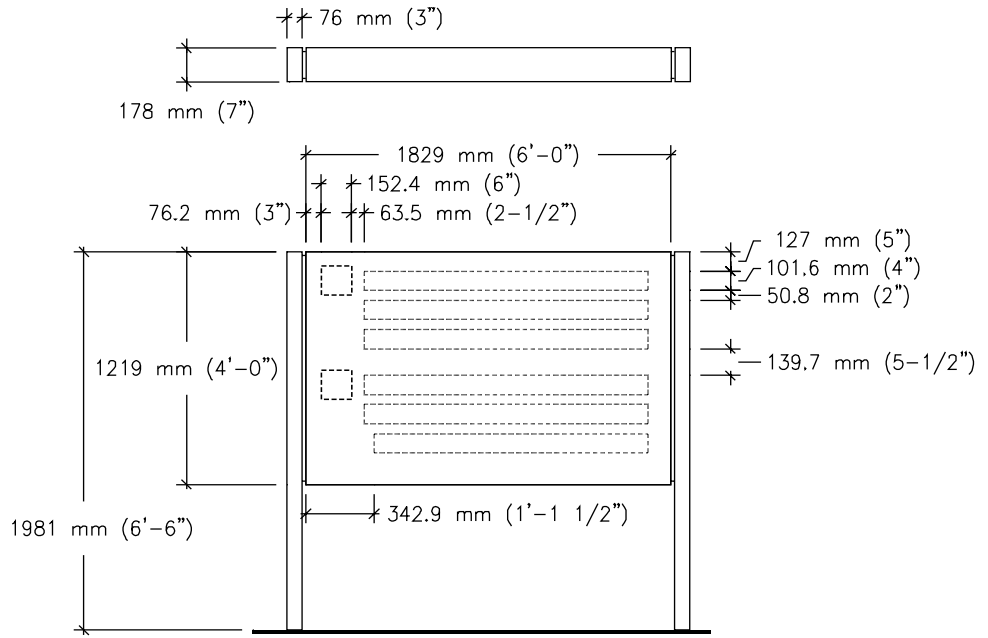

Message Layout A

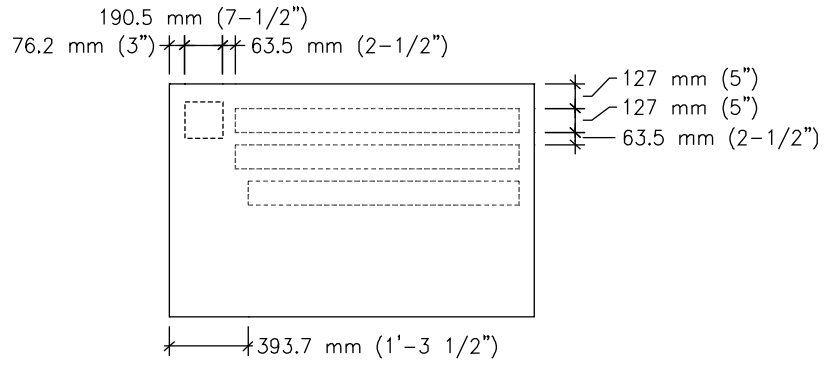

Message Layout B

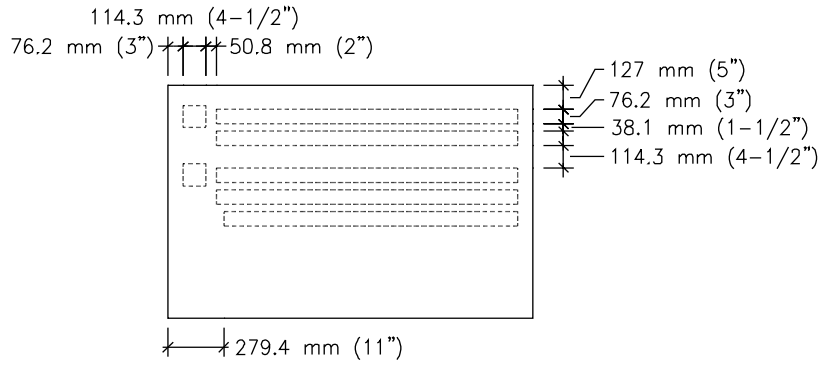

Message Layout C

Post and Panel Directional

Size

Sign Face:
1219 mm H x 2438 mm W
(4' 0" H x 8' 0" W)

Overall Sign Height:
1981 mm (6' 6")

Description & Use

Internally illuminated large/long auto oriented stacking 8 directional sign strips with messages directed specifically to drivers. Internally illuminated sign to be used only in locations where there is a heavy night time driver need for directional information.

Message Configuration

(Refer to construction drawing for dimensions)

Layout A is for the first line of text with an arrow of direction.

Layout B is for message with no arrow which is located immediately under a copy bar with an arrow.

Layout C is for indented text. This is for situations where the message has to run over onto a second copy bar.

Graphic Process

Illuminated, routed out copy backed with white translucent acrylic.

Colors

Text: White
Background: Refer to color chart
Posts: Refer to color chart

Recommendations

Position sign so drivers have a clear, unobstructed view of the sign.

Directional information for services ahead should always be at the top of the sign.

Always leave a blank copy strip between groups of directional information. This will aid in the ability of the driver to read grouped directional information more quickly.

Generally, configure a sign with at least one blank copy strip at the bottom of the sign. This will aid in the ability of the driver to read the sign. It will also allow for an additional line of text to be added to the sign in the future.

On-off illumination of sign can be controlled through the use of a timer, manual or photoelectric switch. Consult with sign fabricator at time of order for appropriate method to use.

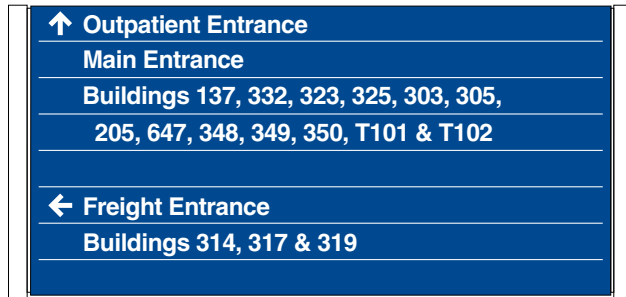

Message Layout A



Message Layout B



Message Layout C

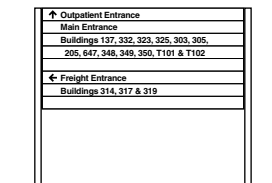

EI-04.01A (8 Strip)

Post and Panel Directional

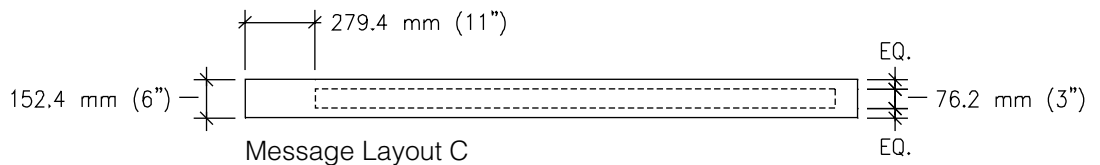
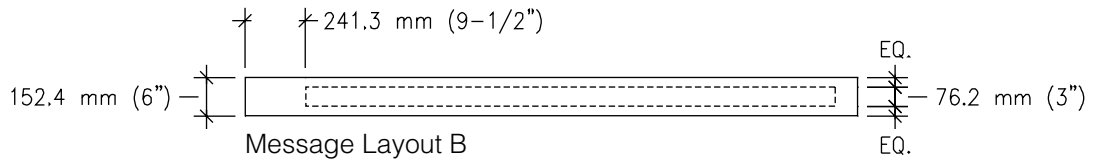
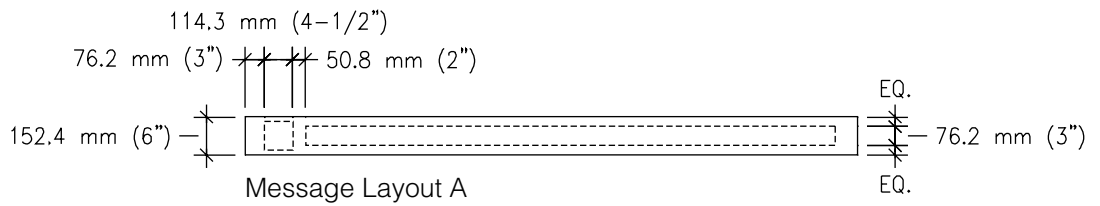
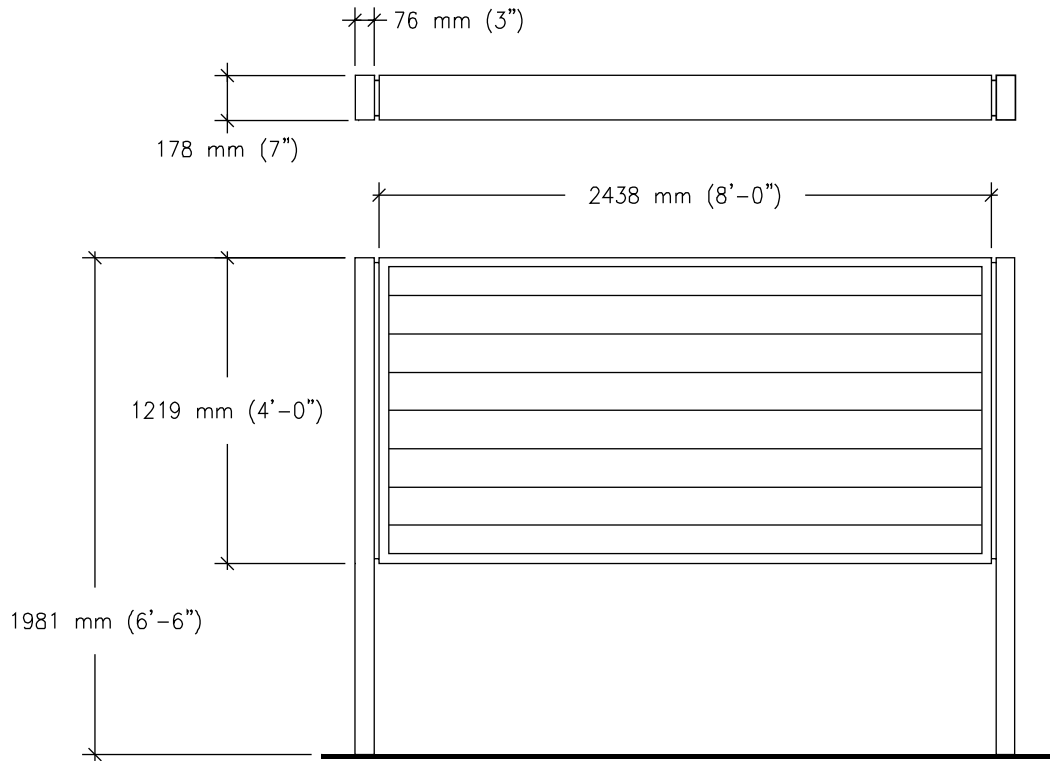

Post and Panel Directional

Size

Sign Face:
1219 mm H x 1829 mm W
(4' 0" H x 6' 0" W)

Overall Sign Height:
1829 mm (6' 0")

Description & Use

Internally illuminated standard auto oriented stacking 8 strip bar directional sign with messages directed specifically to drivers. Internally illuminated sign to be used only in locations where there is a heavy night time driver need for directional information.

Message Configuration

(Refer to construction drawing for dimensions)

Layout A is for the first line of text with an arrow of direction.

Layout B is for message with no arrow which is located immediately under a copy bar with an arrow.

Layout C is for indented text. This is for situations where the message has to run over onto a second copy bar.

Graphic Process

Illuminated, routed out copy backed with white translucent acrylic.

Colors

Text: White
Background: Refer to color chart
Posts: Refer to color chart

Recommendations

Position sign so drivers have a clear, unobstructed view of the sign.

Directional information for services ahead should always be at the top of the sign.

Always leave a blank copy strip between groups of directional information. This will aid in the ability of the driver to read grouped directional information more quickly.

Generally, configure a sign with at least one blank copy strip at the bottom of the sign. This will aid in the ability of the driver to read the sign. It will also allow for an additional line of text to be added to the sign in the future without having to order another copy strip.

On-off illumination of sign can be controlled through the use of a timer, manual or photoelectric switch. Consult with sign fabricator at time of order for appropriate method to use.

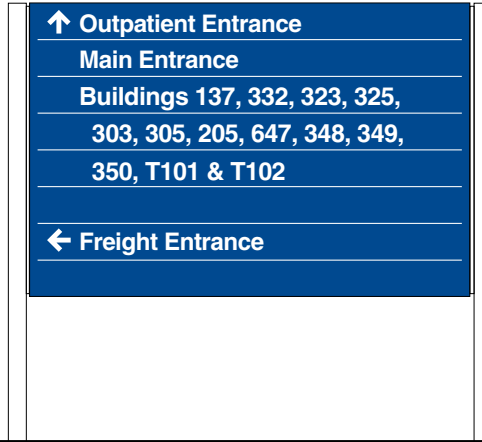

Message Layout A



Message Layout B



Message Layout C

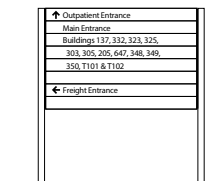

EI-04.02A (8 Strip)

Post and Panel Directional

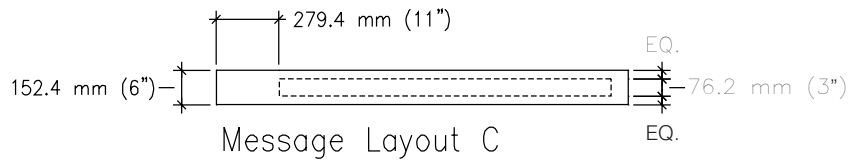
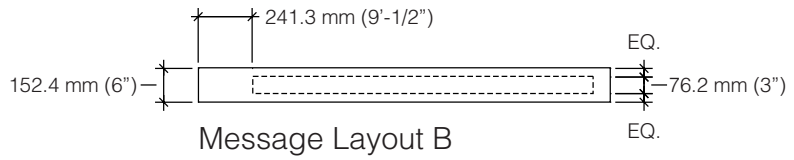
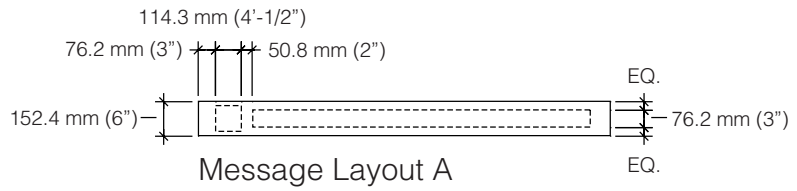
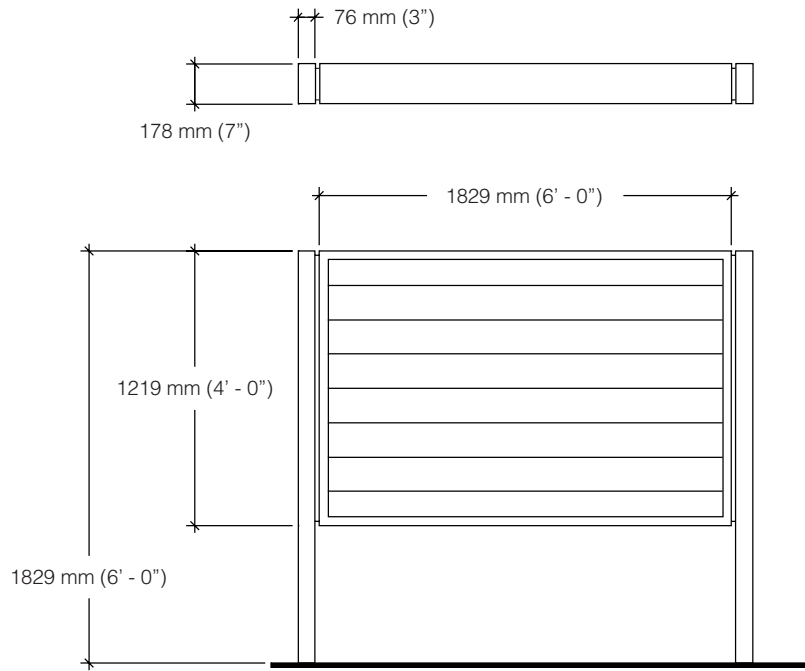

Wall Mounted Overhead

Size

Sign Face:
610 mm H x 2438 mm W
(2' 0" H x 8' 0" W)

Description & Use

Internally illuminated overhead wall mounted identification sign for a stand alone building, that is not a medical center. This sign type can also be used to identify an entrance to a building.

Message Configuration

(Refer to message layout drawing for dimensions)

Message Layout A, B and C are for identifying an entrance to a building.

Message Layout D is for identifying a non-medical center, stand alone building, typically off campus.

Graphic Process

Illuminated, routed out copy backed with white translucent acrylic.

Colors

Text: White
Background: Refer to color chart

Recommendations

For a stand alone non medical center building, use this type of sign when there is not place to install a free standing sign.

Use this type of sign for "titling" major building entrances that have a very high volume of patient and visitor traffic and need to be clearly distinguished.

On-off illumination of sign can be controlled through the use of a timer, manual or photoelectric switch. Consult with sign fabricator at time of order for appropriate method to use.



Message Layout A



Message Layout B



Message Layout C



Message Layout D



Wall Mounted Overhead

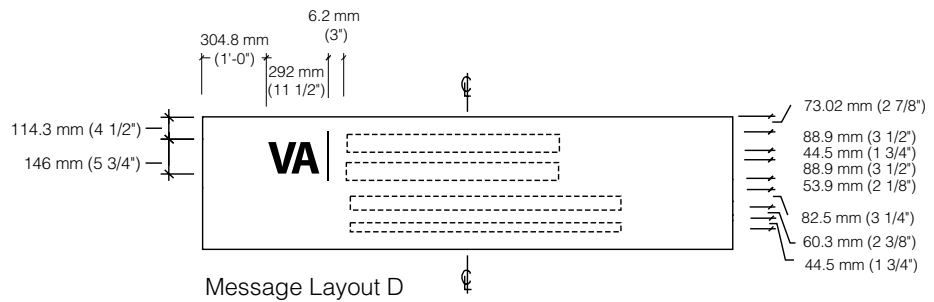
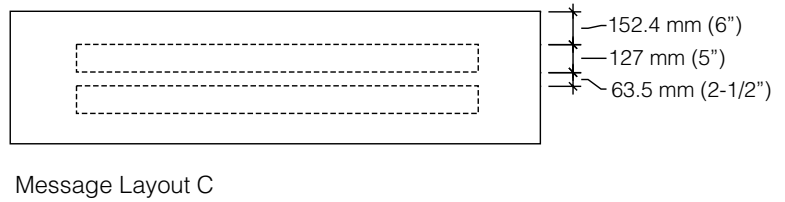
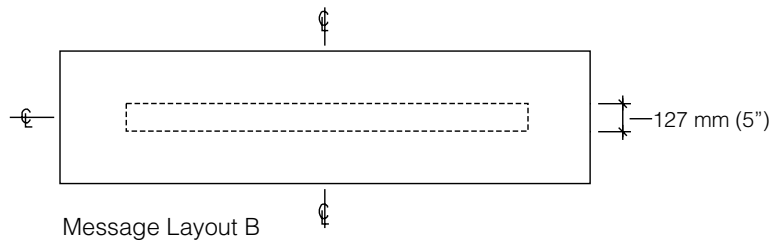
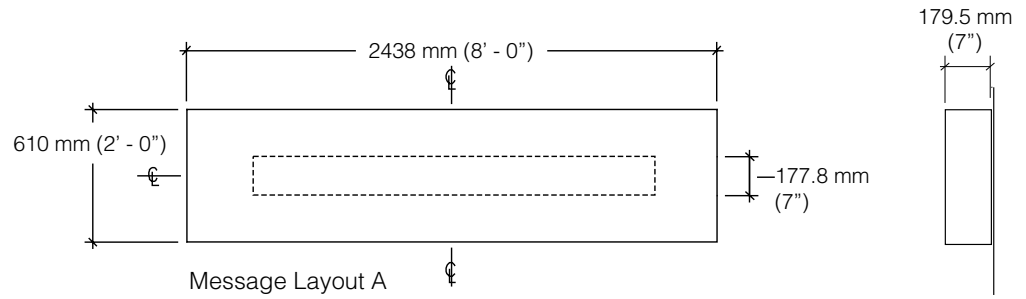

Wall Mounted Building Identification

Size

Sign Face:
914 mm H x 1219 mm W
(3' 0" H x 4' 0" W)

Description & Use

Internally illuminated large wall mounted sign type that can be used to identify a building on a medical center campus. It also can be used for identification of a stand alone building that is not a medical center and there is no place to install a free standing sign.

Message Configuration

(Refer to message layout drawing for dimensions)

Message Layout A is for identifying a non-medical center stand alone building, typically off campus.

Message Layout B and C are for identifying building on a medical center campus.

Graphic Process

Illuminated, routed out copy backed with white translucent acrylic.

Colors

Text: White
Background: Refer to color chart

Recommendations

For a stand alone non medical center building, use this type of sign when there is not place to install a free standing sign.

Use this type of sign for "titling" building entrances that have a very high volume of patient and visitor traffic and needs to be clearly distinguished. It also can be use on a building that is set back a considerable distance from the roadway.

Position the sign adjacent the main entrance, if possible. If the sign is not readable in this position, then locate on the corner of the building.

This large sign should not be used on small buildings or buildings with minor uses.

On-off illumination of sign can be controlled through the use of a timer, manual or photoelectric switch. Consult with sign fabricator at time of order for appropriate method to use.

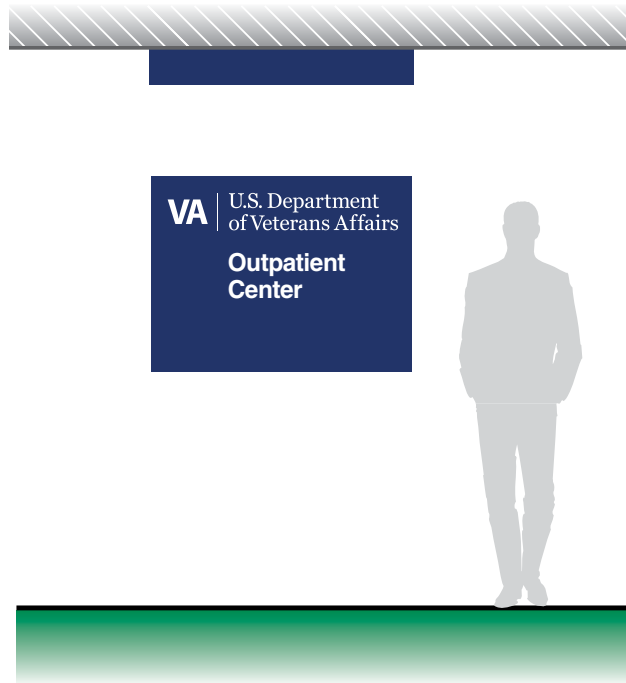

Message Layout A



Message Layout B

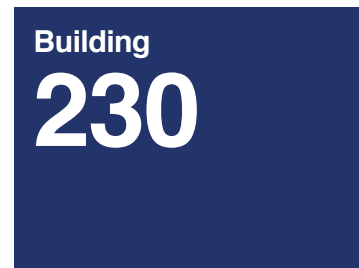

Message Layout C



Wall Mounted Building Identification

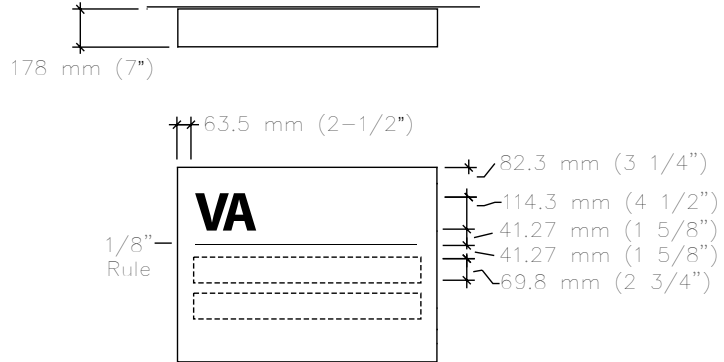

Message Layout A

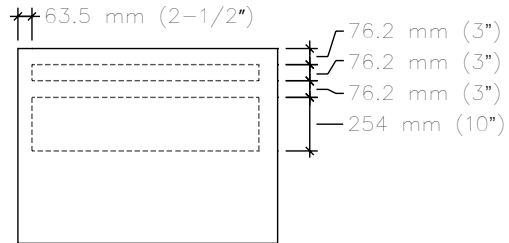

Message Layout B

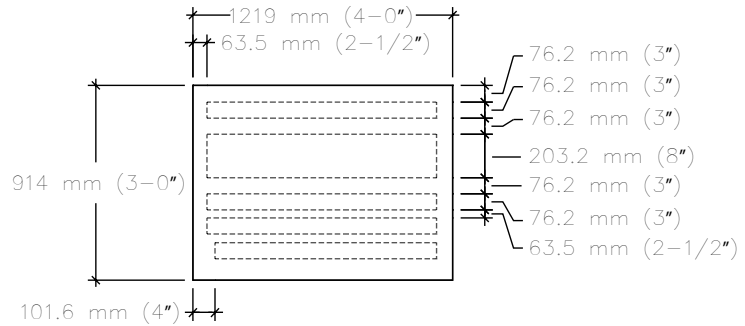

Message Layout C

Wall Mounted Ambulance Entrance Identification

Size

Sign Face:
610 mm H x 2438 mm W
(2' 0" H x 8' 0" W)

Description & Use

Internally illuminated overhead wall mounted sign to be placed above the ambulance entrance.

Message Configuration

(Refer to message layout drawing for dimensions)
Conform to the layout shown.

Graphic Process

Illuminated, routed out copy backed with white translucent acrylic.

Colors

Text: White
Symbol Background: White
Sign Background: Red

Recommendations

Place sign in a position of the building where it clearly identifies the "Ambulance Entrance" and is visible to both vehicles and pedestrians.

On-off illumination of sign can be controlled through the use of a timer, manual or photoelectric switch.
Consult with sign fabricator at time of order for appropriate method to use.

**Message Layout A**

Wall Mounted Ambulance Entrance Identification

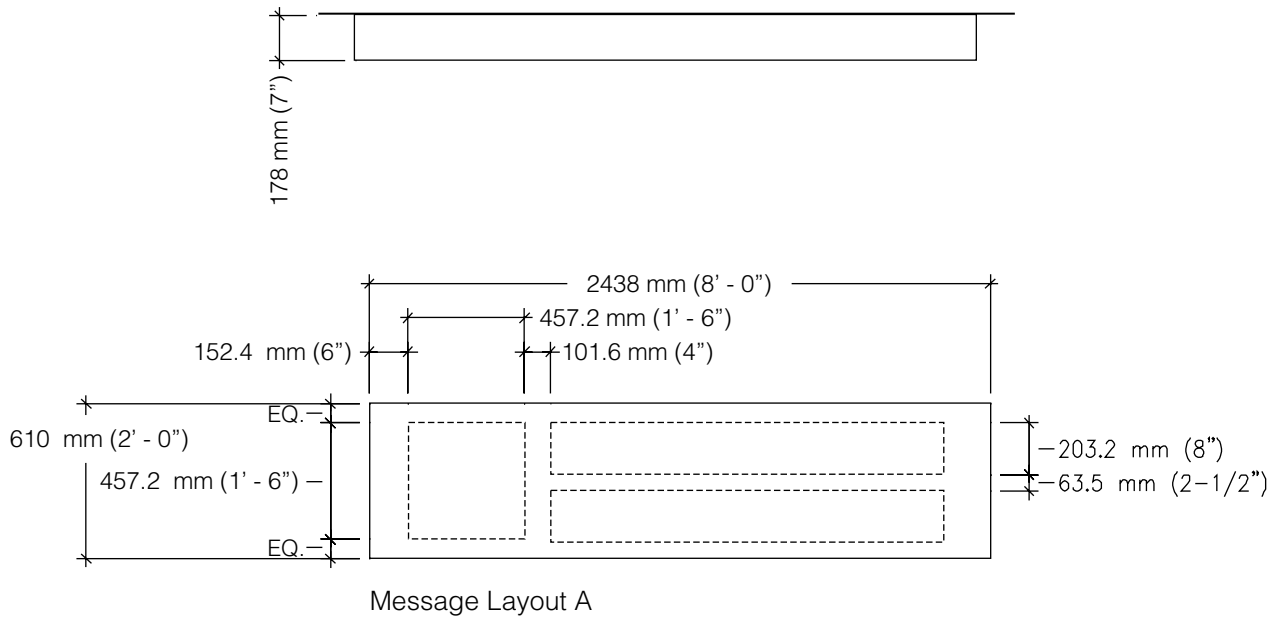

Wall Mounted Ambulance Entrance Identification

Size

Sign Face:
914 mm H x 1219 mm W
(3' 0" H x 4' 0" W)

Description & Use

Internally illuminated wall mounted sign to be placed on the wall adjacent to the ambulance entrance.

Message Configuration

(Refer to message layout drawing for dimensions)
Conform to the layouts shown.

Graphic Process

Illuminated, routed out copy backed with white translucent acrylic.

Colors

Text: White
Symbol Background: White
Sign Background: Red .

Recommendations

Place sign in a position of the building where it clearly identifies the "Ambulance Entrance" and is visible to both vehicles and pedestrians.

On-off illumination of sign can be controlled through the use of a timer, manual or photoelectric switch. Consult with sign fabricator at time of order for appropriate method to use.



Message Layout A



Message Layout B



Wall Mounted Ambulance Entrance Identification

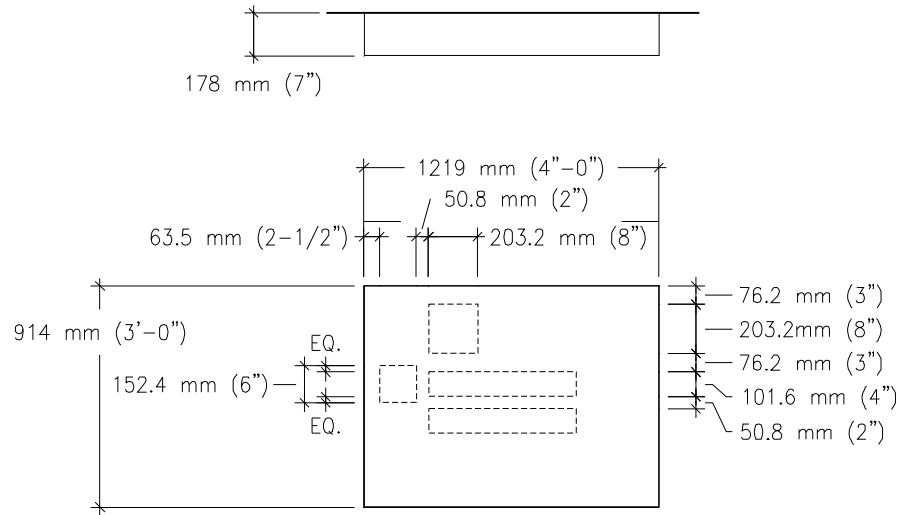

Message Layout A

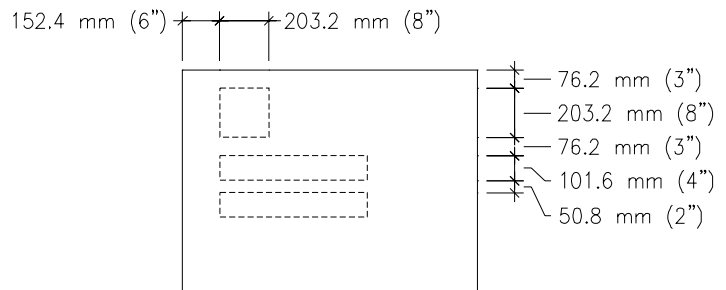

Message Layout B

Post and Panel Ambulance Entrance Identification

Size

Sign Face:
914 mm H x 1219 mm W
(3' 0" H x 4' 0" W)

Overall Sign Height:
1676 mm (5' 6")

Description & Use

Internally illuminated post and panel sign to be placed on the roadway, adjacent to the ambulance entrance to direct ambulance drivers to the correct building entrance.

Message Configuration

(Refer to message layout drawing for dimensions)
Conform to the layouts shown.

Graphic Process

Illuminated, routed out copy backed with white translucent acrylic.

Colors

Text: White
Symbol Background: White
Sign Background: Red
Post: Refer to color chart

Recommendations

Position sign so drivers have a clear, unobstructed view of the sign.

On-off illumination of sign can be controlled through the use of a timer, manual or photoelectric switch. Consult with sign fabricator at time of order for appropriate method to use.



Message Layout A



Message Layout B



Post and Panel Ambulance Entrance Identification

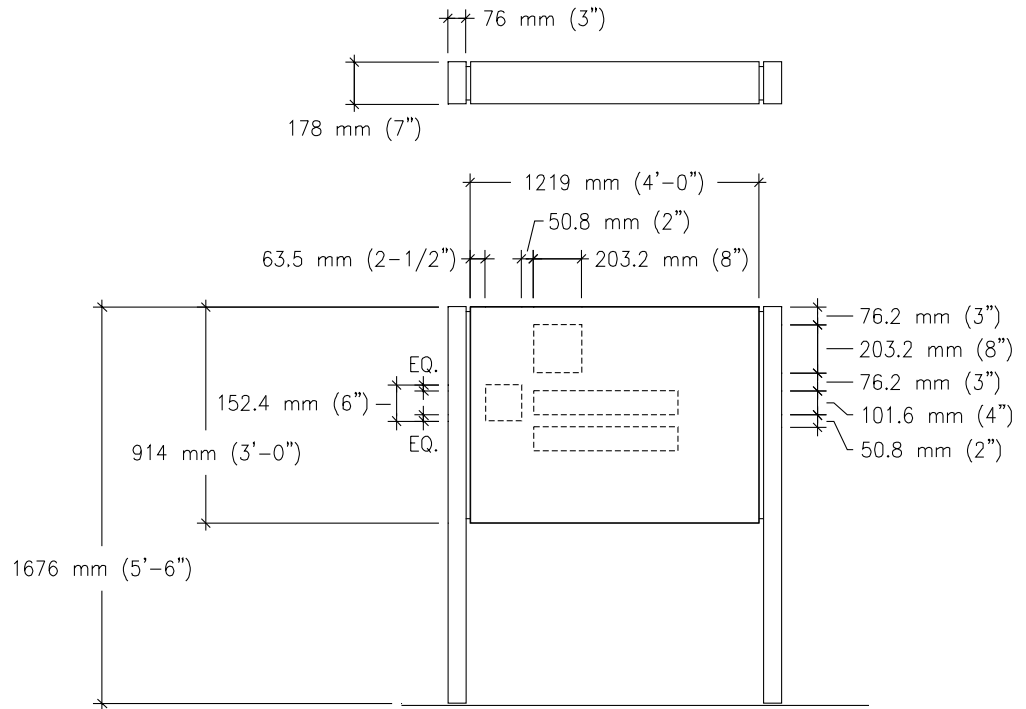

Message Layout A

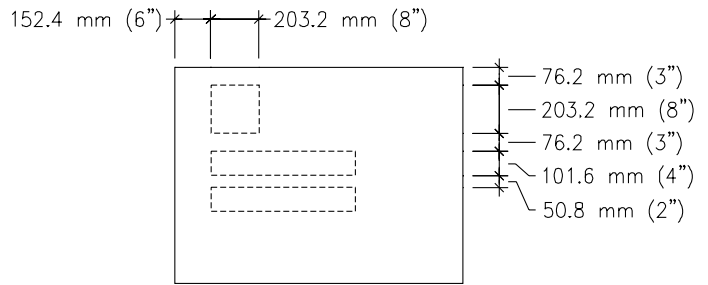

Message Layout B

Dimensional Building Identification Letters

Size

For the various sizes, refer to the adjacent table.

Description & Use

Internal halo-illuminated, fabricated metal dimensional letters and logo for identifying a facility.

This sign should be placed on the medical center building in a location that is highly visible to the public.

Message Configuration

(Refer to message layout drawing for dimensions)

Letters used with the logo should read "Medical Center," "Outpatient Center" or "Veterans Affairs."

Graphic Process

Fabricated aluminum letters with internal LED lighting. Letters are pin mounted off wall to allow light to wash wall and halo illuminate letters.

Colors

White, black, silver or dark bronze. Letter to have high contrast to the building wall color or material. For example use white on red brick, not black.

Illumination color is white light.

Recommendations

Large size letters and logo are intended for use on the top of the building as a skyline sign.

These letters require clear access to the back (inside) of the wall on which they will be installed.

On-off illumination of sign can be controlled through the use of a timer, manual or photoelectric switch.

Consult with sign fabricator at time of order for appropriate method to use.



Sign Type	Y	Z	X	W
EI09.6	450 mm (18")	150 mm (6")	1050 mm (42")	350 mm (19")
EI09.7	600 mm (24")	150 mm (6")	1350 mm (56")	475 mm (25")
EI09.8	750 mm (30")	150 mm (6")	1800 mm (70")	575 mm (31")
EI09.9	900 mm (36")	150 mm (6")	2100 mm (84")	700 mm (38")

Dimensional Building Identification Letters

Outpatient Entrance

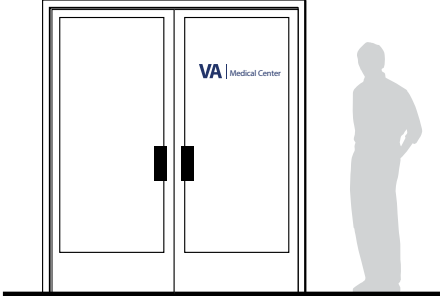

4 Panel Site Monument Kiosk

Size

Sign Face:
4726 mm H x 1524 mm W x 1524 mm D (15' 6" H x 5' 0" W x 5' 0" D)

Description & Use

Internally illuminated vertical free standing monument sign for identifying a medical center or the medical center's main entrance drive.

The base may be constructed of concrete or other masonry material in a color and texture that will provide a coordinated architectural look with the building finishes of the medical center.

Message Configuration

(Refer to message layout drawing for dimensions).

Specific message configuration will vary depending on the particular name of a facility. Variations to the presentation of a facility's name will need special approval from VACO, Washington DC.

Graphic Process

Illuminated, routed out copy backed with white translucent acrylic.

Colors

Text: White
Background: Refer to color chart.
Accent: Refer to color chart.

Recommendations

Position sign so drivers have a clear, unobstructed view of the sign. Keep landscaping around the sign low and position sprinklers so they project away from the sign.

On-off illumination of sign can be controlled through the use of a timer, manual, or photoelectric switch. Consult with sign fabricator at time of order for appropriate method to use.



Message Layout A

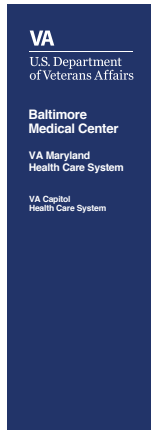

Message Layout B

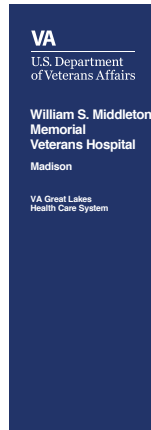

Message Layout C



Message Layout D

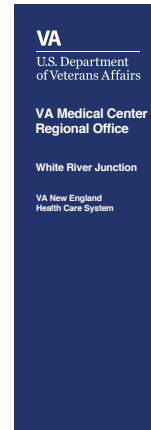

4 Panel Site Monument Kiosk

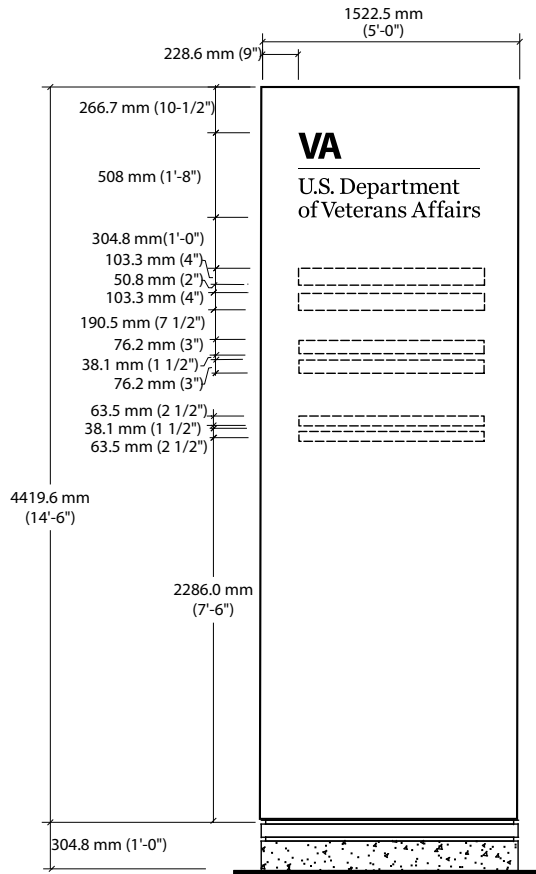

Message Layout A

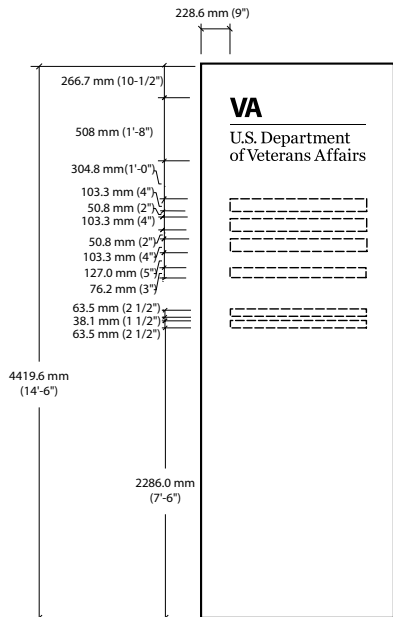

Message Layout B

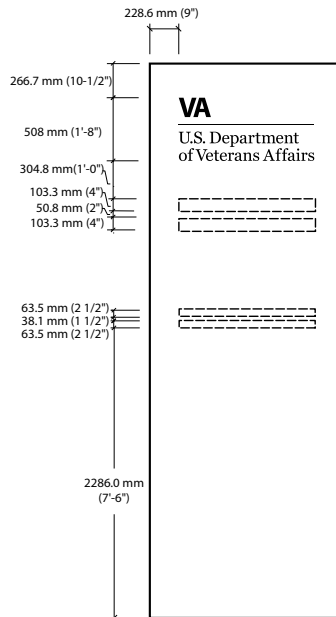

Message Layout C

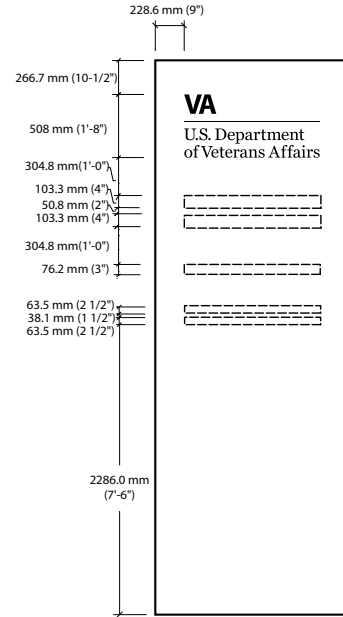

Message Layout D

4 Panel Monument Kiosk with Directional

Size

Sign Face:
4572 mm H x 1524 mm W x 1524 mm D
(15' 0" H x 5' 0" W x 5' 0" D)

Description & Use

Internally illuminated vertical free standing monument sign for identifying a medical center or the medical center's main entrance drive.

Lower section of sign has modular changeable sign panels that can be used for directional information.

The base can be constructed of concrete or other masonry material in a color and texture that will provide a coordinated architectural look with the building finishes of the medical center.

Message Configuration

(Refer to message layout drawing for dimensions)

Specific message configuration will vary depending on the particular name of a facility. Variations to the presentation of a facility's name will need special approval from Washington DC.

Care is to be taken when preparing directional text and arrow direction. Pay particular attention to the directional messages being communicate relative to the signs orientation.

Graphic Process

Illuminated, routed out copy backed with white translucent acrylic.

Colors

Text: White
Background: Refer to color chart
Accent: Refer to color chart

Recommendations

Position sign so drivers have a clear, unobstructed view of the sign. Keep landscaping around the sign low and position sprinklers so they project away from the sign.

On-off illumination of sign can be controlled through the use of a timer, manual or photoelectric switch. Consult with sign fabricator at time of order for appropriate method to use.



Message Layout A

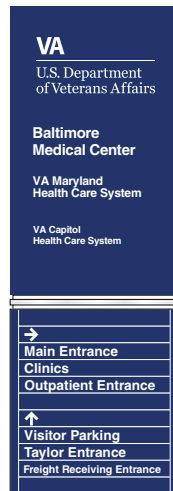

Message Layout B

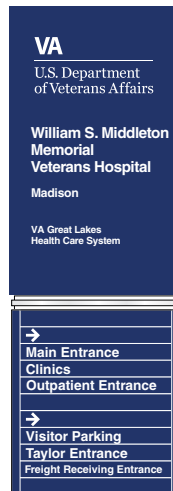

Message Layout C

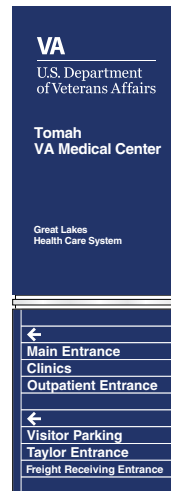

Message Layout D

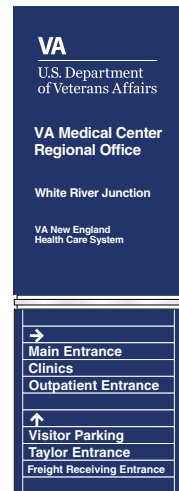

4 Panel Monument Kiosk with Directional

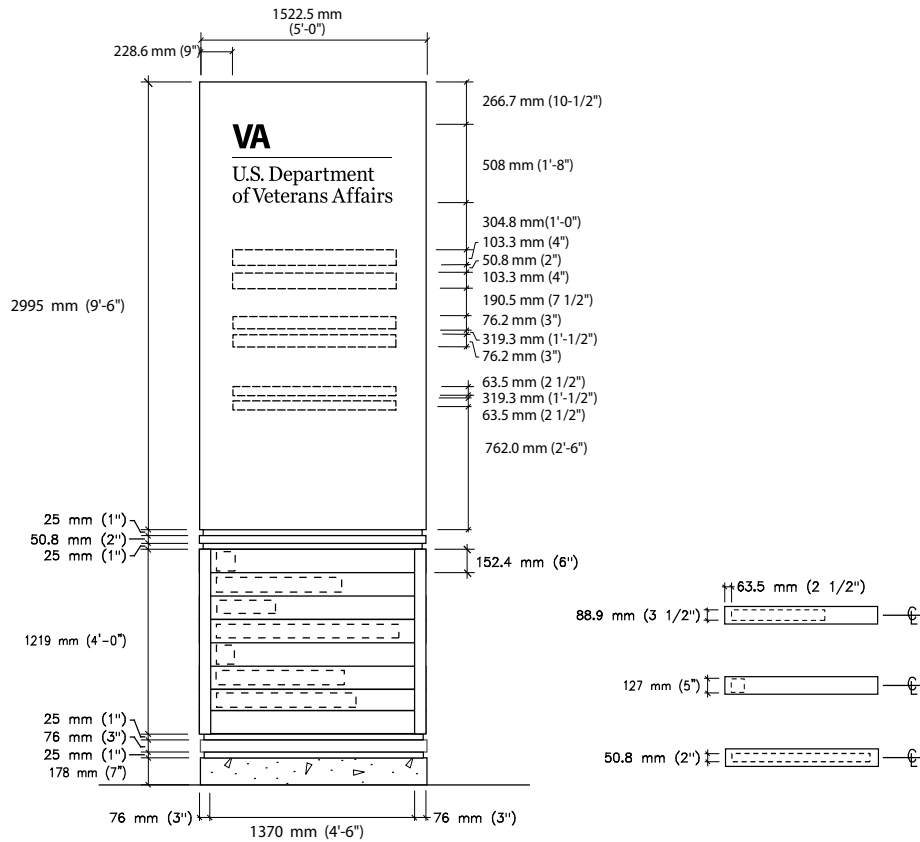

Message Layout A

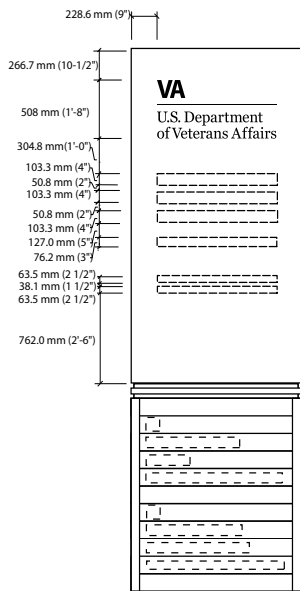

Message Layout B

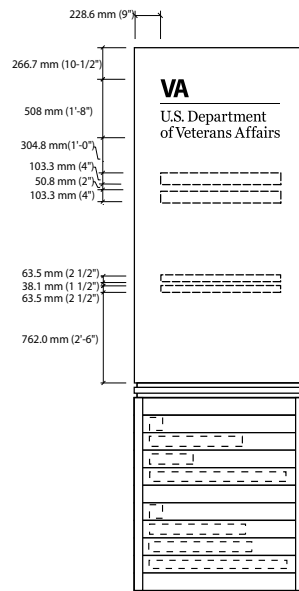

Message Layout C

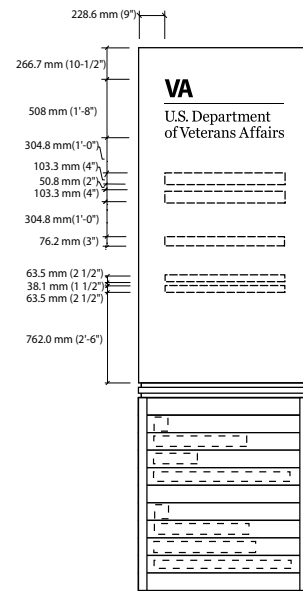

Message Layout D

4 Panel Monument Kiosk with Directional & Address

Size

Overall Sign:
4726 mm H x 1524 mm W x 1524 mm D
(15' 6" H x 5' 0" W x 5' 0" D)

Description & Use

Internally illuminated vertical free standing monument sign for identifying a medical center or the medical center's main entrance drive.

Lower section of sign has modular changeable sign panels that can be used for directional information.

The base can be constructed of concrete or other masonry material in a color and texture that will provide a coordinated architectural look with the building finishes of the medical center.

Message Configuration

(Refer to message layout drawing for dimensions).

Specific message configuration will vary depending on the particular name of a facility. Variations to the presentation of a facility's name will need special approval from VACO, Washington DC.

Care is to be taken when preparing directional text and arrow direction. Pay particular attention to the directional messages being communicate relative to the signs orientation.

Graphic Process

Illuminated, routed out copy backed with white translucent acrylic.

Colors

Text: White
Background: Refer to color chart.
Accent: Refer to color chart.

Recommendations

Position sign so drivers have a clear, unobstructed view of the sign. Keep landscaping around the sign low and position sprinklers so they project away from the sign.

On-off illumination of sign can be controlled through the use of a timer, manual, or photoelectric switch. Consult with sign fabricator at time of order for appropriate method to use.



Message Layout A

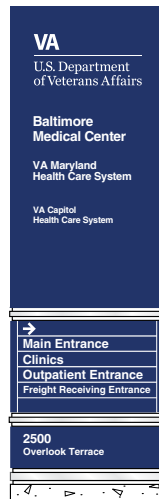

Message Layout B

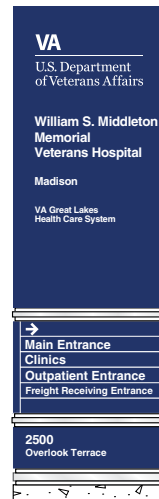

Message Layout C

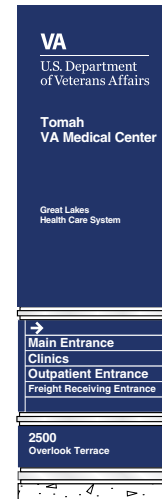

Message Layout D

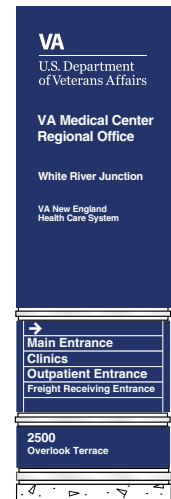

4 Panel Monument Kiosk with Directional & Address

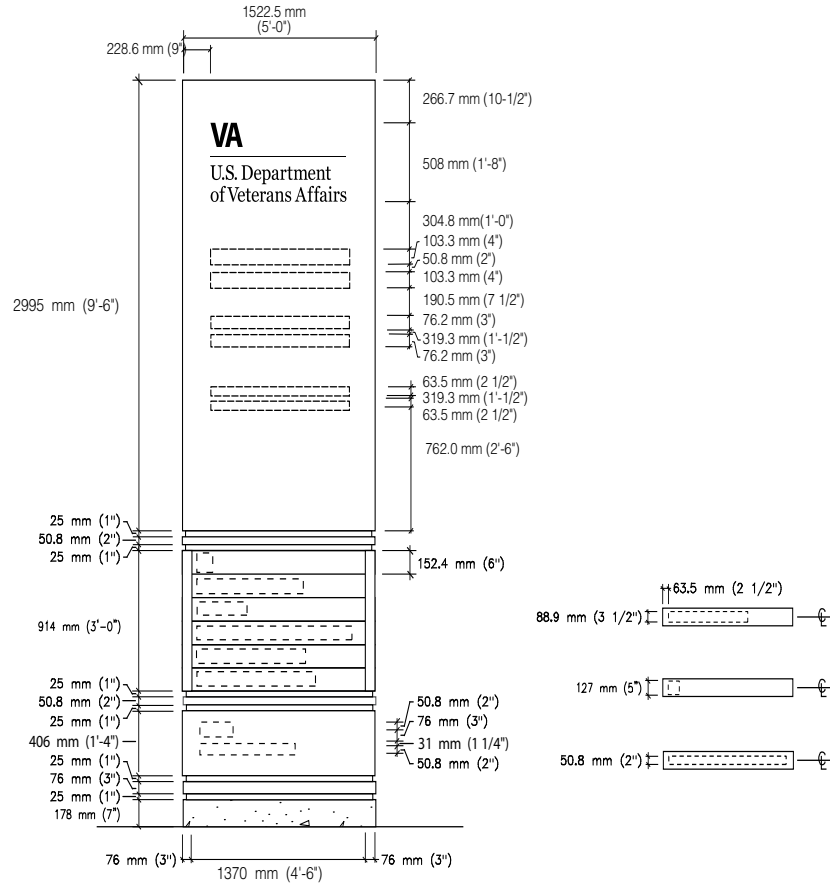

Message Layout A

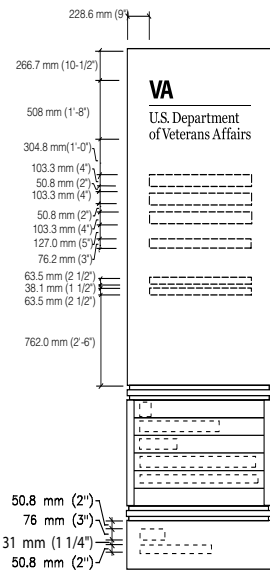

Message Layout B

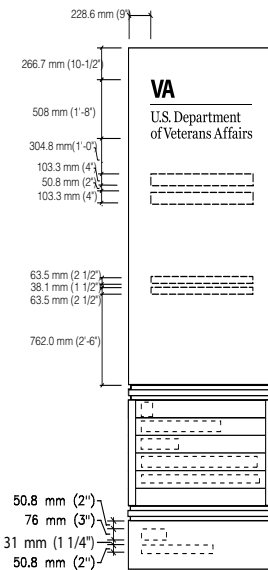

Message Layout C

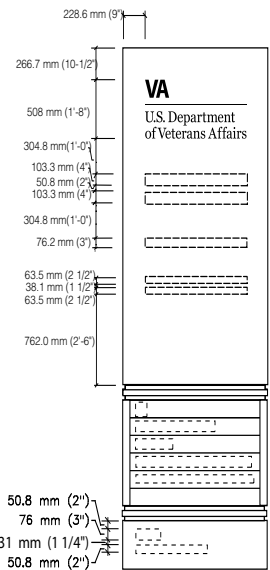

Message Layout D

Vertical Site Monument with Electronic Message Center

Size

Sign Face:
3658 mm H x 1524 mm W
(15' 0" H x 5' 0" W)

Description & Use

Internally illuminated vertical free standing monument sign for identifying a medical center or the medical center's main entrance drive.

Electronic message centers are available from several manufacturers. These units are computer driven and require a data connection to the sign. Contact a local sign company for site evaluation and feasibility along with the affiliated costs of connecting the message center to a computer. Sign face size may need to be adjusted to match to message center size constraints.

Technology for electronic message centers is consistently advancing. Evaluate several manufacturers by examining the type of electronic display they sell. Look at the display in the same sun path orientation that the sign will be installed. Direct sunlight on a display can alter its ability to be read clearly.

The base can be constructed of concrete or other masonry material in a color and texture that will provide a coordinated architectural look with the building finishes of the medical center.

Message Configuration

Refer to Sign Type EI-15.02 for message layout and configuration.

Graphic Process

Illuminated, routed out copy backed with white translucent acrylic.

Colors

Text: White

Background: Refer to color chart

Accent: Refer to color chart

Recommendations

Position sign so drivers have a clear, unobstructed view of the sign. Keep landscaping around the sign low. Position sprinklers so they do not spray the sign.

When evaluating electronic message centers, consider a maintenance/service contract and have several people trained in operation and message implementation.

On-off illumination of sign can be controlled through the use of a timer, manual or photoelectric switch. Consult with sign fabricator at time of order for appropriate method to use.

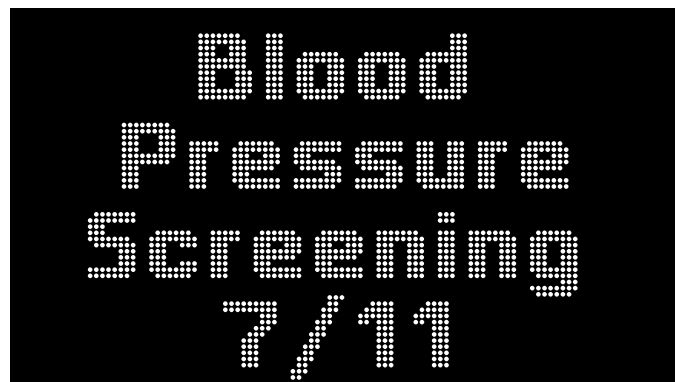
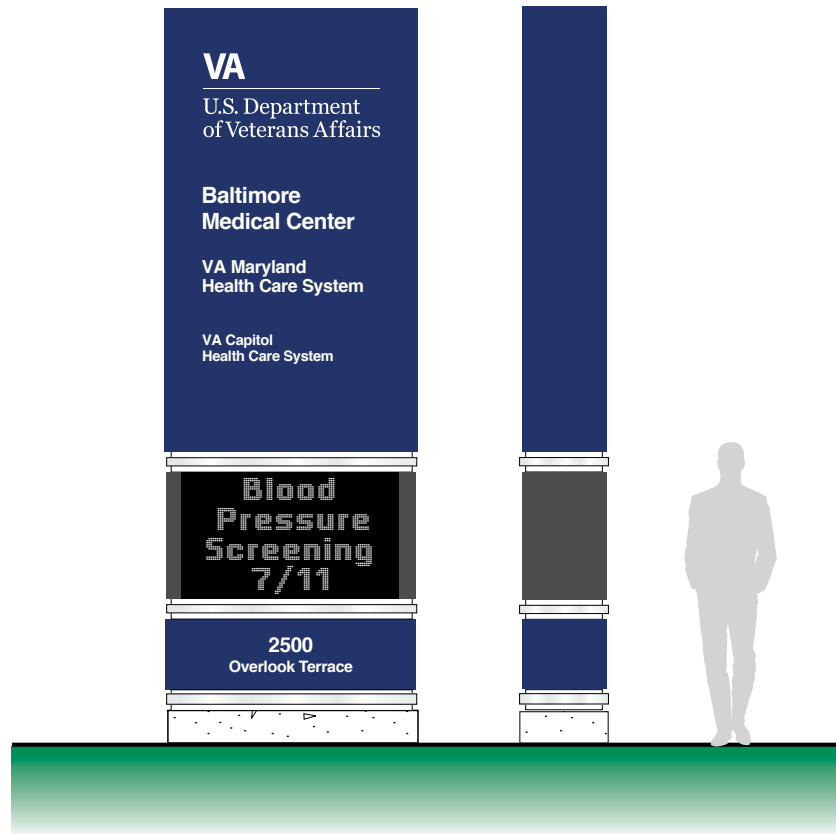

Vertical Site Monument with Electronic Message Center

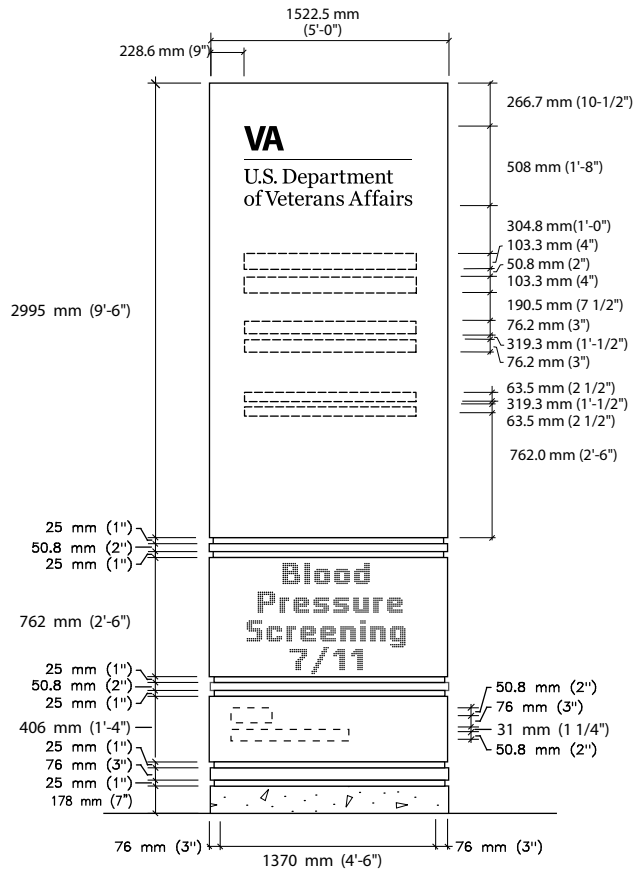

Message Layout A

Horizontal Site Monument with Electronic Message Center

Size

Sign Face:

2895 mm H x 3886 mm W x 535 mm D
(9' 6" H x 12' 9" W x 1' 9" D)

Description & Use

Internally illuminated vertical free standing monument sign for identifying a medical center or the medical center's main entrance drive.

Electronic message centers are available from several manufacturers. These units are computer driven and require a data connection to the sign. Contact a local sign company for site evaluation and feasibility along with the affiliated costs of connecting the message center to a computer. Sign face size may need to be adjusted to match message center constraints.

Technology for electronic message centers is consistently advancing. Evaluate several manufacturers by examining the type of electronic display they sell. Look at the display in the same sun path orientation that the sign will be installed. Direct sunlight on a display can alter its ability to be read clearly.

The base may be constructed of concrete or other masonry material in a color and texture that will provide a coordinated architectural look with the building finishes of the medical center.

Message Configuration

Refer to Sign Type EI-01.01 for message layout and configuration.

Graphic Process

Illuminated, routed out copy backed with white translucent acrylic.

Colors

Text: White

Background: Refer to color chart.

Accent: Refer to color chart.

Recommendations

Position sign so drivers have a clear, unobstructed view of the sign. Keep landscaping around the sign low and position sprinklers so they project away from the sign.

When evaluating electronic message centers, consider a maintenance/service contract and have several people trained in operation and message implementation.

On-off illumination of sign can be controlled through the use of a timer, manual or photoelectric switch. Consult with sign fabricator at time of order for appropriate method to use.

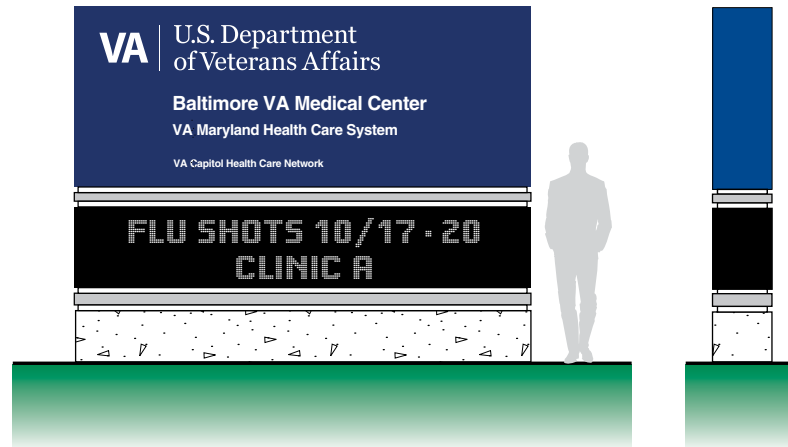

Horizontal Site Monument with Electronic Message Center

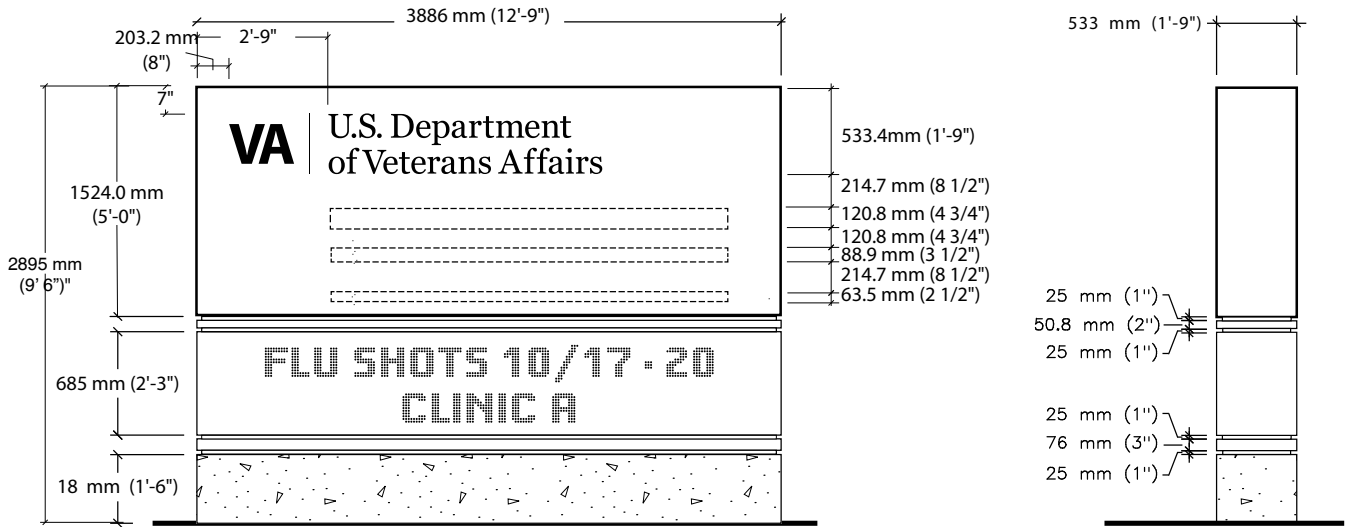

Message Layout A

Non-Illuminated Exterior Signs

This page is intentionally left blank

Primary Directional Monument

Size

Sign Face:
1829 mm H x 1829 mm W
(6' 0" H x 6' 0" W)

Description

Large, non-illuminated 10 strip directional monument sign with messages directed specifically to drivers. Monument type directional signs should only be used on the main entrance drive and in front of the medical center.

Message Configuration

(Refer to message layout drawing for dimensions)

Layout A is for the first line of text with an arrow of direction.

Layout B is for message with no arrow which is located immediately under a copy bar with an arrow.

Layout C is for indented text. This is for situations where the message has to run over onto a second copy strip.

Graphic Process

Surface applied white reflective vinyl.

Colors

Text: White
Background: Refer to color chart

Recommendations

Position sign so drivers have a clear, unobstructed view of the sign.

Directional information for services ahead should always be at the top of the sign.

Always leave a blank copy strip between groups of directional information. This will aid in the ability of the driver to read grouped directional information more quickly.

Always leave a blank strip at the top of the sign. This strip is smaller than the text strips.

Configure a sign with at least one blank copy strip at the bottom of the sign. This will aid in the ability of the driver to read the sign.

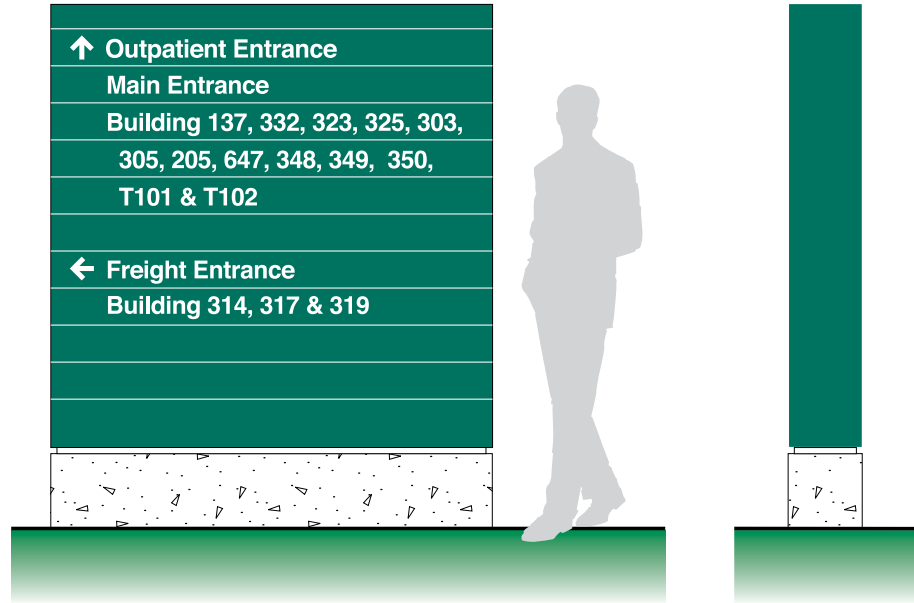

Message Layout A



Message Layout B



Message Layout C



This layout shows an indentation for a second line of copy

Primary Directional Monument

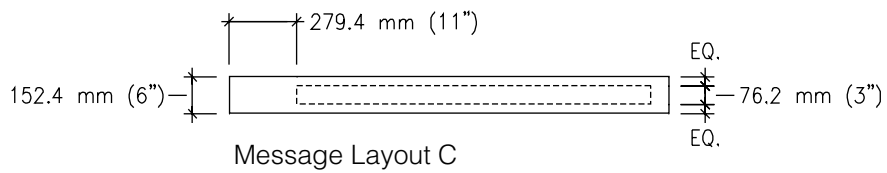
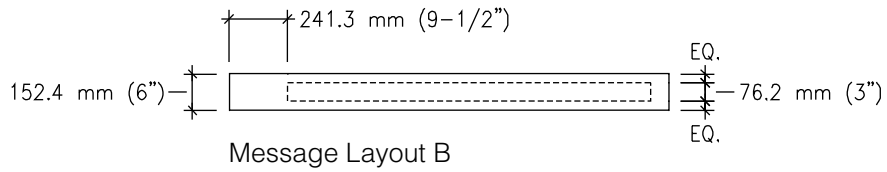
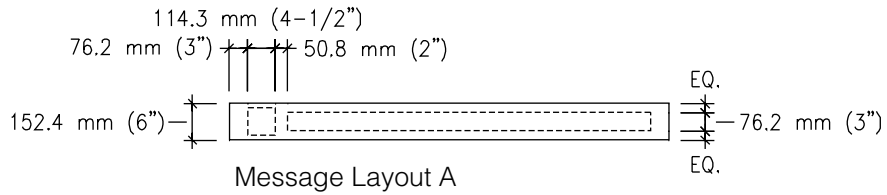
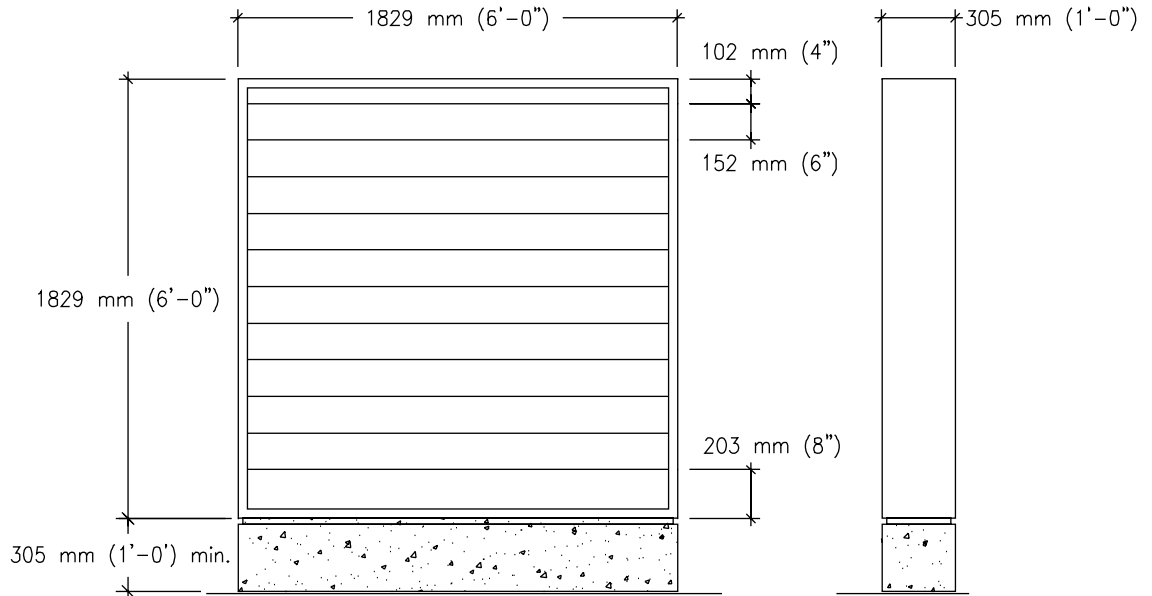

Secondary Directional Monument

Size

Sign Face:
1829 mm H x 1219 mm W
(6' 0" H x 4' 0" W)

Description

Small, non-illuminated 10 strip directional monument sign with messages directed specifically to drivers. Monument type directional signs should only be used on the main entrance drive and in front of the medical center.

Message Configuration

(Refer to message layout drawing for dimensions)

Layout A is for the first line of text with an arrow of direction.

Layout B is for message with no arrow which is located immediately under a copy bar with an arrow.

Layout C is for indented text. This is for situations where the message has to run over onto a second copy bar.

Graphic Process

Surface applied white reflective vinyl.

Colors

Text: White
Background: Refer to color chart

Recommendations

Position sign so drivers have a clear, unobstructed view of the sign.

Directional information for services ahead should always be at the top of the sign.

Always leave a blank copy strip between groups of directional information. This will aid in the ability of the driver to read grouped directional information more quickly.

Always leave a blank strip at the top of the sign. This strip is smaller than the text strips.

Configure a sign with at least one blank copy strip at the bottom of the sign. This will aid in the ability of the driver to read the sign.

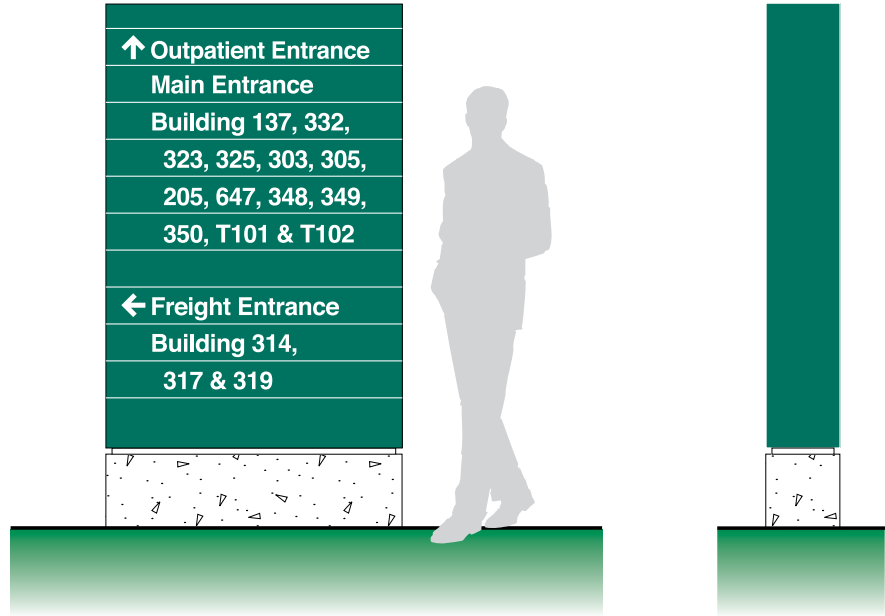

Message Layout A



Message Layout B



Message Layout C



This layout shows an indentation for a second line of copy

Secondary Directional Monument

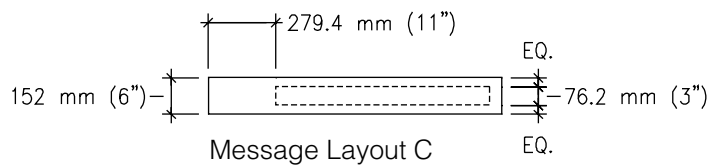
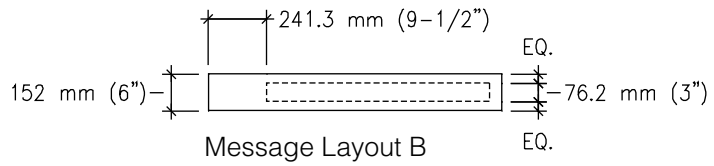
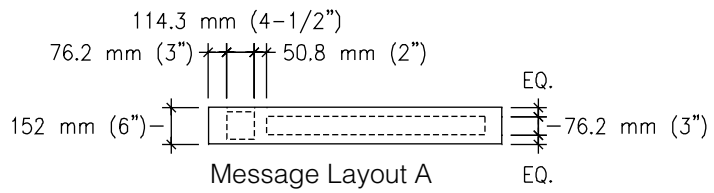
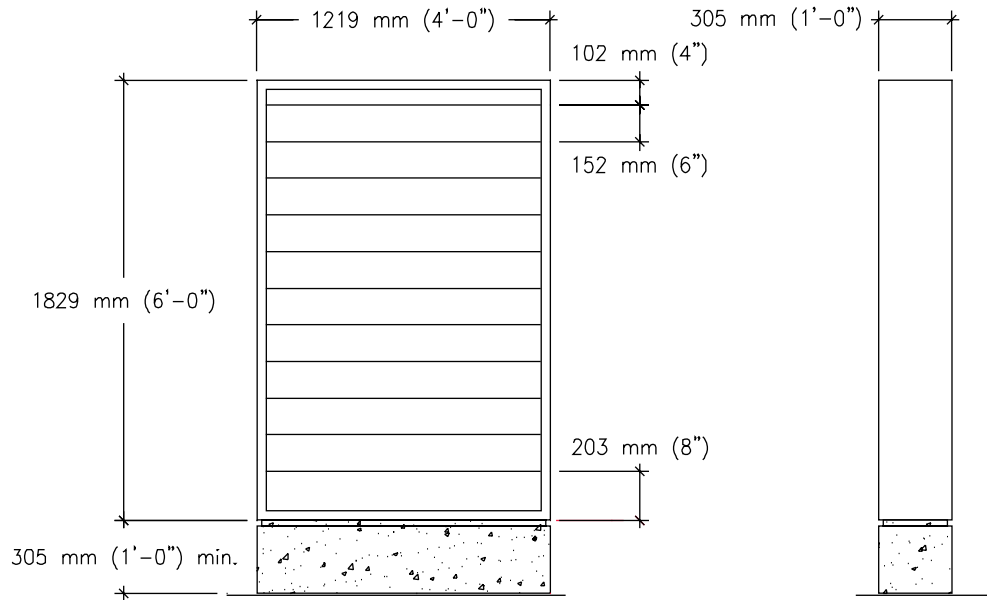

Primary Directional Post and Panel

Size

Sign Face:
1219 mm H x 1829 mm W
(4' 0" H x 6' 0" W)

Overall Sign Height:
1981 mm (6' 6")

Description

Standard non-illuminated auto oriented post and panel sign with messages directed specifically to drivers.

Message Configuration

(Refer to message layout drawing for dimensions)

Message size and layout should adjust to the volume of information being presented. Layouts illustrated show small, medium and large size text. Smaller text than shown should not be used as the messages will be unreadable to drivers. Larger text than shown will result in words that may not fit on the sign.

Graphic Process

Surface applied white reflective vinyl.

Colors

Text: White
Background: Refer to color chart
Post: Refer to color chart

Recommendations

This type of directional sign should be used only when the particular message that it will contain is not likely to change.

Directional information for services ahead should always be at the top of the sign.

Always leave space between groups of directional information. This will aid in the ability of the driver to read grouped directional information more quickly.

Generally, configure a sign with blank space at the bottom of the sign. This will aid in the ability of the driver to read the sign.

Position sign so drivers have a clear, unobstructed view of the sign.



Message Layout A



Message Layout B

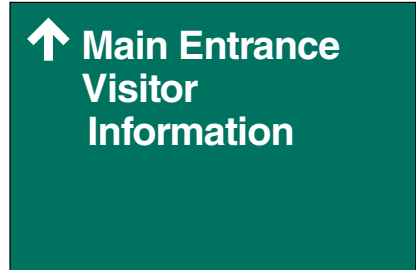

Message Layout C

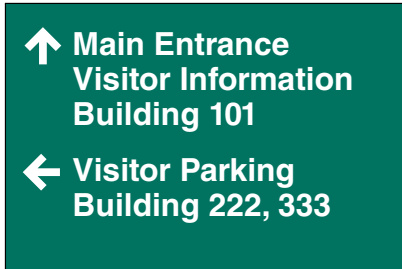

Primary Directional Post and Panel

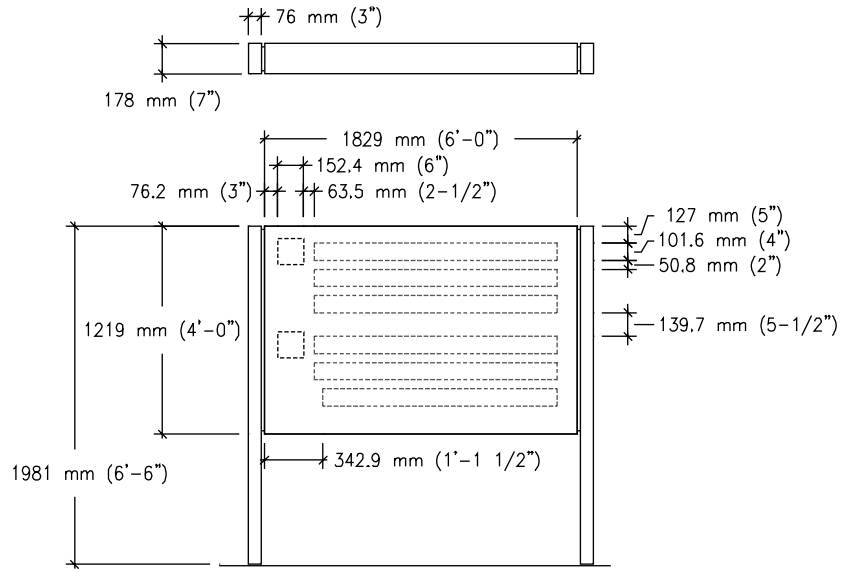

Message Layout A

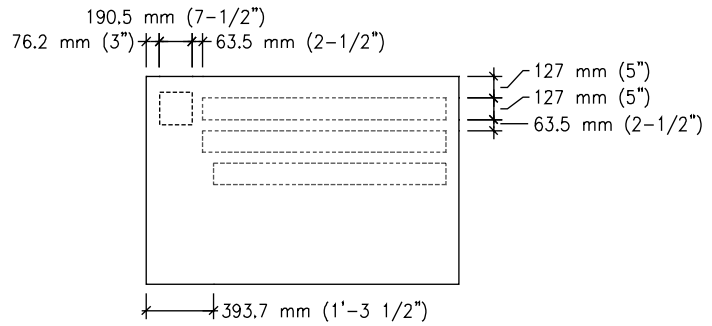

Message Layout B

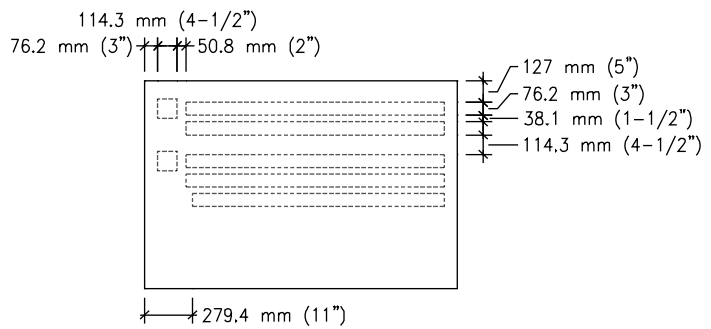

Message Layout C

Secondary Post and Panel

Size

Sign Face:
914 mm H x 1219 mm W
(3' 0" H x 4' 0" W)

Overall Sign Height:
1676 mm (5' 6")

Description

Small non-illuminated post and panel sign with messages directed specifically to drivers. This sign can also be used to identify buildings.

Message Configuration

(Refer to message layout drawing for dimensions)

Message size and layout should adjust to the volume of information being presented. Layouts illustrated show small, medium and large size text. Smaller text than shown should not be used as the messages will be unreadable to drivers. Larger text than shown will result in words that may not fit on the sign.

Graphic Process

Surface applied white reflective vinyl.

Colors

Text: White
Background: Refer to color chart
Post: Refer to color chart

Recommendations

As a directional sign it should be used only when the particular message that it will contain is not likely to change and directional information for services ahead should always be at the top of the sign.

Always leave space between groups of directional information. This will aid in the ability of the driver to read grouped directional information more quickly.

Generally, configure a sign with blank space at the bottom of the sign. This will aid in the ability of the driver to read the sign.

Position sign so drivers have a clear, unobstructed view of the sign.



Message Layout A

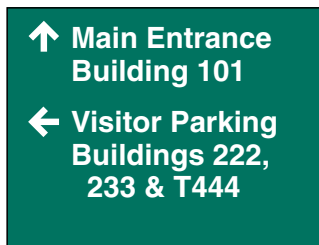

Message Layout B

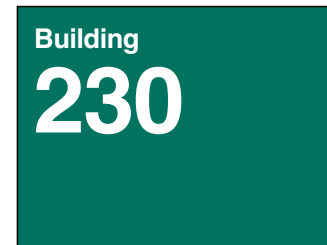

Message Layout C



Message Layout D

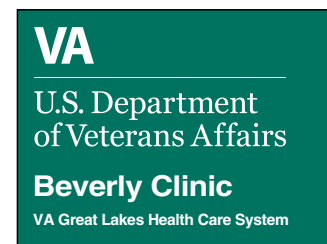

Secondary Post and Panel

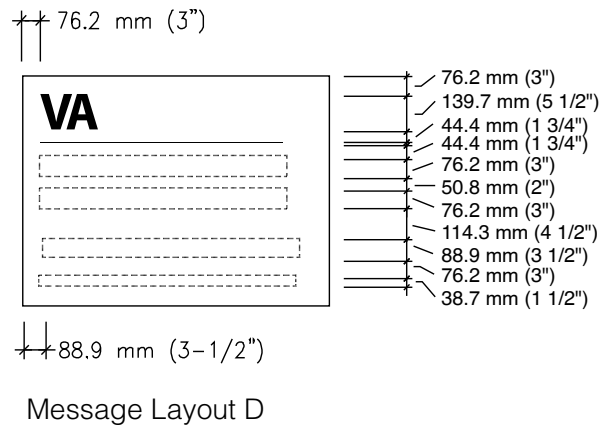
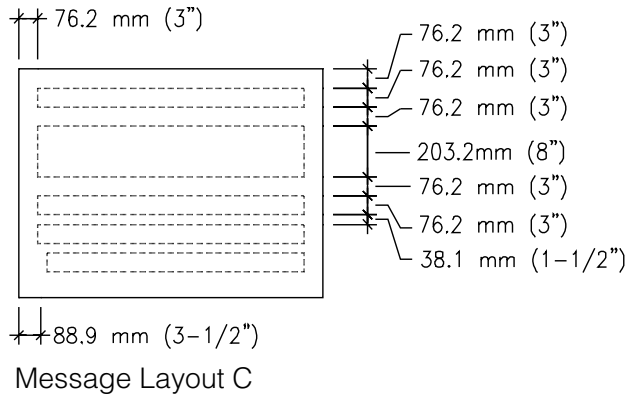
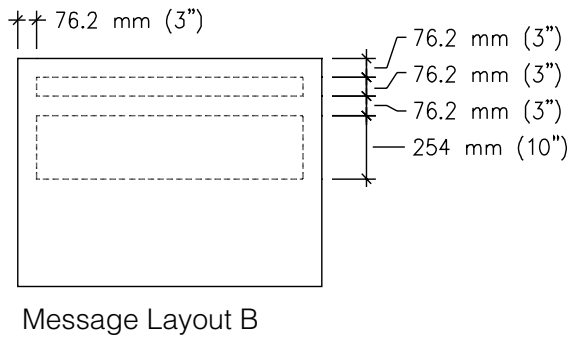
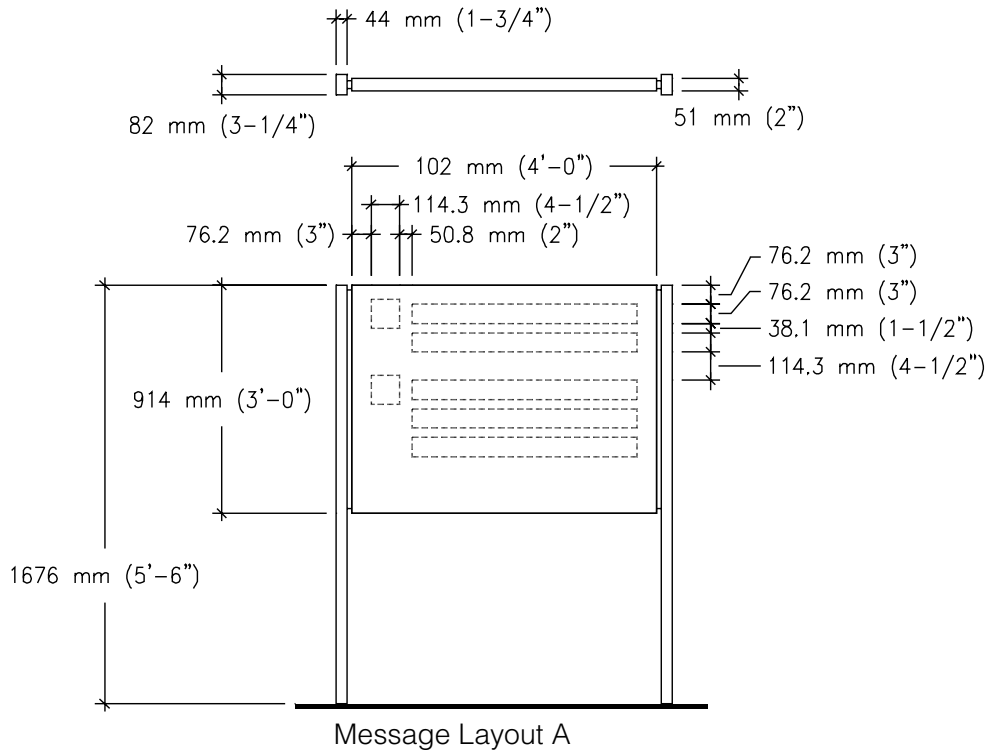

Secondary Post and Panel

Size

Sign Face:
610 mm H x 914 mm W
(2' 0" H x 3' 0" W)

Overall Sign Height:
1524 mm (5' 0")

Description

Non-illuminated, post and panel sign directional sign with messages directed specifically to pedestrians. Also, the sign can be used to identify buildings.

Message Configuration

(Refer to message layout drawing for dimensions)

Message size and layout should adjust to the volume of information being presented. Smaller text than shown should not be used as the messages will be unreadable. Larger text than shown will result in words that may not fit on the panel.

Graphic Process

Surface applied white reflective vinyl.

Colors

Text: White
Background: Refer to color chart
Post: Refer to color chart

Recommendations

Position sign so pedestrians have a clear, unobstructed view of the sign.

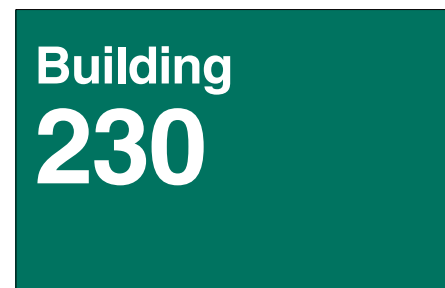
**Message Layout A****Message Layout B****Message Layout C**

Secondary Post and Panel

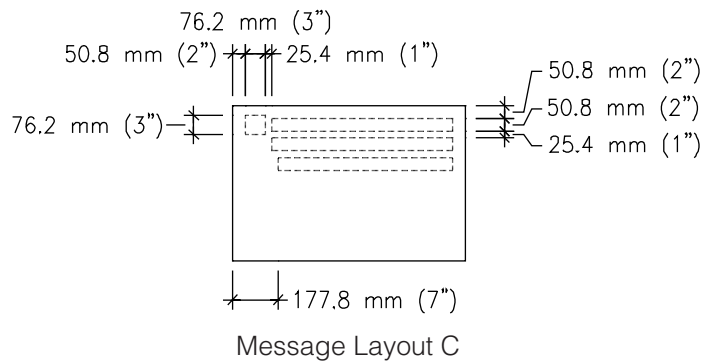
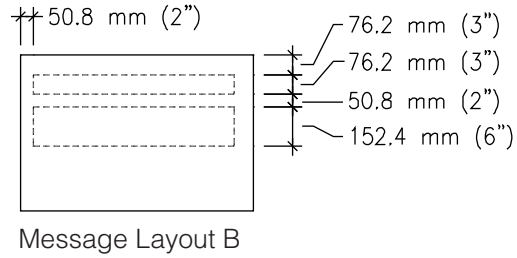
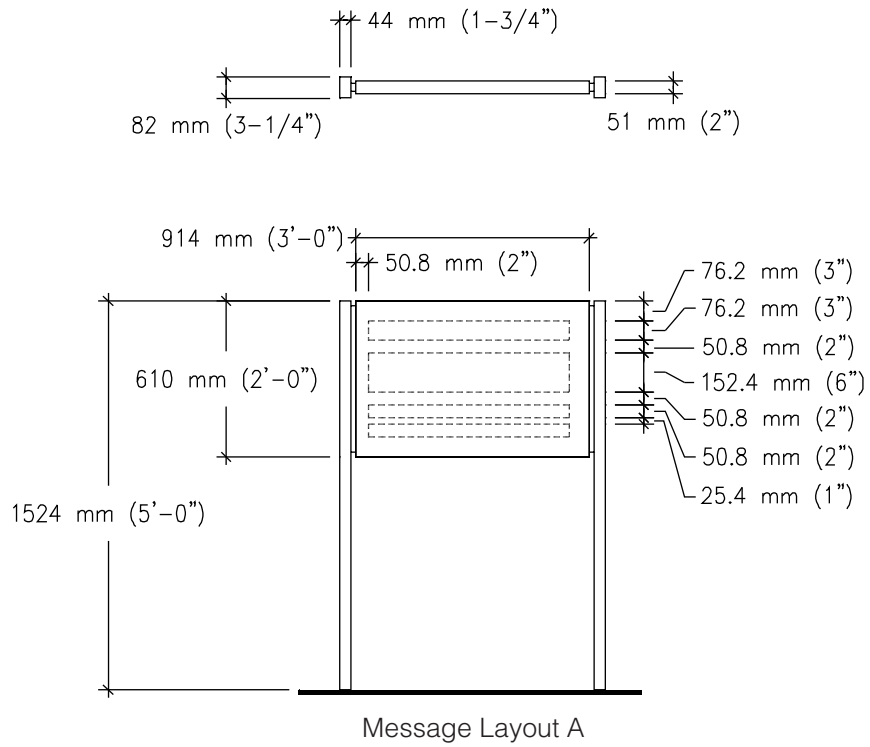

Primary Building Identification

Size

Sign Face:
914 mm H x 914 mm W
(3' 0" H x 3' 0" W)

Overall Sign Height:
1676 mm (5' 6")

Description

Large, non-illuminated auto oriented building number/ identification post and panel sign for identification of a building when a large sign is needed because the building is set back away from the roadway or the architectural scale (size) of the building warrants a large sign.

Message Configuration

(Refer to message layout drawing for dimensions)

Message size and layout should adjust to the volume of information being presented. Layouts illustrated show small, medium and large size text. Smaller text than shown should not be used as the messages will be unreadable to drivers. Larger text than shown will result in words that may not fit on the sign.

Graphic Process

Surface applied white reflective vinyl.

Colors

Text: White
Background: Refer to color chart
Post: Refer to color chart

Recommendations

Position sign so drivers have a clear, unobstructed view of the sign.



Message Layout A

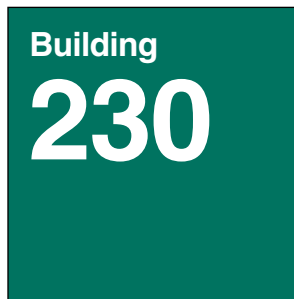

Message Layout B



Primary Building Identification

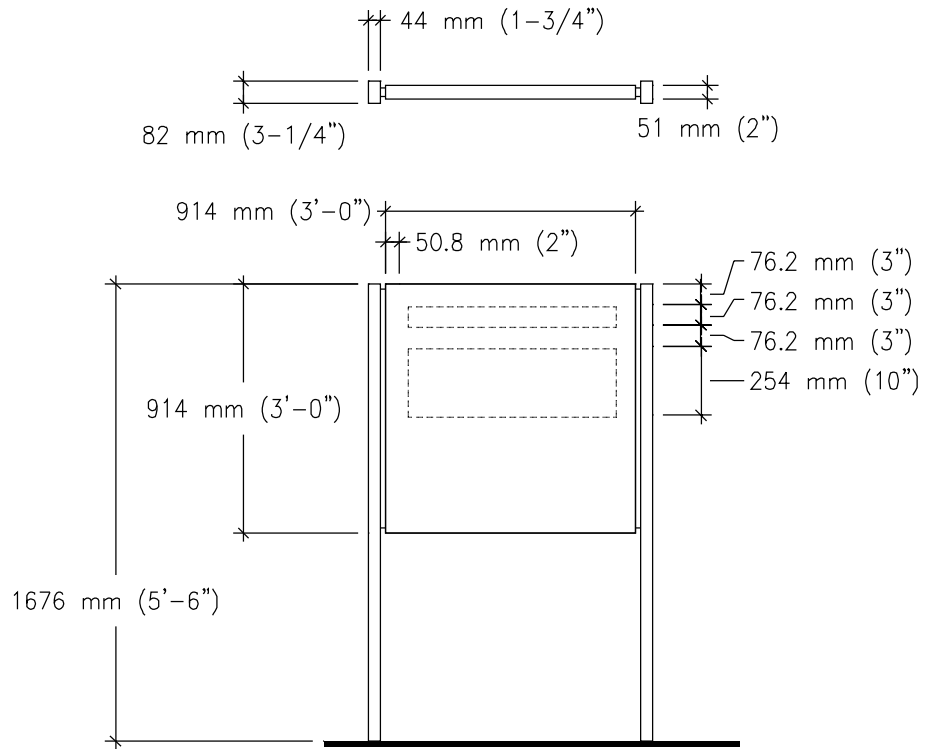

Message Layout A

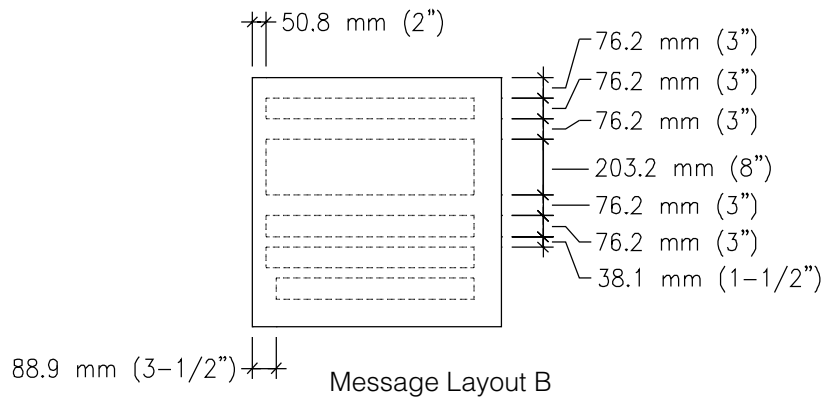

Message Layout B

Secondary Building Identification & Informational

Size

Sign Face:
610 mm H x 610 mm W
(2' 0" H x 2' 0" W)

Overall Sign Height:
1524 mm (5' 0")

Description

Non-illuminated, pedestrian oriented building number/ identification post and panel sign. This sign can be used for other general applications from information text to identifying specific functions or activities.

Message Configuration

(Refer to message layout drawing for dimensions)

Message size and layout should adjust to the volume of information being presented. Layouts illustrated show various sizes of text. Smaller text than shown should not be used as the messages will be unreadable. Larger text than shown will result in words that may not fit on the sign.

Graphic Process

Surface applied white reflective vinyl.

Colors

Text: White
Background: Refer to color chart
Post: Refer to color chart

Recommendations

Position sign so drivers and pedestrians have a clear view. This sign has a limited viewing range for drivers because of its small size.



Message Layout A

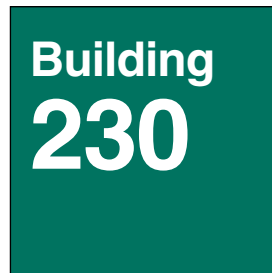

Message Layout B



Message Layout C



Message Layout D

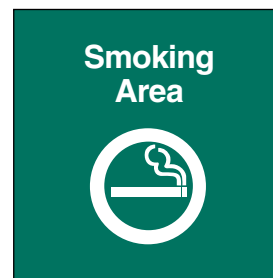

Message Layout E

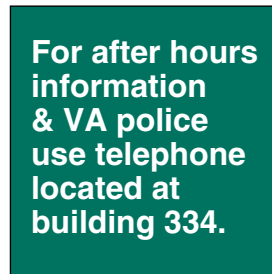

Secondary Building Identification & Informational

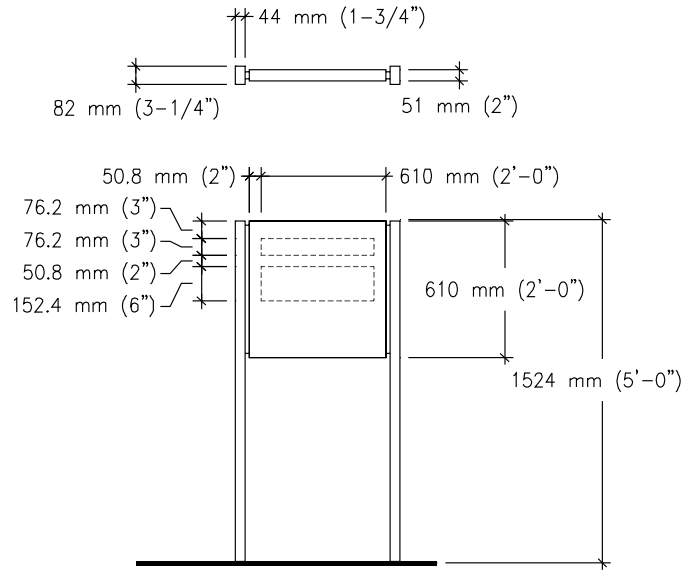

Message Layout A

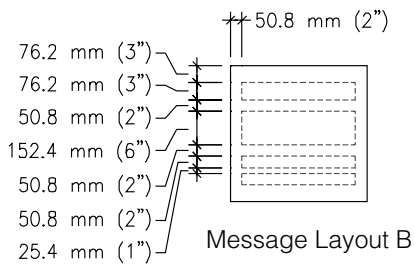

Message Layout B

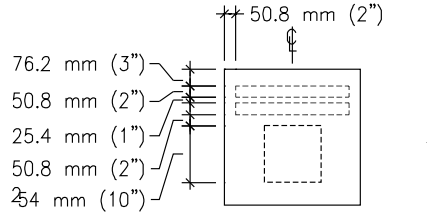

Message Layout C & D

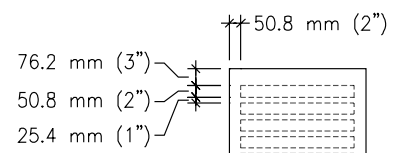

Message Layout E

Primary Directional Post and Stacking Bar

Size

Sign Face:
1219 mm H x 2438 mm W
(4' 0" H x 8' 0" W)

Overall Sign Height:
1981 mm (6' 6")

Description

Large/long, non-illuminated auto oriented 6-8 stacking bar directional sign.

Message Configuration

(Refer to construction drawing for dimensions)

Layout A is for the first line of text with an arrow of direction.

Layout B is for message with no arrow which is located immediately under a copy bar with an arrow.

Layout C is for indented text. This is for situations where the message has to run over onto a second copy bar.

Graphic Process

Surface applied white reflective vinyl.

Colors

Text: White
Background: Refer to color chart
Post: Refer to color chart

Recommendations

Position sign so drivers have a clear, unobstructed view of the sign.

Directional information for services ahead should always be at the top of the sign.

Always leave a blank copy bar between groups of directional information. This will aid in the ability of the driver to read grouped directional information more quickly.

Generally, configure a sign with at least one blank copy bar at the bottom of the sign. This will aid in the ability of the driver to read the sign. It will also allow for an additional line of text to be added to the sign in the future without having to order another copy strip.

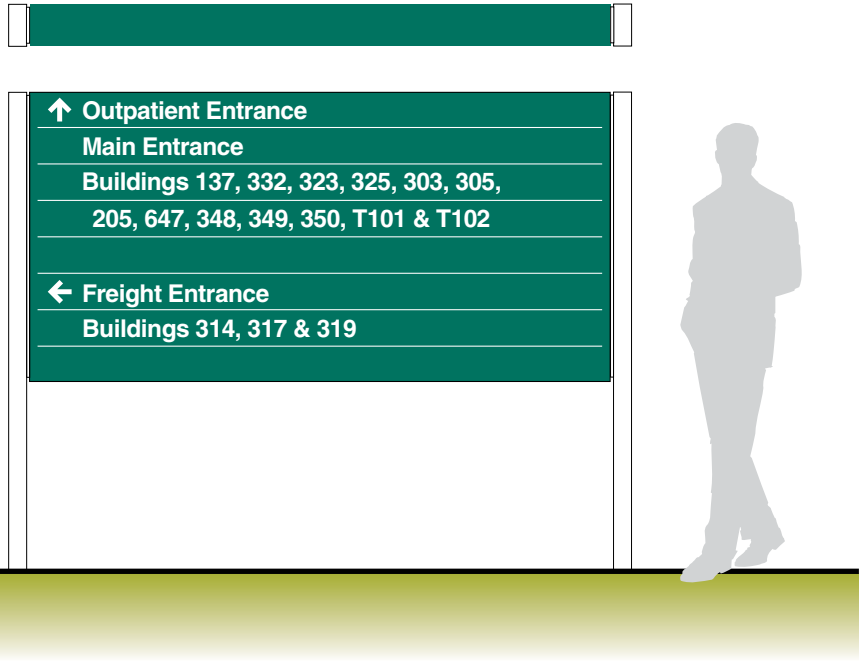

Message Layout A



Message Layout B



Message Layout C

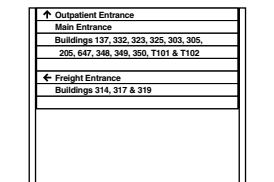

EN-04.01A (8 Bar)

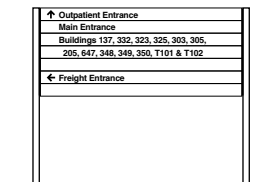

EN-04.01B (7 Bar)

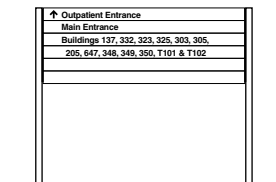

EN-04.01C (6 Bar)

Primary Directional Post and Stacking Bar

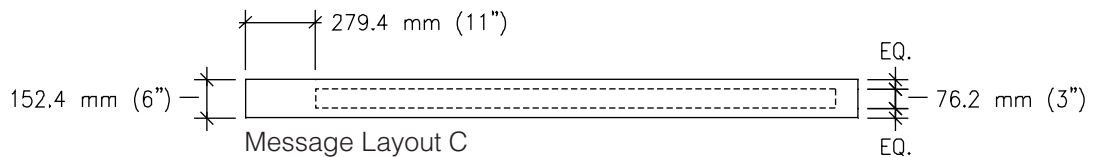
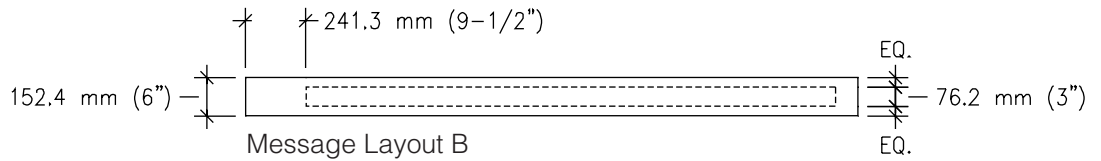
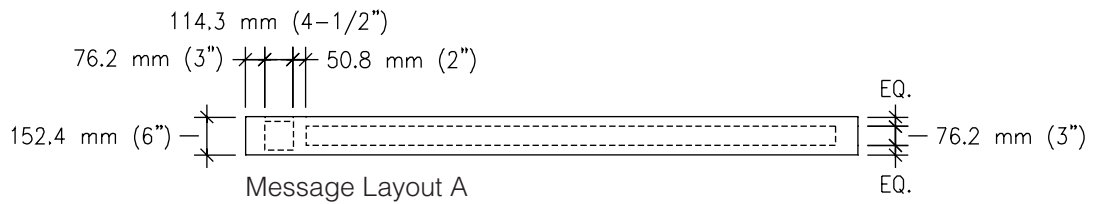
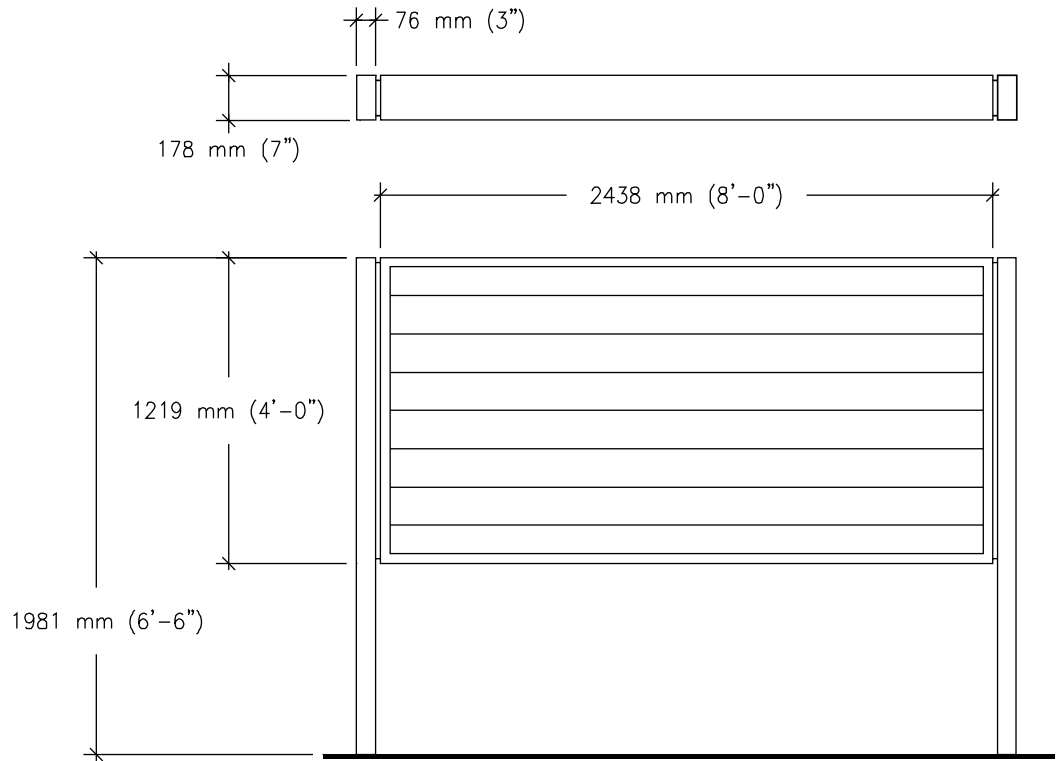

Secondary Directional Post and Stacking Bar

Size

Sign Face:
1219 mm H x 1829 mm W
(4' 0" H x 6' 0" W)

Overall Sign Height:

1829 mm (6' 0")

Description

Standard non-illuminated auto oriented 5 to 8 stacking bar directional sign.

Message Configuration

(Refer to construction drawing for dimensions)

Layout A is for the first line of text with an arrow of direction.

Layout B is for message with no arrow which is located immediately under a copy bar with an arrow.

Layout C is for indented text. This is for situations where the message has to run over onto a second copy bar.

Graphic Process

Surface applied white reflective vinyl.

Colors

Text: White
Background: Refer to color chart
Post: Refer to color chart

Recommendations

Position sign so drivers have a clear, unobstructed view of the sign.

Directional information for services ahead should always be at the top of the sign.

Always leave a blank copy bar between groups of directional information. This will aid in the ability of the driver to read grouped directional information more quickly.

Generally, configure a sign with at least one blank copy bar at the bottom of the sign. This will aid in the ability of the driver to read the sign. It will also allow for an additional line of text to be added to the sign in the future without having to order another copy bar.

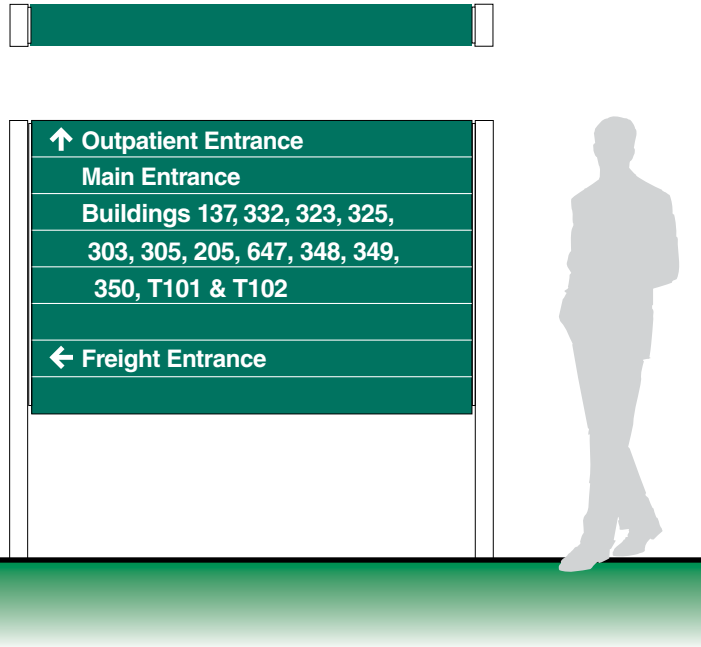

Message Layout A



Message Layout B



Message Layout C



The layout shows an indentation for a second line of copy

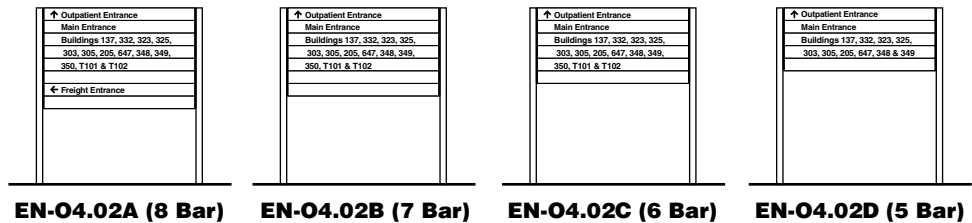

Secondary Directional Post and Stacking Bar

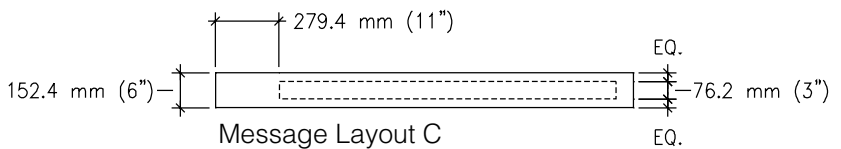
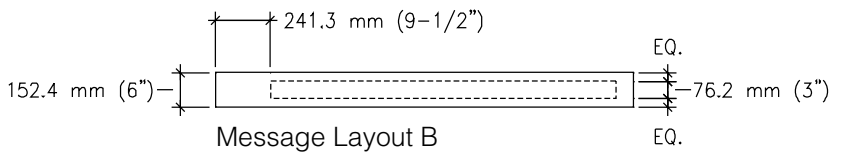
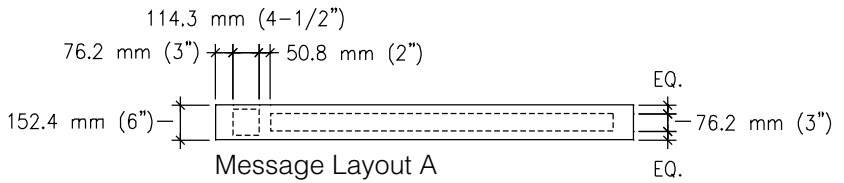
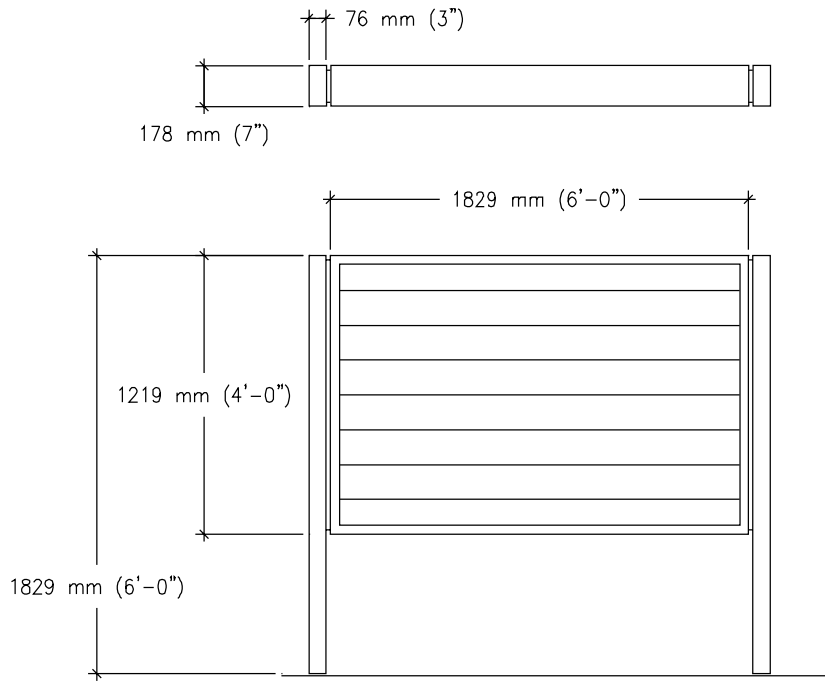

Secondary Directional Post and Stacking Bar

Size

Sign Face:
914 mm H x 1219 mm W
(3' 0" H x 4' 0" W)

Overall Sign Height:
1676 mm (5' 6")

Description

Small, non-illuminated auto oriented 4 to 6 stacking bar directional sign.

Message Configuration

(Refer to construction drawing for dimensions)

Layout A is for the first line of text with an arrow of direction.

Layout B is for message with no arrow which is located immediately under a copy bar with an arrow.

Layout C is for indented text. This is for situations where the message has to run over onto a second copy bar.

Graphic Process

Surface applied white reflective vinyl.

Colors

Text: White
Background: Refer to color chart
Post: Refer to color chart

Recommendations

Position sign so drivers have a clear, unobstructed view of the sign.

Directional information for services ahead should always be at the top of the sign.

Always leave a blank copy bar between groups of directional information. This will aid in the ability of the driver to read grouped directional information more quickly.

Generally, configure a sign with at least one blank copy bar at the bottom of the sign. This will aid in the ability of the driver to read the sign. It will also allow for an additional line of text to be added to the sign in the future without having to order another copy bar.

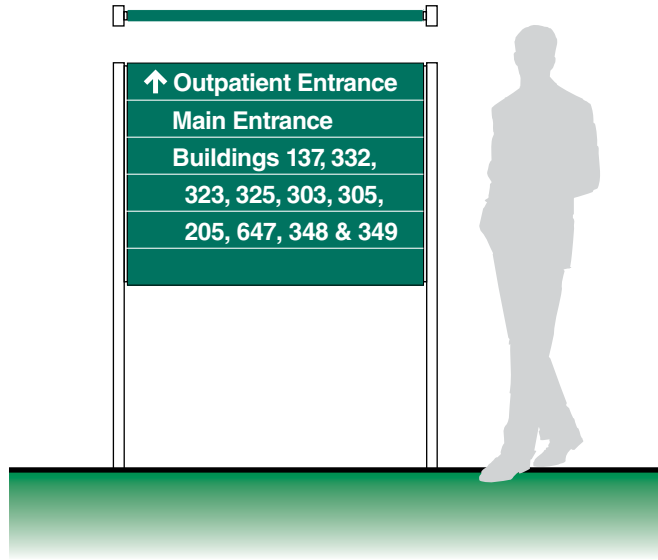

Message Layout A



Message Layout B



Message Layout C



This layout shows an indentation for a second line of copy

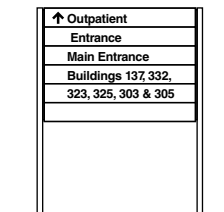

EN-04.03A (6 Bar)

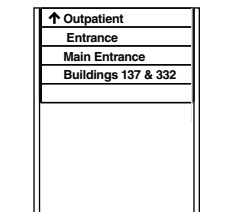

EN-04.03B (5 Bar)

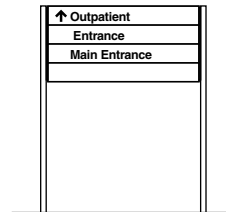

EN-04.03C (4 Bar)

Secondary Directional Post and Stacking Bar

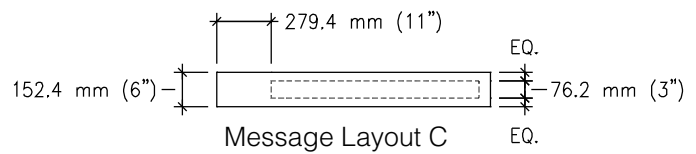
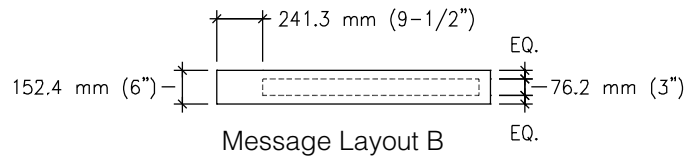
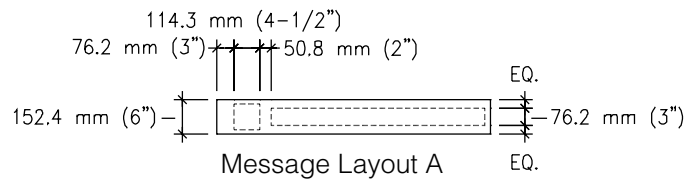
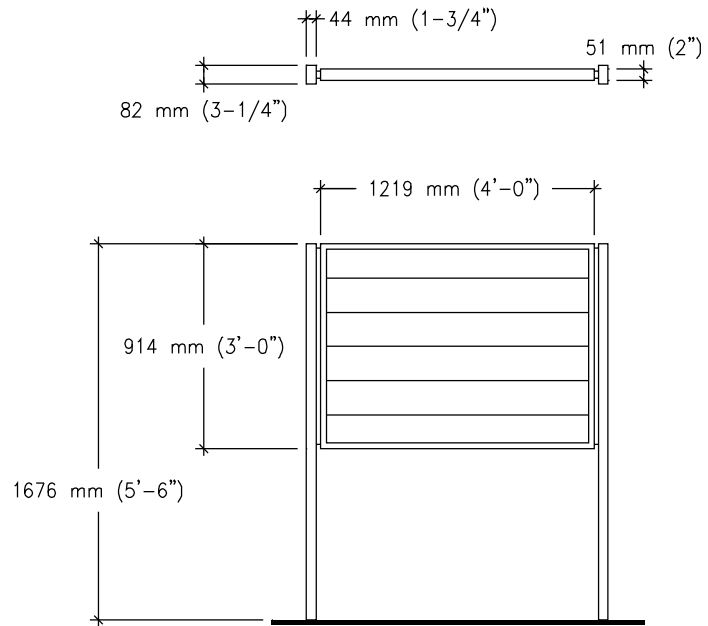

Secondary Directional Post and Stacking Bar

Size

Sign Face:
610 mm H x 914 mm W
(2' 0" H x 3' 0" W)

Overall Sign Height:
1524 mm (5' 0")

Description

Non-illuminated, pedestrian oriented 3 to 4 stacking directional bar sign.

Message Configuration

(Refer to construction drawing for dimensions)

Layout A is for the first line of text with an arrow of direction.

Layout B is for message with no arrow which is located immediately under a copy bar with an arrow.

Layout C is for indented text. This is for situations where the message has to run over onto a second copy bar.

Graphic Process

Surface applied white reflective vinyl.

Colors

Text: White
Background: Refer to color chart
Post: Refer to color chart

Recommendations

Position sign so drivers have a clear, unobstructed view of the sign.

Directional information for services ahead should always be at the top of the sign.

Always leave a blank copy bar between groups of directional information. This will aid in the ability of the driver to read grouped directional information more quickly.

Generally, configure a sign with at least one blank copy bar at the bottom of the sign. This will aid in the ability of the driver to read the sign. It will also allow for an additional line of text to be added to the sign in the future without having to order another copy bar.

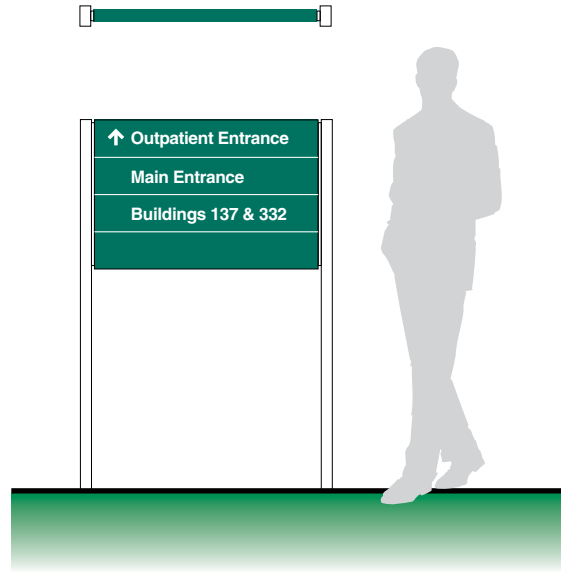

Message Layout A



Message Layout B

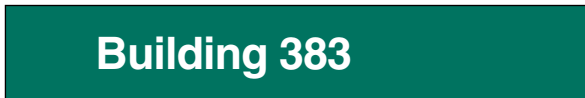

Message Layout C



This layout shows an indentation for a second line of copy

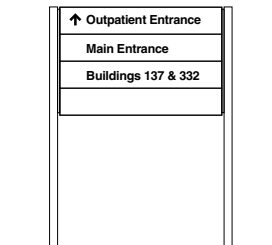

EN-04.04A (4 Bar)

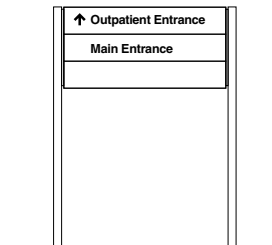

EN-04.04B (3 Bar)

Secondary Directional Post and Stacking Bar

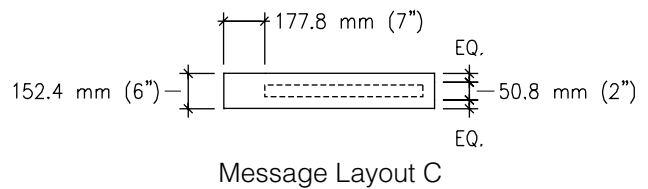
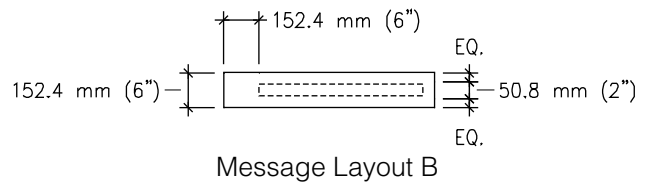
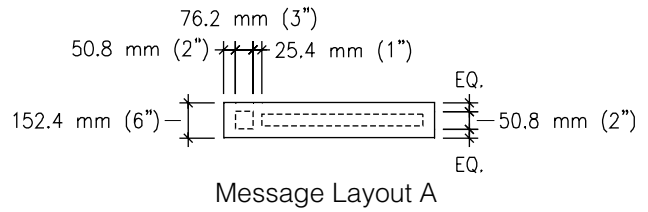
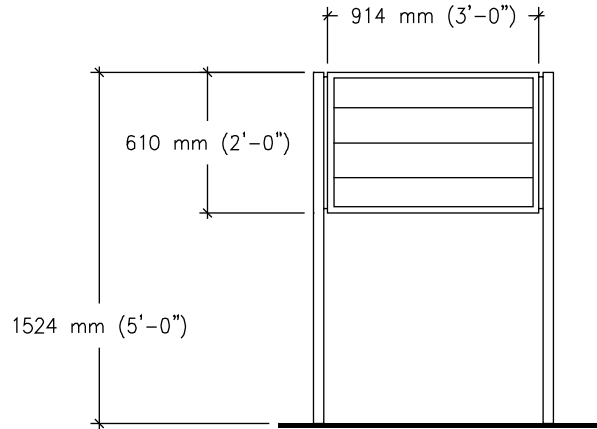
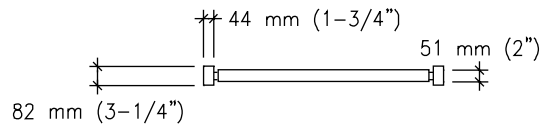

Large Single Post Informational

Size

Sign Face:
762 mm H x 610 mm W
(2' 6" H x 2' 0" W)

Overall Sign Height:
1829 mm (6' 0")

Description

Large, non-illuminated single post identification, informational and directional sign. This type of sign is for miscellaneous uses and can be utilized in landscape areas, at the head of parking stalls, or in other locations which have space limitations.

Message Configuration

(Refer to message layout drawing for dimensions)

Message configurations shown illustrate various adaptable uses for this particular style of sign.

Graphic Process

Surface applied white reflective vinyl.

Colors

Text: White
Background: Refer to color chart
Post: Refer to color chart

Recommendations

Position sign so drivers have a clear, unobstructed view of the sign.

It is recommended that this type of sign be placed in situations where a smaller sign is required or a particular situation precludes the use of a double post and panel sign.

When placing this type of sign near curbs or parking places, be sure the sign is set far enough back that over hanging front and rear of automobiles do not come in contact with the sign post.



Message Layout A



Message Layout B



Message Layout C



Message Layout D

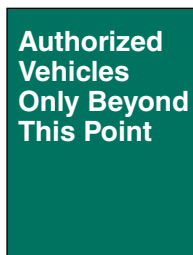

Message Layout E



Large Single Post Informational

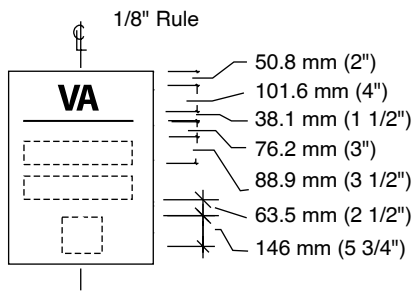
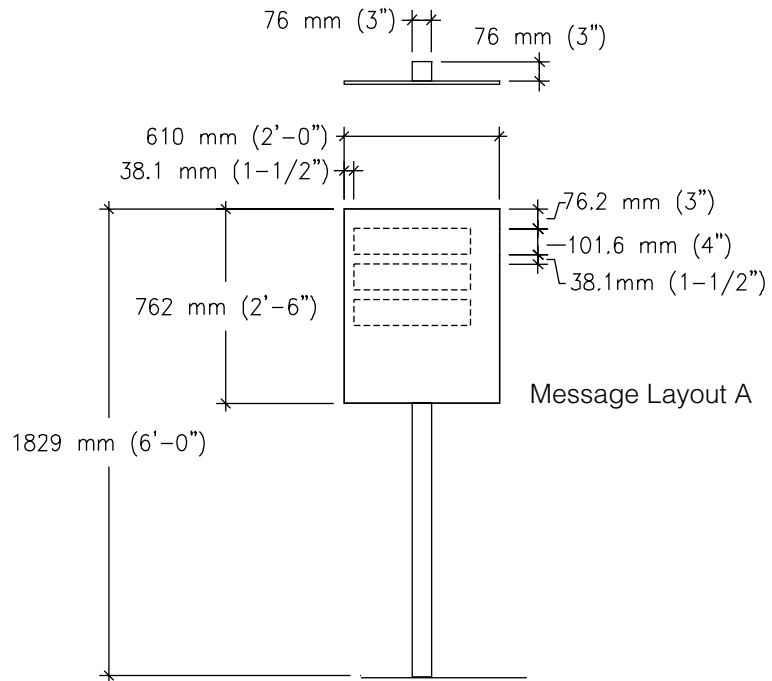

Message Layout B

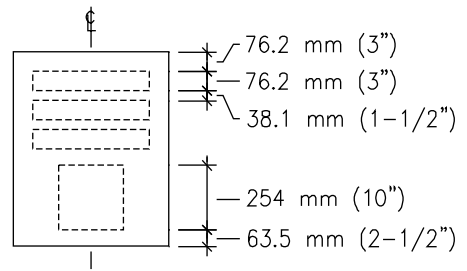

Message Layout C

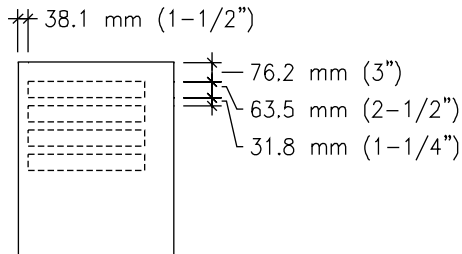

Message Layout D

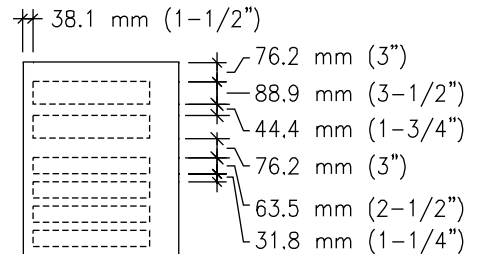

Message Layout E

Medium Single Post Informational

Size

Sign Face:
610 mm H x 457 mm W
(2' 0" H x 1' 6" W)

Overall Sign Height:
1829 mm (6' 0")

Description

Standard, non-illuminated single post identification, informational and directional sign. This type of sign is the standard one for miscellaneous uses. It can be utilized in landscape areas, at the head of parking stalls, or in other locations which have space limitations which preclude the use of a double post and panel sign.

Message Configuration

(Refer to message layout drawing for dimensions)

Message configurations shown illustrate various adaptable uses for this particular style of sign.

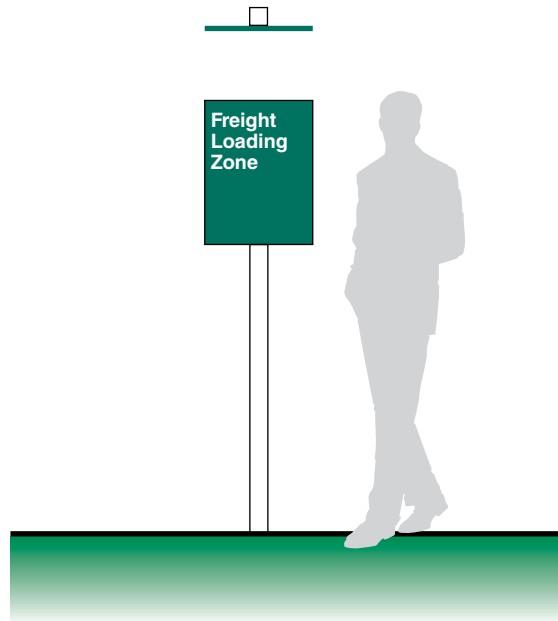

Graphic Process

Surface applied white reflective vinyl.

Colors

Text: White
Background: Refer to color chart
Post: Refer to color chart

Recommendations

Position sign so drivers have a clear, unobstructed view of the sign.

When placing this type of sign near curbs or parking places, be sure the sign is set far enough back that over hanging front and rear of automobiles do not come in contact with the sign post.

Message Layout A



Message Layout B



Message Layout C



Message Layout D

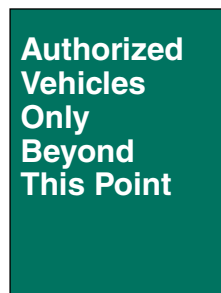

Message Layout E



Medium Single Post Informational

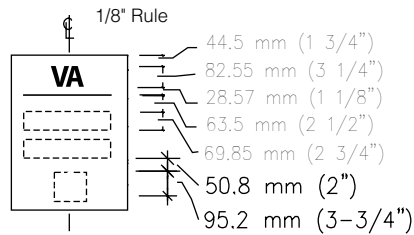
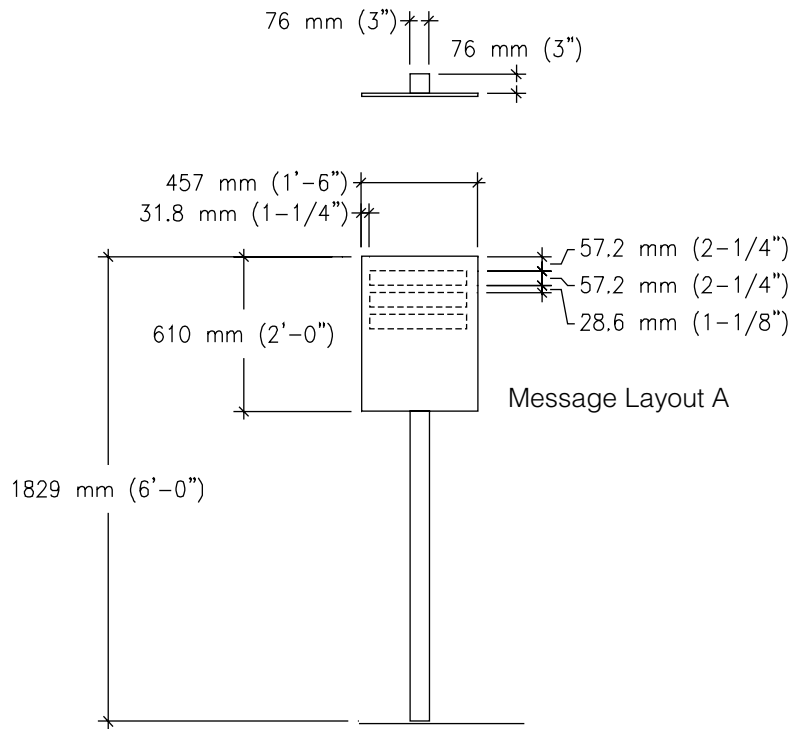

Message Layout B

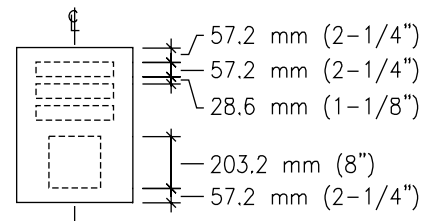

Message Layout C

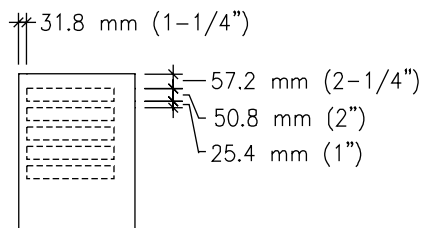

Message Layout D

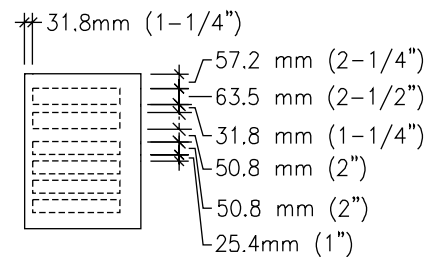

Message Layout E

Small Single Post Informational

Size

Sign face:
457 mm H X 305 mm W
(1'6" H X 1'0" W)

Overall Sign High:
1829 mm (6' 0")

Description

Small, non-illuminated single post identification and informational sign. This type of sign is for miscellaneous uses and can be utilized in landscape areas at the head of parking stalls, or in other locations which have space limitations. This type of sign would be placed in situations where a small sign is required.

Message Configuration

(Refer to message layout drawing for dimensions)

Message configurations shown, illustrate various adaptable uses for this particular style of sign.

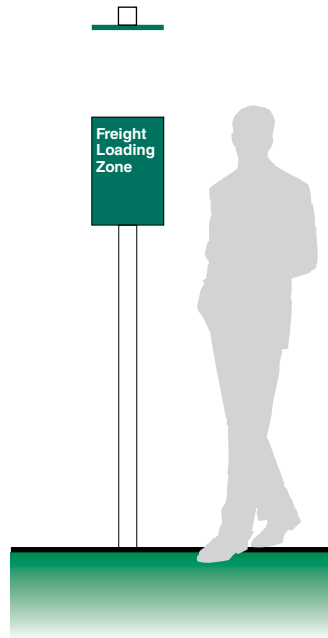

Graphic Process

Surface applied white reflective Vinyl.

Colors

Text: White
Background: Refer to color chart
Post: Refer to color chart

Recommendations

Position sign so drivers have a clear, unobstructed view of the sign.

When placing this type of sign near curbs or parking places, be sure the sign is set far enough back that over-hanging front and rear of automobiles do not come in contact with the sign post.

Message Layout A



Message Layout B



Message Layout C

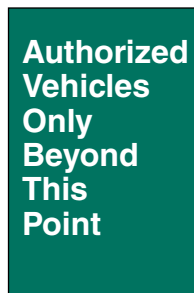

Message Layout D



Small Single Post Informational

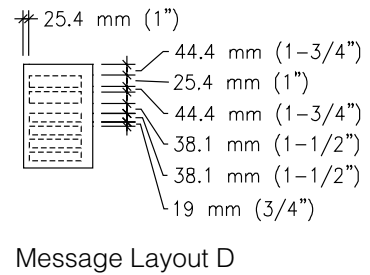
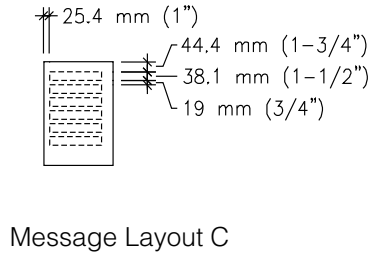
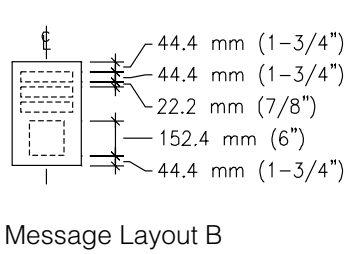
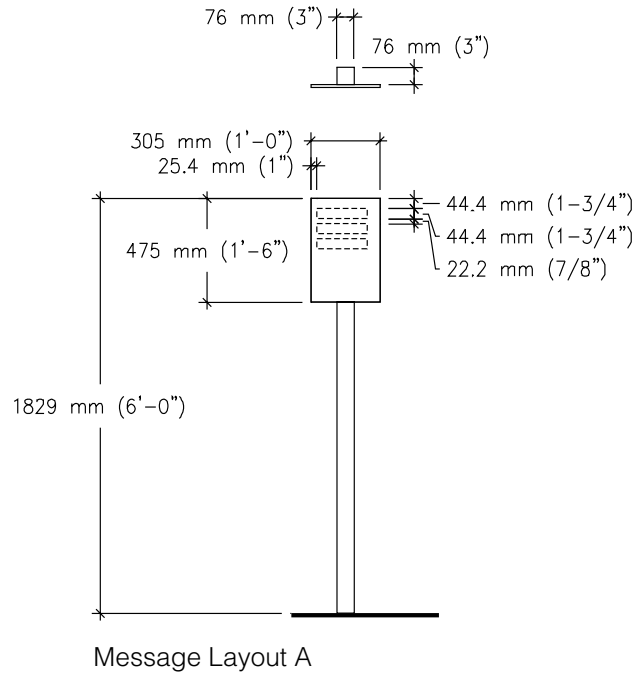

Wall Mounted Overhead

Size

Sign Face:
610 mm H x 2438 mm W
(2' 0" H x 8' 0" W)

Description

Non-illuminated, overhead wall mounted sign. Identification of a stand alone building that is not a medical center. This sign type can also be used to identify an entrance to a building.

Message Configuration

(Refer to message layout drawing for dimensions)

Message Layout A, B and C are for identifying an entrance to a building.

Message Layout D is for identifying a non-medical center stand alone building.

Graphic Process

Surface applied white reflective vinyl.

Colors

Text: White
Background: Refer to color chart

Recommendations

For a stand alone non medical center building, use this type of sign when there is not place to install a free standing sign.

Use this type of sign for "titling" major building entrances that have a very high volume of patient and visitor traffic and need to be clearly distinguished.



Message Layout A



Message Layout B



Message Layout C



Message Layout D



Wall Mounted Overhead

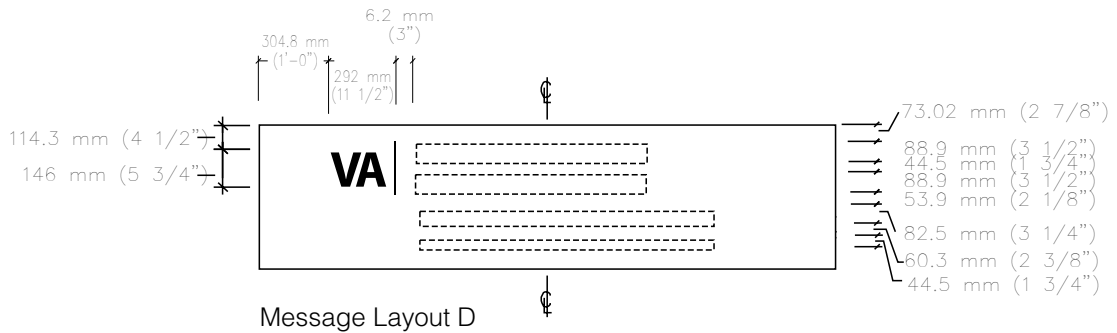
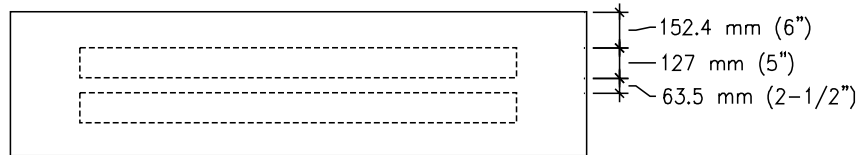
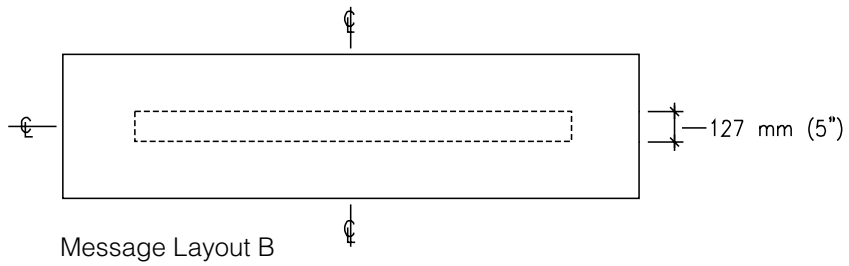
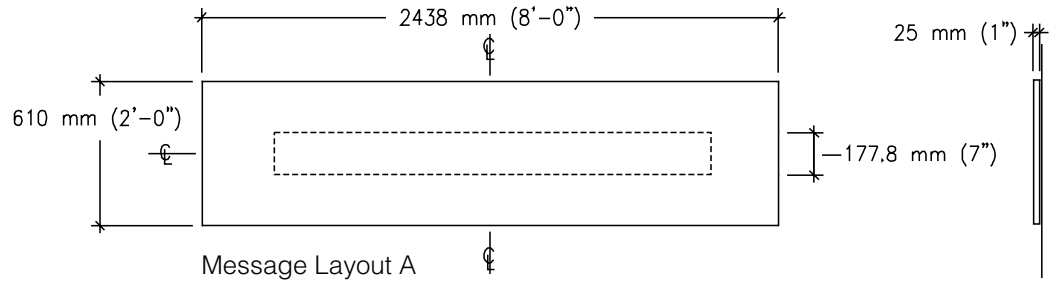

Wall Mounted Building Identification

Size

Sign Face:
914 mm H x 1219 mm W
(3' 0" H x 4' 0" W)

Description

Large, non-illuminated wall mounted sign This sign type can be used to identify a building on a medical center campus. It also can be used for identification of a stand alone building that is not a medical center and there is not place to install a free standing sign.

Message Configuration

(Refer to message layout drawing for dimensions)

Message Layout A is for identifying a non-medical center, stand alone building.

Message Layout B and C are for identifying building on a medical center campus.

Graphic Process

Surface applied white reflective vinyl.

Colors

Text: White
Background: Refer to color chart

Recommendations

For a stand alone non-medical center building, use this type of sign when there is not place to install a free standing sign.

Use this type of sign for "titling" building entrances that have a very high volume of patient and visitor traffic and needs to be clearly distinguished. It also can be use on a building that is set back a considerable distance from the roadway.

Position the sign adjacent the main entrance, if possible. If the sign is not readable in this position, then locate on the corner of the building.

This large sign should not be used on small buildings or buildings with minor uses.



Message Layout A



Message Layout B

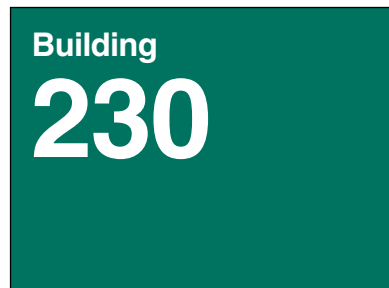

Message Layout C



Wall Mounted Building Identification

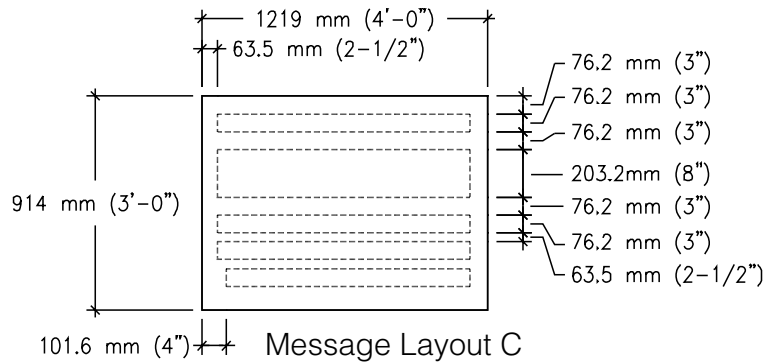
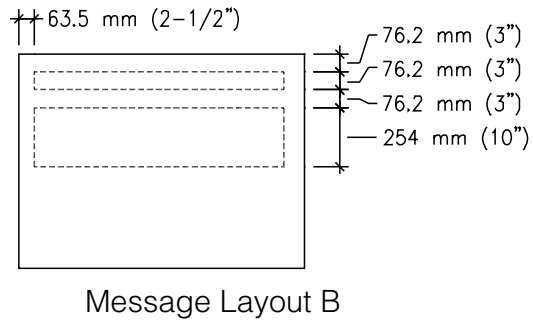
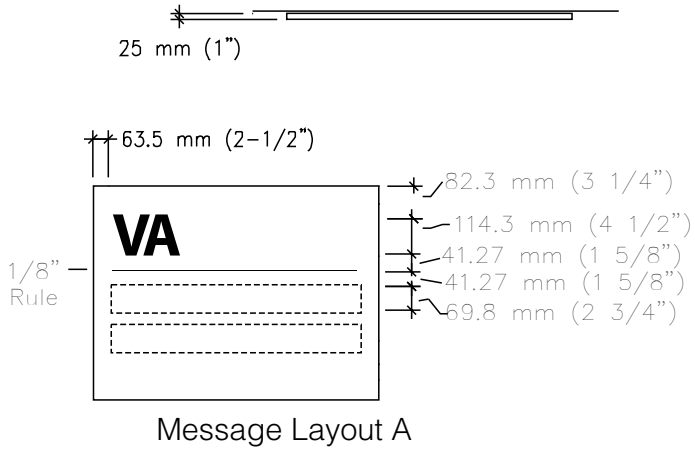

Wall Mounted Building Identification

Size

Sign Face:
1219 mm H x 914 mm W
(4' 0" H x 3' 0" W)

Description

Large, non-illuminated wall mounted sign with separate name panel. Building identification with and without names of the occupant or service. The secondary name of the occupant or service is on a changeable panel to allow modification to the sign without changing the entire sign.

Message Configuration

(Refer to message layout drawing for dimensions)

Message layouts show application of the sign with building identification number and number with secondary information.

Graphic Process

Surface applied white reflective vinyl.

Colors

Text: White
Background: Please Refer to color chart

Recommendations

Use on a building that is set back a considerable distance from the roadway.

Position the sign adjacent to or above the main entrance, if possible. If the sign is not readable in this position, then locate on the corner of the building.

This large sign should not be used on small buildings or buildings with minor uses.



Message Layout A

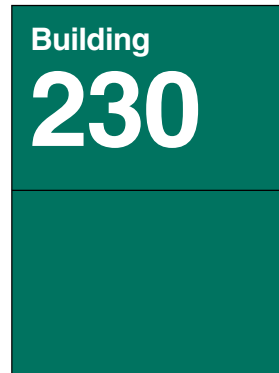

Message Layout B



Message Layout C

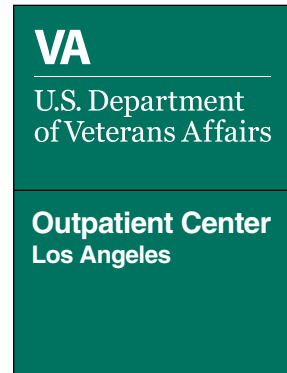

Wall Mounted Building Identification

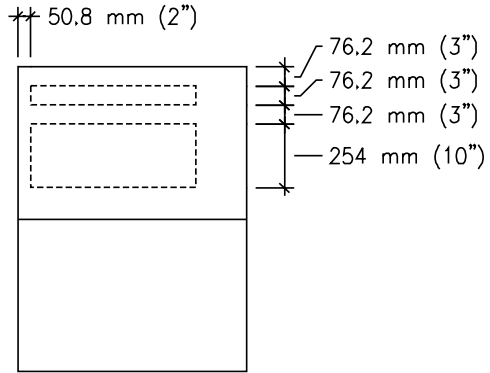

Message Layout A

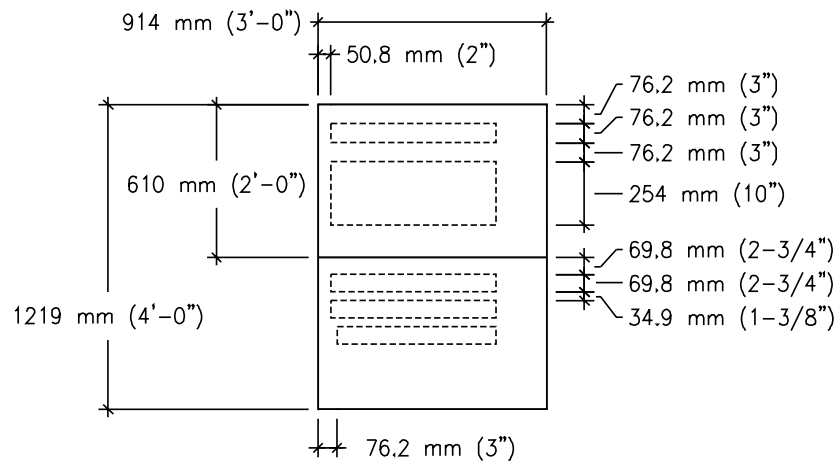

Message Layout B

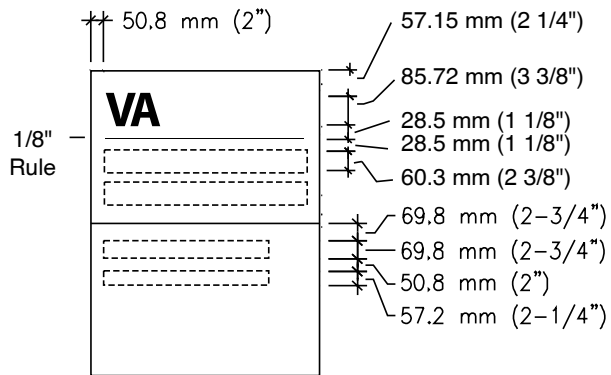

Message Layout C

Wall Mounted Building Identification

Size

Sign Face:
914 mm H x 914 mm W
(3' 0" H x 3' 0" W)

Description

Medium, non-illuminated wall mounted sign. Building identification. When names of the occupant or service are used along with the building number, it should be text that will not likely change.

Message Configuration

(Refer to message layout drawing for dimensions)

Message layouts show application of the sign with building identification number and number with secondary information.

Graphic Process

Surface applied white reflective vinyl.

Colors

Text: White
Background: Refer to color chart

Recommendations

Use on a building that is set back a considerable distance from the roadway.

Position the sign adjacent to or above the main entrance, if possible. If the sign is not readable in this position, then locate on the corner of the building.

This large sign should not be used on small buildings or buildings with minor uses.

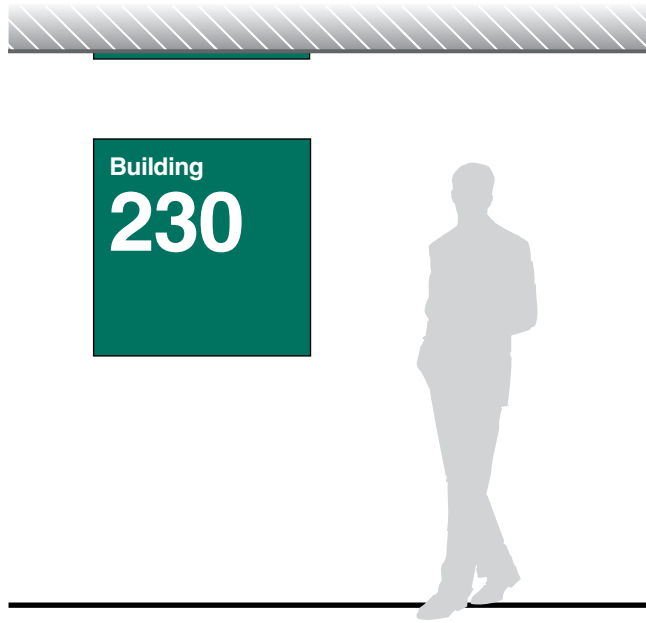

Message Layout A

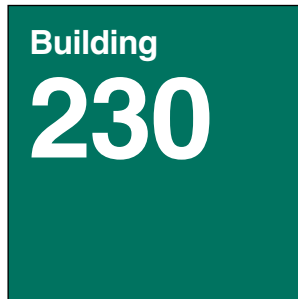

Message Layout B



Wall Mounted Building Identification

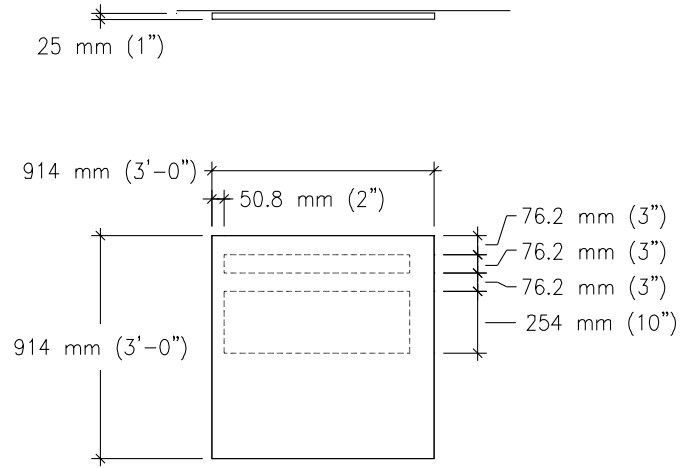

Message Layout A

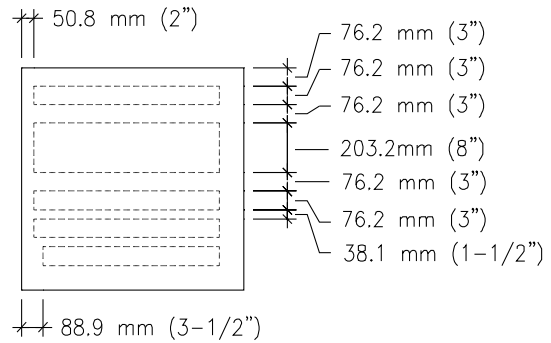

Message Layout B

Wall Mounted Building Identification

Size

Sign Face:
914 mm H x 610 mm W
(3' 0" H x 2' 0" W)

Description

Standard size, non-illuminated wall mounted sign with separate name panel. Building identification with and without names of the occupant or service. The secondary name of the occupant or service is on a changeable panel to allow modification to the sign without changing the entire sign.

Message Configuration

(Refer to message layout drawing for dimensions)

Message layouts show application of the sign with building identification number and number with secondary information.

Graphic Process

Surface applied white reflective vinyl.

Colors

Text: White
Background: Refer to color chart

Recommendations

Use on any building. Position the sign adjacent to or above the main entrance, if possible. If the sign is not readable in this position, then locate on the corner of the building.



Message Layout A

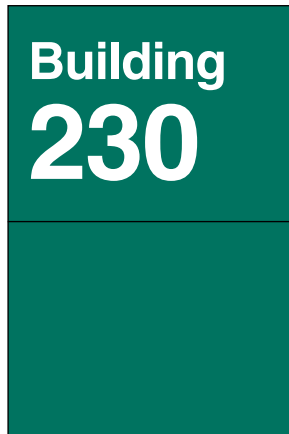

Message Layout B



Wall Mounted Building Identification

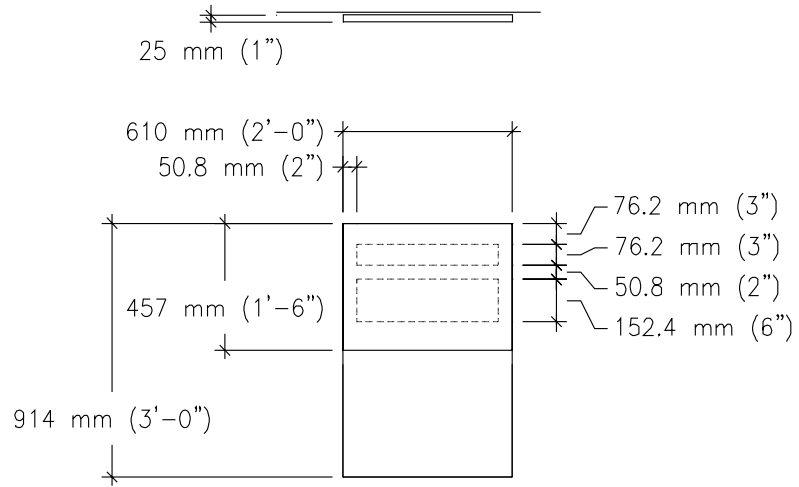

Message Layout A

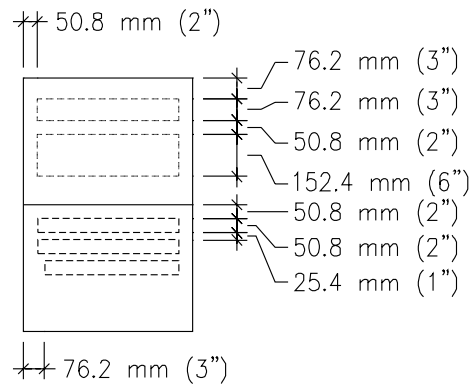

Message Layout B

Wall Mounted Building Identification

Size

Sign Face:
610 mm H x 610 mm W
(2' 0" H x 2' 0" W)

Description

Standard size, non-illuminated wall mounted sign. Building identification with and without names of the occupant or service.

Message Configuration

(Refer to message layout drawing for dimensions)

Message layouts show application of the sign with building identification number and number with secondary information.

Graphic Process

Surface applied white reflective vinyl.

Colors

Text: White
Background: Refer to color chart

Recommendations

Use on any building. Position the sign adjacent to or above the main entrance, if possible. If the sign is not readable in this position, then locate on the corner of the building.



Message Layout A



Message Layout B



Message Layout C



Wall Mounted Building Identification Sign

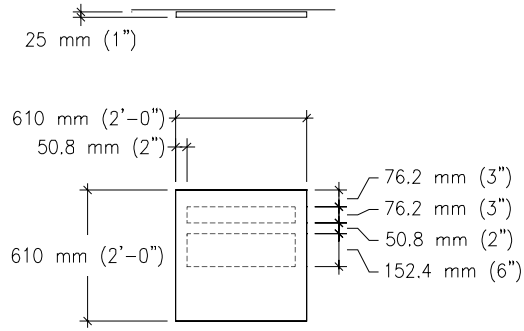

Message Layout A

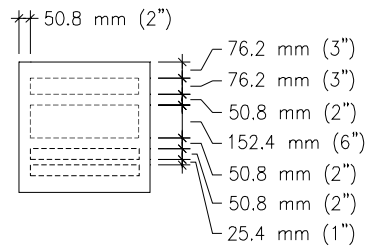

Message Layout B

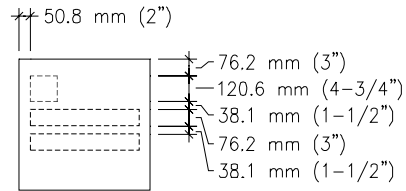

Message Layout C

Wall Mounted Informational

Size

Sign Face:
457 mm H x 457 mm W
(1' 6" H x 1' 6" W)

Description

Small, non-illuminated wall mounted sign. This sign is for miscellaneous uses such as identifying minor entrances, information messages, identifying sheds and equipment buildings, etc.

Message Configuration

(Refer to message layout drawing for dimensions)

Message layouts show ideas of type sizes relative to possible different uses and application of the sign type.

Graphic Process

Surface applied white reflective vinyl.

Colors

Text: White
Background: Refer to color chart

Recommendations

Use for general purpose minor sign needs.

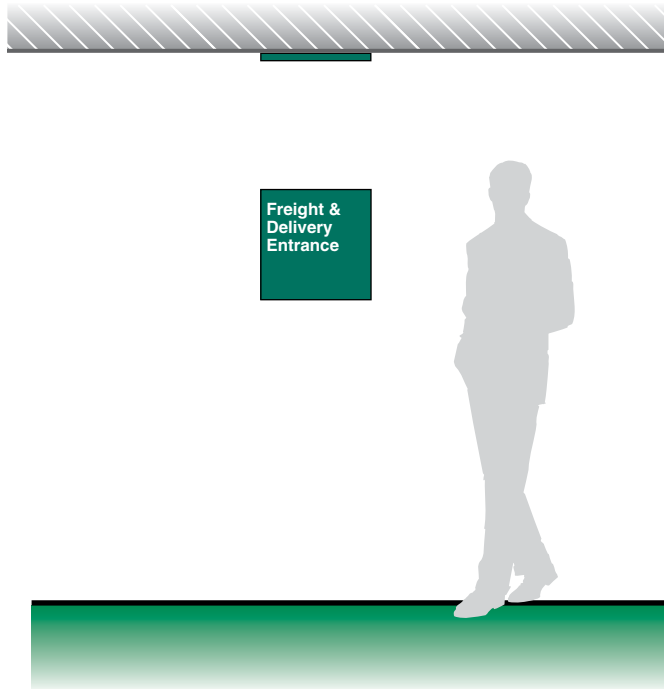

Message Layout A



Message Layout B



Wall Mounted Informational

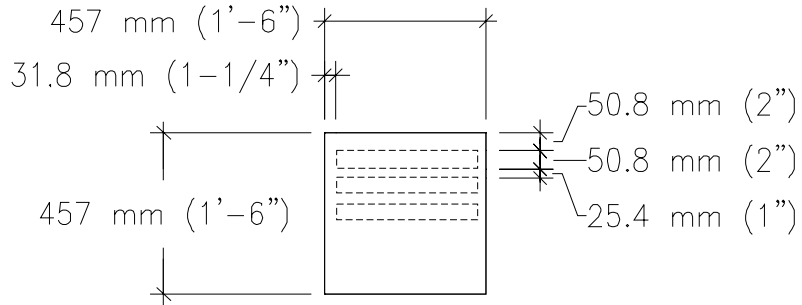
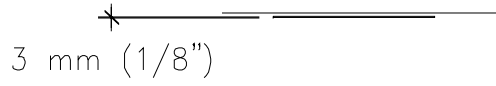

Message Layout A

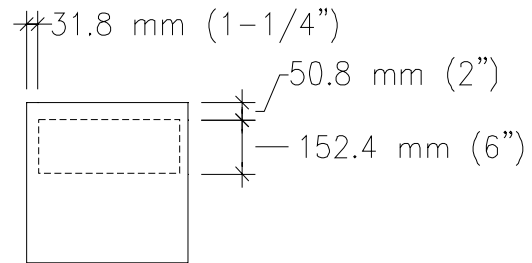

Message Layout B

Wall Mounted Informational

Size

Sign Face:
457 mm H x 305 mm W
(1' 6" H x 1' 0" W)

Description

Minor informational, non-illuminated wall mounted sign. This sign is for miscellaneous uses such as identifying minor entrances, information messages, identifying sheds and equipment buildings, etc.

Message Configuration

(Refer to message layout drawing for dimensions)

Message layouts show ideas of type sizes relative to possible different uses and application of the sign type.

Graphic Process

Surface applied white reflective vinyl.

Colors

Text: White
Background: Refer to color chart

Recommendations

Use for general purpose minor sign needs.



Message Layout A



Message Layout B



Message Layout C



Message Layout D



Message Layout E



Message Layout F



Wall Mounted Informational

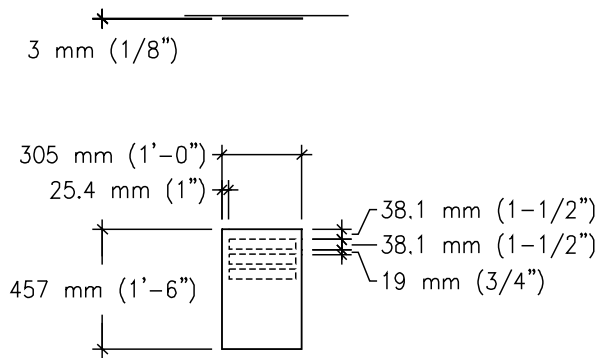

Message Layout A

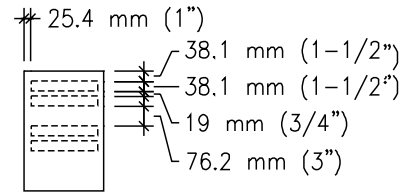

Message Layout B

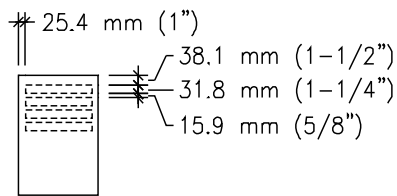

Message Layout C

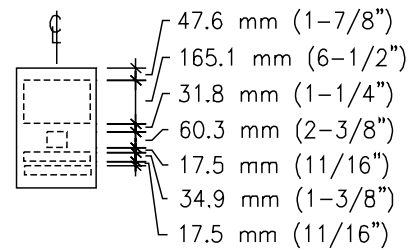

Message Layout D

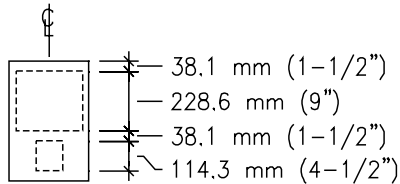

Message Layout E

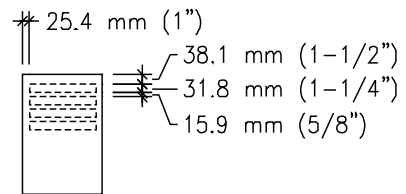

Message Layout F

Wall Mounted Ambulance Entrance Identification

Size

Sign Face:
610 mm H x 2438 mm W
(2' 0" H x 8' 0" W)

Description

Overhead, non-illuminated wall mounted sign to be placed above the ambulance entrance.

Message Configuration

(Refer to message layout drawing for dimensions)

Conform to the layout shown.

Graphic Process

Surface applied white reflective vinyl.

Colors

Background: Text: White
Symbol Background: White
Background: Red .

Recommendations

Place sign in a position of the building where it clearly identifies the "Ambulance Entrance" and is visible to both vehicles and pedestrians.

**Message Layout A**

Wall Mounted Ambulance Entrance Identification

Size

Sign Face:
914 mm H x 1219 mm W
(3' 0" H x 4' 0" W)

Description

Non-illuminated wall mounted sign to be placed on the wall adjacent to the ambulance entrance.

Message Configuration

(Refer to message layout drawing for dimensions)

Conform to the layouts shown.

Graphic Process

Surface applied white reflective vinyl.

Colors

Text: White
Symbol Background: White
Background: Red

Recommendations

Place sign in a position of the building where it clearly identifies the "Ambulance Entrance" and is visible to both vehicles and pedestrians.



Message Layout A



Message Layout B



Wall Mounted Ambulance Entrance Identification

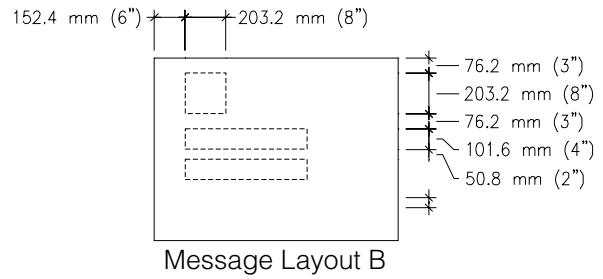
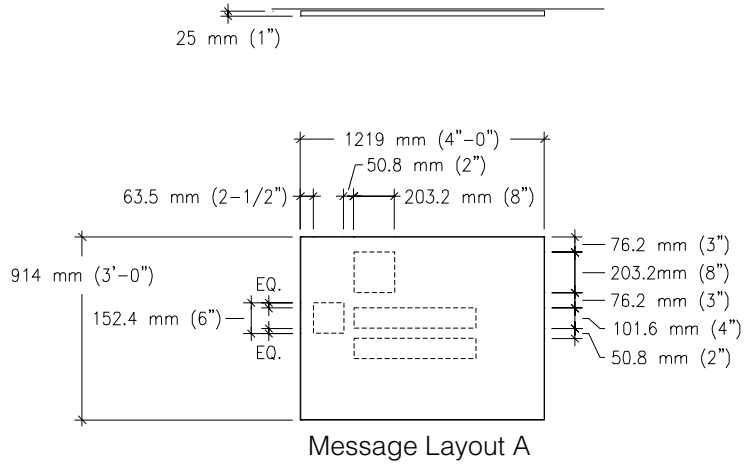

Post and Panel Ambulance Entrance Identification

Size

Sign Face:
914 mm H x 1219 mm W
(3' 0" H x 4' 0" W)

Overall Sign Height:
1676 mm (5' 6")

Description

Non-illuminated post and panel sign to be placed on the roadway, adjacent to the ambulance entrance to direct ambulance drivers to the correct building entrance.

Message Configuration

(Refer to message layout drawing for dimensions)

Conform to the layouts shown.

Graphic Process

Surface applied white reflective vinyl.

Colors

Text: White
Symbol Background: White
Background: Red
Post: Refer to color chart

Recommendations

Position sign so drivers have a clear, unobstructed view of the sign.



Message Layout A



Message Layout B



Post and Panel Ambulance Entrance Identification

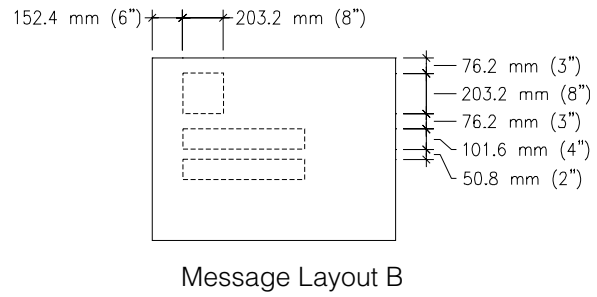
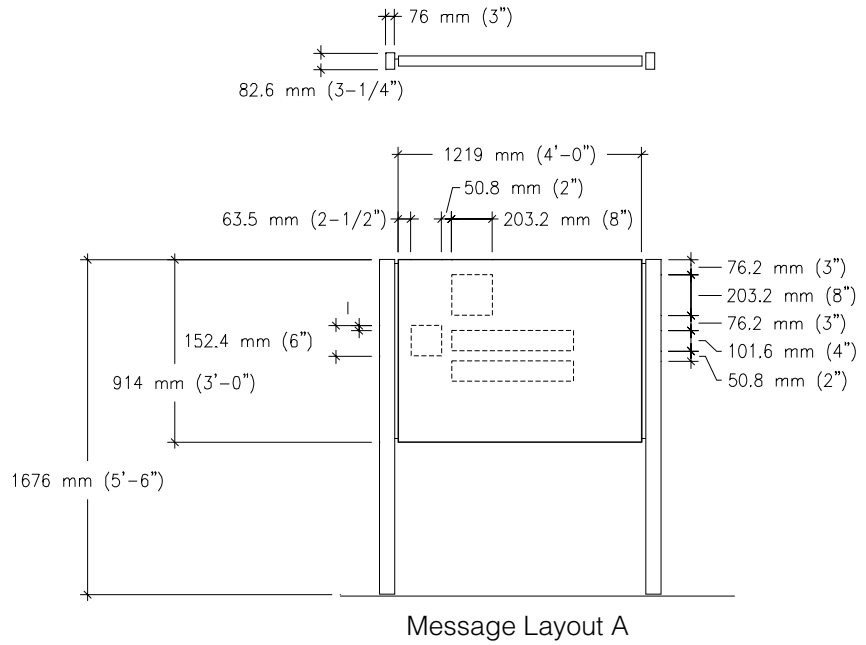

Dimensional Letters

Size

For the various sizes, refer to the adjacent table.

Description

Non-illuminated dimensional letters for identifying a facility. Should be placed on the building in a location that is highly visible to the public.

Message Configuration

(Refer to message layout drawing for dimensions)

Graphic Process

Fabricated or cut out of aluminum letters

Colors

White, black, silver or dark bronze. Letter to have high contrast to the building wall color or material. For example, use white on red brick, not black.

Recommendations

Dimensional letters can be used on a building to identify the building. Large letters and logo are intended for use on the top of the building as a skyline sign.

Outpatient Entrance



Sign Type	Y	Z	X	W
EN-09.01	100 mm (4")	10 mm (3/8")		
EN-09.02	150 mm (6")	10 mm (3/8")		
EN-09.03	200 mm (8")	13 mm (1/2")		
EN-09.04	250 mm (10")	13 mm (1/2")	575 mm (23")	190 mm (10")
EN-09.05	300 mm (12")	19 mm (3/4")	675 mm (27")	225 mm (12")
EN-09.06	450 mm (18")	25 mm (1")	1050 mm (42")	350 mm (19")
EN-09.07	600 mm (24")	50 mm (2")	1350 mm (56")	475 mm (25")
EN-09.08	750 mm (30")	65 mm (2 1/2")	1800 mm (70")	575 mm (31")
EN-09.09	900 mm (36")	75 mm (3")	2100 mm (84")	700 mm (38")

Dimensional Letters

Outpatient Entrance

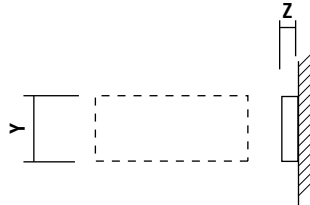
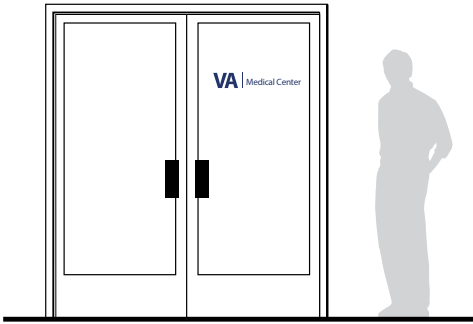

Sign Type	Y	Z
EN-09.01	100 mm (4")	10 mm (3/8")
EN-09.02	150 mm (6")	10 mm (3/8")
EN-09.03	200 mm (8")	13 mm (1/2")
EN-09.04	250 mm (10")	13 mm (1/2")
EN-09.05	300 mm (12")	19 mm (3/4")
EN-09.06	450 mm (18")	25 mm (1")
EN-09.07	600 mm (24")	50 mm (2")
EN-09.08	750 mm (30")	65 mm (2 1/2")
EN-09.09	900 mm (36")	75 mm (3")

Traffic Regulatory Signs

Size

EN-10.01: Stop (R1-1): 24", 30", 36"

EN-10.02: Do Not Enter (R5-1):
30", 36"

EN-10.03: Yield (R1-2): 30", 36"

EN-10.04: Speed Limit (R2-8)

EN-10.05: Keep Right (R4-7A)

EN-10.06: One Way (R6-2L,
R6-2R)

EN-10.07: No Right/Left Turn (R3-
1R, R3-2L)

EN-10.08: No U Turn (R3-4)

EN-10.09: Pedestrian Crossing
(W11-2A)

Description

Traffic regulatory signs

Sign Use & Application

The "Manual on Uniform Traffic Control Devices for Streets and Highways" has been adopted as the standard for all Regulatory and Warning Signs used on the Department of Veterans Affairs roadways for vehicular traffic.

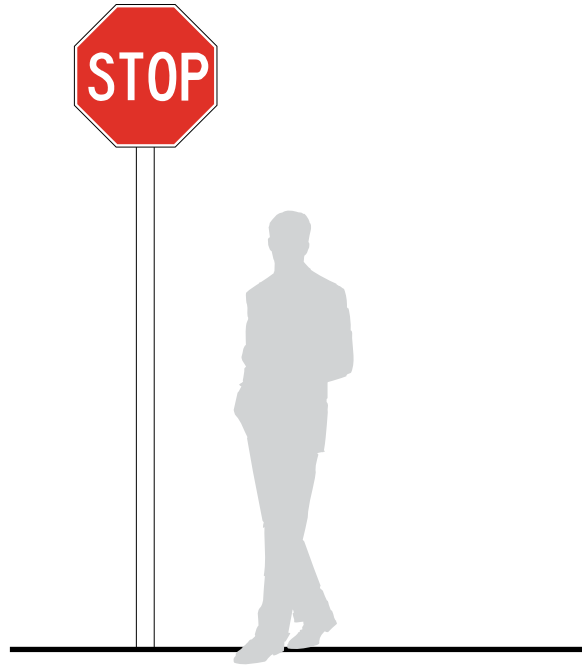

Message Configuration

(Refer to message layout drawing for dimensions)

Text, text size, text position and color must conform with the Manual on Uniform Traffic Control Devices (MUTCD)

Colors

Text & Background: "MUTCD" standard colors;
Post: Refer to color chart.

Recommendations

Display the most commonly used signs as indicated. If other Traffic Regulatory and Warning Signs are need, refer to MUTCD.

Position sign so drivers have a clear, unobstructed view of the sign.

It should be noted that the decision to use a particular traffic control device at a specific location should be made on the basis of a standard traffic engineering study of the location. Sign size should be based on traffic conditions. Where these conditions are the same, all signs of a similar type should be the same size.

EN-10.01



EN-10.02



EN-10.03



EN-10.04



EN-10.05



EN-10.06



EN-10.07



EN-10.08



EN-10.09



Traffic Regulatory Signs

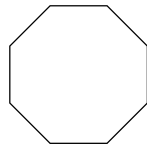
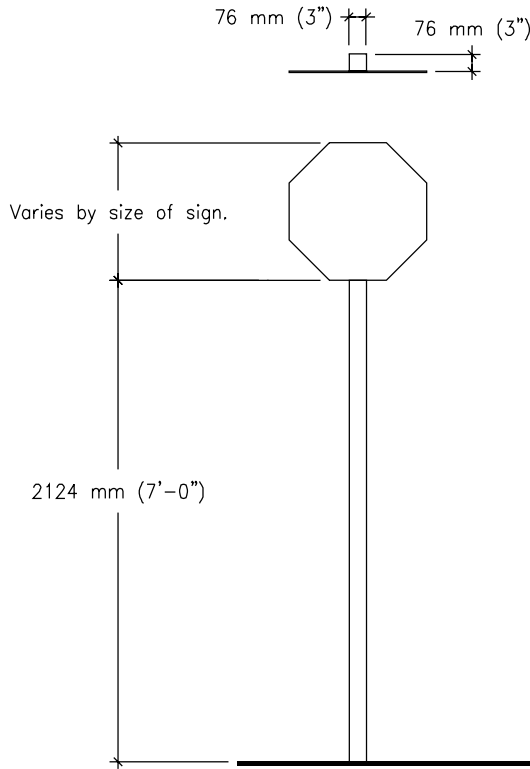

EN-10.01

610mm x 610mm
(24" x 24")
762mm x 762mm
(30" x 30")
914mm x 914
(36" x 36")

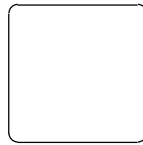

EN-10.02

762mm x 762mm
(30" x 30")
914mm x 914mm
(36" x 36")

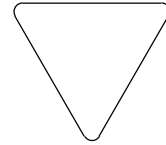

EN-10.03

732mm Triangle
(30" Triangle)
914mm Triangle
(36" Triangle)

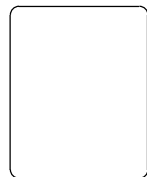

EN-10.04
EN-10.05
EN-10.06

610mm x 762mm
(24" x 30")

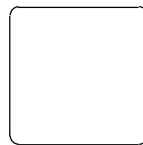

EN-10.07
EN-10.08

610mm x 610mm
(24" x 24")

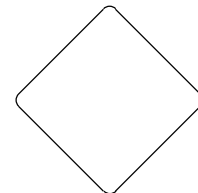

EN-10.10

610mm x 610mm
(24" x 24")

2 Blade Street Sign

Size

Blade: 152 mm H x 610 mm W
 (6" H x 2'-0" W)
 152 mm H x 762 mm W
 (6" H x 2'-6" W)
 152 mm H x 914 mm W
 (6" H x 3'-0" W)

Description

Non-illuminated double blade name sign for an intersection

Message Configuration

(Refer to message layout drawing for dimensions)

Select size required for length of name. Message will be the same on both sides of the sign blade. The following are some standard abbreviations: Boulevard - BLVD; Circle - CIR; Court - CT; Drive - DR; Avenue - AVE; Lane - LN; Place - PL; Road - RD; Street - ST; Terrace - TERR.

Graphic Process

Surface applied white reflective vinyl.

Colors

Text: White
 Background: Refer to color chart
 Post: Refer to color chart

Typography

Helvetica Bold Condensed

Recommendations

Position sign so drivers have a clear, unobstructed view of the sign. Locate as close to intersection as possible.

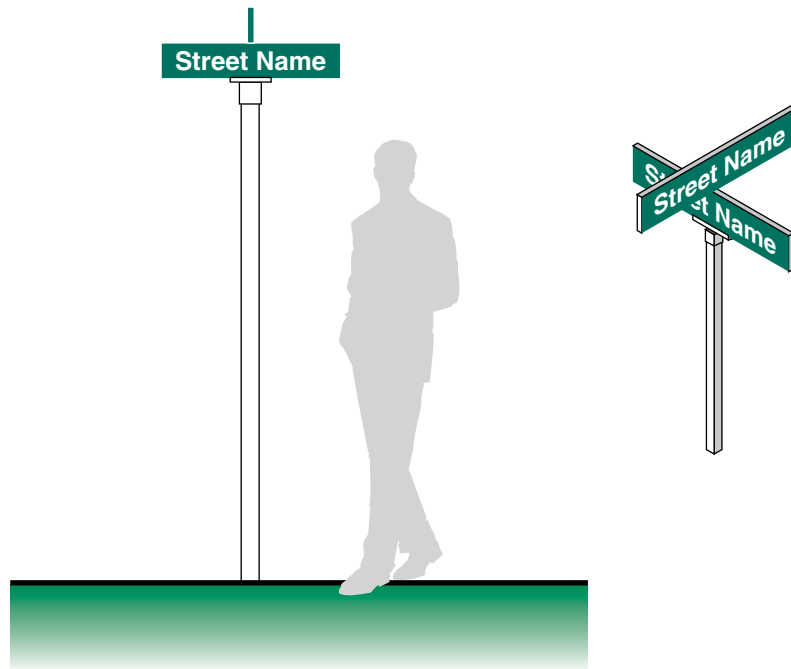
**Message Layout A**

Main St.

Message Layout B

Main Street

Message Layout C

N. Main Street

2 Blade Street Sign

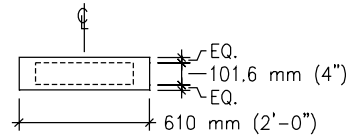
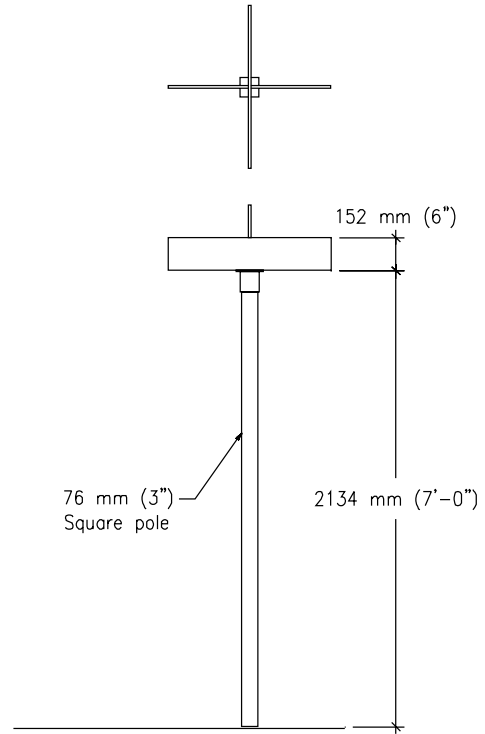

Message Layout A

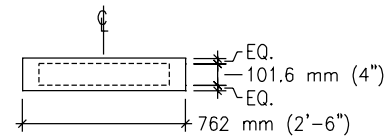

Message Layout B

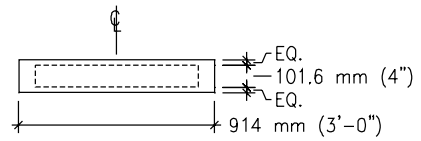

Message Layout C

1 Blade Street Sign

Size

Blade: 152 mm H x 610 mm W
 (6" H x 2' 0" W)
 152 mm H x 762 mm W
 (6" H x 2'-6" W)
 152 mm H x 914 mm W
 (6" H x 3'-0" W)

Description

Tall, Non-illuminated single blade street name identification for a single street

Message Configuration

(Refer to message layout drawing for dimensions)

Select size required for length of name. Message will be the same on both sides of the sign blade. The following are some standard abbreviations: Boulevard - BLVD; Circle - CIR; Court - CT; Drive - DR; Avenue - AVE; Lane - LN; Place - PL; Road - RD; Street - ST; Terrace - TERR.

Graphic Process

Surface applied white reflective vinyl.

Colors

Text: White
 Background: Refer to color chart
 Post: Refer to color chart

Typography

Helvetica Bold Condensed

Recommendations

Position sign so drivers have a clear, unobstructed view of the sign. Locate as close to intersection as possible.

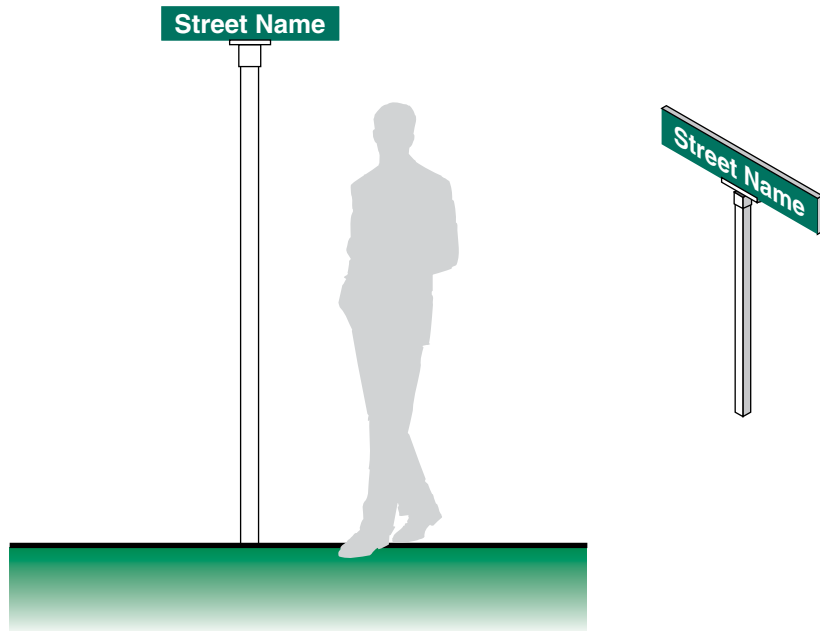
**Message Layout A**

Main St.

Message Layout B

Main Street

Message Layout C

N. Main Street

1 Blade Street Sign

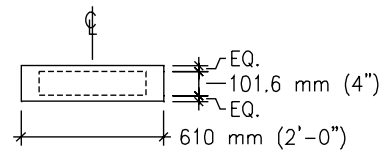
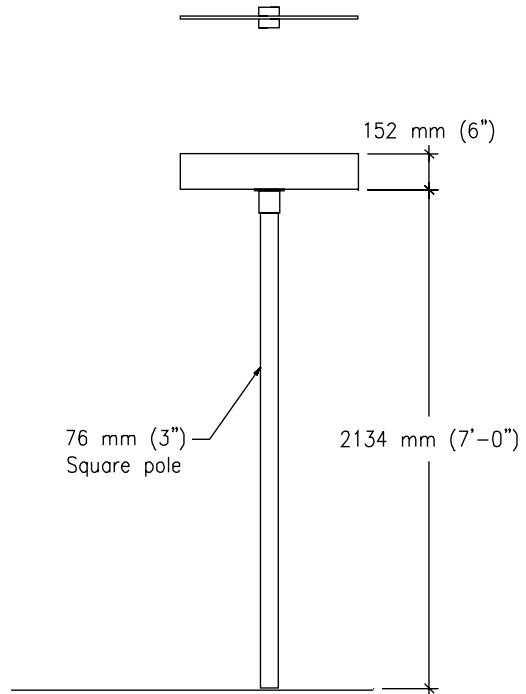

Message Layout A

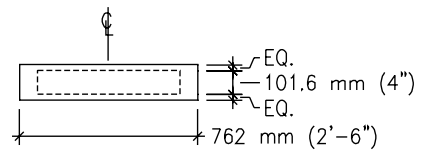

Message Layout B

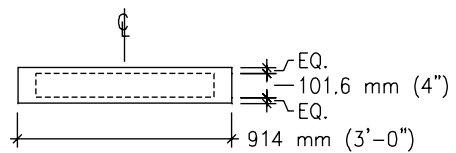

Message Layout C

Pylon Street Sign

Size

Blade: 1524 mm H x 152 mm W x
152 mm D
(5' 0" H x 6" W x 6" D)

Description

Non-illuminated Pylon type Street Sign

Message Configuration

(Refer to message layout drawing for dimensions) The same message will be the opposite sides of the post. The name always starts at the top of the post and has been rotated clockwise from the horizontal to vertical. The following are some standard abbreviations: Boulevard - BLVD; Circle - CIR; Court - CT; Drive - DR; Avenue - AVE; Lane - LN; Place - PL; Road - RD; Street - ST; Terrace - TERR.

Graphic Process

Surface applied white reflective vinyl.

Colors

Post: Refer to color chart.

Typography

Helvetica Bold Condensed

Recommendations

Position sign so drivers have a clear, unobstructed view of the sign. Locate as close to intersection as possible.

**Message Layout**

Main Street

Pylon Street Sign

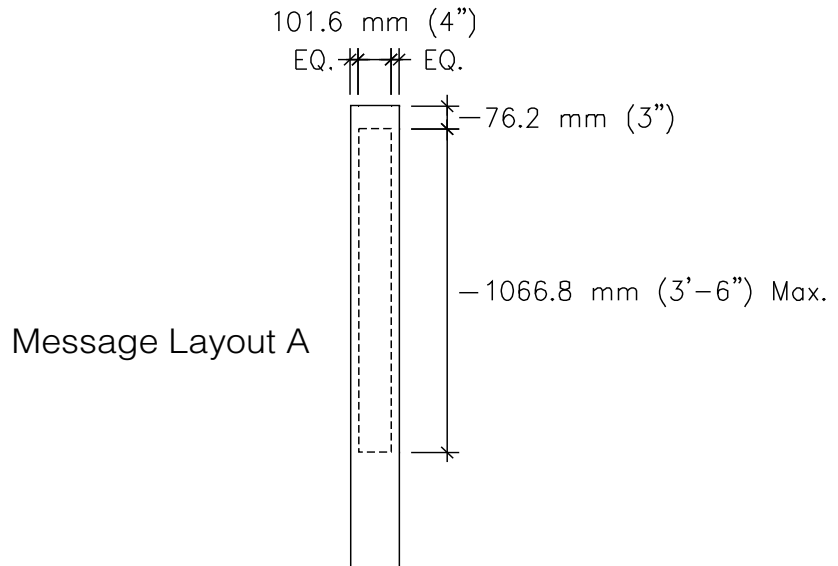
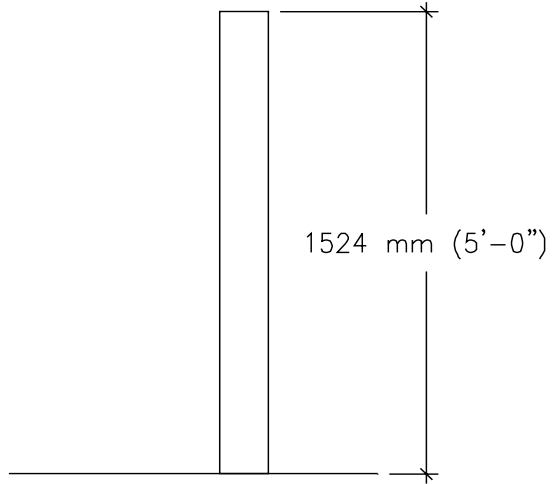
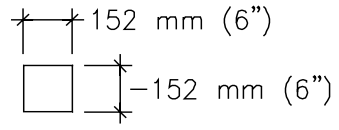

Building Entrance Door Identification

Size

Sign Characters: See layout

Overall Sign Height:
1650 mm (5' 6")

Description

Non-illuminated, applied vinyl letter identification sign with messages directed specifically to pedestrians. The sign can also be used to identify buildings.

Message Configuration

(Refer to message layout drawing for dimensions)

Message size and layout should adjust to the volume of information being presented. Smaller text than shown should not be used as the messages will be unreadable. Larger text than shown will result in words that may not fit on the sign.

Graphic Process

First surface applied white reflective vinyl.

Colors

Text: White

Do not use colored vinyl.

Recommendations

Position sign so pedestrians have a clear, unobstructed view of the sign.

VA

**U.S. Department
of Veterans Affairs**

**Baltimore
VA Medical Center**

**Building 16
Main Entrance**

These doors are locked from 6 p.m. to 6 a.m.
When doors are locked, use Ambulance Entrance



Smoking is only permitted outside in designated areas.

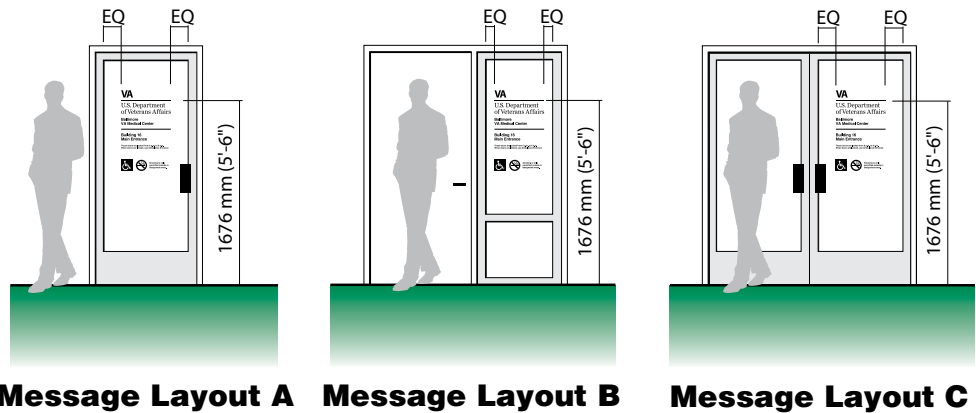

Building Entrance Door Identification

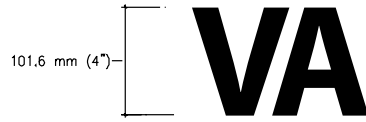

U.S. Department of Veterans Affairs

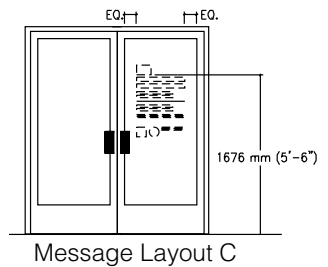
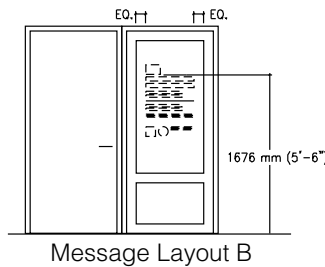
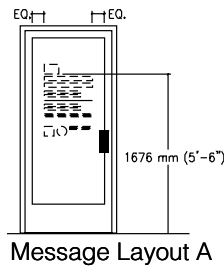
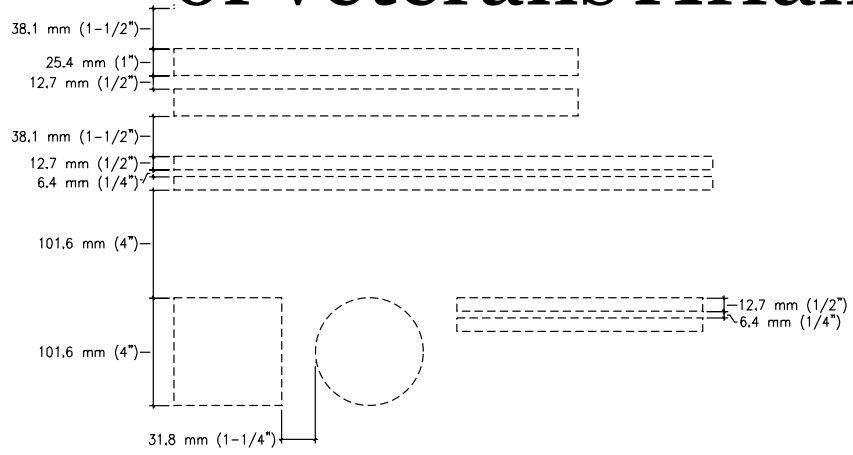

The specifications for signs are available in the Master Construction Specifications (PG-18-1) area of the VA Technical Information Library, which is available on the VA web site under Office of Construction & Facilities Management.

www.cfm.va.gov/til/

Refer to Signage in the specifications, Division 10, Section 10 14 00.

For more information regarding specifications, contact the Office of Construction & Facilities Management, Facility Standards Service.

The specifications require close coordination, taking into account the existing sign program at a medical center, any sign demolition, sign maintenance and future signing needs.

When preparing the specifications for a project, it will require editing to add and indicate new signs or eliminate signs that are not needed. Also, it will be necessary to adapt the specifications to project requirements required for the specific project in which they are intended.

The sign message schedule is considered a part of the specifications and would comprise a portion of the spec section. The configuration and format of the message schedule may vary according to individual project requirements. The sign message schedule format is shown in the Need a Sign Program section of the VA Signage Design Guide. It provides the method for identifying each sign location, type and message along with other notations. The sign schedule contains important information that the sign manufacturer and the sign installer will require for manufacturing and sign installation.

The sign message schedule must be coordinated with a sign location plan drawing showing where signs are to be placed within a building or on the site. Refer to the sign location plan example shown in the **Need a Sign Program** section of the VA Signage Design Guide.

For convenience, the sign type drawings can also be included in the specifications as it own section.

This page is intentionally left blank

The type of exterior sign and sign system selected for a particular application or facility, requires several decisions and involves different construction and components to satisfy the desired requirements. This section provides an overview of the intended criteria for exterior signs.

The details, showing the construction of the monument signs, post and panel signs, wall mounted signs, and the stacking bar signs, are based on a concept of an aluminum extrusion component system. Many sign manufacturers currently market extrusions and component systems that will accomplish the illustrated objectives of a exterior sign system. These extruded, molded, and fabricated components are acceptable so long as the illustrated and stated specifications are adhered to. Once a particular manufacturer's system is selected for a sign program, ongoing maintenance and replacement signs will need to come from that same manufacturer's component system.

The illustrations are intended to show the desired configuration and intent of the various sign types. Sections of the extrusions are for illustration purposes and have not been engineered or configured for extruding and do not represent a finished form or a particular manufacturer. Many manufacturers' extrusion systems will accomplish the illustrated objectives of the intended exterior sign system.

Creating a custom look for signs, with various shapes of posts and cabinets, is an option that can create a specific look for a campus and can create a visual theme that can be tied to the geographic region, neighborhood or architecture of the buildings. Once shapes are selected, it should become the standard for the entire medical center campus. Different shapes being used on the same campus will create a disorganized appearance to the sign program.

In the following pages, further discussion of shape and sign design is discussed along with examples.

Internally illuminated signs should have the electrical supply coordinated, and voltage confirmed, before a sign is ordered and fabricated. Illuminated signs should contain a "UL" sticker that their construction conforms to UL Standard 48. Text for illuminated signs should also be confirmed and finalized before the sign is ordered and fabricated because revisions after fabrication, are very expensive and time consuming.

Community reaction should be taken into account before large "skyline letters" are installed on top of a medical center. Various communities have standards that may not permit these types of signs and installing them could create a local controversy. Also, when large letters are planned for a building, coordination should take place to ensure issues of building skin integrity, structural loads, installation, electrical service and maintenance access are evaluated.

Monument signs larger than those shown in the Guide may also create local community reaction. Check with the Planning Department of the local City or County to see if they have a sign ordinance that may have guidelines for the type of sign being proposed. Federal facilities are not required to obtain local sign permits, but respecting the local ordinances will prevent possible controversy.

Particular care should be taken to ensure that sign footings and foundations are correctly matched to the type of sign being installed.

Design Options Detail 1

Posts: The illustration shows different post shape forms that can allow a sign program to bring an image to a medical center campus. These forms can also create a coordinated look with the architectural theme of buildings on a medical center campus. Additional post shapes are available and a sign designer can develop concepts to illustrate various looks that incorporate different post structures that will work with various cabinet designs.

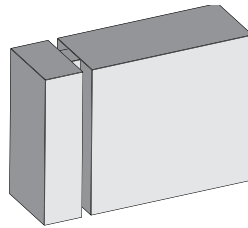

Post: P1

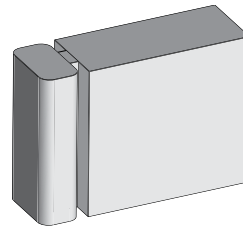

Post: P2

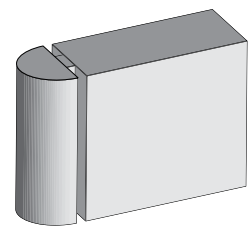

Post: P3

Detail 2

Post Caps: Post caps (finials) can be used to create a theme or feeling enhancing a signs look. The caps can be round or pointed or even a decorative element that is associated with the medical center's architecture. There are companies that manufacture finials and can be consulted of available options or even custom applications.

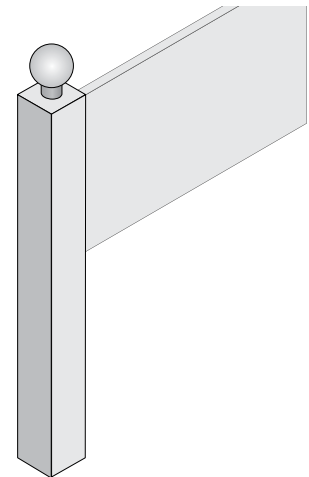
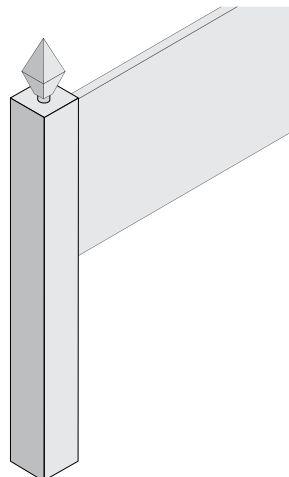
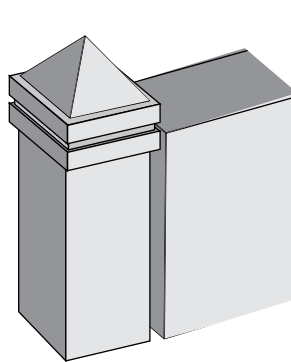

Detail 3

Revels: The look of a component extrusion based exterior sign program allows for signs to be assembled and installed with or without a revels. The extruded aluminum posts have the capability for interlocking with a reveal extrusion that allows for the sign to have a large reveal, small reveal or no reveal. This reveal can also be used to incorporate an accent color into the sign program.

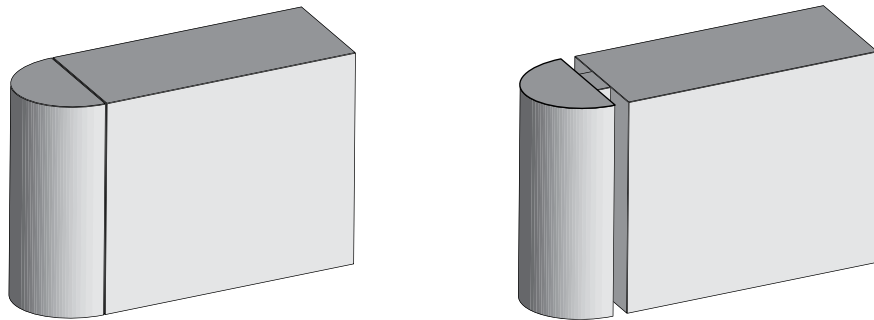

Detail 4

Look of the Sign: By incorporating various simple enhancements to a sign a look can be created that can be specific to a site or campus. Changing the post shape, incorporating a reveal, having the posts and cabinet in two different colors, or having an accent color in the reveal are all things that will give a sign a distinct look, but not add to its costs. Using dimensional letters can also provide a more upscale appearance for signs that identify buildings. Adding shape to the sign cabinet and a distinct treatment to the top of the posts, adds cost to the sign, but these details can “de-institutionalize” a sign program and allow it have a “personality” that aligns with a hospitals architecture or a campus theme.

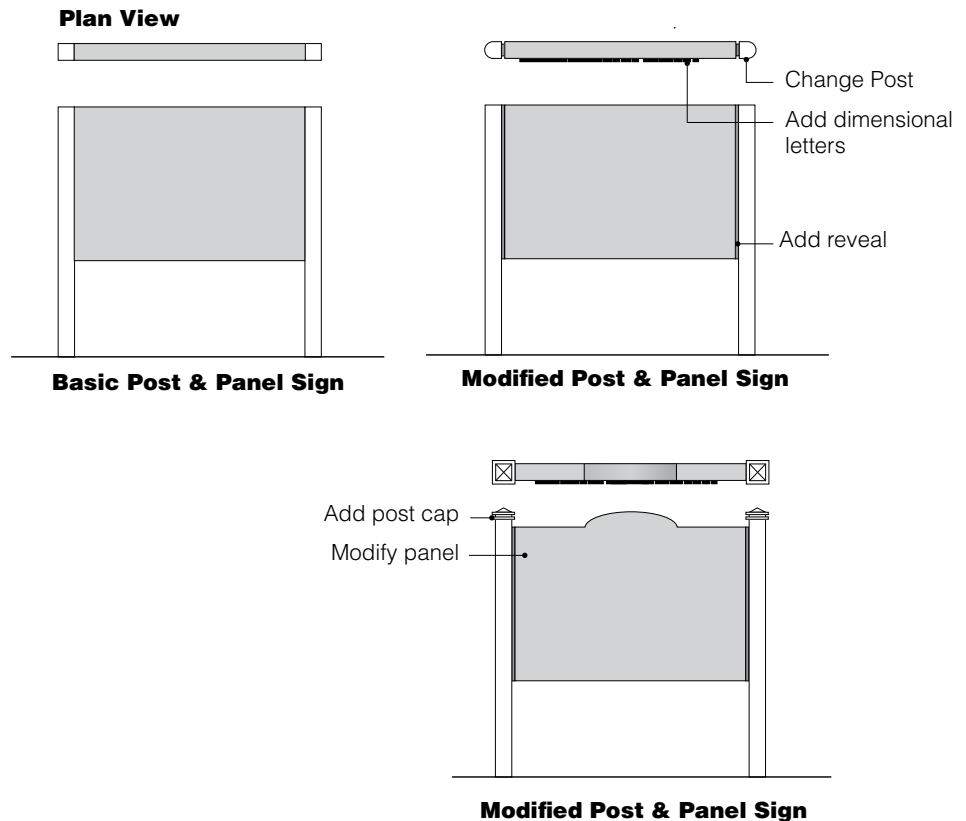

Detail 5

Sign Cabinet Shapes and Forms

This illustrates several examples of expanding the design of the exterior sign to incorporate different post, cap, reveals and cabinet shapes.

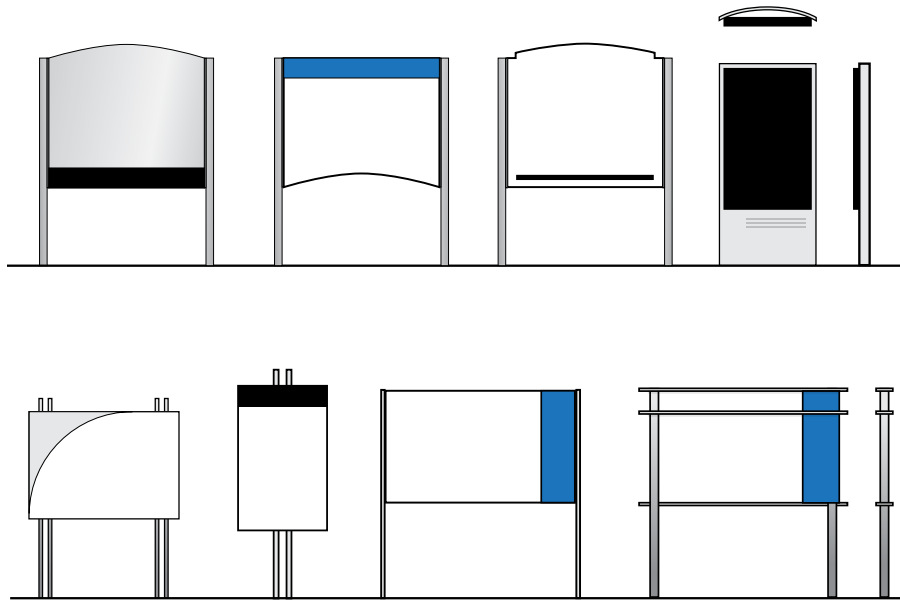

Detail 6

Internally Illuminated Monument Sign

This sign is constructed with an illuminated double faced sign cabinet mounted to a masonry base with a reveal between the base and the cabinet.

Sign face is aluminum with “routed out” graphics backed with a translucent diffuser.

Illumination is by internal fluorescent lamping 225 mm (9”) on center.

Sign face is held within a hinged/ removable frame which will allow for replacement of the sign face without disassembly or abandonment of entire sign.

Sign is to be constructed to conform to UL requirements.

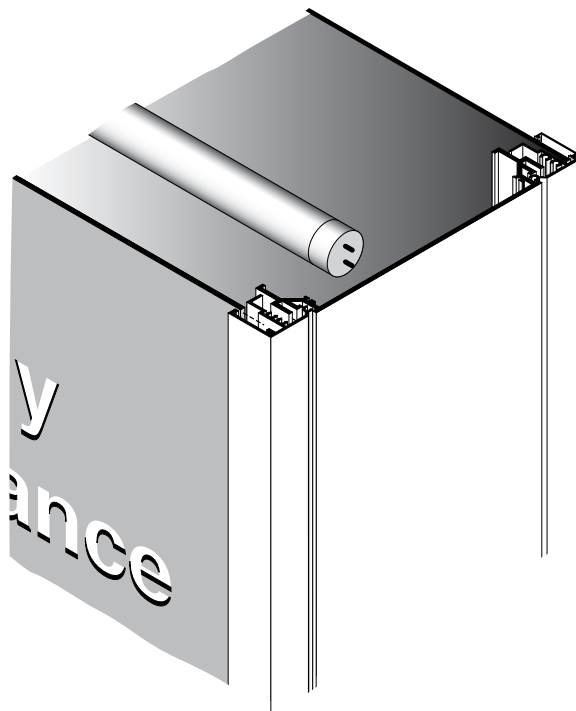

Detail 7

Internally Illuminated
Post & Panel Sign

This sign is constructed with an illuminated double faced sign cabinet mounted to extruded aluminum posts with an adjustable reveal between the posts and the cabinet.

Sign face is aluminum with “routed out” graphics backed with a translucent diffuser.

Illumination is by internal fluorescent lamping 225 mm (9”) on center.

Sign face is held within a hinged/ removable frame which will allow for replacement of the sign face without disassembly or abandonment of entire sign.

Sign is to be constructed to conform to UL requirements.

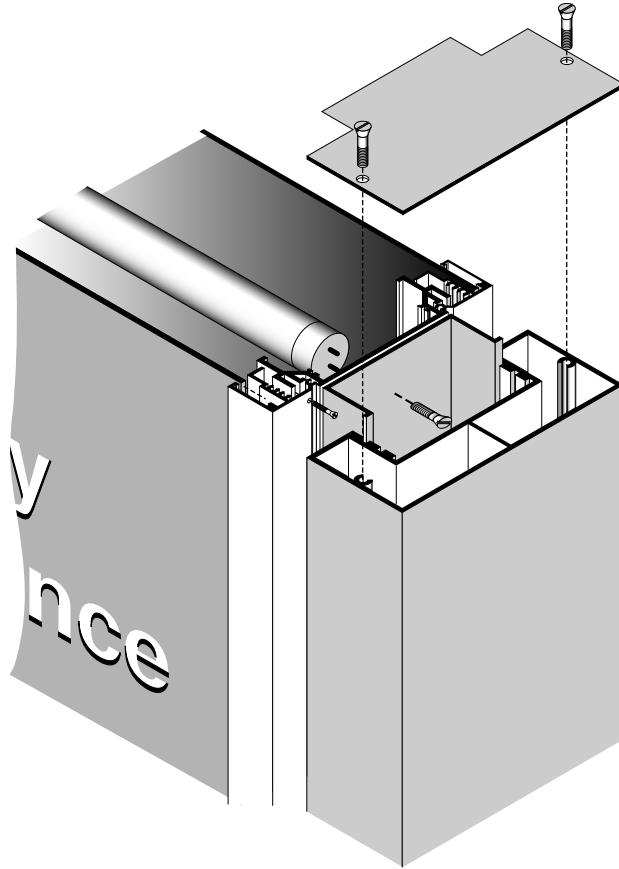

Detail 8

LED Internally Illuminated
Sign Cabinet

Current trends are to replace fluorescent lamping with LED lighting. The initial cost for LED's will cause the sign to be slightly more expensive, but over the life of the sign there will be considerable savings realized. The saving come in the form of lower energy costs and considerably less maintenance.

There are several systems and methods of installing LED lights in sign cabinets and all will work, but check with the sign company to make sure the system they are using will not result in pin prick hot light spots that will be visible through the sign's diffuser.

Sign is to be constructed to conform to UL requirements.

LED's attached to removable white aluminum panel

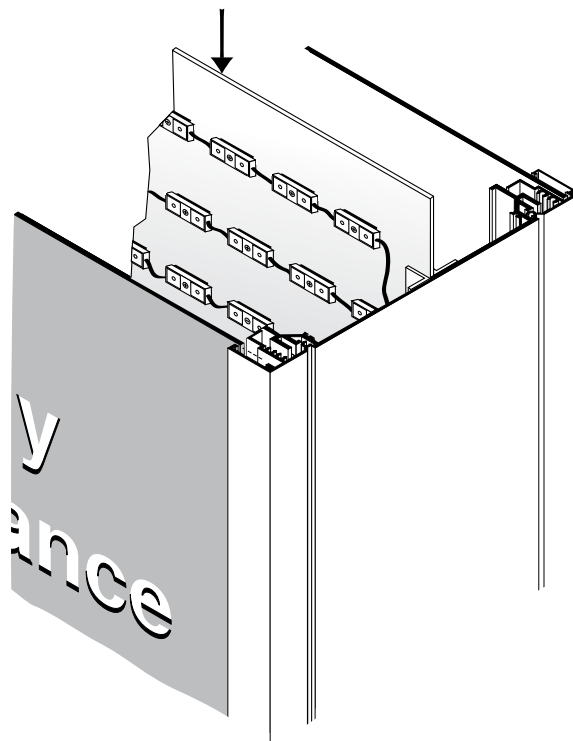

Detail 9

Internally Illuminated
Wall Mounted Sign

This sign is constructed with a single faced illuminated sign cabinet that can be mounted to a wall. A complete enclosed back is required.

Sign face is aluminum with "routed out" graphics backed with a translucent diffuser.

Illumination is by internal fluorescent lamping 225 mm (9") on center.

Sign face is held within a hinged/ removable frame which will allow for replacement of the sign face without disassembly or abandonment of entire sign.

Sign is to be constructed to conform to UL requirements.

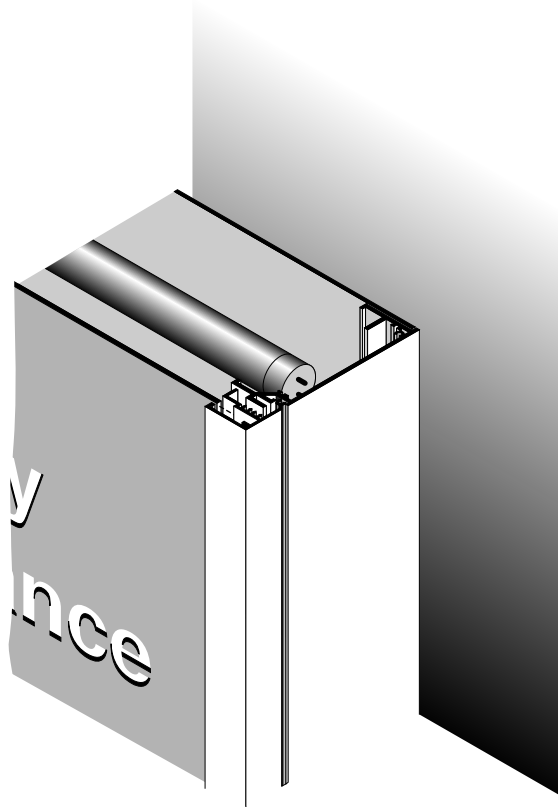

Detail 10

Internally Illuminated Sign
Electrical

Electrical connections to illuminated signs are to be made in a junction box that is located adjacent to the sign. Junction boxes are not to be installed on the sides of cabinets or mounted on posts.

Exposed conduit is not to be mounted to the exterior of sign cabinets or posts.

Sign is to be constructed to conform to UL requirements.

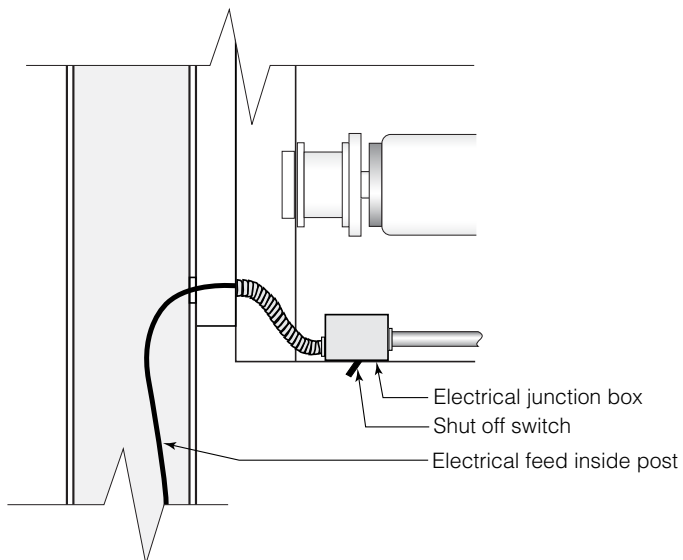

Detail 11

Internally Illuminated
Routed-out Graphics

Illuminated signs with routed out aluminum sign faces require white translucent diffusers.

The translucent acrylic or polycarbonate diffusers are to be mechanically fastened to the sign face.

Letter voids of all upper case letters "A B D O P Q R" and all lower case letters "a b d o p q r a b d e g o p q" and number voids "4 6 8 9 0" are to be **mechanically** fastened to the diffuser.

Diffusers are not to be installed on a sign face using any type of tape or adhesive system.

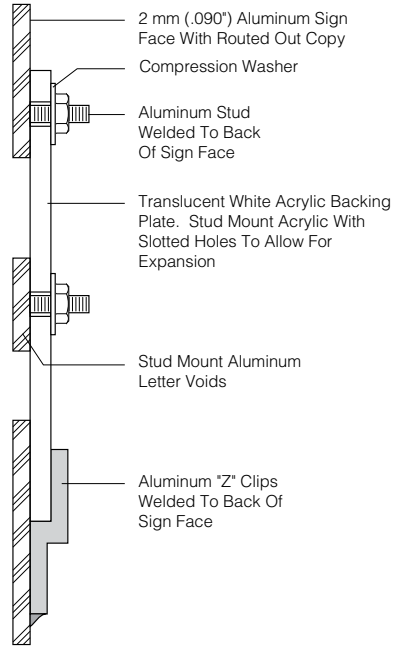

Detail 12

Internally Illuminated
4 Sided Monument Sign

This sign is constructed with an illuminated 4 faced sign cabinet mounted to a masonry base with a reveal between the base and the cabinet.

Sign face is aluminum with "routed out" graphics backed with a translucent diffuser.

Illumination is by internal metal halide lamping placed horizontally on center.

Sign face is held within a hinged/removable frame which will allow for replacement of the sign face without disassembly or abandonment of entire sign.

Sign is to be constructed to conform to UL requirements.

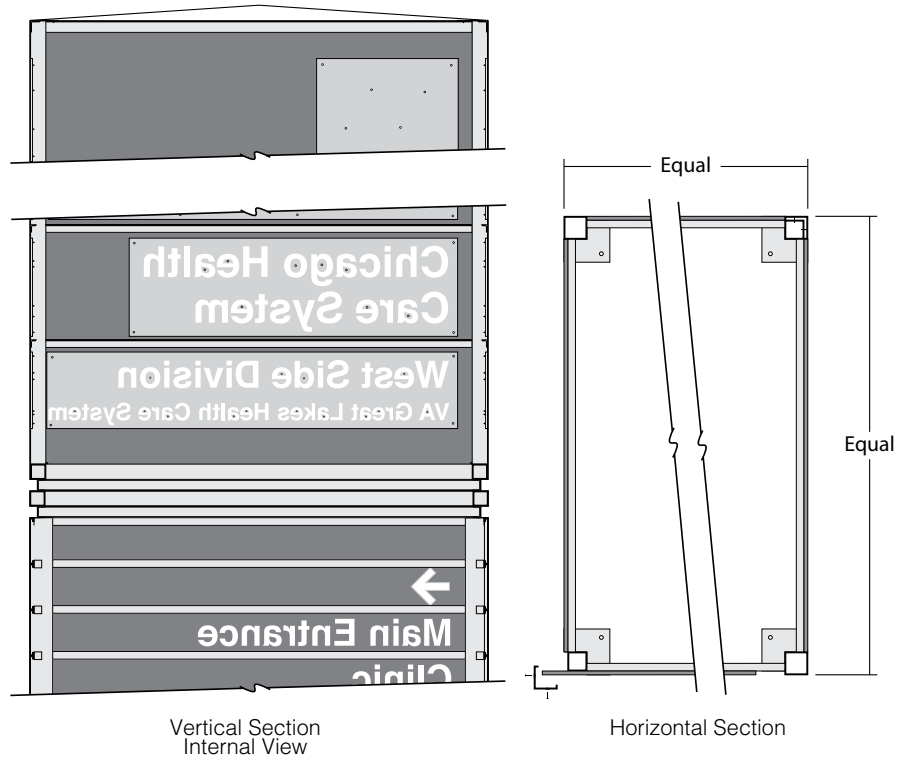

Detail 13

Non-illuminated Post & Panel Sign

This sign is constructed with a non-illuminated sign cabinet mounted to extruded aluminum posts with an adjustable reveal between the posts and the cabinet.

The sign cabinet extrusion should have the capability to hold the sign faces and allow for the removal and replacement of faces without total sign disassembly or abandonment of the sign.

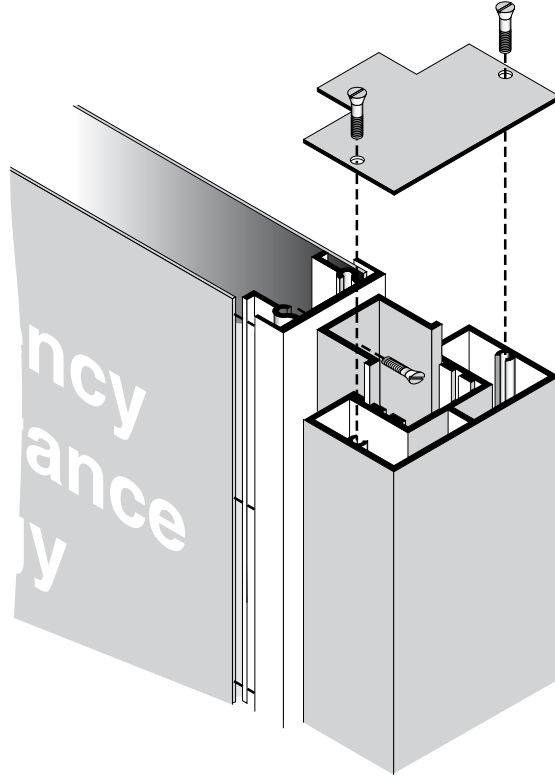

Detail 14

Non-illuminated Post & Stacking Bar Sign

This sign is constructed with a series of aluminum tubes mounted to extruded aluminum posts with an adjustable reveal between the posts and the stacking tubes.

Tubes are to be flush and touching with no gaps between them.

Sign is constructed in a manner that will allow the removal or addition of faces at a future time.

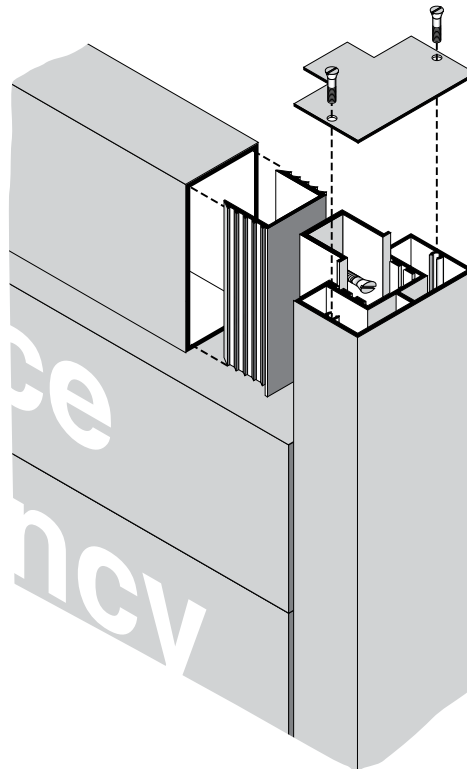

Detail 15

Internally Illuminated Strip Sign

A stacking strip illuminated sign incorporates individual extruded aluminum strips that enable the panels to be removed and rearranged as necessary.

The sign is constructed similar to the internally illuminated monument or post and panel sign.

The graphics on the strips are constructed in the same manner as an internally illuminated sign face.

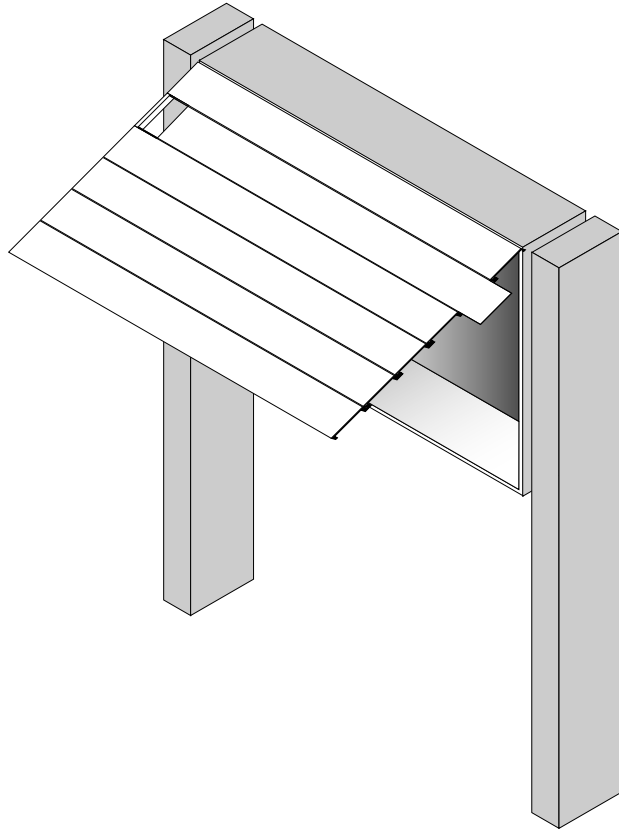
**Detail 16**Internally Illuminated
Changeable Strips

Modular illuminated sign strip extrusions are to be interlocking in such a manner as to prevent light leaks and also provide flexibility for replacement and rearrangement.

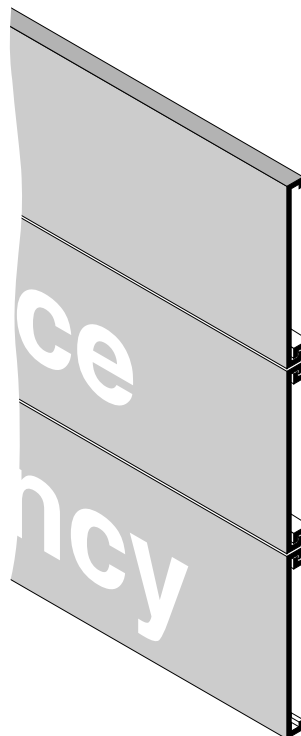

Detail 17

Exterior Sign Utilizing Component Assembly

The illustration shows how a sign is assembled which is constructed using an aluminum extrusion system of component parts. Several manufacturers build signs in this manner and this approach allows for simplified manufacturing and a consistent appearing product.

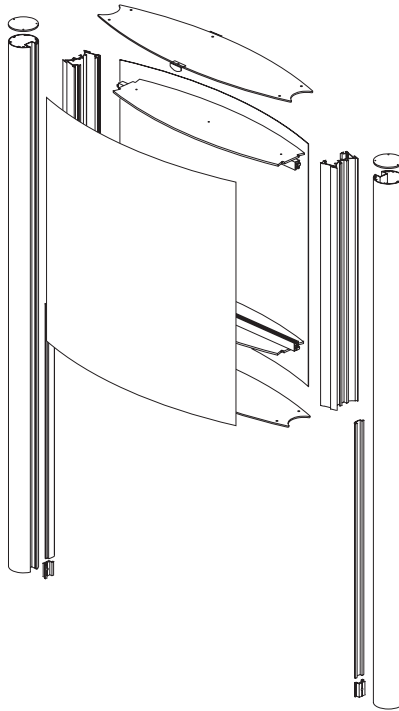

Detail 18

The exploded view illustration shows how an exterior component based sign can be installed to allow for simple future modifications or updating.

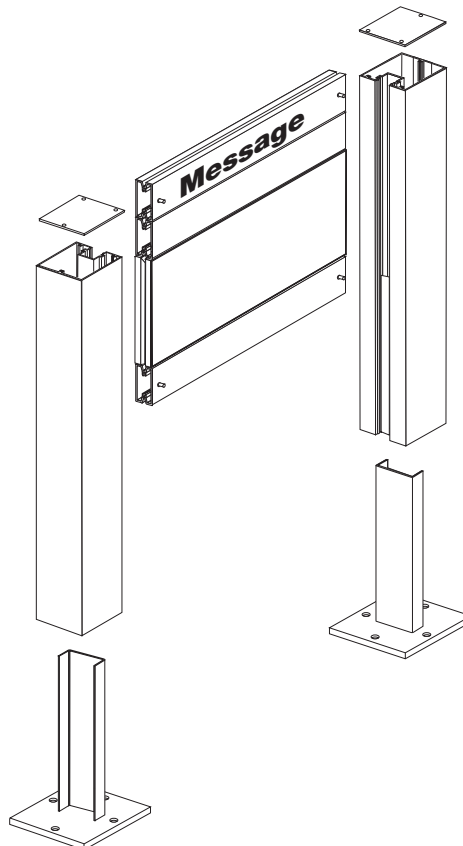

Detail 19

Basic aluminum post and panel sign.

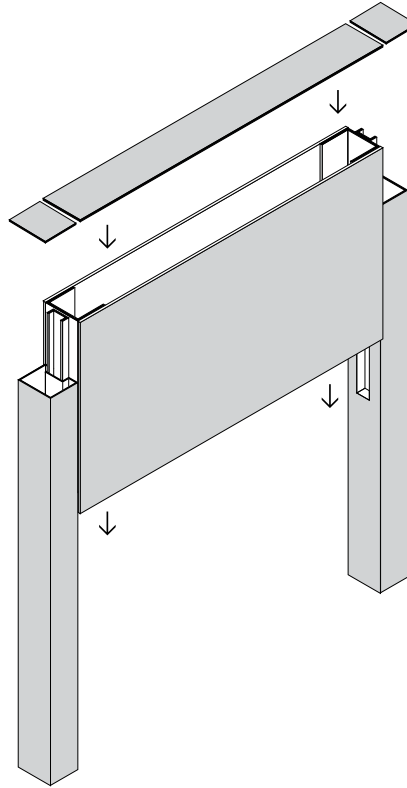

Detail 20

The simplest form of a post and panel sign.

While this basic sign is functional and inexpensive, it is critical the the sign face be a thick aluminum panel that will bend or twist.

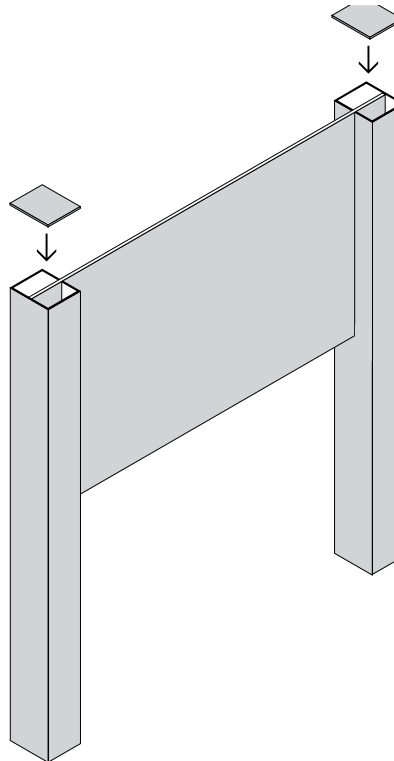

Detail 23

Fluorescent light assembly

The drawings illustrate the use of fluorescent lamping for illuminated signs.

Vertical or horizontal lamp arrangements are usually selected based upon the sign cabinet size and shape. Typically common size of bulbs are used that fit the shape and enable even placement of tubes. Normal bulb spacing is approximately 9" on center.

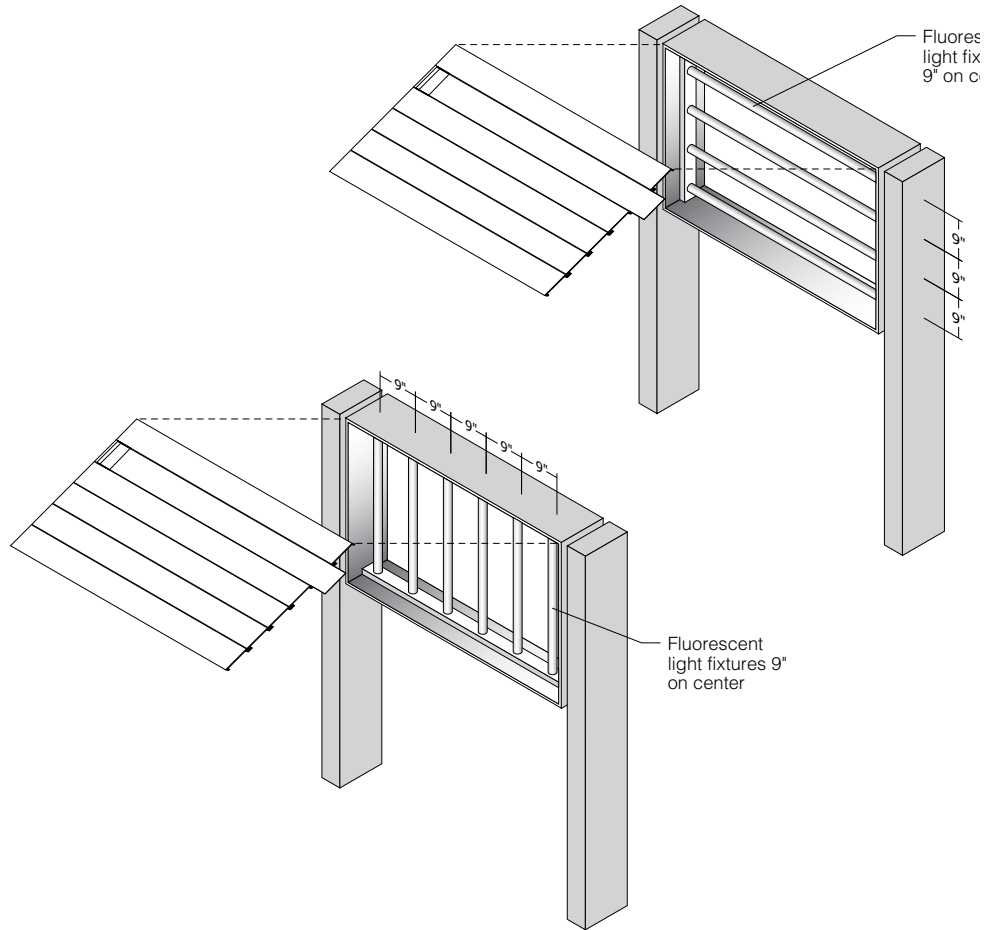

Detail 24

Non-illuminated Wall Mounted Sign

This sign is constructed with an aluminum panel mounted into an extruded aluminum frame configured for wall mounting.

Sign face is held within a frame which will allow for replacement of the sign face without disassembly or abandonment of entire sign.

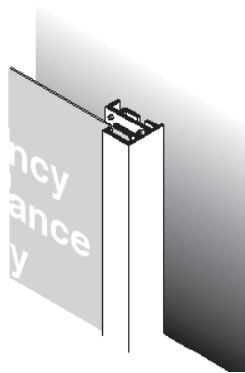
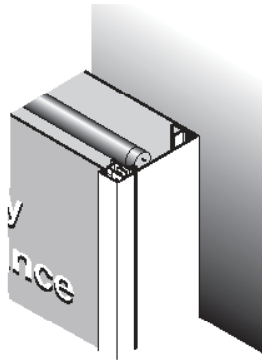

Detail 25

Single Post & Panel Sign

Aluminum sign panel mounted to a square aluminum post with tamper proof mechanical fasteners.

Sign panels have the corners eased with a 6 mm (0.25") radius. The post shall have a permanent top cap.

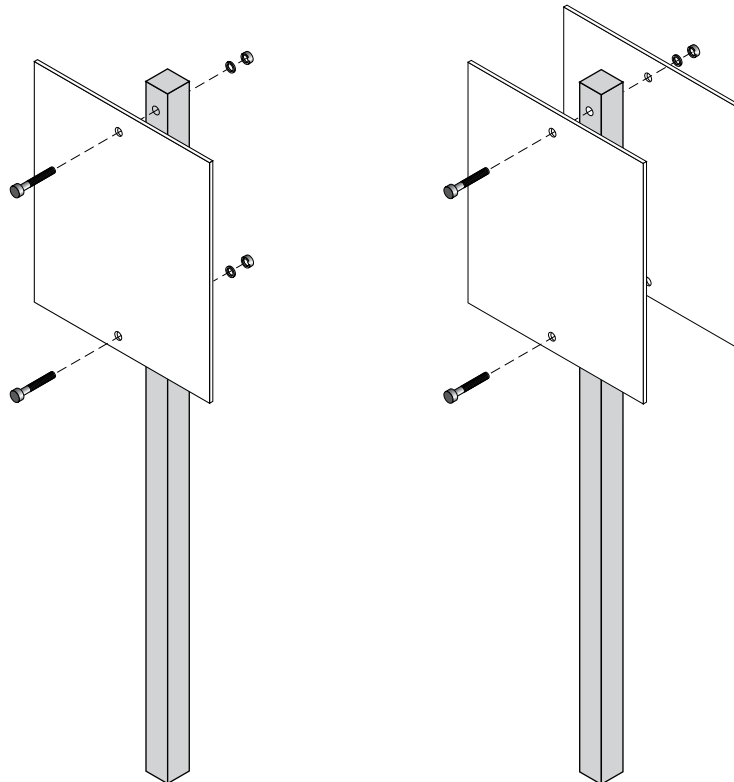

Detail 26

Traffic sign mounted to a round post

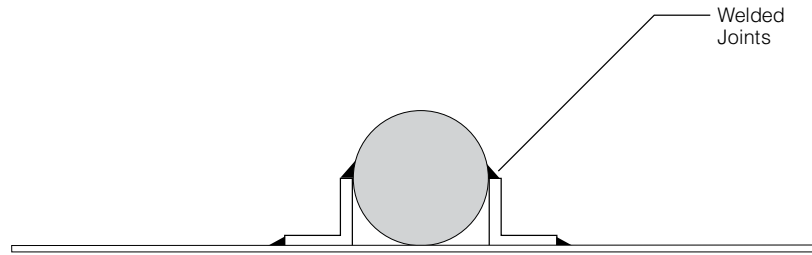

Detail 27

Street Identification Sign

Cast or fabricated aluminum post cap configured to hold aluminum name panel.

For double bladed signs there is a cast or fabricated aluminum connector that is mounted to the lower blade and holds the upper blade.

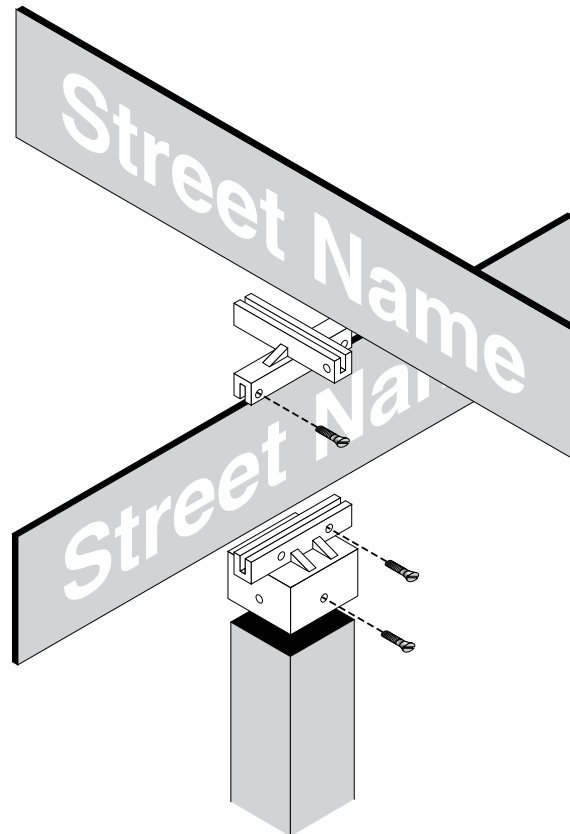

**Detail 28
Face Illuminated
Letters**

Face Illumination with LED's

Installation of these letters should be done only by a licensed electrical sign company.

Consult with a local electrical sign company regarding the wall surface, accessibility and method of installation.

LED GENERAL GUIDE LINES

LED's to be UL recognized and carry the UL label

Rated life of LED's to exceed 40,000 hours

Color temp to match 5000k to 6500k

Low voltage 12v system

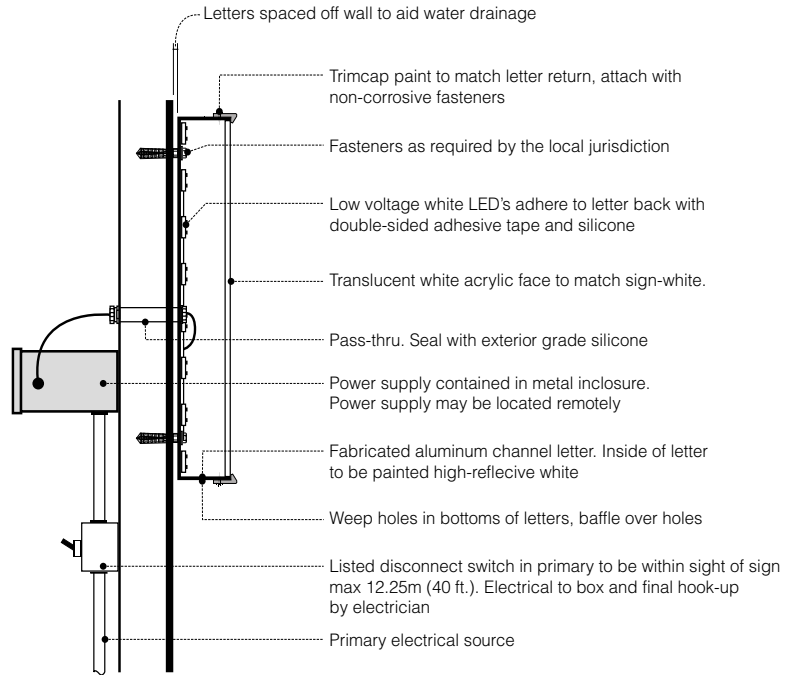

SECTION DETAIL

**Detail 29
Halo Illuminated
Letters**

Halo Illumination with LED's

Installation of these letters should be done only by a licensed electrical sign company.

Consult with a local electrical sign company regarding the wall surface, accessibility and method of installation.

Low voltage 12v system

LED Guidelines

LED's to be UL recognized and carry the UL label

Rated life of LED's to exceed 40,000 hours

Color temp to match 5000k to 6500k

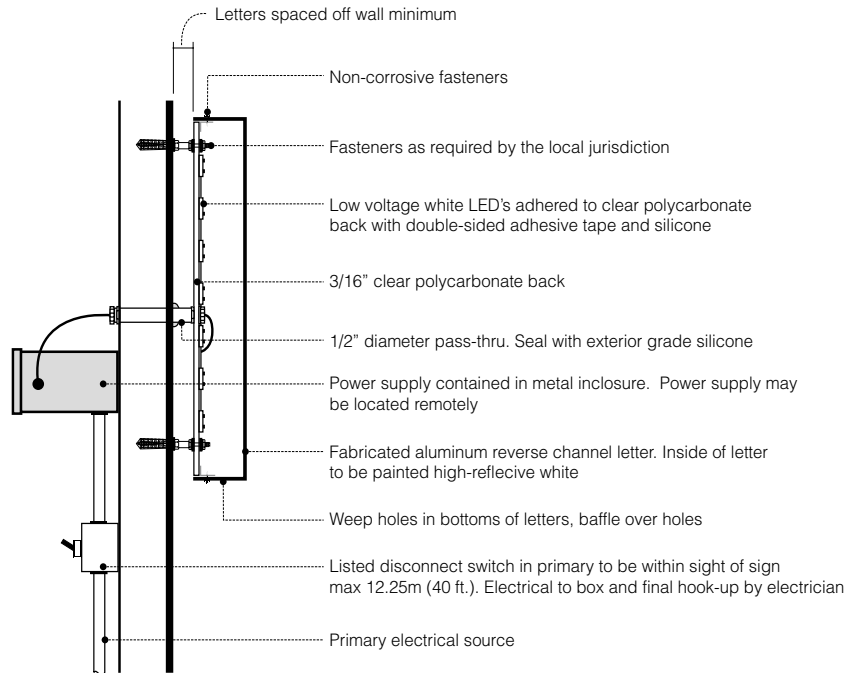

SECTION DETAIL

Detail 30

Illuminated Letters & Logo

Fabricated metal letters and logo are intended for use on exterior building applications.

These letters are custom fabricated to meet the size, illumination and mounting requirements for the intended location on a building. Clear access is required to backs of the letters to allow installation of electrical connections and for maintenance.

Consult with a local exterior electrical sign company regarding these letters, their construction and installation requirements before ordering illuminated letters.

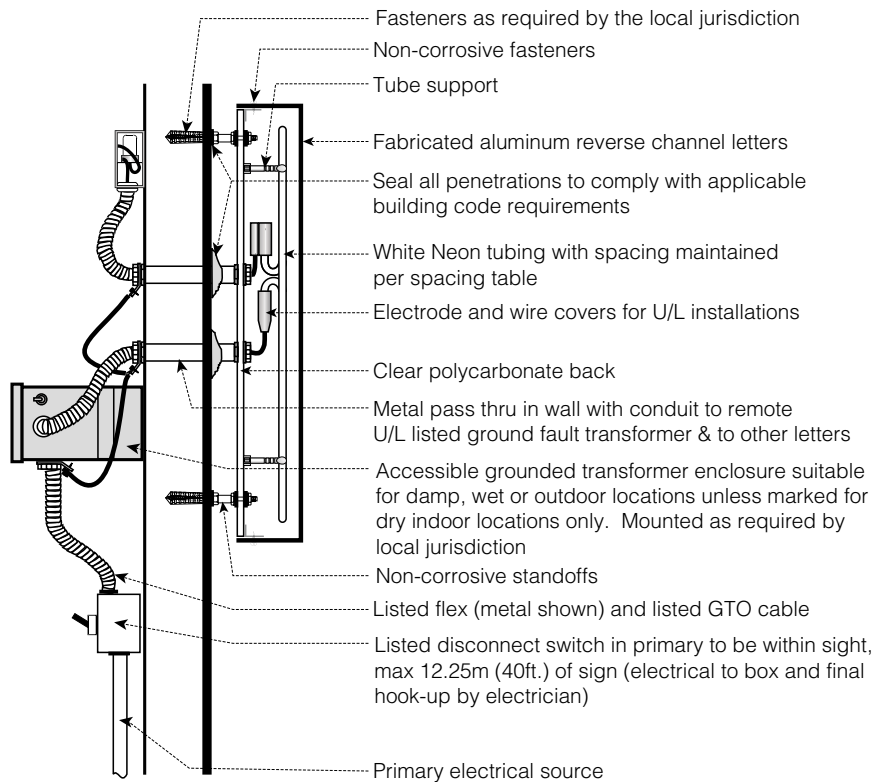

SPACING TABLE

- A. Between insulated high voltage and 1)primary wiring and 2)dead metal where dead metal parallels high voltage wiring for more then 25mm(1") in length.
- B. Between neon tubing and nearest surface.
- C. Between uninsulated high voltage parts and 1) dead metal and 2) insulated high voltage or supply conductors.
- D. Between uninsulated high voltage parts and 1) other uninsulated high voltage parts and 2) uninsulated supply and low voltage parts.

Voltage	A	B	C	D
1001 to 5000	13 mm (1/2")	6 mm (1/4")	19 mm (3/4")	25 mm (1")
5001 to 10000	19 mm (3/4")	6 mm (1/4")	29 mm (1 1/8")	38 mm (1 1/2")
10001 to 15000	25 mm (1")	6 mm (1/4")	38 mm (1 1/2")	54 mm (2")

Detail 31

Fabricated Metal Letter & Logo

Fabricated metal letters and logo are intended for use on exterior building applications.

These letters would be typically custom fabricated relative to the placement position on a building.

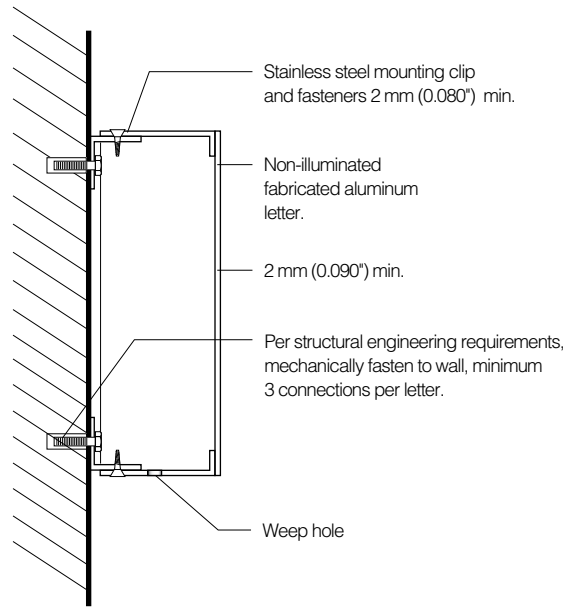

This page is intentionally left blank

The installation of exterior signs requires coordination of several criteria. Careful consideration should be given to the following:

- Criteria**
- Character and configuration of the roadway system.
 - Desired path of travel on the roadway system for visitors, staff and deliveries.
 - Location of buildings on the facility campus in relation to roads, parking, and walkways.
 - Location of building entrances.
 - Weather such as wind and snow.
 - Utilities and landscaping.
 - Adequate light on and around directional signs.
 - Placement of signs in locations where people are expecting them to be.

Visibility These elements help establish the basis of a clear sign program.

Exterior signs function to communicate to both drivers and pedestrians and their placements need to be planned relative to the intended viewer. Sign visibility to the user is the principal objective and is the basis of correct sign placement.

Readability Signs that are to be read from a car moving down a road need to be installed in locations that provide for clear readability without obstructions.

Equally important is the installation of signs, taking into account the potential effects on drivers. Signs with too much information can cause a driver to stop or slow to a very low speed, thus creating a traffic hazard.

Coordination Coordination needs to take place with things like irrigation systems, electrical service and other underground utilities.

Climate Every site has different climate conditions that effect an exterior sign program. Wind load on signs effects the footing requirements. Considerations for snowfall and frost line will also have an impact on post length and footing depth.

Footing Within this installation section of the guide there is a table to provide assistance in determining the size of a footing for various signs. This is a general guide and structural engineering maybe required to adequately confirm that a particular footing will be adequate for a sign in the required conditions, at site or sign location.

Engineering Structural engineering should be consulted to ensure building walls can adequately support large “skyline letters and logo” before having them fabricated. Monument signs should also have their bases designed by a structural engineer to ensure the signs can withstand wind loads in the signs location.

Mounting Sign mounting methods have been standardized to create visual uniformity for all signs placed around a facility. Mounting heights and locations have been determined for ease of reading.

There are two principal methods of mounting signs. These are:

- Ground Mounted: Placing a sign panel on one or more posts fixed in the ground or sign cabinets mounted to masonry or concrete bases.
- Wall Mounted: Placing a sign on a vertical surface such as the wall or door of a building or fence.

Viewing Each type of sign utilizes a mounting method appropriate to the viewing requirements.

During the course of installation, always ensure that the signs are positioned with a clear line-of-sight from the viewing point to the sign face.

Planning A sign program for a campus that works well is one that has been planned as an integrated whole. All the way from the main identification sign, directional signs, building and building entrance identification through to the parking lot signs. Proper placement is part of a well-planned program.

Placement: Ground Mounted Signs

All signs should be located a minimum of 600 mm (2'-0") from the curb. The exact location of a sign will vary depending on the type of sign and site conditions.

Sign placement must be carefully considered to ensure that the sign fits the location without major regrading. It may be necessary to clear some shrubs or bushes or relocate an obstruction.

When ground mounted signs on two posts are placed on sloping or inclined grades, adjustments must be made to the post lengths. Extreme differences between post lengths should be minimized.

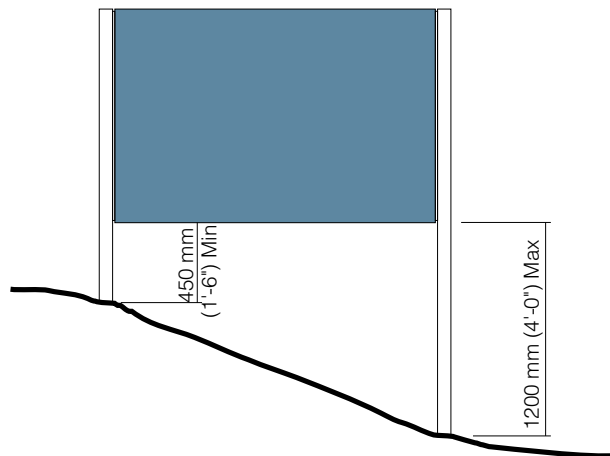
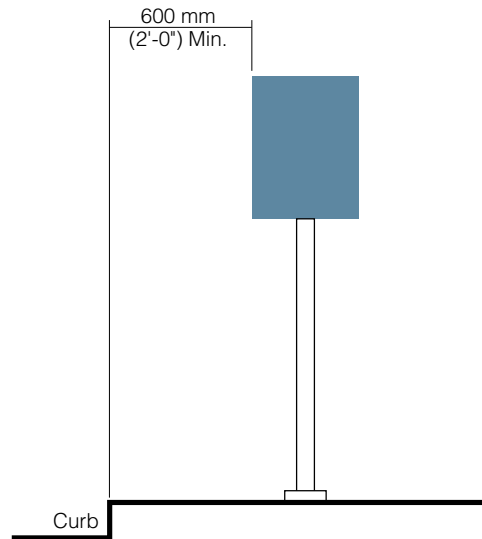
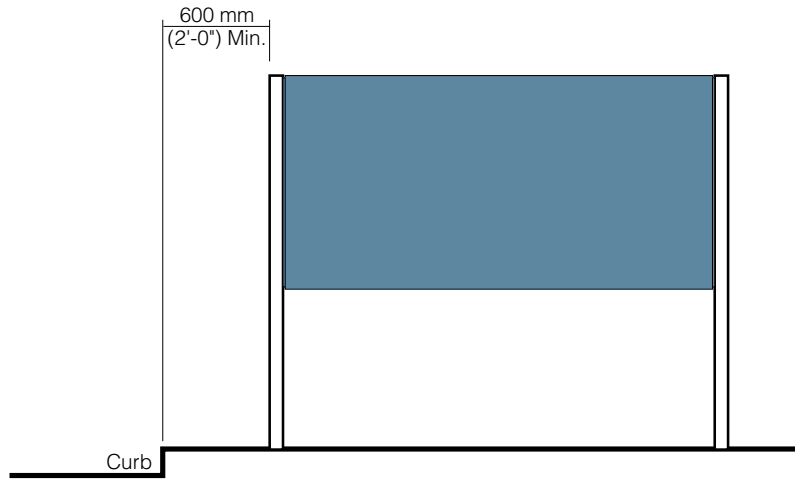

Placement: Wall Mounted Signs

Signs are placed to alert and inform in sufficient time to avoid a hazard or take appropriate action. They should be sized for easy reading from the viewing distance required.

A sign that is too small will be lost. Conversely, an overly large sign can overwhelm an area.

Signs should be placed where they will not create distractions. Care should be taken to avoid grouping too many signs together in one location.

Small sign panels placed for close viewing are appropriately placed at eye level. Larger signs posted in big spaces or for viewing at greater distances should be placed proportionally higher.

Signs should not be placed where objects may obscure them.

Before ordering a sign, place a cardboard panel in the proposed location to verify the size and placement location.

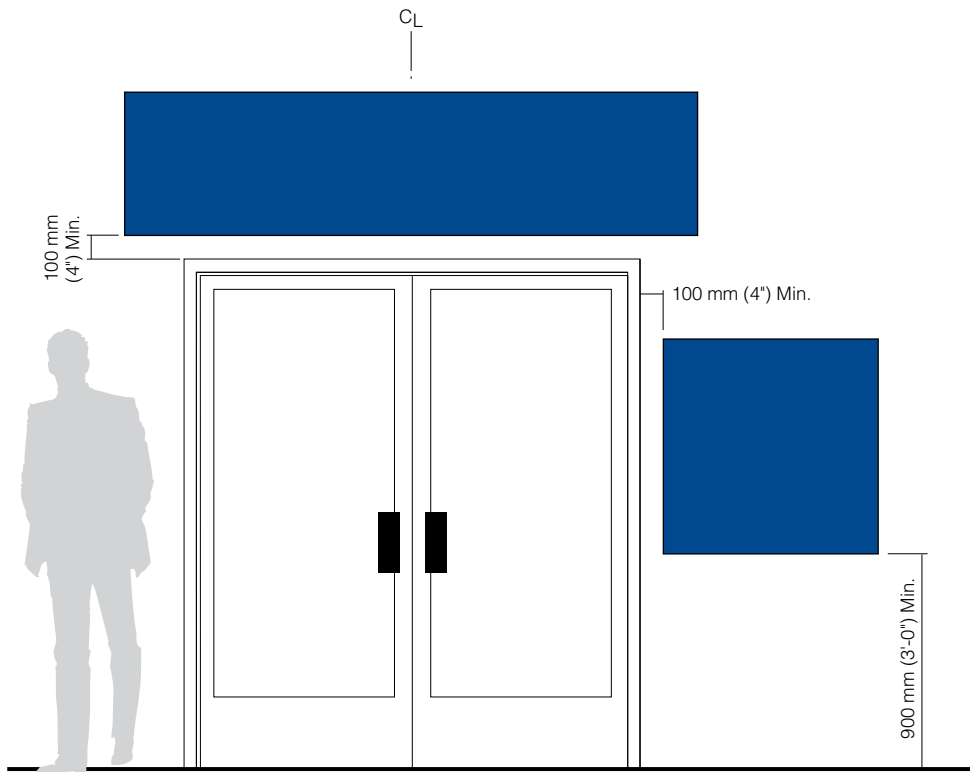
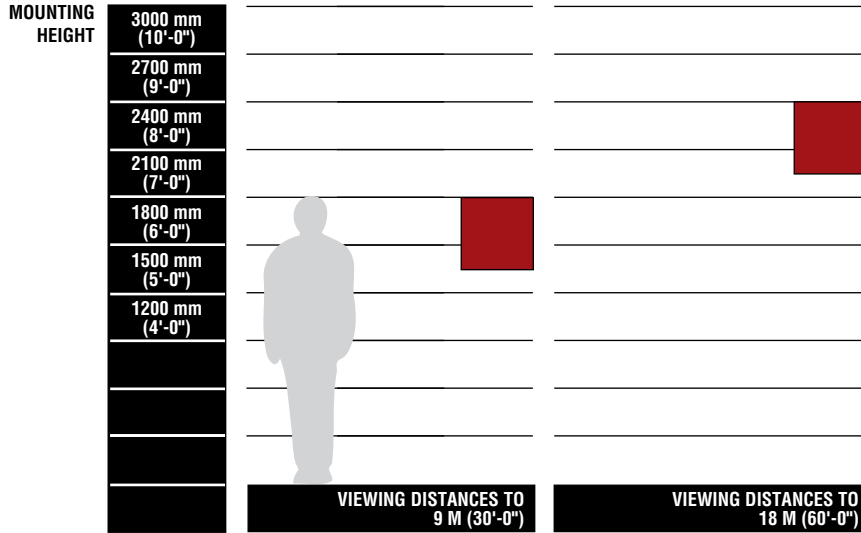

**Placement:
Parking Stall
Identification**

This illustration indicates the location of single post & panel signs in relationship to both handicapped and standard parking stalls.

Signs should be visually centered to the driver/vehicle at the head of the stall.

Make sure that the sign post cannot be struck by the bumper of a vehicle.

If an area of parking stalls are being signed with the same message, the number of signs can be reduced. A single sign can be used to label multiple stalls. A good guide is 1 sign for every 2 or 3 stalls. One sign for 4 stalls will not work because the sign will be too far from a driver's vision.

For handicapped parking stalls it is best to provide a sign for each individual stall and then there is no opportunity for confusion.

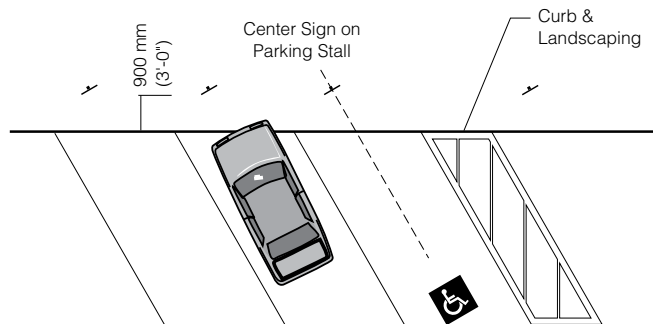
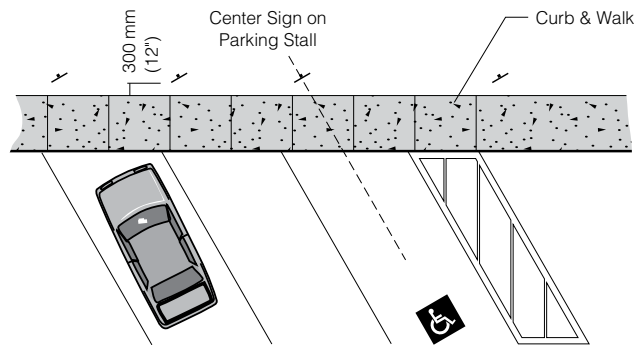
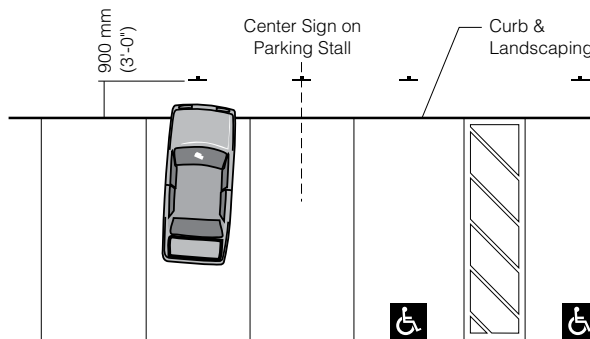
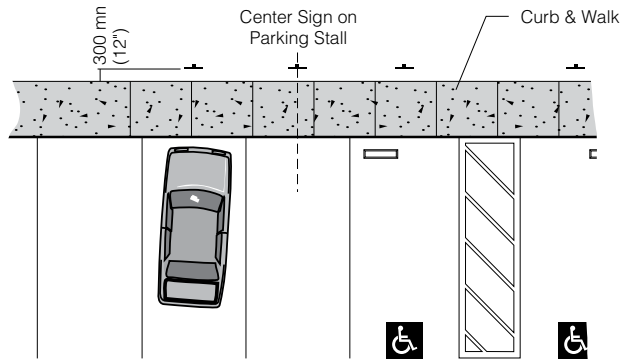

Placement: Sight Triangle at Intersections and Driveways

For safety reasons, signs should not be placed in the sight triangle (shaded area) where they could obscure a driver's vision. Also, make sure that a sign's location is not blocking a driver's vision of pedestrians.

Ensuring that there are no signs in the sight triangle applies to roadway intersections as well as driveways.

Traffic regulatory signs are an exception to this rule. Traffic regulatory signs such as STOP and YIELD signs should be placed at the point at which compliance is to be made.

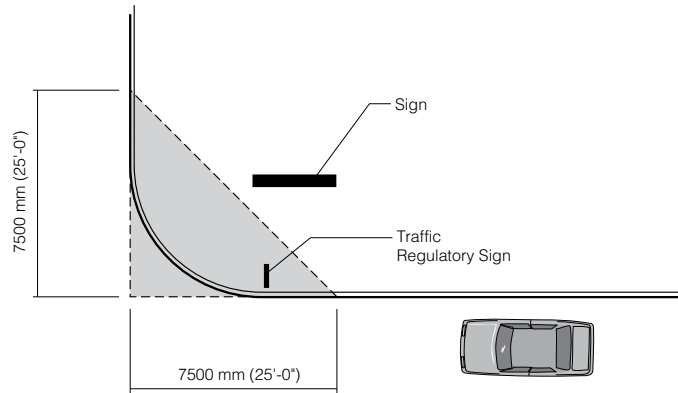

No sign to be installed in this area except traffic regulatory signs

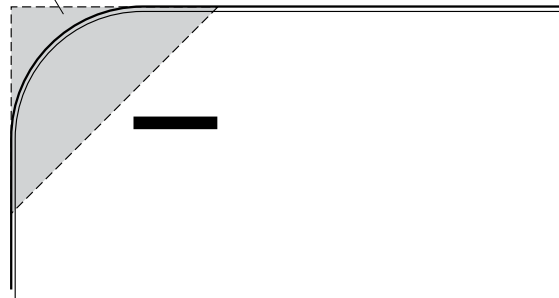

Footings: Size Configurations

Footing depth requirements vary from location to location and size of sign.

A large sign requires a larger diameter and deeper footing or base to withstand higher wind loads. Poor soil compaction will also require larger footings.

The depth of winter frost penetration also effects the size of footing required.

Locate your area of the country on the map and then refer to the chart to determine the size of footings required for the various sizes of signs.

It is recommended for Sign Types EI-01.01, EI-01.02, EI-01.04 and EI-01.05, the sign base be designed by a licensed structural engineer providing "sealed and signed" drawings. This is to ensure that the base will structurally support the sign taking into account wind loads, the type of soil, and winter frost penetration.

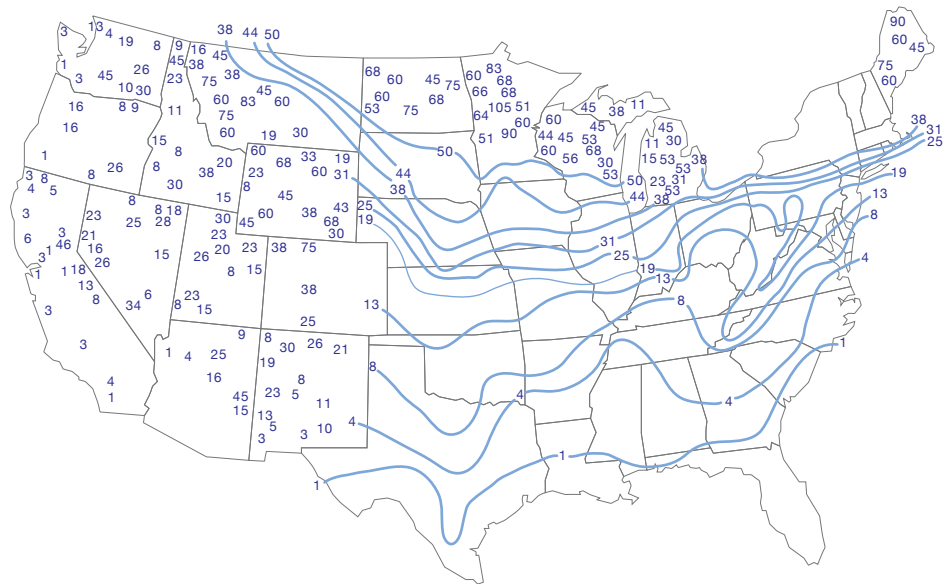

Footing Configuration Chart

Number Of Posts	Sign Panel Height	Sign Panel Width	Sign Panel Sq. Ft.	Overall Sign Height	0"-30" Frost Depth		30"-36" Frost Depth		36"-48" Frost Depth	
					Footing Cross Section	Footing Depth	Footing Cross Section	Footing Depth	Footing Cross Section	Footing Depth
1	1'-6"	1'-0"	1.5 sq ft	6'-0"	1'-6"	2'-6"	1'-6"	3'-0"	1'-6"	4'-0"
1	2'-0"	1'-6"	3 sq ft	6'-0"	1'-6"	2'-6"	1'-6"	3'-0"	1'-6"	4'-0"
1	2'-6"	2'-0"	5 sq ft	6'-0"	1'-6"	2'-6"	1'-6"	3'-0"	1'-6"	4'-0"
2	2'-0"	2'-0"	4 sq ft	5'-0"	1'-6"	2'-6"	1'-6"	3'-0"	1'-6"	4'-0"
2	2'-0"	3'-0"	6 sq ft	5'-0"	1'-6"	2'-6"	1'-6"	3'-0"	1'-6"	4'-0"
2	3'-0"	3'-0"	9 sq ft	5'-6"	1'-6"	2'-6"	1'-6"	3'-0"	1'-6"	4'-0"
2	3'-0"	4'-0"	12 sq ft	5'-6"	1'-6"	2'-6"	1'-6"	3'-0"	1'-6"	4'-0"
2	4'-0"	3'-0"	12 sq ft	6'-6"	1'-6"	2'-6"	1'-6"	3'-0"	1'-6"	4'-0"
2	4'-0"	6'-0"	24 sq ft	6'-0"	1'-6"	4'-0"	1'-6"	3'-0"	1'-6"	4'-0"
2	4'-0"	6'-0"	24 sq ft	6'-6"	1'-6"	4'-0"	1'-6"	3'-0"	1'-6"	4'-0"
2	4'-0"	8'-0"	32 sq ft	6'-6"	1'-6"	4'-0"	1'-6"	4'-0"	1'-6"	4'-0"
2	6'-0"	5'-0"	30 sq ft	8'-6"	1'-6"	4'-0"	1'-6"	4'-0"	1'-6"	4'-0"

**Footing:
Metric Size
Configurations**

Number Of Posts	Sign Panel Height	Sign Panel Width	Sign Panel Sq. M	Overall Sign Height	0-762 Frost Depth		762-915 Frost Depth		915-1220 Frost Depth	
					Footing Cross Section	Footing Depth	Footing Cross Section	Footing Depth	Footing Cross Section	Footing Depth
1	450 mm	300 mm	.1 sq M	1800 mm	450 mm	750 mm	450 mm	900 mm	450 mm	1200 mm
1	600 mm	450 mm	.2 sq M	1800 mm	450 mm	750 mm	450 mm	900 mm	450 mm	1200 mm
1	750 mm	600 mm	.5 sq M	1800 mm	450 mm	750 mm	450 mm	900 mm	450 mm	1200 mm
2	600 mm	600 mm	.4 sq M	1500 mm	450 mm	750 mm	450 mm	900 mm	450 mm	1200 mm
2	600 mm	900 mm	.5 sq M	1500 mm	450 mm	750 mm	450 mm	900 mm	450 mm	1200 mm
2	900 mm	900 mm	.8 sq M	1650 mm	450 mm	750 mm	450 mm	900 mm	450 mm	1200 mm
2	900 mm	1200 mm	1.1 sq M	1650 mm	450 mm	750 mm	450 mm	900 mm	450 mm	1200 mm
2	1200 mm	900 mm	1.1 sq M	1950 mm	450 mm	750 mm	450 mm	900 mm	450 mm	1200 mm
2	1200 mm	1800 mm	2.2 sq M	1800 mm	450 mm	1200 mm	450 mm	900 mm	450 mm	1200 mm
2	1200 mm	1800 mm	2.2 sq M	1950 mm	450 mm	1200 mm	450 mm	900 mm	450 mm	1200 mm
2	1200 mm	2400 mm	2.9 sq M	1950 mm	450 mm	1200 mm	450 mm	1200 mm	450 mm	1200 mm
2	1800 mm	1500 mm	2.7 sq M	2550 mm	450 mm	1200 mm	450 mm	1200 mm	450 mm	1200 mm

**Footings:
Post & Panel Signs**

All footings must meet width and depth requirements to accommodate height and size of sign, soil conditions, wind loads and winter ground freezing.

Style 1
Permanent installation in landscaped areas.

Signs installed in grass can have the raised concrete collars extended to cover the area between posts.

Style 2
Permanent installation in paved areas. Either core drill or surface mount.

Style 1

In landscaped areas, footing shall be boxed so as to extend 90mm (3 1/2") above grade with 50mm (2") bevel. Replace surrounding landscaping to original condition.

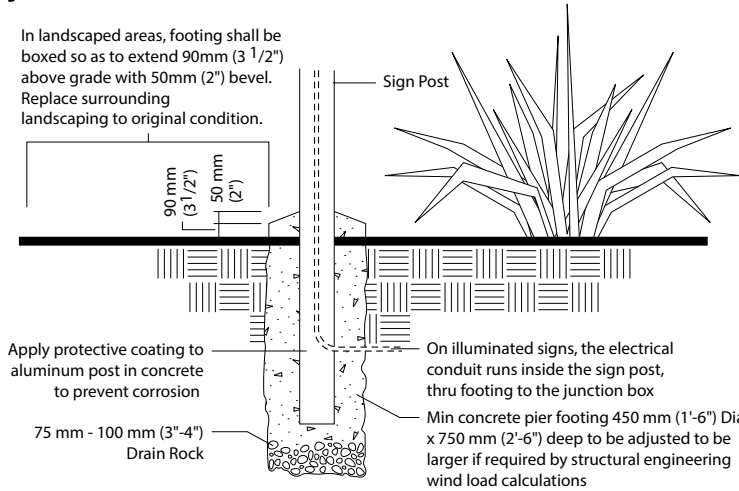

**Style 2
Core Drill**

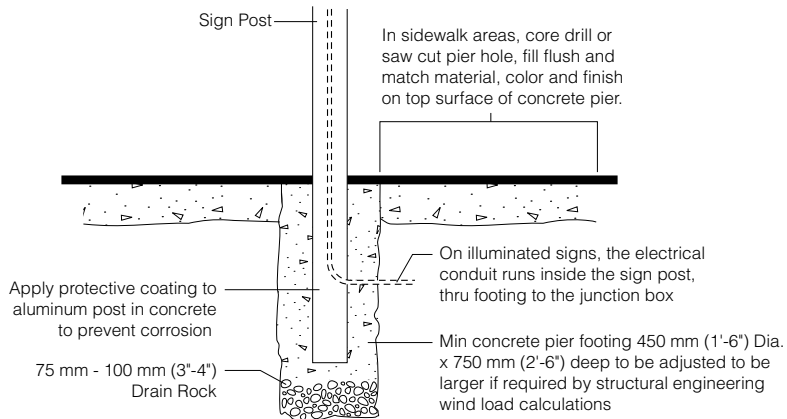

**Style 2
Surface Mount**

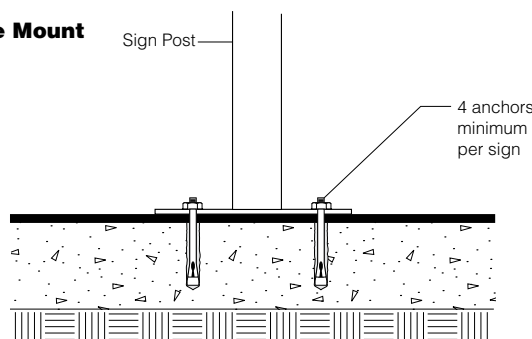

Footings: Post & Panel Signs

All footings must meet width and depth requirements to accommodate height and size of sign, soil conditions, wind loads and winter ground freezing.

Style 3
Semi-permanent installation in landscaped areas.

Use this type of installation when it is known that a sign will need to be removed or replaced in the near future.

Signs installed in grass can have the raised concrete colors extended to cover the area between the posts.

Style 4
Semi-permanent installation.

Use this type of installation when it a sign will need to be removed or replaced in the near future.

Style 3

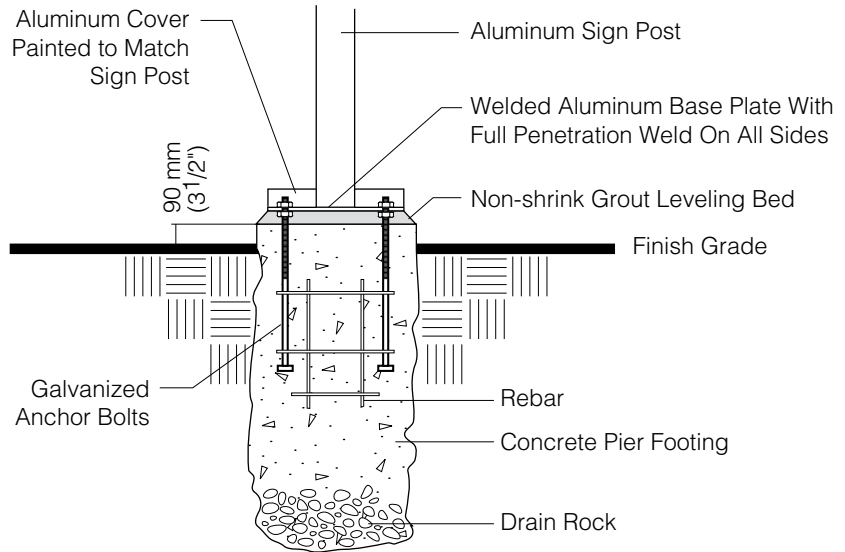

Style 4

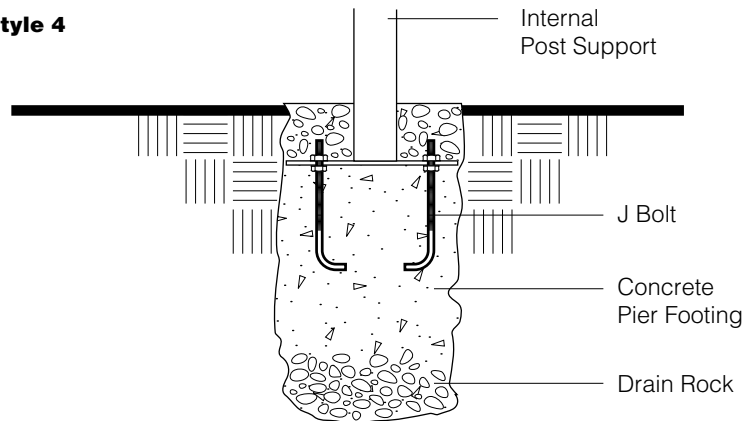

Mounting: Non-illuminated Letters

Metal letters that are installed on the exterior of the building should be done with spacers behind the letters. This will allow for rain to run down the building surface without creating streaking under the letters.

The size and length of the studs are to correlate to the size of the letter and the depth that is required for installation on a particular building surface.

Plaster and stucco building surfaces should have complete adhesive sealant application around the stud, where it penetrates the building, to prevent water intrusion into the building.

Letters that are installed on wall surfaces below 2438 mm (8 feet) should be installed flush to the wall with no spacers and additional adhesive applied to the back of the letters. This will increase the security of the letters against vandalism or theft.

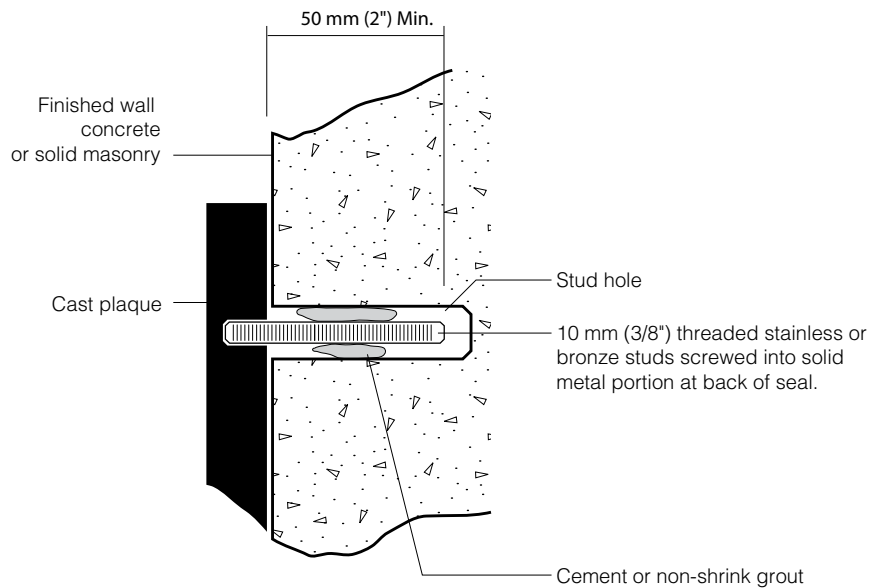
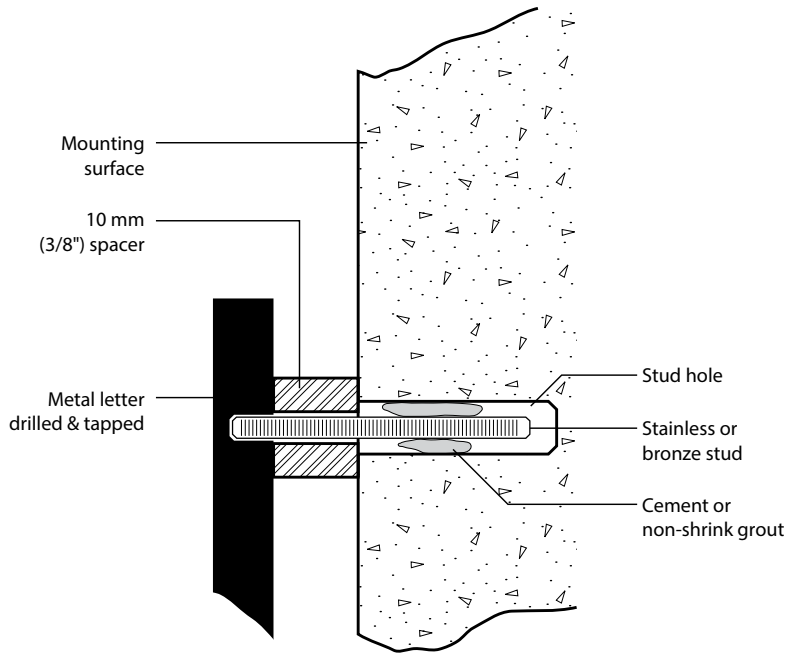

**Mounting:
Non-illuminated
Fabricated Metal
Letters**

Fabricated metal letters that are installed on the exterior of the building should be done with slight space between the letter and the wall. This will allow for rain to run down the building surface without creating streaking under the letters.

Plaster and stucco building surfaces should have complete adhesive sealant application around the mounting clip, where its fastener penetrates the building. This is to prevent water intrusion into the building.

Letters that are installed on wall surfaces below 2438 mm (8 feet) should be installed with tamperproof fasteners. This will increase the security of the letters against vandalism or theft.

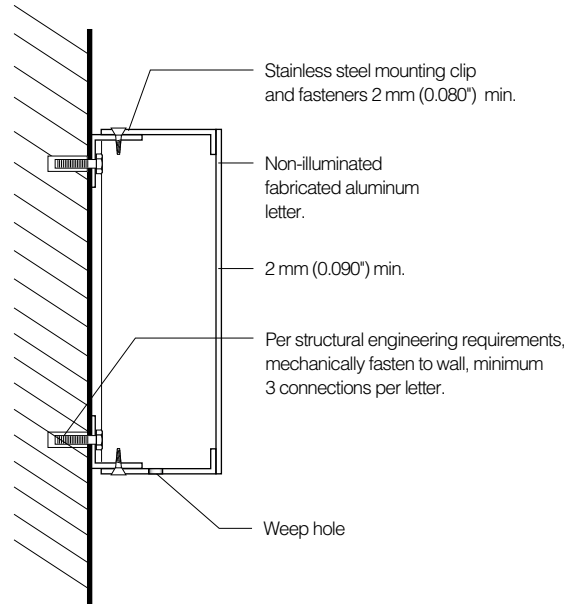

**Mounting:
Illuminated Letters**

Installation of these letters should be done only by a licensed electrical sign company.

Consult with a local electrical sign company regarding the wall surface, accessibility and method of installation.

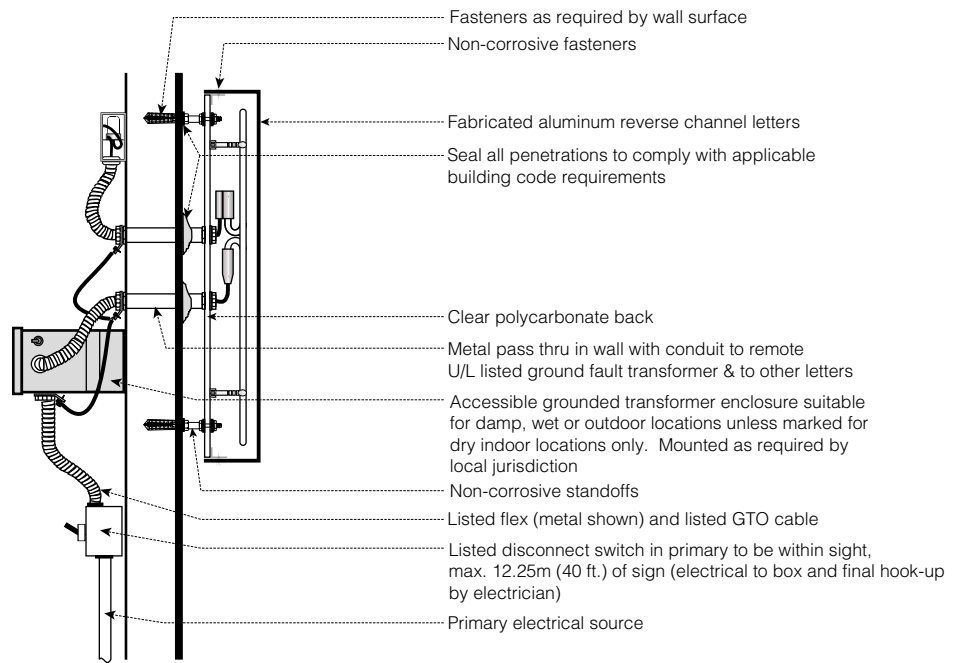

Wall Mounting: Non-Illuminated Signs

Aluminum wall panel signs shall be fastened with a minimum of 2 mechanical fasteners.

Anchors should be provided in the wall that are suitable for the particular type of wall surface where the sign is being installed.

