

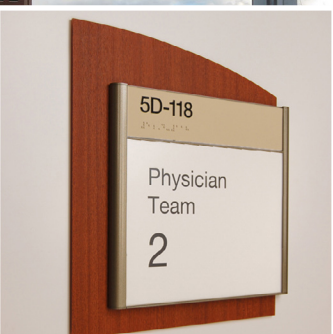

U.S. Department
of Veterans Affairs

VA Signage Design Guide

Veterans Health Administration Washington, DC 20420

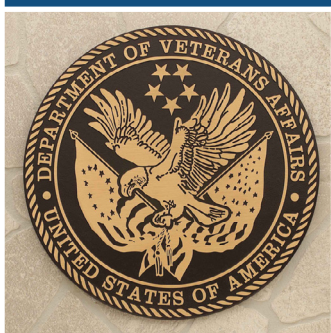

This page is intentionally left blank.



U.S. Department
of Veterans Affairs

VA Signage Design Guide

December 2012



Trim width of
paper to match
spine width of
binder pocket.

This page is intentionally left blank.

VA Signage Design Guide

- Introduction
- Acknowledgments
- Design Elements Section 1
- Need a New Sign Program Section 2
- Room Renumbering Section 3
- Exterior Signs Section 4
- Parking Structure Signs Section 5
- Parking Lot Signs Section 6
- Mandatory VA Policy Signs Section 7
- Code and Life Safety Signs Section 8
- Interior Signs Section 9
- "You Are Here" Maps and Directories Section 10
- Specialty Signs Section 11
- Cemetery Signs Section 12
- Glossary Section 13
- Appendix
 - Emerging Technologies Appendix 1
 - Sustainability Appendix 2
 - Sign Index Appendix 3

This page is intentionally left blank.

This detailed program guide provides guidelines for the design of signs and sign programs at VA facilities. It provides detail guidance for the development of a sign system that assists VA customers as they approach the property, locate buildings and functions within them.

Executive Summary

This VA Signage Design Guide is a revision of the previous Design Guide published in February 2005.

The revised design guide provides information and suggestions for the development of sign programs at Veterans Affairs Facilities. The guide provides detailed guidance for the development of a sign system that assists VA customers and staff as they approach the property, locate buildings and services within the facility.

The Signage Design Guide includes revisions, which are the result of new sign products, new sign manufacturing techniques and materials, regulatory changes, expansion of VA facilities, procedural changes, and practical knowledge gained from field experience. The revision of the guide has been a collaborative effort, with comments and suggestions from VAMC and administration, and VACO program officials including designers, fire and safety, security and law enforcement, National Cemetery, and Veterans Benefits Administration.

The Guide has added new sections to assist VA facilities contemplating small room renumbering programs or a complete revision of their existing signage systems. The new sections educate program officials, designers, and planners on identifying the need for a signage program and steps on interviewing and selecting a qualified environmental graphic design firm. The sections also include an in-depth guide for parking lots and parking structures signage.

The following are highlights of both the updated sections and the new sections that have been added:

Updated Sections

- Proper/Improper use of VA Seal/Signature.
- Interior sign types and their specification, layout, construction, and installation guidelines. Along with new interior sign products and expanded sign type families.
- Exterior sign types and their specifications, layout and construction. New sign products, expanded sign type families and new illumination methods.
- Expanded exterior building mounted marquee signs (both illuminated and non-illuminated).
- Mandatory VA policy signs containing specific text, layout, size, placement, and location requirements that cannot be altered.
- Added Specialty Signs including construction site signs, construction site safety sign, banners, memory boxes, freestanding sanitizing stations signs plus others.
- An expanded Code and Life Safety signs section with additional pictorials for installation of stairwell signs and those surrounding it.
- A greatly expanded wayfinding discussion in both the interior and exterior sign sections
- Expanded campus/site plan design/layout options

- Expanded “Need a Sign Program” chapter
- Expanded “Room & Floor Renumbering” chapter
- New signs added to Mandatory “VA Policy Signs by Directive”
- Additional options have been added to the monument sign design.
- Various topics within the sections were revised to include more information and details.
- Within sections new subjects have been added on how to review shop drawings and submittals, how to select the correct type of sign company.
- New colors for exterior and interior signs have been provided along with updated colors for parking lot and parking structures.
- An expanded section discussing room renumbering and floor renumbering.
- Additional subjects that were revised include “Tips and Hints” and “Construction and Assembly Details”

New Sections

- A section on Your Are Here Maps and Directories.
- A section on Parking Lot Signs
- A section devoted to National Cemetery Signs.
- A glossary of terms used in the sign industry
- A new section titled, “Emerging Sign Technologies” provides an overview of conceptual developments toward the use of new products and technology. The section also discusses applications of new technologies.

The revised VA Signage Design Guide is a living document that will be periodically updated. When changes do occur, “Design Alerts” will be e-mailed with the included changes.

The VA Signage Design Guide incorporates guidelines from ABAAS, ABA/ADA and NFPA.

Lloyd H. Siegel, FAIA Associate, Director, Strategic Management Office
October 2012

Acknowledgments

This Program Guide for the Department of Veterans Affairs has involved work and input from many departments, individuals and VA Medical Centers. The following identifies the participants and acknowledges their contributions.

Department of Veterans Affairs

Veterans Health Administration

Christa Fairchild
Interior Designer
VAMC Huntington

Desiree Lee, LEED AP
Interior Designer
VAMC Kansas City

Keith Frost
Security Specialist / Team Leader
VA OSP / Office of Security
and Law Enforcement

Katie Willis
Interior Designer
VAMC Dallas

David P. Klein, P.E.
Fire Protection Engineer
VA Central Office

Office of Construction & Facilities Management

Orest Burdiak
Principal Interior Designer

Alejandra De La Torre
Architect

Fei Chan (Linda), AIA
Planner / Architect

Nancy Zivitz Sussman
Management & Program Analyst

Veterans Benefits Administration

Samuel Gyulnazarian, AIA, IIDA, LEED BD+C®
Architect, Project Manager

National Cemetery Administration

Peggy Jensen
Architect / Project Manager

Design Consultants

KAL Architects

Rita Kalwani, AIA, NCARB, IIDA, LEED AP BD+C®
Principal, Project Manager

Jennifer Hanscome, CID, IIDA, LEED AP BD+C®
Senior Interior Designer

Mark Niese, AIA, CSI, CDT, ACIA, LEED AP BD+C®
Technical Support

Anne Blomberg, CID, LEED Green Associate®
Technical Support

Solsis LLC

Bill Englund
Principal
Fran Kalbfeld
Environmental Graphic Designer
Sarah Braun
Environmental Graphic Designer

Robin Eckert
Environmental Graphic Designer
Mark Englund
Environmental Graphic Designer

This page is intentionally left blank.



Design Elements

- **Typography**
- **Letterspacing**
- **Logo Signature**
- **Seal**
- **Arrow**
- **ABA/ADA Specifications**
- **Colors**
- **Images and Patterns**
- **Languages**
- **Metric**

This page is intentionally left blank.

The Department of Veterans Affairs signage system has been designed using a selected group of common design elements and visual standards.

The design elements include the Department of Veterans Affairs logo signature and seal, three versions (weight and style) of the Helvetica typeface and specifications for letter and word spacing. Visual standards include: colors, finishes, and letter size in relation to viewing distance.

The design elements become the component building blocks upon which signs are configured. The elements have been adopted to provide functional consistency in signs for the Department of Veterans Affairs.

If specialized or unique sign applications require deviation from the signage guide, contact the U.S. Department of Veterans Affairs, Office of Construction & Facilities Management for approval as required.

Typography

Helvetica Bold is the standard typeface for the VA Sign System and will be used predominantly throughout the sign program. Signs identifying permanent rooms shall be ABA compliant, to accommodate the visually impaired (refer to ABA sections). All non-ABA signs are to maintain an upper and lower case (Initial Caps) format.

The secondary language of a multilingual sign shall be Helvetica Regular.

Overhead signs shall be Helvetica Bold Condensed.

Building Standard - Helvetica Bold

ABCDEFGHIJKLMNOPQRSTUVWXYZ
abcdefghijklmnopqrstuvwxyz
1234567890

Second Language - Helvetica Regular

ABCDEFGHIJKLMNOPQRSTUVWXYZ
 abcdefghijklmnopqrstuvwxyz
 1234567890

Overhead Signs - Helvetica Bold Condensed

ABCDEFGHIJKLMNOPQRSTUVWXYZ
abcdefghijklmnopqrstuvwxyz
1234567890

Letterspacing

Normal letter spacing is utilized when the readability ratio factor (capital letter height in inches to maximum readable viewing distance in feet) is 1:25 for a word using upper and lower case letters. Word spacing shall be equivalent to the width of a lower case "v".

ABA letters should be spaced so that tactile readers can feel where one letter ends and the next begins. Braille needs to be spaced so the reader can feel where one dot ends and the next dot begins (refer to ABA sections).

Normal letter spacing should not be used when letter forms are to be illuminated as light bleed causes letters to fuse together visually.

Distance letter spacing shall be utilized when the copy content is intended for readability at greater viewing distances than normal letter spacing allows. The readability ratio factor is 1:40. Distance letter spacing shall be used for all exterior and illuminated signs.

Normal Spacing

Correct Spacing

Administration

Correct Spacing

Administration

Distance Spacing

Correct Spacing

Building

Correct Spacing

Building

Spacing is too tight

Administration

Spacing is too tight

Administration

Spacing is too tight

Building

Spacing is too tight

Building

Spacing is too loose

Administration

Spacing is too loose

Administration

Spacing is too loose

Building

Spacing is too loose

Building

Interline Spacing

Interline spacing will generally be noted on sign type drawings. As a rule, line spacing shall be no less than 1/2 the height of the upper case letter form.



Paragraph Spacing

Paragraph spacing will generally be noted on sign type drawings. As a rule, paragraph spacing shall be no less than the height of the upper case letter form.

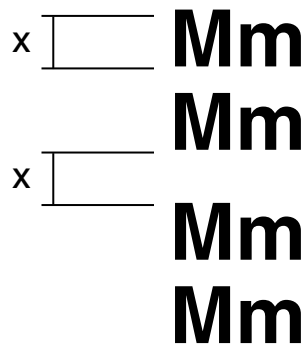

Alignment

A flush upper left copy format shall be the general rule though certain exceptions shall be noted.

As a rule, all copy placed on inserts, changeable directional modules, listing strips, overhead panels, and changeable exterior panels shall be vertically centered, (equal margins top and bottom) Graphic symbols used in square format shall be centered on four sides.

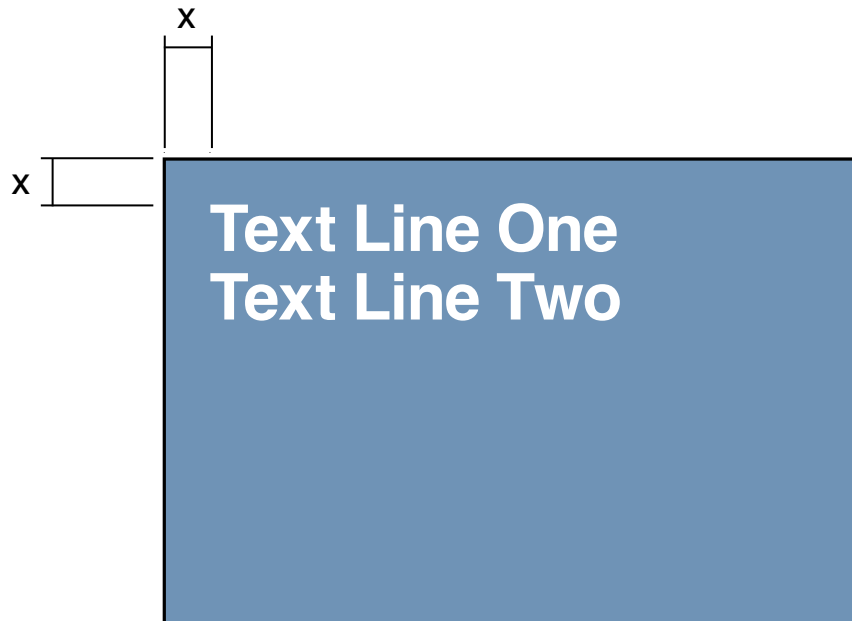

X - Dimensions vary per sign type.
See Sign Type Drawings for exact dimensions

Logo Signature

The VA has developed a new logo/signature for use in signage. You will note that the name is also now presented differently.

The new logo and name signature replaces the old logo and name presentation effective immediately.

The old logo may remain in use in and on existing signs, but all new signs shall incorporate the new logo/signature.

Adjacent are its application in a horizontal format and a vertical format. These are the only formats to use for signs. Do not use the format/art from the VA Graphic Standards that incorporate the VA seal.

The master art for the new logo/signature for signage is available as an electronic file, for downloading, in the Technical Information Library.

NOTE: The master art and typography shall not be altered. The font, the size relationship between the elements, and the letter spacing for the "VA" and "U.S. Department of Veterans Affairs" name, shall remain as presented in the master art. The ruled line is considered a part of the master art and shall not be moved or deleted.

New VA Blue

The VA has selected Pantone 541 as the new standard color. The CMYK values are as follows:
C: 100 M: 60 Y: 0 K: 40

The image shows the letters "VA" in a bold, sans-serif font, oriented vertically. A thin vertical line is positioned to the right of the letters.

U.S. Department
of Veterans Affairs

The image shows the letters "VA" in a bold, sans-serif font, oriented horizontally.

U.S. Department
of Veterans Affairs

New VA Blue

Pantone 541
C: 100 M:60 Y:0 K:40

Seal

The illustrated VA Seal is new.

There are specific requirements regarding its use and reproduction in both the full color version and one color version. Consult the VA Graphic Standards for complete details regarding the seal.

NOTE: In regard to signage, the seal is NOT to be used. It is not to be altered, stylized or treated as an accent element in signs.

It's use remains as before, to be displayed within a buildings entry or lobby and reproduced per the specifications and art exhibited in the VA Graphic Standards.



Arrow

Illustrations show the prescribed arrow for use in the VA sign program.

The arrow is always centered within a square field.

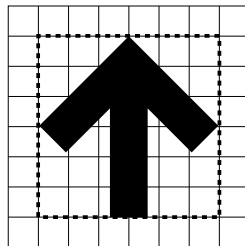

POSITION 1

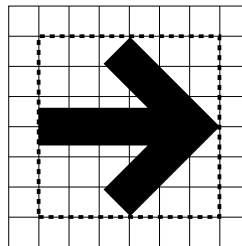

POSITION 2

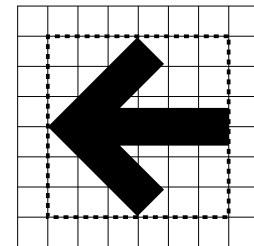

POSITION 3

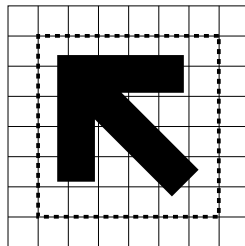

POSITION 4

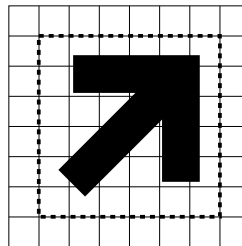

POSITION 5

Arrow Alignment with Text

The arrow is always positioned in such a manner that it is centered in relationship to the capital letter that it precedes. The standard position for arrows, in relationship to text, is either on the left of the first line of text or immediately above the first line of text.

On signs with numerous destinations, a single arrow will be placed adjacent to the first line of text to identify the direction for all destinations grouped together.

The arrow size is one and one half (1 1/2) times the capital letter height.



Text Line

**Architectural Barriers Act
Tactile Sign Specifications**

Character Specifications

Characters shall be sans serif, all capitals, and shall not be italic, bold, script or highly decorative.

Characters and Braille shall be in a horizontal format. Character height shall be 5/8" minimum and 2" maximum, depending on viewing distance (see Table 703.5.5 in "ABA Accessibility standards for federal facilities").

Character stroke thickness of the uppercase letter "I" shall be 15% maximum of the height of the character.

Character spacing to be 1/8" minimum and four times the character stroke width maximum.

Line spacing to be 135% minimum and 170% maximum of the letter height.

Characters shall be separated from raised borders and decorative elements by 3/8" minimum

Characters shall be raised 1/32" minimum above their background.

Characters to be used shall be selected from styles where the width of the uppercase letter "O" is 55% minimum and 110% maximum based on the height of the uppercase letter "I".

Pictograms

Pictograms shall have a field height of 6". Characters and Braille shall not be located within the pictogram field. Pictogram text descriptions to be located directly below the pictogram field.

Finish & Contrast

Characters and their background to have a non-glare finish. Characters shall contrast with their background with either light lettering on a dark background or dark letters on a light background.

General

Where both visual and tactile characters are required, either one sign with both visual and tactile lettering or two separate signs, one with visual, one with tactile lettering shall be provided.

Raised letters to be read by touch should not have sharp or abrasive edges.

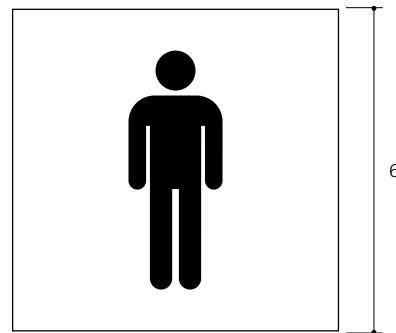
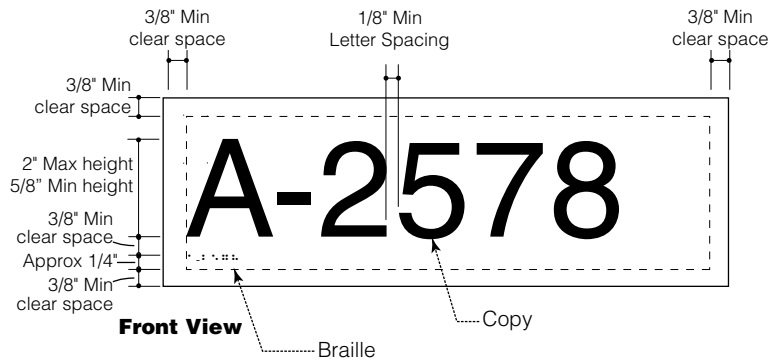
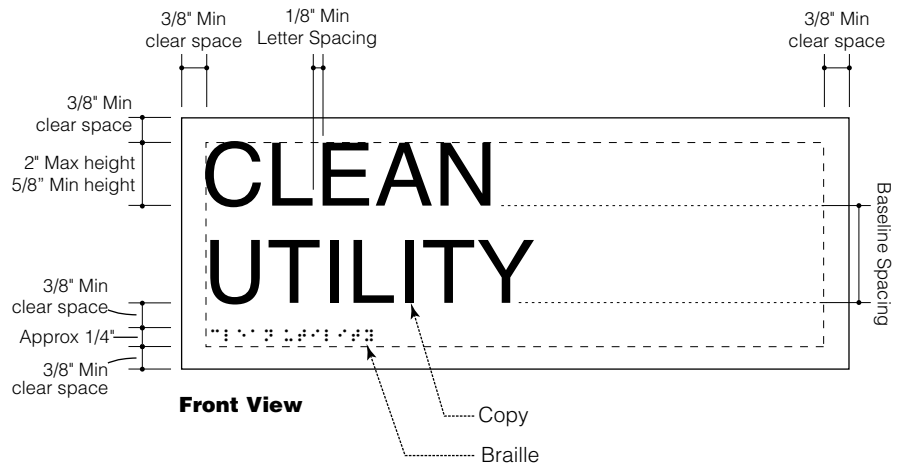

**Architectural Barriers Act
Tactile Sign Specification**

Braille

Shall be contracted, (Grade 2).

See measurements shown at right.

Braille dots shall have a domed or rounded shape.

The indication of an uppercase letter or letters shall only be used before the first word of sentences, proper nouns and names, Individual letters of the alphabet, initials, and acronyms.

Braille shall be positioned below the corresponding text. If text is multi-lined, Braille shall be placed below the entire text. Braille shall be separated 3/8" minimum from any other tactile letters and 3/8" from raised borders.

Exception

Braille provided on elevator car controls shall be separated by 3/16" minimum and shall be located either directly below or adjacent to the corresponding raised letters and symbols.

Location

Where a tactile sign is provided at a door the sign shall be located alongside the door at the latch side. Where a tactile sign is provided at double doors with one active leaf the sign shall be located on the inactive leaf. With two active leaves the sign shall be located to the right of the right hand door. Where there is no wall space at the latch side of a single door or at the right side of double doors, signs shall be located on the nearest adjacent wall. Signs containing Tactile characters shall be located so that a clear floor space 18" minimum by 18" minimum centered on the Tactile characters is proposed beyond the arc of any door swing between the closed position and 40 degrees open position.

Tactile lettering on signs shall be located 48" minimum above the finish floor or ground surface, measured from the baseline of the lowest tactile character and 60" maximum above the finish floor or ground surface, measured from the baseline of the highest tactile character.

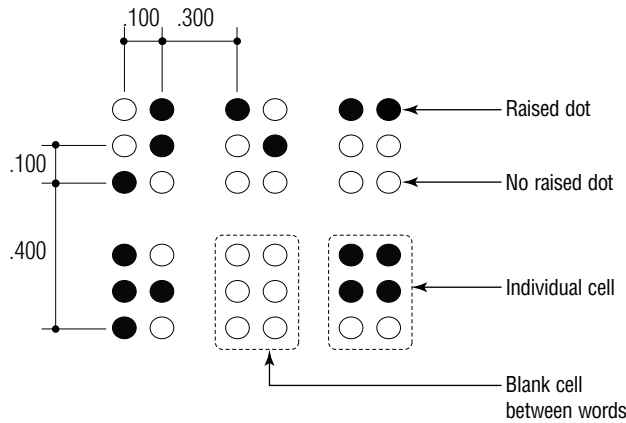

Braille Specifications

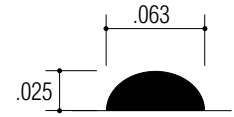

Raised Braille

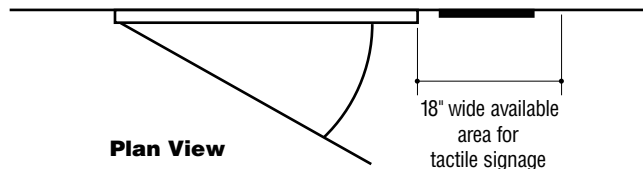

Plan View

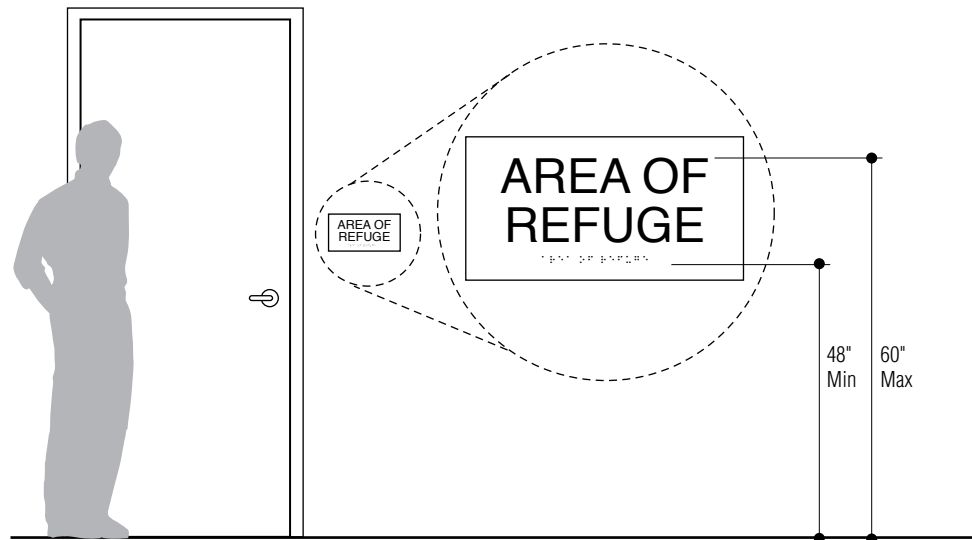

Elevation

Architectural Barriers Act Requirements

Cane Sweep

Objects with leading edges more than 27 inches (686 mm) and not more than 80 inches (2129 mm) above the finish floor or ground may protrude 4 inches (102 mm) maximum horizontally into the circulation path.

EXCEPTION: Handrails shall be permitted to protrude 4 1/2 inches (114 mm) maximum.

Protrusion Limits

When a cane is used and the element is in the detectable range, it gives a person sufficient time to detect the element with the cane before there is body contact. Elements located on circulation paths, including operable elements, must comply with requirements for protruding objects. For example, awnings and their supporting structures cannot reduce the minimum required vertical clearance. Similarly, casement windows, when open, cannot encroach more than 4 inches (102 mm) into circulation paths above 27 inches (686 mm).

Post Mounted Protruding Objects

Free-standing objects mounted on posts or pylons shall overhang circulation paths 12 inches (305 mm) maximum when located 27 inches (686 mm) minimum and 80 inches (2129 mm) maximum above the finish floor or ground.

Where a sign or other obstruction is mounted between posts or pylons and the clear distance between the posts or pylons is greater than 12 inches (305 mm), the lowest edge of such sign or obstruction shall be 27 inches (686 mm) maximum or 80 inches (2129 mm) minimum above the finish floor or ground.

EXCEPTION: The sloping portions of handrails serving stairs and ramps shall not be required to comply.

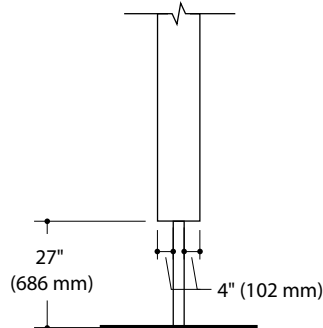
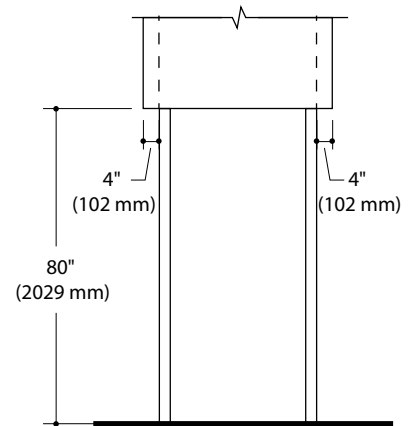
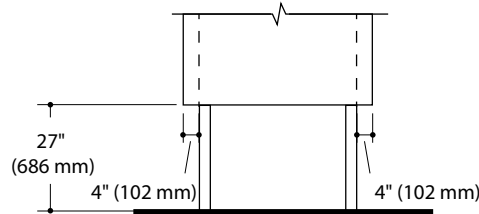
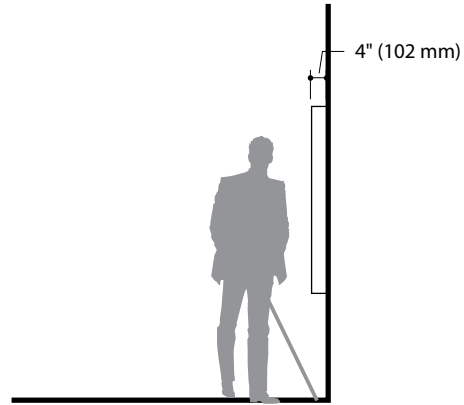

Sign Colors

The chart and accompanying illustrations provide a listing of sign colors that allow a medical center to coordinate an interior or exterior sign program to the architectural colors and finishes of the buildings on the campus.

The color options listed have been selected because they provide contrast between typography and the sign background; the contrast shall be light on dark or dark on light.

Night and day light conditions for exterior signs can vary, therefore, readability should be field verified with actual color samples.

High contrast for readability is equally important for interior signs, especially for the elderly and vision impaired. Light background colors require black or dark gray text and deep or dark colors require white text.

If a facility deviates from the identified family of colors, sufficient contrast between the typography and sign background under all lighting situations shall be maintained.

Placement, type of light fixture, sodium and halide lights, warm and cool fluorescent lights can also change colors and affect contrast, so this needs to be taken into account.

Some colors listed can be used for both interior and exterior applications and are so indicated. There are however certain colors that should not be used for interior or exterior signs because of their unsuitability or because they are only for special applications.

ABA Sign Colors

Generally, ABA related signage shall consist of white text and/or figures on a blue background, blue shall be equal to color no. 15090 in Federal Standard 59513; white is not defined in the ABA standards. VA may approve other colors to complement decor or unique design.

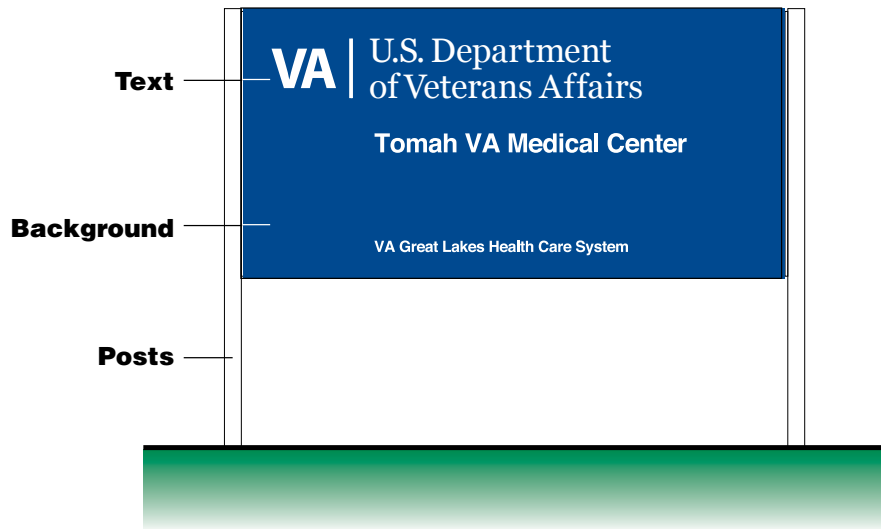
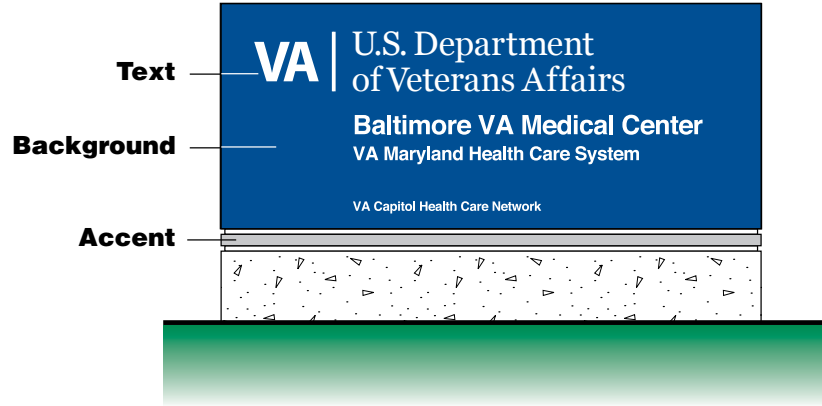

For exterior signs use the chart at right to select a background color and a type color.

The paint colors listed are acrylic polyurethane paint systems manufactured by the following two companies. These are commonly used in the sign industry:

Matthews Paint
760 Pittsburg Drive
Delaware, OH 43015
www.matthewspaint.com

Akzo Nobel
5555 Spaulding Drive
Norcross, GA 30092
www.akzonobel.com

Note: Always obtain color samples from the paint company. Colors shown are for representational purposes only. The actual paint colors may vary significantly from the corresponding swatches indicated in this document. Colors will appear differently when viewed on different computer monitors and/or printed from different printers. For a true color sample, it is best to obtain an actual paint sample of the desired color.

All traffic sign faces should use the prescribed colors as listed in the Manual for Uniform Traffic Control Devices.

All OSHA Safety Colors are to meet ANSI specification Z53.1/OSHA.

Exterior Sign Background Colors

Color Ref #	Color Description	Text Color	Matthews #	Azko Nobel #
B1	Drake	White	MP05732	SIGNM05732
B2	Wells Fargo Black	White	MP26309	SIGNM26309
B3	Lime Peel	White	MP12444	SIGNM12444
B4	Marinated Olive	White	MP15975	SIGNM15975
B5	Bear Creek	White	MP07050	SIGNM07050
B6	Kaffe Tan	White	MP03290	SIGNM03290
B7	Indian Throne Blue	White	MP10261	SIGNM10261
B8	Djbouti Flag Blue	White	MP10273	SIGNM10273
B9	Mudstone	White	MP00547	SIGNM00547
B10	Brown County	White	MP04991	SIGNM04991
B11	Blue News	White	MP05040	SIGNM05040
B13	Claret Jug	White	MP10658	SIGNM10658
B14	Asgard Wall	White	MP05480	SIGNM05480
B16	Handicapped Blue	White	MP26511	SIGNM26511
B17	Red (OSHA)	White	MP09251	SIGNM09251
B18	New VA Blue	White	MP09829	SIGNM09144
B19	Yellow (OSHA)	Black	MP09144	SIGNM09829
B20	White	Black, Red, Purple	MP32071	SIGNM32071

B19 - White can be paint, white opaque vinyl application or translucent white vinyl application for illuminated signs

Additional Colors for Trims, Accents, Posts & Brackets

A1	Dark Bronze Anodized	A4	Polished Aluminum
A2	Black	A5	Satin Aluminum
A3	Clear Anodized Aluminum		



For parking garage signs, vinyl colors will be applied to either white or one of the other paint colors listed in the chart at right. The colors and their respective numbers listed in the chart.

The paint colors listed are acrylic polyurethane paint systems manufactured by the following two companies:

Matthews Paint
760 Pittsburg Drive
Delaware, OH 43015
www.matthewspaint.com

Akzo Nobel
5555 Spaulding Drive
Norcross, GA 30092
www.akzonobel.com

The vinyl colors listed are premium high performance vinyls manufactured by the following two companies:

Avery Dennison Graphics and Reflective Products Division
250 Chester Street, Building 6
Painesville, Ohio 44077

3M Graphics Market Center
3M Center, Bld 2002-12-E-04
St. Paul, MN 55144

Note: Always obtain color samples from the paint company. Colors shown are for representational purposes only. The actual paint colors may vary significantly from the corresponding swatches indicated in this document. Colors will appear differently when viewed on different computer monitors and/or printed from different printers. For a true color sample, it is best to obtain an actual paint sample of the desired color.

Parking Structure & Parking Lot Sign Colors

Color Ref #	Color Description	Paint Colors		Vinyl Text Colors	
		Matthews Paint #	Azko Nobel #	3M #	Avery #
B30	Purple Print	MP02112	SIGNM02112	Purple 7725-48	Lavender A9475-0
B31	Gravity Tractor	MP10844	SIGNM10844	Tomato Red 7725-13	Tomato Red A9325-0
B32	Wells Fargo Black	MP26309	SIGNM26309	Black 7725-22	Black A9090-0
B33	Modena Mud	MP00607	SIGNM00607	Saddle Brown 7725-139	Cocoa A9278-0
B34	Sailboat Blue	MP02160	SIGNM02160	Vivid Blue 7725-17	Vivid Blue A9570-0
B35	Anole Green	MP13427	SIGNM13427	Apple Green 7725-196	Apple Green A9660-0
B36	Antartica Orange	MP01229	SIGNM01229	Light Orange 7725-54	Orange A9160-0
B38	Aqua Riva	MP14879	SIGNM14879	Teal 7725-96	Real Teal A9615-0
B39	Rose Essence	MP15170	SIGNM15170	Magenta 7725-103	Magenta A9411-0
B40	White Wonder	MP32071	SIGNM32071	White 7725-10	White A9005-0
B41	Shell Oil	MP05585	SIGNM05585	Sunflower 7725-25	Med. Yellow A9130-0

Additional Colors for Trims, Accents, Posts & Brackets

A1	Dark Bronze Anodized	A4	Polished Aluminum
A2	Black	A5	Satin Aluminum
A3	Clear Anodized Aluminum		

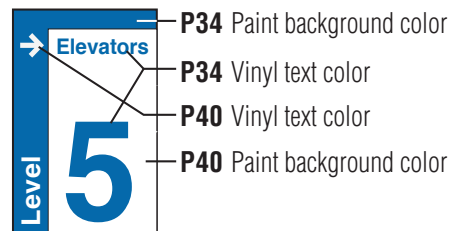
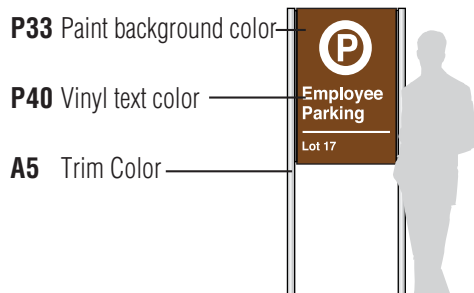

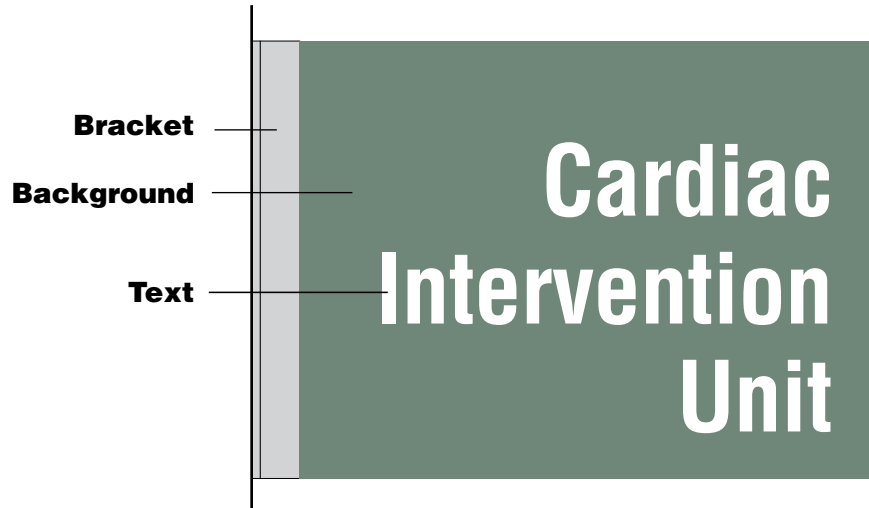
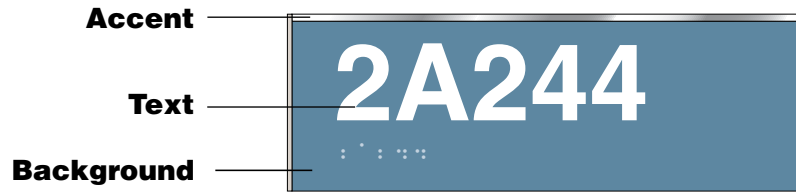

For interior signs use the chart to the right to select a background color and a type color.

The paint colors listed are acrylic polyurethane paint systems manufactured by the following two companies:

Matthews Paint
760 Pittsburg Drive
Delaware, OH 43015
www.matthewspaint.com

Akzo Nobel
5555 Spaulding Drive
Norcross, GA 30092
www.akzonobel.com

Note: Always obtain color samples from the paint company. Colors shown are for representational purposes only. The actual paint colors may vary significantly from the corresponding swatches indicated in this document. Colors will appear differently when viewed on different computer monitors and/or printed from different printers. For a true color sample, it is best to obtain an actual paint sample of the desired color.

Interior Sign Background Colors

Color Ref #	Color Description	Text Color	Matthews #	Azko Nobel #
B1	Drake	White	MP05732	SIGNM05732
B2	Wells Fargo Black	White	MP26309	SIGNM26309
B3	Lime Peel	White	MP12444	SIGNM12444
B8	Djibouti Flag Blue	White	MP10273	SIGNM10273
B10	Brown County	White	MP04991	SIGNM04991
B28	Orange County	White	MP07869	SIGNM07869
B29	Spice Trader	White	MP02795	SIGNM02795
B31	Gloomy Gray	White	MP10124	SIGNM10124
B33	Fresh Fields	White	MP11532	SIGNM11532
B34	Plum Crazy	White	MP04400	SIGNM04400
B35	Antwerp Blue	White	MP03362	SIGNM03362
B16	Handicapped Blue	White	MP26511	SIGNM26511
B17	Red (OSHA)	White	MP09251	SIGNM09251
B18	New VA Blue	White	MP09144	SIGNM09144
B30	Spruce Pine	Black	MP13106	SIGNM13106
B32	Baby Boy Blue	Black	MP00344	SIGNM00344
B21	Garbo Silver	Black	MP02650	SIGNM02650
B22	Clintonite Green	Black	MP14762	SIGNM14762
B23	Old Copper Roof	Black	MP03397	SIGNM03397
B24	Foie Gras	Black	MP04685	SIGNM04685
B25	Winter Slush	Black	MP04982	SIGNM04982
B26	Toasty Gold	Black	MP05322	SIGNM05322
B27	Corn Silk	Black	MP11392	SIGNM11392
B19	Yellow (OSHA)	Black	MP09829	SIGNM09829
B20	White	Black, Red, Purple	MP32071	SIGNM32071

Additional Colors for Trims, Accents, Posts & Brackets

A1	Dark Bronze Anodized	A4	Polished Aluminum
A2	Black	A5	Satin Aluminum
A3	Clear Anodized Aluminum		



Integration of Images and Patterning with Signage

Visual iconography, such as images and patterns, can be incorporated into the design of both interior and exterior signage systems. Their inclusion can add visual interest, unify, or differentiate, signs related to specific areas of a building and/or campus. Imagery should be thematically cohesive and integrated in a consistent manner throughout the sign program.

Imagery can be cut from vinyl, screened, painted, etched or applied as a vinyl or laminated digital print.

Imagery should be visually of secondary importance to messaging and not distract or conflict with readability of sign.



Example shows possible use of a repeating pattern as visual texture, in this case the texture has been applied to separate substrate behind the sign panel.

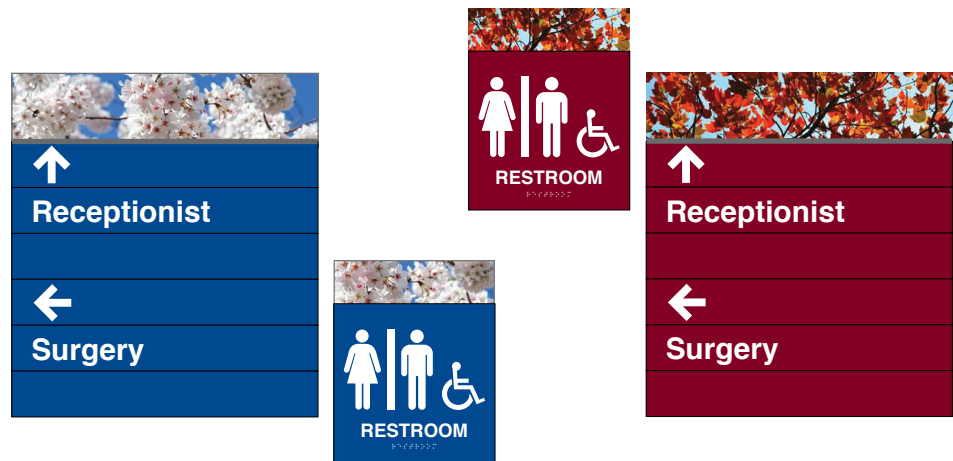

Example shows integration of photographic imagery. Example also illustrates the use different images related to a common theme. This approach can be useful when implementing a sign system in a facility where different areas of that facility have been assigned different color and material palettes.

Glass or Acrylic with either etched graphic or application of translucent film to simulate appearance of etched glass

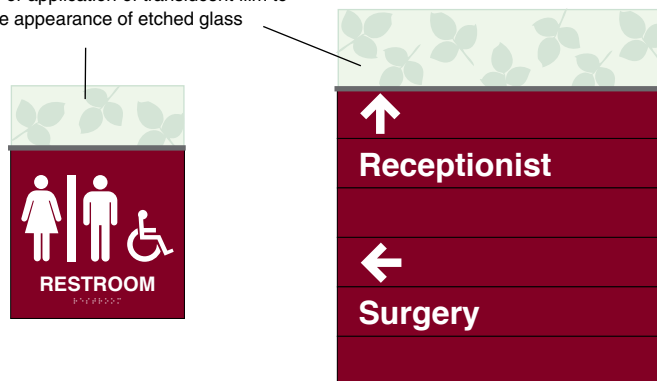

Example shows graphic as silhouetted images. This example illustrates a subtle approach to integration of imagery/patterning

Second Language

In facilities in the United States, the English text is listed above the second language text. The cap height and interline spacing of the second language text are half the cap height and interline spacing of the English text, unless noted otherwise (see sign type drawings for specific dimensions).

In facilities in the Puerto Rico, the Spanish text is listed above the English text and the cap height and interline spacing of the English text are half the cap height and interline spacing of the Spanish text, unless noted otherwise.

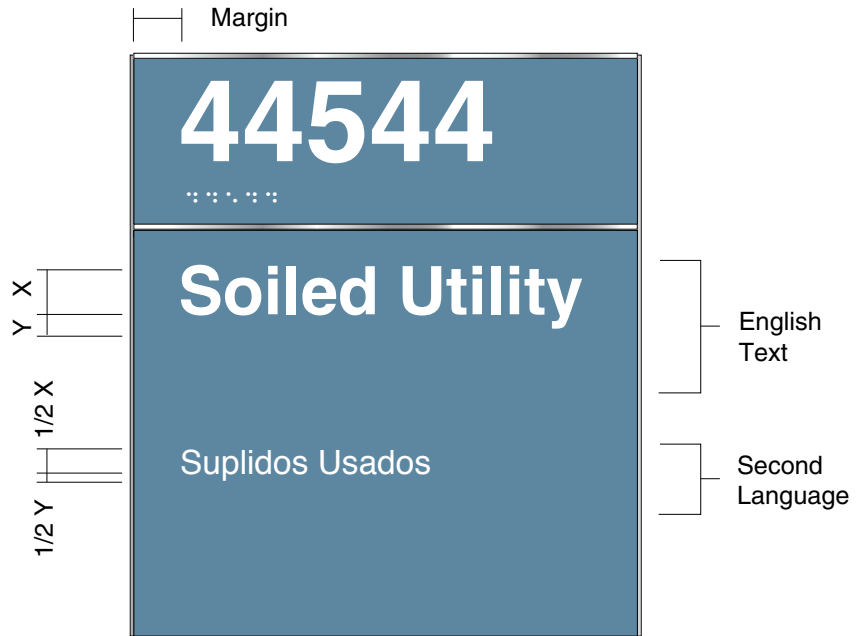

Sign used in U.S Facility

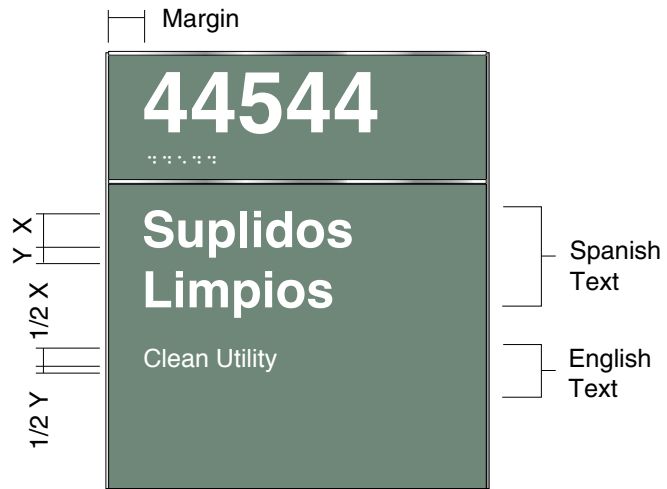

Sign used in Facility in Puerto Rico

Metric

The metric system is the preferred system of measurement in accordance with the Metric Conversion Act of 1975, P.L. 94-168, as amended by Section 5164 of Omnibus Trade and Competitiveness Act of 1988, and Executive Order 12770.

In accord with the Department of Veteran Affairs metric conversion plan, the sign system is preferably to be constructed in metric, however, the English system can be used on VA projects, if it meets the needs of a specific facility. The use of metric should not add cost to a project and "off the shelf" metric sign systems are preferred.

The VA does not intend to impose rigid metric conversions on the sign industry and will support sign manufacturers as their industry converts to the metric standard.

For assistance in transition to metric, the drawings with dimensions should be prepared showing direct metric English conversion. While typography is generally referred to in the graphic industry by point sizes and the sign industry in inches, the VA sign program is showing text layouts developed in inches and then directly converted to metric. It is preferred, however, that metric dimensions be rounded up to the nearest 1 mm up to 1 inch; 5 mm up to 4 inches; and, above 4 inches rounded down to the nearest 25 mm.

The adjacent conversion chart should provide assistance in determining conversions from inches to millimeters.

For further information on the conversion to metric, contact the Department of Veteran Affairs, Office of Construction & Facilities Management.

Inches	Nearest 1 mm (1/25")	Nearest 5 mm (1/5")	Nearest 5 mm (2/5")	1"= 25mm EXACTLY
1/32"	1			
1/16"	2			
3/32"	2			
1/8"	3			
3/16"	5			
1/4"	6			
5/16"	8			
3/8"	10			
7/16"	11			
1/2"	13			
9/16"	14			
5/8"	16			
3/4"	19			
7/8"	22			
1"	25	25		
1 1/4"	32	30		
1 1/2"	38	40		
1 3/4"	44	45		
2"	51	50		
2 1/4"	57	55		
2 1/2"	64	65		
2 3/4"	70	70		
3"	76	75		
3 1/4"	83	85		
3 1/2"	89	90		
3 3/4"	95	95		
4"	102	100	100	100
5"	127	125	130	125
6"	152	150	150	150
7"	178	180	180	175
8"	203	205	200	200
9"	229	230	230	225
10"	254	255	250	250
11"	279	280	280	275
1'-0"	305	305	300	300
2'-0"	610	610	610	600
3'-0"		915	910	900
4'-0"		1220	1220	1200
5'-0"		1525	1520	1500
6'-0"		1830	1830	1800
7'-0"		2135	2130	2100
8'-0"		2440	2440	2400
9'-0"		2745	2740	2700
10'-0"		3050	3050	3000
15'-0"		4570	4570	4500
20'-0"		6095	6100	6000

This page is intentionally left blank.