

VA



U.S. Department of Veterans Affairs

Office of Construction & Facilities Management

Office of Facilities Planning

Facilities Standards Service



VA Signage

PG-18-10

May, 16, 2023

designmanual

VA Program Offices, project teams, designers, and constructors, are obligated to make the most effective and efficient use of resources, by providing a continuum of safe, secure, high quality, high performance, and high value environments of care and service for Veterans. The VA Office of Construction and Facilities Management (CFM) supports the Department's mission through development and application of standards as a basis for disciplined planning, design, and construction of VA facilities. VA Standards are the culmination of a partnership among the Department of Veterans Affairs (VA), the VA Administrations, Program Officials, Clinicians, Industry, Academic and Research Organizations, Expert Consultants, and the Office of Construction and Facilities Management. VA Standards are developed through integration of VA-specific requirements, Federal law and regulation, benchmarking of industry best practice, evidence-based research and design, and value-based analysis of leading-edge innovation. The result is the establishment of best value standards which provide the basis of functionality, quality, performance, safety, security, and compliance, while enhancing life cycle value of facilities throughout the VA environment of care and service.

The VA Technical Information Library (TIL) (www.cfm.va.gov/TIL) provides standards for all VA planning, design, and construction projects. VA TIL Standards are required to be utilized by project teams working on new construction and renovations of existing facilities. VA Standards will maximize the effectiveness and efficiency of the planning and design process, facilitate a high level of design, while controlling design, construction, operating, and maintenance costs.

For all VA projects, project teams must comply with the following in all phases of project development:

1) All applicable VA Standards published in the VA Technical Information Library (TIL) must be applied as a basis, foundation, and framework in planning, design, and construction. Any substantial variance from Standards shall be considered only as required to accommodate specific site, functional, and operational conditions. Upon consideration of variance CFM shall be consulted, and each Administration will function as Authority Having Jurisdiction for decision. Each substantial variance shall have a basis rationale and be documented in the project record.

2) Clinicians, providers, primary users, and other stakeholders shall be involved in all phases of project development to best adapt Standards for specific functional, operational, and site conditions, and to provide optimum service environments for Veterans. This includes installations and modifications of systems or technology involving safety, security, functionality, or environmental quality. Stakeholder involvement shall be documented in the project record.

VA TIL Standards are not project specific. Each site and project will have unique requirements or conditions. Site-specific issues must be addressed within the context of these Standards and applied to each individual project. Use of these Standards does not preclude the need for, nor absolve planners, designers, and constructors of their responsibility to provide complete, functional, high quality, high performance, safe, and secure designs suited to the unique requirements of each project, within budget, and on schedule. Materials, equipment and systems are shown in an illustrative, performance-based format and are not intended to depict, suggest, or otherwise constitute endorsement of any specific product or manufacturer. Manufacturers should be consulted for actual dimensions, configurations, and utility requirements. For additional information regarding the VA Technical Information Library and development and application of VA planning, design, and construction standards, please contact Donald L. Myers, Director, Facilities Standards Service.

Donald L. Myers, AIA, NCARB, AAH, ASHE
Director, Facilities Standards Service
US Department of Veterans Affairs
Office of Construction and Facilities Management



This detailed program manual provides baseline standards and criteria for the design of signage and wayfinding programs at VA owned and leased facilities.

Executive Summary

This VA Signage Design Manual is a revision of the previous Design Guide published in December 2012.

The VA Signage Design Manual includes revisions, which are the result of new sign products, new sign manufacturing techniques and materials, regulatory changes, expansion of VA facilities, procedural changes, and practical knowledge gained from field experience. Revision of this manual has been a collaborative effort, with input from medical center staff, Department of Veterans Affairs, Health Administration, National Cemetery Administration, and Veterans Benefits Administration program officials including designers, fire and safety, security, and law enforcement.

This Manual includes sections to assist VA facilities planning and/ or implementing signage projects of various sizes and complexities. It provides guidance for the development of a signage system that assists VA customers and staff as they approach the property, locate buildings, and navigate to destinations within the facility. These sections educate program officials, designers, and planners on identifying the need for a signage program and describes implementation processes and procedures. The manual also provides in-depth information on wayfinding methodologies and the importance of a cohesive wayfinding master plan.

Structure of the Manual

The manual is composed of four primary Sections containing new content and information from the previous version that has been consolidated and updated to improve readability and meet the practical needs of modern signage projects. Each Section covers different aspects of the signage process from planning through implementation.

[Section 1: Planning, Wayfinding, and Technology](#)

Foundational information about planning and implementing a signage project, principles of wayfinding, and how technology can assist with signage and wayfinding.

[Section 2: Sign Type Guidelines](#)

Helpful guidelines, recommendations, and information specific to each category of signage building on the information detailed in Section 1.

[Section 3: Sign Type Drawings](#)

Drawings and specifications for all standard sign types applicable to each category of signage discussed in [Section 2 Sign Type Guidelines](#) (Interior, Code & Life Safety, Mandatory, Specialty, Exterior, Parking Structures, and Cemetery).



Introduction

Structure of the Manual (Continued)

[Section 4: Supplementary Information](#)

Standard design elements, including the specifications for use of the VA logo, typeface, and color palettes. It also includes supplemental information about Architectural Barriers Act (ABA) requirements for signage, VA department nomenclature, room and floor renumbering, frequently asked questions (FAQ), sign drawing index, and glossary of terms.

What's Changed

Universal Changes:

- Changed from “Design Guide” to “Design Manual” to reflect the document’s purpose more accurately.
- Transitioned the document per VA requirements to Microsoft Word to meet accessibility guidelines.
- Added hyperlinks throughout the document to easily reference other sections and websites.
- Streamlined layout and titling systems.
- The Manual now fully follows Architectural Barriers Act (ABA) requirements.
- Added & modified sign types in all categories.
- All narratives and notations have been revised or re-written.

Changes to Content:

- Section 02 “Need a Sign Program” from 2012 is now Section 1.1 “Planning a Sign System.” The entire section has been overhauled to align more closely with modern VA signage projects and provide more practical guidelines and suggestions. It covers the entire process from evaluating existing conditions to planning and implementing a sign program, hiring a firm, and reviewing submittals.
- New Section 1.2 “Fundamentals of Wayfinding” is added to help readers understand basic principles of successful wayfinding design such as the different categories of wayfinding, and components that make up a wayfinding master plan.
- New Section 1.3 “Signage and Wayfinding Technology” is added to inform readers of the current technologies and processes relevant to digital wayfinding and signage fabrication.
- Sections 04 through 12 from 2012 have been completely reorganized and consolidated into two sections, separating the narrative guidelines from the sign type drawings. Section 2 “Sign Type Guidelines” and Section 3 “Sign Type Drawings”. Sign categories in both have been prioritized to align with typical VA signage projects.
- Section 2 “Sign Type Guidelines”
 - Each sign category in Section 2 is consistently structured to provide specific guidelines and suggestions for Planning, Programming, and Implementation. All narratives from 2012 have been revised and updated.



Introduction

What's Changed *(Continued)*

- Section 3 “Sign Type Drawings”
 - Each sign category in Section 3 has been updated to include new and revised sign drawings and notations.
 - Improved note consistency and information for increased clarity.
 - Imperial dimensions have been prioritized over metric.
 - Changes to mandatory VA policy and directives have been incorporated.
 - Sign types have been added, removed, and revised from all categories to reflect the modern needs of VA facilities.
- Section 4 Supplementary Information
 - The “Design Elements” section has been updated to clarify ABA requirements, and revised guidelines for using typography, VA logo and seal, arrows, and colors.
 - “Room Renumbering” has been moved to this section with revised narratives.
 - A “FAQ” section has been included to help readers find quick answers to many common questions.



The following identifies the participants and acknowledges their contributions:

Department of Veterans Affairs (VA)

Veterans Health Administration (VHA)

Healthcare Environment and Facilities Programs (HEFP)

Vincent Rizzo, P.E.
Director
Office of Healthcare
Engineering

David P. Klein
Director
Office of Occupational
Safety and Health

Peter A. Larrimer, P.E.
Manager
National Fire Protection
Operations

David Sabol
General Engineer
Architect

Christine Emanuelson
NCIDQ, CHID
Program Manager
Interior Design

Calvin Clawson
Program Manager
Interior Design

Office of Construction & Facilities Management (CFM)

Ross Davidson, DBIA, Assoc. AIA, FHF
Associate Executive Director
Office of Facilities Planning

Gary Fischer, AIA
Senior Healthcare Architect
Facilities Standards Service

John G. Bulick Jr.
Director
Facilities Planning
Development Service

Orest Burdiak
Principal Interior Designer
Facilities Standards Service

Donald L. Myers, AIA
NCARB, AAH, ASHE
Director
Facilities Standards Service

Peter Leszczak
Fire Protection Engineer
Consulting Support
Services (CSS)

Diosdado M. Madlansacay
Program Manager
Quality Assurance Service

James Symanski, PE, MBA,
LEED AP, CEM
Director, Sustainability
Program Office

Veterans Benefits Administration (VBA)

Samuel Gyulnazarian, AIA, IIDA, LEED BD+C
Architect
Program Manager

National Cemetery Administration (NCA)

Homayoun Kazempour
Architect
Project Manager

Police and Security Services

Todd A. S. Trebuna
VISN Security Officer | VISN 9

Timothy W. Jantz
Chief
Police Services | VAMC
Milwaukee



Design Consultants

Spur Design

Seth Cavin, AIA, NCARB,
LEED AP
Senior Architect
Managing Principal

Andrew Stevens AIA,
NCARB
Architect
Project Manager

Noah Medley AIA,
NCARB
Architect
Project Architect

Colin Bost
Architectural Designer

Creative Sign Systems

Troy Mayer
Vice President

Ettore Mormile
Principal Environmental
Graphic Designer

Doug Richard
Senior Designer





U.S. Department
of Veterans Affairs

SECTION 1

PLANNING, WAYFINDING & TECHNOLOGY

1.1.Planning a Signage System	9
1.1.1. Evaluation	10
1.1.2. Project Approach	15
1.1.3. Project Process	17
1.1.4. Small Projects	25
1.1.5. Sign Industry	27
1.1.6. Submittals	28
1.2.Fundamentals of Wayfinding	36
1.2.1. What is Wayfinding	37
1.2.2. Categories	38
1.2.3. Master Plan	41
1.2.4. Patient Experience	46
1.2.5. Keys to Success	50
1.3.Signage & Wayfinding Technology	52
1.3.1. Overview	53
1.3.2. Components	55
1.3.3. Sign Management	60
1.3.4. Fabrication	62





U.S. Department
of Veterans Affairs

SECTION 1.1

PLANNING A SIGN SYSTEM



1.1.1 EVALUATION

Planning a successful signage system requires a significant amount of research and coordination. This chapter outlines the process necessary to evaluate, plan, and implement a signage and wayfinding project.

How one initially approaches a signage and wayfinding project will be heavily influenced by the size, type of project, current conditions of the facility, and whether there is an existing wayfinding master plan (See [Section 1.2 Fundamentals of Wayfinding](#)). Whether the project is for new construction or for an existing facility, a wayfinding master plan, and signage system standard must be established.

Determining Project Type

The primary signage project types are described below. Knowing which type of project will help determine the best approach to engaging a team and getting help ([Section 1.1.2 Project Approach](#)) and the project process to follow.

Comprehensive Signage System Upgrade: The primary project type is used when an existing medical center requires a comprehensive signage system upgrade. In this circumstance, a new or updated wayfinding master plan and signage system standards are developed. A detailed description of the process for this project type is found in [Section 1.1.3 Project Process](#).

New Construction and Renovations: If signage is needed for a new building addition or renovation, the wayfinding plan will need to be referenced if one exists. If not, the existing signage and wayfinding system may be aging, and a plan should be developed to address the entire facility. Design, planning, and programming of the system should be done before project commissioning and occupancy. Additions and renovations will need to adhere to the wayfinding plan and signage system standards that may require removing or retrofitting aging and/ or non-standard signage.

Operational Updates: These include ongoing updates needed to maintain an existing signage system related to department requests, nomenclature changes, updates to policies and procedures, and relocations.

Leased Property Considerations

Leased VA facilities will also influence signage application and use. VA Mandatory Signage is to be used at all VA properties. Additionally, leased properties must follow local lessor guidelines and city and state signage codes, laws, ordinances, and permitting regulations in which they are located. These regulations can influence all factors of the signage system including the types of signs, mounting methods, sizes, quantities, and specifications. Therefore, it is important to research and understand the lessor requirements and applicable codes before planning a signage system for leased spaces. Ensure any applicable permits required have been filed and approved before fabricating signage.

The following assessment criteria, [Section 1.1.2 Project Approach](#), and [Section 1.1.3 Project Process](#) assume the project is a comprehensive signage system upgrade. For smaller projects, and renovations see [Section 1.1.4 Small Projects](#).



Evaluation

Planning a Sign System

General Wayfinding Assessment

In 2022, the median age of the VA's property portfolio was 58 years. Over time, many of these VA facilities have added and removed buildings, relocated entrances, and moved services to improve health care service for Veterans. These changes have a direct impact on signage and wayfinding programs. Unless these signage systems have been regularly maintained, the signage program may require replacement. The following list of conditions can be used to identify overall signage and wayfinding system deficiencies and opportunities for improvement. If several of these conditions exist at a facility, a wayfinding project may be beneficial.



Figure 1-1 (Above) A well-maintained exterior sign system can last 10-15 years. Regular cleaning, paint touchups, electrical maintenance, and message updates will maximize the system's lifecycle.



Figure 1-2 (Above) Inconsistent and conflicting information negatively impacts wayfinding and confuses visitors. Seen here: "Not an Entrance" on the door and "Entrance 10" on the sign next to the door."

- Patients and visitors are frequently lost and in need of direction.
- It has been over 5 years since signage and wayfinding systems were last evaluated.
- The wayfinding master plan is outdated or nonexistent.
- Signs are not aligned with the current wayfinding master plan.
- There is no signage system standards document illustrating the sign types, product design, colors, and finishes.
- Signage does not adhere to the VA Signage Design Manual.
- Multiple signage systems are used and are inconsistent in appearance.
- The signage system is difficult and expensive to update.
- There are handmade, temporary, and/or unapproved signs being used.
- Staff is not trained to give directions consistent with the wayfinding master plan.
- Terminology for destinations is used inconsistently on signs, appointment letters, and in written and verbal communications.
- Wayfinding maps and visitor guides do not accurately reflect the conditions of the campus and facility.
- Wayfinding information and visitor guides are unavailable on the facility's external facing website.



Evaluation

Exterior Signage Assessment

Planning a Sign System

The following conditions indicate that a campus and facility may need a new exterior signage system.

- The exterior signage system is older than ten years.
- Metal sign components show rust, bubbling paint, rippling, or buckling.
- The facility name is incorrect on the site identification signs.
- Signs are faded, damaged, leaning, or falling over.
- Buildings, parking lots and/or structures are not clearly and correctly identified with signage.
- Temporary signs have been erected to serve as directional or identification signs.
- Signs are covered or hidden by landscaping or trees.
- Exterior signs inaccurately reference or misidentify departments, entrances, or services.
- Building entrances are not identified and do not clearly communicate operation times and their use.

Aging Exterior Signage



Figure 1-3 (Above) Over time, a buildup of dirt and oxidization can obscure a sign's message, making it difficult to read.

Exterior signage is impacted by weather and environmental conditions, which vary by geographic location. For example, Northwest or East coast facilities may experience extreme precipitation and humidity, while Southwestern locations experience harsh sun for much of the year. The most common physical effects of age are fading, peeling, and weathering of painted surfaces, which may not arise for 5-10 years. Other common environmental effects are damage from vehicle impacts, vandalism, and extreme wind. During the lifecycle of exterior signs, typical maintenance includes cleaning, substrate touchups, repairing peeling or missing lettering, replacing lighting components, general electrical repairs, and message updates. A well-maintained exterior signage system can last for 10-15 years before needing to be replaced.



Figure 1-4 (Right) This old and poorly maintained exterior sign has paint wearing off the posts, and the sign panel is faded, yellowing, and dirty.



Evaluation

Planning a Sign System

Interior Signage Assessment



Figure 1-5 (Above) This directional sign has multiple issues. Message panels are missing or broken, some text is too small, and arrow placement is confusing.

Figure 1-6 (Below) Paper signs are being used where directional signage is needed.



Figure 1-7 (Right) The overhead sign is confusing because it lists too many destinations and the directional arrows are used incorrectly. To minimize confusion, overhead signs should only include a limited number of major destinations. Additionally, a single directional arrow pointing in the direction of travel should be used in combination with wall-mounted signs that provide more detailed information.

The following conditions indicate that a campus and facility may need a new interior signage system.

- The interior signage system is older than 15 years.
- There are permanent room signs that do not have tactile text and Grade II Braille.
- The room numbering system is antiquated, inconsistent, and contains redundancies.
- Elevators are not named and/or clearly identified with signage.
- Code and life safety signs are missing or inaccurate.
- Handmade, temporary, and/or unapproved signs are being used to identify rooms or function as directional signs.
- Directional signs and graphics direct people to destinations that no longer exist or have been relocated.
- Multiple signage systems with inconsistent colors, graphics and terminology are being used.
- Signage pollution and/or over-signing causes confusion and visual clutter.
- Interior signs are taped to the wall instead of mechanically fastened.
- Signage does not reflect changes to circulation routes due to renovations or construction.
- Primary corridors are not clearly defined and difficult to navigate, making the facility feel like a maze.
- There has been a major relocation of services within the Facility.
- Directional signs have long, confusing lists of destinations.
- Wayfinding maps and directories are not conveniently located near entrances and elevators.



Evaluation

Figure 1-8 (Left) The directory sign shown has an outdated design and is mounted too closely to policy signs that are arranged incorrectly.

Figure 1-9 (Right) This photo shows protruding signs mounted too low, violating ABA code. Additionally, there are too many signs mounted too closely together, and displaying inconsistent text sizes.

Planning a Sign System

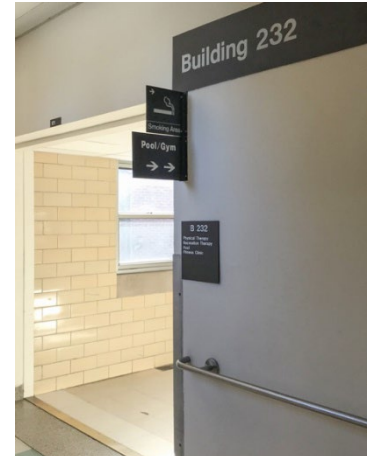
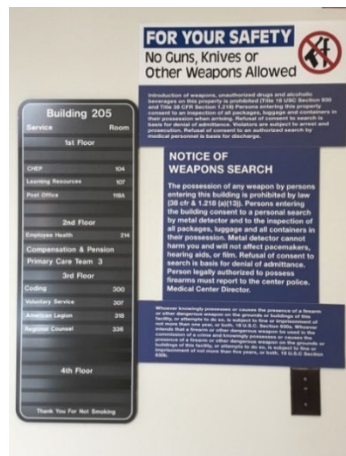

Aging Interior Signage

If your interior signage system is well-maintained, it can typically last up to 10-15 years before needing replacement. Key factors that support an effective signage maintenance program include having a facility wayfinding standard overseen by a signage manager through the Interior Design Department, and an external signage and wayfinding consultant that can consistently plan and implement changes. For more information on maintaining your signage system, see [Section 1.1.4 Small Projects](#).

When an interior system is not properly maintained, expanded, and updated, it will lose effectiveness over time. This negatively impacts the patient experience, reduces the return on investment, and shortens the system's life. This commonly occurs when numerous individuals, both internal and external to the facility manage an existing signage program in an uncoordinated fashion, compromising the logic and cohesive structure of that signage program. As a result, the signage program can become confusing and difficult to understand.

After 15 years, even a well-maintained interior signage system is likely past its useful life and should be replaced due to organizational changes and the age of fabricated components.

Room Renumbering

Building alterations present many challenges to planners, designers, and building managers. As facilities evolve, many times the room naming and numbering convention presents challenges for a logical numerical or alphanumeric continuation. This becomes especially problematic when using room numbers on directional maps or directories. Patients and visitors should be guided to a check-in location and not a specific room number. Below are probable indicators that a building's rooms need to be renumbered and need a new interior room identification signage system is needed.

- There has been major or ongoing remodeling within the building.
- There are duplicate room numbers within the building.
- Building addition room numbers do not coordinate with existing room numbers.
- Additional letters have been added to room numbers to accommodate new rooms.

Refer to [Section 4.4 Room Renumbering](#) for additional information about room renumbering.



1.1.2 PROJECT APPROACH

An effective signage system for a facility should be holistically planned and coordinate all signage types. The basis of design for the signage system should be developed as part of a wayfinding master plan.

The project approach should account for facility-specific priorities, budgets, and operational needs of a VA medical facility, including:

- The potential for phased implementation due to funding, priorities, and construction/renovation.
- The need to implement the new sign standard in small and ongoing projects as the facility works to fully adopt the new system.
- Variability of budgets and priorities that prevent commitment to fund implementation of the design in future years.
- The need for ongoing design support, maintenance, and physical sign updates over the life of the system.

Getting Help

Below are two approaches for engaging a professional design and planning team of your signage and wayfinding project. Choose the approach that works best for your facility's needs. Editable templates for sample statements of work, evaluation criteria, and interview questions are available to download from the Technical Information Library (TIL).

Approach 1: Design-Bid-Build

Hire an Experiential Graphic Design (EGD) firm with significant healthcare wayfinding experience to develop a wayfinding master plan. Once complete, establish a contract with an experienced architectural signage company to implement the project. Contractual options for hiring an EGD firm are: (A) Include as part of the scope of an overall facility master plan (B) Utilize existing "Open-Ended Architect-Engineer" contracts and engage the firm as a subcontractor; (C) Hire an EGD firm like any other A-E firm.

Advantages: An Experiential Graphic Design (EGD) Firm, when working in collaboration with a full-service Architecture and Engineering (AE) firm, especially as part of a facility-wide master plan or new construction, can work to address architectural features and building layout to improve wayfinding. This can include the design and renovation of future spaces, such as new circulation routes, the configuration of check-in locations, the design of entrances and primary hallways, building finishes, landscape architecture, and the placement of future buildings, departments, and services. For example, working on grouping common outpatient services in close proximity to an entrance and each other such as pharmacy, outpatient lab, agent cashier/travel, and radiology service.

Disadvantages: Once the wayfinding masterplan is complete, the programming of the signage system should only take place shortly before implementation to avoid errors and duplication of work. This information has a short shelf life because conditions quickly change in large medical facilities, rendering the programming data invalid. Therefore, the programming (i.e., developing specific sign locations and messages) of the signage system will have to be done under a separate contract at a later date, or the facility must have available funding to fully award project implementation within six months.



Project Approach**Planning a Sign System****Getting Help**
(Continued)

Some of the collaborative benefits are diminished if an overall facility-wide masterplan is not underway or being planned.

Approach 2: Design, Build & Maintain

Hire a design-build EGD firm and architectural signage team with significant healthcare wayfinding experience. This unified team can develop, program, implement and maintain the system as a single source. This can be accomplished by a teaming agreement between two firms or one that offers all necessary disciplines. Contractual options for hiring a design-build EGD and architectural signage team are: (A) Establish a GSA Schedule Blanket Purchase Agreement (BPA) with a base year and four option years. (B) Issue a firm-fixed design-build contract to develop a wayfinding masterplan and implement the project or a specific portion of it (i.e., all interior wayfinding signage or complete a specific building).

Advantages: A design-build approach can provide a streamlined process, a single point of accountability, and full integration between design and fabrication.

When using a GSA Schedule Blanket Purchase Agreement (BPA), additional advantages are realized, making it the preferred method for getting help.

Most comprehensive signage system upgrades for large VA facilities tend to be implemented in phases to meet VA budgets, priorities, and renovations over a multi-year period. There is also a need to maintain the system with updates and adjustments due to ongoing renovations, relocations, and new policies and procedures that occur in a large medical center. The GSA BPA structure allows all of these objectives to be accomplished during the base year and four option years with a consistent design team and signage system. There is no commitment from the government to use the BPA or to fund a certain amount of work.

Disadvantages: As with any project, it is important to hire a team with significant past performance in healthcare wayfinding and architectural signage that will work in the facility's best interests. This can be verified as part of the evaluation criteria.

If using a firm fixed price contract as opposed to a BPA, the portion of the project to be implemented requires a scope of work detailing the exact work to be performed.



1.1.3 PROJECT PROCESS

The following outlines the general project process, tasks, and documentation for a large-scale signage program. For more information about specific concepts discussed in this overview, refer to [Section 2 Sign Type Guidelines](#) and [Section 1.2 Fundamentals of Wayfinding](#).

Identify & Engage

Project Scope, Approach, Team & Procurement

Scope & Budget: Identify which areas will be covered by the wayfinding master plan. Ideally, it should cover the entire campus or healthcare system. If necessary, it can be separated into smaller scopes. For example, the main hospital interior, campus exterior or all patient-oriented buildings. This allows the scope and budget to fit within the facility's timeline and priorities.

Project Approach: Based on factors specific to your facility, including available contracts, budget, and upcoming projects, choose the project approach that best suits your facility, as discussed in [Section 1.1.2 Project Approach](#).

The VA Team: Develop a core team that will function as the VA Project Team and be involved in the source selection review process. The team must include individuals with significant knowledge of the operational characteristics of the facility.

Coordinate with Contracting: Based on the project approach selected, coordinate with contracting on the process and documentation required. The Technical Information Library (TIL) has sample statements of work, evaluation criteria, and interview questions based on the project approach.

Procurement: Work with contracting as the source selection committee to review potential firms and select the most qualified team with significant healthcare wayfinding and signage experience representing the best government value.

Kick-Off Meeting

Once a consultant / contractor has been awarded the project, conduct a kick-off meeting.

Identify Fast Track Items:

- Identify any portions of the project that may require an expedited process due to code violations, new construction, or policy changes.

Project Timeline & Milestones:

- Review the project timeline and deliverables and establish project milestones.

Review Submittal Process:

- Establish a plan for reviewing project documentation.
- Develop a process and channel of approvals that will be utilized for answering questions on various facility operational characteristics, policies, procedures and naming conversations.



Plan

A. Site Survey & Evaluation

Objective: Conduct on-site assessments, stakeholder meetings, and surveys to evaluate conditions, gain an in-depth understanding of the facility, and identify wayfinding and signage challenges.

Consultant / Contractor Tasks:

- Identify points of entry & destinations.
- Analyze paths of travel.
- Locate intersections & decision points.
- Conduct a photo essay.
- Annotate architectural conditions.
- Meet with VA stakeholders.

Documentation:

- Wayfinding report to identify architectural, design, and communication problems at the facility that need to be updated and improved
- Photo essay of existing conditions
- Survey plans of existing conditions showing the location and existing naming conventions for all facility features, including but not limited to entrances, buildings, paths of travel, elevators, and destinations
- Summary of stakeholder meetings and surveys (if applicable)

VA Tasks:

- Provide architectural plans.
- Compile a list of future renovations and relocations, and the facility-wide master plan if available.
- Provide a list of departments and services currently used in visitor guides and appointment letters.
- Coordinate stakeholder meetings.

Approvals:

- Provide feedback on initial recommendations in the wayfinding report.



Project Process**Planning a Sign System****Plan (Continued)****B. Wayfinding Analysis & Design Development**

Objective: Develop three preliminary design concepts to improve signage and wayfinding.

Consultant / Contractor Tasks:

- Draft concepts for an information hierarchy and terminology.
- Develop conceptual graphics, maps, and design themes.
- Determine the general types of signs required.
- Develop potential sign design styles.
- Create a preliminary budget.

Documentation:

- Presentation drawings showing each proposed concept, including conceptual maps, graphics, sign drawings, and elevations
- Sample sign locations and user journeys to illustrate and evaluate each concept
- Leadership/stakeholder presentation
- Preliminary budget

VA Tasks:

- Provide ongoing feedback to consultant, answering questions on various facility operational characteristics, policies, procedures, and naming conventions.
- Coordinate leadership/stakeholder presentation.
- Review design concepts, drawings, and the budget.

Approvals:

- Select a design concept and provide feedback.



Plan (Continued)

C. Finalize Design & Wayfinding Masterplan

Objective: Finalize the wayfinding master plan, signage system standards, and budget for programming and implementation.

Consultant / Contractor Tasks:

- Finalize the information hierarchy and terminology that will guide users effectively from general to specific.
- Finalize the facility directory listing with associated check-ins.
- Prepare final sign type drawings with construction details.
- Create detailed orientation plans for signs and visitor guides.
- Prepare final artwork for all graphics assets developed.
- Finalize an implementation budget with estimated sign quantities.
- Produce physical sign samples.
- Create specifications documents for small projects.
- Develop a wayfinding training guide for staff.

Documentation:

- Information hierarchy
- Facility directory
- Signage system standards drawings showing all sign types, details, mounting, and layouts
- Specifications including a 10 14 00
- The final budget for programming and implementation
- Wayfinding training guide
- Leadership/stakeholder presentation
- Physical sign samples
- Graphic assets for all designs created

VA Tasks:

- Review final planning documents.
- Determine the next steps for programming and implementation.

Approvals:

- VA approval of the wayfinding master plan and final planning documents.



Project Process**Planning a Sign System****Plan** *(Continued)***Next Steps**

The next steps after the planning phase depend on the selected project approach, available funding, and facility priorities.

When funding is available to implement the project (or a phase of it):

- If using the **Design-Bid-Build** Approach: Coordinate with contracting to solicit proposals from qualified architectural signage firms on GSA Schedule utilizing the statement of work, sign standard, and best value evaluation criteria developed in the planning process.
- If using the **Design-Build-Maintain** Approach: Issue a task order to the BPA holder for the programming and implementation when funding for the project or a portion of the project becomes available. Task orders can also be issued to implement the new sign standard in small and ongoing projects as the facility works to adopt the new signage system fully.

Note: It is recommended to only begin the programming phase when funding is available for implementation. Information and existing conditions quickly change, rendering the programming data invalid after 6-12 months.



Program

Location, Placement & Messaging

Objective: Determine the signage system's final locations, placement, and messaging based on the signage system standards and wayfinding master plan established in the planning phase.

Consultant / Contractor Tasks:

- Identify sign locations and survey for suitability (available space/existing conditions, viewing distance, scale, ceiling height, etc.).
- Document all existing conditions for demolition (if applicable).
- Survey and meet with VA Staff to determine messaging for room id, informational postings, and specialty / regulatory information.
- Program all messaging for directional signs based on the wayfinding master plan.
- Prepare submittals, revise, and re-submit as necessary based on VA review.

Documentation:

- Message schedule
- Facility directory
- Location plan
- Submittal/fabrication drawings with installation details
- Elevation drawings for non-standard configurations or areas where multiple signs are needed like front entries or lobbies
- Production-ready artwork for orientation maps, graphics, images, etc.

VA Tasks:

- Review the final sign location plan, message schedule, and drawings.

Approvals:

- VA approval of documents for implementation.



Project Process**Planning a Sign System****Implement by Phase****Manufacture, Demolish & Install**

Objective: Manufacture and install the new signage system.

Consultant / Contractor Tasks:

- Produce pre-production samples and submittals.
- Fabricate signage.
- Coordinate delivery, demolition, and installation activities.
- Mark items for demolition / removal.
- Conduct pre-installation walkthrough.
- Perform demolition and installation activities.
- Create a punch list report.
- Correct punch list items.
- Train VA staff on how to make updates to the system.

Documentation:

- Pre-production samples and submittals
- Punchlist report
- As built drawings, location plans, and message schedule

VA Tasks:

- Review pre-production samples and submittals.
- Review and confirm the punch list.
- Coordinate implementation with facility staff.

Approvals:

- Acceptance of installed project
- Receiving report



Project Process**Planning a Sign System****Maintain**

Objective: Keep the signage system current, ensure consistency across all categories of wayfinding (appointment letters, visitors guide, etc.), and provide staff/volunteers with wayfinding training.

Consultant / Contractor Tasks:

When using a Design-Bid-Build approach, the contract typically ends after implementation. If using a Design-Build-Maintain approach with a BPA, the consultant/contractor can assist in the following areas:

- Regularly evaluate the system for potential updates.
- Based on an upcoming facility change (department move, name change, etc.) identify and perform updates to all applicable signs.
- Specify and implement signage for new construction or renovation projects.
- Provide consistent signage for future updates.

VA Tasks:

- Update appointment letters to use accurate and consistent nomenclature.
- Provide staff and volunteers with wayfinding training.
- Maintain the facility's signage system by consistently updating signs, messages, and graphics.
- Ensure all future construction and renovations use the sign standards and specifications developed in the planning phase.



1.1.4 SMALL PROJECTS

Existing signage systems will frequently require small projects including updating and maintaining current signs and expanding the system with new signage and wayfinding elements. If the system is not consistently maintained, its efficacy will break down over time, negatively impacting patient experience, reducing the return on investment, and shortening its lifecycle. When implementing small projects, it is important to:

- Adhere to the facility's wayfinding master plan and signage system standards.
- Identify a facility wayfinding / signage manager.
- Consult with an experienced design partner and architectural signage vendor.
- Utilize an insert-based component signage system and use the same manufacturer's system throughout the entire facility.
- Document and track the existing signage system and all patient destinations with associated check-in locations. This includes keeping an up-to-date record of each sign's location, type, and message. A sign data management system can assist in this effort facilitating more efficient, accurate, and cohesive sign projects over the life of the system. Some EGD firms and architectural signage companies offer these types of software platforms as part of their service. Refer to [Section 1.3 Signage & Wayfinding Technology](#) for more information.

The following are additional recommendations per project type:

Operational Updates

Operational updates include but are not limited to sign requests from specific departments/staff, nomenclature changes, updates to policies and procedures, and relocations.

- The facility wayfinding manager should have the authority to act as the gatekeeper for requests to ensure consistency and prevent visual clutter. Some requests should be solved by facility leadership and not by more signs.
- Changes in nomenclature, policies, and service locations often require updates to numerous signs located throughout the facility. If the change requires updates to directional signs, it is recommended that the contractor who programmed the system advise the facility on how the change should be implemented. Otherwise, the logic and structure of the wayfinding system can begin to break down, often resulting in laundry lists of departments appearing sporadically on signs.
- A Design-Build BPA contract grants the facility access to a design partner and architectural sign vendor who are familiar with the facility. These partners can consistently program and implement requests in collaboration with the facility. Other contractual options include issuing government purchase card contracts for individual projects or separate GSA Schedule procurements for projects exceeding the micro-purchase threshold.



Small Projects

Planning a Sign System

New Construction & Renovation Projects

There are often numerous active construction or renovation projects associated with a medical facility, such as a new addition, renovation of a wing, or a new outpatient clinic.

- The wayfinding masterplan, facility-specific signage system standards, and VA Master Specification on the TIL will guide signage development for these projects.
- The programming of the signage system for these projects can be performed by the architectural/engineering (A/E) firm based on the facility standards or by the consultant who originally developed the facility sign standard.
- Signage for these projects can be procured directly by the VA using a GSA Schedule signage vendor that can provide a matching system, or it can be included in the scope of work for the general contractor or initial outfitting firm. If the signage is included in the scope of work for the general contractor or initial outfitting firm, it's essential to require the brand name or equivalent component-based signage system to ensure that the signage matches and is interchangeable with the facility-wide standard.
- When completed, new construction or renovations at the facility may require updates to the existing signage system in other areas of the facility. See operational updates above for guidance.



1.1.5 SIGN INDUSTRY

Selecting a Sign Company

Not all sign companies are the same and they do not all have the same capabilities. Typically, sign companies specialize in one of two types of sign categories. These categories are generally the ones that fit the company's manufacturing capabilities. There are certain sign products that almost all sign companies buy from select vendors because of the specialized processes required to produce the product (i.e. cast metal plaques, cast metal letters, etc.).

Types of Sign Companies

The sign industry is generally divided into four main categories – Architectural, Electrical, Commercial, Service, and Lighting. These companies range in size and provide products and services locally, regionally, and nationally.

Architectural Sign Company: An architectural sign company typically manufactures interior and exterior sign products found in "institutional" or public facilities, such as hospitals, civic buildings, airports, corporate buildings, and schools. Many offer established product lines and component-based signage systems that should be used at VA facilities. They will have installation staff, permit services, design and drafting departments, and maintenance services. In addition, reputable architectural signage companies often have internal EGD design teams or partnerships with EGD teams that have significant signage and wayfinding design experience. These companies or teams can provide a comprehensive Design, Build & Maintain approach as detailed in [Section 1.1.2 Project Approach](#). In general, architectural signage companies are best suited for providing signage to a VA facility.

Electrical Sign Company: The electrical sign company typically has a sizable manufacturing facility and can fabricate large electrical signs, including pylon signs, skyline building signs, illuminated letters, dynamic electronic displays, and other types of custom-lighted signs. They typically have advanced machinery for custom cutting, welding, and fabrication. They will also have boom trucks, crane trucks for high-rise and large sign installation, and various service vehicles. In addition, they will have installation staff and vehicles, permit services, drafting departments, and maintenance services.

Commercial Sign Company: This group comprises Retail Sign Companies, Franchise Sign Companies, and Small Neighborhood Sign Companies. These sign companies are often found in strip malls, retail outlets, and small industrial buildings. They rarely have large, complex equipment for manufacturing, but offer quick turnaround time for vinyl lettering, vehicle wraps and graphics, decals, and banners. They may also manufacture sandblasted wooden signs and do various types of printing. These sign companies can be a resource for temporary, informational, and event signs and banners.

Service and Lighting Company: These companies repair existing signs. They can be called to repair a sign that is no longer illuminating or functioning properly. They have service trucks and staff familiar with sign construction and installation. Some of these companies provide services to maintain facilities' light fixtures inside and outside of buildings, as well as parking lots and structures.



1.1.6 SUBMITTALS

Submittal & Shop Drawing Check List

When implementing a signage program, it is important to review the sign company's submittals in detail.

The following outline provides an overview of items to look for and check during the submittal review. It should be noted that each project is different, so this manual cannot be inclusive of every possible item to check.

It is recommended that the submittal review process be conducted with a complete submittal, meaning all samples and all drawings are submitted together. Partial submittals can result in items being missed or misunderstood.

When a question is raised, needing more information or clarification in the review process, the sooner it is asked in the submittal review process, the easier it is to address. Once the submittal and shop drawings are approved, the sign company has authorization to proceed into manufacturing. Any changes after the approved shop drawings typically result in a change order with additional costs.

Interior Sign Message Schedule

The Interior Sign Message Schedule is a spreadsheet listing the various specifications for each sign in the project. It is developed during the programming phase of the signage system. The Message Schedule specifies sign location, sign type, and specific sign text. Additional information as to the quantity, layout symbols, notes, revision dates, and special conditions should be included.

Floor: Interior sign schedules include a floor level number for each sign.

Location: A number designating the location of a sign on a particular floor (location numbers should not be repeated on the same floor). A symbol typically indicates the orientation of a sign in plan view.

Sign Type: A variety of sign types are typically used in a project. The size, design configuration, and text layout vary amongst different sign types.

Sign Text: The Message Schedule lists the text on each sign. The text required is specific to each location.

Sign Side: Needs to be specified on all double-sided signs. The words (blank) will appear in the message schedule if one side is blank.

Quantity: In some situations, more than one sign will be necessary at a location. Signs are often stacked horizontally on a wall to accommodate multiple signs sharing the same location.

Layout/Symbol: Many signs use icons. For example, the accessible symbol of a person in a wheelchair indicates an accessible restroom.

Notes: Critical information in any project can be listed in the notes. "Client to verify text" is often listed, indicating that the copy is not final and needs client approval before fabrication.

Glass Backers: Signs installed on glass doors, windows, and side lights require glass backers installed to cover the back side of mounting tape.



Submittals

Planning a Sign System

Figure 1-10 Example Interior Sign Message Schedule

Interior Message Schedule										
Building Name										
Floor	Location	Sign Type	Sign Text	Side	Quantity	Layout / Symbol	Notes	Glass Backer	Revised Date	Installation
2	201	IN14.01	→ Clinic E Main Lobby ----- ← Therapy Services Radiation Therapy		1					
2	203	IN19.01	Pharmacy		1		Mount to sidelight	yes		
2	206	IN03.01 IN04.02	CAUTION BIOHAZARD (Symbol) 1359		1	BioHaz symbol	Mount to Door			
2	207	IN01.22	Soiled Utility		1					

Interior Sign Location Plan

Sign Location Plans are architectural floor plan drawings showing sign locations cross-referenced to the corresponding interior sign message schedule. These drawings can be part of the architectural drawing set or a separate document. The drawings must be drawn to scale, and exterior plans need a north arrow orientation. Location plans can be a variety of sheet sizes, including Architectural A to E size or 11"x 17" layouts. The drawings must be printed so that location callouts are legible.

A symbol parallel to a wall designates the general location of a sign on a wall. Symbols for overhead signs are often located in the center of a hallway or at a doorway opening. Symbols perpendicular to a wall indicate flag signs. To determine the specific horizontal placement of a sign, refer to the sign type drawing. To determine the mounting height, refer to the installation details.

Figure 1-11 Example Interior Sign Location Plan

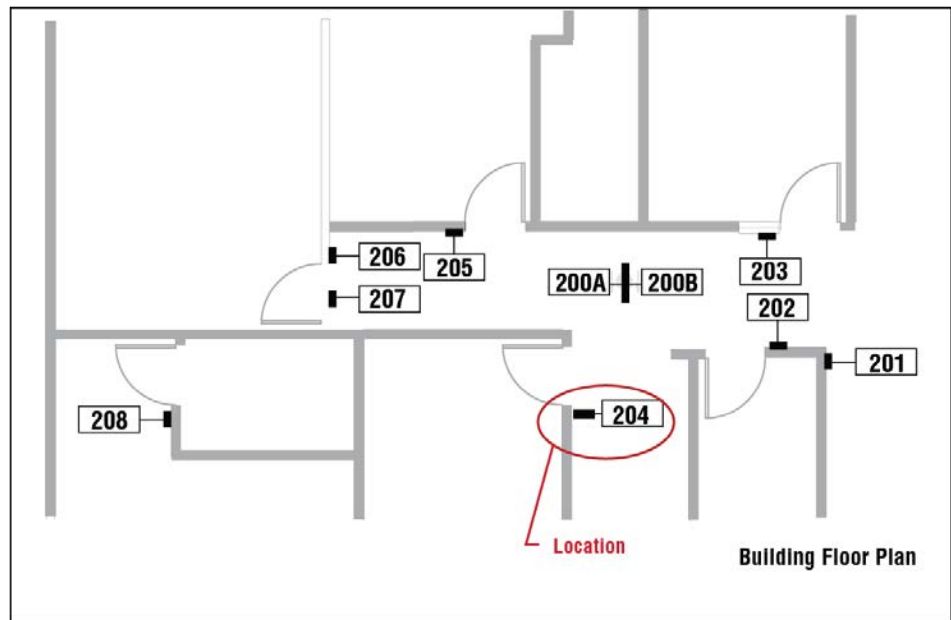

Submittals

Planning a Sign System

Exterior Sign Message Schedule

The Exterior Sign Message Schedule is a spreadsheet listing the various specifications for each sign in the project. It is developed during the programming phase of the signage system.

The Message Schedule specifies the sign location, sign type, and specific sign text. Additional information as to the quantity, layout symbols, notes revision dates, and special conditions should be included.

Location: A unique number representing each sign location. The symbol indicates the orientation of the sign on the site.

Sign Type: A variety of sign types are used in a project. The size, design configuration, and text layout vary for different sign types.

Sign Text: The Message Schedule lists the text on each sign. The text required is specific to each location.

Sign Side: Needs to be specified on all double-sided signs. The word (blank) will appear in the message schedule if one side is blank.

Quantity: In some situations, more than one sign will be necessary at a location.

Notes: Critical information in any project can be listed in the notes. "Client to verify text" is often listed, indicating that the copy is not final and needs client approval before fabrication.

Figure 1-12 Example Exterior Sign Message Schedule

Exterior Message Schedule							
Location	Sign Type	Sign Text	Side	Quantity	Notes	Revised Date	Installation
002	EN03.02	→ Exit ----- ← Visitor Parking Patient Drop Off	A B	1	Top Mounted		
002	EN09.07	Medical Center (Logo) (Underscore)		1			
003	EN09.03	2151 N Harbor Blvd.		1			
004	EN05.03	Service Vehicles Only		1	Post Mounted		
007	EN10.03	YIELD		1	Post Mounted		



Submittals

Planning a Sign System

Exterior Sign Location Plan

Exterior Location Plans show the building location within a site and vehicular and pedestrian paths of travel, roads, buildings, landscape layouts, building entries. Sign Location Plans are Architectural or Civil plan drawings showing sign locations.

These drawings can be part of the architectural drawing set or a separate document. Drawings must be drawn to scale, and exterior plans need a north orientation.

Location plans can be a variety of sheet sizes, including Architectural A to E size or 11"x 17" layouts. The drawings must be printed, so that location callouts are legible.

Figure 1-13 Example Exterior Sign Location Plan

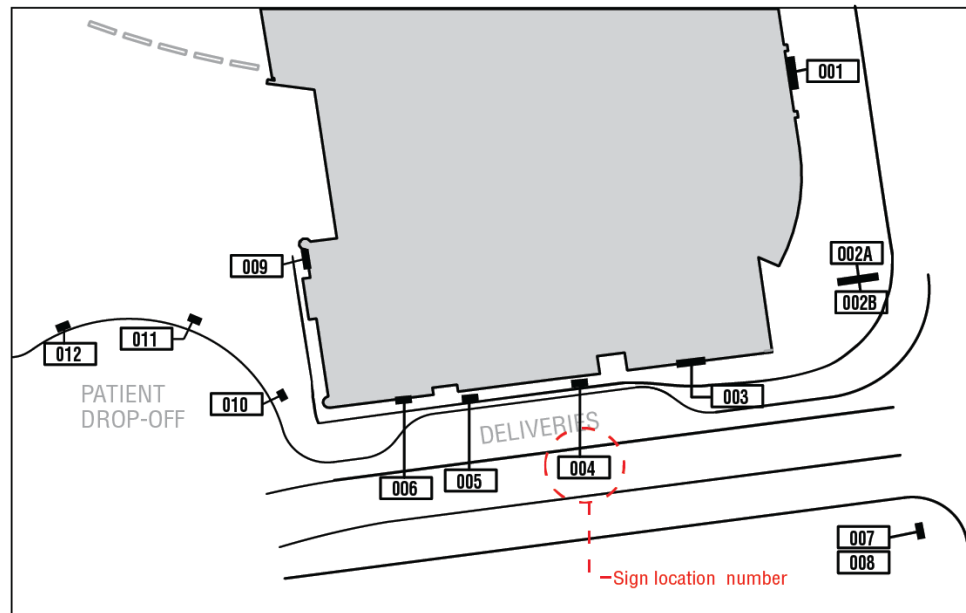

Drawings

General – Exterior and Interior

The following items apply to the review of any signage program submittal, interior or exterior:

- Do the drawings make sense? Are they logical, consistent, and complete?
- Are all sign types required for the job included and indicated in the drawings?
- Are paint colors specified by color number, name, and paint manufacturer? If a custom color is mixed, is the added information of the formula included?
- All the graphic symbols and fonts should be noted.
- All drawings need to be drawn in scale, and the scale noted.
- All sign face layouts must be fully dimensioned with capital letter size, interline spacing and margins. All Braille symbols need to be properly defined.
- Are all code-required and VA-mandatory signs included?



Submittals

Planning a Sign System

Drawings (Continued)

- On double-sided signs, is the layout for each side shown and dimensioned?
- Are the job colors, materials, and finishes noted and correct for each sign?
- Are the dimensions shown for each sign type and its components detailing length, height, and thickness?
- Are the dimensions shown for the placement of all graphics on the sign?
- Do the dimensions for the intended size and the placement of the graphics add up?
- Do the drawings clearly show how the sign is assembled?
- Do exterior signs that utilize adhesive in the assembly process identify the type of adhesive (glue or tape) and the method of surface preparation?
- Is the sign type installation specifically shown and detailed? Will it adequately secure the sign to its intended location?
- Are instructions provided for the correct cleaning methods for the signs?
- Are instructions provided on maintenance of the signs (i.e., how to access electrical components, how to change directory strips, etc.)?

It is important to remember that shop drawings will become the file document used for future reference when servicing, repairing, updating, or ordering new signs.

Exterior Sign Drawings

General – Illuminated and Non-illuminated

The following items apply to the review of any exterior signage program submittal:

- All signs over 8 feet tall require a structurally engineered footing (foundation). Footing drawings should have the engineer's name and license/stamp visible on the drawing with calculations that substantiate the foundation design.
- Drawings should show how the sign is connected to its footing.
- Exterior signs with a visible concrete base must have the finish of the exposed concrete identified.
- All sign cabinets and structural components should be fully dimensioned.
- Exterior signs on private property (leased facilities) require building/sign permits from the local city or county. Only begin fabrication of signs once permits have been approved. The signs also may require final inspections by city or county inspectors.
- The shop drawings should clearly show where the signs are to be installed with any field conditions noted that have a bearing on the sign location (curbs, walks, electrical service points, underground utilities, etc.). These drawings should be drawn in "plan-view," clearly noting street names, and distance from sidewalks, streets, buildings, and easements.



Submittals**Planning a Sign System****Exterior Sign Drawings***(Continued)*

- All hardware should be noted as being corrosion resistant.
- Exterior signs with dissimilar metals in contact must have isolating material between them.
- Are the sign construction and installation method appropriate for the materials used? (e.g., acrylic cannot be welded to steel.)
- All exterior signs and letters attached to a building must show and identify how the building penetrations will be sealed to prevent water intrusion.
- All exterior signs and letters must have a small spacer to slightly space the sign off the wall, allowing for water run-off and preventing streaking on the building surface.
- All specified vinyl and paint applications should be exterior grade with adequate UV protection.

Illuminated Exterior Signs

The following items are specifically applicable to the review of an illuminated exterior signage program submittal:

- The service voltage required, and circuit load should be noted on each electrical sign.
- Sign footings for all electrical signs should show footing dimensions and details regarding reinforcing steel and concrete. Does the footing design require a structural engineer?
- Exterior illuminated sign cabinets must show details on how the cabinet opens for access to servicing internal components.
- Internally illuminated signs with LED's must identify the LED manufacturer and the LED part number.
- Where does electrical wiring enter the sign?
- Large exterior illuminated sign cabinets' sign faces should be hinged.
- Where is the "UL sticker" located on the sign?
- Where is the shut-off switch's placement and how does one access it?
- The interior of an illuminated sign cabinet must be noted as being painted with a reflective white finish.
- Exterior illuminated signs with aluminum sign faces and routed-out text must show the mechanical attachment of letter voids to the diffuser. Adhesive attachment of the letter void is NOT an alternate construction method because it will fail.
- Illuminated letters must show the attachment points of the letters to the building surface and identify the type of hardware.
- Is the depth and construction of the footing shown and detailed and appropriate for the soil conditions where the sign will be installed?



Submittals**Planning a Sign System****Exterior Sign Drawings***(Continued)***Non-illuminated Exterior Signs**

The following items are specifically applicable to a non-illuminated exterior signage program submittal:

- Sign footings for all signs should show footing dimensions and details regarding concrete.
- Is the depth and construction of the footing shown and detailed and appropriate for the soil conditions where the sign will be installed?
- The finish on the edges of letters needs to be noted.

Parking Lot Signs

Refer to the general and exterior sign list.

Parking Structure Signs

Refer to the general and exterior sign list:

- Determine if the type of mounting hardware is suitable for the type of construction used for the parking structure.
- Any mechanical fasteners used in a post-tension construction structure need to be coordinated with the structure's construction drawings to ensure the method of attachment does not contact or affect the tension system.

Interior Sign Drawings

The following items are specifically applicable to the review of an interior signage program submittal:

- The Interior sign method of mounting to the wall surface should be noted and specified. Is the method appropriate for the wall surface?
- What is the assembly method shown for interior signs that have component parts?
- Interior sign drawings must show the mounting placement on the wall, with dimensions, for each type of sign.
- The finish on the edges of the letters must be noted.
- Flag type signs should detail the method of mechanical attachment of the sign to the wall.
- For hanging and overhead signs, details must be provided showing the mounting method and clearance height to the bottom of the sign for each type of ceiling condition. Is the method of attachment appropriate?



Submittals

Planning a Sign System

Samples

The quantity of samples submitted can vary for different projects, but a quantity of 3 is recommended as a minimum. This allows one set to be returned to the manufacturer when approved, one set to remain in the project master file, and one set to be used by the designer, during this phase of the project, for reference purposes, meetings, field comparisons, etc. Additional copies are required if the signage program is part of a renovation project. When reviewing the shop drawings, the following considerations must be addressed before the shop drawings can be considered complete:

- All materials, colors, and finishes should have been provided.
- Colors and finishes should be labeled with their reference/color code and manufacturer name.
- Color submittals, samples, and material finishes should be at least 4" x 4". If there is a grain, finish, pattern, or texture, the direction should be indicated.
- All the correct sign type samples should have been submitted.
- On letters with a satin grain finish, the direction of the grain on the letter face should be indicated.
- Verify that the original material specifications have been met and not altered or substituted with an inferior product.

Figure 1-14 (Right) Not all sign manufacturers are created equal. It's important to develop detailed evaluation criteria in order to select qualified vendors with established product lines. The sign shown here is relatively new, but the message panels are warped and sagging. To help prevent situations like this, always ask sign contractors for product samples and install photos of similar signs, prior to contract award.





U.S. Department
of Veterans Affairs

SECTION 1.2

FUNDAMENTALS OF WAYFINDING



1.2.1 WHAT IS WAYFINDING

Overview

For an efficient and effective signage system at a VA facility, it is important to understand the fundamentals of wayfinding within built environments, and the specific conditions and challenges in healthcare facilities. Wayfinding solutions in built environments and campuses work best when viewed from the patient's and visitor's perspective and developed as a cohesive system.

Definition

In general, the term “wayfinding” can refer to various forms of navigation over sea and land. However, modern usage typically describes the process of finding destinations within planned and built environments. Signs play an active role in this process by providing the primary form of communication in wayfinding.

Why It's Important

Wayfinding systems are critical to a functioning facility, affecting visitors' and staff's safety and quality of experience. Successful design projects of any kind require empathy and a deep understanding of the end user. In the case of healthcare environments, the audience is comprised of patients, visitors, and staff, whom all vary in age, education, culture, and ability.

Facility-Wide Benefits

When successfully implemented, the wayfinding system can produce facility-wide benefits that compound over time.

Improving Patient Experience: A patient's healthcare journey from home, getting to the facility, reaching their destination and back, can be a complex and disorienting experience. An effective wayfinding system helps reduce the anxiety and confusion they may feel by providing clear and consistent guidance and information, increasing patient satisfaction.

Operational Efficiency: Poor wayfinding leads to staff spending additional time giving directions and helping lost patients and visitors. This can compound at facilities that have numerous problem areas. When wayfinding works, fewer people are lost, and staff can focus on their primary responsibilities. Additionally, when patients know where they are going, they are less likely to arrive late or miss appointments.

Environment of Care: When wayfinding is successful, it contributes to the positive experience of patients, visitors, and staff, improving the overall care environment.

Aesthetic Improvement: Well-designed signage projects improve the function and professional appearance of the facility.



1.2.2 CATEGORIES

Wayfinding can take many forms along a visitor's journey, collectively helping them create a mental model of their environment. These touchpoints work together as an integrated system of information that helps the visitor make decisions, orient themselves, and navigate to a destination.

Navigation Strategies: Humans naturally use a combination of two types of knowledge to navigate: *Route Knowledge* and *Survey Knowledge*. Route knowledge consists of a sequence of points along the journey from the first-person perspective. Survey knowledge is the top-down, map-like perspective of the journey. People tend to gravitate towards one strategy, so a wayfinding system should account for both.

Signage

The most obvious forms of wayfinding are signs located throughout the campus, on exterior building façades, and in building interiors. Signs can be static or digital, flat or dimensional, freestanding, suspended from the ceiling, or wall mounted.

Identification: These signs identify the name of a specific location. They can be used to identify the campus, buildings, departments, rooms, and more.

Directional: Signs that help guide visitors in one or more specific directions along the journey.

Orientation: Signs containing maps and/or directories that help viewers orient themselves within a space and plan a route to a destination.

Informational: Non-wayfinding signs that contain information about policy, patient services, the surrounding environment, and more.

Code, Regulatory & Safety: Non-wayfinding signs required to meet ABA code requirements, regulate traffic, or alert viewers of safety hazards, requirements, or equipment.

Pre-Visitation Information

Figure 1-15 (Right) A printed visitor guide, with map and directory, helps a patient plan their visit before arriving.

Websites, online maps, call centers, and patient documents such as appointment letters can all include information to help a patient find their way. To prevent confusion, information must be consistent across all media and updated when a wayfinding master plan is fully implemented.

For example, if a patient's appointment letter lists the destination as "Radiology - Building 100" but signage only refers to "X-Ray" and "Main Hospital," this will create unnecessary confusion.



Categories

Fundamentals of Wayfinding

Verbal Directions

Many patients and visitors will instinctively ask for directions from staff in conjunction with reading signs. Upon entering a building for the first time, they will gravitate toward the most obvious source of information, which usually takes the form of a large welcome map and reception desk. Optimally, staff at VA facilities should have a common understanding of the wayfinding system to provide consistent and reliable directions. The wayfinding master plan should include a guide for training staff to give directions using the system.

Landmarks

Figure 1-16 The flag in the photo acts as a landmark that can help visitors remember where the main elevators are. The large atrium is a memorable architectural feature that clearly distinguishes the main entry hall.

As visitors and patients navigate a campus or building interior, they will begin to notice and recall visual landmarks along their journey, helping them to form a mental model of the environment. Features such as sculptures, artwork, graphics, furniture, and amenities like a café or courtyard will all contribute to this mental model. These landmarks can be subsequently used to enhance verbal directions given by staff members.



Architecture

Architectural design and layout play a large role in wayfinding for both campus and interior environments. For example, when approaching a hospital, the main entrance may have a welcoming appearance with sets of glass doors, a vehicular drop-off, landscaping, and identity signage. Within the building, entry lobbies will often have higher ceilings, waiting areas, and a reception desk. Connecting corridors and pathways on the way to departments and clinics will likely have narrower halls with lower ceilings and fewer amenities. These features, both subtle and obvious, will add to the visitor's mental model of the environment. An aging facility's architecture can also negatively impact wayfinding, which can be improved by signage and graphics. For example, this can be done by highlighting building/zone transitions that may lack architectural definition or by utilizing directional signage to guide through winding hallways.

Maps

Orientation maps at VA facilities typically provide a simplified illustration of a campus, building, or floor/level layout to help viewers understand their surroundings and plan their route. Maps can come in several different forms with specific purposes.

Online: A digital version of the campus map or interactive visitor guide may be listed in a healthcare system's "Locations" section on VA.gov. The listed facility's address can also link to online navigation websites to help patients plan a trip.



Categories

Fundamentals of Wayfinding

Maps (Continued)

Figure 1-17 Rocky Mountain Regional VA Medical Center Aurora, CO. Orientation Plan

More information on requirements for developing and maintaining site maps can be found in [Section 4.2 Wayfinding Maps](#).

Printed Visitor Guides: Visitor guides with maps can be provided to patients in entry lobbies or mailed as part of a welcome packet. They may seem obsolete in the digital age, but they are still useful since visitors can carry a printed map as they navigate the environment. Mobile devices, though ubiquitous, often have small screens that make it difficult to view large maps and require continuous cellular or Wi-Fi service to function.

Campus Map: Campus or facility map signs are usually located along primary roadways and in main entrance lobbies. When located outside, they are typically used to identify buildings, parking lots, and structures. When located inside of a building, they are often accompanied by a corresponding directory of patient services. Increasingly, these interior maps are interactive digital displays connected to a centralized software system and database. They may also display QR codes that can be scanned by mobile devices allowing the visitor to access maps and directions easily or download an app.

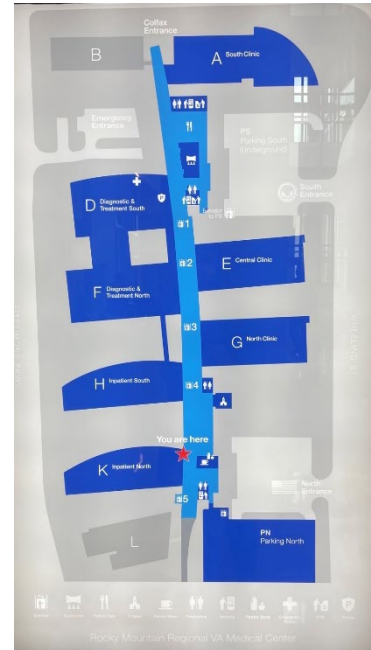

Orientation Plans: These localized maps help visitors orient themselves along their journey within a specific floor, department, or other subsection of the facility. They are most commonly placed near elevator banks and entrances to help visitors identify their location.

Evacuation Plans: Maps that help guide people to the appropriate exit during an emergency.

Mobile Devices & Indoor Positioning Systems

Mobile devices enable the use of Indoor Positioning Systems (IPS) and third-party applications to navigate environments. These services can include interactive maps, turn-by-turn directions, and spoken text. A variety of systems utilize different technologies and require prior planning and infrastructure to implement.



1.2.3 MASTER PLAN

Why You Need a Master Plan

For new facilities, the wayfinding master plan is typically developed in conjunction with the architectural master plan. At aging facilities, a holistic analysis of wayfinding is needed to truly improve the navigation experience. A wayfinding master plan takes a medical center's complex floorplans and long list of departments, sub-services, and destinations and creates a logical hierarchy of information that improves a visitor's ability to navigate the environment.

A well-designed software user interface feels fluid and effortless to use. Similarly, when wayfinding works well, it reduces confusion, anxiety, and friction. Like software, a well-designed wayfinding master plan reduces complexity by applying principles of Progressive Disclosure. For instance, it would be extremely confusing to navigate a software application that showed every menu option in the entire system all at once. For the same reason, listing too many destinations on signage because there is not an effective wayfinding plan can do more harm than good.

Once complete, the wayfinding master plan and resulting documentation of strategy, design, signage system standards, and nomenclature will establish the foundation for an effective system and ensure the quality and consistency of future projects, ongoing maintenance, and updates.

Components of a Master Plan:

1. **Analysis & Design:** Through a series of on-site assessments, staff interviews, and patient surveys, the wayfinding designer can evaluate conditions and tailor solutions to meet the facility's unique needs. Patient surveys and staff interviews are critical as they often reveal pain points that go unnoticed under casual observation. This research often reveals that the distinction between floors is less important than the clear identification of areas, primary paths, and destinations on the same floor. When patients and visitors are lost, they are typically on the right floor, but confused in the maze of departments and halls.

Figure 1-18 A wayfinding master plan reduces the complexity of information and simplifies the wayfinding experience by creating a logical structure of the space.

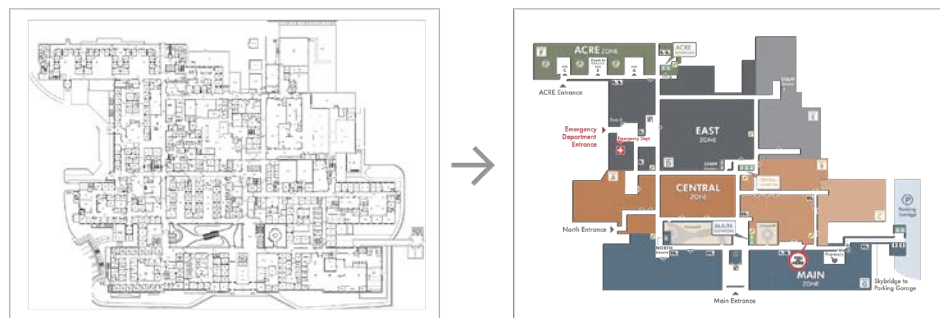

Master Plan

Fundamentals of Wayfinding

Components of a Master Plan: (Continued)

2. **Information Hierarchy:** After thoroughly analyzing the facility's environments and visitor experience, a logical hierarchy of information is developed to help guide visitors from general to specific destinations. The resulting system establishes naming conventions and how the campus and facility are divided to simplify and improve wayfinding. The following list provides a breakdown of the potential areas that comprise an information hierarchy for a typical large medical center:
 - **Campus:** The campus or facility name is at the top level of the hierarchy representing the entire property of the VA location.
 - **Campus Regions & Entrances:** Large campuses may be divided into multiple regions, such as "East Campus" and "West Campus," and have several named entrances to help visitors determine where to enter or exit the campus.
 - **Parking Lots / Structures:** Campuses with multiple parking lots or structures require a naming system to distinguish them. Typically, they are named by letter, number, color, or function, such as "Visitor Lot". Where applicable, parking lots should indicate which building and/or services it is associated with.
 - **Buildings & Building Groups:** Campuses with several buildings may be referred to by their number, but in many cases, the numbers are non-sequential and difficult for visitors to remember. In these cases, buildings (or groups of connected buildings) may be given names for easier distinction.
 - **Building Entrances and Elevators:** Buildings will often have multiple entrances and elevator banks that each require logical naming conventions to help visitors choose and find the correct one.
 - **Floor Area Divisions:** Buildings or clusters of buildings with poor architectural definition may be divided into wings ("North Wing" / "South Wing") or named zones ("Historic Hall"). Each zone or wing may contain multiple departments.

Figure 1-19 This example shows the facility being split into two "wings", "North Wing" and "South Wing" to better define the space. Elevators were then named after the areas ("North Elevators" and "South Elevators") to create a logical structure that simplifies wayfinding.



Master Plan

Fundamentals of Wayfinding

Components of a Master Plan: *(Continued)*

Figure 1-20 Example of branding a Primary Pathway. Now patients can easily be guided to follow this long primary pathway that connects multiple buildings and entrances. Architectural signage and branding elements re-assure patients as they navigate through the multiple turns, decision points, and changes in architecture on this path.



- **Primary Pathways:** In some instances, connecting corridors critical to wayfinding can be named and defined to help simplify navigation in complex environments.

- **Departments, Clinics, and Check-Ins:** In wayfinding design, it is necessary to guide patients to check-in locations which may or may not be the same as the department / service. This is because departments may have multiple check-in locations for sub-services. Conversely, multiple departments or services may be grouped together with a single check-in location. Therefore, the list of wayfinding destinations should be organized by check-ins which may differ from department names. Whenever possible, check-in locations should be named in simple terms for easy comprehension by patients and visitors. For the list of VA/VHA approved department names, refer to the VHA Standardized Nomenclature document in [Section 4.3 Nomenclature](#).

Figure 1-21 Creating a logical information hierarchy and grouping services by check-in, effectively reduces the number of destinations and simplifies the wayfinding experience.

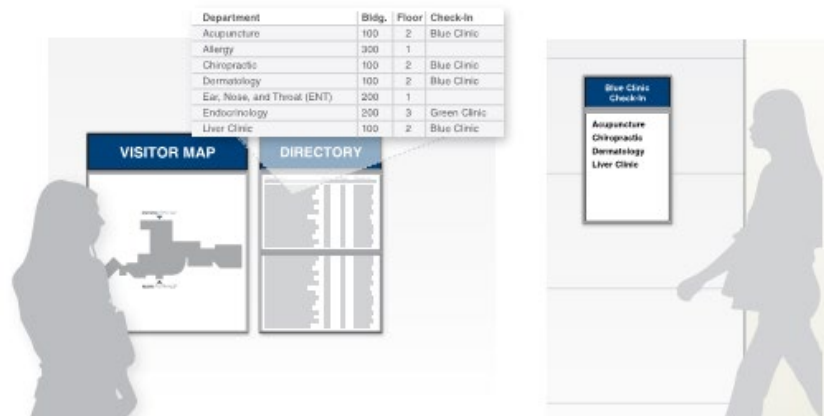

Master Plan

Fundamentals of Wayfinding

Components of a Master Plan: (Continued)

3. Signage System Standards

Based on the wayfinding analysis and information hierarchy, a signage system standard is designed within the parameters of the VA Signage Design Manual. This set of drawings and specifications establishes the facility-specific design and component-based signage system to be used in both current and future projects. The following items are typically included in the document:

- **Family of Components (Drawings):** Scaled drawings and specifications for all necessary sign types in the wayfinding system. This may also include components outside the current project scope to be used in the future. For elevation drawings of typical VA sign components, see [Section 3 Sign Type Drawings](#).
- **Colors:** Detailed color palette and color match specifications.
- **Finishes:** Palette of special materials and finishes such as metals and decorative laminates.
- **Graphics:** Any custom graphics or artwork created for the project.
- **Updatable Insert Templates:** Static signs should allow for easy message updates. For insert-based signs, updatable templates should be created for consistent design and layouts.

Figure 1-22 Example drawings of a family of components from a sign system standards document.



4. Facility Directory (Patient Services List)

The facility directory lists all clinical departments including sub-services, amenities, and associated check-ins. It should be updated frequently to reflect the facility's current conditions and be consistent with other sign messaging.



Master Plan

Fundamentals of Wayfinding

Components of a Master Plan: *(Continued)*

5. Location Plans & Message Schedule

Sign Location Plans are a set of modified floor plans that place numbered location tags of relevant signs in each area of the project. The numbered tags correspond to a record in the Message Schedule, which details the sign type, message, and other details. NOTE: It is recommended that the programming of these items be done in phases at the time of implementation. If done during the master planning phase, changes are likely to occur, and additional surveys will be required before implementation.

6. Wayfinding System Overview & Training Guide

A training guide should be created and distributed that explains how the wayfinding system works, the logic of the information hierarchy, naming conventions, and how to properly give directions using the system.

Figure 1-23 How a visitor may comprehend wayfinding information and plan their route based on a logical Information Hierarchy. Staff should be able to provide directions in a similar straightforward manner.

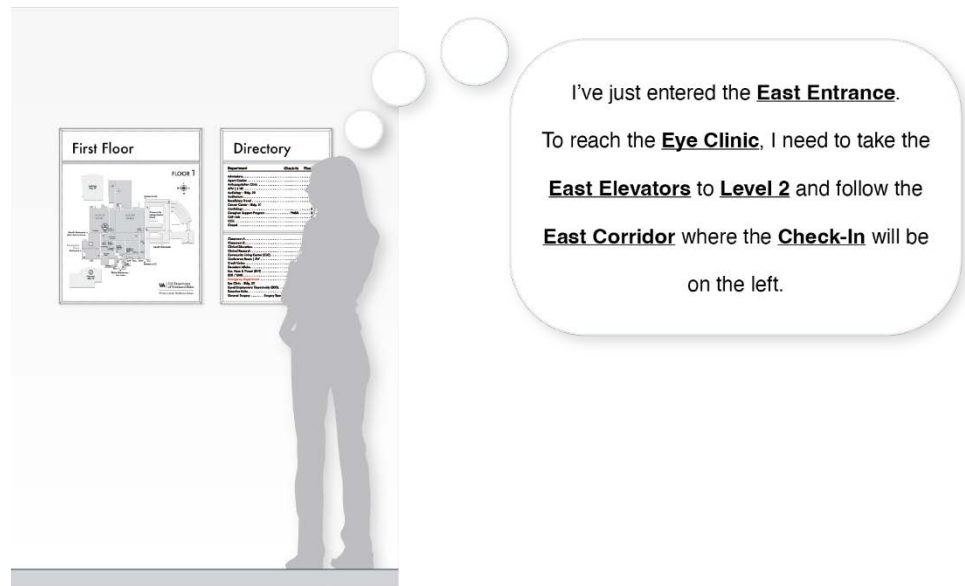

1.2.4 PATIENT EXPERIENCE

The Patient's Perspective

Developing a successful wayfinding master plan requires starting from the patient's perspective. The patient's journey starts long before entering the building and ends well after the scheduled appointment. It includes integrated information across various media, documents, and platforms.

The following sequence covers the basic stages of a typical patient's journey. In addition, example tools and general recommendations are listed for each stage. Individual circumstances and preferences will affect the patient's experience by determining factors such as which media they prefer, how they perceive and remember information, modes of transportation, which entrance they use, and more. The patient's familiarity with the facility and physical condition will also greatly impact how they navigate and experience every stage of the journey. For detailed information and recommendations about specific sign types see [Section 2 Sign Type Guidelines](#) of this manual.

The Patient's Journey



1. **Get Information (Pre-visitation):** The patient's journey begins with information. They may have scheduled an appointment online, on the phone, or on-site, and the appointment confirmation or letter that they receive needs to have accurate information for them to easily know where and when to arrive. To plan the trip they may need to check public transit schedules or arrange for personal transportation.

Example Tools: Appointment Letter, Email Confirmation, Call Center, VA.gov (visitor guide or interactive maps), and Local Transit Websites.

Recommendations: Patients should be provided with pre-visitation information that includes detailed information on how to get to the appointment (correct facility location, department/check-in name that matches wayfinding signs, and a short description of location, building, floor & zone), URL (web address) to online visitor guide/map, and where to access information about transportation options. Access to an up-to-date visitor guide or interactive map is important because it can aid them throughout their journey.

2. **Find the Campus:** A patient's unique circumstances will determine their mode of transportation to and from the facility and whether they are accompanied by a caregiver. If driving, they will likely utilize a GPS-enabled mobile device and follow Department of Transportation and city-owned signs to reach the campus. Patients taking public transportation may need to take multiple bus, rail, or shuttle lines to reach the campus.

Example Tools: Main Site Identification Signs, Skyline Logos, Public Roadway Signs, Mobile Navigation Apps Like Google Maps, Apple Maps, and Waze, and Local Transit Organization Websites or Apps.

Recommendations: Each healthcare system may have several locations, so pre-visitation information should clearly state the correct location information. Verify that correct location information appears in search engines and online maps.



Patient Experience

Fundamentals of Wayfinding

The Patient's Journey (Continued)

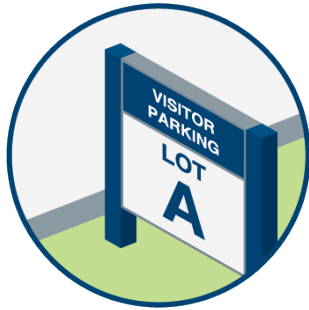

- 3. Enter Campus & Find Parking:** When approaching the campus by vehicle, the patient needs to know which entrance or gate they should enter and where to park. If there are multiple parking lots or structures, they must follow roadway signs to the location and find an available parking space. Patients using public transit will need to get off at the correct stop or drop-off location.

Example Tools: Entrance Identification Signs, Campus Roadway Signs, Parking Identification Signs, Street Signs

Recommendations: Make sure each entrance is logically named and displayed on signage. Parking lots and structures should also be named and identified, communicating who can park there and, if applicable, which building or services it is associated with. Directional signage should clearly guide to accessible and valet parking where available.

- 4. Enter the Building:** Patients must locate the right building entrance from the parking garage, parking lot, or street. When there are multiple building entrances, they must find the one closest to their destination.

Example Tools: Roadway and Pedestrian Directional Signs, Campus Orientation Plans, Building and Entrance Identification Signs.

Recommendations: If the facility has multiple buildings, clearly identify each from a distance and at street level. If a building has multiple entrances, they should be logically named and align with the master plan. Clearly identify accessible entrances or directions to the nearest entrance that is. Clearly post information regarding after-hours and emergency entry.

- 5. Orientation:** Upon entering the building, patients should feel welcome and intuitively comprehend the environment, orient themselves, and see helpful resources. There should be highly conspicuous options to self-navigate to their destination, such as facility maps and directories, or the opportunity to ask for directions from staff at an information desk. If the facility has an online or app-based mobile indoor navigation system, the patient may choose to use it to plan their route.

Example Tools: Facility Maps/Directories, Printed Visitor Guide, Verbal or Written Directions, Welcoming Architectural Letters And Graphics.

Recommendations: Within building entrances and lobbies, utilize signage and graphics that welcome and reassure visitors of the building, floor, and zone they have entered. Locate facility maps and directories near entrances to allow visitors to understand where their destination is in relation to where they are. If no obvious information desk is nearby, provide directions to it. If core services such as the emergency department or pharmacy are located elsewhere, provide clear directions to them from the main entrances.



Patient Experience

Fundamentals of Wayfinding

The Patient's Journey (Continued)



7. **Navigate and Return:** Once the patient knows their route, they will attempt to follow it to their destination. Based on the size of the facility, the route may include using elevators or stairs to get to another level or walking to other buildings. If the patient uses a wheelchair, their route may need to be modified to take accessible ramps and elevators. Along the way, they will follow directional signs to their destination, which should be clearly visible from the path and identified with signage. After checking in and proceeding with their appointment, they will need to navigate back the way they came, exit the building, and head back to their parking space or transit stop. Or, in some cases, they will visit other services elsewhere on the campus.

Example Tools: Directional, Orientation and Identification Signs, Printed or Online Visitor Guide, Mobile App.

Recommendations: Develop a wayfinding master plan to help solve wayfinding problems and logically guide visitors. Progressively disclose information and destinations on signage, guiding from general to specific. Prominently identify departments, clinics, and amenities with signage.

Human Factors

For a wayfinding system to best serve patients and visitors along their journey, the full range of subpopulations must be considered rather than simply designing for the average person. Reasonably addressing these factors leads to solutions that service the widest possible audience. Below is a list of common factors to be aware of and examples of wayfinding solutions that address them. Note that this is not an exhaustive list. Each facility's unique conditions should be assessed prior to implementation. See [Section 1.1 Planning a Sign System](#) to learn more about project planning and assessment.

1. **Physical Condition:** A patient's physical condition may require them to use a wheelchair or have hunched posture, limiting their line of sight.

Solution: Mounting signage at accessible viewing heights. Planning and clearly marking accessible routes.
2. **Impaired Vision:** Patients with limited vision may still be capable of reading signs, while patients with full or partial blindness will likely require guidance through some combination of mobile voice navigation and caretaker or staff assistance.

Solution: Signs that have high-contrast text in relation to the background. Including tactile and braille text on room identification signs.
3. **Impaired Hearing:** Hearing impairment will not directly affect a patient's ability to read signs. However, it will impact how they interpret verbal directions.

Solution: Accurate and up-to-date information on all signs and printed materials.



Patient Experience

Fundamentals of Wayfinding

Human Factors *(Continued)*

4. **Cognitive Impairment:** Patients with dementia, brain injury, and other cognitive impairments will have an especially difficult experience finding their way without assistance.

Solution: Using large, familiar imagery and icons in signs and accompanying graphics to act as landmarks and improve memory recall. Reduce visual clutter, especially in close proximity to directional signs.

5. **Language:** Some facilities are located in communities with high populations of bilingual or non-English speaking patients.

Solution: Using simple wording and universally VHA approved iconography on signage. Multi-language messages may also make sense in certain conditions.

6. **Reading Level:** To account for the widest range of reading ability, use simple, non-technical wording where possible outside of VHA approved naming conventions.

Solution: Simplifying non departmental names, for example, referring to “Ophthalmology” as “Eye Clinic.”

7. **Age:** Advanced age increases the likelihood of vision, hearing, cognitive, and physical impairment.

Solution: See human factors 1 through 4.

Figure 1-24 Large, familiar icons are used in this sign for easy comprehension.



1.2.5 KEYS TO SUCCESS



Figure 1-25 This directional sign lists a limited number of check-in destinations in alphanumeric order and graphically separates corridor and floor information to create a visual hierarchy.

1. **Focusing on Patient Experience:** Tell visitors what they need to know, when they need to know it, and in the medium they prefer. From planning through implementation, ensure that the wayfinding system addresses the specific needs of the facility and its visitors.
2. **Consistency of Information:** An overarching expectation of visitors is that all the wayfinding information they interact with, such as appointment letters, directions from staff members, or on signs, maps, and other tools, are accurate and up to date. Maintain consistent nomenclature — the system of names and symbols used to direct visitors to destinations — across all wayfinding tools. Refer to the VHA Standardized Nomenclature document for the full list of approved department names.
3. **wayfinding master plan:** A comprehensive master plan will establish a logical hierarchy of information and wayfinding solutions to guide visitors around your facility successfully.
4. **Progressive Disclosure:** As a general principle, too much information on signage and displays can overwhelm the viewer. Avoid long lists of departments on directional signs, and guide from general to specific destinations along the visitor's journey.
5. **Informed Staff:** Frontline staff members should be trained on the wayfinding system logic, giving directions, and introducing wayfinding tools to visitors.
6. **Management Systems & Accountability:** From the start, create a management plan that identifies the people, processes, and tools to keep wayfinding content accurate and technology operational. Assign and train "wayfinding managers" to update and maintain the wayfinding system. Create a centralized database to manage wayfinding content such as building, department, and destination names. Establish procedures for updating the wayfinding system elements when a change occurs, such as a department move, temporary construction re-routing, or a name change.
7. **Effective Products & Solutions:** A new signage system can remain in operation for 10-15 years. Setting a facility-wide sign standard and consistently using the same component-based signage system that is sustainable, easy to update, and well-supported by the manufacturer will extend the system's life cycle. Use cost-effective high-impact solutions, leveraging and extending assets and platforms as much as possible.



Keys to Success

Fundamentals of Wayfinding

Keys to Success *(Continued)*

8. **Consideration for Patient Sub-Populations:** Each medical center will have a unique composition of patient sub-populations to consider. Therefore, the specialized needs of each should be taken into consideration when planning a wayfinding system. This includes but is not limited to Inpatient Units, Blind Rehabilitation, Spinal Cord Injury, Mental Health, and Community Living Centers.

Examples: Mental health facilities and secure inpatient units are now required to be completely free of hazardous removable accessories that could be used as weapons, and items that could provide hook or anchor points. This impacts the physical requirements for signage.

In Contrast: Community Living Centers (CLC) aim to create a welcoming, home-like atmosphere for their long-term patients. Signage in these facilities should feel less institutional and foster a community environment reminiscent of residential and civic areas in the greater community.

Figure 1-26 This Community Living Center Sign contributes to a welcoming home-like environment for long-term care patients.



Figure 1-27 (Right) Specialized sign systems, free of hazardous components, are used in mental health facilities and secure inpatient units.





U.S. Department
of Veterans Affairs

SECTION 1.3

SIGNAGE & WAYFINDING TECHNOLOGY



1.3.1 OVERVIEW

Enhancing Wayfinding with Technology

When successfully implemented, technological solutions can significantly enhance the ease and convenience of navigation and improve the overall visitor experience at VA facilities. However, it is essential to note that solutions such as digital signage and mobile applications are most effective when adhering to the facility's wayfinding master plan and in conjunction with a traditional signage system. Without the foundation of the wayfinding master plan, poorly planned technology projects can negatively impact wayfinding and visitor experience. Adhering to the facility's wayfinding master plan and making practical improvements will increase the likelihood of success with technological enhancements.

Quick Projects

Before considering a large-scale digital wayfinding project, there are smaller, practical projects that can significantly improve the overall experience for visitors and patients.

Include detailed pre-visitation information, such as maps and visitor guides on the facility's page on VA.gov.

Add QR codes to wayfinding maps, printed visitor guides, and appointment letters that patients can scan to download maps, directions, and other vital information to reference along their journey. See [QR Codes](#).

Technological Evolution

This section of the manual aims to provide awareness of technologies relevant to developing and implementing signage and wayfinding systems as of 2023, but the pace of innovation is rapidly increasing. While long-term trends may exist, it is nearly impossible to accurately predict what the market leaders and dominant technologies will be years from now. Therefore, additional research will always be required before taking on any project.

Many of the technologies mentioned here have existed for decades, but only in recent years has their usage become widespread due to the improvement of individual technologies and through the convergence with other technologies. For example, Global Positioning System (GPS) technology, existing since the 1970s, reached widespread consumer adoption partly due to the growth of the cellphone and mobile device industries, fundamentally changing how people navigate the world. Currently, emerging technologies and trends such as 5G broadband cellular service, the Internet of Things (IoT), artificial intelligence (AI), and machine learning (ML) are all growing exponentially. As a result, their impact on the signage and wayfinding industry is just beginning to take shape and will likely lead to unforeseen changes in the coming years.



Overview**Signage & Wayfinding Technology****Human Factors**

Each VA facility must evaluate the best solutions for its demographic makeup of visitors and patients. Not all VA visitors and patients feel comfortable navigating hallways using a mobile device rather than asking for directions. Interactive kiosks may be effective with one demographic group of users and not another. Technology is not intended to replace volunteers and traditional signage but may assist with an alternative method of delivering information and directions. More information about human factors can be found in [Section 1.2 Fundamentals of Wayfinding](#).

A Cohesive Experience

Due to the complexity of signage and wayfinding systems, projects may require coordination between multiple contractors, vendors, and internal departments. Amidst this complexity, it is crucial to maintain a cohesive experience across all patient communication channels, including appointment letters, signage, digital and printed visitor guides, websites, and mobile apps. In addition, the information and graphic standards presented in digital wayfinding experiences should be consistent with the facility's wayfinding master plan.



1.3.2 COMPONENTS

The following outlines relevant technologies and recommendations for indoor wayfinding projects involving solutions beyond traditional signage. Since GPS-powered applications are ubiquitous among all contemporary smartphones, there is less often a need to develop additional infrastructure or platforms to help visitors navigate campus roadways.

As discussed in [Section 1.2 Fundamentals of Wayfinding](#), wayfinding systems can include various technological components such as digital displays, indoor positioning systems, online maps, and mobile applications. Note that if a wayfinding project requires any of these technologies, the complexity of planning and implementation can increase significantly. The wide range of existing digital wayfinding and navigation solutions requires an in-depth analysis of the individual facility to meet its needs successfully. Special consideration is needed for these projects as they potentially require additional infrastructure, including electrical and data connections and coordination with building operations and IT. They may also incur ongoing costs in software licensing, data management, cloud storage, IT infrastructure and support, and device repair and replacement. Training staff to use the system and keep its information consistent and up to date is also required. Ultimately, all digital signage and navigation technologies within a facility should utilize existing infrastructure and information systems, integrating with existing platforms when possible. This will minimize the duplication of information and efforts, improving the system's efficiency and performance.

Principle Components

The blend of technologies and services that each firm in this industry offers or recommends may vary. Still, one can become familiar with the principle components of a digital wayfinding system. A comprehensive solution will differ for each facility and may require a combination of technologies, services, and potential coordination between multiple consultants.

Exterior campus areas have the benefits of already having mapping data from major tech companies and more accurate GPS. However, additional consideration will be necessary at more extensive medical facilities with multiple parking lots, parking structures, and buildings to help visitors navigate from parking to a specific building or transition between buildings.

Indoor Mapping Data Capture

Unlike outdoor areas, interior spaces initially have little or no publicly available mapping data, requiring all wayfinding maps to be adapted from existing floor plans and verified from an onsite survey of the environment. A meaningful indoor navigation experience involves digitizing the interior environment and converting it to an illustrated map using one or more processes. Additionally, a thorough survey of all public corridors and check-in locations will be needed due to the complexity of operations at VA facilities. The result should be digital 2D or 3D maps that designers, software developers, and facility professionals can use in signage, printed or web-based visitor guides, and other navigation platforms. Capturing the data can be achieved with one of two approaches:

Manual Mapping - Designers can use architectural floor plans as a basis to illustrate 2D and 3D wayfinding maps. This is the standard method used by signage and design firms. In addition, a walkthrough survey of the site is



Components

Signage & Wayfinding Technology

Indoor Mapping Data Capture (Continued)

recommended to verify the current environmental conditions and locate check-ins and other points of interest.

Mobile Mapping Systems - Using various electronic devices and software applications, indoor environmental data can be captured and used to map the entire 2D or 3D indoor environment with high accuracy. The process requires a walkthrough of the entire space to achieve this level of accuracy. Many of the latest consumer mobile devices have built-in LiDAR sensors, which can be utilized with mobile mapping apps to map smaller rooms and environments. For larger environments like medical facilities, professional services that use advanced, commercial-grade equipment and robotics can be hired. Some of these firms also provide modeling services to build a virtual 3D model of the space and full-fledged navigation applications.

Figure 1-28 An advanced method of capturing three-dimensional indoor data is by scanning the interior with LiDAR enabled devices.

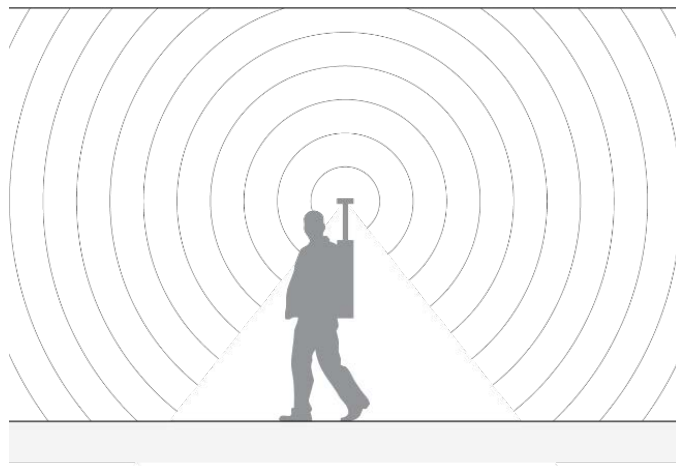

Indoor Positioning Systems (IPS)

An Indoor Positioning System is a network of devices that work together to locate people and objects where GPS is less effective. GPS accuracy can be limited indoors with a further reduction of accuracy for vertical travel between floors. Therefore, different technology is required inside buildings to produce accurate location data to provide navigation for visitors and equipment tracking.

An IPS typically consists of environmental sensors such as Bluetooth Low Energy (BLE) beacons placed throughout a facility that transmit a signal detectable by smartphones and other mobile devices. A dedicated mobile application interprets this data to illustrate the user's location and provide actionable navigation information.

An IPS can also integrate with other environmental systems, such as a Real-Time Locating System (RTLS), which locates and tracks RFID tags attached to objects and equipment. While an IPS and RTLS may serve different purposes, they may share data and be managed through a centralized database and software application.

The technologies used in digital wayfinding will likely vary from vendor to vendor. Some companies use widely available products, while others have proprietary technology and software. In addition, multiple positioning technologies are often used in conjunction to supplement their individual limitations and produce better results. Some technologies used to transmit indoor location data include Ultra-Wide Band (UWB), Wi-Fi, Wi-Fi RTT (Round Trip Time), Ultrasonic, and Angle of Arrival (AOA).



Components

Signage & Wayfinding Technology

Figure 1-29 Some Indoor Positioning Systems use Bluetooth beacons placed throughout the environment that are detectable by mobile devices

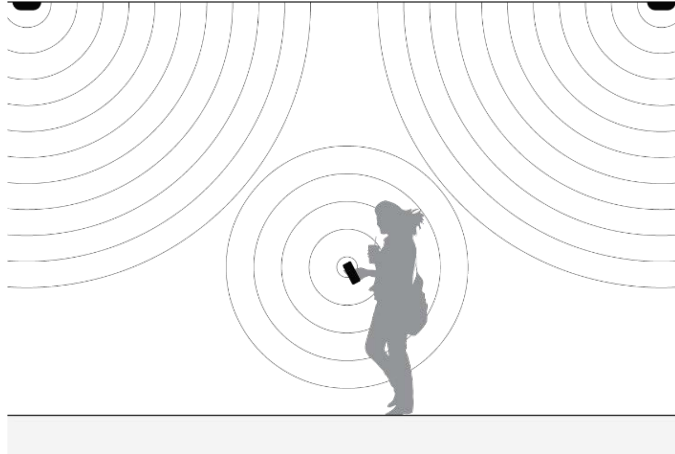

Digital Signage & Kiosks

Digital signage is the primary expression of a digital wayfinding system in the built environment. A familiar example is a directory and map displayed on a digital kiosk near entrances to a medical center. The use case, project requirements, and environmental conditions will determine the size, position, and placement of digital components. Like consumer smart TVs, digital signage can display static images and motion graphics or be interactive. The primary difference is that consumer TV displays are made for 3 to 6 hours of use a day, while commercial-grade digital signage displays have a life cycle rated for 8 to 24 hours of use a day. Interactivity can include touch, voice, or gestural activation, as well as QR code scanners allowing patients to scan appointment letters to receive wayfinding information.

In recent years, LED technology has replaced LCD as the primary type of consumer and commercial flat-panel digital display. LED technology advancements such as OLED and QLED aim to improve performance and image quality. However, the model of display and technology used will usually be specified by the vendor. As digital displays decrease in cost and energy consumption over time, it becomes easier to include them in wayfinding projects. At the same time, the ubiquity and power of mobile devices continue on an upward trend reducing the need for numerous digital displays.

Figure 1-30 (Left) Digital maps and directories can be freestanding or wall-mounted and portrait or landscape orientation.

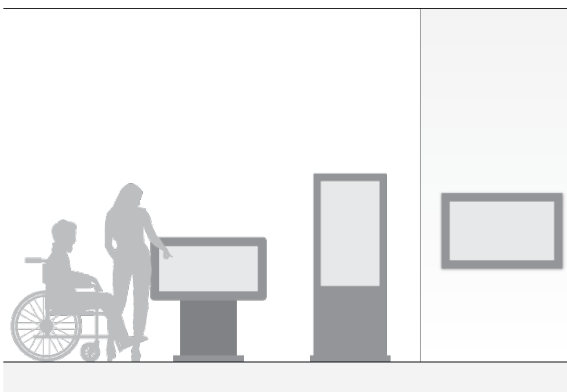

Figure 1-31 (Right) Interactive displays and visitor guides can complement traditional signage.



Components

Signage & Wayfinding Technology

Web/Browser-Based Applications

Web-based applications (web apps) are developed using the same tools and programming languages as websites and are only accessible through common internet browsers on mobile devices. Web apps can only be used with an internet connection. Typical examples at VA facilities are interactive maps and visitor guides that can be linked to on the facility's website. The benefits of web-based applications are ease of access and responsive design, which allows for use on various devices with different size screens, including mobile devices, interactive kiosks, and signage.

Figure 1-32 (Right) Web based interactive VA facilities map



Native Mobile Applications

Native mobile apps are developed specifically for a mobile operating system such as Apple's iOS and Google's Android and downloaded via their respective app stores. Native apps can offer more robust capabilities as they can access more of the smartphone's features and functionality than a browser-based app can. They can also have increased performance and the capability of offline use. However, many native apps still require an internet connection for some or all features.

The navigation strategy used by the mobile app will vary based on the requirements of the facility. Some apps use a map-based navigation strategy where a path is illustrated on a floor plan to guide the user, while others provide an "augmented reality" experience where the user points their device in the direction of travel and the app uses the device's camera to show the environment with superimposed navigation information.



Components

Signage & Wayfinding Technology

Native Mobile Applications
(Continued)

Mobile applications should always be developed in conjunction with a wayfinding master plan to provide a cohesive visitor experience. Some useful features found in mobile apps for healthcare facilities:

- Turn-by-turn navigation with voice and text guidance
- Multi-language support
- Multi-building support for indoor/outdoor transitions
- Out-of-route rerouting
- Visual landmark-aided navigation
- Patient appointment info and alerts
- Parking reminders

QR Codes

QR Codes have grown in prevalence as a versatile digital communication device. Compared to standard UPC barcodes, they have a greater storage capacity for information due to their two-dimensional matrix configuration. As a result, QR codes are used to trigger various actions when scanned using a mobile device. Among the many uses, they can include a URL that opens a specific website, display text or images, send contact information to the user's device, and open applications. They can also be used similarly to UPCs to track and catalog objects and equipment with the added ability to store location data. Currently, the most relevant use cases in facility wayfinding are to display QR codes on wayfinding maps, kiosk displays, and visitor guides. When scanned by the user, the code can open a wayfinding map or application on their device, allowing them to utilize the information on their journey. Additionally, including QR codes on appointment letters can give patients easy access to wayfinding and appointment information.

Figure 1-33 QR Codes included on printed visitor guides and signage provide an easy way for visitors to quickly access the online guide via their mobile device.



1.3.3 SIGN MANAGEMENT

Overview

Every signage system, digital or traditional, has documents and datasets that must be efficiently managed and maintained. See [Section 1.2.3 Master Plan](#) to read about the components of a wayfinding master plan. Using technology to help manage this information including the department listings, terminology, sign locations, and associated messages can help keep information consistent and extend the useful life of the signage system.

Approach 1: Consumer Software Tools

Popular applications within Microsoft Office and Adobe Creative Cloud can be used in conjunction to create, manage, and share wayfinding data and documents. For example, Microsoft Excel can be used to create and manage message schedules and directory lists. At the same time, location plans can be made in Adobe Illustrator or Corel Draw but may require a graphics professional to create and update. The designer or manufacturer will typically provide sign drawings as a PDF document.

Pros:

- Relatively inexpensive software that most office professionals already know and use regularly.

Cons:

- Must coordinate between multiple file types and applications.
- Files can be overwritten, and mistakes can be made.
- Difficult to keep track of changes made by multiple users over time.

Approach 2: Specialized Software Platforms

Subscription-based web applications such as SignAgent and Wayfindit provide tools for managing sign details, message schedules, and location plans for multiple projects.

Pros:

- These applications are cloud-based and can be used via all standard internet browsers.
- They have mobile-friendly versions for use in the field.
- Monthly per-user fees are relatively inexpensive.
- They act as a centralized database for all related information.

Cons:

- User interface and features are geared towards signage and EGD professionals and may not be intuitive to the average user.
- The initial process for data entry can be tedious.
- They have closed APIs, which require coordination with the vendor to custom-develop integrations with building management systems.



Sign Management**Signage & Wayfinding Technology****Approach 3: Custom Software Platforms**

In some cases, a custom software solution is needed to manage signage and digital wayfinding tools such as interactive directories and maps. Numerous companies provide bespoke indoor mapping and wayfinding management solutions. In addition, some architectural signage companies have software to help both manage and update the signage system.

Pros:

- They are highly tailored to the needs of the individual facility.
- Wayfinding systems can be integrated with other facility management systems.

Cons:

- They are high-cost and time-consuming to develop.
- They incur ongoing maintenance and support fees.



1.3.4 FABRICATION

Overview

The following section provides an overview of contemporary processes used in signage production. The equipment and capabilities of signage firms will vary.

Digital Printing

Advances in Digital Printing have made it an efficient alternative to painting and screen printing of signage and graphics. Digital printing can be used in both indoor and outdoor applications. Ultimately, the type of printer and inks used will vary based on the signage firm.

Benefits:

- Faster production runs for low-quantity items due to less setup.
- Water-based inks have low or no Volatile Organic Compounds (VOCs), which help reduce indoor air pollutants.
- Modern printers print at high enough resolutions to produce photographic quality images and large solid color fields without creating a noticeable moiré pattern or streaking.
- Durable coatings can protect graphics against scratches and fading.

Wide Format Printers

Signage and graphics are typically printed using Large Format Printers. These commercial printers enable printing on a variety of large-format substrates.

Roll-Fed:

Roll-fed printers accept roll substrates, including paper, adhesive vinyl, and films. The print head remains fixed as the substrate moves through the feed. The print size is limited by the printer's width, which can range from 17in to 100in, but the length can extend up to 50 or 150 feet depending on the model. Printing at sizes wider than 100" is called Super-Wide or Grand format.

Flatbed:

Flatbed printers enable printing directly to a wide variety of sheet substrates such as acrylic, metal, and MDF. The dimensions of the flatbed limit the size of the printing.

The substrate lays stationary on the flatbed while the print head moves along the print path.

Hybrid:

Hybrid printers are similar to roll-fed ones as the printer head is stationary but accepts sheet substrates to be fed through on rollers or a conveyor belt. This enables printing on rigid substrates like a flatbed while allowing longer print lengths like a roll-fed.

Figure 1-34 Wide-format digital printers allow for greater flexibility in design and low VOCs in comparison to silk-screening or painting. They also allow for surface or subsurface printing directly to the substrate



Ink Categories

Aqueous inks use water as a solvent and either dye or pigment as a colorant.

- **Dye-Based** aqueous are typically used on paper or canvas as the ink stains the porous surface when applied and dries as the water evaporates. They can produce bright colors and high-quality images but are not water or UV-resistant without lamination.
- **Pigment-Based** aqueous inks combine a powdered substance with a water carrier. The pigment rests on the surface of the substrate once applied and requires an ink-receptive primer coating before printing. Pigment-based inks can result in more muted colors than dye-based inks but are water and UV-resistant.

Solvent-Based inks use pigment as well but use a solvent as the carrier. They adhere well to plastics, not requiring a primer, and are water and UV-resistant. The drawback is that solvents are Volatile Organic Compounds (VOC), requiring extra ventilation when printing and drying. ECO-solvent inks have been developed that do not produce harmful fumes and can be used in enclosed spaces.

Dye Sublimation is a pigment-based ink typically used on fabrics and banners. A reverse image is printed on coated heat-resistant transfer paper and then transferred to the substrate surface.

UV Curable (UVC) inks are aqueous-based and can have dye or pigment-based colorants, but they are cured using ultraviolet light. Their advantages are that they can adhere well to most substrates and are waterproof. The disadvantages are that they can be more expensive and have lower print quality.

Latex inks are similar to aqueous pigment-based inks but contain particles of latex that, when heat-cured, encapsulate and bind the pigments to the surface of the substrate. These inks are also waterproof and do not produce harmful fumes. Limitations to the process are that it requires heat which limits the range of media or substrates that can be used and consumes more energy.

Lamination

When printing on delicate substrates like paper and vinyl, various forms of lamination can be used to increase the durability and lifespan of signage applications.

Overlaminates are adhesive films that are applied to printed graphics as a protective barrier. They are manufactured in a variety of finishes, but matte or satin are typically used in signage applications to reduce glare. In addition, some overlaminates have unique properties such as graffiti, scratch, and UV resistance.

Hot Lamination is a process where a transparent film with a heat-activated adhesive is applied to a printed graphic by running it through a hot-roll laminator. This lamination is primarily intended for indoor use as it does not provide UV resistance.



Fabrication

Signage & Wayfinding Technology

Subtractive Manufacturing (Cutting, Routing & Milling)



Figure 1-35 Example of text routed from a sheet of brushed stainless steel using a CNC machine

Most signage fabrication and manufacturing firms will utilize a wide variety of standard shop tools and machines. The category of machines most relevant to subtractive processes for signage fall under the umbrella term Computer Numerical Control (CNC), where the cutting path is determined by a CAD/CAM file. The three most common CNC categories are:

CNC Routing machines are composed of a flatbed capable of receiving a variety of sheet or block materials and a mechanized arm that can be equipped with different tool bits for routing and milling. Standard CNC routers operate on three axes (X, Y, and Z) where the cutting arm moves in all lateral directions and at varying heights above the flatbed.

Water Jet Cutting machines use a high-pressure water jet to cut various hard or soft materials. An abrasive is sometimes added to the mixture to cut harder materials like glass, stone, and metal. The benefits of the process are that it produces a precise, clean-cut edge without the heat generated by other methods.

Laser Cutting is typically used for smaller, more intricate components where standard CNC tools are unsuitable. Safe materials include wood, paper, cork, and some specific plastics. Since the laser melts, burns, or vaporizes the material to create a cut edge, it produces heat and smoke, which can be hazardous without proper ventilation. Note that some plastics, such as PVC, cannot be used due to the production of toxic fumes.

5-Axis refers to the number of axes that the cutting tool can move along, X, Y, and Z, plus A and B rotational axes. The additional axes allow the cutting tool to approach the material from any direction and create fully three-dimensional shapes without turning or resetting the material. Due to high cost of these machines and the technical knowledge to operate them, not all signage firms will have them.

Additive Manufacturing (3D Printing)

While not widely used in the manufacture of wayfinding components, there are potential applications for 3D printing in signage design. This industry is growing as 3D printers continue to increase in fidelity and decrease in cost. 3D printing is a computer-aided, additive process in which the material is built up to produce complex, three-dimensional forms.





U.S. Department
of Veterans Affairs

SECTION 2

SIGN TYPE GUIDELINES

2.1. Interior Signage Guidelines	67
2.1.1 Planning	68
2.1.2 Programming	76
2.1.3 Sign Overview	84
2.1.4 Specifications	94
2.1.5 Construction	95
2.1.6 Installation	100
2.2. Code & Life Safety Signage Guidelines	111
2.2.1 Planning	112
2.2.2 Programming	114
2.2.3 Sign Overview	116
2.2.4 Specifications	121
2.2.5 Installation	122
2.3. Mandatory VA Policy & Directive Signage Guidelines	128
2.3.1 Introduction	129
2.3.2 Sign Overview	130
2.3.3 Construction	137
2.4. Specialty Signage Guidelines.....	138
2.4.1 Introduction	139
2.4.2 Sign Overview	140



2.5.Exterior Signage Guidelines 143

- 2.5.1 Planning 144
- 2.5.2 Programming 150
- 2.5.3 Facility Names 158
- 2.5.4 Sign Overview 159
- 2.5.5 Specifications 167
- 2.5.6 Construction 168
- 2.5.7 Installation 182

2.6.Parking Structure Signage Guidelines 194

- 2.6.1 Planning 195
- 2.6.2 Programming 201
- 2.6.3 Sign Overview 204
- 2.6.4 Specifications 212
- 2.6.5 Construction 213
- 2.6.6 Installation 216

2.7.National Cemetery Administration Guidelines 220

- 2.7.1 Planning 221
- 2.7.2 Programming 222
- 2.7.3 Specifications 224
- 2.7.4 Signpost Families 225
- 2.7.5 Design Elements 226
- 2.7.6 Sign Overview 228
- 2.7.7 Construction 229
- 2.7.8 Installation 240





U.S. Department
of Veterans Affairs

SECTION 2.1

INTERIOR SIGNAGE GUIDELINES



2.1.1 PLANNING

An effective signage program for a facility has been holistically planned and coordinates all signage, including, but not limited to, room identification, department identification, informational / regulatory postings, directionals, directories, and orientation maps. For a large medical center, the basis of design for the interior signage system should be developed as part of a new or existing wayfinding master plan. For more information on developing a comprehensive wayfinding master plan, see [Section 1.2 Fundamentals of Wayfinding](#). If your project includes mandatory policy or life safety signage, see [Section 2.2 Code & Life Safety Signage Guidelines](#) and [Section 2.3 Mandatory VA Policy & Directives](#) in addition to this section.

Developing a wayfinding master plan, and subsequently, planning and programming should be performed by a professional with significant experience developing interior signage systems for large healthcare facilities. The discussion of various topics in this Manual is not meant to convey that the facility and VA Staff should perform these tasks.

Site Evaluation

A detailed site evaluation must be performed when planning an interior signage project. To begin the site evaluation, obtain and evaluate architectural floor plans for all the relevant buildings and spaces. Most facilities have building plans on file with the Engineering or Facilities Management Department. If the building has been remodeled or has additions, a combination of campus, building, and renovation plans may need to be referenced. Request the document format that matches your software capabilities. (Note: CAD and BIM files can be printed as PDF drawings and imported into Adobe Illustrator or other similar programs).

During the Site Evaluation

Floor plans will be utilized for reference and documentation, but a thorough walk-through of the spaces will be required to verify conditions during the site evaluation. As you walk the spaces, look at the buildings from the perspective of a first-time patient or visitor and what they encounter. Below are general tasks and considerations. The site evaluation and information collected may vary depending on project scope (ex: Room ID vs. Directional / Wayfinding) and complexity (ex: Outpatient Clinic vs. Medical Center).

Identify Points of Entry and Destinations

- Primary and secondary entry and exit points of the building.
- Check-in locations of departments and services.
- Points of vertical transition within the building, such as elevators, stairs, and ramps.
- Points of horizontal transition within the building leading to other buildings, such as ramps, tunnels, and tramways.

Figure 2-1 Accurately identifying check-in locations and associated services is critical during a site-survey. In a large medical facility, signage should guide users to well identified check-in locations, not room numbers.



Planning

Interior Signage Guidelines

During the Site Evaluation (Continued)

Analyze Paths of Travel

- Primary paths of travel are from originating points, or main entries, to destinations.
- Secondary paths of travel are from a service or location to another service or location within the building, for example, from "Clinic B" to the "Pharmacy." Paths of travel are both horizontal, e.g., along a hallway, and vertical, e.g., traveling up and down on an elevator or stairs.
- For vertical travel, identify the floor range and destinations served by elevator bank.
- Are all paths accessible? If not, signage will need to direct to accessible paths.

Locate Intersections and Decision Points

- Intersections are locations where visitors must decide whether to turn or continue forward.
- Major high-traffic corridor intersections require more communication than minor, secondary intersections, and decision points.
- Tertiary decision points can be located within a department or service, guiding back out to reception or other areas within the department.

Conduct a Photo Essay

- Document all existing conditions, postings, and signs. A detailed photo essay is a valuable tool in developing a wayfinding master plan, presentation documents, programming the system, and discussing various signage needs in the future. Make sure to obtain VA approval before taking photos.

Annotate Architectural Conditions

- When points of entry, destinations, primary paths of travel, and intersections have been identified, review the locations to determine a variety of additional environmental considerations
- Sight lines, viewing distance, availability of wall space, ceiling height, corridor width, lighting, windows, wall type (glass, masonry, drywall, etc.), wall finish (paint, wallpaper, etc.), lighting, exit signs, firewalls, and sprinklers all play into the type of sign solution selected for each location.

Figure 2-2 On architectural plans, identify points of entry, destinations, paths of travel, intersections, and architectural conditions.

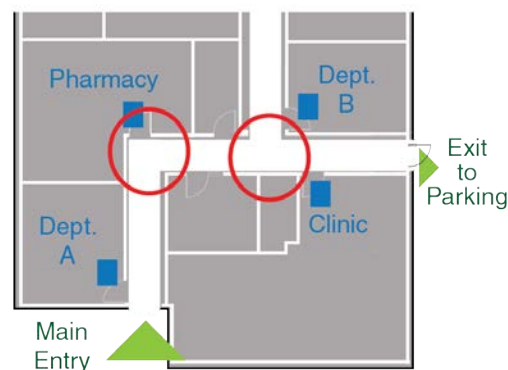

Planning

Interior Signage Guidelines

During the Site Evaluation (Continued)

Meet with VA Stakeholders

- Discuss future plans that may affect existing conditions or locations of various departments or services (construction, renovations, relocations, etc.).
- Review facility-wide policies, procedures, and regulations that may influence wayfinding (check-in processes, etc.).
- Meet with departments and services to understand specific signage needs.
- Solicit feedback from Staff and Veteran user groups.

Questions to Consider During the Site Evaluation

The questions below provide a starting point to develop a wayfinding plan for building interiors.

- If there are multiple entrances to the building(s), do they serve different purposes or user groups (ex: valet, shuttle, staff, or a specific department such as SCI)? Are they accessible per ABA requirements?

Figure 2-3 Naming entrances simplifies wayfinding by enabling users to easily identify the correct entrance, establish a recognizable landmark, and navigate back to their starting point. To ensure effectiveness, entrance names should be kept simple and logical, such as using 'Main Entrance' as the primary entrance identifier.



- Is there an after-hours entrance that should be considered in the wayfinding plan?
- Are the locations of building entrances and elevators easily found?
- Have the elevator lobbies been clearly identified and provide proper guidance to users, including the elevator bank name, current level, levels served, directory, and orientation map?

Figure 2-4 Signs at elevator banks should identify the floor range and destinations served.



Planning

Interior Signage Guidelines

Questions to Consider During the Site Evaluation (Continued)

- What is the configuration of the corridor system?
- Are primary corridors easy to identify and follow?
- Are the hallways wide or narrow, and are they well-illuminated?
- Is there adequate lighting around intersections and elevator lobbies?
- Are existing paths of travel optimal and safe for the visitor?
- Do the employees access the building differently than the public? If so, what is the employees' desired path of travel within the building?
- Are department and service names accurate and consistent with the facility directory, appointment letters, and VHA-approved nomenclature?
- Are departments or services grouped by check-in location on maps and directories? Are check-in locations clearly identified on maps and signage?

Figure 2-5 When multiple departments or services check-in at one location, develop an overarching name for the check-in point. Appointment letters and signage should then guide to the check-in. At the check-in location, easy to update insert-based signs can list the departments / services served.

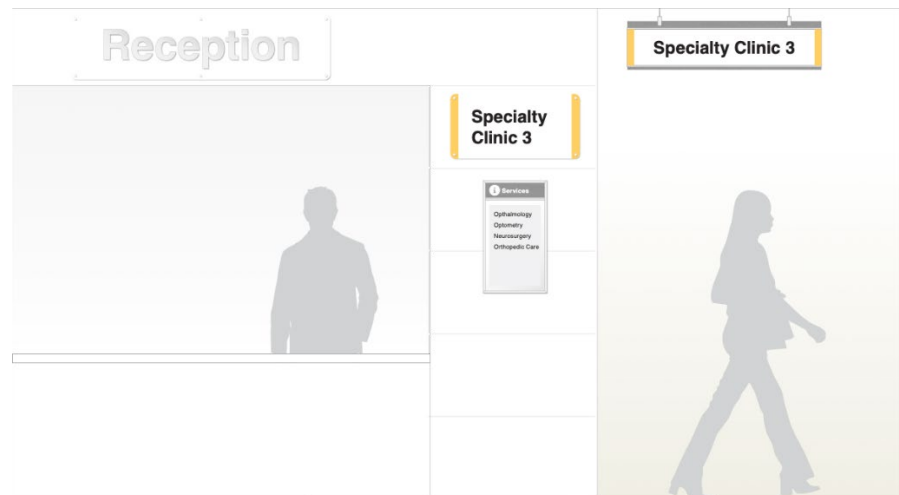

- Does the existing building numbering system help or hinder wayfinding?
- Is the building or building group divided into logical areas so you can guide from general to specific?
- Are there important departments located outside of the connected main building complex?
- Does signage clearly guide to the Emergency Department or Urgent Care?
- Which signs can have permanent messages, and which ones need to be changeable?
- Are placements of signs in locations where people are expecting them to be?
- Do existing signs adhere to ABA standards?
- Is there too much information on directional signs?
- Are restricted areas clearly marked?



Planning

Interior Signage Guidelines

Wayfinding Analysis

Reviewing the information gathered and answering the questions from the site survey will help establish the basis of a wayfinding plan that communicates and informs simply and directly. As part of the wayfinding master plan, develop a clear information hierarchy that establishes naming conventions (for buildings, building groups, building entrances, floors, elevators, and check-in locations) and how the buildings or building groups are logically divided into areas (if required) to simplify and improve wayfinding.

Keep in mind that the distinction between floors is typically less important in a large medical center than the clear identification of areas, primary paths, and destinations on the same floor. When patients and visitors are lost, they are typically on the right floor but confused in the maze of departments and halls.

Once a potential interior wayfinding plan is established, it should be tested and refined using draft sign locations on primary and secondary paths of travel and intersections. What seems logical in plan view may require further refinement to simplify the amount of information from the user’s perspective at these decision points.

Refer to [Section 1.2 Fundamentals of Wayfinding](#) for additional guidance on developing a wayfinding master plan that works for your facility.

Figure 2-6 A successful wayfinding plan establishes a clear information hierarchy and naming conventions, simplifying the complex environment.

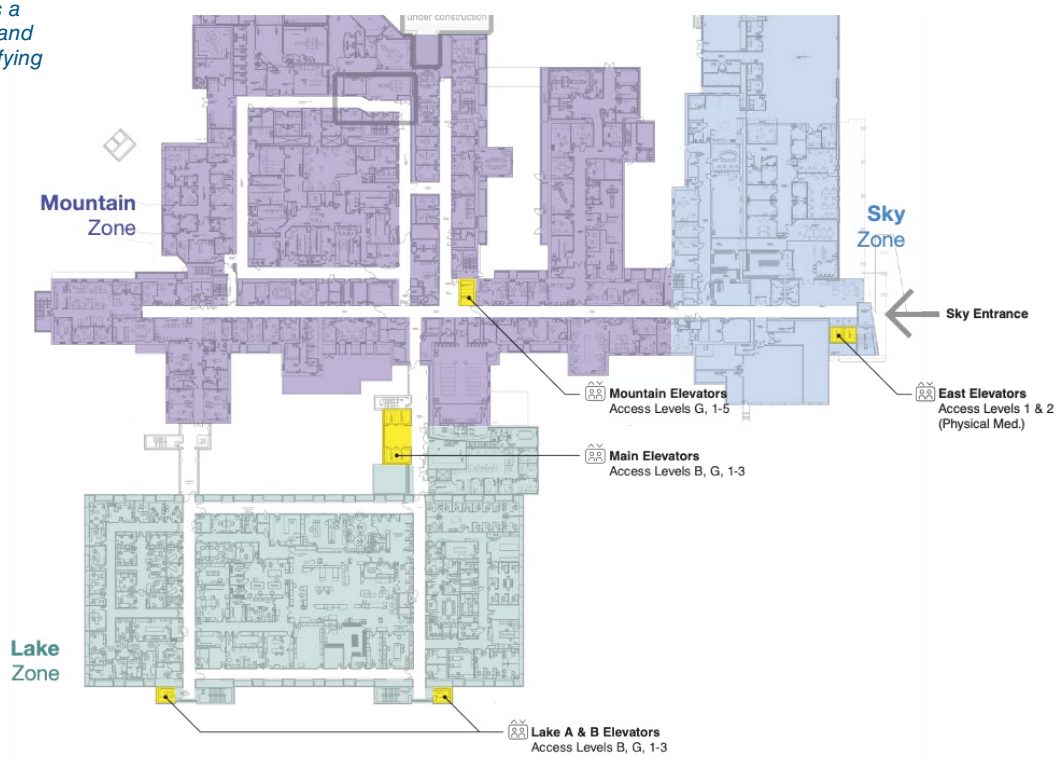

Planning

Develop a Signage System Standard

Interior Signage Guidelines

Using the guidelines outlined in the VA Signage Design Manual, develop a facility-specific signage system standard that aligns with the wayfinding plan and complements facility architecture and interior design. The signage system standard should be developed for a large medical center as part of the overall wayfinding master plan.

Colors, imagery, graphics, and decorative finishes can be incorporated into the sign design to help visually communicate the wayfinding plan, differentiate areas of the facility, add visual interest, and complement the architectural environments. An ideal signage system design looks professional and polished, is based on an enduring style that will not quickly look outdated and can transcend the various architecture and interior design styles often found throughout a large medical center.

- The color palette used in a signage system can range in complexity per the unique conditions of each facility. For example, a large facility with several buildings and zones may benefit from a logical color-coding / branding system that distinguishes the different areas. Conversely, a smaller single-building clinic may use a relatively simple and consistent color palette and design.
- Images, icons, and patterns related to a common theme can also be used in the sign design. This can be useful when implementing a signage system in a facility where different areas have been assigned different color and material palettes.
- In [Section 4.1 Design Elements](#), a standard palette of colors has been prepared for use in interior signage designs. These colors are intended to complement VA branding but are not required to be used in a signage program. Ultimately, the colors and finishes used in signage will be determined by the requirements and conditions of the individual facility. Any colors used as a background for text must meet the contrast requirements of ABA.
- Not all VA colors work well together. Consult your facility's Interior Designer and Signage Specialist to verify that the colors selected will work with your interior palette and that signage readability is maintained.
- The VA Logo and Seal cannot be superimposed, used as a background, or altered in any way, as per the VA Tier 1 Graphic Standards Guide.

For more information on developing the look of the signage system, including VA standard fonts and arrows, refer to [Section 4.1 Design Elements](#).

Figure 2-7 Colors, symbols, and naming conventions can all be incorporated into the signage system standards to communicate the Wayfinding Master Plan.



Planning

Interior Signage Guidelines

Use a Component Signage System

Interior signs for VA facilities should be based on a component signage system that allows for easy and inexpensive updates. Component signage systems can be updated with inserts printed on digital printers, allowing immediate message replacements to be created at the facility rather than being ordered from a sign manufacturer. They also should be able to mechanically fasten to the wall for easy replacement or reconfiguration without significant wall damage. This approach applies to both room and directional signs. See the [construction details](#) in this section for further information about component based interior sign systems.

Various types of component signage systems are available. Once a component signage system is selected, it should become the facility's standard and not be mixed with other systems, maintaining interchangeability and a cohesive look.

Figure 2-8 Facilities benefit from using insert-based component signage systems due to ease of updatability, replacements, and ongoing maintenance.



Interior Sign Categories

Interior Signs fall into various categories. This section covers room identification, department identification, informational / regulatory postings, directionals, directories, and orientation maps. Code and life safety signage, mandatory policy, and specialty signs are in other sections of this Manual.

- **Room Identification:** All permanent rooms in a facility should be labeled with a room number sign in tactile raised text and matching Braille to meet ABA specifications. Signs communicating the room activity to the patient and public, such as those identifying specific offices, exam rooms, and services, must accommodate an updatable text insert.

Security note: Signs identifying electrical, mechanical, telecommunication, data, and other rooms deemed sensitive for security reasons should consist of the room number only, which should follow the master building room numbering system. No descriptive name or title should be used, nor should they have a unique numbering system.



Planning

Interior Signage Guidelines

Interior Sign Categories (Continued)

- **Department / Check-In Identification:** Departments that occupy larger areas and include waiting rooms will require additional identification signage designed for high visibility. Multiple departments and services will often check-in at the same location, which should be clearly identified with signage.
- **Informational and Regulatory Postings:** Informational postings can communicate policies or procedures eliminating the use of paper signs which should NOT be used. Informational signs are often insert based so they can easily be updated. To avoid visual clutter, only post facility approved information that cannot effectively be communicated by staff. Regulatory signs can be door or wall mounted and communicate various restrictions such as authorized personnel only.
- **Directional:** Wall, soffit, and ceiling-mounted directional signs provide solutions for communicating wayfinding information in differing building conditions. Typically, ceiling or soffit-mounted directional signs display directional information for high-traffic destinations like Pharmacy or Outpatient Clinic Services. Wall-mounted directional signs can be used in hallways at intersections and decision points.
- **Maps and Directories:** Directories in lobbies and at elevator landings assist people in finding or confirming the location of services within a building or in other buildings. Information on directories, in most cases, should list destinations alphabetically, not by floors. Directories accompanied by an orientation map allow visitors to visualize the location of their destination and plan a route. For more information on Maps and Directories, see [Section 4 Appendix](#).

Figure 2-9 In key areas, custom environmental graphics can supplement the component signage system to highlight important information and create a memorable landmark.



2.1.2 PROGRAMMING

Location, Placement & Messaging

Further information and example Location Plans, Sign Schedules and Drawings related to this section can be found in [Section 1.1.6 Submittals](#).

The location, placement, and messaging of signs occurs during the Programming Phase. For a large medical center, a wayfinding master plan should be developed before programming a signage system. See the planning part of this Section and [Section 1.1 Planning a Sign System](#) & [Section 1.2 Fundamentals of Wayfinding](#) to better understand how to approach a project.

The location plan establishes where a sign is located. The sign message schedule establishes what message is on each sign. Finally, the sign drawings show the type of sign and how the information is displayed. These three documents are the main components of signage programming.

To create the sign location plan, place a mark and a location number on the plan document as a placeholder for a sign type and sign message associated with that location. In the sign message schedule spreadsheet, enter the location plan number and corresponding sign type designation, and establish the text message of what that sign says. Sign type drawings are design documents that describe the sign size, text layouts, and fabrication information. The programming process can be done for all categories of interior signs concurrently or separately.

The programming of a signage system should take place shortly before implementation to avoid errors and duplication of work. Information and existing conditions can quickly change, rendering the programming data invalid.

General Guidelines

The following are best practice guidelines that should be followed when developing an interior signage program. It is not intended to be a training section of the Manual but to provide essential information, instructions, and suggestions that will help reduce common errors when programming an interior sign project. A signage system must serve not only Veterans of all ages and genders but family, friends, and staff that will need to locate patient rooms, departments, and services. In addition, consideration of mobility, eyesight, cognitive ability, stooped walking posture, and individuals using wheelchairs will all affect sign position, location, and text size.

- All tactile room number signs or other tactile room identification signs must meet ABA requirements for height and Braille text.
- Signs identifying electrical closets, mechanical rooms, and telecommunication rooms should only consist of the room number, which should follow the master building room numbering system. No descriptive name or title should be used, nor should they have a unique number system.
- Signs with updatable, digitally printed message inserts should be used, when possible, to allow for frequent changes.
- Overhead and protruding signs should have a minimum of 80 inches of clearance from the bottom of the sign to the floor.
- Overhead signs must not visually block EXIT signs and shall not block fire sprinkler spray patterns.



Programming

Interior Signage Guidelines

Message Content

- Keep messaging brief. Unnecessary information is confusing to the viewer.
- Use words that are familiar to the viewer and use the same words consistently throughout the signage program.
- When possible, sign messages should be worded positively to improve the viewer's experience.
- Reference the VHA Standardized Nomenclature document for a list of approved department names.
- For large medical centers, messages on directional signs should utilize a logical hierarchy of information established in the wayfinding master plan.
- Signs should progressively disclose information, guiding viewers from general to specific destinations. Do not anticipate decisions that can be made later. Unnecessary or premature information will confuse the reader. Instead, provide only information necessary to decide at that specific location.
- Typically, a person only reads 6 to 8 destinations on a directional sign. Any information greater than that is less likely to be read. Often secondary or minor information will need to be left off the signs to avoid a long list of information. Therefore, prioritization of communication, based on a hierarchy of information and progressive disclosure principles guiding from general to specific, is essential in large medical facilities.
- When developing the information for directional signs, keep in mind that high-traffic destinations should take top priority for being listed. Secondary destinations closest to the signs' location then become the next group of items to list.
- Overhead signs should only display a limited list of high-priority destinations and information.
- Room ID sign messages should identify the room based on its function or the role of the user (ex: Exam Room 1 or Nurse Manager). Using the names of individuals or providers is typically not recommended for security reasons and the level of future updates required.

Message Layout

- Use title-case (capitalization of the first letter of each word) text on directional and identification sign messages whenever possible. Title-case text is easier to read and is understood faster than text in all capital letters.
- Line spacing between two different messages should be greater than line spacing between lines of the same multi-line message group.
- Message areas should have margins on all four sides. Text should not be printed to the edge of the viewable message area.
- If a line of text needs to be reduced to fit on a sign, use only commonly understood abbreviations or decrease the text size for the entire message. It is typically not recommended to condense the typeface.
- On wall-mounted and overhead directional signs, destinations should be listed alphabetically and grouped by direction.
- On wall-mounted directional signs, avoid listing destinations located behind the viewer or on a different floor.



Programming

Interior Signage Guidelines

Contrast



Choose text and field colors to achieve a high contrast level. In addition, the sign should contrast with its surroundings and in low light levels. Therefore, one should avoid combining mid-tone text colors with mid-tone field colors in low light levels.

Conciseness



Simplify text and names to improve comprehension. Visitors and patients will not likely spend more than a few seconds looking at a sign. The information presented needs to be simple and relevant to the current location. The sign should also be located where a user expects to find information. It is imperative to use words and terminology that the average person understands. The words and terminology must be consistent throughout a signage program. Complex medical terms are generally NOT familiar to most people, so use terms easily understood by visitors and patients. Acronyms are even less understood by visitors, patients, and staff and should be avoided if possible.

Readability



Use "initial caps" (capitalizing the first letter of each word) or "title case" (capitalizing the first letter of most words except prepositions like "at" or "in" and conjunctions like "and" or "the.") as it is the most readable format for messages. Save the use of "all capital letters" for warnings and emphasis. Text layout and word choice are critical to the readability and effectiveness of a sign. Do not use redundant words when labeling a room. For example, use "Soiled Utility," not "Soiled Utility Room." Placing several signs with the same message creates visual clutter. State your message concisely and avoid filling empty space with extra words. This will increase the effectiveness and readability of a sign. Remember, visual clutter creates a visual overload similar to a loud, noisy environment.



Programming

Interior Signage Guidelines

Legibility & Copy Size

- In most conditions, sign text must be a minimum of 5/8" capital letter height. ABA has requirements for both tactile and visual copy. See [Section 4.1 Design Elements](#) for more information on ABA requirements.
- The text size needs to be an appropriate height in relation to the viewing distance and the message being communicated. Directional signs need to have text larger than room identification signs. Overhead signs and low light conditions require larger text sizes.

Table 703.5.5 Visual Character Height

Height to Finish Floor or Ground From Baseline of Character	Horizontal Viewing Distance	Minimum Character Height
40 inches (1015 mm) to less than or equal to 70 inches (1780 mm)	less than 72 inches (1830 mm)	5/8 inch (16 mm)
	72 inches (1830 mm) and greater	5/8 inch (16 mm), plus 1/8 inch (3.2 mm) per foot (305 mm) of viewing distance above 72 inches (1830 mm)
Greater than 70 inches (1780 mm) to less than or equal to 120 inches (3050 mm)	less than 180 inches (4570 mm)	2 inches (51 mm)
	180 inches (4570 mm) and greater	2 inches (51 mm), plus 1/8 inch (3.2 mm) per foot (305 mm) of viewing distance above 180 inches (4570 mm)
greater than 120 inches (3050 mm)	less than 21 feet (6400 mm)	3 inches (75 mm)
	21 feet (6400 mm) and greater	3 inches (75 mm), plus 1/8 inch (3.2 mm) per foot (305 mm) of viewing distance above 21 feet (6400 mm)

Figure 2-10 Visual Character Height chart from Architectural Barriers Act (ABA) Standards (2015)

Arrows

- The correct use of arrows on directional signs ensures that the reader quickly understands directional information. See [Section 4.1 Design Elements](#) for the recommended arrow style and usage.
- Grouping information together that is in one direction and using one arrow is preferred. Using an arrow for each message can make the sign more difficult to read.
- Arrows should be placed to visually precede the message. This allows the reader to understand direction first and information second. It also allows the arrows to be visually separated from the text.
- Arrows should always be larger than the text they are affiliated with. It is recommended that the arrow size is at least one and one half (x1.5) times the capital letter height. For example, wall directional signs with a 1" capital letter size should have a 1 1/2" arrow size.
- The orientation of arrows is important to communicate direction effectively.



Programming

Interior Signage Guidelines

Arrow Usage

Number	Location Plan	Interpretation
Orientation		
①		Straight Ahead
②		Up
③		Ahead on Left
④		Up on Left
⑤		Ahead on Right
⑥		Up on Right

Number	Location Plan	Interpretation
Orientation		
⑦		Right
⑧		Down on Right
⑨		Left
⑩		Down on Left
⑪		Down



Programming

Interior Signage Guidelines

Visibility

- Signs should be located where a user expects to find information. Signs with high contrast to the surrounding surface aids those who are vision impaired.
- Evaluate the sign color selections for effective contrast and readability in the actual building condition or location where the sign will be installed.
- Limit other items mounted to walls and suspended from the ceiling near signage as they will compete for attention and create visual clutter.
- In addition to locating a sign at a wayfinding decision point, the legibility of the message at that location must be considered. Evaluate sign locations for visibility from afar. Each sign should be large enough to display its message with adequate text height for the viewing distance. Hallway ceilings have soffits and door openings which often restrict visibility. Existing equipment and architectural elements such as illuminated exit signs, pipes, ducts, and wall-mounted devices may also affect the sign's legibility.

Figure 2-11

Line of Sight:

The total approximate field of vision is 135° (60° up and 75° down).

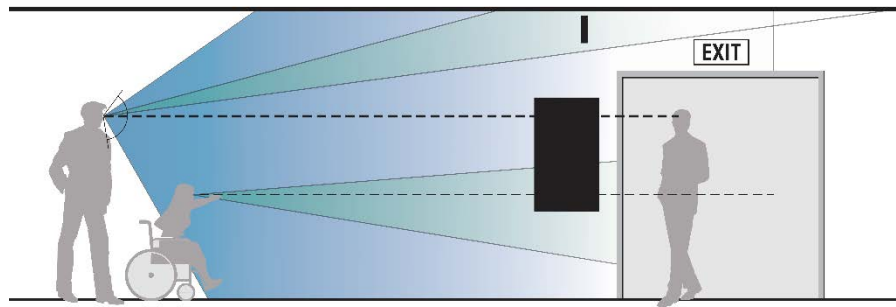

Location of Signs

- Whenever possible, signs should face the intended viewer's position or path of travel.
- Position signs with a clear line of sight from the viewing point to the sign face.
- All signs should be placed in a location that is clearly visible without temporary or permanent obstructions.
- Surfaces and areas for proper sign placement do not always exist. Either the ceiling is too low to install an overhead sign, or the wall space is unavailable in the normal line of sight. Evaluate the location and select the next best location.
- Keep signs to a minimum and consolidate them whenever possible. Signs in lobbies should consist of only those necessary for people to find their way within the building. Announcement banners, notices, and other promotional items should be discouraged in lobbies and throughout the corridor system.
- If an Emergency Department or Urgent Care is located within the facility, ensure signs are located throughout the entry level(s) and entrances to guide to the department easily.
- A flag type sign can be used when a door or entrance to a restroom, stairwell, or other important room is recessed or not easily seen.



Programming

Interior Signage Guidelines

Placement on the Wall

- Room identification signs must be installed in specific locations and conform to specific dimension parameters. Refer to the discussion on ABA requirements in the Design Elements [Section 4.1 Design Elements](#) for more information.
- Refer to [Section 3.1 Interior Signage Drawings](#) for detailed drawings of each sign type showing the placement position required for its use.
- Correct placement of signs will result in the use of fewer signs. Too many signs in one location can create a cluttered appearance, cause confusion, and increase the difficulty for a viewer to find the information they are seeking.
- Interior lighting, wall colors, and material finishes need to be considered due to their effect on the visibility of signs.
- Signs may be installed on glass when there is no available wall surface. This includes rooms with glass sidelights on the latch side of the door. In these conditions, the preferred room identification sign placement is directly on the glass. A blank vinyl or acrylic back-up is necessary on the opposite side of the glass, exactly behind the sign being installed. This will cover the sign mounting adhesive, which typically includes double-sided tape.
- Items such as light switches, card readers, chart holders, bulletin boards, memory boxes, framed photos, and artwork must be coordinated with sign locations.
- Signs should be clearly visible and not obscured by furniture or equipment.

Figure 2-12 This preferred placement provides advance warning, perpendicular to the path of travel.

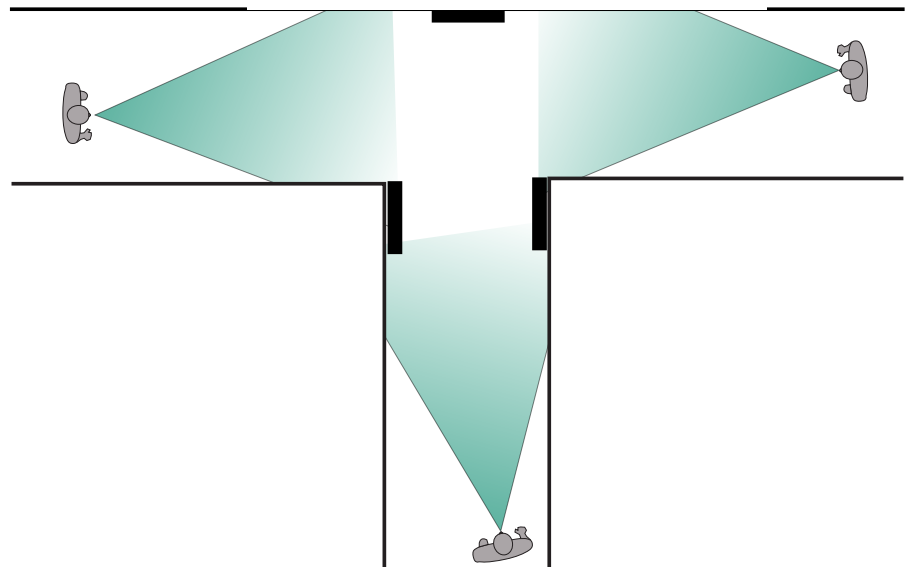

Programming

Interior Signage Guidelines

Historic VA Buildings

It is just as important in historical buildings to let people know where they are and where they need to go.

In a historic building, if original signs exist, they should be used as a starting point for developing a new signage program that respects the original design style but meets the current requirements for interior signs.

Sensitivity to colors, materials, finishes, building details, and the original architect's intent for the look of the building should be incorporated into the design of a new signage program. In addition, the sign product for a new signage program should be of the type that allows for updating and text changes to be conducted without complete sign removal and reinstallation.

Care must be taken not to harm building materials when removing old signs and installing new ones. Placement of wayfinding signs in a historic building must consider circulation constraints that are sometimes a part of older corridor systems, as well as vertical movement within a building. Glass doors, special doors, high wainscot, special paneling, carvings, and trim detail may require compromise on sign placement, but locating signs should follow the interior sign installation guidelines as closely as possible.

Additional assistance with signage programs for historic buildings is available from the Office of Construction & Facilities Management.

Existing Signage Program Removal

Before implementing a new interior signage program, perform a thorough evaluation of the demolition requirements of the current signage program and its impact on the facility's walls, doors, and ceilings.

Request information from the facility on the location of fire walls and any known hazards that may affect sign removal including, but not limited to, asbestos and lead in ceilings, walls, or flooring. Determine what is required to patch, seal, and repair the building surfaces exposed because of the removal of old signs or letters. Repairs should match adjoining surfaces. Evaluate if tile or stone surfaces require repair or refurbishment. For example, will doors need to be refinished or painted?

Make sure the sign removal scope of work requires the contractor to disconnect and remove any live electrical connections. In addition, make sure existing conductors and conduit are removed to the nearest junction box and are made safe.

Be sure to clearly identify any signs that are to remain. It is especially important to save signs and plaques related to special dedications, donors, or displays that may be of historical importance. Cover or protect signs that are to remain or catalog, remove, safely store, and then reinstall as necessary.



2.1.3 SIGN OVERVIEW

The following overview illustrates the various types of interior signs for individual buildings, off-site clinics, or a complete medical center campus. Code and life safety signage, mandatory policy, and specialty signs are in other sections of this manual.

[Section 3.1 Interior Signage Drawings](#) of this manual provides detailed drawings of each of these signs.

The drawings should be used as a starting point to develop a facility-specific sign standard. The facility specific sign standard drawings should reflect the facility specific component-based signage system, sign types, colors, finishes, and graphics.

For more information on developing the look of the signage system, including VA standard fonts and arrows, refer to [Section 4.1 Design Elements](#).

Sign Designations

Each sign in the program manual has been given a specific sign type number designation. This designation provides a common description that can be referenced when programming a site and ordering signs. The following explains how the sign type designations are derived.

IN - 03 .01 A

- IN** Designates an interior sign.
- 03** Two-digit number identifies the sign type family.
- .01** The two-digit number following the period identifies a specific sign within the sign family.
- A** The letter designates a specific sign configuration, version and / or layout for graphics or symbols.



Sign Overview

Interior Signage Guidelines

IN-03.01

Room Number Identification



[IN-03.01](#)

IN-04.01

Primary Room Identification with Insert

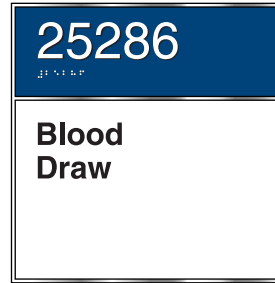

[IN-04.01](#)



[IN-04.02](#)

IN-04.02

Secondary Room Identification with Insert

IN-05.06

Patient Room Identification with Write-On Panel

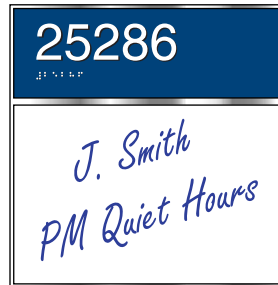

[IN-05.06](#)

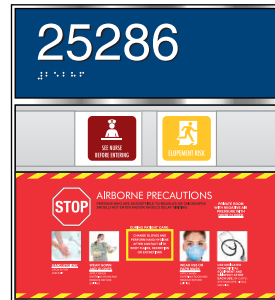

[IN-05.07](#)

IN-05.07

Patient Room Identification with Room Alert & Contact Precautions



[IN-06.05](#)

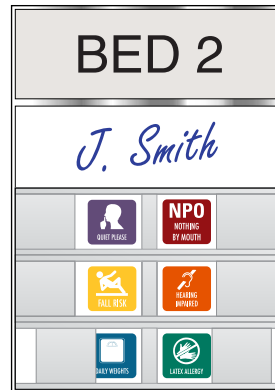

[IN-06.06](#)

IN-06.05-.06

Patient Bed Signs

IN-06.07

Patient Information Tabs



IN-06.08

Patient Contact Precaution Cards



[IN-06.07](#)



[IN-06.08](#)



Sign Overview

Interior Signage Guidelines

IN-07.01-.02

Room Identification with Insert & Indicator

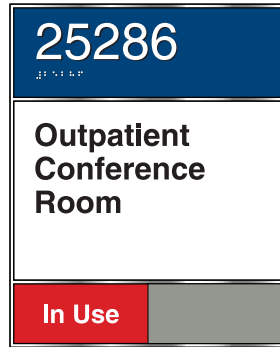

[IN-07.01](#)

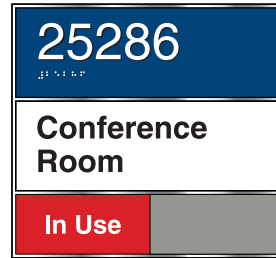

[IN-07.02](#)

IN-08.01

No Smoking / No Vaping



[IN-08.01](#)

IN-08.02

Restricted Area Identification

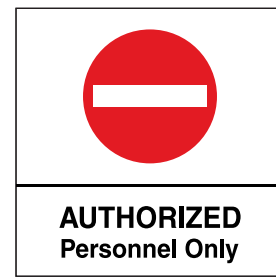

[IN-08.02](#)

IN-09.01-.06

Restroom Identification

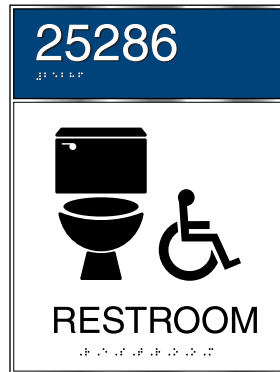

[IN-09.01-.06](#)

IN-09.07

Required Restroom Postings



[IN-09.07](#)

IN-09.08

Required Restroom Postings

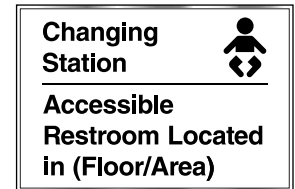

[IN-09.08](#)



Sign Overview

Interior Signage Guidelines

IN-09.09
Pictogram and Symbol



[IN-09.09](#)

IN-09.10
Privacy Notice



[IN-09.10](#)

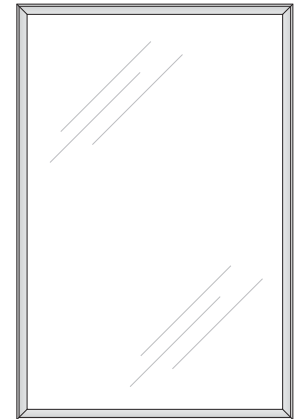

[IN-10.01-.06](#)

IN-10.01-.06
Sign Frame Insert Holder

IN-10.07
Informational Posting Large Insert



[IN-10.07](#)

IN-10.08
Informational Posting Standard Insert

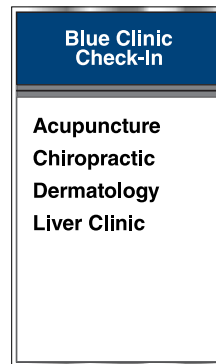

[IN-10.08](#)

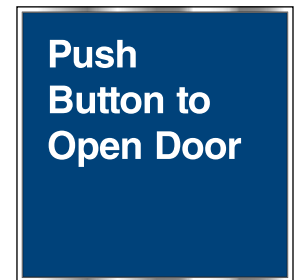

[IN-11.01-.04](#)

IN-11.01-.04
Permanent Message Panel

IN-12.01-.04
Desk or Counter Sign



[IN-12.01-.04](#)

IN-13.01
Perpendicular Flag Mount

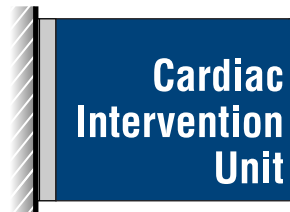

[IN-13.01](#)

IN-13.02
Perpendicular Flag Mount Small



[IN-13.02](#)



Sign Overview

Interior Signage Guidelines

IN-14.01-.05

Wall Directional - Permanent Panel

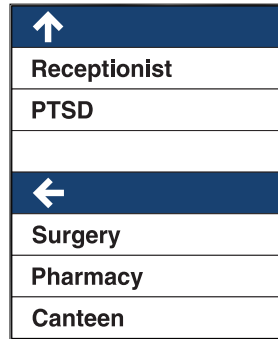

[IN-14.01-.05](#)

IN-14.06-.07

Wall Directional - Single Insert

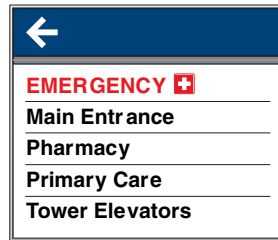

[IN-14.06-.07](#)

IN-14.08-.11

Wall Directional - Dual Inserts

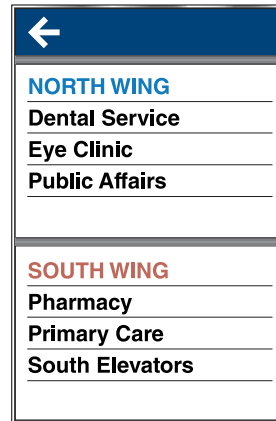

[IN-14.08-.11](#)

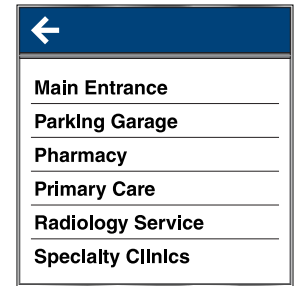

[IN-14.12-.13](#)

IN-14.12-.13

Wall Directional - Oversized Inserts

IN-14.14-.17

Floor Level Directional - Permanent Panel



[IN-14.14-.17](#)

IN-14.18

Floor Level Directional - Dual Inserts

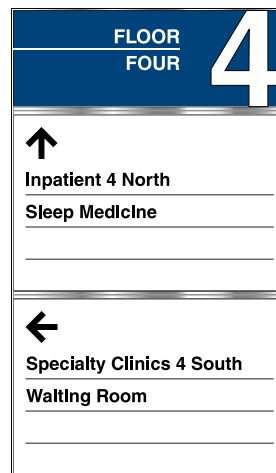

[IN-14.18](#)



Sign Overview

Interior Signage Guidelines

Overhead Hanging Series IN-15

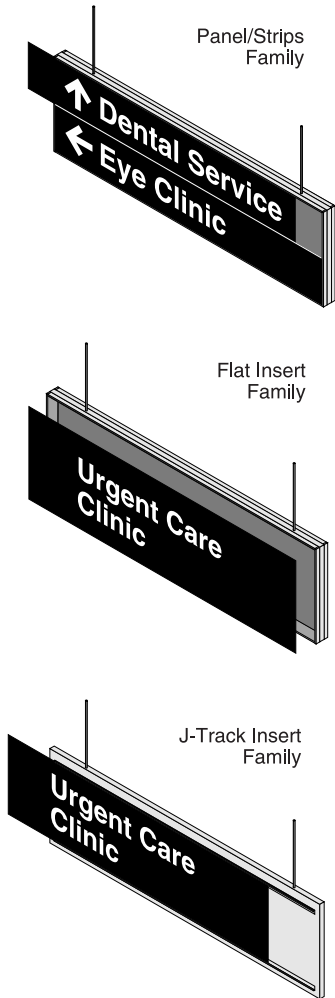

Sign Type	Width	Height	Text Size	Mounting	Family
IN-15.51	40"	6"	3" & 2"	Hanging	Panel/Strips
IN-15.55	40"	6"	3" & 2"	Hanging	Insert
IN-15.52	40"	12"	3" & 2"	Hanging	Panel/Strips
IN-15.56	40"	12"	3" & 2"	Hanging	Insert
IN-15.61	60"	6"	3" & 2"	Hanging	Panel/Strips
IN-15.65	60"	6"	3" & 2"	Hanging	Insert
IN-15.62	60"	12"	3" & 2"	Hanging	Panel/Strips
IN-15.66	60"	12"	3" & 2"	Hanging	Insert
IN-15.71	80"	6"	3" & 2"	Hanging	Panel/Strips
IN-15.75	80"	6"	3" & 2"	Hanging	Insert
IN-15.72	80"	12"	3" & 2"	Hanging	Panel/Strips
IN-15.76	80"	12"	3" & 2"	Hanging	Insert

NOTE: Overhead sign IN15 series are hanging signs. To determine sign type and size required at a specific location, Verify project sign family, ceiling height, distance the sign is to be viewed and quantity of text. 2" high copy is NOT recommended for long hallways or for a sign that will be read at a great distance.

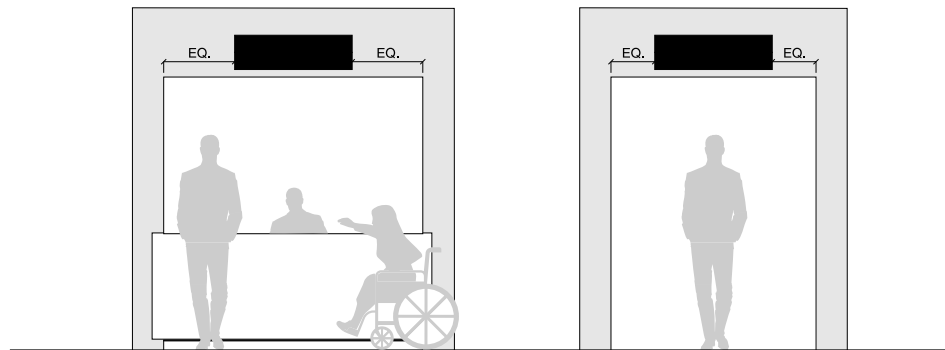

Sign Overview

Interior Signage Guidelines

IN-15.51/.55
Ceiling Mounted Directional and
Department ID – 6" x 40"



[IN-15.51/.55](#)

IN-15.52/.56
Ceiling Mounted Directional and
Department ID – 12" x 40"



[IN-15.61/.65](#)

IN-15.61/.65
Ceiling Mounted Directional and
Department ID – 6" x 60"



[IN-15.52/.56](#)

IN-15.62/.66
Ceiling Mounted Directional and
Department ID – 12" x 60"



[IN-15.62/.66](#)

IN-15.71/.75
Ceiling Mounted Directional and
Department ID – 6" x 80"



[IN-15.71/.75](#)

IN-15.72/.76
Ceiling Mounted Directional and
Department ID – 12" x 80"



[IN-15.72/.76](#)



Sign Overview

Interior Signage Guidelines

Overhead Soffit Series IN-16

Sign Type	Width	Height	Text Size	Mounting	Family
IN-16.51	40"	6"	3" & 2"	Soffit	Panel/Strips
IN-16.55	40"	6"	3" & 2"	Soffit	Insert
IN-16.52	40"	12"	3" & 2"	Soffit	Panel/Strips
IN-16.56	40"	12"	3" & 2"	Soffit	Insert
IN-16.61	60"	6"	3" & 2"	Soffit	Panel/Strips
IN-16.65	60"	6"	3" & 2"	Soffit	Insert
IN-16.62	60"	12"	3" & 2"	Soffit	Panel/Strips
IN-15.66	60"	12"	3" & 2"	Soffit	Insert
IN-16.71	80"	6"	3" & 2"	Soffit	Panel/Strips
IN-16.75	80"	6"	3" & 2"	Soffit	Insert
IN-16.72	80"	12"	3" & 2"	Soffit	Panel/Strips
IN-16.76	80"	12"	3" & 2"	Soffit	Insert

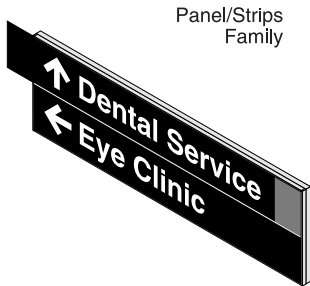

Panel/Strips Family

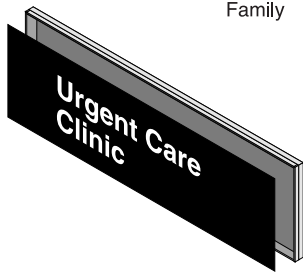

Flat Insert Family

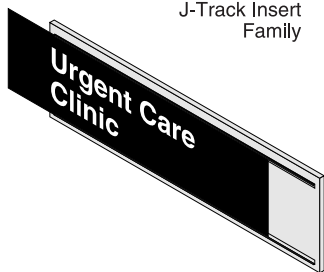

J-Track Insert Family

NOTE: Overhead sign IN16 series are soffit or wall-mounted signs. To determine sign type and size required at a specific location, Verify project sign family, ceiling height, distance the sign is to be viewed and quantity of text. 2" high copy is NOT recommended for long hallways or for a sign that will be read at a great distance.

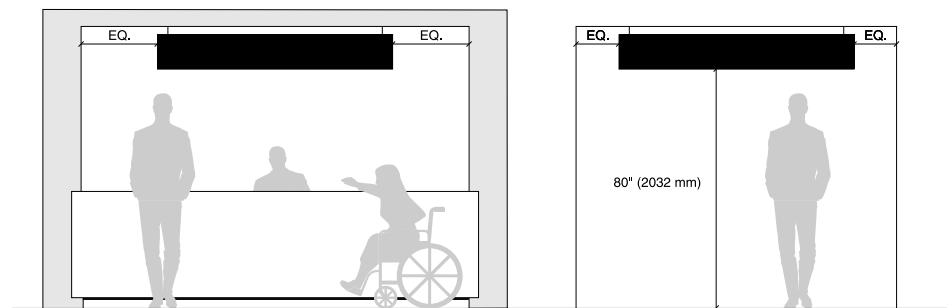

Sign Overview

Interior Signage Guidelines

IN-16.51/.55

Soffit Mounted Directional and Department ID – 6" x 40"



[IN-16.51/.55](#)

IN-16.52/.56

Soffit Mounted Directional and Department ID – 12" x 40"



[IN-16.61/.65](#)

IN-16.61/.65

Soffit Mounted Directional and Department ID – 6" x 60"



[IN-16.52/.56](#)

IN-16.62/.66

Soffit Mounted Directional and Department ID – 12" x 60"



[IN-16.62/.66](#)

IN-16.71/.75

Soffit Mounted Directional and Department ID – 6" x 80"



[IN-16.71/.75](#)

IN-16.72/.76

Soffit Mounted Directional and Department ID – 12" x 80"



[IN-16.72/.76](#)



Sign Overview

Interior Signage Guidelines

IN-17.01
Large Orientation Map

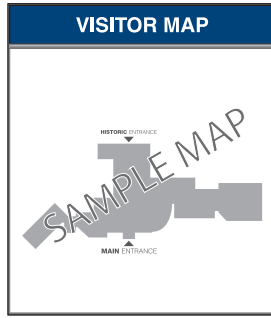

IN-17.01

IN-17.02
Large Directory Listing

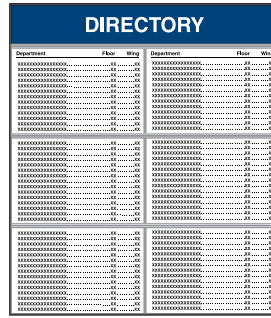

IN-17.02

IN-17.03
Orientation Map



IN-17.03

IN-17.04
Directory Listing

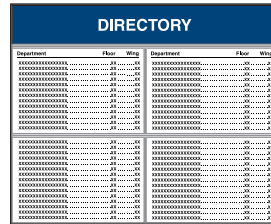

IN-17.04

IN-17.05
Small Directory Listing

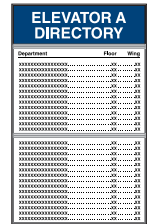

IN-17.05

IN-18.01
Glass Door and Side Light Graphics

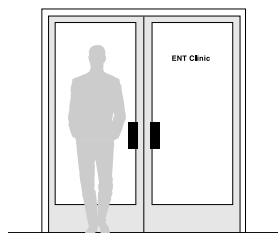

IN-18.01

IN-19.01-.03
Dimensional Letters

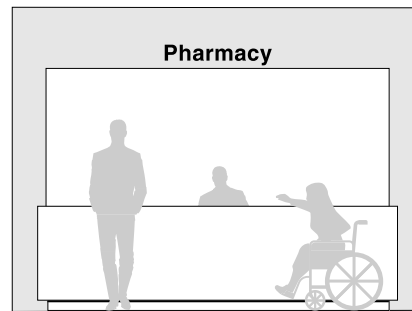

IN-19.01-.03



2.1.4 SPECIFICATIONS

The specifications for signs are available in the Master Construction Specifications (PG-18-1) area of the VA Technical Information Library, which is available on the VA web site under Office of Construction & Facilities Management.

Visit online: www.cfm.va.gov/til/spec.asp#10

Refer to Signage in the specifications, Division 10, Section 10 14 00.

For more information regarding specifications, contact the Office of Construction & Facilities Management, Facility Standards Service.

When preparing the specifications for a project, it will be necessary to adapt them to the individual facility and project. This may include information regarding the facility's specific component-based signage system, colors / finishes, and project requirements, such as specific sign types or installation requirements.

Depending on the project type, signage specifications can include the Sign Message Schedule, Sign Location Plans, and Sign Drawings. The Sign Message Schedule is a table that lists each sign's location number, sign type, and message, as well as other relevant details. The Sign Location Plans are a set of architectural plans showing numbered tags at the location of each sign. Sign Drawings illustrate the details and design intent for each sign type in the system. This information is required by the sign manufacturer and installer for production and implementation of the signs.

More information about signage system planning & programming and submittal examples can be found in [Section 1.1 Planning a Sign System](#) of the VA Signage Design Manual.



2.1.5 CONSTRUCTION

Overview

This section provides a sampling of component-based signage systems that meet the desired requirements for interior signage programs at VA facilities.

Component signage systems are made from standardized parts that can be configured to a wide range of sizes and use cases. They are well-suited for healthcare environments because they can be efficiently manufactured to meet performance requirements and be easily maintained, updated, and replaced over time. Systems with insert-based message components allow for updates to be made quickly and inexpensively by facility staff using a digital or laser printer. Insert-based signs are recommended for room identification, directionals, maps, directories, and any other sign types where message information periodically changes.

Component signage systems are available from several architectural sign companies and each company may offer multiple product lines and variations. Four generic system styles are described in this section, but other systems may be available that also meet the needed requirements.

The component system that has been selected should become the standard for the entire facility. Implementation of a component system requires commitment to a specific manufacturer's product. Carefully review the advantages and disadvantages of various component systems from different manufacturers. Contact other facilities that have installed the system that is being considered for feedback.

Component Signage System Styles:

The following pages illustrate four generic examples of signage system styles commonly used in VA facilities. The end-product and design customization will vary by provider and facility. See manufacturer drawings and documentation for more information.

- Flex-Fit System
- Sliding Rail System
- Snap-In Frame System
- Frame and Backplate System



Construction**Interior Signage Guidelines****Flex-Fit System**

Flex-fit frame systems are composed of a frame with extruded aluminum parts that are mechanically fastened together. The frame receives interchangeable, frontloading sign face panels and insert-based components. The frame accepts components of variable thicknesses, securing them in place, flush with the sign face, using hidden spring clips or a similar mechanism.

Advantages to this system are that internal components are interchangeable and can integrate a wide variety of standard sheet materials and decorative finishes. Additionally, the extruded frame can be manufactured to any length allowing for a greater range of sign sizes. Each component within the frame system can be replaced, reconfigured, or updated so the sign can evolve with facility changes.

As with all component systems shown, this system can be insert-based for easy updates and mechanically fasten to the wall.

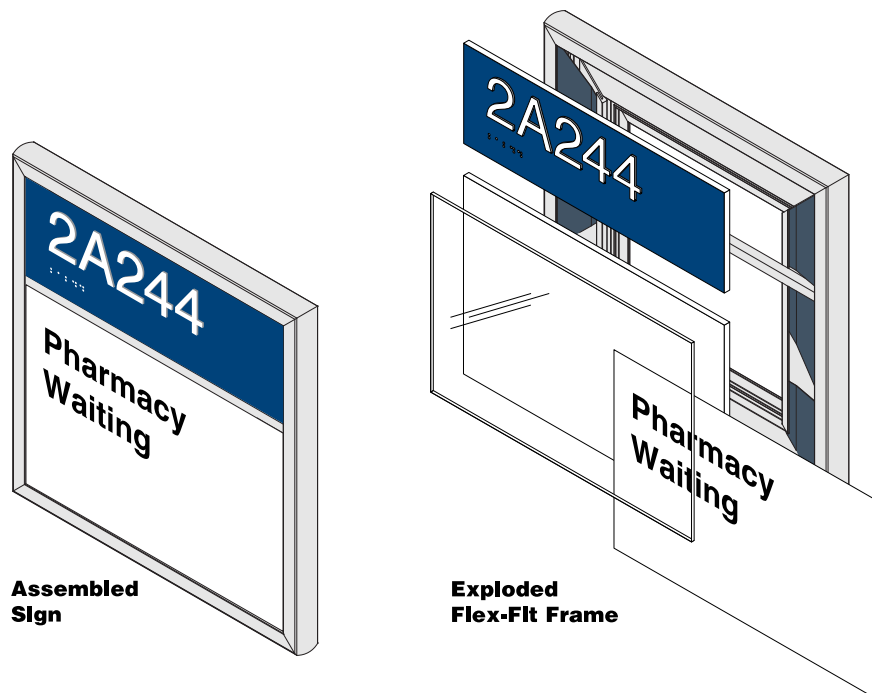

Construction

Interior Signage Guidelines

Sliding Rail System

A Sliding Rail System is composed of a backplate with evenly spaced rails that the sign face components attach to. The edges of the rail and sign components are concealed with extrusions that frame the entire sign. The dimensions of each sign type can vary in fixed increments limited by rail spacing on the backplate and standard component sizes. Components, of the same size and type, from one sign can be interchanged with similar components from another sign quickly and easily.

As with all component systems shown, this system can be insert-based for easy updates and mechanically fasten to the wall.

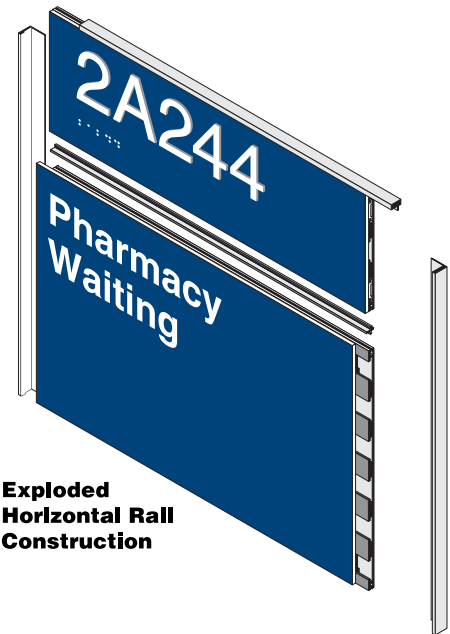

Construction

Interior Signage Guidelines

Snap-In Frame System

The components of this signage system connect in a stacked configuration and the frame components snap into the sides to secure the components and conceal the edges. The dimensions of each sign type can vary in fixed increments limited on the standard component sizes. Components of the same size and type from one sign can be interchanged with similar components from another sign quickly and easily.

As with all component systems shown, this system can be insert-based for easy updates and mechanically fasten to the wall.

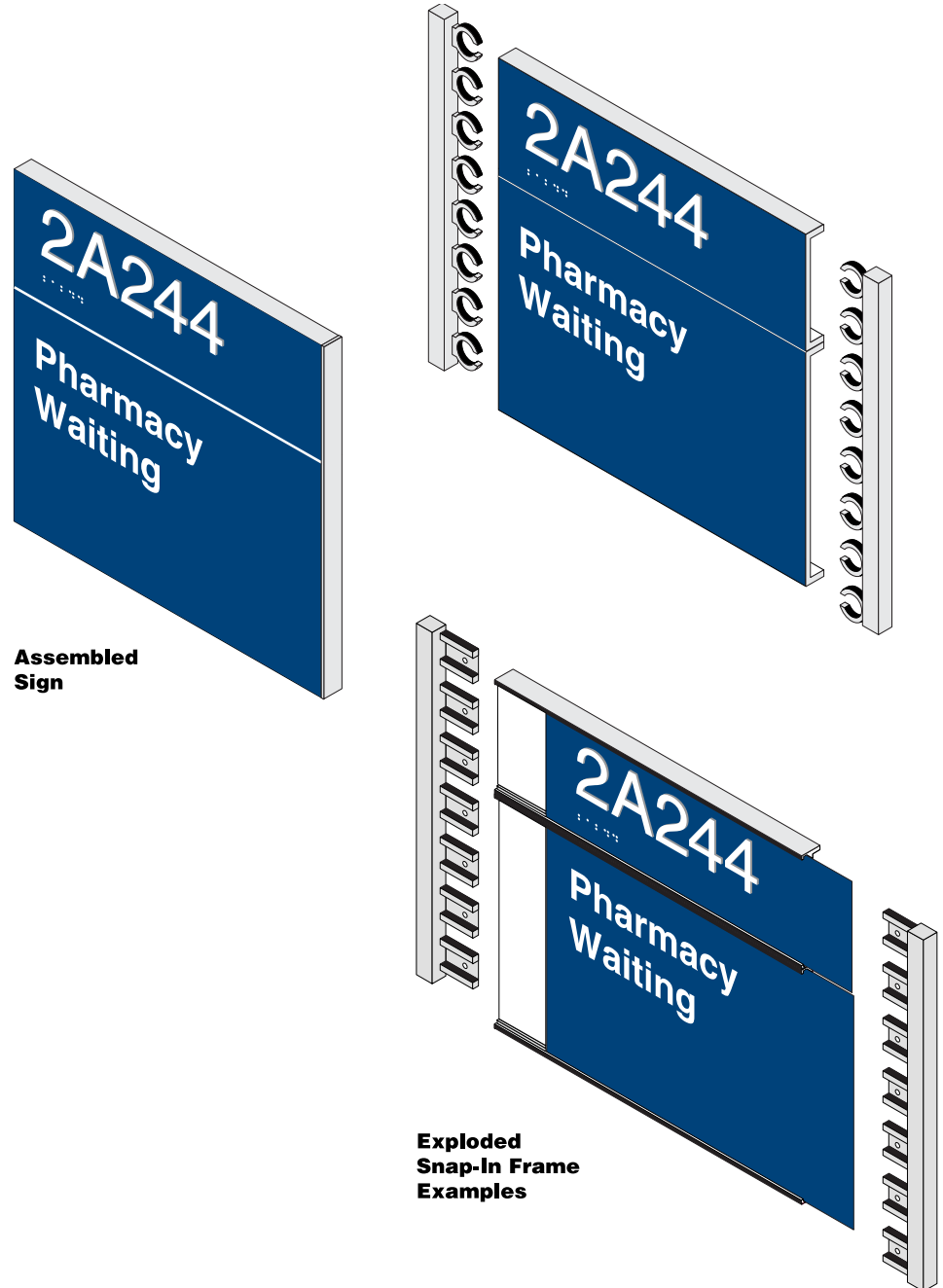

Construction

Interior Signage Guidelines

Frame and Backplate System

This type of signage systems has a simple construction comprised of a decorative extruded aluminum frame secured to a backplate that provides structural integrity. Sign face components are secured to the backplate either permanently or magnetically. The internal component edges are concealed by the aluminum frame.

As with all component systems shown, this system can be insert based for easy updates and mechanically fasten to the wall.

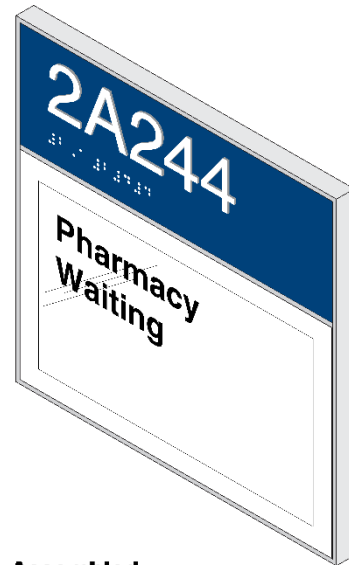

Assembled Sign

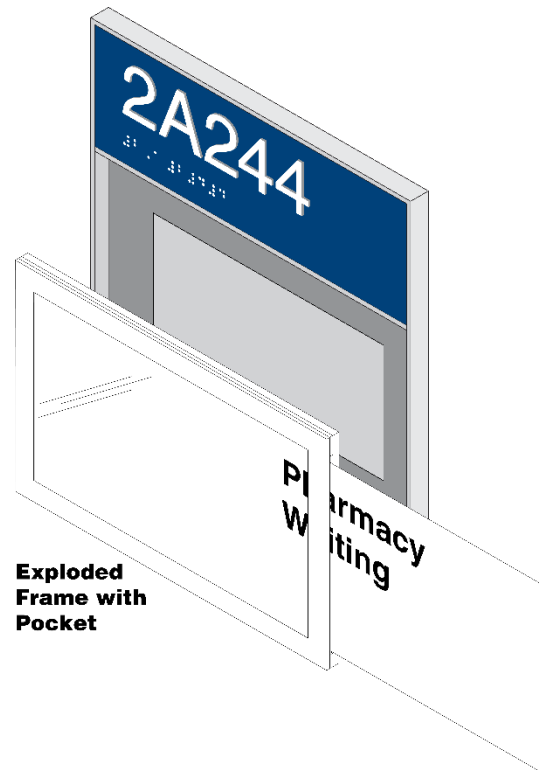

Exploded Frame with Pocket



2.1.6 INSTALLATION

The required installation method depends on several factors, including the type of sign, weight, size, mounting location (ceiling or wall), surface material, and whether the sign needs to be removable in the future.

Wall Signs

Mechanical Fastening: Mechanical fastening is the preferred method for installing interior wall signs. Many interior signs are lightweight enough to not require this method, but it adds security and minimizes wall damage during removal. When using wall anchors the fasteners should penetrate a stud or backer behind the wall or use hollow wall anchors. Screws or tamper-proof fasteners can be used to prohibit vandalism.

Masonry and Glass: Mechanical fastening should be avoided when installing on masonry, glass, or doors. On masonry surfaces, a combination of double-sided tape and silicone adhesive should be used. On glass, the sign should be mounted with VHB double-sided tape and silicone adhesive. A blank vinyl or acrylic back-up is necessary on the opposite side of the glass, exactly behind the sign being installed. This will cover the sign mounting adhesive.

Door Mount: Since users may push or brush against doors, a low-profile acrylic panel sign with eased corners should be used in lieu of a thicker component-based sign. Mount signs to doors with VHB double-sided tape and silicone adhesive.

Flag-Mounted Projecting Signs

Projecting signs must always be mechanically fastened to the wall surface with wall anchors penetrating a solid substrate, such as a stud or backing material behind the wall. In corridors, a flag-mounted sign should always be placed with the bottom of the sign height at 80" for clearance of pedestrians and equipment.

Ceiling Mounted Signs

Signs mounted above the pedestrian path of travel should always be mechanically fastened to a solid substrate with the bottom of the sign height at 80" for clearance of pedestrians and equipment. Typical placement of a ceiling mounted sign is in the center of a corridor or over the pedestrian path of travel.

Illuminated exit signs should not be blocked by ceiling signs and fire sprinkler heads should not have their spray pattern impacted by a ceiling mounted sign. Sprinkler systems, exit signs, and other ceiling mounted items also must not block the clear viewing area of the sign. The sign should be relocated in any of these situations.

Vinyl Lettering and Graphics

Vinyl lettering can be installed on most hard clean surfaces. Plastic and glass should be cleaned and any dry matter, such as tape or glue, removed. Drywall should have a level 5 finish and, if freshly painted, should be allowed to dry for at least 72 hours prior to the application of vinyl graphics.



Installation**Interior Signage Guidelines****Dimensional Letters**

Dimensional letters can be installed on most hard-to-clean surfaces. Letters can be mounted with double sided tape or an adhesive appropriate for the wall surface. Typically letters larger than 4 inches also have studs attached to the back. These studs are imbedded into the wall surface to support the weight of the letters. Studs must be used when a surface is rough and high textured.

Room Identification Signs

Height of room identification signs, with tactile characters and Braille, require specific placement to meet the requirements of the Architectural Barriers Act. Please refer to [Section 4.1 Design Elements](#) for relevant ABA requirements and refer to the installation drawings near the end of this Section.



Installation

Interior Signage Guidelines

Door Mount Signage

Acrylic Plaque

Construction & Installation:

A low-profile acrylic panel sign with eased corners should be used when mounting signs on doors.

Thicker component signage systems with multiple pieces are not recommended.

The acrylic signs should be of non-glare acrylic construction with second surface copy and graphics for durability.

Mount signs to doors with VHB double-sided tape and silicone adhesive.

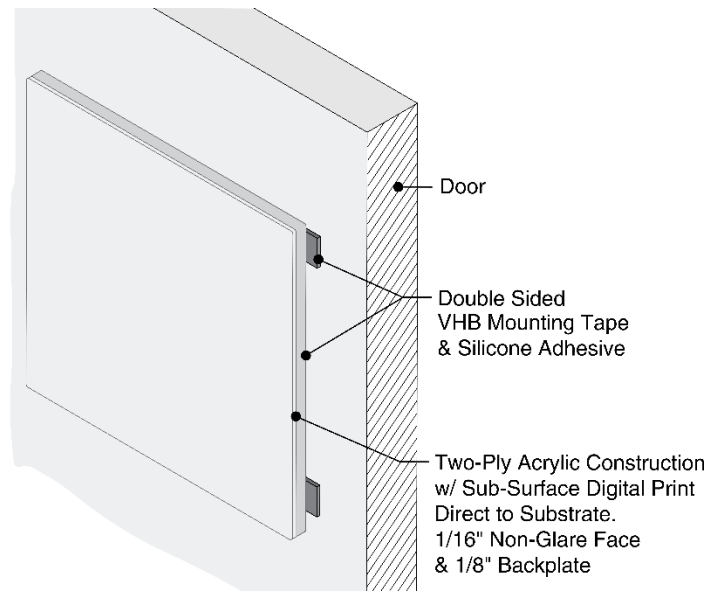

Glass Mount Signage

Construction & Installation:

For interior signs mounted to glass, an adhesive vinyl backing or 1/16" acrylic panel is required on the opposite side of the glass. The color should be neutral and align precisely with the sign to conceal its mounting.

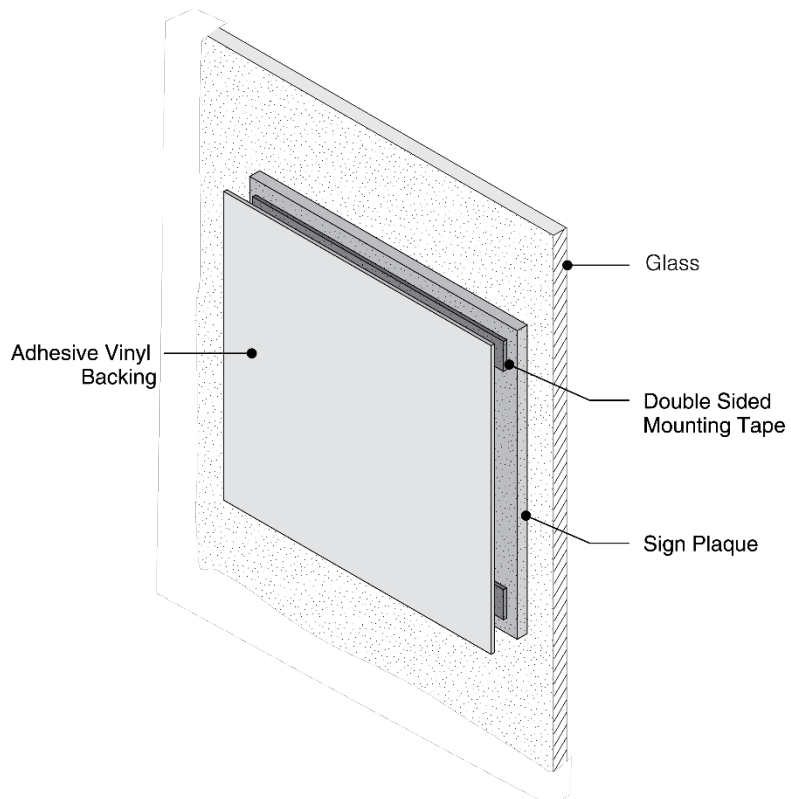

Installation Interior Signage Guidelines

Interior Wall Bracing for Heavy Signs and Cast Plaques:

Stud Backing Plate A

1. Maximum Weight: 25 lbs point load. If sign load exceeds this use Stud Backing Plate B.
2. Attach plates to 3 studs minimum.
3. Verify length, height, location, and number required.
4. Use #12 Self Tapping Screws when attaching items to backing, U.O.N.

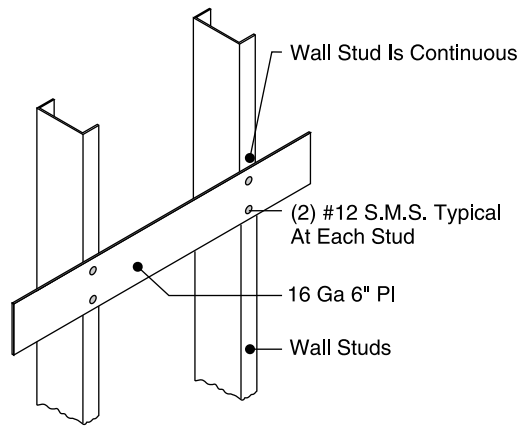

Stud Backing Plate A

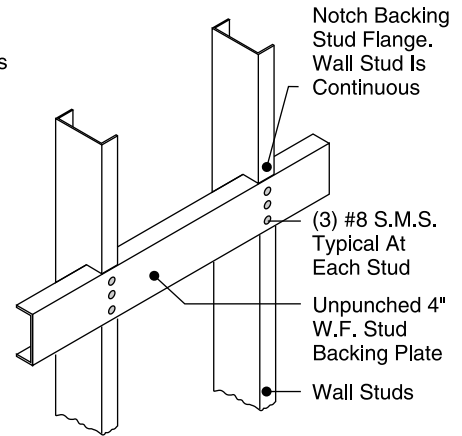

Stud Backing Plate B

Stud Backing Plate B

1. Maximum Weight: 50 lbs point load. If sign load exceeds this use Stud Backing Plate C.
2. Attach plates to 3 studs minimum.
3. Verify length, height, location, and number required.
4. Use double stud when stud is supporting more than 2 backing plates

Stud Backing Plate C

1. Maximum Weight: 200 lbs/ft.
2. Attach plates to 3 studs minimum.
3. Verify length, height, location, and number required.
4. Use double stud when stud is supporting more than 2 backing plates.

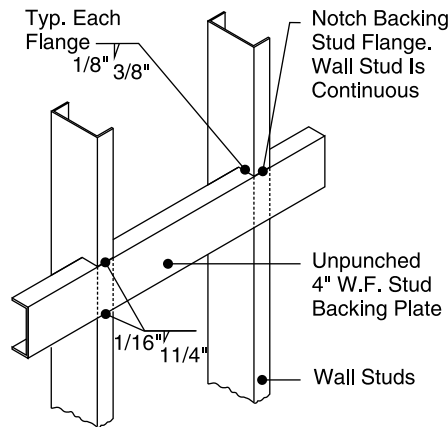

Stud Backing Plate C

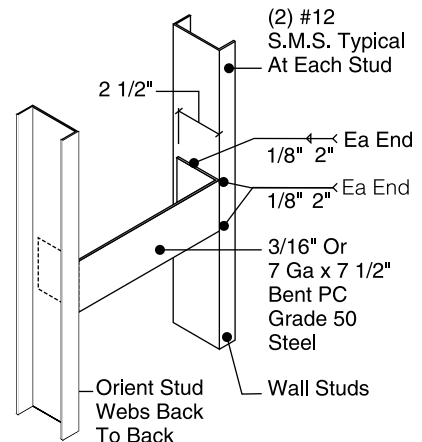

Stud Backing Plate D

Stud Backing Plate D

1. Maximum Weight: 300 lbs point load.
2. Attach plates to 3 studs minimum.
3. Verify length, height, location, and number required.



Installation

Interior Signage Guidelines

Ceiling Mounted Sign Detail:

Use for signs that weigh over 20 pounds and are mounted from a suspended ceiling system

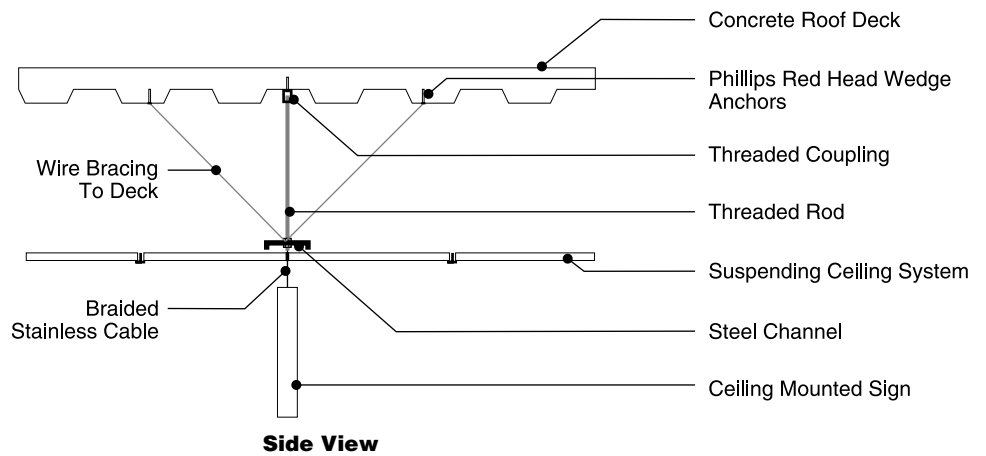
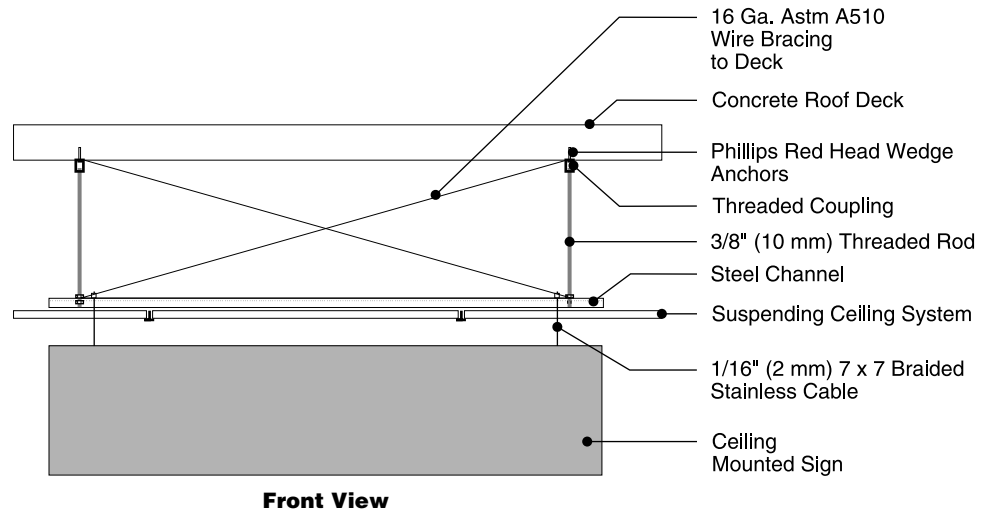

Installation

Interior Signage Guidelines

Ceiling Mounted Sign

Use for signs that weigh over 20 pounds and are mounted from above a suspended ceiling system where attachment to ceiling is not possible. Sign support to be distributed to load bearing walls. Additional Unistrut beam may be required.

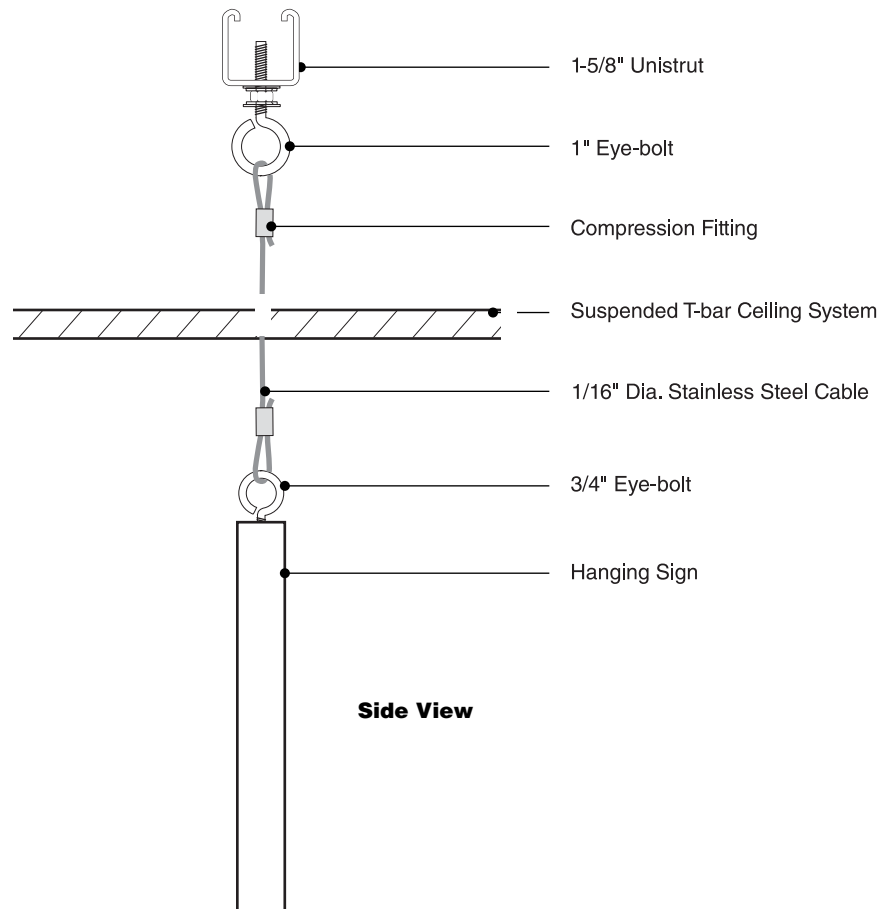
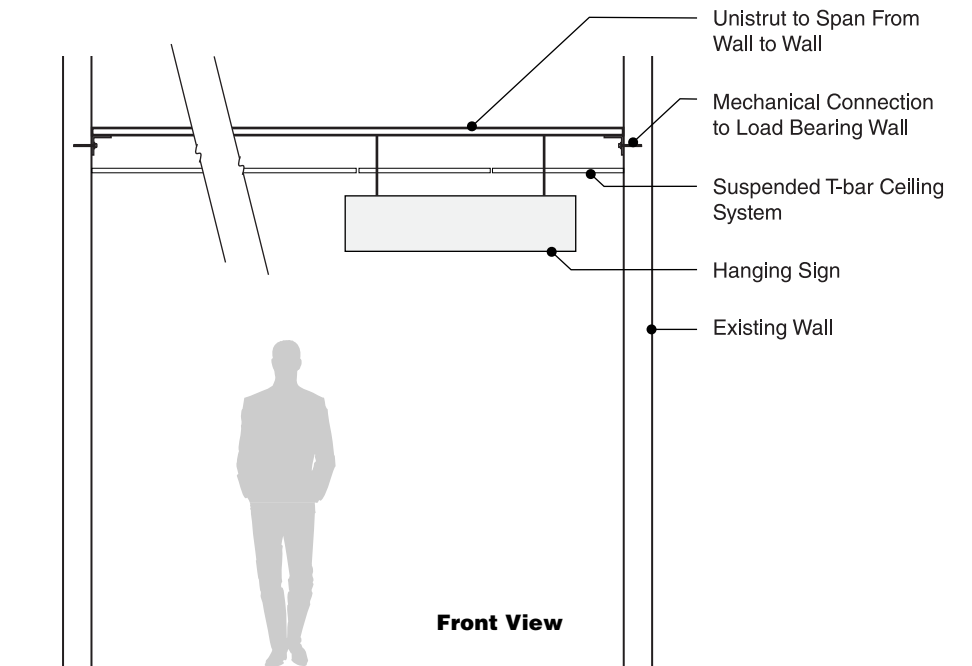

Installation

Interior Signage Guidelines

Detail 1

Installation detail:
Sign Type IN-03.01

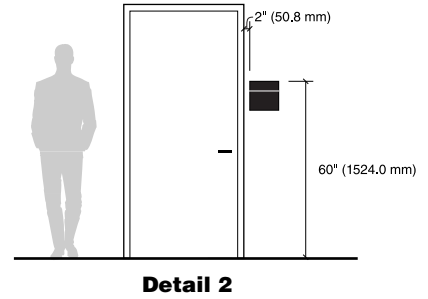
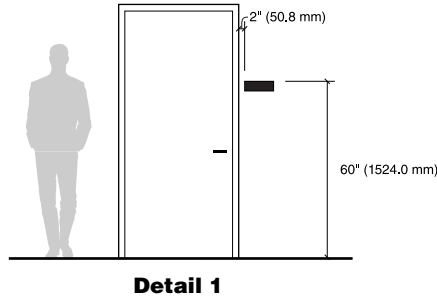

Detail 2

Installation detail:
Sign Types IN-04.01, 04.02, 05.06,
05.07, 06.05, 06.06, 07.01, &
07.02.

Detail 3

Installation detail:
Sign Types IN-08.01, 08.02, 09.01,
09.02, 09.03, 09.04, 09.05, & 09.06

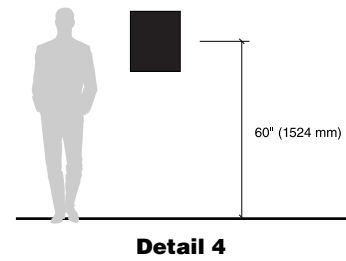
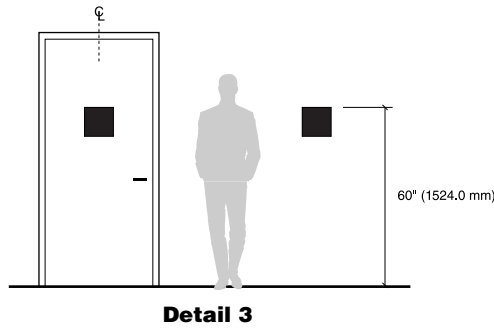

Detail 4

Installation detail:
Sign Types IN-09.09, 09.10, 10.01,
10.02, 10.03, 10.04, 10.05, 10.06,
10.07, 10.08, 11.01, 11.02, 11.03,
11.04, 14.01, 14.02, 14.03, 14.04,
14.05, 14.06, 14.07, 14.08, 14.09,
14.10, 14.11, 14.12, 14.13, 14.14,
14.15, 14.16, 14.17, 14.18, 17.01,
17.02, 17.03, 17.04, & 17.05

Detail 5

Installation detail:
Sign Types IN-13.01 & 13.02

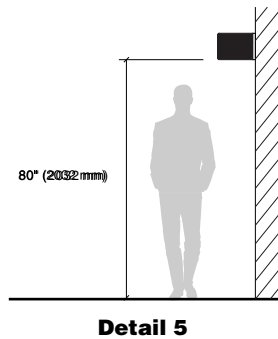

Installation

Interior Signage Guidelines

Detail 6

Installation detail:

Sign Types IN-15.51, 15.52, 15.55, 15.56, 15.61, 15.62, 15.65, 15.66, 15.71, 15.72, 15.75, & 15.76

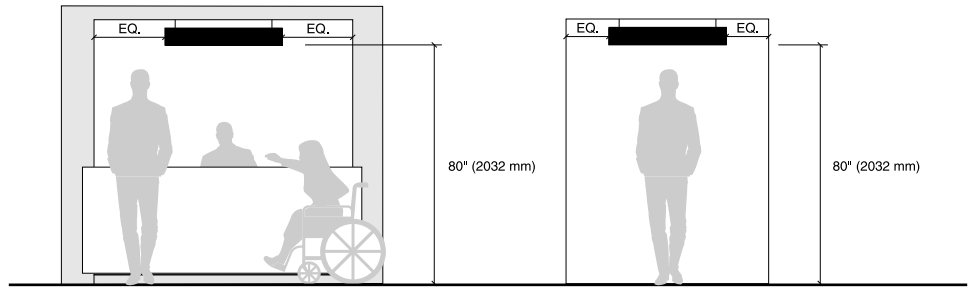

Detail 6

Detail 7

Installation detail:

Sign Types IN-16.51, 16.52, 16.55, 16.56, 16.61, 16.62, 16.65, 16.66, 16.71, 16.72, 16.75, & 16.76

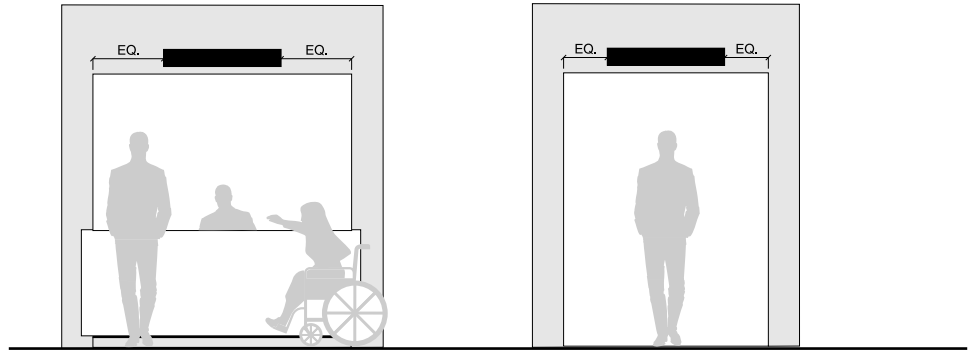

Detail 7



Installation

Interior Signage Guidelines

Detail 8

Installation detail:
Sign Type IN-18.01

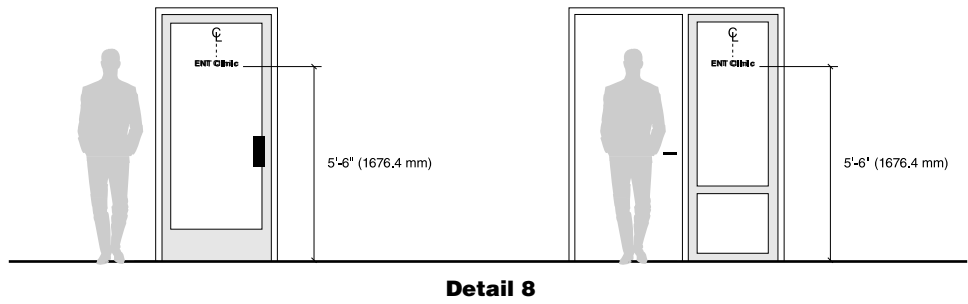
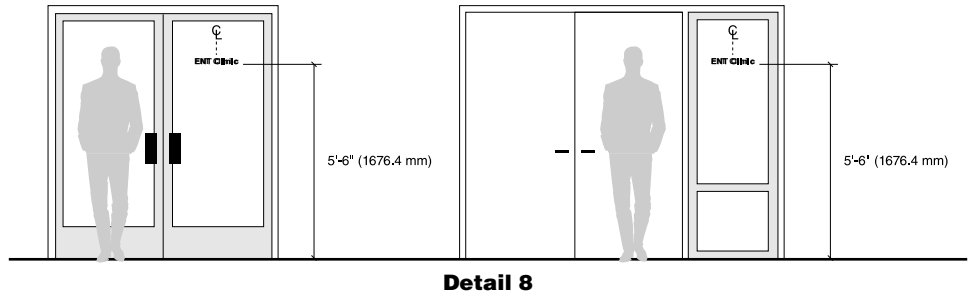

Detail 9

Installation detail:
Sign Types IN-19.01, 19.02, &
19.03

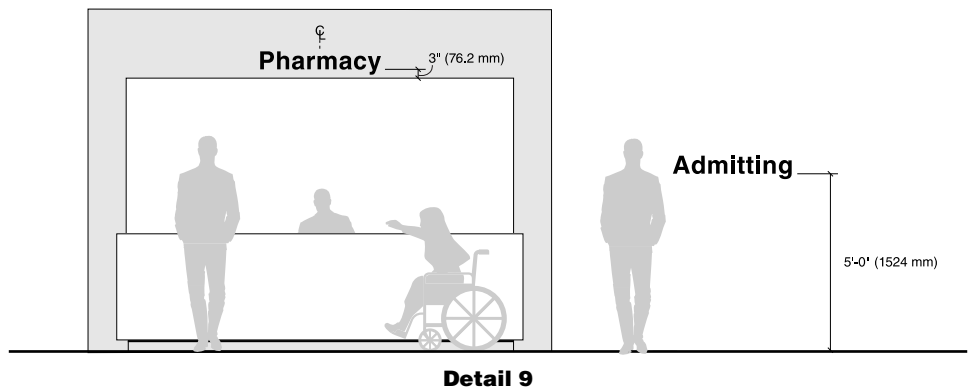

Installation

Interior Signage Guidelines

Detail 10

Tile wainscot wall installation guide for room identification signs.

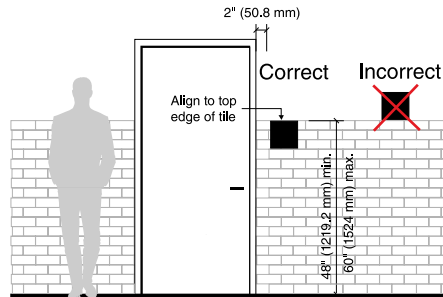

Detail 10

Detail 11

Room identification sign installation guide for spinal rehabilitation and nursing home facilities.

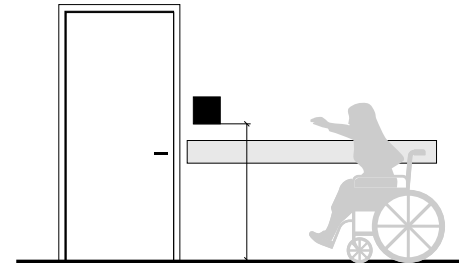

Detail 11

Detail 12

Overhead sign installation over counter or registration desk. Minimum 6'-8" off the floor on a free hanging header.

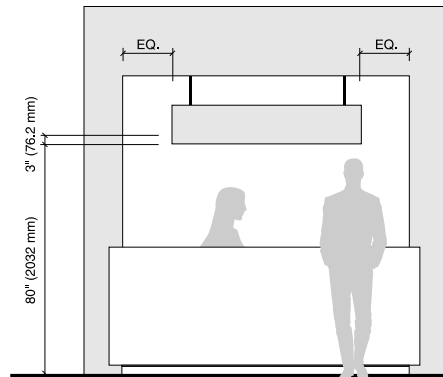

Detail 12: Front View

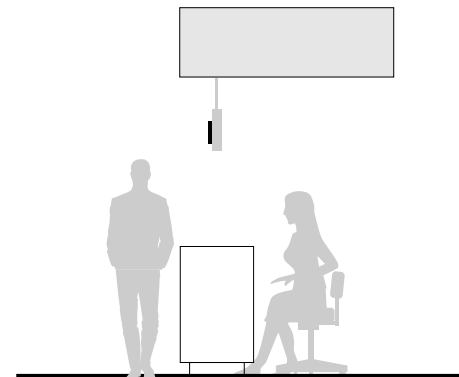

Detail 12: Side View

Detail 13

Overhead sign installation over opening with walk through and counter or registration desk. DO NOT place hanging header over opening.

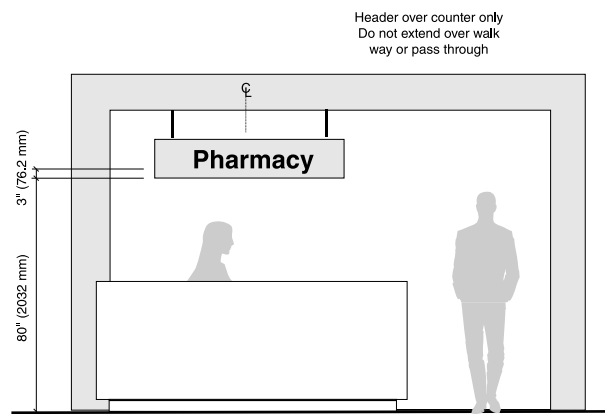

Detail 13



Installation

Interior Signage Guidelines

Detail 14

Overhead lobby or waiting room hanging sign for high ceilings. DO NOT install hanging sign in areas with ceilings higher than 12'-0". Use a wall-mounted flag sign.

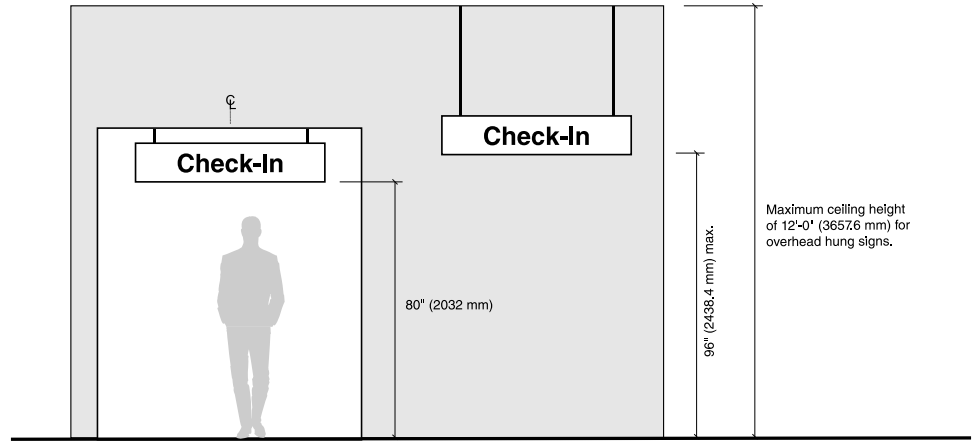



U.S. Department
of Veterans Affairs

SECTION 2.2

CODE & LIFE SAFETY SIGNAGE GUIDELINES



2.2.1 PLANNING

This section of the Signage Design Manual provides guidelines for Code and Life Safety Signage. When planning a project, determine whether you are replacing all Code and Life Safety Signs or addressing a specific requirement. Review [Section 1.1 Planning a Sign System](#) and coordinate with other planned or implemented Interior Signage discussed in [Section 2.1 Interior Signage Guidelines](#) and [Section 2.3 Mandatory VA Policy & Directives](#).

From the onset of the project, it is important to engage facility life safety personnel to:

- Discuss the project and establish them as a key member of the team.
- Identify known needs and deficiencies.
- Determine whether the new signs will require any local or state codes be followed as the authority having jurisdiction (AHJ) in addition to national requirements.
- Obtain information on the locations of life safety equipment such as pull boxes, fire extinguishers, and AEDs.
- Act as a subject matter expert to answer questions, review submittals, and provide facility specific information.

Site Evaluation

After the project scope has been determined, a detailed site evaluation needs to be performed. Obtain all applicable building floor plans. The plans need to be scaled with a notation of cardinal direction. Most facilities have building plans on file with the Engineering or Facilities Management Department. If applicable, obtain Life Safety Plans that show the location of life safety equipment to field verify.

During the Site Evaluation

- Meet with the VA project team to identify future plans that may affect existing conditions (construction, renovations, relocations, etc.).
- Conduct a photo essay of existing life safety signage (if applicable).
- Identify building entrances, exits, stairwells, and elevators.
- Obtain egress route information (if applicable).
- Verify stairwell information including stair number, roof access, floor range, and exit discharge(s) (if applicable).
- Survey for other Code and Life Safety signage needs within the project scope.
- Meet with other VA stakeholders, as needed, that may require specialized regulatory signage. This may include staff from Radiology and Nuclear Medicine, VA Police, or other departments that have specific regulatory signage requirements.



Planning**Code & Life Safety Signage Guidelines****Signage System Standard**

Using the guidelines set forth in this document, a standard family of Code and Life Safety components should be developed to meet the conditions of the facility.

- The facility's component-based signage system should be used to determine the Code and Life Safety signage specifications. The Code and Life Safety signage should maintain a consistent and cohesive signage system and standard.
- Background colors for signs not having a specific color requirement should match the facility standard or be complimentary to the building wall colors.



2.2.2 PROGRAMMING

Determining the exact location, placement, and messaging for each sign occurs during the Programming Phase. The programming of a signage system should take place shortly before implementation to avoid errors and duplication of work. Information and existing conditions can quickly change, rendering the programming data invalid. Coordination with other signage and consideration of the following guidelines will assist in programming an effective Code and Life Safety signage system.

Adapt for Code Changes

This section covers the required Code and Life Safety signs at the time of publication. Regulations are constantly changing, and revised signs may be required for code compliance. Consult with facility life safety personnel and the latest applicable codes for the most current requirements.

Types of Signs

Code and Life Safety signs are identified in [Section 3.2 Code & Life Safety Signage Drawings](#) and include a description of use and application for each sign. These signs are in the color, size, and shape to conform with their respective function and requirement. Some colors, sizes, and shapes are determined by codes and regulations and cannot be altered. If a sign must be altered for a specific condition, verification of compliance is required.

Sign Placement Considerations

- Some Code and Life Safety signs have specific placement and location requirements that are not to be altered. Refer to the detailed drawings in [Section 3.2 Code & Life Safety Signage Drawings](#) and installation details at the end of this section for instructions and placement of each sign type.
- The placement of Code and Life Safety signs takes priority over placement of all wall accessories such as bulletin boards, hand sanitizers, and artwork. These types of items will have to be relocated to meet the installation requirements of Code and Life Safety signs.
- Coordinate ceiling mounted signs so they do not obstruct or block fire sprinkler systems, exit signs, or other signage.
- Code and Life Safety signs need to be mounted in locations that allow for clear viewing. Place signs so they are not obscured by furniture or equipment.

Sign Size

Code and Life Safety sign sizes that are illustrated in [Section 3.2 Code & Life Safety Signage Drawings](#) have been determined to work in most situations and conform to codes and regulations.

Message Content

Certain signs will require specific text developed for each sign location. Refer to the sign type drawings in [Section 3.2 Code & Life Safety Signage Drawings](#).

Message Layout

Some Code and Life Safety signs have specific text layout and text size requirements that are not to be altered. The text and its size, as shown, have been determined to conform to codes and regulations.



Programming

Code & Life Safety Signage Guidelines

Existing Signage Program Removal

Before implementing a new interior signage program, perform a thorough evaluation of the demolition requirements of the current signage program and its impact on the facility's walls, doors, and ceilings.

Request information from the facility on the location of fire walls and any known hazards that may affect sign removal including, but not limited to, asbestos and lead in ceilings, walls, or flooring. Determine what is required to patch, seal, and repair the building surfaces exposed due to the removal of old signs or letters. Repairs should match adjoining surfaces.

Do not remove any Code and Life Safety signs without having a temporary or replacement sign available to install at the same time the old signs are removed.



2.2.3 SIGN OVERVIEW

The following overview illustrates the various types of Code and Life Safety Signs that are necessary for a medical center campus or single building.

[Section 3.2 Code & Life Safety Signage Drawings](#) of this manual provides detailed drawings of each of these signs.

These signs are shown in the color, size, and shape to conform with their respective function and requirement. Some colors, sizes, and shapes are determined by codes and regulations and cannot be altered. If a sign must be altered for a specific condition, verification of compliance is required.

Sign Designations

Each sign in the program manual has been given a specific sign type number designation. This designation provides a common description that can be referenced when programming a site and ordering signs. The following explains how the sign type designations are derived.

IN - 01 .28 .03 C

- IN** Designates an interior sign.
- 01** Two-digit number identifies the Code & Life Safety sign family.
- 28** The two-digit number following the period identifies a specific sign type within the sign family.
- .03** The two-digit number following the period identifies a specific sup-group of sign within the sign family.
- C** The letter designates a specific sign configuration, version and / or layout for graphics or symbols.



Sign Overview

Code & Life Safety Signage Guidelines

IN-01.01.01
Evacuation Plan Sign

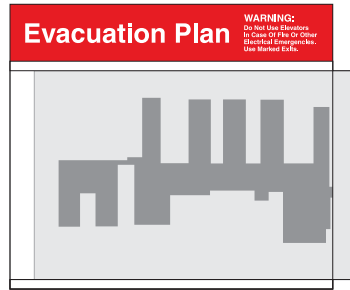

IN-01.01.01

IN-01.01.03
Guest Rooms Evacuation Plan Sign

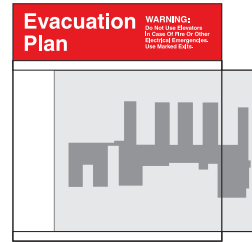

IN-01.01.03 A



IN-01.01.03 B

IN-01.02
Fire Extinguisher Identification Sign

IN-01.31
Fire Extinguisher Identification Flag Sign



IN-01.02



IN-01.31

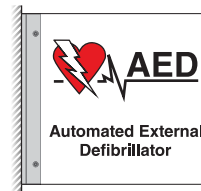

IN-01.36



IN-01.37

IN-01.37
Crash Cart Identification Flag Sign

IN-01.03
Fire Procedure "R.A.C.E." Sign

IN-01.04
Elevator Call Button Sign



IN-01.03



IN-01.04



IN-01.05



IN-01.06

IN-01.05
Fire Door Sign

IN-01.06
No Exit Sign

IN-01.07.01-04
Exit Sign

IN-01.08
Automatic Fire Door Sign – Hinged Door



IN-01.07.01-04

IN-01.09
Automatic Fire Shutter Sign – Roll Up



IN-01.08



IN-01.09



Sign Overview

Code & Life Safety Signage Guidelines

IN-01.13
Push/Pull Alarm Identification Sign



IN-01.14
Open Door Fire Safety Sign



IN-01.13 A & B

IN-01.14

IN-01.26
Push to Exit Sign



IN-01.27
Emergency Push to Open Sign



IN-01.26

IN-01.27

IN-01.28

IN-01.28
Emergency Slide to Open Sign

IN-01.10
Stair Identification Sign



IN-01.11
NFPA Stairwell Identification Sign

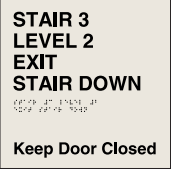

IN-01.12
Area of Refuge Sign



IN-01.10

IN-01.11

IN-01.12

IN-01.25
No Re-Entry Floor Sign

IN-01.29
Direction of Exit Sign

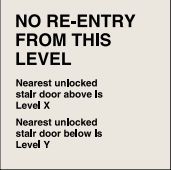

IN-01.30
No Re-Entry Sign

IN-01.33
Re-Entry Sign

IN-01.25

IN-01.29

IN-01.30

IN-01.33



Sign Overview

Code & Life Safety Signage Guidelines

IN-01.15
Hazardous Material Information Sign



[IN-01.15](#)

IN-01.16.01
Oxygen in Use Warning Sign

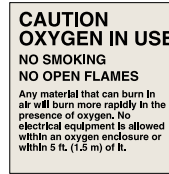

[IN-01.16.01](#)

IN-01.16.02
Medical Gases Warning Sign

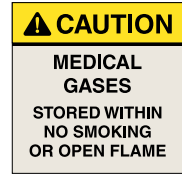

[IN-01.16.02](#)

IN-01.16.03
Oxidizing Gases Warning Sign

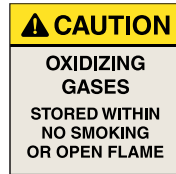

[IN-01.16.03](#)

IN-01.16.04
Positive Pressure Gases Warning Sign

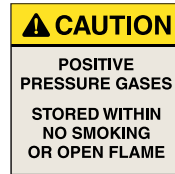

[IN-01.16.04](#)

IN-01.17
Compressed Gas Warning Sign

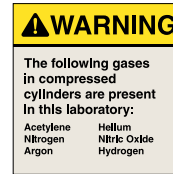

[IN-01.17](#)

IN-01.18
Nonflammable Anesthesia Restriction Sign



[IN-01.18](#)

IN-01.19
Radioactive Material Warning Sign



[IN-01.19](#)

IN-01.20
Radioactive Area Warning Sign



[IN-01.20](#)

IN-01.35
Radiation Warning Sign

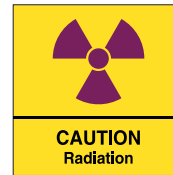

[IN-01.35](#)

IN-01.21
High Voltage Warning Sign

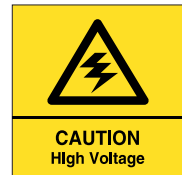

[IN-01.21](#)

IN-01.22
Biohazard Warning Sign



[IN-01.22](#)

IN-01.23
Laser Warning Sign



[IN-01.23](#)

IN-01.24
Occupational Exposure Area Warning Sign



[IN-01.24](#)

IN-01.32
Pregnancy Notification Sign

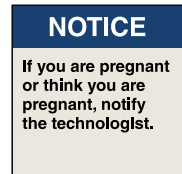

[IN-01.32](#)



Sign Overview

Code & Life Safety Signage Guidelines

IN-01.34

Proper Attire Required Beyond this Point Sign

IN-01.38

Emergency Eye Wash Station Sign

IN-01.39

Emergency Shower Sign

IN-01.40

Emergency Shower / Emergency Eye Wash Station Sign



IN-01.34



IN-01.38



IN-01.39



IN-01.40



2.2.4 SPECIFICATIONS

The specifications for signs are available in the Master Construction Specifications (PG-18-1) area of the VA Technical Information Library, which is available on the VA web site under Office of Construction & Facilities Management.

Visit online: www.cfm.va.gov/til/spec.asp#10

Refer to Signage in the specifications, Division 10, Section 10 14 00.

For more information regarding specifications, contact the Office of Construction & Facilities Management, Facility Standards Service.

When preparing the specifications for a project, it will be necessary to adapt the specifications to the individual facility and project. This may include information regarding the facility's specific component-based signage system, colors and finishes, and project requirements such as specific sign types or installation requirements.

Depending on the project type, signage specifications can include the Sign Message Schedule, Sign Location Plans, and Sign Drawings. The Sign Message Schedule is a table that lists each sign's location number, sign type, and message, as well as other relevant details. The Sign Location Plans are a set of architectural plans showing numbered tags at the location of each sign. Sign Drawings illustrate the details and design intent for each sign type in the system. This information is required by the sign manufacturer and installer for production and implementation of the signs.

More information about signage system planning and programming, and submittal examples, can be found in [Section 1.1 Planning a Sign System](#) of the VA Signage Design Manual.



2.2.5 INSTALLATION

Code & Life Safety signs have specific location and placement requirements based upon their use, function, and code requirements.

Each sign type should be installed as illustrated in [Section 3.2 Code & Life Safety Signage Drawings](#) without deviation. This may require that furniture be moved, bulletin boards be relocated, etc. to ensure Code & Life Safety signage is installed in its correct location.

Wall Mount Signage:

Wall-mounted Code & Life Safety signage should adhere to the construction and specifications of the facility's component-based signage system to maintain consistency and cohesion. Concealed mechanical fasteners are the preferred installation method, consistent with all other interior signage.

Detail 1 - Glass & Door Sign Back-Up:

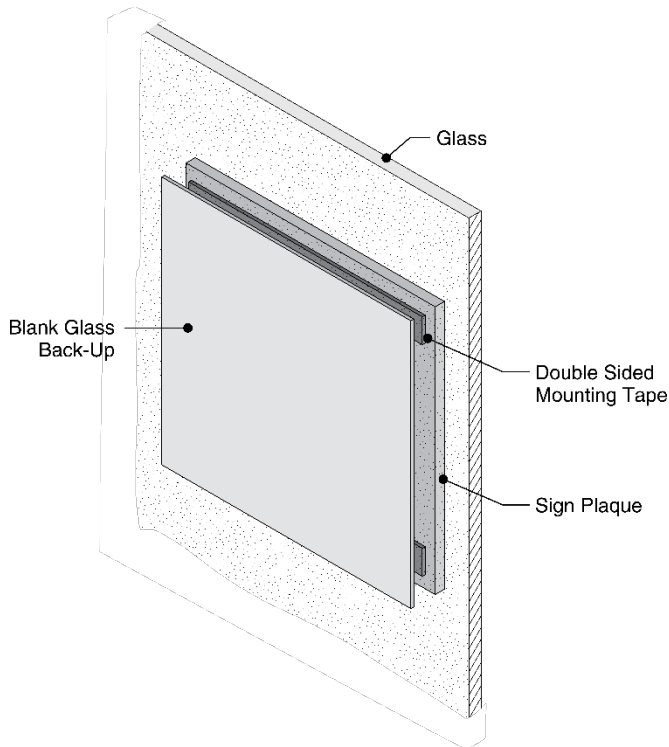

Back-Up for Glass Application

For signs mounted to glass, an adhesive vinyl backing is required on the opposite side of the glass. The color should be white or neutral, and align precisely with the sign to conceal it's mounting.

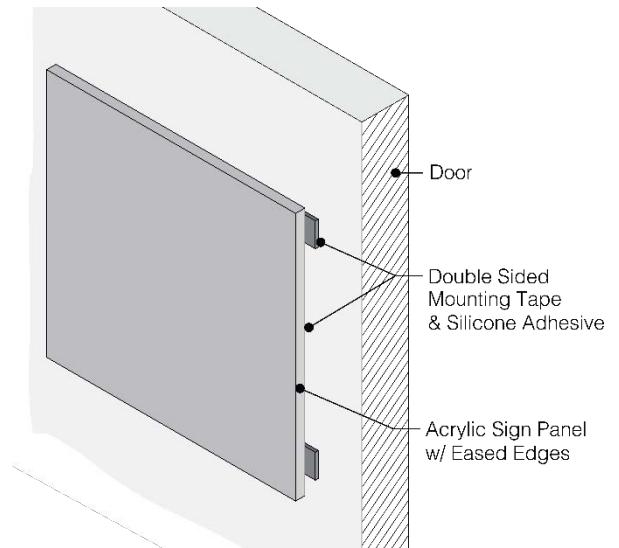

Back-Up for Door Application



Installation

Code & Life Safety Signage Guidelines

Door Mount Signage Construction & Installation:

A low-profile acrylic panel sign with eased corners should be used when mounting signs on doors.

Thicker component signage systems with multiple pieces are not recommended.

The acrylic signs should be of non-glare acrylic construction with second surface copy and graphics for durability.

Mount signs to doors with VHB double-sided tape and silicone adhesive.

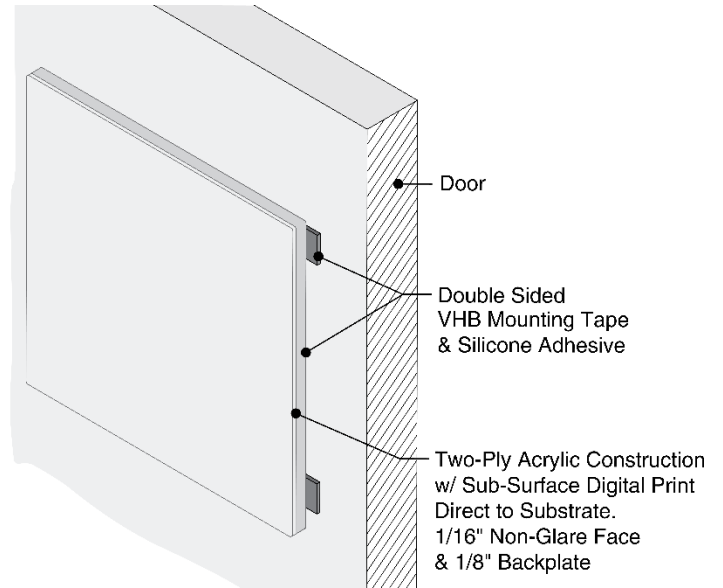

Glass Mount Signage Construction & Installation:

For interior signs mounted to glass, an adhesive vinyl backing or 1/16" acrylic panel is required on the opposite side of the glass. The color should be neutral and align precisely with the sign to conceal its mounting.

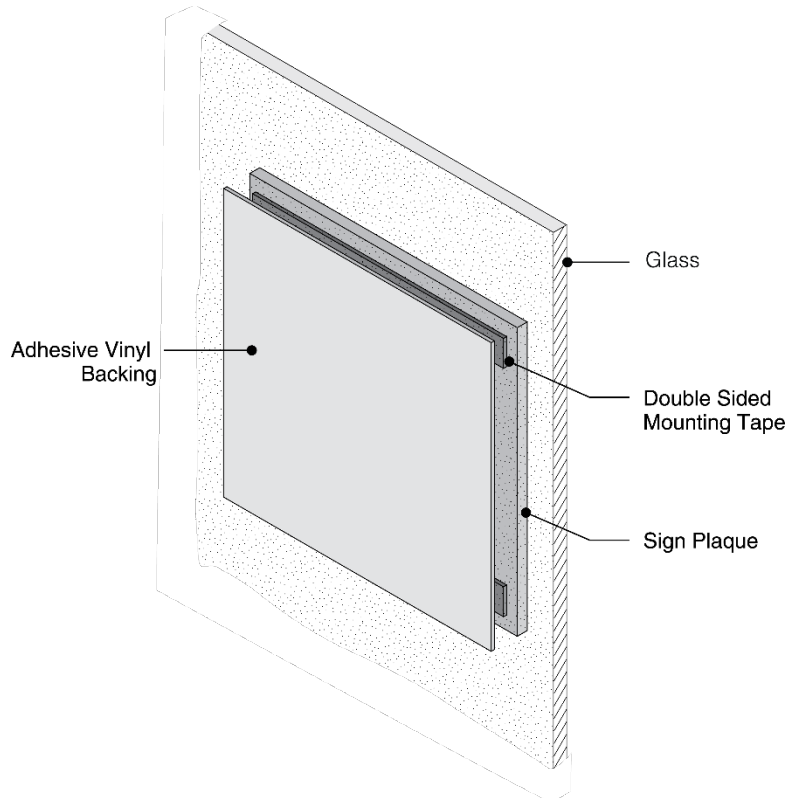

Installation

Code & Life Safety Signage Guidelines

Stairwell Guide

Certain signs relating to stairs require that they be installed at specific locations as defined by what floor they are located on.

Illustration 1 - Exit Level with Exterior Exit:

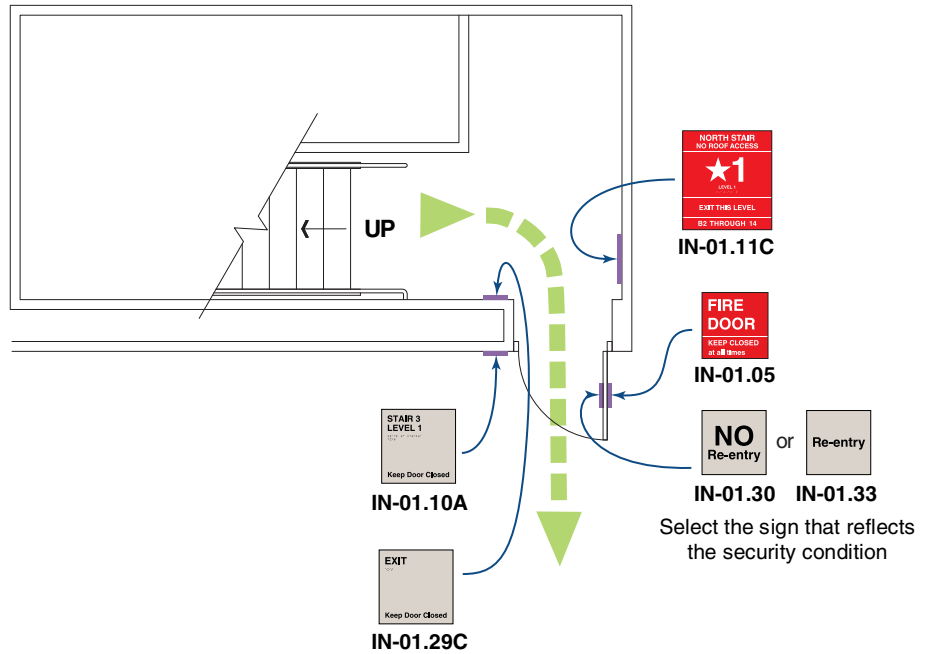
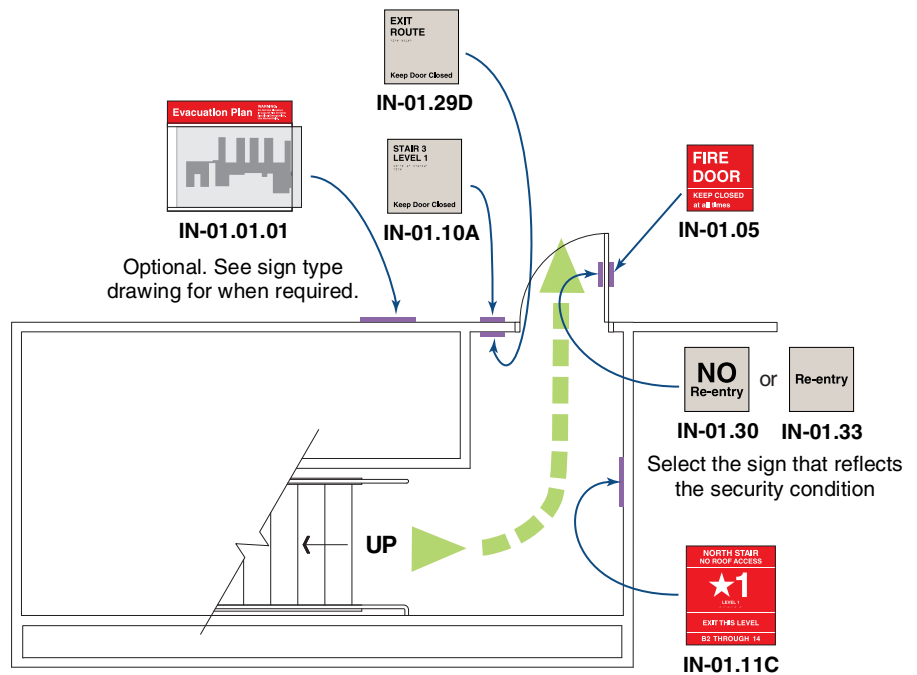

Illustration 2 - Exit Level with Interior Exit:



Installation **Code & Life Safety Signage Guidelines**

Illustration 3 - Exit Level with Two Exit Doors:

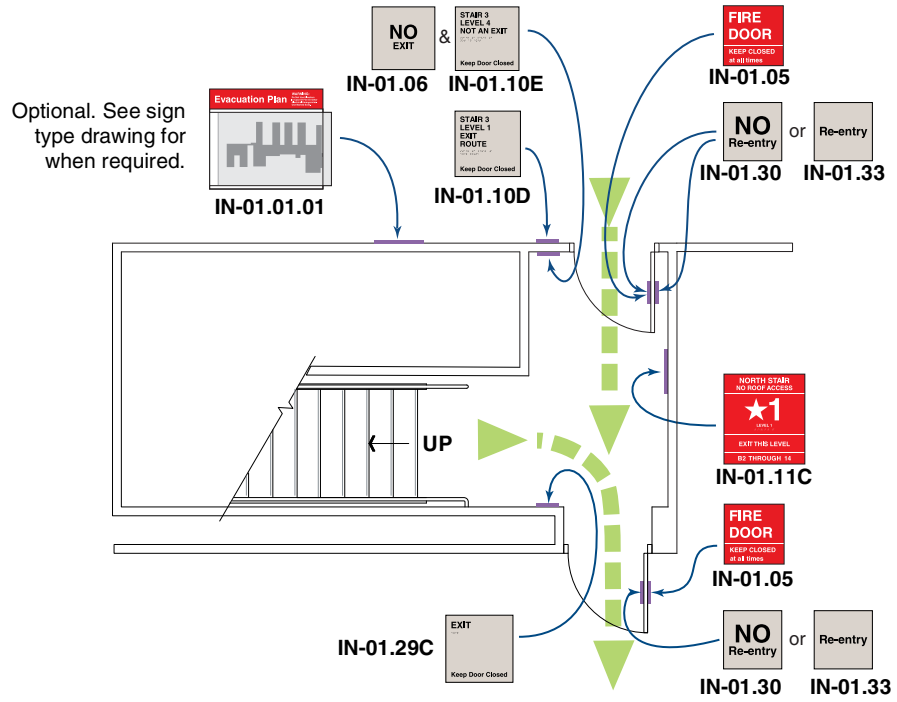
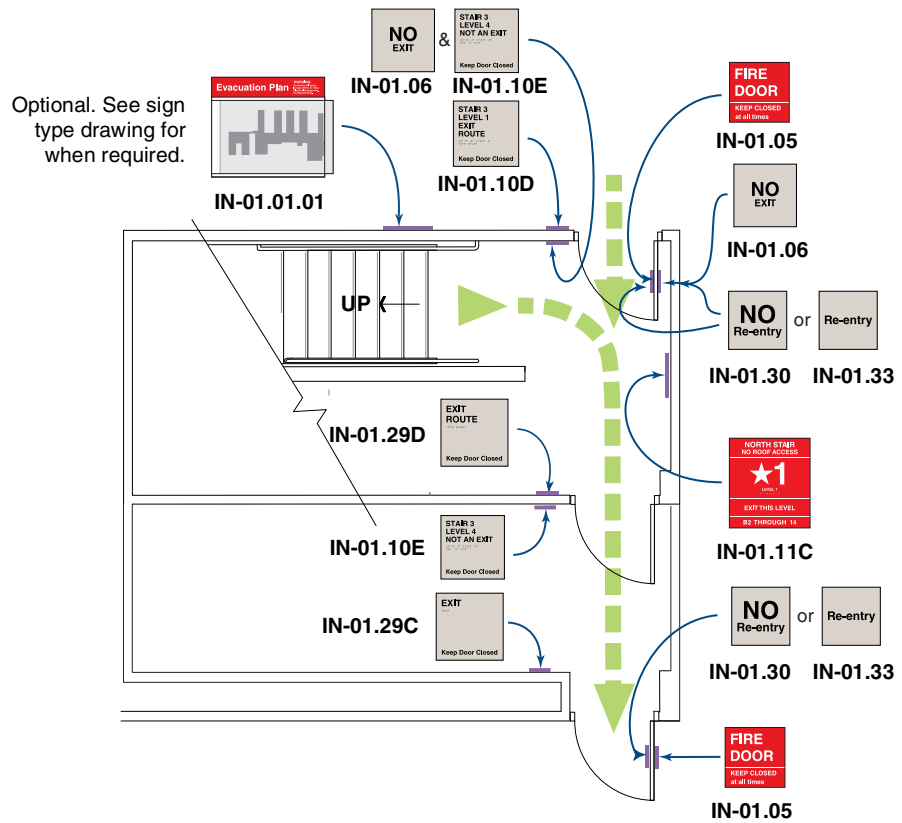

Illustration 4 - Exit Level with Exit Path thru Interior Space:



Installation Code & Life Safety Signage Guidelines

Illustration 5 – Level of Exit Discharge:

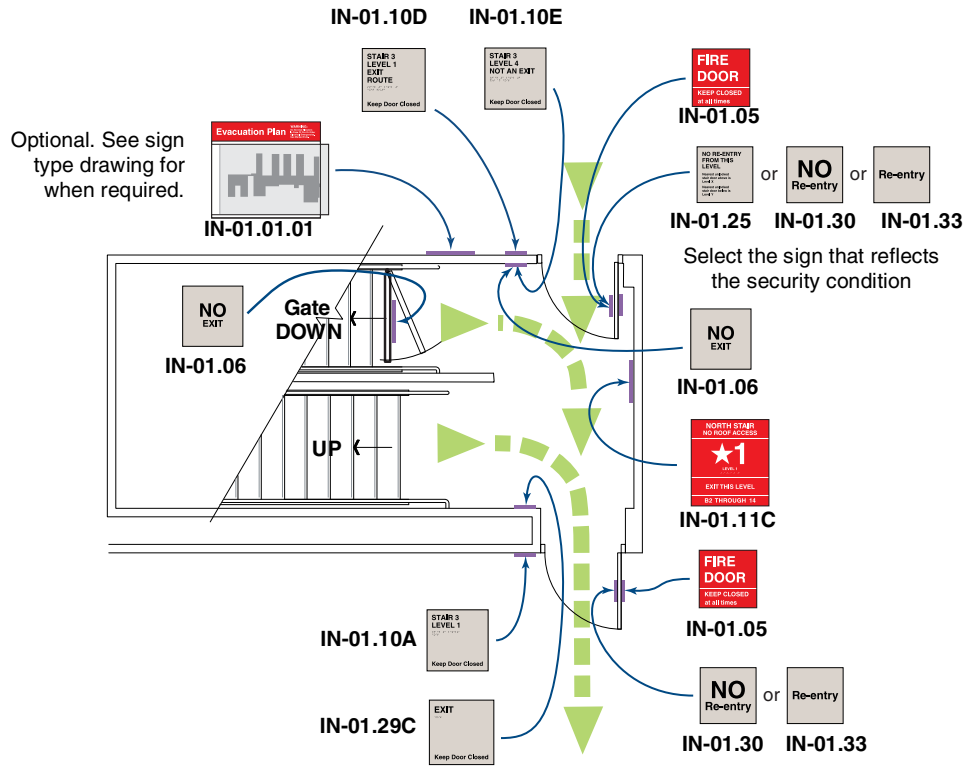
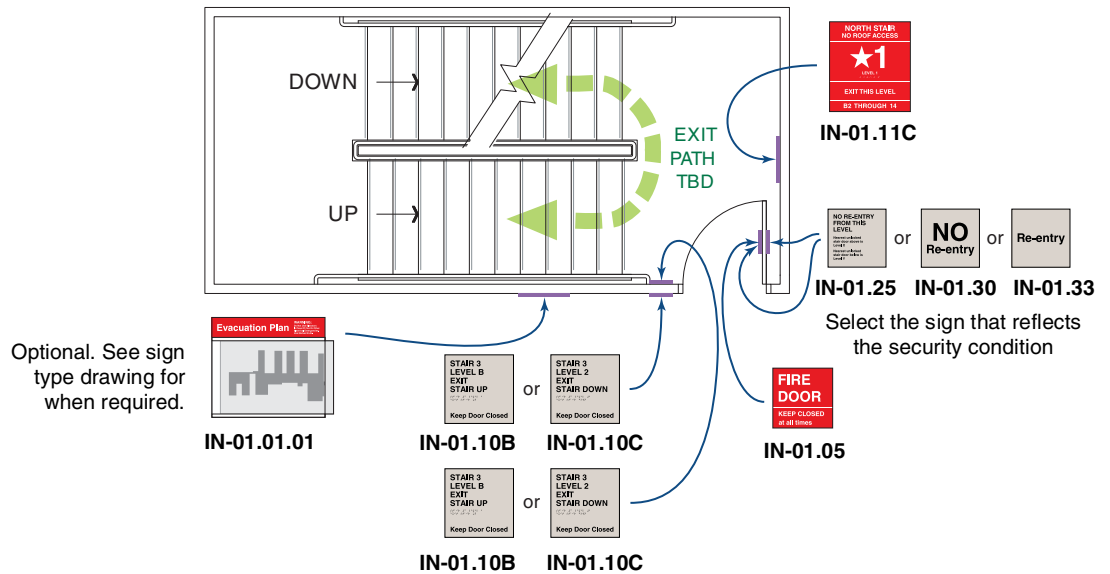

Illustration 6 – Stair Entry for Floor Levels Above Ground Level and Below Roof Level:



Installation

Code & Life Safety Signage Guidelines

Illustration 7 – Roof Level:

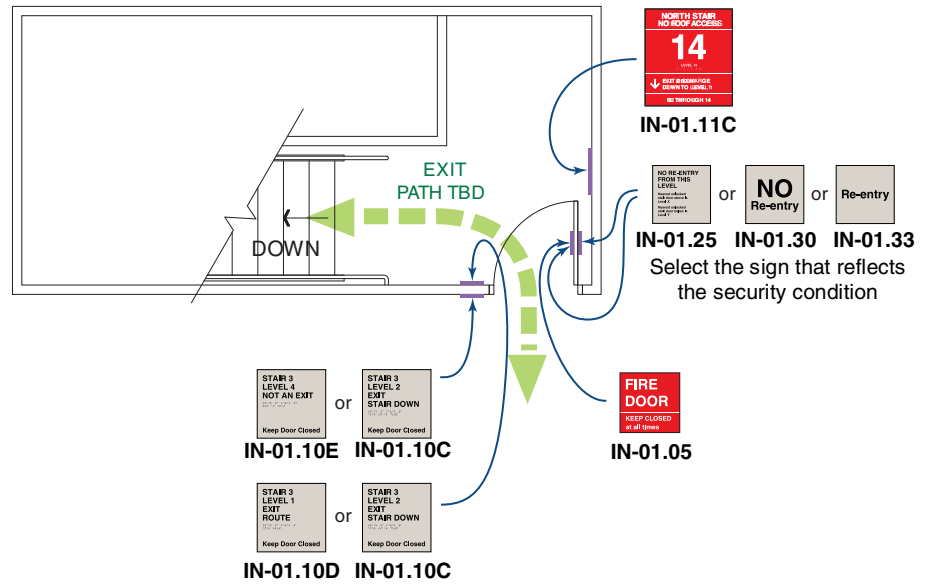



U.S. Department
of Veterans Affairs

SECTION 2.3

MANDATORY VA POLICY & DIRECTIVE SIGNAGE GUIDELINES



2.3.1 INTRODUCTION

Introduction

This section of the VA Signage Design Manual is comprised of **policy and regulations** that are REQUIRED to be posted by applicable codes, laws, and VA Policy Directive. Only mandatory postings are included in this section.

Other types of signs required by code, regulatory bodies, or VA Policy Directive are found in each respective section of this Manual ([Section 2.1 Interior Signage Guidelines](#), [Section 2.2 Code & Life Safety Signage Guidelines](#), and [Section 2.5 Exterior Signage Guidelines](#)).

For each mandatory posting in this section, when it is used, where it is located, and what it says is specifically directed and not open to modification or revisions. See the detailed sign drawings in [Section 3.3 Mandatory VA Policy & Directive Signage Drawings](#) for more information.

Check for Policy Changes

This section covers the mandatory postings at the time of publication. VA Policy Directives constantly evolve and change, so check for any VA Policy Directives issued after the date of this publication that require signage to be posted.

Avoid Visual Clutter

While the content of the mandatory postings is not open to modification, the signage system used and configuration of the signage components should match the facility's sign standard and complement the architectural design whenever possible. When placing signs near each other, it is important to consider how all components will work together as a cohesive whole. Refer to the [Layout Examples](#) in [Section 3.3 Mandatory VA Policy & Directive Signage Drawings](#) for how these signs and others may be configured on a wall.

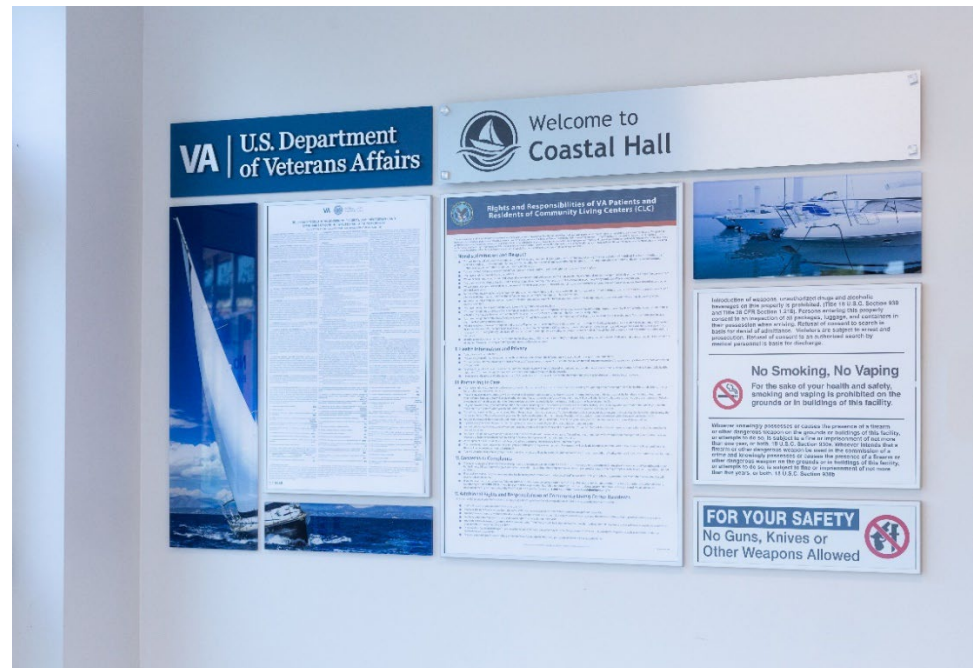

2.3.2 SIGN OVERVIEW

The following Overview illustrates mandatory postings that are REQUIRED by applicable codes, laws, and VA Policy Directive.

[Section 3.3 Mandatory VA Policy & Directive Signage Drawings](#) of this manual provides detailed drawings of each of these signs and associated posting requirements.

Sign Designations

Each sign in the program manual has been given a specific sign type number designation. This designation provides a common description that can be referenced when programming a site and ordering signs. The following explains how the sign type designations are derived.

Note: This Section includes both interior and exterior Mandatory VA Policy & Directive signs despite being attributed with the prefix "IN".

For the sake of consistency amongst all VA official documentation, no sign designation shall change within this manual without the express written consent of the VA, followed by a VA Design Alert that is distributed on a monthly basis.

IN - 02 .06 A

- I** Designates an interior sign.
- N** Identifies that the sign is non-illuminated.
- 02** Two-digit numbers identify a particular sign type family.
- .01** The two-digit number following the period identifies a specific sign within the sign family.
- A** The letter designates a specific sign configuration, version, or layout for graphics.



Sign Overview

Mandatory VA Policy & Directive Signage Guidelines

IN-02.01
Consent to Inspection Sign

IN-02.10
No Weapons Notice Sign - Interior

IN-02.03
No Weapons Permitted Sign

IN-02.14
Video Surveillance Sign

IN-02.15
Service Dogs Sign

IN-02.02
No Smoking, No Vaping Sign



Sign Overview

Mandatory VA Policy & Directive Signage Guidelines

Grouped Signs

Signs may be combined as follows:

- IN-02.01 - Consent to Inspection
- IN-02.10 - No Weapons Notice
- IN-02.03 - No Weapons Policy

- IN-02.14 – Video Surveillance
- IN-02.15 – Service Dogs
- IN-02.02 – No Smoking, No Vaping

The signs can be grouped together in one display or broken into two displays of 3 signs each, following the same sequence.

Refer to the [Layout Examples](#) in [Section 3.3 Mandatory VA Policy & Directive Signage Drawings](#) for how these signs and others may be configured on a wall.

FOR YOUR SAFETY
No Guns, Knives or Other Weapons Allowed

Whoever knowingly possesses or causes the presence of a firearm or other dangerous weapon on the grounds or building of this facility, or attempts to do so, is subject to fine or imprisonment of not more than one year, or both, 18 U.S.C. Section 930a. Whoever intends that a firearm or other dangerous weapon be used in the commission of a crime and knowingly possesses or causes the presence of a firearm or other dangerous weapon on the grounds or buildings of this facility, or attempts to do so, is subject to fine or imprisonment of not more than five years, or both, 18 U.S.C. Section 930b.

Video Surveillance
Video and audio surveillance, including body-worn cameras, are in use on these premises.

Service Dogs Welcome
No Pets Allowed
A service dog is specifically trained to do work for a person with a disability. Service dogs must be under control at all times. Dogs in training are not considered service dogs and are not allowed on VA property.

No Smoking, No Vaping
For the sake of your health and safety, smoking and vaping is prohibited on the grounds or in buildings of this facility.

Grouped Signs: Multiple Panels

FOR YOUR SAFETY
No Guns, Knives or Other Weapons Allowed

Whoever knowingly possesses or causes the presence of a firearm or other dangerous weapon on the grounds or building of this facility, or attempts to do so, is subject to fine or imprisonment of not more than one year, or both, 18 U.S.C. Section 930a. Whoever intends that a firearm or other dangerous weapon be used in the commission of a crime and knowingly possesses or causes the presence of a firearm or other dangerous weapon on the grounds or buildings of this facility, or attempts to do so, is subject to fine or imprisonment of not more than five years, or both, 18 U.S.C. Section 930b.

Video Surveillance
Video and audio surveillance, including body-worn cameras, are in use on these premises.

Service Dogs Welcome
No Pets Allowed
A service dog is specifically trained to do work for a person with a disability. Service dogs must be under control at all times. Dogs in training are not considered service dogs and are not allowed on VA property.

No Smoking, No Vaping
For the sake of your health and safety, smoking and vaping is prohibited on the grounds or in buildings of this facility.

Grouped Signs: Single Panel

IN-02.04.01

Business Hours & Video Surveillance Sign - Vinyl

IN-02.04.02

Business Hours & Video Surveillance Sign - Exterior

VA
U.S. Department of Veterans Affairs
Baltimore
VA Medical Center

Building 16
Main Entrance
When doors are locked, use Ambulance Entrance

Monday - Friday
7:00 AM - 5:30 PM
Closed Weekends & Federal Holidays

Video and audio surveillance, including body-worn cameras, are in use on these premises.

VA
U.S. Department of Veterans Affairs
Monday - Friday
7:00 AM - 5:30 PM
Closed Weekends & Federal Holidays

IN-02.04.01

IN-02.04.02



Sign Overview

Mandatory VA Policy & Directive Signage Guidelines

IN-02.04.03

Business Hours Sign - Interior

IN-02.05

Notice of Weapons Search Sign

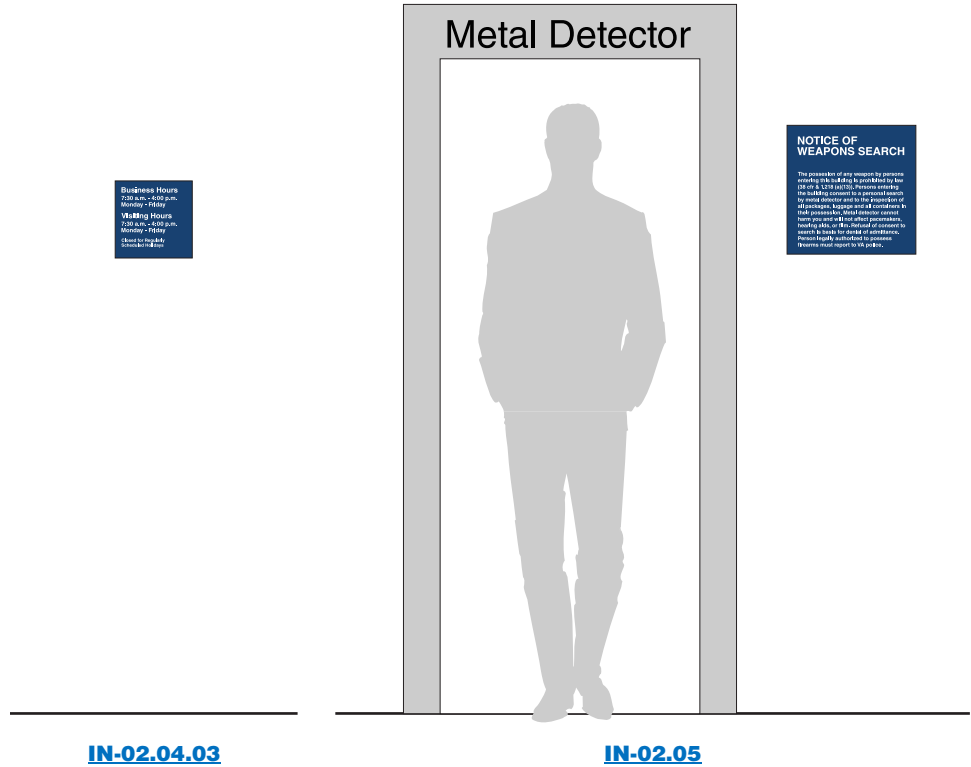

IN-02.06

Parking Restrictions Sign

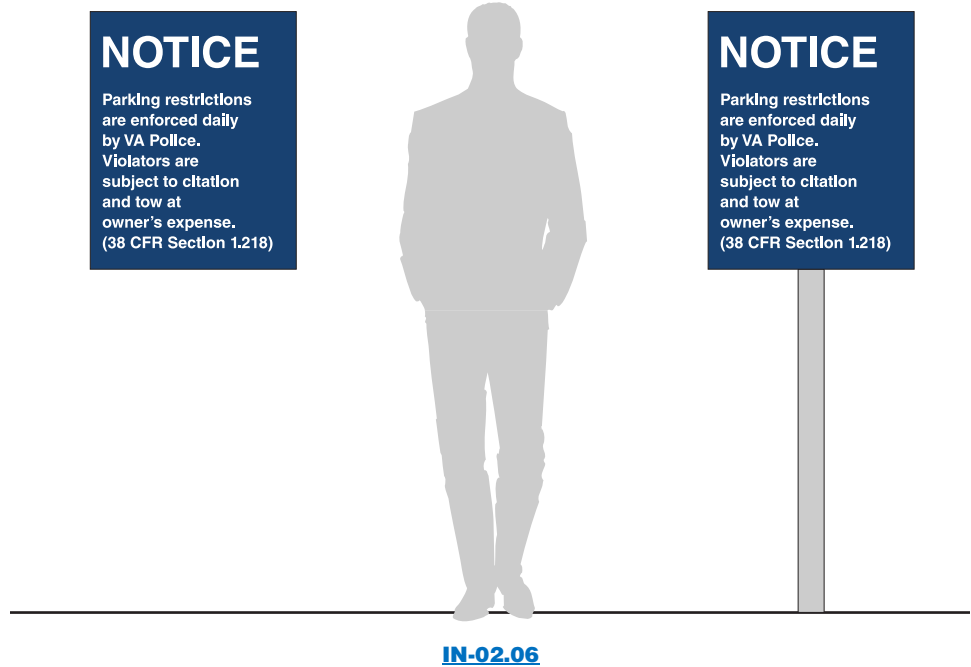

Sign Overview

Mandatory VA Policy & Directive Signage Guidelines

IN-02.07.01

Rights and Responsibilities of VA Patients

IN-02.07.02

Rights and Responsibilities of Family Members of VA Patients

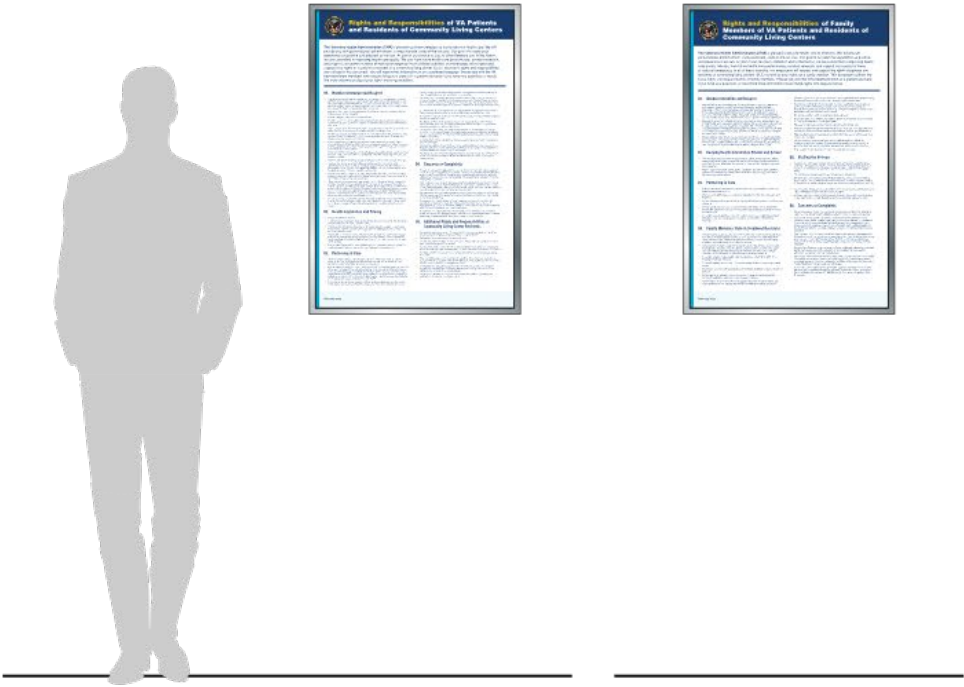

IN-02.07.01

IN-02.07.02

IN-02.07.03

Policies and Directives

IN-02.07.04

Notice of Privacy Practices

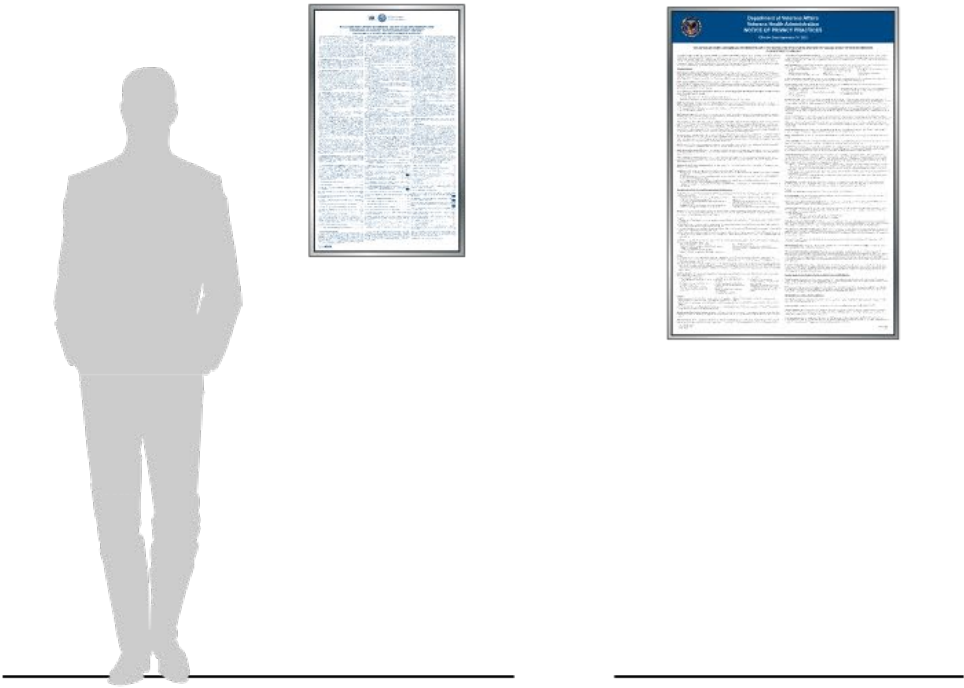

IN-02.07.03

IN-02.07.04



Sign Overview

Mandatory VA Policy & Directive Signage Guidelines

IN-02.08

Anti-Sexual Harassment / Anti-Sexual Assault

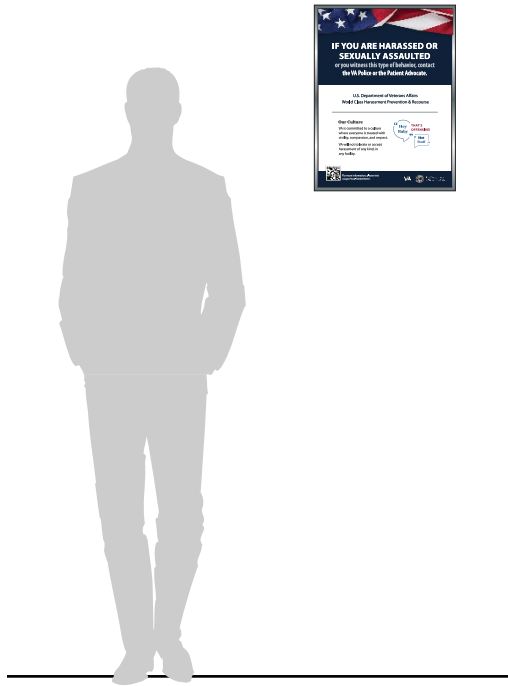

IN-02.08

IN-02.11

No Weapons Sign Large - Exterior

IN-02.12

No Weapons Sign Small - Exterior



IN-02.11

IN-02.12



Sign Overview

Mandatory VA Policy & Directive Signage Guidelines

IN-02.13
Video Surveillance Sign - Exterior

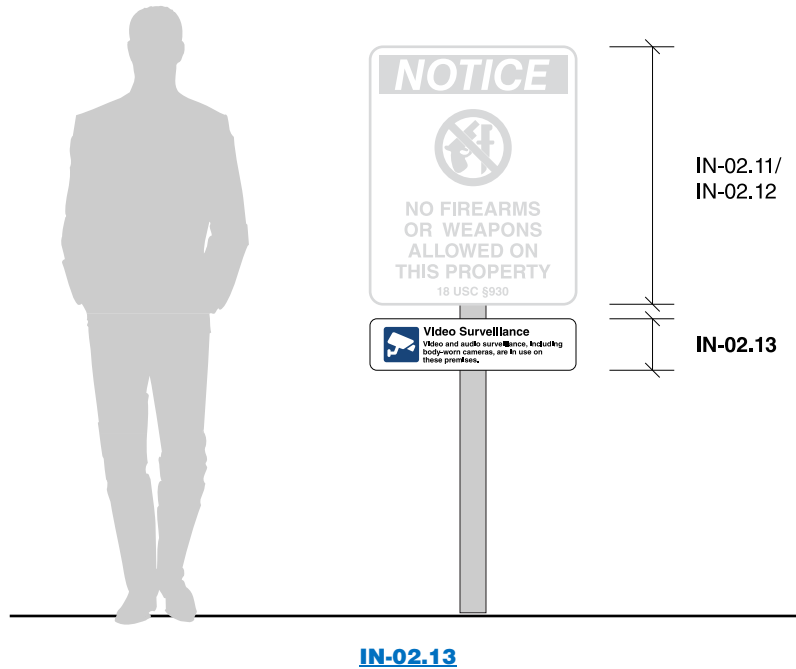

IN-02.16
No Trespassing Sign

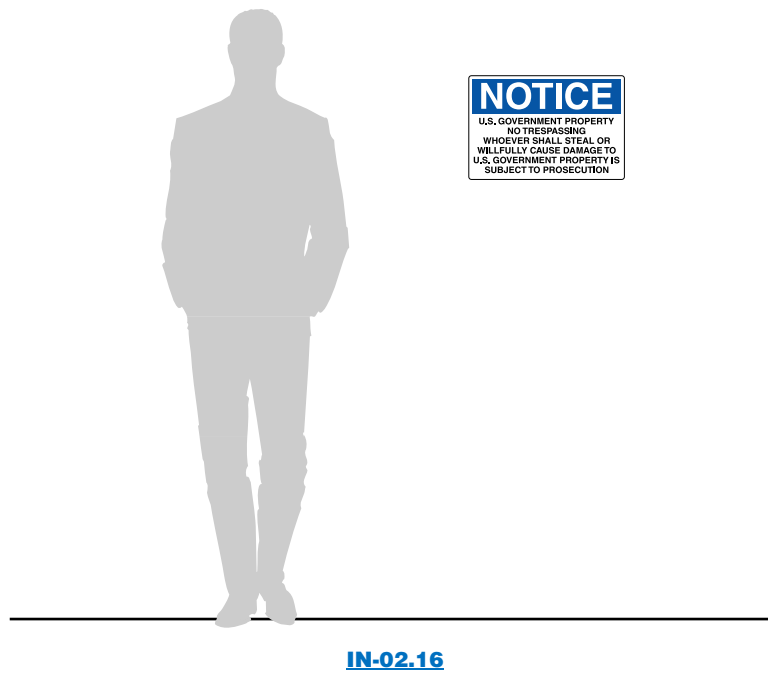

2.3.3 CONSTRUCTION

All Mandatory Policy & Directive Signage should adhere to the construction and specifications of the facility's component-based sign system to maintain consistency. See [Section 2.1 Interior Signage Guidelines](#) and [Section 2.5 Exterior Signage Guidelines](#) for additional information.

Three construction details are shown below for poster holders required by IN-02.07 sign types

Detail 1: Hinged Swing Frame

Standard hinged poster case with swinging glass door.

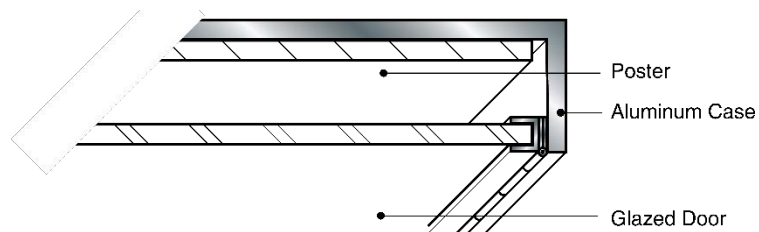

Detail 2: Snap / Clip Frame

Snap frame option where the frame bezel clamps onto the poster and lens, securing it to a backplate.

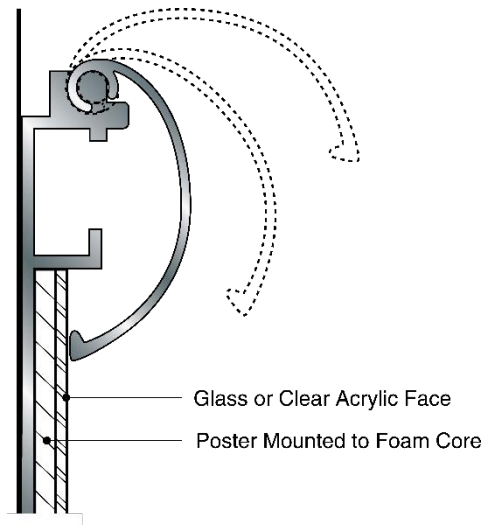

Detail 3: Flex-Fit Frame

A frame style with internal spring clips that secure the backplate, poster and lens layers against the front of the frame with pressure.

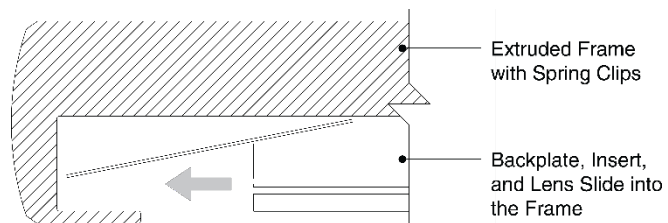



U.S. Department
of Veterans Affairs

SECTION 2.4

SPECIALTY SIGNAGE GUIDELINES



2.4.1 INTRODUCTION

Overview

This section of the VA Signage Design Manual contains a variety of signage and related items that serve special purposes relevant to VA facilities. These items include manufactured products for:

- Freestanding Interior Signs
- Infection Control Stations
- Paper & Chart Holders
- Specialty Signs for Inpatient Mental Health and Community Living Centers
- Patient & Resident Dry Erase Boards
- Outdoor Banners
- Exterior Construction Signs

This is not an exhaustive catalog of items, only a sampling of those most commonly used. Many of these items are standard products that can be easily ordered and vary slightly based on manufacturer.

Specialty items may be included in larger interior or exterior sign projects, as well as smaller standalone projects. See [Section 1.1 Planning a Sign System](#) to learn more about the planning process. It may also be helpful to review [Section 2.1 Interior Signage Guidelines](#) and [Section 2.5 Exterior Signage Guidelines](#).

Avoid Visual Clutter

While all the items in this section are approved for use in VA facilities, it is important to make sure the products and systems used match the facility's sign standard and complement the architectural design whenever possible. Consider how all components will work together as a cohesive whole and avoid creating crowded and cluttered walls and environments.



2.4.2 SIGN OVERVIEW

The following overview illustrates specialty signs and products approved for use in VA facilities. [Section 3.4 Specialty Signage Drawings](#) of this manual provides detailed drawings of each of these items and their associated requirements.

Sign Designations

Each sign in the program manual has been given a specific sign type number designation. This designation provides a common description that can be referenced when programming a site and ordering signs. The following explains how the sign type designations are derived.

SP - 21 .03 A

- SP** Designates a specialty sign.
- 03** Two-digit number identifies the sign type family.
- .01** The two-digit number following the period identifies a specific sign within the sign family.
- A** The letter designates a specific sign configuration, version and / or layout for graphics or symbols.



Sign Overview

Specialty Signage Guidelines

Sign Type SP-21

Specialty Signs

SP-21.01

Freestanding Single Post Stanchion

SP-21.02

Freestanding Interior Pylon



SP-21.01

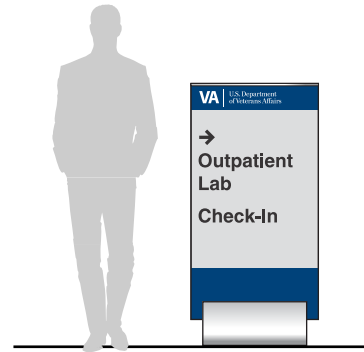

SP-21.02

SP-21.03

Freestanding Temporary Posting

SP-21.05

Infection Control Sign



SP-21.03

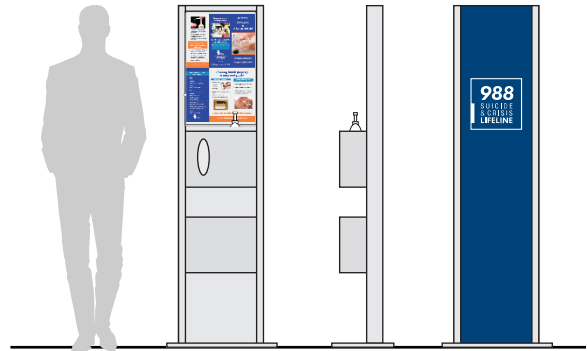

SP-21.05

Sign Type SP-22

Specialty Room Signs

SP-22.01

Card or Laminated Paper Holder

SP-22.02-03

File or Binder Holder

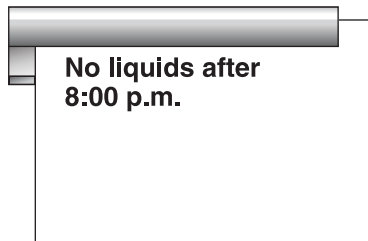

SP-22.01

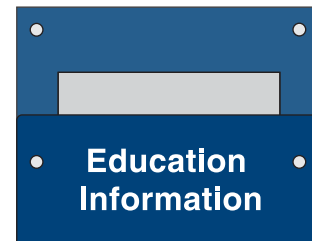

SP-22.02-03



Sign Overview

Specialty Signage Guidelines

Sign Type SP-22

Specialty Room Signs

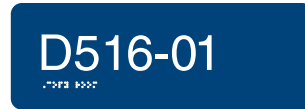

SP-22.05

SP-22.05

Mental Health Room Number

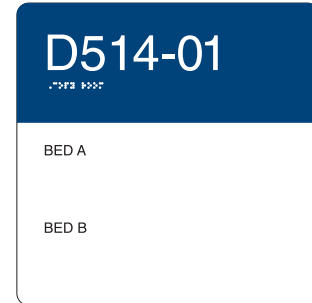

SP-22.06

SP-22.06

Mental Health Room Identification

SP-22.07

Patient & Resident Room Dry Erase Boards

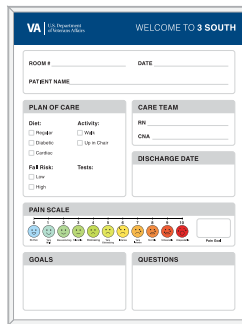

SP-22.07

SP-22.08

Resident Memory Case

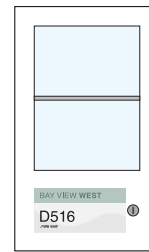

SP-22.08

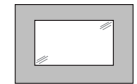

SP-22.09

SP-22.09

Digital Memory Monitor

Sign Type SP-23

Pole Mounted Banner Signs

SP-23.01

Banners: Pole Mounted

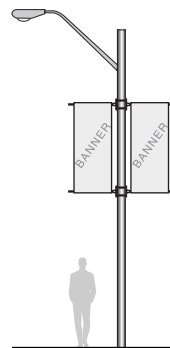

SP-23.01

Sign Type SP-24

Temporary Construction Signs

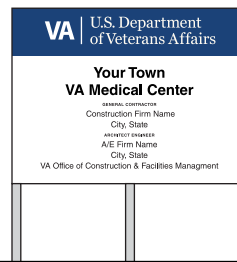

SP-24.01

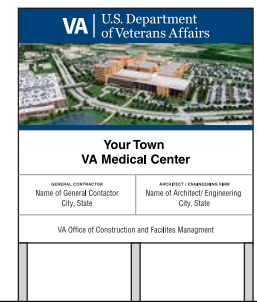

SP-24.02

SP-24.01

Construction Sign – Text Only

1

SP-24.02

Construction Sign – Text with Rendering

SP-24.03

Construction Sign - Rendering



SP-24.03

SP-24.04

Construction Sign – Safety

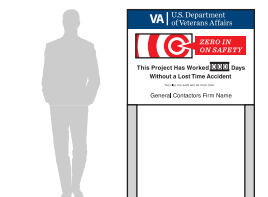

SP-24.04

Sign Type SP-25

Dedication Plaque



SP-25





U.S. Department
of Veterans Affairs

SECTION 2.5

EXTERIOR SIGNAGE GUIDELINES



2.5.1 PLANNING

An effective signage program for a campus is one that has been holistically planned and coordinates all signage, including, but not limited to, the main site identification sign, directional signs, building and entrance identification signs, and parking signage. The objective of all exterior signage is to clearly direct users to their destination and provide traffic control. For a large medical center, the basis of the exterior signage system should be developed as part of a new or existing wayfinding master plan. For more information on developing a comprehensive wayfinding master plan, see [Section 1.2 Fundamentals of Wayfinding](#). For Mandatory VA Policy and Directive exterior signage, see [Section 2.3 Mandatory VA Policy & Directive Signage Guidelines](#).

Developing a wayfinding master plan and, subsequently, planning and programming should be performed by a professional with significant experience developing exterior signage systems for large healthcare facilities. The discussion of various topics in the Manual is not meant to convey that the facility and VA Staff should perform these tasks.

Site Evaluation

A detailed site evaluation needs to be performed when planning an exterior signage project. To begin the site evaluation, obtain a site plan of the campus. The plan should be to scale with a notation of cardinal direction, such as North. The plan needs to identify all major and minor roadways, driveways, alleys, access roads, parking lots, and parking structure locations. The plan should also indicate sidewalks, pathways, crosswalks, ramps, and stairways. Request the document format that matches your software capabilities. (Note: CAD and BIM files can be printed as PDF drawings and imported into Adobe Illustrator or other similar programs).

During the Site Evaluation

Visit the site and drive and walk all major roads and pathways. Keep in mind that approaching the site by private vehicle or public transportation may be significantly different when there are multiple entrances. Below are general tasks and considerations. The site evaluation and information collected may vary depending on the project's scope and complexity (ex: Outpatient Clinic vs. Medical Center).

Identify Points of Entry and Destinations

- Primary and secondary entry and exit points of the campus.
- The location and function of buildings and associated building entrances.
- The Emergency Department or Urgent Care, including patient and ambulance access points.
- Parking locations (lots and garages) and associated restrictions or designations.
- Drop-off points, including valet parking if available.
- Public transportation access points, bus stops, shuttle stops, connections to partner facilities, and other points of interest.



Planning**Exterior Signage Guidelines****During the Site Evaluation**
(Continued)**Analyze Paths of Travel**

- The campus exterior includes vehicular and pedestrian paths of travel. A vehicular path may include the roadway system from the main entry into the campus to a specific visitor parking lot. In contrast, a pedestrian path may consist of traveling from the parking lot to a building entrance.
- Observe and map out all circulation routes (vehicular and pedestrian), including primary and secondary roadways (with the direction of traffic flow), pedestrian paths (ex: sidewalks, crosswalks, tunnels, skywalks), and shuttle routes.

Locate Intersections and Decision Points

- Vehicular and pedestrian intersections and decision points should be identified and prioritized by how much traffic they receive and by their destinations.
- For vehicular intersections, note traffic restrictions and flow (ex: right turn only, 2 or 4 way stop, yield, and turning lanes).
- Major high-traffic intersections require larger scale and more concise communication than minor secondary intersections and decision points.
- Tertiary decision points can be located within parking areas, guiding to roadways, entrances, or drop-off points.

Conduct a Photo Essay

- Document all existing conditions, postings, and signs. A detailed photo essay is a valuable tool when developing a wayfinding master plan, creating presentation documents, programming the system, and discussing various signage needs in the future.

Annotate Environmental Conditions

- When points of entry, destinations, primary paths of travel, and intersections have been identified, review the locations to determine additional environmental considerations.
- Sight lines, viewing distance, landscaping, lighting, climate conditions, utilities, obstructions, retaining walls, grading, existing structures, and ground conditions all play into determining the type of sign solution selected for each location.

Meet with VA Stakeholders

- Discuss future plans that may affect existing conditions or locations of various departments or services (construction, renovations, relocations, etc.).
- Review facility-wide policies, procedures, and regulations that may influence signage or wayfinding.
- Meet with VA police to review traffic, policy, or parking procedures currently in place or that may be planned.
- Solicit feedback from Staff and Veteran user groups.



Planning**Exterior Signage Guidelines****Questions to Consider
During the Site Evaluation**

The questions below provide a starting point to develop a wayfinding plan for the exterior campus. Consider the campus from the perspective of first-time patients and visitors and what they encounter along their journey.

- If there are multiple entrances to the campus, do they serve different purposes or user groups?
- What is the desired path of travel on the roadway system for visitors?
- What is the desired path of travel on the roadway system for employees and delivery personnel?
- How do visitors and ambulances reach the Emergency Department or Urgent Care (if applicable)?
- Where is patient/visitor parking located?
- Should patients/visitors park in different locations based on their desired destination?
- Where is staff parking located?
- Where is accessible parking located?
- Is there valet parking?
- How do visitors currently navigate the site and parking lots?
- How do the campus buildings' locations relate to roads, parking lots, and walkways?
- Where are building entrances located, and how do they relate to parking locations?
- What is the desired path of pedestrian travel from parking locations to building entrances? Are those paths accessible?
- Are there specific vehicular and building entrances for after-hours access?
- Which building entrances can visitors enter?
- Are building entrances accessible? If not, where is the closest accessible entrance?
- Will signs be located on federal property? If not, local sign codes and permitting may apply as they are the authority having jurisdiction.



Planning

Exterior Signage Guidelines

Wayfinding Analysis

Reviewing the information gathered and answering the questions from the site survey will help establish the basis of a wayfinding plan that communicates and informs simply and directly. As part of the wayfinding master plan, develop a clear information hierarchy that establishes naming conventions (for campus entrances, parking areas, buildings, building groups, and building entrances) and how the buildings or building groups are logically divided into areas (if required) to simplify and improve wayfinding.

Once a potential exterior wayfinding plan is established, it should be tested and refined using draft sign locations on vehicular and pedestrian paths of travel and intersections. What seems logical in plan view may require further refinement to simplify the amount of information from the user’s perspective at these decision points.

Refer to [Section 1.2 Fundamentals of Wayfinding](#) for additional guidance on developing a wayfinding master plan that works for your facility.

Example Exterior Information Hierarchy

OLD – Naming Conventions from Site Survey

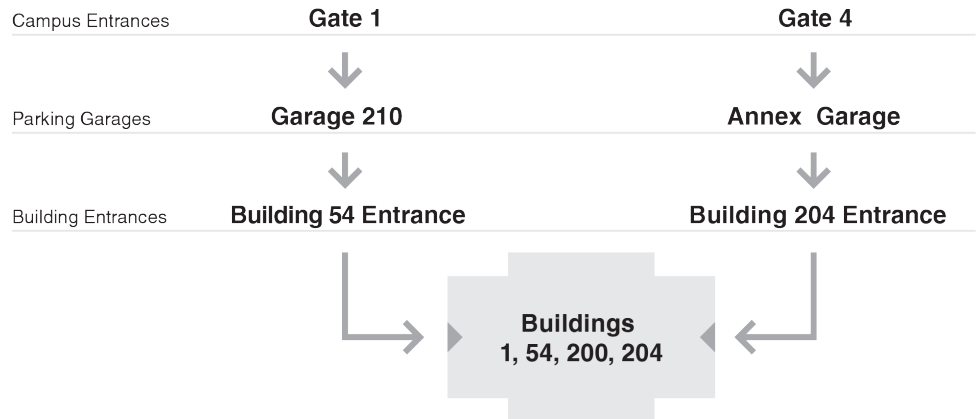

NEW - Naming Conventions with Logical Information Hierarchy

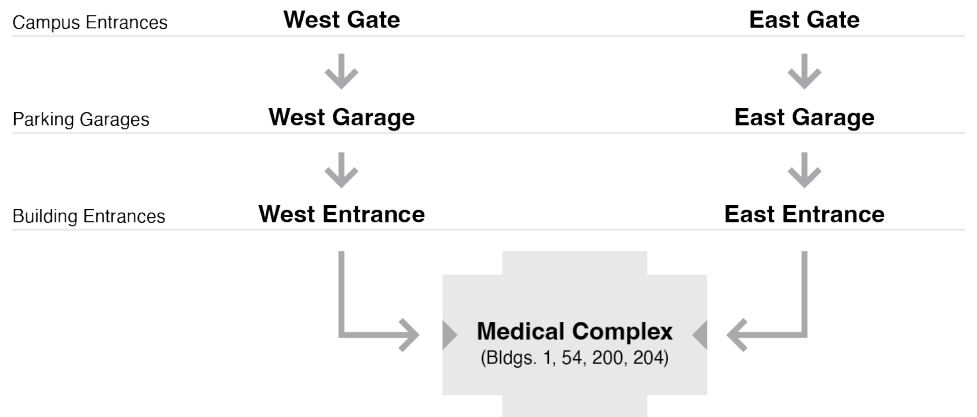

Planning

Develop a Signage System Standard

Exterior Signage Guidelines

Using the guidelines outlined in this Manual, develop a facility-specific signage system standard that aligns with the wayfinding plan and complements facility architecture and surroundings. The signage system standard should be developed for a large medical center or facility as part of the overall wayfinding master plan.

- By incorporating various design elements such as paint colors, sign cabinet shape, reveals, post style, decorative caps/finials, and masonry bases, a custom design theme can be created that ties into the wayfinding plan, geographic region, neighborhood, and architecture.
- Climate conditions must also be considered when developing a facility-specific sign standard. For example, wind load on signs affects footing and sign construction requirements. Snowfall and frost line will also impact post length and footing.

For more information on developing the look of the signage system, including VA standard fonts and arrows, refer to [Section 4.1 Design Elements](#) and the construction details in this section.

Use a Component Signage System

Exterior monument, post-and-panel, and wall-mounted signs for VA facilities should be based on an aluminum extrusion component signage system that allows for updates and interchangeable components. The sign and extrusion drawings shown in this Manual have not been engineered or configured for extruding and do not represent a finish form or manufacturer. However, many manufacturers' extrusion systems will accomplish the illustrated objectives while differing slightly in dimensions or configuration.

Various types of component signage systems are available. Once a component signage system is selected, it should become the facility's standard and not be mixed with other systems to maintain a cohesive look and interchangeable system. See the [construction details](#) in this section for further information about component based exterior sign systems.



Planning

Exterior Signage Guidelines

Exterior Sign Categories

Exterior signs fall into various categories and can be illuminated or non-illuminated. An overview of the five most common exterior sign categories is provided below. For information on signage for Parking Structures, see [Section 2.6 Parking Structure Signage Guidelines](#).

- **Monument:** Monument signs can be illuminated or non-illuminated. They are often used as the main identification sign for a medical center or large clinic and may incorporate a digital LED message display. In addition, they may be used for directional and building identification along primary routes and at primary structures. As part of the design, masonry bases can be specified to increase height, protect the sign, and enhance the appearance.
- **Post & Panel:** Post & Panel signs are often non-illuminated but can be illuminated when a larger cabinet depth is specified. They are a versatile sign category and typically can be used to identify smaller VA facility locations and secondary entrances and serve as directionals, building/parking lot identification, and informational postings. An above-ground concrete pad can be specified to help protect the sign when installed in grass locations.
- **Single Post & Panel:** Single Post signs are non-illuminated. Typical use cases include traffic control, parking designations, mandatory postings, and pedestrian directionals.
- **Wall Mount:** Wall Mount signs can be illuminated or non-illuminated. They are mounted to a building or structure. The scale of these sign can vary significantly from large, illuminated cabinets to small aluminum panels. They are often used to identify buildings, entrances, and display informational postings.
- **Dimensional Letters:** Dimensional Letters can be illuminated or non-illuminated. They are mounted to a building or structure and can vary in scale and depth. Typical use cases include building identification, entrance identification, or a skyline logo mounted on the top of a hospital or VA facility. They can also be used as the main site identification sign for a medical center or large VA facility when attached to a structure such as a masonry entry wall.
- **Illuminated:** Internally illuminated signs should be considered for those locations where important information and directions must be communicated at night and during the day. The locations where internally illuminated signage should be used include, but are not limited to, primary entrances, along the primary path of vehicular travel, and buildings and entrances that have public activity in the early morning, late afternoon, and evening. A sign that is illuminated with floodlights can also be effective at night. Typically, this is a less expensive way to obtain an illuminated sign, but the ongoing maintenance will be considerably higher as ground-based lights get damaged frequently.
- **Non-Illuminated:** Non-illuminated signs can be specified with or without reflective copy. Reflective characters can typically function well for secondary signs at night and should be specified for most non-illuminated vehicular directional signs. Note: When using reflective copy, use a dark background color to ensure the sign is not "washed out" when illuminated with a vehicle's headlights.



2.5.2 PROGRAMMING

Location, Placement & Messaging

Determining the specific location, placement, and messaging for each sign occurs during the Programming Phase. For a large medical facility, a wayfinding master plan should be developed before programming a signage system. See the planning part of this section and [Section 1.1 Planning a Sign System](#) & [Section 1.2 Fundamentals of Wayfinding](#) to better understand how to approach a project.

There are three main components of signage programming. The location plan establishes where a sign is located. The sign message schedule establishes what text message on the sign is to say. Finally, the sign drawings show the type of sign, fabrication information, and how the information is displayed.

To create the sign location plan, place a mark and a location number on the plan document as a placeholder for a sign type and sign message associated with that location. In the sign message schedule spreadsheet, enter the location plan number and corresponding sign type designation, and establish the text message of what that sign says.

The programming of a signage system should take place shortly before implementation to avoid errors and duplication of work. Information and existing conditions can quickly change, rendering the programming data invalid.

General Guidelines

The following are best practice guidelines that should be referred to when developing an exterior signage program. This is not intended to be a training section of the Manual but to provide key information, instructions, and suggestions that hopefully reduce common errors when programming an exterior signage program.

- Never use text smaller than 3" capital letter height when a sign is intended to be read from a moving vehicle. Reference the [Viewing Distance Chart](#) for additional information.
- Text intended to be read by pedestrians should be a minimum of 1" capital letter height.
- All sign messages should be a minimum of 24" above grade.
- Signs require maintenance. Cleaning and waxing will extend the life of exterior signs.
- If overhead signs are suspended over vehicular paths of travel, ensure they have adequate clearance for trucks and other large vehicles. Adequate clearance can be interpreted to be 15'-0".
- Stacking bar signs should always have a blank bar between two different sets of directional information.
- Consideration should be given to the hours of operation of a facility (i.e., whether a department or building offers nighttime services) when determining if a sign should be illuminated.



Programming

Exterior Signage Guidelines

General Guidelines (Continued)

- Signs not located on federal property may be required to comply with local sign codes and permitting. This often applies to outpatient clinic locations. In these instances, researching local sign codes and requirements must be performed before programming and sign manufacturing. Local codes can be highly prescriptive regarding the type, size, location, and quantity of signs allowed.

Message Content

- Keep sign messages brief.
- Use messages that the viewer can read and understand quickly.
- With the exclusion of directional signs, all other signs should convey no more than one concept or idea.
- Consider the vehicle's speed for signs to be read from a moving vehicle. At slow speeds, the driver may be able to read 7 or 8 words. At faster speeds, they will only be able to read 4 or 5.
- Use the same wording throughout the signage program consistent with the terminology developed in the wayfinding master plan.
- Signs should progressively disclose information, guiding viewers from general to specific destinations. Do not anticipate decisions that can be made later. Unnecessary or premature information will confuse the reader. Instead, provide only information necessary to decide at that specific location.
- When possible, sign messages should be worded positively to improve the viewer's experience.

Message Layout

- Use title-case (capitalization of the first letter of each word) text on directional and identification sign messages whenever possible. Title-case text is easier to read and is understood faster than text in all capital letters.
- Line spacing between two different messages should be greater than line spacing between lines of the same multi-line message group.
- Message areas should have margins on all four sides. Text should not go to the edge of the viewable message area.
- If a line of text needs to be reduced to fit on a sign, use only commonly understood abbreviations or decrease the text size for the entire message. It is typically not recommended to condense the typeface.
- The most important message or directional information should appear as the first line of text.



Programming

Exterior Signage Guidelines

Sign Size











- The surrounding landscape will impact what size sign should be specified for that area. It is also important that shrubs and other plants do not hide or obscure the sign.
- Lettering and sign panel size should be appropriate for the distance and speed at which a sign is viewed.
- Signs intended to be seen from a moving vehicle need to be larger and require larger text than signs intended for pedestrians.

Viewing Distance

The following charts aid in determining the size of text in relation to the distance a sign is to be read. These charts are general, and some situations may require larger text than what is indicated.

Figure 2-13 Viewing Distance Chart

Text

Viewing Distance Up To:		Letter Height		Application
7.5 M	25'	25 mm	1"	
12 M	40'	40 mm	1½"	
15 M	50'	50 mm	2"	
24 M	80'	75 mm	3"	
33 M	110'	100 mm	4"	
48 M	160'	150 mm	6"	
75 M	250'	225 mm	9"	
97.5 M	325'	300 mm	12"	
150 M	500'	450 mm	18"	
195 M	650'	600 mm	24"	

Symbols

Viewing Distance Up To:		Letter Height	
7.5 M	25'	75 mm	3"
10.5 M	35'	100 mm	4"
15 M	50'	125 mm	5"
18 M	60'	150 mm	6"
30 M	100'	200 mm	8"
34.5 M	115'	225 mm	9"
39 M	130'	250 mm	10"
45 M	150'	300 mm	12"



Programming

Exterior Signage Guidelines

Arrows

Using arrows correctly on directional signs ensures the reader quickly understands the information. Avoid adding arrows to every line of text. Instead, all messages relating to a single direction should be grouped to improve readability.

Figure 2-14 Sign Face Layout Illustration

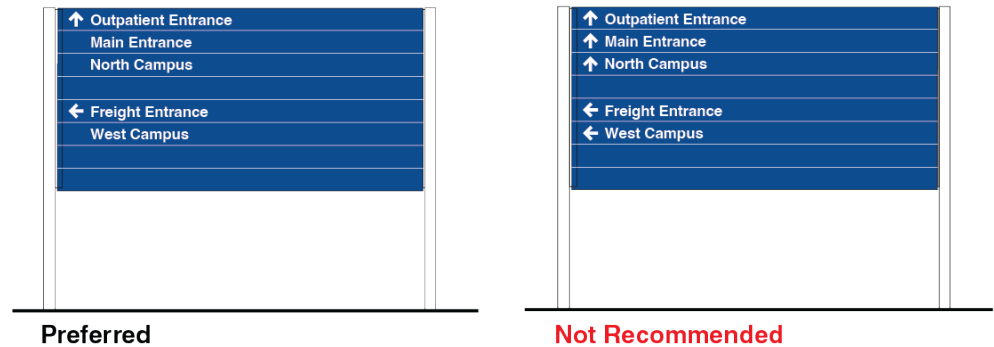

Arrows should precede the message, visually separated from the text, allowing the reader to understand direction first and information second. Arrows should be roughly 1.5 times as large as the adjacent text. For example, 3" capital letter size text would require an arrow of 4-1/2".

Figure 2-15 Arrow Direction Illustration

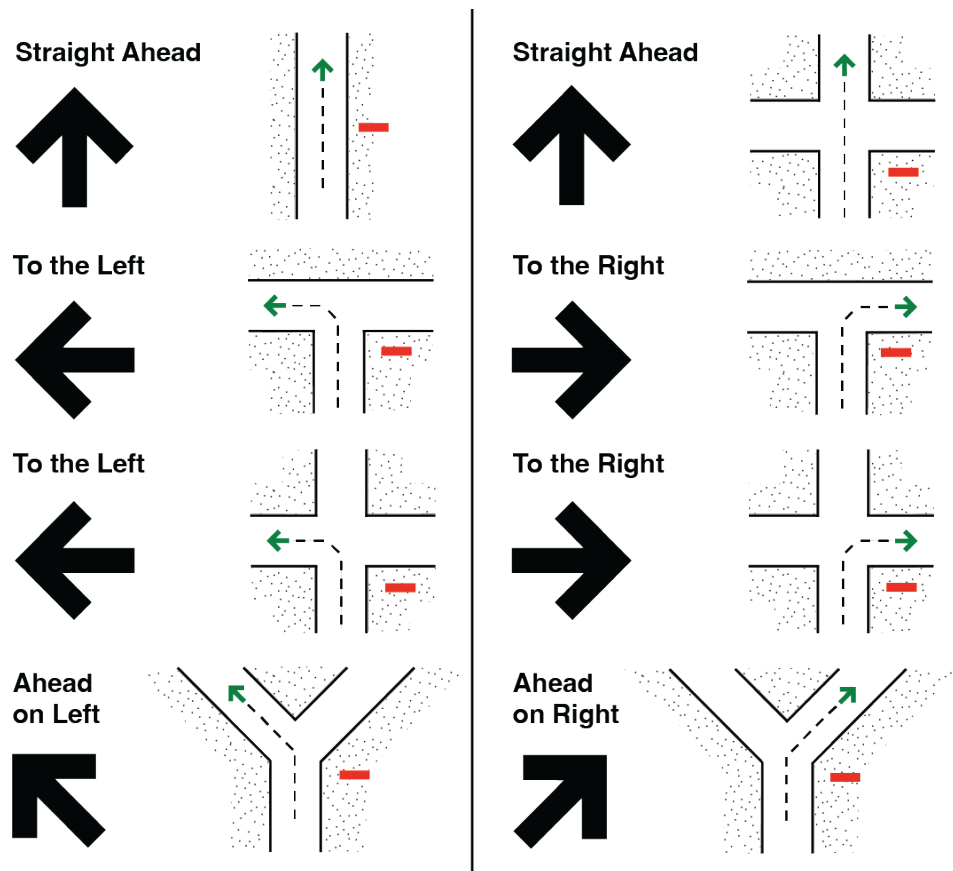

Programming

Exterior Signage Guidelines

Sign Location Guidelines

The following are general guidelines for locating signs for appropriate vehicular and pedestrian viewing. Guidelines for specific sign types are shown in their respective sections.

Straight Ahead: Sign placement must be within the approaching driver's immediate cone-of-vision. Drivers cannot be expected to turn their heads to read a sign. Signs mounted more than 40 feet off the roadway because of special circumstances may require a larger panel to increase readability because the sign is outside the normal cone-of-vision.

Perpendicular: The face of the sign should be perpendicular to approaching viewers so that it is easily noticeable without them having to turn their heads. Sign faces should never be parallel to the viewer as they could be easily missed.

Right Side: Place signs on the right side of the roadway whenever possible. Drivers are not conditioned to look to the left side of the road for driving information. An exception to this rule is when a double-face standard identification sign is used and mounted perpendicular to a facility entrance roadway. This sign should be sized and placed with clear visibility and readability from both directions.

Distance Legibility: All signs must be clearly legible from the distance they are to be read. The [Viewing Distance Chart](#) illustrates the appropriate text size.

Advance Warning: Signs on roadways that communicate the desired reaction should be placed in advance of the intersection to afford a safe distance for reaction to and execution of the maneuver.

Viewing Angle: Mount signs at eye level. The height of the average viewer's eye level is 5'-6" (1650 mm) standing and 4'-6" (1350 mm) while driving a car. Signs placed for viewing from long distances will be mounted higher than those in the immediate foreground. Mounting height is measured from the ground level to the bottom edge of the sign panel.

For signs mounted along roadways, the grade of the road is considered ground level. When ground-mounted signs on two posts are placed on sloping or inclined grades, adjustments must be made to the post lengths and mounting heights. Extreme differences between post lengths should be minimized whenever possible.

Spacing: Signs must be located with consideration to other signs in the area. The location of signs should be carefully selected so that groups of signs are placed without creating a cluttered appearance. Also, drivers must be given time to read and react to one sign before another is presented.

Site Preparation: Placement must be carefully considered to ensure that the sign fits the location without major modification. It may be necessary to clear some shrubs or bushes or relocate an obstruction.

Field Test: If needed, an effective way to determine a sign placement location is to place the actual sign in the proposed location for verification. This is relatively simple for pedestrian signs as they are viewed from relatively short distances. For signs viewed from a moving vehicle, testing should include driving the approach from which it is viewed to verify the proposed location. A temporary mockup, such as a paper banner (the same size as the proposed sign), can be used to check placement against the criteria listed above.



Programming

Exterior Signage Guidelines

Sign Location Guidelines
(Continued)

Correctly locating signage usually means fewer signs are required. Too many signs can create a cluttered appearance and increase the difficulty for viewers to find the information they seek. The colors and material finish of buildings need to be considered as this impacts the visibility of signs.

Figure 2-16 Sign Location Illustration

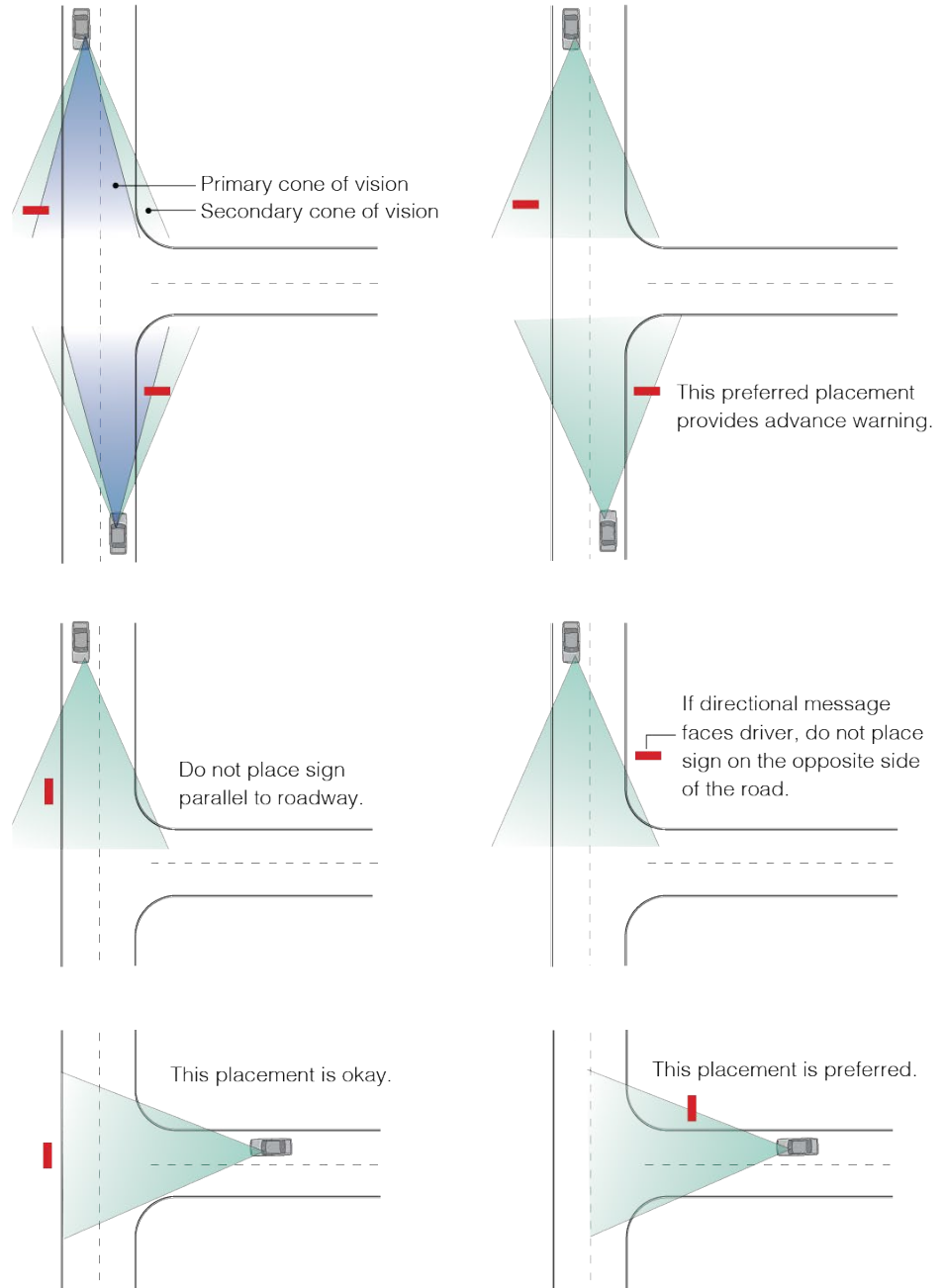

Programming

Exterior Signage Guidelines

Sign Placement Considerations

- Always evaluate a sign's placement at night and in the daylight. Lighting conditions and visibility may change at night or sunset, making a particular placement unsuitable.
- For illuminated signs, consider where suitable electrical utilities are located.
- All signs should be placed in a manner that will be clearly visible to a driver at all times of the year. For example, ensure that snow or removal piles do not bury signs.
- Signs that receive spray from irrigation sprinklers will show a buildup of residue from the minerals in the water, resulting in a poor appearance. The sign's life could be shortened depending on the materials used in its construction.
- Do not place signs in locations where people may walk into them or where they will constrict accessible paths of travel. Do not place signs any closer than 12" from a walkway.
- Do not place signs too close to curbs. Car overhangs and door swings should be considered.
- Signs placed at the head of a parking stall need to be set far enough away that the bumper of a car does not strike the sign (reference the installation portion of this section).

Figure 2-17 Placement / Roadway Illustration

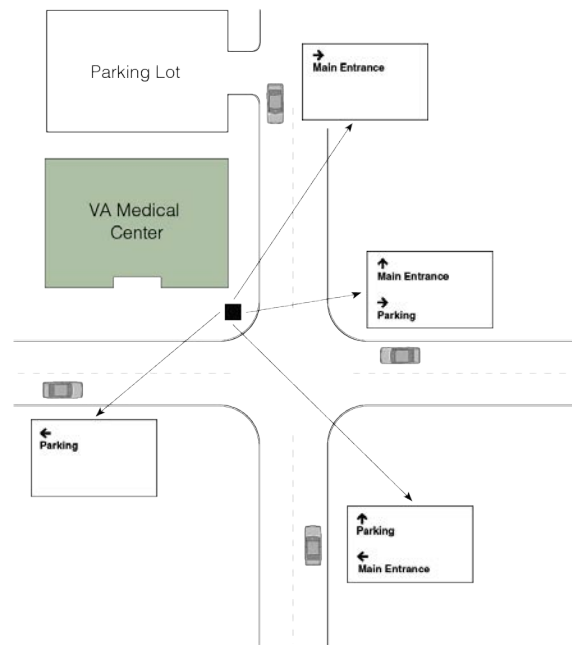

Programming

Exterior Signage Guidelines

Existing Signage Program Removal

Before implementing a new signage program, perform a thorough evaluation of the demolition requirements of the current signage program and the effects and impact on the facility's landscaping and irrigation system.

Old sign footings do not typically have to be removed completely. They should, however, be demolished to at least 1 foot below grade. Check to see what is required to patch, seal and repair building penetrations and surfaces exposed after the removal of signs or letters. Repairs should be planned to match adjoining surfaces.

Make sure the sign demolition scope of work requires the contractor to close off any live electrical connections. Remove existing conductors and conduit to the nearest junction box and make it safe.

Be sure to clearly identify signs that are supposed to remain. It is especially important to identify markers and signs related to special objects or displays on the medical center campus or a building.

DO NOT remove any traffic signs without having the replacement signs available and installed at the time the old signs are removed.



2.5.3 FACILITY NAMES

The following layouts depict the various ways that facility names are to be shown on the main identification sign. In all cases, note that there is a hierarchy in the presentation. The “VA Logo” and “U.S. Department of Veterans Affairs” is always on the top of the sign and in larger letters than the rest of the name. VISN identification is always at the bottom of the sign and has the smallest letters.

Facility Name Message Layouts

Message Layout A

Consolidated Medical Centers

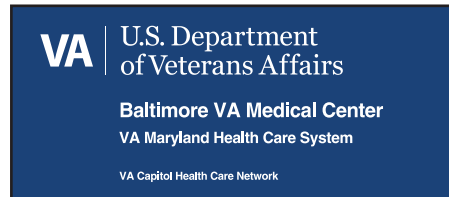

Message Layout B

Congressionally mandated named facilities



Message Layout C

Typical facility naming practice

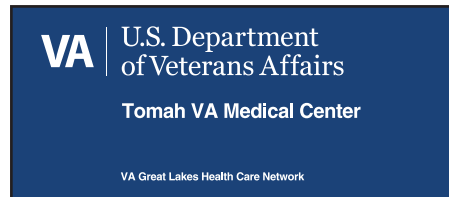

Message Layout D

Combined VHA and VBA locations

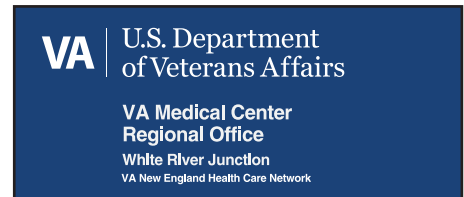

Message Layout E

Independent VBA Regional Offices



Message Layout F

Health Care Centers



Message Layout G

Large Outpatient Clinics

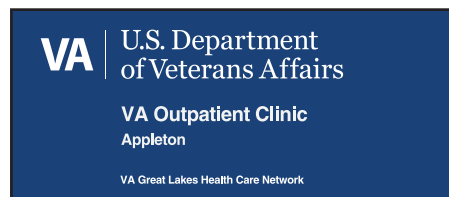

Message Layout H

Smaller Community Based Outpatient Clinics

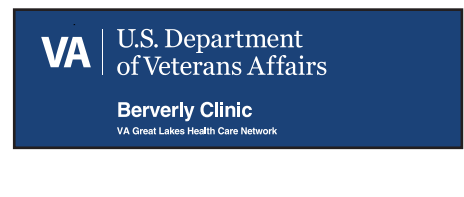

2.5.4 SIGN OVERVIEW

The following overview illustrates exterior signs for VA leased or owned facilities. For exterior Mandatory VA Policy & Directive signage refer to [Section 2.3 Mandatory VA Policy & Directive Signage Guidelines](#).

[Section 3.5 Exterior Signage Drawings](#) of this manual provides detailed drawings of each of these signs.

The drawings can be used as a starting point to develop a facility specific sign standard using colors, cabinet shapes, post styles, decorative caps / finials, and sign bases that tie into the wayfinding plan, geographic region, neighborhood, and architecture.

For more information on developing the look of the signage system, including VA standard fonts and arrows, refer to [Section 4.1 Design Elements](#) and the construction details in this section.

Sign Designations

Each sign in the program manual has been given a specific sign type number designation. This designation provides a common description that can be referenced when programming a site and ordering signs. The following explains how the sign type designations are derived.

EI - 03 .01 A

- E** Designates an exterior sign.
- I** Identifies that the sign is internally illuminated.
- 03** Two-digit numbers identify a particular sign type family.
- .01** The two-digit number following the period identifies a specific sign within the sign family.
- A** The letter designates a specific sign configuration, version, or layout for graphics.

This Section includes Exterior Illuminated (EI), Exterior Non-Illuminated (EN), and Parking Lot (PL) signage, all of which are illustrated in the following Overview pages.



Sign Overview

Exterior Signage Guidelines

EI-01.01
Site Monument Large –
5' x 12'

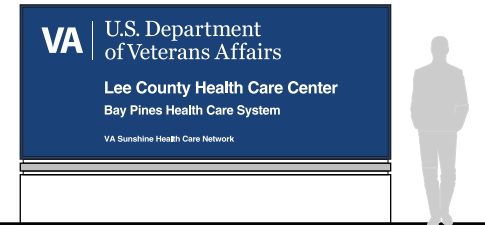

EI-01.01

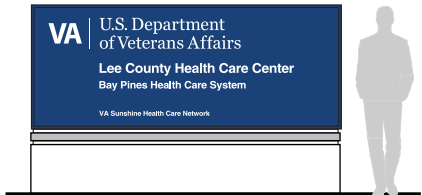

EI-01.02

EI-01.02
Site Monument Medium –
4' x 10'

EI-01.03
Site Monument Small –
4' x 8'

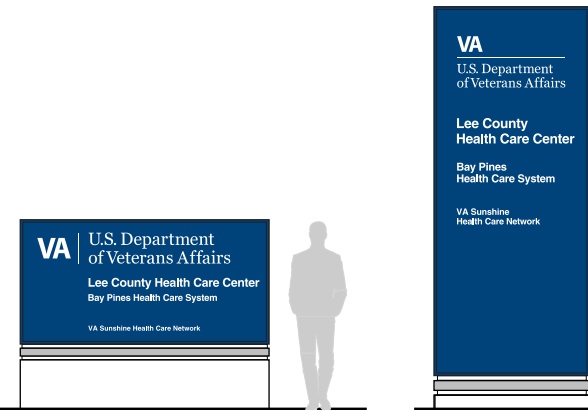

EI-01.03

EI-01.04
Vertical Site Monument Large –
12' x 5'

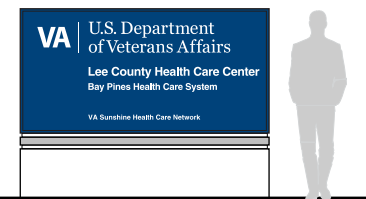

EI-01.04

EI-01.05
Vertical Site Monument Small –
8' x 4'

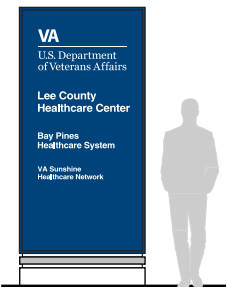

EI-01.05

EI-02.01
Directional Monument Large –
6' x 6'

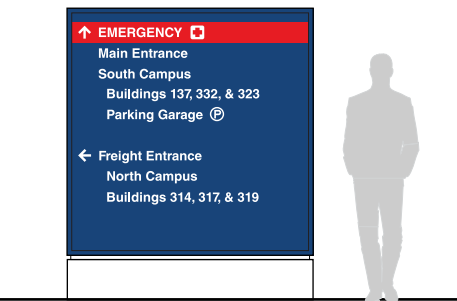

EI-02.01

EI-02.02
Directional Monument Small –
6' x 4'

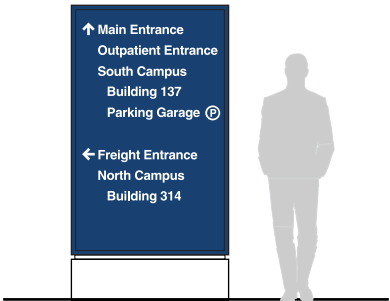

EI-02.02

EI-03.01
Post & Panel Site Identification –
4' x 8'

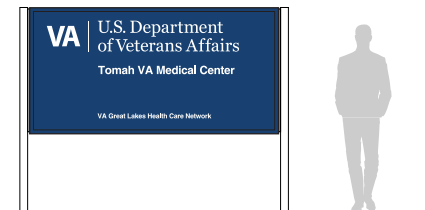

EI-03.01

EI-03.02
Post & Panel Directional –
4' x 6'

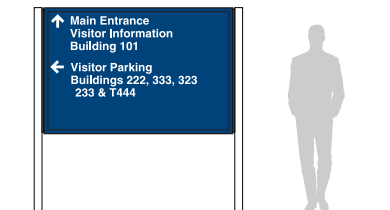

EI-03.02



Sign Overview

Exterior Signage Guidelines

EI-04.01

Post & Panel Stacking Bar
Directional – 4' x 8'

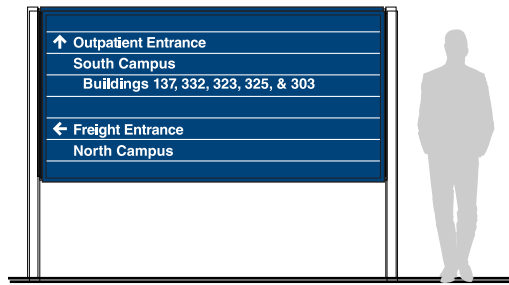

EI-04.01

EI-04.02

Post & Panel Stacking Bar
Directional – 4' x 6'

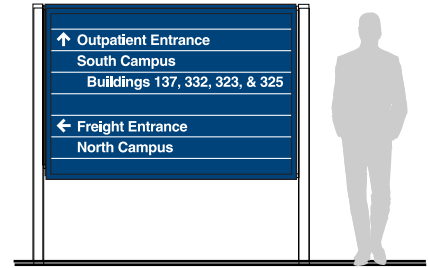

EI-04.02

EI-06.01

Wall Mounted Overhead



EI-06.01

EI-06.02

Wall Mounted Building Identification



EI-06.02

EI-08.01

Wall Mounted Ambulance /
Emergency Overhead



EI-08.01

EI-08.02

Wall Mounted Ambulance /
Emergency Identification



EI-08.02

EI-08.03

Post & Panel Ambulance /
Emergency Entrance Identification



EI-08.03

EI-09

Illuminated Letters & Logo



EI-09



Sign Overview

Exterior Signage Guidelines

EI-14
4-Sided Site Monument

EI-15.01
4-Sided Directional Site Monument

EI-15.02
4-Sided Directional Site Monument with Address



EI-14

EI-15.01

EI-15.02

EI-16.01
Vertical Site Monument with Electronic Message Unit

EI-16.02
Horizontal Site Monument with Electronic Message Unit

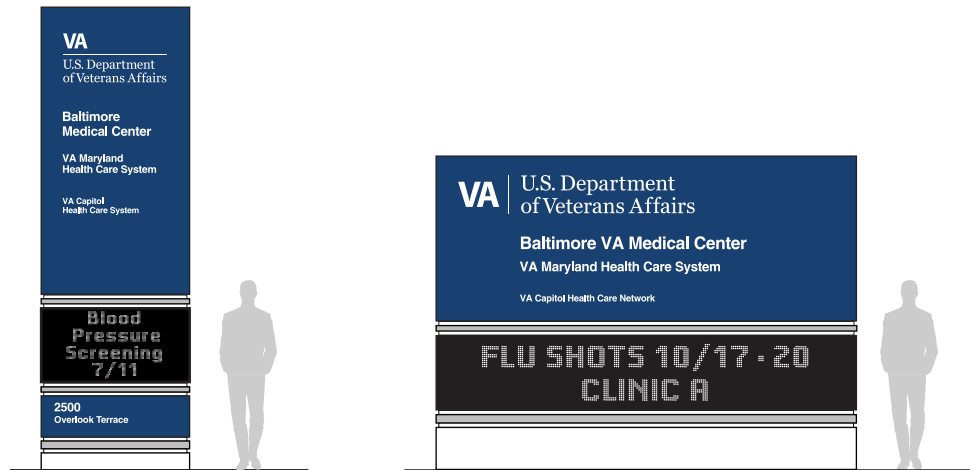

EI-16.01

EI-16.02

EI-17
Information Center Monument

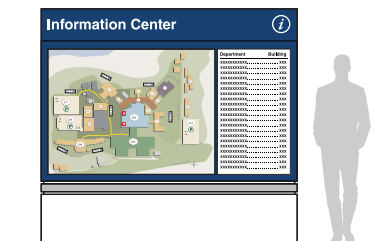

EI-17



Sign Overview

Exterior Signage Guidelines

EN-02.01
 Directional Monument Large –
 6' x 6'

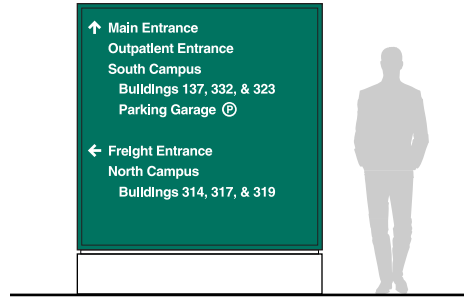

EN-02.01

EN-02.02
 Directional Monument Small –
 6' x 4'

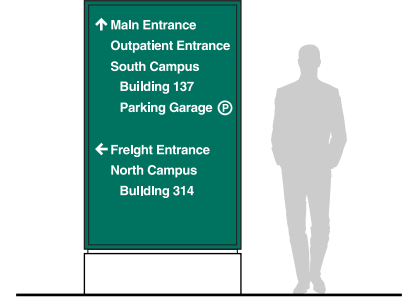

EN-02.02

EN-03.02
 Post & Panel – 4' x 6'

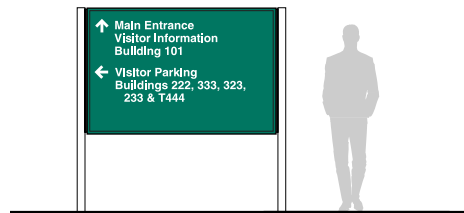

EN-03.02

EN-03.03
 Post & Panel – 3' x 4'

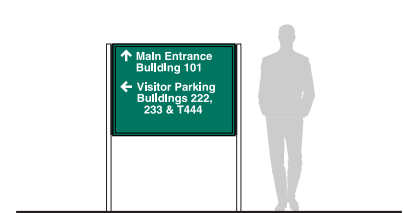

EN-03.03

EN-03.04
 Post & Panel – 2' x 3'



EN-03.04

EN-03.05
 Post & Panel Building Identification –
 3' x 3'

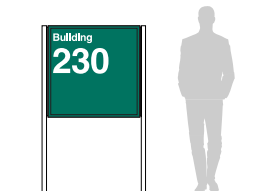

EN-03.05

EN-03.06
 Post & Panel Identification &
 Information – 2' x 2'

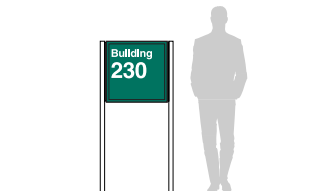

EN-03.06

EN-04.01
 Post & Panel Stacking Bar
 Directional – 4' x 8'

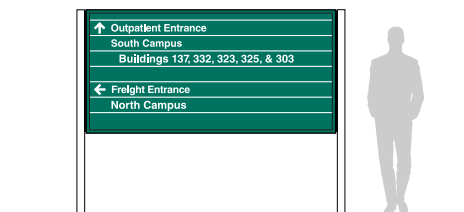

EN-04.01

EN-04.02
 Post & Panel Stacking Bar
 Directional – 4' x 6'

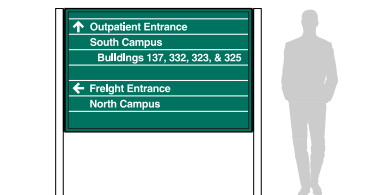

EN-04.02

EN-04.03
 Post & Panel Stacking Bar
 Directional – 3' x 4'

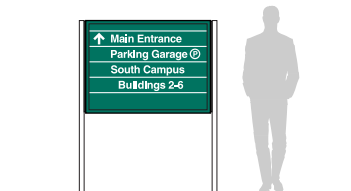

EN-04.03

EN-04.04
 Post & Panel Stacking Bar
 Directional – 2' x 3'

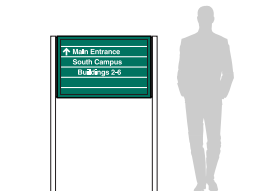

EN-04.04



Sign Overview

Exterior Signage Guidelines

EN-05.01

Single Post & Panel Large –
2'-6" x 2'

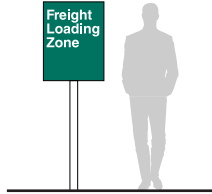

EN-05.01

EN-05.02

Single Post & Panel Medium –
2' x 1'-6"

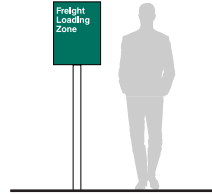

EN-05.02

EN-05.03

Single Post & Panel Small –
1'-6" x 1'

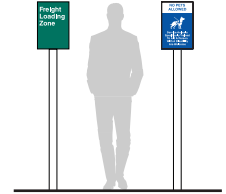

EN-05.03

EN-06.01

Wall Mounted Overhead



EN-06.01

EN-06.02

Wall Mounted Building Identification
Large



EN-06.02

EN-06.03

Wall Mounted Building Identification
Large with Message Panel



EN-06.03

EN-06.04

Wall Mounted Building Identification
Medium



EN-06.04

EN-06.05

Wall Mounted Building Identification
Medium with Message Panel



EN-06.05

EN-06.06

Wall Mounted Building Identification
Small



EN-06.06

EN-06.07

Wall Mounted Informational
Medium



EN-06.07

EN-06.08

Wall Mounted Informational Small



EN-06.08



Sign Overview

Exterior Signage Guidelines

PL-12.01
Post & Panel Parking Identification



EN-08.01

PL-12.02
Single Post & Panel Informational



EN-08.02

PL-12.03
Single Post & Panel Parking Stall Designation



EN-08.03

PL-12.04
Single Post & Panel Accessible Parking Stall Designation



PL-12.05
Single Post & Panel Accessible Parking Area

EN-09

PL-12.06
Pole Mounted Parking Lot or Area Identification



EN-10.01



EN-10.02



EN-10.03

PL-12.07
Wall Mounted Informational



EN-10



EN-10.04



EN-10.05



EN-10.06

PL-12.08
Single Post & Panel Permit Parking Stall Designation



EN-10.07



EN-10.08



EN-10.09

PL-12.09
Single Post & Panel Permit Parking Stall Designation

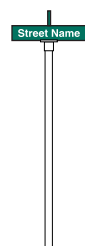

EN-11.01

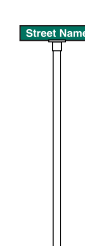

EN-11.02



EN-11.03

PL-13
Electronic Stall Availability Sign



EN-14

PL-15
Painted Stall Identification Number



Sign Overview

Exterior Signage Guidelines

PL-12.01
Post & Panel Parking Identification



PL-12.01

PL-12.02
Single Post & Panel Informational

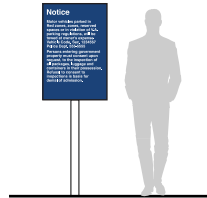

PL-12.02

PL-12.03
Single Post & Panel Parking Stall Designation



PL-12.03

PL-12.04
Single Post & Panel Accessible Parking Stall Designation



PL-12.04

PL-12.05
Single Post & Panel Accessible Parking Area



PL-12.05

PL-12.06
Pole Mounted Parking Lot or Area Identification

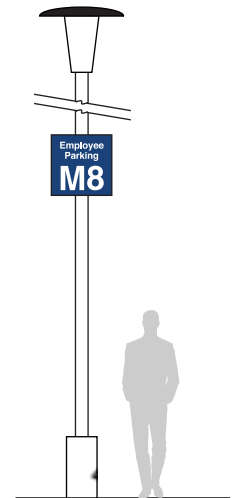

PL-12.06

PL-12.07
Wall Mounted Informational



PL-12.07

PL-12.08
Single Post & Panel Permit Parking Stall Designation



PL-12.08

PL-12.09
Single Post & Panel Permit Parking Stall Designation



PL-12.09

PL-13
Electronic Stall Availability Sign

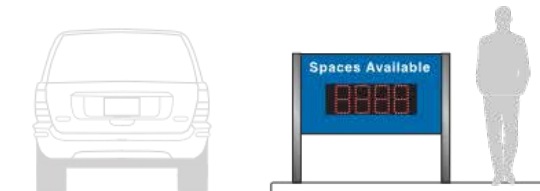

PL-13

PL-15
Painted Stall Identification Number

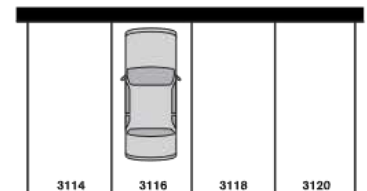

PL-15



2.5.5 SPECIFICATIONS

The specifications for signs are available in the Master Construction Specifications (PG-18-1) area of the VA Technical Information Library, which is available on the VA web site under Office of Construction & Facilities Management.

Visit online: www.cfm.va.gov/til/spec.asp#10

Refer to Signage in the specifications, Division 10, Section 10 14 00.

For more information regarding specifications, contact the Office of Construction & Facilities Management, Facility Standards Service.

When preparing the specifications for a project, it will be necessary to adapt the specifications to the specific facility and project. This may include information regarding the facility's specific component-based signage system, colors / finishes, and project requirements such as specific sign types or installation requirements.

Depending on the project type, signage specifications can include the Sign Message Schedule, Sign Location Plans, and Sign Drawings. The Sign Message Schedule is a table that lists each sign's location number, sign type, and message, as well as other relevant details. The Sign Location Plans are a set of architectural plans showing numbered tags at the location of each sign. Sign Drawings illustrate the details and design intent for each sign type in the system. This information is required by the sign manufacturer and installer for production and implementation of the signs.

More information about signage system planning and programming, and submittal examples can be found in [Section 1.1 Planning a Sign System](#).



2.5.6 CONSTRUCTION

This section provides example design options and construction details relevant to exterior signs that meet the VA's requirements.

Details showing the construction of monument signs, post-and-panel signs, wall-mounted signs, and stacking bar signs, are based on a concept of an aluminum extrusion component system. Many sign manufacturers currently market extrusions and component systems that will accomplish the illustrated objectives of an exterior signage system. These extruded, molded, and fabricated components are acceptable so long as the illustrated and stated specifications are adhered to. Once a manufacturer's system is selected for a signage program, ongoing maintenance and replacement signs will need to come from that same manufacturer's component system.

The illustrations are intended to show the desired configuration and intent of the various sign types. Sections of the extrusions are for illustration purposes and have not been engineered or configured for extruding and do not represent a finished form or a particular manufacturer. Many manufacturers' extrusion systems will accomplish the illustrated objectives of the desired exterior signage system.

In the following pages, further discussion of shape and sign design is discussed along with examples.

Internally illuminated signs should have the electrical supply coordinated, and voltage confirmed, before a sign is ordered and fabricated. Illuminated signs should contain a "UL" sticker that their construction conforms to UL Standard 48. Text for illuminated signs should also be confirmed and finalized before the sign is ordered and fabricated because revisions after fabrication, are expensive and time consuming.

Community reaction should be considered before large "skyline letters" are installed on top of a medical center. Various communities have standards that may not permit these types of signs and installing them could create a local controversy. Also, when large letters are planned for a building, coordination should take place to ensure issues of building skin integrity, structural loads, installation, electrical service, and maintenance access are evaluated.

Monument signs larger than those shown in the Manual or include electronic message units may also create local community reaction. Check with the Planning Department of the local City or County to see if they have a sign ordinance with guidelines for the proposed sign type. Federal facilities are not required to obtain local sign permits but respecting the local ordinances will prevent possible controversy.

Care should be taken to ensure that sign footings and foundations are correctly matched to the type of sign being installed.



Construction

Exterior Signage Guidelines

Detail 1 - Posts:

Post-and-panel signage systems often come in a variety of profile shapes that can alter the design motif. The post style should complement the facility's architectural design and be used consistently throughout the exterior signage system. Additional post shapes maybe available. It is recommended to only use post styles within the manufacturer's standard extrusions.

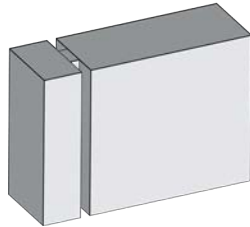

Post: P1

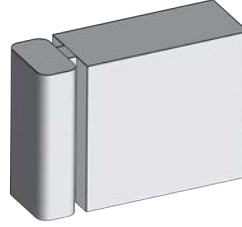

Post: P2

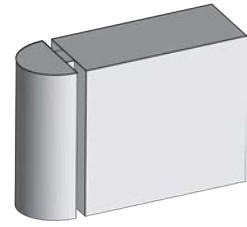

Post: P3

Detail 2 - Post Caps:

Post caps, also known as finials, can be used to enhance the style of post and the design of the sign as a whole. The caps can come in a wide variety of designs but will need to be compatible with the post as well as complement the architectural design of the facility. Sign manufacturers will likely have a standard set of options compatible with their extrusion systems.

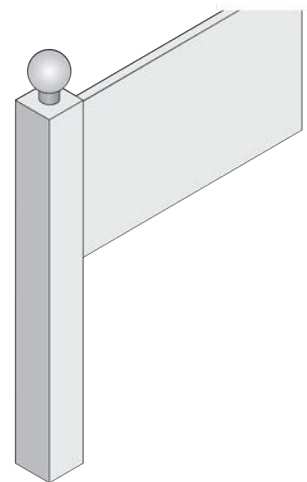
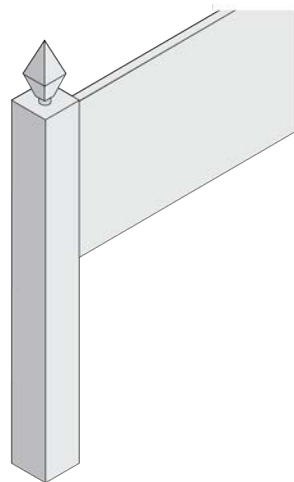
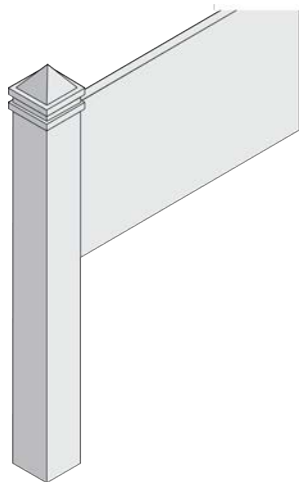

Construction

Exterior Signage Guidelines

Detail 3 - Reveals:

Component based exterior signage systems allow for a reveal or gap between the post and sign panel that can enhance the design. In some cases, a color accent can be applied to the reveal. Sign manufacturers may have a variety of options available.

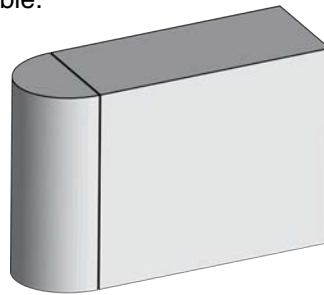

No Reveal

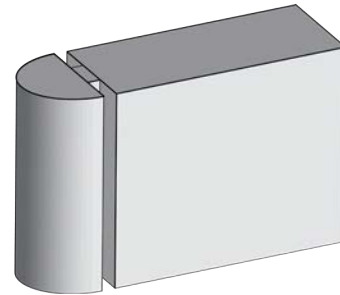

Reveal

Detail 4 - Facility Specific Sign Standard:

By incorporating various simple enhancements to a sign, a style can be created specific to a building or campus. Changing the post shape, incorporating a reveal, having the posts and cabinet in two different colors, or having an accent color in the reveal are all things that will give a sign a distinct style. Using dimensional letters can also provide a more upscale appearance for signs that identify buildings. Adding shape to the sign cabinet and a distinct treatment to the top of the posts, adds cost to the sign, but these details can “de-institutionalize” a signage program and allow it to have a “personality” that aligns with a hospital’s architecture and wayfinding plan.

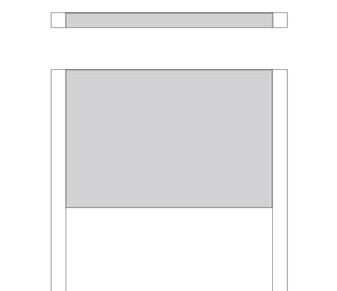

Basic Post & Panel

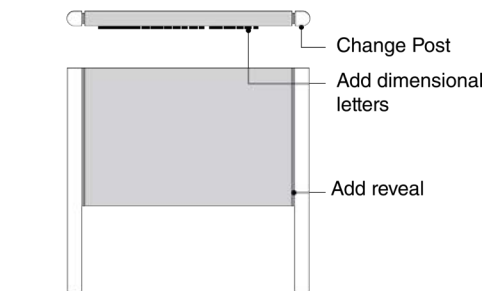

Modified Post & Panel Sign

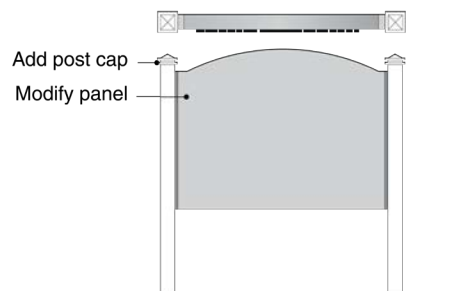

Modified Post & Panel Sign



Construction

Exterior Signage Guidelines

Detail 5 - Sign Cabinet Shapes and Forms:

This illustrates several examples of expanding the design of the exterior sign to incorporate different posts, caps, reveals, and cabinet styles.

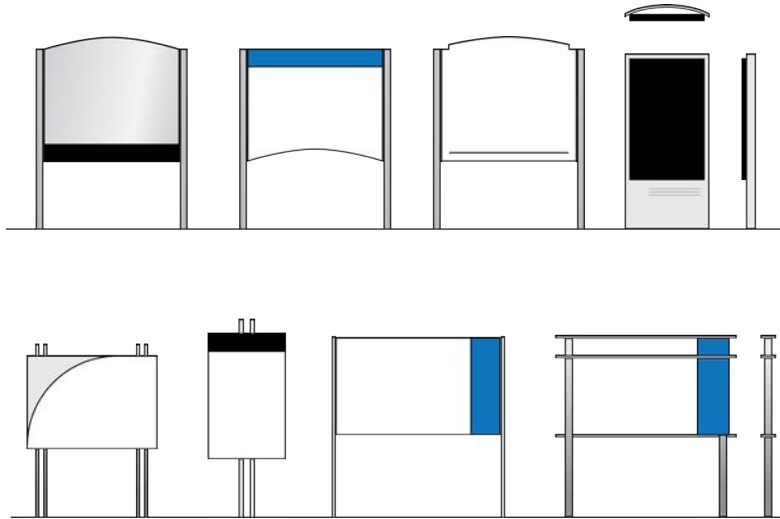

Detail 6 - Internally Illuminated Sign Cabinet:

This sign is constructed with an illuminated double-faced sign cabinet mounted to a masonry base with a reveal between the base and the cabinet.

Sign face is aluminum with routed text and graphics backed with a translucent diffuser.

Illumination is by a grid of LED's attached to a white aluminum panel.

Sign face to slide out for sign maintenance or replacement of sign face without abandonment of entire sign.

Sign shall be constructed to conform to UL requirements.

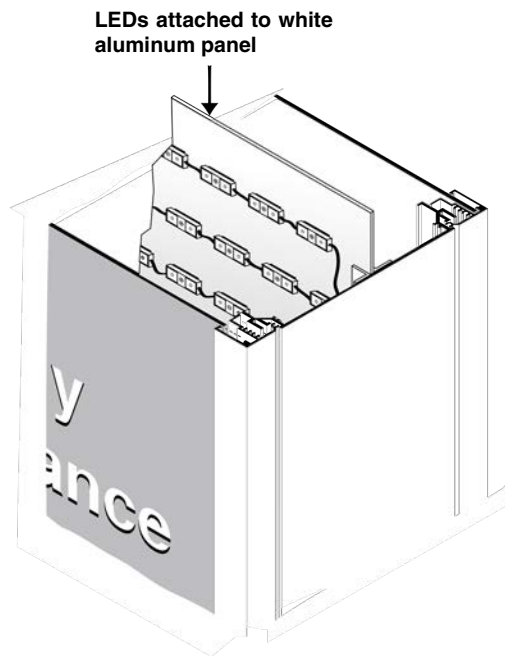

Construction

Exterior Signage Guidelines

Detail 7- Internally Illuminated Post and Panel Sign:

This sign is constructed with an illuminated double-faced sign cabinet mounted to extruded aluminum posts with an adjustable reveal between the posts and the cabinet.

Sign face is aluminum with routed text and graphics backed with a translucent diffuser.

Illumination is by a grid of LEDs attached to a white aluminum panel.

Sign face to slide out for sign maintenance or replacement of sign face without abandonment of entire sign.

Sign shall be constructed to comply with UL requirements.

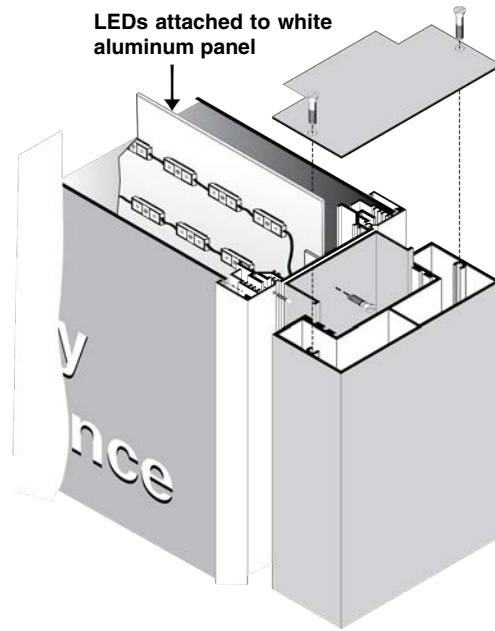

Detail 8 – Internally Illuminated Wall Mounted Sign:

This sign is constructed with a single faced illuminated sign cabinet that can be mounted to a wall. A complete enclosed back is required.

Sign face is aluminum with routed text and graphics backed with a translucent diffuser.

Illumination is by a grid of LED's attached to a white aluminum panel.

Sign face to slide out for sign maintenance or replacement of sign face without abandonment of entire sign.

Sign shall be constructed to comply with UL requirements.

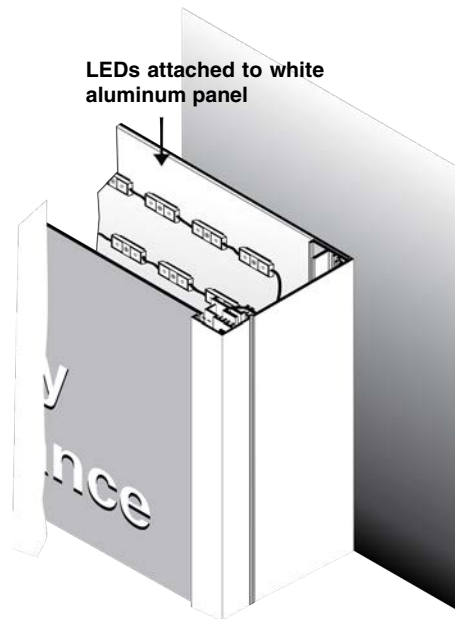

Construction

Exterior Signage Guidelines

Detail 9 - Internally Illuminated Sign Electrical:

Electrical connections to illuminated signs are to be made in a junction box that is located adjacent to the sign.

Exposed conduit is not to be mounted to the exterior of sign cabinets or posts.

Sign shall be constructed to comply with UL requirements.

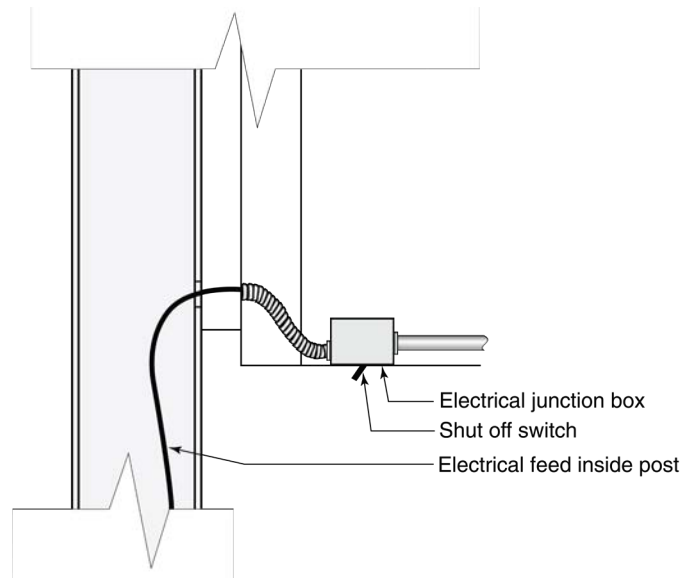

Detail 10- Internally Illuminated Routed Text & Graphics:

Illuminated signs with cut out aluminum sign faces require white translucent diffusers.

The translucent acrylic or polycarbonate diffusers are to be mechanically fastened to the sign face.

Letter voids of all upper-case letters "A B D O P Q R" and all lower-case letters "a b d o p q r a b d e g o p q" and number voids "4 6 8 9 0" are to be mechanically fastened to the diffuser.

Diffusers are not to be installed on a sign face using any type of tape or adhesive system.

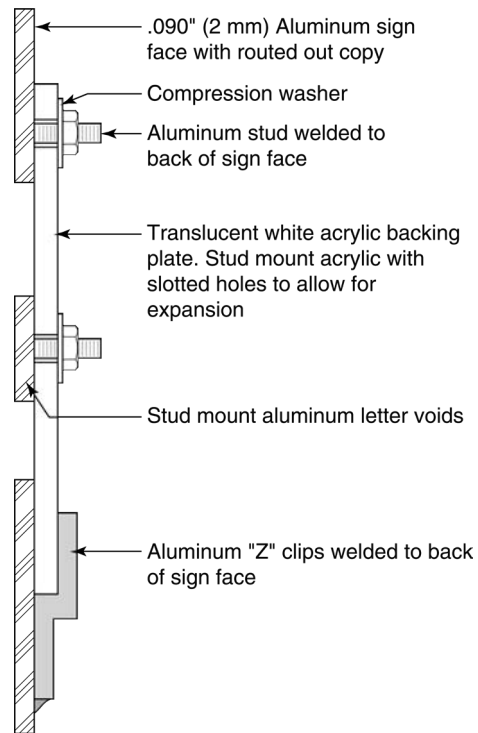

Construction

Exterior Signage Guidelines

Detail 11 - Internally Illuminated 4-Sided Monument Sign:

This sign is constructed with an illuminated 4 faced sign cabinet mounted to a masonry base with a reveal between the base and the cabinet.

Sign face is aluminum with routed text & graphics backed with a translucent diffuser.

Illumination is by a grid of LED's attached to a white aluminum panel for each side. Sign face to slide out for sign maintenance or replacement of sign face without abandonment of entire sign.

Sign is to be constructed to conform to UL requirements.

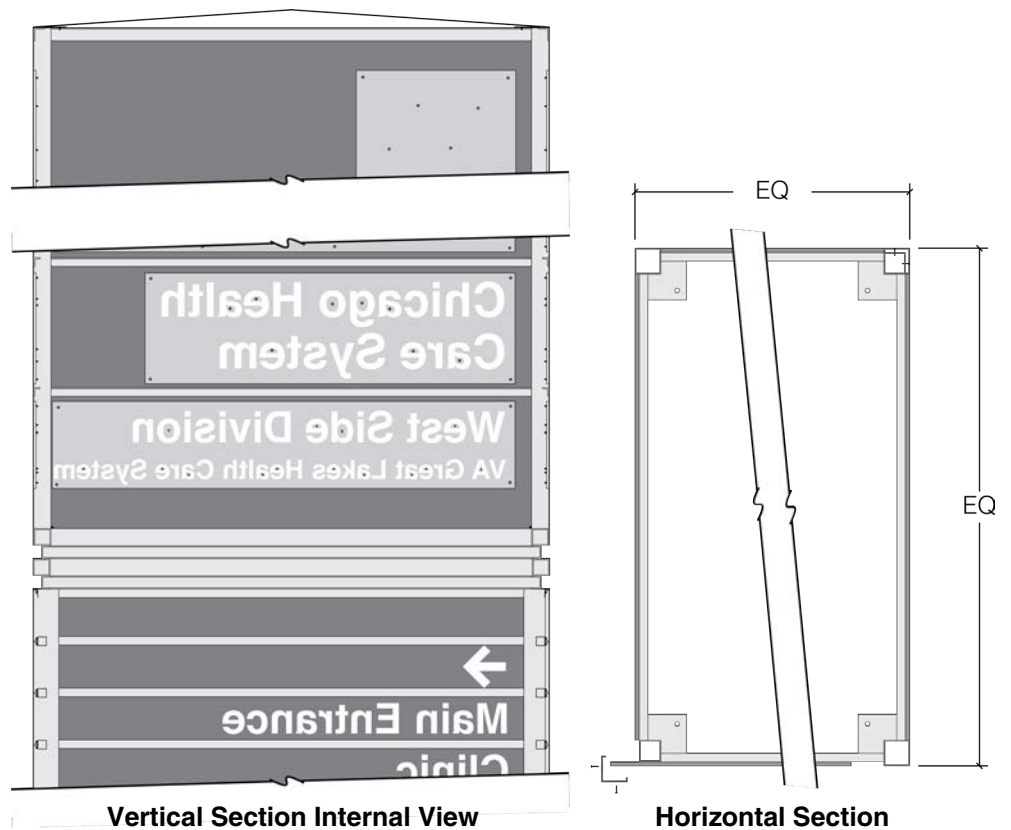

Construction

Exterior Signage Guidelines

Detail 12 - Non-Illuminated Post & Panel Sign:

This sign is constructed with a non-illuminated sign cabinet mounted to extruded aluminum posts with an adjustable reveal between the posts and the cabinet.

The sign cabinet extrusion should have the capability to hold the sign faces and allow for the removal and replacement of faces without total sign disassembly or abandonment of the sign.

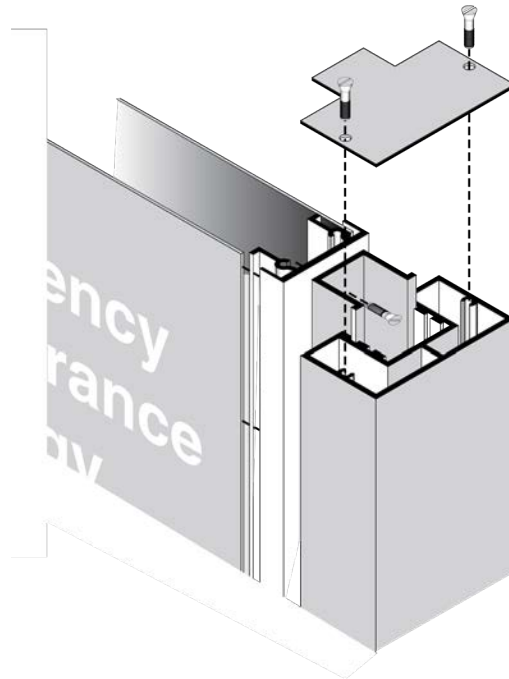

Detail 13 - Non-Illuminated Post & Stacking Bar Sign:

This sign is constructed with a series of aluminum tubes mounted to extruded aluminum posts with an adjustable reveal between the posts and the stacking tubes.

Tubes are to be flush and touching with no gaps between them.

Sign is constructed in a manner that will allow the removal or addition of faces at a future time.

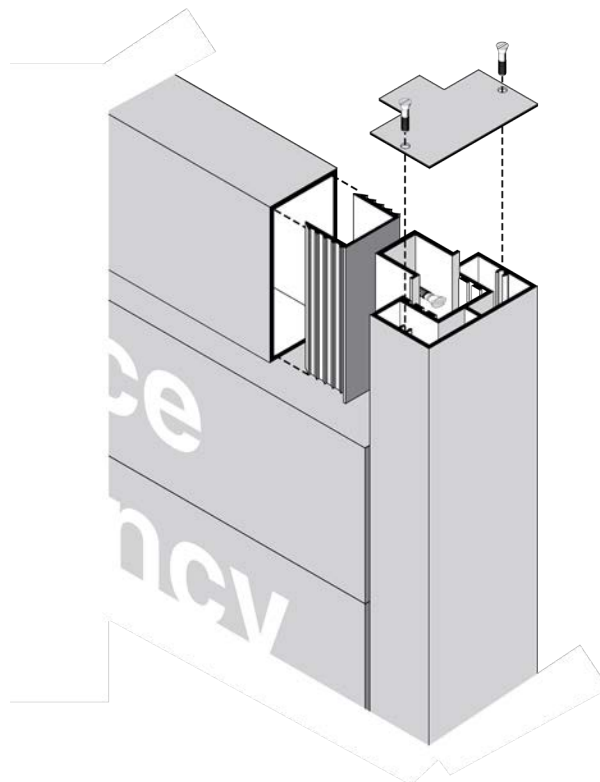

Construction

Exterior Signage Guidelines

Detail 14 - Internally Illuminated Strip Sign:

A stacking strip illuminated sign incorporates individual extruded aluminum strips that enable the panels to be removed and rearranged as necessary.

The sign is constructed similar to the internally illuminated monument or post and panel sign.

The graphics on the strips are constructed in the same manner as an internally illuminated sign face.

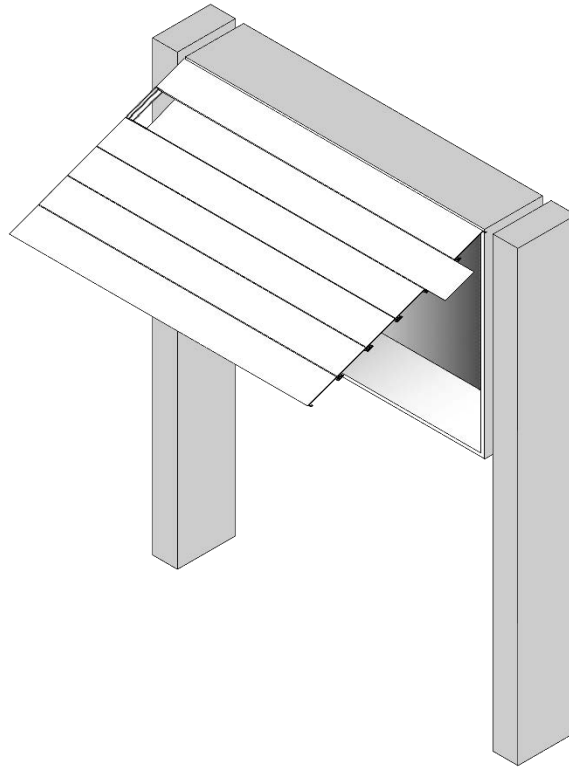

Detail 15 - Internally Illuminated Changeable Strips:

Modular illuminated sign strip extrusions are to be interlocking in such a manner as to prevent light leaks and also provide flexibility for replacement and rearrangement.

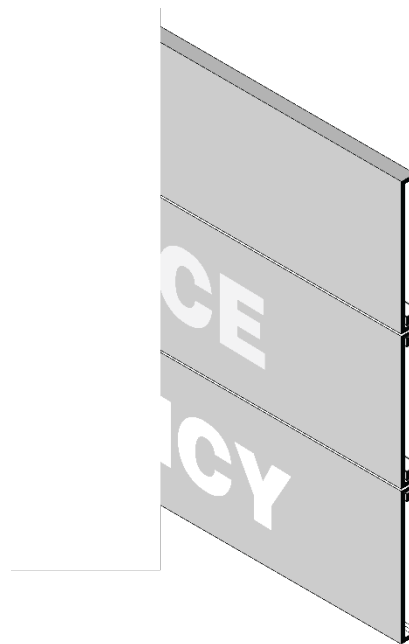

Construction

Exterior Signage Guidelines

Detail 16 - Exterior Sign Utilizing Component Assembly:

The illustration shows how a sign is assembled which is constructed using an aluminum extrusion system of component parts. Several manufacturers build signs in this manner and this approach allows for simplified manufacturing and a consistent appearing product.

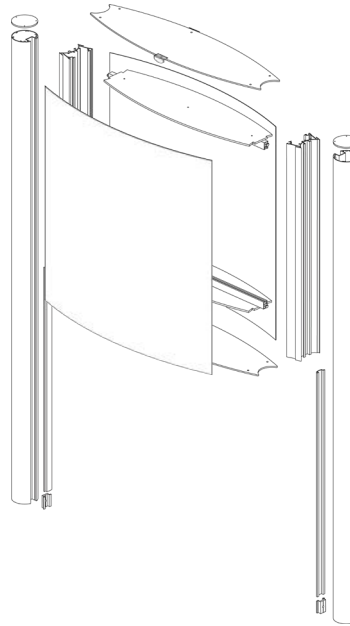

Detail 17 - Exterior Sign Assembly Modifications:

The exploded view illustration shows how an exterior component-based sign can be installed to allow for simple future modifications or updating.

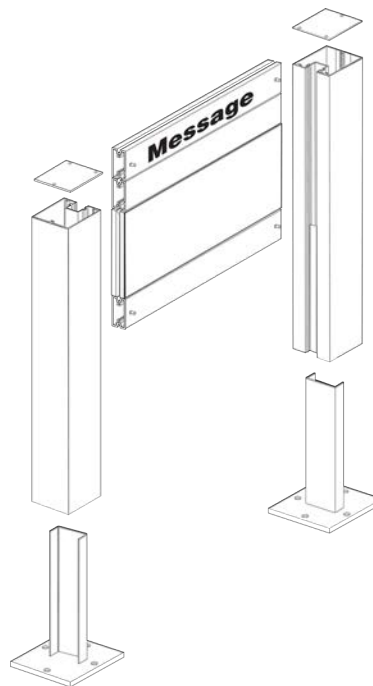

Construction

Exterior Signage Guidelines

Detail 18 - Basic Aluminum Post & Panel Sign:

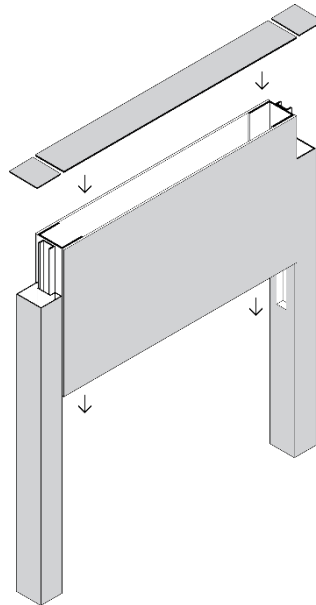

Detail 19 – Non-Illuminated Wall Mounted Sign:

This sign is constructed with an aluminum panel mounted into an extruded aluminum frame configured for wall mounting.

Sign face is held within a frame which will allow for replacement of the sign face without disassembly or abandonment of the entire sign.

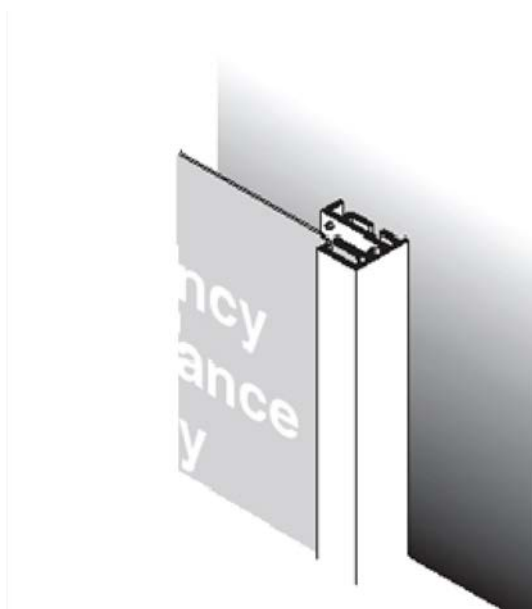

Construction

Exterior Signage Guidelines

Detail 20 - Single Post & Panel Recommended Mounting:

Extruded aluminum signpost with sliding dove tail groove. Aluminum sign panel with integrated dove tail tongue slides into pole extrusion with post filler and tension screw.

Sign panels have the corners eased with a 1/4" (6 mm) radius. The post shall have a permanent top cap.

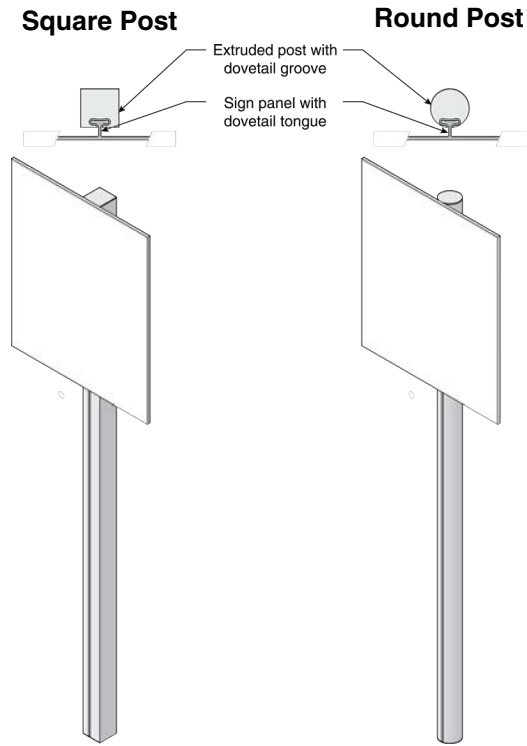

Detail 21 - Single Post & Panel Street Signs & Alternate Conditions:

Aluminum sign panel mounted to a square aluminum post with tamper proof mechanical fasteners.

Sign panels have the corners eased with a 1/4" (6 mm) radius. The post shall have a permanent top cap.

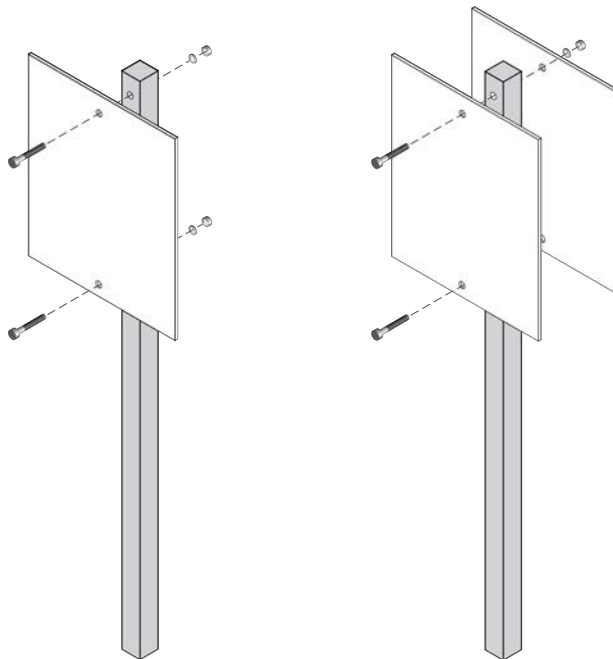

Construction

Exterior Signage Guidelines

Detail 22 – Street Identification:

Cast or fabricated aluminum post cap configured to hold aluminum name panel.

For double bladed signs there is a cast or fabricated aluminum connector that is mounted to the lower blade and holds the upper blade.

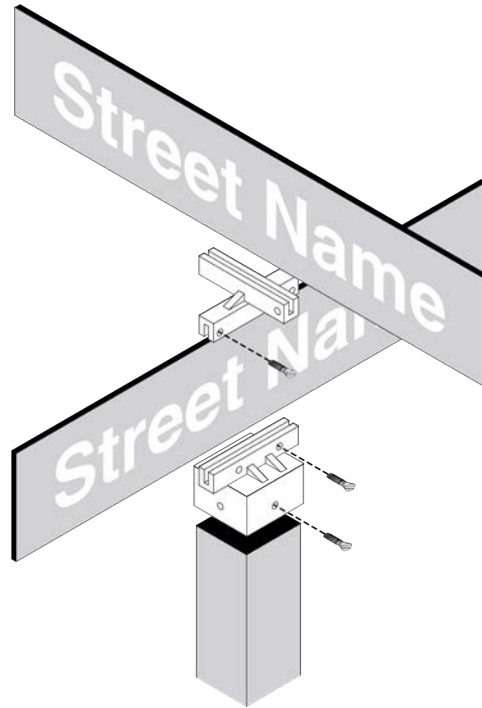

Detail 23 – Face Illuminated Letters:

Face Illumination with LED's

Installation of these letters should be done only by a licensed electrical sign company.

Consult with a local electrical sign company regarding the wall surface, accessibility, and method of installation.

LED Guidelines:

LED's to be UL recognized and carry the UL label

Rated life of LED's to exceed 40,000 hours

Color temp to match 5000k to 6500k

Low voltage 12v system

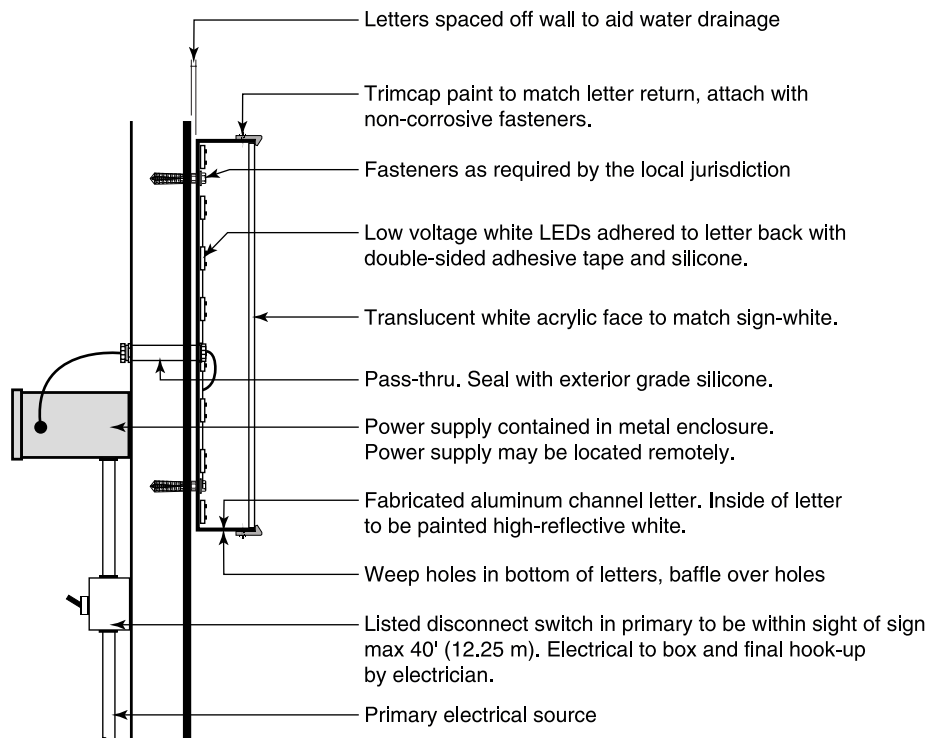

Construction

Exterior Signage Guidelines

Detail 24 - Halo Illuminated Letters:

“Halo Effect” letters are illuminated with LED’s.

Installation of these letters should be done only by a licensed electrical sign company.

Consult with a local electrical sign company regarding the wall surface, accessibility, and method of installation.

LED Guidelines:

LED’s to be UL recognized and carry the UL label

Rated life of LED’s to exceed 40,000 hours

Color temp to match 5000k to 6500k

Low voltage 12v system

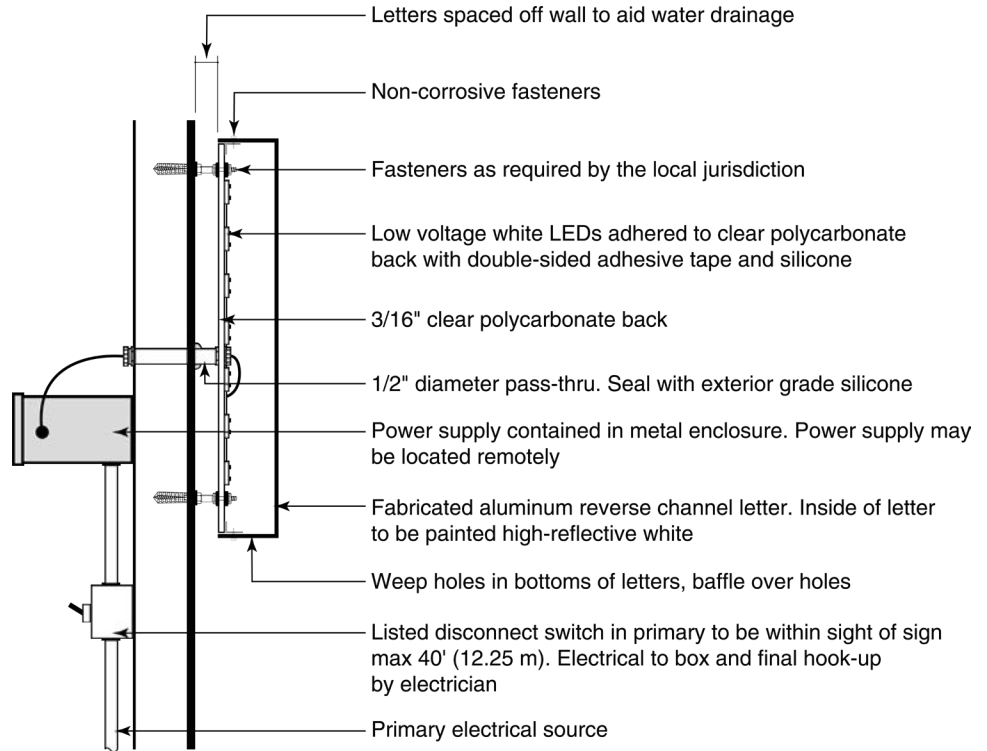

Detail 25 - Fabricated Metal Letter & Logo:

Fabricated metal letters and logo are intended for use on exterior building applications.

These letters are custom fabricated to meet the size, illumination, and mounting requirements for the intended location on a building. Clear access is required to backs of the letters to allow installation of electrical connections and for maintenance.

Consult with a local exterior electrical sign company regarding these letters, their construction and installation requirements before ordering illuminated letters.

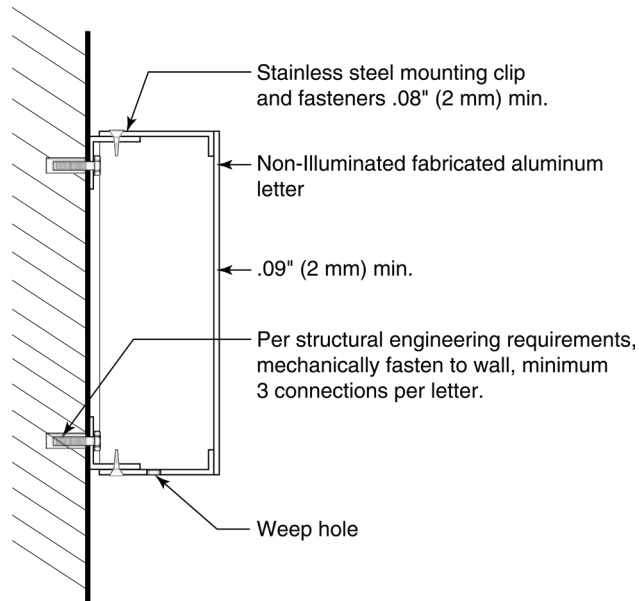

2.5.7 INSTALLATION

This section describes the conditions to consider prior to the installation of exterior signs, ensuring successful implementation. It also includes figures that detail typical installation standards for exterior sign placement, footings and mounting.

Planning

Sign placement in an exterior signage system is determined as part of a campus wayfinding master plan. Programming of the message schedule should be done just prior to manufacturing to ensure accuracy of information.

Visibility

Exterior signs communicate to both drivers and pedestrians, and placement should be planned for optimal visibility in relation to the intended viewer. Signs should be installed at optimal viewing height for the speed and distance of the viewer. Avoid installing where conditions obstruct the viewing of the sign.

Readability

Sign messages should have the correct letter height to be read at the speed and distance of the viewer. Additionally, consider the potential effects the sign's design and content have on drivers. Signs with too much information can create confusion and slow traffic.

Coordination

It is necessary to coordinate with irrigation systems, electrical service, and other underground utilities. Ideally this is done during the Planning and Programming phases.

Climate

Every site has different climate conditions that effect an exterior signage program. Wind load, snowfall, and frost line impact the post length and footing depth required for sign installation.

Footing

Within this installation section of the manual there is a table to aid in determining the size of a footing for various signs. This is a general guide and structural engineering maybe required to confirm that footing is adequate for the conditions at a sign's location.

Engineering

Structural engineering should be consulted to ensure building walls can adequately support large "skyline letters and logo" before having them fabricated. Monument signs should also have their bases designed by a structural engineer to ensure the signs can withstand wind loads at their location.

Mounting

Sign mounting methods have been standardized to create visual uniformity for all signs placed around a facility. Mounting heights and placement have been determined for ease of planning and are illustrated in the following diagrams.

The two principal methods of mounting signs are:

- Ground-Mounted: Placing a sign panel on one or more posts fixed in the ground or sign cabinets mounted to masonry or concrete bases.
- Wall-Mounted: Placing a sign on a vertical surface such as the wall or door of a building or fence.



Installation

Exterior Signage Guidelines

**Placement:
Ground Mounted Signs**

All signs should be located a minimum of 2'-0" (609.6 mm) from the curb. The exact location of a sign will vary depending on the type of sign and site conditions.

Sign placement must be carefully considered to ensure that the sign fits the location without major regrading. It may be necessary to clear some shrubs or bushes or relocate an obstruction.

When ground mounted signs on two posts are placed on sloping or inclined grades, adjustments must be made to the post lengths. Extreme differences between post lengths should be minimized.

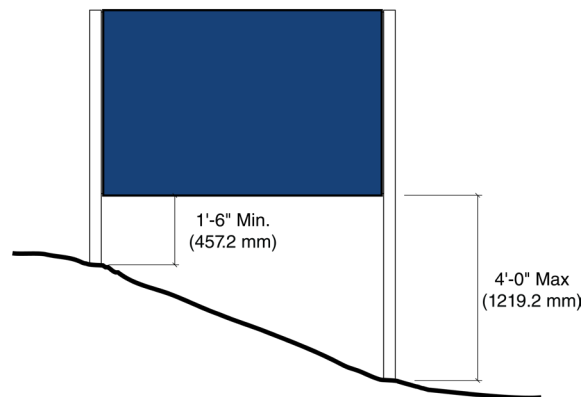
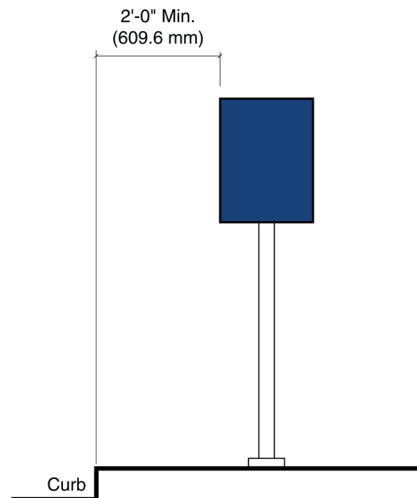
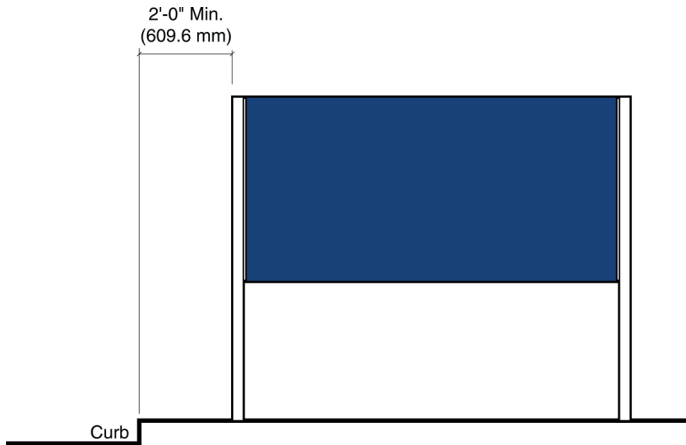

Installation

Exterior Signage Guidelines

**Placement:
Wall Mounted Signs**

Signs are placed to alert and inform in sufficient time to avoid a hazard or take appropriate action. They should be sized for easy reading from the viewing distance required.

A sign that is too small will be lost. Conversely, an overly large sign can overwhelm an area.

Signs should be placed where they will not create distractions. Care should be taken to avoid grouping too many signs together in one location.

Small sign panels placed for close viewing should be appropriately placed at eye level. Larger signs posted in big spaces or for viewing at greater distances should be placed proportionally higher.

Signs should not be placed where objects may obscure them.

Before ordering a sign, you can place a cardboard panel in the proposed location to verify the size and placement location.

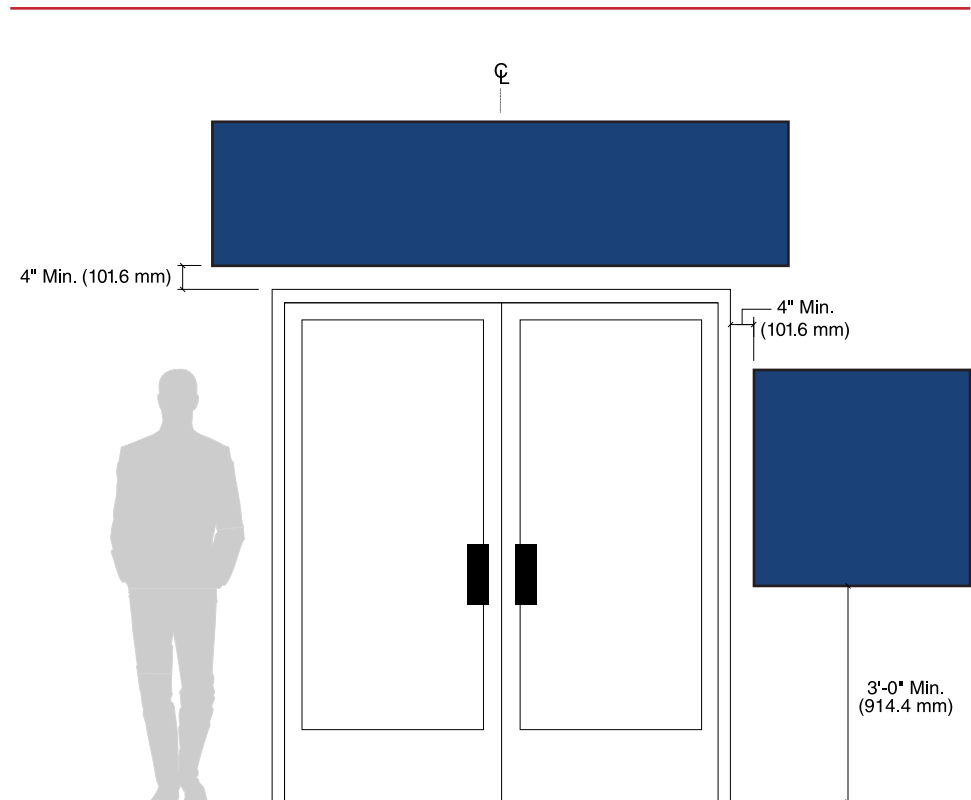

Installation

Exterior Signage Guidelines

**Placement:
Parking Stall Identification**

This illustration indicates the location of single post & panel signs in relationship to both handicapped and standard parking stalls.

Signs should be visually centered to the driver/vehicle at the head of the stall.

Make sure that the signpost cannot be struck by the bumper of a vehicle.

If an area of parking stalls are being signed with the same message, the number of signs can be reduced. A single sign can be used to label multiple stalls. A good guide is 1 sign for every 2 or 3 stalls. One sign for 4 stalls will not work because the sign will be too far from a driver's vision.

For handicapped parking stalls it is best to provide a sign for each individual stall and then there is no opportunity for confusion.

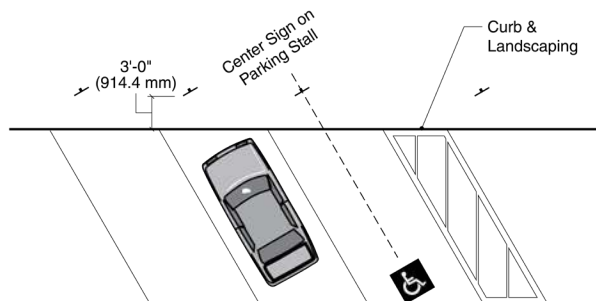
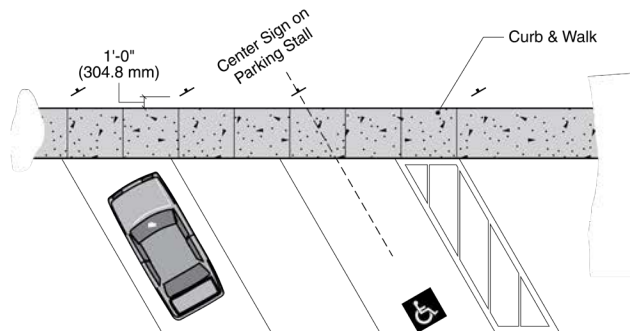
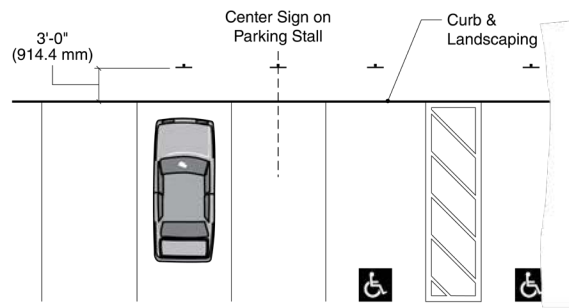
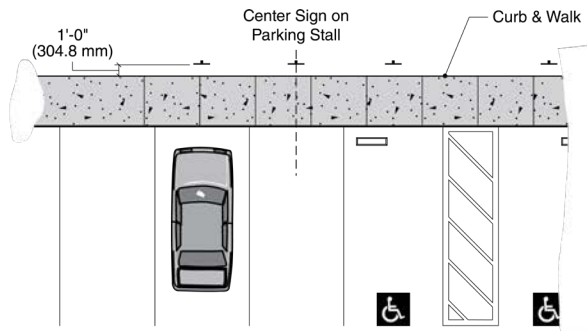

Installation

Exterior Signage Guidelines

**Placement:
Sight Triangle at
Intersections and
Driveways**

For safety reasons, signs should not be placed in the sight triangle (shaded area) where they could obscure a driver's vision. Also, make sure that a sign's location is not blocking a drivers vision of pedestrians.

Ensuring that there are no signs in the sight triangle applies to roadway intersections as well as driveways.

Traffic regulatory signs are an exception to this rule. Traffic regulatory signs such as STOP and YIELD signs should be placed at the point at which compliance is to be made.

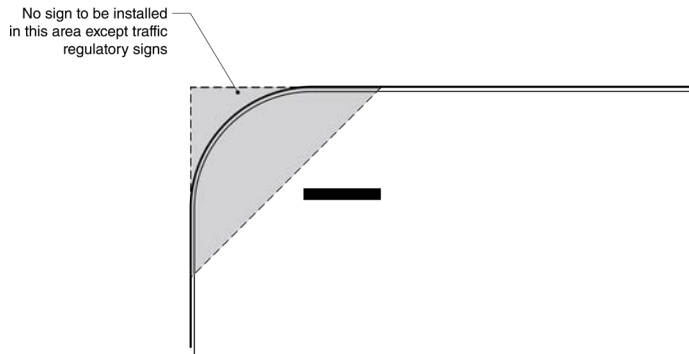
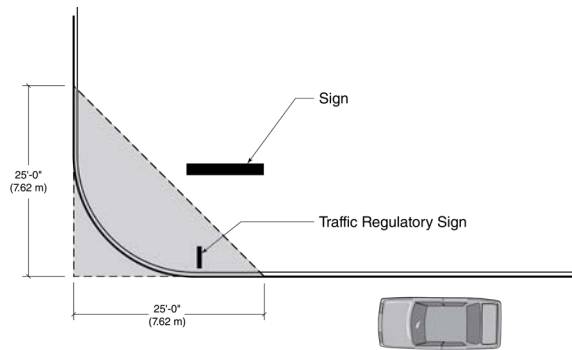

**Footing:
Size Configurations**

Footing depth requirements vary from location to location and size of sign.

A large sign requires a larger diameter and deeper footing or base to withstand higher wind loads. Poor soil compaction will also require larger footings.

The depth of winter frost penetration also effects the size of footing required.

Locate your area of the country on the map and then refer to the chart to determine the size of footings required for the various sizes of signs.

It is recommended that the base for all large monument signs be designed by a licensed structural engineer providing "signed and sealed" drawings. This is to ensure that the base will structurally support the sign taking into account wind loads, the type of soil, and winter frost penetration.

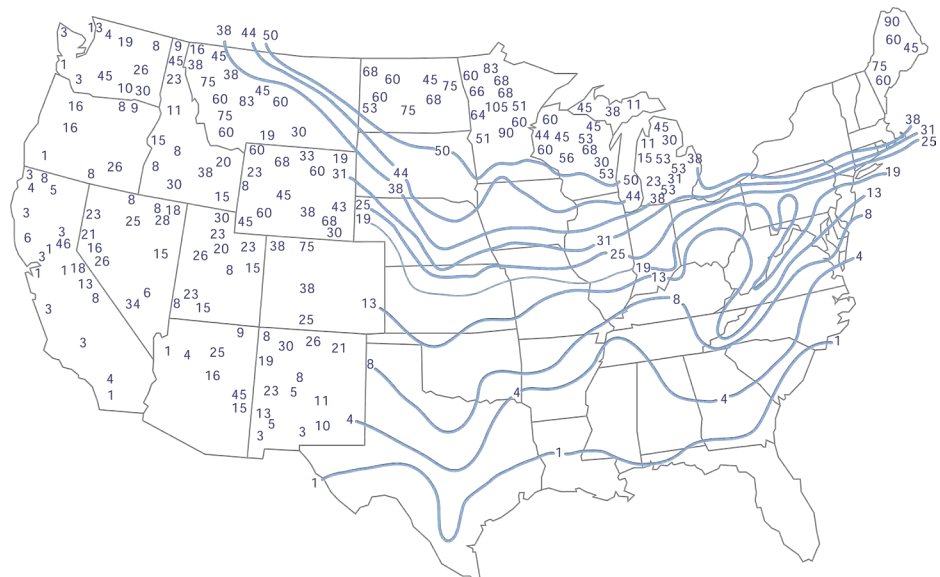

Installation

Exterior Signage Guidelines

Footing Configuration Chart (Imperial)

Number Of Posts	Sign Panel Height	Sign Panel Width	Sign Panel Sq. Ft.	Overall Sign Height	0"-30" Frost Depth		30"-36" Frost Depth		36"-48" Frost Depth	
					Footing Cross Section	Footing Depth	Footing Cross Section	Footing Depth	Footing Cross Section	Footing Depth
1	1'-6"	1'-0"	1.5 sq ft	6'-0"	1'-6"	2'-6"	1'-6"	3'-0"	1'-6"	4'-0"
1	2'-0"	1'-6"	3 sq ft	6'-0"	1'-6"	2'-6"	1'-6"	3'-0"	1'-6"	4'-0"
1	2'-6"	2'-0"	5 sq ft	6'-0"	1'-6"	2'-6"	1'-6"	3'-0"	1'-6"	4'-0"
2	2'-0"	2'-0"	4 sq ft	5'-0"	1'-6"	2'-6"	1'-6"	3'-0"	1'-6"	4'-0"
2	2'-0"	3'-0"	6 sq ft	5'-0"	1'-6"	2'-6"	1'-6"	3'-0"	1'-6"	4'-0"
2	3'-0"	3'-0"	9 sq ft	5'-6"	1'-6"	2'-6"	1'-6"	3'-0"	1'-6"	4'-0"
2	3'-0"	4'-0"	12 sq ft	5'-6"	1'-6"	2'-6"	1'-6"	3'-0"	1'-6"	4'-0"
2	4'-0"	3'-0"	12 sq ft	6'-6"	1'-6"	2'-6"	1'-6"	3'-0"	1'-6"	4'-0"
2	4'-0"	6'-0"	24 sq ft	6'-0"	1'-6"	4'-0"	1'-6"	3'-0"	1'-6"	4'-0"
2	4'-0"	6'-0"	24 sq ft	6'-6"	1'-6"	4'-0"	1'-6"	3'-0"	1'-6"	4'-0"
2	4'-0"	8'-0"	32 sq ft	6'-6"	1'-6"	4'-0"	1'-6"	4'-0"	1'-6"	4'-0"
2	6'-0"	5'-0"	30 sq ft	8'-6"	1'-6"	4'-0"	1'-6"	4'-0"	1'-6"	4'-0"

Footing Configuration Chart (Metric)

Number Of Posts	Sign Panel Height	Sign Panel Width	Sign Panel Sq. M	Overall Sign Height	0-762 Frost Depth		762-915 Frost Depth		915-1220 Frost Depth	
					Footing Cross Section	Footing Depth	Footing Cross Section	Footing Depth	Footing Cross Section	Footing Depth
1	450 mm	300 mm	.1 sq M	1800 mm	450 mm	750 mm	450 mm	900 mm	450 mm	1200 mm
1	600 mm	450 mm	.2 sq M	1800 mm	450 mm	750 mm	450 mm	900 mm	450 mm	1200 mm
1	750 mm	600 mm	.5 sq M	1800 mm	450 mm	750 mm	450 mm	900 mm	450 mm	1200 mm
2	600 mm	600 mm	.4 sq M	1500 mm	450 mm	750 mm	450 mm	900 mm	450 mm	1200 mm
2	600 mm	900 mm	.5 sq M	1500 mm	450 mm	750 mm	450 mm	900 mm	450 mm	1200 mm
2	900 mm	900 mm	.8 sq M	1650 mm	450 mm	750 mm	450 mm	900 mm	450 mm	1200 mm
2	900 mm	1200 mm	1.1 sq M	1650 mm	450 mm	750 mm	450 mm	900 mm	450 mm	1200 mm
2	1200 mm	900 mm	1.1 sq M	1950 mm	450 mm	750 mm	450 mm	900 mm	450 mm	1200 mm
2	1200 mm	1800 mm	2.2 sq M	1800 mm	450 mm	1200 mm	450 mm	900 mm	450 mm	1200 mm
2	1200 mm	1800 mm	2.2 sq M	1950 mm	450 mm	1200 mm	450 mm	900 mm	450 mm	1200 mm
2	1200 mm	2400 mm	2.9 sq M	1950 mm	450 mm	1200 mm	450 mm	1200 mm	450 mm	1200 mm
2	1800 mm	1500 mm	2.7 sq M	2550 mm	450 mm	1200 mm	450 mm	1200 mm	450 mm	1200 mm



Installation

Exterior Signage Guidelines

Detail 1 - Footing: Post & Panel Signs

All footings must meet width and depth requirements to accommodate height and size of sign, soil conditions, wind loads and winter ground freezing.

Style 1:
Permanent installation in landscaped areas.

Signs installed in grass can have the raised concrete collars extended to cover the area between posts.

Style 2:
Permanent installation in paved areas. Either core drill or surface mount.

Style 1

In landscaped areas, the footing shall be boxed so as to extend 3 1/2" (88.9 mm) above grade with a 2" (50.8 mm) bevel. Replace surrounding landscaping to original condition.

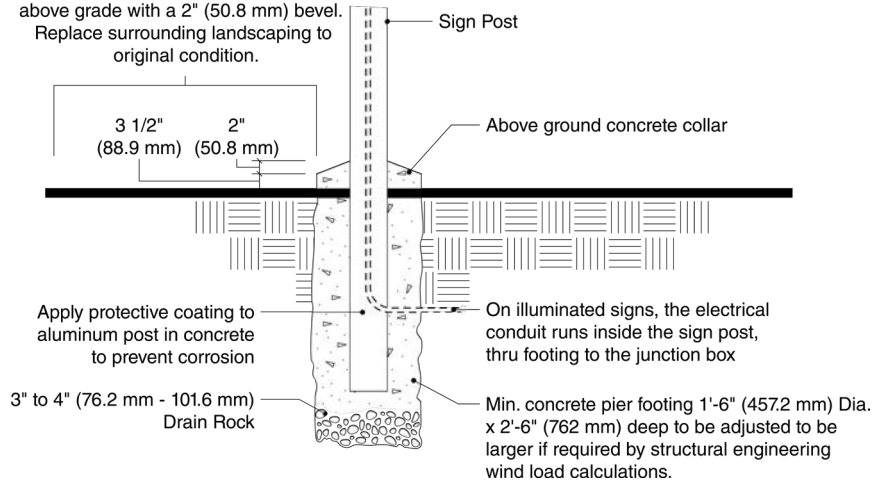

Style 2 Core Drill

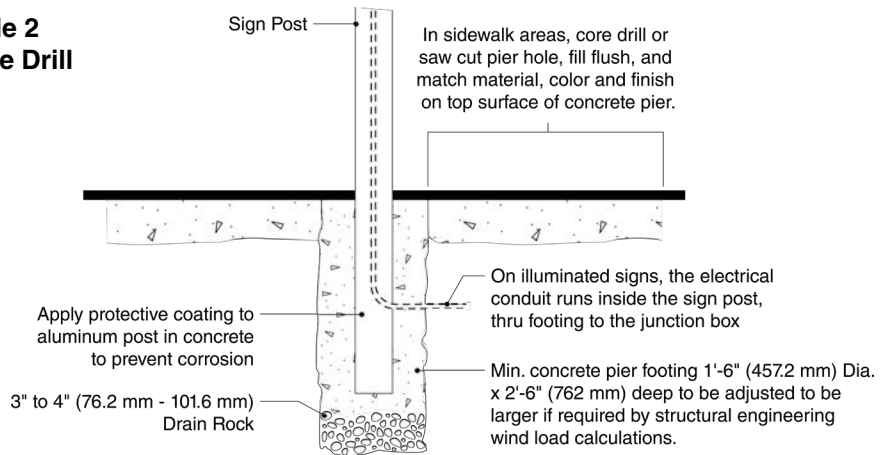

Style 2 Surface Mount

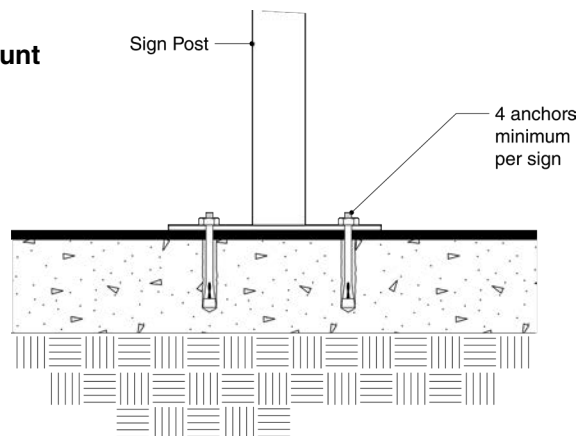

Installation

Exterior Signage Guidelines

Detail 1 - Footing: Post & Panel Signs (Continued)

All footings must meet width and depth requirements to accommodate height and size of sign, soil conditions, wind loads and winter ground freezing.

Style 3:
Semi-permanent installation in landscaped areas.

Use this type of installation when it is known that a sign will need to be removed or replaced in the near future.

Signs installed in grass can have the raised concrete colors extended to cover the area between the posts.

Style 4:
Semi-permanent installation. Use this type of installation when a sign will need to be removed or replaced in the near future.

Style 3

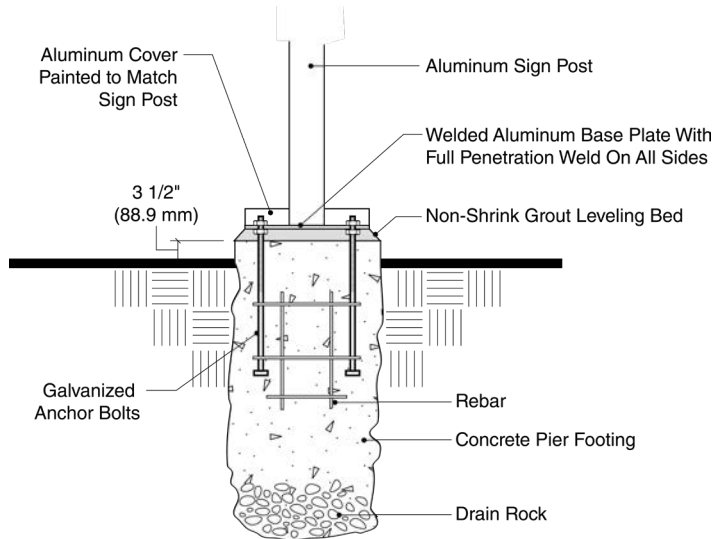

Style 4

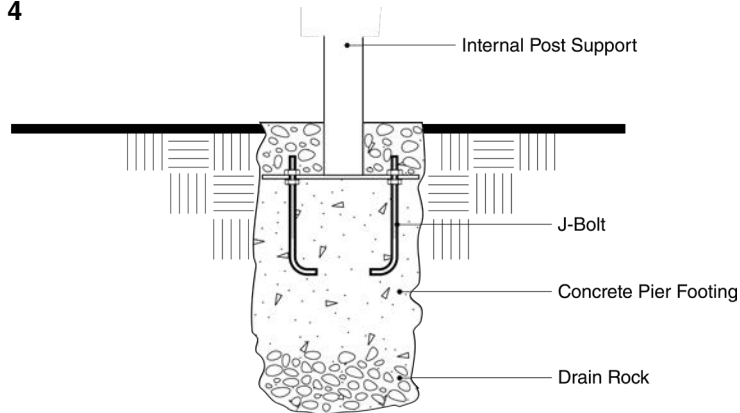

Installation

Exterior Signage Guidelines

Detail 1 - Footing: Post & Panel Signs (Continued)

Style 5: Flexible Sign Post

Style 5:

Flexible sign posts may be useful for signage located in front of a parking stall. There are occasions when a driver may accidentally hit / bump these types of signs with their vehicle. Having a flexible sign will prevent damage to the sign as well as reduce damage to the vehicle.

There are different methods for installing these types of signs. The method of installation may be dependent on the type of flexible sign utilized as well as the conditions of the pavement where the sign is to be installed. A flexible sign post vendor should be able to provide installation instructions.

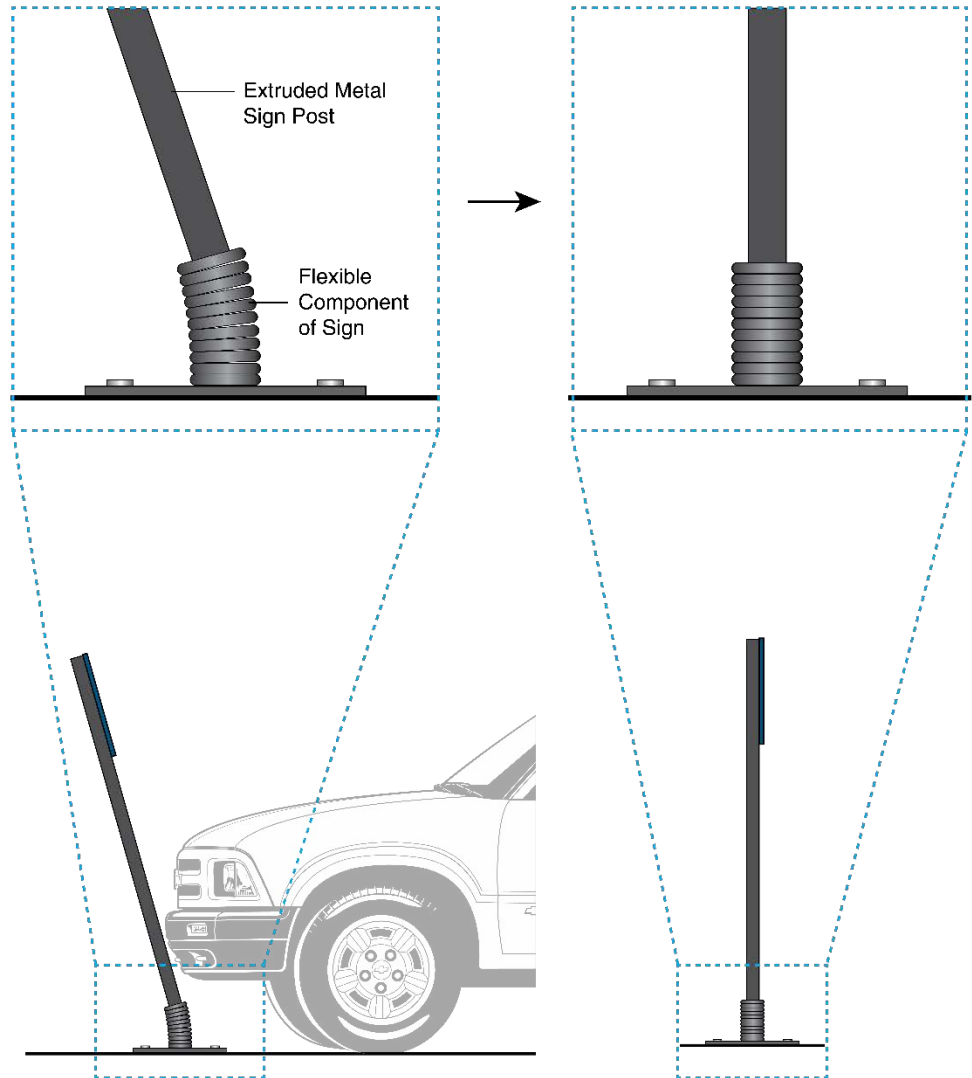

Flexible component at bottom of post allows sign to be pushed in a single direction if sufficient force is applied.

Sign returns to upright position after pushing force is removed.



Installation

Exterior Signage Guidelines

Detail 2 - Mounting: Non-Illuminated Letters

Metal letters that are installed on the exterior of the building should be done with spacers behind the letters. This will allow for rain to run down the building surface without creating streaking under the letters.

The size and length of the studs are to correlate to the size of the letter and the depth that is required for installation on a particular building surface.

Plaster and stucco building surfaces should have complete adhesive sealant application around the stud, where it penetrates the building, to prevent water intrusion into the building.

Letters that are installed on wall surfaces below 8 feet (2438 mm) should be installed flush to the wall with no spacers and additional adhesive applied to the back of the letters. This will increase the security of the letters against vandalism or theft.

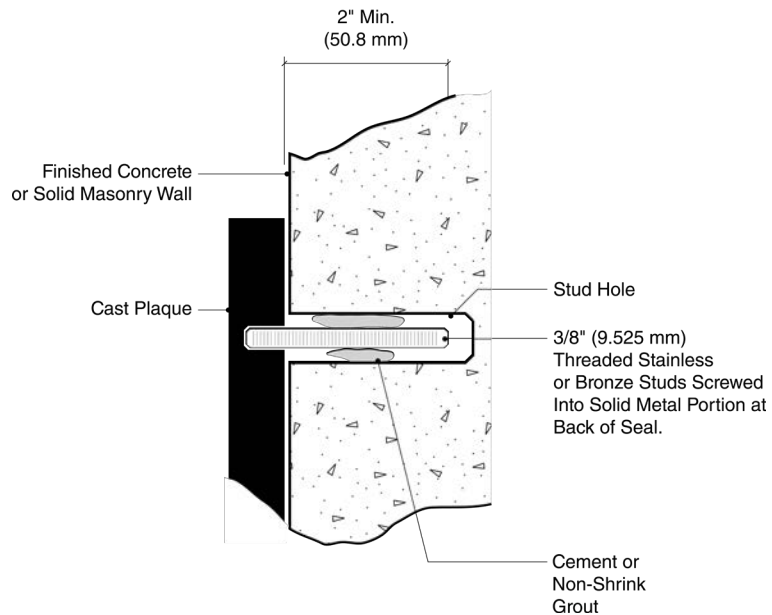
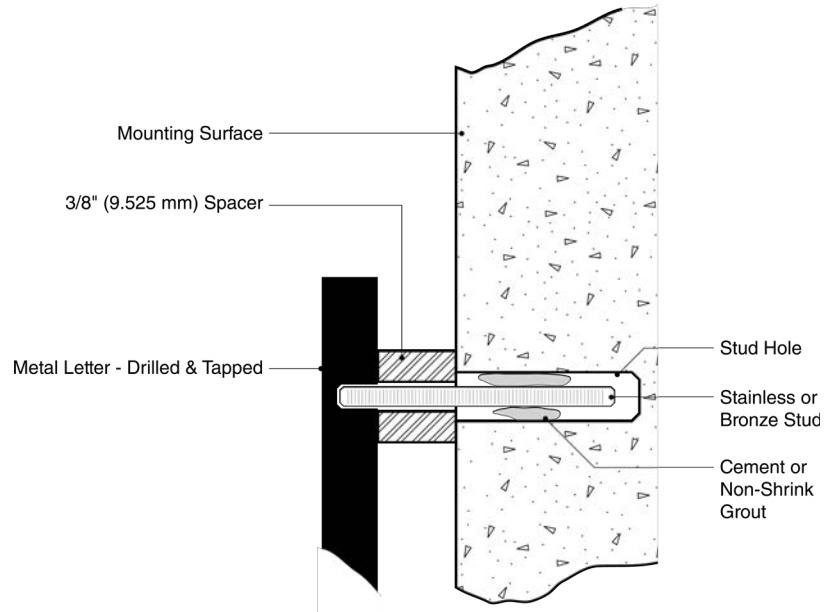

Installation

Exterior Signage Guidelines

Detail 3 - Mounting: Non-Illuminated Fabricated Metal Letters

Fabricated metal letters that are installed on the exterior of the building should be done with a slight space between the letter and the wall. This will allow for rain to run down the building surface without creating streaking under the letters.

Plaster and stucco building surfaces should have a complete adhesive sealant application around the mounting clip where its fastener penetrates the building. This is to prevent water intrusion into the building.

Letters that are installed on wall surfaces below 8 feet (2438 mm) should be installed with tamperproof fasteners. This will increase the security of the letters against vandalism or theft.

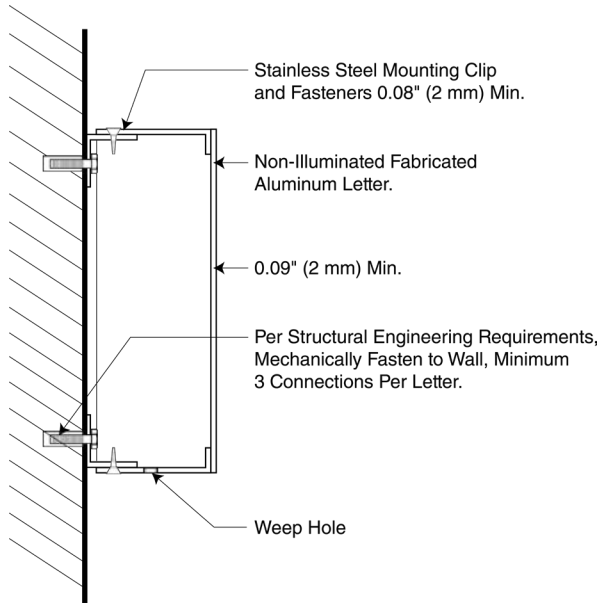

Detail 4 - Mounting: Illuminated Letters

Installation of these letters should be done only by a licensed electrical sign company.

Consult with a local electrical sign company regarding the wall surface, accessibility, and method of installation.

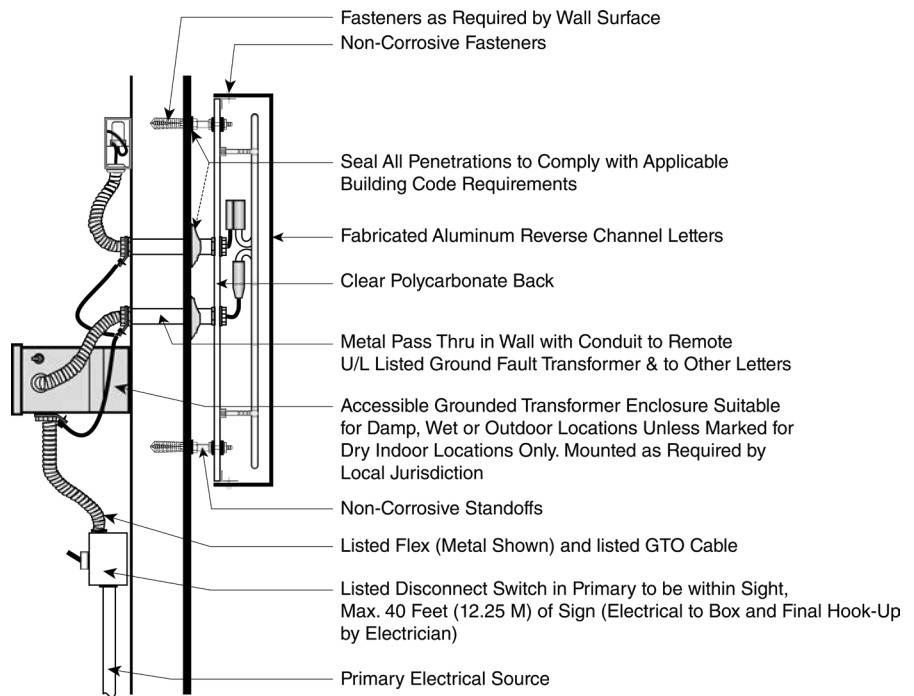

Installation**Exterior Signage Guidelines****Detail 5 - Wall Mounting:
Non-Illuminated Signs**

Aluminum wall panel signs shall be fastened with a minimum of 2 mechanical fasteners.

Anchors should be provided in the wall that are suitable for the particular type of wall surface where the sign is being installed.

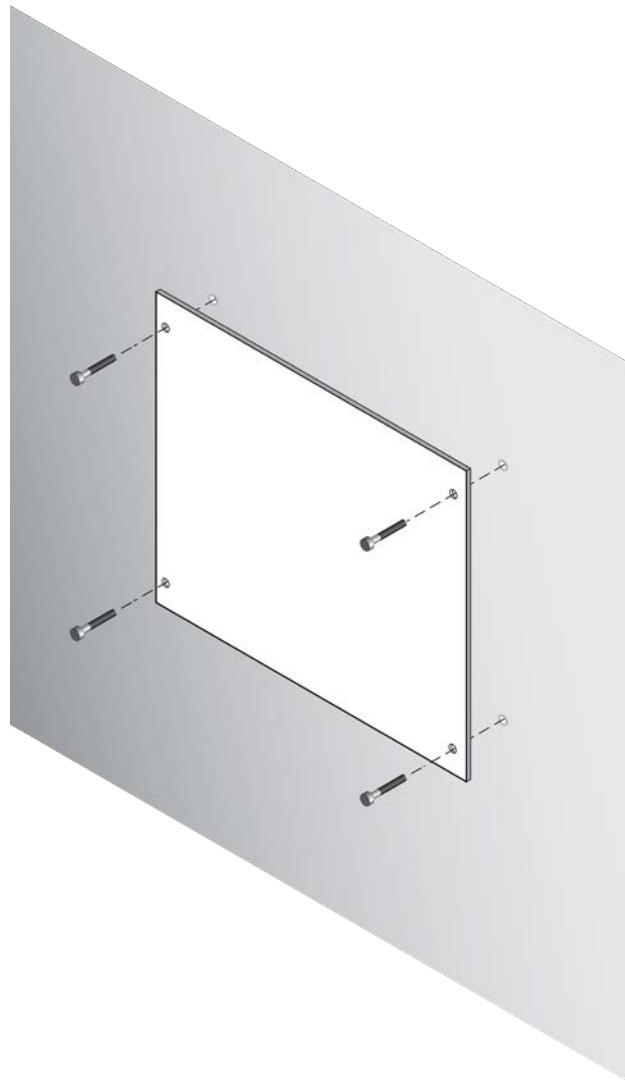



U.S. Department
of Veterans Affairs

SECTION 2.6

PARKING STRUCTURE SIGNAGE GUIDELINES



2.6.1 PLANNING

Whether the need for parking structure signage arises as part of new construction, a facility wide signage upgrade, or as a standalone project, it must be coordinated with the campus wayfinding master plan. For more information on developing a comprehensive wayfinding master plan, see [Section 1.2 Fundamentals of Wayfinding](#).

Site Evaluation

A detailed site evaluation must be performed when planning a parking structure signage project. To begin the site evaluation, obtain plans of the site and parking garage. Plans need to be to scale with a notation of cardinal direction, usually North, and should indicate all entrances, exits, and direction of traffic, as well as all stairs and elevators. If the plans do not illustrate how the structure is oriented within the campus plan or how it relates to other buildings, you may need to obtain additional campus and building plans. Request the document format that matches your software capabilities. (Note: CAD and BIM files can be printed as PDF drawings and imported into Adobe Illustrator or other similar programs).

During the Site Evaluation

Drive and walk all vehicular and pedestrian pathways of the parking structure. Below are general tasks and considerations. The site evaluation and information collected may vary depending on the size and configuration of the structure. (ex: 2 levels below ground vs 8 levels detached from the medical center).

Perform the following tasks during the evaluation:

- Document all existing conditions, postings, and signs. A detailed photo essay is a valuable tool when developing a wayfinding master plan, creating presentation documents, programming the system, and discussing various signage needs in the future. Make sure to obtain VA approval before taking photos.
- Study the visibility of the parking structure from highways, main roads, campus entrances, and campus roadways. Consider the value of placing skyline signage to identify the facility, parking structure, or both.
- Identify vehicular and pedestrian points of entry and exits.
- Analyze vehicular and pedestrian paths of travel.
- Analyze the vehicular circulation pattern on and between levels of the structure.
- Locate intersections and decision points.
- Locate all elevator lobbies and stairs.
- Analyze the parking structure's connections to other buildings, and whether the conditions cause confusion as to which level a visitor is entering or exiting.
- Annotate environmental conditions: Ceiling structure, clearance height, sight lines, viewing distance, lighting, utilities, obstructions, grading, all play into the type of sign solution selected for each location.



Planning

Parking Structure Signage Guidelines

During the Site Evaluation (Continued)

- **Meet with VA Stakeholders:**
 - Discuss future plans that may affect existing conditions or locations of various departments or services (construction, renovations, relocations, etc.).
 - Review facility-wide policies, procedures, and regulations that may influence signage or wayfinding.
 - Meet with VA police to review traffic, policy, or parking procedures currently in place or that may be planned.
 - Solicit feedback from Staff and Veteran user groups.
 - Consider the impact of skyline signage on the surrounding community.

Questions to Consider During the Site Evaluation

The questions below provide a starting point to develop a wayfinding plan for parking structures. Consider the perspective of first-time patients and visitors and what they encounter along their journey.

- Is the parking structure easily seen and identified from major roadways and campus entrances?
- Is the structure attached to other buildings, above or below ground?
- How is the vehicular circulation system configured?
- Are visitors currently getting confused by signage and regulations when approaching and within the parking structure?
- Is this structure for patients and visitors, staff only, or both?
- Where are building entrances located in relation to parking?
- If the facility has multiple parking lots or garages, should patients/visitors park in different lots or garages based on their desired destination?
- Should patients/visitors park in different locations/levels within the garage based on their desired destination?
- Where are designated staff parking spaces located?
- Where are accessible parking spaces located?
- Where are building entrances located, and how do they relate to parking locations?
- What is the desired path of pedestrian travel from parked vehicles to building entrances? Are those paths accessible?
- How do visitors currently navigate from parking spaces to building entrances?
- What are the hours of operation for the parking structure? Do they align with the hours of operation of the facility and entrances?
- Where is electricity available, and what is the voltage?
- What are lighting conditions on and around directional signs?



Planning

Parking Structure Signage Guidelines

Wayfinding Analysis

Reviewing the information gathered and answering the questions from the site survey will help establish the basis of a wayfinding plan that communicates and informs simply and directly.

First, the wayfinding plan should address how the parking garage logically fits within the context and information hierarchy of the entire campus exterior.

Second, the plan should analyze how the parking garage is color-coded or themed by level, and the connections to other buildings and structures (if applicable).

Once a potential wayfinding plan is established, it should be tested and refined using draft sign locations on vehicular and pedestrian paths of travel and intersections. What seems logical in plan view may require further refinement to simplify the amount of information from the user’s perspective at these decision points.

Refer to [Section 1.2 Fundamentals of Wayfinding](#) for additional guidance on developing a wayfinding master plan that works for your facility.

Example Exterior Campus Information Hierarchy

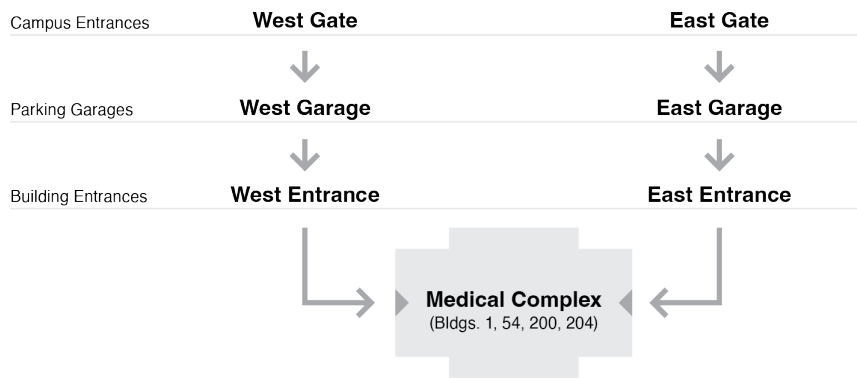

If the parking structure connects to other buildings, analyze conditions that could cause confusion as to which level a visitor is entering or exiting.



Planning

Parking Structure Signage Guidelines

Level Colors & Theming

It is recommended that any parking structure with three or more levels should have a color-coding system. The system should include a distinct color for each level of the structure to help visitors remember the level they parked on. Additionally, thematic imagery or icons can be paired with each color to further distinguish levels and aid in memory recall. Visitors with color blindness may be unable to distinguish between some of the level colors and may rely more heavily on the number and theme to remember where they parked.

Imagery should be bold and easily interpreted such as icons or silhouetted shapes. However, the imagery should be visually distinct and separate from the information on the sign so that the message can be easily read from a distance. Local landmarks, flora, and fauna are a great place to start when choosing a theme.

This example Column Level Marker incorporates the level number with distinct colors and themed imagery.



This example illustrates a variation on color palette and layout.



In this example the illustrated imagery intersects with the level number but does so with adequate contrast between the background and foreground.



Planning

Parking Structure Signage Guidelines

Painted & Applied Vinyl Graphics

Applied vinyl or painted graphics can be used in combination with the sign panels detailed in this section and [Section 3.6 Parking Structure Signage Drawings](#).

While paint or adhesive vinyl can be used interchangeably for many graphic applications within parking structures, they each have limitations and advantages. Paint can be an economical option to use on large color areas and simple wayfinding graphics. Vinyl, on the other hand, can be digitally printed on to display high-resolution imagery and CAD-cut to create complex forms and text. Although vinyl has these advantages, it can become economically unfeasible for large areas of application. It is important to weigh these factors when designing and planning parking structure graphics.

Column level markers and elevator core graphics are the primary opportunities for paint and vinyl applications. While the color and theme (e.g. mountain, forest) will vary per level, the style and placement of art, graphics, and information should remain consistent across all levels.

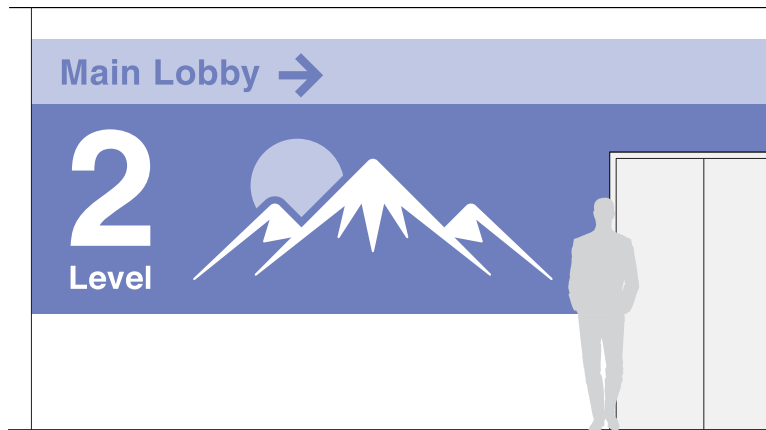

Elevator Core Graphics: Partially covering the wall height

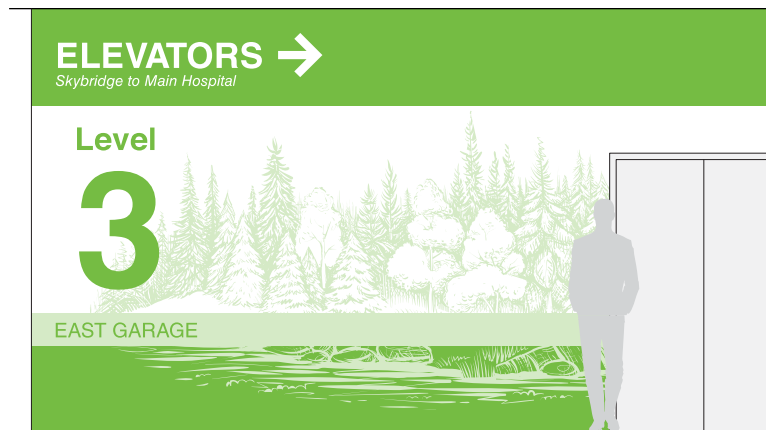

Elevator Core Graphics: Covering the wall height from floor to ceiling



Planning

Parking Structure Signage Guidelines

Column graphics may consist of a light color on a dark painted background or a dark color on a light painted background. Background color may extend the entire length of the column or may be limited to a designated area behind the painted number. Level numbers (painted, vinyl or dimensional) need to be large enough to read from a distance.

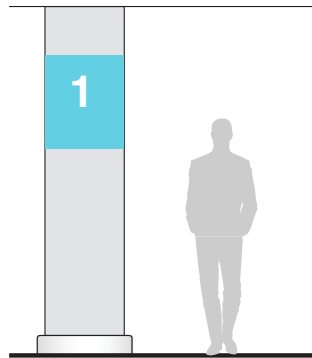

Partial Column Painted

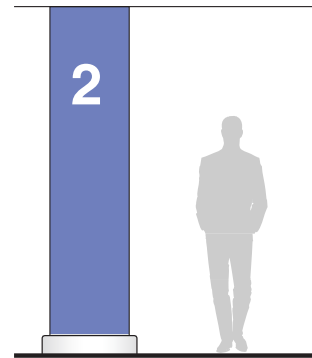

Entire Column Painted



2.6.2 PROGRAMMING

Location, Placement & Messaging

The location, placement, and messaging of signs occurs during the Programming Phase. For a large medical center, a wayfinding master plan should be developed before programming a signage system. See the planning part of this section and [Section 1.1 Planning a Sign System](#) & [Section 1.2 Fundamentals of Wayfinding](#) to approach a project.

The location plan establishes where a sign is located. The sign message schedule establishes what the message on the sign is to say. Finally, the sign drawings show the type of sign and how the information is displayed. These three documents are the main components of signage programming.

To create the sign location plan, place a mark and a location number on the plan document as a placeholder for a sign type and sign message associated with that location. In the sign message schedule spreadsheet, enter the location plan number and corresponding sign type designation, and establish the text message of what that sign says. Sign type drawings are design documents that describe the sign size, text layouts, and fabrication information.

The programming of a signage system should take place shortly before implementation to avoid errors and duplication of work. Information and existing conditions can quickly change, rendering the programming data invalid.

General Guidelines

The following are best practice guidelines that should be referred to when developing a signage program for parking structures. This is not intended to be a training section of the Manual but to provide key information, instructions, and suggestions that hopefully reduce common errors when programming a parking structure signage program.

- Never use text smaller than 3" capital letter height when a sign is intended to be read from a moving vehicle. Reference the "Viewing Distance" part of this section for more information.
- Text intended to be read by pedestrians from a distance should be a minimum of 1" capital letter height. Some informational signs intended to be read at close distance may require smaller text height.
- All sign messages intended for pedestrians should be a minimum of 24" above the floor. Vehicular sign messages should be above the minimum clearance height of the individual parking structure.
- Ensure overhead signs suspended over vehicular paths of travel have adequate clearance for trucks and other large vehicles.
- It is good practice to use reflective copy on non-illuminated vehicular directional signs.
- Consider the hours of operation of the facility and parking structure.
- Signs not located on federal property may be required to comply with local sign codes and permitting. This often applies to outpatient clinic locations. In these instances, researching local sign codes and requirements must be performed before programming and sign manufacturing. Local codes can be highly prescriptive regarding the type, size, and quantity of signs allowed.



Programming

Parking Structure Signage Guidelines

Message Content

- Keep sign messages brief.
- Use messages that the viewer can quickly read.
- With the exclusion of directional signs, all other signs should convey no more than one concept or idea.
- Consider the vehicle's speed for signs to be read from a moving vehicle. At slow speeds, the driver may be able to read 7 or 8 words. At faster speeds, they will only be able to read 4 or 5.
- Use the same wording throughout the signage program consistent with the terminology developed in the wayfinding plan.
- Signs should progressively disclose information, guiding viewers from general to specific destinations. Do not anticipate decisions that can be made later. Unnecessary or premature information will confuse the reader. Instead, provide only information necessary to decide at that specific location.
- When possible, sign messages should be worded in a positive tone to improve the viewer's experience.

Message Layout

- Use title case (capitalization of the first letter of each word) text on directional and identification sign messages whenever possible. Title case text is easier to read and is understood faster than text in all capital letters.
- Line spacing between two different messages should be greater than line spacing between lines of the same multi-line message group.
- Message areas should have margins on all four sides. Text should not go to the edge of the viewable message area.
- If a line of text needs to be reduced to fit on a sign, use only commonly understood abbreviations or decrease the text size for the entire message. It is typically not recommended to condense the typeface.

Sign Size

- Lighting conditions within parking structures are often dim during the day with minimal lighting at night. Sign messages should be large enough and with sufficient color contrast to be read in low light conditions.
- Lettering and sign panel size should be appropriate for the distance and speed at which a sign is viewed.
- Signs intended to be seen from a moving vehicle need to be larger and require larger text than signs intended for pedestrians.

Viewing Distance

The following charts aid in determining the size of text in relation to the distance a sign is to be read. These charts are general, and some situations may require larger text than what is indicated.













Programming

Parking Structure Signage Guidelines

Viewing Distance Chart

Text

Viewing Distance Up To:		Letter Height		Application
7.5 M	25'	25 mm	1"	
12 M	40'	40 mm	1 1/2"	
15 M	50'	50 mm	2"	
24 M	80'	75 mm	3"	
33 M	110'	100 mm	4"	
48 M	160'	150 mm	6"	
75 M	250'	225 mm	9"	
97.5 M	325'	300 mm	12"	
150 M	500'	450 mm	18"	
195 M	650'	600 mm	24"	

Symbols

Viewing Distance Up To:		Letter Height	
7.5 M	25'	75 mm	3"
10.5 M	35'	100 mm	4"
15 M	50'	125 mm	5"
18 M	60'	150 mm	6"
30 M	100'	200 mm	8"
34.5 M	115'	225 mm	9"
39 M	130'	250 mm	10"
45 M	150'	300 mm	12"

Sign Placement Considerations

- Always evaluate a sign’s placement at night and in the daylight. Lighting conditions and visibility may change at night or sunset, making a specific placement unsuitable.
- For illuminated signs, consider where suitable electrical utilities are located.
- Signs placed at the head of a parking stall need to be set far enough away that the bumper of a car does not strike the sign.
- Ensure ceilings and bulkheads do not obstruct the view of overhead signage from an adequate viewing distance.

Existing Signage program

Before implementing a new signage program, perform a thorough evaluation of the demolition requirements of the current signage program and the effects and impact on the parking structure.

Check to see what is required to patch, seal, and repair building penetrations and surfaces exposed as a result of the removal of signs or letters. Repairs should be planned to match adjoining surfaces.

Make sure the sign demolition scope of work requires the contractor to close off any live electrical connections. Remove existing conductors and conduit to the nearest junction box and make it safe.

Be sure to clearly identify signs that are supposed to remain. DO NOT remove any traffic signs without having the replacement signs available and installed at the time the old signs are removed.



2.6.3 SIGN OVERVIEW

The following overview illustrates parking structure signs for VA leased or owned facilities. For exterior Mandatory VA Policy & Directive signage refer to [Section 2.3 Mandatory VA Policy & Directive Signage Guidelines](#).

[Section 3.6 Parking Structure Signage Drawings](#) of this manual provides detailed drawings of each of these signs.

The drawings can be used as a starting point to develop a facility specific parking garage sign standard using colors, graphics and icons that tie into the wayfinding plan.

For more information on developing the look of the signage system, including VA standard fonts and arrows, refer to [Section 4.1 Design Elements](#).

Sign Designation

Each sign in the program manual has been given a specific sign type number designation. This designation provides a common description that can be referenced when programming a site and ordering signs. The following explains how the sign type designations are derived.

PS - 01 .01 A

- PS** Designates a parking structure sign.
- 01** Two digit number identifies the sign type family.
- .01** The two digit number following the period identifies a specific sign within the sign family.
- A** The letter designates a specific sign configuration, version and / or layout for graphics or symbols.



Sign Overview

Parking Structure Signage Guidelines

Sign Type PS-01

Ceiling-hung non-illuminated directional sign with vinyl lettering

PS-01.01

22" – Long Ceiling-Hung Directional

PS-01.02

22" – Short Ceiling-Hung Directional

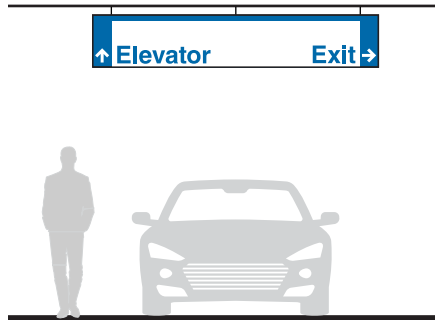

PS-01.01

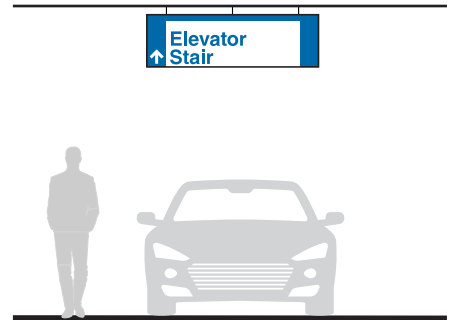

PS-01.02



PS-01.03



PS-01.04

PS-01.03

15" – Long Ceiling-Hung Directional

PS-01.04

15" – Short Ceiling-Hung Directional

Sign Type PS-02

Beam-mounted non-illuminated directional sign with vinyl lettering

PS-02.01

22" – Long Beam-Mounted Directional

PS-02.02

22" – Short Beam-Mounted Directional

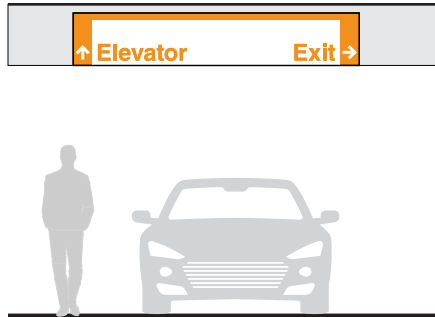

PS-02.01

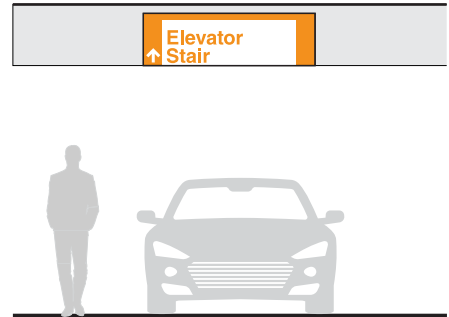

PS-02.02



PS-02.03



PS-02.04

PS-02.03

15" – Long Beam-Mounted Directional

PS-02.04

15" – Short Beam-Mounted Directional



Sign Overview

Parking Structure Signage Guidelines

Sign Type PS-03

Wall mounted directional

PS-03.01

Small Wall-Mounted Level and Directional

PS-03.02

Large Wall-Mounted Level and Directional

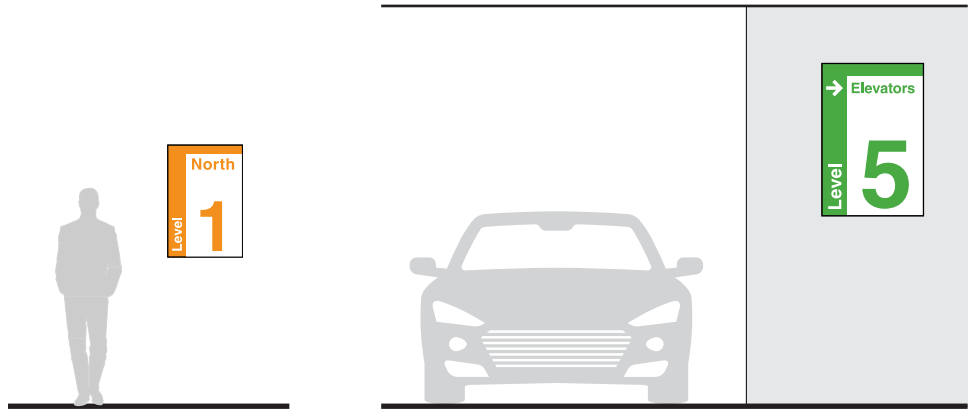

PS-03.01

PS-03.02

PS-03.03

Elevator Core Branding and Directional



PS-03.03

Sign Type PS-04

Wall-mounted warning sign

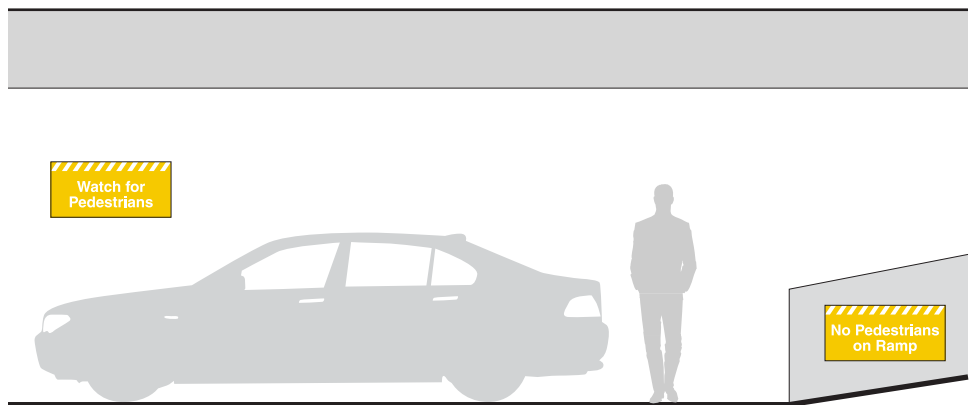

PS-04



Sign Overview

Parking Structure Signage Guidelines

Sign Type PS-05

Vehicular oriented column level marker

PS-05.01

Square Column Marker

PS-05.02

Narrow Column Marker



PS-05.01

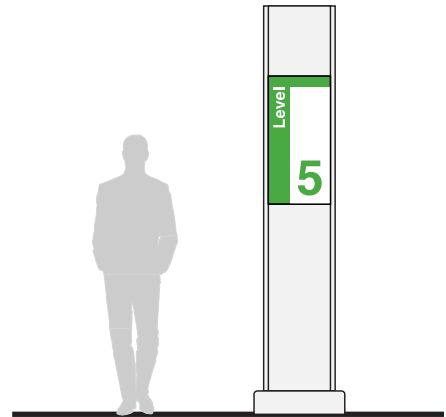

PS-05.02

PS-05.03

Round Column Marker

PS-05.04

Small Round Column Marker - Painted

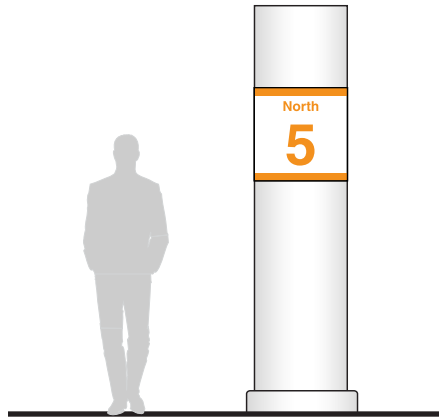

PS-05.03

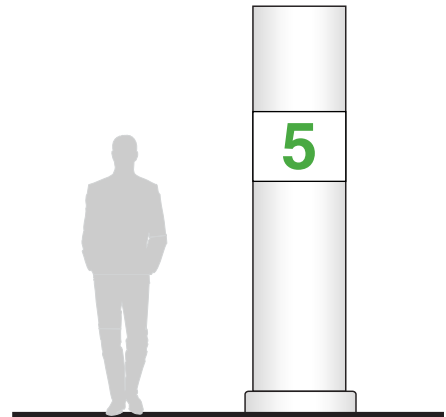

PS-05.04

PS-05.05

Pole-Mounted Marker

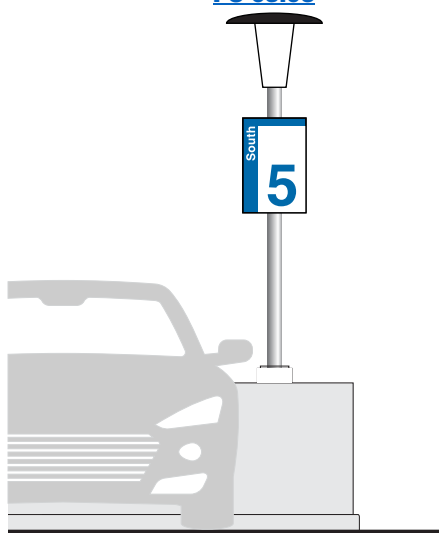

PS-05.05



Sign Overview

Parking Structure Signage Guidelines

Sign Type PS-06
Elevator Identification

Sign Type PS-07
Elevator Level Directory

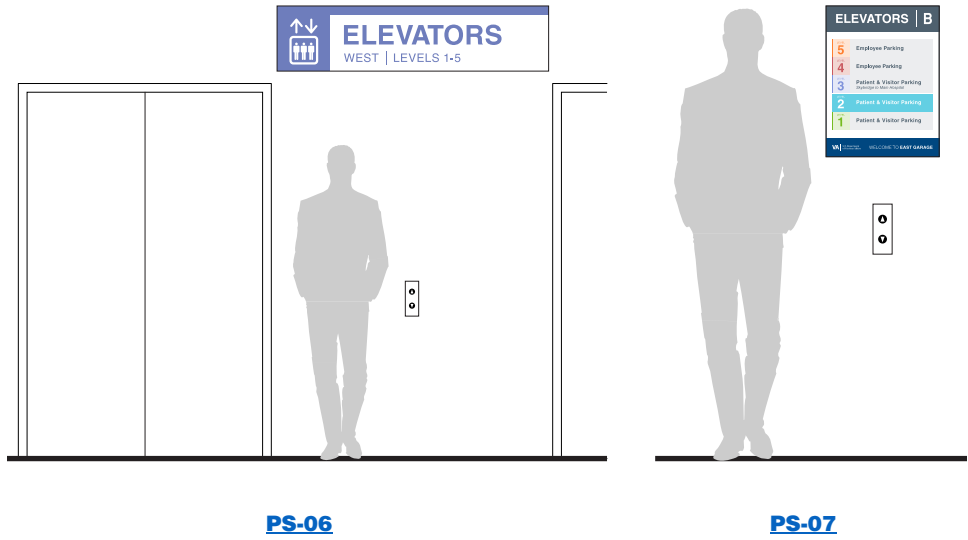

Sign Type PS-08, PS-09, & PS-10
Entrance / Occupancy signs

PS-08
Dimensional Letters

PS-09
Clearance Height Bar

PS-10
Electronic Lane Use Sign

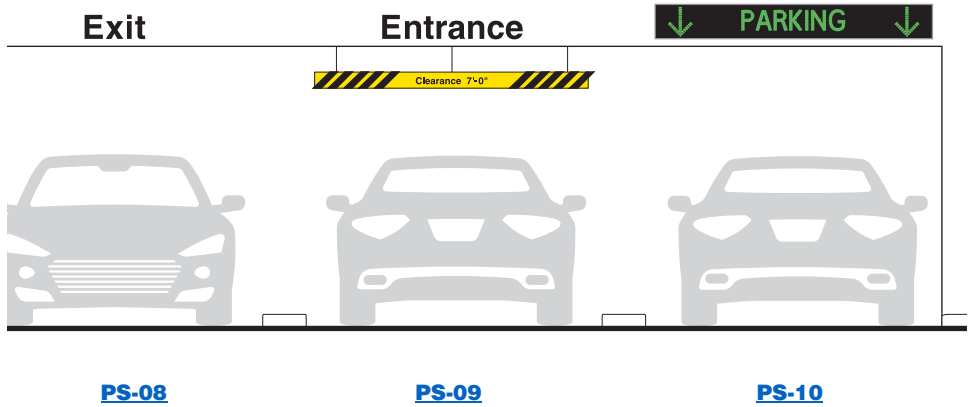

Sign Type PS-11
Entrance and Exit Identification

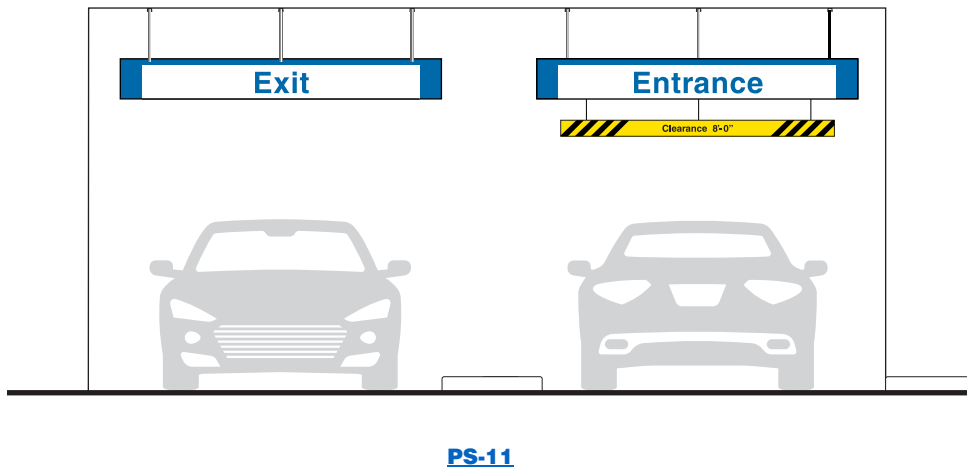

Sign Overview

Parking Structure Signage Guidelines

Sign Type PS-12
Panel informational signs

PS-12.03
Parking Stall Designation

PS-12.04
Accessible Parking Stall

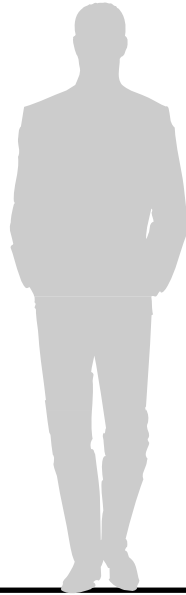

PS-12.03



PS-12.04



PS-12.05

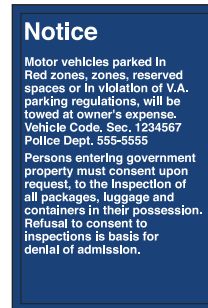

PS-12.07

PS-12.05
Accessible Parking Area

PS-12.07
Informational Panel



Sign Overview

Parking Structure Signage Guidelines

Sign Type PS-13
Electronic Stall Availability Sign

Sign Type PS-14
Exterior Building-Mounted Parking
Directional / Availability Sign

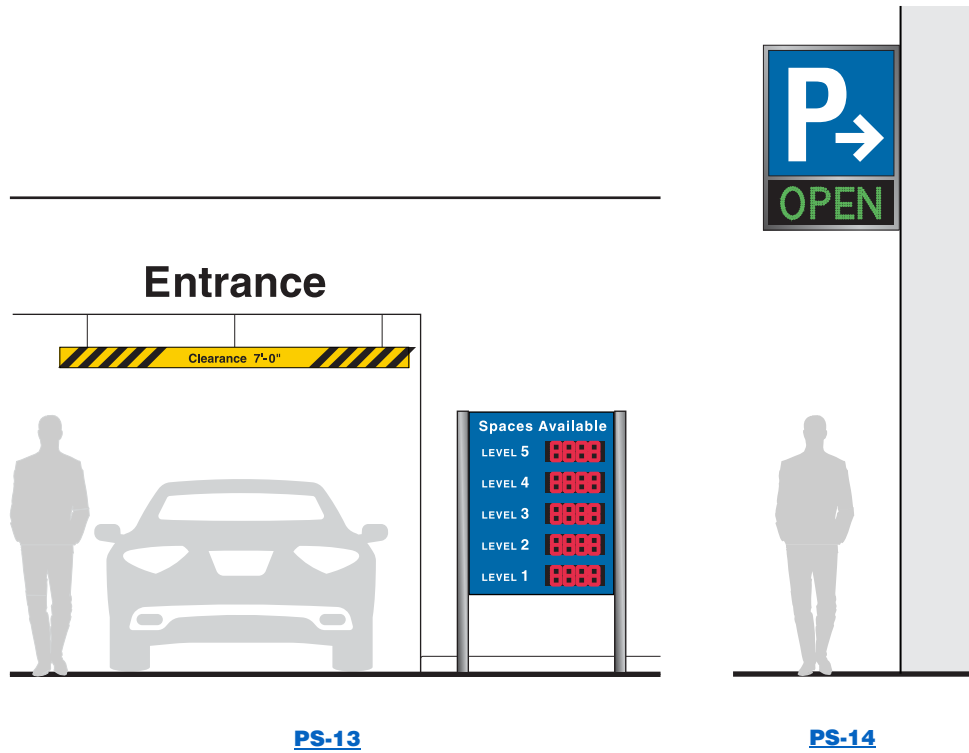

Sign Type PS-15
Painted Parking Stall Identification

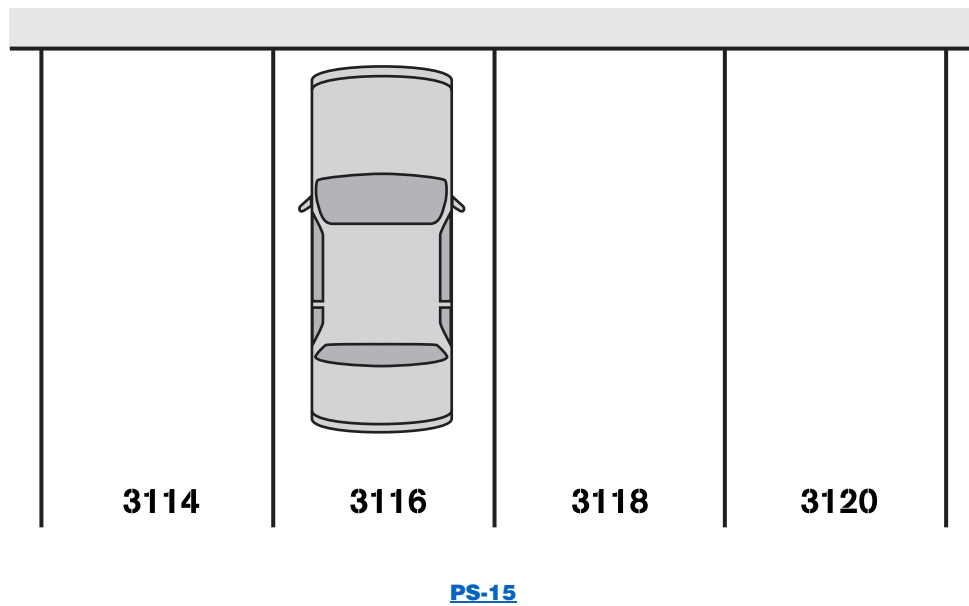

Sign Overview

Parking Structure Signage Guidelines

Informational Signs

Coordinate with signs from other Sections as required.

See [Section 3.1 Interior Signage Drawings](#) and [Section 3.2 Code & Life Safety Signage Drawings](#) for more information.

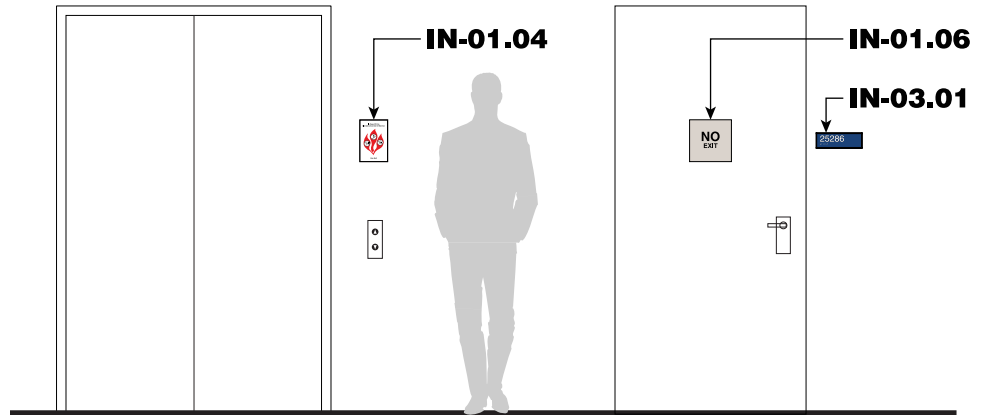

Informational Signs

Regulatory Signs

Refer to Sign Type EN-10 in [Section 3.5 Exterior Signage Drawings](#) for more information.

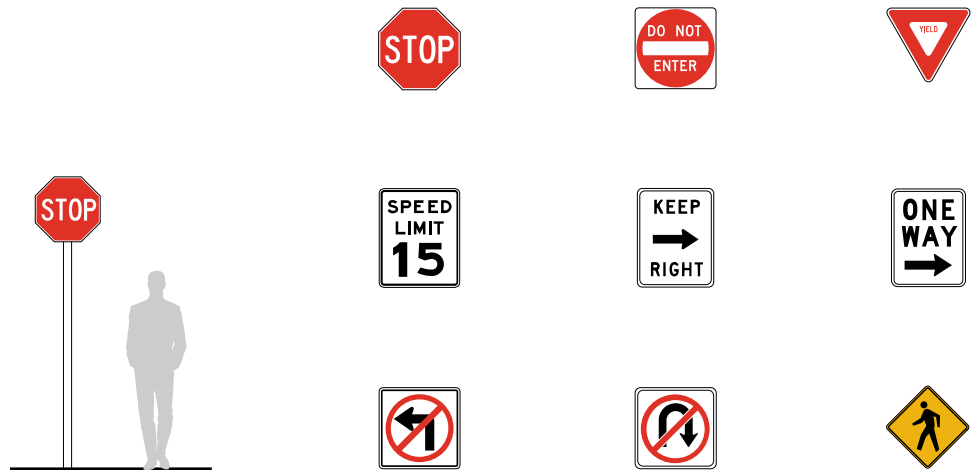

Regulatory Signs



2.6.4 SPECIFICATIONS

The specifications for signs are available in the Master Construction Specifications (PG-18-1) area of the VA Technical Information Library, which is available on the VA web site under Office of Construction & Facilities Management.

Visit online: www.cfm.va.gov/til/spec.asp#10

Refer to Signage in the specifications, Division 10, Section 10 14 00.

For more information regarding specifications, contact the Office of Construction & Facilities Management, Facility Standards Service.

When preparing the specifications for a project, it will be necessary to adapt them to the individual facility and project. This may include information regarding the facility specific signage system standards, colors / finishes, and project requirements such as specific sign types or installation requirements.

Depending on the project type, signage specifications can include the Sign Message Schedule, Sign Location Plans, and Sign Drawings. The Sign Message Schedule is a table that lists each sign's location number, sign type, and message, as well as other relevant details. The Sign Location Plans are a set of architectural plans showing numbered tags at the location of each sign. Sign Drawings illustrate the details and design intent for each sign type in the system. This information is required by the sign manufacturer and installer for production and implementation of the signs.

More information about signage system planning and programming, and submittal examples can be found in [Section 1.1 Planning a Sign System](#) of the VA Signage Design Manual.



Construction **Parking Structure Signage Guidelines**

2.6.5 CONSTRUCTION

Detail 1 – Cable Suspension:

Sign Types: PS-01.01, PS-01.02, PS-01.03, & PS-01.04

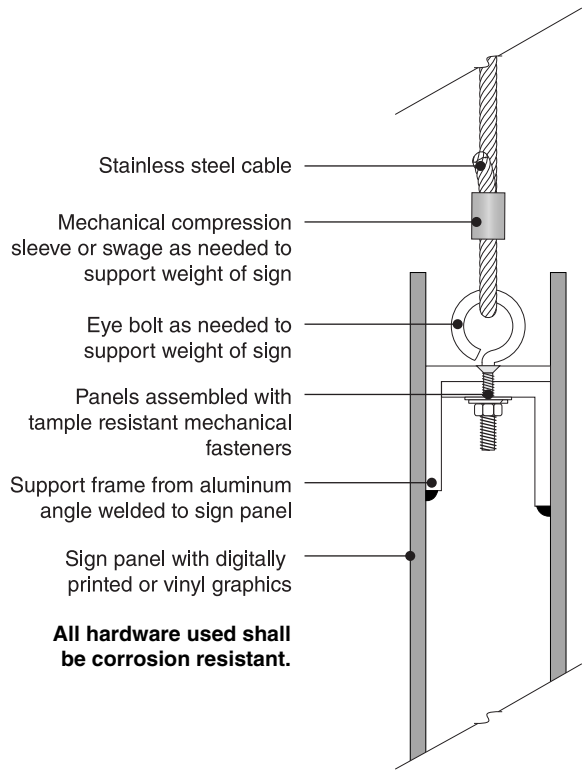

Detail 2 – Beam Mounting:

Sign Types: PS-02.01, PS-02.02, PS-02.03, & PS-02.04

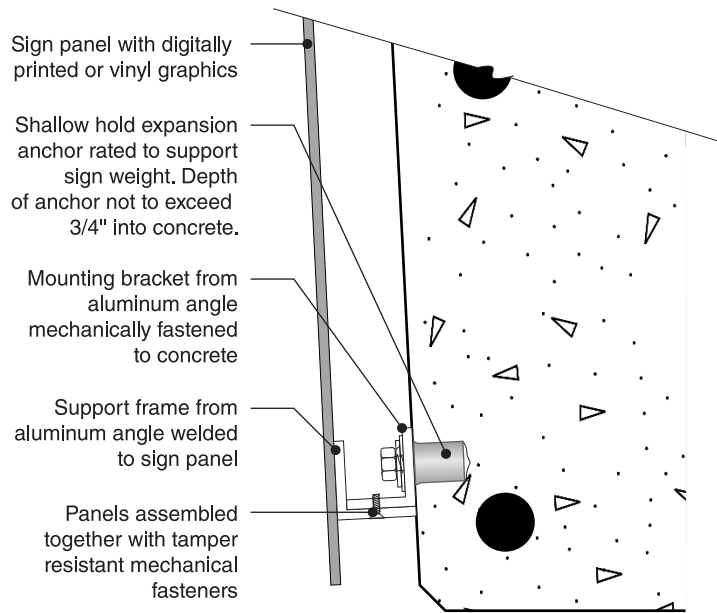

All hardware used shall be corrosion resistant.



Construction

Parking Structure Signage Guidelines

Detail 3 – Square Column Mounting:

Sign Types: PS-05.01, PS-05.02, PS-03, & PS-04

Drive rivet nail-in anchor with heads painted to match adjacent color. Depth of anchor not to exceed 3/4" into concrete.

Sign panel with digitally printed or vinyl graphics

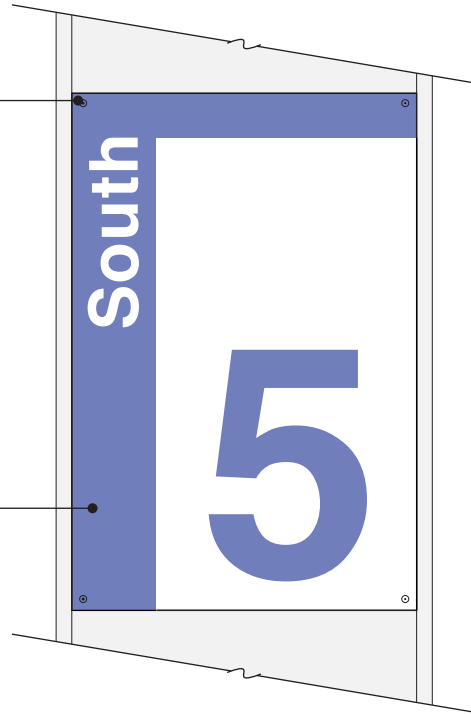

Detail 4 – Round Column Mounting

Sign Type: PS-05.03

Drive rivet nail-in anchor with heads painted to match adjacent color. Depth of anchor not to exceed 3/4" into concrete.

Sign panel with digitally printed or vinyl graphics. Bend as needed to match curvature of column.

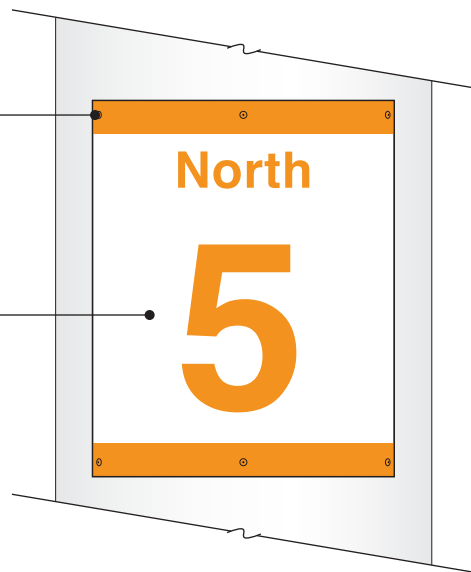

Construction

Parking Structure Signage Guidelines

Detail 5 – Entrance / Exit Sign with Clearance Height Bar Mounting:

Sign Type: PS-09 & PS-11

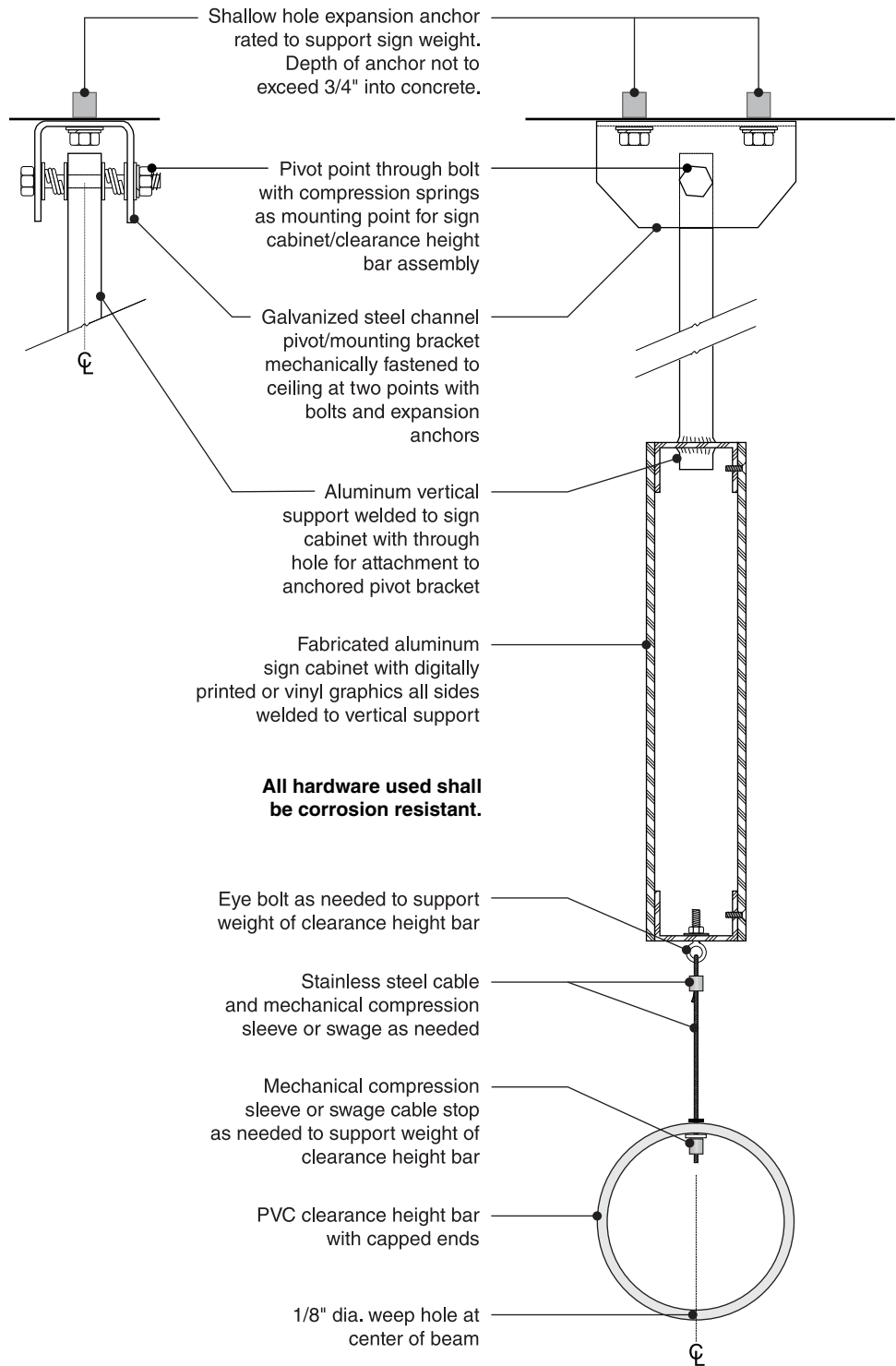

Installation **Parking Structure Signage Guidelines**

2.6.6 INSTALLATION

Detail 1 – Cable Suspension:

Sign Types: PS-01.01, PS-01.02, PS-01.03, & PS-01.04

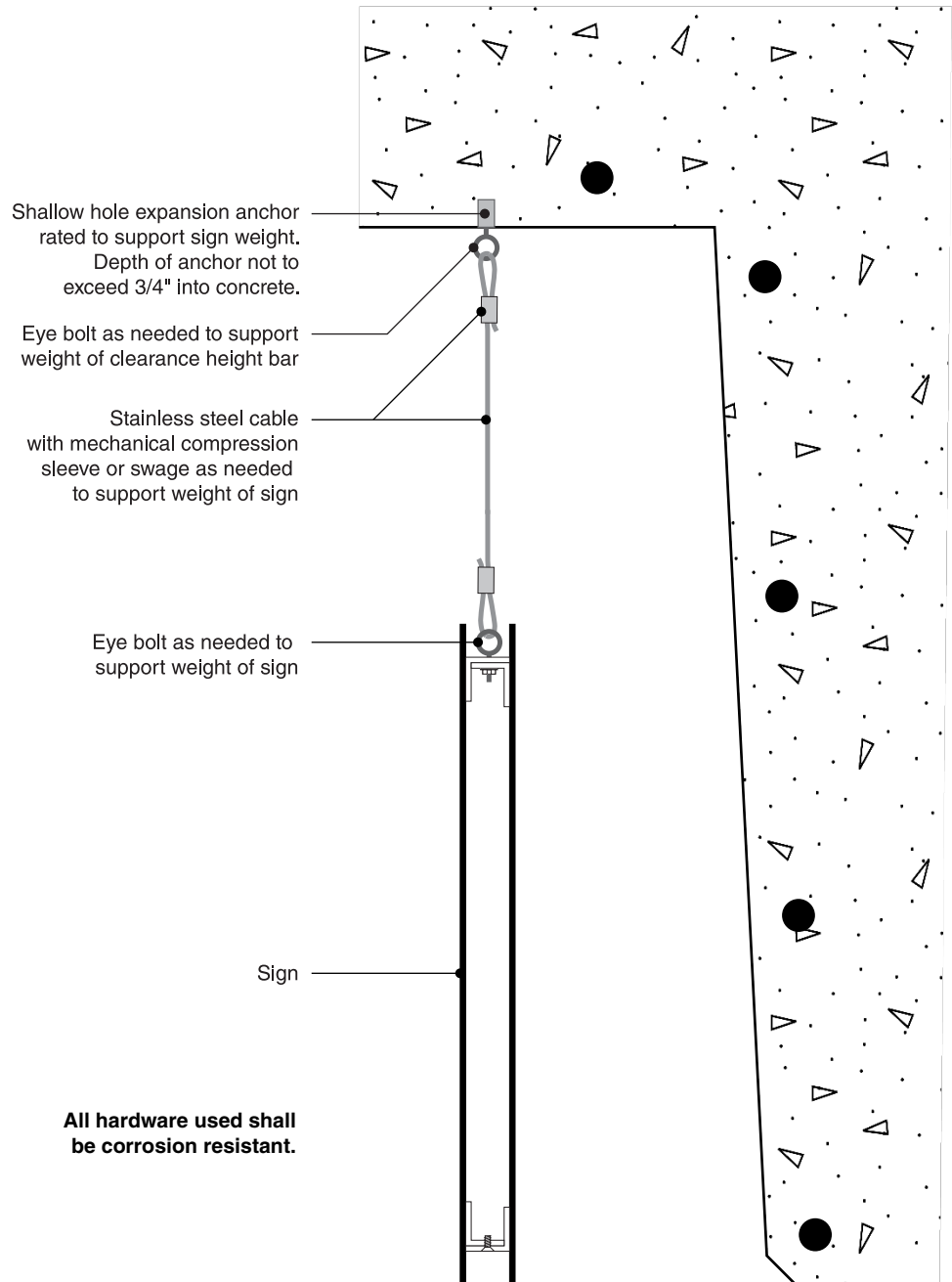

Installation

Parking Structure Signage Guidelines

Detail 2 – Cable Suspension Cross Bracing:

Sign Types: PS-01.01, PS-01.02, PS-01.03, & PS-01.04

Note: Hanging signs subjected to windy conditions should be mounted with 3 wires

Cross bracing cable hanging method to be used on all hanging signs where the ceiling to sign hang distance is 2'-0" or greater, or in areas of excessive wind.

Shallow hole expansion anchor rated to support sign weight.
Depth of anchor not to exceed 3/4" into concrete.

Stainless steel cable cross bracing with mechanical compression sleeve or swage as needed to support weight of sign

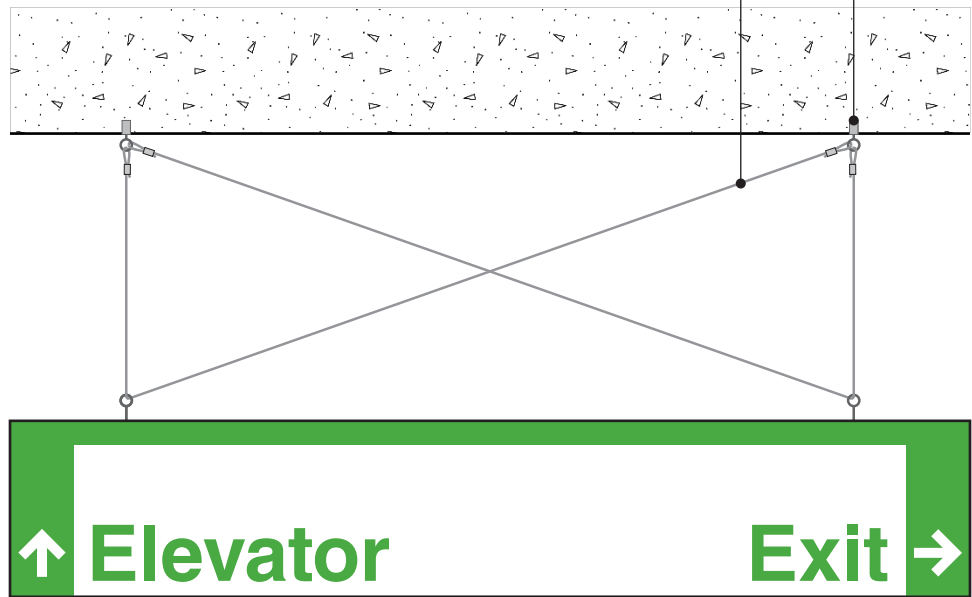

Detail 3 – Beam Mounting:

Sign Types: PS-02.01, PS-02.02, PS-02.03, & PS-02.04

Mounting bracket from interlocking angle with set screw attachment to sign panel

All hardware used shall be corrosion resistant.

Sign

Shallow hole expansion anchor rated to support sign weight.
Depth of anchor not to exceed 3/4" into concrete.

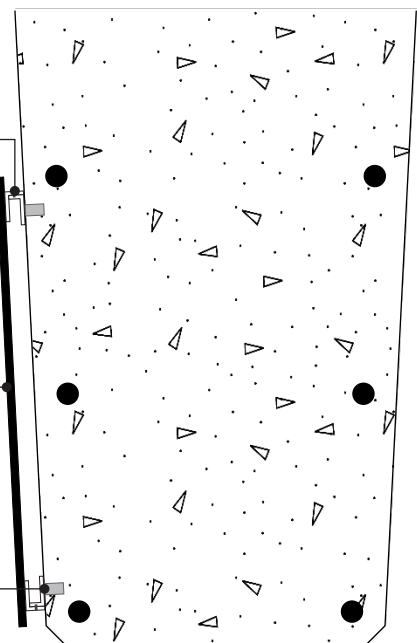

Installation

Parking Structure Signage Guidelines

Detail 4 – Square Column Mounting:

Sign Types: PS-05.01 & PS-05.02

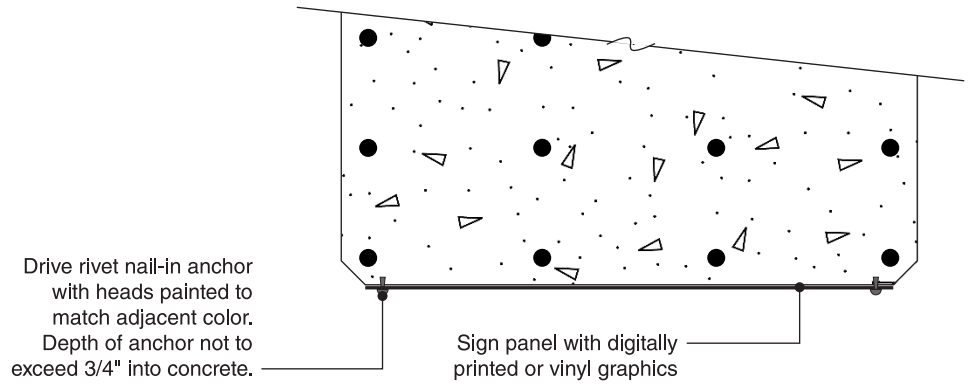

Detail 5 – Round Column Mounting:

Sign Types: PS-05.03

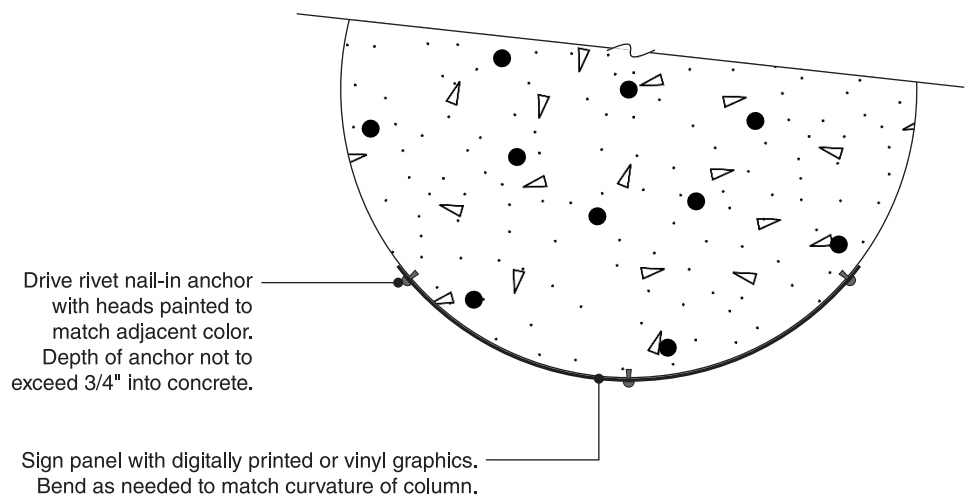

Installation**Parking Structure Signage Guidelines****Detail 6 - Wall Mounting:
Non-Illuminated Signs**

Aluminum wall panel signs shall be fastened with a minimum of 2 mechanical fasteners.

Anchors should be provided in the wall that are suitable for the particular type of wall surface where the sign is being installed.

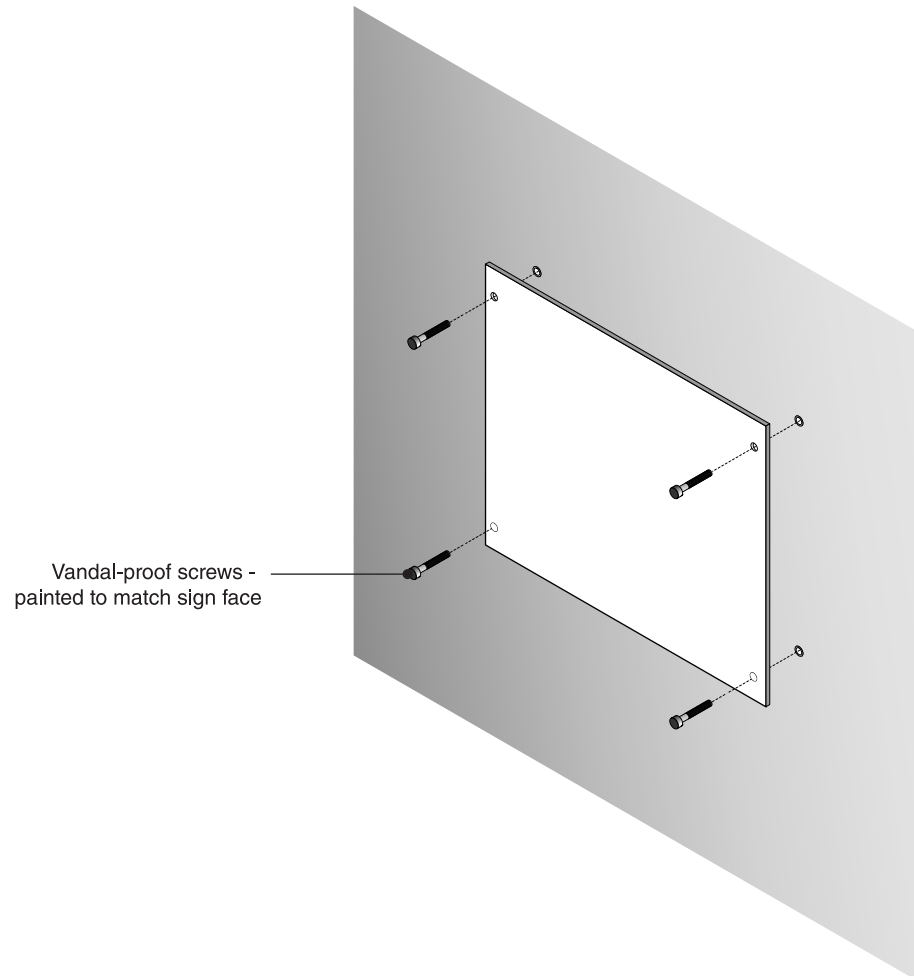



U.S. Department
of Veterans Affairs

SECTION 2.7

NATIONAL CEMETERY ADMINISTRATION SIGNAGE GUIDELINES



2.7.1 PLANNING

The National Cemetery Administration follows different signage design standards (font, sign types, construction, etc.) than VHA facilities due to the differing conditions, aesthetics, and purpose.

A successful signage program should be planned as an integrated whole. The design, placement, and messaging of all components of the signage system, including the site identification, informational, directional, street and building identification signs, as well as burial section markers must be considered.

Site Evaluation

When developing a new signage program or performing updates to it, a detailed site evaluation needs to be performed. To begin the site evaluation, obtain a site plan of the campus. This plan needs to be to-scale with a notation of cardinal direction, such as North, and to identify all major and minor roadways, driveways, alleys, access roads, and parking lots and structures. It should also indicate sidewalks, pathways, cross walks, ramps, and stairways. Request the document format that matches your software capabilities. (Note: CAD and BIM files can be printed as PDF drawings and imported into Adobe Illustrator or other similar programs).

During the Site Evaluation

- Conduct a photo essay of all existing signage, campus entrances, intersections, parking lots, pedestrian paths, buildings and building entrances.
- Observe and map out all circulation routes, and desired paths of travel (vehicular and pedestrian).
- Identify cemetery entrances, roadways, parking lots, pedestrian paths, section markers, and buildings / structures. Ensure there are logical and appropriate names.
- Locate existing signage (if applicable).

Reviewing the information gathered from the site survey will help establish the basis of a clear signage plan that communicates and informs in a direct and simple manner.

Develop a Signage System Standard

The first step in selecting signs for a site is choosing the sign post family and style. The sign type illustrations included in this section show the different post families and styles which include precast concrete or metal post configurations. Once a post family and style has been selected, that style and product line should become the standard for all signs in the cemetery.

- When selecting a sign post one should consider choosing an option that is reflective of the regional aesthetic of the individual cemetery. Refer to the Design Elements section for colors, fonts, and other design details specific to National Cemetery Administration Signs.
- Once the Family and Style have been established, specific sign types can be selected. Sign type drawing numbers specify use such as Directional, Informational, Identification or Traffic signs.



2.7.2 PROGRAMMING

The location, placement, and messaging of a signage system takes place during the Programming phase. These guidelines will help to establish a clear and consistent signage program:

General Guidelines

- Never use text smaller than 3" capital letter height when a sign is intended to be read from a moving vehicle.
- Text intended to be read by pedestrians should be a minimum of 1" capital letter height.
- Use text that is familiar, easy to understand, and comfortable to the viewer.
- Always use the same words, names, or titles throughout the signage program.
- All sign messages need to be a minimum of 24" above grade.
- All signs should be placed in a manner that will be clearly visible to a driver at all times of the year. For example, make sure that snow or removal piles do not bury signs.
- Do not place signs in locations where people may walk into them, or where they will constrict accessible paths of travel. Do not place signs any closer than 12" from a walkway.
- Do not place signs too close to curbs. Car overhangs and door swings should be considered.
- Signs placed at the head of a parking stall need to be set far enough away that the bumper of a car does not strike the sign.
- Signs that receive spray from irrigation sprinklers will show a buildup of residue from the minerals in the water, resulting in a poor appearance. The sign's life could be shortened depending on the materials used in its construction.
- Signs require maintenance. Cleaning and waxing will extend the life of exterior signs.
- Be aware that landscaping around signs will need to be regularly trimmed to prevent plants from obscuring the signs.

Visibility

Exterior signs communicate to both drivers and pedestrians, and placement should be planned for optimal visibility in relation to the intended viewer. Signs should be installed at optimal viewing height for the speed and distance of the viewer. Avoid installing where conditions obstruct the viewing of the sign.

Always evaluate a sign's placement at night as well as in the daylight. Lighting conditions and visibility may change at night, or at sunset, making a specific location unsuitable. Additional placement guidelines found in the installation portion of this section will help to improve visibility.



Programming**National Cemetery Administration Signage Guidelines****Readability**

Sign messages should have the correct letter height to be read at the speed and distance of the viewer. Additionally, consider the potential effects the sign's design and content have on drivers. Signs with too much information can create confusion and slow traffic.

Coordination

It is necessary to coordinate with irrigation systems, electrical service, and other underground utilities. Ideally this is done during the Planning and Programming phases.

Climate

Every site has different climate conditions that effect an exterior signage program. Wind load, snowfall, and frost line impact the post length and footing depth required for sign installation. See the map of Footing Size Configurations in the Installation portion of this section for more information.



2.7.3 SPECIFICATIONS

The specifications for signs are available in the Master Construction Specifications (PG-18-1) area of the VA Technical Information Library, which is available on the VA website under Office of Construction & Facilities Management.

Visit online: www.cfm.va.gov/til/spec.asp#10

Refer to Signage in the specifications, Division 10, Section 10 14 00.

For more information regarding specifications, contact the Office of Construction & Facilities Management, Facility Standards Service.



2.7.4 SIGNPOST FAMILIES

Sign Post Family

The standard sign post family and style options are illustrated here. The cast concrete family has two style options for the recessed area of the post: C1 has square recess areas and C2 has rounded recessed areas. The metal post family has two options for the profile of the post: M1 has a squared post profile and M2 has a rectangular post profile.



Post: c1

Concrete with square recess

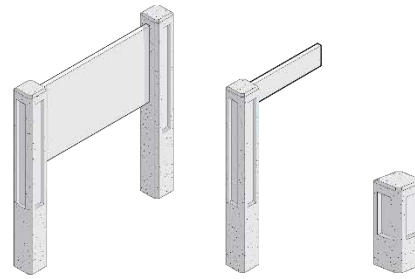

Concrete Post Family - Square Recess Style

c1 – Pre Cast Concrete with square detail in 5 1/2" and 7-1/2"

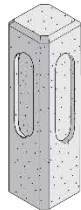

Post: c2

Concrete with round recess

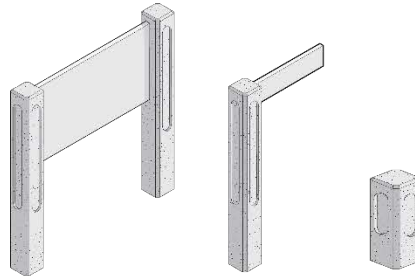

Concrete Post Family – Round Recess Style

c2 – Pre Cast Concrete post with round detail in 5 1/2" and 7-1/2"



Post: m1

Metal post

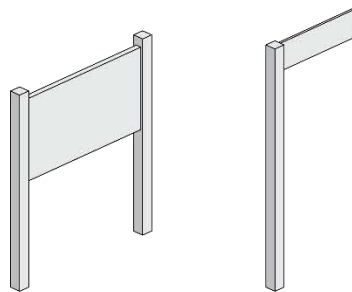

Metal Post Family – Square Post Style

m1 – Metal post in square size. 2" x 2", 6" x 6", 8" x 8"



Post: m2

Metal post

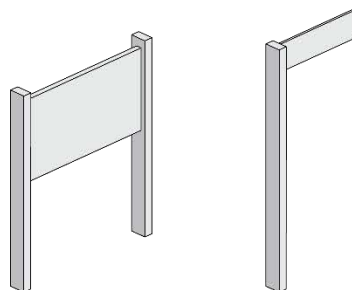

Metal Post Family - Rectangle Post Style

m2 – Metal post in rectangle size. 2" x 4"



2.7.5 DESIGN ELEMENTS

Typeface

The preferred typefaces for the National Cemetery System are Optima Bold and Times Roman Bold. Helvetica Bold is the standard typeface for the VA signage program and can be used throughout the signage program.

Signs identifying permanent rooms shall be ABA compliant, to accommodate the visually impaired. ABA compliant signs must have tactile letters in all caps with accompanying Grade 2 Braille.

All non-ABA compliant signs are to maintain an upper and lower case (title case) format.

National Cemetery projects may use Optima Bold or Times Roman Bold for dimensional letters on entry and columbarium walls.

Arrows

Illustrations show the recommended arrow for use in the VA signage program. The arrow is always centered within a square field. Electronic files for arrow illustrations are available for download from the Technical Information Library.

Arrow Alignment with Text

The arrow is always positioned in such a manner that it is centered in relationship to the capital letter that it precedes. The standard position for arrows, in relationship to text, is either on the left of the first line of text or immediately above the first line of text.

On signs with numerous destinations, a single arrow will be placed adjacent to the first line of text to identify the direction for all destinations grouped together.

It is recommended on typical directional signs that the arrow size is at least one and one half (1 1/2) times the capital letter height.

National Cemetery Preferred Typeface - Optima Bold

ABCDEFGHIJKLMNOPQRSTUVWXYZ
abcdefghijklmnopqrstuvwxyz
1234567890

National Cemetery Preferred Typeface – Times Roman Bold

ABCDEFGHIJKLMNOPQRSTUVWXYZ
abcdefghijklmnopqrstuvwxyz
1234567890

VA Primary Typeface – Helvetica Bold

ABCDEFGHIJKLMNOPQRSTUVWXYZ
abcdefghijklmnopqrstuvwxyz
1234567890

VA Secondary & ABA Compliant Typeface – Helvetica Regular

ABCDEFGHIJKLMNOPQRSTUVWXYZ
 abcdefghijklmnopqrstuvwxyz
 1234567890

Special Conditions (Not ABA Compliant) – Helvetica Bold Condensed

ABCDEFGHIJKLMNOPQRSTUVWXYZ
abcdefghijklmnopqrstuvwxyz
1234567890



Design Elements

National Cemetery Administration Signage Guidelines

Seal

The Seal is for use on the main entry wall. The seal shall be bas-relief in cast bronze only.

Refer to [VA Technical Information Library](#) on the VA web site for more information on the seal. All seals must conform to the master artwork which is available from the Department of Veterans Affairs.



Color

Background color of sign panels: bronze/dark brown, dark green or black unless noted otherwise.

Concrete color: Natural or other integrally colored concrete as selected on a case-by-case basis.

Traffic sign colors will comply with U.S. Department of Transportation (DOT) Standard Highway Signs

Copy Color: Reflective white, equal to engineering grade 3M Scotchlite

NOTE: Color samples are for representational purposes only. The actual paint colors may vary drastically from the corresponding swatches shown in this document. Colors will appear differently when viewed on different computer monitors and/or printed from different printers. For a true color sample, it is best to obtain a paint sample of the desired color from a vendor.

Color Ref #	Color Description	Text Color	Matthews #
	Cast Bronze	White	MP07458
	Wells Fargo Black	White	MP26309
	Gaeta Olive	White	MP15718
	Ship Yard Grey	White	MP07458
	Trendy Grey Metallic	White	MP12416
B1	Dark Brown Anodized	White	MP30896
B2	Accessible Blue	White	MP26511
B3	Red (OSHA)	White	MP09251
B4	New VA Blue	White	MP09144
B7	White	Black, Red, Purple	MP32071
B8	Yellow (OSHA)	Black	MP09829



2.7.6 SIGN OVERVIEW

The following overview illustrates the various types of National Cemetery Administration signage. [Section 3.7 National Cemetery Administration Signage Drawings](#) of this manual provides detailed drawings of each of these signs.

Sign Designations

Each sign in the program manual has been given a specific sign type number designation. This designation provides a common description that can be referenced when programming a site and ordering signs. The following explains how the sign type designations are derived.

NC - 07.01 A - m1

- NC** Designates a National Cemetery sign.
- 07** Two-digit numbers identify a particular sign type.
- .01** The two-digit number following the period identifies a specific sign size within the sign type.
- A** The letter designates a specific sign configuration, version and/or layout for graphics.
- m1** The letter and number designates the post family and style.
 - c1 denotes concrete family with square recess style
 - c2 denotes concrete family with round recess style
 - m1 denotes metal family with square style
 - m2 denotes metal family with rectangle style



Sign Overview

National Cemetery Administration Signage Guidelines

NC-01.01
 Visitor Information/Floral
 Regulations Sign - Medium

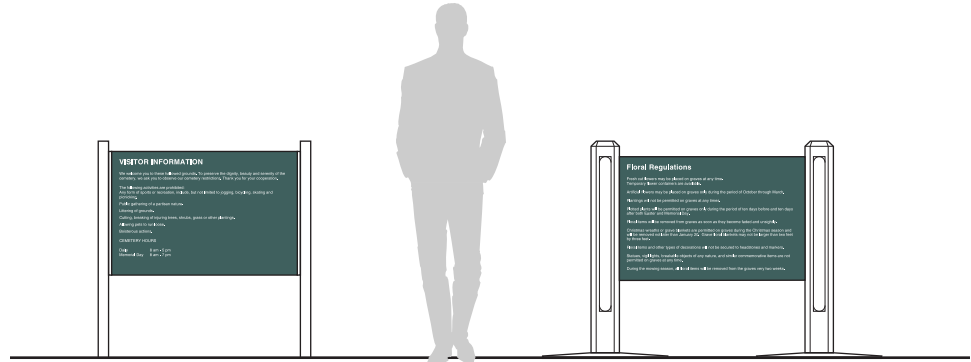

NC-01.01

NC-01.02
 Visitor Information/Floral
 Regulations Sign - Large

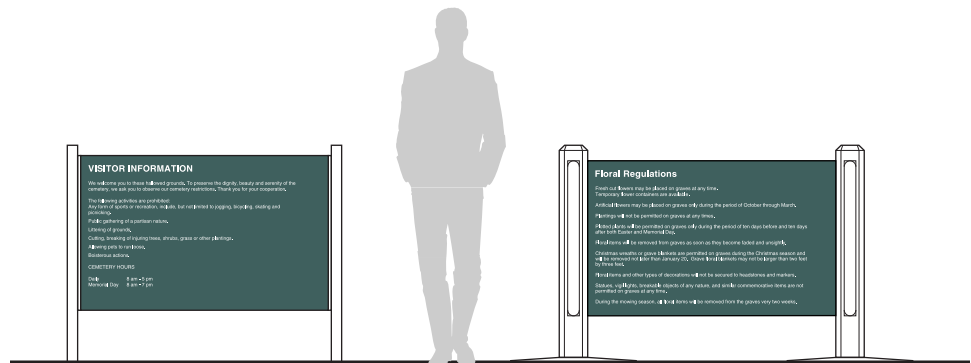

NC-01.02

NC-01.03
 Visitor Information/Regulation Sign
 - Small

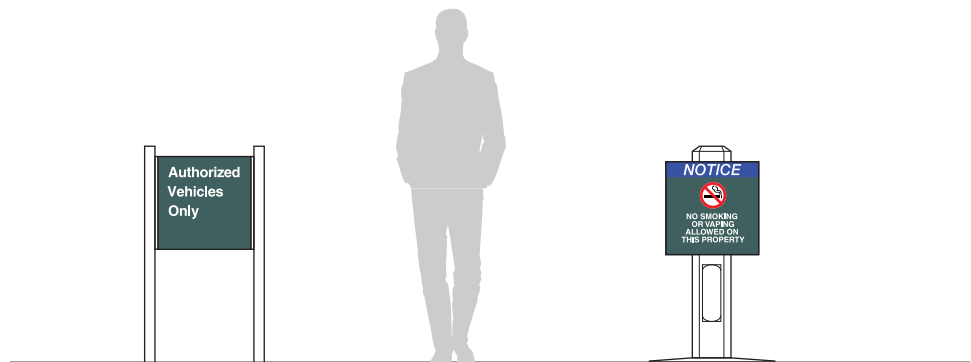

NC-01.03



Sign Overview

National Cemetery Administration Signage Guidelines

NC-02.01
Horizontal "You Are Here" Map

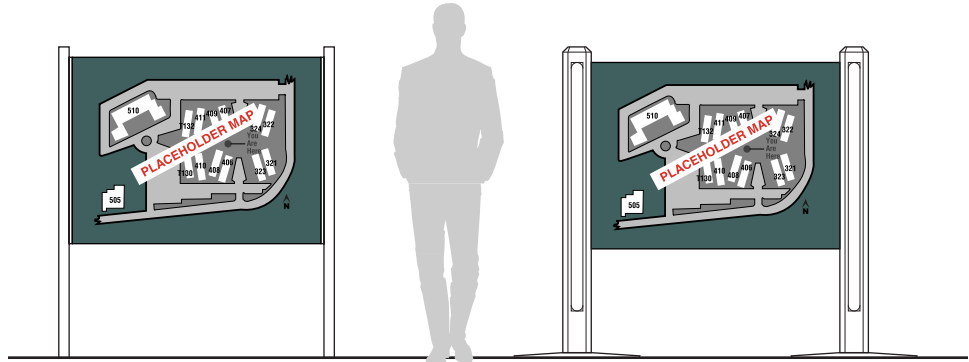

NC-02.01

NC-02.02
Vertical "You Are Here" Map

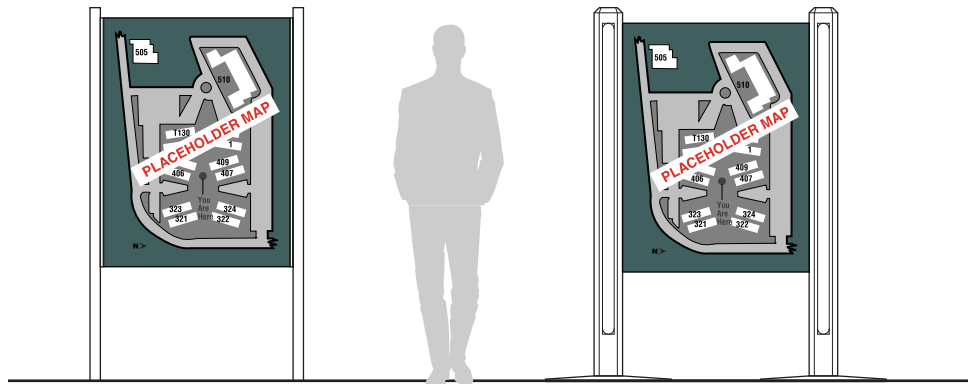

NC-02.02

NC-03.01
Low Profile Traffic Regulatory Signs

NC-03.09
Accessible Parking Regulatory Sign

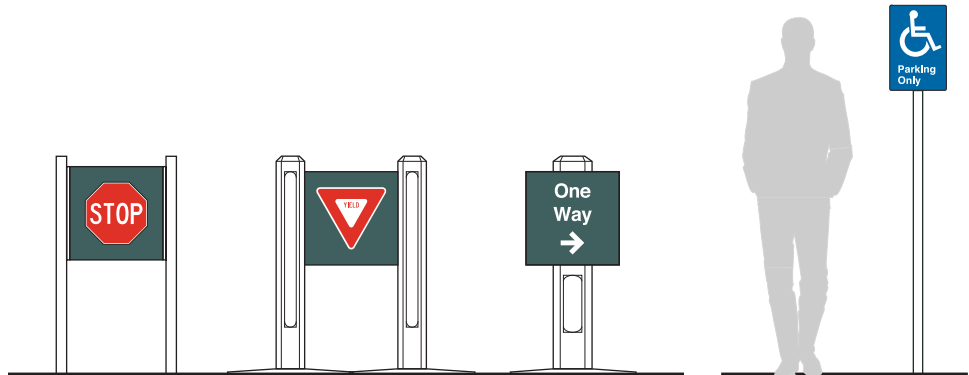

NC-03.01

NC-03.09



Sign Overview

National Cemetery Administration Signage Guidelines

NC-04.01

Post and Panel Sign -
One Line of Text

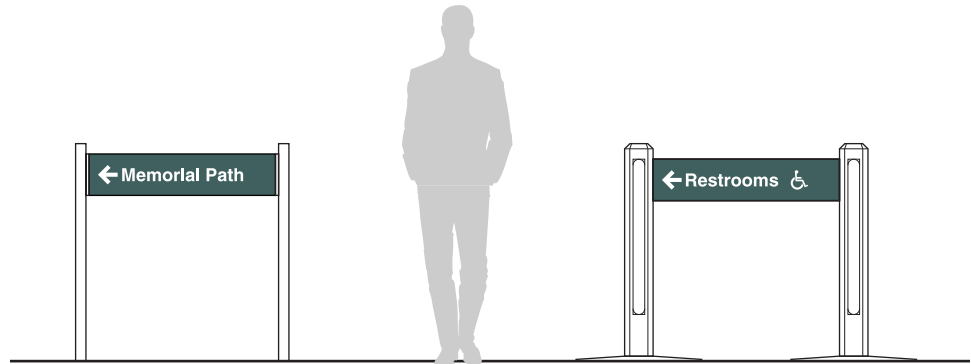

NC-04.01

NC-04.02

Post and Panel Sign -
Two Lines of Text

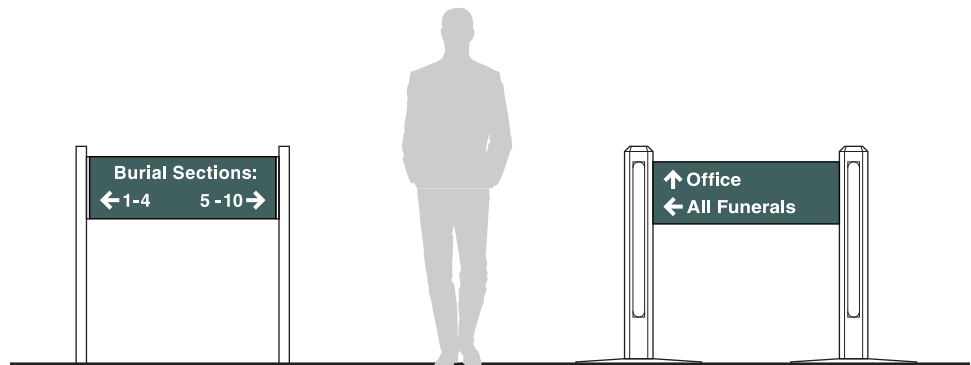

NC-04.02

NC-04.03

Post and Panel Sign -
Three Lines of Text

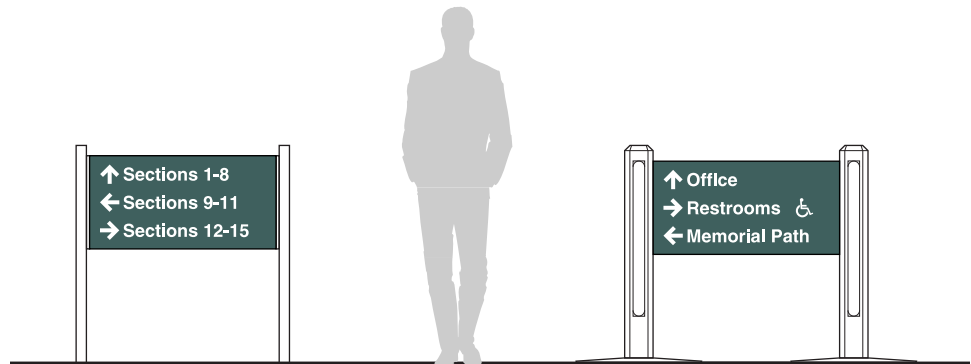

NC-04.03



Sign Overview

National Cemetery Administration Signage Guidelines

NC-06.01

Pylon Street Sign

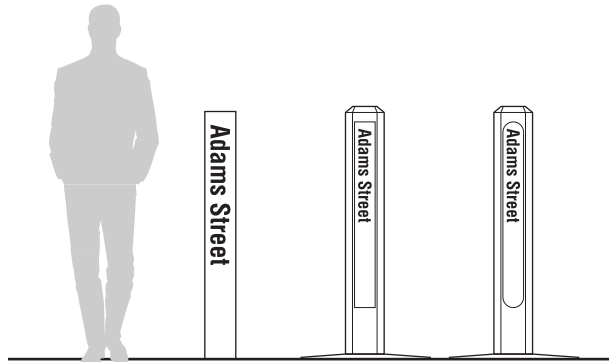

NC-06.01

NC-06.02

Street Marker Flag Sign - Short

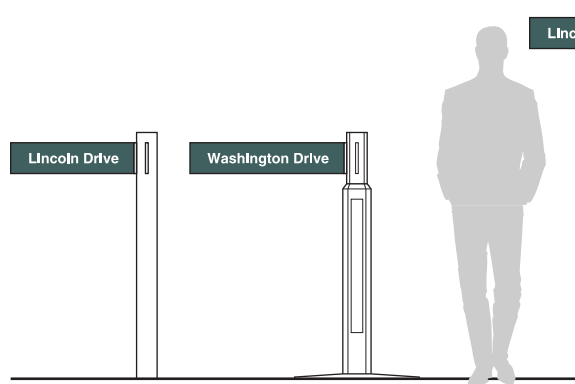

NC-06.02

NC-06.03

Street Marker Flag Sign - Tall

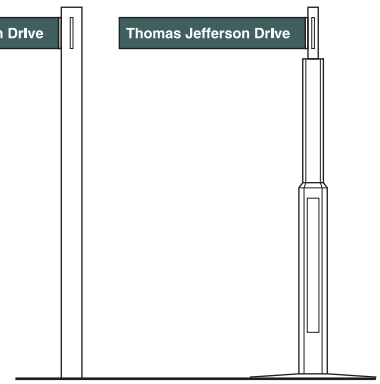

NC-06.03

NC-07.01

Pylon Section Marker

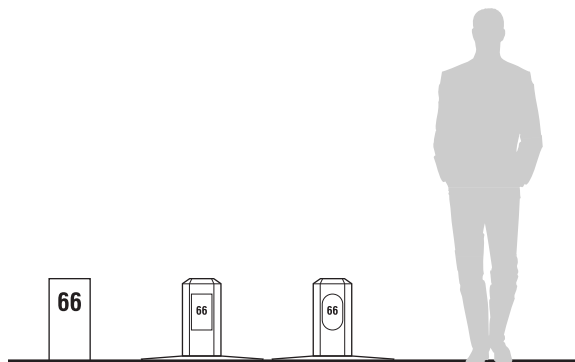

NC-07.01

NC-07.02

Water Spigot Instructional Sign

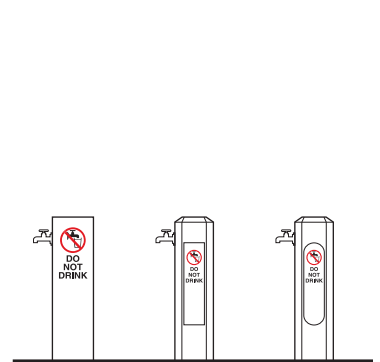

NC-07.02



Sign Overview

National Cemetery Administration Signage Guidelines

NC-07.03
Standard Granite Section Marker

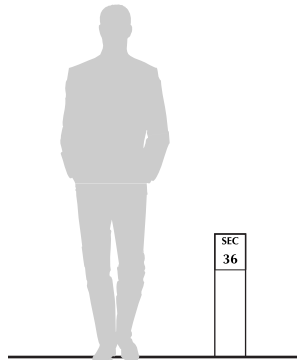

NC-07.03

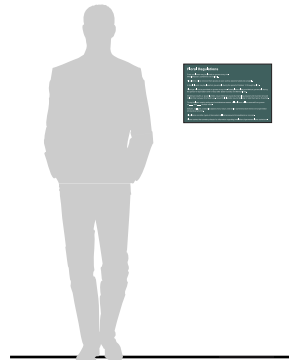

NC-08.01



Enlarged View

NC-09.01-.03
Incised Lettering



NC-09.01
(8" High x 1/2" Deep)



NC-09.02
(10" High x 3/4" Deep)



NC-09.03
(12" High x 1" Deep)

NC-10.01-.03
Dimensional Lettering



NC-10.01
(8" High x 1 1/2" Deep)



NC-10.02
(10" High x 2" Deep)



NC-10.03
(12" High x 2 1/2" Deep)

NC-11.01
Dimensional Seal



NC-11.01



Sign Overview

National Cemetery Administration Signage Guidelines

NC-14.01
Primary Room Identification Sign



NC-14.01

NC-15.01-.06
Restroom Identification Signs



NC-15.01



NC-15.02



NC-15.03

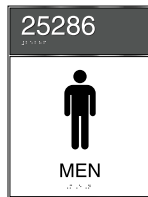

NC-15.04



NC-15.05



NC-15.06

NC-16.01-.06
Pictogram and Symbol Signs



NC-16.01

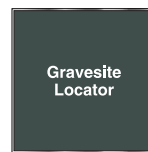

NC-16.02



NC-16.03



NC-16.04

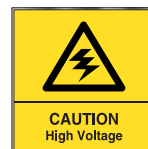

NC-16.05



NC-16.06



Construction National Cemetery Administration Signage Guidelines

2.7.7 CONSTRUCTION

Detail 1

Precast Concrete Double Post and Panel

Size

Post size:
5 1/2" (139.7 mm) square double post. Height to vary as needed

Description and Use

Post support for sign

Sign Components

Use with 1" (25.4 mm) square framed sign panels.

Colors

Precast concrete

Installation

In-ground installation in accordance with local jurisdiction guidelines



PLAN – Sign Panel Finish both sides

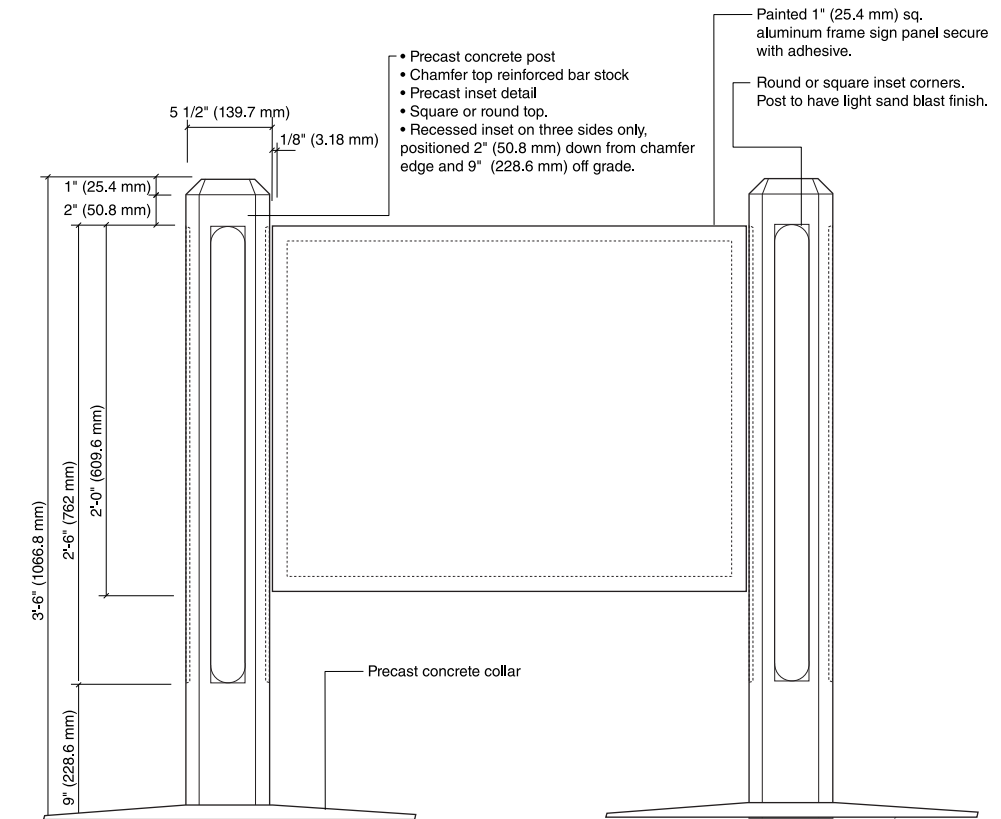

ELEVATION – Precast Concrete Post & Panel

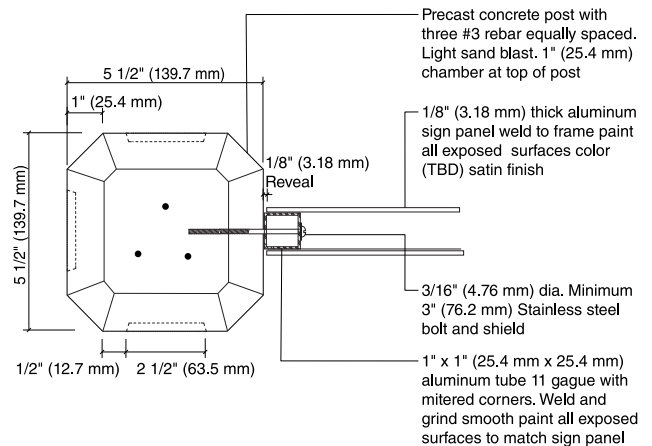

Construction

National Cemetery Administration Signage Guidelines

Detail 2

Precast Concrete Single Post and Panel

Size

Post size:
7 1/2" (190.5 mm) square double post. Height to vary as needed

Description and Use

Post support for sign

Colors

Precast concrete

Installation

In-ground installation in accordance with local jurisdiction guidelines

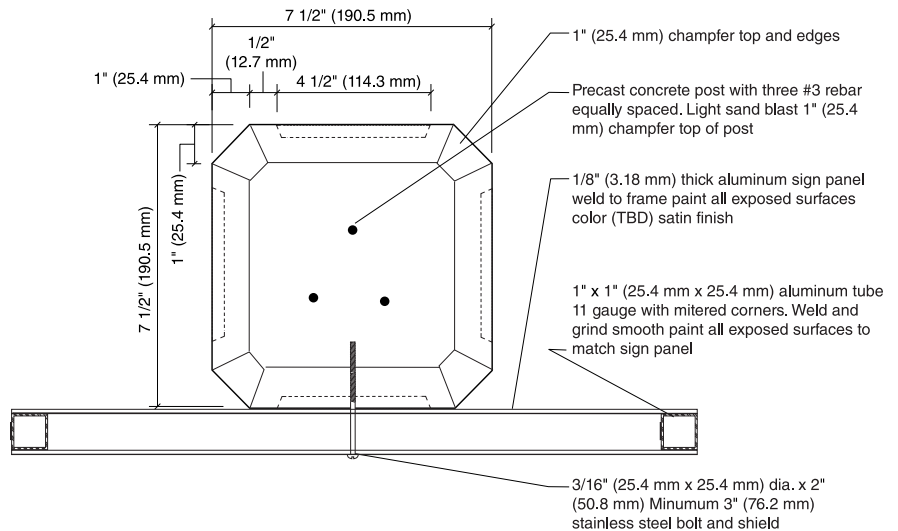
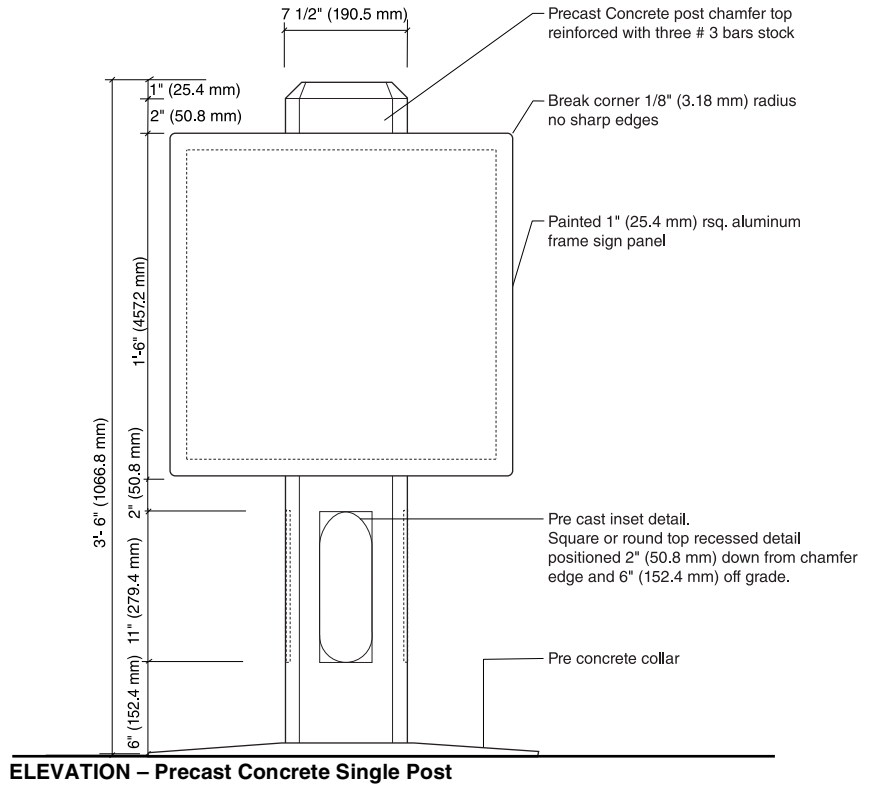
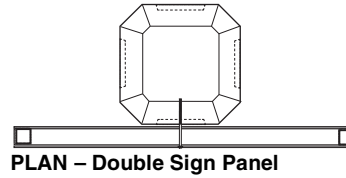

Construction

National Cemetery Administration Signage Guidelines

Detail 3

Precast Concrete Sign Tall Post

Size

Post size:
5 1/2" (139.7 mm) square 6'-0"
(1828.8 mm) height

Description and Use

Post support for street sign

Colors

Precast concrete

Installation

In-ground installation in accordance
with local jurisdiction guidelines

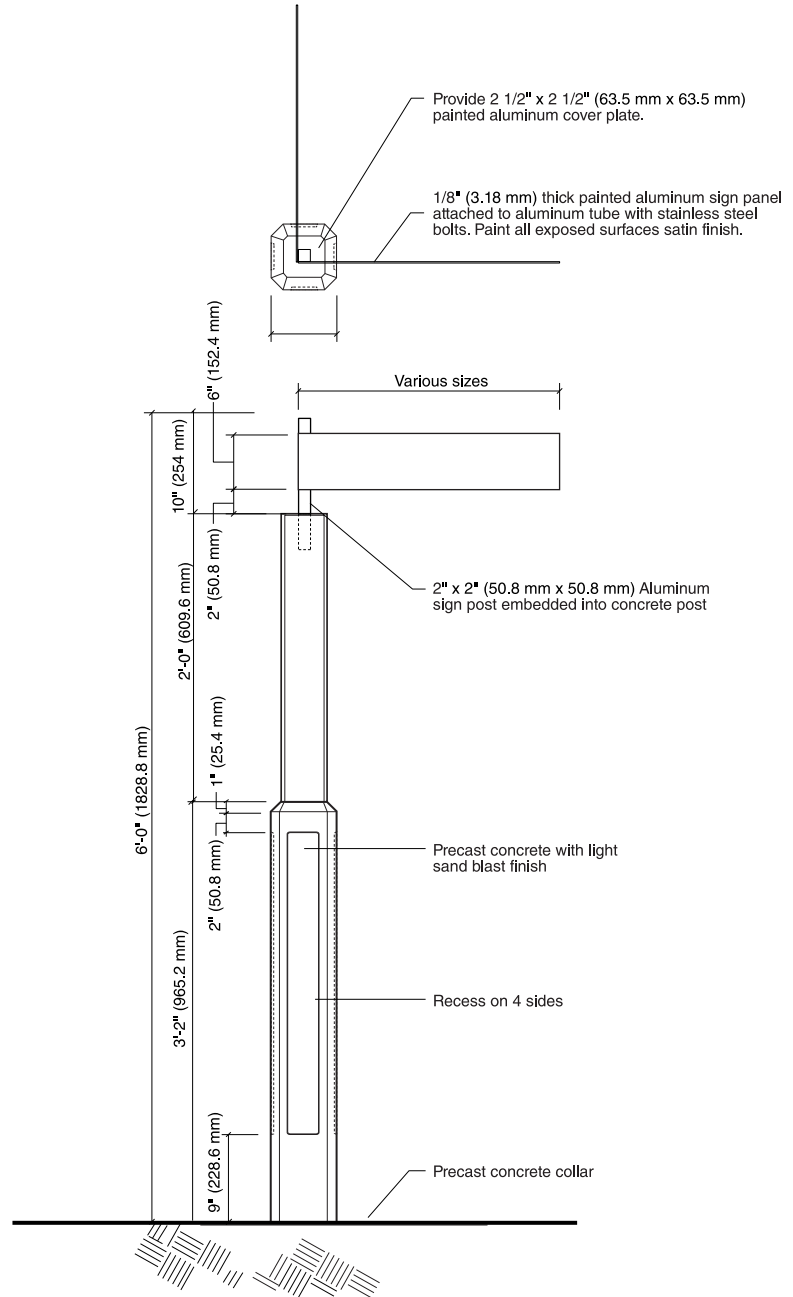

Street Sign Post NC-06.03

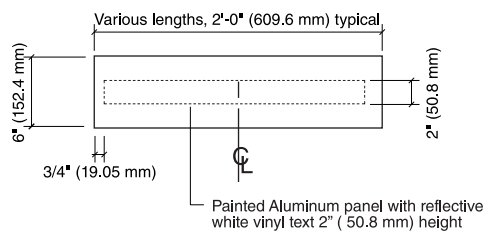

Construction

National Cemetery Administration Signage Guidelines

Detail 4

Bronze VA Seal

Size

Size 2'-0" (609.6 mm) diameter

Description and Use

Identifies National Cemetery as a US Government Facility

Sign Components

Used with dimensional or incised letters

Material

The plaque shall be cast of a lead free tin bronze, such as C90300 (Navy "G" Bronze) or similar alloy approved by VA.

Bas-relief casting based on VA Drawing, shall be of uniform quality and condition, free from injurious blow holes and porosity, cracks and other defects and not warped or distorted, well finished, free from burrs, sharp edges, scratches and defects that may affect appearance or service ability. Casting shall not be repaired, plugged, welded or burned. Finish to be detailed, hand chased for true alignment, filed, belt polished, sides ground smooth, raised surfaces and borders to be polished and buffed to a bright satin finish, background textures to be reverse medium pebble background, fine pebble background, moss as cast. Bronze to be chemically oxidized to a statuary medium color and finish with one coat of clear protective exterior metal lacquer. Fasteners to be corrosion resistant metal compatible with material or casting.

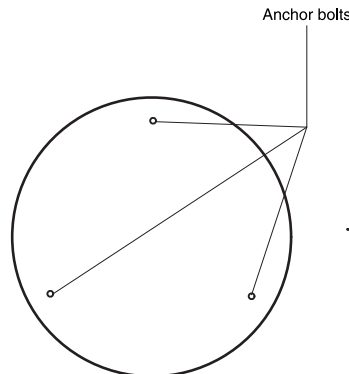

Back Elevation

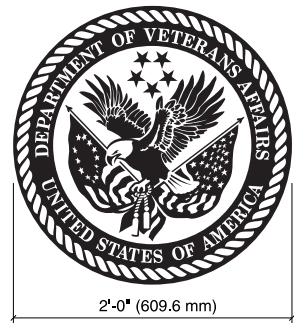

Front Elevation

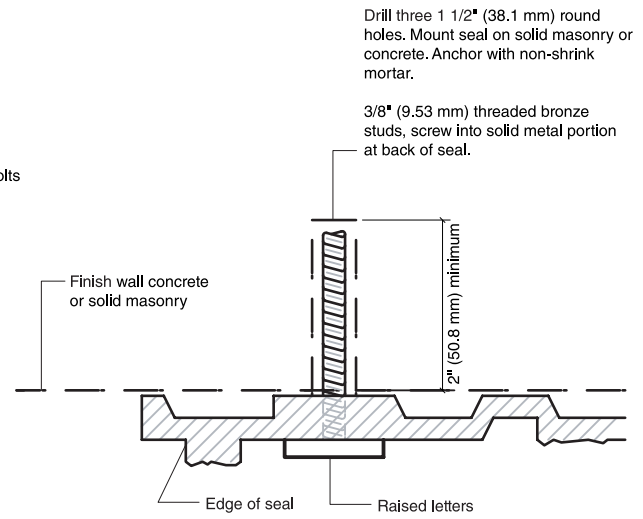

Section at Fastener

Drill three 1 1/2" (38.1 mm) round holes. Mount seal on solid masonry or concrete. Anchor with non-shrink mortar.

3/8" (9.53 mm) threaded bronze studs, screw into solid metal portion at back of seal.

General Notes:

1. Seals' location should be taken from contract drawings.
2. 2'-0" (609.6 mm) dia. unless otherwise determined
3. Material is cast bronze
4. Detail of anchorage must be provided by A/E for anchorage in any material other than solid masonry or concrete.



Construction

National Cemetery Administration Signage Guidelines

Detail 5

Precast Post and Panel

Sign is precast concrete post of required height and width either 5-1/2" (139.7 mm) square or 7 1/2" (190.5 mm) square. 1" (25.4 mm) sq. framed panel either double sided or single sided depending on the sign type. Precast collar is used to create mow base.

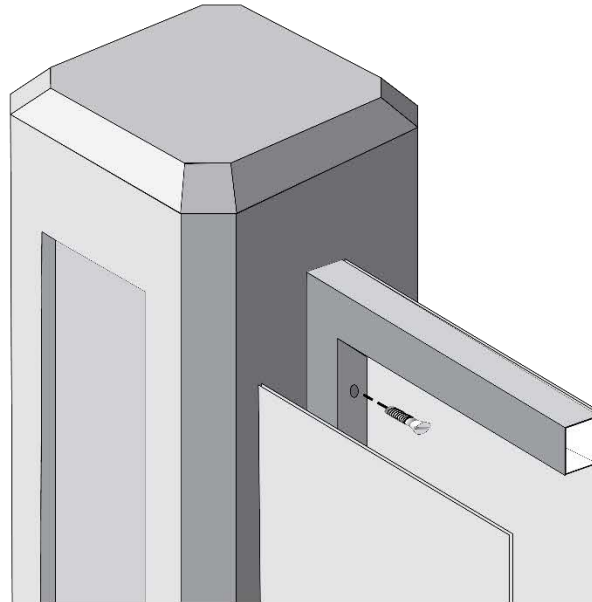

Detail 6

Metal Post and Panel sign

Sign is constructed with a non-illuminated sign cabinet mounted to extruded aluminum posts with an adjustable reveal between the posts and the cabinet.

The sign cabinet extrusion should have the capability to hold the sign faces and allow for the removal and replacement of faces without total sign disassembly or abandonment of the sign.

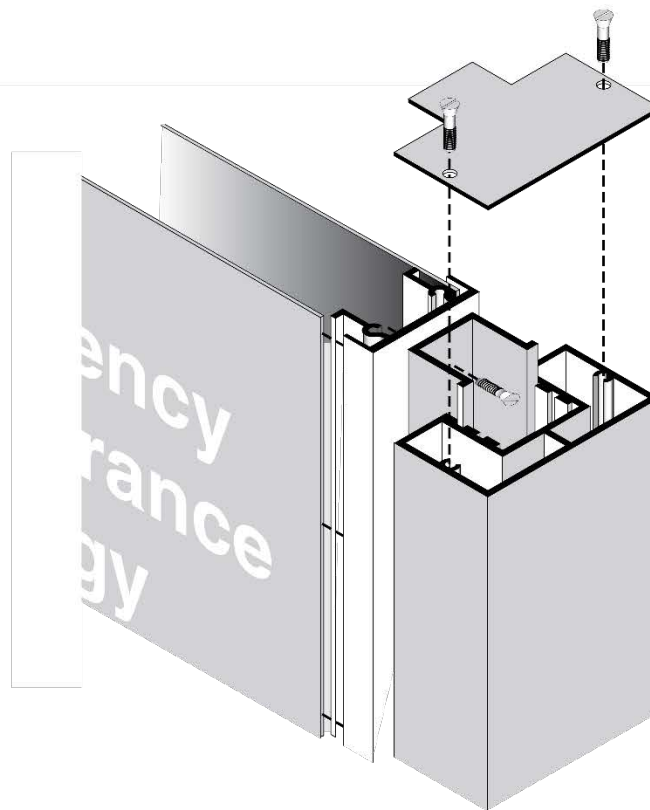

2.7.8 INSTALLATION

Detail 7

Precast Street sign

Aluminum sign panel mounted to a square aluminum post with tamper proof mechanical fasteners. Set in to precast concrete post.

Sign panels have the corners eased with a 1/4" (6.35 mm) radius. The post shall have a permanent top cap.

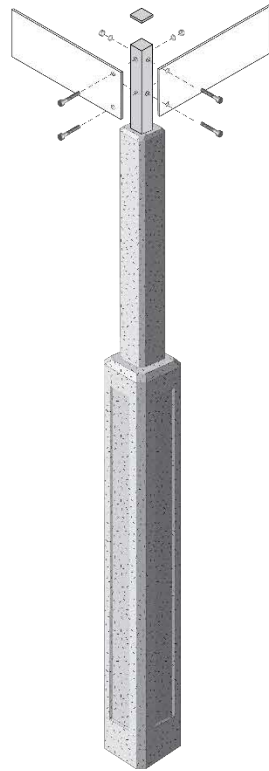

Detail 8

Single Post and Panel sign

Extruded aluminum signpost with sliding dove tail groove. Aluminum sign panel with integrated dove tail tongue slides into pole extrusion with post filler and tension screw.

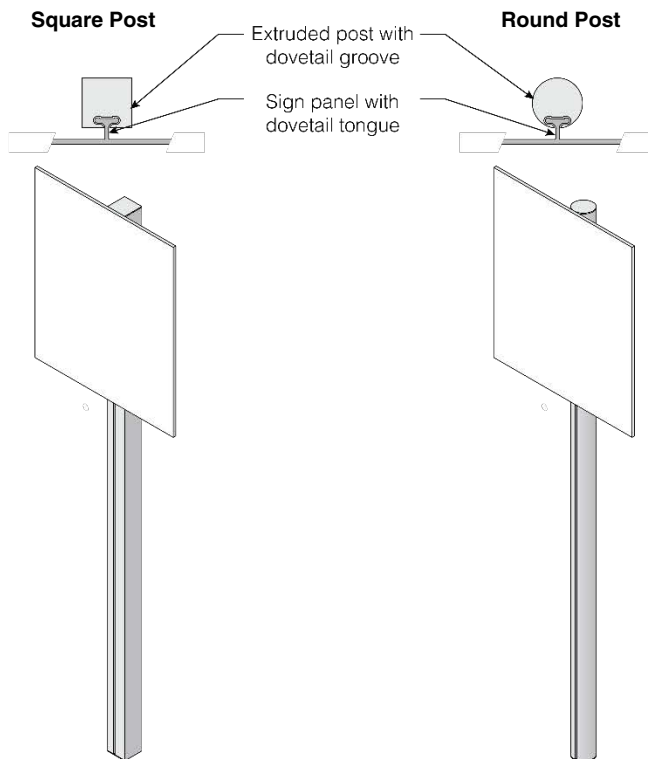

Installation

National Cemetery Administration Signage Guidelines

Detail 9

Placement:
Ground Mounted Signs

All signs should be located a minimum of 2'-0" (609.6 mm) from a curb. The exact location of a sign will differ depending on the type of sign and site conditions.

Sign placement must be carefully considered to ensure the sign fits the location without major regrading. It may be necessary to clear some landscaping or remove an obstruction.

When ground mounted signs on two posts are placed on sloping or inclined grades, adjustments must be made to the post lengths. Extreme differences between post lengths should be minimized.

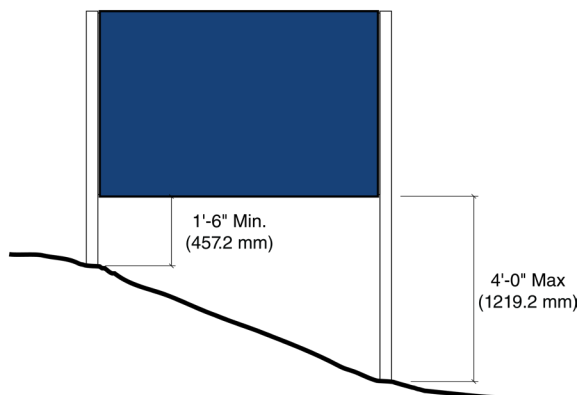
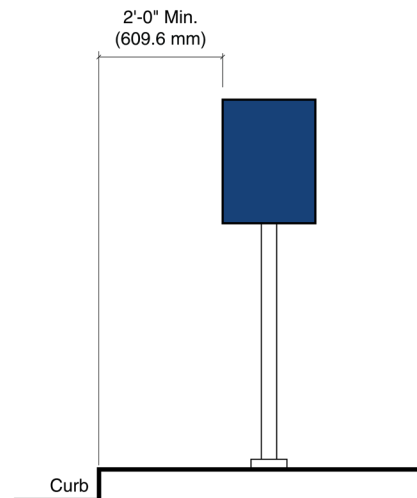
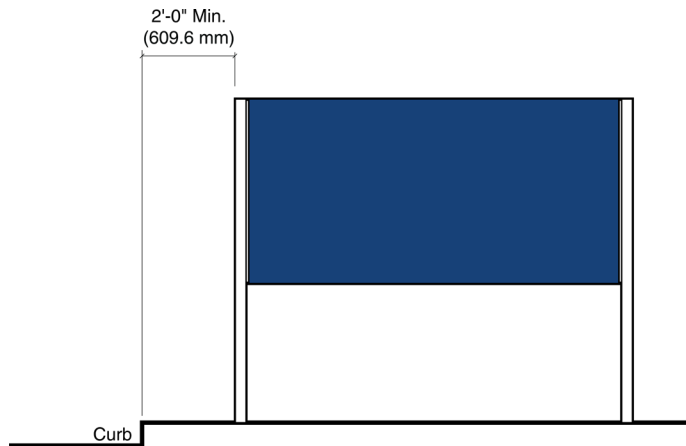

Installation

National Cemetery Administration Signage Guidelines

Detail 10

Placement:
Sight Triangle at Intersections
and Driveways

For safety reasons, signs should not be placed in the sight triangle (shaded area) where they could obscure a driver's vision. Also, ensure the location of a sign does not block a driver's vision of pedestrians.

Ensuring that there are no signs in the sight triangle applies to roadway intersections as well as driveways.

Traffic regulatory signs such as Stop, Yield, Street, and Pedestrian Crossing are an exception to this rule.

When installing signs adjust locations for utilities, irrigation lines and street trees.

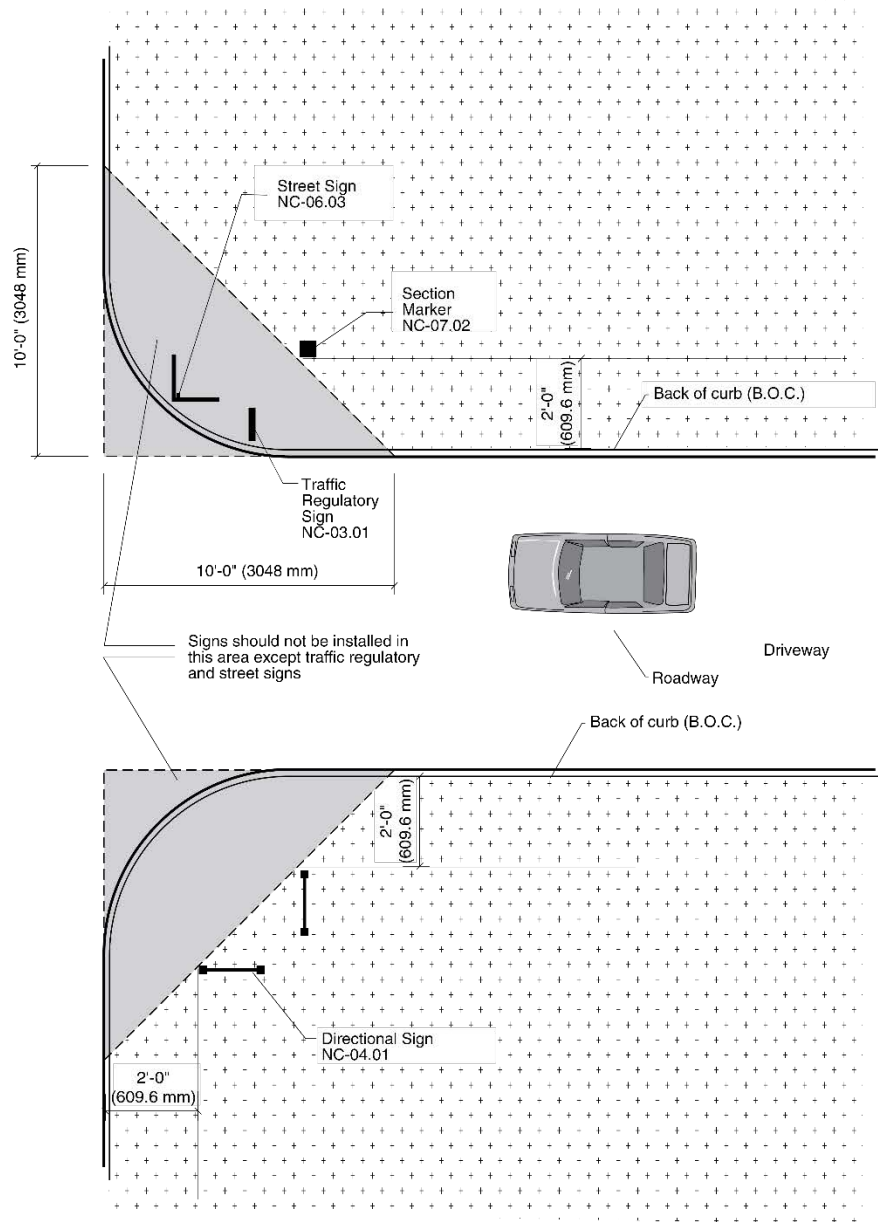

Installation

National Cemetery Administration Signage Guidelines

Detail 11

Metal Post Footings:

All footings must meet width and depth requirements to accommodate height and size of sign, soil conditions, wind loads and winter ground freezing.

Style 1

Permanent installation in landscaped areas: Signs installed in turf should have the raised concrete collar extended to cover the area between posts.

Style 2

Walkway installation. Location which requires post base to be flush with paving material.

NOTE: Foundation and footings must extend to the frost line. See the Footing Size Configurations map in Section 2.5.8 Installation for more information.

Style 1

In landscaped areas, footing shall be boxed so as to extend 3 1/2" (90 mm) above grade with 2" (50 mm) bevel. Replace surrounding landscaping to original condition.

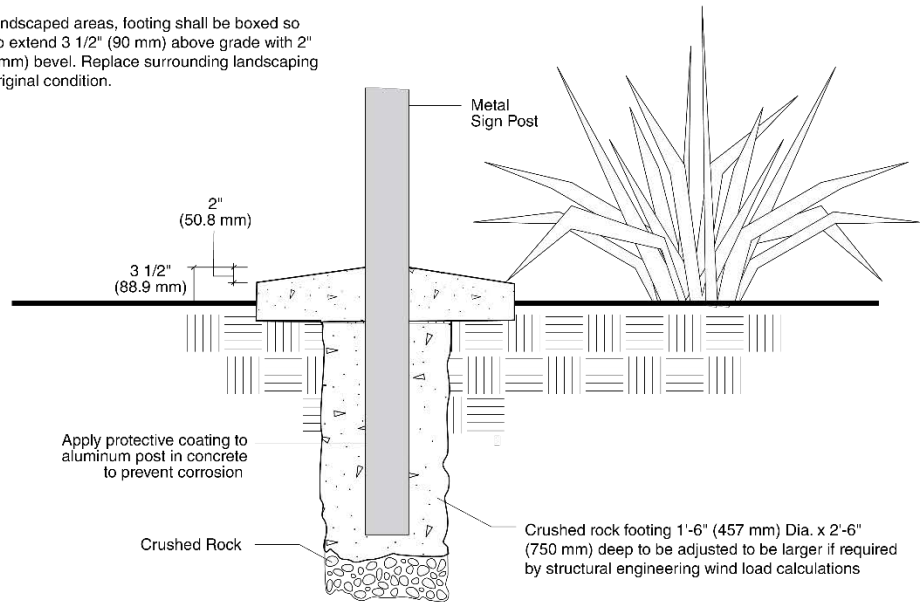

Style 2

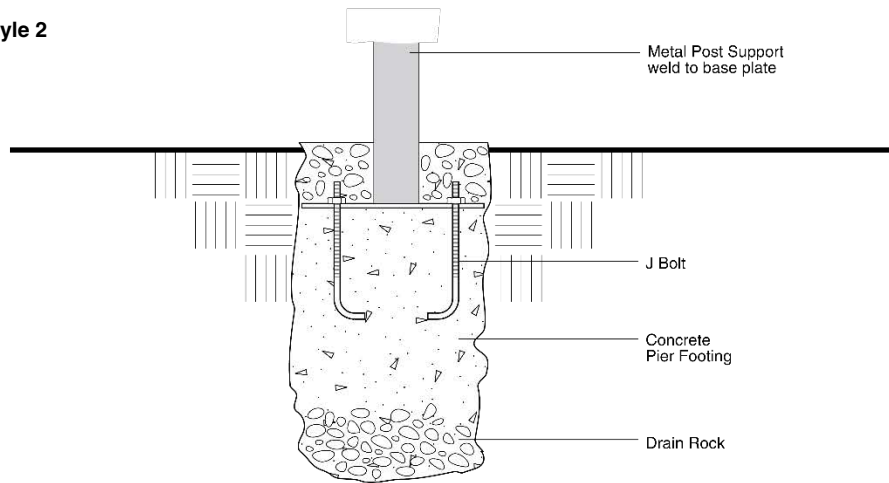

Installation

National Cemetery Administration Signage Guidelines

Detail 12

Concrete Post Footing:

All footings must meet width and depth requirements to accommodate height and size of sign, soil conditions, wind loads, and winter ground freezing.

Style 3

Permanent collar cast in place installation in landscaped areas. Signs installed in turf to have the raised concrete collars extended to cover the area between the posts.

Style 4

Permanent installation for precast concrete post and collars.

NOTE: Foundation and footings must extend to the frost line. See the Footing Size Configurations map in Section 2.5.8 Installation for more information.

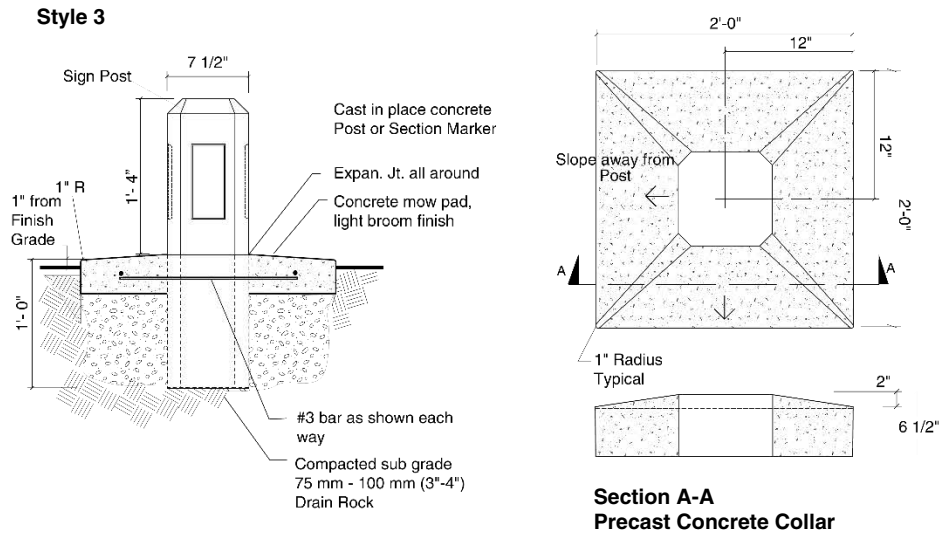

Style 4

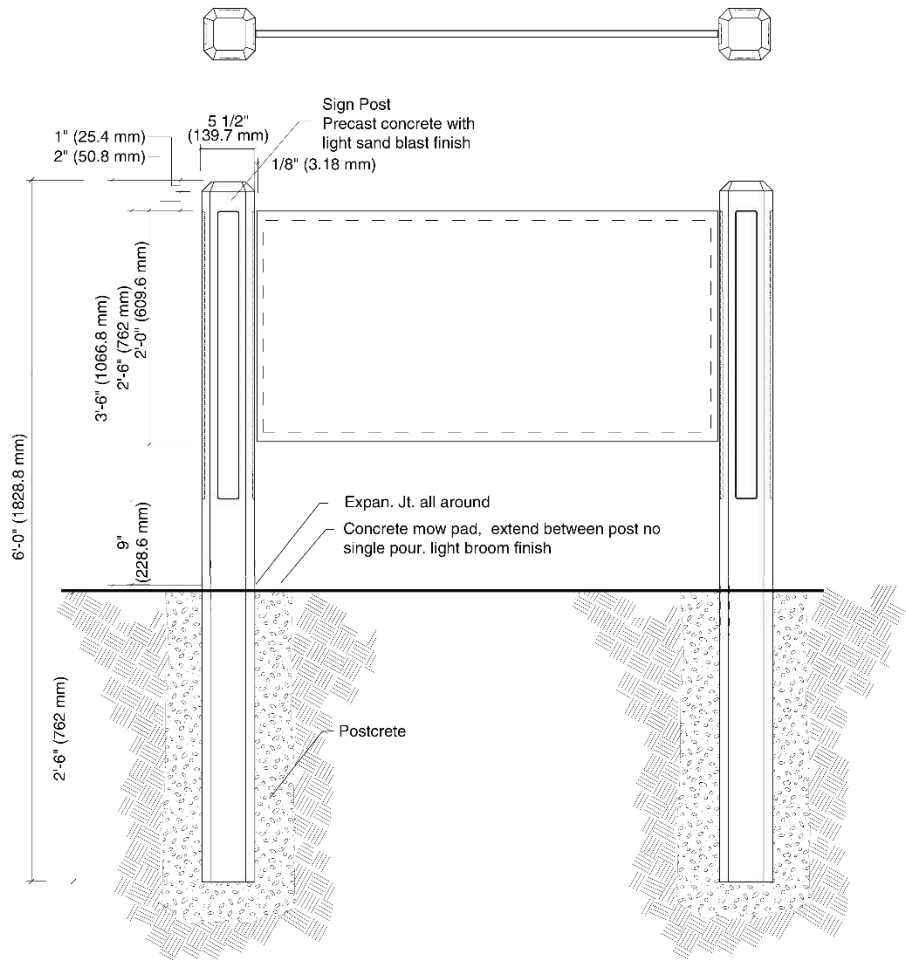

Installation

National Cemetery Administration Signage Guidelines

Detail 13

Mounting: Dimensional Letters

Metal letters that are installed on an exterior wall: Letters that are installed on all wall surfaces should be installed tight to the wall with no spacers and additional adhesive applied to the back of the letters. This will increase the security of the letters against vandalism or theft.

The size and length of the studs are to correlate to the size of the letter and the depth required for installation on the specific building surface.

Plaster and stucco building surfaces should have complete adhesive sealant applied around the stud, where it penetrates the building, to prevent water intrusion into the building.

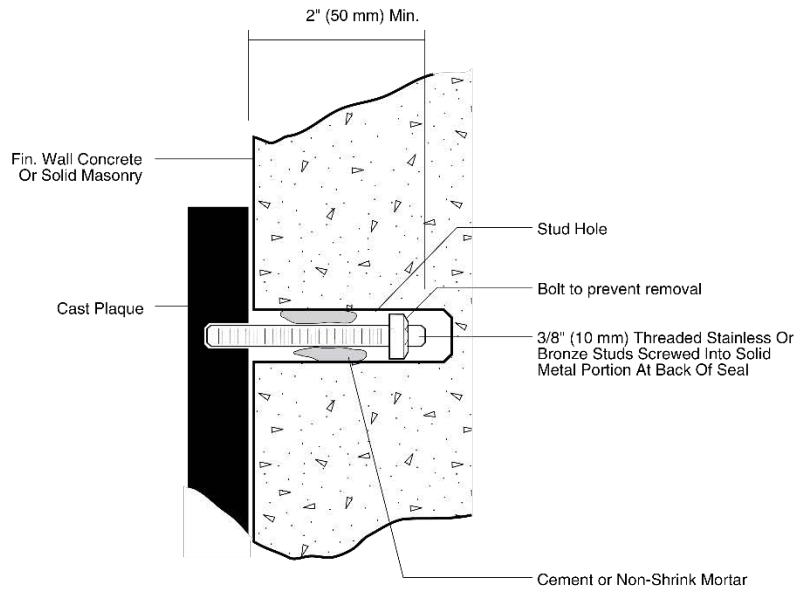

Detail 14

Wall Mounting: Non-Illuminated Signs

Aluminum wall panel signs shall be fastened with a minimum of 4 tamper resistant mechanical fasteners.

Anchors should be suitable for the specific type of wall surface where the sign is being installed.

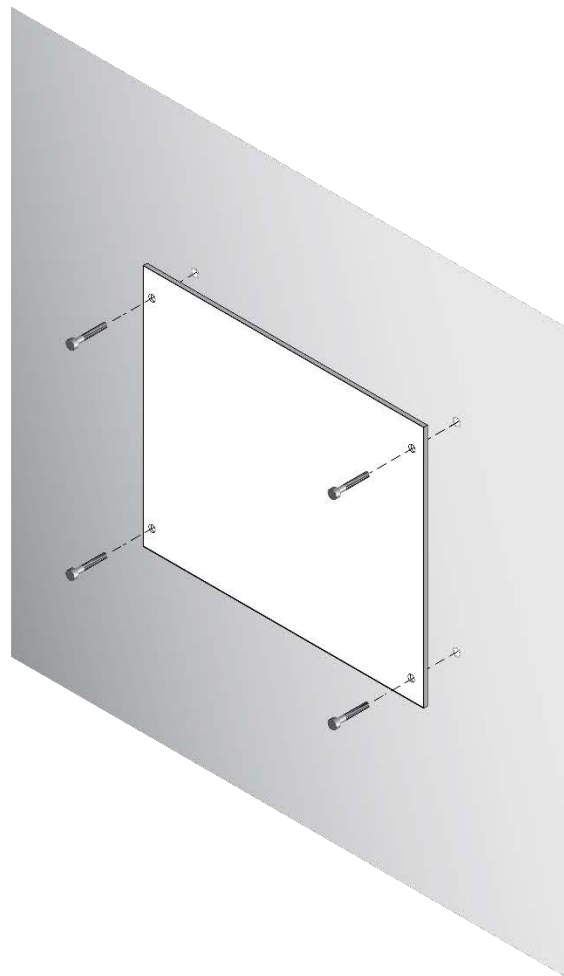



U.S. Department
of Veterans Affairs

SECTION 3

SIGN TYPE DRAWINGS

3.1 Interior Signage Drawings.....	247
3.2 Code & Life Safety Signage Drawings.....	353
3.3 Mandatory VA Policy & Directive Signage Drawings.....	449
3.4 Specialty Signage Drawings	500
3.5 Exterior Signage Drawings.....	538
3.6 Parking Structure Signage Drawings.....	676
3.7 National Cemetery Administration Signage Drawings.....	745





U.S. Department
of Veterans Affairs

SECTION 3.1

INTERIOR SIGNAGE DRAWINGS



Introduction

This section contains detailed drawings of all typical interior sign types for VA facilities. Individual facilities may have unique conditions that require modifications or additional sign types not shown in the Manual. The following drawings provide general design intent and do not function as fabrication-ready shop drawings.

Code and life safety signage, mandatory policy, and specialty signs are in other sections of this Manual.

Guidelines

- The drawings should be used as a starting point to develop a sign standard with a component-based sign system, sign types, colors, finishes, and graphics specific to the individual facility.
- For more information on developing the look of the sign system, including VA standard fonts, arrows, and color suggestions, refer to [Section 4.1 Appendix](#). Color palettes are intended as suggestions and usage is not required. Colors, materials, and finishes used in interior signage should complement and enhance the appearance of interior environments whenever possible.
- Please review [Section 2.1 Interior Signage Guidelines](#) which contains information regarding Planning, Programming, Construction, and Installation prior to starting signage projects.

Requirements

- The use of component-based sign systems is required at VA facilities except for door-mounted signs which consist of a low-profile acrylic plaque mounted with VHB tape and silicone adhesive (see [Sections 2.1.5 & 2.1.6](#)). The exact materials, parts, finishes, and dimensions of a component sign system will vary by manufacturer.
- Helvetica Lt Std is the standard font required for use in signage at all VA facilities with the exclusion of NCA locations.
- Design and placement of all signs should meet ABA requirements where applicable. Refer to [Section 4.1 Appendix](#) for a summary of applicable requirements.

Message Inserts

- Insert-based sign messages should follow an approved template established as part of the facility's sign standard and wayfinding plan.
- To increase durability and moisture resistance, updatable inserts should be printed on synthetic paper or clear acetate sheets. Standard printer paper can absorb moisture causing wrinkles and yellowing over time.
- For more information regarding message insert standards, see [4.5 Frequently Asked Questions](#).



Sign Designations

Each sign in the program manual has been given a specific sign type number designation. This designation provides a common description that can be referenced when programming a site and ordering signs. The following explains how the sign type designations are derived.

IN - 03 .01 A

- IN** Designates an interior sign.
- 03** Two-digit number identifies the sign type family.
- .01** The two-digit number following the period identifies a specific sign within the sign family.
- A** The letter designates a specific sign configuration, version and / or layout for graphics or symbols.



Sign Overview

Interior Signage Drawings

IN-03.01
Room Number Identification



IN-03.01

IN-04.01
Primary Room Identification with Insert

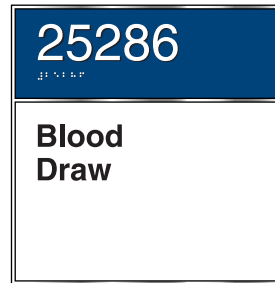

IN-04.01



IN-04.02

IN-05.06
Patient Room Identification with Write-On Panel

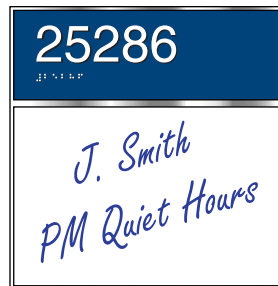

IN-05.06

IN-05.07
Patient Room Identification with Room Alert & Contact Precautions

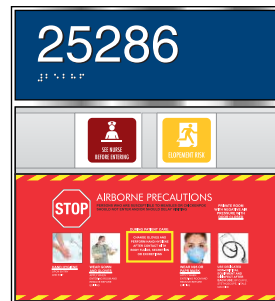

IN-05.07

IN-06.05-06
Patient Bed Signs



IN-06.05



IN-06.06

IN-06.07
Patient Information Tabs



IN-06.08
Patient Contact Precaution Cards



IN-06.07

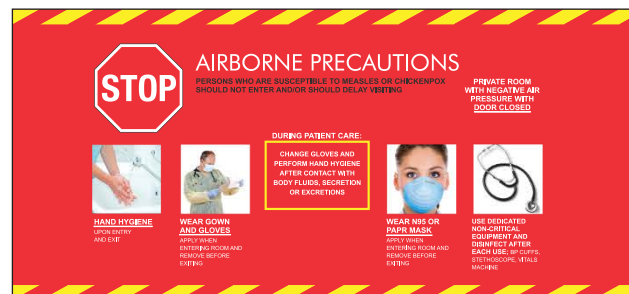

IN-06.08



Sign Overview

Interior Signage Drawings

IN-07.01-.02

Room Identification with Insert & Indicator

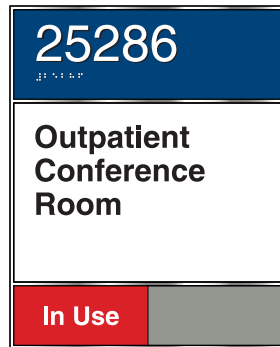

IN-07.01

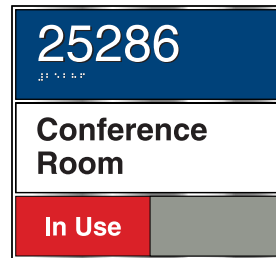

IN-07.02

IN-08.01

No Smoking / No Vaping



IN-08.01

IN-08.02

Restricted Area Identification

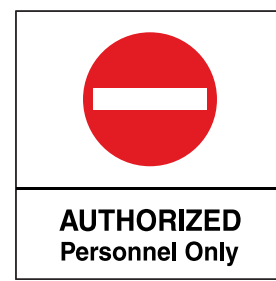

IN-08.02

IN-09.01-.06

Restroom Identification

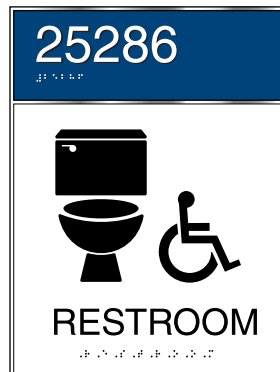

IN-09.01-.06

IN-09.07-.08

Required Restroom Postings



IN-09.07

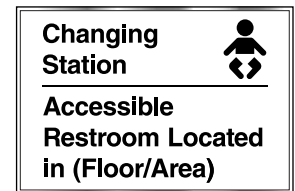

IN-09.08



Sign Overview

Interior Signage Drawings

IN-09.09
Pictogram and Symbol



IN-09.09

IN-09.10
Privacy Notice



IN-09.10

IN-10.01-.06
Sign Frame Insert Holder



IN-10.01-.06

IN-10.07
Informational Posting Large Insert



IN-10.07

IN-10.08
Informational Posting Standard Insert



IN-10.08

IN-11.01-.04
Permanent Message Panel



IN-11.01-.04

IN-12.01-.03
Desk or Counter Sign



IN-12.01-.03

IN-13.01
Perpendicular Flag Mount



IN-13.01

IN-13.02
Perpendicular Flag Mount Small



IN-13.02



Sign Overview

Interior Signage Drawings

IN-14.01-.05

Wall Directional - Permanent Panel

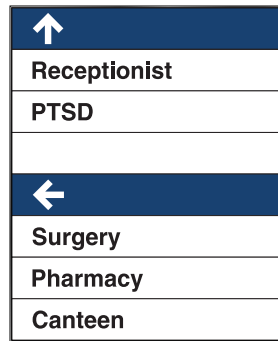

IN-14.01-.05

IN-14.06-.07

Wall Directional - Single Insert

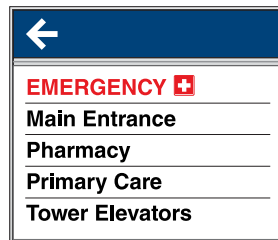

IN-14.06-.07

IN-14.08-.11

Wall Directional - Dual Inserts

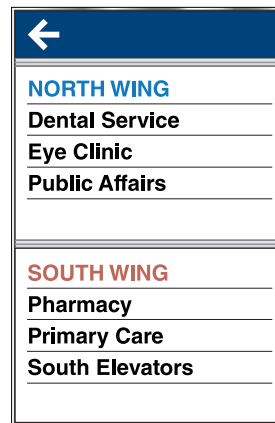

IN-14.08-.11

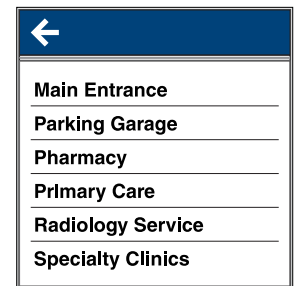

IN-14.12-.13

IN-14.12-.13

Wall Directional - Oversized Inserts

IN-14.14-.17

Floor Level Directional - Permanent Panel



IN-14.14-.17

IN-14.18

Floor Level Directional - Dual Inserts

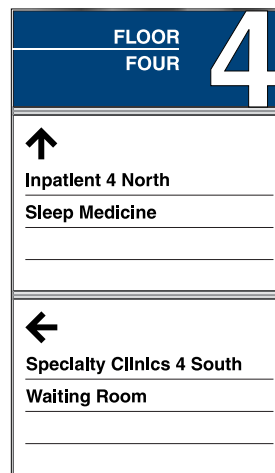

IN-14.18



Sign Overview

Interior Signage Drawings

Overhead Hanging Series IN-15

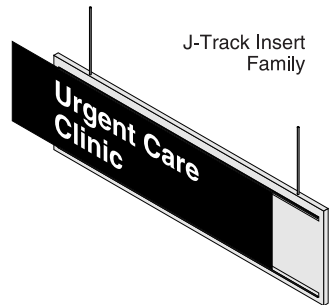
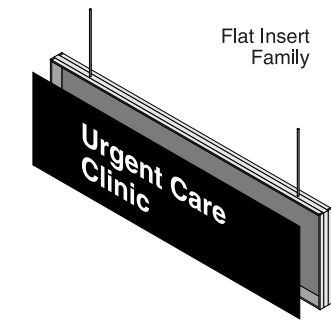
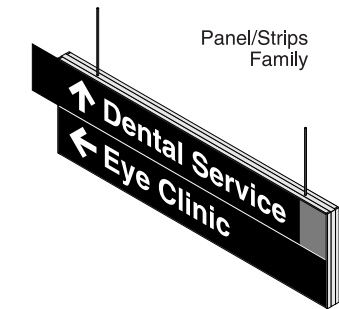

Sign Type	Width	Height	Text Size	Mounting	Family
IN-15.51	40"	6"	3" & 2"	Hanging	Panel/Strips
IN-15.55	40"	6"	3" & 2"	Hanging	Insert
IN-15.52	40"	12"	3" & 2"	Hanging	Panel/Strips
IN-15.56	40"	12"	3" & 2"	Hanging	Insert
IN-15.61	60"	6"	3" & 2"	Hanging	Panel/Strips
IN-15.65	60"	6"	3" & 2"	Hanging	Insert
IN-15.62	60"	12"	3" & 2"	Hanging	Panel/Strips
IN-15.66	60"	12"	3" & 2"	Hanging	Insert
IN-15.71	80"	6"	3" & 2"	Hanging	Panel/Strips
IN-15.75	80"	6"	3" & 2"	Hanging	Insert
IN-15.72	80"	12"	3" & 2"	Hanging	Panel/Strips
IN-15.76	80"	12"	3" & 2"	Hanging	Insert

NOTE: Overhead sign IN15 series are hanging signs. To determine sign type and size required at a specific location, Verify project sign family, ceiling height, distance the sign is to be viewed and quantity of text. 2" high copy is NOT recommended for long hallways or for a sign that will be read at a great distance.

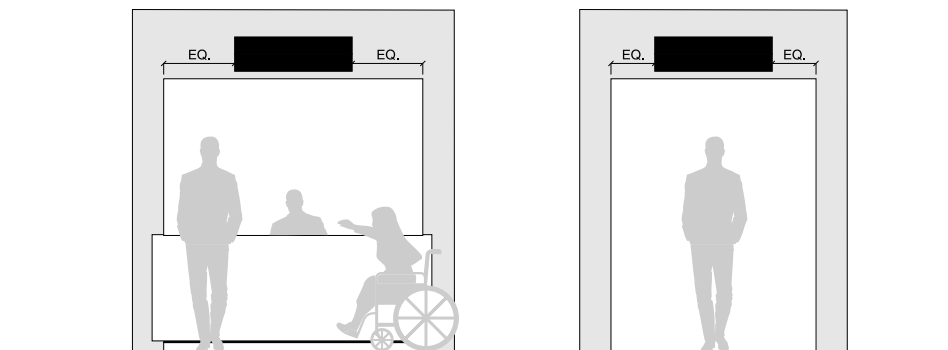

Sign Overview

Interior Signage Drawings

IN-15.51/.55

Ceiling Mounted Directional and Department ID – 6" x 40"



[IN-15.51/.55](#)

IN-15.52/.56

Ceiling Mounted Directional and Department ID – 12" x 40"



[IN-15.52/.56](#)

IN-15.61/.65

Ceiling Mounted Directional and Department ID – 6" x 60"



[IN-15.61/.65](#)

IN-15.62/.66

Ceiling Mounted Directional and Department ID – 12" x 60"



[IN-15.62/.66](#)

IN-15.71/.75

Ceiling Mounted Directional and Department ID – 6" x 80"



[IN-15.71/.75](#)

IN-15.72/.76

Ceiling Mounted Directional and Department ID – 12" x 80"



[IN-15.72/.76](#)



Sign Overview

Interior Signage Drawings

Overhead Soffit Series IN-16

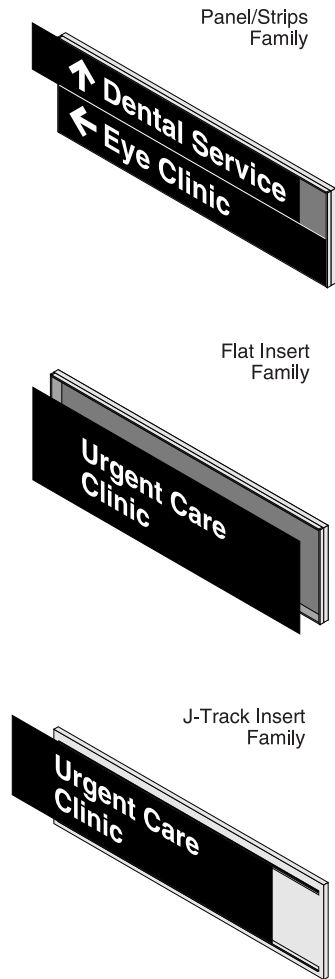

Sign Type	Width	Height	Text Size	Mounting	Family
IN-16.51	40"	6"	3" & 2"	Soffit	Panel/Strips
IN-16.55	40"	6"	3" & 2"	Soffit	Insert
IN-16.52	40"	12"	3" & 2"	Soffit	Panel/Strips
IN-16.56	40"	12"	3" & 2"	Soffit	Insert
IN-16.61	60"	6"	3" & 2"	Soffit	Panel/Strips
IN-16.65	60"	6"	3" & 2"	Soffit	Insert
IN-16.62	60"	12"	3" & 2"	Soffit	Panel/Strips
IN-15.66	60"	12"	3" & 2"	Soffit	Insert
IN-16.71	80"	6"	3" & 2"	Soffit	Panel/Strips
IN-16.75	80"	6"	3" & 2"	Soffit	Insert
IN-16.72	80"	12"	3" & 2"	Soffit	Panel/Strips
IN-16.76	80"	12"	3" & 2"	Soffit	Insert

NOTE: Overhead sign IN16 series are soffit or wall-mounted signs. To determine sign type and size required at a specific location, Verify project sign family, ceiling height, distance the sign is to be viewed and quantity of text. 2" high copy is NOT recommended for long hallways or for a sign that will be read at a great distance.

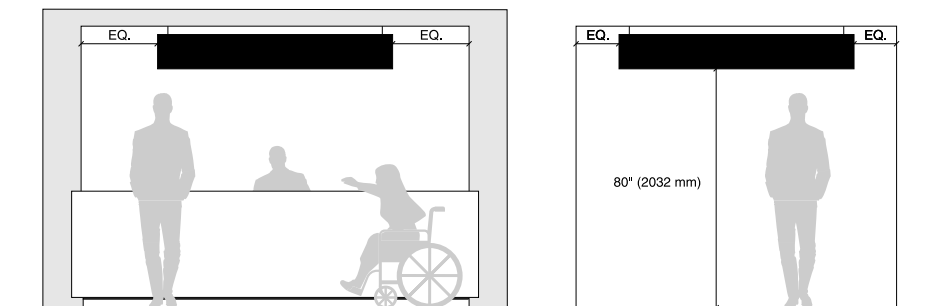

Sign Overview

Interior Signage Drawings

IN-16.51/.55
Soffit Mounted Directional and
Department ID - 6"x 40"



[IN-16.51/.55](#)

IN-16.52/.56
Soffit Mounted Directional and
Department ID - 12"x 40"



[IN-16.61/.65](#)

IN-16.61/.65
Soffit Mounted Directional and
Department ID - 6"x 60"



[IN-16.52/.56](#)

IN-16.62/.66
Soffit Mounted Directional and
Department ID - 12"x 60"



[IN-16.62/.66](#)

IN-16.71/.75
Soffit Mounted Directional and
Department ID - 6"x 80"



[IN-16.71/.75](#)

IN-16.72/.76
Soffit Mounted Directional and
Department ID - 12"x 80"



[IN-16.72/.76](#)



Sign Overview

Interior Signage Drawings

IN-17.01
Large Orientation Map

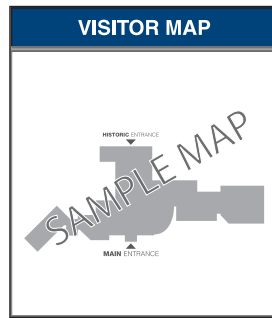

IN-17.01

IN-17.02
Large Directory Listing

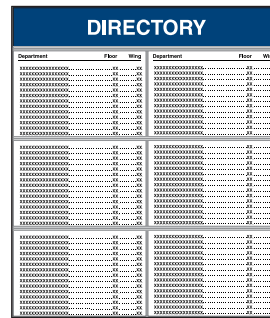

IN-17.02

IN-17.03
Orientation Map



IN-17.03

IN-17.04
Directory Listing

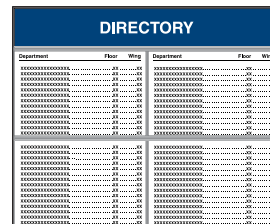

IN-17.04

IN-17.05
Small Directory Listing

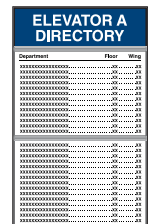

IN-17.05

IN-18.01
Vinyl Applied Letters

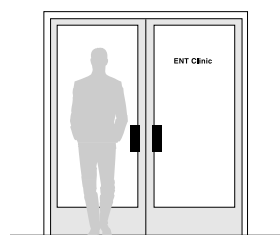

IN-18.01

IN-19.01-.03
Dimensional Letters

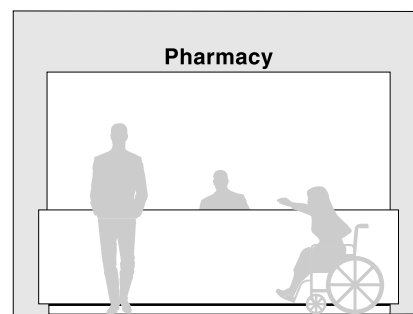

IN-19.01-.03



IN-03.01

Interior Signage Drawings

Room Number Identification

Size

Sign Face:
3" High x 9" Wide
(76.2 mm H x 228.6 mm W)

Description & Use

This sign is used to identify electrical, mechanical, telecommunication, data, closets, inpatient restrooms, and other rooms where a descriptive name is not required or poses a security risk.

Message Configuration

Refer to message layout drawing for dimensions.

Sign Components

Component based sign system.

See [Section 2.1](#) for applicable component sign system styles.

Graphic Process

Tactile raised characters & Grade 2 Braille.

Colors

Refer to the color chart in the Appendix.

Typography

Helvetica
Grade 2 Braille

Mounting

Preferred: Concealed mechanical fasteners.

Alternate: Double-sided VHB foam tape and silicone adhesive.

Installation

Wall-mounted, knob side of door at 60" (1524 mm) to top of sign from finished floor and 2" (50.8 mm) over from door frame.

See [Section 2.1](#) for installation details.

Recommendations

Signs identifying electrical closets, mechanical rooms, and telecommunication rooms should only consist of the room number, which should follow the master building room numbering system. No descriptive name or title should be used, nor should they have a unique number system.

See [Section 2.1](#) for additional information.

See [Section 4.1 Design Elements](#) for relevant ABA requirements.

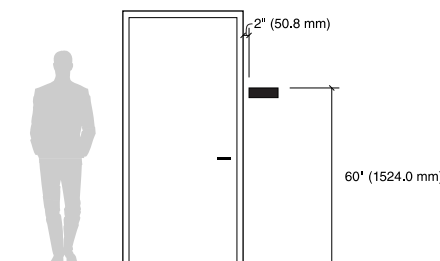

IN-03.01

Interior Signage Drawings

Room Number Identification

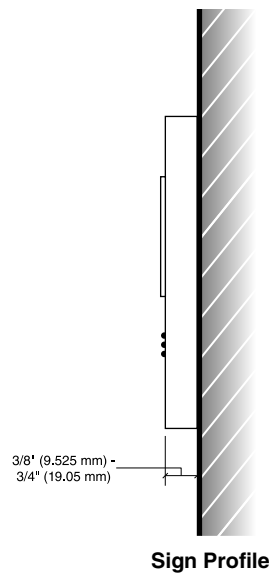
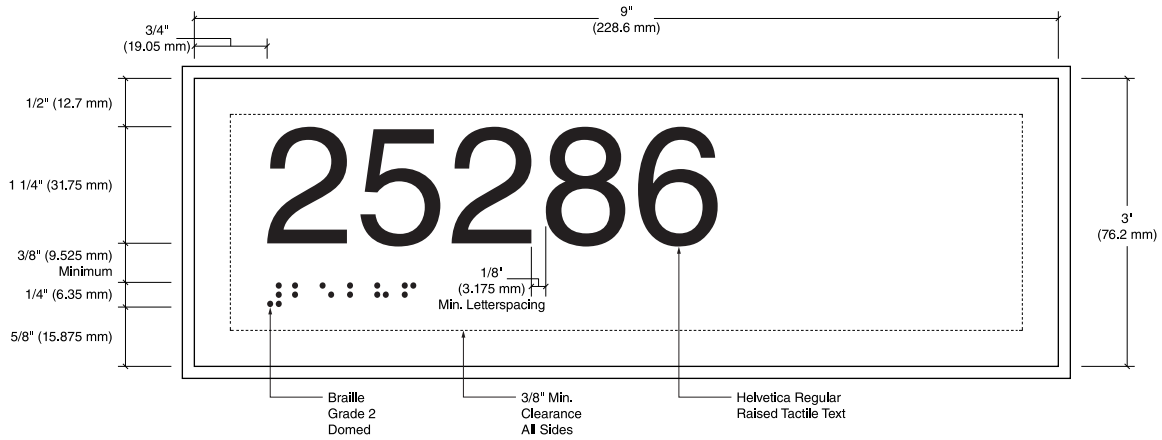

IN-04.01

Interior Signage Drawings

Primary Room Identification with Insert

Size

Sign Face:
9" High x 9" Wide
(228.6 mm H x 228.6 mm W)

Description & Use

This is the primary room identification sign type. The room number is composed of raised, tactile characters and Braille, and the room's occupant/use is displayed on an updatable insert.

Message Configuration

Layouts A & B are for typical room and department identification. Layout C accommodates rooms and departments with longer names. Layout D is for rooms where a designation is important to differentiate the room from other spaces with the same use.

Sign Components

Component based signage system. Some signage systems have 8.5" wide insert components allowing for easier use of standard letter size stock when printing inserts.

Graphic Process

Room Number: Tactile raised characters & Grade 2 Braille.
Message Insert: Paper or acetate sheet with digital print.

Colors

Refer to the color chart in the Appendix.

Typography

Helvetica & Grade 2 Braille.

Installation

Wall-mounted, knob side of door at 60" (1524 mm) to top of sign from finished floor and 2" (50.8 mm) over from door frame.

Recommendations

Using names of individuals or providers is not recommended for security reasons and the level of future updates required.

Inserts should follow an approved template established as part of the facility's sign standard and wayfinding plan.

Signs identifying electrical closets, mechanical rooms, and telecommunication rooms should only consist of the room number, which should follow the master building room numbering system.

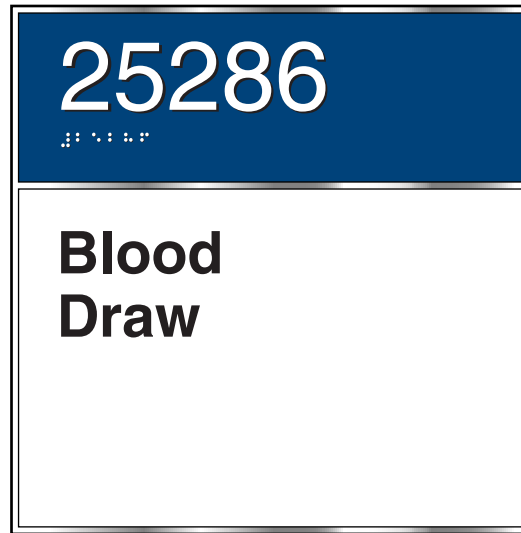

Message Layout A

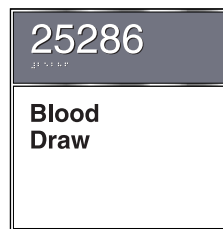

Message Layout B

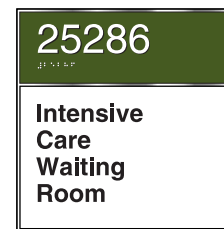

Message Layout C

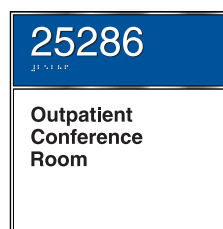

Message Layout D

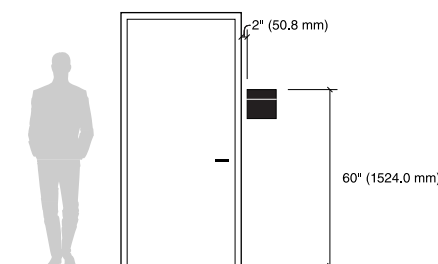
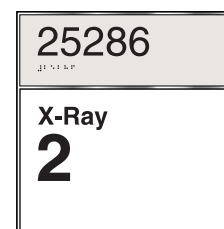

Mounting

Preferred: Concealed mechanical fasteners.
Alternate: Double-sided VHB foam tape and silicone adhesive.



Primary Room Identification with Insert

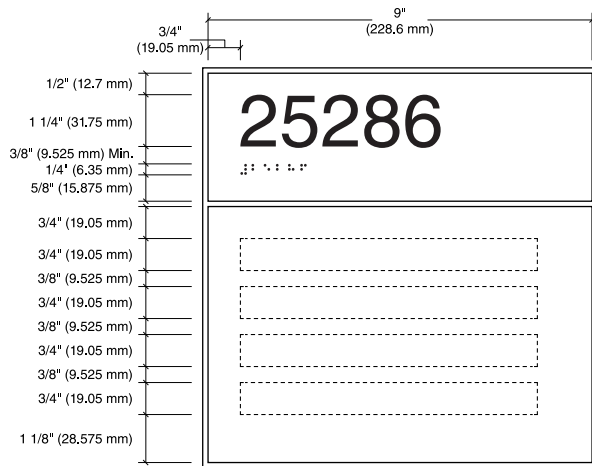

Message Layout A & B

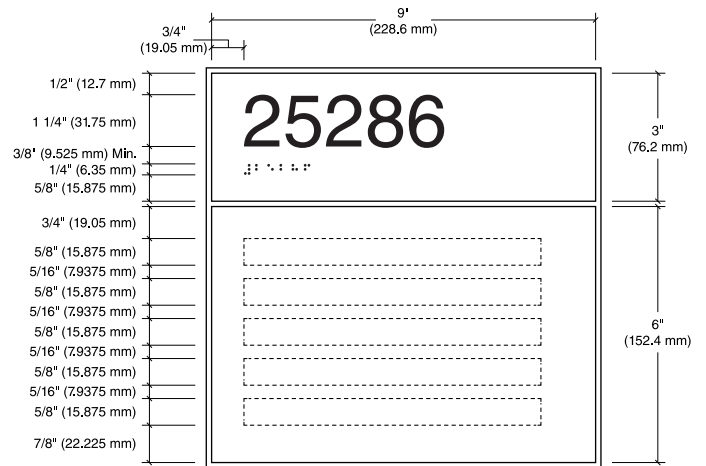

Message Layout C

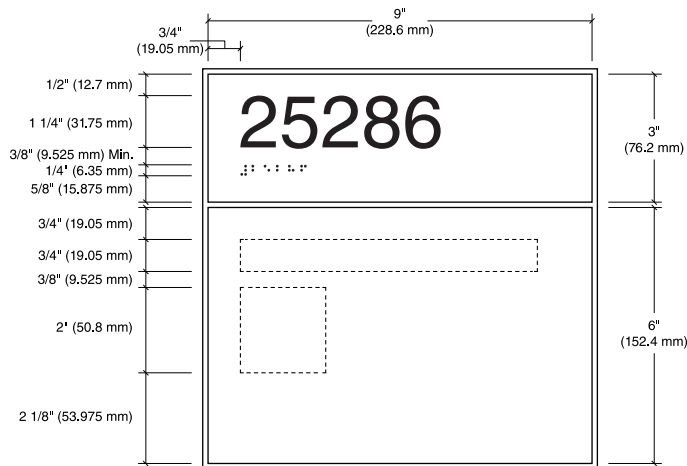

Message Layout D

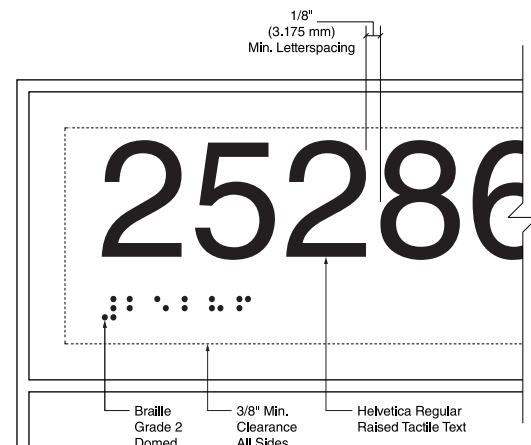

Tactile Sign Detail

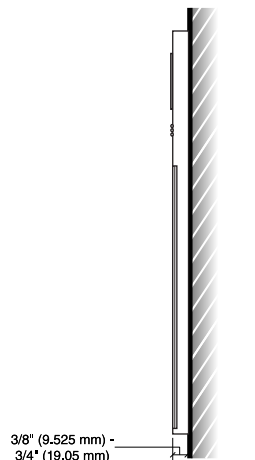

Sign Profile



IN-04.02

Interior Signage Drawings

Secondary Room Identification with Insert

Size

Room Number & Message Insert:
6" High x 9" Wide
(152.4 mm H x 228.6 mm W)

Description & Use

The room number is composed of raised, tactile characters and Braille, and the room's occupant/use is displayed on an updatable insert. This sign can be used for secondary rooms or buildings.

Message Configuration

Layouts A & B are for typical room and department identification. Layout C accommodates rooms and departments with longer names. Layout D is for rooms where a designation is important to differentiate the room from other spaces with the same use.

Sign Components

Component based sign system. Some sign systems have 8.5" wide insert components allowing for easier use of standard letter size stock when printing inserts.

Graphic Process

Room Number: Tactile raised characters & Grade 2 Braille.
Message Insert: Paper or acetate sheet with digital print.

Colors

Refer to the color chart in the Appendix.

Typography

Helvetica & Grade 2 Braille.

Installation

Wall-mounted, knob side of door at 60" (1524 mm) to top of sign from finished floor and 2" (50.8 mm) over from door frame.

Recommendations

Using names of individuals or providers is not recommended for security reasons and the level of future updates required.

Inserts should follow an approved template established as part of the facility's sign standard and wayfinding plan.

Signs identifying electrical closets, mechanical rooms, and telecommunication rooms should only consist of the room number, which should follow the master building room numbering system.

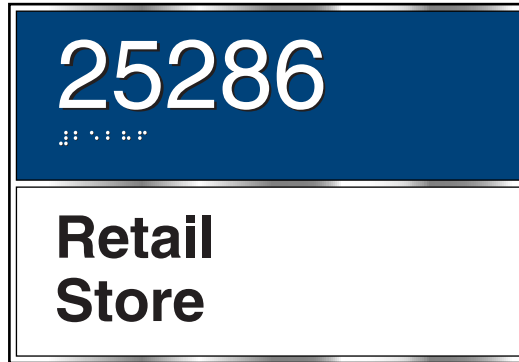

Message Layout A



Message Layout B



Message Layout C

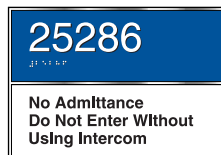

Message Layout D

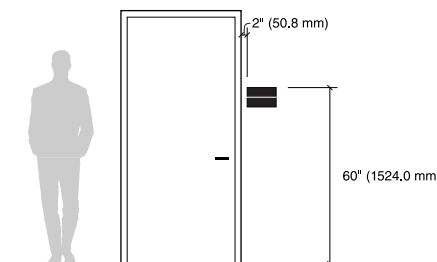

Mounting

Preferred: Concealed mechanical fasteners.
Alternate: Double-sided VHB foam tape and silicone adhesive.



IN-04.02

Interior Signage Drawings

Secondary Room Identification with Insert

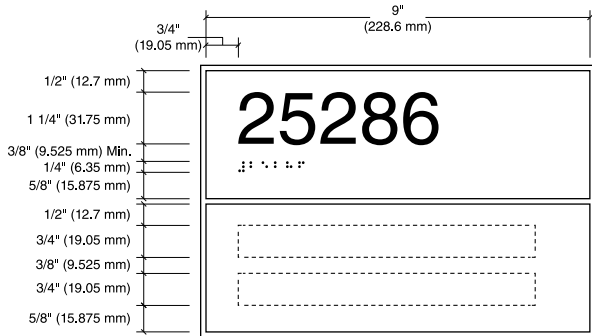

Message Layout A & B

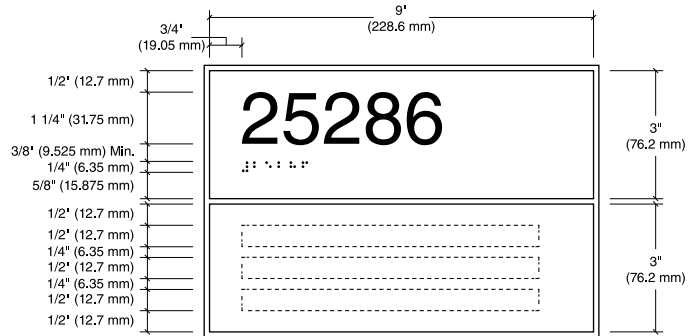

Message Layout C

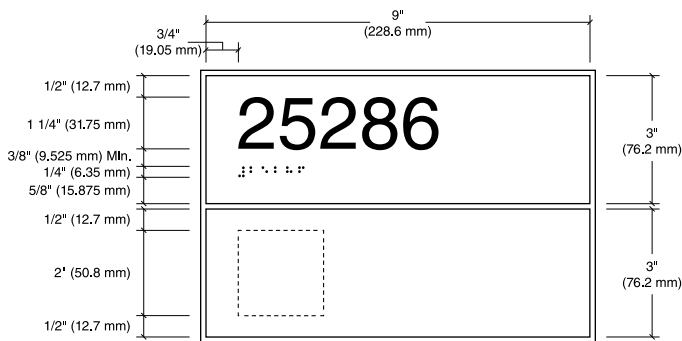

Message Layout D

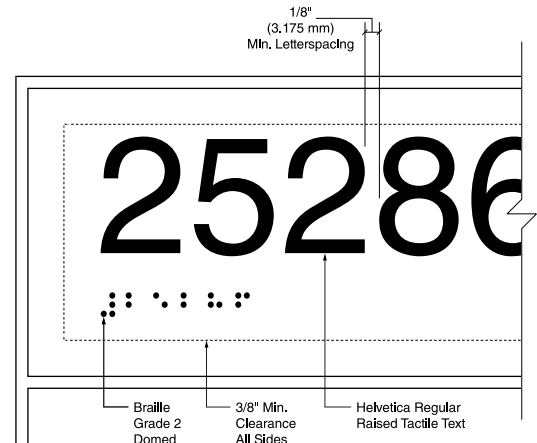

Tactile Sign Detail

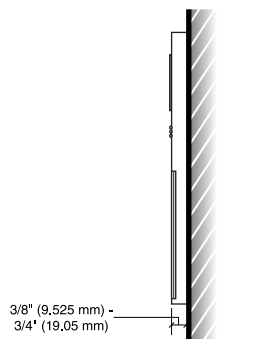

Sign Profile



Patient Room Identification with Write-On Panel

Size

Sign Face:
9" High x 9" Wide
(228.6 mm H x 228.6 mm W)

Description & Use

This sign can be used to identify patient rooms. It includes a write-on panel for temporary messages like the patient's name.

Message Configuration

Refer to message layout drawing for dimensions.

Layout A has a blank write-on panel
Layout B is used for rooms with two beds.

Sign Components

Component based sign system with write-on panel and optional paper grip strip SP-22.01

Graphic Process

Room Number: Tactile raised characters & Grade 2 Braille

Colors

Refer to the color chart in the Appendix.

Typography

Helvetica
Grade 2 Braille

Mounting

Preferred: Concealed mechanical fasteners

Alternate: Double-sided VHB foam tape and silicone adhesive

Installation

Wall-mounted, knob side of door at 60" (1524 mm) to top of sign from finished floor and 2" (50.8 mm) over from door frame.

See [Section 2.1](#) for installation details.

Recommendations

All signs and messages must be in accordance with patient privacy regulations.

Ensure that the patient room identification signs cater to the specific needs of the unit. Signs without write-on board configurations, such as the IN-04.01 sign type, can be used. Additionally, unit specific sign configurations can be developed.

See [Section 2.1](#) for additional information.



Optional – Grip Strip Holder SP-22.01



Message Layout A



Message Layout B

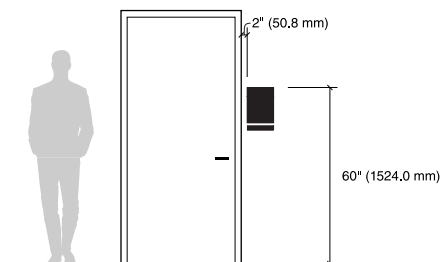
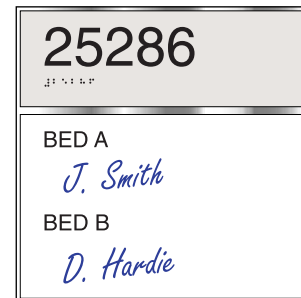

Patient Room Identification with Write-On Panel

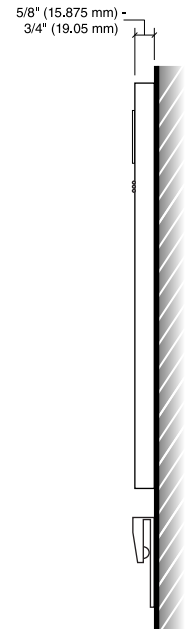
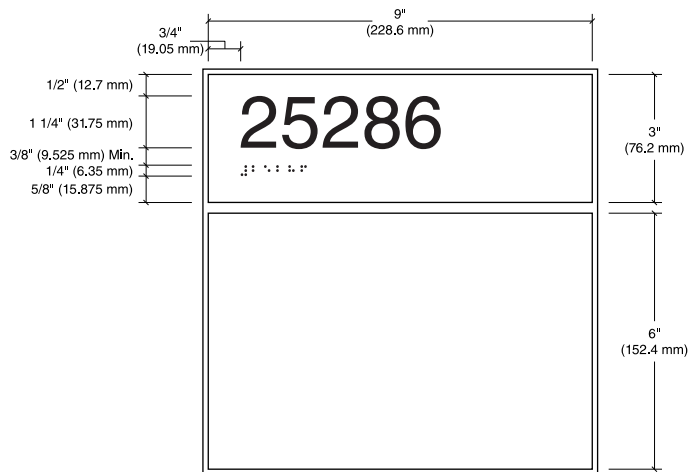

Sign Profile

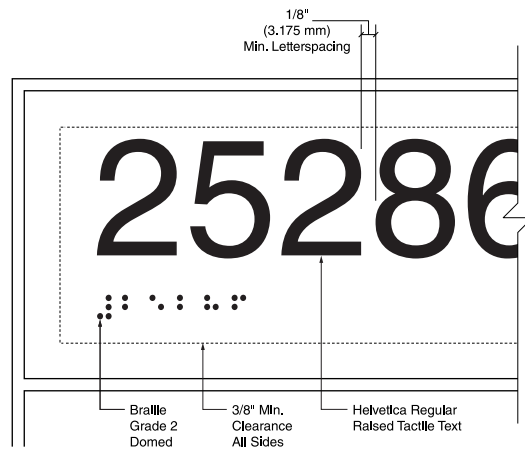

IN-05.07

Interior Signage Drawings

Patient Room Identification with Room Alert & Contact Precautions

Size

Sign Face:
9 1/2" High x 9" Wide
(241.3 mm H x 228.6 mm W)

Description & Use

This sign can be used to identify patient rooms with added components for patient notification alerts and contact precaution notices.

Message Configuration

Refer to message layout drawing for dimensions.

See IN-06.07 for Additional Patient Notification Alerts.

See IN-06.08 for Additional Contact Precaution Notices.

Sign Components

Component based sign system with patient notification alerts and contact precaution notices.

Graphic Process

Room Number: Tactile raised characters & Grade 2 Braille

Alert/Precaution Inserts: laminated paper or polystyrene sheet with digital print

Colors

Refer to the color chart in the Appendix.

Typography

Helvetica
Grade 2 Braille

Installation

Wall-mounted, knob side of door at 60" (1524 mm) to top of sign from finished floor and 2" (50.8 mm) over from door frame.

See [Section 2.1](#) for installation details.

Recommendations

All signs and messages must be in accordance with patient privacy regulations.

Ensure that the patient room identification signs cater to the specific needs of the unit. Signs without write-on board configurations, such as the IN-04.01 sign type, can be used. Additionally, unit specific sign configurations can be developed.

See [Section 2.1](#) for additional information.



Optional – Grip Strip Holder SP-22.01

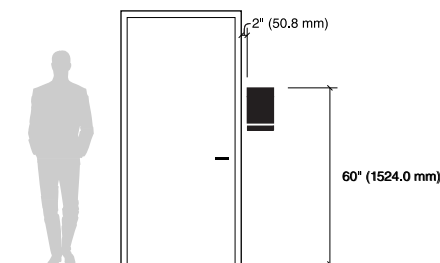

Mounting

Preferred: Concealed mechanical fasteners
Alternate: Double-sided VHB foam tape and silicone adhesive



Patient Room Identification with Room Alert & Contact Precautions

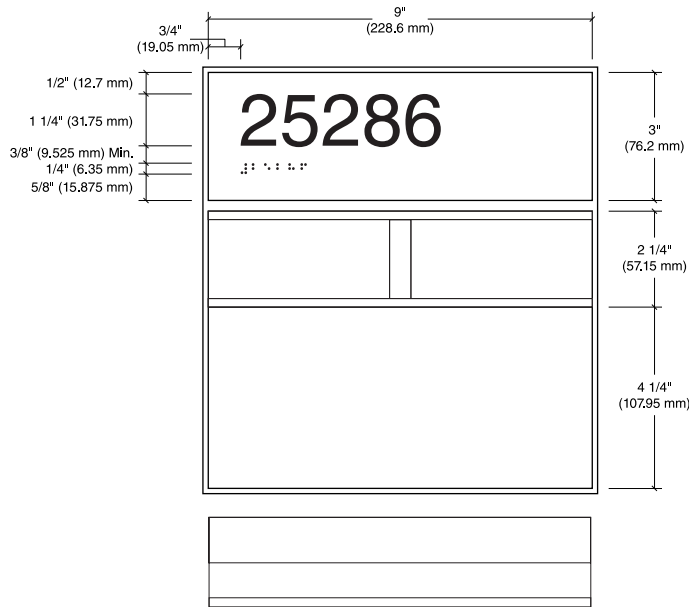

Optional – Grip Strip Holder SP-22.01

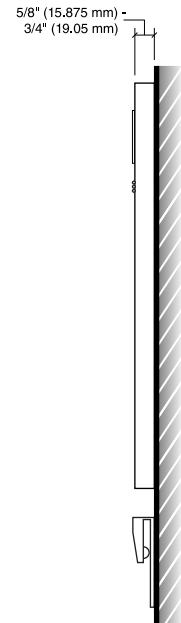

Sign Profile

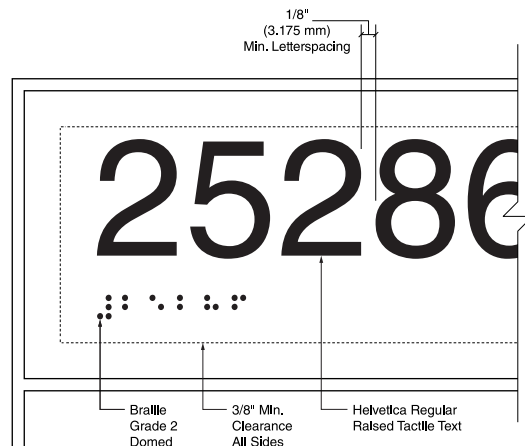

Tactile Sign Detail

IN-06.05-.06

Interior Signage Drawings

Patient Bed Signs

Size

IN-06.05:
6" High x 9" Wide
(152.4 mm H x 228.6 mm W)

IN-06.06:
12 1/2" High x 9" Wide
(317.5 mm H x 228.6 mm W)

Description & Use

These signs can be used to identify patient beds within the patient room. It includes a write-on panel for temporary messages like the patient's name and optional patient information tabs.

Message Configuration

Refer to message layout drawing for dimensions.

See IN-06.07 for Additional Patient Notification Alerts.

Sign Components

Component based sign system with write-on panel, patient notification alerts and optional paper grip strip SP-22.01.

Colors

Refer to the color chart in the Appendix.

Typography

Helvetica
Grade 2 Braille

Mounting

Preferred: Concealed mechanical fasteners.

Alternate: Double-sided VHB foam tape and silicone adhesive.

Installation

Inside room adjacent to patient bed.

See [Section 2.1](#) for installation details.

Recommendations

All signs and messages must be in accordance with patient privacy regulations.

Ensure that the patient bed signs cater to the specific needs of the unit. Signs without patient / contact precaution configurations, such as the IN-04.01 sign type, can be used. Additionally, unit specific sign configurations can be developed.

See [Section 2.1](#) for additional information.



Optional – Grip Strip Holder SP-22.01



IN-06.05



IN-06.06

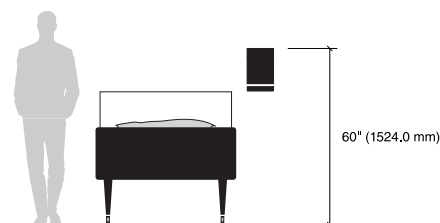

Patient Bed Signs

IN-06.05

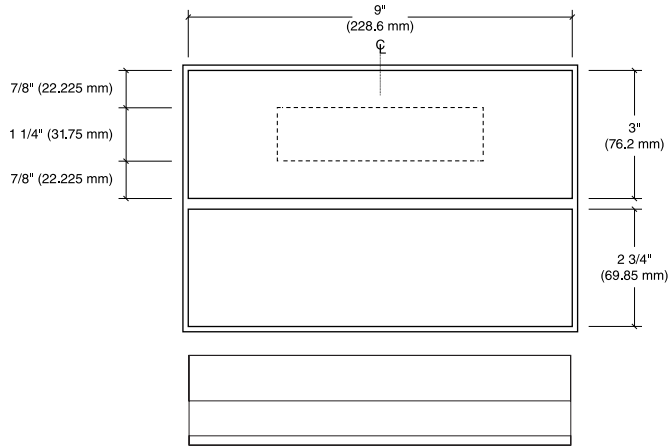

Optional – Grip Strip Holder SP-22.01

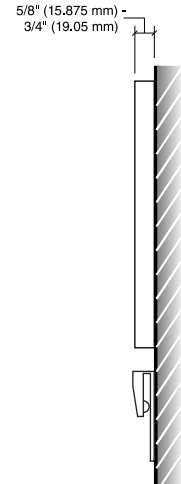

Sign Profile

IN-06.06

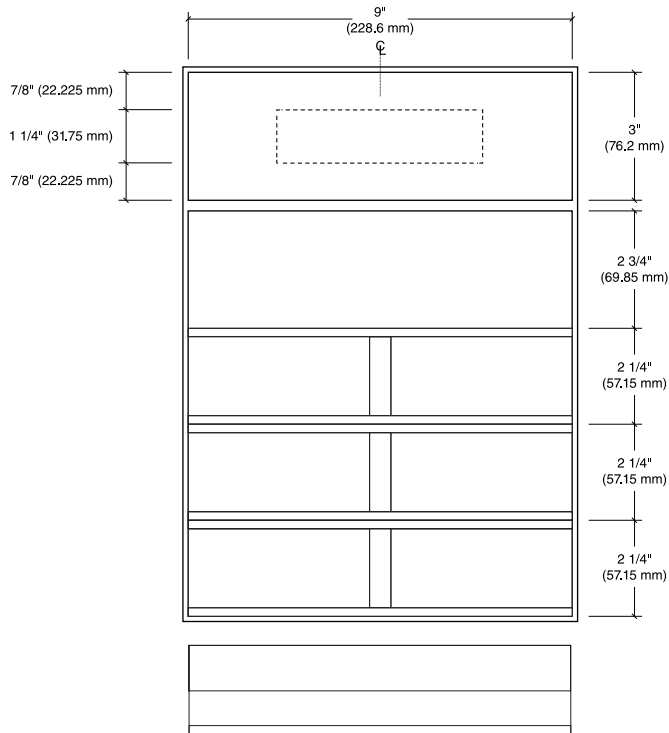

Optional – Grip Strip Holder SP-22.01

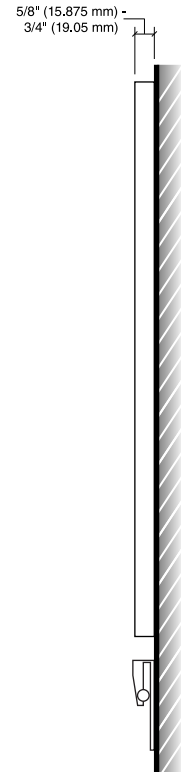

Sign Profile



IN-06.07

Interior Signage Drawings

Patient Information Tabs

Size

2" High x 4 1/2" Wide
(50.8 mm H x 114.3 mm W)

Description & Use

These tabs are used to display relevant patient care information for in-patient room and patient bed identification signs.

Sign Components

For use with IN-05.07 and IN-06.06

Card sizes may vary between sign systems. Confirm that cards purchased separately are compatible with the facility's sign system.

Graphic Process

Laminated paper or polystyrene sheet with digital print

Recommendations

All signs and messages must be in accordance with patient privacy regulations.

Example patient information tabs are shown. Manufacturers may have graphics that are specific to their product line. It is important to collaborate with the unit to choose and design patient information tabs that cater to their specific needs and the patient population.



IN-06.07

Interior Signage Drawings

Patient Information Tabs

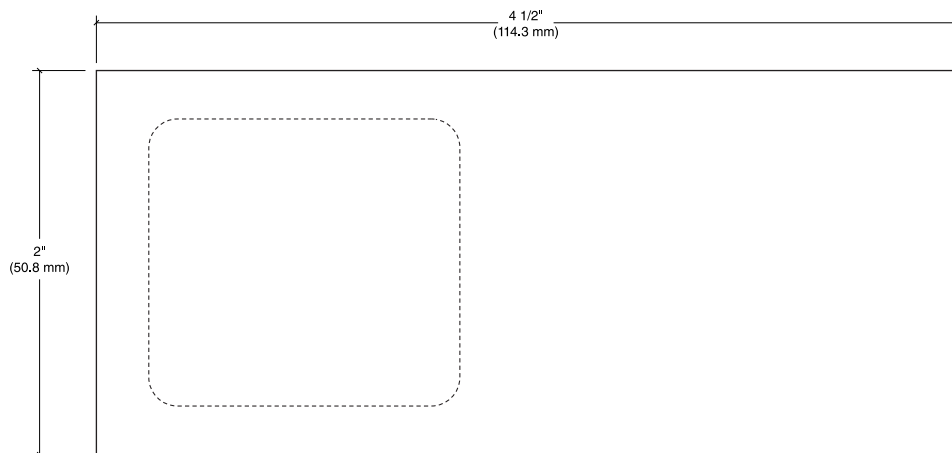
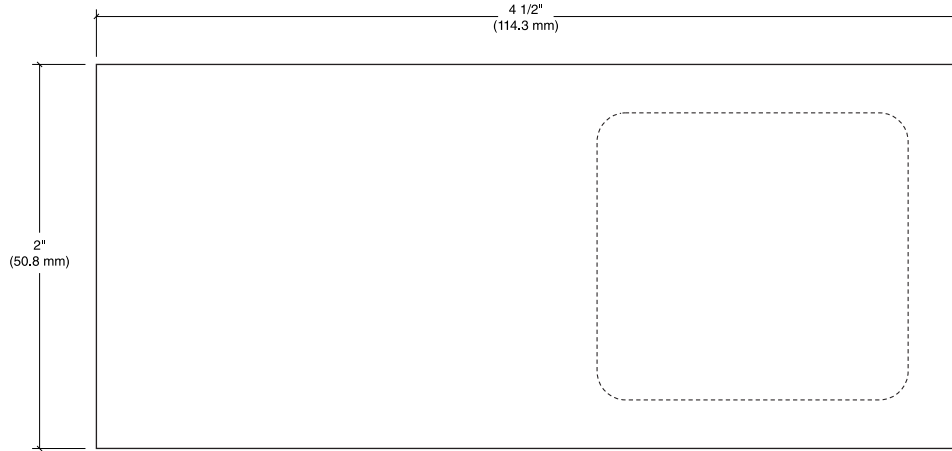

IN-06.08

Interior Signage Drawings

Patient Contact Precaution Cards

Size

4 1/4" High x 9" Wide
(107.95 mm H x 228.6 mm W)

Description & Use

These cards are used to display relevant contact precautions in patient room identification signs.

Sign Components

For use with IN-05.07

Card sizes may vary between sign systems. Confirm that cards purchased separately are compatible with the facility's sign system.

Graphic Process

Laminated paper or polystyrene sheet with digital print.

Recommendations

All signs and messages must be in accordance with patient privacy regulations.

Example contact precaution notifications are shown.

Manufacturers may have graphics that are specific to their product line. It is important to collaborate with the unit to choose and design patient information tabs that cater to their specific needs and the patient population.

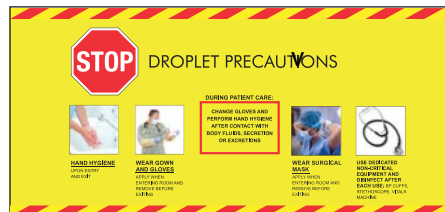
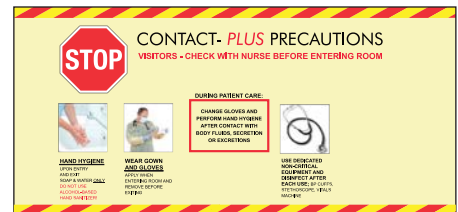
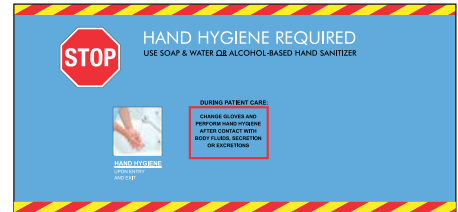
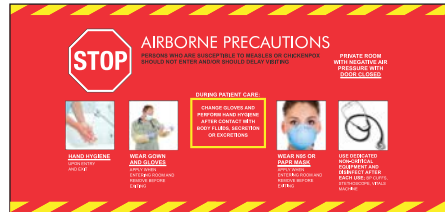

Patient Contact Precaution Cards

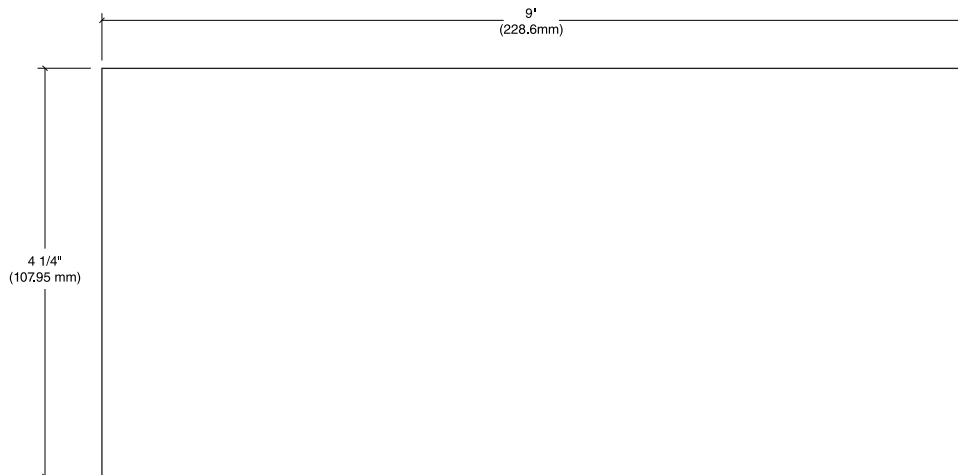

IN-07.01-.02

Interior Signage Drawings

Room Identification with Insert & Indicator

Size

IN-07.01:
11" High x 9" Wide
(279.4 mm H x 228.6 mm W)

IN-07.02:
8" High x 9" Wide
(203.2 mm H x 228.6 mm W)

Description & Use

Use this sign for conference rooms, meeting rooms, exam rooms, treatment rooms, and offices where the occupants want to indicate that the room is in use.

Message Configuration

Typical message content for the bottom slider component is "In Use" on the left and a blank solid color on the right.

Sign Components

Component based sign system

Some sign systems have 8.5" wide insert components allowing for easier use of standard letter size stock when printing inserts.

Graphic Process

Room Number: Tactile raised characters & Grade 2 Braille.

Message Insert: Paper or acetate sheet with digital print.

Colors

Refer to the color chart in the Appendix.

Typography

Room Number: Helvetica & Grade 2 Braille.
Message Insert: Helvetica Bold

Mounting

Preferred: Concealed mechanical fasteners.
Alternate: Double-sided VHB foam tape and silicone adhesive.

Installation

Wall-mounted, knob side of door at 60" (1524 mm) to top of sign from finished floor and 2" (50.8 mm) over from door frame.

Recommendations

For rooms with dedication names, avoid adding the name to this sign. Instead, use a separate dedication plaque.

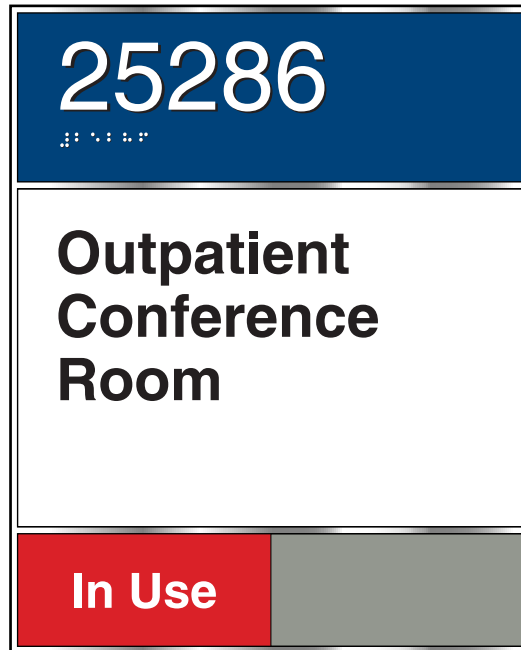

IN-07.01 (Message Layout A)



IN-07.01 (Message Layout B)

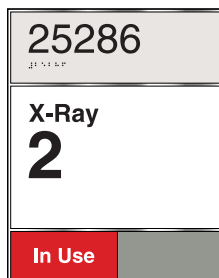

IN-07.02

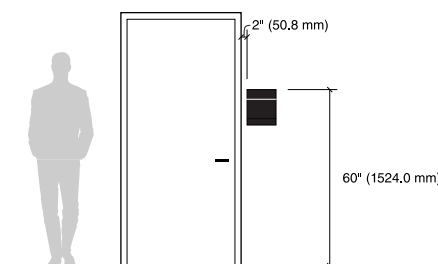
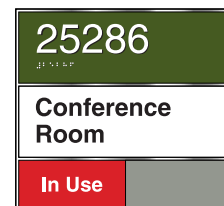

Room Identification with Insert & Indicator

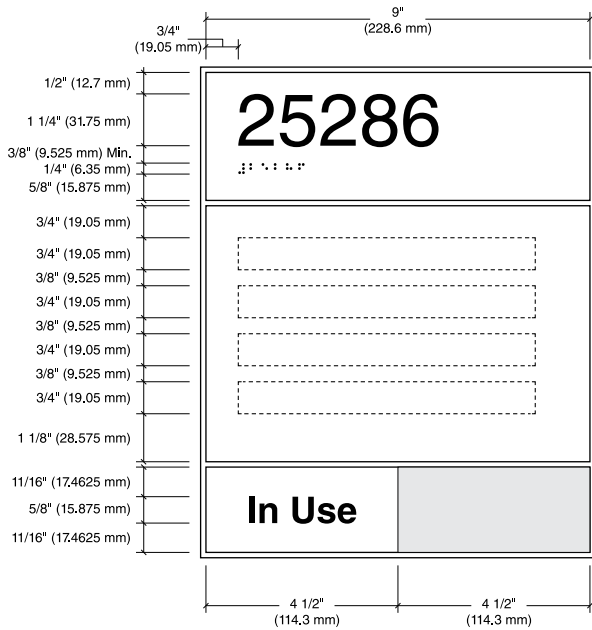

IN-07.01 (Message Layout A)

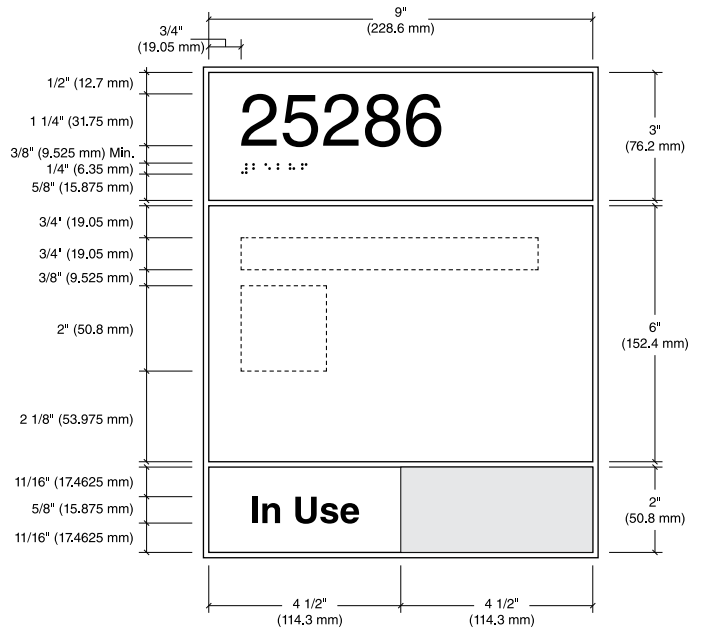

IN-07.01 (Message Layout B)

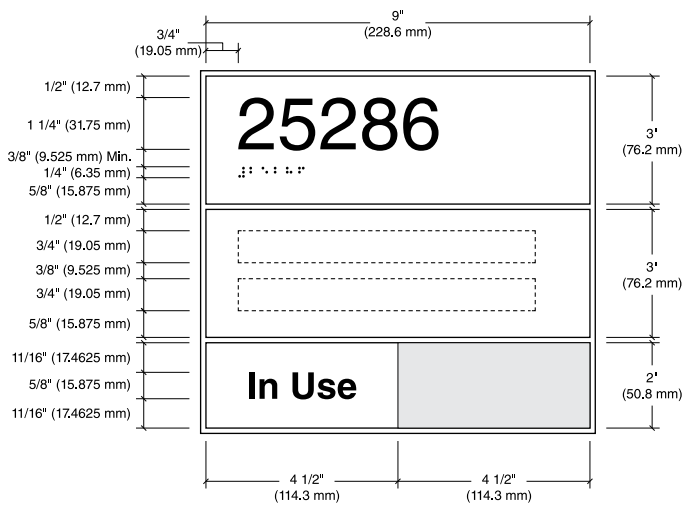

IN-07.02

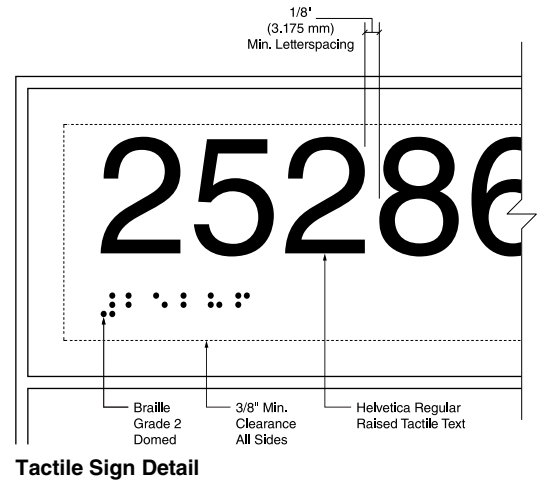

Tactile Sign Detail

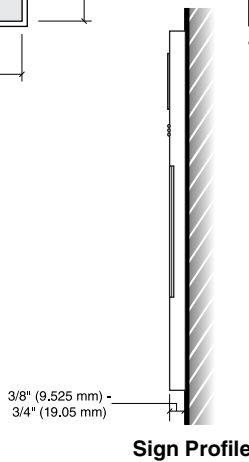

Sign Profile



IN-08.01

Interior Signage Drawings

No Smoking / No Vaping

Size

Sign Face:
9" High x 9" Wide
(228.6 mm H x 228.6 mm W)

Description & Use

This is an optional sign used to reinforce the "No Smoking or Vaping" policy in supplement to the mandatory posting of sign type IN-02.02 in [Section 3.3](#).

Message Configuration

Refer to message layout drawing for dimensions.

Sign Components

Component Based Sign System (Wall Mount) or Acrylic Construction (Door Mount).

See [Section 2.1](#) for applicable component sign system styles and acrylic construction.

Graphic Process

Direct second surface digital print or silk-screened.

Colors

Text: Black
Symbol: Red and Black
Background: White

Refer to the color chart in the Appendix.

Typography

Helvetica

Mounting

Concealed mechanical fasteners or double-sided VHB foam tape and silicone adhesive

Installation

Mount on wall or door, 60" (1524 mm) to top or center of sign. If installed on door, it should be on center.

Recommendations

This sign is optional and used in areas deemed necessary to reinforce policy.



Message Layout A



Message Layout B

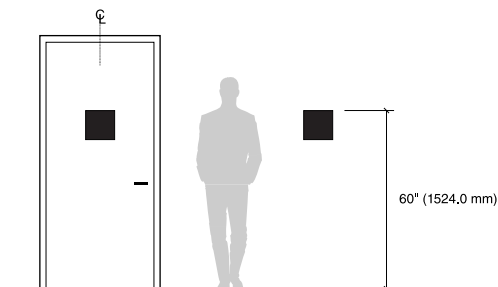

IN-08.01

Interior Signage Drawings

No Smoking / No Vaping

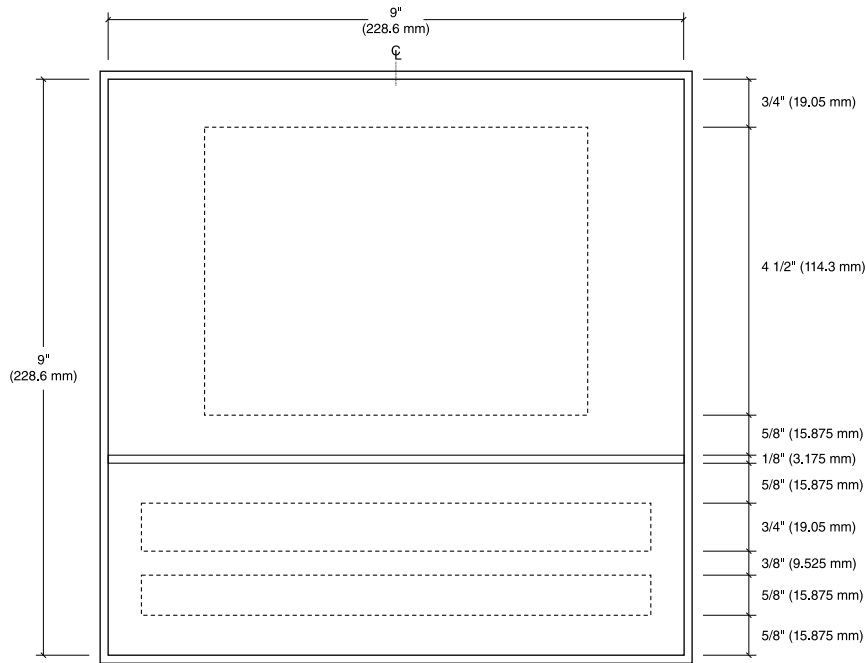

Message Layout A

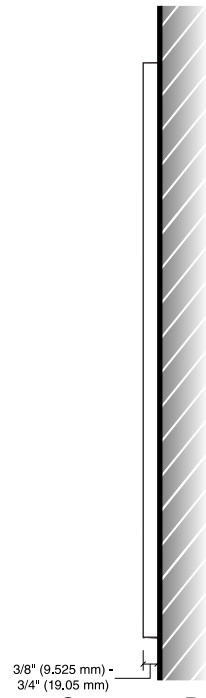

Component Based Sign Profile

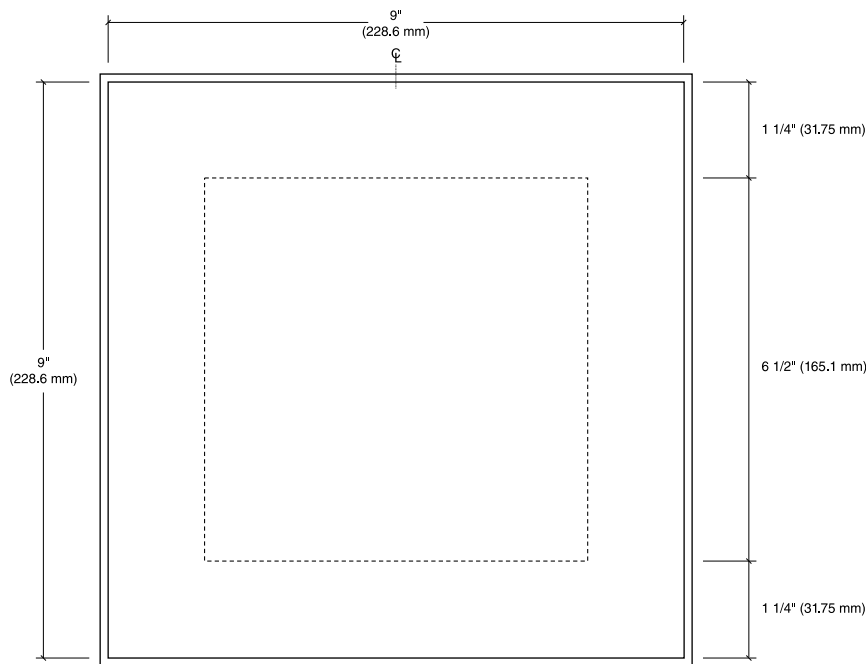

Message Layout B

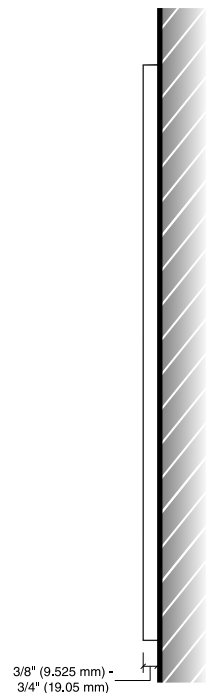

Sign Profile



Restricted Area Identification

Size

Sign Face:
9" High x 9" Wide
(228.6 mm H x 228.6 mm W)

Description & Use

This sign is used to regulate access to restricted rooms and areas. It should be used sparingly to avoid creating an unwelcoming environment.

Message Configuration

Refer to message layout drawing for dimensions.

Sign Components

Component Based Sign System (Wall Mount) or Acrylic Construction (Door Mount).

See [Section 2.1](#) for applicable component sign system styles and acrylic construction.

Graphic Process

Direct second surface digital print or silk-screened.

Colors

Text: Black
Symbol: Red and White
Background: White

Refer to the color chart in the Appendix.

Typography

Helvetica

Mounting

Concealed mechanical fasteners or double-sided VHB foam tape and silicone adhesive

Installation

Mount on wall or door, 60" (1524 mm) to top or center of sign. If installed on door, it should be on center.

Recommendations

This sign is optional and should be used only when necessary to regulate access to rooms and areas.

Message Layout A

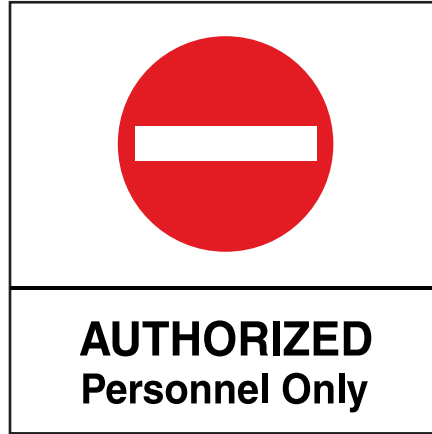

Message Layout B



Message Layout C

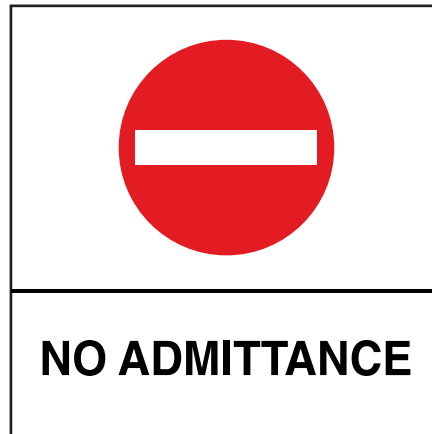

Message Layout D

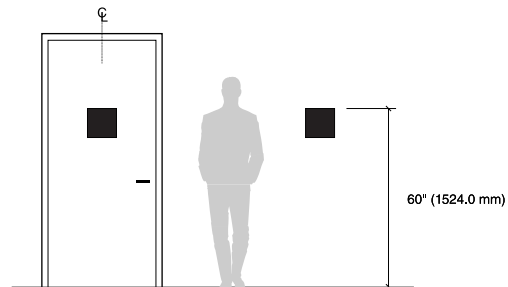

Restricted Area Identification

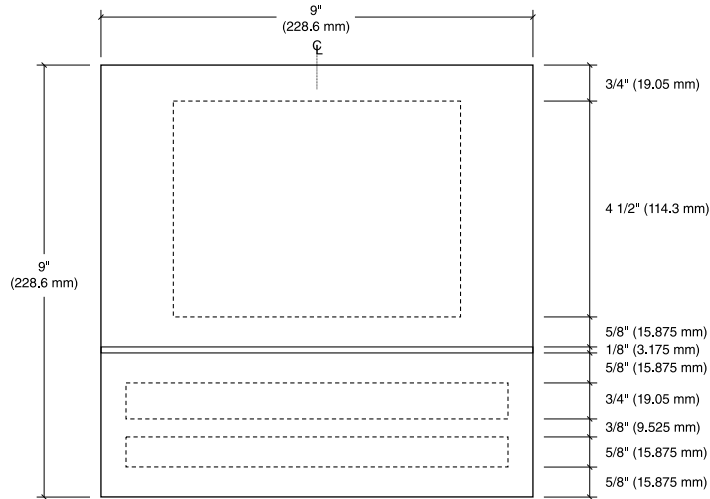

Message Layout A & D

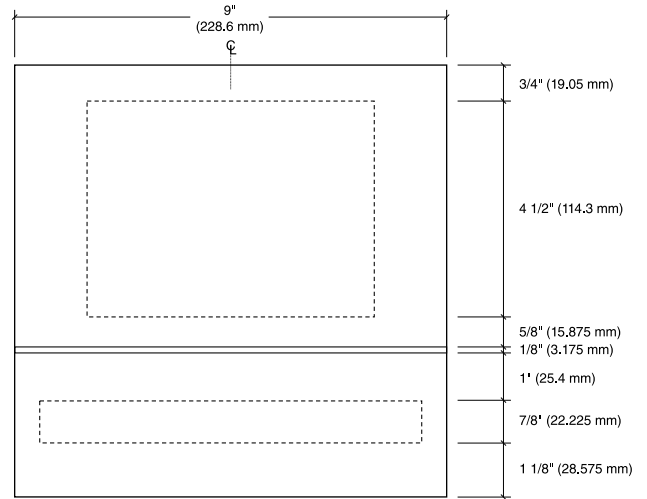

Message Layout B

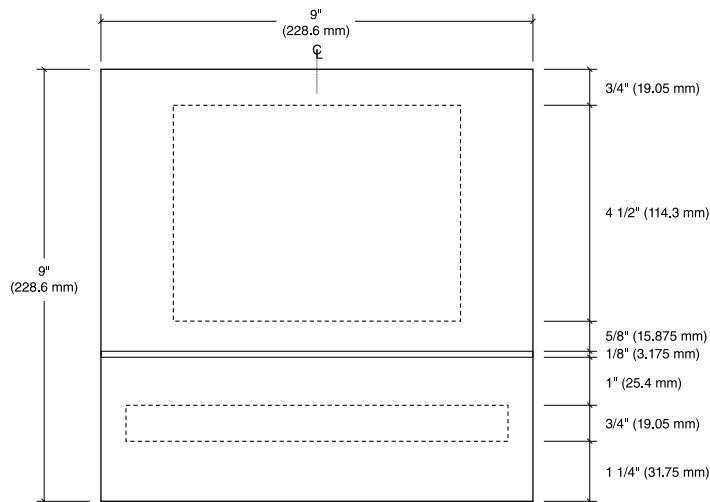

Message Layout C

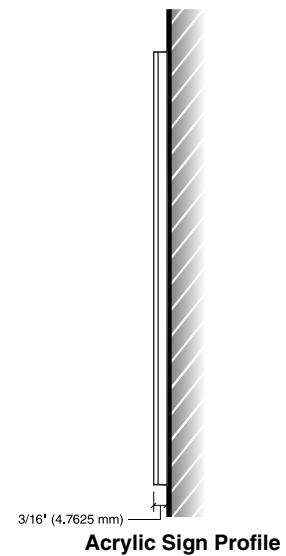

IN-09.01-.06

Interior Signage Drawings

Restroom Identification

Size

Sign Face:
12" High x 9" Wide
(304.8 mm H x 228.6 mm W)

Description & Use

This sign is used to identify restrooms with name, pictogram, and room number.

Message Configuration

Refer to message layout drawing for dimensions.

All-gender restroom signs should use the toilet pictogram and say "RESTROOM".

Restrooms that are not accessible or do not contain a baby changing station require additional postings specified in IN-09.07 & .08.

For restrooms in staff areas, "STAFF ONLY" can be used in place of the standard restroom names.

Sign Components

Component based sign system.

See [Section 2.1](#) for applicable component sign system styles.

Graphic Process

Digitally printed pictogram, tactile room number and text, accompanying Grade 2 Braille

Colors

Refer to the color chart in the Appendix.

Typography

Helvetica
Grade 2 Braille

Mounting

Preferred: Concealed mechanical fasteners

Alternate: Double-sided VHB foam tape and silicone adhesive

Installation

Mount on wall or door, 60" (1524 mm) to top of sign. If installed on door, it should be on center.

Recommendations

A sign with room number only (IN-03.01) can be used at inpatient restrooms.

See [Section 2.1](#) for additional information.



IN-09.01



IN-09.02



IN-09.03



IN-09.04

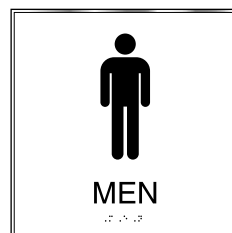

IN-09.05

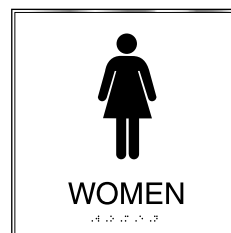

IN-09.06

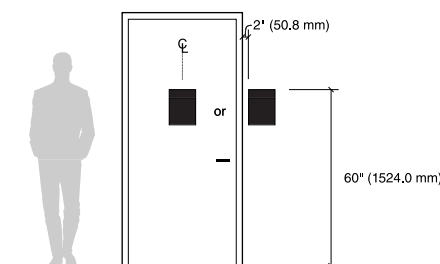

IN-09.01-.06

Interior Signage Drawings

Restroom Identification

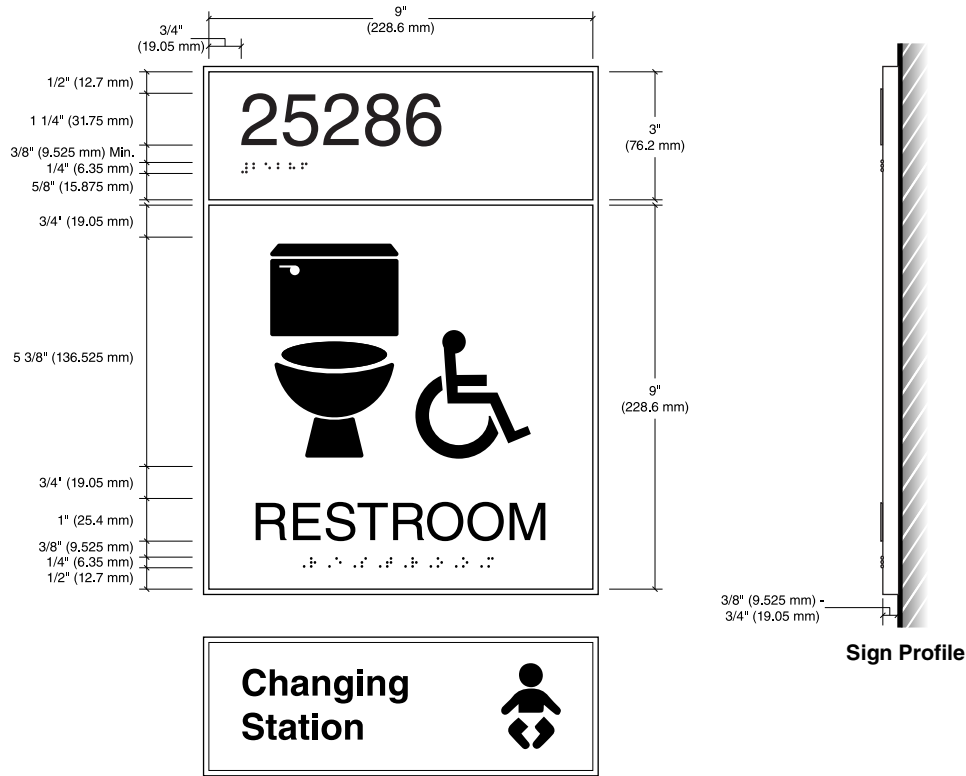

Required Changing Station and/or Non-Accessible Posting IN-09.07-.08

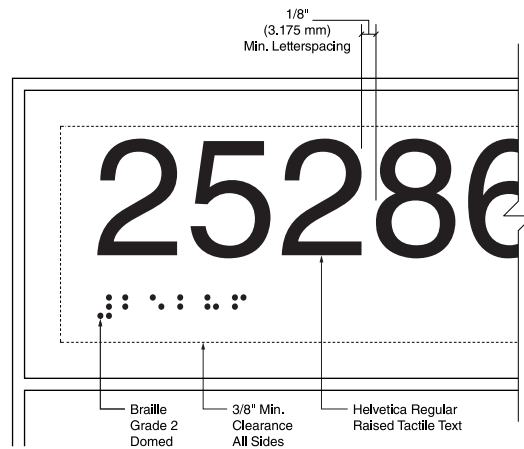

Tactile Sign Detail



IN-09.07-.08

Interior Signage Drawings

Required Restroom Postings

Size

IN-09.07:
3" High x 9" Wide
(76.2 mm H x 228.6 mm W)

IN-09.08:
6" High x 9" Wide
(152.4 mm H x 228.6 mm W)

Description & Use

These signs are additional required postings used to notify whether a restroom has a changing station and is accessible or not.

Message Configuration

Refer to message layout drawing for dimensions.

IN-09.07: Used when restroom has a changing station

IN-09.08 Layout A: Used when a restroom is accessible but has no changing station.

IN-09.08 Layout B: Used when a restroom is not accessible.

IN-09.08 Layout C: Used when a restroom is not accessible and has a changing station

IN-09.08 Layout D: Used when a restroom is not accessible and does not have a changing station.

Sign Components

Component based sign system

See [Section 2.1](#) for applicable component sign system styles.

Graphic Process

Direct second surface digital print or silk-screened

Colors

Refer to the color chart in the Appendix.

Typography

Helvetica

Mounting

Preferred: Concealed mechanical fasteners.

Alternate: Double-sided VHB foam tape and silicone adhesive.

Installation

Mount directly below restroom identification sign.



IN-09.07



IN-09.08 (Message Layout A)



IN-09.08 (Message Layout B)



IN-09.08 (Message Layout C)

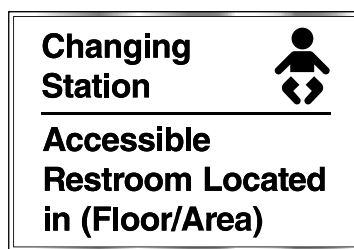

IN-09.08 (Message Layout D)

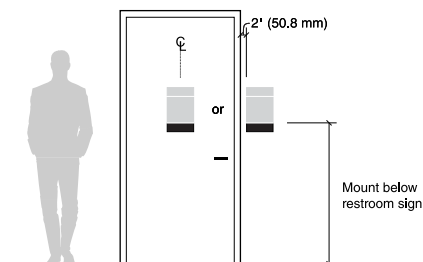

IN-09.07-.08

Interior Signage Drawings

Required Restroom Postings

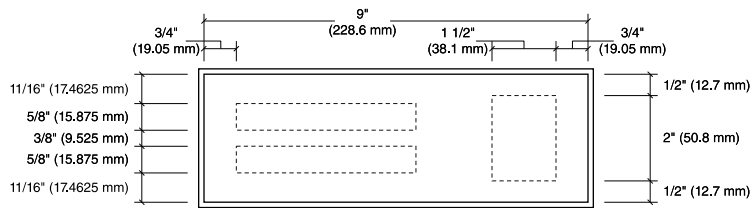

IN-09.07

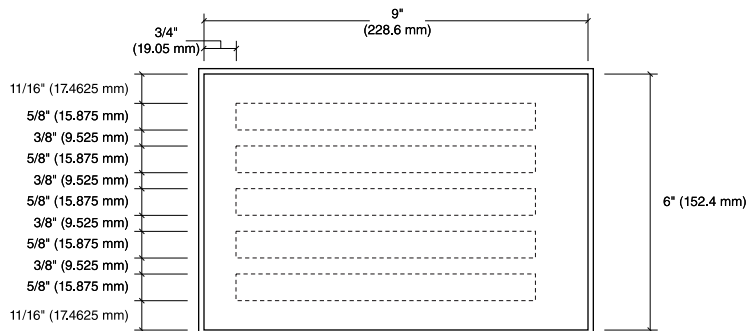

IN-09.08 (Message Layout A, B, & D)

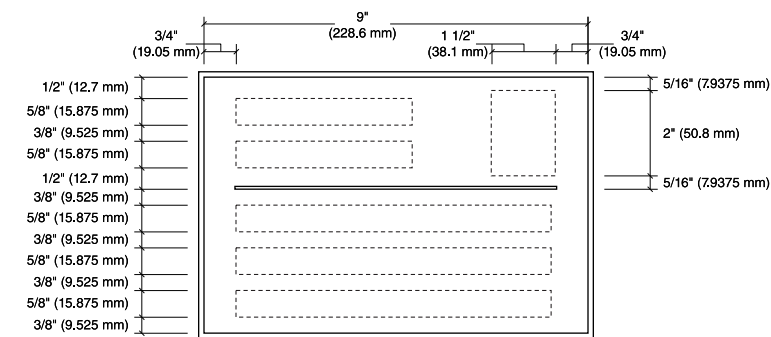

IN-09.08 (Message Layout C)

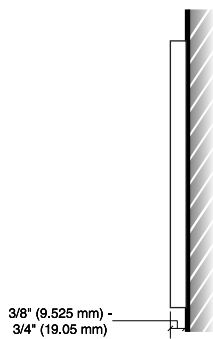

Sign Profile



Pictogram and Symbol

Size

Sign Face: 9" High x 9" Wide
(228.6 mm H x 228.6 mm W)

Description & Use

This sign type is used to identify destinations and points of interest with a large pictogram and text.

Example uses include identifying: Accessible routes, Department Check-Ins, Information Kiosks, & Elevator Lobbies.

Message Configuration

Refer to message layout drawing for dimensions.

Sign Components

Component based sign system.

See Section 2.1 for applicable component sign system styles.

Graphic Process

Direct second surface digital print or silk-screened.

Colors

Refer to the color chart in the Appendix.

Typography

Helvetica

Mounting

Preferred: Concealed mechanical fasteners.

Alternate: Double-sided VHB foam tape and silicone adhesive.

Installation

Mount at 60" (1524 mm) above finished floor to the center of the sign.

Alternate mounting 60" (1524 mm) to top of the sign if adjacent to room signs.

Message Layout A



Message Layout B



Message Layout C



Message Layout D

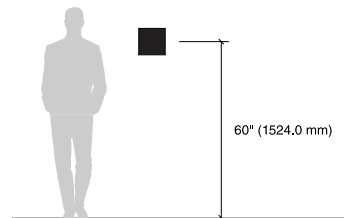

IN-09.09

Interior Signage Drawings

Pictogram and Symbol

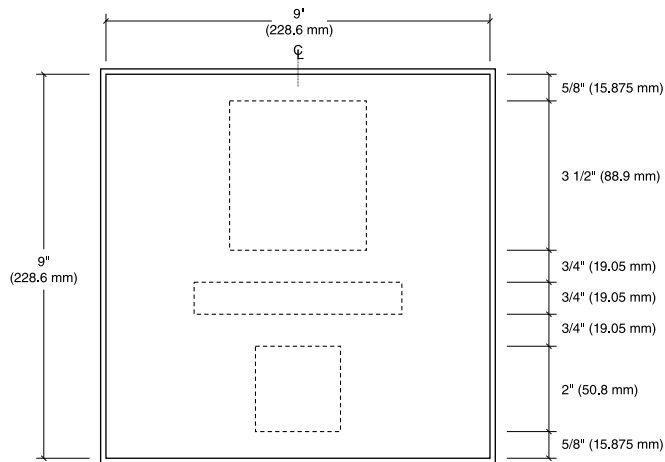

Message Layout A

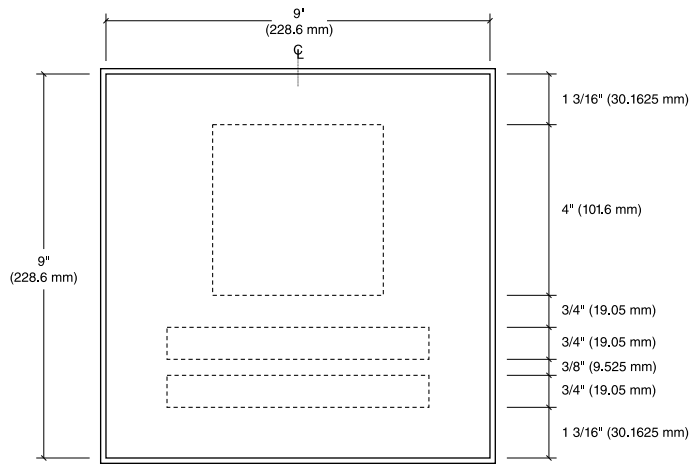

Message Layout B

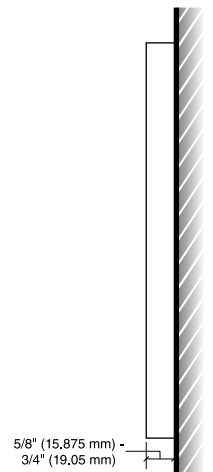

Sign Profile

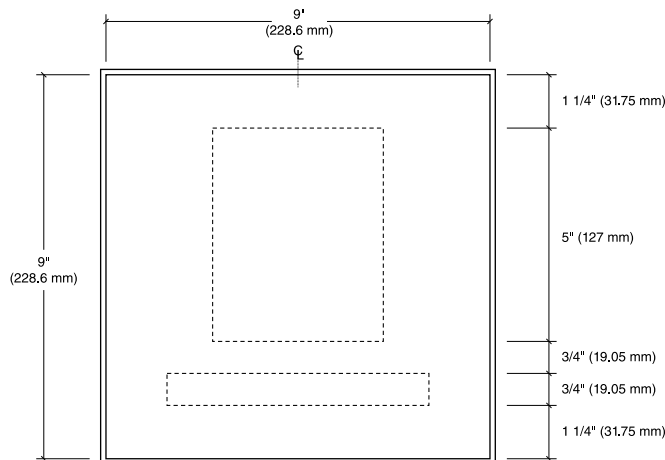

Message Layout C & D



Privacy Notice

Size

Sign Face: 6" High x 9" Wide
(152.4 mm H x 228.6 mm W)

Description & Use

This sign can be used in areas where video or audio recording may be taking place such as videoconferencing. It can be placed within the room/area or below the Room ID sign. Required video surveillance signage is in [Section 3.3](#) (See VHA directive 1078).

Message Configuration

Refer to message layout drawing for dimensions.

Sign Components

Component based sign system.

See [Section 2.1](#) for applicable component sign system styles.

Graphic Process

Direct second surface digital print or silk-screened.

Colors

Refer to the color chart in the Appendix.

Typography

Helvetica

Mounting

Preferred: Concealed mechanical fasteners.

Alternate: Double-sided VHB foam tape and silicone adhesive.

Installation

Mount at 60" (1524 mm) above finished floor to the center of the sign.

Alternate mounting directly below room identification sign.



Message Layout

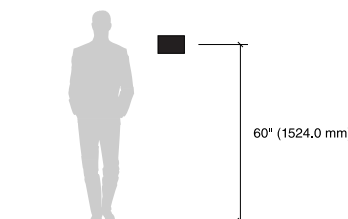

IN-09.10

Interior Signage Drawings

Privacy Notice

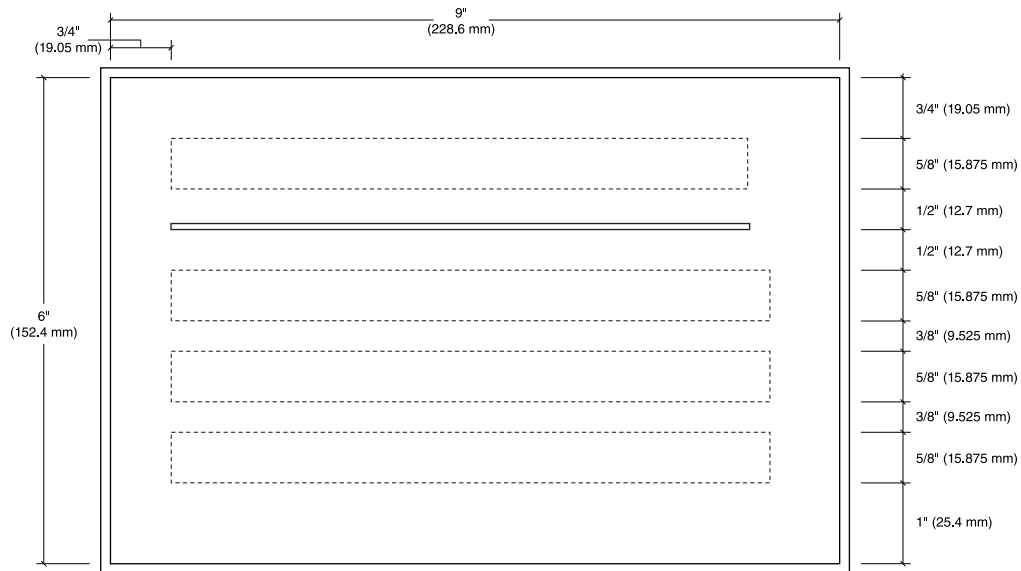

Message Layout

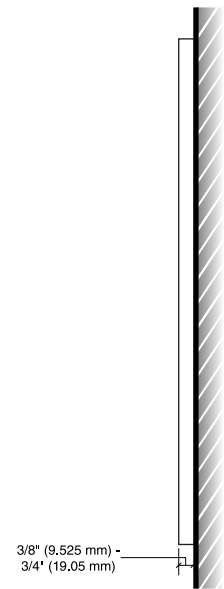

Sign Profile



IN-10.01-.06

Interior Signage Drawings

Sign Frame Insert Holder

Size

IN-10.01: 18" High x 12" Wide
(457.2 mm H x 304.8 mm W)

IN-10.02: 21" High x 15" Wide
(533.4 mm H x 381 mm W)

IN-10.03: 12" High x 18" Wide
(304.8 mm H x 457.2 mm W)

IN-10.04: 12" High x 9 1/2" Wide
(304.8 mm H x 241.3 mm W)

IN-10.05: 9 1/2" High x 12" Wide
(241.3 mm H x 304.8 mm W)

IN-10.06: 7" High x 10" Wide
(177.8 mm H x 254 mm W)

Description & Use

These insert holders can be used to display easily updatable posters, directives, and miscellaneous information.

Sign Components

Component based sign system

See [Section 2.1](#) for applicable component sign system styles.

Graphic Process

Paper or acetate sheet with digital print.

Colors

Refer to the color chart in the Appendix.

Mounting

Preferred: Concealed mechanical fasteners

Alternate: Double-sided VHB foam tape and silicone adhesive

Recommendations

Avoid visual clutter by only posting information that is necessary at a given location.

The sign system used and configuration of the components should match the facility's sign standard and complement the architectural environment whenever possible. When placing signs near each other, it is important to consider how all components will work together as a cohesive whole.

Avoid taping paper notices or posters directly to wall and always use insert holders.

Whenever possible, use predefined templates designed to match the facility sign standards.

IN-10.01

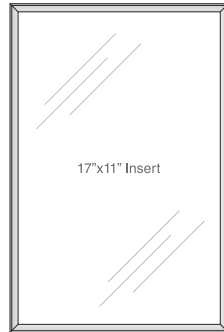

IN-10.02

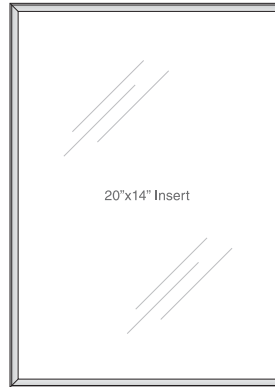

IN-10.03

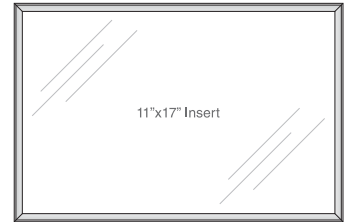

IN-10.04

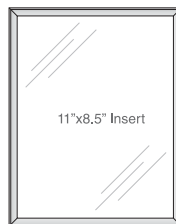

IN-10.05



IN-10.06

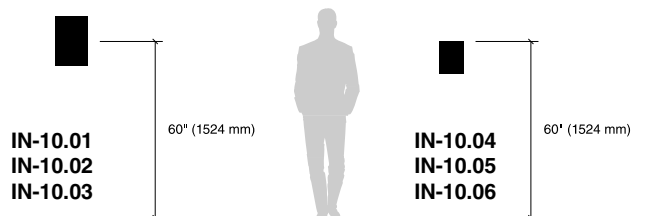
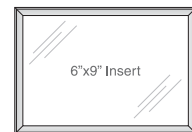

IN-10.01-.06

Interior Signage Drawings

Sign Frame Insert Holder

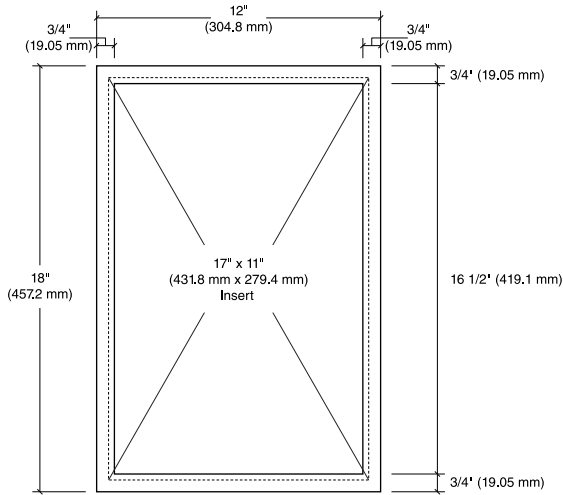

IN-10.01

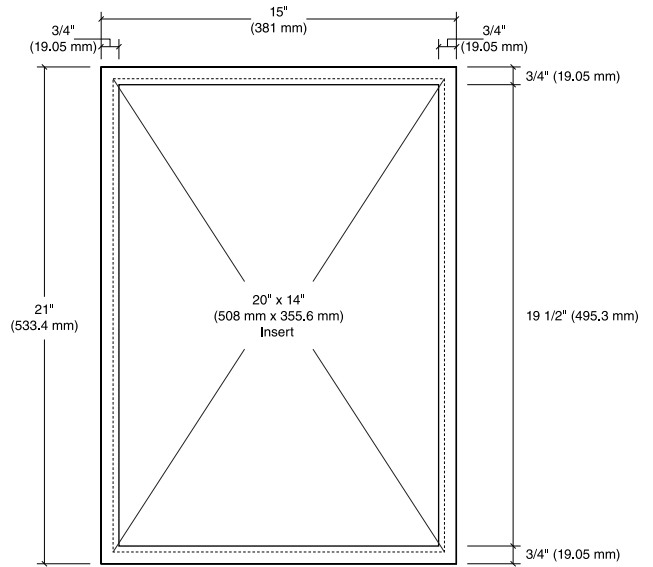

IN-10.02

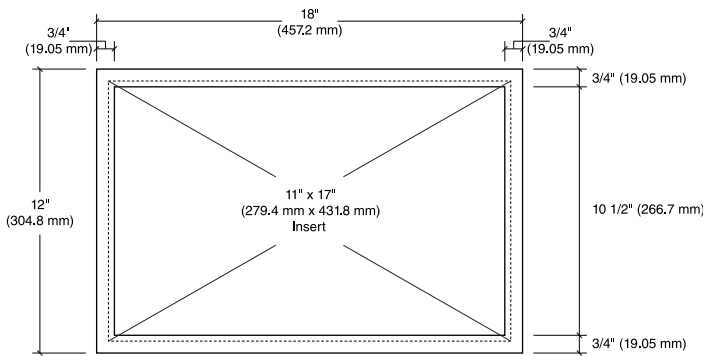

IN-10.03

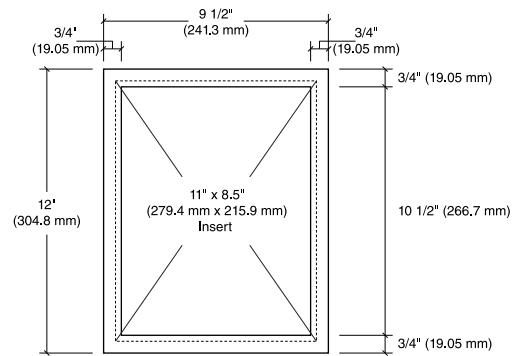

IN-10.04

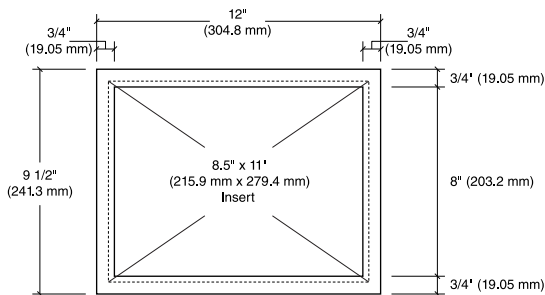

IN-10.05

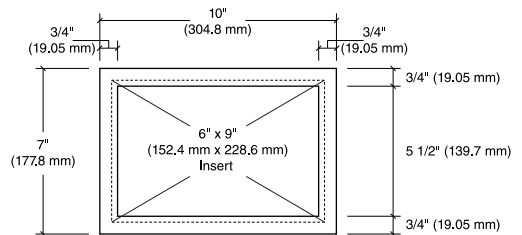

IN-10.06



IN-10.07

Interior Signage Drawings

Informational Posting – Large Insert

Size

Sign Face:
20" High x 11" Wide
(508 mm H x 279.4 mm W)

Description & Use

These signs are used to display a variety of information. Sign header has a permanent message and insert component accepts easily updatable message insert that accepts standard tabloid paper size message.

Example uses include identifying: General Facility/Policy Information, Facility Amenities, Check-in Information, Departments/Clinics served by a Check-in.

Message Configuration

Refer to message layout drawing for dimensions.

Sign Components

Component based sign system

See [Section 2.1](#) for applicable component sign system styles.

Graphic Process

Header: Direct second surface digital print or silk-screened.

Message Insert: Paper or acetate sheet with digital print.

Colors

Refer to the color chart in the Appendix.

Typography

Helvetica

Mounting

Preferred: Concealed mechanical fasteners.

Alternate: Double-sided VHB foam tape and silicone adhesive.

Installation

Mount at 60" (1524 mm) above finished floor to the center of the sign.

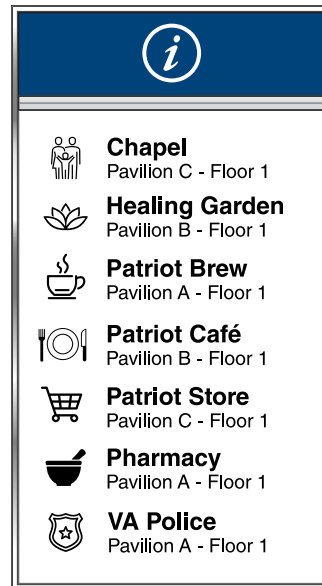

Message Layout A



Message Layout B

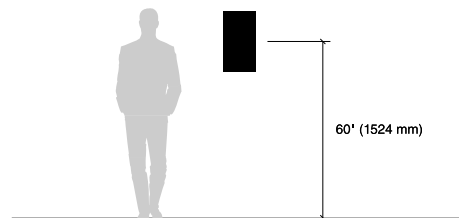
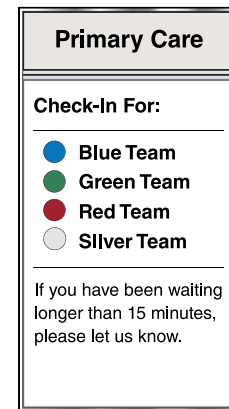

IN-10.07

Interior Signage Drawings

Informational Posting – Large Insert

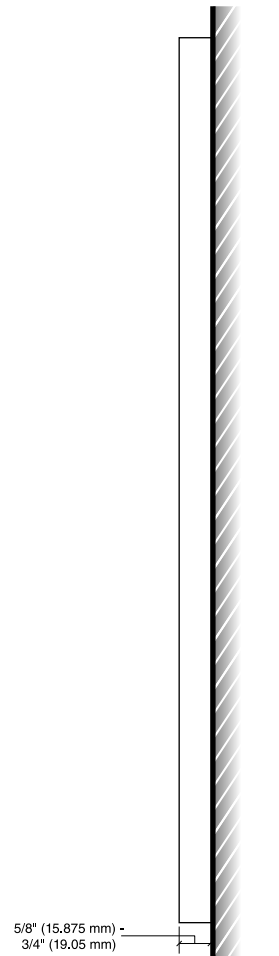
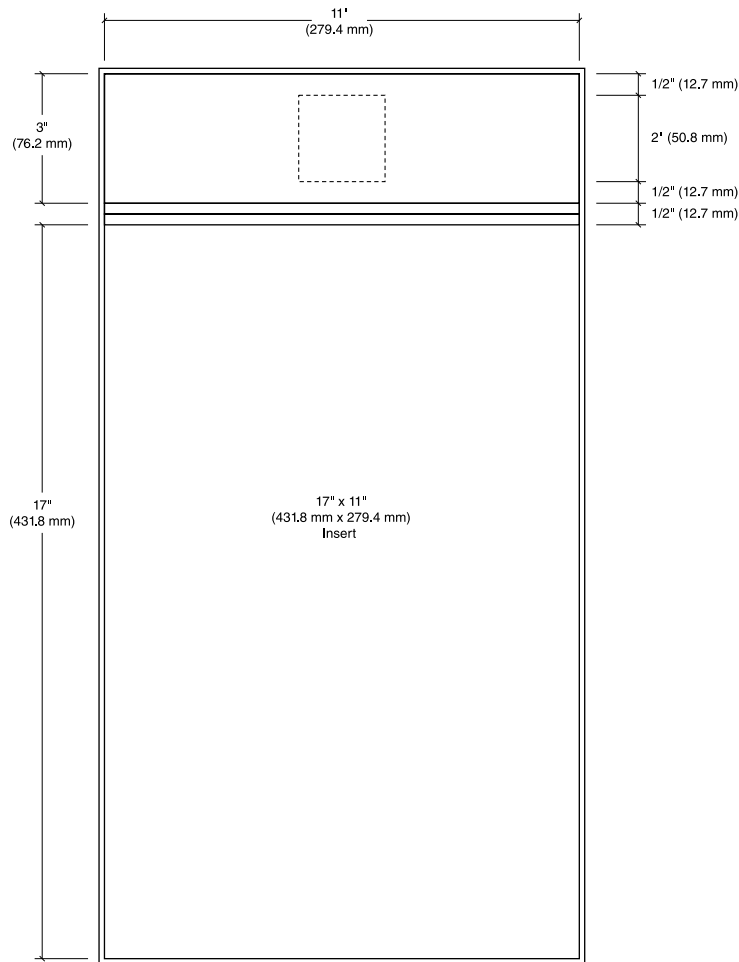

Sign Profile

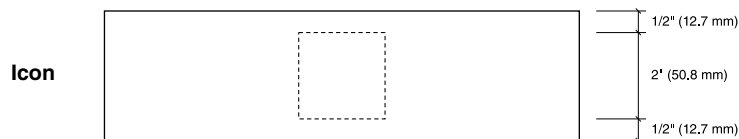
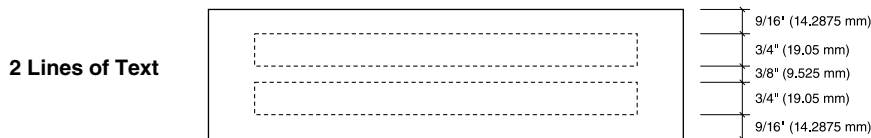
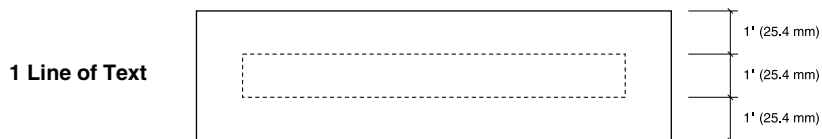

IN-10.08

Interior Signage Drawings

Informational Posting – Standard Insert

Size

Sign Face:
14" High x 8.5" Wide
(355.6 mm H x 215.9 mm W)

Description & Use

These signs are used to display a variety of information. Sign header has a permanent message and insert component accepts easily updatable standard letter paper size message.

Example uses include identifying: General Facility/Policy Information, Facility Amenities, Check-in Information, Departments/Clinics served by a Check-in.

Message Configuration

Refer to message layout drawing for dimensions.

Sign Components

Component based sign system

See [Section 2.1](#) for applicable component sign system styles.

Graphic Process

Header: Direct second surface digital print or silk-screened.

Message Insert: Paper or acetate sheet with digital print.

Colors

Refer to the color chart in the Appendix.

Typography

Helvetica

Mounting

Preferred: Concealed mechanical fasteners.

Alternate: Double-sided VHB foam tape and silicone adhesive.

Installation

Mount at 60" (1524 mm) above finished floor to the center of the sign.

Alternate mounting 60" (1524 mm) to top of the sign if adjacent to room signs.

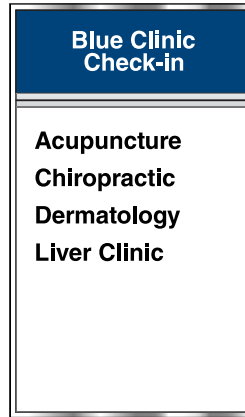

Message Layout A

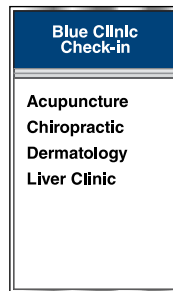

Message Layout B

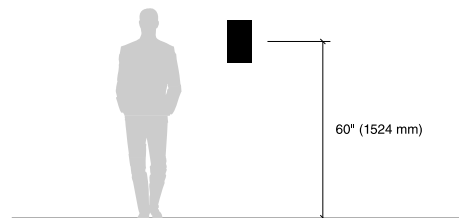
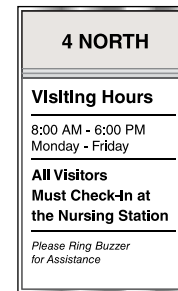

IN-10.08

Interior Signage Drawings

Informational Posting – Standard Insert

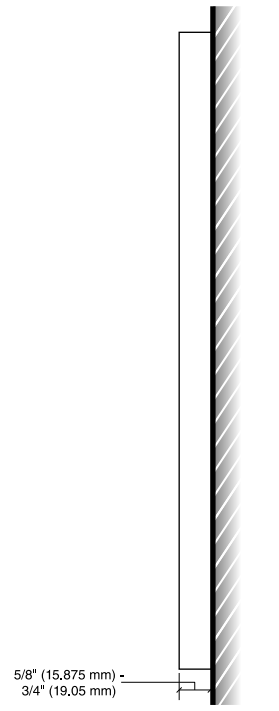
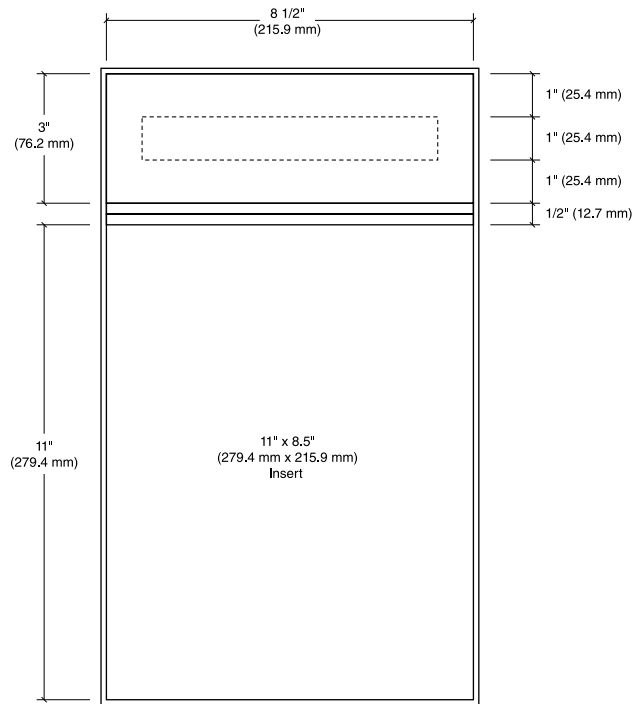

Sign Profile

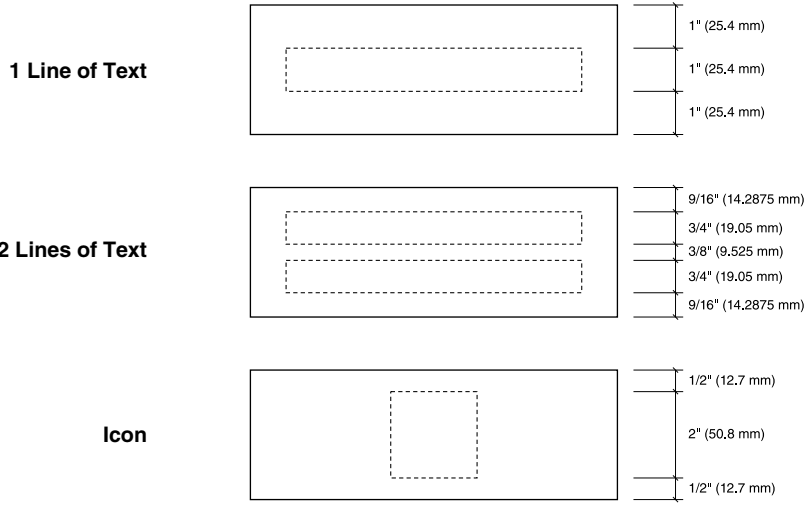

IN-11.01-.04

Interior Signage Drawings

Permanent Message Panel

Size

IN-11.01: 20" High x 20" Wide
(508 mm H x 508 mm W)

IN-11.02: 15" High x 15" Wide
(381 mm H x 381 mm W)

IN-11.03: 9" High x 9" Wide
(228.6 mm H x 228.6 mm W)

IN-11.04: 6" High x 6" Wide
(152.4 mm H x 152.4 mm W)

Description & Use

Used for permanent messages that will not require updates.

Message Configuration

Refer to message layout drawing for dimensions.

Sign Components

Component based sign system

See [Section 2.1](#) for applicable component sign system styles.



IN-11.04

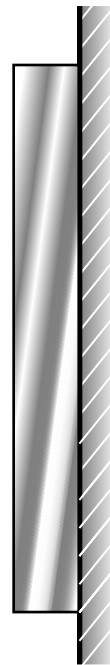

Graphic Process

Direct second surface digital print or silk-screened.

Colors

Refer to the color chart in the Appendix.

Typography

Helvetica

Mounting

Preferred: Concealed mechanical fasteners

Alternate: Double-sided VHB foam tape and silicone adhesive

Installation

Mount at 60" (1524 mm) above finished floor to the center of the sign.

Recommendations

If needed, a new sign panel can be ordered to update the sign.



IN-11.01

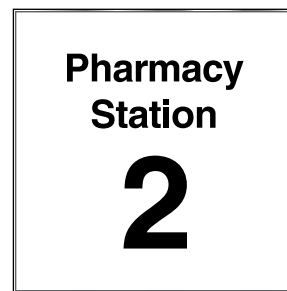

IN-11.02



IN-11.03

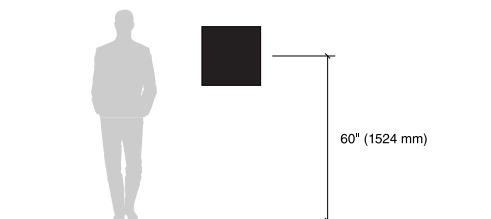

IN-11.01-.04

Interior Signage Drawings

Permanent Message Panel

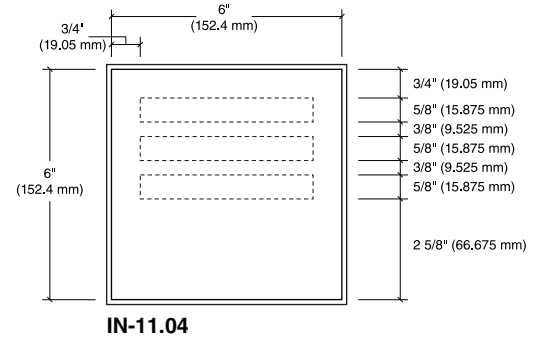
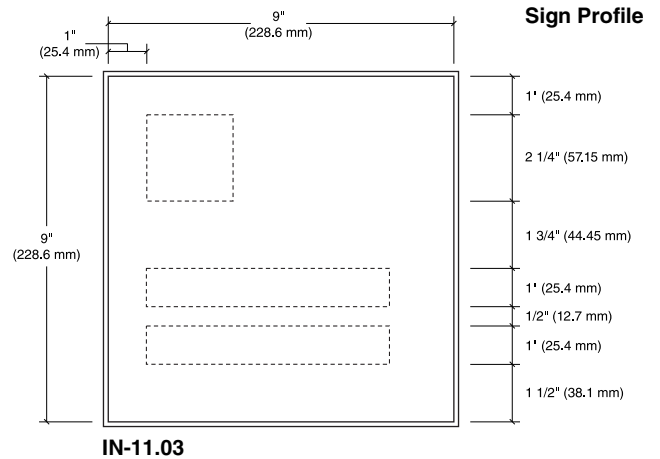
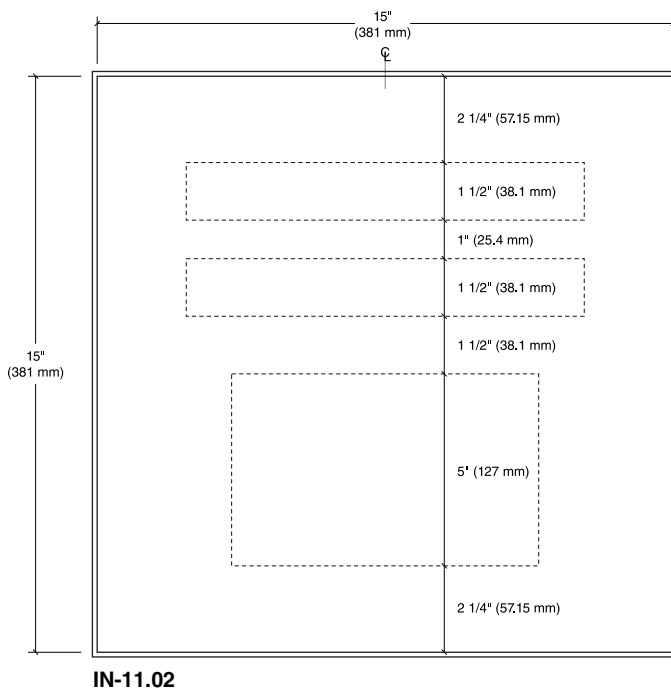
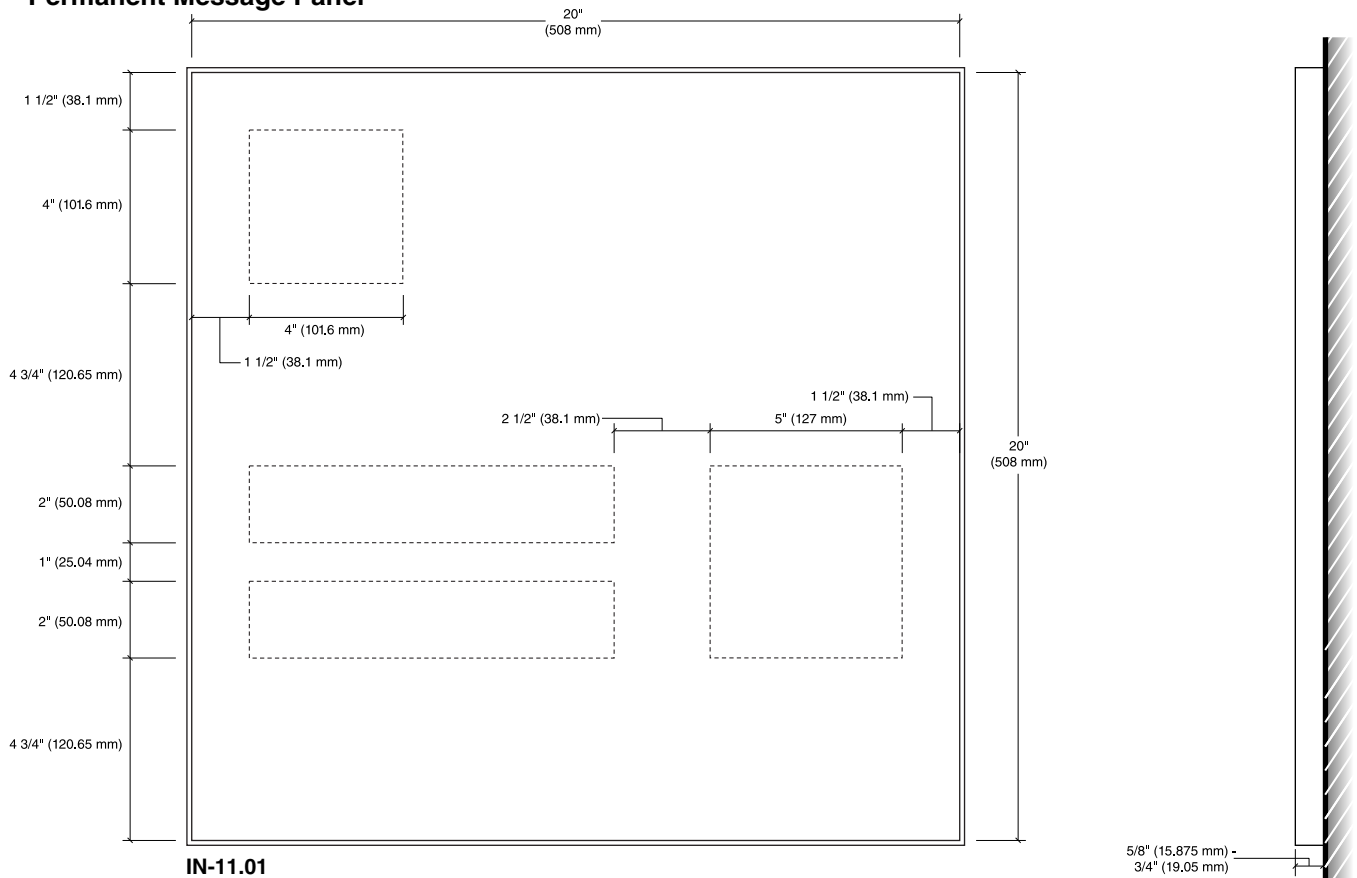

IN-12.01-.03

Interior Signage Drawings

Desk or Counter Sign

Size

IN-12.01: 11" High x 8 1/2" Wide
(279.4 mm H x 215.9 mm W)

IN-12.02: 3" High x 9" Wide
(76.2 mm H x 228.6 mm W)

IN-12.03: 6" High x 9" Wide
(152.4 mm H x 228.6 mm W)

Description & Use

These freestanding signs are used for messages that can be moved or relocated based on the function of the counter. Sign can be double-sided or single-sided.

Message Configuration

Refer to message layout drawing for dimensions.

Sign Components

Panel or insert based depending on sign system.

Graphic Process

Direct second surface digital print or insert

Colors

Refer to the color chart in the Appendix.

Typography

Helvetica

Mounting

Freestanding

Installation

Placed on counter or desk.



IN-12.01

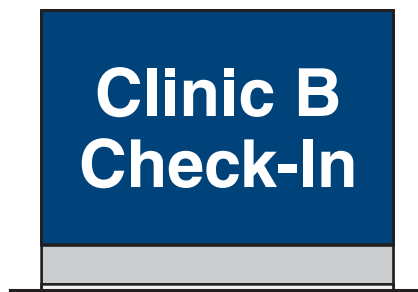
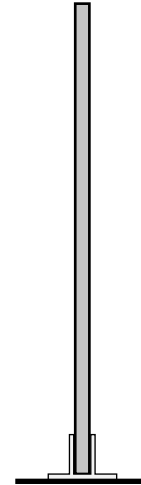

IN-12.03



IN-12.02



IN-12.01-.03

Interior Signage Drawings

Desk or Counter Sign

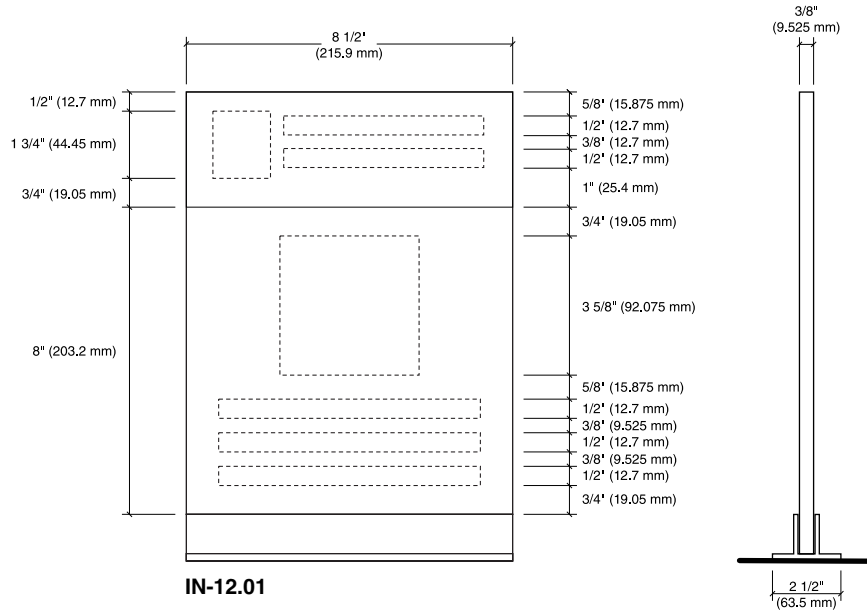

IN-12.01

Sign Profile

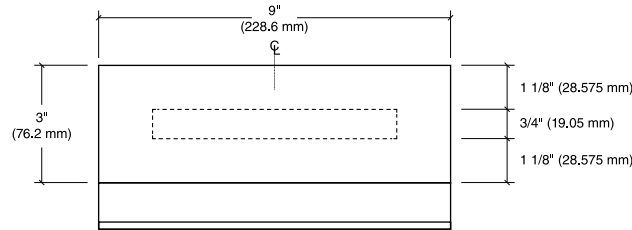

IN-12.02

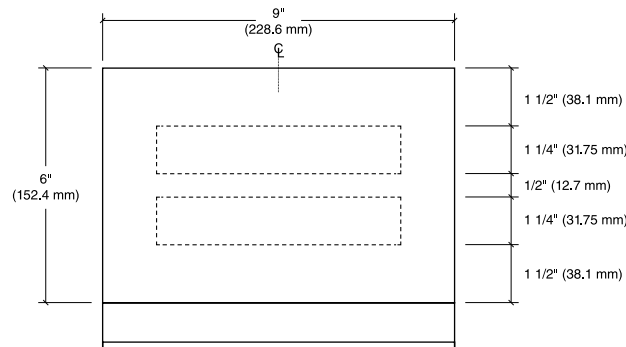

IN-12.03



IN-13.01

Interior Signage Drawings

Perpendicular Flag Mount

Size

Sign Face: 9" High x 12" Wide
(228.6 mm H x 304.8 mm W)

Description & Use

This sign is used to identify or guide to high traffic destinations and rooms like restrooms.

Message Configuration

Refer to message layout drawing for dimensions.

Layout A is for a pictogram with text.

Layout B is for a directional arrow with text.

Layout C is for a department name.

Sign Components

Mounting bracket and sign panel.

Graphic Process

Direct second surface digital print or silk-screened.

Colors

Refer to the color chart in the Appendix.

Typography

Helvetica

Mounting

Mechanical fasteners

Installation

Projecting signs must always be mechanically fastened to the wall surface with wall anchors penetrating a solid substrate, such as a stud or backing material behind the wall. In corridors, a flag-mounted sign should always be placed with the bottom of the sign at a minimum height at 80" (2032 mm) for clearance of pedestrians and equipment.

See [Section 2.1](#) for installation details.

Recommendations

In narrow hallways or corridors with high ceilings these signs can be used as an alternative to ceiling mount overhead signs.

Text length should be limited due to the size constraints of the sign panel and minimum text height of 2" (50.8 mm).

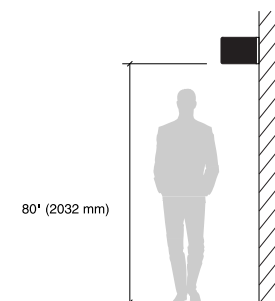
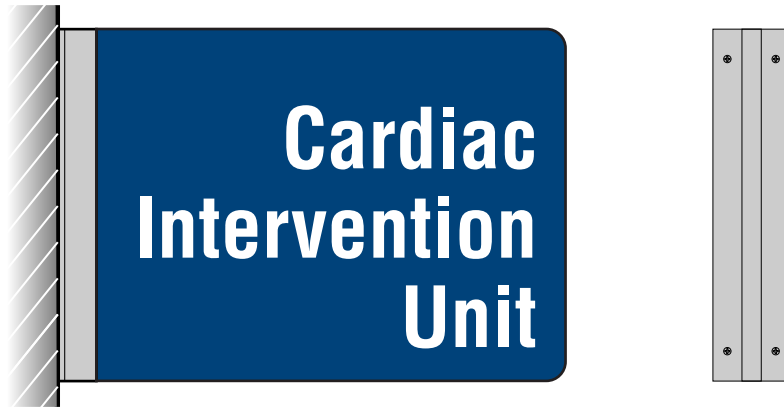

IN-13.01

Interior Signage Drawings

Perpendicular Flag Mount

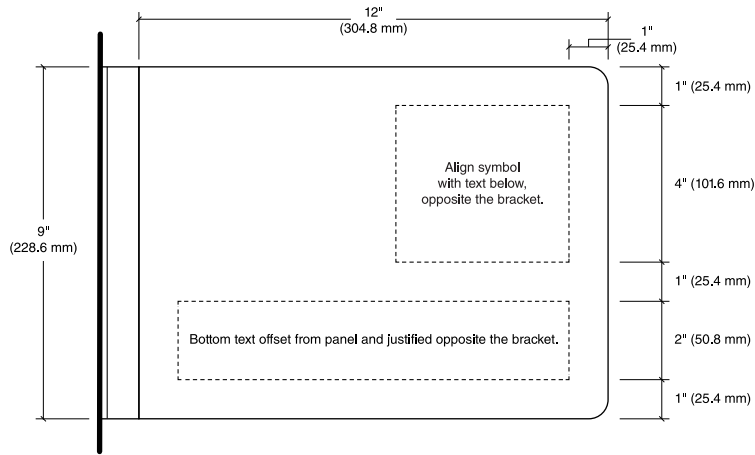

Message Layout A

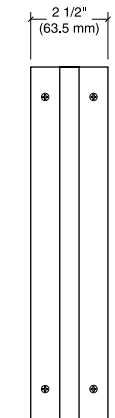

Sign Profile

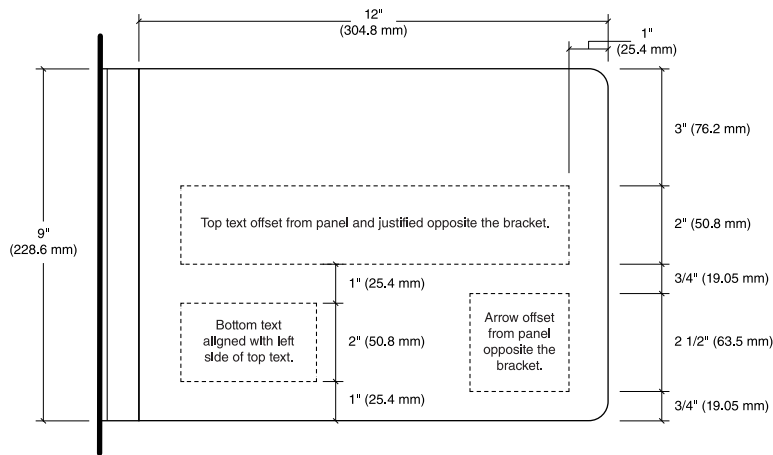

Message Layout B

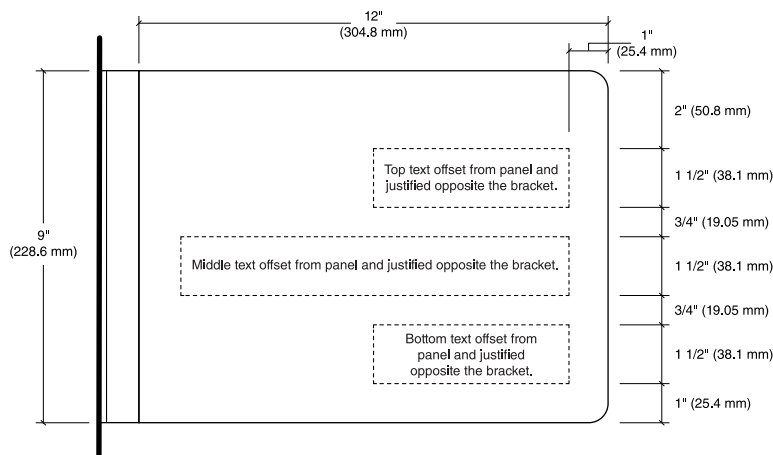

Message Layout C



IN-13.02

Interior Signage Drawings

Perpendicular Flag Mount – Small

Size

Sign Face: 6" High x 6" Wide
(152.4 mm H x 152.4 mm W)

Description & Use

This sign is used to identify small rooms, bed numbers, and stations.

Message Configuration

Refer to message layout drawing for dimensions.

Layout A is for one or two digit numbers.

Layout B is for letters.

Sign Components

Mounting bracket and sign panel.

Graphic Process

Direct second surface digital print or silk-screened.

Colors

Refer to the color chart in the Appendix.

Typography

Helvetica

Mounting

Mechanical fasteners

Installation

Projecting signs must always be mechanically fastened to the wall surface with wall anchors penetrating a solid substrate, such as a stud or backing material behind the wall. In corridors, a flag-mounted sign should always be placed with the bottom of the sign at a minimum height at 80" (2032 mm) for clearance of pedestrians and equipment.

See [Section 2.1](#) for installation details.

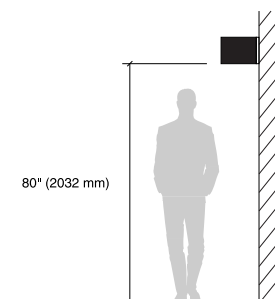
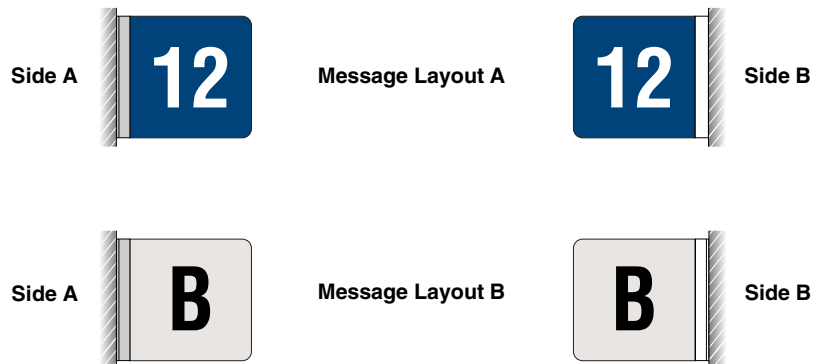

Perpendicular Flag Mount – Small

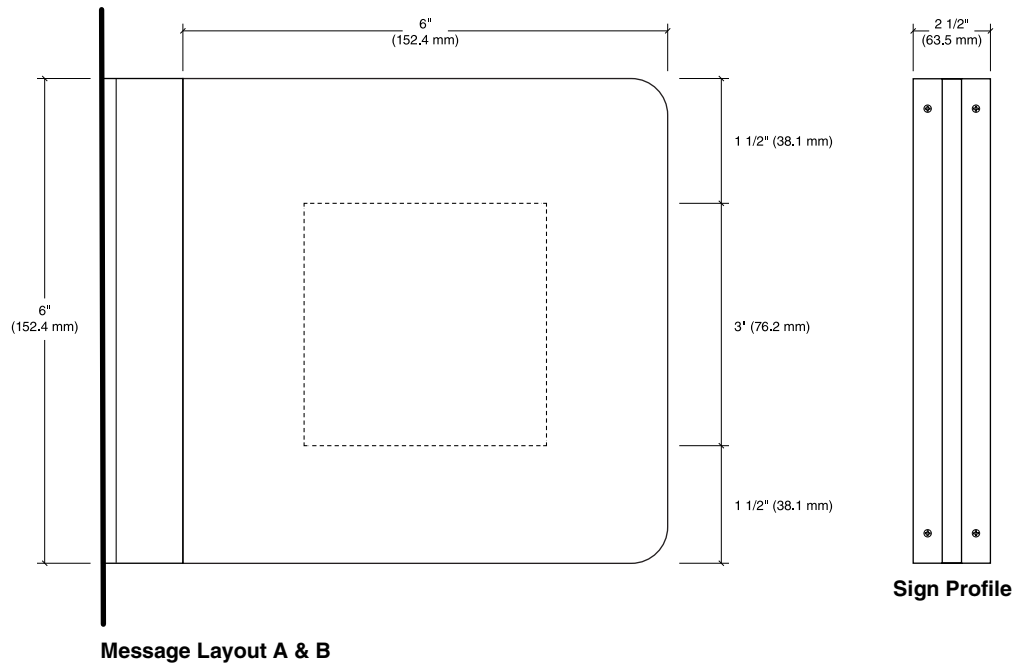

IN-14.01-.05

Interior Signage Drawings

Wall Directional – Permanent Panel

Size

IN-14.01: 24" High x 20" Wide
(609.6 mm H x 508 mm W)

IN-14.02: 30" High x 20" Wide
(762 mm H x 508 mm W)

IN-14.03: 36" High x 20" Wide
(914.4 mm H x 508 mm W)

IN-14.04: 21" High x 20" Wide
(533.4 mm H x 508 mm W)

IN-14.05: 15" High x 20" Wide
(381 mm H x 508 mm W)

Description & Use

These signs are used to display directional information on walls. Sign has removeable component panels with permanent messages.

Message Configuration

Refer to message layout drawing for dimensions.

Sign Components

This component based sign system has removeable component panels with permanent messages.

A single sign system and standard should be used throughout the facility. Avoid simultaneously using panel based systems and insert based directional signs within the same facility.

Graphic Process

Direct second surface digital print or silk-screened.

Colors

Refer to the color chart in the Appendix.

Installation

Mount at 60" (1524 mm) above finished floor to the center of the sign.

Recommendations

These signs can be paired side by side (not stacked) for multi directional information.

Keep directional messages simple, providing only information necessary to decide at that specific location.

Use consistent terminology throughout the facility, online, and on appointment letters.

Refer to the VHA Standardized Nomenclature document for a list of approved department names.

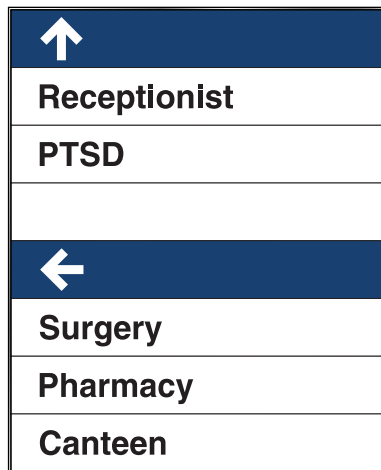

IN-14.01

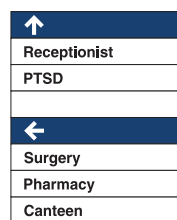

IN-14.02

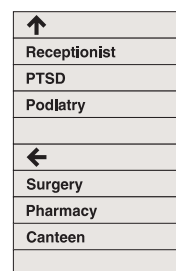

IN-14.03

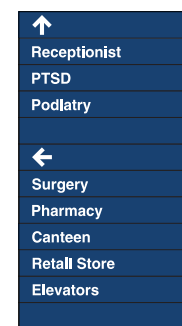

IN-14.04

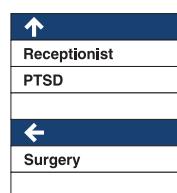

IN-14.05

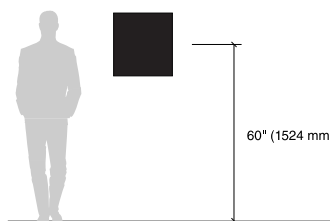
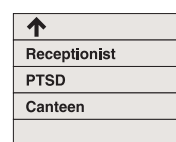

Mounting

Concealed mechanical fasteners.



IN-14.01-.05

Interior Signage Drawings

Wall Directional – Permanent Panel

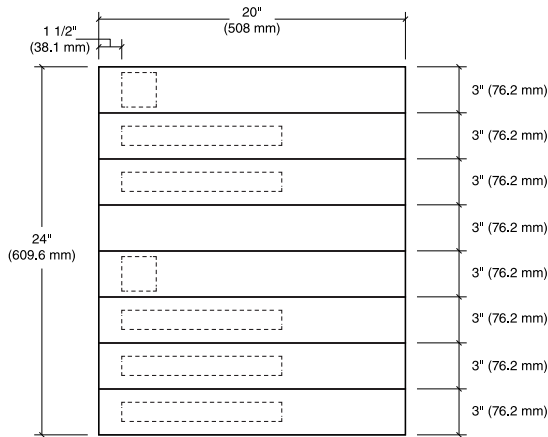

IN-14.01

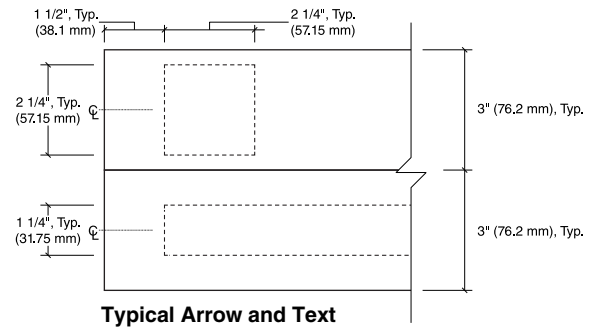

Typical Arrow and Text

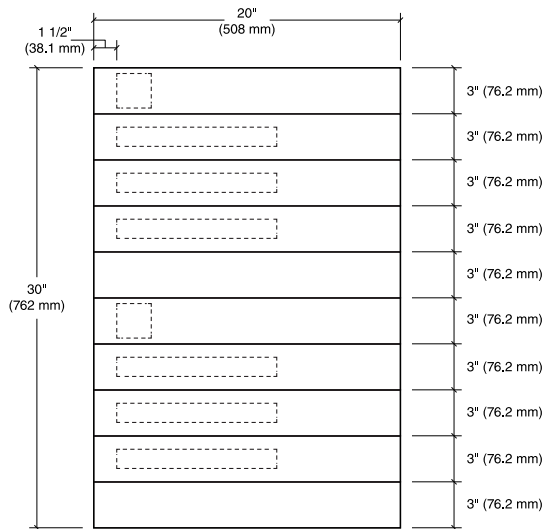

IN-14.02

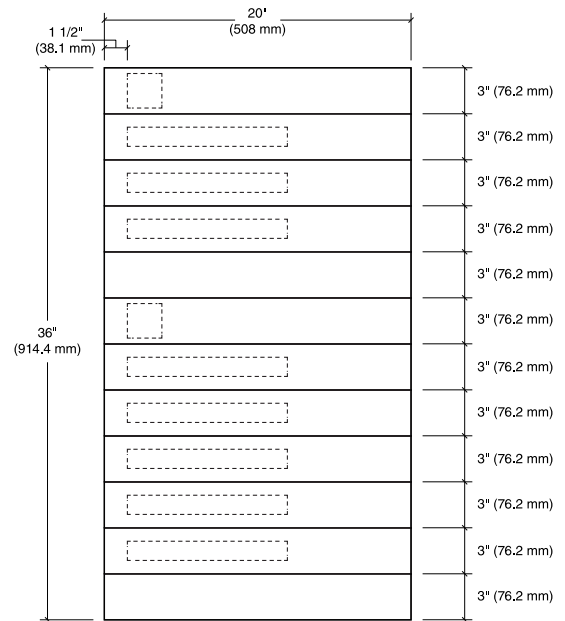

IN-14.03

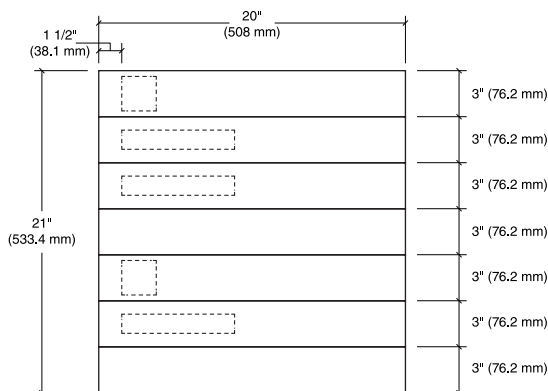

IN-14.04

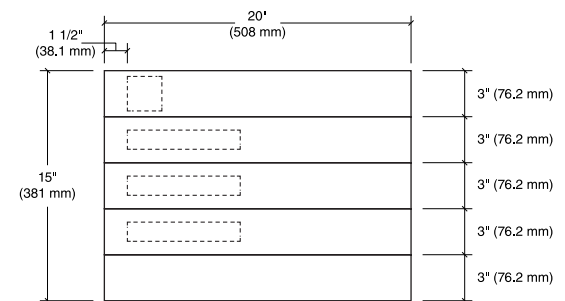

IN-14.05



IN-14.06-.07

Interior Signage Drawings

Wall Directional – Single Insert

Size

IN-14.06: 14" High x 17" Wide
(355.6 mm H x 431.8 mm W)

IN-14.07: 17" High x 17" Wide
(431.8 mm H x 431.8 mm W)

Description & Use

These signs are used to display directional information on walls. Sign has permanent header and/or footer and easily updatable message insert that accepts standard tabloid paper size.

Message Configuration

Refer to message layout drawing for dimensions.

Rule lines are printed on insert to visually separate messages.

IN-14.06: Header with directional arrow and updatable insert with five lines of copy

IN-14.07: Adds an optional footer for additional wayfinding information like building/floor number or wing/zone name.

Sign Components

Component based sign system.

Graphic Process

Header: Direct second surface digital print or silk-screened.

Message Insert: Paper or acetate sheet with digital print.

Colors

Refer to the color chart in the Appendix.

Typography

Helvetica Bold

Installation

Mount at 60" (1524 mm) above finished floor to the center of the sign.

Recommendations

These signs can be paired side by side (not stacked) for multi directional information.

Keep directional messages simple, providing only information necessary to decide at that specific location.

Use consistent terminology throughout the facility, online, and on appointment letters.

Refer to the VHA Standardized Nomenclature document for a list of approved department names.

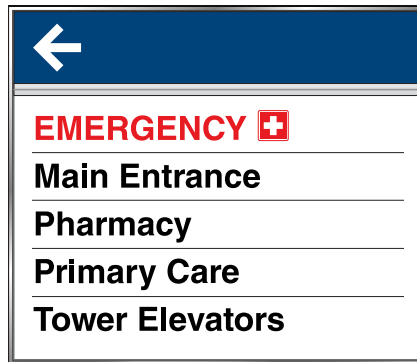

IN-14.06

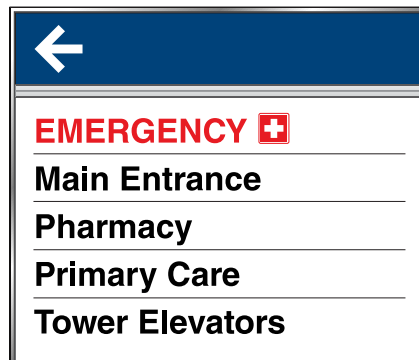

IN-14.07

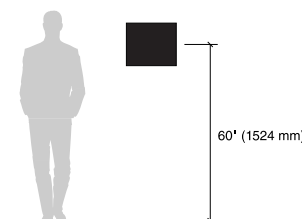
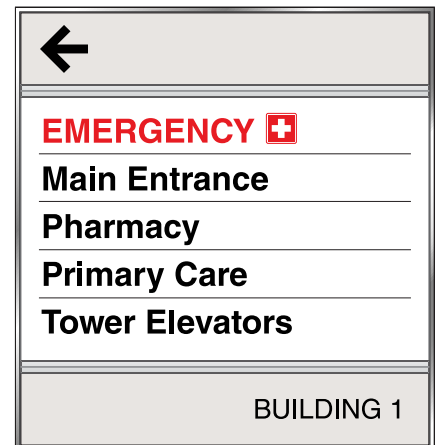

Mounting
Concealed mechanical fasteners.



Wall Directional – Single Insert

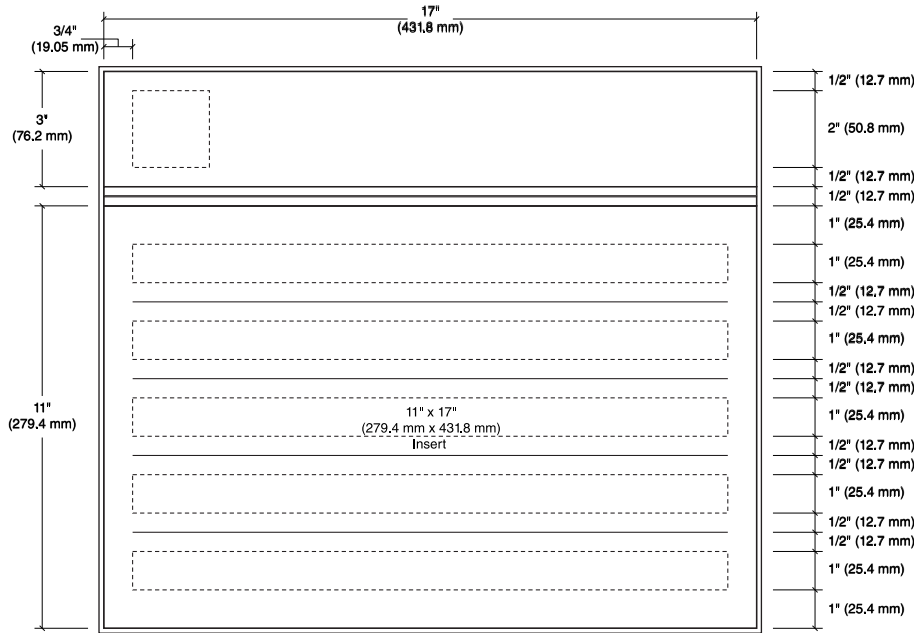

IN-14.06

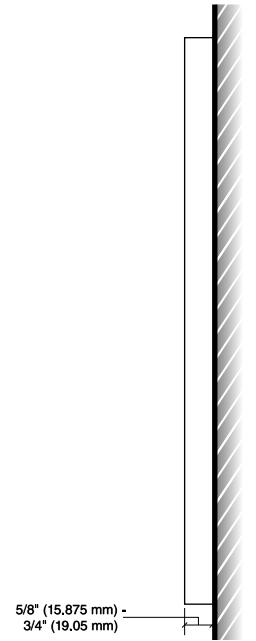

Sign Profile

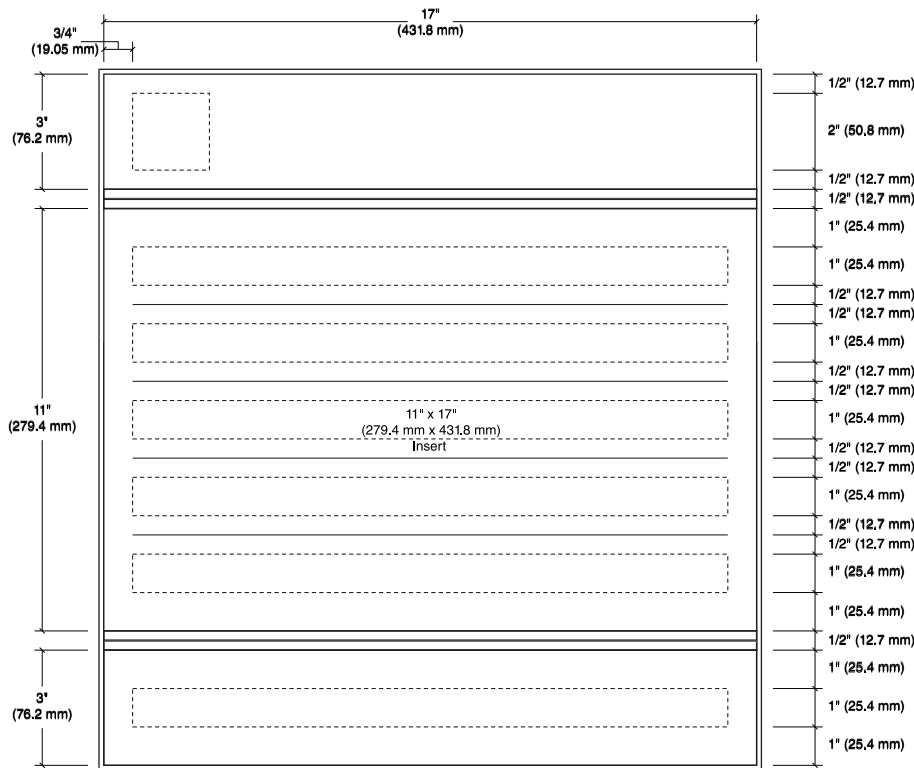

IN-14.07



IN-14.08-11

Interior Signage Drawings

Wall Directional – Dual Inserts

Description & Use

These signs are used to display extended directional information on walls where more than five lines of copy are needed. Sign has permanent headers and/or footers and two easily updatable message inserts that accept standard tabloid paper size.

Message Configuration

Refer to message layout drawing for dimensions.

Rule lines are printed on insert to visually separate messages.

IN-14.08: Header with directional arrow and two updatable inserts with five lines of copy each

IN-14.09: Two headers with directional arrows and two updatable inserts with five lines of copy each

IN-14.10: Header with directional arrow, two updatable inserts with five lines of copy each, and footer with additional wayfinding information

IN-14.11: Two headers with directional arrows, two updatable inserts with five lines of copy each, and footer with additional wayfinding information

Sign Components

Component based sign system

Graphic Process

Header: Direct second surface digital print or silk-screened.

Message Insert: Paper or acetate sheet with digital print.

Colors

Refer to the color chart in the Appendix.

Typography

Helvetica Bold

Installation

Mount at 60" (1524 mm) above finished floor to the center of the sign.

Recommendations

Keep directional messages simple, providing only information necessary to decide at that specific location.

Use consistent terminology throughout the facility, online, and on appointment letters.

Refer to the VHA Standardized Nomenclature document for a list of approved department names.

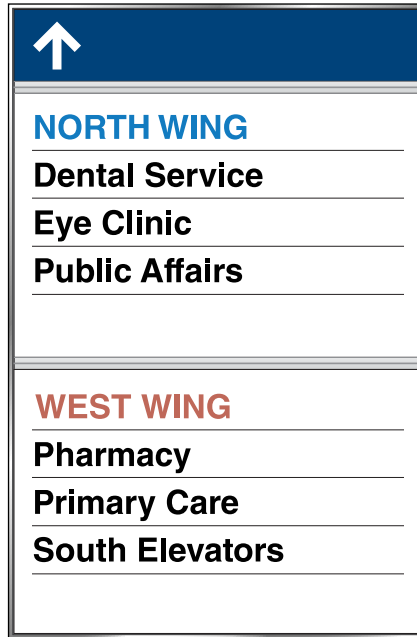

IN-14.08

25" High x 17" Wide
(635 mm H x 431.8 mm W)

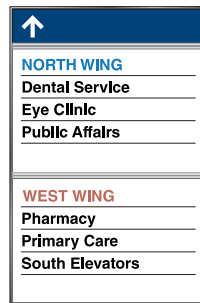

IN-14.10

28" High x 17" Wide
(711.2 mm H x 431.8 mm W)

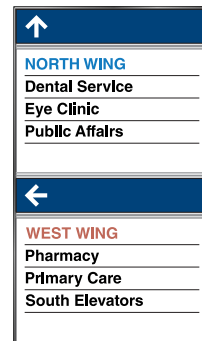

IN-14.10

28" High x 17" Wide
(711.2 mm H x 431.8 mm W)

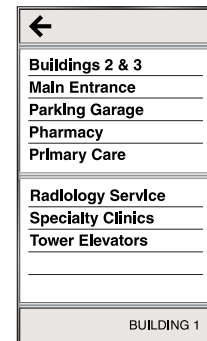

IN-14.11

31" High x 17" Wide
(787.4 mm H x 431.8 mm W)

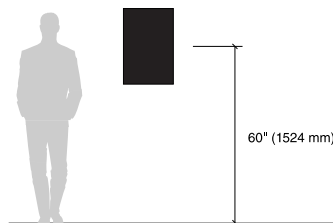
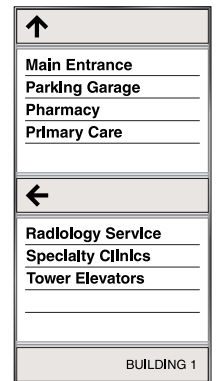

IN-14.08-11

Interior Signage Drawings

Wall Directional – Dual Inserts

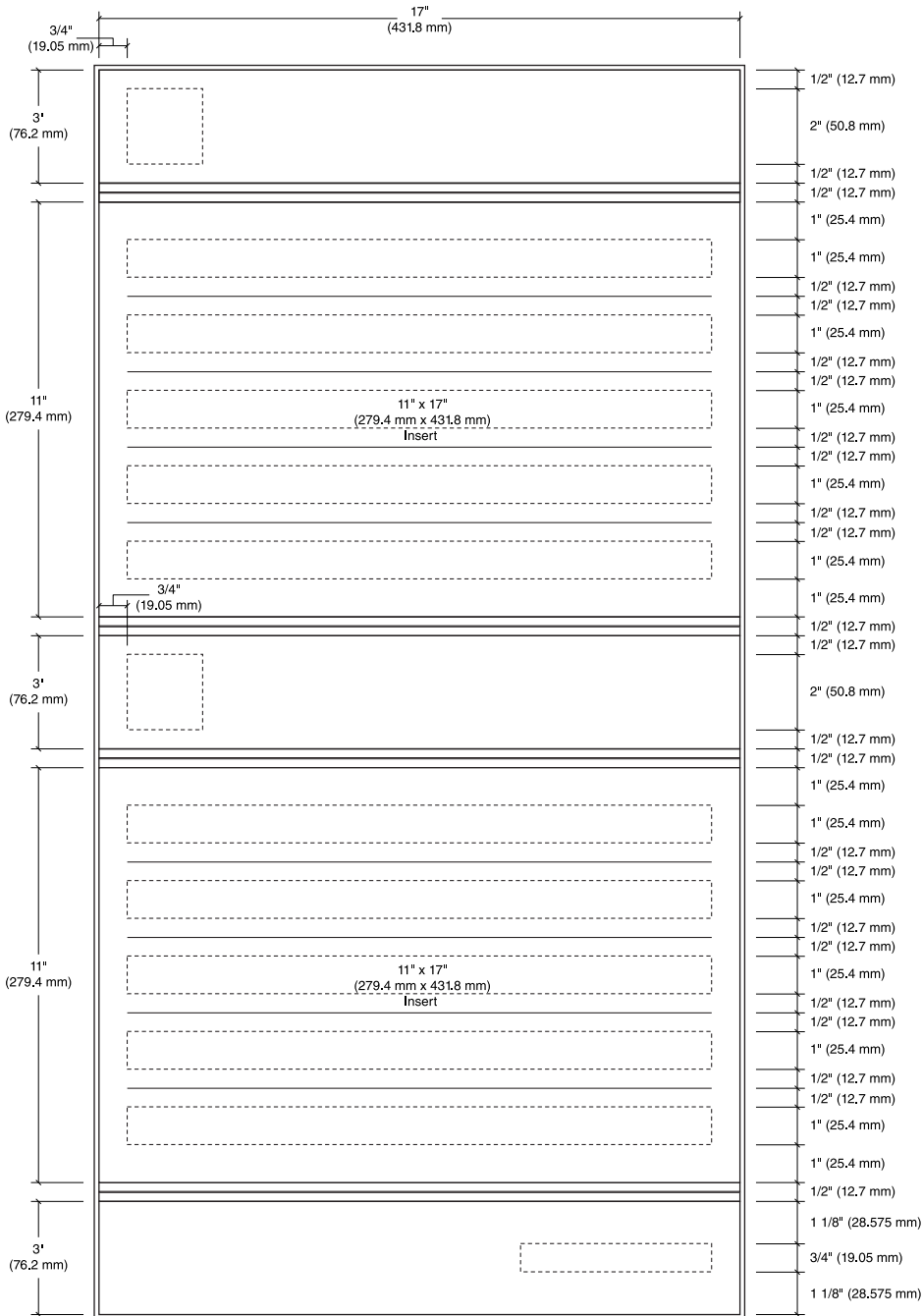

Message Layout

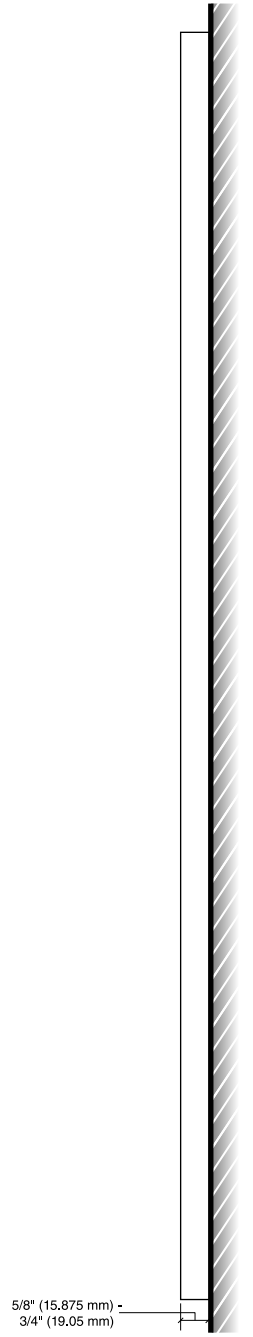

Sign Profile



IN-14.12-.13

Interior Signage Drawings

Wall Directional – Oversized Insert

Size

IN-14.12: 24" High x 24" Wide
(609.6 mm H x 609.6 mm W)

IN-14.13: 28" High x 24" Wide
(711.2 mm H x 609.6 mm W)

Description & Use

These signs are used to display directional information on walls in areas where larger copy is needed for greater viewing distance. Sign has permanent header and/or footer and easily updatable message insert.

Message Configuration

Refer to message layout drawing for dimensions.

Rule lines are printed on insert to visually separate messages.

IN-14.12: Header with directional arrow and updatable insert with six lines of copy

IN-14.13: Adds an optional footer for additional wayfinding information like building/floor number or wing/zone name.

Sign Components

Component based sign system

Graphic Process

Header: Direct second surface digital print or silk-screened.

Message Insert: Paper or acetate sheet with digital print.

Colors

Refer to the color chart in the Appendix.

Typography

Helvetica Bold

Installation

Mount at 60" (1524 mm) above finished floor to the center of the sign.

Recommendations

These signs can be paired side by side (not stacked) for multi directional information.

Keep directional messages simple, providing only information necessary to decide at that specific location. Use consistent terminology throughout the facility, online, and on appointment letters.

Refer to the VHA Standardized Nomenclature document for a list of approved department names.

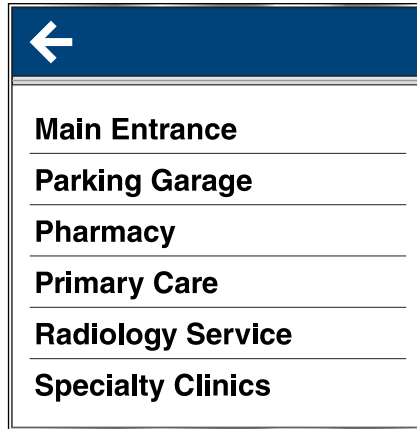

IN-14.12

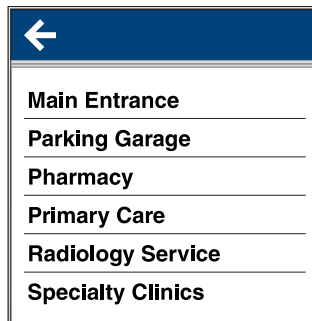

IN-14.13

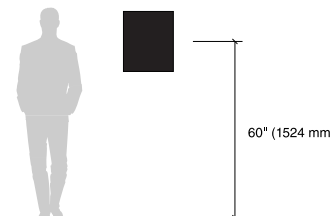
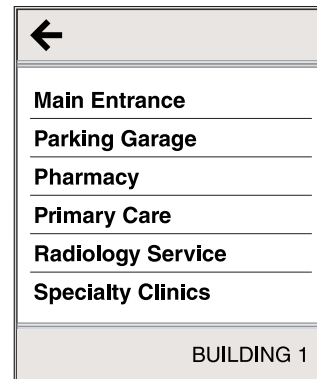

Mounting

Concealed mechanical fasteners.



Wall Directional – Oversized Inserts

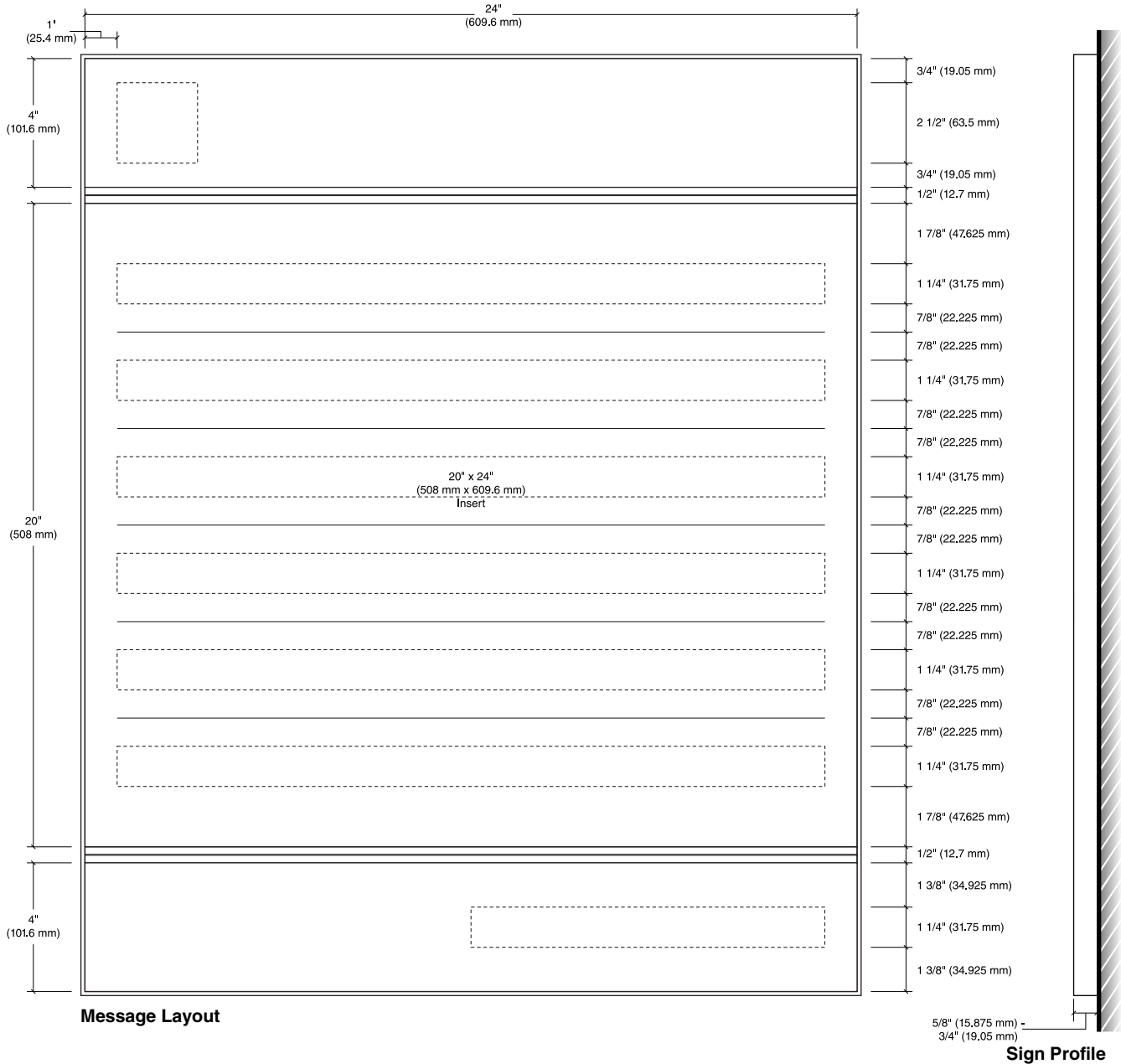

IN-14.14-.17

Interior Signage Drawings

Floor Level Directional – Permanent Panel

Size

IN-14.14: 22" High x 20" Wide
(558.8 mm H x 508 mm W)

IN-14.15: 28" High x 20" Wide
(711.2 mm H x 508 mm W)

IN-14.16: 34" High x 20" Wide
(863.6 mm H x 508 mm W)

IN-14.17: 40" High x 20" Wide
(1016 mm H x 508 mm W)

Description & Use

These signs are used to display directional information and current level number at elevator lobbies where there are no other forms of level identification. Sign has removeable component panels with permanent messages.

Message Configuration

Refer to message layout drawing for dimensions.

Sign Components

This component-based sign system has removeable component panels with permanent messages.

A single sign system and standard should be used throughout the facility. Avoid simultaneously using panel-based systems and insert based directional signs within the same facility.

Graphic Process

Direct digital print or silk-screened.

Colors

Refer to the color chart in the Appendix.

Typography

Helvetica Bold

Installation

Mount at 60" (1524 mm) above finished floor to the center of the sign.

Recommendations

Keep directional messages simple, providing only information necessary to decide at that specific location. List destinations in alphanumeric order and limit the number per sign.

Use consistent terminology throughout the facility, online, and on appointment letters.

Refer to the VHA Standardized Nomenclature document for a list of approved department names.



IN-14.14



IN-14.15

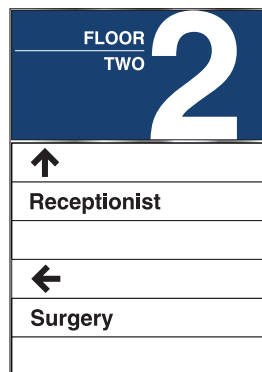

IN-14.16

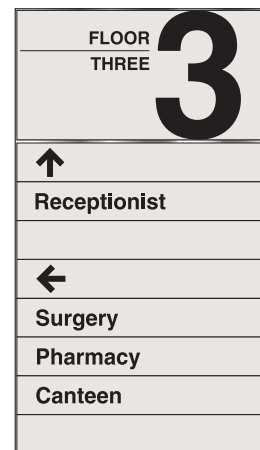

IN-14.17

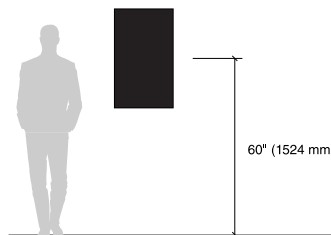
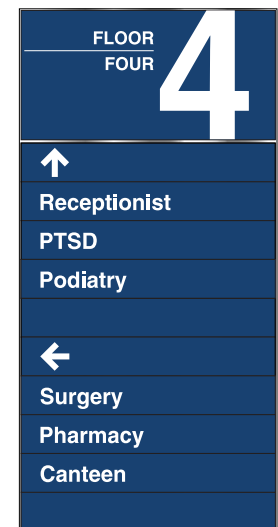

Mounting

Concealed mechanical fasteners.



Floor Level Directional – Permanent Panel

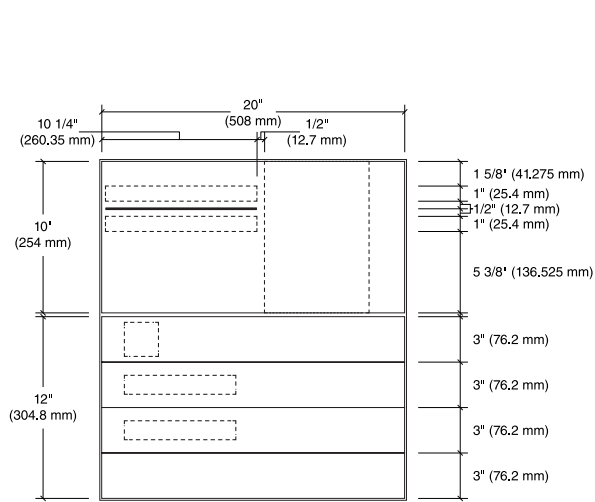

IN-14.14

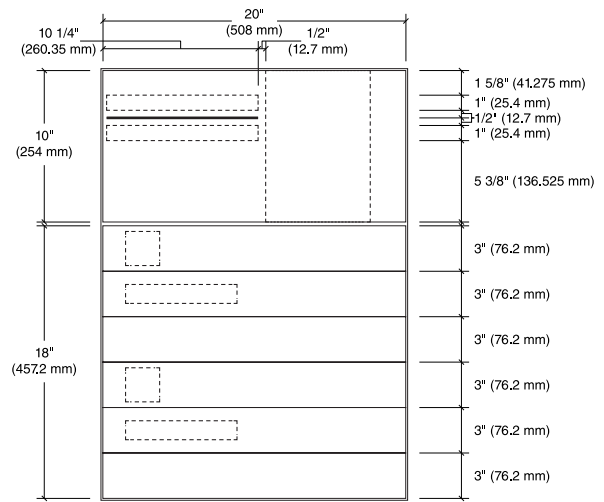

IN-14.15

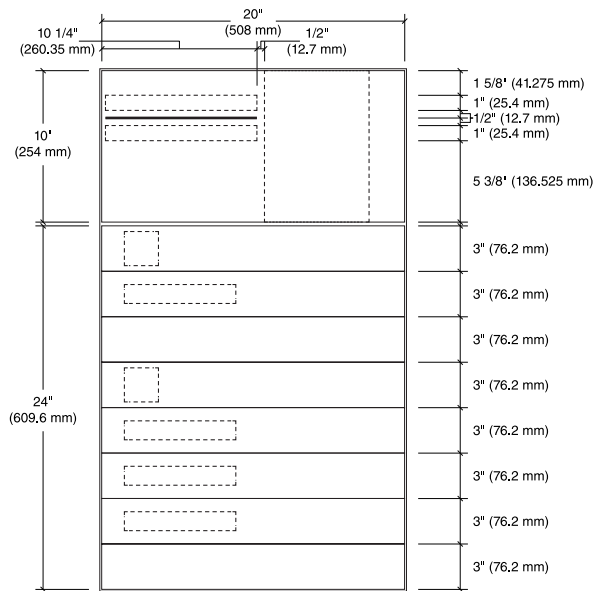

IN-14.16

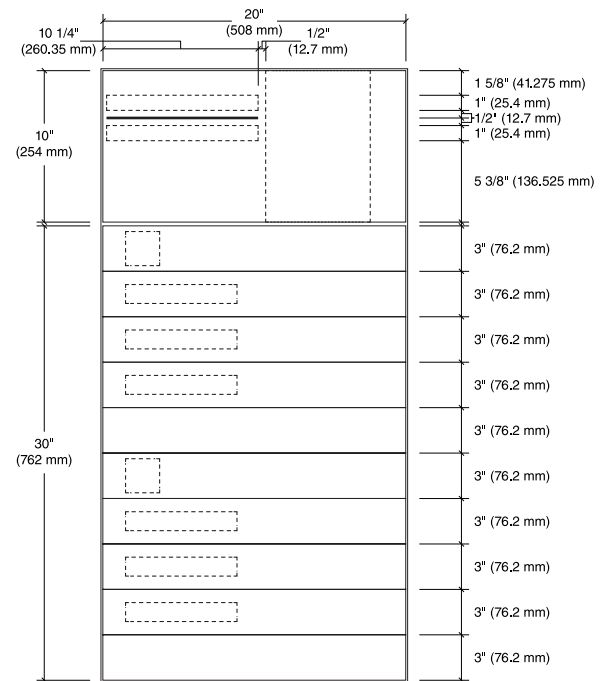

IN-14.17

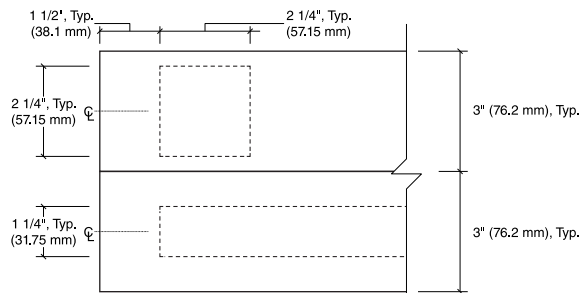

Typical Arrow and Text



IN-14.18

Interior Signage Drawings

Floor Level Directional – Dual Inserts

Size

Sign Face:
28" High x 17" Wide
(711.2 mm H x 431.8 mm W)

Description & Use

These signs are used to display directional information and current level number at elevator lobbies where there are no other forms of level identification. Sign has permanent header and easily updatable message insert that accepts standard tabloid paper size.

Message Configuration

Refer to message layout drawing for dimensions.

Rule lines are printed on insert to visually separate messages.

Sign Components

Component based sign system

See [Section 2.1](#) for applicable component sign system styles.

Graphic Process

Header: Direct second surface digital print or silk-screened

Message Insert: Paper or acetate sheet with digital print

Colors

Refer to the color chart in the Appendix.

Typography

Helvetica Bold

Mounting

Concealed mechanical fasteners

Installation

Mount at 60" (1524 mm) above finished floor to the center of the sign.

Recommendations

Keep directional messages simple, providing only information necessary to decide at that specific location. List destinations in alphanumeric order and limit the number per sign.

Use consistent terminology throughout the facility, online, and on appointment letters.

Refer to the VHA Standardized Nomenclature document for a list of approved department names.

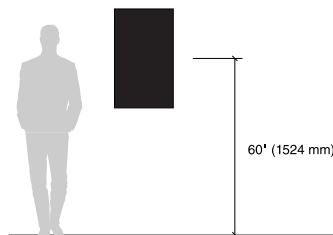
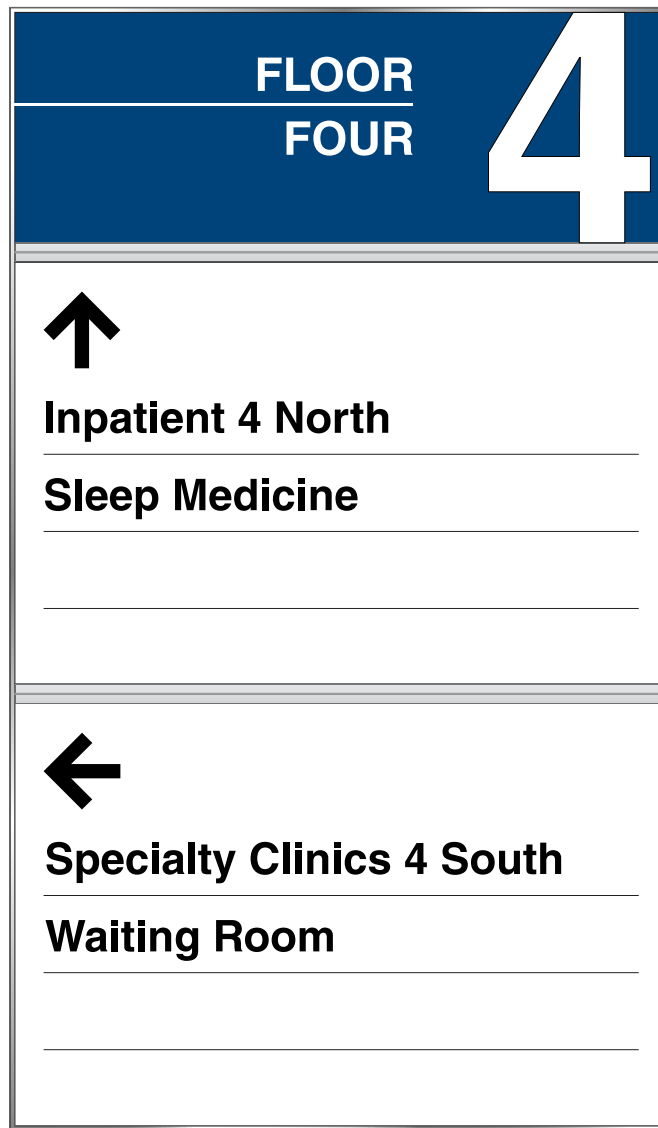

IN-14.18

Interior Signage Drawings

Floor Level Directional – Dual Inserts

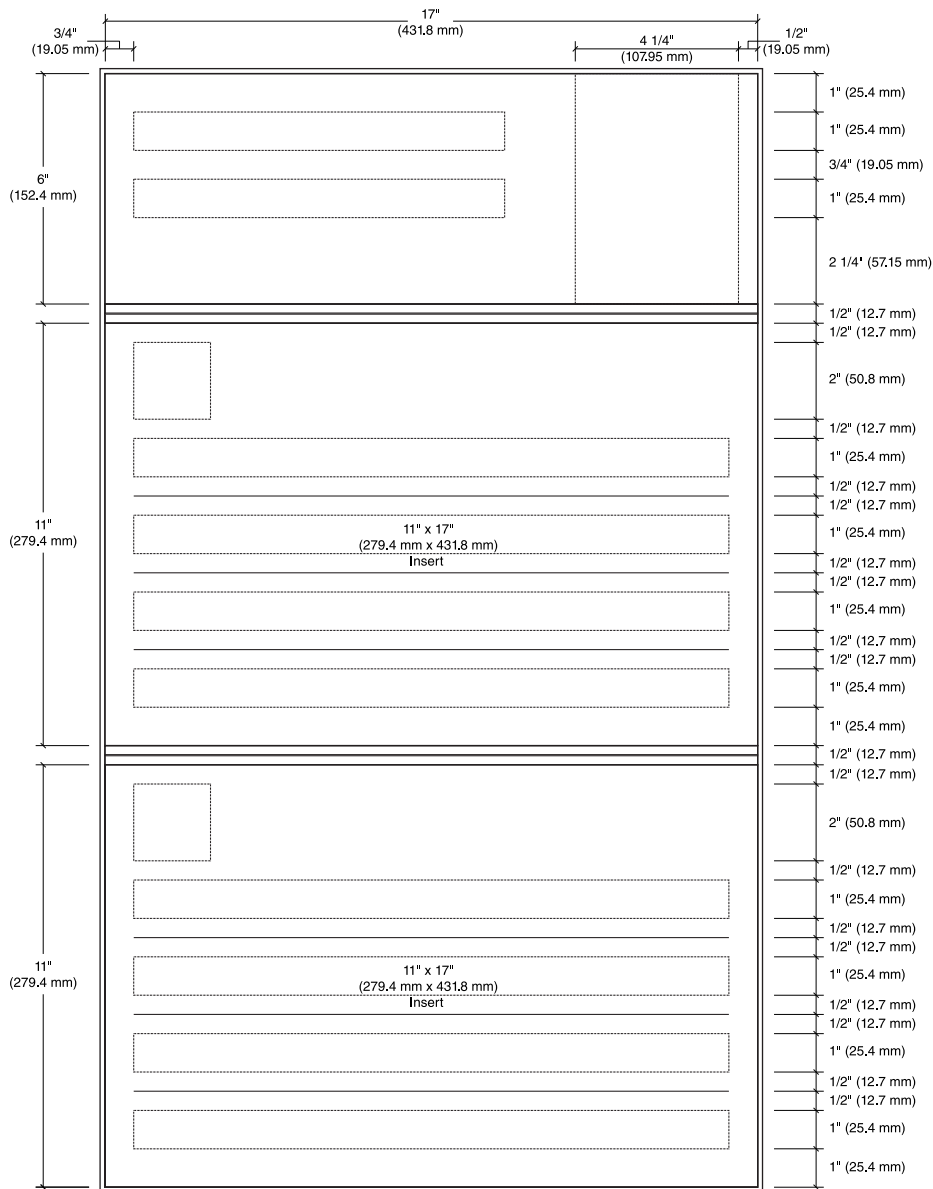

Message Layout

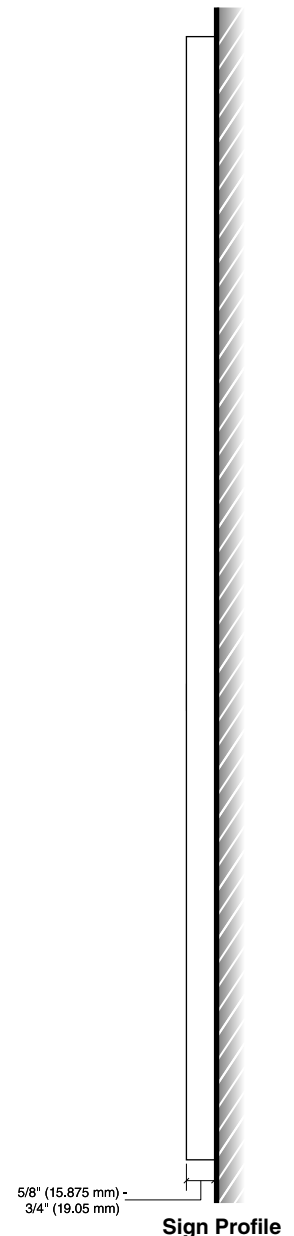

Sign Profile



IN-15.51/55

Interior Signage Drawings

Ceiling Mounted Directional and Department ID

Size

Sign Face:
6" High x 40" Wide
(152.4 mm H x 1016 mm W)

Description & Use

Ceiling-mounted sign for directional and department identification information. Can be single or double-sided.

Message Configuration

Refer to message layout drawings for dimensions.

Sign Components

Varies by component sign system:

Component Strips, Flat Insert or J-Track Insert-Based Sign Systems.

Graphic Process

Applied vinyl for semi-permanent messages or digitally printed insert for updatable messages.

Colors

Refer to the color chart in the Appendix.

Typography

Helvetica Bold

Mounting

Suspended from ceiling with braided stainless steel cable.

Installation

Mount at minimum 80" (2032 mm) above finished flooring to the bottom of the sign.

See [Section 2.1](#) for installation details.

Recommendations

Keep directional messages simple, providing only information necessary to decide at that specific location. List destinations in alphanumeric order and limit the number per sign.

Use consistent terminology throughout the facility, online, and on appointment letters.

Refer to the VHA Standardized Nomenclature document for a list of approved department names.

Inserts should follow an approved template established as part of the facility's sign standard and wayfinding plan. Ideally, all message updates should be documented and managed by a designated staff member or department such as Interior Design.

Sign Type	Width	Height	Text Size	Mounting	Family
IN-15.51	40"	6"	3" & 2"	Hanging	Panel/Strips
IN-15.55	40"	6"	3" & 2"	Hanging	Insert

Message Layout A



Message Layout B



Message Layout C

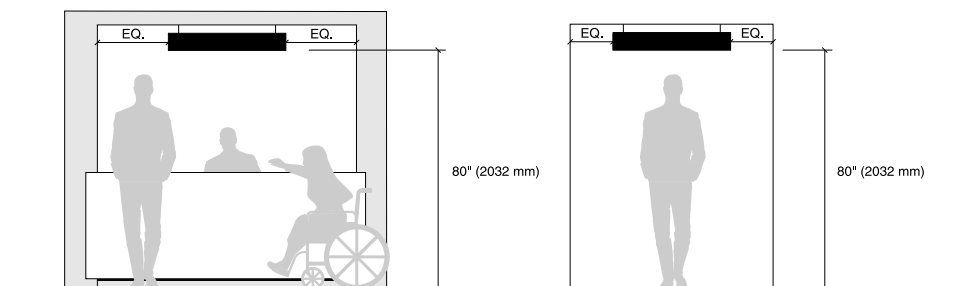

Ceiling Mounted Directional and Department ID

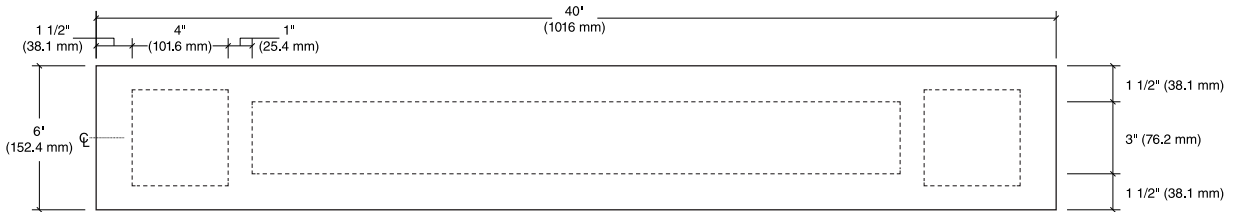

Message Layout A

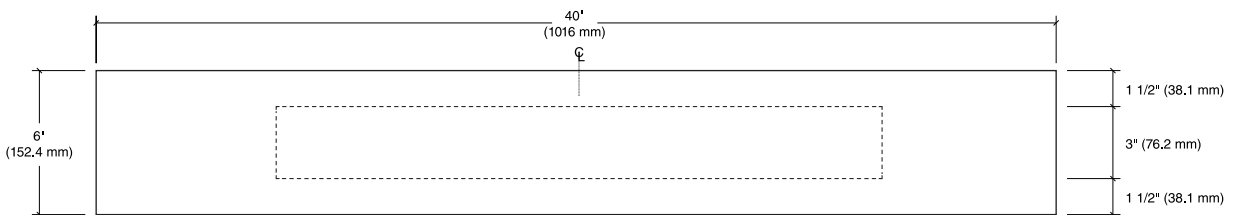

Message Layout B

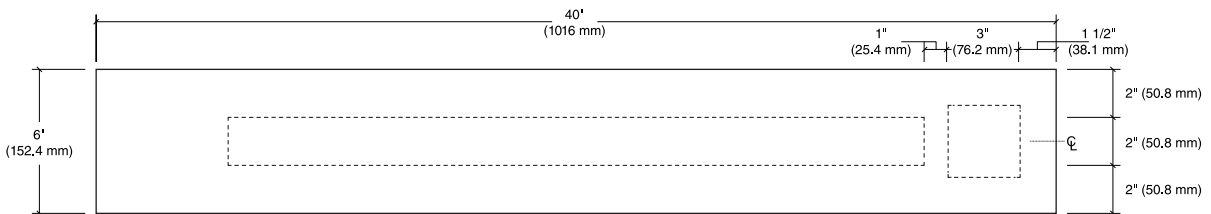

Message Layout C



IN-15.52/.56

Interior Signage Drawings

Ceiling Mounted Directional and Department ID

Size

Sign Face:
12" High x 40" Wide
(304.8 mm H x 1016 mm W)

Description & Use

Ceiling-mounted sign for directional and department identification information. Can be single or double-sided.

Message Configuration

Refer to message layout drawings for dimensions.

Sign Components

Varies by component sign system:

Component Strips, Flat Insert or J-Track Insert-Based Sign Systems.

Graphic Process

Applied vinyl for semi-permanent messages or digitally printed insert for updatable messages.

Colors

Refer to the color chart in the Appendix.

Typography

Helvetica Bold

Mounting

Suspended from ceiling with braided stainless steel cable.

Installation

Mount at minimum 80" (2032 mm) above finished flooring to the bottom of the sign.

See [Section 2.1](#) for installation details.

Recommendations

Keep directional messages simple, providing only information necessary to decide at that specific location. List destinations in alphanumeric order and limit the number per sign.

Use consistent terminology throughout the facility, online, and on appointment letters.

Refer to the VHA Standardized Nomenclature document for a list of approved department names.

Inserts should follow an approved template established as part of the facility's sign standard and wayfinding plan. Ideally, all message updates should be documented and managed by a designated staff member or department such as Interior Design.

Sign Type	Width	Height	Text Size	Mounting	Family
IN-15.52	40"	12"	3" & 2"	Hanging	Panel/Strips
IN-15.56	40"	12"	3" & 2"	Hanging	Insert

Message Layout A

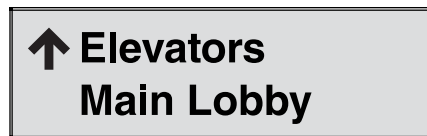

Message Layout B



Message Layout C



Message Layout D

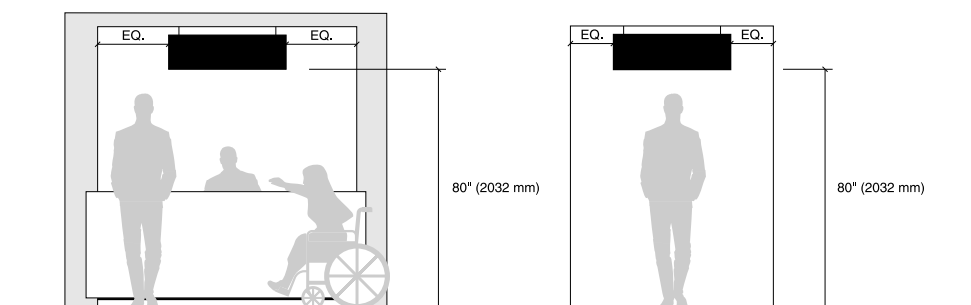

Ceiling Mounted Directional and Department ID

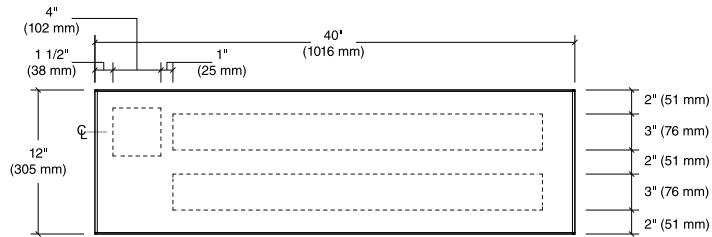

Message Layout A

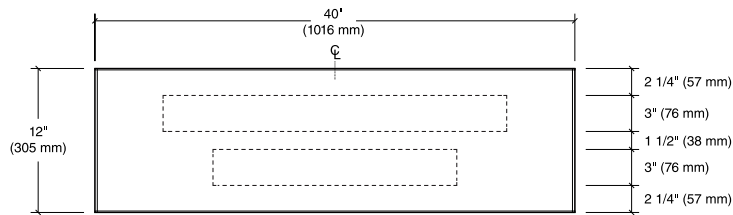

Message Layout B

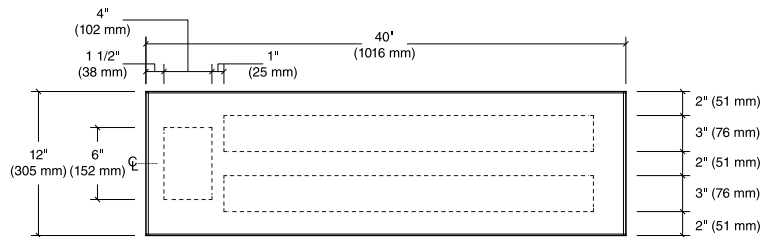

Message Layout C

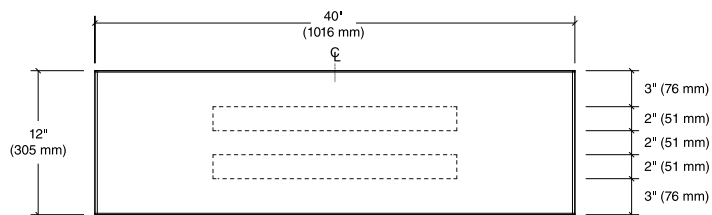

Message Layout D



IN-15.61/65

Interior Signage Drawings

Ceiling Mounted Directional and Department ID

Size

Sign Face:
6" High x 60" Wide
(152.4 mm H x 1524 mm W)

Description & Use

Ceiling-mounted sign for directional and department identification information. Can be single or double-sided.

Message Configuration

Refer to message layout drawings for dimensions.

Sign Components

Varies by component sign system:

Component Strips, Flat Insert or J-Track Insert-Based Sign Systems.

Graphic Process

Applied vinyl for semi-permanent messages or digitally printed insert for updatable messages.

Colors

Refer to the color chart in the Appendix.

Typography

Helvetica Bold

Mounting

Suspended from ceiling with braided stainless steel cable.

Installation

Mount at minimum 80" (2032 mm) above finished flooring to the bottom of the sign.

See [Section 2.1](#) for installation details.

Recommendations

Keep directional messages simple, providing only information necessary to decide at that specific location. List destinations in alphanumeric order and limit the number per sign.

Use consistent terminology throughout the facility, online, and on appointment letters.

Refer to the VHA Standardized Nomenclature document for a list of approved department names.

Inserts should follow an approved template established as part of the facility's sign standard and wayfinding plan. Ideally, all message updates should be documented and managed by a designated staff member or department such as Interior Design.

Sign Type	Width	Height	Text Size	Mounting	Family
IN-15.61	60"	6"	3" & 2"	Hanging	Panel/Strips
IN-15.65	60"	6"	3" & 2"	Hanging	Insert

Message Layout A



Message Layout B



Message Layout C

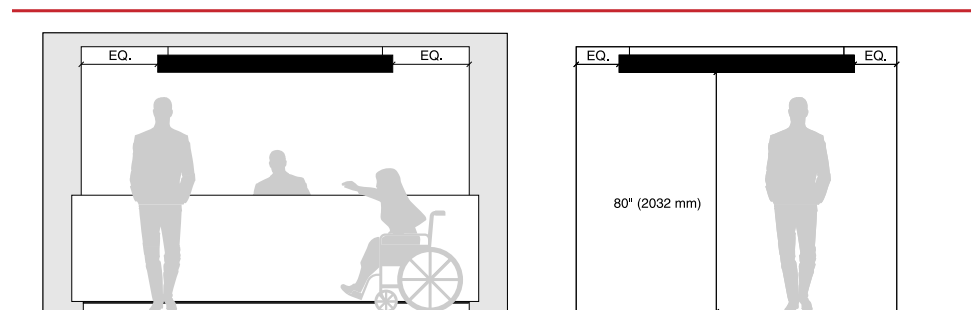

Ceiling Mounted Directional and Department ID

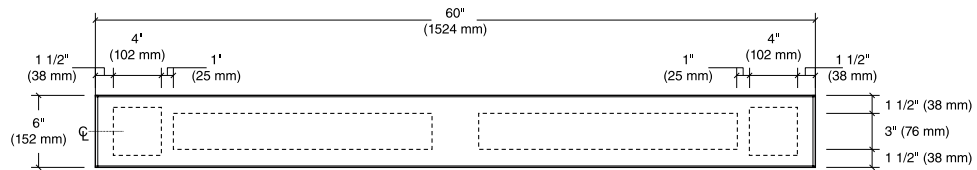

Message Layout A

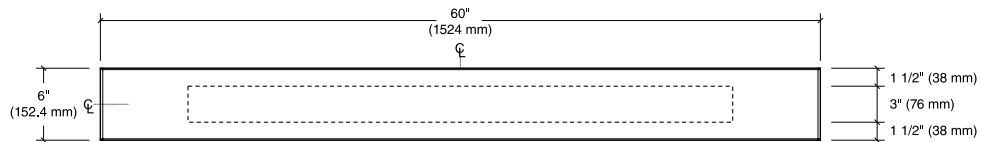

Message Layout B

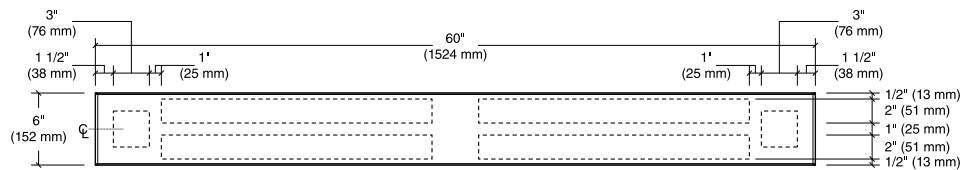

Message Layout C



IN-15.62/.66

Interior Signage Drawings

Ceiling Mounted Directional and Department ID

Size

Sign Face:
12" High x 60" Wide
(304.8 mm H x 1524 mm W)

Description & Use

Ceiling-mounted sign for directional and department identification information. Can be single or double-sided.

Message Configuration

Refer to message layout drawings for dimensions.

Sign Components

Varies by component sign system:

Component Strips, Flat Insert or J-Track Insert-Based Sign Systems.

Graphic Process

Applied vinyl for semi-permanent messages or digitally printed insert for updatable messages.

Colors

Refer to the color chart in the Appendix.

Typography

Helvetica Bold

Mounting

Suspended from ceiling with braided stainless steel cable.

Installation

Mount at minimum 80" (2032 mm) above finished flooring to the bottom of the sign.

See [Section 2.1](#) for installation details.

Recommendations

Keep directional messages simple, providing only information necessary to decide at that specific location. List destinations in alphanumeric order and limit the number per sign.

Use consistent terminology throughout the facility, online, and on appointment letters.

Refer to the VHA Standardized Nomenclature document for a list of approved department names.

Inserts should follow an approved template established as part of the facility's sign standard and wayfinding plan. Ideally, all message updates should be documented and managed by a designated staff member or department such as Interior Design.

Sign Type	Width	Height	Text Size	Mounting	Family
IN-15.62	60"	12"	3" & 2"	Hanging	Panel/Strips
IN-15.66	60"	12"	3" & 2"	Hanging	Insert

Message Layout A



Message Layout B



Message Layout C

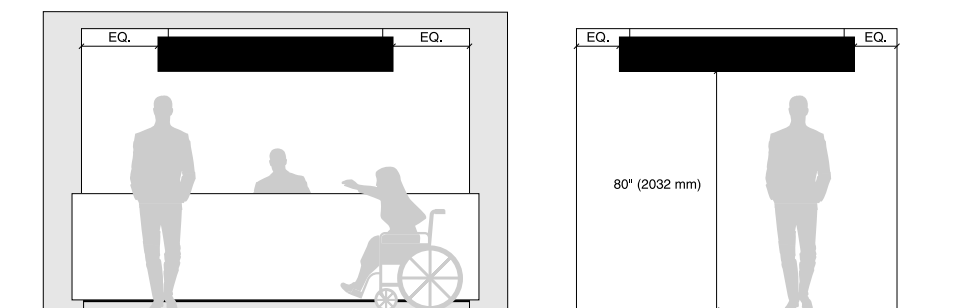
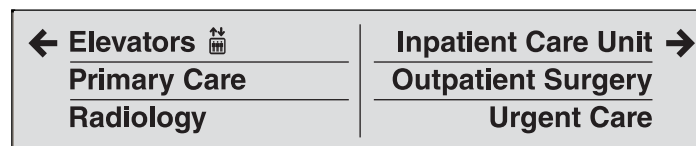

Ceiling Mounted Directional and Department ID

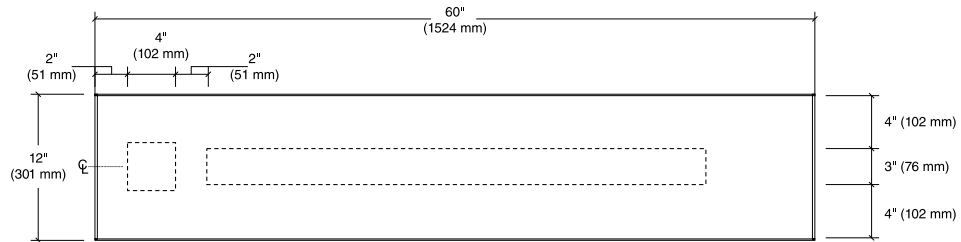

Message Layout A

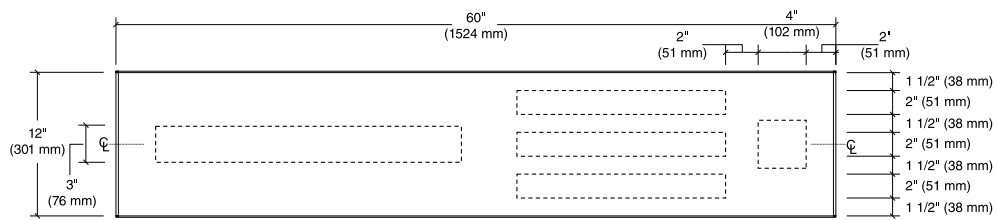

Message Layout B

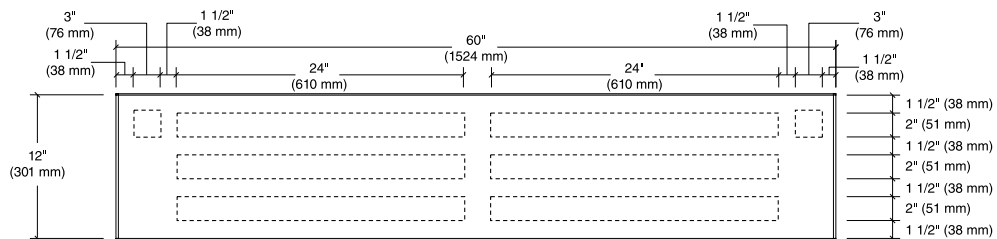

Message Layout C



IN-15.71/75

Interior Signage Drawings

Ceiling Mounted Directional and Department ID

Size

Sign Face:
6" High x 80" Wide
(152.4 mm H x 2032 mm W)

Description & Use

Ceiling-mounted sign for directional and department identification information. Can be single or double-sided.

Message Configuration

Refer to message layout drawings for dimensions.

Sign Components

Varies by component sign system:

Component Strips, Flat Insert or J-Track Insert-Based Sign Systems.

Graphic Process

Applied vinyl for semi-permanent messages or digitally printed insert for updatable messages.

Colors

Refer to the color chart in the Appendix.

Typography

Helvetica Bold

Mounting

Suspended from ceiling with braided stainless steel cable.

Installation

Mount at minimum 80" (2032 mm) above finished flooring to the bottom of the sign.

See [Section 2.1](#) for installation details.

Recommendations

Keep directional messages simple, providing only information necessary to decide at that specific location. List destinations in alphanumeric order and limit the number per sign.

Use consistent terminology throughout the facility, online, and on appointment letters.

Refer to the VHA Standardized Nomenclature document for a list of approved department names.

Inserts should follow an approved template established as part of the facility's sign standard and wayfinding plan. Ideally, all message updates should be documented and managed by a designated staff member or department such as Interior Design.

Sign Type	Width	Height	Text Size	Mounting	Family
IN-15.71	80"	6"	3" & 2"	Hanging	Panel/Strips
IN-15.75	80"	6"	3" & 2"	Hanging	Insert

Message Layout A



Message Layout B



Message Layout C

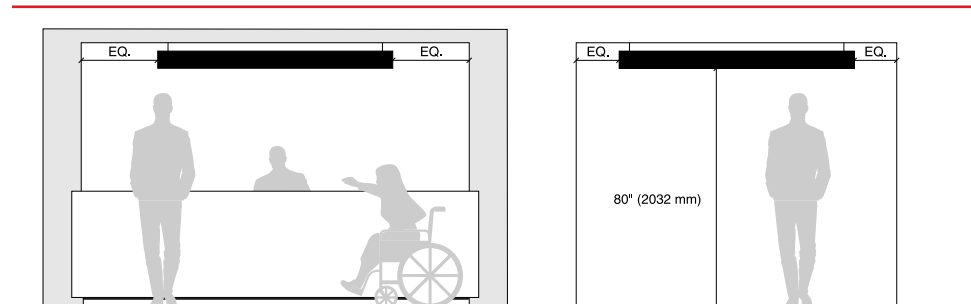

Ceiling Mounted Directional and Department ID

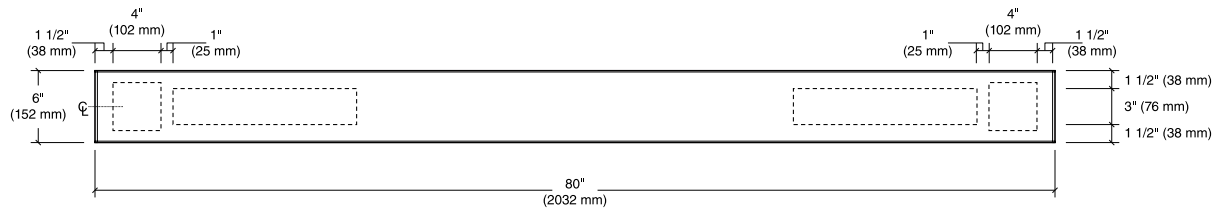

Message Layout A

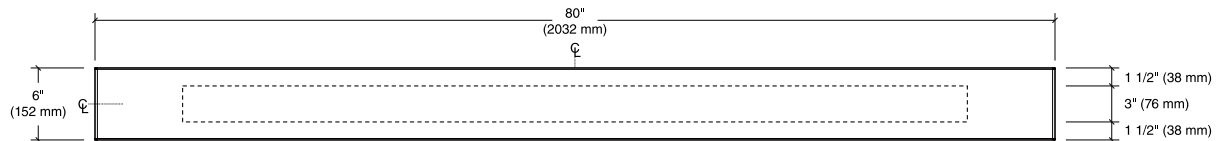

Message Layout B

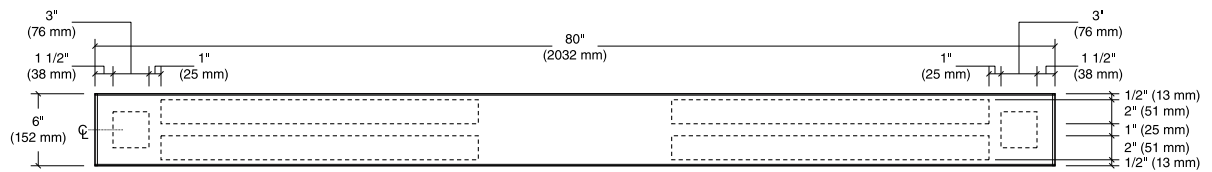

Message Layout C



IN-15.72/76

Interior Signage Drawings

Ceiling Mounted Directional and Department ID

Size

Sign Face:
12" High x 80" Wide
(304.8 mm H x 2032 mm W)

Description & Use

Ceiling-mounted sign for directional and department identification information. Can be single or double-sided.

Message Configuration

Refer to message layout drawings for dimensions.

Sign Components

Varies by component sign system:

Component Strips, Flat Insert or J-Track Insert-Based Sign Systems.

Graphic Process

Applied vinyl for semi-permanent messages or digitally printed insert for updatable messages.

Colors

Refer to the color chart in the Appendix.

Typography

Helvetica Bold

Mounting

Suspended from ceiling with braided stainless steel cable.

Installation

Mount at minimum 80" (2032 mm) above finished flooring to the bottom of the sign.

See [Section 2.1](#) for installation details.

Recommendations

Keep directional messages simple, providing only information necessary to decide at that specific location. List destinations in alphanumeric order and limit the number per sign.

Use consistent terminology throughout the facility, online, and on appointment letters.

Refer to the VHA Standardized Nomenclature document for a list of approved department names.

Inserts should follow an approved template established as part of the facility's sign standard and wayfinding plan. Ideally, all message updates should be documented and managed by a designated staff member or department such as Interior Design.

Sign Type	Width	Height	Text Size	Mounting	Family
IN-15.72	80"	12"	3" & 2"	Hanging	Panel/Strips
IN-15.76	80"	12"	3" & 2"	Hanging	Insert

Message Layout A

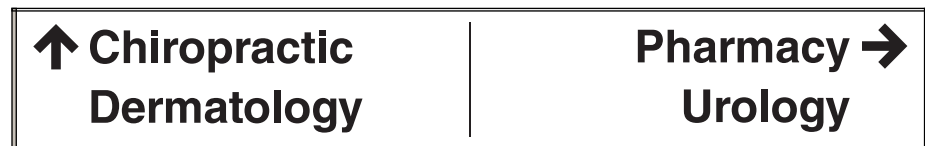

Message Layout B

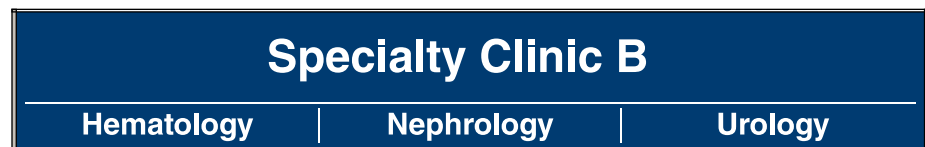

Message Layout C

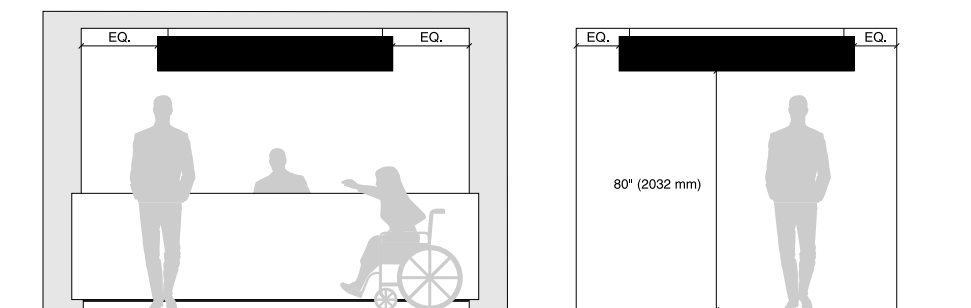
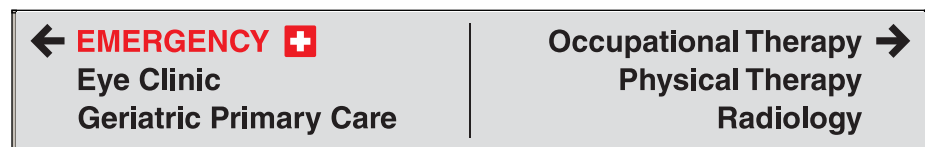

Ceiling Mounted Directional and Department ID

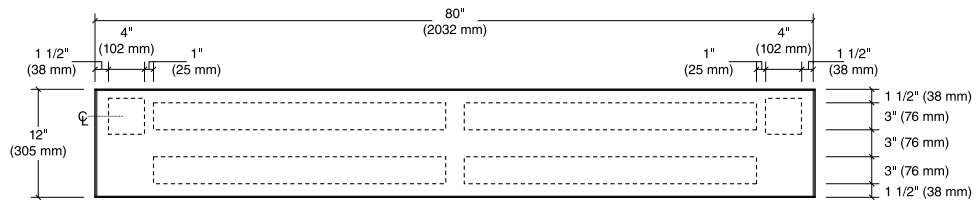

Message Layout A

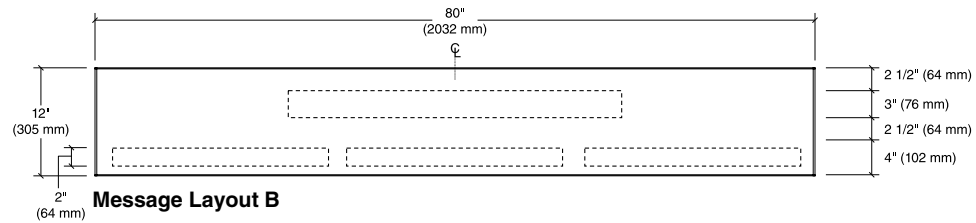

Message Layout B

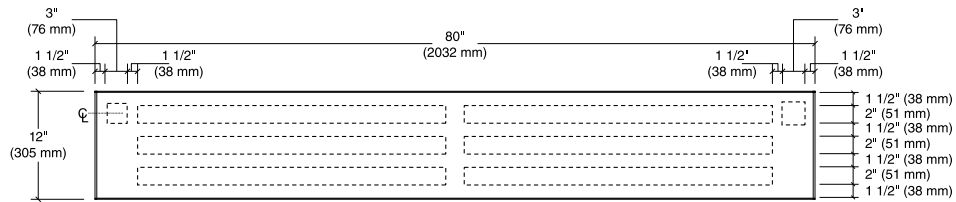

Message Layout C



IN-16.51/55

Interior Signage Drawings

Soffit Mounted Directional and Department ID

Size

Sign Face:
6" High x 40" Wide
(152.4 mm H x 1016 mm W)

Description & Use

Wall or soffit-mounted sign for directional and department identification information.

Message Configuration

Refer to message layout drawings for dimensions.

Sign Components

Varies by component sign system:

Component Strips, Flat Insert or J-Track Insert-Based Sign Systems.

Graphic Process

Applied vinyl for semi-permanent messages or digitally printed insert for updatable messages.

Colors

Refer to the color chart in the Appendix.

Typography

Helvetica Bold

Mounting

Concealed mechanical fasteners - do not use on firewalls without proper accommodations.

Installation

See [Section 2.1](#) for installation details.

Recommendations

Keep directional messages simple, providing only information necessary to decide at that specific location. List destinations in alphanumeric order and limit the number per sign.

Use consistent terminology throughout the facility, online, and on appointment letters.

Refer to the VHA Standardized Nomenclature document for a list of approved department names.

Inserts should follow an approved template established as part of the facility's sign standard and wayfinding plan. Ideally, all message updates should be documented and managed by a designated staff member or department such as Interior Design.

Sign Type	Width	Height	Text Size	Mounting	Family
IN-16.51	40"	6"	3" & 2"	Soffit	Panel/Strips
IN-16.55	40"	6"	3" & 2"	Soffit	Insert

Message Layout A



Message Layout B



Message Layout C

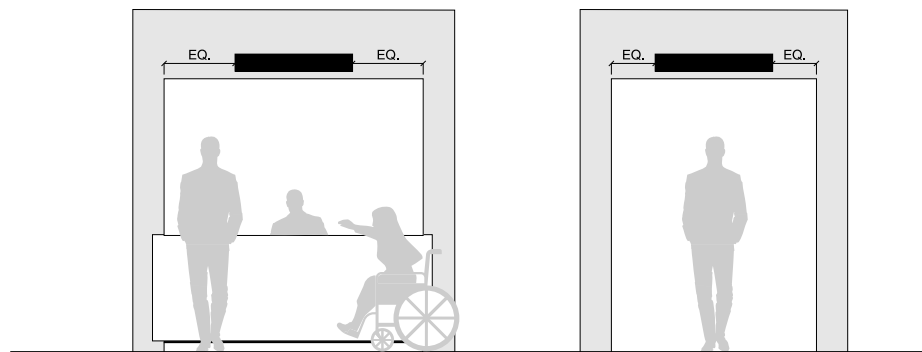

Soffit Mounted Directional and Department ID

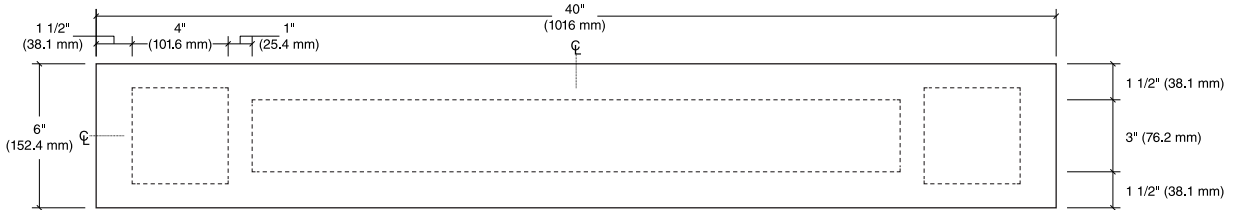

Message Layout A

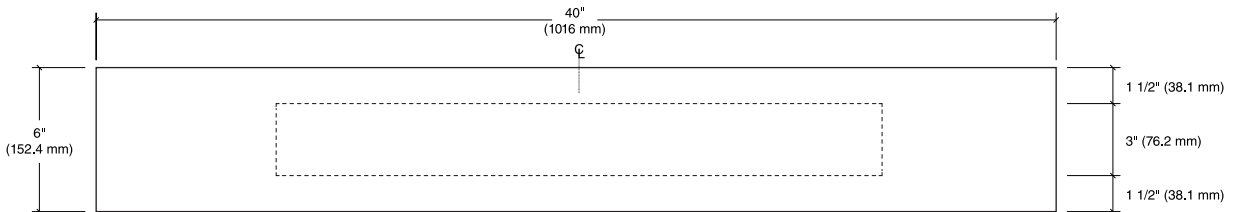

Message Layout B

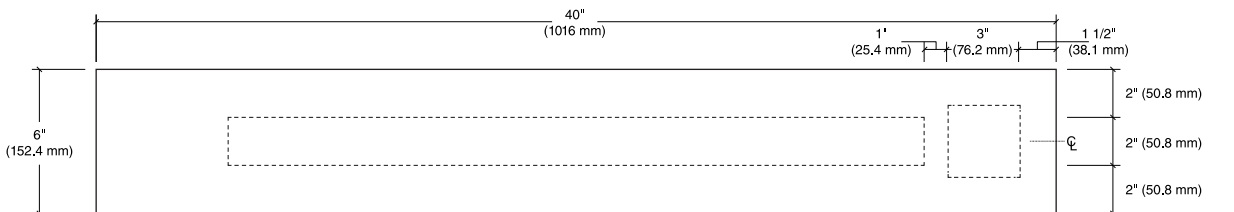

Message Layout C



IN-16.52/.56

Interior Signage Drawings

Soffit Mounted Directional and Department ID

Size

Sign Face:
12" High x 40" Wide
(304.8 mm H x 1016 mm W)

Description & Use

Wall or soffit-mounted sign for directional and department identification information.

Message Configuration

Refer to message layout drawings for dimensions.

Sign Components

Varies by component sign system:

Component Strips, Flat Insert or J-Track Insert-Based Sign Systems.

Graphic Process

Applied vinyl for semi-permanent messages or digitally printed insert for updatable messages.

Colors

Refer to the color chart in the Appendix.

Typography

Helvetica Bold

Mounting

Concealed mechanical fasteners - do not use on firewalls without proper accommodations.

Installation

See [Section 2.1](#) for installation details.

Recommendations

Keep directional messages simple, providing only information necessary to decide at that specific location. List destinations in alphanumeric order and limit the number per sign.

Use consistent terminology throughout the facility, online, and on appointment letters.

Refer to the VHA Standardized Nomenclature document for a list of approved department names.

Inserts should follow an approved template established as part of the facility's sign standard and wayfinding plan. Ideally, all message updates should be documented and managed by a designated staff member or department such as Interior Design.

Sign Type	Width	Height	Text Size	Mounting	Family
IN-16.52	40"	12"	3" & 2"	Soffit	Panel/Strips
IN-16.56	40"	12"	3" & 2"	Soffit	Insert

Message Layout A



Message Layout B



Message Layout C



Message Layout D

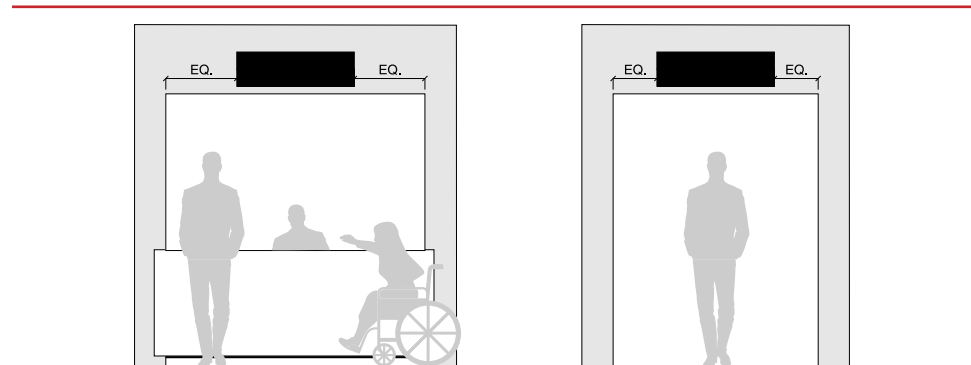
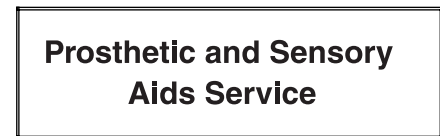

Soffit Mounted Directional and Department ID

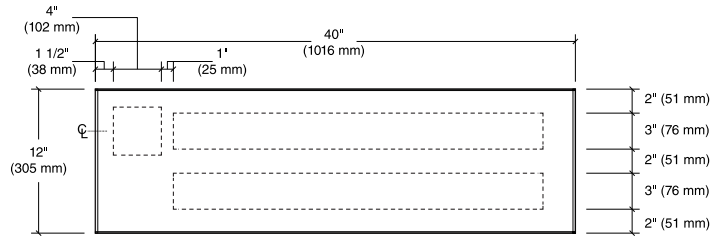

Message Layout A

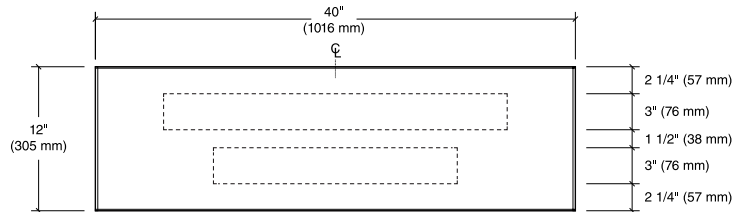

Message Layout B

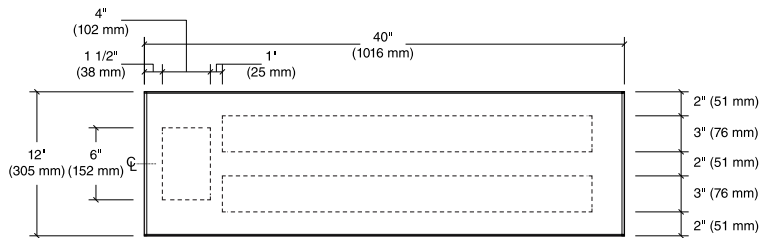

Message Layout C

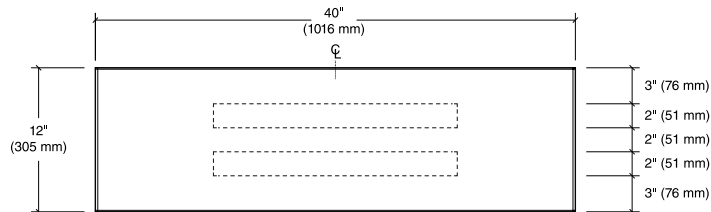

Message Layout D



IN-16.61/65

Interior Signage Drawings

Soffit Mounted Directional and Department ID

Size

Sign Face:
6" High x 60" Wide
(152.4 mm H x 1524 mm W)

Description & Use

Wall or soffit-mounted sign for directional and department identification information.

Message Configuration

Refer to message layout drawings for dimensions.

Sign Components

Varies by component sign system:

Component Strips, Flat Insert or J-Track Insert-Based Sign Systems.

Graphic Process

Applied vinyl for semi-permanent messages or digitally printed insert for updatable messages.

Colors

Refer to the color chart in the Appendix.

Typography

Helvetica Bold

Mounting

Concealed mechanical fasteners - do not use on firewalls without proper accommodations.

Installation

See [Section 2.1](#) for installation details.

Recommendations

Keep directional messages simple, providing only information necessary to decide at that specific location. List destinations in alphanumeric order and limit the number per sign.

Use consistent terminology throughout the facility, online, and on appointment letters.

Refer to the VHA Standardized Nomenclature document for a list of approved department names.

Inserts should follow an approved template established as part of the facility's sign standard and wayfinding plan. Ideally, all message updates should be documented and managed by a designated staff member or department such as Interior Design.

Sign Type	Width	Height	Text Size	Mounting	Family
IN-16.61	60"	6"	3" & 2"	Soffit	Panel/Strips
IN-16.65	60"	6"	3" & 2"	Soffit	Insert

Message Layout A



Message Layout B



Message Layout C

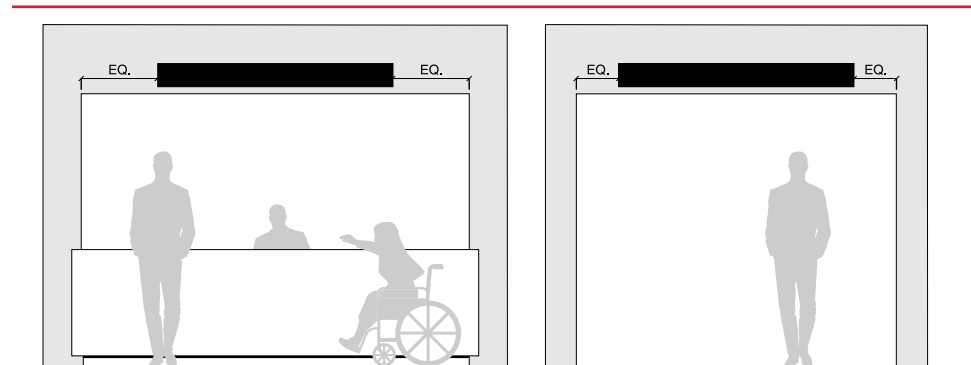

Soffit Mounted Directional and Department ID

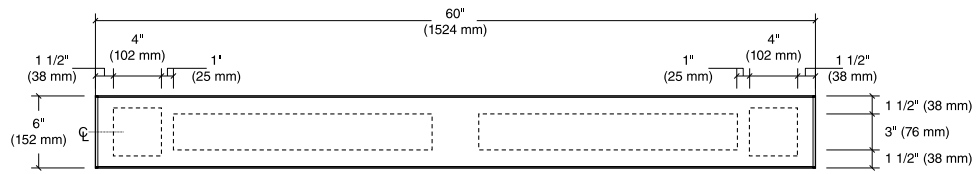

Message Layout A

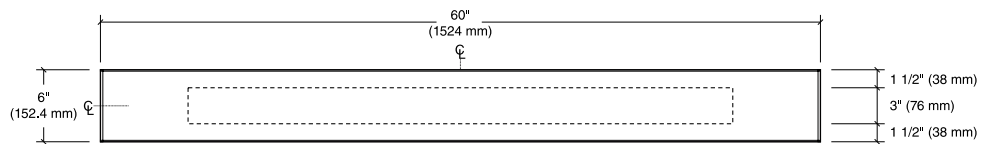

Message Layout B

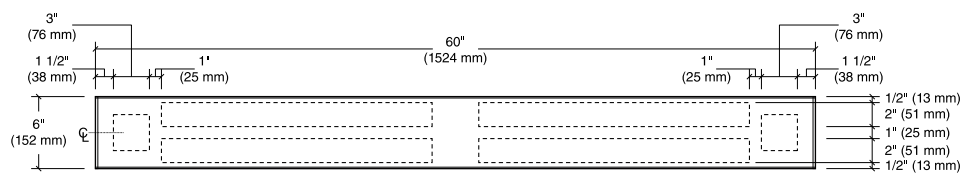

Message Layout C



IN-16.62/.66

Interior Signage Drawings

Soffit Mounted Directional and Department ID

Size

Sign Face:
12" High x 60" Wide
(304.8 mm H x 1524 mm W)

Description & Use

Wall or soffit-mounted sign for directional and department identification information.

Message Configuration

Refer to message layout drawings for dimensions.

Sign Components

Varies by component sign system:

Component Strips, Flat Insert or J-Track Insert-Based Sign Systems.

Graphic Process

Applied vinyl for semi-permanent messages or digitally printed insert for updatable messages.

Colors

Refer to the color chart in the Appendix.

Typography

Helvetica Bold

Mounting

Concealed mechanical fasteners - do not use on firewalls without proper accommodations.

Installation

See [Section 2.1](#) for installation details.

Recommendations

Keep directional messages simple, providing only information necessary to decide at that specific location. List destinations in alphanumeric order and limit the number per sign.

Use consistent terminology throughout the facility, online, and on appointment letters.

Refer to the VHA Standardized Nomenclature document for a list of approved department names.

Inserts should follow an approved template established as part of the facility's sign standard and wayfinding plan. Ideally, all message updates should be documented and managed by a designated staff member or department such as Interior Design.

Sign Type	Width	Height	Text Size	Mounting	Family
IN-16.62	60"	12"	3" & 2"	Soffit	Panel/Strips
IN-16.66	60"	12"	3" & 2"	Soffit	Insert

Message Layout A



Message Layout B



Message Layout C

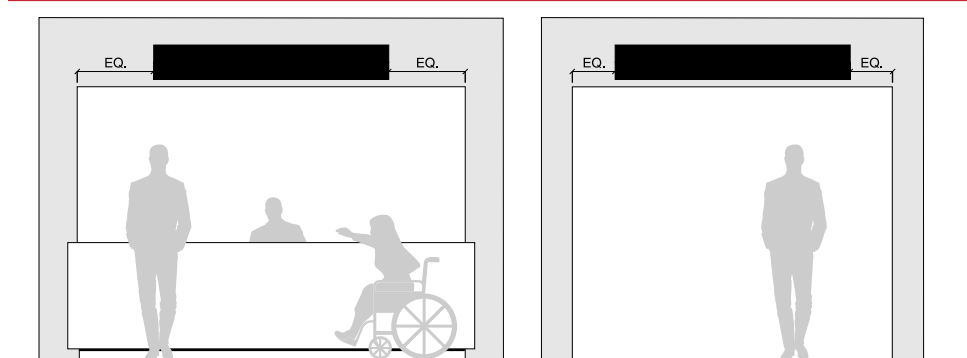
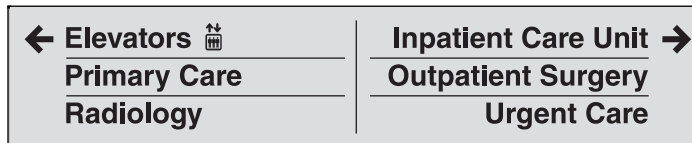

Soffit Mounted Directional and Department ID

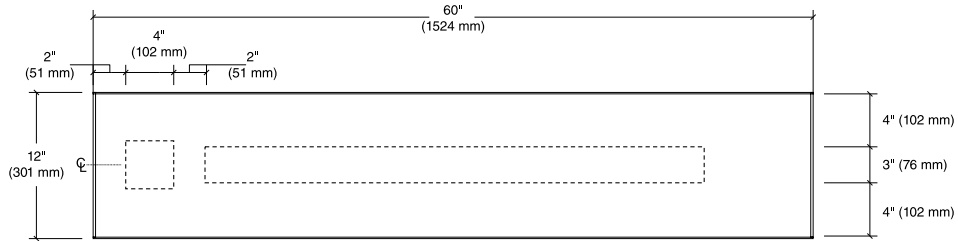

Message Layout A

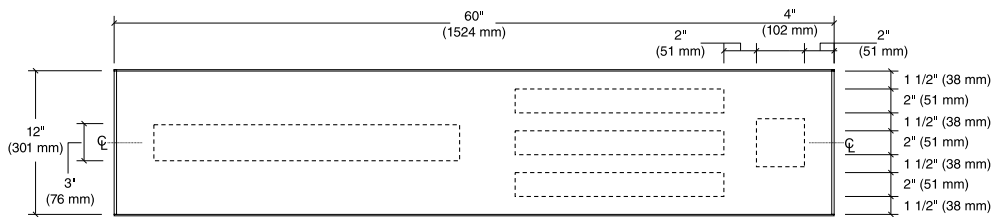

Message Layout B

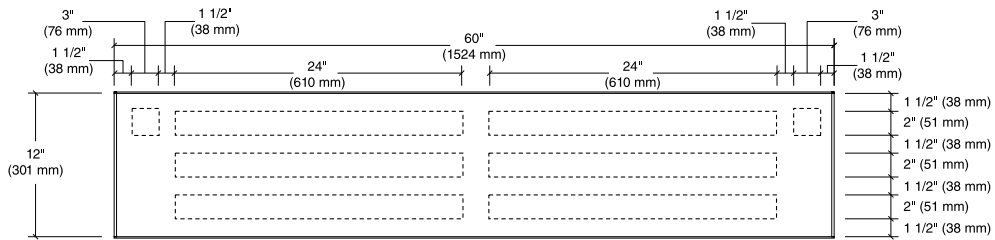

Message Layout C



IN-16.71/75

Interior Signage Drawings

Soffit Mounted Directional and Department ID

Size

Sign Face:
6" High x 80" Wide
(152.4 mm H x 2032 mm W)

Description & Use

Wall or soffit-mounted sign for directional and department identification information.

Message Configuration

Refer to message layout drawings for dimensions.

Sign Components

Varies by component sign system:

Component Strips, Flat Insert or J-Track Insert-Based Sign Systems.

Graphic Process

Applied vinyl for semi-permanent messages or digitally printed insert for updatable messages.

Colors

Refer to the color chart in the Appendix.

Typography

Helvetica Bold

Mounting

Concealed mechanical fasteners - do not use on firewalls without proper accommodations.

Installation

See [Section 2.1](#) for installation details.

Recommendations

Keep directional messages simple, providing only information necessary to decide at that specific location. List destinations in alphanumeric order and limit the number per sign.

Use consistent terminology throughout the facility, online, and on appointment letters.

Refer to the VHA Standardized Nomenclature document for a list of approved department names.

Inserts should follow an approved template established as part of the facility's sign standard and wayfinding plan. Ideally, all message updates should be documented and managed by a designated staff member or department such as Interior Design.

Sign Type	Width	Height	Text Size	Mounting	Family
IN-16.71	80"	6"	3" & 2"	Soffit	Panel/Strips
IN-16.75	80"	6"	3" & 2"	Soffit	Insert

Message Layout A



Message Layout B



Message Layout C

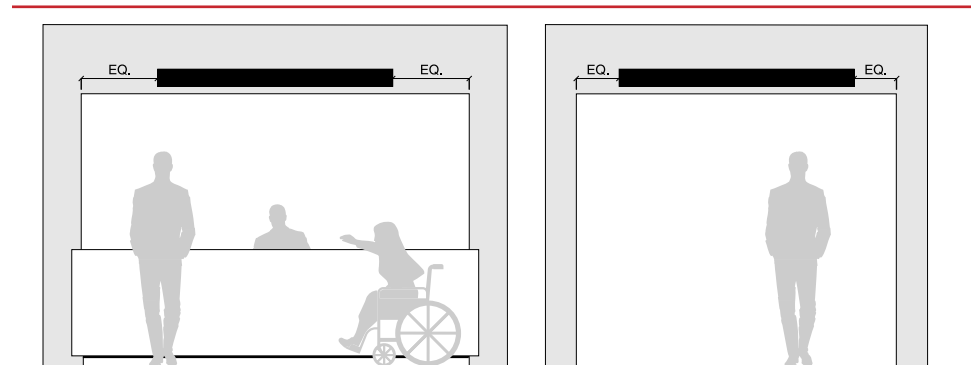

Soffit Mounted Directional and Department ID

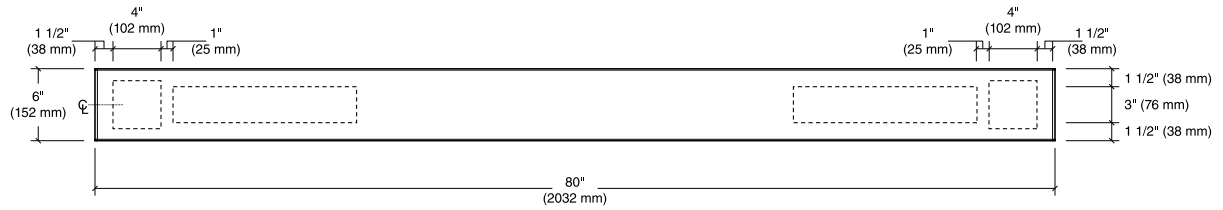

Message Layout A

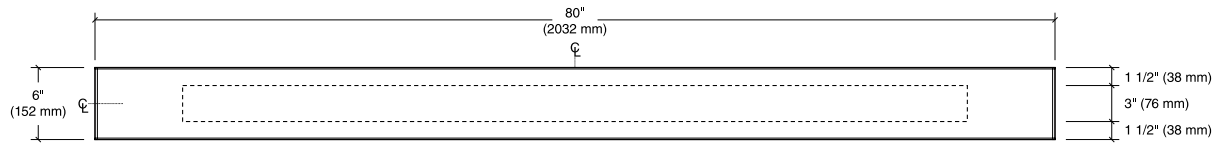

Message Layout B

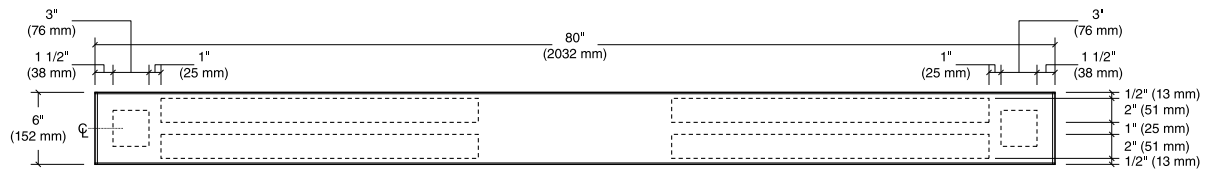

Message Layout C



IN-16.72/.76

Interior Signage Drawings

Soffit Mounted Directional and Department ID

Size

Sign Face:
12" High x 80" Wide
(304.8 mm H x 2032 mm W)

Description & Use

Wall or soffit-mounted sign for directional and department identification information.

Message Configuration

Refer to message layout drawings for dimensions.

Sign Components

Varies by component sign system:

Component Strips, Flat Insert or J-Track Insert-Based Sign Systems.

Graphic Process

Applied vinyl for semi-permanent messages or digitally printed insert for updatable messages.

Colors

Refer to the color chart in the Appendix.

Typography

Helvetica Bold

Mounting

Alternate: Concealed mechanical fasteners - do not use on firewalls without proper accommodations.

Installation

See [Section 2.1](#) for installation details.

Recommendations

Keep directional messages simple, providing only information necessary to decide at that specific location. List destinations in alphanumeric order and limit the number per sign.

Use consistent terminology throughout the facility, online, and on appointment letters.

Refer to the VHA Standardized Nomenclature document for a list of approved department names.

Inserts should follow an approved template established as part of the facility's sign standard and wayfinding plan. Ideally, all message updates should be documented and managed by a designated staff member or department such as Interior Design.

Sign Type	Width	Height	Text Size	Mounting	Family
IN-16.72	80"	12"	3" & 2"	Soffit	Panel/Strips
IN-16.76	80"	12"	3" & 2"	Soffit	Insert

Message Layout A

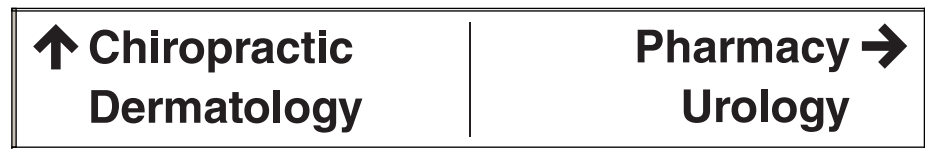

Message Layout B

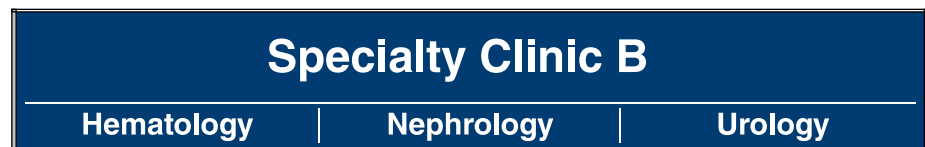

Message Layout C

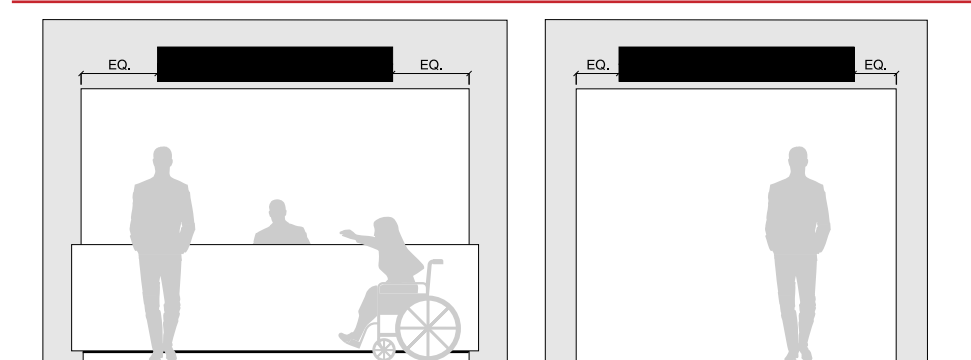

Soffit Mounted Directional and Department ID

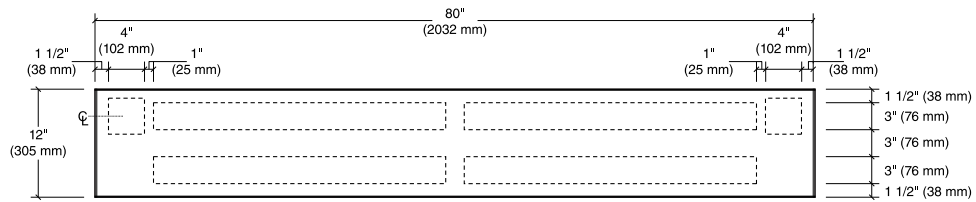

Message Layout A

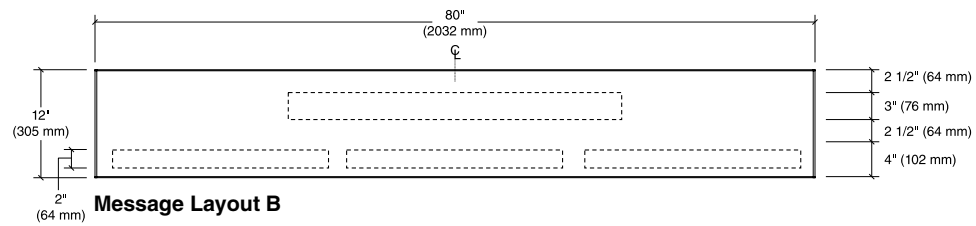

Message Layout B

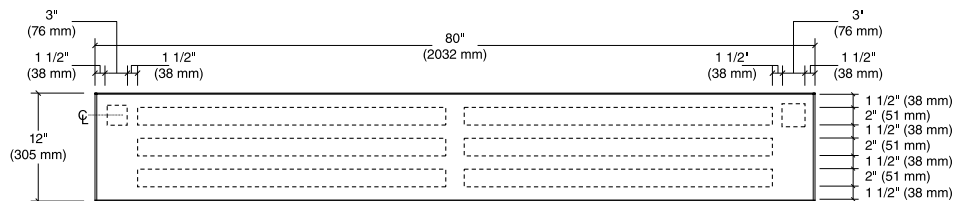

Message Layout C



IN-17.01

Interior Signage Drawings

Large Orientation Map

Size

Sign Face:
39" High x 34" Wide
(990.6 mm H x 863.6 mm W)

Description & Use

This sign is used to display wayfinding maps of a facility near primary entrances and lobbies. These maps help viewers orient themselves upon enter the facility and plan a route to their destination.

Message Configuration

Refer to message layout drawings for dimensions.

Sign Components

Component based sign system

See [Section 2.1](#) for applicable component sign system styles.

Graphic Process

Header: Direct second surface digital print or silk-screened

Message Insert: Digital Print Insert

Colors

Refer to the color chart in the Appendix.

Typography

Helvetica

Mounting

Alternate: Concealed mechanical fasteners

Installation

See [Section 2.1](#) for installation details.

Recommendations

Maps should be oriented to the viewer. The top of the map should be the direction that the viewer is standing while facing the sign.

Maps should be a stylized and simplified representation of the floor plan. Avoid excessively detailed illustrations.

Use consistent terminology throughout the facility, online, and on appointment letters.

Refer to the VHA Standardized Nomenclature document for a list of approved department names.

See [Section 4.2](#) for more about wayfinding maps and directories.

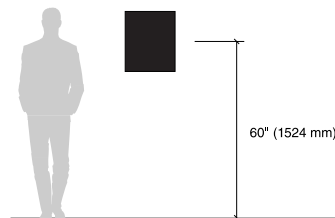
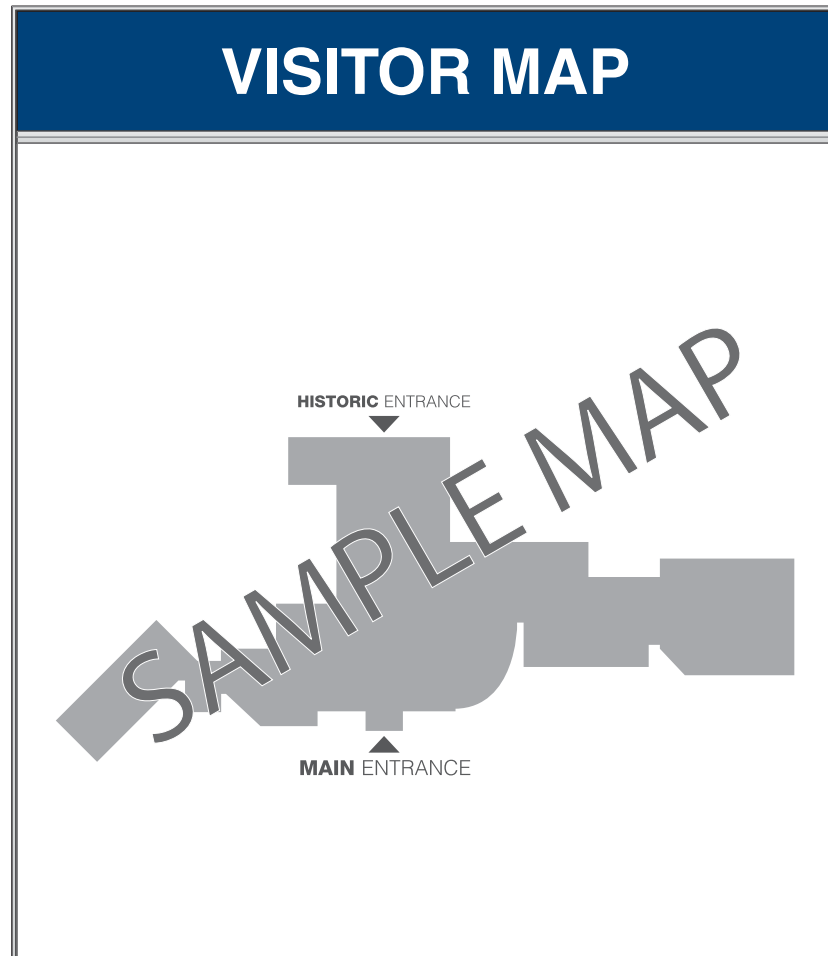

IN-17.01

Interior Signage Drawings

Large Orientation Map

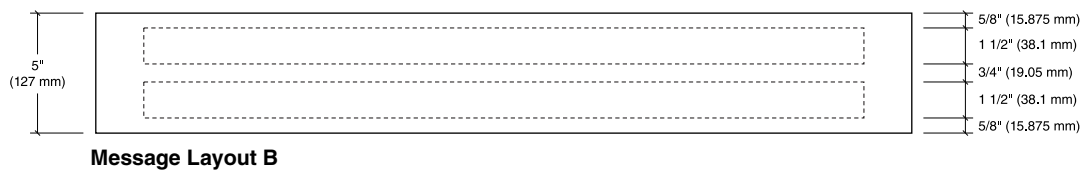
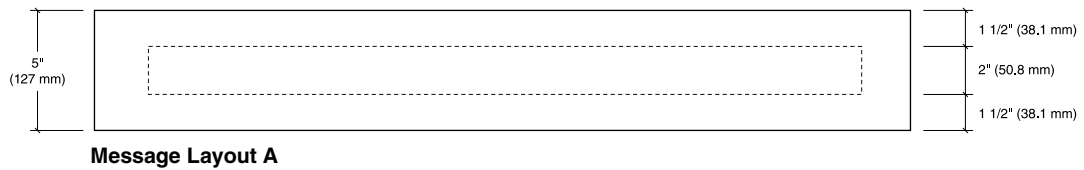
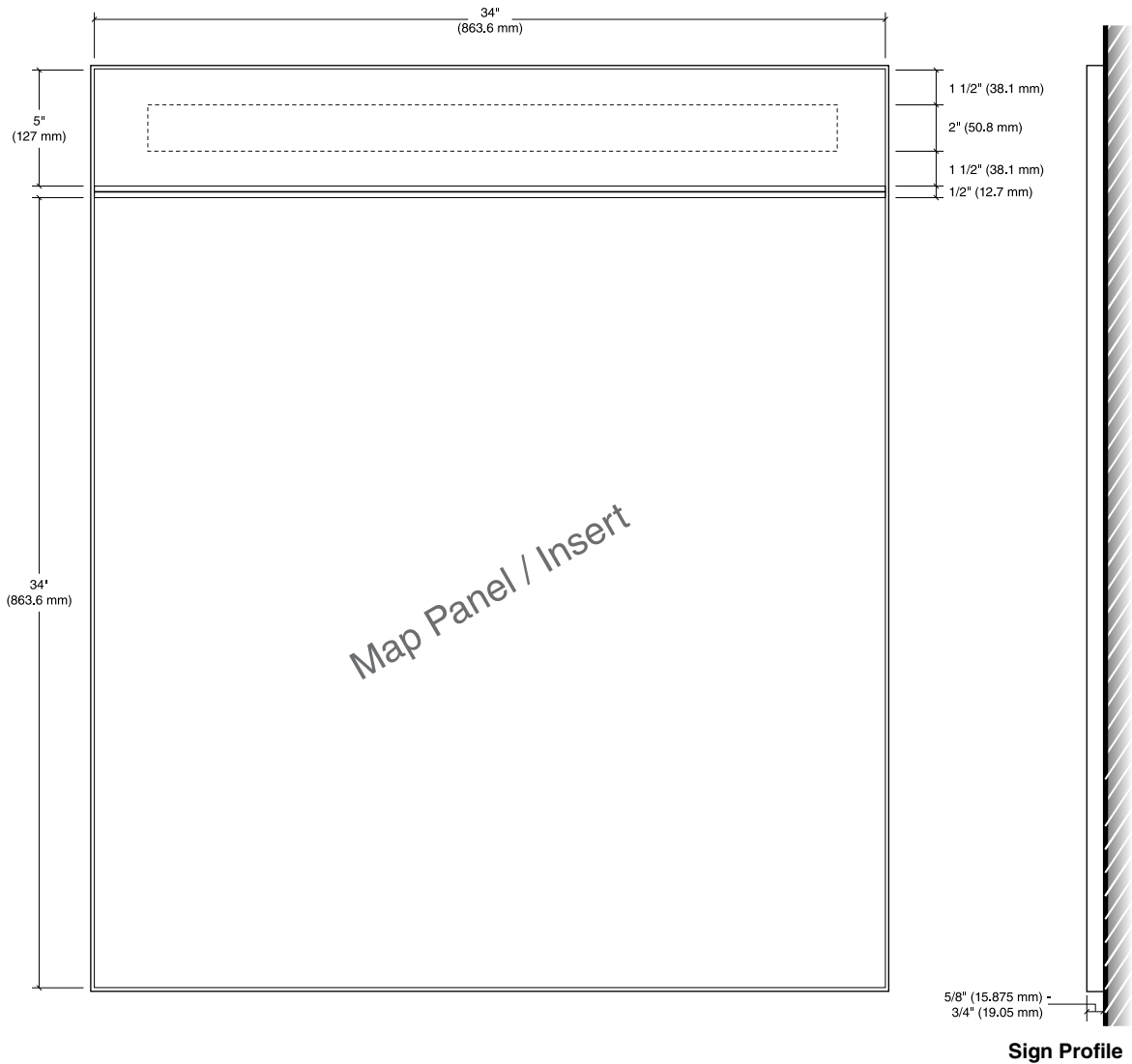

IN-17.02

Interior Signage Drawings

Large Directory Listing

Size

Sign Face:
39" High x 34" Wide
(990.6 mm H x 863.6 mm W)

Description & Use

This sign is used to display the directory list of patient & visitor focused destinations within the facility.

Message Configuration

Refer to message layout drawings for dimensions.

Sign Components

Component based sign system

See Section 2.1 for applicable component sign system styles.

Graphic Process

Header: Direct second surface digital print or silk-screened

Message Insert: Digital Print Insert

Colors

Refer to the color chart in the Appendix.

Typography

Helvetica

Mounting

Concealed mechanical fasteners

Installation

See Section 2.1 for installation details.

Recommendations

A single directory insert typically fits 15 to 16 lines of copy at a minimum text height of 3/8" (9.525 mm). Make sure the number of inserts is sufficient for the size of the facility and number of destinations.

Use consistent terminology throughout the facility, online, and on appointment letters.

Refer to the VHA Standardized Nomenclature document for a list of approved department names.

See Section 4.2 for more about wayfinding maps and directories.

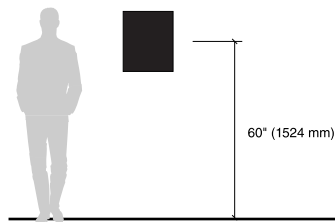
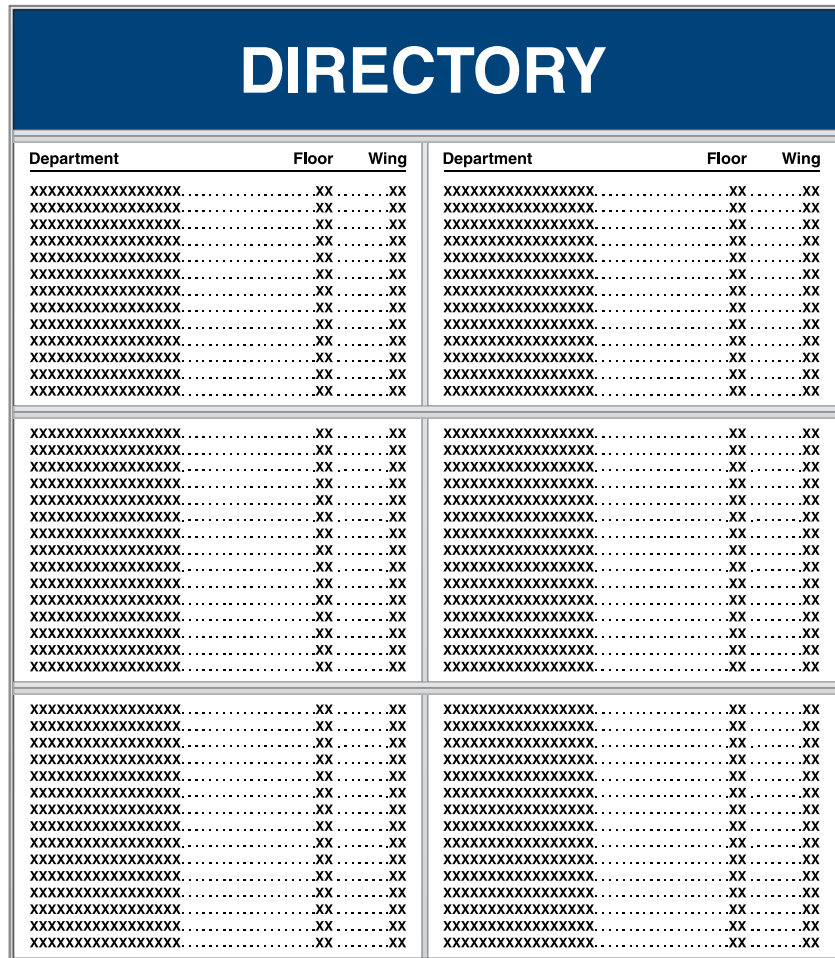

Large Directory Listing

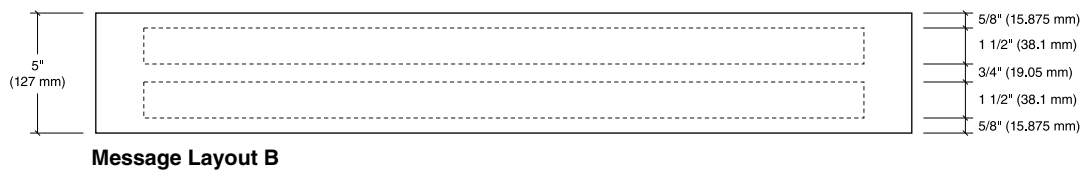
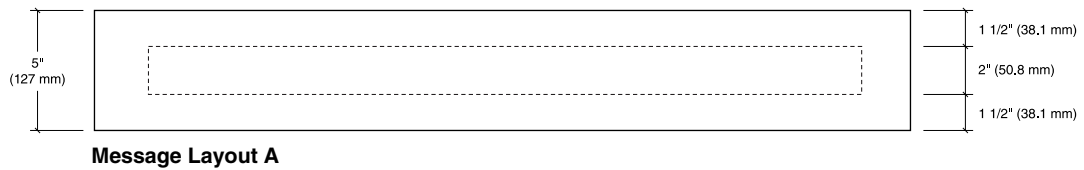
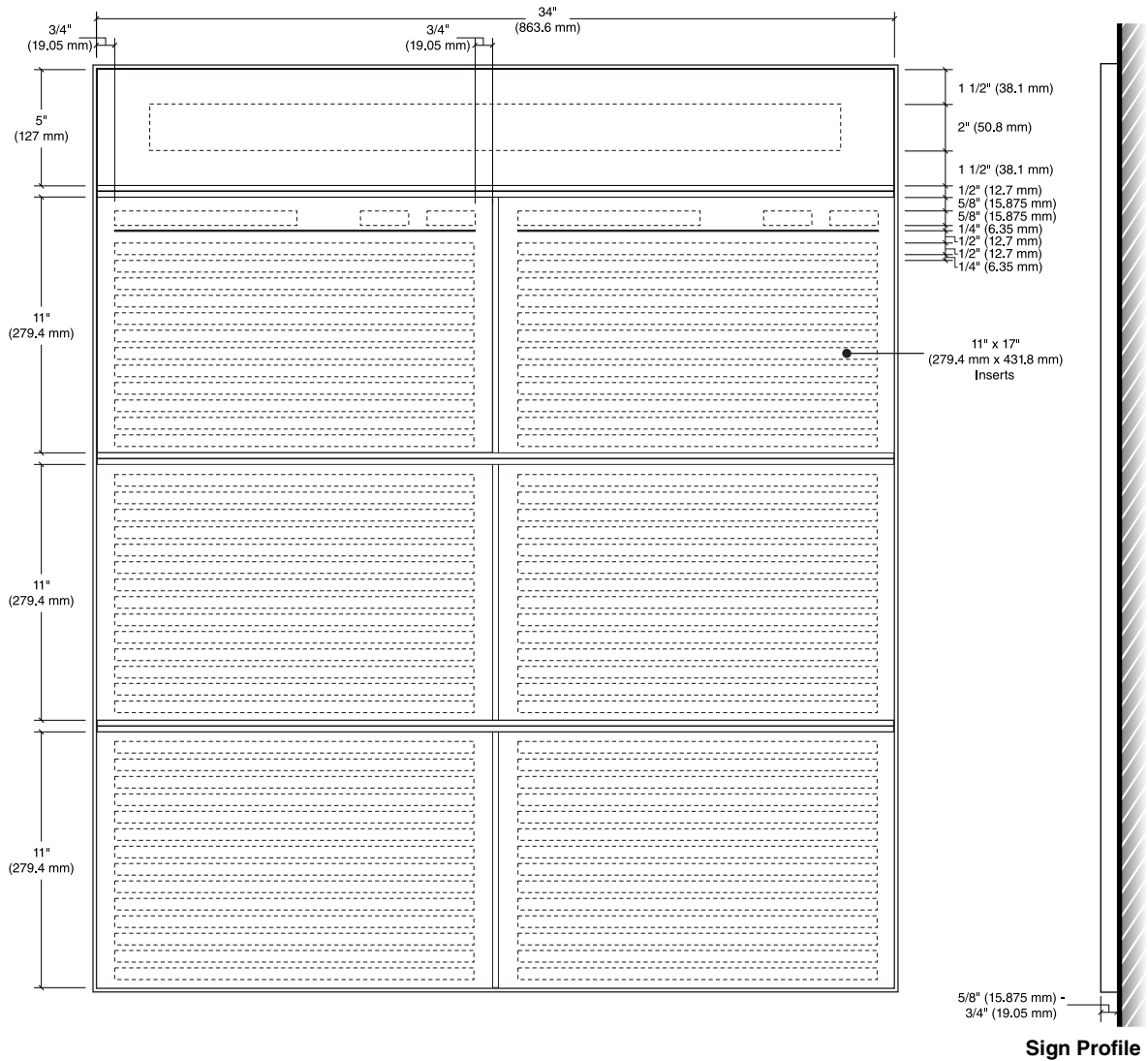

IN-17.03

Interior Signage Drawings

Orientation Map

Size

Sign Face:
27 1/2" High x 22 1/2" Wide
(698.5 mm H x 571.5 mm W)

Description & Use

This sign is used to display wayfinding maps of the current floor of the building near elevator lobbies or secondary entrances. These maps help viewers orient themselves as they exit the elevator or enter an area.

Message Configuration

Refer to message layout drawings for dimensions.

Sign Components

Component based sign system

See Section 2.1 for applicable component sign system styles.

Graphic Process

Header: Direct second surface digital print or silk-screened

Message Insert: Digital Print Insert

Colors

Refer to the color chart in the Appendix.

Typography

Helvetica

Mounting

Concealed mechanical fasteners

Installation

See Section 2.1 for installation details.

Recommendations

Maps should be oriented to the viewer. The top of the map should be the direction that the viewer is standing while facing the sign.

Maps should be a stylized and simplified representation of the floor plan. Avoid excessively detailed illustrations.

Use consistent terminology throughout the facility, online, and on appointment letters.

Reference the VHA Standardized Nomenclature document for a list of approved department names.

See [Section 4.2](#) for more about wayfinding maps and directories.

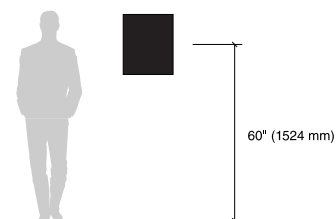
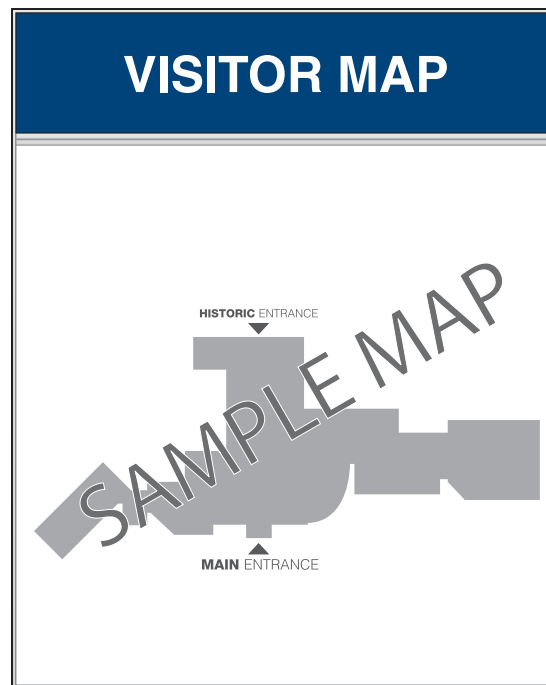

IN-17.03

Interior Signage Drawings

Orientation Map

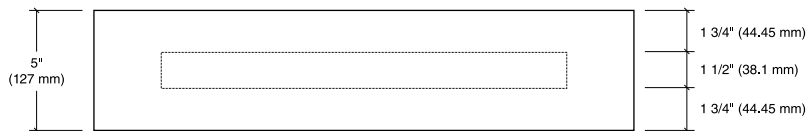
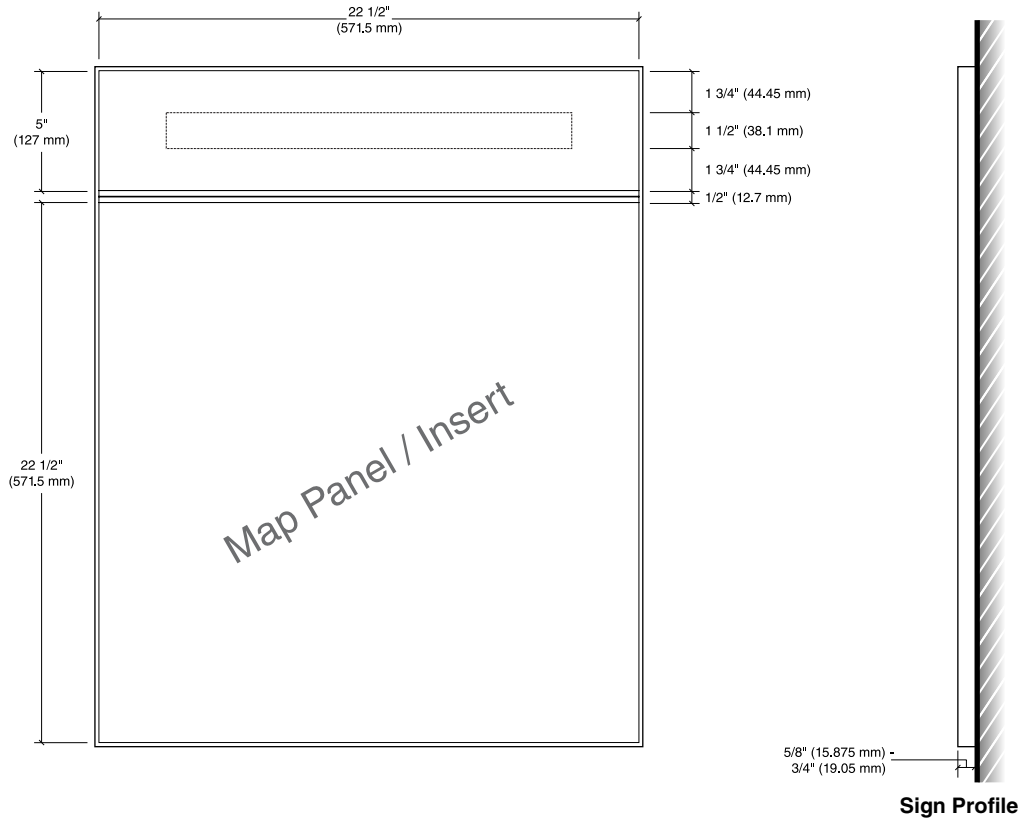

Message Layout A

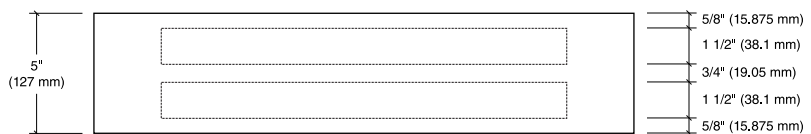

Message Layout B



IN-17.04

Interior Signage Drawings

Directory Listing

Size

Sign Face:
27" High x 34 1/4" Wide
(685.8 mm H x 869.95 mm W)

Description & Use

This sign is used to display the directory list of patient & visitor focused destinations within the facility.

Message Configuration

Refer to message layout drawings for dimensions.

Sign Components

Component based sign system

See Section 2.1 for applicable component sign system styles.

Graphic Process

Header: Direct second surface digital print or silk-screened

Message Insert: Paper or acetate sheet with digital print

Colors

Refer to the color chart in the Appendix.

Typography

Helvetica

Mounting

Concealed mechanical fasteners

Installation

See Section 2.1 for installation details.

Recommendations

A single directory insert typically fits 15 to 16 line of copy at a minimum text height of 3/8". Make sure the number of inserts is sufficient for the size of the facility and number of destinations.

Use consistent terminology throughout the facility, online, and on appointment letters.

Refer to the VHA Standardized Nomenclature document for a list of approved department names.

See [Section 4.2](#) for more about wayfinding maps and directories.

Department			Floor	Wing	Department			Floor	Wing
XXXXXXXXXXXXXXXXXXXXXX			XXXXXXXXXXXXXXXXXXXXXX		
XXXXXXXXXXXXXXXXXXXXXX			XXXXXXXXXXXXXXXXXXXXXX		
XXXXXXXXXXXXXXXXXXXXXX			XXXXXXXXXXXXXXXXXXXXXX		
XXXXXXXXXXXXXXXXXXXXXX			XXXXXXXXXXXXXXXXXXXXXX		
XXXXXXXXXXXXXXXXXXXXXX			XXXXXXXXXXXXXXXXXXXXXX		
XXXXXXXXXXXXXXXXXXXXXX			XXXXXXXXXXXXXXXXXXXXXX		
XXXXXXXXXXXXXXXXXXXXXX			XXXXXXXXXXXXXXXXXXXXXX		
XXXXXXXXXXXXXXXXXXXXXX			XXXXXXXXXXXXXXXXXXXXXX		
XXXXXXXXXXXXXXXXXXXXXX			XXXXXXXXXXXXXXXXXXXXXX		
XXXXXXXXXXXXXXXXXXXXXX			XXXXXXXXXXXXXXXXXXXXXX		
XXXXXXXXXXXXXXXXXXXXXX			XXXXXXXXXXXXXXXXXXXXXX		
XXXXXXXXXXXXXXXXXXXXXX			XXXXXXXXXXXXXXXXXXXXXX		
XXXXXXXXXXXXXXXXXXXXXX			XXXXXXXXXXXXXXXXXXXXXX		
XXXXXXXXXXXXXXXXXXXXXX			XXXXXXXXXXXXXXXXXXXXXX		
XXXXXXXXXXXXXXXXXXXXXX			XXXXXXXXXXXXXXXXXXXXXX		
XXXXXXXXXXXXXXXXXXXXXX			XXXXXXXXXXXXXXXXXXXXXX		
XXXXXXXXXXXXXXXXXXXXXX			XXXXXXXXXXXXXXXXXXXXXX		
XXXXXXXXXXXXXXXXXXXXXX			XXXXXXXXXXXXXXXXXXXXXX		

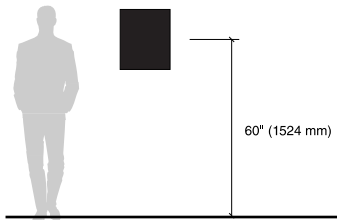

Directory Listing

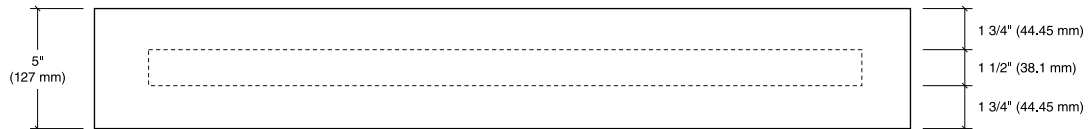
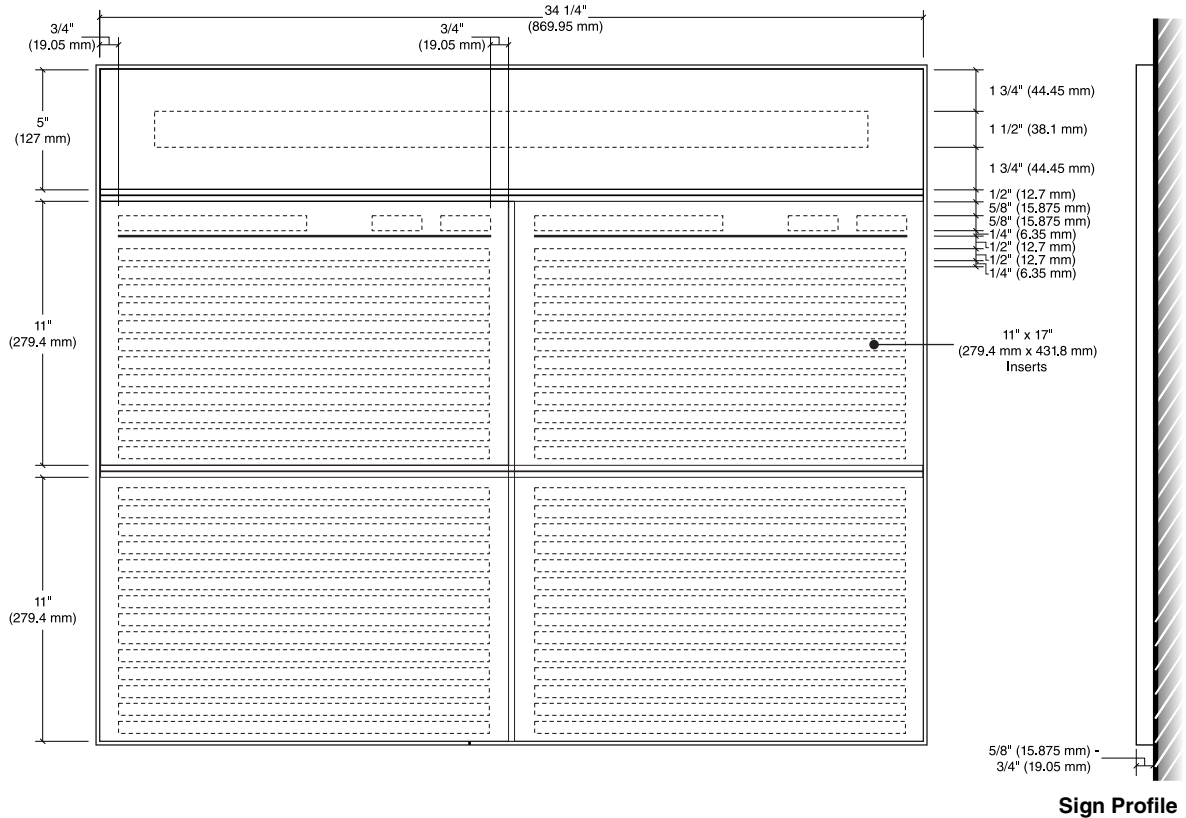

Message Layout A

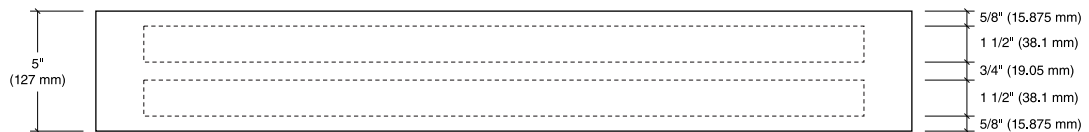

Message Layout B



IN-17.05

Interior Signage Drawings

Small Directory Listing

Size

Top:
27" High x 17" Wide
(685.8 mm H x 431.8mm W)

Description & Use

This sign is used to display the directory list of patient & visitor focused destinations within the facility.

Message Configuration

Refer to message layout drawings for dimensions.

Sign Components

Component based sign system

See Section 2.1 for applicable component sign system styles.

Graphic Process

Header: Direct second surface digital print or silk-screened

Message Insert: Paper or acetate sheet with digital print

Colors

Refer to the color chart in the Appendix.

Typography

Helvetica

Mounting

Preferred: Concealed mechanical fasteners

Alternate: Double-sided VHB foam tape and silicone adhesive

Installation

See Section 2.1 for installation details.

Recommendations

A single directory insert typically fits 15 to 16 lines of copy at a minimum text height of 3/8". Make sure the number of inserts is sufficient for the size of the facility and number of destinations.

Use consistent terminology throughout the facility, online, and on appointment letters.

Refer to the VHA Standardized Nomenclature document for a list of approved department names.

See [Section 4.2](#) for more about wayfinding maps and directories.

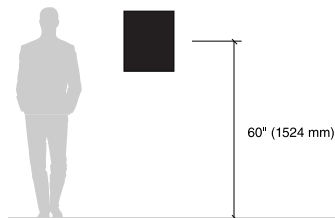
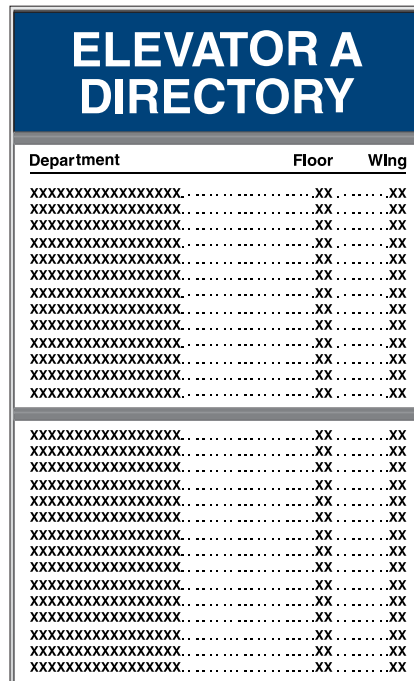

IN-17.05

Interior Signage Drawings

Small Directory Listing

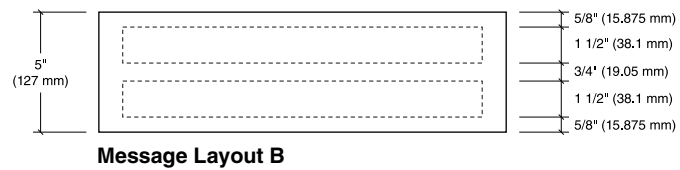
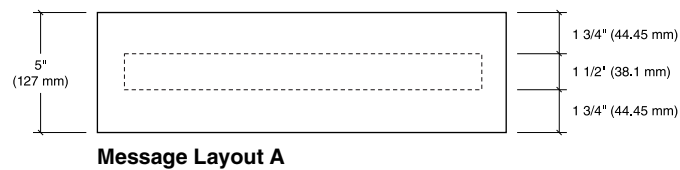
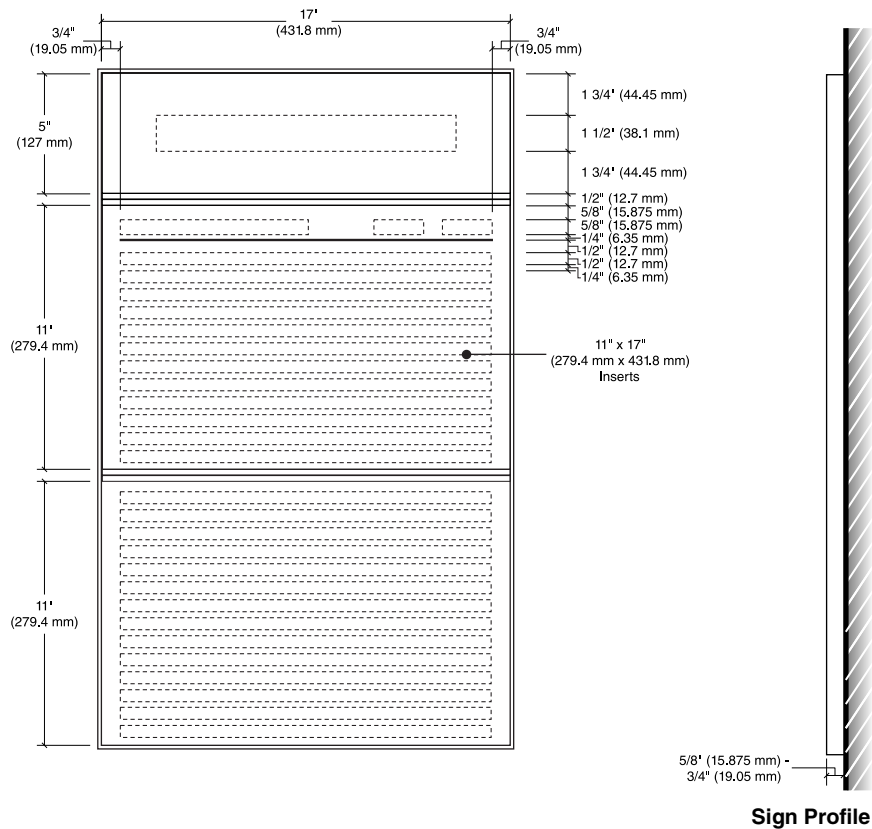

IN-18.01

Interior Signage Drawings

Vinyl Applied Letters

Size

1 1/2" High (38.1 mm H)

2" High (50.8 mm H)

Other sizes may be used as appropriate.

Description & Use

Vinyl letters for use at glass entry doors to rooms or departments that are used by patients and the public.

Message Configuration

Refer to layout drawing for lettering sizes and dimensions.

Graphic Process

Surface applied high performance vinyl.

Colors

Text: White or other color that provides high contrast.

Refer to the color chart in the Appendix.

Typography

Helvetica

Mounting

Glass sidelight and glass doors

Installation

Apply to front reading surface of glass or second surface of glass with reverse (backward) cut letters.

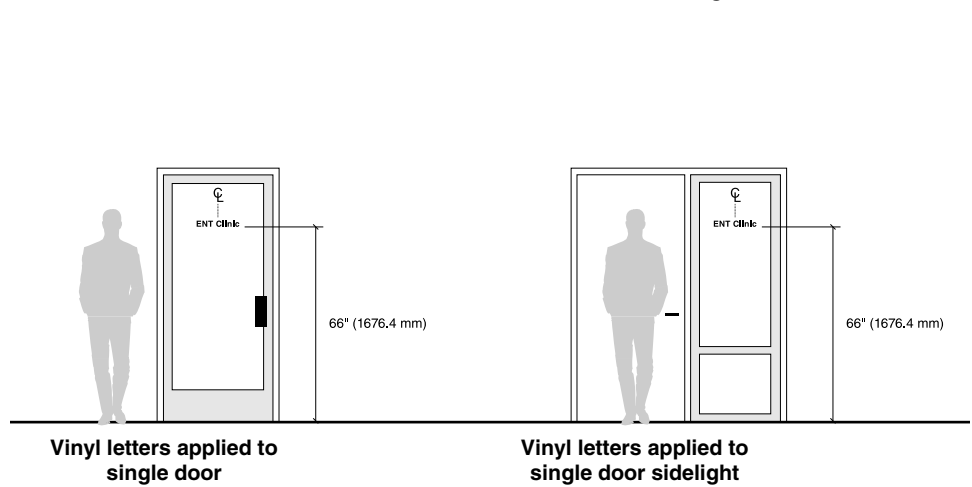
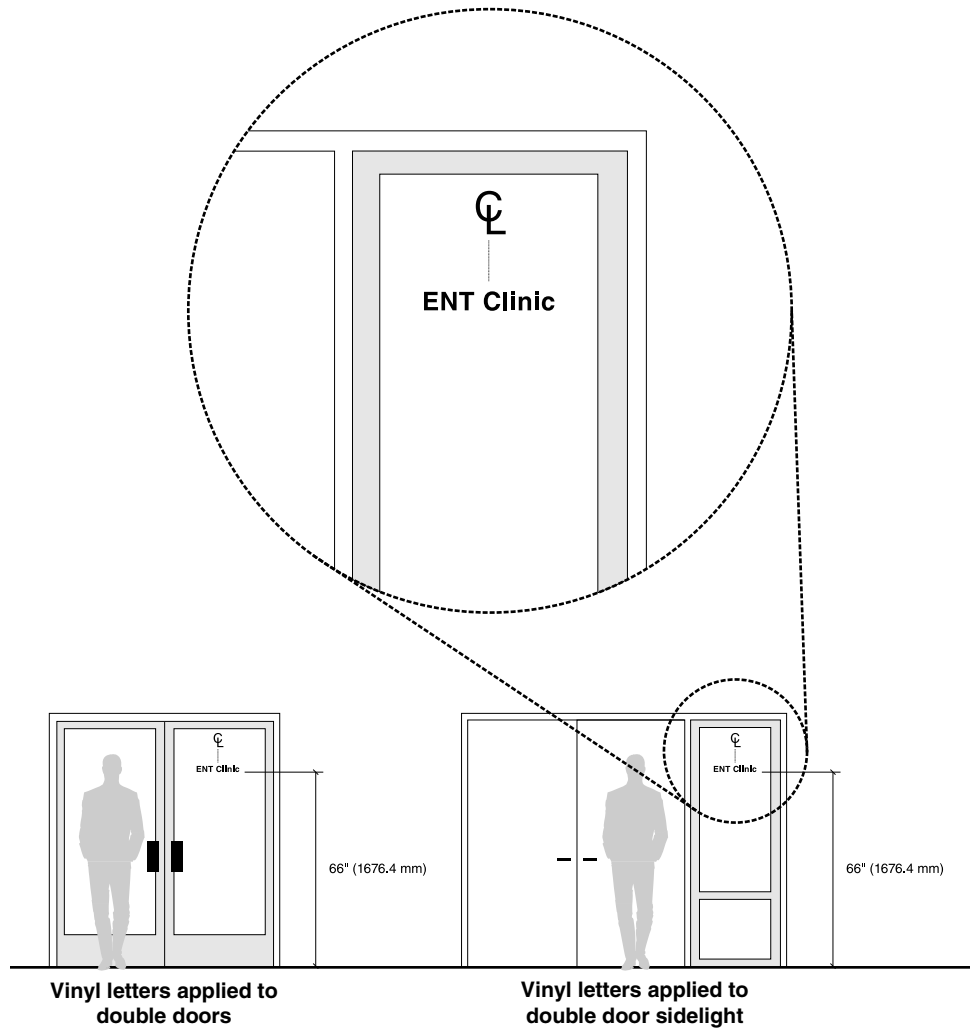

Glass Door and Side Light Graphics



Message Layout A – 1 1/2" Text (Sample Text Shown)



Message Layout B – 2" Text (Sample Text Shown)

IN-19.01-.03

Interior Signage Drawings

Dimensional Letters

Size

IN-19.01: 3" High (558.8 mm H)

IN-19.02: 4" High (711.2 mm H)

IN-19.03: 6" High (863.6 mm H)

Description & Use

Identification of information counters, major departments, or services.

Message Configuration

Refer to layout drawing for lettering sizes and dimensions.

Sign Components

Painted acrylic

Graphic Process

Cut out acrylic dimensional letters

Colors

Lettering color should have a high contrast with surrounding wall color and surface.

Refer to the color chart in the Appendix.

Typography

Helvetica

Mounting

Silicone adhesive and studs

Installation

On wall or above wall openings

Recommendations

Dimensional letters provide high impact, high visibility, and formal identification. Do not use for departments or services that have frequent relocations or name changes. Suggested typical uses would be for Information, Check In, Canteen, Pharmacy, etc.

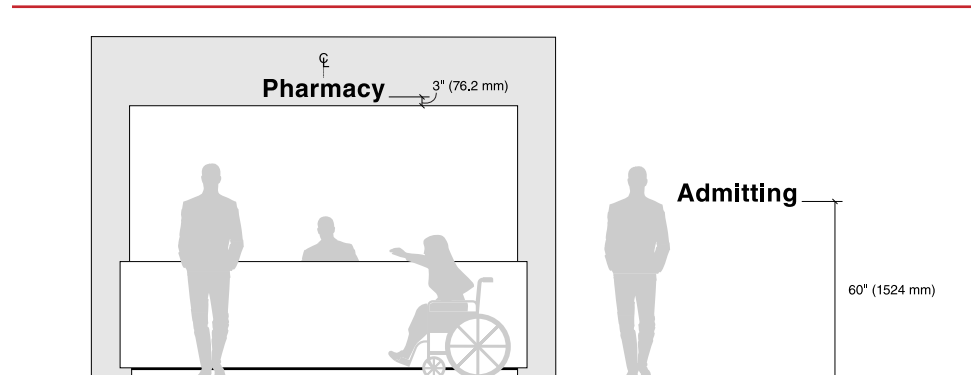

Dimensional Letters

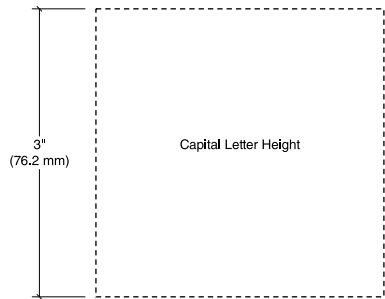

IN-19.01

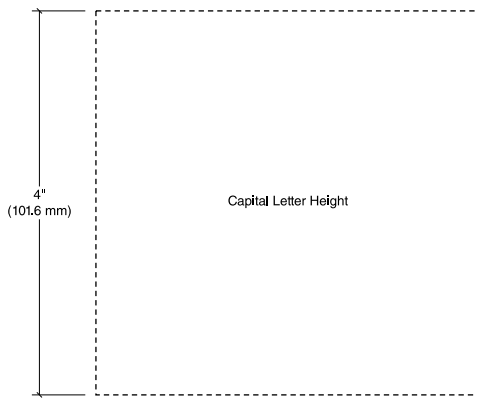

IN-19.02

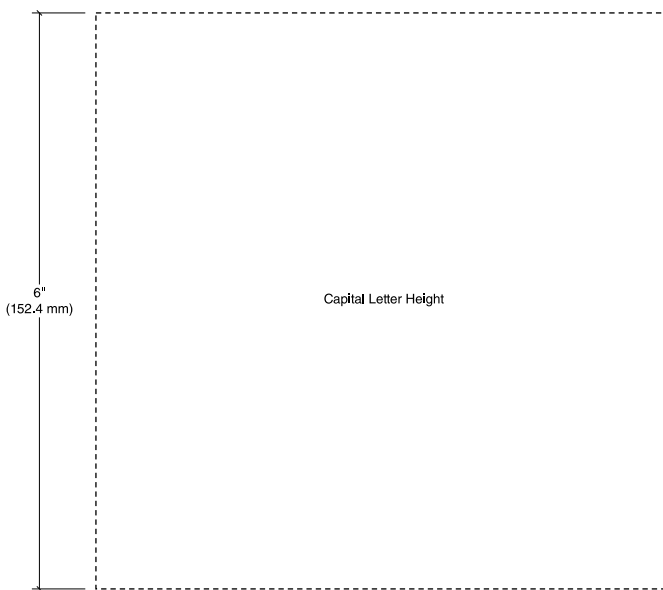

IN-19.03





U.S. Department
of Veterans Affairs

SECTION 3.2

CODE & LIFE SAFETY SIGNAGE DRAWINGS



Sign Overview

Code & Life Safety Signage Drawings

Introduction

This section contains detailed drawings of all typical Code & Life Safety sign types for VA facilities. Individual facilities may have unique conditions that require modifications or additional sign types not shown in the Manual. The following drawings provide general design intent and do not function as fabrication-ready shop drawings.

Guidelines

- The drawings should be used as a starting point to develop a sign standard with a component-based sign system, sign types, colors, finishes, and graphics specific to the individual facility.
- Please review [Section 2.2 Code & Life Safety Signage Guidelines](#) which contains information regarding Planning, Programming, Construction, and Installation prior to starting signage projects.

Requirements

- Most Code and Life Safety signs have specific location and placement requirements based upon their use, function, and code requirements. Each type of sign should be installed as shown in the following illustrations. This may require that furniture be moved, bulletin boards be relocated, etc. to ensure the Code and Life Safety sign is installed in its correct location.
- The use of component-based sign systems is required at VA facilities except for door-mounted signs which consist of a low-profile acrylic plaque mounted with VHB tape and silicone adhesive (see [Sections 2.1.5 & 2.1.6](#)). The exact materials, parts, finishes, and dimensions of a component sign system will vary by manufacturer.
- Helvetica Lt Std is the standard font required for use in signage at all VA facilities with the exclusion of NCA locations.
- Design and placement of all signs should meet ABA requirements where applicable. Refer to [Section 4.1 Appendix](#) for a summary of applicable requirements.

Message Inserts

- Insert-based sign messages should follow an approved template established as part of the facility's sign standard and wayfinding plan.
- To increase durability and moisture resistance, updatable inserts should be printed on synthetic paper or clear acetate sheets. Standard printer paper can absorb moisture causing wrinkles and yellowing over time.



Sign Overview

Code & Life Safety Signage Drawings

Life Safety Colors

Code and Life Safety signs use specific colors to indicate the purpose of their message. The exact color values listed below are not required to meet code but are intended to ensure that safety signs are highly visible and easily recognizable, even from a distance or in low-light conditions. Color matching accuracy will differ based on the production processes used. Near matches of the colors below are acceptable.

DANGER Red: Indicates danger or location of fire protection equipment.

PMS value: 186 C

CMYK values: 0,100,75,4

WARNING - Orange: Indicates dangerous equipment, and bio-hazards.

PMS value: 151 C

CMYK values: 0,55,100,0

CAUTION - Yellow: Indicates caution regarding physical hazards.

PMS value: 109 C

CMYK values: 0,10,100,0

SAFETY Green: Indicates the location of safety equipment and instructions.

PMS value: 335 C

CMYK values: 100,0,58,22

NOTICE Blue: Indicates notices and warnings that are not physically dangerous.

PMS value: 285 C

CMYK values: 90,48,0,0

Purple: Indicates radiation hazards, often in combination with yellow.

PMS value: 259 C

CMYK values: 69,100,1,5

The exact color values of neutral background colors illustrated on sign drawings in this section are not mandatory. White or other neutral color values may be used in order to complement interior environments as long as sufficient contrast is achieved.



Sign Designations

Each sign in the program manual has been given a specific sign type number designation. This designation provides a common description that can be referenced when programming a site and ordering signs. The following explains how the sign type designations are derived.

IN - 01 .28 .03 C

- IN** Designates an interior sign.
- 01** Two-digit number identifies the Code & Life Safety sign family.
- 28** The two-digit number following the period identifies a specific sign type within the sign family.
- .03** The two-digit number following the period identifies a specific sup-group of sign within the sign family.
- C** The letter designates a specific sign configuration, version and / or layout for graphics or symbols.



Sign Overview

Code & Life Safety Signage Drawings

IN-01.01.01
Evacuation Plan Sign

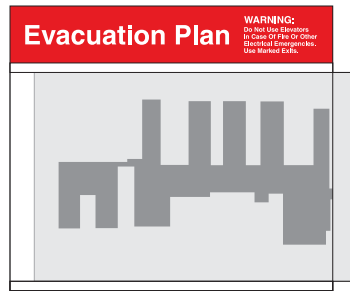

IN-01.01.01

IN-01.01.03
Guest Rooms Evacuation Plan Sign

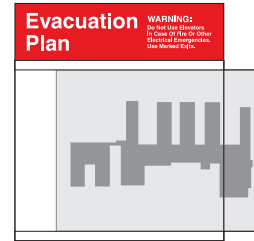

IN-01.01.03 A

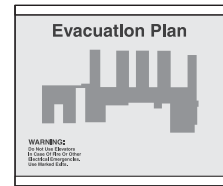

IN-01.01.03 B

IN-01.02
Fire Extinguisher Identification Sign

IN-01.31
Fire Extinguisher Identification Flag Sign



IN-01.02



IN-01.31

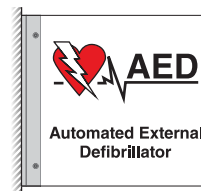

IN-01.36

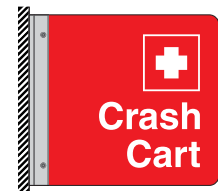

IN-01.37

IN-01.36
AED Identification Flag Sign

IN-01.37
Crash Cart Identification Flag Sign

IN-01.03
Fire Procedure "R.A.C.E." Sign

IN-01.04
Elevator Call Button Sign



IN-01.03



IN-01.04



IN-01.05



IN-01.06

IN-01.05
Fire Door Sign

IN-01.06
No Exit Sign

IN-01.07.01-04
Exit Sign



IN-01.07.01-04

IN-01.08
Automatic Fire Door Sign – Hinged Door



IN-01.08

IN-01.09
Automatic Fire Shutter Sign – Roll Up



IN-01.09



Sign Overview

Code & Life Safety Signage Drawings

IN-01.13
Push/Pull Alarm Identification Sign



IN-01.14
Open Door Fire Safety Sign



IN-01.13 A & B

IN-01.14

IN-01.26
Push to Exit Sign



IN-01.27
Emergency Push to Open Sign



IN-01.26

IN-01.27

IN-01.28

IN-01.28
Emergency Slide to Open Sign

IN-01.10
Stair Identification Sign

IN-01.11
NFPA Stairwell Identification Sign

IN-01.12
Area of Refuge Sign

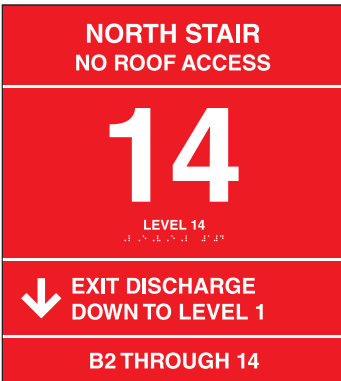
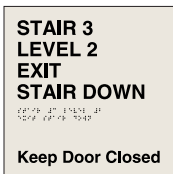

IN-01.10

IN-01.11

IN-01.12

IN-01.25
No Re-Entry Floor Sign

IN-01.29
Direction of Exit Sign

IN-01.30
No Re-Entry Sign

IN-01.33
Re-Entry Sign

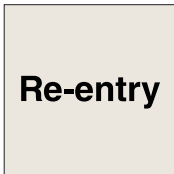
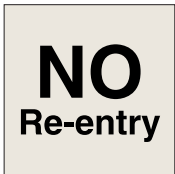
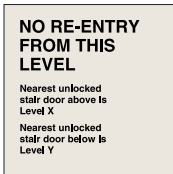

IN-01.25

IN-01.29

IN-01.30

IN-01.33



Sign Overview

Code & Life Safety Signage Drawings

IN-01.15
Hazardous Material Information Sign



[IN-01.15](#)

IN-01.16.01
Oxygen in Use Warning Sign

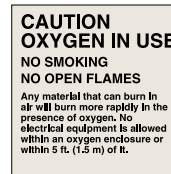

[IN-01.16.01](#)

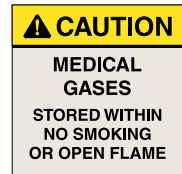

[IN-01.16.02](#)

IN-01.16.03
Oxidizing Gases Warning Sign

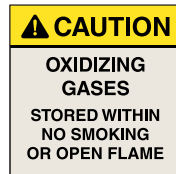

[IN-01.16.03](#)

IN-01.16.04
Positive Pressure Gases Warning Sign

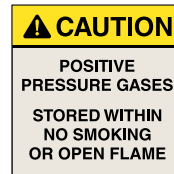

[IN-01.16.04](#)

IN-01.17
Compressed Gas Warning Sign

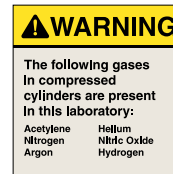

[IN-01.17](#)



[IN-01.18](#)

IN-01.18
Nonflammable Anesthesia Restriction Sign

IN-01.19
Radioactive Material Warning Sign



[IN-01.19](#)

IN-01.20
Radioactive Area Warning Sign



[IN-01.20](#)

IN-01.35
Radiation Warning Sign

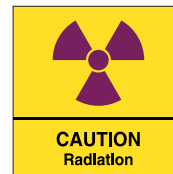

[IN-01.35](#)

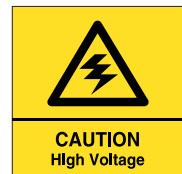

[IN-01.21](#)

IN-01.21
High Voltage Warning Sign

IN-01.22
Biohazard Warning Sign



[IN-01.22](#)

IN-01.23
Laser Warning Sign



[IN-01.23](#)

IN-01.24
Occupational Exposure Area Warning Sign



[IN-01.24](#)

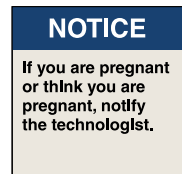

[IN-01.32](#)

IN-01.32
Pregnancy Notification Sign



Sign Overview

Code & Life Safety Signage Drawings

IN-01.34
Proper Attire Required Beyond this Point Sign

IN-01.38
Emergency Eye Wash Station Sign

IN-01.39
Emergency Shower Sign

IN-01.40
Emergency Shower / Emergency Eye Wash Station Sign



IN-01.34



IN-01.38



IN-01.39



IN-01.40



IN-01.01.01

Code & Life Safety Signage Drawings

Evacuation Plan Sign

Size

15" High x 17" Wide
(381 mm H x 431.8 mm W)

Description and Use

This sign type is ONLY required for areas with hotel / dormitory type occupancy such as "Hoptels" and Fishers Houses. It is NOT required for inpatient settings or other healthcare areas.

When Required:

The International Fire Code (IFC) requires the posting of evacuation plans in each guest room (sign type IN-01.01.03) and at each elevator bank (sign type IN-01.01.01).

The evacuation map must indicate the viewer location (You Are Here), display a minimum of two evacuation routes, and indicate the location of fire extinguishers and fire alarm pull stations.

Optional Use:

Evacuation plans can be located at elevator banks, exit stairwells, waiting areas, and other high-traffic locations at the discretion of the facility.

Message Configuration

Refer to layout drawing for lettering sizes and dimensions.

Sign Components

Component based sign system

See [Section 2.1.5 Construction](#) for applicable component sign system styles.

Graphic Process

Sign: Direct digital on second surface print or silk-screened

Insert: Printed

Colors

Refer to the chart in the Appendix.

Typography

Helvetica Bold

Mounting

Preferred: Concealed mechanical fasteners
Alternate: Double-sided VHB foam tape and silicone adhesive

Installation

Mount on wall, 60" (1524 mm) to the center of the sign.

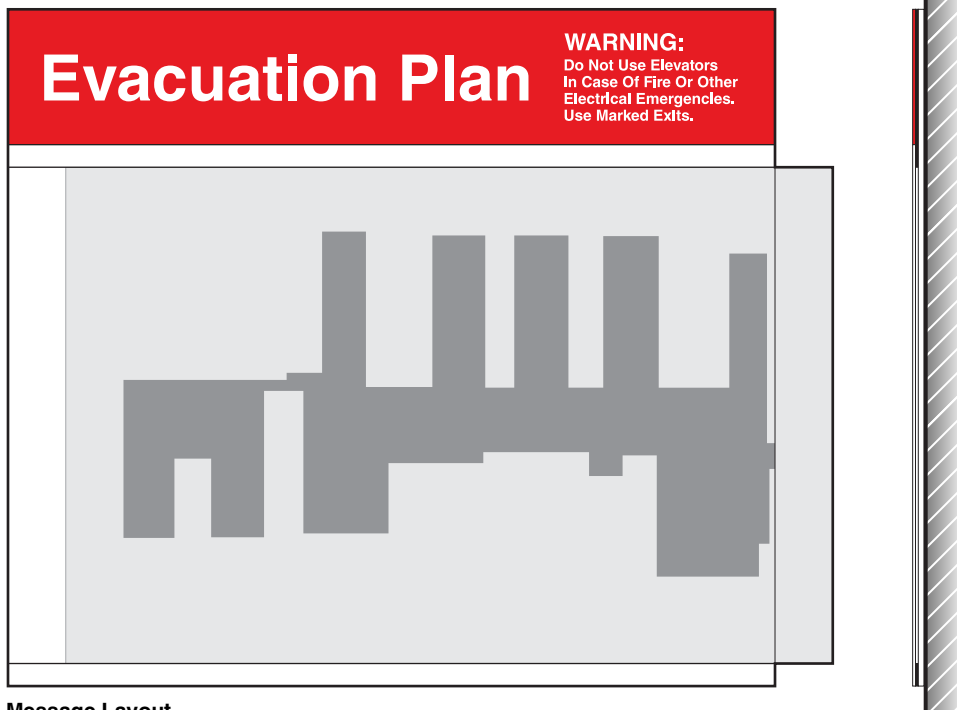

Message Layout

The Joint Commission and the Life Safety Code do not require these signs be installed in Healthcare Occupancies, but the local fire department may. If requested, coordinate location with their requirements. If the facility chooses to use posted evacuation maps be sure to keep them up-to-date and accurate, so they reflect the current state of the area.

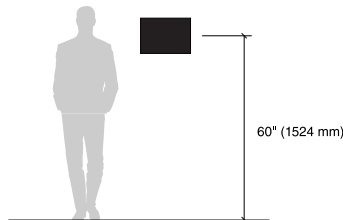

IN-01.01.01

Code & Life Safety Signage Drawings

Evacuation Plan Sign

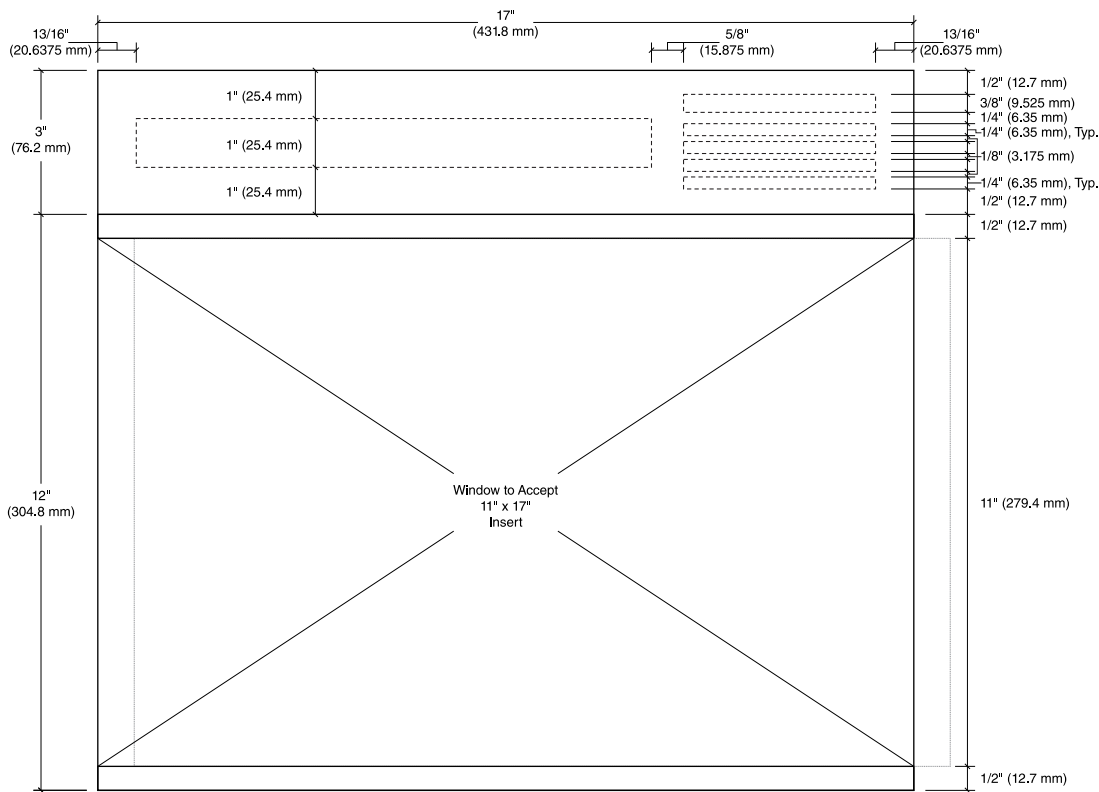

Message Layout



IN-01.01.03

Code & Life Safety Signage Drawings

Guest Rooms Evacuation Plan Sign

Size

Message Layout A:
1'-1/2" High x 11" Wide
(317.5 mm H x 279.4 mm W)

Message Layout B:
9 1/2" High x 11" Wide
(241.3 mm H x 279.4 mm W)

Description and Use

This sign type is ONLY required for areas with hotel / dormitory type occupancy such as "Hoptels" and Fishers Houses. It is NOT required for inpatient settings or other healthcare areas.

When Required:

The International Fire Code (IFC) requires the posting of evacuation plans in each guest room (sign type IN-01.01.02) and at each elevator bank (sign type IN-01.01.01).

The evacuation map must indicate the viewer location (You Are Here), display a minimum of two evacuation routes, and indicate the location of fire extinguishers and fire alarm pull stations.

Message Configuration

Refer to layout drawing for lettering sizes and dimensions.

Sign Components

Acrylic Construction
1/16" (1.5 mm) non-glare acrylic sign face with subsurface background color creating a clear window, 1/16" spacer to create window, 1/8" acrylic back-panel surface printed or painted

Graphic Process

Sign: Direct digital print on second surface or silk-screened

Insert: Printed

Colors

Refer to the chart in the Appendix.

Typography

Helvetica Bold

Mounting

Double-sided VHB foam tape and silicone adhesive

Installation

Mount on wall or door, 60" (1524 mm) to top or center of the sign.

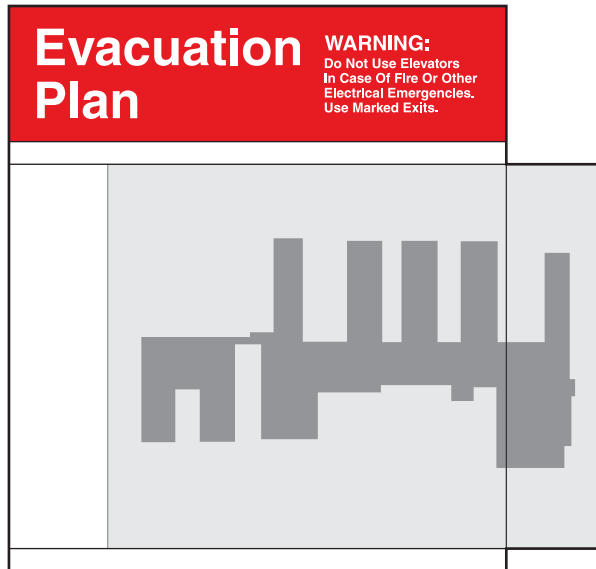

Message Layout A

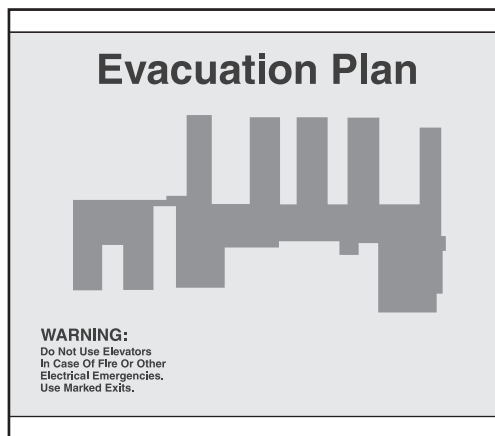

Message Layout B

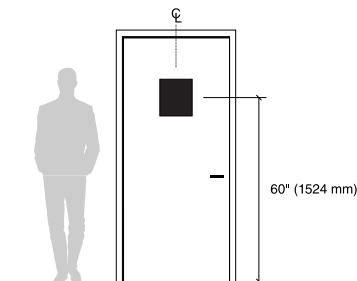

Guest Rooms Evacuation Plan Sign

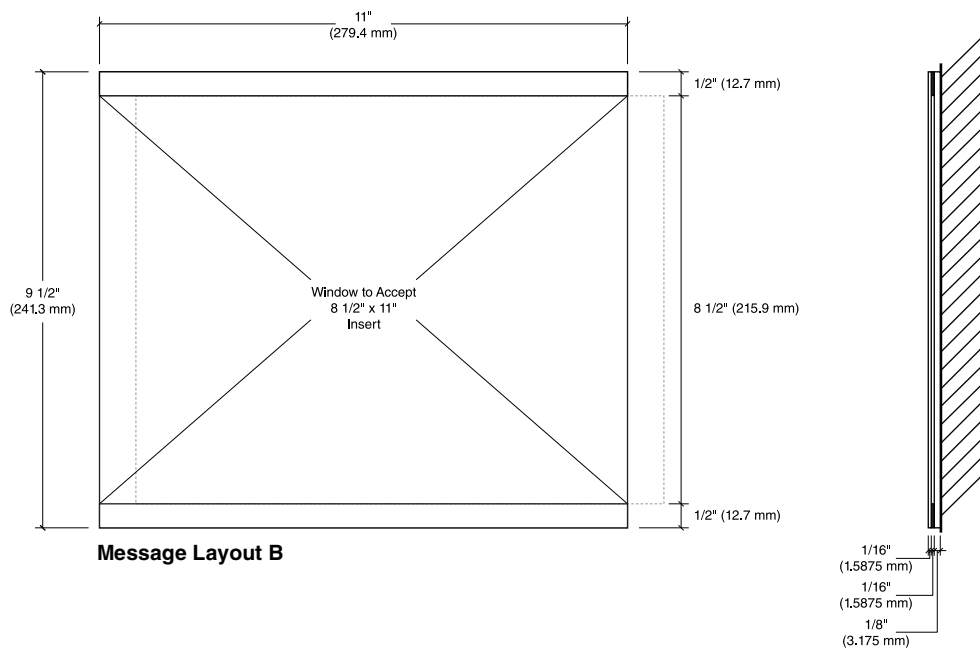
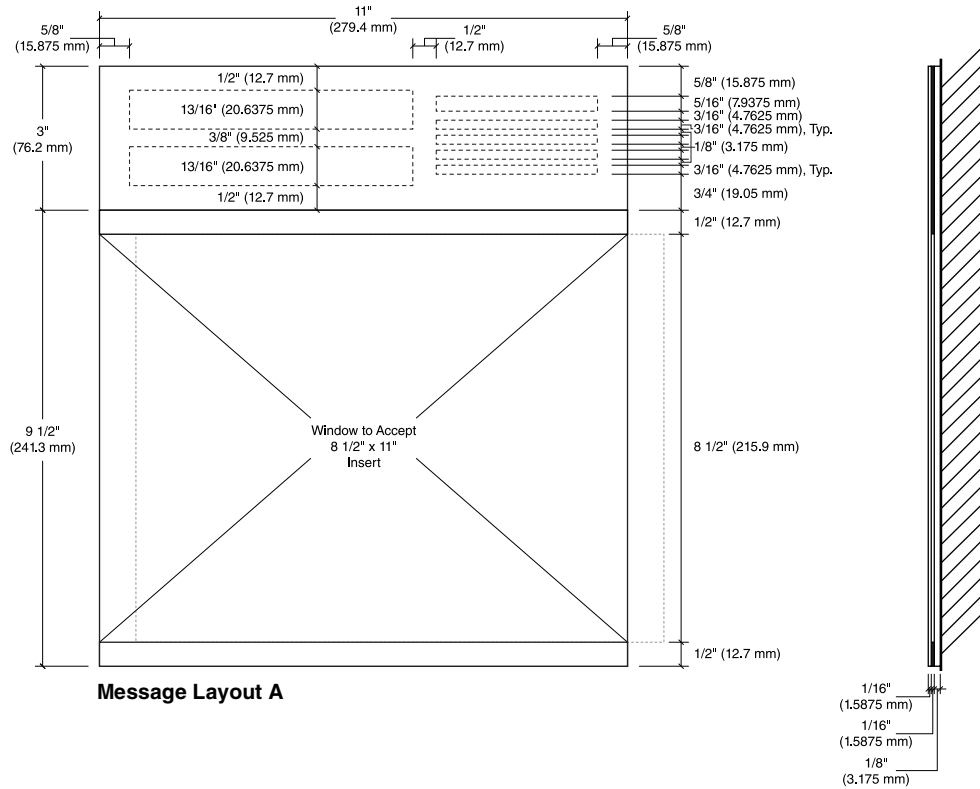

IN-01.02**Code & Life Safety Signage Drawings****Fire Extinguisher Identification Sign****Size**

9" High x 9" Wide
(228.6 mm H x 228.6 mm W)

Description and Use

This sign is used to locate and identify fire extinguisher cabinets.

Fire extinguisher signs should be installed perpendicular to the wall (sign type IN-01.31). Only use sign type IN-01.02 where visibility of a perpendicular sign would not be adequate.

Message Configuration

Refer to layout drawing for lettering sizes and dimensions.

Sign Components

Component based sign system

See [Section 2.1.5 Construction](#) for applicable component sign system styles.

Graphic Process

Direct digital print on second surface or silk-screened

Colors

Text and Symbol: White
Background: Red
Refer to the chart in the Appendix.

Typography

Helvetica Bold

Mounting

Preferred: Concealed mechanical fasteners
Alternate: Double-sided VHB foam tape and silicone adhesive

Installation

Mount on wall, 72" (1828.8 mm) to top of sign.



Message Layout

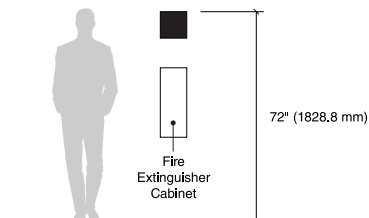

Fire Extinguisher Identification Sign

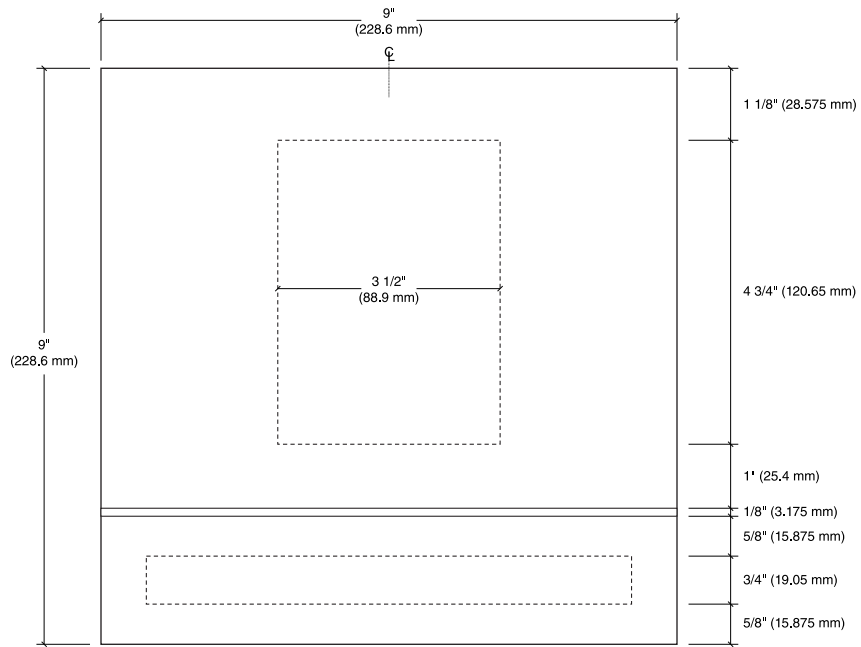

Message Layout

IN-01.03

Code & Life Safety Signage Drawings

Fire Procedure "R.A.C.E." Sign

Size

6" High x 9" Wide
(152.4 mm H x 228.6 mm W)

Description and Use

Fire procedure sign to be installed above fire alarm pull stations as needed.

This sign is optional.

All of the information provided on these signs should be coordinated with the facility personnel who are responsible for the facility fire plan.

Message Configuration

Refer to layout drawing for lettering sizes and dimensions.

Sign Components

Component based sign system

See [Section 2.1.5 Construction](#) for applicable component sign system styles.

Graphic Process

Direct digital print on second surface or silk-screened

Colors

Text: White
Background: Red
Refer to the chart in the Appendix.

Typography

Helvetica Bold

Mounting

Preferred: Concealed mechanical fasteners
Alternate: Double-sided VHB foam tape and silicone adhesive

Installation

Mount on wall adjacent to fire alarm pull station, typically centered 2" (50.8 mm) above.

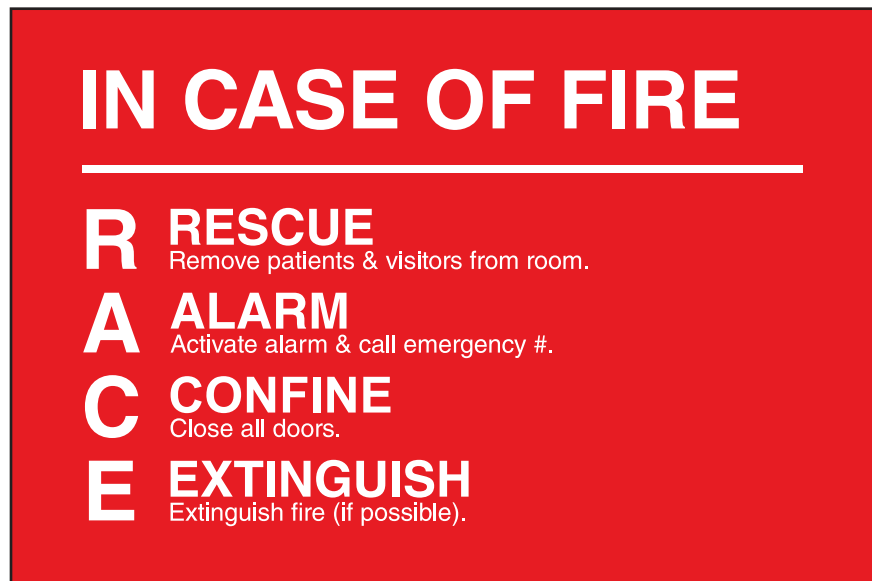

Message Layout

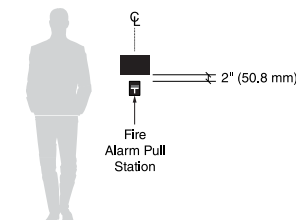

IN-01.03

Code & Life Safety Signage Drawings

Fire Procedure "R.A.C.E." Sign

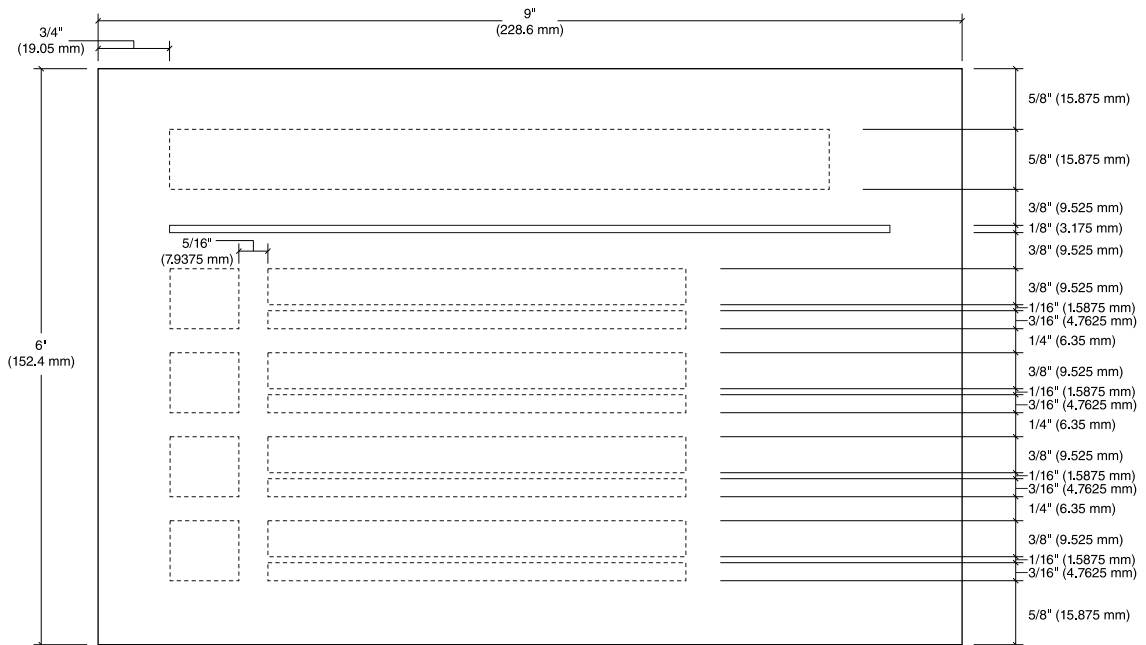

Message Layout



IN-01.04

Code & Life Safety Signs

Elevator Call Button Sign

Size

9" High x 6" Wide
(228.6 mm H x 152.4 mm W)

Description and Use

Elevator call button fire procedure sign to be installed at elevators.

Message Configuration

Refer to layout drawing for lettering sizes and dimensions.

Sign Components

Component based sign system

See [Section 2.1.5 Construction](#) for applicable component sign system styles.

Graphic Process

Direct digital print on second surface or silk-screened

Colors

Text: Black
Symbol: Black, Red, & White
Background: White
Refer to the chart in the Appendix.

Typography

Helvetica Bold

Mounting

Preferred: Concealed mechanical fasteners
Alternate: Double-sided VHB foam tape and silicone adhesive

Installation

Mount on wall adjacent to elevator call button, typically centered 2" (50.8 mm) above.

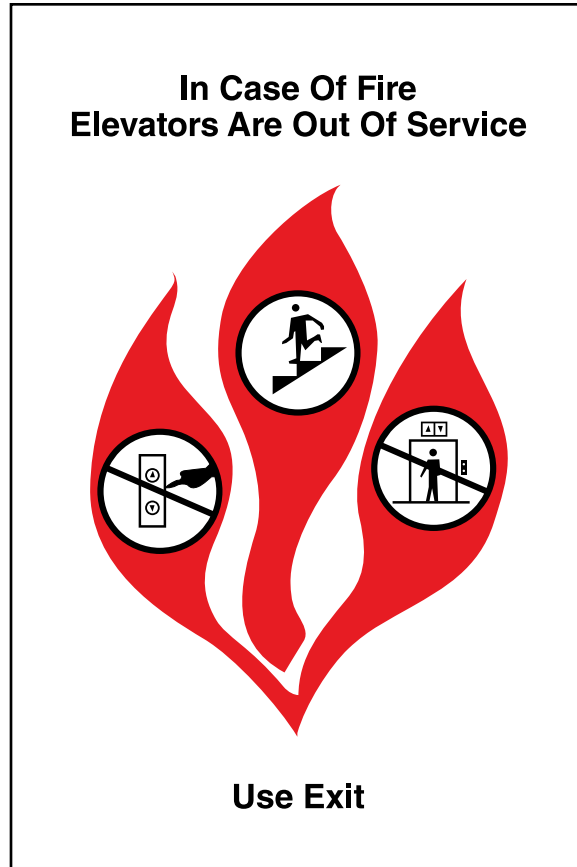

Message Layout

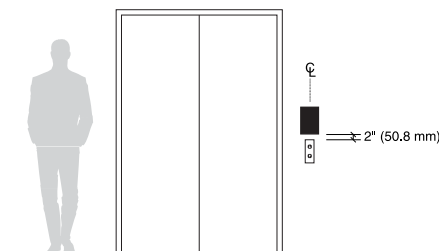

IN-01.04

Code & Life Safety Signage Drawings

Elevator Call Button Sign

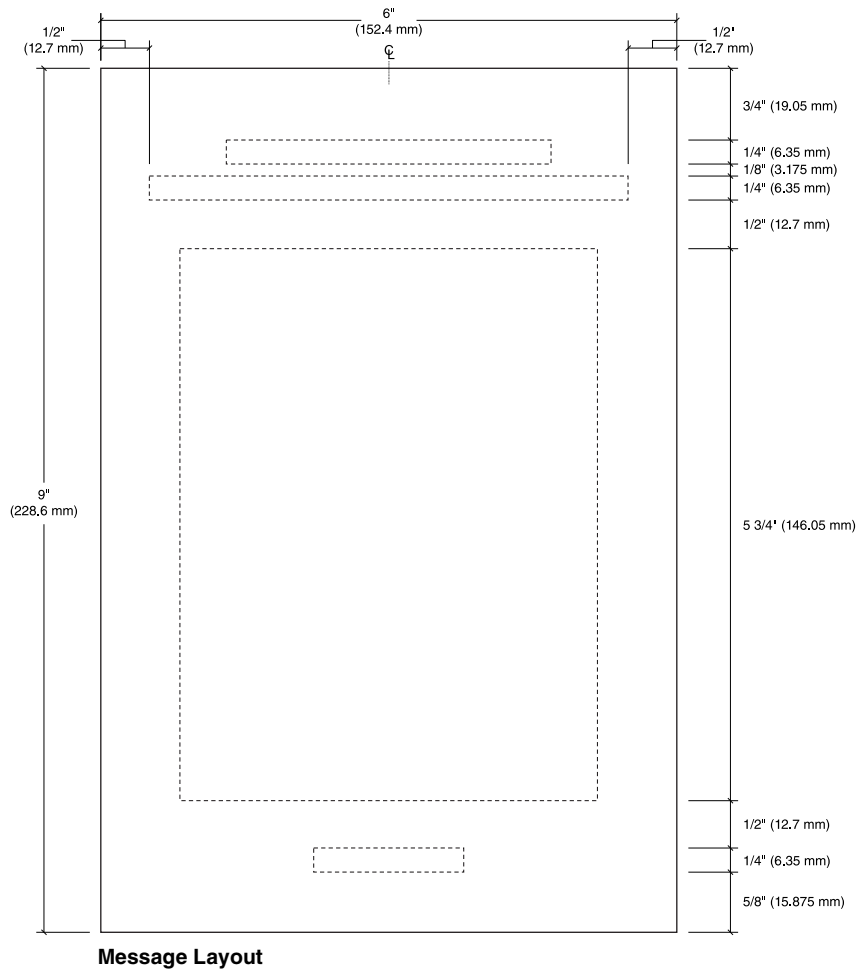

Fire Door Sign

Size

9" High x 9" Wide
(228.6 mm H x 228.6 mm W)

Description and Use

This sign is used to identify fire doors typically at stairwells. Do not install this sign on smoke barrier doors. See NFPA 80 for additional information.

Exception: Sign shall not be provided for fire doors that are held open by automatic devices.

Message Configuration

Refer to layout drawing for lettering sizes and dimensions.

Sign Components

Component based sign system (wall mount) or acrylic plaque (door mount).

See [Section 2.1.5 Construction](#) & [Section 2.1.6 Installation](#) for applicable component sign system styles and acrylic construction.

Graphic Process

Direct digital print on second surface or silk-screened

Colors

Text: White
Background: Red
Refer to the chart in the Appendix.

Typography

Helvetica Bold

Mounting

Preferred: Concealed mechanical fasteners
Alternate: Double-sided VHB foam tape and silicone adhesive

Installation

Preferred:
On wall: 60" (1524 mm) to top of sign, 6" away from door frame's latch side.

Optional:
Mount centered on door 60" (1524 mm) above finished floor to the center or top of the sign.



Message Layout

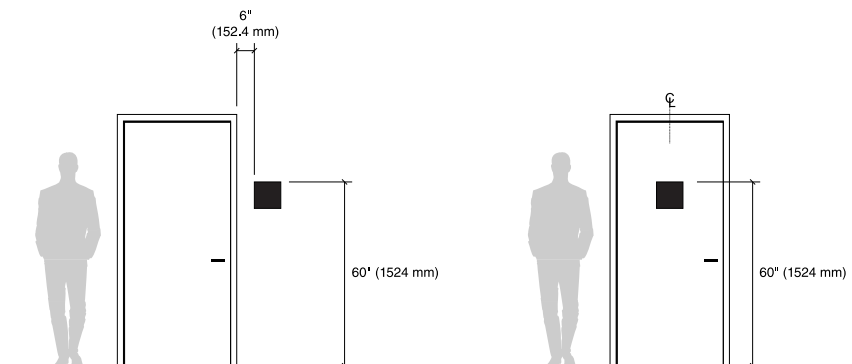

IN-01.05

Code & Life Safety Signage Drawings

Fire Door Sign

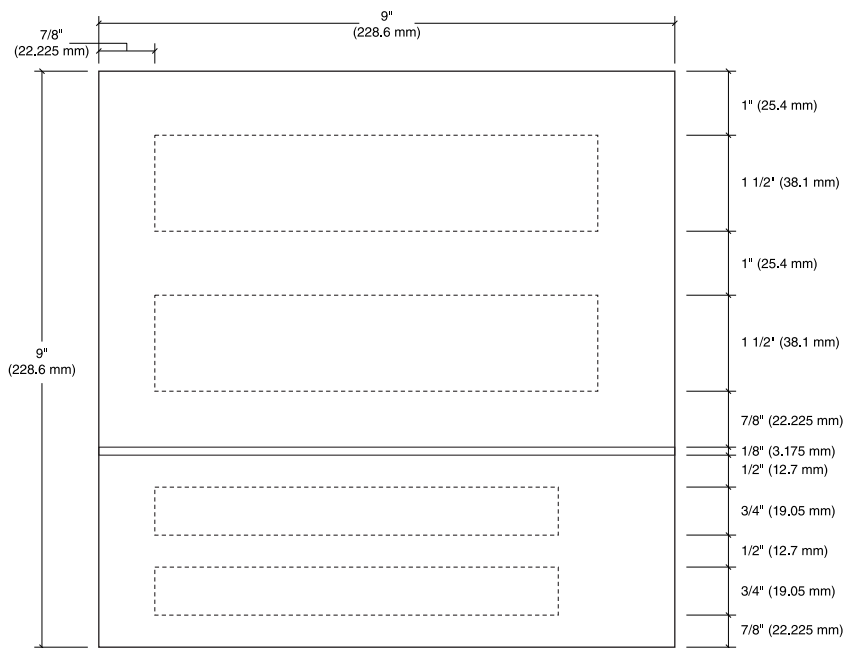

Message Layout



IN-01.06

Code & Life Safety Signage Drawings

No Exit Sign

Size

9" High x 9" Wide
(228.6 mm H x 228.6 mm W)

Description and Use

This sign is used to identify a door in a stairwell or other locations that are not exits.

Message Configuration

Refer to layout drawing for lettering sizes and dimensions.

Letters in "NO" must be 2" high and 3/8" stroke width; letters in "EXIT" must be 1" high and below "NO" per NFPA 101.

Sign Components

Component based sign system (wall mount) or acrylic plaque (door mount).

See [Section 2.1.5 Construction](#) & [Section 2.1.6 Installation](#) for applicable component sign system styles and acrylic construction.

Graphic Process

Direct digital print on second surface or silk-screened

Colors

Refer to the chart in the Appendix.

Typography

Helvetica Bold

Mounting

Preferred: Concealed mechanical fasteners
Alternate: Double-sided VHB foam tape and silicone adhesive

Installation*Preferred:*

On wall: 60" (1524 mm) to top of sign, 6" away from door frame's latch side.

Optional:

Mount centered on door 60" (1524 mm) above finished floor to the center or top of the sign.



Message Layout

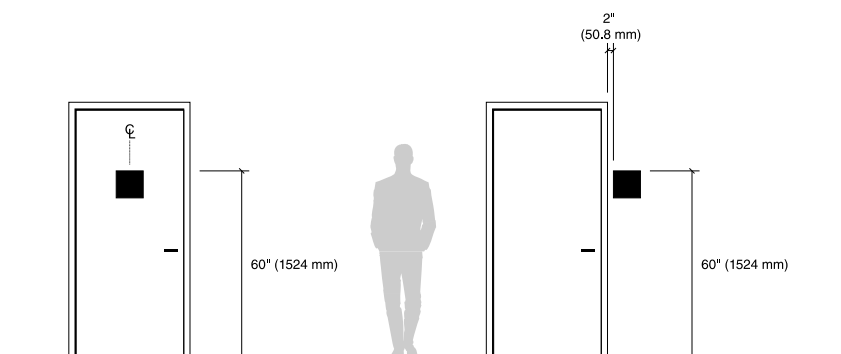

IN-01.06

Code & Life Safety Signage Drawings

No Exit Sign

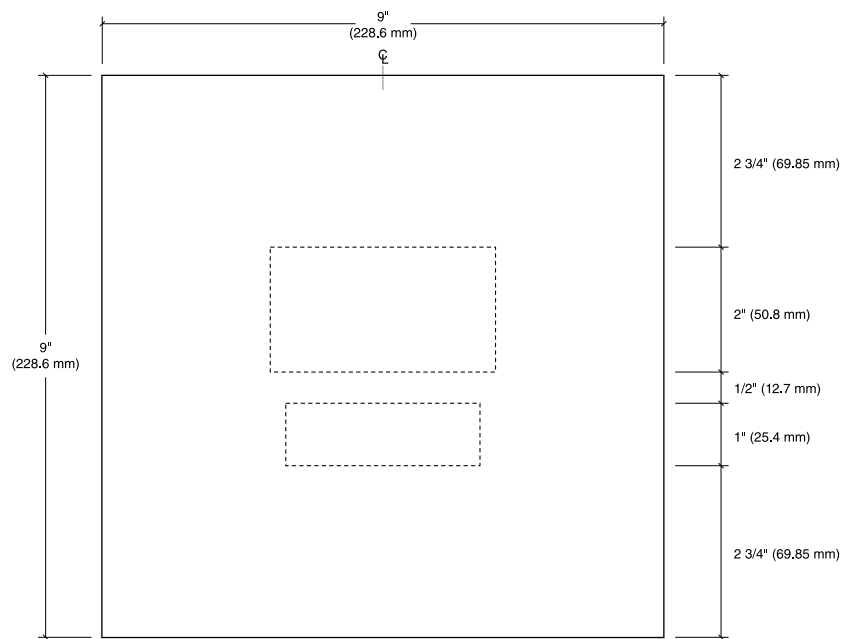

Message Layout



IN-01.07.01-04

Code & Life Safety Signage Drawings

Exit Sign

Size

IN-01.07.01

9" High x 22" Wide
(228.6 mm H x 558.8 mm W)

IN-01.07.02

9" High x 22" Wide
(228.6 mm H x 558.8 mm W)

IN-01.07.03

9" High x 22" Wide
(228.6 mm H x 558.8 mm W)

IN-01.07.04

9" High x 28" Wide
(228.6 mm H x 711.2 mm W)

Description and Use

Non-illuminated exit sign used to identify exit or direction to exit.

Message Configuration

Refer to layout drawing for lettering sizes and dimensions.

Letters must be no less than 6" in height per NFPA 101. Principal stroke of letters must be no less than 3/4" wide. Each letter must have a width of no less than 2" except the letter "T". Minimum spacing between letters must be no less than 3/8".

Sign Components

Component based sign system

See [Section 2.1.5 Construction](#) for applicable component sign system styles.

Graphic Process

Direct digital print on second surface or silk-screened

Colors

Refer to the chart in the Appendix.

Typography

Helvetica Medium Condensed

Mounting

Preferred: Concealed mechanical fasteners

Alternate: Double-sided VHB foam tape and silicone adhesive

Installation

On wall: Directly above door frame, centered



IN-01.07.01



IN-01.07.02



IN-01.07.03



IN-01.07.04

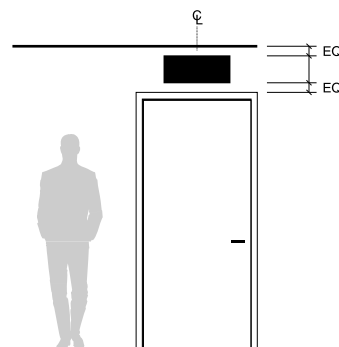

IN-01.07.01-04

Code & Life Safety Signage Drawings

Exit Sign

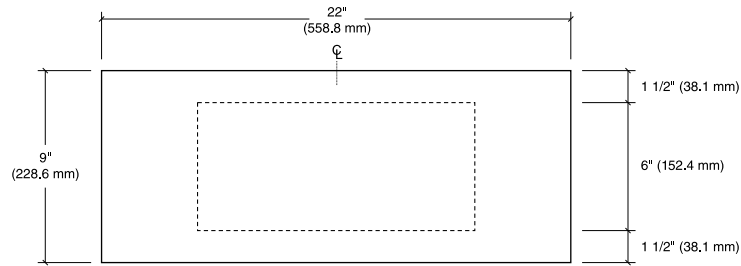

IN-01.07.01

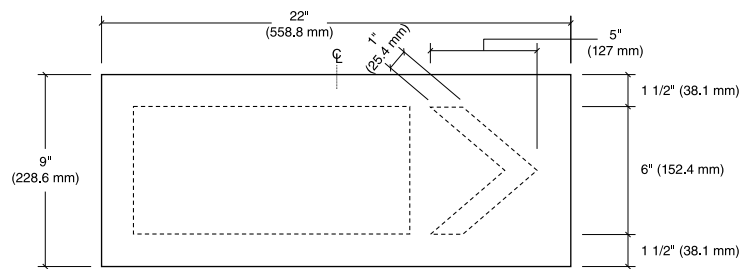

IN-01.07.02

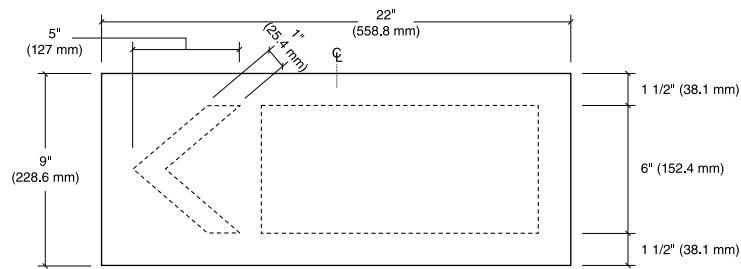
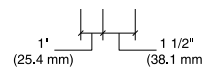

IN-01.07.03

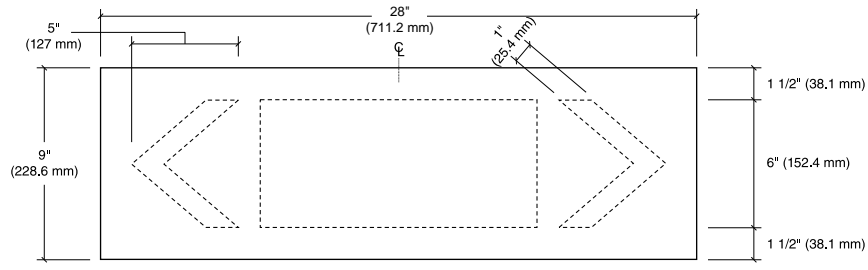
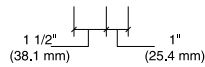

IN-01.07.04

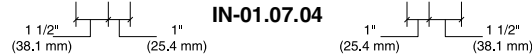

IN-01.08

Code & Life Safety Signage Drawings

Automatic Fire Door Sign – Hinged Door

Size

9" High x 9" Wide
(228.6 mm H x 228.6 mm W)

Description and Use

"Do not block" information to be communicated at hinged fire doors held open by automatic devices.

Message Configuration

Refer to layout drawing for lettering sizes and dimensions.

Sign Components

Acrylic plaque

See [Section 2.1.6 Installation](#) for applicable acrylic construction.

Graphic Process

Direct digital print on second surface or silk-screened

Colors

Refer to the chart in the Appendix.

Typography

Helvetica Bold

Mounting

Double-sided VHB foam tape and silicone adhesive

Installation

Mount on doors 60" (1524 mm) above finished floor to the center or top of the sign and 3" (76.2 mm) over from the door edge.

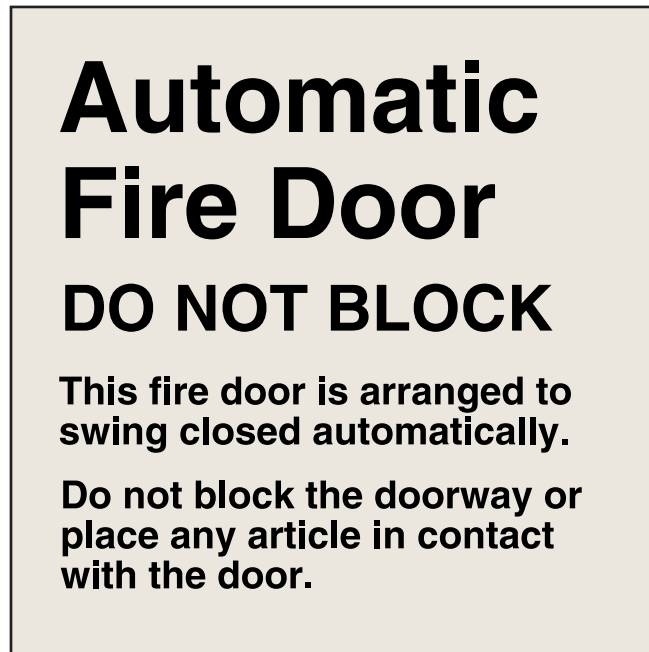

Message Layout

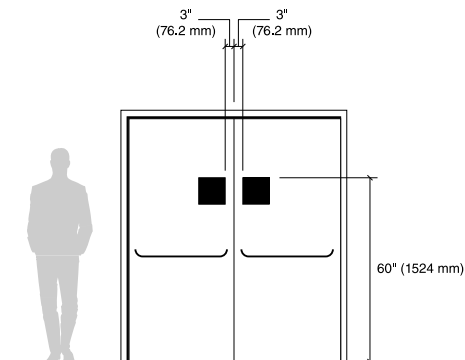

Automatic Fire Door Sign – Hinged Door

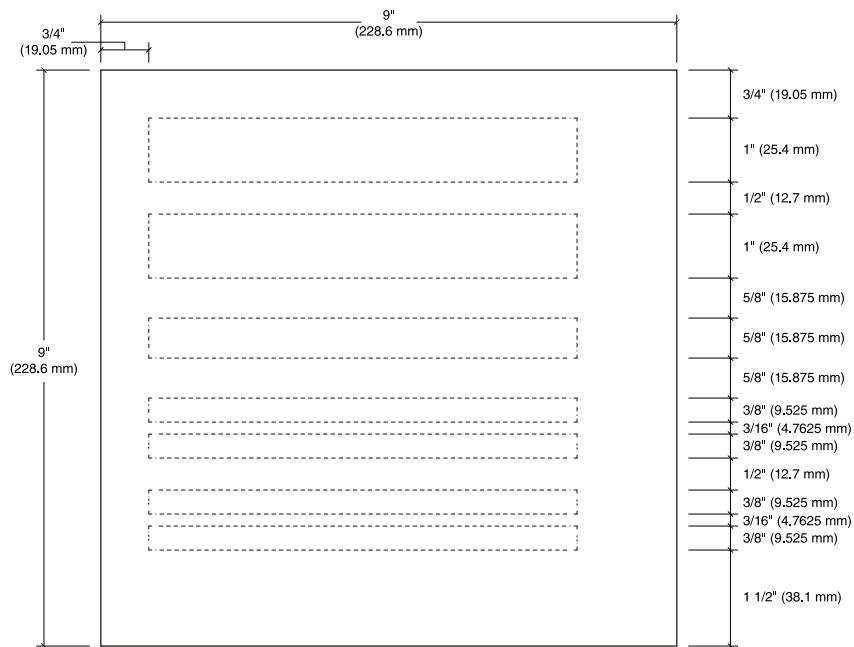

Message Layout



IN-01.09

Code & Life Safety Signage Drawings

Automatic Fire Door Sign – Roll Up

Size

9" High x 9" Wide
(228.6 mm H x 228.6 mm W)

Description and Use

"Do not block" information to be communicated at roll down fire doors held open by automatic devices.

Message Configuration

Refer to layout drawing for lettering sizes and dimensions.

Sign Components

Component based sign system

See [Section 2.1.5 Construction](#) for applicable component sign system styles.

Graphic Process

Direct digital print on second surface or silk-screened

Colors

Refer to the chart in the Appendix.

Typography

Helvetica Bold

Mounting

Preferred: Concealed mechanical fasteners
Alternate: Double-sided VHB foam tape and silicone adhesive

Installation

Mount on wall adjacent to shutter door, 60" (1524 mm) to top of sign and 3" (76.2 mm) over from the opening.

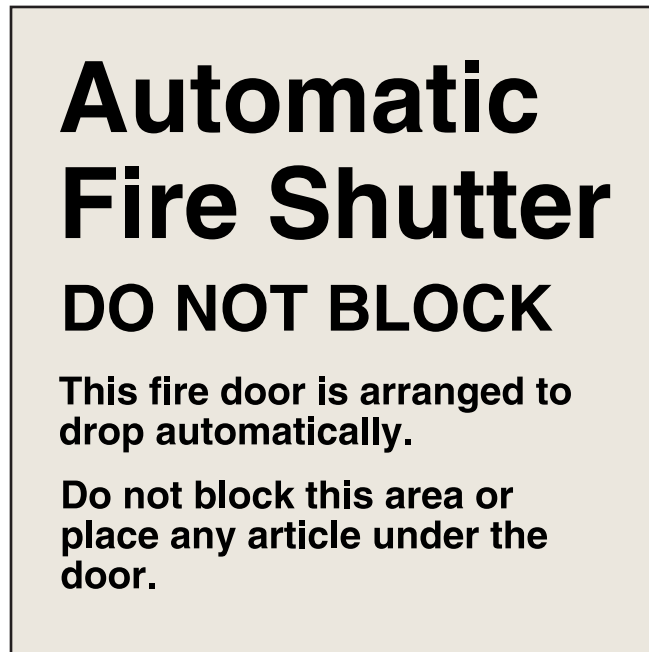

Message Layout

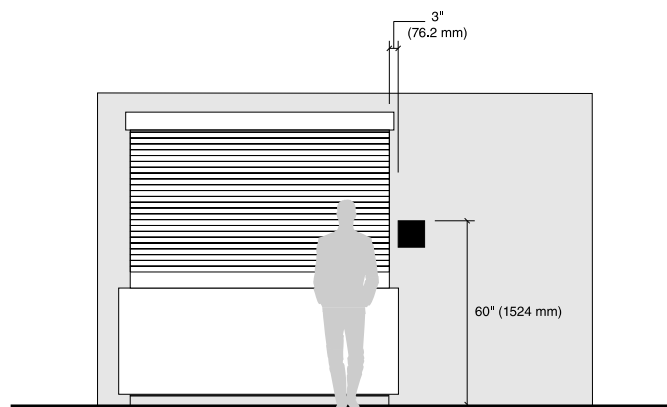

IN-01.09

Code & Life Safety Signage Drawings

Automatic Fire Door Sign – Roll Up

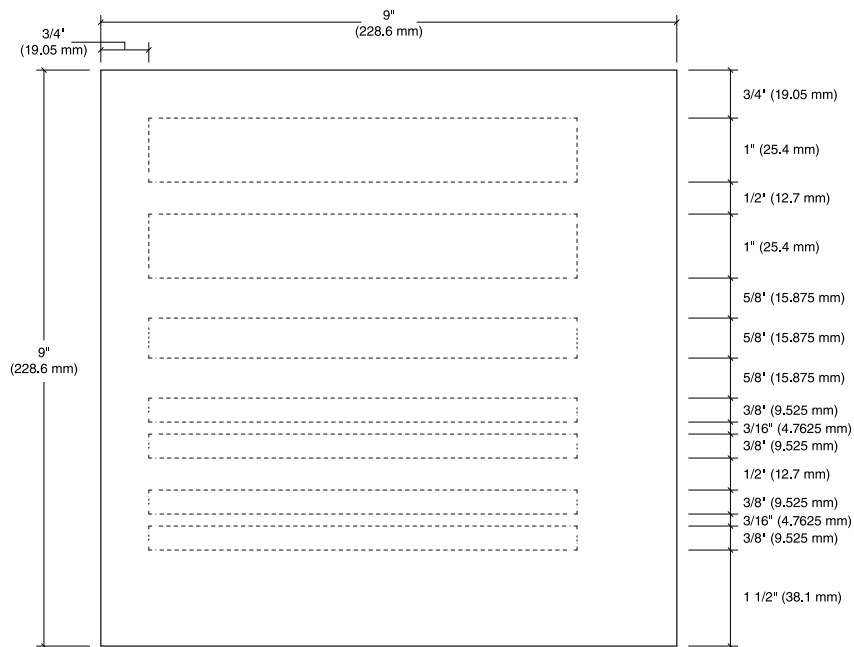

Message Layout



Stair Identification Sign

Size

9" High x 9" Wide
(228.6 mm H x 228.6 mm W)

Description and Use

Identifies stairwell doors that are fire exits.

Message Configuration

Refer to layout drawing for lettering sizes and dimensions.

Message Layout A:

To be used outside the stair access door at ground level.

Message Layout B, C, D, & E:

To be used outside the stair access door at floors other than the ground level.

Sign Components

Component based sign system

See [Section 2.1.5 Construction](#) for applicable component sign system styles.

Graphic Process

Tactile text with accompanying Grade 2 Braille and direct digital print on second surface or silk-screened bottom text

Colors

Refer to the chart in the Appendix.

Typography

Helvetica Bold
Grade 2 Braille

Mounting

Preferred: Concealed mechanical fasteners
Alternate: Double-sided VHB foam tape and silicone adhesive

Installation

Wall-mounted, latch side of door at 60" (1524 mm) to top of sign from finished floor and 2" (50.8 mm) over from door frame.

For sign placement refer to the Stairwell Guide in [Section 2.2.5 Installation](#)

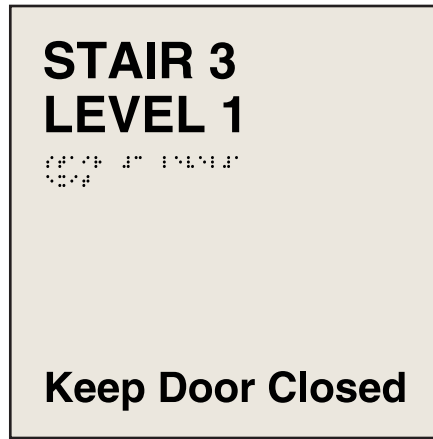

Message Layout A

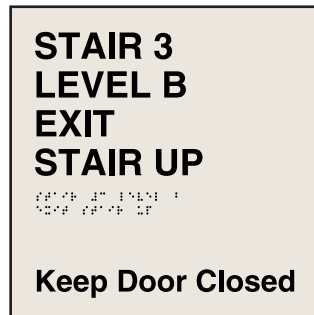

Message Layout B

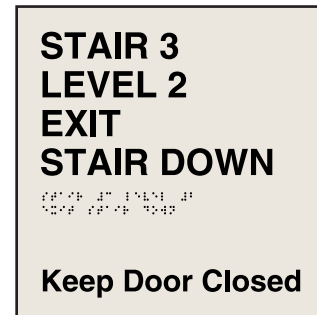

Message Layout C

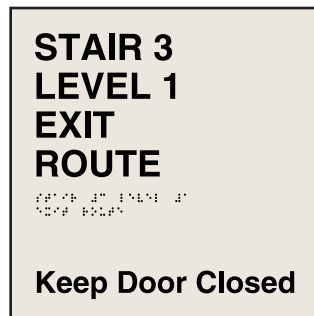

Message Layout D

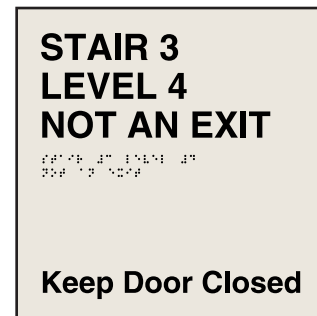

Message Layout E

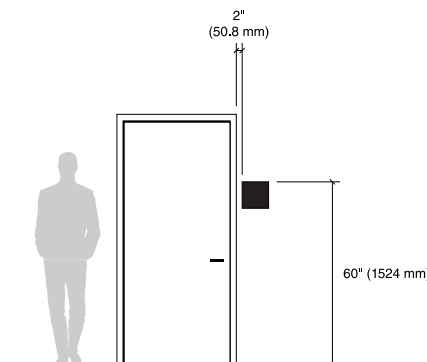

IN-01.10

Code & Life Safety Signage Drawings

Stair Identification Sign

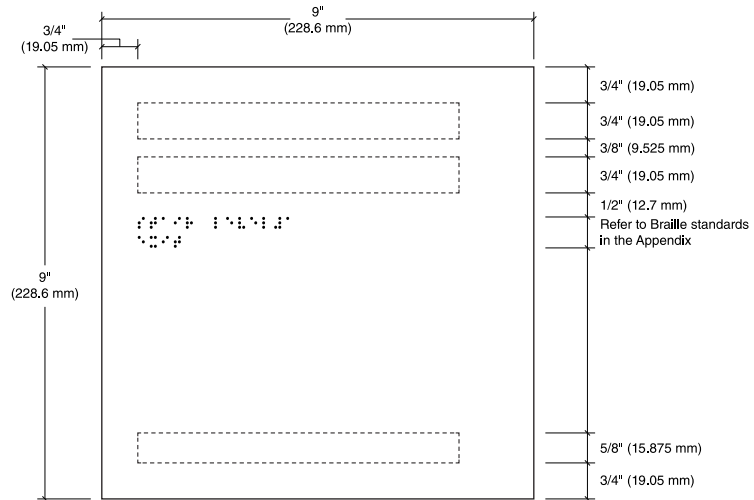

Message Layout A

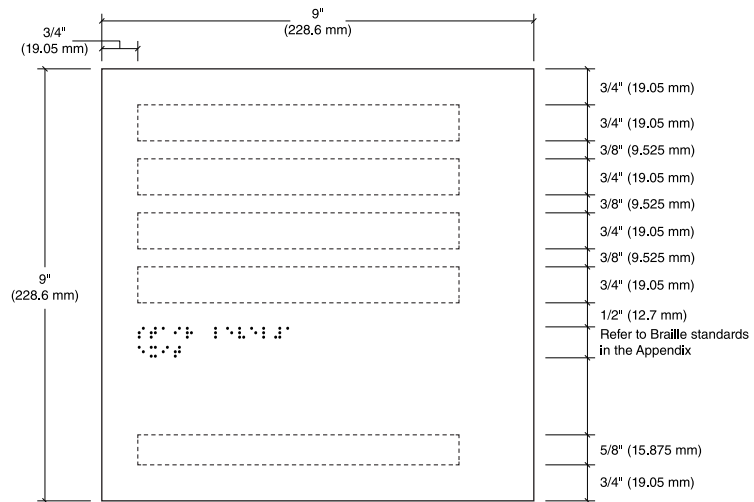

Message Layout B, C, D

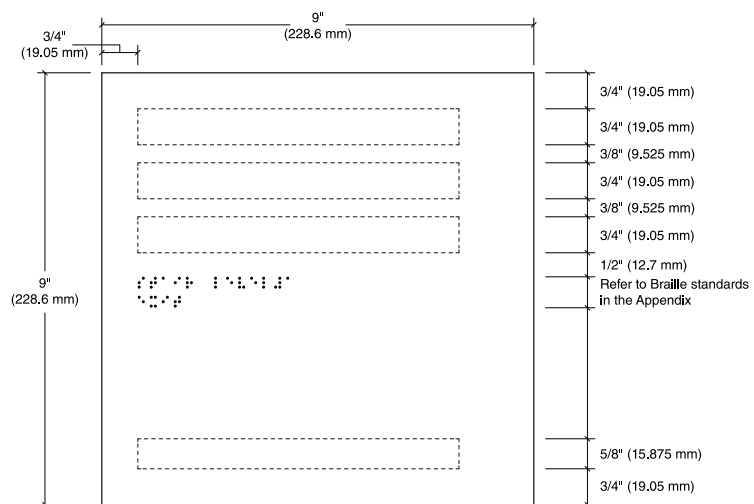

Message Layout E



IN-01.11

Code & Life Safety Signs

NFPA Stairwell Identification Sign

Size

20" High x 18" Wide
(508 mm H x 457.2 mm W)

Description and Use

Stairwell, floor level and egress information. Sign is located within the stair enclosure at each floor landing and must be readily visible when stair door is in open or closed position. Per NFPA 101, Section 7.2.2.5.4, Stairwell Identification signs are required only at new enclosed stairs serving three or more stories and at existing enclosed stairs serving five or more stories.

Message Configuration

Layout A is for stairwells with NO roof access. Layout B is for stairwells that have roof access. Layout C is for an exit discharge level. The sign shall include a raised five-pointed star located to the left of the identifying floor level. Signage that reads NO ROOF ACCESS shall designate stairways that do not provide roof access. It is NOT the intent to require a sign that reads ROOF ACCESS, as such message might be misinterpreted by occupants as an egress route.

Copy sizes specified are required by code. Do not deviate.

Sign Components

Component based sign system or acrylic plaque. See [Section 2.1.5 Construction](#) & Section 2.1.6 Installation for styles and acrylic construction.

Graphic Process

Direct digital print on second surface copy except for 5" tactile level number & 5/8" tactile level descriptor with accompanying braille

Colors

Refer to the chart in the Appendix.

Typography

Helvetica Bold
Grade 2 Braille

Mounting

Preferred: Concealed mechanical fasteners
Alternate: Double-sided VHB foam tape and silicone adhesive

Installation

Mount on wall 60" (1524 mm) above finished floor to the bottom of the sign.

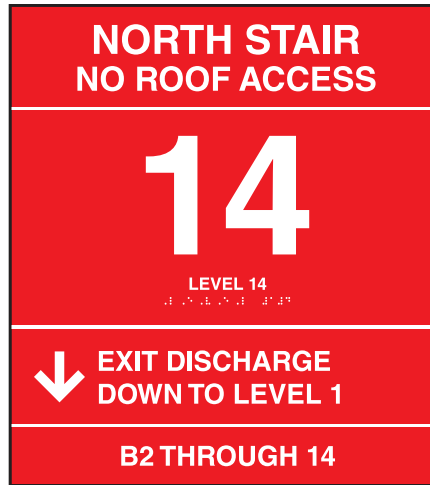

Message Layout A

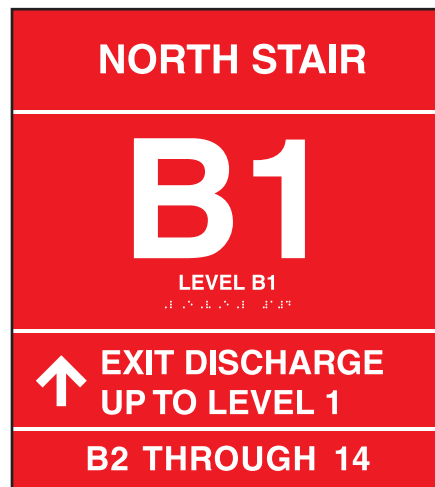

Message Layout B

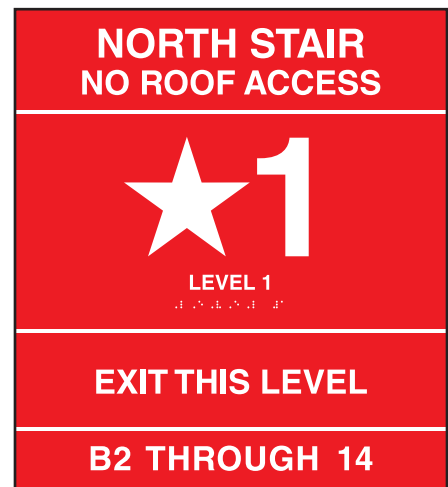

Message Layout C

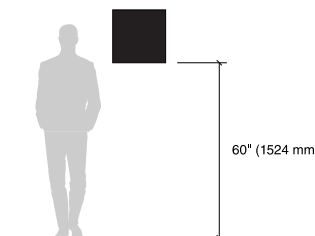

NFPA Stairwell Identification Sign

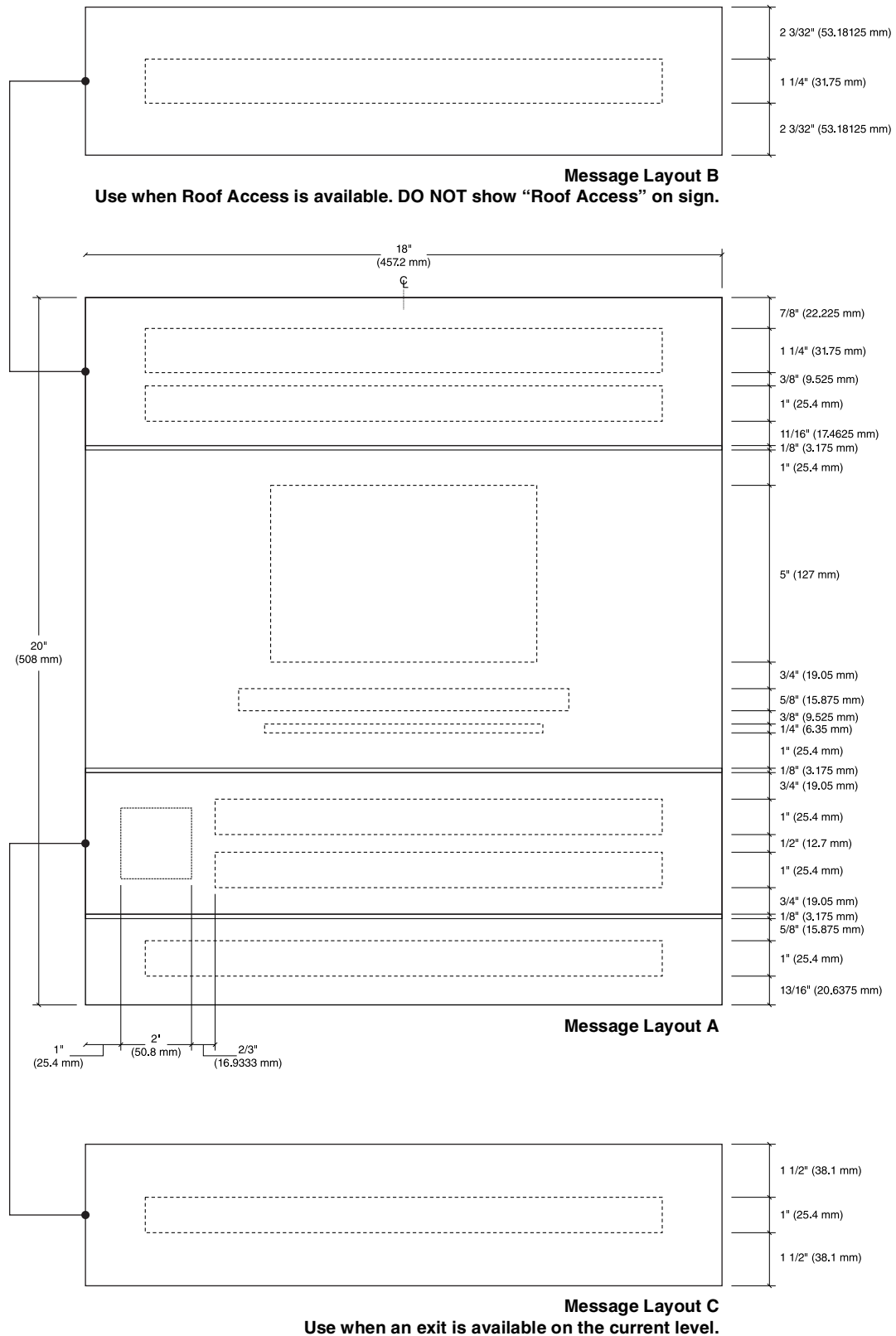

Area of Refuge Sign

Size

6" High x 9" Wide
(152.4 mm H x 228.6 mm W)

Description and Use

Disabled evacuation assistance directional sign indicating area of refuge for evacuation assistance.

This sign must be placed near the door leading into any area of refuge.

Message Configuration

Refer to layout drawing for lettering sizes and dimensions.

Position arrow to communicate direction in relation to the placement of the sign in the building.

Refer to arrow position standards in the Appendix for arrow positioning relative to text.

Sign Components

Component based sign system

See [Section 2.1.5 Construction](#) for applicable component sign system styles.

Graphic Process

Tactile text with accompanying Grade 2 Braille

Colors

Refer to the chart in the Appendix.

Typography

Helvetica Bold
Grade 2 Braille

Mounting

Preferred: Concealed mechanical fasteners

Alternate: Double-sided VHB foam tape and silicone adhesive

Installation

Mount on wall, 60" (1524 mm) to top of sign. If installed next to a door, it should be 2" (50.8 mm) over from door frame on latch side.



Message Layout A



Message Layout B

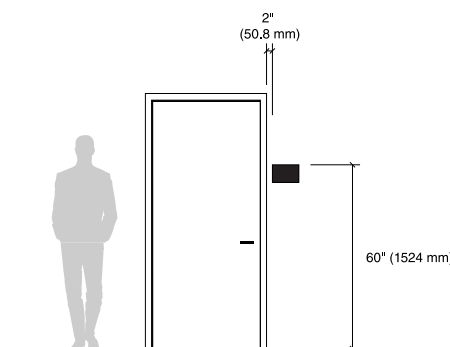

IN-01.12

Code & Life Safety Signage Drawings

Area of Refuge Sign

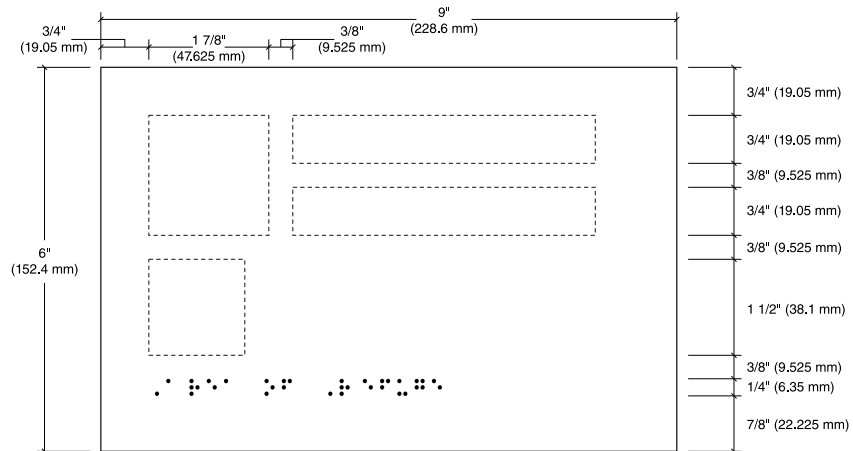

Message Layout A

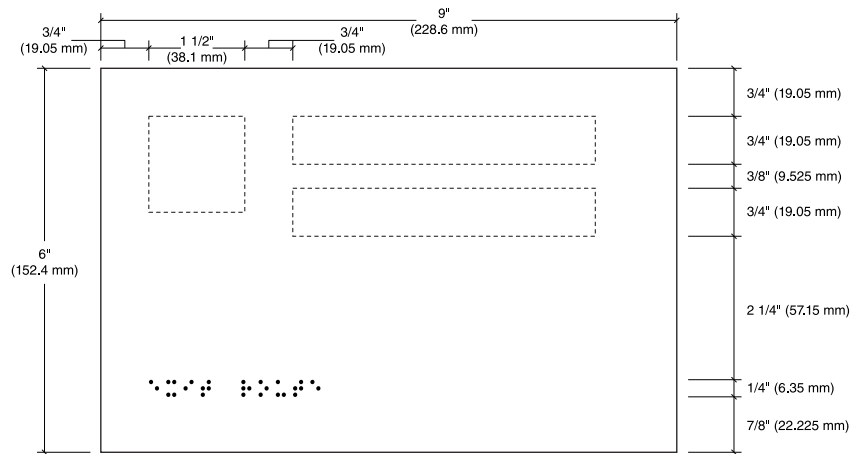

Message Layout B



IN-01.13**Code & Life Safety Signage Drawings****Push/Pull Alarm Identification Sign****Size**

3" High x 24" Wide
(76.2 mm H x 609.6 mm W)

Description and Use

Push/Pull alarm identification sign is an instructional sign for push/pull alarmed doors.

A 30-second delay egress locking configuration is permitted where approved by the authority having jurisdiction. For the VA that is typically the local safety officer and/or VISN Safety Manager.

Refer to NFPA 7.2.1.6.1 for more information.

Message Configuration

Refer to layout drawing for lettering sizes and dimensions.

Message Layout A – Push Sign
Message Layout B – Pull Sign

Sign Components

Acrylic plaque

See [Section 2.1.6 Installation](#) for applicable acrylic construction.

Graphic Process

Direct digital print on second surface or silk-screened

Colors

Refer to the chart in the Appendix.

Typography

Helvetica Bold

Mounting

Double-sided VHB foam tape and silicone adhesive

Installation

Mount centered on door 60" (1524 mm) above finished floor to the center or top of the sign.

**PUSH UNTIL ALARM SOUNDS
DOOR CAN BE OPENED IN 15 SECONDS**

Message Layout A

**PULL UNTIL ALARM SOUNDS
DOOR CAN BE OPENED IN 15 SECONDS**

Message Layout B

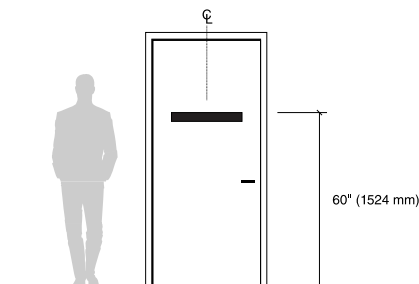

Push/Pull Alarm Identification Sign

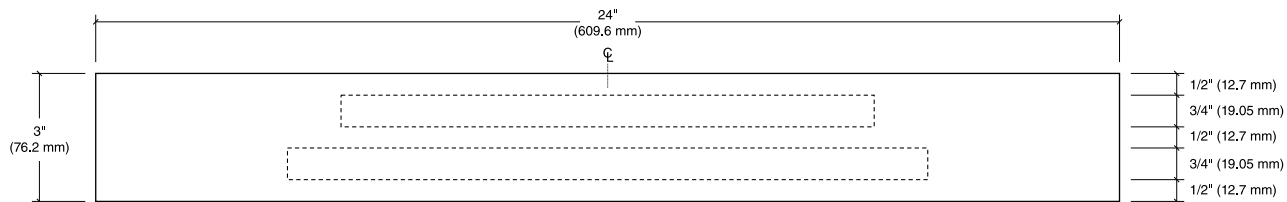

Message Layout A & B



IN-01.14

Code & Life Safety Signage Drawings

Open Door Fire Safety Sign

Size

3" High x 20" Wide
(76.2 mm H x 508 mm W)

Description and Use

Instructional sign used for roll-up security gates and main entrance doors.

Message Configuration

Refer to layout drawing for lettering sizes and dimensions.

Sign Components

Acrylic plaque

See [Section 2.1.6 Installation](#) for applicable acrylic construction.

Graphic Process

Direct digital print on second surface or silk-screened

Colors

Refer to the chart in the Appendix.

Typography

Helvetica Bold

Mounting

Concealed mechanical fasteners or double-sided VHB foam tape and silicone adhesive

Installation

Mount on wall: 2" (50.8 mm) above door frame header to bottom of sign, centered

**THIS DOOR TO REMAIN UNLOCKED
WHEN THE BUILDING IS OCCUPIED**

Message Layout

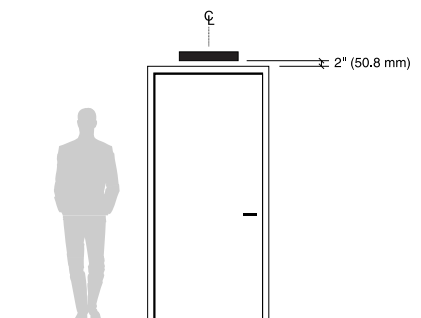

IN-01.14

Code & Life Safety Signage Drawings

Open Door Fire Safety Sign

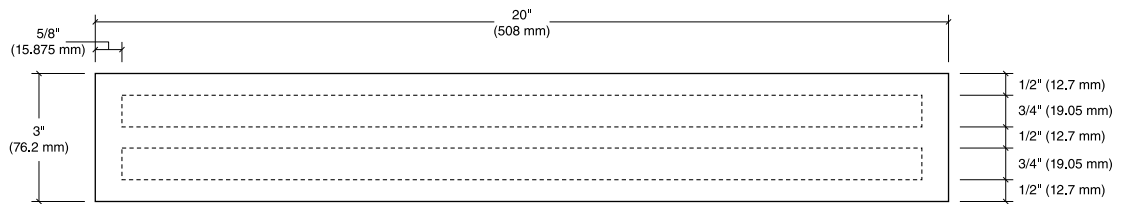

Message Layout



IN-01.15

Code & Life Safety Signage Drawings

Hazardous Material Information Sign

Size

12" High x 12" Wide
(304.8 mm H x 304.8 mm W)

Description and Use

Hazardous materials information sign used to easily identify specific hazards within room, storage cabinet or locker.

Refer to NFPA 704 for more information.

Message Configuration

Refer to layout drawing for lettering sizes and dimensions.

Numbers shown on this drawing are for illustration purposes only. Provide correct numbers, text, and colors to correctly identify the hazardous materials within a room. Refer to NFPA (National Fire Protection Association) or material data sheet relating to materials for more information regarding message.

- A: Identifies specific hazard
- B: Identifies health hazard
- C: Identifies fire hazard
- D: Identifies reactivity

Sign Components

Acrylic plaque

See [Section 2.1.6 Installation](#) for applicable acrylic construction.

Graphic Process

Direct digital print on second surface or silk-screened

Colors

- Text: Black & White
- Background:
- A: White
- B: Safety Blue (OSHA)
- C: Safety Red (OSHA)
- D: Safety Yellow (OSHA)

Refer to the chart in the Appendix.

Typography

Helvetica Bold

Mounting

Double-sided VHB foam tape and silicone adhesive

Installation

Mount on door 60" (1524 mm) to center of sign above floor, centered on door

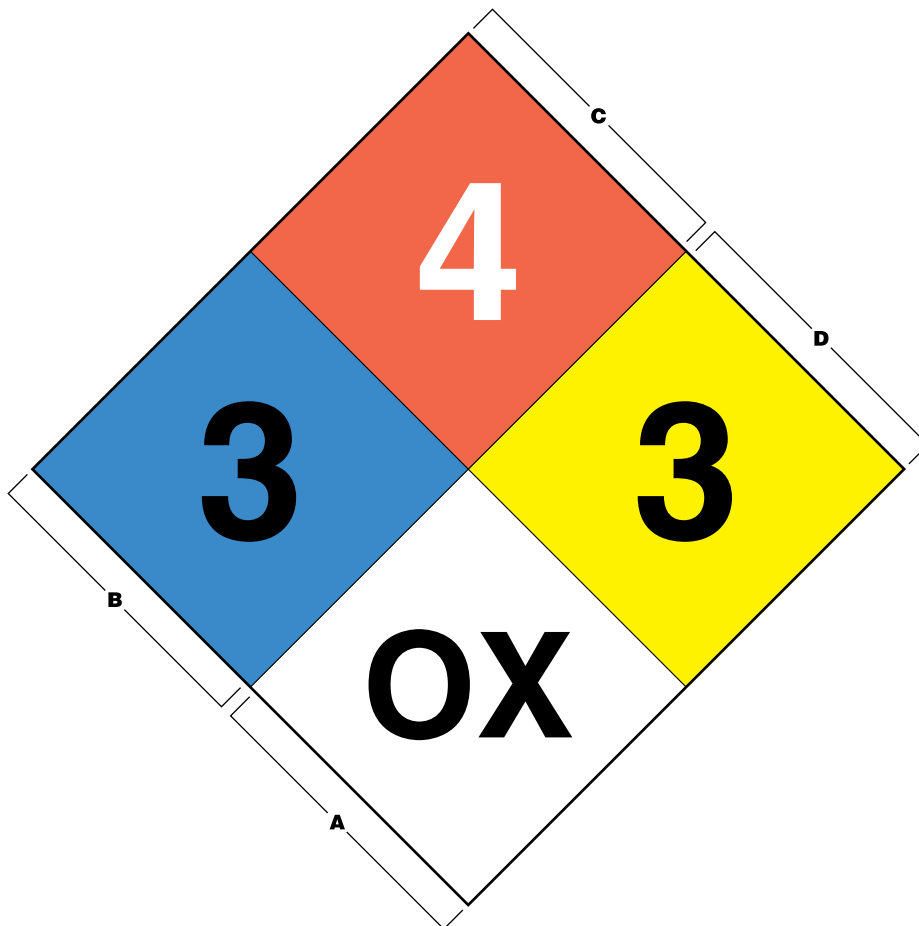

Message Layout

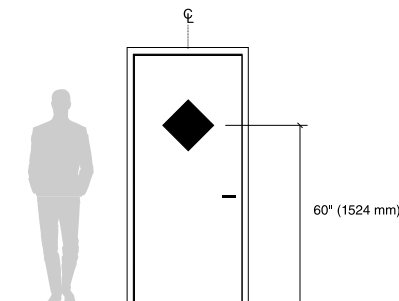

IN-01.15

Code & Life Safety Signage Drawings

Hazardous Material Information Sign

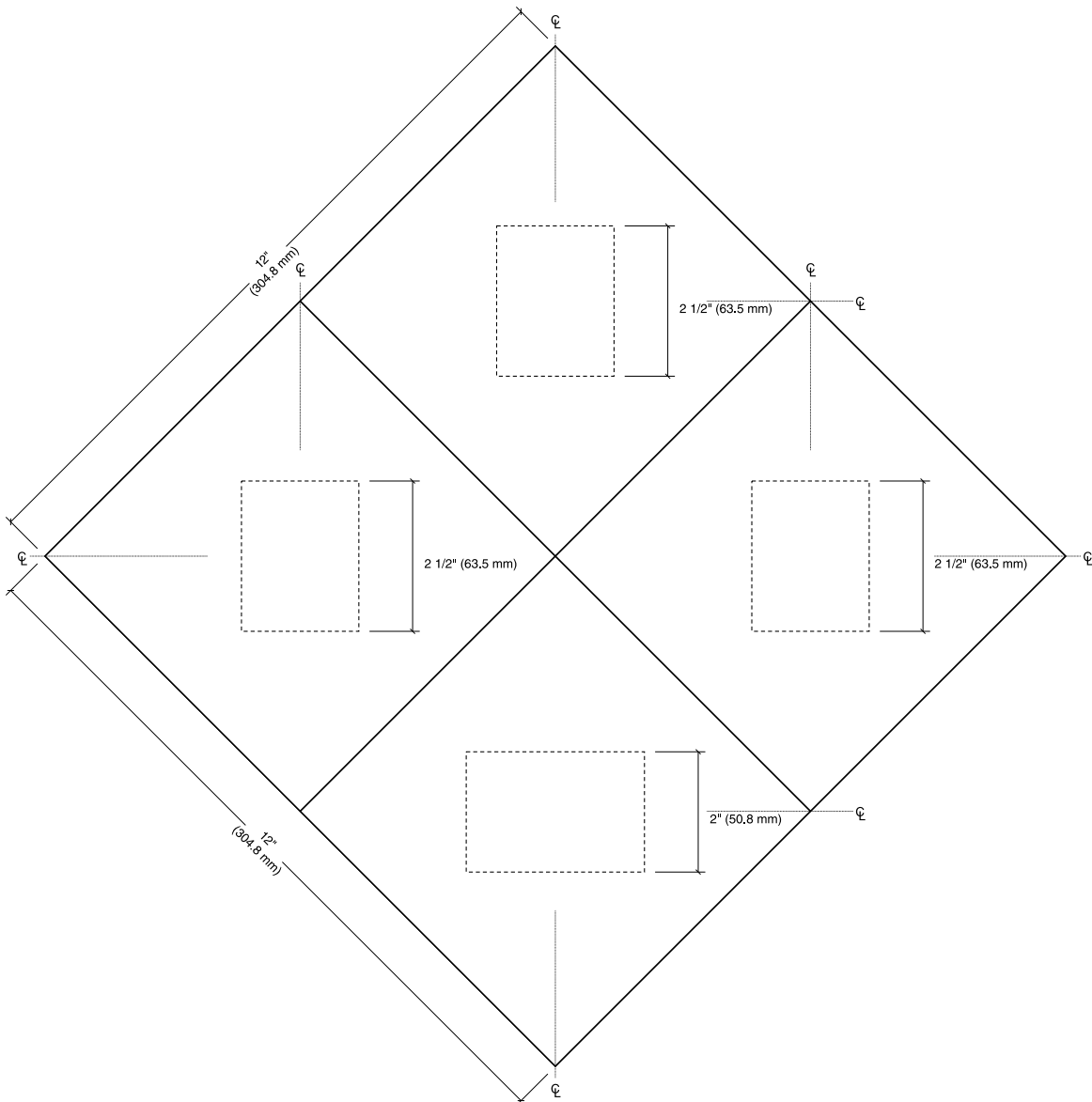

Message Layout



IN-01.16.01

Code & Life Safety Signage Drawings

Oxygen in Use Warning Sign

Size

9" High x 9" Wide
(228.6 mm H x 228.6 mm W)

Description and Use

Caution information regarding oxygen in use. Sign must be installed on all doors to rooms in which oxygen is in use.

Messaging Configuration

Refer to layout drawing for lettering sizes and dimensions.

Sign Components

Acrylic plaque

See [Section 2.1.6 Installation](#) for applicable acrylic construction.

Graphic Process

Direct digital print on second surface or silk-screened

Colors

Refer to the chart in the Appendix.

Typography

Helvetica Bold

Mounting

Double-sided VHB foam tape and silicone adhesive

Installation

Mount centered on door 60" (1524 mm) to center of sign above floor, centered on door

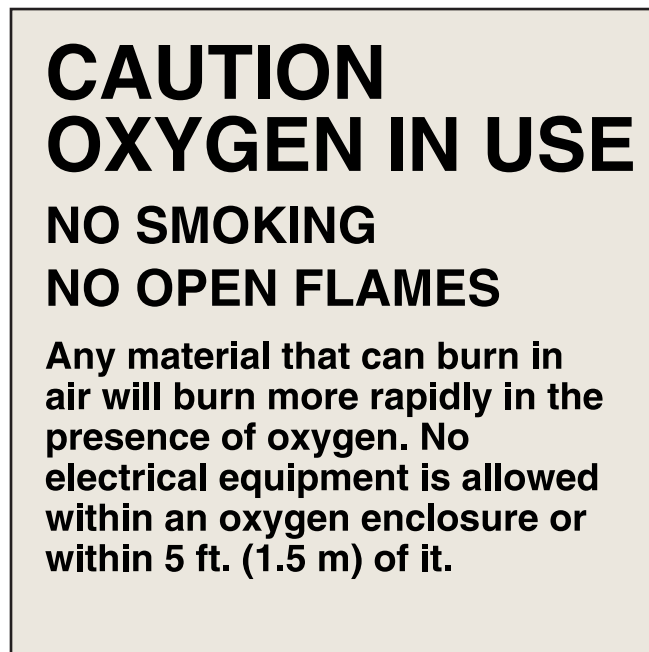

Message Layout

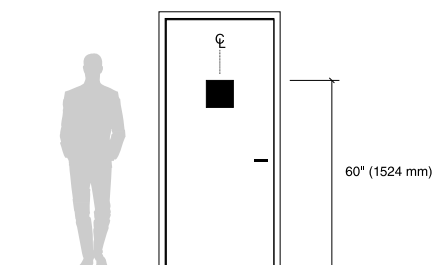

IN-01.16.01

Code & Life Safety Signage Drawings

Oxygen in Use Warning Sign

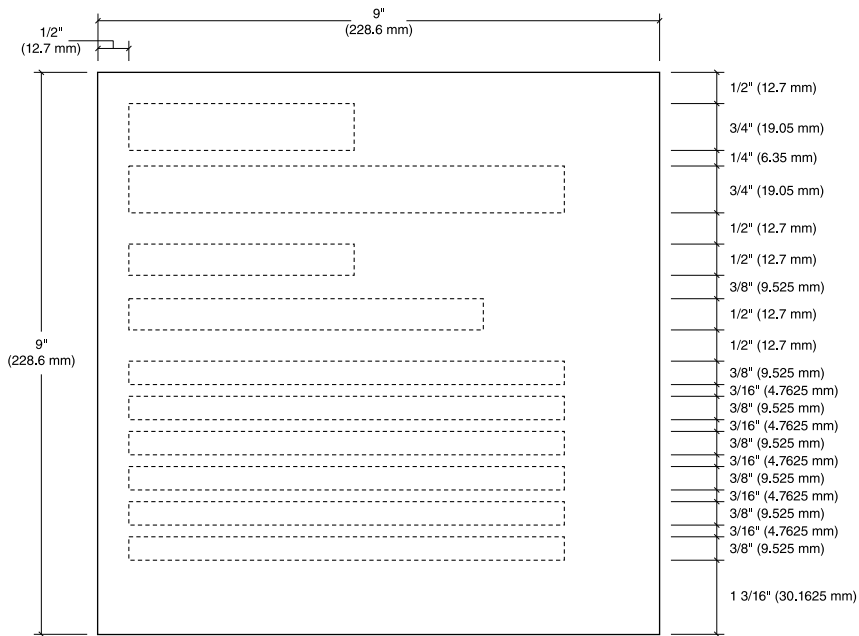

Message Layout



IN-01.16.02

Code & Life Safety Signage Drawings

Medical Gases Warning Sign

Size

9" High x 9" Wide
(228.6 mm H x 228.6 mm W)

Description and Use

Caution information regarding medical gases being stored within a room. Sign must be installed on all doors to central supply rooms in which oxygen and/or medical air is stored. Refer to NFPA 99 for additional requirements and information.

Messaging Configuration

Refer to layout drawing for lettering sizes and dimensions.

Sign Components

Acrylic plaque

See [Section 2.1.6 Installation](#) for applicable acrylic construction.

Graphic Process

Direct digital print on second surface or silk-screened

Colors

Refer to the chart in the Appendix.

Typography

Helvetica Bold

Mounting

Double-sided VHB foam tape and silicone adhesive

Installation

Mount centered on door 60" (1524 mm) above finished floor to the center or top of the sign.



Message Layout

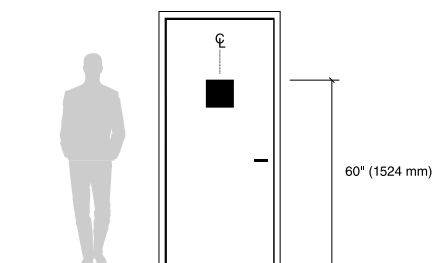

IN-01.16.02

Code & Life Safety Signage Drawings

Medical Gases Warning Sign

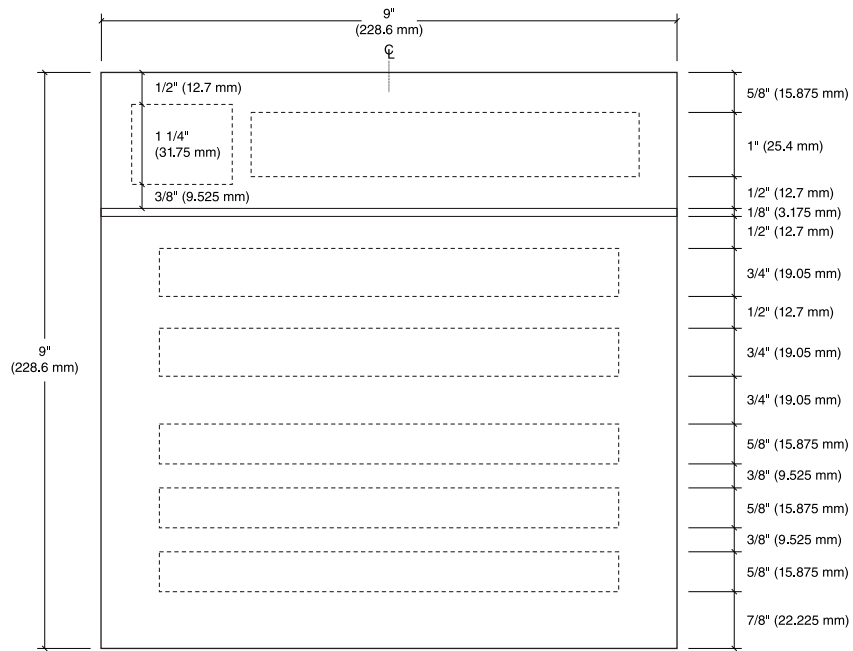

Message Layout



IN-01.16.03

Code & Life Safety Signage Drawings

Oxidizing Gases Warning Sign

Size

9" High x 9" Wide
(228.6 mm H x 228.6 mm W)

Description and Use

Caution information regarding oxidizing gases being stored within a room. Sign must be installed on all doors to all rooms more than 300 square feet in size that contain oxidizing gases (oxygen and/or nitrous oxide) and/or inert gases (CO₂/Nitrogen/Helium). Refer to NFPA 99 for additional requirements and information.

Messaging Configuration

Refer to layout drawing for lettering sizes and dimensions.

Sign Components

Acrylic plaque

See [Section 2.1.6 Installation](#) for applicable acrylic construction.

Graphic Process

Direct digital print on second surface or silk-screened

Colors

Refer to the chart in the Appendix.

Typography

Helvetica Bold

Mounting

Double-sided VHB foam tape and silicone adhesive

Installation

Mount centered on door 60" (1524 mm) above finished floor to the center or top of the sign.



Message Layout

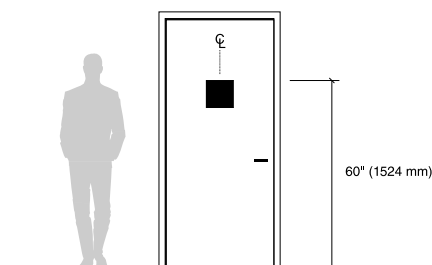

Oxidizing Gases Warning Sign

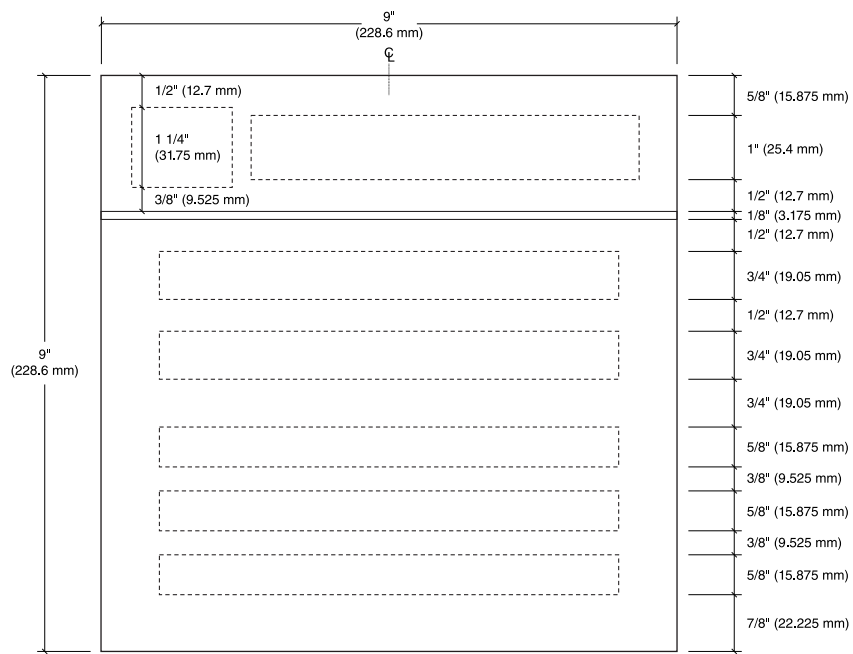

Message Layout



IN-01.16.04

Code & Life Safety Signage Drawings

Positive Pressure Gases Warning Sign

Size

9" High x 9" Wide
(228.6 mm H x 228.6 mm W)

Description and Use

Caution information regarding positive pressure gases being stored within a room. Sign must be installed on all doors to central supply rooms that contain all other gases besides or in addition to oxygen/medical air. Sign must be installed on all doors to all rooms more than 300 square feet in size that contain inert gases (CO₂/Nitrogen/Helium). Refer to NFPA 99 for additional requirements and information.

Messaging Configuration

Refer to layout drawing for lettering sizes and dimensions.

Sign Components

Acrylic plaque

See [Section 2.1.6 Installation](#) for applicable acrylic construction.

Graphic Process

Direct digital print on second surface or silk-screened

Colors

Refer to the chart in the Appendix.

Typography

Helvetica Bold

Mounting

Double-sided VHB foam tape and silicone adhesive

Installation

Mount centered on door 60" (1524 mm) above finished floor to the center or top of the sign.



Message Layout

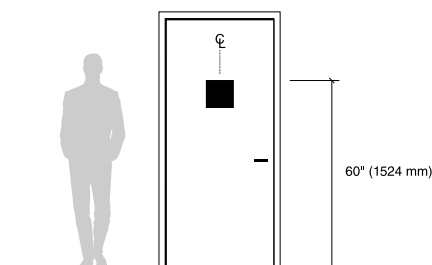

IN-01.16.04

Code & Life Safety Signage Drawings

Positive Pressure Gases Warning Sign

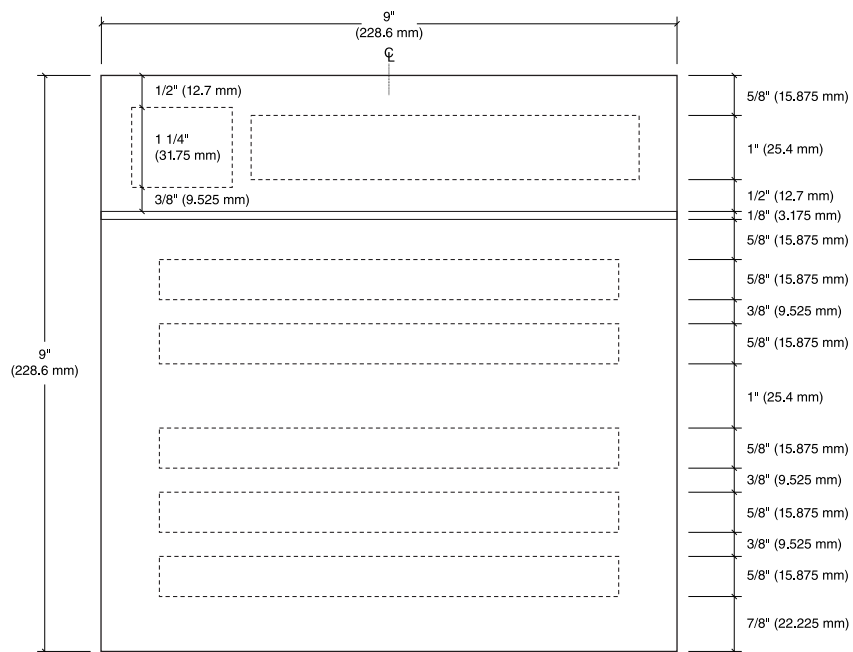

Message Layout



IN-01.17

Code & Life Safety Signage Drawings

Compressed Gas Warning Sign

Size

9" High x 9" Wide
(228.6 mm H x 228.6 mm W)

Description and Use

Caution information regarding gases in use. Sign must be installed on all doors to rooms that contain the listed gases. Adjust the listing of gases to reflect the actual gases being used in the laboratory.

Messaging Configuration

Refer to layout drawing for lettering sizes and dimensions.

Sign Components

Acrylic plaque

See [Section 2.1.6 Installation](#) for applicable acrylic construction.

Graphic Process

Direct digital print on second surface or silk-screened

Colors

Refer to the chart in the Appendix.

Typography

Helvetica Bold

Mounting

Double-sided VHB foam tape and silicone adhesive

Installation

Mount centered on door 60" (1524 mm) above finished floor to the center or top of the sign.

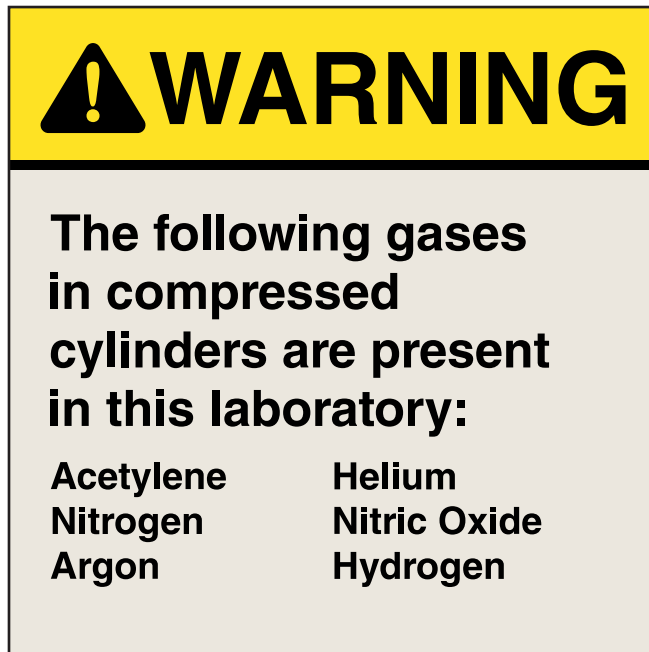

Message Layout

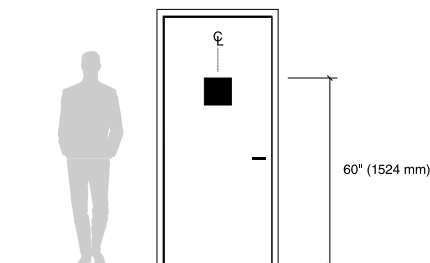

IN-01.17

Code & Life Safety Signage Drawings

Compressed Gas Warning Sign

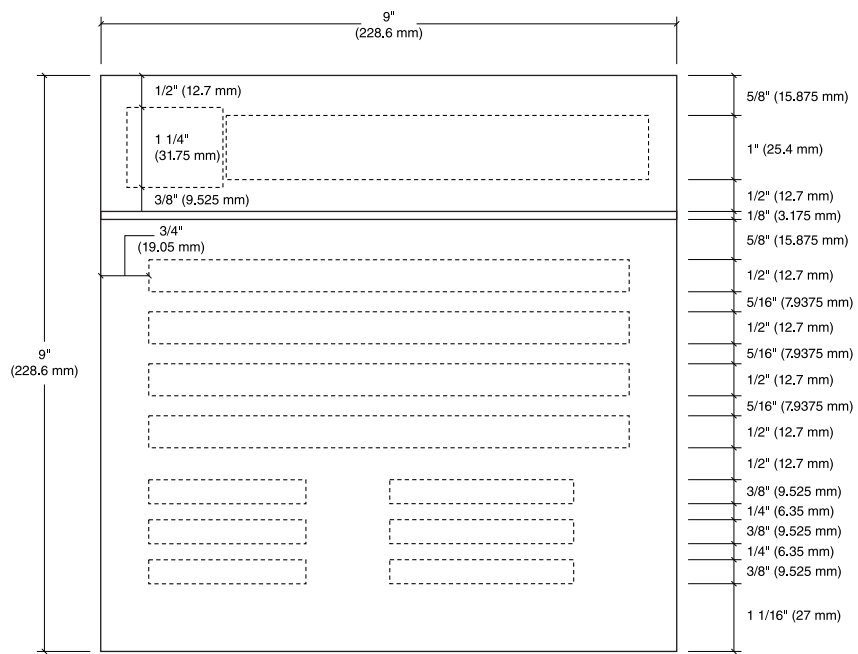

Message Layout



IN-01.18

Code & Life Safety Signs

Nonflammable Anesthesia Restriction Sign

Size

9" High x 9" Wide
(228.6 mm H x 228.6 mm W)

Description and Use

Caution information regarding anesthetic agents in use. Sign is to be installed on the doors to all operating rooms.

Messaging Configuration

Refer to layout drawing for lettering sizes and dimensions.

Sign Components

Acrylic plaque

See [Section 2.1.6 Installation](#) for applicable acrylic construction.

Graphic Process

Direct digital print on second surface or silk-screened

Colors

Refer to the chart in the Appendix.

Typography

Helvetica Bold

Mounting

Double-sided VHB foam tape and silicone adhesive

Installation

Mount centered on door 60" (1524 mm) above finished floor to the center or top of the sign.



Message Layout

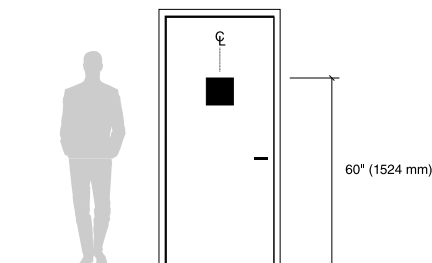

Nonflammable Anesthesia Restriction Sign

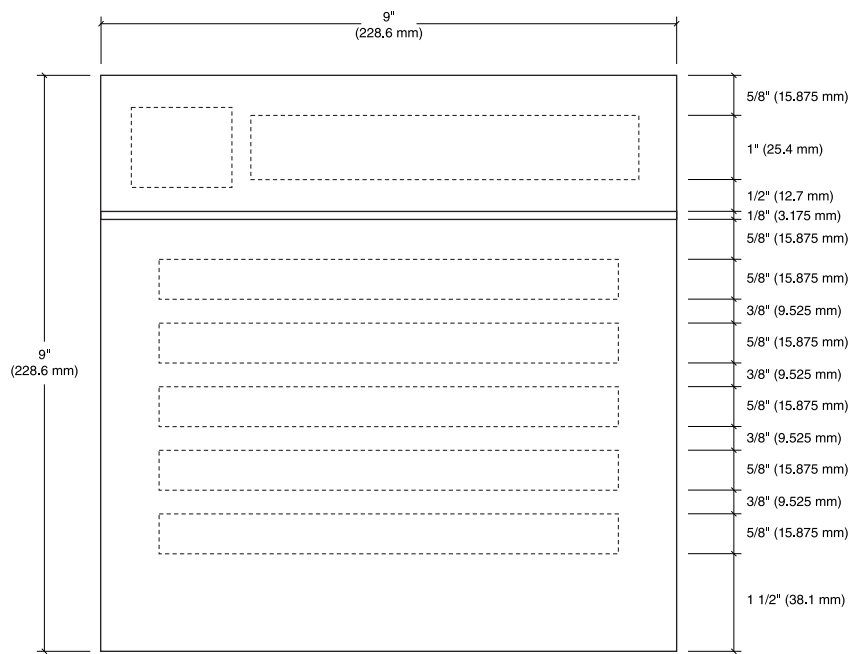

Message Layout



IN-01.19

Code & Life Safety Signage Drawings

Radioactive Material Warning Sign

Size

9" High x 9" Wide
(228.6 mm H x 228.6 mm W)

Description and Use

Caution information regarding radioactive material. Sign is to be installed on the doors to all rooms where radioactive materials are in use or stored.

Messaging Configuration

Refer to layout drawing for lettering sizes and dimensions.

Sign Components

Acrylic plaque

See [Section 2.1.6 Installation](#) for applicable acrylic construction.

Graphic Process

Direct digital print on second surface or silk-screened

Colors

Text: Black
Symbol: Purple
Background: Yellow
Refer to the chart in the Appendix.

Typography

Helvetica Bold

Mounting

Double-sided VHB foam tape and silicone adhesive

Installation

Mount centered on door 60" (1524 mm) above finished floor to the center or top of the sign.



Message Layout

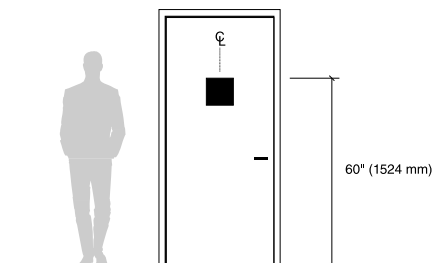

Radioactive Material Warning Sign

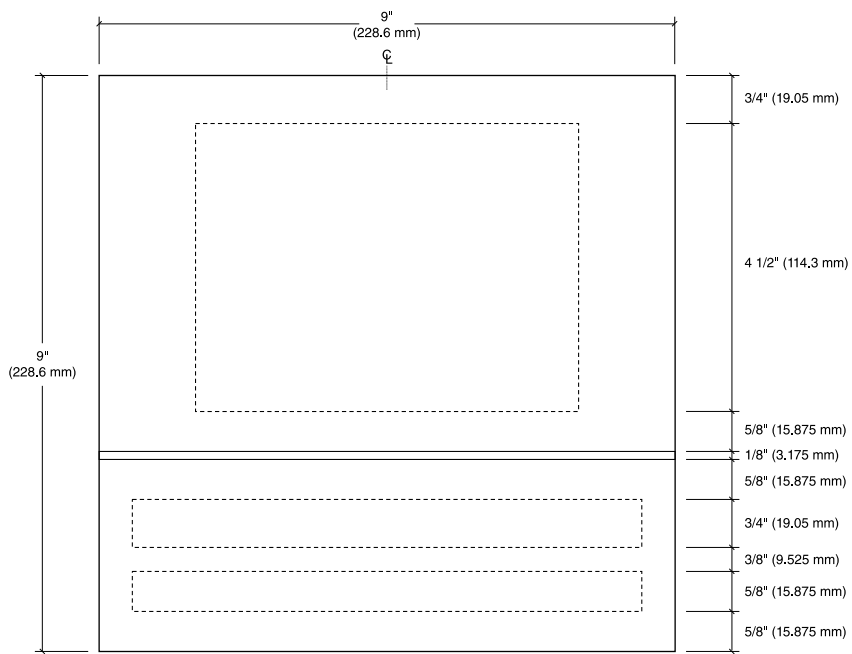

Message Layout



IN-01.20

Code & Life Safety Signage Drawings

Radioactive Area Warning Sign

Size

9" High x 9" Wide
(228.6 mm H x 228.6 mm W)

Description and Use

Caution information regarding area with radioactive material. Sign is to be installed on the doors to all rooms where radioactive materials are in use or stored.

Messaging Configuration

Refer to layout drawing for lettering sizes and dimensions.

Sign Components

Acrylic plaque

See [Section 2.1.6 Installation](#) for applicable acrylic construction.

Graphic Process

Direct digital print on second surface or silk-screened

Colors

Text: Black
Symbol: Purple
Background: Yellow
Refer to the chart in the Appendix.

Typography

Helvetica Bold

Mounting

Double-sided VHB foam tape and silicone adhesive

Installation

Mount centered on door 60" (1524 mm) above finished floor to the center or top of the sign.



Message Layout

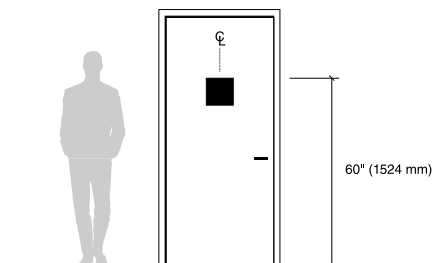

Radioactive Area Warning Sign

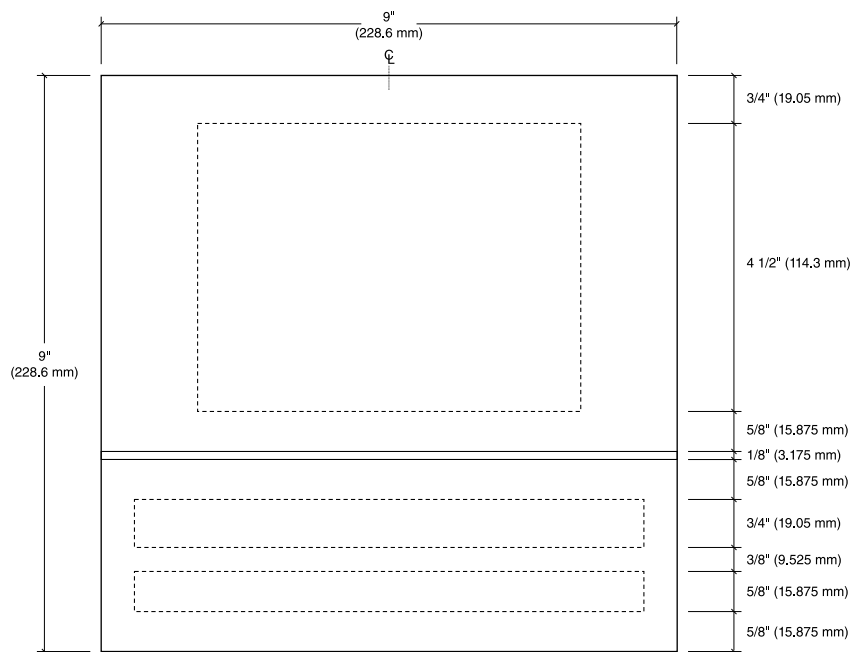

Message Layout



IN-01.21

Code & Life Safety Signage Drawings

High Voltage Warning Sign

Size

9" High x 9" Wide
(228.6 mm H x 228.6 mm W)

Description and Use

Caution information regarding high electrical voltage. Sign must be installed on the doors to all rooms with high voltage (>600 volts) equipment.

Messaging Configuration

Refer to layout drawing for lettering sizes and dimensions.

Sign Components

Acrylic plaque

See [Section 2.1.6 Installation](#) for applicable acrylic construction.

Graphic Process

Direct digital print on second surface or silk-screened

Colors

Text and Symbol: Black
Background: Yellow
Refer to the chart in the Appendix.

Typography

Helvetica Bold

Mounting

Double-sided VHB foam tape and silicone adhesive

Installation

Mount centered on door 60" (1524 mm) above finished floor to the center or top of the sign.

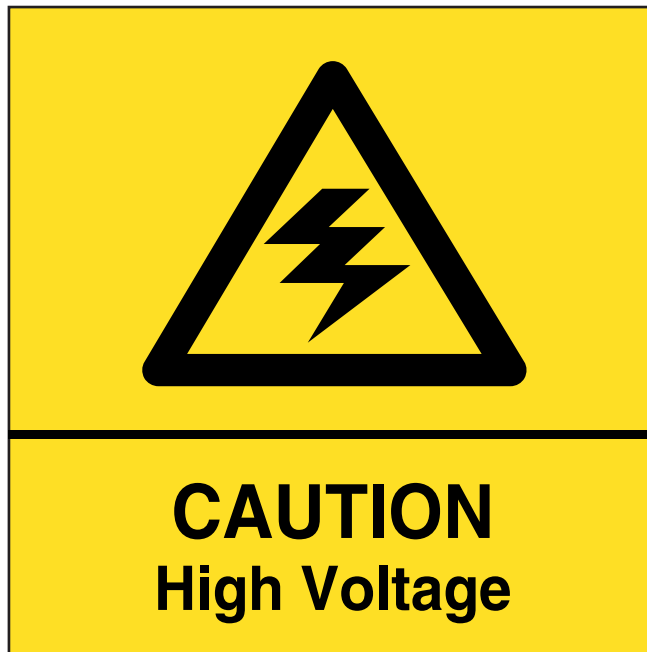

Message Layout

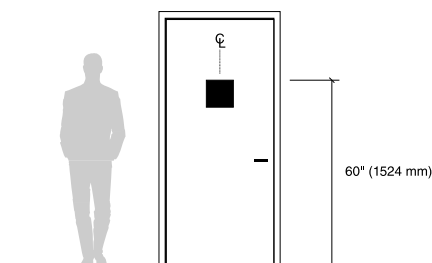

IN-01.21

Code & Life Safety Signage Drawings

High Voltage Warning Sign

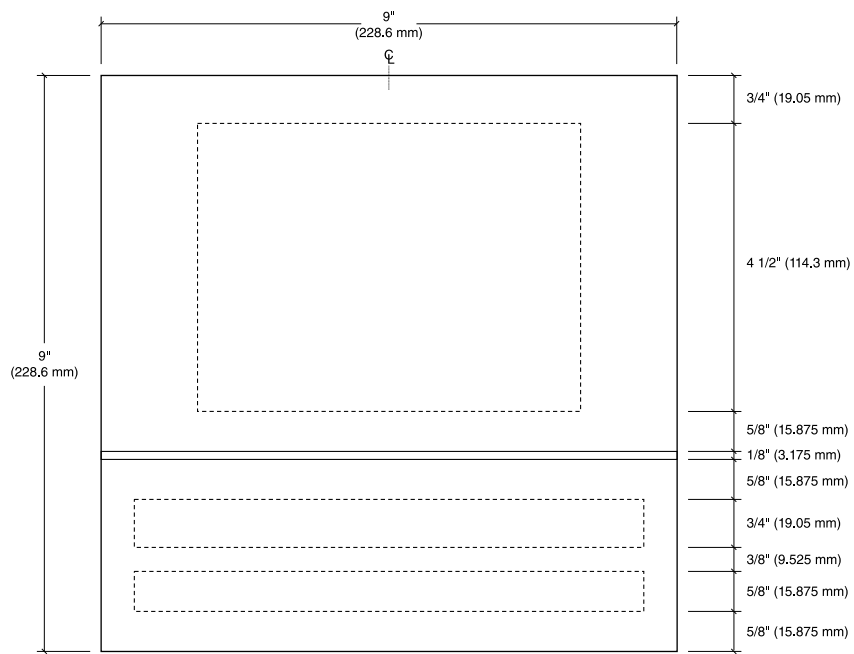

Message Layout



IN-01.22

Code & Life Safety Signage Drawings

Biohazard Warning Sign

Size

9" High x 9" Wide
(228.6 mm H x 228.6 mm W)

Description and Use

Caution information regarding biohazard materials. Sign must be installed on the doors of all rooms where there are biohazard materials.

Messaging Configuration

Refer to layout drawing for lettering sizes and dimensions.

Sign Components

Acrylic plaque

See [Section 2.1.6 Installation](#) for applicable acrylic construction.

Graphic Process

Direct digital print on second surface or silk-screened

Colors

Text and Symbol: Black
Background: Orange
Refer to the chart in the Appendix.

Typography

Helvetica Bold

Mounting

Double-sided VHB foam tape and silicone adhesive

Installation

Mount centered on door 60" (1524 mm) above finished floor to the center or top of the sign.



Message Layout

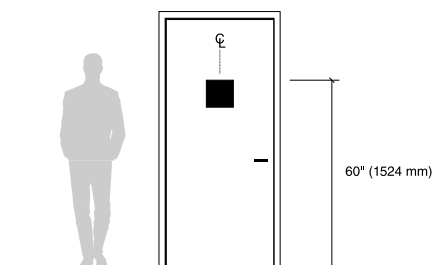

IN-01.22

Code & Life Safety Signage Drawings

Biohazard Warning Sign

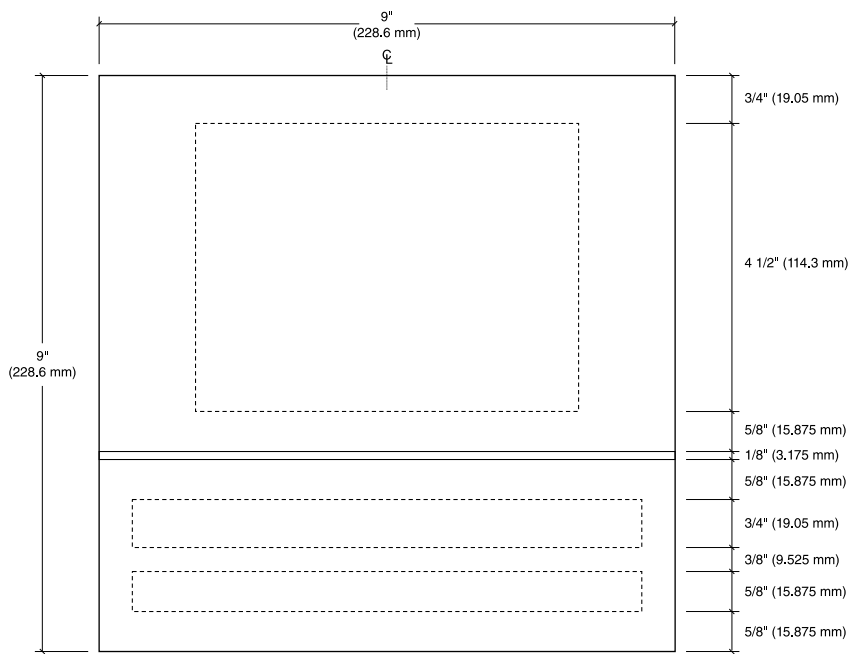

Message Layout



IN-01.23

Code & Life Safety Signage Drawings

Laser Warning Sign

Size

9" High x 9" Wide
(228.6 mm H x 228.6 mm W)

Description and Use

Caution information regarding lasers. Sign must be installed on the doors to all rooms where lasers are used.

Refer to the Occupational Safety and Health Administration (OSHA) Manual for more information.

Messaging Configuration

Refer to layout drawing for lettering sizes and dimensions.

Sign Components

Acrylic plaque

See [Section 2.1.6 Installation](#) for applicable acrylic construction.

Graphic Process

Direct digital print on second surface or silk-screened

Colors

Text and Symbol: Black
Background: Yellow
Refer to the chart in the Appendix.

Typography

Helvetica Bold

Mounting

Double-sided VHB foam tape and silicone adhesive

Installation

Mount centered on door 60" (1524 mm) above finished floor to the center or top of the sign.

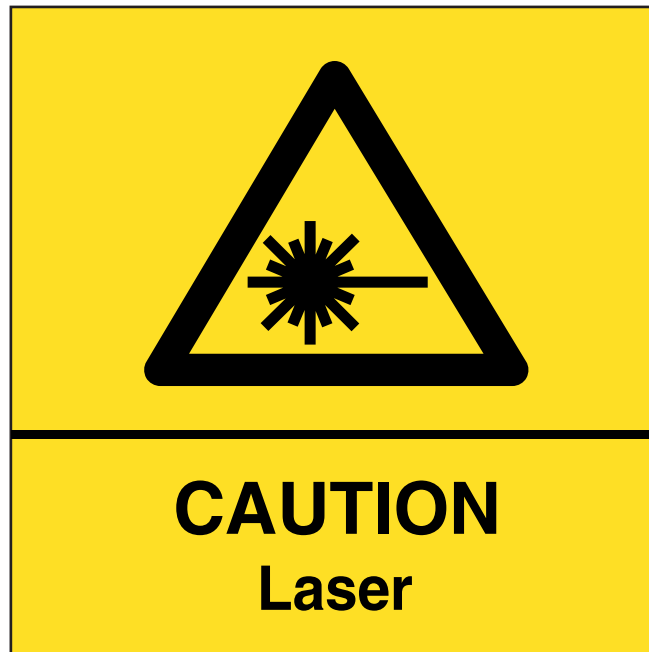

Message Layout

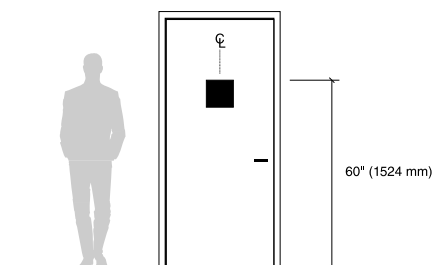

IN-01.23

Code & Life Safety Signage Drawings

Laser Warning Sign

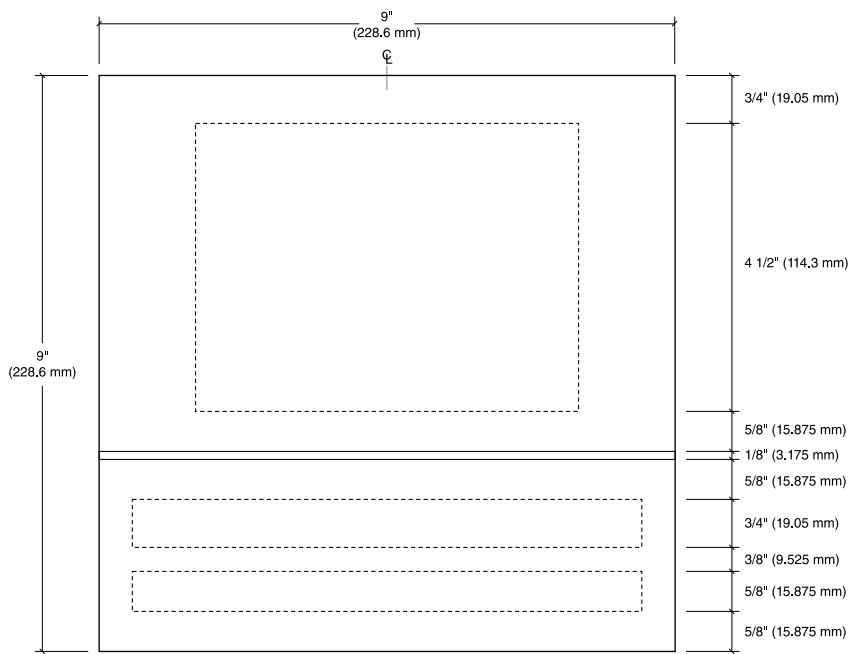

Message Layout



IN-01.24

Code & Life Safety Signage Drawings

Occupational Exposure Area Warning Sign

Size

9" High x 9" Wide
(228.6 mm H x 228.6 mm W)

Description and Use

Caution information regarding occupational exposure. Sign is to be installed on doors to all rooms where there is occupational exposure.

Messaging Configuration

Refer to layout drawing for lettering sizes and dimensions.

Sign Components

Acrylic plaque

See [Section 2.1.6 Installation](#) for applicable acrylic construction.

Graphic Process

Direct digital print on second surface or silk-screened

Colors

Text and Symbol: Black
Background: Yellow
Refer to the chart in the Appendix.

Typography

Helvetica Bold

Mounting

Double-sided VHB foam tape and silicone adhesive

Installation

Mount centered on door 60" (1524 mm) above finished floor to the center or top of the sign.



Message Layout

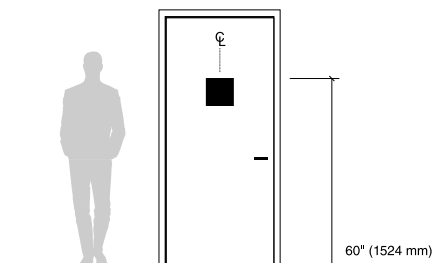

Occupational Exposure Area Warning Sign

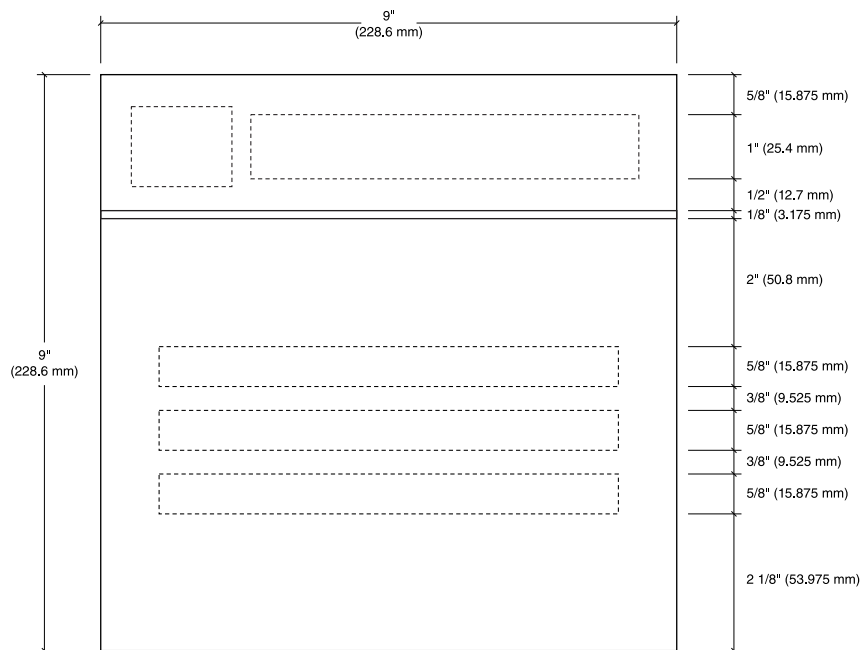

Message Layout



IN-01.25

Code & Life Safety Signage Drawings

No Re-Entry Floor Sign

Size

9" High x 9" Wide
(228.6 mm H x 228.6 mm W)

Description and Use

No re-entry floor sign is used to identify a door which once closed will not reopen from the other side.

Messaging Configuration

Refer to layout drawing for lettering sizes and dimensions.

Sign Components

Acrylic plaque

See [Section 2.1.6 Installation](#) for applicable acrylic construction.

Graphic Process

Direct digital print on second surface or silk-screened

Colors

Refer to the chart in the Appendix.

Typography

Helvetica Bold

Mounting

Double-sided VHB foam tape and silicone adhesive

Installation

Mount centered on door 60" (1524 mm) above finished floor to the center or top of the sign.

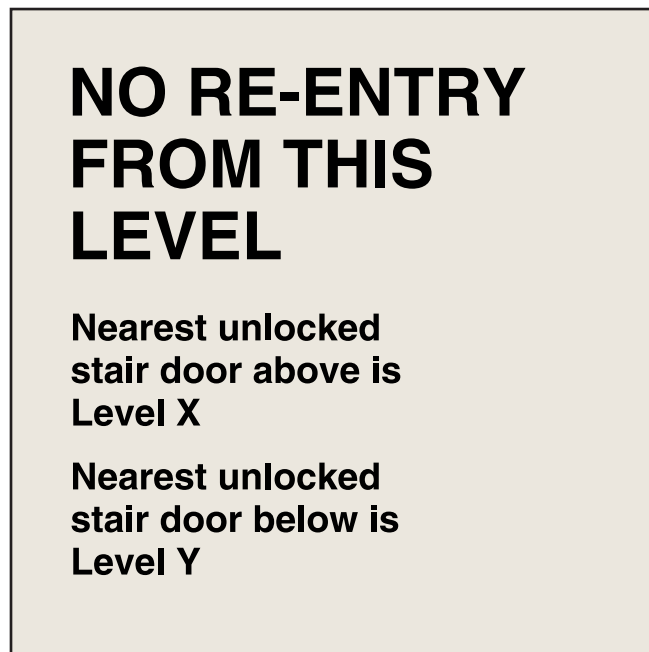

Message Layout

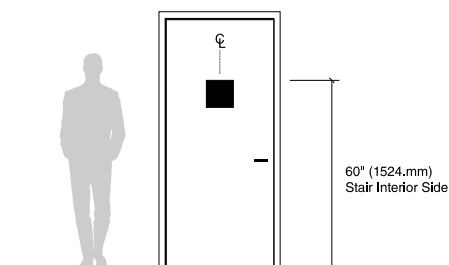

IN-01.25

Code & Life Safety Signage Drawings

No Re-Entry Floor Sign

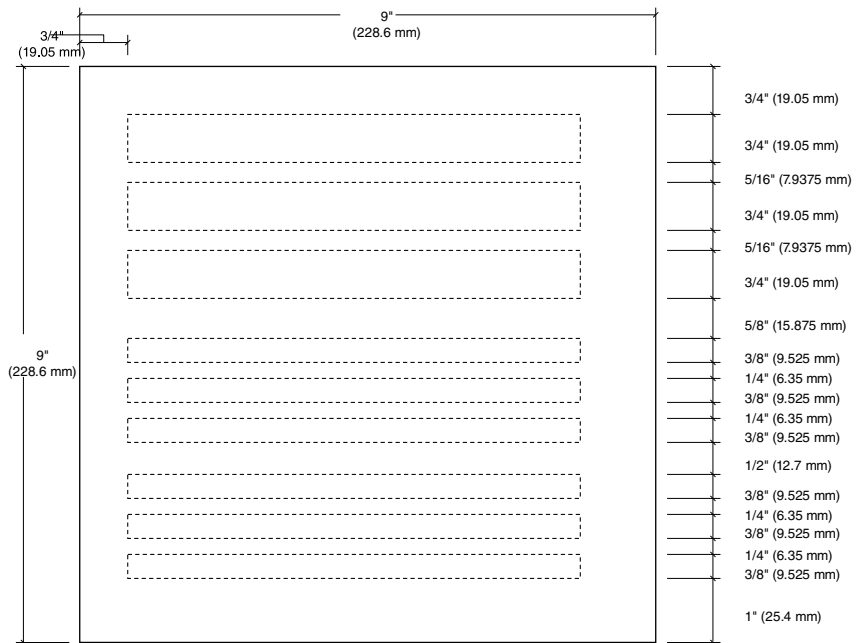

Message Layout



IN-01.26

Code & Life Safety Signage Drawings

Push to Exit Sign

Size

6" High x 6" Wide
(152.4 mm H x 152.4 mm W)

Description and Use

Push to exit sign is used to inform type of action needed to activate door. Sign is to be installed on doors to all exits where push motion is needed to activate door.

Messaging Configuration

Refer to layout drawing for lettering sizes and dimensions.

Sign Components

Acrylic plaque

See [Section 2.1.6 Installation](#) for applicable acrylic construction.

Graphic Process

Direct digital print on second surface or silk-screened

Colors

Refer to the chart in the Appendix.

Typography

Helvetica Bold

Mounting

Double-sided VHB foam tape and silicone adhesive

Installation

Mount centered on door 60" (1524 mm) above finished floor to the center or top of the sign.



Message Layout

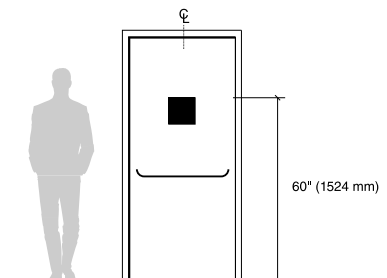

IN-01.26

Code & Life Safety Signage Drawings

Push to Exit Sign

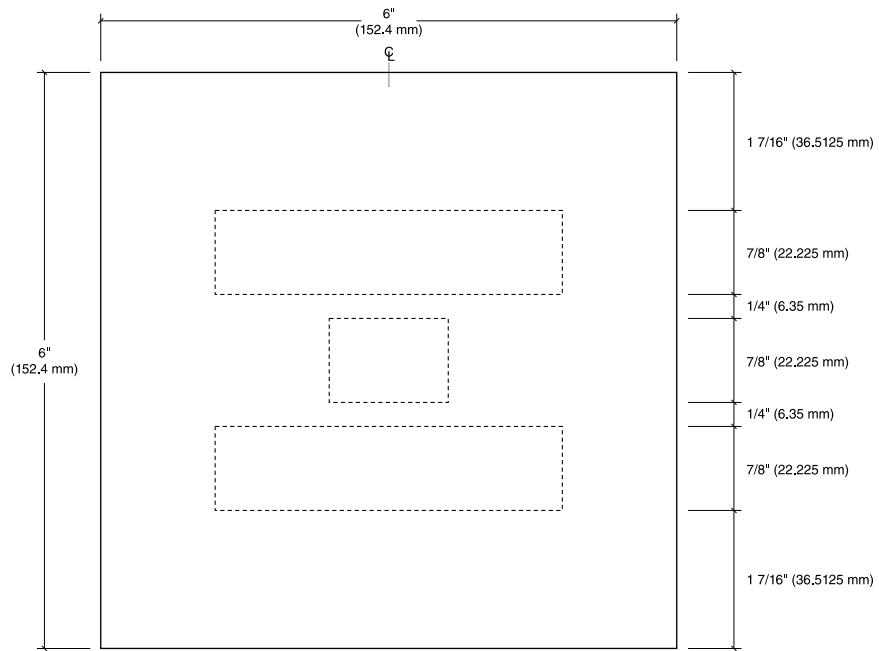

Message Layout



IN-01.27

Code & Life Safety Signage Drawings

Emergency Push to Open Sign

Size

3" High x 12" Wide
(76.2 mm H x 304.8 mm W)

Description and Use

Emergency push to open sign is used to inform type of action needed to activate door in case of an emergency.

Sign is to be installed on doors at all exits where push motion is needed to activate door.

Messaging Configuration

Refer to layout drawing for lettering sizes and dimensions.

Sign Components

Acrylic plaque

See [Section 2.1.6 Installation](#) for applicable acrylic construction.

Graphic Process

Direct digital print on second surface or silk-screened

Colors

Refer to the chart in the Appendix.

Typography

Helvetica Bold

Mounting

Double-sided VHB foam tape and silicone adhesive

Installation

Mount on door 60" (1524 mm) above finished floor to the center or top of the sign and 2" (50.8 mm) from strike side of door.



Message Layout

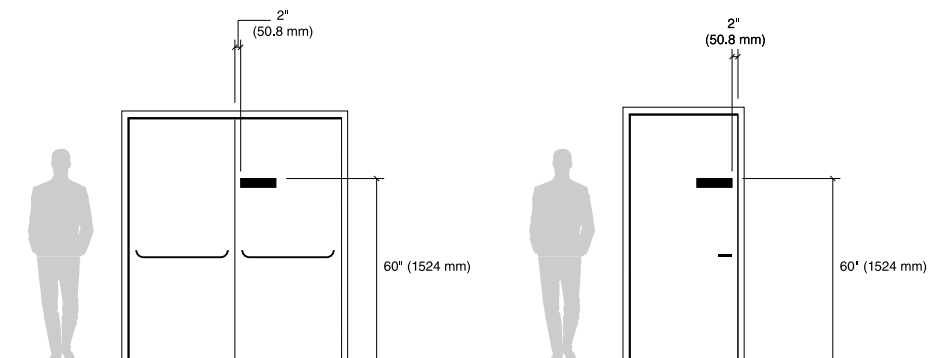

Emergency Push to Open Sign

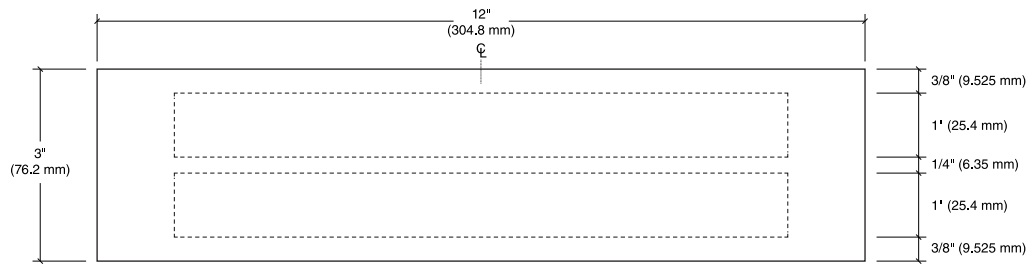

Message Layout



IN-01.28

Code & Life Safety Signage Drawings

Emergency Slide to Open Sign

Size

3" High x 12" Wide
(76.2 mm H x 304.8 mm W)

Description and Use

Emergency push to open sign is used to inform type of action needed to activate door in case of an emergency.

Sign is to be installed next to doors at all exits where push motion is needed to activate door.

Messaging Configuration

Refer to layout drawing for lettering sizes and dimensions.

Sign Components

Component based sign system

See [Section 2.1.5 Construction](#) for applicable component sign system styles.

Graphic Process

Direct digital print on second surface or silk-screened

Colors

Refer to the chart in the Appendix.

Typography

Helvetica Bold

Mounting

Preferred: Concealed mechanical fasteners

Alternate: Double-sided VHB foam tape and silicone adhesive

Installation

Mount on wall 60" (1524 mm) above finished floor to the top of the sign and 2" (50.8 mm) over from door frame.



Message Layout

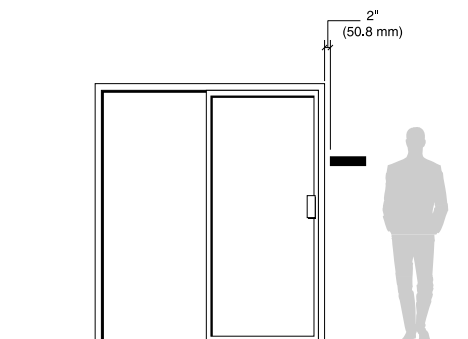

IN-01.28

Code & Life Safety Signage Drawings

Emergency Slide to Open Sign

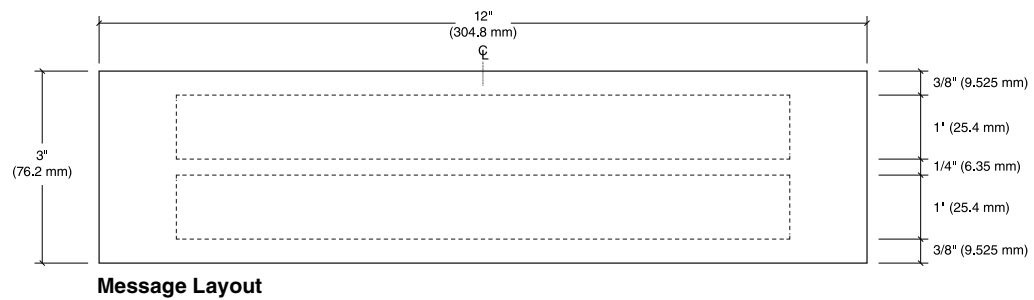

IN-01.29

Code & Life Safety Signage Drawings

Direction of Exit Sign

Size

9" High x 9" Wide
(228.6 mm H x 228.6 mm W)

Description and Use

Direction of exit sign used to indicate direction egress. Sign is to be installed next to doors at all exits where direction is needed to exit.

Message Configuration

Refer to layout drawing for lettering sizes and dimensions.

Sign Components

Component based sign system

See [Section 2.1.5 Construction](#) for applicable component sign system styles.

Graphic Process

Tactile text with accompanying Grade 2 Braille and direct digital print on second surface or silk-screened bottom text

Colors

Refer to the chart in the Appendix.

Typography

Helvetica Bold
Grade 2 Braille

Mounting

Preferred: Concealed mechanical fasteners

Alternate: Double-sided VHB foam tape and silicone adhesive

Installation

Wall-mounted, latch side of door at 60" (1524 mm) to top of sign from finished floor and 2" (51 mm) over from door frame.

For sign placement, refer to the Stairwell Guide in [Section 2.2.5 Installation](#).



Message Layout A



Message Layout B



Message Layout C



Message Layout D

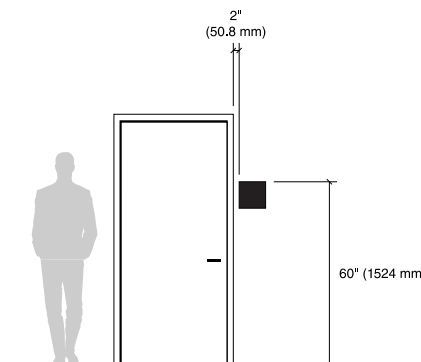

IN-01.29

Code & Life Safety Signage Drawings

Direction of Exit Sign

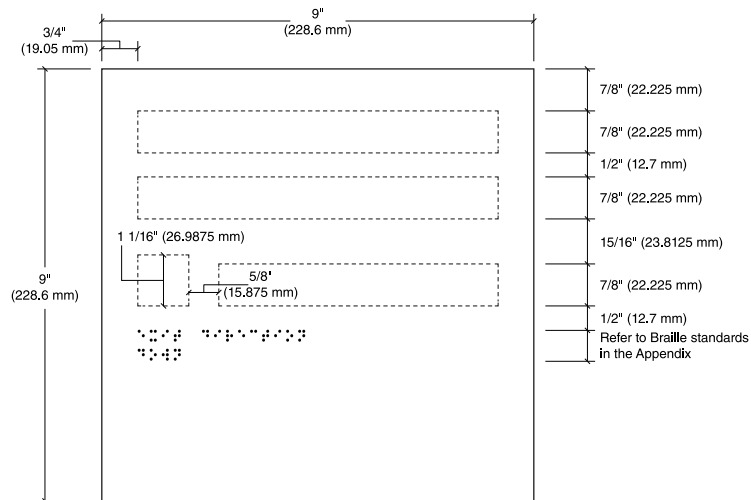

Message Layout A & B

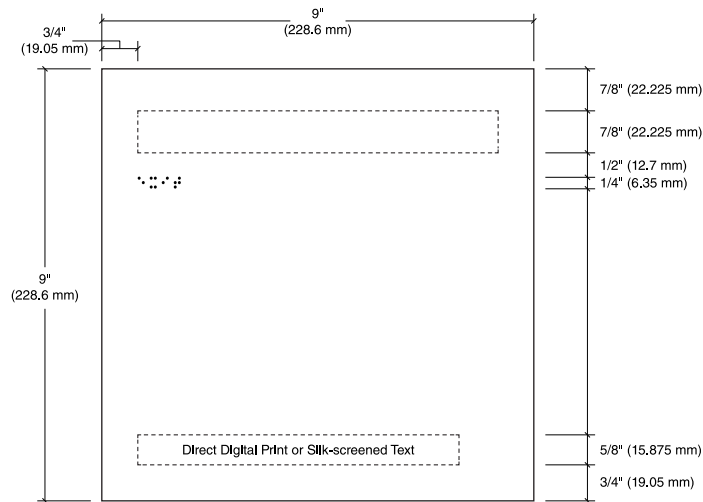

Message Layout C

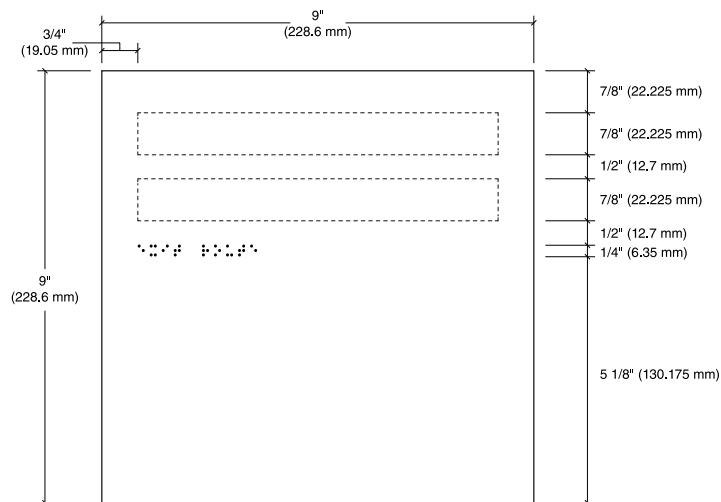

Message Layout D



No Re-Entry Sign

Size

9" High x 9" Wide
(228.6 mm H x 228.6 mm W)

Description and Use

The No Re-entry sign is used to identify an exit door which will lock when shut and not allow re-entry into room, floor, or building.

Message Configuration

Refer to layout drawing for lettering sizes and dimensions.

Sign Components

Acrylic plaque

See [Section 2.1.6 Installation](#) for applicable acrylic construction.

Graphic Process

Direct digital print on second surface or silk-screened

Colors

Refer to the chart in the Appendix.

Typography

Helvetica Bold

Mounting

Double-sided VHB foam tape and silicone adhesive

Installation

Mount centered on door 60" (1524 mm) above finished floor to the center or top of the sign.

For sign placement refer to the Stairwell Guide in [Section 2.2.5 Installation](#)

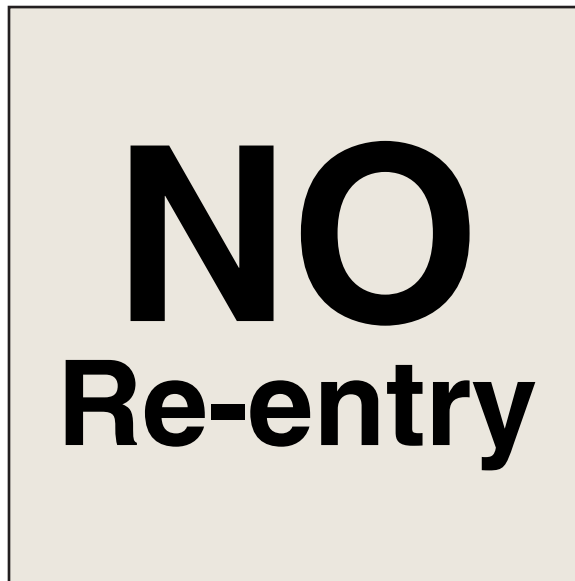

Message Layout

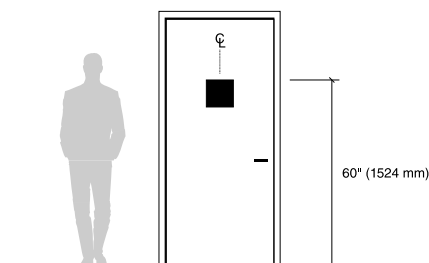

IN-01.30

Code & Life Safety Signage Drawings

No Re-Entry Sign

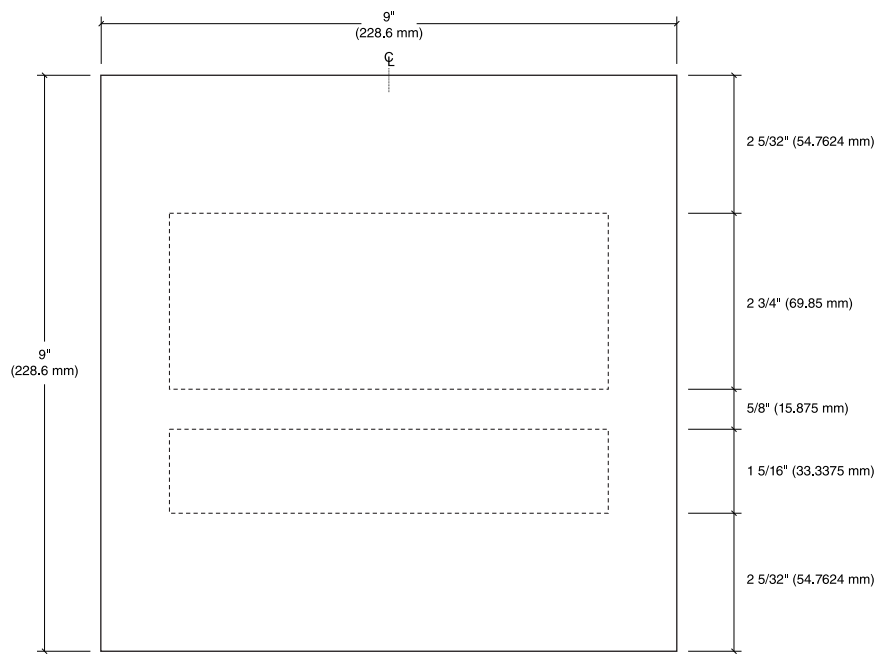

Message Layout



IN-01.31

Code & Life Safety Signage Drawings

Fire Extinguisher Identification Flag Sign

Size

9" High x 9" Wide
(228.6 mm H x 228.6 mm W)

Description and Use

Fire extinguisher identification sign is a flag sign used to identify a fire extinguisher cabinet.

Use this sign in lieu of sign IN-01.02 except where there is a dead-end corridor in which viewing the sign would be difficult.

Message Configuration

Refer to layout drawing for lettering sizes and dimensions.

Sign Components

Acrylic plaque with aluminum bracket for flag mounting

Graphic Process

Direct digital print on second surface or silk-screened

Colors

Text and Symbol: White
Background: Red
Bracket: Aluminum
Refer to the chart in the Appendix.

Typography

Helvetica Bold

Mounting

Mechanical fasteners with expandable anchors as needed for wall type

Installation

Mount on wall centered above fire extinguisher cabinet. A flag-mounted sign should always be placed with the bottom of the sign at a minimum height at 80" (2032 mm) for clearance of pedestrians and equipment.



Message Layout

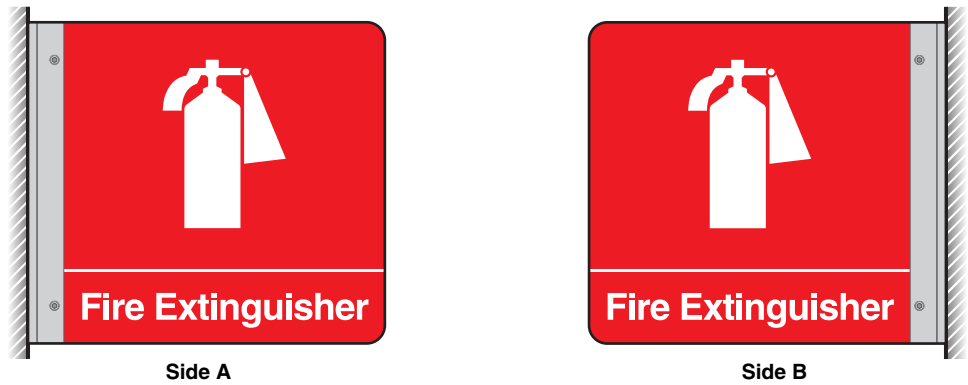

Side A

Side B

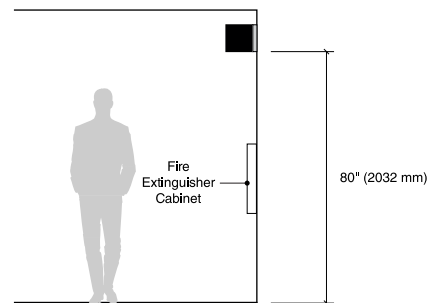

Fire Extinguisher Identification Flag Sign

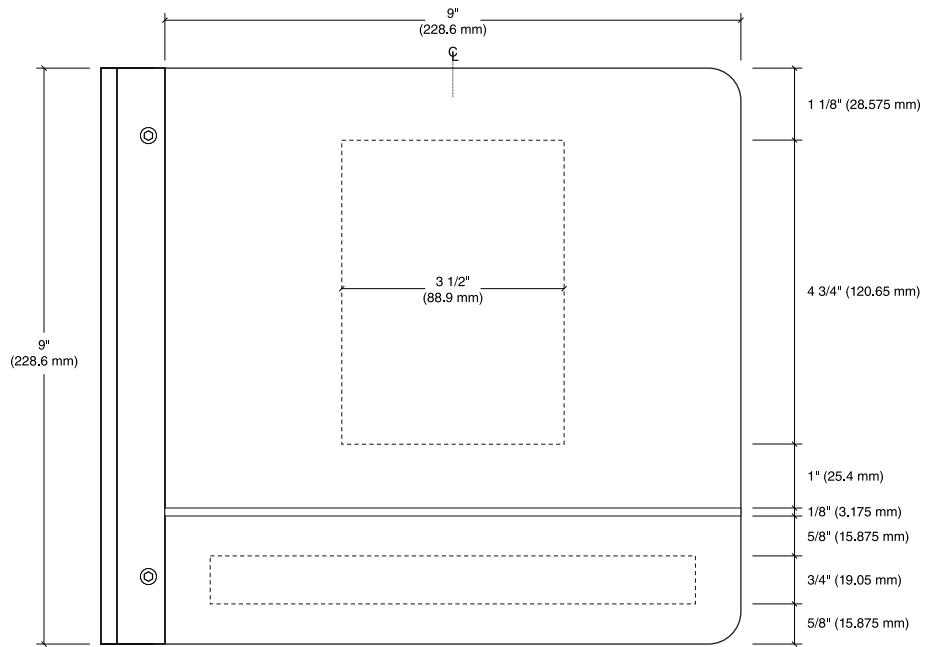

Message Layout



IN-01.32

Code & Life Safety Signage Drawings

Pregnancy Notification Sign

Size

9" High x 9" Wide
(228.6 mm H x 228.6 mm W)

Description and Use

Pregnancy notification sign is used to convey a request for patient information. Sign is placed in patient waiting areas, treatment rooms, and dressing rooms.

Messaging Configuration

Refer to layout drawing for lettering sizes and dimensions.

Sign Components

Component based sign system

See [Section 2.1.5 Construction](#) for applicable component sign system styles.

Graphic Process

Direct digital print on second surface or silk-screened

Colors

Refer to the chart in the Appendix.

Typography

Helvetica Bold

Mounting

Preferred: Concealed mechanical fasteners

Alternate: Double-sided VHB foam tape and silicone adhesive

Installation

Mount on wall or door, 60" (1524 mm) to top or center of the sign.

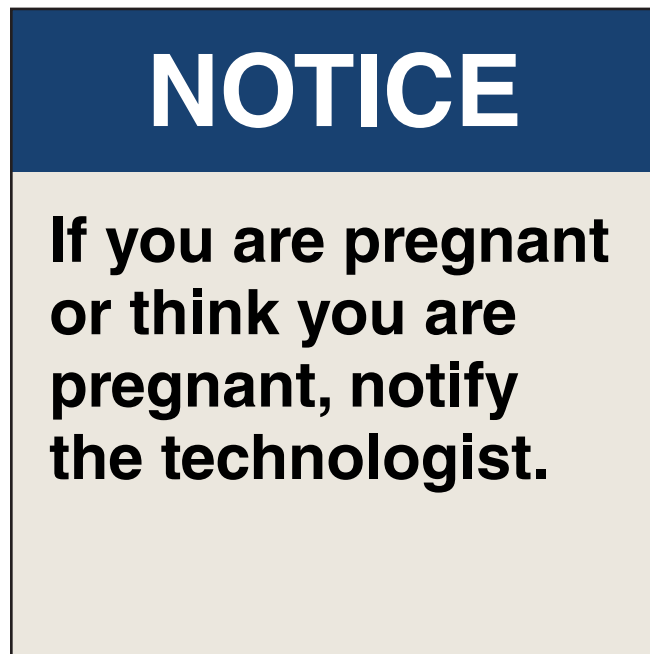

Message Layout

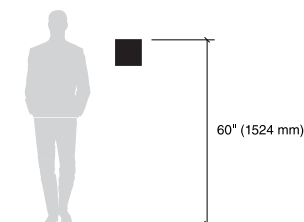

IN-01.32

Code & Life Safety Signage Drawings

Pregnancy Notification Sign

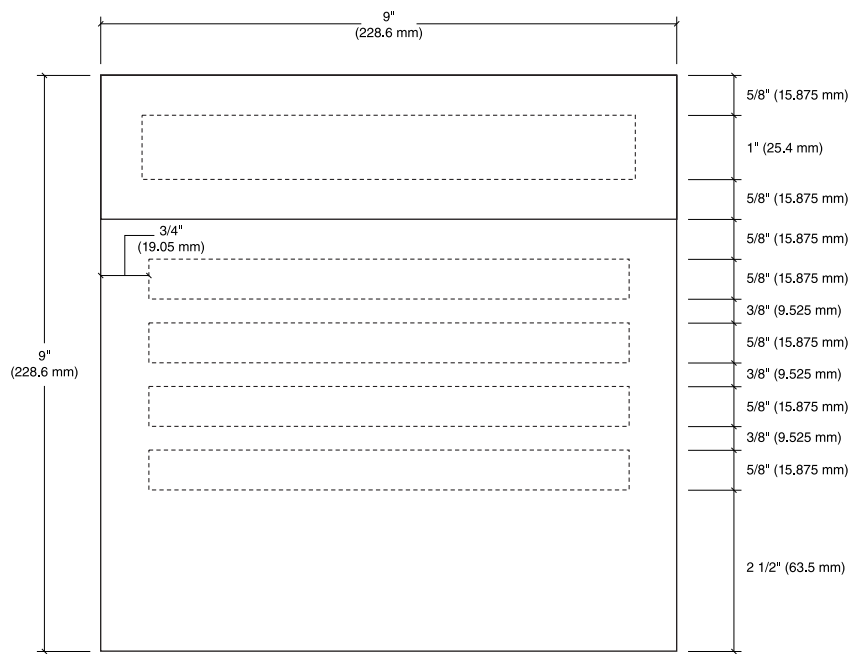

Message Layout



IN-01.33

Code & Life Safety Signage Drawings

Re-Entry Sign

Size

9" High x 9" Wide
(228.6 mm H x 228.6 mm W)

Description and Use

Re-entry sign is used to identify an entry door which will allow re-entry into room, floor, or building when door is shut.

Messaging Configuration

Refer to layout drawing for lettering sizes and dimensions.

Sign Components

Acrylic plaque

See [Section 2.1.6 Installation](#) for applicable acrylic construction.

Graphic Process

Direct digital print on second surface or silk-screened

Colors

Refer to the chart in the Appendix.

Typography

Helvetica Bold

Mounting

Double-sided VHB foam tape and silicone adhesive

Installation

Mount centered on door 60" (1524 mm) above finished floor to the center or top of the sign.

For sign placement refer to the Stairwell Guide in [Section 2.2.5 Installation](#)

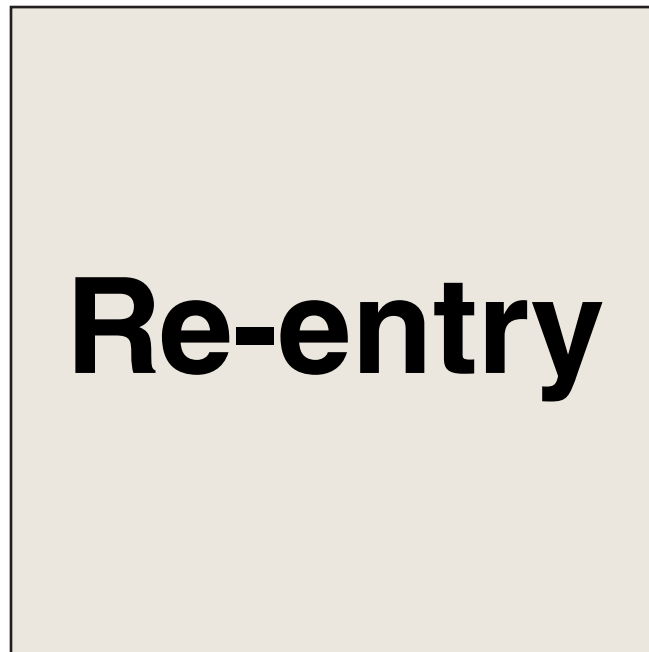

Message Layout

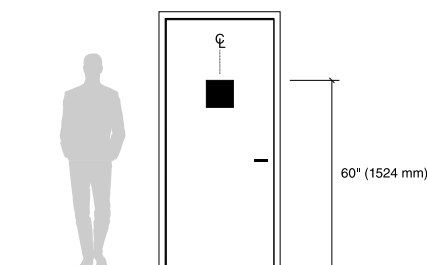

IN-01.33

Code & Life Safety Signage Drawings

Re-Entry Sign

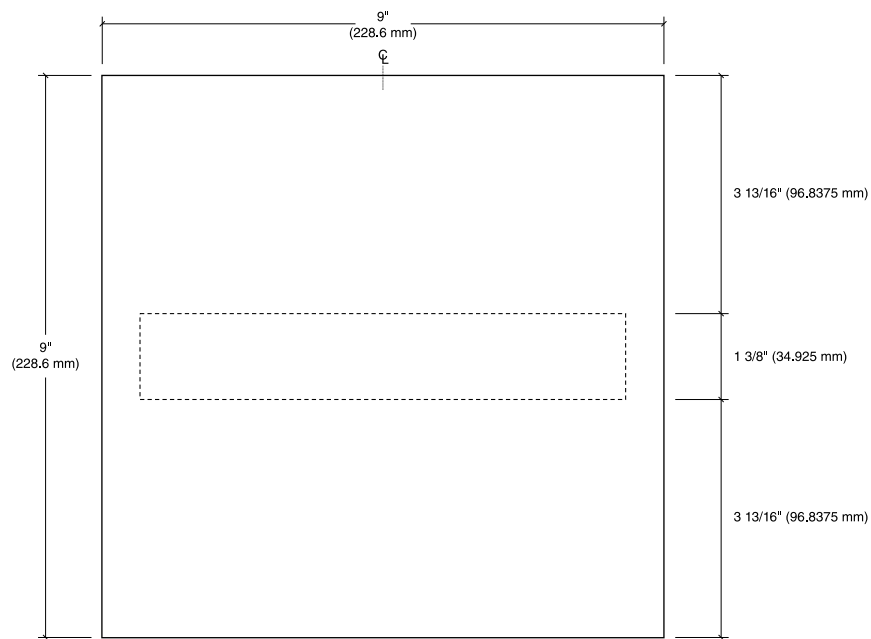

Message Layout



IN-01.34

Code & Life Safety Signage Drawings

Proper Attire Required Beyond this Point Sign

Size

9" High x 9" Wide
(228.6 mm H x 228.6 mm W)

Description and Use

This sign is used to identify spaces which require the observer to wear proper medical attire before entering.

Messaging Configuration

Refer to layout drawing for lettering sizes and dimensions.

Sign Components

Component-based sign system (wall mount) or acrylic plaque (door mount).

See [Section 2.1.5 Construction](#) & [2.1.6 Installation](#) for applicable component sign system styles and acrylic construction.

Graphic Process

Direct digital print on second surface or silk-screened

Colors

Refer to the chart in the Appendix.

Typography

Helvetica Bold

Mounting

Preferred: Concealed mechanical fasteners

Alternate: Double-sided VHB foam tape and silicone adhesive

Installation

Mount on wall or door, 60" (1524 mm) to top of sign. If installed on door, it should be on center.

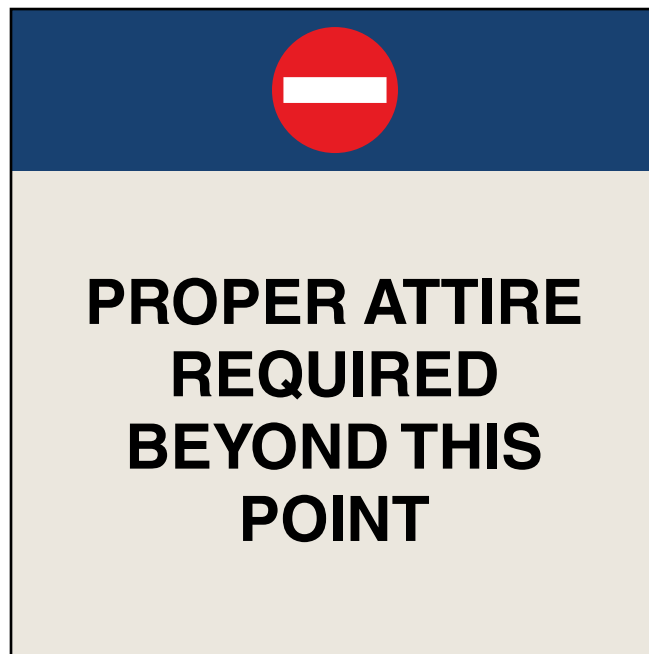

Message Layout

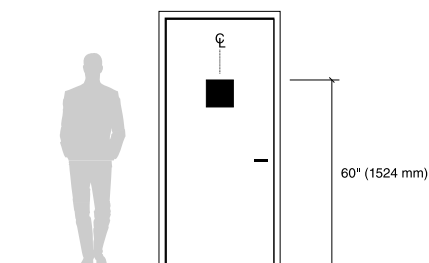

IN-01.34

Code & Life Safety Signage Drawings

Proper Attire Required Beyond this Point Sign

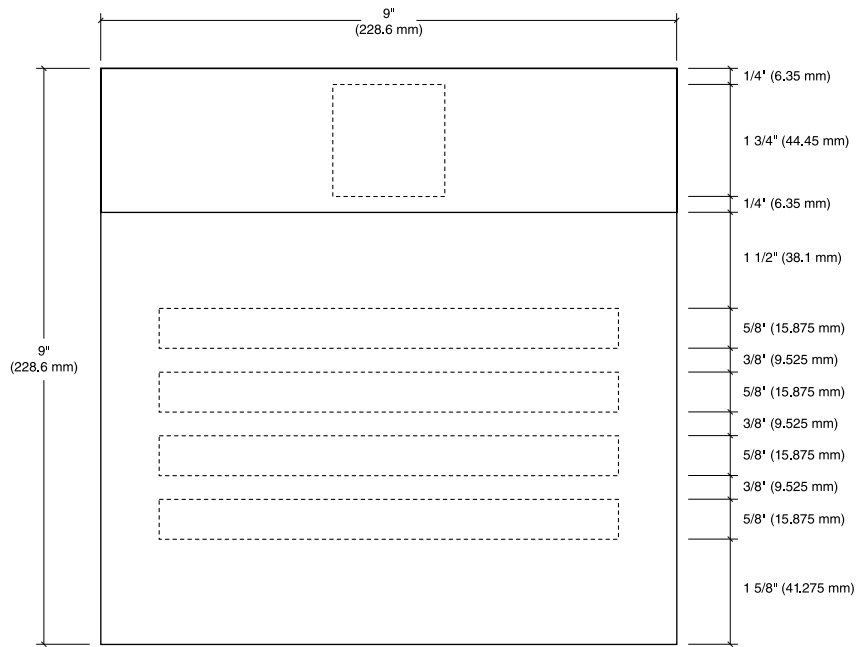

Message Layout



IN-01.35

Code & Life Safety Signage Drawings

Radiation Warning Sign

Size

9" High x 9" Wide
(228.6 mm H x 228.6 mm W)

Description and Use

Caution information regarding spaces with equipment that are actively producing radiation such as X-Ray machines.

Sign is to be installed on the doors to all rooms where these conditions are met.

Messaging Configuration

Refer to layout drawing for lettering sizes and dimensions.

Sign Components

Acrylic plaque

See [Section 2.1.6 Installation](#) for applicable acrylic construction.

Graphic Process

Direct digital print on second surface or silk-screened

Colors

Text: Black
Symbol: Purple
Background: Yellow
Refer to the chart in the Appendix.

Typography

Helvetica Bold

Mounting

Double-sided VHB foam tape and silicone adhesive

Installation

Mount centered on door 60" (1524 mm) above finished floor to the center or top of the sign.

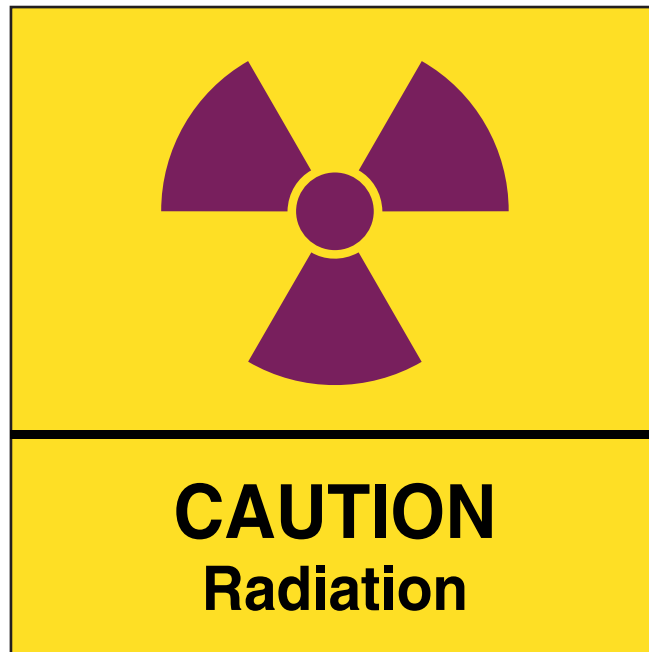

Message Layout

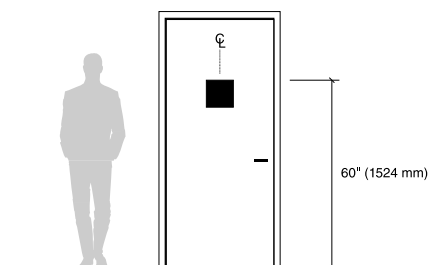

IN-01.35

Code & Life Safety Signage Drawings

Radiation Warning Sign

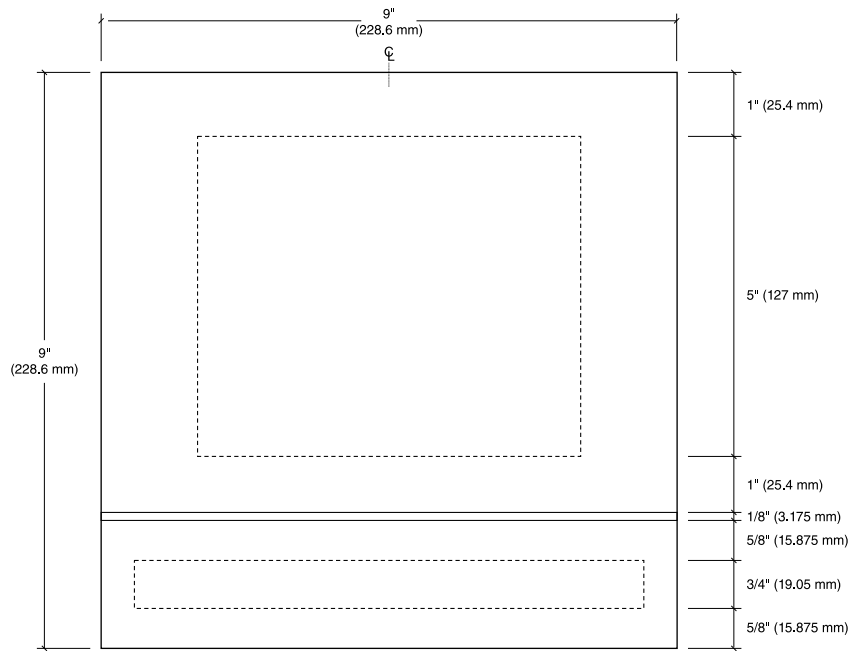

Message Layout



IN-01.36

Code & Life Safety Signage Drawings

AED Identification Flag Sign

Size

9" High x 9" Wide
(228.6 mm H x 228.6 mm W)

Description and Use

Automated External Defibrillator sign is a flag sign used to identify an AED cabinet.

Message Configuration

Refer to layout drawing for lettering sizes and dimensions.

Sign Components

Acrylic plaque with aluminum bracket for flag mounting

Graphic Process

Direct digital print on second surface or silk-screened

Colors

Text and Symbol: Red & Black
Background: White
Bracket: Aluminum
Refer to the chart in the Appendix.

Typography

Helvetica Bold

Mounting

Mechanical fasteners with expandable anchors as needed for wall type

Installation

Mount on wall centered above AED cabinet. A flag-mounted sign should always be placed with the bottom of the sign at a minimum height at 80" (2032 mm) for clearance of pedestrians and equipment.

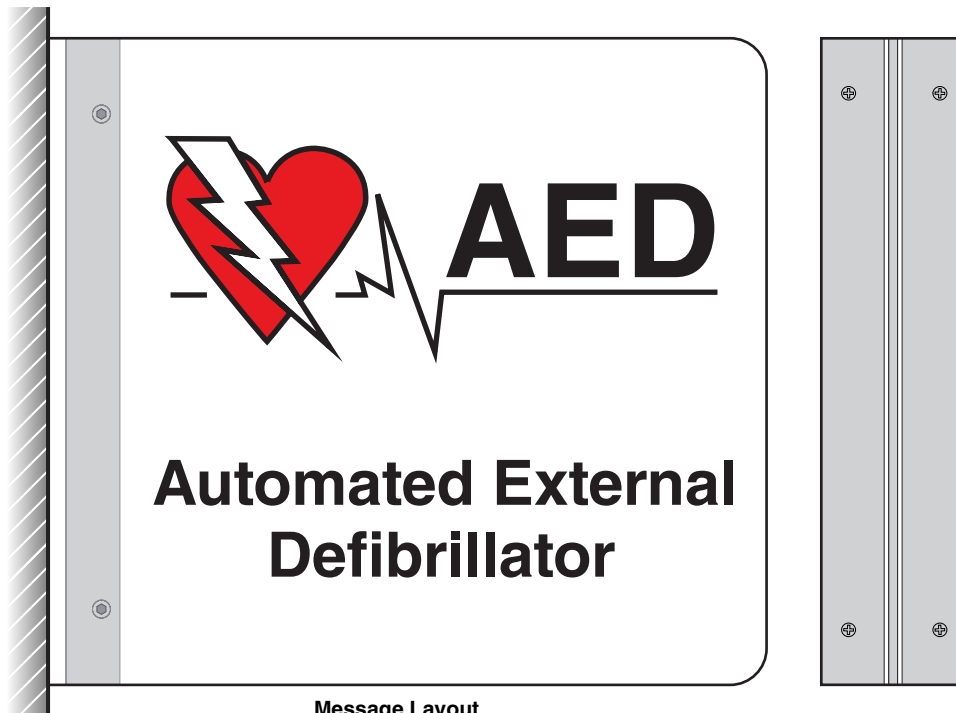

Message Layout



Side A

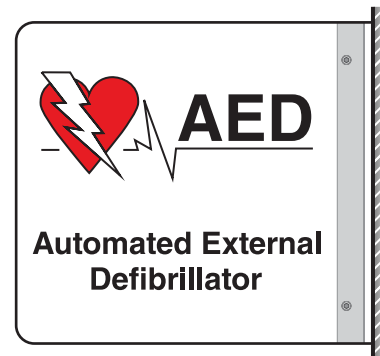

Side B

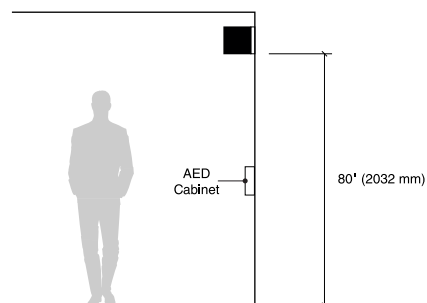

AED Identification Flag Sign

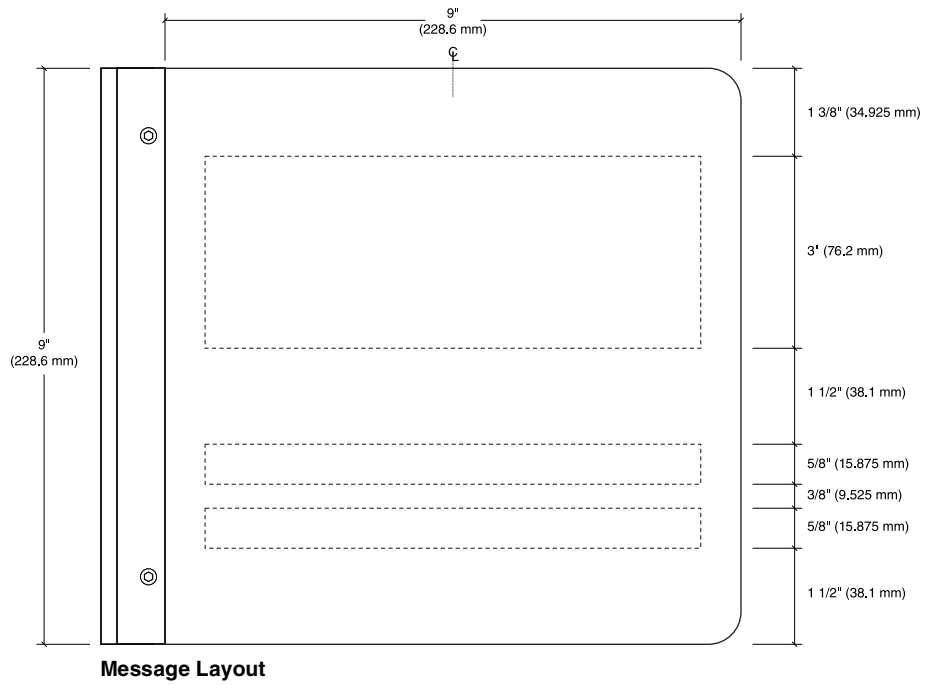

IN-01.37

Code & Life Safety Signage Drawings

Crash Cart Identification Flag Sign

Size

9" High x 9" Wide
(228.6 mm H x 228.6 mm W)

Description and Use

Crash Cart sign is a flag sign used to identify crash cart locations.

Message Configuration

Refer to layout drawing for lettering sizes and dimensions.

Sign Components

Acrylic plaque with aluminum bracket for flag mounting

Graphic Process

Direct digital print on second surface or silk-screened

Colors

Text and Symbol: White
Background: Red
Bracket: Aluminum
Refer to the chart in the Appendix.

Typography

Helvetica Bold

Mounting

Mechanical fasteners with expandable anchors as needed for wall type

Installation

Mount on wall centered above crash cart. A flag-mounted sign should always be placed with the bottom of the sign at a minimum height at 80" (2032 mm) for clearance of pedestrians and equipment.

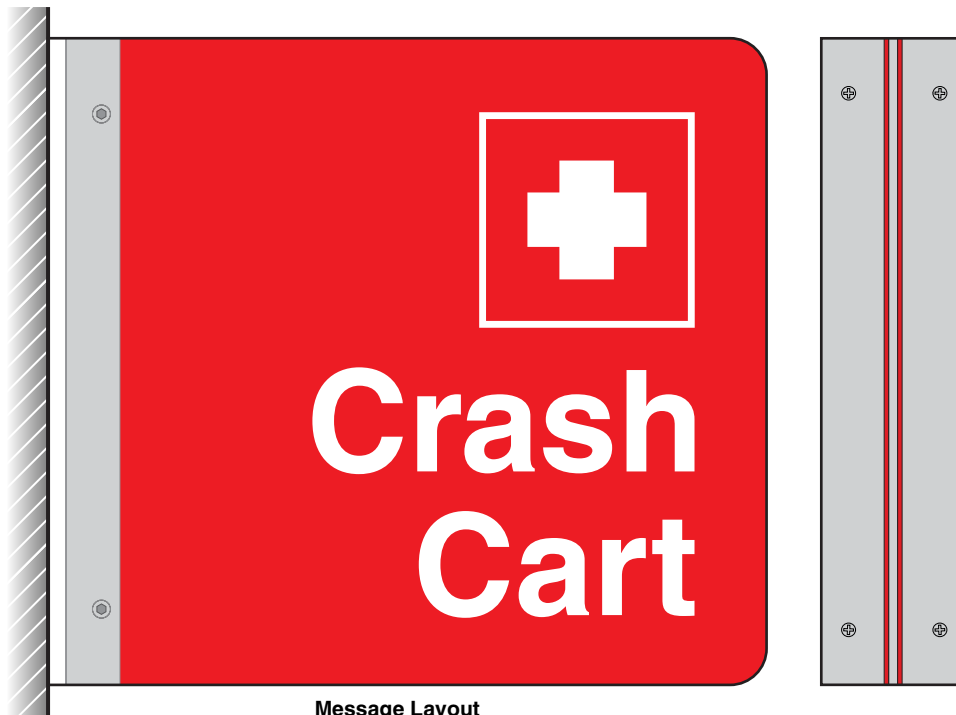

Message Layout

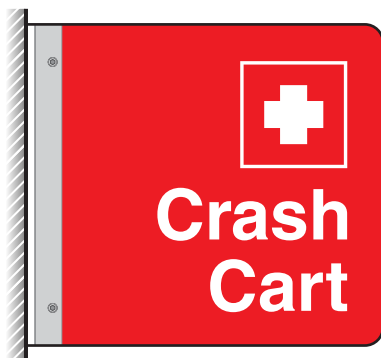

Side A

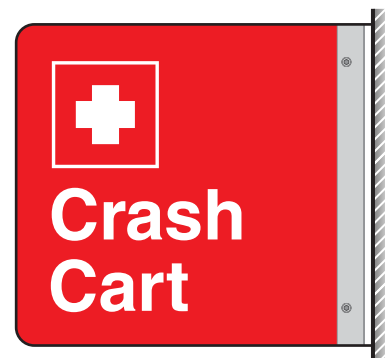

Side B

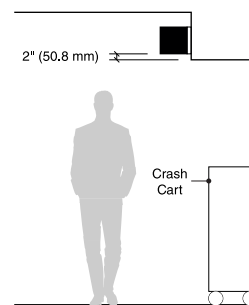
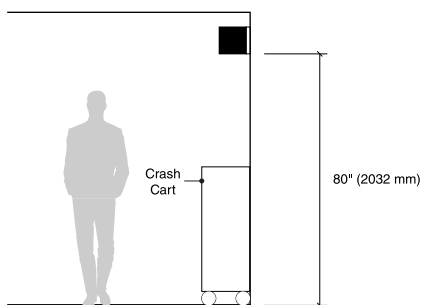

IN-01.37

Code & Life Safety Signage Drawings

Crash Cart Identification Flag Sign

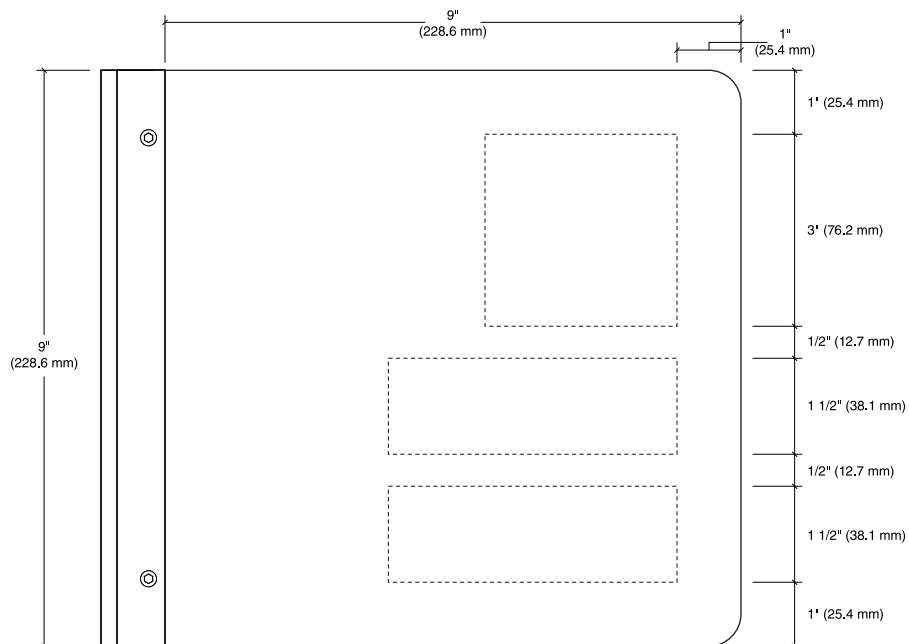

Message Layout



IN-01.38

Code & Life Safety Signage Drawings

Emergency Eye Wash Station Sign

Size

9" High x 9" Wide
(228.6 mm H x 228.6 mm W)

Description and Use

Sign indicating nearby eye wash station for use in emergency situations.

Messaging Configuration

Refer to layout drawing for lettering sizes and dimensions.

Sign Components

Component based sign system

See [Section 2.1.5 Construction](#) for applicable component sign system styles.

Graphic Process

Direct digital print on second surface or silk-screened

Colors

Refer to the chart in the Appendix.

Typography

Helvetica Bold

Mounting

Preferred: Concealed mechanical fasteners

Alternate: Double-sided VHB foam tape and silicone adhesive

Installation

Mount on wall adjacent eye wash station, typically 60" (1524 mm) to top or center of sign.



Message Layout

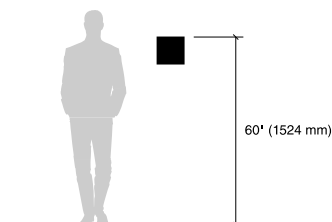

Emergency Eye Wash Station Sign

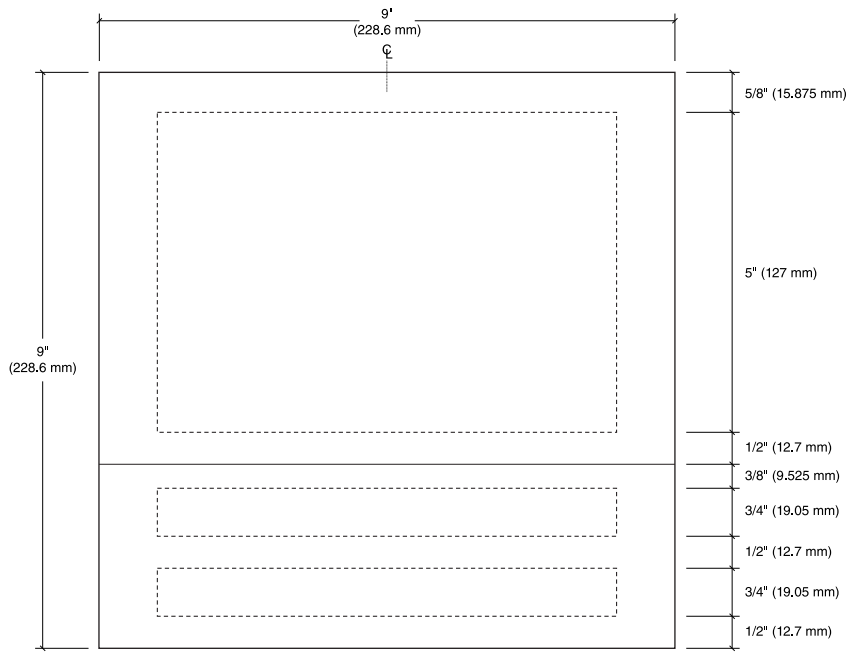

Message Layout



IN-01.39

Code & Life Safety Signage Drawings

Emergency Shower Sign

Size

9" High x 9" Wide
(228.6 mm H x 228.6 mm W)

Description and Use

Sign indicating nearby emergency shower for use in emergency situations.

Messaging Configuration

Refer to layout drawing for lettering sizes and dimensions.

Sign Components

Component based sign system

See [Section 2.1.5 Construction](#) for applicable component sign system styles.

Graphic Process

Direct digital print on second surface or silk-screened

Colors

Refer to the chart in the Appendix.

Typography

Helvetica Bold

Mounting

Preferred: Concealed mechanical fasteners
Alternate: Double-sided VHB foam tape and silicone adhesive

Installation

Mount on wall adjacent emergency shower, typically 60" (1524 mm) to top or center of sign.



Message Layout

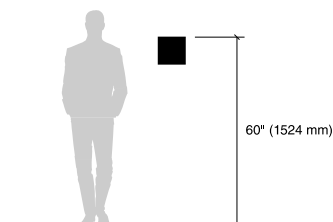

IN-01.39

Code & Life Safety Signage Drawings

Emergency Shower Sign

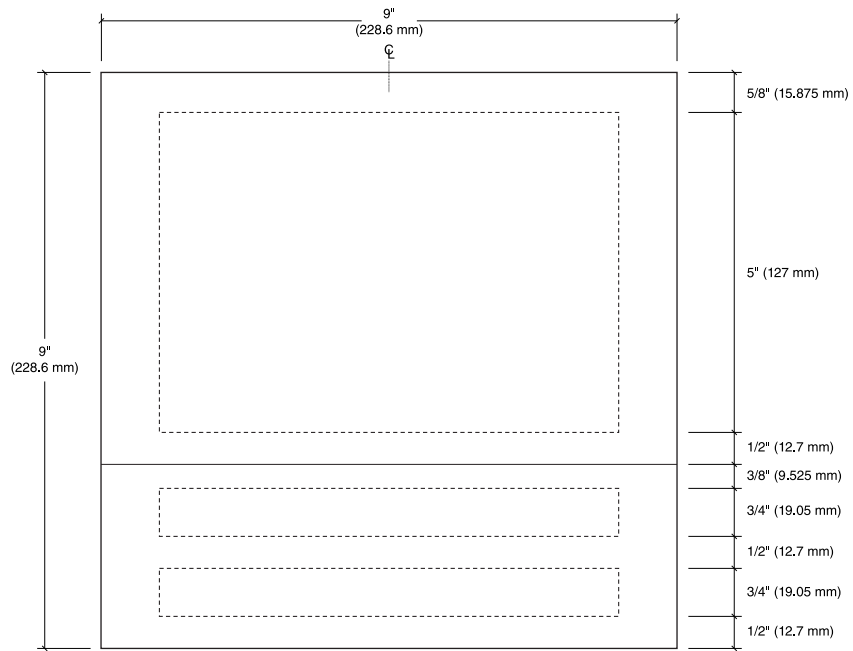

Message Layout



IN-01.40

Code & Life Safety Signage Drawings

Emergency Shower / Emergency Eye Wash Station Sign

Size

9" High x 9" Wide
(228.6 mm H x 228.6 mm W)

Description and Use

Sign indicating nearby emergency shower and emergency eye wash station for use in emergency situations.

Messaging Configuration

Refer to layout drawing for lettering sizes and dimensions.

Sign Components

Component based sign system

See [Section 2.1.5 Construction](#) for applicable component sign system styles.

Graphic Process

Direct digital print on second surface or silk-screened

Colors

Refer to the chart in the Appendix.

Typography

Helvetica Bold

Mounting

Preferred: Concealed mechanical fasteners
Alternate: Double-sided VHB foam tape and silicone adhesive

Installation

Mount on wall adjacent emergency eye wash / shower, typically 60" (1524 mm) to top or center of sign.



Message Layout

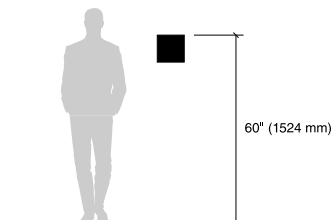

IN-01.40

Code & Life Safety Signage Drawings

Emergency Shower / Emergency Eye Wash Station Sign

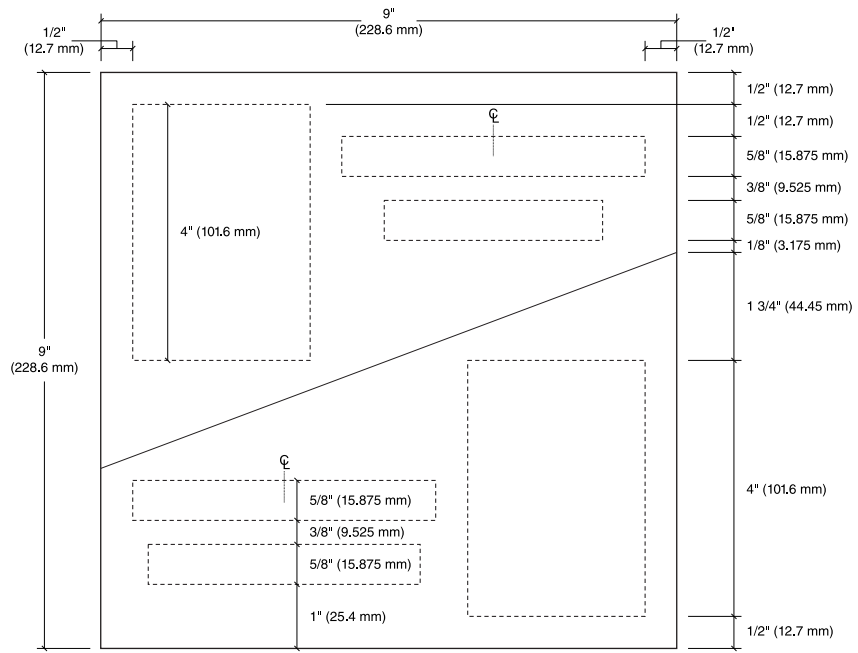

Message Layout





U.S. Department
of Veterans Affairs

SECTION 3.3

MANDATORY VA POLICY & DIRECTIVE SIGNAGE DRAWINGS



Introduction

This section is comprised of policy and regulations that are REQUIRED to be posted by applicable codes, laws, and VA Policy Directive. Only mandatory postings are included in this section. Other types of signs required by code, regulatory bodies, or VA Policy Directive are found in each respective section of this Manual (Section 3.1, Section 3.2, and Section 3.5).

The following drawings provide general design intent and do not function as fabrication-ready shop drawings.

Guidelines

- This section covers the mandatory postings at the time of publication. VA Policy Directives constantly evolve and change, so check for any VA Policy Directives issued after the date of this publication that require signage to be posted.
- Component-based sign systems used should match the established sign standard specific to the individual facility.
- Please review [Section 2.3 Mandatory VA Policy & Directive Signage Guidelines](#) which contains information regarding Planning, Programming, Construction, and Installation prior to starting signage projects.
- Creative example configurations of mandatory entrance signs can be found at the end of this section.

Requirements

- The content for each mandatory posting in this section is not open to modification or revision unless specifically stated in drawing notes.
- All Mandatory VA Policy & Directives signs are to be fabricated, located, and installed per the specifications contained in this section and [Section 2.3](#).
- The use of component-based sign systems is required at VA facilities except for door-mounted signs (see [Sections 2.1.5 & 2.1.6](#)). The exact materials, parts, finishes, and dimensions of a component sign system will vary by manufacturer.

Updatable Inserts

- To increase durability and moisture resistance, updatable inserts should be printed on synthetic paper or clear acetate sheets. Standard printer paper can absorb moisture causing wrinkles and yellowing over time.



Sign Designations

Each sign in the program manual has been given a specific sign type number designation. This designation provides a common description that can be referenced when programming a site and ordering signs. The following explains how the sign type designations are derived.

Note: This Section includes both interior and exterior Mandatory VA Policy & Directive signs despite being attributed with the prefix "IN".

For the sake of consistency amongst all VA official documentation, no sign designation shall change within this manual without the express written consent of the VA, followed by a VA Design Alert that is distributed on a monthly basis.

IN - 02 .06 A

- I** Designates an interior sign.
- N** Identifies that the sign is non-illuminated.
- 02** Two-digit numbers identify a particular sign type family.
- .01** The two-digit number following the period identifies a specific sign within the sign family.
- A** The letter designates a specific sign configuration, version, or layout for graphics.



Sign Overview

Mandatory VA Policy & Directive Signage Drawings

IN-02.01
Consent to Inspection Sign

IN-02.10
No Weapons Notice Sign - Interior

IN-02.03
No Weapons Permitted Sign

IN-02.01 **IN-02.10** **IN-02.03**

IN-02.14
Video Surveillance Sign

IN-02.15
Service Dogs Sign

IN-02.02
No Smoking, No Vaping Sign

IN-02.14 **IN-02.15** **IN-02.02**

Sign Overview

Mandatory VA Policy & Directive Signage Drawings

Grouped Signs

Signs may be combined as follows:

- IN-02.01 - Consent to Inspection
- IN-02.10 - No Weapons Notice
- IN-02.03 - No Weapons Policy

- IN-02.14 – Video Surveillance
- IN-02.15 – Service Dogs
- IN-02.02 – No Smoking, No Vaping

These signs can be grouped together in one display or broken into two displays of 3 signs each, following the same sequence.

Refer to the [Layout Examples](#) at the end of this section for how these signs and others may be configured on a wall.

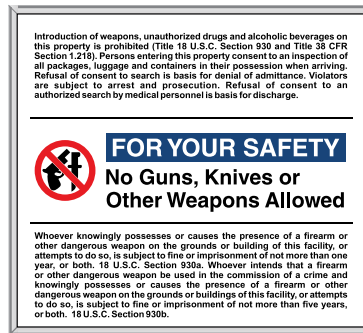

Grouped Signs: Multiple Panels



Grouped Signs: Single Panel

IN-02.04.01

Business Hours & Video Surveillance Sign - Vinyl

IN-02.04.02

Business Hours & Video Surveillance Sign - Exterior

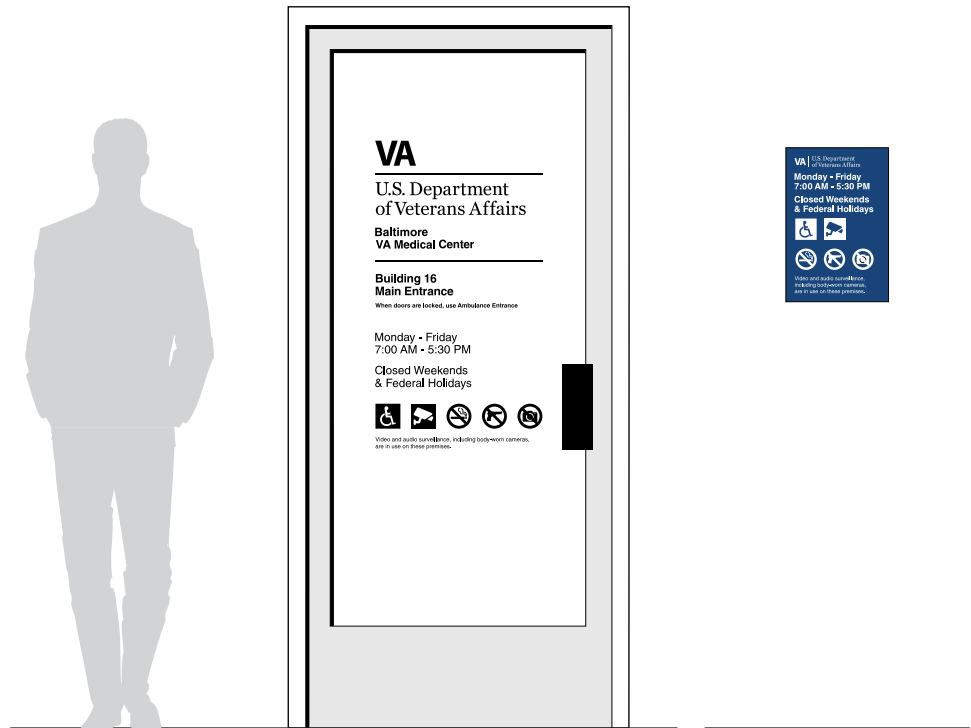

IN-02.04.01

IN-02.04.02



Sign Overview

Mandatory VA Policy & Directive Signage Drawings

IN-02.04.03

Business Hours Sign - Interior

IN-02.05

Notice of Weapons Search Sign

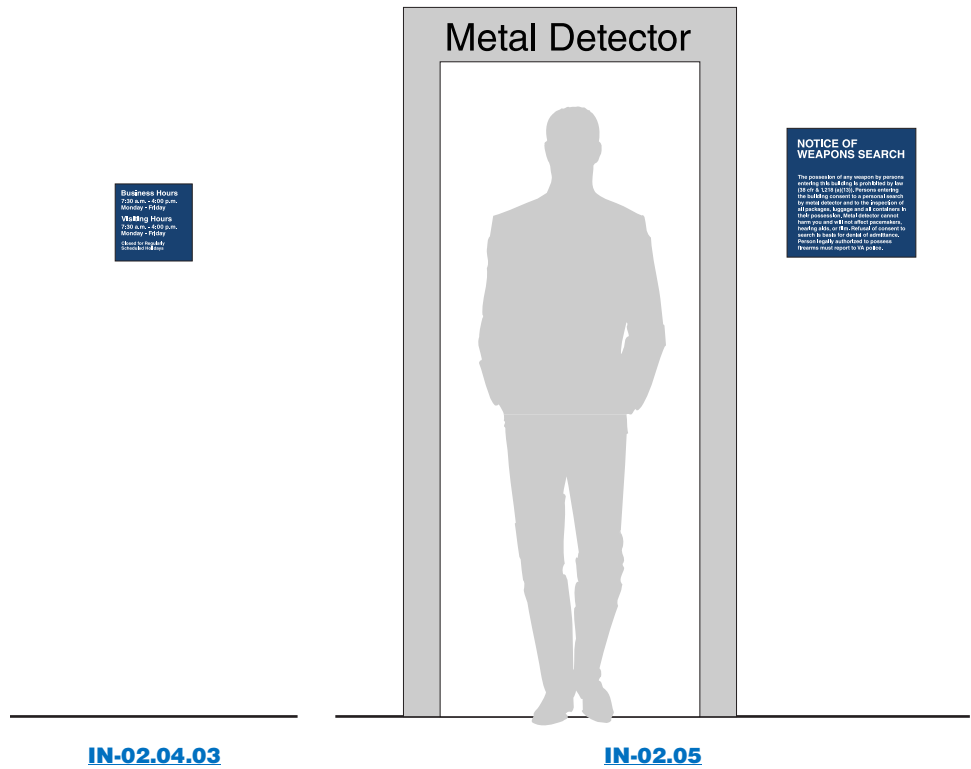

IN-02.04.03

IN-02.05

IN-02.06

Parking Restrictions Sign

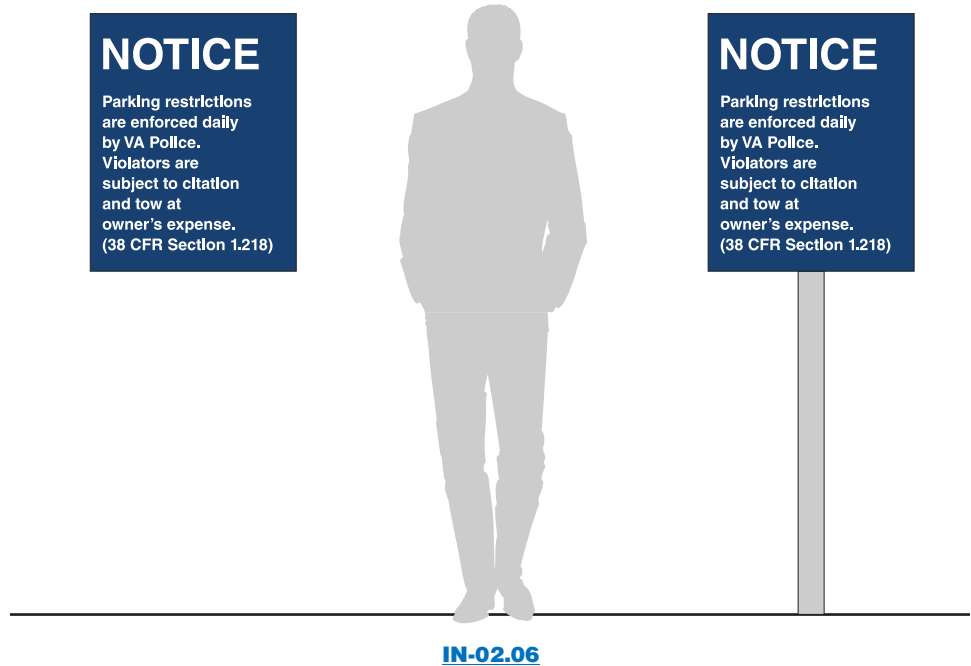

IN-02.06



Sign Overview

Mandatory VA Policy & Directive Signage Drawings

IN-02.07.01

Rights and Responsibilities of VA Patients

IN-02.07.02

Rights and Responsibilities of Family Members of VA Patients

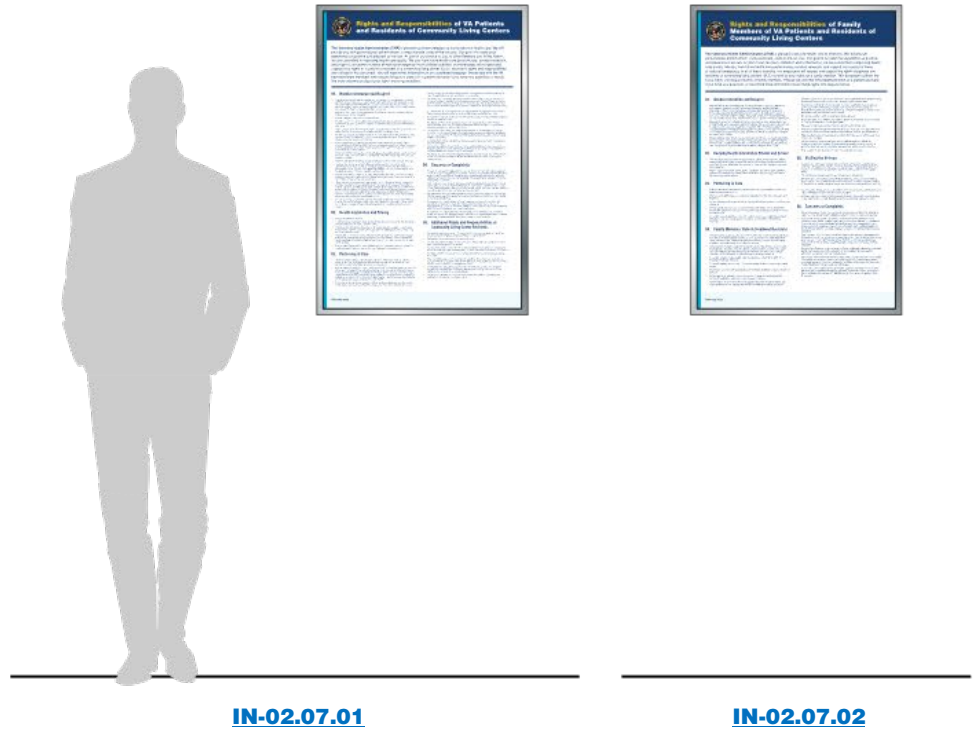

IN-02.07.03

Policies and Directives

IN-02.07.04

Notice of Privacy Practices

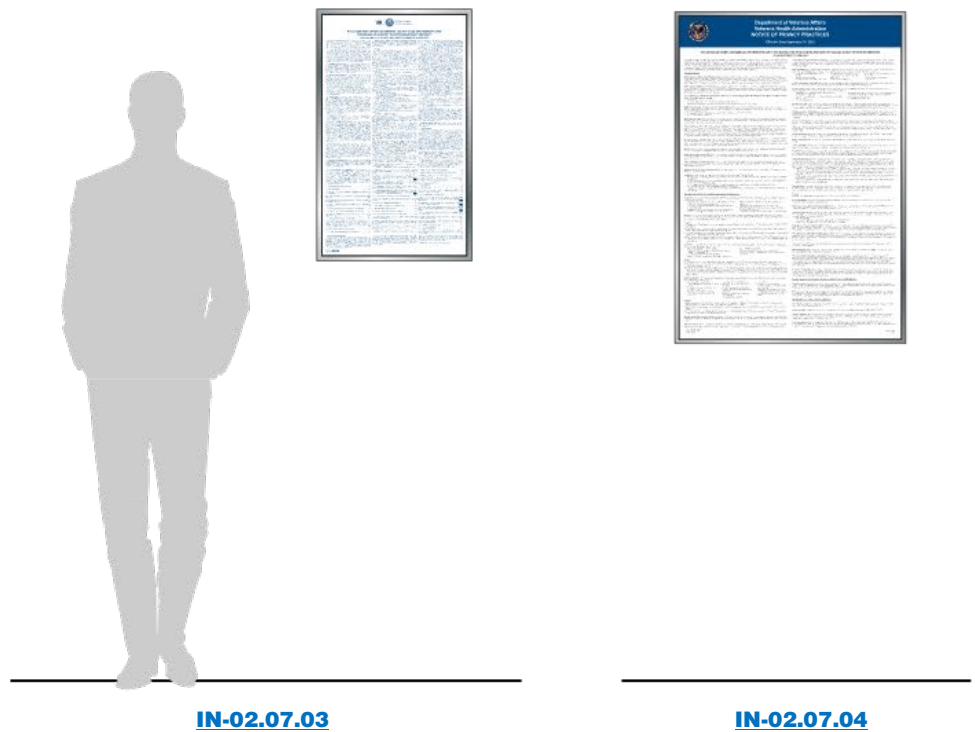

Sign Overview

Mandatory VA Policy & Directive Signage Drawings

IN-02.08

Anti-Sexual Harassment /
Anti-Sexual Assault

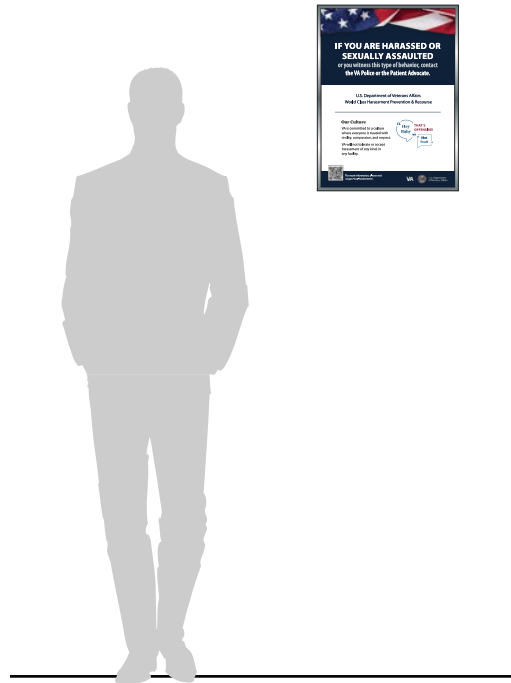

IN-02.08

IN-02.11

No Weapons Sign Large - Exterior

IN-02.12

No Weapons Sign Small - Exterior



IN-02.11

IN-02.12



Sign Overview

Mandatory VA Policy & Directive Signage Drawings

IN-02.13

Video Surveillance Sign - Exterior

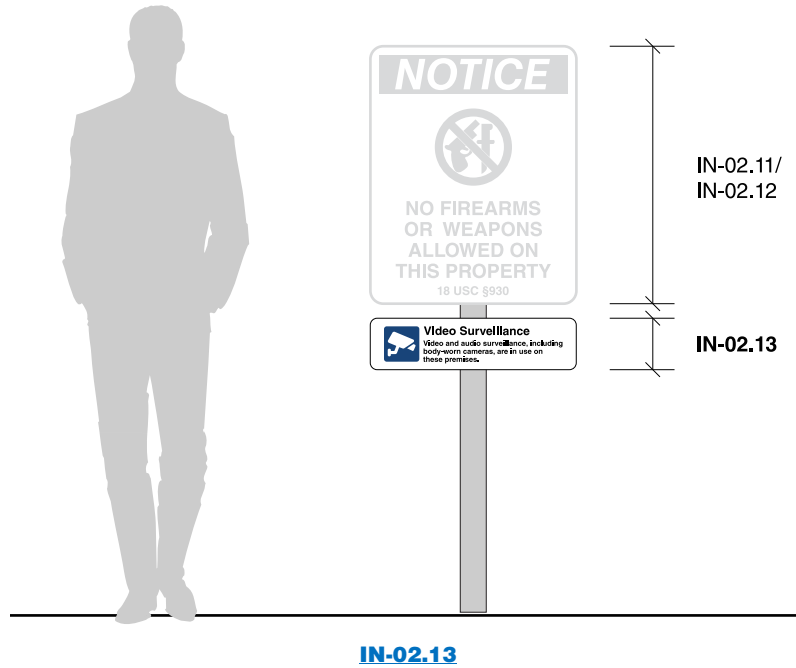

IN-02.16

No Trespassing Sign

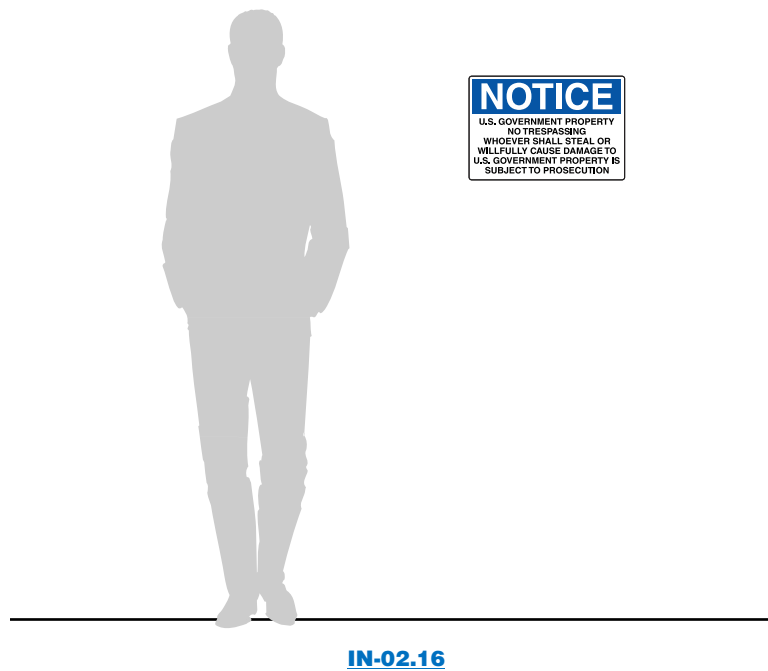

IN-02.01

Mandatory VA Policy & Directive Signage Drawings

Consent to Inspection Sign

Size

Sign Face:
6" High x 20" Wide
(152.4 mm H x 508 mm W)

Description

"Consent to Inspection" sign is required to be placed on an interior wall at all public entrances to a building.

Message Configuration

Refer to message layout drawing for dimensions. When combining 6" x 20" policy signs into one display, add a 1/16" rule line to separate each sign visually.

Sign Components

Component based signage system

Graphic Process

Direct digital print on second surface or silk-screened

Colors

Refer to the chart in the Appendix.

Typography

Helvetica Bold

Mounting

Preferred: Concealed mechanical fasteners
Alternate: Double-sided VHB foam tape and silicone adhesive

Installation

Display the 6" x 20" policy signs in the following sequence:

- IN-02.01 - Consent to Inspection
- IN-02.10 - No Weapons Notice
- IN-02.03 - No Weapons Policy

- IN-02.14 – Video Surveillance
- IN-02.15 – Service Dogs
- IN-02.02 – No Smoking, No Vaping

These signs can be grouped together in one display or broken into two displays of 3 signs each, following the same sequence.

Coordinate placement with other policy signs required at entrances.

See example layouts at the end of this section.

Introduction of weapons, unauthorized drugs and alcoholic beverages on this property is prohibited (Title 18 U.S.C. Section 930 and Title 38 CFR Section 1.218). Persons entering this property consent to an inspection of all packages, luggage and containers in their possession when arriving. Refusal of consent to search is basis for denial of admittance. Violators are subject to arrest and prosecution. Refusal of consent to an authorized search by medical personnel is basis for discharge.

Message Layout

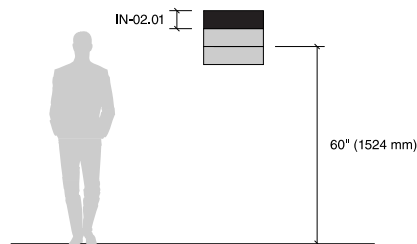

Adjust installation height as needed to coordinate with other policy signs.



IN-02.01

Mandatory VA Policy & Directive Signage Drawings

Consent to Inspection Sign

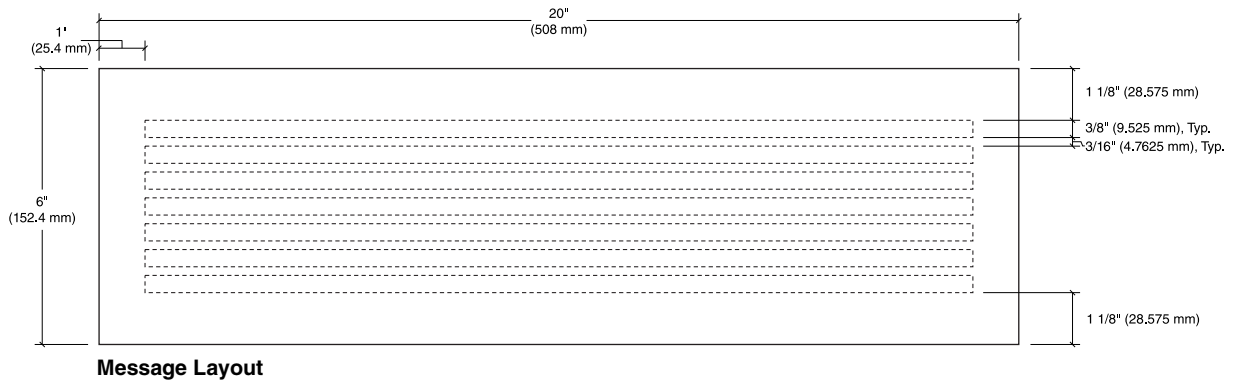

IN-02.02

Mandatory VA Policy & Directive Signage Drawings

No Smoking, No Vaping Sign

Size

Sign Face:
6" High x 20" Wide
(152.4 mm H x 508 mm W)

Description

"No Smoking, No Vaping" sign is required to be placed on an interior wall at all public entrances to a building.

Message Configuration

Refer to message layout drawing for dimensions. When combining 6" x 20" policy signs into one display, add a 1/16" rule line to separate each sign visually.

Sign Components

Component based sign system

Graphic Process

Direct digital print on second surface or silk-screened

Colors

Refer to the chart in the Appendix.

Typography

Helvetica Bold

Mounting

Preferred: Concealed mechanical fasteners
Alternate: Double-sided VHB foam tape and silicone adhesive

Installation

Display the 6" x 20" policy signs in the following sequence:

- IN-02.01 - Consent to Inspection
- IN-02.10 - No Weapons Notice
- IN-02.03 - No Weapons Policy

- IN-02.14 – Video Surveillance
- IN-02.15 – Service Dogs
- IN-02.02 – No Smoking, No Vaping

These signs can be grouped together in one display or broken into two displays of 3 signs each, following the same sequence.

Coordinate placement with other policy signs required at entrances.

See example layouts at the end of this section.

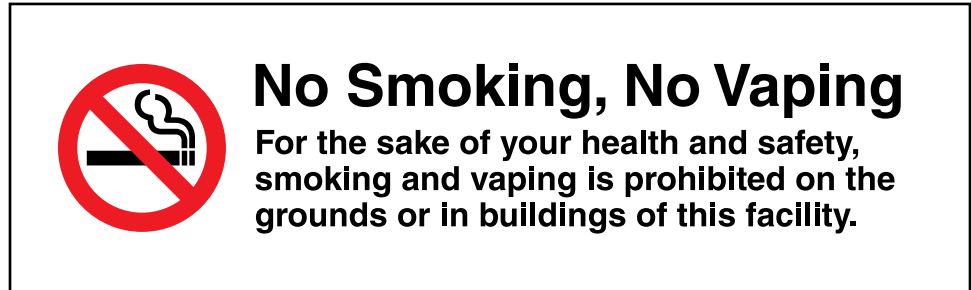

Message Layout

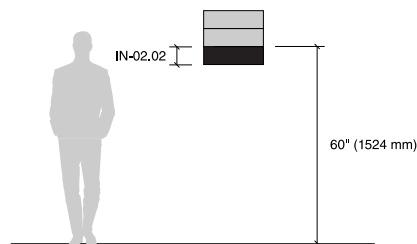

Adjust installation height as needed to coordinate with other policy signs.



IN-02.02

Mandatory VA Policy & Directive Signage Drawings

No Smoking or Vaping Sign

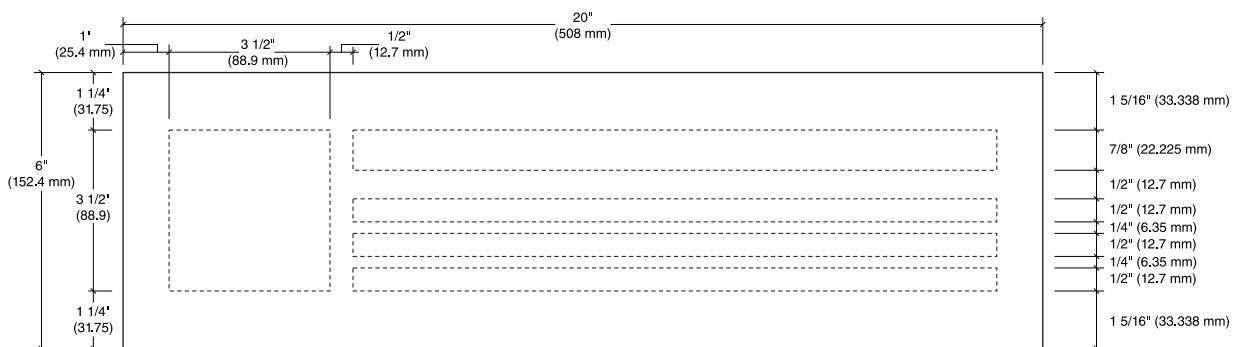

Message Layout



IN-02.03

Mandatory VA Policy & Directive Signage Drawings

No Weapons Permitted Sign

Size

Sign Face:
6" High x 20" Wide
(152.4 mm H x 508 mm W)

Description

"No Weapons Permitted" sign is required to be placed on an interior wall at all public entrances to a building.

Message Configuration

Refer to message layout drawing for dimensions. When combining 6" x 20" policy signs into one display, add a 1/16" rule line to separate each sign visually.

Sign Components

Component based sign system

Graphic Process

Direct digital print on second surface or silk-screened

Colors

Refer to the chart in the Appendix.

Typography

Helvetica Bold

Mounting

Preferred: Concealed mechanical fasteners
Alternate: Double-sided VHB foam tape and silicone adhesive

Installation

Display the 6" x 20" policy signs in the following sequence:

- IN-02.01 - Consent to Inspection
- IN-02.10 - No Weapons Notice
- IN-02.03 - No Weapons Policy

- IN-02.14 – Video Surveillance
- IN-02.15 – Service Dogs
- IN-02.02 – No Smoking, No Vaping

These signs can be grouped together in one display or broken into two displays of 3 signs each, following the same sequence.

Coordinate placement with other policy signs required at entrances.

See example layouts at the end of this section.

Whoever knowingly possesses or causes the presence of a firearm or other dangerous weapon on the grounds or building of this facility, or attempts to do so, is subject to fine or imprisonment of not more than one year, or both. 18 U.S.C. Section 930a. Whoever intends that a firearm or other dangerous weapon be used in the commission of a crime and knowingly possesses or causes the presence of a firearm or other dangerous weapon on the grounds or buildings of this facility, or attempts to do so, is subject to fine or imprisonment of not more than five years, or both. 18 U.S.C. Section 930b.

Message Layout

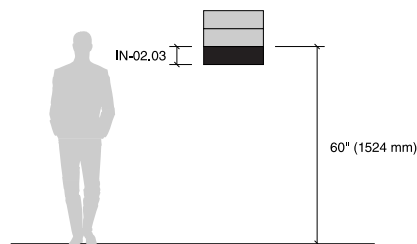

Adjust installation height as needed to coordinate with other policy signs.



IN-02.03

Mandatory VA Policy & Directive Signage Drawings

No Weapons Permitted Sign

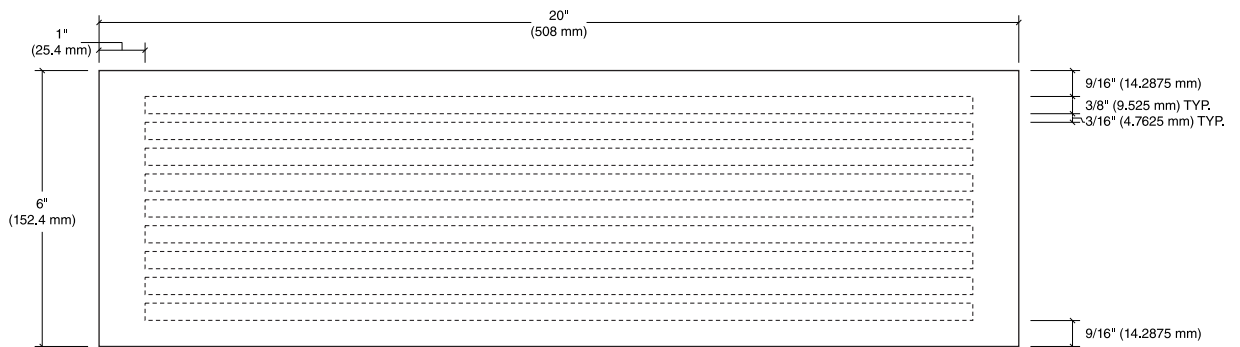

Message Layout



IN-02.04.01

Mandatory VA Policy & Directive Signage Drawings

Business Hours & Video Surveillance Sign – Vinyl

Size

Sign Characters: See layout

Overall Sign Height:
5'-6" High (1676.4 mm H)

Description

A "Business Hours" sign is required to be placed at public entrances to a building. In addition, the facility must notify individuals if they are subject to photography, digital recording or video or audio recording. This sign covers both requirements. Two options are provided:

- IN-02.04.01 - Glass Mount Option
- IN-02.04.02 - Wall Mount Option

Message Configuration

Refer to message layout drawing for dimensions.

Note: Hours and days of operation are to be established on a facility-by-facility bases.

Sign size, color and layout are not mandated and can be adjusted to appropriately fit use case.

Graphic Process

Surface applied white vinyl

Colors

Text: White
Do not use colored vinyl.
Refer to the chart in the Appendix.

Typography

Helvetica

Installation

On storefront: 5'-6" (1676.4 mm) to top of sign, at public entrances.

36 3/4"
(933.45 mm)

EN-14
Optional

3" (76.2 mm)

IN-02.04.01
Required

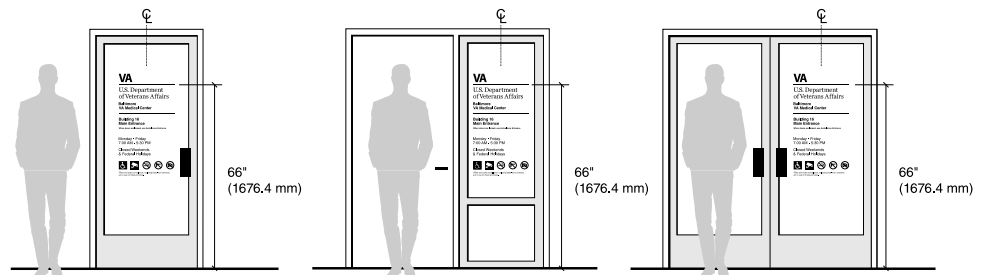

IN-02.04.01

Mandatory VA Policy & Directive Signage Drawings

Business Hours & Video Surveillance Sign – Vinyl



IN-02.04.02

Mandatory VA Policy & Directive Signage Drawings

Business Hours & Video Surveillance Sign – Exterior

Size

Sign Face:
18" High x 12" Wide
(457.2 mm H x 304.8 mm W)

Description

A "Business Hours" sign is required to be placed at public entrances to a building. In addition, the facility must notify individuals if they are subject to photography, digital recording or video or audio recording. This sign covers both requirements. Two options are provided:

IN-02.04.01 - Glass Mount Option
IN-02.04.02 - Wall Mount Option

Message Configuration

Refer to message layout drawing for dimensions.

Note: Hours and days of operation are to be established on a facility-by-facility bases.

Sign size, color and layout are not mandated and can be adjusted to appropriately fit use case.

Sign Components

Aluminum panel

Graphic Process

Surface applied white reflective vinyl.

Colors

Refer to the chart in the Appendix.

Typography

Helvetica Bold

Mounting

Mechanical fasteners

Installation

On wall: 60" (1524 mm) to center of sign, at public entrances.



Message Layout

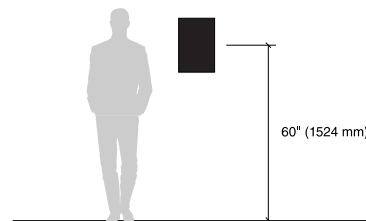

IN-02.04.02

Mandatory VA Policy & Directive Signage Drawings

Business Hours & Video Surveillance Sign – Exterior

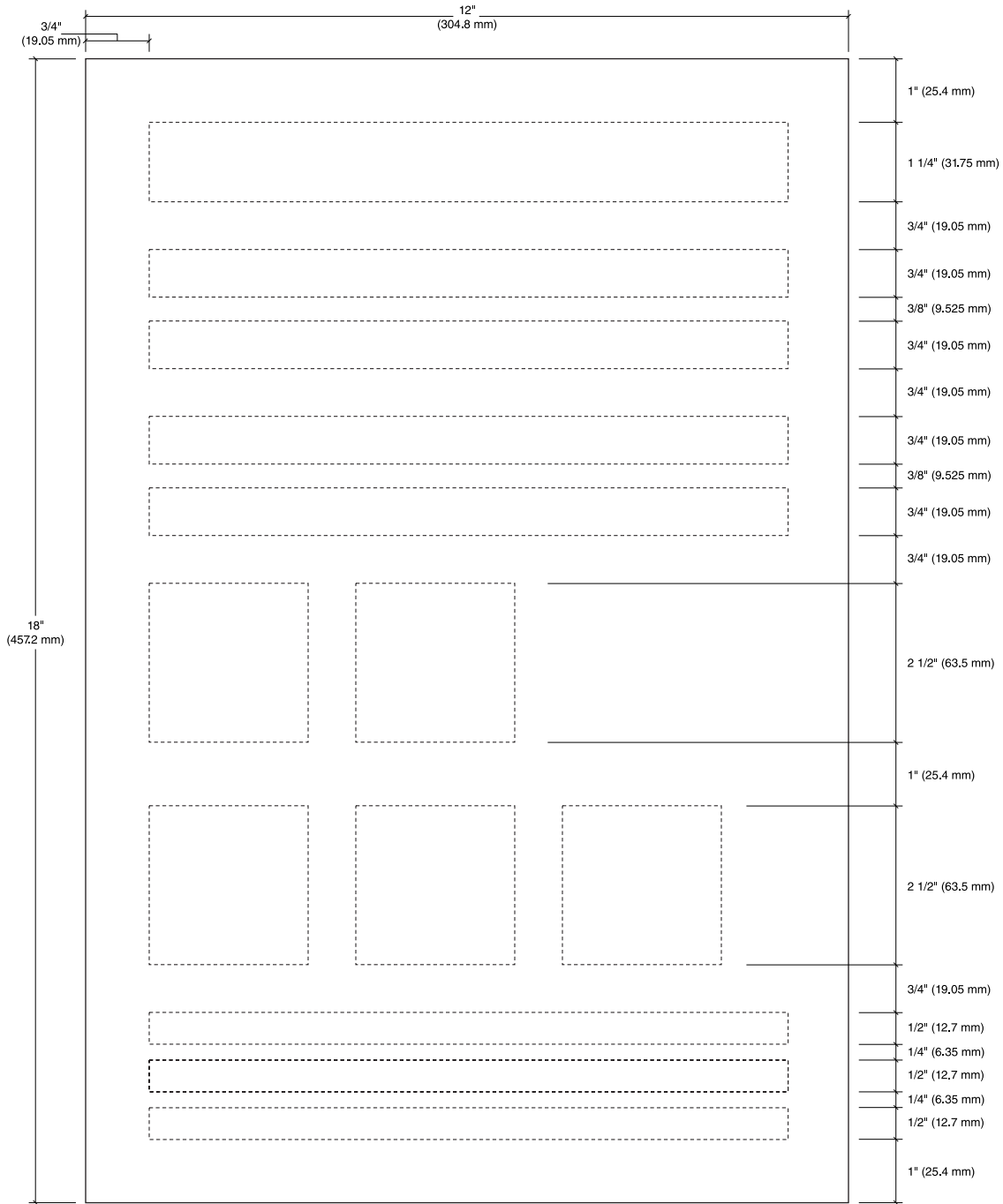

Message Layout



IN-02.04.03

Mandatory VA Policy & Directive Signage Drawings

Business Hours Sign – Interior

Size

Sign Face:
9" High x 9" Wide
(228.6 mm H x 228.6 mm W)

Description

"Business Hours" sign required to be placed at interior locations where hours of operations differ from the rest of the campus.

Message Configuration

Refer to message layout drawing for dimensions.

Note: Hours and days of operation are to be established on a case-by-case basis.

Sign size, color and layout are not mandated and can be adjusted to appropriately fit use case.

Sign Components

Component based sign system

Graphic Process

Direct digital print on second surface or silk-screened

Colors

Refer to the chart in the Appendix.

Typography

Helvetica Bold

Mounting

Preferred: Concealed mechanical fasteners

Alternate: Double-sided VHB foam tape and silicone adhesive

Installation

On wall: 5'-0" (1524 mm) to top of sign, at the entrance to the department / location where hours differ from the rest of the campus.



Message Layout

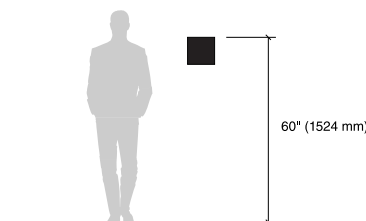

IN-02.04.03

Mandatory VA Policy & Directive Signage Drawings

Business Hours Sign – Interior

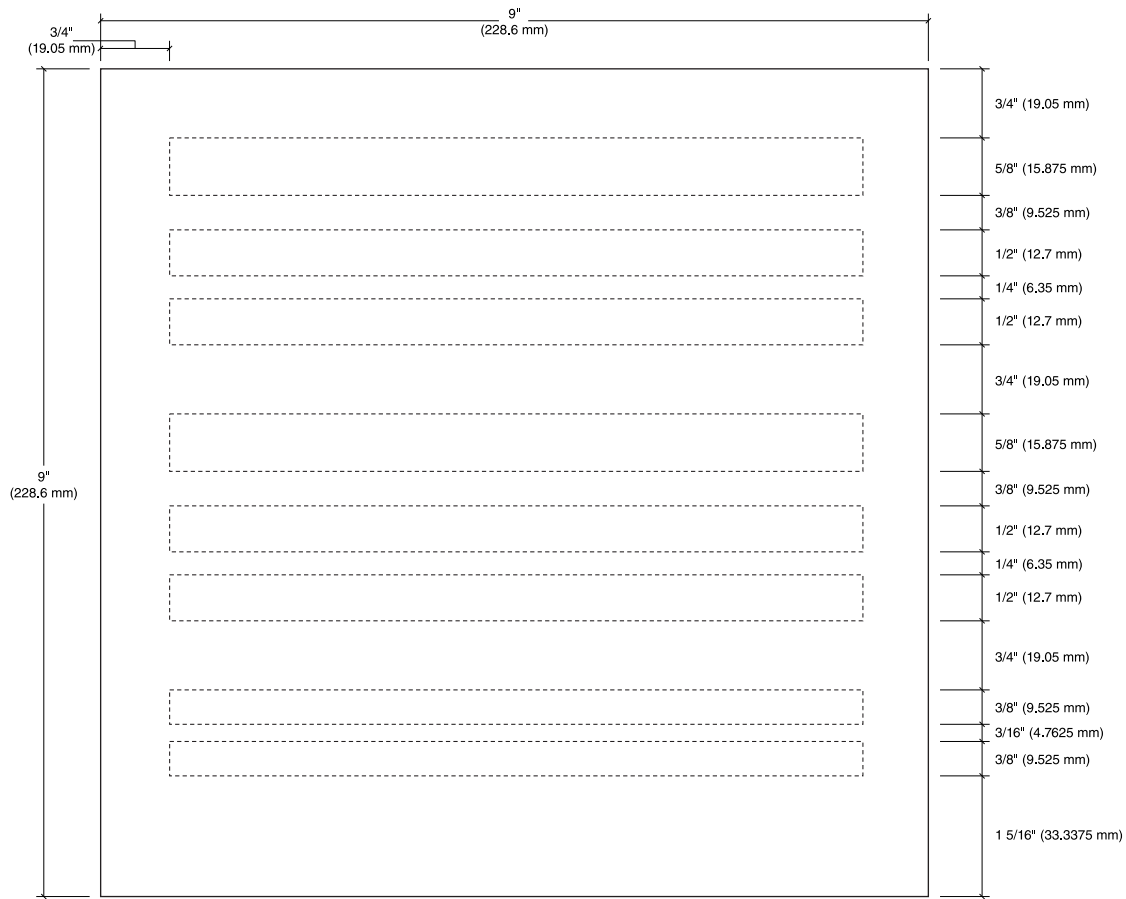

Message Layout



IN-02.05

Mandatory VA Policy & Directive Signage Drawings

Notice of Weapons Search Sign

Size

Sign Face:
15" High x 15" Wide
(381 mm H x 381 mm W)

Description

This sign only required at metal detector screening devices and is to be installed next to the detector and in a location that is visible before passing through the machine.

Message Configuration

Refer to message layout drawing for dimensions.

Sign Components

Component based sign system

Graphic Process

Direct digital print on second surface or silk-screened

Colors

Refer to the chart in the Appendix.

Typography

Helvetica Bold

Mounting

Preferred: Concealed mechanical fasteners

Alternate: Double-sided VHB foam tape and silicone adhesive

Installation

On wall: 60" (1524 mm) to center of sign, adjacent to metal detector/screening device

NOTICE OF WEAPONS SEARCH

The possession of any weapon by persons entering this building is prohibited by law (38 cfr & 1.218 (a)(13)). Persons entering the building consent to a personal search by metal detector and to the inspection of all packages, luggage and all containers in their possession. Metal detector cannot harm you and will not affect pacemakers, hearing aids, or film. Refusal of consent to search is basis for denial of admittance. Person legally authorized to possess firearms must report to VA police.

Message Layout

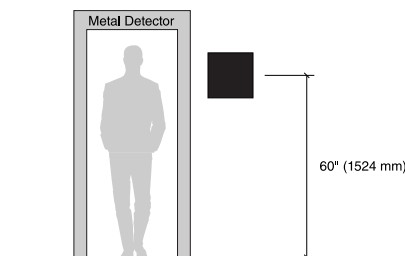

IN-02.05

Mandatory VA Policy & Directive Signage Drawings

Notice of Weapons Search Sign

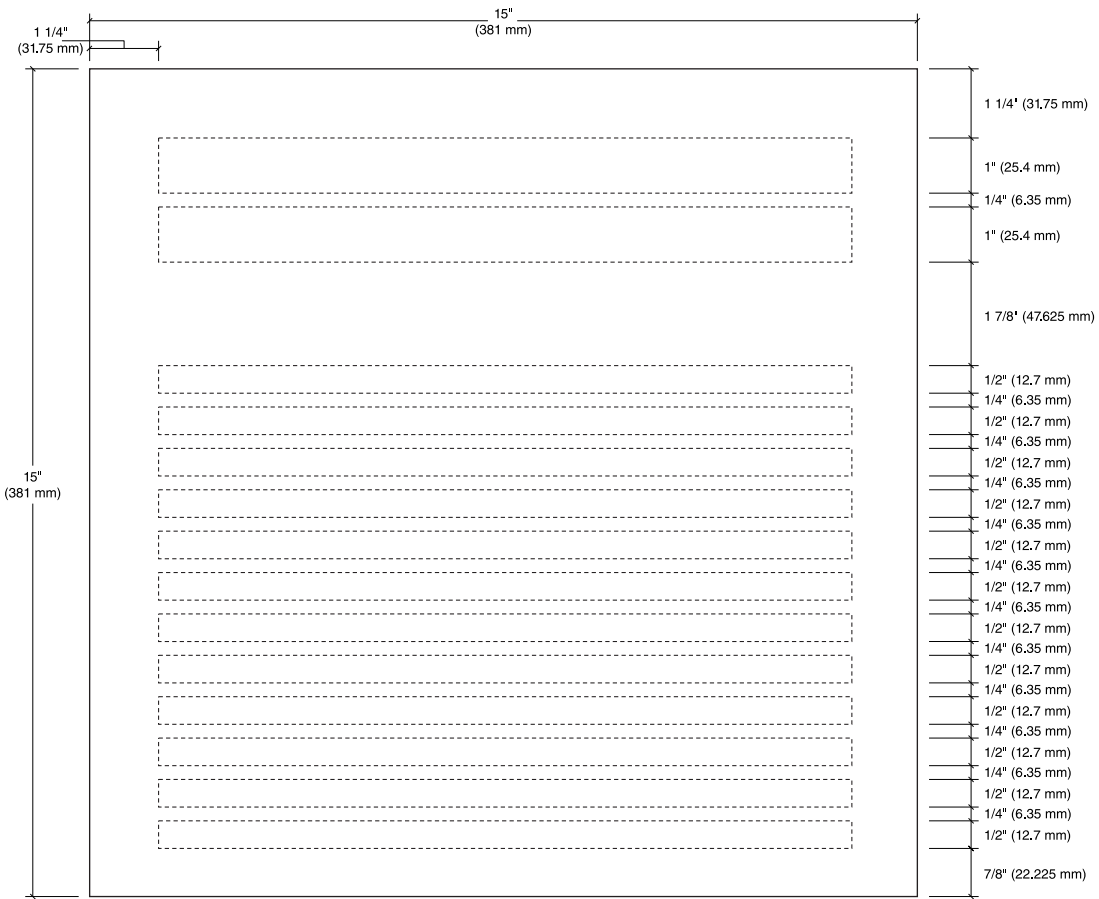

Message Layout



IN-02.06

Mandatory VA Policy & Directive Signage Drawings

Parking Restrictions Sign

Size

Sign Face: 30" High x 24" Wide x 1/8" Thick (762 mm H x 609.6 mm W x 3.175 mm T)

Alternate size for areas with limited space:

24" High x 18" Wide x 1/8" Thick (609.6 mm H x 457.2 mm W x 3.175 mm T)

Description

Parking restriction sign is required to be placed at all public vehicular entrances to a VA facility.

Sign is similar to sign type EN-05.01. See [2.5 Exterior Signs](#) for construction and installation details.

Message Configuration

Refer to message layout drawing for dimensions.

Graphic Process

Surface applied reflective vinyl

Colors

Refer to the chart in the Appendix.

Installation

Position sign so drivers have a clear, unobstructed view of the sign.

When placing this type of sign near curbs or parking places, be sure the sign is set far enough back that over hanging front and rear of automobiles do not come in contact with the signpost.



Message Layout

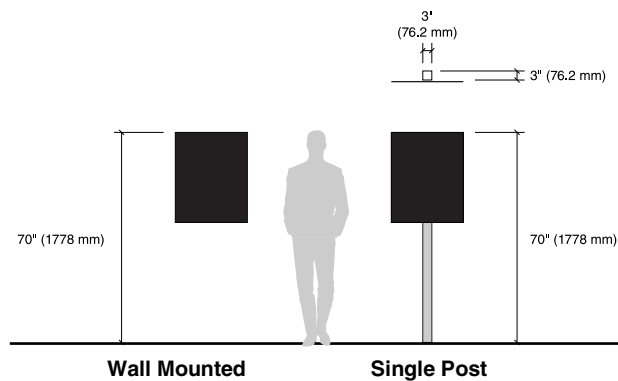

IN-02.06

Mandatory VA Policy & Directive Signage Drawings

Parking Restrictions Sign

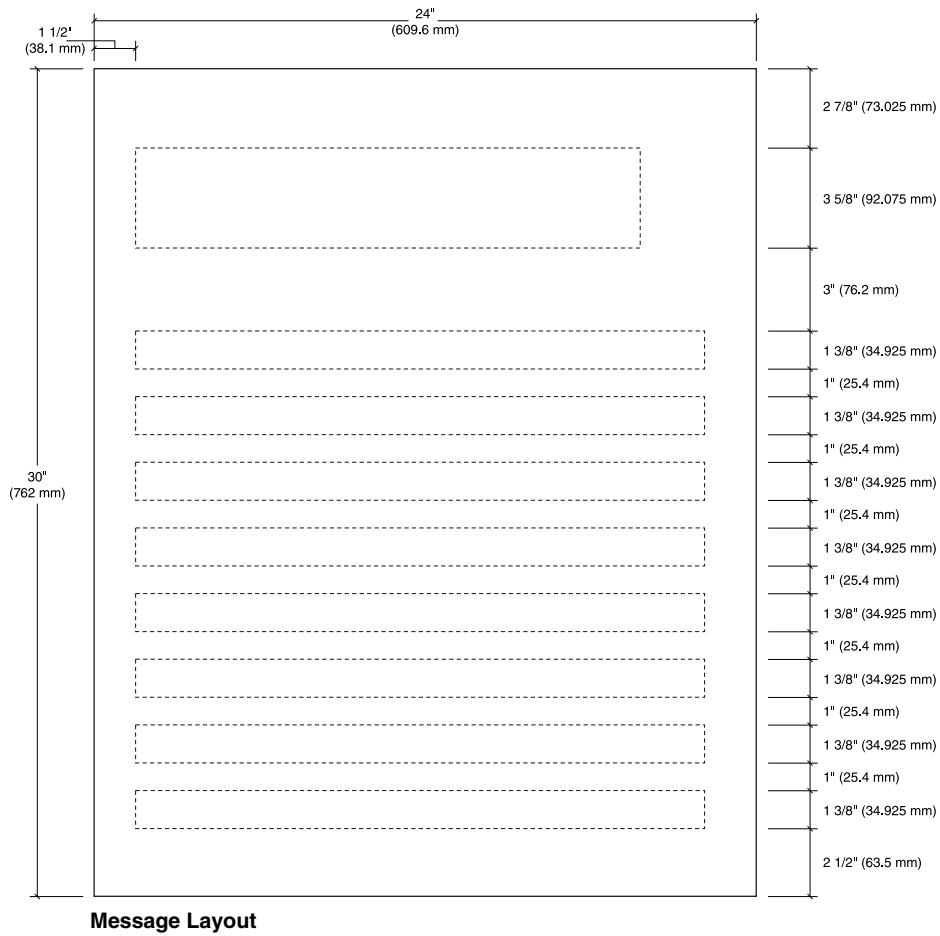

IN-02.07.01

Mandatory VA Policy & Directive Signage Drawings

Rights and Responsibilities of VA Patients

Size

Display Window to Accommodate VA Supplied Poster

36" High x 24" Wide
(914.4 mm H x 609.6 mm W)

Description

Patient rights and responsibilities sign required at the main entrance/lobby of all buildings where patient care is provided.

Sign Components

Sign frame/case with acrylic or glass cover to accommodate VA supplied poster. Options to include front-loading snap/spring loaded frame or swing frame. See [Section 2.3.3](#) for additional details.

Graphic Process

VA provided poster

Colors

Frame to match or complement any existing or designated color and material palette.

Refer to the chart in the Appendix.

Mounting

Concealed mechanical fasteners adequate for weight and wall type

Installation

Coordinate placement with other policy signs required at entrances.

See [example layouts](#) at the end of this section.

Recommendations

If conditions do not allow for a poster of this size, the VA approved design can be scaled down to a minimum poster size of 24" x 18". Avoid warping or altering the artwork in any way.



Message Layout

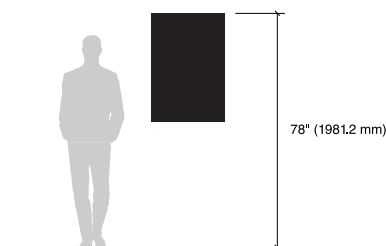

Adjust installation height as needed to coordinate with other policy signs.



Rights and Responsibilities of VA Patients

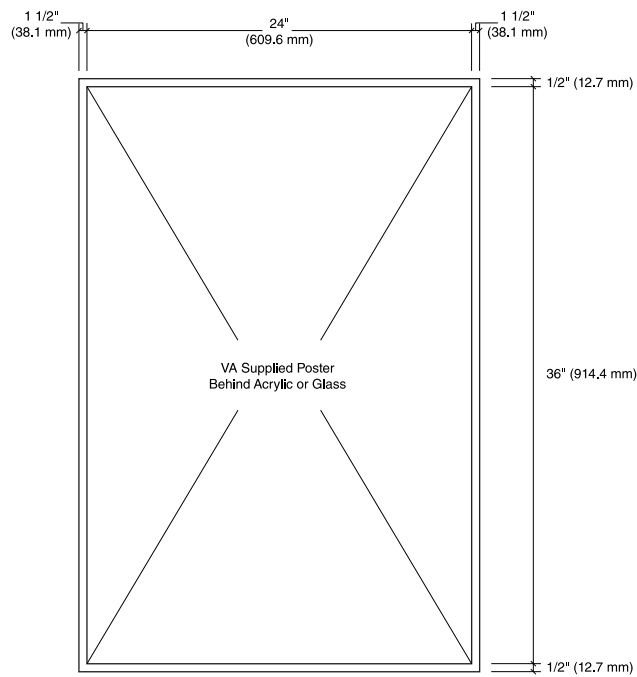

Message Layout



IN-02.07.02

Mandatory VA Policy & Directive Signage Drawings

Rights and Responsibilities of Family Members of VA Patients

Size

Display Window to Accommodate
VA Supplied Poster

36" High x 24" Wide
(914.4 mm H x 609.6 mm W)

Description

Family member rights and responsibilities sign required at the main entrance/lobby of all buildings where patient care is provided.

Sign Components

Sign frame/case with acrylic or glass cover to accommodate VA supplied poster. Options to include front-loading snap/spring loaded frame or swing frame. See [Section 2.3](#) for additional details.

Graphic Process

VA provided poster

Colors

Frame to match or complement any existing or designated color and material palette.

Refer to the chart in the Appendix.

Mounting

Concealed mechanical fasteners adequate for weight and wall type

Installation

Coordinate placement with other policy signs required at entrances.

See [example layouts](#) at the end of this section

Recommendations

If conditions do not allow for a poster of this size, the VA approved design can be scaled down to a minimum poster size of 24" x 18". Avoid warping or altering the artwork in any way.



Message Layout

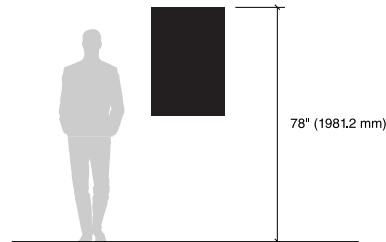

Adjust installation height as needed to coordinate with other policy signs.



Rights and Responsibilities of Family Members of VA Patients

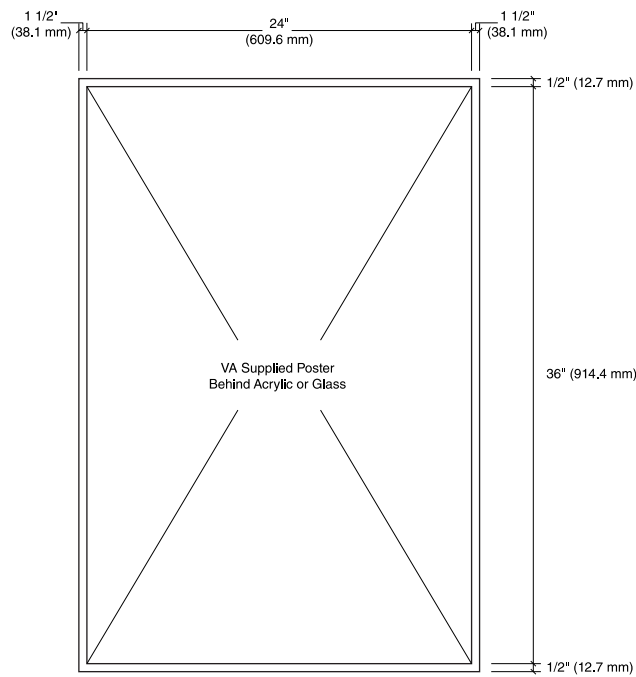

Message Layout



IN-02.07.03

Mandatory VA Policy & Directive Signage Drawings

Policies and Directives

Size

Display Window to Accommodate
VA Supplied Poster:
30" High x 18" Wide
(762 mm H x 457.2 mm W)

Description

Policies and Directives (VA Form 0088) required at the main entrance/lobby of all buildings where patient care is provided.

Sign Components

Sign frame/case with acrylic or glass cover to accommodate VA supplied poster. Options to include front-loading snap/spring loaded frame or swing frame. See [Section 2.3.3](#) for additional details.

Graphic Process

VA provided poster

Colors

Frame to match or complement any existing or designated color and material palette.

Refer to the chart in the Appendix.

Mounting

Concealed mechanical fasteners adequate for weight and wall type

Installation

Coordinate placement with other policy signs required at entrances.

See [example layouts](#) at the end of this section.

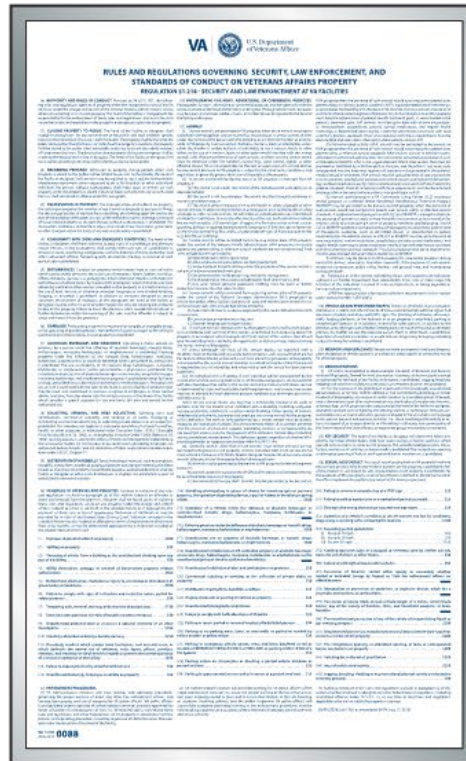

Message Layout

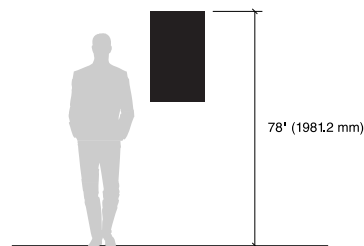

Adjust installation height as needed to coordinate with other policy signs.



IN-02.07.03

Mandatory VA Policy & Directive Signage Drawings

Policies and Directives

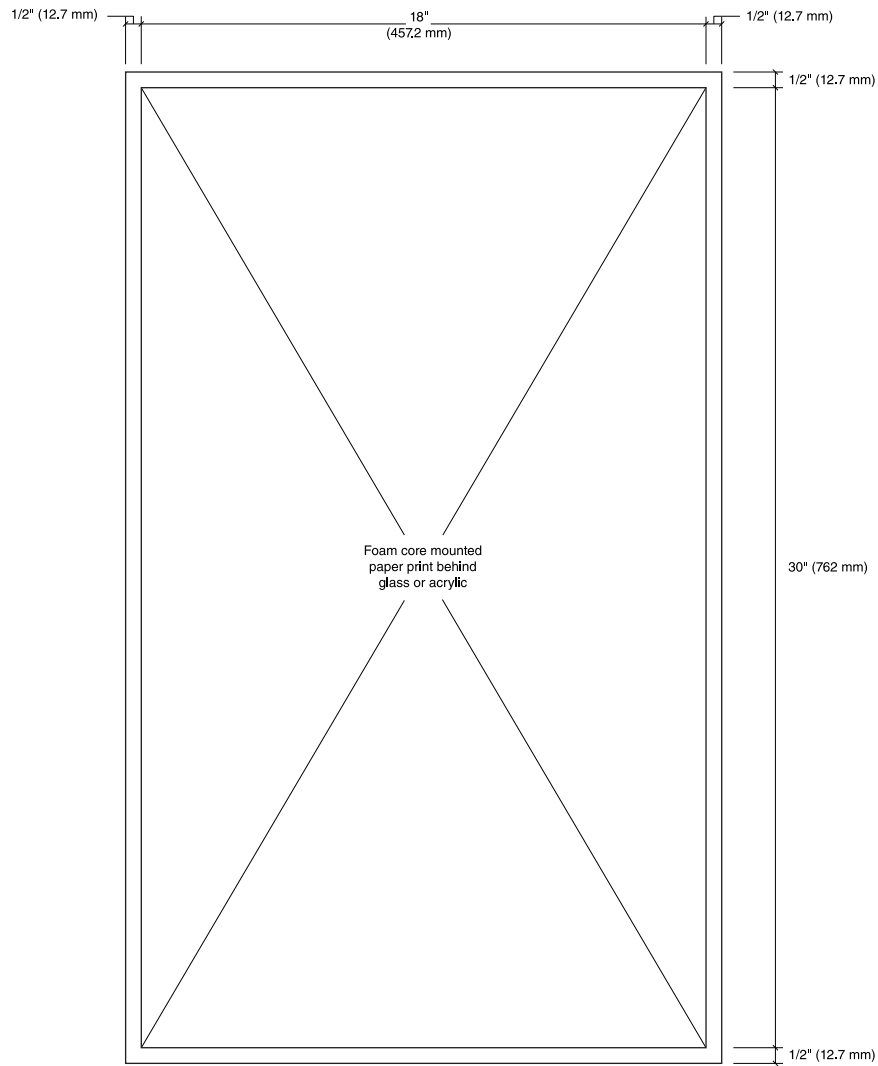

Message Layout



IN-02.07.04

Mandatory VA Policy & Directive Signage Drawings

Notice of Privacy Practices

Size

Display Window to Accommodate
VA Supplied Poster:
39" High x 26 3/4" Wide
(990.6 mm H x 679.45 mm W)

Description

Notice of Privacy Practices sign required in a prominent location(s) where it is reasonable to expect that individuals seeking service will be able to read the Notice of Privacy Practices (e.g., Release of Information (ROI) Office, Eligibility Office, Employee Health Office).

Sign Components

Sign frame/case with acrylic or glass cover to accommodate VA supplied poster. Options to include front-loading snap/spring loaded frame or swing frame. See [Section 2.3.3](#) for additional details.

Graphic Process

VA provided poster

Colors

Frame to match or complement any existing or designated color and material palette.

Refer to the chart in the Appendix.

Mounting

Concealed mechanical fasteners adequate for weight and wall type



Message Layout

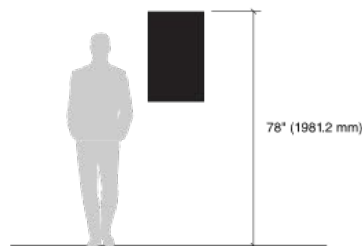

IN-02.07.04

Mandatory VA Policy & Directive Signage Drawings

Notice of Privacy Practices

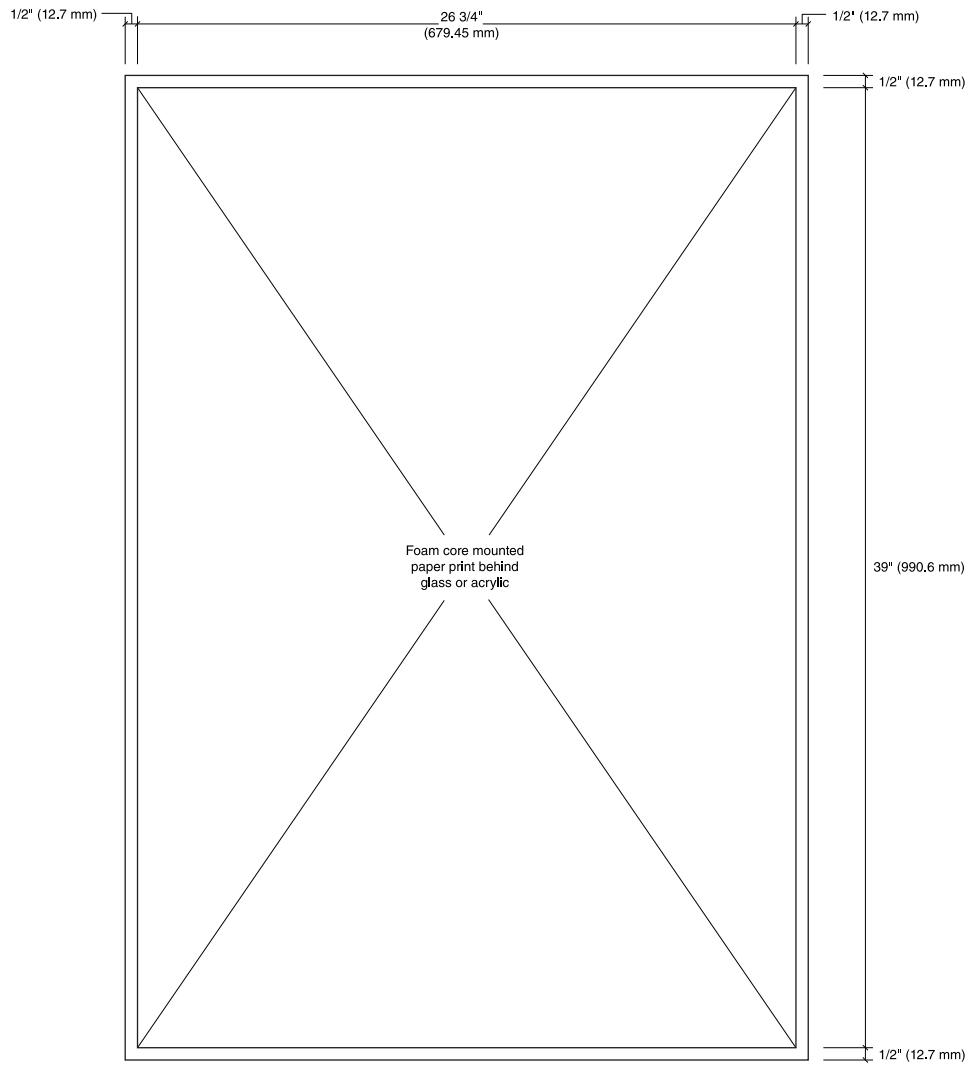

Message Layout



IN-02.08

Mandatory VA Policy & Directive Signage Drawings

Anti-Sexual Harassment / Anti-Sexual Assault

Size

Display Window to Accommodate
VA Supplied Poster
Available in Two Sizes:

Message Layout A
17" High x 11" Wide
(431.8 mm H x 279.4 mm W)

Message Layout B
24" High x 18" Wide
(609.6 mm H x 457.2 mm W)

Description

Anti-Sexual Harassment / Assault
posting required to be displayed in
prominent spaces (such as lobbies
or other gathering areas).

Sign Components

Sign frame/case with acrylic cover
to accommodate VA supplied
poster. Options to include front-
loading snap/spring loaded frame or
acrylic pocket. See [Section 2.3.3](#) for
additional details.

Graphic Process

VA provided poster

Colors

Frame to match or complement any
existing or designated color and
material palette.

Refer to the chart in the Appendix.

Mounting

Concealed mechanical fasteners
adequate for weight and wall type

Installation

Coordinate placement with other
policy or VHA Directive postings to
avoid visual clutter or a disjointed
appearance.

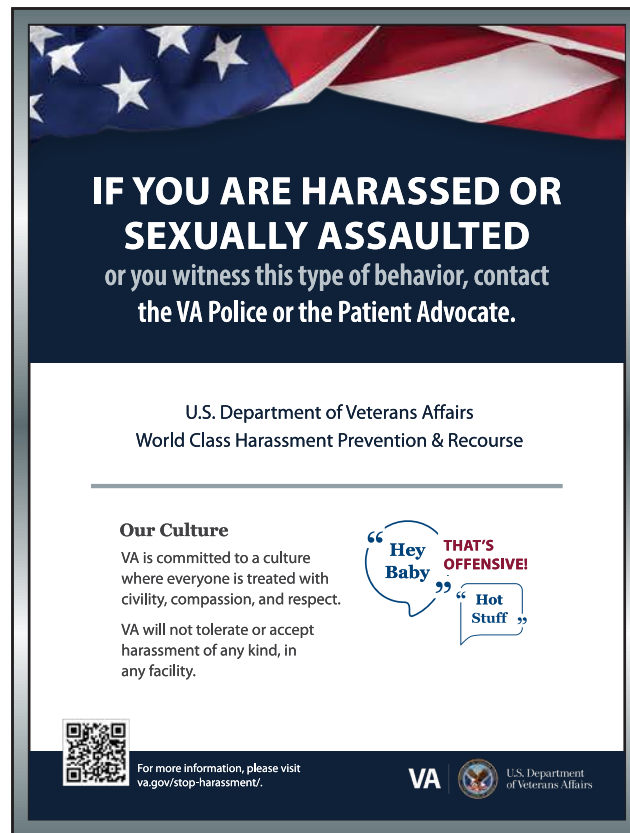

Message Layout

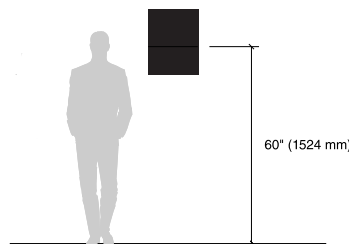

Adjust installation height as needed to
coordinate with other policy signs.



Anti-Sexual Harassment / Anti-Sexual Assault

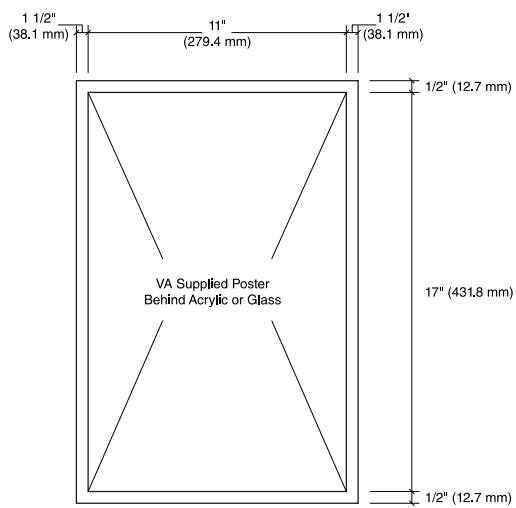

Message Layout A

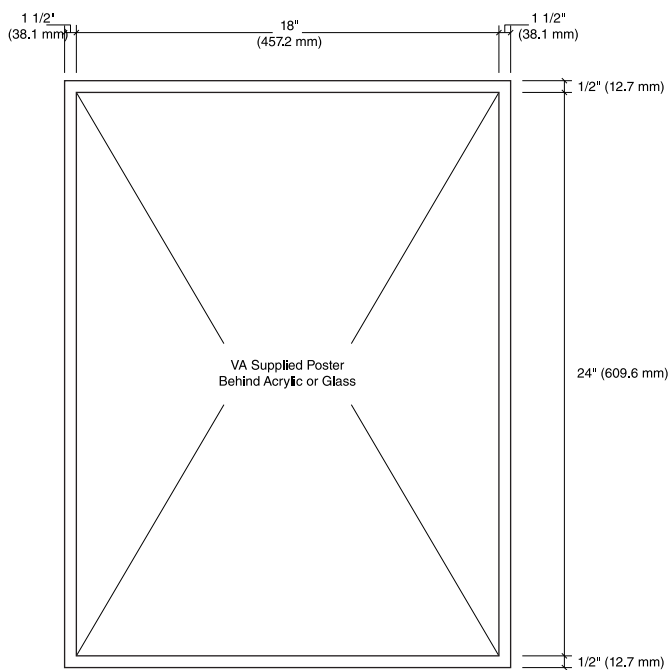

Message Layout B



IN-02.10

Mandatory VA Policy & Directive Signage Drawings

No Weapons Notice Sign - Interior

Size

Sign Face:
6" High x 20" Wide
(152.4 mm H x 508 mm W)

Description

No weapons sign to be placed on an interior wall at all public entrances to a building.

Message Configuration

Refer to message layout drawing for dimensions.

Sign Components

Component based sign system

Graphic Process

Direct digital print on second surface or silk-screened

Colors

Background: White
Graphics: Red, White, Blue, and Black

Refer to the chart in the Appendix.

Typography

Helvetica Bold

Mounting

Preferred: Concealed mechanical fasteners
Alternate: Double-sided VHB foam tape and silicone adhesive

Installation

Display the 6" x 20" policy signs in the following sequence:

- IN-02.01 - Consent to Inspection
- IN-02.10 - No Weapons Notice
- IN-02.03 - No Weapons Policy

- IN-02.14 – Video Surveillance
- IN-02.15 – Service Dogs
- IN-02.02 – No Smoking, No Vaping

These signs can be grouped together in one display or broken into two displays of 3 signs each, following the same sequence.

Coordinate placement with other policy signs required at entrances.

See [example layouts](#) at the end of this section.

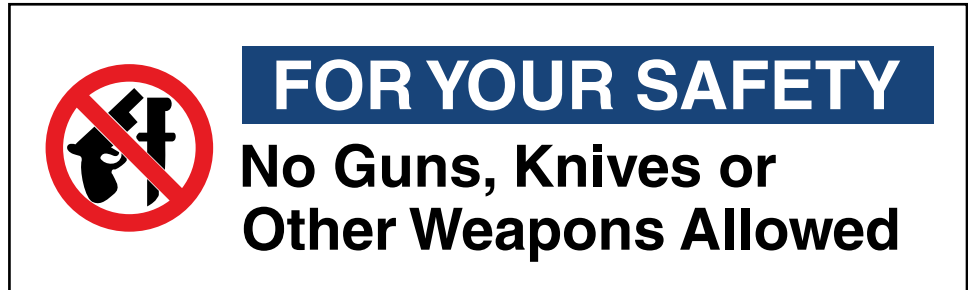

English Version



Spanish Version

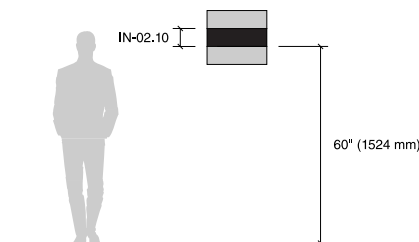

Adjust installation height as needed to coordinate with other policy signs.



IN-02.10

Mandatory VA Policy & Directive Signage Drawings

No Weapons Notice Sign - Interior

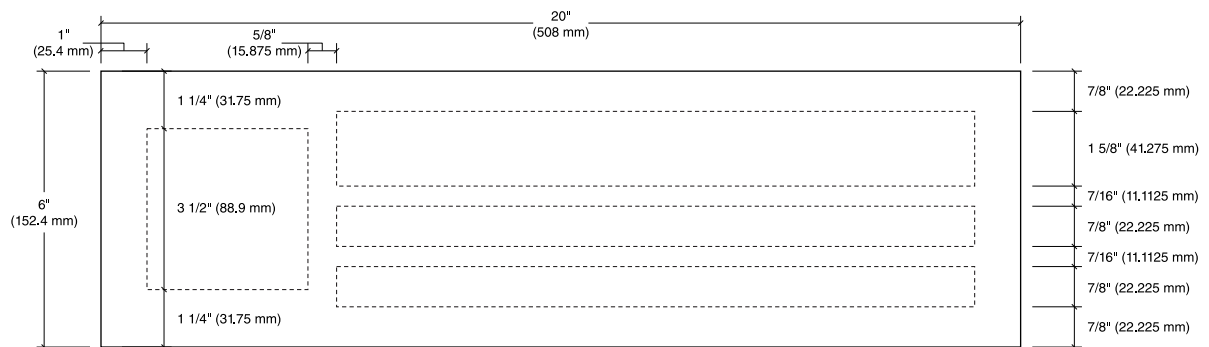

Message Layout



IN-02.11

Mandatory VA Policy & Directive Signage Drawings

No Weapons Sign Large - Exterior

Size

Sign Face:
30" High x 24" Wide
(762 mm H x 609.6 mm W)

Description

No weapons sign to be placed at all exterior entrances to VA property.

Message Configuration

Refer to message layout drawing for dimensions.

Sign Components

Aluminum sign panel

Graphic Process

Silk-screened or surface applied vinyl

Colors

Background: White
Graphics: Red, White, Blue, and Black
Refer to the chart in the Appendix.

Typography

Helvetica Bold
Helvetica Bold Italic

Installation

Position signs so drivers have a clear, unobstructed view of the sign.

Install IN-02.13 Video Surveillance Sign below IN-02.11.

When placing this type of sign near curbs or parking places, be sure the sign is set far enough back that over hanging front and rear of automobiles do not come in contact with the signpost.



English Version

Spanish Version

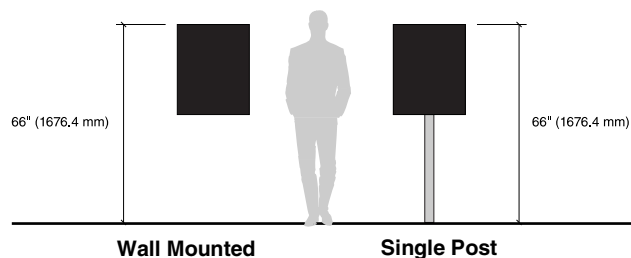

IN-02.11

Mandatory VA Policy & Directive Signage Drawings

No Weapons Sign Large - Exterior

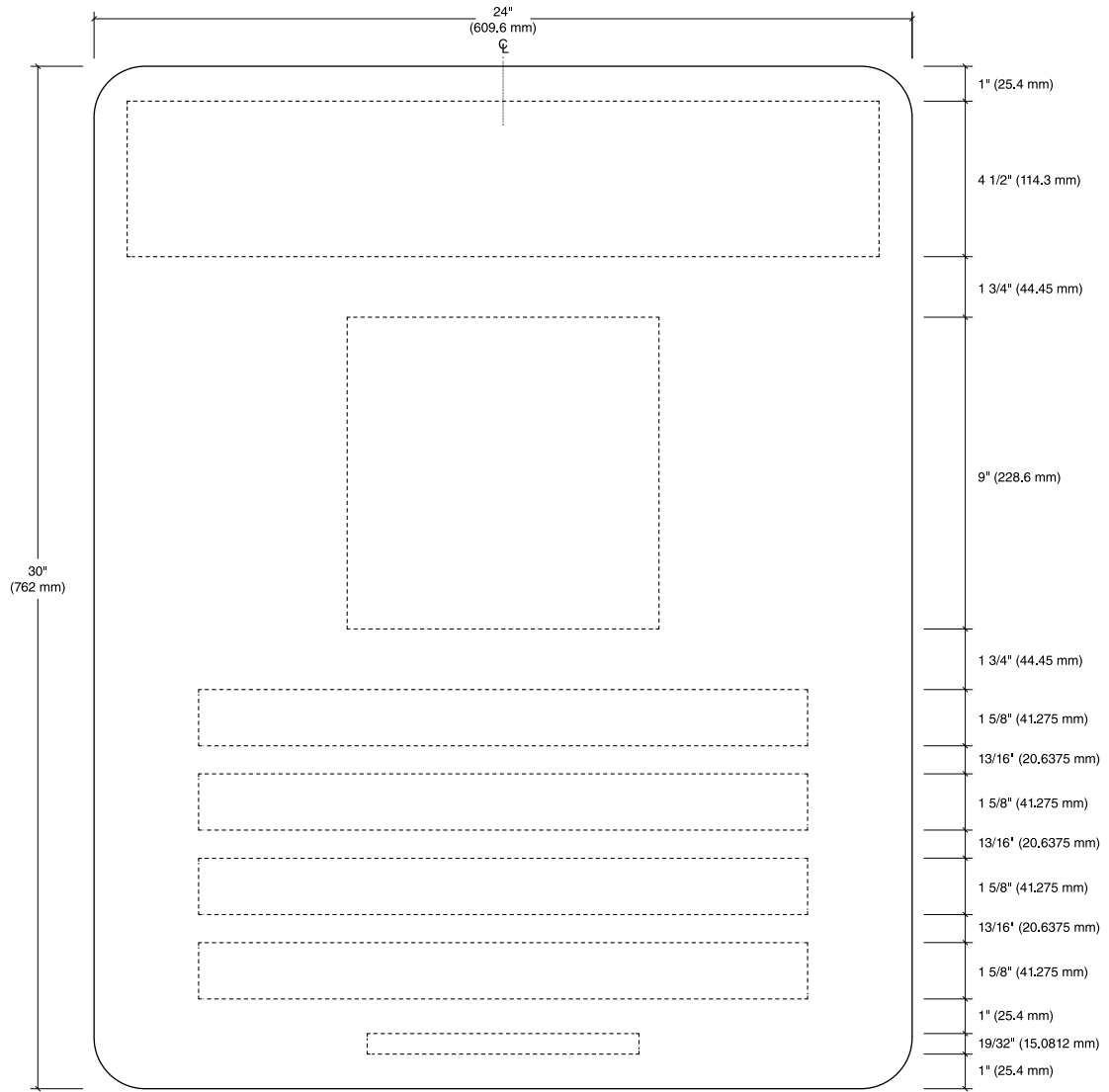

Message Layout



IN-02.12

Mandatory VA Policy & Directive Signage Drawings

No Weapons Sign Small - Exterior

Size

Sign Face:
24" High x 18" Wide
(609.6 mm H x 457.2 mm W)

Description

Small Exterior "No Weapons" sign for limited spaces with pedestrian visibility.

Message Configuration

Refer to message layout drawing for dimensions.

Sign Components

Aluminum sign panel

Graphic Process

Silk-screened or surface applied vinyl

Colors

Background: White
Graphics: Red, White, Blue, and Black
Refer to the chart in the Appendix.

Typography

Helvetica Bold

Installation

Position signs so pedestrians have a clear, unobstructed view of the sign. Install IN-02.13 Video Surveillance Sign below IN-02.12. When placing this type of sign near curbs or parking places, be sure the sign is set far enough back that over hanging front and rear of automobiles do not come in contact with sign post.



English Version



Spanish Version

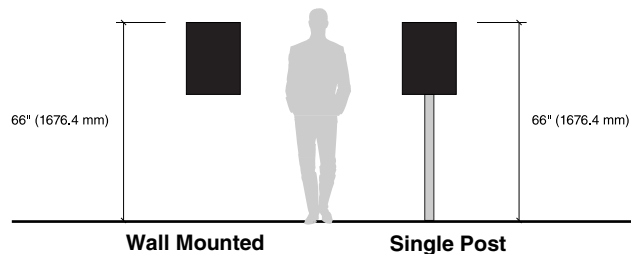

IN-02.12

Mandatory VA Policy & Directive Signage Drawings

No Weapons Sign Small - Exterior

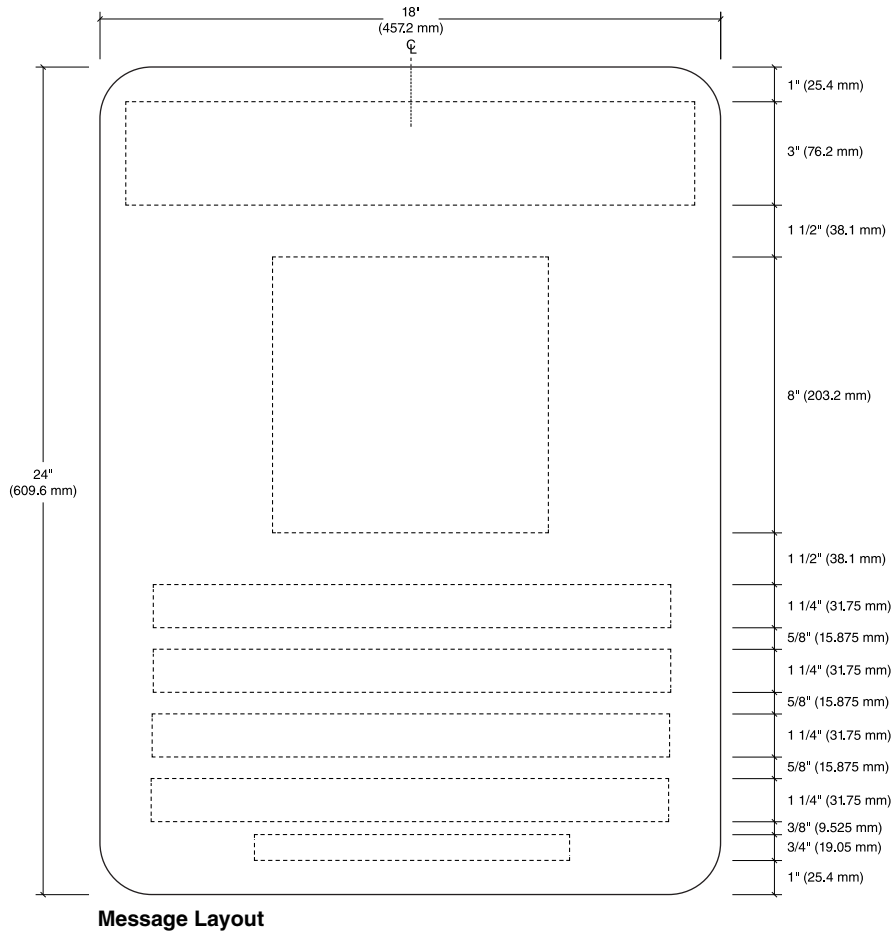

IN-02.13

Mandatory VA Policy & Directive Signage Drawings

Video Surveillance Sign - Exterior

Size

Message Layout A:
6" High x 24" Wide
(152.4 mm H x 609.6 mm W)

Message Layout B:
6" High x 18" Wide
(152.4 mm H x 457.2 mm W)

Description

Exterior video surveillance sign to be placed at all exterior entrances to VA property and other locations deemed necessary.

Message Configuration

Refer to message layout drawing for dimensions.

Sign Components

Aluminum sign panel

Graphic Process

Silk-screened or surface applied vinyl

Colors

Refer to the chart in the Appendix.

Typography

Helvetica Bold

Installation

Position so there is a clear, unobstructed view of the sign. Install below exterior no weapons sign IN-02.11 or IN-02.12 and in other locations deemed necessary.

Message Layout A

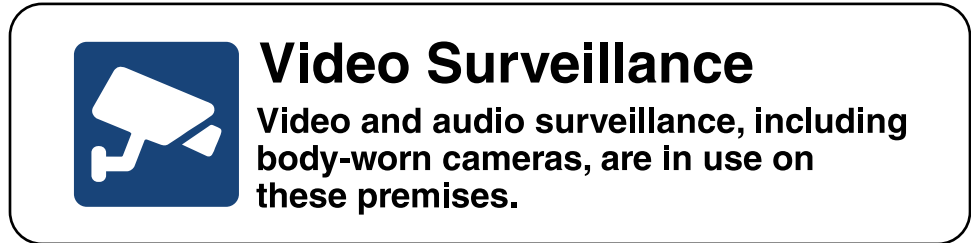

Message Layout B

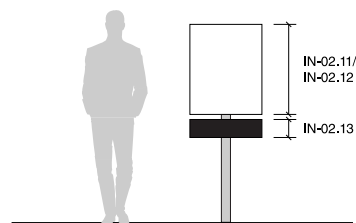
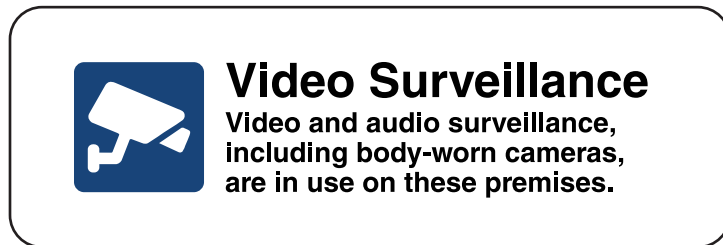

IN-02.13

Mandatory VA Policy & Directive Signage Drawings

Video Surveillance Sign - Exterior

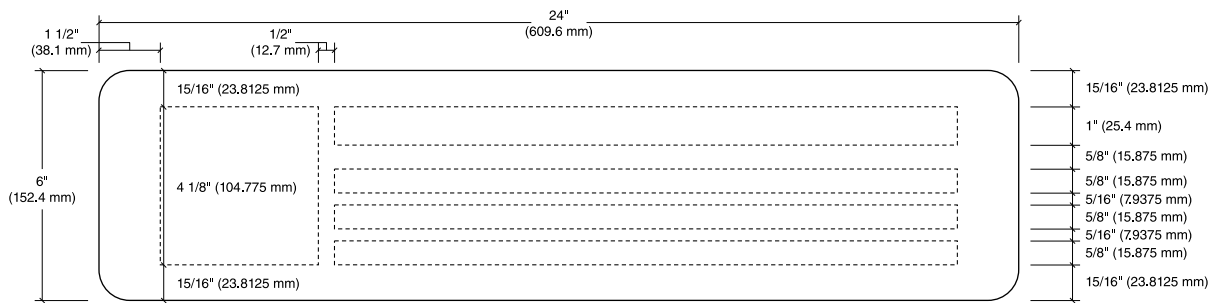

Message Layout A

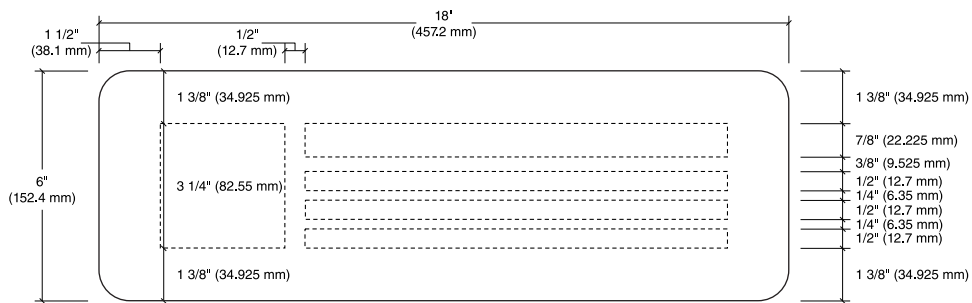

Message Layout B



IN-02.14

Mandatory VA Policy & Directive Signage Drawings

Video Surveillance Sign

Size
 6" High x 20" Wide
 (152.4 mm H x 609.6 mm W)

Description
 "Video Surveillance Sign" is required to be placed on an interior wall at all public entrances to a building.

Message Configuration
 Refer to message layout drawing for dimensions. When combining 6" x 20" policy signs into one display, add a 1/16" rule line to separate each sign visually.

Sign Components
 Component based sign system

Graphic Process
 Direct digital print on second surface or silk-screened

Colors
 Refer to the chart in the Appendix.

Typography
 Helvetica Bold

Mounting
 Preferred: Concealed mechanical fasteners
 Alternate: Double-sided VHB foam tape and silicone adhesive

Installation
 Display the 6" x 20" policy signs in the following sequence:

- IN-02.01 - Consent to Inspection
- IN-02.10 - No Weapons Notice
- IN-02.03 - No Weapons Policy

- IN-02.14 – Video Surveillance
- IN-02.15 – Service Dogs
- IN-02.02 – No Smoking, No Vaping

These signs can be grouped together in one display or broken into two displays of 3 signs each, following the same sequence.

Coordinate placement with other policy signs required at entrances.

See [example layouts](#) at the end of this section.



Message Layout

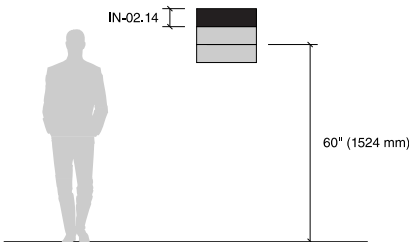

IN-02.14

Mandatory VA Policy & Directive Signage Drawings

Video Surveillance Sign

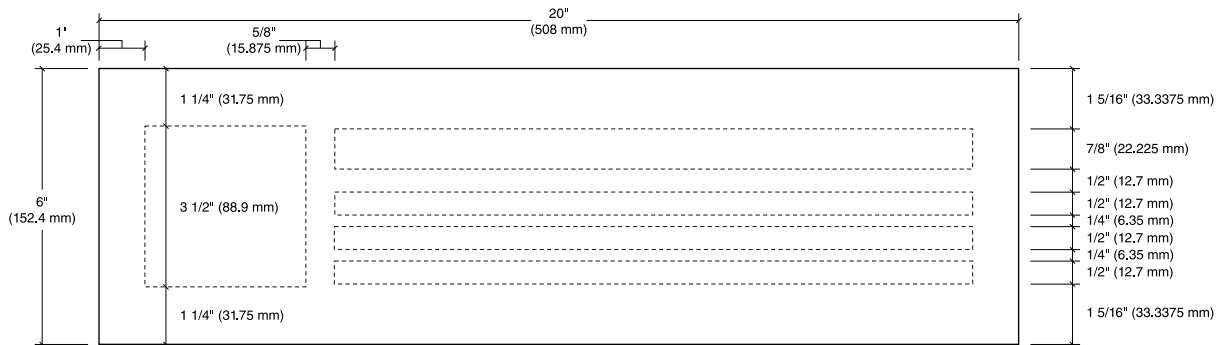

Message Layout



IN-02.15**Mandatory VA Policy & Directive Signage Drawings****Service Dogs Sign****Size**

6" High x 20" Wide
(152.4 mm H x 609.6 mm W)

Description

"Service Dogs Sign" can be placed on an interior wall at all public entrances to a building with other policy signs. At the time of publishing, this sign is NOT required.

Message Configuration

Refer to message layout drawing for dimensions. When combining 6" x 20" policy signs into one display, add a 1/16" rule line to separate each sign visually.

Sign Components

Component based sign system

Graphic Process

Direct digital print on second surface or silk-screened

Colors

Refer to the chart in the Appendix.

Typography

Helvetica Bold

Mounting

Preferred: Concealed mechanical fasteners

Alternate: Double-sided VHB foam tape and silicone adhesive

Installation

Display the 6" x 20" policy signs in the following sequence:

-IN-02.01 - Consent to Inspection
-IN-02.10 - No Weapons Notice
-IN-02.03 - No Weapons Policy

-IN-02.14 – Video Surveillance
-IN-02.15 – Service Dogs
-IN-02.02 – No Smoking, No Vaping

These signs can be grouped together in one display or broken into two displays of 3 signs each, following the same sequence.

Coordinate placement with other policy signs required at entrances.

See [example layouts](#) at the end of this section.



Message Layout

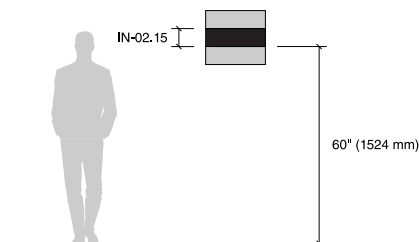

IN-02.15

Mandatory VA Policy & Directive Signage Drawings

Service Dogs Sign

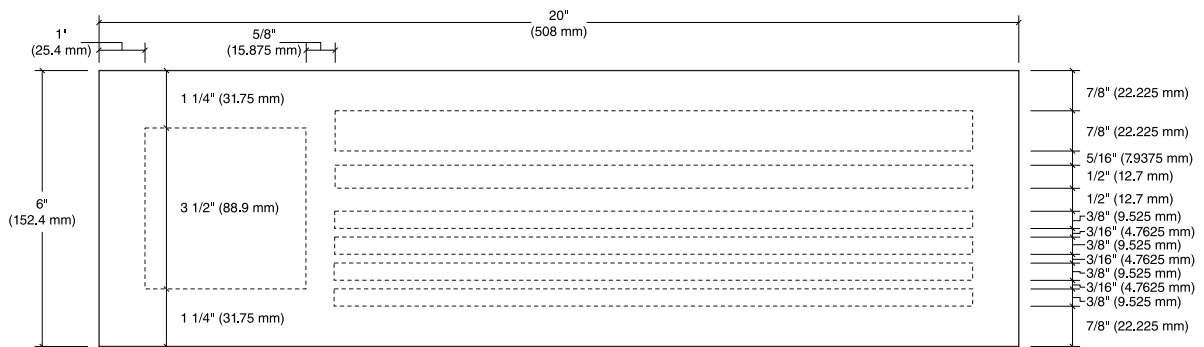

Message Layout



IN-02.16

Mandatory VA Policy & Directive Signage Drawings

No Trespassing Sign

Size

Sign Face:
12" High x 18" Wide
(304.8 mm H x 457.2 mm W)

Description

No trespassing sign to be placed at all exterior entrances to VA property.

Message Configuration

Refer to message layout drawing for dimensions.

Sign Components

Aluminum sign panel

Graphic Process

Silk-screened or surface applied vinyl

Colors

Background: White/Blue
Text: Black/White
Refer to the chart in the Appendix.

Typography

Helvetica Bold

Installation

Position signs so drivers and pedestrians have a clear, unobstructed view of the sign.

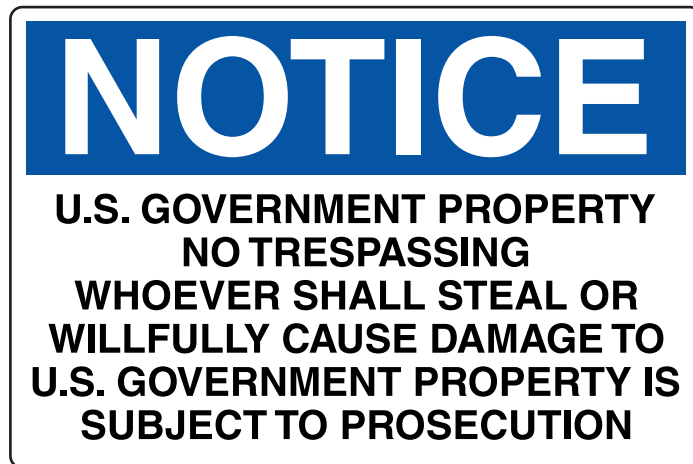

Message Layout

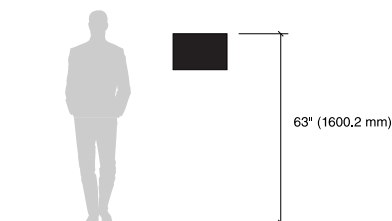

IN-02.16

Mandatory VA Policy & Directive Signage Drawings

No Trespassing Sign

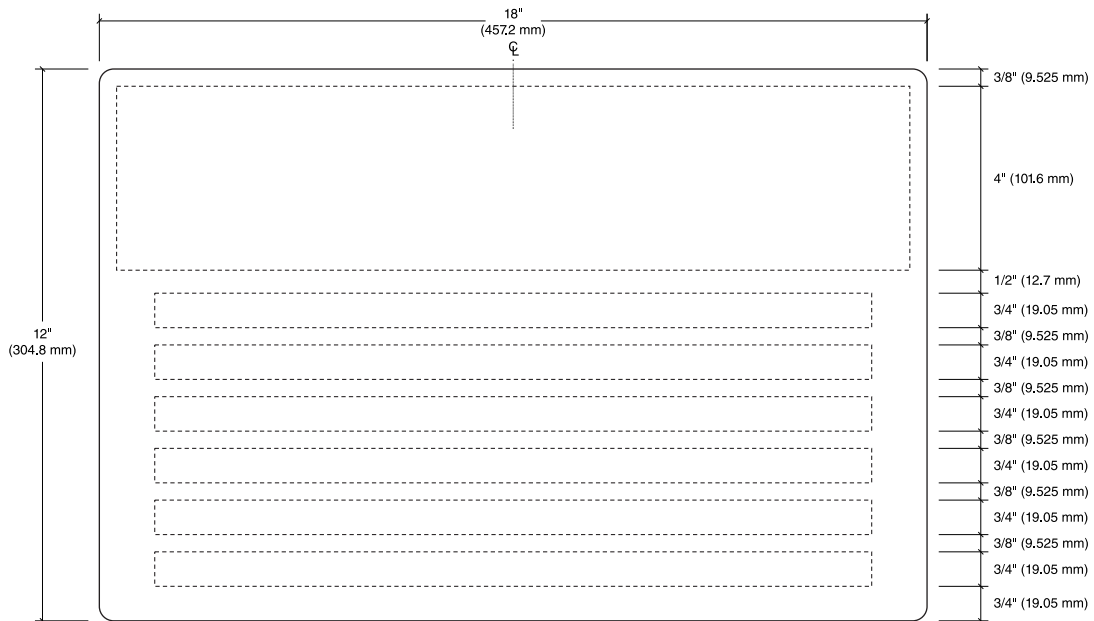

Message Layout



Layout

Description

The designs are based on mandatory postings required at the main entrances/lobbies of all buildings where patient care is provided. At secondary public entrances, only the following sign types are required: IN-02.01 Consent to Inspection, IN-02.10 No Weapons Notice, IN-02.03 No Weapons Policy, IN-02.14 Video Surveillance, and IN-02.02 No Smoking/Vaping.

Installation

When placing signs near each other, it is important to consider how all components will work together as a cohesive whole. The following layouts provide examples of how entrance policy signs can be coordinated with other design elements to welcome visitors and clearly communicate important messages.

The graphic panels incorporated into the design can be used in various ways. For wayfinding, they can help reinforce the name of the entrance, facility, area/zone, or building number. Other options include a welcome message or military emblems combined with inspiring imagery.

Mount message configuration on wall at 60" (1524 mm) to center.

Mandatory VA Policy & Directive Signage Drawings

Layout Examples for Mandatory Entrance Signs

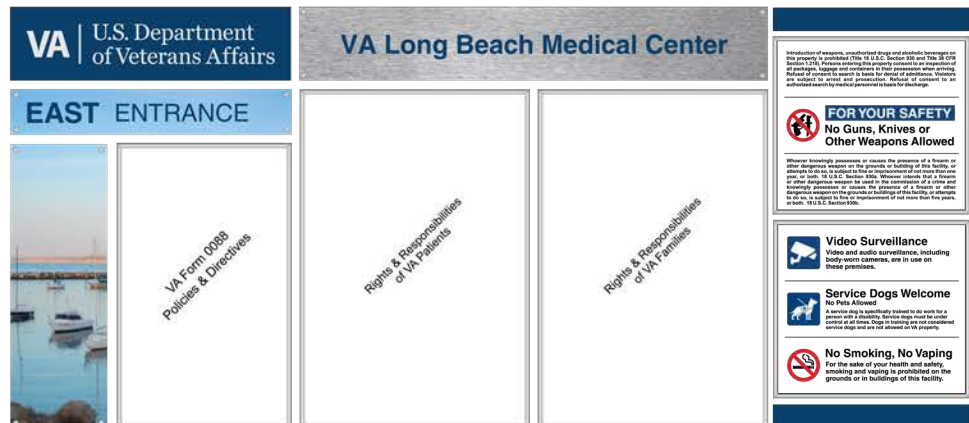

Layout A

This layout has three separate header panels allowing the concept to be divided into two or three sections if there is limited wall space. In this example, the 6" x 20" policy signs are separated into two displays of 3 signs each following the prescribed sequence.



Layout B

This layout has two header panels and combines all 6" x 20" policy signs into one display for a more streamlined approach if there is adequate wall space.

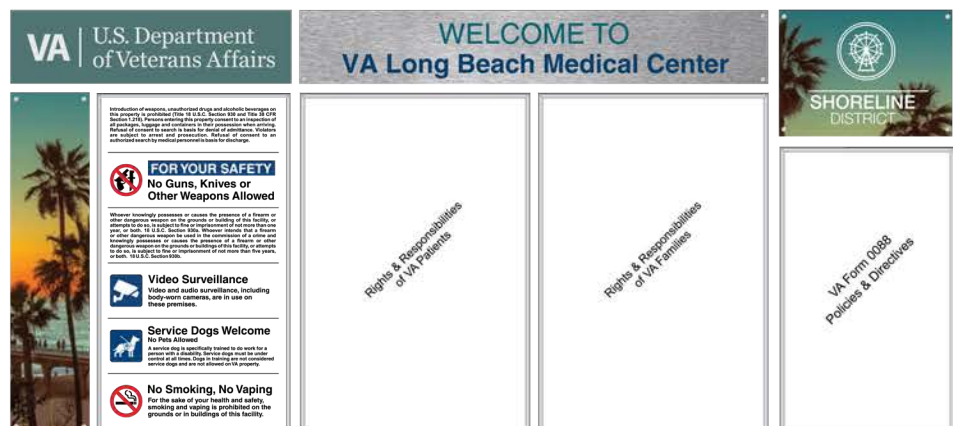

Layout C

This layout has three separate header panels allowing the concept to be divided into two or three sections if there is limited wall space. At secondary public entrances the far-left section, which comprises of the VA Logo, image panel and 6" x 20" policy signs, can be used independently.



Layout **Mandatory VA Policy & Directive Signage Drawings**

Layout Examples for Mandatory Entrance Signs

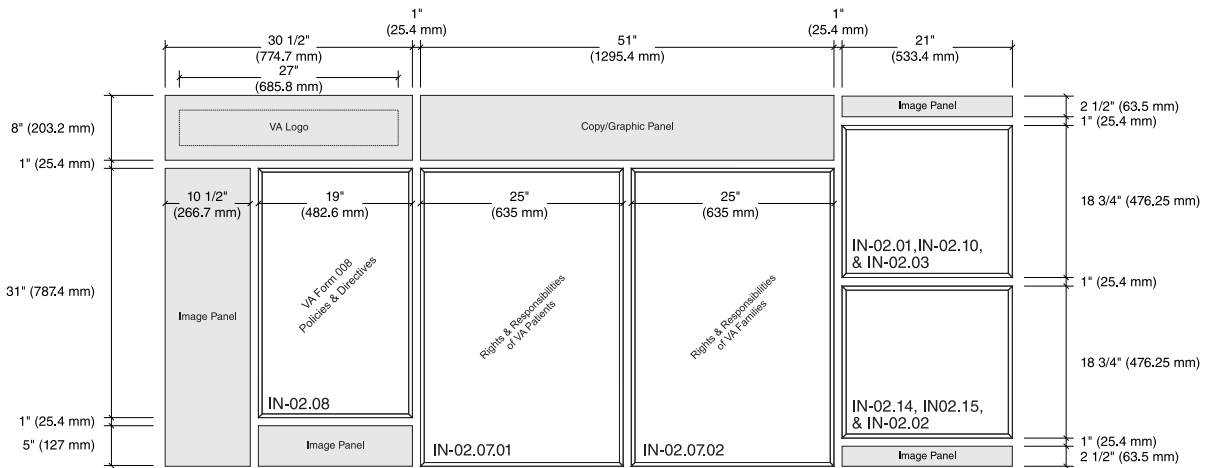

Layout A

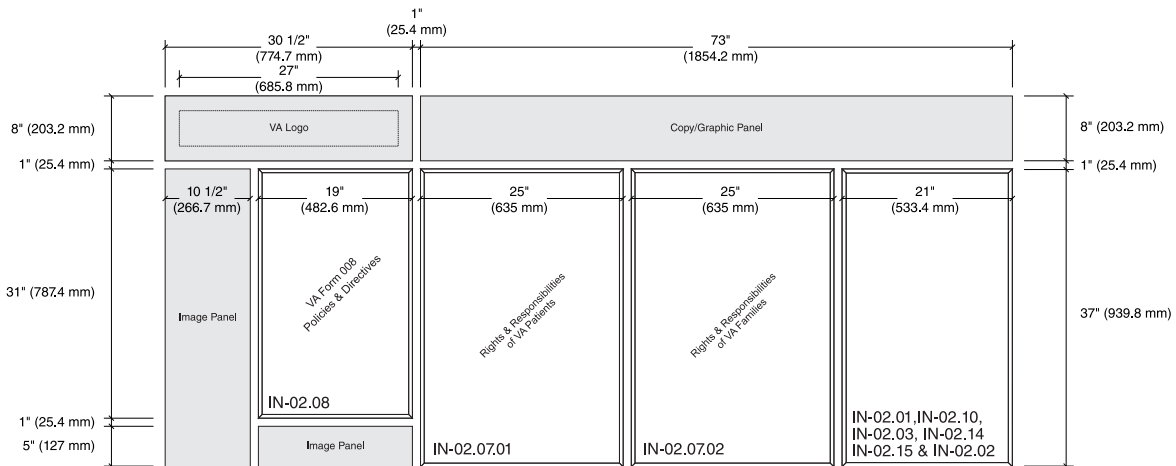

Layout B

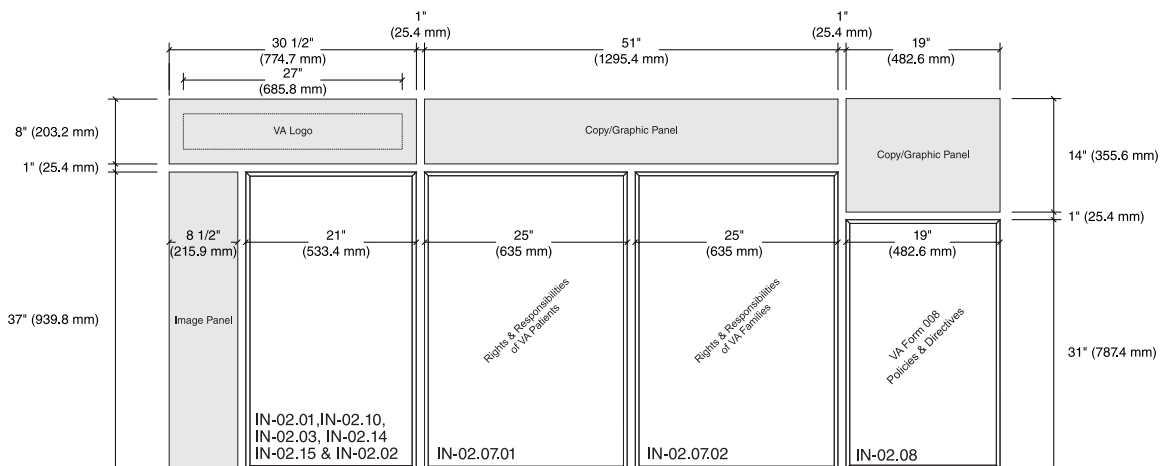

Layout C





U.S. Department
of Veterans Affairs

SECTION 3.4

SPECIALTY SIGNAGE DRAWINGS



Introduction

This section contains detailed drawings of a variety of specialty signs and products approved for use in VA facilities.

This is not an exhaustive catalog of items, only a sampling of those most commonly used. Many of these items are standard products that can be easily ordered and vary slightly based on manufacturer.

The following drawings provide general design intent and do not function as fabrication-ready shop drawings.

Guidelines

- Please review [Section 2.4 Specialty Signage Guidelines](#) which contains information regarding Planning, Programming, Construction, and Installation prior to starting signage projects.

Updatable Inserts

To increase durability and moisture resistance, updatable inserts should be printed on synthetic paper or clear acetate sheets. Standard printer paper can absorb moisture causing wrinkles and yellowing over time.

Sign Designations

Each sign in the program manual has been given a specific sign type number designation. This designation provides a common description that can be referenced when programming a site and ordering signs. The following explains how the sign type designations are derived.

SP - 21 .03 A

- SP** Designates a specialty sign.
- 03** Two-digit number identifies the sign type family.
- .01** The two-digit number following the period identifies a specific sign within the sign family.
- A** The letter designates a specific sign configuration, version and / or layout for graphics or symbols.



Sign Overview

Specialty Signage Drawings

Sign Type SP-21

Specialty Signs

SP-21.01

Freestanding Single Post Stanchion

SP-21.02

Freestanding Interior Pylon



SP-21.01

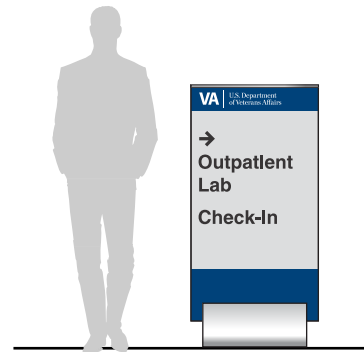

SP-21.02

SP-21.03

Freestanding Temporary Posting

SP-21.05

Infection Control Sign



SP-21.03

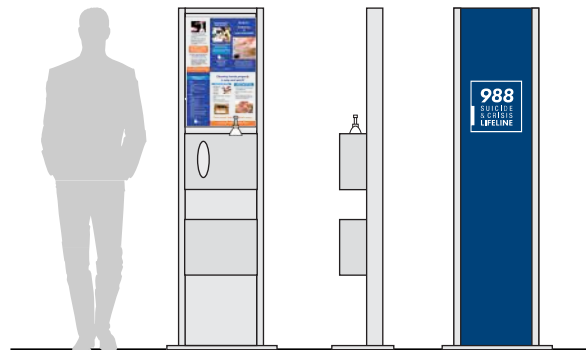

SP-21.05

Sign Type SP-22

Specialty Room Signs

SP-22.01

Card or Laminated Paper Holder

SP-22.02-03

File or Binder Holder

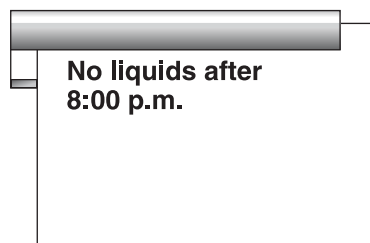

SP-22.01

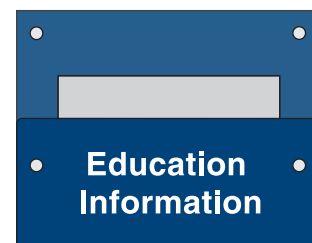

SP-22.02-03



Sign Overview

Specialty Signage Drawings

Sign Type SP-22

Specialty Room Signs



SP-22.05



SP-22.06

SP-22.05

Mental Health Room Number

SP-22.06

Mental Health Room Identification

SP-22.07

Patient & Resident Room Dry Erase Boards

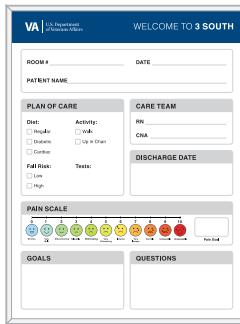

SP-22.07

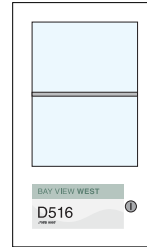

SP-22.08

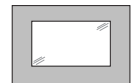

SP-22.09

SP-22.08

Resident Memory Case

SP-22.09

Digital Memory Monitor

Sign Type SP-23

Pole Mounted Banner Signs

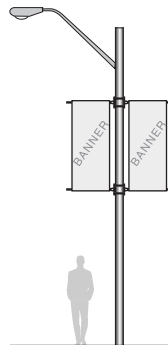

SP-23.01

SP-23.01

Banners: Pole Mounted

Sign Type SP-24

Temporary Construction Signs

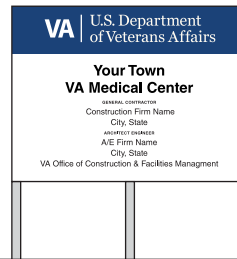

SP-24.01

SP-24.01

Construction Sign – Text Only

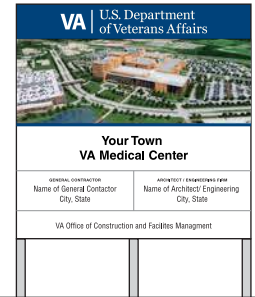

SP-24.02

SP-24.02

Construction Sign – Text with Rendering

SP-24.03

Construction Sign - Rendering

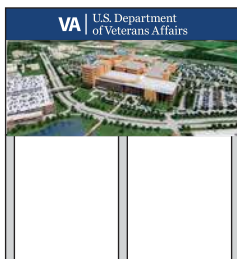

SP-24.03

SP-24.04

Construction Sign – Safety



SP-24.04

Sign Type SP-25

Dedication Plaque



SP-25



Freestanding Single Post Stanchion

Size

Message Layout A
 Sign Face: 14" High x 11" Wide
 (355.6 mm H x 279.4 mm W)

Message Layout B
 Sign Face: 22" High x 14" Wide
 (558.8 mm H x 355.6 mm W)

Post Height: 36" (914.4 mm)

Post Tube Diameter:
 2 1/2" (63.5 mm)

Base Diameter: 14" (355.6 mm)

Description

Freestanding single post stanchion to hold updatable insert(s).

Message Configuration

Sign to hold custom message insert. Two size options are shown.

Sign Components

Sign Holder: Aluminum frame with ACM core and clear polycarbonate lenses to hold insert(s).

Post: Anodized aluminum post and base

Graphic Process

Digital Print

Colors

Refer to the color chart in the Appendix.

Installation

This sign is to be used indoors for small, temporary messages in conditions where wall space is limited or queuing for lines.

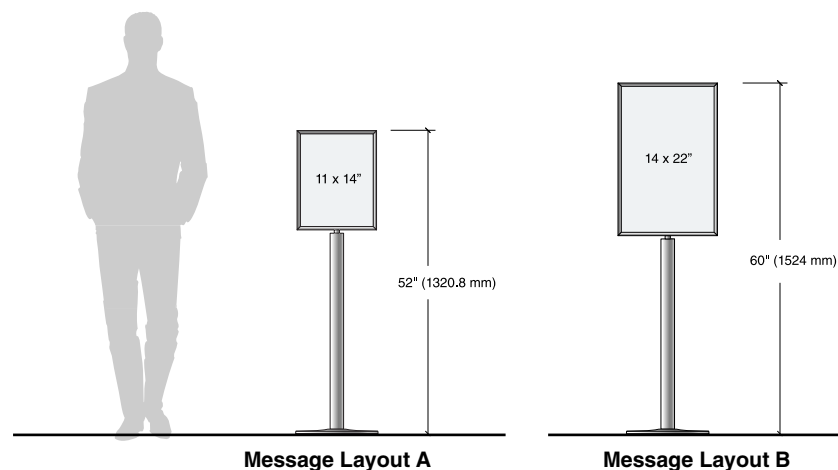
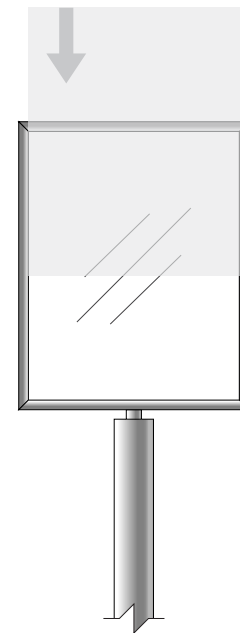
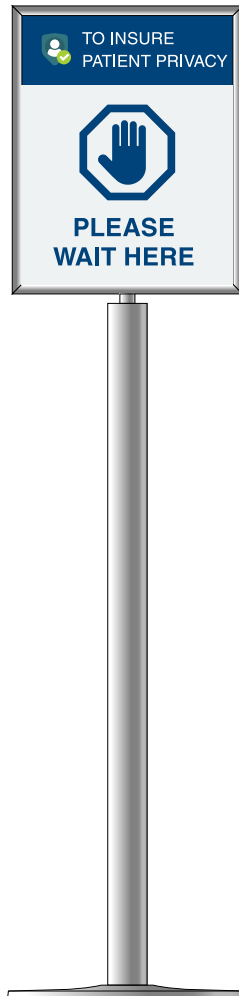

Freestanding Single Post Stanchion

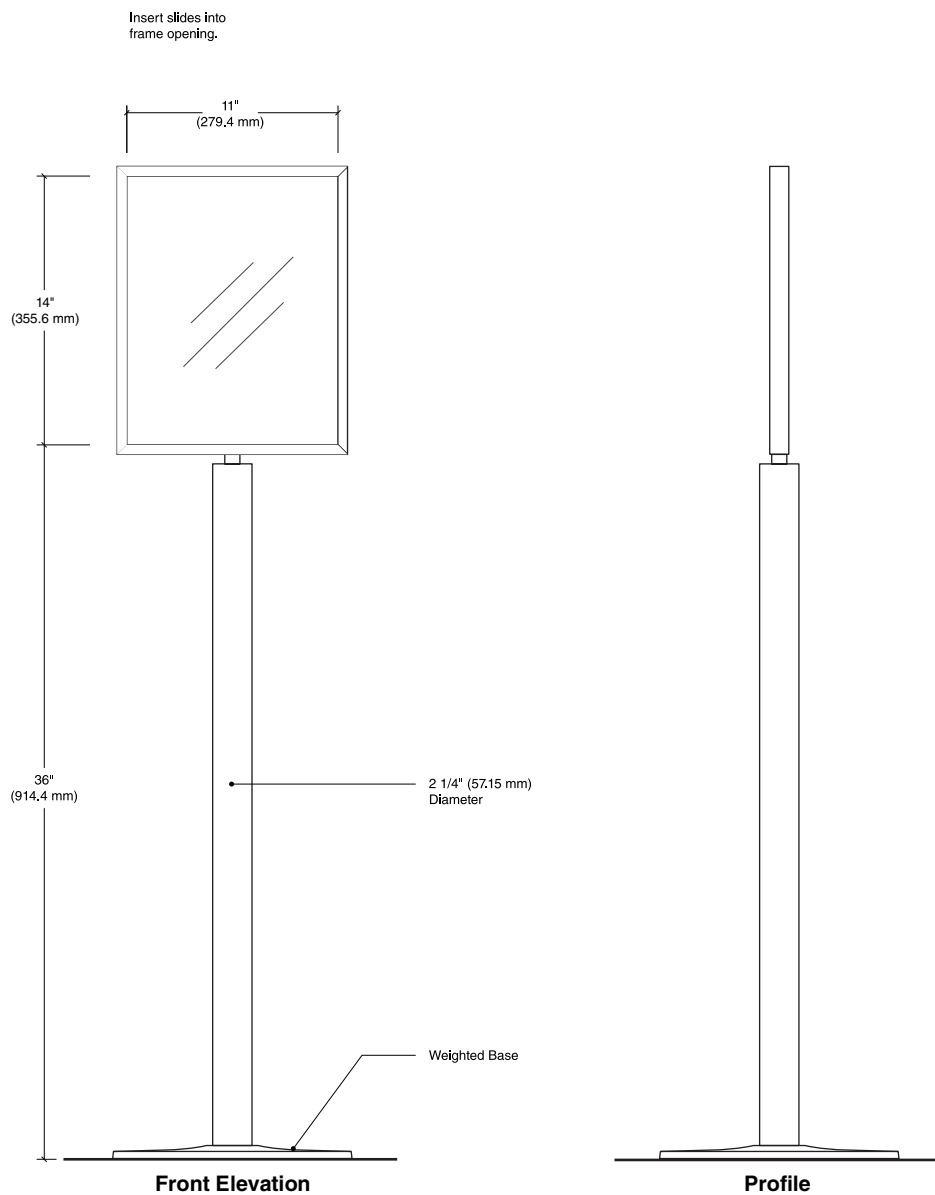

Freestanding Interior Pylon

Size

Sign Face: 50" High x 27" Wide x 1/2" Thick
(1270 mm H x 685.8 mm W x 12.7 mm T)

Base Height: 9 1/2" (241.3 mm)

Base Width: 14" (355.6 mm)

Description

Vertical freestanding pylon for indoor semi-permanent messages.

Message Configuration

Sign to hold custom message insert.

Sign Components

Panel:

Tempered glass panels with laminated paper or polystyrene insert and aluminum cap.

Base:

Extruded aluminum base

Graphic Process

Digital print

Colors

Refer to the color chart in the Appendix.

Recommendations

This sign is to be used for large, semi-permanent indoor messages in conditions where wall space is limited.

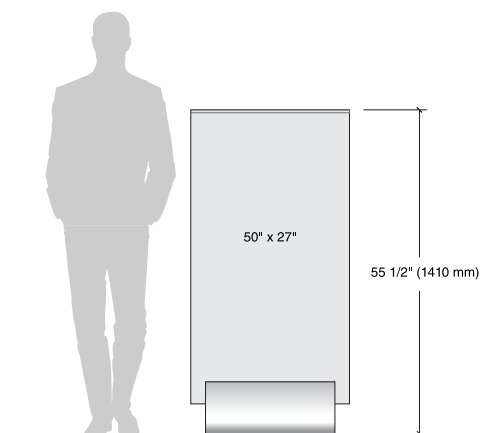
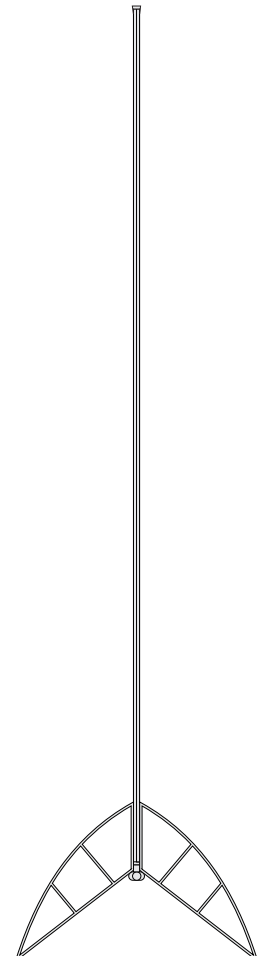
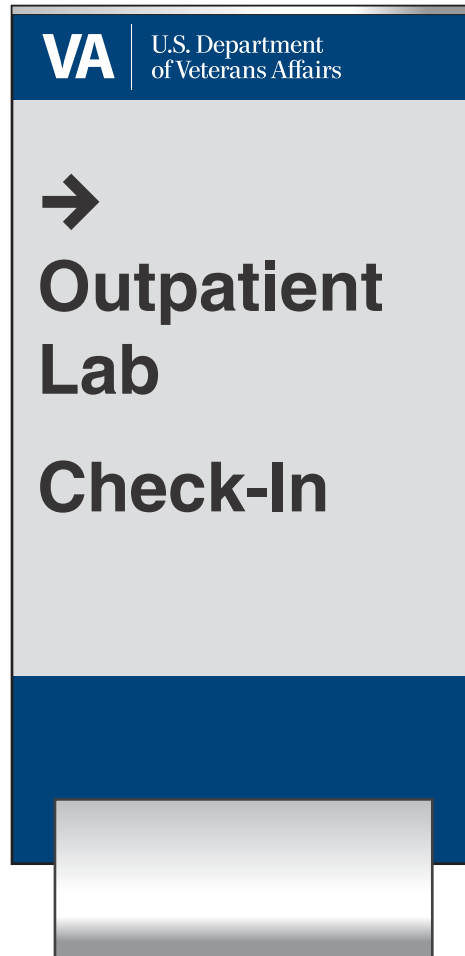

SP-21.02

Specialty Signage Drawings

Freestanding Interior Pylon

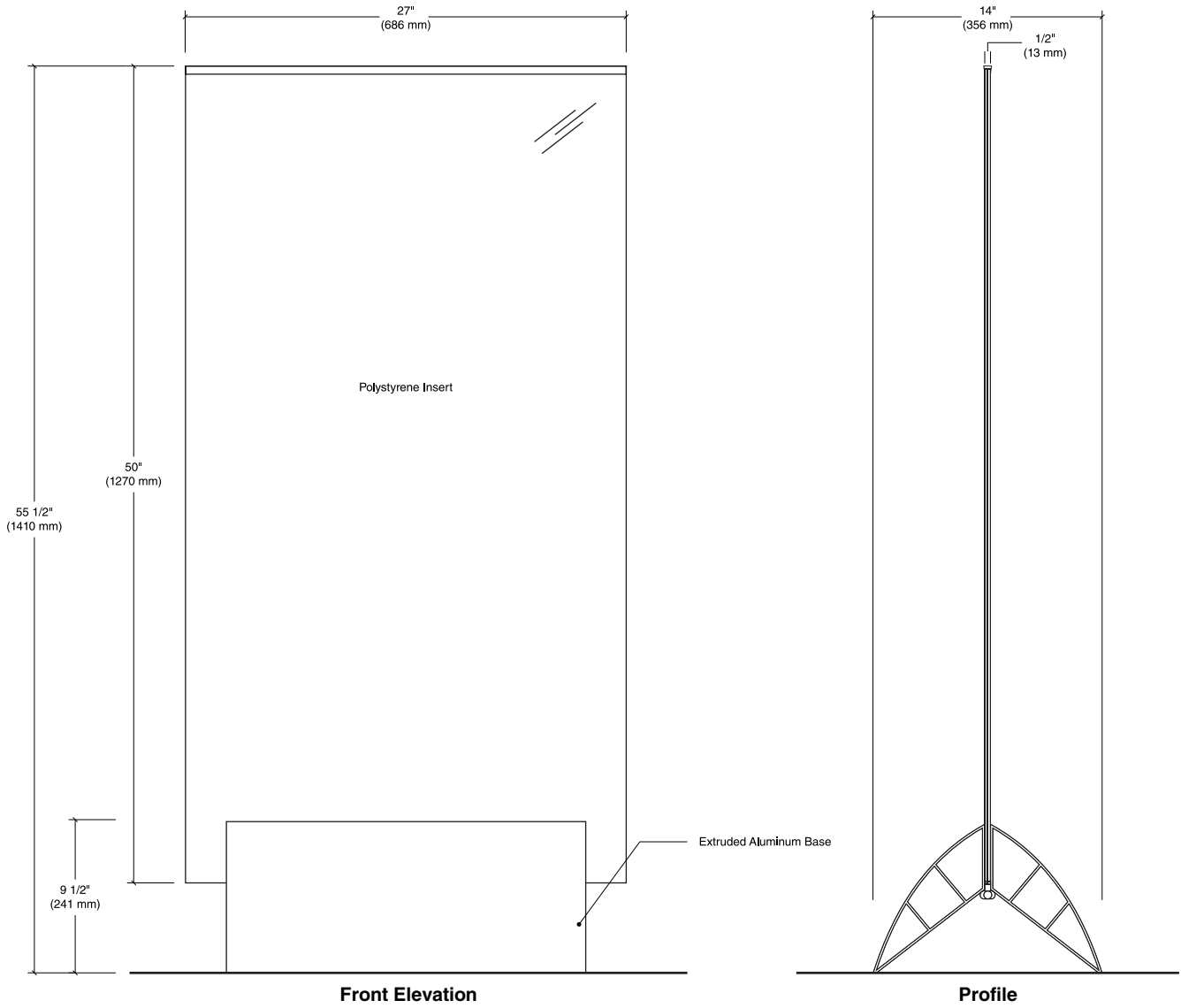

Freestanding Temporary Posting

Size

Sign Face: 72" High x 24" Wide x 1/2" Thick
(1828.8 mm H x 609.6 mm W x 12.7 mm T)

Base Height: 9 1/2" (241.3 mm)

Base Width: 7 3/4" (196.85)

Description

Vertical freestanding indoor graphic panel for temporary messages.

Message Configuration

Sign to hold custom message insert.

Sign Components

Panel:

1/2" (12.7 mm) thick panel with high-impact polystyrene surface for digital printing and UV coating to prevent yellowing.

Base:

Solid metal stand with satin silver powder coat finish Accepts 1/2" (12.7 mm) thick rigid media up to 7' H (2133.6 mm)

Graphic Process

Digital print

Colors

Refer to the color chart in the Appendix.

Recommendations

This sign is to be used for large, temporary indoor messages in conditions where wall space is limited.

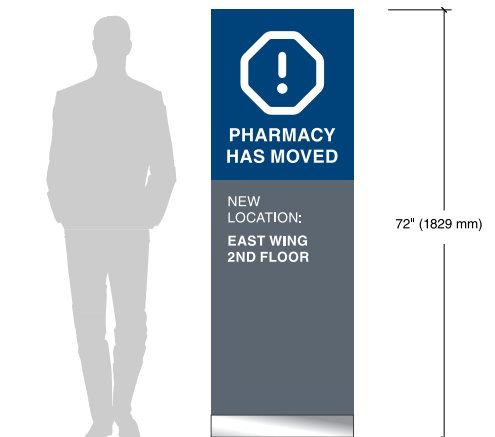
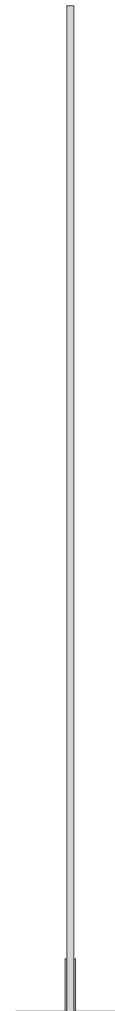
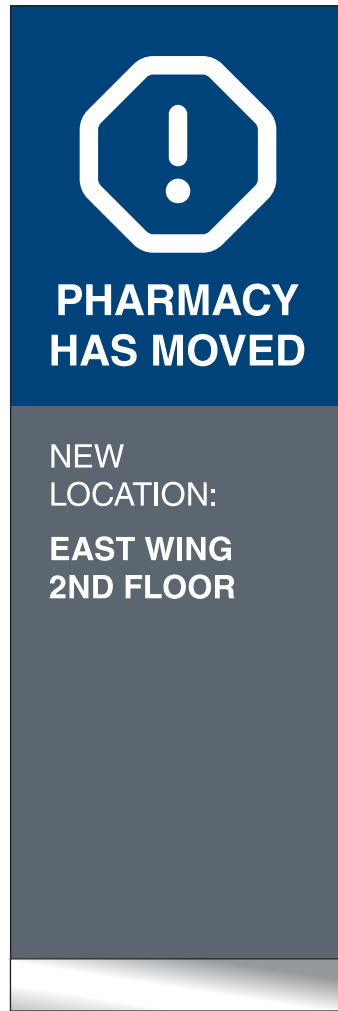

Freestanding Temporary Posting

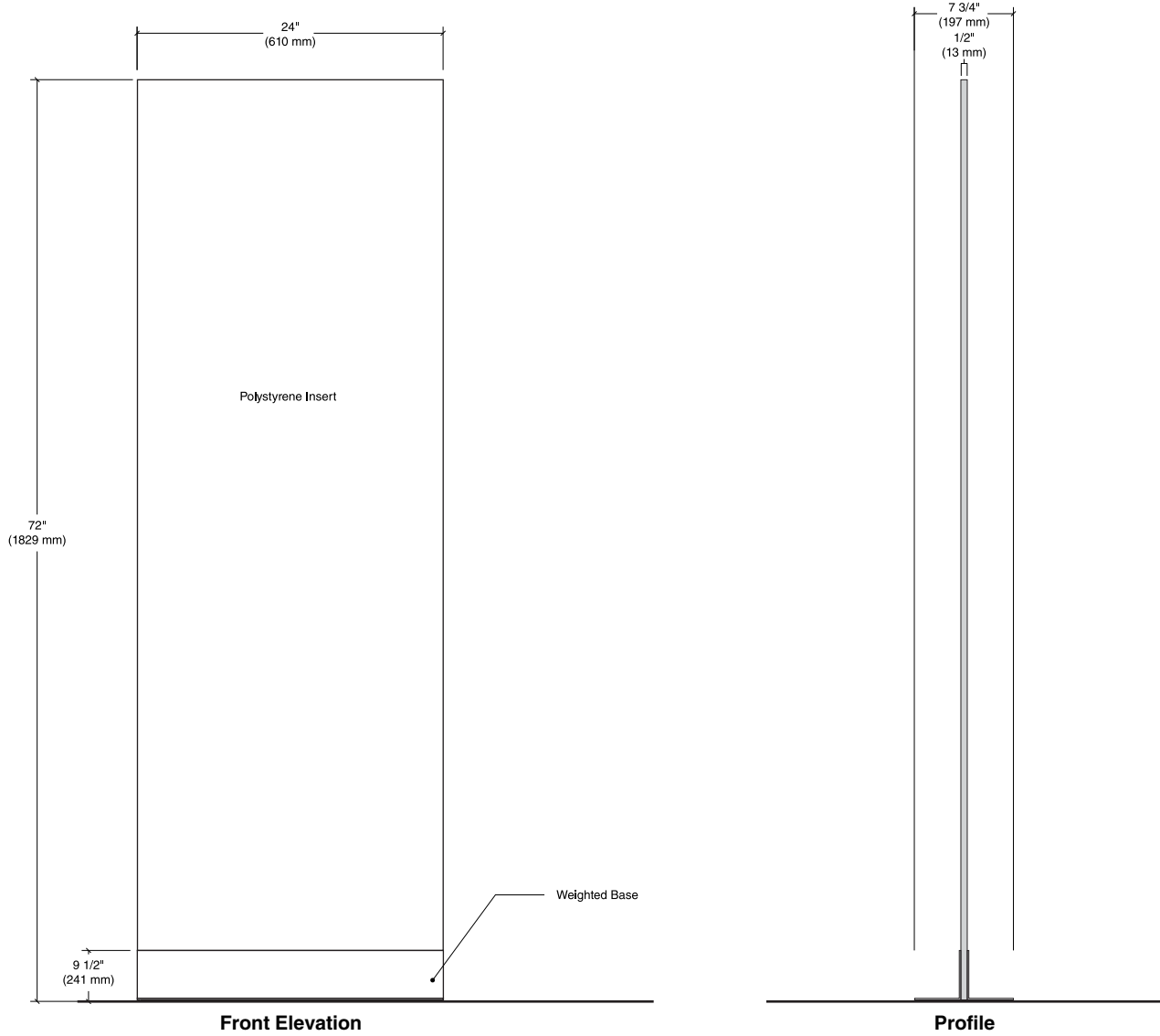

Infection Control Sign

Size

Approx. 5'-0" High x 15" Wide
(1524 mm H x 381 mm W)

Sign Insert: 17" High x 11" Wide
(431.8 mm H x 279.4 mm W)

Description

Non-illuminated, freestanding, single sided kiosk to provide hand sanitizer, tissues, gloves, information regarding infection control and face-masks.

Sign Components

Freestanding kiosk structure with compartments to hold hand sanitizer dispenser, tissue dispenser, waste receptacle (for tissues), gloves, and acrylic sleeve to insert (11" x 17") printed graphic/instructions.

Graphic Process

Printed paper

Colors

Colors and materials to match or complement existing palette.

Mounting

Movable weighted base

Typography

Helvetica Bold

Installation

It is recommended that this sign be placed at building entries and high traffic areas such as the Canteen, Lobby, and retail locations.

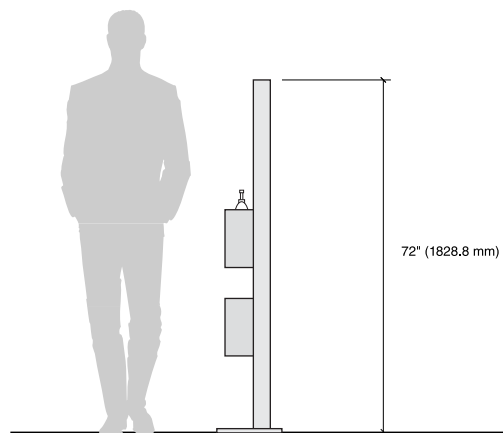
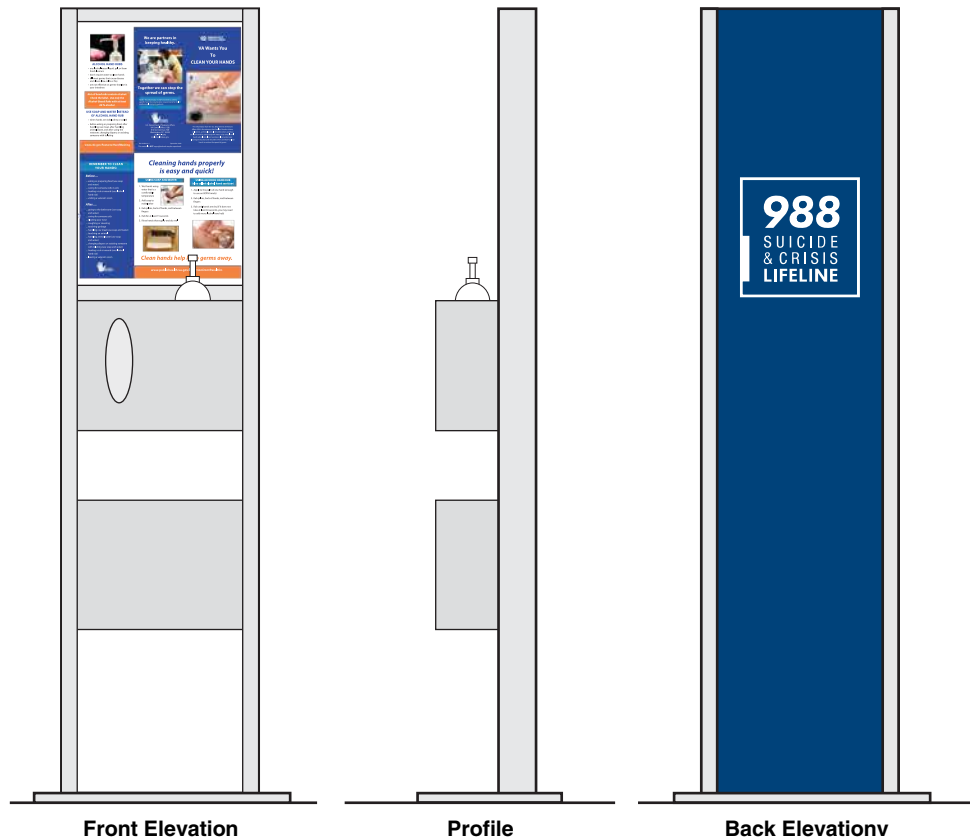

Infection Control Sign

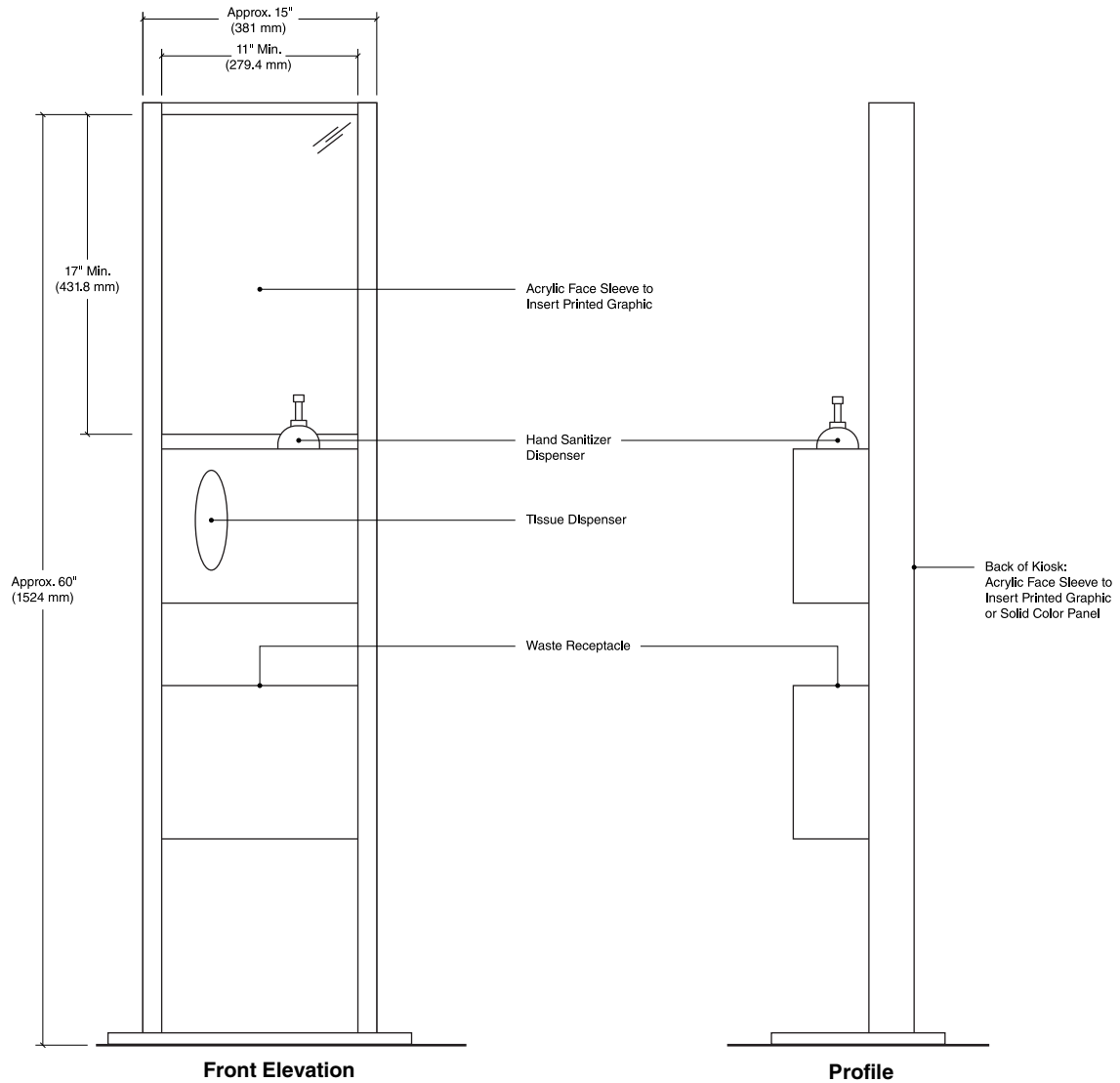

SP-22.01

Specialty Signage Drawings

Card or Laminated Paper Holder

Size

Size to vary depending upon messaging requirement. Holders are available to accommodate small size inserts that are approximately 9" (228.6 mm) Wide to larger/poster sized inserts, approx. 2'-0" (609.6 mm) Wide.

Description

Card or paper holder to temporarily hold paper or notices

Sign Components

Aluminum extrusion with ball or cylinder pinch roller

Colors

Per manufacturer

Mounting

Double sided VHB foam tape or silastic adhesive

Installation

On wall directly under sign

Recommendations

Can be installed under a patient room sign or a patient bed sign to hold various sheets of paper.

Can be installed under office sign for use as a message placement holder or used at conference rooms to hold room schedules.

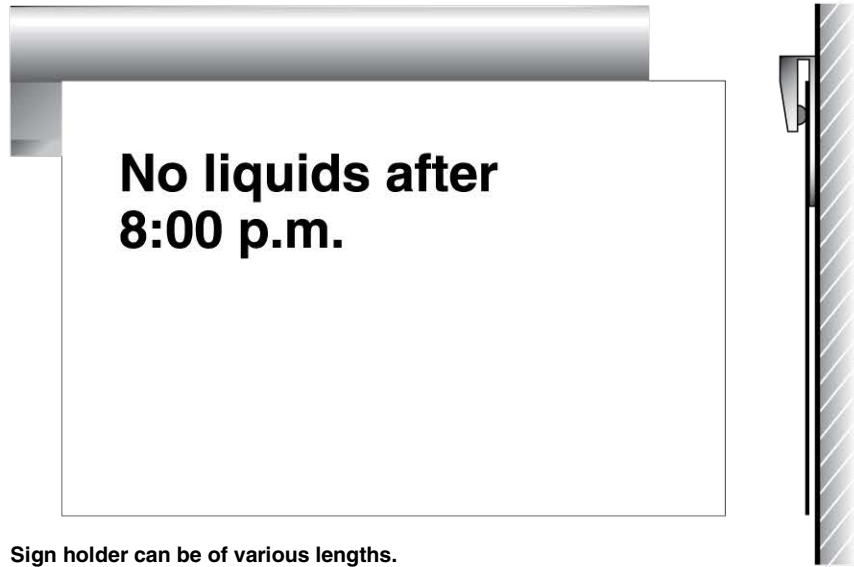

Sign holder can be of various lengths.

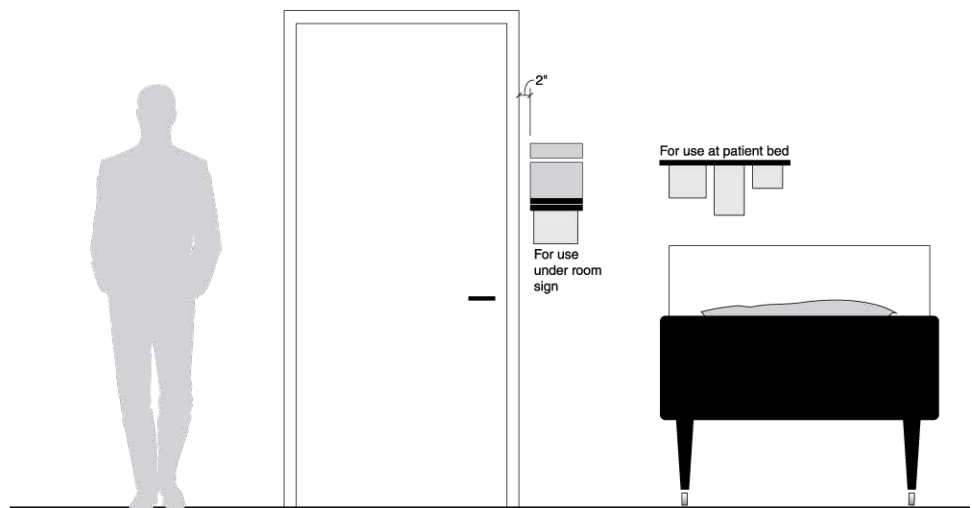
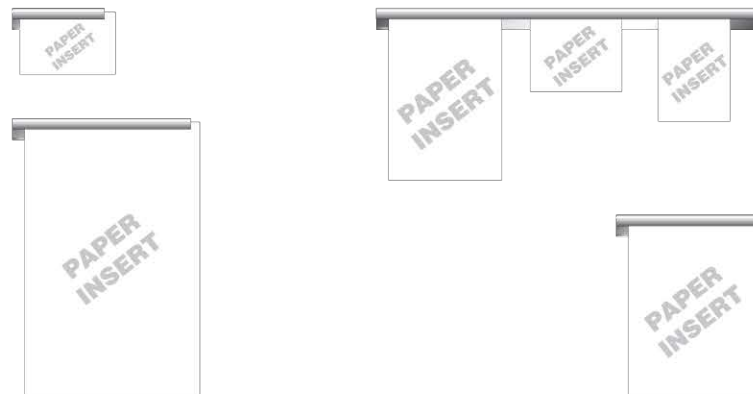

Card or Paper Laminated Holder

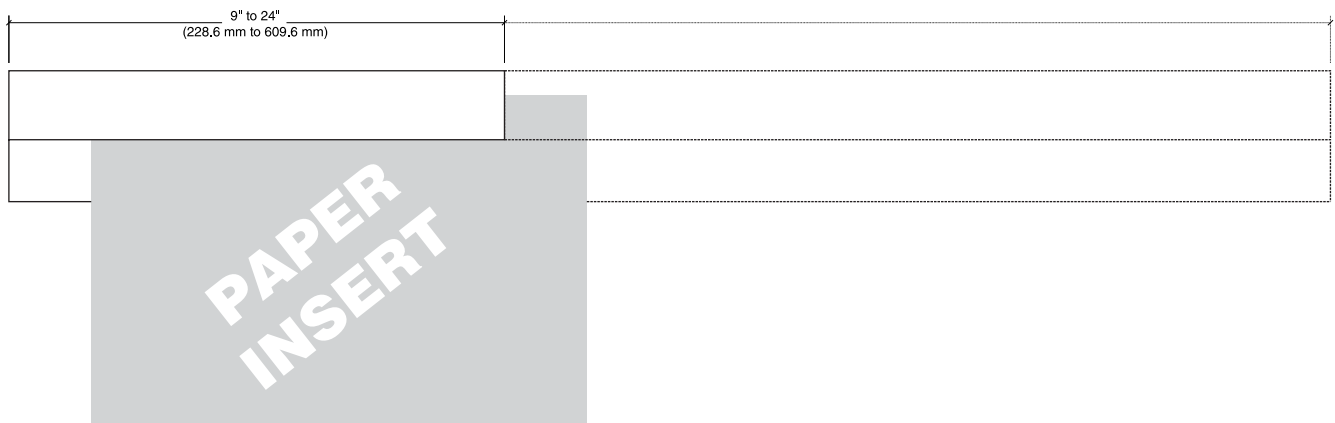

SP-22.02-.03

Specialty Signage Drawings

File or Binder Holder

Size

SP-22.02: 11 3/4" High x 1'-3" Wide
x 2 1/2" Deep (298.45 mm H x
381 mm W x 63.5 mm D)

SP-22.03: 11 3/4" High x 1'-3" Wide
x 4" Deep (298.45 mm H x
381 mm W x 101.6 mm D)

Description

File or binder holder

Sign Components

Painted, formed metal

Colors

Refer to the color chart in the
Appendix.

Mounting

Mechanical fasteners

Installation

On wall

Recommendations

DO NOT use this sign to transfer
patient information.

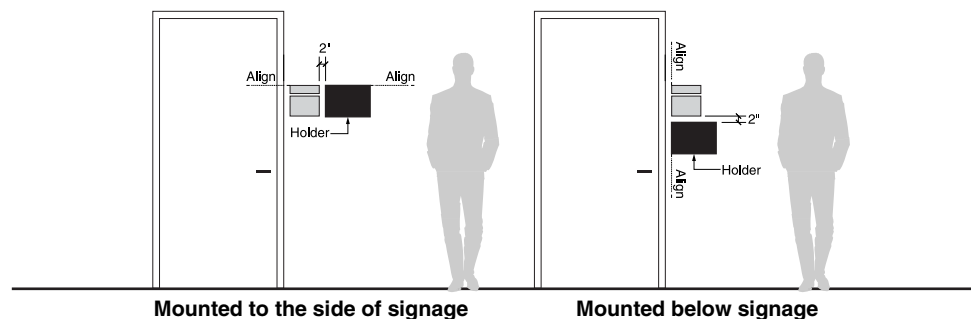
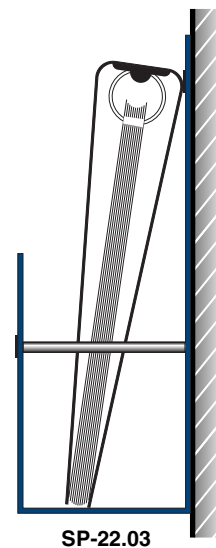
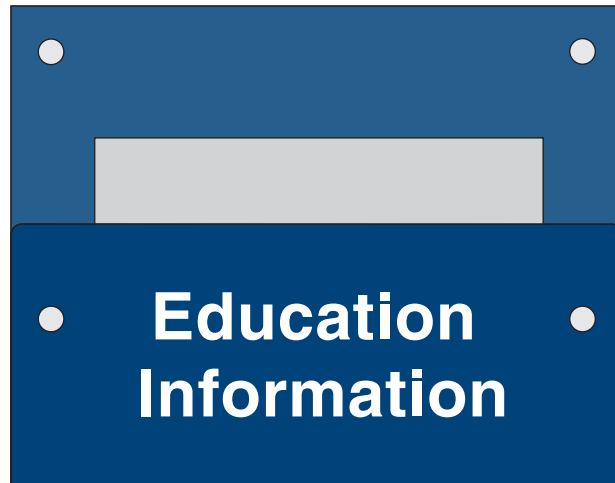

File or Binder Holder

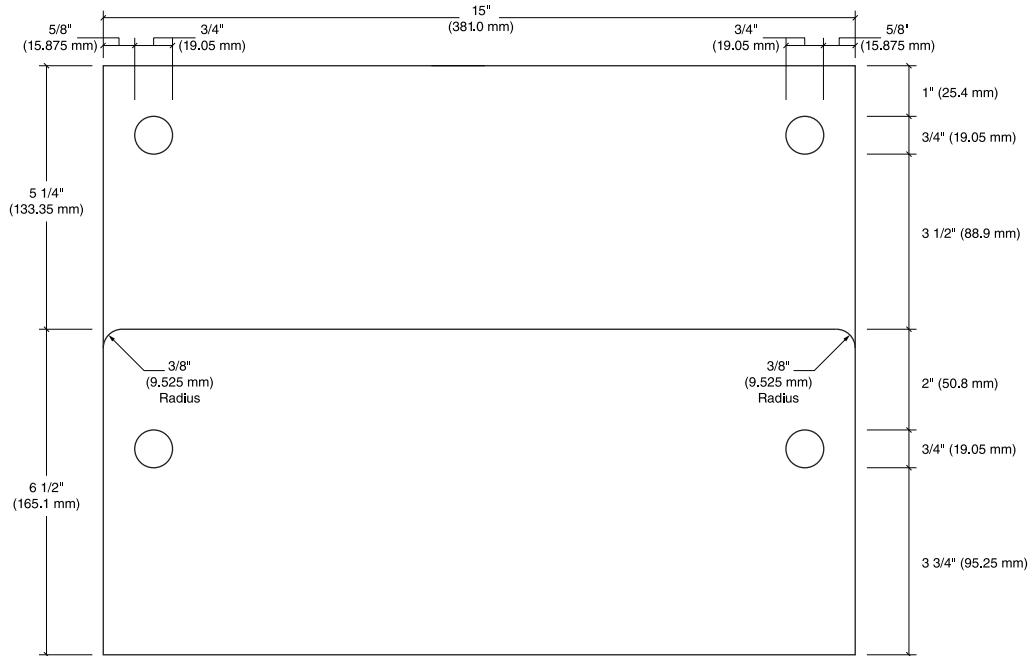

Front Elevation

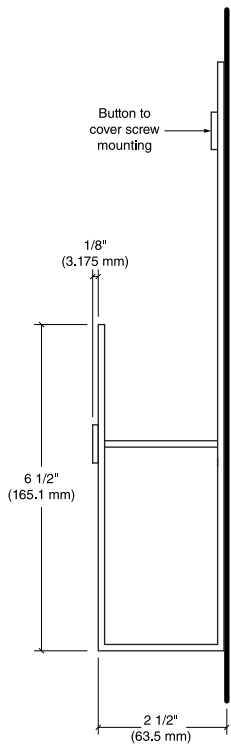

SP-22.02 - Profile

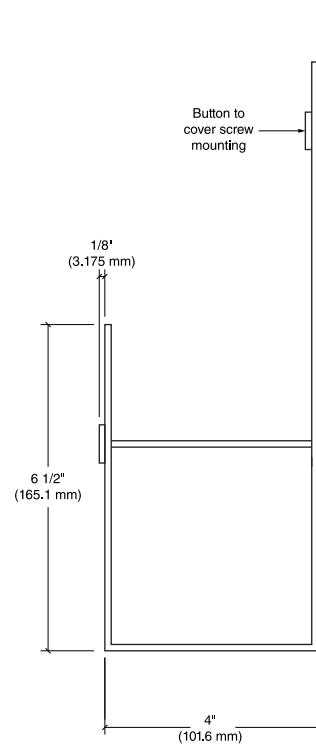

SP-22.03 - Profile



SP-22.05

Specialty Signage Drawings

Mental Health Room Number

Size

Sign Face:
 3" High x 8 1/2" Wide x 0.045"
 Thick Graphic Carrier (76.2 mm H x
 215.9 mm W x 1.143 mm T)

Description

Anti-ligature flexible ABA compliant
 room number sign

Sign Construction

Multilayered composite
 thermoplastic sheet with rounded
 corners

Graphic Process

Tactile room number with
 accompanying Braille

Colors

Text: Refer to the color chart in the
 Appendix.

Background: Based on
 manufacturer capabilities

Typography

Helvetica Regular
 Grade 2 Braille

Mounting

Full coverage double sided VHB
 tape and silicone adhesive

Installation

Wall-mounted, latch side of door at
 60" (1524 mm) to top of sign from
 finished floor and 2" (51 mm) over
 from door frame.

Recommendations

This sign is to be used for inpatient
 mental health areas or other
 secured areas where anti-ligature
 signs are required for patient safety.



Message Layout

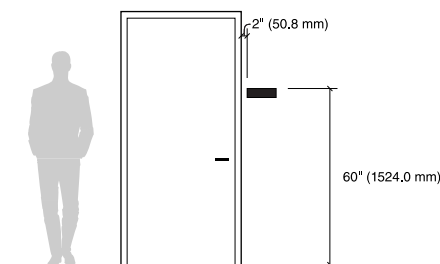

Mental Health Room Number

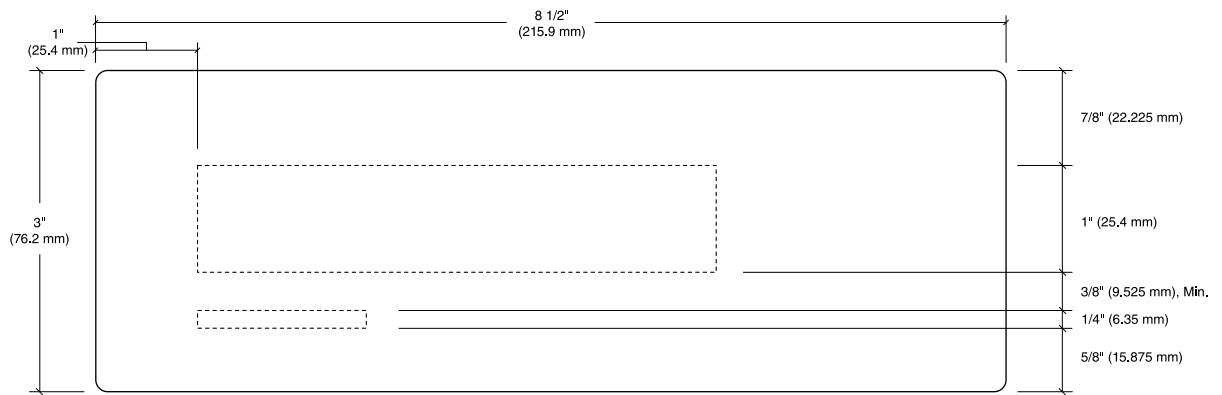

Message Layout



Mental Health Room ID

Size

Sign Face:
8 1/2" High x 8 1/2" Wide x 0.045"
Thick Graphic Carrier (215.9 mm H
x 215.9 mm W x 1.143 mm T)

Description

Anti-ligature flexible ABA compliant
room number sign with message or
write-on area below.

Message Configuration

Message Layout A: Permanent
Message

Message Layout B: Write-On Board

Sign Construction

Multilayered composite
thermoplastic sheet with rounded
corners and optional write-on vinyl
laminate

Graphic Process

Tactile text with accompanying
braille on top section.

Direct digital print or silk-screened
message below.

Colors

Text: Refer to the color chart in the
Appendix.

Background: Based on
manufacturer capabilities

Typography

Helvetica Regular
Grade 2 Braille

Mounting

Full coverage double sided VHB
tape and silicone adhesive

Installation

Wall-mounted, latch side of door at
60" (1524 mm) to top of sign from
finished floor and 2" (51 mm) over
from door frame.

Recommendations

This sign is to be used for inpatient
mental health areas or other
secured areas where anti-ligature
signs are required for patient safety.

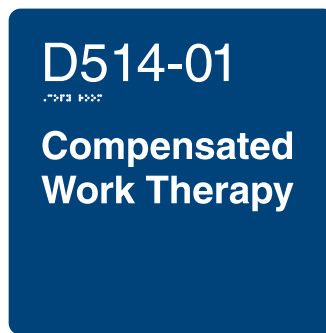
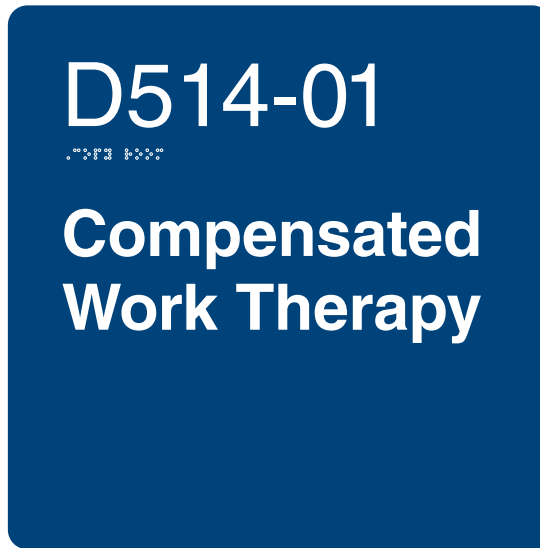

Message Layout A

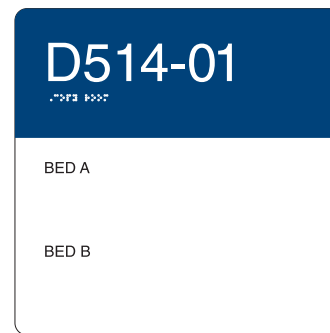

Message Layout B

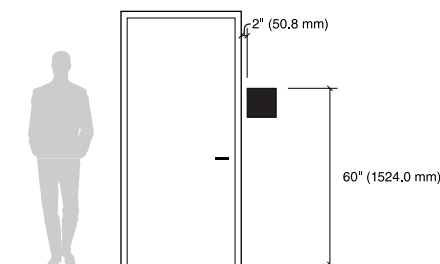

Mental Health Room ID

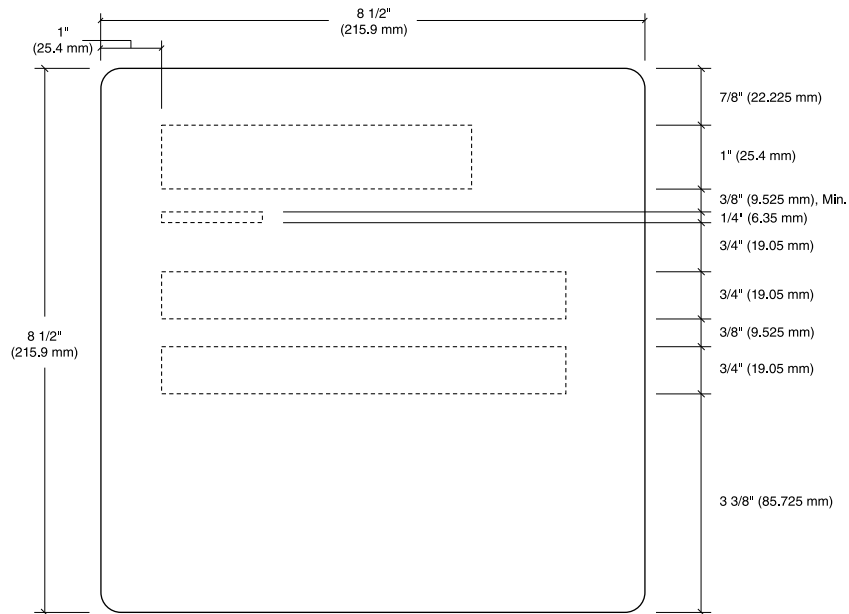

Message Layout A

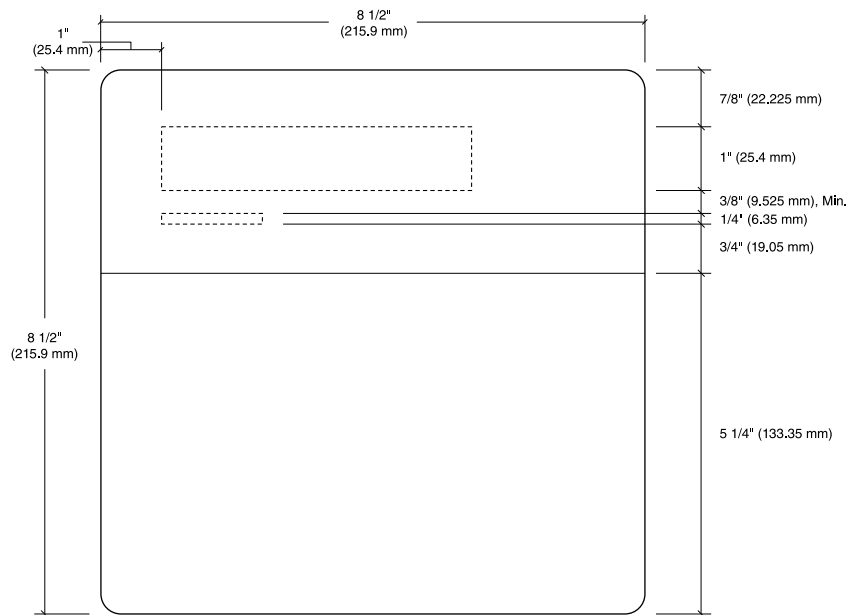

Message Layout B



Reality Orientation Sign

Size

Varies to fit application.

Description

Message board on which staff members can display information such as time, place, and personnel information to patients.

Sign Components

Option 1: Tempered glass dry erase board with subsurface permanent print and option to make magnetic

Option 2: Framed dry erase acrylic board with updatable insert

Option 3: Porcelain magnetic dry erase board with custom permanent print

Colors

Colors and materials to match or complement existing palette.

Mounting

Wall mounted mechanical fasteners

Installation

It is recommended that this sign be placed in patient's room visible from the patient's bed.

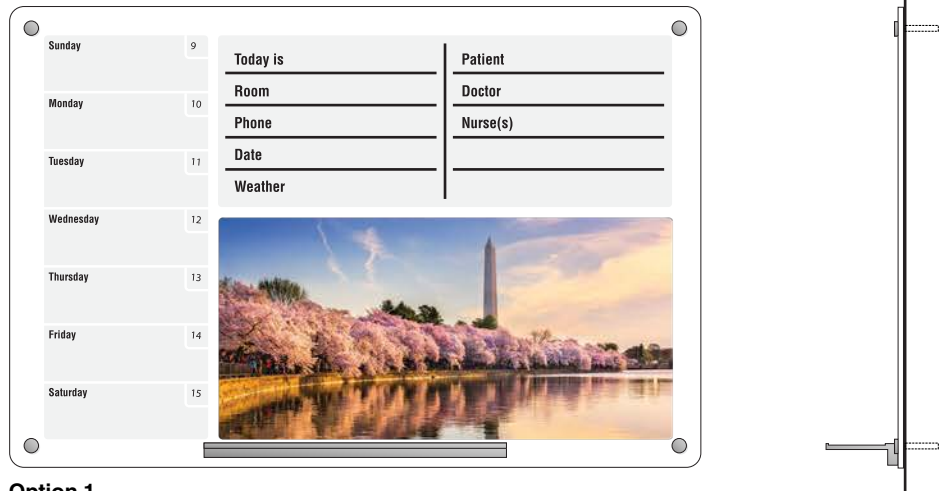

Option 1
Tempered Glass Dry Erase Board with Subsurface Permanent Print and Option to Make Magnetic



Option 2
Framed Dry Erase Acrylic Board with Updatable Insert

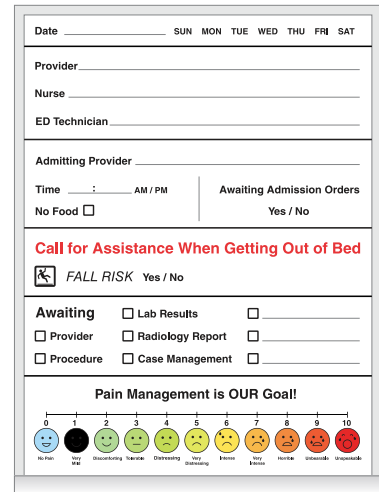

Option 3
Porcelain Magnetic Dry Erase Board with Custom Permanent Print

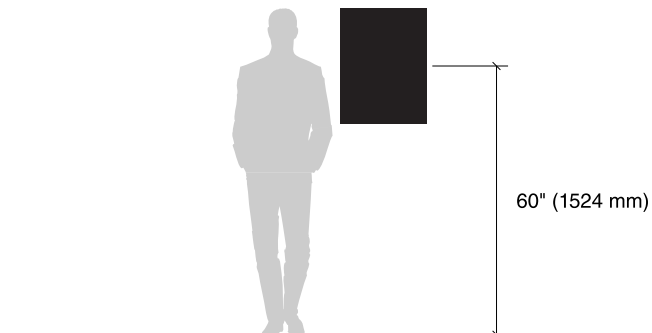

Reality Orientation Sign

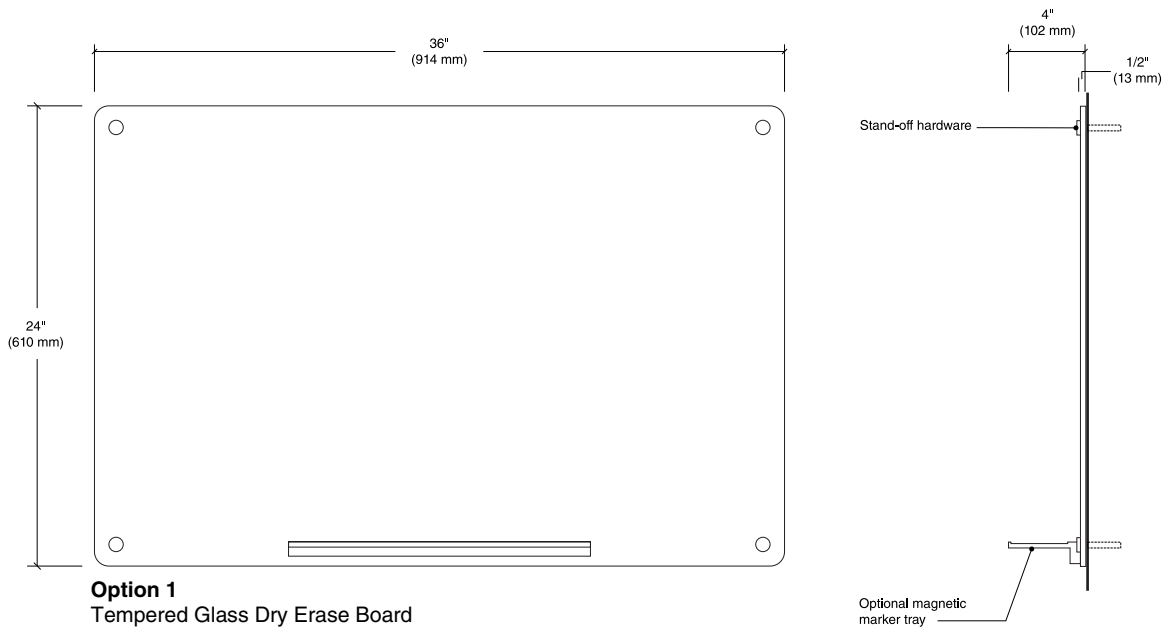

Option 1
Tempered Glass Dry Erase Board
with Subsurface Permanent Print and
Option to Make Magnetic

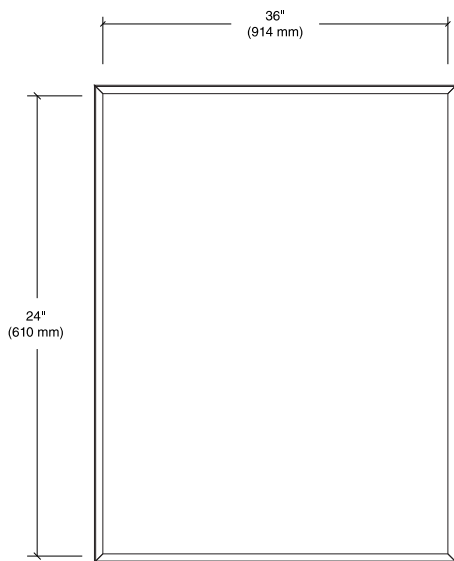

Option 2
Framed Dry Erase Acrylic Board
with Updatable Insert

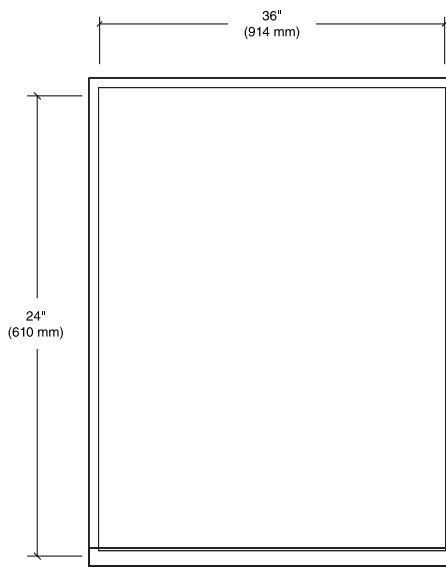

Option 3
Porcelain Magnetic Dry Erase Board
with Custom Permanent Print



Resident Memory Case

Size

Varies to fit application.

Description

Non-illuminated display case for resident pictures, cards, and mementos. Case can be configured for a one or two bed patient room. An ABA compliant room number can be incorporated into the design.

Sign Configuration

Display case with one or two adjustable shelves and framed glass or acrylic. Hinged door for front access with optional lock.

Mounting

Cases can be recessed into the wall or flush mounted.

Installation

Place outside patient's room next to entry door. If the case includes an ABA compliant room number, follow code required mounting location and height. When using a separate sign to identify the patient room, coordinate placement.

Recommendation

Resident rooms require an ABA room number and may have other specialized signage needs at entry doors such as patient alerts or contact precautions. Coordinate and develop a plan that considers all needs in relation to available wall space.

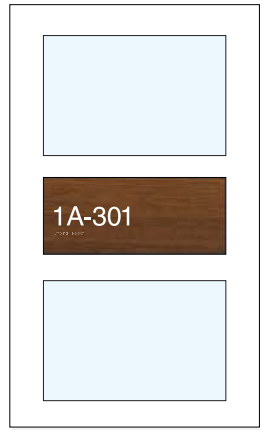

Flush Mounted Double Box

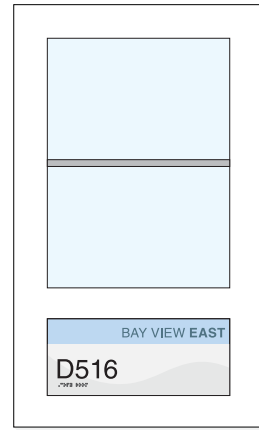

Flush Mounted Single Box

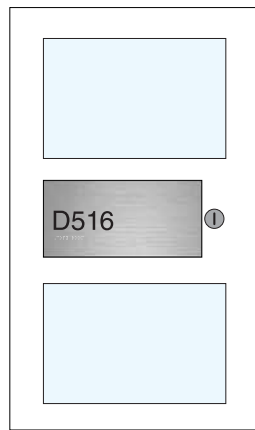
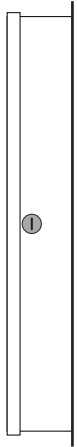

Recessed Double Box

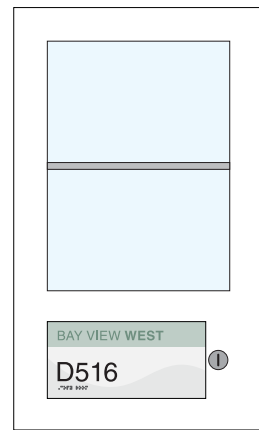

Recessed Single Box

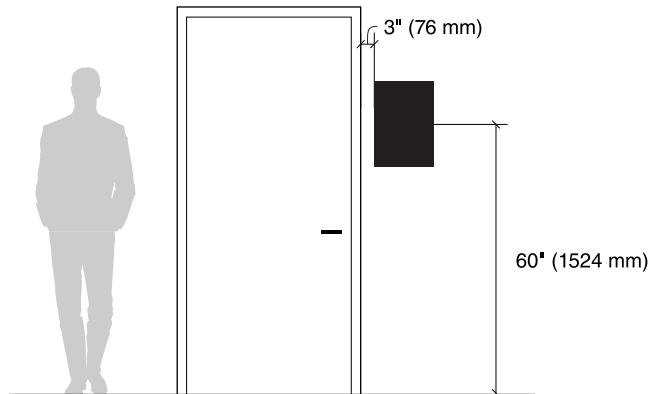

Resident Memory Case

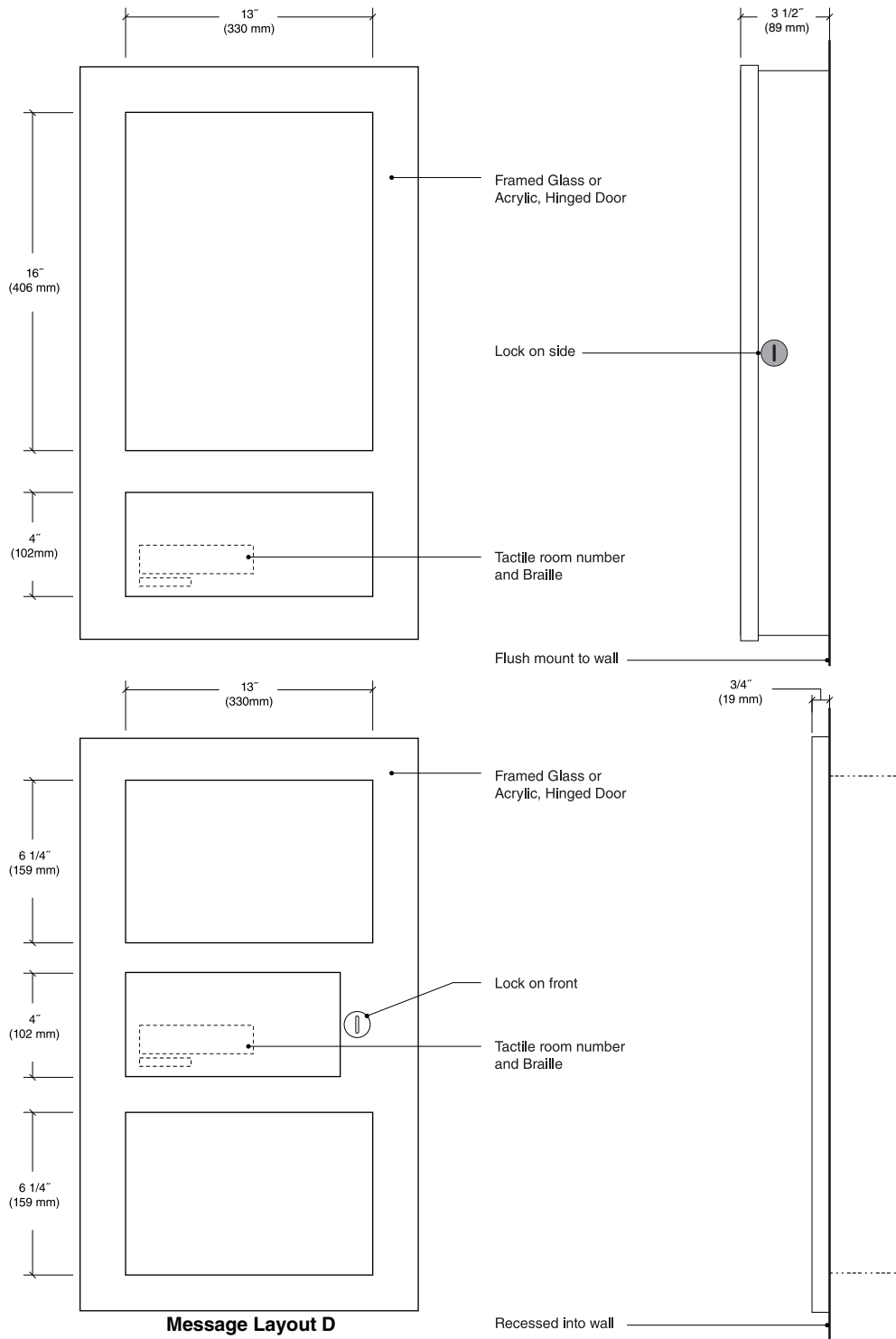

Digital Memory Monitor

Size

Approx. 6" High x 9" Wide x 3" Deep (152.4 mm H x 288.6 mm W x 76.2 mm D)

Description

LCD monitor set in wall with front access cover. LCD Screen to display resident's pictures.

Use

Memory Monitors allow residents to display pictures and images of their life, family, and interests. The monitor can be positioned outside their doors to let others know a little bit about them and their families.

Unit bezel can be finished to match the interior materials and finishes.

Sign Components

Recessed display space monitor and images by others.

Colors

Colors and materials to match or complement existing palette.

Mounting

Recessed into wall

Installation

It is recommended that this case with monitor be placed outside patient's room, adjacent to room sign next to entry door.

Recommendations

Small LCD screens are available, 7" screen size is recommended.

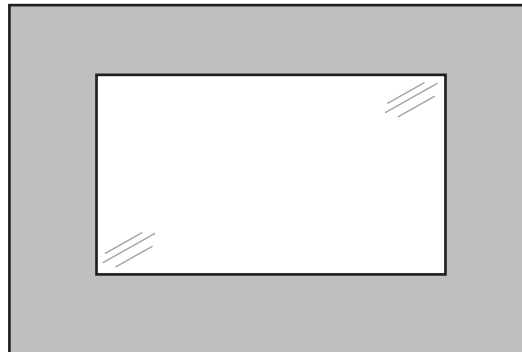

Front Elevation

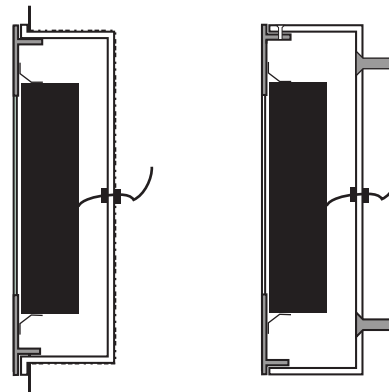

Recessed

Surface Mounted

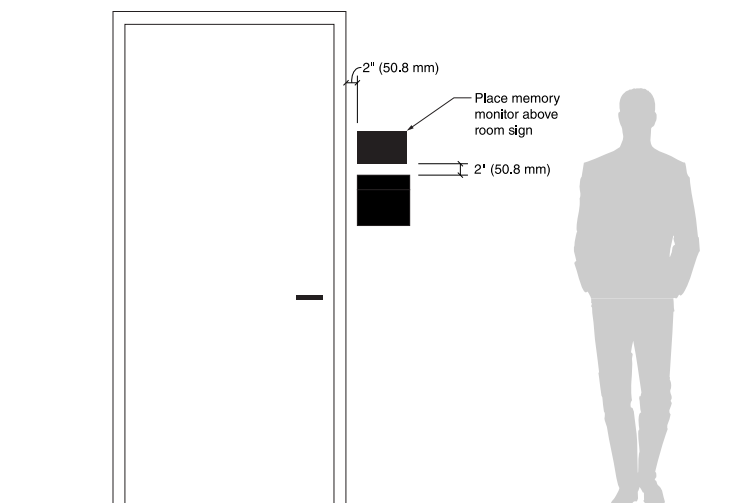

Digital Memory Monitor

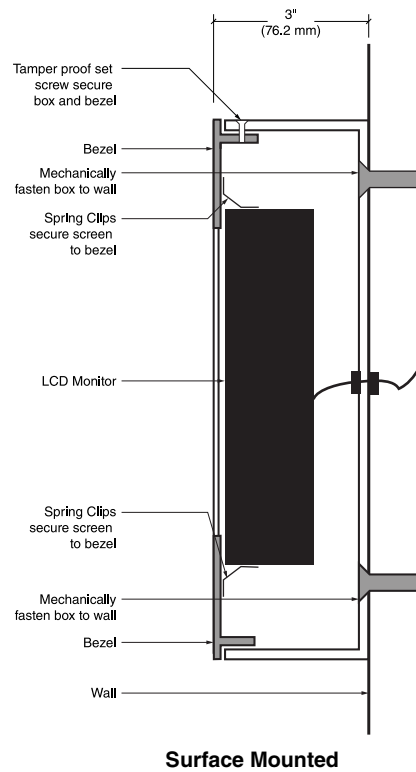
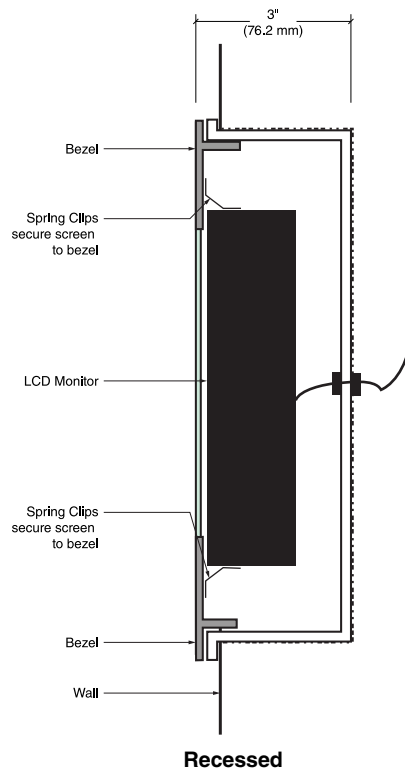
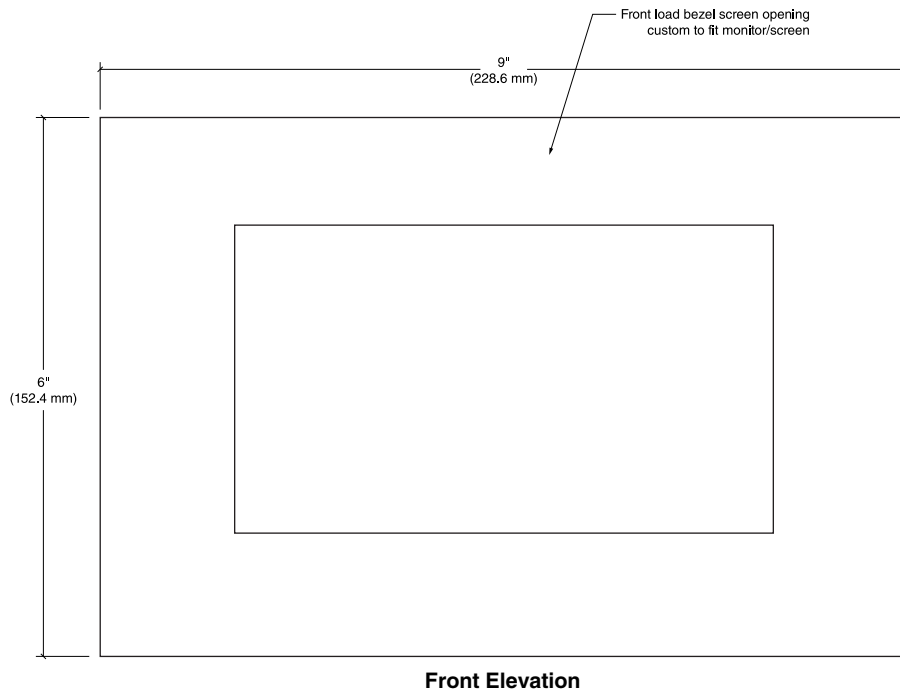

SP-23.01

Specialty Signage Drawings

Banners: Pole Mounted

Size

Sizes vary.

Typical banner arms lengths:

- 26" (660.4 mm)
- 32" (812.8 mm)
- 38" (965.2 mm)

Typical banner widths are:

- 24" (609.6 mm)
- 30" (762 mm)
- 36" (914.4 mm)

Typical banner heights:

- 48"-84" (1219.2-2133.6 mm)

Description

Changeable exterior banners mounted perpendicular to light poles (or other existing poles or posts). Banners may be vinyl, canvas or nylon with printed or screened graphic imagery. Graphic imagery to vary. Banners may contain graphics on front and back sides of banner. Graphics may be informational or decorative.



Single Banner Bracket

Double Banner Bracket

Sign Components

Top and bottom pole mounted banner brackets, top and bottom banner bracket arms, and banners. Brackets are available to hold a single banner or a double banner.

Mounting

Brackets mount to pole with heavy duty steel banding that wraps the pole to secure the bracket. Brackets can be mounted to a round, fluted, or square pole. An arm is attached to each bracket. Banners contain top and bottom pockets that slip over bracket arms to secure placement.



Installation

On light pole or other exterior poles or posts at a minimum height of 10'-0" (3048 mm) from the bottom of the banner to the ground.

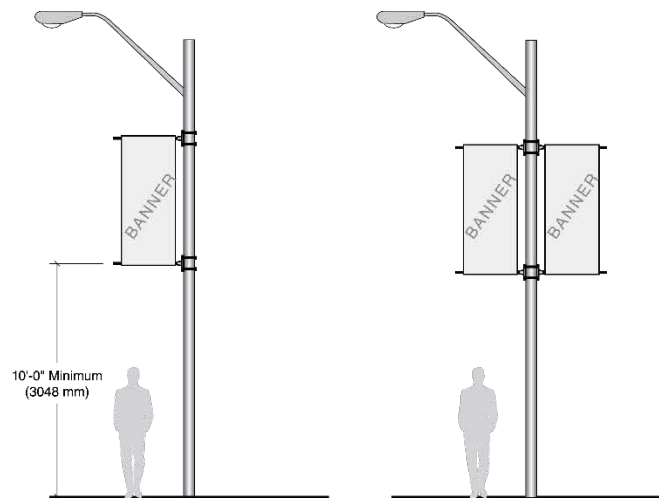

Single Banner Bracket

Double Banner Bracket



Banners: Pole Mounted



Plan – Square Post - Single



Plan – Square Post - Double



Plan – Round Post - Single



Plan – Round Post - Double

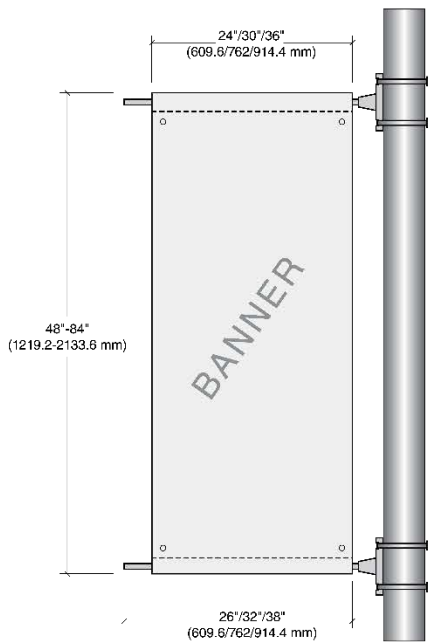

**Single Banner Bracket:
For Round Pole or Square Post**

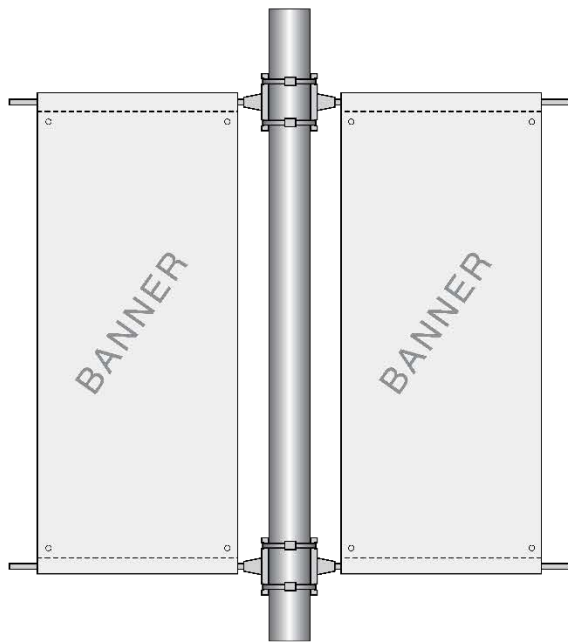

**Double Banner Bracket:
For Round Pole or Square Post**



SP-24.01

Specialty Signage Drawings

Construction Sign: Text Only

Size

Sign Panel: 6'-0" High x 8'-0" Wide
(1828.8 mm H x 2438.4 mm W)

Description

Sign used on construction sites to provide information designating the specific "Department of Veterans Affairs" project under construction as well as the name of the general contractor and other project specific consultants.

Message Configuration

Refer to message layout drawing for dimensions.

Sign Components

Posts (metal or wood) and framed MDO plywood or aluminum skin laminated to a wood or plastic core with edges physically sealed.

Face panel shall be exterior grade or better.

Graphic Process

Surface applied vinyl or screened graphics

Colors

Background: VA Blue & White
Type: Black

Refer to the color chart in the Appendix.

Typography

Helvetica Bold

Mounting

Post mounted framed sign panel

Installation

It is recommended that this sign be placed at the entry, or a visible location, on a construction site.

All visible surfaces to be primed and painted. Signposts, framing, and face to be fastened with wood screws & lag bolts.

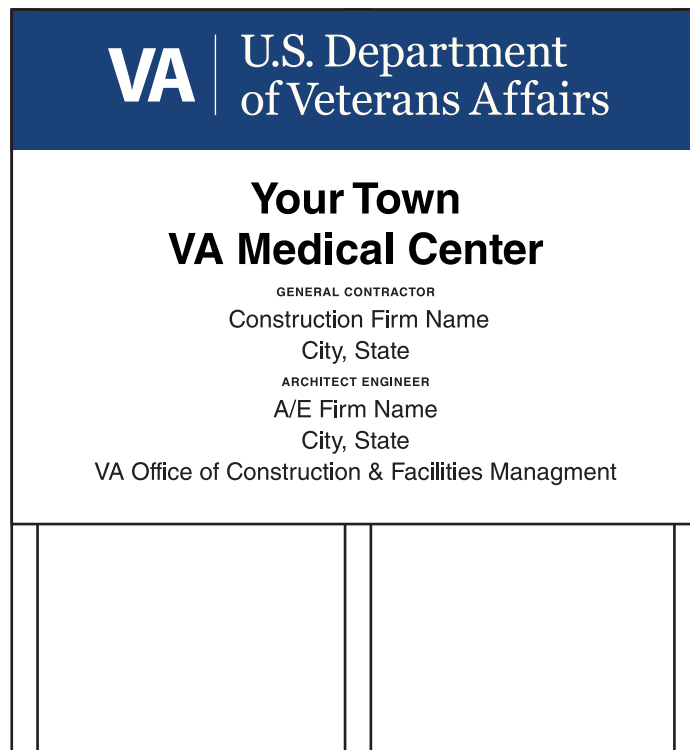

Construction Sign: Text Only

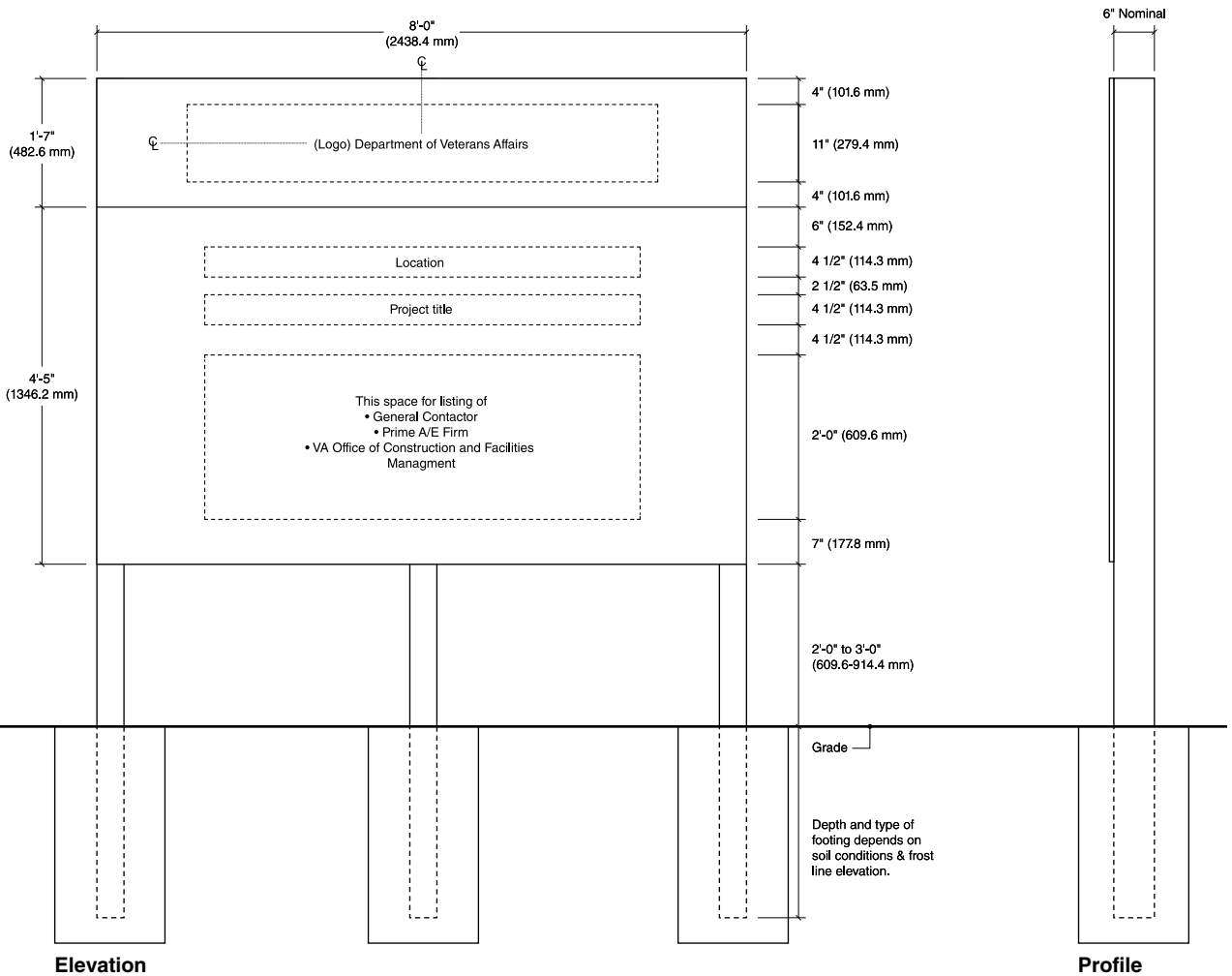
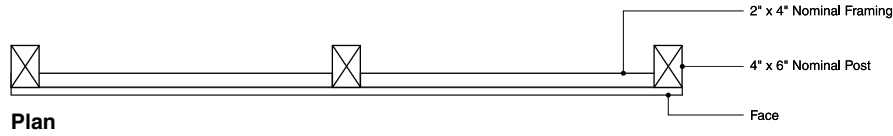

SP-24.02

Specialty Signage Drawings

Construction Sign: Text with Rendering

Size

Sign Panel: 8'-0" High x 8'-0" Wide
(2438.4 mm H x 2438.4 mm W)

Description

Sign used on construction sites to provide information designating the specific "Department of Veterans Affairs" project under construction as well as the name of the general contractor and other project specific consultants.

Message Configuration

Refer to message layout drawing for dimensions.

Sign Components

Posts (metal or wood) and framed MDO plywood or aluminum skin laminated to a wood or plastic core with edges physically sealed.

Face panel shall be exterior grade or better.

Graphic Process

Surface applied vinyl or screened graphics

Colors

Background: VA Blue & White
Type: Black

Refer to the color chart in the Appendix.

Typography

Helvetica Bold

Mounting

Post mounted framed sign panel

Installation

It is recommended that this sign be placed at the entry to the construction site or along site perimeter at a major street.

All visible surfaces to be primed and painted. Signposts, framing, and face to be fastened with wood screws & lag bolts.

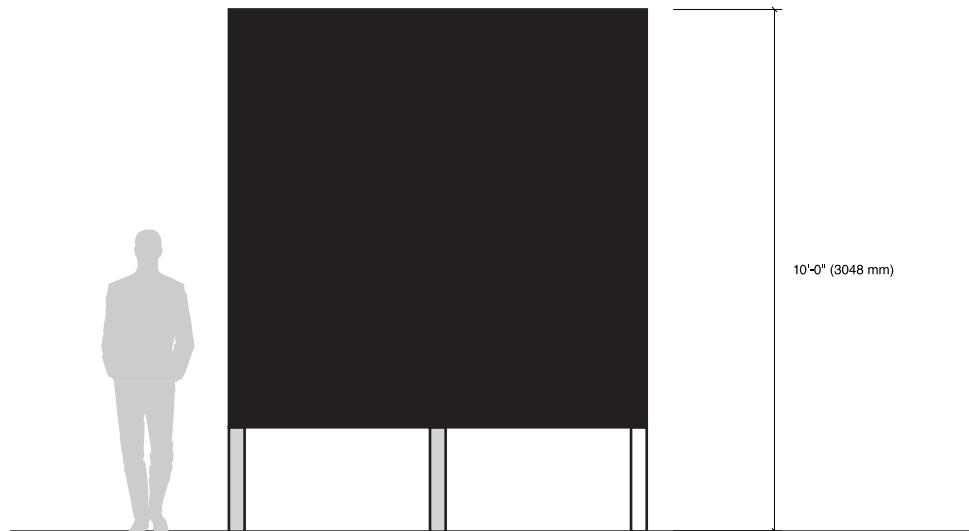
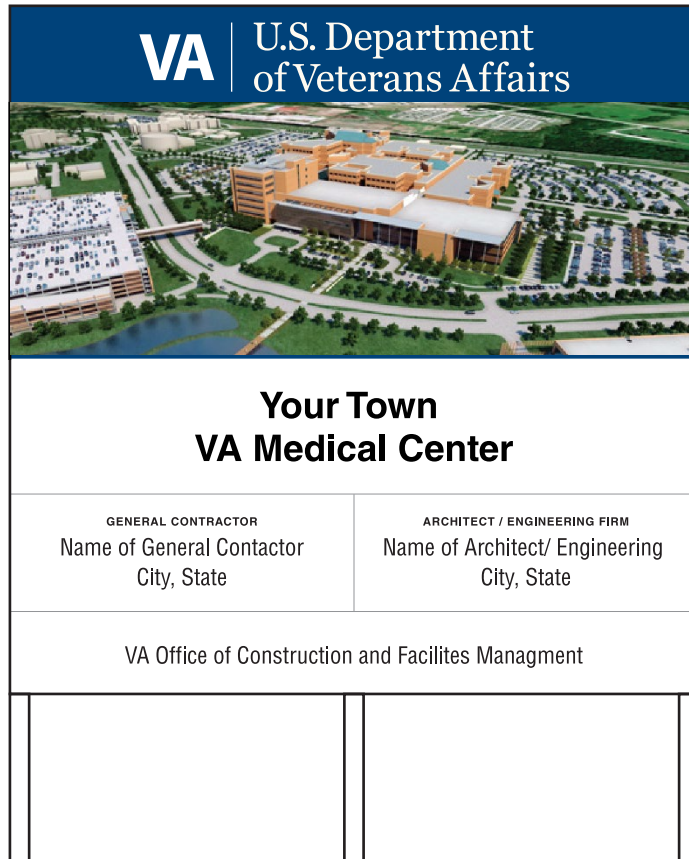

Construction Sign: Text with Rendering

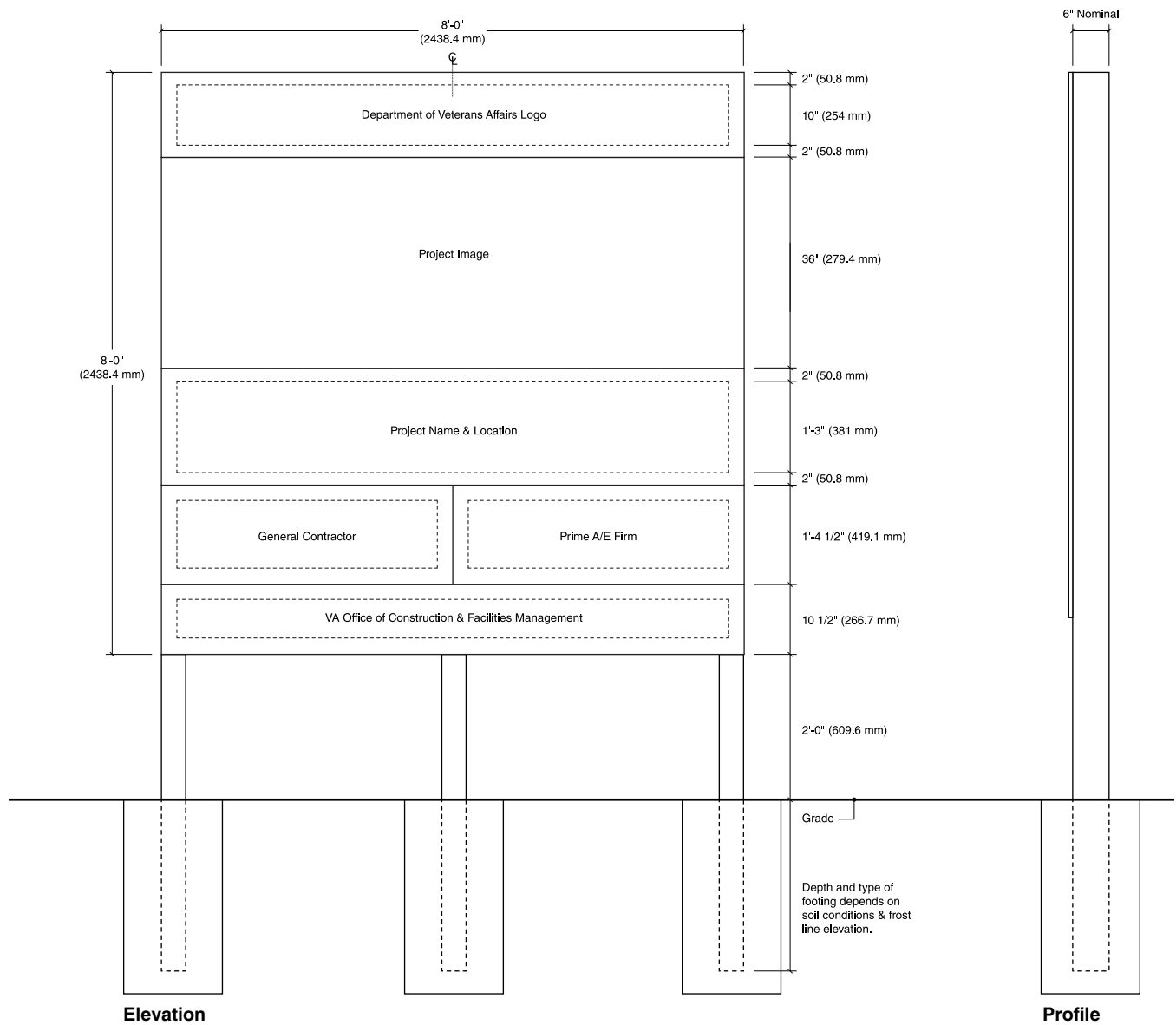

SP-24.03

Specialty Signage Drawings

Construction Sign: Rendering

Size

Sign Panel: 4'-0" High x 8'-0" Wide
(1219.2 mm H x 2438.4 mm W)

Description

Sign used on construction sites to provide information designating the specific "Department of Veterans Affairs" project under construction.

Message Configuration

Refer to message layout drawing for dimensions.

Sign Components

Posts (metal or wood) and framed MDO plywood or aluminum skin laminated to a wood or plastic core with edges physically sealed.

Face panel shall be exterior grade or better.

Graphic Process

Surface applied vinyl or screened graphics

Colors

Refer to the color chart in the Appendix.

Typography

Helvetica Bold

Mounting

Post mounted framed sign panel

Installation

It is recommended that this sign be placed at the entry to the construction site or along site perimeter at a major street.

All visible surfaces to be primed and painted. Signposts, framing, and face to be fastened with wood screws & lag bolts.



Construction Sign: Rendering

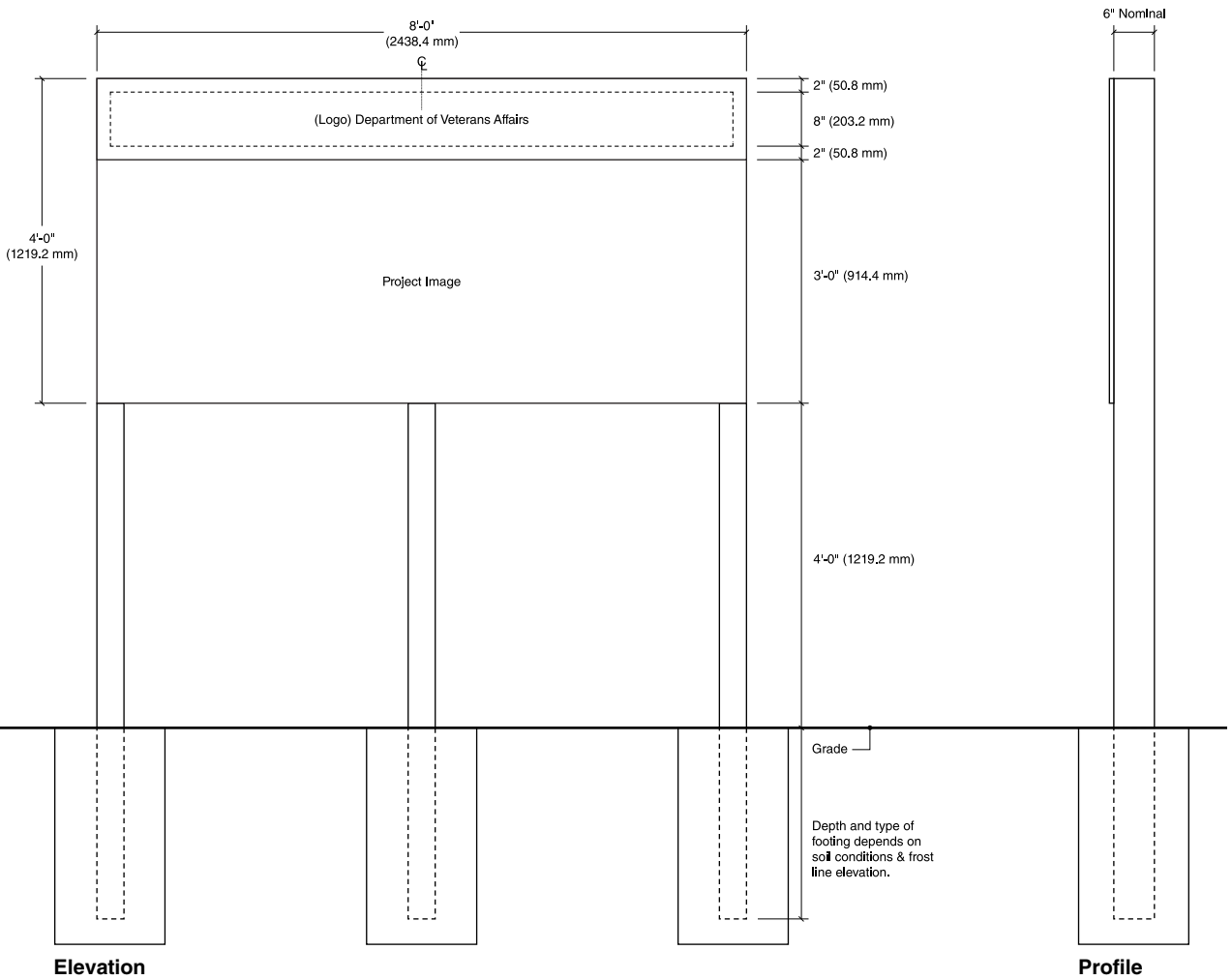

Construction Sign: Safety

Size

Sign Panel: 3'-0" High x 4'-0" Wide
(914.4 mm H x 1219.2 mm W)

Description

Sign used on construction sites to provide information regarding frequency of onsite construction related accidents. Sign panel is built with a region to display changeable numbers to indicate the number of days since time was lost due to a construction accident.

Message Configuration

Refer to message layout drawing for dimensions.

Sign Components

Posts (metal or wood) and framed MDO plywood or aluminum skin laminated to a wood or plastic core with edges physically sealed.

Sign panel may or may not be framed.

Face panel shall be exterior grade or better.

Sign panel is equipped with a region to display changeable numbers.

Graphic Process

Surface applied vinyl or screened graphics

Colors

Refer to the color chart in the Appendix.

Typography

Helvetica Bold

Mounting

Post mounted sign panel

Installation

It is recommended that this sign be placed at a visible location on a construction site near field office.

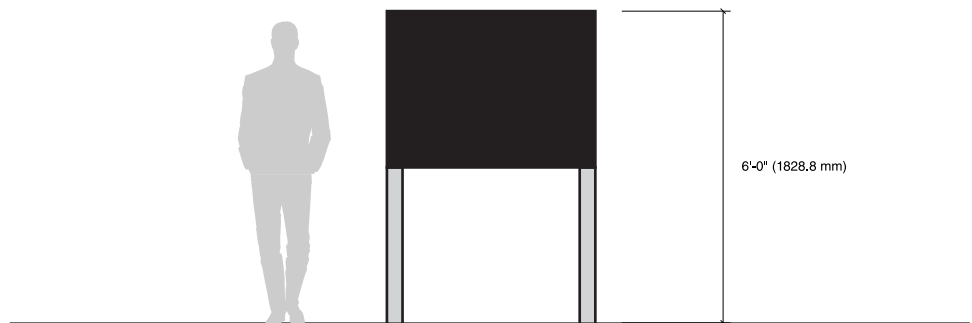

SP-24.04

Specialty Signage Drawings

Construction Sign: Safety

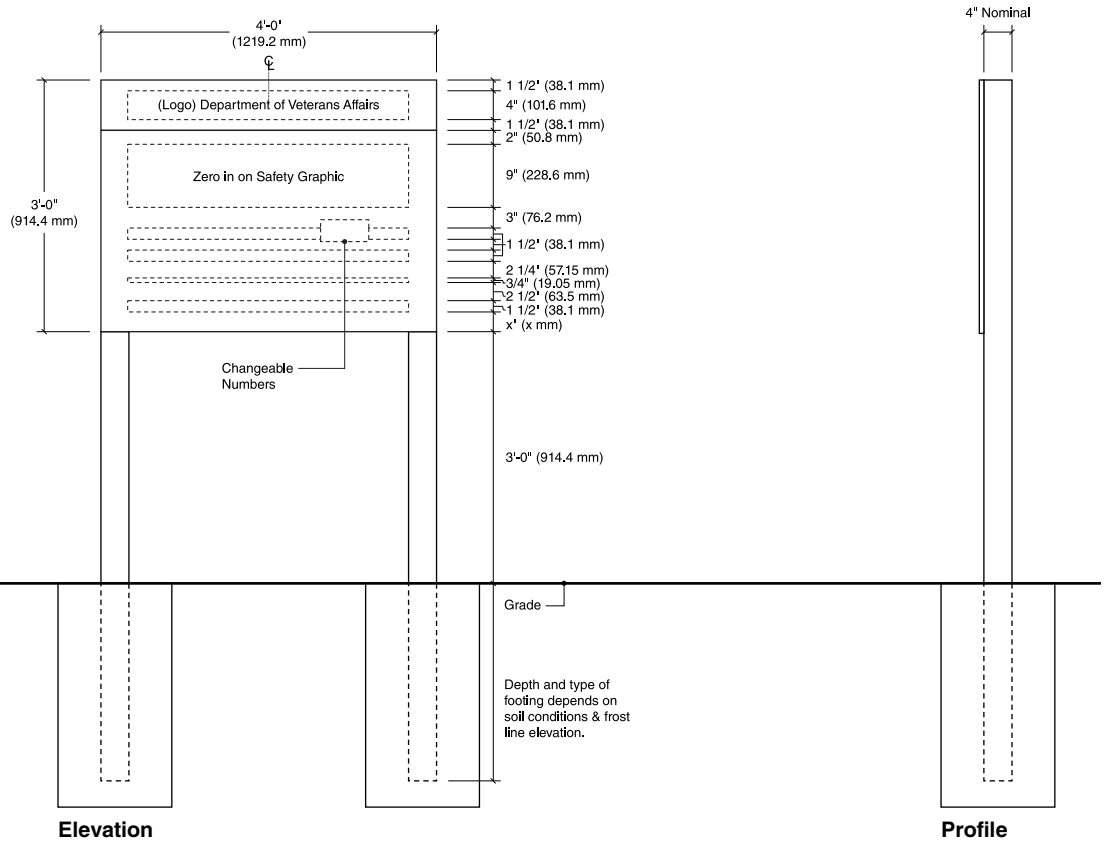
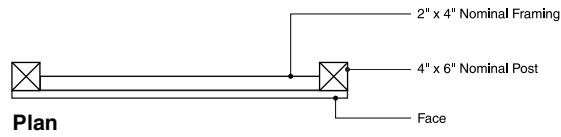

SP-25

Specialty Signage Drawings

Dedication Plaque

Size

Sign Panel: 36" High x 24" Wide
(914.4 mm H x 609.6 mm W)

Description

This sign can be used to dedicate a building or space to the individuals involved in its planning, design, and procurement. A full list of requirements and recommendations can be found on the [VA TIL](#).

Message Configuration

Refer to message layout drawing for dimensions.

Sign Components

Bronze plaque with satin bright finish exterior frame and lettering and reverse medium pebble background.

Stars cover heads of fasteners at all four corners.

Mounting

Corrosion resistant metal fasteners comparable with material or casting.

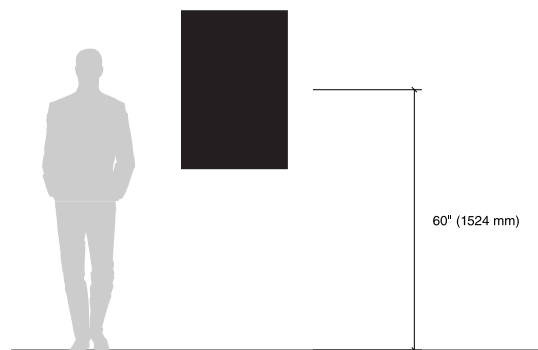
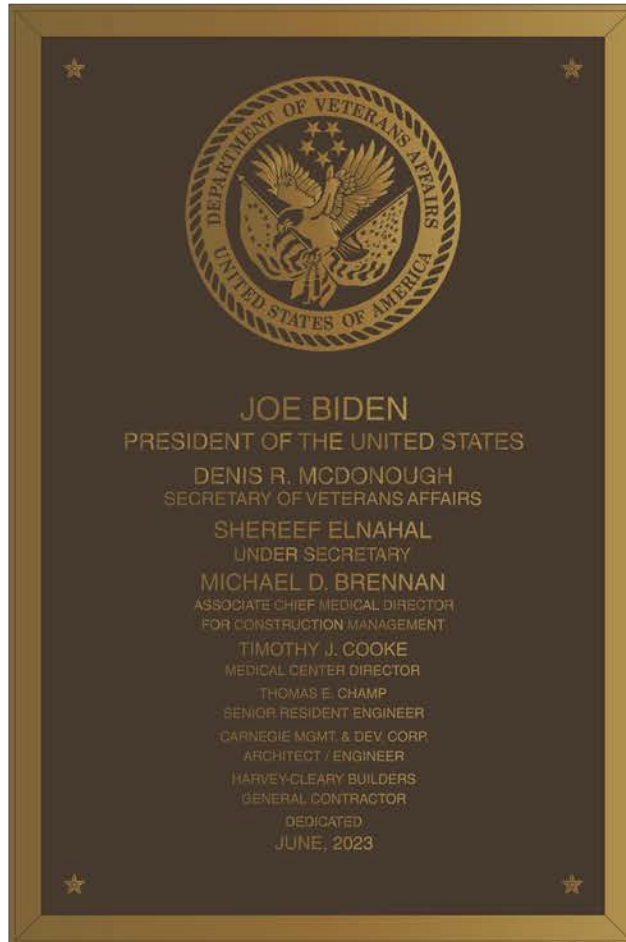

SP-25

Specialty Signage Drawings

Dedication Plaque

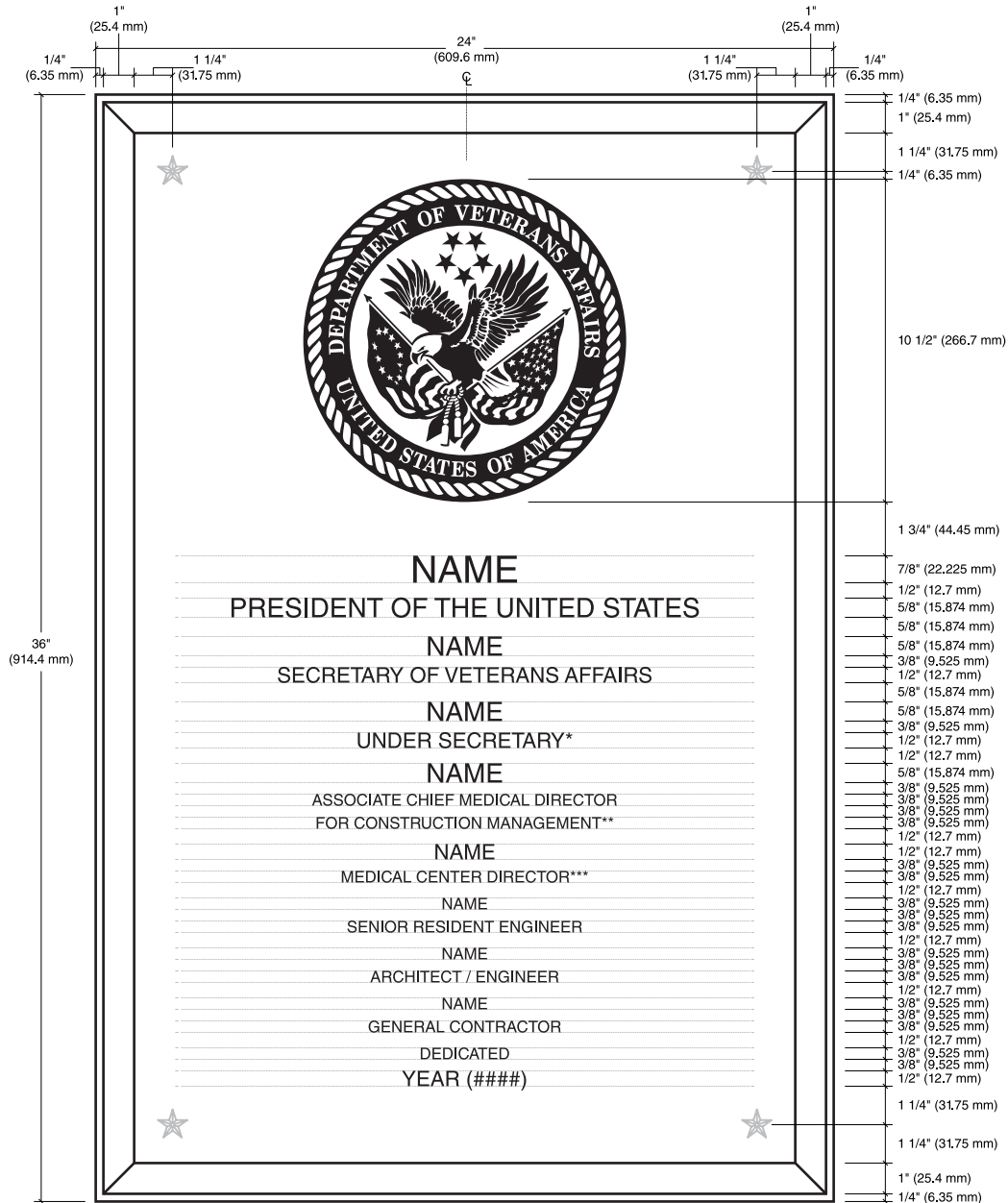

* Under Secretary for Health, or Under Secretary for Benefits, or both may be required.

** Some plaques will not include Associate Chief Medical Director for OFM construction management. Adjust spacing between lines of text and increase dimension below last line to accommodate the number of lines of text.

*** Medical Center Director, Regional VISN Office Director, Regional Office and Insurance Center Director, or Medical and Regional Office Center Director may be required. Long text lines may require two lines and adjustment of spacing.





U.S. Department
of Veterans Affairs

SECTION 3.5

EXTERIOR SIGNAGE DRAWINGS



Introduction

This section provides detailed drawings of all typical exterior sign types for VA facilities. Individual facilities may have unique conditions that require modifications or additional sign types not shown in the Manual. The following drawings provide general design intent and do not function as fabrication-ready shop drawings.

Guidelines

- The drawings should be used as a starting point to develop a sign standard with a component-based sign system, sign types, colors, finishes, and graphics specific to the individual facility.
- For more information on developing the look of the sign system, including VA standard fonts, arrows, and color suggestions, refer to [Section 4.1 Appendix](#). Color palettes are intended as suggestions and usage is not required. Colors, materials, and finishes used in exterior signage should complement and enhance the appearance of campus environments whenever possible.
- Please review [Section 2.5 Exterior Signage Guidelines](#) which contains information regarding Planning, Programming, Construction, and Installation prior to starting signage projects.

Requirements

- It is required that all VA facilities follow the facility name formats found in [Section 2.5](#) and illustrated on signs in [Section 3.5](#).
- The use of component-based sign systems is required at VA facilities (see [Section 2.5.6 & 2.5.7](#)). The exact materials, parts, finishes, and dimensions of a component sign system will vary by manufacturer.
- Helvetica Lt Std is the standard font required for use in signage at all VA facilities with the exclusion of National Cemetery Administration locations.



Sign Designation

Each sign in the program manual has been given a specific sign type number designation. This designation provides a common description that can be referenced when programming a site and ordering signs. The following explains how the sign type designations are derived.

EI - 03 .01 A

- E** Designates an exterior sign.
- I** Identifies that the sign is internally illuminated.
- 03** Two-digit numbers identify a particular sign type family.
- .01** The two-digit number following the period identifies a specific sign within the sign family.
- A** The letter designates a specific sign configuration, version, or layout for graphics.

This Section includes Exterior Illuminated (EI), Exterior Non-Illuminated (EN), and Parking Lot (PL) signage, all of which are illustrated in the following Overview pages.



Sign Overview

Exterior Signage Drawings

EI-01.01
Site Monument Large –
5' x 12'

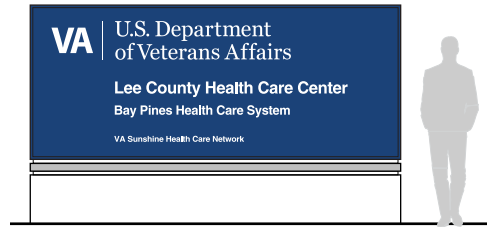

EI-01.01

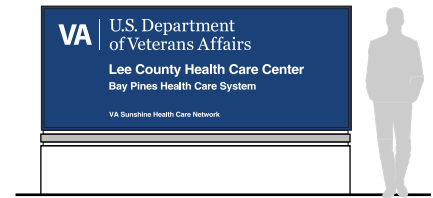

EI-01.02

EI-01.02
Site Monument Medium –
4' x 10'

EI-01.03
Site Monument Small –
4' x 8'

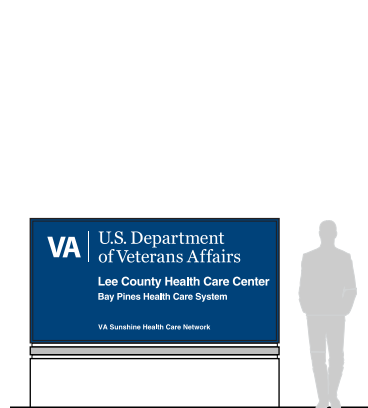

EI-01.03

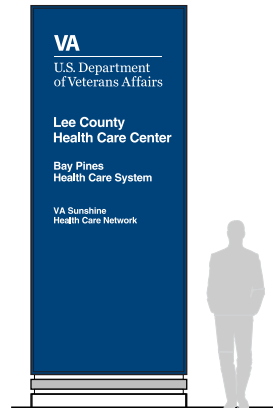

EI-01.04

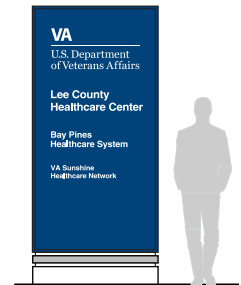

EI-01.05

EI-01.04
Vertical Site Monument Large –
12' x 5'

EI-01.05
Vertical Site Monument Small –
8' x 4'

EI-02.01
Directional Monument Large –
6' x 6'

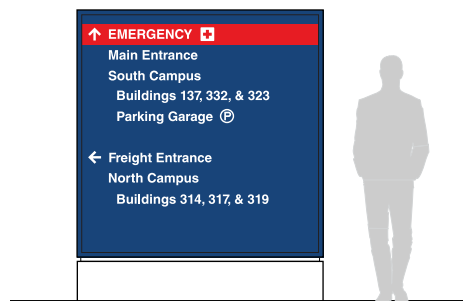

EI-02.01

EI-02.02
Directional Monument Small –
6' x 4'

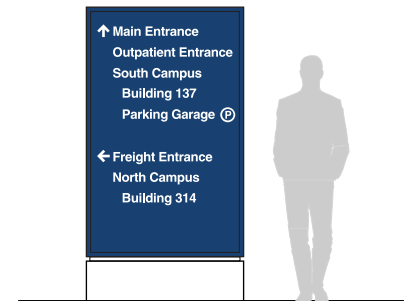

EI-02.02

EI-03.01
Post & Panel Site Identification –
4' x 8'

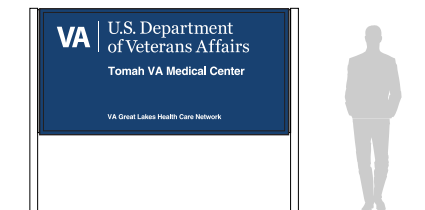

EI-03.01

EI-03.02
Post & Panel Directional –
4' x 6'



EI-03.02



Sign Overview

Exterior Signage Drawings

EI-04.01

Post & Panel Stacking Bar
Directional – 4' x 8'

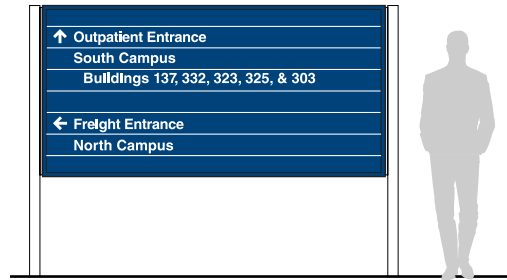

EI-04.01

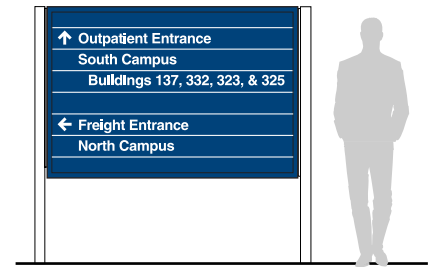

EI-04.02

EI-04.02

Post & Panel Stacking Bar
Directional – 4' x 6'

EI-06.01

Wall Mounted Overhead



EI-06.01

EI-06.02

Wall Mounted Building Identification



EI-06.02

EI-08.01

Wall Mounted Ambulance /
Emergency Overhead



EI-08.01

EI-08.02

Wall Mounted Ambulance /
Emergency Identification



EI-08.02

EI-08.03

Post & Panel Ambulance /
Emergency Entrance Identification



EI-08.03

EI-09

Illuminated Letters & Logo



EI-09



Sign Overview

Exterior Signage Drawings

EI-14
4-Sided Site Monument

EI-15.01
4-Sided Directional Site Monument

EI-15.02
4-Sided Directional Site Monument
with Address

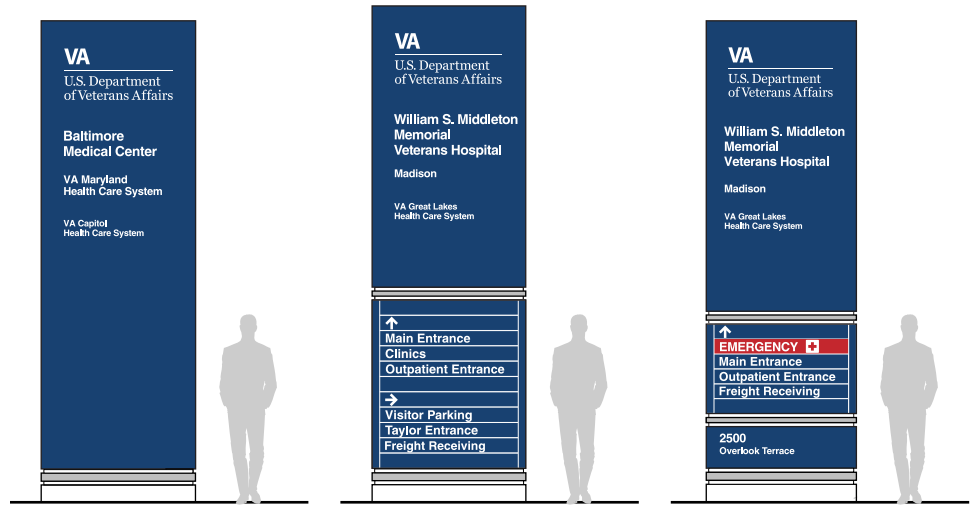

EI-14

EI-15.01

EI-15.02

EI-16.01
Vertical Site Monument with
Electronic Message Unit

EI-16.02
Horizontal Site Monument with
Electronic Message Unit

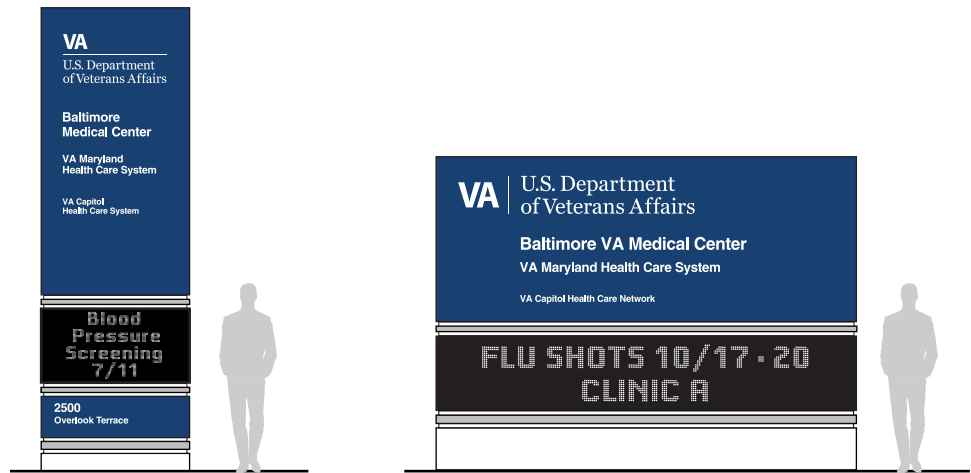

EI-16.01

EI-16.02

EI-17
Information Center Monument

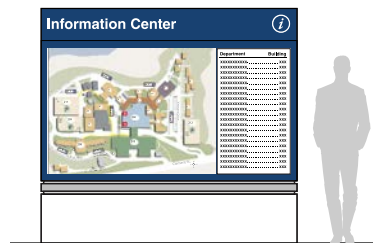

EI-17



Sign Overview

Non Illuminated Exterior Signage Drawings

EN-02.01
 Directional Monument Large –
 6' x 6'

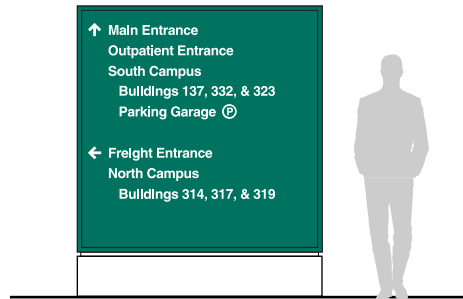

EN-02.01

EN-02.02
 Directional Monument Small –
 6' x 4'

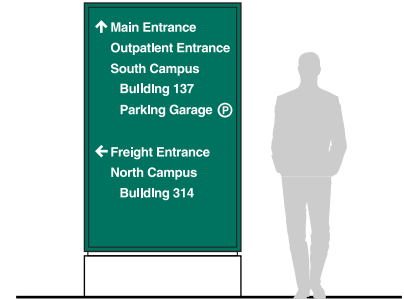

EN-02.02

EN-03.02
 Post & Panel – 4' x 6'

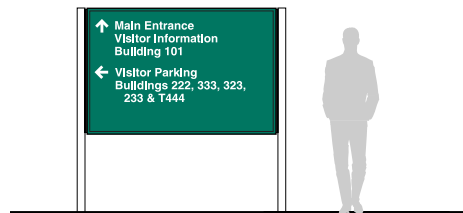

EN-03.02

EN-03.03
 Post & Panel – 3' x 4'

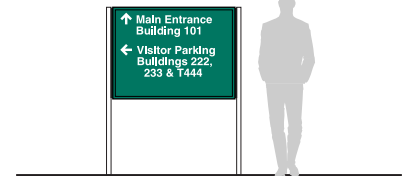

EN-03.03

EN-03.04
 Post & Panel – 2' x 3'

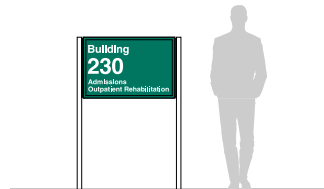

EN-03.04

EN-03.05
 Post & Panel Building Identification –
 3' x 3'

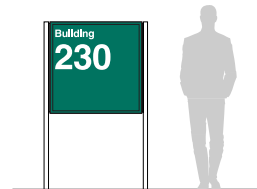

EN-03.05

EN-03.06
 Post & Panel Identification &
 Information – 2' x 2'

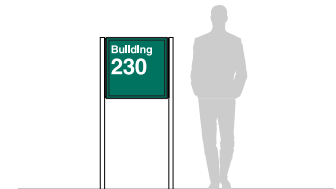

EN-03.06

EN-04.01
 Post & Panel Stacking Bar
 Directional – 4' x 8'

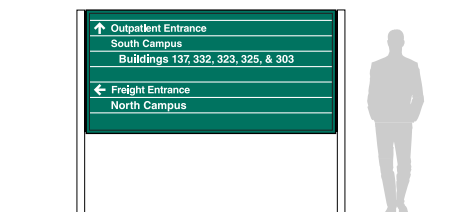

EN-04.01

EN-04.02
 Post & Panel Stacking Bar
 Directional – 4' x 6'

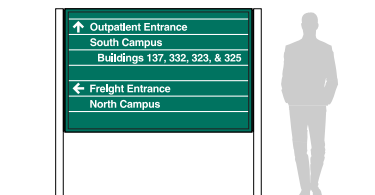

EN-04.02

EN-04.03
 Post & Panel Stacking Bar
 Directional – 3' x 4'

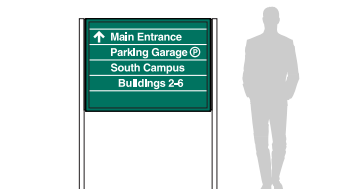

EN-04.03

EN-04.04
 Post & Panel Stacking Bar
 Directional – 2' x 3'

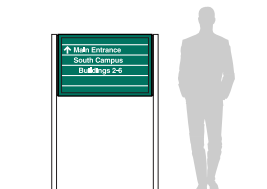

EN-04.04



Sign Overview

Non Illuminated Exterior Signage Drawings

EN-05.01

Single Post & Panel Large –
2'-6" x 2'



EN-05.01

EN-05.02

Single Post & Panel Medium –
2' x 1'-6"

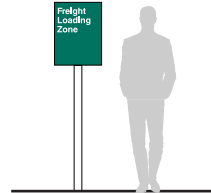

EN-05.02

EN-05.03

Single Post & Panel Small –
1'-6" x 1'

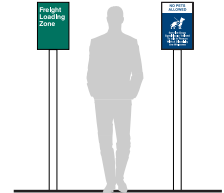

EN-05.03

EN-06.01

Wall Mounted Overhead



EN-06.02

Wall Mounted Building Identification
Large



EN-06.02

EN-06.03

Wall Mounted Building Identification
Large with Message Panel



EN-06.03

EN-06.04

Wall Mounted Building Identification
Medium



EN-06.04

EN-06.05

Wall Mounted Building Identification
Medium with Message Panel



EN-06.05

EN-06.06

Wall Mounted Building Identification
Small



EN-06.06

EN-06.07

Wall Mounted Informational
Medium



EN-06.07

EN-06.08

Wall Mounted Informational Small



EN-06.08



Sign Overview

Non Illuminated Exterior Signage Drawings

EN-08.01
Wall Mounted Ambulance /
Emergency Overhead



EN-08.01

EN-08.02
Wall Mounted Ambulance /
Emergency Identification



EN-08.02

EN-08.03
Post & Panel Ambulance /
Emergency Identification



EN-08.03

EN-09
Non-Illuminated Letters & Logo



EN-09

EN-10
Traffic Regulatory Signs

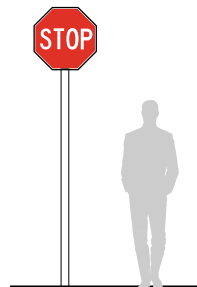

EN-10



EN-10.01



EN-10.02



EN-10.03



EN-10.04



EN-10.05



EN-10.06



EN-10.07



EN-10.08



EN-10.09

EN-11.01
2 Blade Street Sign

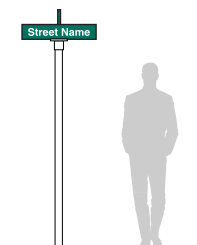

EN-11.01

EN-11.02
1 Blade Street Sign

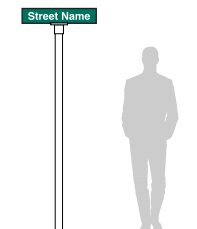

EN-11.02

EN-11.03
Pylon Street Sign

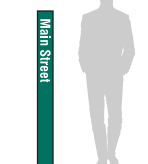

EN-11.03

EN-14
Building Entrance Vinyl



EN-14



Sign Overview

Parking Lot Signage Drawings

PL-12.01
Post & Panel Parking Identification



PL-12.01

PL-12.02
Single Post & Panel Informational

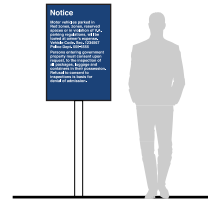

PL-12.02

PL-12.03
Single Post & Panel Parking Stall Designation



PL-12.03

PL-12.04
Single Post & Panel Accessible Parking Stall Designation



PL-12.04

PL-12.05
Single Post & Panel Accessible Parking Area



PL-12.05

PL-12.06
Pole Mounted Parking Lot or Area Identification

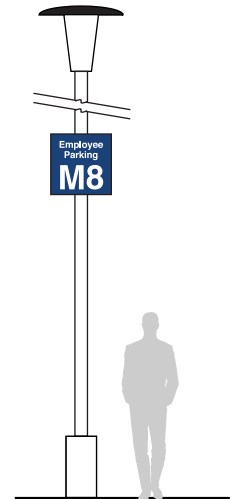

PL-12.06

PL-12.07
Wall Mounted Informational

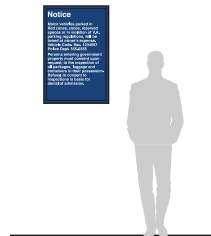

PL-12.07

PL-12.08
Single Post & Panel Permit Parking Stall Designation



PL-12.08

PL-12.09
Single Post & Panel Permit Parking Stall Designation



PL-12.09

PL-13
Electronic Stall Availability Sign

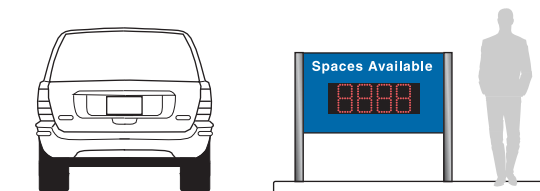

PL-13

PL-15
Painted Stall Identification Number

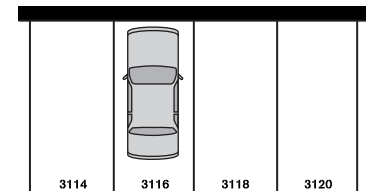

PL-15



EI-01.01

Illuminated Exterior Signage Drawings

Site Monument Large – 5' x 12'

Size

Sign Face:
5'-0" High x 12'-0" Wide x 1'-0" Deep
(1524 mm H x 3657.6 mm W x 304.8 mm D)

Description & Use

Internally illuminated large horizontal freestanding monument sign for identifying a VA facility or the main entrance drive of a VA facility.

The base can be constructed of concrete or other masonry material in a color and texture that will complement architectural design and building finishes.

Message Configuration

Refer to message layout drawing for dimensions.

See [Section 2.5.3](#) for additional name configurations.

Specific message configuration will vary depending on the name of a facility. Variations to the presentation of a facility's name will need special approval from the Veterans Affairs Central Office (VACO) in Washington DC.

Graphic Process

Illuminated, routed out copy backed with white translucent acrylic.

Colors

Refer to the color chart in the Appendix.

Recommendations

Position sign so drivers have a clear, unobstructed view of the sign. Keep landscaping around the sign low and position sprinklers so they project away from the sign.

On-off illumination of sign can be controlled using a timer or photoelectric switch. Consult with sign fabricator at time of order for appropriate method to use.

See [Section 2.5.6](#) & [2.5.7](#) for exterior construction & installation details.

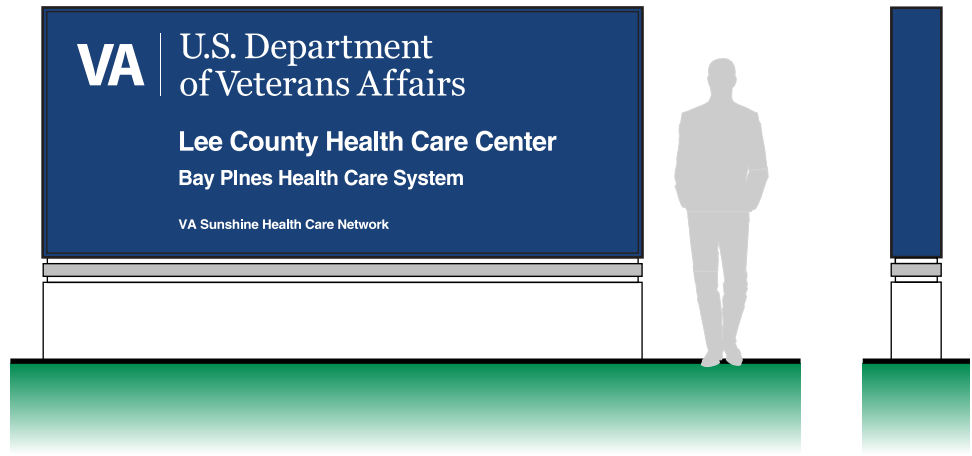

Message Layout A

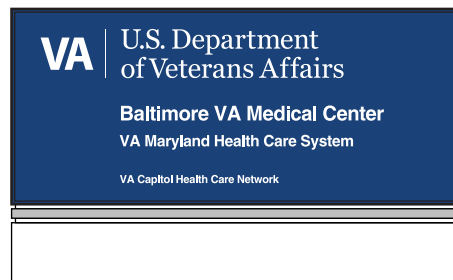

Message Layout B

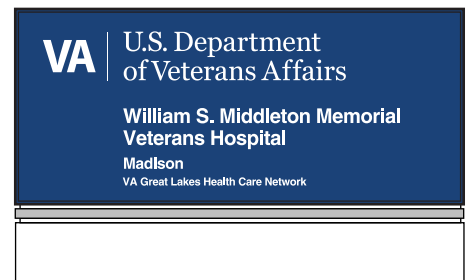

Message Layout C

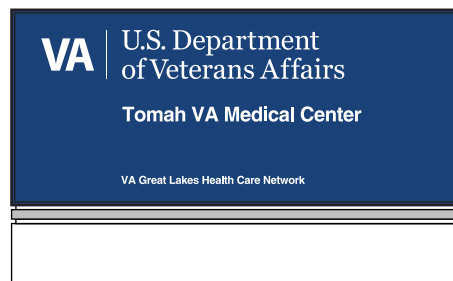

Message Layout D

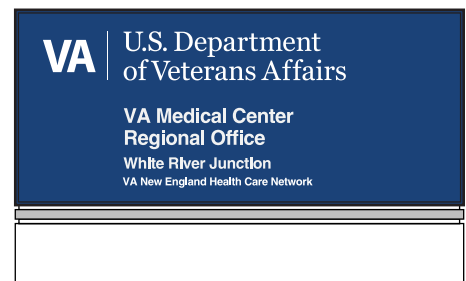

Message Layout E

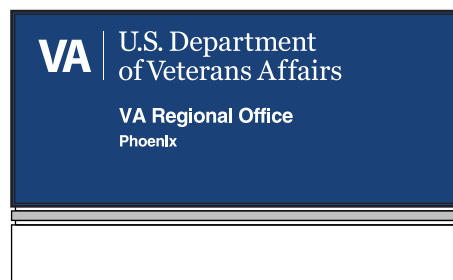

Message Layout F



EI-01.01

Illuminated Exterior Signage Drawings

Site Monument Large – 5' x 12'

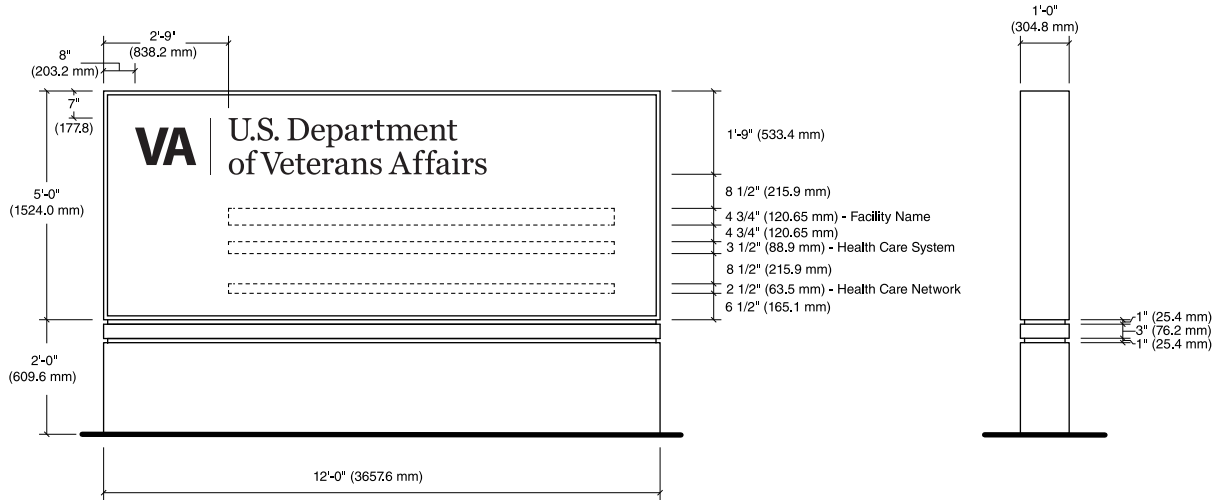

Message Layout A & F

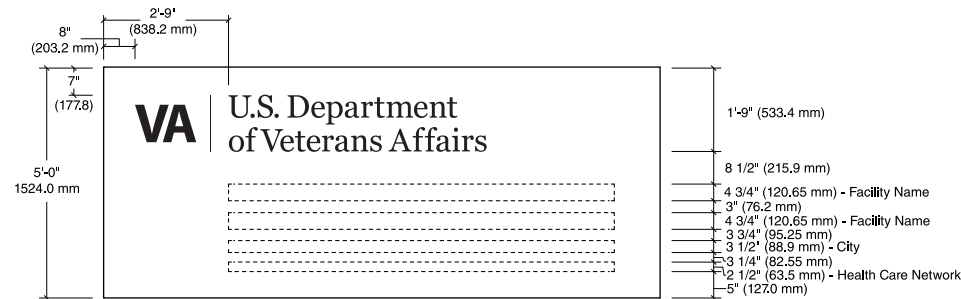

Message Layout B & D



Message Layout C

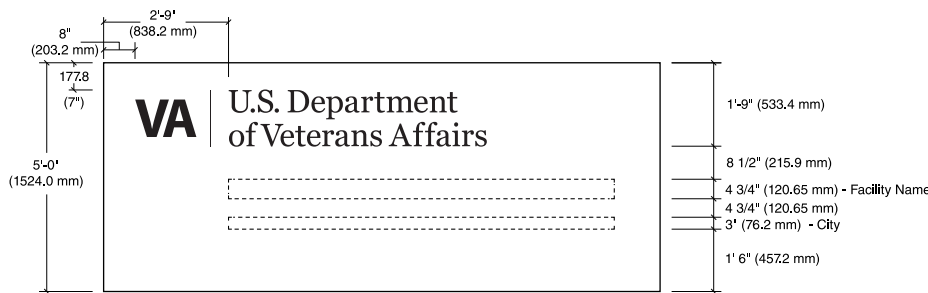

Message Layout E



EI-01.02

Illuminated Exterior Signage Drawings

Site Monument Medium – 4' x 10'

Size

Sign Face:
4'-0" High x 10'-0" Wide x 1'-0" Deep
(1219.2 mm H x 3048 mm W x 304.8 mm D)

Description & Use

Internally illuminated horizontal freestanding monument sign for identifying a VA facility or the main entrance drive of a VA facility.

The base can be constructed of concrete or other masonry material in a color and texture that will complement architectural design and building finishes.

Message Configuration

Refer to message layout drawing for dimensions.

See [Section 2.5.3](#) for additional name configurations.

Specific message configuration will vary depending on the name of a facility. Variations to the presentation of a facility's name will need special approval from the Veterans Affairs Central Office (VACO) in Washington DC.

Graphic Process

Illuminated, routed out copy backed with white translucent acrylic.

Colors

Refer to the color chart in the Appendix.

Recommendations

Position sign so drivers have a clear, unobstructed view of the sign. Keep landscaping around the sign low and position sprinklers so they project away from the sign.

On-off illumination of sign can be controlled using a timer or photoelectric switch. Consult with sign fabricator at time of order for appropriate method to use.

See [Section 2.5.6](#) & [2.5.7](#) for exterior construction & installation details.

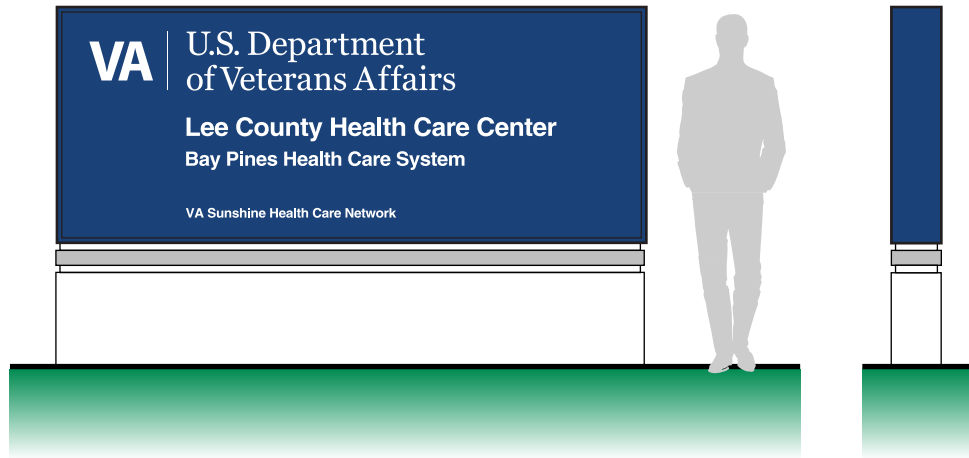

Message Layout A

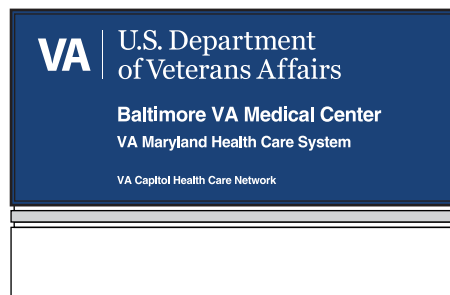

Message Layout B

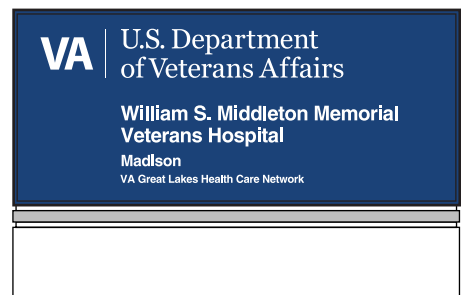

Message Layout C

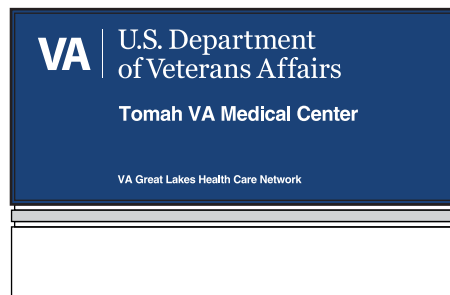

Message Layout D

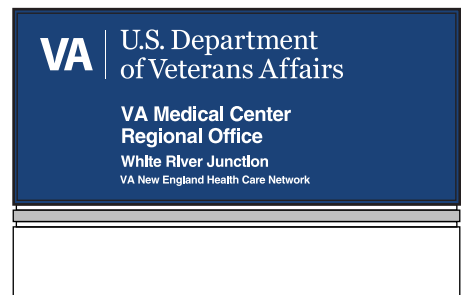

Message Layout E



Message Layout F

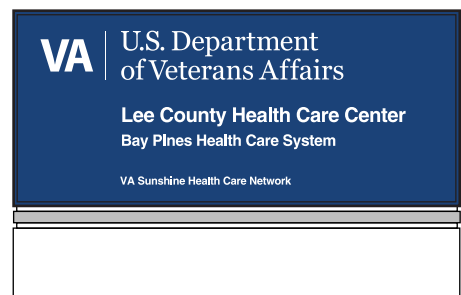

EI-01.02

Illuminated Exterior Signage Drawings

Site Monument Medium – 4' x 10'

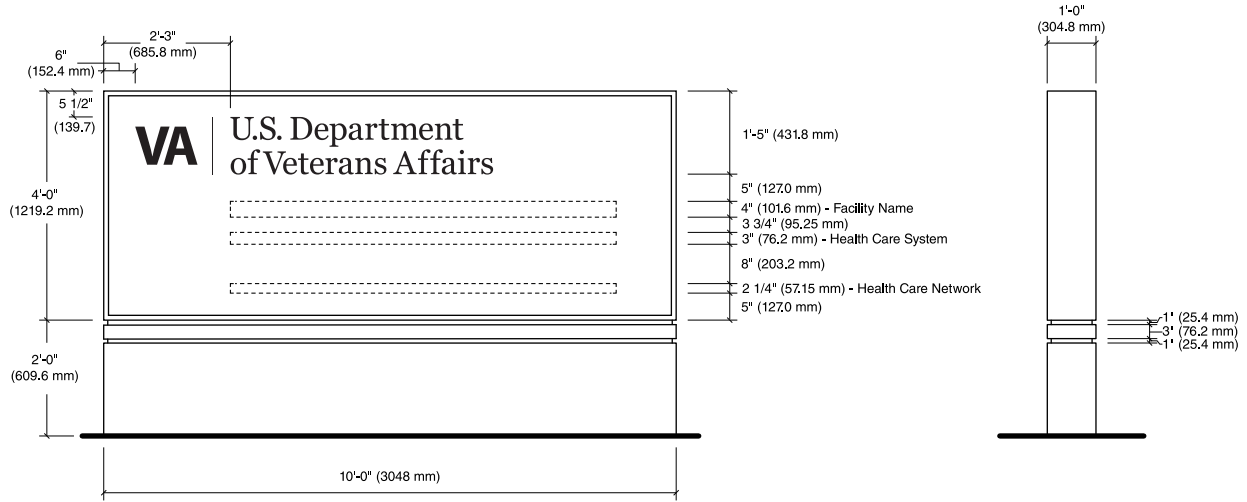

Message Layout A & F

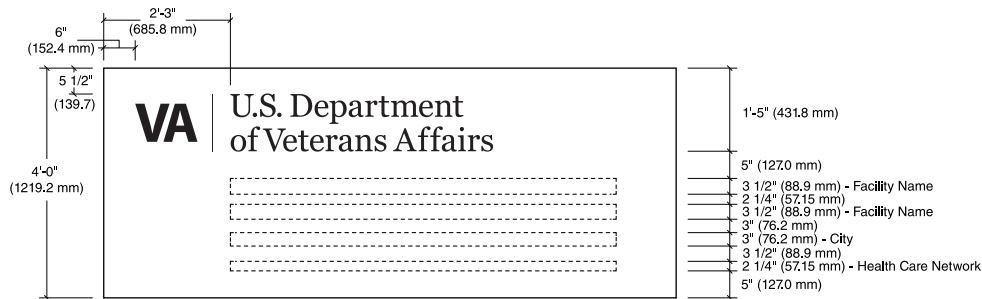

Message Layout B & D



Message Layout C

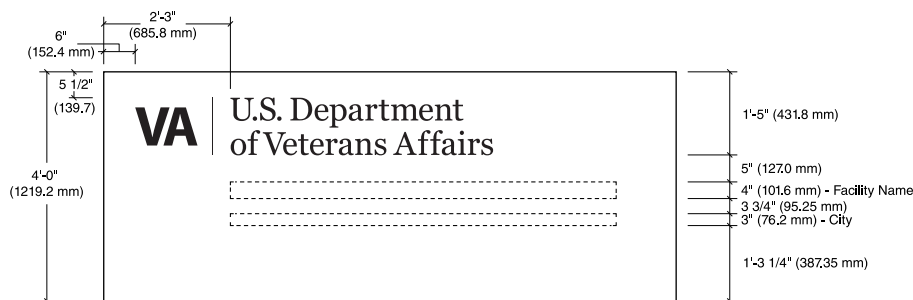

Message Layout E



EI-01.03

Illuminated Exterior Signage Drawings

Site Monument Small – 4' x 8'

Size

Sign Face:
4'-0" High x 8'-0" Wide x 1'-0" Deep
(1219.2 mm H x 2438.4 mm W x 304.8 mm D)

Description & Use

Internally illuminated small horizontal freestanding monument sign for identifying a VA facility where there is a space limitation. This sign can also be used to identify secondary drive entrances to the VA facility.

The base can be constructed of concrete or other masonry material in a color and texture that will complement architectural design and building finishes.

Message Configuration

Refer to message layout drawing for dimensions.

See [Section 2.5.3](#) for additional name configurations.

Specific message configuration will vary depending on the name of a facility. Variations to the presentation of a facility's name will need special approval from the Veterans Affairs Central Office (VACO) in Washington DC.

Graphic Process

Illuminated, routed out copy backed with white translucent acrylic.

Colors

Refer to the color chart in the Appendix.

Recommendations

Position sign so drivers have a clear, unobstructed view of the sign. Keep landscaping around the sign low and position sprinklers so they project away from the sign.

On-off illumination of sign can be controlled using a timer or photoelectric switch. Consult with sign fabricator at time of order for appropriate method to use.

See [Section 2.5.6](#) & [2.5.7](#) for exterior construction & installation details.

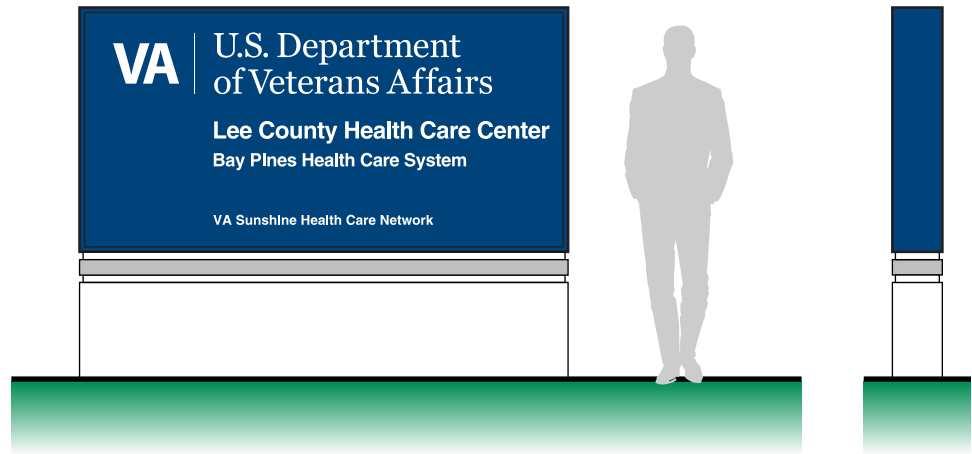

Message Layout A

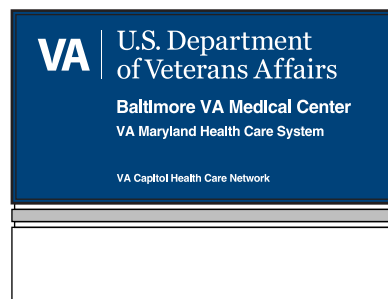

Message Layout B

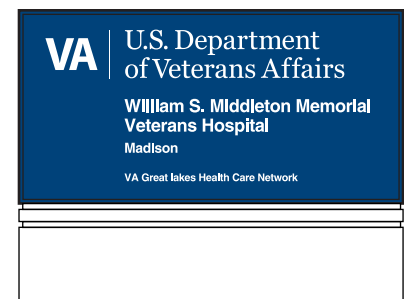

Message Layout C

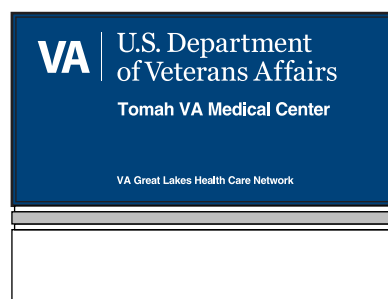

Message Layout D

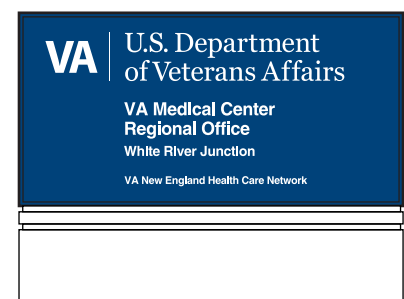

Message Layout E

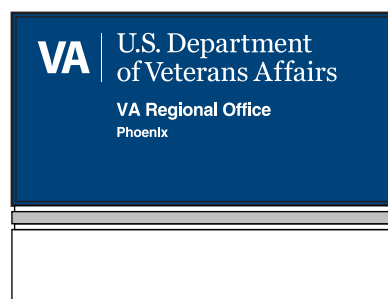

Message Layout F



EI-01.03

Illuminated Exterior Signage Drawings

Site Monument Small – 4' x 8'

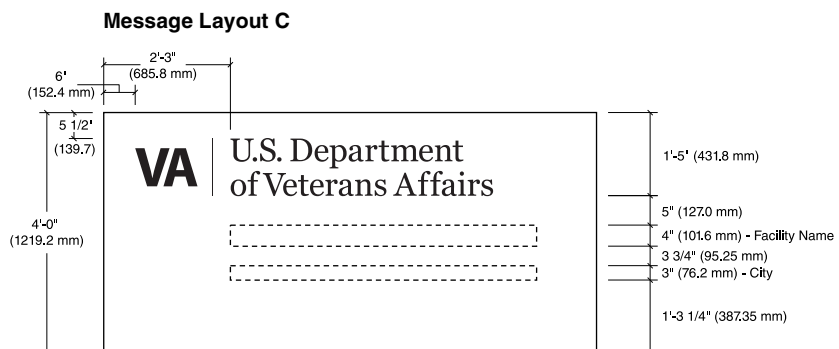
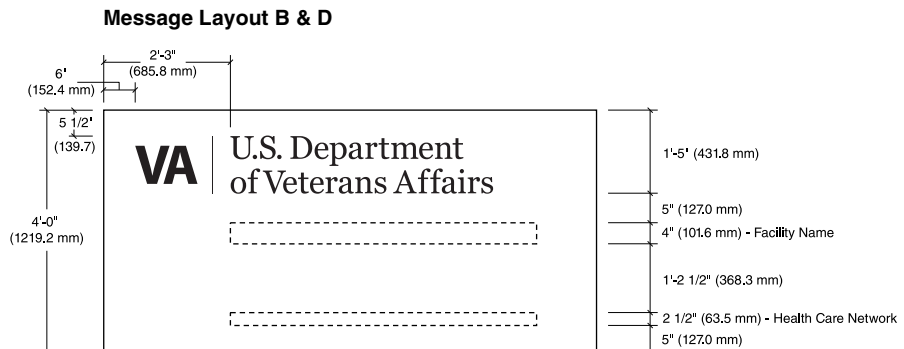
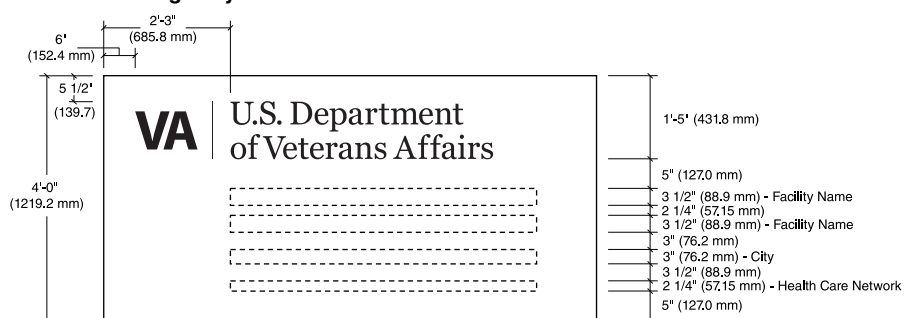
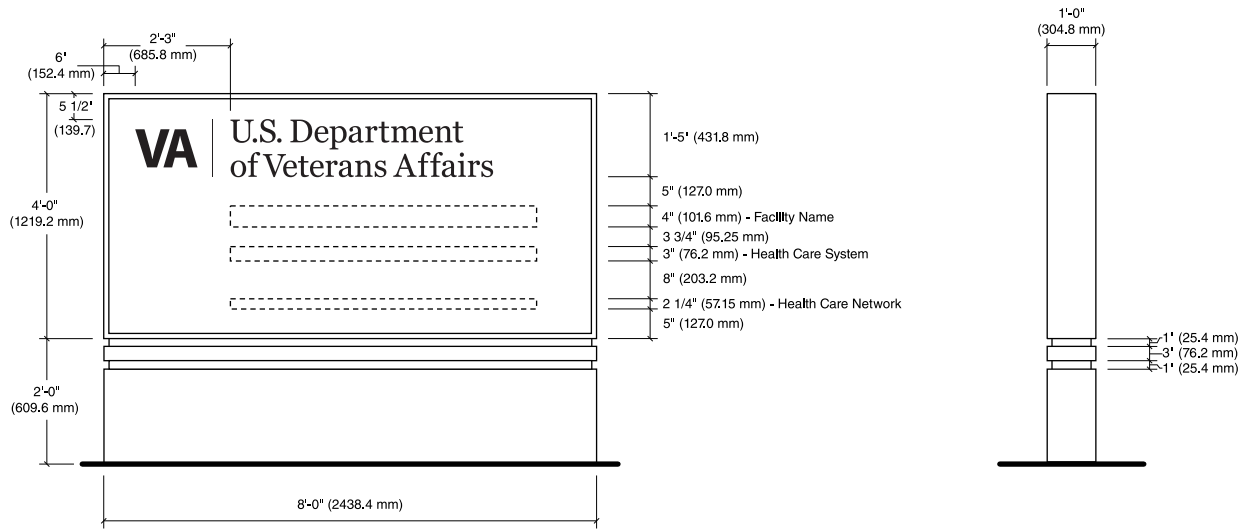

EI-01.04

Illuminated Exterior Signage Drawings

Vertical Site Monument Large – 12' x 5'

Size

Sign Face:
12'-0" High x 5'-0" Wide x 1'-0" Deep
(3657.6 mm H x 1524 mm W x 304.8 mm D)

Description & Use

Internally illuminated vertical freestanding monument sign for identifying a VA facility or the main entrance drive of a VA facility.

The base can be constructed of concrete or other masonry material in a color and texture that will complement architectural design and building finishes.

Message Configuration

Refer to message layout drawing for dimensions.

See [Section 2.5.3](#) for additional name configurations.

Specific message configuration will vary depending on the name of a facility. Variations to the presentation of a facility's name will need special approval from the Veterans Affairs Central Office (VACO) in Washington DC.

Graphic Process

Illuminated, routed out copy backed with white translucent acrylic.

Colors

Refer to the color chart in the Appendix.

Recommendations

Position sign so drivers have a clear, unobstructed view of the sign. Keep landscaping around the sign low and position sprinklers so they project away from the sign.

On-off illumination of sign can be controlled using a timer or photoelectric switch. Consult with sign fabricator at time of order for appropriate method to use.

See [Section 2.5.6](#) & [2.5.7](#) for exterior construction & installation details.

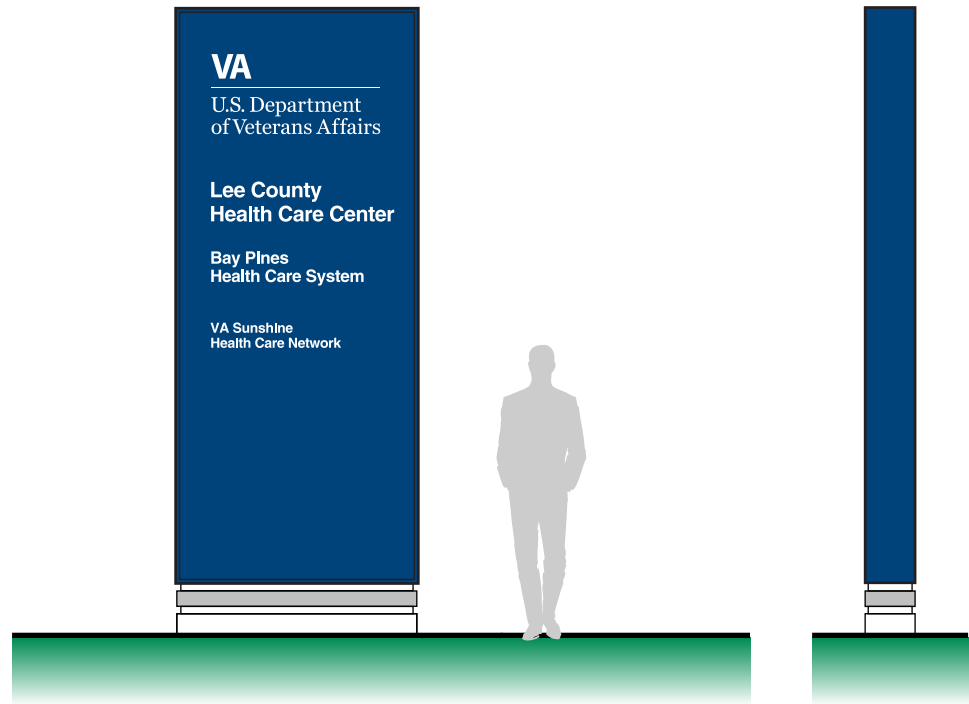

Message Layout A

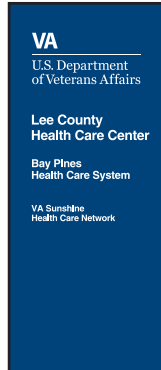

Message Layout B

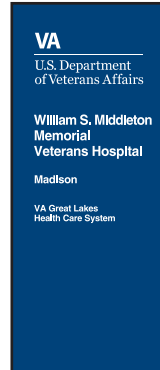

Message Layout C

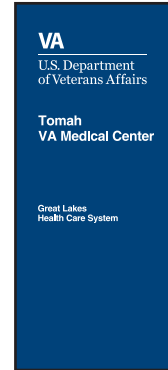

Message Layout D

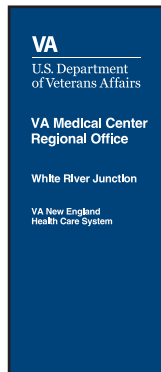

Message Layout E

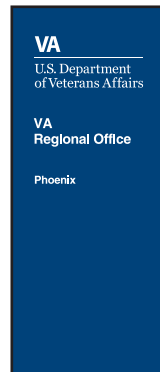

Message Layout F

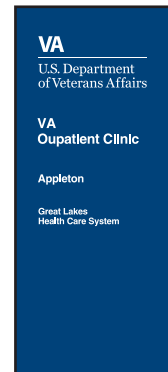

EI-01.04

Illuminated Exterior Signage Drawings

Vertical Site Monument Large – 12' x 5'

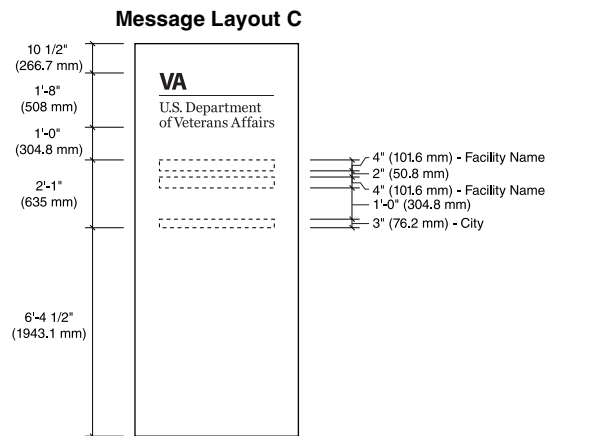
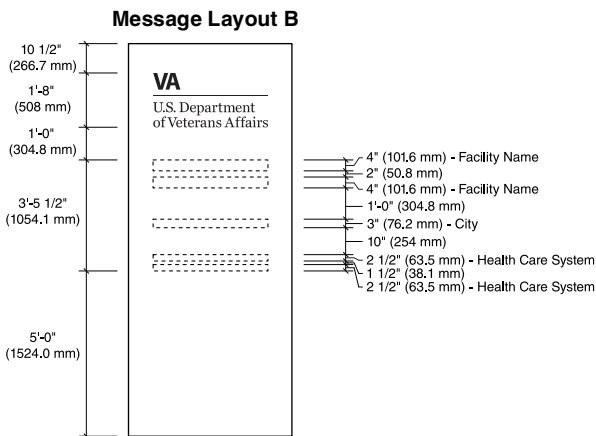
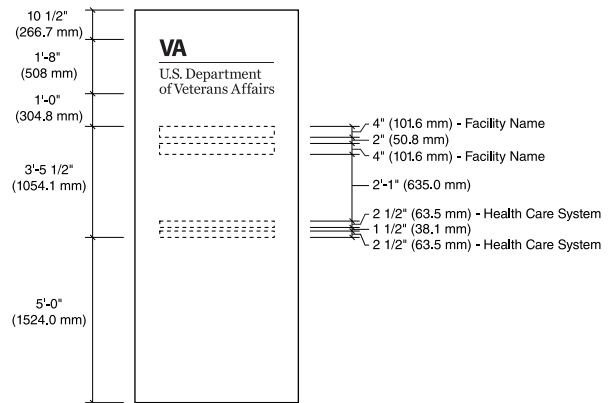
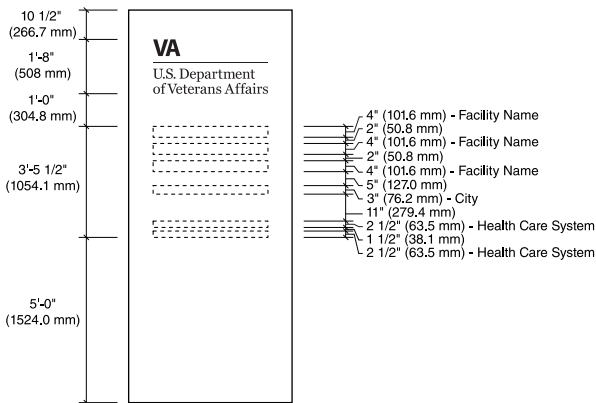
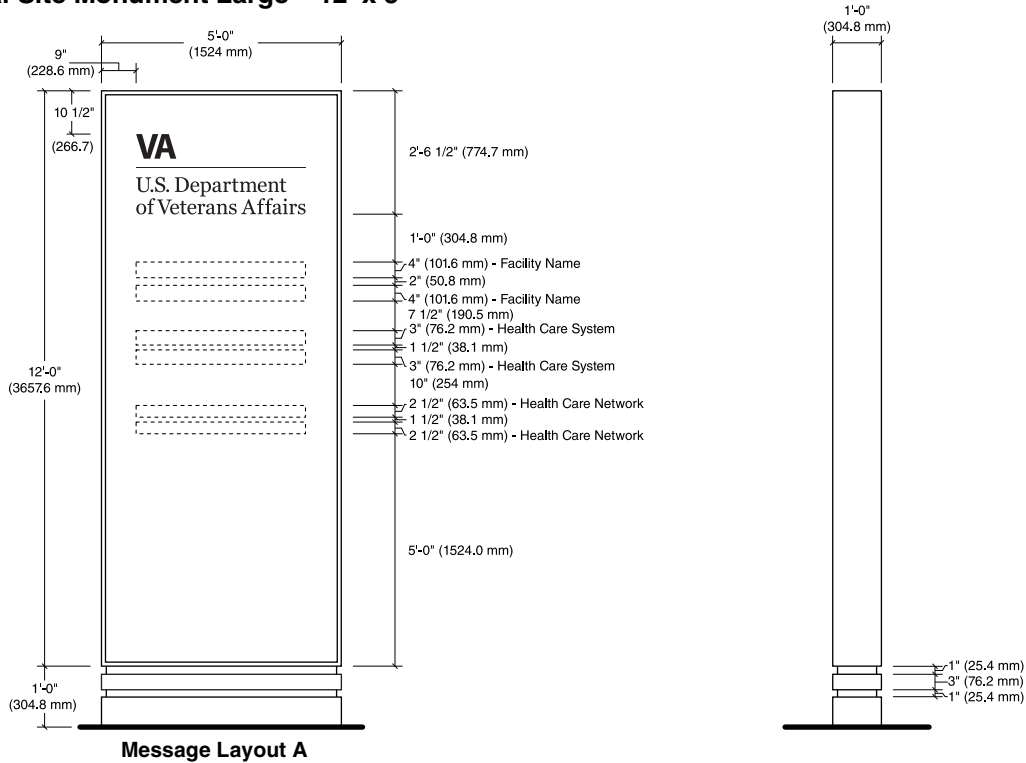

EI-01.05

Illuminated Exterior Signage Drawings

Vertical Site Monument Small – 8' x 4'

Size

Sign Face:
8'-0" High x 4'-0" Wide x 1'-0" Deep
(2438.4 mm H x 1219.2 mm W x 304.8 mm D)

Description & Use

Internally illuminated small freestanding vertical monument sign for identifying a VA facility where there is a space limitation. This sign can also be used to identify secondary drive entrances to the VA facility.

The base can be constructed of concrete or other masonry material in a color and texture that will complement architectural design and building finishes.

Message Configuration

Refer to message layout drawing for dimensions.

See [Section 2.5.3](#) for additional name configurations.

Specific message configuration will vary depending on the name of a facility. Variations to the presentation of a facility's name will need special approval from the Veterans Affairs Central Office (VACO) in Washington DC.

Graphic Process

Illuminated, routed out copy backed with white translucent acrylic.

Colors

Refer to the color chart in the Appendix.

Recommendations

Position sign so drivers have a clear, unobstructed view of the sign. Keep landscaping around the sign low and position sprinklers so they project away from the sign.

On-off illumination of sign can be controlled using a timer or photoelectric switch. Consult with sign fabricator at time of order for appropriate method to use.

See [Section 2.5.6](#) & [2.5.7](#) for exterior construction & installation details.

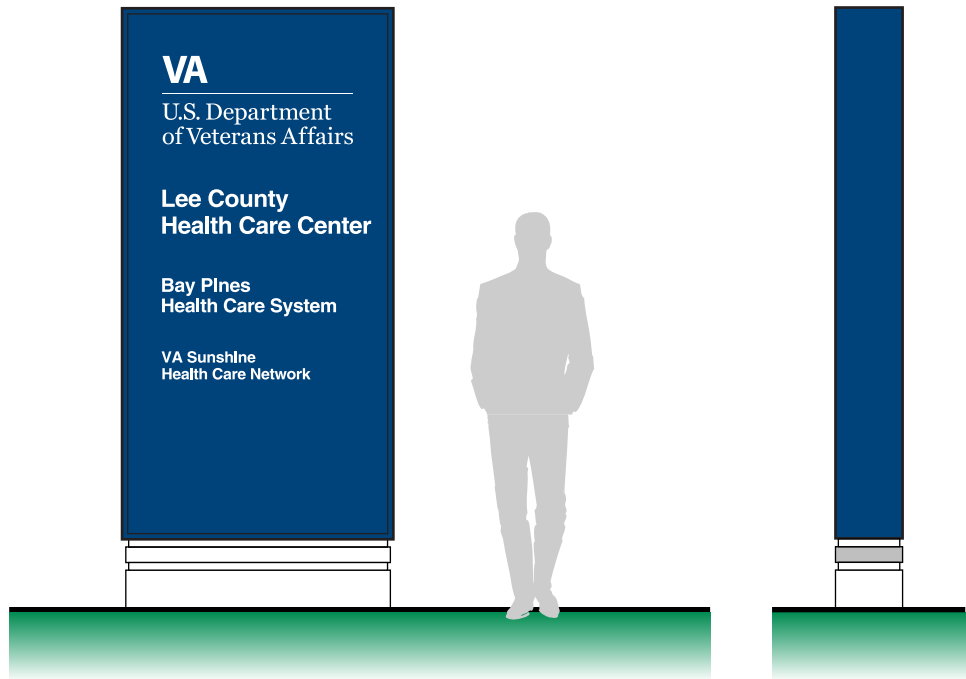

Message Layout A

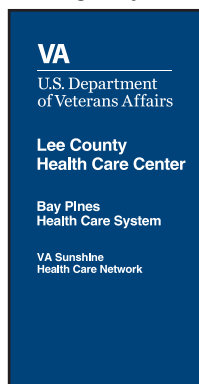

Message Layout B

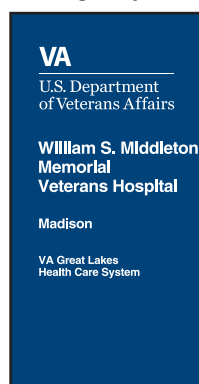

Message Layout C

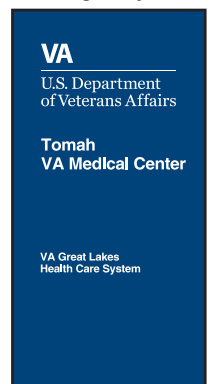

Message Layout D

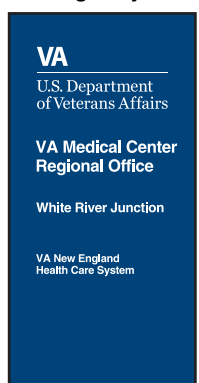

Message Layout E

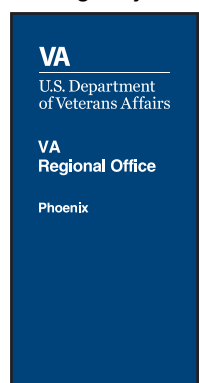

Message Layout F

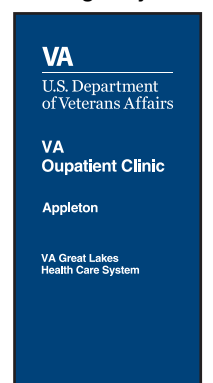

EI-01.05

Illuminated Exterior Signage Drawings

Vertical Site Monument Small – 8' x 4'

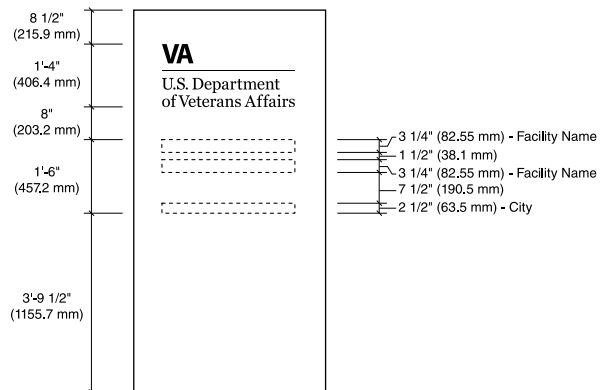
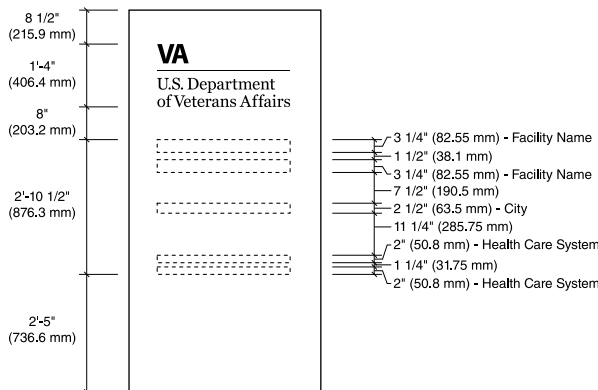
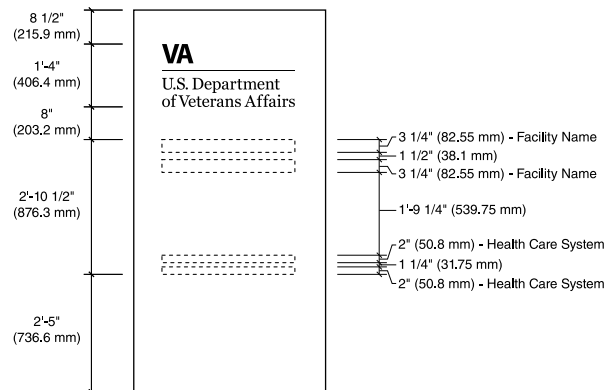
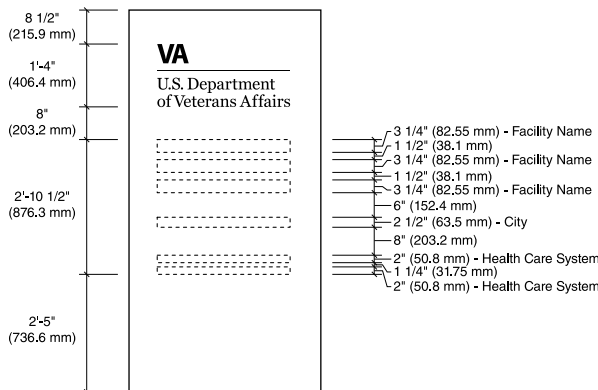
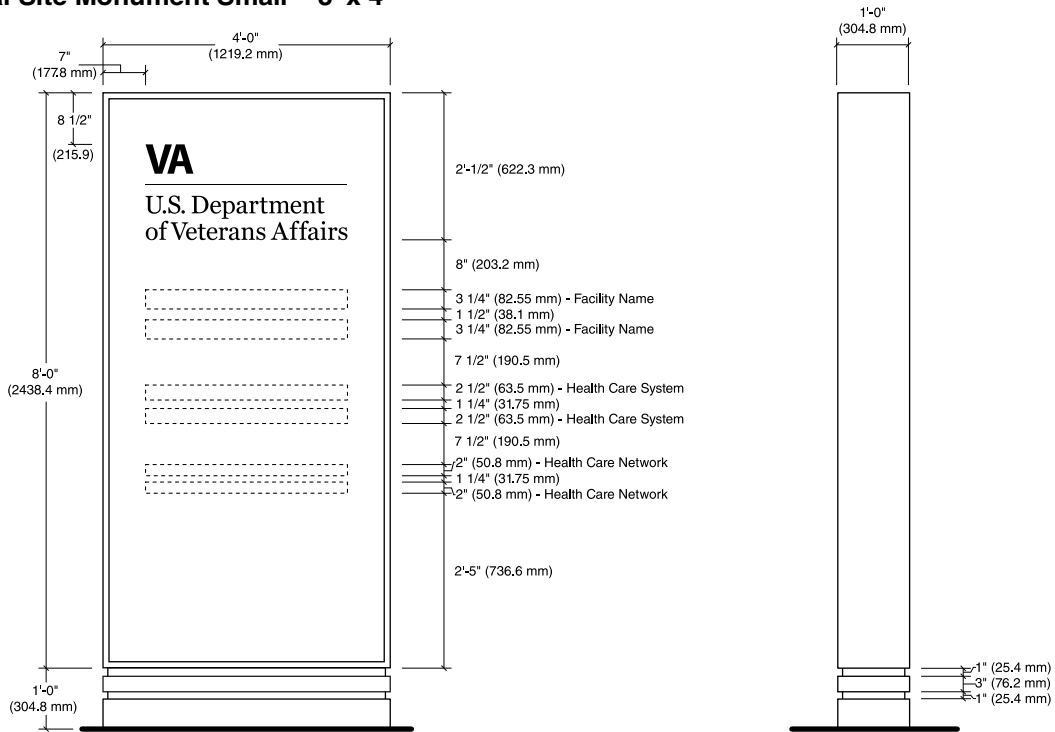

EI-02.01

Illuminated Exterior Signage Drawings

Directional Monument Large – 6' x 6'

Size

Sign Face:
6'-0" High x 6'-0" Wide x 1'-0" Deep
(1828.8 mm H x 1828.8 mm W x 304.8 mm D)

Description & Use

Internally illuminated large directionally illuminated sign with a single interchangeable panel or 10 stacking strips. Directional sign with messages relevant to drivers.

Internally illuminated signs should be used in locations where there is a heavy nighttime driver need for directional information.

Message Configuration

Refer to message layout drawing for dimensions.

Layout A is for the first line of text with an arrow of direction.

Layout B is for message with no arrow which is located immediately under a line of copy with an arrow.

Layout C is for indented text. This can be used to show a hierarchy of information. Alternatively, it can be used when the message is too long and must run onto a second line.

Graphic Process

Illuminated, routed out copy backed with white translucent acrylic.

Colors

Refer to the color chart in the Appendix.

Recommendations

Position sign so drivers have a clear, unobstructed view of the sign. Directional information for services ahead should always be at the top of the sign.

Ensure that there is always a blank margin or copy strip between groups of directional information and at the bottom of the sign. Additionally, leave a smaller blank margin or strip at the top of the sign compared to the text strips.

On-off illumination of sign can be controlled using a timer or photoelectric switch. Consult with sign fabricator at time of order for appropriate method to use.

See [Section 2.5.6](#) & [2.5.7](#) for exterior construction & installation details.

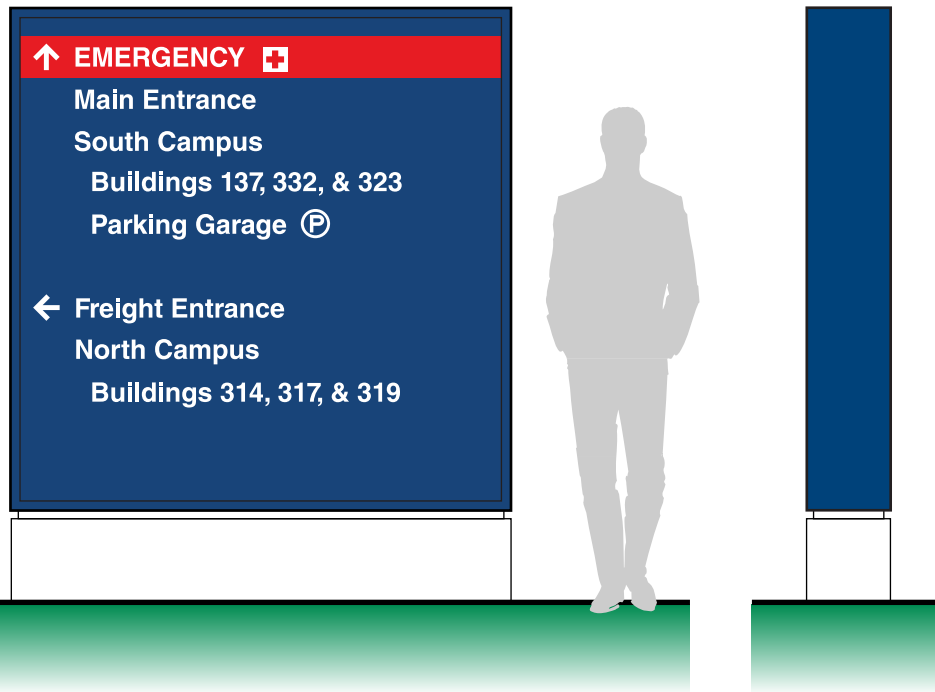

Message Layout A



Message Layout B



Message Layout C



EI-02.01 Illuminated Exterior Signage Drawings

Directional Monument Large – 6' x 6'

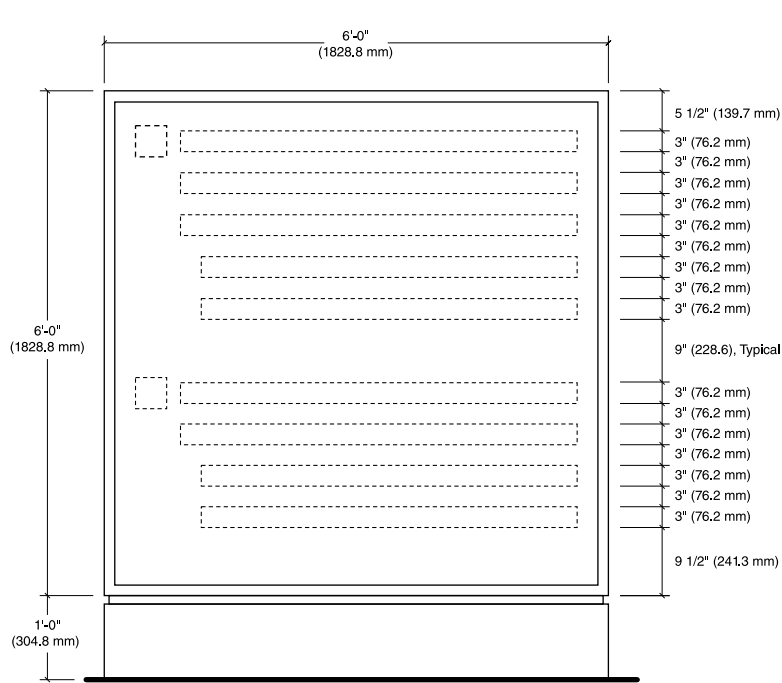

Single Panel Method

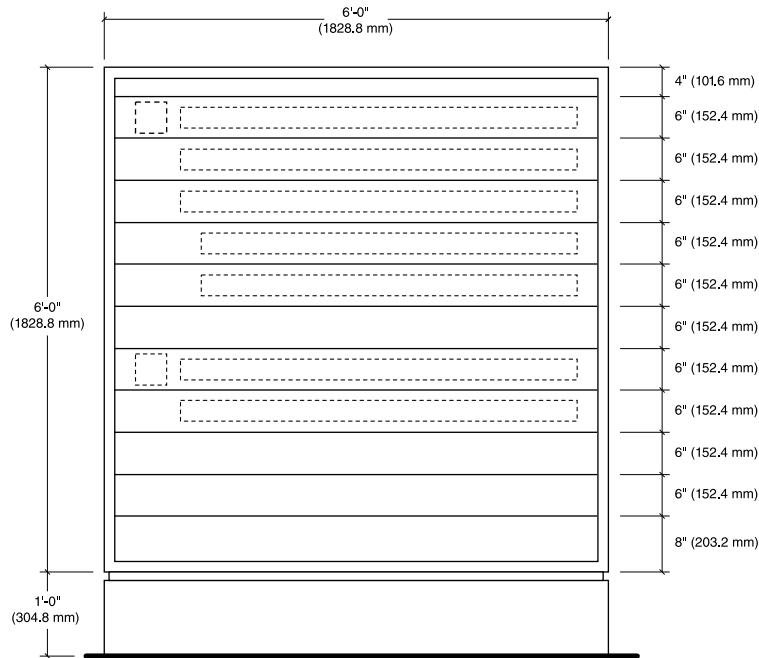
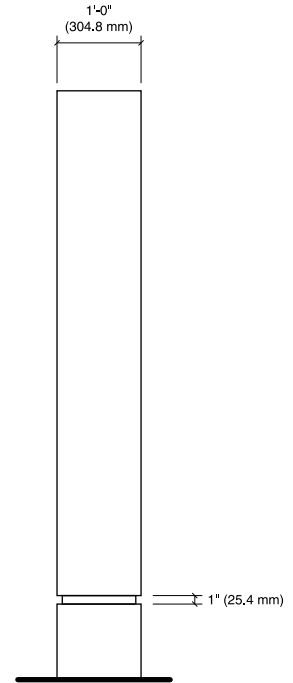

Multi-Panel Method

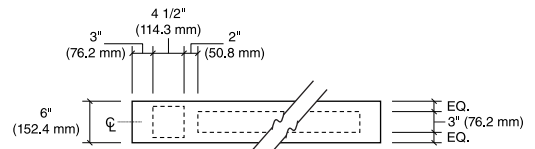

Message Layout A

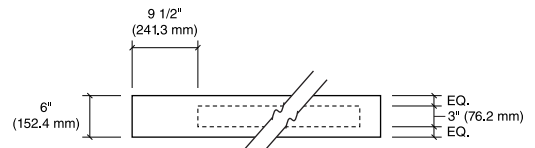

Message Layout B

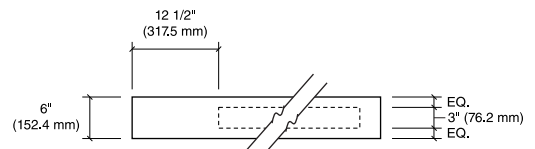

Message Layout C



EI-02.02

Illuminated Exterior Signage Drawings

Directional Monument Small – 6' x 4'

Size

Sign Face:
6'-0" High x 4'-0" Wide x 1'-0" Deep
(1828.8 mm H x 1219.2 mm W x 304.8 mm D)

Description & Use

Internally illuminated small directional monument sign with a single interchangeable panel or 10 stacking strips. Directional sign with messages relevant to drivers.

Internally illuminated signs should be used in locations where there is a heavy nighttime driver need for directional information.

Message Configuration

Refer to message layout drawing for dimensions.

Layout A is for the first line of text with an arrow of direction.

Layout B is for message with no arrow which is located immediately under a line of copy with an arrow.

Layout C is for indented text. This can be used to show a hierarchy of information. Alternatively, it can be used when the message is too long and must run onto a second line.

Graphic Process

Illuminated, routed out copy backed with white translucent acrylic.

Colors

Refer to the color chart in the Appendix.

Recommendations

Position sign so drivers have a clear, unobstructed view of the sign. Directional information for services ahead should always be at the top of the sign.

Ensure that there is always a blank margin or copy strip between groups of directional information and at the bottom of the sign. Additionally, leave a smaller blank margin or strip at the top of the sign compared to the text strips.

On-off illumination of sign can be controlled using a timer or photoelectric switch. Consult with sign fabricator at time of order for appropriate method to use.

See [Section 2.5.6](#) & [2.5.7](#) for exterior construction & installation details.

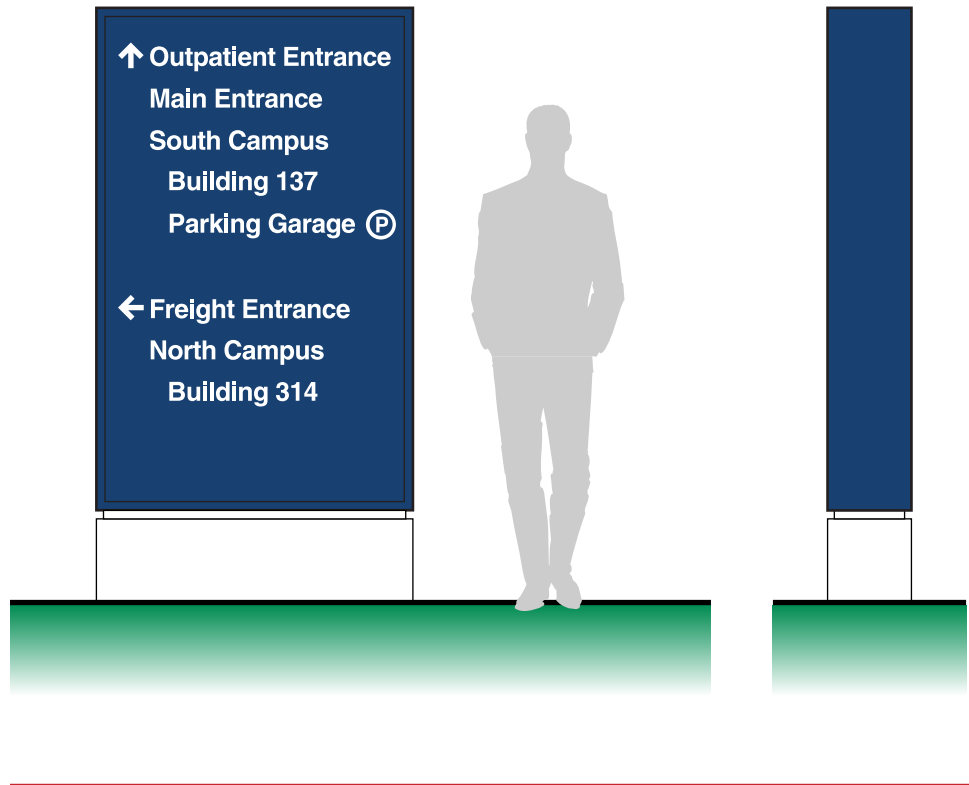

Message Layout A



Message Layout B



Message Layout C



EI-02.02

Illuminated Exterior Signage Drawings

Directional Monument Small – 6' x 4'

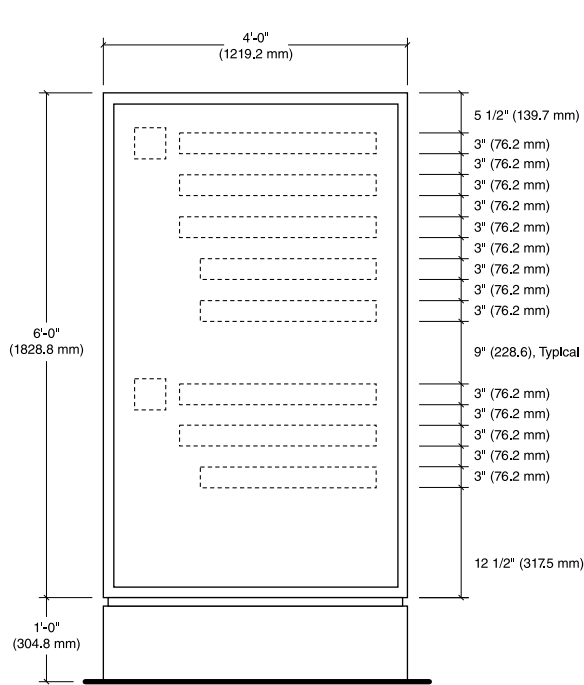

Single Panel Method

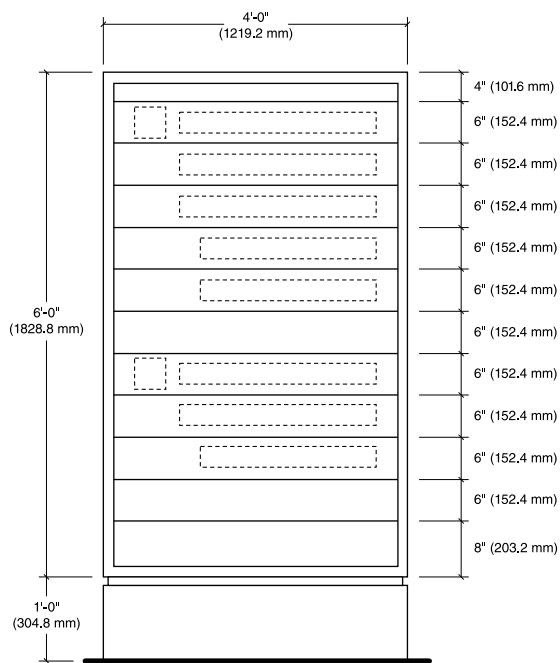
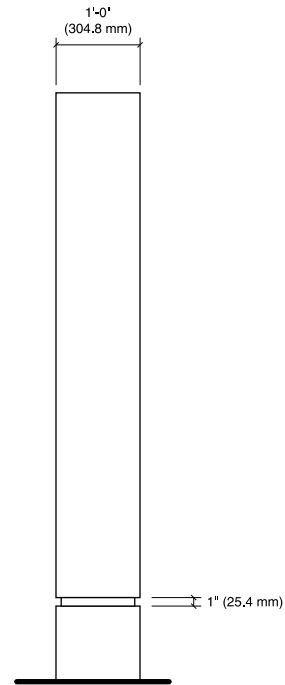

Multi-Panel Method

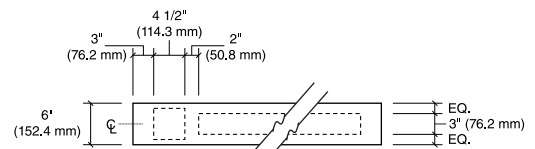

Message Layout A

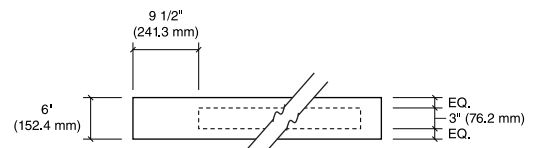

Message Layout B

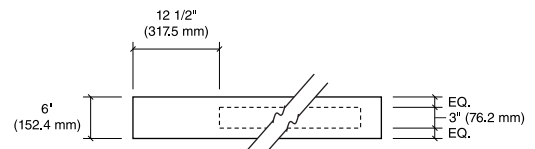

Message Layout C



EI-03.01

Illuminated Exterior Signage Drawings

Post & Panel Site Identification – 4' x 8'

Size

Sign Face:
4'-0" High x 8'-0" Wide
(1219 mm H x 2438 mm W)

Overall Sign Height:
6'-6" (1981.2 mm)

Description & Use

Internally illuminated large post and panel sign for identifying a VA facility of smaller scale such as an Outpatient Clinic. Alternatively, this sign can be used where physical restraints prevent a monument sign from being installed.

Message Configuration

Refer to message layout drawing for dimensions.

See [Section 2.5.3](#) for additional name configurations.

The specific message configuration will vary depending on the name of a facility. Variations to the presentation of a facility's name will need special approval from the Veterans Affairs Central Office (VACO) in Washington DC.

Graphic Process

Illuminated, routed out copy backed with white translucent acrylic.

Colors

Refer to the color chart in the Appendix.

Recommendations

Position sign so drivers have a clear, unobstructed view of the sign.

On-off illumination of sign can be controlled using a timer or photoelectric switch. Consult with sign fabricator at time of order for appropriate method to use.

See [Section 2.5.6](#) & [2.5.7](#) for exterior construction & installation details.

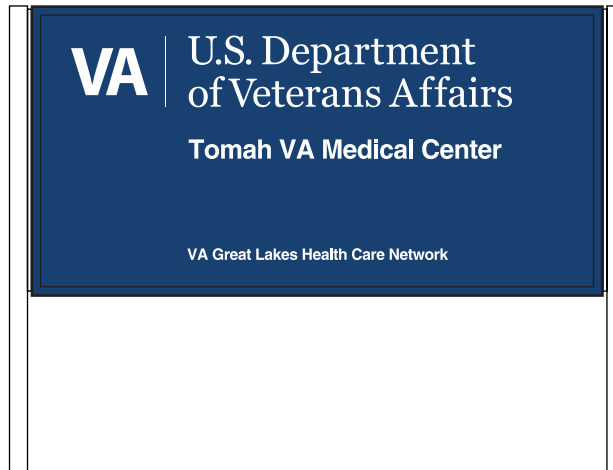

Message Layout C

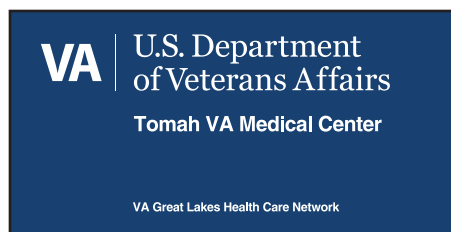

Message Layout D

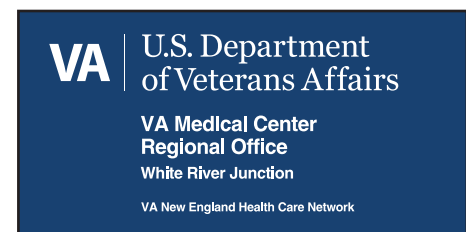

Message Layout E



Message Layout F



EI-03.01

Illuminated Exterior Signage Drawings

Post & Panel Site Identification – 4' x 8'

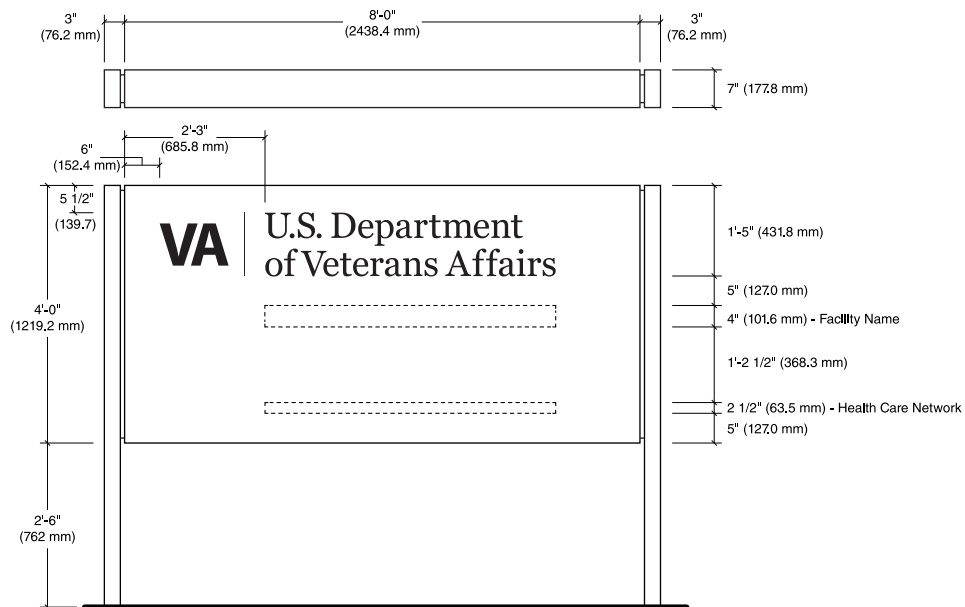

Message Layout C



Message Layout D



Message Layout E



Message Layout F



EI-03.02

Illuminated Exterior Signage Drawings

Post & Panel Directional – 4' x 6'

Size

Sign Face:
4'-0" High x 6'-0" Wide
(1219.2 mm H x 1828.8 mm W)

Overall Sign Height:
6'-6" (1981.2 mm)

Description & Use

Internally illuminated post and panel directional sign with messages relevant to drivers.

Message Configuration

Refer to message layout drawing for dimensions.

Message size and layout should adjust to the volume of information being presented. Layouts illustrated show small, medium and large size text. Smaller text than shown should not be used as the messages will be unreadable to drivers. Larger text than shown will result in words that may not fit on the sign. Refer to the viewing distance chart in [Section 2.5](#) for additional guidance.

Graphic Process

Illuminated, routed out copy backed with white translucent acrylic.

Colors

Refer to the color chart in the Appendix.

Recommendations

Position sign so drivers have a clear, unobstructed view of the sign. Directional information for services ahead should always be at the top of the sign.

Ensure that there is always a blank margin or copy strip between groups of directional information and at the bottom of the sign. Additionally, leave a smaller blank margin or strip at the top of the sign compared to the text strips.

On-off illumination of sign can be controlled using a timer or photoelectric switch. Consult with sign fabricator at time of order for appropriate method to use.

See [Section 2.5.6](#) & [2.5.7](#) for exterior construction & installation details.

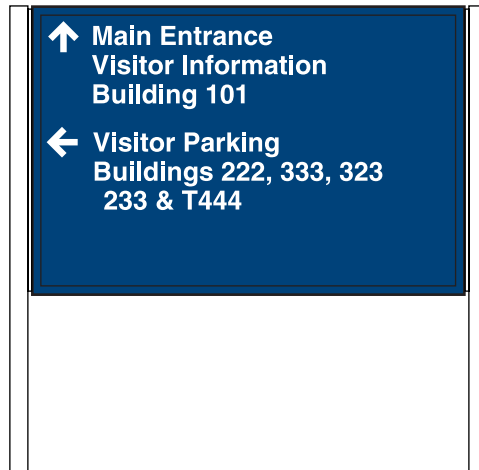

Message Layout A

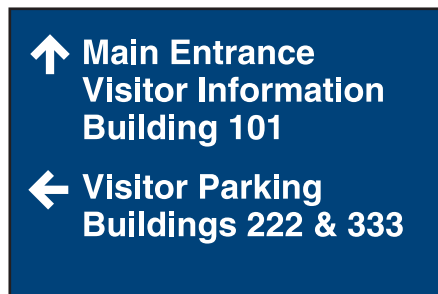

Message Layout B

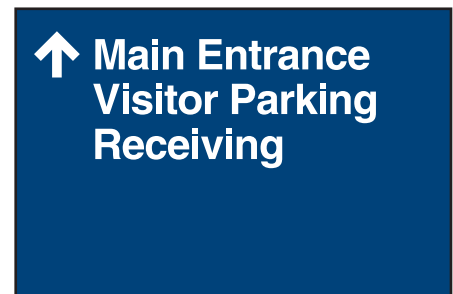

Message Layout C

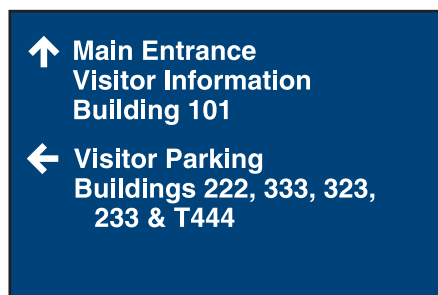

EI-03.02

Illuminated Exterior Signage Drawings

Post & Panel Directional – 4' x 6'

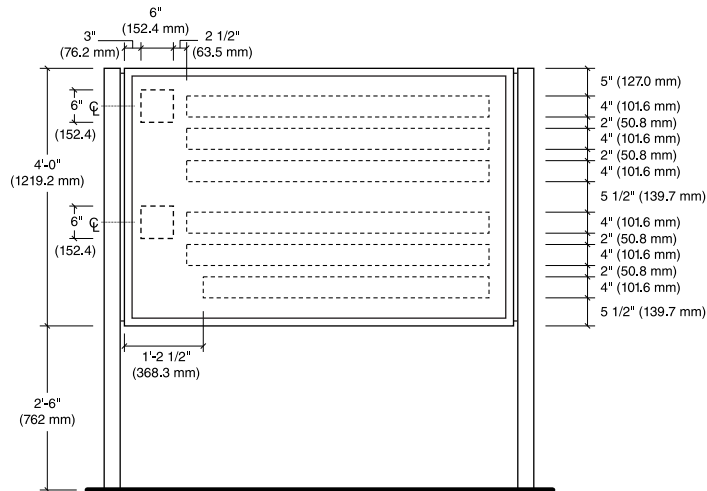
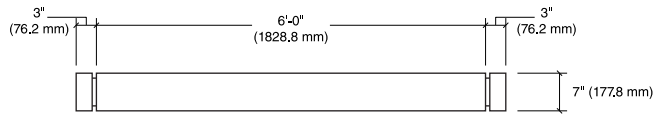

Message Layout A

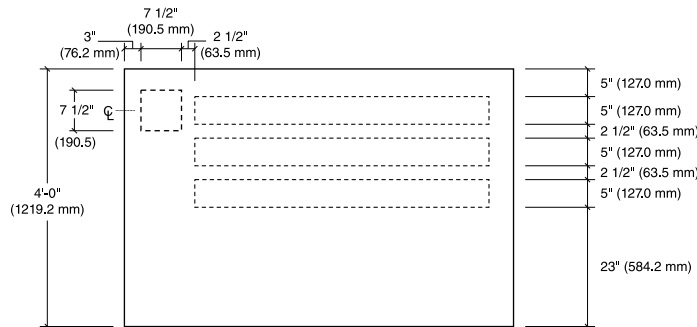

Message Layout B

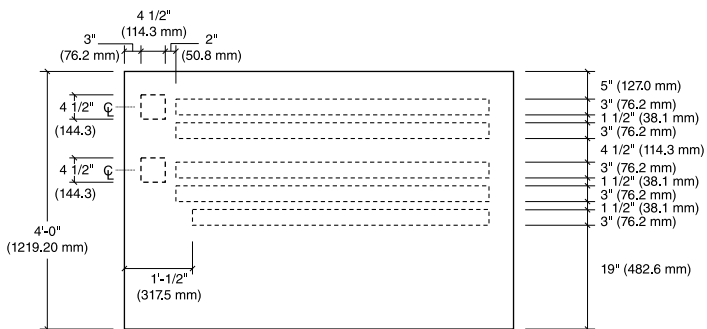

Message Layout C



EI-04.01

Illuminated Exterior Signage Drawings

Post & Panel Stacking Bar Directional – 4' x 8'

Size

Sign Face:
4'-0" High x 8'-0" Wide
(1219.2 mm H x 2438.4 mm W)

Overall Sign Height:
6'-6" (1981.2 mm)

Description & Use

Internally Illuminated large/long stacking bar post and panel comprised of 8 directional sign strips with messages relevant to drivers.

Internally illuminated signs to be used in locations where there is a heavy nighttime driver need for directional information.

Message Configuration

Refer to message layout drawing for dimensions.

Layout A is for the first line of text with an arrow of direction.

Layout B is for message with no arrow which is located immediately under a copy bar with an arrow.

Layout C is for indented text. This can be used to show a hierarchy of information. Alternatively, it can be used when the message is too long and must run onto a second line.

Graphic Process

Illuminated, routed out copy backed with white translucent acrylic.

Colors

Refer to the color chart in the Appendix.

Recommendations

Position sign so drivers have a clear, unobstructed view of the sign. Directional information for services ahead should always be at the top of the sign.

Ensure that there is always a blank margin or copy strip between groups of directional information and at the bottom of the sign. Additionally, leave a smaller blank margin or strip at the top of the sign compared to the text strips.

On-off illumination of sign can be controlled using a timer or photoelectric switch. Consult with sign fabricator at time of order for appropriate method to use.

See [Section 2.5.6](#) & [2.5.7](#) for exterior construction & installation details.

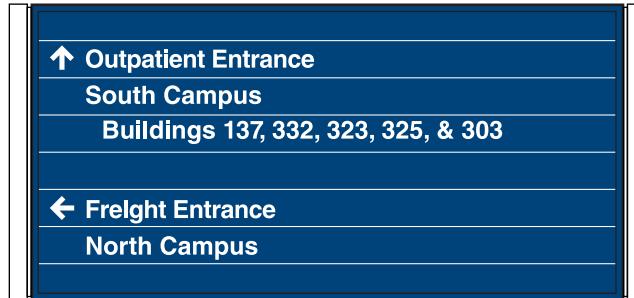

Message Layout A



Message Layout B



Message Layout C



EI-04.01

Illuminated Exterior Signage Drawings

Post & Panel Stacking Bar Directional – 4' x 8'

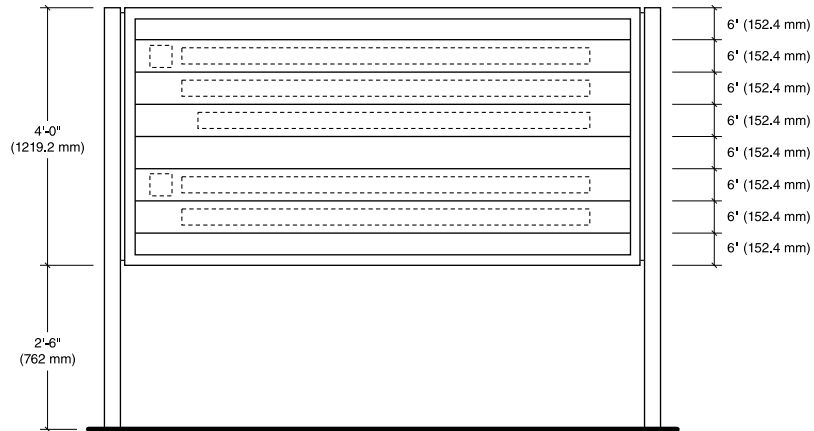
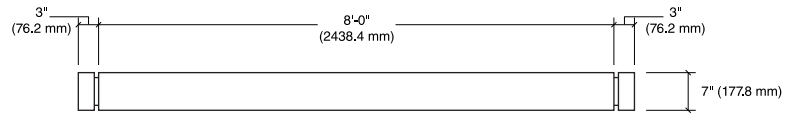

Multi-Panel Method

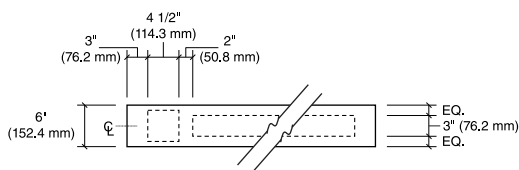

Message Layout A

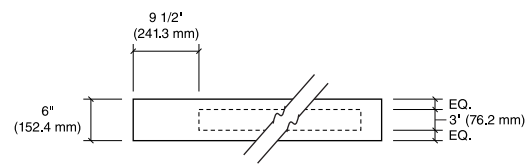

Message Layout B

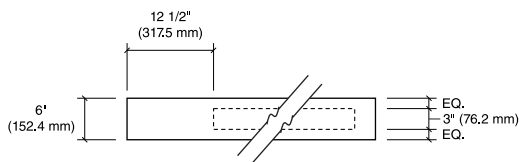

Message Layout C



EI-04.02

Illuminated Exterior Signage Drawings

Post & Panel Stacking Bar Directional – 4' x 6'

Size

Sign Face:
4'-0" High x 6'-0" Wide
(1219.2 mm H x 1828.8 mm W)

Overall Sign Height:
6'-0" (1829 mm)

Description & Use

Internally illuminated stacking bar post and panel comprised of 8 directional sign strips with messages relevant to drivers.

Internally illuminated signs to be used in locations where there is a heavy nighttime driver need for directional information.

Message Configuration

Refer to message layout drawing for dimensions.

Layout A is for the first line of text with an arrow of direction.

Layout B is for message with no arrow which is located immediately under a copy bar with an arrow.

Layout C is for indented text. This can be used to show a hierarchy of information. Alternatively, it can be used when the message is too long and must run onto a second line.

Graphic Process

Illuminated, routed out copy backed with white translucent acrylic.

Colors

Refer to the color chart in the Appendix.

Recommendations

Position sign so drivers have a clear, unobstructed view of the sign. Directional information for services ahead should always be at the top of the sign.

Ensure that there is always a blank margin or copy strip between groups of directional information and at the bottom of the sign. Additionally, leave a smaller blank margin or strip at the top of the sign compared to the text strips.

On-off illumination of sign can be controlled using a timer or photoelectric switch. Consult with sign fabricator at time of order for appropriate method to use.

See [Section 2.5.6](#) & [2.5.7](#) for exterior construction & installation details.

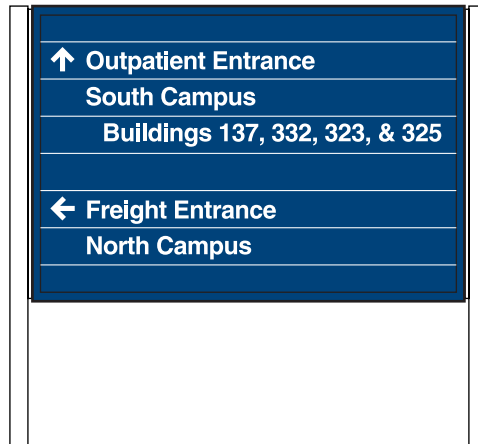

Message Layout A



Message Layout B



Message Layout C



EI-04.02

Illuminated Exterior Signage Drawings

Post & Panel Stacking Bar Directional – 4' x 6'

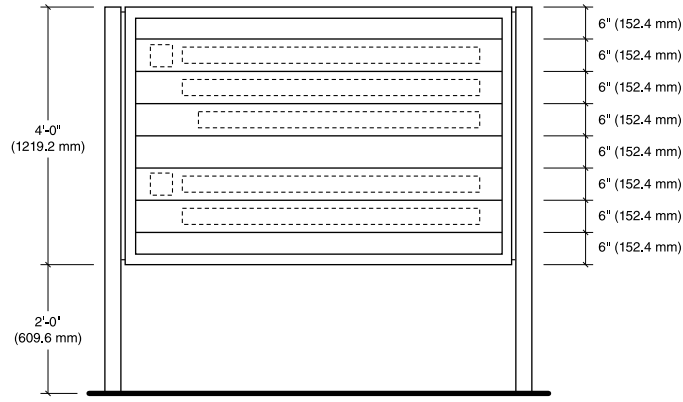
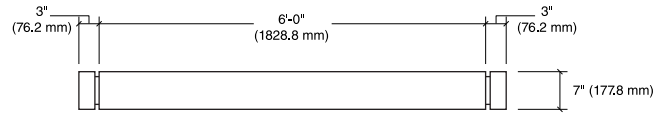

Multi-panel Method

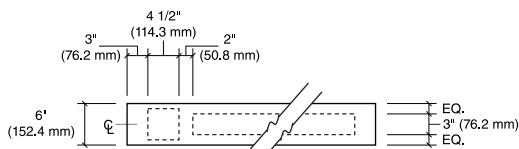

Message Layout A

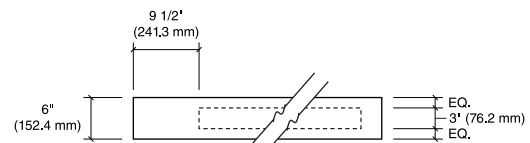

Message Layout B

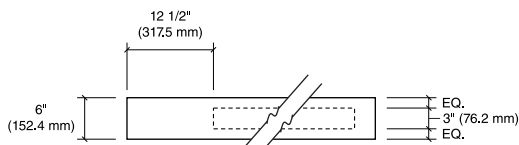

Message Layout C



EI-06.01

Illuminated Exterior Signage Drawings

Wall Mounted Overhead

Size

Sign Face:
2'-0" High x 8'-0" Wide
(609.6 mm H x 2438.4 mm W)

Description & Use

Internally illuminated overhead wall mounted identification sign used to identify a building or building entrance.

Message Configuration

Refer to message layout drawing for dimensions.

Layout A and B are for identifying an entrance to a building.

Layout C and D are for identifying a non-medical center, or standalone building, typically off campus.

Graphic Process

Illuminated, routed out copy backed with white translucent acrylic.

Colors

Refer to the color chart in the Appendix.

Recommendations

Use this type of sign for identifying major building entrances that have a very high volume of patient and visitor traffic and need to be clearly distinguished.

This sign can also be used to identify buildings on a campus or small standalone facility like an outpatient clinic.

On-off illumination of sign can be controlled using a timer or photoelectric switch. Consult with sign fabricator at time of order for appropriate method to use.

See [Section 2.5.6](#) & [2.5.7](#) for exterior construction & installation details.



Message Layout A



Message Layout B



Message Layout C



Message Layout D



EI-06.01

Illuminated Exterior Signage Drawings

Wall Mounted Overhead

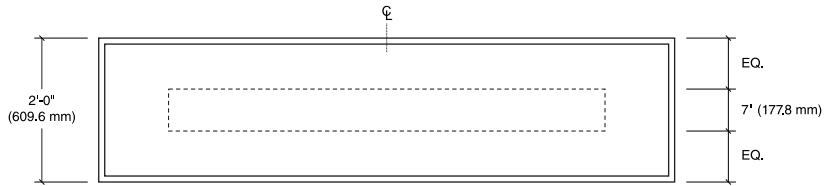
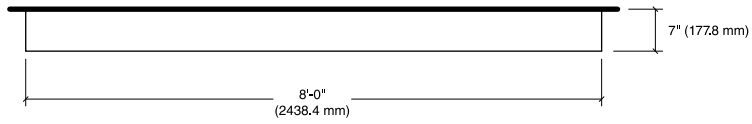

Message Layout A

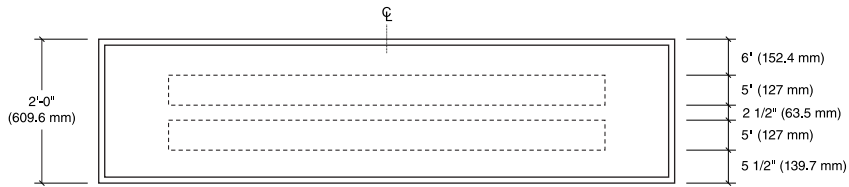

Message Layout B

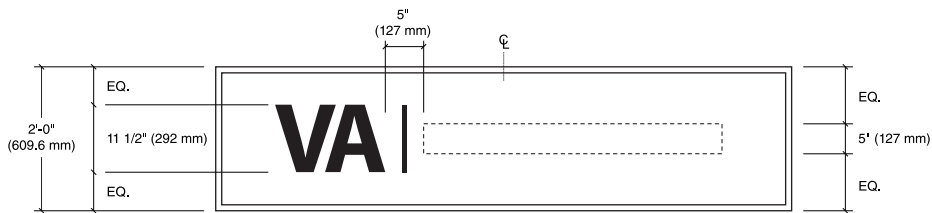

Message Layout C

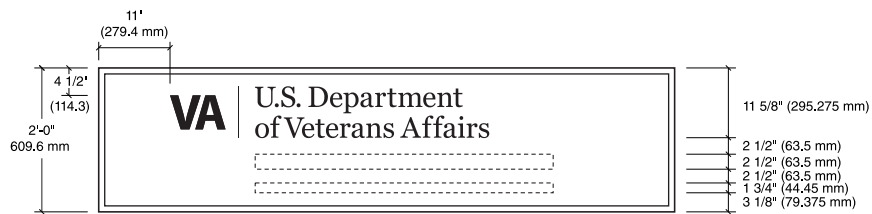

Message Layout D



EI-06.02

Illuminated Exterior Signage Drawings

Wall Mounted Building Identification

Size

Sign Face:
3'-0" High x 4'-0" Wide
(914.4 mm H x 1219.2 mm W)

Description & Use

Internally illuminated large wall mounted sign type that can be used to identify a building on a VA campus.

It may also be used for identification of a standalone building that is not a medical center where there is no place to install a freestanding sign.

Message Configuration

Refer to message layout drawing for dimensions.

Layout A is for identifying a standalone building, typically off campus.

Layout B and C are for identifying buildings on a medical center campus.

Graphic Process

Illuminated, routed out copy backed with white translucent acrylic.

Colors

Refer to the color chart in the Appendix.

Recommendations

Use this sign type for identifying buildings that have a high volume of patient and visitor traffic and need to be clearly distinguished.

This sign can also be used to identify buildings on a campus or small standalone facility like an outpatient clinic.

Position the sign adjacent the main entrance, if possible. If the sign is not readable in this position, then locate on the corner of the building.

This large sign should not be used on small buildings or buildings with minor uses.

On-off illumination of sign can be controlled using a timer or photoelectric switch. Consult with sign fabricator at time of order for appropriate method to use.

See [Section 2.5.6](#) & [2.5.7](#) for exterior construction & installation details.



Message Layout A



Message Layout B



Message Layout C

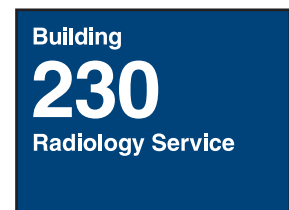

EI-06.02

Illuminated Exterior Signage Drawings

Wall Mounted Building Identification

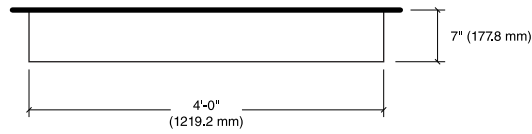

Message Layout A

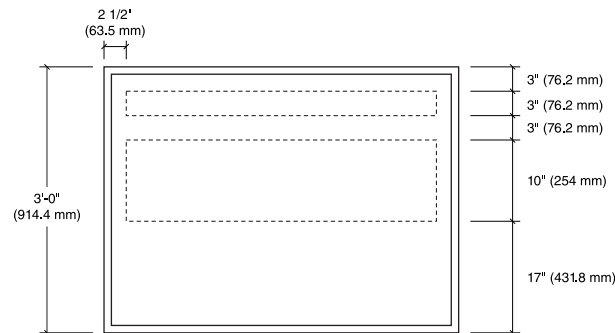

Message Layout B

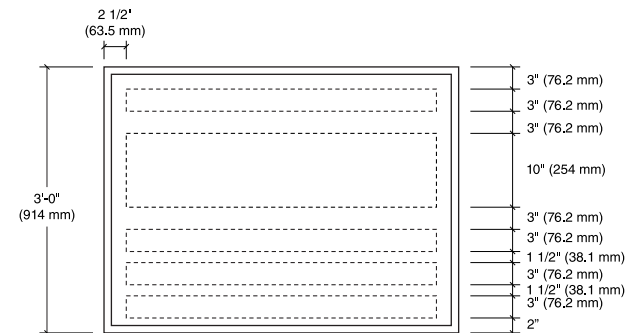

Message Layout C



EI-08.01

Illuminated Exterior Signage Drawings

Wall Mounted Ambulance / Emergency Overhead

Size

Sign Face:
2'-0" High x 8'-0" Wide
(609.6 mm H x 2438.4 mm W)

Description & Use

Internally illuminated overhead wall mounted signs to be placed above the emergency or ambulance entrance.

Message Configuration

Refer to message layout drawing for dimensions.

Conform to the layout shown.

Graphic Process

Illuminated, routed out copy backed with white translucent acrylic.

Colors

Refer to the color chart in the Appendix.

Background: Red
Text: White

Recommendations

Place sign in a position of the building where it clearly identifies the entrance and is visible to both vehicles and pedestrians.

On-off illumination of sign can be controlled using a timer or photoelectric switch. Consult with sign fabricator at time of order for appropriate method to use.

See [Section 2.5.6](#) & [2.5.7](#) for exterior construction & installation details.



Message Layout A



Message Layout B



EI-08.01

Illuminated Exterior Signage Drawings

Wall Mounted Ambulance / Emergency Overhead

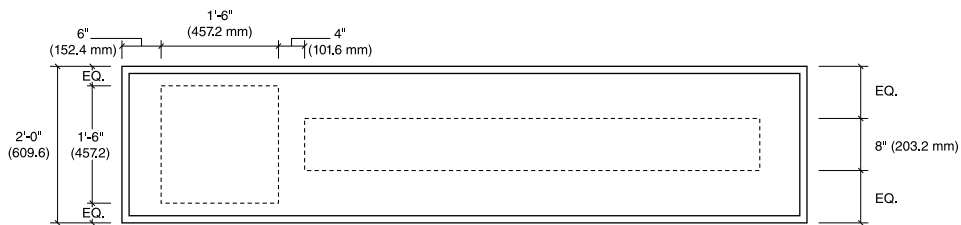
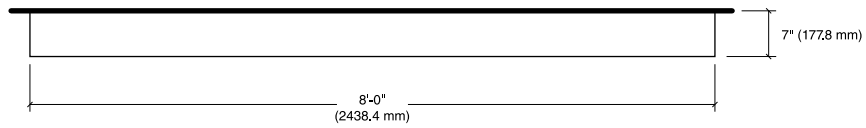

Message Layout A & B



EI-08.02

Illuminated Exterior Signage Drawings

Wall Mounted Ambulance / Emergency Identification

Size

Sign Face:
3'-0" High x 4'-0" Wide
(914.4 mm H x 1219.2 mm W)

Description & Use

Internally illuminated wall mounted signs to be placed on the wall adjacent to the ambulance or emergency entrance.

Message Configuration

Refer to message layout drawing for dimensions.

Conform to the layouts shown.

Graphic Process

Illuminated, routed out copy backed with white translucent acrylic.

Colors

Refer to the color chart in the Appendix.

Background: Red
Text: White

Recommendations

Place sign in a position of the building where it clearly identifies the entrance and is visible to both vehicles and pedestrians.

On-off illumination of sign can be controlled using a timer or photoelectric switch. Consult with sign fabricator at time of order for appropriate method to use.

See [Section 2.5.6](#) & [2.5.7](#) for exterior construction & installation details.



Message Layout A



Message Layout B



EI-08.02

Illuminated Exterior Signage Drawings

Wall Mounted Ambulance / Emergency Identification

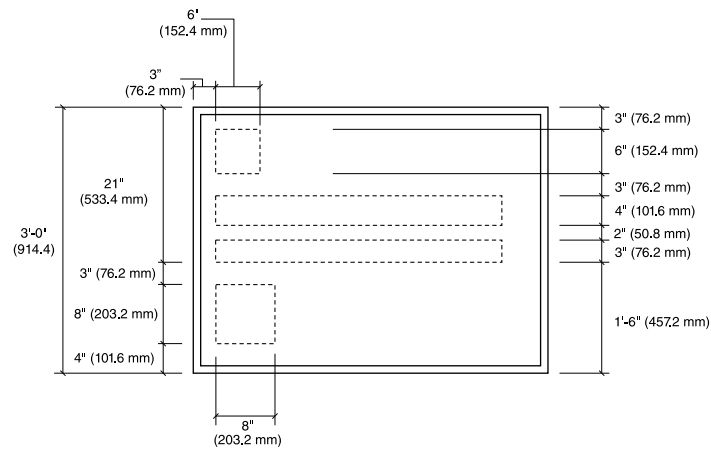
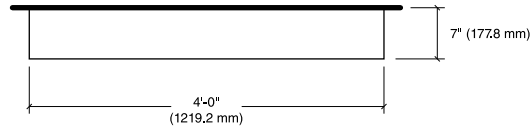

Message Layout A

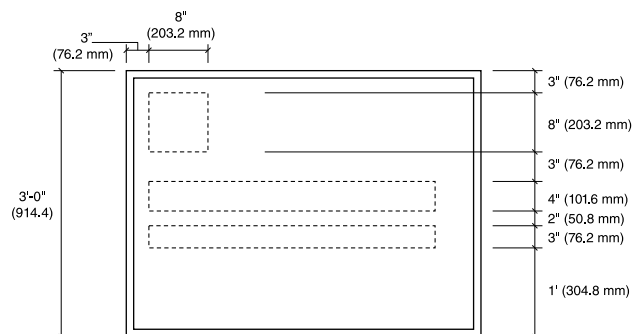

Message Layout B



EI-08.03

Illuminated Exterior Signage Drawings

Post & Panel Ambulance / Emergency Identification

Size

Sign Face:
3'-0" High x 4'-0" Wide
(914.4 mm H x 1219.2 mm W)

Overall Sign Height:
5'-6" (1676.4 mm)



Description & Use

Internally illuminated post and panel signs to be placed on the roadway, adjacent to the ambulance or emergency entrance to direct drivers to the correct building entrance.

Message Configuration

Refer to message layout drawing for dimensions.

Conform to the layouts shown.

Graphic Process

Illuminated, routed out copy backed with white translucent acrylic.

Colors

Refer to the color chart in the Appendix.

Background: Red
Text: White

Recommendations

Position sign so drivers have a clear, unobstructed view of the sign.

On-off illumination of sign can be controlled using a timer or photoelectric switch. Consult with sign fabricator at time of order for appropriate method to use.

See [Section 2.5.6](#) & [2.5.7](#) for exterior construction & installation details.



Message Layout A



Message Layout B



EI-08.03

Illuminated Exterior Signage Drawings

Post & Panel Ambulance / Emergency Identification

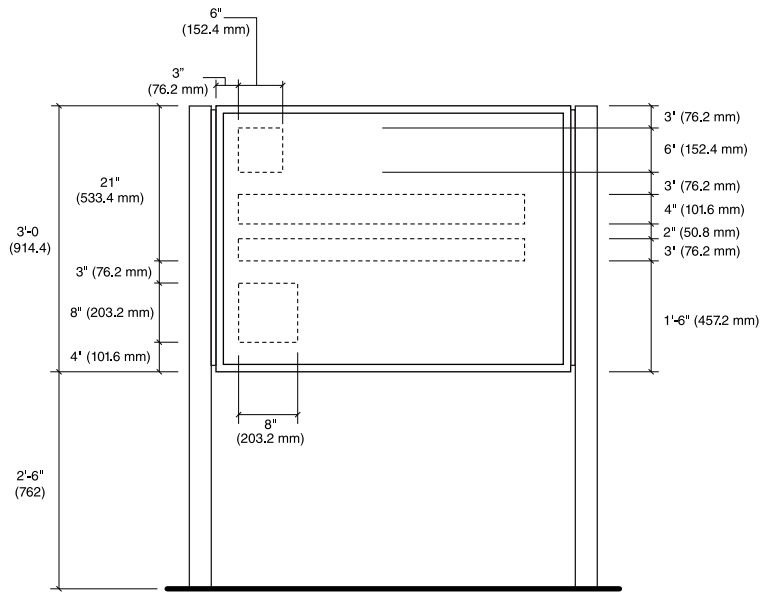
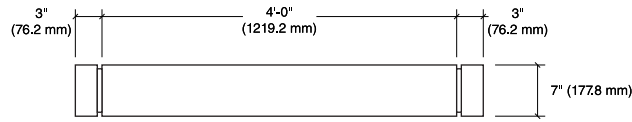

Message Layout A

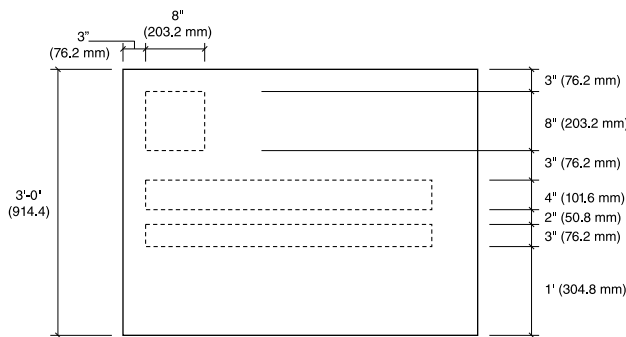

Message Layout B



EI-09

Illuminated Exterior Signage Drawings

Illuminated Letters & Logo

Size

For the various sizes, refer to the adjacent table.

Description & Use

Internal halo-illuminated, fabricated metal dimensional letters and logo for identifying a facility.

This sign should be placed on the building in a location that is highly visible to the public.

Message Configuration

Refer to message layout drawing for dimensions.

Letters used with the logo should read “Medical Center”, “Outpatient Clinic”, “Health Care Center”, or “Veterans Affairs”. They can be on one line or stacked on two lines.

Graphic Process

Fabricated aluminum letters with internal LED lighting. Letters are pin mounted off wall to allow light to wash wall and halo illuminate letters.

Colors

Refer to the color chart in the Appendix.

Letters to have high contrast to the building wall color or material. For example, use white on red brick instead of black.

Illumination color is white light.

Recommendations

Large size letters and logo are intended for use on the top of the building as a skyline sign.

These letters require clear access to the back (inside) of the wall on which they will be installed.

On-off illumination of sign can be controlled using a timer or photoelectric switch. Consult with sign fabricator at time of order for appropriate method to use.

See [Section 2.5.6](#) & [2.5.7](#) for exterior construction & installation details.

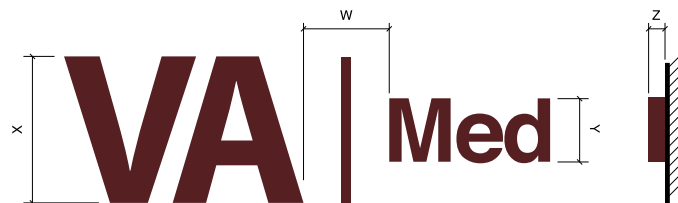

Sign Type	Y	Z	X	W
EI-09.06	18" (450 mm)	6" (150 mm)	42" (1050 mm)	19" (350 mm)
EI-09.07	24" (600 mm)	6" (150 mm)	56" (1350 mm)	25" (475 mm)
EI-09.08	30" (750 mm)	6" (150 mm)	70" (1800 mm)	31" (575 mm)
EI-09.09	36" (900 mm)	6" (150 mm)	84" (2100 mm)	38" (700 mm)



EI-14

Illuminated Exterior Signage Drawings

4-Sided Site Monument

Size

Sign Face:
14'-6" High x 5'-0" Wide x 5'-0" Deep
(4419.6 mm H x 1524 mm W x 1524 mm D)

Description & Use

Internally illuminated vertical freestanding monument sign for identifying a medical center or the medical center's main entrance drive.

The base may be constructed of concrete or other masonry material in a color and texture that will complement architectural design and building finishes.

Message Configuration

Refer to message layout drawing for dimensions.

See [Section 2.5.3](#) for additional name configurations.

Specific message configuration will vary depending on the name of a facility. Variations to the presentation of a facility's name will need special approval from the Veterans Affairs Central Office (VACO) in Washington DC.

Graphic Process

Illuminated, routed out copy backed with white translucent acrylic.

Colors

Refer to the color chart in the Appendix.

Recommendations

Position sign so drivers have a clear, unobstructed view of the sign. Keep landscaping around the sign low and position sprinklers so they project away from the sign.

On-off illumination of sign can be controlled using a timer or photoelectric switch. Consult with sign fabricator at time of order for appropriate method to use.

See [Section 2.5.6](#) & [2.5.7](#) for exterior construction & installation details.



Message Layout A

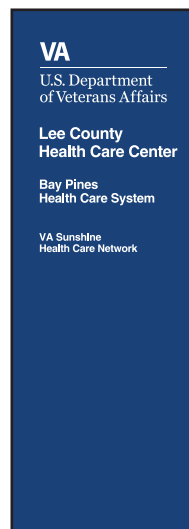

Message Layout B

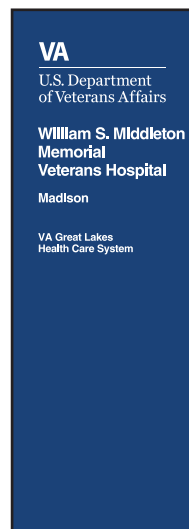

Message Layout C

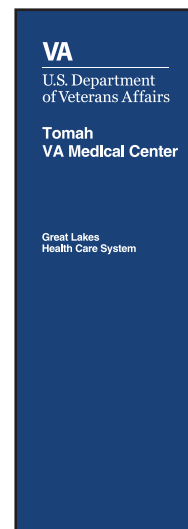

Message Layout D

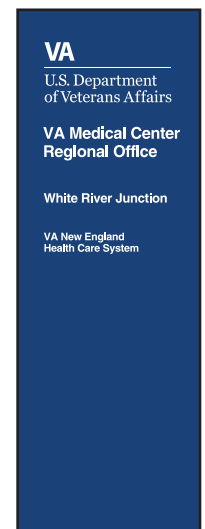

EI-14

Illuminated Exterior Signage Drawings

4-Sided Site Monument

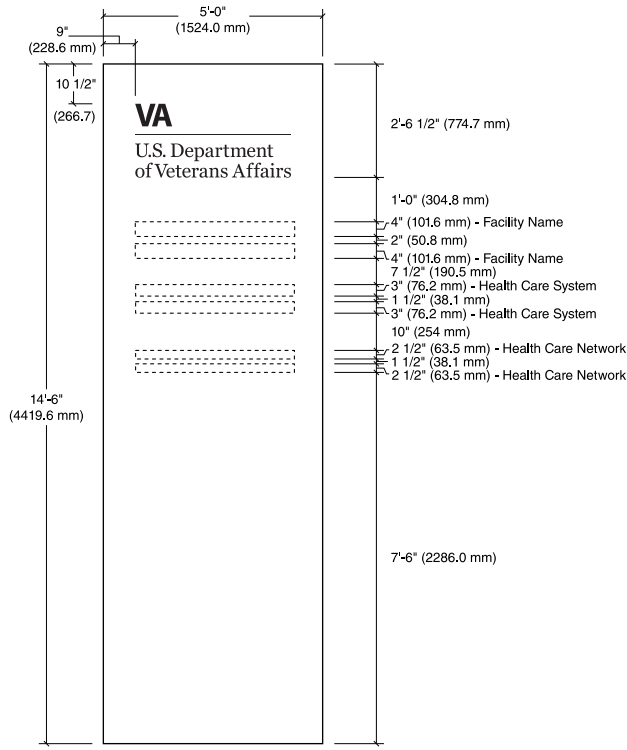

Message Layout A

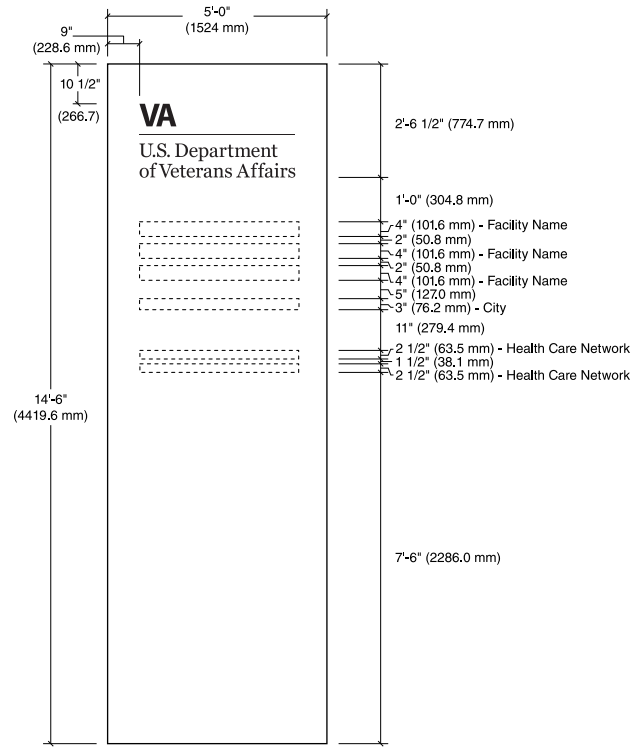

Message Layout B

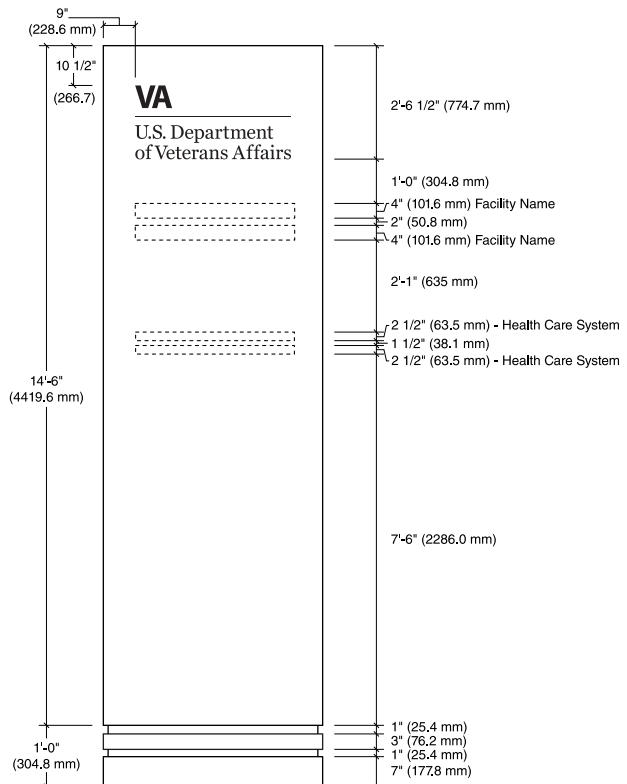

Message Layout C

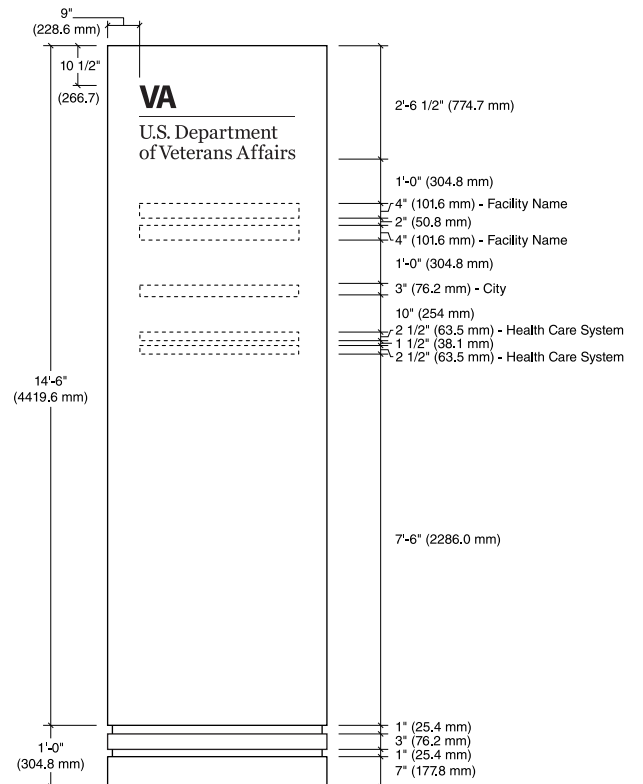

Message Layout D



EI-15.01

Illuminated Exterior Signage Drawings

4-Sided Directional Site Monument

Size

Sign Face:
15'-0" High x 5'-0" Wide x 5'-0" Deep
(4572 mm H x 1524 mm W x 1524 mm D)

Description & Use

Internally illuminated vertical freestanding monument sign for identifying a medical center or the medical center's main entrance drive.

Lower section of sign has modular changeable sign panel(s) that can be used for directional information.

The base can be constructed of concrete or other masonry material in a color and texture that will complement architectural design and building finishes.

Message Configuration

Refer to message layout drawing for dimensions.

See [Section 2.5.3](#) for additional name configurations.

Specific message configuration will vary depending on the name of a facility. Variations to the presentation of a facility's name will need special approval from the Veterans Affairs Central Office (VACO) in Washington DC.

Graphic Process

Illuminated, routed out copy backed with white translucent acrylic.

Colors

Refer to the color chart in the Appendix.

Recommendations

Position sign so drivers have a clear, unobstructed view of the sign. Keep landscaping around the sign low and position sprinklers so they project away from the sign.

On-off illumination of sign can be controlled using a timer or photoelectric switch. Consult with sign fabricator at time of order for appropriate method to use.

See [Section 2.5.6](#) & [2.5.7](#) for exterior construction & installation details.

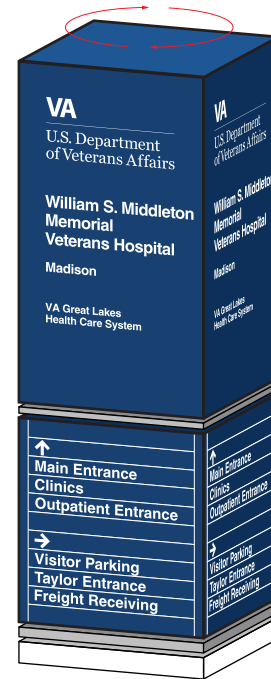
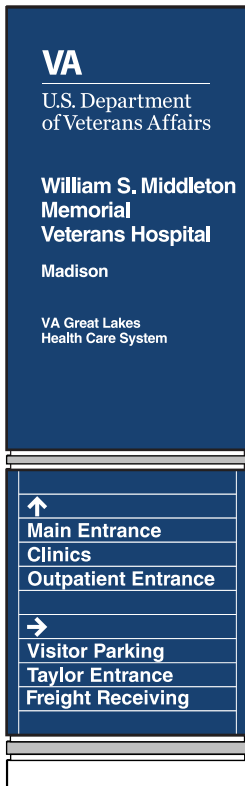

Lower portion of sign can be a single panel system.



Message Layout A

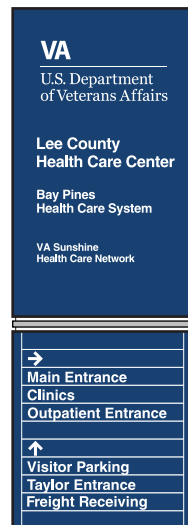

Message Layout B

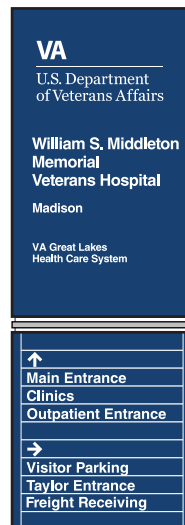

Message Layout C

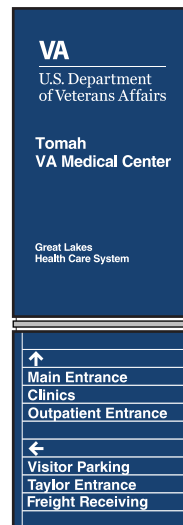

Message Layout D

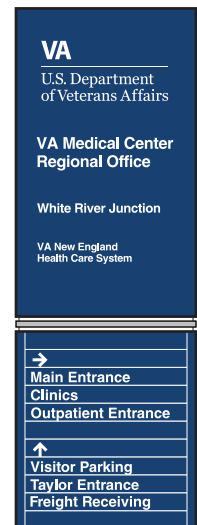

EI-15.01

Illuminated Exterior Signage Drawings

4-Sided Directional Site Monument

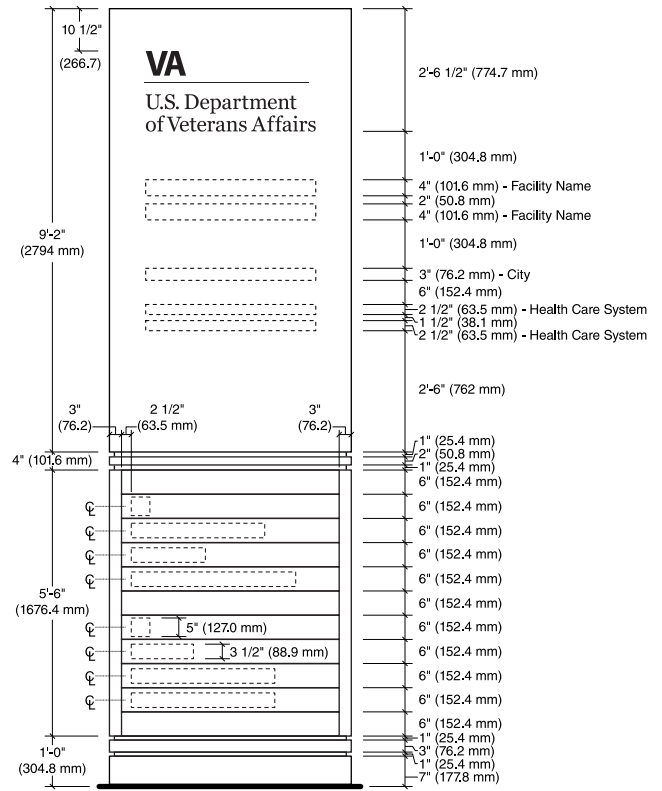
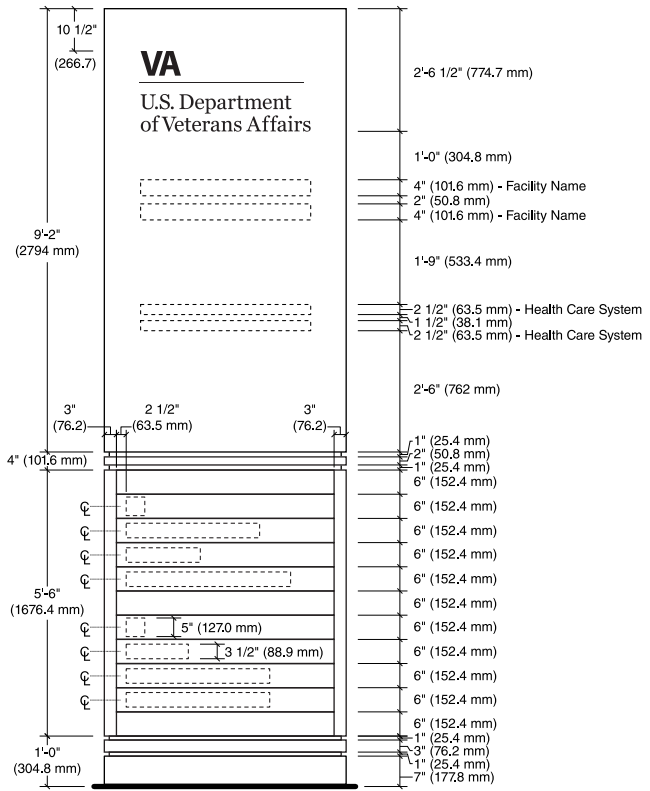
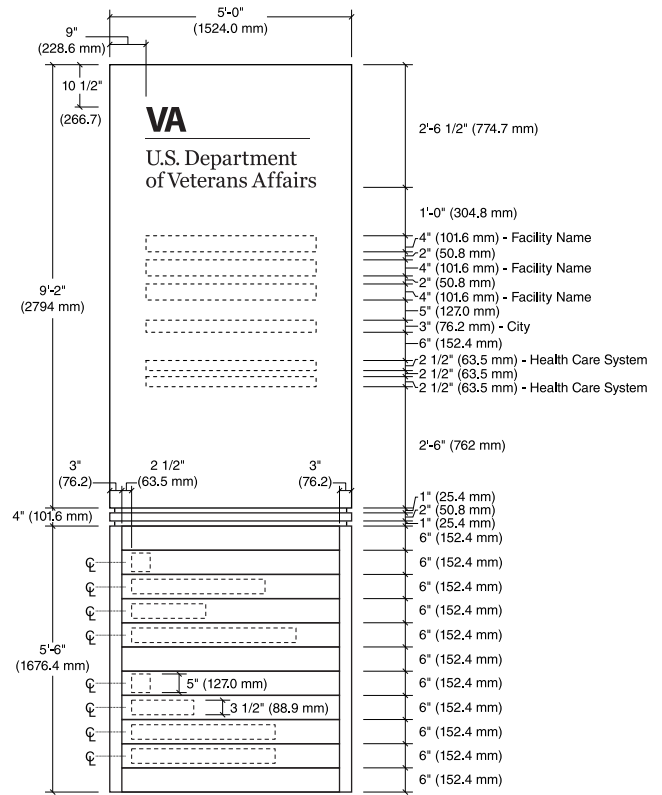
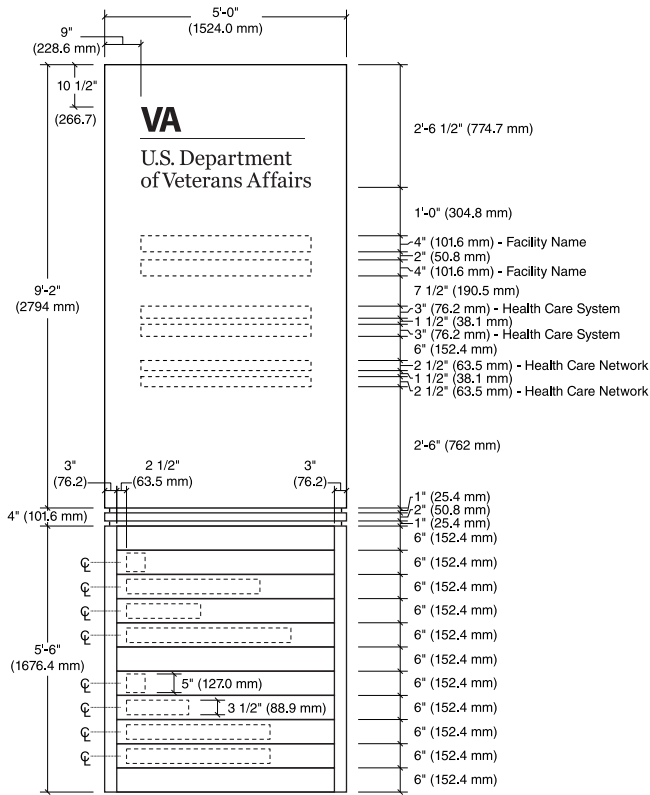

EI-15.02

Illuminated Exterior Signage Drawings

4-Sided Directional Site Monument with Address

Size

Overall Sign:
14'-6" High x 5'-0" Wide x 5'-0" Deep
(4419.6 mm H x 1524 mm W x 1524 mm D)

Description & Use

Internally illuminated vertical freestanding monument sign for identifying a medical center or the medical center's main entrance drive.

Lower section of sign has modular changeable sign panel(s) that can be used for directional information.

The base can be constructed of concrete or other masonry material in a color and texture that will complement architectural design and building finishes.

Message Configuration

Refer to message layout drawing for dimensions.

See [Section 2.5.3](#) for additional name configurations.

Specific message configuration will vary depending on the name of a facility. Variations to the presentation of a facility's name will need special approval from the Veterans Affairs Central Office (VACO) in Washington DC.

Graphic Process

Illuminated, routed out copy backed with white translucent acrylic.

Colors

Refer to the color chart in the Appendix.

Recommendations

Position sign so drivers have a clear, unobstructed view of the sign. Keep landscaping around the sign low and position sprinklers so they project away from the sign.

On-off illumination of sign can be controlled using a timer or photoelectric switch. Consult with sign fabricator at time of order for appropriate method to use.

See [Section 2.5.6](#) & [2.5.7](#) for exterior construction & installation details.

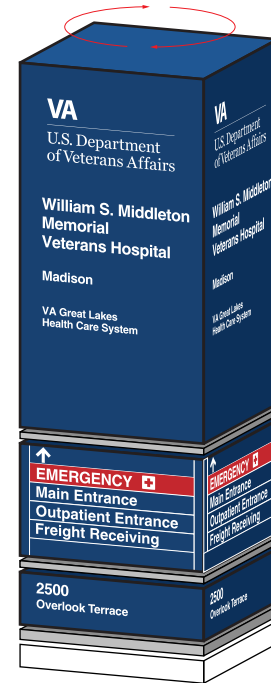
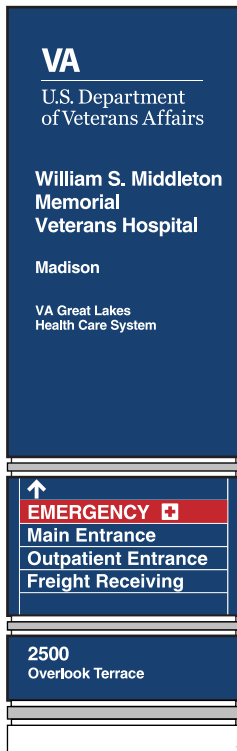

Lower portion of sign can be a single panel system.

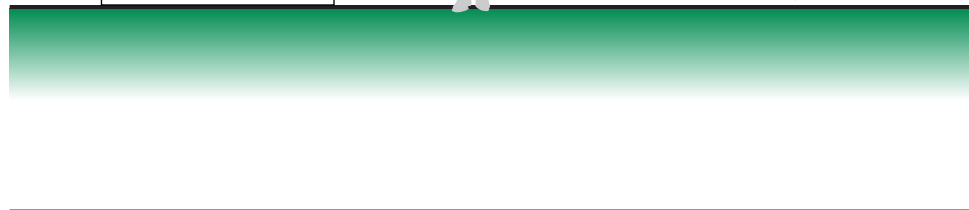

Message Layout A

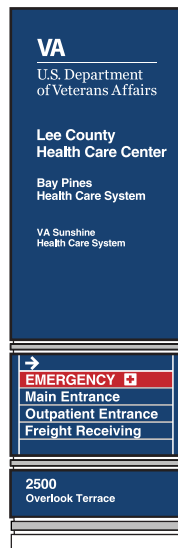

Message Layout B

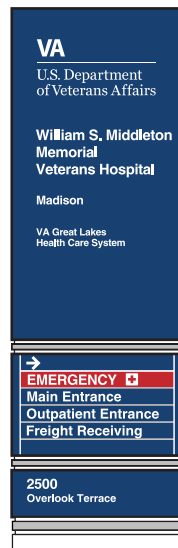

Message Layout C

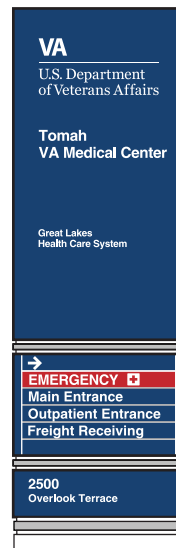

Message Layout D

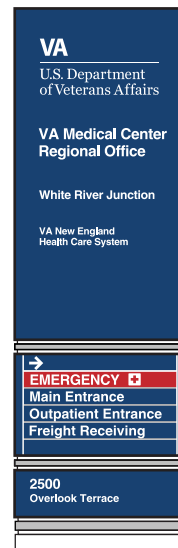

EI-15.02

Illuminated Exterior Signage Drawings

4-Sided Directional Site Monument with Address

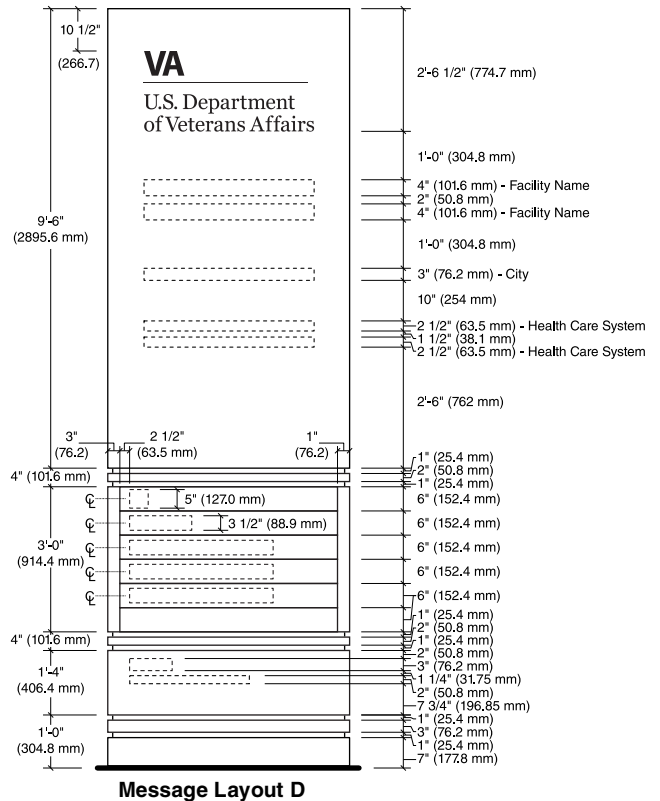
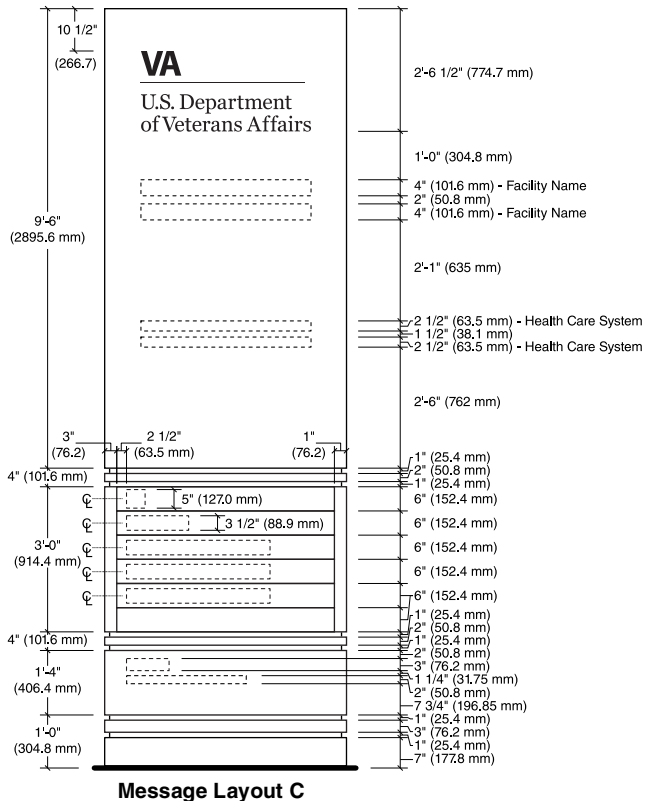
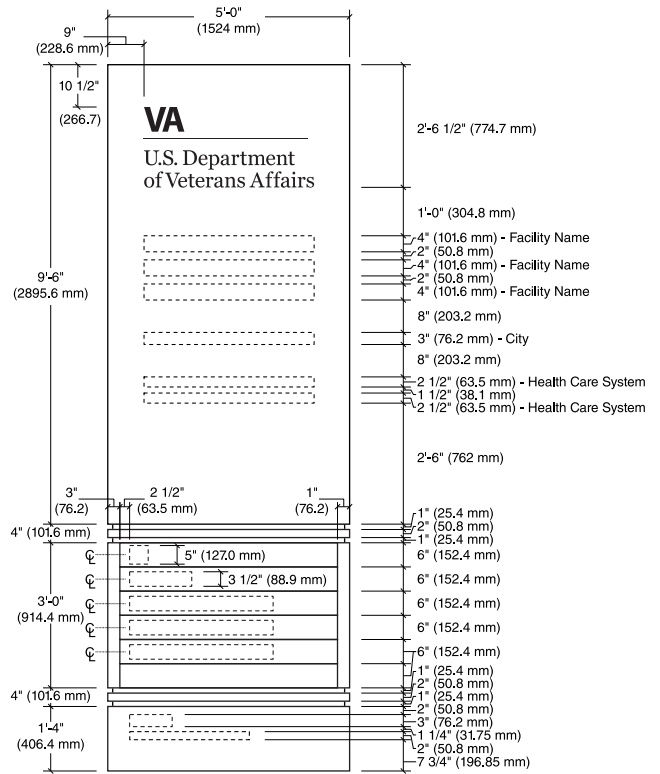
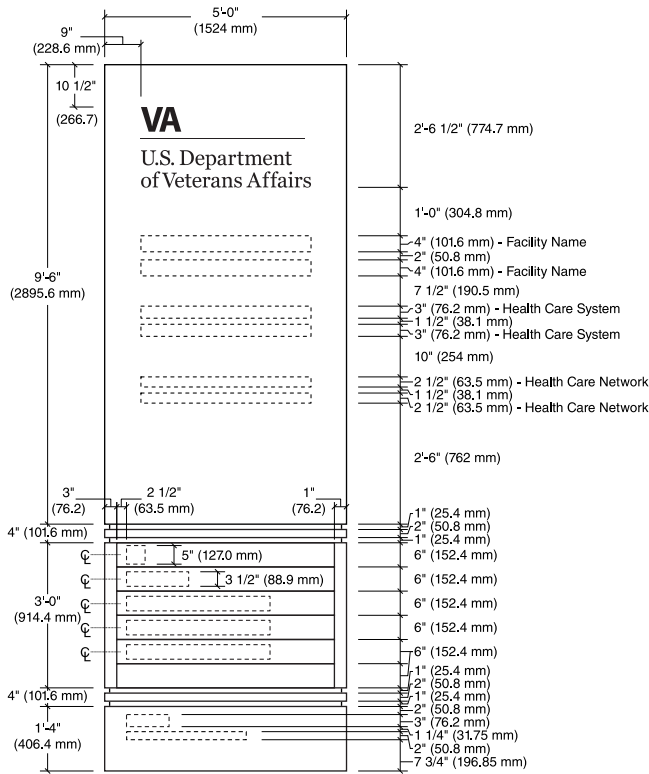

EI-16.01

Illuminated Exterior Signage Drawings

Vertical Site Monument with Electronic Message Unit

Size

Sign Face:
14'-0" High x 5'-0" Wide x 1'-9" Deep
(4267.2 mm H x 1524 mm W x 533.4 mm D)

Description & Use

Internally illuminated vertical freestanding monument sign for identifying a medical center or the medical center's main entrance drive.

The digital display panel unit should be fully incorporated into the architectural sign. The architectural sign size may need to be adjusted to fit the selected display panel. When selecting the electronic message unit take into consideration viewing distance, traffic speed, space restriction, and zoning constraints. Also discuss the type of content to be displayed including still images, animation, or both.

Technology for digital displays is consistently changing. Evaluate several manufacturers and discuss site specific options.

The base can be constructed of concrete or other masonry material in a color and texture that will provide a coordinated architectural look with the building finishes of the medical center.

Message Configuration

Refer to [EI-15.02](#) for message layout and configuration.

Recommendations

Position sign so drivers have a clear, unobstructed view of the sign. Keep landscaping around the sign low. Position sprinklers so they do not spray the sign.

When evaluating digital displays, consider a maintenance/service contract and have several staff trained in operation and message implementation.

On-off illumination of sign can be controlled using a timer or photoelectric switch. Consult with sign fabricator at time of order for appropriate method to use.

See [Section 2.5.6](#) & [2.5.7](#) for exterior construction & installation details.

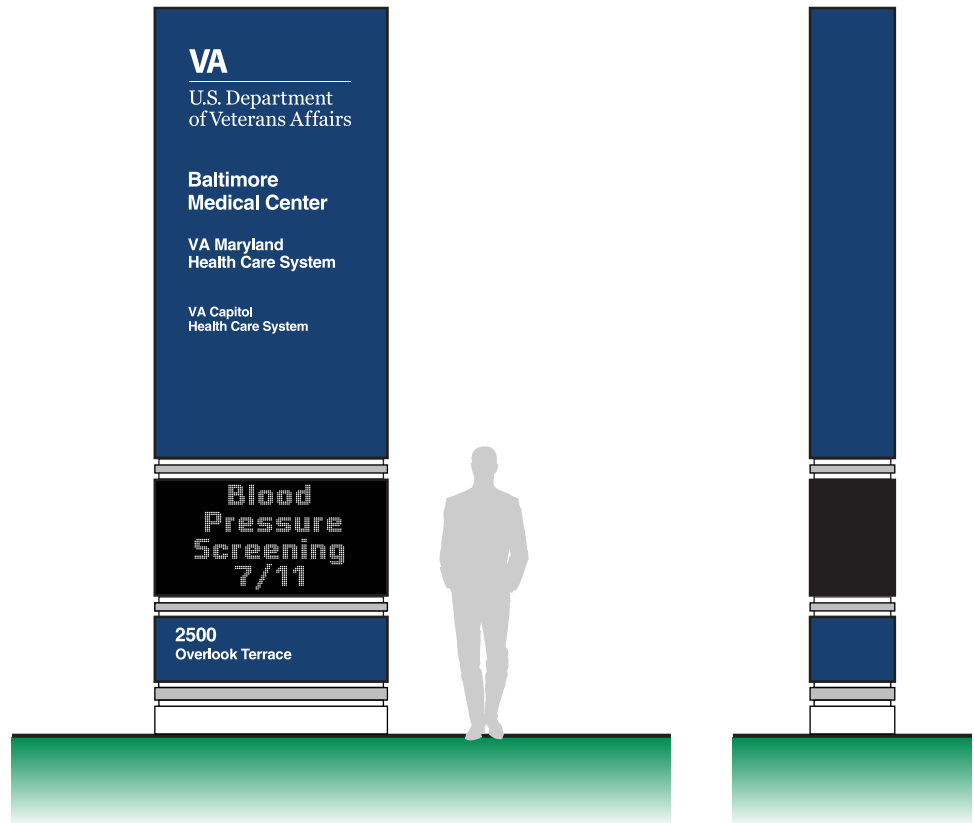

Message Layout



Pixel pitch is the standard measurement to indicate the resolution of a digital sign which typically ranges from 6 mm (highest resolution) to 19 mm (lowest resolution). The resolution has a significant effect on the cost of the message unit. Standard communication options to update the sign include cellular broadband, hardwire data connection or line of site radio.



EI-16.01

Illuminated Exterior Signage Drawings

Vertical Site Monument with Electronic Message Unit

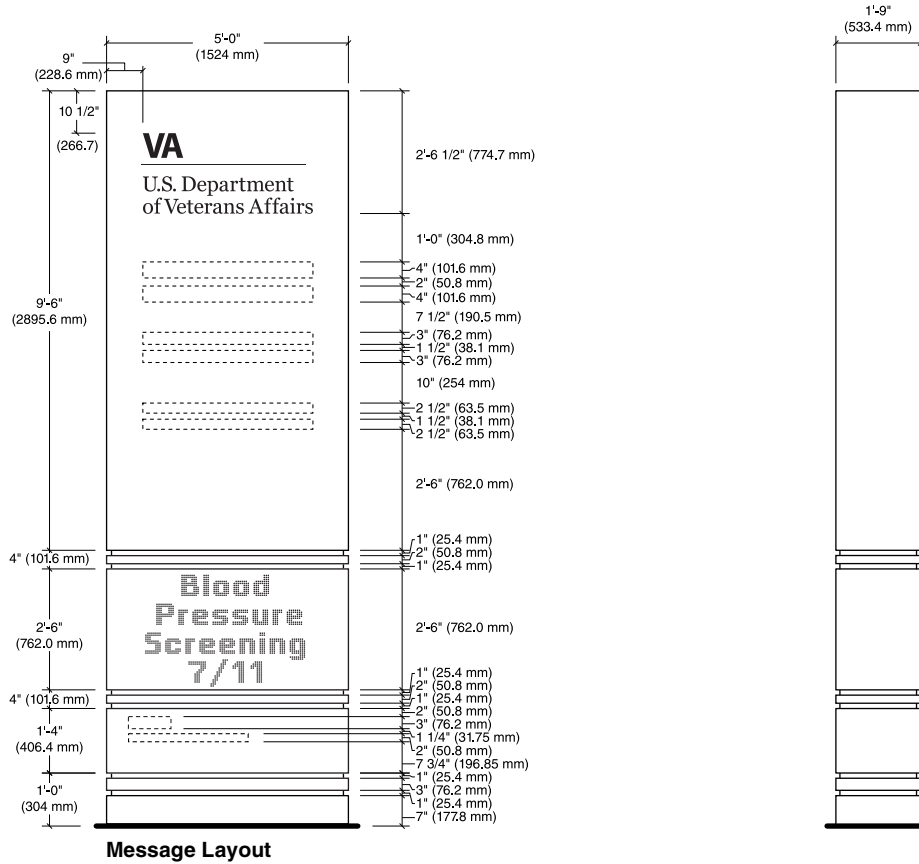

EI-16.02

Illuminated Exterior Signage Drawings

Horizontal Site Monument with Electronic Message Unit

Size

Sign Face:
8'-0" High x 12'-9" Wide x 1'-9" Deep
(2438.4 mm H x 3886.2 mm W x 533.4 mm D)

Description & Use

Internally illuminated vertical freestanding monument sign for identifying a medical center or the medical center's main entrance drive.

The digital display panel should be fully incorporated into the architectural sign. The architectural sign size may need to be adjusted to fit the selected display panel. When selecting the electronic message unit take into consideration viewing distance, traffic speed, space restriction, and zoning constraints. Also discuss the type of content to be displayed including still images, animation, or both.

Technology for digital displays is consistently changing. Evaluate several manufacturers and discuss site specific options.

The base may be constructed of concrete or other masonry material in a color and texture that will provide a coordinated architectural look with the building finishes of the medical center.

Message Configuration

Refer to [Sign Type EI-01.01](#) for message layout and configuration.

Recommendations

Position sign so drivers have a clear, unobstructed view of the sign. Keep landscaping around the sign low and position sprinklers so they project away from the sign.

When evaluating digital displays, consider a maintenance/service contract and have several staff trained in operation and message implementation.

On-off illumination of sign can be controlled using a timer or photoelectric switch. Consult with sign fabricator at time of order for appropriate method to use.

See [Section 2.5.6](#) & [2.5.7](#) for exterior construction & installation details.

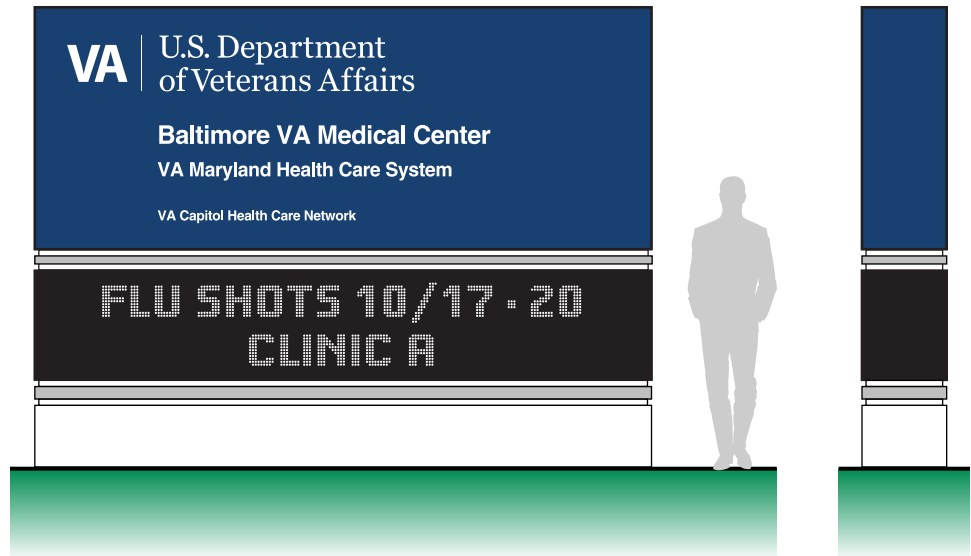

Message Layout



Pixel pitch is the standard measurement to indicate the resolution of a digital sign which typically ranges from 6 mm (highest resolution) to 19 mm (lowest resolution). The resolution has a significant effect on the cost of the message unit. Standard communication options to update the sign include cellular broadband, hardwire data connection or line of site radio.



EI-16.02

Illuminated Exterior Signage Drawings

Horizontal Site Monument with Electronic Message Unit

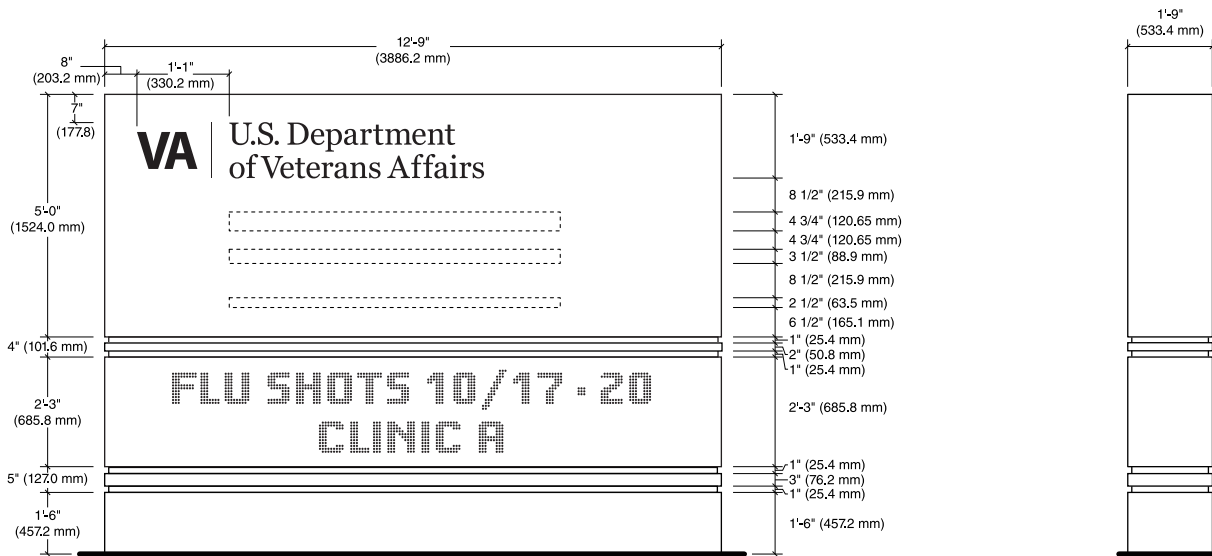

Message Layout



Information Center Monument

Size

Sign Face:
5'-6" High x 8'-2" Wide x 1'-0" Deep
(1676.4 mm H x 2489.2 mm W x
304.8 mm D)

Description & Use

Internally illuminated freestanding information center.

Exterior campus map and directory to provide information and orientation to motorists and pedestrians on a large campus.

The base can be constructed of concrete or other masonry material in a color and texture that will complement architectural design building finishes.

Message Configuration

Refer to message layout drawing for dimensions.

Graphic Process

Illuminated, routed copy backed with white translucent acrylic.

Digitally printed map and directory panel inserts to slide into sign system frame with clear acrylic windows.

Colors

Refer to the color chart in the Appendix.

Recommendations

The size and complexity of the campus will determine the necessity and quantity of campus information centers. A smaller campus may not benefit from one, but larger campuses may require one or more strategically located throughout the campus.

The sign should be located in safe vehicular pull-off areas to avoid affecting traffic flow.

Maps and directories should only include information relevant to vehicular and pedestrian wayfinding.

See [Section 4.2](#) for more information about campus maps.

See [Section 2.5.6](#) & [2.5.7](#) for exterior construction & installation details.

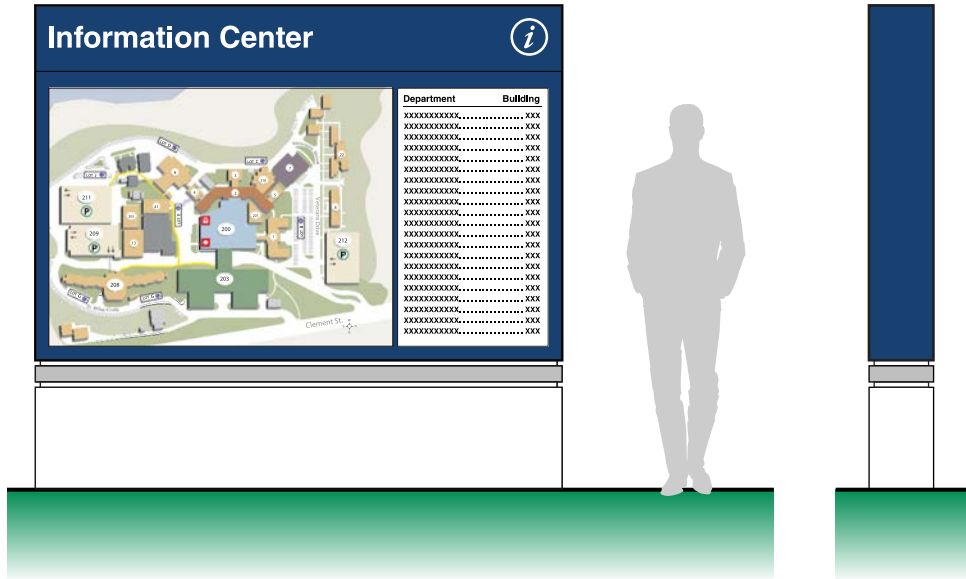

Information Center Monument

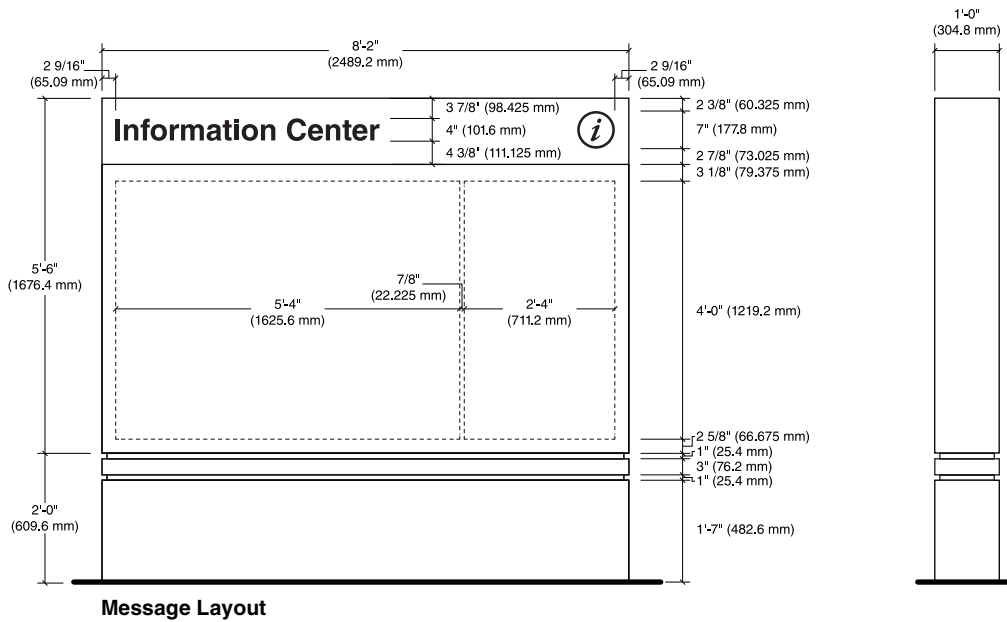

EN-02.01

Non Illuminated Exterior Signage Drawings

Directional Monument Large – 6' x 6'

Size

Sign Face:
6'-0" High x 6'-0" Wide x 1'-0" Deep
(1828.8 mm H x 1828.8 mm W x 304.8 mm D)

Description

Non-illuminated large directional monument sign with a single interchangeable panel or 10 stacking strips. Directional sign with messages relevant to drivers.

Non-illuminated signs should not be used in locations where there is a heavy nighttime driver need for directional information.

Message Configuration

Refer to message layout drawing for dimensions.

Layout A is for the first line of text with an arrow of direction.

Layout B is for a message with no arrow which is located under a line of copy with an arrow.

Layout C is for indented text. This can be used to show a hierarchy of information. Alternatively, it can be used for situations where the message is too long and must run onto a second line.

Refer to the viewing distance chart in [Section 2.5](#) for additional guidance.

Graphic Process

Surface applied white reflective vinyl.

Colors

Refer to the color chart in the Appendix.

Recommendations

Position sign so drivers have a clear, unobstructed view of the sign. Directional information for services ahead should always be at the top of the sign.

Ensure that there is always a blank margin or copy strip between groups of directional information and at the bottom of the sign. Additionally, leave a smaller blank margin or strip at the top of the sign compared to the text strips.

Configure sign with at least one blank copy strip at the bottom of the sign.

See [Section 2.5.6](#) & [2.5.7](#) for exterior construction & installation details.

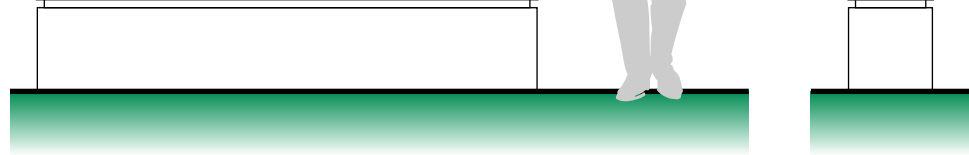
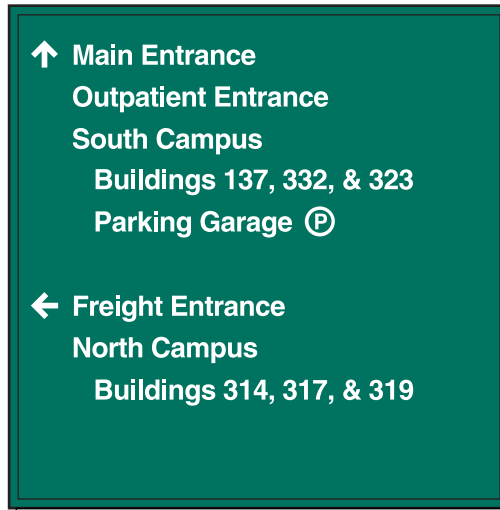

Message Layout A



Note: When listing emergency destinations, it is recommended the text shall be red or the background for that line of text shall be red with white text. An emergency graphic symbol may also be added. Text can be all uppercase or title case.

Message Layout B



Message Layout C



EN-02.01

Non Illuminated Exterior Signage Drawings

Directional Monument Large – 6' x 6'

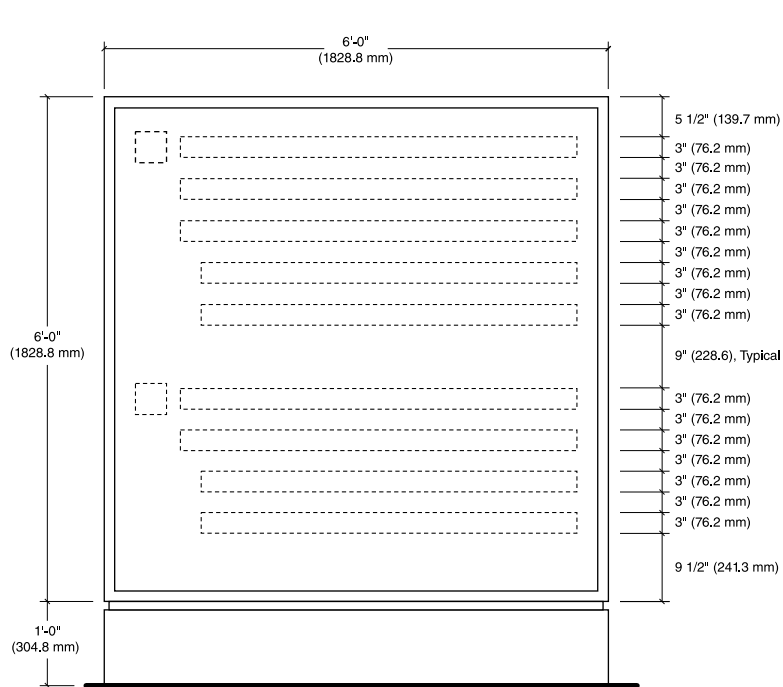

Single Panel Method

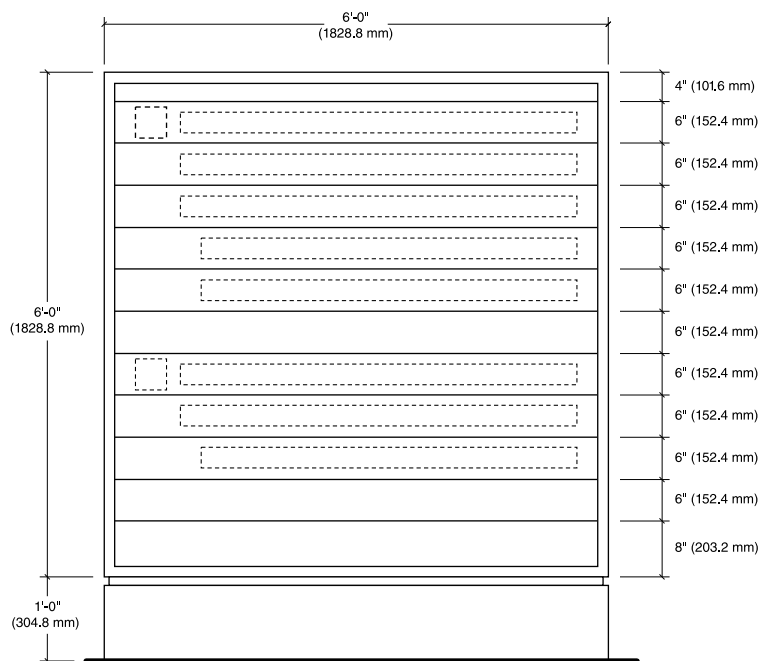
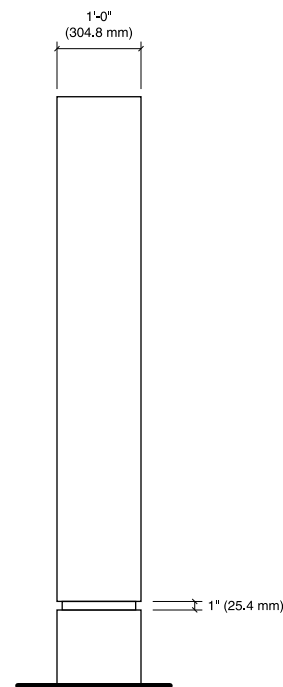

Multi-Panel Method

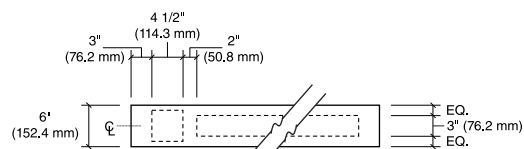

Message Layout A

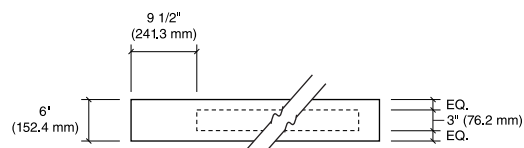

Message Layout B

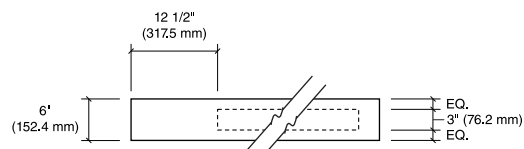

Message Layout C



EN-02.02

Non Illuminated Exterior Signage Drawings

Directional Monument Small – 6' x 4'

Size

Sign Face:
6'-0" High x 4'-0" Wide x 1'-0" Deep
(1828.8 mm H x 1219.2 mm W x 304.8 mm D)

Description

Non-illuminated small directional monument sign with a single interchangeable panel or 10 stacking strips. Directional sign with messages relevant to drivers.

Non-illuminated signs should not be used in locations where there is a heavy nighttime driver need for directional information.

Message Configuration

Refer to message layout drawing for dimensions.

Layout A is for the first line of text with an arrow of direction.

Layout B is for message with no arrow which is located under a line of copy with an arrow.

Layout C is for indented text. This can be used to show a hierarchy of information. Alternatively, it can be used for situations where the message is too long and must run onto a second line.

Refer to the viewing distance chart in [Section 2.5](#) for additional guidance.

Graphic Process

Surface applied white reflective vinyl.

Colors

Refer to the color chart in the Appendix.

Recommendations

Position sign so drivers have a clear, unobstructed view of the sign. Directional information for services ahead should always be at the top of the sign.

Ensure that there is always a blank margin or copy strip between groups of directional information and at the bottom of the sign. Additionally, leave a smaller blank margin or strip at the top of the sign compared to the text strips.

Configure sign with at least one blank copy strip at the bottom of the sign.

See [Section 2.5.6](#) & [2.5.7](#) for exterior construction & installation details.

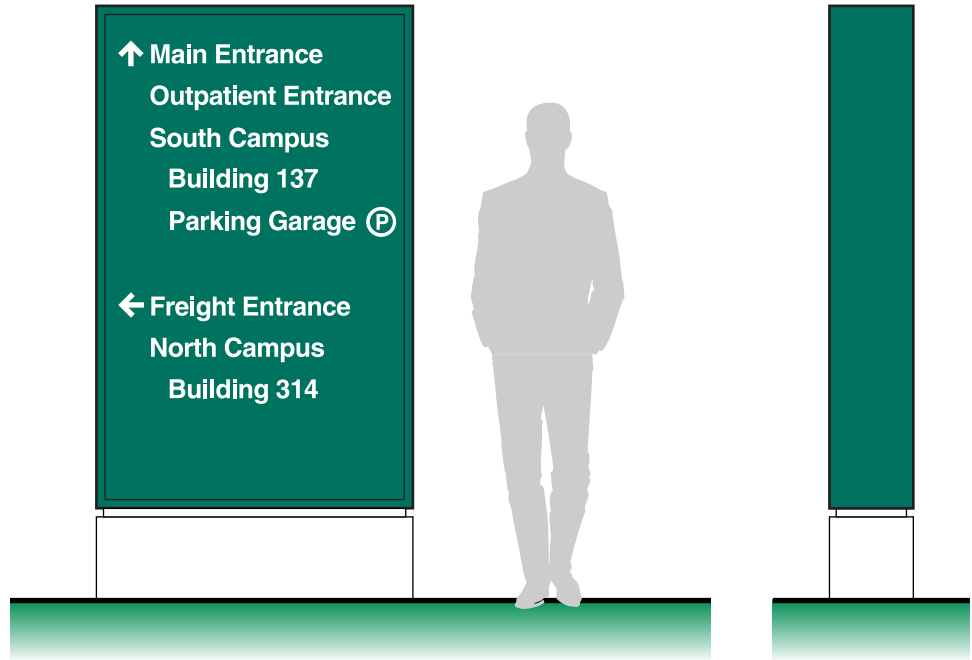

Message Layout A



Note: When listing emergency destinations, it is recommended the text shall be red or the background for that line of text shall be red with white text. An emergency graphic symbol may also be added. Text can be all uppercase or title case.

Message Layout B



Message Layout C



EN-02.02

Non Illuminated Exterior Signage Drawings

Directional Monument Small – 6' x 4'

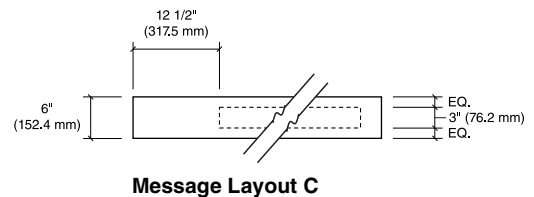
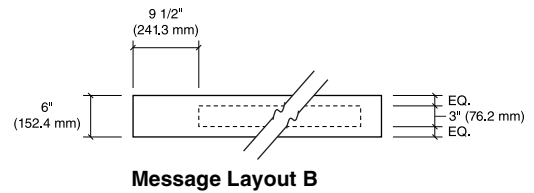
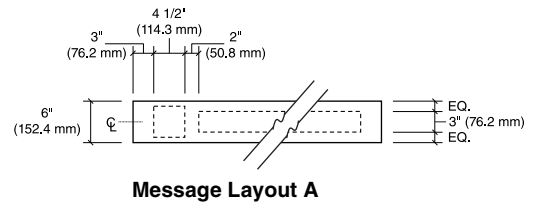
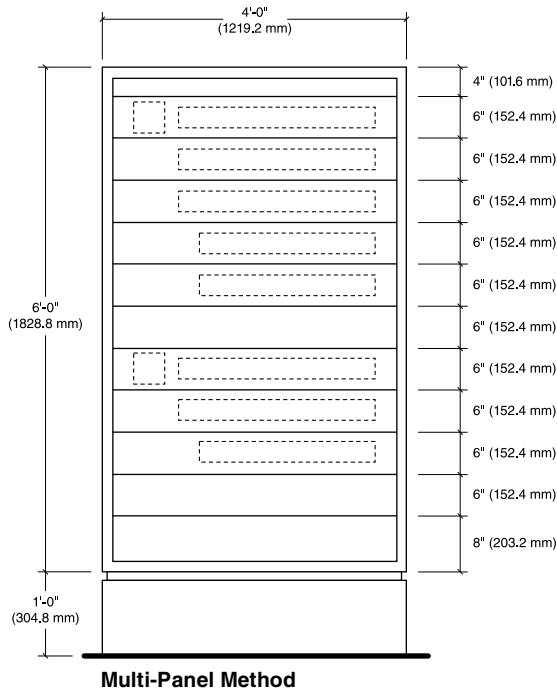
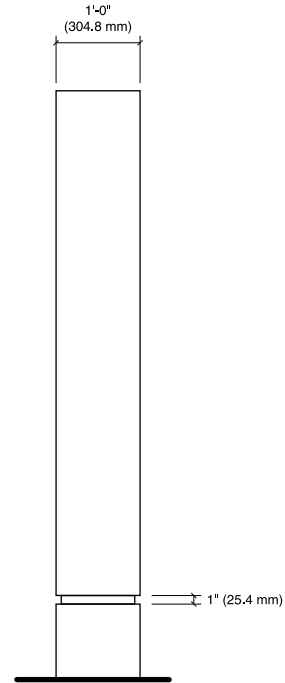
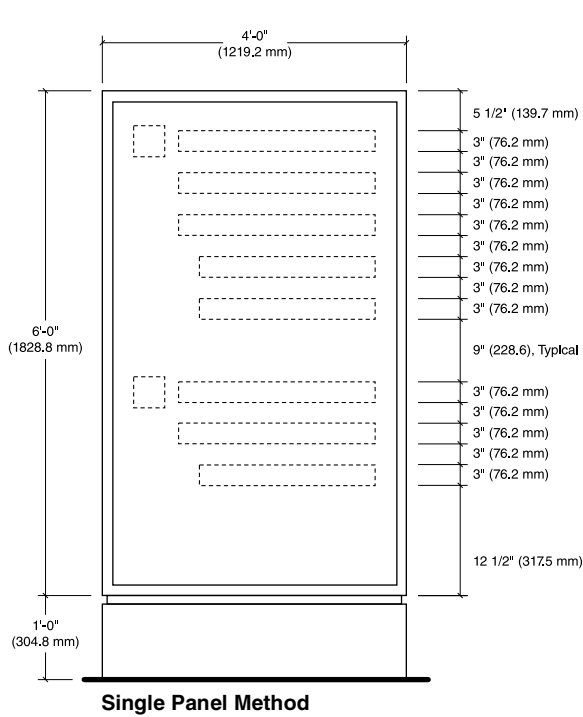

EN-03.02

Non Illuminated Exterior Signage Drawings

Post & Panel – 4' x 6'

Size

Sign Face:
4'-0" High x 6'-0" Wide
(1219.2 mm H x 1828.8 mm W)

Overall Sign Height:
6'-6" (1981.2 mm)

Description

Non-illuminated post and panel directional sign with messages relevant to drivers.

Message Configuration

Refer to message layout drawing for dimensions.

Message size and layout should adjust to the volume of information being presented. Layouts illustrated show small, medium, and large size text. Smaller text than shown should not be used as the messages will be unreadable to drivers. Larger text than shown will result in words that may not fit on the sign. Refer to the viewing distance chart in [Section 2.5](#) for additional guidance.

Graphic Process

Surface applied white reflective vinyl.

Colors

Refer to the color chart in the Appendix.

Recommendations

Position sign so drivers have a clear, unobstructed view of the sign. Directional information for services ahead should always be at the top of the sign.

Ensure that there is always a blank margin or copy strip between groups of directional information and at the bottom of the sign. Additionally, leave a smaller blank margin or strip at the top of the sign compared to the text strips.

See [Section 2.5.6](#) & [2.5.7](#) for exterior construction & installation details.

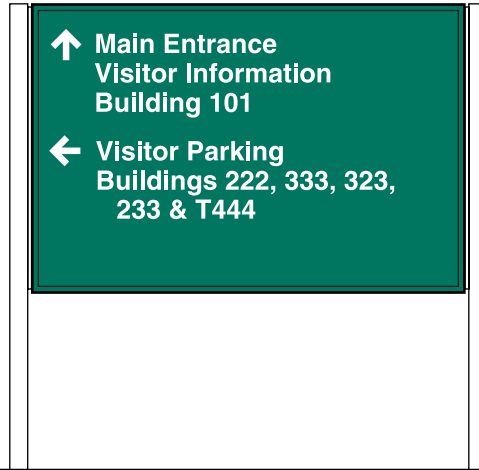

Message Layout A

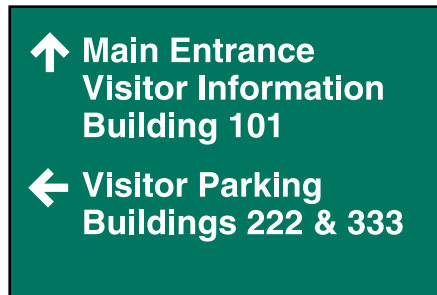

Message Layout B

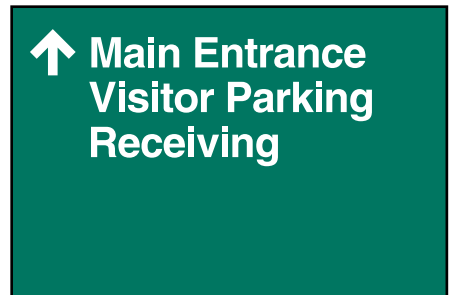

Message Layout C

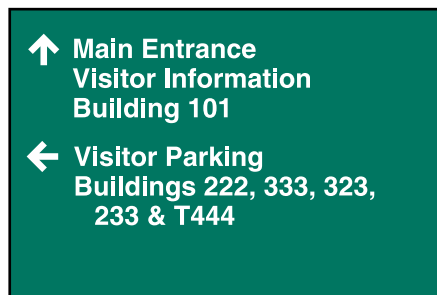

EN-03.02

Non Illuminated Exterior Signage Drawings

Post & Panel – 4' x 6'

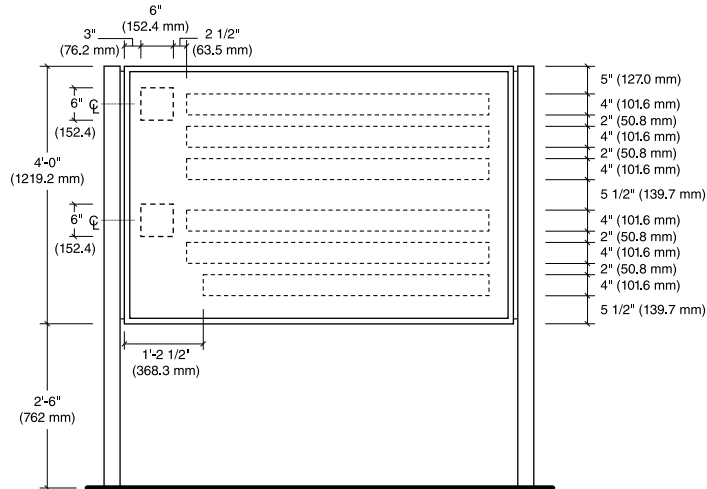
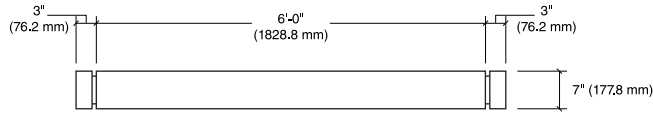

Message Layout A

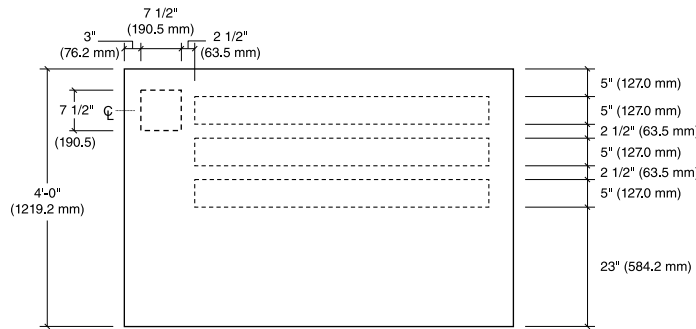

Message Layout B

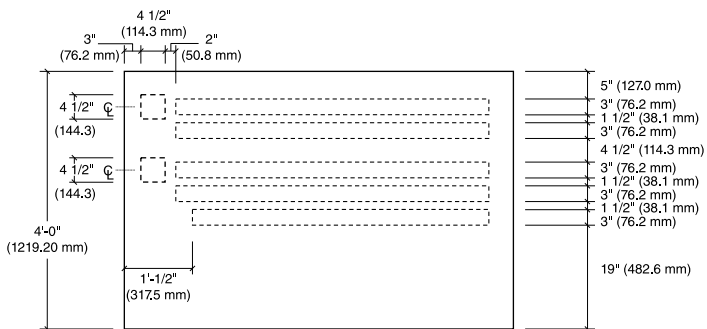

Message Layout C



EN-03.03

Non Illuminated Exterior Signage Drawings

Post & Panel – 3' x 4'

Size

Sign Face:
3'-0" High x 4'-0" Wide
(914.4 mm H x 1219.2 mm W)

Overall Sign Height:
5'-6" (1676.4 mm)

Description

Small non-illuminated post and panel sign with messages directed specifically to drivers. This sign can also be used to identify buildings.

Message Configuration

Refer to message layout drawing for dimensions.

Message size and layout should adjust to the volume of information being presented.

Refer to the viewing distance chart in [Section 2.5](#) for additional guidance.

Graphic Process

Surface applied white reflective vinyl.

Colors

Refer to the color chart in the Appendix.

Recommendations

Position sign so drivers have a clear, unobstructed view of the sign. Directional information for services ahead should always be at the top of the sign.

Ensure that there is always a blank margin or copy strip between groups of directional information and at the bottom of the sign. Additionally, leave a smaller blank margin or strip at the top of the sign compared to the text strips.

See [Section 2.5.6](#) & [2.5.7](#) for exterior construction & installation details.



Message Layout A

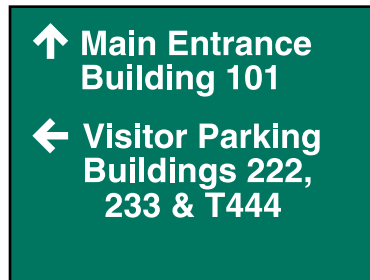

Message Layout B

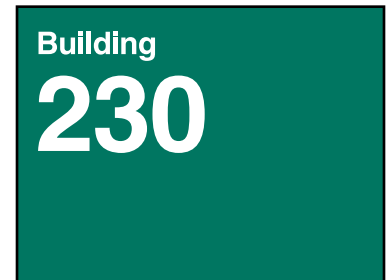

Message Layout C



Message Layout D

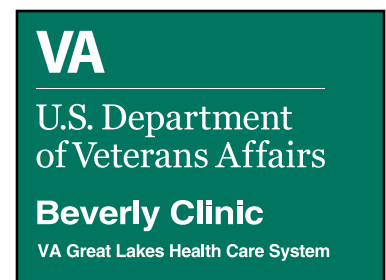

EN-03.03

Non Illuminated Exterior Signage Drawings

Post & Panel – 3' x 4'

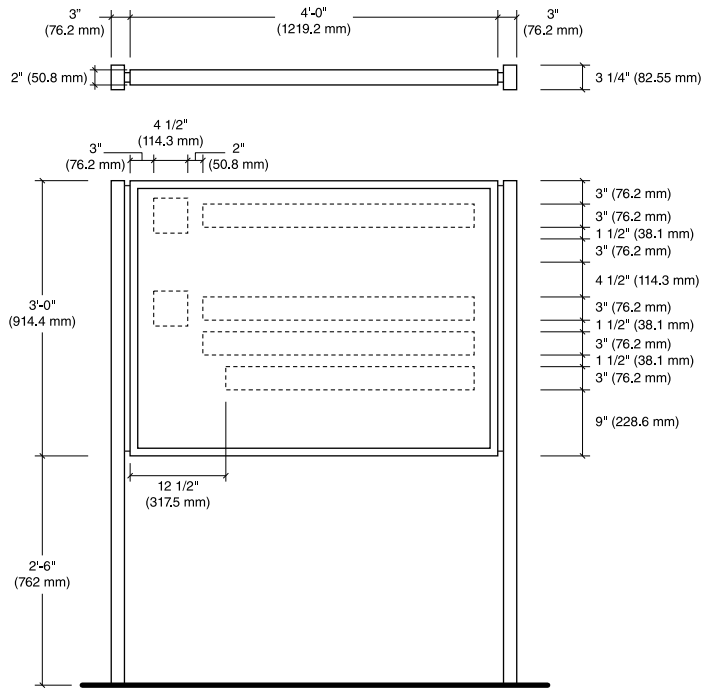

Message Layout A

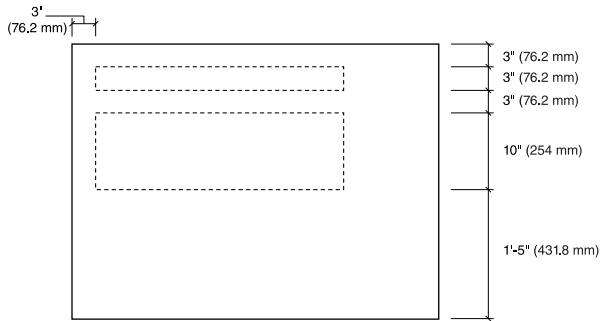

Message Layout B

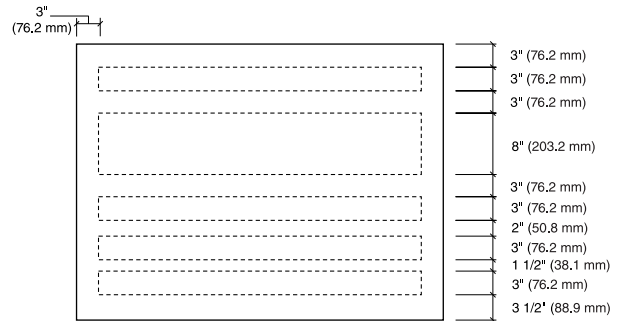

Message Layout C

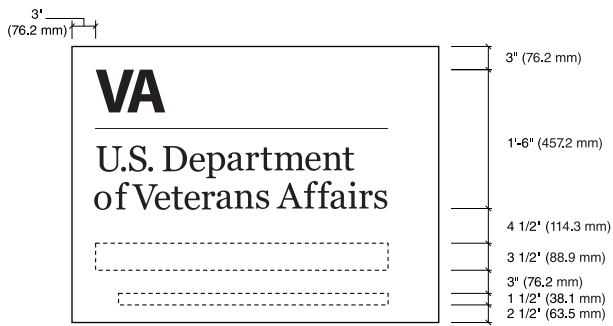

Message Layout D

6" (152.4 mm)



EN-03.04

Non Illuminated Exterior Signage Drawings

Post & Panel – 2' x 3'

Size

Sign Face:
2'-0" High x 3'-0" Wide
(609.6 mm H x 914.4 mm W)

Overall Sign Height:
5'-0" (1524 mm)

Description

Non-illuminated, post and panel sign directional sign with messages relevant to pedestrians.

The sign can also be used to identify buildings.

Message Configuration

Refer to message layout drawing for dimensions.

Message size and layout should adjust to the volume of information being presented.

Refer to the viewing distance chart in [Section 2.5](#) for additional guidance.

Graphic Process

Surface applied white reflective vinyl.

Colors

Refer to the color chart in the Appendix.

Recommendations

Position sign so pedestrians have a clear, unobstructed view of the sign.

See [Section 2.5.6](#) & [2.5.7](#) for exterior construction & installation details.

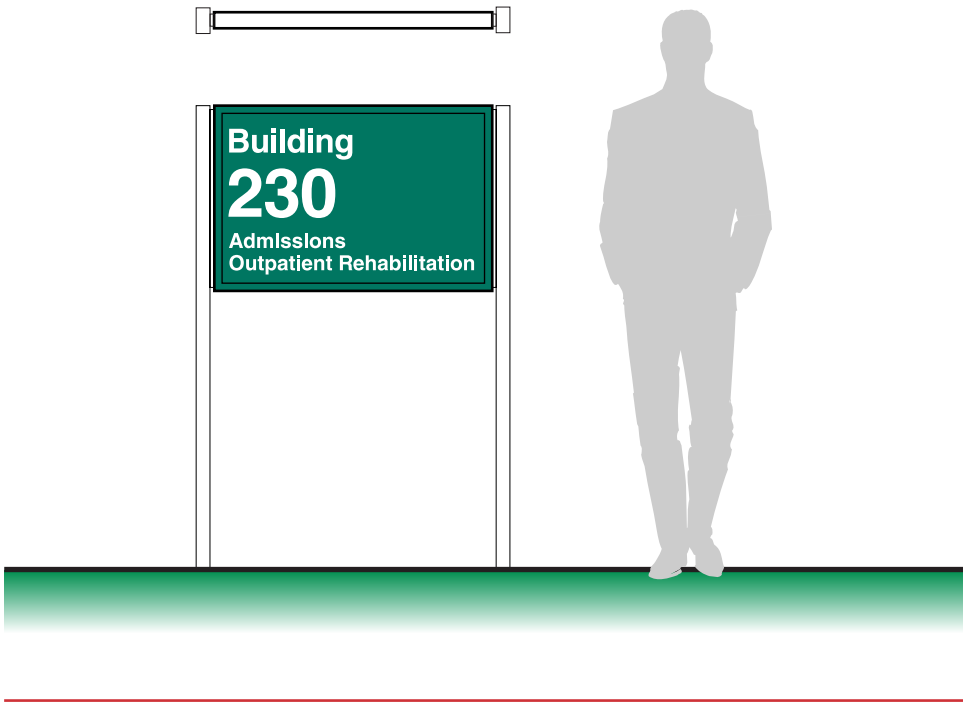

Message Layout A



Message Layout

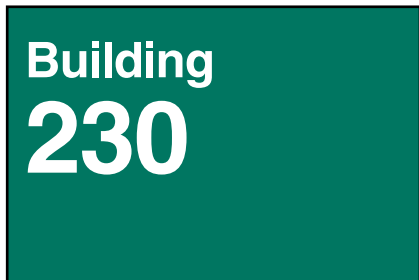

Message Layout C

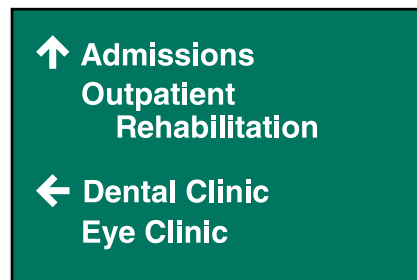

EN-03.04

Non Illuminated Exterior Signage Drawings

Post & Panel – 2' x 3'

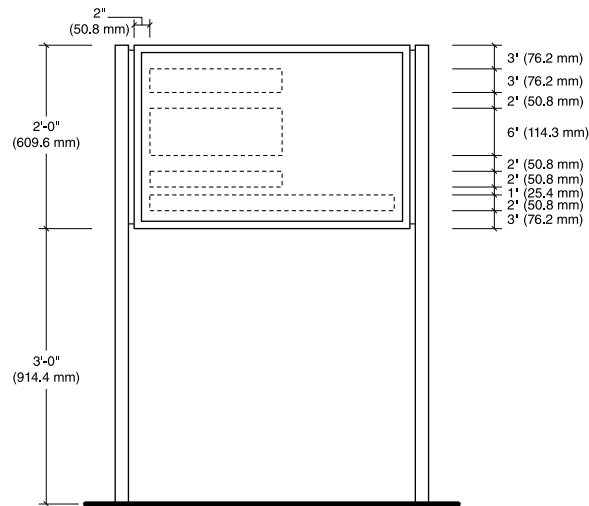
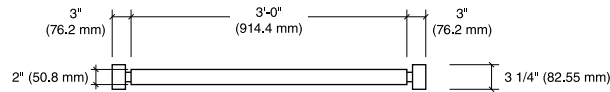

Message Layout A

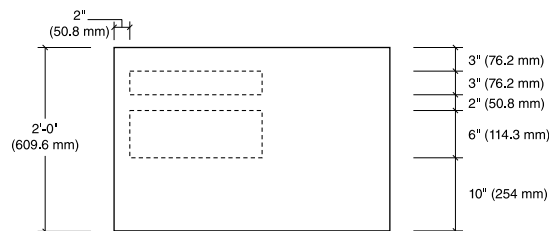

Message Layout B

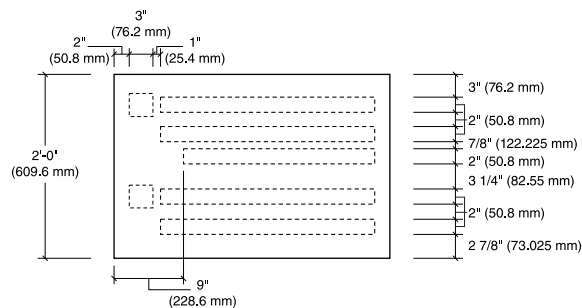

Message Layout C



EN-03.05

Non Illuminated Exterior Signage Drawings

Post & Panel Building Identification – 3' x 3'

Size

Sign Face:
3'-0" High x 3'-0" Wide
(914.4 mm High x 914.4 mm Wide)

Overall Sign Height:
5'-6" (1676.4 mm)

Description

Large, non-illuminated auto oriented building number/identification post and panel sign for identification of a building when a large sign is needed because the building is set back away from the roadway or the architectural scale (size) of the building warrants a large sign.

Message Configuration

Refer to message layout drawing for dimensions.

Message size and layout should adjust to the volume of information being presented.

Refer to the viewing distance chart in [Section 2.5](#) for additional guidance.

Graphic Process

Surface applied white reflective vinyl.

Colors

Refer to the color chart in the Appendix.

Recommendations

Position sign so drivers have a clear, unobstructed view of the sign.

See [Section 2.5.6](#) & [2.5.7](#) for exterior construction & installation details.

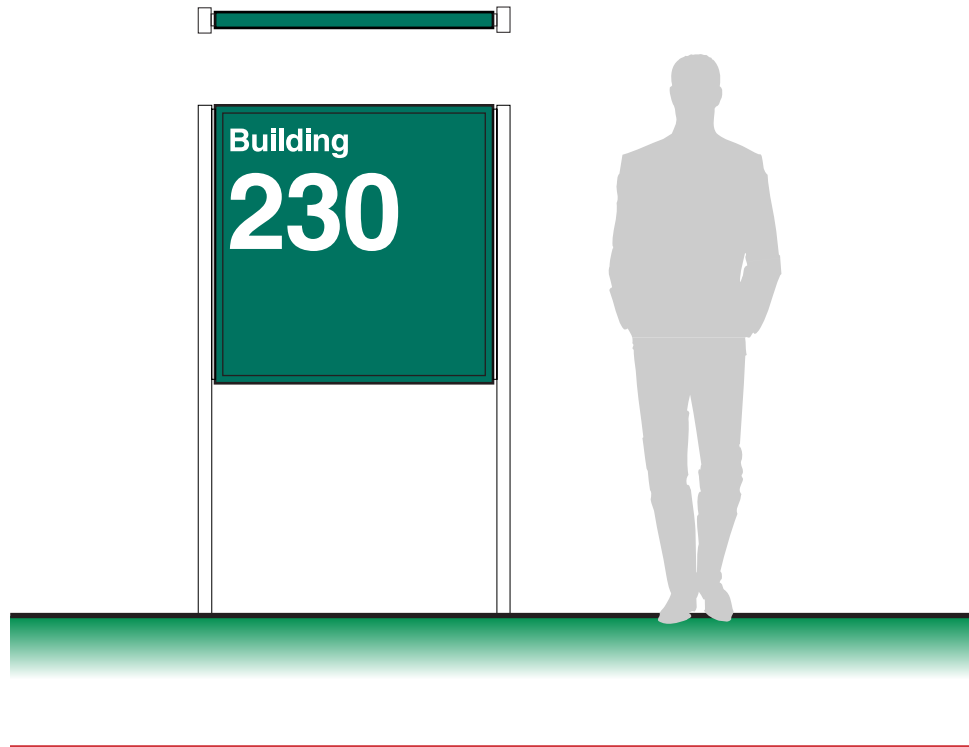

Message Layout A



Message Layout B



EN-03.05

Non Illuminated Exterior Signage Drawings

Post & Panel Building Identification – 3' x 3'

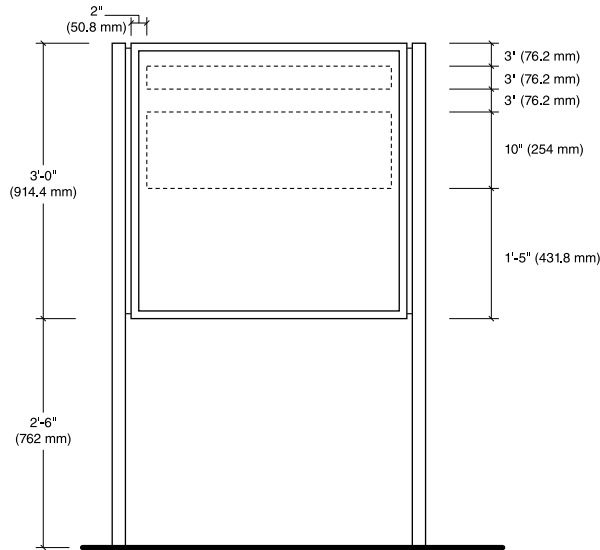
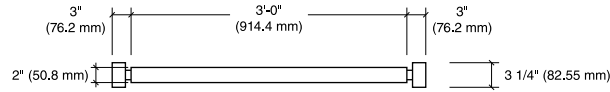

Message Layout A

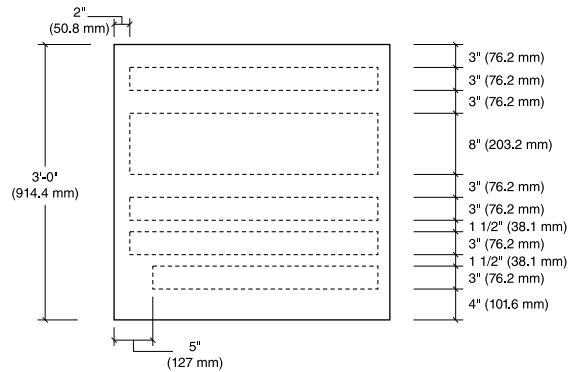

Message Layout B



EN-03.06

Non Illuminated Exterior Signage Drawings

Post & Panel Building Identification & Information – 2' x 2'

Size

Sign Face:
2'-0" High x 2'-0" Wide
(609.6 mm H x 609.6 mm W)

Overall Sign Height:
5'-0" (1524 mm)

Description

Non-illuminated, pedestrian oriented building number/identification post and panel sign. This sign can be used for other general applications from information text to identifying specific functions or activities.

Message Configuration

Refer to message layout drawing for dimensions.

Message size and layout should adjust to the volume of information being presented.

Refer to the viewing distance chart in [Section 2.5](#) for additional guidance.

Graphic Process

Surface applied white reflective vinyl.

Colors

Refer to the color chart in the Appendix.

Recommendations

Position sign so drivers and pedestrians have a clear view. This sign has a limited viewing range for drivers because of its small size.

See [Section 2.5.6](#) & [2.5.7](#) for exterior construction & installation details.

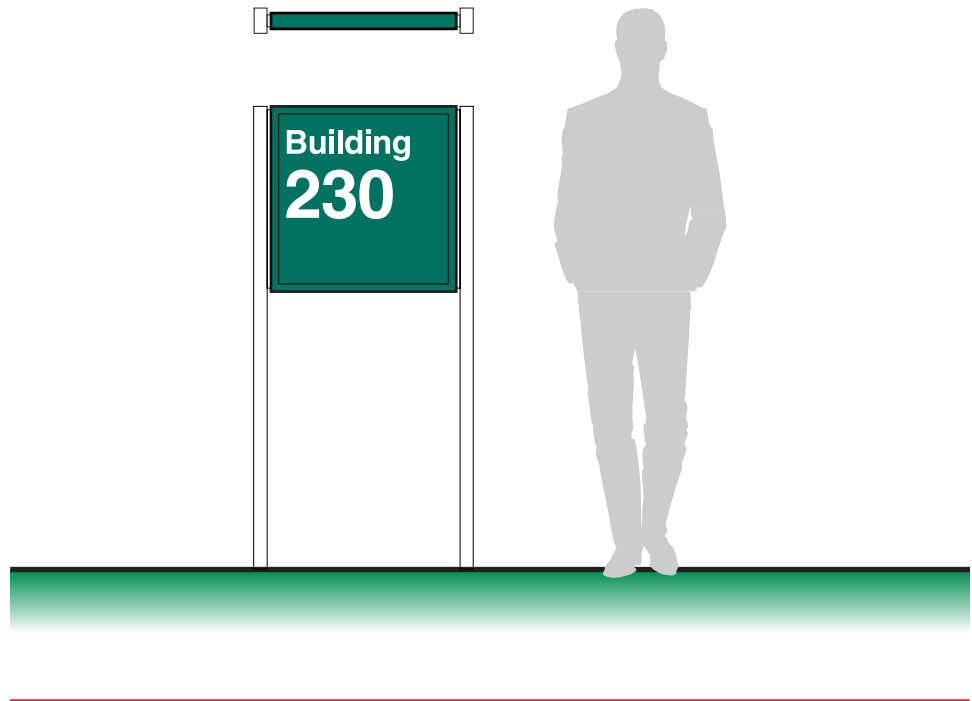

Message Layout A



Message Layout B

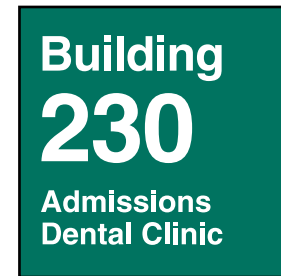

Message Layout C



Message Layout D

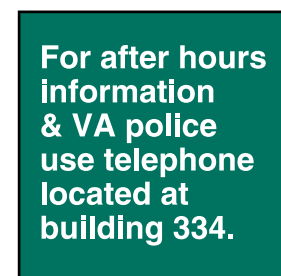

Post & Panel Building Identification & Information – 2' x 2'

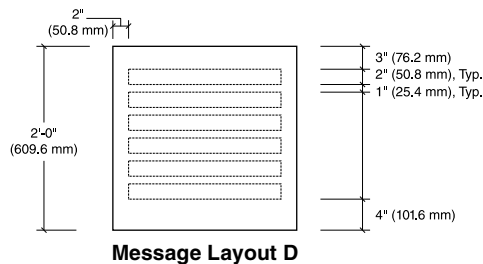
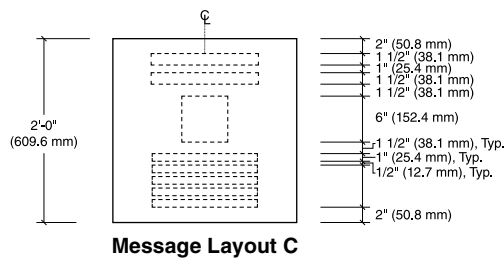
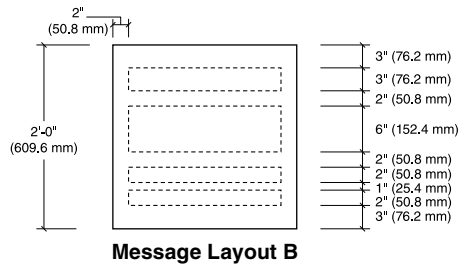
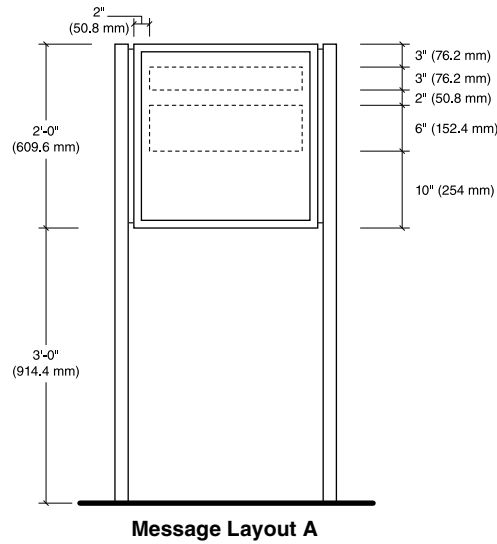
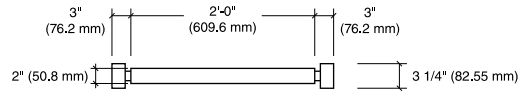

EN-04.01

Non Illuminated Exterior Signage Drawings

Post & Panel Stacking Bar Directional – 4' x 8'

Size

Sign Face:
4'-0" High x 8'-0" Wide
(1219.2 mm H x 2438.4 mm W)

Overall Sign Height:
6'-6" (1981.2 mm)

Description

Non-Illuminated large/long stacking bar post and panel comprised of 8 directional sign strips with messages relevant to drivers.

Non-illuminated signs should not be used in locations where there is a heavy nighttime driver need for directional information.

Message Configuration

Refer to message layout drawing for dimensions.

Layout A is for the first line of text with an arrow of direction.

Layout B is for a message with no arrow which is located under copy with an arrow.

Layout C is for indented text. This can be used to show a hierarchy of information. Alternatively, it can be used for situations where the message is too long and must run onto a second line.

Graphic Process

Surface applied white reflective vinyl.

Colors

Refer to the color chart in the Appendix.

Recommendations

Position sign so drivers have a clear, unobstructed view of the sign. Directional information for services ahead should always be at the top of the sign.

Ensure that there is always a blank margin or copy strip between groups of directional information and at the bottom of the sign. Additionally, leave a smaller blank margin or strip at the top of the sign compared to the text strips.

See [Section 2.5.6](#) & [2.5.7](#) for exterior construction & installation details.

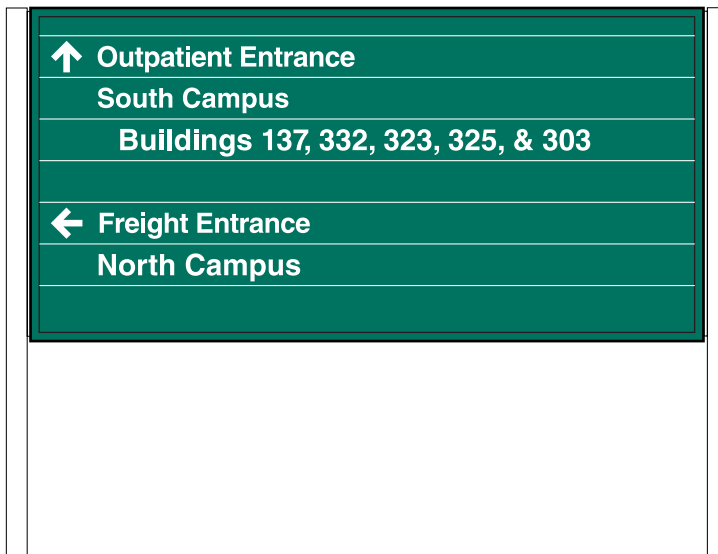

Message Layout A



Note: When listing emergency destinations, it is recommended the text shall be red or the background for that line of text shall be red with white text. An emergency graphic symbol may also be added. Text can be all uppercase or title case.

Message Layout B



Message Layout C



EN-04.01

Non Illuminated Exterior Signage Drawings

Post & Panel Stacking Bar Directional – 4' x 8'

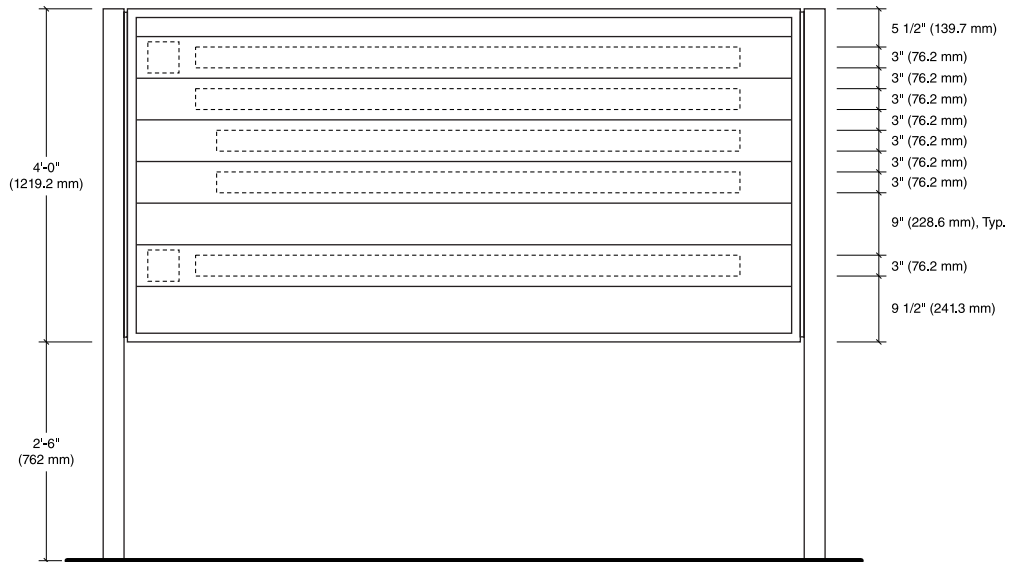
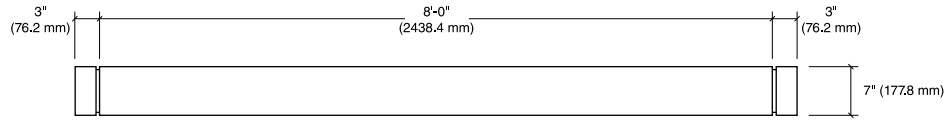

Multi-Panel Method

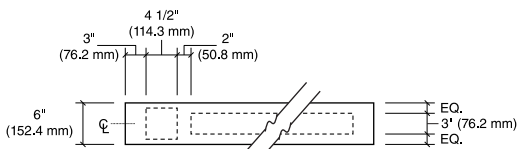

Message Layout A

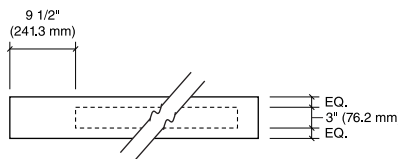

Message Layout B

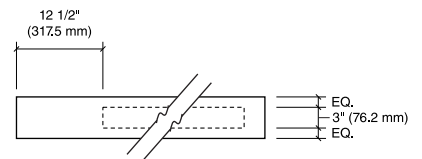

Message Layout C



EN-04.02

Non Illuminated Exterior Signage Drawings

Post & Panel Stacking Bar Directional – 4' x 6'

Size

Sign Face:
4'-0" High x 6'-0" Wide
(1219.2 mm H x 1828.8 mm W)

Overall Sign Height:
6'-0" (1828.8 mm)

Description

Non-illuminated stacking bar post and panel comprised of 8 directional sign strips with messages relevant to drivers.

Non-illuminated signs should not be used in locations where there is a heavy nighttime driver need for directional information.

Message Configuration

Refer to message layout drawing for dimensions.

Layout A is for the first line of text with an arrow of direction.

Layout B is for a message with no arrow which is located under copy with an arrow.

Layout C is for indented text. This can be used to show a hierarchy of information. Alternatively, it can be used for situations where the message is too long and must run onto a second line.

Graphic Process

Surface applied white reflective vinyl.

Colors

Refer to the color chart in the Appendix.

Recommendations

Position sign so drivers have a clear, unobstructed view of the sign. Directional information for services ahead should always be at the top of the sign.

Ensure that there is always a blank margin or copy strip between groups of directional information and at the bottom of the sign. Additionally, leave a smaller blank margin or strip at the top of the sign compared to the text strips.

See [Section 2.5.6](#) & [2.5.7](#) for exterior construction & installation details.

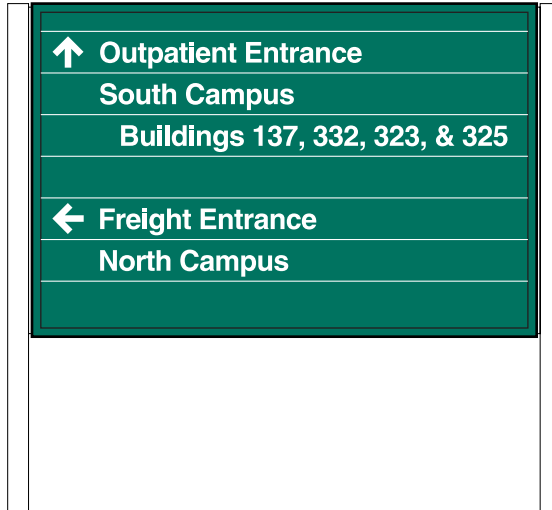

Message Layout A



Note: When listing emergency destinations, it is recommended the text shall be red or the background for that line of text shall be red with white text. An emergency graphic symbol may also be added. Text can be all uppercase or title case.

Message Layout B



Message Layout C



EN-04.02

Non Illuminated Exterior Signage Drawings

Post & Panel Stacking Bar Directional – 4' x 6'

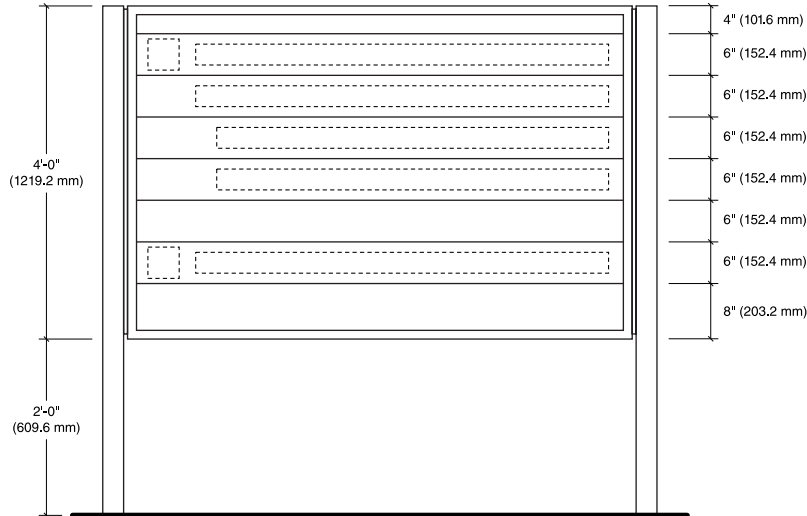
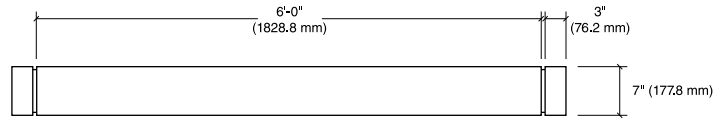

Multi-Panel Method

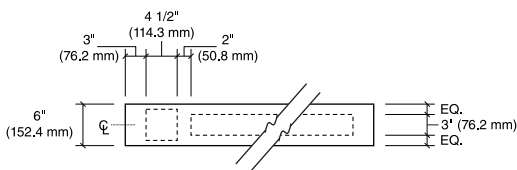

Message Layout A

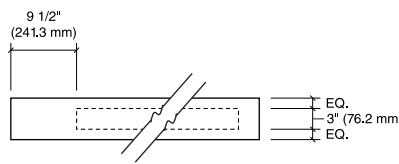

Message Layout B

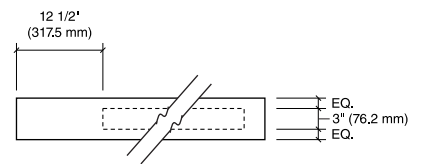

Message Layout C



EN-04.03

Non Illuminated Exterior Signage Drawings

Post & Panel Stacking Bar Directional – 3' x 4'

Size

Sign Face:
3'-0" High x 4'-0" Wide
(914.4 mm H x 1219.2 mm W)

Overall Sign Height:
5'-6" (1676.4 mm)

Description

Non-illuminated stacking bar post and panel comprised of 6 directional sign strips with messages relevant to drivers.

Non-illuminated sign should not be used in locations where there is a heavy nighttime driver need for directional information.

Message Configuration

Refer to message layout drawing for dimensions.

Layout A is for the first line of text with an arrow of direction.

Layout B is for a message with no arrow which is located under copy with an arrow.

Layout C is for indented text. This can be used to show a hierarchy of information. Alternatively, it can be used for situations where the message is too long and must run onto a second line.

Graphic Process

Surface applied white reflective vinyl.

Colors

Refer to the color chart in the Appendix.

Recommendations

Position sign so drivers have a clear, unobstructed view of the sign. Directional information for services ahead should always be at the top of the sign.

Ensure that there is always a blank margin or copy strip between groups of directional information and at the bottom of the sign. Additionally, leave a smaller blank margin or strip at the top of the sign compared to the text strips.

See [Section 2.5.6](#) & [2.5.7](#) for exterior construction & installation details.

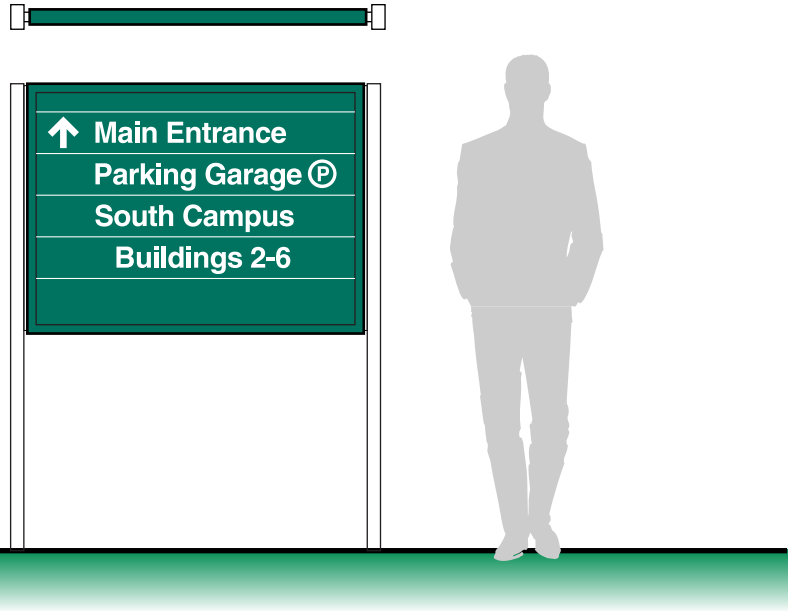

Message Layout A



Note: When listing emergency destinations, it is recommended the text shall be red or the background for that line of text shall be red with white text. An emergency graphic symbol may also be added. Text can be all uppercase or title case.

Message Layout B



Message Layout C



EN-04.03

Non Illuminated Exterior Signage Drawings

Post & Panel Stacking Bar Directional – 3' x 4'

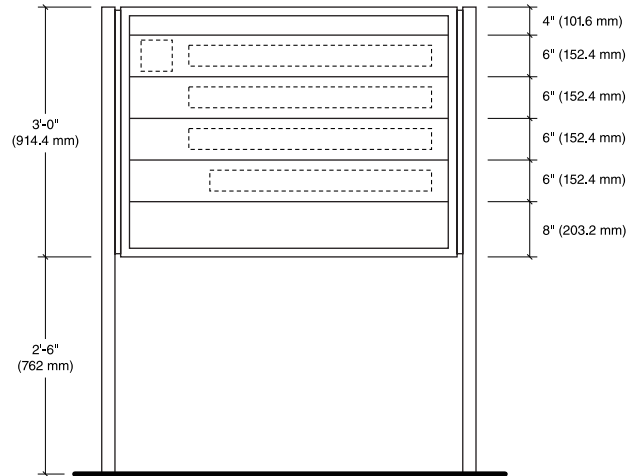
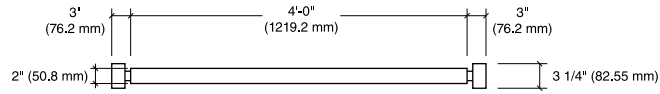

Multi-Panel Method

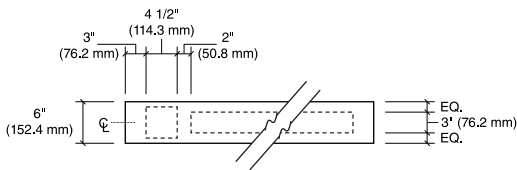

Message Layout A

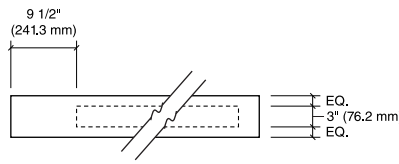

Message Layout B

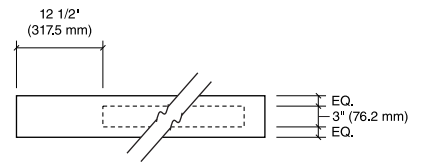

Message Layout C



EN-04.04

Non Illuminated Exterior Signage Drawings

Post & Panel Stacking Bar Directional – 2' x 3'

Size

Sign Face:
2'-0" High x 3'-0" Wide
(609.6 mm H x 914.4 mm W)

Overall Sign Height:
5'-0" (1524 mm)

Description

Non-Illuminated stacking bar post and panel comprised of 4 directional sign strips with messages relevant to pedestrians.

Message Configuration

Refer to message layout drawing for dimensions.

Layout A is for the first line of text with an arrow of direction.

Layout B is for a message with no arrow which is located under copy with an arrow.

Layout C is for indented text. This can be used to show a hierarchy of information. Alternatively, it can be used for situations where the message is too long and must run onto a second line.

Graphic Process

Surface applied white reflective vinyl.

Colors

Refer to the color chart in the Appendix.

Recommendations

Position sign so drivers have a clear, unobstructed view of the sign. Directional information for services ahead should always be at the top of the sign.

Ensure that there is always a blank margin or copy strip between groups of directional information and at the bottom of the sign. Additionally, leave a smaller blank margin or strip at the top of the sign compared to the text strips.

See [Section 2.5.6](#) & [2.5.7](#) for exterior construction & installation details.

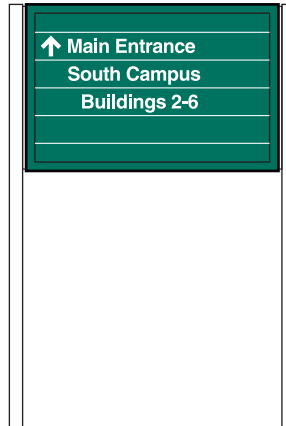

Message Layout A



Note: When listing emergency destinations, it is recommended the text shall be red or the background for that line of text shall be red with white text. An emergency graphic symbol may also be added. Text can be all uppercase or title case.

Message Layout B



Message Layout C



EN-04.04

Non Illuminated Exterior Signage Drawings

Post & Panel Stacking Bar Directional – 2' x 3'

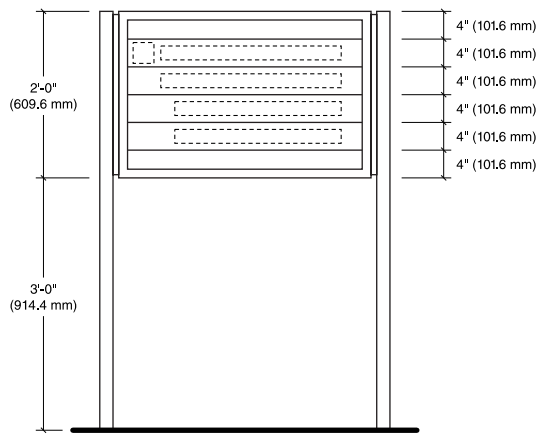
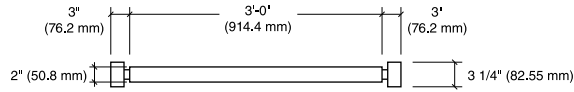

Multi-Panel Method

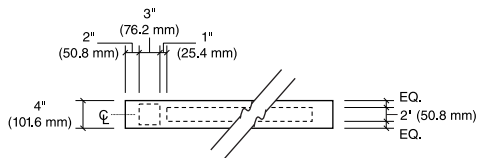

Message Layout A

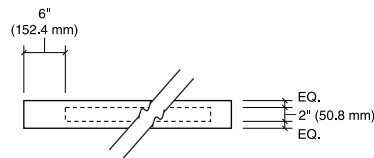

Message Layout B

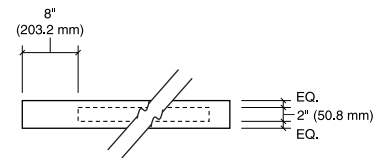

Message Layout C



EN-05.01

Non Illuminated Exterior Signage Drawings

Single Post & Panel Large – 2'-6" x 2'

Size

Sign Face:
2'-6" High x 2'-0" Wide
(762 mm H x 609.6 mm W)

Overall Sign Height:
6'-0" (1828.8 mm)

Description

Large, non-illuminated single post identification, informational and directional sign. This type of sign is for miscellaneous uses and can be utilized in landscape areas, at the head of parking stalls, or in other locations which have space limitations.

Message Configuration

Refer to message layout drawing for dimensions.

Message configurations shown illustrate various adaptable uses for this style of sign.

Only a single message or concept should be displayed on this sign type.

Graphic Process

Surface applied white reflective vinyl.

Colors

Refer to the color chart in the Appendix.

Recommendations

Position sign so drivers have a clear, unobstructed view of the sign.

When placing this type of sign near curbs or parking places, be sure the sign is set far enough back that over hanging front and rear of automobiles do not come in contact with the signpost.

See [Section 2.5.6](#) & [2.5.7](#) for exterior construction & installation details.



Message Layout A



Message Layout B



Message Layout C



Message Layout D

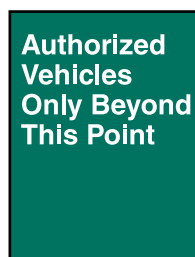

Message Layout E



Single Post & Panel Large – 2'-6" x 2'

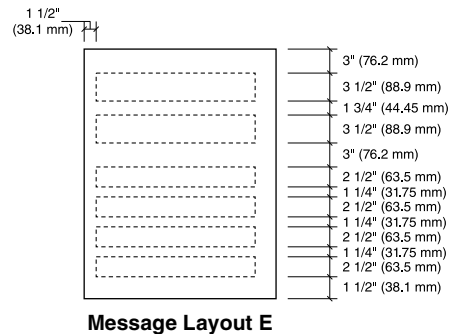
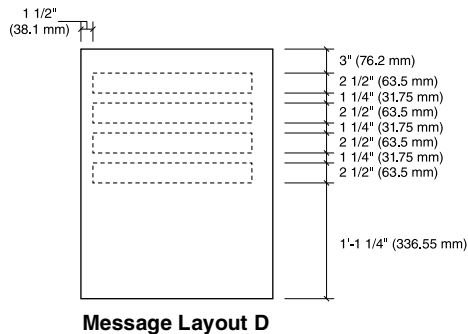
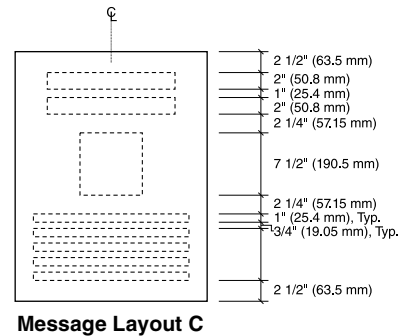
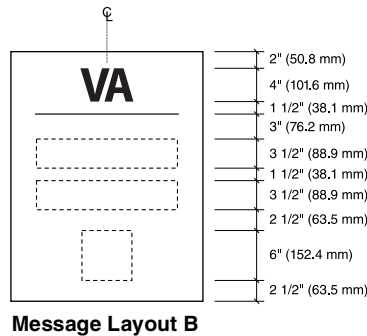
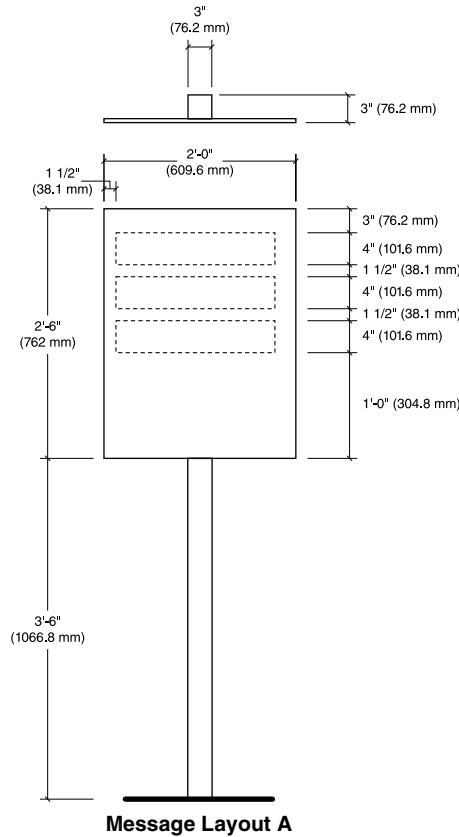

EN-05.02

Non Illuminated Exterior Signage Drawings

Single Post & Panel Medium – 2' x 1'-6"

Size

Sign Face:
2'-0" High x 1'-6" Wide
(609.6 mm H x 457.2 mm W)

Overall Sign Height:
6'-0" (1828.8 mm)

Description

Standard, non-illuminated single post identification, informational and directional sign. This type of sign is for miscellaneous uses and can be utilized in landscape areas, at the head of parking stalls, or in other locations which have space limitations.

Message Configuration

Refer to message layout drawing for dimensions.

Message configurations shown illustrate various adaptable uses for this style of sign.

Only a single message or concept should be displayed on this sign type.

Graphic Process

Surface applied white reflective vinyl.

Colors

Refer to the color chart in the Appendix.

Recommendations

Position sign so drivers have a clear, unobstructed view of the sign.

When placing this type of sign near curbs or parking places, be sure the sign is set far enough back that over hanging front and rear of automobiles do not come in contact with the signpost.

See [Section 2.5.6](#) & [2.5.7](#) for exterior construction & installation details.



Message Layout A



Message Layout B



Message Layout C



Message Layout D

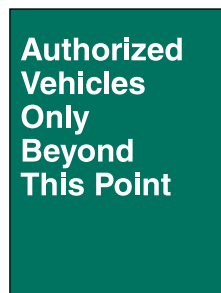

Message Layout E



Single Post & Panel Medium – 2' x 1'-6"

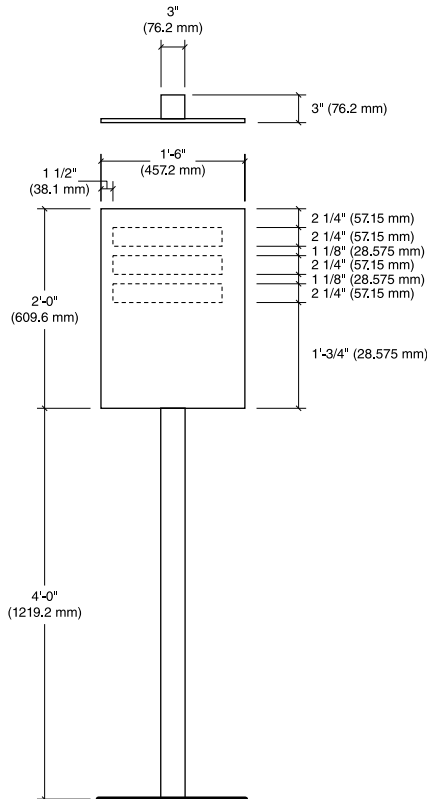

Message Layout A

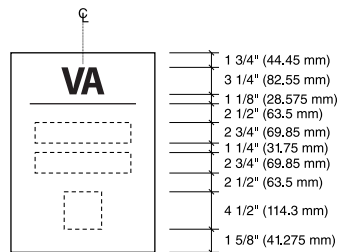

Message Layout B

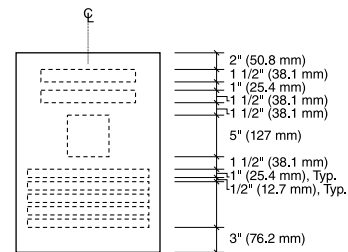

Message Layout C

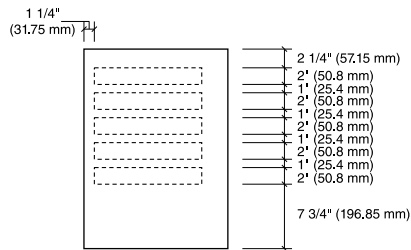

Message Layout D

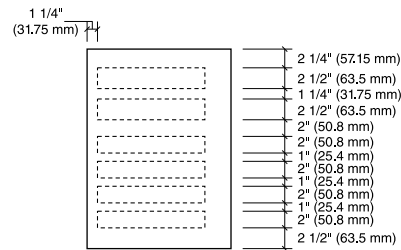

Message Layout E



EN-05.03

Non Illuminated Exterior Signage Drawings

Single Post & Panel Small – 1'-6" x 1'

Size

Sign Face:
1'-6" High x 1'-0" Wide
(457.2 mm H x 304.8 mm W)

Overall Sign Height:
6'-0" (1828.8 mm)

Description

Small, non-illuminated single post identification, informational and directional sign. This type of sign is for miscellaneous uses and can be utilized in landscape areas, at the head of parking stalls, or in other locations which have space limitations.

Message Configuration

Refer to message layout drawing for dimensions.

Message configurations shown illustrate various adaptable uses for this style of sign.

Only a single message or concept should be displayed on this sign type.

Graphic Process

Surface applied white reflective vinyl.

Colors

Refer to the color chart in the Appendix.

Recommendations

Position sign so drivers have a clear, unobstructed view of the sign.

When placing this type of sign near curbs or parking places, be sure the sign is set far enough back that over hanging front and rear of automobiles do not come in contact with the signpost.

See [Section 2.5.6](#) & [2.5.7](#) for exterior construction & installation details.

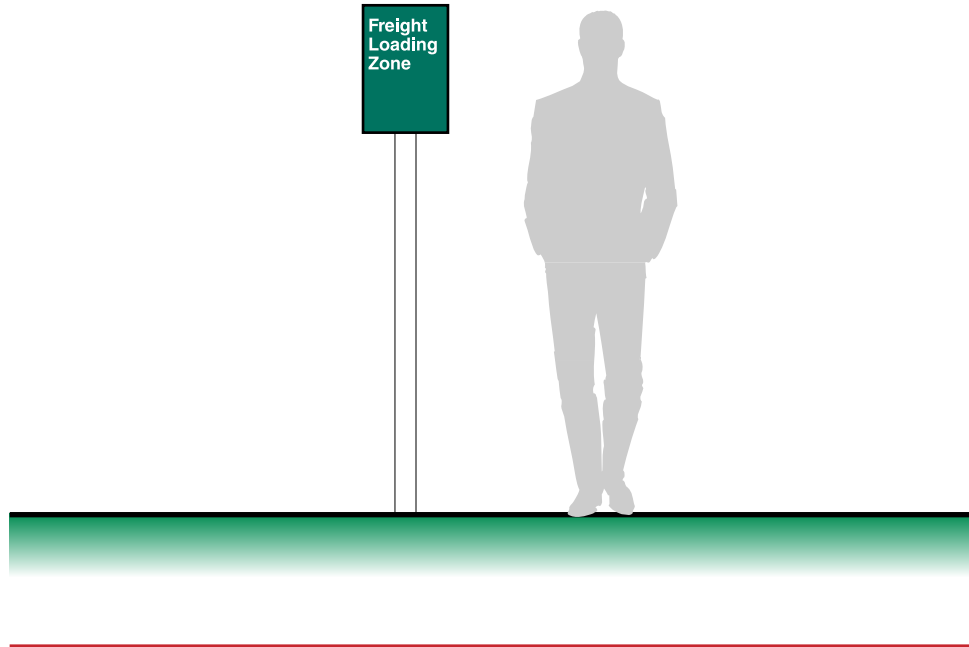

Message Layout A



Message Layout B



Message Layout C

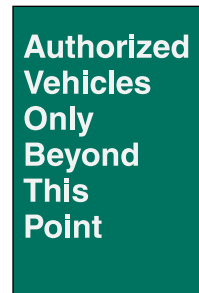

Message Layout D



Message Layout E

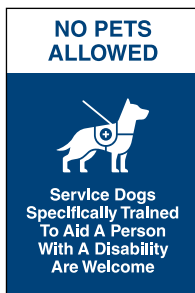

Message Layout F

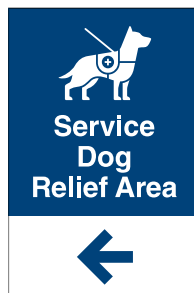

Message Layout G



EN-05.03

Non Illuminated Exterior Signage Drawings

Single Post & Panel Small – 1'-6" x 1'

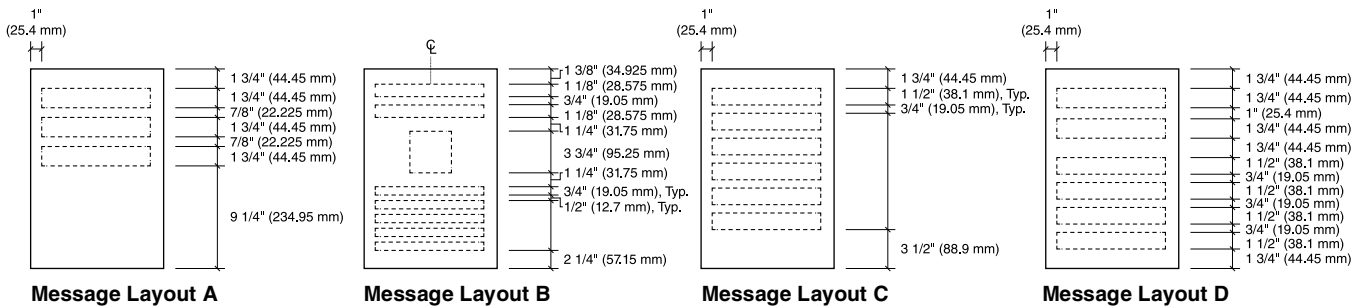
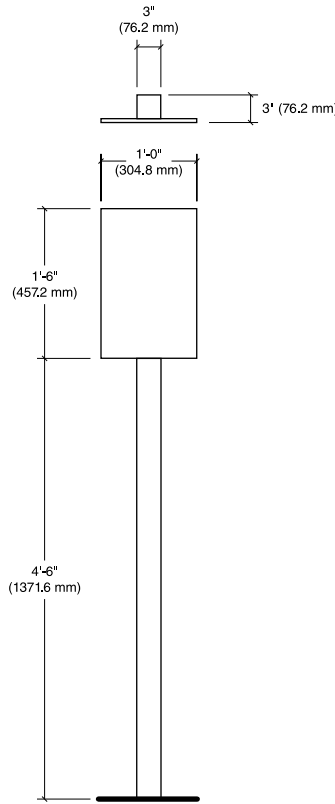

EN-06.01

Non Illuminated Exterior Signage Drawings

Wall Mounted Overhead

Size

Sign Face:
2'-0" High x 8'-0" Wide
(609.6 mm H x 2438.4 mm)

Description

Non-illuminated, overhead wall mounted sign to identify a building or building entrance.

Message Configuration

Refer to message layout drawing for dimensions.

Message Layout A and B are for identifying an entrance to a building.

Message Layout C and D are for identifying a standalone building, typically off campus.

Graphic Process

Surface applied white reflective vinyl.

Colors

Refer to the color chart in the Appendix.

Recommendations

Use this type of sign for identifying major building entrances that have a very high volume of patient and visitor traffic and need to be clearly distinguished.

This sign can also be used to identify buildings on a campus or small standalone facility like an outpatient clinic.

See [Section 2.5.6](#) & [2.5.7](#) for exterior construction & installation details.



Message Layout A



Message Layout B



Message Layout C



Message Layout D



EN-06.01

Non Illuminated Exterior Signage Drawings

Wall Mounted Overhead

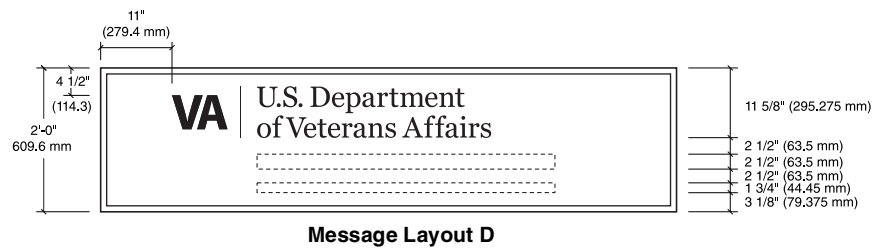
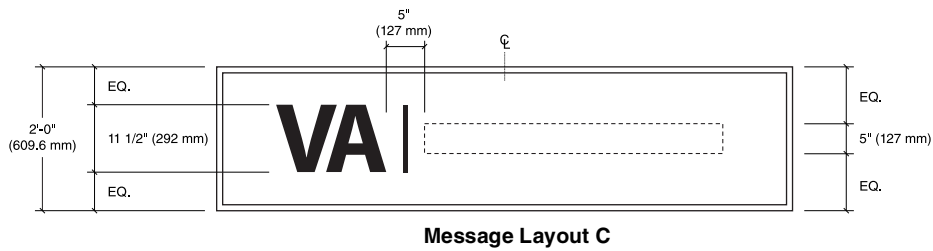
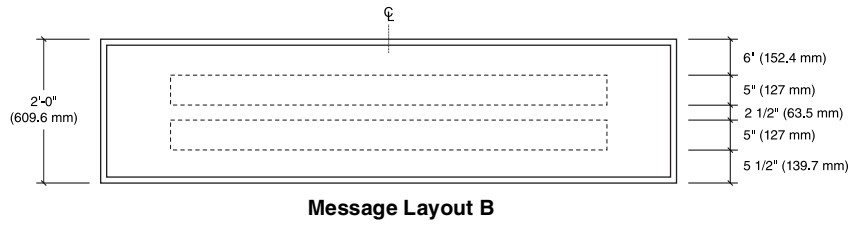
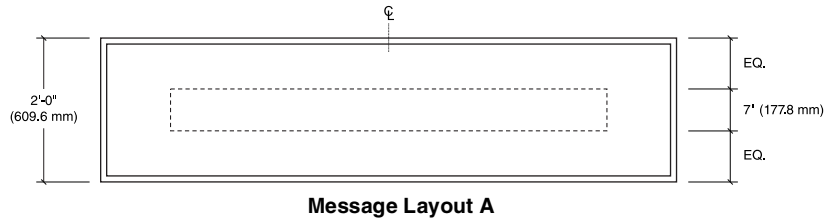
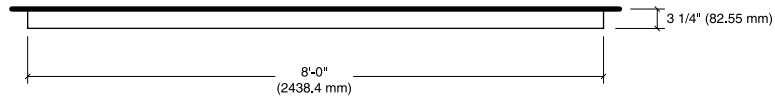

EN-06.02

Non Illuminated Exterior Signage Drawings

Wall Mounted Building Identification Large

Size

Sign Face:
3'-0" High x 4'-0" Wide
(914.4 mm H x 1219.2 mm)

Description

Large, non-illuminated wall mounted sign. This sign type can be used to identify a building on a medical center campus. It also can be used for identification of a standalone building that is not a medical center and there is no place to install a freestanding sign.

Message Configuration

Refer to message layout drawing for dimensions.

Message Layout A is for identifying a standalone building, typically off campus.

Message Layout B and C are for identifying buildings on a medical center campus.

Graphic Process

Surface applied white reflective vinyl.

Colors

Refer to the color chart in the Appendix.

Recommendations

Use this sign type for identifying buildings that have a high volume of patient and visitor traffic and need to be clearly distinguished.

This sign can also be used to identify buildings on a campus or small standalone facility like an outpatient clinic.

Position the sign adjacent the main entrance, if possible. If the sign is not readable in this position, then locate on the corner of the building.

This large sign should not be used on small buildings or buildings with minor uses.

See [Section 2.5.6](#) & [2.5.7](#) for exterior construction & installation details.



Message Layout A



Message Layout B



Message Layout C

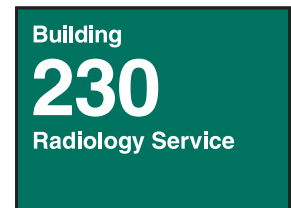

Wall Mounted Building Identification Large

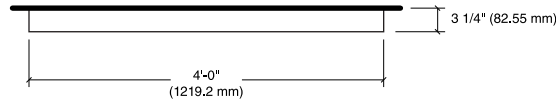

Message Layout A

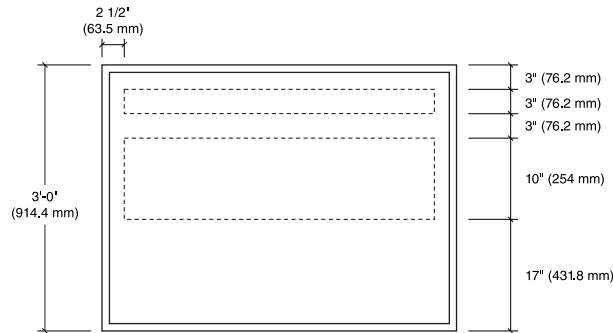

Message Layout B

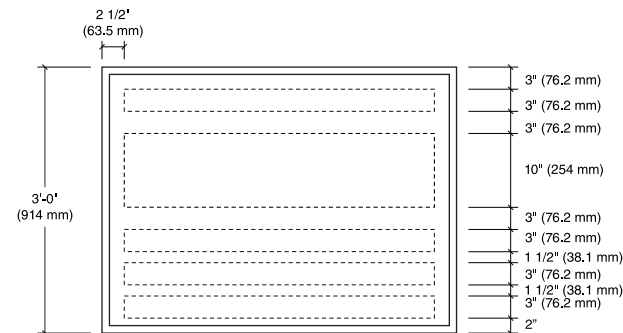

Message Layout C



EN-06.03

Non Illuminated Exterior Signage Drawings

Wall Mounted Building Identification Large with Message Panel

Size

Sign Face:
4'-0" High x 3'-0" Wide
(1219.2 mm H x 914.4 mm W)

Description

Large, non-illuminated wall mounted sign with separate name panel. Building identification with and without names of the occupant or service. The secondary name of the occupant or service is on a changeable panel to allow modification to the sign without changing the entire sign.

Message Configuration

Refer to message layout drawing for dimensions.

Message layouts show application of the sign with building identification number and number with secondary information.

Graphic Process

Surface applied white reflective vinyl.

Colors

Refer to the color chart in the Appendix.

Recommendations

Use on a building that is set back a considerable distance from the roadway.

Position the sign adjacent to or above the main entrance, if possible. If the sign is not readable in this position, then locate it on the corner of the building.

This large sign should not be used on small buildings or buildings with minor uses.

See [Section 2.5.6](#) & [2.5.7](#) for exterior construction & installation details.



Message Layout A

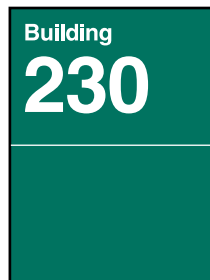

Message Layout B



Message Layout C

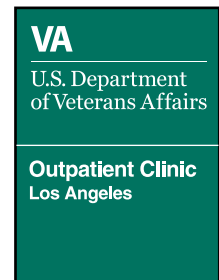

Wall Mounted Building Identification Large with Message Panel

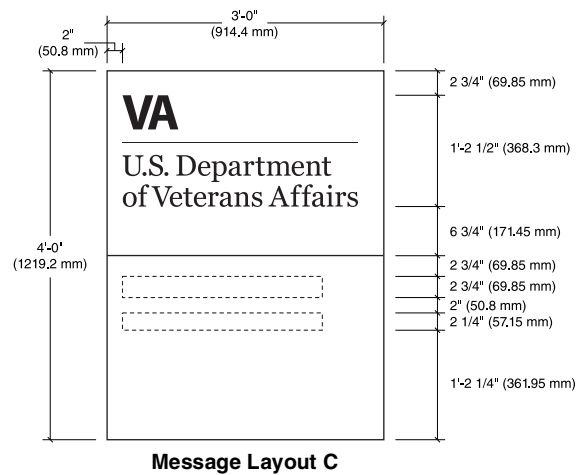
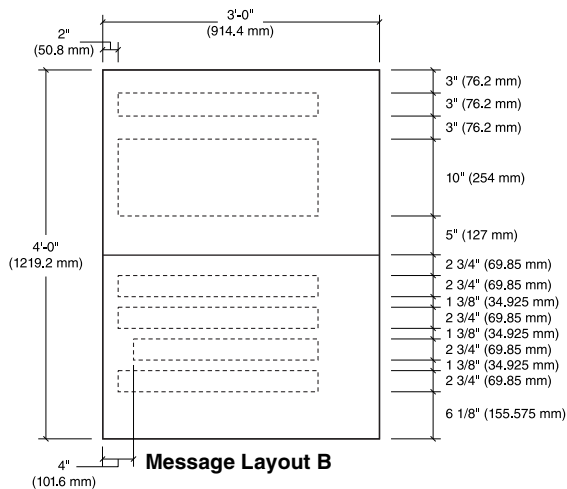
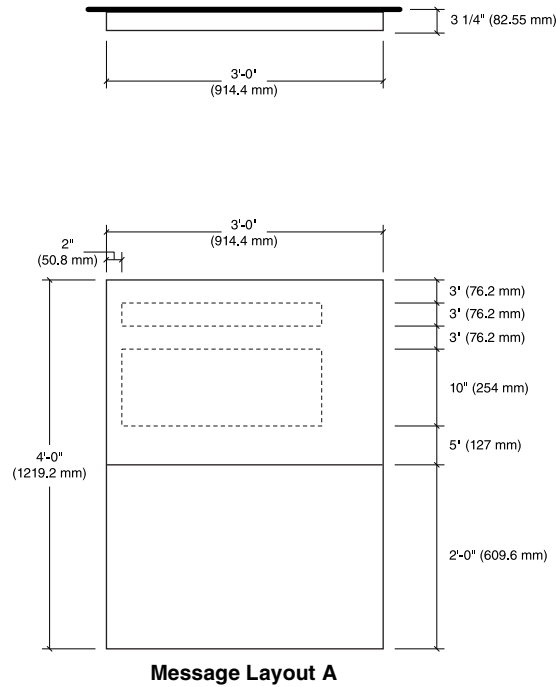

EN-06.04

Non Illuminated Exterior Signage Drawings

Wall Mounted Building Identification Medium

Size

Sign Face:
3'-0" High x 3'-0" Wide
(914.4 mm H x 914.4 mm W)

Description

Medium, non-illuminated wall mounted building identification sign. When names of the occupant or service are used along with the building number, it should be text that will not likely change.

Message Configuration

Refer to message layout drawing for dimensions.

Message layouts show application of the sign with building identification number and number with secondary information.

Graphic Process

Surface applied white reflective vinyl.

Colors

Refer to the color chart in the Appendix.

Recommendations

Use on a building that is set back a considerable distance from the roadway.

Position the sign adjacent to or above the main entrance, if possible. If the sign is not readable in this position, then locate it on the corner of the building.

This large sign should not be used on small buildings or buildings with minor uses.

See [Section 2.5.6](#) & [2.5.7](#) for exterior construction & installation details.



Message Layout A



Message Layout B

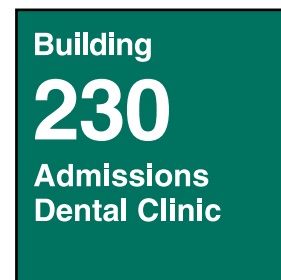

Wall Mounted Building Identification Medium

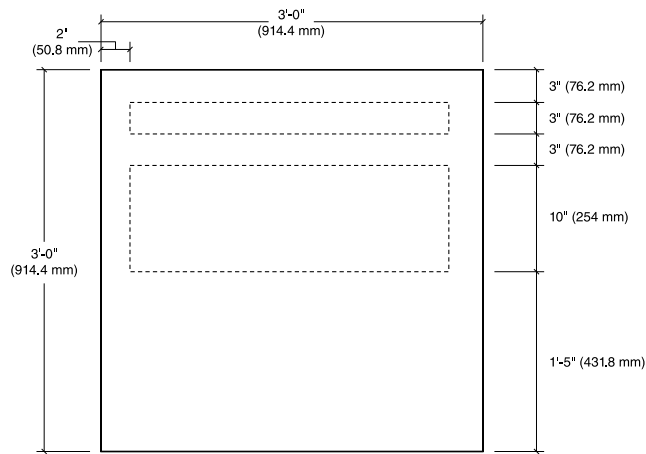
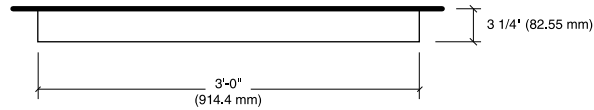

Message Layout A

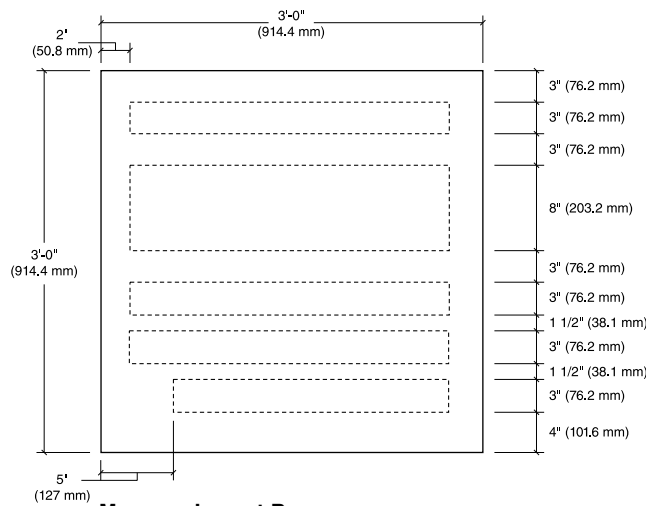

Message Layout B



EN-06.05

Non Illuminated Exterior Signage Drawings

Wall Mounted Building Identification Medium with Message Panel

Size

Sign Face:
3'-0" High x 2'-0" Wide
(914.4 mm H x 609.6 mm W)

Description

Standard size, non-illuminated wall mounted sign with separate name panel. Building identification with and without names of the occupant or service. The secondary name of the occupant or service is on a changeable panel to allow modification to the sign without changing the entire sign.

Message Configuration

Refer to message layout drawing for dimensions.

Message layouts show application of the sign with building identification number and number with secondary information.

Graphic Process

Surface applied white reflective vinyl.

Colors

Refer to the color chart in the Appendix.

Recommendations

Use on any building. Position the sign adjacent to or above the main entrance, if possible. If the sign is not readable in this position, then locate it on the corner of the building.

See [Section 2.5.6](#) & [2.5.7](#) for exterior construction & installation details.

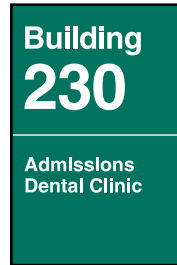

Message Layout A

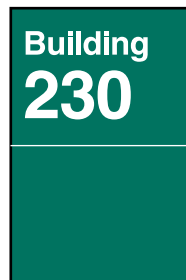

Message Layout B



EN-06.05

Non Illuminated Exterior Signage Drawings

Wall Mounted Building Identification Medium with Message Panel

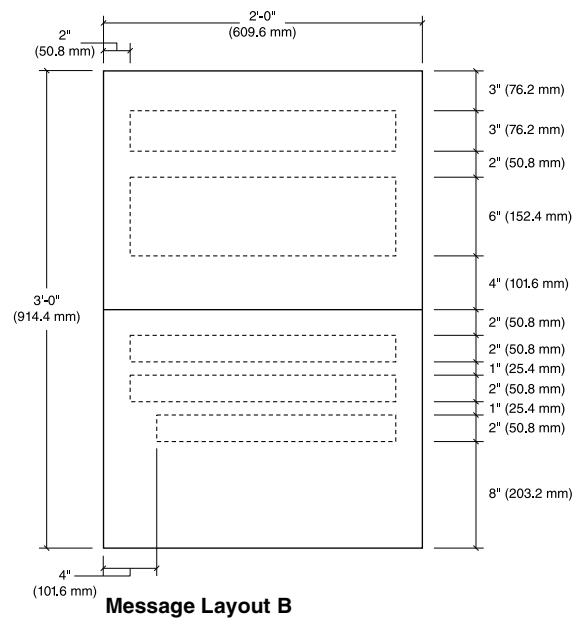
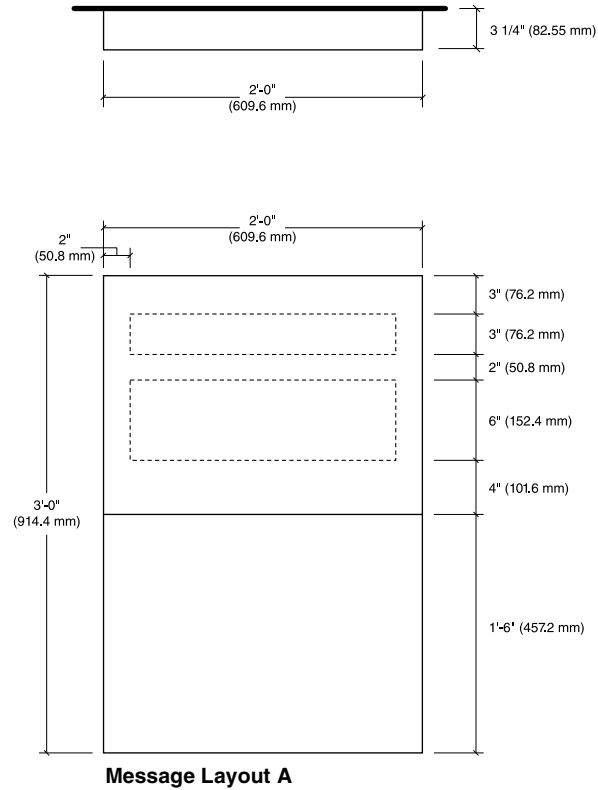

EN-06.06

Non Illuminated Exterior Signage Drawings

Wall Mounted Building Identification Small

Size

Sign Face:
2'-0" High x 2'-0" Wide
(609.6 mm H x 609.6 mm W)

Description

Standard size, non-illuminated wall mounted sign. Building identification with and without names of the occupant or service.

Message Configuration

Refer to message layout drawing for dimensions.

Message layouts show application of the sign with building identification number and number with secondary information.

Graphic Process

Surface applied white reflective vinyl.

Colors

Refer to the color chart in the Appendix.

Recommendations

Use on any building. Position the sign adjacent to or above the main entrance, if possible. If the sign is not readable in this position, then locate it on the corner of the building.

See [Section 2.5.6](#) & [2.5.7](#) for exterior construction & installation details.



Message Layout A



Message Layout B

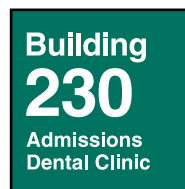

Message Layout C



Wall Mounted Building Identification Small

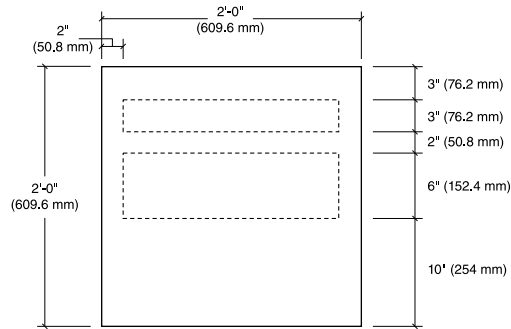
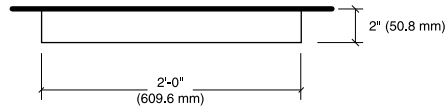

Message Layout A

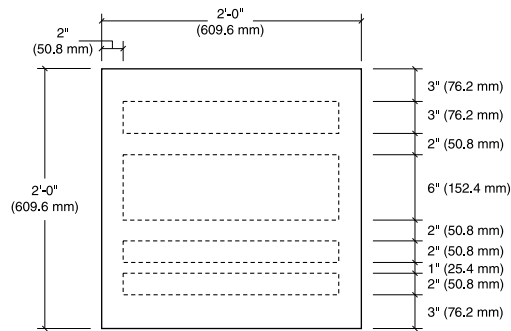

Message Layout B

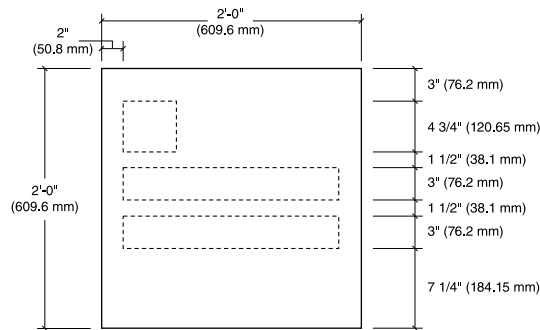

Message Layout C



EN-06.07

Non Illuminated Exterior Signage Drawings

Wall Mounted Informational Medium

Size

Sign Face:
 1'-6" High x 1'-6" Wide x 1/8" Thick
 (457.2 mm H x 457.2 mm W x
 3.175 mm T)

Description

Small, non-illuminated wall mounted sign. This sign is for miscellaneous uses such as identifying minor entrances, sheds, and equipment buildings, and displaying other information.

Message Configuration

Refer to message layout drawing for dimensions.

Message layouts show example type sizes relative to different uses and applications of the sign type.

Graphic Process

Surface applied white reflective vinyl.

Colors

Refer to the color chart in the Appendix.

Recommendations

Use for general purpose minor sign needs.

See [Section 2.5.6](#) & [2.5.7](#) for exterior construction & installation details.



Message Layout A



Message Layout B



Wall Mounted Informational Medium

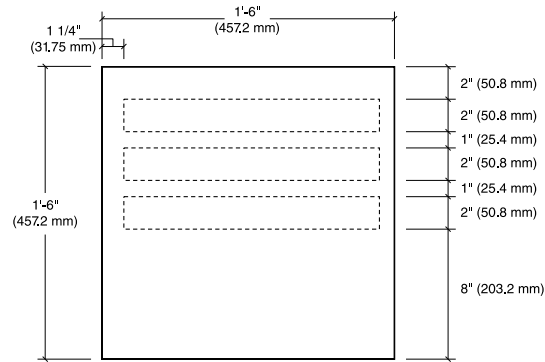

Message Layout A

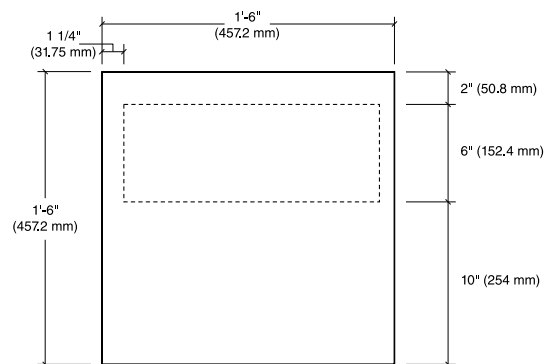

Message Layout B



EN-06.08

Non Illuminated Exterior Signage Drawings

Wall Mounted Informational Small

Size

Sign Face:
 1'-6" High x 1'-0" Wide x 1/8" Thick
 (457.2 mm H x 304.8 mm W x
 3.175 mm T)

Description

Minor informational, non-illuminated wall mounted sign. This sign is for miscellaneous uses such as identifying minor entrances, sheds, and equipment buildings, and displaying other information.

Message Configuration

Refer to message layout drawing for dimensions.

Message layouts show example type sizes relative to possible different uses and application of the sign type.

Graphic Process

Surface applied white reflective vinyl.

Colors

Refer to the color chart in the Appendix.

Recommendations

Use for general purpose minor sign needs.

See [Section 2.5.6](#) & [2.5.7](#) for exterior construction & installation details.



Message Layout A

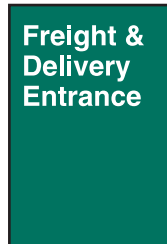

Message Layout B

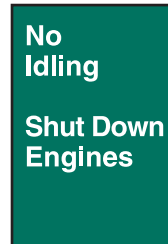

Message Layout C



Message Layout D



Message Layout E



Message Layout F



Message Layout G

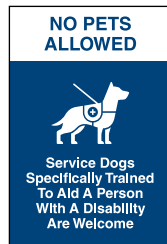

Message Layout H



Message Layout I



Wall Mounted Informational Small

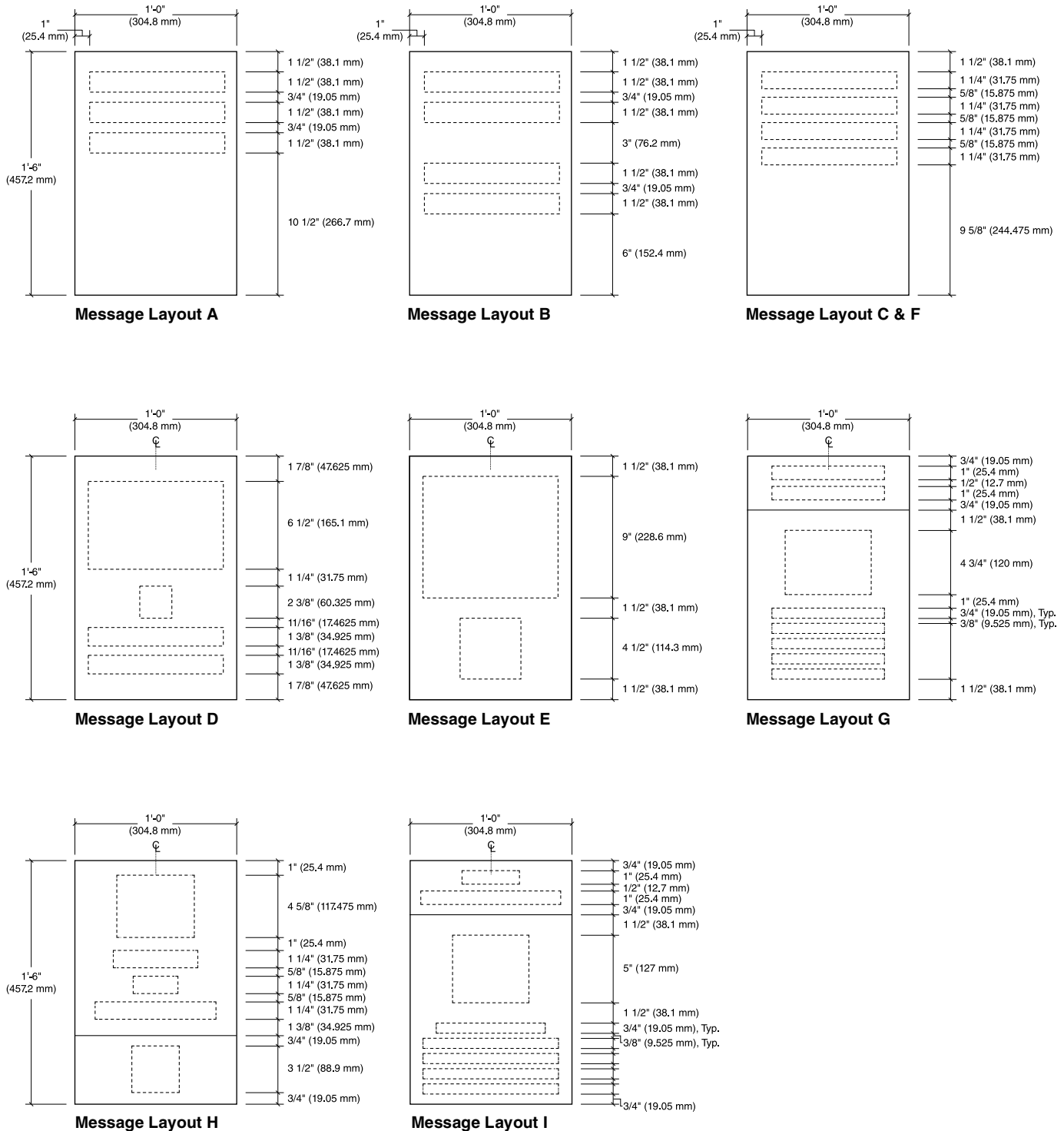

EN-08.01

Non Illuminated Exterior Signage Drawings

Wall Mounted Ambulance / Emergency Overhead

Size

Sign Face:
2'-0" High x 8'-0" Wide
(609.6 mm H x 2438.4 mm W)

Description

Overhead, non-illuminated wall mounted sign to be placed above the emergency or ambulance entrance when applicable.

Message Configuration

Refer to message layout drawing for dimensions.

Conform to the layout shown.

Graphic Process

Surface applied white reflective vinyl.

Colors

Text: White
Symbol Background: White
Background: Red

Refer to the color chart in the Appendix.

Recommendations

Place sign in a position of the building where it clearly identifies the entrance and is visible to both vehicles and pedestrians.

See [Section 2.5.6](#) & [2.5.7](#) for exterior construction & installation details.

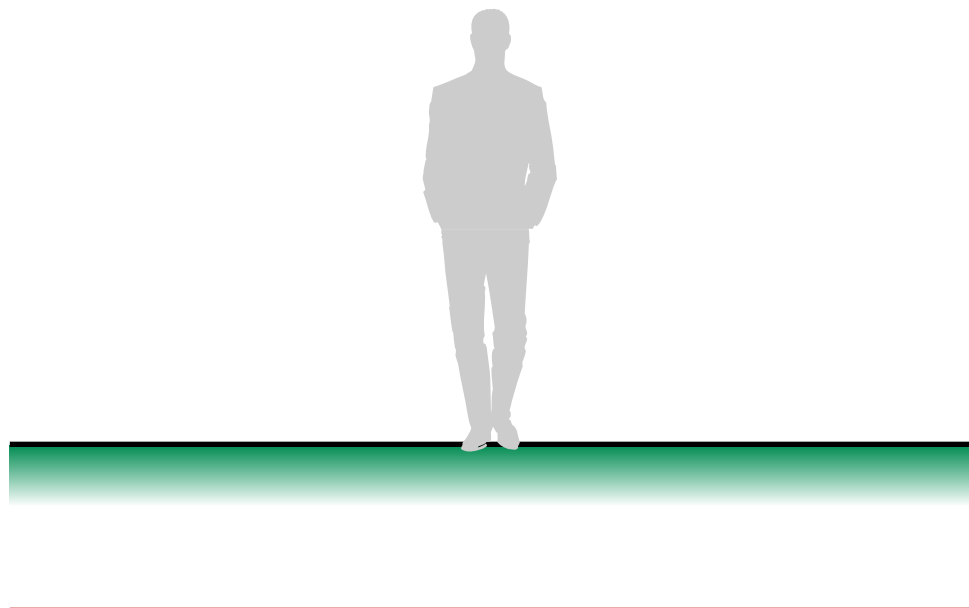

Message Layout A



Message Layout B



Wall Mounted Ambulance / Emergency Overhead

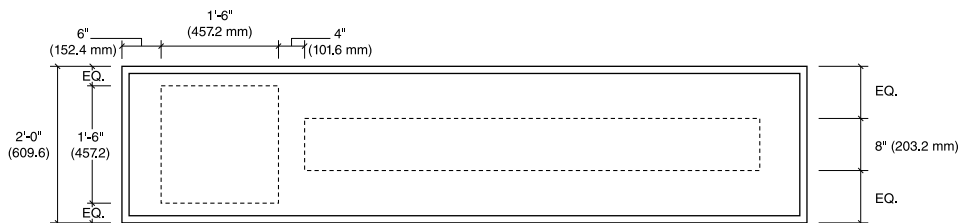
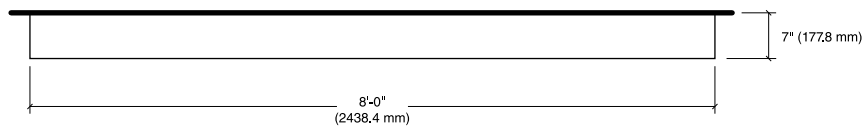

Message Layout A & B



EN-08.02

Non Illuminated Exterior Signage Drawings

Wall Mounted Ambulance / Emergency Identification

Size

Sign Face:
3'-0" High x 4'-0" Wide
(914.4 mm H x 1219.2 mm W)

Description

Non-illuminated wall mounted sign to be placed on the wall adjacent to the emergency or ambulance entrance when applicable.

Message Configuration

Refer to message layout drawing for dimensions.

Conform to the layout shown.

Graphic Process

Surface applied white reflective vinyl.

Colors

Text: White
Symbol Background: White
Background: Red

Refer to the color chart in the Appendix.

Recommendations

Place sign in a position of the building where it clearly identifies the entrance and is visible to both vehicles and pedestrians.

See [Section 2.5.6](#) & [2.5.7](#) for exterior construction & installation details.



Message Layout A



Message Layout B

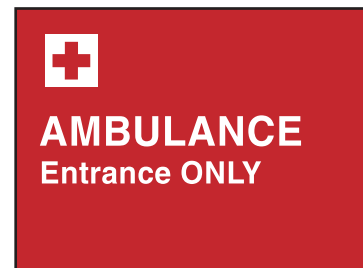

Wall Mounted Ambulance / Emergency Identification

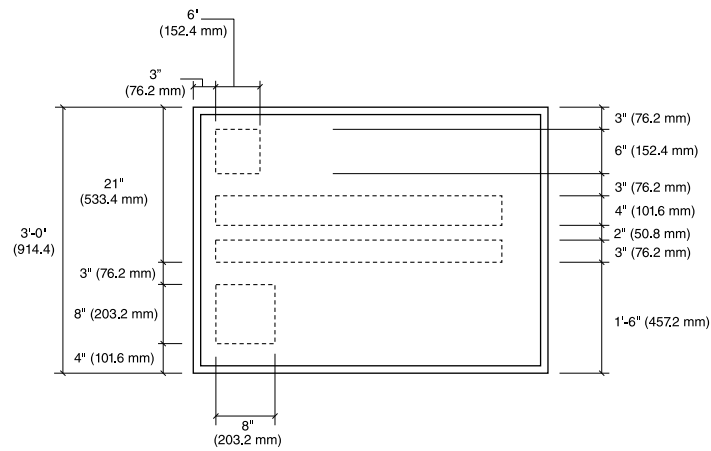
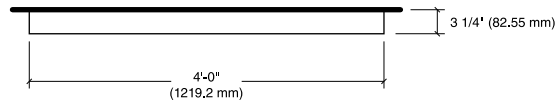

Message Layout A

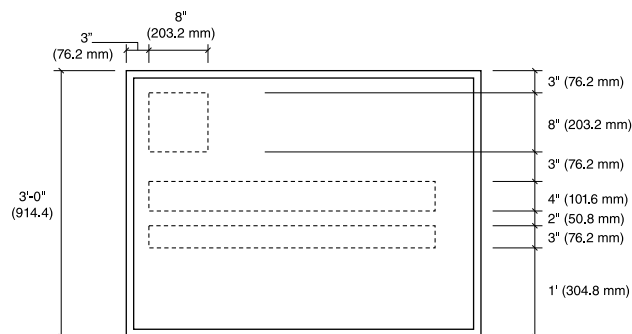

Message Layout B



EN-08.03

Non Illuminated Exterior Signage Drawings

Post & Panel Ambulance / Emergency Identification

Size

Sign Face:
3'-0" High x 4'-0" Wide
(914.4 mm H x 1219.2 mm W)

Overall Sign Height:
5'-6" (1676.4 mm)



Description

Non-illuminated post and panel sign to be placed on the roadway, adjacent to the emergency or ambulance entrance to direct drivers to the correct building entrance where applicable.

Message Configuration

Refer to message layout drawing for dimensions.

Conform to the layout shown.

Graphic Process

Surface applied white reflective vinyl.

Colors

Text: White
Symbol Background: White
Background: Red
Post: Refer to color chart.

Refer to the color chart in the Appendix.

Recommendations

Position sign so drivers have a clear, unobstructed view of the sign.

See [Section 2.5.6](#) & [2.5.7](#) for exterior construction & installation details.



Message Layout A



Message Layout B



Post & Panel Ambulance / Emergency Identification

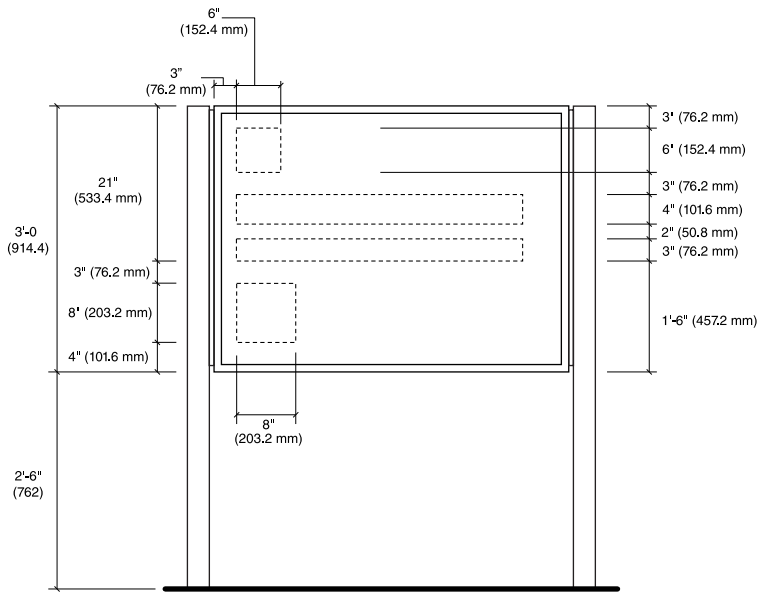
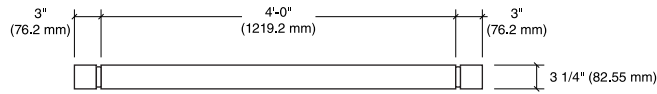

Message Layout A

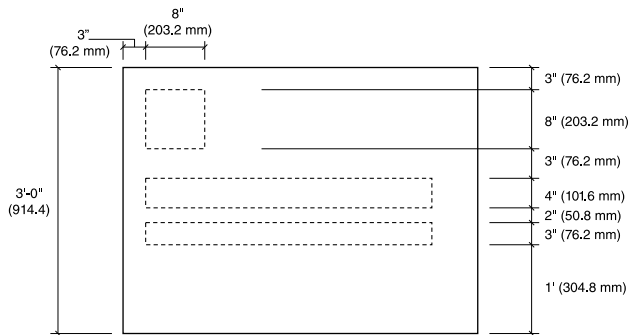

Message Layout B



EN-09

Non Illuminated Exterior Signage Drawings

Non-Illuminated Letters & Logo

Size

For the various sizes, refer to the adjacent table.

Description

Non-illuminated dimensional letters for identifying a facility, building, or entrance. Should be placed on the building in a location that is highly visible to the public.

Message Configuration

Refer to message layout drawing for dimensions.

Graphic Process

Fabricated, cast, or cut out aluminum letters.

Colors

White, black, silver or dark bronze. Letter to have high contrast to the building wall color or material. For example, use white on red brick, not black.

Recommendations

Dimensional letters can be used on a building to identify the building. Large letters and logo are intended for use on the top of the building as a skyline sign.

See [Section 2.5.6](#) & [2.5.7](#) for exterior construction & installation details.

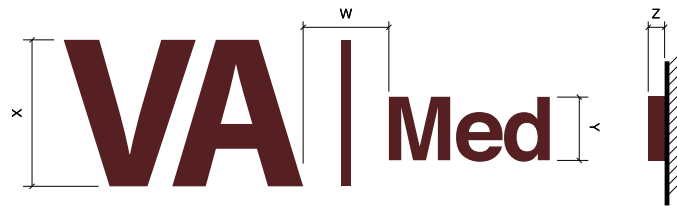

Sign Type	Y	Z	X	W
EN-09.01	4" (101.6 mm)	3/8" (9.525 mm)		
EN-09.02	6" (152.4 mm)	3/8" (9.525 mm)		
EN-09.03	8" (203.2 mm)	1/2" (12.7 mm)		
EN-09.04	10" (254 mm)	1/2" (12.7 mm)	23" (584.2 mm)	10" (254 mm)
EN-09.05	12" (304.8 mm)	3/4" (19.05 mm)	27" (685.8 mm)	12" (304.8 mm)
EN-09.06	18" (457.2 mm)	1" (25.4 mm)	42" (1066.8 mm)	19" (482.6 mm)
EN-09.07	24" (609.6 mm)	2" (50.8 mm)	56" (1422.4 mm)	25" (635 mm)
EN-09.08	30" (762 mm)	2 1/2" (63.5 mm)	70" (1778 mm)	31" (787.4 mm)
EN-09.09	36" (914.4 mm)	3" (76.2 mm)	84" (2133.6 mm)	38" (965.2 mm)



EN-10

Non Illuminated Exterior Signage Drawings

Traffic Regulatory Signs

Size

EN-10.01: Stop: 24", 30", 36"

EN-10.02: Do Not Enter: 30", 36"

EN-10.03: Yield: 30", 36"

EN-10.04: Speed Limit

EN-10.05: Keep Right

EN-10.06: One Way

EN-10.07: No Right/Left Turn

EN-10.08: No U Turn

EN-10.09: Pedestrian Crossing

Description

Traffic regulatory signs.

Sign Use & Application

The "Manual on Uniform Traffic Control Devices for Streets and Highways" has been adopted as the standard for all Regulatory and Warning Signs used on the Department of Veterans Affairs roadways for vehicular traffic.

Message Configuration

Refer to message layout drawing for dimensions.

Text, text size, text position and color must conform with the Manual on Uniform Traffic Control Devices (MUTCD)

Colors

Text & Background: "MUTCD" standard colors.

Refer to the color chart in the Appendix.

Recommendations

Typical signs are shown. If other Traffic Regulatory and Warning Signs are needed, refer to MUTCD.

Position sign so drivers have a clear, unobstructed view of the sign.

Note that the decision to use a traffic control device at a specific location should be made on the basis of a traffic engineering study of the location. Sign size should be based on traffic conditions. Where these conditions are the same, all signs of a similar type should be the same size.

See [Section 2.5.6](#) & [2.5.7](#) for exterior construction & installation details.

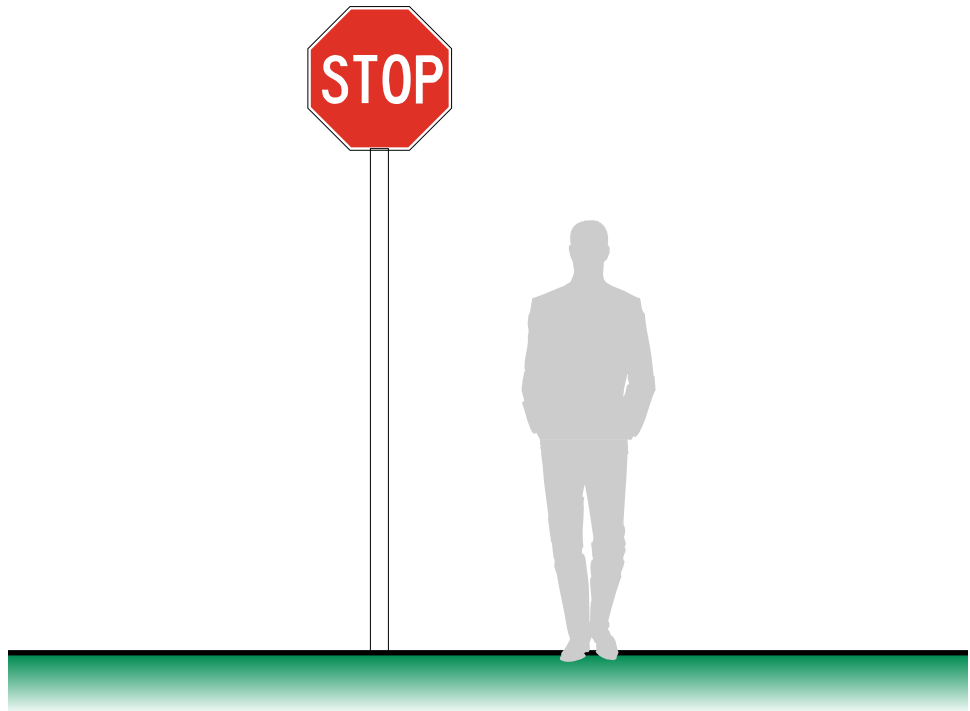

EN-10.01



EN-10.02



EN-10.03



EN-10.04



EN-10.05



EN-10.06



EN-10.07



EN-10.08



EN-10.09



EN-10

Non Illuminated Exterior Signage Drawings

Traffic Regulatory Signs

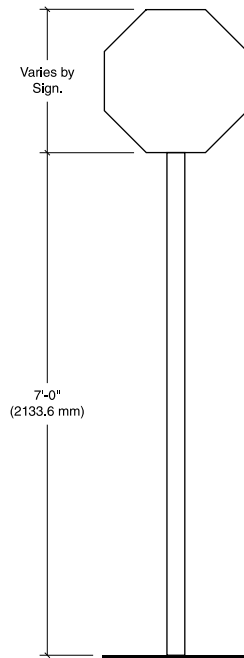
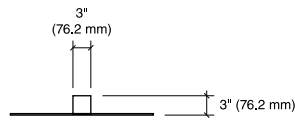

EN-10.01

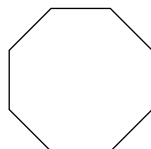

- 24" x 24"
(609.6 mm x 609.6 mm)
- 30" x 30"
(762 mm x 762 mm)
- 36" x 36"
(914.4 mm x 914.4 mm)

EN-10.02

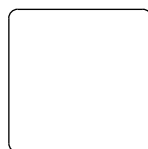

- 30" x 30"
(762 mm x 762 mm)
- 36" x 36"
(914.4 mm x 914.4 mm)

EN-10.03

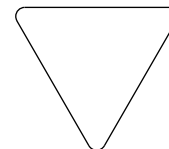

- 30" Triangle
(762 mm)
- 36" Triangle
(914.4 mm)

EN-10.04, EN-10.05, & EN-10.06

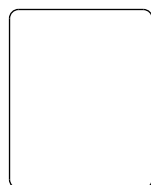

24" x 30"
(609.6 mm x 762 mm)

EN-10.07 & EN-10.08

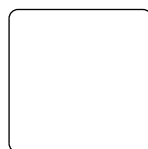

24" x 24"
(609.6 mm x 609.6 mm)

EN-10.10

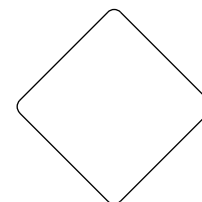

24" x 24"
(609.6 mm x 609.6 mm)



EN-11.01

Non Illuminated Exterior Signage Drawings

2 Blade Street Sign

Size

Blade:

Layout A:

6" High x 2'-0" Wide
(152.4 mm H x 609.6 mm W)

Layout B:

6" High x 2'-6" Wide
(152.4 mm H x 762 mm W)

Layout C:

6" High x 3'-0" Wide
(152.4 mm H x 914.4 mm W)

Description

Non-illuminated double blade name sign for an intersection.

Message Configuration

Refer to message layout drawing for dimensions.

Select size required for length of name. Message will be the same on both sides of the sign blade. The following are some standard abbreviations:

- Boulevard – BLVD
- Circle – CIR
- Court – CT
- Drive - DR
- Avenue – AVE
- Lane – LN
- Place – PL
- Road – RD
- Street – ST
- Terrace - TERR.

Graphic Process

Surface applied reflective vinyl.

Colors

Refer to the color chart in the Appendix.

Typography

Helvetica Bold Condensed

Recommendations

Position sign so drivers have a clear, unobstructed view of the sign. Locate as close to intersection as possible.

See [Section 2.5.6](#) & [2.5.7](#) for exterior construction & installation details.

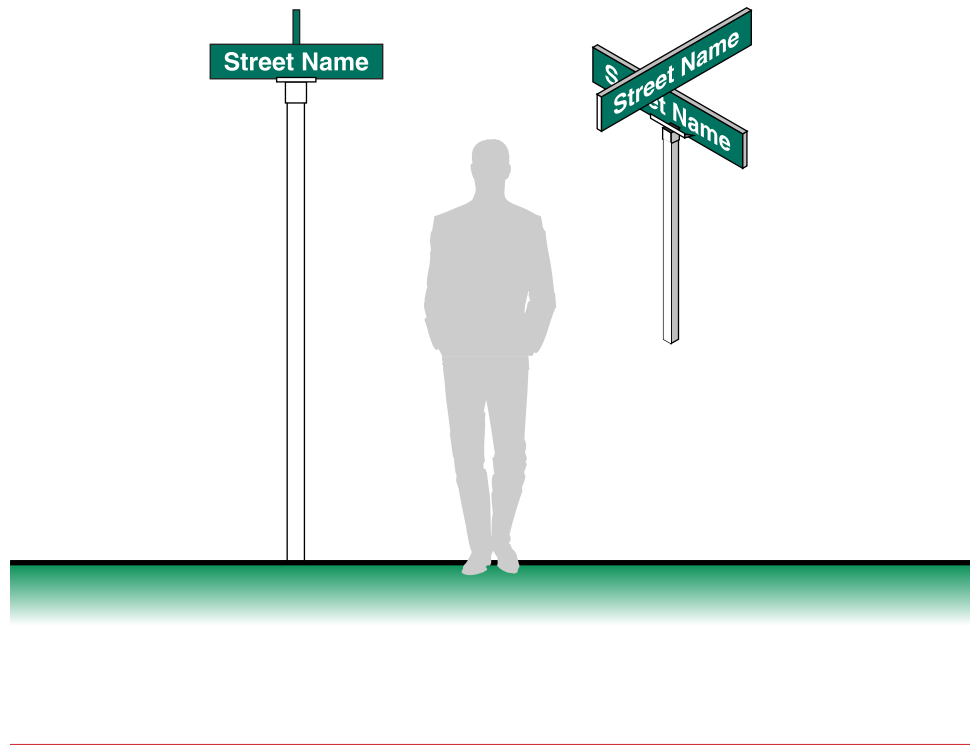

Message Layout A



Message Layout B



Message Layout C



EN-11.01

Non Illuminated Exterior Signage Drawings

2 Blade Street Sign

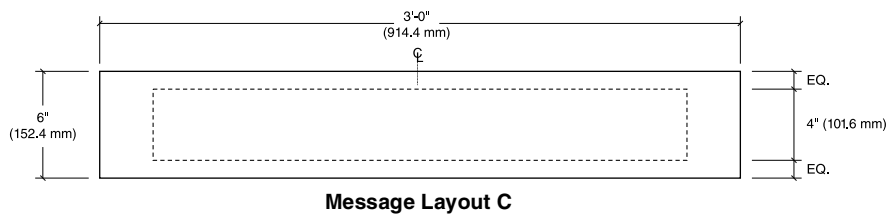
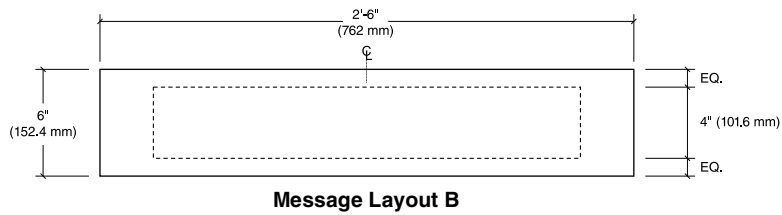
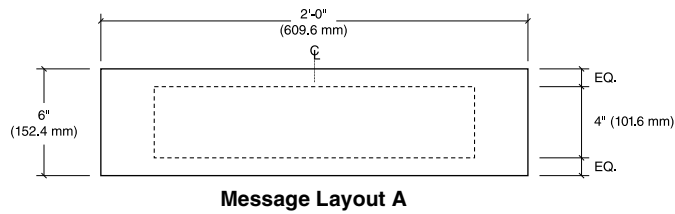
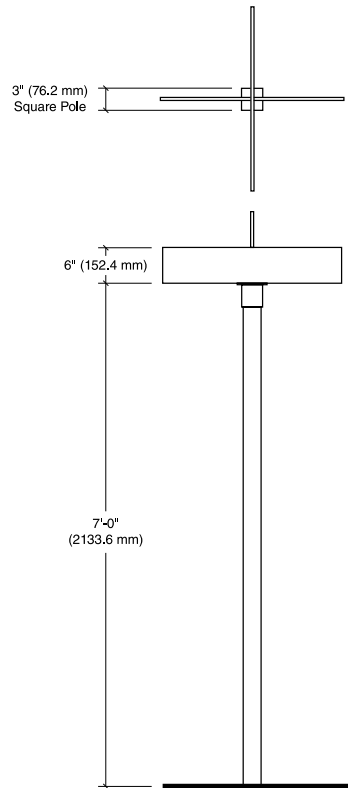

EN-11.02

Non Illuminated Exterior Signage Drawings

1 Blade Street Sign

Size

Blade:

Layout A:

6" High x 2'-0" Wide
(152.4 mm H x 609.6 mm W)

Layout B:

6" High x 2'-6" Wide
(152.4 mm H x 762 mm W)

Layout C:

6" High x 3'-0" Wide
(152.4 mm H x 914.4 mm W)

Description

Non-illuminated single blade street name identification for a single street.

Message Configuration

Refer to message layout drawing for dimensions.

Select size required for length of name. Message will be the same on both sides of the sign blade. The following are some standard abbreviations:

- Boulevard – BLVD
- Circle – CIR
- Court – CT
- Drive – DR
- Avenue – AVE
- Lane – LN
- Place – PL
- Road – RD
- Street – ST
- Terrace - TERR.

Graphic Process

Surface applied reflective vinyl.

Colors

Refer to the color char in the Appendix.

Typography

Helvetica Bold Condensed

Recommendations

Position sign so drivers have a clear, unobstructed view of the sign. Locate as close to intersection as possible.

See [Section 2.5.6](#) & [2.5.7](#) for exterior construction & installation details.



Message Layout A



Message Layout B



Message Layout C



EN-11.02

Non Illuminated Exterior Signage Drawings

1 Blade Street Sign

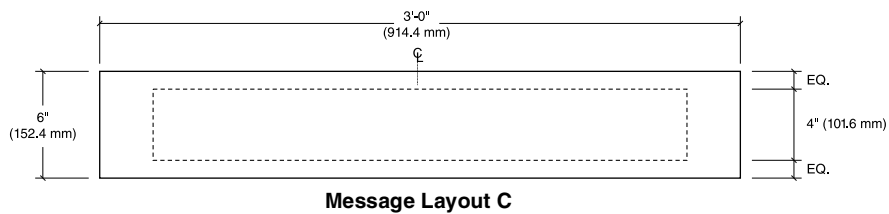
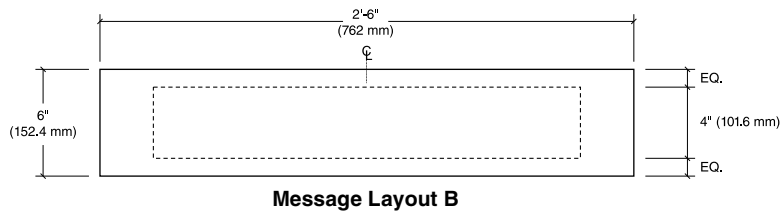
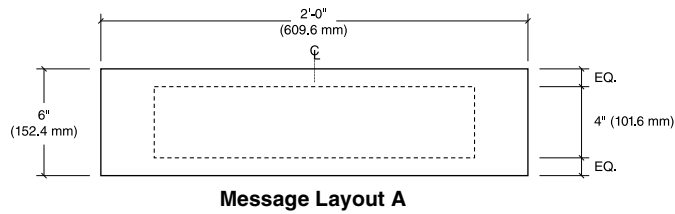
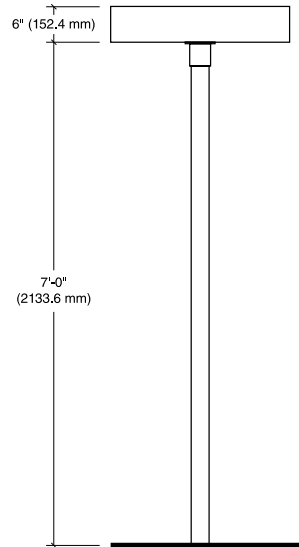
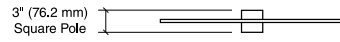

EN-11.03

Non Illuminated Exterior Signage Drawings

Pylon Street Sign

Size

5'-0" High x 6" Wide x 6" Deep
(1524 mm H x 152.4 mm W x 152.4 mm D)

Description

Non-illuminated Pylon type Street Sign.

Message Configuration

Refer to message layout drawing for dimensions.

The same message will be on opposite sides of the post. The name always starts at the top of the post and has been rotated clockwise from horizontal to vertical. The following are some standard abbreviations:

- Boulevard – BLVD
- Circle – CIR
- Court – CT
- Drive – DR
- Avenue – AVE
- Lane – LN
- Place – PL
- Road – RD
- Street – ST
- Terrace - TERR.

Graphic Process

Surface applied white reflective vinyl.

Colors

Refer to the color chart in the Appendix.

Typography

Helvetica Bold Condensed

Recommendations

Position sign so drivers have a clear, unobstructed view of the sign. Locate as close to intersection as possible.

See [Section 2.5.6](#) & [2.5.7](#) for exterior construction & installation details.

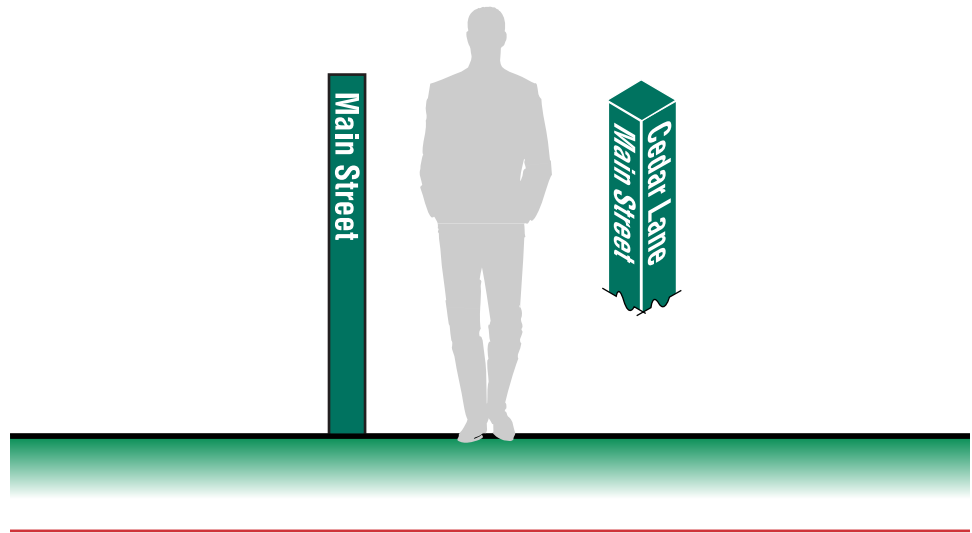

Message Layout A



Pylon Street Sign

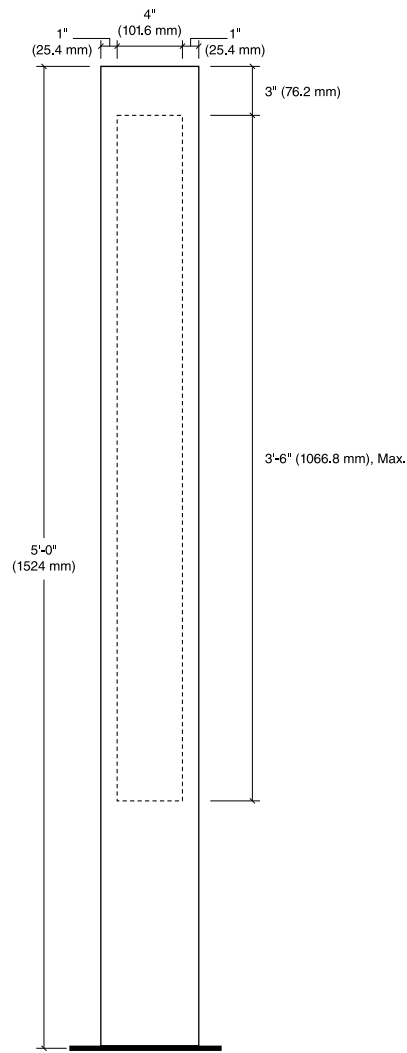

Message Layout A



EN-14

Non-Illuminated Exterior Signage Drawings

Building Entrance Vinyl

Size

Sign Characters: See layout

Description

Applied vinyl letter identification sign with messages relevant to pedestrians. The sign can also be used to identify buildings.

Message Configuration

Refer to message layout drawing for dimensions.

Message size and layout should adjust to the volume of information being presented and viewing distance.

Graphic Process

First surface applied white vinyl.

Colors

Text: White

Do not use colored vinyl.

Recommendations

Position sign so pedestrians have a clear, unobstructed view of the sign.

36 3/4"
(933.45 mm)

EN-14
Optional

3" (76.2 mm)

IN-02.04.01
Required

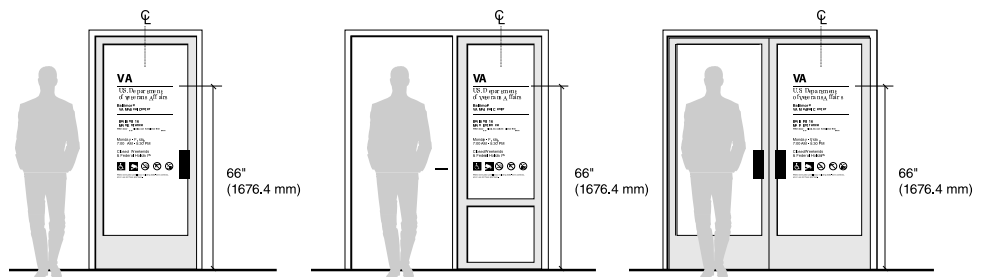

EN-14

Non Illuminated Exterior Signage Drawings

Building Entrance Vinyl

**EN-14.01 –
Door Vinyl for Medical Center**

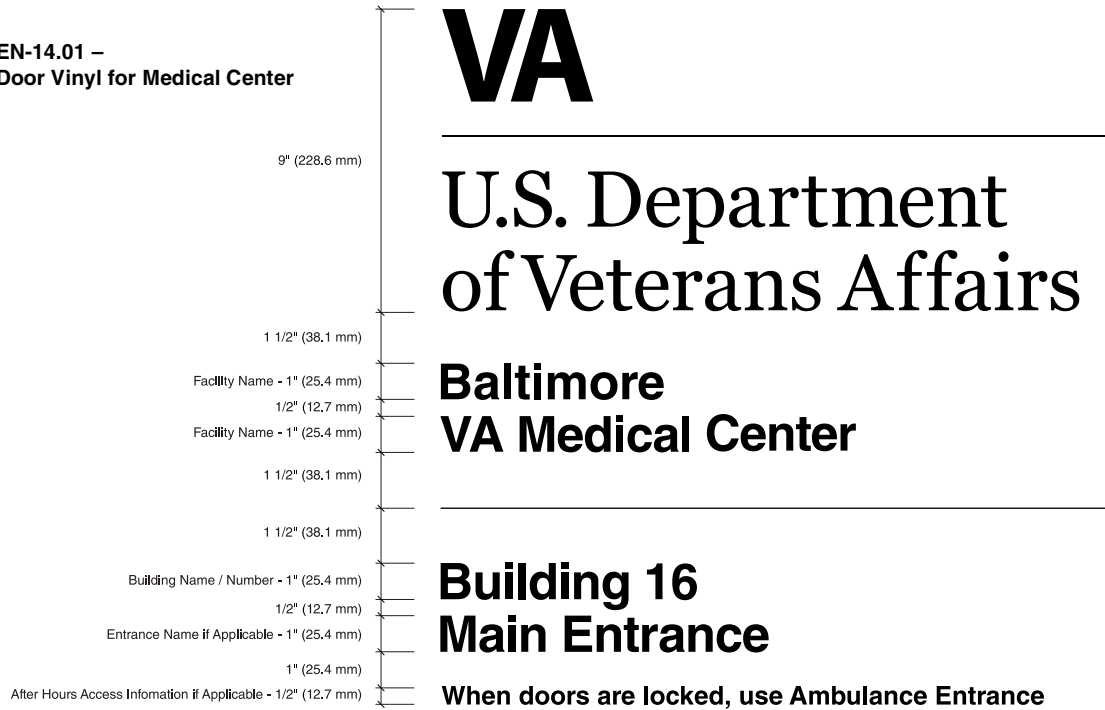

**EN-14.02 –
Door Vinyl for Clinic**

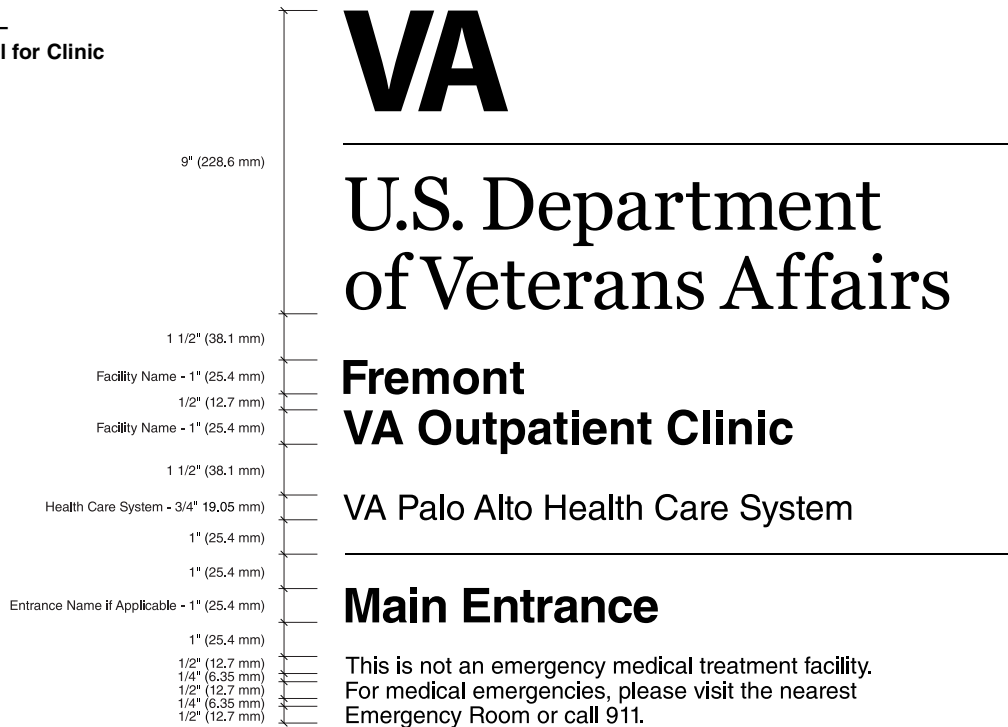

PL-12.01

Parking Lot Signage Drawings

Post & Panel Parking Identification

Size

Sign Face:
3'-0" High x 2'-0" Wide
(914.4 mm H x 609.6 mm W)

Overall Sign Height:
6'-6" High (1981.2 mm)

Description

Large, non-illuminated post and panel parking lot identification sign. This sign type is for identifying parking lots to drivers circulating on a roadway system.

Message Configuration

Refer to message layout drawing for dimensions.

Layout A is for identifying a visitor parking lot.

Layout B and C are for identifying a visitor or employee parking lot with a number or letter.

Graphic Process

Surface applied reflective vinyl.

Colors

Text: White
Background & Post: Refer to the color chart in the Appendix.

Recommendations

Position sign so drivers have a clear, unobstructed view of the sign.

Place signs in a highly visible location adjacent to the driveway entrance to a parking lot.

See [Section 2.5.6](#) & [2.5.7](#) for exterior construction & installation details.



Message Layout A



Message Layout B



Message Layout C



Post & Panel Parking Identification

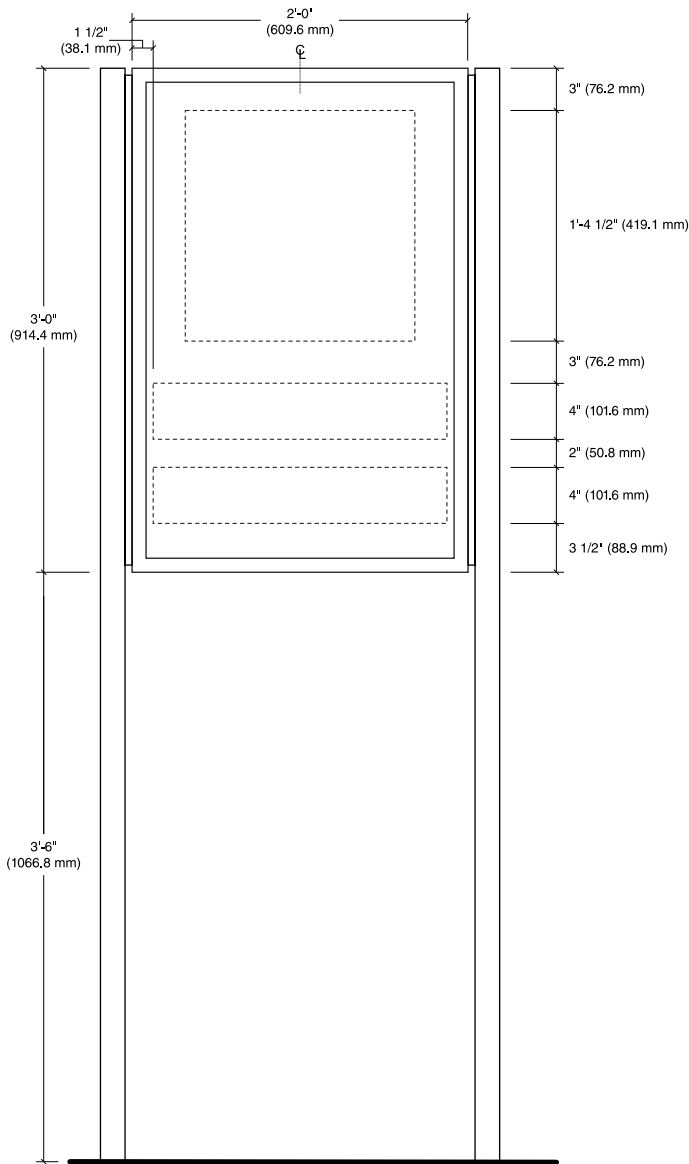
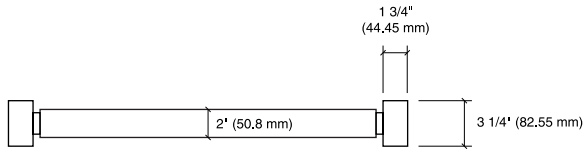

Message Layout A

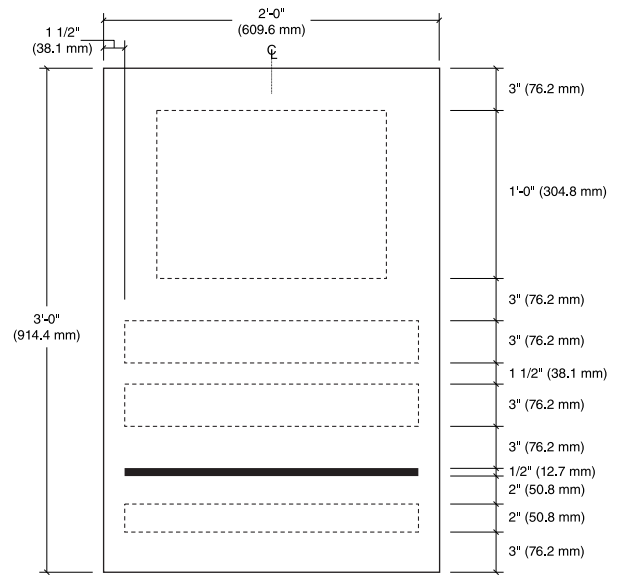

Message Layout B & C



PL-12.02

Parking Lot Signage Drawings

Single Post & Panel Informational

Size

Sign Face:
3'-0" High x 2'-0" Wide
(914.4 mm H x 609.6 mm W)

Overall Sign Height:
6'-0" High (1828.8 mm)

Description

Non-illuminated single post and panel sign with messages relevant to drivers. This sign can be used to communicate various informational or instructional messages.

Message Configuration

Refer to message layout drawing for dimensions.

Graphic Process

Surface applied reflective vinyl.

Colors

Text: White
Background & Post: Refer to the color chart in the Appendix.

Recommendations

Position sign where the message needs to be conveyed and text can be read from a reasonable distance.

See [Section 2.5.6](#) & [2.5.7](#) for exterior construction & installation details.

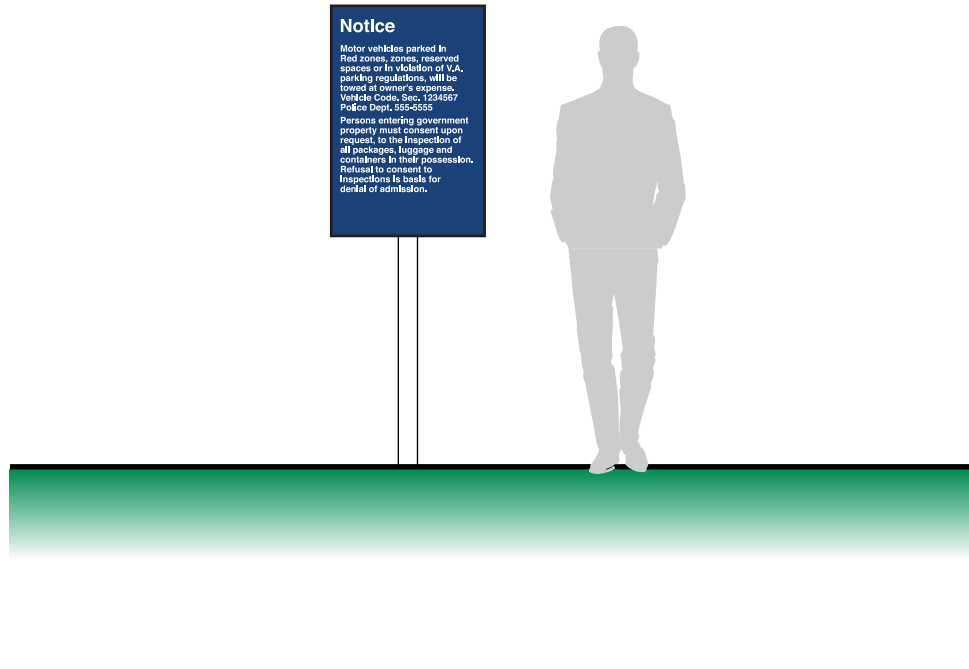

Notice
Motor vehicles parked in Red zones, zones, reserved spaces or in violation of V.A. parking regulations, will be towed at owner's expense. Vehicle Code, Sec. 1234567 Police Dept. 555-5555
Persons entering government property must consent upon request, to the inspection of all packages, luggage and containers in their possession. Refusal to consent to inspections is basis for denial of admission.

Message Layout

Notice
Lorem ipsum dolor sit amet, consectetur adipiscing elit, sed diam nonummy nibh euismod tincidunt ut laoreet dolore magna aliquam erat volutpat. Ut wisi enim ad minim veniam, quis nostrud exerci tation ullamcorper suscipit lobortis nisl ut aliquip ex ea commodo consequat. Duis autem vel eum Irlure dolor in hendrerit in vulputate velit esse molestie consequat, vel illum dolore eu feugiat nulla facilisis at vero eros et accumsan et iusto odio dignissim qui blandit praesent



PL-12.02

Parking Lot Signage Drawings

Single Post & Panel Informational

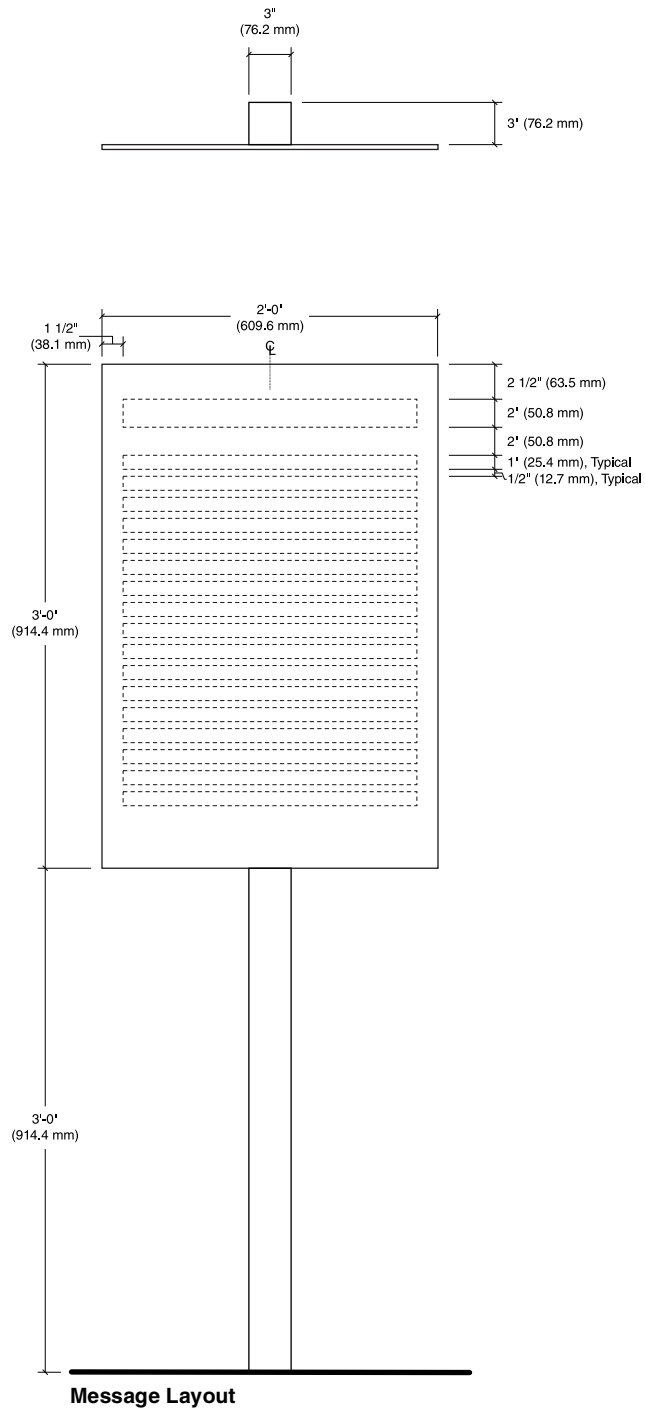

PL-12.03

Parking Lot Signage Drawings

Single Post & Panel Parking Stall Designation

Size

Sign Face:
1'-6" High x 1'-0" Wide
(457.2 mm H x 304.8 mm W)

Overall Sign Height:
6'-0" High (1828.8 mm)

Description

Non-illuminated single post parking identification and informational sign. This sign type is used for identifying or controlling specific parking areas, spaces, or stalls.

Message Configuration

Refer to message layout drawing for dimensions.

This sign with symbol or title and the appropriate text shall be used as shown in the adjacent examples.

Graphic Process

Surface applied reflective vinyl.

Colors

Text: White
Background & Post: Refer to the color chart in the Appendix.

Recommendations

Position sign so drivers have a clear, unobstructed view of the sign.

When placing this type of sign near curbs or parking places, be sure the sign is set far enough back that over hanging front and back bumpers of automobiles do not come into contact with the signpost.

See [Section 2.5.6](#) & [2.5.7](#) for exterior construction & installation details.



Message Layout A



Other messages:

- 1) Visitors Only
- 2) Buses Only
- 3) Authorized Vehicles Only
- 4) On Paved Road Only
- 5) Staff Only

Message Layout B



Other messages:

- 1) Along Roadway
- 2) Any Time
- 3) Fire Lane
- 4) On the Grass
- 5) 00am-00pm

Message Layout C



Other messages:

- 1) Director
- 2) Chief of Staff
- 3) Volunteers
- 4) Consultant
- 5) Motorcycle Parking
- 6) Officer of the Day
- 7) Outpatient Only
- 8) Government Vehicle
- 9) Police Only
- 10) Vanpool



Single Post & Panel Parking Stall Designation

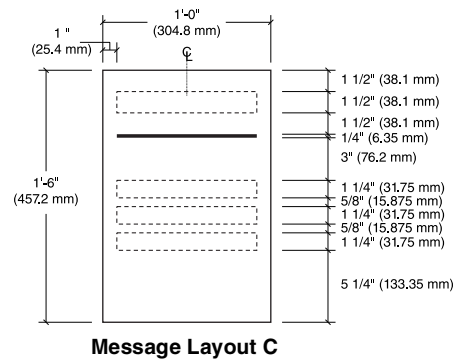
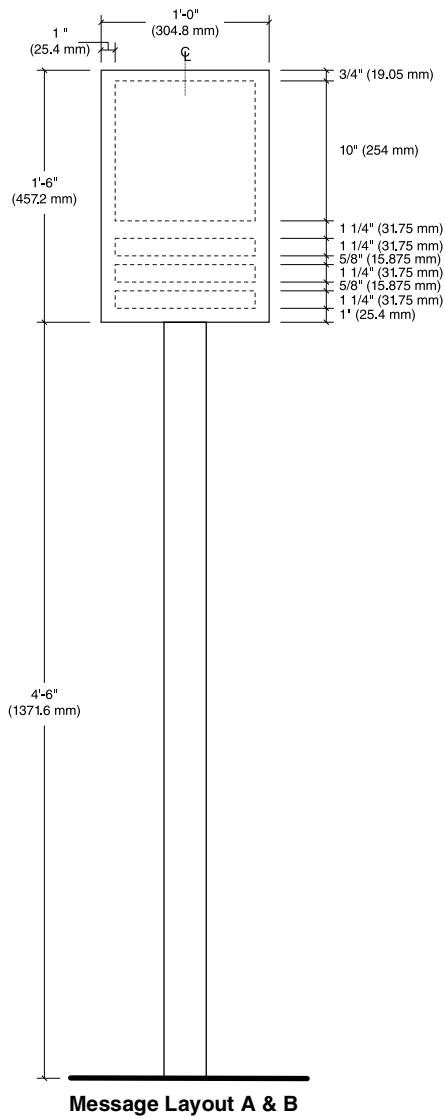
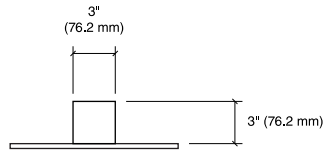

PL-12.04

Parking Lot Signage Drawings

Single Post & Panel Accessible Parking Stall Designation

Size

Sign Face:
1'-6" High x 1'-0" Wide
(457.2 mm H x 304.8 mm W)

Description

Single post, non-illuminated
handicap parking stall sign.

Message Configuration

Refer to message layout drawing
for dimensions.

Symbol and text must conform to
layout as shown.

Graphic Process

Surface applied reflective vinyl.

Colors

Text: White
Background: Accessible Blue
Post: Refer to the color chart in the
Appendix.

Recommendations

Position sign so drivers have a
clear, unobstructed view of the sign.

Accessible parking spaces must be
identified with signs that include the
ISA symbol.

ABA/ADA regulations require
bottom of sign to be at least 5'-0"
(1524 mm) from grade.

When placing this type of sign near
curbs or parking places, be sure the
sign is set far enough back that
over hanging front and back
bumpers of automobiles do not
come into contact with the signpost.

See [Section 2.5.6](#) & [2.5.7](#) for
exterior construction & installation
details.

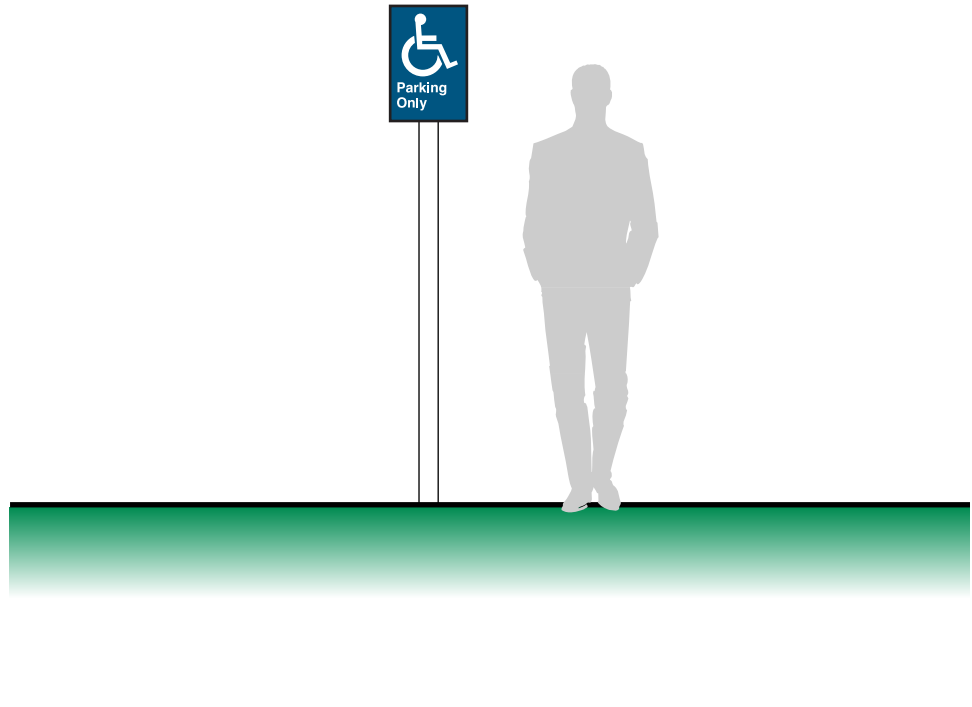

Message Layout A



Message Layout B



Message Layout C



PL-12.04

Parking Lot Signage Drawings

Single Post & Panel Accessible Parking Stall Designation

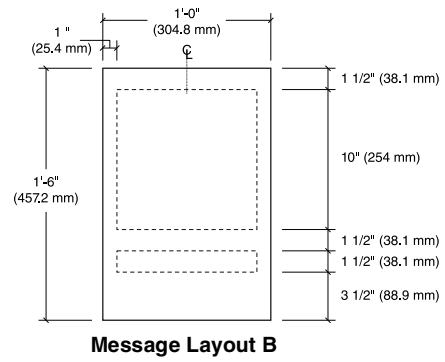
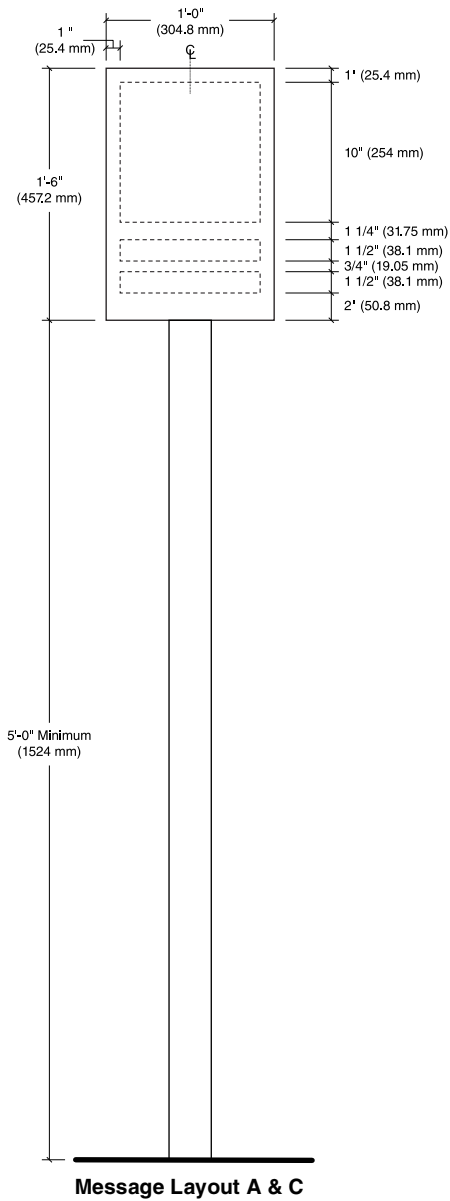
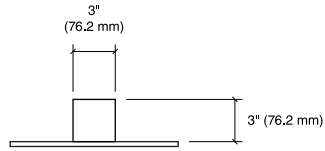

PL-12.05

Parking Lot Signage Drawings

Single Post & Panel Accessible Parking Area

Size

Sign Face:
2'-0" High x 2'-0" Wide
(609.6 mm H x 609.6 mm W)

Description

Single post, non-illuminated handicap parking area sign.

This sign is used to identify handicap parking areas and directional information regarding access.

Message Configuration

Refer to message layout drawing for dimensions.

Symbol to remain constant.

Graphic Process

Surface applied reflective vinyl.

Colors

Text: White
Background: Accessible Blue
Post: Refer to the color chart in the Appendix.

Recommendations

Position sign so drivers have a clear, unobstructed view of the sign.

Accessible parking spaces must be identified with signs that include the ISA symbol.

ABA/ADA regulations require bottom of sign to be at least 5'-0" (1524 mm) from grade.

When placing this type of sign near curbs or parking places, be sure the sign is set far enough back that over hanging front and back bumpers of automobiles do not come into contact with the signpost.

See [Section 2.5.6](#) & [2.5.7](#) for exterior construction & installation details.



Message Layout A



Message Layout B



Single Post & Panel Accessible Parking Area

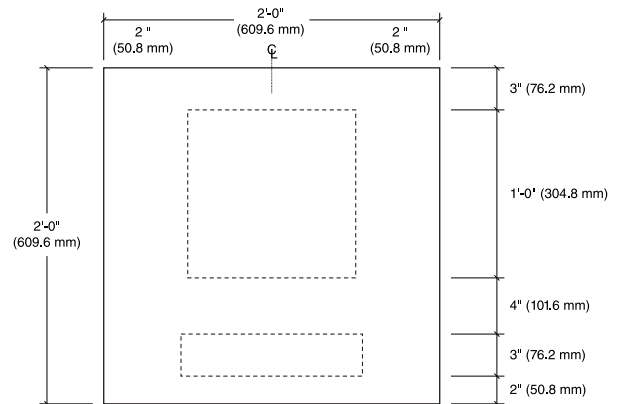
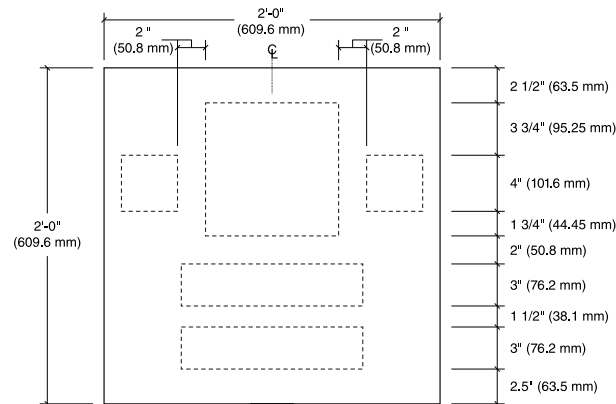
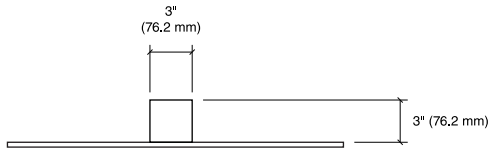

Message Layout B

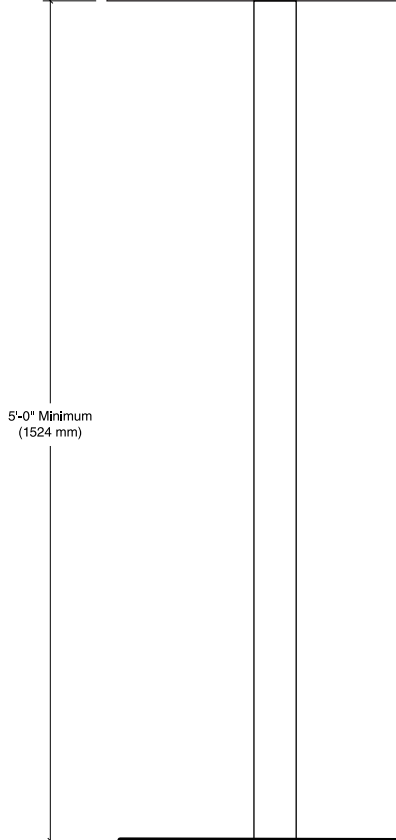

Message Layout A



Pole Mounted Parking Lot or Area Identification

Size

Sign Face:
2'-0" High x 2'-0" Wide
(609.6 mm H x 609.6 mm W)

Overall Sign Height:
12'-0" High (3657.6 mm)

Description

Light pole mounted parking area identification sign for use in lots large enough to be divided into zones.

These signs should be double faced (on each side of the pole) and high enough to be clearly visible throughout the parking lot.

Signs may be mounted in front of the pole, or on either side of the pole.

Message Configuration

Refer to message layout drawing for dimensions.

Message layouts show various applications.

Graphic Process

Surface applied reflective vinyl.

Colors

Text: White
Background & Post: Refer to the color chart in the Appendix.

Recommendations

Install the signs in a position that is clearly visible to drivers and pedestrians up and down the path of travel in a parking lot.

See [Section 2.5.6](#) & [2.5.7](#) for exterior construction & installation details.

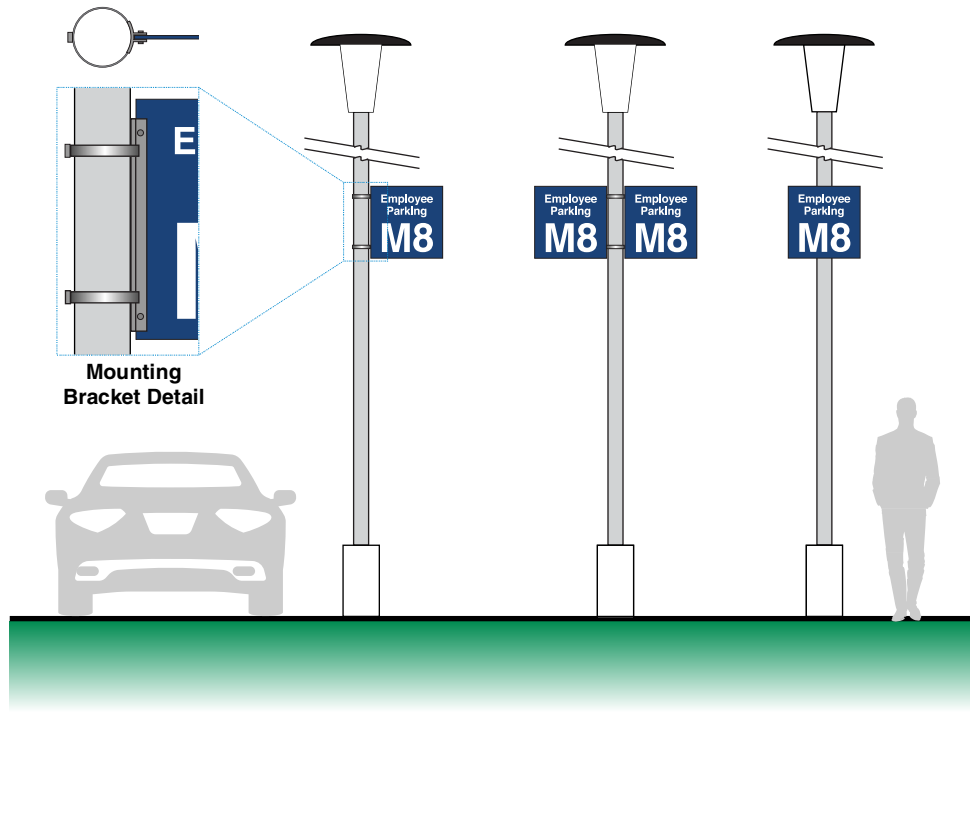

Message Layout A



Message Layout B



Message Layout C



Message Layout D



Pole Mounted Parking Lot or Area Identification

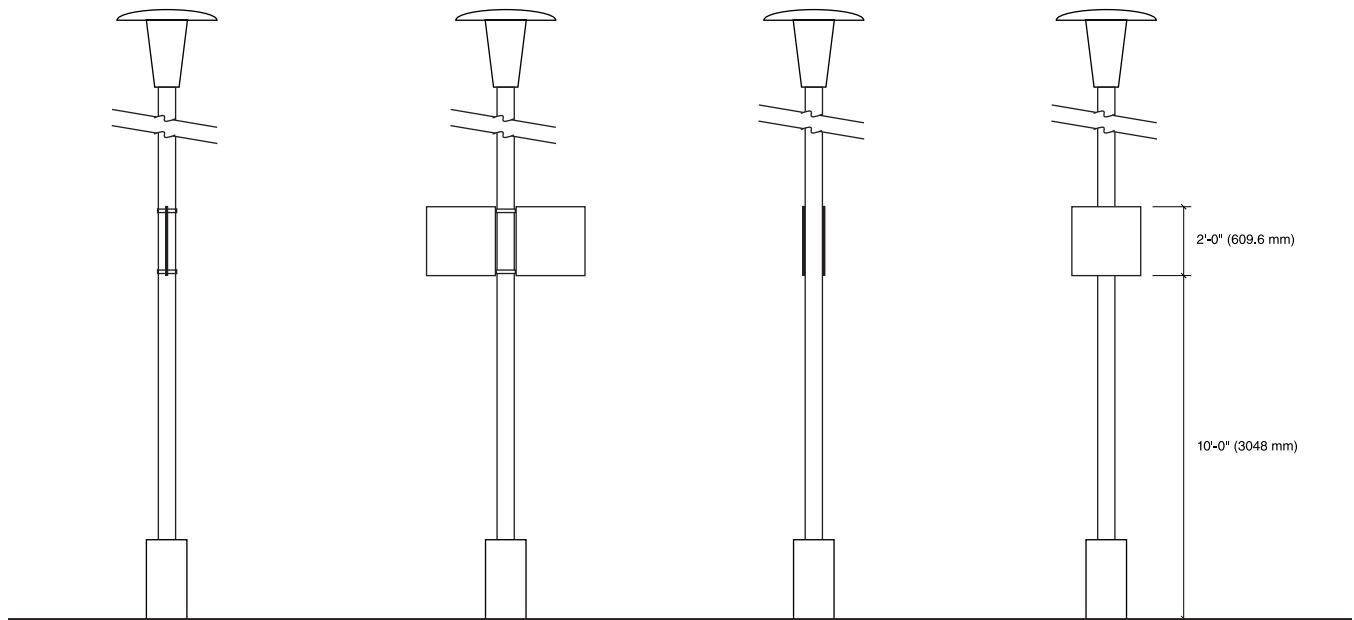

Profile:
Sign(s) mounted
on side(s) of pole

Elevation:
Sign(s) mounted
on side(s) of pole

Profile:
Sign mounted in
front of pole

Elevation:
Sign mounted in
front of pole

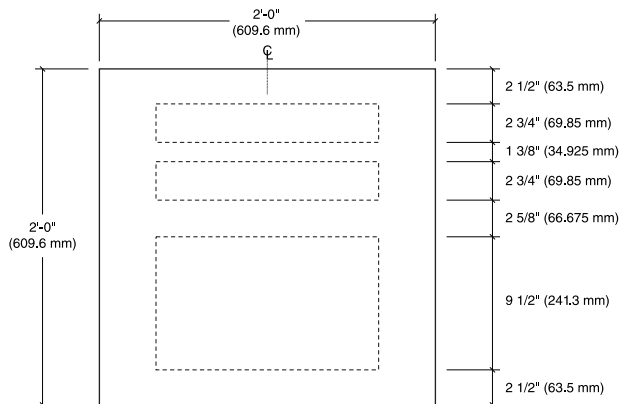

Message Layout A

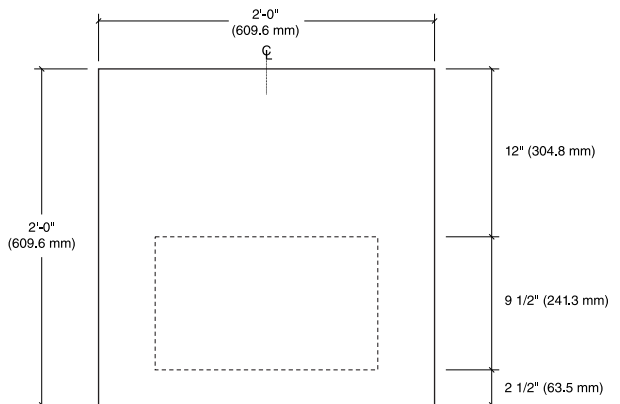

Message Layout B

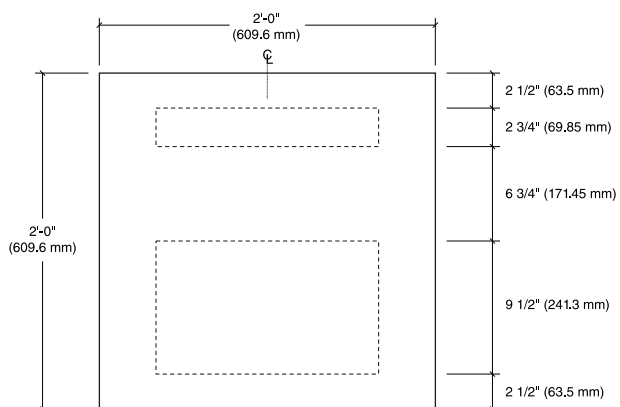

Message Layout C

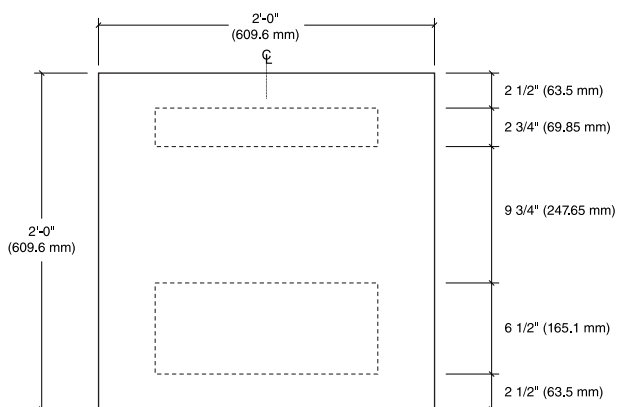

Message Layout D



PL-12.07

Parking Lot Signage Drawings

Wall Mounted Informational

Size

Sign Face:
3'-0" High x 2'-0" Wide
(914.4 mm H x 609.6 mm W)

Overall Sign Height:
7'-0" High (2133.6 mm)

Description

Non-illuminated panel sign with messages relevant to drivers and pedestrians. This sign can be used to communicate various informational or instructional messages.

Message Configuration

Refer to message layout drawing for dimensions.

Graphic Process

Surface applied reflective vinyl.

Colors

Text: White
Background & Post: Refer to the color chart in the Appendix.

Recommendations

Position sign where the message needs to be conveyed and text can be read from a reasonable distance.

See [Section 2.5.6](#) & [2.5.7](#) for exterior construction & installation details.

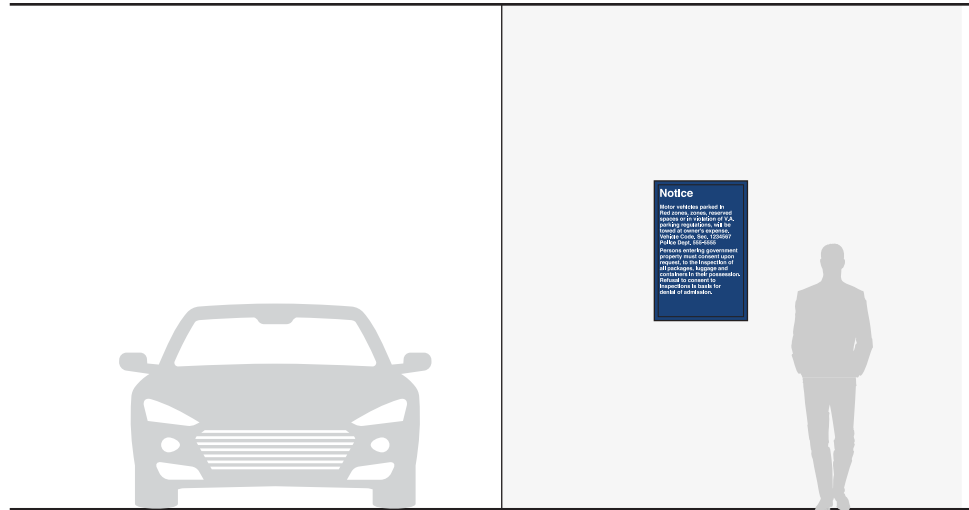

Message Layout

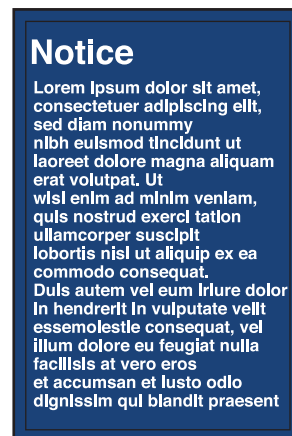

PL-12.07

Parking Lot Signage Drawings

Wall Mounted Informational

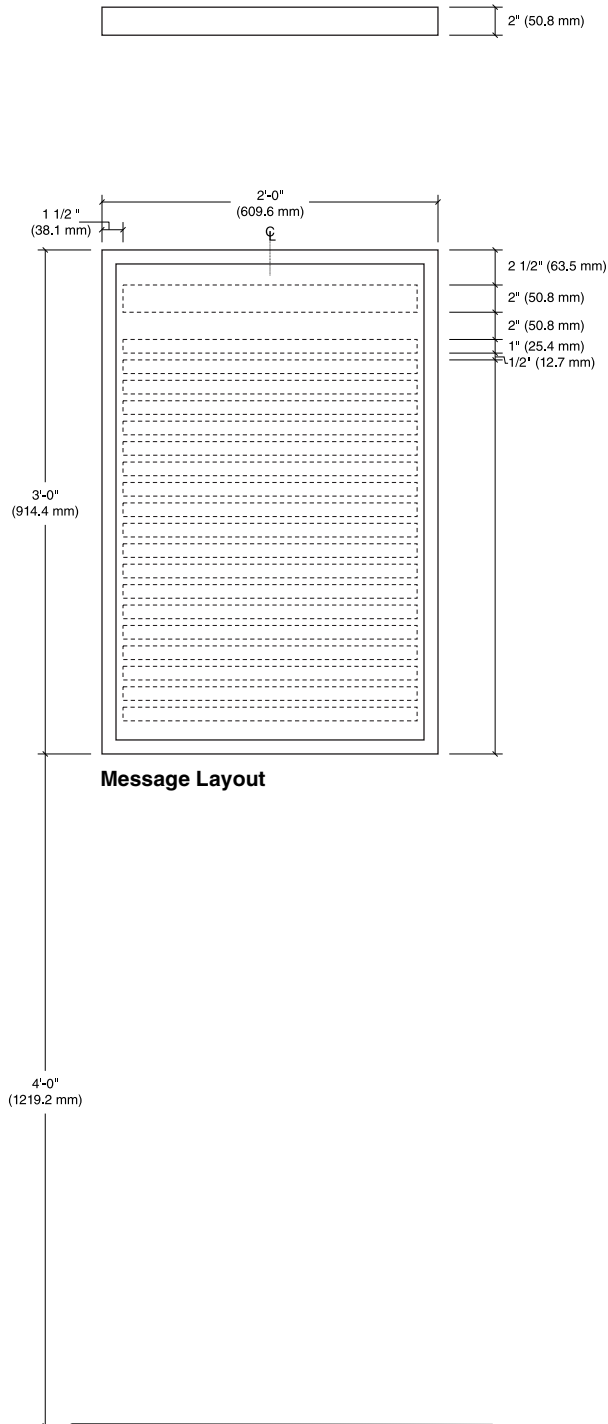

PL-12.08

Parking Lot Signage Drawings

Single Post & Panel Permit Parking Stall Designation

Size

Sign Face:
1'-6" High x 1'-0" Wide
(457.2 mm H x 304.8 mm W)

Description

Non-illuminated single post permit parking sign.

Message Configuration

Refer to message layout drawing for dimensions.

Graphic Process

Surface applied reflective vinyl.

Colors

Text: White & Black
Background: Red & White
Post: Refer to the color chart in the Appendix.

Installation

Position sign so drivers have a clear, unobstructed view of the sign.

When placing this type of sign near curbs or parking places, be sure the sign is set far enough back that over hanging front and back bumpers of automobiles do not come into contact with the signpost.

See [Section 2.5.6](#) & [2.5.7](#) for exterior construction & installation details.



Message Layout A



Message Layout B



Single Post & Panel Permit Parking Stall Designation

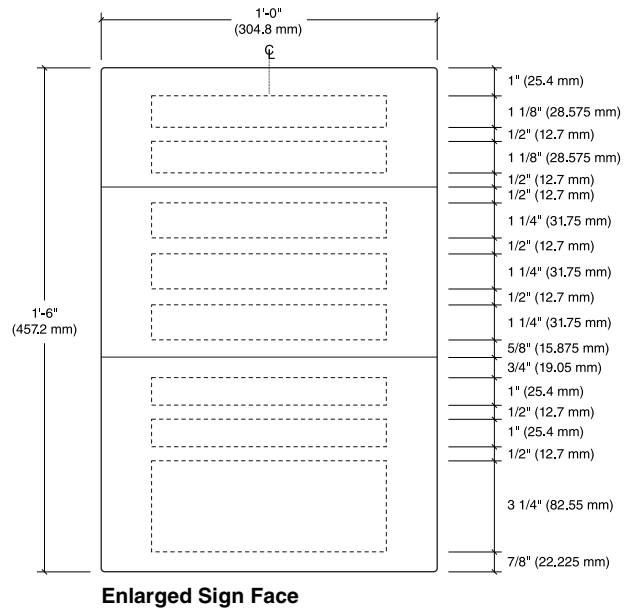
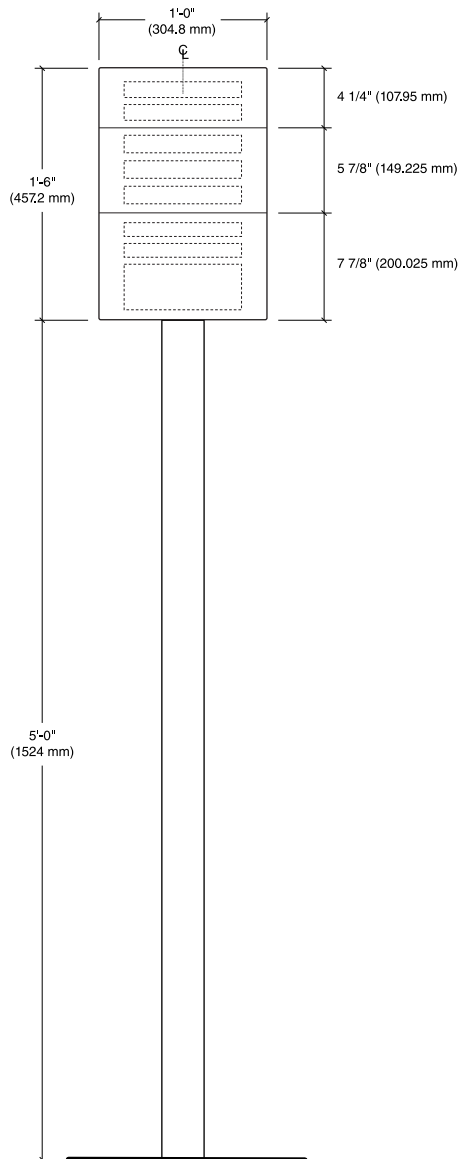
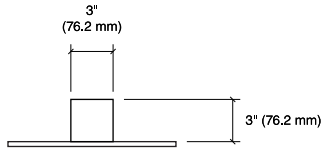

PL-12.09

Parking Lot Signage Drawings

Single Post & Panel Permit Parking Stall Designation

Size

Sign Face:
1'-9" High x 1'-0" Wide
(533.4 mm H x 304.8 mm W)

Description

Non-illuminated, van parking only, single post permit parking sign.

Message Configuration

Refer to message layout drawing for dimensions.

Graphic Process

Surface applied reflective vinyl.

Colors

Text: White & Black
Background: Red & White
Post: Refer to the color chart in the Appendix.

Installation

Position sign so drivers have a clear, unobstructed view of the sign.

When placing this type of sign near curbs or parking places, be sure the sign is set far enough back that over hanging front and back bumpers of automobiles do not come into contact with the signpost.

See [Section 2.5.6](#) & [2.5.7](#) for exterior construction & installation details.



Message Layout A



Message Layout B



Single Post & Panel Permit Parking Stall Designation

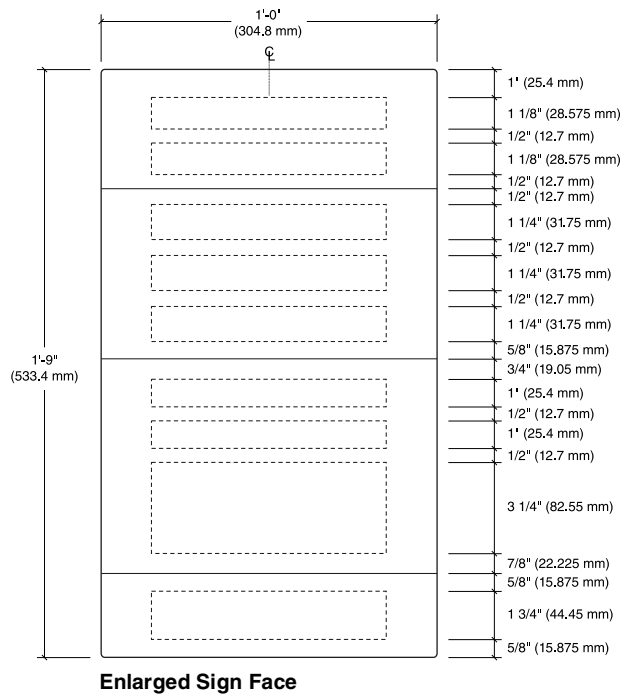
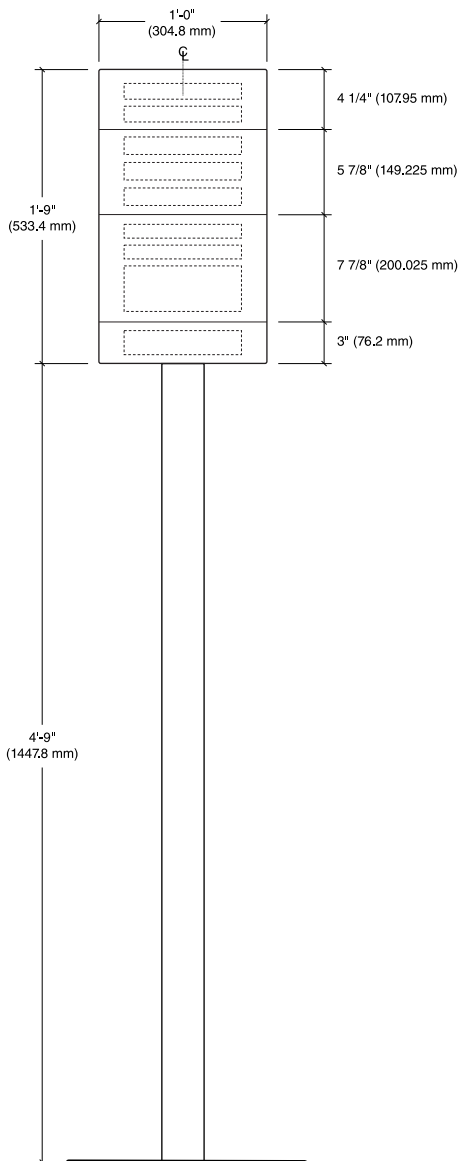
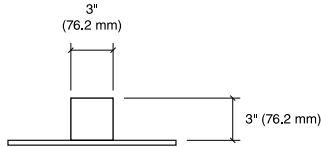

PL-13

Parking Lot Signage Drawings

Electronic Stall Availability Sign

Size

Size to vary depending upon number of lots indicated and electronic system used.

Description

Sign to inform visitors as to the number of available parking spaces per lot. Electronic counting devices record the number of cars that enter and exit the lot(s).

As this information changes, the corresponding number of parking stalls available per lot is reflected on the sign.

An alternate to an electronic sign that displays the actual number of available parking spaces is an electronic sign that only displays "open" when spaces are available and "full" when no spaces are available.

Sign Components

Sign cabinet with electronic occupancy information.

Graphic Process

Painted, screened or vinyl graphics with electronic (LED) occupancy information.

Colors

Color and materials to match rest of exterior parking signage.

Mounting

Post mounted.

Installation

It is recommended that this sign be placed at, or approaching, parking lot entry.

Electrical requirements for power and data to be coordinated prior to installation.

See [Section 2.5.6](#) & [2.5.7](#) for exterior construction & installation details.

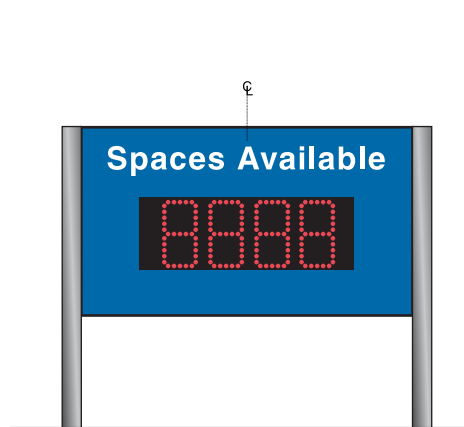
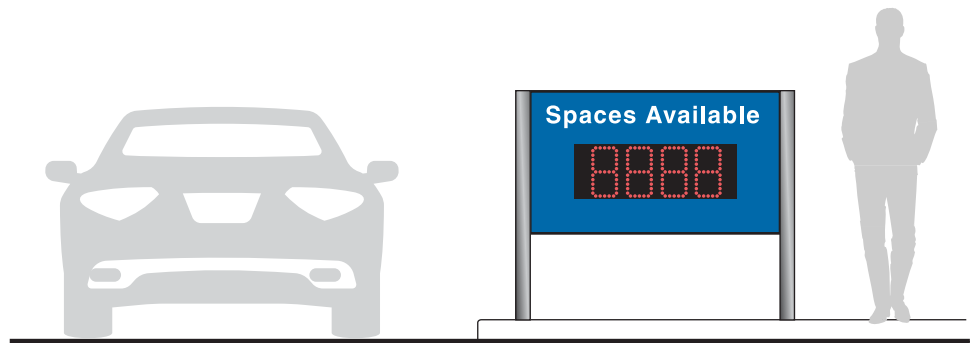

Example of single lot parking availability sign



Alternate to parking space availability sign

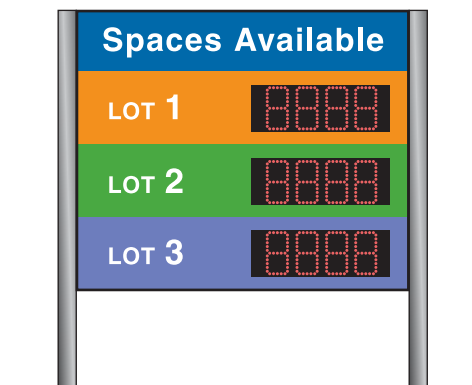
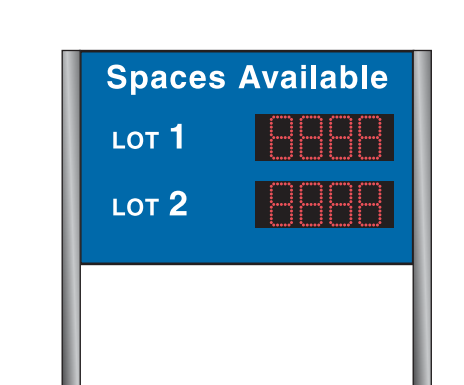

Examples of signs indicating parking availability for multiple lots. Sign on the right illustrates the integration of a color-coded system



Electronic Stall Availability Sign

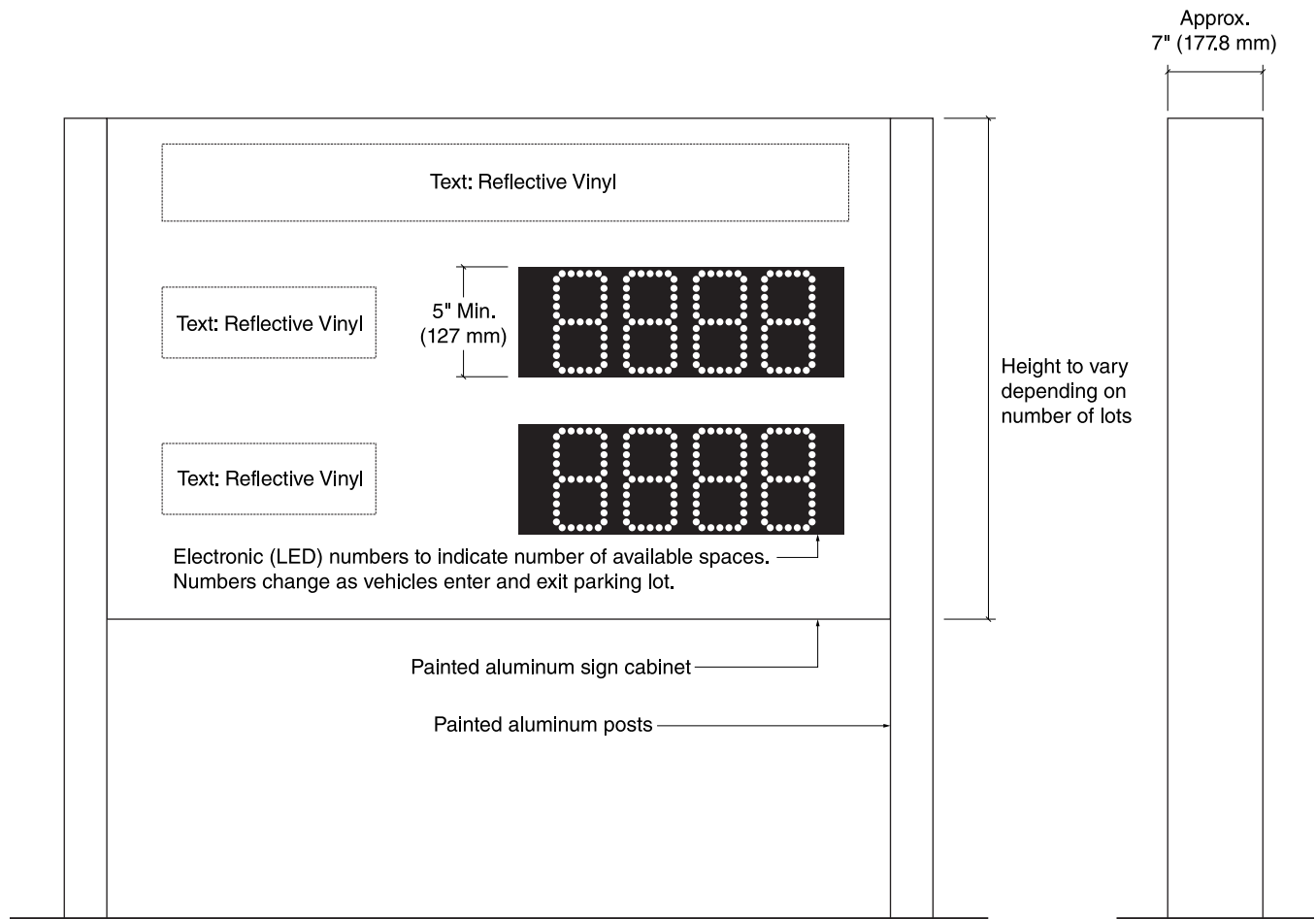

PL-15

Parking Lot Signage Drawings

Painted Stall Identification Number

Description

Painted parking stall numbers.

Graphic Process

Painted stenciled numbers.

Colors

Colors need to contrast the parking lot pavement. If the pavement is light in color, the numbers should be black. If the pavement is a dark color, the numbers should be white or yellow.

Recommendations

Stalls can be assigned a designated number based on a logical and sequential stall numbering system.

It is recommended that each number be painted at the isle facing end of each stall. The ideal number height is 6" (152.4 mm). Numbers should be no less than 4" (101.6 mm) in height.

See [Section 2.5.6](#) & [2.5.7](#) for exterior construction & installation details.

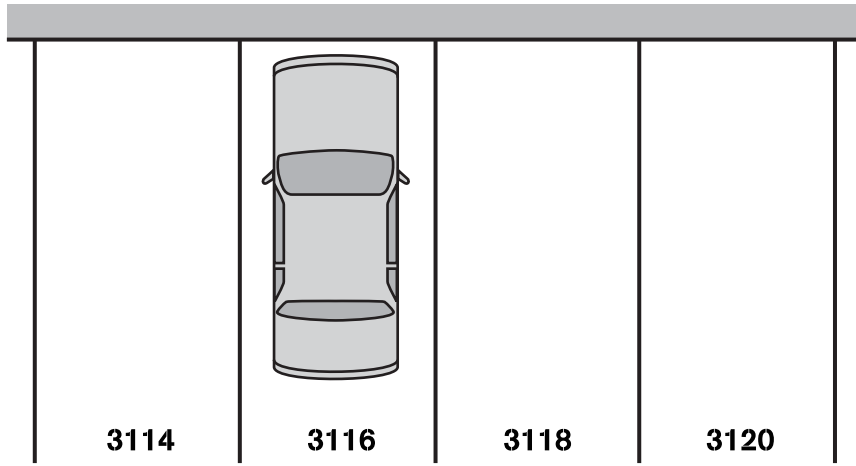

DRIVE AISLE

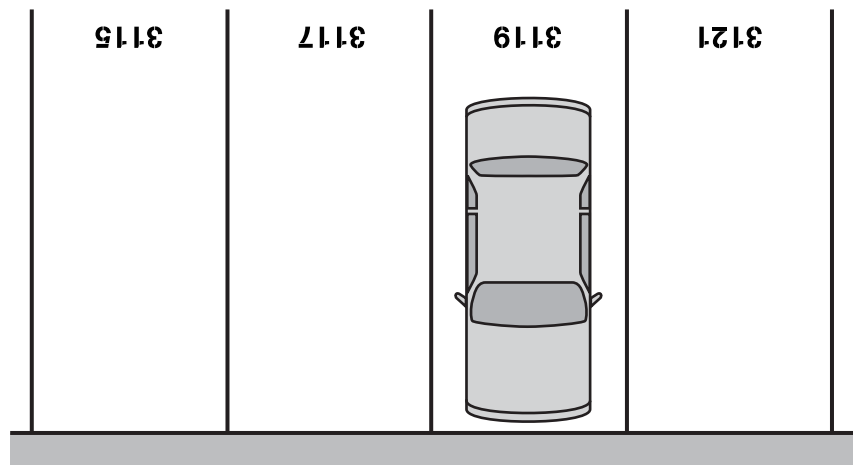

Painted Stall Identification Number

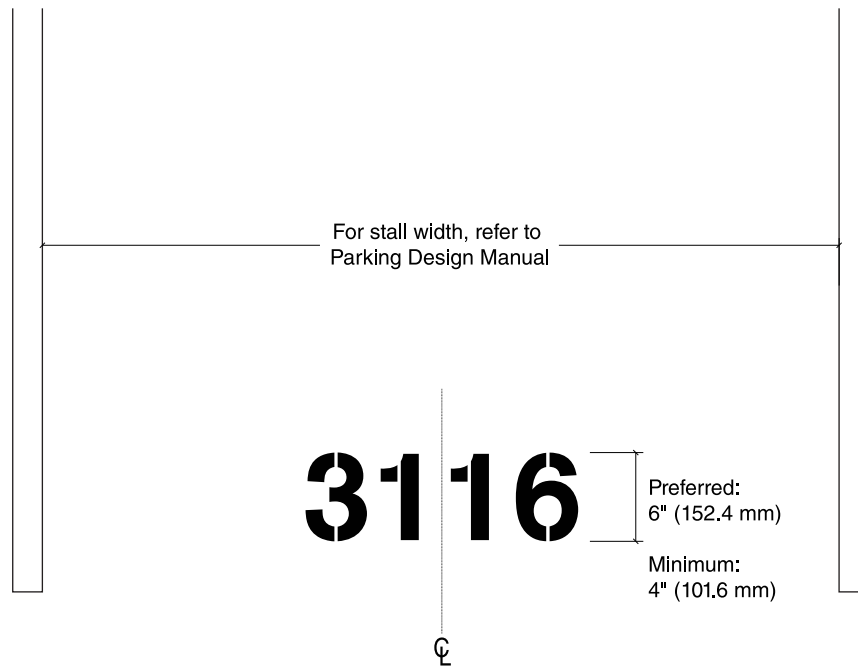



U.S. Department
of Veterans Affairs

SECTION 3.6

PARKING STRUCTURE SIGNAGE DRAWINGS



Introduction

This section provides detailed drawings of all typical sign types and graphics for parking structures at VA facilities. Individual facilities may have unique conditions that require modifications or additional sign types not shown in the Manual. The drawings can be used as a starting point to develop a facility-specific parking structure sign standard using colors, graphics, and icons that tie into the wayfinding plan.

Guidelines

- For more information on developing the look of the sign system, including VA standard fonts, arrows, and color suggestions, refer to [Section 4.1 Design Elements](#). Color palettes are intended as suggestions and usage is not required. Colors, materials, and finishes used in parking structure signage should complement and enhance the appearance of campus environments whenever possible.
- Please review [Section 2.6 Parking Structure Signage Guidelines](#) which contains information regarding Planning, Programming, Construction, and Installation prior to starting signage projects.

Requirements

- Helvetica Lt Std is the standard font required for use in signage at all VA facilities with the exclusion of National Cemetery Administration locations.

Sign Designations

Each sign in the program manual has been given a specific sign type number designation. This designation provides a common description that can be referenced when programming a site and ordering signs. The following explains how the sign type designations are derived.

PS - 01 .01 A

PS Designates a parking structure sign.

01 Two digit number identifies the sign type family.

.01 The two digit number following the period identifies a specific sign within the sign family.

A The letter designates a specific sign configuration, version and / or layout for graphics or symbols.



Sign Overview

Parking Structure Signage Drawings

Sign Type PS-01

Ceiling-Hung Non-Illuminated
Directional Sign with Vinyl Lettering

PS-01.01

22" – Long Ceiling-Hung
Directional

PS-01.02

22" – Short Ceiling-Hung
Directional

PS-01.03

15" – Long Ceiling-Hung
Directional

PS-01.04

15" – Short Ceiling-Hung
Directional



PS-01.01



PS-01.02



PS-01.03



PS-01.04

Sign Type PS-02

Beam-Mounted Non-Illuminated
Directional Sign with Vinyl Lettering

PS-02.01

22" – Long Beam-Mounted
Directional

PS-02.02

22" – Short Beam-Mounted
Directional

PS-02.03

15" – Long Beam-Mounted
Directional

PS-02.04

15" – Short Beam-Mounted
Directional



PS-02.01



PS-02.02



PS-02.03



PS-02.04



Sign Overview

Parking Structure Signage Drawings

Sign Type PS-03

Wall-Mounted Level Identification and Directional

PS-03.01

Small Wall-Mounted Level Identification and Directional

PS-03.02

Large Wall-Mounted Level Identification and Directional

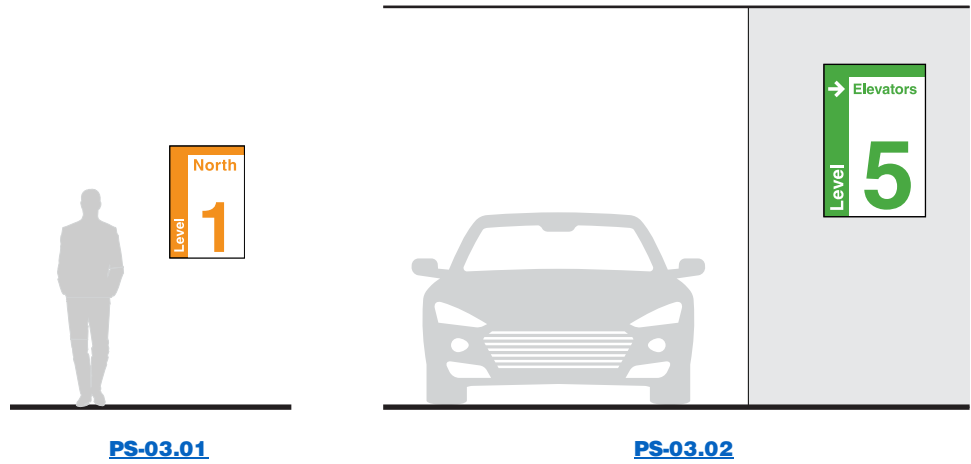

PS-03.03

Elevator Core Branding and Directional

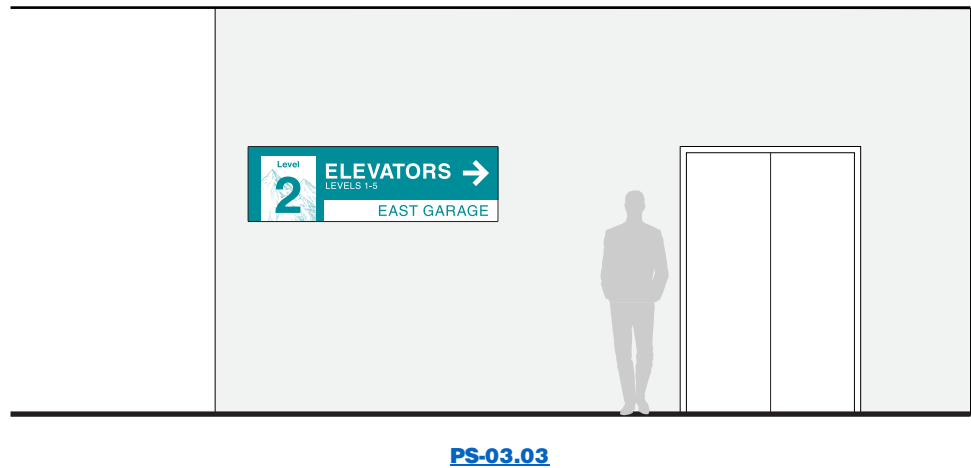

Sign Type PS-04

Wall-Mounted Warning Sign

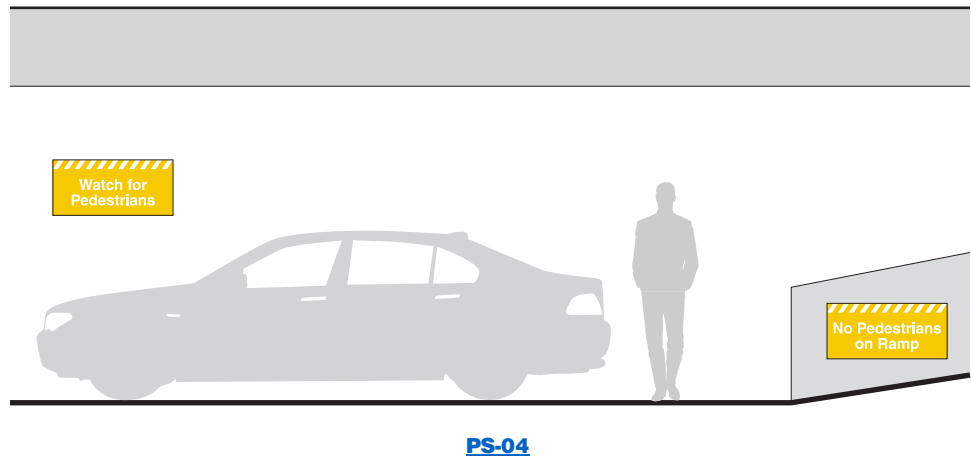

Sign Overview

Parking Structure Signage Drawings

Sign Type PS-05

Column-Mounted Level Marker

PS-05.01

Square Column Marker

PS-05.02

Narrow Column Marker

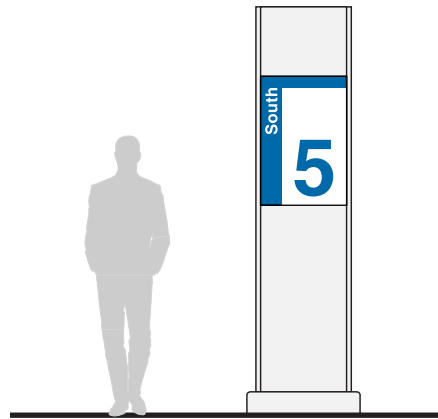

PS-05.01

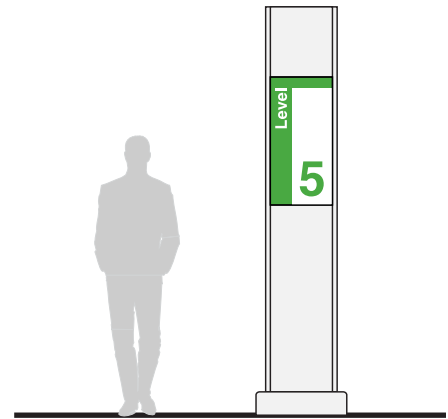

PS-05.02

PS-05.03

Round Column Marker

PS-05.04

Small Round Column Marker - Painted

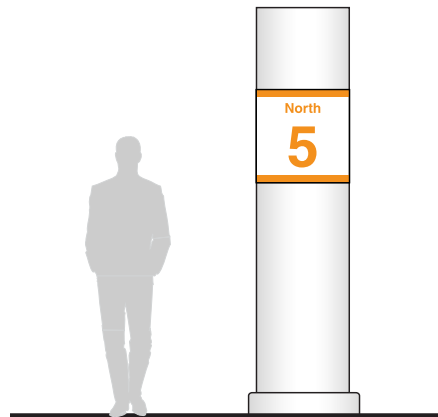

PS-05.03

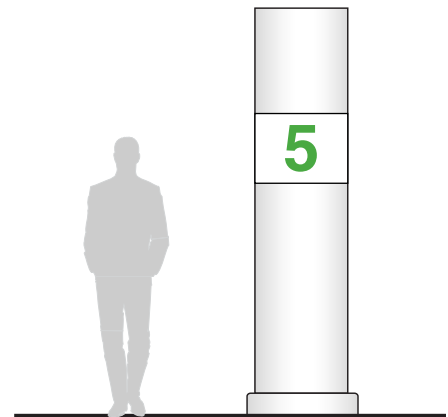

PS-05.04

PS-05.05

Pole-Mounted Marker

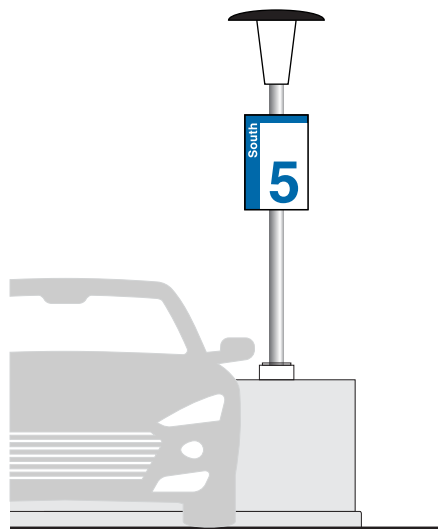

PS-05.05



Sign Overview

Parking Structure Signage Drawings

Sign Type PS-06

Elevator Identification

Sign Type PS-07

Elevator Level Directory

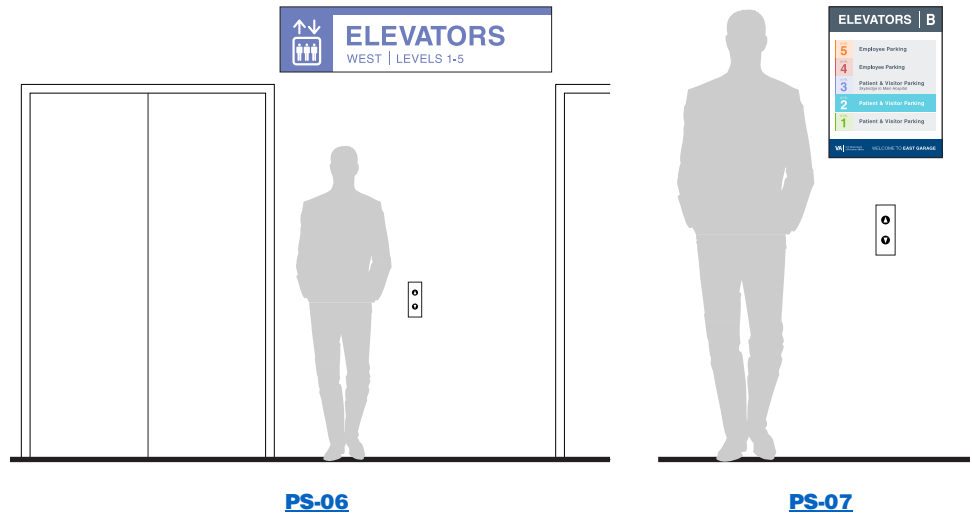

Sign Type PS-08, PS-09, & PS-10

Entrance / Occupancy signs

PS-08

Dimensional Letters

PS-09

Clearance Height Bar

PS-10

Electronic Lane Use Sign

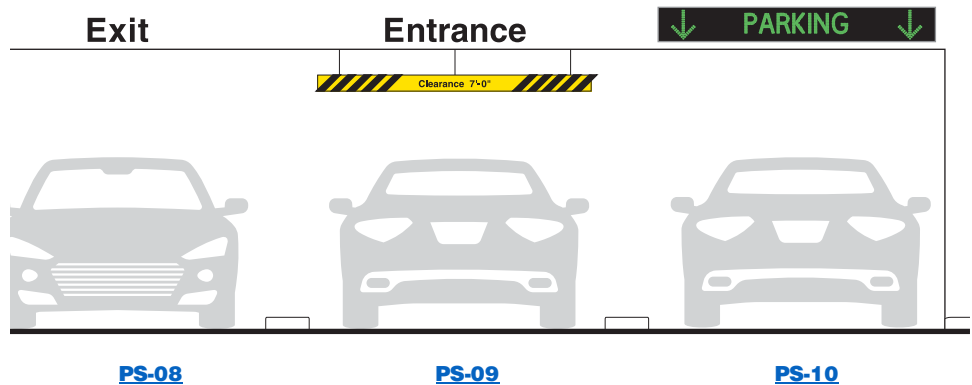

Sign Type PS-11

Entrance and Exit Identification

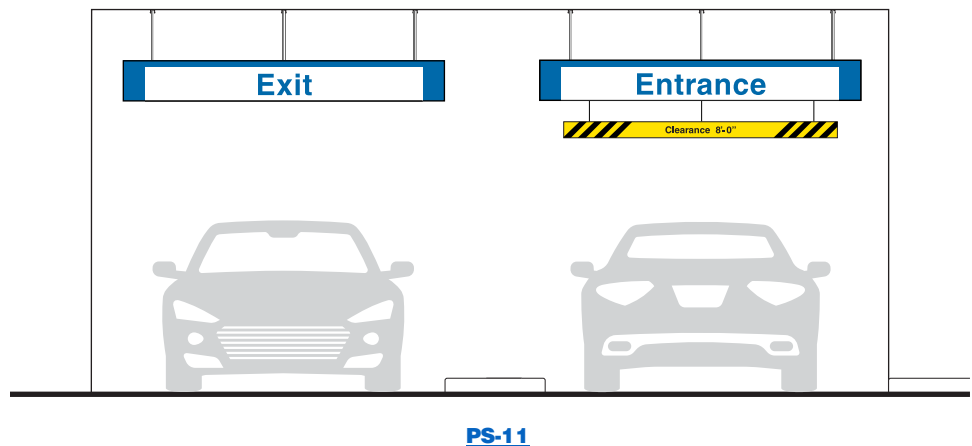

Sign Overview

Parking Structure Signage Drawings

Sign Type PS-12

Panel Informational Signs

PS-12.03

Parking Stall Designation

PS-12.04

Accessible Parking Stall

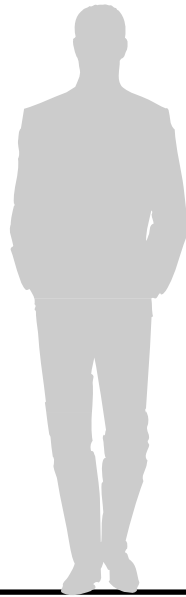

PS-12.03



PS-12.04

PS-12.05

Accessible Parking Area

PS-12.07

Informational Panel



PS-12.05

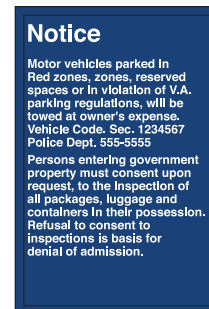

PS-12.07



Sign Overview

Parking Structure Signage Drawings

Sign Type PS-13

Electronic Stall Availability Sign

Sign Type PS-14

Exterior Building-Mounted Parking Directional / Availability Sign

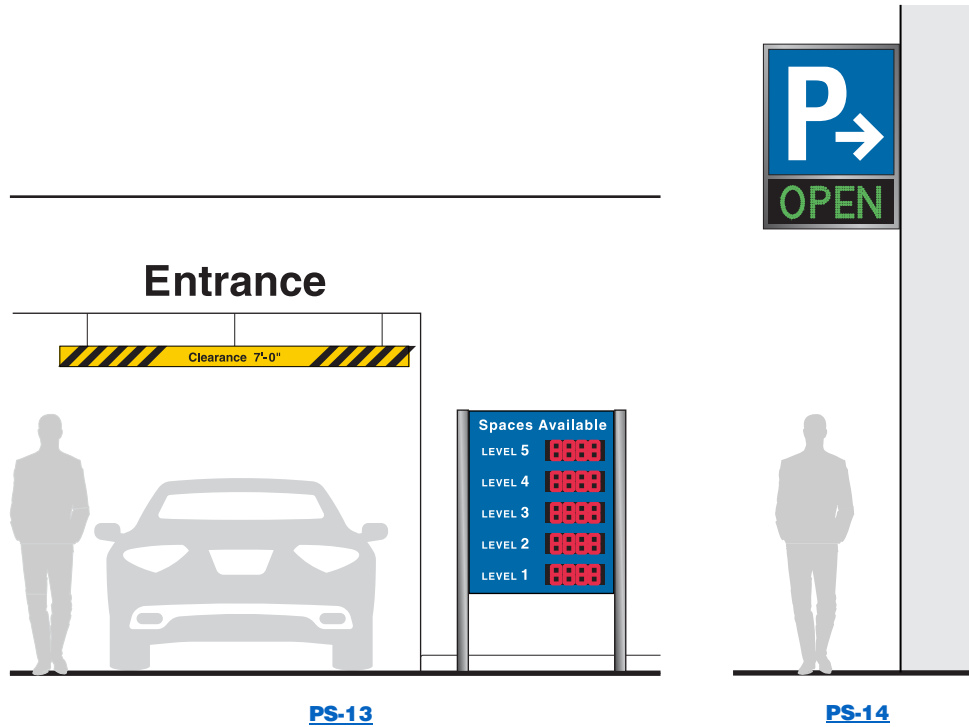

Sign Type PS-15

Painted Parking Stall Identification

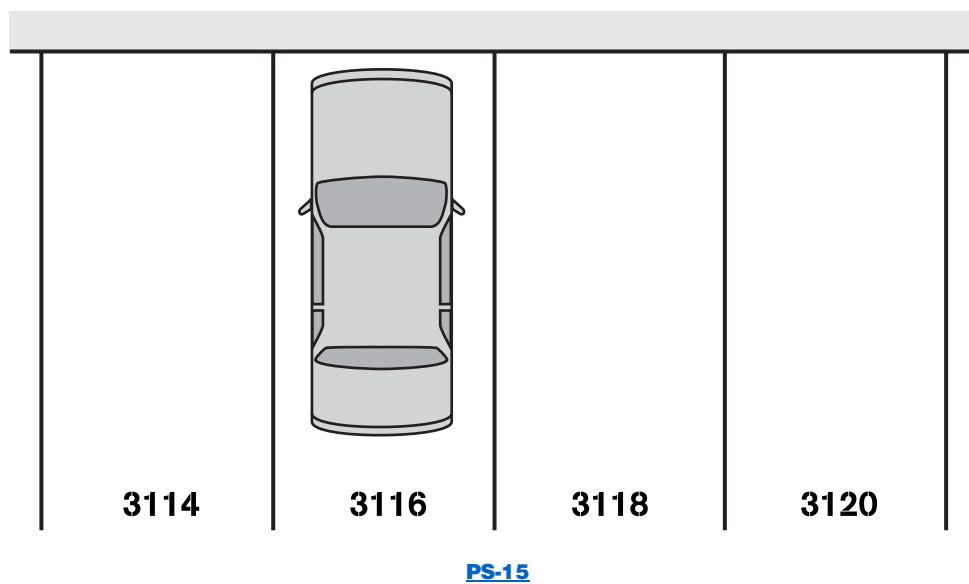

Sign Overview

Parking Structure Signage Drawings

Additional Signage

Coordinate with signs from other Sections as required.

See [Section 3.1 Interior Signage Drawings](#), [Section 3.2 Code & Life Safety Signage Drawings](#), and [Section 3.3 Mandatory VA Policy & Directive Signage Drawings](#) for more information.

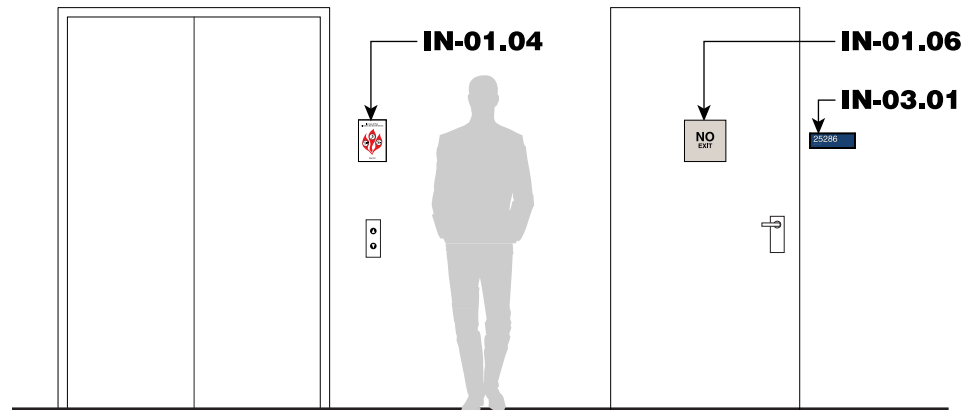

Regulatory Signs

Refer to Sign Type EN-10 in [Section 3.5 Exterior Signage Drawings](#) for more information.

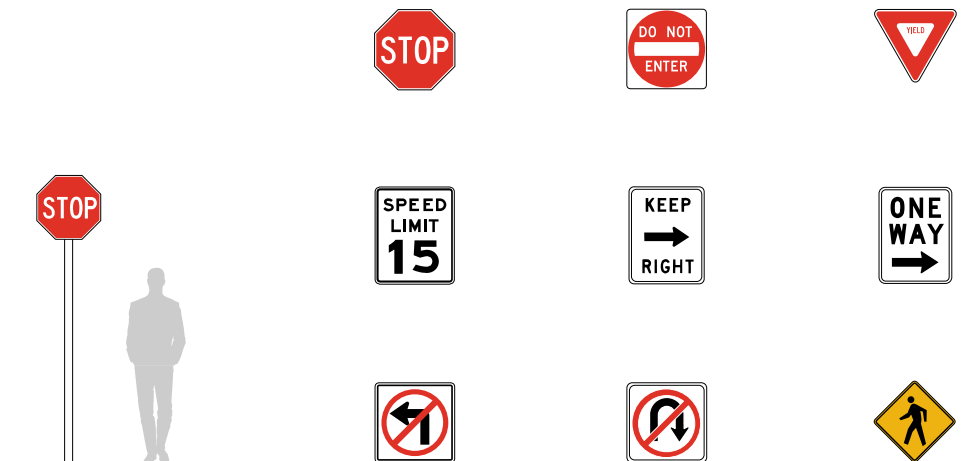

PS-01.01

Parking Structure Signage Drawings

22" – Long Ceiling-Hung Directional

Size

Sign Face:
22" High x 120" Wide
(558.8 mm H x 3048 mm W)

Description & Use

Non-illuminated, ceiling-hung sign. This sign type is directed to drivers, providing them with information such as the exit, additional parking, and locations of elevators or stairs.

Message Configuration

Refer to message layout drawing for dimensions.

Message Layout A

Allows for two message fields at a larger type size.

Message Layout B

Allows for up to four message fields at a smaller type size.

Graphic Process

Surface applied vinyl.

Colors

Refer to the color chart in the Appendix.

Recommendations

Position sign so visibility is not obstructed by building support beams. Align sign with flow of traffic.

See [Section 2.6.5](#) & [2.6.6](#) for construction & installation details.

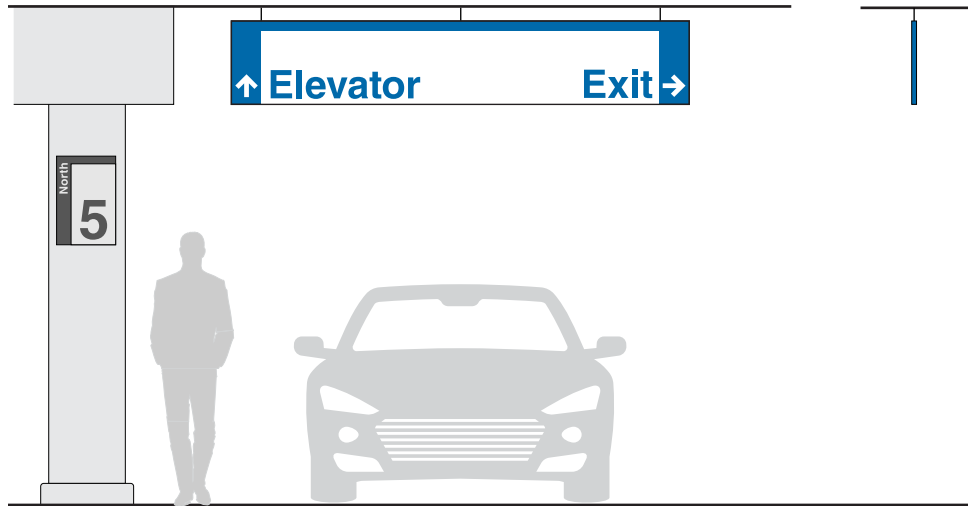

Message Layout A



Message Layout B



22" – Long Ceiling-Hung Directional

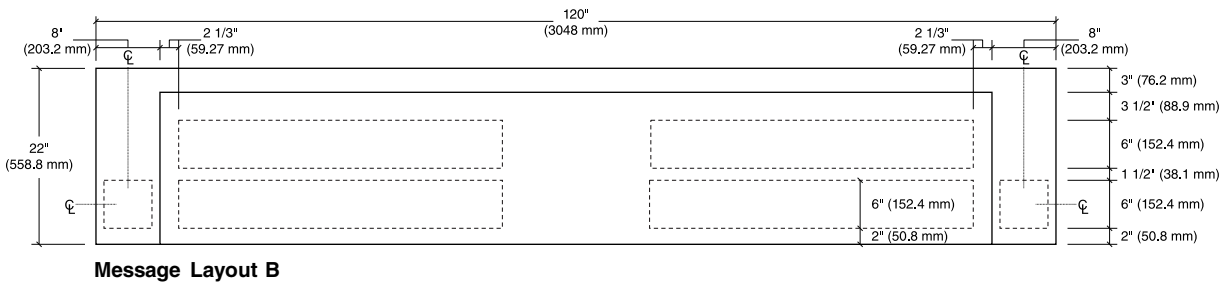
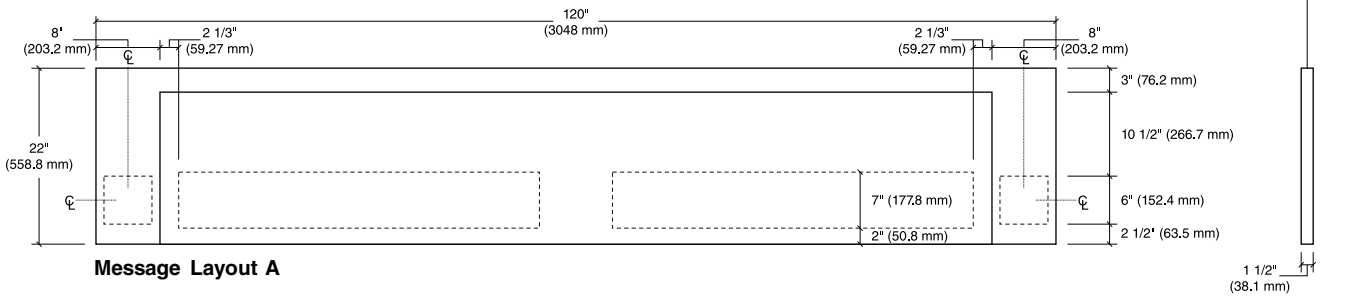

PS-01.02

Parking Structure Signage Drawings

22" – Short Ceiling-Hung Directional

Size

Sign Face:
22" High x 72" Wide
(558.8 mm H x 1828.8 mm W)

Description & Use

Non-illuminated, ceiling-hung sign. This sign type is directed to drivers, providing them with information such as the exit, additional parking, and locations of elevators or stairs.

Message Configuration

Refer to message layout drawing for dimensions.

Message Layout A

Allows for one message field at a larger type size.

Message Layout B

Allows for two message fields at a smaller type size.

Graphic Process

Surface applied vinyl.

Colors

Refer to the color chart in the Appendix.

Recommendations

Position sign so visibility is not obstructed by building support beams. Align sign with flow of traffic.

See [Section 2.6.5](#) & [2.6.6](#) for construction & installation details.

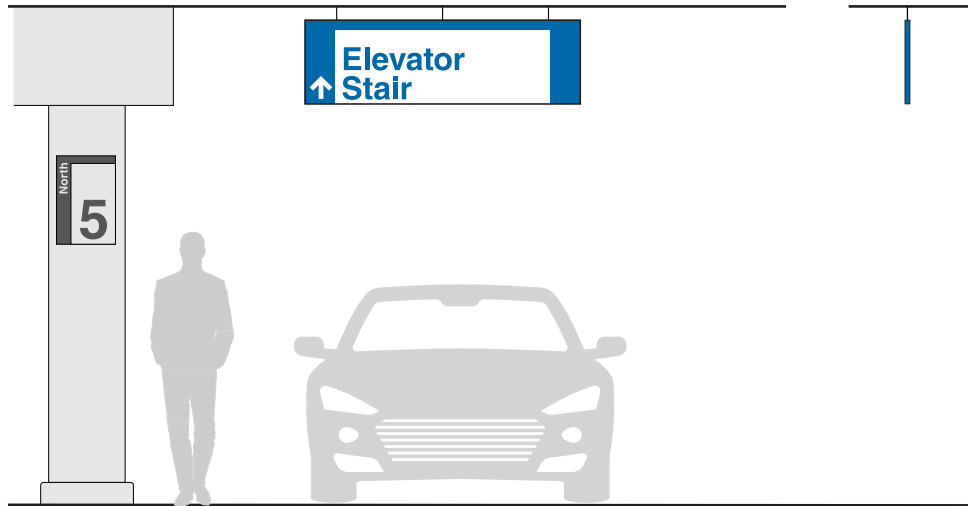

Message Layout A



Message Layout B



22" – Short Ceiling-Hung Directional

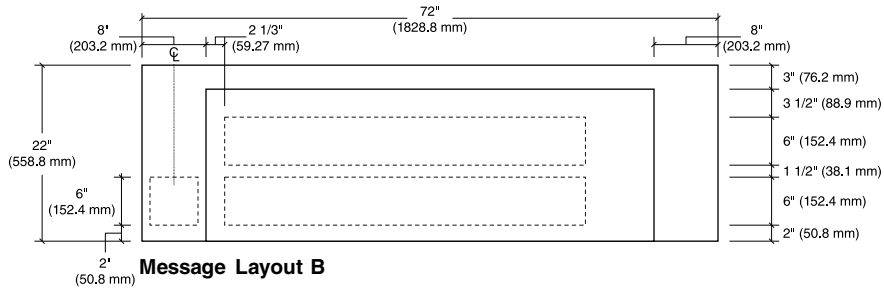
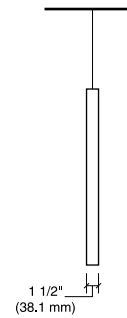
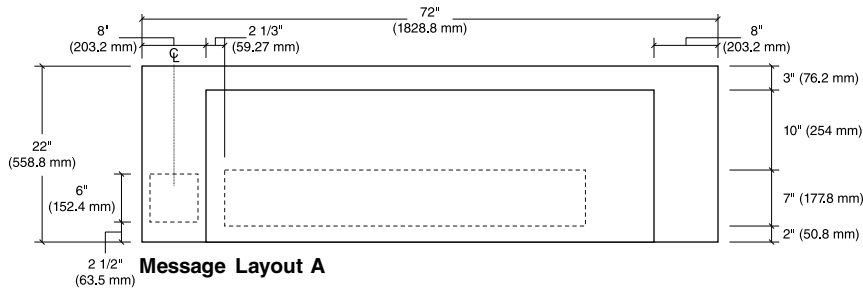

PS-01.03

Parking Structure Signage Drawings

15" – Long Ceiling-Hung Directional

Size

Sign Face:
15" High x 120" Wide
(381 mm H x 3048 mm W)

Description & Use

Non-illuminated, ceiling-hung sign. This sign type is directed to drivers, providing them with information such as the exit, additional parking, and locations of elevators or stairs.

Message Configuration

Refer to message layout drawing for dimensions.

Message Layout A

Allows for two message fields at a larger type size.

Message Layout B

Allows for four message fields at a smaller type size.

Graphic Process

Surface applied vinyl.

Colors

Refer to the color chart in the Appendix.

Recommendations

Position sign so visibility is not obstructed by building support beams. Align sign with flow of traffic.

See [Section 2.6.5](#) & [2.6.6](#) for construction & installation details.

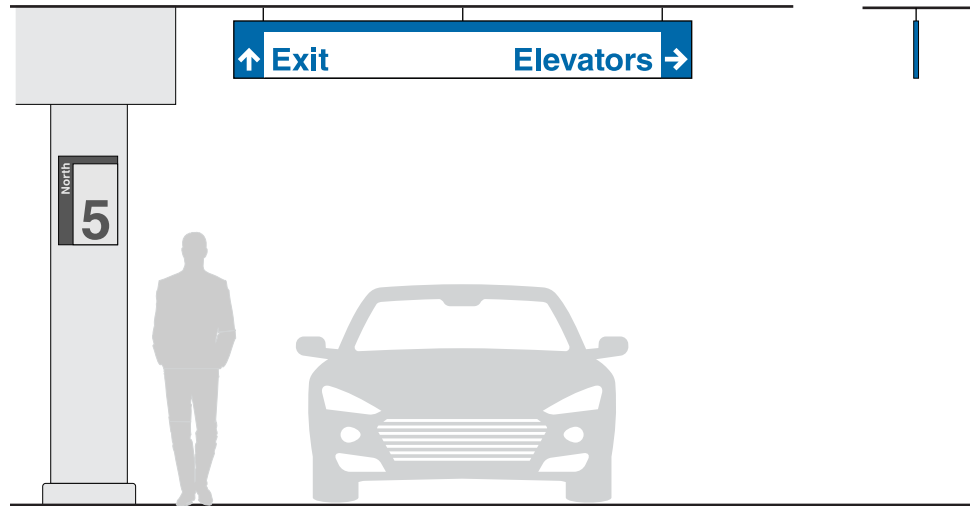

Message Layout A



Message Layout B



PS-01.03

Parking Structure Signage Drawings

15" – Long Ceiling-Hung Directional

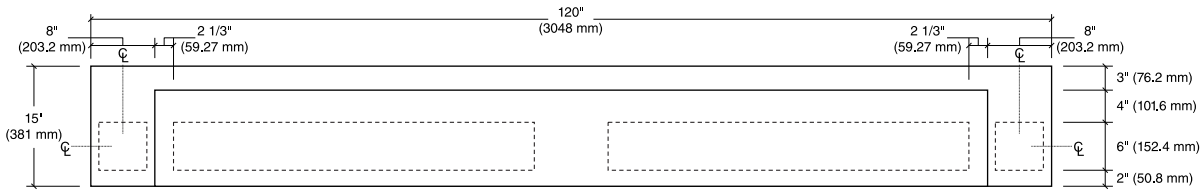

Message Layout A

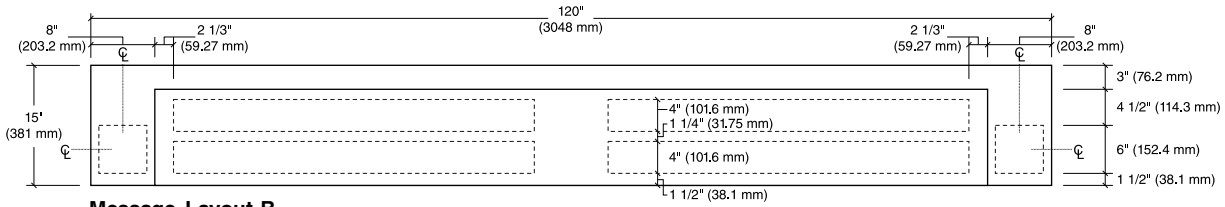
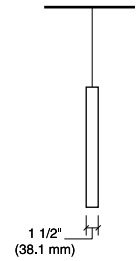

Message Layout B



PS-01.04

Parking Structure Signage Drawings

15" – Short Ceiling-Hung Directional

Size

Sign Face:
15" High x 72" Wide
(381 mm H x 1829 mm W)

Description & Use

Non-illuminated, ceiling-hung sign. This sign type is directed to drivers, providing them with information such as the exit, additional parking, and locations of elevators or stairs.

Message Configuration

Refer to message layout drawing for dimensions.

Message Layout A

Allows for one message field at a larger type size.

Message Layout B

Allows for two message fields at a smaller type size.

Graphic Process

Surface applied vinyl.

Colors

Refer to the color chart in the Appendix.

Recommendations

Position sign so visibility is not obstructed by building support beams. Align sign with flow of traffic.

See [Section 2.6.5](#) & [2.6.6](#) for construction & installation details.

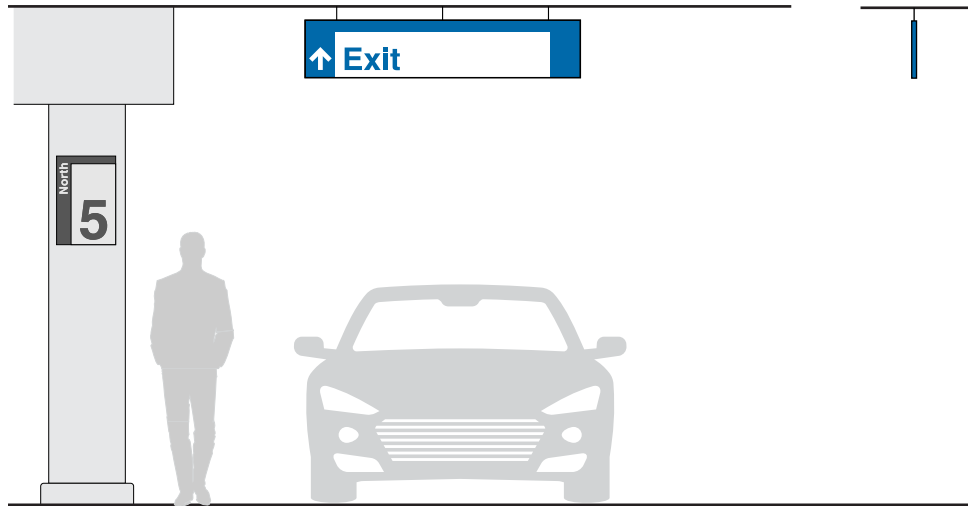

Message Layout A



Message Layout B



15" – Short Ceiling-Hung Directional

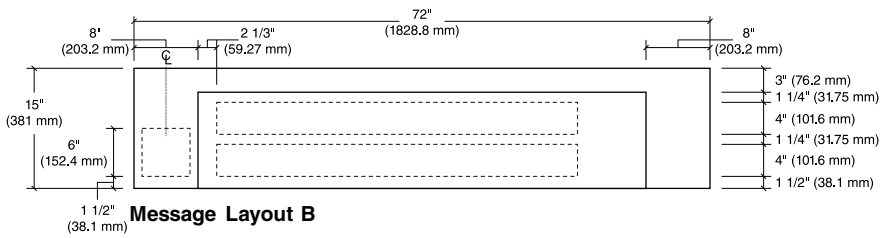
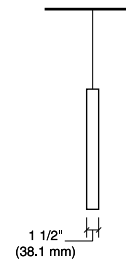
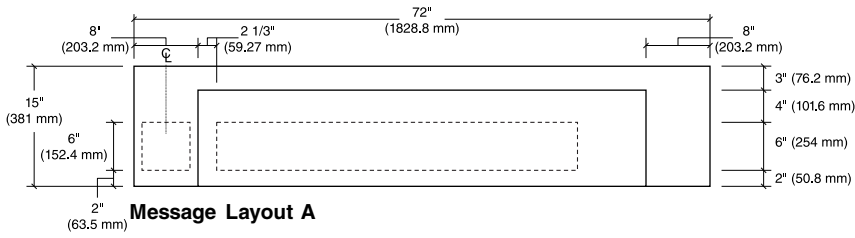

PS-02.01

Parking Structure Signage Drawings

22" – Long Beam-Mounted Directional

Size

Sign Face:
22" High x 120" Wide
(558.8 mm H x 3048 mm W)

Description & Use

Non-illuminated, beam-mounted sign. This sign type is directed to drivers, providing them with information such as the exit, additional parking, and locations of elevators or stairs.

Message Configuration

Refer to message layout drawing for dimensions.

Message Layout A

Allows for two message fields at a larger type size.

Message Layout B

Allows for up to four message fields at a smaller type size.

Graphic Process

Surface applied vinyl.

Colors

Refer to the color chart in the Appendix.

Recommendations

Position sign on bottom edge of beam / soffit and align sign with flow of traffic.

See [Section 2.6.5](#) & [2.6.6](#) for construction & installation details.

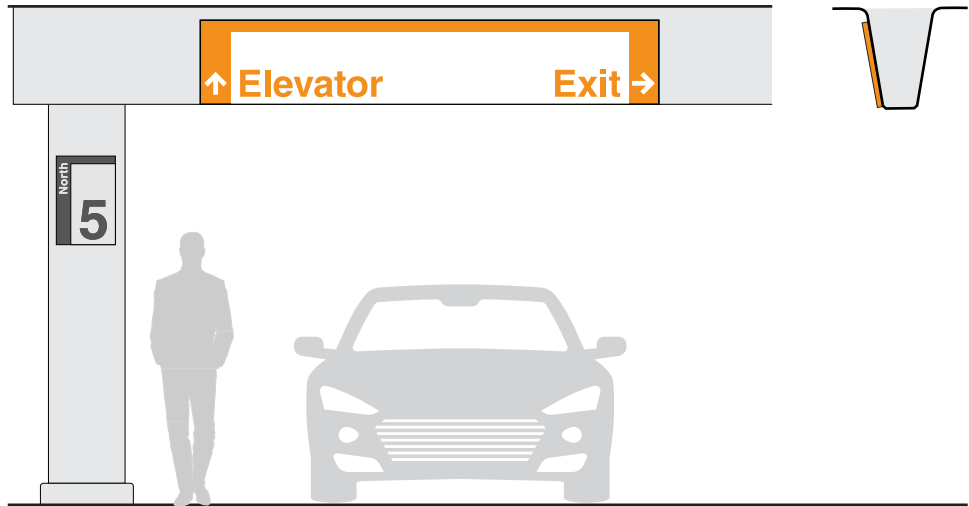

Message Layout A



Message Layout B



22" – Long Beam-Mounted Directional

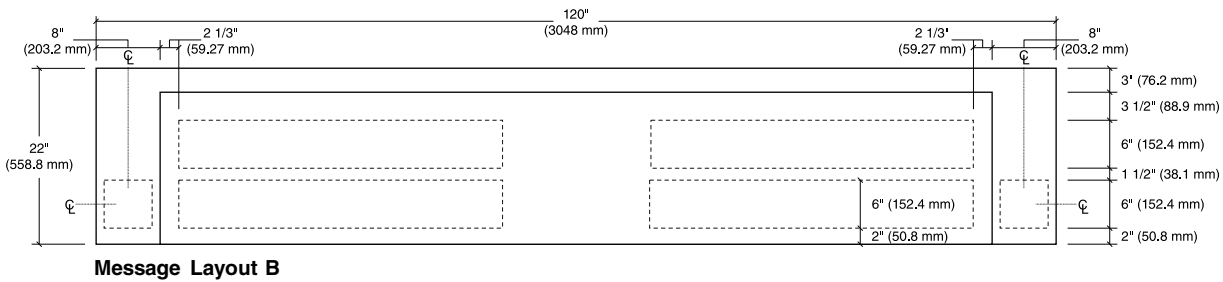
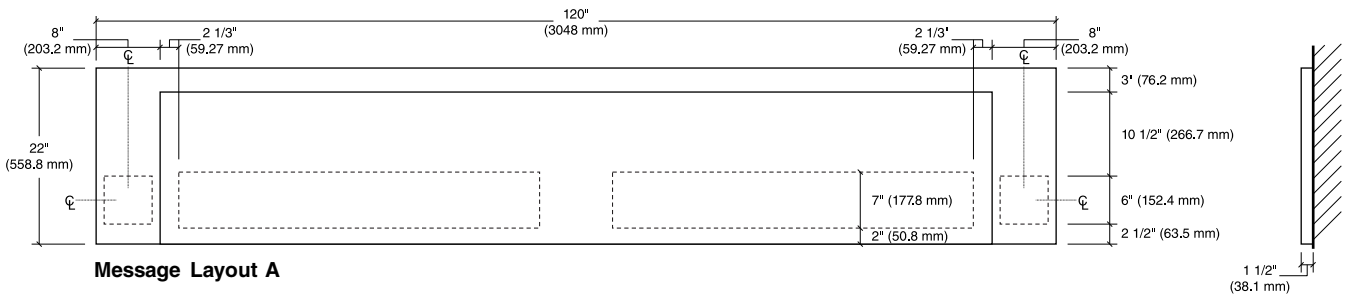

22" – Short Beam-Mounted Directional

Size

Sign Face:
22" High x 72" Wide
(558.8 mm H x 1828.8 mm W)

Description & Use

Non-illuminated, beam-mounted sign. This sign type is directed to drivers, providing them with information such as the exit, additional parking, and locations of elevators or stairs.

Message Configuration

Refer to message layout drawing for dimensions.

Message Layout A

Allows for one message field at a larger type size.

Message Layout B

Allows for two message fields at a smaller type size.

Graphic Process

Surface applied vinyl.

Colors

Refer to the color chart in the Appendix.

Recommendations

Position sign on bottom edge of beam / soffit and align sign with flow of traffic.

See [Section 2.6.5](#) & [2.6.6](#) for construction & installation details.

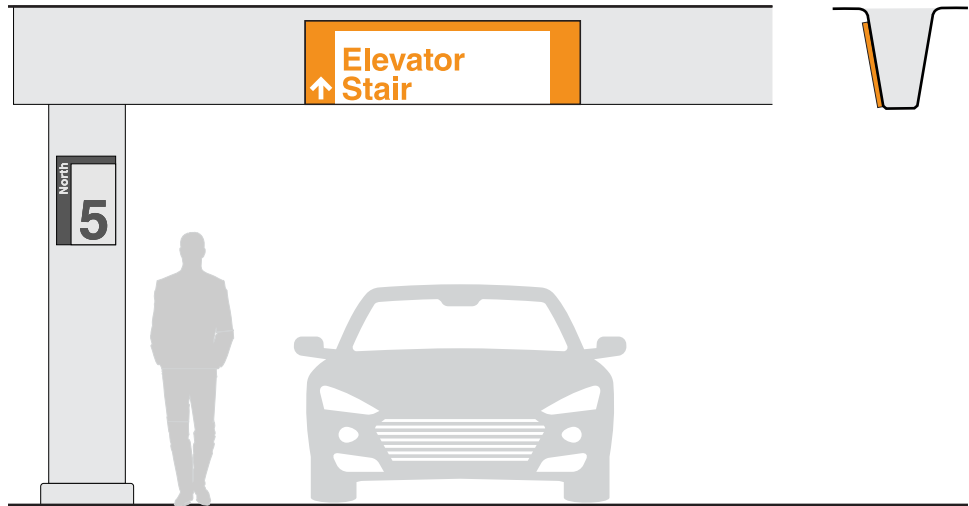

Message Layout A



Message Layout B



22" – Short Beam-Mounted Directional

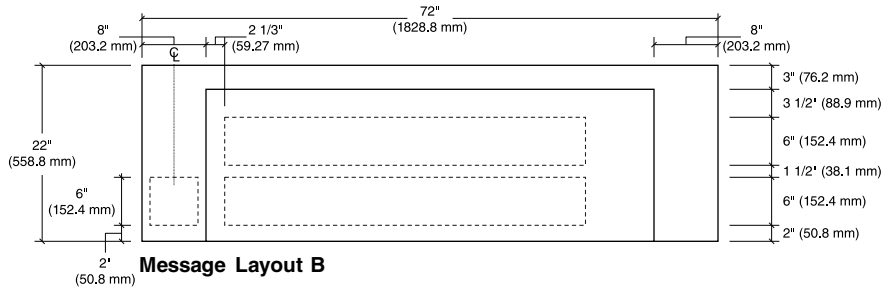
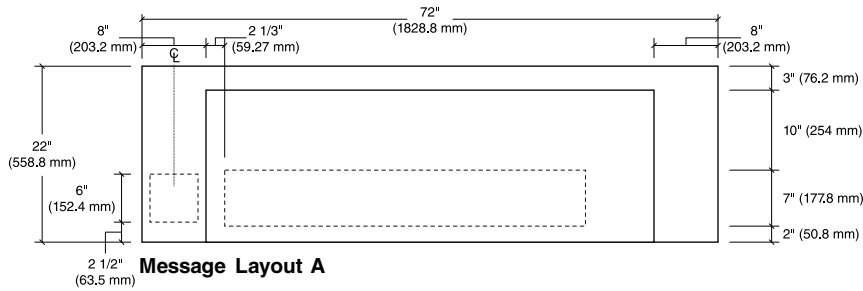

PS-02.03

Parking Structure Signage Drawings

15" – Long Beam-Mounted Directional

Size

Sign Face:
15" High x 120" Wide
(381 mm H x 3048 mm W)

Description & Use

Non-illuminated, beam-mounted sign. This sign type is directed to drivers, providing them with information such as the exit, additional parking, and locations of elevators or stairs.

Message Configuration

Refer to message layout drawing for dimensions.

Message Layout A

Allows for two message fields at a larger type size.

Message Layout B

Allows for four message fields at a smaller type size.

Graphic Process

Surface applied vinyl.

Colors

Refer to the color chart in the Appendix.

Recommendations

Position sign on bottom edge of beam / soffit and align sign with flow of traffic.

See [Section 2.6.5](#) & [2.6.6](#) for construction & installation details.

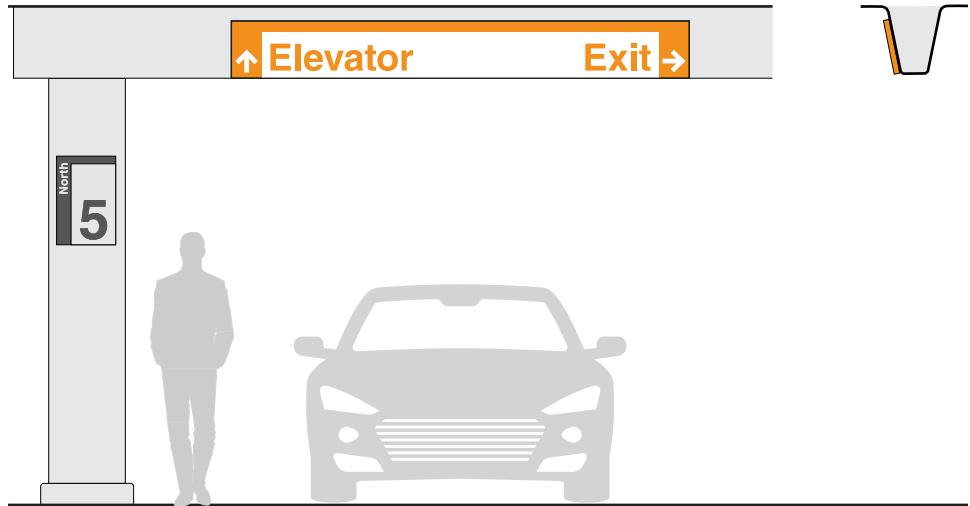

Message Layout A



Message Layout B



15" – Long Beam-Mounted Directional

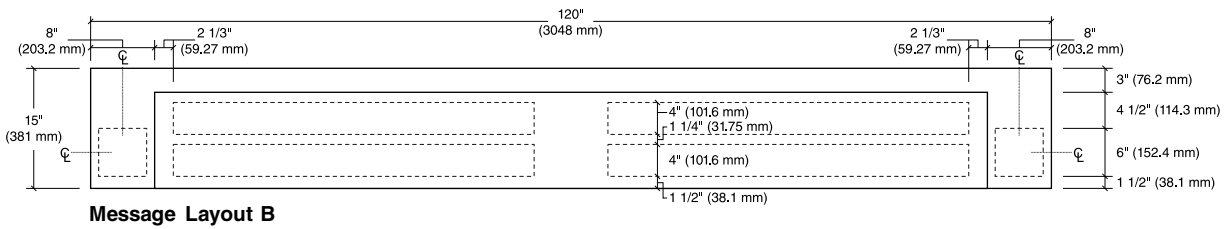
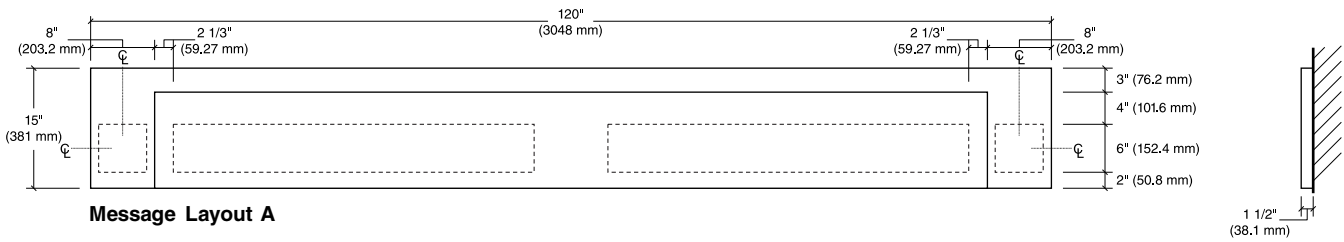

15" – Short Beam-Mounted Directional

Size

Sign Face:
15" High x 72" Wide
(381 mm H x 1828.8 mm W)

Description & Use

Non-illuminated, beam-mounted sign. This sign type is directed to drivers, providing them with information such as the exit, additional parking, and locations of elevators or stairs.

Message Configuration

Refer to message layout drawing for dimensions.

Message Layout A

Allows for one message field at a larger type size.

Message Layout B

Allows for two message fields at a smaller type size.

Graphic Process

Surface applied vinyl.

Colors

Refer to the color chart in the Appendix.

Recommendations

Position sign on bottom edge of beam / soffit and align sign with flow of traffic.

See [Section 2.6.5](#) & [2.6.6](#) for construction & installation details.

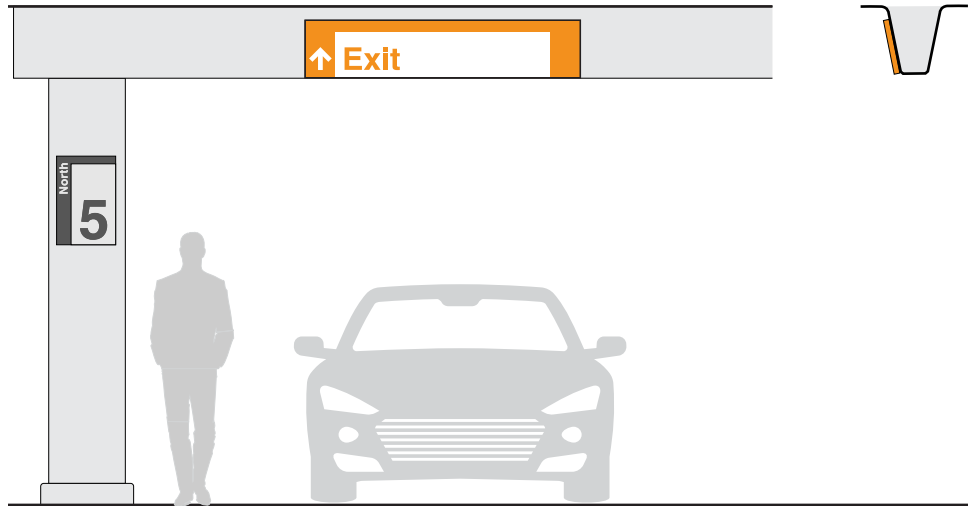

Message Layout A



Message Layout B



15" – Short Beam-Mounted Directional

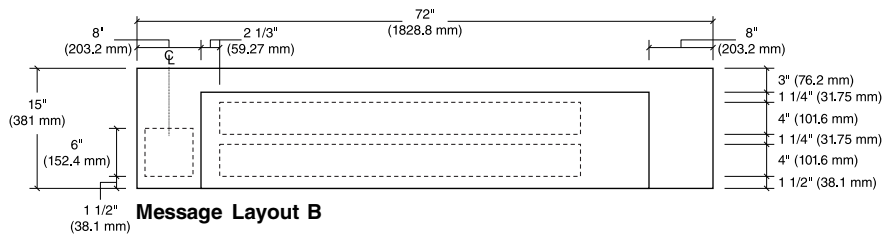
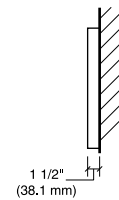
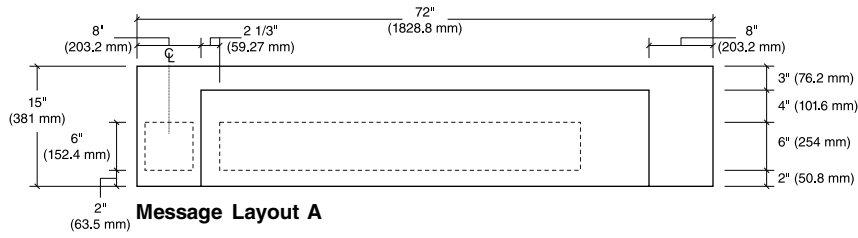

PS-03.01

Parking Structure Signage Drawings

Small Wall-Mounted Level Identification and Directional

Size

Sign Face:
36" High x 24" Wide
(914.4 mm H x 609.6 mm W)

Description & Use

Floor identification and directional information relevant to pedestrians. Floor identification signs to be placed next to, or near, elevators, stairs, and exits.

Message Configuration

Refer to message layout drawing for dimensions.

Message Layout A

Used to provide directional information as well as floor level information.

Message Layout B

Used for floor level identification.

Message Layout C

Used to provide directional information.

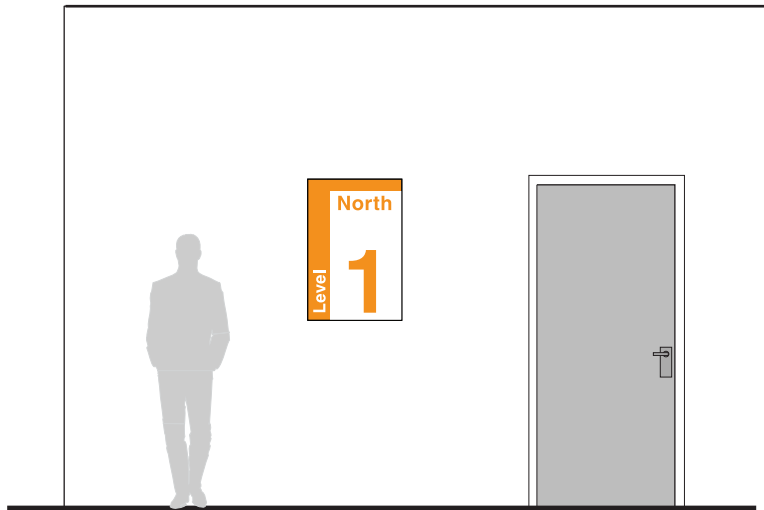

Graphic Process

Surface applied vinyl.

Colors

Refer to the color chart in the Appendix.

Recommendations

Position sign so pedestrians have a clear, unobstructed view of the sign.

See [Section 2.6.5](#) & [2.6.6](#) for construction & installation details.

Message Layout A



Message Layout B



Message Layout C

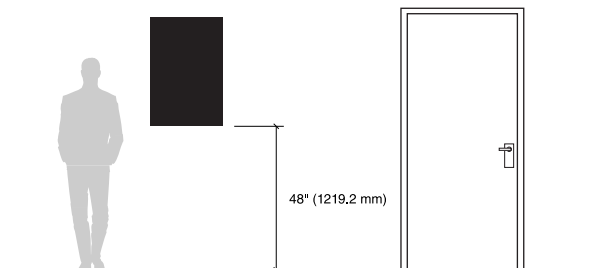

Small Wall-Mounted Level Identification and Directional

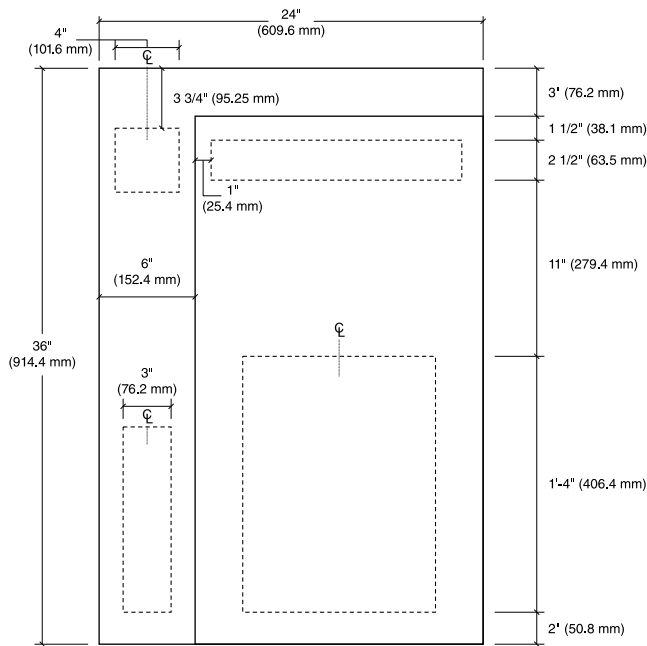

Message Layout A

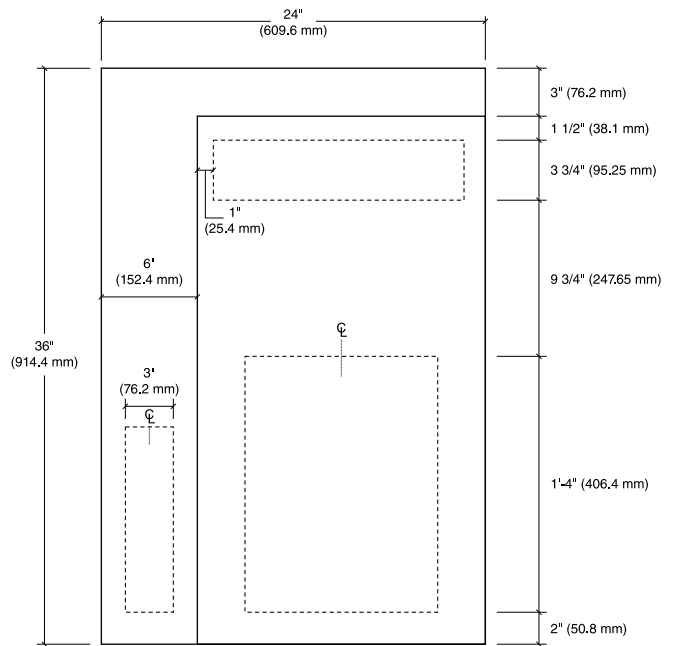

Message Layout B

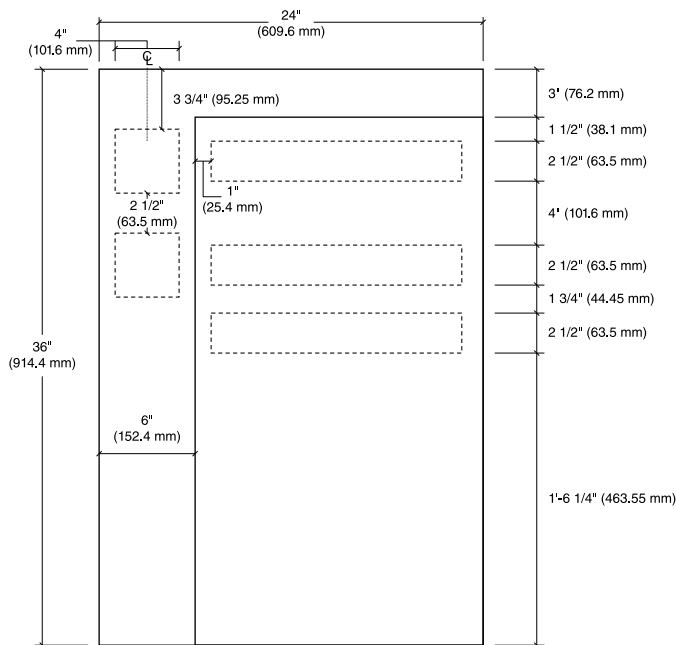

Message Layout C



PS-03.02

Parking Structure Signage Drawings

Large Wall-Mounted Level Identification and Directional

Size

Sign Face:
48" High x 32" Wide
(1219.2 mm H x 812.8 mm W)

Description & Use

Floor identification and directional information relevant to drivers and pedestrians. Floor identification signs to be placed next to, or near, elevators, stairs, and exits.

Message Configuration

Refer to message layout drawing for dimensions.

Message Layout A

Used to provide directional information as well as floor level information.

Message Layout B

Used for floor level identification.

Message Layout C

Used to provide directional information.

Graphic Process

Surface applied vinyl.

Colors

Refer to the color chart in the Appendix.

Recommendations

Position sign so drivers and pedestrians have a clear, unobstructed view of the sign.

See [Section 2.6.5](#) & [2.6.6](#) for construction & installation details.

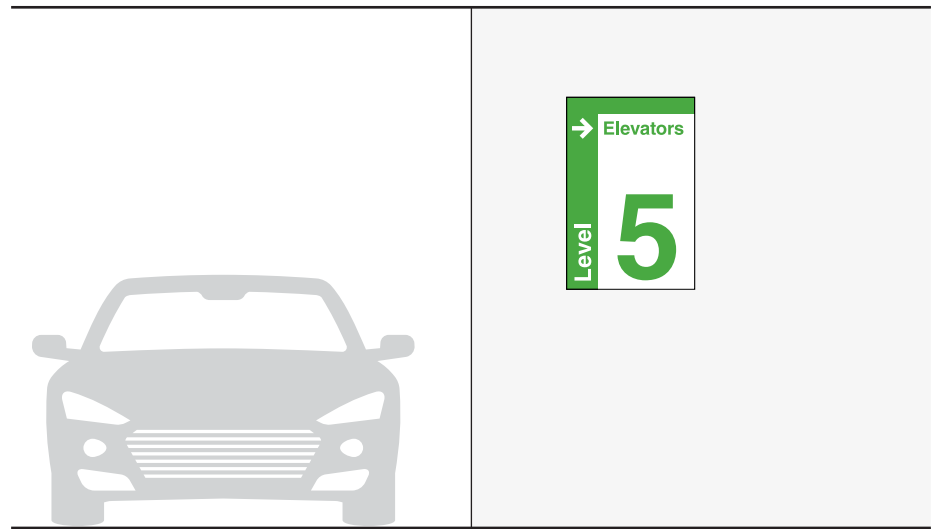

Message Layout A



Message Layout B



Message Layout C

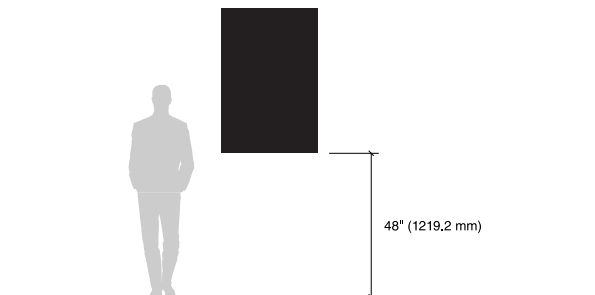

Large Wall-Mounted Level Identification and Directional

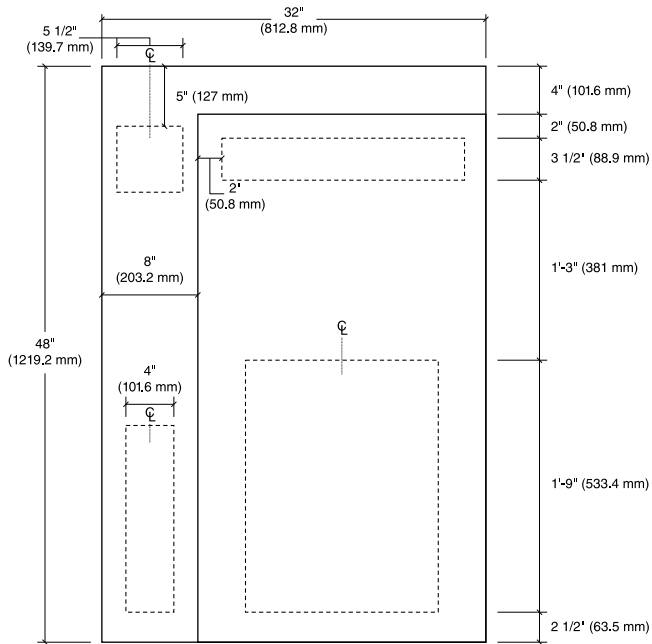

Message Layout A

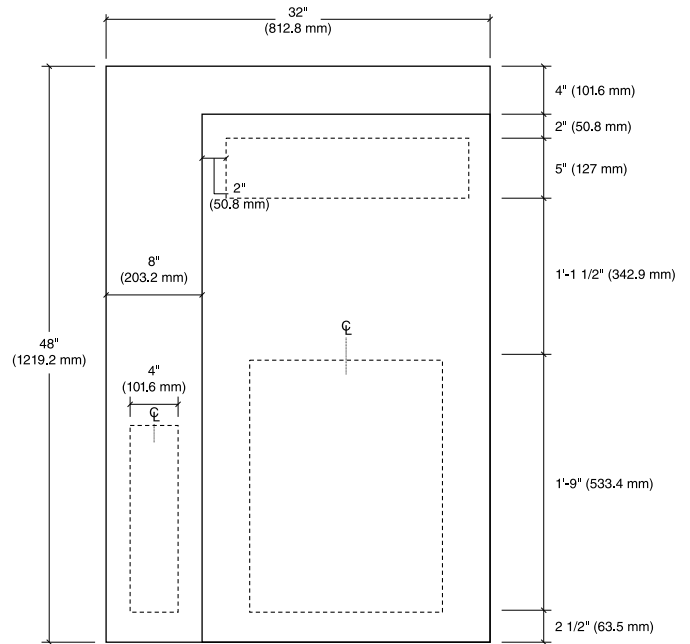

Message Layout B

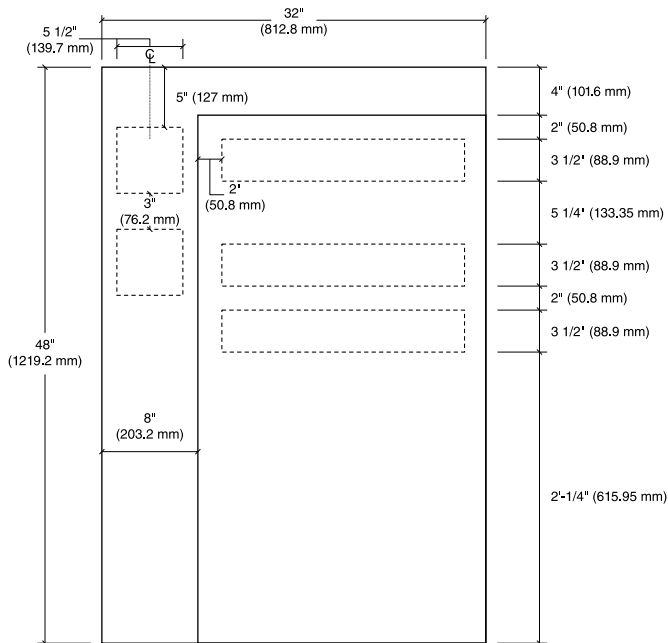

Message Layout C



PS-03.03

Parking Structure Signage Drawings

Elevator Core Branding and Directional

Size

Sign Face:

Message Layout A

24" High x 80" Wide

(609.6 mm H x 2032 mm W)

Message Layout B

20" High x 80" Wide

(508 mm H x 2032 mm W)

Description & Use

Floor identification, level branding, and directional information to be seen from pedestrian and vehicular pathways. Placed next to, or near primary elevator cores.

Message Configuration

Refer to message layout drawing for dimensions.

Message Layout A

Includes level branding and garage identification with directional information.

Message Layout B

Includes elevator identification and directional information

Graphic Process

Surface applied vinyl or digital print on substrate panel.

Colors

Refer to the color chart in the Appendix.

Recommendations

Position sign near primary elevators with a clear, unobstructed view of the sign by pedestrians and from vehicles.

See [Section 2.6.5](#) & [2.6.6](#) for construction & installation details.

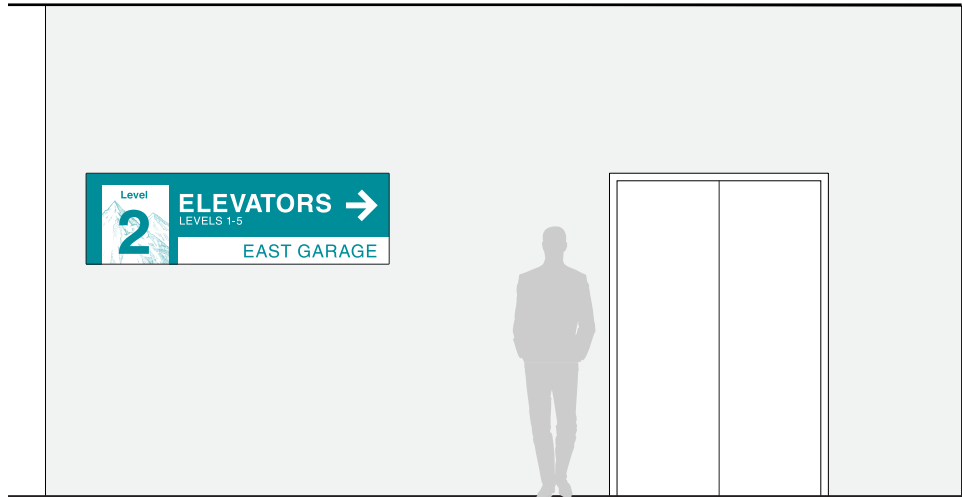

Message Layout A



Message Layout B



Elevator Core Branding and Directional

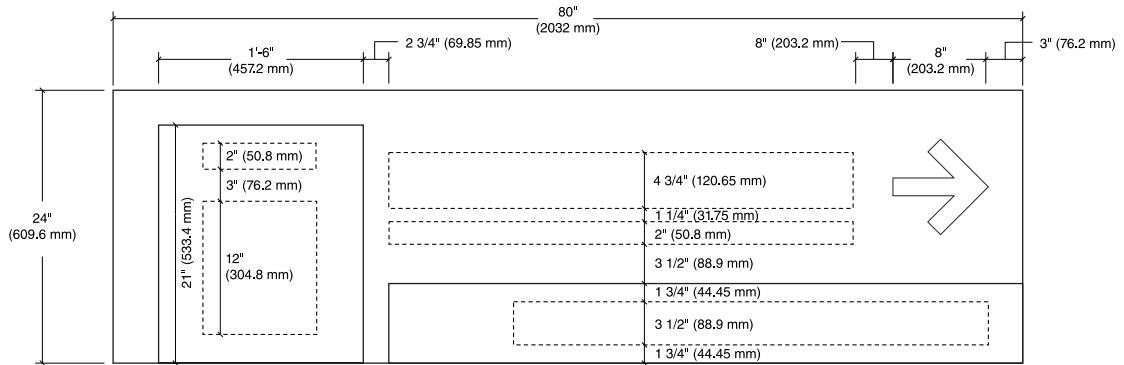

Message Layout A

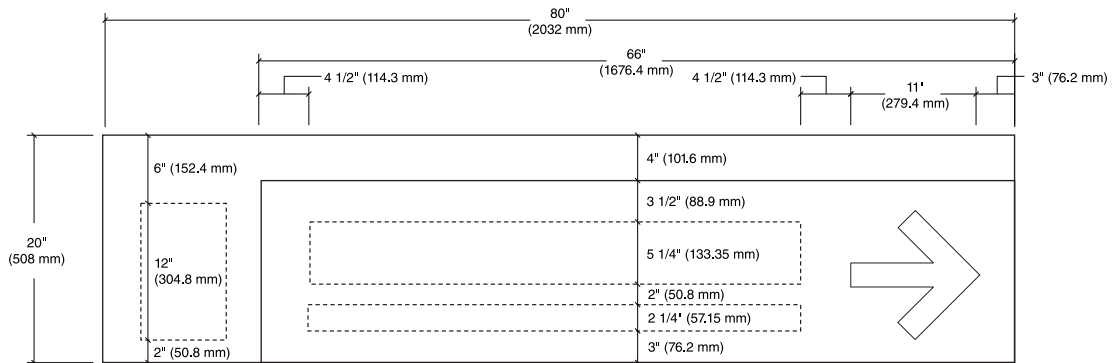

Message Layout B



PS-04.01

Parking Structure Signage Drawings

Wall-Mounted Warning Sign

Size

Sign Face:
18" High x 39" Wide
(457.2 mm H x 990.6 mm W)

Description & Use

Precautionary information strategically placed to avoid traffic conflict or accidents.

Message Configuration

Refer to message layout drawing for dimensions.

Message Layout A

Pedestrian regulatory sign.

Message layout B, C, D, E and F

Used primarily for vehicular traffic.

Graphic Process

Surface applied vinyl.

Colors

Refer to the color chart in the Appendix.

Recommendations

Position sign so drivers have a clear, unobstructed view of the sign.

See [Section 2.6.5](#) & [2.6.6](#) for construction & installation details.

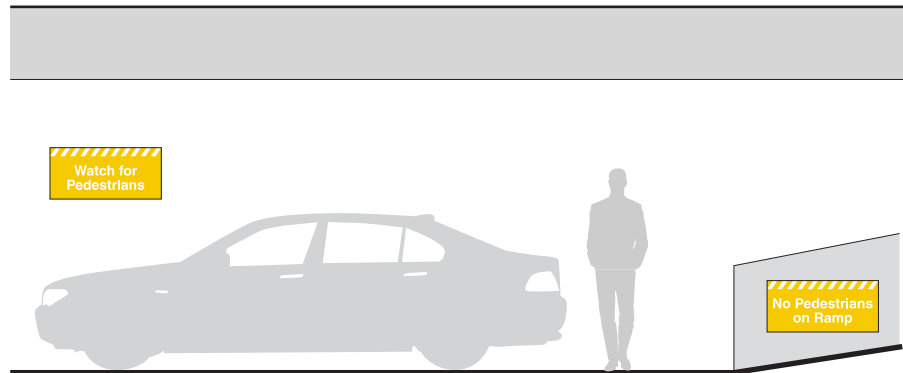

Message Layout A



Message Layout B



Message Layout C

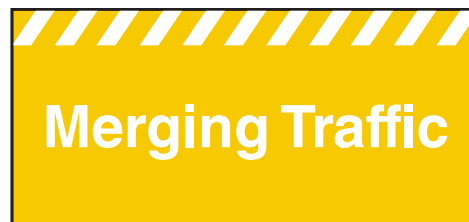

Message Layout D



Message Layout E



Message Layout F



Wall-Mounted Warning Sign

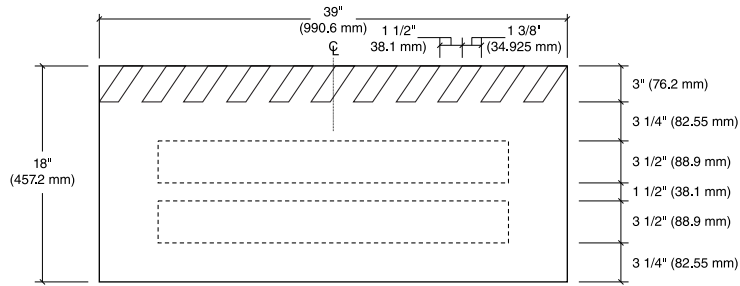

Message Layout A

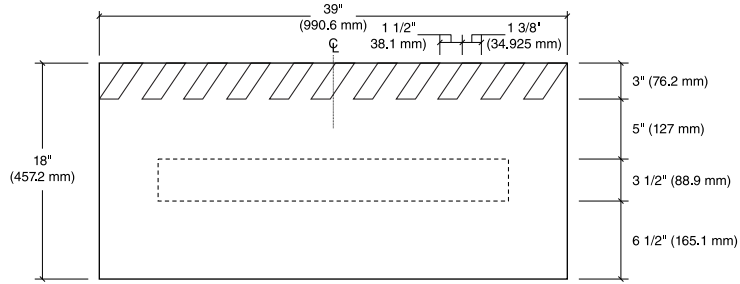

Message Layout B

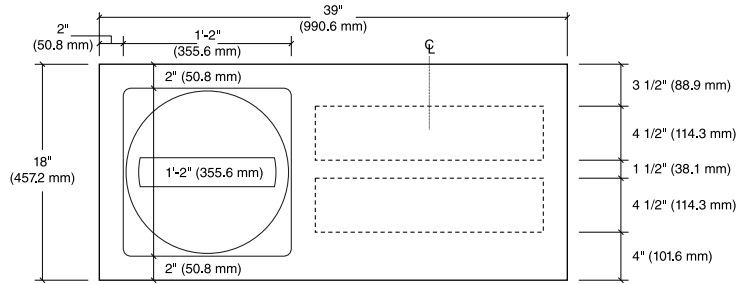

Message Layout C

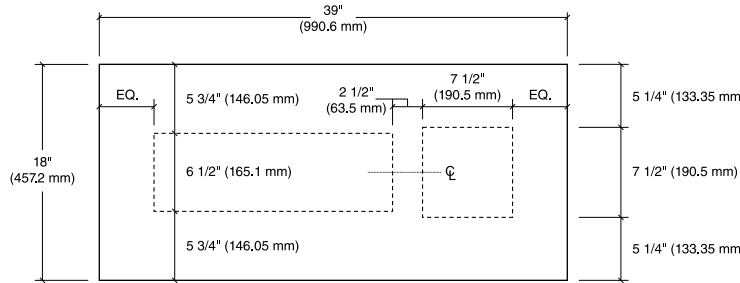

Message Layout D

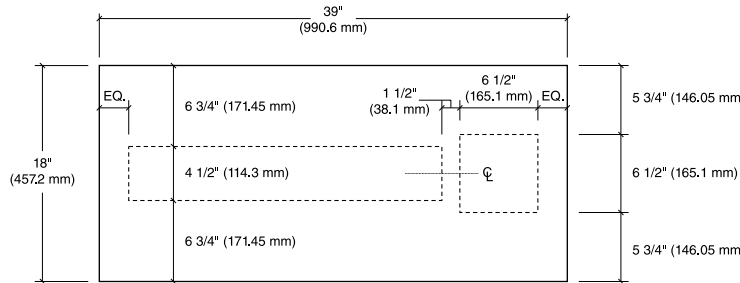

Message Layout E



PS-05.01

Parking Structure Signage Drawings

Square Column Marker

Size

Sign Face:
33" High x 22" Wide
(838.2 mm H x 558.8 mm W)

Description & Use

Floor level identification marker for placement on faces of wide columns.

Message Configuration

Refer to message layout drawing for dimensions.

Graphic Process

Surface applied vinyl.

Colors

Refer to the color chart in the Appendix.

Recommendations

Position sign so drivers have a clear, unobstructed view of the sign.

See [Section 2.6.5](#) & [2.6.6](#) for construction & installation details.

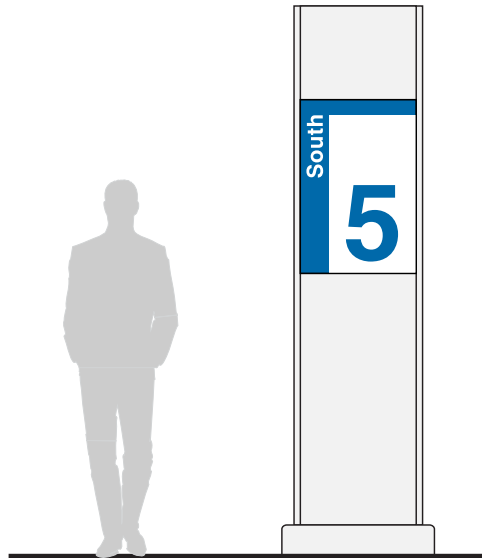

Message Layout

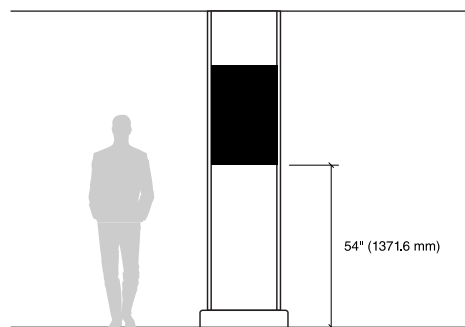

PS-05.01

Parking Structure Signage Drawings

Square Column Marker

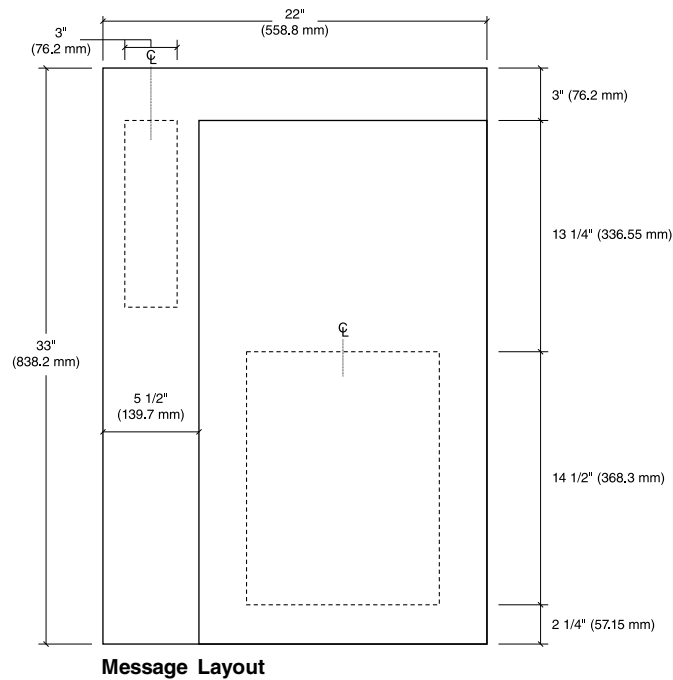

PS-05.02

Parking Structure Signage Drawings

Narrow Column Marker

Size

Sign Face:
33" High x 16" Wide
(838.2 mm H x 406.4 mm W)

Description & Use

Floor level identification marker for placement on faces of narrow columns.

Message Configuration

Refer to message layout drawing for dimensions.

Graphic Process

Surface applied vinyl.

Colors

Refer to the color chart in the Appendix.

Recommendations

Position sign so drivers have a clear, unobstructed view of the sign.

See [Section 2.6.5](#) & [2.6.6](#) for construction & installation details.

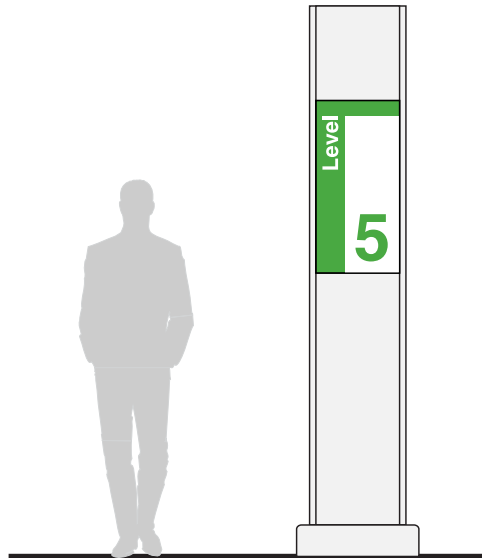

Message Layout

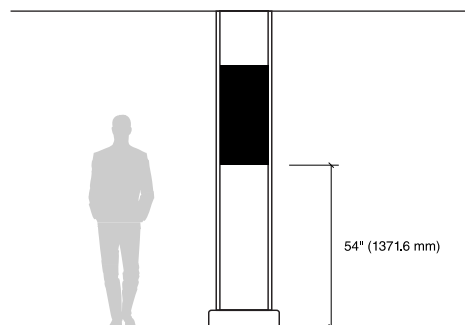
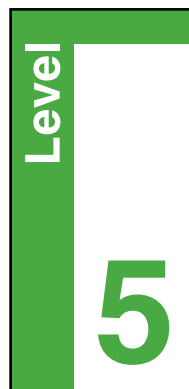

PS-05.02

Parking Structure Signage Drawings

Narrow Column Marker

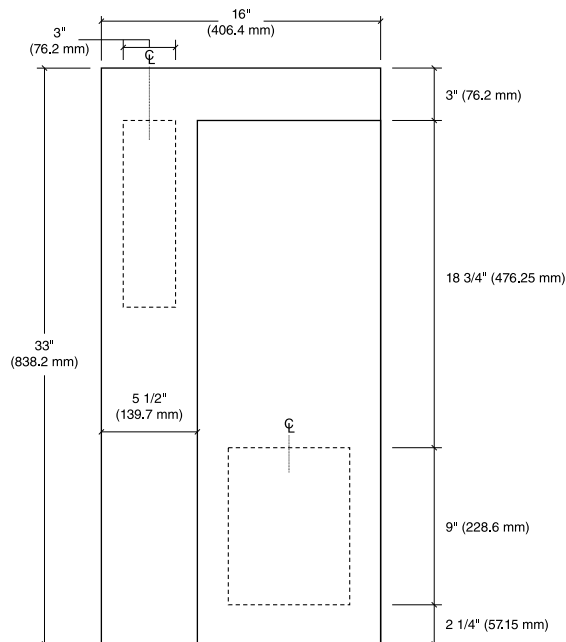

Message Layout



PS-05.03

Parking Structure Signage Drawings

Round Column Marker

Size

Sign Face:
24" High x 24" Wide
(609.6 mm H x 609.6 mm W)

Description & Use

Floor level identification marker for placement on round columns.

Message Configuration

Refer to message layout drawing for dimensions.

Graphic Process

Surface applied vinyl.

Colors

Refer to the color chart in the Appendix.

Recommendations

Position sign so drivers have a clear, unobstructed view of the sign.

See [Section 2.6.5](#) & [2.6.6](#) for construction & installation details.

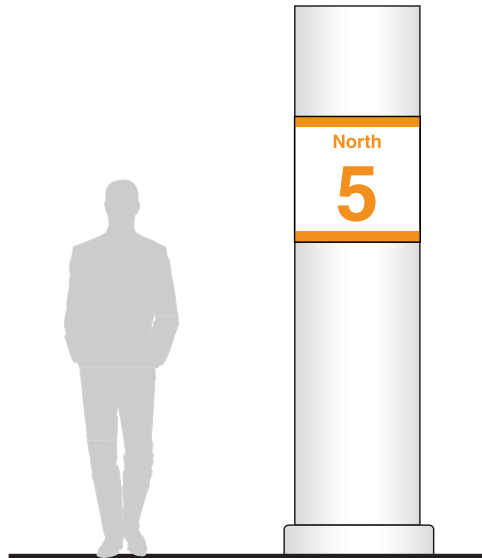

Message Layout

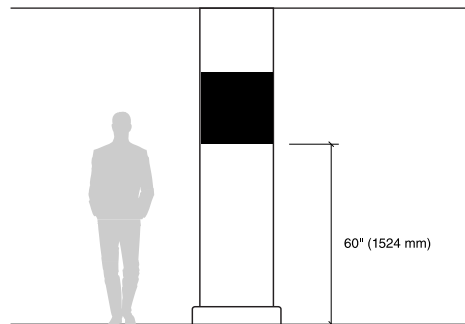

PS-05.03

Parking Structure Signage Drawings

Round Column Marker

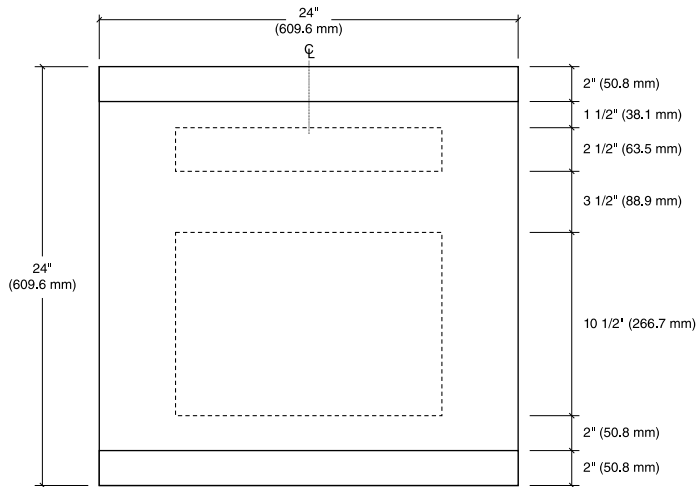

Message Layout



PS-05.04

Parking Structure Signage Drawings

Small Round Column Marker – Painted

Size

Sign Face:
18" High
(457.2 mm H)

Description & Use

Floor level identification marker for placement on small round columns.

Message Configuration

Refer to message layout drawing for dimensions.

Graphic Process

Surface painted.

Colors

Refer to the color chart in the Appendix.

Recommendations

Position sign so drivers have a clear, unobstructed view of the sign.

See [Section 2.6.5 & 2.6.6](#) for construction & installation details.

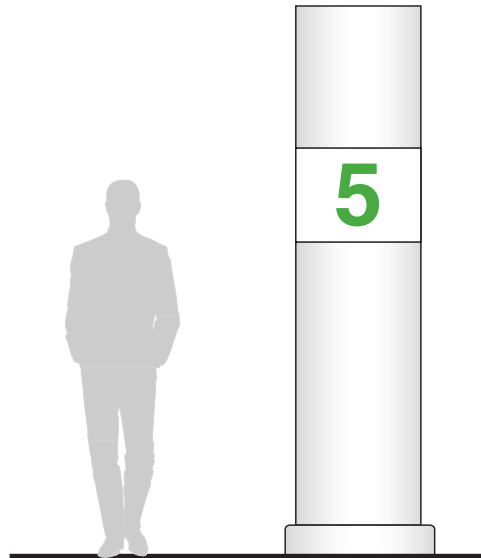

Message Layout

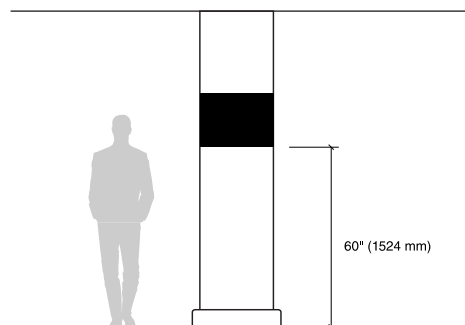
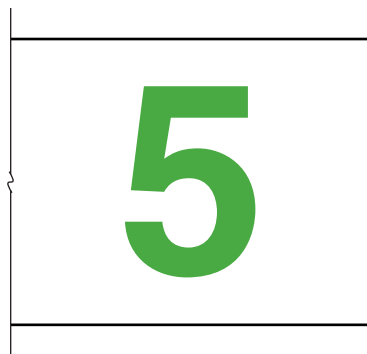

Small Round Column Marker – Painted

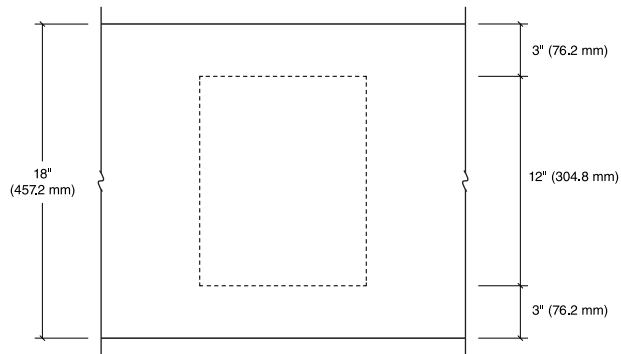

Message Layout



PS-05.05

Parking Structure Signage Drawings

Pole-Mounted Marker

Size

Sign Face:
33" High x 22" Wide
(838.2 mm H x 558.8 mm W)

Description & Use

Floor level identification marker for placement on poles.

Message Configuration

Refer to message layout drawing for dimensions.

Graphic Process

Surface applied vinyl.

Colors

Refer to the color chart in the Appendix.

Recommendations

Position sign so drivers have a clear, unobstructed view of the sign.

See [Section 2.6.5](#) & [2.6.6](#) for construction & installation details.

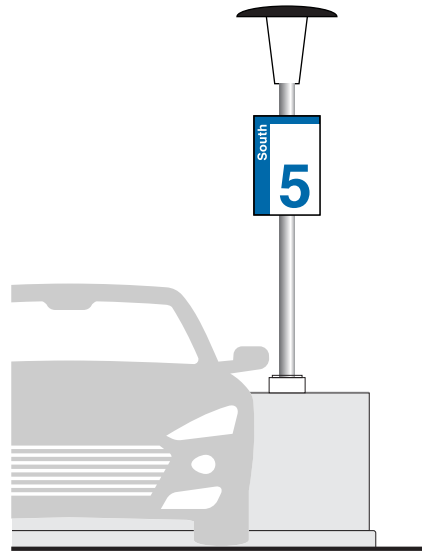

Sign Mounted on Front and Back of Pole

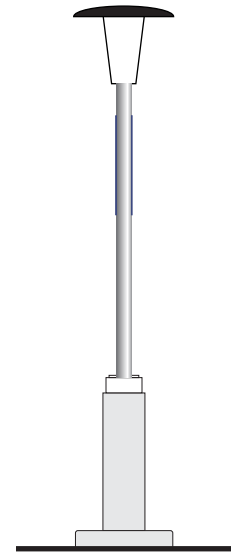

Profile View

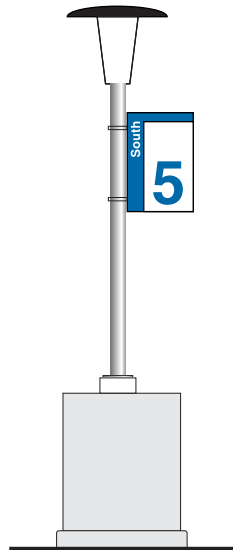

Single Flag Mounted Sign

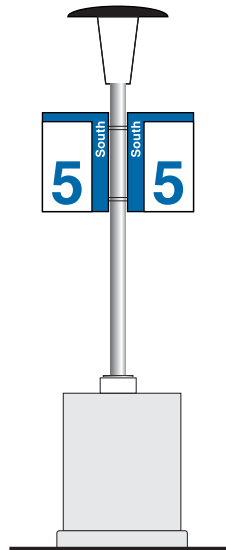

Double Flag Mounted Sign

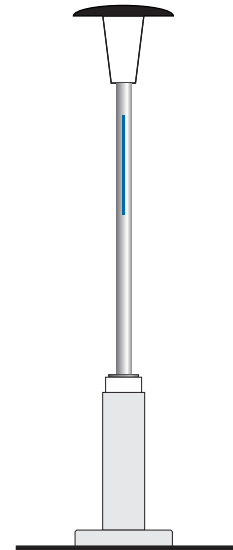

Profile View

Message Layout



PS-05.05

Parking Structure Signage Drawings

Pole-Mounted Marker

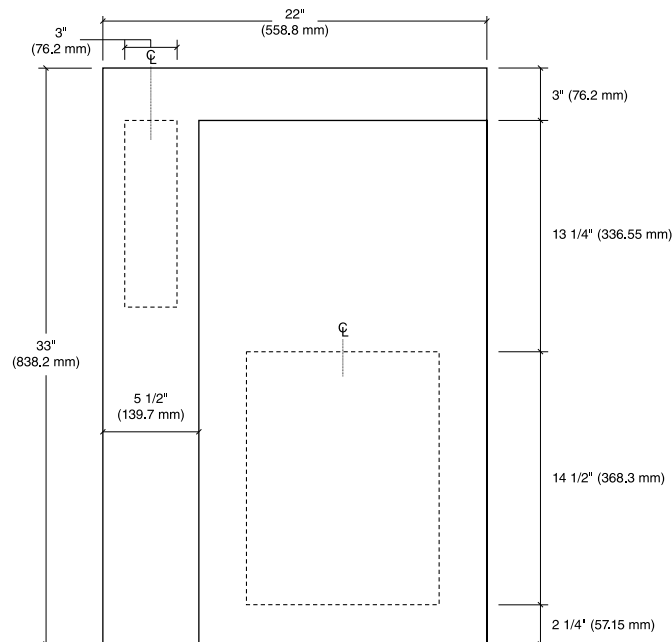

Message Layout



PS-06

Parking Structure Signage Drawings

Elevator Identification

Size

Sign Face:
15" High x 62" Wide
(381 mm H x 1574.8 mm W)

Description & Use

Elevator identification placed above elevator cores displaying serviced levels and elevator name (if applicable).

Message Configuration

Refer to message layout drawing for dimensions.

Graphic Process

Surface applied vinyl or digital print on substrate panel.

Colors

Refer to the color chart in the Appendix.

Recommendations

Position sign above primary pedestrian elevators.

See [Section 2.6.5](#) & [2.6.6](#) for construction & installation details.

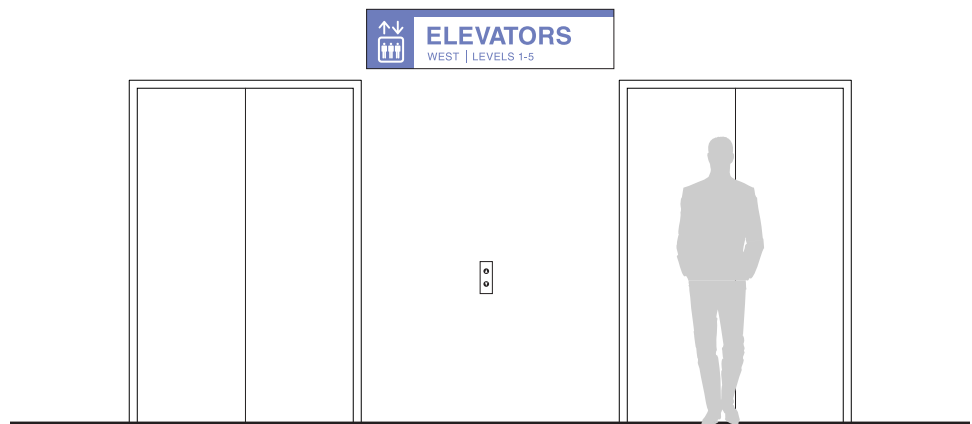

PS-06

Parking Structure Signage Drawings

Elevator Identification

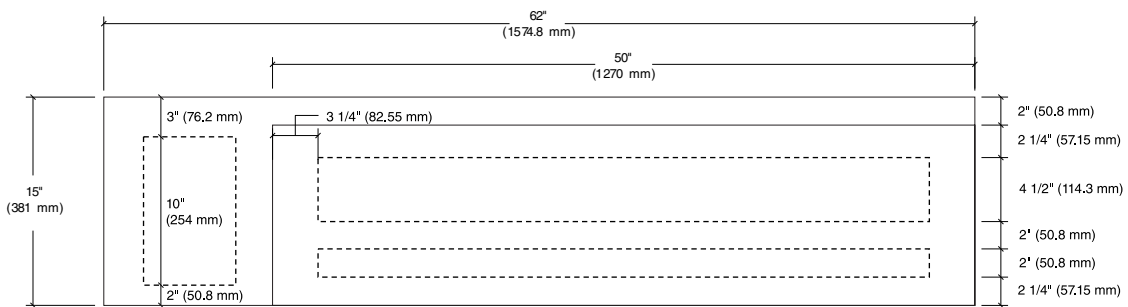

Message Layout



PS-07

Parking Structure Signage Drawings

Elevator Level Directory

Size

Sign Face:
24" High x 18" Wide
(609.6 mm H x 457.2 mm W)

Description & Use

Elevator level directory placed near elevator doors displaying all serviced levels, current level identification, and additional information as needed.

Message Configuration

Refer to message layout drawing for dimensions.

Graphic Process

Digital print on substrate panel.

Colors

Refer to the color chart in the Appendix.

Recommendations

Position sign near or between pedestrian elevator doors above or beside call button. Sign can also include welcome message and garage / elevator identification.

See [Section 2.6.5](#) & [2.6.6](#) for construction & installation details.

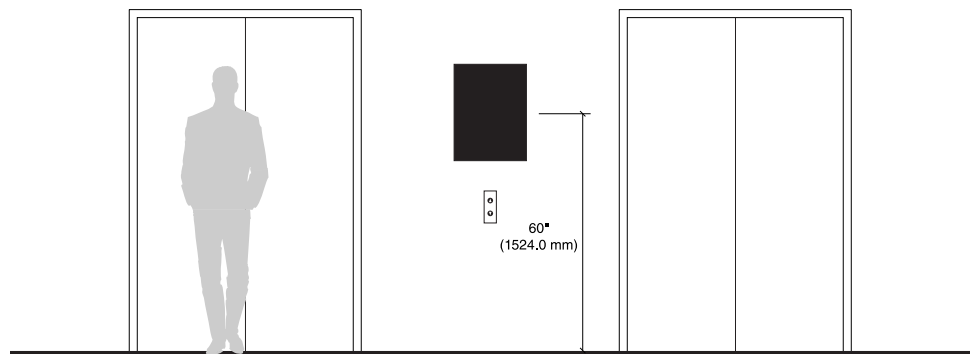

PS-07

Parking Structure Signage Drawings

Elevator Level Directory

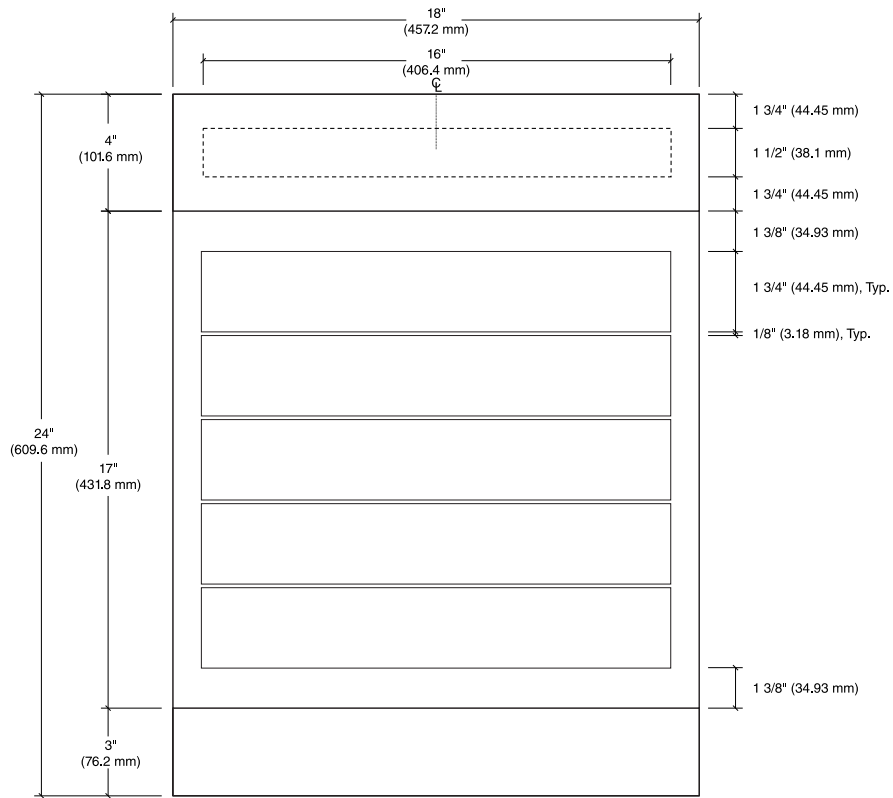

Message Layout



PS-08

Parking Structure Signage Drawings

Dimensional Letters

Size

Sign Face:
10" High x 1" Deep
(254 mm H x 25.4 mm D)

Description & Use

Non-illuminated dimensional letters for identifying an entrance or exit. Should be placed on the building in a location that is highly visible to the public.

Message Configuration

Refer to message layout drawing for dimensions.

Graphic Process

Fabricated, cast, or cut out aluminum letters.

Colors

Refer to the color chart in the Appendix.

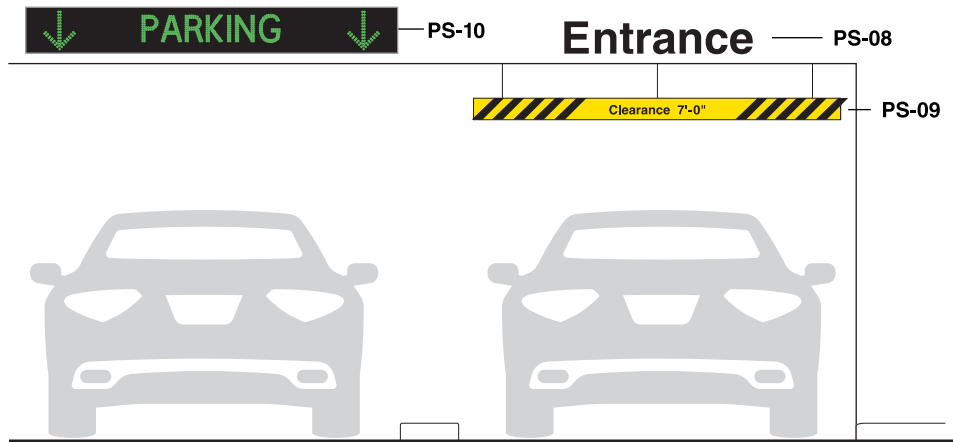

Message Layout

Exit



Dimensional Letters

Exit

Message Layout

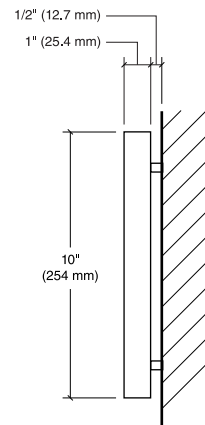

PS-09

Parking Structure Signage Drawings

Clearance Height Bar

Size

Sign Face:
6" High / Dia. x Various Lengths
(152.4 mm H)

Description & Use

Ceiling-hung vehicular clearance identification marker to be placed at all entrances and at grade level changes.

Clearance height bars are required within a parking structure when clearance levels change on ramps or between floors.

Message Configuration

Refer to message layout drawing for dimensions.

Graphic Process

Surface applied vinyl.

Colors

Text: Black
Background: Yellow and Black
Refer to the color chart in the Appendix.

Recommendations

Clearance bars made from PVC provide sufficient clearance notification and will not damage vehicles upon contact. Do not use aluminum or steel pipe as they can damage vehicles.

See [Section 2.6.5](#) & [2.6.6](#) for construction & installation details.

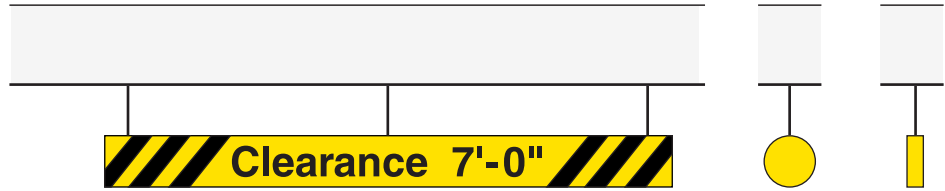

Message Layout



Note: Confirm actual clearance height in the parking structure. Mount bottom of sign to match clearance height stated on sign.



PS-09

Parking Structure Signage Drawings

Clearance Height Bar

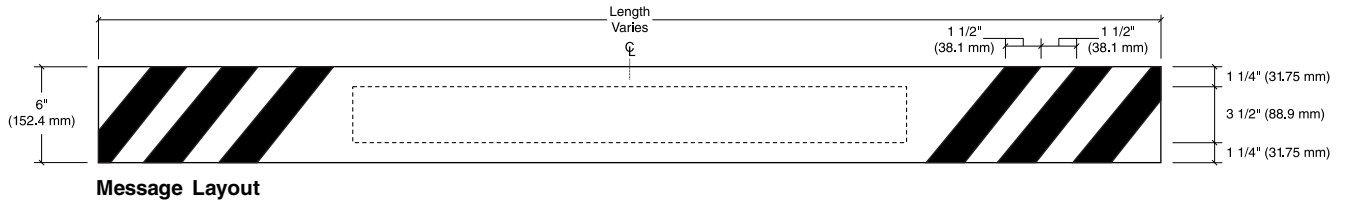
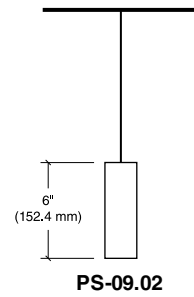
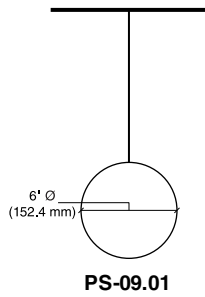

PS-10

Parking Structure Signage Drawings

Electronic Lane Use Sign

Size

Sign Face:
12" High x 96" Wide
(304.8 mm H x 2438.4 mm W)

Description & Use

Sign to inform status of alternating entrance / exit lane.

Sign Components

Sign cabinet with electronic lane use information.

Graphic Process

Electronic LED.

Mounting

Wall or beam mounted.

Installation

It is recommended that this sign be installed above entry to alternating entrance / exit lane.

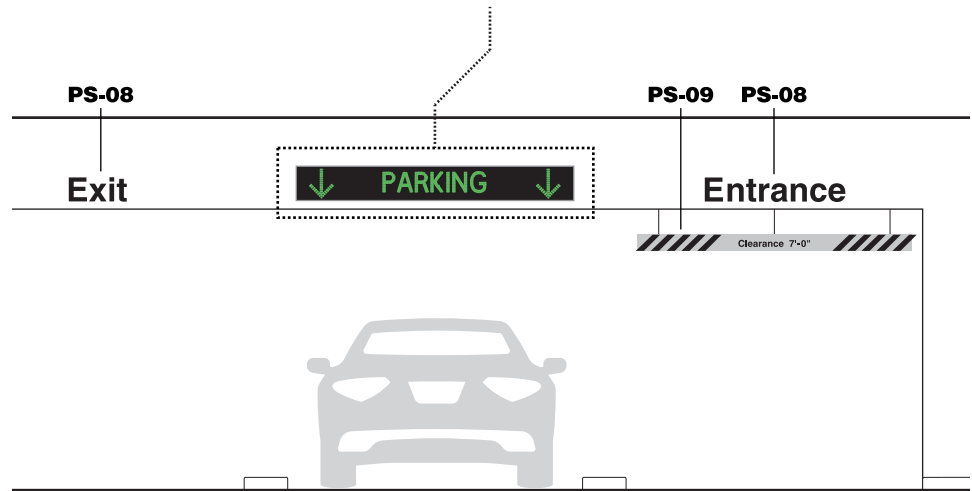
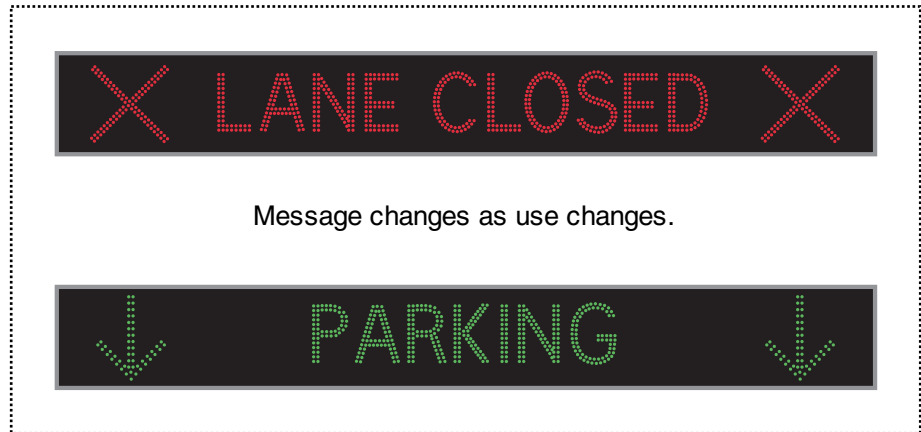

Electronic Lane Use Sign may be used in concurrence with other types of signs.

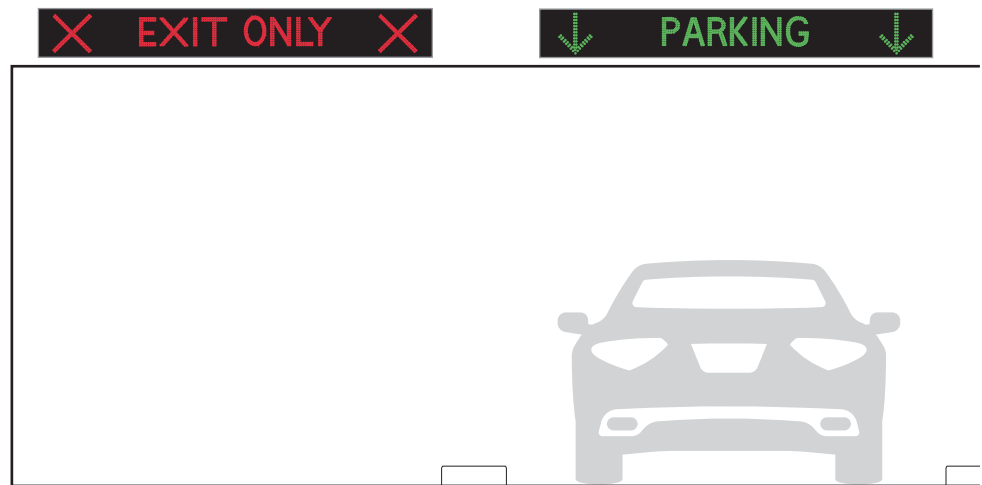

This sign can be used to display different messages depending on the circumstance.



PS-10

Parking Structure Signage Drawings

Electronic Lane Use Sign

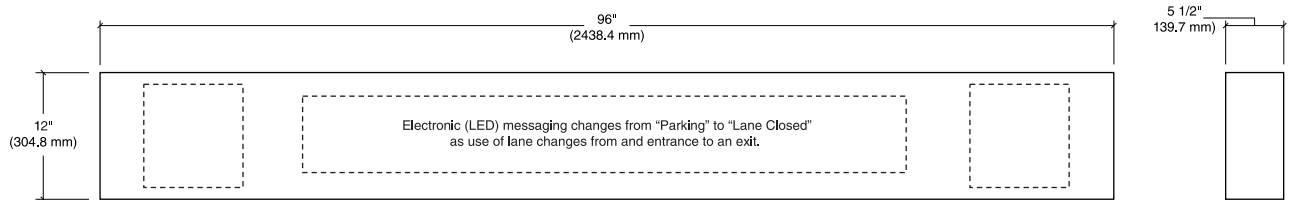

Message Layout



PS-11

Parking Structure Signage Drawings

Entrance and Exit Identification

Size

Sign Face:
15" High x 120" Wide
(381 mm H x 3048 mm W)

Description & Use

Non-illuminated, free-swinging, ceiling-hung sign. Can be installed with or without a clearance bar (PS-09). This sign type is relevant to drivers, providing them entrance identification and information.

Message Configuration

Refer to message layout drawing for dimensions.

Graphic Process

Surface applied vinyl.

Colors

Refer to the color chart in the Appendix.

Recommendations

Sign is for parking structure entrances that are high or do not have a surface to mount letters or a sign panel.

See [Section 2.6.5](#) & [2.6.6](#) for construction & installation details.

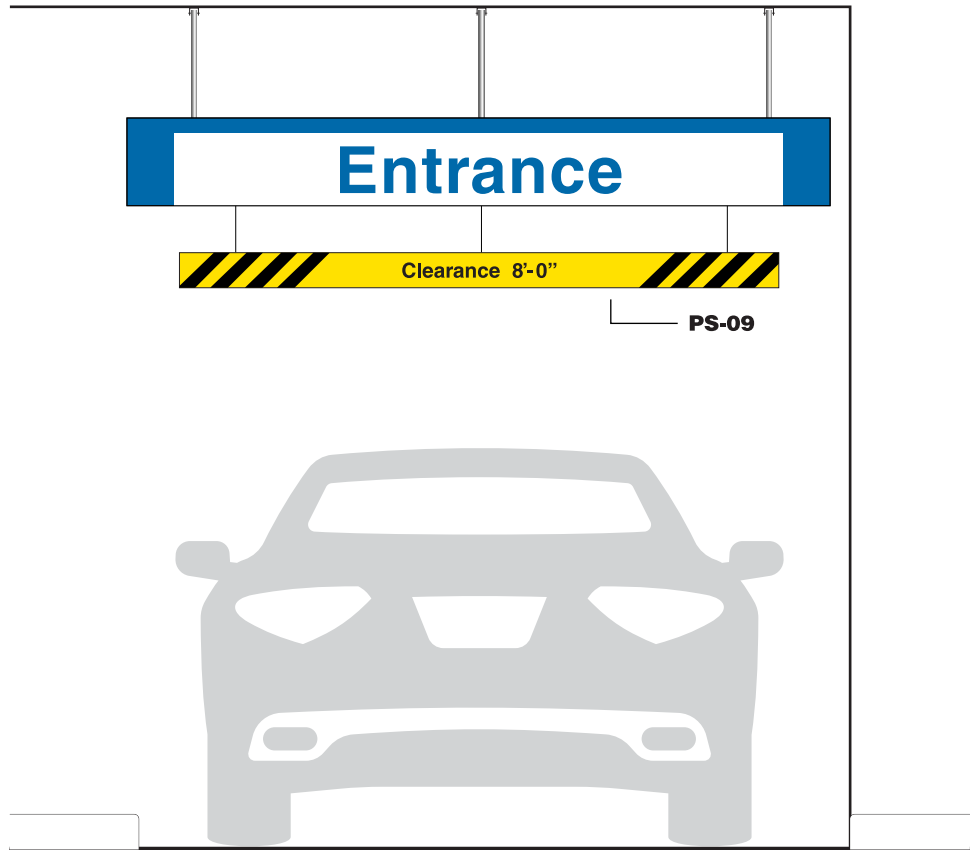

Message Layout

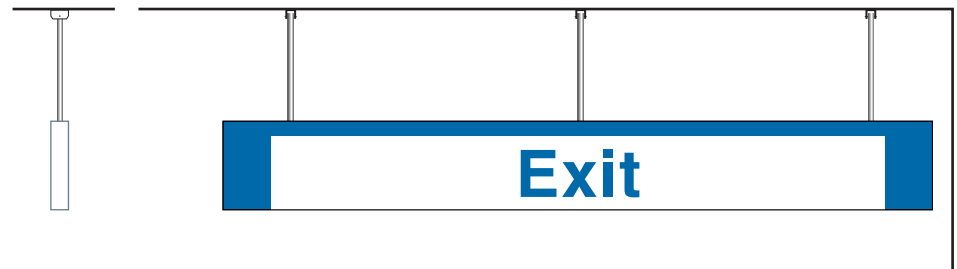

Entrance and Exit Identification

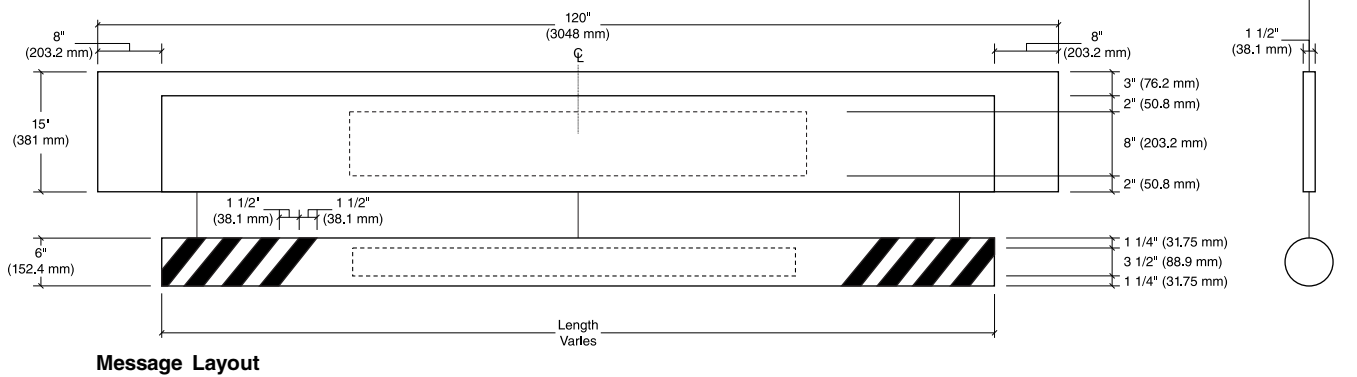

Parking Stall Designation

Size

Sign Face:
18" High x 12" Wide
(457.2 mm H x 304.8 mm W)

Description & Use

Non-illuminated single post or wall mounted parking identification and informational sign. This type of sign is for use in identifying or controlling specific parking areas, spaces, or stalls.

Message Configuration

Refer to message layout drawing for dimensions.

This sign with symbol or title and the appropriate text shall be used as shown in the adjacent examples.

Graphic Process

Surface applied reflective vinyl.

Colors

Text: White
Refer to the color chart in the Appendix.

Recommendations

Position sign on wall so drivers have a clear, unobstructed view of the sign.

When placing this type of sign near curbs or parking places, be sure the sign is set far enough back that over-hanging front and back bumpers of automobiles do not come into contact with the signpost.

See [Section 2.6.5](#) & [2.6.6](#) for construction & installation details.

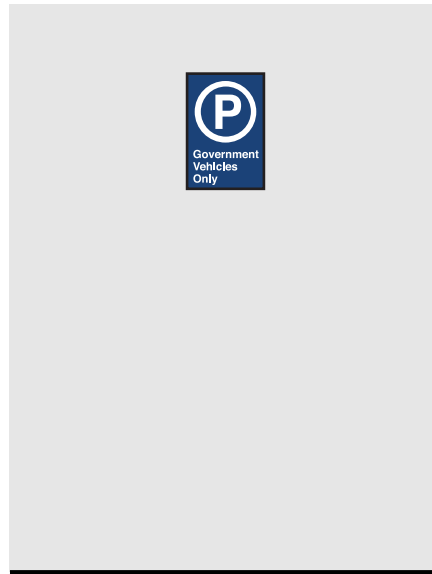

Wall-Mounted



Post-Mounted

Message Layout A



Other messages:

- 1) Visitors Only
- 2) Buses Only
- 3) Authorized Vehicles Only
- 4) Staff Only

Message Layout B



Other messages:

- 1) Any Time
- 2) Fire Lane
- 3) 00am-00pm

Message Layout C



Other messages:

- 1) Director
- 2) Chief of Staff
- 3) Volunteers
- 4) Consultant
- 5) Motorcycle Parking
- 6) Officer of the Day
- 7) Outpatient Only
- 8) Government Vehicle
- 9) Police Only
- 10) Carpool



Parking Stall Designation

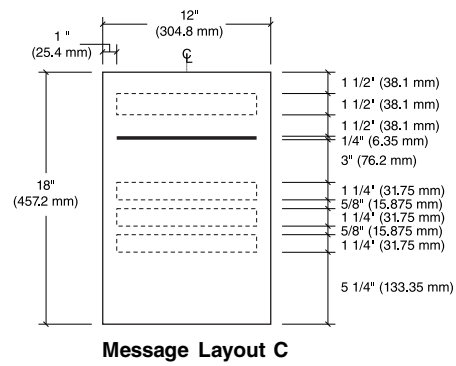
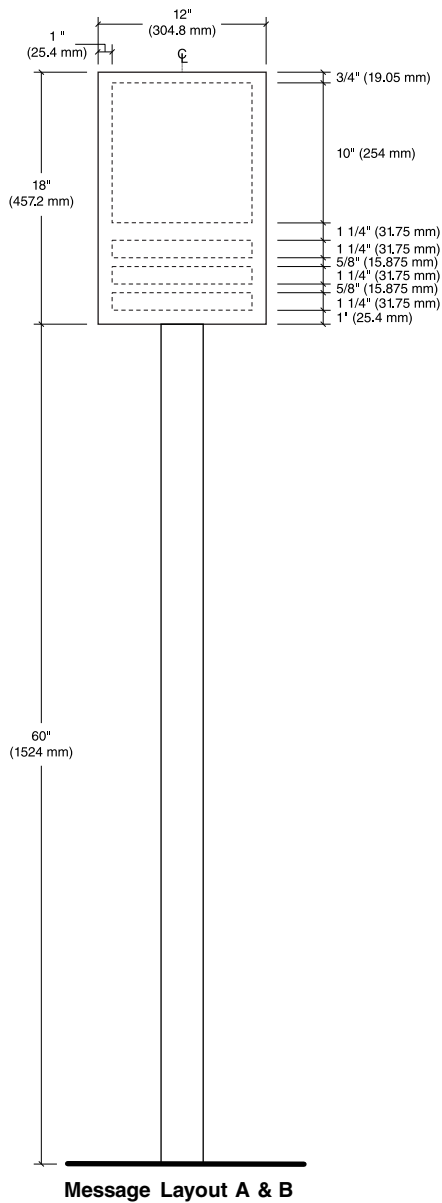
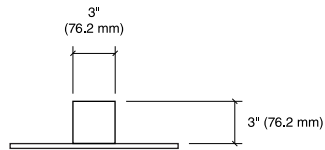

PS-12.04

Parking Structure Signage Drawings

Accessible Parking Stall

Size

Sign Face:
18" High x 12" Wide
(457.2 mm H x 304.8 mm W)

Description & Use

Wall-mounted or single post, non-illuminated accessible parking stall sign.

Message Configuration

Refer to message layout drawing for dimensions.

Symbol and text must conform to layout as shown.

Graphic Process

Surface applied reflective vinyl.

Colors

Text: White
Background: Accessible Blue
Refer to the color chart in the Appendix.

Recommendations

Position sign so drivers have a clear, unobstructed view of the sign.

Accessible parking spaces must be identified with signs that include the ISA symbol.

ABA/ADA regulations require bottom of sign to be at least 60" (1524 mm) from grade.

When placing this type of sign near curbs or parking places, be sure the sign is set far enough back that over-hanging front and back bumpers of automobiles do not come into contact with the signpost.

See [Section 2.6.5](#) & [2.6.6](#) for construction & installation details.

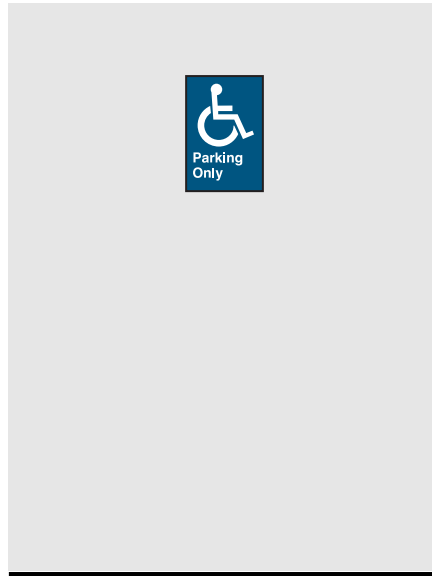

Wall-Mounted

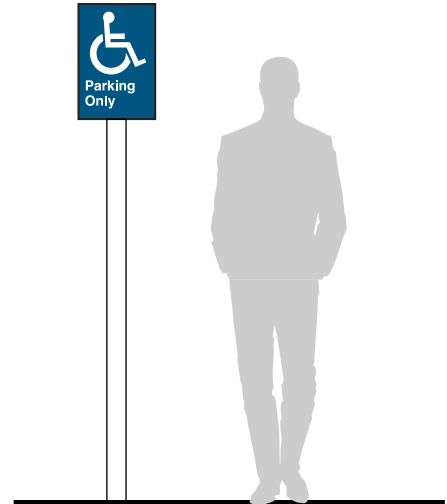

Post-Mounted

Message Layout A



Message Layout B



Message Layout C



Accessible Parking Stall

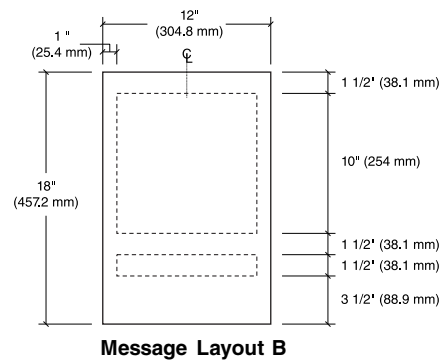
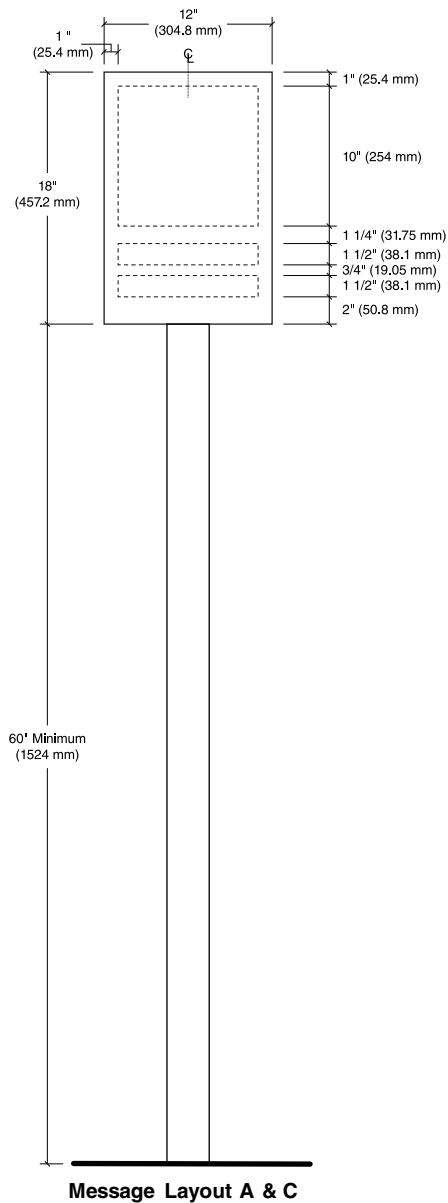
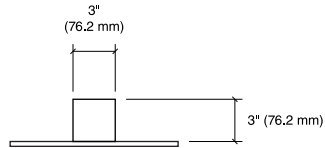

Accessible Parking Area

Size

Sign Face:
24" High x 24" Wide
(609.6 mm H x 609.6 mm W)

Description & Use

Wall-mounted or single post, non-illuminated accessible parking area sign. Identification of accessible parking areas and directional information regarding access. These signs can also be used to provide direction information to drivers to direct them to accessible parking that may not be obvious.

Message Configuration

Refer to message layout drawing for dimensions.

Symbol is to remain constant. Below symbol arrows, text or text and arrows can be used.

Graphic Process

Surface applied reflective vinyl.

Colors

Text: White
Background: Accessible Blue
Refer to the color chart in the Appendix.

Recommendations

Position sign so drivers have a clear, unobstructed view of the sign.

Accessible parking spaces must be identified with signs that include the ISA symbol.

ABA/ADA regulations require bottom of sign to be at least 60" (1524 mm) from grade.

When placing this type of sign near curbs or parking places, be sure the sign is set far enough back that over-hanging front and back bumpers of automobiles do not come into contact with the signpost.

See [Section 2.6.5](#) & [2.6.6](#) for construction & installation details.

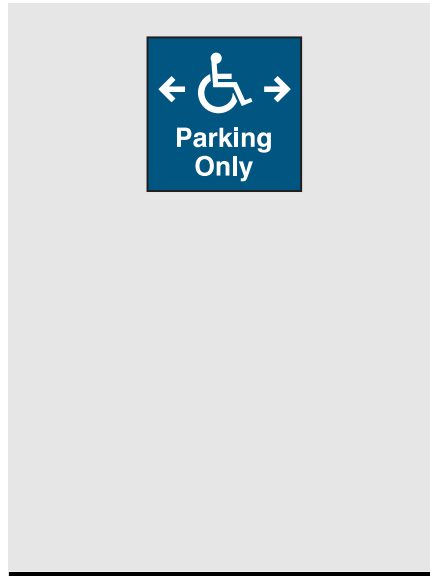

Wall-Mounted



Post-Mounted

Message Layout A



Message Layout B



Accessible Parking Area

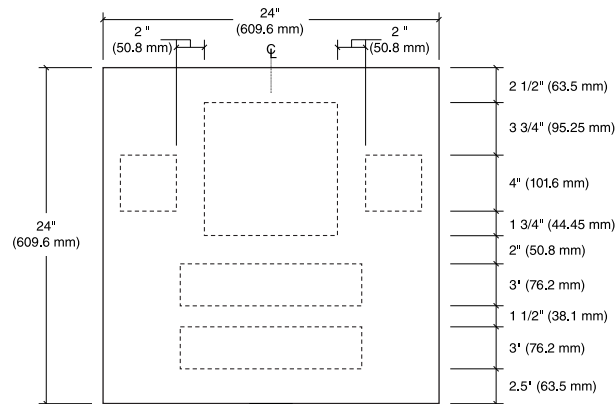
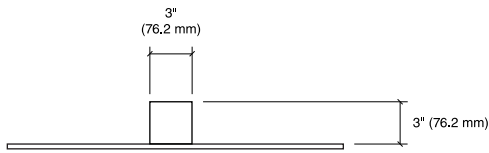

60' Minimum
(1524 mm)

Message Layout A

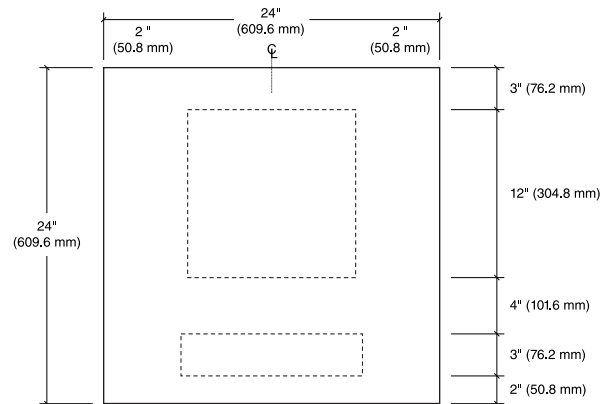

Message Layout B



PS-12.07

Parking Structure Signage Drawings

Informational Panel

Size

Sign Face:
36" High x 24" Wide
(914.4 mm H x 609.6 mm W)

Overall Sign Height:
84" High (2133.6 mm)

Description & Use

Non-illuminated wall-mounted sign used to communicate various informational or instructional messages.

Message Configuration

Refer to message layout drawing for dimensions.

Graphic Process

Surface applied reflective vinyl.

Colors

Text: White
Refer to the color chart in the appendix.

Recommendations

Position sign where the message needs to be conveyed and text can be read from a reasonable distance.

See [Section 2.6.5](#) & [2.6.6](#) for construction & installation details.

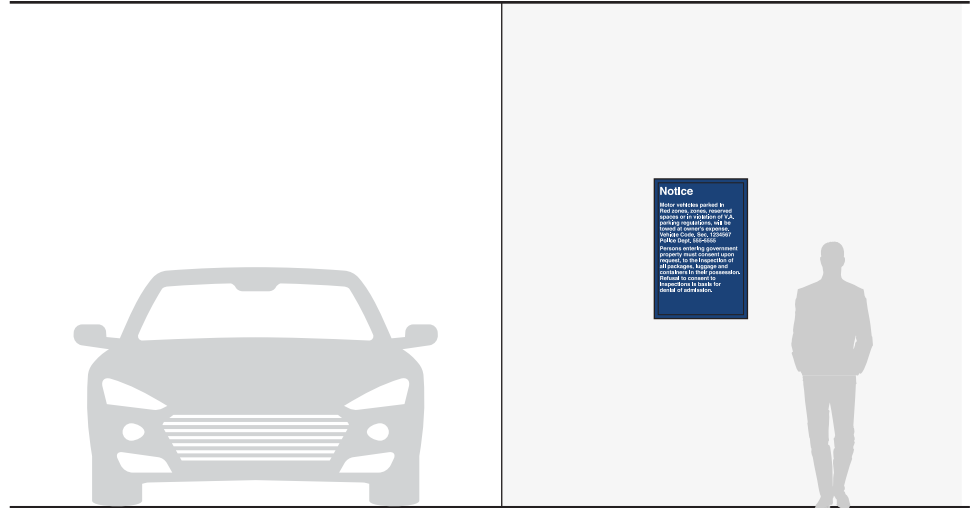

Message Layout

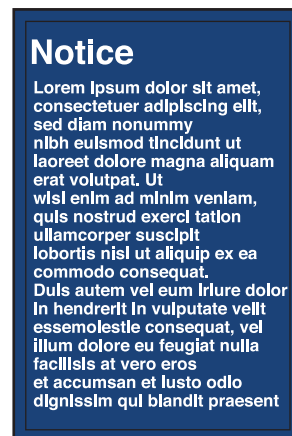

PS-12.07

Parking Structure Signage Drawings

Informational Panel

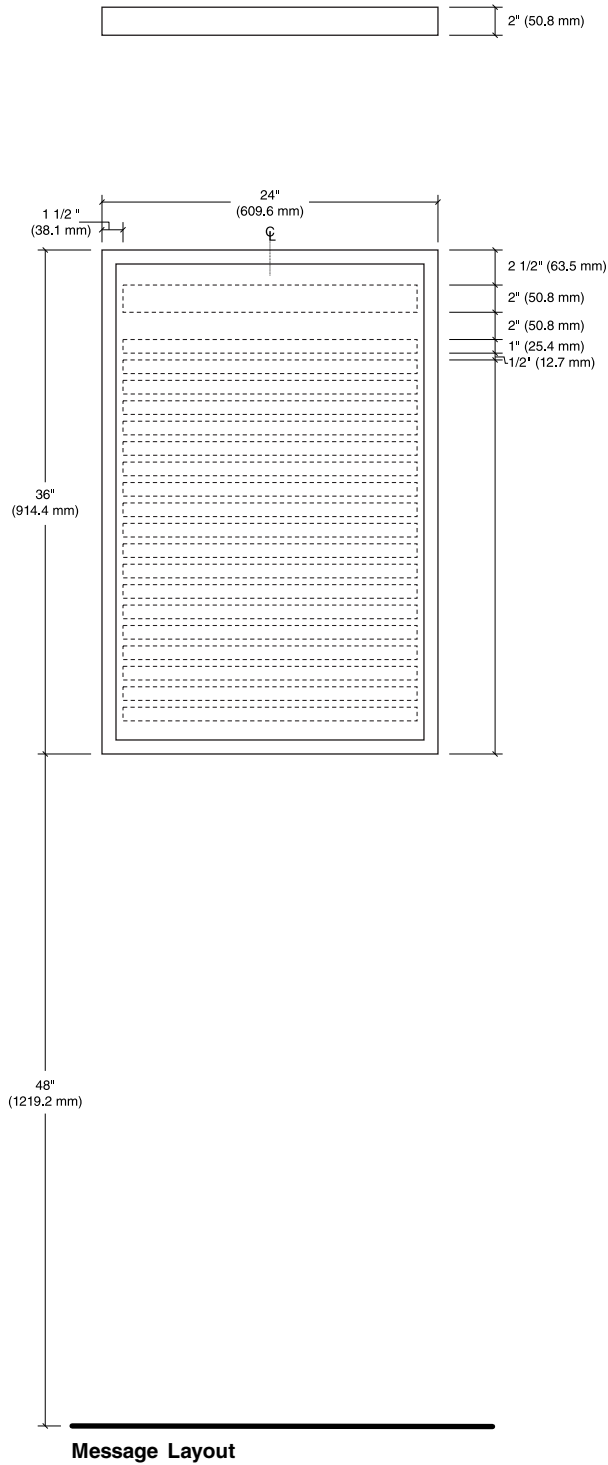

Electronic Stall Availability Sign

Size

Size to vary depending upon number of levels and electronic system used.

Description & Use

Sign informs visitors of the number of available parking spaces per floor. Electronic counting devices record the number of cars that enter and exit the garage and floor levels. This information changes as the corresponding number of parking spaces per floor is reflected.

Sign Components

Sign cabinet with electronic occupancy information.

Graphic Process

Painted, screened or vinyl type / graphics with electronic (LED) occupancy information.

Colors

Color and materials to match rest of exterior parking structure signage.

Mounting

Either post-mounted or wall-mounted

Installation

It is recommended that this sign be placed at entrance, or approaching, parking structure entry.

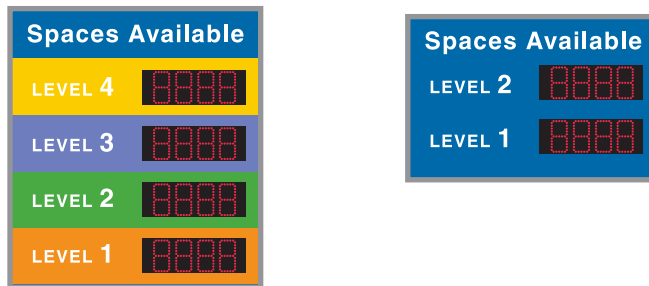
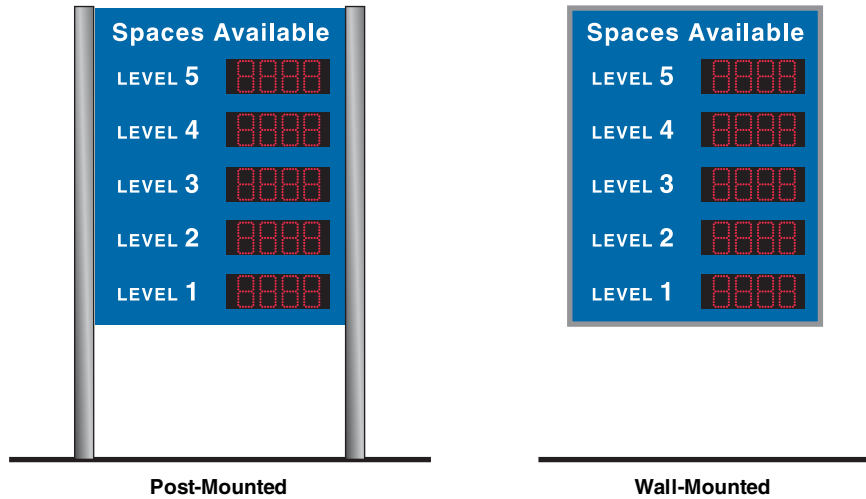

Examples of signs for parking structures of various levels. The example on the left illustrates the integration of a color-coded system.

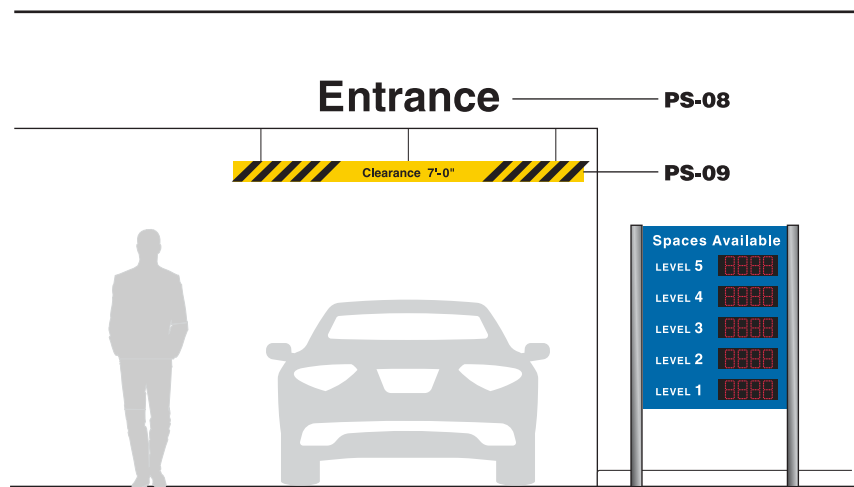

Electronic Stall Availability Sign

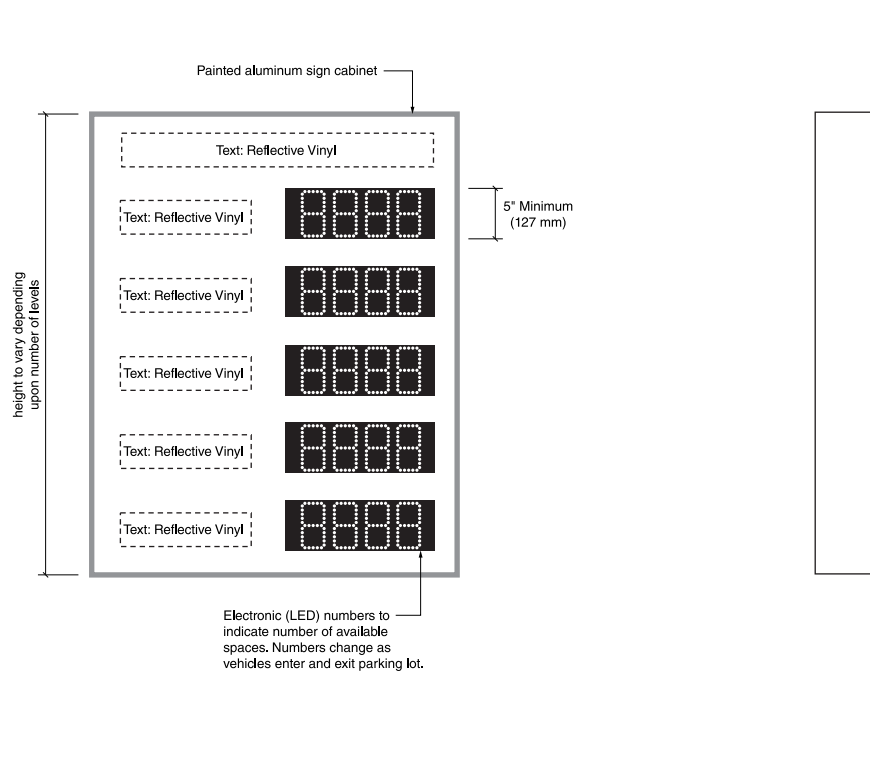
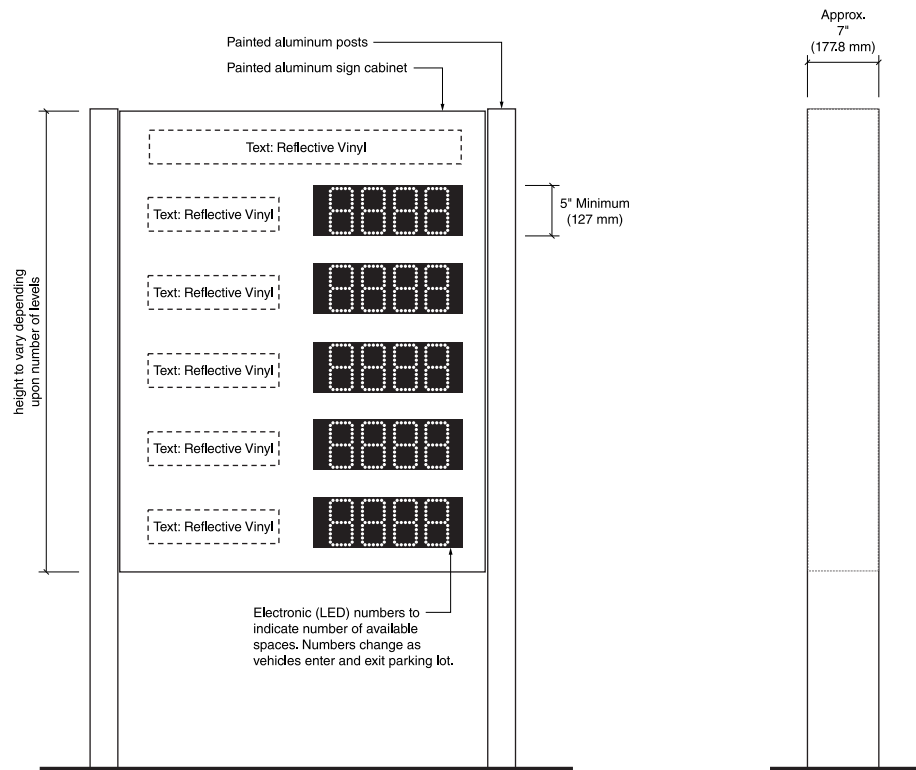

Exterior Building-Mounted Parking Directional / Availability Sign

Size

Sign Face:
Varies – Approximately
50" High x 40" Wide
(1270 mm H x 1016 mm W)

Description & Use

Illuminated double-sided parking lot identification and parking stall availability sign.

Sign Components

Framed sign cabinet with an illuminated arrow and "parking" identification message, and an electronic occupancy information screen.

Graphic Process

Internally illuminated directional arrow and "Parking" identification. Electronic (LED) occupancy information.

Colors

"P" and Arrow: White,
Background Color: Blue - T8.
Refer to the color chart in the Appendix.

Mounting

Mounted perpendicular to exterior wall of parking structure.

Installation

It is recommended that this sign be placed above, or above and adjacent to, the entrance to the parking structure.

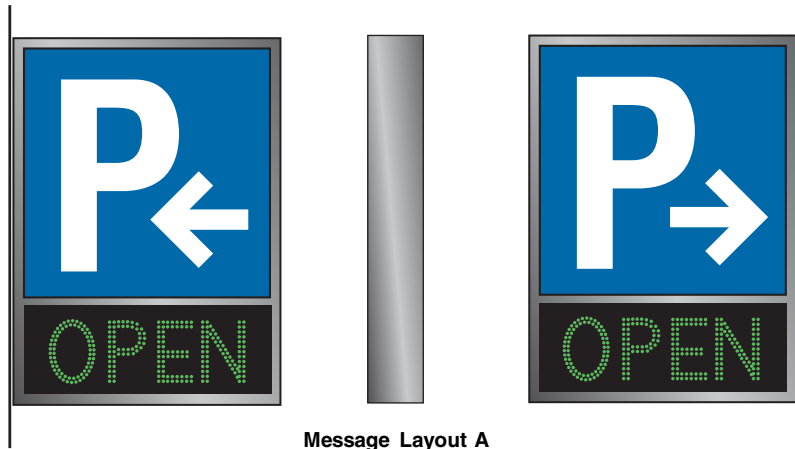

Message Layout A



Message Layout B



Message Layout C

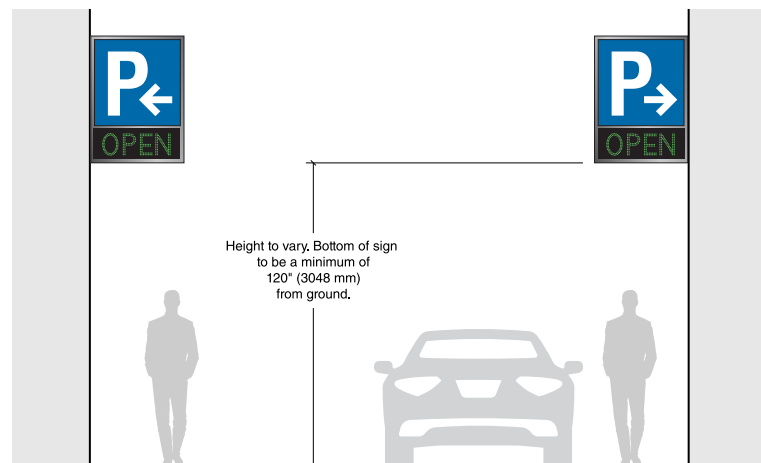

Exterior Building-Mounted Parking Directional / Availability Sign

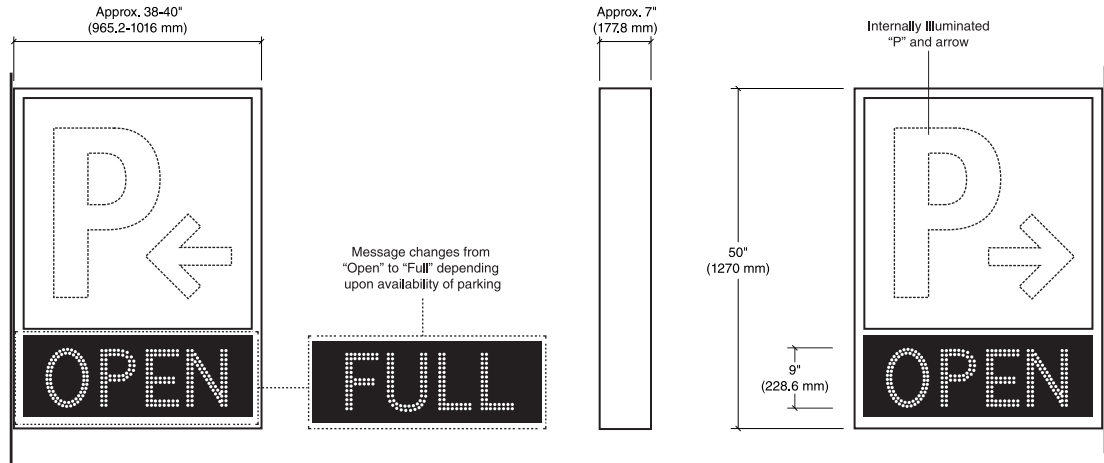

Message Layout A

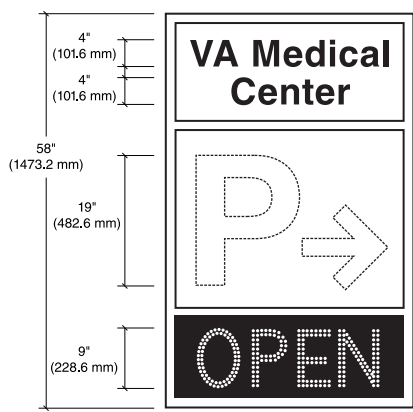

Message Layout B

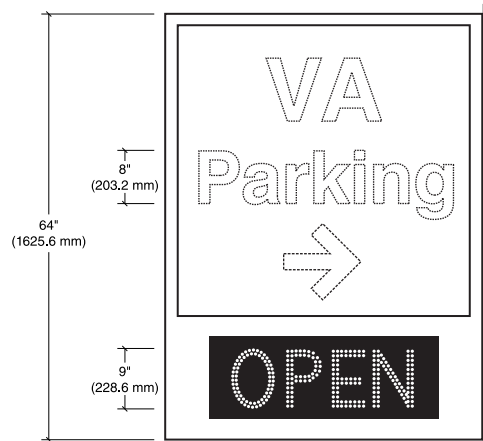

Message Layout C



PS-15

Parking Structure Signage Drawings

Stall Identification Number

Description

Painted parking stall numbers.

Graphic Process

Painted stenciled numbers.

Colors

Colors need to contrast the parking lot pavement. If the pavement is light in color, the numbers should be black. If the pavement is a dark color, the numbers should be white or yellow.

Recommendations

Stalls can be assigned a designated number based on a logical and sequential stall numbering system.

It is recommended that each number be painted at the isle facing end of each stall. The ideal number height is 6" (152.4 mm). Numbers should be no less than 4" (101.6 mm) in height.

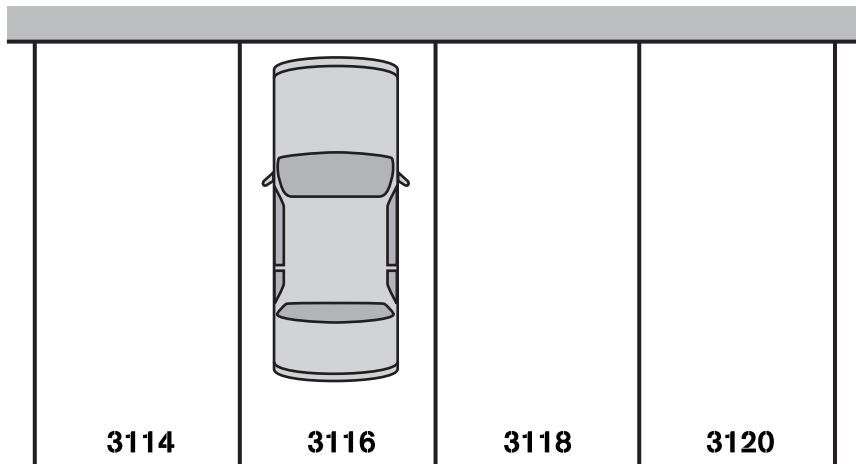

DRIVE AISLE

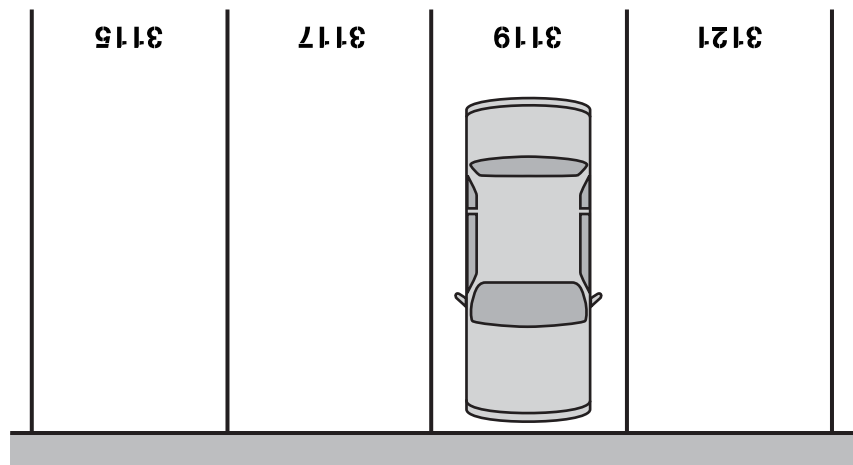

PS-15

Parking Structure Signage Drawings

Stall Identification Number

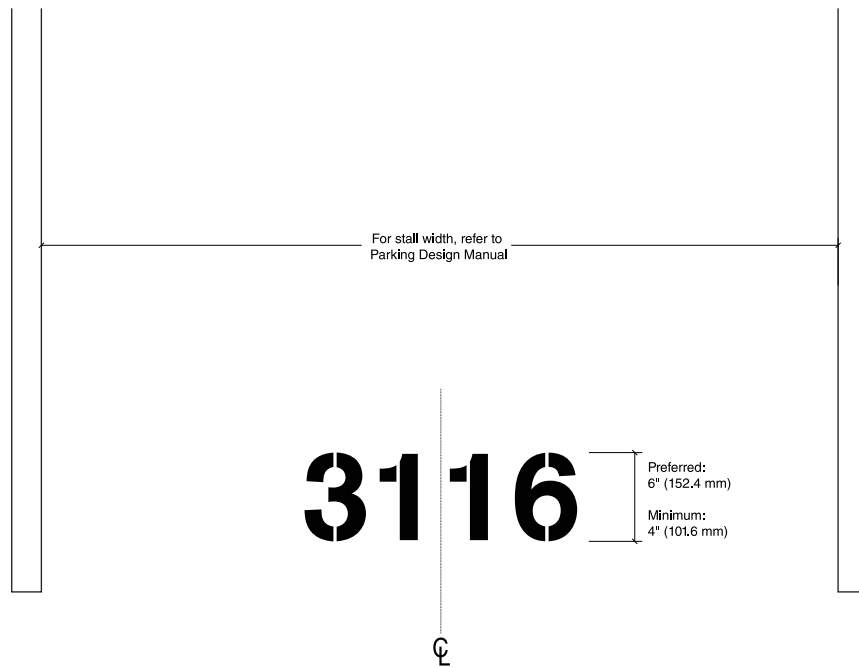



U.S. Department
of Veterans Affairs

SECTION 3.7

NATIONAL CEMETERY ADMINISTRATION SIGNAGE DRAWINGS



Sign Overview

National Cemetery Administration Signage Drawings

Introduction

This section provides detailed drawings of the various types of signs for National Cemetery Administration facilities.

The National Cemetery Administration follows different signage design standards (font, sign types, construction, etc.) than VHA facilities due to the differing conditions, aesthetics, and purpose.

Guidelines

- Please review [Section 2.7 National Cemetery Administration](#) which contains information regarding Planning, Programming, Construction, and Installation prior to starting signage projects.
- See [Section 2.7.4 Signpost Families](#) and [2.7.5 Design Elements](#) for "Design Elements" including typeface and color options specific to National Cemetery Administration facilities.

Sign Designations

Each sign in the program manual has been given a specific sign type number designation. This designation provides a common description that can be referenced when programming a site and ordering signs. The following explains how the sign type designations are derived.

NC - 07.01 A - m1

- NC** Designates a National Cemetery sign.
- 07** Two-digit numbers identify a particular sign type.
- .01** The two-digit number following the period identifies a specific sign size within the sign type.
- A** The letter designates a specific sign configuration, version and/or layout for graphics.
- m1** The letter and number designates the post family and style.
 c1 denotes concrete family with square recess style
 c2 denotes concrete family with round recess style
 m1 denotes metal family with square style
 m2 denotes metal family with rectangle style



Sign Overview

National Cemetery Administration Signage Drawings

NC-01.01
 Visitor Information/Floral
 Regulations Sign - Medium

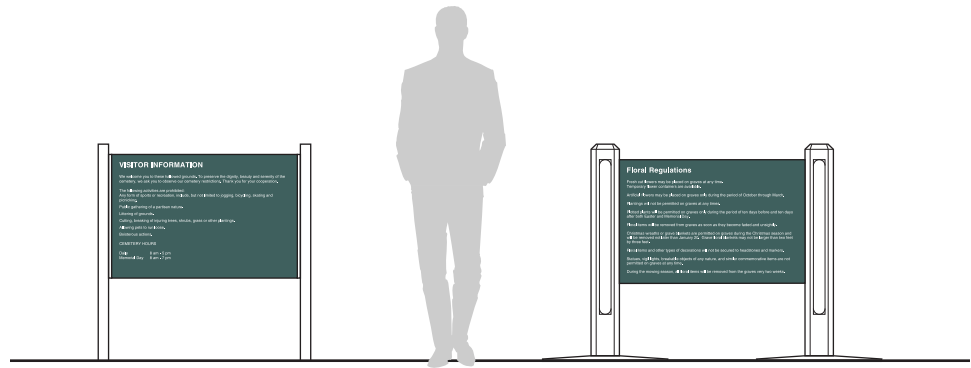

NC-01.01

NC-01.02
 Visitor Information/Floral
 Regulations Sign - Large

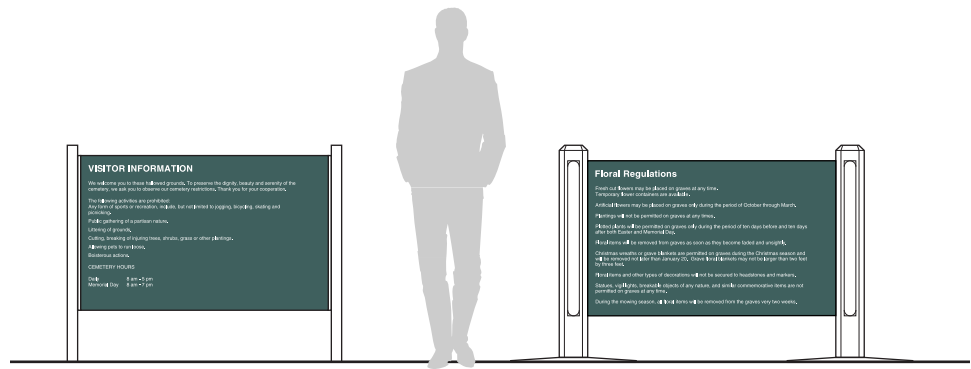

NC-01.02

NC-01.03
 Visitor Information/Regulation Sign
 – Small

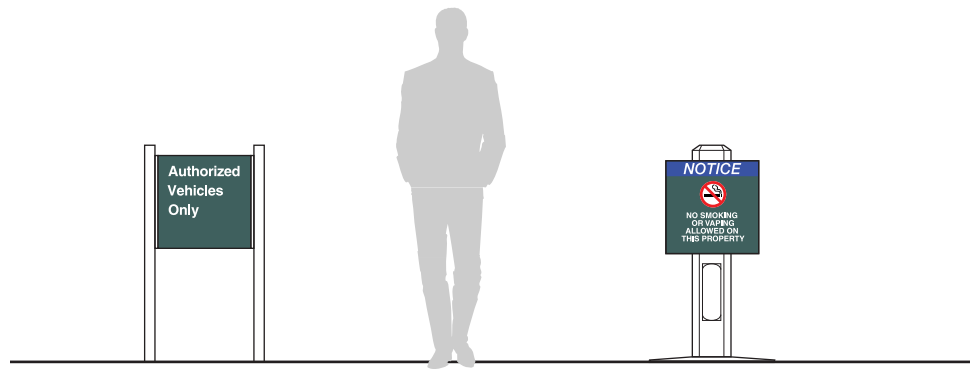

NC-01.03



Sign Overview

National Cemetery Administration Signage Drawings

NC-02.01
Horizontal "You Are Here" Map

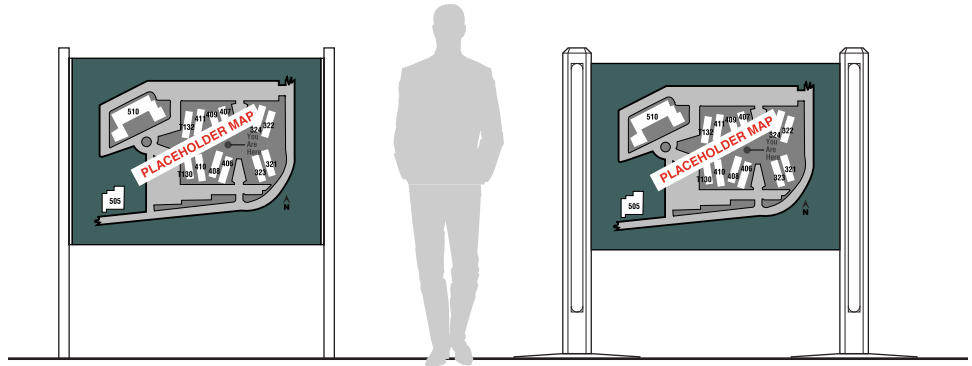

NC-02.01

NC-02.02
Vertical "You Are Here" Map

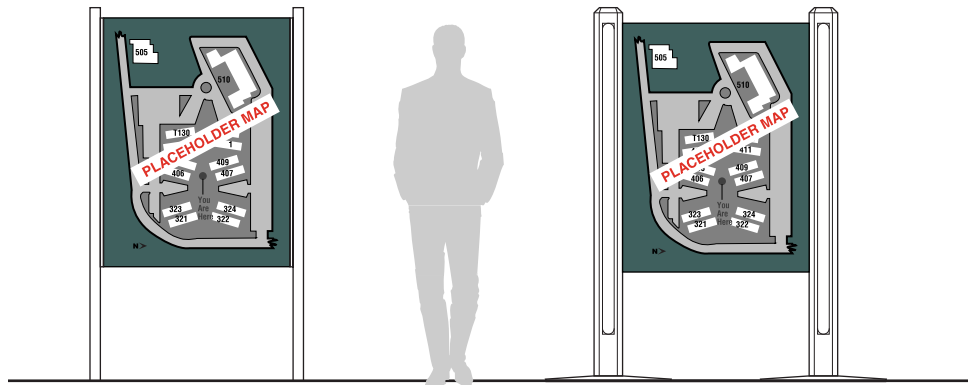

NC-02.02

NC-03.01
Low Profile Traffic Regulatory Signs

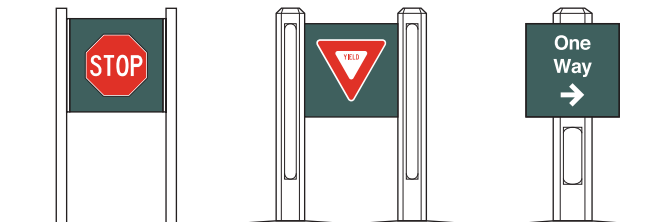

NC-03.01

NC-03.09
Accessible Parking Regulatory Sign

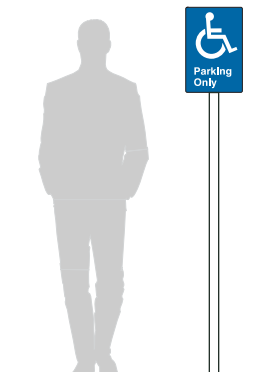

NC-03.09



Sign Overview

National Cemetery Administration Signage Drawings

NC-04.01
 Post and Panel Sign -
 One Line of Text

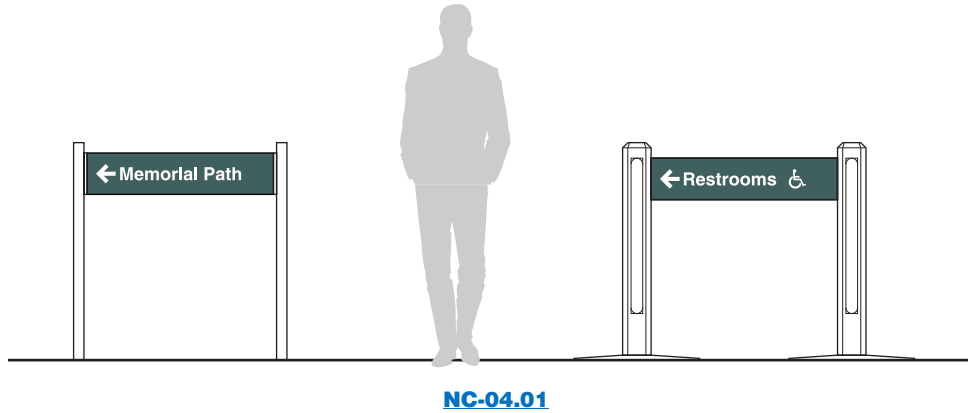

NC-04.02
 Post and Panel Sign -
 Two Lines of Text

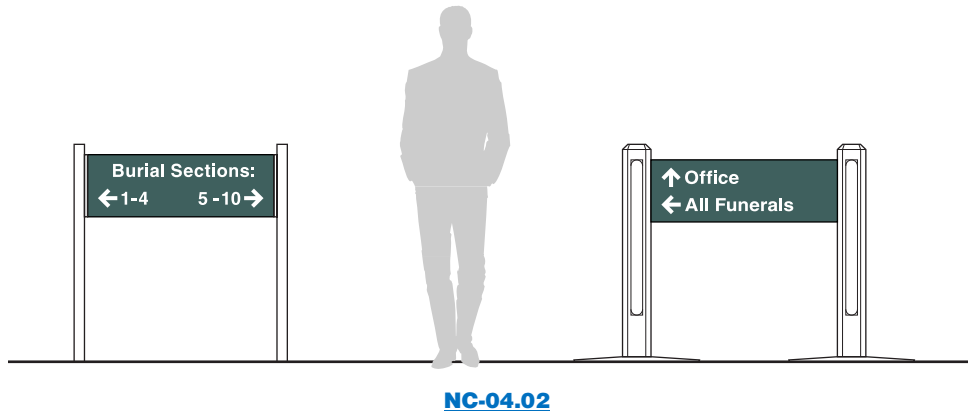

NC-04.03
 Post and Panel Sign -
 Three Lines of Text

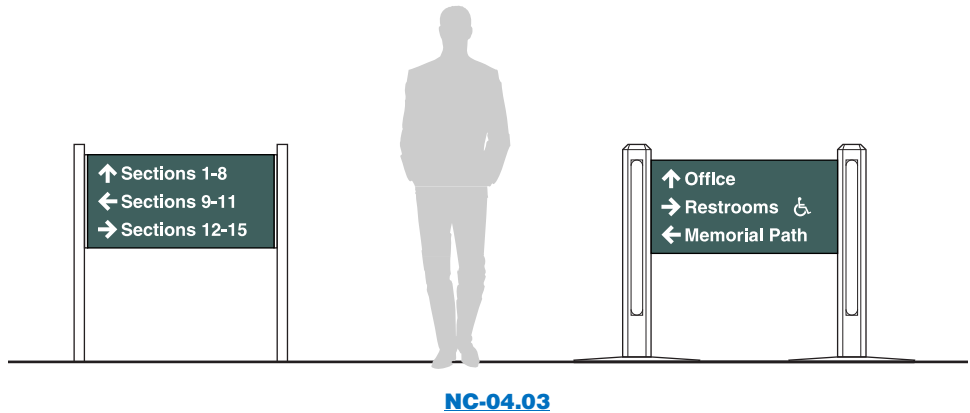

Sign Overview

National Cemetery Administration Signage Drawings

NC-06.01
Pylon Street Sign

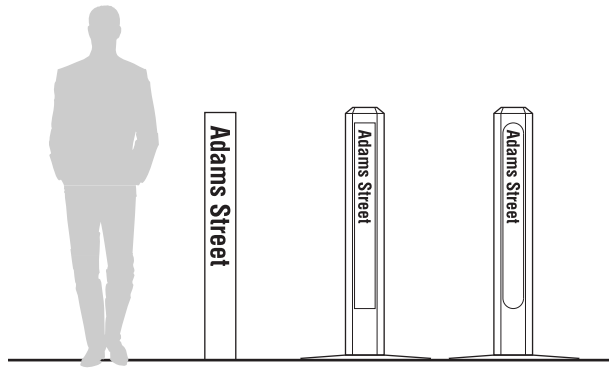

NC-06.01

NC-06.02
Street Marker Flag Sign - Short

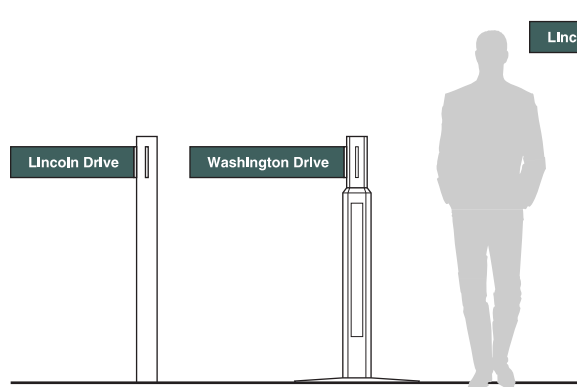

NC-06.02

NC-06.03
Street Marker Flag Sign - Tall

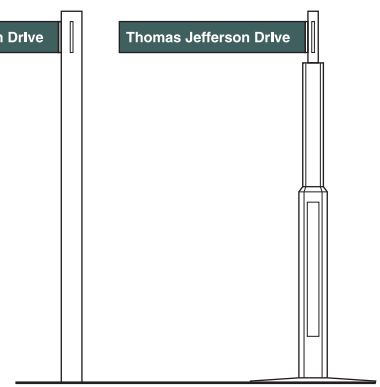

NC-06.03

NC-07.01
Pylon Section Marker

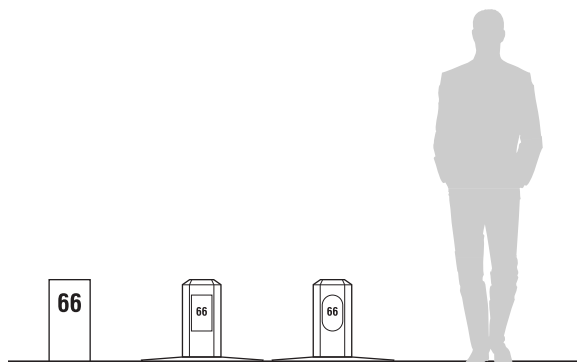

NC-07.01

NC-07.02
Water Spigot Instructional Sign



NC-07.02



Sign Overview

National Cemetery Administration Signage Drawings

NC-07.03
Standard Granite Section Marker

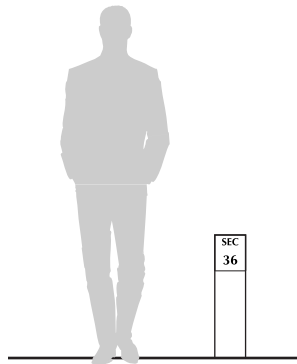

NC-07.03

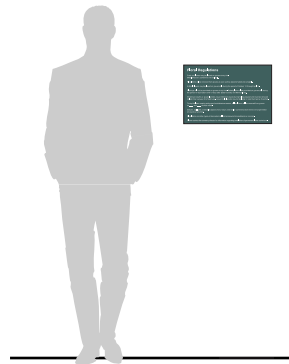

NC-08.01

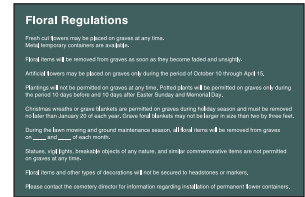

Enlarged View

NC-09.01-.03
Incised Lettering



NC-09.01
(8" High x 1/2" Deep)



NC-09.02
(10" High x 3/4" Deep)



NC-09.03
(12" High x 1" Deep)

NC-10.01-.03
Dimensional Lettering



NC-10.01
(8" High x 1 1/2" Deep)



NC-10.02
(10" High x 2" Deep)



NC-10.03
(12" High x 2 1/2" Deep)

NC-11.01
Dimensional Seal



NC-11.01



Sign Overview

National Cemetery Administration Signage Drawings

NC-14.01
Primary Room Identification Sign



NC-14.01

NC-15.01-.06
Restroom Identification Signs



NC-15.01



NC-15.02



NC-15.03

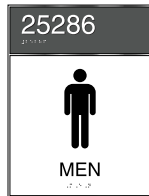

NC-15.04



NC-15.05



NC-15.06

NC-16.01-.06
Pictogram and Symbol Signs



NC-16.01

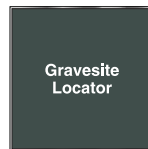

NC-16.02



NC-16.03



NC-16.04

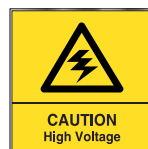

NC-16.05



NC-16.06



NC-01.01

National Cemetery Administration Signage Drawings

Visitor Information/Floral Regulations Sign - Medium

Size

Sign Face:
2'-0" High x 3'-0" Wide
(609.6 mm H x 914.4 mm W)

Overall Sign Height:
3'-6" (1066.8 mm)

Description & Use

National Cemetery non-illuminated, post and panel. Informative sign with visitor instructions and hours.

Message Configuration

Refer to message layout drawing for dimensions.

Message size and layout should be adjusted to the volume of information presented. Smaller fonts than shown should not be used because the messages will be unreadable. Larger fonts than shown will result in messages that may not fit on the sign.

Graphic Process

Surface applied vinyl

Colors

Text: White
Background & Post: Refer to the color chart in the Appendix.

Recommendations

Position sign to provide viewers with a clear, unobstructed view of the sign.



Message Layout A

VISITOR INFORMATION

We welcome you to these hallowed grounds. To preserve the dignity, beauty and serenity of the cemetery, we ask you to observe our cemetery restrictions. Thank you for your cooperation.

The following activities are prohibited:
Any form of sports or recreation, include, but not limited to jogging, bicycling, skating and picnicking.

Public gathering of a partisan nature.
Littering of grounds.
Cutting, breaking or injuring trees, shrubs, grass or other plantings.
Allowing pets to run loose.
Boisterous actions.

CEMETERY HOURS

Daily	8 am - 5 pm
Memorial Day	8 am - 7 pm

Message Layout B

Floral Regulations

Fresh cut flowers may be placed on graves at any time.
Temporary flower containers are available.

Artificial flowers may be placed on graves only during the period of October through March.
Plantings will not be permitted on graves at any times.

Plotted plants will be permitted on graves only during the period of ten days before and ten days after both Easter and Memorial Day.

Floral items will be removed from graves as soon as they become faded and unsightly.

Christmas wreaths or grave blankets are permitted on graves during the Christmas season and will be removed not later than January 20. Grave floral blankets may not be larger than two feet by three feet.

Floral items and other types of decorations will not be secured to headstones and markers.
Statues, vigil lights, breakable objects of any nature, and similar commemorative items are not permitted on graves at any time.

During the mowing season, all floral items will be removed from the graves every two weeks.



NC-01.01

National Cemetery Administration Signage Drawings

Visitor Information/Floral Regulations Sign - Medium

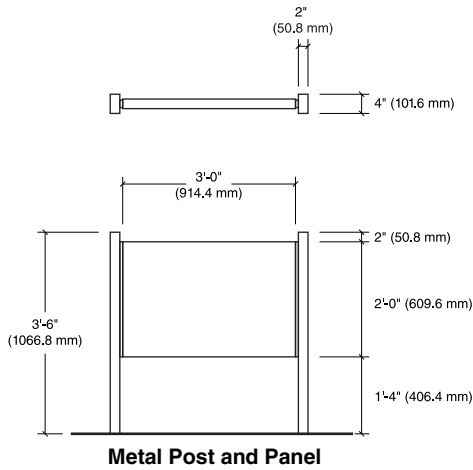

Metal Post and Panel

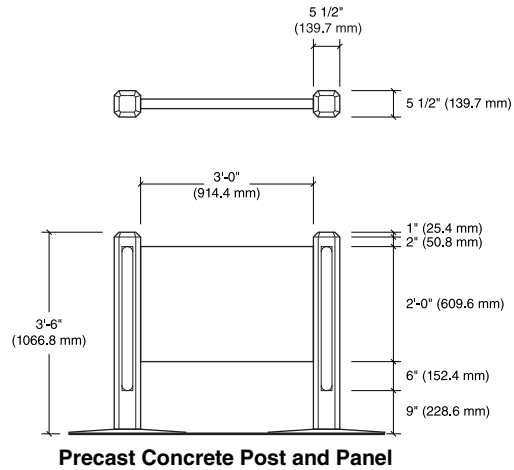

Precast Concrete Post and Panel

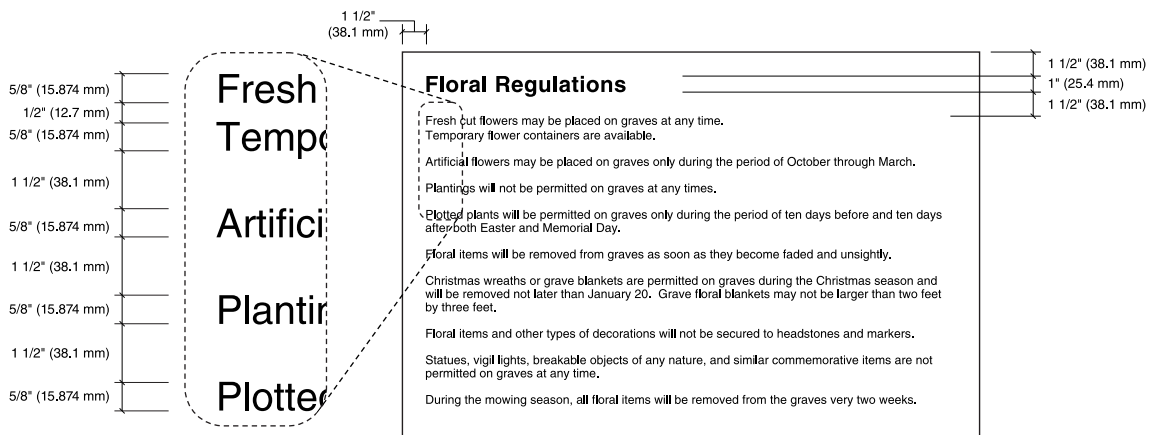
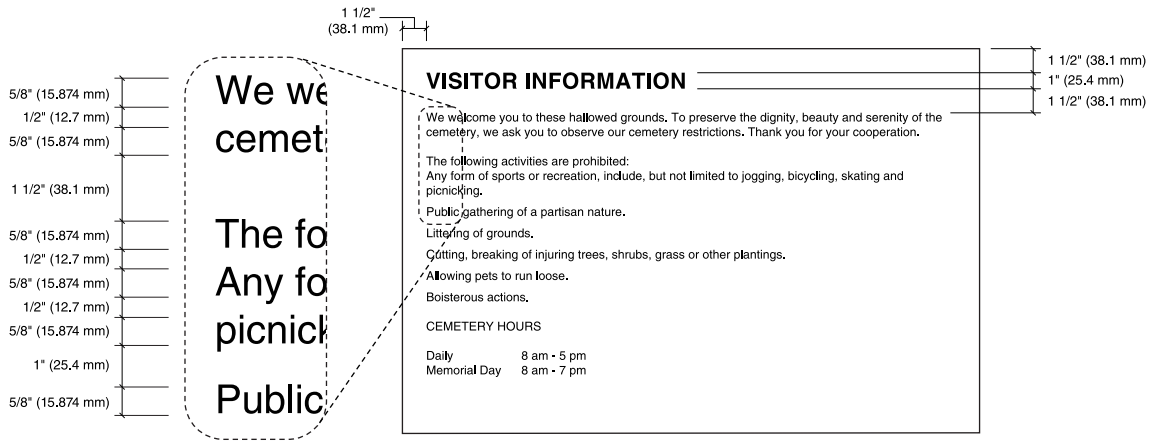

NC-01.02

National Cemetery Administration Signage Drawings

Visitor Information/Floral Regulations Sign - Large

Size

Sign Face:
2'-6" High x 4'-0" Wide
(762 mm H x 1219.2 mm W)

Overall Sign Height:
3'-6" (1066.8 mm)

Description & Use

National Cemetery non-illuminated, post and panel informative sign with visitor instructions and hours.

Message Configuration

Refer to message layout drawing for dimensions.

Message size and layout should be adjusted to the volume of information being presented. Smaller fonts than shown should not be used because the messages will be unreadable. Larger fonts than shown will result in messages that may not fit on the sign.

Graphic Process

Surface applied vinyl

Colors

Text: White
Background & Post: Refer to the color chart in the Appendix.

Recommendations

Position sign to provide viewers with a clear, unobstructed view of the sign.

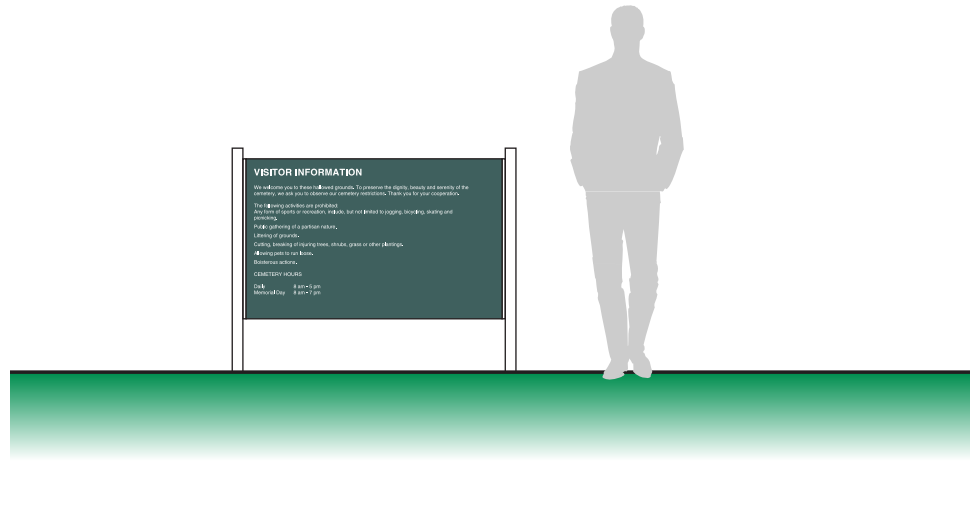

Message Layout A

VISITOR INFORMATION

We welcome you to these hallowed grounds. To preserve the dignity, beauty and serenity of the cemetery, we ask you to observe our cemetery restrictions. Thank you for your cooperation.

The following activities are prohibited:
Any form of sports or recreation, include, but not limited to jogging, bicycling, skating and picnicking.
Public gathering of a partisan nature.
Littering of grounds.
Cutting, breaking or injuring trees, shrubs, grass or other plantings.
Allowing pets to run loose.
Boisterous actions.

CEMETERY HOURS

Daily	8 am - 5 pm
Memorial Day	8 am - 7 pm

Message Layout B

Floral Regulations

Fresh cut flowers may be placed on graves at any time. Temporary flower containers are available.

Artificial flowers may be placed on graves only during the period of October through March.

Plantings will not be permitted on graves at any times.

Plotted plants will be permitted on graves only during the period of ten days before and ten days after both Easter and Memorial Day.

Floral items will be removed from graves as soon as they become faded and unsightly.

Christmas wreaths or grave blankets are permitted on graves during the Christmas season and will be removed not later than January 20. Grave floral blankets may not be larger than two feet by three feet.

Floral items and other types of decorations will not be secured to headstones and markers.

Statues, vigil lights, breakable objects of any nature, and similar commemorative items are not permitted on graves at any time.

During the mowing season, all floral items will be removed from the graves very two weeks.



NC-01.02

National Cemetery Administration Signage Drawings

Visitor Information/Floral Regulations Sign - Large

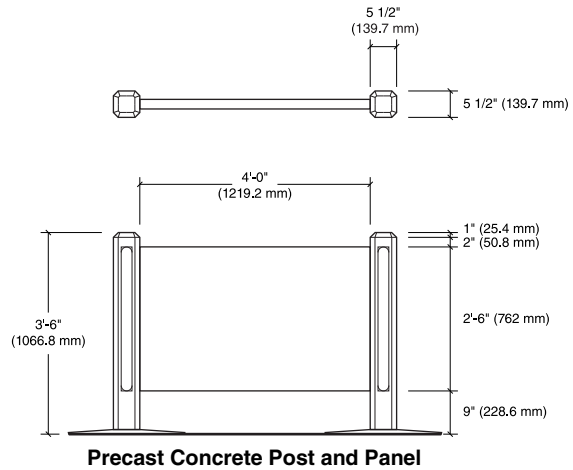
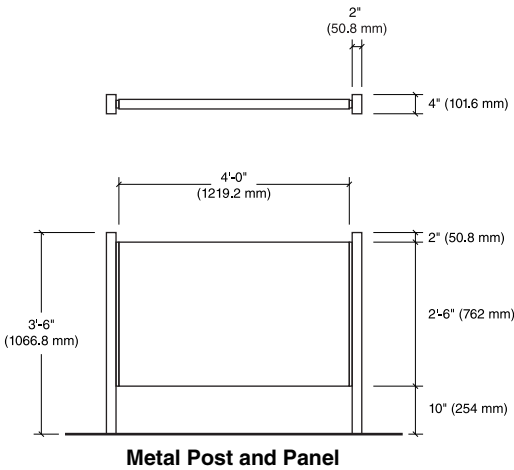

Metal Post and Panel

Precast Concrete Post and Panel

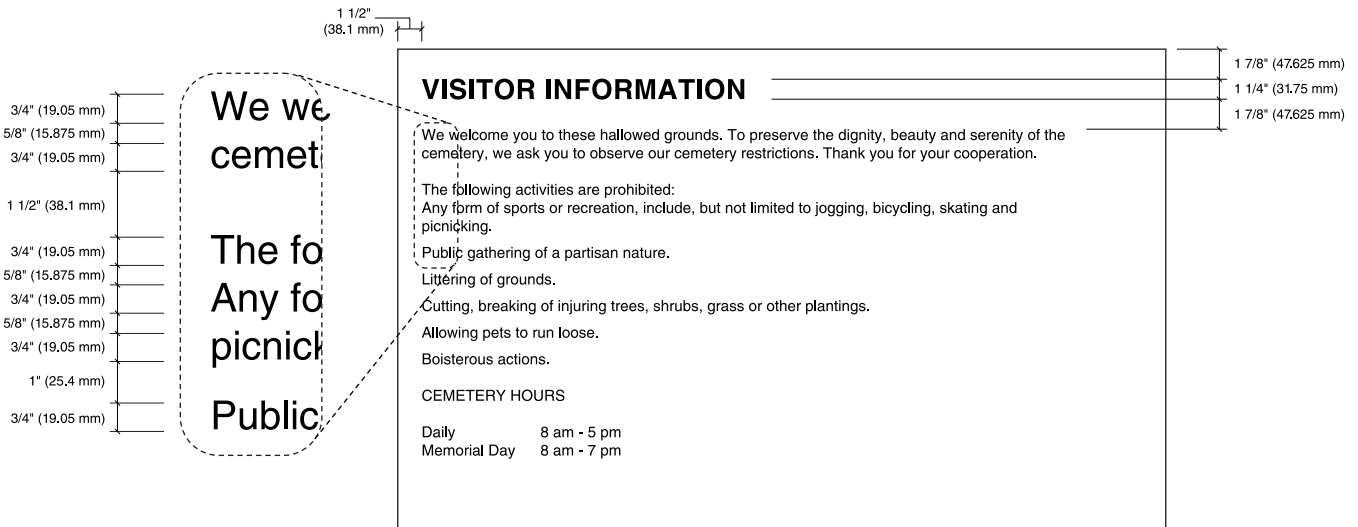

Message Layout A

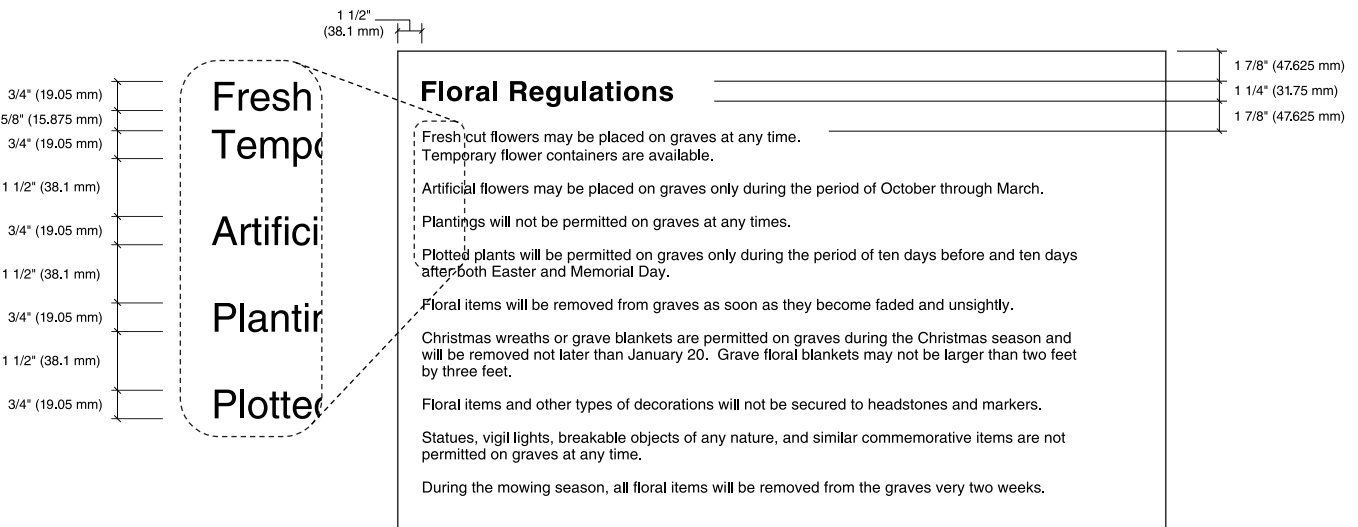

Message Layout B



NC-01.03

National Cemetery Administration Signage Drawings

Visitor Information/Regulation Sign – Small

Size

Sign Face:
1'-6" High x 1'-6" Wide
(457.2 mm H x 457.2 mm W)

Overall Sign Height:
3'-6" (1066.8 mm)

Description & Use

National Cemetery non-illuminated, post and panel informative sign with visitor instructions.

Message Configuration

Refer to message layout drawing for dimensions.

Message size and layout should be adjusted to the volume of information being presented. Smaller fonts than shown should not be used because the messages will be unreadable. Larger fonts than shown will result in messages that may not fit on the sign.

Graphic Process

Surface applied vinyl

Colors

Text: White
Background & Post: Refer to the color chart in the Appendix.

Recommendations

Position sign to provide viewers with a clear, unobstructed view of the sign.

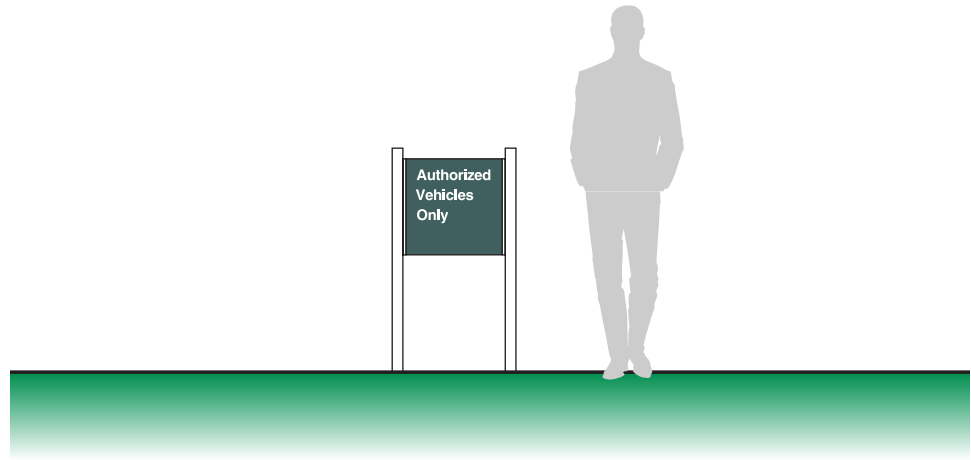

Message Layout A

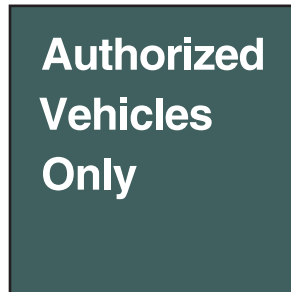

Message Layout B



Message Layout C



Message Layout D



Message Layout E



Message Layout F



Visitor Information/Regulation Sign – Small

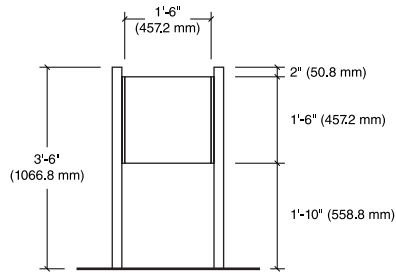
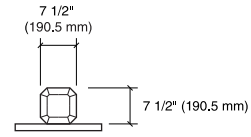
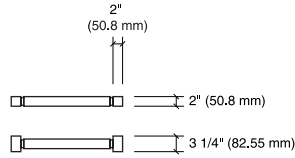

Metal Post and Panel

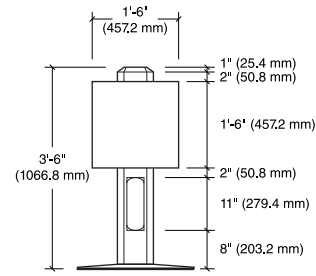

Precast Concrete Post

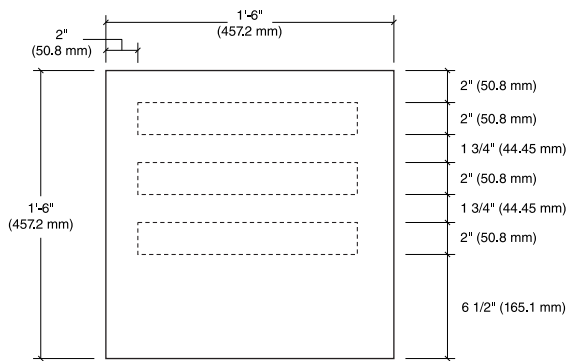

Message Layout A, B, & C

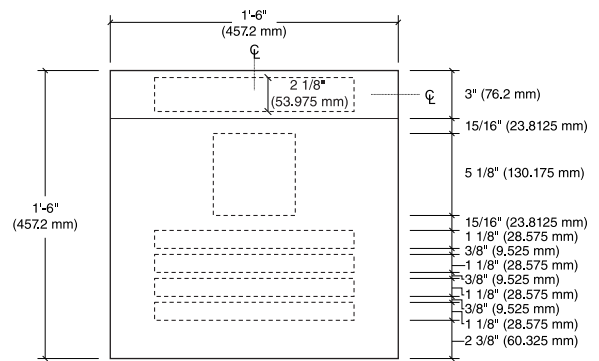

Message Layout D & F

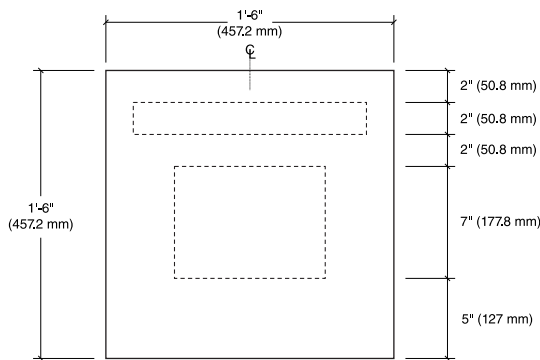

Message Layout E



NC-02.01

National Cemetery Administration Signage Drawings

Horizontal "You Are Here" Map

Size

Sign Face:
3'-0" High x 4'-0" Wide
(914.4 mm H x 1219.2 mm W)

Overall Sign Height:
5'-0" (1524 mm)

Description & Use

Horizontal non-illuminated cemetery orientation map "You Are Here" sign with map and messages directed specifically to pedestrians. Position to provide pedestrians with an unobstructed view of the sign.

Message Configuration

Refer to message layout drawing for dimensions.

Map art is custom to each site and should be made as large as possible on the sign.

Graphic Process

Surface applied reflective vinyl for text. Map is surface silk-screened or large format "printer/plotter" print on vinyl with UV resistant ink and clear UV resistant overcoat.

Colors

Refer to the color chart in the Appendix.

Recommendations

Use this type of sign for maps that are to be viewed by pedestrians.

Use North arrow, entry, and special features for orienting. The campus map should be simple showing streets, burial sections with numbering of sections, columbarium walls, courts, buildings, and memorial walkway. Labeling shows features such as assembly area large memorials. Map should be positioned and oriented in the direction that is being viewed.

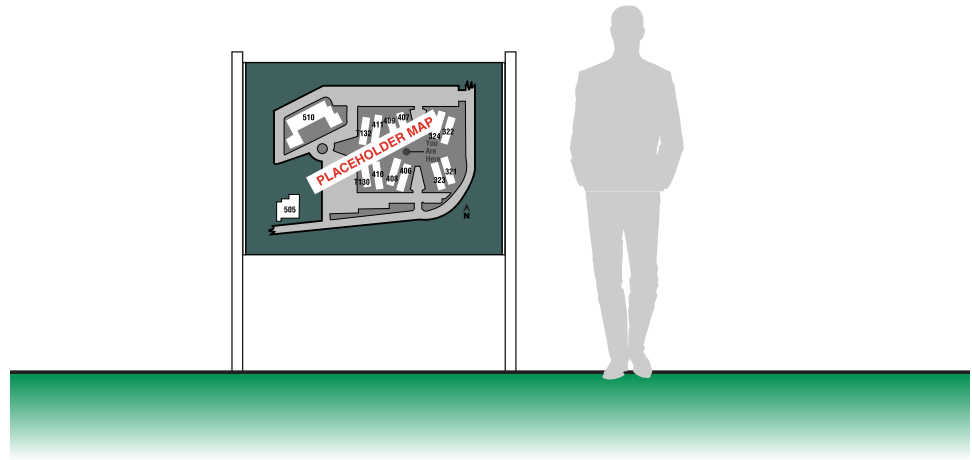

Placeholder Example of Map to be Inserted

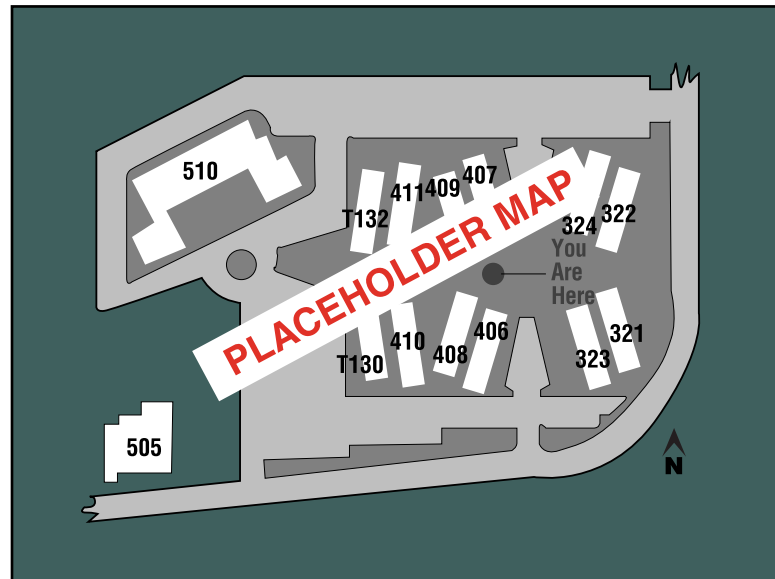

Horizontal "You Are Here" Map

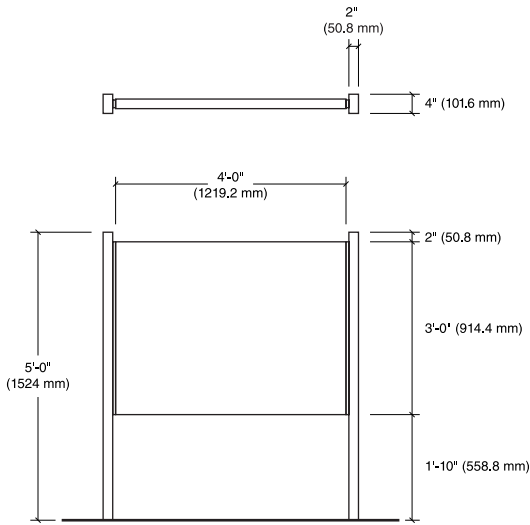

Metal Post and Panel

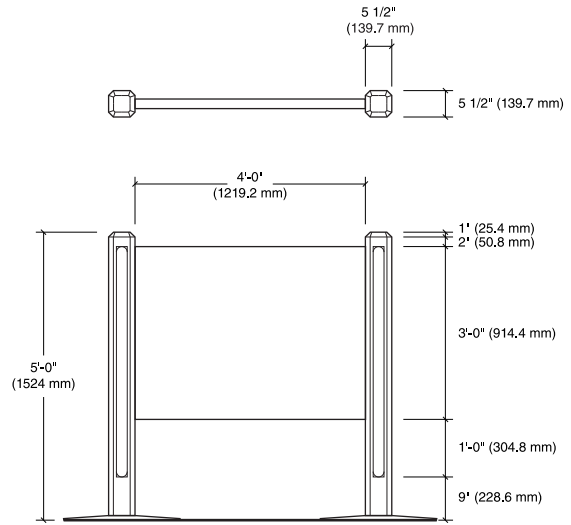

Precast Concrete Post and Panel

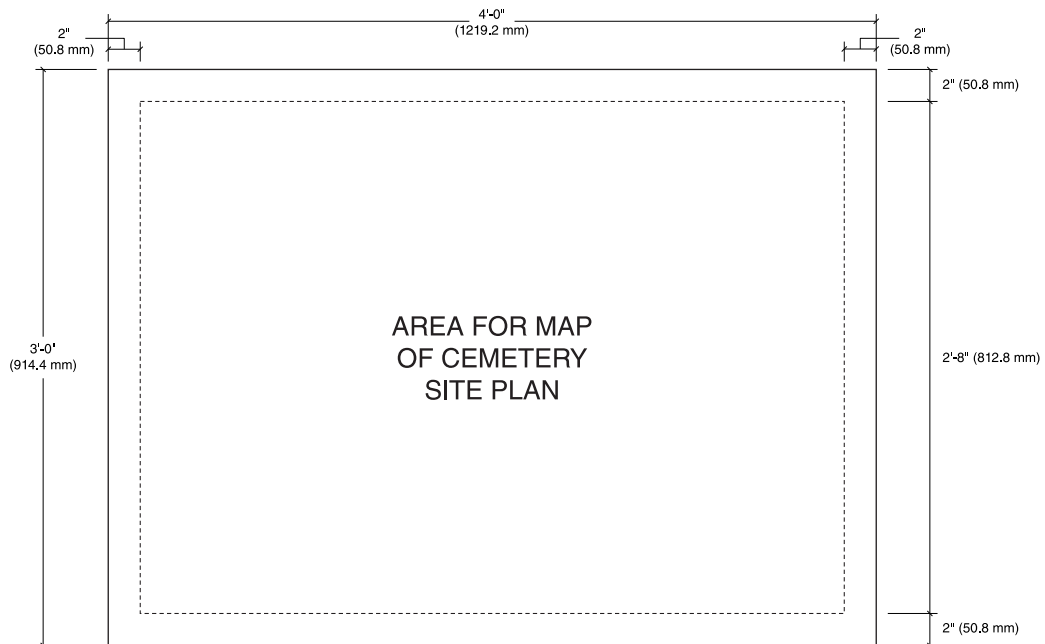

Map Area Constraints



NC-02.02

National Cemetery Administration Signage Drawings

Vertical “You Are Here” Map

Size

Sign Face:
4'-0" High x 3'-0" Wide
(1219.2 mm H x 914.4 mm W)

Overall Sign Height:
6'-0" (1828.8 mm)

Description & Use

Vertical, non-illuminated cemetery orientation sign, “You Are Here” map and messages directed specifically to pedestrians. Position to provide pedestrians with an unobstructed view of the sign.

Message Configuration

Refer to message layout drawing for dimensions.

Map art is custom to each site and should be made as large as possible on the sign

Graphic Process

Surface applied reflective vinyl for text. Map is surface silkscreened or large format “printer/plotter” print on vinyl with UV resistant ink and clear UV resistant overcoat.

Colors

Refer to the color chart in the Appendix.

Recommendations

Use this type of sign for maps that are to be viewed by pedestrians.

Use North arrow, entry, and special features for orienting. The campus map should be simple showing streets, burial sections with numbering of sections, columbarium walls, courts, buildings, and memorial walkway. Labeling shows features such as assembly area large memorials. Map should be positioned and oriented in the direction that is being viewed.

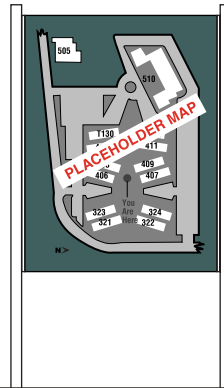

Placeholder Example of Map to be Inserted

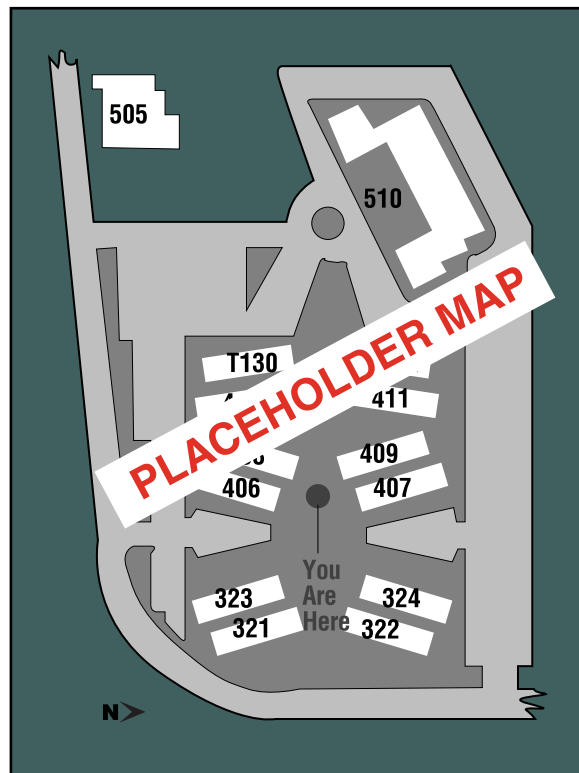

Vertical "You Are Here" Map

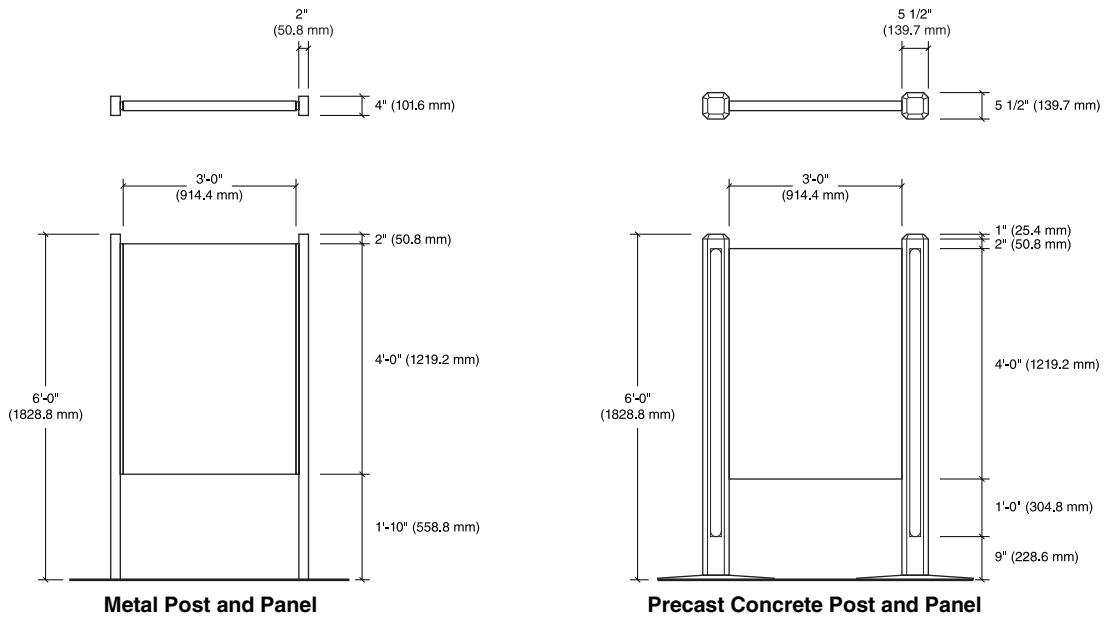

Metal Post and Panel

Precast Concrete Post and Panel

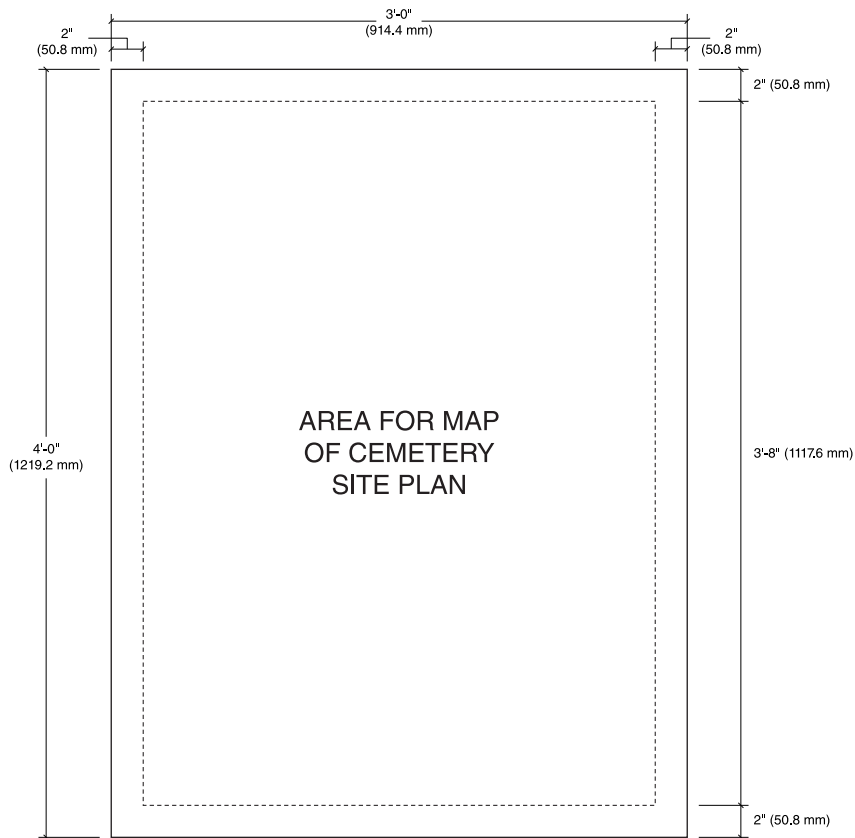

Map Area Constraints



NC-03.01

National Cemetery Administration Signage Drawings

Low Profile Traffic Regulatory Sign

Size

Sign Face:
1'-6" High x 1'-6" Wide
(457.2 mm H x 457.2 mm W)

Overall Sign Height:
3'-6" (1066.8 mm)

Description

National Cemetery post and panel traffic regulatory sign.

Message Configuration

Refer to message layout drawing for dimensions.

Message size and layout should be adjusted to the volume of information being presented. Smaller fonts than shown should not be used because the messages will be unreadable. Larger fonts than shown will result in messages that may not fit on the sign.

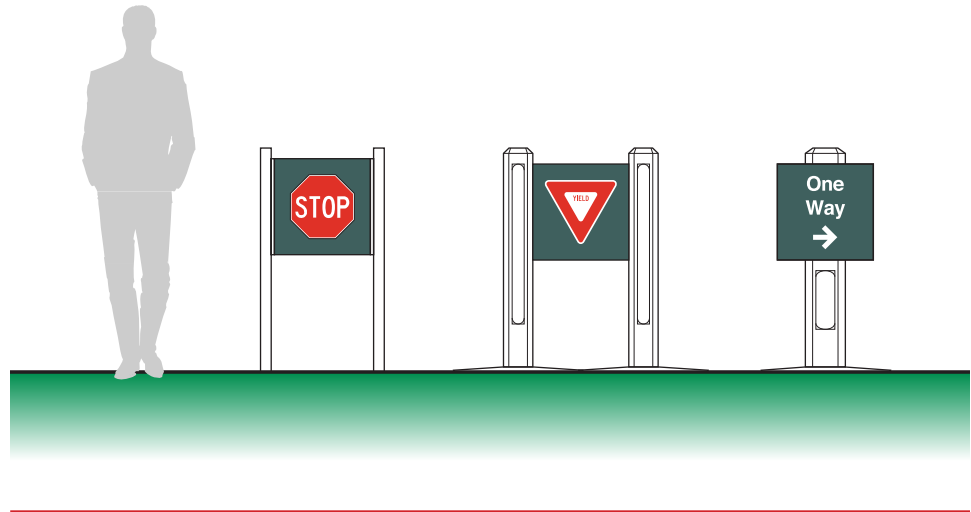

Graphic Process

Surface applied reflective vinyl.

Colors

Text: White
Background & Post: Refer to the color chart in the Appendix.

Recommendations

Position sign to provide viewers with a clear, unobstructed view of the sign.

Message Layout A



Message Layout B



Message Layout C



Message Layout D



Message Layout E



Message Layout F



Message Layout G



Message Layout H



Message Layout J



Message Layout K



Low Profile Traffic Regulatory Signs

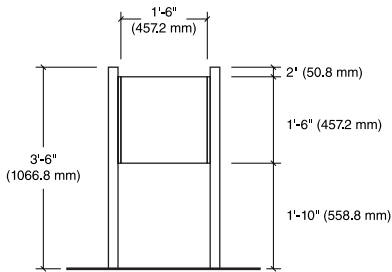
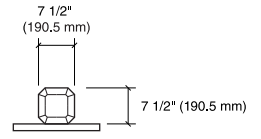
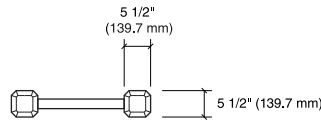
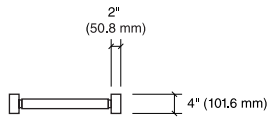

Metal Post & Panel Sign

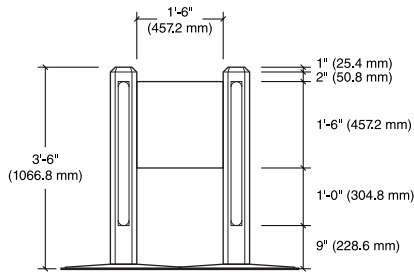

Precast Concrete Post & Panel

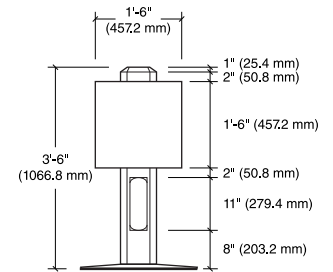

Precast Concrete Post & Panel

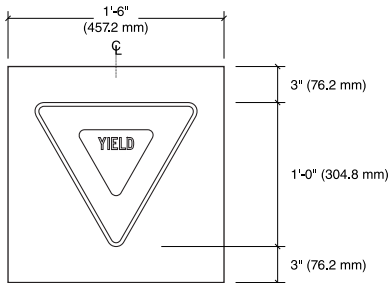

Message Layout A & B

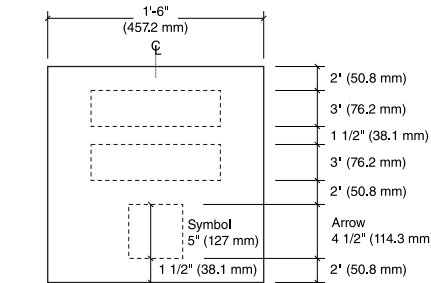

Message Layout C, D, E, & H

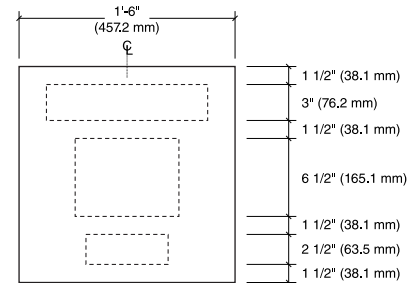

Message Layout F

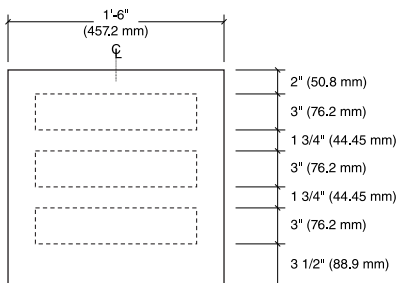

Message Layout G & J

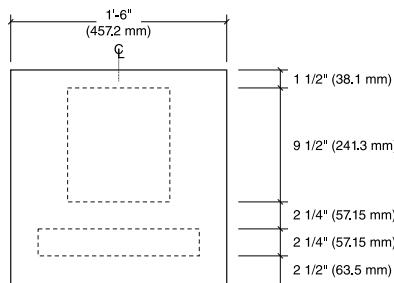

Message Layout K



NC-03.09

National Cemetery Administration Signage Drawings

Accessible Parking Regulatory Sign

Size

Sign Face:
1'-6" High x 1'-0" Wide
(457.2 mm H x 304.8 mm W)

Overall Sign Height:
6'-6" (1981.2 mm)

Description

National Cemetery non-illuminated, post sign identifying accessible parking and pathways.

Message Configuration

Refer to message layout drawing for dimensions.

Graphic Process

Surface applied vinyl

Colors

Text: White
Background: Handicap Blue
Post: Refer to the color chart in the Appendix.

Recommendations

Position sign to provide viewers with a clear, unobstructed view of the sign. ABA/ADA regulations require bottom of sign be at least 5'-0" (1524 mm) from grade.

If this sign is suspended above a circulation path, bottom of sign must be at least 6'-8" (2032 mm) from grade.

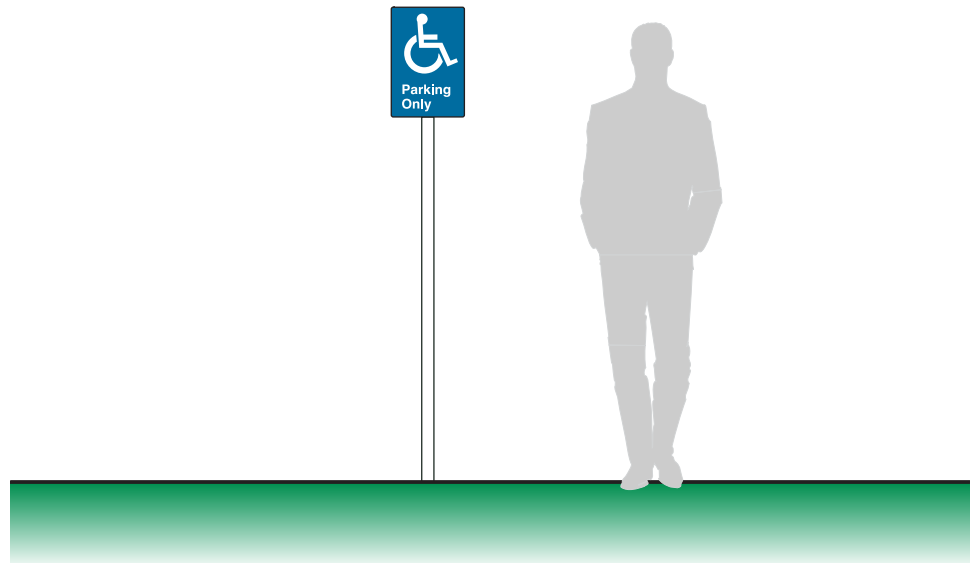

Message Layout A



Message Layout B



Message Layout C



Accessible Parking Regulatory Sign

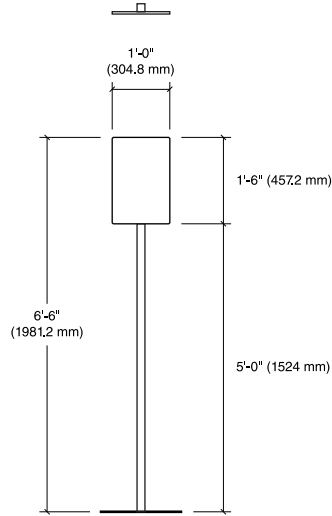

Pole Mounted Sign

Note: If this sign is suspended above a circulation path, bottom of sign must be at least 6'-8" (2032 mm) from grade.

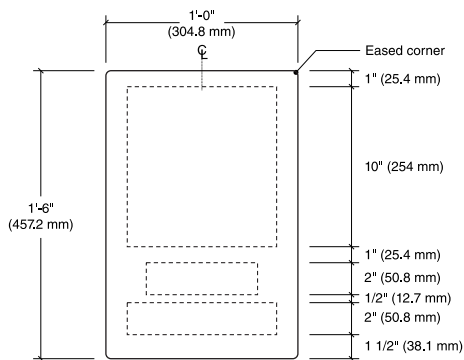

Message Layout A & B

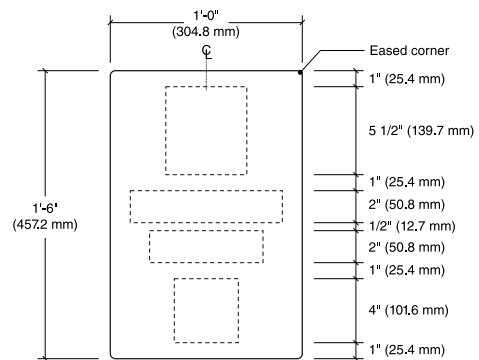

Message Layout C



NC-04.01

National Cemetery Administration Signage Drawings

Post and Panel Sign – One Line of Text

Size

Sign Face:
8" High x 3'-0" Wide
(203.2 mm H x 914.4 mm W)

Overall Sign Height:
3'-6" (1066.8 mm)

Description

National Cemetery non-illuminated, post and panel directional sign with messages with one line of text. This sign can also be used to identify buildings.

Message Configuration

Refer to message layout drawing for dimensions.

Message size and layout should be adjusted to the volume of information being presented. Smaller fonts than shown should not be used because the messages will be unreadable. Larger fonts than shown will result in messages that may not fit on the sign.

Graphic Process

Surface applied reflective vinyl

Colors

Text: White
Background & Post: Refer to the color chart in the Appendix.

Recommendations

Position sign to provide pedestrians with a clear, unobstructed view of the sign.

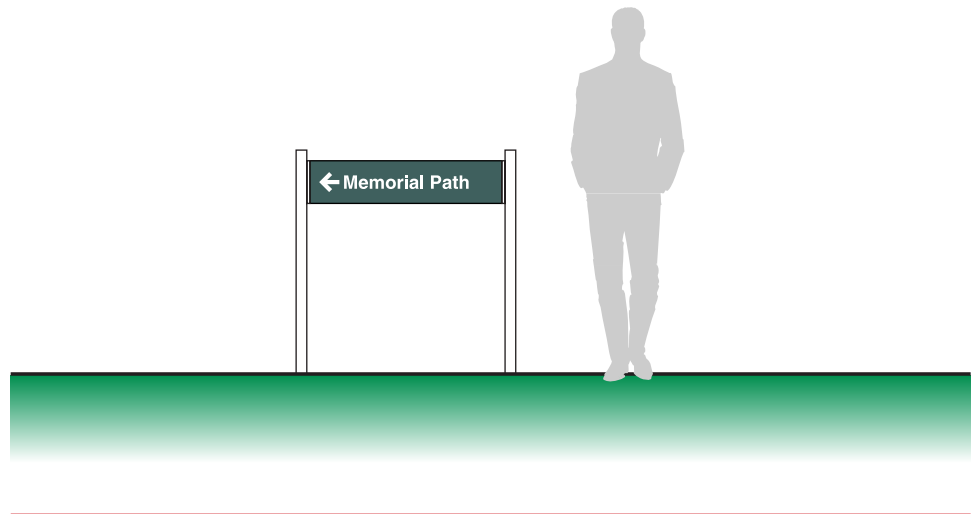

Message Layout A



Message Layout B



Message Layout C



NC-04.01

National Cemetery Administration Signage Drawings

Post and Panel Sign – One Line of Text

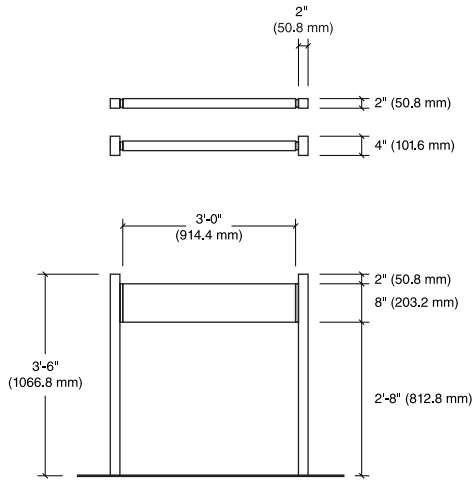

Metal Post and Panel

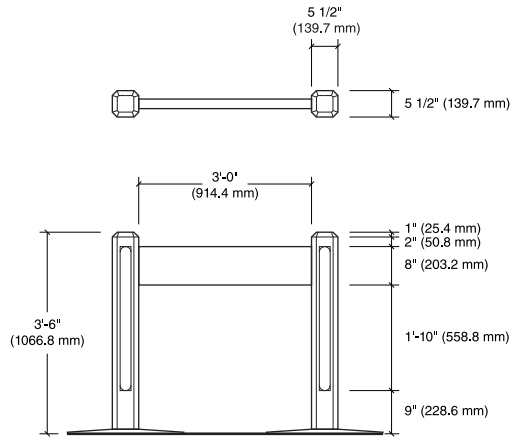

Precast Concrete Post and Panel

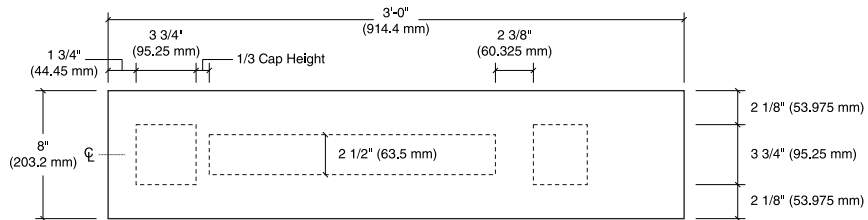

Message Layout A

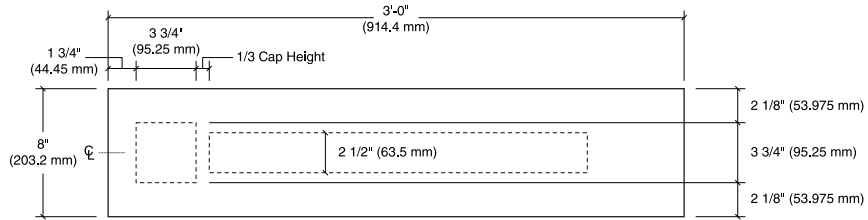

Message Layout B

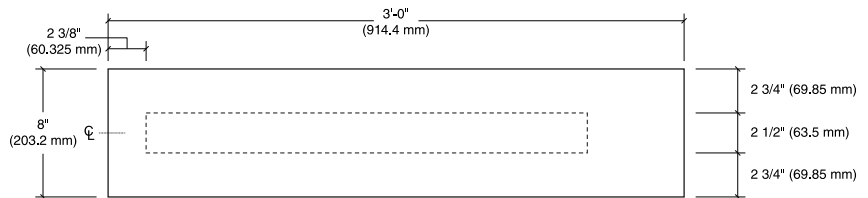

Message Layout C



NC-04.02

National Cemetery Administration Signage Drawings

Post and Panel Sign – Two Lines of Text

Size

Sign Face:
1'-0" High x 3'-0" Wide
(304.8 mm H x 914.4 mm W)

Overall Sign Height:
3'-6" (1066.8 mm)

Description

National Cemetery non-illuminated, post and panel directional sign with messages with two lines of text. The sign can also be used to identify buildings.

Message Configuration

Refer to message layout drawing for dimensions.

Message size and layout should be adjusted to the volume of information being presented. Smaller fonts than shown should not be used because the messages will be unreadable. Larger fonts than shown will result in messages that may not fit on the sign.

Graphic Process

Surface applied reflective vinyl

Colors

Text: White
Background & Post: Refer to the color chart in the Appendix.

Recommendations

Position sign to provide pedestrians with a clear, unobstructed view of the sign.

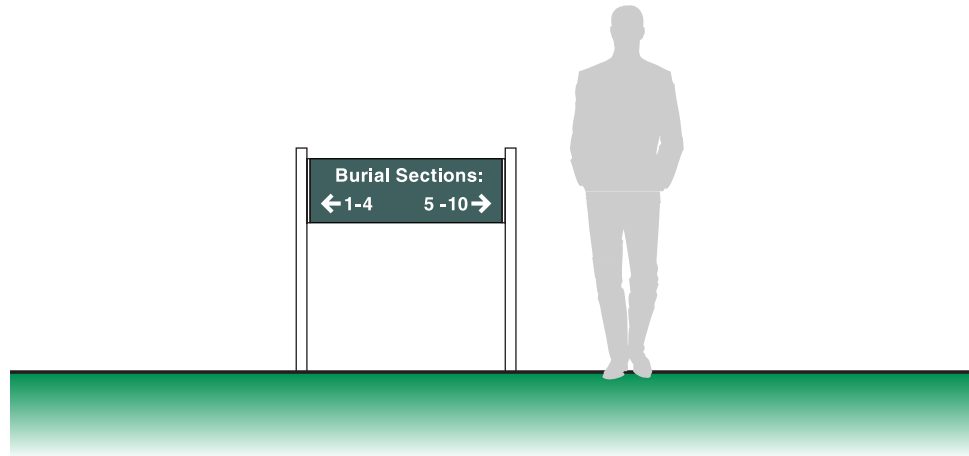

Message Layout A

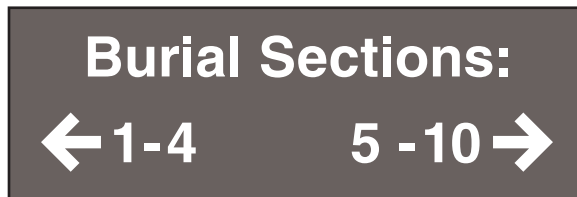

Message Layout B

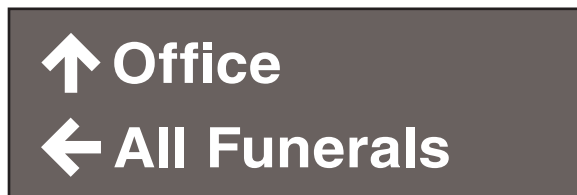

NC-04.02

National Cemetery Administration Signage Drawings

Post and Panel Sign – Two Lines of Text

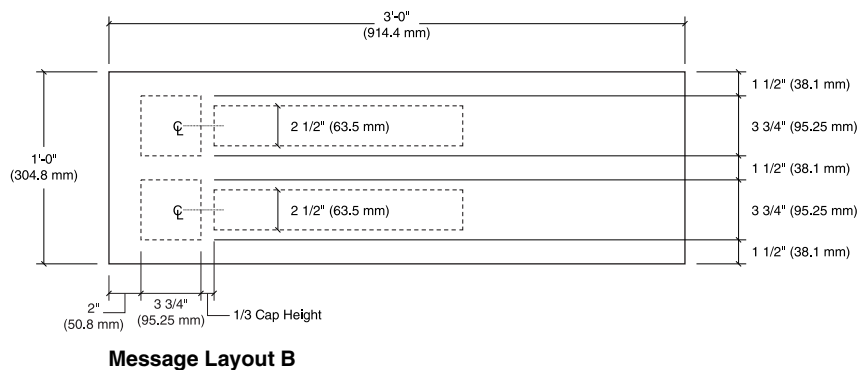
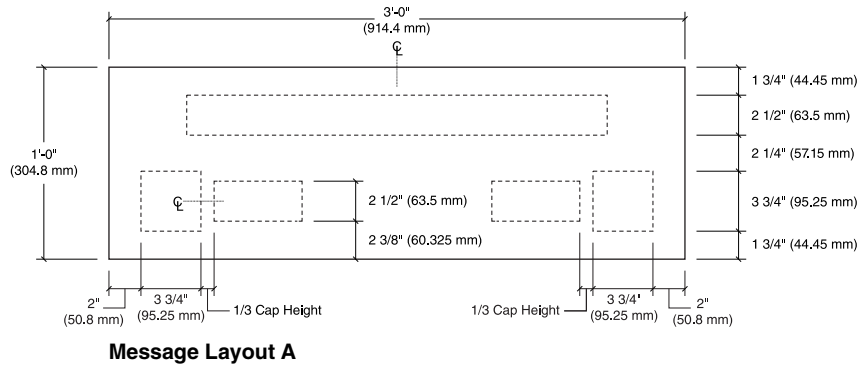
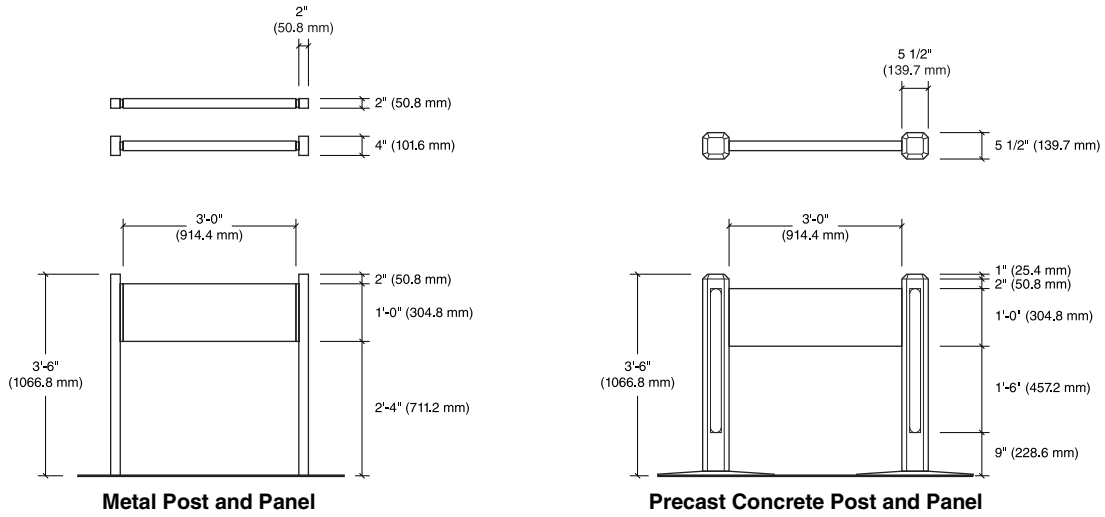

NC-04.03

National Cemetery Administration Signage Drawings

Post and Panel Sign – Three Lines of Text

Size

Sign Face:
1'-6" High x 3'-0"
(457.2 mm H x 914.4 mm W)

Overall Sign Height:
3'-6" (1066.8 mm)

Description

National Cemetery non-illuminated, post and panel directional sign with messages with three lines of text.

Message Configuration

Refer to message layout drawing for dimensions.

Message size and layout should be adjusted to the volume of information being presented. Smaller fonts than shown should not be used because the messages will be unreadable. Larger fonts than shown will result in messages that may not fit on the sign.

Graphic Process

Surface applied reflective vinyl

Colors

Text: White
Background & Post: Refer to the color chart in the Appendix.

Recommendations

Position sign to provide vehicles and pedestrians with a clear, unobstructed view of the sign.



Message Layout A

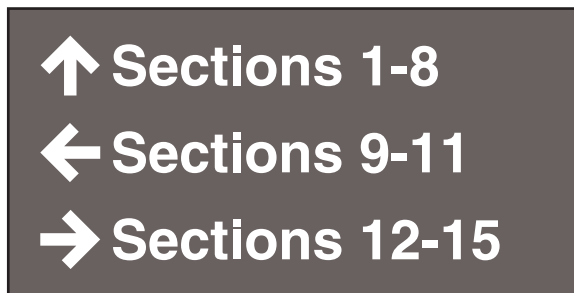

Message Layout B

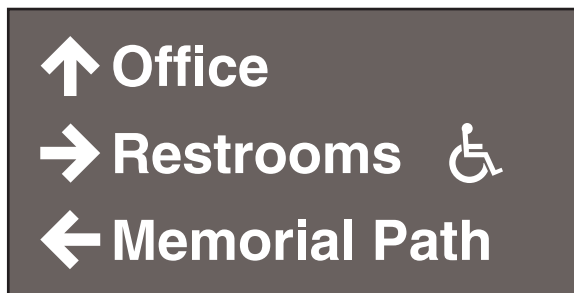

NC-04.03

National Cemetery Administration Signage Drawings

Post and Panel Sign – Three Lines of Text

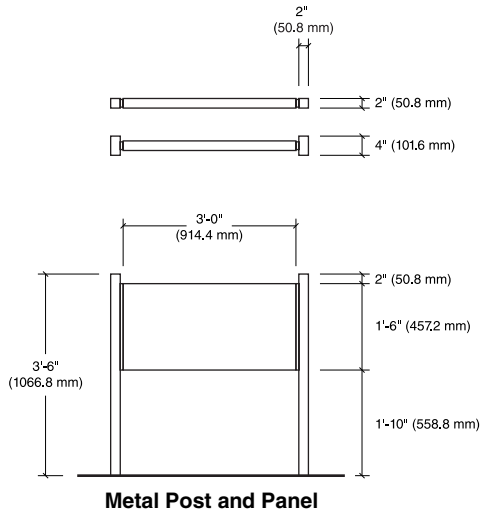

Metal Post and Panel

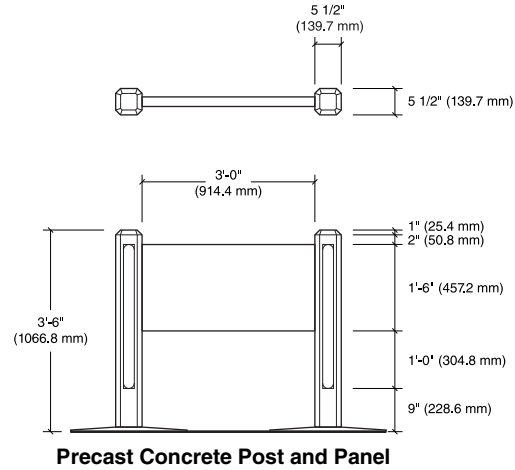

Precast Concrete Post and Panel

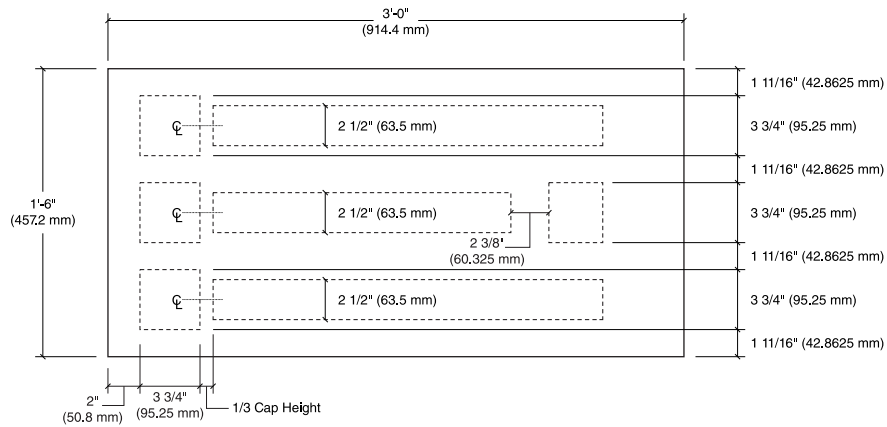

Message Layout A & B



NC-06.01

National Cemetery Administration Signage Drawings

Pylon Street Sign

Size

Sign Face:
3'-0" High x 3 3/4" Wide
(914.4 mm H x 95.25 mm W)

Metal Post:
4'-0" High x 6" Wide x 6" Deep
(1219.2 H x 152.4 W x 152.4 D)

Concrete Post:
4'-0" High x 7 1/2" Wide x 7 1/2" Deep
(1219.2 H x 190.5 W x 190.5 D)

Description

National Cemetery non-illuminated, Street post with messages directed specifically to vehicles.

Message Configuration

Refer to message layout drawing for dimensions.

Message size and layout should fit in small text area. Smaller fonts than shown should not be used because the messages will be unreadable. A long text line may not fit on the sign.

Graphic Process

Surface applied reflective vinyl

Colors

Text: White
Background & Post: Refer to the color chart in the Appendix.

Typography and Size

Helvetica Bold Condensed

Recommendations

Position sign to provide vehicles and pedestrians with a clear, unobstructed view of the sign.

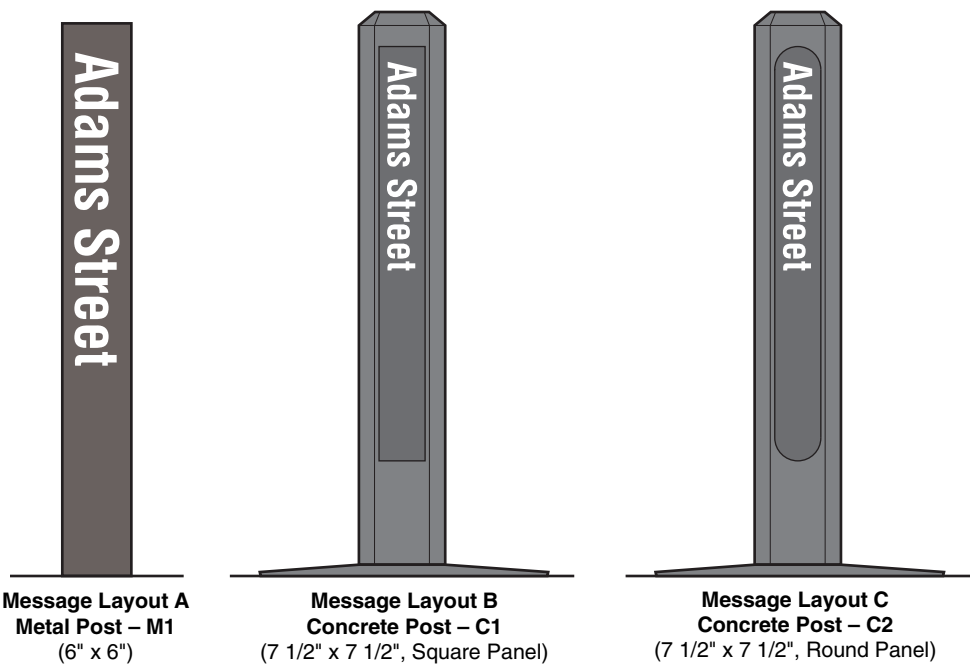
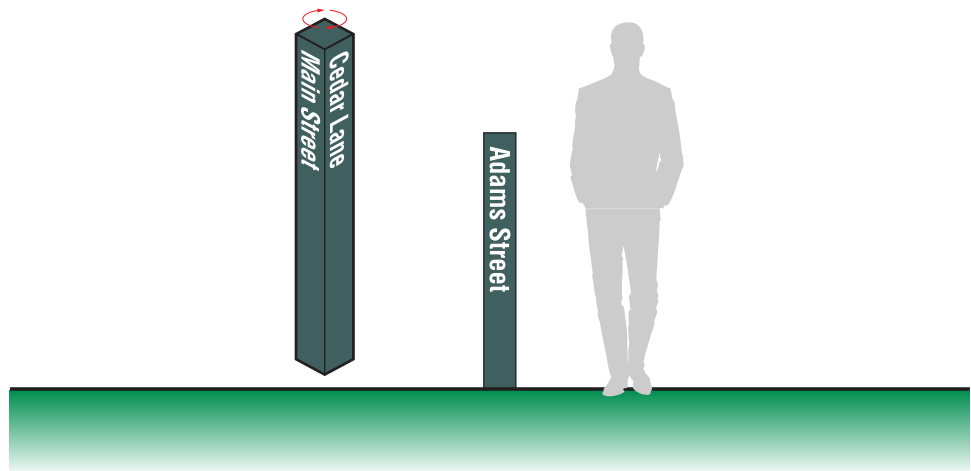

NC-06.01

National Cemetery Administration Signage Drawings

Pylon Street Sign

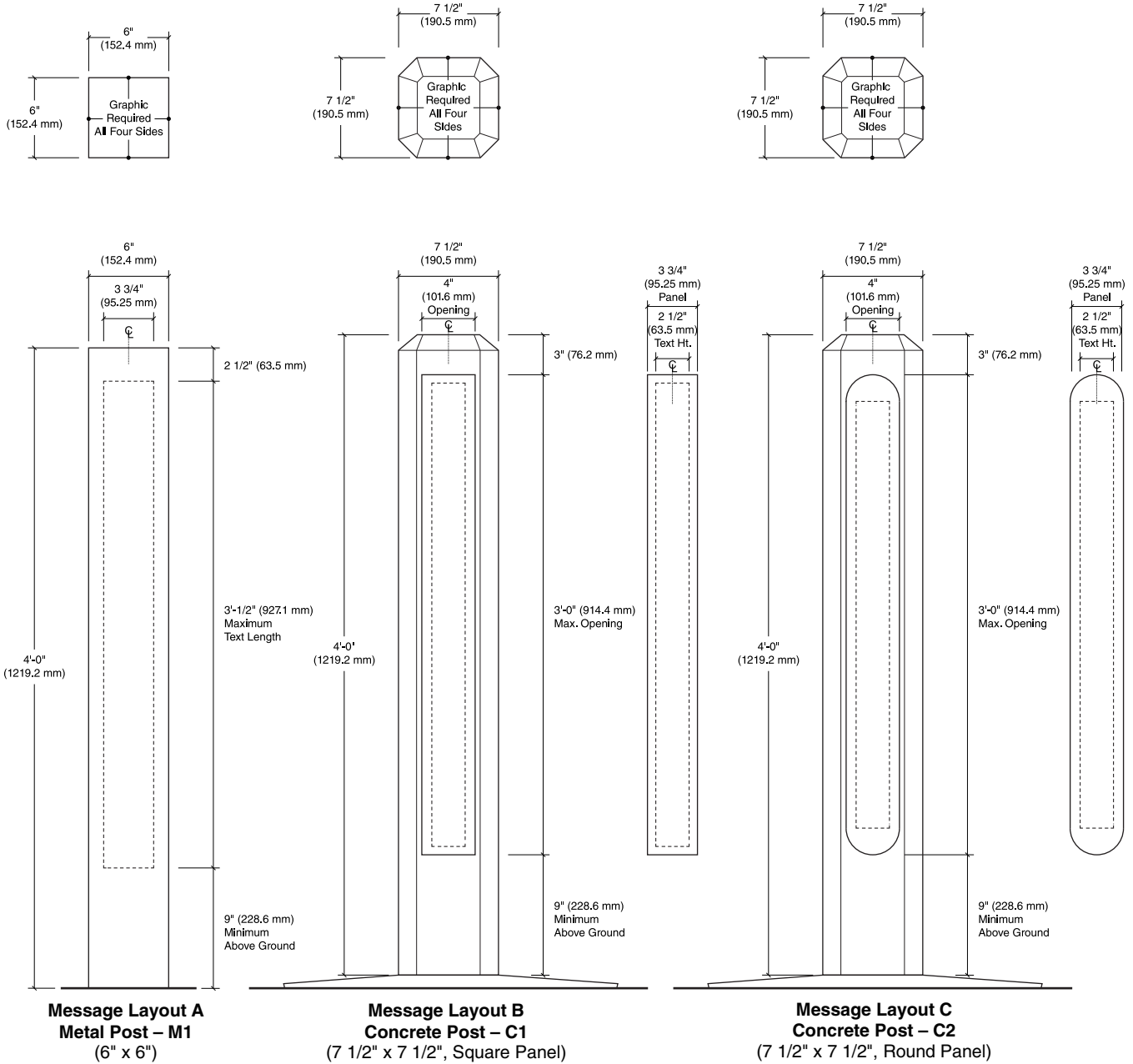

NC-06.02

National Cemetery Administration Signage Drawings

Street Marker Flag Sign – Short

Size

Sign Face:
6" High x Various Widths
(152.4 mm H x Various W)

Overall Sign Height:
4'-0" (1219.2 mm)

Description

National Cemetery non-illuminated, post and flag panel street identification sign with messages directed specifically at vehicles and pedestrians. The sign may also be used to identify buildings.

Message Configuration

Refer to message layout drawing for dimensions.

Street name will determine panel size. Smaller fonts than shown should not be used because the messages will be unreadable. Larger fonts than shown will result in messages that may not fit on the sign.

Graphic Process

Surface applied reflective vinyl

Colors

Text: White
Background & Post: Refer to the color chart in the Appendix

Recommendations

Position sign to provide vehicles and pedestrians with a clear, unobstructed view of the sign.

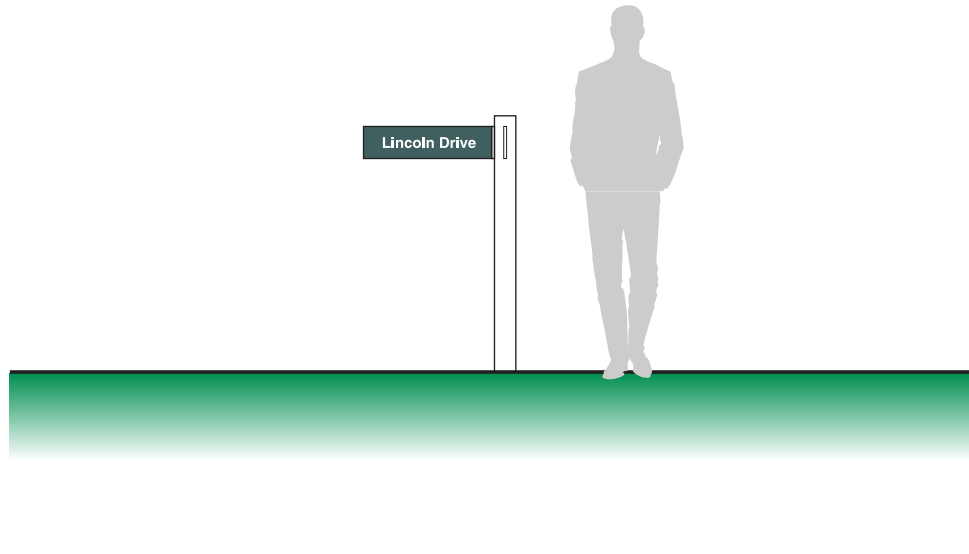

Message Layout A



Message Layout B



Message Layout C



NC-06.02

National Cemetery Administration Signage Drawings

Street Marker Flag Sign – Short

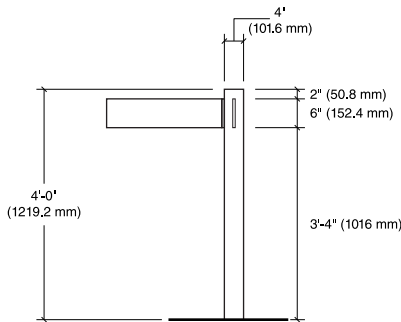
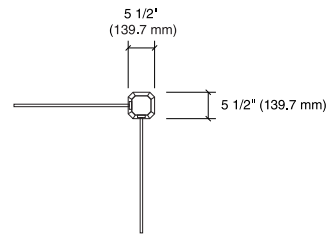
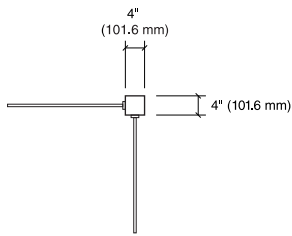

Metal Post

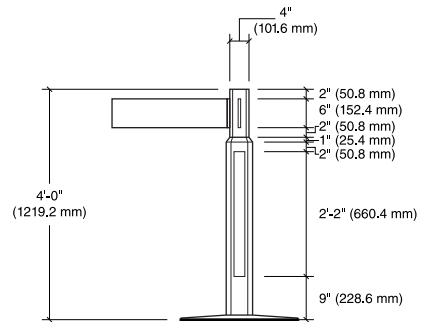

Precast Concrete Post

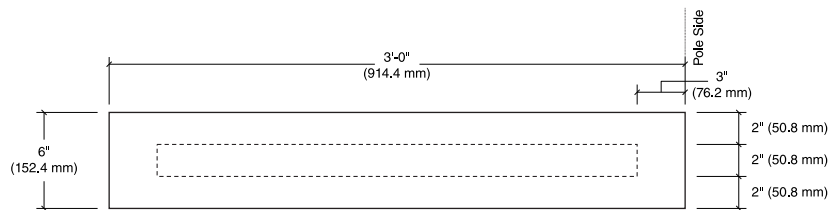

Message Layout A

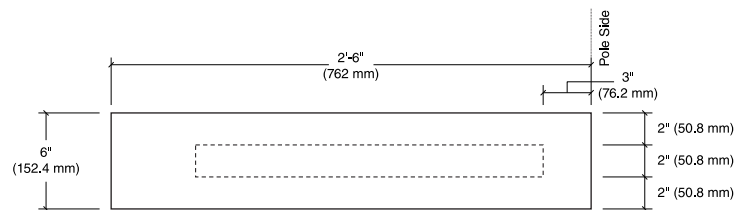

Message Layout B

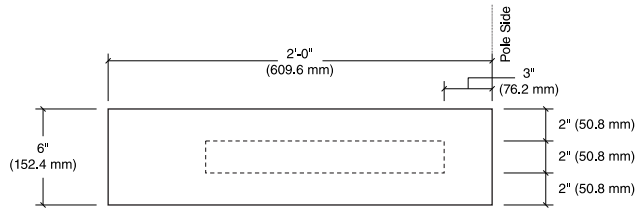

Message Layout C



NC-06.03

National Cemetery Administration Signage Drawings

Street Marker Flag Sign – Tall

Size

Sign Face:
6" High x Various Widths
(152.4 mm H x Various W)

Overall Sign Height:
6'-0" (1828.8 mm)

Description

National Cemetery non-illuminated, post and flag panel street identification sign with messages directed specifically at vehicles.

Message Configuration

Refer to message layout drawing for dimensions.

Street name will determine panel size. Smaller fonts than shown should not be used because the messages will be unreadable. Larger fonts than shown will result in messages that may not fit on the sign.

Graphic Process

Surface applied reflective vinyl.

Colors

Text: White
Background & Post: Refer to the color chart in the Appendix

Recommendations

Position sign to provide vehicles with a clear, unobstructed view of the sign.

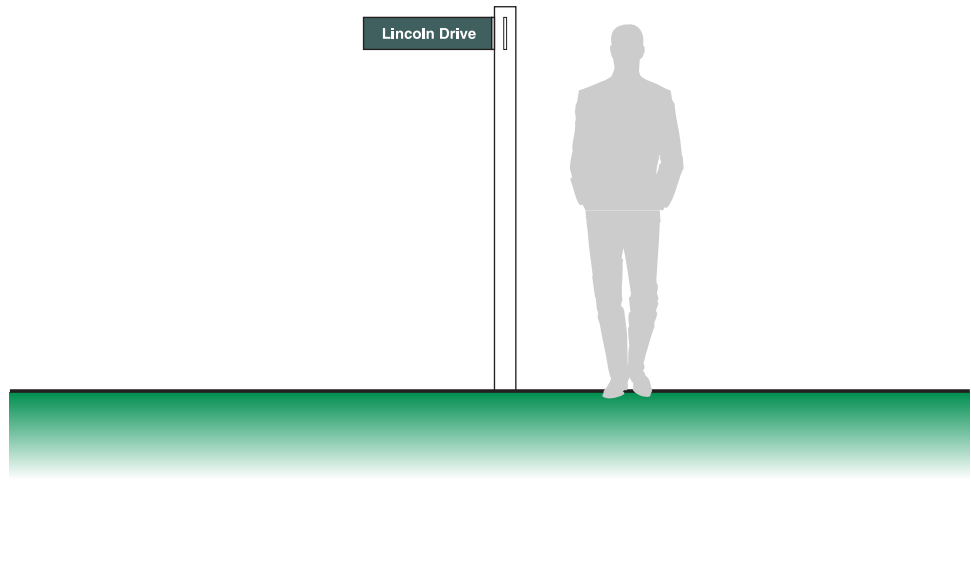

Message Layout A



Message Layout B



Message Layout C



NC-06.03

National Cemetery Administration Signage Drawings

Street Marker Flag Sign – Tall

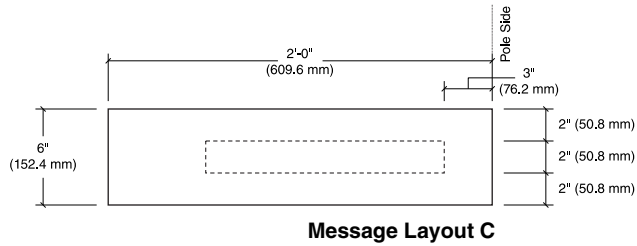
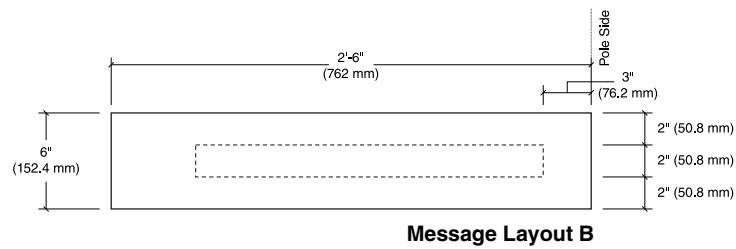
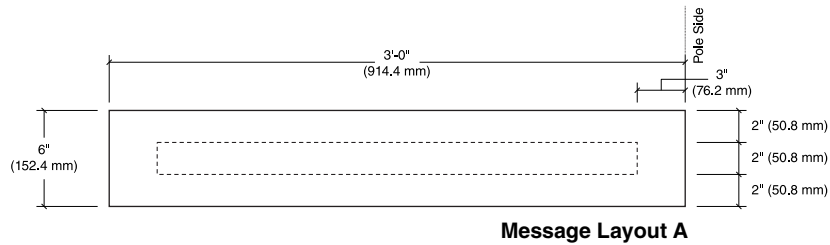
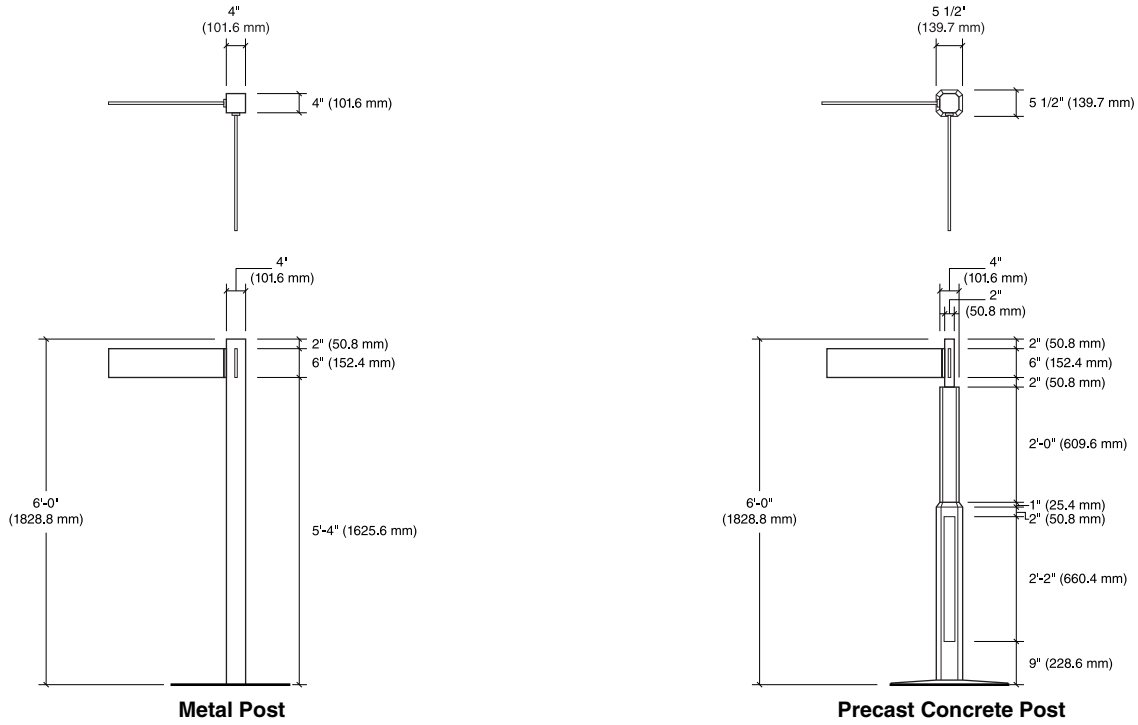

NC-07.01

National Cemetery Administration Signage Drawings

Pylon Section Marker

Size

Panel Face:
7" High x 3 3/4" Wide
(177.8 mm H x 95.25 mm W)

Metal Post:
1'-4" High x 8" Wide x 8" Deep
(406.4 H x 203.2 W x 203.2 D)

Concrete Post:
1'-4" High x 7 1/2" Wide x 7 1/2" Deep
(406.4 H x 190.5 W x 190.5 D)

Description

National Cemetery non-illuminated, pylon sign with messages directed specifically at pedestrians.

Message Configuration

Refer to message layout drawing for dimensions.

Markers can present a maximum of three characters on a side. Smaller fonts than shown should not be used because the messages will be unreadable. Larger fonts than shown will result in messages or text that may not fit on the sign.

Graphic Process

Surface applied reflective vinyl.

Colors

Text: White
Background & Post: Refer to the color chart in the Appendix

Typography and Size

Helvetica Bold Condensed

Recommendations

Position sign to provide vehicles and pedestrians with a clear, unobstructed view of the sign.

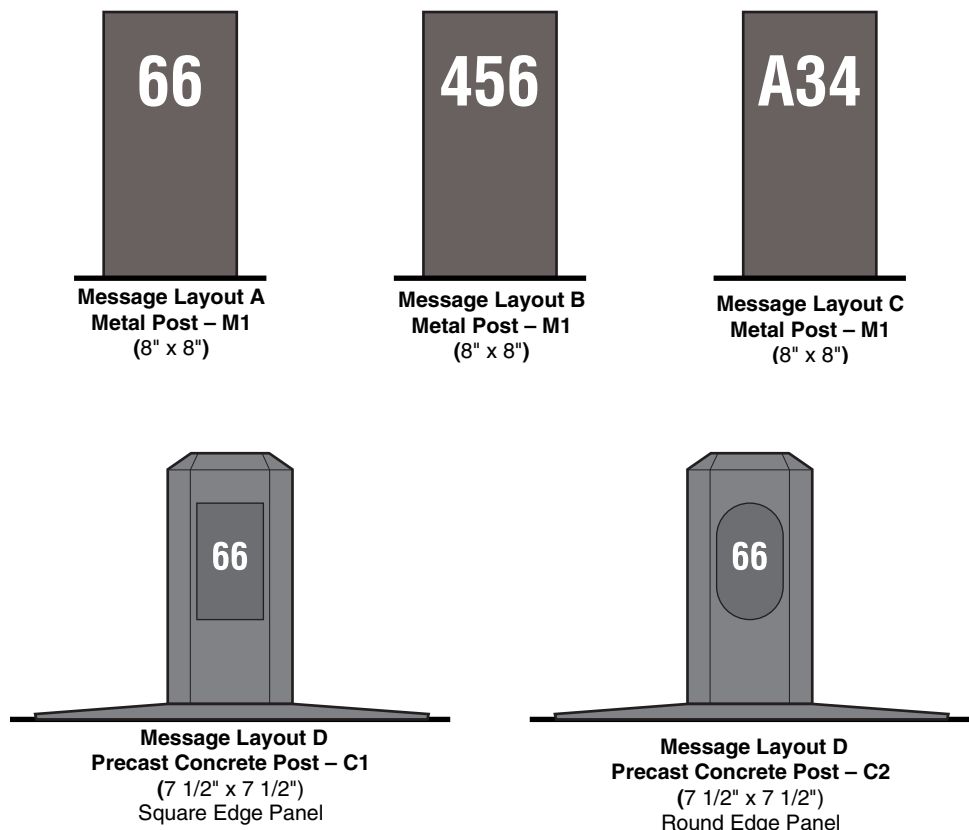
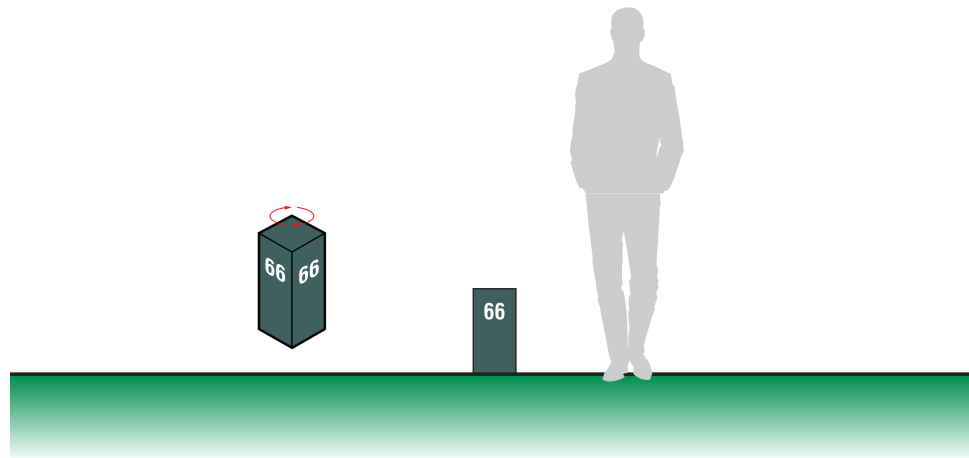

Pylon Section Marker

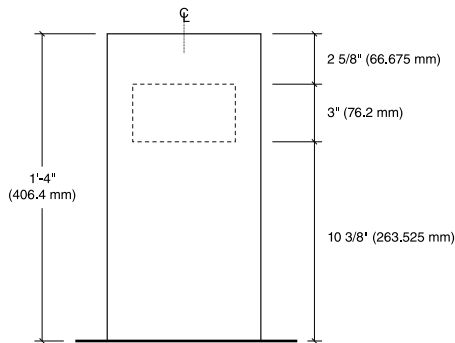
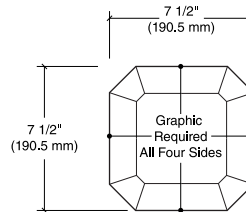
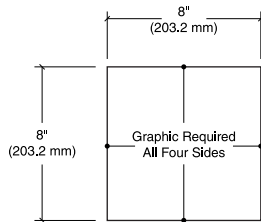

**Message Layout A, B, & C
Metal Post**

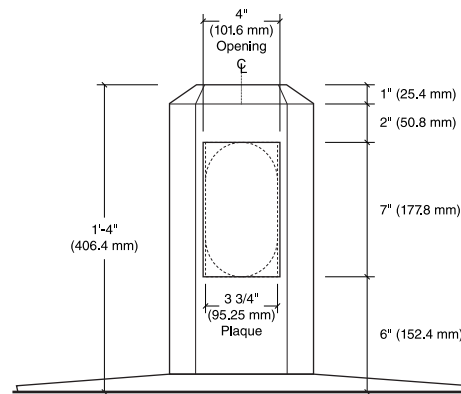

**Message Layout D
Precast Concrete Post**

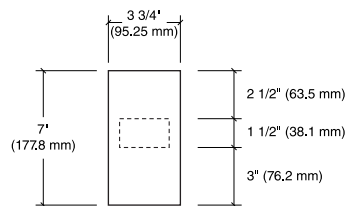

**Message Layout D
Square Edge Panel**

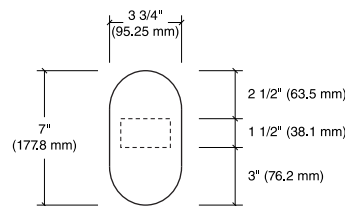

**Message Layout D
Round Edge Panel**



NC-07.02

National Cemetery Administration Signage Drawings

Water Spigot Instructional Sign

Size

Sign Face:
1'-3 3/4" High x 3 3/4" Wide
(400.05 mm H x 95.25 mm W)

Metal Post:
2'-4" High x 8" Wide x 8" Deep
(711.2 H x 203.2 W x 203.2 D)

Concrete Post:
2'-4" High x 7 1/2" Wide x 7 1/2"
Deep
(711.2 H x 190.5 W x 190.5 D)

Description

National Cemetery non-illuminated, pylon sign with messages directed specifically at pedestrians.

These posts contain the faucet for public use to obtain water for flowers placed in the cemetery.

The posts house the water pipe and the faucet. The posts are never used solely as signposts.

Message Configuration

Refer to message layout drawing for dimensions.

Graphic Process

Surface applied reflective vinyl.

Colors

Text: White
Symbol: Black & Red
Background & Post: Refer to the color chart in the Appendix

Recommendations

Position sign to provide pedestrians with a clear, unobstructed view of the sign.

Surround post with gravel opening to prevent splash from faucet.

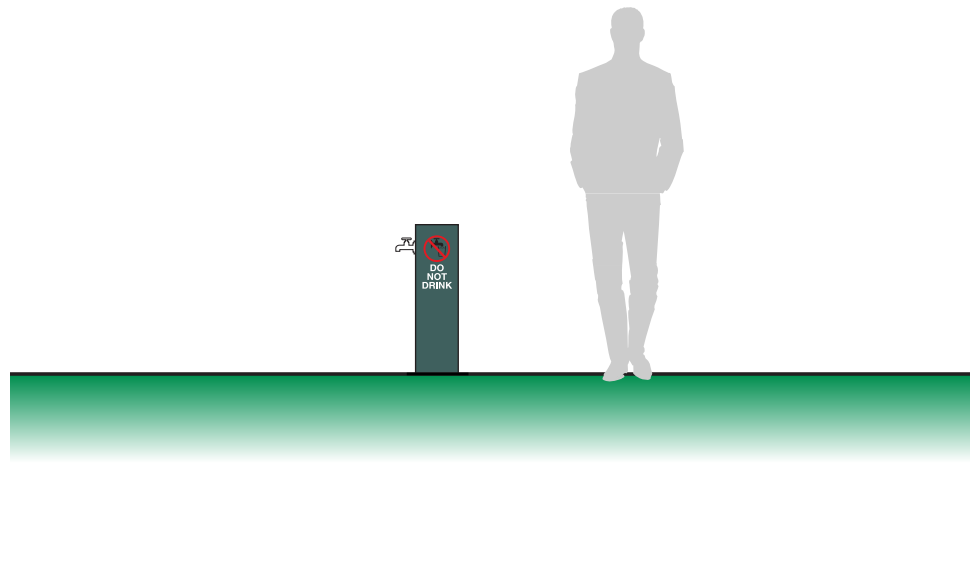

Message Layout A
Metal Post – M1
(8" x 8")



Message Layout B
Concrete Post – C1
(7 1/2" x 7 1/2")
Square Panel



Message Layout C
Concrete Post – C2
(7 1/2" x 7 1/2")
Round Panel



Water Spigot Instructional Sign

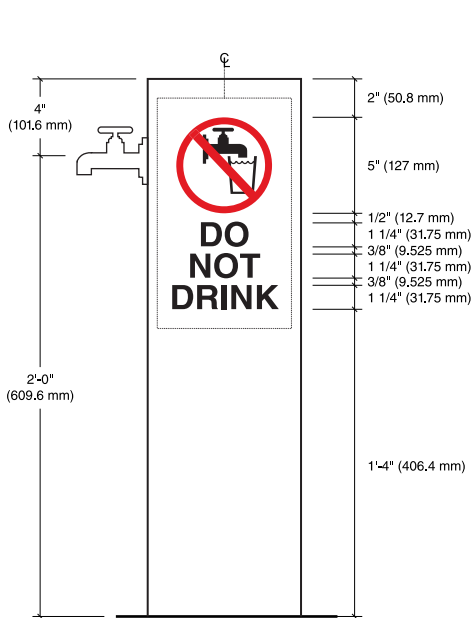
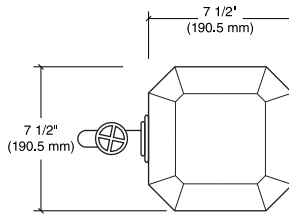
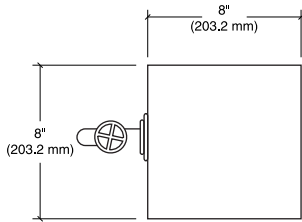

Message Layout A
Metal Post – M1

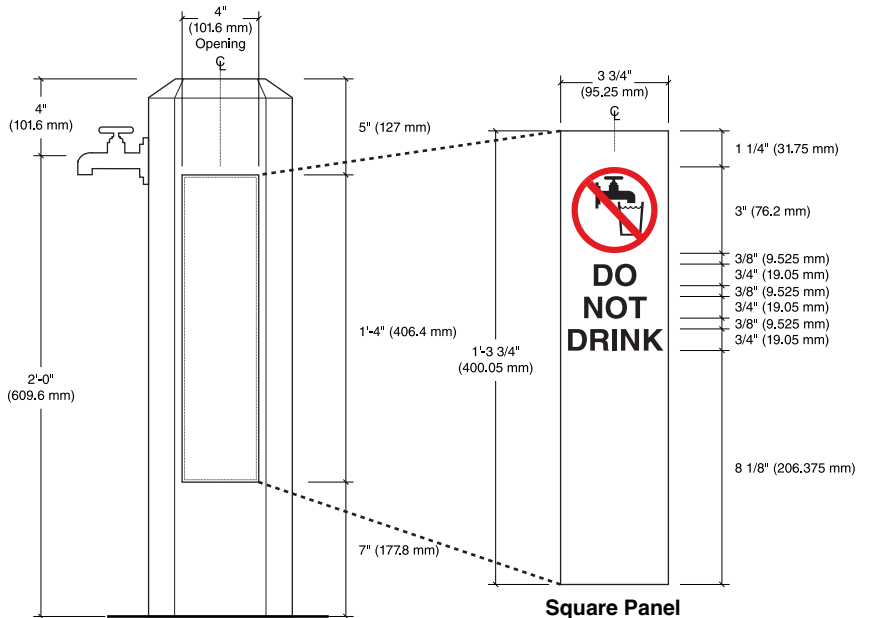

Message Layout B
Concrete Post – C1

Square Panel

Decal has Clear background with White text and black and red symbol. Spanish translation recommended

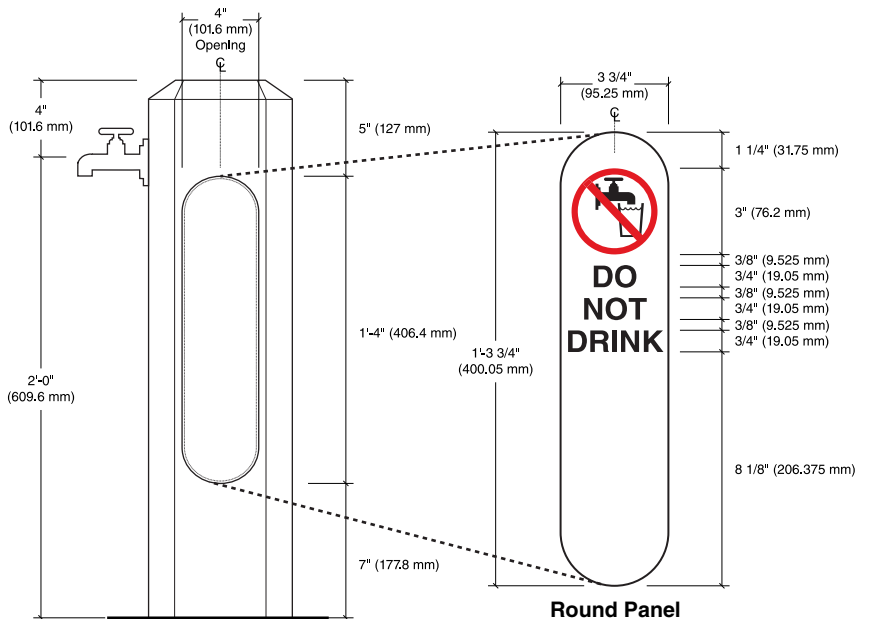

Message Layout C: Concrete Post – C2

Round Panel



NC-07.03

National Cemetery Administration Signage Drawings

Standard Granite Section Marker

Size

Sign Face:
8" High x 6" Wide
(203.2 mm H x 152.4 mm W)

Overall Sign Dimensions:
2'-0" High x 6" Wide x 6" Deep
(609.6 mm H x 152.4 mm W x
152.4 mm D)

Description

National Cemetery granite section marker.

Honed smooth inscription face, all other surfaces to be smooth saw-cut finish.

All corners and edges including 2" below ground level shall be rounded to 3/8" radius.

Message Configuration

Refer to message layout drawing for dimensions.

Graphic Process

"SEC" letting to be engraved:
(1 1/2" High x 3/16" Deep)
3/16" stems & bars.

Bottom text for section ID numbers shall be as shown on project plan, approved by the VA & engraved:
(2" High x 3/16" Deep)
3/8" stems & bars.

Typography

Optima Bold

Recommendations

Position sign to provide pedestrians with a clear, unobstructed view of the sign.

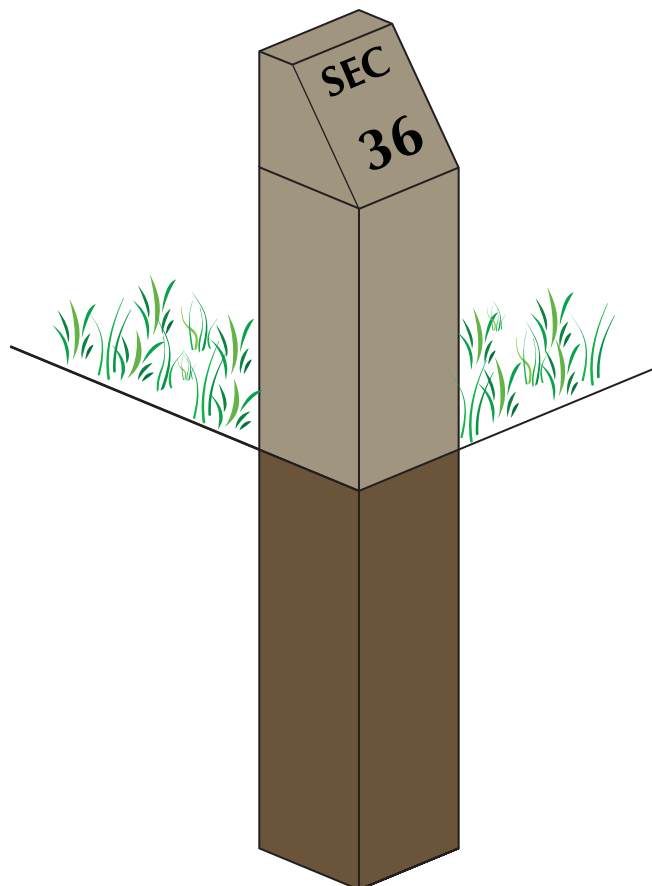
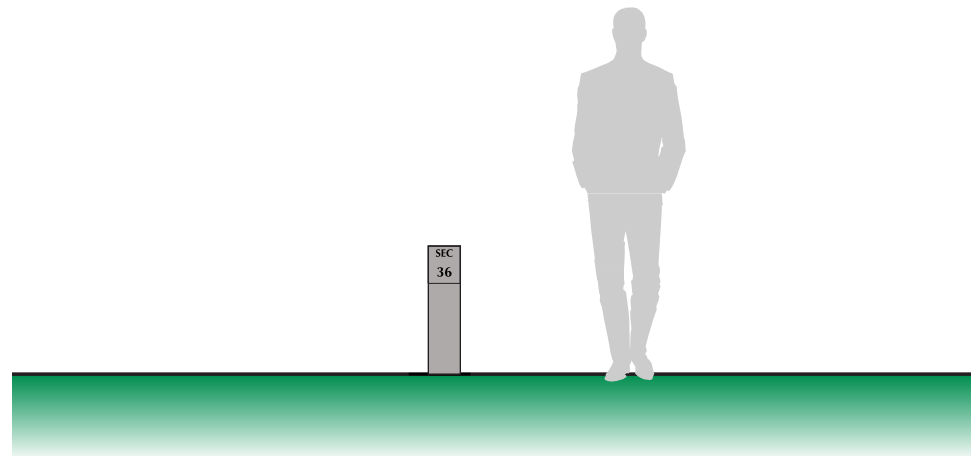

Standard Granite Section Marker

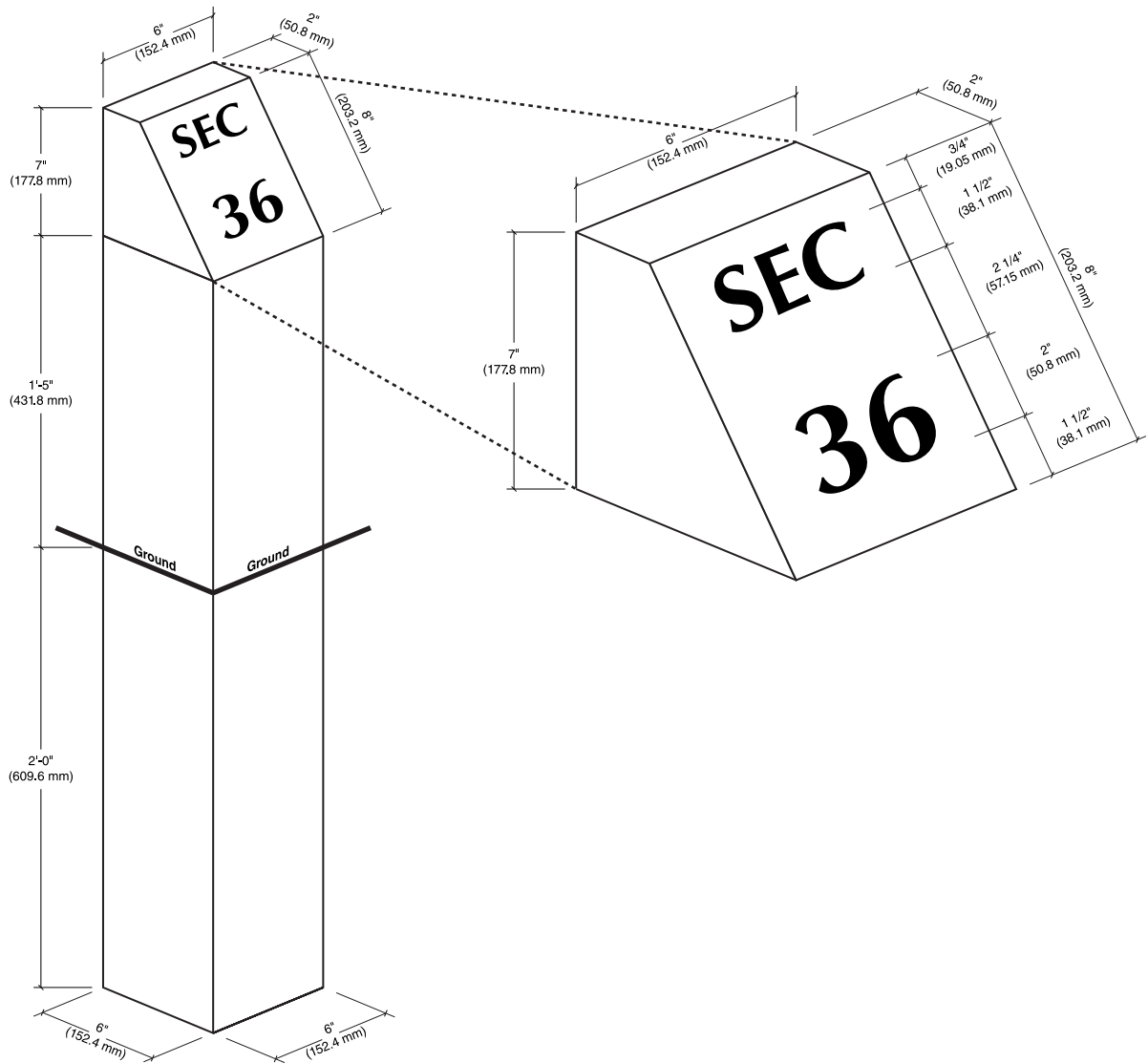

NC-08.01

National Cemetery Administration Signage Drawings

Wall Mounted Informational Sign

Size

12" High x 18" Wide
(304.8 mm H x 457.2 mm W)

Description and Use

This sign has applied graphics and is informational.

Message Configuration

Refer to message layout drawing for dimensions.

Text to be verified at time of project/need.

Sign Components

Aluminum Panel

Graphic Process

Surface Applied Vinyl

Colors

Background & Text: Refer to the color chart in the Appendix

Typography and Size

Helvetica Bold & Regular

Mounting

Concealed mechanical fasteners or double-sided foam tape and silicone adhesive

Installation

Secure to wall 60" above floor.

Floral Regulations

Fresh cut flowers may be placed on graves at any time. Metal temporary containers are available.

Floral items will be removed from graves as soon as they become faded and unsightly.

Artificial flowers may be placed on graves only during the period of October 10 through April 15.

Plantings will not be permitted on graves at any time. Potted plants will be permitted on graves only during the period 10 days before and 10 days after Easter Sunday and Memorial Day.

Christmas wreaths or grave blankets are permitted on graves during holiday season and must be removed no later than January 20 of each year. Grave foral blankets may not be larger in size than two by three feet.

During the lawn mowing and ground maintenance season, all floral items will be removed from graves on ____ and ____ of each month.

Statues, vigil lights, breakable objects of any nature, and similar commemorative items are not permitted on graves at any time.

Floral items and other types of decorations will not be secured to headstones or markers.

Please contact the cemetery director for information regarding installation of permanent flower containers.

Message Layout

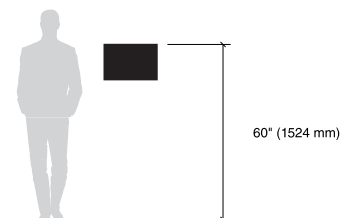

Wall Mounted Informational Sign

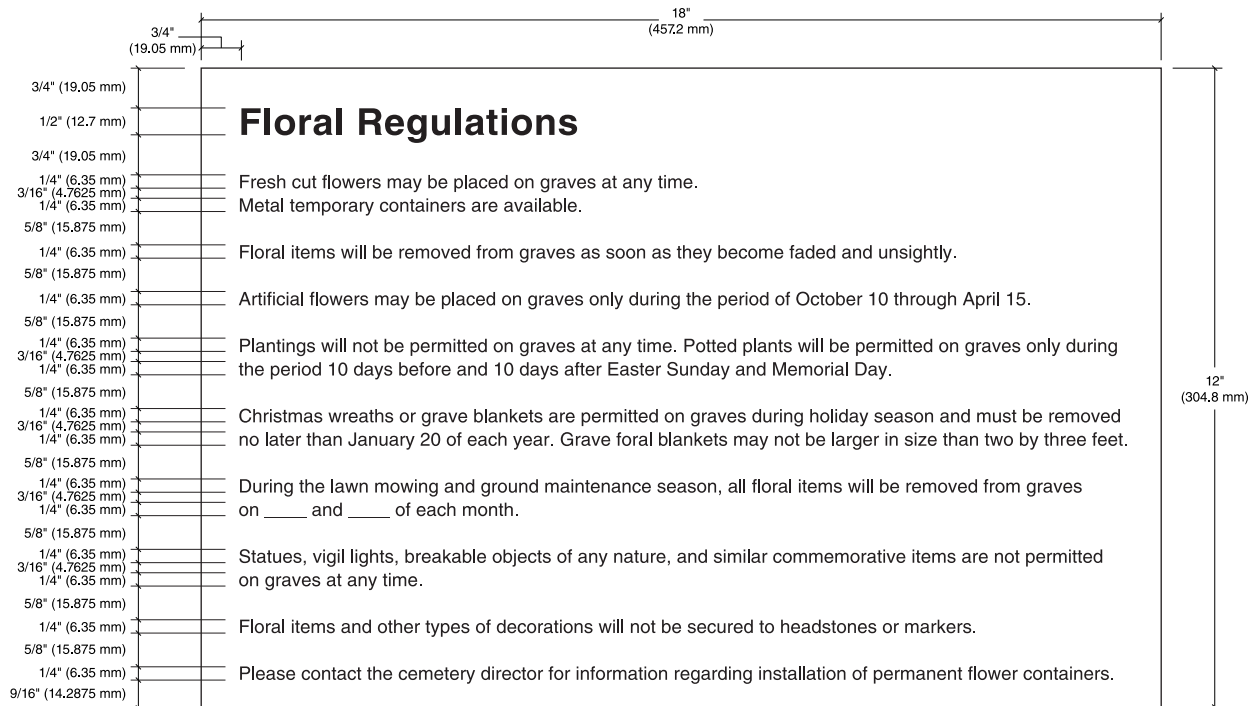

Message Layout



NC-09.01-.03

National Cemetery Administration Signage Drawings

Incised Lettering

Size

NC-09.01:
8" High x 1/2" Deep
(203.2 mm H x 12.7 mm D)

NC-09.02:
10" High x 3/4" Deep
(254 mm H x 19.05 mm D)

NC-09.03:
12" High x 1" Deep
(304.8 mm H x 25.4 mm D)

Description

Incised letters cast into wall.

Message Configuration

Refer to message layout drawing for dimensions.

"National Cemetery" can be one or two lines depending on wall size. Design and fabrication of entry wall by others.

Typography

Times New Roman Regular

Colors

Refer to the color chart in the Appendix.

Recommendations

Position sign to provide vehicles and pedestrians with a clear, unobstructed view of the sign.

When used on Lithichrome, incised letter size may be considered on a project specific basis.



NC-09.01: 8" Letter, 1/2" Deep



NC-09.02: 10" Letter, 3/4" Deep



NC-09.03: 12" Letter, 1" Deep



NC-09.01-.03

National Cemetery Administration Signage Drawings

Incised Lettering

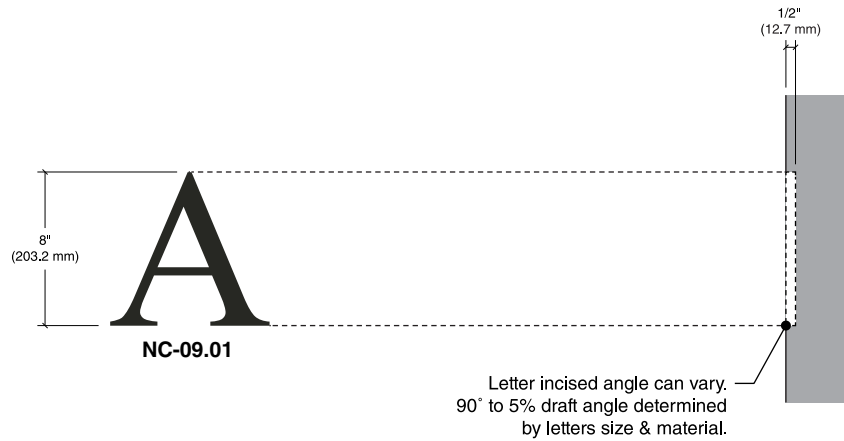

NC-10.01-.03

National Cemetery Administration Signage Drawings

Dimensional Lettering

Size

NC-10.01:
8" High x 1 1/2" Deep
(203.2 mm H x 38.1 mm D)

NC-10.02:
10" High x 2" Deep
(254 mm H x 50.8 mm D)

NC-10.03:
12" High x 2 1/2" Deep
(304.8 mm H x 63.5 mm D)

Description

Cast metal dimensional letters.
Surface mounted, tight to wall.

Message Configuration

Refer to message layout drawing for dimensions.

"National Cemetery" may be one or two lines depending on wall size.
Design and fabrication of entry wall by others.

Typography

Times New Roman Regular

Colors

Refer to the color chart in the Appendix.

Recommendations

Position sign to provide vehicles and pedestrians with a clear, unobstructed view of the sign.

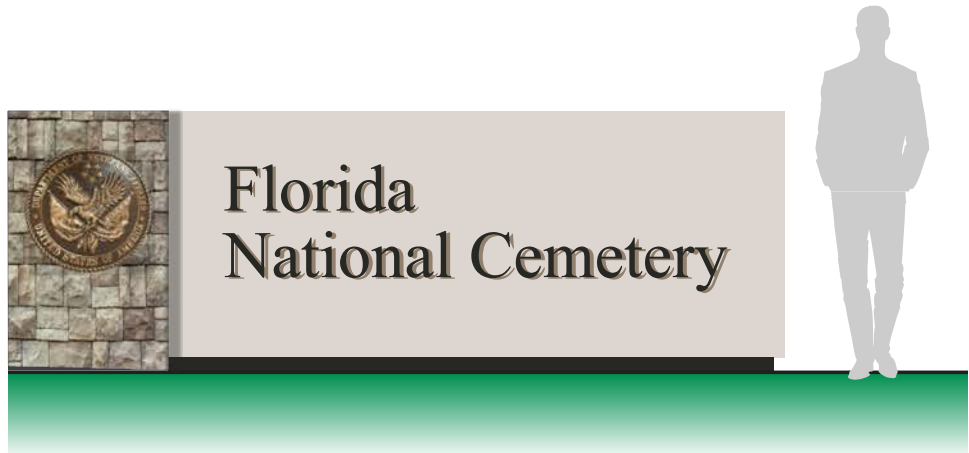

NC-10.01: 8" Letter, 1 1/2" Deep



NC-10.02: 10" Letter, 2" Deep



NC-10.03: 12" Letter, 2 1/2" Deep



NC-10.01-.03

National Cemetery Administration Signage Drawings

Dimensional Lettering



NC-11.01

National Cemetery Administration Signage Drawings

Dimensional Seal

Size

Diameter varies as needed for entry wall, 24" typical.

1" (25.4 mm) Deep for small diameter plaques.

1 1/2" (38.1 mm) Deep for larger diameter plaques.

Description

Cast metal seal inset or applied to entry wall.

Colors

Refer to specifications for bronze.

Recommendations

Position sign to provide vehicles and pedestrians with a clear, unobstructed view of the sign.



VA Seal

Standard size used on entry wall is 24" diameter.
 Sizes up to 48" diameter may be considered on project specific basis.
 Bas relief (not flat relief) cast in bronze. Only use VA approved artwork and bronze specifications.



Military Emblems

Military *seals* may NOT be used for any signage at VA facilities. However, military *emblems*, as shown above, may be used under certain circumstances. Emblems may not be stacked or displayed in any manner other than horizontal. For more information regarding requirements for displaying emblems, refer to [Section 4.5.1 FAQ](#) in the appendix.



NC-11.01

National Cemetery Administration Signage Drawings

Dimensional Seal



Primary Room Identification with Insert

Size

9" High x 9" Wide
(228.6 mm H x 228.6 mm W)

Description and Use

This is the primary room identification sign type. The room number is composed of raised, tactile characters and Braille, and the room's occupant/use is displayed on an updateable insert.

Message Configuration

Layout A, B, & C are for typical room identification. Layouts D & E accommodate rooms and departments with longer names. Layout F is for rooms where a designation is important to differentiate the room from other spaces with the same use.

Sign Components

Component based signage system. Some signage systems have 8 1/2" wide insert components allowing for easier use of standard letter size stock when printing inserts.

Graphic Process

Room Number: Tactile raised characters & Grade 2 Braille.
Message Insert: Paper or acetate sheet with digital print.

Colors

Refer to the color chart in the Appendix.

Typography

Helvetica & Grade 2 Braille.

Installation

Wall-mounted, knob side of door at 60" (1524 mm) to top of sign from finished floor and 2" (50.8 mm) over from door frame.

Recommendations

Using names of individuals or providers is not recommended for security reasons and the level of future updates required.

Inserts should follow an approved template established as part of the facility's sign standard and wayfinding plan.

Signs identifying electrical closets, mechanical rooms, and telecommunication rooms should only consist of the room number, which should follow the master building room numbering system.



Message Layout A

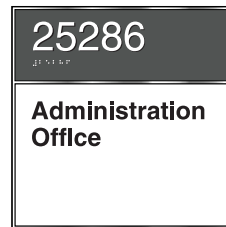

Message Layout B



Message Layout C

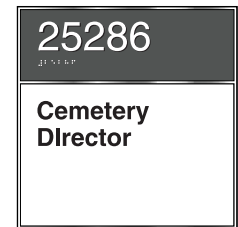

Message Layout D

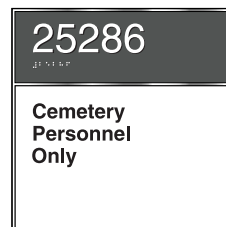

Message Layout E

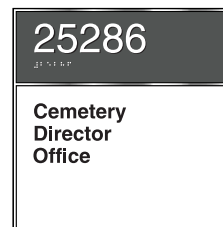

Message Layout F

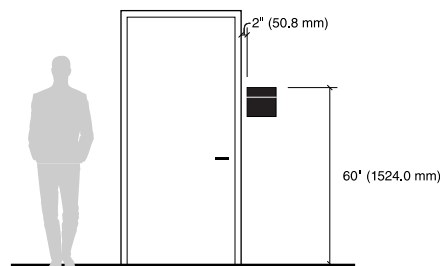
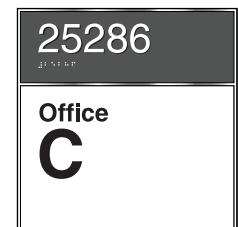

Mounting

Preferred: Concealed mechanical fasteners.
Alternate: Double-sided VHB foam tape and silicone adhesive.



Primary Room Identification with Insert

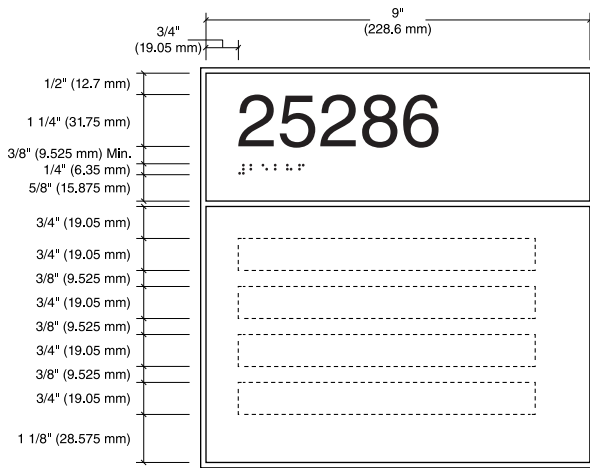

Message Layout A, B, & C

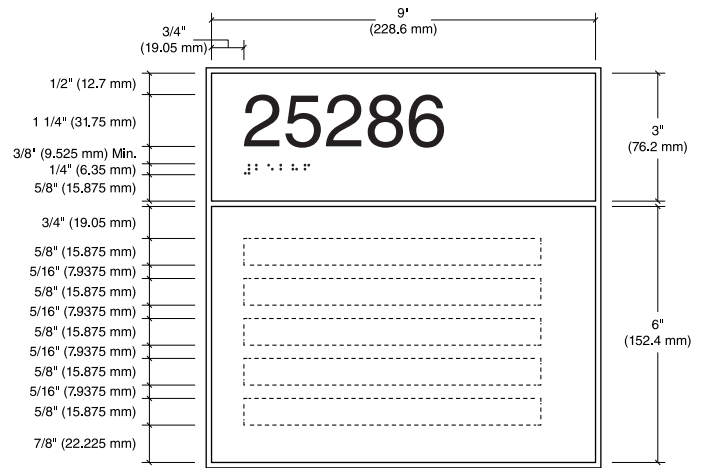

Message Layout D & E

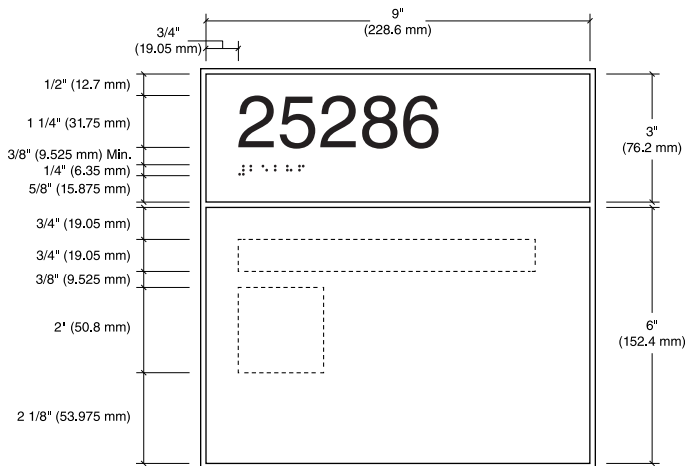

Message Layout F

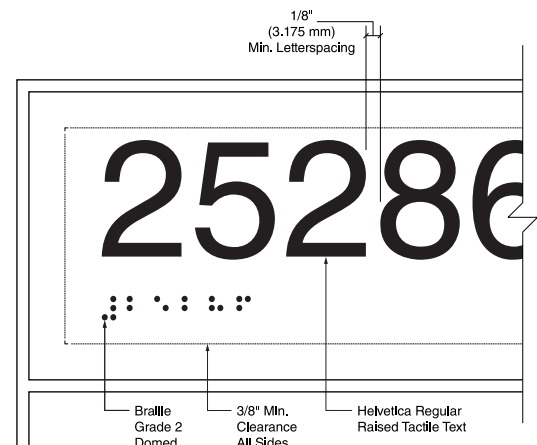

Tactile Sign Detail

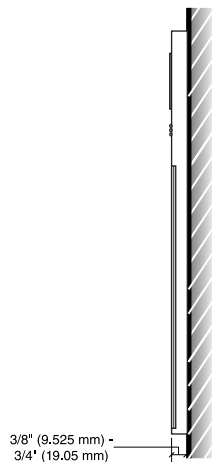

NC-15.01-.06

National Cemetery Administration Signage Drawings

Restroom Identification

Size

Room Number:
3" High x 9" Wide
(76.2 mm H x 228.6 mm W)

Sign Face:
9" High x 9" Wide
(228.6 mm H x 228.6 mm W)

Description and Use

This sign is used to identify restrooms with name, pictogram, and optional room number.

Message Configuration

Refer to message layout drawing for dimensions.

All-gender restroom signs should use the toilet pictogram and say "RESTROOM".

Restrooms that are not accessible or do not contain a baby changing station require additional postings specified in [IN-09.07 & .08](#). See [Section 3.1 Interior Signage Drawings](#) for relevant signs.

For restrooms in staff areas, "STAFF ONLY" can be used in place of the standard restroom names.

Sign Components

Component based sign system.

See [Section 2.1 Interior Signage Guidelines](#) for applicable component sign system styles.

Graphic Process

Digitally printed pictogram, tactile room number and text, accompanying Grade 2 Braille

Colors

Refer to the color chart in the Appendix.

Typography

Helvetica
Grade 2 Braille

Mounting

Preferred: Concealed mechanical fasteners

Alternate: Double-sided VHB foam tape and silicone adhesive

Installation

Mount on wall or door, 60" (1524 mm) to top of sign. If installed on door, it should be on center.

Recommendations

See [Section 2.1 Interior Signage Guidelines](#) for additional information.



NC-15.01



NC-15.02



NC-15.03



NC-15.04

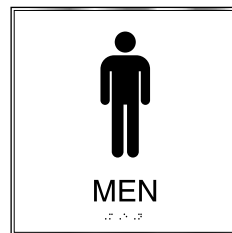

NC-15.05

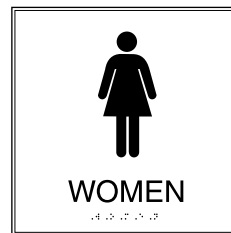

NC-15.06

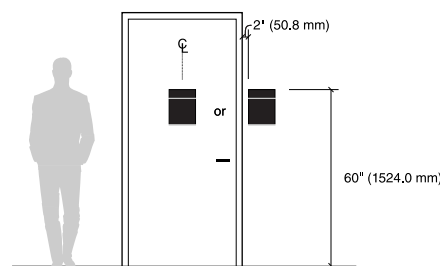

NC-15.01-06

National Cemetery Administration Signage Drawings

Restroom Identification

Room Number
[IN-03.01](#)

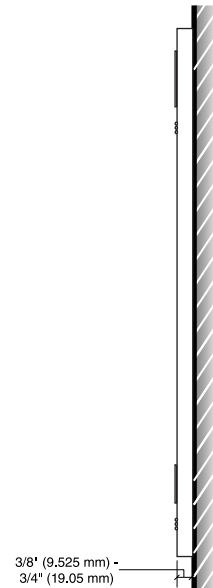
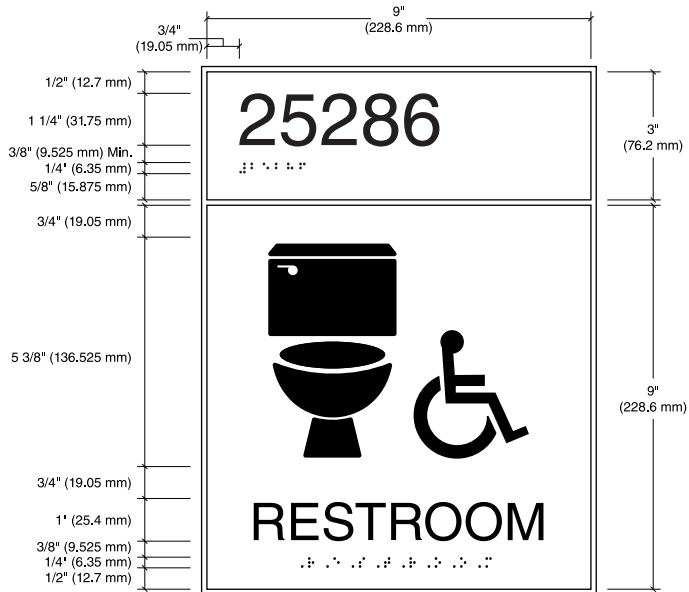

Sign Profile

Required Changing Station and/or Non-Accessible Posting
[IN-09.07-08](#)

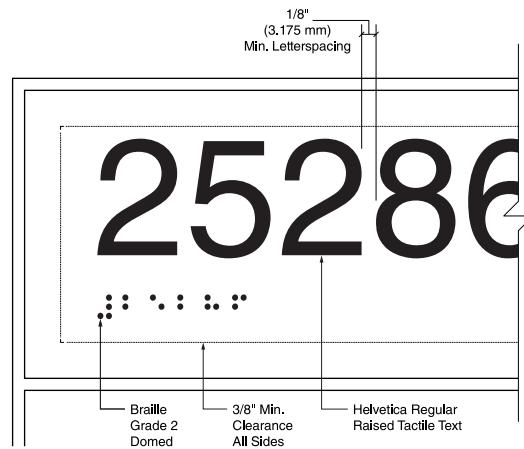

Tactile Sign Detail



NC-16.01-.06

National Cemetery Administration Signage Drawings

Pictogram and Symbol Signs

Size

9" High x 9" Wide
(228.6 mm H x 228.6 mm W)

Description and Use

Use these signs to inform with a symbol as well as text.

Not all required Code & Life Safety signs are shown, refer to [Section 3.2 Code & Life Safety Signage Drawings](#) for additional information.

Message Configuration

Refer to layout drawing for lettering sizes and dimensions.

Sign Components

Component based sign system.

See [Section 2.1 Interior Signage Guidelines](#) for applicable component sign system styles.

Graphic Process

Direct second surface digital print or silk-screened.

Colors

Refer to the color chart in the Appendix.

Typography

Helvetica

Mounting

Preferred: Concealed mechanical fasteners

Alternate: Double-sided VHB foam tape and silicone adhesive

Installation

On wall: Knob side of door, 60" (1524 mm) to top of sign and 2" (50.8 mm) over from door frame, if adjacent to door.

On door: 60" (1524 mm) to top of sign, centered.



NC-16.01



NC-16.02

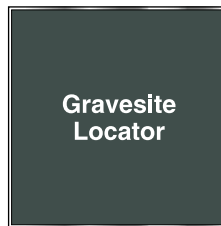

NC-16.03



NC-16.04



NC-16.05

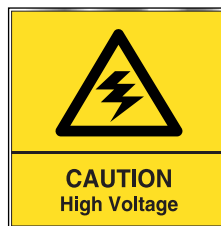

NC-16.06

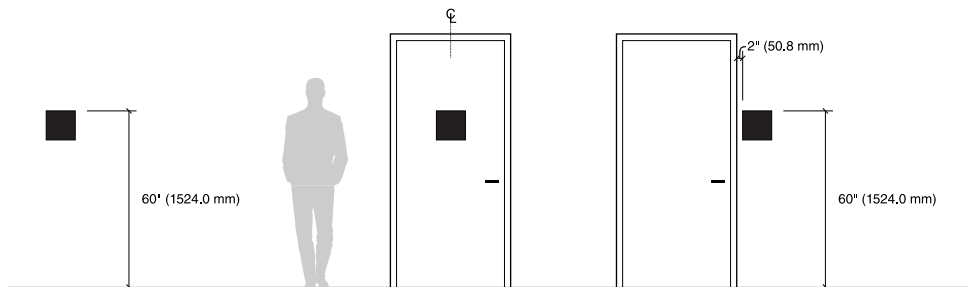

NC-16.01-.06

National Cemetery Administration Signage Drawings

Pictogram and Symbol Signs

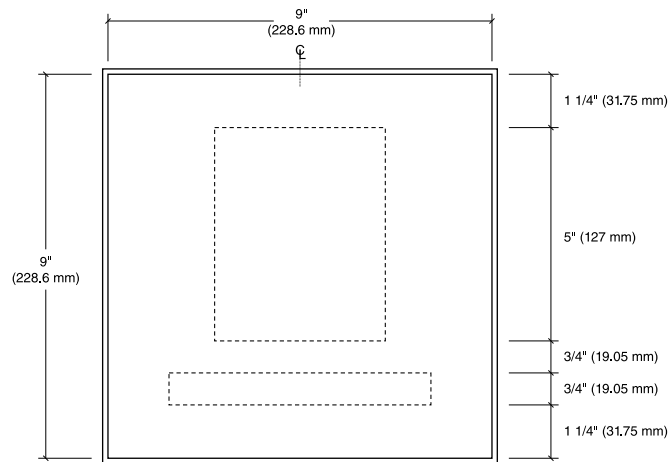

NC-16.01

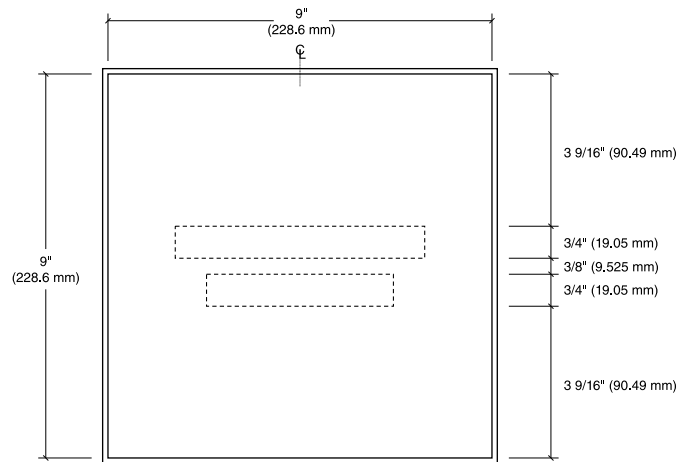

NC-16.02

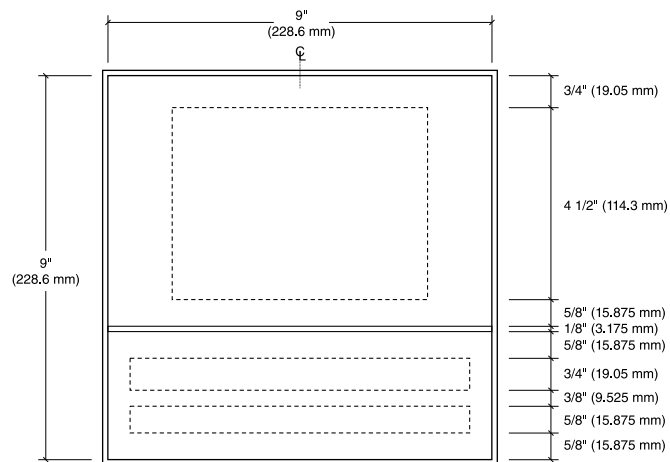

NC-16.03-.06





U.S. Department
of Veterans Affairs

SECTION 4

APPENDIX

4.1. Design Elements	801
4.1.1 Introduction	801
4.1.2 Typography	803
4.1.3 Logos & Seals	806
4.1.4 ABA (Architectural Barriers Act) Requirements	809
4.1.5 Color & Finish.....	815
4.2. Wayfinding Maps	823
4.2.1 Overview	824
4.3. VHA Standardized Department Nomenclature	833
4.3.1 Overview	834
4.4. Room Renumbering.....	835
4.4.1 Renumbering.....	836
4.5. Frequently Asked Questions (FAQ).....	849
4.5.1 FAQ	850
4.6. Example Photos	857
4.6.1 Exterior Photos.....	858
4.6.2 Interior Photos.....	859



Introduction

Design Elements

4.7. Sign Index 860

- 4.7.1 Overview 861
- 4.7.2 Section 3.1 Interior Signage Drawings..... 862
- 4.7.3 Section 3.2 Code & Life Safety Signage Drawings..... 866
- 4.7.4 Section 3.3 Mandatory VA Policy & Directive Signage Drawings..... 870
- 4.7.5 Section 3.4 Specialty Signage Drawings 872
- 4.7.6 Section 3.5 Exterior Signage Drawings 874
- 4.7.7 Section 3.6 Parking Structure Signage Drawings..... 880
- 4.7.8 Section 3.7 National Cemetery Administration Signage Drawings..... 883

4.8. Glossary 885





U.S. Department
of Veterans Affairs

SECTION 4.1

DESIGN ELEMENTS



Introduction

The Department of Veterans Affairs signage manual has been designed using a selected group of common design elements and visual standards.

The design elements include the Department of Veterans Affairs logo, signature, and seal, three versions (weight and style) of the Helvetica typeface and specifications for letter and word spacing. Visual standards include colors, finishes, and letter sizes in relation to viewing distance.

The design elements become the component building blocks upon which signs are configured. The elements have been adopted to provide functional consistency in signs for the Department of Veterans Affairs.

Deviation from the signage manual standards requires formal VA approval. If specialized or unique sign applications require deviation from the manual, contact the U.S. Department of Veterans Affairs, Office of Construction & Facilities Management to inquire about formally requesting a deviation from the VA signage manual.

The design elements including Typography, Logo Signature, VA Blue and Seal are requirements. Other design elements are guidelines and recommendations to help develop a wayfinding system and sign standard that meets the needs of the individual facility.



4.1.2 TYPOGRAPHY

Typography

Helvetica LT Std Bold is the standard typeface for the VA Signage System and will be used predominantly throughout the sign program. Signs identifying permanent rooms shall be ABA compliant, to accommodate the visually impaired (refer to ABA sections).

In most cases it is recommended that text on non-ABA signs should utilize Title Case or Headline Case (where the first letter of each word is capitalized except for minor words such as "of" and "and") as it is the most legible. There are many exceptions such as signs where full sentences or paragraphs are used. In these cases, standard Sentence Case should be used. Another exception is displaying the word "EMERGENCY" in all uppercase.

Typefaces

Helvetica LT Std Bold

Primary Typeface

ABCDEFGHIJKLMNOPQRSTUVWXYZ
abcdefghijklmnopqrstuvwxyz
1234567890

Helvetica LT Std Regular

Secondary/ABA Typeface

ABCDEFGHIJKLMNOPQRSTUVWXYZ
 abcdefghijklmnopqrstuvwxyz
 1234567890

Helvetica LT Std Bold Condensed

Alternative Typeface

ABCDEFGHIJKLMNOPQRSTUVWXYZ
abcdefghijklmnopqrstuvwxyz
1234567890

Letter Spacing/Tracking

The default tracking settings for Helvetica typefaces are optimized for legibility. It is not recommended to manipulate default kerning or tracking settings for text on signage, with some exceptions.

In some cases, for exterior signs and signs viewed at a significant distance, tracking may need to be slightly expanded for better legibility. Signs with illuminated text can become difficult to read at a distance due to light bleed and may require expansion of the tracking. This will vary per site conditions and needs to be evaluated on a case-by-case basis.



Typography

Design Elements

Letter Spacing Examples

Helvetica Bold

Correct Spacing Spacing is too tight Spacing is too loose

Administration Administration Administration

Helvetica Regular

Correct Spacing Spacing is too tight Spacing is too loose

Administration Administration Administration

Helvetica Bold Condensed

Correct Spacing Spacing is too tight Spacing is too loose

Administration Administration Administration

Interline Spacing (Leading)

Interline spacing will generally be noted on sign type drawings. As a rule, line spacing is no less than 1/2 the height of the upper-case letter “M”.

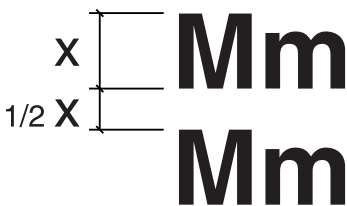

Paragraph Spacing

Paragraph spacing will generally be noted on sign type drawings. As a rule, paragraph spacing is no less than the height of the upper-case letter “M”.

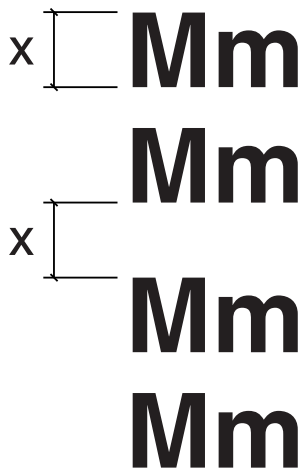

Alignment

A flush upper left copy format is recommended in most conditions. On signs where each line of text is on a changeable insert or panel, the text should be centered vertically with equal margins on top and bottom. Graphic symbols should be centered within a square field with equal margin spacing on all sides.

Figure 4-1 Message areas should have equal margins on all sides to improve legibility. Dimensions will vary per sign type. See sign type drawings for exact dimensions.

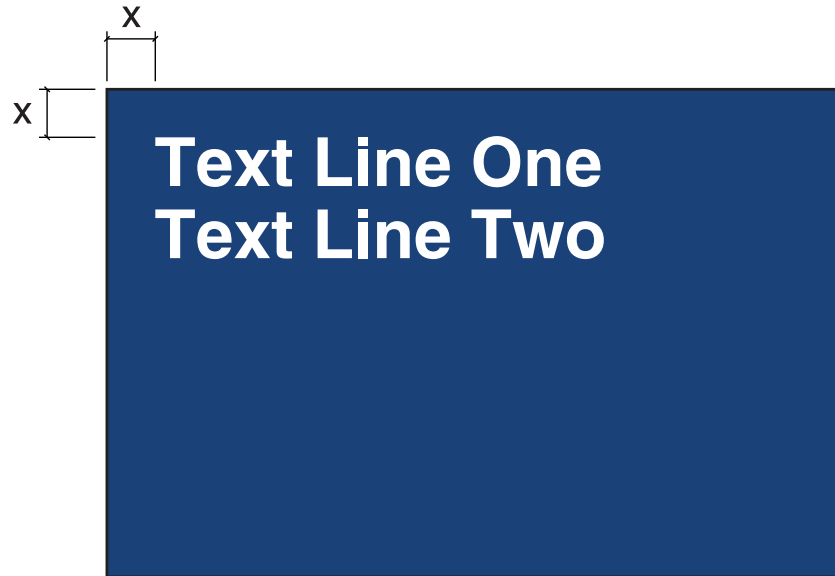

4.1.3 LOGOS & SEALS

Logo Signature

The VA has developed a logo for use in signage. All new signs containing the VA logo should use the versions illustrated here in this Manual.

The horizontal and vertical formats in this Manual should be used in signs and NOT the format shown in the VA Graphic Standards document which incorporates the VA seal.

The VA Signature electronic files are available for download on the [Technical Information Library](#).

NOTE: The master art and typography shall not be altered. The font, size relationship between the elements, and letter spacing for the “VA” and “U.S. Department of Veterans Affairs” name, shall remain as presented in the master art. The rule line is considered a part of the master art and shall not be moved or deleted.

Horizontal Format

VA | U.S. Department
of Veterans Affairs

Vertical Format

VA

U.S. Department
of Veterans Affairs

VA Blue



Standard VA brand color. Not required to be used for all signs.

Pantone 541

C: 100

M: 60

Y: 0

K: 40



Logos & Seals

Design Elements

Seal



The illustrated VA Seal is current.

There are specific requirements regarding its use and reproduction in both the full color version and one-color version. Consult the VA Graphic Standards for complete details regarding the seal.

NOTE: The VA seal is NOT to be used in signage. It is not to be altered, stylized, or treated as an accent element in signs.

The seal may only be displayed within a building's entry or lobby and reproduced per the specifications and art exhibited in the VA Graphic Standards.

Arrows

Illustrations show the recommended arrow for use in the VA sign program. The arrow is always centered within a square field. Electronic files for arrow illustrations are available for download from the [Technical Information Library](#).

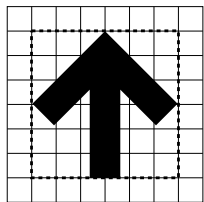

Position 1

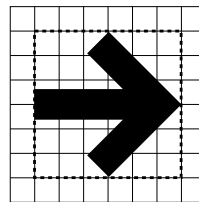

Position 2

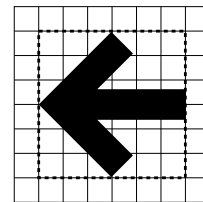

Position 3

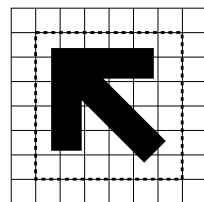

Position 4

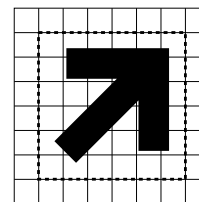

Position 5



Arrow Alignment with Text

Arrows should be positioned to the left of, or directly above, the first line of the text group for that direction. When an arrow is adjacent to text, it should be centered in relation to the capital letter height.

On signs with numerous destinations, a single arrow will be placed adjacent to the first line of text to identify the direction for all destinations grouped together.

It is recommended on typical directional signs that the arrow size is at least one and one half (1 1/2) times the capital letter height.



4.1.4 ABA (ARCHITECTURAL BARRIERS ACT) REQUIREMENTS

Tactile vs. Visual Character Requirements

This section details specifications for signs or sign messages covered by Architectural Barriers Act (ABA) tactile requirements. Signs covered by the ABA standards must meet the specifications for either visual or tactile requirements based on sign type and content. Signs exempt from ABA standards and not required to meet visual or tactile requirements include temporary postings, directories, building addresses, occupant names / titles, menus, and seat / row designations in assembly areas.

Signs that provide direction to or information about interior spaces and facilities must meet visual requirements but are not required to be tactile.

Tactile requirements apply to interior and exterior signs identifying permanent rooms and spaces and required door labels at exit stairways, exit passageways and exit discharge.

Tactile Character Specifications

Two Line Copy Sign

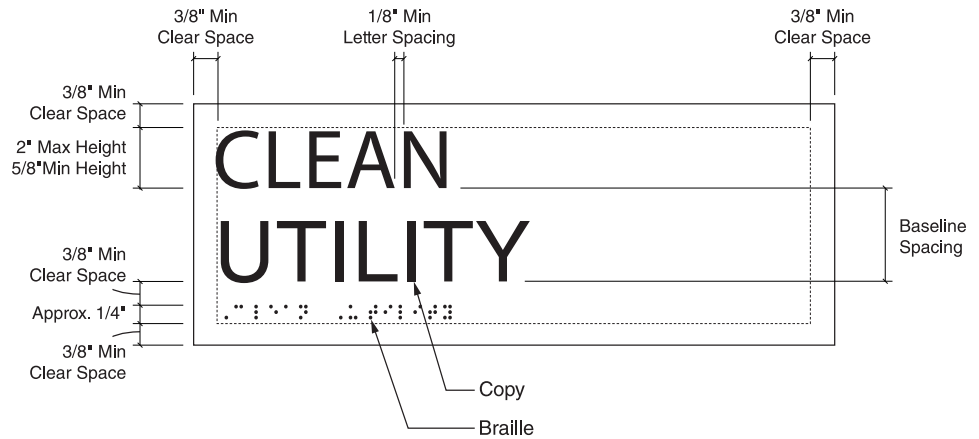

Single Line Copy Sign

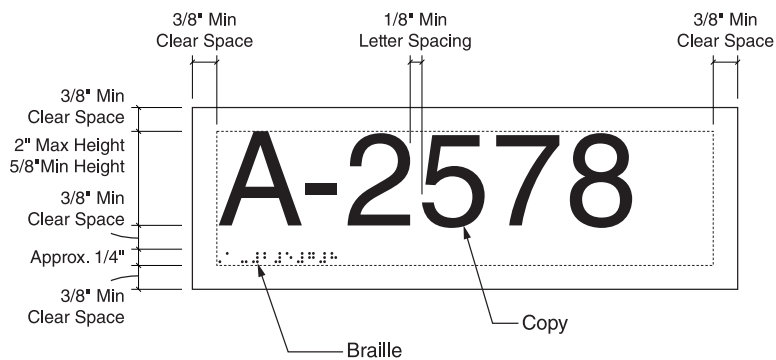

Characters shall be sans serif and uppercase. Characters shall not be italic, oblique, script, highly decorative, or of other unusual forms.

Characters and Braille shall be in a horizontal format. Character height shall be 5/8" minimum and 2" maximum, depending on viewing distance. See [Table 703.5.5](#) in the "Architectural Barriers Act (ABA) Standards (2015)".



ABA

Design Elements

Tactile Character Specifications *(Continued)*

Character stroke thickness of the uppercase letter “I” shall be 15% maximum of the height of the character.

Character spacing to be 1/8" minimum and four times the character stroke width maximum.

Line spacing to be 135% minimum and 170% maximum of the letter height.

Characters shall be separated from raised borders and decorative elements by 3/8" minimum.

Characters shall be raised 1/32" minimum above their background.

Characters to be used shall be selected from styles where the width of the uppercase letter “O” is 55% minimum and 110% maximum based on the height of the uppercase letter “I”.

Braille Specifications

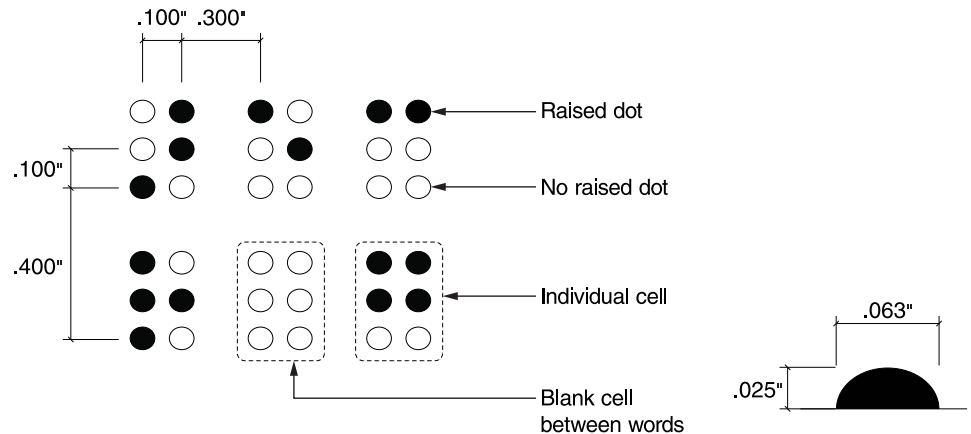

Shall be contracted (Grade 2). See measurements shown above.

Braille dots shall have a domed or rounded shape.

The indication of an uppercase letter or letters shall only be used before the first word of sentences, proper nouns and names, individual letters of the alphabet, initials, and acronyms.

Braille shall be positioned below the corresponding text. If text is multi-lined, Braille shall be placed below the entire text. Braille shall be separated 3/8" minimum from any other tactile letters and 3/8" from raised borders.

Braille provided on elevator car controls shall be separated by 3/16" minimum and shall be located either directly below or adjacent to the corresponding raised characters or symbols.



ABA

Design Elements

Visual Character Specifications

Signs that provide direction to or information about interior spaces and facilities must meet visual requirements but are not required to be tactile.

Specifications for visual characters require characters to be a minimum of 40" above the finished floor, provide adequate contrast between characters and their background with a non-glare finish, line spacing to be 135%-170% of character height, and meet a minimum character height based on the height above the finished floor and horizontal viewing distance.

Refer to the below chart for visual character height requirements.

Visual Character Height Requirements:

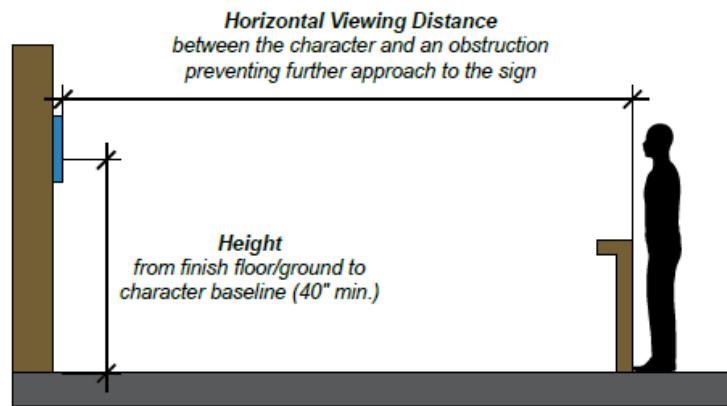

Figure 4-2 Images and text integrated from the U.S. Access Board Guide to the Architectural Barriers Act Accessibility Standards.

Height	Viewing Distance	Min. Character Height
40" – 70"	under 6'	5/8"
	6' or more	5/8" + 1/8" per foot of viewing distance above 6'
above 70" to 10'	under 15'	2"
	15' or more	2" + 1/8" per foot of viewing distance above 15'
above 10'	under 21'	3"
	21' or more	3" + 1/8" per foot of viewing distance above 21'



Pictograms

Figure 4-3 Images and text integrated from the U.S. Access Board Guide to the Architectural Barriers Act Accessibility Standards.

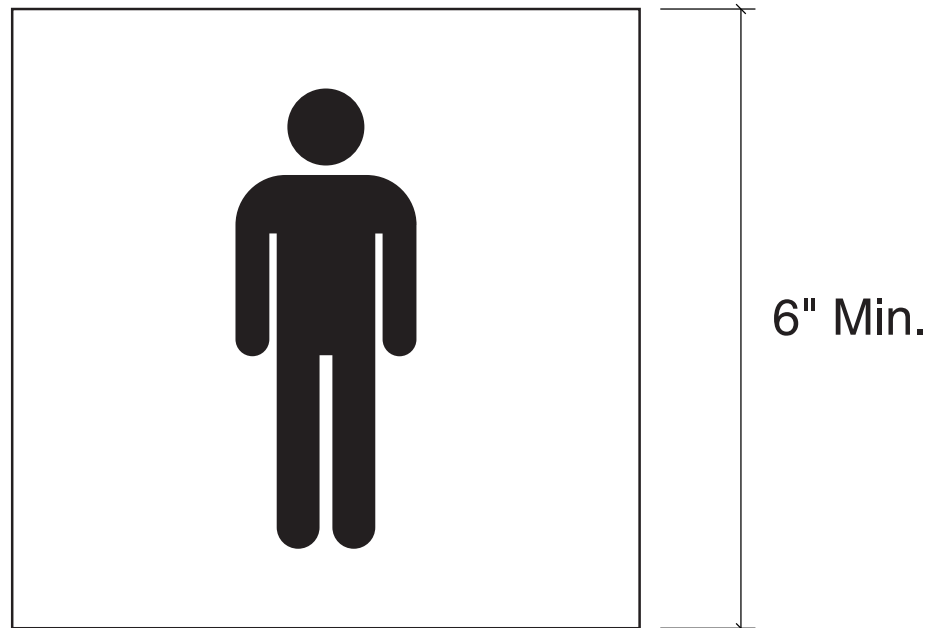

Pictograms used to designate a permanent room or space, shall have a field height of 6" (minimum height requirement applies to the visual field, not the height of the pictogram). Characters and Braille shall not be located within the pictogram field. Pictogram text descriptions to be located directly below the pictogram field.

Pictograms that are on directional / informational signs or provide information about a room or space are not required to meet these requirements.

Finish & Contrast

Characters and background to have a non-glare finish. Characters shall contrast with background with either light letters on a dark background or dark letters on a light background.

Graphic

Where both visual and tactile characters are required, they can be provided on one sign or two separate signs.

Raised letters to be read by touch should not have sharp or abrasive edges.



Location of Tactile Signs

Tactile characters on signs shall be located 48" minimum above the finish floor or ground surface, measured from the baseline of the lowest tactile character and 60" maximum above the finish floor or ground surface, measured from the baseline of the highest tactile character.

Figure 4-4 Images and text integrated from the U.S. Access Board Guide to the Architectural Barriers Act Accessibility Standards.

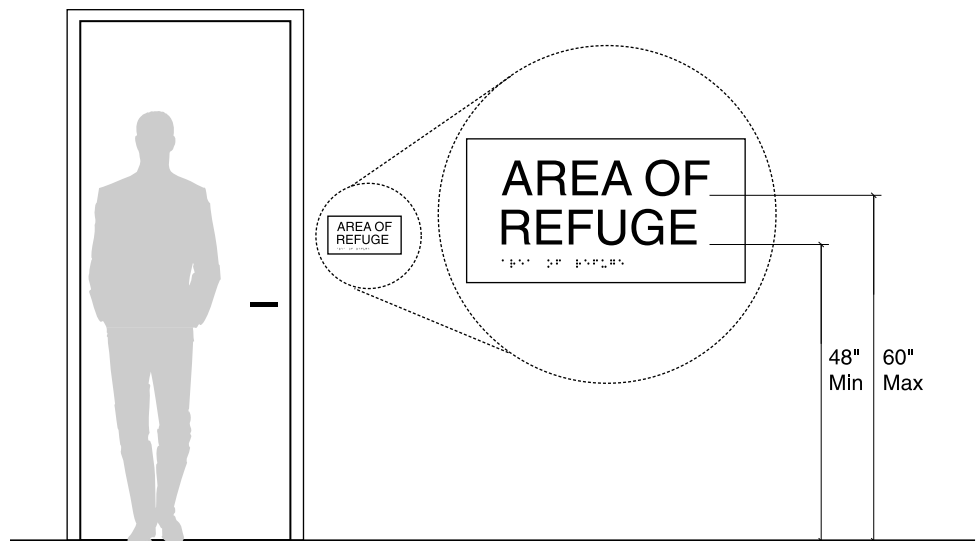

Where a tactile sign is provided at a door, the sign shall be located alongside the door at the latch side.

Where a tactile sign is provided at double doors with one active leaf, the sign shall be located on the inactive leaf.

With two active leaves, the sign shall be located to the right of the right-hand door.

Where there is no wall space at the latch side of a single door or at the right side of double doors, signs shall be located on the nearest adjacent wall.

Signs containing tactile characters shall be located so that a clear floor space 18" minimum by 18" minimum centered on the tactile characters is proposed beyond the arc of any door swing between the closed position and 45 degrees open position.

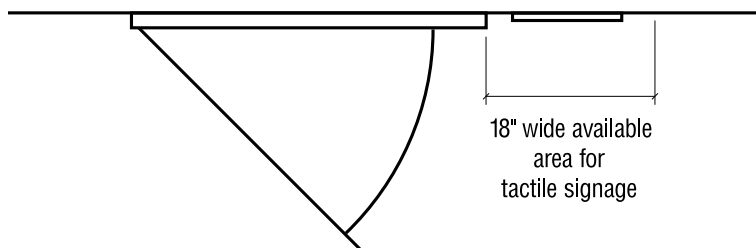

Protruding Objects

Objects with leading edges more than 27 inches and not more than 80 inches above the finish floor or ground may protrude 4 inches maximum horizontally into the circulation path.

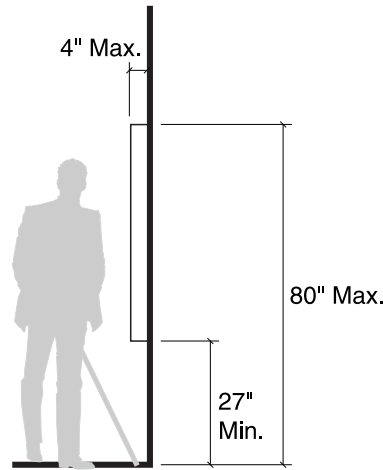

Protruding Objects Illustration

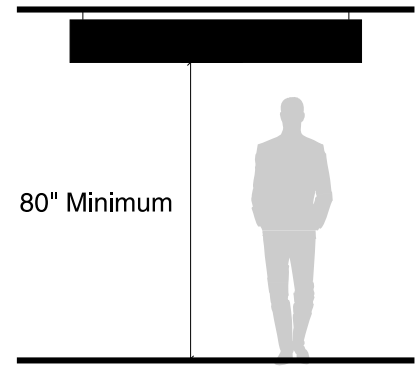

Headroom Clearance Illustration

Headroom Clearance

Signs above circulation paths, including overhead and flag mount signs must have a minimum headroom clearance of 80 inches from the finished floor.

Post-Mounted Objects

Figure 4-5 Images and text integrated from the U.S. Access Board Architectural Barriers Act Accessibility Standards.

Figure 307.3 Post-Mounted Protruding Objects

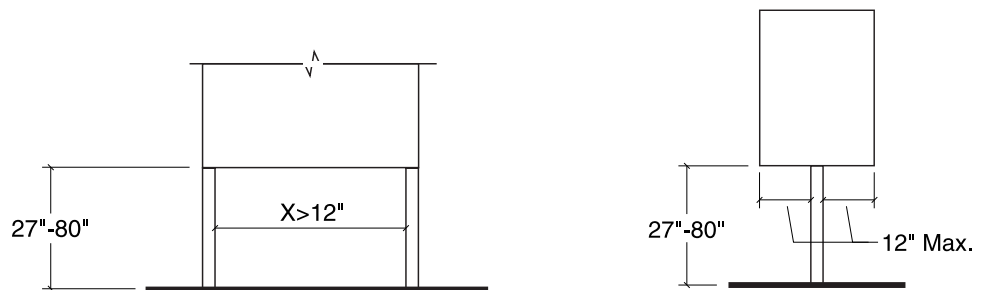

Free-standing objects mounted on posts or pylons shall overhang circulation paths 12 inches maximum when located 27 inches minimum and 80 inches maximum above the finish floor or ground. Where a sign or other obstruction is mounted between posts or pylons and the clear distance between the posts or pylons is greater than 12 inches, the lowest edge of such sign or obstruction shall be 27 inches maximum or 80 inches minimum above the finish floor or ground.

The sloping portions of handrails serving stairs and ramps shall not be required to comply.

4.1.5 COLOR & FINISH

Sign Colors

The accompanying illustrations and charts provide a listing of sign colors that allow a VA facility to coordinate an interior or exterior sign program to the architectural colors and finishes of the buildings on the campus.

The color options listed have been selected because they provide contrast between typography and the sign background; the contrast shall be light on dark or dark on light.

Night and day light conditions for exterior signs can vary, therefore, readability should be field verified with actual color samples.

High contrast for readability is equally important for interior signs, especially for the elderly and vision impaired. Light background colors require black or dark gray text, and deep or dark colors require white text.

If a facility deviates from the identified family of colors, sufficient contrast between the typography and sign background under all lighting situations shall be maintained.

Placement, type, and color temperature of light fixtures can also affect contrast, so it is important that these factors be considered.

Signs that call for specific text, background, accent, or post color(s) should be followed. If reflective text is called for, light text on a dark background should be the contrast method used.

Figure 4-6 Example: Exterior Site Monument Sign Type.

Text, background, and accents can vary with use of the provided color charts.

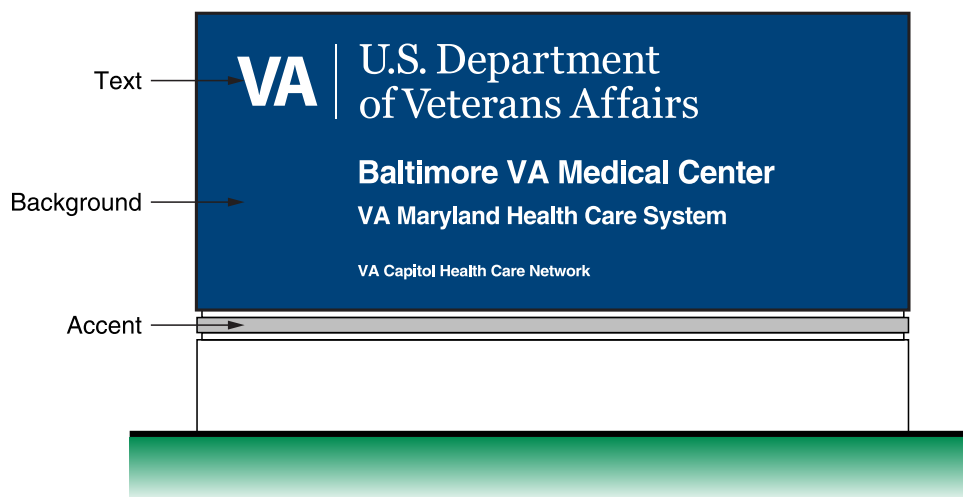

Color & Finish

Design Elements

Figure 4-7 Example: Exterior Post and Panel Sign Type

Text, background, and posts can vary with use of the provided color charts.

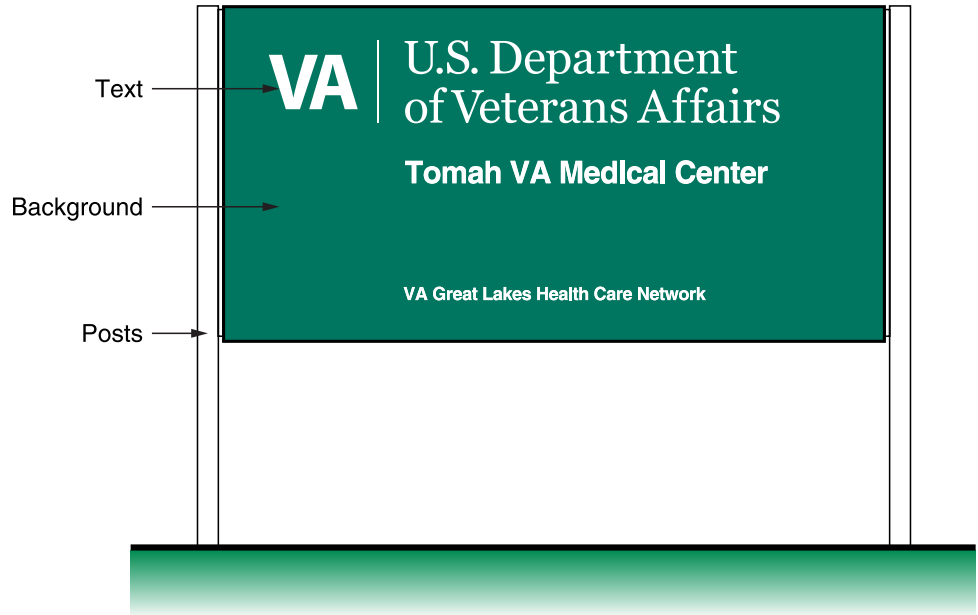

Exterior Sign Colors

For exterior signs use the provided chart to select background, text, and accent colors.

The listed paint colors are acrylic polyurethane paint systems. Matthews Paint is one manufacturer used by the VA, but there are many others which may be used. Any reference to paint numbers is for the designer’s convenience and may be matched with another manufacturer’s catalogue.

All traffic sign faces should use the prescribed colors as listed in the Manual for Uniform Traffic Control Devices.

All OSHA Safety Colors are to meet ANSI specification Z53.1/OSHA.



Color & Finish

Design Elements

Exterior Sign Color Chart

Figure 4-8

Text can be painted, opaque vinyl application, or translucent acrylic for illuminated signs.

Always obtain color samples from the paint company. Colors shown are for representational purposes only. The actual paint colors may vary significantly from the corresponding swatches indicated in this document. Colors will appear differently when viewed on different computer monitors or printed from different printers. For a true color sample, it is best to obtain an actual paint sample of the desired color.

Color Ref #	Color Description	Text Color	Matthews #	CMYK
B1	Drake	White	MP5732	c 48 m 43 y 51 k 10
B2	Wells Fargo Black	White	MP26309	c 77 m 66 y 66 k 82
B3	Lime Peel	White	MP12444	c 56 m 44 y 82 k 27
B4	Marinated Olive	White	MP15975	c 56 m 44 y 71 k 22
B5	Bear Creek	White	MP7050	c 42 m 56 y 65 k 22
B6	Kaffe Tan	White	MP3290	c 30 m 39 y 63 k 3
B7	Indanthrone Blue	White	MP10261	c 100 m 97 y 32 k 27
B8	Djibouti Flag Blue	White	MP10273	c 87 m 71 y 30 k 13
B9	Mudstone	White	MP547	c 61 m 54 y 52 k 24
B10	Brown County	White	MP4991	c 37 m 53 y 68 k 15
B11	Blue News	White	MP5040	c 93 m 55 y 27 k 6
B13	Claret Jug	White	MP10658	c 37 m 93 y 57 k 31
B14	Asgard Wall	White	MP5480	c 61 m 55 y 37 k 11
B16	Accessible Blue	White	MP26511	c 84 m 31 y 0 k 35
B17	Safety RED	White	MP9251	c 0 m 54 y 56 k 15
B18	VA BLUE	White		c 100 m 60 y 0 k 40
B19	Safety YELLOW	Black	MP9144	c 0 m 18 y 70 k 0
B20	Sheep's Wool	Black, Red, Purple	MP32071	c 1 m 0 y 2 k 0
B21	Wooster White	Black	MP6966	c 2 m 4 y 13 k 0
B22	Gentle Gray	Black	MP7596	c 24 m 18 y 19 k 0

Additional Colors for Trims, Accents, Posts & Brackets

A1	Statuary Bronze Metallic MP20158	A4	Stone Grey Metallic MP18169
A2	Wells Fargo Black MP26309	A5	Silver Slate Metallic MP46633
A3	Clear Anodized Aluminum		

Figure 4-9 Example of how colors are applied to signs related to their chart values.



Color & Finish

Design Elements

Parking Structure & Parking Lot Sign Colors

For parking structure signs, vinyl colors will be applied to either white or another listed paint color in the provided chart. The colors and their respective numbers are listed in the chart.

The listed paint colors are acrylic polyurethane paint systems. Matthews Paint is one manufacturer used by the VA, but there are many others which may be used. Any reference to paint numbers is for the designer's convenience and may be matched with another manufacturer's catalogue.

The listed vinyl colors are premium high-performance vinyls. 3M and Avery are two manufacturers which have been used by the VA, but they are not the only companies which may be used. Any reference to vinyl numbers is for the designer's convenience and may be matched with another manufacturer's catalogue.

Parking Structure & Parking Lot Sign Color Chart

Color Ref#	Color Description	Paint Colors		Vinyl Text Colors	
		Matthews Paint #	CMYK	3M #	Avery #
P30	Purple Print	MP2112	c 61 m 78 y 20 k 4	Purple 7225-48	Levender A9475-0
P31	Gravelly Tractor	MP10844	c 13 m 100 y 100 k 3	Tomato Red 7725-13	Tomato Red A9325-0
P32	Wells Fargo Black	MP26309	c 77 m 66 y 66 k 82	Black 7725-22	Black A9090-0
P33	Modena Mud	MP607	c 36 m 60 y 71 k 21	Saddle Brown 7725-139	Cocoa A9278-0
P34	Sailboat Blue	MP2160	c 95 m 76 y 0 k 0	Vivid Blue 7725-17	Vivid Blue A9570-0
P35	Anole Green	MP13427	c 69 m 17 y 96 k 3	Apple Green 7725-196	Apple Green A9660-0
P36	Aranciata Orange	MP1229	c 4 m 67 y 86 k 0	Light Orange 7725-54	Orange A9160-0
P38	Aqua Riva	MP14879	c 80 m 24 y 47 k 3	Teal 7725-96	Real Teal A9615-0
P39	Rose Essence	MP15170	c 18 m 86 y 46 k 2	Magenta 7725-103	Magenta A9411-0
P40	Sheep's Wool	MP32071	c 1 m 0 y 2 k 0	White 7725-10	White A9005-0
P41	Shell Oil	MP5585	c 4 m 19 y 94 k 0	Sunflower 7725-25	Med. Yellow A9130-0

Figure 4-10

Text can be painted, opaque vinyl application, or translucent acrylic for illuminated signs.

Note: Always obtain color samples from the paint company. Colors shown are for representational purposes only. The actual paint colors may vary significantly from the corresponding swatches indicated in this document. Colors will appear differently when viewed on different computer monitors and/or printed from different printers. For a true color sample, it is best to obtain an actual paint sample of the desired color.



Color & Finish

Design Elements

Parking Structure & Parking Lot Colors for Trims, Accents Posts & Bracket

A1	Statuary Bronze Metallic MP20158	A4	Stone Grey Metallic MP18169
A2	Wells Fargo Black MP26309	A5	Silver Slate Metallic MP46633
A3	Clear Anodized Aluminum		

Figure 4-11 Example of how colors are applied to signs related to their chart values.

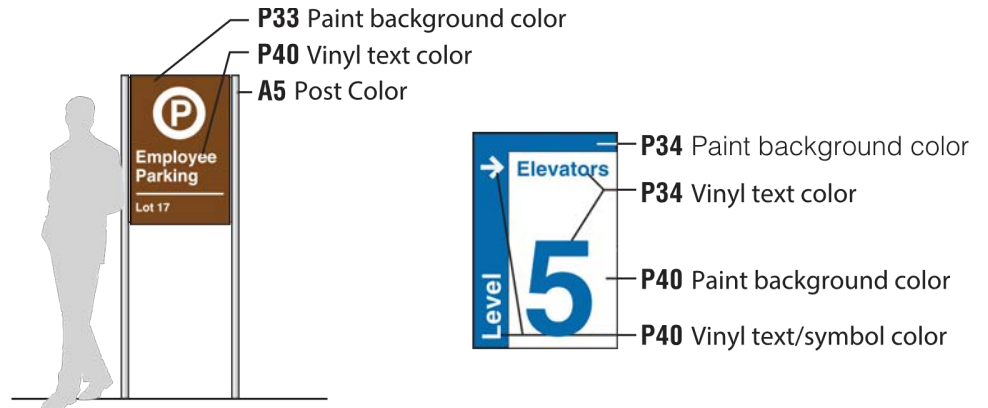

Color & Finish

Design Elements

Interior Sign Color Chart

Figure 4-12 Notes: For interior signage systems, it is recommended that the background color be digitally printed direct to the substrates subsurface. Digital printing reduces VOCs common in polyurethane paints and allows for greater design flexibility.

Always obtain color samples from the signage company. Colors shown are for representational purposes only. The actual colors may vary significantly from the corresponding swatches indicated in this document. Colors will appear differently when viewed on different computer monitors or printed from different printers. For a true color sample, it is best to obtain an actual print / paint sample of the desired color.

Category	Text Color	PMS	CMYK	
Neutral	White	Black	NA	c 0 m 0 y 0 k 0
	Cool Grey	Black	P 179-1 C	c 0 m 0 y 0 k 3
	Warm Gray	Black	P 169-1 C	c 8 m 7 y 8 k 0
VA	Black	White	Black 6 C	c 0 m 0 y 0 k 100
	VA BLUE	White	541 C	c 100 m 60 y 0 k 40
VA Secondary	White	White	7461 C	c 30 m 100 y 70 k 30
	White	White	129 C	c 50 m 0 y 100 k 40
	Black	Black	1575 C	c 0 m 50 y 70 k 0
	White	White	7544 C	c 10 m 0 y 0 k 50
	Black	Black	Cool Gray 3 C	c 21 m 16 y 17 k 0
	Black	Black	4525 C	c 10 m 15 y 35 k 0
VA Deep Tones	Black	Black	5777 C	c 5 m 0 y 50 k 25
	White	White	532 C	c 90 m 63 y 54 k 45
	White	White	3435 C	c 80 m 47 y 94 k 57
	White	White	518 C	c 60 m 94 y 42 k 36
	White	White	471 C	c 22 m 76 y 86 k 11
	White	White	549 C	c 73 m 46 y 38 k 10
VA Light Tones	White	White	117 C	c 22 m 40 y 100 k 2
	Black	Black	2716 C	c 27 m 25 y 0 k 0
	Black	Black	Warm Gray 3 C	c 26 m 24 y 28 k 0
	Black	Black	7499 C	c 6 m 7 y 35 k 0
	Black	Black	366 C	c 32 m 0 y 68 k 0
Life Safety	Black	Black	657 C	c 24 m 7 y 0 k 0
	White	White	186 C	c 0 m 100 y 75 k 4
	Black	Black	151 C	c 0 m 55 y 100 k 0
	Black	Black	109 C	c 0 m 10 y 100 k 0
	White	White	335 C	c 86 m 28 y 70 k 10
	White	White	285 C	c 90 m 48 y 0 k 0
	White	259 C	c 69 m 100 y 1 k 5	

Additional Colors for Trims, Accents Posts & Bracket

A1	Bronze Anodized	A4	Polished Anodized Aluminum
A2	Black Anodized	A5	Brushed Aluminum
A3	Clear Anodized Aluminum		



Color & Finish

Design Elements

Images/Finishes

Figure 4-13 Imagery, graphics, and decorative finishes can be incorporated into signage designs to add visual interest, differentiate areas of the facility, and complement architectural environments.

All design themes and imagery should develop as a logical system and consistent with the Signage System Standards created as part of the wayfinding master plan. See Section 1.2 Fundamentals of Wayfinding for more information about the wayfinding master plan.

All imagery should be digitally printed directly to the substrate's subsurface to protect from scratches.

In addition to imagery and patterns, decorative materials and finishes can be creatively incorporated into signage design.

There are a wide variety of high-pressure laminates (HPL) and adhesive films that can enhance the signage design and complement architectural features and finishes. Standard acrylic sheets come in a variety of options including clear, frosted, and non-glare.

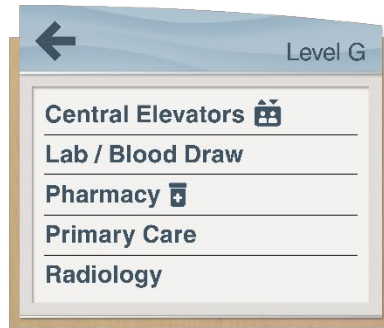

A background graphic pattern can be used to add aesthetic appeal as well as to distinguish zones within the facility.

Architectural materials, laminates, and films can be incorporated into the sign design to complement the facility's interior.

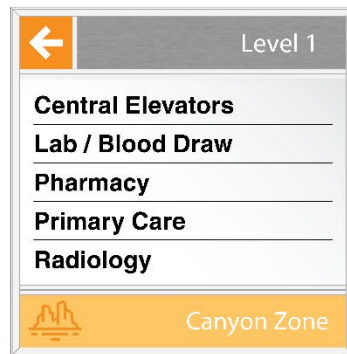

Canyon Zone



Mountain Zone



Lake Zone

In the example above, three distinct zones are identified with thematic symbols and vibrant colors whereas the metallic frame and textured laminate in the header are used as a common design attribute throughout the signage system.



Thematic imagery can be integrated with signage to highlight zones, add emphasis to an area and enhance the mood of the environment.



Color & Finish

Design Elements

Secondary Language

In some areas within the United States and Puerto Rico, it is necessary to include another line of text beneath the English copy for a secondary language. Below is an example which shows the proper dimensional proportions between the English and secondary language copies on signs.

Note: English should always be the language used on the top portion of the sign.

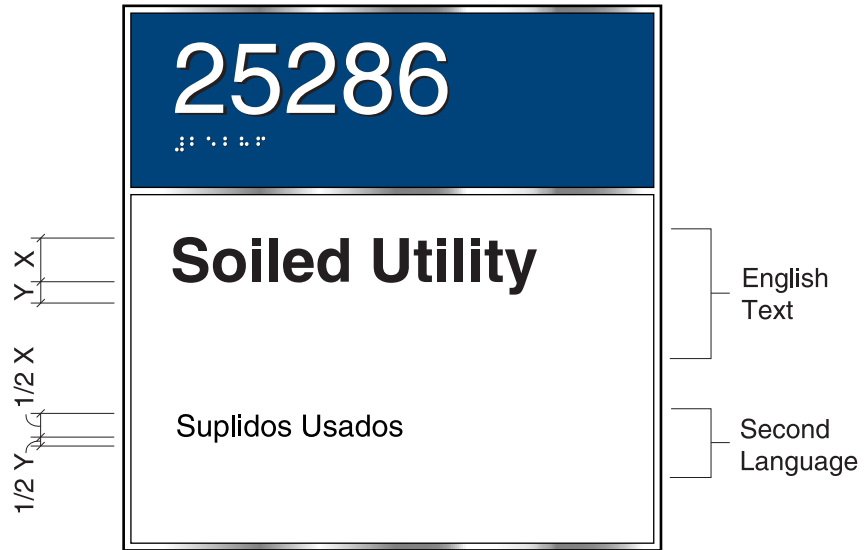



U.S. Department
of Veterans Affairs

SECTION 4.2

WAYFINDING MAPS



4.2.1 OVERVIEW

Maps are a critical component of a successful wayfinding system and are required at all VA facilities. This section describes different types of campus and facility wayfinding maps and provides recommendations for their design and placement. Design and planning of all wayfinding maps should coordinate with the facility's wayfinding master plan. See [Section 1.2 Fundamentals of Wayfinding](#) Fundamentals of Wayfinding to learn more.

It is encouraged that all facilities add visitor guides or wayfinding maps to their webpage at VA.gov. Digital and online maps should reflect the same information and style of design as those found in campus and facility signage. For additional information about Signage and Wayfinding Technology, including online, mobile, and interactive maps, see [Section 1.3 Signage & Wayfinding Technology](#).

Categories

Wayfinding maps fall into four general categories based on purpose and location:

1. **Exterior Vehicular** maps provide wayfinding information to motorists entering a large campus and are placed along roads within the site. These are simplistic and only provide wayfinding information related to vehicular paths of travel. Such information would include roads, points of entry and exit, designation of campus buildings, and associated parking areas.
2. **Campus Pedestrian** maps provide wayfinding information to pedestrians navigating around the campus or between buildings. They are typically placed along complex pedestrian paths, within non-connected parking structures, and inside building lobbies when users must navigate between multiple buildings on a campus. These maps include information related to the entire campus, such as roads, parking lots, walkways, and specific buildings.
3. **Interior** maps provide wayfinding information within a particular building, floor level, or group of buildings. These types of maps illustrate the location of departments and amenities relevant to patients and visitors, such as restrooms, elevators, entrances, vending, and cafeterias. Combined facility maps and directories are often found near primary entrances to help patients and visitors orient themselves and plan their route when entering a building. Additional maps found near elevator lobbies help orient the viewer as they exit elevators on a new floor.
4. **Evacuation** maps are designed to provide emergency exit information in the event of a fire or disaster, where it may be necessary to evacuate a building quickly. They are located at building entrances, stairwells, elevators, and along intersecting corridors and provide only the information necessary to exit a building. These types of maps do not depict specific rooms or departments, instead they are simplified diagrammatic plans showing exit routes and may include the location of fire alarm pulls and fire extinguishers.



Overview

Wayfinding Maps

Presentation Styles

There are different methods for displaying/presenting visitor orientation map information. Maps can be limited to a diagrammatic plan view of the site or building interior, or they can be more complex, including isometric, three dimensional or exploded views where multiple floors of a building are depicted in a single diagram.

Visitor orientation maps are often color-coded to distinguish one area of a site or building from another. In addition to color-coding, hatch patterns can be used to aid the color blind.

Plan View Diagram: This is the most common presentation method for depicting a visitor orientation map where the campus or facility plan is illustrated in a top-down view. The buildings, departments, or zones are typically simplified as solid blocks of color with minimal architectural definition.

Figure 4-14 Example Plan View Maps

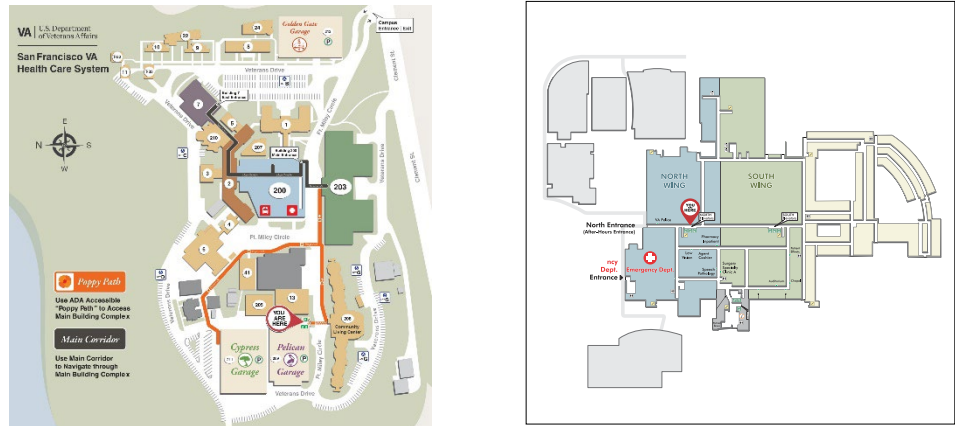

Isometric / Aerial View: This is a more complex method of depicting a map that illustrates the campus or building interior in three-dimensions. The advantage of this style of map is that it can provide a more appealing and detailed representation of vertical forms and spaces. This can help visitors orient themselves by easily recognizing environmental and architectural details. One disadvantage of this style of map is that the complexity of the illustration may add to the time and cost of development and ongoing updates. Another issue is that areas of the plan can be blocked or obscured from view by buildings unless it has multiple views, so this style is typically more effective for exterior campus guides.

Figure 4-15 Example Isometric Campus Maps

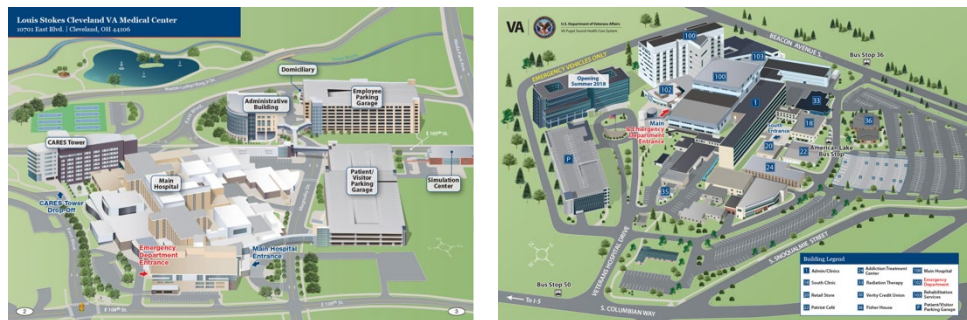

Exploded View: This method is useful when depicting wayfinding information on various levels of a multi-level building in one diagram. This style of map may be useful in certain conditions, but due to visual complexity, may not be suitable for the VA patient populations.



Overview

Wayfinding Maps

Map Orientation

All wayfinding maps (including evacuation maps) should be oriented to the direction that the viewer is facing. This means that the direction at the top of the map should be the same direction that the viewer is facing when viewing the map. For example, if the map is situated so that the viewer is looking east, the map should be positioned so that the top of the map is also facing east.

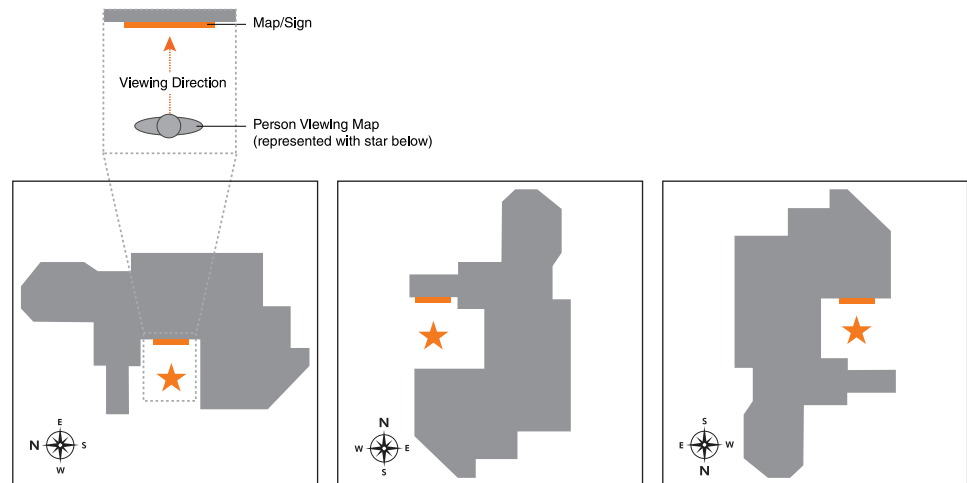

Figure 4-16 The diagram illustrates how maps should be oriented. Each map shows the "You Are Here" star in the same location, with the orange line indicating the location of the map. In each example, the map has been rotated to reflect the orientation of the viewer.



Overview

Wayfinding Maps

Placement, Sizing, Mounting, and Content

Placement: Maps should be strategically placed near entrances and at critical decision points where the viewer needs to orient themselves and plan their route. Vehicular maps are often placed along roadways within the campus where the driver needs to locate the relevant building and designated parking. Interior maps are typically placed near entrance lobbies and at elevator banks.

Sizing and Mounting: All information should be presented at a size large enough to be easily readable and visible from the distance of the intended viewer. A typical size for a wall mounted interior map is 34" x 34" for the floor of a large Medical Center and 22" x 22" for a smaller upper floor or building. Maps can be produced as a digital print on a variety of substrates such as vinyl, laminated paper, aluminum composite, or sheet metal. It is important that the configuration allows for the map to be updated in the future with a new insert or panel to accommodate facility changes. The method of production needs to be compatible with the environmental conditions as well as with the structure that the map is to be integrated with. For example, a laminated digital print on paper will be suitable for an interior environment with placement under glass or acrylic. However, it will not be suitable for an exposed exterior application.

Figure 4-17 (Right) Example map mounting and placement conditions.

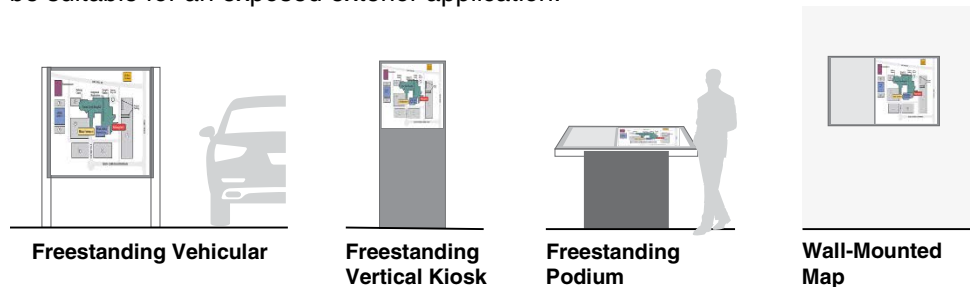

Content: Visitor orientation maps should only include information that is relevant to visitors. Areas such as a loading dock, laundry facility, or utility rooms should be excluded. Non-public buildings can be shown on a campus map, however, they should not be labeled or referenced. If buildings are identified by number, then the map should clearly show the number.

Symbols: Only simple and easily recognized symbols should be used on maps. These symbols should be reproduced in a size and contrast that is easy to identify and locate within the complexity of map illustration.

Figure 4-18 (Right) Example map symbols



Overview

Wayfinding Maps

Exterior Vehicular Maps

Considerations to address when developing vehicular wayfinding maps:

Orientation: Vehicular maps should always be positioned in the direction that a vehicle is facing. For example, if the map is situated so that the viewer is looking down the main campus road, the map should be positioned so that the top of the map is also facing that direction. If there are significant geographic or architectural features that will help orient the driver, these should be included on the map (e.g., a river that runs along the campus or an adjacent Interstate highway).

Placement: Vehicular maps are intended to direct motorists from the site entry to the parking facility associated with their destination. Maps that are directed to drivers must be placed in a location where a driver can safely pull over and stop to read the map. Maps should not be read while driving. A small campus may not need a map, but a large campus with a complex roadway system may need several maps at different locations. These maps are to be located along vehicular paths of travel, strategically placed so that as visitors drive from one area of the site towards their destination there are additional maps and directional signage along the way.

Sizing and Mounting: All information should be presented large enough so that it is easily legible from an approaching vehicle. Because the map will be viewed from a vehicle, the information needs to be as simple as possible. These types of maps are typically freestanding and should not obstruct the view of the motorist.

Figure 4-19 Example Exterior Vehicular Maps

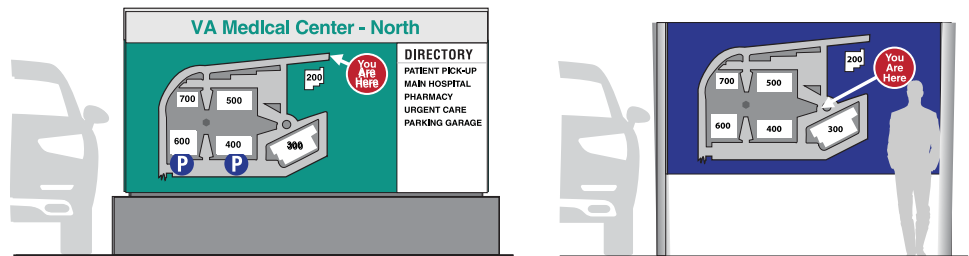

Content: Vehicular maps should only include information that is relevant to vehicular wayfinding, no extraneous information should be included. Information to include is as follows: site entries and exits, “You are Here” symbol, visitor accessible roads, and visitor related buildings, along with associated parking areas. It may be helpful to color code maps to visually distinguish one area from another.

Directory: Campus maps that are directed toward vehicular viewing, or that contain a directory, require restraint when assembling the directory listings. Only the primary destination should be listed in the directory, such as Main Entrance, Visitor Parking, Clinic Entrance, Hospital, Emergency Department, Community Living Center, etc. Limiting the listings to only the most important destinations will shorten viewing time and allow for quicker decision making by the viewer.



Overview

Wayfinding Maps

Campus Pedestrian Maps

Considerations to address when developing campus pedestrian wayfinding maps:

Orientation: Pedestrian maps should always be positioned in the direction that the viewer is facing. For example, if the map is situated so that the viewer is looking down a pathway, toward a specific building, that building should be shown towards the top of the map. If there are significant geographic or architectural features that will help pedestrian orientation, these should be included on the map (such as a river that runs along the campus, a building with a clock tower, a large sculpture, etc.).

Placement: Pedestrian wayfinding maps can be located along sidewalks where there are complex paths of travel, within non-connected parking structures, and inside building lobbies when users must navigate between multiple buildings on a campus. In building lobbies and parking garages, campus maps are typically wall mounted to orient the user on where they are located and display the path of travel required to reach their desired destination, including shuttle stops, if available. Freestanding exterior campus maps can be located along sidewalks at decision points and at complex paths to provide orientation information.

Sizing and Mounting: All information should be presented large enough so that it is easily legible from approximately 3 to 5 feet away for exterior applications, and 2 to 3 feet away for interior locations. Pedestrian wayfinding maps may be freestanding, wall mounted, mounted to a vertically freestanding structure or kiosk, or podium mounted.

Content: Exterior wayfinding maps should only include information that is relevant to visitors. Areas such as a loading dock or administrative offices should not be labeled. Information to include is as follows: “You Are Here” symbol, restrooms, main building entries, parking areas, various campus visitor related departments, and bus/shuttle stops. It is also helpful to color code maps to visually distinguish one area from another.

Figure 4-20 Example Exterior Pedestrian Maps

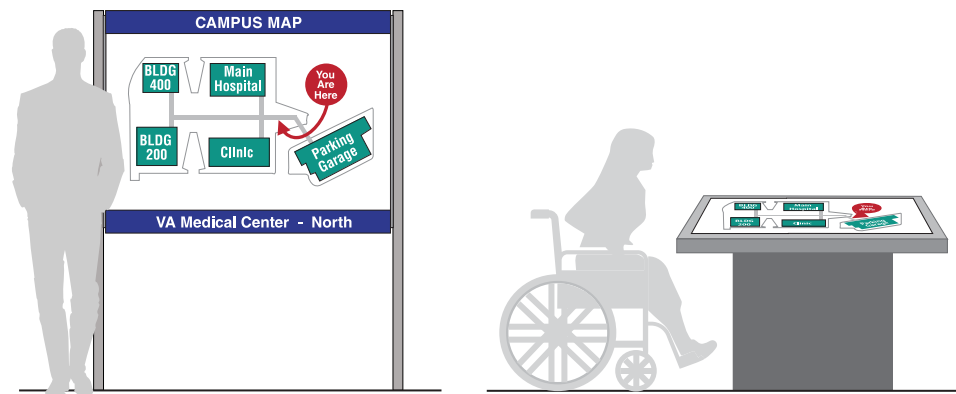

Overview

Wayfinding Maps

Interior Maps

Considerations to address when developing interior wayfinding maps:

Orientation: Interior maps should always be positioned in the direction that the viewer is facing. For example, if the map is situated so that the viewer is looking toward a specific hallway, that hallway should be towards the top of the map. If the viewer needs to turn left to get to the elevators, then the elevators should be shown towards the left on the map. If there are significant architectural features that will help pedestrian orientation in a building, these should be included on the map (e.g., an atrium, courtyard, elevators, etc.).

Placement: Interior wayfinding maps are to be located at building entry lobbies and at elevator lobbies on each visitor accessible floor.

Sizing and Mounting: All information should be presented large enough so that it is easily legible from approximately 2 to 3 feet away. These types of maps are typically wall-mounted, however, they may also be freestanding or podium-mounted, depending upon the surrounding conditions.

Content: All interior wayfinding maps are to include “You Are Here” symbol. Those maps located at lobby entries are to include general information for the entire building, such as location of restrooms and various building departments (like Pharmacy, Blood Draw, Waiting Room, Clinics) as well as visitor related facilities (such as cafeterias, shops, and vending). Maps found in elevator lobbies should include visitor-related information for that floor only. Areas such as laundry facilities, utility rooms, and other non-public areas should not be shown.

Directory: At primary building entrance lobbies, interior maps should be accompanied by a building or facility service directory. Directories should include only services relevant to patients and visitors. Services should be listed alphabetically. For each department / service, the directory needs to provide the necessary information to find that service based on the wayfinding master plan. That often includes the building / area, floor, and the name of the check-in location, if applicable for that department / service. For example, Dermatology – Building 1 – Floor 2 – Blue Clinic.

Figure 4-21 Example Interior Maps and Directory Combinations



Overview

Wayfinding Maps

Digital Maps and Directories

Digital displays can be used in map/directory signage in place of traditional printed graphics. The shift from analog to digital displays comes with several benefits and tradeoffs. Benefits can include more easily updatable information and graphics, and advanced capabilities such as touch, voice, mobile device interactivity, animated graphical interfaces, patient check-in, and turn-by-turn directions. On the other hand, tradeoffs may include higher costs of initial development and skilled maintenance, longer development time, and future obsolescence of hardware and software. For more information on Wayfinding and Signage Technology, see [Section 1.3 Signage & Wayfinding Technology](#).

Evacuation Maps

Evacuation maps are designed to provide exit information in the event of a fire or emergency. The only information that is necessary are the pathways through main hallways or corridors leading to the facility exits. No additional information is to be included.

Layout, Colors and Typography: Evacuation maps need not conform to a specific layout or color palette. The maps must contain the necessary content discussed above and be easily readable from 18–24 inches away. It is important that all elements have sufficient contrast to the background on which they are placed (darker colors on lighter colors and vice versa). It is also important that the layout, typography, and colors are consistent across all evacuation maps in the facility. Typography should be a sans serif typeface, preferably Helvetica Bold.

Figure 4-22 Example Interior Maps and Directory Combinations

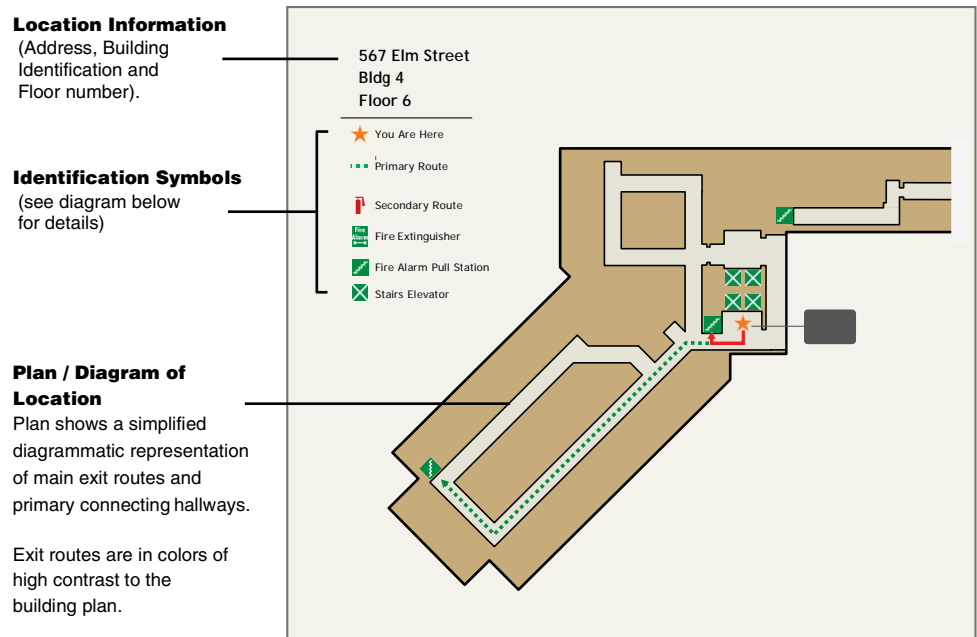

Evacuation Map: Not to Scale, Approx 1/3 of full size



Overview







Wayfinding Maps

Symbols and Necessary Content: The following information must be included on all evacuation maps: Location information such as address, building number and floor level (if applicable), “You Are Here” symbol, location of stairwells, elevators (in multi-level buildings), and primary corridors. The plan may also show a designated path of travel for a primary exit route, an alternate (secondary) exit route, and the location of fire extinguishers and fire alarm pulls. The information on exit routes and the location of fire extinguishers and fire alarm pulls must be provided by the facility life safety or engineering personnel to ensure accuracy and conformance with facility plans.

Figure 4-23

Evacuation Map Symbols:

Full Size (symbols should be no smaller than those shown)

	You Are Here Symbol: To be placed on map at location of specific map.		Fire Alarm Pull Symbol: To be placed on map at location of fire alarm pull
	Primary Exit Route: Used to show most direct route from location of map to exit.		Stair Symbol: To be placed on map at location of stairwells.
	Secondary Exit Route: Used to show alternate exit route from map location.		Elevator Symbol: To be placed on map at location of elevators.
	Fire Extinguisher: To be placed on map at location of fire extinguishers.		

Orientation and Placement:

When required, the International Fire Code (IFC) requires the posting of evacuation plans in each guest room and at each elevator bank. The evacuation map must indicate the viewer location (You Are Here), display a minimum of two evacuation routes, and indicate the location of fire extinguishers and fire alarm pull stations.

They are optional in other types of buildings. If a facility elects to install evacuation maps, coordinate with the facility life safety or engineering personnel for their specific requirements regarding content, size, and layout of evacuation map information. These requirements should be obtained prior to developing and installing evacuation maps.

Figure 4-24

Evacuation Map Orientation and Placement:

Evacuation maps are **ONLY** required in areas with hotel / dormitory type occupancy such as “Hoptels” and Fisher Houses. They are **NOT** required for inpatient settings or other healthcare areas.

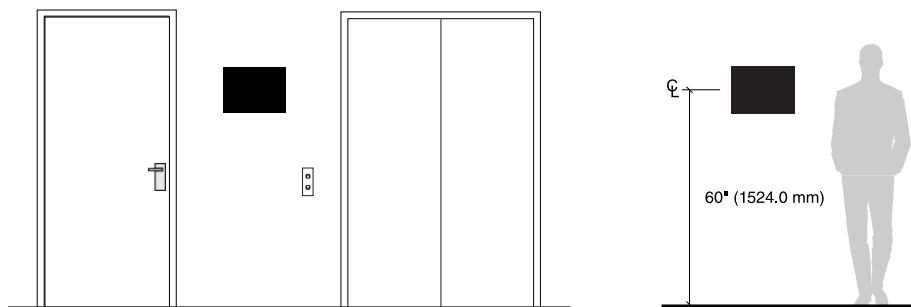

Evacuation Map Symbols





U.S. Department
of Veterans Affairs

SECTION 4.3

VHA STANDARDIZED DEPARTMENT NOMENCLATURE



4.3.1 OVERVIEW

Introduction

The [VHA Standardized Department Nomenclature](#) document outlines a set of guidelines for clinical, non-clinical, and administrative areas within the VA. The document serves as a definitive strategy that should be reinforced through facility signage, maps, and patient appointment letters.

EPS formed an Integrated Product Team consisting of Interior Design and an Office of Construction & Facilities Management representative to review and determine the appropriate departmental and sub-departmental name for signage. The Standardized Nomenclature document has been vetted through the program offices responsible for each department, CFM and EPS. Veteran experience is a high priority of VA and VHA Leadership; consistent department names and signage will contribute to a more positive Veteran experience in our VHA environments. Standardized Nomenclature will also allow for easier navigation through our medical centers.

Disorganized and inconsistent naming systems can detract from Veteran and visitor experience and lead to confusion. In the absence of a formally documented program, naming systems can ultimately convey an unorganized, disconnected, and poor image for VA. The Standardized Nomenclature document sets out to convey a naming system that will enhance the environment across all VA.

The most up-to-date version of the [Standardized Nomenclature](#) document can be found on the VA TIL.





U.S. Department
of Veterans Affairs

SECTION 4.4

ROOM RENUMBERING



4.4.1 RENUMBERING

Introduction

Situations that require renumbering rooms or floors are extremely rare. Building, floor, and room numbers are established in architectural and engineering documentation, and are embedded within most of the facility management and operational systems. A thorough analysis of all information and communication systems within the facility is needed to identify the scope and impact of any renumbering project.

The following section explains and illustrates how floor levels and room numbering should work in a variety of typical conditions, and how one should approach potential renumbering.

Floor Level Identification

When a person enters a building from an entrance adjacent to the main lobby, it is natural for them to expect to be located on that building's first floor, but due to varying site conditions, this is not always the case. Therefore, it is important to establish a clear and consistent identity for all floor levels in a building.

Site Considerations

Clear and consistent level identification is essential for buildings located on sloped sites with portions of the levels partially above and below grade.

When multiple buildings are adjacent to one another on a sloped site and have floors that do not align, each building should have clear level identification along with effective directional information. Ideally, the main entrance and lobby of a VA facility should be identified as the first floor.

On a sloped site condition where buildings are connected with an enclosed walkway or corridor and the building floor levels do not align, an evaluation must be made regarding coordination of floor level identification.

One example would be when a patient enters the facility at the medical center main lobby and wants to go to a clinic that is located in another building, which is physically connected to the hospital.

In the scenario above, if the transition while walking from one building to the next is visually very clear, then the buildings can retain their individual floor level numbers. However, at the entry points to each building, highly visual floor level identification must be displayed at the building entry points.

If the transition from one building to the next is not clear and a person is not aware they have entered another building, then the buildings' floor level numbers must be coordinated. This may mean renumbering the floors in the secondary building in a nonconforming way.



Renumbering

Room Renumbering

Assigning Floor Levels

Figure 4-25

First Floor

The first floor of a building is the level where the main entrance for patients and visitors is located. This floor shall be labeled “1”.

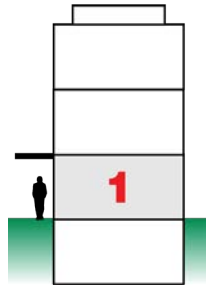

Figure 4-26

Upper Levels

The levels above the first floor shall be labeled in ascending order. The second floor is labeled “2”, the third floor is labeled “3”, and so on.

Basements

The first level below the first floor shall be labeled “B1”, the second “B2”, and so on.

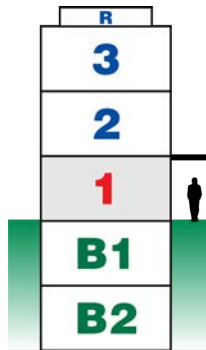

Figure 4-27

Mezzanines

A mezzanine is a low story between two levels in a building.

Most VA buildings do not have Mezzanines.

This level shall be labeled “M”.

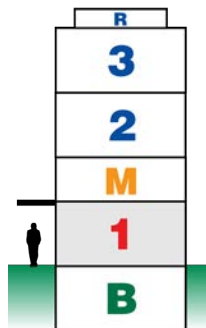

Figure 4-28

Interstitial Levels

An interstitial level is one that is not accessible to the public. Generally, these levels are only for building support equipment.

Most VA buildings do not have interstitial levels.

This level shall be labeled “I” followed by the level number below it.

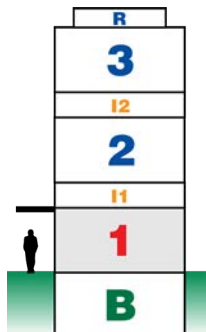

Renumbering

Room Renumbering

Figure 4-29

Sloping Sites

When a building is on a sloping site, the first floor is the level which patients and visitors enter the building, at a main entrance which leads into a main lobby reception area.

The lower level shall then be designated as a basement, even though it is at grade.

Previously, the levels below the first floor were sometimes labeled as the "ground floor". Where this is the case, these floors shall be redesignated as basements.

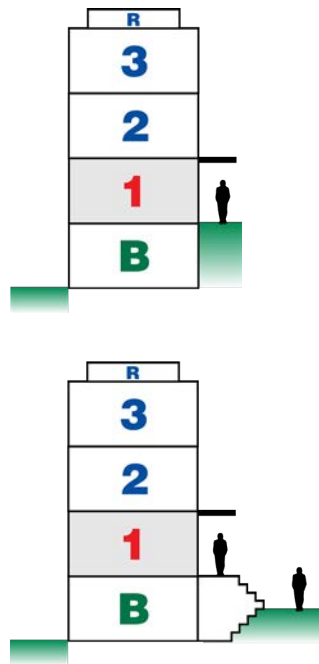
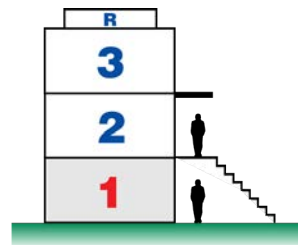

Figure 4-30

Staircase Leading to Main Level

Older buildings which were constructed with a staircase leading up a full flight of stairs to the main level typically had this level designated as the first floor and the level below labeled as the ground floor or basement.

If the ground level is accessible from grade, the designation of that level shall be "1".



Renumbering

Room Renumbering

Figure 4-31

Connected Buildings

If two or more buildings are connected by a corridor or covered walkway, if the transition from one building to the next is not clear and a person is not aware they have entered another building, then the buildings' floor level numbers must be coordinated based on the level that serves as the main entrance.

If the transition from one building to the next is visually very clear, then the buildings may retain their individual floor level numbers, but highly visual floor level identification must be displayed at the building entry points.

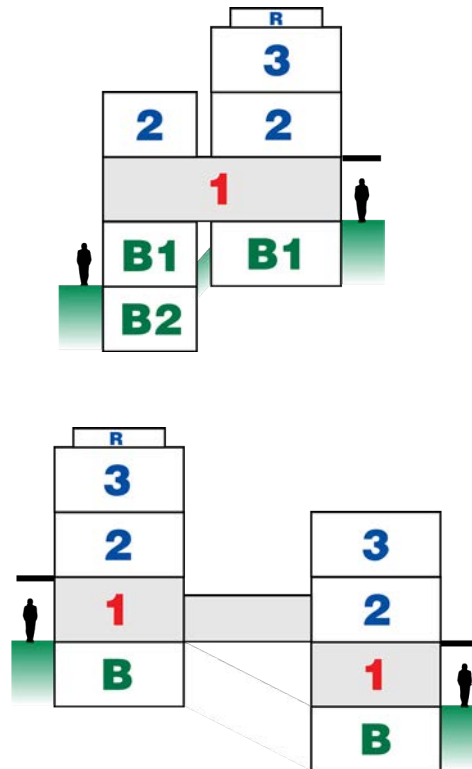

Implementation of Floor/Level Number Changes

Process

- Conduct a survey of existing floor level identification and conditions.
- Develop revised floor level designations.
- Determine what needs to be changed in the sign program: elevator cabs, elevator lobbies, stairwell signs, directories, automatic alarm annunciators, building automation systems, etc.
- Coordinate with facility manager, engineering, dietary, information management, safety, and nursing.
- Advise the on-site, and/or local Fire and Police Departments of this change in the facility.
- Develop documentation necessary to implement the change. This will involve changes to both the elevators and the sign program at the same time.
- Arrange for implementation through typical procedures.
- Alert all staff, prior to the conversion, via email and notifications posted throughout the facility. Include actual conversion dates along with contact information for either the department or individual(s) responsible for addressing relevant inquiries.



Renumbering

Room Renumbering

When

- Floor / room numbering projects are preferable to occur during the completion of a renovation or remodeling project or as part of the completion of a new construction project.
- Based on the scale of the project, schedule the installation and change during a weekend or holiday period, if possible. All items have to be coordinated and scheduled to change at the same time often requiring the coordination of multiple vendors and personnel from elevator cab buttons to complex fire alarm systems and software platforms.

Considerations

- Install the entire program at one time to avoid confusion.
- Create a translation sheet which indicates “old” and “new” level names. Widely distribute this information, along with the date of change, to staff with plenty of time before the change takes place.
- After converting to the new level designations, in the elevator lobbies, display a paper copy of the old vs. new floor levels for several weeks as staff and patients adjust to the change.

Room Renumbering as a Wayfinding Tool

While the sequential numbering of rooms can help visitors and staff locate rooms more easily when nearing the destination, room numbers should not be relied upon as a substitute for a logical hierarchy of information and wayfinding master plan. In a large medical center environment, users should be guided to the correct building, floor, area, and finally the department / check-in location as opposed to an individual room number.

Room Numbering Effects on Operations

Patients and staff rely on room numbering systems to confirm destinations throughout a facility. Based on the scale of changes made to a numbering system, many departments can be directly affected including, but not limited to, Facility Management, Engineering, Environmental Management, Pharmacy, Medical Administration, Nutrition and Food Service, Police Services, and Information Resource Management. Planning and implementation will take time and constant communication with all relevant parties.



Renumbering

Room Renumbering

Implementing New Room Numbers While Retaining Old Numbers

It is possible to implement a new room numbering system while retaining the old one.

The new room number system is put in place on the wall at the side of the door as a part of a new sign program. The old room number can be put on a small sign (i.e., 1" X 4") mounted on the top of the door frame on the hinge side. With this approach, when a new corrected room numbering system is put in place, the old room number designation is not affected. The old room number on the plaque that is attached to the door frame retains the old number for as long as necessary. The new room number is then in place for the public and the wayfinding system.

While this approach may address the concerns of those who do not want to change numbers, it does introduce two systems into a building. Typically, the new system will get adapted by people in a couple of weeks. Then a decision must be made regarding what departments will continue to use the old system.

Although engineering may want to remain with the old system, it is not recommended. There are ways for engineering to make room number revisions while maintaining the integrity of their databases. For example, Computer Aided Facility Management (CAFM) systems can include programs for old room numbers and new room numbers that will electronically solve such concerns.

Criteria for Room Numbering

The following is a guide for a door/room numbering system and a proposed method to implement the system. They are intended to be a starting point for developing an effective system.

General Considerations

Building layout and shape play a significant role in the development of a room number system that functions correctly.

Review a site plan identifying the building entrances and access usage. Evaluate the building floor plan and identify main features, primary entrance, exits, hallways, elevators and determine major paths of travel. When determining the paths of travel, also identify where these paths of travel originate.

Identify major and secondary corridors, waiting rooms, office suites, service and activity rooms, open office areas, and mechanical/utility rooms and spaces.

Determine major, secondary, and tertiary destinations such as clinics, reception areas, offices, nursing stations, pharmacy, restrooms, and the like. Note locations of vertical circulation elements (elevators, stairs).

Survey and make note of the building's structural "grid", beams, columns, windows, and shear walls. Note corridor alignments and other architectural elements like atriums, courtyards, and patios.

Note patterning in building construction: Do walls tend to follow a pattern of placement? Do walls follow a pattern from floor to floor? Are corridors in the same location from floor to floor? Are certain rooms in the same location on each floor? Also, identify where existing room numbers function well and may not require any revisions.



Renumbering

Room Renumbering

Room numbers are a label of identification. They can convey identification of the floor level, building area as well as the specific number of the room.

Room numbers would typically be formatted with the first digit(s) designating the floor, the second digit (or letter) designating the building area, and depending on the size of the building area, the next 2 or 3 digits are identifying the actual room.

Smaller buildings or building configurations that permit the use of 4 digits is a preferred system. The use of 4 digits for a room number tends to be easier for people to remember.

Figure 4-32 Note: It is recommended that individual room numbers not exceed 5 numeral/characters. Room numbers composed of more than 5 numerals/characters tend to be more difficult to remember. If a building is over 9 stories, exceeding the 5-character guide is acceptable. Adding an additional digit designation for a room within a room is also allowed, as well as inserting a hyphen between the building area designation and room number.

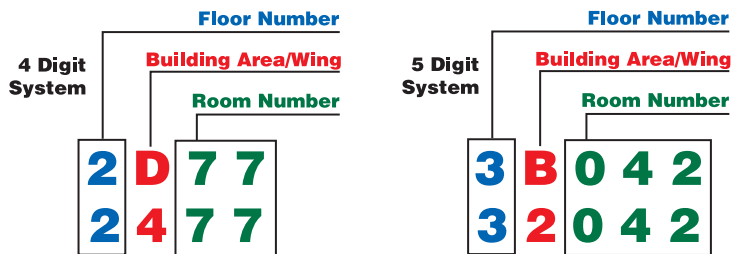

Building Area Designation

Depending on the configuration of the building floor plan, there are several methods to use in order to designate areas or features to support a clear and coherent room numbering system.

Based on the floor plan, generate a key plan delineating blocks of rooms and access corridors. Establish area symbols (A, B, C or 1, 2, 3, etc.) on a key plan. The area identifier is then used as part of room number and corridor number.

Figure 4-33 Use numbers or letters to identify separated areas within buildings.

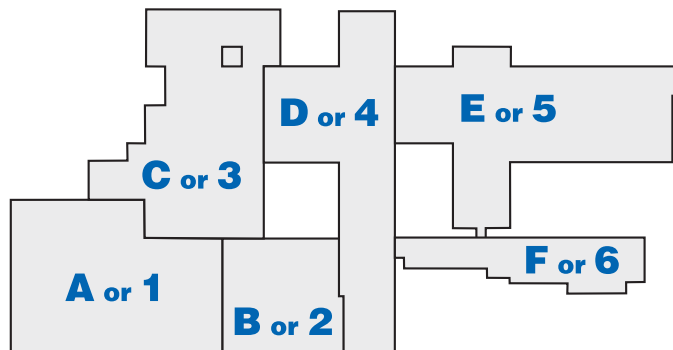

Renumbering

Room Renumbering

Lobby and Waiting Area

Lobby identification should follow the numbering sequence of rooms. Assign a number in sequence to the room adjacent or closest to the lobby entry.

Corridors

Corridor identification can also follow the numbering sequence of rooms.

Zones

Establishing zones is a method of assigning a “room number” to constantly changing areas such as workstation areas located in open floor plans.

Create a reference grid based on an architectural feature such as column lines. Use letters on one axis and numbers on the other axis to identify each location within the grid.

Room Numbering Scenarios

In the following pages we will discuss two numbering systems. One numbering scenario is based upon a grid applied to the building floor plan. The other scenario is based upon sequential numbering.

Numbering off a grid allows for room numbers to be added and deleted without affecting the numbering system. It does mean that numbers appear to jump when going down a hallway where there are no doors.

Numbering in a sequential fashion has numbers following the sequence of the doors along a corridor. Following this approach requires introducing numbers with a “sub-set” designation when new rooms are created within an existing numbered space.

Odd/Even Grid Room Numbering Scenario

With the odd/even grid system, analyze the floor plan and develop a grid based on consistent architectural building elements such as columns, window patterns etc.

After developing a grid, assign odd room numbers to one side of the corridor grid and even room numbers to the opposite side of the corridor. This patterning follows the common addressing pattern used in cities and towns.

Figure 4-34 Floor Plan Example with Grid Numbers Applied

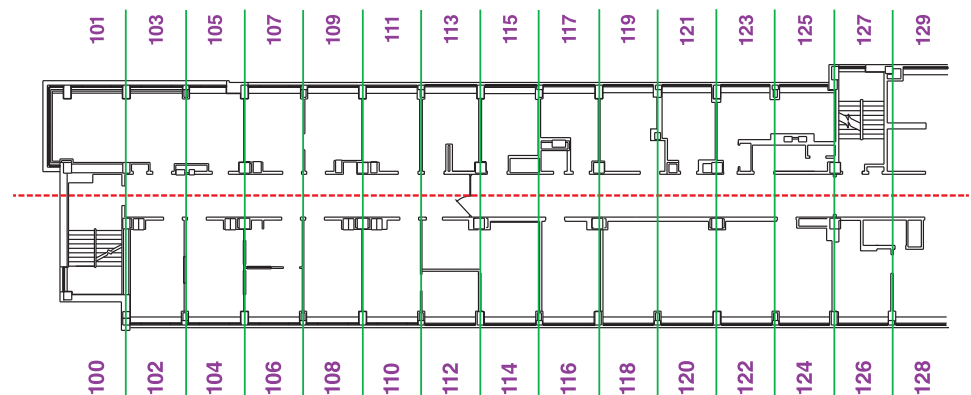

After applying the grid, assign room numbers based upon which grid area contains the room door opening. The grid numbering always stays constant and if there are no door openings in a grid area, then that grid number is not used.



Renumbering

Room Renumbering

A grid number system assigns a number to an area of the building and allows remodeling to occur with rooms being added or deleted without changes to the number system.

Figure 4-35 Floor Plan Example with Room Numbers Applied

*3B117A

**This room could be numbered 3B126 because it could be remodeled to have access off the hall, or it could be numbered 3B128B because it is accessed from room 3B128.

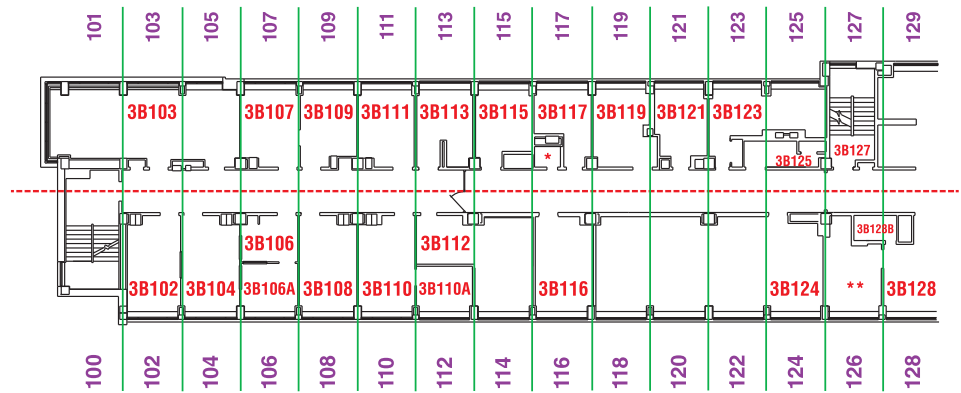

After applying room numbers, based upon the room door opening on to the corridor, within the grid area, address the numbering for rooms that are located within rooms.

Typically, these interior rooms are given a sub-set designation. This designation can be in the form of a letter or number. Using a letter tends to be easier for people to remember and use.

4B123 - Room with a corridor door in the assigned grid area

4B123A or **4B123a** or **4B123.1** - Designation for a room accessed through the room that is accessed from the corridor.

The preceding illustration shows several examples of how to address rooms within rooms, rooms extending over several grid zones, and two rooms opening in the same grid zone.

Sequential Room Numbering Scenario

With the sequential system, take the floor plan and apply room numbers down the corridor.

At logical breaks in the corridor, like at stairs or elevators, some numbers can be skipped. This will allow some flexibility within the sequential system in case of future room reconfigurations and remodels.

The same as the odd/even scenario, interior rooms, off rooms, are given a subset designation.

This designation can be in the form of a letter or number. Using a letter tends to be easier for people to remember and use.



Renumbering

Room Renumbering

Figure 4-36 Note: While the adjacent illustration is showing the use of a number and letter designation system (i.e., 3B109), a five number designation works equally as well (i.e., 32109).

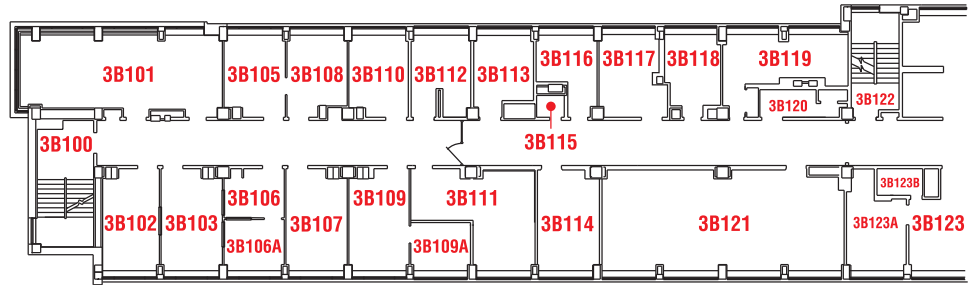

Every building has conditions that may require deviation from the room numbering scenario being applied, but these deviations should be kept to a minimum. If there are too many, then there may be a problem with the scenario.

Sometimes there are buildings, or floors, where it is virtually impossible to implement a logical numbering system. There may be too many disconnected corridors, rooms within rooms, or simply no defining pattern to the rooms in the building or space.

Adding and Deleting Room Numbers

A numbering system for existing rooms/spaces should allow for future additions or subtractions to the original system.

Large rooms that have been sub-divided and remodeled to serve other functions can be identified by adding a sequential sub-set letter or number to the original room/space number.

- Original Room/Space Number - 1A013 (Retain for 1 room/space)
Added Rooms/Space Number - 1A013A, 1A013B
- Original Room/Space Number - 1A014 (Retain for 1 room/space)
Added Rooms/Space Number - 1A014.1, 1A014.2, 1A014.3

Groups of small rooms/spaces remodeled into larger rooms/spaces by removing walls/partitions should retain one of the original room/space numbers that follows in sequence to the numbers patterned off the entrance from the corridor.

A number that has not been used in the existing plan may be assigned within the renovated area/space or new area/space if it falls within the sequence.

An available room number may be reassigned to another room after a plan change.

A room number should not change if the function or use of a room changes.

In the case where a room/space is served by more than one door, the room number should follow a number designation based upon the access to the room from corridor, anteroom, or lobby in sequence.

Rooms/spaces that could be accessed by multiple door conditions are usually office suites, alcoves, secretarial area, closets, air/mechanical shafts, stairs, elevators, and mechanical/electrical rooms.

When deleting old room numbers keep existing numbers in place unless the deleted numbers create confusion.



Renumbering

Room Renumbering

Figure 4-37 Adding Rooms Via the Grid System

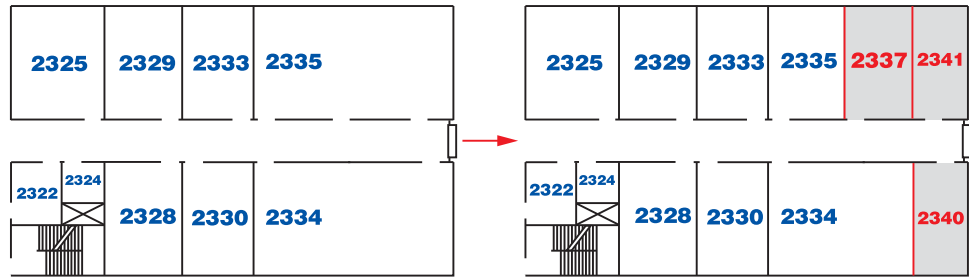
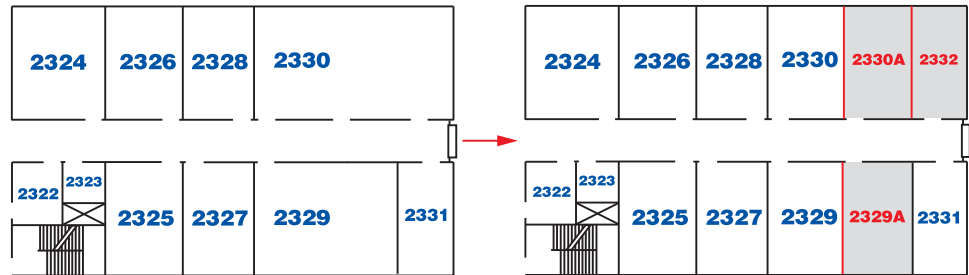

Figure 4-38 Adding Rooms Via the Sequential System



Open Office Plan Zone Numbers

Large rooms that have been sub-divided with open office systems can identify zones within the room by adding a sequential subset letter or number to the room/space number.

- Room Number - 1A013
Open Office Zone/Space Number - 1A013a1, 1A013a2
- Room Number - 2334
Open Office Zone/Space Number – 2334b1, 2334b2

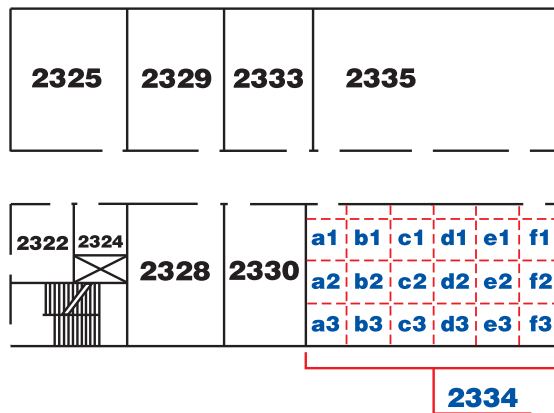

Renumbering

Room Renumbering

Implementation of Room Number Changes

Process

- Conduct a survey of existing room locations, floor plans, and conditions.
- Develop proposed room number scenarios.
- Determining the changes that will follow renumbering can be an enormous undertaking. Consider all potential effects on stairwell signs, directories, automatic alarm annunciators, building automation systems, and all other operational and communication services that utilize room and level numbers.
- Develop preliminary sign location plans and message schedules for new signs.
- Coordinate with all department managers, facility management, engineering, dietary, information management, safety, nursing, pharmacy, and fiscal.
- Develop final documentation necessary to implement the change. This will involve implementing the changes to both the room identification signs and the directional sign program at the same time.
- Arrange for implementation through typical procedures.

When

- It is preferable to implement room number changes during the completion of a renovation or remodeling project or as part of the completion of a new construction project.
- Based on the scale of the project, schedule the installation and change during a weekend or holiday period, if possible. All items have to be coordinated and scheduled to change at the same time often requiring the coordination of multiple vendors and personnel from signage to complex fire alarm systems and software platforms.

Considerations

- Install the entire new room renumbering program at one time to avoid confusion.
- Create a translation sheet that has “old” and “new” room numbers. Widely distribute this information, and the date of change, to staff with plenty of time before the change.
- It is recommended to install all the signs with the new numbers and then cover them up with paper signs showing the old number. On the day and time of the change, remove all the paper signs. This way the entire building gets changed out at once.
- Code requirements may require updating some sign types and/or locations.
- Directories and directional signs will need to be updated with the new room numbers.



Renumbering

Room Renumbering

- New room signs will probably require existing wall surfaces to be cleaned and freshened up or even painted prior to installation.
- Prior to converting to new room numbers, plan for impacting system changes, such as alarm annunciators, building automation systems, telephones, fire alarm systems, code blue, and other room number dependent information systems.

Corridor Numbering

Revising or developing a corridor number system is a task that is directly influenced by the architectural configuration of the corridors within a building. The shape and form of a building as well as the location of building entrances and circulation hubs like elevators, stairs, and atriums all impact the corridor number system. It is difficult to define a simple method of identification that can be universally applicable.

Corridor numbers are rarely used in wayfinding except in situations where the architecture of a building, and its circulation, allow corridors to define a distinct pattern. In this case, the corridors are given names, rather than numbers, as the method of identification.

There are, however, a few general guidelines for corridor numbers:

- Corridor numbers and the number system need to be distinctly different from room numbers and the room number system, yet they need to have a relationship to the room numbering system on the corridor.
- Corridor numbers must include a digit that designates the floor level.
- Corridors do not need to be signed for wayfinding purposes.

Stairwell Numbering

Stairwell numbering needs to be coordinated with a facility life safety plan. The identification needs to be consistent throughout a building and from building-to-building.

Each stairwell designation needs to be unique and specific to each stairwell and the designation not repeated within a building or even on a campus.

Stairwell numbers can have a digit that designates a building and a digit that designates it as an emergency exit or an inner-level circulation path.

Stairwells that have outside exits should have a sign on the outside, adjacent to or on the door, identifying that this is an exit stairwell and its specific number. This allows emergency personnel to be directed to a specific stairwell without confusion.

Elevator Cab Numbering

Elevator cab numbering is typically done for maintenance purposes only.

If two buildings are connected together, the elevator designations should not repeat. Each elevator cab should have a distinct number as the people using the building may have no reference that they have changed buildings.





U.S. Department
of Veterans Affairs

SECTION 4.5

FREQUENTLY ASKED QUESTIONS (FAQ)



4.5.1 FAQ

This section provides answers to frequently asked questions regarding signage at VA facilities. It also clarifies several policies that have been addressed since the release of the previous document in 2012. This is not an exhaustive list of all policy updates and changes.

Requirement or Guideline?

The VA Signage Manual outlines the necessary signage requirements that must be followed at all VA facilities. In addition to these requirements, the manual also includes numerous guidelines and suggestions that are not strictly mandatory. The distinction between a requirement and a guideline is that requirements are essential items that must be implemented, whereas guidelines are general principles or recommendations that offer direction. By following both the requirements and the guidelines outlined in the manual, VA facilities can create signage that is informative, consistent, and enhances the user experience.

Deviation Waivers are only required for items that are considered Requirements.

Requirement Examples:

- It is required that all VA facilities follow the name formats found in [Section 2.5 Exterior Signage Guidelines](#) and illustrated on signs in [Section 3.5 Exterior Signage Drawings](#).
- ABA requirements are to be met for signage at all VA facilities.
- All Code and Life Safety signs are to be fabricated, located, and installed per the specifications contained in [Sections 2.2 Code & Life Safety Signage Guidelines](#) and [Section 3.2 Code & Life Safety Signage Drawings](#).
- All Mandatory VA Policy & Directives signs are to be fabricated, located, and installed per the specifications contained in [Sections 2.3 Mandatory VA Policy & Directives Guidelines](#) and [Section 3.3 Mandatory VA Policy & Directives Signage Drawings](#).
- Correct usage of the VA Logo and Seal, typography, arrows, and Military Emblems described in [Section 4.1 Design Elements](#) and [Section 2.7.5 Design Elements](#) for NCA facilities.
- The use of component-based signage systems is required at VA facilities, but exact materials, parts, finishes, and dimensions will vary based by manufacturer.

Guideline Examples:

Colors, layouts, materials, and dimensions in all drawings in [Section 3 Sign Type Drawings](#) (excluding Sections 3.2 and Section 3.3) are typical guidelines and may vary slightly by facility conditions and component based product line.

- Color palettes in [Section 4.1 Design Elements](#) (excluding VA Blue) are intended as suggestions and usage is not required.
- Specialty sign products mentioned and illustrated in [Section 2.4 Specialty Signage Guidelines](#) and [Section 3.4 Specialty Signage Drawings](#) are intended as examples and will vary based on facility conditions and needs.
- All Planning and Programming subsections in [Section 2 Sign Type Guidelines](#) contain narratives intended to inform the reader, but conditions will vary by facility and project.



FAQ

Frequently Asked Questions (FAQ)

Military Seals VS Emblems



NOTE: If the word "Department of" is in the logo it is a Seal and cannot be used in VA Signage.

For example, the United State Coast Guard Seal is distinguished by the gold rope surrounding the anchor instead of the words "Department of".

Department of Defense and Military Seals are protected by law from unauthorized use. Each Military service has a Trademark Licensing Program Office that manages its graphic and word trademarks (including common law trademarks). These protected trademarks are for official DoD use only.

Military Service Emblems CAN be used in signage at VA facilities, with permission from the respective Trademark Licensing Office.

For more information regarding DOD Branding & Trademarks visit:

defense.gov/Resources/Branding-and-Trademarks

For Special Rules for Federal, State and County Veterans Affairs Departments visit:

defense.gov/Resources/Branding-and-Trademarks/DOD-Trademark-Licensing-Guide/

Always follow branding guidelines for Military Emblems when using with permission. Some general guidelines:

- Avoid displaying the emblem as outlines or using drop shadows.
- Avoid rotating, distorting, or skewing the emblem in any way.
- Avoid changing the colors of the emblem.
- Avoid using transparency or using the emblem as a watermark behind text.
- When displaying multiple emblems, they are to be in order from left to right by the birthdate of the service branch (see below). They should never be stacked vertically.

Correct emblem order: Army | USMC | USN | USAF | USSF | USCG



Leased Property Considerations

Leased VA facilities must utilize the Signage Design Manual and require the same VA Mandatory Signage as all other VA properties. Additionally, leased properties must follow local lessor guidelines and city and state signage codes, laws, ordinances, and permitting regulations based on location as they are the authorities having jurisdiction (AHJ). These regulations can influence the types of signs, mounting methods, sizes, quantities, and specifications of the signage system. Therefore, it is important to research and understand the lessor requirements and applicable codes before planning a signage system for leased spaces. Required permits should be filed and approved before fabricating signage.

FAQ

Frequently Asked Questions (FAQ)

Facility Naming Guidance

NOTE: It has been observed that the word Health Care has been spelled both "Health Care" and Healthcare" on websites, signage, and literature. For consistency VHA requires all signage that includes the word "Health Care" to spell it as two words.

VA | Health Care Center

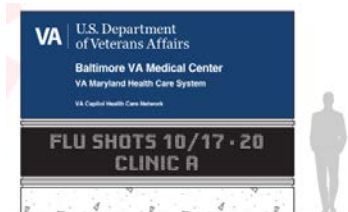

It is VHA policy that all clinical sites of care with a unique street address must have a unique station number. VAST is the authoritative source for tracking all sites of care and contains the station number, station name and station attributes in the database. Since station numbers are the official identification numbers for funding and budgetary purposes, therefore a station number suffix not found in VAST may still be included in other VHA Data Systems such as Financial Management Services and Financial Services Center.

Clear, descriptive names of VHA facilities improve transparency and communication for both Veterans and staff.

Each of the directives below include information to be reviewed prior to entering changes in VAST. These documents are located on the VAST Tools under Directives & General Information. Documents pertinent to improving consistency and standardization in the naming of VHA clinical sites of care include:

[Naming Guidance in the VAST Data System V5 \(Sharepoint\)](#)

[VHA Publications \(Handbooks\)](#)

[VHA Publications \(Directives\)](#)

Room Dedication Plaques

Dedication plaques may be displayed outside of rooms with dedication names, such as Conference Rooms, Auditoriums, Foyers, and Lobbies. The dedication name should be displayed on the plaque only and not on the ABA compliant room identification signs. Room identification and all wayfinding signage guiding to that room should display the room's function and not name on plaques.

Highway Signs

Highway Signs are provided by the Department of Transportation (DOT) for VA Medical Centers (VAMC), Community Based Outpatient Centers (CBOC) and Health Care Centers (HCC). In order to have the appropriate signage installed along major routes directing to the facility's main entrances, stations should contact DOT.

Employee Names on Signs

It is strongly recommended not to use staff names on office signage within public areas, however, it will be at the discretion of the individual facility. If allowed, it must be an insert-based sign, allowing for easy future updates. Fonts used in insert must follow [Section 4.1.2 Typography](#). Watermarks, drop shadows and unique fonts are not to be used in sign inserts.

Infrastructure Room Signs

Signs identifying electrical closets, mechanical rooms, and telecommunication rooms should only consist of the room number, which should follow the master building room numbering system.

Patient Room Signs

Personal or private patient information should never be displayed on signs outside of the patient's room.



FAQ

Frequently Asked Questions (FAQ)

Restroom Signage Requirements

Gender-Neutral: All single-occupant restrooms (men, women, unisex, and family) will now display the gender-neutral “toilet” pictogram and the word “RESTROOM” using sign types [IN-09.03](#) & [IN-09.06](#). Gender-specific, multi-occupant restrooms will continue to display the Female or Male pictograms and “WOMEN” or “MEN”.

Figure 4-39 Restroom signs with gender-neutral pictogram and additional messages for the availability of baby changing stations and accessible restrooms.

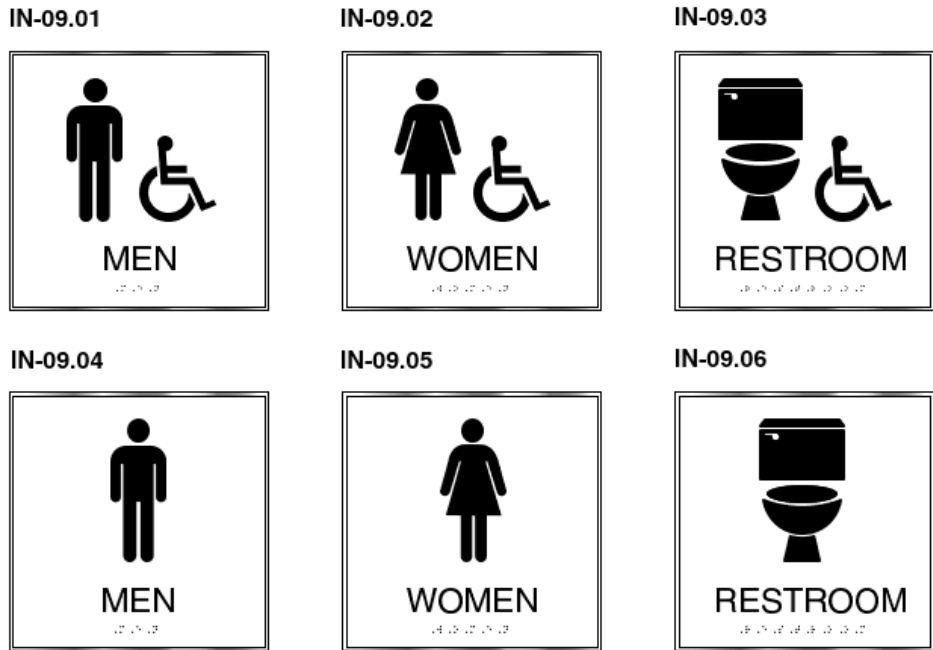

Baby Changing Stations & Accessibility: All public restrooms will now specify if they have a changing station or provide the location of the nearest restroom with one. All non-accessible restrooms will now provide the location of the nearest accessible restroom.

Figure 4-40 Directive language 133.01 (6) (e) Diaper changing tables shall be available in designated public male, female, unisex, and family toilet rooms. Diaper hanging tables shall be placed at least one per floor in male, female, and unisex toilet rooms, and no more than 300 feet from areas accessible to a patient. Rooms with changing table must be identified, and toilet rooms without changing tables should include signage directing users to the nearest changing table.

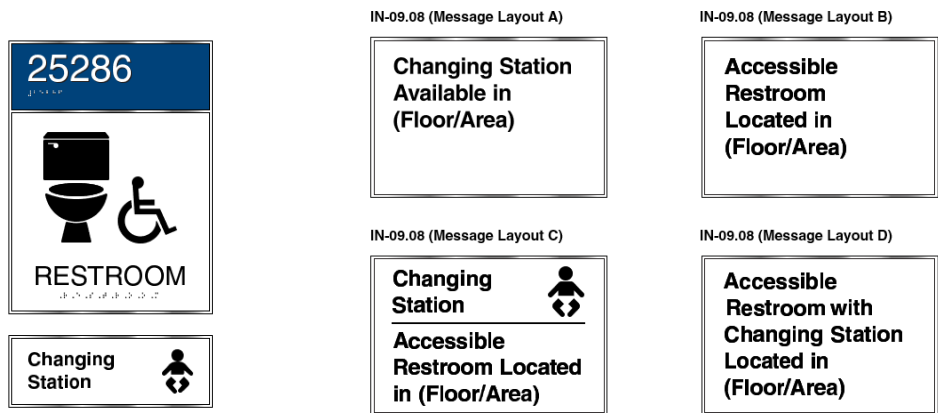

EV Charging Stations and Signage

Public EV charging is not allowed on VA property, therefore no signage is required.



FAQ**Frequently Asked Questions (FAQ)****Approved Department Names vs Check-In Names**

This Manual includes a link to the VHA Standardized Nomenclature document that lists approved department names at VA facilities. While this list provides clarity and consistency for administration and communication, signage and wayfinding conditions may require additional destination names and abbreviated department names.

The evolving nature of VA facility architecture often locates multiple unrelated departments within an area that all check-in at a single location. Or conversely, subservices within the same department may be located in different areas of the facility. Wayfinding should guide patients to the check-in locations rather than the individual departments. Each facility will have distinct conditions that require assessment prior to developing unique wayfinding solutions.

Braille & Tactile Character Usage

Tactile letters and Braille are required on all interior and exterior signs identifying permanent rooms / spaces and exits.

Signs that provide direction to or information about interior spaces and facilities must meet ABA requirements for visual characters but are not required to be tactile or include Braille.

For more information, see [Section 4.1 Design Elements](#).

Character Size

For signs requiring tactile characters, the text height can be a minimum of 5/8" and maximum of 2".

For signs with visual character requirements, text height is based on the placement and viewing distance to the sign with a minimum of 5/8".

For more information, see [Section 4.1 Design Elements](#).

What Type of Signage Systems Meet VA Requirements

To meet VA requirements, component-based systems should be used for both interior and exterior signage. While sign products may vary slightly between manufacturers, there are specific criteria that all component-based signage systems must meet.

For interior signs, this includes the ability to mechanically fasten to the wall, offer insert-based options, and modularity to allow for easy replacement or rearrangement of components without having to replace the entire sign.

For exterior signs, a system of aluminum extrusions is required to allow for sign faces, cabinets, and panels to be updated and changed.

The drawings in this Manual are intentionally generic in design and do not reflect any manufacturer's specifications. For more detailed information about signage system construction, please refer to [Section 2.1.5](#) and [Section 2.5.6](#).



FAQ

Frequently Asked Questions (FAQ)

Mounting Interior Signs

The preferred method for mounting all wall mounted interior signs is to mechanically fasten to the wall. This limits wall damage when removing or replacing the sign in the future. Exceptions to this rule are when a sign is mounted to glass, masonry, marble, or a door where mechanical mounting could lead to increased damage or prove unfeasible.

For detailed information about mounting and installation of interior signs, see [Section 2.1.6](#).

Sign Message Insert Standards

To ensure consistency and maintain graphic integrity when using insert-based signs, it is crucial to establish and follow standards. These standards should cover the design of inserts, as well as their formatting and messaging. By adhering to established standards, you can ensure that your signs convey information effectively and efficiently, while maintaining a cohesive visual identity throughout your facility. While the design of each insert will vary based on sign type, system, and individual facility, there are several requirements for insert that must be followed.

- Helvetica Lt Std is the preferred font of the VA and should be used on all signage. Helvetica Lt Std *Bold* should be used as the primary style for message inserts.
- Message inserts for all directional and informational signs (excluding temporary postings, directories, building addresses, occupant names, menus, and seat / row designations in assembly areas) need to meet ABA requirements for visual characters. See [Section 4.1 Design Elements](#).
- Message insert templates must be developed for each sign type as part of the facility specific signage system standards to ensure consistency and standardization among all sign types and messages. These templates can be created as a digital file format such as Word or PDF, or through a software platform provided by the manufacturer. When updates are made, it is crucial to use these templates to guarantee that all modifications align with the established standards.
- Text should have a minimum margin of 3/8" and should not be printed to the edge of the sheet.
- Text should have adequate contrast to its background.
- Guidelines for individual interior sign types can be found in [Section 2.1](#) and [Section 3.1](#).

Lactation Room Signage

Lactation Room signage shall be non-descript and have an occupied/unoccupied slider.

Elevator Wraps

Elevator door coverings are not allowed.

VA Sustainability Requirements

All lighting requirements have been upgraded to LED type systems to fall in line with the VA's sustainability requirements. When selecting additional components to enhance the signage system such as electronic displays, energy star-rated equipment is preferred.



FAQ

Frequently Asked Questions (FAQ)

Secondary Languages

All signs are required to be posted in English. Other languages are allowed as an additional sign on stations of non-English speaking populations. Non-English posters can be ordered off the VHA website by the station. All non-English posters need to be mounted adjacent to the English version. Not all posters are currently available in multiple languages. See [Section 4.1.5](#) for spacing requirements on insert based signage systems.

Affiliate Signage

The VA/VHA does not allow affiliate designations on exterior/monument site signs of any kind. Signs can direct to affiliate buildings if they are standalone buildings on VA property for wayfinding purposes only. If your station is affiliated with a local university, please consider composing some type of informational display to hang on site.

New VA Mission Statement

The Department of Veterans Affairs announced an updated version of its 1959 mission statement. The new mission statement is: **“To fulfill President Lincoln's promise to care for those who have served in our nation's military and for their families, caregivers, and survivors.”** Facilities are not required to display the mission statement.





U.S. Department
of Veterans Affairs

SECTION 4.6

EXAMPLE PHOTOS



4.6.1 EXTERIOR PHOTOS

Collection of photos provided by CFM showing different ways to utilize this Design Manual



Interior Photos

Example Photos

4.6.2 INTERIOR PHOTOS

Collection of photos provided by CFM showing different ways to utilize this Design Manual

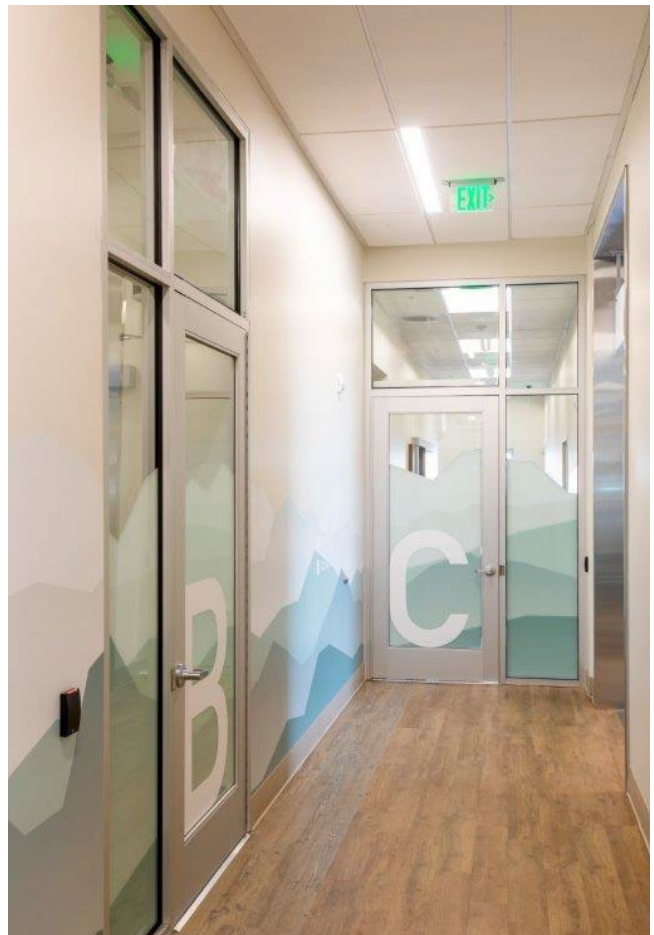



U.S. Department
of Veterans Affairs

SECTION 4.7

SIGN INDEX



4.7.1 OVERVIEW

Sign Numbering System

Each sign in this manual is given a specific index number that can be used to easily identify each individual sign. Signs are named based on the sign type, the family of sign they belong to, and then given a specific number. Signs are grouped based on their purpose, configuration, layout, and installation specifications. Certain sign families may have only one sign, whereas others may have several signs assigned to them.

Certain signs that have been used in the past may have been moved, renamed or have been removed from the manual altogether; when determining which signs are needed, consult the manual to obtain the appropriate number for each necessary sign. If planning on updating any or all signs, refer to [Section 1.1 – Planning a Signage System](#) for more information.

Signs are named in the following manner:

IN - 17.01 A

XX designates the type of sign:

IN = Interior/Code & Life Safety/Mandatory VA Policy & Directive Signs

SP = Specialty Signs

EI = Exterior Illuminated Signs

EN = Exterior Non-Illuminated Signs

PL = Parking Lot Signs

PS = Parking Structure Signs

NC = Cemetery Signs

17 Two-digit number identifies a particular directory family.

.01 The two-digit number, following the period, identifies a specific sign within the directory family.

A The letter designates a specific sign configuration, version and/or layout for graphics.

Example Sign

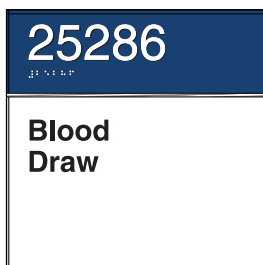

IN - 04.03: Primary Room Identification with Insert

IN Designates that this sign is an Interior Sign.

04 Designates that this sign is a Primary Room Identification Sign.

.03 Identifies this specific sign in the Room Identification sign family.



Section 3.1

Sign Index

4.7.2 SECTION 3.1 INTERIOR SIGNAGE DRAWINGS

Sign	Name	Description	Page #
IN-03.01	Room Number Identification	This sign is used to identify electrical, mechanical, telecommunication, data, closets, inpatient restrooms, and other rooms where a descriptive name is not required or poses a security risk.	259
IN-04.01	Primary Room Identification with Insert	This is the primary room identification sign type. The room number is composed of raised, tactile characters and Braille, and the room's occupant/use is displayed on an updatable insert.	261
IN-04.02	Secondary Room Identification with Insert	The room number is composed of raised, tactile characters and Braille, and the room's occupant/use is displayed on an updatable insert. This sign can be used for secondary rooms or buildings.	263
IN-05.06	Patient Room Identification with Write-On Panel	This sign can be used to identify patient rooms. It includes a write-on panel for temporary messages like the patient's name.	265
IN-05.07	Patient Room Identification with Room Alert & Contact Precautions	This sign can be used to identify patient rooms with added components for patient notification alerts and contact precaution notices.	267
IN-06.05-.06	Patient Bed Signs	These signs can be used to identify patient beds within the patient room. It includes a write-on panel for temporary messages like the patient's name and optional patient information tabs.	269
IN-06.07	Patient Information Tabs	These tabs are used to display relevant patient care information for in-patient room and patient bed identification signs.	271
IN-06.08	Patient Contact Precaution Cards	These cards are used to display relevant contact precautions in patient room identification signs.	273
IN-07.01-.02	Room Identification with Insert & Indicator	Use this sign for conference rooms, meeting rooms, exam rooms, treatment rooms, and offices where the occupants want to indicate that the room is in use.	275
IN-08.01	No Smoking / No Vaping	This is an optional sign used to reinforce the "No Smoking or Vaping" policy in supplement to the mandatory posting of sign type IN-02.02 in Section 3.3.	277
IN-08.02	Restricted Area Identification	This sign is used to regulate access to restricted rooms and areas. It should be used sparingly to avoid creating an unwelcoming environment.	279



Section 3.1

Sign Index

Sign	Name	Description	Page #
IN-09.01-.06	Restroom Identification	This sign is used to identify restrooms with name, pictogram, and room number.	281
IN-09.07-.08	Required Restroom Postings	These signs are additional required postings used to notify whether a restroom has a changing station and is accessible or not.	283
IN-09.09	Pictogram and Symbol	This sign type is used to identify destinations and points of interest with a large pictogram and text.	285
IN-09.10	Privacy Notice	This sign can be used in areas where video or audio recording may be taking place such as videoconferencing. It can be placed within the room/area or below the Room ID sign. Required privacy notice signage is in Section 3.3 (See VHA directive 1078).	287
IN-10.01-.06	Sign Frame Insert Holder	These insert holders can be used to display easily updatable posters, directives, and miscellaneous information.	289
IN-10.07	Informational Posting – Large Insert	These signs are used to display a variety of information. Sign header has a permanent message and insert component accepts easily updatable message insert that accepts standard tabloid paper size message.	291
IN-10.08	Informational Posting – Standard Insert	These signs are used to display a variety of information. Sign header has a permanent message and insert component accepts easily updatable message insert that accepts standard letter paper size message.	293
IN-11.01-.04	Permanent Message Panel	Used for permanent messages that will not require updates.	295
IN-12.01-.03	Desk or Counter Sign	These freestanding signs are used for messages that can be moved or relocated based on the function of the counter. Sign can be double-sided or single-sided.	297
IN-13.01	Perpendicular Flag Mount	This sign is used to identify or guide to high traffic destinations and rooms like restrooms.	299
IN-13.02	Perpendicular Flag Mount - Small	This sign is used to identify small rooms, bed numbers, and stations.	301
IN-14.01-.05	Wall Directional – Permanent Panel	These signs are used to display directional information on walls. Sign has removeable component panels with permanent messages.	303



Section 3.1

Sign Index

Sign	Name	Description	Page #
IN-14.06-.07	Wall Directional – Single Insert	These signs are used to display directional information on walls. Sign has permanent header and/or footer and easily updatable message insert that accepts standard tabloid paper size.	305
IN-14.08-.11	Wall Directional – Dual Inserts	These signs are used to display extended directional information on walls where more than five lines of copy are needed. Sign has permanent headers and/or footers and two easily updatable message inserts that accepts standard tabloid paper size.	307
IN-14.12-.13	Wall Directional – Oversized Insert	These signs are used to display directional information on walls in areas where larger copy is needed for greater viewing distance. Sign has permanent header and/or footer and easily updatable message insert.	309
IN-14.14-.17	Floor Level Directional – Permanent Panel	These signs are used to display directional information and current level number at elevator lobbies where there are no other forms of level identification. Sign has removeable component panels with permanent messages.	311
IN-14.18	Floor Level Directional – Dual Inserts	These signs are used to display directional information and current level number at elevator lobbies where there are no other forms of level identification. Sign has permanent header and easily updatable message insert that accepts standard tabloid paper size.	313
IN-15.51/.55	Ceiling Mounted Directional and Department ID	Ceiling-mounted sign for directional and department identification information. Can be single or double-sided.	315
IN-15.52/.56	Ceiling Mounted Directional and Department ID	Ceiling-mounted sign for directional and department identification information. Can be single or double-sided.	317
IN-15.61/.65	Ceiling Mounted Directional and Department ID	Ceiling-mounted sign for directional and department identification information. Can be single or double-sided.	319
IN-15.62/.66	Ceiling Mounted Directional and Department ID	Ceiling-mounted sign for directional and department identification information. Can be single or double-sided.	321
IN-15.71/.75	Ceiling Mounted Directional and Department ID	Ceiling-mounted sign for directional and department identification information. Can be single or double-sided.	323
IN-15.72/.76	Ceiling Mounted Directional and Department ID	Ceiling-mounted sign for directional and department identification information. Can be single or double-sided.	325



Section 3.1

Sign Index

Sign	Name	Description	Page #
IN-16.51/.55	Soffit Mounted Directional and Department ID	Wall or soffit-mounted sign for directional and department identification information.	327
IN-16.52/.56	Soffit Mounted Directional and Department ID	Wall or soffit-mounted sign for directional and department identification information.	329
IN-16.61/.65	Soffit Mounted Directional and Department ID	Wall or soffit-mounted sign for directional and department identification information.	331
IN-16.62/.66	Soffit Mounted Directional and Department ID	Wall or soffit-mounted sign for directional and department identification information.	333
IN-16.71/.75	Soffit Mounted Directional and Department ID	Wall or soffit-mounted sign for directional and department identification information.	335
IN-16.72/.76	Soffit Mounted Directional and Department ID	Wall or soffit-mounted sign for directional and department identification information.	337
IN-17.01	Large Orientation Map	This sign is used to display wayfinding maps of a facility near primary entrances and lobbies. These maps help viewers orient themselves upon enter the facility and plan a route to their destination.	339
IN-17.02	Large Directory Listing	This sign is used to display the directory list of patient & visitor focused destinations within the facility.	341
IN-17.03	Orientation Map	This sign is used to display wayfinding maps of the current floor of the building near elevator lobbies or secondary entrances. These maps help viewers orient themselves as they exit the elevator or enter an area.	343
IN-17.04	Directory Listing	This sign is used to display the directory list of patient & visitor focused destinations within the facility.	345
IN-17.05	Small Directory Listing	This sign is used to display the directory list of patient & visitor focused destinations within the facility.	347
IN-18.01	Vinyl Applied Letters	Vinyl letters for use at glass entry doors to rooms or departments that are used by patients and the public.	349
IN-19.01-.03	Dimensional Letters	Identification of information counters, major departments, or services.	351



4.7.3 SECTION 3.2 CODE & LIFE SAFETY SIGNAGE DRAWINGS

Sign	Name	Description	Page #
IN-01.01.01	Evacuation Plan Sign	This sign type is ONLY required for areas with hotel / dormitory type occupancy such as “Hoptels” and Fishers Houses. It is NOT required for inpatient settings or other healthcare areas.	361
IN-01.01.03	Guest Rooms Evacuation Plan Sign	This sign type is ONLY required for areas with hotel / dormitory type occupancy such as “Hoptels” and Fishers Houses. It is NOT required for inpatient settings or other healthcare areas.	363
IN-01.02	Fire Extinguisher Identification Sign	This sign is used to locate and identify fire extinguisher cabinets.	365
IN-01.03	Fire Procedure “R.A.C.E.” Sign	Fire procedure sign to be installed above fire alarm pull stations as needed. This sign is optional.	367
IN-01.04	Elevator Call Button Sign	Elevator call button fire procedure sign to be installed at elevators.	369
IN-01.05	Fire Door Sign	This sign is used to identify fire doors typically at stairwells. Do not install this sign on smoke barrier doors. See NFPA 80 for additional information.	371
IN-01.06	No Exit Sign	This sign is used to identify a door in a stairwell or other locations that are not exits.	373
IN-01.07.01-.04	Exit Sign	Non-illuminated exit sign used to identify exit or direction to exit.	375
IN-01.08	Automatic Fire Door Sign – Hinged Door	“Do not block” information to be communicated at hinged fire doors held open by automatic devices.	377
IN-01.09	Automatic Fire Door Sign – Roll Up	“Do not block” information to be communicated at roll down fire doors held open by automatic devices.	379
IN-01.10	Stair Identification Sign	Identifies stairwell doors that are fire exits.	381
IN-01.11	NFPA Stairwell Identification Sign	Stairwell, floor level and egress information. Sign is located within the stair enclosure at each floor landing and must be readily visible when stair door is in open or closed position.	383
IN-01.12	Area of Refuge Sign	Disabled evacuation assistance directional sign indicating area of refuge for evacuation assistance.	385



Section 3.2

Sign Index

Sign	Name	Description	Page #
IN-01.13	Push/Pull Alarm Identification Sign	Push/Pull alarm identification sign is an instructional sign for push/pull alarmed doors.	387
IN-01.14	Open Door Fire Safety Sign	Instructional sign used for roll-up security gates and main entrance doors.	389
IN-01.15	Hazardous Material Information Sign	Hazardous materials information sign used to easily identify specific hazards within room, storage cabinet or locker.	391
IN-01.16.01	Oxygen in Use Warning Sign	Caution information regarding oxygen in use. Sign must be installed on all doors to rooms in which oxygen is in use.	393
IN-01.16.02	Medical Gases Warning Sign	Caution information regarding medical gases being stored within a room. Sign must be installed on all doors to central supply rooms in which oxygen and/or medical air is stored. Refer to NFPA 99 for additional requirements and information.	395
IN-01.16.03	Oxidizing Gases Warning Sign	Caution information regarding oxidizing gases being stored within a room. Sign must be installed on all doors to all rooms more than 300 square feet in size that contain oxidizing gases (oxygen and/or nitrous oxide) and/or inert gases (CO2/Nitrogen/Helium). Refer to NFPA 99 for additional requirements and information.	397
IN-01.16.04	Positive Pressure Gases Warning Sign	Caution information regarding positive pressure gases being stored within a room. Sign must be installed on all doors to central supply rooms that contain all other gases besides or in addition to oxygen/medical air. Sign must be installed on all doors to all rooms more than 300 square feet in size that contain inert gases (CO2/Nitrogen/Helium). Refer to NFPA 99 for additional requirements and information.	399
IN-01.17	Compressed Gas Warning Sign	Caution information regarding gases in use. Sign must be installed on all doors to rooms that contain the listed gases. Adjust the listing of gases to reflect the actual gases being used in the laboratory.	401
IN-01.18	Nonflammable Anesthesia Restriction Sign	Caution information regarding anesthetic agents in use. Sign is to be installed on the doors to all operating rooms.	403
IN-01.19	Radioactive Material Warning Sign	Caution information regarding radioactive material. Sign is to be installed on the doors to all rooms where radioactive materials are in use or stored.	405
IN-01.20	Radioactive Area Warning Sign	Caution information regarding area with radioactive material. Sign is to be installed on the doors to all rooms where radioactive materials are in use or stored.	407



Section 3.2

Sign Index

Sign	Name	Description	Page #
IN-01.21	High Voltage Warning Sign	Caution information regarding high electrical voltage. Sign must be installed on the doors to all rooms with high voltage (>600 volts) equipment.	409
IN-01.22	Biohazard Warning Sign	Caution information regarding biohazard materials. Sign must be installed on the doors of all rooms where there are biohazard materials.	411
IN-01.23	Laser Warning Sign	Caution information regarding lasers. Sign must be installed on the doors to all rooms where lasers are used.	413
IN-01.24	Occupational Exposure Area Warning Sign	Caution information regarding occupational exposure. Sign is to be installed on doors to all rooms where there is occupational exposure.	415
IN-01.25	No Re-Entry Floor Sign	No re-entry floor sign is used to identify a door which once closed will not reopen from the other side.	417
IN-01.26	Push to Exit Sign	Push to exit sign is used to inform type of action needed to activate door. Sign is to be installed on doors to all exits where push motion is needed to activate door.	419
IN-01.27	Emergency Push to Open Sign	Emergency push to open sign is used to inform type of action needed to activate door in case of an emergency.	421
IN-01.28	Emergency Slide to Open Sign	Emergency push to open sign is used to inform type of action needed to activate door in case of an emergency.	423
IN-01.29	Direction of Exit Sign	Direction of exit sign used to indicate direction egress. Sign is to be installed next to doors at all exits where direction is needed to exit.	425
IN-01.30	No Re-Entry Sign	The No Re-entry sign is used to identify an exit door which will lock when shut and not allow re-entry into room, floor, or building.	427
IN-01.31	Fire Extinguisher Identification Flag Sign	Fire extinguisher identification sign is a flag sign used to identify a fire extinguisher cabinet.	429
IN-01.32	Pregnancy Notification Sign	Pregnancy notification sign is used to convey a request for patient information. Sign is placed in patient waiting areas, treatment rooms, and dressing rooms.	431
IN-01.33	Re-Entry Sign	Re-entry sign is used to identify an entry door which will allow re-entry into room, floor, or building when door is shut.	433



Section 3.2

Sign Index

Sign	Name	Description	Page #
IN-01.34	Proper Attire Required Beyond this Point Sign	This sign is used to identify spaces which require the observer to wear proper medical attire before entering.	435
IN-01.35	Radiation Warning Sign	Caution information regarding spaces with equipment that are actively producing radiation such as X-Ray machines.	437
IN-01.36	AED Identification Flag Sign	Automated External Defibrillator sign is a flag sign used to identify an AED cabinet.	439
IN-01.37	Cart Crash Identification Flag Sign	Crash Cart sign is a flag sign used to identify crash cart locations.	441
IN-01.38	Emergency Eye Wash Station Sign	Sign indicating nearby eye wash station for use in emergency situations.	443
IN-01.39	Emergency Shower Sign	Sign indicating nearby emergency shower for use in emergency situations.	445
IN-01.40	Emergency Shower / Emergency Eye Wash Station Sign	Sign indicating nearby emergency shower and emergency eye wash station for use in emergency situations.	447



4.7.4 SECTION 3.3 MANDATORY VA POLICY & DIRECTIVE SIGNAGE DRAWINGS

Sign	Name	Description	Page #
IN-02.01	Consent to Inspection Sign	"Consent to Inspection" sign is required to be placed on an interior wall at all public entrances to a building.	458
IN-02.02	No Smoking, No Vaping Sign	"No Smoking, No Vaping" sign is required to be placed on an interior wall at all public entrances to a building.	460
IN-02.03	No Weapons Permitted Sign	"No Weapons Permitted" sign is required to be placed on an interior wall at all public entrances to a building.	462
IN-02.04.01	Business Hours & Video Surveillance Sign - Vinyl	A "Business Hours" sign is required to be placed at public entrances to a building. In addition, the facility must notify individuals if they are subject to photography, digital recording or video or audio recording. This sign covers both requirements.	464
IN-02.04.02	Business Hours & Video Surveillance Sign - Exterior	A "Business Hours" sign is required to be placed at public entrances to a building. In addition, the facility must notify individuals if they are subject to photography, digital recording or video or audio recording. This sign covers both requirements.	466
IN-02.04.03	Business Hours Sign - Interior	"Business Hours" sign required to be placed at interior locations where hours of operations differ from the rest of the campus.	468
IN-02.05	Notice of Weapons Search Sign	This sign only required at metal detector screening devices and is to be installed next to the detector and in a location that is visible before passing through the machine.	470
IN-02.06	Parking Restrictions Sign	Parking restriction sign is required to be placed at all public vehicular entrances to a VA facility.	472
IN-02.07.01	Rights and Responsibilities of VA Patients	Patient rights and responsibilities sign required at the main entrance/lobby of all buildings where patient care is provided.	474
IN-02.07.02	Rights and Responsibilities of Family Members of VA Patients	Family member rights and responsibilities sign required at the main entrance/lobby of all buildings where patient care is provided.	476
IN-02.07.03	Policies and Directives	Policies and Directives (VA Form 0088) required at the main entrance/lobby of all buildings where patient care is provided.	478



Section 3.3

Sign Index

Sign	Name	Description	Page #
IN-02.07.04	Notice of Privacy Practices	Notice of Privacy Practices sign required in a prominent location(s) where it is reasonable to expect that individuals seeking service will be able to read the Notice of Privacy Practices (e.g., Release of Information (ROI) Office, Eligibility Office, Employee Health Office).	480
IN-02.08	Anti-Sexual Harassment / Anti-Sexual Assault	Anti-Sexual Harassment / Assault posting required to be displayed in prominent spaces (such as lobbies or other gathering areas).	482
IN-02.10	No Weapons Notice Sign - Interior	No weapons sign to be placed on an interior wall at all public entrances to a building.	484
IN-02.11	No Weapons Sign Large - Exterior	No weapons sign to be placed at all exterior entrances to VA property.	486
IN-02.12	No Weapons Sign Small - Exterior	Small Exterior "No Weapons" sign for limited spaces with pedestrian visibility.	488
IN-02.13	Video Surveillance Sign - Exterior	Exterior video surveillance sign to be placed at all exterior entrances to VA property and other locations deemed necessary.	490
IN-02.14	Video Surveillance Sign	"Video Surveillance Sign" is required to be placed on an interior wall at all public entrances to a building.	492
IN-02.15	Service Dogs Sign	"Service Dogs Sign" can be placed on an interior wall at all public entrances to a building with other policy signs. At the time of publishing, this sign is NOT required.	494
IN-02.16	No Trespassing Sign	No trespassing sign to be placed at all exterior entrances to VA property.	496



4.7.5 SECTION 3.4 SPECIALTY SIGNAGE DRAWINGS

Sign	Name	Description	Page #
SP-21.01	Freestanding Single Post Stanchion	Freestanding single post stanchion to hold updatable insert(s).	504
SP-21.02	Freestanding Interior Pylon	Vertical freestanding pylon for indoor semi-permanent messages.	506
SP-21.03	Freestanding Temporary Posting	Vertical freestanding indoor graphic panel for temporary messages.	508
SP-21.05	Infection Control Sign	Non-illuminated, freestanding, single sided kiosk to provide hand sanitizer, tissues, gloves, information regarding infection control and face-masks.	510
SP-22.01	Card or Laminated Paper Holder	Card or paper holder to temporarily hold paper or notices.	512
SP-22.02-.03	File or Binder Holder	File or Binder Holder.	514
SP-22.05	Mental Health Room Number	Anti-ligature flexible ABA compliant room number sign.	516
SP-22.06	Mental Health Room ID	Anti-ligature flexible ABA compliant room number sign with message or write-on area below.	518
SP-22.07	Reality Orientation Sign	Message board on which staff members can display information such as time, place, and personnel information to patients.	520
SP-22.08	Resident Memory Case	Non-illuminated display case for resident pictures, cards, and mementos. Case can be configured for a one or two bed patient room. An ABA compliant room number can be incorporated into the design.	522
SP-22.09	Digital Memory Monitor	LCD monitor set in wall with front access cover. LCD Screen to display resident's pictures.	524
SP-23.01	Banners: Pole Mounted	Changeable exterior banners mounted perpendicular to light poles (or other existing poles or posts). Banners may be vinyl, canvas or nylon with printed or screened graphic imagery. Graphic imagery to vary. Banners may contain graphics on front and back sides of banner. Graphics may be informational or decorative.	526
SP-24.01	Construction Sign: Text Only	Sign used on construction sites to provide information designating the specific "Department of Veterans Affairs" project under construction as well as the name of the general contractor and other project specific consultants.	528



Section 3.4

Sign Index

Sign	Name	Description	Page #
SP-24.02	Construction Sign: Text with Rendering	Sign used on construction sites to provide information designating the specific "Department of Veterans Affairs" project under construction as well as the name of the general contractor and other project specific consultants.	530
SP-24.03	Construction Sign: Rendering	Sign used on construction sites to provide information designating the specific "Department of Veterans Affairs" project under construction.	532
SP-24.04	Construction Sign: Safety	Sign used on construction sites to provide information regarding frequency of onsite construction related accidents. Sign panel is built with a region to display changeable numbers to indicate the number of days since time was lost due to a construction accident.	534
SP-25	Dedication Plaque	This sign can be used to dedicate a building or space to the individuals involved in its planning, design, and procurement.	536



4.7.6 SECTION 3.5 EXTERIOR SIGNAGE DRAWINGS

Illuminated Exterior Signage Drawings

Sign	Name	Description	Page #
EI-01.01	Site Monument Large – 5' x 12'	Internally illuminated large horizontal freestanding monument sign for identifying a VA facility or the main entrance drive of a VA facility.	548
EI-01.02	Site Monument Medium - 4' x 10'	Internally illuminated horizontal freestanding monument sign for identifying a VA facility or the main entrance drive of a VA facility.	550
EI-01.03	Site Monument Small – 4' x 8'	Internally illuminated small horizontal freestanding monument sign for identifying a VA facility where there is a space limitation. This sign can also be used to identify secondary drive entrances to the VA facility.	552
EI-01.04	Vertical Site Monument Large - 12' x 5'	Internally illuminated vertical freestanding monument sign for identifying a VA facility or the main entrance drive of a VA facility.	554
EI-01.05	Vertical Site Monument Small - 8' x 4'	Internally illuminated small freestanding vertical monument sign for identifying a VA facility where there is a space limitation. This sign can also be used to identify secondary drive entrances to the VA facility.	556
EI-02.01	Directional Monument Large - 6' x 6'	Internally illuminated large directional monument sign with a single interchangeable panel or 10 stacking strips. Directional sign with messages relevant to drivers.	558
EI-02.02	Directional Monument Small - 6' x 4'	Internally illuminated small directional monument sign with a single interchangeable panel or 10 stacking strips. Directional sign with messages relevant to drivers.	560
EI-03.01	Post & Panel Site Identification - 4' x 8'	Internally illuminated large post and panel sign for identifying a VA facility of smaller scale such as an Outpatient Clinic. Alternatively, this sign can be used where physical restraints prevent a monument sign from being installed.	562
EI-03.02	Post & Panel Directional - 4' x 6'	Internally illuminated post and panel directional sign with messages relevant to drivers.	564
EI-04.01	Post & Panel Stacking Bar Directional - 4' x 8'	Internally illuminated large/long stacking bar post and panel comprised of 8 directional sign strips with messages relevant to drivers.	566



Section 3.5

Sign Index

Sign	Name	Description	Page #
EI-04.02	Post & Panel Stacking Bar Directional - 4' x 6'	Internally illuminated stacking bar post and panel comprised of 8 directional sign strips with messages relevant to drivers.	568
EI-06.01	Wall Mounted Overhead	Internally illuminated overhead wall mounted identification sign used to identify a building or building entrance.	570
EI-06.02	Wall Mounted Building Identification	Internally illuminated large wall mounted sign type that can be used to identify a building on a VA campus.	572
EI-08.01	Wall Mounted Ambulance / Emergency Overhead	Internally illuminated overhead wall mounted signs to be placed above the emergency or ambulance entrance.	574
EI-08.02	Wall Mounted Ambulance / Emergency Identification	Internally illuminated wall mounted signs to be placed on the wall adjacent to the ambulance or emergency entrance.	576
EI-08.03	Post & Panel Ambulance / Emergency Identification	Internally illuminated post and panel signs to be placed on the roadway, adjacent to the ambulance or emergency entrance to direct drivers to the correct building entrance.	578
EI-09	Illuminated Letters & Logo	Internal halo-illuminated, fabricated metal dimensional letters and logo for identifying a facility.	580
EI-14	4-Sided Site Monument	Internally illuminated vertical freestanding monument sign for identifying a medical center or the medical center's main entrance drive.	581
EI-15.01	4-Sided Directional Site Monument	Internally illuminated vertical freestanding monument sign for identifying a medical center or the medical center's main entrance drive.	583
EI-15.02	4-Sided Directional Site Monument with Address	Internally illuminated vertical freestanding monument sign for identifying a medical center or the medical center's main entrance drive.	585
EI-16.01	Vertical Site Monument with Electronic Message Unit	Internally illuminated vertical freestanding monument sign for identifying a medical center or the medical center's main entrance drive.	587
EI-16.02	Horizontal Site Monument with Electronic Message Unit	Internally illuminated vertical freestanding monument sign for identifying a medical center or the medical center's main entrance drive.	589
EI-17	Information Center Monument	Internally illuminated freestanding information center.	591



Section 3.5

Sign Index

Non-Illuminated Exterior
Signage Drawings

EN-02.01	Directional Monument Large – 6' x 6'	Non-illuminated large directional monument sign with a single interchangeable panel or 10 stacking strips. Directional sign with messages relevant to drivers.	593
EN-02.02	Directional Monument Small - 6' x 4'	Non-illuminated small directional monument sign with a single interchangeable panel or 10 stacking strips. Directional sign with messages relevant to drivers.	595
EN-03.02	Post & Panel - 4' x 6'	Non-illuminated post and panel directional sign with messages relevant to drivers.	597
EN-03.03	Post & Panel - 3' x 4'	Small non-illuminated post and panel sign with messages directed specifically to drivers. This sign can also be used to identify buildings.	599
EN-03.04	Post & Panel - 2' x 3'	Non-illuminated, post and panel sign directional sign with messages relevant to pedestrians.	601
EN-03.05	Post & Panel Building Identification - 3' x 3'	Large, non-illuminated auto oriented building number/identification post and panel sign for identification of a building when a large sign is needed because the building is set back away from the roadway or the architectural scale (size) of the building warrants a large sign.	603
EN-03.06	Post & Panel Building Identification & Information - 2' x 2'	Non-illuminated, pedestrian oriented building number/identification post and panel sign. This sign can be used for other general applications from information text to identifying specific functions or activities.	605
EN-04.01	Post & Panel Stacking Bar Directional - 4' x 8'	Non-Illuminated large/long stacking bar post and panel comprised of 8 directional sign strips with messages relevant to drivers.	607
EN-04.02	Post & Panel Stacking Bar Directional - 4' x 6'	Non-Illuminated stacking bar post and panel comprised of 8 directional sign strips with messages relevant to drivers.	609
EN-04.03	Post & Panel Stacking Bar Directional - 3' x 4'	Non-Illuminated stacking bar post and panel comprised of 6 directional sign strips with messages relevant to drivers.	611
EN-04.04	Post & Panel Stacking Bar Directional - 2' x 3'	Non-Illuminated stacking bar post and panel comprised of 4 directional sign strips with messages relevant to pedestrians.	613



Section 3.5

Sign Index

EN-05.01	Single Post & Panel Large - 2'-6" x 2'	Large, non-illuminated single post identification, informational and directional sign. This type of sign is for miscellaneous uses and can be utilized in landscape areas, at the head of parking stalls, or in other locations which have space limitations.	615
EN-05.02	Single Post & Panel Medium - 2' x 1'-6"	Standard, non-illuminated single post identification, informational and directional sign. This type of sign is for miscellaneous uses and can be utilized in landscape areas, at the head of parking stalls, or in other locations which have space limitations.	617
EN-05.03	Single Post & Panel Small - 1'-6" x 1'	Small, non-illuminated single post identification, informational and directional sign. This type of sign is for miscellaneous uses and can be utilized in landscape areas, at the head of parking stalls, or in other locations which have space limitations.	619
EN-06.01	Wall Mounted Overhead	Non-illuminated, overhead wall mounted sign to identify a building or building entrance.	621
EN-06.02	Wall Mounted Building Identification Large	Large, non-illuminated wall mounted sign. This sign type can be used to identify a building on a medical center campus. It also can be used for identification of a standalone building that is not a medical center and there is no place to install a freestanding sign.	623
EN-06.03	Wall Mounted Building Identification Large with Message Panel	Large, non-illuminated wall mounted sign with separate name panel. Building identification with and without names of the occupant or service. The secondary name of the occupant or service is on a changeable panel to allow modification to the sign without changing the entire sign.	625
EN-06.04	Wall Mounted Building Identification Medium	Medium, non-illuminated wall mounted building identification sign. When names of the occupant or service are used along with the building number, it should be text that will not likely change.	627
EN-06.05	Wall Mounted Building Identification Medium with Message Panel	Standard size, non-illuminated wall mounted sign with separate name panel. Building identification with and without names of the occupant or service. The secondary name of the occupant or service is on a changeable panel to allow modification to the sign without changing the entire sign.	629
EN-06.06	Wall Mounted Building Identification Small	Standard size, non-illuminated wall mounted sign. Building identification with and without names of the occupant or service.	631
EN-06.07	Wall Mounted Informational Medium	Small, non-illuminated wall mounted sign. This sign is for miscellaneous uses such as identifying minor entrances, sheds, and equipment buildings, and displaying other information.	633
EN-06.08	Wall Mounted Informational Small	Minor informational, non-illuminated wall mounted sign. This sign is for miscellaneous uses such as identifying minor entrances, sheds, and equipment buildings, and displaying other information.	635
EN-08.01	Wall Mounted Ambulance / Emergency Overhead	Overhead, non-illuminated wall mounted sign to be placed above the emergency or ambulance entrance when applicable.	637



Section 3.5

Sign Index

EN-08.02	Wall Mounted Ambulance / Emergency Identification	Non-illuminated wall mounted sign to be placed on the wall adjacent to the emergency or ambulance entrance when applicable.	639
EN-08.03	Post & Panel Ambulance / Emergency Identification	Non-illuminated post and panel sign to be placed on the roadway, adjacent to the emergency or ambulance entrance to direct drivers to the correct building entrance where applicable.	641
EN-09	Non-Illuminated Letters & Logo	Non-illuminated dimensional letters for identifying a facility, building, or entrance. Should be placed on the building in a location that is highly visible to the public.	643
EN-10	Traffic Regulatory Signs	Traffic regulatory signs.	644
EN-11.01	2 Blade Street Sign	Non-illuminated double blade name sign for an intersection.	646
EN-11.02	1 Blade Street Sign	Non-illuminated single blade street name identification for a single street.	648
EN-11.03	Pylon Street Sign	Non-illuminated Pylon type Street Sign.	650
EN-14	Building Entrance Vinyl	Applied vinyl letter identification sign with messages relevant to pedestrians. The sign can also be used to identify buildings.	652



Section 3.5

Sign Index

Parking Lot Signage
Drawings

PL-12.01	Post & Panel Parking Identification	Large, non-illuminated post and panel parking lot identification sign. This sign type is for identifying parking lots to drivers circulating on a roadway system.	654
PL-12.02	Single Post & Panel Informational	Non-illuminated single post and panel sign with messages relevant to drivers. This sign can be used to communicate various informational or instructional messages.	656
PL-12.03	Single Post & Panel Parking Stall Designation	Non-illuminated single post parking identification and informational sign. This sign type is used for identifying or controlling specific parking areas, spaces, or stalls.	658
PL-12.04	Single Post & Panel Accessible Parking Stall Designation	Single post, non-illuminated handicap parking stall sign.	660
PL-12.05	Single Post & Panel Accessible Parking Area	Single post, non-illuminated handicap parking area sign.	662
PL-12.06	Pole Mounted Parking Lot or Area Identification	Light pole mounted parking area identification sign for use in lots large enough to be divided into zones.	664
PL-12.07	Wall Mounted Informational	Non-illuminated panel sign with messages relevant to drivers and pedestrians. This sign can be used to communicate various informational or instructional messages.	666
PL-12.08	Single Post & Panel Permit Parking Stall Designation	Non-illuminated single post permit parking sign.	668
PL-12.09	Single Post & Panel Permit Parking Stall Designation	Non-illuminated, van parking only, single post permit parking sign.	670
PL-13	Electronic Stall Availability Sign	Sign to inform visitors as to the number of available parking spaces per lot. Electronic counting devices record the number of cars that enter and exit the lot(s).	672
PL-15	Painted Stall Identification Number	Painted parking stall numbers.	674



4.7.7 SECTION 3.6 PARKING STRUCTURE SIGNAGE DRAWINGS

Sign	Name	Description	Page #
PS-01.01	22" – Long Ceiling-Hung Directional	Non-illuminated, ceiling-hung sign. This sign type is directed to drivers, providing them with information such as the exit, additional parking, and locations of elevators or stairs.	685
PS-01.02	22" – Short Ceiling-Hung Directional	Non-illuminated, ceiling-hung sign. This sign type is directed to drivers, providing them with information such as the exit, additional parking, and locations of elevators or stairs.	687
PS-01.03	15" – Long Ceiling-Hung Directional	Non-illuminated, ceiling-hung sign. This sign type is directed to drivers, providing them with information such as the exit, additional parking, and locations of elevators or stairs.	689
PS-01.04	15" – Short Ceiling-Hung Directional	Non-illuminated, ceiling-hung sign. This sign type is directed to drivers, providing them with information such as the exit, additional parking, and locations of elevators or stairs.	691
PS-02.01	22" – Long Beam-Mounted Directional	Non-illuminated, beam-mounted sign. This sign type is directed to drivers, providing them with information such as the exit, additional parking, and locations of elevators or stairs.	693
PS-02.02	22" – Short Beam-Mounted Directional	Non-illuminated, beam-mounted sign. This sign type is directed to drivers, providing them with information such as the exit, additional parking, and locations of elevators or stairs.	695
PS-02.03	15" – Long Beam-Mounted Directional	Non-illuminated, beam-mounted sign. This sign type is directed to drivers, providing them with information such as the exit, additional parking, and locations of elevators or stairs.	697
PS-02.04	15" – Short Beam-Mounted Directional	Non-illuminated, beam-mounted sign. This sign type is directed to drivers, providing them with information such as the exit, additional parking, and locations of elevators or stairs.	699
PS-03.01	Small Wall-Mounted Level Identification and Directional	Floor identification and directional information relevant to pedestrians. Floor identification signs to be placed next to, or near, elevators, stairs, and exits.	701
PS-03.02	Large Wall-Mounted Level Identification and Directional	Floor identification and directional information relevant to drivers and pedestrians. Floor identification signs to be placed next to, or near, elevators, stairs, and exits.	703
PS-03.03	Elevator Core Branding and Directional	Floor identification, level branding, and directional information to be seen from pedestrian and vehicular pathways. Placed next to, or near primary elevator cores.	705



Section 3.6

Sign Index

Sign	Name	Description	Page #
PS-04.01	Wall-Mounted Warning Sign	Precautionary information strategically placed to avoid traffic conflict or accidents.	707
PS-05.01	Square Column Marker	Floor level identification marker for placement on faces of wide columns.	709
PS-05.02	Narrow Column Marker	Floor level identification marker for placement on faces of narrow columns.	711
PS-05.03	Round Column Marker	Floor level identification marker for placement on round columns.	713
PS-05.04	Small Round Column Marker - Painted	Floor level identification marker for placement on small round columns.	715
PS-05.05	Pole-Mounted Marker	Floor level identification marker for placement on poles.	717
PS-06	Elevator Identification	Elevator identification placed above elevator cores displaying serviced levels and elevator name (if applicable).	719
PS-07	Elevator Level Directory	Elevator level directory placed near elevator doors displaying all serviced levels, current level identification, and additional information as needed.	721
PS-08	Dimensional Letters	Non-illuminated dimensional letters for identifying an entrance or exit. Should be placed on the building in a location that is highly visible to the public.	723
PS-09	Clearance Height Bar	Ceiling-hung vehicular clearance identification marker to be placed at all entrances and at grade level changes.	725
PS-10	Electronic Lane Use Sign	Sign to inform status of alternating entrance / exit lane.	727
PS-11	Entrance and Exit Identification	Non-illuminated, free-swinging, ceiling-hung sign. Can be installed with or without a clearance bar (PS-09). This sign type is relevant to drivers, providing them entrance identification and information.	729
PS-12.03	Parking Stall Designation	Non-illuminated single post or wall mounted parking identification and informational sign. This type of sign is for use in identifying or controlling specific parking areas, spaces, or stalls.	731
PS-12.04	Accessible Parking Stall	Wall-mounted or single post, non-illuminated accessible parking stall sign.	733



Section 3.6

Sign Index

Sign	Name	Description	Page #
PS-12.05	Accessible Parking Area	Wall-mounted or single post, non-illuminated accessible parking area sign. Identification of accessible parking areas and directional information regarding access. These signs can also be used to provide direction information to drivers to direct them to accessible parking that may not be obvious.	735
PS-12.07	Informational Panel	Non-illuminated wall-mounted sign used to communicate various informational or instructional messages.	737
PS-13	Electronic Stall Availability Sign	Sign informs visitors of the number of available parking spaces per floor. Electronic counting devices record the number of cars that enter and exit the garage and floor levels. This information changes as the corresponding number of parking spaces per floor is reflected.	739
PS-14	Exterior Building-Mounted Parking Directional / Availability Sign	Illuminated double-sided parking lot identification and parking stall availability sign.	741
PS-15	Stall Identification Number	Colors need to contrast the parking lot pavement. If the pavement is light in color, the numbers should be black. If the pavement is a dark color, the numbers should be white or yellow.	743



4.7.8 SECTION 3.7 NATIONAL CEMETERY ADMINISTRATION SIGNAGE DRAWINGS

Sign	Name	Description	Page #
NC-01.01	Visitor Information/Floral Regulations Sign - Medium	National Cemetery non-illuminated, post and panel. Informative sign with visitor instructions and hours.	753
NC-01.02	Visitor Information/Floral Regulations Sign - Large	National Cemetery non-illuminated, post and panel informative sign with visitor instructions and hours.	755
NC-01.03	Visitor Information/Regulation Sign - Small	National Cemetery non-illuminated, post and panel informative sign with visitor instructions.	757
NC-02.01	Horizontal "You Are Here" Map	Horizontal non-illuminated cemetery orientation map "You Are Here" sign with map and messages directed specifically to pedestrians. Position to provide pedestrians with an unobstructed view of the sign.	759
NC-02.02	Vertical "You Are Here" Map	Vertical, non-illuminated cemetery orientation sign, "You Are Here" map and messages directed specifically to pedestrians. Position to provide pedestrians with an unobstructed view of the sign.	761
NC-03.01	Low Profile Traffic Regulatory Sign	National Cemetery post and panel traffic regulatory sign.	763
NC-03.09	Accessible Parking Regulatory Sign	National Cemetery non-illuminated, post sign identifying accessible parking and pathways.	765
NC-04.01	Post and Panel Sign – One Line of Text	National Cemetery non-illuminated, post and panel directional sign with messages with one line of text. This sign can also be used to identify buildings.	767
NC-04.02	Post and Panel Sign – Two Lines of Text	National Cemetery non-illuminated, post and panel directional sign with messages with two lines of text. The sign can also be used to identify buildings.	769
NC-04.03	Post and Panel Sign – Three Lines of Text	National Cemetery non-illuminated, post and panel directional sign with messages with three lines of text.	771
NC-06.01	Pylon Street Sign	National Cemetery non-illuminated, Street post with messages directed specifically to vehicles.	773
NC-06.02	Street Marker Flag Sign - Short	National Cemetery non-illuminated, post and flag panel street identification sign with messages directed specifically at vehicles and pedestrians. The sign may also be used to identify buildings.	775



Section 3.7

Sign Index

Sign	Name	Description	Page #
NC-06.03	Street Marker Flag Sign - Tall	National Cemetery non-illuminated, post and flag panel street identification sign with messages directed specifically at vehicles.	777
NC-07.01	Pylon Section Marker	National Cemetery non-illuminated, pylon sign with messages directed specifically at pedestrians.	779
NC-07.02	Water Spigot Instructional Sign	National Cemetery non-illuminated, pylon sign with messages directed specifically at pedestrians. These posts contain the faucet for public use to obtain water for flowers placed in the cemetery. The posts house the water pipe and the faucet. The posts are never used solely as signposts.	781
NC-07.03	Standard Granite Section Marker	National Cemetery granite section marker.	783
NC-08.01	Wall Mounted Informational Sign	This sign has applied graphics and is informational.	785
NC-09.01-.03	Incised Lettering	Incised letters cast into wall.	787
NC-10.01-.03	Dimensional Lettering	Cast metal dimensional letters. Surface mounted, tight to wall.	789
NC-11.01	Dimensional Seal	Cast metal seal inset or applied to entry wall.	791
NC-14.01	Primary Room Identification with Insert	This is the primary room identification sign type. The room number is composed of raised, tactile characters and Braille, and the room's occupant/use is displayed on an updatable insert.	793
NC-15.01-.06	Restroom Identification	This sign is used to identify restrooms with name, pictogram, and optional room number.	795
NC-16.01-.06	Pictogram and Symbol Signs	Use these signs to inform with a symbol as well as text.	797





U.S. Department
of Veterans Affairs

SECTION 4.8

GLOSSARY



Glossary

A

- A.B.A.** **Architectural Barriers Act.** Legislation (Public Law 90-480) enacted by the federal government in 1968 requiring that all buildings designed, constructed, renovated, or leased with federal funds meet the Uniform Federal Accessibility Standards (UFAS), and be accessible to the public. Some departments have, as a matter of privacy, also required compliance with the Americans with Disabilities Act Accessibility Guidelines, which otherwise DO NOT apply to the federal sector, in addition to the UFAS. VA now follows GSA and other standard-setting agencies in replacing UFAS with the Architectural Barriers Act Accessibility Standards (ABAAS) for Federal Facilities. In addition, VA uses the VA Barrier Free Design Standard (PG-18-13) to meet the needs of the Department of Veterans Affairs in its Healthcare Facilities.
- A.B.A.A.S.** **Architectural Barriers Act Accessibility Standards.** National standards enacted in 2006-07 to insure accessibility to federally funded facilities for all persons in America.
- Access Panel** A door or panel that provides access to concealed equipment for inspection, maintenance, and repair.
- Acetate** A thin flexible plastic sheet that is durable and stretch-resistant. This clear material can be used as a substrate for inserts in pocket signs.
- Acid Etching** A method similar to sandblasting, used primarily for marking glass and metal. A stencil of the artwork is applied to the material, which is then brushed with an acid mixture. After a length of time, the surface is washed and the stencil removed.
- Acrylic** A generic term for plastics used in sign making. Acrylic is a specific type of plastic characterized by clarity, as well as transparent and opaque color ranges. It also has excellent machinability. Cast and extruded acrylics have different qualities and tolerances. Cast and extruded acrylic is known for its innate surface hardness, as well as offering excellent scratch resistance.



Glossary

A.D.A.	Americans with Disabilities Act: Legislation enacted by the federal government in 1990 to remove barriers that limit any individual's ability to function in the physical environment. ADA standards govern the construction and alteration of places of public accommodation, commercial facilities, and state and local government facilities. The Department of Justice (DOJ) maintains ADA standards that apply to all ADA facilities except transportation facilities, which are subject to similar standards issued by the Department of Transportation (DOT). Federal facilities are covered by standards consistent with those of the ADA issued under a different law, the Architectural Barriers Act (ABA). Within the five titles of the ADA, Title III pertains to signs.
A.D.A.A.G.	ADA Accessibility Guidelines: National guidelines enacted in 1991 and amended through 2002 to insure accessibility of buildings and facilities for all persons in America.
Advanced Notice Sign	A sign used to provide an advance notice prior to a roadway, street, or building entrance. Similar to a directional sign, however, this sign usually announces a single destination. Also called an "approach sign".
Aluminum Alloy	A combination of the soft metal aluminum with one or more metals such as copper, manganese, silicon, magnesium, or zinc to make aluminum harder. Aluminum alloys are graded by number from softest, 1100, to hardest, 7075. Alloy numbers 6061 and 6063 are typically used in general construction.
Ambient Light	The general level of light, direct and indirect, or background light, in a given environment emitted by natural and/or manmade sources at a given time. Ambient light can affect the legibility of signs.
Anchor	Any device that firmly secures an object in position, or firmly secures one object to another.
Anodized Finish	An electrochemical coating applied to the surface of aluminum, to harden, protect, and enhance the beauty and durability of a metal surface. The finish may be clear or include tints and colors.
Approach	The area from where a sign first becomes visible until the sign is no longer readable as the viewer passes by.
Architectural Signage	A term that was developed in the 1960's to identify signs, visual communications, and wayfinding information in the built environment.
Area of Refuge	A safe location where physically challenged individuals are to wait for assistance in case of emergency.



Glossary

Art or Artwork	Copy, images, graphics, and logos used in preparing a job. Also refer to COPY and ELECTRONIC ART.
Ascender	In a typeface, the portions of the lower case letters b, d, f, h, k, and l that extend above the height of the lower case x. See also DESCENDER.
Aspect Ratio	The relationship between an image's horizontal length and vertical height.

B

Backlit Sign	A sign consisting of a cabinet containing a light source and one or more translucent faces, which are illuminated for night visibility.
Baked Enamel	A type of paint with a special finish. Special enamel paint is sprayed or screen-printed on a surface, dried, and then cured with heat or light resulting in an extremely durable surface.
Ballast	A device designed to provide sufficient starting voltage for fluorescent lighting. The ballast may also heat the lamp electrodes and, once the tube is in operation, limit the amount of electrical energy passing through the lamp.
Banding	In a color gradation, visibly distinct differences, or sequential patterns between color levels, instead of a smooth transition of colors or other effects. Applies to an imperfect printed, screened, airbrushed, or painted gradation.
Banner	A sign made of fabric, plastic, or other flexible material which has no enclosing framework. It may be painted, screen-printed, digitally printed, or decorated with vinyl appliques. Typically used as a temporary sign.
Base	<ol style="list-style-type: none">1. The trim beneath the bottom molding of a sign.2. The foundation or support of a freestanding sign. See also FOOTING.
Bead Braille	Small beads that are inserted into sign faces to create Braille text, as required by ABA/ADA. These beads can be clear, plastic or metal depending on the material into which they are inserted.
Blade Sign/Flag Sign	A type of projecting sign mounted perpendicular to the sign's support. These signs are typically double sided and mounted to a building wall, façade, storefront, or pole.



Glossary

Blank	<ol style="list-style-type: none">1. A painted sign face without copy or graphics applied.2. An undecorated sign face with no cabinet.3. An undecorated insert.
Blind Fasteners	Also known as Concealed Fasteners . Mechanical attachment devices hidden from view that are used to assemble a sign, attach letters, attach a sign face, or mount a sign. Can be tamper-proof, removable, or permanent.
Blistering	The end result of poor adhesion by either paint or vinyl to a substrate, leaving the surface covered with bumps of various sizes and indeterminate shapes similar to blisters on human skin.
Border	Commonly a line or repetitive design used to emphasize or set apart all or portions of a sign's art. In electric signs, illuminated tubes or decorative molding may serve as borders.
Braille	A form of written language for the blind, in which characters are represented by patterns of raised dots that are felt with the fingertips. Grade 2 Braille is a type of Braille and is required by ABA/ADA, on interior signs that identify (label) a room.
Break Away Sign Mount	A type of signpost or footing designed to give way on impact. Used along roadways to reduce damage to automobiles in accidents.
Bronze	An alloy of copper and tin with traces of other metals (zinc, nickel, and lead), used for sculpture, sign plaques, and dimensional letters. Letters or plaques can be cut out of solid material, can be cast and even be fabricated from thin sheets to create dimensional letters (fabricated and soldered). Bronze plaques and letters may be lacquered to prevent oxidation, pre-oxidized, or left to oxidize naturally. Finishes can be painted, oil-rubbed, clear-lacquer, polished, brushed, etc.
Brushed Finish	A non-reflective, abraded finish applied to metal surfaces for decorative purposes. This process can be produced mechanically or chemically, resulting in a texture consisting of tiny scratches which form a visible directional pattern.
Burnish	To polish or shine by rubbing.
Butt Joint	A type of seam where two pieces of material are joined by placing their ends together without any special shaping.



Glossary

C

Camera Ready Art	Artwork that was once prepared for production via a photographic process. This term is still used however it now refers to scanned and digital imagery.
Carved Letters	V-carved, U-carved, or squared-carved into wood or stone. Created by hand-carving with chisel and mallet, sandblasting technique, or by a computer-controlled router or engraver. Bas-relief and incised carved letters are usually done by hand.
Carved Signs	Letters or shapes incised or relieved into sign substrate surface. Can refer to routing process.
Cast Acrylic	A type of plastic sheeting formed by spreading a molten acrylic mixture on a carrier sheet or web, then baking at high temperatures to remove solvents and to fuse the material into a film/sheet.
Cast Dimensional Letter or Number	Metal letters or numbers used for signage typically cast in aluminum, bronze, acrylic, or resin.
Cast Metal Plaque	A solid metal plaque or sculptural element. Aluminum or bronze are typical metals used for casting.
Changeable Copy Sign	A sign in which the copy can be changed, either manually through the use of attachable letters, mechanically using rotating panel elements, or electronically using computer-controlled incandescent bulbs, light-emitting diodes (LEDs), liquid crystal displays (LCDs), or plasma screens.
Channel	An extruded length of material, typically plastic, aluminum, or steel, in the shape of a squared-off U.
Channel Letter	A fabricated letter, with metal returns, into which a neon tube or LEDs are placed. The depth of the channel may vary, depending on the size of the letter, viewing angle, and type of illumination. The channel letter may be open-faced, translucent plastic-faced, or a reverse channel letter with halo (indirect) illumination.
Character	A symbol or mark used in a writing system.



Glossary

Chrome Plate	An electrochemical process to plate steel, brass, or aluminum, most commonly with a mirror chrome finish, such as automobile trim. It can also be brushed or dulled down to create a less reflective surface.
Cladding	A facade or decorative cover added to an existing sign pole or base after it is installed.
Clearance	The distance between the lowest portion of a sign and the finished grade level as well as the distance between the sign's faces and any surrounding obstructions.
Component	One of the parts or pieces that together make a complete sign, system, or design.
Component Based Sign System	A sign system that incorporates different parts for individual signs, allowing for interchangeable parts and for the sign to be mechanically fastened to walls. There are various types of component based sign system. Once one is selected, it should become the facility's standard and not be mixed with other systems.
Concrete Sign	A poured-in-place, precast sign made of concrete. It is the substrate to which plaques, letters, or panels are attached, painted on, cast into, incised into, or sandblasted into, to create an identifying device.
Condensed Font	A font which has been altered by reducing the width of the letters, numbers, and symbols to bring them closer together, to fit on a sign.
Conduit	A tube of various materials for protecting electrical wiring.
Construction Site Sign	Announces a construction project credits and information regarding the type of project, architect, consultants, contractor, and others associated with the project. Typically painted, vinyl, or digital print mounted onto exterior-grade plywood substrate.
Contrast	The use of opposing elements such as colors, forms, or the like, in proximity to one another to produce an intensified effect. See LIGHT REFLECTIVE VALUE (LRV).
Contract Documents	Written specifications and design drawings used to establish a contract and to define the deliverable sign products between two parties.



Glossary

Copy	Most commonly, the words or message to be displayed on a sign.
Craze	Thin cracks or breaks in paint, plastic, or vinyl. The main cause of crazing is weathering, but it may also be caused by the incompatibility of paint layers or solvents.
Curing	The process of effecting a chemical change in some inks, paints, or plastics by the application of heat or ultraviolet light.
Current	The rate of flow, of electrical charge in a conductor. A unit of current is typically referred to in amperes or milliamps.
Cut-off Switch	See KILL SWITCH.
Cut-off Copy	Letters that have been removed out of a sign panel via routing, laser or water-jet methods leaving a hole in the shape of the letter form, generally to allow light to show through.

D

Deboss	The process of producing depressed letters in a surface, particularly those produced by engraving dies or plates.
Decal	An applique of words, graphics, or a combination of the two, printed on the non-adhesive side of a film, then cut to a specified shape using a plotter or die. Decals are created when a large number of identical pieces are required.
Delamination	The separation of layers in a laminated substrate. This is usually the result of adhesive failure.
Descender	In a given typeface, the portions of the lowercase g, j, p, q, y, and in some fonts f as well as uppercase J that extend below the baseline of the letter. See also ASCENDER.
Design Intent Drawings	Drawings that show only the size, profile, and basic relationship of parts, but no specific details of material or construction.
Directional Sign	An interior or exterior sign intended to provide directional information.



Glossary

Directory	A sign that contains a list of names of people, offices, or destinations at a specific building, facility, or public venue. May provide text listings or include maps, site plans, or diagrams.
Double Sided	Two or more sign faces mounted on a common structure but facing in opposite directions.
Dynamic Sign	General term for any sign where the message or graphic is adjustable automatically through electronic or mechanical means.

E

Edge	The frame, or part of the sign that encloses the back and face/faces.
Edge Lighting	A technique used to illuminate (by internal refraction) carved, incised, or sandblasted lettering and images, by lighting the edge of the transparent material. This technique is typically used with glass or acrylic.
Egg Crate	A patterned piece of plastic installed below a light source in illuminated awnings or light fixtures to protect the light source from damage or direct visibility. Also used to soften and evenly distribute the transmitted light.
Electric Sign	A sign that contains electrical fixtures or connections and has some method of illumination.
Electrode	A terminal that conducts an electrical current between two conducting substances. Electrodes are found at both of the ends of a neon unit.
Electronic Art	Computer software generated artwork files (sometimes called “camera-ready art”) used in production of signs and graphic elements.
Electronic Sign	Also known as a Message Center . A sign that utilizes computer-generated messages or other electric means of changing text. Changeable message displays or signs may use LEDs, LCDs, and other technologies.



Glossary

Electrostatic Film	Polyvinyl chloride (PVC) sheet treated with a small charge of static electricity enabling the sheet to temporarily, but firmly, adhere to glass and similar smooth substrates.
Embellishments	Any addition to a sign face that provides a three-dimensional effect. Cut-outs, push-through shapes/letters, lighting strips, and clocks are all examples of embellishments.
Embossing	The process of producing raised letters, particularly those produced by engraving dies or plates.
Engraving	A method of cutting shallow, negative relief graphics or lettering into metal, plastic, or glass utilizing a bit or graver. Engraving may be achieved using a pantograph, or by computer-driven equipment. The engraved area may be filled to create greater contrast.
Environmental Graphics	The planning, design, and execution of graphic elements in the built and natural environment. Environmental graphics includes communication systems that identify, direct, inform, interpret, and visually enhance the environment.
Etched or Engraved and Paint Filled	Etched (chemically) or engraved/incised (mechanically) and then filled with color to create a desired contrast and appearance.
Etching	See ACID-ETCHING.
Extended Font	A font in which the proportion of the letters, numbers, and symbols, has been altered by increasing their width.
Extrusion	General term for pre-manufactured bars, rods, tubes, and channels created by forcing raw material through a die to create a desired shape. Extruded stock, typically made from metal or plastic is often used in sign fabrication.

F

Fabricate	The manufacturing of a sign from components, raw materials, or parts.
Fabricated Letter/Numeral	A dimensional letter usually fabricated from thin metal, which is joined and soldered to appear solid.



Glossary

Facade	The exterior appearance of a building usually composed of a decorative material such as brick or cladding and made up of doors, windows, and store front to create an easily identifiable entrance.
Face	See SIGN FACE.
Fascia Mounted Sign	A wall mounted sign in which the sign face is parallel to the wall. Also see WALL SIGN.
Fasteners	Mechanical items, including rivets, screws, nuts, and bolts, that are used to assemble a sign or attach a sign to a surface.
Flag	A piece of plastic or cloth suspended from one side. The cloth may or may not be decorated.
Flag Sign/Blade Sign	A type of projecting sign mounted perpendicular to the sign's surface and the normal flow of traffic. These signs are typically double sided and mounted to a building wall, façade, storefront, or pole.
Flasher	A mechanical device designed to interrupt the electrical current in a sign at regular intervals, thus turning the light source on and off to create a flashing image.
Flush	Text aligned at a right margin (flush right) or left margin (flush left). When copy is flushed both right and left, it is referred to as justified.
Foam Board	A type of lightweight, rigid board used for interior signs. Foam board consists of plastic foam sheet laminated on both sides with paper or plastic substrates.
Foam Tape	Double-sided adhesive tape used for mounting sign plaques, letters, or other sign materials to smooth surfaces. It is available in various thicknesses, widths, and adhesives. Foam tape with a special adhesive is necessary for mounting signs to vinyl wall covering.
Font	A specific style and group of letterforms consisting of one complete set of letters, numerals, symbols, and punctuation used for composing written communications in a given typeface. Fonts come in various weights, italic formats, condensed or extended.



Glossary

Footing	The projecting base of a sign pole or pylon, including the portion buried in the ground. The footing bears all the weight of the sign, while anchoring it against overturning momentum. Also called FOUNDATION.
Form	A mold or shape into which concrete is poured to harden. When referring to signage, the term is typically associated with the making of an exterior sign footing.
Formed	A material such as metal or plastic that has been shaped into a dimensional object or letter.
Foundation	See FOOTING.
Frangible Sign Mount	See BREAK-AWAY SIGN.
Frisket	An adhesive masking of paper or plastic used for (stencil-like methods of) painting, sandblasting, silk-screening, and other processes. Friskets may be hand or digitally cut.

G

Galvanize	A process by which steel or iron is protected by a zinc coating or plating. This process is achieved by hot dipping the metal into molten zinc utilizing electrolysis. The galvanized coating protects the underlying metal from corrosion.
Gateway Sign	A sign announcing the entrance to a neighborhood or large facility.
Gauge	A measurement indicating the thickness of sheet metal. Also used to denote size of wire.
Gilding/Gilt	The application of thin metal sheets such as gold, silver, and copper to glass, signs, and vehicles. A protective clear coat is sometimes applied when used in an outdoor application.
Glass Signs	Signs fabricated from glass. Painting, engraving, sandblasting and/or etching are the most popular ways to decorate glass for signage.



Glossary

Gold Leaf	Gold processed into very thin sheets. The gold is used in gilding and is available in a variety of colors and karats. Fourteen to eighteen karat leaf is used for interior applications, such as glass. Twenty-three karat leaf is used for outdoor applications, such as exterior signs, and architectural elements.
Gradation/Gradient	Steps of transition between two colors or two values, created by mixing varying percentages of each of those two colors and/or values.
Grade	The contour of the ground surface, whether in its natural state or after development. Signs are often measured in height above grade.
Grade 2 Braille	Grade 2 Braille is similar to Grade 1 Braille, however, it includes additional characters and character combinations representing contractions of certain words and word components such as “the” and “-ation”. Considerable care must be taken to translate Grade 2 Braille correctly, using a computer-based, or other, translation program. All Braille should be proofread by a Braille proofreader, prior to approval of all final artwork.
Grayscale	The range of colors between black and white. Each step’s color value is usually shifted by constant amounts. A grayscale color can be determined by a value of a one-dimensional color space: On a white surface (e.g., paper) the grayscale’s color value equals to the relative intensity of black (ink) applied to the medium. On a black surface (e.g., monitor) the grayscale color’s value equals to the relative intensity of white (light) applied to the medium.
Grommet	In banners, a reinforced metal eyelet used to receive cords or other fasteners.
H	
Halo Lighting	Typically used for back-lit letters (reverse-pan channel letters) to create a glow of light around the letter by illuminating the wall surface, behind the letter, via a light source located within the letterform.
Hanging Sign	A sign that hangs from a bracket or support and projects from a wall, building, or pole. See also PROJECTING SIGN.
Header	A separate panel, often containing a block of headline text, placed above the supporting sign copy.
Height Above Grade	The vertical distance from the grade to the highest point of the sign (face).



Glossary

Hinged Side	The face on a double-face sign that swings open for service.
Hoptel	A place of temporary lodging for veterans who come from out of town and are receiving medical care at a local VA Medical Center. A hospital hotel.
Hue	Pure color in terms of “red”, “green” or “magenta. Also defines mixtures of two pure colors like “red-yellow” (~”orange”) or “yellow-green”.
	
Identification Sign	A sign providing the name of the business, building or service for purposes of identification.
Illuminated Sign	A sign which is illuminated by either an internal or indirect, external light source.
Incidental Sign	Signs, usually smaller in size and of a noncommercial nature, which appear in almost every location where the public may be found. Examples of incidental signs include hours of operation, location of rest rooms, as well as entrance and exit signs.
Incised	Cutting into or indenting the surface of a material. Incised letters are carved or engraved into the surface of stone, wood, plastic, or sandblasted into glass or stone.
Indirect Illumination	Illumination that is provided from a light source separate from the sign itself, such as a floodlight.
Information Hierarchy	Information provided on wayfinding signage by organizing destinations from general to specific and separating these groups of destinations logically so that end users can more easily find their destination.
Insert	A sign message printed on a thin material like paper or vinyl intended to be slid into a pocket on a manufactured sign. Inserts can be easily removed or changed as necessary.
International Symbol of Accessibility (ISA)	Symbol used to communicate disabled-accessible routes and entrances consisting of a stylized figure seated in a wheelchair.



Glossary

International Symbol of TTY

Symbol used to communicate hook up location or availability of a TTY device of a representation of a typewriter keyboard with a telephone headset above.

Internally Illuminated Sign

A sign that emits light by using an artificial light source such as LEDs or light bulbs from within the sign itself. See also BACK-LIGHTED SIGN.

Interactive

Two-way electronic or communications system in which response is direct and continual. Interactive displays incorporate a touch screen, buttons or switches, or a keyboard to generate a signal that activates an information display.

Interpretive Sign or Kiosk

A free-standing sign that provides cultural or historic information.

J

J-bolt

An angled rod, usually steel, embedded in a concrete footing, or anchor, and threaded at the exposed top end for attachment to a freestanding sign.

Job Site Sign

See CONSTRUCTION SITE SIGN.

Justified

Describes copy that is set with even margins on the left and right (often resulting in irregular word and letter spacing).

K

Kerning

The process of moving pairs of letters farther apart or closer together to make words in a line or block of text appear more evenly spaced.

Kick Plate

A plate or strip that runs along the bottom edge of a sign structure or kiosk to protect it from being marred.

Kill Switch

A switch found on or next to an electrical sign that can be used to turn off a sign.

Kiosk

A portable or permanent freestanding structure onto (and into) which messages and pertinent information can be housed and displayed. Kiosks can also have interactive elements such as touch screen monitors.



Glossary**L**

Lamp Bank	Typically refers to the lighting on the inside of a sign used to illuminate the sign face.
Laser Cutting	Use of a laser to cut letters and shapes out of various flat materials, such as acrylic, glass and metal.
Layout	The total arrangement of a sign's graphic elements. Indicates the overall plan of how copy, and possible imagery, will be arranged on the face.
Leading	A typographic term referring to the space between lines of text. Typically measured from baseline to baseline. Also see LINE SPACING.
LCD Sign	A type of changeable copy sign utilizing liquid crystal display.
LED Sign	Electronic "message" sign using light-emitting diodes.
Legibility	The clarity of a typeface, used on a sign, which allows it to be easily read and deciphered. See also READABILITY.
Letterspacing	The amount of space between a group of letters to affect the visual density in a line or block of text. Also see TRACKING and KERNING.
Letter Form	The development or design of the shape of an alphabet letter.
Letter Styles	Variations of a font, such as: serif, sans serif, slab serif, italic, light, Roman, medium, demi-bold, bold, extra bold.
Letter Visibility Chart	An established set of numbers representing approximate visibility of letters over a range of distances. Readable distances vary with various color combinations and typefaces as well as with surrounding visual busyness and whether the observer is still or in motion.
Letter Void	The enclosed areas within letterforms or symbols, such as those found in the letters a, b, d, e, g, o, p and q.



Glossary

Life Safety Signs	Signs for fire, security, evacuation, and other life safety information, subject to code enforcement and review. Sign locations are defined by code.
Light Reflective Value (LRV)	The degree of contrast expressed as a percentage between sign text and background colors. VA requires a minimum LRV of 70% for signage. This value is an industry “rule of thumb” and is not a requirement of ABA/ADA codes.
Lightness	A range from dark (0%) to fully illuminated (100%). Any original hue has the average lightness level of 50%. A painter may say lightness is the range from fully shaded to fully tinted.
Line Spacing	A typographic term referring to the space between lines of text. Typically measured from baseline to baseline. Also see LEADING.
Logo	An often stylized group of letters, words, symbols or shapes used to represent a business or product.
Lumen	The SI derived unit of luminous flux, a measure of the total “amount” of visible light emitted by a source.

M

Magnesium Plate	A metal sign material which can be acid-etched with fine detail for use in interior and exterior signs. Good for exterior-grade ABA/ADA signs and more durable than photopolymer.
Magnetic Sheeting	Magnetized sheet material laminated to a flexible plastic sheet and available in rolls.
Marquee	A type of canopy, sign, or architectural element protruding from a building face that projects over the public street or sidewalk.
Masonite	A brand of hardboard made from wood chips that have been pressed into sheets of varying thickness.



Glossary

Matrix	A term used in lighting to refer to a regular array of lighting units in the display area of an electronic changeable message sign.
Matte	A dull surface that is not shiny or reflective.
Medium-Density Fiberboard (MDF)	A type of particle board made from wood dust mixed with a binder and heat pressed into a panel. MDF has a smooth finish which paints well. Typically produced in 4' x 8' sheets of varying thickness.
Medium-Density Overlay (MDO)	A type of plywood overlaid with a paper face. MDO is designed to have a smooth, paint receptive surface. Typically produced in 4' x 8' sheets.
Memorial Sign	A building sign or plaque noting such information as the name of the building or structure, when it was built, and by whom or who it honors.
Menu Board	A changeable point-of-purchase advertising display which accommodates a listing of products and prices.
Message Center	Any sign that displays changeable copy through electronic or mechanical means.
Message Controller	In an electronic sign, the device that stores messages entered by the operator and conveys them to the display area of the sign in the proper order.
Message Schedule	A list of signs programmed for a given facility providing location, sign type, message (text), and notations regarding installation, location conditions, or other information. This document is used with the sign location plan and sign type drawings.
Metal Finishes	Typically include mill, polished, brushed, satin, matte, painted, anodized, antique, oxidized, galvanized, chrome-plated, nickel-plated, engine-turned, and many others. Also refers to the levels of finishes relating to gloss and reflectance including matte, satin, grained, abraded, brushed, and mirror.
Metals	Metals used in sign making include: aluminum, brass, bronze, cast iron, copper, gold, iridium, lead, magnesium, mild steel, Muntz metal, nickel, pewter, platinum, silver, stainless steel, tin, titanium, weathering steel, zinc.
Mild Steel	Steel containing less than three-tenths of one percent (0.003) carbon. Not used in structural applications due to its relatively low strength.



Glossary

Mill Finish	The natural finish of a material resulting from the manufacturing process.
Mirror	<ol style="list-style-type: none">1. Function of reversing type or an image in design. Used mainly for cutting copy or images to be installed on the inside surface of a transparent substrate such as a window.2. Highly polished, virtually specular finish on a surface or material.
Mock-up	Typically a full-size model used to test scale, color, appearance, legibility and/or aesthetic aspects; and made to simulate final construction materials and finishes.
Model	Typically a smaller-scale, proportionally reduced version of a larger element.
Moire	An interference pattern created by the overlay of two regular patterns. In screen-printing, the undesirable pattern on halftones caused by incorrect screen angles.
Moulding	A trim, commonly of wood or metal, used as detail on different types of signs. Molding is available in a variety of shapes and profiles.
Monument Sign	A freestanding sign which sits directly on the ground or is mounted on a low base. This type of sign typically identifies a facility, building, or entrance.
Muntz Metal	An alloy of copper and zinc with a very small amount of lead. This metal has a “brass” appearance and is highly malleable. It is used for sign plaques and letters.
Mural	A wall surface that has been treated with a paint, tile, or vinyl graphic pattern, image, or shape. Murals can be achieved using large-format digital prints that can emulate any material or finish desired.
M.U.T.C.D.	Manual on Uniform Traffic Control Devices from the US Department of Transportation. Defines highway sign standards and traffic control graphics.

N

Name Plate	A sign that identifies only the name, occupation, and/or professional title of the occupant of a desk, office, or building.
-------------------	---



Glossary

National Electrical Code	Electrical safety code adopted by many, but not all states, counties, and cities in the United States. Published by the National Fire Protection Association (NFPA) as NFPA 70.
Negative Space	The background of a sign. The area around and within the art and copy.
Nickel Plate	A thin layer of nickel that has been electroplated onto another metal. See also METAL FINISHES.
Numeral	A symbol or mark used to represent a number.

O

Oil-Canning	Typically used to refer to a metal surface that shows uneven deflection from unsuitable inner structure, poor attachment, or insufficient thickness of face material.
Outline/Inline	In computer graphics, a closed-loop path that copies an original's shape. Following outside the shape is an outline, inside the original shape is an inline.

P

Paint Finish	In descending order of reflectance: gloss, semigloss, 20 percent gloss (preferred by the ABA/ADA), eggshell, and matte (flat finish).
Pantone Matching System	Also known as PMS . A standardized color reproducing system, primarily used in the printing industry. Colors are assigned identification numbers which correspond with specific color formulations.
Patina	A finish applied, or achieved by age, to metal surfaces called "verdigris"- the blue green patina that forms on metals, especially copper, brasses, and bronze.
Pavement Graphics	Typically white or yellow graphics applied to asphalt or concrete roadways and parking areas to supplement traffic markings.



Glossary

Pennant	A piece of plastic or cloth, pointed at the bottom and suspended by its top. Often undecorated, it is a temporary attention-getting device.
Photopolymer	A specialized plastic with light sensitive coating which is masked and photo etched to create tactile graphics. Used primarily for ABA/ADA signage requiring tactile copy and Braille.
Pictogram	A pictorial representation or graphic symbol identifying a location, action, activity, or a warning.
Pin Mount	Letters have “pins” or “studs” on their back, and these protrude into the surface of the wall on which the letters are mounted. Used to keep letters aligned on a rough surface or used to stand letters off (float) on a wall surface.
Plastic Faced Letters	Channel letters in which the front of the channel is covered by a translucent plastic face, diffusing the lighting within.
Plexiglass	The trade name for a brand of acrylic sheeting, which is often used as a generic term.
Pole Sign	A freestanding sign, mounted on a round or square tube, or other fabricated member without any type of secondary support. Pole signs are typically double-faced.
Polycarbonate	A specific thermosetting resin characterized by its durability, flexibility, machinery, and endurance under UV exposure. Lexan® is a polycarbonate.
Polypropylene	A type of plastic sheet used in banners, noted for its flexibility at low temperatures and its resistance to chemicals.
Polyurethane	A type of hard thermoset plastic foam used in sign production. It has the density and characteristics of wood, with only one-third of the weight. It can be used for carving and sandblasting signs.
Polyvinyl Chloride (PVC)	A specific thermoset plastic which is weather and chemical resistant. It can be extruded into many forms or cast as sheets in a variety of colors and thicknesses.
Porcelain Enamel	A process to coat metal with a ceramic slip, which is fired at extremely high heat, to create a durable, glass like surface impervious to degradation from environmental conditions.



Glossary

Portable Sign	A freestanding sign not intended to be permanently affixed in place.
Poster	A sign typically printed on paper and intended for indoor use.
Poured in Place	Refers to concrete footings for signs.
Powder Coating	A process for electrostatically applying a coating of free-flowing, dry powder to a surface which is then cured under heat or ultraviolet light to create a finish.
Precast Concrete	A concrete product produced by casting concrete into a reusable mold. After the concrete has cured, the cast product is transported to the site where it is lifted into place.
Prime	To coat a substrate prior to the application of paint or adhesive.
Projecting Sign	A type of projecting sign mounted perpendicular to the sign's surface and normal flow of traffic. These signs are typically double sided and mounted to a building wall, façade, storefront or pole. See BLADE SIGN.
Prototype	Typically, a full-sized sample using intended materials, fasteners, and finishes, as well as methods of construction, to test assembly, design, construction, and appearance issues. See MOCK-UP.
Push Through	A letter or graphic which has been cut out, then pushed through a corresponding space that has been removed from a sign substrate. Typically used with a sign cabinet which has an opaque sign face and internal lighting. "Push-thru letters" are most often translucent acrylic and flush with, or slightly protruding through, the front surface of the sign face.
Pylon	A free standing sign monolithic in shape. Does not refer to a pole sign or a low-profile monument sign.

Q

Quarter Round	Wood or metal molding, and trim, with a profile in the shape of a quarter circle.
----------------------	---



Glossary

R

Raceway	A metal structure enclosing the electrical wiring and sign components.
Raster Graphics	The representation of images generally as an array of pixels or points of color. Typically used for the representation of photographic images. See BITMAP
Readability	The quality of a sign's overall design which allows the viewer to correctly interpret the presented information within an optimum time and distance.
Reflective Vinyl	Film with very small glass or glasslike bead material encapsulated below the surface, creating the ability to reflect light back to its source, such as from a car headlight back to the driver.
Regulatory Signs	Signs required by various government bodies to inform the public of traffic laws and other regulations.
Relief	The projection of art from a flat surface. The shortened form of "bas-relief."
Rendering	An artistic sketch or representation of a design concept.
Resolution	The number of pixels per inch designated to a digital image. A higher pixel ratio, i.e., the greater the density of pixels, will yield a more precise and detailed image.
Retainer	The projecting rim or trim around the sign face which holds the sign face in place.
Reverse Channel Letter	An illuminated backless channel letter, with opaque face and sides, pin mounted on a background surface. The interior of the letter form contains a light source (LED, neon) which when illuminated, will produce a halo effect of reflected light around the letter.
Revolving Sign	A sign which has the ability to turn 360 degrees via an electric motor which drives its movable parts.
Roof Sign	A sign structure which is erected on or above a roof, or installed directly on a roof's surface.



Glossary

Router Cut Sign

Describing a sign cut with a hand or computerized router, using various shaped cutting bits.

S

Sandblasting

A method for creating an etched image on a material by forcibly propelling a stream of abrasive material against its surface. Typically used on glass, wood, and stone.

Sans-serif

Any typeface that does not have extending features known as “serifs” at the end of strokes. I.E., Helvetica.

Saturation

A range from pure color (100%) to gray (0%) at a constant lightness level. A pure color is fully saturated. From a perceptual point of view, saturation influences the grade of purity or vividness of a color/image. A desaturated image is said to be dull, less colorful, or washed out but can also make the impression of being softer.

Schematic Design

A conceptual design developed at the beginning of a project which demonstrates a design approach or strategy.

Screen Printing

A print made using a squeegee to force ink through a stencil or emulsion that is supported by fabric which has been stretched over a frame to create a screen. A photographic process can be used to create and control the resist for more precise imaging.

Seam

A line formed by the joining together of two separate pieces of the same or different materials along their edges.

Second Surface

Refers to a sign made of a clear substrate, such as acrylic, where the graphics and background color are applied on the reverse (or inside) side of a sign face to provide extra protection from environmental conditions and tampering. Some exterior signs are painted in this manner, as are many interior signs.

Serif

A small line or embellishment finishing off the strokes of letters in some fonts. Times New Roman is a familiar serif font.

Service

The general maintenance of a sign which may include: cleaning, repainting, replacement of bulbs or lamps, and repairs on a regular basis, and sometimes covered under a contract.



Glossary

Service Cover	A panel in an electric sign cabinet which allows access to electrical components and fixtures for maintenance, repair and replacement of bulbs and lamps.
Setback	The distance between the sign and a property line or right of way.
Shadow	Duplication of an image which is slightly offset. Also referred to as a “drop shadow”.
Shade	A color made darker than the original by adding black.
Shop Drawings	In signage, this refers to fabricator prepared drawings which describe intended methods of construction as well as sequence of assembly. Shop drawings are to be reviewed by the designer and owner for approval prior to construction or fabrication to ensure that the intended design concepts are accurately implemented throughout the construction process.
Sign	Any device, structure, display, or placard, on, in, or near a building, to attract the attention of the public for the purposes of advertising, identifying, or communicating information about goods and services.
Signage/Signing	Interchangeable terms used to describe signs.
Sign Cabinet	The enclosure of an electric sign, not including the components and mounting structure.
Sign Categories	Signs are typically used for the following purposes: life safety or fire code, directional, identification, informational, orientation, ornamentation, regulatory, wayfinding.
Sign Face	The front surface of a sign (in elevation), onto which graphics are applied.
Sign Location Plan	Usually a site plan, or floor plan, indicating where signs will be placed (called “sign locations”).
Sign Schedule	A list of signs programmed for a given facility to include information regarding: location, sign type, and message (text) as well as notations regarding: installation, location conditions, and/or other information. This document is used in conjunction with the sign location plan and sign type drawings to implement a sign program.



Glossary

Signage System Standards	Standards developed within the parameters of the VA Signage Design Manual and based on the wayfinding analysis and information hierarchy. This set of drawings and specifications establishes the facility-specific design and component-based signage system to be used in both current and future projects.
Sign Type	Defines the design, use or style of each unique sign in a system. Sign types are individually determined in each sign project to meet the specific need(s) or function at a particular location.
Sign-Foam	A brand of specialized polymer foam cell products designed for three-dimensional signage applications, available in different densities and strengths.
Silicone Adhesive	General term for an adhesive used in the installation of letters and signs. Silicone is a popular product due to its elasticity, strength, reasonable curing time, and its impermeable nature.
Silk-screening	See SCREEN PRINTING.
Single Face	A sign consisting of one face, rather than back-to-back faces on a common frame or back-to-back messages on the same piece of material.
Skeleton	The frame onto which a sign is installed.
Spacer	Any device used in mounting letters or signs which separates those components from the surface to which they are applied.
Spotlight	A source of illumination for an externally illuminated sign; a lamp with a strong focused beam directed toward a sign.
Star	The five-pointed star symbol indicating the main EXIT level in a building. Required next to floor level indication on elevator control panels and on elevator door jambs.
Stone Signs	Typically sandstone, granite, marble, limestone, or other common decorative stone material. Letters can be stud-mounted to stone or carved/incised into the face.
Stroke	A single movement of a hand, arm, or marking tool. Stroke can also refer to: a pass of the squeegee in screen-printing, a pass of the brush in painting, as well as a line making up a letter. See also STROKE WIDTH.



Glossary

Stroke Width	The width of the major lines comprising a letterform. Wide strokes are used to create a bold letter whereas narrow strokes are used to create a light letter.
Structure	In the sign industry, a fabrication designed for, and capable of, supporting a sign. Can refer to internal or external skeleton (exoskeleton) of sign as well as support pole or mechanism.
Subsurface	See SECOND SURFACE.
Substrate	The material out of which the face is made. Wood, metal sheeting, paper, and acrylic are some examples of sign substrates.
Symbol	A letter, number, or other character or mark, or a combination of letters or the like, used to designate something.

T

Tactile Sign	A sign, or an area within a larger sign, where a message is conveyed through raised or engraved artwork, thus creating accessibility for the visually impaired. Required by ABA/ADA for all permanently identified rooms.
Tamper Resistant Hardware	Any screw, bolt, nut, and fastener that require specialized tooling to install and remove. Used to discourage theft, vandalism, and tampering.
TDD	Telecommunications Device for the Deaf. An electronic device, for text communicating over a telephone line that is designed for use by persons with hearing or speech difficulties. Also known as a teleprinter or teletypewriter. See TTY.
Template	A full-sized pattern, layout, or computerized printout showing the exact size and placement of letters. Typically used for installing dimensional letters, signs, or architectural elements.
Temporary Sign	Any sign that is not intended to be permanently installed.
Thermoforming	A process by which a dimensional object is created from a flat sheet of material which has been heated to a pliable temperature and formed into shape through a mold. This process can be achieved either mechanically or pneumatically. See also VACUUM-FORMING.



Glossary

Thumbnail	A type of rough sketch of a design made prior to developing more finalized presentations.
Time Switch	A switch which utilizes a clock or timer to automatically turn an electric sign on and off at set times each day.
Tint	A color made lighter than the original by adding white.
Tone	<ol style="list-style-type: none">1. A result of mixing a pure color with any neutral/grayscale color including the two extremes white and black. By this definition all tints and shades are also to be considered tones.2. A result of mixing a pure color with any grayscale color excluding white and black. By this definition a certain amount of white and black must have been added to the original color. Furthermore, the following is true: If changing the tonal value of a color, gray has been added (any ratio of mixture) to the original color.
Touch Screen	An interactive digital display activated by touch.
Tracking	The ability of a computer to add or subtract minute increments of space between letters throughout a single word or block of text. Should not be confused with kerning. See also LETTERSPACING.
Transformer	In electric signs, the mechanical or electronic component that changes voltage supplied to the sign into a higher or lower voltage necessary to run the sign.
Translucence	The property of a material such as glass, vinyl, paint, or ink that allows the passage of some light through it without being transparent.
TTY	Teletypewriter (originally), or a text display device, as used by the hearing or speech impaired to read voice communication converted to text by a Communication Assistant Device (CAD). Digital TTYs have largely replaced analog TDDs.
Typeface	The design of a given set of letters, numbers, symbols, and punctuation, without reference to its size or width. See also FONT.
Typographic Terms	Terminology associated with typesetting, as utilized in the sign industry: ascender, condensed, counter, descender, extended, flush, font, kerning, leading, letterspacing, line spacing, sans serif, serif, stroke width, tracking, typeface, word spacing, etc.



Glossary**U**

- Ultraviolet Light (UV)** That part of the light spectrum ranging from 185 to 450 nanometers. UV has several influences on the sign industry. When UV strikes certain surfaces, such as the phosphors in neon and fluorescent tubes, it is transformed into visible light. UV is used for curing some screen-printing inks and paints. UV light is the prime cause of pigment failure in some paints and vinyls, especially red colors.
- Underwriters Laboratory** Also known as **UL**. A nationally recognized private organization responsible for safety testing, and certification of, electrical devices, for fire rating materials and assemblies, and other related activities.

V

- Vacuum Forming** A process, for constructing a sign face, by which dimensional imagery and letters are created from a flat sheet of material. The material is heated to a pliable temperature and formed into shape through a mold from which air is drawn out of. The force from the vacuum presses the material against the contours of the mold, thus forming the desired dimensional shape(s).
- Value Engineering** Designing and developing a desired product or sign to be as inexpensive to produce as possible without sacrificing the quality or visual integrity of the final item.
- VHB (Very High Bond)** High strength double sided tape. The tape can be applied between parts to eliminate the need for mechanical fasteners or welds. This tape is available in many grades and thicknesses.
- Vinyl** Polyvinyl chloride (PVC) film that, in sign making, is backed with an adhesive that creates a strong bond to a surface when pressure is applied. Different integral colors are available with adhesives having varying levels of aggressiveness (adhesion) for various applications from permanent to semi-permanent to temporary.
- Vinyl Letters** Letters cut from an adhesive-backed material, available in dozens of opaque, translucent, metallic, and transparent colors and patterns.



Glossary

W

Wall Mount	A sign mounted on a wall. Another name for a WALL SIGN.
Wall Sign	A interior or exterior sign painted on a wall or attached to the wall of a building.
Wall Resistant	Describing a sign, or sign face, that has been chemically treated to make it impervious to any damage or deterioration caused by water.
Waterjet Cutting	Computerized high-pressure stream of water used to cut stone and metal up to 2" thick. Also called "hydro-cutting".
Wayfinding	The ability of a person to find their way to a given destination in a built, or planned, environment, using information provided through out that environment. This process can involve signs, colors, objects, materials, and architecture. The term can also be used to describe the process to establish or improve the function of a particular environment. Wayfinding is not a separate or different activity from traditional signage design, but rather a broader, more inclusive way of assessing all the environmental issues which affect our ability to find our way.
Wayfinding Master Plan	An organized approach to developing a signage system by using a VA facility's complex floorplans and long list of departments, sub-services, and destinations to create a logical hierarchy of information that improves a visitor's ability to navigate the environment. The wayfinding master plan is then used as a foundation for all future projects to ensure the same level of quality and ease of navigation. For new buildings, the wayfinding master plan is created alongside the floor plans.
Weathering Steel	A steel alloy that forms a tenacious, self-protecting rust layer when exposed to the atmosphere.
Weed	The process of peeling extraneous file (vinyl or matrix) away from a plotter cut, leaving only the sections representing the final image or letter.
Weep Hole	A small, water drainage hole, placed at the lowest point in the bottom of a fabricated letter or a sign cabinet.
Wet Location Fixture	A watertight electrical or light fixture which is sealed to protect against moisture.
Window Sign	A sign mounted for display in or on a window and viewed from the outside.



Glossary**X****X-Height**

In any typeface, the height of the lowercase letters which do not have ascenders or descenders. Normally referring to the lower-case x.

Y**Yield**

1. In vehicular traffic, a regulatory sign pertaining to traffic flow, conceding right of way.
2. In manufacturing, the amount of material utilized versus what is waste or discarded.

Z**Zinc**

A malleable metal which has a gray appearance and can be used raw, or painted, in exterior applications.

