

VA

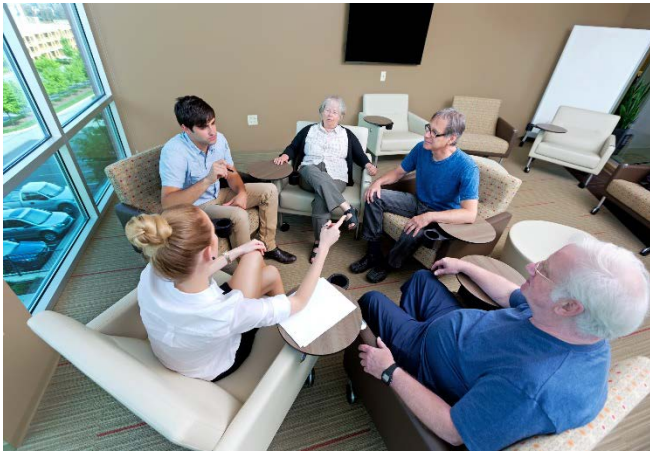

U.S. Department  
of Veterans Affairs



# Mental Health Outpatient Services Design Guide

July 2018

TABLE OF CONTENTS

1.0 General..... 1-1

    1.1. Foreword ..... 1-1

    1.2 Acknowledgement ..... 1-3

    1.3 Introduction..... 1-12

    1.4 VA Policies/Standards and Industry Codes/Standards..... 1-14

    1.5 Abbreviations..... 1-17

2.0 Narrative..... 2-1

    2.1 General..... 2-1

        2.1.1 Clinical and Operational Summary ..... 2-1

            2.1.1.1 Introduction..... 2-1

            2.1.1.2 Guiding Principles..... 2-2

            2.1.1.3 VA Mental Health Outpatient Services Delivery Locations ..... 2-3

        2.1.2 Outpatient Mental Health Services ..... 2-4

            2.1.2.1 Introduction..... 2-4

            2.1.2.2 Level 1: Self-Directed Care..... 2-5

            2.1.2.3 Level 2: Primary Care Mental Health Integration (PCMHI) ..... 2-6

            2.1.2.4 Level 3: General Mental Health Services..... 2-8

            2.1.2.5 Level 4.a: Specialty Mental Health Services..... 2-9

            2.1.2.6 Level 4.a.1: Services Provided by Post-Traumatic Stress  
Disorders Clinical Teams (PCT)..... 2-9

            2.1.2.7 Level 4.a.2: Intensive Outpatient Specialty Mental Health Care,  
including Substance Use Disorder (SUD) ..... 2-9

            2.1.2.8 Level 4.a.3: Special Interventions..... 2-12

            2.1.2.9 Level 4.b: Community Based/Focused Programs..... 2-14

            2.1.2.10 Level 4.b.1: Psychosocial Rehabilitation and Recovery Center  
(PRRC) ..... 2-14

            2.1.2.11 Level 4.b.2: Intensive Community Mental Health Recovery  
(ICMHR) Programs ..... 2-15



2.1.2.12	Level 4.b.3: Therapeutic and Supported Employment Services (TSES) .....	2-16
2.1.2.13	Level 4.b.4: VHA Homeless Programs .....	2-17
2.1.3	VA Trends in Outpatient Mental Health Services.....	2-19
2.1.3.1	Shift from Inpatient to Outpatient Services .....	2-19
2.1.3.2	Expansion of Service Offerings .....	2-19
2.1.3.3	Integration of Behavioral Health into Primary Care.....	2-19
2.1.3.4	Increased Team-Based Care.....	2-21
2.1.3.5	Non-Institutional Treatment Environment .....	2-21
2.1.3.6	On-Stage and Off-Stage Design.....	2-22
2.1.3.7	Use of Technology.....	2-25
2.1.4	Space Planning and Design Concepts .....	2-28
2.1.4.1	Flexibility and Adaptability .....	2-28
2.1.4.2	Adjacency and Flow.....	2-31
2.1.4.3	Interior Design and Wayfinding.....	2-32
2.1.4.4	Accessibility .....	2-32
2.1.4.5	Patient Privacy and Confidentiality .....	2-32
2.1.4.6	Safety and Security.....	2-34
2.1.4.7	Additional Design Considerations for PRRCs.....	2-35
2.1.4.8	Additional Design Considerations for CRRCs and HCHV Service Centers .....	2-35
2.1.5	Design Considerations for Specific Spaces.....	2-37
2.1.5.1	Waiting and Reception.....	2-37
2.1.5.2	Patient Care Spaces.....	2-38
2.1.5.3	Staff Space .....	2-46
2.1.5.4	Outdoor Space .....	2-47
2.1.6	Renovation of Existing Facilities for Outpatient Mental Health .....	2-48
2.2	Technical Considerations .....	2-54
2.2.1	VA Policies, Codes and Standards.....	2-54



2.2.2 Outdoor Therapeutic Spaces..... 2-56

2.2.3 Architectural..... 2-57

    2.2.3.1 Interior Design ..... 2-58

    2.2.3.2 Patient and Staff Safety and Security Overview ..... 2-66

    2.2.3.3 Partitions..... 2-67

    2.2.3.4 Ceilings..... 2-68

    2.2.3.5 Interior Doors ..... 2-68

    2.2.3.6 Windows and Glazing ..... 2-69

2.2.4 Structural Design ..... 2-70

2.2.5 Heating, Ventilation and Air Conditioning Systems..... 2-70

    2.2.5.1 General..... 2-70

    2.2.5.2 Outdoor Air Requirements ..... 2-70

    2.2.5.3 Noise Criteria ..... 2-70

    2.2.5.4 HVAC Design Features ..... 2-71

    2.2.5.5 Indoor Mechanical Equipment Locations ..... 2-71

2.2.6 Plumbing Systems..... 2-72

    2.2.6.1 General..... 2-72

    2.2.6.2 Domestic Water Systems ..... 2-72

    2.2.6.3 Sanitary, Vent and Storm Systems ..... 2-72

    2.2.6.4 Natural Gas System..... 2-72

    2.2.6.5 Plumbing Fixtures..... 2-72

    2.2.6.6 Medical Gas Systems ..... 2-72

    2.2.6.7 Seismic Requirements..... 2-72

2.2.7 Lighting and Electrical Systems..... 2-73

    2.2.7.1 General..... 2-73

    2.2.7.2 Lighting ..... 2-73

    2.2.7.3 Power ..... 2-74

2.2.8 Telecommunications, and Special Telecommunications, Monitoring and Signal Systems..... 2-74



- 2.2.8.1 General..... 2-74
- 2.2.8.2 Telecommunications Network Outlets ..... 2-75
- 2.2.8.3 Telemental Health Video-Conferencing ..... 2-75
- 2.2.8.4 Nurse Call..... 2-75
- 2.2.8.5 Television ..... 2-75
- 2.2.8.6 Security..... 2-75
- 2.2.8.7 Duress Alarm ..... 2-76
- 2.2.8.8 PACS (Physical Access Control System) ..... 2-76
- 2.2.8.9 Video Assessment and Surveillance ..... 2-76
- 2.2.8.10 Radio Systems (Site Specific Requirement) ..... 2-77
- 2.2.8.11 Public Address System (PAS) ..... 2-77
- 2.2.9 Fire Protection and Life Safety ..... 2-78
  - 2.2.9.1 General..... 2-78
  - 2.2.9.2 Automatic Sprinkler..... 2-78
  - 2.2.9.3 Seismic Requirements..... 2-78
  - 2.2.9.4 Fire Alarm ..... 2-78
- 3.0 Functional Diagrams..... 3-1
  - 3.1 Introduction..... 3-1
  - 3.2 Universal Module..... 3-2
    - 3.2.1 VHA Space Need / Utilization Toolkit ..... 3-4
    - 3.2.2 Operational Assumptions for the Universal Module..... 3-8
    - 3.2.3 Design Priorities and Advantages of the Universal Module Approach ... 3-9
  - 3.3 Flexibility and Adaptability at the Room-by-Room Level..... 3-11
    - 3.3.1 Basic Clinical Office Module ..... 3-11
    - 3.3.2 Team Work Areas and Conference Space ..... 3-14
    - 3.3.3 Group Care Rooms ..... 3-16
    - 3.3.4 Intensive Outpatient Specialty Mental Health Care, including Substance Use Disorder (SUD)..... 3-18
  - 3.4 Flexibility and Adaptability at the Clinic Module Level ..... 3-20



- 3.5 Facilities for Community Based Programs..... 3-22
  - 3.5.1 Psychosocial Rehabilitation and Recovery Centers (PRRC)..... 3-22
  - 3.5.2 Community Resource and Referral Centers (CRRC) and Health Care for Homeless Veterans (HCHV) Service Centers ..... 3-24
- 4.0 ROOM TEMPLATES – FLOOR PLANS, REFLECTED CEILING PLANS, ROOM DATA SHEET, EQUIPMENT LIST & GENERAL NOTES ..... 4-1
  - 4.1 General..... 4-4
    - Introduction ..... 4-4
    - Legend of Symbols..... 4-6
  - 4.2 Transcranial Magnetic Stimulation (TMS) Room (XXYYC)..... 4-9
    - 4.2 TMS Room - Axonometric..... 4-9
    - 4.2 TMS Room - Floor Plan ..... 4-10
    - 4.2 TMS Room - Reflected Ceiling Plan..... 4-11
    - 4.2 TMS Room - Room Data Sheet ..... 4-12
    - 4.2 TMS Room - Equipment List ..... 4-14
  - 4.3 Group Therapy Room (OPMH1)..... 4-16
    - 4.3 Group Therapy Room – Axonometric..... 4-16
    - 4.3 Group Therapy Room – Reflected Ceiling Plan ..... 4-18
    - 4.3 Group Therapy Room – Room Data Sheet ..... 4-19
    - 4.3 Group Therapy Room – Equipment List..... 4-21
  - 4.4 Group Therapy Room, Conference Format (XXYYC)..... 4-23
    - 4.4 Group Therapy Room, Conference Format – Axonometric..... 4-23
    - 4.4 Group Therapy Room, Conference Format – Floor Plan ..... 4-24
    - 4.4 Group Therapy Room, Conference Format – Reflected Ceiling Plan ..... 4-25
    - 4.4 Group Therapy Room, Conference Format – Room Data Sheet ... 4-26
    - 4.4 Group Therapy Room, Conference Format – Equipment List .... 4-28
  - 4.5 OFFICE, CLINICAL, SINGLE ACCESS (XXYYC)..... 4-30
    - 4.5 Office, Clinical, Single Access – Axonometric..... 4-30
    - 4.5 Office, Clinical, Single Access – Floor Plan ..... 4-31



- 4.5 Office, Clinical, Single Access – Reflected Ceiling Plan (2 options) ..... 4-32
- 4.5 Office, Clinical, Single Access – Room Data Sheet ..... 4-33
- 4.5 Office, Clinical, Single Access – Equipment List ..... 4-35
- 4.6. OFFICE, CLINICAL, DUAL ACCESS (XXYYC)..... 4-37
  - 4.6 Office, Clinical, Dual Access – Axonometric ..... 4-37
  - 4.6 Office, Clinical, Dual Access – Floor Plan ..... 4-38
  - 4.6 Office, Clinical, Dual Access – Reflected Ceiling Plan (2 options) ..... 4-39
  - 4.6 Office, Clinical, Dual Access – Room Data Sheet..... 4-40
  - 4.6 Office, Clinical, Dual Access – Equipment List..... 4-42
- 4.7 CONSULTATION ROOM, SINGLE ACCESS (XXYYC) ..... 4-43
  - 4.7 Consultation Room, Single Access – Axonometric ..... 4-43
  - 4.7 Consultation Room, Single Access – Floor Plan ..... 4-44
  - 4.7 Consultation Room, Single Access – Reflected Ceiling Plan (2 options)..... 4-45
  - 4.7 Consultation Room, Single Access – Room Data Sheet..... 4-46
  - 4.7 Consultation Room, Single Access – Equipment List..... 4-48
- 4.8 CONSULTATION ROOM, DUAL ACCESS (XXYYC)..... 4-49
  - 4.8 Consultation Room, Dual Access – Axonometric ..... 4-49
  - 4.8 Consultation Room, Dual Access – Floor Plan ..... 4-50
  - 4.8 Consultation Room, Dual Access – Reflected Ceiling Plan (2 options)..... 4-51
  - 4.8 Consultation Room, Dual Access – Room Data Sheet ..... 4-52
  - 4.8 Consultation Room, Dual Access – Equipment List ..... 4-54
- 4.9 FAMILY CONSULTATION/THERAPY ROOM (XXYYC) ..... 4-55
  - 4.9 Family Consultation/Therapy Room - Axonometric ..... 4-55
  - 4.9 Family Consultation/Therapy Room – Floor Plan..... 4-56
  - 4.9 Family Consultation/Therapy Room – Reflected Ceiling Plan .... 4-57
  - 4.9 Family Consultation/Therapy Room – Room Data Sheet..... 4-58



- 4.9 Family Consultation/Therapy Room – Equipment List ..... 4-60
- 4.10 MULTIPURPOSE ROOM (OPMH1) ..... 4-62
  - 4.10 Multipurpose Room - Axonometric ..... 4-62
  - 4.10 Multipurpose Room – Floor Plan ..... 4-63
  - 4.10 Multipurpose Room – Reflected Ceiling Plan ..... 4-64
  - 4.10 Multipurpose Room – Room Data Sheet ..... 4-65
  - 4.10 Multipurpose Room – Equipment List ..... 4-67
- 4.11 GROUP TESTING ROOM (OPMH2) ..... 4-69
  - 4.11 Group Testing Room - Axonometric ..... 4-69
  - 4.11 Group Testing Room – Floor Plan ..... 4-70
  - 4.11 Group Testing Room – Reflected Ceiling Plan ..... 4-71
  - 4.11 Group Testing Room – Room Data Sheet ..... 4-72
  - 4.11 Group Testing Room – Equipment List ..... 4-74
- 4.12 SOCIAL ACTIVITIES/DINING/MULTIPURPOSE ROOM (XXYYC).. 4-76
  - 4.12 Social Activities/Dining/Multipurpose Room - Axonometric ..... 4-76
  - 4.12 Social Activities/Dining/Multipurpose Room – Floor Plan ..... 4-77
  - 4.12 Social Activities/Dining/Multipurpose Room – Reflected Ceiling Plan  
..... 4-78
  - 4.12 Social Activities/Dining/Multipurpose Room – Room Data Sheet  
..... 4-79
  - 4.12 Social Activities/Dining/Multipurpose Room – Equipment List ... 4-81
- 4.13 ACTIVITIES/DINING ROOM WITH KITCHENETTE (XXYYC) ..... 4-83
  - 4.13 Activities/Dining Room with Kitchenette - Axonometric ..... 4-83
  - 4.13 Activities/Dining Room with Kitchenette – Floor Plan ..... 4-84
  - 4.13 Activities/Dining Room with Kitchenette – Reflected Ceiling Plan  
..... 4-85
  - 4.13 Activities/Dining Room with Kitchenette – Room Data Sheet ..... 4-86
  - 4.13 Activities/Dining Room with Kitchenette – Equipment List ..... 4-88
- 4.14 ACTIVITIES/DINING ROOM (FSCD1) ..... 4-90
  - 4.14 Activities/Dining Room - Axonometric ..... 4-90





- 4.14 Activities/Dining Room – Floor Plan ..... 4-91
- 4.14 Activities/Dining Room – Reflected Ceiling Plan ..... 4-92
- 4.14 Activities/Dining Room – Room Data Sheet..... 4-93
- 4.14 Activities/Dining Room – Equipment List..... 4-95
- 4.15 OCCUPATIONAL THERAPY ROOM (OTGC1)..... 4-97
  - 4.15 Occupational Therapy Room - Axonometric ..... 4-97
  - 4.15 Occupational Therapy Room – Floor Plan ..... 4-98
  - 4.15 Occupational Therapy Room – Reflected Ceiling Plan ..... 4-99
  - 4.15 Occupational Therapy Room – Room Data Sheet ..... 4-100
  - 4.15 Occupational Therapy Room – Equipment List..... 4-102
- 4.16 CONFERENCE ROOM/CLASSROOM (XXYYC) ..... 4-105
  - 4.16 Conference Room/Classroom – Axonometric – conference format  
.....4-105
  - 4.16 Conference Room/Classroom - Floor Plan – conference format  
.....4-106
  - 4.16 Conference Room/Classroom – Reflected Ceiling Plan ..... 4-107
  - 4.16 Conference Room/Classroom – Room Data Sheet..... 4-108
  - 4.16 Conference Room/Classroom – Equipment List – conference  
format .....4-110
- 4.17 METHADONE AREA (XXYYC) ..... 4-112
  - 4.17 Methadone Area - Axonometric..... 4-112
  - 4.17 Methadone Area – Floor Plan ..... 4-113
  - 4.17 Methadone Area – Reflected Ceiling Plan ..... 4-114
  - 4.17 Methadone Area – Room Data Sheet ..... 4-115
  - 4.17 Methadone Area – Equipment List..... 4-117
- 5.0 Appendix ..... 5-1
- Index of Figures and Tables: ..... 5-1



THIS PAGE WAS INTENTIONALLY LEFT BLANK



## 1.0 General

### 1.1 Foreword

The Department of Veterans Affairs (VA) Program Offices, project teams, designers and constructors, are obligated to our Nation's Veterans and taxpayers to make the most effective and efficient use of resources, by providing a continuum of safe, secure, high quality, high performance, and high value environments of care and service for Veterans. The VA Office of Construction and Facilities Management (CFM) supports the Department's mission through development and application of standards as a basis for disciplined planning, design, and construction of VA facilities.

VA Standards are the culmination of a partnership among the Department of Veterans Affairs (VA), Veterans Health Administration Program Officials and Clinicians, Industry, Academic and Research Organizations, Expert Consultants, and the Office of Construction and Facilities Management. Design Guides are developed through integration of VA-specific requirements, Federal law and regulation, benchmarking of industry best practice, evidence-based research and design, and value-based analysis of leading edge innovation. The result is the establishment of best value standards for optimum functionality, safety, operability, performance, and quality throughout the VA environment of care and service.

Design Guides (PG-18-12) are a critical component of the VA Technical Information Library (TIL) ([www.cfm.va.gov/TIL](http://www.cfm.va.gov/TIL)) which contains standards for all VA planning, design, and construction projects. Design Guides focus on selected healthcare departments and services, and include an overview narrative of VA-specific planning and design principles and concepts, room templates, equipment lists, and basic technical/engineering requirements. They communicate the basis of design and are required to be utilized by project teams working on new construction projects and renovations of existing facilities. Design Guides will maximize the effectiveness and efficiency of the planning and design process and ensure a high level of design, while controlling construction, operating, and maintenance costs.

The information contained in Design Guides constitutes a Standard for VA Planning, Design and Construction. For all VA projects, it is required that project teams comply with the following in all phases of project development:

- 1) All applicable VA Standards published in the VA Technical Information Library (TIL) shall be applied as a basis, foundation, and framework in planning, design, and construction. Any substantial variance from Standards shall be considered



only as required to accommodate specific site, functional, and operational conditions. Upon consideration of variance, CFM shall be consulted, and VA will function as Authority Having Jurisdiction for decision. Each substantial variance shall have a basis rationale and be documented in the project record

2) Clinicians, providers, primary users, and other stakeholders shall be involved in all phases of project development to best adapt Standards for specific functional, operational, and site conditions, and to provide optimum service environments for Veterans. This also includes installations and modifications of systems or technology involving safety, security, functionality, or environmental quality. Stakeholder involvement shall be documented in the project record.

Design Guides are not project-specific. It is impossible to foresee all rapidly evolving requirements of healthcare facilities and each site or project will have unique requirements or conditions. Site-specific issues must be addressed within the context of these standards and applied to each individual project. Use of this Guide does not preclude the need for, nor absolve planners, architects, and constructors of their responsibility to provide complete, functional, safe, and secure designs suited to the unique requirements of each project, within budget, and on schedule.

Material, equipment and systems are shown in an illustrative, performance-based format and are not intended to depict, suggest, or otherwise constitute endorsement of any specific product or manufacturer. Manufacturers should be consulted for actual dimensions, configurations, and utility requirements.

All participants in the project development process must embrace VA Planning, Design and Construction Standards as fundamental in providing optimum environments for Veterans' care and services, in fulfilling VA's mission.



## 1.2 Acknowledgement

Credit is due to the following individuals whose leadership, knowledge, skills, and ability made this document possible:

### **Department of Veterans Affairs, Veterans Health Administration (VHA)**

#### Office of Mental Health and Suicide Prevention (10NC5)

Loren Wilkenfeld, Psychologist	National Mental Health Director for Inpatient and Outpatient Policy, Ret.
Peggy Henderson, Psy. D.	Deputy Director, Psychosocial Rehabilitation and Recovery (VACO)
Jay Cohen, Ph.D., LP	MH Technical Assistance and Business Operations (VHA OMHSP)
Mark Bondeson	Associate Chief of Staff for Behavioral Health, Boise VA Medical Center
Marsden McGuire, MD, MBA	Director, Continuum of Care and General Mental Health Services (OMHSP)
Clifford Smith, MD	Director, Field Support and Data Analytics, Office of Mental Health and Suicide Prevention (10NC5)
Karen Drexler, MD	National Mental Health Program Director – Substance Use Disorders (SUD), OMHSP, VA Central Office
Kendra Weaver, Psy.D.	Senior Consultant, Mental Health Clinical Operations (OMHSP)
Hugh Myrick, MD	ACOS, Mental Health Services Line (RHJ VAMC)
Peter D. Mills, Ph.D., MS	Director – VA National Center for Patient Safety Field Office, Adjunct Associate Professor of Psychiatry, The Geisel School of Medicine at Dartmouth
Andrew S. Pomerantz, MD	National Mental Health Director, Integrated Services (OMHSP)



Matt Miller, Ph.D., MPH	Director, Veterans Crisis Line
Susan K. Hoopengartner	Program Support Assistant, PSR&RS
Timothy R. Smith, Ph.D.	Psychologist and National Director, Inpatient and Outpatient Psychosocial Rehabilitation and Recovery Services, VACO – Office of Mental Health and Suicide Prevention (10NC5)
Michal Wilson, MD	Medical Director, Homeless Programs
Allison Bond, LCSW	CRRC & HCHV Outreach National Program Manager, VHA Homeless Programs
Shana Bakken, PhD	Director, Therapeutic and Supported Employment Services

#### Environmental Program Service (EPS)

Vonda K. Broom	Deputy Director, Environmental Programs Service (10NA7)
Christine Emanuelson, NCIDQ	Program Manager, Interior Design, VHA Environmental Programs Service (10NA7)

#### Office of Capital Management Engineering Services (OCAMES)

Don Wainwright, FACHE	Compliance Engineer, Office of Capital Asset Management and Engineering Support
-----------------------	--

#### Telecommunications

Forrest Frakes, PG, (FCC), CET, PC	Senior Telecommunications Specialist
Keith A. Van Bakel, ATS	Telecommunications Specialist, VACO, OSP (007A)



**Department of Veterans Affairs (VA)**Office of Construction and Facilities Management (CFM)

Donald L. Myers, AIA	Director, Facilities Standards Service
Kayvan Madani Nejad, Ph.D., AIA	Senior Healthcare Architect, Project Manager
Gary Fischer, AIA	Senior Healthcare Architect
Fei (Linda) Chan, Assoc. AIA, NCARB	Planner
Rand Hakim, AIA, NCARB	Senior Healthcare Architect/Planner
Matt Shepardson, MHS, MSIR	Senior Planner
Jacob J. Brown	Medical Equipment Specialist
Dave Tash, PE, LEED AP BD+C	Mechanical Engineer, Subject Matter Expert
Lam Vu, PE, CEM	Senior Electrical Engineer
Nathan Sears, RA, MBA, CGC, AVS	Value Manager
Mark Goeller, RA, M.Arch	Architect, SME
Fred Lau, PE	Structural Engineer
Juan Archilla, PE	Structural Engineer
Michael Taylor, PE, LEED AP	Senior Mechanical Engineer
Scott D. Hurst	Contracting Officer
Orest Burdiak	Principal Interior Designer
David Treece	OCFM Consulting Support Service (003C5), Architecture
Ward Newcomb, MD, MMM	Director of Integrated Clinical Design, Palo Alto Veterans Healthcare System, Consultant PACT Space and Operations, VACO Primary Care Services 10P4F



VA Center for Innovation

Melissa Chapman	Chief Designer
Amber Schleuning	Deputy Director

VA Medical Centers

Katrina Johnson Norris R.A.	Space Planner, VA Tennessee Valley Healthcare System
Margaret Healy, MSN, RN-BC PMHN	Program Manager, Outpatient Mental Health VA St. Louis Health Care System, St. Louis, MO
Shannon Fragmin, RN, CEN	Nurse Manager, OPBH, Louis A. Johnson VA Medical Center, North Central West Virginia
Catherine Woodman, MD	Director, Outpatient Mental Health. Iowa City VA Health Care System, Iowa City, IA
Julie Low, MD	Director, Mental Health Clinic, Philadelphia, PA
Anthony Thompson, BSBA, CPSS	Charlotte HCC, W.G. (Bill) Hefner VA Medical Center, Salisbury, NC
Michael W. Roach, LCSW-BACS	Deputy Associate Chief of Staff for Mental Health, Alexandria VA Healthcare System, Pineville, LA
Glenn G. Wikel, Jr., MS	Business Manager, Behavioral Health and Sciences Care Lines, Lebanon VA Medical Center, Lebanon, PA
Jesse Burgard, Psy.D.	Director of Mental Health, VA Healthcare System of Indiana, Michigan and Ohio (VISN 10)
Catherine Ayers, Ph.D.	Section Chief, Outpatient Mental Health Clinics, VA San Diego Healthcare System
Melissa Taylor	Memphis VA Medical Center, Memphis, TN





**Site Visits**VA Palo Alto Health Care System

Steven Lindley, MD, Ph.D	Director, Outpatient Mental Health,
Tina T. Lee, MD, MS	Deputy Chief of Staff, Mental Health
Ronald Suarez, MD	Medical Director, VA South Bay Mental Health Clinics
Katranker Thompson, LCSW	South Bay Clinical Coordinator (San Jose, Monterey and Capitola)
Dave Roberts, MBA, LCDR, USN (Ret.)	Process Improvement Specialist, Major General William H. Gourley (VA-DoD OPC)
James Romer, Architect	Office of Facility Planning and Development
Beth Kane	Program Analyst, Office of Deputy Director
Bill McGurk	Office of Facility Planning and Development

Orlando VA Medical Center at Lake Nona

Paul Deci, MD	Associate Chief of Staff/Mental Health
Steven J. Shea, Ph.D.	Local Recovery Coordinator, Psychologist Program Manager, MH Recovery Programming and Transformation
Sree Yalamanchili, MD	ACOS Ambulatory Care
Elaine Elmore, MSN, RN	Mental Health Nurse Manager
April Engelbrecht	AO to ACOS Ambulatory Care
Sandra Kirkland	Chief Nurse, MH
Hina Lone	Team Lead Patient Clinic
Margaret Amott	PCMHI Program Lead



James A. Haley Veterans Hospital – Tampa, Florida

Glenn Catalano, MD	Associate Chief of Staff for Mental and Behavioral Sciences
William Hervey, MD, MBA	Program Lead, Substance Use Disorders Service
Mary Dorritie, Psychologist	Acting Team Leader, Trauma Recovery Program
Angela Denietolis, MD	Executive Director, Office of Primary Care
Ronald Girona, Ph.D.	Assistant Chief, MH&BS Service/Chief, Psychology Section
Brian Zilka, MD	Assistant Chief, Ambulatory Care
Ben Lord	PCMHI
Vanessa Milsom, Ph.D.	Supervisory Psychologist, James A. Haley VA

Lake Baldwin Outpatient Clinic, Orlando VA Medical Center

Steve Sabol	Lake Baldwin Administrative Officer
Leslee Davis	Lake Baldwin PC Section Chief

VA Ann Arbor Healthcare System

Brian Martis, MD	Chief Psychiatrist
MaryGrace Lauver, LMSW	Outreach Section Chief, Mental Health Service
Nancy Anderson	Senior Interior Designer
Eric Deters	Planning and Analysis
Erin Smith, Ph.D.	PTSD Clinical Team Chief
Mark Lyubkin, MD	Mental Health Clinic Chief
Joseph VanderVeen, Ph.D.	SUD-IOP Clinic Chief



Deborah Wilson

Eric Pear, MS/MA

Program Analyst

Robert Spencer, Ph.D.

Neuropsychology Team Chief

Sarah Richards, LMSW

Social Work

Liz Haas, LMSW

Psychiatric Social Work

Reiko Buckles, LMSW

Primary Care Mental Health Team Lead

### Battle Creek VA Medical Center

Joseph L. Dudley, LCSW

Chief, Social Work Service

Daleth C. Jean-Jules,  
MSSW, LMSW, FAC-COR

Homeless Continuum Program Manager

Tiyanna (Whitt) Payne, LMSW, ACSW  
BCD

Healthcare for Homeless Veterans Supervisor

Susan Lee

Peer Support Specialist

William Bloem, Ph.D., ABPP

Associate Chief of Staff for Mental Health

### Louis Stokes Cleveland VA Medical Center

Kevin J. Smith, Ph.D.

Psychology

David Sabol, RA

Chief of Engineering Service

George Jurjus, MD

Director, Outpatient and Emergency  
Psychiatric Services

### University of Michigan, Psychiatry Department

Thomas Fluent, MD

Medical Director of Ambulatory Services

Tammy LaPrell

Patient Account Supervisor



Kaiser Permanente, Oakland, San Rafael and Daly City, CA

John Kouletsis	Vice President of Facilities Planning and Design
Tony Guarino	Facilities Planning and Design
Linda Raker	Facilities Planning and Design
Michelle Taylor	Facilities Planning and Design
Jay Murphy	National Facilities Services, Capitol Projects
Nick Winer	The Permanente Medical Group
Ken Shigematsu	Director, Department of Psychiatry, Kaiser Permanente, South San Francisco
Riley Guy	The Permanente Medical Group
Frances Sooy	National Facilities Services
Jody Clay	National Facilities Services
Stefani Komaru	The Permanente Medical Group



**Consultants**Cannon Design

Tim Rommel, AIA, MRAIC, ACHA	Principal, Behavioral Healthcare Practice Leader
David W. Esch, AIA	Vice President
Gary P. Richmond, AIA, LEED AP, BD+C	Associate Vice President
Theodore Fowler, PE, PEng, CDT	Principal, Electrical Engineering
Christine Soto, NCIDQ	Vice President
Jerome Bobak, PE	Vice President, Mechanical Engineering
Ronald Curtis, PE	Associate Vice President, Structural Engineering
Jon Beyer, CPD, CDT	Associate Vice President, Plumbing and Fire Protection
F. Patrick Mahoney, RCDD, CDT	Senior Associate
Kassam Master	Technology Designer
David Sass, RA, LEED AP	Senior Vice President
Cheri Weatherston, AIA	Senior Associate
Stephanie Vito, AIA	Associate Vice President

**Sub-Consultants**The Innova Group

Chris Phillips	Project Manager, Medical Equipment Planning
Eric Hunt	Medical Equipment Planner



### 1.3 Introduction

The Mental Health Outpatient Services Design Guide was developed as a tool to assist VA clinical, contracting, planning, construction and engineering staff in better understanding the space, equipment and planning concepts for Outpatient Mental Health Services. The Guide addresses general space and equipment planning, as well as functional and technical requirements for outpatient mental health.

The A/E design team shall understand and be familiar with the most current editions of the applicable VA and industry codes and standards. VA design and construction standards can be accessed at the Office of Construction and Facilities Management's Technical Information Library (TIL) (<http://www.cfm.va.gov/TIL>).

This VA Mental Health Outpatient Services Design Guide has been developed as a stand-alone document in contrast to the 2010/2014 edition of the VA Mental Health Design Guide, which addresses both inpatient and outpatient mental health care. It was determined that a single Design Guide could not efficiently address the extensive array of services that are provided by VA. Thus, separate documents for outpatient and inpatient care were deemed essential.

This document focuses on the continuum of outpatient services offered by the VA. It includes integration of mental health providers into primary care; general mental health clinics; specialty mental health outpatient programs; psychosocial rehabilitation and recovery centers; and a range of settings that provide health care to homeless Veterans.

Residential and inpatient mental health services will be covered in a separate Inpatient Mental Health Design Guide, to be updated and issued at a future date. Related and supporting programs covered in other Space Planning Criteria chapters and Design Guides include the following:



**TABLE 1: REFERENCES TO VA PROGRAMS RELATED TO OUTPATIENT MENTAL HEALTH**

Program / Service	Cross-reference to:
Patient Aligned Care Teams (PACT) – Primary Care	Mental Health Outpatient Services Design Guide discusses Primary Care Mental Health Integration (PCMHI) Planning. Space and design standards for PCMHI must be considered when designing PACT Clinic Space
Mental Health treatment space in Emergency Departments	Refer to Space Planning Criteria Chapter 256 Emergency Department (ED) and Urgent Care Clinic (UCC)
Electroconvulsive Therapy (ECT)	This procedure is done in Surgical Service
Mental Health Residential Rehabilitation Treatment Program (MH RRTP)	Refer to 2010/2014 Mental Health Design Guide for residential programs.
Research	Need for researcher workspace should be considered in the programming of mental health outpatient facilities. See also Space Planning Criteria Chapter 278 Research & Development.



#### 1.4 VA Policies/Standards and Industry Codes/Standards

- VHA Handbooks, Directives and Policies: Refer to the most current published version.
  1. VHA Handbook 1160.01, Uniform Mental Health Services in VA Medical Centers and Clinics (amended Nov 16, 2015)
  2. VHA Handbook 1160.03, Programs for Veterans with Post-Traumatic Stress Disorder (PTSD), Revised Dec 8, 2015
  3. VHA Handbook 1160.04, Programs for Veterans with Substance Use Disorders (SUD), Revised Dec 8, 2015
  4. VHA Handbook 1160.05, Local Implementation of Evidence-Based Psychotherapies for Mental and Behavioral Health Conditions, Revised Dec 8, 2015
  5. VHA Handbook 1162.05, Housing and Urban Development (HUD) – Department of Veterans Affairs Supported Housing (VASH) Program, Sept 14, 2011
  6. VHA Handbook 1162.09, Health Care for Homeless Veterans (HCHV) Program, May 2, 2014
  7. VHA Directive 1163, Psychosocial Rehabilitation and Recovery Services, July 1, 2011
  8. VHA Handbook 1163.01, Psychosocial Rehabilitation and Recovery Services, July 1, 2011
  9. VHA Handbook 1163.02, Therapeutic and Supported Employment Services Program, July 1, 2011
  10. VHA Handbook 1163.03 Psychosocial Rehabilitation and Recovery Centers (PRRC), July 1, 2011
  11. VHA Handbook 1163.05 Psychosocial Rehabilitation and Recovery Centers Peer Support, July 1, 2011
  12. VHA Handbook 1163.06 Intensive Community Mental Health Recovery Services, January 7, 2016
  13. VHA Directive 1501, VHA Homeless Programs, October 21, 2016
- VA Design and Construction Standards: Refer to the most current published version:
  1. Master Construction Specifications PG-18-1
  2. Design and Construction Procedures PG-18-3, including list of Codes, Standards and Executive Orders
  3. Standard Details and CAD Standards PG-18-4





4. Equipment Guide List PG-18-5
  5. VHA Space Planning Criteria PG-18-9, Chapter 260: Mental Health Outpatient Services, which updates and supersedes standards previously provided in Chapter 260: Mental Health Clinic, Chapter 202: Substance Abuse Clinic and Chapter 261: Day Treatment (“Psychosocial Rehabilitation and Recovery Center”)
  6. Barrier-Free Design Handbook PG-18-13
  7. Room Finishes, Door, and Hardware Schedule PG-18-14
  8. Current version of Technical Criteria (Design Manuals PG-18-10), including:
    - Architectural Design Manual
    - Interior Design Manual
    - HVAC Design Manual
    - Plumbing Design Manual (PDM)
    - Fire Protection Design Manual
    - Lighting Design Manual (LDM)
    - Electrical Design Manual (EDM)
    - Telecommunications and Special Telecommunications Design Manual (TDM)
    - Physical Security Design Manual for Mission Critical Facilities
    - Physical Security Design Manual for Life-Safety Protected Facilities (PSDM)
  9. VA Healing Environment Design Guidelines
  10. Seismic Design Requirements H-18-8
- Industry Codes/Standards
    1. FGI Guidelines for Design and Construction of Outpatient Facilities, including Specific Requirements for Outpatient Psychiatric Centers
    2. International Building Code (IBC) including International Mechanical and Plumbing Codes
    3. National Fire Protection Association (NFPA) 101 Life Safety Code

NFPA 101 primarily addresses life safety and fire protection features while the IBC addresses a wide range of considerations, including, but not limited to, structural strength, stability, sanitation, adequate light and ventilation, and energy conservation.
    4. NFPA National Fire Codes with the exception of NFPA 5000 and NFPA 900



5. Occupational, Safety and Health Administration (OSHA) standards
6. Uniform Federal Accessibility Standards (UFAS), including VA Supplement Barrier Free Design Guide
7. The Healthcare Insurance Portability and Accountability Act of 1996 (HIPAA) protects individual's rights to audible as well as visual privacy



## 1.5 Abbreviations

### General Terms

<b>A</b>	Amps
<b>ABA</b>	Architectural Barriers Act
<b>ACH</b>	Air Changes per Hour
<b>AFF</b>	Above Finished Floor
<b>AHJ</b>	Authority Having Jurisdiction
<b>AIA</b>	American Institute of Architects
<b>BICSI</b>	Building Industry Consulting Services
<b>CCTV</b>	Closed Circuit Television System
<b>CFM</b>	Office of Construction & Facilities Management
<b>CMS</b>	Centers for Medicare and Medicaid Services
<b>FC</b>	Foot Candle
<b>FMS</b>	Facilities Management Service (Services)
<b>HIPAA</b>	Health Insurance Portability and Accountability Act
<b>HVAC</b>	Heating, Ventilating and Air Conditioning
<b>IBC</b>	International Building Code
<b>JSN</b>	Joint Schedule Number
<b>LB</b>	<b>Pound</b>
<b>LED</b>	Light Emitting Diode
<b>LEED</b>	Leadership in Energy and Environmental Design
<b>LUX</b>	Lumen Per Square Meter
<b>MATV</b>	Master-Antenna Television
<b>NFPA</b>	National Fire Protection Association



<b>NSF</b>	Net Square Feet
<b>NSM</b>	Net Square Meters
<b>NTS</b>	Not to Scale
<b>ORP</b>	VA Office of Real Property
<b>OSHA</b>	Occupational Safety and Health Administration
<b>PACS</b>	Physical Access Control System
<b>PG</b>	Program Guide
<b>RCDD</b>	Registered Communications Distribution Designer
<b>SF</b>	Square Feet, Square Foot
<b>SMS</b>	Safety Management System
<b>SSTV</b>	Security Surveillance Television System
<b>STC</b>	Sound Transmission Class
<b>TIL</b>	Technical Information Library
<b>TR</b>	Telecommunications Room
<b>TV</b>	Television
<b>UPS</b>	Uninterruptible Power Supply
<b>V</b>	Volts
<b>VA</b>	Department of Veteran Affairs
<b>VACO</b>	Veterans Affairs Central Office
<b>VAMC</b>	Veterans Affairs Medical Center



**Mental Health Specific Terms**

<b>BHIP</b>	Behavioral Health Interdisciplinary Program
<b>CARF</b>	Commission on Accreditation of Rehabilitation Facilities
<b>CBES</b>	Community-Based Employment Services
<b>CBOC</b>	Community Based Outpatient Clinic
<b>CCC</b>	Co-located Collaborative Care
<b>CRRC</b>	Community Resource and Referral Center
<b>CWT</b>	Compensated Work Therapy
<b>DTC</b>	Day Treatment Center
<b>GMH</b>	General Mental Health
<b>HCHV</b>	Health Care for Homeless Veterans
<b>H-PACT</b>	Homeless – Patient Aligned Care Teams
<b>HUD-VASH</b>	Housing and Urban Development – VA Supported Housing
<b>ICMHR</b>	Intensive Community Mental Health Recovery
<b>IOP</b>	Intensive Outpatient Program
<b>MH RRTP</b>	Mental Health Residential Rehabilitation Treatment Program
<b>MHICM</b>	Mental Health Intensive Care Management
<b>PACT</b>	Patient Aligned Care Team
<b>PCMHI</b>	Primary Care Mental Health Integration
<b>PCT</b>	PTSD Clinical Team
<b>PRRC</b>	Psychosocial Rehabilitation and Recovery Programs
<b>PTSD</b>	Post-Traumatic Stress Disorder
<b>RANGE</b>	Rural Access Network for Growth Enhancement Programs
<b>SE</b>	Supported Employment



<b>SEd</b>	Supported Education
<b>SSE</b>	Supported Self-Employment
<b>SMI</b>	Serious Mental Illness
<b>SUD</b>	Substance Use Disorder
<b>TBI</b>	Traumatic Brain Injury
<b>TMS (rTMS)</b>	(Repetitive) Transcranial Magnetic Stimulation
<b>TSES</b>	Therapeutic and Supported Employment Services
<b>VARC</b>	Veteran Addiction Recovery Center

### **LOGISTICAL CATEGORIES (LOG CATS)**

<b>VV</b>	VA furnished and installed – Medical Care Appropriations
<b>VC</b>	VA furnished and Contractor Installed – Medical Care Appropriations for Equipment and Construction Appropriations for Installation
<b>CC</b>	Contractor Furnished and Installed – Construction Appropriations
<b>CF</b>	Construction Appropriations – VA furnished. Installed by the Department of VA or Contractor
<b>L_RE</b>	Leased / Rented Equipment



**2.0 Narrative**

**2.1 General**

**2.1.1 Clinical and Operational Summary**

**2.1.1.1 Introduction**

The Veterans Health Administration (VHA) operates one of the most comprehensive mental health care delivery systems. The continuum of mental health care provided within VHA covers a wide range of mental health conditions that may be experienced by Veterans. Access to the appropriate level of care and ongoing continuity of care are vital facility design issues. The VHA’s continuum of services for mental health is delivered in settings that include outpatient, intensive outpatient, residential, and inpatient care, as well as community based settings. Within each of these settings, services are provided to promote recovery and individual potential, with an emphasis on evidence-based practices.

**TABLE 2: LEVELS OF CARE FOR VA MENTAL HEALTH**

	Outpatient				Residential	Inpatient
Level 1	Level 2	Level 3	Level 4a	Level 4b	Level 5	Level 6
Self-directed care (biblio-therapy, web-based mental health programs, etc.)	PACT (includes Primary Care Mental Health Integration [PCMHI] Providers)	General Mental Health (e.g. Behavioral Health Inter-disciplinary Program [BHIP] Team-Based Care)	Specialty Outpatient Programs (4a.1 PCT, 4a.2 SUD / IOP, 4a.3 Special Interventions)	Community-Based/ Focused Programs (4b.1 PRRC, 4b.2 ICMHR, 4b.3 TSES, 4b.4 Homeless Service Centers)	Residential Rehabilitation & Treatment Programs (RRTPs)	Inpatient Mental Health Services



Table 2 summarizes levels of care provided for VHA Mental Health services. These services will be defined in Section 2.1.2.1 and further described in the balance of Section 2.1.2 of this narrative. Levels 2 through 4 are the focus of this Outpatient Services Design Guide. Refer to VA Handbooks and Directives (list in Section 1.4 of this Design Guide) for additional guidance on design and services for other levels of care. Program acronyms are also defined in Section 1.5 of this Design Guide.

### 2.1.1.2 Guiding Principles

VHA health care is guided by principles including the need to provide high quality, timely, proactive, evidence-based, state-of-the-art, and holistic patient-centered care to Veterans. Mental health care in VHA is built upon the foundational principle of “recovery.” The definition of recovery used by VHA comes from the Substance Abuse and Mental Health Services Administration (SAMHSA) which states:

**“[Recovery is] a process of change through which individuals improve their health and wellness, live a self-directed life, and strive to reach their full potential.”**

Emphasis is placed on maximizing hope, meaning and individual potential. VHA is committed to promoting recovery in all patients, including those living with serious mental illness.

Mental health care delivery in VHA is delivered within an interprofessional team context, where team members interact and work together with the Veteran as partners in the treatment process. Interprofessional treatment teams are comprised of mental health professionals representing multiple disciplines as well as other professions. These professionals include, but are not limited to the following:

- Addiction Therapists
- Advance Practice Nurses/Nurse Practitioners
- Chaplains
- Clinical Pharmacists
- Dieticians
- Licensed Practical Nurses
- Licensed Professional Counselors
- Licensed Vocational Nurses
- Marriage and Family Therapists
- Peer Specialists
- Psychiatrists
- Psychologists
- Recreational Therapists





Registered Nurses  
Rehabilitation Technicians  
Social Workers  
Vocational Rehabilitation Counselors/Specialists

A supportive care environment is essential to assisting each Veteran in her or his recovery journey. Recovery is facilitated by team-based care providing therapeutic programming in warm, calming, and peaceful physical settings that utilize natural light, comfortable space and furniture design, soothing colors and art.

A supportive work environment is essential to enabling care teams to offer the therapeutic programming that promotes patient recovery. Treatment areas for individual therapy, family therapy, group therapy, and rooms for psychoeducation classes all have a place in the treatment process. In addition, it is important to provide areas to support staff in their work responsibilities and to promote collaboration with their colleagues.

### **2.1.1.3 VA Mental Health Outpatient Services Delivery Locations**

The outpatient component of the VA mental health care delivery system includes a wide range of specialized mental health treatment settings (see Section 2.1.2. for details).

These VA outpatient mental health services are most commonly included in:

- VA Medical Centers
- VA Outpatient Clinics, including Community Based Outpatient Clinics (CBOC), or
- Community-based settings that are not VA-based

For this third scenario, a Veteran may be referred to a community provider if they live too far from a VA facility, the needed specialist is not available, or the length of time is too long before they can be seen at a VA facility.

Through efforts to promote innovation in mental health care delivery and enhance service access and quality, outpatient mental health services are also increasingly being provided in non-mental health specialty settings including, but not limited to, Spinal Cord Injury Centers and Blind Rehabilitation Centers. Additionally, Veterans with mental health needs who find it burdensome to leave their homes and are otherwise eligible may receive services through the Home-based Primary Care (HBPC) program.

Note: The VHA Handbook 1160.01 Uniform Mental Health Services in VA Medical Centers and Clinics (amended Nov 16, 2015) defines program requirements for the mental health services that must be provided in CBOCs according to the size of the clinics. For VA space planning guidelines that pertain to CBOCs, refer to PG-18-9



Chapter 265 Outpatient / PACT Clinic and Prototype for Standardized Design and Construction of Community Based Outpatient Clinics, available on the VA TIL.

## 2.1.2 Outpatient Mental Health Services

### 2.1.2.1 Introduction

Outpatient components in the VA mental health care system include:

- Patient Aligned Care Team (PACT) Services provided by mental health staff embedded in primary care (PCMHI, Level 2; See Table 2, page 2-1). Space for the extended care team – discipline-specific or allied clinical team members such as Clinical Pharmacists, Dietitians, Social Workers and Mental Health Integration staff – is described in the PACT Space Module Design Guide as well as in Space Planning Criteria Chapters 264 and 265.
- General Mental Health Services, including Behavioral Health Interdisciplinary Program (BHIP) team-based care (Level 3; See Table 2, page 2-1)
- Specialty Mental Health Services (Level 4a; See Table 2, page 2-1):
  - Post-Traumatic Stress Disorders Clinical Teams (PCT)
  - Intensive Outpatient Specialty Mental Health Care (IOP, or Intensive Outpatient Programs), including Substance Use Disorder (SUD)
  - Special Interventions, location non-specific such as neuropsychological testing and repetitive Transcranial Magnetic Stimulation (rTMS) therapy
- Community Based/Focused Programs (Level 4b; See Table 2, page 2-1):
  - Psychosocial Rehabilitation and Recovery Centers (PRRC)
  - Intensive Community Mental Health Recovery (ICMHR), Mental Health Intensive Case Management (MHICM) and Rural Access Network for Growth Enhancement Programs (RANGE and E-RANGE)
  - Homeless Programs: Community Resource and Referral Centers (CRRC)
  - Therapeutic and Supported Employment Services (TSES) Community-Focused Programs. Note that some of these services take place on VA campuses and other services are provided in a community setting.

A brief narrative of each of these outpatient components is provided below. Additional information pertaining to mental health services and operational intent can be found in



VHA Handbook 1160.01 Uniform Mental Health Services in VA Medical Centers and Clinics, amended Nov 16, 2015,

[http://www1.va.gov/vhapublications/ViewPublication.asp?pub\\_ID=1762](http://www1.va.gov/vhapublications/ViewPublication.asp?pub_ID=1762)

Spaces that are designed to provide mental health care must accommodate the broad services provided within these spaces. Such services may include but are not limited to:

- Diagnostic and treatment planning evaluations for the full range of mental health conditions
- Treatment, including individual, group and family psychotherapy, with emphasis on evidence-based therapies (psychotherapy and pharmacotherapy)
- Cognitive and psychological assessment
- Patient education
- Consultation and referral
- Care/case management
- Family education when it is associated with benefits to the Veterans
- Care coordination with other levels of mental health care (e.g., PACT/PCMHI, specialty, residential, and inpatient) as needed.
- Vocational training
- Physical examinations, specimen collection and administration of medications

### **2.1.2.2 Level 1: Self-Directed Care**

Self-directed care involves the use of selected reading materials – books or web-based – to assist people in solving personal problems that may be related to mental or psychological disorders. This level of care is not a focus of this Design Guide.

Refer also to VA resources on the whole health approach, including the following:

[https://www.va.gov/PATIENTCENTEREDCARE/docs/2017-AR-Vet-Facing\\_FNL-W508.pdf](https://www.va.gov/PATIENTCENTEREDCARE/docs/2017-AR-Vet-Facing_FNL-W508.pdf).

The whole health approach is focused on empowering and equipping Veterans to take charge of their health and well-being.



### 2.1.2.3 Level 2: Primary Care Mental Health Integration (PCMHI)

Mental health services for conditions prevalent in the primary care population can often be provided by PCMHI providers working in an interprofessional Patient Aligned Care Team (PACT). Components of PCMHI include:

- Co-located mental health staff (co-located collaborative care, or CCC) providing direct assessment, treatment and informal consultative advice, and
- Collaborative care managers, who provide follow-up care, usually by telephone.

PCMHI's primary targets – conditions of mild to moderate depression, anxiety, and alcohol misuse – are gradually expanding as new evidence based approaches for more complicated conditions are developed. Locating necessary general and specialty mental health services in close proximity to primary care can enhance access and engagement for many of those with more complex illness. Space for the extended care team, which includes CCC providers, is described in the VA PACT Space Module Design Guide (2015). For the care management component of PCMHI, much of the care provided currently occurs by telephone. However, this may change (along with an impact on spatial need), as some research findings are demonstrating that an initial face-to-face contact with a care manager may lead to improved outcomes. Such contact can also be accomplished by clinical video telehealth, which is defined as remote visual/audio communication between the patient and care team professionals.

VA medical centers, healthcare centers (HCC), and large CBOCs shall accommodate the integration of mental health services in the primary care clinics on a full time basis. Smaller primary care CBOCs may have programs in place during times the clinic is open to provide same day access to mental health care that is coordinated with activities of PACT. Such CBOCs should be able to address common mental health conditions using the integrated care format, using onsite providers or telemental health. Initial access to a detailed screening assessment for triage can be done using care management.



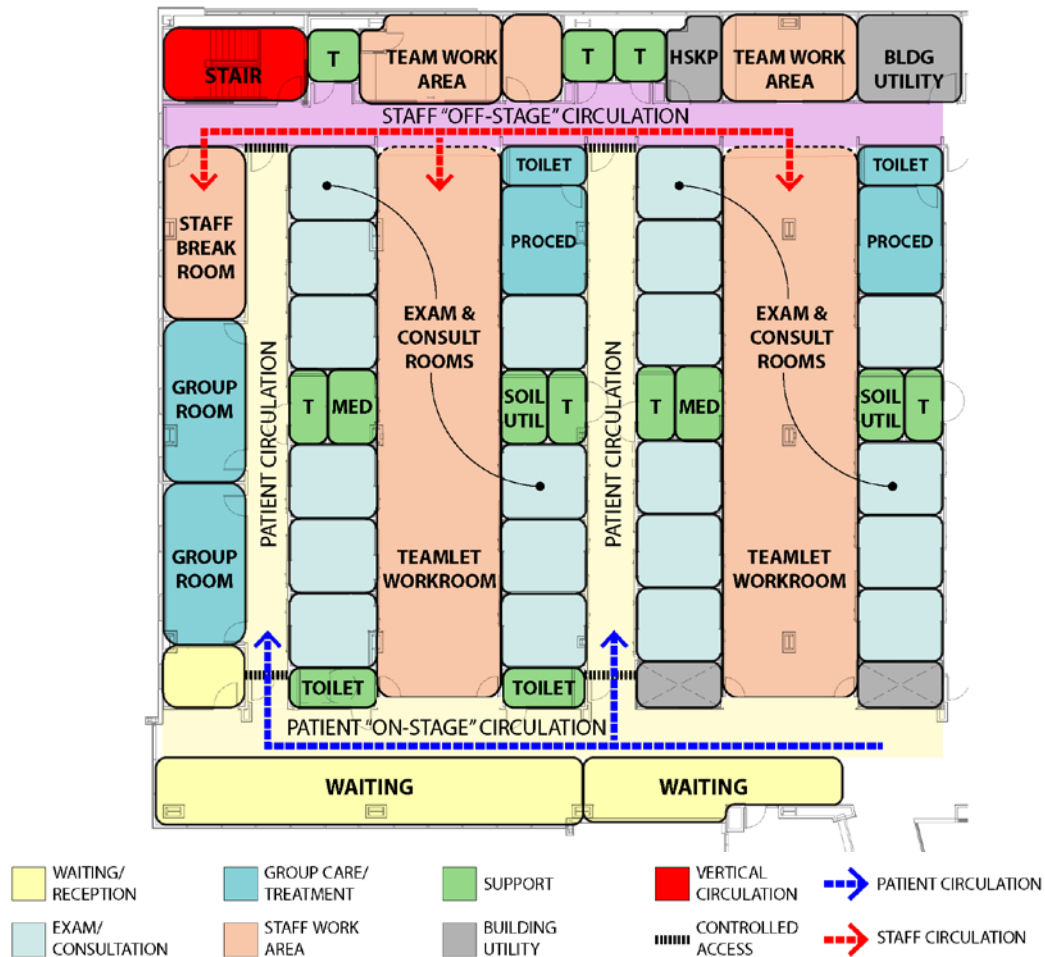

Figure 2.1.2.a. Partial plan diagram based on Major General William H. Gourley VA – DOD Outpatient Clinic in Monterey, CA

Figure 2.1.2.a illustrates two planning modules in a new VA facility that provides integrated primary care and mental health outpatient care, and houses some Department of Defense (DoD) clinical space. This clinic opened in August 2017. As of late 2017, four out of five PACT modules provide primary care and outpatient mental health care at the same time. Providers access the exam / treatment / consult rooms from a dedicated team work area (“off stage”) and patients access these rooms from patient corridors (“on-stage”). The concept of on-stage and off-stage, which is seen in this design, is more fully explained in Section 2.1.3.6 of the Design Guide.

Refer also to VA PACT Space Module Design Guide (<https://www.cfm.va.gov/til/dGuide/dgPACT.pdf>)



**2.1.2.4 Level 3: General Mental Health Services**

General Mental Health (GMH) includes team-based care for a full range of mental health services via the programs listed in Section 2.1.2.1. The major focus is on moderate-severe functional impairment. Within GMH, Behavioral Health Interdisciplinary Program (BHIP) teams are interdisciplinary groups of providers and administrative staff working collaboratively to provide recovery-oriented, Veteran-centered, and coordinated care. These teams work closely with PACT/PCMHI as well as specialty mental health to ensure Veterans receive the right intensity of treatment at the right time. Where GMH is provided in the same facility as PACT/PCMHI and/or specialty mental health programs, consider locating GMH services as close as possible to these programs to promote maximum access and coordination of care.

Refer also to VHA Handbook 1160.01 for a description of services.

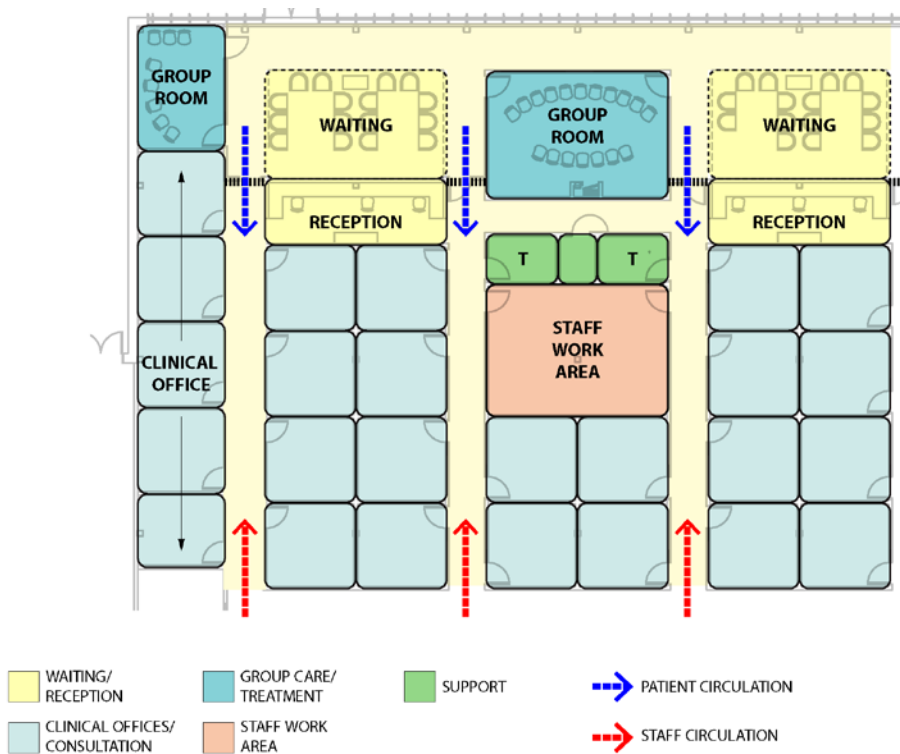

Figure 2.1.2.b. Partial plan diagram based on a recently constructed Department of Defense Behavioral Health Clinic

Figure 2.1.2.b depicts an example of a “traditional” clinic layout in a general Behavioral Health Clinic. Primary care services are not provided in this example. Although the layout provides separation of patient and staff access, patients and staff share the same corridors within the treatment zone.



### **2.1.2.5 Level 4.a: Specialty Mental Health Services**

Specialty mental health treatments are usually offered for Veterans with more complex or severe functional impairments, including those with serious mental illnesses (e.g., schizophrenia, depression or bipolar disorder, PTSD, and substance use disorders) who need more intensive, time-limited mental health care. These services are provided at medical centers and in CBOCs of various sizes.

Refer also to VHA Handbook 1160.01 for a description of services.

### **2.1.2.6 Level 4.a.1: Services Provided by Post-Traumatic Stress Disorders Clinical Teams (PCT)**

PTSD can occur after a person has a very serious or life threatening traumatic experience. For Veterans, this life-threatening event often occurs during combat. However, other non-combat related events—such as a natural disaster, motor vehicle accident, or sexual trauma—can also threaten life and can result in PTSD.

- Veterans with PTSD can be treated in a specialized PTSD clinic, GMH services clinic, or primary care PCMH service clinic.
- All VA medical centers and very large CBOCs shall provide space – including group therapy and clinical office / consultation rooms – to provide specialized outpatient PTSD programs that provide care and support for Veterans with PTSD.
- Other CBOCs shall provide space to provide diagnostic evaluations and treatment planning for PTSD through full-or part-time staffing or by telemental health with parent VA medical centers.

Refer also to VHA Handbook 1160.01 and VHA Handbook 1160.03, Programs for Veterans with Post-Traumatic Stress Disorder (PTSD) for a description of services.

### **2.1.2.7 Level 4.a.2: Intensive Outpatient Specialty Mental Health Care, including Substance Use Disorder (SUD)**

Substance Use Disorders Clinics provide outpatient screening, diagnostic assessment, and treatment for various substance use disorders (SUD). Serving a range of special Veteran populations, patients receiving care in this clinic may include but not be limited to patients with PTSD and other psychiatric conditions, as well as infectious diseases (e.g., HIV, AIDS, hepatitis C), traumatic brain injury (TBI) and spinal cord injury (SCI).



Where Intensive Outpatient Programs (IOP) are provided, it is beneficial to locate the IOP and SUD programs adjacent. Because most SUDs are chronic or episodic recurring conditions that require ongoing care, many Veterans receiving treatment, along with their families, will access the clinic frequently. Intensive outpatient services typically last 3 hours per day, 3 days per week. Consequently, the waiting area in this clinic should be comfortable with a choice of private and group seating options and other amenities for family members waiting for a patient receiving treatment for therapy. Direct access to an attractive outdoor space where possible is also recommended as an area for patients and families. Figure 2.1.2.c. provides a diagram of a facility that provides treatment to Veterans with SUD.

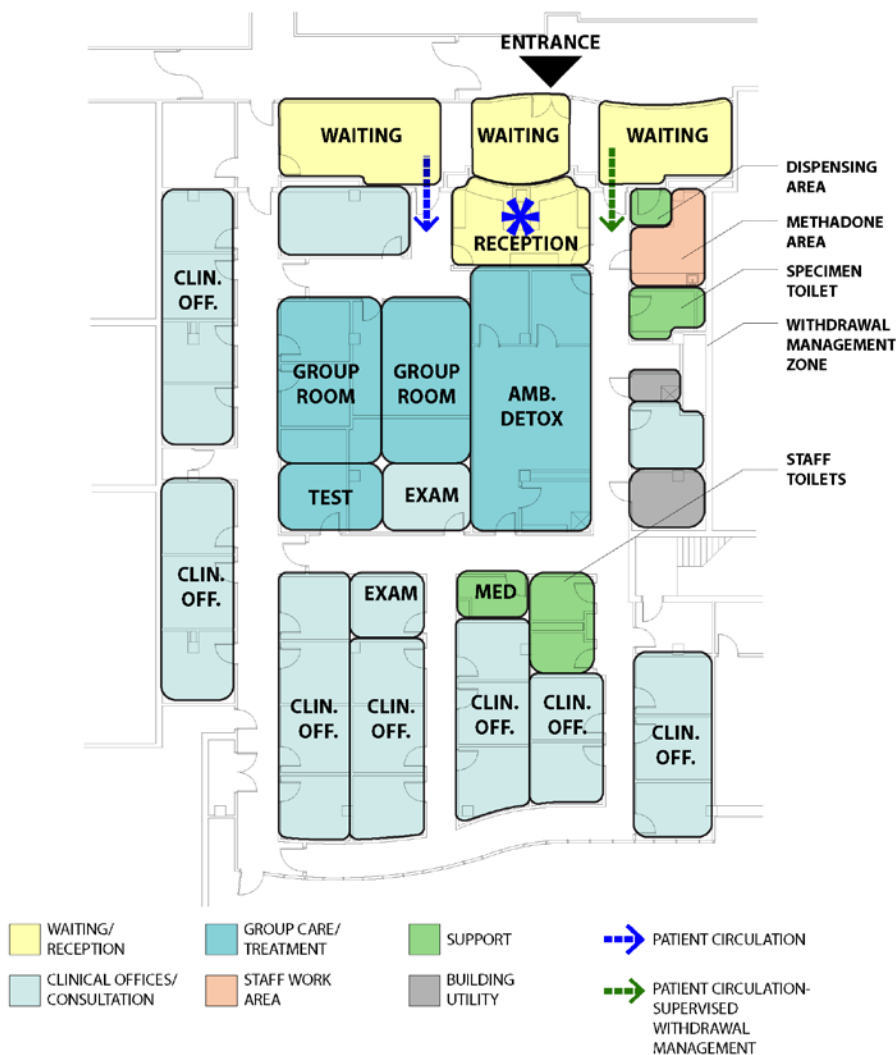

Figure 2.1.2.c. Floor plan diagram based on a Veterans Addiction Recovery Center

Medically supervised withdrawal management – defined as gradual reduction or tapering of medication dosage over time under the supervision of a physician – may





also be provided. Since methadone or suboxone may be dispensed at these facilities, these locations must comply with applicable regulatory requirements for confidentiality and security, including The Joint Commission, HIPAA, and Commission on Accreditation of Rehabilitation Facilities (CARF) standards.

In support of patient confidentiality and privacy standards, there should be at least two distinct waiting areas to separate patients undergoing medically supervised withdrawal management from patients being treated at the facility through intensive counseling. The reception area should be located adjacent to both waiting areas (Figures 2.1.2.c and 2.1.2.d).

Refer also to VHA Handbook 1160.01 and VHA Handbook 1160.04, Programs for Veterans with Substance Use Disorders (SUD) for a description of services.

Flow chart with arrows pointing from reception to waiting areas on either side. Arrows point from the waiting areas to the intensive counseling area and medically supervised withdrawal management. Flow chart with arrows pointing from reception to waiting areas on either side. Arrows point from the waiting areas to the intensive counseling area and medically supervised withdrawal management.

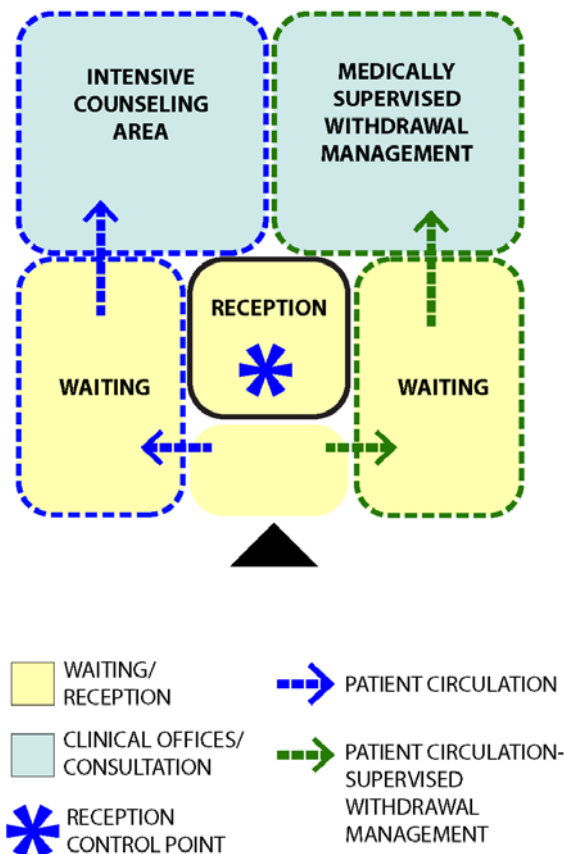

Figure 2.1.2.d. Entrance and waiting concept diagram for clinics where medically supervised withdrawal management service is provided

**2.1.2.8 Level 4.a.3: Special Interventions**

Certain mental health interventions (diagnostic testing and treatments) are most appropriately delivered in an outpatient setting and have unique space requirements. Examples include neuropsychological testing, which may require equipment to aid in the diagnostic process, and rTMS, which requires equipment for the delivery of magnetic stimulation and provisions for the reduction of equipment-generated noise. Refer to Figure 2.1.2.e for an example of a neuropsychology suite within a renovated VA Mental Health Clinic. Refer to Section 2.1.5.3 of this Design Guide for more detailed description of rTMS.

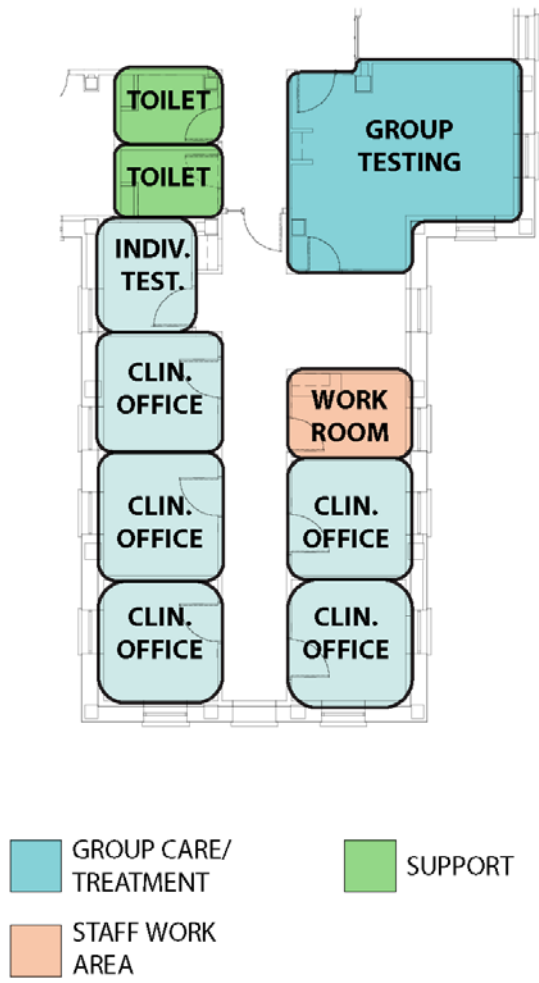

Figure 2.1.2.e. Floor plan diagram based on VA Battle Creek Neuropsychology suite, Mental Health Clinic renovation



### **2.1.2.9 Level 4.b: Community Based/Focused Programs**

Many VA Mental Health programs are community based, and are focused on assisting Veterans with community integration. These programs include the following:

- Psychosocial Rehabilitation and Recovery Centers (PRRC) are outpatient centers designed to support recovery and integration of Veterans with serious mental illness into the community.
- Intensive Community Mental Health Recovery (ICMHR) provides community-based services such as intensive case management to Veterans with serious mental illness.
- Community Resource and Referral Centers (CRRC) are outreach centers that work with community partners to assist Veterans who are homeless or at risk of being homeless.
- Therapeutic and Supported Employment Services (TSES) provides vocational opportunities to Veterans recovering from chronic mental illness, chemical dependency, physical disabilities and/or homelessness.

### **2.1.2.10 Level 4.b.1: Psychosocial Rehabilitation and Recovery Center (PRRC)**

The President's New Freedom Commission on Mental Health (2003), the Department of Veterans Affairs (VA) Mental Health Strategic Plan (MHSP), and the Uniform Mental Health Services in VA Medical Centers (VAMC) and Clinics (VHA Handbook 1160.01) all call for a transformation of mental health care to a recovery-oriented model. A key component of this transformation, detailed in VHA Handbook 1160.01, involves transforming all existing day treatment centers (DTC), day hospitals, partial hospitals, or analogous programs to PRRCs and establishing new PRRCs where they are needed.

Older DTC programs were outpatient stabilization programs intended for Veterans challenged with serious mental illness and significant functional impairment. The primary aim of these programs was to manage chronic symptoms and assist Veterans with avoiding re-hospitalization. However, they had limited expectations for those receiving treatment to recover or to be fully integrated into the community. The PRRCs that replaced these programs are now designed to help Veterans with such challenges to recover and to develop and enact meaningful, self-determined personal and community roles.

PRRCs are designed to maximize functioning for Veterans by providing a therapeutic and supportive learning environment. The PRRC may be located as part of a mental health facility or VA medical center, but ideally will be located independent of other mental health services and in a community setting.



Refer to VHA Handbook 1163.03 Psychosocial Rehabilitation and Recovery Centers (PRRC) (available on VA TIL) and the PRRC Implementation Checklist (available to VA internally for use by staff) for the complete description of PRRC program specifications and requirements.

### **2.1.2.11 Level 4.b.2: Intensive Community Mental Health Recovery (ICMHR) Programs**

ICMHR Services include Mental Health Intensive Case Management (MHICM), Rural Access Network for Growth Enhancement (RANGE), and Enhanced Rural Access Network for Growth Enhancement (E-RANGE), which are adaptations of Assertive Community Treatment (ACT) for Veterans with serious mental illness (SMI) and severe functional impairment. MHICM programs are required in all VA facilities with more than 1,500 Veterans included on the National Psychosis Registry (NPR) annual reports produced by SMI Treatment Resource and Evaluation Center (SMITREC). VHA Handbook 1163.06 requires office space for ICMHR team members, preferably in close proximity to each other so they can meet daily to coordinate care. Figure 2.1.2.f. depicts an office work environment that is suitable for team collaboration.

Refer also to VHA Handbook 1163.06 Intensive Community Mental Health Recovery Services for a description of services.



Figure 2.1.2.f. Example of open office collaborative work environment



### 2.1.2.12 Level 4.b.3: Therapeutic and Supported Employment Services (TSES)

TSES includes Compensated Work Therapy (CWT) programs (Supported Employment [SE]), Transitional Work, and a new model of service delivery that VA Medical Centers are encouraged to provide – Community-Based Employment Services (CBES). CWT services at some locations also include vocational assistance and strong practices of Supported Self-Employment (SSE) and Supported Education (SEd). A computer lab may be used by Veterans as part of a CWT program (Figure 2.1.2.g). These services are recovery-oriented, and are primarily provided in the community.

Refer also to VHA Handbook 1163.02 Therapeutic and Supported Employment Services Program for a description of services.

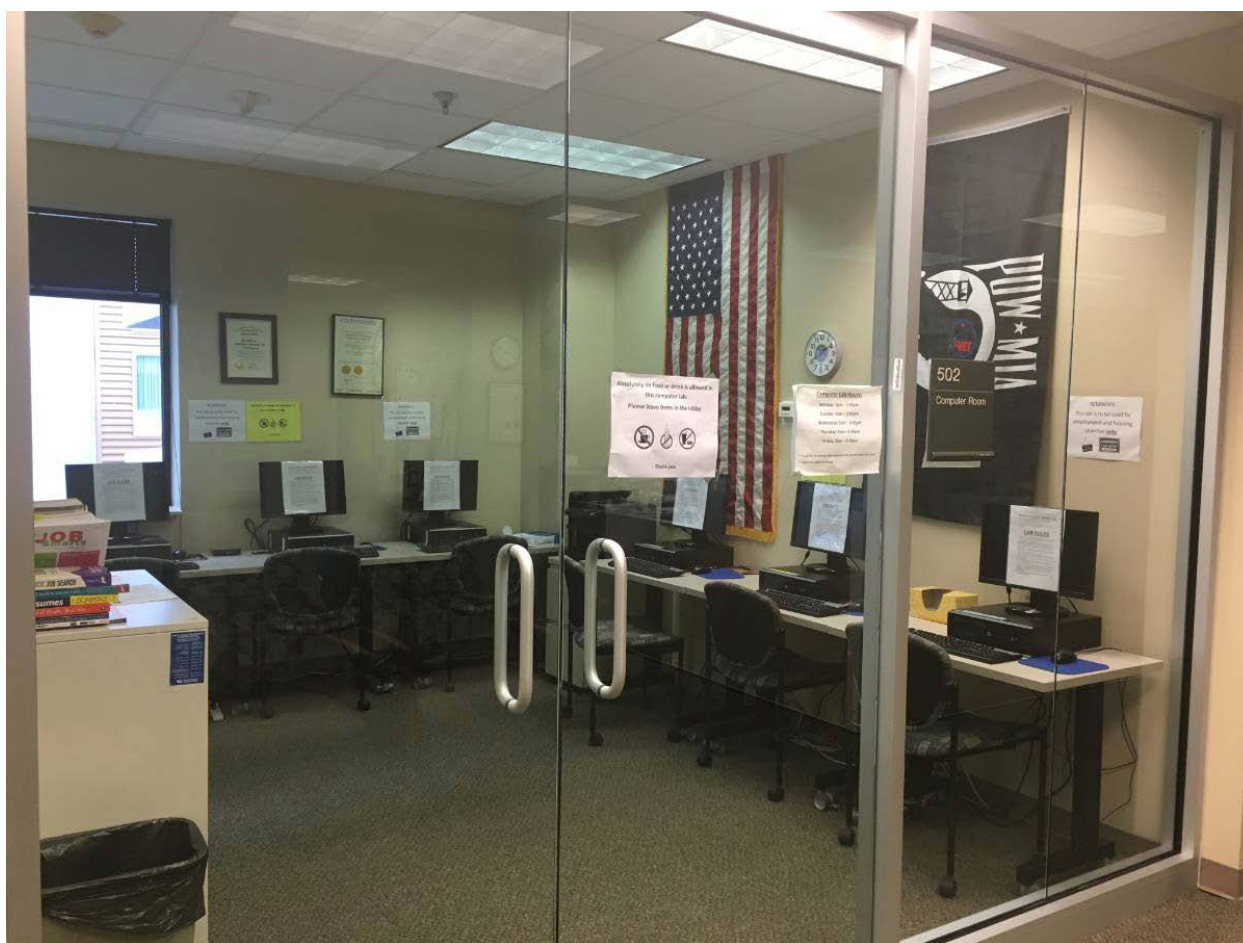

Figure 2.1.2.g. Veteran Computer Lab, William S. Middleton Memorial Veterans Hospital, Madison, WI.



### 2.1.2.13 Level 4.b.4: VHA Homeless Programs

Ending homelessness among Veterans is a key objective of VHA. VA has launched comprehensive strategies to end Veteran homelessness, including “Housing First” with supportive services to ensure Veterans are able to end the cycle of homelessness.

Community Resource and Referral Centers (CRRC) are VA funded and operated outreach centers that provide outreach and referrals for Veterans who are homeless or at risk of being homeless. CRRCs also enhance community partnerships. CRRCs are places where Veterans who are homeless or at risk of homelessness are connected to stable housing and an array of supportive services. CRRCs provide a “one-stop shopping” opportunity in many densely populated, strategically located sites across America. Health Care for Homeless Veterans Programs (HCHV), Health Care for Reentry Veterans Services (HCRV) and Housing and Urban Development-VA Supportive Housing Program (HUD-VASH) are programs and services that are often provided primarily in the community. Refer to Figures 2.1.2.h and 2.1.2.i (floor plan diagram) for an example of an HCHV Service Center in Grand Rapids, MI.

Refer also to VHA Directive 1501 VHA Homeless Programs, VHA Handbook 1162.05, Housing and Urban Development (HUD) – Department of Veterans Affairs Supported Housing (VASH) Program and VHA Handbook 1162.09, Health Care for Homeless Veterans (HCHV) Program.



Figure 2.1.2.h. Education Classroom in Health Care for Homeless Veterans (HCHV) Service Center, Grand Rapids, MI.



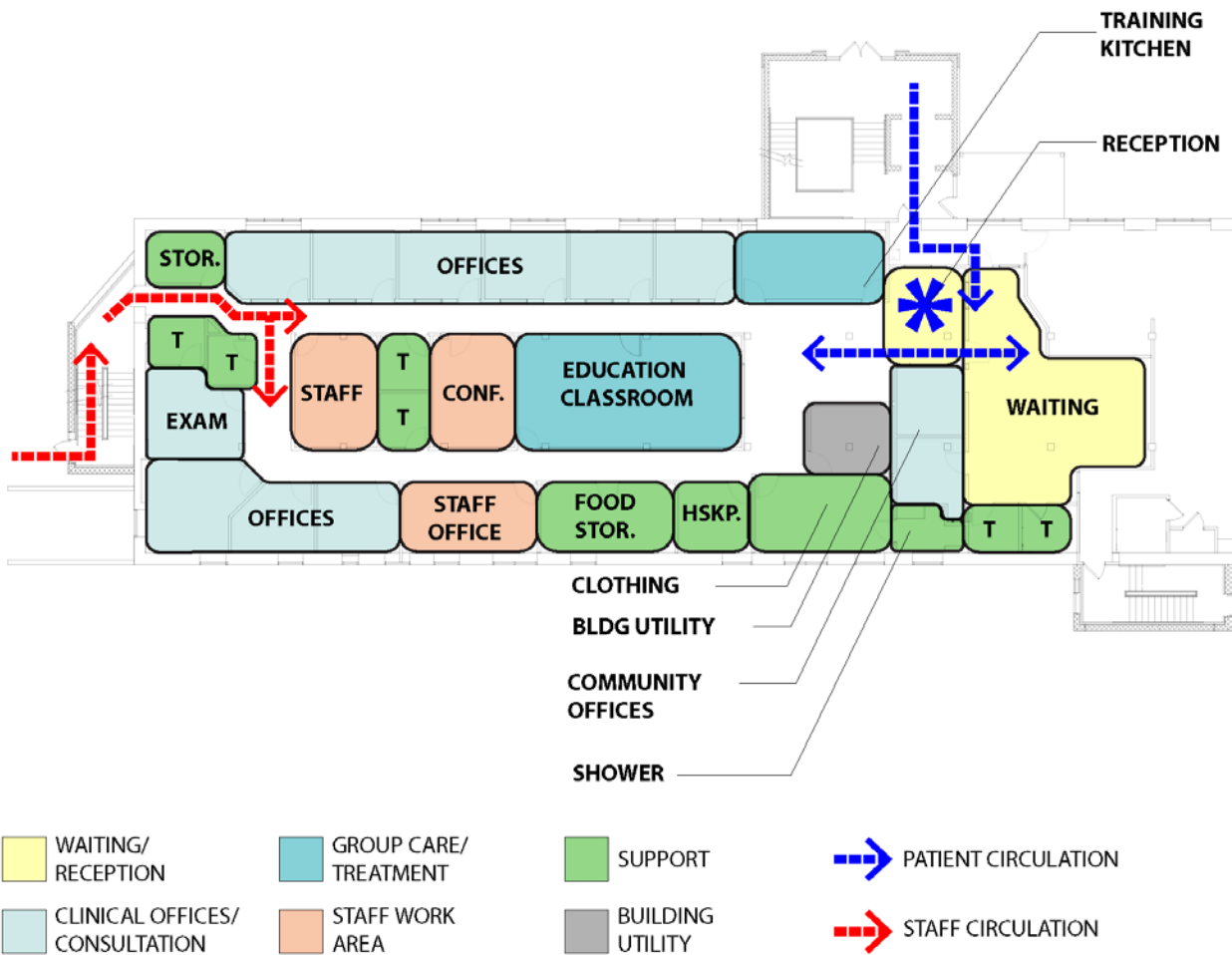

Figure 2.1.2.i. Floor plan diagram based on Health Care for Homeless Veterans (HCHV) Service Center, Grand Rapids, MI.





### **2.1.3 VA Trends in Outpatient Mental Health Services**

#### **2.1.3.1 Shift from Inpatient to Outpatient Services**

It is expected that outpatient mental health services will continue to grow at a faster rate than inpatient mental health services – in the private sector as well as in VA. The rapid growth is anticipated in CBOCs as part of VA efforts to improve access for Veterans, especially in underserved areas.

Effect on space planning:

- Focus of space need on outpatient settings
- Potential for more space in community settings, including leased space
- More opportunity for integration with primary care

#### **2.1.3.2 Expansion of Service Offerings**

In recent years, newer program types have emerged that “bridge the gap” between inpatient and outpatient mental health care. In the private sector, these include Psychiatric Emergency Departments (Psych EDs) and Crisis Stabilization Units, partial hospitalization, and intensive outpatient programs. The wider range of programs are aimed at providing the appropriate level of patient care and avoiding unnecessary inpatient utilization.

Examples of expanded service offerings at VA include PRRCs, intensive outpatient programs, community-based programs, and programs for homeless Veterans.

Effect on space planning:

- Development of services that bridge the gap between outpatient and inpatient care
- Potential for more space in community settings, including leased space

#### **2.1.3.3 Integration of Behavioral Health into Primary Care**

As noted in the PCMHI section (2.1.2.3), the integration of mental health services into primary care is a significant evolving change in how mental health services are provided. Literature has long confirmed that most mental health problems first present in primary care. More recently, numerous studies, including those published by VA, have demonstrated improved recognition and treatment of mental disorders if treatment is available in primary care. Section 2.2.1 of this Design Guide provides a selected list of citations to pertinent research articles.



PCMHI staff are integrated into PACT and are included in the “on-stage/off-stage” corridor layout that provides collaborative team work areas in each of the “off-stage” (staff-only) zones (refer to Section 2.1.3.6 for explanation of “on-stage/off-stage” concept and to Figures 2.1.3.d through 2.1.3.f). Although the need for general and specialty mental health space is expected to remain, increased clinical integration of PACT/PCMHI and general mental health (e.g. BHIP teams) and specialty mental health care is likely to occur over time, so consideration for proximal space layouts is important. Refer to Figure 2.1.3.a for an image of a PCMHI team work area.

Effect on space planning:

- Physical adjacencies of General Mental Health, Specialty Mental Health, and PACT/PCMHI services may be more commonly planned and implemented.

Physical adjacencies promote:

- Ease of referrals (“warm hand-offs”)
- Ease of provider communication and collaboration
- Facilitated treatment of co-occurring conditions
- Less need for the Veteran to travel long distances to other clinical locations; less travel may increase likelihood that the Veteran will follow through with the referred treatment
- Reduced time that the Veteran spends at the VA facility
- Increased Veteran satisfaction with their care experience



Figure 2.1.3.a. PCMHI extended care team work area, VA Primary Care Annex, Tampa, FL



#### 2.1.3.4 Increased Team-Based Care

Throughout the mental health continuum of services, there is a movement toward increased team-based care. For example, PCMHI is part of the team-based care in PACT; BHIP team members operate as a cohesive unit in GMH, and specialty mental health teams partner to provide intensive services (e.g., ICMHR/MHICM teams). Providing adequate amounts and types of space to support team-based functions and increased opportunities for team collaboration is critical. With the physical grouping of interdisciplinary team members, the team-based approach facilitates collaborative and timely treatment and reduces need for Veterans to travel to additional locations for care.

Effect on space planning:

- Design that provides a range of workspace, including “huddle” space for informal team collaboration and space for quiet activities
- Design that enhances visual connections among staff
- Design that accommodates quiet work space, including use of acoustic detailing and materials as well as technologies that support auditory privacy
- Use of modular planning approach that can support future rearrangement and changes in staffing and work flow

#### 2.1.3.5 Non-Institutional Treatment Environment

Development of non-institutional environments is a current and ongoing trend in the design of mental health and other health care environments. Creating a more familiar therapeutic environment helps reinforce the recovery focus of the program and reduce institutional stigma often associated with mental health treatment facilities. To this end, interior and exterior features of mental health facilities are incorporating spaces where patients, families, and caregivers can comfortably interact before or between appointments. Opportunities for relaxation, private conversation, education and self-report of symptom and satisfaction levels may more readily occur in these enhanced spaces (refer to patient education area Figure 2.1.3.b).

Other strategies for creating non-institutional environments include use of natural or natural-looking materials, use of familiar elements and recognizable landmarks, ease of access, and ease of movement. The ambiance and functionality of the space are intended to reduce stress, anxiety and negative distractions, and enable patients to focus on their recovery goals.

The exterior architecture, including outdoor space, and interior design impact the way patients and their families experience the care environment. This Design Guide



addresses these key components and provides guidance on creating warm, familiar, and welcoming settings and structures, based on available evidence and best practices.

Refer also to the Healing Environment Design Guidelines, available on the TIL at <https://www.cfm.va.gov/til/etc/HealEnvir.pdf>

Effect on space planning:

- Increased programming of family-friendly space such as:
  - Family consult room, including consideration for room size
  - Family waiting area, designed to accommodate family members with children
  - Family toilets, designed as unisex and including infant changing stations and feminine hygiene dispensers and disposals
- Designs that incorporate more varied waiting room seating arrangements and amenities (Figure 2.1.3.c), including:
  - Views to outdoors and nature
  - Access to natural daylight
  - Access to snacks and beverages
  - Seating for individuals (private), small groups and family groups



Figure 2.1.3.b. Opportunity for patient education and small-group seating



Figure 2.1.3.c. Views to outdoors and nature

### 2.1.3.6 On-Stage and Off-Stage Design



The “on-stage/off-stage” concept separates, where possible, patient pathways (“on-stage”) from staff support areas (“off-stage”). This minimizes noise, disruption and distractions in areas actively used by patients, thus providing a benefit to both patients and staff, including reduced stress and improved experience of care.

At newer VA Community Based Outpatient Clinics (CBOCs), a specific type of “on-stage/off-stage” concept provides off-stage team collaboration space that is separated from patient access corridors, most with dual-access exam and consult rooms (refer to Figures 2.1.3.d, 2.1.3.e and 2.1.3.f). This type of “on-stage/off-stage” approach is Veteran-centric with the goal of optimizing the patient’s experience of care. Providers come to the patient rather than the patient being sent to different providers. Design of these clinics thus supports excellent patient care in ways that include:

- Fewer unscheduled interruptions of patients and staff due to visual and physical separation of patient and staff circulation and space
- Improved wayfinding due to simplified patient circulation that is not shared with staff and service (fewer decision points for patients)
- Improved patient experience, which may include shorter visit duration due to fewer clinic stops per visit and close proximity of multi-disciplinary care teams

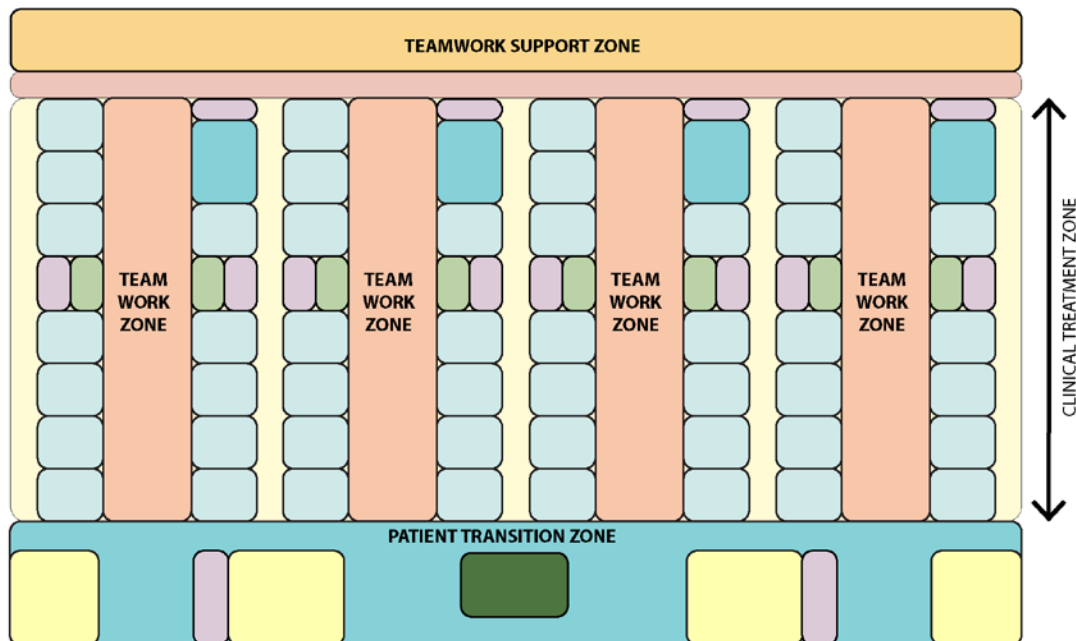

Figure 2.1.3.d. Diagram illustrating on-stage / off-stage layout of PACT modules used for PCMHI. Orange and red-shaded areas are “off-stage” staff areas. Blue and yellow-shaded areas are “on-stage” patient areas. (VA PACT Space Module Design Guide, 2015).





Figure 2.1.3.e. Patient (on-stage) corridor, Major General William H. Gourley VA – DOD Outpatient Clinic in Monterey, CA



Figure 2.1.3.f. Staff work area (off-stage) Major General William H. Gourley VA – DOD Outpatient Clinic in Monterey, CA (construction photo showing staff doors to patient care rooms)

The “on-stage/off-stage” concept can also be adapted for mental health clinic settings that are not integrated into primary care or other non-mental health services. Compared to primary care environments, layouts for mental health clinics may require different proportions of collaborative team space and private patient encounter space to better align with the mental health team structure and reflect the amount of provider time spent in consultation with patients. Patients in such settings still may benefit from the Veteran-centric advantages of the “on-stage/off-stage” design concept as described in the preceding paragraph. Refer to Section 3.0 Functional Diagrams, including the basic modular diagram (Figures 3.2.1 and 3.2.2) for illustrations of this concept for outpatient mental health.

For care team staff who work in shared “off-stage” space, the design accommodates personal storage and allows access to enclosed space for private meetings or telephone calls.

Effect on space planning:

- Emphasis on modular planning and standardized room sizes
- Sharing of staff spaces: the open “off-stage” Team Work Zone and Teamwork Support Zone allow sharing of staff support spaces among co-located teams



- Opportunity for access to enclosed staff spaces for private meetings, telephone calls or consultations

### 2.1.3.7 Use of Technology

Technology can facilitate integration and enhance patient documentation, security, patient education and patient access. For example, the increased adoption of telemental health has improved communication between primary care providers and behavioral health specialists, thus facilitating care integration, as well as allowing virtual visits between providers and patients, thereby improving patient access.

In addition to facilitating integration, the use of technology in mental health facilities provides benefits in enhancing security and communications. Security enhancements include door control, inventory control, and facility monitoring and alarm systems (local and remote). Duress alarms may be provided in reception, therapy and activity spaces. Door control may be used to control access to treatment area corridors and staff (off-stage) corridors. Security enhancements will also be required for medication rooms.

Communication enhancements include access to continuously updated patient treatment documentation by all appropriate members of a patient's interdisciplinary care team as well as the ability to consult with other providers and trusted entities via, email, instant messaging, telephone, and video conferencing. These enhancements will be found mostly in the "off-stage" areas of the outpatient setting.

Perhaps the greatest benefits of technology can be seen in the area of patient care enhancements. A key component of the VA's patient care includes telemental health. Telemental health refers to remote visual/audio communication between the patient and care team professionals. Individual consultations may utilize personal computers with a camera. This technology is important to ensuring continuity of care for those patients living in remote or rural areas. There is a focus on increased use of audio-and video-conferencing capability for direct clinical care use in all facilities, for individual patients and for groups. Appropriate technical support and capacity for data transfer (bandwidth) are required at the facility to allow for maximal use of telemental health care. These enhancements will be found mostly in the "on-stage" areas of the outpatient setting. Physical space requirements include:

- Space to accommodate the patient and provider comfortably in their respective rooms, including consideration of space to accommodate family or other groups where appropriate to the service offered
- Selection and placement of lighting sources to adequately illuminate the faces of the participants



- Acoustic isolation in both the originating and distant site to provide privacy and confidentiality, and also to limit distracting noise from outside the room
- Secure space to prevent tampering or unauthorized use of the equipment

Another example of facilitating integrated patient care is direct patient access to computers. This direct access is an important component of recovery and rehabilitation and should be incorporated into the design of mental health facilities across all levels of the care continuum. In integrated primary care – mental health (PCMHI) and general mental health settings, computers are essential tools for recording a patient’s current self-assessment of symptoms and functioning, which can then be used by the clinician and patient to evaluate clinical progress and determine appropriate changes in the treatment plan. Options for the delivery of this information include desks with computers and mobile units (e.g. tablets and similar portable devices, Figure 2.1.3.h) that allow patients to enter information without the requirement for a dedicated space in the waiting area. In addition, fixed units such as kiosks (refer to Figure 2.1.3.g) may be used patients for clinic registration / check-in.



Figure 2.1.3.g. Registration kiosk



Figure 2.1.3.h. Mobile device (tablet) in waiting area

Effect on space planning:

- Reduced space for queueing at registration desks
- Every clinical office and consultation room should be capable of supporting telemental health
- Space for computer-based patient education, typically in or near waiting rooms (refer to Figure 2.1.3.i room scheduling display and Figure 2.1.3.j computer lab)







Figure 2.1.3.i. Electronic room scheduling display, Orlando VA Medical Center at Lake Nona



Figure 2.1.3.j. Veteran Computer Lab, Coatesville VAMC, PA

## 2.1.4 Space Planning and Design Concepts

### 2.1.4.1 Flexibility and Adaptability

Design of an outpatient mental health facility needs to respond to changing workloads, care objectives and technologies. One goal of flexible and adaptable design is to reduce the potential cost and disruption of physical changes to facilities as program and functional needs change. Strategies for flexibility and adaptability include:

- Standardized room size to provide flexibility, with the ability to convert between the most common space types –consultation and exam and office function – over time (refer to Figure 2.1.4.a)
- Standardized clinical module configuration and clinical unit layouts to facilitate staff re-orientation to different clinical units, and to simplify reassignment and expansion of clinical zones. Clinical zones are illustrated in Figure 2.1.3.d for primary care and Figure 3.2.1 for General Mental Health.
- Ability to convert modules to accommodate other mental health specialties or evolving operational concepts (refer to Section 3.4)

#### 1 OFFICE MODULE

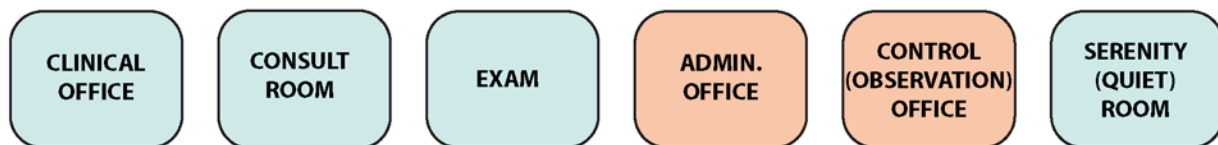

#### 1-1/2 OFFICE MODULE

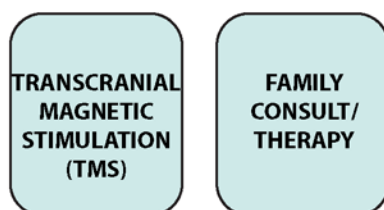

#### 1/2 OFFICE MODULE

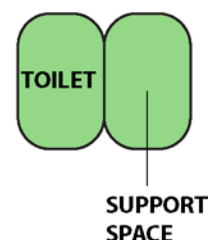

Figure 2.1.4.a. Diagram of modular room sizes based on standard clinical office size





Figure 2.1.4.b. Standardized meeting or education spaces with alternative furniture layouts for lecture and discussion formats (VA Tampa Primary Care Annex). Moveable partition shown in left image.

- Locate and design group care spaces to accommodate a range of functions, and to enable change in function. For example, a group-sized room may also accommodate conference, training, or group testing functions depending on furniture arrangement (refer to Figure 2.1.4.b). Note that group therapy appointments, by definition, accommodate no more than 12 patients. An education room or conference/classroom will accommodate more than 12 patients.
- Location of furniture and equipment storage rooms near larger group spaces to support flexibility of furniture arrangements. Ability to quickly and conveniently store chairs, tables, and other equipment can facilitate:
  - Use of the same room for different group sizes
  - Sequential use of the same room for different therapeutic, testing, meeting or educational functions
  - Improved group room utilization



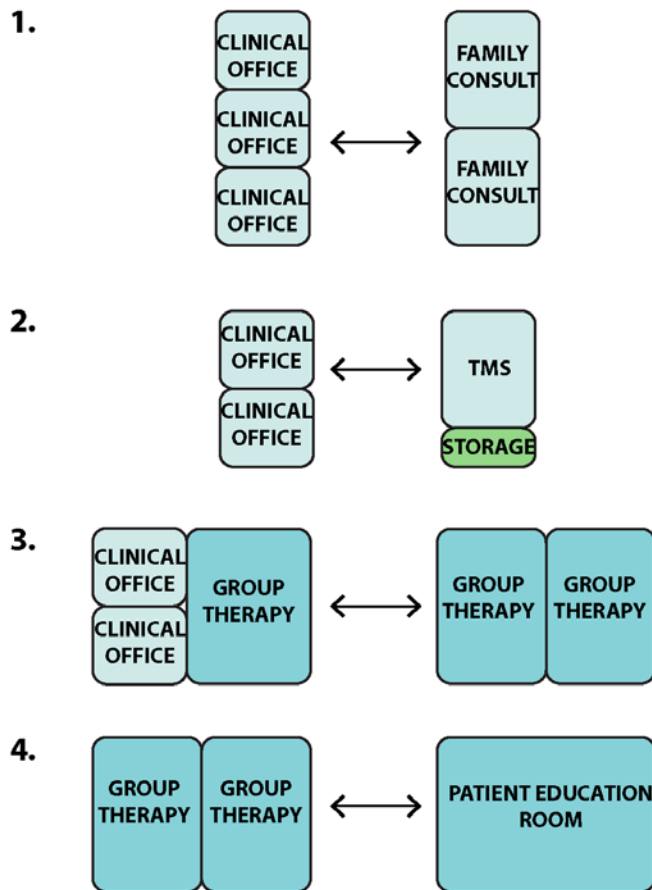

Figure 2.1.4.c. Illustrations of modular design strategies that facilitate modifications to plan layouts

- For outpatient mental health, a modular design strategy with standardized room sizing will facilitate future changes such as combining adjacent consult rooms to provide additional group therapy rooms (refer to Figure 2.1.4.c). Examples (keyed to numbers on the diagram) include:
  1. Convert between three clinical offices and two family consultation rooms
  2. Convert between two clinical offices and a treatment room + storage
  3. Convert between group therapy + two clinical offices and two group therapy rooms
  4. Convert between two group therapy and a patient education or conference room / classroom

Refer also to Section 3.3 Functional Diagrams that illustrate these examples in more detail.



- “Generic” spaces, including clinical offices, consultation rooms, and group therapy rooms, are typically the most common room types in outpatient mental health facilities. Consider room proportions for specialized rooms – such as treatment spaces that use specialized equipment – that coordinate with modular dimensions to facilitate future changes, as long as the room proportions for the specialized rooms are also functional.
- Use of moveable partitions provide flexibility for use of group and conference space, for example, to convert a large conference room to two group therapy rooms. However, acoustic privacy requirements must be met.
- Providing all consultation rooms, offices, group therapy and education rooms with technology systems such as telehealth, thus reducing patient and staff movement.
- The provision of telecommunications cable runs (data drops) in all rooms should be planned to enable flexibility of use for those spaces over time.
- Consider locating other infrastructure – for example, plumbing for sinks – to enable future conversion of offices to exam rooms or other functions. Details of this strategy may be considered on a project-specific basis.

#### **2.1.4.2 Adjacency and Flow**

The “on-stage/off-stage” design concept – as described in Section 2.1.3.6 of this Design Guide – separates patient pathways (on-stage) from service and staff support areas (off-stage). This minimizes noise, disruption and distractions in areas actively used by patients. Simple and predictable circulation paths with a limited number of decision points also help patients with wayfinding throughout a facility.

Space adjacencies that support desirable zoning and flow include:

- Locate larger group therapy and patient education spaces closer to main waiting, which supports separation of high volume, active, and noisy areas from quieter areas
- Reception as “control point” between patient arrival and patient care and staff work zones
- Patient care spaces easily accessible from arrival and waiting to minimize patient travel distance



- Space for formal and informal team collaboration located near other staff work locations. Staff spaces, including conference room, team room, training room, staff lounge and team work area, are identified in Space Planning Criteria Chapter 260.

Section 3 of this Design Guide documents concept diagrams that illustrate adjacency, flow and other planning principles. Figure 3.2.1, for example, illustrates on-stage/off-stage zoning, location of group therapy spaces, reception as control point, and location of team collaboration space.

#### **2.1.4.3 Interior Design and Wayfinding**

Interior design, including room finishes, furnishings and lighting design should support a calm and non-institutional therapeutic environment. Wall color, trim, accent colors and securely anchored artwork in common areas and patient therapy rooms all contribute to enhance the environment. Refer to Interior Design Section 2.2.3.1 of this Design Guide for specific design strategies.

Signage should be clear and easy for patients to read from a distance. Active wayfinding systems (signage and electronic signage) should complement passive, or intuitive, wayfinding, including use of color and landmarks. Refer to the VA Signage Design Guide.

#### **2.1.4.4 Accessibility**

Corridor widths and rooms should accommodate mobility devices including motorized scooters. All areas must be wheelchair accessible. Corridors shall be a minimum of 6 feet [1.83 m] clear to allow passage of two wheelchairs.

Provide minimum turning space of 6 feet [1.83 m] where needed to accommodate use of bariatric wheelchairs. Provide minimum 5'-6" turning space in spaces not designated as "bariatric". Beyond these required minimum standards, designers should consider actual sizing and clearances required to accommodate the majority of persons using mobility devices, including motorized scooters. Refer to VA Barrier Free Design Standard PG-18-13.

#### **2.1.4.5 Patient Privacy and Confidentiality**

Privacy and confidentiality in the clinic is supported by appropriate planning and design concepts that serve the diverse Veteran population. Refer, for example, to VA Directive 1330.01 Health Care Services for Women Veterans for a discussion of privacy, dignity,



and sense of security for all Veterans, and particularly women Veterans, in ambulatory care settings.

- Provide sound insulation in partitions around therapy rooms and telemental health space to prevent confidential but loud conversation from traveling beyond those rooms. For information on acoustic controls and sound transmission criteria, refer to Section 2.2.3 Architectural and Section 4 Room Data Sheets in this Design Guide.
- In a scenario where the care team is working in a common area with open workstations, provide private clinical office space for private telephone conversations. Consultation rooms or conference rooms may be used to meet this need. Refer to Figure 3.2.1 for an illustration.
- Check-in / interview areas should be designed to provide both visual access and auditory privacy (refer to Figure 2.1.4.d and to Interior Design Section 2.2.3.1).



Figure 2.1.4.d. Check-in area



#### 2.1.4.6 Safety and Security

Safety considerations for outpatient mental health are similar to safety considerations for primary care. Many of the same patients use primary care and outpatient mental health services. Incidents can occur in either setting and may involve patients not currently receiving outpatient mental health services. Design for safety should be provided in all areas.

Planning and design should seek balance between risk and quality of environment. To the extent possible, the design should incorporate “passive” safety measures – that is, built-in planning features such as clear sight lines and architectural elements as barriers where appropriate.

Security and safety in the clinics can be supported by the following design strategies:

- Clear staff sight lines from reception to waiting areas
- Co-location of staff spaces for staff “backup”, for example, work areas near reception
- Environments and amenities that, along with staff actions, facilitate stress reduction. For example, clinic layout and furnishings can support a staff or volunteer practice of greeting an arriving Veteran.
- Secured access to all functional areas for all users
- Avoidance of fall opportunities such as open multi-story spaces
- Technology, including electronic access and location monitoring of patients
- Thoughtfully placed convex corner mirrors as an option if necessary







Figure 2.1.4.e. Rooftop terrace

#### **2.1.4.7 Additional Design Considerations for PRRCs**

Ideally, Psychosocial Rehabilitation and Recovery Centers are located in the community.

For all PRRC programs, including those located on hospital sites, landscaped outdoor space should be available to program participants during their extended participation in the program. The outdoor space should be furnished to allow program participants to utilize the space for activities such as dining and socializing as part of the therapeutic experience. Figure 2.1.4.e depicts an outdoor space that supports dining and socializing.

All PRRCs are required to have a recovery resource area, which serves as a resource library for personal use by Veterans and is ideally located close to the waiting area. Indoor therapeutic activity spaces such as dining and occupational therapy, as described in Section 2.1.5.2, may also be provided.

#### **2.1.4.8 Additional Design Considerations for CRRCs and HCHV Service Centers**

Community Resource and Referral Centers (CRRCs) are facilities that serve homeless Veterans. Their preferred location is in community settings that are easily accessed by public transportation. These facilities provide space to accommodate VA and community agency staff. Other than location and office space, there are few formal space program requirements but many options for program space components.



Potential space types include waiting / reception, exam room, clinical office or consultation room, group therapy, occupational therapy and other activity or educational spaces. Program space components are determined by local VA leadership based on clinical demand and programming needs. Prior to the development of CRRCs, some Health Care for Homeless Veterans (HCHV) programs had Service Centers, which are very similar to CRRCs.

Shared offices and flexible assignment of offices shall be encouraged where staff spend varying amounts of time offsite. Similarly, hoteling space should be provided for visiting staff, including community partners.

Clothing closet (storage room for donated clothing), washer and dryer room (to clean Veterans' clothing), and shower room may be provided in these facilities. The washer and dryer room may be co-located with clothing storage room or with occupational therapy room if that space is programmed.

A teaching kitchen (Figure 2.1.4.f) may be provided in CRRCs and HCHV Service Centers as well as in PRRCs (Section 2.1.4.7 above). Homeless Veterans served here may not have access or may not feel comfortable utilizing a teaching kitchen elsewhere.



Figure 2.1.4.f. Teaching kitchen in HCHV Service Center, Grand Rapids, MI.



## 2.1.5 Design Considerations for Specific Spaces

### 2.1.5.1 Waiting and Reception

Waiting spaces shall accommodate the full range of users and allow for different preferences in seating arrangement:

- Users include patients as well as spouses and children.
- Effectively differentiating sub-spaces within the larger waiting area can help to make the space comfortable for different users (refer to Figure 2.1.5.a).
- Seating options should accommodate private, small clusters and larger groups for patient choice.
- Lobby areas shall not provide fall opportunities such as open multi-story spaces.



Figure 2.1.5.a. Adjacent waiting (left) and children's play area (right) in Women's Clinic, VA Tampa Primary Care Annex

The reception area shall be located adjacent to the waiting area, for greeting and observation of patients, family members and other visitors. Entrances to patient corridors in the treatment zone of the clinic shall be easily observable from the reception desk. Also refer to Section 2.2.3.1 Interior Design for design strategies related to waiting and reception areas.

In clinics where medically supervised withdrawal management is provided, there should be at least two distinct waiting areas to separate patients undergoing medically supervised withdrawal management from patients being treated at the facility through intensive counseling (refer to Section 2.1.2.6 of this Design Guide).



### 2.1.5.2 Patient Care Spaces

The following descriptions should be reviewed in conjunction with the Room Templates documented in Section 4 of this Design Guide.

**Transcranial Magnetic Stimulation (TMS)** is a non-invasive procedure that uses magnetic pulses to stimulate nerve cells in the brain to improve symptoms of depression. Refer to Figure 2.1.5.b. Room design considerations include:

- Provider/technician view to patient's face from workstation
- Adequate clearances to allow staff movement around treatment chair and unit
- Mitigation of acoustic/sound transmission related to loud clicking sounds that are generated by magnetic coils.

Level of noise generated by the magnetic coil equipment may vary by equipment manufacturer and model. Designers should refer to manufacturer recommendations and/or coordinate with a professional acoustical consultant to provide a sound suppression system. Strategies to mitigate noise may include:

- Construction methods that limit sound transmission to adjacent rooms (Sound Transmission Class, or STC rating)
- Provision of sound-absorbing finishes in the treatment room
- Location of this room so it is not directly adjacent to a clinical office or group therapy room where noise emanating from the TMS room may cause distraction.



Figure 2.1.5.b. Transcranial Magnetic Stimulation (TMS) Room in Rachel Upjohn Building, University of Michigan Psychiatry Department, Ann Arbor, MI



**Clinical Office or Consultation Room** is the basic building block of outpatient mental health facilities. This Design Guide refers to an office assigned to a provider as a “clinical office”. A room that is not dedicated to a specific provider and is used for patient counseling is called a “consultation room”. Four design variations are documented in Design Guide Section 4 (Room Templates). Examples (keyed to numbers on the diagram) are shown in Figure 2.1.5.c:

1. Dedicated Clinical Office with single access
2. Dedicated Clinical Office with dual access
3. Non-dedicated Consultation Room with single access
4. Non-dedicated Consultation Room with dual access

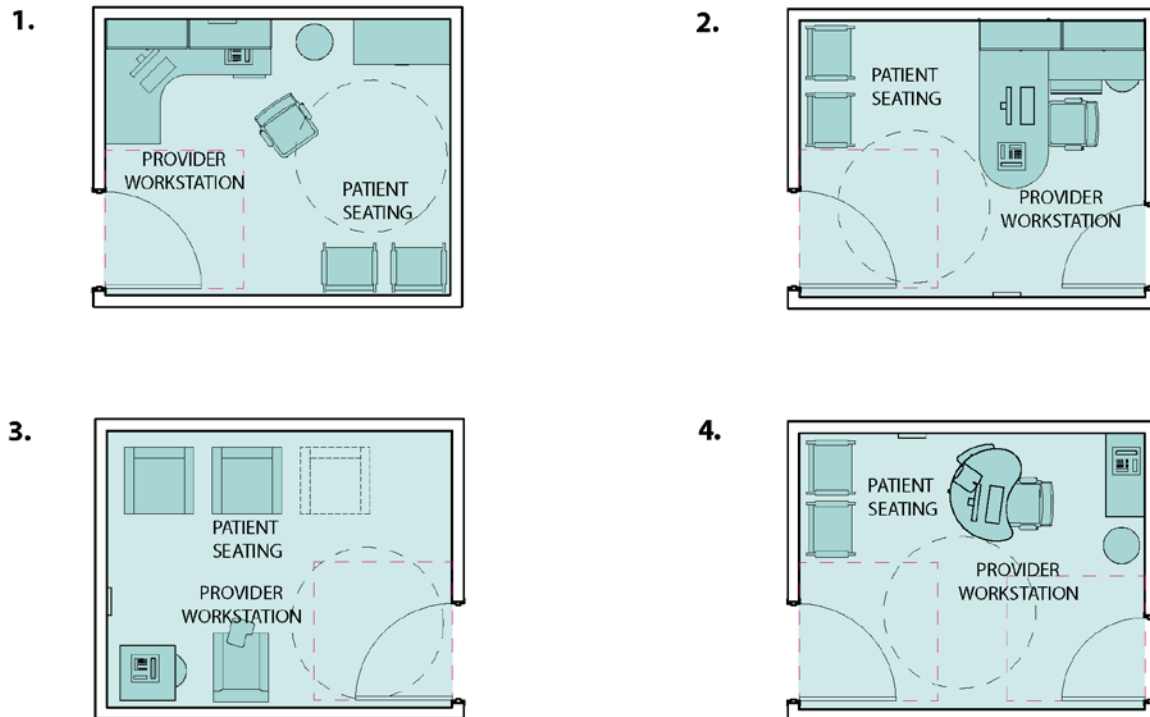

Figure 2.1.5.c. Illustration of clinical office and consultation room layouts

For example, a dedicated office with single access (Example 1) reflects a “traditional” model of service delivery, whereas a non-dedicated office with dual access (Example 4) can be found in a PCMHI setting. A room layout where the desk surface is situated between the Veteran and the therapist (Example 2) is often suitable for neuropsychology testing. Seating layout should have provider facing the Veteran. In



Example 1, the clinician will face the patient during a therapy session and can turn their chair to use the desk for documentation between sessions.

Other design considerations include:

- Provider workstation situated in close proximity to door (Figure 2.1.5.c) so the provider can have first egress unimpeded by the patient.
- Flexible furniture arrangement
- Options for clinician documentation include a desk (modular casework), mobile workstation, articulating arm work surface, and chair with tablet arm (refer to Figures 2.1.5.d, 2.1.5.e and 2.1.5.f)



Figure 2.1.5.d. Mobile computer workstation



Figure 2.1.5.e. Articulating work surface



Figure 2.1.5.f. Chair with tablet arm

- Non-institutional, comfortable environment, which may be supported by:
  - Use of furniture and finish materials that do not look institutional
  - Warm lighting
  - Natural daylight where possible
- Sliding door may be considered instead of a swinging door, especially in dual access clinical office, to support maneuverability within the room. Where sliding doors are selected, they should be gasketed with a sound transmission coefficient (STC) rating. Minimum STC 50 is recommended for the room, based on FGI Guidelines Table 1.2-6 Design Criteria for Minimum Sound Isolation Performance between Enclosed Rooms (refer to Section 2.2.3.3 of this Design Guide).
- Consider capping plumbing lines in the wall for room adaptability (e.g., future conversion to exam room). Architectural designers should confer with plumbing engineers and cost estimators when pursuing this strategy.
- The **Family Consultation/Therapy Room** will be sized to accommodate up to six occupants, including the counselor. This consultation room is a scheduled space for groups too large for a standard-size consultation room. The same list of design considerations described for “clinical office or consultation room” (non-institutional, comfortable environment, etc.) also apply to this room. Consider including a small area for children’s play.



Figure 2.1.5.g. Group therapy room, University of Michigan Psychiatry Department, Rachel Upjohn Building, Ann Arbor, MI

The **Group Therapy Room** is typically sized to accommodate up to 12 patients and is used for patient activities and counseling. Freedom of movement during sessions is an integral part of the treatment. These rooms also serve as education space for patients and staff and accommodate staff conferences, treatment team meetings and large family therapy sessions. Design considerations include:

- Non-institutional, relaxed and comfortable environment (Figure 2.1.5.g)
- Flexible furniture arrangements that may include an open circle of seating or seating around conference table. Flexibility is supported by:
  - Stackable chairs
  - Foldable tables
  - Access to storage room
- Spacing of chairs that recognizes needs of Veterans
- Provider workstation closest to door of the room. The office furniture should be arranged so that the patient is not in a position to block access to the exit.
- Furniture selection – e.g., mobile computer workstation – that supports clinician documentation needs
- Co-location of group therapy rooms such that moveable partitions, if provided between rooms, may be opened to create spaces for larger groups
- Some sessions or classes used by Veterans need to accommodate more than 12 patients. A patient education room or conference room / classroom will accommodate the larger group.

A **Group Testing Room** may be provided as part of a neuropsychology clinic (Special Interventions), General Mental Health clinic, or community-based program such as Therapeutic and Supported Employment Services (TSES). The same room layout may serve as a computer lab in TSES. Design considerations include:

- Staff workstation is provided in the room, located closest to door
- Seating for Veterans' workstations should face staff desk and door to room
- Number of testing workstations may vary by project and facility
- Each workstation to accommodate computer, monitor, keyboard and area for writing
- Ample space to allow ease of circulation





- Room proportions should support efficient use of space

A **Multipurpose Room** may be provided for use by Veterans. Refer to Figure 2.1.5.h. Design considerations include:

- Room to accommodate occupational, music or art therapies, display of artwork, social activities or wellness activities such as yoga or Pilates
- Flexible furniture arrangement to support the various activities
- Room to accommodate storage for seating, tables, equipment and supplies
- Sizing of room to support alternative use as a group therapy or training room

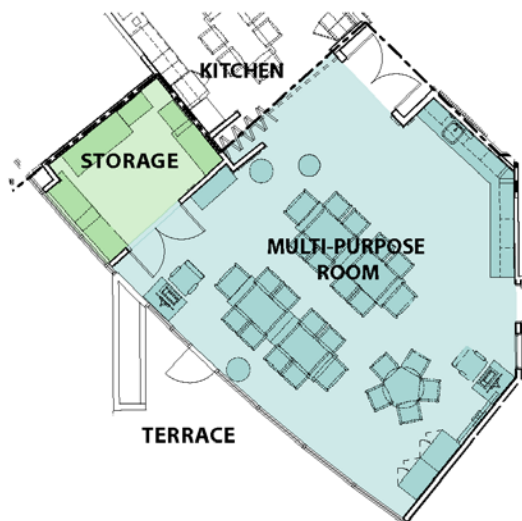

Figure 2.1.5.h. Plan diagram based on a multipurpose room with direct access to furniture storage room, kitchen and outdoor terrace, VA Denver



Figure 2.1.5.i. Multipurpose / dining room

**Social Activities / Dining / Multipurpose Room** may be provided in PRRCs or similar settings that involve longer patient stays (same day). Refer to Figure 2.1.5.i for an example. Design considerations include:

- Food warming and refrigeration
- Storage capacity for seating, tables, equipment and supplies
- Flexibility of layout
- Access to natural daylight



Social Activities / Dining / Multipurpose Room accommodates dining function but specific food service area is not included. Design of the **Activities / Dining Room** includes provision for food service. Two food service options are presented in the Room Templates section:

- Activities / dining room adjacent to a kitchen / servery, or
- Kitchenette with refrigerator, counter and storage units incorporated into the dining room.

An **Occupational Therapy Room** may be authorized as part of PRRC, CRRC or similar community-based facility. Design considerations include:

- Flexible furniture arrangement to support the various activities
- Spacing of seats, especially around a table or at a work counter (refer also to Room Template)
- Direct access to storage room

**Conference Room / Classroom** may be used by staff or used to provide patient education to groups that are too large to be accommodated in a group therapy room. Design considerations noted above regarding flexible furniture arrangements also apply to this room type. Options for classroom/lecture format and conference/discussion formats are depicted in Figure 2.1.4.b in the previous section of this Design Guide.

- Seating should face door(s) to the room
- Provide space to store stacking chairs, tables and supplies
- Locate staff work station near door where it can be used to facilitate presentations

A **Methadone Area**, where authorized as part of the program, may be provided in an IOP – SUD clinic. The methadone area consists of two functional spaces: a staff workroom and a patient area. Workroom typically accommodates two staff, and must comply with security requirements for storage of controlled substances (VA Handbook 0730) and security regulations from the Drug Enforcement Administration (DEA). Design includes a dispensing window and pass through between the workroom and patient area. The Veteran takes the dose under observation by staff. The patient area accommodates one patient. Refer to Figures 2.1.5.j through 2.1.5.l for examples of this area. Refer to Methadone Area Room Template and Room Data Sheet in Section 4 for detailed requirements.





Figure 2.1.5.j. Staff work area, Cleveland VARC



Figure 2.1.5.k. Patient area with view window from staff area, Cleveland VARC

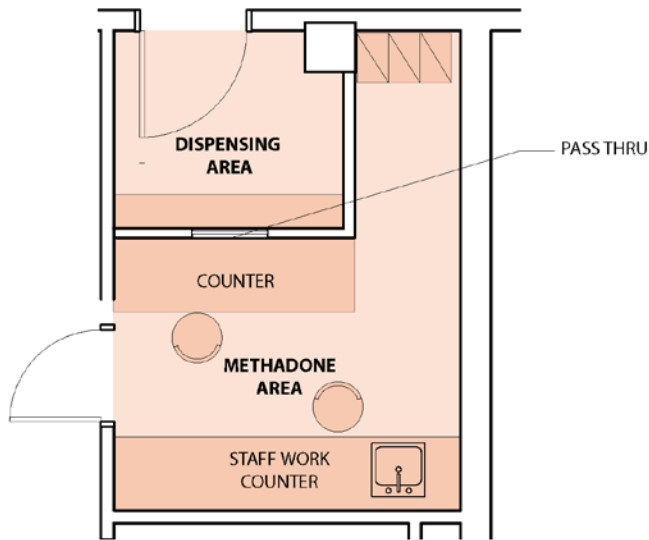

Figure 2.1.5.l. Floor plan diagram of methadone area, Cleveland VARC

### 2.1.5.3 Staff Space

Design of interior environment and availability of supportive technology will encourage formal and informal collaboration by Mental Health teams. Design strategies to facilitate informal, or spontaneous, discussions include:

- Physical proximity and visual connections between staff work and staff respite spaces
- Informal breakout areas or sitting nooks located along off-stage circulation paths
- Huddle areas (small tables with seating) within team work spaces for ad hoc meetings

A staff lounge (Figure 2.1.5.m) is required as a quiet, or respite space. Respite spaces contribute to staff satisfaction and reduce stress. Provide access to natural daylight.



Figure 2.1.5.m. Staff break room, VA Primary Care Annex, Tampa, FL



#### 2.1.5.4 Outdoor Space

When possible, provide convenient access to outdoor space to allow patients to sit or talk with others outside. Landscaped outdoor space will also provide an opportunity for staff use as respite, or “decompression” space. Refer to Figure 2.1.5.n for an example of landscaped outdoor space serving a behavioral health facility with a significant outpatient component.



Figure 2.1.5.n. Landscaped outdoor space



## 2.1.6 Renovation of Existing Facilities for Outpatient Mental Health

A large number of VA outpatient mental health projects are renovations or fit-outs of existing buildings. The planning and design concepts in this Design Guide and associated Space Planning Criteria chapters (PG-18-9) are generally based on conditions that are likely to be found in new construction scenarios. However, renovation projects should follow the same general concepts.

Renovation projects present additional challenges to the planning of spaces and layouts. These challenges include narrower building footprints with structural elements at a shorter spacing than typically encountered in new construction, as well as limitations imposed by other existing building systems (HVAC, electrical, plumbing). To the extent possible – as determined by the authority having jurisdiction – renovation of existing facilities for outpatient mental health should follow the same guidelines and include the same spaces as new construction described in other sections of this Design Guide. Although there may be square footage challenges, the quality of the space – including construction, spatial environment, building systems, materials and finishes – shall comply with the same standards as new construction.

Refer to Section 2.2.1 of this Design Guide for a more detailed discussion of compliance with codes and standards. The Renovation section of FGI [Guidelines for Design and Construction of Outpatient Facilities](#) may also be consulted for compliance guidelines and exceptions that may be considered for various types of renovation.

High priority criteria for outpatient mental health renovations include:

- Interior finishes and non-institutional feel of the space
- Layouts that provide design flexibility, as discussed in more detail in Section 2.1.4 of this Design Guide and illustrated in Section 3 Functional Diagrams. When identifying buildings for potential renovation, planning teams should consider existing structures that support flexible and efficient layouts.
- Zoning of functional use and patient / staff flow that includes:
  - Clear patient arrival sequence
  - Functional grouping of clinical zones by clinic types / specialties
  - Central location of higher-traffic functions and functions shared by several clinic types
  - Distribution of staff support areas to support efficient work flow
  - Control points at corridors for security



- Consider opportunities for future expansion. For example, “soft space” (functions that may relocate in the future) may be located adjacent to clinical space such that a clinic module system can be extended in the future.
- Quiet or “respite” space for staff to include space for private discussions and phone calls, especially in plans where not all clinical staff have assigned private offices in the clinic.
- Ensure that required space clearances are met, including space for mobility devices such as motorized scooters. Refer to VA Barrier Free Design Standard PG-18-13.
- Family consultation / therapy room and other family-friendly spaces should be included.
- Access to natural daylight and outdoor therapeutic space are a high priority, just as they are in new construction.
- Provide room layouts as consistent with these standards as possible. Although physical constraints of an existing building may require adjustments in room size or proportion, functional requirements must be met.

The examples on the following pages (Figures 2.1.6.a through 2.1.6 f) illustrate approaches to functional zoning and patient flow in renovations of older VA buildings with long, multi-wing footprints and, in most of the building wings, within the limitations of linear double-loaded corridor layouts. Note that all of these examples take advantage of access to natural daylight in staff and patient care rooms.

Refer to Section 2.2.3.1 of this Design Guide for interior design images of the VA Manhattan Ninth Floor Renovation Project.



**Case Study 1: VA Lebanon, PA, Renovation for a Specialty Behavioral Health Clinic**

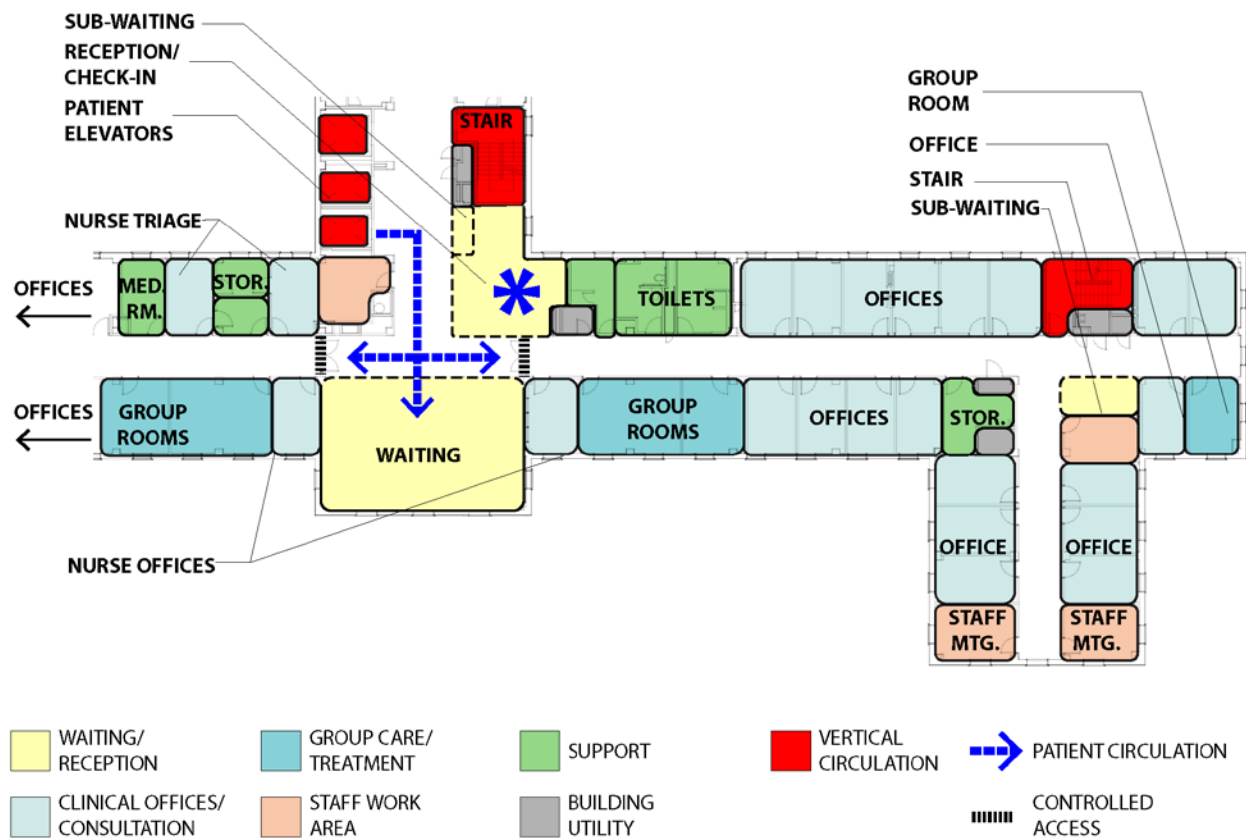

Figure 2.1.6.a. Diagram based on VA Lebanon, PA, renovation

The building wings depicted in Figure 2.1.6.a illustrate the following principles:

- Clear patient arrival and departure sequence. In this example, patient elevators lead directly to reception, check-in and main waiting.
- Central location for unique functions that may be shared by several Mental Health specialty services, including waiting, reception, nurse triage area, medication room, and toilet rooms
- Central location for higher-traffic functions, including group therapy rooms in close proximity to the main waiting area





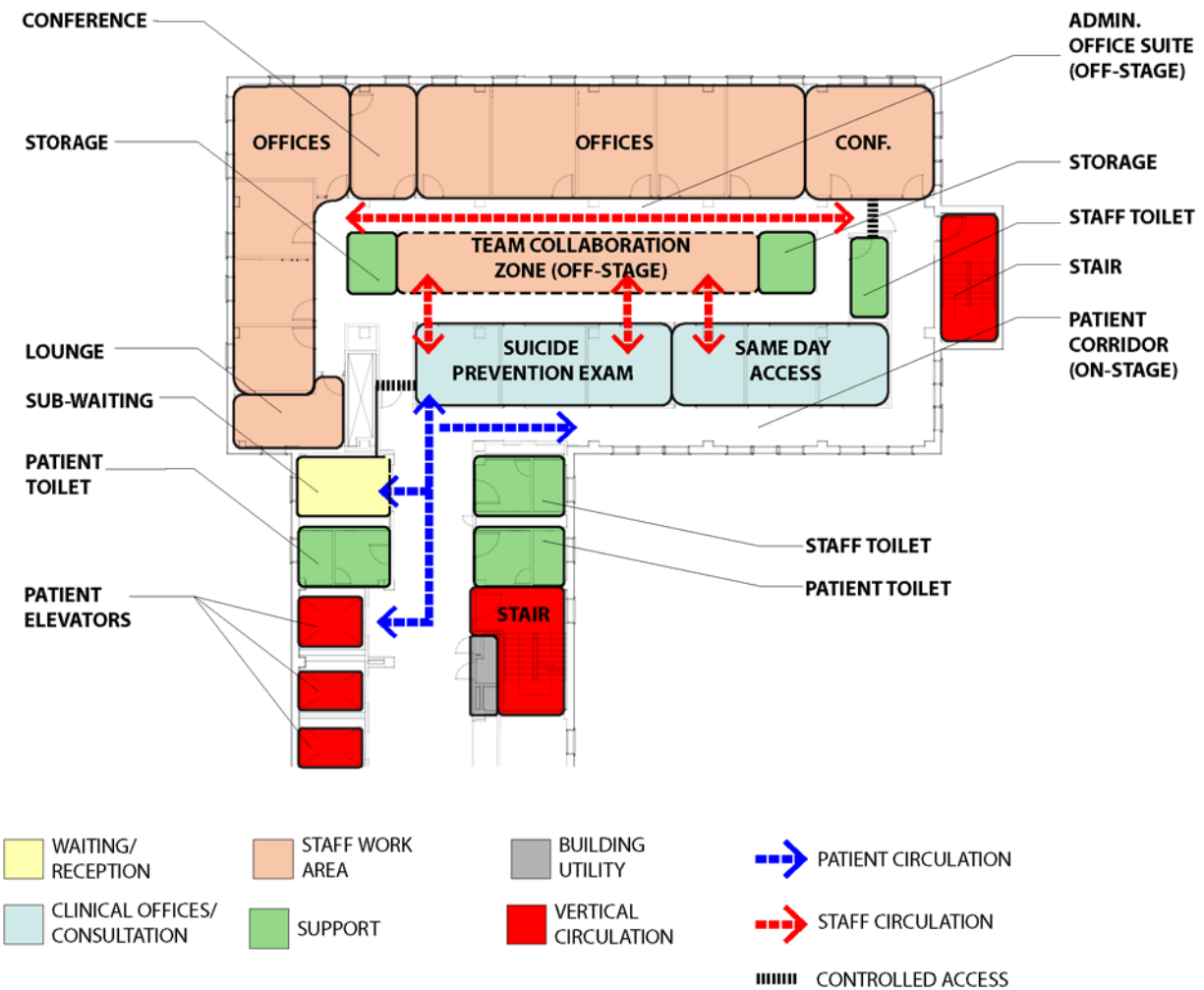

Figure 2.1.6.b. Diagram based on VA Lebanon, PA, renovation

The building wing depicted in Figure 2.1.6.b provides distinct on-stage and off-stage zones:

- Off-stage staff zone that includes an administrative office suite and a team collaboration zone
- Six dual-access exam / consultation rooms for specific programs: Suicide Prevention and Same Day Access. Patients access these rooms from the on-stage zone, and providers enter from the off-stage collaborative team area.
- Large conference room (upper right corner of the plan) can flex between on-stage and off-stage zones



**Case Study 2: VA Ann Arbor Medical Center, Liberty Building Seventh Floor Renovation**

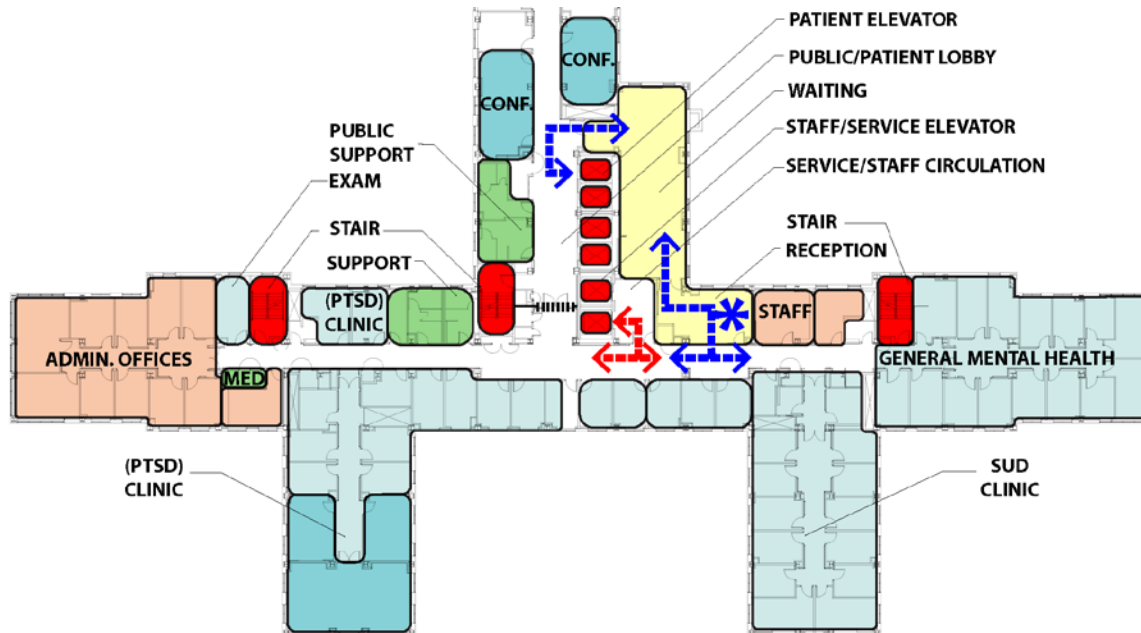

Figure 2.1.6.c. Diagram based on VA Ann Arbor, MI, renovation

Figure 2.1.6.c illustrates the following zoning and flow:

- Patient circulation flow from public elevators (Figure 2.1.6.d), to clinic entrance and waiting, to check-in and clinical areas
- General Mental Health, SUD Clinic, PCT Clinic and administrative offices grouped by building wing
- Due to the building configuration, patients and staff share the corridor within the clinical treatment zone, similar to Figure 2.1.6.a.



Figure 2.1.6.d. VA Ann Arbor, MI,



Figure 2.1.6.e. VA Battle Creek, MI,



renovated elevator lobby

new clinic entrance

**Case Study 3: VA Battle Creek Mental Health Clinic, Building 7 Renovation**

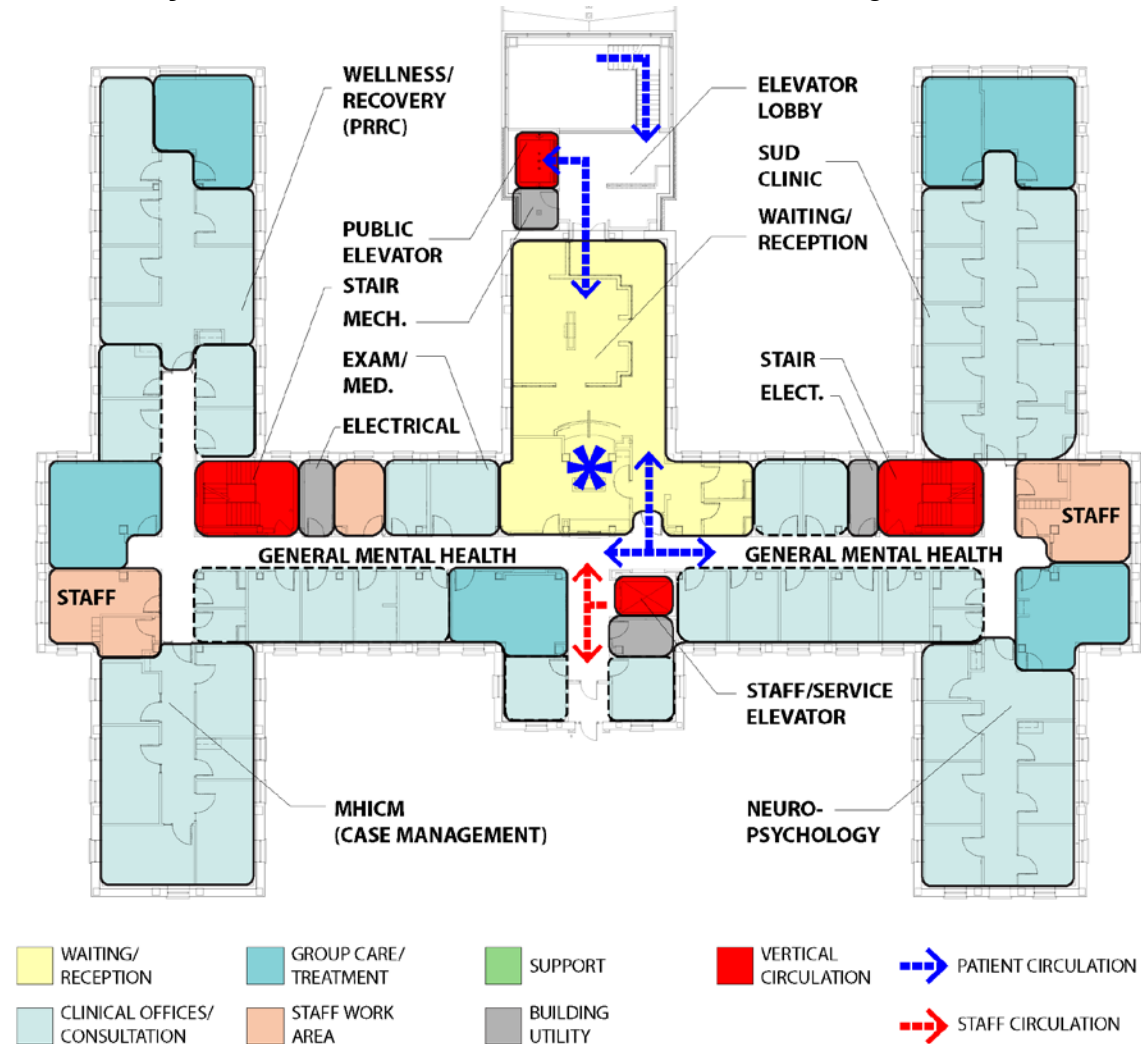

Figure 2.1.6.f. Diagram based on VA Battle Creek, MI, renovation

Figure 2.1.6.f illustrates the following zoning and flow:

- Patient flow from building entrance (Figure 2.1.6.e) to public elevators, to clinic entrance and waiting, to check-in and clinical areas
- General Mental Health and shared exam and medication rooms centrally located
- SUD Clinic, Neuropsychology, Wellness and Recovery (PRRC) and Mental Health Intensive Case Management (MHICM) grouped by building wing
- One staff area on each side of the clinical floor. Patients and staff share the corridor within the clinical treatment zone.
- Distributed group therapy and group testing rooms



## 2.2 Technical Considerations

### 2.2.1 VA Policies, Codes and Standards

For VA-owned building projects, VA functions as the Authority Having Jurisdiction (AHJ) and has the responsibility to guard public health and safety through enforcement of its adopted codes. For VA-leased facilities, the AHJ for the building permit and code requirements is the local authority.

Planning, design, and construction of all VA outpatient mental health facilities must be in accordance with this document and with the latest editions of all VA and industry's applicable codes and standards. Requirements in this Design Guide shall not be construed as authorization or permission to disregard or violate applicable local codes and regulations.

Refer to the VA Design and Construction Procedures PG-18-3 (Topic 1) for a list of Codes, Standards and Executive orders.

Refer also to Section 1.4 of this Design Guide: Policies/Standards and Industry Codes and Standards, which includes an expanded list of VA resources and VHA handbooks and directives related to VA Mental Health services.

As noted in PG-18-3 (Topic 1), should a conflict exist between VA requirements and VA-adopted, nationally recognized codes and standards, the conflict shall be brought to the attention of VA. The resolution of the conflict shall be made by the authority having jurisdiction for VA to ensure a consistency system wide.

### Other Recommended References and Standards

FGI Guidelines for Design and Construction of Outpatient Facilities, Specific Requirements for Outpatient Psychiatric Centers. The FGI Guidelines are referenced by the VA Architectural Design Manual PG-18-10.

Design Guide for the Built Environment of Behavioral Health Facilities, Current Edition, by David Sine, ARM, CSP, CPHRM and James M. Hunt, AIA. Available on the web site of the Facilities Guidelines Institute (FGI), [www.fgiguide.org/beyond](http://www.fgiguide.org/beyond). This resource is primarily focused on inpatient environments, but is the source of the five levels of interior construction cited in section 2.2.3 of this Design Guide

Center for Health Design, [www.healthdesign.org](http://www.healthdesign.org), has been a leader in providing findings of ongoing research related to evidence-based healthcare design. Refer to



Design Research and Behavioral Health Facilities, July 2013, for results of a comprehensive literature search on this topic. Although the emphasis in the literature is placed on residential and inpatient facilities, the design principles also apply to outpatient environments.

### **Research Articles on Integration of Mental Health Services in Primary Care**

Croghan TW, Brown JD. Integrating Mental Health Treatment Into the Patient Centered Medical Home. AHRQ Publication No. 10-0084-EF. Rockville, MD: Agency for Healthcare Research and Quality. June 2010.

Pomerantz, A.S., Kearney, L.K., Wray, L.O., Post, E.P., Mccarthy, J.A.(2014) Mental health services in the medical home in the Veterans Health Administration: Critical factors for success. *Psychological Services*. 11(3), 243-253 (NATIONAL VA DATA)

Bohnert, K. M, Pfeiffer, P. N., Szymanski, B. R., & McCarthy, J.F. 2013. Continuation of care following an initial primary care visit with a mental health diagnosis: Differences by receipt of VHA primary care–mental health integration services. *General Hospital Psychiatry*, 35, 66–70. (NATIONAL VA DATA)

Wray, L.O., Szymanski BR, Kearney, LK, Mccarthy, JF., Implementation of primary care-mental health integration services in the veterans health administration: program activity and associations with engagement in specialty mental health services. *J Clin Psychol Med Settings*, 2012. 19(1): p. 105-16 (NATIONAL VA DATA)



## 2.2.2 Outdoor Therapeutic Spaces

All mental health programs will benefit from access to outdoor therapeutic space. Refer to Figure 2.2.2.a for an image of a landscaped garden at a comprehensive mental health center.

All PRRC programs – even those located at hospitals – shall have access to some outdoor space. This is necessary for program participants to renew themselves during their extended participation in the program. Specifically, all PRRCs should include an enclosed outdoor space for program participants to enjoy as a part of their daily routine at the PRRC.

These outdoor spaces should be landscaped, furnished and shaded to allow program participants to utilize this space for activities such as dining and conversing with other program participants. These exterior spaces should also facilitate staff observation. Provide barriers to avoid fall opportunities in outdoor areas, for example terraces or balconies that are higher than their surroundings (see also Section 2.1.4.6 Safety and Security). The healing qualities of exterior spaces shall be key design criteria.



Figure 2.2.2.a: Landscaped garden



### 2.2.3 Architectural

Numerous aspects of the architecture and interior design can affect the end user's experience. The architecture, including aspects of the facility's exterior, provides users with an important first impression of the facility and affects initial expectations. This includes the degree of visual and physical access to nature incorporated into the design. The architecture also includes the internal environment, including the size, layout, and configuration of space. The interior design includes furniture, flooring, wall color, texture, trim, use of artwork, lighting, and other aesthetic features. Wayfinding is part of exterior as well as interior design.

Section 2.2.3 includes the following sub-topics:

- Interior Design
- Patient and Staff Safety and Security Overview
- Partitions
- Ceilings
- Interior Doors
- Windows and Glazing

This section focuses on design considerations specific to mental health outpatient services. For additional information, refer to the most current version of the following VA resources available on the TIL website:

- Architectural Design Manual for New Hospitals, Replacement Hospitals, Ambulatory Care, Clinical Additions, Community Living Centers, Domiciliaries, Energy Centers, Outpatient Clinics, and Regional Office Projects  
<http://www.cfm.va.gov/til/dManual/dmARhosp.pdf>
- Design and Construction Practices PG-18-3, Topic 11: Noise Transmission Control  
<https://www.cfm.va.gov/til/cPro.asp>
- Barrier-Free Design Handbook PG-18-13  
<https://www.cfm.va.gov/til/etc/dsBarrFree.pdf>
- Room Finish and Door Hardware Schedule PG-18-14  
<https://www.cfm.va.gov/til/room/roomfinishes.pdf>
- Interior Design Manual for New Construction and Renovations of Hospitals and Clinics  
<http://www.cfm.va.gov/til/dManual/dmIDhnh.pdf>
- VA Signage Design Guide: <https://www.cfm.va.gov/til/signs/Signage01-Intro.pdf>



- PG-18-10 Physical Security Design Manual  
(<http://www.cfm.va.gov/til/PhysicalSecurity/dmPhySecMC.pdf>) or  
(<http://www.cfm.va.gov/til/PhysicalSecurity/dmPhySecLS.pdf>)

### 2.2.3.1 Interior Design

#### Introduction

The primary objective of the interior design of outpatient mental health facilities is to create a recovery-oriented, patient-centered and nurturing environment, where Veterans experience dignity, respect, and trust in a safe, therapeutic environment. A balance between a safe healing environment and non-institutional feel is essential for both patient and staff. A comfortable, welcoming, and familiar environment can help calm patients and promote active participation in treatment and ownership in their rehabilitation journey.

General design strategies include:

- Design teams should strive to understand use of the facilities from the perspective of Veterans, their families and staff. Spaces must support the therapy the Veteran and their family are receiving.
- No one scheme will fit all buildings and spaces. Each design team shall collaborate with local VA staff and Veteran focus groups and consider regional or vernacular themes or materials when developing the design.
- Avoid design of sterile spaces that may feel like hospital inpatient units. Avoid heavy or bolted down furnishings and artwork that look and feel institutional.
- Designers are encouraged to integrate the look of natural materials within the built environment. For example, this may include selection of products such as Luxury Vinyl Plank Wood flooring to replicate real wood flooring. The introduction of natural looking and familiar materials can help patients feel grounded in their surroundings.
- Design should be flexible, including ability to adjust furniture arrangement or lighting level for different patient groups or types of therapeutic activities.





## Lighting

Lighting is an important design element that helps define and create the feel of a space. Lighting and the types of fixtures should enhance the design as accents and focal points for destinations. Indirect lighting allows light but avoids the harsh views from lamps provided by direct fixtures. Where feasible, provide daylighting with capabilities to shade the direct sun.

Multiple levels of lighting are required in different spaces throughout an outpatient setting. It is important to reduce dark shadows that could appear to be something unknown. Waiting rooms and corridors require consistent, even lighting to minimize shadows. Refer also to Section 2.2.6 Lighting and Electrical Systems. Refer to recommended light color temperature for various room types in Section 4 Room Data Sheets.

Group therapy rooms, patient education rooms, consultation rooms, and offices require flexibility of light levels. Patients may be more comfortable with the lights at a lower level for certain tasks. Higher lighting levels may be required in the same spaces when doing detailed work. Staff should have control of light levels in these spaces.

## Visual Contrast and Patterns

Many Veterans may have a visual impairment or may have incurred an injury that affects their depth perception. It is important that floors and walls have a color contrast so there is a clear distinction where the wall stops and the floor begins. This will better enable the patient to distinguish the wall from the floor. When the colors and tones have low contrast, the floor and wall may appear to meld into one another and create a flattened look, making it more difficult to move through the space.

Incorporating patterns in flooring can reinforce wayfinding as a guide throughout the facility. The tonal and pattern contrast in the flooring should be minimal to avoid creating a perception of a hole or step in the floor surface. The flooring should have a non-glare no-wax finish. Flooring that creates glare can cause people with visual impairments to perceive the floor as slippery and it creates added distractions when walking. Refer to Figures 2.2.3.1.a and 2.2.3.1.b for illustration of these design principles.





Figure 2.2.3.1.a. VA Manhattan, Ninth Floor Renovation Project



Figure 2.2.3.1.b. VA Manhattan, Ninth Floor Renovation Project



## Wayfinding and Signage

Entering an unfamiliar building can add to the stress of a visit. When entering a building, it should be easy to find the reception / greeter desk. Wayfinding design in the building shall provide a clear and consistent visual communication system with concise messaging. Veterans and their families should be able to navigate throughout with ease.

The interior design shall reinforce wayfinding. This can be accomplished by the following:

- Design architectural elements at door openings to create a cue that signifies an arrival (see Figures 2.2.3.1.b and 2.2.3.1.d)
- Introduce color or material changes at destinations. Color or images should be unique to the destination. These colors/images can be part of the signage to reinforce the message (see Figure 2.2.3.1.c).
- Integrate landmarks at key decision points.
- Create ceiling soffits that tie into patterns in the flooring. This will passively enhance perception of a location or destination. (see Figure 2.2.3.1.d)



Figure 2.2.3.1.c VA Manhattan, Ninth Floor Renovation Project



Figure 2.2.3.1.d VA Manhattan, Ninth Floor Renovation Project





Figure 2.2.3.1.e. VA Manhattan, Ninth Floor Renovation Project

### Lobby / Check In Areas

In an outpatient mental health clinic, the main entrance should be welcoming and easy to understand. Locate the reception/check-in desk where it will be easily seen by Veterans as they first enter (see Figures 2.2.3.1.e). The desk should be open above the counter for ease of communication, and provide auditory privacy where confidential information is exchanged. This can be created using side panels that are high enough to reduce transmission of sound for standing height speech (see Figure 2.2.3.1.f). Use of sound absorbing material on the back wall of the check-in area is also recommended.



Figure 2.2.3.1.f. VA Manhattan, Ninth Floor Renovation Project





Figure 2.2.3.1.g. Waiting area



Figure 2.2.3.1.h. Waiting area

### Waiting Area Seating

Veterans may have different levels of anxiety and levels of PTSD. Quick movements from behind can elevate their level of anxiousness and sense of vulnerability.

Recommendations for waiting room seating include:

- Incorporate dividers to reinforce smaller groupings and allow space between back-to-back seating. (see Figure 2.2.3.1.g)
- Create smaller intimate waiting spaces. Design main seating with back to wall or small divider walls. (see Figure 2.2.3.1.h)

### Group Therapy Rooms

Group therapy rooms require flexibility. The group size will vary (by definition, 12 or fewer patients), which will affect furniture quantity and size as well as seating arrangements. Consider the following:

- Lounge furniture with tablet arms.
- Loose stackable seating with and without arms.
- Provide a storage area for tables, chairs, and supplies to serve larger group rooms.



- Tables and chairs with and without arms, suitable for small work groups.
- Bariatric design requirements need to be incorporated.

These spaces will require staff input for the selection of furniture that best supports the programs they provide.

Refer to Figure 2.2.3.1.i for an example of a small group area that includes a mix of chairs with and without arms. Refer to Section 2.1.5.3 for discussion of functionality and flexibility of group therapy rooms.



Figure 2.2.3.1.i. Small group area

## Artwork

Artwork in mental health spaces enhances the goal of creating a normalized, therapeutic, healing environment for Veterans. Images that reinforce appropriate messages such as hope, dignity and joy enhance the healing process. They send a subliminal signal to the patient that his or her well-being is the caregiver's primary



concern. In mental health clinics, harsh colors, jagged lines or images with chaotic movement shall be avoided as they can trigger patient anxiety or confusion. Graphic art that creates optical illusions shall never be used.

Public areas need artwork that provides general appeal. Examples include military themes, patriotic and local geography/landscape images, still life, black and white, and architecture images. Refer to Figure 2.2.3.1.j for an example of artwork inspired by local geography. Incorporating local geography can reinforce a sense of community and neighborhood pride.

During their active duty careers, Veterans have been stationed around the globe and involved in different conflicts. When selecting geography/landscape images, designers must understand the potential sensitivity to a particular region and use care in selecting images.



Figure 2.2.3.1.j. VA Manhattan, Ninth Floor Renovation Project

The VA offers opportunities for individual facilities to create artwork for their buildings. One example is Project Healing Waters Fly Fishing, a recreation therapy program that focuses on treating individuals experiencing the negative symptoms of PTSD. Photos taken during the fishing trips were developed into art for the walls (see Figures 2.2.3.1.k



and 2.2.3.1.l). Other examples include local and national Veterans Creative Arts competitions.



Figure 2.2.3.1.k. Project Healing Waters Fly Fishing, VA Memphis, Photograph



Figure 2.2.3.1.l. Project Healing Waters Fly Fishing, VA Memphis, Artwork Installation

It is recommended that Veteran focus groups and clinicians working with Mental Health Veterans be consulted on the selection of artwork for the spaces.

Artwork shall be approved following VA Directive 7531: Acquisition of Artwork, Decorative Furnishings and Decorative Items, [https://www.va.gov/vapubs/viewPublication.asp?Pub\\_ID=855&FType=2](https://www.va.gov/vapubs/viewPublication.asp?Pub_ID=855&FType=2)

### 2.2.3.2 Patient and Staff Safety and Security Overview

In the Design Guide for the Built Environment of Behavioral Health Facilities referenced in Section 2.2.1 of this chapter, five interior construction levels are identified. These levels correspond with the types of spaces within a mental health facility. For Level 1 areas, no specific interior construction, finishes, fixtures or devices unique to mental health facilities are required – by definition, patients are not allowed in these spaces. At the other end of the spectrum, Level 5 requires construction, finishes, fixtures and devices in rooms that are specific to an inpatient mental health facility. Patients who present unknown potential harm risks may safely occupy these spaces. Levels 2 through 4 require some specific finishes, fixtures and devices that support patient safety in these spaces depending on functions and services being provided.

These levels are not part of VA standards but are used as a reference in this chapter.

Level 1: Staff and Service areas where patients are not allowed.

Level 2: Counseling rooms, examination rooms, group therapy, multi- purpose and interview rooms where patients are highly supervised and not left alone for periods of time.





- Level 3: Corridors, dayrooms and dining areas where patients may spend time with minimal supervision
- Level 4: Patient Rooms (semi-private and private) and Patient Toilets where patients spend a great deal of time alone with minimal or no supervision.
- Level 5: Admissions rooms and seclusion rooms where staff interacts with newly admitted patients that present unknown potential risks and/or where patients might be in a highly agitated condition.

“Level 5” generally applies to inpatient and residential environments. Outpatient mental health facilities will typically function as “Level 2” as the patient encounter rooms listed above are highly supervised, and corridors, waiting areas and activity rooms are generally supervised or observed as well. In outpatient facilities, durability may be considered a greater concern than tamper or ligature risk.

In addition to utilizing appropriate finishes, devices and fixtures, the plan of the facility should allow direct, ongoing observation of patient areas by staff – such as waiting rooms. In a VA outpatient mental health facility, observation in “on-stage” corridors is often accomplished by staff escorting a patient from the waiting room to the patient encounter room.

Technology such as door control, facility monitoring and alarm systems should be used to support the staff’s ability to maintain safety and security for both patients and staff. Technology should not be used as a replacement for on-going, informal staff observation and interaction with patients.

### **2.2.3.3 Partitions**

Acoustics: Interior partitions in outpatient mental health facilities will primarily be gypsum board on metal studs. Interior partitions around group therapy rooms and consultation rooms/offices shall have sound attenuation features such as fiberglass batt insulation between studs. The partitions extend to the underside of the roof or floor deck above. A Sound Transmission Class (STC) rating is based on how well a building partition attenuates airborne sound, thereby providing acoustical isolation and speech privacy. Planners should be aware that STC ratings higher than 45 are likely to require a double layer of gypsum board in addition to batt insulation to meet the minimum STC requirements required or recommended for that area. For example, STC 50 is recommended for a clinical office / consultation room.



Wall penetrations such as doors, view windows, electrical outlets and mechanical ductwork should be carefully considered and detailed to avoid sound transmission in a partition system. Detailing includes staggering and offsetting electrical outlets such that acoustic insulation is continuous between the back of the outlet and the other side of the partition.

FGI Guidelines Table 1.2-6 Design Criteria for Minimum Sound Isolation Performance between Enclosed Rooms provides current STC standards for consultation and other pertinent room types. The Room Templates (Data Sheets) in this Design Guide provide recommended STC ratings. These must be coordinated with adjacent spaces as a part of the design process.

VA Design and Construction Procedures PG 18-3 Topic 11 Noise Transmission Control notes that “where an area generating unusual noise or vibration is located adjacent to occupied spaces, the A/E should obtain the services of a professional acoustical consultant to design the sound suppression system.” Designers should be aware that where a Transcranial Magnetic Stimulation (TMS) Room is provided in a Mental Health clinic, the TMS unit has the potential to generate “unusual noise.”

Abuse Resistance: VA Program Guide PG-18-14 recommends abuse resistant, or impact resistant, wall material in various locations in inpatient and residential Mental Health facilities. Given the level of supervision in outpatient mental health facilities, it is not necessary to provide impact resistant gypsum board in partition assemblies unless there are patient activity areas in these outpatient facilities with lower levels of supervision than typical counseling spaces.

#### **2.2.3.4 Ceilings**

Acoustic tile ceilings are typically provided in most spaces with the exception of gypsum board ceilings in toilet rooms or in soffits that are provided as part of the interior design concept – for example, in lobbies and waiting areas. Minimum ceiling height of 9’-0” is recommended for outpatient mental health facilities, including clinical offices / consultation rooms.

#### **2.2.3.5 Interior Doors**

Refer to VA PG-18-14 Room Finishes, Door and Hardware Schedule for general door construction and hardware requirements.



**View Panels:** For safety of patients and staff, it is recommended that doors in patient encounter rooms have half-light glazing to enhance visibility. All glazing used in doors must be laminated glass.

**General Door Hardware:** Refer to PG-18-14.

**Staff Door Hardware:** Spaces that are accessed only by staff – such as medication rooms, food service areas, conference or team rooms, and staff corridors – shall be locked under normal operation and with card readers or key pads to allow authorized access. Provide door closers on staff area doors to allow them to close automatically.

### 2.2.3.6 Windows and Glazing

**Glazing:** For durability and safety, tempered laminated glass is recommended for interior glazed openings in patient care areas. For activity rooms such as multipurpose room, social activities/dining and occupational therapy, designers should consider half-height glazing along the entrance side of the room (along corridor) to encourage Veteran participation in activities. Glazed sidelights are not recommended for individual or group therapy rooms.

One-way mirrored glazing will be utilized in interior applications where an office/control room abuts a treatment or therapy room to be used for observation (for training purposes, refer to Figure 2.2.3.6.a). Provision of a control room is based on local programming decision. In such applications, lighting design requires special attention so that the one-way glazing functions effectively.



Figure 2.2.3.6.a: One-way mirrored window from viewing room to group therapy room, VA Tampa Primary Care Annex



## 2.2.4 Structural Design

Structural systems shall comply with state and local building codes. Replace state and local seismic requirements with those indicated in VA Handbook H-18-8 Seismic Design Requirements (<https://www.cfm.va.gov/til/etc/seismic.pdf>). Projects requiring seismic retrofit shall comply with VA Structural Design Manual for Seismic Retrofit Projects (<http://www.cfm.va.gov/til/dManual/dmSTseis.pdf>). Projects requiring heightened physical security (for example, progressive collapse and blast resistance) shall comply with PG-18-10 Physical Security Design Manual for Mission Critical Facilities (<http://www.cfm.va.gov/til/PhysicalSecurity/dmPhySecMC.pdf>) or Physical Security Design Manual for Life-Safety Protected Facilities (<http://www.cfm.va.gov/til/PhysicalSecurity/dmPhySecLS.pdf>). Inclusion of heightened physical security is a project specific requirement.

## 2.2.5 Heating, Ventilation and Air Conditioning Systems

### 2.2.5.1 General

The HVAC system shall comply with the most current version of Department of Veterans Affairs (VA) HVAC Design Manual, <http://www.cfm.va.gov/til/dManual/dmHVAC.pdf>, VA Design and Construction Procedures, VA Master Construction Specifications and VA Standard Details, where applicable. Deviations from the VA guidelines may be made provided approval is obtained from VA per PG 18-15 A/E Submission Requirements for VA Medical Center Major New Facilities, Additions, & Renovations <http://www.cfm.va.gov/til/ae/aeSubMaj.xlsx>.

Refer to PG-18-10 Physical Security Design Manual where applicable.

### 2.2.5.2 Outdoor Air Requirements

In variable air volume (VAV) air distribution system type, minimum ventilation requirements must be maintained during low supply air conditions.

### 2.2.5.3 Noise Criteria

HVAC systems should be designed to eliminate any startling or loud system noises.



#### **2.2.5.4 HVAC Design Features**

Properly designed HVAC systems are essential for the Outpatient Mental Health Services staff, patients, and visitors to efficiently maintain comfort conditions in a non-institutional environment (refer to general discussion of non-institutional treatment environment in Section 2.1.3.5).

The design A/E shall refer to the Reflected Ceiling Plan in Section 4 – Room Templates of this Design Guide for the general placement of diffusers and grilles. However, these RCPs do not preclude the A/E from responsibility for designing a properly functioning system.

Heating and cooling load calculation for each room or area shall be performed to validate compliance with setpoint targets and energy conservation requirements. The calculations shall be documented and provided to VA for review and concurrence.

HVAC controls shall be provided to efficiently maintain comfort conditions. Automatic occupancy and vacancy sensors should be considered for automatic control to reduce energy usage during unoccupied periods. Controls shall be of the electric/electronic type.

#### **2.2.5.5 Indoor Mechanical Equipment Locations**

Where practical, provide separate mechanical equipment rooms with clearances in accordance with the requirements of the VA HVAC Design Manual. Install serviceable equipment within mechanical equipment rooms. Outside of mechanical equipment rooms, all serviceable HVAC items should be either concealed or tamper-proof, located to minimize: 1) access into patient care areas, and 2) the use of ladders for service personnel.



## **2.2.6 Plumbing Systems**

### **2.2.6.1 General**

The plumbing system shall comply with the most current version of Department of Veterans Affairs (VA) Plumbing Design Manual (PDM) (<http://www.cfm.va.gov/til/dManual/dmPlbg.pdf>), VA Design and Construction Procedures, VA Master Construction Specifications and VA Standard Details, where applicable. Deviations from VA guidelines may be made on a case-by-case basis upon approval from the Authority Having Jurisdiction (AHJ). Where state or local codes are more stringent than the above requirements, submit criteria to the AHJ for review and approval.

Refer to PG-18-10 Physical Security Design Manual where applicable.

### **2.2.6.2 Domestic Water Systems**

Follow the current version of the VA PDM.

### **2.2.6.3 Sanitary, Vent and Storm Systems**

Follow the current version of the VA PDM.

### **2.2.6.4 Natural Gas System**

Follow the current version of the VA PDM.

### **2.2.6.5 Plumbing Fixtures**

The plumbing fixtures types shall be in accordance with the VA PDM and VA specification section 224000.

### **2.2.6.6 Medical Gas Systems**

It is anticipated that there are no requirements for medical gases in this type of facility. If required, design shall follow VA PDM.

### **2.2.6.7 Seismic Requirements**

Follow the VA PDM.



## 2.2.7 Lighting and Electrical Systems

### 2.2.7.1 General

Design of lighting and electrical power distribution systems shall comply with the PG-10 Lighting Design Manual (LDM) <http://www.cfm.va.gov/til/dManual/dmLighting.pdf>, Electrical Design Manual (EDM) <http://www.cfm.va.gov/til/dManual/dmElec.pdf>, and Physical Security Resiliency Design Manual where applicable.

### 2.2.7.2 Lighting

The Lighting Design Manual (LDM) provides guidance for lighting design parameters, as well as recommended types of luminaires for some specific rooms within the Behavioral Health Areas. The Illuminating Engineering Society of North America (IESNA) lighting guidelines shall be used as a reference if the LDM or this Design Guide does not provide guidance for certain rooms. The design A/E has the option of using fluorescent or LED lighting technology to coordinate with facility standards. The design A/E shall follow the Reflected Ceiling Plans in Section 4 – Room Templates of this Design Guide for the placement of luminaires, although the design A/E is responsible for a lighting design appropriate for these functions. The design A/E shall select appropriate number of lamps in each luminaire to render the required illuminance level for each room and task.

Controlled natural lighting should be provided wherever possible to reduce glare and to promote a healing and energy-efficient environment while still providing for appropriate privacy. Daylighting provides orientation and sense of therapeutic calm essential to these facilities. Distribute daylight uniformly, with no significant dark spots. Artificial lighting shall be provided as required and to supplement natural lighting.

Lighting controls shall be provided to meet the therapy and tasks of the space and in compliance with associated energy code requirements. Provide dimming in patient spaces. Automatic occupancy and vacancy sensors shall be provided for automatic control. Controls should be of the silent actuating type.

Provide daylight sensors in day lighted areas to maintain illumination levels and maximize associated efficiencies. Lighting control sensors in corridors and areas where patients are left unattended should be protected from vandalism or located to minimize patient access – all coordinated with the facility.



### **2.2.7.3 Power**

The A/E shall provide electrical system design for all electrically operated equipment and general room power. The A/E shall confirm electrical requirements of all equipment to provide correct design and load calculations. The A/E shall coordinate placement of receptacles or hardware connections for all electrically operated equipment. The design A/E shall follow the Floor Plan in Section 4 – Room Templates of this Design Guide for the placement of receptacles. In a case where there is no room template, provide receptacles or hard-wired connections to comply with project scope, NFPA codes, and all applicable industry standards.

#### **2.2.7.3.1 Normal Power**

General use receptacles and special outlets shall be connected to Normal power.

#### **2.2.7.3.2 Emergency Power**

Essential Electrical Systems shall comply with the Type 2 system as defined in NFPA 99. In addition to emergency egress standby power lighting requirements, upon loss of normal power instant-on battery or UPS power shall provide minimum 25% lighting in waiting areas and group therapy spaces.

## **2.2.8 Telecommunications, and Special Telecommunications, Monitoring and Signal Systems**

### **2.2.8.1 General**

Facilities Management Service (FMS) special communications, OI&T telephone and computer systems are required for facility spaces to perform and function efficiently, and effectively. The Office Information & Technology (OI&T) provides design professionals guidance on telecommunications room layouts in the PG18-12 OI&T Design Guide (DG) (2011). The design A/E shall ensure FMS Telecommunications and Special Telecommunications along with some approved shared OI&T systems complies with the requirements of PG 18-10, Telecommunications and Special Telecommunications Systems Design Manual (TDM-2017), <http://www.cfm.va.gov/til/dManual/dmTelecomm.pdf>

The design A/E shall be familiar with the most current editions of applicable codes, telecommunications standards, design guides and manuals; and, provide certified proof





of he/she maintains the minimum BICSI RCDD; plus, the credentials identified in the TDM (2016).

### **2.2.8.2 Telecommunications Network Outlets**

Telecommunications outlets shall comply with the Telecommunications and Special Telecommunications Systems Design Manual.

### **2.2.8.3 Telemental Health Video-Conferencing**

Video-conferencing equipment for telemental health is provided for remote communication between patient and mental health professionals. This video-conferencing capability shall be installed in clinical offices, consultation rooms, group rooms and/or conference rooms as determined by the local facilities. VA video-conferencing units use VA's IT network for IP-based videoconferencing, consequently telecommunications outlets are necessary in these locations. The video conferencing units are typically cart-based; provide space to store securely when not in use.

### **2.2.8.4 Nurse Call**

Nurse call is generally desired in VA mental health units, including locations in toilet rooms, group therapy, activity rooms, and exam rooms. The specific needs for call system locations shall be coordinated with the functional design of the outpatient unit and the design of each space.

The nurse call should consist of a push button in patient care rooms. Two push buttons, one high and one low, should be provided in the patient toilet rooms. IP Wireless technologies should be studied, along with hard wired or integrated systems, to meet the needs of individual facilities.

### **2.2.8.5 Television**

Master antenna television (MATV) and electrical outlets for televisions should be located in waiting rooms. Use of televisions is determined by each facility.

### **2.2.8.6 Security**

Security design and devices shall comply with the standards of the VHA Police Service and the local police service.

Electronic Security systems shall comply with the VA Physical Security Design Manual for Life Safety Protected Facilities (PSDM).



### **2.2.8.7 Duress Alarm**

A duress alarm system is recommended for outpatient mental health facilities. It shall comply with PG 18-10, TDM (2016). Portable (aka wireless) duress devices allow staff to discreetly request assistance in a potentially threatening situation from any point within the unit or facility. The use of this type system must be approved on a case-by-case basis to ensure compliance with all Life and Public Safety Codes/Standards. The duress system should be monitored at a central reception or security office for the facility. In addition to portable duress alarms, duress push buttons shall also be located in reception desks, in mental health staff offices, consultation rooms, and exam rooms as approved. The staff duress provisions should be coordinated with the overall security protocol established in the facility and the host VAMC.

### **2.2.8.8 PACS (Physical Access Control System)**

Provide a complete and separate Federal Information Processing Standard (FIPS) 202-1 and National Institute of Standards and Technology (NIST) Personally Identifiable Information (PII) Electronic PACS with position ID, connected, controlled and operated by the VA Police Service. The PACS must function with existing facility and host VAMC PACS and Safety Management System (SMS) and equipment standards. Refer to VA Master Specifications on the TIL (28 13 00 – Physical Access Control System and 28 13 16 –PACS ID Cards (aka NIST PIV) must be of non-proprietary construction and function as approved by AHJ NCS 07A2 during Project Design and Technical Reviews at the beginning and throughout the project. Connections to the facility's telecommunications rooms (TR) must be approved by the AHJ. Head end equipment located in the FMS area of a TR, and must be monitored, operated, controlled and managed by the SMS.

### **2.2.8.9 Video Assessment and Surveillance**

Provide a Video Assessment and Surveillance system to monitor building entrances, restricted areas, and alarm conditions. System shall include surveillance of defined exterior areas, such as site and roadway access points, parking lots, and building perimeter, and interior areas.

Provide Patient Areas with a CCTV color video camera monitoring system (no audio component) with clear tamper-proof camera enclosures secured with tamper-proof screws to solid facility components, in conduit and standalone design routed to the local police services for control and management. (Note - CCTV system must be installed



according to Patient Privacy and HIPAA Rules AND NOT connected to additional location[s] unless specifically pre-approved by AHJ NCS 07A2).

### **2.2.8.10 Radio Systems (Site Specific Requirement)**

#### **2.2.8.10.1 Radio Paging System**

- Shall be provided when Nurses Call and/or Code Blue Emergency Communications Systems are a part of the facility.
- When approved, shall comply with PG 18-10, TDM (2016).
- Contact VA AHJ NCS 07A2 as listed in PG 18-10, TDM (2016), Paragraph 1.3 for technical assistance with VA radio frequency/spectrum management coordination, systems design, preparation and review of construction documents, proof of performance testing and VA certification.
- IEEE 802.11 (Wi-Fi) based Add-On Systems shall not be included in design.

#### **2.2.8.10.2 Two-Way Radio Paging System**

- Typically uses the host VAMC Radio Coverage, if capable.
- When approved, shall comply with PG 18-10, TDM (2016).
- Contact VA AHJ NCS 07A2 as listed in PG 18-10, TDM (2016), Paragraph 1.3 for technical assistance with VA radio frequency/spectrum management coordination, systems design, preparation and review of construction documents, proof of performance testing and VA certification.
- IEEE 802.11 (Wi-Fi) based Add-On Systems shall not be included in design.

#### **2.2.8.11 Public Address System (PAS)**

- Shall be provided when Nurses Call and/or Code Blue Emergency Communications Systems are a part of the facility
- When approved, shall comply with PG 18-10, TDM (2016).
- Contact VA AHJ NCS 07A2 as listed in PG 18-10, TDM (2016), Paragraph 1.3 for technical assistance with VA radio frequency/spectrum management coordination, systems design, preparation and review of construction documents, proof of performance testing and VA certification.
- IEEE 802.11 (Wi-Fi) based Add-On Systems shall not be included in design.



## **2.2.9 Fire Protection and Life Safety**

### **2.2.9.1 General**

The Fire Protection system shall comply with the most current version of Department of Veterans Affairs (VA) Fire Protection Design Manual, <http://www.cfm.va.gov/til/dManual/dmTelecomm.pdf>, VA Design and Construction Procedures, VA Master Construction Specifications and VA Standard Details, where applicable. Deviations from the VA guidelines may be made provided with approval from the AHJ. Where state or local codes are more stringent than the above requirements, submit criteria to the AHJ for review and approval. Refer to PG-18-10 Physical Security Design Manual where applicable.

### **2.2.9.2 Automatic Sprinkler**

The fire sprinkler and standpipe system design shall comply with the requirements of VA Fire Protection Design Manual.

### **2.2.9.3 Seismic Requirements**

Follow the current version of the VA Fire Protection Design Manual.

### **2.2.9.4 Fire Alarm**

Provide fire alarm systems in compliance with VA Fire Protection Design Manual.



THIS PAGE WAS INTENTIONALLY LEFT BLANK



## 3.0 Functional Diagrams

### 3.1 Introduction

The purpose of this section is to provide a planning framework and strategies that can apply to a wide variety of outpatient mental health program types and allow for adaptability over time. The functional diagrams in the following sections are based on a modular approach at two levels of organization:

- Room-by-room: this includes individual rooms or small groups of rooms.
- Planning module: this includes multiple groupings of rooms, a regular pattern of circulation, and defined patient and staff zones, as illustrated by Figure 3.2.1 below. A planning module can encompass an entire clinic program or part of a clinic program. The regularity of the structural components can support the ability to repeat modules side-by-side and facilitate reuse or reconfiguration for future needs.

Section 3.2 defines a “Universal” module that can be repeated or adapted for most general and specialty outpatient mental health programs. For renovation projects, this concept can and should be adapted to the existing building configuration where feasible.

Section 3.3 offers a series of planning vignettes, or small descriptive illustrations, that provide examples of how parts of the Universal Module can be adapted for various outpatient programs. A “kit of parts” approach can substitute similar sized rooms with different functions to support the diverse needs of Outpatient Mental Health.

Section 3.4 illustrates how a Universal Module can be modified to maximize the number of clinical offices. This section also presents a strategy that transforms the Universal Module to a primary care clinic module consistent with the PACT model.

Section 3.5 provides supplementary diagrams for two outpatient mental health programs – Psychosocial Rehabilitation and Recovery Center (PRRC) and Community Resource and Referral Centers (CRRC) – that can use standardized planning grids and room dimensions but may vary somewhat from the Universal Module.

The diagrams in Section 3 also provide specific illustrations of the Space Planning and Design principles outlined in Section 2.1.4 of this Design Guide.



### 3.2 Universal Module

Figures 3.2.1 and 3.2.2 depict a “base” condition of the Universal Module diagram that includes space types that are typical of General Mental Health services. Figure 3.2.1 (following page) provides a room-by-room illustration and indicates overall dimensions. With some adjustments (refer to Section 3.3), the diagram can accommodate Intensive Outpatient Specialty Mental Health Care, Special Interventions, Intensive Community Mental Health Recovery Programs (ICMHR), and Therapeutic and Supported Employment Services (TSES).

Spaces are organized within three major zones:

- Patient Transition Zone includes waiting and reception areas, public toilets and some group therapy spaces
- Clinical Treatment Zone includes individual and group therapy rooms and associated support functions
- Staff Support Zone includes team work areas, conference and training space, staff locker, lounge and toilet facilities, and building utility space

Staff-only space is considered “off-stage” and patient corridors, waiting and care space is considered “on-stage”. An off-stage corridor serves the Staff Work Zone. Staff work area or conference space that is accessed from this corridor may extend into the Clinical Treatment Zone.

A patient corridor that extends along the edge of the Patient Transition Zone is used to access group care spaces. Corridors that extend perpendicular from the Patient Transition Zone provide patient access to private therapy rooms. The depth of the Clinical Treatment Zone is approximately 80 feet, which includes rows of seven 10-ft wide clinical offices plus a 6-foot wide intermediate corridor plus an allowance for wall thicknesses. A 20-ft wide band of space between rows of clinical offices includes a team work area (accessed from the staff corridor), group therapy room (accessed from the patient corridor), and associated support spaces.



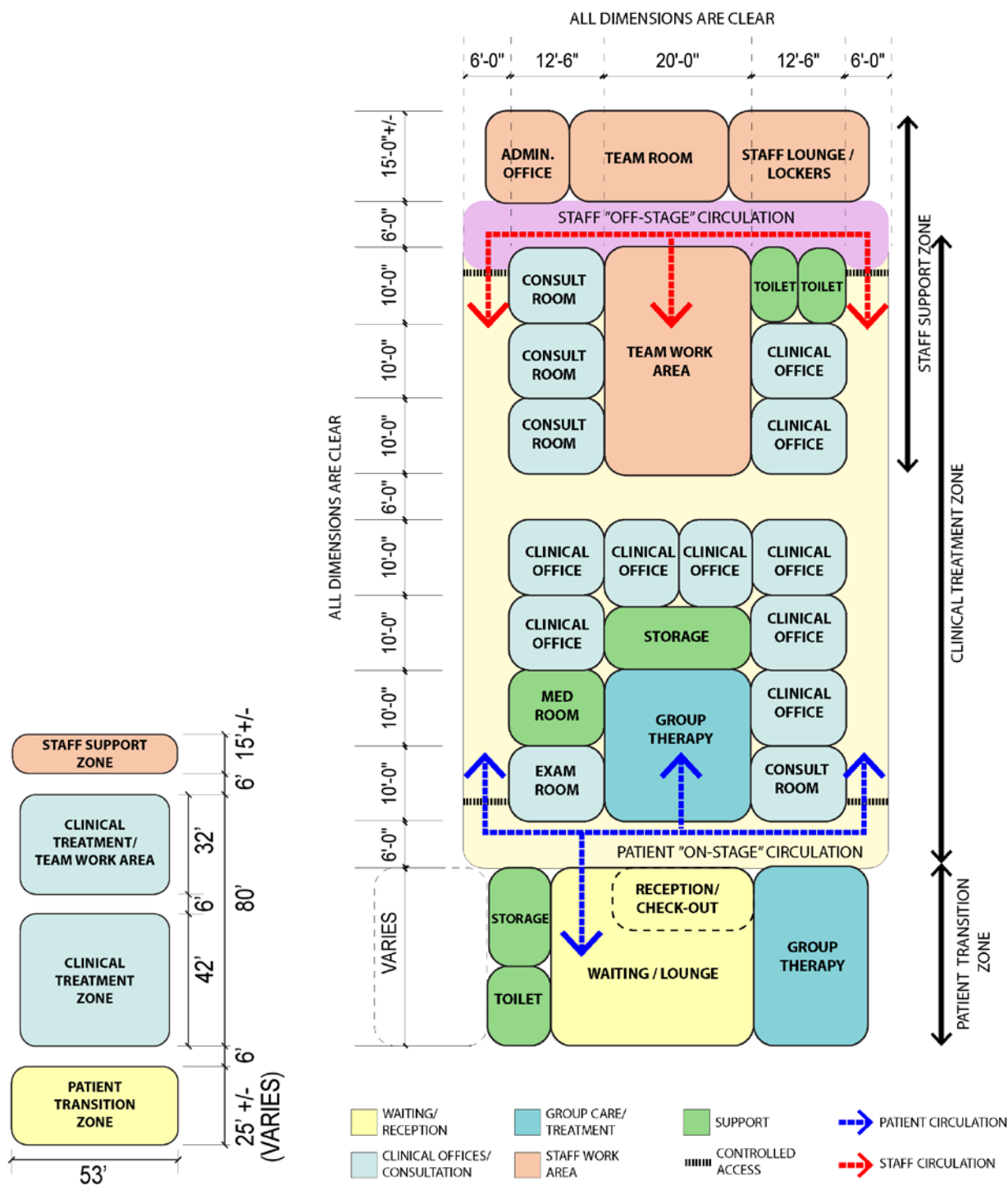

Figure 3.2.1. Universal Module, Outpatient Mental Health





The organization of the modules allows them to be repeated in a side-by-side arrangement (Figure 3.2.2). The “end condition” in this diagram reflects the opportunity to provide an additional row of clinical spaces that is not attached to a 20-foot wide core but is accessed from a common on-stage corridor. Such a condition may be found at the end of a series of planning modules along an exterior wall of a facility.

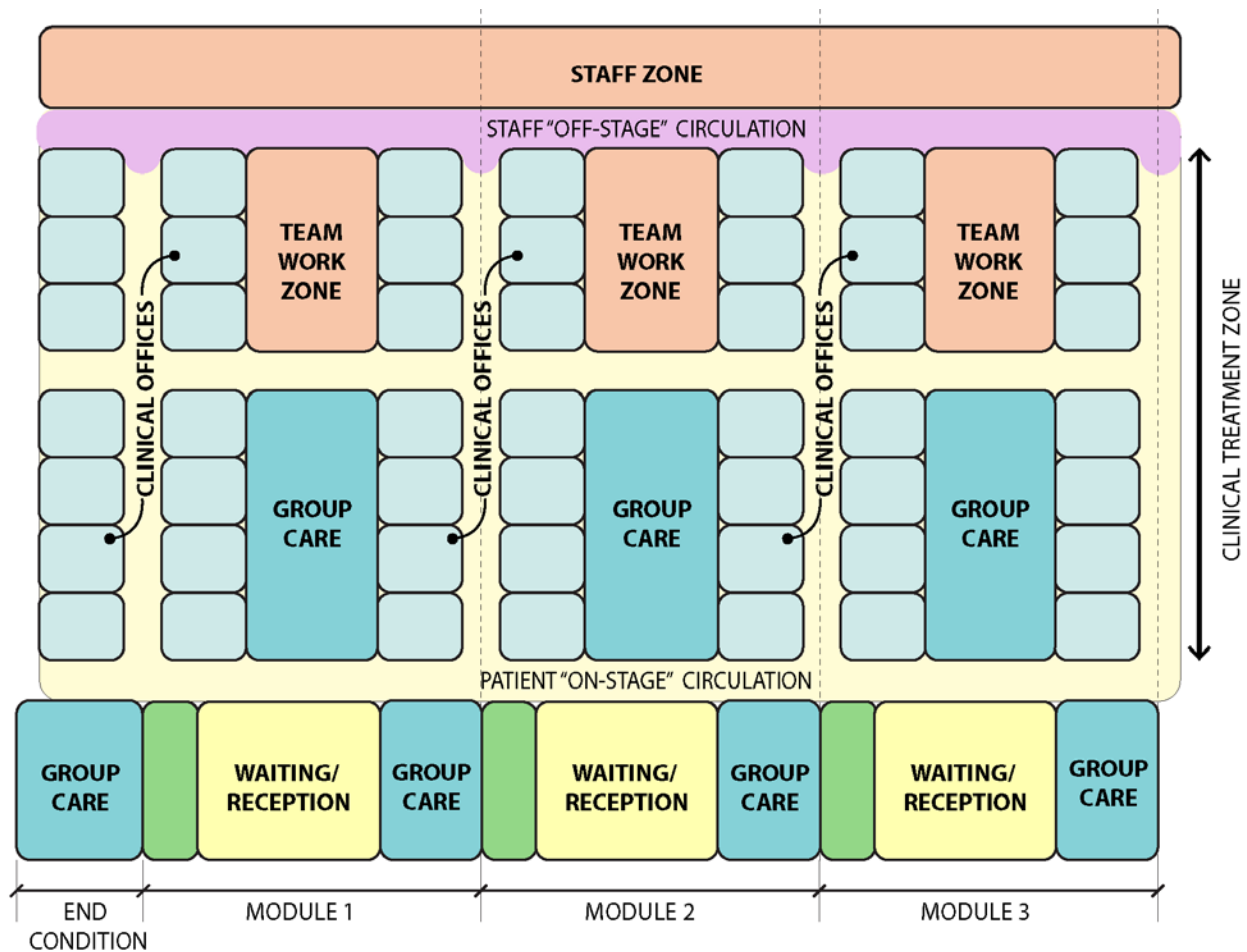

Figure 3.2.2. Module Organization: clinical modules repeated side-by-side

### 3.2.1 VHA Space Need / Utilization Toolkit

It is recognized that space planning rules-of-thumb may vary for outpatient mental health by project type and location. VHA Office of Mental Health Services has developed a Space Need / Utilization Toolkit to address the complexities specific to planning for outpatient mental health facilities. This Toolkit is available to VA internally for use by VA staff. It can be made available to planners during the programming and planning process.



The following description of the Space Need / Utilization Toolkit has been provided by VHA Mental Health.

### **Number of Unique Mental Health Patients**

Mental Health service demand (number of unique Mental Health patients) is based on a percentage of the total number of enrollees. This percentage is called the “desired Mental Health utilization” for VAMC and it may include a factor for projected growth rate.

### **Staffing Ratio**

Recommended minimum staffing ratio is 7.7 per 1,000 unique patients. Eight providers per 1,000 outpatients is a recommended minimum, and the staffing ratio could be higher, for example, in programs such as Intensive Community Mental Health Recovery (ICMHR) or where special circumstances require it. This ratio includes licensed providers (psychologists and psychiatrists) and other providers such as nurse practitioners and peer support specialists. This ratio does not include administrative clerical support or trainees, who may number four per team.

### **Projected Office Need**

Projected office need can be calculated using a heuristic (rule of thumb) for number of projected unique Veterans per provider, as explained below. Two types of provider are considered: Psychotherapist and Medication Prescriber. The time-based calculation (separate worksheet in the Toolkit) can be used to customize the number of unique patients per provider, as described below under the “Time-Based Calculation” heading.

One BHIP team serves 1,000 unique patients. Per minimum recommended staffing to outpatient ratio of 7.7 to 1,000, that translates to 8 BHIP clinical team members. These may consist of medication providers, psychotherapists, counselors, case managers, nurses, and peer support. For the purposes of simplification, we will include all non-medication providers in one category of Psychotherapists. The ratio of Psychotherapists to Medication Prescribers may vary by location and clinic type. For example, the potential number of offices could be 6 needed for Psychotherapy / Counseling and 2 needed for Medication Management, or the numbers could be 5 and 3, or there could be a different mix of staff as determined by policy and clinical need.

As with PACT projections, once utilization of existing staff resources exceeds 30% capacity, planning must be expedited for additional staff / BHIP teams, with the necessary space resources to accommodate growth.



### Time-Based Calculation

A more detailed “time-based” calculation evaluates space needs based on workload, utilization, and service format (individual vs group). This is intended to provide a rough estimate and guide to clinic planners. The following types of user input are required (example in Table 3):

- Operating days / available days per year (base assumption is 5 (days per week) x 52 (weeks per year) – 10 (holidays) – (locally determined expected leave used per year per provider))
- Hours per day (base assumption is 7.5)
- Minutes per clinic visit (base assumption is 60 minutes for Psychotherapist and 30 minutes for Medication Prescriber)
- Clinical Labor Mapping (fraction of provider’s time devoted to clinical care, assumed at 100% for a typical front-line provider with no administrative responsibilities)
- No Show Rate (using historical data, this is 15%; sites may wish to use the predictive tool and set this according to locally derived expectations and/or national targets)
- Desired Revisit Rate (locally determined based on historical data and clinical expectation for each provider category. Typical targets are 7 for Psychotherapist and 4 for Medication Prescriber.)

Available Days for a room are calculated to account for provider availability, allowing for annual leave and sick leave. Clinical Labor Mapping is used to adjust full-time and part-time employee workloads.

**TABLE 3: VHA TOOLKIT SAMPLE INPUT FOR A PSYCHOTHERAPIST VISIT**

Available Days (5*52-10-10-7)	233
Hours per day	7.5
Minutes Clinic	60
Clinical Labor Mapping	100%
Typical CPT Coding	2.00
No Show Rate	15%
Desired Revisit Rate	7



**TABLE 4: VHA TOOLKIT SAMPLE OUTPUT FOR A PSYCHOTHERAPIST VISIT**

Encounters			
Bookable Time			
100%	85%	80%	75%
1485	1263	1188	1144

Using a revisit rate of 7 for psychotherapists, the number of unique Mental Health patients is calculated at  $1,188 / 7 = 170$ .

Unique Patients			
Bookable Time			
100%	85%	80%	75%
212	180	170	159

The Toolkit calculates encounters per room as a rough estimate for a range of expected bookable times. The number of encounters are calculated for provider face-to-face bookable time at 85%, 80%, or 75% of labor mapped clinical time. The remaining (15%, 20%, or 25%) is non-bookable time and is necessary for non-face-to-face clinical activities (e.g. reviewing records, writing notes, conferring with other clinicians, researching clinical conditions).

The Toolkit’s output (example in Table 4) provides the number of patient encounters per room as well as number of unique patients per room. Separate calculations are done for Psychotherapists and Medication Prescribers. Typical Current Procedural Terminology (CPT) coding input will affect wRVUs per room (work Relative Value Units, not illustrated in Table 4). Projected number of unique patients is derived by dividing the projected number of patient encounters by the Desired Revisit Rate. Modification to Revisit Rate will affect the number of unique patients. Modification to any of the other inputs will result in modification to the number of patient encounters per room.

The Time-Based Calculation worksheet includes a “Workload for Additional Rooms Needed (30% Baseline)” table. This table can be used to calculate the 30% threshold that defines when the next room will be needed.



### 3.2.2 Operational Assumptions for the Universal Module

The basic Universal Module, as depicted in Figure 3.2.1, will support the following:

- Typically 12 to 14 clinical offices or consultation rooms (in addition to examination and medication rooms), depending on program variations, such as family consultation / therapy room (refer to Figure 3.3.2)
- Depending on specialty mix, the layout with 14 clinical offices (plus examination and medication rooms) will support a maximum of approximately 2,000 unique patients.
- For application to General Mental Health, this module will typically support between 1.5 and 2 BHIP teams. For comparison, the smallest clinic – a Small CBOC – will typically have 1 or 2 offices and a group room to provide Mental Health services to roughly 420 unique Veterans.
- Given the base assumptions in the Time-Based worksheet and Bookable Time of 80%, a room used by a Psychotherapist will accommodate 1,188 patient encounters per year or 170 unique patients (assuming patient revisit rate of 7).
- Given the base assumptions in the Time-Based worksheet and Bookable Time of 80%, a room used by a Medication Prescriber will accommodate 2,377 encounters per year or 594 unique patients (assuming patient revisit rate of 4).
- Assuming a ratio of 3 Psychotherapists per each Medication Prescriber and given the base assumptions above, this module will support roughly 18,000 to 21,000 patient encounters per year.
- One examination room is assumed for General Mental Health. This quantity may vary for specialty clinics.



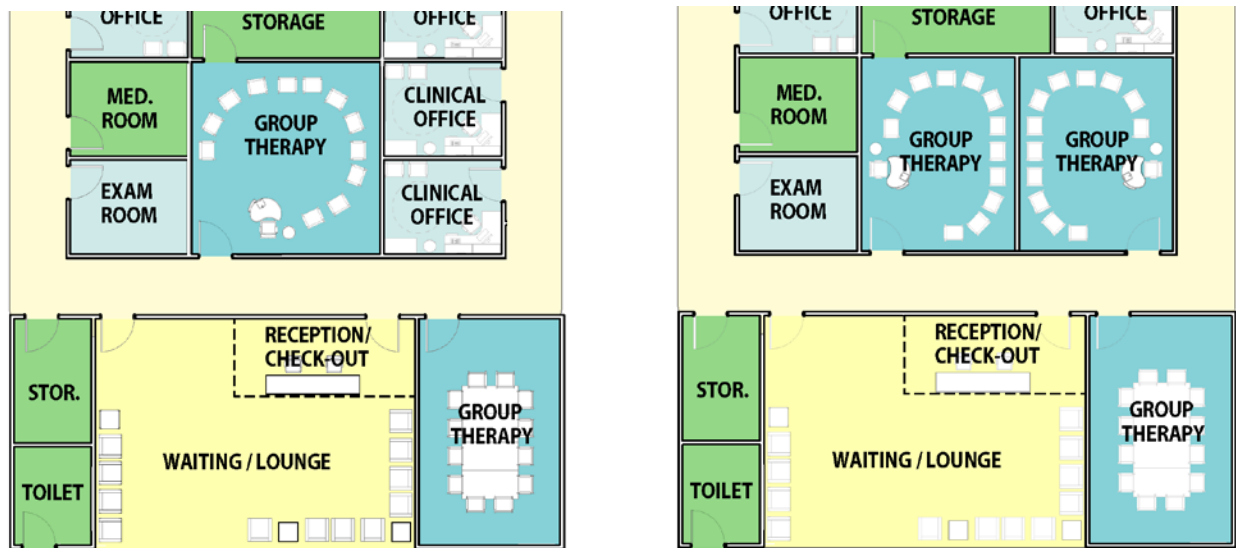

Figure 3.2.3. Illustration of flexibility for two and three group therapy room scenarios

- Two group therapy rooms. A third group therapy room can be added if the number of consultation rooms are reduced by two (see Figure 3.2.3). Utilization and quantity of group therapy rooms may vary by site and program type. Based on CMS guidelines, group therapy defines a maximum group size of 12 patients. Education rooms that have greater capacity are more appropriate for shared medical appointments and psycho-education classes.
- 20' x 31' team work area can support as many as six workstations (approximately 50 square feet per workstation) plus circulation space.
- The above assumptions are based on General Mental Health and BHIP teams. Different inputs for specialty programs will generate different numbers.

### 3.2.3 Design Priorities and Advantages of the Universal Module Approach

Design priorities include the following:

- Defined planning grid with modules that can be repeated:
  - Side-by-side repetition (Figure 3.2.2)
  - Blocks of clinical treatment space along “depth” of module (Figures 3.2.1 and 3.2.2)
- Regular corridor system that supports:
  - Separation / zoning of patient (on-stage) and staff (off-stage) circulation
  - Ease of staff and patient circulation



- Room and module dimensions that support flexibility and adaptability (illustrated in planning vignettes Figures 3.3.2 through 3.3.8):
  - Ability to change room function without demolishing and reconstructing partitions (e.g., clinical office, exam room, administrative office)
  - Ability to combine adjacent space or sub-divide larger spaces – such as group therapy and conference rooms – with minimal impact on surrounding areas
- Location of group therapy spaces close to waiting area
- Private therapy spaces accessed from parallel corridors that extend from waiting areas to the boundary of the staff-only zone
- Intermediate cross-corridor to facilitate staff circulation
- Supports the internal addition of clinical offices (refer to Module 2 in Figure 3.4.1)

Advantages of the Universal Module approach include:

- Supports a “kit of parts” approach to address the diverse needs of various clinic types and sizes
- Provides flexibility and adaptability to accommodate future changes in the delivery of outpatient mental health care
- The ability to change room function without changing room size – and to combine and sub-divide adjacent spaces with minimal impact on existing corridors – helps localize disruption to surrounding areas during future renovation projects
- Built-in flexibility has potentially positive impact on renovation costs by localizing the scope of future renovation projects
- Efficient utilization of space



### 3.3 Flexibility and Adaptability at the Room-by-Room Level

This section provides planning vignettes that illustrate how components of the Universal Module can be adapted for specialized functions.

#### 1 OFFICE MODULE

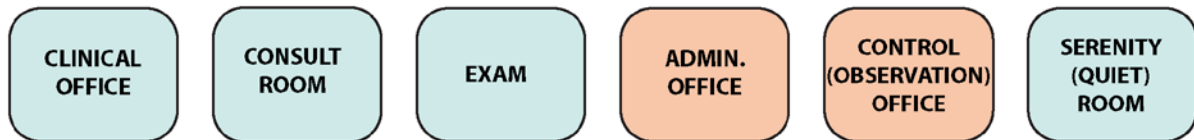

#### 1-1/2 OFFICE MODULE

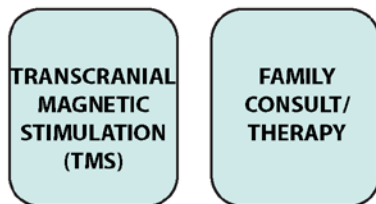

#### 1/2 OFFICE MODULE

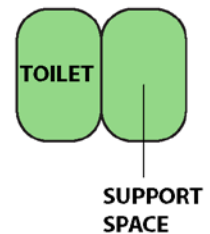

Figure 3.3.1. Illustration of modular sizing of rooms

#### 3.3.1 Basic Clinical Office Module

The clinical office (or consultation room) is a basic building block of outpatient mental health facilities. The same room dimensions (10' x 12'-6") will support the various functions listed in Figure 3.3.1 in the row labeled "1 Office Module". Some specialized rooms such as Transcranial Magnetic Stimulation (TMS) or family consultation / therapy room are accommodated by an area that is 1-1/2 times the size of the basic clinical office, with the 12'-6" dimension as a constant.





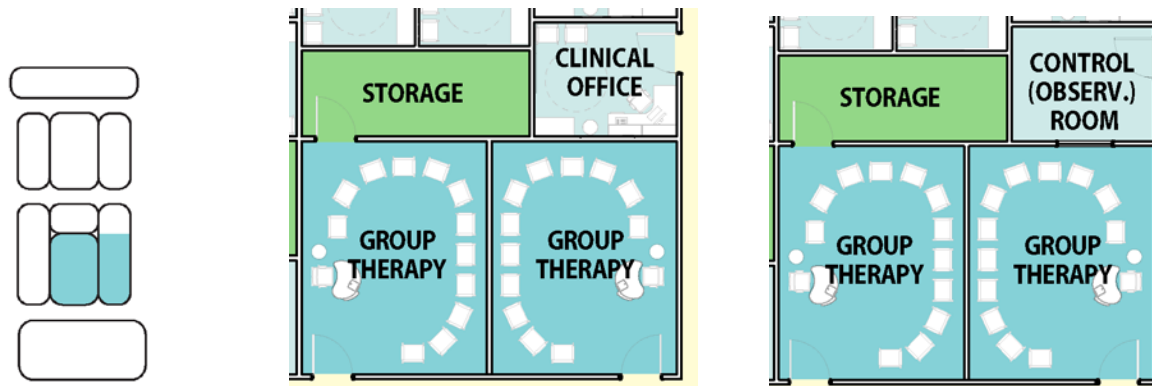

Figure 3.3.2. A clinical office module adjacent to a group therapy room may be developed as a Control (Observation) Room.

Figure 3.3.2 illustrates the ability of a clinical office room module to supports a control (observation) room function. In this example, the control room is adjacent to one of the group therapy rooms. If provided in the Program for Design, a control room is equipped with one-way viewing capability and microphones and is used for training purposes. Figures 3.3.3 and 3.3.4 illustrate how specialized room types can fit into the Universal Module framework. For additional information, refer to Section 4 Room Templates.

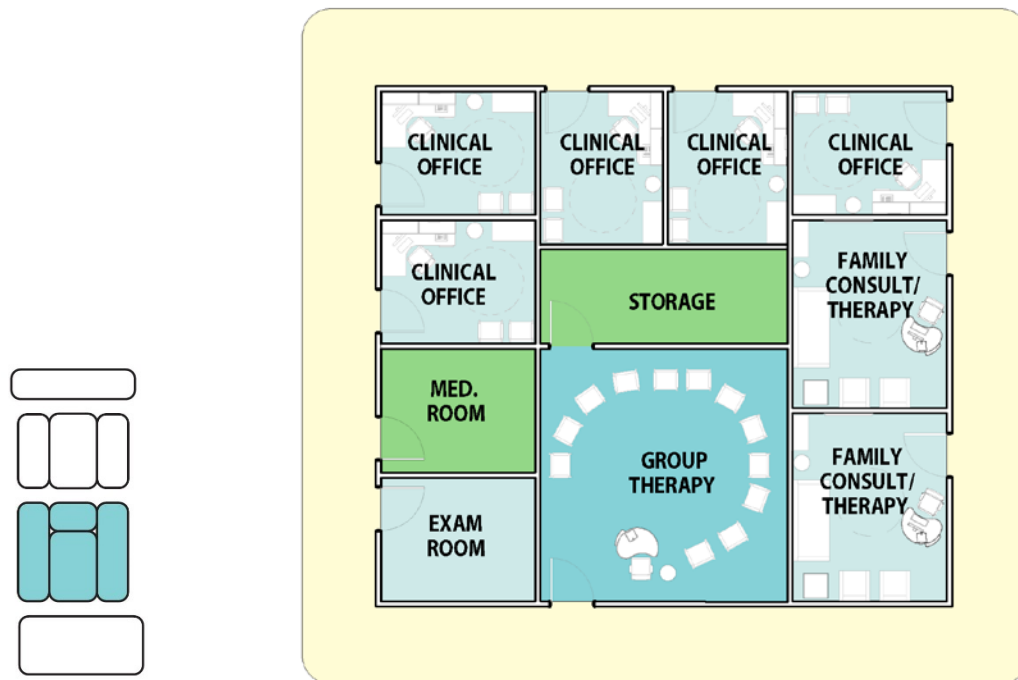

Figure 3.3.3. Two family consultation rooms in a space equivalent to three clinical offices



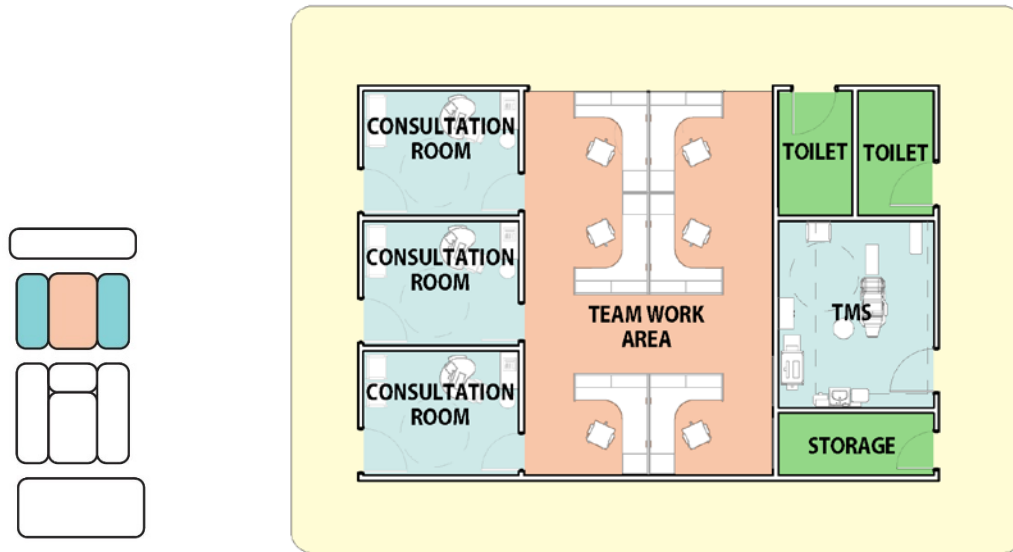

Figure 3.3.4. TMS Room and storage in a space equivalent to two clinical offices,



### 3.3.2 Team Work Areas and Conference Space

Recommended clear width of the space between rows of clinical offices is 20 feet. This dimension is also consistent with the recommended width of a team work area in a Primary Care PACT model. The base diagram (3.2.1) shows a shared workspace approximately 20' x 31' between rows of clinical offices or consultation rooms, with access from the staff off-stage zone. The open area can accommodate six staff workstations that can be used by Mental Health trainees, program support assistants, or community-based programs such as ICMHR and TSES (Figure 3.3.5). In these scenarios, the adjacent 10' x 12'-6" offices may be adapted for use on a hoteling basis as consultation rooms for staff who work in the open office area, may spend time working at community locations, and may also need space to meet with Veterans. It is recommended that these consultation rooms provide dual access – one door for staff and another door for patients – to reinforce the separation of on-stage and off-stage functions. Alternatively, this area can be adapted for a conference room.

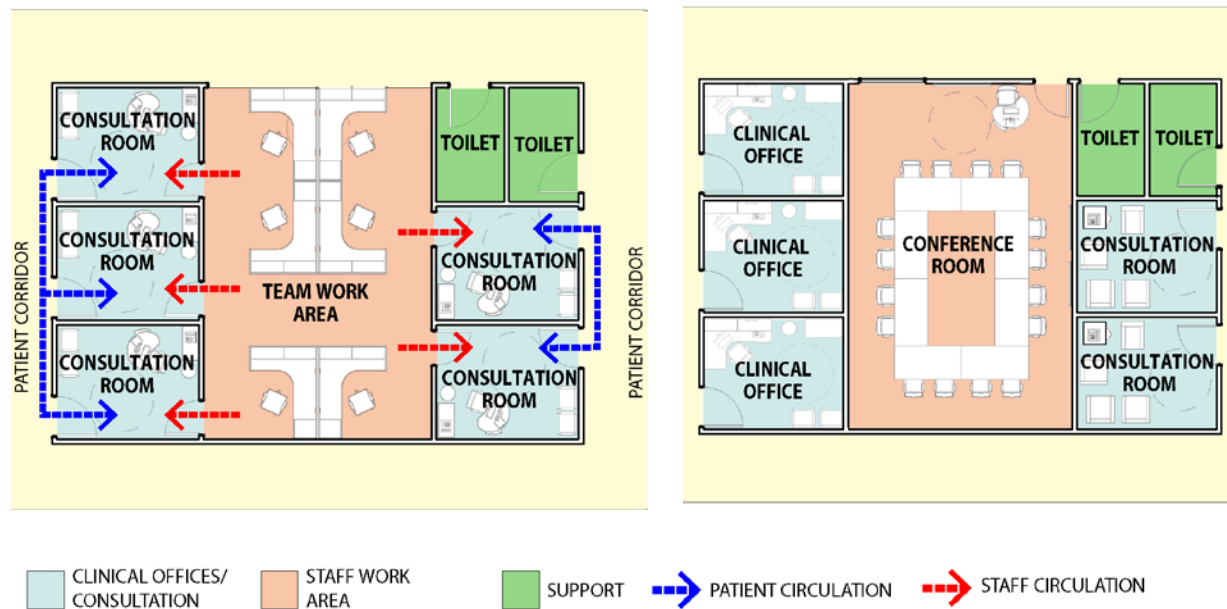

Figure 3.3.5. Staff work area and adjacent bookable rooms for patient consultations (left), and separation of staff and patient circulation. Option for conference room in large central space (right)



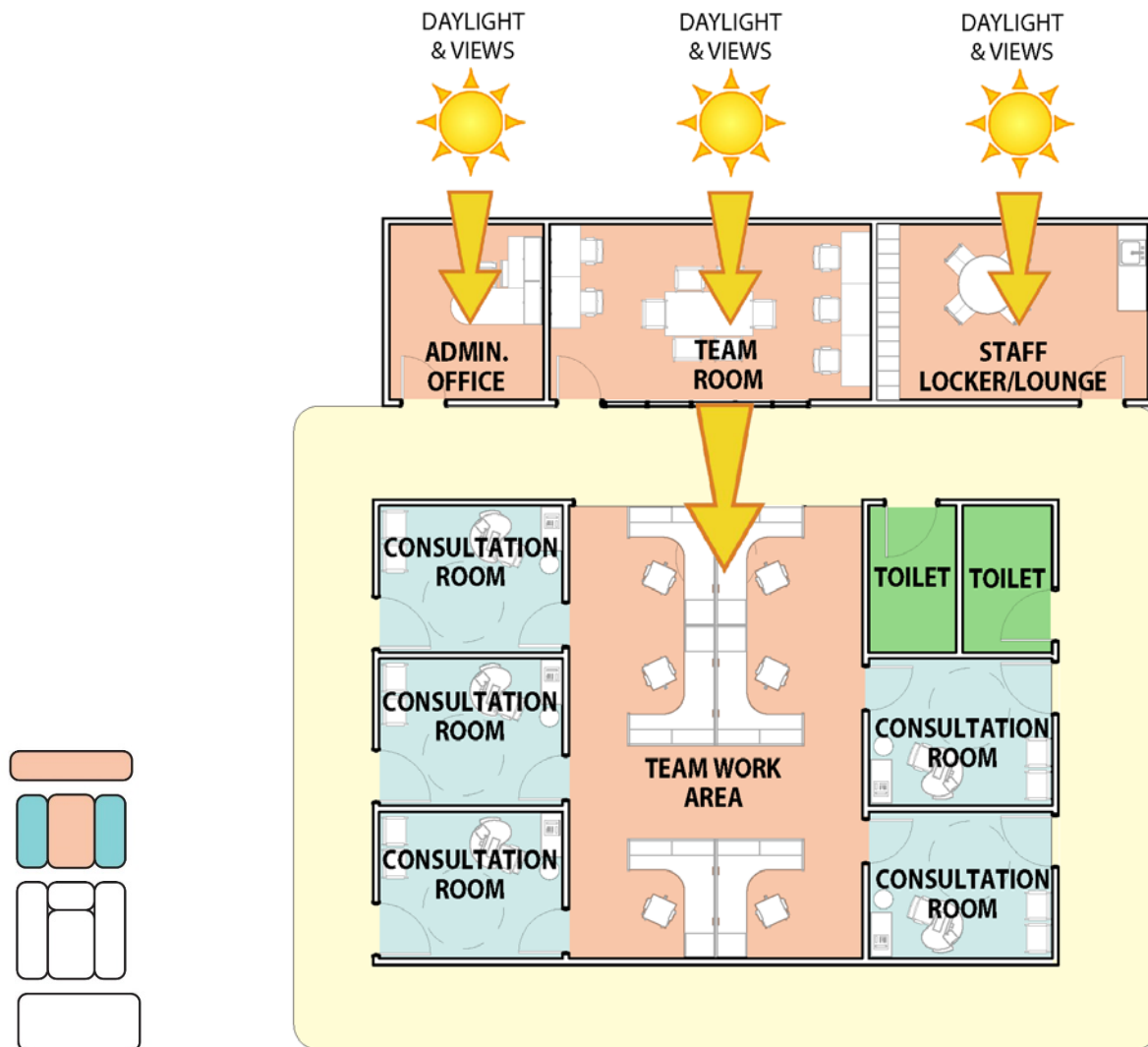

Figure 3.3.6. Alignment of team spaces and internal work areas to optimize access to daylight

It is recommended that Team space on the perimeter of the building (Figure 3.3.6) be aligned with the larger inboard work area to maximize the opportunity for natural daylighting to reach the inboard team work area.



### 3.3.3 Group Care Rooms

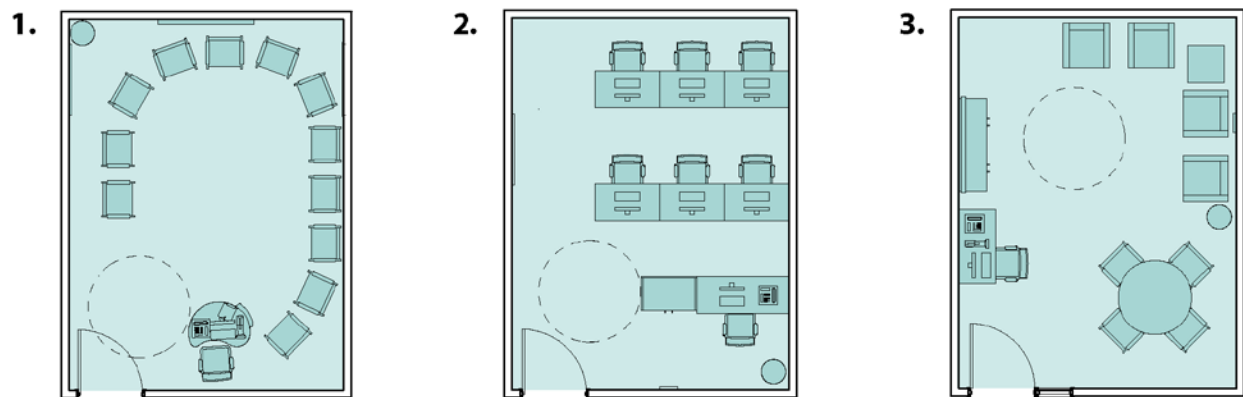

Figure 3.3.7. Illustration of modular sizing of group care rooms

The group therapy room is also a basic building block of outpatient mental health planning. These rooms should be accessed by patients from the waiting room or from the patient corridor adjacent to the waiting room without requiring patient passage through the corridors that serve private clinical offices. Figure 3.3.7 illustrates the potential for other room functions that can be accommodated as interchangeable pieces in the “kit of parts” strategy for group care rooms:

1. Group Therapy Room
2. Group Testing Room
3. Multipurpose Room

If a group care room serves 12 or fewer patients, it can be designated as a group therapy room. If the space will serve groups larger than 12 patients, it will then be considered a patient education or classroom/conference room.



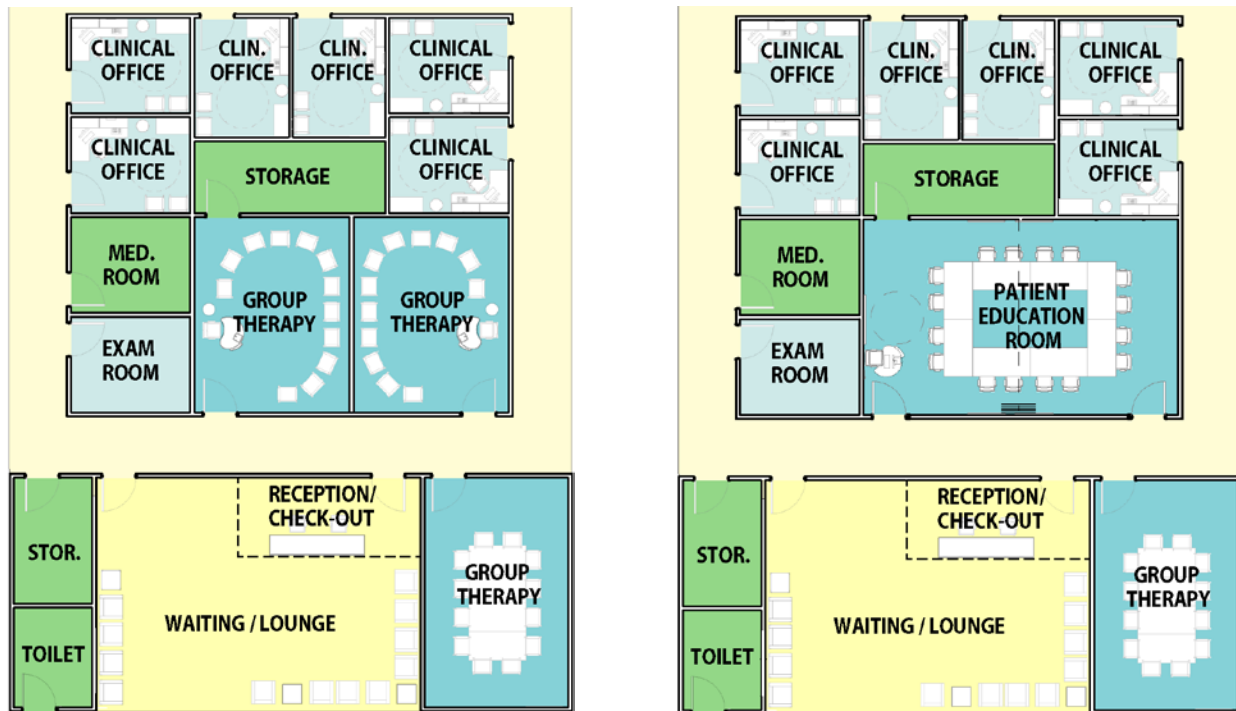

Figure 3.3.8. Space suitable for two group therapy rooms may developed as a patient education or classroom/conference space depending on functional need of a clinic.

Figure 3.3.8 illustrates the flexibility of modular design: a space that can accommodate two adjacent group therapy rooms can alternatively be developed as a patient education room. A facility has the option to provide moveable partition in the patient education room to allow functional flexibility, as long as acoustic privacy requirements are met.

Adjacent storage space – for storage of furniture – supports multiple room layouts and thus enhances the flexible use of these group care rooms. All group therapy rooms are accessed from the patient corridor adjacent to the waiting area.



### 3.3.4 Intensive Outpatient Specialty Mental Health Care, including Substance Use Disorder (SUD)

Figure 3.3.9 (on the following page) illustrates how the basic module, plus part of an adjacent module, can be adapted to accommodate an Intensive Outpatient Program – Substance Use Disorder (IOP-SUD) Clinic, where both intensive counseling and medically supervised withdrawal management are provided. It illustrates the following planning criteria:

- To support patient confidentiality and privacy standards, the waiting area is divided into two zones, one for patients undergoing medically supervised withdrawal management and the other for patients being treated at the facility through intensive counseling. A centrally located reception area observes waiting areas for each functional zone.
- The corridor on the right side of the diagram supports a medically supervised withdrawal management zone. Within that zone, the planning framework will accommodate a specimen toilet and, if provided in the Program for Design, a methadone area. For more detailed information, refer to Section 2.1.5.2, Methadone Area, and Section 4 Room Template and Room Data Sheet for Methadone Area.
- A second corridor (left side) supports intensive counseling zone. Although IOPs provide some individual therapies, group care is more common. The diagram illustrates a modification to the basic modular diagram and the use of a building “end condition” – see Figure 3.2.2 or Figure 3.4.1 – to facilitate use of two corridors and to increase the number of group therapy rooms.
- The quantity of group therapy rooms in Figure 3.3.9 is illustrative. Actual number may vary by workload and practice model.
- This diagram reflects the practice of taking specimens from patients when they arrive for group therapy sessions. There are a few options for layout of the specimen toilet, but an ideal configuration provides both a toilet stall and an immediately adjacent nurse work area with a sink and work counter for nurse supplies. This room must provide the opportunity for direct observation of patient by the nurse, who is located in the space with the lavatory and counter. The nurse may use the counter to place the specimen after receiving it from the patient.
- Ratio of one specimen toilet per group therapy room is considered ideal. A specimen toilet room may be used as a general toilet room when not needed for the specimen function.



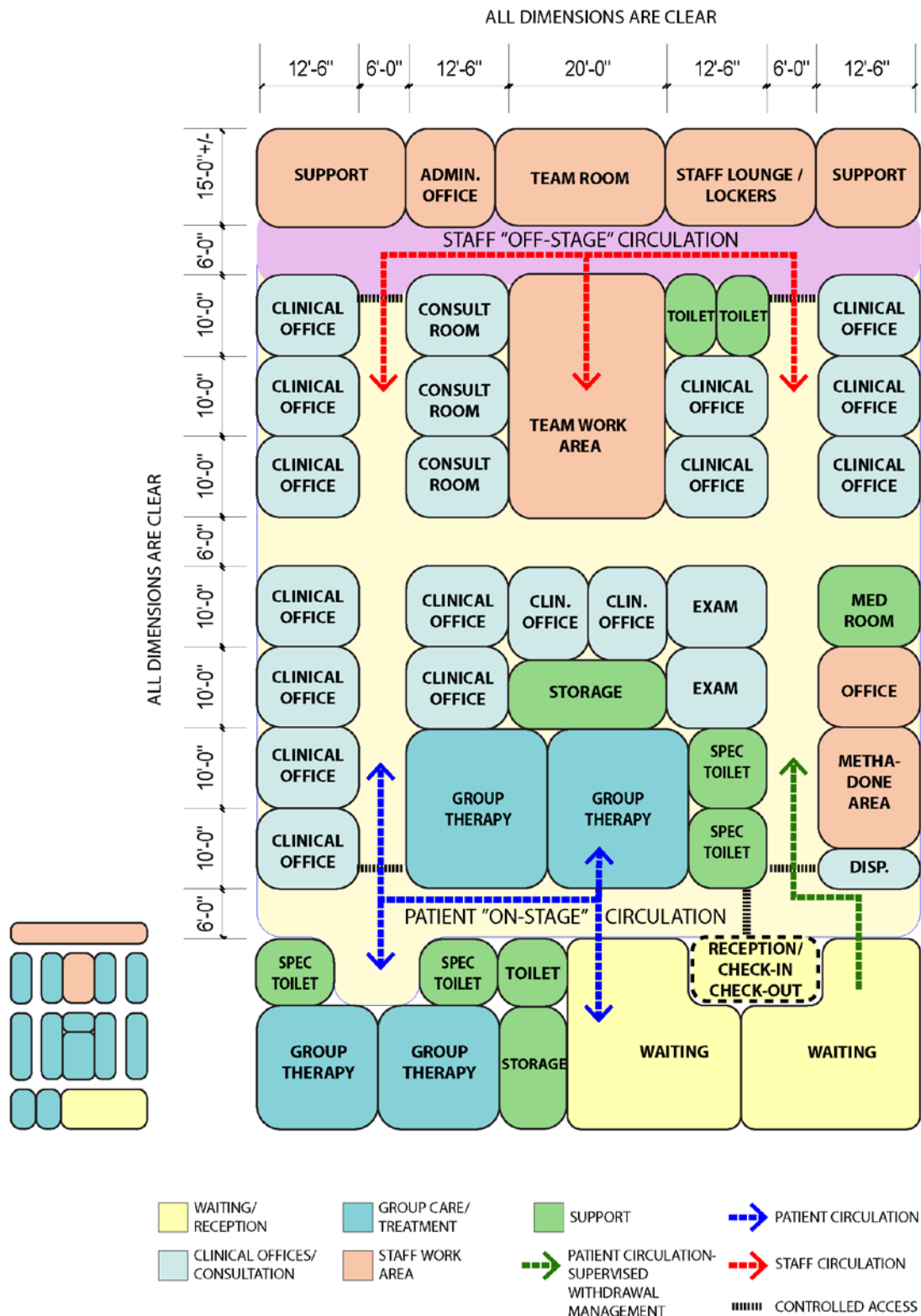

Figure 3.3.9. Plan diagram, adaptation of Universal Module to accommodate IOP – SUD Clinic





### 3.4 Flexibility and Adaptability at the Clinic Module Level

Over the expected useful life of a clinic facility, changes in health care delivery, demographics, technology, etc., can be anticipated. It is possible that one type of clinic will be converted to another type. It is also possible that a General Mental Health clinic will be located next to Specialty Mental Health clinic or next to a Primary Care clinic with Mental Health integration (PCMHI)

Figure 3.4.1 (on following page) illustrates the flexibility of the modular strategy to accommodate variants of the basic module side-by-side, including one module that increases the number of clinical offices and another module that is suitable for PCMHI. In Module 2, a full row of clinical offices plus a patient corridor has been added to the layout in place of the central staff workspace and group care space. In Module 3, the 20-ft wide central band of space has been extended to create an open team work area for the entire 80-ft length of the Clinical Treatment Zone. These strategies rely on group care space located in the Patient Transition Zone. Such modifications to the 20-ft wide band of space could be implemented with limited impact to adjacent clinical areas.



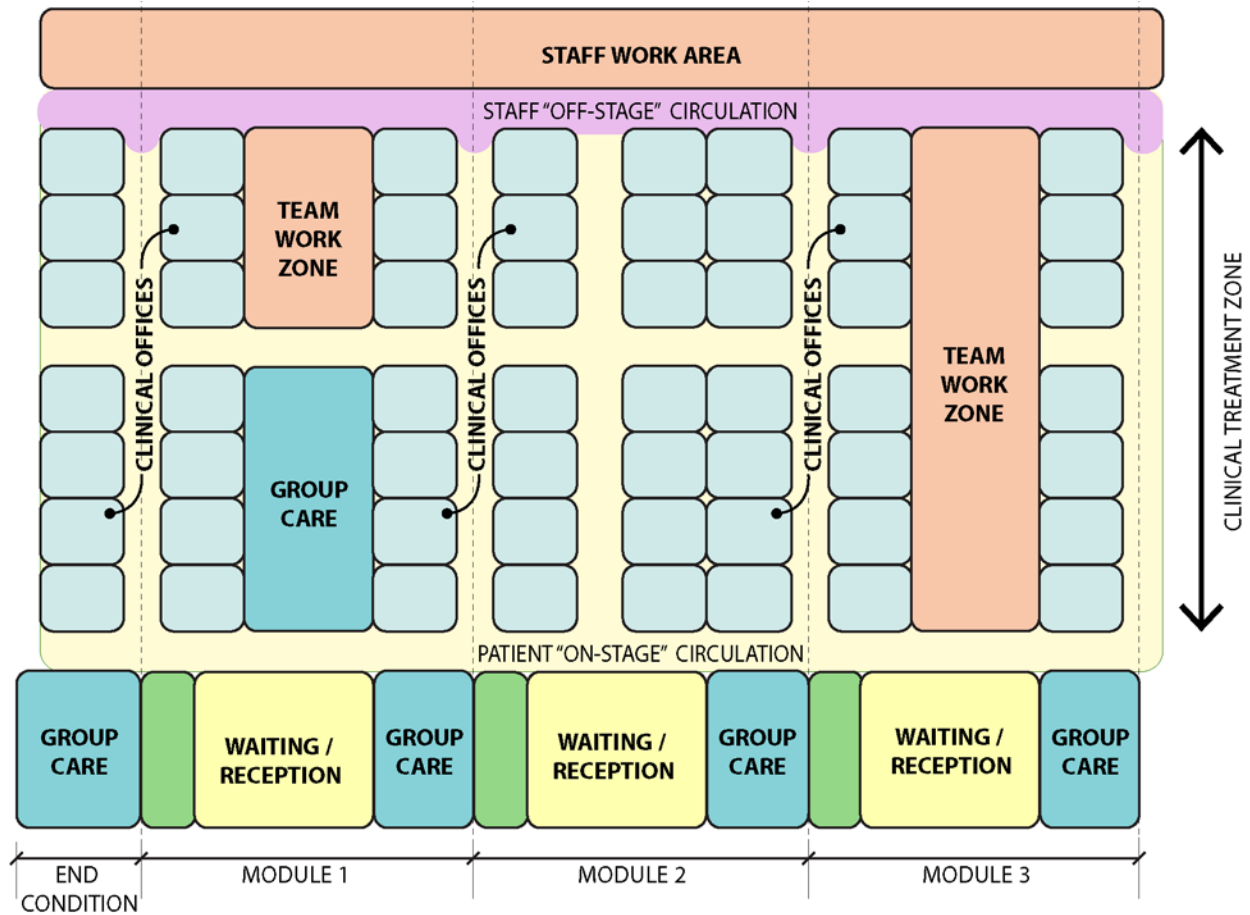

Figure 3.4.1. Modular concept showing Module 1 as Mental Health “Universal Module”, Module 2 with added number of clinical offices and Module 3 configured for Primary Care with Mental Health Integration (PCMHI)



### 3.5 Facilities for Community Based Programs

The following programs are ideally located in community settings. Planning diagrams for these programs use standardized room dimensions but do not match the Universal Module described in Sections 3.1 through 3.4. Planning concepts are similar to general and specialty mental health in the following ways:

- Organization of functions into Patient Transition Zone, Clinical Zone and Staff Work Zone, with reception as the control point between waiting and the Clinical Zone
- Group therapy and patient education rooms are located close to the Patient Transition Zone
- Storage is located close to group care rooms

#### 3.5.1 Psychosocial Rehabilitation and Recovery Centers (PRRC)

Figure 3.5.1 illustrates program-specific considerations (refer to Section 2.1.4.7).

Not all PRRCs will have all of the diagrammed components. For example, occupational therapy, dining and kitchen are not considered part of the “core” program but may be provided. Furthermore, these programs may be located in leased facilities that do not readily meet “universal” module dimensions. Thus, Figure 3.5.1 should be considered illustrative of desired adjacencies for PRRCs rather than prescriptive for modular planning grid dimensions.

Illustrated planning considerations include:

- The Recovery Resource Area serves as a resource library that may include self-help books, pamphlets, workbooks, educational materials and computers for personal use by Veterans. It may be designed as an alcove near the waiting area or as an enclosed room.
- Social and therapeutic activity spaces such as dining and occupational therapy are grouped on one side of the plan, and clinical offices / consultation rooms are located on the other side, with convenient access to both zones from waiting
- Kitchen / servery, where provided, is adjacent to social activities / dining and accessed from an off-stage service corridor
- Furniture storage space is located adjacent to social activities and occupational therapy rooms to support flexible use of these rooms.



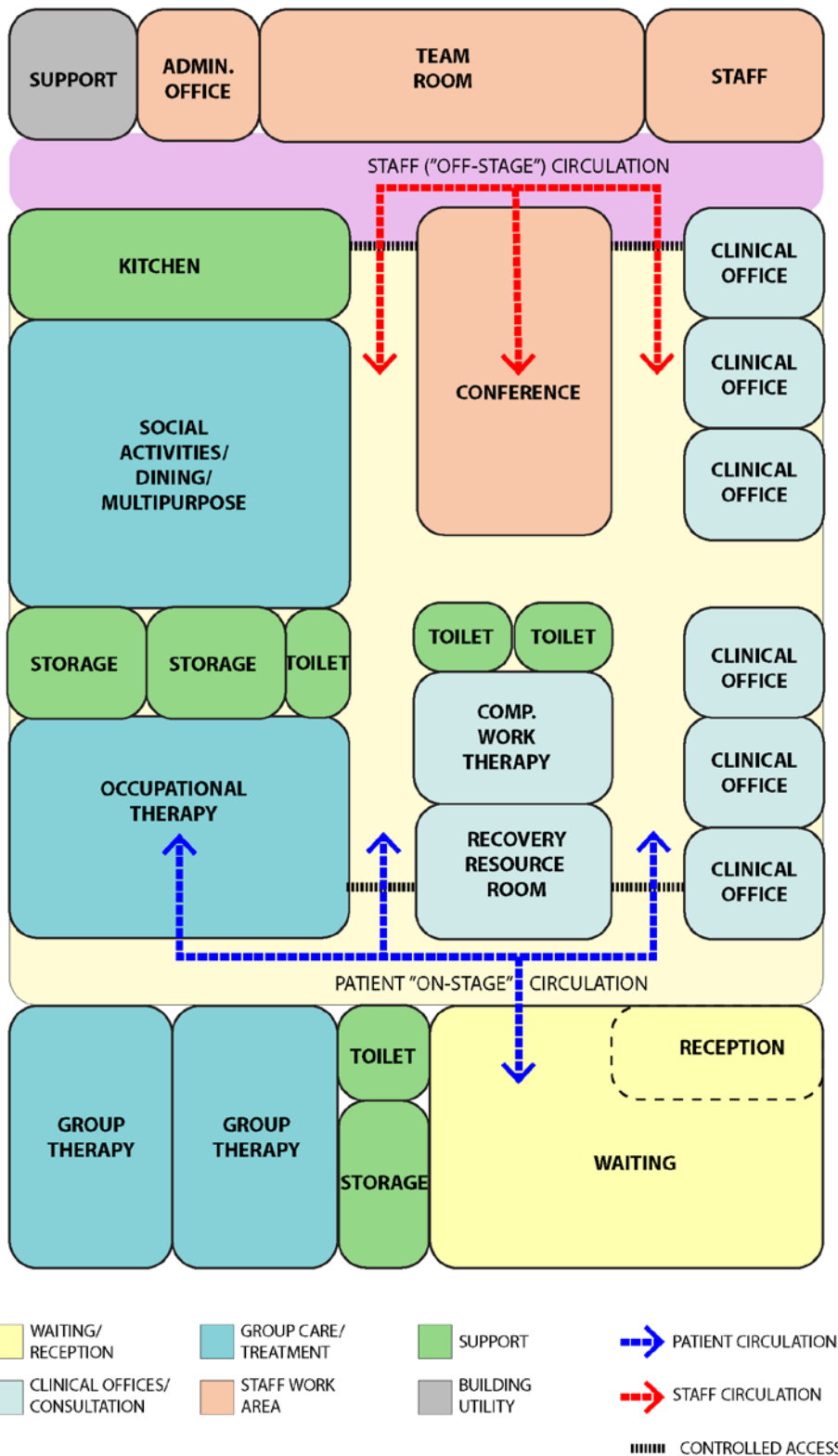

Figure 3.5.1. Psychosocial Rehabilitation and Recovery Center (PRRC) adjacency diagram



### 3.5.2 Community Resource and Referral Centers (CRRC) and Health Care for Homeless Veterans (HCHV) Service Centers

These facilities support VHA Homeless Programs (refer to Section 2.1.4.8). Other than community location and workspace for VA and community providers, there are few formal space program requirements for CRRCs, and program space components vary considerably by project. Furthermore, these programs are often located in leased facilities that do not readily meet “universal” module dimensions. Thus, Figure 3.5.2 should be considered illustrative of desired adjacencies for CRRCs rather than prescriptive for modular planning grid dimensions. Not all CRRCs will have all of the diagrammed components. Program-specific considerations include:

- At least one office / consult room has direct access from the waiting area for use by community partners
- Direct access is provided from waiting to a multipurpose (community) room. Either the community room or an education classroom – as shown in Figure 3.5.2 – can be configured and furnished to accommodate the group therapy function (up to 12 patients).
- Exam room may be used by CRRC-based Homeless PACT (H-PACT) program, which provides medical care in this non-traditional setting to homeless Veterans not otherwise receiving VA care. Easy access from waiting room to exam room is desirable.
- If an exam room is provided for H-PACT, allow for associated medical supply storage space on site.
- Veteran access to computers is desirable. Design solutions may include locating computers in a zone of the waiting room or in a computer lab (also refer to images in Figures 2.1.2.g and 2.1.3.j) or resource area.
- Room types specific to CRRC and HCHV Service Centers may include laundry, clothing closet, shower, pantry and teaching kitchen. Figure 3.5.1 depicts these functions located close to waiting and reception area.



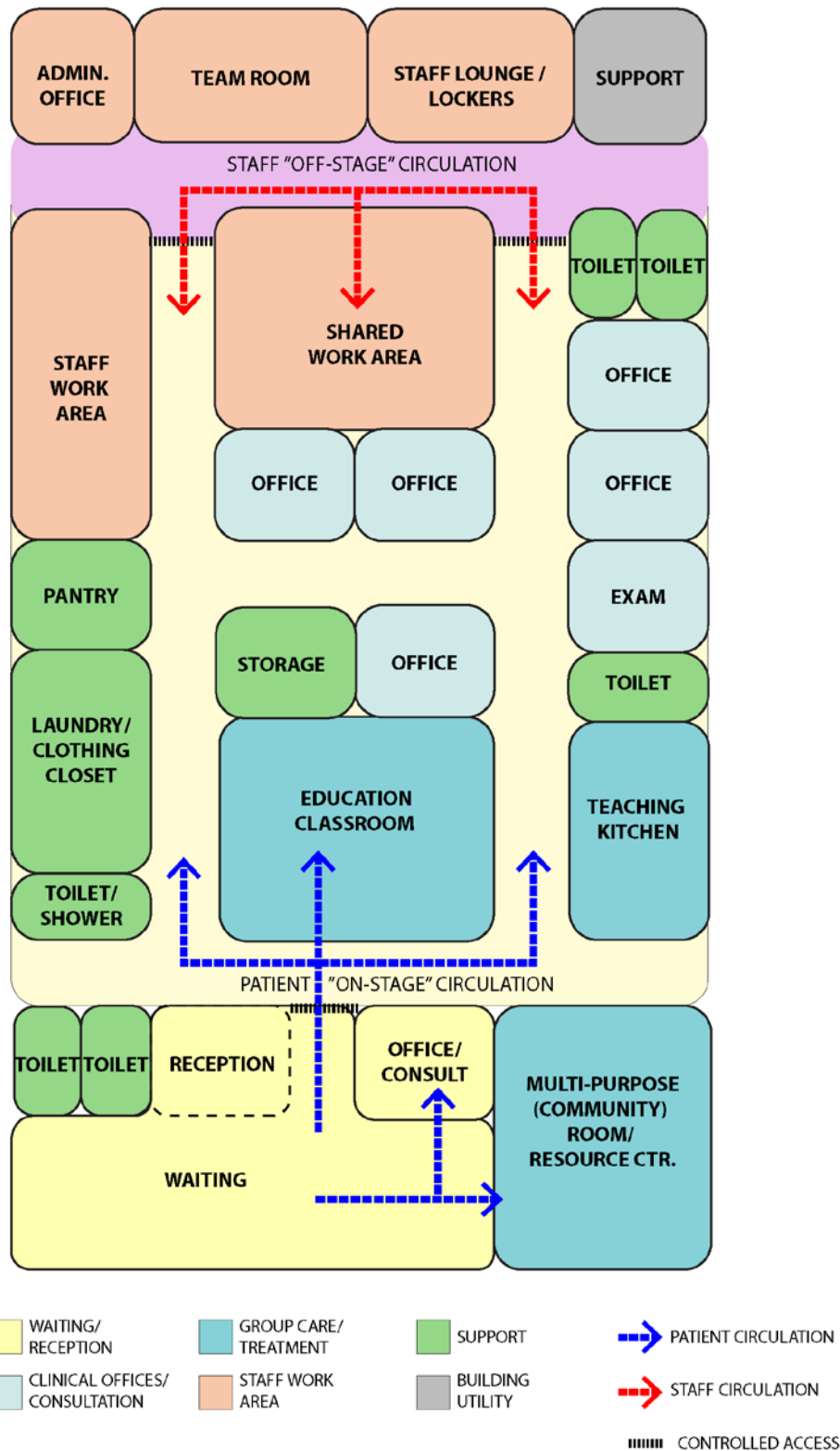

Figure 3.5.2. Community Resource and Referral Center (CRRC) adjacency diagram



THIS PAGE WAS INTENTIONALLY LEFT BLANK



## INDEX OF ROOM TEMPLATES

## 4.0 ROOM TEMPLATES – FLOOR PLANS, REFLECTED CEILING PLANS, ROOM DATA SHEET, EQUIPMENT LIST &amp; GENERAL NOTES

4.1	General	4-4
	• Introduction	4-4
	• Legend of Symbols	4-6
4.2	Transcranial Magnetic Stimulation (TMS) Room (XXYYC)	
	• Axonometric View	4-9
	• Floor Plan	4-10
	• Reflected Ceiling Plan	4-11
	• Room Data Sheet	4-12
	• Equipment List	4-14
4.3	Group Therapy Room (OPMH1)	
	• Axonometric View	4-16
	• Floor Plan	4-17
	• Reflected Ceiling Plan	4-18
	• Room Data Sheet	4-19
	• Equipment List	4-21
4.4	Group Therapy Room, Conference Format (XXYYC)	
	• Axonometric View	4-23
	• Floor Plan	4-24
	• Reflected Ceiling Plan	4-25
	• Room Data Sheet	4-26
	• Equipment List	4-28
4.5	Office, Clinical, Single Access (XXYYC)	
	• Axonometric View	4-30
	• Floor Plan	4-31
	• Reflected Ceiling Plan	4-32
	• Room Data Sheet	4-33
	• Equipment List	4-35
4.6	Office, Clinical, Dual Access (XXYYC)	
	• Axonometric View	4-37
	• Floor Plan	4-38
	• Reflected Ceiling Plan	4-39





• Room Data Sheet	4-40
• Equipment List	4-42
4.7 Consultation Room, Single Access (XXYYC)	
• Axonometric View	4-43
• Floor Plan	4-44
• Reflected Ceiling Plan	4-45
• Room Data Sheet	4-46
• Equipment List	4-48
4.8 Consultation Room, Dual Access (XXYYC)	
• Axonometric View	4-49
• Floor Plan	4-50
• Reflected Ceiling Plan	4-51
• Room Data Sheet	4-52
• Equipment List	4-54
4.9 Family Consultation / Therapy Room (XXYYC)	
• Axonometric View	4-55
• Floor Plan	4-56
• Reflected Ceiling Plan	4-57
• Room Data Sheet	4-58
• Equipment List	4-60
4.10 Multipurpose Room (XXYYC)	
• Axonometric View	4-62
• Floor Plan	4-63
• Reflected Ceiling Plan	4-64
• Room Data Sheet	4-65
• Equipment List	4-67
4.11 Group Testing Room (OPMH2)	
• Axonometric View	4-69
• Floor Plan	4-70
• Reflected Ceiling Plan	4-71
• Room Data Sheet	4-72
• Equipment List	4-74
4.12 Social Activities / Dining / Multipurpose Room (XXYYC)	
• Axonometric View	4-76
• Floor Plan	4-77
• Reflected Ceiling Plan	4-78



• Room Data Sheet	4-79
• Equipment List	4-81
4.13 Activities / Dining Room with Kitchenette (XXYYC)	
• Axonometric View	4-83
• Floor Plan	4-84
• Reflected Ceiling Plan	4-85
• Room Data Sheet	4-86
• Equipment List	4-88
4.14 Activities / Dining Room (FSCD1)	
• Axonometric View	4-90
• Floor Plan	4-91
• Reflected Ceiling Plan	4-93
• Room Data Sheet	4-94
• Equipment List	4-95
4.15 Occupational Therapy Room (XXYYC)	
• Axonometric View	4-97
• Floor Plan	4-98
• Reflected Ceiling Plan	4-99
• Room Data Sheet	4-100
• Equipment List	4-102
4.16 Conference Room / Classroom (XXYYC)	
• Axonometric View	4-105
• Floor Plan	4-106
• Reflected Ceiling Plan	4-107
• Room Data Sheet	4-108
• Equipment List	4-110
4.17 Methadone Area (XXYYC)	
• Axonometric View	4-112
• Floor Plan	4-113
• Reflected Ceiling Plan	4-114
• Room Data Sheet	4-115
• Equipment List	4-117



## 4.0 Room Templates

### 4.1 General

#### Introduction

The Room Templates illustrate standard layouts for key functional spaces, and represent best practice layouts based on room function, room occupancy, room equipment and contents, and room utilities. The Room Templates were developed as a design tool to assist the Project Team in understanding the choices to be made during design, and to assist designers in understanding VA's space and functional requirements for outpatient mental health services. The Room Templates are not project specific and are not meant to limit design opportunities. However, the net square feet (NSF), room geometry and layout are provided as a standard to be achieved for each project design.

While this information is provided for the key clinical and support spaces required, it is not possible to foresee all possible variations or future requirements. The project-specific space program shall be used as the basis for individual project design.

The Room Templates must be reviewed against project criteria and any special requirements. Specific infrastructure design requirements are contained in VA Design Manuals located in the VA Technical Information Library. Equipment manufacturers shall be consulted for the most current equipment information such as actual dimensions, weights and utility requirements of equipment.



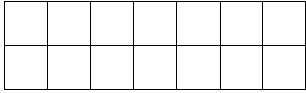
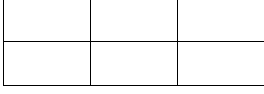

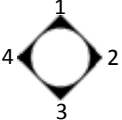
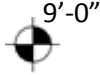
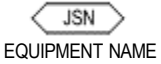



**TABLE 5: ROOM TEMPLATES BY OUTPATIENT MENTAL HEALTH SERVICE-  
WHERE THEY MAY BE LOCATED**

Room Code	Room Name	General Mental Health Services	PCT (PTSD Clinical Teams)	Intensive Outpatient Specialty Mental Health Care, including SUD	Special Interventions	Psychosocial Rehab and Recovery Center (PRRC)	Community-Based Programs, including ICMHR and TSES	VHA Homeless Programs, including CRRC
XXYYC	Transcranial Magnetic Stimulation (TMS) Rm	Y			Y		Y	
OPMH1	Group Therapy Room	Y	Y	Y		Y	Y	Y
XXYYC	Clinical Office	Y	Y	Y	Y	Y	Y	Y
XXYYC	Consultation Room	Y	Y	Y	Y	Y	Y	Y
XXYYC	Family Consultation / Therapy Room	Y	Y	Y				
XXYYC	Multipurpose Room	Y	Y	Y	Y	Y		Y
OPMH2	Group Testing Room	Y			Y		Y	
XXYYC	Social Activities / Dining / Multipurpose Room	Y		Y		Y		Y
FSCD1	Activities / Dining Room					Y		Y
XXYYC	Occupational Therapy Room					Y		Y
XXYYC	Conference Room / Classroom	Y	Y	Y		Y	Y	Y
XXYYC	Methadone Area			Y				

Table 5 identifies which Room Templates may be found in a particular outpatient clinic or center. For more specific and detailed programming of spaces for various outpatient mental health services, please refer to Space Planning Criteria Chapter 260 Mental Health Outpatient Services.



Legend of Symbols

SYSTEM	DESCRIPTION OF SYMBOLS	SYMBOL
<b>ARCHITECTURAL</b>	2'X2' ACOUSTIC TILE CEILING	
	2'X4' ACOUSTIC TILE CEILING	
	GYPSUM BOARD	
	INTERIOR ELEVATION REFERENCE	
	HEIGHT OF CEILING FINISH ABOVE FINISH FLOOR	
	JSN AND EQUIPMENT NAME	
	WHEELCHAIR CLEARANCE	
	CENTERLINE	
<b>WIRING DEVICES SWITCHES</b>	SINGLE POLE SWITCH (SUBSCRIPT INDICATES FIXTURES CONTROLLED), 48" AFF	S <sub>a</sub>
	THREE-WAY SWITCH, 48" AFF	S <sub>3</sub>
	LOW VOLTAGE DIMMER SWITCH, 48" AFF	S <sub>D</sub>
	OCCUPANCY SENSOR, 48" AFF	S <sub>Mo</sub>
	OCCUPANCY SENSOR (IN CEILING)	





















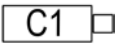

Legend of Symbols (continued)

SYSTEM	DESCRIPTION OF SYMBOLS	SYMBOL
<b>LIGHTING DEVICES/ FIXTURES</b>	2'X4' RECESSED LIGHT FIXTURE	
	2'X4' RECESSED EMERGENCY LIGHT FIXTURE	
	2'X2' RECESSED FLUORESCENT LIGHT FIXTURE	
	2'X2' RECESSED EMERGENCY LIGHT FIXTURE	
	RECESSED DOWNLIGHT FIXTURE	
<b>WIRING DEVICES RECEPTACLES</b>	DUPLEX RECEPTACLE, 18" AFF	
	GROUND FAULT INTERRUPTER RECEPTACLE, 18" AFF	
	DOUBLE DUPLEX RECEPTACLE, 18" AFF	
	ABOVE FINISHED COUNTER	AFC
	2-GANG COMPARTMENT BOX IN FLOOR FOR DATA AND RECEPTACLE	



Legend of Symbols (continued)

SYSTEM	DESCRIPTION OF SYMBOLS	SYMBOL
<b>COMMUNICATIONS SYSTEMS</b>	TELEPHONE DATA OUTLET	
	TELEVISION CABLE OUTLET - WALL MOUNTED/CEILING MOUNTED	
	SPEAKER - WALL MOUNTED/CEILING MOUNTED	
	RECEPTACLE, CLOCK HANGER	
	NURSE CALL DEVICE (PULL CORD)	
	NURSE CALL DEVICE (CODE BLUE)	
	PUSH PLATE (AUTO OPENING DOOR)	
	MOTION INTRUSION DETECTION SYSTEM	
	INTERCOM SYSTEM	
	EMERGENCY PHONE (EP)	
	PACS	
	SATELLITE TELEVISION SYSTEM (SATV)	
	DURESS ALARM SYSTEM (DA)	
	CCTV & SSTV	
<b>MECHANICAL</b>	ROOM THERMOSTAT	
	CARBON DIOXIDE TRANSMITTER	
	HVAC SUPPLY	
	HVAC RETURN	
	LINEAR DIFFUSER	
	EXHAUST REGISTER	
	HOOD EXHAUST	
<b>PLUMBING</b>	SPRINKLER HEAD	



**4.2 Transcranial Magnetic Stimulation (TMS) Room (XXYYC)**

4.2 TMS Room - Axonometric

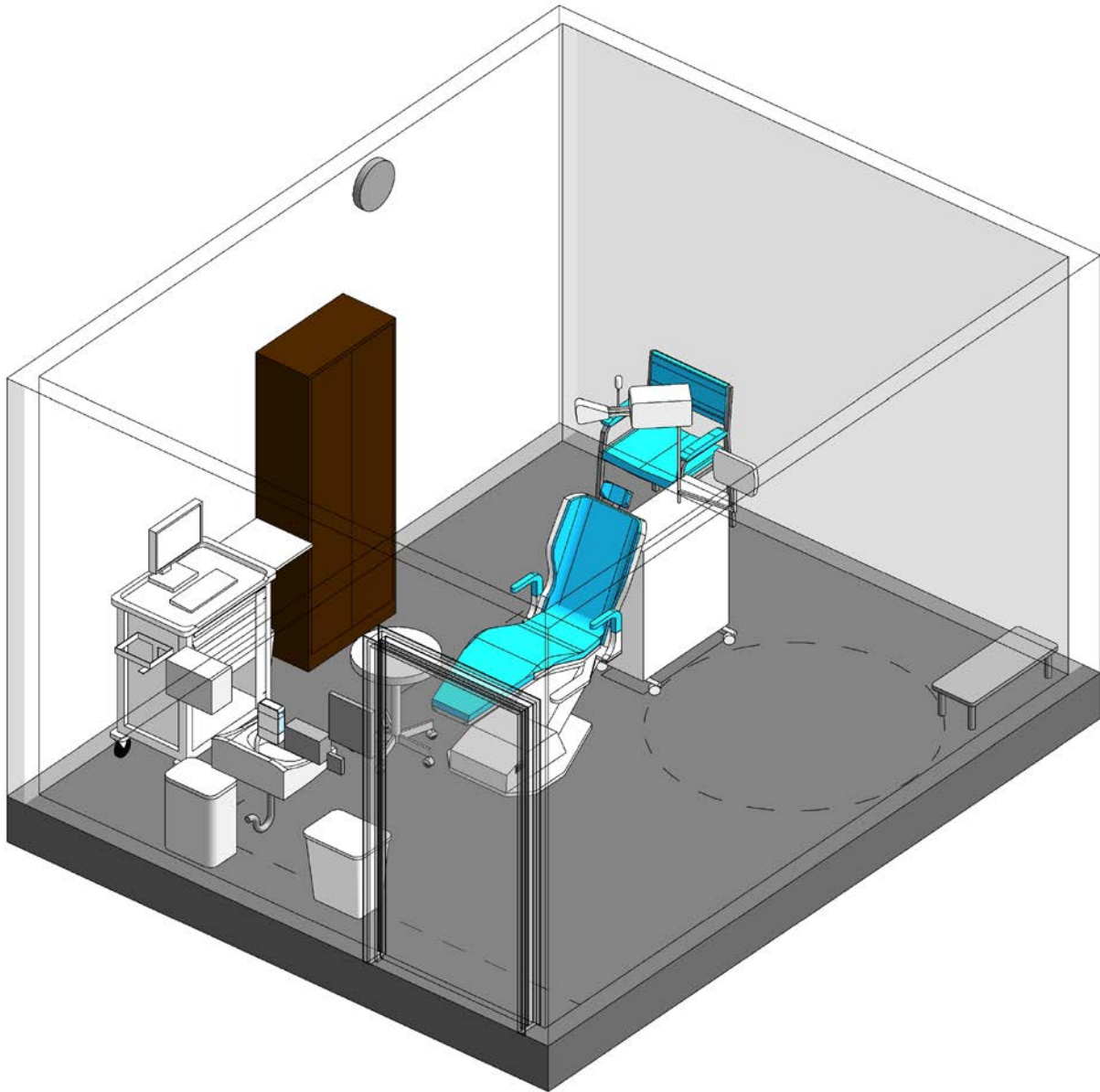



4.2 TMS Room - Floor Plan

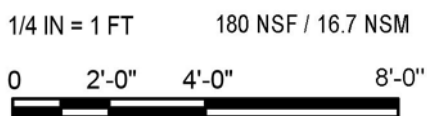
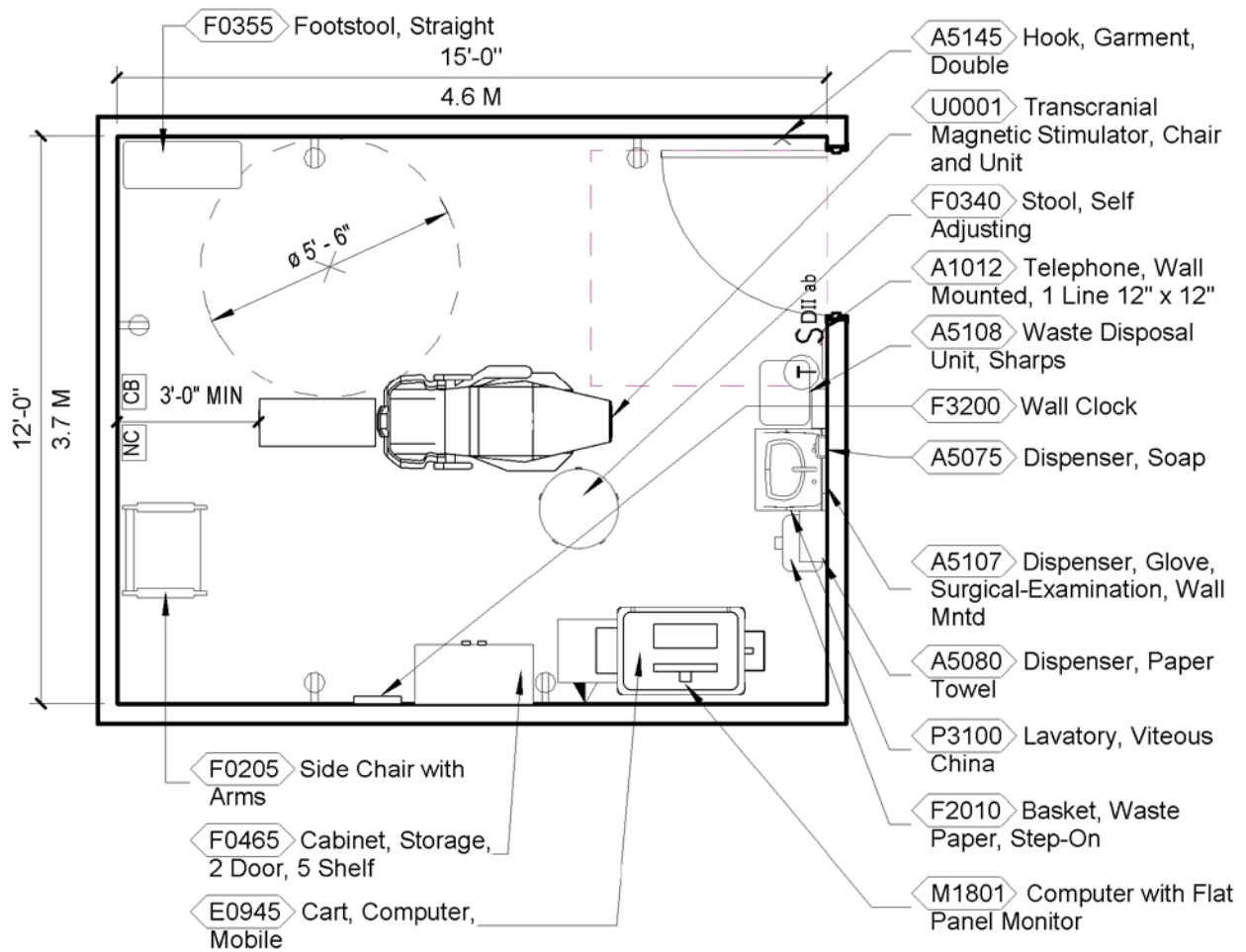

4.2 TMS Room - Reflected Ceiling Plan

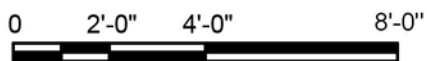
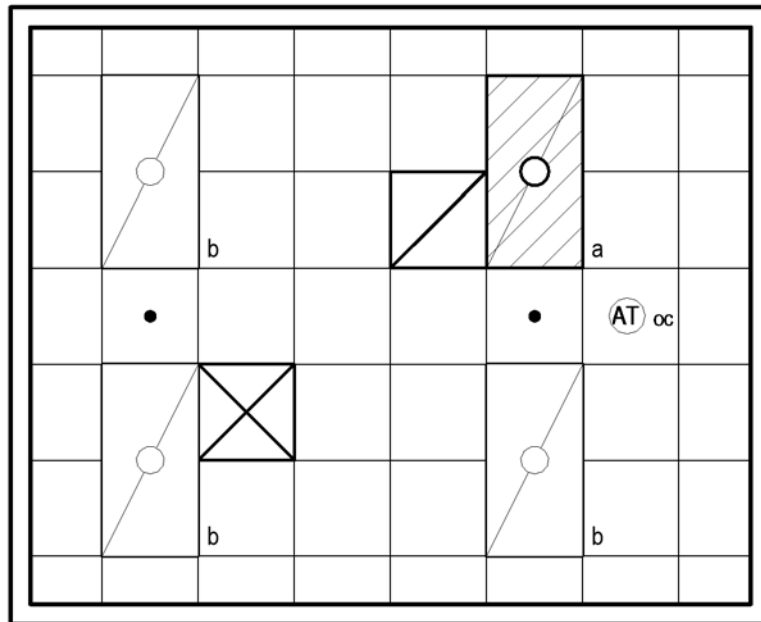

4.2 TMS Room - Room Data Sheet

**ARCHITECTURAL**

<b>Ceiling Type:</b>	Acoustical Ceiling Tile
<b>Ceiling Height:</b>	9'-0" (2700 mm)
<b>Ceiling Finish:</b>	Acoustical Ceiling Tile
<b>Wall Finish:</b>	Paint
<b>Wainscot:</b>	None
<b>Base:</b>	Resilient Millwork Style (min. 4"/ 101 mm)
<b>Floor Finish:</b>	Luxury Vinyl Tile
<b>Slab Depression:</b>	None Special
<b>Sound Protection:</b>	Professional acoustical consultant to determine
<b>Doors:</b>	3'-6" x 7'-0" wood

**LIGHTING**

<b>Maintained Average Illumination – Ambient:</b>	500 Lux (50 FC)
<b>Maintained Average Illumination – Task Focus:</b>	1000 Lux (100 FC) on treatment chair
<b>Luminaire Type:</b>	2'x4' Fluorescent or LED, Virgin Acrylic – Prismatic Lens, Radio Frequency Filter, sealed housing, gasketed frame
<b>Lamps:</b>	4 Fluorescent or LED equivalent, 3500K – 4100K CCT, CRI >= 80%, 25% above treatment chair shall be on emergency power
<b>Controls:</b>	Dimming or multi-level switching, occupancy sensor

**Notes:** Coordinate location of luminaires with other ceiling obstructions

**POWER**

<b>Normal Power:</b>	To be connected to selected receptacles and equipment
<b>Emergency Power:</b>	To be connected to selected lighting

**Notes:** Provide a minimum of one receptacle on each wall

**COMMUNICATIONS**

<b>Data:</b>	Yes
<b>Telephone:</b>	Yes
<b>Cable Television:</b>	No
<b>Duress Alarm:</b>	Yes
<b>Electronic Access and Door Control:</b>	No
<b>Intercom:</b>	No
<b>Motion Intrusion Detection (MID):</b>	No
<b>Nurse Call:</b>	Yes
<b>Code Blue:</b>	Yes
<b>Public Address:</b>	No
<b>Security Surveillance Television (SSTV):</b>	No
<b>VA Satellite TV:</b>	No
<b>Video Teleconferencing (TEL):</b>	No
<b>Clock:</b>	Yes



4.2 TMS Room - Room Data Sheet (Continued)

**HEATING, VENTILATING AND AIR CONDITIONING**

Refer to HVAC Design Manual Chapter 6 Mental Health Outpatient Services – Room Data Sheet Treatment Room

**PLUMBING AND MEDICAL GASES**

<b>Cold Water:</b>	Yes
<b>Hot Water</b>	Yes
<b>Waste:</b>	Yes
<b>Reagent Grade Water:</b>	No
<b>Medical Air:</b>	No
<b>Medical Vacuum:</b>	No
<b>Oxygen:</b>	No

**FIRE PROTECTION AND LIFE SAFETY**

<b>Fire Alarm:</b>	Yes - Detection
<b>Sprinkler:</b>	Yes
<b>Hazard Type:</b>	Light Hazard



## 4.2 TMS Room - Equipment List

JSN	NAME	QTY	ACQ/INS	DESCRIPTION
A1012	Telephone, Wall Mounted, 1 Line	1	V / V	Telephone, wall mounted, 1 line.
A5075	Dispenser, Soap, Disposable	1	V / V	Disposable soap dispenser. One-handed dispensing operation. Designed to accommodate disposable soap cartridge and valve.
A5082	Dispenser, Paper Towel, Sensor, Hands Free	1	C / C	A surface mounted, sensor activated, automatic, roll paper towel dispenser. The unit dispenses a paper towel automatically only when hands are placed in position below the dispenser for maximum sanitation and hygiene. May include adjustable settings for sheet length, time delay, and sensor range. Unit is battery operated or with optional AC power adapter.
A5107	Dispenser, Glove, Surgical/ Examination, Wall Mntd	1	V / V	Examination glove dispenser box for wall mounting. Fabricated of either cold rolled steel with a white baked enamel finish, plastic or acrylic. Provided with wall bracket to facilitate mounting and demounting.
A5108	Waste Disposal Unit, Sharps	1	V / V	A container for collecting and transporting syringes and other sharps for decontamination and disposal. Available in 2 gallon and 8 gallon with locking rotor. Complies with OSHA regulations for handling sharps.
A5145	Hook, Garment, Double, SS, Surface Mounted	1	C / C	A surface mounted, satin finish stainless steel, double garment hook. Equipped with a concealed mounting bracket that is secured to a concealed wall plate. For general purpose use throughout the facility to hang various items of apparel.
E0945	Cart, Computer, Mobile	1	V / V	A mobile computer cart for use throughout the facility. The cart dimensions will be approximately 45" H x 30" W x 22" D with casters. May include drawers and miscellaneous other accessories that will be determined at time of purchase. This Typical may include: 1 Cart Body, w/Computer Support, Style-A Narrow, w/Raised Edge Top 1 Flip-Up Shelf, 1 Sharps Container Holder, 1 Wastebasket, 1 Chart Holder 2 Drawers, 3"H 2 Drawers, 6"H 3 Accessory Rail, Side Drawer Organizer Bins



JSN	NAME	QTY	ACQ/INS	DESCRIPTION
F0205	Chair, Side With Arms	1	V / V	Upholstered side chair, 32" high X 21" wide X 23" deep with arms, padded seats and padded backs. Seat height is a minimum of 17". Available with or without sled base.
F0340	Stool, Self-Adjusting	1	V / V	Self-adjusting stool. Consists of a foam padded upholstered seat with attached footrest for added comfort. Mounted on swivel casters. Designed for doctor's use during examinations.
F0355	Footstool, Straight	1	V / V	Step stool. Used to assist patients getting on and off exam or surgical tables. Fitted with electrically conductive rubber tips.
F0465	Cabinet, Storage, 2 Door, 5 Shelf	1	V / V	Storage cabinet, 78" high X 48" wide X 24" deep with two (2) doors and five (5) adjustable shelves.
F2010	Basket, Wastepaper, Step-On	1	V / V	"Step-on" wastepaper basket with inner liner and foot pedal activated flip top.
F3200	Clock, Battery, 12" Diameter	1	V / V	Clock, 12" diameter. Round surface, easy to read numbers with sweep second hand. Wall mounted unit for use when impractical to install a fully synchronized clock system. Battery operated, (batteries not included).
M1801	Computer, Microprocessing, w/Flat Panel Monitor	1	V / V	Desktop microprocessing computer. The unit shall consist of a central processing mini tower, flat panel monitor, keyboard, mouse and speakers. The system shall have the following minimum characteristics: a 2.8 GHz Pentium processor; 512 MB memory; 80GB hard drive; 32/48x CD-ROM/DVD combo; 1.44MB network interface card; video 32 MB NVIDIA; a 18 inch flat panel monitor. The computer is used throughout the facility to input, manipulate and retrieve information.
P3100	Lavatory, Vitreous China, Slab Type	1	C / C	Wall mounted, slab type, vitreous china, lavatory (approximate bowl size 7"x15"x10") with: faucet holes on 4" centers; gooseneck spout; wrist blade handles; and grid strainer. It shall be suitable for use in clinics, offices, washrooms or patient care area.
U0001	Transcranial Magnetic Stimulator	1	V / V	A non-invasive clinical treatment usually reserved for those suffering from severe treatment-resistant depression. TMS is the most commonly practice brain stimulation technique in the medical field.



**4.3 Group Therapy Room (OPMH1)**

4.3 Group Therapy Room – Axonometric

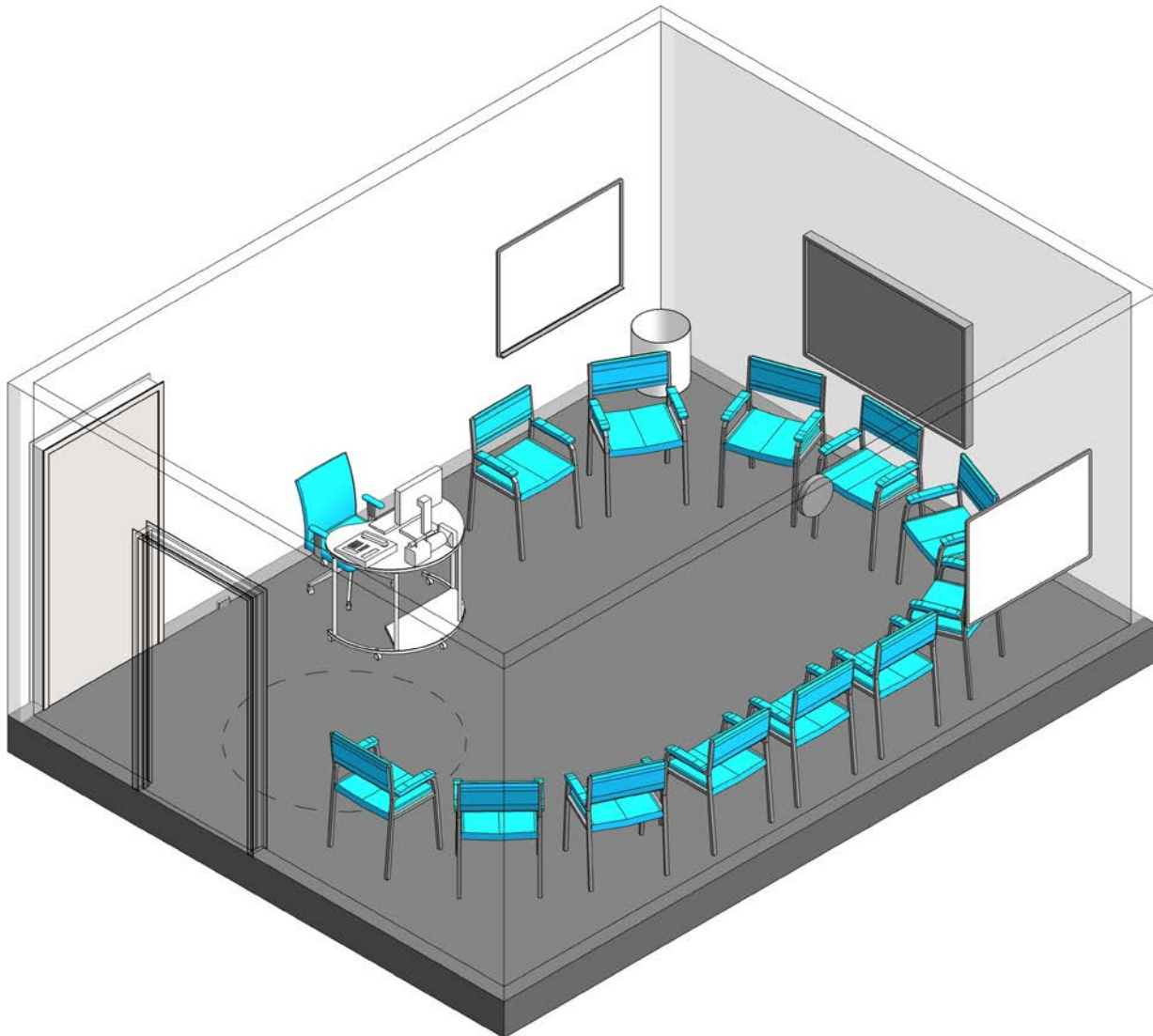

4.3 Group Therapy Room - Floor Plan

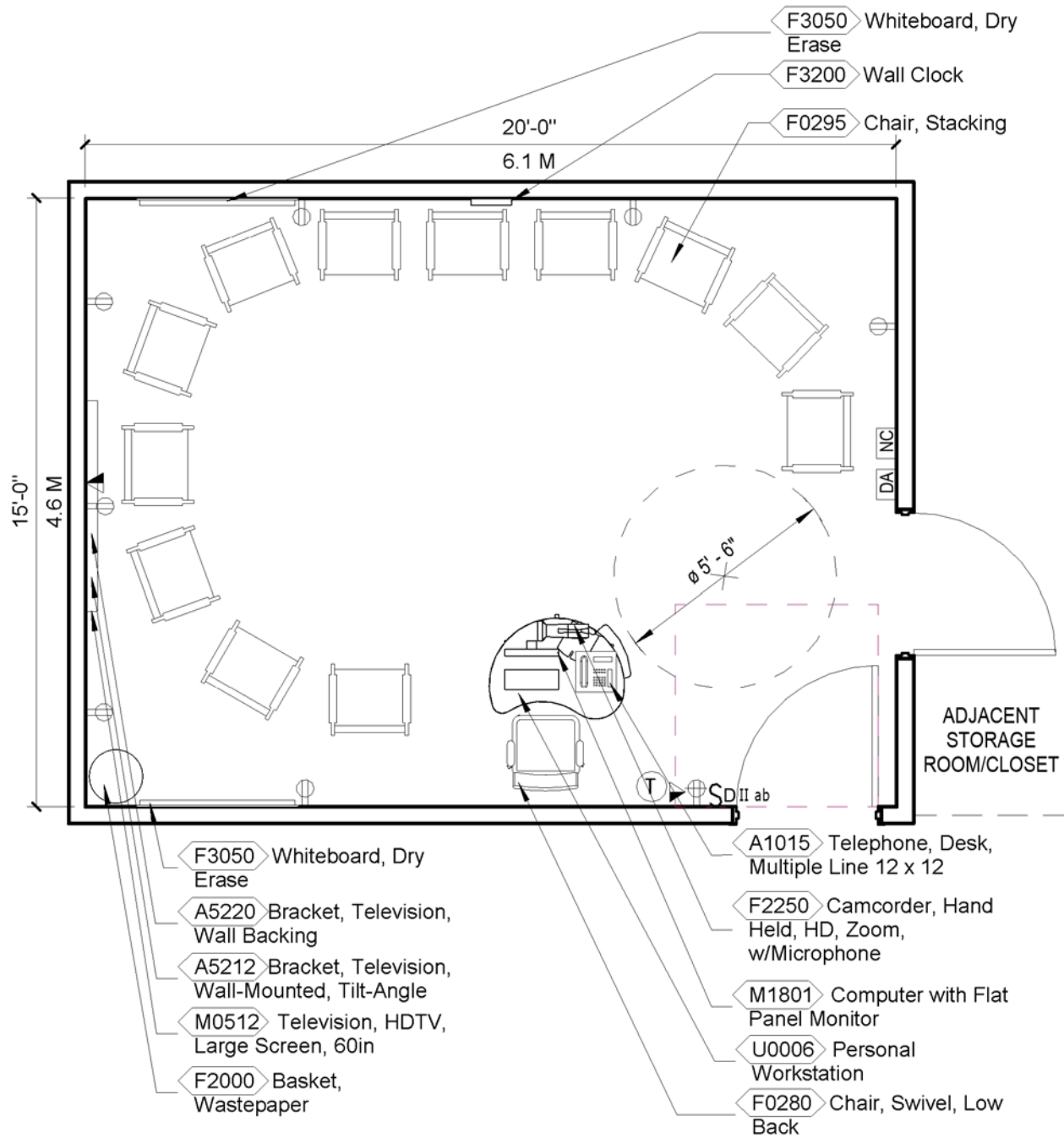

1/4 IN = 1 FT      300 NSF / 27.9 NSM

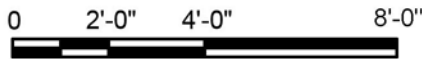



### 4.3 Group Therapy Room – Reflected Ceiling Plan

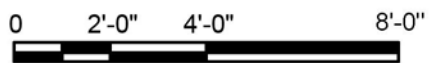
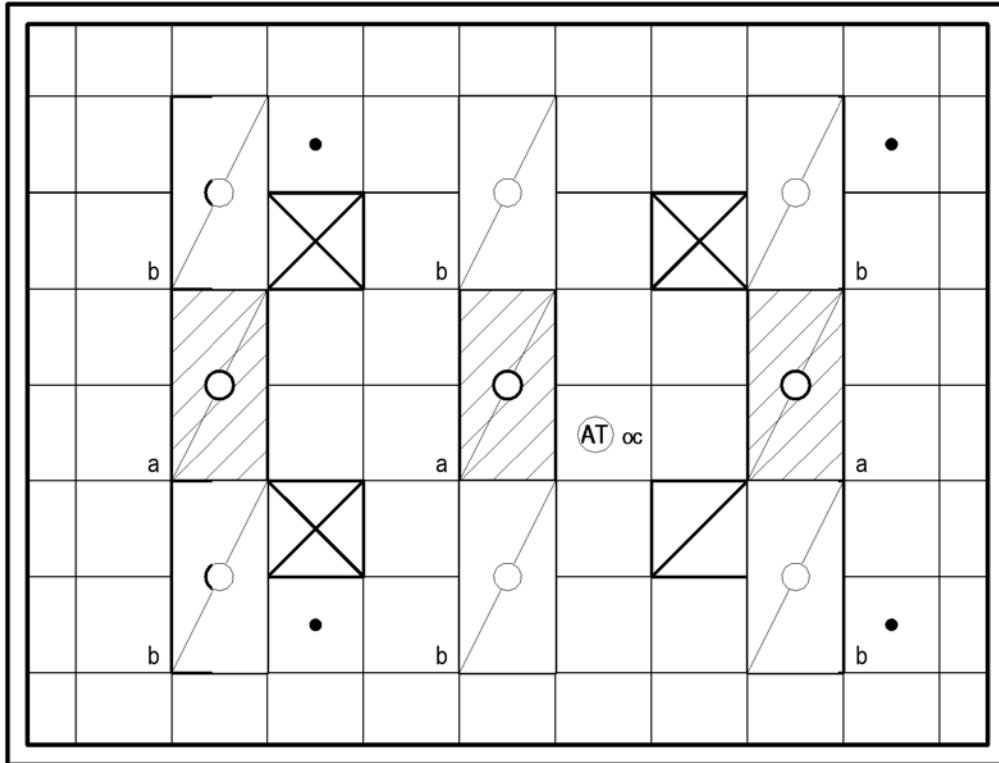

### 4.3 Group Therapy Room – Room Data Sheet

<b>ARCHITECTURAL</b>		<b>POWER</b>	
<b>Ceiling Type:</b>	Acoustical Ceiling Tile	<b>Normal Power:</b>	To be connected to selected receptacles and equipment.
<b>Ceiling Height:</b>	9'-0" (2700 mm)	<b>Emergency Power:</b>	To be connected to selected lighting.
<b>Ceiling Finish:</b>	Acoustical Ceiling Tile		
<b>Wall Finish:</b>	Paint		
<b>Wainscot:</b>	None		
<b>Base:</b>	Resilient Millwork Style (min. 4" / 101 mm)	<b>Notes:</b>	Provide a minimum of one receptacle on each wall.
<b>Floor Finish:</b>	Luxury Vinyl Tile		
<b>Slab Depression:</b>	None Special	<b>COMMUNICATIONS</b>	
<b>Sound Protection:</b>	STC 50 minimum	<b>Data:</b>	Yes
<b>Doors:</b>	3'-6" x 7'-0" wood	<b>Telephone:</b>	Yes
		<b>Cable Television:</b>	Yes
		<b>Duress Alarm:</b>	Yes
		<b>Electronic Access and Door Control:</b>	No
		<b>Intercom:</b>	No
		<b>Motion Intrusion Detection (MID):</b>	No
		<b>Nurse Call:</b>	Yes
		<b>Code Blue:</b>	No
		<b>Public Address:</b>	No
		<b>Security Surveillance Television (SSTV):</b>	No
		<b>VA Satellite TV:</b>	Yes
		<b>Video Teleconferencing (TEL):</b>	No
		<b>Clock:</b>	Yes
<b>LIGHTING</b>			
<b>Maintained Average Illumination – Ambient:</b>	500 Lux (50 FC)		
<b>Luminaire Type:</b>	2'x4' Fluorescent or LED, Virgin Acrylic Prismatic Lens, sealed housing, gasketed frame		
<b>Lamps:</b>	4 Fluorescent or LED equivalent, 3500K – 4100K CCT, CRI >= 80%, 25% lighting shall be on emergency power		
<b>Controls:</b>	Dimming or multi-level switching, occupancy sensor		
<b>Notes:</b> Coordinate location of luminaires with other ceiling obstructions			



4.3 Group Therapy Room – Room Data Sheet (continued)

**HEATING, VENTILATING AND AIR CONDITIONING**

Refer to HVAC Design Manual Chapter 6 Mental Health Outpatient Services – Room Data Sheet Group Therapy Room

**Note:** Where occupant density exceeds one person per 25 square feet, provide CO<sub>2</sub> sensing and control to limit CO<sub>2</sub> not to exceed 800 ppm.

**PLUMBING AND MEDICAL GASES**

<b>Cold Water:</b>	No
<b>Hot Water</b>	No
<b>Waste:</b>	No
<b>Reagent Grade Water:</b>	No
<b>Medical Air:</b>	No
<b>Medical Vacuum:</b>	No
<b>Oxygen:</b>	No

**FIRE PROTECTION AND LIFE SAFETY**

<b>Fire Alarm:</b>	Yes - Notification
<b>Sprinkler:</b>	Yes
<b>Hazard Type:</b>	Light Hazard



## 4.3 Group Therapy Room – Equipment List

JSN	NAME	QTY	ACQ/INS	DESCRIPTION
A1015	Telephone, Desk, Multiple Line	1	V / V	Telephone, desk, multiple line.
A5212	Bracket, Television, Wall-Mounted, Tilt/Angle	1	V / V	A wall mounted, tilt/angled TV bracket for 37" to 80" TVs. Mount will be a universal and VESA compliant unit with a load capacity of up to 130 lbs.
A5220	Bracket, Television, Wall Backing	1	C / C	Wall mounted television bracket backing which provides additional support and strength for the installation of the television bracket. Option available for interior or exterior plate and sized for 12" 16" or 24" stud spacing.
F0280	Chair, Swivel, Low Back	1	V / V	Low back contemporary swivel chair, 37" high X 25" wide X 31" deep with a five (5) caster swivel base, arms and foam padded seat and back upholstered with either woven textile fabric or vinyl.
F0295	Chair, Stacking	12	V / V	Stacking chair, approximately 34" H X 21" W X 24" D. May be stacked up to 20 high depending upon the model selected. These chairs are intended primarily as overflow capacity for conference rooms.
F2000	Basket, Wastepaper, Fire Resistant	1	V / V	Wastepaper basket, fire resistant, approximately 40-quart capacity. This unit is used to collect and temporarily store small quantities of paper refuse in patient rooms, administrative areas and nursing stations. Size and shape varies depending on the application and manufacturer selected.
F2250	Camcorder, Hand Held, HD, Zoom, w/Microphone	1	V / V	Hand held camcorder with full HD recording, LCD display and microphone. Camcorder will also have capability for still picture capture. Audio and video output will be fully transferable to a computer.
F3050	Whiteboard, Dry Erase	2	V / V	Whiteboard unit, approximately 36" H x 48" W consisting of a white porcelain enamel writing surface with an attached chalk tray. Magnetic surface available. Image can be easily removed with a standard chalkboard eraser. For use with watercolor pens. Unit is ready to hang.
F3200	Clock, Battery, 12" Diameter	1	V / V	Clock, 12" diameter. Round surface, easy to read numbers with sweep second hand. Wall mounted unit for use when impractical to install a fully synchronized clock system. Battery operated, (batteries not included).



JSN	NAME	QTY	ACQ/INS	DESCRIPTION
M0512	Television, HDTV, Large Screen, 60"	1	V / V	A high definition (HDTV) multimedia, slim design, 60"W to 65"W color television. The TV will have a 16.9 wide screen aspect ratio with full HD 1080p resolution and HDMI connections. TV may be LED, Plasma or LCD. TV will include a stand.
M1801	Computer, Microprocessing, w/Flat Panel Monitor	1	V / V	Desktop microprocessing computer. The unit shall consist of a central processing mini tower, flat panel monitor, keyboard, mouse and speakers. The system shall have the following minimum characteristics: a 2.8 GHz Pentium processor; 512 MB memory; 80GB hard drive; 32/48x CD-ROMDVD combo; 1.44MB network interface card; video 32 MB NVIDIA; a 18 inch flat panel monitor. The computer is used throughout the facility to input, manipulate and retrieve information.
U0006	Personal Workstation	1	V / V	Versatile computer workstation



**4.4 Group Therapy Room, Conference Format (XXYYC)**

4.4 Group Therapy Room, Conference Format – Axonometric

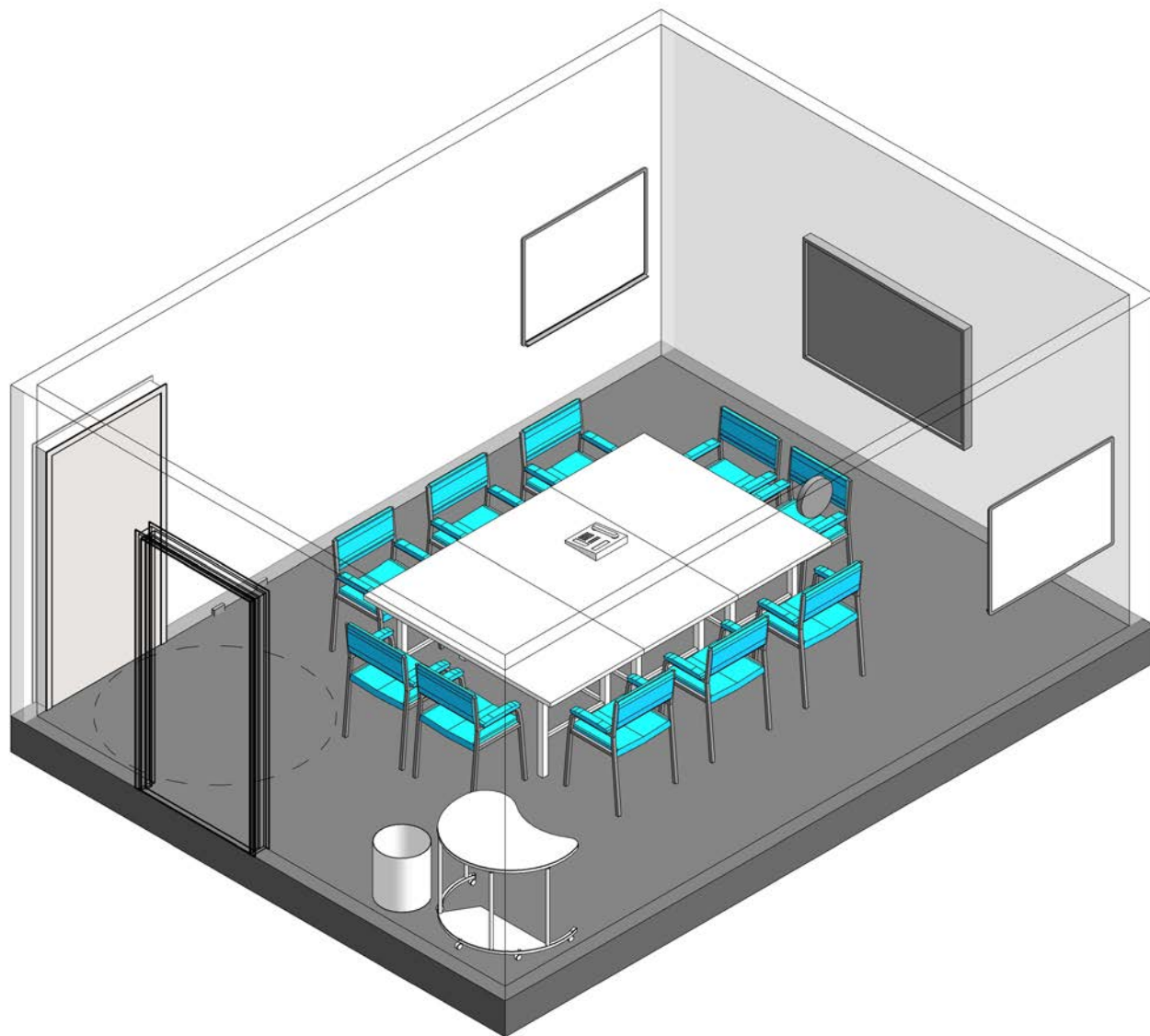

4.4 Group Therapy Room, Conference Format – Floor Plan

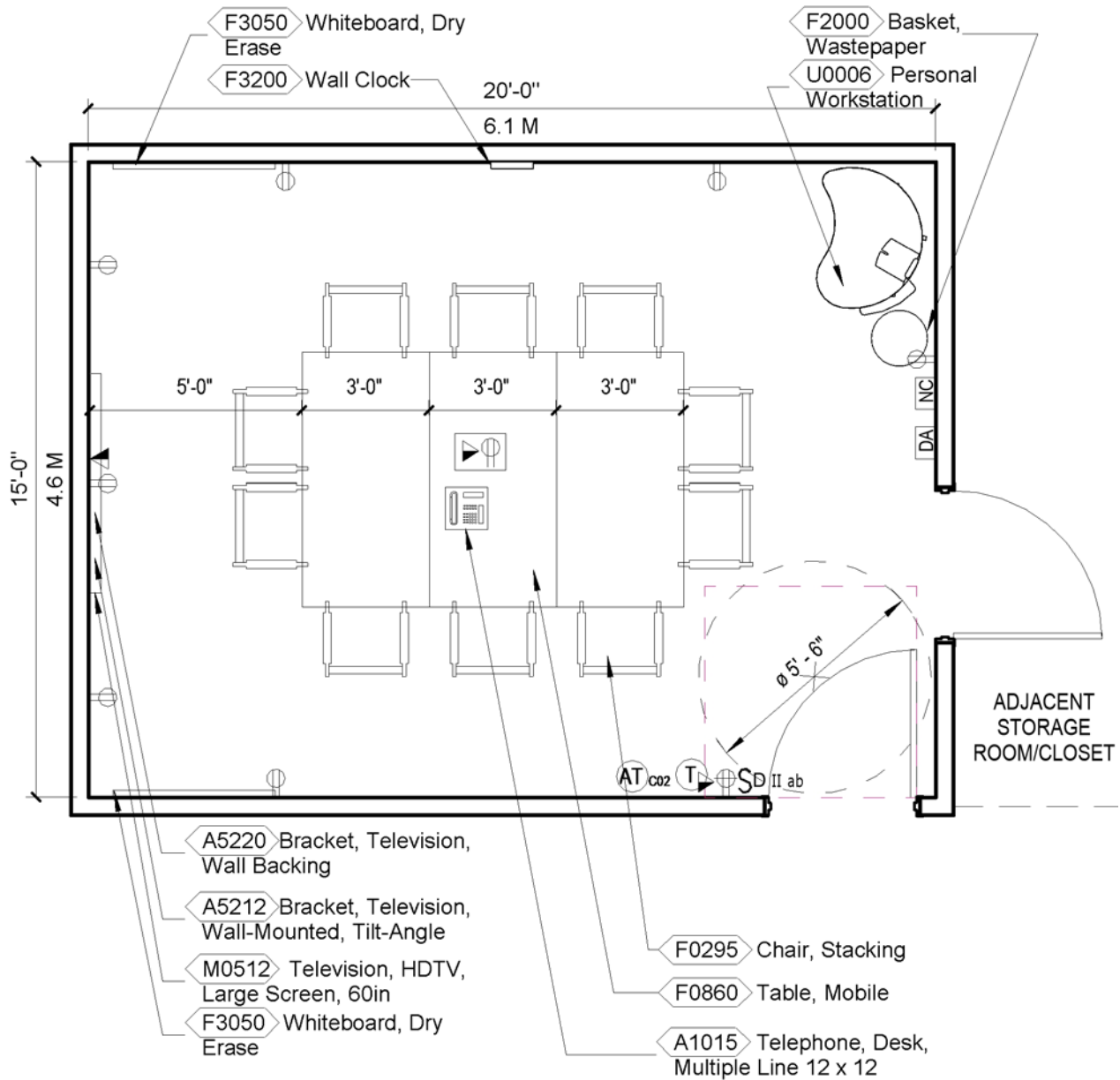

1/4 IN = 1 FT      300 NSF / 27.9 NSM

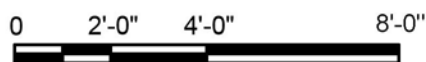

4.4 Group Therapy Room, Conference Format – Reflected Ceiling Plan

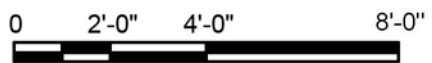
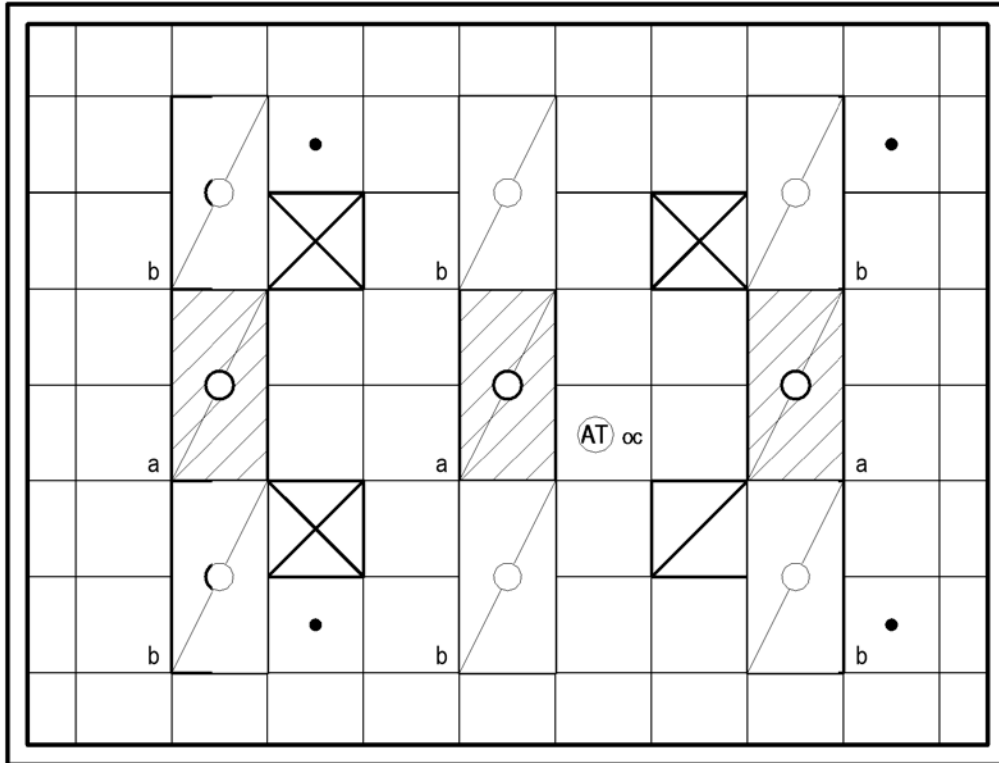



4.4 Group Therapy Room, Conference Format – Room Data Sheet

ARCHITECTURAL	
<b>Ceiling Type:</b>	Acoustical Ceiling Tile
<b>Ceiling Height:</b>	9'-0" (2700 mm)
<b>Ceiling Finish:</b>	Acoustical Ceiling Tile
<b>Wall Finish:</b>	Paint
<b>Wainscot:</b>	None
<b>Base:</b>	Resilient Millwork Style (min. 4" / 101 mm)
<b>Floor Finish:</b>	Luxury Vinyl Tile
<b>Slab Depression:</b>	None Special
<b>Sound Protection:</b>	STC 50 minimum
<b>Doors:</b>	3'-6" x 7'-0" wood

LIGHTING	
<b>Maintained Average Illumination – Ambient:</b>	500 Lux (50 FC)
<b>Luminaire Type:</b>	2'x4' Fluorescent or LED, Virgin Acrylic Prismatic Lens, sealed housing, gasketed frame
<b>Lamps:</b>	4 Fluorescent or LED equivalent, 3500K – 4100K CCT, CRI >= 80%, 25% lighting shall be on emergency power
<b>Controls:</b>	Dimming or multi-level switching, occupancy sensor

**Notes:** Coordinate location of luminaires with other ceiling obstructions

POWER	
<b>Normal Power:</b>	To be connected to selected receptacles and equipment.
<b>Emergency Power:</b>	To be connected to selected lighting.
<b>Notes:</b> Provide a minimum of one receptacle on each wall.	

COMMUNICATIONS	
<b>Data:</b>	Yes
<b>Telephone:</b>	Yes
<b>Cable Television:</b>	Yes
<b>Duress Alarm:</b>	Yes
<b>Electronic Access and Door Control:</b>	No
<b>Intercom:</b>	No
<b>Motion Intrusion Detection (MID):</b>	No
<b>Nurse Call:</b>	Yes
<b>Code Blue:</b>	No
<b>Public Address:</b>	No
<b>Security Surveillance Television (SSTV):</b>	No
<b>VA Satellite TV:</b>	Yes
<b>Video Teleconferencing (TEL):</b>	No
<b>Clock:</b>	Yes



4.4 Group Therapy Room, Conference Format – Room Data Sheet (continued)

**HEATING, VENTILATING AND AIR CONDITIONING**

Refer to HVAC Design Manual Chapter 6 Mental Health Outpatient Services – Room Data Sheet Group Therapy Room

**Note:** Where occupant density exceeds one person per 25 square feet, provide CO<sub>2</sub> sensing and control to limit CO<sub>2</sub> not to exceed 800 ppm.

**PLUMBING AND MEDICAL GASES**

<b>Cold Water:</b>	No
<b>Hot Water</b>	No
<b>Waste:</b>	No
<b>Reagent Grade Water:</b>	No
<b>Medical Air:</b>	No
<b>Medical Vacuum:</b>	No
<b>Oxygen:</b>	No

**FIRE PROTECTION AND LIFE SAFETY**

<b>Fire Alarm:</b>	Yes - Notification
<b>Sprinkler:</b>	Yes
<b>Hazard Type:</b>	Light Hazard



## 4.4 Group Therapy Room, Conference Format – Equipment List

JSN	NAME	QTY	ACQ/INS	DESCRIPTION
A1015	Telephone, Desk, Multiple Line	1	V / V	Telephone, desk, multiple line.
A5212	Bracket, Television, Wall-Mounted, Tilt/Angle	1	V / V	A wall mounted, tilt/angled TV bracket for 37" to 80" TVs. Mount will be a universal and VESA compliant unit with a load capacity of up to 130 lbs.
A5220	Bracket, Television, Wall Backing	1	C / C	Wall mounted television bracket backing which provides additional support and strength for the installation of the television bracket. Option available for interior or exterior plate and sized for 12" 16" or 24" stud spacing.
F0295	Chair, Stacking	12	V / V	Stacking chair, approximately 34" H X 21" W X 24" D. May be stacked up to 20 high depending upon the model selected. These chairs are intended primarily as overflow capacity for conference rooms.
F0860	Table, Mobile	4	V / V	Mobile table. The unit provides mobile or isolated freestanding work surface. Characteristics and components include 3-1/2 inch casters and attached drawer bearers. Unit is used for general work applications, primarily in dry areas.
F2000	Basket, Wastepaper, Fire Resistant	1	V / V	Wastepaper basket, fire resistant, approximately 40-quart capacity. This unit is used to collect and temporarily store small quantities of paper refuse in patient rooms, administrative areas and nursing stations. Size and shape varies depending on the application and manufacturer selected.
F2250	Camcorder, Hand Held, HD, Zoom, w/Microphone	1	V / V	Hand held camcorder with full HD recording, LCD display and microphone. Camcorder will also have capability for still picture capture. Audio and video output will be fully transferable to a computer.
F3050	Whiteboard, Dry Erase	2	V / V	Whiteboard unit, approximately 36" H x 48" W consisting of a white porcelain enamel writing surface with an attached chalk tray. Magnetic surface available. Image can be easily removed with a standard chalkboard eraser. For use with watercolor pens. Unit is ready to hang
F3200	Clock, Battery, 12" Diameter	1	V / V	Clock, 12" diameter. Round surface, easy to read numbers with sweep second hand. Wall mounted unit for use when impractical to install a fully synchronized clock system. Battery operated, (batteries not included).



JSN	NAME	QTY	ACQ/INS	DESCRIPTION
M0512	Television, HDTV, Large Screen, 60"	1	V / V	A high definition (HDTV) multimedia, slim design, 60"W to 65"W color television. The TV will have a 16.9 wide screen aspect ratio with full HD 1080p resolution and HDMI connections. TV may be LED, Plasma or LCD. TV will include a stand.
U0006	Personal Workstation	1	V / V	Versatile computer workstation



**4.5 OFFICE, CLINICAL, SINGLE ACCESS (XXYYC)**

4.5 Office, Clinical, Single Access – Axonometric

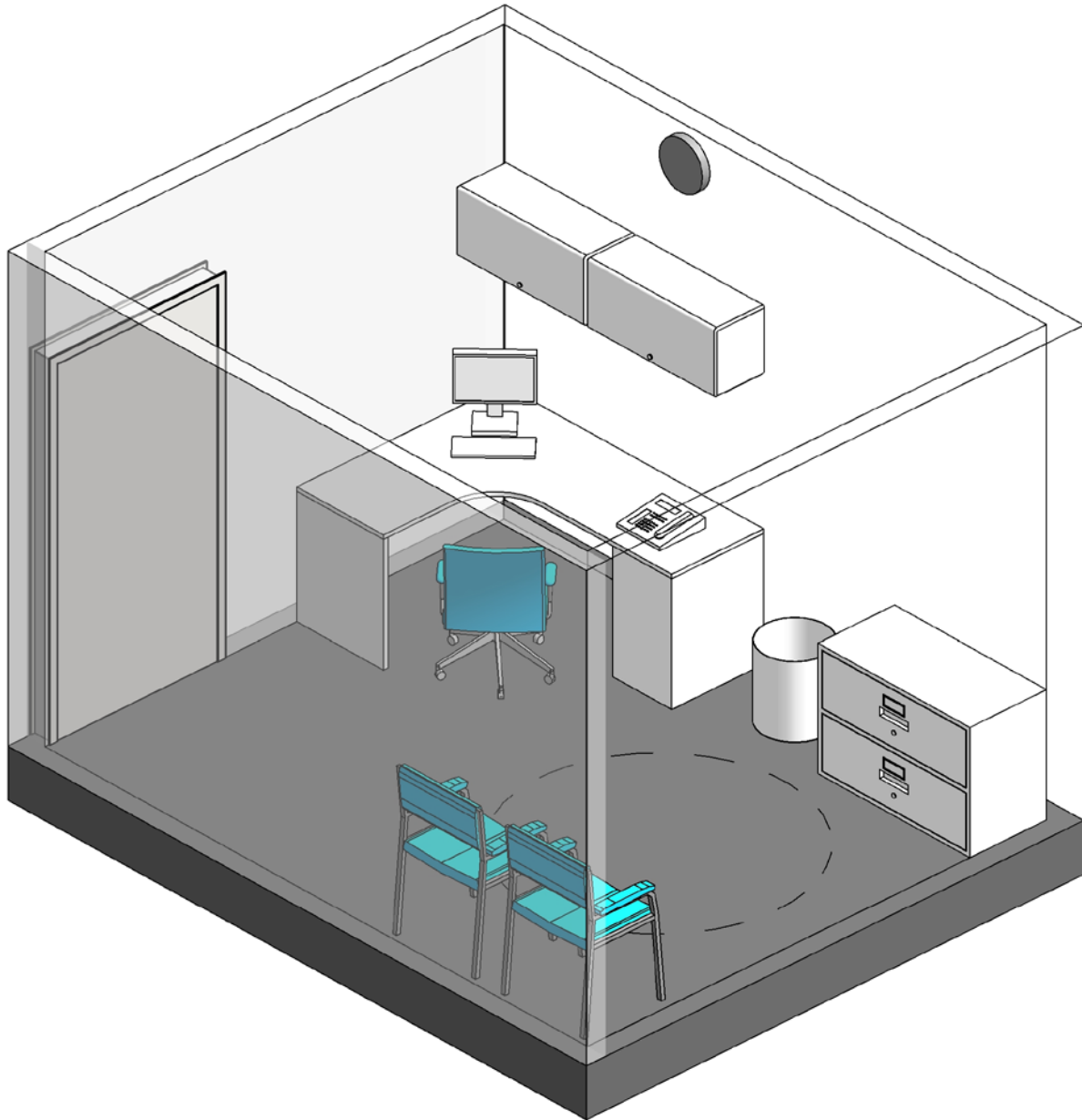

4.5 Office, Clinical, Single Access – Floor Plan

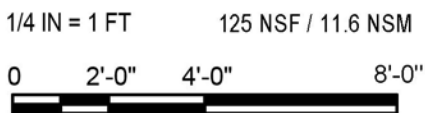
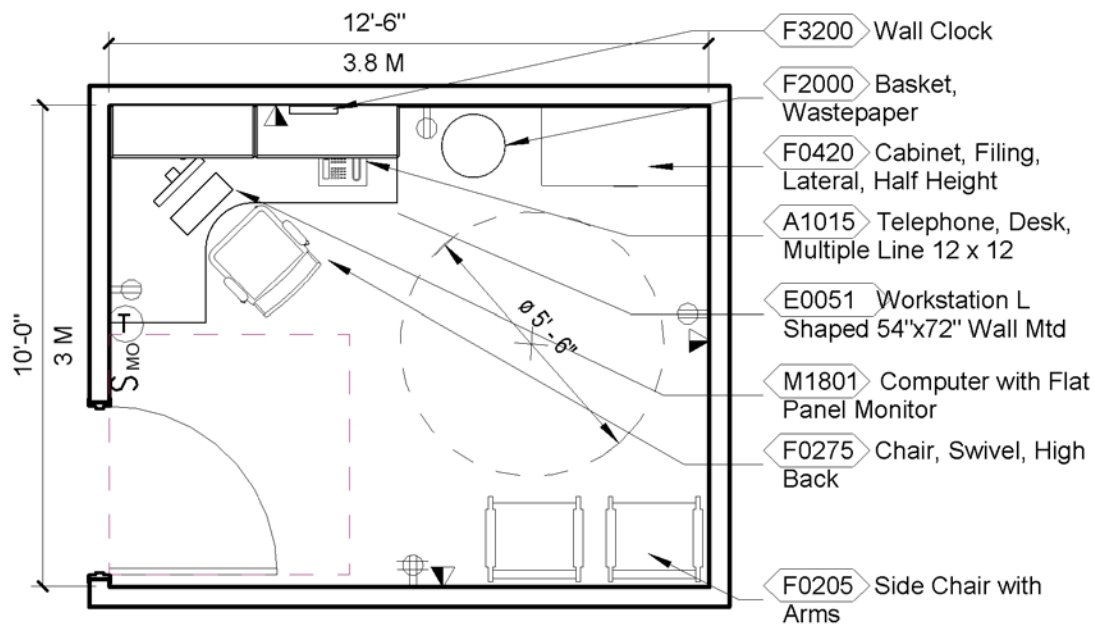

4.5 Office, Clinical, Single Access – Reflected Ceiling Plan (2 options)

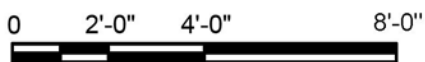
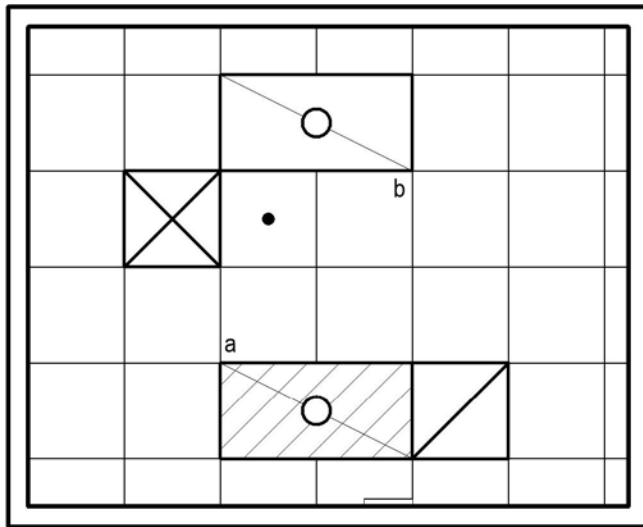
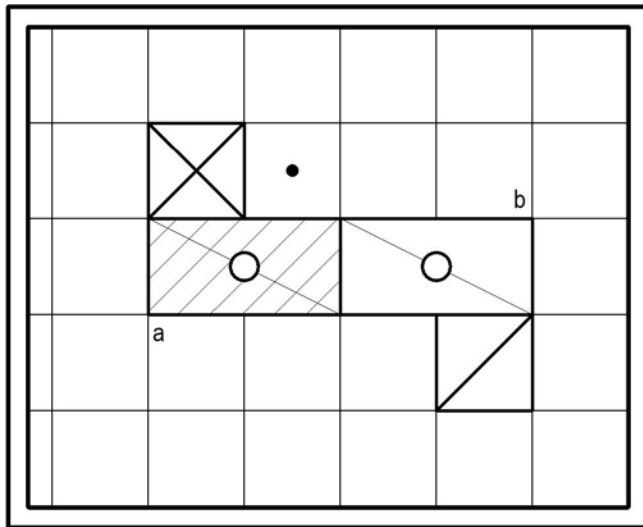

4.5 Office, Clinical, Single Access – Room Data Sheet

**ARCHITECTURAL**

<b>Ceiling Type:</b>	Acoustical Ceiling Tile
<b>Ceiling Height:</b>	9'-0" (2700 mm)
<b>Ceiling Finish:</b>	Acoustical Ceiling Tile
<b>Wall Finish:</b>	Paint
<b>Wainscot:</b>	None
<b>Base:</b>	Cove, Resilient Millwork Style (min. 4" / 101 mm)
<b>Floor Finish:</b>	Carpet, Luxury Vinyl Tile
<b>Slab Depression:</b>	None Special
<b>Sound Protection:</b>	STC 50 minimum
<b>Doors:</b>	3'-6" x 7'-0" wood, option for sliding doors in dual access offices.

**Notes:** Coordinate location of luminaires with other ceiling obstructions

**POWER**

**Normal Power:** To be connected to selected receptacles and equipment.

**Notes:**

- 1) Provide a minimum of one receptacle on each wall.
- 2) Provide double duplex receptacle at desk wall.

**COMMUNICATIONS**

<b>Data:</b>	Yes
<b>Telephone:</b>	Yes
<b>Cable Television:</b>	No
<b>Duress Alarm:</b>	Yes
<b>Electronic Access and Door Control:</b>	No
<b>Intercom:</b>	No
<b>Motion Intrusion Detection (MID):</b>	No
<b>Nurse Call:</b>	No
<b>Code Blue:</b>	No
<b>Public Address:</b>	No
<b>Security Surveillance Television (SSTV):</b>	No
<b>VA Satellite TV:</b>	No
<b>Video Conferencing (TEL):</b>	No
<b>Clock:</b>	Yes

**LIGHTING**

<b>Maintained Average Illumination – Ambient:</b>	100 Lux (10 FC)
<b>Maintained Average Illumination – Task Focus:</b>	500 Lux (50 FC) on desk
<b>Luminaire Type:</b>	2'x4' Fluorescent or LED, Virgin Acrylic Prismatic Lens, sealed housing, gasketed frame
<b>Lamps:</b>	4 Fluorescent or LED equivalent, 3500K – 4100K CCT, CRI >= 80%
<b>Controls:</b>	Dimming or multi-level switching, occupancy sensor





4.5 Office, Clinical, Single Access – Room Data Sheet (continued)

**HEATING, VENTILATING AND AIR CONDITIONING**

Refer to HVAC Design Manual Chapter 6 Mental Health Outpatient Services – Room Data Sheet Counselor Office

**Note:** Individual room control is not required for every room. Offices with similar HVAC load characteristics may share a temperature sensor. No more than three offices may share one sensor.

**PLUMBING AND MEDICAL GASES**

<b>Cold Water:</b>	No
<b>Hot Water</b>	No
<b>Waste:</b>	No
<b>Reagent Grade Water:</b>	No
<b>Medical Air:</b>	No
<b>Medical Vacuum:</b>	No
<b>Oxygen:</b>	No

**FIRE PROTECTION AND LIFE SAFETY**

<b>Fire Alarm:</b>	No
<b>Sprinkler:</b>	Yes
<b>Hazard Type:</b>	Light Hazard



## 4.5 Office, Clinical, Single Access – Equipment List

JSN	NAME	QTY	ACQ/INS	DESCRIPTION
A1015	Telephone, Desk, Multiple Line	1	V / V	Telephone, desk, multiple line.
E0051	Workstation, Corner Work Surface, Wall Mtd, 72x48	1	V / V	THIS TYPICAL INCLUDES: 4 Vertical Hanging Strips 2 Lockable Flipper Units 2 Shelf, Storage/Display 2 Light 1 Tackboard 2 Tool Rail 2 Paper Tray 1 Diagonal Tray 1 Cantilevered Work Surface 1 Cantilevered Corner Work Surface 1 Adjustable Keyboard Tray 1 Mobile Pedestal, Box/File 1 Cpu Holder
F0205	Chair, Side With Arms	2	V / V	Upholstered side chair, 32" high X 21" wide X 23" deep with arms, padded seats and padded backs. Seat height is a minimum of 17". Available with or without sled base.
F0275	Chair, Swivel, High Back	1	V / V	Highback contemporary swivel chair, 41" high X 23" wide X 23" deep with five (5) caster swivel base and arms. Chair may be used at desks or in conference rooms. Back and seat are foam padded and upholstered with either woven textile fabric or vinyl.
F0420	Cabinet, Filing, Lateral, Half Height	1	V / V	Half height two (2) or three (3) drawer lateral filing cabinet, 28" high X 42" wide X 18" deep with recessed handles, locking device and drawer label holders. Drawers are adaptable to either letter or legal size materials.
F2000	Basket, Wastepaper, Fire Resistant	1	V / V	Wastepaper basket, fire resistant, approximately 40-quart capacity. This unit is used to collect and temporarily store small quantities of paper refuse in patient rooms, administrative areas and nursing stations. Size and shape varies depending on the application and manufacturer selected.
F3200	Clock, Battery, 12" Diameter	1	V / V	Clock, 12" diameter. Round surface, easy to read numbers with sweep second hand. Wall mounted unit for use when impractical to install a fully synchronized clock system. Battery operated, (batteries not included).



JSN	NAME	QTY	ACQ/INS	DESCRIPTION
M1801	Computer, Microprocessing, w/Flat Panel Monitor	1	V / V	Desktop microprocessing computer. The unit shall consist of a central processing mini tower, flat panel monitor, keyboard, mouse and speakers. The system shall have the following minimum characteristics: a 2.8 GHz Pentium processor; 512 MB memory; 80GB hard drive; 32/48x CD-ROMDVD combo; 1.44MB network interface card; video 32 MB NVIDIA; a 18 inch flat panel monitor. The computer is used throughout the facility to input, manipulate and retrieve information.



**4.6. OFFICE, CLINICAL, DUAL ACCESS (XXYYC)**

4.6 Office, Clinical, Dual Access – Axonometric

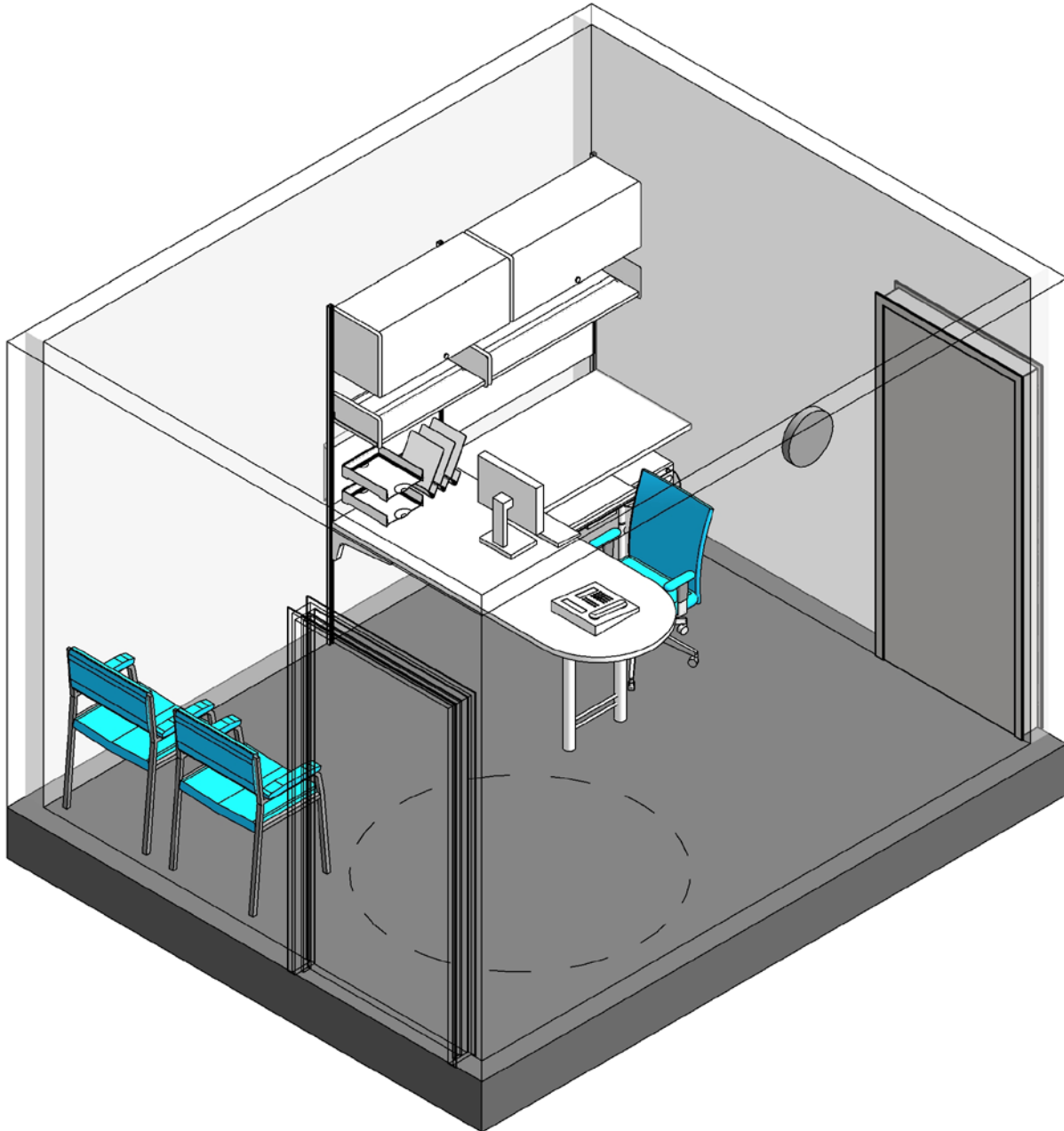

4.6 Office, Clinical, Dual Access – Floor Plan

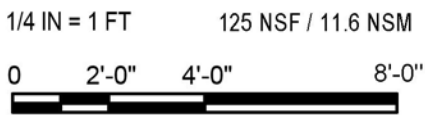
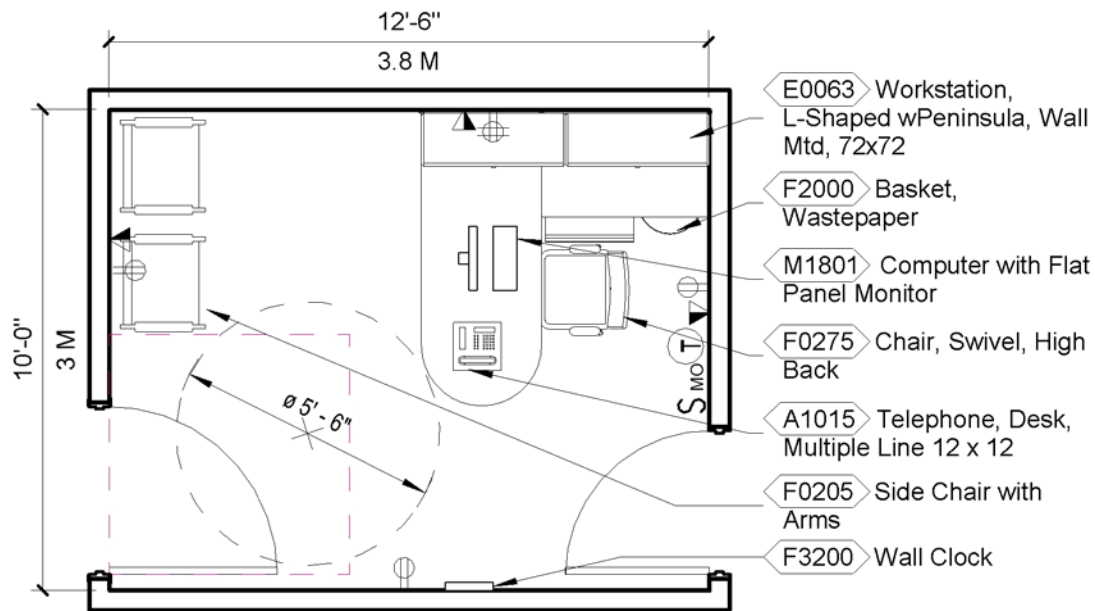

4.6 Office, Clinical, Dual Access – Reflected Ceiling Plan (2 options)

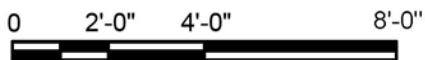
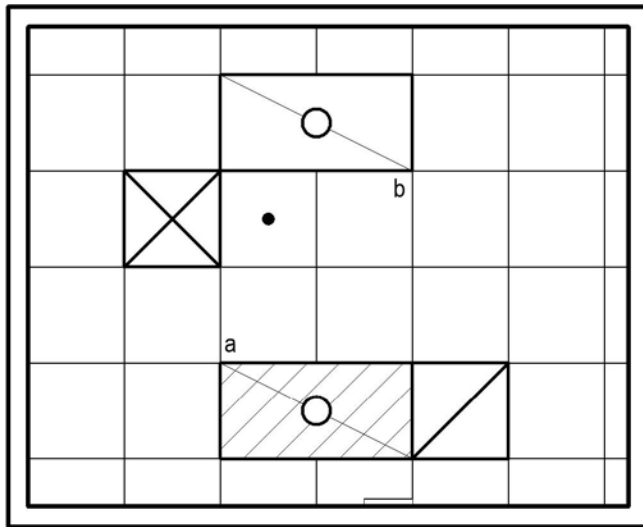
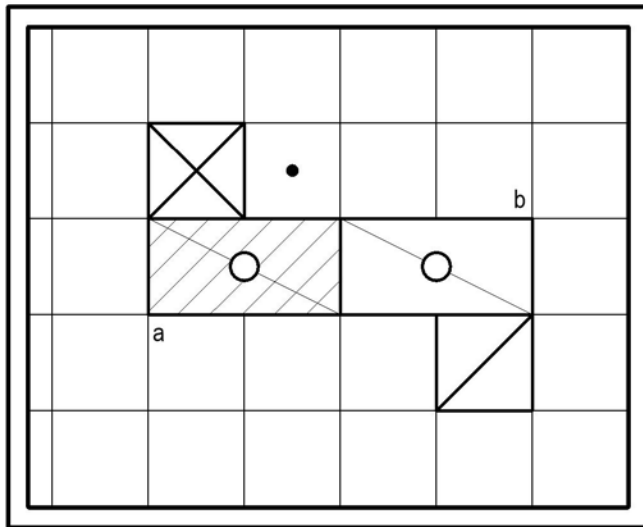

4.6 Office, Clinical, Dual Access – Room Data Sheet

**ARCHITECTURAL**

<b>Ceiling Type:</b>	Acoustical Ceiling Tile
<b>Ceiling Height:</b>	9'-0" (2700 mm)
<b>Ceiling Finish:</b>	Acoustical Ceiling Tile
<b>Wall Finish:</b>	Paint
<b>Wainscot:</b>	None
<b>Base:</b>	Cove, Resilient Millwork Style (min. 4" / 101 mm)
<b>Floor Finish:</b>	Carpet, Luxury Vinyl Tile
<b>Slab Depression:</b>	None Special
<b>Sound Protection:</b>	STC 50 minimum
<b>Doors:</b>	3'-6" x 7'-0" wood, option for sliding doors in dual access offices. Staff door (only) may be 3'-0" wide.

**LIGHTING**

<b>Maintained Average Illumination – Ambient:</b>	100 Lux (10 FC)
<b>Maintained Average Illumination – Task Focus:</b>	500 Lux (50 FC) on desk
<b>Luminaire Type:</b>	2'x4' Fluorescent or LED, Virgin Acrylic Prismatic Lens, sealed housing, gasketed frame
<b>Lamps:</b>	4 Fluorescent or LED equivalent, 3500K – 4100K CCT, CRI >= 80%

**Controls:** Dimming or multi-level switching, occupancy sensor

**Notes:** Coordinate location of luminaires with other ceiling obstructions

**POWER**

**Normal Power:** To be connected to selected receptacles and equipment.

**Notes:**

- 3) Provide a minimum of one receptacle on each wall.
- 4) Provide double duplex receptacle at desk wall.

**COMMUNICATIONS**

<b>Data:</b>	Yes
<b>Telephone:</b>	Yes
<b>Cable Television:</b>	No
<b>Duress Alarm:</b>	Yes
<b>Electronic Access and Door Control:</b>	No
<b>Intercom:</b>	No
<b>Motion Intrusion Detection (MID):</b>	No
<b>Nurse Call:</b>	No
<b>Code Blue:</b>	No
<b>Public Address:</b>	No
<b>Security Surveillance Television (SSTV):</b>	No
<b>VA Satellite TV:</b>	No
<b>Video Teleconferencing (TEL):</b>	No
<b>Clock:</b>	Yes



4.6 Office, Clinical, Dual Access – Room Data Sheet (continued)

**HEATING, VENTILATING AND AIR CONDITIONING**

Refer to HVAC Design Manual Chapter 6 Mental Health Outpatient Services – Room Data Sheet Counselor Office

**Note:** Individual room control is not required for every room. Offices with similar HVAC load characteristics may share a temperature sensor. No more than three offices may share one sensor.

**PLUMBING AND MEDICAL GASES**

<b>Cold Water:</b>	No
<b>Hot Water</b>	No
<b>Waste:</b>	No
<b>Reagent Grade Water:</b>	No
<b>Medical Air:</b>	No
<b>Medical Vacuum:</b>	No
<b>Oxygen:</b>	No

**FIRE PROTECTION AND LIFE SAFETY**

<b>Fire Alarm:</b>	No
<b>Sprinkler:</b>	Yes
<b>Hazard Type:</b>	Light Hazard





## 4.6 Office, Clinical, Dual Access – Equipment List

JSN	NAME	QTY	ACQ/INS	DESCRIPTION
A1015	Telephone, Desk, Multiple Line	1	V / V	Telephone, desk, multiple line.
E0063	Workstation, L-Shaped w/Peninsula, Wall Mtd, 72x72	1	V / V	THIS TYPICAL INCLUDES:3 Vertical Hanging Strips2 Lockable Flipper Units2 Shelves, Storage/Display2 Lights1 Tackboard2 Tool Rails2 Paper Trays1 Diagonal Tray1 Cantilevered Work Surface1 Peninsula Work Surface1 Adjustable Keyboard Tray1 Mobile Pedestal, Box/File1 Pencil Drawer1 CPU Holder
F0205	Chair, Side With Arms	2	V / V	Upholstered side chair, 32" high X 21" wide X 23" deep with arms, padded seats and padded backs. Seat height is a minimum of 17". Available with or without sled base.
F0275	Chair, Swivel, High Back	1	V / V	Highback contemporary swivel chair, 41" high X 23" wide X 23" deep with five (5) caster swivel base and arms. Chair may be used at desks or in conference rooms. Back and seat are foam padded and upholstered with either woven textile fabric or vinyl.
F2000	Basket, Wastepaper, Fire Resistant	1	V / V	Wastepaper basket, fire resistant, approximately 40-quart capacity. This unit is used to collect and temporarily store small quantities of paper refuse in patient rooms, administrative areas and nursing stations. Size and shape varies depending on the application and manufacturer selected.
F3200	Clock, Battery, 12" Diameter	1	V / V	Clock, 12" diameter. Round surface, easy to read numbers with sweep second hand. Wall mounted unit for use when impractical to install a fully synchronized clock system. Battery operated, (batteries not included).
M1801	Computer, Microprocessing, w/Flat Panel Monitor	1	V / V	Desktop microprocessing computer. The unit shall consist of a central processing mini tower, flat panel monitor, keyboard, mouse and speakers. The system shall have the following minimum characteristics: a 2.8 GHz Pentium processor; 512 MB memory; 80GB hard drive; 32/48x CD-ROMDVD combo; 1.44MB network interface card; video 32 MB NVIDIA; a 18 inch flat panel monitor. The computer is used throughout the facility to input, manipulate and retrieve information.



**4.7 CONSULTATION ROOM, SINGLE ACCESS (XXYYC)**

4.7 Consultation Room, Single Access – Axonometric

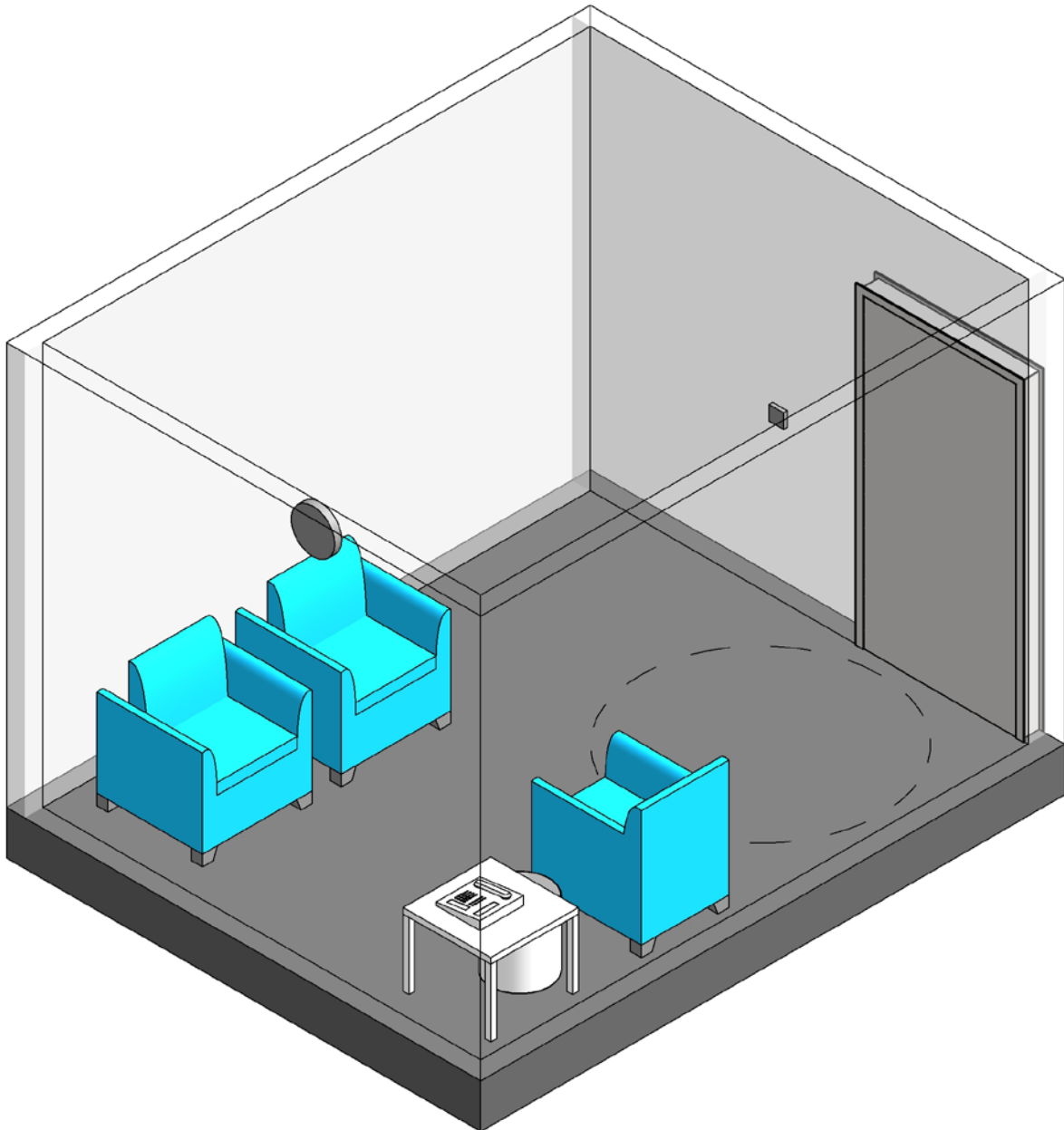

4.7 Consultation Room, Single Access – Floor Plan

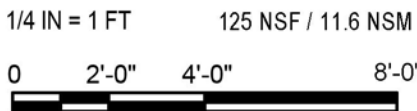
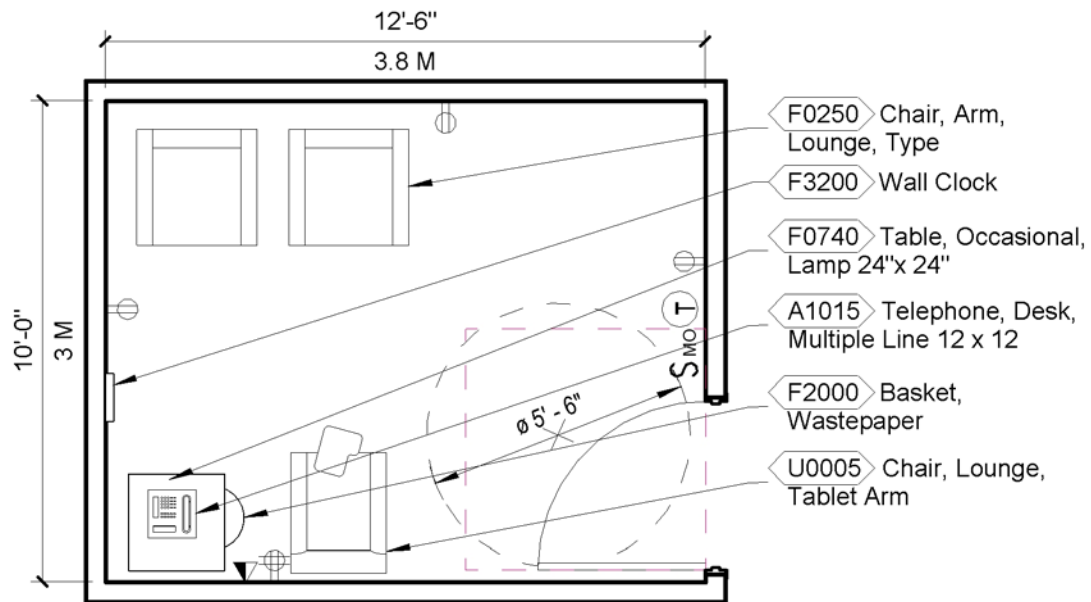

4.7 Consultation Room, Single Access – Reflected Ceiling Plan (2 options)

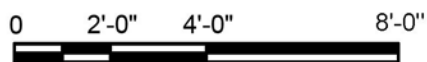
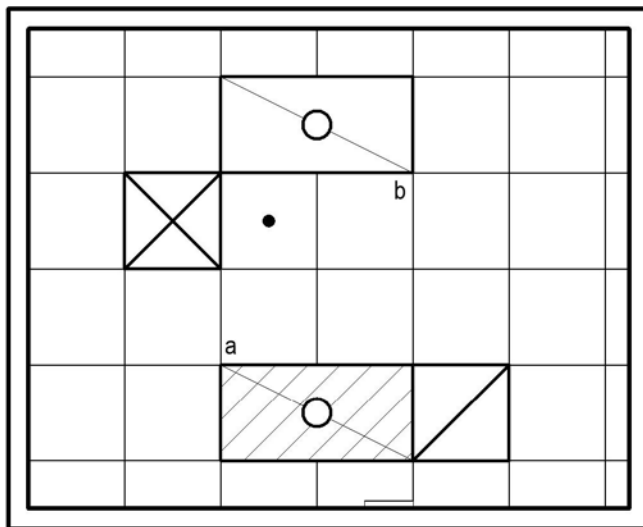
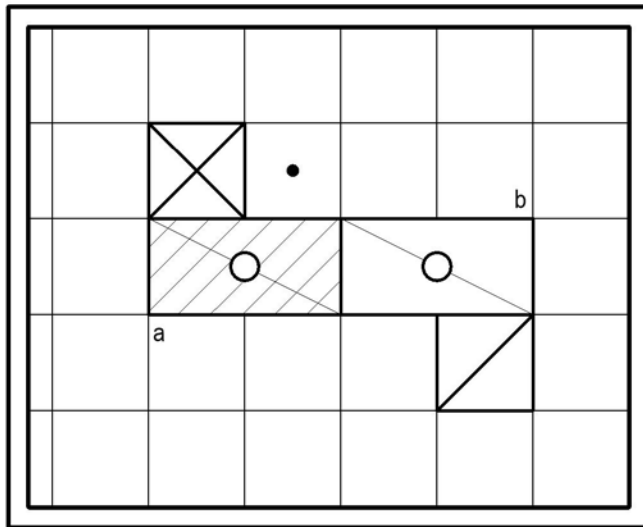

## 4.7 Consultation Room, Single Access – Room Data Sheet

**ARCHITECTURAL**

<b>Ceiling Type:</b>	Acoustical Ceiling Tile
<b>Ceiling Height:</b>	9'-0" (2700 mm)
<b>Ceiling Finish:</b>	Acoustical Ceiling Tile
<b>Wall Finish:</b>	Paint
<b>Wainscot:</b>	None
<b>Base:</b>	Cove, Resilient Millwork Style (min. 4" / 101 mm)
<b>Floor Finish:</b>	Carpet, Luxury Vinyl Tile
<b>Slab Depression:</b>	None Special
<b>Sound Protection:</b>	STC 50 minimum
<b>Doors:</b>	3'-6" x 7'-0" wood, option for sliding doors in dual access offices.

**Notes:** Coordinate location of luminaires with other ceiling obstructions

**POWER**

**Normal Power:** To be connected to selected receptacles and equipment.

**Notes:**

- 1) Provide a minimum of one receptacle on each wall.
- 2) Provide double duplex receptacle at desk wall.

**COMMUNICATIONS**

<b>Data:</b>	Yes
<b>Telephone:</b>	Yes
<b>Cable Television:</b>	No
<b>Duress Alarm:</b>	Yes
<b>Electronic Access and Door Control:</b>	No
<b>Intercom:</b>	No
<b>Motion Intrusion Detection (MID):</b>	No
<b>Nurse Call:</b>	No
<b>Code Blue:</b>	No
<b>Public Address:</b>	No
<b>Security Surveillance Television (SSTV):</b>	No
<b>VA Satellite TV:</b>	No
<b>Video Conferencing (TEL):</b>	No
<b>Clock:</b>	Yes

**LIGHTING**

<b>Maintained Average Illumination – Ambient:</b>	100 Lux (10 FC)
<b>Maintained Average Illumination – Task Focus:</b>	500 Lux (50 FC) on desk
<b>Luminaire Type:</b>	2'x4' Fluorescent or LED, Virgin Acrylic Prismatic Lens, sealed housing, gasketed frame
<b>Lamps:</b>	4 Fluorescent or LED equivalent, 3500K – 4100K CCT, CRI >= 80%
<b>Controls:</b>	Dimming or multi-level switching, occupancy sensor



4.7 Consultation Room, Single Access – Room Data Sheet (continued)

**HEATING, VENTILATING AND AIR CONDITIONING**

Refer to HVAC Design Manual Chapter 6 Mental Health Outpatient Services – Room Data Sheet Counselor Office

**Note:** Individual room control is not required for every room. Offices with similar HVAC load characteristics may share a temperature sensor. No more than three offices may share one sensor.

**PLUMBING AND MEDICAL GASES**

<b>Cold Water:</b>	No
<b>Hot Water</b>	No
<b>Waste:</b>	No
<b>Reagent Grade Water:</b>	No
<b>Medical Air:</b>	No
<b>Medical Vacuum:</b>	No
<b>Oxygen:</b>	No

**FIRE PROTECTION AND LIFE SAFETY**

<b>Fire Alarm:</b>	No
<b>Sprinkler:</b>	Yes
<b>Hazard Type:</b>	Light Hazard



## 4.7 Consultation Room, Single Access – Equipment List

JSN	NAME	QTY	ACQ/INS	DESCRIPTION
A1015	Telephone, Desk, Multiple Line	1	V / V	Telephone, desk, multiple line.
F0250	Chair, Arm, Lounge Type	2	V / V	Lounge chair approximately 33" high X 28" wide X 29" deep, with arms and floor glides. Chair completely padded and upholstered in either woven textile fabric or vinyl.
F0740	Table, Occasional, Lamp	1	V / V	Occasional lamp table (end table) approximately 20" high X 27" wide X 27" deep with choice of finishes (wood, oak veneer, or high pressure laminate).
F2000	Basket, Wastepaper, Fire Resistant	1	V / V	Wastepaper basket, fire resistant, approximately 40-quart capacity. This unit is used to collect and temporarily store small quantities of paper refuse in patient rooms, administrative areas and nursing stations. Size and shape varies depending on the application and manufacturer selected.
F3200	Clock, Battery, 12" Diameter	1	V / V	Clock, 12" diameter. Round surface, easy to read numbers with sweep second hand. Wall mounted unit for use when impractical to install a fully synchronized clock system. Battery operated, (batteries not included).
U0005	Lounge Chair with Tablet Arm	1	V / V	Lounge Chair with Tablet Arm



**4.8 CONSULTATION ROOM, DUAL ACCESS (XXYYC)**

4.8 Consultation Room, Dual Access – Axonometric

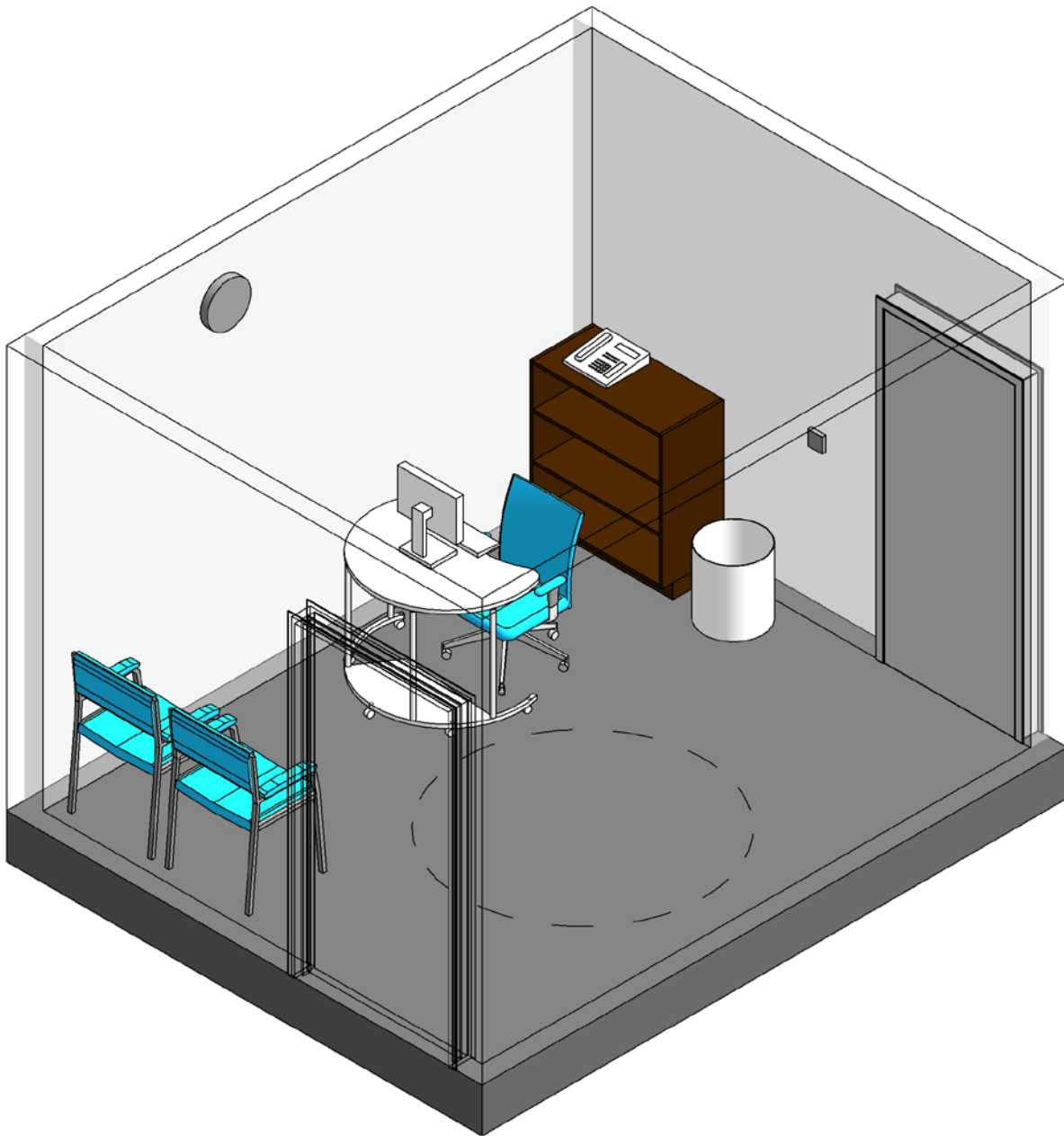



4.8 Consultation Room, Dual Access – Floor Plan

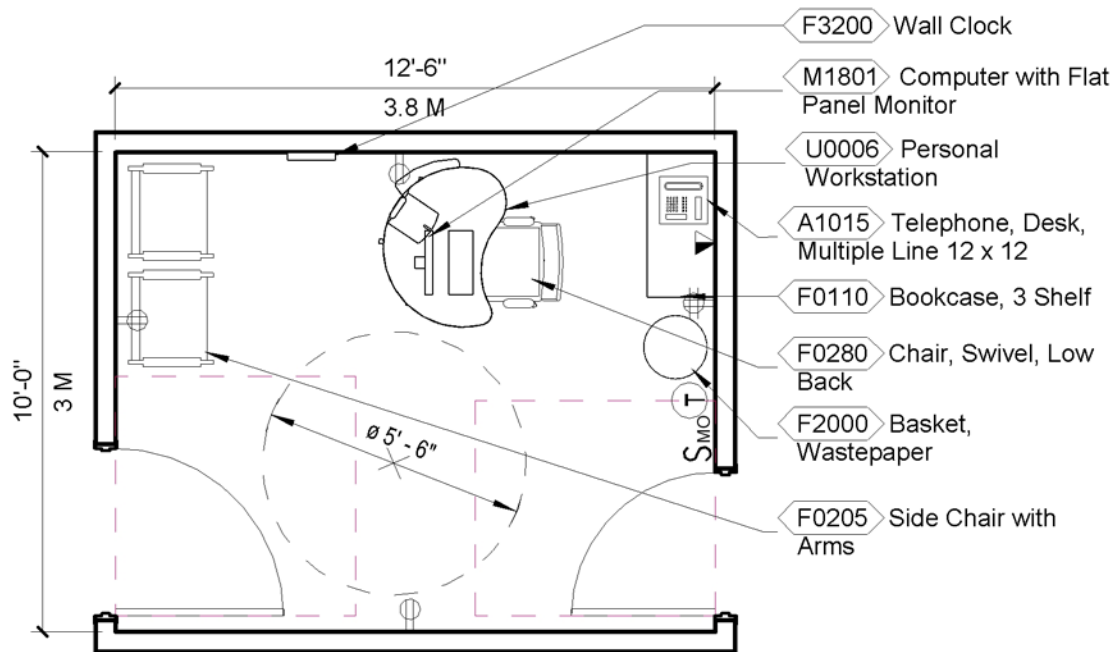

4.8 Consultation Room, Dual Access – Reflected Ceiling Plan (2 options)

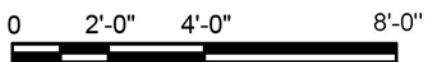
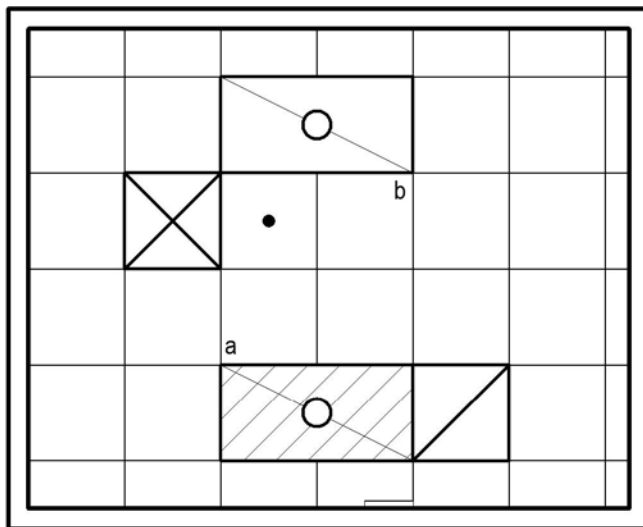
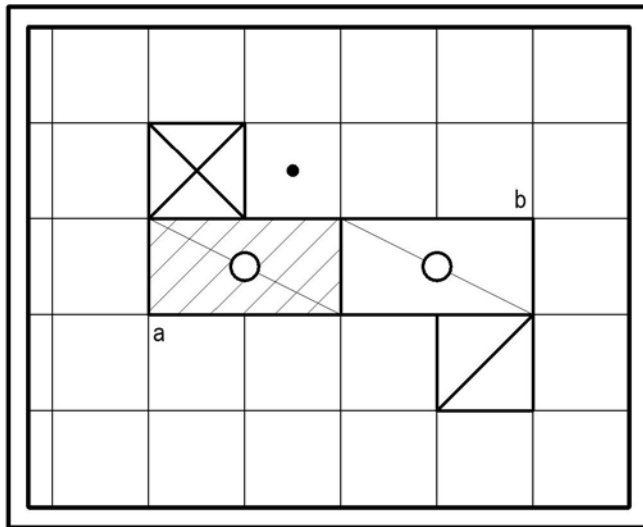

4.8 Consultation Room, Dual Access – Room Data Sheet

**ARCHITECTURAL**

<b>Ceiling Type:</b>	Acoustical Ceiling Tile
<b>Ceiling Height:</b>	9'-0" (2700 mm)
<b>Ceiling Finish:</b>	Acoustical Ceiling Tile
<b>Wall Finish:</b>	Paint
<b>Wainscot:</b>	None
<b>Base:</b>	Cove, Resilient Millwork Style (min. 4" / 101 mm)
<b>Floor Finish:</b>	Carpet, Luxury Vinyl Tile
<b>Slab Depression:</b>	None Special
<b>Sound Protection:</b>	STC 50 minimum
<b>Doors:</b>	3'-6" x 7'-0" wood, option for sliding doors in dual access offices. Staff door (only) may be 3'-0" wide

**Controls:** Dimming or multi-level switching, occupancy sensor

**Notes:** Coordinate location of luminaires with other ceiling obstructions

**POWER**

**Normal Power:** To be connected to selected receptacles and equipment.

- Notes:**
- 3) Provide a minimum of one receptacle on each wall.
  - 4) Provide double duplex receptacle at desk wall.

**LIGHTING**

<b>Maintained Average Illumination – Ambient:</b>	100 Lux (10 FC)
<b>Maintained Average Illumination – Task Focus:</b>	500 Lux (50 FC) on desk
<b>Luminaire Type:</b>	2'x4' Fluorescent or LED, Virgin Acrylic Prismatic Lens, sealed housing, gasketed frame
<b>Lamps:</b>	4 Fluorescent or LED equivalent, 3500K – 4100K CCT, CRI >= 80%

**COMMUNICATIONS**

<b>Data:</b>	Yes
<b>Telephone:</b>	Yes
<b>Cable Television:</b>	No
<b>Duress Alarm:</b>	Yes
<b>Electronic Access and Door Control:</b>	No
<b>Intercom:</b>	No
<b>Motion Intrusion Detection (MID):</b>	No
<b>Nurse Call:</b>	No
<b>Code Blue:</b>	No
<b>Public Address:</b>	No
<b>Security Surveillance Television (SSTV):</b>	No
<b>VA Satellite TV:</b>	No
<b>Video Teleconferencing (TEL):</b>	No
<b>Clock:</b>	Yes



4.8 Consultation Room, Dual Access – Room Data Sheet (continued)

**HEATING, VENTILATING AND AIR CONDITIONING**

Refer to HVAC Design Manual Chapter 6 Mental Health Outpatient Services – Room Data Sheet Counselor Office

**Note:** Individual room control is not required for every room. Offices with similar HVAC load characteristics may share a temperature sensor. No more than three offices may share one sensor.

**PLUMBING AND MEDICAL GASES**

<b>Cold Water:</b>	No
<b>Hot Water</b>	No
<b>Waste:</b>	No
<b>Reagent Grade Water:</b>	No
<b>Medical Air:</b>	No
<b>Medical Vacuum:</b>	No
<b>Oxygen:</b>	No

**FIRE PROTECTION AND LIFE SAFETY**

<b>Fire Alarm:</b>	No
<b>Sprinkler:</b>	Yes
<b>Hazard Type:</b>	Light Hazard



## 4.8 Consultation Room, Dual Access – Equipment List

JSN	NAME	QTY	ACQ/INS	DESCRIPTION
A1015	Telephone, Desk, Multiple Line	1	V / V	Telephone, desk, multiple line.
F0110	Bookcase, 3 Shelf	1	V / V	Freestanding open metal shelf bookcase, approximately 60" high X 36" wide X 18" deep with three (3) adjustable shelves and four (4) non-marking floor glides.
F0205	Chair, Side With Arms	2	V / V	Upholstered side chair, 32" high X 21" wide X 23" deep with arms, padded seats and padded backs. Seat height is a minimum of 17". Available with or without sled base.
F0280	Chair, Swivel, Low Back	1	V / V	Low back contemporary swivel chair, 37" high X 25" wide X 31" deep with a five (5) caster swivel base, arms and foam padded seat and back upholstered with either woven textile fabric or vinyl.
F2000	Basket, Wastepaper, Fire Resistant	1	V / V	Wastepaper basket, fire resistant, approximately 40-quart capacity. This unit is used to collect and temporarily store small quantities of paper refuse in patient rooms, administrative areas and nursing stations. Size and shape varies depending on the application and manufacturer selected.
F3200	Clock, Battery, 12" Diameter	1	V / V	Clock, 12" diameter. Round surface, easy to read numbers with sweep second hand. Wall mounted unit for use when impractical to install a fully synchronized clock system. Battery operated, (batteries not included).
M1801	Computer, Microprocessing, w/Flat Panel Monitor	1	V / V	Desktop microprocessing computer. The unit shall consist of a central processing mini tower, flat panel monitor, keyboard, mouse and speakers. The system shall have the following minimum characteristics: a 2.8 GHz Pentium processor; 512 MB memory; 80GB hard drive; 32/48x CD-ROM/DVD combo; 1.44MB network interface card; video 32 MB NVIDIA; a 18 inch flat panel monitor. The computer is used throughout the facility to input, manipulate and retrieve information.
U0006	Personal Workstation	1	V / V	Versatile computer workstation



**4.9 FAMILY CONSULTATION/THERAPY ROOM (XXYYC)**

4.9 Family Consultation/Therapy Room - Axonometric

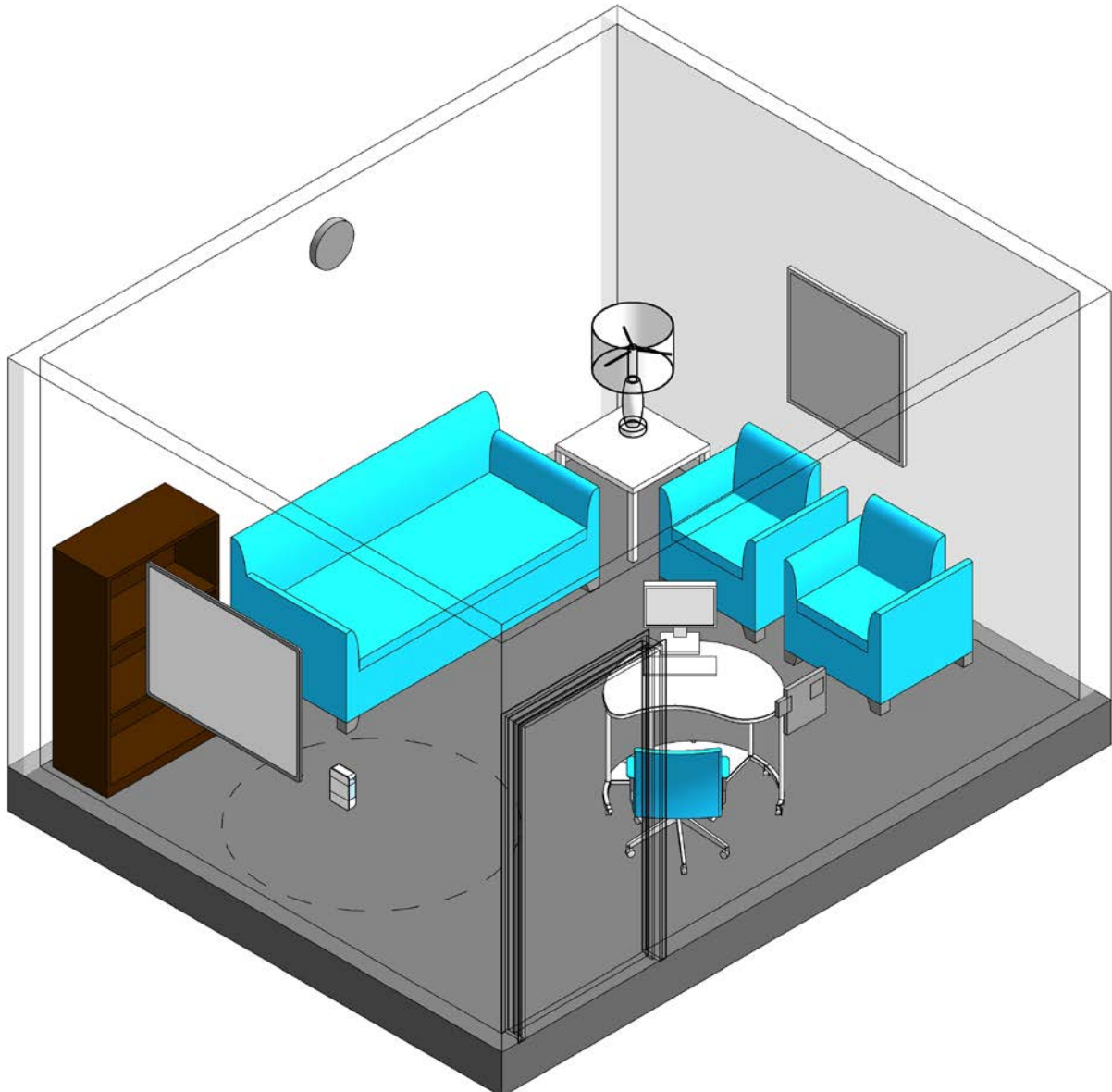

4.9 Family Consultation/Therapy Room – Floor Plan

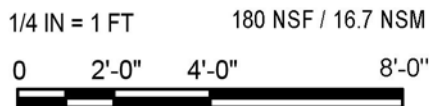
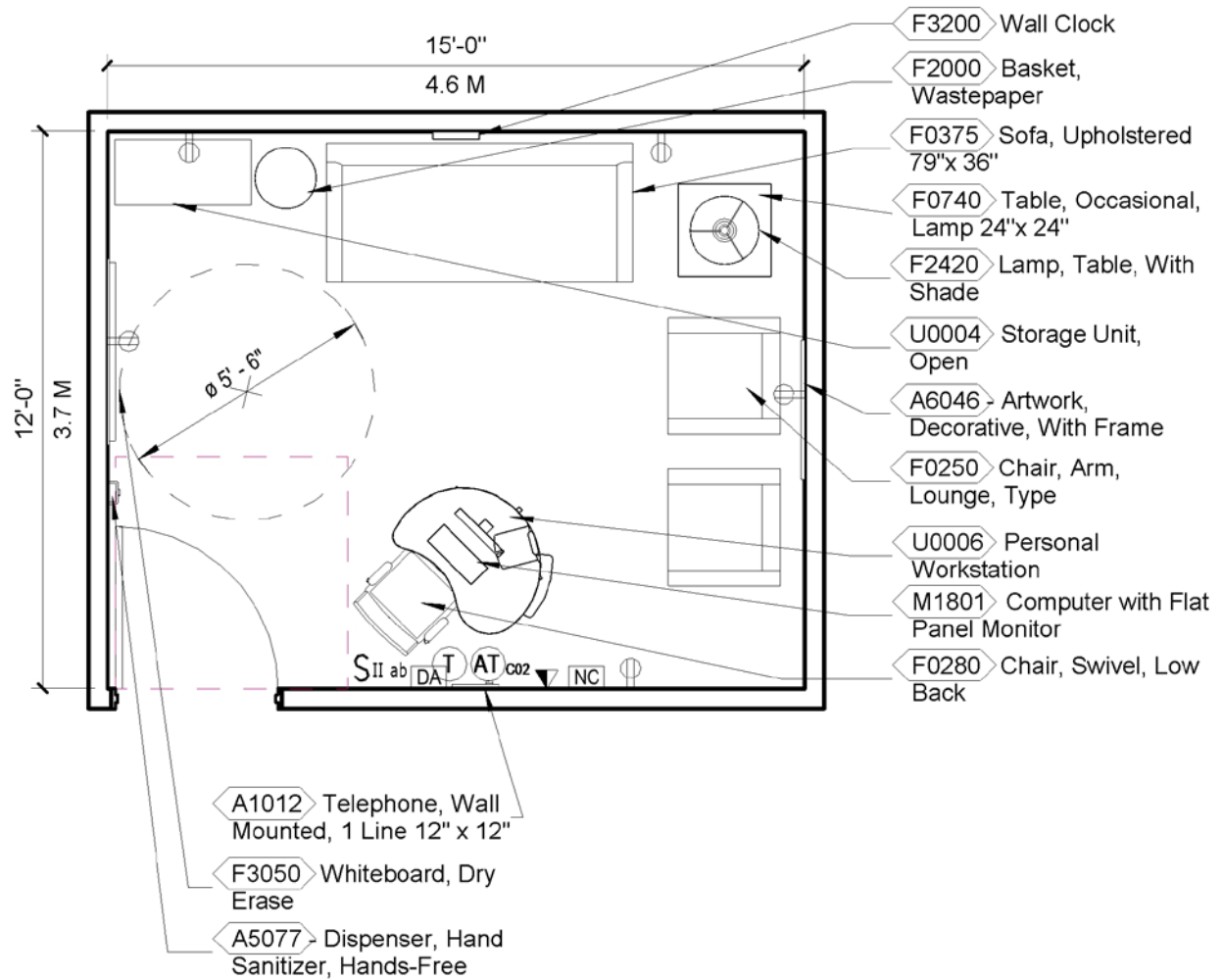

4.9 Family Consultation/Therapy Room – Reflected Ceiling Plan

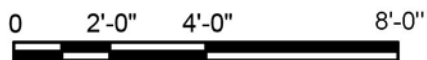
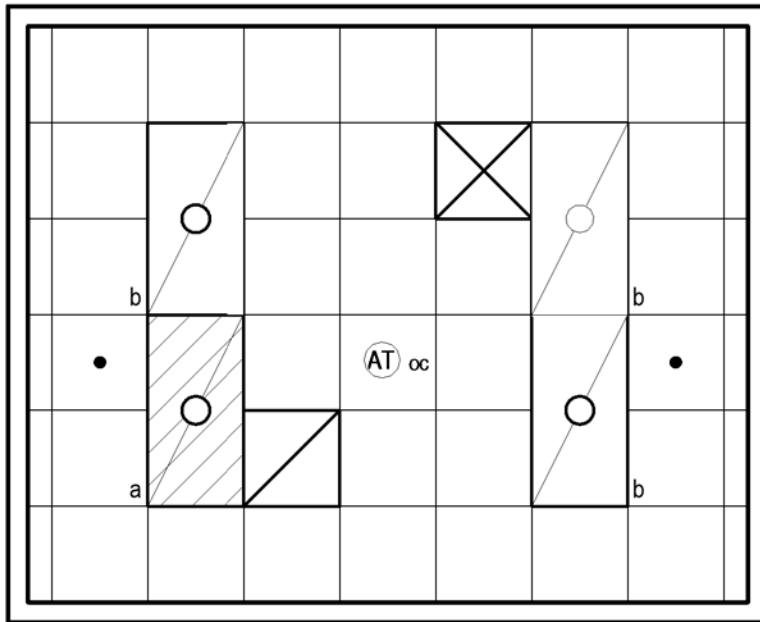



4.9 Family Consultation/Therapy Room – Room Data Sheet

ARCHITECTURAL	
<b>Ceiling Type:</b>	Acoustical Ceiling Tile
<b>Ceiling Height:</b>	9'-0" (2700 mm)
<b>Ceiling Finish:</b>	Acoustical Ceiling Tile
<b>Wall Finish:</b>	Paint
<b>Wainscot:</b>	None
<b>Base:</b>	Resilient Millwork Style (min. 4" / 101 mm)
<b>Floor Finish:</b>	Luxury Vinyl Tile
<b>Slab Depression:</b>	None Special
<b>Sound Protection:</b>	STC 50 minimum
<b>Doors:</b>	3'-6" x 7'-0" wood

LIGHTING	
<b>Maintained Average Illumination –</b>	
<b>Ambient:</b>	500 Lux (50 FC)
<b>Luminaire Type:</b>	2'x4' Fluorescent or LED, Virgin Acrylic Prismatic Lens, sealed housing, gasketed frame
<b>Lamps:</b>	4 Fluorescent or LED equivalent, 3500K – 4100K CCT, CRI >= 80%, 25% lighting shall be on emergency power
<b>Controls:</b>	Dimming or multi-level switching, occupancy sensor

**Notes:** Coordinate location of luminaires with other ceiling obstructions

POWER	
<b>Normal Power:</b>	To be connected to selected receptacles and equipment.
<b>Emergency Power:</b>	To be connected to selected lighting.
<b>Notes:</b> Provide a minimum of one receptacle on each wall.	

COMMUNICATIONS	
<b>Data:</b>	Yes
<b>Telephone:</b>	Yes
<b>Cable Television:</b>	No
<b>Duress Alarm:</b>	Yes
<b>Electronic Access and Door Control:</b>	No
<b>Intercom:</b>	No
<b>Motion Intrusion Detection (MID):</b>	No
<b>Nurse Call:</b>	Yes
<b>Code Blue:</b>	No
<b>Public Address:</b>	No
<b>Security Surveillance Television (SSTV):</b>	No
<b>VA Satellite TV:</b>	No
<b>Video Teleconferencing (TEL):</b>	No
<b>Clock:</b>	Yes



4.9 Family Consultation/Therapy Room – Room Data Sheet (continued)

**HEATING, VENTILATING AND AIR CONDITIONING**

Refer to HVAC Design Manual Chapter 6 Mental Health Outpatient Services – Room Data Sheet Group Therapy Room

**Note:** Where occupant density exceeds one person per 25 square feet, provide CO<sub>2</sub> sensing and control to limit CO<sub>2</sub> not to exceed 800 ppm.

**PLUMBING AND MEDICAL GASES**

<b>Cold Water:</b>	No
<b>Hot Water</b>	No
<b>Waste:</b>	No
<b>Reagent Grade Water:</b>	No
<b>Medical Air:</b>	No
<b>Medical Vacuum:</b>	No
<b>Oxygen:</b>	No

**FIRE PROTECTION AND LIFE SAFETY**

<b>Fire Alarm:</b>	Yes – Notification
<b>Sprinkler:</b>	Yes
<b>Hazard Type:</b>	Light Hazard



## 4.9 Family Consultation/Therapy Room – Equipment List

JSN	NAME	QTY	ACQ/INS	DESCRIPTION
A1012	Telephone, Wall Mounted, 1 Line	1	V / V	Telephone, wall-mounted, 1 line.
A5077	Dispenser, Hand Sanitizer, Hands-Free	1	V / V	A touch free wall-mounted hand sanitizer dispenser. For use throughout a healthcare facility. Unit does not include the sanitizing liquid. Units are battery operated.
A6046	Artwork, Decorative, With Frame	1	V / V	This JSN is to be used for determining and defining location of decorative artwork.
F0250	Chair, Arm, Lounge Type	2	V / V	Lounge chair approximately 33" high X 28" wide X 29" deep, with arms and floor glides. Chair completely padded and upholstered in either woven textile fabric or vinyl.
F0280	Chair, Swivel, Low Back	1	V / V	Low back contemporary swivel chair, 37" high X 25" wide X 31" deep with a five (5) caster swivel base, arms and foam padded seat and back upholstered with either woven textile fabric or vinyl.
F0375	Sofa, Upholstered	1	V / V	Executive sofa with woven fabric textile or vinyl upholstery, foam padded arms, steel spring and foam rubber backs and seats, and floor glides.
F0740	Table, Occasional, Lamp	1	V / V	Occasional lamp table (end table) approximately 20" high X 27" wide X 27" deep with choice of finishes (wood, oak veneer, or high pressure laminate).
F2000	Basket, Wastepaper, Fire Resistant	2	V / V	Wastepaper basket, fire resistant, approximately 40-quart capacity. This unit is used to collect and temporarily store small quantities of paper refuse in patient rooms, administrative areas and nursing stations. Size and shape varies depending on the application and manufacturer selected.
F2420	Lamp, Table, With Shade	1	V / V	Table lamp, 27-34" high X 6" wide X 6" deep with linen shade. Convenience outlet required at point of use.



JSN	NAME	QTY	ACQ/INS	DESCRIPTION
F3050	Whiteboard, Dry Erase	1	V / V	Whiteboard unit, approximately 36" H x 48" W consisting of a white porcelain enamel writing surface with an attached chalk tray. Magnetic surface available. Image can be easily removed with a standard chalkboard eraser. For use with watercolor pens. Unit is ready to hang.
F3200	Clock, Battery, 12" Diameter	1	V / V	Clock, 12" diameter. Round surface, easy to read numbers with sweep second hand. Wall mounted unit for use when impractical to install a fully synchronized clock system. Battery operated, (batteries not included).
M1801	Computer, Microprocessing, w/Flat Panel Monitor	1	V / V	Desktop microprocessing computer. The unit shall consist of a central processing mini tower, flat panel monitor, keyboard, mouse and speakers. The system shall have the following minimum characteristics: a 2.8 GHz Pentium processor; 512 MB memory; 80GB hard drive; 32/48x CD-ROM/DVD combo; 1.44MB network interface card; video 32 MB NVIDIA; a 18 inch flat panel monitor. The computer is used throughout the facility to input, manipulate and retrieve information.
U0004	Storage Unit, Open	1	V / V	Cubicle Storage Organizer with 9-cube design.
U0006	Personal Workstation	1	V / V	Versatile computer workstation



#### 4.10 MULTIPURPOSE ROOM (OPMH1)

##### 4.10 Multipurpose Room - Axonometric

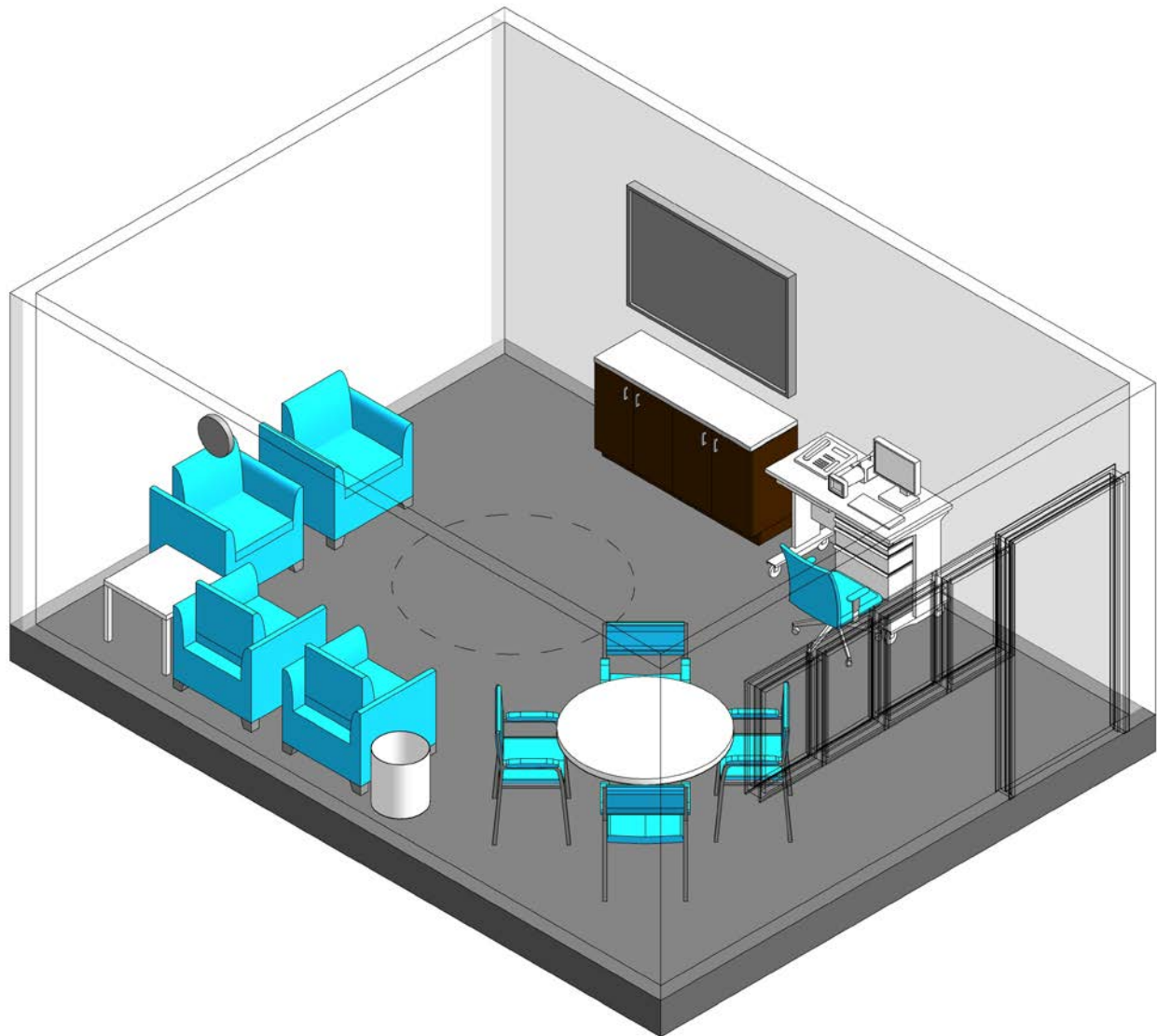

4.10 Multipurpose Room – Floor Plan

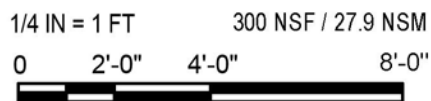
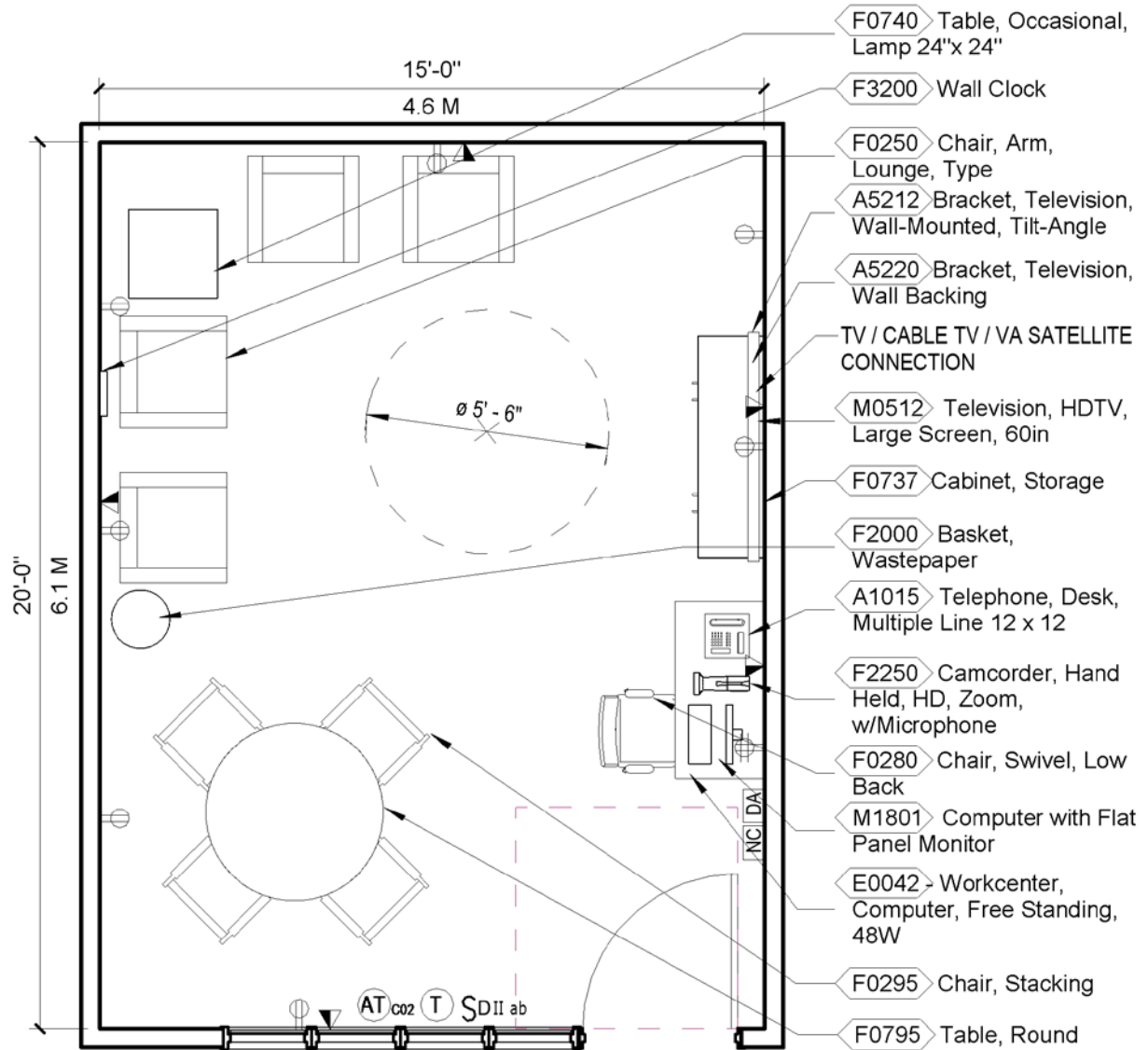

4.10 Multipurpose Room – Reflected Ceiling Plan

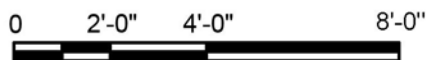
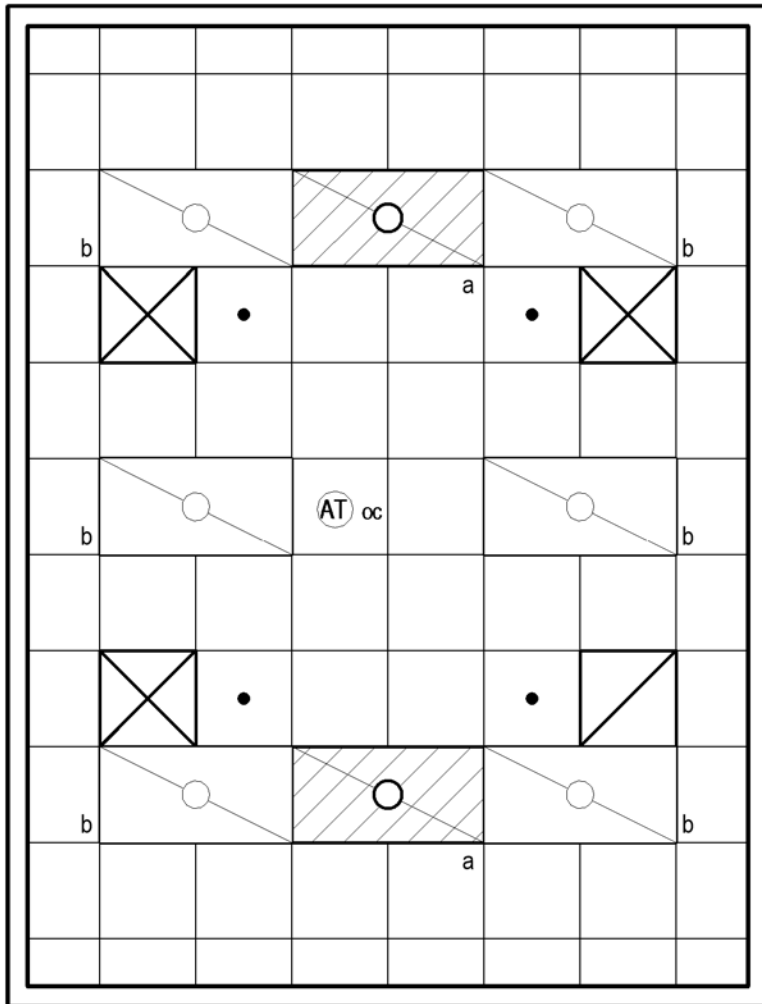

4.10 Multipurpose Room – Room Data Sheet

<b>ARCHITECTURAL</b>		<b>POWER</b>	
<b>Ceiling Type:</b>	Acoustical Ceiling Tile	<b>Normal Power:</b>	To be connected to selected receptacles and equipment.
<b>Ceiling Height:</b>	9'-0" (2700 mm)	<b>Emergency Power:</b>	To be connected to lighting identified.
<b>Ceiling Finish:</b>	Acoustical Ceiling Tile		
<b>Wall Finish:</b>	Paint		
<b>Wainscot:</b>	None		
<b>Base:</b>	Resilient Millwork Style (min. 4" / 101 mm)	<b>Notes:</b>	Provide a minimum of one receptacle on each wall.
<b>Floor Finish:</b>	Luxury Vinyl Tile		
<b>Slab Depression:</b>	None Special		
<b>Sound Protection:</b>	STC 45 minimum		
<b>Doors:</b>	3'-6" x 7'-0" wood		
<b>LIGHTING</b>		<b>COMMUNICATIONS</b>	
<b>Maintained Average Illumination – Ambient:</b>	500 Lux (50 FC)	<b>Data:</b>	Yes
<b>Luminaire Type:</b>	2'x4' Fluorescent or LED, Virgin Acrylic Prismatic Lens, sealed housing, gasketed frame	<b>Telephone:</b>	Yes
<b>Lamps:</b>	4 Fluorescent or LED equivalent, 3500K – 4100K CCT, CRI >= 80%, 25% lighting shall be on emergency power	<b>Cable Television:</b>	Yes
<b>Controls:</b>	Dimming or multi-level switching, occupancy sensor	<b>Duress Alarm:</b>	Yes
		<b>Electronic Access and Door Control:</b>	No
		<b>Intercom:</b>	No
		<b>Motion Intrusion Detection (MID):</b>	No
		<b>Nurse Call:</b>	Yes
		<b>Code Blue:</b>	No
		<b>Public Address:</b>	No
		<b>Security Surveillance Television (SSTV):</b>	No
		<b>VA Satellite TV:</b>	Yes
		<b>Video Teleconferencing (TEL):</b>	No
<b>Notes:</b> Coordinate location of luminaires with other ceiling obstructions			





## 4.10 Multipurpose Room – Room Data Sheet (continued)

**HEATING, VENTILATING AND  
AIR CONDITIONING**

Refer to HVAC Design Manual Chapter 6 Mental Health Outpatient Services – Room Data Sheet Group Therapy Room

**Note:** Where occupant density exceeds one person per 25 square feet, provide CO<sub>2</sub> sensing and control to limit CO<sub>2</sub> not to exceed 800 ppm.

**PLUMBING AND MEDICAL GASES**

<b>Cold Water:</b>	No
<b>Hot Water</b>	No
<b>Waste:</b>	No
<b>Reagent Grade Water:</b>	No
<b>Medical Air:</b>	No
<b>Medical Vacuum:</b>	No
<b>Oxygen:</b>	No

**FIRE PROTECTION AND LIFE  
SAFETY**

<b>Fire Alarm:</b>	Yes – Notification
<b>Sprinkler:</b>	Yes
<b>Hazard Type:</b>	Light Hazard



## 4.10 Multipurpose Room – Equipment List

JSN	NAME	QTY	ACQ/INS	DESCRIPTION
A1015	Telephone, Desk, Multiple Line	1	V / V	Telephone, desk, multiple line.
A5212	Bracket, Television, Wall-Mounted, Tilt/Angle	1	V / V	A wall mounted, tilt/angled TV bracket for 37" to 80" TVs. Mount will be a universal and VESA compliant unit with a load capacity of up to 130 lbs.
A5220	Bracket, Television, Wall Backing	1	C / C	Wall mounted television bracket backing which provides additional support and strength for the installation of the television bracket. Option available for interior or exterior plate and sized for 12" 16" or 24" stud spacing.
E0042	Workcenter, Computer, Free Standing, 48" W	1	V / V	THIS TYPICAL INCLUDES: 1 Tool Rail 2 Paper Tray 1 Diagonal Tray 1 Freestanding Work Surface 1 Mobile Pedestal, Box/File 1 Adjustable Keyboard Tray
F0250	Chair, Arm, Lounge Type	4	V / V	Lounge chair approximately 33" high X 28" wide X 29" deep, with arms and floor glides. Chair completely padded and upholstered in either woven textile fabric or vinyl.
F0295	Chair, Stacking	4	V / V	Stacking chair, approximately 34" H X 21" W X 24" D. May be stacked up to 20 high depending upon the model selected. These chairs are intended primarily as overflow capacity for conference rooms.
F0737	Table, Sideboard, w/ Storage	1	V / V	Residential living table made with solid wood construction and hand finished. Table has 3-4 doors and/or 2-3 drawers for storage underneath the top, and approximate dimensions are 60 W x 15 D x 35 H. Typically positioned in a residential setting living room but could be used at the discretion of the facility.
F0740	Table, Occasional, Lamp	2	V / V	Occasional lamp table (end table) approximately 20" high X 27" wide X 27" deep with choice of finishes (wood, oak veneer, or high pressure laminate).
F0795	Table, Dining	1	V / V	Dining table. Round 42" diameter or square 42" X 42". Used in dining facilities and can comfortably seat up to four (4) persons.



JSN	NAME	QTY	ACQ/INS	DESCRIPTION
F2250	Camcorder, Hand Held, HD, Zoom, w/Microphone	1	V / V	Hand held camcorder with full HD recording, LCD display and microphone. Camcorder will also have capability for still picture capture. Audio and video output will be fully transferable to a computer.
F3200	Clock, Battery, 12" Diameter	1	V / V	Clock, 12" diameter. Round surface, easy to read numbers with sweep second hand. Wall mounted unit for use when impractical to install a fully synchronized clock system. Battery operated, (batteries not included).
M0512	Television, HDTV, Large Screen, 60"	1	V / V	A high definition (HDTV) multimedia, slim design, 60"W to 65"W color television. The TV will have a 16.9 wide screen aspect ratio with full HD 1080p resolution and HDMI connections. TV may be LED, Plasma or LCD. TV will include a stand.
M1801	Computer, Microprocessing, w/Flat Panel Monitor	1	V / V	Desktop microprocessing computer. The unit shall consist of a central processing mini tower, flat panel monitor, keyboard, mouse and speakers. The system shall have the following minimum characteristics: a 2.8 GHz Pentium processor; 512 MB memory; 80GB hard drive; 32/48x CD-ROMDVD combo; 1.44MB network interface card; video 32 MB NVIDIA; an 18-inch flat panel monitor. The computer is used throughout the facility to input, manipulate and retrieve information.



#### 4.11 GROUP TESTING ROOM (OPMH2)

##### 4.11 Group Testing Room - Axonometric

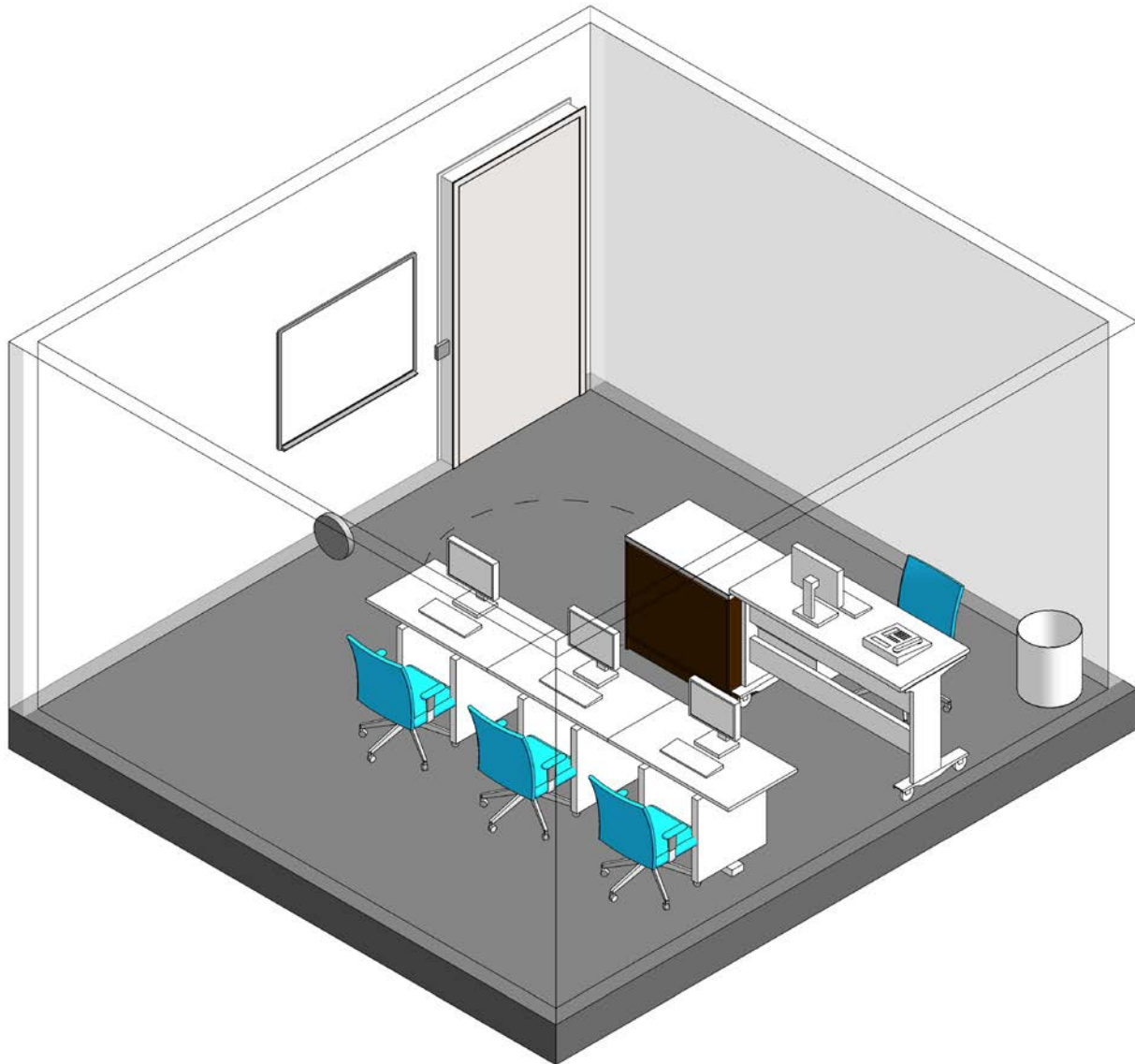

4.11 Group Testing Room – Floor Plan

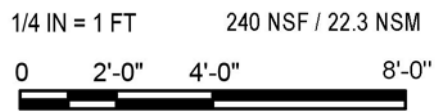
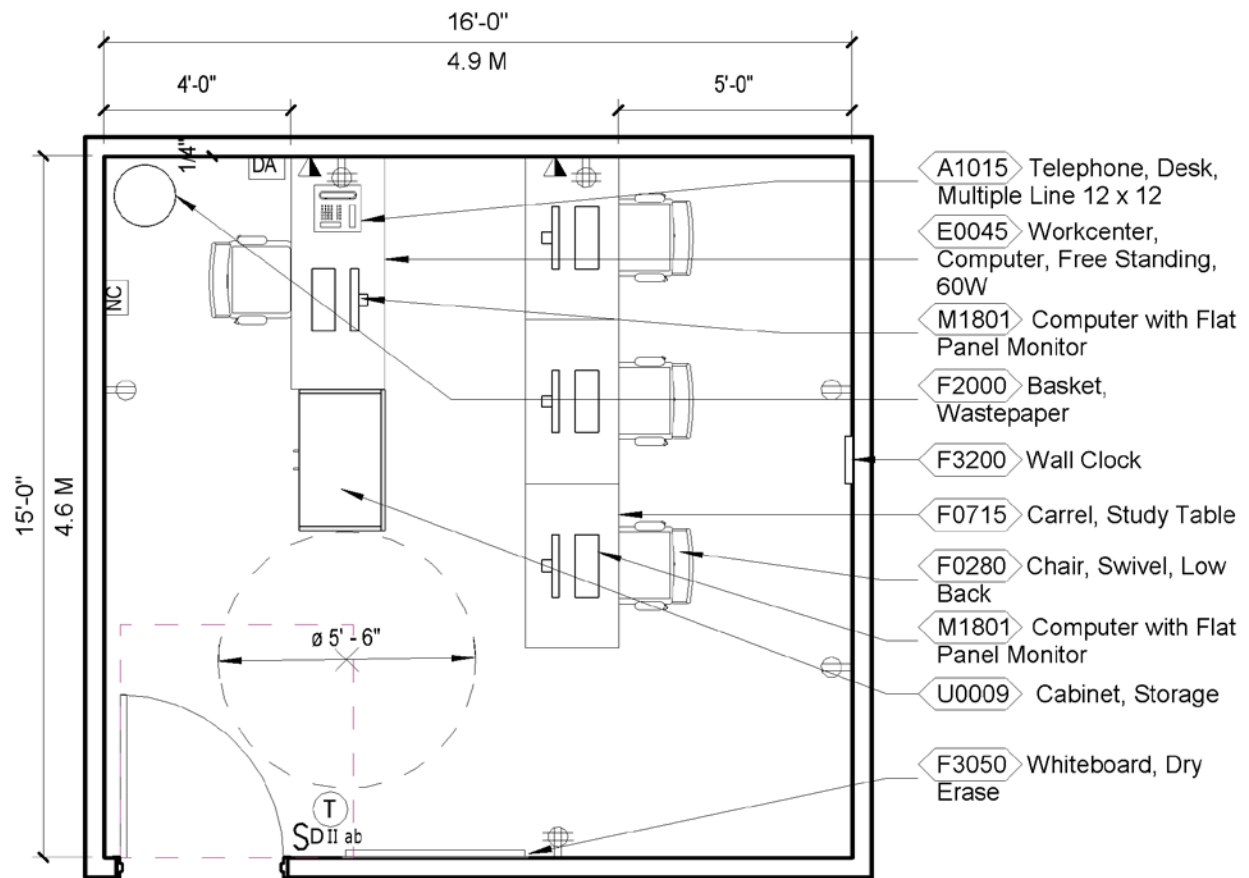

4.11 Group Testing Room – Reflected Ceiling Plan

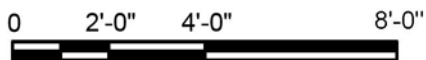
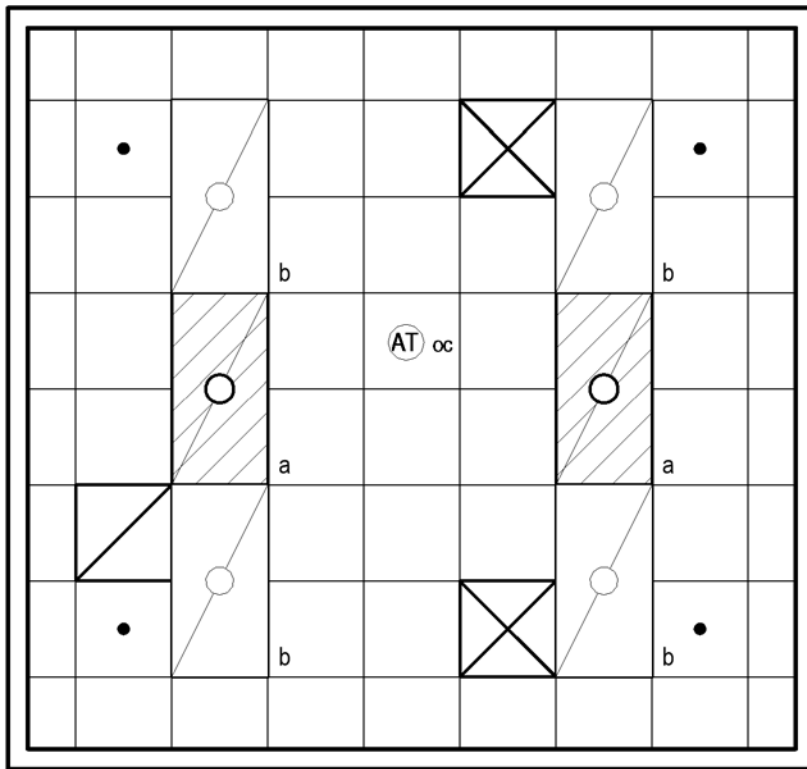

4.11 Group Testing Room – Room Data Sheet

<b>ARCHITECTURAL</b>	
<b>Ceiling Type:</b>	Acoustical Ceiling Tile
<b>Ceiling Height:</b>	9'-0" (2700 mm)
<b>Ceiling Finish:</b>	Acoustical Ceiling Tile
<b>Wall Finish:</b>	Paint
<b>Wainscot:</b>	None
<b>Base:</b>	Resilient Millwork Style (min. 4" / 101 mm)
<b>Floor Finish:</b>	Luxury Vinyl Tile
<b>Slab Depression:</b>	None Special
<b>Sound Protection:</b>	STC 45 minimum
<b>Doors:</b>	3'-6" x 7'-0" wood

<b>LIGHTING</b>	
<b>Maintained Average Illumination –</b>	
<b>Ambient:</b>	500 Lux (50 FC)
<b>Luminaire Type:</b>	2'x4' Fluorescent or LED, Virgin Acrylic Prismatic Lens, sealed housing, gasketed frame
<b>Lamps:</b>	4 Fluorescent or LED equivalent, 3500K – 4100K CCT, CRI >= 80%, 25% lighting shall be on emergency power
<b>Controls:</b>	Dimming or multi-level switching, occupancy sensor

**Notes:** Coordinate location of luminaires with other ceiling obstructions

<b>POWER</b>	
<b>Normal Power:</b>	To be connected to selected receptacles and equipment.
<b>Emergency Power:</b>	To be connected to selected lighting.
<b>Notes:</b> Provide a minimum of one receptacle on each wall.	

<b>COMMUNICATIONS</b>	
<b>Data:</b>	Yes
<b>Telephone:</b>	Yes
<b>Cable Television:</b>	No
<b>Duress Alarm:</b>	Yes
<b>Electronic Access and Door Control:</b>	No
<b>Intercom:</b>	No
<b>Motion Intrusion Detection (MID):</b>	No
<b>Nurse Call:</b>	Yes
<b>Code Blue:</b>	No
<b>Public Address:</b>	No
<b>Security Surveillance Television (SSTV):</b>	No
<b>VA Satellite TV:</b>	No
<b>Video Teleconferencing (TEL):</b>	No
<b>Clock:</b>	Yes



## 4.11 Group Testing Room – Room Data Sheet (Continued)

**HEATING, VENTILATING AND  
AIR CONDITIONING**

Refer to HVAC Design Manual Chapter 6 Mental  
Health Outpatient Services – Room Data Sheet  
Group Testing Room

**PLUMBING AND MEDICAL GASES**

<b>Cold Water:</b>	No
<b>Hot Water</b>	No
<b>Waste:</b>	No
<b>Reagent Grade Water:</b>	No
<b>Medical Air:</b>	No
<b>Medical Vacuum:</b>	No
<b>Oxygen:</b>	No

**FIRE PROTECTION AND LIFE  
SAFETY**

<b>Fire Alarm:</b>	Yes – Notification
<b>Sprinkler:</b>	Yes
<b>Hazard Type:</b>	Light Hazard





## 4.11 Group Testing Room – Equipment List

JSN	NAME	QTY	ACQ/INS	DESCRIPTION
A1015	Telephone, Desk, Multiple Line	1	V / V	Telephone, desk, multiple line.
E0045	Workcenter, Computer, Free Standing, 60" W	1	V / V	THIS TYPICAL INCLUDES: 1 Tool Rail 2 Paper Tray 1 Diagonal Tray 1 Freestanding Work Surface 1 Mobile Pedestal, Box/File 1 Adjustable Keyboard Tray
F0280	Chair, Swivel, Low Back	4	V / V	Low back contemporary swivel chair, 37" high X 25" wide X 31" deep with a five (5) caster swivel base, arms and foam padded seat and back upholstered with either woven textile fabric or vinyl.
F0715	Carrel, Study Table	3	V / V	Study carrel with table. Equipped with shelf for one (1) 12" monitor and bookshelf, wire access grommets, built-in cable chase for wire management and adjustable floor glides. A convenience outlet is required at point of use to service computer equipment if used. Work surface is 29" high.
F2000	Basket, Wastepaper, Fire Resistant	1	V / V	Wastepaper basket, fire resistant, approximately 40-quart capacity. This unit is used to collect and temporarily store small quantities of paper refuse in patient rooms, administrative areas and nursing stations. Size and shape varies depending on the application and manufacturer selected.
F3050	Whiteboard, Dry Erase	1	V / V	Whiteboard unit, approximately 36" H x 48" W consisting of a white porcelain enamel writing surface with an attached chalk tray. Magnetic surface available. Image can be easily removed with a standard chalkboard eraser. For use with watercolor pens. Unit is ready to hang.
F3200	Clock, Battery, 12" Diameter	1	V / V	Clock, 12" diameter. Round surface, easy to read numbers with sweep second hand. Wall mounted unit for use when impractical to install a fully synchronized clock system. Battery operated, (batteries not included).



JSN	NAME	QTY	ACQ/INS	DESCRIPTION
M1801	Computer, Microprocessing, w/Flat Panel Monitor	4	V / V	Desktop microprocessing computer. The unit shall consist of a central processing mini tower, flat panel monitor, keyboard, mouse and speakers. The system shall have the following minimum characteristics: a 2.8 GHz Pentium processor; 512 MB memory; 80GB hard drive; 32/48x CD-ROMDVD combo; 1.44MB network interface card; video 32 MB NVIDIA; an 18-inch flat panel monitor. The computer is used throughout the facility to input, manipulate and retrieve information.
U0009	Side Storage Cabinet	1	V / C	2 Door, 1 shelf, desk side storage cabinet.



**4.12 SOCIAL ACTIVITIES/DINING/MULTIPURPOSE ROOM (XXYYC)**

4.12 Social Activities/Dining/Multipurpose Room - Axonometric

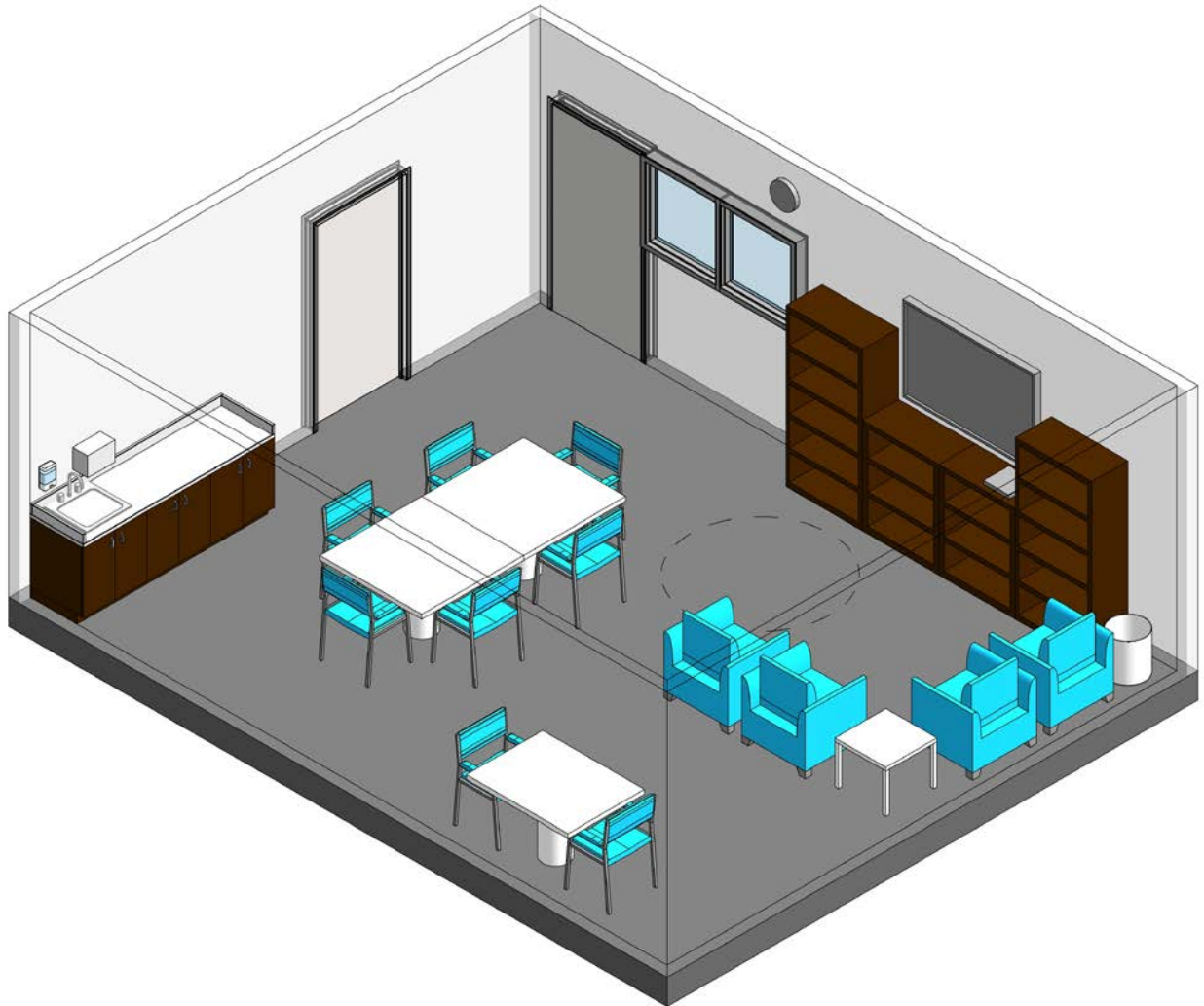

4.12 Social Activities/Dining/Multipurpose Room – Floor Plan

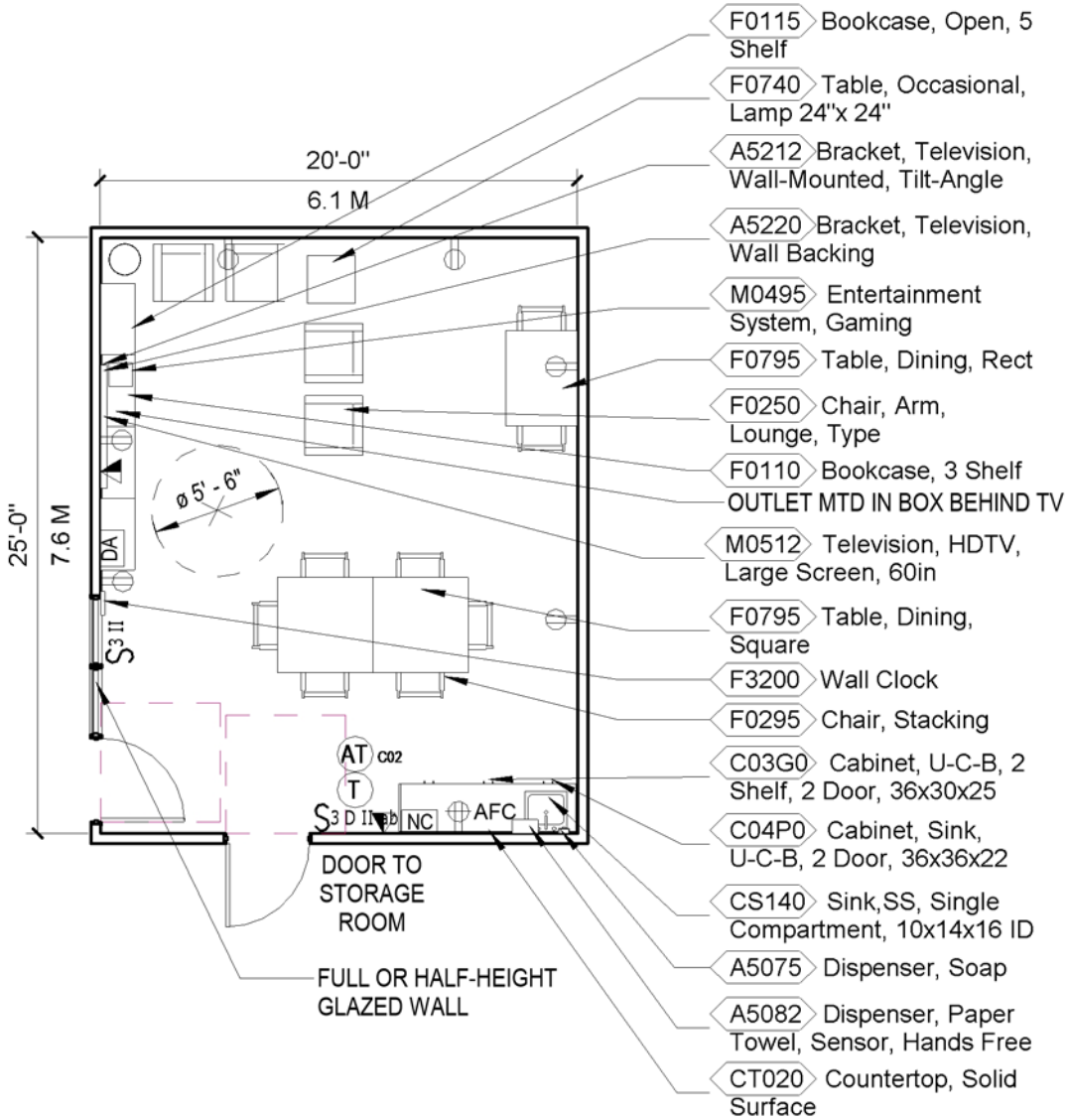

1/8 IN = 1 FT      500 NSF / 46.5 NSM

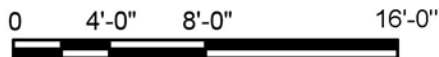

4.12 Social Activities/Dining/Multipurpose Room – Reflected Ceiling Plan

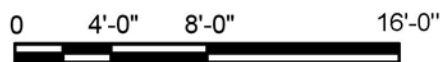
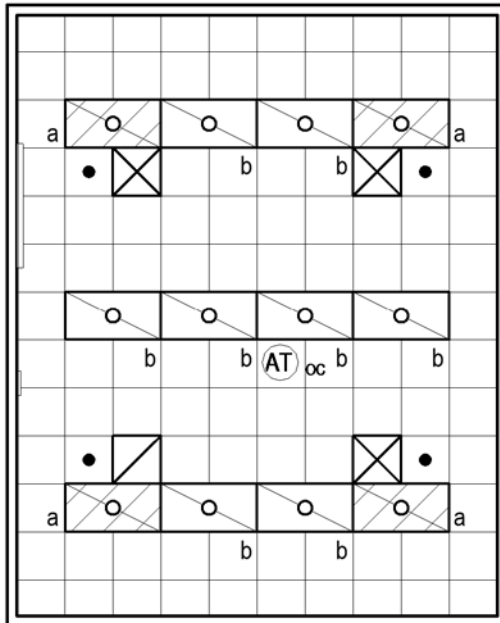

4.12 Social Activities/Dining/Multipurpose Room – Room Data Sheet

<b>ARCHITECTURAL</b>	
<b>Ceiling Type:</b>	Acoustical Ceiling Tile
<b>Ceiling Height:</b>	9'-0" (2700 mm)
<b>Ceiling Finish:</b>	Acoustical Ceiling Tile
<b>Wall Finish:</b>	Paint
<b>Wainscot:</b>	None
<b>Base:</b>	Resilient Millwork Style (min. 4" / 101 mm)
<b>Floor Finish:</b>	Luxury Vinyl Tile
<b>Slab Depression:</b>	None Special
<b>Sound Protection:</b>	STC 50 minimum
<b>Doors:</b>	3'-6" x 7'-0" wood

<b>LIGHTING</b>	
<b>Maintained Average Illumination –</b>	
<b>Ambient:</b>	500 Lux (50 FC)
<b>Luminaire Type:</b>	2'x4' Fluorescent or LED, Virgin Acrylic Prismatic Lens, sealed housing, gasketed frame
<b>Lamps:</b>	4 Fluorescent or LED equivalent, 3500K – 4100K CCT, CRI >= 80%, 25% lighting shall be on emergency power
<b>Controls:</b>	Dimming or multi-level switching, occupancy sensor

**Notes:** Coordinate location of luminaires with other ceiling obstructions

<b>POWER</b>	
<b>Normal Power:</b>	To be connected to selected receptacles and equipment.
<b>Emergency Power:</b>	To be connected to selected lighting.
<b>Notes:</b> Provide a minimum of one receptacle on each wall.	

<b>COMMUNICATIONS</b>	
Data:	Yes
Telephone:	Yes
Cable Television:	Yes
Duress Alarm:	Yes
Electronic Access and Door Control:	No
Intercom:	No
Motion Intrusion Detection (MID):	No
Nurse Call:	Yes
Code Blue:	No
Public Address:	No
Security Surveillance Television (SSTV):	No
VA Satellite TV:	Yes
Video Teleconferencing (TEL):	No
Clock:	Yes



## 4.12 Social Activities/Dining/Multipurpose Room – Room Data Sheet (continued)

**HEATING, VENTILATING AND  
AIR CONDITIONING**

Refer to HVAC Design Manual Chapter 6 Mental Health Outpatient Services – Room Data Sheet Social Activities/Dining/Multipurpose Room

**Notes:**

1. Where occupant density exceeds one person per 25 square feet, provide CO<sub>2</sub> sensing and control to limit CO<sub>2</sub> not to exceed 800 ppm
2. Where equipped with microwave, in addition to return air, provide a ducted general exhaust fan with a wall switch for occupant control. Locate the exhaust grille close to the microwave.

**PLUMBING AND MEDICAL GASES**

<b>Cold Water:</b>	Yes
<b>Hot Water</b>	Yes
<b>Waste:</b>	Yes
<b>Reagent Grade Water:</b>	No
<b>Medical Air:</b>	No
<b>Medical Vacuum:</b>	No
<b>Oxygen:</b>	No

**FIRE PROTECTION AND LIFE  
SAFETY**

<b>Fire Alarm:</b>	Yes – Notification
<b>Sprinkler:</b>	Yes
<b>Hazard Type:</b>	Light Hazard



## 4.12 Social Activities/Dining/Multipurpose Room – Equipment List

JSN	NAME	QTY	ACQ/INS	DESCRIPTION
A5212	Bracket, Television, Wall-Mounted, Tilt/Angle	1	V / V	A wall mounted, tilt/angled TV bracket for 37" to 80" TVs. Mount will be a universal and VESA compliant unit with a load capacity of up to 130 lbs.
A5220	Bracket, Television, Wall Backing	1	C / C	Wall mounted television bracket backing which provides additional support and strength for the installation of the television bracket. Option available for interior or exterior plate and sized for 12" 16" or 24" stud spacing.
C03G0	Cabinet, U/C/B, 2 Shelf, 2 Door, 36x30x22	1	C / C	Standing height under counter base cabinet with two adjustable shelves and two solid hinged doors. Also referred to as a cupboard cabinet. For general purpose use throughout the facility.
C04P0	Cabinet, Sink, U/C/B, 2 Door, 36x36x22	1	C / C	Standing height under counter base sink cabinet with solid hinged doors. Also referred to as a double-door sink cabinet. For general purpose use throughout the facility where a sink is to be used. Coordinate actual clear cabinet dimension with the actual outside dimension of sink that is specified to ensure that they are compatible.
CS140	Sink, SS, Single Compartment, 10x14x16 ID	1	C / C	Single compartment stainless steel sink, drop-in, self-rimming, ledge-type, connected with a drain and provided with a mixing faucet. It shall also be provided with punched fixture holes on 4" center, integral back ledge to accommodate deck-mounted fixtures, brushed/polished interior and top surfaces, and sound deadened. Recommended for use in suspended or U/C/B sink cabinets having a high plastic laminate or Chemsurf laminate countertop/work surface. Coordinate actual outside sink dimensions with the actual clear dimension of cabinet specified to ensure that they are compatible. For general purpose use throughout the facility.
CT020	Countertop, Solid Surface	6	C / C	A solid, nonporous countertop with a smooth seamless appearance. Easy to clean and maintain and with proper cleaning does not support the growth of mold. An acrylic-based solid surface product. Standard thickness of 1", and a 4" butt backsplash/curb. Also referred to as a work surface or work top. Available in a choice of colors and depths. Used in lab and other hospital areas requiring optimum physical and chemical resisting properties.





JSN	NAME	QTY	ACQ/INS	DESCRIPTION
F0110	Bookcase, 3 Shelf	2	V / V	Freestanding open metal shelf book case, approximately 60" high X 36" wide X 18" deep with three (3) adjustable shelves and four (4) non-marking floor glides.
F0115	Bookcase, Open, 5 Shelf	2	V / V	Freestanding open shelf bookcase, approximately 82" high X 37" wide X 18" deep with 5 (five) adjustable shelves. Unit can be separate or part of a system with available add-on shelving.
F0250	Chair, Arm, Lounge Type	3	V / V	Lounge chair approximately 33" high X 28" wide X 29" deep, with arms and floor glides. Chair completely padded and upholstered in either woven textile fabric or vinyl.
F0295	Chair, Stacking	8	V / V	Stacking chair, approximately 34" H X 21" W X 24" D. May be stacked up to 20 high depending upon the model selected. These chairs are intended primarily as overflow capacity for conference rooms.
F0740	Table, Occasional, Lamp	1	V / V	Occasional lamp table (end table) approximately 20" high X 27" wide X 27" deep with choice of finishes (wood, oak veneer, or high pressure laminate).
F0795	Table, Dining	3	V / V	Dining table. Round 42" diameter or square 42" X 42". Used in dining facilities and can comfortably seat up to four (4) persons.
F3200	Clock, Battery, 12" Diameter	1	V / V	Clock, 12" diameter. Round surface, easy to read numbers with sweep second hand. Wall mounted unit for use when impractical to install a fully synchronized clock system. Battery operated, (batteries not included).
M0495	Entertainment System, Gaming	1	V / V	An entertainment system consisting of a game console, built-in Wi-Fi, 250GB of hard drive storage, high definition blue-ray player and motion sensing controllers. Unit is used to play video games.
M0512	Television, HDTV, Large Screen, 60"	1	V / V	A high definition (HDTV) multimedia, slim design, 60"W to 65"W color television. The TV will have a 16.9 wide screen aspect ratio with full HD 1080p resolution and HDMI connections. TV may be LED, Plasma or LCD. TV will include a stand.



**4.13 ACTIVITIES/DINING ROOM WITH KITCHENETTE (XXYYC)**

4.13 Activities/Dining Room with Kitchenette - Axonometric

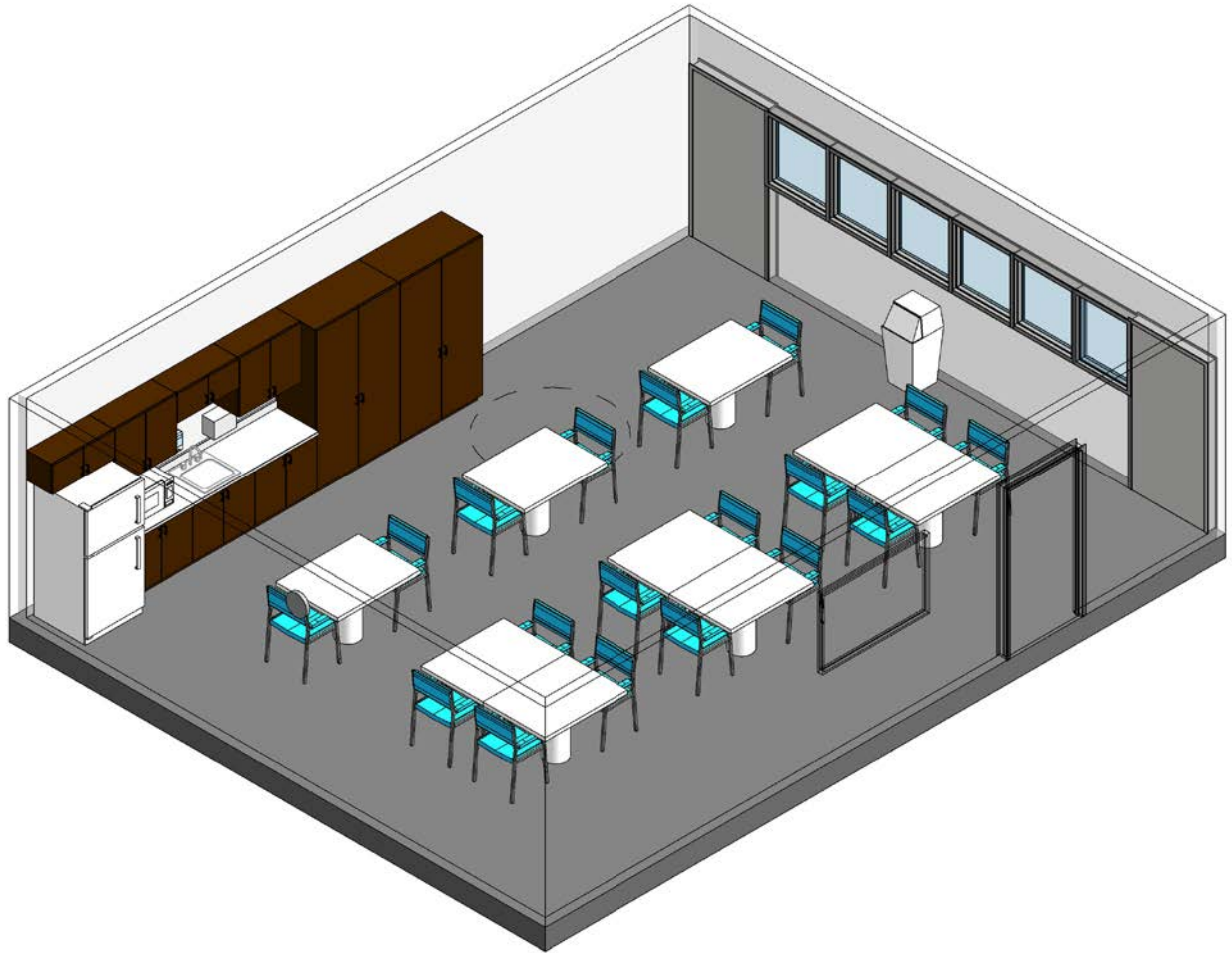

4.13 Activities/Dining Room with Kitchenette – Floor Plan

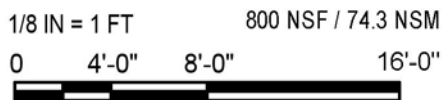
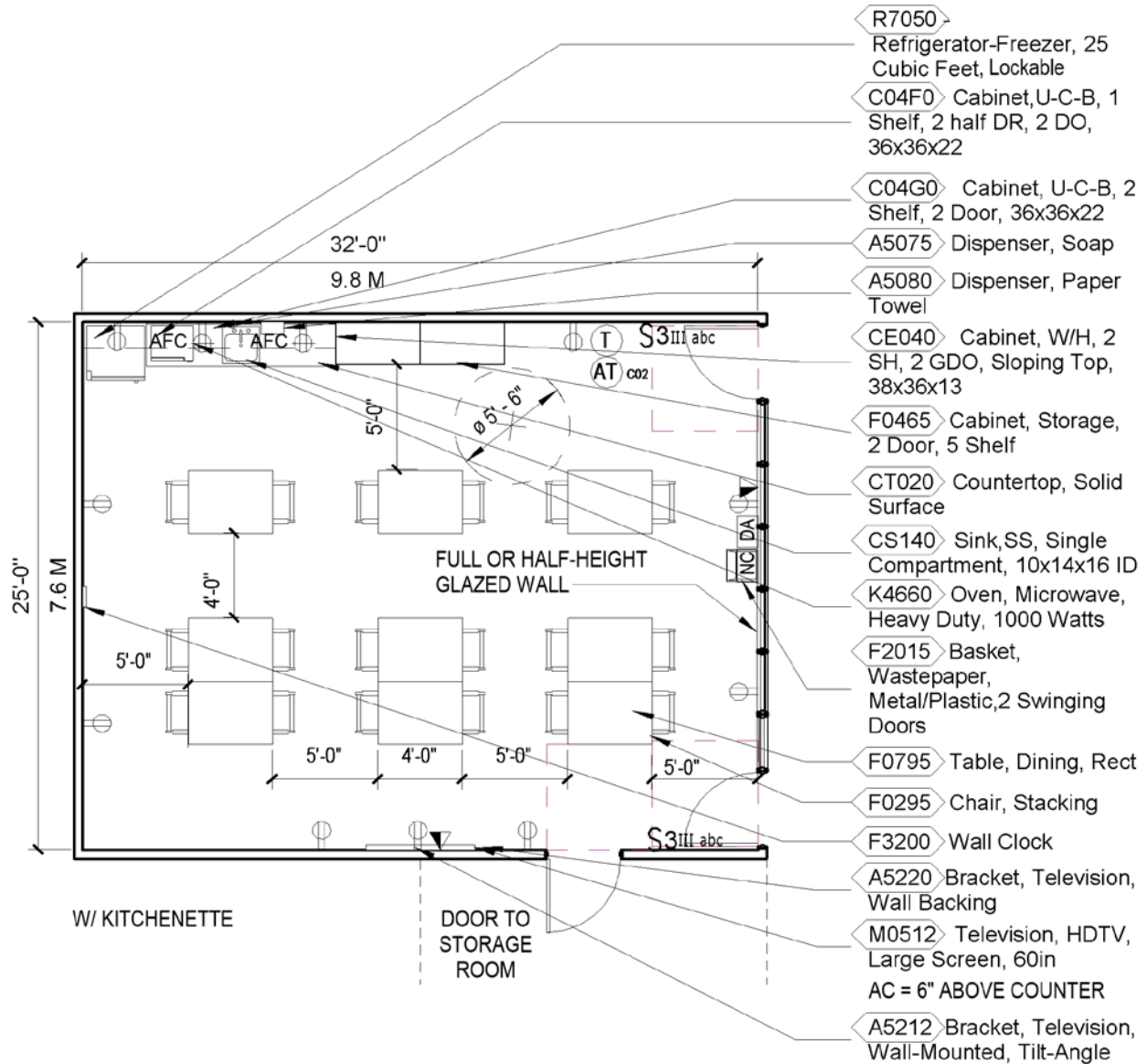

4.13 Activities/Dining Room with Kitchenette – Reflected Ceiling Plan

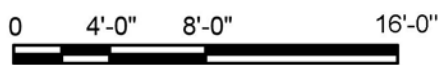
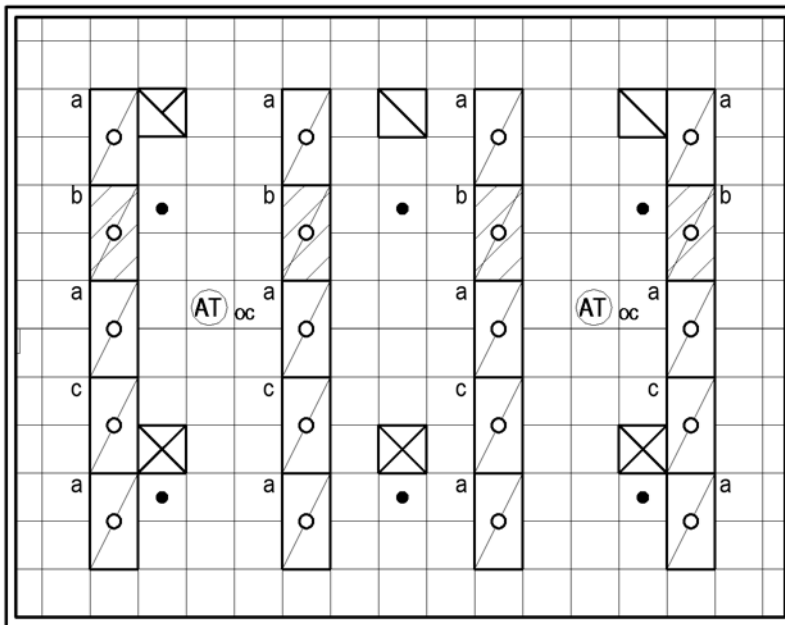

4.13 Activities/Dining Room with Kitchenette – Room Data Sheet

ARCHITECTURAL	
<b>Ceiling Type:</b>	Acoustical Ceiling Tile
<b>Ceiling Height:</b>	9'-0" (2700 mm)
<b>Ceiling Finish:</b>	Acoustical Ceiling Tile
<b>Wall Finish:</b>	Paint
<b>Wainscot:</b>	None
<b>Base:</b>	Resilient Millwork Style (min. 4" / 101 mm)
<b>Floor Finish:</b>	Luxury Vinyl Tile
<b>Slab Depression:</b>	None Special
<b>Sound Protection:</b>	STC 45 minimum
<b>Doors:</b>	3'-6" x 7'-0" wood

LIGHTING	
<b>Maintained Average Illumination –</b>	
<b>Ambient:</b>	500 Lux (50 FC)
<b>Luminaire Type:</b>	2'x4' Fluorescent or LED, Virgin Acrylic Prismatic Lens, sealed housing, gasketed frame
<b>Lamps:</b>	4 Fluorescent or LED equivalent, 3500K – 4100K CCT, CRI >= 80%, 25% lighting shall be on emergency power
<b>Controls:</b>	Dimming or multi-level switching, occupancy sensor

**Notes:** Coordinate location of luminaires with other ceiling obstructions

POWER	
<b>Normal Power:</b>	To be connected to selected receptacles and equipment.
<b>Emergency Power:</b>	To be connected to selected lighting.
<b>Notes:</b> Provide a minimum of one receptacle on each wall.	

COMMUNICATIONS	
<b>Data:</b>	Yes
<b>Telephone:</b>	Yes
<b>Cable Television:</b>	Yes
<b>Duress Alarm:</b>	Yes
<b>Electronic Access and Door Control:</b>	No
<b>Intercom:</b>	No
<b>Motion Intrusion Detection (MID):</b>	No
<b>Nurse Call:</b>	Yes
<b>Code Blue:</b>	No
<b>Public Address:</b>	No
<b>Security Surveillance Television (SSTV):</b>	No
<b>VA Satellite TV:</b>	Yes
<b>Video Teleconferencing (TEL):</b>	No
<b>Clock:</b>	Yes



4.13 Activities/Dining Room with Kitchenette – Room Data Sheet (Continued)

**HEATING, VENTILATING AND AIR CONDITIONING**

Refer to HVAC Design Manual Chapter 6 Mental Health Outpatient Services – Room Data Sheet Social Activities/Dining/Multipurpose Room

**Notes:**

1. Where occupant density exceeds one person per 25 square feet, provide CO<sub>2</sub> sensing and control to limit CO<sub>2</sub> not to exceed 800 ppm
2. Where equipped with microwave, in addition to return air, provide a ducted general exhaust fan with a wall switch for occupant control. Locate the exhaust grille close to the microwave.
3. Where equipped with range hood, in addition to return air, provide a ducted general exhaust fan with a wall switch for occupant control.

**PLUMBING AND MEDICAL GASES**

<b>Cold Water:</b>	Yes
<b>Hot Water</b>	Yes
<b>Waste:</b>	Yes
<b>Reagent Grade Water:</b>	No
<b>Medical Air:</b>	No
<b>Medical Vacuum:</b>	No
<b>Oxygen:</b>	No

**FIRE PROTECTION AND LIFE SAFETY**

<b>Fire Alarm:</b>	Yes – Notification
<b>Sprinkler:</b>	Yes
<b>Hazard Type:</b>	Light Hazard



## 4.13 Activities/Dining Room with Kitchenette – Equipment List

JSN	NAME	QTY	ACQ/INS	DESCRIPTION
A5220	Bracket, Television, Wall Backing	1	C / C	Wall mounted television bracket backing which provides additional support and strength for the installation of the television bracket. Option available for interior or exterior plate and sized for 12" 16" or 24" stud spacing.
C04F0	Cabinet, U/C/B, 1 Shelf, 2 Half DR, 2 DO, 36x36x22	1	C / C	Standing height under counter base cabinet with an adjustable shelf and two half-width drawers above solid hinged doors. Also referred to as a combination cabinet or a drawer and cupboard cabinet. For general purpose use throughout the facility.
C04G0	Cabinet, U/C/B, 2 Shelf, 2 Door, 36x36x22	1	C / C	Standing height under counter base cabinet with two adjustable shelves and two solid hinged doors. Also referred to as a cupboard cabinet. For general purpose use throughout the facility.
CE040	Cabinet, W/H, 2 SH, 2 GDO, Sloping Top, 38x36x13	3	C / C	Wall hung cabinet with two adjustable shelves, framed-glass hinged doors, and sloping top. Also referred to as a framed-glass hinged double door wall case. For general purpose use throughout the facility.
CS080	Sink, SS, Single Compartment, 7.5x18x14 ID	1	C / C	Single compartment stainless steel sink, drop-in, self-rimming, ledge-type, connected with a drain and provided with a mixing faucet. It shall also be provided with pre-punched fixture holes on 4" center, integral back ledge to accommodate deck-mounted fixtures, brushed/polished interior and top surfaces, and sound deadened. Recommended for use in suspended or U/C/B sink cabinets having a high plastic laminate or Chemsurf laminate countertop/work surface. Coordinate actual outside sink dimensions with the actual clear dimension of cabinet specified to ensure that they are compatible. For general purpose use throughout the facility.
CT020	Countertop, Solid Surface	7	C / C	A solid, nonporous countertop with a smooth seamless appearance. Easy to clean and maintain and with proper cleaning does not support the growth of mold. An acrylic-based solid surface product. Standard thickness of 1", and a 4" butt backsplash/curb. Also referred to as a work surface or work top. Available in a choice of colors and depths. Used in lab and other hospital areas requiring optimum physical and chemical resisting properties.



JSN	NAME	QTY	ACQ/INS	DESCRIPTION
F0295	Chair, Stacking	18	V / V	Stacking chair, approximately 34" H X 21" W X 24" D. May be stacked up to 20 high depending upon the model selected. These chairs are intended primarily as overflow capacity for conference rooms.
F0465	Cabinet, Storage, 2 Door, 5 Shelf	2	V / V	Storage cabinet, 78" high X 48" wide X 24" deep with two (2) doors and five (5) adjustable shelves.
F0795	Table, Dining	9	V / V	Dining table. Round 42" diameter or square 42" X 42". Used in dining facilities and can comfortably seat up to four (4) persons.
F2015	Basket, Wastepaper, Metal/Plastic, 2 Swinging Doors	1	V / V	Metal receptacle for soiled / used towels or waste. Equipped with a removable tapered top with two independently operating self-closing, spring-hinged doors. Used in public facilities for the collection and temporary storage of refuse.
F3200	Clock, Battery, 12" Diameter	1	V / V	Clock, 12" diameter. Round surface, easy to read numbers with sweep second hand. Wall mounted unit for use when impractical to install a fully synchronized clock system. Battery operated, (batteries not included).
K4660	Oven, Microwave, Heavy Duty, 1000 Watts	1	V / V	Heavy duty, counter mounted, microwave oven which delivers 1000 watts of microwave energy for rapid reheating, defrosting or cooking. The unit's cabinet is made from stainless steel or other rugged material. The touchpad has programmable keys for timing the cooking of specific items and a multiple portion cooking time adjustment key. The unit features an electronic timer with a digital readout. Some models have an additional manual dial timer. The unit can be mounted in a cabinet recess or on a shelf.
M0512	Television, HDTV, Large Screen, 60"	1	V / V	A high definition (HDTV) multimedia, slim design, 60"W to 65"W color television. The TV will have a 16.9 wide screen aspect ratio with full HD 1080p resolution and HDMI connections. TV may be LED, Plasma or LCD. TV will include a stand.
R7050	Refrigerator, 25 Cubic Feet	1	V / V	General purpose refrigerator approximately 84x27x37. This unit is corrosion resistant stainless steel. It has a single self-closing door with safety stops. This refrigerator is generally used in commercial kitchens, hospitals and schools.





#### 4.14 ACTIVITIES/DINING ROOM (FSCD1)

##### 4.14 Activities/Dining Room - Axonometric

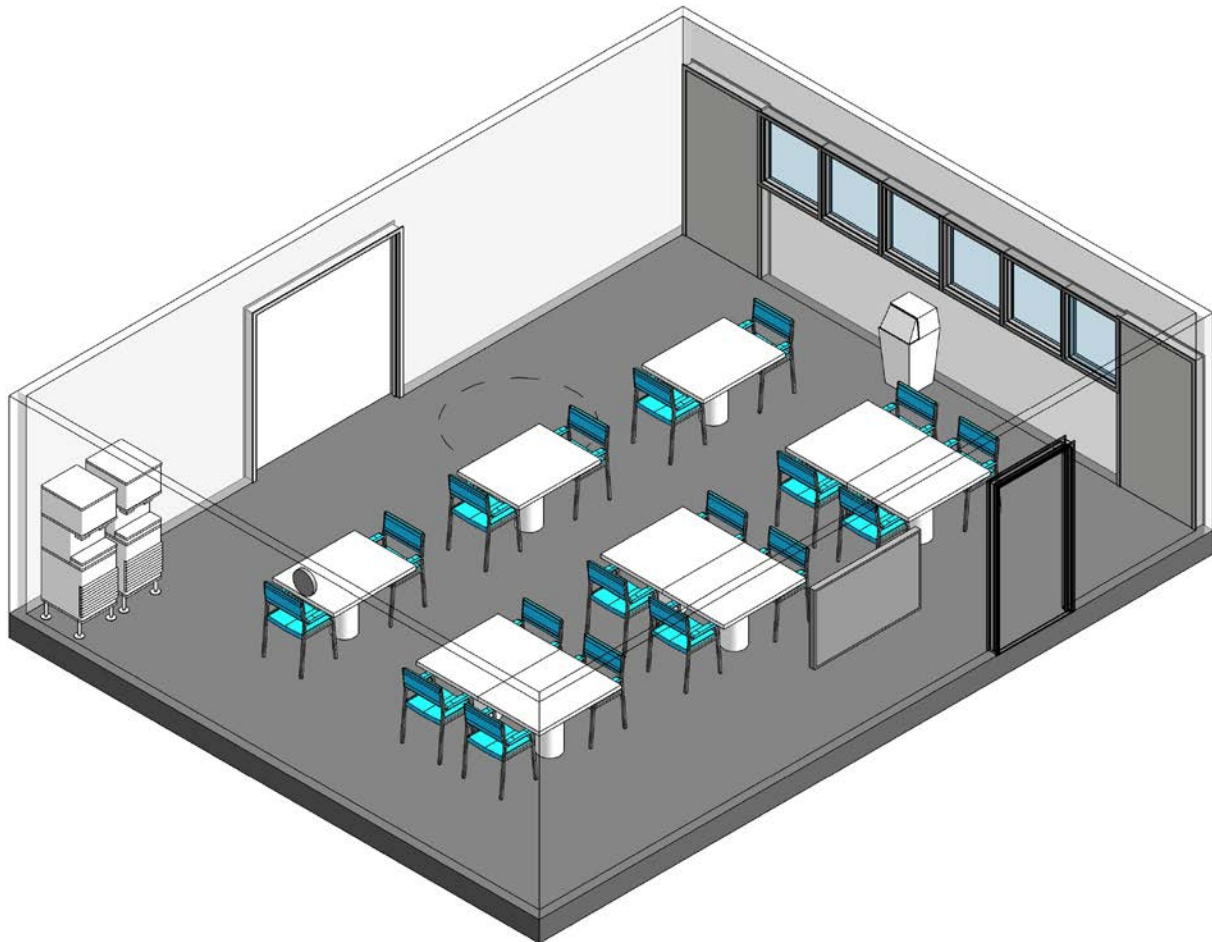

4.14 Activities/Dining Room – Floor Plan

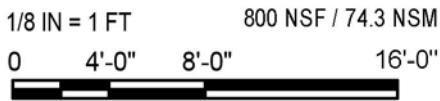
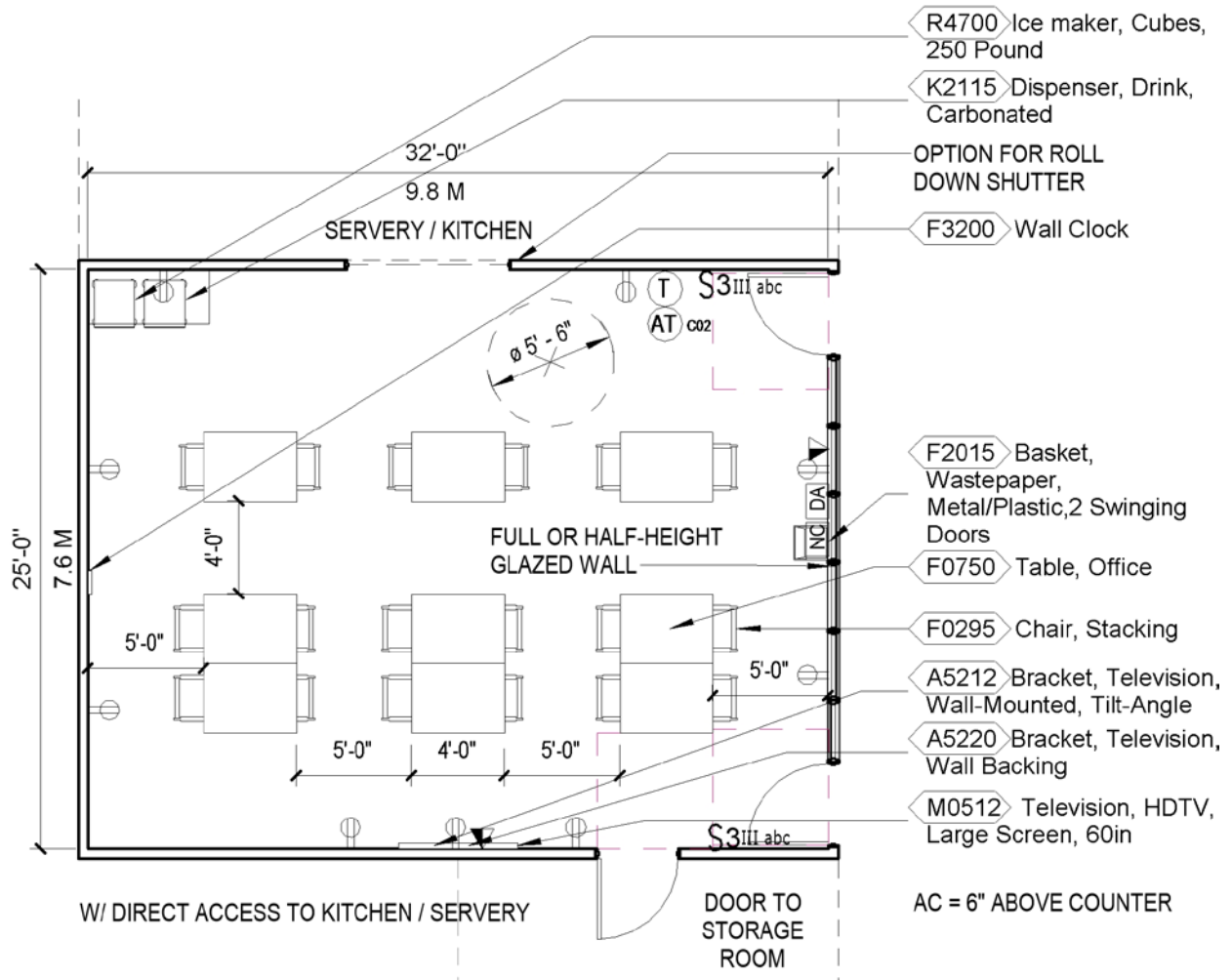

4.14 Activities/Dining Room – Reflected Ceiling Plan

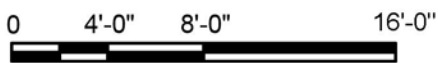
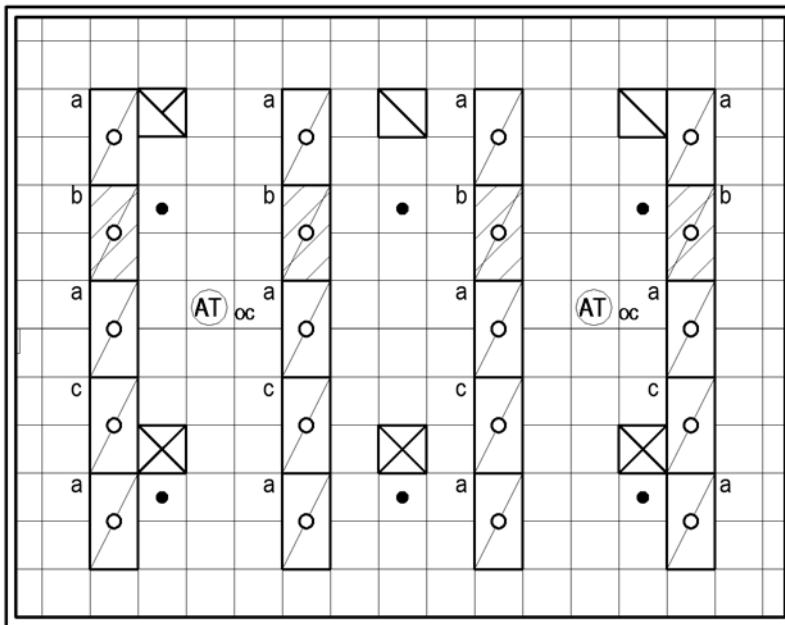

4.14 Activities/Dining Room – Room Data Sheet

ARCHITECTURAL	
<b>Ceiling Type:</b>	Acoustical Ceiling Tile
<b>Ceiling Height:</b>	9'-0" (2700 mm)
<b>Ceiling Finish:</b>	Acoustical Ceiling Tile
<b>Wall Finish:</b>	Paint
<b>Wainscot:</b>	None
<b>Base:</b>	Resilient Millwork Style (min. 4" / 101 mm)
<b>Floor Finish:</b>	Luxury Vinyl Tile
<b>Slab Depression:</b>	None Special
<b>Sound Protection:</b>	STC 45 minimum
<b>Doors:</b>	3'-6" x 7'-0" wood

LIGHTING	
<b>Maintained Average Illumination –</b>	
<b>Ambient:</b>	500 Lux (50 FC)
<b>Luminaire Type:</b>	2'x4' Fluorescent or LED, Virgin Acrylic Prismatic Lens, sealed housing, gasketed frame
<b>Lamps:</b>	4 Fluorescent or LED equivalent, 3500K – 4100K CCT, CRI >= 80%, 25% lighting shall be on emergency power
<b>Controls:</b>	Dimming or multi-level switching, occupancy sensor

**Notes:** Coordinate location of luminaires with other ceiling obstructions

POWER	
<b>Normal Power:</b>	To be connected to selected receptacles and equipment.
<b>Emergency Power:</b>	To be connected to selected lighting.
<b>Notes:</b> Provide a minimum of one receptacle on each wall.	

COMMUNICATIONS	
<b>Data:</b>	Yes
<b>Telephone:</b>	Yes
<b>Cable Television:</b>	Yes
<b>Duress Alarm:</b>	Yes
<b>Electronic Access and Door Control:</b>	No
<b>Intercom:</b>	No
<b>Motion Intrusion Detection (MID):</b>	No
<b>Nurse Call:</b>	Yes
<b>Code Blue:</b>	No
<b>Public Address:</b>	No
<b>Security Surveillance Television (SSTV):</b>	No
<b>VA Satellite TV:</b>	Yes
<b>Video Conferencing (TEL):</b>	No
<b>Clock:</b>	Yes



## 4.14 Activities/Dining Room – Room Data Sheet (Continued)

**HEATING, VENTILATING AND  
AIR CONDITIONING**

Refer to HVAC Design Manual Chapter 6 Mental Health Outpatient Services – Room Data Sheet Social Activities/Dining/Multipurpose Room

**Notes:**

2. Where occupant density exceeds one person per 25 square feet, provide CO<sub>2</sub> sensing and control to limit CO<sub>2</sub> not to exceed 800 ppm
4. Where equipped with microwave, in addition to return air, provide a ducted general exhaust fan with a wall switch for occupant control. Locate the exhaust grille close to the microwave.
5. Where equipped with range hood, in addition to return air, provide a ducted general exhaust fan with a wall switch for occupant control.

**PLUMBING AND MEDICAL GASES**

<b>Cold Water:</b>	Yes
<b>Hot Water</b>	Yes
<b>Waste:</b>	Yes
<b>Reagent Grade Water:</b>	No
<b>Medical Air:</b>	No
<b>Medical Vacuum:</b>	No
<b>Oxygen:</b>	No

**FIRE PROTECTION AND LIFE  
SAFETY**

<b>Fire Alarm:</b>	Yes – Notification
<b>Sprinkler:</b>	Yes
<b>Hazard Type:</b>	Light Hazard



## 4.14 Activities/Dining Room – Equipment List

JSN	NAME	QTY	ACQ/INS	DESCRIPTION
A5212	Bracket, Television, Wall-Mounted, Tilt/Angle	1	V / V	A wall mounted, tilt/angled TV bracket for 37" to 80" TVs. Mount will be a universal and VESA compliant unit with a load capacity of up to 130 lbs.
A5220	Bracket, Television, Wall Backing	1	C / C	Wall mounted television bracket backing which provides additional support and strength for the installation of the television bracket. Option available for interior or exterior plate and sized for 12" 16" or 24" stud spacing.
F0295	Chair, Stacking	18	V / V	Stacking chair, approximately 34" H X 21" W X 24" D. May be stacked up to 20 high depending upon the model selected. These chairs are intended primarily as overflow capacity for conference rooms.
F0795	Table, Dining	9	V / V	Dining table. Round 42" diameter or square 42" X 42". Used in dining facilities and can comfortably seat up to four (4) persons.
F2015	Basket, Wastepaper, Metal/Plastic, 2 Swinging Doors	1	V / V	Metal receptacle for soiled / used towels or waste. Equipped with a removable tapered top with two independently operating self-closing, spring-hinged doors. Used in public facilities for the collection and temporary storage of refuse.
F3200	Clock, Battery, 12" Diameter	1	V / V	Clock, 12" diameter. Round surface, easy to read numbers with sweep second hand. Wall mounted unit for use when impractical to install a fully synchronized clock system. Battery operated, (batteries not included).
K2115	Dispenser, Drink, Carbonated	1	L_RE	Carbonated drink dispenser. The unit dispenses eight carbonated beverages and ice from a self-service counter machine. The ice hopper holds 100 lb. of ice and may be connected to a remote ice maker from which it automatically loads ice. If not connected to an ice maker, the unit's ice bin will require manual refilling. The unit does not include the syrup racks, mixing valves, carbon dioxide supply or the chilled water pump. This unit is used to dispense cold carbonated drinks in food service activities.
M0512	Television, HDTV, Large Screen, 60"	1	V / V	A high definition (HDTV) multimedia, slim design, 60"W to 65"W color television. The TV will have a 16.9 wide screen aspect ratio with full HD 1080p resolution and HDMI connections. TV may be LED, Plasma or LCD. TV will include a stand.



JSN	NAME	QTY	ACQ/INS	DESCRIPTION
R4700	Ice Maker, Cubes, 250 Pound	1	C / C	Ice cube maker approximately 39" H x 29" D x 26" W. This unit is self-contained and provides 250 pounds of ice every 24 hours. The exterior is made of sturdy stainless steel. It is used in hospitals, hotels, and restaurants for dispensing ice.



#### 4.15 OCCUPATIONAL THERAPY ROOM (OTGC1)

##### 4.15 Occupational Therapy Room - Axonometric





4.15 Occupational Therapy Room – Floor Plan

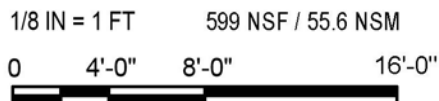
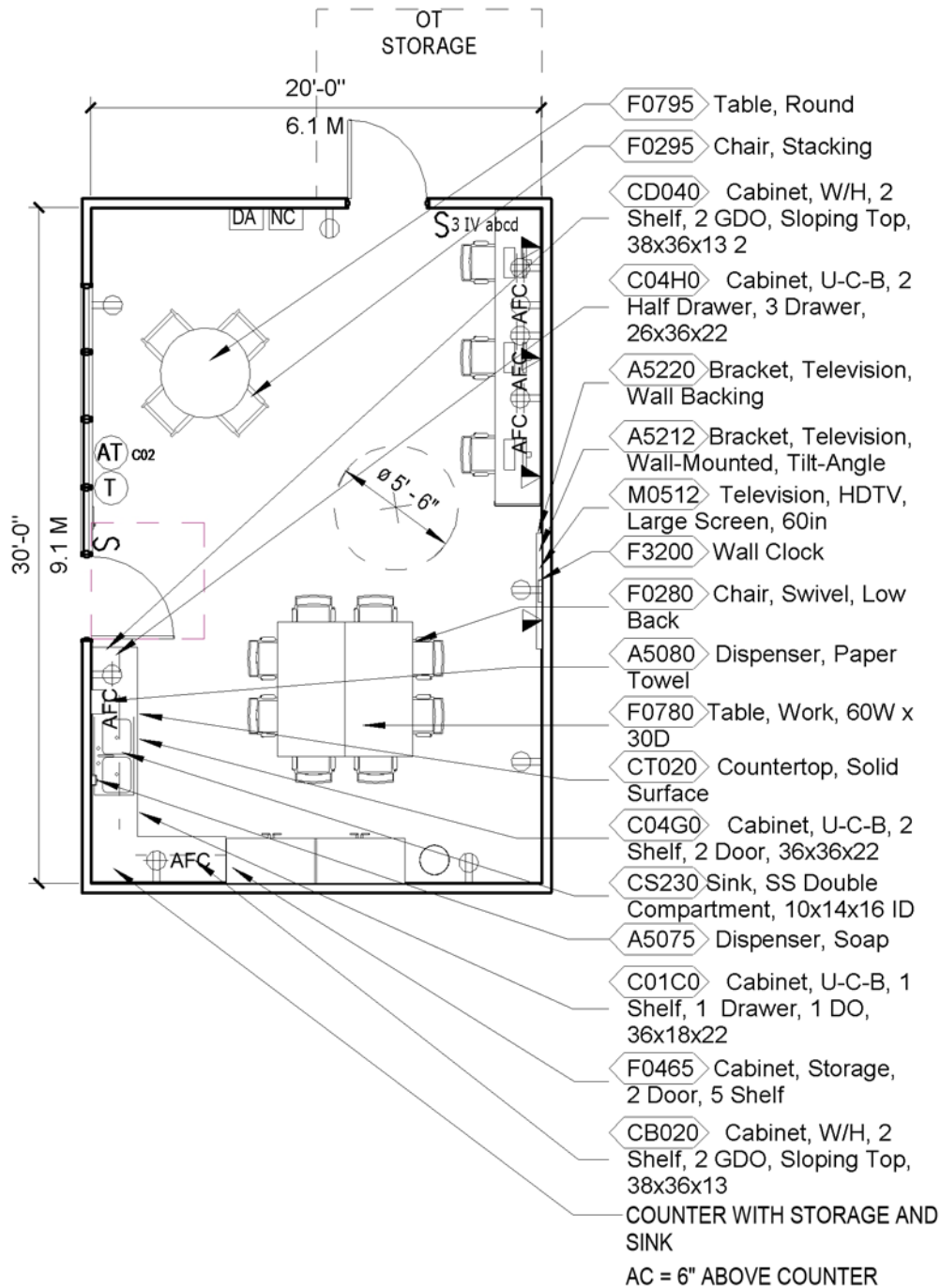

4.15 Occupational Therapy Room – Reflected Ceiling Plan

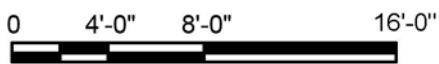
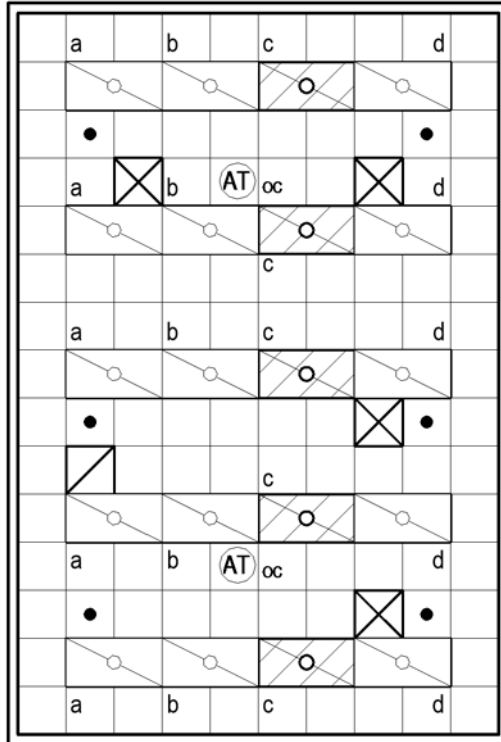

## 4.15 Occupational Therapy Room – Room Data Sheet

**ARCHITECTURAL**

<b>Ceiling Type:</b>	Acoustical Ceiling Tile
<b>Ceiling Height:</b>	9'-0" (2700 mm)
<b>Ceiling Finish:</b>	Acoustical Ceiling Tile
<b>Wall Finish:</b>	Paint
<b>Wainscot:</b>	None
<b>Base:</b>	Resilient Millwork Style (min. 4" / 101 mm)
<b>Floor Finish:</b>	Luxury Vinyl Tile
<b>Slab Depression:</b>	None Special
<b>Sound Protection:</b>	STC 45 minimum
<b>Doors:</b>	3'-6" x 7'-0" wood

**LIGHTING**

<b>Maintained Average Illumination – Ambient:</b>	500 Lux (50 FC)
<b>Luminaire Type:</b>	2'x4' Fluorescent or LED, Virgin Acrylic Prismatic Lens, sealed housing, gasketed frame
<b>Lamps:</b>	4 Fluorescent or LED equivalent, 3500K – 4100K CCT, CRI >= 80%, 25% lighting shall be on emergency power
<b>Controls:</b>	Dimming or multi-level switching, occupancy sensor

**Notes:** Coordinate location of luminaires with other ceiling obstructions

**POWER**

<b>Normal Power:</b>	To be connected to selected receptacles and equipment.
<b>Emergency Power:</b>	To be connected to selected lighting.

**Notes:** Provide a minimum of one receptacle on each wall.

**COMMUNICATIONS**

<b>Data:</b>	Yes
<b>Telephone:</b>	Yes
<b>Cable Television:</b>	Yes
<b>Duress Alarm:</b>	Yes
<b>Electronic Access and Door Control:</b>	No
<b>Intercom:</b>	No
<b>Motion Intrusion Detection (MID):</b>	No
<b>Nurse Call:</b>	Yes
<b>Code Blue:</b>	No
<b>Public Address:</b>	No
<b>Security Surveillance Television (SSTV):</b>	No
<b>VA Satellite TV:</b>	Yes
<b>Video Teleconferencing (TEL):</b>	No
<b>Clock:</b>	Yes



## 4.15 Occupational Therapy Room – Room Data Sheet (Continued)

**HEATING, VENTILATING AND  
AIR CONDITIONING**

Refer to HVAC Design Manual Chapter 6 Mental Health Outpatient Services – Room Data Sheet Occupational Therapy (including footnote regarding kiln)

**Notes:**

1. Where occupant density exceeds one person per 25 square feet, provide CO<sub>2</sub> sensing and control to limit CO<sub>2</sub> not to exceed 800 ppm.
2. Where equipped with kiln or other high heat-producing equipment, provide exhaust over hot equipment, and room air balance shall be negative. Additional HVAC system requirements will depend on type of room equipment is selected.

**PLUMBING AND MEDICAL GASES**

<b>Cold Water:</b>	Yes
<b>Hot Water</b>	Yes
<b>Waste:</b>	Yes
<b>Reagent Grade Water:</b>	No
<b>Medical Air:</b>	No
<b>Medical Vacuum:</b>	No
<b>Oxygen:</b>	No

**FIRE PROTECTION AND LIFE SAFETY**

<b>Fire Alarm:</b>	Yes – Notification
<b>Sprinkler:</b>	Yes
<b>Hazard Type:</b>	Light Hazard



## 4.15 Occupational Therapy Room – Equipment List

JSN	NAME	QTY	ACQ/INS	DESCRIPTION
A5212	Bracket, Television, Wall-Mounted, Tilt/Angle	1	V / V	A wall mounted, tilt/angled TV bracket for 37" to 80" TVs. Mount will be a universal and VESA compliant unit with a load capacity of up to 130 lbs.
A5220	Bracket, Television, Wall Backing	1	C / C	Wall mounted television bracket backing which provides additional support and strength for the installation of the television bracket. Option available for interior or exterior plate and sized for 12" 16" or 24" stud spacing.
C01C0	Cabinet, U/C/B, 1 Shelf, 1 Drawer, 1 DO, 36x18x22	1	C / C	Standing height under counter base cabinet with an adjustable shelf and a full width drawer above a solid right or left-hinged door (appropriate door hinge configuration to be indicated on equipment elevation drawings). Also referred to as a combination cabinet or a drawer and cupboard cabinet. For general purpose use throughout the facility.
C04G0	Cabinet, U/C/B, 2 Shelf, 2 Door, 36x36x22	1	C / C	Standing height under counter base cabinet with two adjustable shelves and two solid hinged doors. Also referred to as a cupboard cabinet. For general purpose use throughout the facility.
C04H0	Cabinet, U/C/B, 2 Half Drawer, 3 Drawer, 36x36x22	1	C / C	Standing height under counter base cabinet with two half width drawers side-by-side above three full width drawers. Also referred to as a drawer cabinet. For general purpose use throughout the facility.
CB020	Cabinet, W/H, 2 Shelf, 1 DO, Sloping Top, 38x24x13	3	C / C	Wall hung cabinet with two adjustable shelves, solid right or left-hinged door (appropriate door hinge configuration to be indicated on equipment elevation drawings), and sloping top. Also referred to as a solid hinged single door case. For general purpose use throughout the facility.
CD040	Cabinet, W/H, 2 Shelf, 2 DO, Sloping Top, 38x36x13	2	C / C	Wall hung cabinet with two adjustable shelves, solid hinged doors, and sloping top. Also referred to as a solid hinged double door wall case. For general purpose use throughout the facility.
CS230	Sink, SS, Double Compartment, 10x14x16 ID	1	C / C	Double compartment stainless steel sink, drop-in, self-rimming, ledge-type, connected with a drain and provided with a mixing faucet. It shall also be provided with pre-punched fixture holes on 4" center, integral back ledge to accommodate deck-mounted fixtures, brushed/polished interior and top surfaces, and sound deadened. Recommended for use in suspended or U/C/B sink cabinets having a high plastic laminate or Chemsurf laminate countertop/work surface. Coordinate actual outside sink dimensions with the actual clear dimension of cabinet specified to ensure that they are compatible. For general purpose use throughout the facility.



JSN	NAME	QTY	ACQ/INS	DESCRIPTION
CT020	Countertop, Solid Surface	21	C / C	A solid, nonporous countertop with a smooth seamless appearance. Easy to clean and maintain and with proper cleaning does not support the growth of mold. An acrylic-based solid surface product. Standard thickness of 1", and a 4" butt backsplash/curb. Also referred to as a work surface or work top. Available in a choice of colors and depths. Used in lab and other hospital areas requiring optimum physical and chemical resisting properties.
F0225	Chair, Dining Room	4	V / V	Dining room chair with glides. Chair has straight legs with cushioned cloth or vinyl seat.
F0280	Chair, Swivel, Low Back	11	V / V	Low back contemporary swivel chair, 37" high X 25" wide X 31" deep with a five (5) caster swivel base, arms and foam padded seat and back upholstered with either woven textile fabric or vinyl.
F0465	Cabinet, Storage, 2 Door, 5 Shelf	2	V / V	Storage cabinet, 78" high X 48" wide X 24" deep with two (2) doors and five (5) adjustable shelves.
F0780	Table, Work, 60W x 30D	2	V / V	Work table approximately 29" high X 60" wide X 30" deep with top and four (4) non-folding legs.
F0795	Table, Dining	1	V / V	Dining table. Round 42" diameter or square 42" X 42". Used in dining facilities and can comfortably seat up to four (4) persons.
F2000	Basket, Wastepaper, Fire Resistant	1	V / V	Wastepaper basket, fire resistant, approximately 40-quart capacity. This unit is used to collect and temporarily store small quantities of paper refuse in patient rooms, administrative areas and nursing stations. Size and shape varies depending on the application and manufacturer selected.
F3200	Clock, Battery, 12" Diameter	1	V / V	Clock, 12" diameter. Round surface, easy to read numbers with sweep second hand. Wall mounted unit for use when impractical to install a fully synchronized clock system. Battery operated, (batteries not included).
M0512	Television, HDTV, Large Screen, 60"	1	V / V	A high definition (HDTV) multimedia, slim design, 60"W to 65"W color television. The TV will have a 16.9 wide screen aspect ratio with full HD 1080p resolution and HDMI connections. TV may be LED, Plasma or LCD. TV will include a stand.



JSN	NAME	QTY	ACQ/INS	DESCRIPTION
M1801	Computer, Microprocessing, w/Flat Panel Monitor	3	V / V	Desktop microprocessing computer. The unit shall consist of a central processing mini tower, flat panel monitor, keyboard, mouse and speakers. The system shall have the following minimum characteristics: a 2.8 GHz Pentium processor; 512 MB memory; 80GB hard drive; 32/48x CD-ROMDVD combo; 1.44MB network interface card; video 32 MB NVIDIA; an 18-inch flat panel monitor. The computer is used throughout the facility to input, manipulate and retrieve information.



**4.16 CONFERENCE ROOM/CLASSROOM (XXYYC)**

4.16 Conference Room/Classroom – Axonometric – conference format

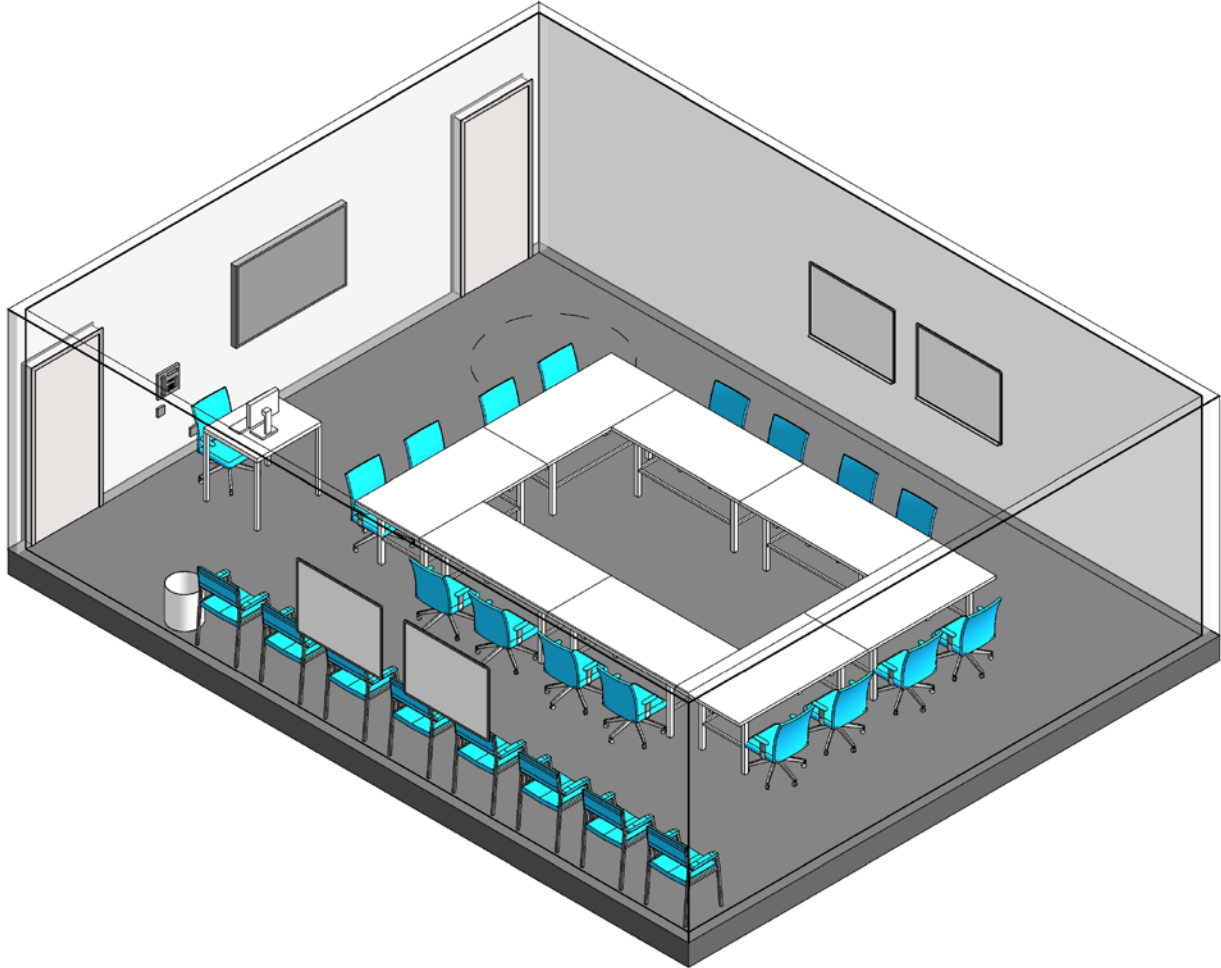



4.16 Conference Room/Classroom - Floor Plan – conference format

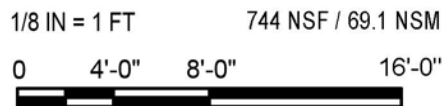
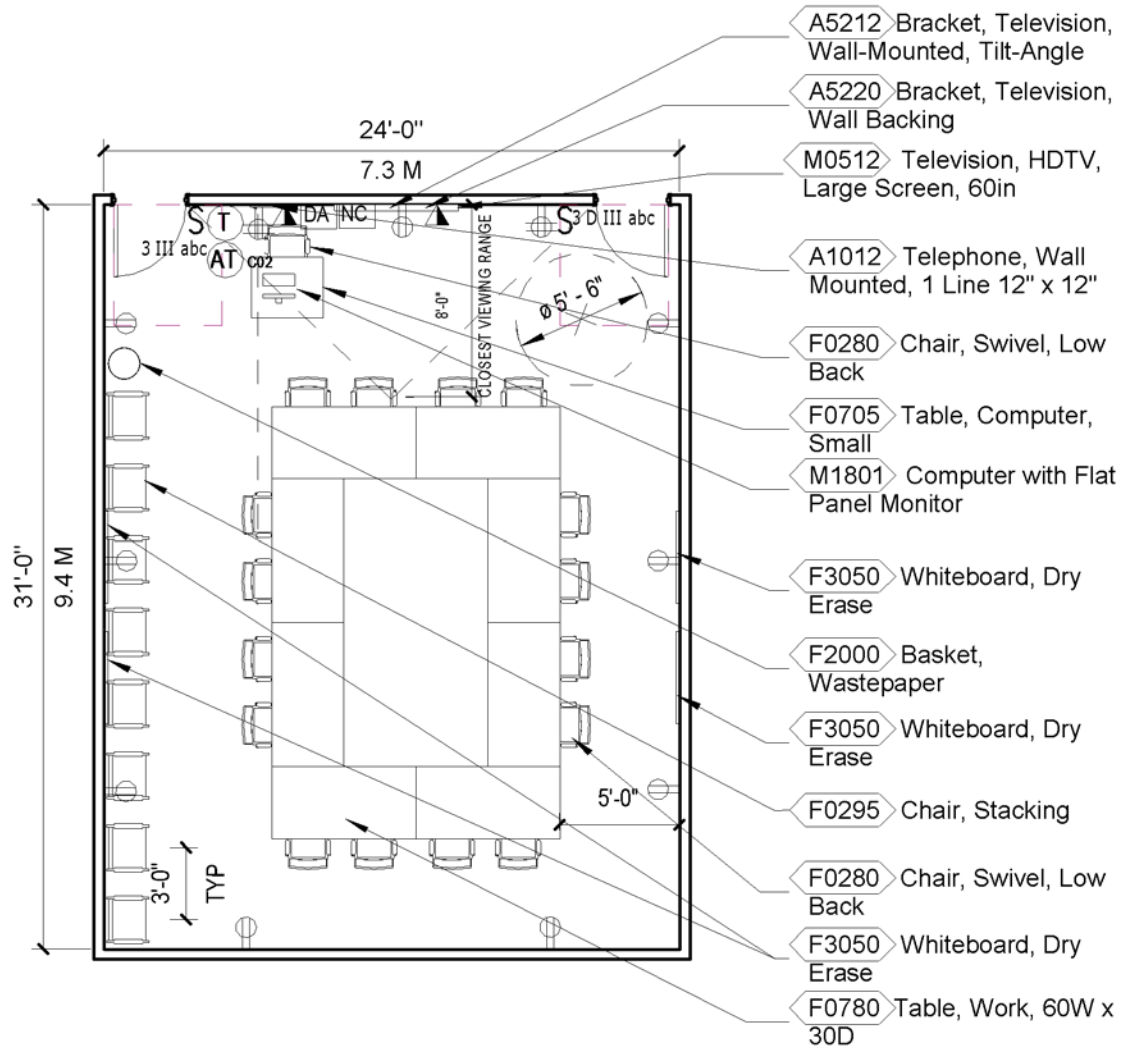

4.16 Conference Room/Classroom – Reflected Ceiling Plan

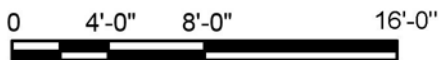
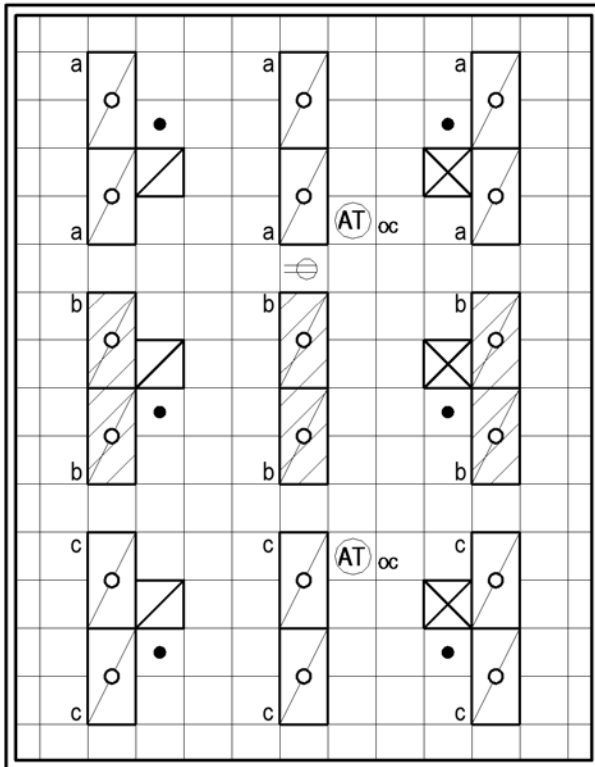

4.16 Conference Room/Classroom – Room Data Sheet

ARCHITECTURAL	
<b>Ceiling Type:</b>	Acoustical Ceiling Tile
<b>Ceiling Height:</b>	9'-0" (2700 mm)
<b>Ceiling Finish:</b>	Acoustical Ceiling Tile
<b>Wall Finish:</b>	Paint
<b>Wainscot:</b>	None
<b>Base:</b>	Resilient Millwork Style (min. 4" / 101 mm)
<b>Floor Finish:</b>	Carpet, Luxury Vinyl Tile
<b>Slab Depression:</b>	None Special
<b>Sound Protection:</b>	STC 50 minimum
<b>Doors:</b>	3'-6" x 7'-0" wood

LIGHTING	
<b>Maintained Average Illumination –</b>	
<b>Ambient:</b>	500 Lux (50 FC)
<b>Luminaire Type:</b>	2'x4' Fluorescent or LED, Virgin Acrylic Prismatic Lens, sealed housing, gasketed frame
<b>Lamps:</b>	4 Fluorescent or LED equivalent, 3500K – 4100K CCT, CRI >= 80%, 25% lighting shall be on emergency power
<b>Controls:</b>	Dimming or multi-level switching, occupancy sensor

**Notes:** Coordinate location of luminaires with other ceiling obstructions

POWER	
<b>Normal Power:</b>	To be connected to selected receptacles and equipment.
<b>Emergency Power:</b>	To be connected to selected lighting.
<b>Notes:</b> Provide a minimum of one receptacle on each wall.	

COMMUNICATIONS	
<b>Data:</b>	Yes
<b>Telephone:</b>	Yes
<b>Cable Television:</b>	Yes
<b>Duress Alarm:</b>	Yes
<b>Electronic Access and Door Control:</b>	No
<b>Intercom:</b>	No
<b>Motion Intrusion Detection (MID):</b>	No
<b>Nurse Call:</b>	Yes
<b>Code Blue:</b>	No
<b>Public Address:</b>	No
<b>Security Surveillance Television (SSTV):</b>	No
<b>VA Satellite TV:</b>	Yes
<b>Video Teleconferencing (TEL):</b>	No



## 4.16 Conference Room/Classroom – Room Data Sheet (Continued)

**HEATING, VENTILATING AND  
AIR CONDITIONING**

Refer to HVAC Design Manual Chapter 6 Mental Health Outpatient Services – Room Data Sheet Classroom/Group Room

**Notes:** Where occupant density exceeds one person per 25 square feet, provide CO<sub>2</sub> sensing and control to limit CO<sub>2</sub> not to exceed 800 ppm.

**PLUMBING AND MEDICAL GASES**

<b>Cold Water:</b>	No
<b>Hot Water</b>	No
<b>Waste:</b>	No
<b>Reagent Grade Water:</b>	No
<b>Medical Air:</b>	No
<b>Medical Vacuum:</b>	No
<b>Oxygen:</b>	No

**FIRE PROTECTION AND LIFE SAFETY**

<b>Fire Alarm:</b>	Yes – Notification
<b>Sprinkler:</b>	Yes
<b>Hazard Type:</b>	Light Hazard



## 4.16 Conference Room/Classroom – Equipment List – conference format

JSN	NAME	QTY	ACQ/INS	DESCRIPTION
A1012	Telephone, Wall Mounted, 1 Line	1	V / V	Telephone, wall-mounted, 1 line.
A5212	Bracket, Television, Wall-Mounted, Tilt/Angle	1	V / V	A wall mounted, tilt/angled TV bracket for 37" to 80" TVs. Mount will be a universal and VESA compliant unit with a load capacity of up to 130 lbs.
A5220	Bracket, Television, Wall Backing	1	C / C	Wall mounted television bracket backing which provides additional support and strength for the installation of the television bracket. Option available for interior or exterior plate and sized for 12" 16" or 24" stud spacing.
F0280	Chair, Swivel, Low Back	17	V / V	Low back contemporary swivel chair, 37" high X 25" wide X 31" deep with a five (5) caster swivel base, arms and foam padded seat and back upholstered with either woven textile fabric or vinyl.
F0295	Chair, Stacking	4	V / V	Stacking chair, approximately 34" H X 21" W X 24" D. May be stacked up to 20 high depending upon the model selected. These chairs are intended primarily as overflow capacity for conference rooms.
F0705	Table, Computer, Small	1	V / V	Small sized computer table/workstation, approximately 35" high X 36" wide X 30" deep with enough surface for a CPU, monitor and keyboard.
F0780	Table, Work, 60W x 30D	8	V / V	Work table approximately 29" high X 60" wide X 30" deep with top and four (4) non-folding legs.
F2000	Basket, Wastepaper, Fire Resistant	1	V / V	Wastepaper basket, fire resistant, approximately 40-quart capacity. This unit is used to collect and temporarily store small quantities of paper refuse in patient rooms, administrative areas and nursing stations. Size and shape varies depending on the application and manufacturer selected.
F3050	Whiteboard, Dry Erase	4	V / V	Whiteboard unit, approximately 36" H x 48" W consisting of a white porcelain enamel writing surface with an attached chalk tray. Magnetic surface available. Image can be easily removed with a standard chalkboard eraser. For use with watercolor pens. Unit is ready to hang.



JSN	NAME	QTY	ACQ/INS	DESCRIPTION
F3200	Clock, Battery, 12" Diameter	1	V / V	Clock, 12" diameter. Round surface, easy to read numbers with sweep second hand. Wall mounted unit for use when impractical to install a fully synchronized clock system. Battery operated, (batteries not included).
M0512	Television, HDTV, Large Screen, 60"	1	V / V	A high definition (HDTV) multimedia, slim design, 60"W to 65"W color television. The TV will have a 16.9 wide screen aspect ratio with full HD 1080p resolution and HDMI connections. TV may be LED, Plasma or LCD. TV will include a stand.
M1801	Computer, Microprocessing, w/Flat Panel Monitor	1	V / V	Desktop microprocessing computer. The unit shall consist of a central processing mini tower, flat panel monitor, keyboard, mouse and speakers. The system shall have the following minimum characteristics: a 2.8 GHz Pentium processor; 512 MB memory; 80GB hard drive; 32/48x CD-ROMDVD combo; 1.44MB network interface card; video 32 MB NVIDIA; a 18 inch flat panel monitor. The computer is used throughout the facility to input, manipulate and retrieve information.



#### 4.17 METHADONE AREA (XXYYC)

#### 4.17 Methadone Area - Axonometric

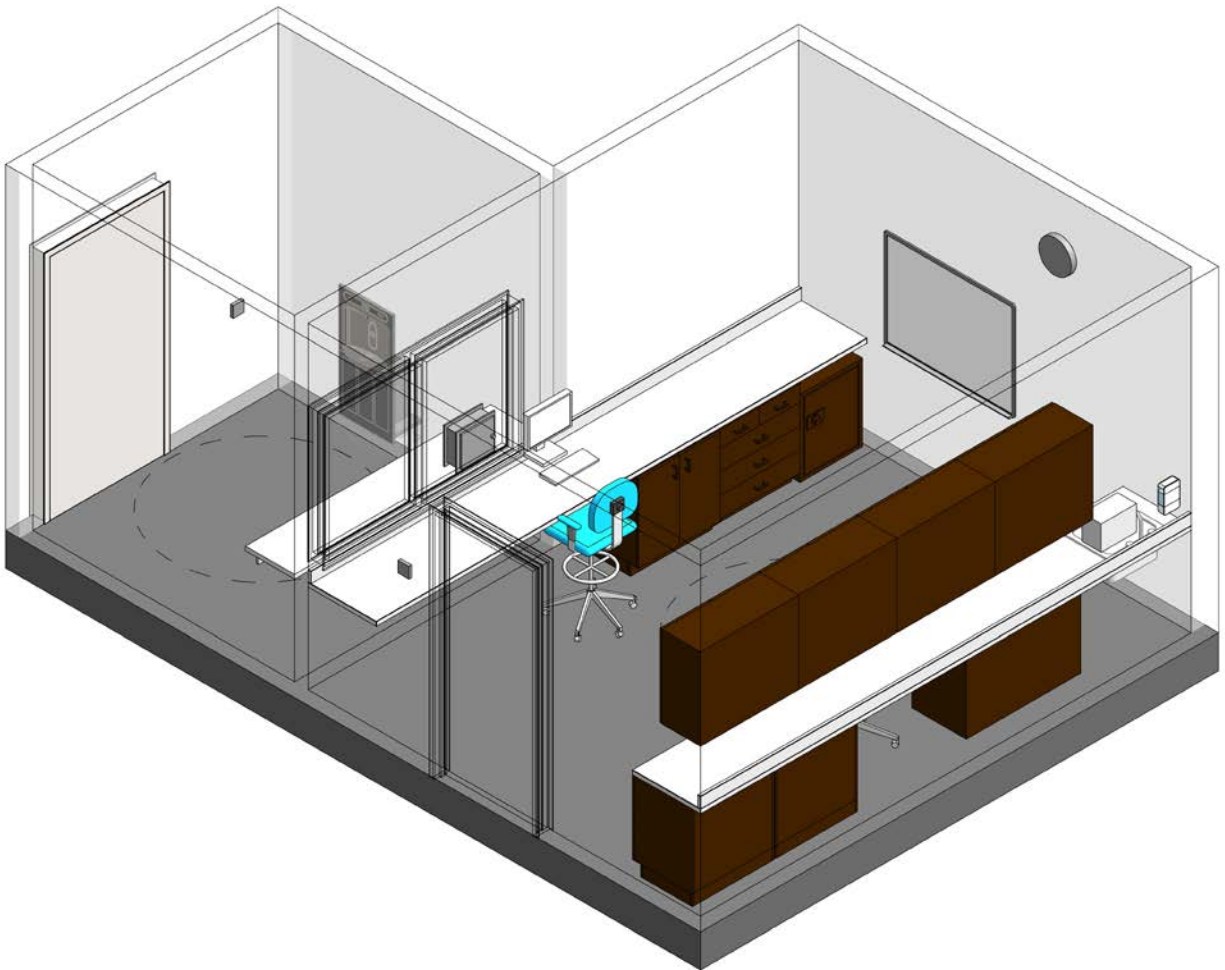

4.17 Methadone Area – Floor Plan

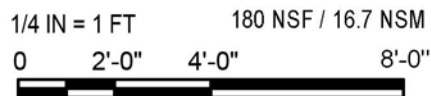
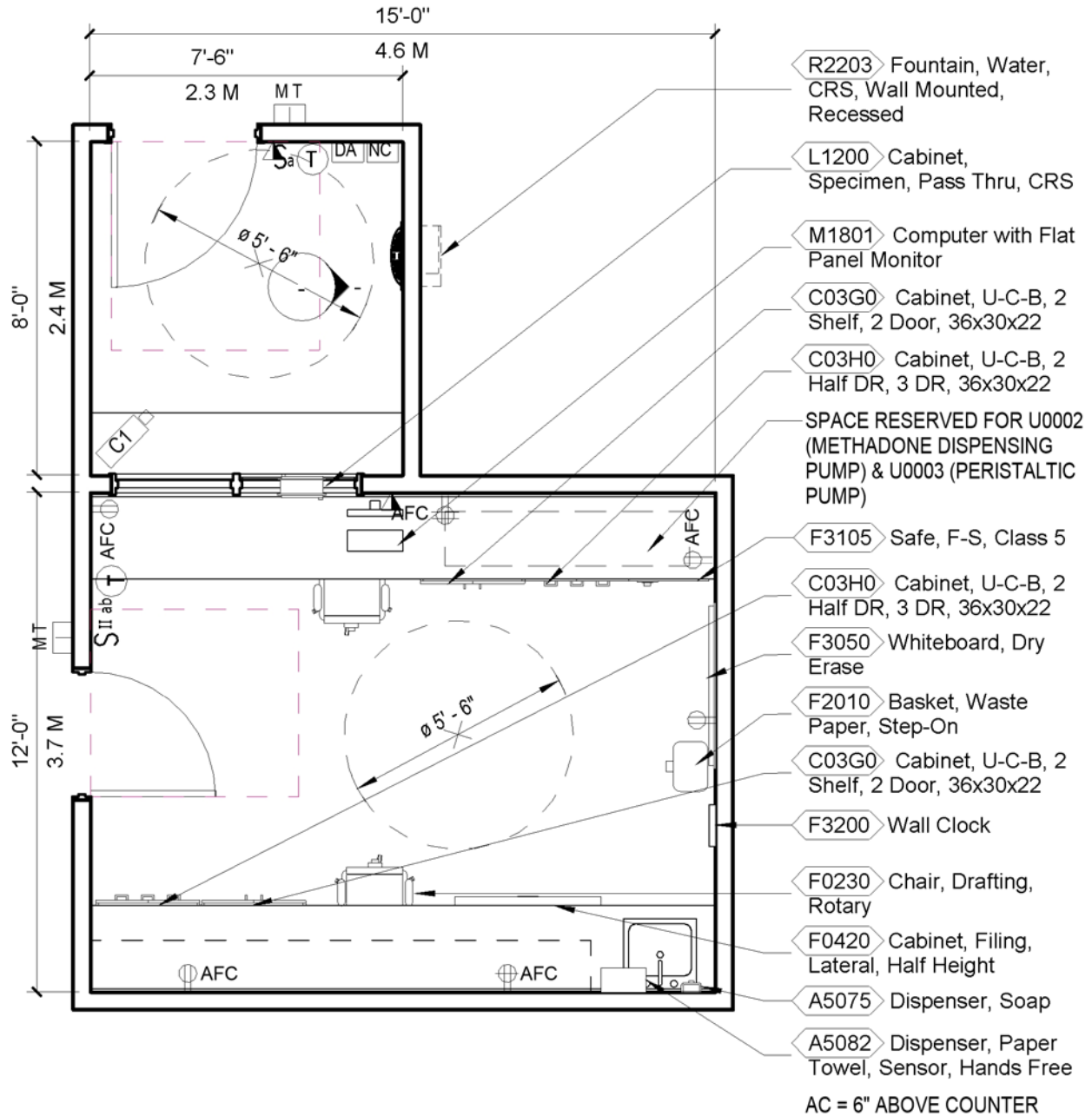



4.17 Methadone Area – Reflected Ceiling Plan

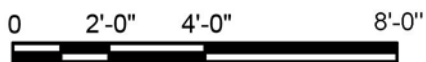
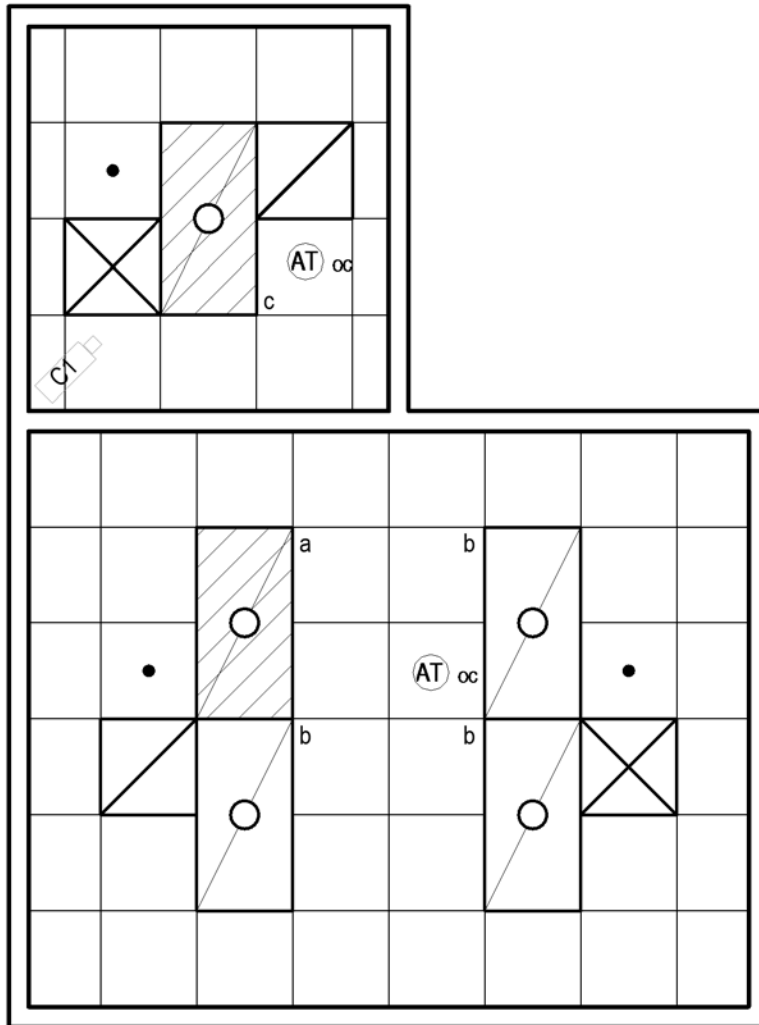

4.17 Methadone Area – Room Data Sheet

**ARCHITECTURAL**

<b>Ceiling Type:</b>	Acoustical Ceiling Tile
<b>Ceiling Height:</b>	9'-0" (2700 mm)
<b>Ceiling Finish:</b>	Acoustical Ceiling Tile
<b>Wall Finish:</b>	Paint
<b>Wainscot:</b>	None
<b>Base:</b>	Resilient Millwork Style (min. 4" / 101 mm)
<b>Floor Finish:</b>	Luxury Vinyl Tile
<b>Slab Depression:</b>	None Special
<b>Sound Protection:</b>	STC 45 minimum
<b>Doors:</b>	3'-6" x 7'-0" wood (patient area) 3'-0" x 7'-0" wood (staff work room)

**Notes:**

- 1) Dispensing window must meet requirements of VA Handbook 0730, including bullet-proof glass
- 2) Ceiling construction must prevent access by crawling through adjacent room
- 3) Doors and door locks must meet requirements of VA Handbook 0730

**LIGHTING**

<b>Maintained Average Illumination – Ambient:</b>	500 Lux (50 FC)
<b>Luminaire Type:</b>	2'x4' Fluorescent or LED, Virgin Acrylic Prismatic Lens, sealed housing, gasketed frame
<b>Lamps:</b>	4 Fluorescent or LED equivalent, 3500K – 4100K CCT, CRI >= 80%, 25% lighting shall be on emergency power

<b>Controls:</b>	Dimming or multi-level switching, occupancy sensor
------------------	--

**Notes:** Coordinate location of luminaires with other ceiling obstructions

**POWER**

<b>Normal Power:</b>	To be connected to selected receptacles and equipment.
<b>Emergency Power:</b>	To be connected to selected lighting.

**Notes:** Provide a minimum of one receptacle on each wall.

**COMMUNICATIONS**

<b>Data:</b>	Yes
<b>Telephone:</b>	Yes
<b>Cable Television:</b>	No
<b>Duress Alarm:</b>	Yes
<b>Electronic Access and Door Control:</b>	Yes
<b>Intercom:</b>	Yes
<b>Motion Intrusion Detection (MID):</b>	Yes
<b>Nurse Call:</b>	Yes
<b>Code Blue:</b>	No
<b>Public Address:</b>	No
<b>Security Surveillance Television (SSTV):</b>	Yes
<b>VA Satellite TV:</b>	Yes
<b>Video Conferencing (TEL):</b>	No
<b>Clock:</b>	Yes

**Notes:** Staff must have a way to speak with the Veteran through the dispensing window glass



4.17 Methadone Area – Room Data Sheet (continued)

**HEATING, VENTILATING AND AIR CONDITIONING**

Refer to HVAC Design Manual Chapter 6 Non Patient Rooms – Room Data Sheet Medication Room

**PLUMBING AND MEDICAL GASES**

<b>Cold Water:</b>	Yes
<b>Hot Water</b>	Yes
<b>Waste:</b>	Yes
<b>Reagent Grade Water:</b>	No
<b>Medical Air:</b>	No
<b>Medical Vacuum:</b>	No
<b>Oxygen:</b>	No

**FIRE PROTECTION AND LIFE SAFETY**

<b>Fire Alarm:</b>	Yes – Notification (staff room)
<b>Sprinkler:</b>	Yes
<b>Hazard Type:</b>	Light Hazard



## 4.17 Methadone Area – Equipment List

JSN	NAME	QTY	ACQ/INS	DESCRIPTION
A5075	Dispenser, Soap, Disposable	1	V / V	Disposable soap dispenser. One-handed dispensing operation. Designed to accommodate disposable soap cartridge and valve.
A5082	Dispenser, Paper Towel, Sensor, Hands Free	1	C / C	A surface mounted, sensor activated, automatic, roll paper towel dispenser. The unit dispenses a paper towel automatically only when hands are placed in position below the dispenser for maximum sanitation and hygiene. May include adjustable settings for sheet length, time delay, and sensor range. Unit is battery operated or with optional AC power adapter.
C03G0	Cabinet, U/C/B, 2 Shelf, 2 Door, 36x30x22	2	C / C	Standing height under counter base cabinet with two adjustable shelves and two solid hinged doors. Also referred to as a cupboard cabinet. For general purpose use throughout the facility.
C03H0	Cabinet, U/C/B, 2 Half Drawers, 3 DR, 36x30x22	2	C / C	Standing height under counter base cabinet with two half-width drawers side-by-side above three full width drawers. Also referred to as a drawer cabinet. For general purpose use throughout the facility.
CD040	Cabinet, W/H, 2 Shelf, 2 DO, Sloping Top, 38x36x13	4	C / C	Wall hung cabinet with two adjustable shelves, solid hinged doors, and sloping top. Also referred to as a solid hinged double door wall case. For general purpose use throughout the facility.
CS010	Sink, SS, Single Compartment, 7.5x12x12 ID	1	C / C	Single compartment stainless steel sink, drop-in, self-rimming, ledge-type, connected with a drain and provided with a mixing faucet. It shall also be provided with pre-punched fixture holes on 4" center, integral back ledge to accommodate deck-mounted fixtures, brushed/polished interior and top surfaces, and sound deadened. Recommended for use in suspended or U/C/B sink cabinets having a high plastic laminate or Chemsurf laminate countertop/work surface. For general purpose use throughout the facility.
CT020	Countertop, Solid Surface	38	C / C	A solid, nonporous countertop with a smooth seamless appearance. Easy to clean and maintain and with proper cleaning does not support the growth of mold. An acrylic-based solid surface product. Standard thickness of 1", and a 4" butt backsplash/curb. Also referred to as a work surface or work top. Available in a choice of colors and depths. Used in lab and other hospital areas requiring optimum physical and chemical resisting properties.



JSN	NAME	QTY	ACQ/INS	DESCRIPTION
F0230	Chair, Drafting, Rotary	2	V / V	Drafting chair approximately 47" high X 20" wide X 20" deep with rotary stool and a 5 (five) star base with casters. Padded seat and back. Foot ring adjusts with chair.
F0420	Cabinet, Filing, Lateral, Half Height	2	V / V	Half height two (2) or three (3) drawer lateral filing cabinet, 28" high X 42" wide X 18" deep with recessed handles, locking device and drawer label holders. Drawers are adaptable to either letter or legal size materials.
F2000	Basket, Wastepaper, Fire Resistant	1	V / V	Wastepaper basket, fire resistant, approximately 40 quart capacity. This unit is used to collect and temporarily store small quantities of paper refuse in patient rooms, administrative areas and nursing stations. Size and shape varies depending on the application and manufacturer selected.
F2010	Basket, Wastepaper, Step-On	1	V / V	"Step-on" wastepaper basket with inner liner and foot pedal activated flip top.
F3050	Whiteboard, Dry Erase	1	V / V	Whiteboard unit, approximately 36" H x 48" W consisting of a white porcelain enamel writing surface with an attached chalk tray. Magnetic surface available. Image can be easily removed with a standard chalkboard eraser. For use with watercolor pens. Unit is ready to hang.
F3105	Safe, F/S , Class 5	1	V / V	Class 5 safe, floor-standing model with combination lock. Used for storage of narcotics, plans, film, and other classified or control materials.
F3200	Clock, Battery, 12" Diameter	1	V / V	Clock, 12" diameter. Round surface, easy to read numbers with sweep second hand. Wall mounted unit for use when impractical to install a fully synchronized clock system. Battery operated, (batteries not included).
L1200	Cabinet, Specimen, Pass Thru, CRS	1	C / C	Pass-through specimen cabinet. The unit has a sight-proof interlocking door that permits only one door to open at a time. It also includes a removable spill tray, corrosion resistant stainless steel welded construction with seamless corners and burr-free edges and is able to adjust to wall thickness between 3-6 inches. Used for passage of specimens from patient area to laboratory.



JSN	NAME	QTY	ACQ/INS	DESCRIPTION
M1801	Computer, Microprocessing, w/Flat Panel Monitor	1	V / V	Desktop microprocessing computer. The unit shall consist of a central processing mini tower, flat panel monitor, keyboard, mouse and speakers. The system shall have the following minimum characteristics: a 2.8 GHz Pentium processor; 512 MB memory; 80GB hard drive; 32/48x CD-ROMDVD combo; 1.44MB network interface card; video 32 MB NVIDIA; a 18 inch flat panel monitor. The computer is used throughout the facility to input, manipulate and retrieve information.
R2203	Fountain, Water, CRS, Wall Mounted, Recessed	1	C / C	Drinking water fountain. Unit is fully recessed and wall mounted, with an air-cooled compressor. Unit must be specified with or without glass filler. The unit provides easy access with push bars or button. The unit is used in hospitals and commercial office buildings.
U0002	Methadone Dispensing Pump	2	V / V	Used in methadone treatment centers providing automatic, high precision, computer controlled dispensing and documentation of methadone usage.
U0003	Pump, Fluid Dispensing	2	V / V	Pharmacy fluid dispensing pump. Delivers same dose volume to syringe, IV bag, oral liquid vial or other container from large source container. Delivery range 0.2 mL to 9.9 L. Includes foot pedal, power cord and operation manual.



## 5.0 Appendix

### Index of Figures and Tables:

Figure #	Credits	Title/Caption	Page
--	15	(cover image, upper left)	cover
--	8	(cover image, upper right)	cover
--	4	(cover image, lower left)	cover
--	1	(cover image, lower right)	cover
TABLE 1	1	REFERENCES TO VA PROGRAMS RELATED TO OUTPATIENT MENTAL HEALTH	1-13
TABLE 2	2	LEVELS OF CARE FOR VA MENTAL HEALTH	2-1
2.1.2.a	3	Partial plan diagram based on Major General William H. Gourley VA – DOD Outpatient Clinic in Monterey, CA	2-7
2.1.2.b	1	Partial plan diagram based on a recently constructed DoD Behavioral Health Clinic Floorplan	2-8
2.1.2.c	3	Floor plan diagram based on a Veterans Addiction Recovery Center	2-10
2.1.2.d	2	Entrance and waiting concept diagram for clinics where medically supervised withdrawal management service is provided	2-11
2.1.2.e	3	Floor plan diagram based on VA Battle Creek Neuropsychology suite, Mental Health Clinic renovation	2-12
2.1.2.f	16	Example of open office collaborative work environment	2-14
2.1.2.g	1	VA Computer Lab, William S. Middleton Memorial Veterans Hospital, Madison, WI	2-15
2.1.2.h	3	Education Classroom in Health Care for Homeless Veterans (HCHV) Service Center, Grand Rapids, MI	2-16
2.1.2.i	2	Floor plan diagram based on Health Care for Homeless Veterans (HCHV) Service Center, Grand Rapids, MI.	2-17
2.1.3.a	2	PCMHI extended care team work area, VA Primary Care Annex, Tampa, FL	2-19
2.1.3.b	3	Opportunity for patient education and small-group seating	2-21
2.1.3.c	4	Views to outdoors and nature	2-21
2.1.3.d	1	Diagram illustrating on-stage / off-stage layout of PACT modules used for PCMHI (VA PACT Space Module Design Guide, 2015).	2-22
2.1.3.e	2	Patient (on-stage) corridor, Major General William H. Gourley VA – DOD Outpatient Clinic in Monterey, CA	2-23
2.1.3.f	2	Staff work area (off-stage) corridor, Major General William H. Gourley VA – DOD Outpatient Clinic in Monterey, CA (construction photograph)	2-23
2.1.3.g	2	Registration kiosk	2-25
2.1.3.h	7	Mobile device (tablet) in waiting area	2-25
2.1.3.i	2	Electronic room scheduling display, Orlando VA Medical Center at Lake Nona	2-26
2.1.3.j	2	Veteran Computer Lab, Coatesville VAMC (PA)	2-26
2.1.4.a	2	Diagram of modular room sizes based on standard Clinical Office size	2-27



Figure #	Credits	Title/Caption	Page
2.1.4.b	2	Standardized meeting or education spaces with alternative furniture layouts for lecture and discussion formats (VA Tampa Primary Care Annex)	2-28
2.1.4.c	2	Illustrations of modular design strategies that facilitate modifications to plan layouts	2-29
2.1.4.d	10	Check-in area	2-32
2.1.4.e	17	Rooftop terrace	2-34
2.1.4.f	2	Teaching Kitchen in HCHV Service Center, Grand Rapids, MI	2-35
2.1.5.a	2	Adjacent waiting and children's play area in Women's Clinic, VA Tampa Primary Care Annex	2-36
2.1.5.b	5	Transcranial Magnetic Stimulation (TMS) Room in Rachel Upjohn Building, University of Michigan Psychiatry Department, Ann Arbor, MI	2-37
2.1.5.c	2	Illustration of Clinical Office and Consultation Room layouts	2-38
2.1.5.d	11	Mobile computer workstation	2-39
2.1.5.e	12	Articulating work surface	2-39
2.1.5.f	13	Chair with tablet arm	2-39
2.1.5.g	5	Group Therapy room, University of Michigan Psychiatry Department, Rachel Upjohn Building, Ann Arbor, MI	2-40
2.1.5.h	3	Plan diagram based on a Multipurpose room with direct access to furniture storage room, kitchen area and outdoor terrace, VA Denver.	2-42
2.1.5.i	4	Multipurpose / Dining Room	2-42
2.1.5.j	1	Staff work area, Cleveland VARC	2-44
2.1.5.k	1	Patient area with view window from staff area, Cleveland VARC	2-44
2.1.5.l	3	Floor plan of Methadone Area, Cleveland VARC	2-44
2.1.5.m	1	Staff break room, VA Primary Care Annex, Tampa, FL	2-45
2.1.5.n	8	Landscaped outdoor space	2-46
2.1.6.a	3	Diagram based on VA Lebanon, PA, renovation	2-49
2.1.6.b	3	Diagram based on VA Lebanon, PA, renovation	2-50
2.1.6.c	3	Diagram based on VA Ann Arbor, MI, renovation	2-51
2.1.6.d	2	VA Ann Arbor, MI, renovated elevator lobby	2-51
2.1.6.e	2	VA Battle Creek, MI, new clinic entrance	2-51
2.1.6.f	3	Diagram based on VA Battle Creek, MI, renovation	2-52
2.2.2.a	9	Landscaped garden	2-55
2.2.3.1.a	8	VA Manhattan, Ninth Floor Renovation Project	2-59
2.2.3.1.b	8	VA Manhattan, Ninth Floor Renovation Project	2-59
2.2.3.1.c	8	VA Manhattan, Ninth Floor Renovation Project	2-60
2.2.3.1.d	1	VA Manhattan, Ninth Floor Renovation Project	2-60
2.2.3.1.e	8	VA Manhattan, Ninth Floor Renovation Project	2-61
2.2.3.1.f	8	VA Manhattan, Ninth Floor Renovation Project	2-61
2.2.3.1.g	4	Waiting area	2-62
2.2.3.1.h	6	Waiting area	2-62
2.2.3.1.i	4	Small group area	2-63





Figure #	Credits	Title/Caption	Page
2.2.3.1.j	8	VA Manhattan, Ninth Floor Renovation Project	2-64
2.2.3.1.k	14	Project Healing Waters Fly Fishing, VA Memphis, Photograph	2-65
2.2.3.1.l	2	Project Healing Waters Fly Fishing, VA Memphis, Artwork Installation	2-65
2.2.3.6.a	1	One-way mirrored window from viewing room to group room, VA Tampa Primary Care Annex	2-68
3.2.1	1	Universal Module, Outpatient Mental Health	3-3
3.2.2	1	Module Organization: clinical modules repeated side-by-side	3-4
TABLE 3	2	VHA TOOLKIT SAMPLE INPUT FOR A PSYCHOTHERAPY VISIT	3-6
TABLE 4	2	VHA TOOLKIT SAMPLE OUTPUT FOR A PSYCHOTHERAPY VISIT	3-7
3.2.3	1	Illustration of flexibility for two and three group therapy room scenarios	3-9
3.3.1	1	Illustration of modular sizing of rooms	3-11
3.3.2	1	A Clinical Office module adjacent to a Group Therapy Room may be developed as a Control (Observation) Room.	3-12
3.3.3	1	Two Family Consult Rooms in a space equivalent to three clinical offices	3-12
3.3.4	1	TMS Room and Storage in a space equivalent to two clinical offices	3-13
3.3.5	1	Staff work area and adjacent bookable rooms for patient consultation, and separation of staff and patient circulation. Option for Conference Room in large central space.	3-14
3.3.6	1	Alignment of team spaces and internal work areas to optimize access to daylight	3-15
3.3.7	1	Illustration of modular sizing of group care rooms	3-16
3.3.8	1	Space suitable for two Group Therapy rooms may developed as a Patient Education or Classroom/Conference space depending on functional need of a clinic.	3-17
3.3.9	1	Plan diagram, adaptation of Universal Module to accommodate IOP – SUD Clinic	3-19
3.4.1	1	Modular concept showing Module 1 as Mental Health “Universal Module”, Module 2 with added number of Clinical Offices and Module 3 configured for Primary Care with Mental Health Integration (PCMHI)	3-21
3.5.1	1	Psychosocial Rehabilitation and Recovery Center (PRRC) adjacency diagram	3-23
3.5.2	2	Community Resource and Referral Center (CRRC) adjacency diagram	3-25
TABLE 5	3	ROOM TEMPLATES BY OUTPATIENT MENTAL HEALTH SERVICE - WHERE THEY MAY BE LOCATED	4-5

## Credits:

1. CannonDesign
2. VA
3. VA/CannonDesign
4. CannonDesign
5. CannonDesign, with permission of University of Michigan
6. ©Ron Pollard Photography
7. ©Christopher Barrett Photography
8. ©Björg Magnea Photography



9. ©Tim Wilkes Photography
10. ©Tim Rossiter
11. <http://www.versteel.com/wp-content/uploads/2016/08/iprp-app01-lq.jpg>
12. [https://www.ergotron.com//Portals/0/Reserved/Parts/45-241-026\\_d-560x500.jpg](https://www.ergotron.com//Portals/0/Reserved/Parts/45-241-026_d-560x500.jpg)
13. [http://img.archiexpo.com/images\\_ae/photo-m2/4072-9381053.jpg](http://img.archiexpo.com/images_ae/photo-m2/4072-9381053.jpg)
14. <http://www.projecthealingwaters.org/>
15. © Jodi Jacobson / iStock
16. © KC Kratt
17. © Paul Burk Photography

