

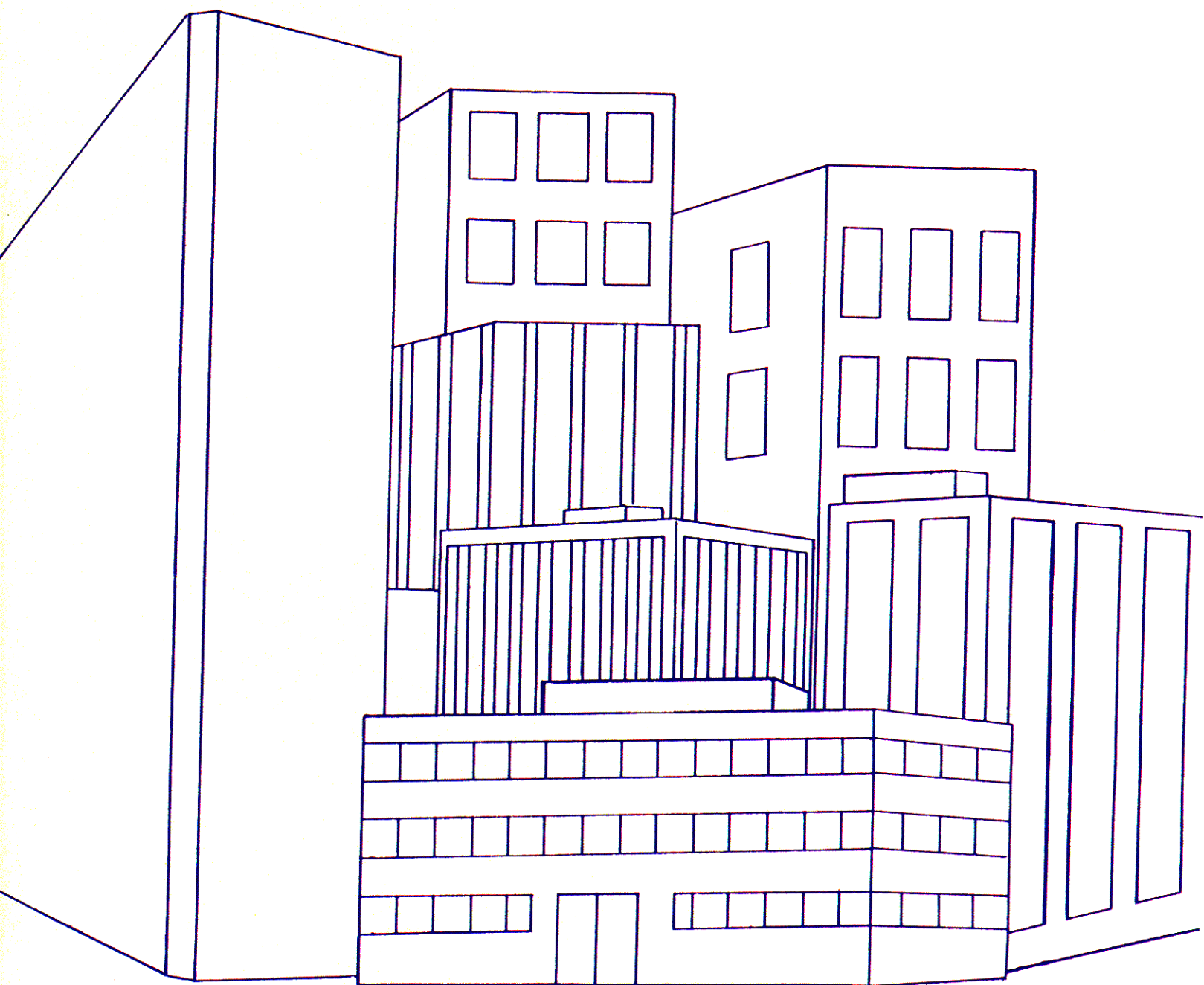

# A Guide to Respiratory Protection for the Asbestos Abatement Industry



# A GUIDE TO RESPIRATORY PROTECTION FOR THE ASBESTOS ABATEMENT INDUSTRY

**A Technical Report by**

**Gary P. Noonan  
Herbert 1. Linn  
Laurence D. Reed**

**U.S. Department of Health and Human Services  
Public Health Service  
Centers for Disease Control  
National Institute for Occupational Safety and Health  
Division of Safety Research  
Morgantown, West Virginia**

**for**

**U.S. Environmental Protection Agency  
Office of Pesticides and Toxic Substances  
Asbestos Action Program  
Susan F. Vogt, Director  
Washington, DC**

**under**

**NIOSH 1A 85-06  
EPA DW 75932235-01-1**

**NIOSH Project Officer: Gary P. Noonan  
EPA Co-Project Officers: Steve Shapiro, David W. Mayer**

**Revised September 1986**

## **DISCLAIMER**

**Mention of company names or products does not constitute endorsement by the National Institute for Occupational Safety and Health.**

## PREFACE

This guide is intended to provide practical guidance in the selection and use of respiratory protection to persons who work in asbestos abatement. The recommendations in this guide will also apply to other working activities, such as maintenance or repair, where exposure or the potential for exposure to asbestos exists. Because of the well documented risk to health associated with asbestos and uncertainties surrounding the level which can cause disease, exposures must be controlled to the lowest level possible as determined by the most sensitive and reliable monitoring methods. This guide is divided into five parts. Part I is an introduction to the hazards associated with airborne asbestos and to the issues involving respiratory protection against asbestos. Part II presents a model respiratory protection program for the asbestos abatement industry which both satisfies current Federal regulations and incorporates the most current information on appropriate respirators for use against airborne asbestos fibers. Part III contains a checklist for developing or evaluating a respiratory protection program. Part IV presents information on breathing air systems for supplied-air respirators. Part V lists sources of help for problems involving respirator use.

**NOTE ON THE SEPTEMBER 1986 REVISION:** The April 1986 printing of this guide included warnings to employers that the regulations governing occupational exposures to asbestos were under revision by the Federal Occupational Safety and Health Administration (OSHA), and in various stages of development by many States. Employers were encouraged to keep current on all mandated requirements, whether Federal, State, or local, that applied to their operations. On June 20, 1986, OSHA promulgated revised asbestos standards for both general industry (29 CFR 1910.1001) and the construction industry (29 CFR 1926.58). The new standards lower the Permissible Exposure Limit (PEL) for asbestos to 0.2 fibers per cubic centimeter of air (f/cc), and establish more stringent requirements for control of asbestos exposures, including more stringent requirements for respiratory protection. OSHA now requires, at a minimum, that combination supplied air respirators with auxiliary escape-only self-contained breathing apparatus (SCBA) operated in the pressure demand mode be worn if exposures exceed 1,000 times the PEL (200 f/cc). NIOSH and EPA recommend that the same type of combination respirator or a pressure-demand SCBA be worn in abatement or maintenance operations where workers are occupationally exposed to airborne asbestos at "any detectable level . . . at or above the lowest limit of reliable quantitation as determined by phase contrast microscopy analysis." Also, OSHA has disallowed the use of single-use, disposable-type dust masks and air-purifying respirators with non-H EPA filters where exposures exceed the PEL. In the interest of providing abatement contractors, abatement workers, and other interested parties with as much pertinent information as possible, this guide has been updated to include the full text of both 29 CFR 1910.1001 (Appendix A1) and 29 CFR 1926.58 (Appendix A2). The first issue of this guide included procedures for qualitative (QLFT) and quantitative (QNFT) fit testing procedures which were adapted from the OSHA lead standard (29 CFR 1910.1025) and the NIOSH A Guide to Industrial Respiratory Protection (DHEW(NIOSH) Publication No. 76-1 89), respectively. However, an appendix to the revised OSHA asbestos standards includes QLFT and QNFT procedures which are somewhat more rigorous than those which were previously included. Therefore, the previously included procedures have been deleted. The authors have also taken this opportunity to correct minor errors which appeared in the first printing. Aside from the few changes and minor corrections noted above, this guide is essentially unchanged. The recommendations regarding appropriate respirator selection and respiratory protection program activities contained in the April 1986 version remain valid and strongly supported by NIOSH and EPA. Employers are still cautioned to consult with State and local regulatory agencies to keep abreast of all standards in effect or under development which could apply to their operations.

## PEER AND EXTERNAL REVIEWERS

Joe A. Adam  
Director, Department of Safety and Health  
United Association of Journeymen  
and Apprentices of the Plumbing  
and Pipefitting Industry  
901 Massachusetts Ave., N.W.  
Washington, DC 20001

Fred W. Boelter, CIH, PE  
President  
Boelter Associates, Inc.  
2733 North Troy  
Chicago, IL 60647

Lawrence S. Brown, A.I.A.  
Partner  
Bull & Kenney, Architects  
1261 Spring St., N.W.  
Atlanta, GA 30309

Paul Burns  
Critical Services  
2828 Broad  
Houston, TX 77087

Eva M. Clay  
Director  
S.W. Asbestos Information Center  
Georgia Tech Research Institute  
Georgia Institute of Technology  
Atlanta, GA 30332

Mark L. Demyanek  
Environmental Specialist  
Environmental Health & Safety  
Division  
Georgia Tech Research Institute  
Georgia Institute of Technology  
Atlanta, GA 30332

William M. Ewing, CIH  
Asbestos Program Group Leader  
Environmental Health & Safety Division  
Georgia Tech Research Institute  
Georgia Institute of Technology  
Atlanta, GA 30332

Dwight Hopkins  
President  
Cross Construction Co. Inc.  
244 Airport Road  
Zephyrhills, FL 34248

John M. Jenkins  
Vice President/Architect/Asbestos  
Consultant  
Southern Engineering Co.  
1800 Peachtree St. NW  
Atlanta, GA 30367-8301

Stephen M. Linkous, R.N.-C.H.C.M.  
Environmental Hygienist  
101 Apple Avenue  
Hampton, VA 23661

Scott P. Schneider  
Industrial Hygienist  
United Brotherhood of Carpenters  
& Joiners of America  
101 Constitution Ave., N.W.  
Washington, DC 20001

William H. Spain, CIH, CSP  
Training and Publications Director  
Environmental Health & Safety Div.  
Georgia Tech Research Institute  
Georgia Institute of Technology  
Atlanta, GA 30332

W. Corey Thompson  
Manager, Metropolitan Washington  
Division  
Aerosol Monitoring & Analysis, Inc.  
4475 Forbes Blvd.  
Lanham, MD 20706

Frederick C. Treadway  
President  
Asbestos Abatement Division  
Specialty Systems, Inc.  
506 West Eaton Pike  
Richmond, IN 47374

Rodney D. Wolford  
Health and Safety Director  
International Brotherhood of Painters &  
Allied Trades  
United Unions Building  
1750 New York Ave., N.W.  
Washington, DC 20006

## TABLE OF CONTENTS

|  |           |
|--|-----------|
| Preface .....  | iii       |
| Peer and External Reviewers .....  | iv        |
| Acknowledgements .....   | ix        |
| <b>Part I Introduction</b> .....   | <b>1</b>  |
| <b>Part II A Model Respiratory Protection Program for Asbestos Abatement Operations.</b> ..... | <b>5</b>  |
| <b>A. Written Statement of Company Policy</b> .....  | <b>6</b>  |
| <b>B. Written Standard Operating Procedures</b> .....  | <b>7</b>  |
| <b>C. Respirator Selection</b> .....   | <b>8</b>  |
| (1) Respiratory Protection Against Asbestos .....  | 8         |
| (2) Respiratory Protection for Non-Abatement Operations .....                                  | 11        |
| <b>D. Medical Examinations</b> .....   | <b>11</b> |
| <b>E. Worker and Supervisor Training</b> .....   | <b>12</b> |
| (1) Worker Training .....  | 12        |
| (2) Supervisor Training .....  | 13        |
| <b>F. Respirator Fit Test</b> .....  | <b>13</b> |
| (1) Quantitative Fit test .....  | 14        |
| (2) Qualitative Fit test .....   | 14        |
| (3) Sealing Tests for Routine Donning of Respirators .....                                     | 15        |
| a. Negative Pressure Test .....  | 15        |
| b. Positive Pressure Test.....   | 16        |
| <b>G. Cleaning and Disinfecting</b> .....  | <b>18</b> |
| <b>H. inspection and Repair</b> .....  | <b>19</b> |
| <b>I. Storage of Respirators</b> .....   | <b>19</b> |
| <b>J. Work Area Surveillance</b> .....   | <b>19</b> |
| <b>K. Regular Program Evaluation</b> .....   | <b>20</b> |
| <b>L. Special Problems</b> .....   | <b>20</b> |
| (1) Facial Hair .....  | 20        |
| (2) Eyeglasses .....   | 20        |
| (3) Contact Lenses .....   | 20        |
| (4) Facial Deformities .....   | 20        |
| (5) Communications .....   | 21        |
| (6) Temperature Extremes .....   | 21        |
| <b>M. Proper Respirator Use</b> .....  | <b>21</b> |

## TABLE OF CONTENTS (CONTINUED)

|   |    |
|---|----|
| Part III Respirator Program Checklist .....               | 27 |
| Part IV Breathing Air Systems .....                       | 31 |
| Part V Sources of Help for Respirator User Problems ..... | 39 |

## LIST OF APPENDICES

|   |     |
|---|-----|
| Appendix A Applicable Federal Regulations .....   | 43  |
| A1 29 CFR 1926.58 .....   | 45  |
| A2 29 CFR 1910.1001 .....   | 75  |
| A3 29 CFR 1910.134 .....  | 83  |
| A4 40 CFR 763.120,121 .....   | 89  |
| Appendix B Sample MSHA/NIOSH Approval Labels .....  | 95  |
| B1 Pressure Demand SCBA .....   | 97  |
| B2 Pressure Demand Combination SAR/SCBA .....   | 99  |
| Appendix C Selected NIOSH Respirator User Notices .....   | 101 |
| Appendix D General Safety Considerations .....  | 117 |
| Appendix E Heat Stress Considerations .....   | 125 |
| Appendix F Breathing Air Systems for Use with Pressure-Demand<br>Supplied Air Respirators in Asbestos Abatement .....   | 131 |
| Appendix G Transcript of NIOSH Testimony Given to the U.S. Department<br>of Labor at a Public Hearing on Occupational Exposure<br>to Asbestos held on June 21, 1984 ..... | 175 |

## LIST OF PHOTOGRAPHS

|  |    |
|--|----|
| Photograph 1. Combination Supplied-Air Respirator with Auxiliary Self-Contained Breathing Apparatus (SAR/SCBA) ..... | 2  |
| Photograph 2. Self-Contained Breathing Apparatus (SCBA) .....  | 3  |
| Photograph 3. Bonnet-type Disposable Headcover .....   | 9  |
| Photograph 4. Fully Encapsulating Suit Which Incorporates Full Head Cover .....                                      | 9  |
| Photograph 5. Quantitative Fit Test Chamber and Instrument .....   | 14 |
| Photograph 6. Negative Pressure Test on SAR or SCBA .....  | 15 |
| Photograph 7. Negative Pressure Test on Air-Purifying Respirator .....   | 16 |
| Photograph 8. Positive Pressure Test; Blocking Exhalation Valve. ....  | 17 |
| Photograph 9. Positive Pressure Test with Exhalation Valve Cover Removed .....                                       | 18 |

## LIST OF FIGURES

|  |     |
|--|-----|
| Figure 1. Typical Decontamination Area .....                               | 22  |
| Figure 2. Typical Installation of Low Pressure Breathing Air System .....  | 32  |
| Figure 3. Typical Low Pressure Breathing Air Purifier Assembly .....       | 34  |
| Figure 4. Typical High Pressure Breathing Air System .....                 | 35  |
| Figure 5. Typical High Pressure Purifier Assembly .....                    | 36  |
| Figure B1. Sample MSHA/NIOSH Approval Label for Pressure Demand SCBA ..... | 97  |
| Figure B2. Sample MSHA/NIOSH Approval Label for Pressure Demand SAR .....  | 99  |
| Figure F1. Theoretical Air Compression .....                               | 139 |
| Figure F2. Typical Installation of Low Pressure Breathing Air System ..... | 148 |
| Figure F3. The Vortex Tube, its Construction and Performance .....         | 149 |
| Figure F4. Typical Low Pressure Breathing Air Purifier Assembly .....      | 154 |
| Figure F5. Typical High Pressure Breathing System .....                    | 157 |
| Figure F6. Typical High Pressure Purifier Assembly .....                   | 160 |

## LIST OF TABLES

|   |     |
|---|-----|
| Table 1. Characteristics of Grade D and Better Breathing Air .....  | 140 |
| Table 2. Typical Pressure and Relative Adsorber Effectiveness ..... | 143 |



## ACKNOWLEDGEMENTS

The authors are indebted to John B. Moran, Director of the NIOSH Division of Safety Research, for his foresight, guidance, and technical input during the development of this guide. Nancy J. Bollinger and Robert H. Schutz of DSR both provided expertise in the area of respiratory protection during key phases of document development.

Susan F. Vogt, David W. Mayer, and Steve Shapiro of the Office of Pesticides and Toxic Substances, Asbestos Action Program of the U.S. Environmental Protection Agency, originally conceived the idea for this guide, and provided continuing support throughout the project. The authors are grateful to Jim Littell, regional asbestos coordinator, and John P. Woods, asbestos technical advisor (both EPA Region IV), who provided invaluable assistance during the field activities in the early stages of this project.

The peer review participants and other external reviewers, listed separately on page iv, helped to refine the ideas contained in the document by providing pertinent and substantive suggestions. William H. Spain, William M. Ewing, Eva M. Clay, and Mark L. Demyanek, all of the Environmental Health and Safety Division of the Georgia Tech Research Institute, took time from their busy schedules to provide continuing support and information throughout the cycle of this project. The National Asbestos Council (NAC) graciously provided NIOSH with meeting space for the peer review group during the Third Annual Asbestos Abatement Exposition and Conference in Baltimore, Maryland, February 18-21, 1986. The NAC also provided materials from their training courses.

Michael J. Peach III, currently with NIOSH Division of Respiratory Disease Studies, coordinated the initial phase of the project, conducted literature searches, and provided an initial draft which the authors found useful in the writing of this guide. Other NIOSH staff members who provided constructive suggestions through a number of in-house reviews, included: Donald L. Campbell, Ph. D.; Christopher C. Coffey; Thomas Hodous, M. D.; Steven W. Lenhart; Gary R. Mills; Warren R. Myers, Ph. D.; Richard M. Ronk; Gregory A. Stevens; and Samuel L. Terry.

Special thanks are offered to Louis T. Diaz, who carefully proofread the manuscript, and to Linda S. DeVor, Rosemary Cianfrocco, and Karole L. Queen, who provided word processing support.

## Part I INTRODUCTION

Scientists and physicians generally agree that asbestos fibers cause human diseases. Research has proven that exposure to asbestos can cause asbestosis and cancers of the lung, stomach, rectum, intestines, and the linings of the lungs and inner abdominal wall. As recently stated by the Occupational Safety and Health Administration (OSHA):

OSHA is aware of no instance in which exposure to a toxic substance has more clearly demonstrated detrimental health effects on humans than has asbestos exposure. The diseases caused by asbestos exposure are life-threatening or disabling . . . Of all of the diseases caused by asbestos, lung cancer constitutes the greatest health risk for American asbestos workers. Lung cancer has been responsible for more than half of the excess mortality from asbestos exposure in some occupational cohorts.

. . . Asbestos-induced lung cancer usually has a latency period in excess of 20 years, and this cancer may be manifested at a younger age than is true for lung cancer victims who are not exposed to asbestos . . . Few cases of lung cancer are curable, despite advances in medical and surgical oncology. Only 9 percent of lung cancer patients survive for 5 or more years after diagnosis . . . Asbestos exposure acts synergistically with cigarette smoking to multiply the risk of developing lung cancer.

Asbestos enters the body when a person breathes or swallows airborne dust bearing microscopic asbestos fibers. When all feasible means of preventing asbestos fibers from becoming airborne are inadequate, the primary additional means of protecting people who must enter an asbestos-contaminated area to work is the use of respirators.

In the past, asbestos was widely used in surfacing and insulating materials, and in a variety of other products (such as ceiling and floor tile and wallboard) used to construct buildings. The effort to abate asbestos and asbestos-containing materials (ACM) from buildings has resulted in a rapidly growing asbestos abatement industry. Asbestos abatement or removal can disturb asbestos or ACM and release the very small fibers into the air.

Workers do not always receive the maximum feasible level of protection against asbestos, primarily because employers and workers underestimate the hazards associated with asbestos exposure. Many employers and workers underestimate or ignore the health risks associated with exposure to asbestos because: (1) most asbestos fibers are invisible to the human eye; (2) breathing or swallowing asbestos fibers does not produce an immediate effect, such as pain or bleeding; and (3) the development of diseases caused by asbestos usually takes many years.

Currently OSHA requires that the concentration of asbestos in air, that is the number of asbestos fibers in a measured amount of air, must be below a level that is known as the Permissible Exposure Limit (PEL). The PEL for asbestos is 200,000 fibers (which are greater than 5 microns in length) per cubic meter of air, which is equivalent to 0.2 fibers per cubic centimeter of air (0.2f/cc). However, the National Institute for Occupational Safety and Health (NIOSH), the Environmental Protection Agency (EPA), and OSHA have concluded that there is no known threshold of exposure to asbestos below which there is no risk. OSHA's regulations also allow the use of respirators which NIOSH believes do not provide the best possible protection against asbestos. NIOSH, EPA, and OSHA agree that where exposures to asbestos can not be eliminated, they must be controlled to the lowest level possible. NIOSH and EPA believe this includes providing workers with the maximum feasible level of respiratory protection when they are or could reasonably be expected to be occupationally exposed to airborne asbestos.

The purpose of this guide is to provide employers with guidelines for developing effective respiratory protection programs, based on the best and most current information. This guide contains:

- a model respiratory protection program which covers the minimum requirements of the Federal regulations, incorporates additional NIOSH/EPA recommendations, and includes detailed discussion of the types of respirators appropriate for asbestos abatement (Part II)
- a checklist which can be used to develop or evaluate a respiratory protection program (Part III)
- a section on breathing air systems (Part IV)

- a listing of sources of help for respirator users (Part V)
- seven technical appendices, including current Federal regulatory requirements (Appendix A), examples of NIOSH approval labels (Appendix B), NIOSH respirator user's notices (Appendix C), general safety considerations (Appendix D), heat stress considerations (Appendix E), breathing air systems (Appendix F), and the transcript of NIOSH testimony at a public hearing on occupational exposure to asbestos held in June 1984 (Appendix G).

Several important considerations, which the reader should bear in mind, form the basis for the guidelines contained in this manual. In making the recommendations in this guide for selecting respirators, NIOSH and EPA have determined the following:

- Asbestos is a known human carcinogen for which no level of exposure is known to be without risk. Single exposures may even present a health risk to some individuals.
- The maximum feasible level of respiratory protection should be provided to and used by workers engaged in either asbestos abatement operations - such as open surface removal, glove bag removal, or encapsulation or enclosure - or other work with or in close proximity to asbestos-containing material - such as maintenance or repair, **WHEN SUCH WORKERS ARE, OR COULD REASONABLY BE EXPECTED TO BE, OCCUPATIONALLY EXPOSED TO AIRBORNE ASBESTOS.** "Occupationally exposed" means exposed to any detectable level of airborne asbestos at or above the lowest limit of reliable quantitation as determined by phase contrast microscopy analysis (NIOSH Method 7400).
- Respirators which use filters to remove contaminants from the air do not provide as high a degree of protection for workers as respirators which supply clean pressurized air to the workers from a protected source.

In consideration of the above, NIOSH and EPA make the following recommendations as the best respiratory protection during any exposure or potential exposure to airborne asbestos:

- A combination respirator which includes a Type-C supplied-air respirator (SAR) with a full facepiece operated in the pressure-demand mode and with an auxiliary self-contained breathing apparatus (SCBA) operated in the pressure-demand mode (Photograph 1).



**Photograph 1. Combination supplied-air respirator with auxiliary self-contained breathing apparatus (SAR/SCBA).**

**[CAUTION: The only “Type-C” supplied air respirator that NIOSH and EPA recommend for use against asbestos is a pressure-demand respirator. This type of respirator is not to be confused with demand or Continuous flow Type C supplied air respirators, which are NOT recommended because they do not provide as much protection. Also, the provision of an escape SCBA does NOT replace the need for having a reserve air system for the SAR. See further discussion under Part IV. Breathing Air Systems and Appendix F.]**

- Self-contained breathing apparatus (SCBA) with a full facepiece operated in the pressure-demand mode (Photograph 2).

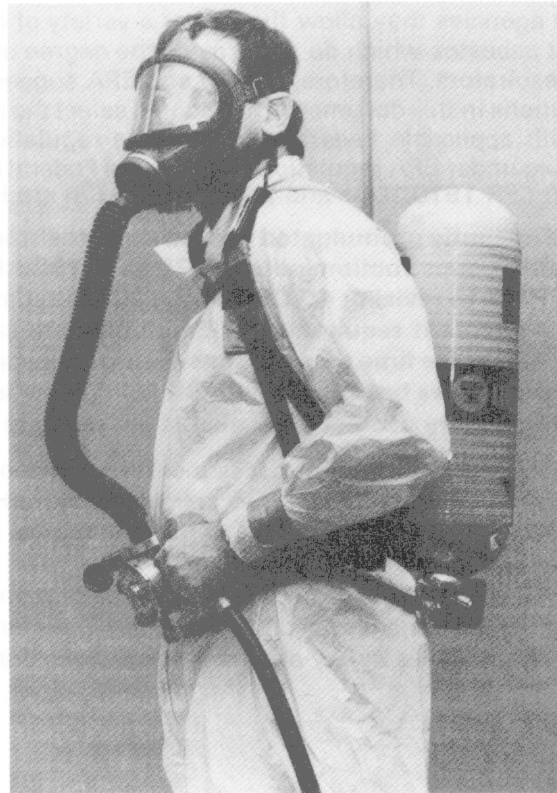

**Photograph 2. Self-contained breathing apparatus (SCBA).**

**[NOTE: NIOSH and EPA realize that SCBA may not be practical for use in many asbestos abatement operations or tasks. However, where SCBA are practical for use, these respirators provide the maximum level of protection currently available.]**

NIOSH and EPA recommend a combination pressure-demand SAR/SCBA instead of only a pressure-demand supplied air respirator primarily to provide continued protection in case the air supply is cut off. If the airline supplying a SAR were cut, crimped, or accidentally disconnected, the wearer would have no choice but to remove the facepiece.

In asbestos atmospheres which contain sufficient oxygen (at least 19.5%) a possible alternative to the recommended SCBA or combined SAR/SCBA would be a pressure-demand, supplied air respirator that is equipped with an emergency backup high efficiency particulate (HEPA) filter. The filter would be used when there was an unanticipated interruption of air flow, and would provide some degree of respiratory protection in emergency egress situations without requiring facepiece removal. The use of a full facepiece with such a device as well as a method of fit testing (see page 29) would be necessary to achieve the best possible facepiece seal. Until very recently, such devices had been available only in

Type C continuous flow models (not recommended by NIOSH and EPA for protection against asbestos). NIOSH has, however, certified the first pressure-demand model under approval number TC-21C-375. The combination SAR/emergency backup HEPA might be appropriate where a backup auxiliary SCBA is not feasible, and where the backup system is clearly intended for EMERGENCY EGRESS ONLY due to SAR air supply disruption. Employers should be cautioned, however, that current OSHA regulations would not allow the use of this type of respirator where airborne levels of asbestos exceeded 1,000 times the PEL (200f/cc). See Appendix A for current OSHA and EPA regulatory requirements.

[Again, the provision of a HE PA filter as an emergency escape system would not replace the need for a reserve air system for the supplied air respirator. See Part IV. Breathing Air Systems for further discussion.]

Federal and State regulatory agencies may allow the use of a variety of other respiratory protective devices for protection against asbestos which do not provide the degree of protection afforded by the NIOSH/EPA recommended respirators. Therefore, NIOSH and EPA suggest that if employers choose not to follow the recommendations in this document, they should select the next best level of respiratory protection, in compliance with applicable Federal and/or State regulations. Respiratory protective devices which may be allowable under EPA regulations (40 Code of Federal Regulations (CFR) 763.1 20) and/or OSHA regulations (29 CFR 1910.1001 and 29 CFR 1926.58) are listed later in this guide.

[IMPORTANT NOTE: OSHA recently promulgated revised asbestos standards for general industry (29 CFR 1910.1 001) and for the construction industry (29 CFR 1926.58). At the time this document was being prepared, EPA was revising 40 CFR 763.120, and many states were developing and promulgating asbestos abatement requirements. Employers are cautioned to determine the regulatory requirements in effect at the time they are considering appropriate respiratory protection for their workers. Choosing respirators based upon NIOSH/EPA recommendations, however, will ensure the highest level of respiratory protection available for workers exposed to asbestos.]

Like other construction work, asbestos abatement poses increased risks of injury to workers. NIOSH estimates that 10,000 workers throughout all industries are fatally injured on the job each year in the U.S. Falls and electrocutions account for 11% and 10% of these fatalities, respectively. Both falls and electrocutions represent risks which are more prevalent in abatement than in general industrial settings. In addition, workers required to wear protective clothing can face increased risk of heat stress. Appendix E and Appendix F of this document provide some general recommendations and references to guide an employer in ways to minimize safety and heat stress risks during asbestos abatement.

## **Part II A MODEL RESPIRATORY PROTECTION PROGRAM FOR ASBESTOS ABATEMENT OPERATIONS**

Good engineering controls coupled with sound work practices can effectively reduce levels of airborne asbestos fibers during abatement or other activities. However, the known potency of asbestos as a cancer-causing substance dictates that workers engaged in abatement must receive the maximum level of protection feasible. Effective respiratory protection can be provided to workers only when employers develop, implement, and maintain effective respiratory protection programs.

Protecting workers from exposure is the responsibility of the employer (29 CFR 1910.1001, 29 CFR 1926.58 and 40 CFR 763.1 20). Employers are required by law (29 CFR 1910.1 34) to establish and maintain an effective respiratory protection program as outlined in American National Standards Institute (ANSI) Standard Z88.2-1 969. (The more recent edition of ANSI Z88.2 (1 980) contains more comprehensive requirements which are not yet incorporated in the OSHA regulation. ) The intent of this part of the guide is to present a model respiratory protection program for asbestos abatement operations which meets or exceeds the requirements within the present OSHA standard.

The recommendations of this guide not only satisfy the current respiratory protection requirements of existing Federal regulations (29 CFR 1910.1001, 29 CFR 1926.58, and 40 CFR 763.121), but also include recommendations based on current information on respiratory protection.

**An Effective Respirator Program should include:**

- A. A written statement of company policy, including assignment of individual responsibility, accountability, and authority for required activities of the respiratory protection program**
- B. Written standard operating procedures governing the selection and use of respirators\***
- C. Respirator selection (from NIOSH/MSHA approved and certified models) on the basis of hazards to which the worker is exposed\***
- D. Medical examination of workers to determine whether or not they may be assigned an activity where respiratory protection is required\***
- E. User training in the proper use and limitations of respirators\* (as well as a way to evaluate the skill and knowledge obtained by the worker through training)**
- F. Respirator fit testing\***
- G. Regular cleaning and disinfecting of respirators\***
- H. Routine inspection of respirators during cleaning, and at least once a month and after each use for those respirators designated for emergency use"**
- I. Storage of respirators in convenient, clean, and sanitary locations\***
- J. Surveillance of work area conditions and degree of employee exposure (e.g., through air monitoring)\***
- K. Regular inspection and evaluation of the continued effectiveness of the program\***
- L. Recognition and resolution of special problems as they affect respirator use (e.g., facial hair, eye glasses, etc. )**
- M. Proper respirator use (procedures for donning and doffing respirators when entering and exiting the abatement area)**

**"Elements presently required by OSHA for the use of respiratory protective equipment in asbestos abatement operations.**

## A. Written Statement of Company Policy

An important cornerstone to an effective respiratory protection program, and indeed to any worker protection program, is a written statement of the employer's intent to provide a safe and healthful workplace for workers. The employer's commitment to worker protection may be the single most important factor contributing to the success of workplace safety and health programs. The written statement should include assignment of individual responsibility, accountability, enforcement procedures, and authority for required activities of the respiratory protection program.

### *Program Responsibilities*

**The employer** - Current Federal regulations assign the employer the responsibility to provide safe and healthful working conditions for workers. This responsibility can be accepted and met in part through the development and implementation of a respiratory protection program that meets the minimum requirements of the "American National Standard Practices for Respiratory Protection" (ANSI Z88.2-1969) as required by 29 CFR 1910.1001, 29 CFR 1926.58, and 40 CFR 763.120. However, the employer may not provide workers with the best respiratory protection possible by merely complying with existing regulatory requirements. NIOSH and EPA have determined that the best respiratory protection possible against airborne concentrations of asbestos is accomplished, within the context of an effective respiratory protection program, by the use of (1) a combination pressure-demand supplied air respirator with an auxiliary self-contained breathing apparatus (SAR/SCBA), or (2) a pressure-demand self-contained breathing apparatus (SCBA)

The employer may choose to delegate the responsibility for developing and implementing a respiratory protection program, but the employer is still legally responsible for ensuring compliance with the requirements set forth by OSHA and EPA.

**The respirator program administrator** - Responsibility and authority for administering the entire respiratory protection program should be assigned to one person. The designated administrator should write the operating procedures for the respiratory protection program. The American National Standards Institute offers some guidelines about selection of a suitable program administrator for companies that do not have organized industrial hygiene, health physics, or safety engineering departments, which is the case with most asbestos abatement contractors. In such cases, ANSI suggests that:

... the respiratory program shall be administered by an upper-level superintendent, foreman, or other qualified person responsible to the principal manager. the administrator shall have sufficient knowledge of respiratory protection to properly supervise the respirator program.

The program administrator should meet the definition of "competent person" used in 29 CFR 1926.58 (b), which describes such an individual as". . . one who is capable of identifying existing asbestos, tremolite, anthophyllite, or actinolite hazards in the workplace and who has the authority to take prompt corrective measures to eliminate them." Among the specific duties of the "competent person," according to OSHA, are ensuring that employees wear the appropriate personal protective equipment, and are trained in the use of appropriate methods of exposure control. It is necessary to provide this central authority and responsibility to ensure that there is coordination and direction of the program. This responsibility is usually designated to the first-line supervisor or site foreman of an asbestos abatement operation. Where other individuals are involved in the administration of the program, they should report directly to the one administrator with overall responsibility. Ultimately, however, the employer is responsible for ensuring compliance with applicable regulations.

In addition to the responsibility for managing the elements of the respiratory protection program outlined above, the program administrator should also be responsible for:

- purchasing approved respirators

- issuing respirators
- controlling inventory, to include, for example, a system of accounting and recordkeeping to track identification of users and to compile maintenance records for specific respirators

Recordkeeping should include:

- a list of employees who are trained in respirator use
- medical records of each respirator user
- results of any pre- or post-training evaluations of workers' knowledge and hands-on skill
- documentation of respirator care and maintenance
- verification that respirators have been inspected for defects
- airborne concentrations of asbestos
- descriptions of any problems encountered during abatement.

Records of a worker's exposure, medical data, and air monitoring results are required by OSHA to be kept a minimum of 30 years.

**The worker** - It is the worker's responsibility to follow instructions and training in the use of respiratory protective equipment. The worker should avoid damaging the equipment, and report immediately to his/her supervisor when a respirator does not work properly or when something unusual happens to it.

## B. Written Standard Operating Procedure

A minimally acceptable respiratory protection program must include written standard operating procedures for the selection and use of respirators.

The level of protection respirators provide may vary greatly, depending on the workplace conditions and the way they are used. In asbestos abatement, proper use of respirators is critical in protecting the health of the user. The potential for misuse can be reduced by written standard operating procedures, supported by strong management commitment and effective supervision of all aspects of the program.

Written procedures should contain all information needed to ensure protection for all workers employed in all phases of asbestos abatement. Federal regulations do not include guidelines regarding the format or content of written procedures. However, the general content of written procedures can be established from the information which follows, and can be adapted to meet the circumstances of a particular abatement operation.

The specific requirements and procedures for the program should be written clearly and simply so that they are easily understood and unambiguous. The person writing the procedures should be aware of who will be using the written procedures. In addition to the program administrator, persons who may need to refer to the written procedure might include: the supervisions responsible for overseeing respirator use on the job; those responsible for fitting respirators and training the workers; respirator maintenance workers; contract, State and Federal inspectors; concerned local officials and individuals; and workers or their representatives.



## C. Respirator Selection

### ***(1) Respiratory Protection Against Asbestos***

Because asbestos fibers are released during asbestos abatement work and are often released during other work in and around buildings such as construction, maintenance, and repair, the risk of breathing airborne asbestos fibers is high in areas where such work is done. The potential harm which can result from even minimal exposure to asbestos fibers has been well documented. Therefore, NIOSH and EPA recommend that employers provide workers with the maximum feasible level of respiratory protection. NIOSH and EPA have determined that the maximum level of respiratory protection can be achieved through use of either:

- A combination respirator which includes a Type-C supplied-air respirator with a full facepiece operated in the pressure-demand mode and with an auxiliary self-contained breathing apparatus (SAR/SCBA) operated in the pressure-demand mode; or
- A self-contained breathing apparatus (SCBA) with a full facepiece operated in the pressure-demand mode.

Respirators of these types should be selected by the program administrator from those approved and certified by the Mine Safety and Health Administration (MSHA) and NIOSH under the provisions of 30 CFR Part 11. (See examples of approval labels in Appendix B.)

NIOSH and EPA recommend that pressure-demand SCBA with a full facepiece or combination pressure-demand SAR/SCBA with a full facepiece should be used by abatement workers and other workers who work with or in close proximity to asbestos-containing materials (such as maintenance or repair workers), when they are working in areas:

- where they are, or could reasonably be expected to be, occupationally exposed to airborne asbestos. "Occupationally exposed" means exposed to any detectable level of airborne asbestos at or above the lowest limit of reliable quantitation as determined by phase contrast microscopy analysis (NIOSH Method 7400).
- where asbestos-containing debris has visibly accumulated.

Such situations can include asbestos abatement operations, such as open surface removal, glove bag removal, or encapsulation or enclosure. These recommendations also apply to workers involved in construction, maintenance, repair, or other work where exposure or the potential for exposure to asbestos exists.

#### *Pressure-Demand SAR/SCBA*

This device combines a short duration (as short as five minutes) SCBA with a supplied air respirator. The SCBA portion of the device is to be used only in an emergency situation to escape from a toxic atmosphere or to give the wearer time to connect to a different supply line and then escape. These units combine the advantage of use for long periods of time (SAR) with the assurance of continued maximum protection should an emergency arise (SCBA).

#### *Pressure-Demand SCBA*

The pressure-demand SCBA has a regulator and valve design which maintains positive pressure in the facepiece at normal workrates. As such, the problem of contaminant leakage into the facepiece is minimized. The air supply is carried on the worker's back in a pressurized cylinder. Pressure-demand SCBA'S consist of: (1) a full facepiece, (2) a regulator, (3) hoses and air lines, (4) a backpack assembly, and (5) a cylinder of compressed air. Gauges are located on the air cylinder, and in another location that is observable by the wearer. NIOSH and EPA recommend that, when SCBA'S are used, they be worn under disposable suits with expandable backs. This will reduce contamination of the SCBA harness and tank assembly which are difficult to decontaminate.

Although SCBA's are recommended for use against respiratory exposure to asbestos, their size, weight and short service life usually relegate their practical use in asbestos abatement work to use by visitors and inspectors, and as stand-by units for rescue work, if necessary.

#### *Headcoverings*

Combination pressure-demand SAR/SCBA or pressure-demand SCBA should be equipped with full facepieces. Full facepieces should be worn with either a bonnet type disposable head cover/hood (Photograph 3) or with a full head cover/hood which is part of a fully encapsulating protective garment (Photograph 4).



Photograph 3. Bonnet-type disposable head-cover.



Photograph 4. Fully encapsulating suit which incorporates full head cover.

When bonnet type head covers/hoods are used with full facepieces, the respirators should always be donned with the head straps located under the hoods. This allows removal of the headcovering prior to showering without disturbing the respirator (which is worn into the shower). This also provides greater stability and a better fit of the respirator facepiece and minimizes the possibility of asbestos-containing material accidentally falling into the respirator facepiece or into the face of the worker when the facepiece is removed during decontamination.

#### *Reserve Air*

OSHA regulations (29 CFR 1910.134) and good standard operating procedures require sufficient reserve air as part of any supplied air system used with any combination or supplied air respirator. This ensures that the worker has sufficient breathing air during escape from the abatement area and during decontamination in the event of compressor or air system failure. (Reserve air systems are discussed in detail in Appendix F.)

### *Auxiliary Backup System*

As previously mentioned, in asbestos atmospheres which contain sufficient oxygen, a possible alternative to the recommended respirators maybe a pressure-demand, full facepiece supplied air respirator that is equipped with an emergency backup HEPA filter. The filter would be used when air flow unexpectedly ceased and would provide some respiratory protection in emergency egress situations.

### *Respirators Allowable Under Existing Regulations for Protection Against Asbestos*

Although only the first two of the following respiratory protective devices are recommended by NIOSH/EPA for use in asbestos abatement operations, the other respirator types (numbered 3 through 13) may be allowable under OSHA regulations (29 CFR 1910.1001) and/or EPA regulations (40 CFR 763.121).

**[CAUTION: Many States are revising regulations pertaining to asbestos abatement. Some of the devices listed below may not be permitted in the future. Employers choosing not to follow the NIOSH/EPA recommendations in this document should verify existing regulatory requirements before selecting these respirators.]**

These devices are listed in order of decreasing protection (the most protective devices are listed first). \* Employers should note that regulatory requirements regarding specific respirator types may be dependent upon measured asbestos exposure levels which must, generally, be determined prior to selection.

#### **Recommended by NIOSH/EPA:**

1. A self-contained breathing apparatus with full facepiece operated in pressure-demand mode;
2. A combination Type C supplied air respirator with full facepiece operated in the pressure-demand mode, and with an emergency backup SCBA operated in the pressure-demand mode;

#### **Not Recommended by NIOSH/EPA:**

3. Any pressure-demand supplied-air respirator with full facepiece;
4. Any pressure-demand supplied-air respirator;
5. Any continuous-flow supplied-air respirator with full facepiece, hood, or helmet;
6. Any continuous-flow supplied-air respirator;
7. Any powered-air-purifying respirator with high-efficiency filter and full facepiece, hood, or helmet;
8. Any dust, fume, and mist respirator with high-efficiency filter(s) and full facepiece;
9. Any powered-air-purifying respirator with high-efficiency filter;
10. Any demand supplied-air respirator or demand self-contained breathing apparatus;

---

\*The determination of relative protection provided by these respirator types is based upon A Guide to Industrial Respiratory Protection (DHEW (NIOSH) Publication No. 76-189) and recent respirator field studies by NIOSH and others.

11. Any dust, fume, and mist respirator with high-efficiency filter(s);

**[IMPORTANT: THE RESPIRATOR TYPES NUMBERED 3 THROUGH 11 ABOVE ARE NOT RECOMMENDED BY NIOSH OR EPA FOR USE AGAINST ASBESTOS. However, various existing regulations allow their use. In fact, the existing respirator certification regulations (30 CFR Part 11 ) require NIOSH to certify single-use or dust, mist, and asbestos respirators. A proposed revision to 30 CFR Part 11 will, when promulgated, delete specific approvals for air-purifying respirators for use against asbestos or asbestos-containing dust and mist. In the interim, however, as a matter of public health policy, NIOSH and EPA DO NOT RECOMMEND THEIR USE IN ASBESTOS ENVIRONMENTS. Employers who are under the jurisdiction of OSHA should be aware that OSHA has disallowed the use of single-use masks and other air-purifying respirators with non-H EPA filters for use against airborne asbestos.]**

*(2) Respiratory Protection for Non-Abatement Operations*

Air-purifying respirators supplied with high-efficiency particulate/aerosol (HEPA) filters or respirators that offer higher protection are recommended for use **ONLY** in special situations such as during pre-abatement inspections, preparation of the abatement area, final cleaning, removal of the last layer of plastic, etc., when measurable concentrations of asbestos are not detectable. The use of air-purifying respirators is only a precaution in the event of an accidental disturbance of asbestos, and for exposures to other dusts and particulate which may be present in the workplace.

*Glove Bag Removal*

Air-purifying respirators may also be suitable for use by workers performing glove bag removal of asbestos from pipes, valves, etc., where the environment in which the glove bag abatement operation is to be conducted is free of any measurable concentration level of asbestos. The use of air-purifying respirators in this case is a precaution in the event of accidental puncture or rupture of the glove bag. Should puncture or rupture occur, workers should immediately leave the area of exposure and begin decontamination procedures in an appropriate designated area.

#### **D. Medical Examinations**

Employer requirements for providing medical examinations to workers are contained in OSHA 29 CFR 1910.1001(l), 29 CFR 1926.58(m), and EPA 40 CFR 763.121 (see Appendix A). In addition to existing regulatory requirements, the initial examination should allow determination as to whether the worker is capable of wearing and using a respirator. Therefore, the worker's previous medical and employment history should also be considered.

The types of information which should be obtained from the worker include:

- (1) History of respiratory disease - identifies workers with a history of asthma, emphysema, or chronic lung disease. These people may be at risk when wearing a respirator.
- (2) Work history - identifies workers who have been exposed to asbestos, silica, cotton dust, beryllium, etc., within the past ten years, or workers who have worked in occupations or industries where such exposure is probable. If past exposures are identified, medical tests can be obtained for comparison. Some of the specific items of information which might be obtained include:
  - previous occupations
  - problems associated with breathing during normal work activities
  - past problems with respirator use.

- (3) Any other medical information which might offer evidence of the worker's ability or inability to wear and use respirators, such as:
- psychological problems or symptoms including claustrophobia
  - any known physical deformities or abnormalities, including those which may interfere with respirator use
  - past and current usage of medication
  - tolerance to increased heart rate, which can be produced by the extra weight, increased work load, and heat stress associated with wearing respirators and protective clothing.

#### **E. Worker and Supervisor Training**

Because asbestos is a carcinogen (a cancer-causing substance), the importance of proper training of workers and supervisors in the asbestos abatement industry cannot be overemphasized. It is imperative that those working with asbestos have a clear understanding of the hazards involved, and receive instruction in the proper selection, use, and maintenance of recommended respirators.

In abatement operations, two levels of training should be provided. One level is necessary for the abatement worker, and a second, additional level is necessary for the foreman or first-line supervisor (who will often provide training for the workers). Training needs will differ in that the supervisor needs a more comprehensive working knowledge of respirators and respiratory protection practices in addition to the basic worker training.

#### **A STRONG MANAGEMENT COMMITMENT TO TRAINING IS ESSENTIAL TO THE SUCCESS OF AN EFFECTIVE RESPIRATORY PROTECTIVE PROGRAM.**

##### *(1) Worker Training*

Formal instruction in the use of respiratory protective equipment is recommended for workers employed in asbestos abatement work. A basic respirator training program for workers should include:

- instruction in the nature of the hazards of asbestos and its potential health effects
- how asbestos enters the body and what happens when it does
- how cigarette smoking increases risk of adverse health effects
- explanation of why respirators are needed (e. g., where the use of engineering controls and other means of control have failed to eliminate exposures to asbestos)
- discussion of the consequences of not wearing respirators in exposure situations from legal, health, and disciplinary perspectives
- discussion of why the respirator selected is the proper type of respirator for use in asbestos abatement operations
- instruction, training and actual hands-on use of the respirator to include proper fitting, practice in wearing and adjusting the respirator, testing the facepiece-to-face seal, performing job functions, and limitations of respirator use (Close frequent supervision should be maintained during training to ensure that the respirator is used properly.)
- inspection and maintenance of the respirator

- classroom and field or simulated field training in recognizing and coping with medical and other emergencies
- respirator cleaning and decontamination procedures
- the purpose of medical evaluation.

The effectiveness of such training should be evaluated by testing to determine if the worker has acquired the knowledge and hands-on competency required. Test elements should correlate to actual job performance and respirator use requirements.

Wearing a respirator can cause discomfort and is inconvenient at best. A major emphasis should be made through training to convince the respirator user that respiratory protection is necessary, and that proper respirator use and maintenance are important. An example of a formal field training course for asbestos abatement workers is the one developed by the National Asbestos Council (NAC) in conjunction with OSHA.

## *(2) Supervisor Training*

The training of supervisors who oversee the daily activities of workers wearing respirators and other personal protective equipment should include the basic worker training and the following:

- basic respiratory protection practices
- the selection and use of respirators to protect workers against airborne asbestos fibers
- the structure and operation of the respirator program
- the legal requirements pertaining to the use of the respirators.

Supervisor training should be acquired from a recognized training facility, such as Georgia Institute of Technology, the University of Kansas, Tufts University, the University of California at Berkeley, the University of Illinois at Chicago, or from other facilities or individuals which provide a comparable level of supervisory training. (Many State and other regulatory agencies have regulations specifying training requirements which must be followed by employers operating in their jurisdictions.)

In supervisor training, supervisors should be required to pass an examination to demonstrate their knowledge of the hazards associated with exposure to asbestos and the proper selection, use, and care of respirators.

## **F. Respirator Fit Test**

The proper fitting of respiratory protective equipment requires the performance of a suitable fit test. The test is needed to determine a proper match between the facepiece of the respirator and face of the wearer.

NIOSH recommends that a quantitative (QNFT) fit test be done to determine the ability of each individual respirator wearer to obtain a satisfactory fit with any respirator which creates a negative pressure in the facepiece, such as negative-pressure air-purifying respirators or the SAR fitted with an emergency backup HEPA filter previously discussed. Fit tests have not been required by regulations for Type "C" pressure-demand supplied air (air line) respirators or for pressure-demand SCBA due to the positive pressure operation of these units. However, employers who choose not to use the NIOSH/EPA recommended positive-pressure respirators should be aware of the importance of fit testing to the protection level provided by air-purifying respirators. Appendix A contains procedures for both quantitative and qualitative fit testing.

### *(1) Quantitative Fit Test*

The purpose of the quantitative fit test is to determine the proper fit of the respirator under simulated wearing conditions. It is intended to provide the best method of fitting the respirator to the individual, using sensitive methods of detection for leakage.

Quantitative respirator fit tests involve exposing the respirator wearer to a test atmosphere containing an easily detectable, nontoxic aerosol, vapor or gas as the test agent (Photograph 5). Instrumentation, which samples the test atmosphere and the air inside the facepiece of the respirator, is used to measure quantitatively the leakage into the respirator. There are a number of test atmospheres, test agents, and exercises to perform during the tests. Because of cost, employers may find it necessary to contract for quantitative fit testing services.



**Photograph 5. Quantitative fit test chamber and instrument.**

Fit testing may be conducted as part of the worker training described previously. Instruction in donning and adjusting the respirator facepiece and the effects of improper adjustment can be demonstrated to the trainee as part of the fit testing procedure.

### *(2) Qualitative Fit Test*

Qualitative fit tests involve a test subject's responding (either voluntarily or involuntarily) to a chemical challenge outside the respirator facepiece. Three of the most popular methods are: (1) an irritant smoke test, (2) an odorous vapor test, and (3) a taste test. These tests are fast, easily performed, and use inexpensive equipment. Because these tests are based on the respirator wearer's subjective response to a test chemical, reproducibility and accuracy may vary.

**[NOTE: When performing a quantitative or qualitative fit test, the wearer should carry out a series of exercises that simulate work movements. Exercises are listed in the American National Standard, 288.2-1980, pp. 34-35.]**

*(3) Sealing Tests for Routine Donning of Respirators*

To ensure proper protection, the wearer of a respirator equipped with a tight fitting facepiece must check the seal of the facepiece routinely prior to each entry into the abatement area. This may be done by using the sealing test procedures recommended by the manufacturer or (where the manufacturer does not provide such recommendations) by using the negative and positive pressure sealing tests described below. Sealing tests should **NOT** be substituted for the initial, required quantitative fit tests. Adequate training of respirator users is essential for satisfactory sealing tests.

*(a) Negative Pressure Test*

This test can be conducted on respirators equipped with tight fitting facepieces.

**i. Respirator Types**

- For self-contained breathing apparatus, combination SAR/SCBA, and supplied air respirators, the end of the breathing tube is blocked so that it will not allow the passage of air. (Photograph 6).



**Photograph 6. Negative pressure test on SAR or SCBA.**



- For negative-pressure air-purifying respirators, the inlet opening of the respirator's cartridge(s) or filter(s) is closed off by covering with the palm of the hand(s). (Photograph 7).



**Photograph 7. Negative pressure test on air-purifying respirator.**

- ii. Wearers are instructed to inhale gently and hold their breath for at least 10 seconds.
- iii. If the facepiece collapses slightly and no inward leakage of air into the facepiece is detected, it can be reasonably assumed that the respirator has been properly donned and the exhalation valve and facepiece are not leaking.

*(b) Positive Pressure Test*

This test can be conducted on respirators equipped with tight fitting facepieces which contain both inhalation and exhalation valves.

- i. For self-contained breathing apparatus, combination SAR/SCBA, supplied air respirators, and for negative pressure air-purifying respirators, the exhalation valve is closed off so that it will not allow the passage of air. (Photograph 8).



**Photograph 8. Positive pressure test; blocking exhalation valve.**

- ii. Wearers are instructed to exhale gently for at least 10 seconds.
- iii. The respirator has been properly donned if a slight positive pressure can be built up inside the facepiece without the detection of any outward leakage of air between the sealing surface of the facepiece and the wearer's face.

**[NOTE: For some respirators (negative-pressure air-purifying and supplied air), this test method requires that the respirator wearer first remove the exhalation valve cover (Photograph 9) from the respirator and replace it after completion of the test. This task is difficult to carry out without disturbing the fit of the respirator.]**

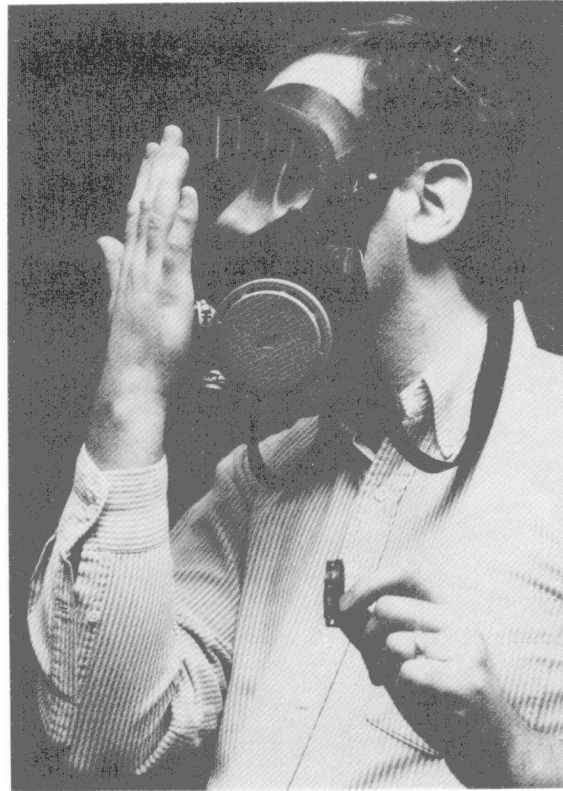

**Photograph 9. Positive pressure test with exhalation valve cover removed.**

## **G. Cleaning and Disinfecting**

Respirators should be cleaned after each use. This cleaning is usually done by the worker. In asbestos abatement operations, respirators should be collected on the clean side of the decontamination shower at the end of each shift for additional cleaning and inspection. (See section M for donning and doffing procedures.) It is best to have one individual responsible for the daily cleaning and inspection of respirators.

Every worker's respirator should bear identification, such as the worker's initials or employment number. When workers are assigned a respirator, they should be briefed on the cleaning procedure and assured (if practicable) that they will always get the same device.

If the respirators are serviced between shifts, only one respirator per worker is needed. If the cleaning is done during a work shift or if a worker will be entering and leaving the abatement area more than once during a shift, each worker requires two or more respirators depending on the number of exits and entries.

**ALL RESPIRATORS SHOULD BE CLEANED AFTER EACH USE IN ACCORDANCE WITH THE MANUFACTURER'S INSTRUCTIONS.**

## H. Inspection and Repair

An important part of a respirator maintenance program is the continual inspection of the devices. If properly performed, inspections will identify damaged or malfunctioning respirators before they can be used.

Respirator cleaning presents a good opportunity to examine each respirator thoroughly. Respirators should be double checked after cleaning operations and reassembly have been accomplished.

**ALL RESPIRATORS SHOULD BE INSPECTED IN ACCORDANCE WITH THE MANUFACTURER'S INSTRUCTIONS.**

Continued usage of respiratory protective equipment may require periodic repair or replacement of component parts of the equipment. Such repairs and parts replacement must be done either by the manufacturer, by an individual(s) trained by the manufacturer, or by the user or supervisor in situations specified by the manufacturer.

Most, if not all, equipment manufacturers supply literature which lists the component parts of their respirators and includes information on servicing. Replacement parts for respirators must be those of the manufacturer of the equipment. SUBSTITUTION OF PARTS FROM A DIFFERENT BRAND OR TYPE OF RESPIRATOR, OR UNAUTHORIZED MODIFICATION, COULD DECREASE WORKER PROTECTION OR CAUSE A TOTAL LOSS OF WORKER PROTECTION. ALSO, SUCH SUBSTITUTION OF PARTS OR MODIFICATION WILL INVALIDATE THE APPROVAL OF THE RESPIRATOR, LEADING TO VIOLATION OF APPLICABLE REGULATIONS.

Maintenance of SCBA equipment is more difficult than supplied air or air-purifying respirators, primarily because of the complexity of the valve and regulator assembly. Because of this, all repairs or adjustments must be done by the manufacturer, by an authorized repair facility, or by a worker who has been trained and certified by the manufacturer.

## I. Storage of Respirators

Respirators should be stored in a convenient, clean, and sanitary location. The purpose of good respirator storage is to ensure that the respirator will function properly when used.

Care must be taken to ensure that respirators are stored properly to protect against dust, harmful chemicals, sunlight, excessive heat or cold, moisture, and mechanical damage. Respirators should be stored in plastic bags which can be sealed, or in containers with tight-fitting lids.

[NOTE: Respirators should be thoroughly dried before being sealed in any container for storage.]

Respirators should be packed or stored so that the facepiece and exhalation valves will rest in the normal position. Respirators should not be hung by their straps. This will ensure that proper function is not impaired by distortion of the respirator or its straps.

## J. Work Area Surveillance

As specified in 29 CFR 1910.1001, 29 CFR 1926.58, and in 40 CFR 763.121, a well designed air sampling and analytical program is an essential part of every asbestos abatement project and will help document the following:

- worker exposure levels
- compliance with regulations (Federal, state, local)
- building/area occupant exposure levels

- levels of asbestos after completion of abatement work
- compliance with contract specifications
- effectiveness of engineering controls and good work practices.

## K. Regular Program Evaluation

The program administrator should periodically assess the effectiveness of the respiratory protection program during all phases of asbestos abatement operations. Frequent walk-through inspections during abatement activities should be conducted to monitor and document supervisor and worker compliance with requirements of the program. In addition to general assessment of the overall respiratory protection program, specific evaluations of the respirator cleaning, inspection, maintenance, repair, storage, and use procedures should be frequently conducted to ensure that the desired results of these operations are consistently achieved.

## L. Special Problems

The following are special problems which may be encountered in the wearing and use of respiratory protective equipment:

### (1) *Facial Hair*

Facial hair, including beards, sideburns, moustaches, or even a few days growth of stubble, must not be permitted on employees who are required to wear respirators that rely on a tight facepiece fit to achieve maximum protection. Facial hair between the wearer's skin and the sealing surfaces of the respirator will prevent a good seal. A respirator that permits negative air pressure inside the facepiece during inhalation may allow leakage of asbestos and, in the case of positive pressure devices, will either reduce service time or waste breathing air. A worker should not enter an asbestos-contaminated work area when conditions prevent a good seal of the respirator facepiece to the face.

### (2) *Eye Glasses*

Ordinary eye glasses should not be used with full facepiece respirators. Eyeglasses with temple bars or straps that pass between the sealing surface of a full facepiece and the worker's face will prevent a good seal, and should not be used. Special corrective lenses can be permanently mounted inside a full facepiece respirator and are available from all manufacturers. To ensure good vision, comfort, and proper sealing of the facepiece, these corrective lenses should be mounted by an individual designated by the manufacturer as qualified to install accessory items

Eye glasses or goggles may interfere with the half facepieces. When interference occurs, a full facepiece with special corrective lenses should be provided and worn.

### (3) *Contact Lenses*

Workers should not, under any circumstances, be permitted to wear contact lenses when wearing any type of respiratory device. With full facepieces, incoming air directed toward the eye can cause discomfort from dirt, lint, or other debris lodging between the contact lens and the pupil.

### (4) *Facial Deformities*

Facial deformities, such as scars, deep skin creases, prominent cheekbones, severe acne, and the lack of teeth or dentures, can prevent a respirator from sealing properly.

#### *(5) Communications*

Talking while wearing a respirator equipped with a facepiece can break the seal of the facepiece. Workers who must speak should be cautioned to keep jaw movement to a minimum. When communication is necessary within a contaminated area, it should be done with the help of special communicating equipment obtained from the manufacturer of the respirator.

#### *(6) Temperature Extremes*

In low temperatures, respirator lenses can become fogged. Fogging can be prevented by coating the inner surface of the lens with an anti-fogging compound. Satisfactory vision can be provided at temperatures down to -30°F. by supplying a full facepiece with a nose cup that directs the warm, moist exhaled air through the exhalation valve without its touching the lens. Airline respirators should provide dry, respirable air to the worker in cold temperatures.

High or low temperatures can make wearing a respirator uncomfortable. Under temperature extremes, a supplied air respirator may be equipped with a vortex tube to either warm or cool the air supply as needed, if such a device has been approved for use with the respirator. Also, air supply systems are now available which heat or cool the air supplied to the respirator facepiece or air hood.

### **M. Proper Respirator Use. (Procedures for Donning and Doffing Respirators When Entering and Exiting the Abatement Area.)**

A well-defined procedure for donning and doffing respirators, as well as the disposal and/or decontamination of personal protective equipment when exiting the asbestos abatement area, is necessary for every abatement operation. An important part of this process is a decontamination unit through which workers must pass when entering and exiting the work area.

Figure 1 shows a typical abatement operation layout, including a decontamination unit fabricated on the abatement site. A typical unit consists of a clean room, a shower room, and an equipment room, each separated by air locks. Customized trailers, which can be readily moved from one location to the next, are also used as decontamination stations. The basic design should be the same, whether the decontamination unit is fabricated on-site or is in the form of a mobile trailer.

The decontamination unit consists of three rooms separated by air locks through which each worker must pass to enter and exit the abatement area:

**Clean Room** — a clean area. No asbestos-contaminated items should enter this room. This area is used for suiting up and donning respiratory protective devices prior to beginning work, and for dressing in clean clothes after work.

**Shower Room** — Workers pass through the shower room on their way to the abatement area, and use the showers on their way out after leaving their contaminated clothing in the equipment room. Respirators are always worn into the shower as part of the personal decontamination procedure.

**Equipment Room** — a contaminated area where equipment, boots or shoes, hardhats, and any other contaminated work articles are stored. This is the area in which contaminated clothing is removed and disposed as the workers exit the work area. Workers keep their respirators on (without disturbing the face fit) until after they have begun their showers.

All abatement workers and other authorized personnel should enter and exit the work area through the worker decontamination enclosure system. Clean respirators and other protective equipment must be provided in the clean room and utilized by each person for each separate entry into the abatement area.

All donning and removal of respiratory protective devices and work clothes should be accomplished using the "buddy" system, involving two employees assisting each other. Prior to entering a work area, each person should be examined by his "buddy" to ensure that all connections in the respirator system are properly made and that the disposable suits, booties, head covers/hoods, etc. are properly donned.

Systematic procedures for entry and exit of the abatement area with each of the recommended respiratory protection devices are given below. These procedures should be followed for each entry and exit of the work area, including lunch breaks, etc.

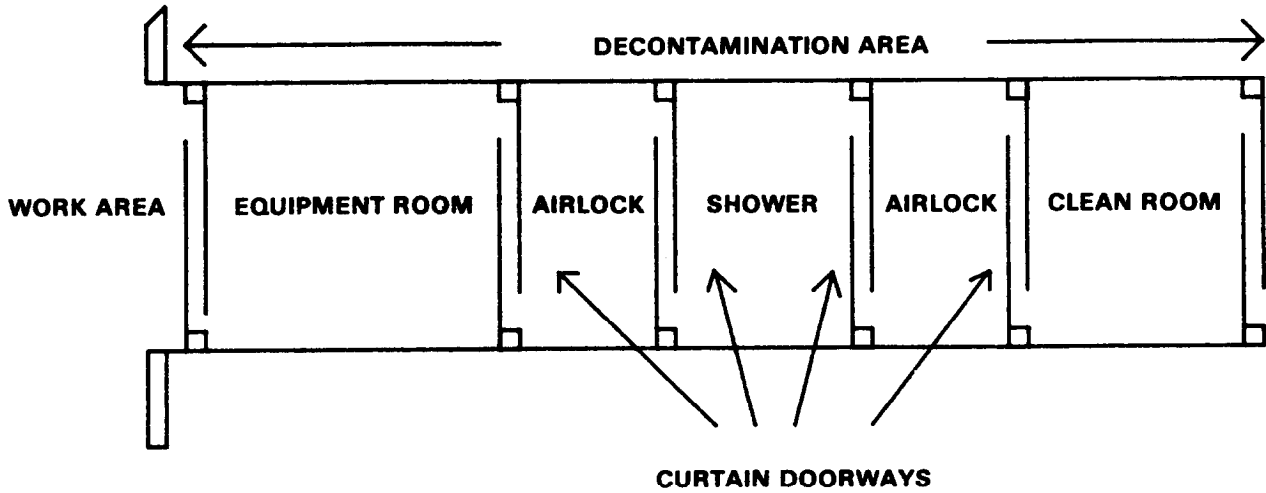

Figure 1. Typical Decontamination Area

## Pressure-Demand SAR

### Clean Room (Entry)

1. Remove all street clothing, including underwear and socks and don disposable briefs, suits, and booties if not attached to the suit.
2. Secure respirator belt assembly to the waist.
3. Proceed to shower room.

## Pressure-Demand SCBA

Clean Room (Entry) — When SCBA's are used, complete donning of these units for entry into the abatement area should be done in the clean room.

1. Remove all street clothing, including underwear and socks, and don disposable briefs, suits and booties, if not attached to the suit.
2. Using the "buddy system" fit the SCBA harness assembly on the worker with the air flow valve closed.
3. Disconnect the breathing tube from the regulator, press the facepiece to the face of the worker, and fit the headstraps over the worker's head and tighten to a comfortable fit.
4. Check the seal of the facepiece as explained in the section on respirator fit testing.
5. Connect the breathing tuba to the regulator, and open the air valve to provide air to the facepiece.
6. Don a disposable, fully-encapsulating suit with an expandable back to cover the air tank to protect the unit from contamination.
7. If a bonnet type hood/headcover is used with the suit, fit it over the headstraps and firmly around the circumference of the respirator facepiece. If full head covers are used, simply fit them over the head and respirator facepiece.
8. Zip up the suit. The workers are ready to proceed directly to the Equipment Room.



### **Pressure-Demand SAR**

#### **Shower Room (Entry)\***

- 1. Vigorously rinse the quick disconnect of the airline with fresh water to remove any foreign material that may have settled on the disconnect overnight.**
- 2. Connect the Type “C” respirator system into the breathing air system (air line quick disconnect); then connect into the air system and adjust the air control valve for desired flow if applicable.**
- 3. If half or full tight fitting respirator facepieces are used, secure the respirator facepiece comfortably to the face with the head straps.**
- 4. Check the facepiece seal as explained in the section on respirator fit testing (sealing tests).**
- 5. Don the bonnet hood/head cover or full head cover as explained in the respirator selection section above.**
- 6. Proceed to the equipment room.**

**\*It is not necessary to shower prior to entry into the asbestos abatement area.**

#### **Equipment Room (Entry)**

- 1. Put on work shoes and other safety equipment as required by the job situation.**
- 2. Proceed to the work area.**

### **Pressure-Demand SCBA**

#### **Shower Room (Entry)\***

- 1. Proceed to Equipment Room.**

#### **Equipment Room (Entry)**

- 1. Put on work shoes and other safety equipment as required by the job situation.**
- 2. Proceed to the work area.**

## Work Area

1. Do not remove the respirator facepiece while in the abatement area if at all possible.
  2. When working on scaffolding, tie the trailing airline off securely to the scaffold railing etc. as a safety precaution. This is to avoid entanglement or being pulled from the scaffolding.
- In the unusual circumstance when it is necessary to connect into a supplied air system in an asbestos laden atmosphere, the worker should always vigorously spray wash the outside and opening of both the male and female quick disconnect assembly with fresh water before connecting into the air system to ensure that both are free of any foreign material. Once the integrity of the air line has been contaminated with any foreign material, the entire length of air line should be examined and decontaminated where possible.
  - When it is necessary to disconnect from the air supply system in the contaminated abatement environment, ensure that the ends of the air line (male and female) are capped. The female disconnect should be tied off on some stable object such as scaffolding cross braces, etc., so that the opening hangs vertically.

Before leaving the work area for exit to the clean room, the worker should vacuum all loose residue from the suit and wet the suit with a water spray to prevent asbestos from becoming airborne while removing the suit.

25

### Pressure-Demand SAR

#### Equipment Room (Exit)

1. If wearing a tight fitting facepiece, carefully remove all protective clothing except the facepiece.
2. After the protective clothing has been removed, place it in the proper container for disposal.
3. Still connected to the air supply system, regardless of the type respirator system, proceed to the shower room.

### Pressure-Demand SCBA

#### Equipment Room (Exit)

1. Remove all protective clothing except the SCBA.
2. After the protective clothing has been removed, place it in a proper container for disposal.
3. With the SCBA still in place, proceed to the shower room.

### **Pressure-Demand SAR**

#### **Shower Room (Exit)**

1. if wearing a tight fitting facepiece, while standing under the shower, thoroughly clean the outside of the respirator facepiece and exposed area of the face prior to removal of the facepiece. Place the respirator on the floor outside the shower (dirty side), and finish primary showering.
2. Bring the respirator back into the shower and clean it. Disconnect from the air supply system and give the entire respirator breathing assembly to the outside man in the clean area.
3. After the respirator has been removed and primary cleaning has been accomplished in the shower, thoroughly wash the entire body with soap and water, and proceed to the clean room.

#### **Clean Room (Exit)**

1. Dress into street clothes.

### **Pressure-Demand SCBA**

#### **Shower Room (Exit)**

1. Thoroughly shower down with the SCBA still on. Turn off the air supply valve, remove the respirator, and place the respirator unit on the floor outside the shower (dirty side), and finish showering.
2. Bring the respirator back into the shower and clean it. Hand the entire SCBA unit to the outside man in the clean room.
3. After the respirator has been removed and primary cleaning has been accomplished in the shower, thoroughly wash the entire body with soap and water, and proceed to the clean room.

#### **Clean Room (Exit)**

1. Dress into street clothes.

**NOTE: Before leaving the job site, ensure that the respirator worn is properly cleaned, repaired (if necessary), dried, and stored in a clean storage area for reuse the next work shift.**

### Part III RESPIRATOR PROGRAM CHECKLIST

In general, the respirator program should be evaluated for each asbestos abatement job or at least annually with program adjustments, as appropriate, made to reflect the evaluation results. Program function can be separated into administration and operation.

#### A. Program Administration

- (1) Is there a written policy which acknowledges employer responsibility for providing a safe and healthful workplace, and assigns program responsibility, accountability, and authority?
- (2) Is program responsibility vested in one individual who is knowledgeable and who can coordinate all aspects of the program at the jobsite?
- (3) Can feasible engineering controls or work practices eliminate the need for respirators?
- (4) Are there written procedures/statements covering the various aspects of the respirator program, including:
  - designation of an administrator;
  - respirator selection;
  - purchase of approved equipment;
  - medical aspects of respirator usage;
  - issuance of equipment;
  - fitting;
  - training;
  - maintenance, storage, and repair;
  - inspection;
  - use under special conditions; and
  - work area under surveillance?

#### B. Program Operation

##### (1) Respiratory protective equipment selection

- Are work area conditions and worker exposures properly surveyed?
- Are respirators selected on the basis of hazards to which the worker is exposed?
- Are selections made by individuals knowledgeable of proper selection procedures?

- \_\_\_\_\_ (2) Are only approved respirators purchased and used; do they provide adequate protection for the specific hazard and concentration of the contaminate?
- \_\_\_\_\_ (3) Has a medical evaluation of the prospective user been made to determine physical and psychological ability to wear the selected respiratory protective equipment?
- \_\_\_\_\_ (4) Where practical, have respirators been issued to the users for their exclusive use, and are there records covering issuance?
- (5) Respiratory protective equipment fitting
- \_\_\_\_\_ Are the *users* given the opportunity to try on several respirators to determine whether the respirator they will subsequently be wearing is the best fitting one?
- \_\_\_\_\_ Is the fit tested at appropriate intervals?
- \_\_\_\_\_ Are those users who require corrective lenses properly fitted?
- \_\_\_\_\_ Are users prohibited from wearing contact lenses when using respirators?
- \_\_\_\_\_ Is the facepiece-to-face seal tested in a test atmosphere?
- \_\_\_\_\_ Are workers prohibited from entering contaminated work areas when they have facial hair or other characteristics which prohibit the use of tight-fitting facepieces?
- (6) Respirator use in the work area
- \_\_\_\_\_ Are respirators being worn correctly (i.e., head covering over respirator straps)?
- \_\_\_\_\_ Are workers keeping respirators on all the time while in the work area?
- \_\_\_\_\_ Are workers wearing respirators into the shower without disturbing the face fit?
- (7) Maintenance of respiratory protective equipment
- Cleaning and Disinfecting
- \_\_\_\_\_ Are respirators cleaned and disinfected after each use when different people use the same device, or as frequently as necessary for devices issued to individual users?
- \_\_\_\_\_ Are proper methods of cleaning and disinfecting utilized?
- Storage
- \_\_\_\_\_ Are respirators stored in a manner so as to protect them from dust, sunlight, heat, excessive cold or moisture, or damaging chemicals?
- \_\_\_\_\_ Are respirators stored properly in a storage facility so as to prevent them from deforming?
- \_\_\_\_\_ Is storage in lockers and tool boxes permitted only if the respirator is in a carrying case or carton?

### Inspection

- \_\_\_\_\_ Are respirators inspected before and after each use and during cleaning?
- \_\_\_\_\_ Are qualified individuals/users instructed in inspection techniques?
- \_\_\_\_\_ Is respiratory protective equipment designated as “emergency use” inspected at least monthly (in addition to after each use)?
- \_\_\_\_\_ Is a record kept of the inspection of “emergency use” respiratory protective equipment?

### Repair

- \_\_\_\_\_ Are replacement parts used in repair those of the manufacturer of the respirator?
- \_\_\_\_\_ Are repairs made by manufacturers or manufacturer-trained individuals?

#### **(8) Special use conditions**

- \_\_\_\_\_ Is a procedure developed for respiratory protective equipment usage in atmospheres immediately dangerous to life or health?
- \_\_\_\_\_ Is a procedure developed for equipment usage for entry into confined spaces?

#### **(9) Training**

- \_\_\_\_\_ Are users trained in proper respirator use, cleaning, and inspection?
- \_\_\_\_\_ Are users trained in the basis for selection of respirators?
- \_\_\_\_\_ Are users evaluated, using competency-based evaluation, before and after training?

## Part IV BREATHING AIR SYSTEMS

The NIOSH/MSHA approval certification requires that sufficient quantities of at least “Grade D” air must be supplied to the certified supplied-air respirators, at the pressures specified by the manufacturer for the length of hose that is being used. There has been some concern raised that this is not always the case under actual use conditions.

**[NOTE: “Grade D” breathing air is air that meets certain criteria established by the Compressed Gas Association, Inc. See Table 1 in Appendix F.]**

The following information is offered for persons who select and operate breathing air systems for providing air to certified supplied-air respirators during asbestos abatement operations.

A breathing air system used in asbestos removal must accomplish the following:

- provide a continuous sufficient supply of “Grade D” or better breathing air
- provide adequate reserve or escape air

**[NOTE: This must be done even if using pressure-demand SAR/SCBA, or pressure-demand SAR with an emergency backup HEPA filter.]**

- provide breathing air temperature control
- provide a continuous monitor and alarm against carbon monoxide (CO) in the airstream.

Four types of breathing air systems are generally available:

- low-pressure breathing air system
- high-pressure breathing air system
- high-pressure air storage cylinders
- ambient air pump (not recommended for use in asbestos abatement).

### A. The Low-Pressure Breathing Air System

The typical low-pressure breathing air system (Figure 2) operates at pressures between 80 to 200 pounds per square inch gauge (psig). It consists of:

- a low-pressure air compressor
- an after cooler assembly with water removal traps
- a compressed air purifier assembly
- a standby high-pressure air reserve assembly
- a distribution hose and manifold with connections for the respirators.

The low-pressure air compressor must have sufficient capacity to provide the flow and pressure specified by the manufacturer for the selected respirator. Flow and pressure are measured at the point where the respirator is connected. The maximum length of hose that may be used on supplied air systems is 300 feet. The compressor should be equipped with sufficient interstage and aftercooling

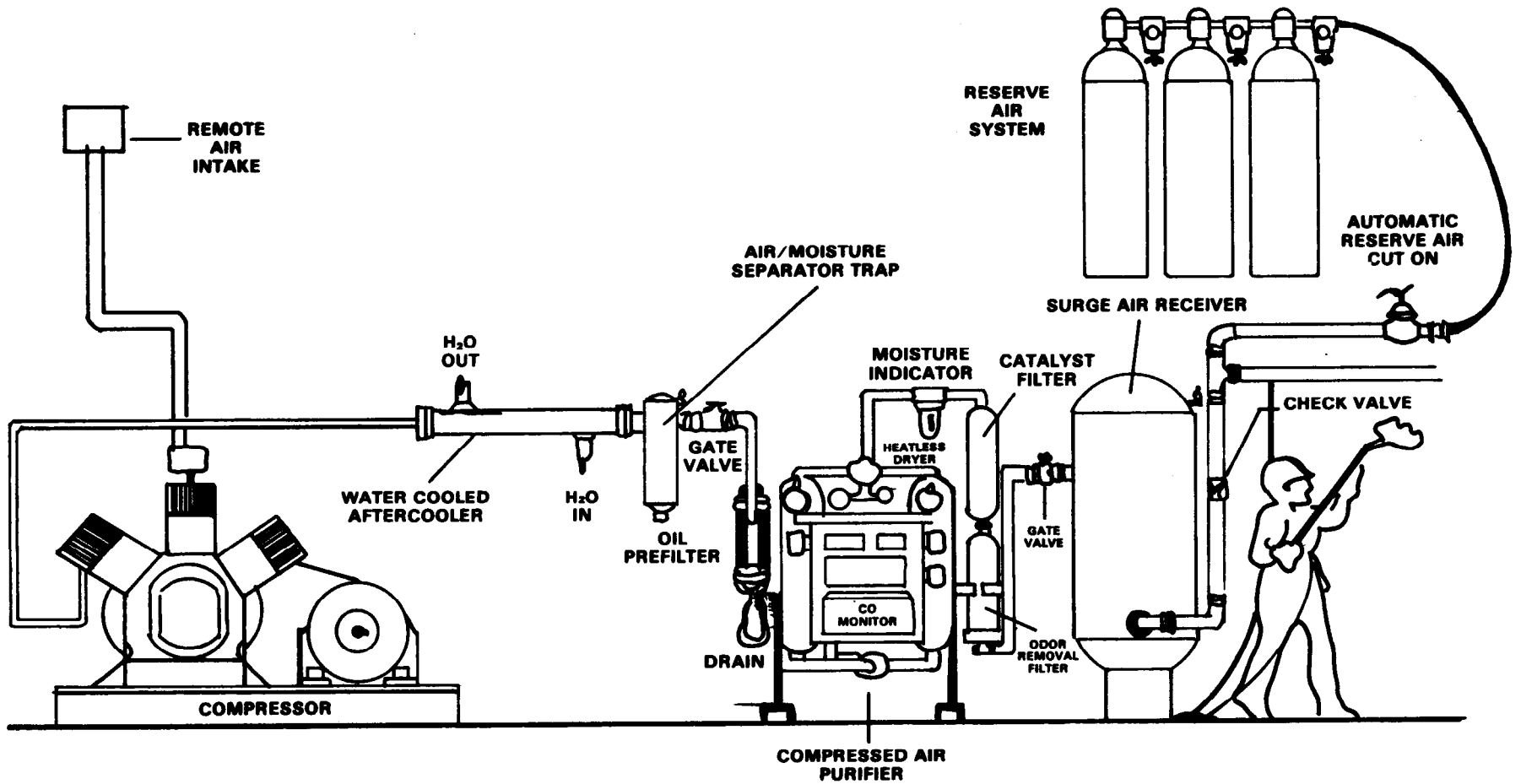

Figure 2. Typical Installation of Low Pressure Breathing Air System



capacity to reduce the output air temperature to within 10°F of the ambient air temperature. (In hot environments, care should be taken to ensure that air supplied to the respirator will not result in additional heat stress burden to the user. See Appendices E and F for additional information regarding heat stress considerations and available methods of cooling air supplied by breathing air systems.) Sufficient moisture removal traps to remove all condensed water should be built in.

The low-pressure breathing air purifier assembly (Figure 3) must purify the air to at least “Grade D” quality. The typical low-pressure breathing air purifier assembly consists of:

- a process air cooler using either air or water to accomplish the cooling
- a water removal trap
- a sequenced set of adsorption canisters, oil removal filter, alternating air regenerative drying towers and a switching mechanism
- a catalytic canister to change carbon monoxide (CO) to carbon dioxide (CO<sub>2</sub>)
- a continuous carbon monoxide monitor and alarm on the output air stream.

The required escape or reserve air supply is provided by a standby high-pressure reserve system. This system provides for uninterrupted airflow should the main compressor airflow cease. Typical escape times for an industrial crew of 5 to 25 workers can range from 30 to 60 minutes. Therefore, it is recommended that a minimum of 1 hour of reserve air be provided.

## **B. The High-Pressure Breathing Air System**

The typical high-pressure breathing air system (Figure 4) operates in the pressure range of 2000 to 4000 psig. It consists of:

- a high-pressure breathing air compressor
- an intercooler/aftercooler assembly with water removal traps
- a high-pressure air purifier assembly
- an in-line high-pressure air storage bank
- a high-pressure distribution line and control panel (with pressure reducer) with connections for respirator airlines.

The high-pressure breathing air compressor uses three to five successive stages of compression to produce pressures of 2000 to 4000 psig. Air temperature reduction and water removal is accomplished following each of the compression stages.

A high-pressure purifier assembly (Figure 5) must, just as the low-pressure system must, purify the air to at least the required “Grade D” quality.

The typical high-pressure breathing air purifier assembly consists of a coalescing water removal trap and a sequenced set of adsorption canisters. The adsorption canisters remove oil, oil vapor, water vapor, and objectionable odors. They may also include a catalytic canister to change carbon monoxide (CO) to carbon dioxide (CO<sub>2</sub>). Due to high pressures, the adsorber material can process more air and, therefore, less of it is needed.

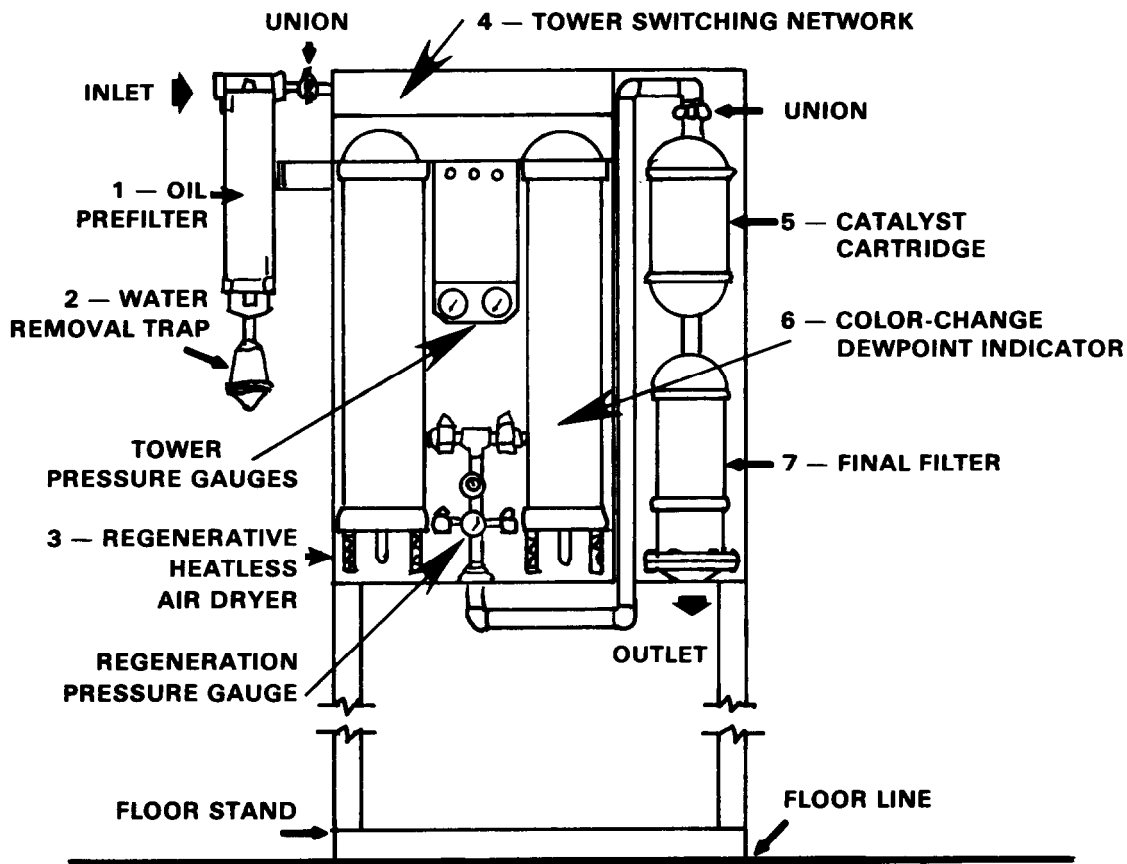

1. Oil Prefilter — removes oil mist, particulate, and entrained water. Color-change replacement notice
2. Water Removal Draintrap — removes condensed water-oil mixtures
3. Dual Regenerative Heatless Air Drying Towers — reduce water vapor content: action is to regenerate its own adsorber material
4. Tower Switching Network — acts with plumbing to provide timed dryer tower switching to effect regeneration
5. Catalyst Cartridge — removes CO by catalytic conversion to CO<sub>2</sub>
6. Color Change Dewpoint Indicator — Color change visually shows the performance of the drying towers
7. Final Filter - effects odor removal

Figure 3. Typical Low Pressure Breathing Air Purifier Assembly

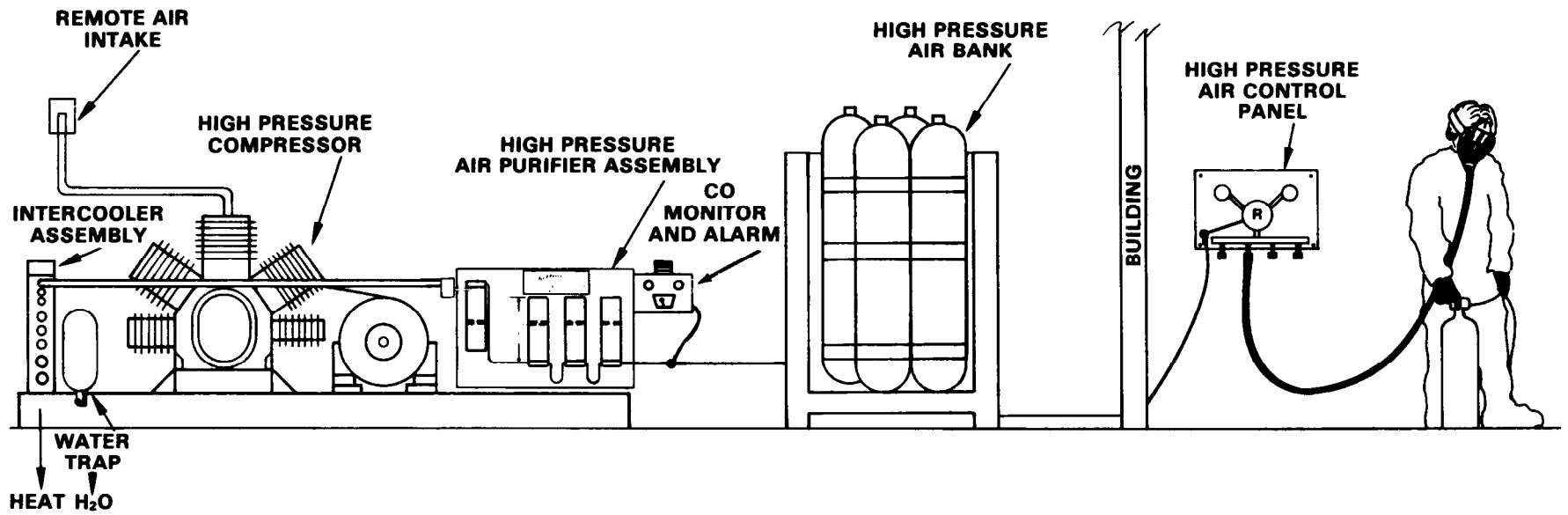

Figure 4. Typical High Pressure Breathing Air System

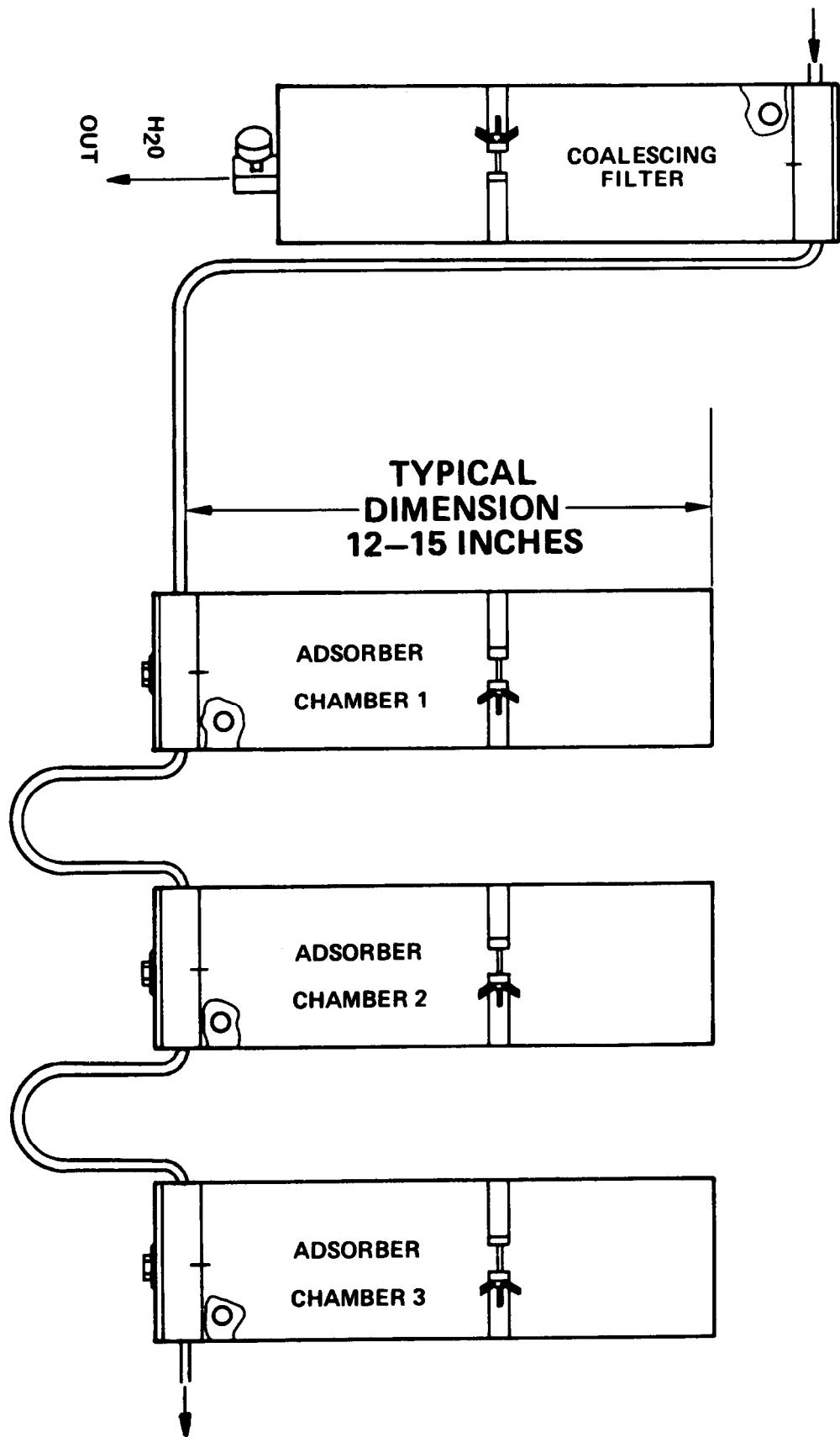

Figure 5. Typical High Pressure Purifier Assembly

A continuous carbon monoxide monitor and alarm is required on the output air stream. The required air for escape or reserve time, is provided by an in-line air bank pumped directly by the high-pressure compressor. A feedline comes from the air bank to an air control panel where the respirator airlines are attached. The air control panel contains an automatic pressure reducing valve which reduces the pressure to the correct respirator hose line pressure. Breathing air temperature is also reduced by the action of the valve. Escape or reserve time available from this air bank is typically much greater than what is required.

[CAUTION: No breathing air system will increase the oxygen content of the air being processed. Therefore, the air intake should be located in a clean air environment where the ambient atmospheric oxygen content is guaranteed. The intake system of any compressor operates at negative pressures. Therefore, no part of the intake system of any compressor should be located within the asbestos removal work zone.]

### C. High-Pressure Prepumped Air Storage Cylinders

Sufficient breathing air for small jobs may be supplied by using prepumped high-pressure cylinders containing Grade D or better air. These cylinders may be obtained from many commercial suppliers, the same sources as for the standby reserve system in the low pressure system. The air source may also be the prepumped air bank obtained from the high-pressure breathing air system. Using such prepumped high-pressure air does not require an on-site compressor. Carbon monoxide (CO) monitoring is required when the cylinders are filled, and therefore no additional carbon monoxide monitoring is needed on the job site.

### D. The Ambient Air Pump

The ambient air pump is a low-power ( $\frac{1}{2}$  HP to 5 HP) pump. These pumps take ambient air and supply it to the respirator through the appropriate hose line. They are not intended to improve the quality of the air being pumped. Ambient air pumps provide output pressures between 8 to 30 psig. They do not provide sufficient pressure to operate any currently approved NIOSH/MSHA pressure-demand, combination SAR/SCBA respirators. Therefore, AMBIENT AIR PUMPS SHOULD NOT BE USED WITH THE RESPIRATORS RECOMMENDED BY NIOSH/EPA FOR USE IN ASBESTOS ABATEMENT OPERATIONS.

Appendix F of this guide contains a more detailed discussion of breathing air systems.

## Part V SOURCES OF HELP FOR RESPIRATOR USER PROBLEMS

NIOSH recognizes that a respirator user may occasionally find a problem which is identified as a defect in the design and/or performance of a NIOSH/MSHA-approved respirator. The user should report these problems to the manufacturer of the respirator and send a copy to NIOSH. To assist the manufacturer and NIOSH in their investigations, the user should report the following information:

- name, address, and telephone number of reporter
- name of respirator manufacturer
- description and model number of respirator
- approval number of respirator
- name and part number (if known) of defective part
- lot number and/or serial number of respirator and/or defective part
- brief description of how respirator was used during discovery of defect
- description of defect
- description of how defect adversely affects performance of respirator.

The respirator user should report the defect to the manufacturer. with a copy or supplemental telephone call to NIOSH. The report to NIOSH should be addressed to:

Respirator Problem Coordinator  
NIOSH Division of Safety Research  
944 Chestnut Ridge Road  
Morgantown, WV 26505-2888  
Telephone: (304) 291-4595 or FTS 923-4595

The following is an up-to-date list of the names and addresses of persons who are responsible for investigation of problems with MSHA/NIOSH-certified respirators. Users may periodically contact NIOSH at the above address for updated information.

Mr. William Washburn  
AGA Corporation  
550 County Avenue  
Secaucus, NJ 07094

Mr. Mark Theno  
Air-Tek Company  
6472 Flying Cloud Drive  
Eden Prairie, MN 55344

Mr. Joseph Zdrok  
American Optical Corp.  
14 Mechanic Street  
Southbridge, MA 01550

Mr. Raymond O. Day  
Mr. Robert Meyer  
Binks Manufacturing Co.  
9201 W. Belmont Ave.  
Franklin Park, IL 60131

Mr. W.F. Moon  
H.S. Cover Co.  
107 East Alexander St.  
Buchanan, MI 49107

Mr. S.B. Shearer  
CSE Corporation  
600 Seco Road  
Monroeville, PA 15146

Mr. Carl M. Fink  
Defense Apparel  
285 Murphy Road  
Hartford, CT 06114

Dr. Helmut Siebar  
Draegerwerk AG Lubeck  
Postfach 1339  
2400 Lubeck 1  
Federal Republic of Germany

Mr. Steve Boro  
E.D. Bullard Company  
2680 Bridgeway  
Sausalito, CA 94965

Mr. Marc Cooper  
Cesco Safety Prod./Parmalee Ind.  
U.S. Safety Service Co.  
P.O. 60X 1237  
Kansas City, MO 64141

Mr. Martin Ziegler  
Mr. Ronald J. DeMeo  
Clifton Precision  
Division of Litton Ind.  
P.O. Box 305  
Frederica, DE 19946

Mr. Donald M. Dawson  
International Safety Instruments, Inc.  
P.O. 60X 846  
Lawrenceville, GA 30246

Mr. Bengt Sjard  
Interspiro AB  
S-181 81 LIDINGO  
SWEDEN

Mr. Ron Theerin  
Lanes Industries  
12704 N.E. 124th Street  
Kirkland, WA 98033-4091

Mr. Robert E. Arroyo  
Masprot Safety Products Corp.  
2655 Le Jeune Road, Suite 302  
Coral Gables, FL 33134

Mr. T.D. McConnell  
Mine Safety Appliances Company  
600 Penn Center Boulevard  
Pittsburgh, PA 15235

Mr. Donald P. Wilmes  
3M Company 3M Center  
Building 230-6-06  
St. Paul, MN 55144

Mr. Albert Mintz  
Moldex/Metrics, Incorporated  
4671 Leahy Street  
Culver City, CA 90230

Mr. Les Boord  
Mr. Wes Kenneweg  
National Draeger, Inc.  
P.O. Box 120  
Pittsburgh, PA 15230

Mr. Willie Yung  
Louis M. Gerson Company  
15 Sproat Street  
Middleboro, MA 02346

Mr. Joel Kaufman  
Glendale Optical Co.  
130 Crossways Park Drive  
Woodbury, NY 11797

Mr. Stephen H. Bates  
Globe Safety Equipment, Inc.  
P.O. 60X 7248  
Dayton, OH 45407

Mr. Earl B. Jacobson  
Nuclear Power Outfitters  
P.O. 60X 84  
Crystal Lake, IL 60014

Mr. Pat Droppleman  
Ocenco, Incorporated  
400 Academy Drive  
Northbrook, IL 60062

Mr. F. Levi-Senlgaglia  
Pirelli Industrial Products  
6 Ram Ridge Road  
Spring Valley, NY 10977

Mr. Ing G. Cappa  
Sekur S.P.A. — Pirelli Group  
Via di Torrespaccata, 140  
00169 Roma, ITALY

Mr. M.D. Shroff  
Pradeep Raja Bahadur Motilai Mansion  
1st Floor 11 /43 Tamarind Street  
Fort Bombay — 400023, INDIA

Mr. Jay Parker  
Pulmosan Safety Equipment Corp.  
30-48 Linden Place  
Flushing, NY 11354

Mr. Donald Burd  
Racal Airstream, Inc.  
7309A Grove Road  
Frederick, MD 21701

Mr. Justin Mills  
Rexnord Safety Products  
45 Great Valley Parkway  
Malvaern, PA 19355

Mr. Stephen C. Smith  
National Mine Service Company  
600 N. Bell Ave., Bldg. 2, Suite 110  
Carnegie, PA 15106

Mr. Ken Vaughn  
Neoterik Health Tech., Inc.  
P.O. Box 78  
Mt. Airy, MD 21771

Ms. C.E. Chappron  
North Safety Equipment  
2000 Plainfield Pike  
Cranston, RI 02920

Mr. Ian V. Maxwell  
Sabre Safety, Ltd.  
Ash Road, Alershot  
Hampshire, GU12 4DD  
England

Mr. Paul McConnaughey  
Safety and Supply Co  
5510 East Marginal Way South  
Seattle, WA 98134

Mr. Robert Brennan  
Scott Aviation  
225 Erie Street  
Lancaster, NY 14086

Mr. Larry Schaefer  
Standard Safety Equipment Corp.  
P.O. Box 188  
Palatine, IL 60067

Mr. Walter Anderson  
Robertshaw Controls Co.  
33 North Euclid Way  
Anaheim, CA 92803

Mr. Gerald S. Gilbert  
Romiro Technology  
3500 Carnegie Avenue  
Cleveland, OH 44115

Ms. Antonette Bonfiglio  
(Air-purifying respirators)  
U.S.D. Corp.  
3323 West Warner Ave.  
Santa Ana, CA 92702

Dr. Richard Stein  
(Atmosphere-supplying respirators)  
U.S. D. Corp  
3323 West Warner Ave.  
Santa Ana, CA 92702

Mr. David Koch  
Willson Safety Products  
P.O. Box 622  
Reading, PA 19603

Mr. Simon Kugler  
Siebe German, Ltd.  
Avondale Way, Cwmbran, Gwent, Wales  
NP4 1 YR, Great Britain

**Mine Safety and Health Administration**

Mr. Kenneth P. Klouse  
MSHA Approval and Certification Center  
P.O. Box 251, Route 1  
Triadelphia, WV 26059



Appendix A.  
Applicable Federal Regulations

## Appendix A1. Occupational Safety and Health Administration (OSHA) Asbestos Regulations for the Construction Industry (29 CFR 1926.58)

### § 1926.58 Asbestos, tremolite, anthophyllite, and actinolite.

(a) *Scope and application.* This section applies to all construction work as defined in 29 CFR 1910.12(b), including but not limited to the following:

(1) Demolition or salvage of structures where asbestos, tremolite, anthophyllite, or actinolite is present

(2) Removal or encapsulation of materials containing asbestos, tremolite, anthophyllite, or actinolite;

(3) Construction, alteration, repair, maintenance, or renovation of structures, substrates, or portions thereof, that contain asbestos, tremolite, anthophyllite, or actinolite;

(4) Installation of products containing asbestos, tremolite, anthophyllite, or actinolite;

(5) Asbestos, tremolite, anthophyllite, and actinolite spill/emergency cleanup; and

(6) Transportation, disposal, storage, or containment of asbestos, tremolite, anthophyllite, or actinolite or products containing asbestos, tremolite, anthophyllite, or actinolite on the site or location at which construction activities are performed.

(b) *Definitions.* “Action level” means an airborne concentration of asbestos, tremolite, anthophyllite, actinolite, or a combination of these minerals of 0.1 fiber per cubic centimeter (f/cc) of air calculated as an eight (8)-hour time-weighted average.

“Asbestos” includes chrysotile, amosite, crocidolite, tremolite asbestos, anthophyllite asbestos, actinolite asbestos, and any of these minerals that has been chemically treated and/or altered.

“Assistant Secretary” means the Assistant Secretary of Labor for Occupational Safety and Health, U.S. Department of Labor, or designee

“Authorized person” means any person authorized by the employer and required by work duties to be present in regulated areas.

“Clean room” means an uncontaminated room having facilities for the storage of employees’ street clothing and uncontaminated materials and equipment.

“Competent person” means one who is capable of identifying existing asbestos, tremolite, anthophyllite, or actinolite hazards in the workplace and who has the authority to take prompt corrective measures to eliminate them, as specified in 29 CFR 1926.32(f). The

duties of the competent person include at least the following establishing the negative-pressure enclosure, ensuring its integrity, and controlling entry to and exit from the enclosure; supervising any employee exposure monitoring required by the standard ensuring that all employees working within such an enclosure wear the appropriate personal protective equipment, are trained in the use of appropriate methods of exposure control, and use the hygiene facilities and decontamination procedures specified in the standard and ensuring that engineering controls in use are in proper operating condition and are functioning properly.

“Decontamination area” means an enclosed area adjacent and connected to the regulated area and consisting of an equipment room, shower area, and clean room, which is used for the decontamination of workers, materials, and equipment contaminated with asbestos, tremolite, anthophyllite, or actinolite.

“Demolition” means the wrecking or taking out of any load-supporting structural member and any related razing, removing, or stripping of asbestos, tremolite, anthophyllite, or actinolite products.

“Director” means the Director, National Institute for Occupational Safety and Health, U.S. Department of Health and Human Services, or designee.

“Employee exposure” means that exposure to airborne asbestos, tremolite, anthophyllite, actinolite, or a combination of these minerals, that would occur if the employee were not using respiratory protective equipment.

“Equipment room (change room)” means a contaminated room located within the decontamination area that is supplied with impermeable bags or containers for the disposal of contaminated protective clothing and equipment.

“Fiber” means a particulate form of asbestos, tremolite, anthophyllite, or actinolite, 5 micrometers or longer, with a length-to-diameter ratio of at least 3 to 1.

“High-efficiency particulate air (HEPA) filter” means a filter capable of trapping and retaining at least 99.97 percent of all monodispersed particles of 0.3 micrometers in diameter or larger,

“Regulated area” means an area established by the employer to demarcate areas where airborne

concentrations of asbestos, tremolite, anthophyllite, actinolite, or a combination of these minerals exceed or can reasonably be expected to exceed the permissible exposure limit. The regulated area may take the form of (1) a temporary enclosure, as required by paragraph (e)(6) of this section, or (2) an area demarcated in any manner that minimizes the number of employees exposed to asbestos, tremolite, anthophyllite, or actinolite,

“Removal” means the taking out or stripping of asbestos, tremolite, anthophyllite, or actinolite or materials containing asbestos, tremolite, anthophyllite, or actinolite.

“Renovation” means the modifying of any existing structure, or portion thereof, where exposure to airborne asbestos, tremolite, anthophyllite, actinolite may result.

“Repair” means overhauling, rebuilding, reconstructing, or reconditioning of structures or substrates where asbestos, tremolite, anthophyllite, or actinolite is present.

“Tremolite, anthophyllite and actinolite” means the non-asbestos form of these minerals, and any of these minerals that have been chemically treated and/or altered.

(c) *Permissible exposure limit (PEL).* The employer shall ensure that no employee is exposed to an airborne concentration of asbestos, tremolite, anthophyllite, actinolite, or a combination of these minerals in excess of 0.2 fiber per cubic centimeter of air as an eight (8) hour time-weighted average (TWA), as determined by the method prescribed in Appendix A of this section, or by an equivalent method.

(d) *Communication among employers.* On multi-employer worksites, an employer performing asbestos, tremolite, anthophyllite, or actinolite work requiring the establishment of a regulated area shall inform other employers on the site of the nature of the employer’s work with asbestos, tremolite, anthophyllite, or actinolite and of the existence of and requirements pertaining to regulated areas.

(e) *Regulated areas—(1) General.* The employer shall establish a regulated area in work areas where airborne concentrations of asbestos, tremolite, anthophyllite, actinolite, or a combination of these minerals exceed or can reasonably be expected to exceed the permissible exposure limit prescribed in paragraph (c) of this

section.

(2) *Demarcation.* The regulated area shall be demarcated in any manner that minimizes the number of persons within the area and protects persons outside the area from exposure to airborne concentrations of asbestos, tremolite, anthophyllite, actinolite, or a combination of these minerals in excess of the permissible exposure limit.

(3) *Access.* Access to regulated areas shall be limited to authorized persons or to persons authorized by the Act or regulations issued pursuant thereto.

(4) *Respirators.* All persons entering a regulated area shall be supplied with a respirator, selected in accordance with paragraph (h)(2) of this section.

(5) *Prohibited activities.* The employer shall ensure that employees do not eat, drink, smoke, chew tobacco or gum, or apply cosmetics in the regulated area.

(6) *Requirements for asbestos removal, demolition, and renovation operations.* (i) Wherever feasible, the employer shall establish negative-pressure enclosures before commencing removal, demolition, and renovation operations.

(ii) The employer shall designate a competent person to perform or supervise the following duties:

(A) Set up the enclosure;

(B) Ensure the integrity of the enclosure;

(C) Control entry to and exit from the enclosure;

(D) Supervise all employee exposure monitoring required by this section

(E) Ensure that employees working within the enclosure wear protective clothing and respirators as required by paragraphs (i) and (h) of this section and

(F) Ensure that employees are trained in the use of engineering controls, work practices, and personal protective equipment;

(G) Ensure that employees use the hygiene facilities and observe the decontamination procedures specified in paragraph (j) of this section; and

(H) Ensure that engineering controls are functioning properly.

(iii) In addition to the qualifications specified in paragraph (b) of this section, the competent person shall be trained in all aspects of asbestos, tremolite, anthophyllite, or actinolite abatement, the contents of this standard, the identification of asbestos, tremolite, anthophyllite, or actinolite and their removal procedures, and other practices for reducing the hazard. Such training shall be obtained in a comprehensive course, such as a course conducted by an EPA Asbestos Training

Center, or an equivalent course.

(iv) *Exception:* For small-scale, short-duration operations, such as pipe repair, valve replacement, installing electrical conduits, installing or removing drywall, roofing, and other general building maintenance or renovation, the employer is not required to comply with the requirements of paragraph (e)(6) of this section.

(f) *Exposure monitoring—(1) General.*

(i) Each employer who has a workplace or work operation covered by this standard shall perform monitoring to determine accurately the airborne concentrations of asbestos, tremolite, anthophyllite, actinolite or a combination of these minerals to which employees may be exposed.

(ii) Determinations of employee exposure shall be made from breathing zone air samples that are representative of the 8-hour TWA of each employee.

(iii) Representative 8-hour TWA employee exposure shall be determined on the basis of one or more samples representing full-shift exposure for employees in each work area.

(2) *Initial monitoring.* (i) Each employer who has a workplace or work operation covered by this standard, except as provided for in paragraphs (f)(2)(ii) and (f)(2)(iii) of this section, shall perform initial monitoring at the initiation of each asbestos, tremolite, anthophyllite, actinolite job to accurately determine the airborne concentrations of asbestos, tremolite, anthophyllite, or actinolite to which employees may be exposed.

(ii) The employer may demonstrate that employee exposures are below the action level by means of objective data demonstrating that the product or material containing asbestos, tremolite, anthophyllite, actinolite, or a combination of these minerals cannot release airborne fibers in concentrations exceeding the action level under those work conditions having the greatest potential for releasing asbestos, tremolite, anthophyllite, or actinolite.

(iii) Where the employer has monitored each asbestos, tremolite, anthophyllite, or actinolite job, and the data were obtained during work operations conducted under workplace conditions closely resembling the processes, type of material, control methods, work practices, and environmental conditions used and prevailing in the employer's current operations, the employer may rely on such earlier monitoring results to satisfy the requirements of paragraph (f)(2)(i) of this section.

(3) *Periodic monitoring within*

*regulated areas.* The employer shall conduct daily monitoring that is representative of the exposure of each employee who is assigned to work within a regulated area. *Exception:* When all employees within a regulated area are equipped with supplied-air respirators operated in the positive-pressure mode, the employer may dispense with the daily monitoring required by this paragraph.

(4) *Termination of monitoring.* If the periodic monitoring required by paragraph (f)(3) of this section reveals that employee exposures, as indicated by statistically reliable measurements, are below the action level, the employer may discontinue monitoring for those employees whose exposures are represented by such monitoring.

(5) *Method of monitoring.* (i) All samples taken to satisfy the monitoring requirements of paragraph (f) of this section shall be personal samples collected following the procedures specified in Appendix A.

(ii) All samples taken to satisfy the monitoring requirements of paragraph (f) of this section shall be evaluated using the OSHA Reference Method (ORM) specified in Appendix A, or an equivalent counting method.

(iii) If an equivalent method to the ORM is used, the employer shall ensure that the method meets the following criteria:

(A) Replicate exposure data used to establish equivalency are collected in side-by-side field and laboratory comparisons;

(B) The comparison indicates that 90 percent of the samples collected in the range 0.5 to 2.0 times the permissible limit have an accuracy range of plus or minus 25 percent of the ORM results with a 95 percent confidence level as demonstrated by a statistically valid protocol; and

(C) The equivalent method is documented and the results of the comparison testing are maintained.

(iv) To satisfy the monitoring requirements of paragraph (f), employers shall rely on the results of monitoring analysis performed by laboratories that have instituted quality assurance programs that include the elements prescribed in Appendix A:

(6) *Employee notification of monitoring results.* (i) The employer shall notify affected employees of the monitoring results that represent that employee's exposure as soon as possible following receipt of monitoring results.

(ii) The employer shall notify affected employees of the results of monitoring representing the employee's exposure in writing either individually or by posting

at a centrally located place that is accessible to affected employees.

(7) *Observation of monitoring.* (i) The employer shall provide affected employees or their designated representatives an opportunity to observe any monitoring of employee exposure to asbestos, tremolite, anthophyllite, or actinolite conducted in accordance with this section.

(ii) When observation of the monitoring of employee exposure to asbestos, tremolite, anthophyllite, or actinolite requires entry into an area where the use of protective clothing or equipment is required, the observer shall be provided with and be required to use such clothing and equipment and shall comply with all other applicable safety and health procedures.

(g) *Methods of compliance.* –(1) *Engineering controls and work practices.* (i) The employer shall use one or any combination of the following control methods to achieve compliance with the permissible exposure limit prescribed by paragraph (c) of this section

(A) Local exhaust ventilation equipped with HEPA filter dust collection systems;

(B) General ventilation systems;

(C) Vacuum cleaners equipped with HEPA filters;

(D) Enclosure or isolation of processes producing asbestos, tremolite, anthophyllite, or actinolite dust;

[E] Use of wet methods, wetting agents, or removal encapsulant to control employee exposures during asbestos, tremolite, anthophyllite, or actinolite handling, mixing, removal, cutting, application, and cleanup;

(F) Prompt disposal of wastes contaminated with asbestos, tremolite, anthophyllite, or actinolite in leak-tight containers; or

(G) Use of work practices or other engineering controls that the Assistant Secretary can show to be feasible.

(ii) Wherever the feasible engineering and work practice controls described above are not sufficient to reduce employee exposure to or below the limit prescribed in paragraph (c), the employer shall use them to reduce employee exposure to the lowest levels attainable by these controls and shall supplement them by the use of respiratory protection that complies with the requirements of paragraph (h) of this section.

(z) *Prohibitions.* (i) High-speed abrasive disc saws that are not equipped with appropriate engineering controls shall not be used for work related to asbestos, tremolite, anthophyllite, or actinolite.

(ii) Compressed air shall not be used to remove asbestos, tremolite, anthophyllite, or actinolite or materials containing asbestos, tremolite, anthophyllite, or actinolite unless the compressed air is used in conjunction with an enclosed ventilation system designed to capture the dust cloud created by the compressed air.

(iii) Materials containing asbestos, tremolite, anthophyllite, or actinolite shall not be applied by spray methods.

(3) *Employee rotation.* The employer shall not use employee rotation as a means of compliance with the exposure limit prescribed in paragraph (c) of this section.

(h) *Respiratory protection.* –(1) *General.* The employer shall provide respirators, and ensure that they are used, where required by this section. Respirators shall be used in the following circumstances:

(i) During the interval necessary to install or implement feasible engineering and work practice controls;

(ii) In work operations such as maintenance and repair activities, or other activities for which engineering and work practice controls are not feasible;

(iii) In work situations where feasible engineering and work practice controls are not yet sufficient to reduce exposure to or below the exposure limit; and

(iv) In emergencies.

(2) *Respirator selection.* (i) Where respirators are used, the employer shall select and provide, at no cost to the employee, the appropriate respirator as specified in Table D-4, and shall ensure

TABLE D-4. – RESPIRATORY PROTECTION FOR ASBESTOS, TREMOLITE, ANTHOPHYLLITE, AND ACTINOLITE FIBERS

| Airborne concentration of asbestos, tremolite, anthophyllite, actinolite, or a combination of these minerals | Required respirator   |
|--|---|
| Not in excess of 2 f/cc (10 X PEL).  | 1. Half-mask air-purifying respirator equipped with high-efficiency filters.  |
| Not in excess of 10 f/cc (50 X PEL).   | 1. Full facepiece air-purifying respirator equipped with high-efficiency filters.   |
| Not in excess of 20 f/cc (100 X PEL).  | 1. Any powered air purifying respirator equipped with high efficiency filters.<br>2. Any supplied-air respirator operated in continuous flow mode.          |
| Not in excess of 200 f/cc (1000 X PEL).  | 1. Full facepiece supplied-air respirator operated in pressure demand mode.   |
| Greater than 200 f/cc (>1,000 X PEL) or unknown concentration.   | 1. Full facepiece supplied air respirator operated in pressure demand mode equipped with an auxiliary positive pressure self-contained breathing apparatus. |

NOTE a. Respirators assigned for higher environmental concentrations may be used at lower concentrations  
b. A high-efficiency filter means a filter that is at least 99.97 percent efficient against mono-dispersed particles of 0.3 micrometers in diameter or larger.

that the employee uses the respirator provided,

(ii) The employer shall select respirators from among those jointly approved as being acceptable for protection by the Mine Safety and Health Administration (MSHA) and the National Institute for Occupational Safety and Health (NIOSH) under the provisions of 30 CFR Part 11.

(iii) The employer shall provide a powered, air-purifying respirator in lieu of any negative-pressure respirator specified in Table D-4 whenever:

(A) An employee chooses to use this type of respirator; and

(B) This respirator will provide adequate protection to the employee.

(3) *Respirator program.* (i) Where respiratory protection is used, the employer shall institute a respirator program in accordance with 29 CFR 1910.134(b), (d), (e), and (f).

(ii) The employer shall permit each employee who uses a filter respirator to change the filter elements whenever an increase in breathing resistance is detected and shall maintain an adequate supply of filter elements for this purpose.

(iii) Employees who wear respirators shall be permitted to leave work areas to wash their faces and respirator facepieces whenever necessary to prevent skin irritation associated with respirator use.

(iv) No employee shall be assigned to tasks requiring the use of respirators if, based on his or her most recent examination, an examining physician determines that the employee will be unable to function normally wearing a respirator, or that the safety or health of the employee or of other employees will be impaired by the use of a respirator. Such employee shall be assigned to another job or given the opportunity to transfer to a different position the duties of which he or she is able to perform with the same employer, in the same geographical area, and with the same seniority, status, and rate of pay he or she had just prior to such transfer, if such a different position is available.

(4) *Respirator fit testing.* (i) The employer shall ensure that the respirator issued to the employee exhibits the least possible facepiece leakage and that the respirator is fitted properly,

(ii) Employers shall perform either quantitative or qualitative face fit tests at the time of initial fitting and at least every 6 months thereafter for each employee wearing a negative-pressure respirator. The qualitative fit tests may be used only for testing the fit of half-

mask respirators where they are permitted to be worn, and shall be conducted in accordance with Appendix C. The tests shall be used to select facepieces that provide the required protection as prescribed in Table 1.

(i) *Protective clothing-(1) General.* The employer shall provide and require the use of protective clothing, such as coveralls or similar whole-body clothing, head coverings, gloves, and foot coverings for any employee exposed to airborne concentrations of asbestos, tremolite, anthophyllite, actinolite or a combination of these minerals that exceed the permissible exposure limit prescribed in paragraph (c) of this section.

(2) *Laundering.* (i) The employer shall ensure that laundering of contaminated clothing is done so as to prevent the release of airborne asbestos, tremolite, anthophyllite, actinolite, or a combination of these minerals in excess of the exposure limit prescribed in paragraph (c) of this section.

(ii) Any employer who gives contaminated clothing to another person for laundering shall inform such person of the requirement in paragraph (i)(2)(i) of this section to effectively prevent the release of airborne asbestos, tremolite, anthophyllite, actinolite, or a combination of these minerals in excess of the exposure limit prescribed in paragraph (c) of this section.

(3) *Contaminated clothing.* Contaminated clothing shall be transported in sealed impermeable bags, or other closed, impermeable containers, and be labeled in accordance with paragraph (k) of this section.

(4) *Protective clothing for removal, demolition, and renovation operations.*

(i) The competent person shall periodically examine worksuits worn by employees for rips or tears that may occur during performance of work.

(ii) When rips or tears are detected while an employee is working within a negative-pressure enclosure, rips and tears shall be immediately mended, or the worksuit shall be immediately replaced.

(j) *Hygiene facilities and practices—(1) General.* (i) The employer shall provide clean change areas for employees required to work in regulated areas or required by paragraph (i)(1) of this section to wear protective clothing. *Exception:* In lieu of the change area requirement specified in paragraph (j)(1)(i), the employer may permit employees engaged in small scale, short duration operations, as described in paragraph (e)(6) of this section, to clean their protective clothing with a portable HEPA-equipped vacuum before such

employees leave the area where maintenance was performed.

(ii) The employer shall ensure that change areas are equipped with separate storage facilities for protective clothing and street clothing, in accordance with section 1910.141(e).

(iii) Whenever food or beverages are consumed at the worksite and employees are exposed to airborne concentrations of asbestos, tremolite, anthophyllite, actinolite, or a combination of these minerals in excess of the permissible exposure limit, the employer shall provide lunch areas in which the airborne concentrations of asbestos, tremolite, anthophyllite, actinolite, or a combination of these minerals are below the action level.

(2) *Requirements for removal, demolition, and renovation operations—*

(i) *Decontamination area.* Except for small scale, short duration operations, as described in paragraph (e)(6) of this section, the employer shall establish a decontamination area that is adjacent and connected to the regulated area for the decontamination of employees contaminated with asbestos, tremolite, anthophyllite, or actinolite. The decontamination area shall consist of an equipment room, shower area, and clean room in series. The employer shall ensure that employees enter and exit the regulated area through the decontamination area.

(ii) *Clean room.* The clean room shall be equipped with a locker or appropriate storage container for each employee's use.

(iii) *Shower area.* Where feasible, shower facilities shall be provided which comply with 29 CFR 1910.141(d)(3). The showers shall be contiguous both to the equipment room and the clean change room, unless the employer can demonstrate that this location is not feasible. Where the employer can demonstrate that it is not feasible to locate the shower between the equipment room and the clean change room, the employer shall ensure that employees:

(A) Remove asbestos, tremolite, anthophyllite, or actinolite contamination from their worksuits using a HEPA vacuum before proceeding to a shower that is not contiguous to the work area: or

(B) Remove their contaminated worksuits, don clean worksuits, and proceed to a shower that is not contiguous to the work area.

(iv) *Equipment room.* The equipment room shall be supplied with impermeable, labeled bags and containers for the containment and

disposal of contaminated protective clothing and equipment.

(v) *Decontamination area entry procedures.* (A) the employer shall ensure that employees:

(1) Enter the decontamination area through the clean room

(z) Remove and deposit street clothing within a locker provided for their use; and

(3) Put on protective clothing and respiratory protection before leaving the clean room.

(B) Before entering the enclosure, the employer shall ensure that employees pass through the equipment room.

(vi) *Decontamination area exit procedures.* (A) Before leaving the regulated area, the employer shall ensure that employees remove all gross contamination and debris from their protective clothing.

(B) The employer shall ensure that employees remove their protective clothing in the equipment room and deposit the clothing in labeled impermeable bags or containers.

(C) The employer shall ensure that employees do not remove their respirators in the equipment room.

(D) The employer shall ensure that employees shower prior to entering the clean room.

(E) The employer shall ensure that, after showering, employees enter the clean room before changing into street clothes.

(k) *Communication of hazards to employees-(1) Signs.* (i) Warning signs that demarcate the regulated area shall be provided and displayed at each location where airborne concentrations of asbestos, tremolite, anthophyllite, actinolite, or a combination of these minerals may be in excess of the exposure limit prescribed in paragraph (c) of this section. Signs shall be posted at such a distance from such a location that an employee may read the signs and take necessary protective steps before entering the area marked by the signs.

(ii) The warning signs required by paragraph (k)(1)(i) of this section shall bear the following information:

DANGER

ASBESTOS

CANCER AND LUNG DISEASE  
HAZARD

AUTHORIZED PERSONNEL ONLY

RESPIRATORS AND PROTECTIVE  
CLOTHING ARE REQUIRED IN THIS  
AREA

(iii) Where minerals in the regulated area are only tremolite, anthophyllite or actinolite, the employer may replace the term “asbestos” with the appropriate mineral name.

(2) *Labels.* (i) Labels shall be affixed to all products containing asbestos, tremolite, anthophyllite, or actinolite and to all containers containing such products, including waste containers. Where feasible, installed asbestos, tremolite, anthophyllite, or actinolite products shall contain a visible label.

(ii) Labels shall be printed in large, bold letters on a contrasting background.

(iii) Labels shall be used in accordance with the requirements of 29 CFR 1910.1200(f) of OSHA’s Hazard Communication standard, and shall contain the following information

DANGER

CONTAINS ASBESTOS FIBERS

AVOID CREATING DUST

CANCER AND LUNG DISEASE

HAZARD

(iv) Where minerals to be labeled are only tremolite, anthophyllite and actinolite, the employer may replace the term “asbestos” with the appropriate mineral name.

(v) Labels shall contain a warning statement against breathing airborne asbestos, tremolite, anthophyllite, or actinolite fibers.

(vi) The provisions for labels required by paragraphs (k)(Z)(i)-(k) (Z)(iv) do not apply where:

(A) asbestos, tremolite, anthophyllite, or actinolite fibers have been modified by a bonding agent, coating, binder, or other material, provided that the manufacturer can demonstrate that, during any reasonably foreseeable use, handling, storage, disposal, processing, or transportation, no airborne concentrations of asbestos, tremolite, anthophyllite, actinolite, or a combination of these mineral fibers in excess of the action level will be released, or

(B) asbestos, tremolite, anthophyllite, actinolite, or a combination of these minerals is present in a product in concentrations less than 0.1 percent by weight.

(3) *Employee information and training.* (i) The employer shall institute a training program for all employees exposed to airborne concentrations of asbestos, tremolite, anthophyllite, actinolite, or a combination of these minerals at or above the action level and shall ensure their participation in the program.

(ii) Training shall be provided prior to or at the time of initial assignment, unless the employee has received equivalent training within the previous 12 months, and at least annually thereafter,

(iii) The training program shall be conducted in a manner that the employee is able to understand. The employer shall ensure that each such employee is informed of the following:

(A) Methods of recognizing asbestos, tremolite, anthophyllite, and actinolite;

(B) The health effects associated with asbestos, tremolite, anthophyllite, or actinolite exposure;

(C) The relationship between smoking and asbestos, tremolite, anthophyllite, and actinolite in producing lung cancer

(D) The nature of operations that could result in exposure to asbestos, tremolite, anthophyllite, and actinolite, the importance of necessary protective controls to minimize exposure including, as applicable, engineering controls, work practices, respirators, housekeeping procedures, hygiene facilities, protective clothing, decontamination procedures, emergency procedures, and waste disposal procedures, and any necessary instruction in the use of these controls and procedures:

(E) The purpose, proper use, fitting instructions, and limitations of respirators as required by 29 CFR 1910.134;

(F) The appropriate work practices for performing the asbestos, tremolite, anthophyllite, or actinolite job; and

(G) Medical surveillance program requirements.

(H) A review of this standard, including appendices.

(4) *Access to training materials.* (i) The employer shall make readily available to all affected employees without cost all written materials relating to the employee training program, including a copy of this regulation,

(ii) The employer shall provide to the Assistant Secretary and the Director, upon request, all information and training materials relating to the employee information and training program,

(1) *Housekeeping-(l) Vacuuming.* Where vacuuming methods are selected, HEPA filtered vacuuming equipment must be used. The equipment shall be used and emptied in a manner that minimizes the reentry of asbestos, tremolite, anthophyllite, or actinolite into the workplace,

(2) *Waste disposal.* Asbestos waste, scrap, debris, bags, containers, equipment, and contaminated clothing consigned for disposal shall be collected and disposed of in sealed, labeled, impermeable bags or other closed, labeled, impermeable containers,

(m) *Medical surveillance-(1)*

*General-(i) Employees covered.* The employer shall institute a medical surveillance program for all employees engaged in work involving levels of asbestos, tremolite, anthophyllite, actinolite or a combination of these minerals, at or above the action level for 30 or more days per year, or who are required by this section to wear negative pressure respirators.

(ii) *Examination by a physician.* (A) The employer shall ensure that all medical examinations and procedures are performed by or under the supervision of a licensed physician, and are provided at no cost to the employee and at a reasonable time and place.

(B) Persons other than such licensed physicians who administer the pulmonary function testing required by this section shall complete a training course in spirometry sponsored by an appropriate academic or professional institution,

(2) *Medical examinations and consultations-(i) Frequency.* The employer shall make available medical examinations and consultations to each employee covered under paragraph (m)(1)(i) of this section on the following schedules:

(A) Prior to assignment of the employee to an area where negative-pressure respirators are worn

(B) When the employee is assigned to an area where exposure to asbestos, tremolite, anthophyllite, actinolite, or a combination of these minerals may be at or above the action level for 30 or more days per year, a medical examination must be given within 10 working days following the thirtieth day of exposure;

(C) And at least annually thereafter.

(D) If the examining physician determines that any of the examinations should be provided more frequently than specified, the employer shall provide such examinations to affected employees at the frequencies specified by the physician.

(E) *Exception: No medical examination is required of any employee if adequate records show that the employee has been examined in accordance with this paragraph within the past 1-year period.*

(ii) *Content.* Medical examinations

made available pursuant to paragraphs (m)(2) (i)(A)-(m)(2)(i)(C) of this section shall include:

[A] A medical and work history with special emphasis directed to the pulmonary, cardiovascular, and gastrointestinal systems.

[B] On initial examination, the standardized questionnaire contained in Appendix D, Part 1, and, on annual examination, the abbreviated standardized questionnaire contained in Appendix D, Part 2.

[C] A physical examination directed to the pulmonary and gastrointestinal systems, including a chest roentgenogram to be administered at the discretion of the physician, and pulmonary function tests of forced vital capacity [PVC] and forced expiratory volume at one second (FEV<sub>1</sub>). Interpretation and classification of chest roentgenograms shall be conducted in accordance with Appendix E.

[D] Any other examinations or tests deemed necessary by the examining physician.

(3) *Information provided to the physician.* The employer shall provide the following information to the examining physician

(i) A copy of this standard and Appendices D, E, and I;

(ii) A description of the affected employee's duties as they relate to the employee's exposure;

(iii) The employee's representative exposure level or anticipated exposure level;

(iv) A description of any personal protective and respiratory equipment used or to be used; and

(v) Information from previous medical examinations of the affected employee that is not otherwise available to the examining physician.

(4) *Physician's written opinion.* (i) The employer shall obtain a written opinion from the examining physician. This written opinion shall contain the results of the medical examination and shall include:

(A) The physician's opinion as to whether the employee has any detected medical conditions that would place the employee at an increased risk of material health impairment from exposure to asbestos, tremolite, anthophyllite, or actinolite;

(B) Any recommended limitations on the employee or on the use of personal protective equipment such as respirators; and

(C) A statement that the employee has been informed by the physician of the

results of the medical examination and of any medical conditions that may result from asbestos, tremolite, anthophyllite, or actinolite exposure.

(ii) The employer shall instruct the physician not to reveal in the written opinion given to the employer specific findings or diagnoses unrelated to occupational exposure to asbestos, tremolite, anthophyllite, or actinolite.

(iii) The employer shall provide a copy of the physician's written opinion to the affected employee within 30 days from its receipt.

(n) *Recordkeeping-(1) Objective data for exempted operations.* (i) Where the employer has relied on objective data that demonstrate that products made from or containing asbestos, tremolite, anthophyllite, or actinolite are not capable of releasing fibers of asbestos, tremolite, anthophyllite, or actinolite or a combination of these minerals, in concentrations at or above the action level under the expected conditions of processing, use, or handling to exempt such operations from the initial monitoring requirements under paragraph (f)(2) of this section, the employer shall establish and maintain an accurate record of objective data reasonably relied upon in support of the exemption.

(ii) The record shall include at least the following information:

[A] The product qualifying for exemption;

[B] The source of the objective data;

[C] The testing protocol, results of testing, and/or analysis of the material for the release of asbestos, tremolite, anthophyllite, or actinolite;

[D] A description of the operation exempted and how the data support the exemption; and

[E] Other data relevant to the operations, materials, processing, or employee exposures covered by the exemption.

(iii) The employer shall maintain this record for the duration of the employer's reliance upon such objective data.

(2) *Exposure measurements.* (i) The employer shall keep an accurate record of all measurements taken to monitor employee exposure to asbestos, tremolite, anthophyllite, or actinolite as prescribed in paragraph (f) of this section.

*Note:* The employer may utilize the services of competent organizations such as industry trade associations and employee associations to maintain the records required by this section.

(ii) This record shall include at least

the following information:

(A) The date of measurement

(B) The operation involving exposure to asbestos, tremolite, anthophyllite, or actinolite that is being monitored

(C) Sampling and analytical methods used and evidence of their accuracy

(D) Number, duration, and results of samples taken;

(E) Type of protective devices worn, if any; and

(F) Name, social security number, and exposure of the employees whose exposures are represented.

(iii) The employer shall maintain this record for at least thirty (30) years, in accordance with 29 CFR 1910.20.

(3) *Medical surveillance.* (i) The employer shall establish and maintain an accurate record for each employee subject to medical surveillance by paragraph (m) of this section, in accordance with 29 CFR 1910.20.

(ii) The record shall include at least the following information

(A) The name and social security number of the employee;

[B] A copy of the employee's medical examination results, including the medical history, questionnaire responses, results of any tests, and physician's recommendations.

[C] Physician's written opinions;

[D] Any employee medical complaints related to exposure to asbestos, tremolite, anthophyllite, or actinolite; and

[E] A copy of the information provided to the physician as required by paragraph (m) of this section.

(iii) The employer shall ensure that this record is maintained for the duration of employment plus thirty (30) years, in accordance with 29 CFR 1910.20.

(4) *Training records.* The employer shall maintain all employee training records for one year beyond the last date of employment by that employer.

(5) *Availability.* (i) The employer, upon written request, shall make all records required to be maintained by this section available to the Assistant Secretary and the Director for examination and copying.

(ii) The employer, upon request, shall make any exposure records required by paragraphs (f) and (n) of this section available for examination and copying to affected employees, former employees, designated representatives, and the Assistant Secretary, in accordance with 29 CFR 1910.20(a)-(e) and (g)-(i).

(iii) The employer, upon request, shall

make employee medical records required by paragraphs (m) and (n) of this section available for examination and copying to the subject employee, anyone having the specific written consent of the subject employee, and the Assistant Secretary, in accordance with 29 CFR 1910.20.

(6) *Transfer of records.* (i) The employer shall comply with the requirements concerning transfer of records set forth in 29 CFR 1910.20 (h).

(ii) Whenever the employer ceases to do business and there is no successor employer to receive and retain the records for the prescribed period, the employer shall notify the Director at least 90 days prior to disposal and, upon request, transmit them to the Director.

(o) *Dates—(1) Effective date.* This section shall become effective [insert date 30 days from publication in the Federal Register]. The requirements of the asbestos standard issued in June 1972 (37 FR 11318), as amended, and published in 29 CFR 1910.1001 (1985) remain in effect until compliance is achieved with the parallel provisions of this standard.

(2) *Start-up dates.* [i] The requirements of paragraphs (c) through (n) of this section, including the engineering controls specified in paragraph (g)(1) of this section, shall be complied with by [insert date 210 days from publication in the Federal Register].

(P) *Appendices.* (1) Appendices A, C, D, and E to this section are incorporated as part of this section and the contents of these appendices are mandatory.

(2) Appendices B, F, G, H, and I to this section are informational and are not intended to create any additional obligations not otherwise imposed or to detract from any existing obligations.

#### Appendix A to §1926.58-Osha Reference Method-Mandatory

This mandatory appendix specifies the procedure for analyzing air samples for asbestos, tremolite, anthophyllite, and actinolite and specifies quality control procedures that must be implemented by laboratories performing the analysis. The sampling and analytical methods described below represent the elements of the available monitoring methods (such as the NIOSH 7400 method) which OSHA considers to be essential to achieve adequate employee exposure monitoring while allowing employers to use methods that are already established within their organizations. All employers who are required to conduct air monitoring under paragraph (f) of the standard are required to utilize analytical laboratories that use this procedure, or an equivalent method, for collecting and

analyzing samples.

#### *Sampling and Analytical Procedure*

1. The sampling medium for air samples shall be mixed cellulose ester filter membranes. These shall be designated by the manufacturer as suitable for asbestos, tremolite, anthophyllite, and actinolite counting. See below for rejection of blanks.

2. The preferred collection device shall be the 25-mm diameter cassette with an open-faced 50-mm extension cowl. The 37-mm cassette may be used if necessary but only if written justification for the need to use the 37-mm filter cassette accompanies the sample results in the employee's exposure monitoring record.

3. An air flow rate between 0.5 liter/rein and 2.5 liters/rein shall be selected for the 25-mm cassette. If the 37-mm cassette is used, an air flow rate between 1 liter/rein and 2.5 liters/rein shall be selected.

4. Where possible, a sufficient air volume for each air sample shall be collected to yield between 100 and 1,300 fibers per square millimeter on the membrane filter. If a filter darkens in appearance or if loose dust is seen on the filter, a second sample shall be started.

5. Ship the samples in a rigid container with sufficient packing material to prevent dislodging the collected fibers. Packing material that has a high electrostatic charge on its surface (e.g., expanded polystyrene) cannot be used because such material can cause loss of fibers to the sides of the cassette.

6. Calibrate each personal sampling pump before and after use with a representative filter cassette installed between the pump and the calibration devices.

7. Personal samples shall be taken in the "breathing zone" of the employee (i.e., attached to or near the collar or lapel near the worker's face).

8. Fiber counts shall be made by positive phase contrast using a microscope with an 8 to 10 X eyepiece and a 40 to 45 X objective for a total magnification of approximately 400 X and a numerical aperture of 0.65 to 0.75. The microscope shall also be fitted with a green or blue filter.

9. The microscope shall be fitted with a Walton-Beckett eyepiece graticule calibrated for a field diameter of 100 micrometers (+/- 2 micrometers).

10. The phase-shift detection limit of the microscope shall be about 3 degrees measured using the HSE phase shift test slide as outlined below.

a. Place the test slide on the microscope stage and center it under the phase objective.

b. Bring the blocks of grooved lines into focus.

Note.—The slide consists of seven sets of grooved lines (ca. 20 grooves to each block) in descending order of visibility from sets 1 to 7, seven being the least visible. The requirements for asbestos, tremolite, anthophyllite, and actinolite counting are that the microscope optics must resolve the grooved lines in set 3 completely, although they may appear somewhat faint, and that the grooved lines in sets 6 and 7 must be invisible. Sets 4 and 5 must be at least

partially visible but may vary slightly in visibility between microscopes. A microscope that fails to meet these requirements has either too low or too high a resolution to be used for asbestos, tremolite, anthophyllite, and actinolite counting.

c. If the image deteriorates, clean and adjust the microscope optics. If the problem persists, consult the microscope manufacturer.

11. Each set of samples taken will include 10 percent blanks or a minimum of 2 blanks. The blank results shall be averaged and subtracted from the analytical results before reporting. Any samples represented by a blank having a fiber count in excess of 7 fibers/100 fields shall be rejected.

12. The samples shall be mounted by the acetone/triacetin method or a method with an equivalent index of refraction and similar clarity.

13. Observe the following counting rules.

a. Count only fibers equal to or longer than 5 micrometers. Measure the length of curved fibers along the curve.

b. Count all particles as asbestos, tremolite, anthophyllite, and actinolite that have a length-to-width ratio (aspect ratio) of 3:1 or greater.

c. Fibers lying entirely within the boundary of the Walton-Beckett graticule field shall receive a count of 1. Fibers crossing the boundary once, having one end within the circle, shall receive the count of one half (1/2). Do not count any fiber that crosses the graticule boundary more than once. Reject and do not count any other fibers even though they may be visible outside the graticule area.

d. Count bundles of fibers as one fiber unless individual fibers can be identified by observing both ends of an individual fiber.

e. Count enough graticule fields to yield 100 fibers. Count a minimum of 20 fields; stop counting at 100 fields regardless of fiber count.

14. Blind recounts shall be conducted at the rate of 10 percent.

#### *Quality Control Procedures*

1. Intralaboratory program. Each laboratory and/or each company with more than one microscopist counting slides shall establish a statistically designed quality assurance program involving blind recounts and comparisons between microscopists to monitor the variability of counting by each microscopist and between microscopists. In a company with more than one laboratory, the program shall include all laboratories and shall also evaluate the laboratory-to-laboratory variability.

2. Interlaboratory program. Each laboratory analyzing asbestos, tremolite, anthophyllite, and actinolite samples for compliance determination shall implement an interlaboratory quality assurance program that as a minimum includes participation of at least two other independent laboratories. Each laboratory shall participate in round robin testing at least once every 6 months with at least all the other laboratories in its interlaboratory quality assurance group. Each



laboratory shall submit slides typical of its own work load for use in this program. The round robin shall be designed and results analyzed using appropriate statistical methodology.

3. All individuals performing asbestos, tremolite, anthophyllite, and actinolite analysis must have taken the NIOSH course for sampling and evaluating airborne asbestos, tremolite, anthophyllite, and actinolite dust or an equivalent course.

4. When the use of different microscopes contributes to differences between counters and laboratories, the effect of the different microscope shall be evaluated and the microscope shall be replaced, as necessary.

5. Current results of these quality assurance programs shall be posted in each laboratory to keep the microscopists informed.

#### Appendix B to §1926.58-Detailed Procedure for Asbestos Tremolite, Anthophyllite, and Actinolite Sampling and Analysis-Non-Mandatory

This appendix contains a detailed procedure for sampling and analysis and includes those critical elements specified in Appendix A. Employers are not required to use this procedure, but they are required to use Appendix A. The purpose of Appendix B is to provide a detailed step-by-step sampling and analysis procedure that conforms to the elements specified in Appendix A. Since this procedure may also standardize the analysis and reduce variability, OSHA encourages employers to use this appendix.

*Asbestos, Tremolite, Anthophyllite, and Actinolite Sampling and Analysis Method*  
Technique: Microscopy, Phase Contrast  
Analyte: Fibers (manual count)  
Sample Preparation Acetone/triacetin

Calibration: Phase-shift detection limit about 3 degrees

Range: 100 to 1300 fibers/mm<sup>2</sup> filter area

Estimated limit of detection 7 fibers/mm<sup>2</sup> filter area

Sampler: Filter (0.8-1.2 urn mixed cellulose ester membrane, 25-mm diameter)

Flow rate: 0.5l/min to 2.5 l/rein (25-mm cassette) 1.0 l/rein to 2.5 l/rein (37-mm cassette)

Sample volume: Adjust to obtain 100 to 1300 fibers/mm<sup>2</sup>

Shipment: Routine

Sample stability Indefinite

Blanks: 10% of samples (minimum 2)

Standard analytical error: 0.25.

Applicability The working range is 0.02 f/cc (1920@-L air sample) to 1.25 f/cc (400-L air sample). The method gives an index of *airborne asbestos*, tremolite, anthophyllite, and actinolite fibers but may be used for other materials such as fibrous glass by inserting suitable parameters into the counting rules. The method does not differentiate between asbestos, tremolite, anthophyllite, and actinolite and other fibers. Asbestos, tremolite, anthophyllite, and

actinolite fibers less than ca. 0.25 um diameter will not be detected by this method.

Interferences: Any other airborne fiber may interfere since all particles meeting the counting criteria are counted. Chainlike particles may appear fibrous. High levels of nonfibrous dust particles may obscure fibers in the field of view and raise the detection limit.

Reagents: 1. Acetone. 2. Triacetin (glycerol triacetate), reagent grade

Special precautions: Acetone is an extremely flammable liquid and precautions must be taken not to ignite it. Heating of acetone must be done in a ventilated laboratory fume hood using a flameless, spark-free heat source.

Equipment 1. Collection device: 25-mm cassette with W-mm extension cowl with cellulose ester filter, 0.8 to 1.2 mm pore size and backup pad.

Note: Analyze representative filters for fiber background before use and discard the filter lot if more than 5 fibers/100 fields are found.

2. Personal sampling pump, greater than or equal to 0.5 L/min. with flexible connecting tubing.

3. Microscope, phase contrast, with green or blue filter, 8 to 10X eyepiece, and 40 to 45X phase objective (total magnification ca 400X numerical aperture = 0.65 to 0.75).

4. Slides, glass, single-frosted, pre-cleaned, 25 x 75 mm.

5. Cover slips, 25x 25 mm, no. 1½ unless otherwise specified by microscope manufacturer.

6. Knife, No. 1 surgical steel, curved blade.

7. Tweezers.

8. Flask, Guth-type, insulated neck, 250 to 500 mL (with single-holed rubber stopper and elbow-jointed glass tubing, 16 to 22 cm long).

9. Hotplate, spark-free, stirring type; heating mantle; or infrared lamp and magnetic stirrer.

10. Syringe, hypodermic, with 22-gauge needle.

11. Graticule, Walton-Beckett type with 100 urn diameter circular field at the specimen plane [area = 0.00785 mm<sup>2</sup>]. (Type G-22).

Note.—the graticule is custom-made for each microscope.

12. HSE/NPL phase contrast test slide, Mark II.

13. Telescope, ocular phase-ring centering.

14. Stage micrometer (0.01 mm divisions).

#### Sampling

1. Calibrate each personal sampling pump with a representative sampler in line.

2. Fasten the sampler to the worker's lapel as close as possible to the worker's mouth. Remove the top cover from the end of the cowl extension (open face) and orient face down. Wrap the joint between the extender and the monitor's body with shrink tape to prevent air leaks.

3. Submit at least two blanks (or 10% of the total samples, whichever is greater) for each set of samples. Remove the caps from the field blank cassettes and store the caps and cassettes in a clean area (bag or box) during the sampling period. Replace the caps in the cassettes when sampling is completed.

4. Sample at 0.5 L/rein or greater. Do not

exceed 1 mg total dust loading on the filter. Adjust sampling flow rate, Q [L/rein], and time to produce a fiber density, E (fibers/mm<sup>2</sup>), of 100 to 1300 fibers/m<sup>2</sup> [3.85X10<sup>3</sup> to 5x 10<sup>4</sup> fibers per 25-mm filter with effective collection area (A<sub>c</sub> = 385 mm<sup>2</sup>)] for optimum counting precision (see step 21 below). Calculate the minimum sampling time, t<sub>minimum</sub> (min) at the action level (one-half of the current standard), L (f/cc) of the fibrous aerosol being sampled

$$t_{\min} = \frac{(Ac)(E)}{(Q)(L)10^3}$$

5. Remove the field monitor at the end of sampling, replace the plastic top cover and small end caps, and store the monitor.

6. Ship the samples in a rigid container with sufficient packing material to prevent jostling or damage.

Note.—Do not use polystyrene foam in the shipping container because of electrostatic forces which may cause fiber loss from the sampler filter.

#### Sample Preparation

Note.—The object is to produce samples with a smooth (non-grainy) background in a medium with a refractive index equal to or less than 1.46. The method below collapses the filter for easier focusing and produces permanent mounts which are useful for quality control and interlaboratory comparison. Other mounting techniques meeting the above criteria may also be used, e.g., the nonpermanent field mounting technique used in P & CAM 239.

7. Ensure that the glass slides and cover slips are free of dust and fibers.

8. Place 40 to 60 ml of acetone into a Guth-type flask. Stopper the flask with a single-hole rubber stopper through which a glass tube extends 5 to 6 cm into the flask. The portion of the glass tube that exits the top of the stopper [8 to 10 cm] is bent downward in an elbow that makes an angle of 20 to 30 degrees with the horizontal.

9. Place the flask in a stirring hotplate or wrap in a heating mantle. Heat the acetone gradually to its boiling temperature (ea. 58 °C).

Caution.—The acetone vapor must be generated in a ventilated fume hood away from all open flames and spark sources. Alternate heating methods can be used, providing no open flame or sparks are present.

10. Mount either the whole sample filter or a wedge cut from the sample filter on a clean glass slide.

a. Cut wedges of ca. 25 percent of the filter area with a curved-blade steel surgical knife using a rocking motion to prevent tearing.

b. Place the filter or wedge, dust side up, on the slide. Static electricity will usually keep the filter on the slide until it is cleared.

c. Hold the glass slide supporting the filter approximately 1 to 2 cm from the glass tube port where the acetone vapor is escaping from the heated flask. The acetone vapor stream should cause a condensation spot on the glass slide ca. 2 to 3 cm in diameter. Move

the glass slide gently in the vapor stream. The filter should clear in 2 to 5 sec. If the filter curls, distorts, or is otherwise rendered unusable, the vapor stream is probably not strong enough. Periodically wipe the outlet port with tissue to prevent liquid acetone dripping onto the filter.

d. Using the hypodermic syringe with a 22-gauge needle, place 1 to 2 drops of triacetin on the filter. Gently lower a clean 25-mm square cover slip down onto the filter at a slight angle to reduce the possibility of forming bubbles. If too many bubbles form or the amount of triacetin is insufficient, the cover slip may become detached within a few hours.

e. Glue the edges of the cover slip to the glass slide using a lacquer or nail polish.

Note.—If clearing is slow, the slide preparation may be heated on a hotplate (surface temperature 50 °C) for 15 min to hasten clearing. Counting may proceed immediately after clearing and mounting are completed.

#### Calibration and Quality Control

11. Calibration of the Walton-Beckett graticule. The diameter,  $d$  (mm), of the circular counting area and the disc diameter must be specified when ordering the graticule.

a. Insert any available graticule into the eyepiece and focus so that the graticule lines are sharp and clear.

b. Set the appropriate interpupillary distance and, if applicable, reset the binocular head adjustment so that the magnification remains constant.

c. Install the 40 to 45 x phase objective.

d. Place a stage micrometer on the microscope object stage and focus the microscope on the graduate lines.

e. Measure the magnified grid length,  $L_o$  (mm), using the stage micrometer.

f. Remove the graticule from the microscope and measure its actual grid length,  $L_c$  (mm). This can best be accomplished by using a stage fitted with verniers.

g. Calculate the circle diameter,  $d_c$  (mm), for the Walton-Beckett graticule:

$$d_c = \frac{L_o \times D}{L_c}$$

Example.—If  $L_o = 108$   $\mu\text{m}$ ,  $L_c = 2.93$  mm and  $D = 100$   $\mu\text{m}$ , then  $d_c = 2.71$  mm.

h. Check the field diameter,  $D$  (acceptable range 100 mm + 2 mm) with a stage micrometer upon receipt of the graticule from the manufacturer. Determine field area ( $\text{mm}^2$ ).

12. Microscope adjustments. Follow the manufacturer's instructions and also the following

a. Adjust the light source for even illumination across the field of view at the condenser iris.

Note.—Kohler illumination is preferred, where available.

b. Focus on the particulate material to be examined.

c. Make sure that the field iris is in focus, centered on the sample, and open only enough to fully illuminate the field of view,

d. Use the telescope ocular supplied by the manufacturer to ensure that the phase rings (annular diaphragm and phase-shifting elements) are concentric.

13. Check the phase-shift detection limit of the microscope periodically.

a. Remove the HSE/NPL phase-contrast test slide from its shipping container and center it under the phase objective.

b. Bring the blocks of grooved lines into focus.

Note.—The slide consists of seven sets of grooves (ea. 20 grooves to each block) in descending order of visibility from sets 1 to 7. The requirements for counting are that the microscope optics must resolve the grooved lines in set 3 completely, although they may appear somewhat faint, and that the grooved lines in sets 6 to 7 must be invisible. Sets 4 and 5 must be at least partially visible but may vary slightly in visibility between microscopes. A microscope which fails to meet these requirements has either too low or too high a resolution to be used for asbestos, tremolite, anthophyllite, and actinolite counting.

c. If the image quality deteriorates, clean the microscope optics and, if the problem persists, consult the microscope manufacturer.

14. Quality control of fiber counts.

a. Prepare and count field blanks along with the field samples. Report the counts on each blank. Calculate the mean of the field blank counts and subtract this value from each sample count before reporting the results.

Note 1.—The identity of the blank filters should be unknown to the counter until all counts have been completed.

Note 2: If a field blank yields fiber counts greater than 7 fibers/100 fields, report possible contamination of the samples.

b. Perform blind recounts by the same counter on 10 percent of filters counted (slides relabeled by a person other than the counter).

15. Use the following test to determine whether a pair of counts on the same filter should be rejected because of possible bias. This statistic estimates the counting repeatability at the 95% confidence level. Discard the sample if the difference between the two counts exceeds  $2.77(F) s_r$ , where  $F$  = average of the two fiber counts and  $s_r$  = relative standard deviation, which should be derived by each laboratory based on historical in-house data.

Note.—If a pair of counts is rejected as a result of this test, recount the remaining samples in the set and test the new counts against the first counts. Discard all rejected paired counts.

16. Enroll each new counter in a training course that compares performance of counters on a variety of samples using this procedure.

#### Measurement

17. Place the slide on the mechanical stage of the calibrated microscope with the center of the filter under the objective lens. Focus the microscope on the plane of the filter.

18. Regularly check phase-ring alignment and Kohler illumination.

19. The following are the counting rules:

a. Count only fibers longer than 5  $\mu\text{m}$ .

Note.—To ensure good reproducibility, all laboratories engaged in asbestos, tremolite, anthophyllite, and actinolite counting are required to participate in the Proficiency Analytical Testing (PAT) Program and should routinely participate with other asbestos, tremolite, anthophyllite, and actinolite fiber counting laboratories in the exchange of field samples to compare performance of counters. Measure the length of curved fibers along the curve.

b. Count only fibers with a length-to-width ratio equal to or greater than 3:1.

c. For fibers that cross the boundary of the graticule field, do the following:

1. Count any fiber longer than 5  $\mu\text{m}$  that lies entirely within the graticule area.

2. Count as  $\frac{1}{2}$  fiber any fiber with only one end lying within the graticule area.

3. Do not count any fiber that crosses the graticule boundary more than once.

4. Reject and do not count all other fibers.

d. Count bundles of fibers as one fiber unless individual fibers can be identified by observing both ends of a fiber.

e. Count enough graticule fields to yield 100 fibers. Count a minimum of 20 fields. Stop at 100 fields regardless of fiber count.

20. Start counting from one end of the filter and progress along a radial line to the other end, shift either up or down on the filter, and continue in the reverse direction. Select fields randomly by looking away from the eyepiece briefly while advancing the mechanical stage. When an agglomerate covers ca. 1/6 or more of the field of view, reject the field and select another. Do not report rejected fields in the number of total fields counted.

Note.—When counting a field, continuously scan a range of focal planes by moving the fine focus knob to detect very fine fibers which have become embedded in the filter. The small-diameter fibers will be very faint but are an important contribution to the total count.

#### Calculations

21. Calculate and report fiber density on the filter,  $E$  (fibers/ $\text{mm}^2$ ); by dividing the total fiber count,  $F$  minus the mean field blank count,  $B$ , by the number of fields,  $n$ ; and the field area,  $A_c$  (0.00785  $\text{mm}^2$  for a properly calibrated Walton-Beckett graticule):

$$E = \frac{F-B}{(n)(A_c)} \text{ fibers}/\text{mm}^2$$

22. Calculate the concentration,  $C$  (f/cc), of fibers in the air volume sampled,  $V$  (L), using the effective collection area of the filter,  $A_c$  (385  $\text{mm}^2$  for a 25-mm filter):

$$C = \frac{(E)(A_c)}{V(10^3)}$$

Note.—Periodically check and adjust the value of  $E$  if necessary.

Appendix C to § 1926.58—Qualitative and Quantitative Fit Testing Procedures—Mandatory Qualitative Fit Test Protocols

I. Isoamyl Acetate Protocol.

A. Odor Threshold Screening

1. Three 1-liter glass jars with metal lids (e.g. Mason or Bell jars) are required.

2. Odor-free water (e.g. distilled or spring water) at approximately 25°C shall be used for the solutions.

3. The isoamyl acetate (IAA) (also known as isopentyl acetate) stock solution is prepared by adding 1 cc of pure IAA to 600 cc of odor free water in a 1-liter jar and shaking for 30 seconds. This solution shall be prepared new at least weekly.

4. The screening test shall be conducted in a room separate from the room used for actual fit testing. The two rooms shall be well ventilated but shall not be connected to the same recirculating ventilation system.

5. The odor test solution is prepared in a second jar by placing 0.4 cc of the stock solution into 500 cc of odor free water using a clean dropper or pipette. Shake for 30 seconds and allow to stand for two to three minutes so that the IAA concentration above the liquid may reach equilibrium. This solution may be used for only one day.

6. A test blank is prepared in a third jar by adding 500 cc of odor free water.

7. The odor test and test blank jars shall be labelled 1 and 2 for jar identification. If the labels are put on the lids they can be periodically peeled, dried off and switched to maintain the integrity of the test.

8. The following instructions shall be typed on a card and placed on the table in front of the two test jars (i.e. 1 and 2): "The purpose of this test is to determine if you can smell banana oil at a low concentration. The two bottles in front of you contain water. One of these bottles also contains a small amount of banana oil. Be sure the covers are on tight, then shake each bottle for two seconds. Unscrew the lid of each bottle, one at a time, and sniff at the mouth of the bottle. Indicate to the test conductor which bottle contains banana oil."

9. The mixtures used in the IAA odor detection test shall be prepared in an area separate from where the test is performed, in order to prevent olfactory fatigue in the subject.

10. If the test subject is unable to correctly identify the jar containing the odor test solution, the IAA qualitative fit test may not be used.

11. If the test subject correctly identifies the jar containing the odor test solution, the test subject may proceed to respirator selection and fit testing.

## B. Respirator Selection

1. The test subject shall be allowed to pick the most comfortable respirator from a selection including respirators of various sizes from different manufacturers. The selection shall include at least five sizes of elastomeric half facepieces, from at least two manufacturers.

2. The selection process shall be conducted in a room separate from the fit-test chamber to prevent odor fatigue. Prior to the selection process, the test subject shall be shown how to put on a respirator, how it should be positioned on the face, how to set strap

tension and how to determine a "comfortable" respirator. A mirror shall be available to assist the subject in evaluating the fit and positioning of the respirator. This instruction may not constitute the subject's formal training on respirator use, as it is only a review.

3. The test subject should understand that the employee is being asked to select the respirator which provides the most comfortable fit. Each respirator represents a different size and shape and, if fit properly and used properly will provide adequate protection.

4. The test subject holds each facepiece up to the face and eliminates those which obviously do not give a comfortable fit. Normally, selection will begin with a half-mask and if a good fit cannot be found, the subject will be asked to test the full facepiece respirators. (A small percentage of users will not be able to wear any half-mask.)

5. The more comfortable facepieces are noted the most comfortable mask is donned and worn at least five minutes to assess comfort. All donning and adjustments of the facepiece shall be performed by the test subject without assistance from the test conductor or other person. Assistance in assessing comfort can be given by discussing the points in #6 below. If the test subject is not familiar with using a particular respirator, the test subject shall be directed to don the mask several times and to adjust the straps each time to become adept at setting proper tension on the straps.

6. Assessment of comfort shall include reviewing the following points with the test subject and allowing the test subject adequate time to determine the comfort of the respiration

- Positioning of mask on nose.
- Room for eye protection.
- Room to talk.
- Positioning mask on face and cheeks.

7. The following criteria shall be used to help determine the adequacy of the respirator fit:

- Chin properly placed.
- Strap tension.
- Fit across nose bridge.
- Distance from nose to chin.
- Tendency to slip.
- Self-observation in mirror.

6. The test subject shall conduct the conventional negative and positive-pressure fit checks (e.g. see ANSI Z88.2-1980). Before conducting the negative- or positive-pressure test the subject shall be told to "seat" the mask by rapidly moving the head from side-to-side and up and down, while taking a few deep breaths.

9. The test subject is now ready for fit testing,

10. After passing the fit test, the test subject shall be questioned again regarding the comfort of the respirator. If it has become uncomfortable, another model of respirator shall be tried.

11. The employee shall be given the opportunity to select a different facepiece and be retested if the chosen facepiece becomes increasingly uncomfortable at any time.

## C. Fit Test

1. The fit test chamber shall be similar to a clear 55 gal drum liner suspended inverted over a 2 foot diameter frame, so that the top of the chamber is about 6 inches above the test subject's head. The inside top center of the chamber shall have a small hook attached.

2. Each respirator used for the fitting and fit testing shall be equipped with organic vapor cartridges or offer protection against organic vapors. The cartridges or masks shall be changed at least weekly.

3. After selecting, donning, and properly adjusting a respirator, the test subject shall wear it to the fit testing room. This room shall be separate from the room used for odor threshold screening and respirator selection, and shall be well ventilated, as by an exhaust fan or lab hood, to prevent general room contamination.

4. A copy of the following test exercises and rainbow passage shall be taped to the inside of the test chamber:

### Test Exercises

- i. Breathe normally.
- ii. Breathe deeply. Be certain breaths are *deep* and *regular*.
- iii. Turn head all the way from one side to the other. Inhale on each side. Be certain movement is complete. Do not bump the respirator against the shoulders.
- iv. Nod head up-and-down. Inhale when head is in the full up position (looking toward ceiling). Be certain motions are complete and made about every second. Do not bump the respirator on the chest.
- v. Talking. Talk aloud and slowly for several minutes. The following paragraph is called the Rainbow Passage. Reading it will result in a wide range of facial movements, and thus be useful to satisfy this requirement. Alternative passages which serve the same purpose may also be used.
- vi. Jogging in place.
- vii. Breathe normally.

### Rainbow Passage

When the sunlight strikes raindrops in the air, they act like a prism and form a rainbow. The rainbow is a division of white light into many beautiful colors. These take the shape of a long round arch, with its path high above, and its two ends apparently beyond the horizon. There is, according to legend, a boiling pot of gold at one end. People look but no one ever finds it. When a man looks for something beyond reach, his friends say he is looking for the pot of gold at the end of the rainbow.

5. Each test subject shall wear the respirator for at least 10 minutes before starting the fit test.

6. Upon entering the test chamber, the test subject shall be given a 6 inch by 5 inch piece of paper towel or other porous absorbent single ply material, folded in half and wetted with three-quarters of one cc of pure IAA. The test subject shall hang the wet towel on the hook at the top of the chamber.

7. Allow two minutes for the IAA test

concentration to be reached before starting the fit-test exercises. This would be an appropriate time to talk with the test subject, to explain the fit test, the importance of cooperation, the purpose for the head exercises, or to demonstrate some of the exercises.

8. Each exercise described in #4 above shall be performed for at least one minute.

9. If at any time during the test, the subject detects the banana-like odor of IAA, the test has failed. The subject shall quickly exit from the test chamber and leave the test area to avoid olfactory fatigue.

10. If the test is failed, the subject shall return to the selection room and remove the respirator, repeat the odor sensitivity test, select and put on another respirator, return to the test chamber, and again begin the procedure described in the c(4) through c(8) above. The process continues until a respirator that fits well has been found. Should the odor sensitivity test be failed, the subject shall wait about 5 minutes before retesting. Odor sensitivity will usually have returned by this time.

11. If a person cannot pass the fit test described above wearing a half-mask respirator from the available selection, full facepiece models must be used.

12. When a respirator is found that passes the test, the subject breaks the face seal and takes a breath before exiting the chamber. This is to assure that the reason the test subject is not smelling the IAA is the good fit of the respirator facepiece seal and not olfactory fatigue.

13. When the test subject leaves the chamber, the subject shall remove the saturated towel and return it to the person conducting the test. To keep the area from becoming contaminated, the used towels shall be kept in a self-sealing bag so there is no significant IAA concentration buildup in the test chamber during subsequent tests.

14. At least two facepieces shall be selected for the IAA test protocol. The test subject shall be given the opportunity to wear them for one week to choose the one which is more comfortable to wear.

15. Persons who have successfully passed this fit test with a half-mask respirator may be permitted the use of the test respirator in atmospheres with up to 10 times the PEL of airborne asbestos. In atmospheres greater than 10 times, and less than 100 times the PEL (up to 100 ppm), the subject must pass the IAA test using a full face negative pressure respirator. (The concentration of the IAA inside the test chamber must be increased by ten times for QLFT of the full facepiece.)

16. The test shall not be conducted if there is any hair growth between the skin the facepiece sealing surface.

17. If hair growth or apparel interfere with a satisfactory fit, then they shall be altered or removed so as to eliminate interference and allow a satisfactory fit. If a satisfactory fit is still not attained, the test subject must use a positive-pressure respirator such as powered air-purifying respirators, supplied air respirator, or self-contained breathing apparatus.

18. If a test subject exhibits difficulty in breathing during the tests, she or he shall be

referred to a physician trained in respirator diseases or pulmonary medicine to determine whether the test subject can wear a respirator while performing her or his duties.

19. Qualitative fit testing shall be repeated at least every six months.

20. In addition, because the sealing of the respirator may be affected, qualitative fit testing shall be repeated immediately when the test subject has a:

- (1) Weight change of 20 pounds or more,
- (2) Significant facial scarring in the area of the facepiece seal,
- (3) Significant dental changes; i.e., multiple extractions without prosthesis, or acquiring dentures,
- (4) Reconstructive or cosmetic surgery, or
- (5) Any other condition that may interfere with facepiece sealing.

#### D. Recordkeeping

A summary of all test results shall be maintained in each office for 3 years. The summary shall include:

- (1) Name of test subject.
- (2) Date of testing,
- (3) Name of the test conductor.
- (4) Respirators selected (indicate manufacturer, model, size and approval number).
- (5) Testing agent.

### 11. Saccharin Solution Aerosol Protocol

#### A. Respirator Selection

Respirators shall be selected as described in section IB (respirator selection) above, except that each respirator shall be equipped with a particulate filter.

#### B. Taste Threshold Screening

1. An enclosure about head and shoulders shall be used for threshold screening (to determine if the individual can taste saccharin) and for fit testing. The enclosure shall be approximately 12 inches in diameter by 14 inches tall with at least the front clear to allow free movement of the head when a respirator is worn.

2. The test enclosure shall have a three-quarter inch hole in front of the test subject's nose and mouth area to accommodate the nebulizer nozzle.

3. The entire screening and testing procedure shall be explained to the test subject prior to conducting the screening test.

4. During the threshold screening test, the test subject shall don the test enclosure and breathe with open mouth with tongue extended.

5. Using a DeVilbiss Model 40 Inhalation Medication Nebulizer or equivalent, the test conductor shall spray the threshold check solution into the enclosure. This nebulizer shall be clearly marked to distinguish it from the fit test solution nebulizer.

6. The threshold check solution consists of 0.83 grams of sodium saccharin, USP in water. It can be prepared by putting 1 cc of the test solution (see C 7 below) in 100 cc of water.

7. To produce the aerosol, the nebulizer bulb is firmly squeezed so that it collapses completely, then is released and allowed to fully expand.

8. Ten squeezes of the nebulizer bulb are

repeated rapidly and then the test subject is asked whether the saccharin can be tasted.

9. If the first response is negative, ten more squeezes of the nebulizer bulb are repeated rapidly and the test subject is again asked whether the saccharin can be tasted.

10. If the second response is negative ten more squeezes are repeated rapidly and the test subject is again asked whether the saccharin can be tasted.

11. The test conductor will take note of the number of squeezes required to elicit a taste response.

12. If the saccharin is not tasted after 30 squeezes (Step 10), the saccharin fit test cannot be performed on the test subject.

13. If a taste response is elicited, the test subject shall be asked to take note of the taste for reference in the fit test.

14. Correct use of the nebulizer means that approximately 1 cc of liquid is used at a time in the nebulizer body.

15. The nebulizer shall be thoroughly rinsed in water, shaken dry, and refilled at least every four hours

#### C. Fit Test

1. The test subject shall don and adjust the respirator without the assistance from any person.

2. The fit test uses the same enclosure described in IIB above,

3. Each test subject shall wear the respirator for at least 10 minutes before starting the fit test.

4. The test subject shall don the enclosure while wearing the respirator selected in section IB above. This respirator shall be properly adjusted and equipped with a particulate filter.

5. The test subject may not eat, drink (except plain water), or chew gum for 15 minutes before the test.

6. A second DeVilbiss Model 40 Inhalation Medication Nebulizer is used to spray the fit test solution into the enclosure. This nebulizer shall be clearly marked to distinguish it from the screening test solution nebulizer.

7. The fit test solution is prepared by adding 63 grams of sodium saccharin to 100 cc of warm water.

8. As before, the test subject shall breathe with mouth open and tongue extended.

9. The nebulizer is inserted into the hole in the front of the enclosure and the fit test solution is sprayed into the enclosure using the same technique as for the taste threshold screening and the same number of squeezes required to elicit a taste response in the screening. (See B8 through B10 above).

10. After generation of the aerosol read the following instructions to the test subject. The test subject shall perform the exercises for one minute each.

i. Breathe normally.

ii. Breathe deeply. Be certain breaths are deep and regular.

iii. Turn head all the way from one side to the other. Be certain movement is complete. Inhale on each side. Do not bump the respirator against the shoulders.

iv. Nod head up-and-down. Be certain

motions are complete. Inhale when head is in the full up position (when looking toward the ceiling). Do not bump the respirator on the chest.

v. Talking. Talk loudly and slowly for several minutes. The following paragraph is called the Rainbow Passage. Reading it will result in a wide range of facial movements, and thus be useful to satisfy this requirement. Alternative passages which serve the same purpose may also be used.

- vi. Jogging in place.
- vii. Breathe normally,

#### *Rainbow Passage*

When the sunlight strikes raindrops in the air, they act like a prism and form a rainbow. The rainbow is a division of white light into many beautiful colors. These take the shape of a long round arch, with its path high above, and its two ends apparently beyond the horizon. There is, according to legend, a boiling pot of gold at one end. People look, but no one ever finds it. When a man looks for something beyond his reach, his friends say he is looking for the pot of gold at the end of the rainbow.

11. At the beginning of each exercise, the aerosol concentration shall be replenished using one-half the number of squeezes as initially described in C9.

12. The test subject shall indicate to the test conductor if at any time during the fit test the taste of saccharin is detected.

13. If the saccharin is detected the fit is deemed unsatisfactory and a different respirator shall be tried.

14. At least two facepieces shall be selected by the IAA test protocol. The test subject shall be given the opportunity to wear them for one week to choose the one which is more comfortable to wear.

15. Successful completion of the test protocol shall allow the use of the half mask tested respirator in contaminated atmospheres up to 10 times the PEL of asbestos. In other words this protocol may be used to assign protection factors no higher than ten.

16. The test shall not be conducted if there is any hair growth between the skin and the facepiece sealing surface.

17. If hair growth or apparel interfere with a satisfactory fit, then they shall be altered or removed so as to eliminate interference and allow a satisfactory fit. If a satisfactory fit is still not attained, the test subject must use a positive-pressure respirator such as powered air-purifying respirators, supplied air respirator, or self-contained breathing apparatus.

18. If a test subject exhibits difficulty in breathing during the tests, she or he shall be referred to a physician trained in respirator diseases or pulmonary medicine to determine whether the test subject can wear a respirator while performing her or his duties.

19. Qualitative fit testing shall be repeated at least every six months.

20. In addition, because the sealing of the respirator may be affected, qualitative fit testing shall be repeated immediately when the test subject has a:

- (1) Weight change of 20 pounds or more,

(2) Significant facial scarring in the area of the facepiece seal.

(3) Significant dental changes; i.e.; multiple extractions without prosthesis, or acquiring dentures,

(4) Reconstructive or cosmetic surgery, or

(5) Any other condition that may interfere with facepiece sealing.

#### D. Recordkeeping

A summary of all test results shall be maintained in each office for 3 years. The summary shall include:

- (1) Name of test subject.
- (2) Date of testing.
- (3) Name of test conductor.
- (4) Respirators selected (indicate manufacturer, model, size and approval number).
- (5) Testing agent.

### III. Irritant Fume Protocol

#### A. Respirator selection

Respirators shall be selected as described in section IB above, except that each respirator shall be equipped with a combination of high-efficiency and acid-gas cartridges.

#### B. Fit test

1. The test subject shall be allowed to smell a weak concentration of the irritant smoke to familiarize the subject with the characteristic odor.

2. The test subject shall properly don the respirator selected as above, and wear it for at least 10 minutes before starting the fit test.

3. The test conductor shall review this protocol with the test subject before testing.

4. The test subject shall perform the conventional positive pressure and negative pressure fit checks (see ANSI Z88.2 1980). Failure of either check shall be cause to select an alternate respirator.

5. Break both ends of a ventilation smoke tube containing stannic oxychloride, such as the MSA part #5845, or equivalent. Attach a short length of tubing to one end of the smoke tube. Attach the other end of the smoke tube to a low pressure air pump set to deliver 200 milliliters per minute.

8. Advise the test subject that the smoke can be irritating to the eyes and instruct the subject to keep the eyes closed while the test is performed.

7. The test conductor shall direct the stream of irritant smoke from the tube towards the facepiece area of the test subject. The person conducting the test shall begin with the tube at least 12 inches from the facepiece and gradually move to within one inch, moving around the whole perimeter of the mask.

8. The test subject shall be instructed to do the following exercises while the respirator is being challenged by the smoke. Each exercise shall be performed for one minute.

- i. Breathe normally.
- ii. Breathe deeply. Be certain breaths are *deep* and *regular*.
- iii. Turn head all the way from one side to the other. Be certain movement is complete. Inhale on each side. Do not bump the respirator against the shoulders.

iv. Nod head up-and-down. Be certain motions are complete and made every second. Inhale when head is in the full up position (looking toward ceiling). Do not bump the respirator against the chest.

v. Talking. Talk aloud and slowly for several minutes. The following paragraph is called the Rainbow Passage. Reading it will result in a wide range of facial movements, and thus be useful to satisfy this requirement. Alternative passages which serve the same purpose may also be used.

#### *Rainbow Passage*

When the sunlight strikes raindrops in the air, they act like a prism and form a rainbow. The rainbow is a division of white light into many beautiful colors. These take the shape of a long round arch, with its path high above, and its two ends apparently beyond the horizon. There is, according to legend, a boiling pot of gold at one end. People look, but no one ever finds it. When a man looks for something beyond his reach, his friends say he is looking for the pot of gold at the end of the rainbow.

vi. Jogging in Place.

vii. Breathe normally.

9. The test subject shall indicate to the test conductor if the irritant smoke is detected. If smoke is detected, the test conductor shall stop the test. In this case, the tested respirator is rejected and another respirator shall be selected.

10. Each test subject passing the smoke test (i.e. without detecting the smoke) shall be given a sensitivity check of smoke from the same tube to determine if the test subject reacts to the smoke. Failure to evoke a response shall void the fit test.

11. Steps B4, B9, B10 of this fit test protocol shall be performed in a location with exhaust ventilation sufficient to prevent general contamination of the testing area by the test agents.

12. At least two facepieces shall be selected by the IAA test protocol. The test subject shall be given the opportunity to wear them for one week to choose the one which is more comfortable to wear.

13. Respirators successfully tested by the protocol may be used in contaminated atmospheres up to ten times the PEL of asbestos.

14. The test shall not be conducted if there is any hair growth between the skin and the facepiece sealing surface.

15. If hair growth or apparel interfere with a satisfactory fit, then they shall be altered or removed so as to eliminate interference and allow a satisfactory fit. If a satisfactory fit is still not attained, the test subject must use a positive-pressure respirator such as powered air-purifying respirators, supplied air respirator, or self-contained breathing apparatus.

18. If a test subject exhibits difficulty in breathing during the tests, she or he shall be referred to a physician trained in respirator diseases or pulmonary medicine to determine whether the test subject can wear a respirator while performing her or his duties.

17. Qualitative fit testing shall be repeated at least every six months.

18. In addition, because the sealing of the respirator may be affected, qualitative fit testing shall be repeated immediately when the test subject has a:

- (1) Weight change of 20 pounds or more,
- (2) Significant facial scarring in the area of the facepiece seal,
- (3) Significant dental changes; i.e.; multiple attractions without prosthesis, or acquiring dentures,
- (4) Reconstructive or cosmetic surgery, or
- (5) Any other condition that may interfere with facepiece sealing.

#### C. Recordkeeping

A summary of all test results shall be maintained in each office for 3 years. The summary shall include:

- (1) Name of test subject.
- (2) Date of testing.
- (3) Name of test conductor.
- (4) Respirators selected (indicate manufacturer, model, size and approval number).
- (5) Testing agent

#### Quantitative Fit Test Procedures

##### 1. General.

a. The method applies to the negative-pressure nonpowered air-purifying respirators only.

b. The employer shall assign one individual who shall assume the full responsibility for implementing the respirator quantitative fit test program,

##### 2. Definition.

a. "Quantitative Fit Test" means the measurement of the effectiveness of a respirator seal in excluding the ambient atmosphere. The test is performed by dividing the measured concentration of challenge agent in a test chamber by the measured concentration of the challenge agent inside the respirator facepiece when the normal air purifying element has been replaced by an essentially perfect purifying element.

b. "Challenge Agent" means the air contaminant introduced into a test chamber so that its concentration inside and outside the respirator may be compared,

c. "Test Subject" means the person wearing the respirator for quantitative fit testing.

d. "Normal Standing Position" means standing erect and straight with arms down, slant the sides and looking straight ahead,

e. "Fit Factor" means the ratio of challenge agent concentration outside with respect to the inside of a respirator inlet covering (facepiece or enclosure),

##### 3. Apparatus.

a. *Instrumentation.* Corn oil, sodium chloride or other appropriate aerosol generation, dilution, and measurement systems shall be used for quantitative fit test.

b. *Test chamber.* The test chamber shall be large enough to permit all test subjects to freely perform all required exercises without distributing the challenge agent concentration or the measurement apparatus. The test chamber shall be equipped and constructed so that the challenge agent is effectively

isolated from the ambient air yet uniform in concentration throughout the chamber.

c. When testing air-purifying respirators, the normal filter or cartridge element shall be replaced with a high-efficiency particular filter supplied by the same manufacturer.

d. The sampling instrument shall be selected so that a strip chart record may be made of the test showing the rise and fall of challenge agent concentration with each inspiration and expiration at fit factors of at least 2,000,

e. The combination of substitute air-purifying elements (if any), challenge agent, and challenge agent concentration in the test chamber shall be such that the test subject is not exposed in excess of PEL to the challenge agent at any time during the testing process.

f. The sampling port on the test specimen respirator shall be placed and constructed so that there is no detectable leak around the port, a free air flow, is allowed into the sampling line at all times and so there is no interference with the fit or performance of the respirator,

g. The test chamber and test set-up shall permit the person administering the test to observe one test subject inside the chamber during the test.

h. The equipment generating the challenge atmosphere shall maintain the concentration of challenge agent constant within a 10 percent variation for the duration of the test.

i. The time lag (interval between an event and its being recorded on the strip chart) of the instrumentation may not exceed 2 seconds.

j. The tubing for the test chamber atmosphere and for the respirator sampling port shall be the same diameter, length and material. It shall be kept as short as possible. The smallest diameter tubing recommended by the manufacturer shall be used.

k. The exhaust flow from the test chamber shall pass through a high-efficiency filter before release to the room.

l. When sodium chloride aerosol is used, the relative humidity inside the test chamber shall not exceed 50 percent.

##### 4. Procedural Requirements.

a. The fitting of half-mask respirators shall be started with those having multiple sizes and a variety of interchangeable cartridges and canisters such as the MSA Comfo II-M, Norton M. Survivair M, A-O M, or Scott-M. Use either of the tests outlined below to assure that the facepiece is properly adjusted.

(1) *Positive pressure test.* With the exhaust port(s) blocked, the negative pressure of slight inhalation should remain constant for several seconds.

(2) *Negative pressure test.* With the intake port(s) blocked, the negative pressure slight inhalation should remain constant for several seconds.

b. After a facepiece is adjusted, the test subject shall wear the facepiece for at least 5 minutes before conducting a qualitative test by using either of the methods described below and using the exercise regime described in 5a., b., c., d, and e.

(1) *Isoamyl acetate test.* When using organic vapor cartridges, the test subject who

can smell the odor should be unable to detect the odor of isoamyl acetate squirted into the air near the most vulnerable portions of the facepiece seal. In a location which is separated from the test area, the test subject shall be instructed to close her/his eyes during the test period. A combination cartridge or canister with organic vapor and high-efficiency filters shall be used when available for the particular mask being tested. The test subject shall be given an opportunity to smell the odor of isoamyl acetate before the test is conducted.

(2) *Irritant fume test.* When using high-efficiency filters, the test subject should be unable to detect the odor of irritant fume (stannic chloride or titanium tetrachloride ventilation smoke tubes) squirted into the air near the most vulnerable portions of the facepiece seal. The test subject shall be instructed to close her/his eyes during the test period,

c. The test subject may enter the quantitative testing chamber only if she or he has obtained a satisfactory fit as stated in 4.b. of this Appendix.

d. Before the subject enters the test chamber, a reasonably stable challenge agent concentration shall be measured in the test chamber.

e. Immediately after the subject enters the test chamber, the challenge agent concentration inside the respirator shall be measured to ensure that the peak penetration does not exceed 5 percent for a half-mask and 1 percent for a full facepiece.

f. A stable challenge agent concentration shall be obtained prior to the actual start of testing.

(1) Respirator restraining straps may not be overtightened for testing. The straps shall be adjusted by the wearer to give a reasonably comfortable fit typical of normal use.

5. *Exercise Regime.* Prior to entering the test chamber, the test subject shall be given complete instructions as to her/his part in the test procedures. The test subject shall perform the following exercises, in the order given, for each independent test.

a. *Normal Breathing (NB).* In the normal standing position, without talking, the subject shall breathe normally for at least one minute.

b. *Deep Breathing (DB).* In the normal standing position the subject shall do deep breathing for at least one minute pausing so as not to hyperventilate.

c. *Turning head side to side (SS).* Standing in place the subject shall slowly turn his/her head from side between the extreme positions to each side. The head shall be held at each extreme position for at least 5 seconds. Perform for at least three complete cycles.

d. *Moving head up and down (UD).* Standing in place, the subject shall slowly move his/her head up and down between the extreme position straight up and the extreme position straight down. The head shall be held at each extreme position for at least 5 seconds. Perform for at least three complete cycles.

e. *Reading (R).* The subject shall read out

slowly and loud so as to be heard clearly by the test conductor or monitor. The test subject shall read the "rainbow passage" at the end of this section.

f. *Grimace (G)*. The test subject shall grimace, smile, frown, and generally contort the face using the facial muscles. Continue for at least 15 seconds.

g. *Bend over and touch toes (B)*. The test subject shall bend at the waist and touch toes and return to upright position. Repeat for at least 30 seconds.

h. *Jogging in place (J)*. The test subject shall perform jog in place for at least 30 seconds.

i. *Normal Breathing (NB)*. Same as exercise a.

#### *Rainbow Passage*

When the sunlight strikes raindrops in the air, they act like a prism and form a *rainbow*. The rainbow is a division of white light into many beautiful colors. These take the shape of a long round arch, with its path high above, and its two ends apparently beyond the horizon. There is, according to legend, a boiling pot of gold at one end. People look, but no one ever finds it. When a man looks for something beyond reach, his friends say he is looking for the pot of gold at the end of the rainbow.

6. The test shall be terminated whenever any single peak penetration exceeds 5 percent for half-masks and 1 percent for full facepieces. The test subject may be refitted and retested. If two of the three required tests are terminated, the fit shall be deemed inadequate. (See paragraph 4.h.)

#### *7. Calculation of Fit Factors.*

a. The fit factor determined by the quantitative fit test equals the average concentration inside the respirator.

b. The average test chamber concentration is the arithmetic average of the test chamber concentration at the beginning and of the end of the test.

c. The average peak concentration of the challenge agent inside the respirator shall be the arithmetic average peak concentrations for each of the nine exercises of the test which are computed as the arithmetic average of the peak concentrations found for

each breath during the exercise.

d. The average peak concentration for an exercise may be determined graphically if there is not a great variation in the peak concentrations during a single exercise.

8. *Interpretation of Test Results*. The fit factor measured by the quantitative fit testing shall be the lowest of the three protection factors resulting from three independent tests.

#### *9. Other Requirements.*

a. The test subject shall not be permitted to wear a half-mask or full facepiece mask if the minimum fit factor of 100 or 1,000, respectively, cannot be obtained. If hair growth or apparel interfere with a satisfactory fit, then they shall be altered or removed so as to eliminate interference and allow a satisfactory fit. If a satisfactory fit is still not attained, the test subject must use a positive-pressure respirator such as powered air-purifying respirators, supplied air respirator, or self-contained breathing apparatus.

b. The test shall not be conducted if there is any hair growth between the skin and the facepiece sealing surface.

c. If a test subject exhibits difficulty in breathing during the tests, she or he shall be referred to a physician trained in respirator diseases or pulmonary medicine to determine whether the test subject can wear a respirator while performing her or his duties.

d. The test subject shall be given the opportunity to wear the assigned respirator for one week. If the respirator does not provide a satisfactory fit during actual use, the test subject may request another ONFT which shall be performed immediately.

e. A respirator fit factor card shall be issued to the test subject with the following information

(1) Name.

(2) Date of fit test.

(3) Protection factors obtained through each manufacturer, model and approval number of respirator tested.

(4) Name and signature of the person that conducted the test.

f. Filters used for qualitative or quantitative fit testing shall be replaced weekly, whenever increased breathing resistance is

encountered, or when the test agent has altered the integrity of the filter media. Organic vapor cartridges/canisters shall be replaced daily or sooner if there is any indication of breakthrough by the test agent.

10. In addition, because the sealing of the respirator may be affected, quantitative fit testing shall be repeated immediately when the test subject has a:

(1) Weight change of 20 pounds or more,

(2) Significant facial scarring in the area of the facepiece seal,

(3) Significant dental change; i.e., multiple extractions without prosthesis, or acquiring dentures.

(4) Reconstructive or cosmetic surgery, or

(5) Any other condition that may interfere with facepiece sealing.

#### *11. Recordkeeping.*

A summary of all test results shall be maintained in for 3 years. The summary shall include:

(1) Name of test subject.

(2) Date of testing.

(3) Name of the test conductor.

(4) Fit factors obtained from every respirator tested (indicate manufacturer, model, size and approval number).

#### **Appendix D to §1926.58—Medical Questionnaires; Mandatory**

This mandatory appendix contains the medical questionnaires that must be administered to all employees who are exposed to asbestos, tremolite, anthophyllite, actinolite, or a combination of these minerals above the action level, and who will therefore be included in their *employer's* medical surveillance program. Part 1 of the appendix contains the Initial Medical Questionnaire, which must be obtained for all new hires who will be covered by the medical surveillance requirements. Part 2 includes the abbreviated Periodical Medical Questionnaire, which must be administered to all employees who are provided periodic medical examinations under the medical surveillance provisions of the standard.

Part 1  
INITIAL MEDICAL QUESTIONNAIRE

1. NAME \_\_\_\_\_  
2. SOCIAL SECURITY #                                
3. CLOCK NUMBER                                   
4. PRESENT OCCUPATION \_\_\_\_\_  
5. PLANT \_\_\_\_\_  
6. ADDRESS \_\_\_\_\_  
7. \_\_\_\_\_  
(Zip Code) \_\_\_\_\_  
8. TELEPHONE NUMBER \_\_\_\_\_  
9. INTERVIEWER \_\_\_\_\_  
10. DATE \_\_\_\_\_  
11. Date of Birth \_\_\_\_\_  
Month Day Year                                      
12. Place of Birth \_\_\_\_\_  
13. Sex 1. Male \_\_\_\_ 2. Female \_\_\_\_  
14. What is your marital status? 1. Single \_\_\_\_ 2. Married \_\_\_\_ 3. Widowed \_\_\_\_ 4. Separated/Divorced \_\_\_\_  
15. Race 1. White \_\_\_\_ 2. Black \_\_\_\_ 3. Asian \_\_\_\_ 4. Hispanic \_\_\_\_ 5. Indian \_\_\_\_ 6. Other \_\_\_\_  
16. What is the highest grade completed in school? \_\_\_\_\_  
(For Example 12 Years is completion of high school)  
OCCUPATIONAL HISTORY  
17A. Have you ever worked full time (30 hours per week or more) for 6 months or more? 1. Yes \_\_\_\_ 2. No \_\_\_\_  
IF YES TO 17A:  
B. Have you ever worked for a Year or more in any dusty job? 1. Yes \_\_\_\_ 2. No \_\_\_\_ 3. Does not Apply \_\_\_\_  
Specify job/industry \_\_\_\_\_ Total Years Worked \_\_\_\_  
Was dust exposure: 1. Mild \_\_\_\_ 2. Moderate \_\_\_\_ 3. Severe \_\_\_\_  
C. Have you ever been exposed to gas or chemical fumes in your work? 1. Yes \_\_\_\_ 2. No \_\_\_\_  
specify job/industry \_\_\_\_\_ Total Years Worked \_\_\_\_  
Was exposure: 1. Mild \_\_\_\_ 2. Moderate \_\_\_\_ 3. Severe \_\_\_\_  
D. What has been your usual occupation or job--the one you have worked at the longest?  
1. Job occupation \_\_\_\_\_  
2. Number of years employed in this occupation \_\_\_\_\_  
3. Position/job title \_\_\_\_\_  
4. Business field or industry \_\_\_\_\_  
(Record on lines the years in which you have worked in any of these industries, e.g. 1960-1969)  
Have you ever worked:  
YES NO  
E. In a mine? [ ] [ ]  
F. In a quarry? [ ] [ ]  
G. In a foundry? [ ] [ ]  
H. In a pottery? [ ] [ ]  
I. In a cotton, flax or hemp mill? [ ] [ ]  
J. With asbestos? [ ] [ ]  
18. PAST MEDICAL HISTORY YES NO  
A. Do You consider yourself to be in good health? [ ] [ ]  
If "No" state reason \_\_\_\_\_  
B. Have you any defect of vision? [ ] [ ]  
It "YES" state nature of defect \_\_\_\_\_  
C. Have You any hearing defect? [ ] [ ]  
If "YES" state nature of defect \_\_\_\_\_

D. Are you suffering from or have you ever suffered from:  
a. Epilepsy (or fits, seizures, convulsions)? [ ] [ ]  
b. Rheumatic fever? [ ] [ ]  
c. Kidney disease? [ ] [ ]  
d. Bladder disease? [ ] [ ]  
e. Diabetes? [ ] [ ]  
f. Jaundice? [ ] [ ]  
19. CHEST COLDS AND ILLNESSES  
19A. If you get a cold, does it usually go to your chest? (usually means more than 1/2 the time) 1. Yes \_\_\_\_ 2. No \_\_\_\_ 3. Don't get colds \_\_\_\_  
20A. During the past 3 years, have you had any chest illnesses that have kept you off work, indoors at home, or in bed? 1. Yes \_\_\_\_ 2. No \_\_\_\_  
IF YES TO 20A:  
B. Did you produce phlem with any of these chest illnesses? 1. Yes \_\_\_\_ 2. No \_\_\_\_ 3. Does Not Apply \_\_\_\_  
C. In the last 3 years, how many such illnesses with (increased) phlegm did you have which lasted a week or more? Number of illnesses \_\_\_\_ No such illnesses \_\_\_\_  
21. Did you have any lung tremble before the age of 16? 1. Yes \_\_\_\_ 2. No \_\_\_\_  
22. Have you ever had any of the following?  
1A. Attacks of bronchitis? 1. Yes \_\_\_\_ 2. No \_\_\_\_  
IF YES TO 1A:  
B. Was it confirmed by a doctor? 1. Yes \_\_\_\_ 2. No \_\_\_\_ 3. Does Not Apply \_\_\_\_  
C. At what age was your first attack? Age in Years \_\_\_\_ Does Not Apply \_\_\_\_  
2A. Pneumonia (include bronchopneumonia)? 1. Yes \_\_\_\_ 2. No \_\_\_\_  
IF YES TO 2A:  
B. Was it confirmed by a doctor? 1. Yes \_\_\_\_ 2. No \_\_\_\_ 3. Does Not Apply \_\_\_\_  
C. At what age did you first have it? Age in Years \_\_\_\_ Does Not Apply \_\_\_\_  
3A. Hay Fever? 1. Yes \_\_\_\_ 2. No \_\_\_\_  
IF YES TO 3A:  
B. Was it confirmed by a doctor? 1. Yes \_\_\_\_ 2. No \_\_\_\_ 3. Does not Apply \_\_\_\_  
C. At what age did it start? Age in Years \_\_\_\_ Does Not Apply \_\_\_\_  
23A. Have you ever had chronic bronchitis? 1. Yes \_\_\_\_ 2. No \_\_\_\_  
IF YES TO 23A:  
B. Do You still have it? 1. Yes \_\_\_\_ 2. No \_\_\_\_ 3. Does Not Apply \_\_\_\_  
C. Was it confirmed by a doctor? 1. Yes \_\_\_\_ 2. No \_\_\_\_ 3. Does Not Apply \_\_\_\_  
D. At what age did it start? Age in Years \_\_\_\_ Does Not Apply \_\_\_\_  
24A. Have you ever had emphysema? 1. Yes \_\_\_\_ 2. No \_\_\_\_  
IF YES TO 24A:  
B. Do You still have it? 1. Yes \_\_\_\_ 2. No \_\_\_\_ 3. Does Not Apply \_\_\_\_  
C. Was it confirmed by a doctor? 1. Yes \_\_\_\_ 2. No \_\_\_\_ 3. Does not Apply \_\_\_\_  
D. At what age did it start? Age in Years \_\_\_\_ Does Not Apply \_\_\_\_  
25A. Have you ever had asthma? 1. Yes \_\_\_\_ 2. No \_\_\_\_  
IF YES TO 25A:  
B. Do you still have it? 1. Yes \_\_\_\_ 2. No \_\_\_\_ 3. Does Not Apply \_\_\_\_  
C. Was it confirmed by a doctor? 1. Yes \_\_\_\_ 2. No \_\_\_\_ 3. Does Not Apply \_\_\_\_  
D. At what age did it start? Age in Years \_\_\_\_ Does Not Apply \_\_\_\_  
E. If you no longer have it, at what age did it stop? Age stopped \_\_\_\_ Does Not Apply \_\_\_\_  
26. Have you ever had:  
A. Any other chest illness? 1. Yes \_\_\_\_ 2. No \_\_\_\_  
If yes, please specify \_\_\_\_\_



B. Any chest operations? 1. Yes \_\_\_ 2. NO \_\_\_  
 If yes, please specify \_\_\_\_\_

C. Any chest injuries? 1. Yes \_\_\_ 2. No \_\_\_  
 If yes, please specify \_\_\_\_\_

27A. Has a doctor ever told you that you had heart trouble? 1. Yes \_\_\_ 2. No \_\_\_

IF YES TO 27A:  
 B. Have you ever had treatment for heart trouble in the past 10 years? 1. Yes \_\_\_ 2. No \_\_\_  
 3. Does Not Apply \_\_\_

28B. Has a doctor ever told you that You had high blood pressure? 1. Yes \_\_\_ 2. No \_\_\_

IF YES TO 28A:  
 B. Have you had any treatment for high blood pressure (hypertension) in the past 10 years? 1. Yes \_\_\_ 2. No \_\_\_  
 3. Does Not Apply \_\_\_

29. When did you last have your chest X-rayed? (Year) \_\_\_ 25 \_\_\_ 26 \_\_\_ 27 \_\_\_ 28 \_\_\_

30. Where did you last have your chest X-rayed (if known)? \_\_\_\_\_  
 What was the outcome? \_\_\_\_\_

**FAMILY HISTORY**

31. Were either of your natural parents ever told by a doctor that they had a chronic lung Condition such as:

|                               | FATHER  |   |   | MOTHER  |   |   |
|-------------------------------|---|---|---|---|---|---|
|                               | 1. Yes  | 2. NO   | 3. Don't Know   | 1. Yes  | 2. No   | 3. Do't Know  |
| A. Chronic Bronchitis?        | ___   | ___   | ___   | ___   | ___   | ___   |
| B. Emphysema ?                | ___   | ___   | ___   | ___   | ___   | ___   |
| C. Asthma ?                   | ___   | ___   | ___   | ___   | ___   | ___   |
| D. Lung cancer?               | ___   | ___   | ___   | ___   | ___   | ___   |
| E. Other chest conditions     | ___   | ___   | ___   | ___   | ___   | ___   |
| F. Is parent currently alive? | ___   | ___   | ___   | ___   | ___   | ___   |
| G. Please specify             | ___ Age if Living<br>___ Age at Death<br>___ Don't Know | ___ Age if Living<br>___ Age at Death<br>___ Don't Know | ___ Age if Living<br>___ Age at Death<br>___ Don't Know | ___ Age if Living<br>___ Age at Death<br>___ Don't Know | ___ Age if Living<br>___ Age at Death<br>___ Don't Know | ___ Age if Living<br>___ Age at Death<br>___ Don't Know |

H. Please specify cause of death \_\_\_\_\_

**COUGH**

32A. Do you usually have a cough? (Count a cough with first smoke or on first going out of doors. Exclude clearing of throat.) (If no, skip to question 32C.) 1. Yes \_\_\_ 2. No \_\_\_

B. Do You usually Cough as much as 4 to 6 times a day 4 or more days out of the week? 1. Yes \_\_\_ 2. No \_\_\_

C. Do you usually cough at all on getting up or first thing in the morning? 1. Yes \_\_\_ 2. No \_\_\_

D. Do you usually cough at all during the rest of the day or at night? 1. Yes \_\_\_ 2. No \_\_\_

IF YES TO ANY OF ABOVE (32A, B, C, or D), ANSWER THE FOLLOWING. IF NO TO ALL, CHECK DOES NOT APPLY AND SKIP TO NEXT PAGE

E. Do you usually cough like this on most days for 3 consecutive months or more during the year? 1. Yes \_\_\_ 2. No \_\_\_  
 3. Does not apply \_\_\_

F. For how many years have you had the cough? Number of years \_\_\_  
 Does not apply \_\_\_

33A. Do You usually bring up phlegm from your chest? (Count phlegm with the first smoke . . . on first going out of doors. Exclude phlegm from the nose. Count swallowed Phlegm.) (If no, skip to 33C) 1. Yes \_\_\_ 2. No \_\_\_

B. Do you usually bring up phlegm like this as much as twice a day 4 or more days out of the week? 1. Yes \_\_\_ 2. No \_\_\_

C. Do you usually bring up phlegm at all on getting up or first thing in the morning? 1. Yes \_\_\_ 2. No \_\_\_

D. Do you usually bring up phlegm at all during the rest of the day or at night? 1. Yes \_\_\_ 2. No \_\_\_

IF YES TO ANY OF THE ABOVE (33A, B, C, or D), ANSWER THE FOLLOWING: IF NO TO ALL, CHECK DOES NOT APPLY AND SKIP TO 34A.

E. Do You bring up phlegm like this on most days for 3 consecutive months or more during the year? 1. Yes \_\_\_ 2. No \_\_\_  
 3. Does not apply \_\_\_

F. For how many years have you had trouble with phlegm? Number of years \_\_\_  
 Does not apply \_\_\_

**EPISODES OF COUGH AND PHLEGM**

34A. Have you had periods or episodes of (increased.) cough and phlegm lasting for 3 weeks or more each year? 1. Yes \_\_\_ 2. No \_\_\_  
 \*For person who usually have Cough and/or phlegm)

IF YES TO 34A  
 B. For how long have you had at least 1 such episode per year? Number of years \_\_\_  
 Does not apply \_\_\_

**WHEEZING**

35A. Does your chest ever sound wheezy or whistling 1. Yes \_\_\_ 2. No \_\_\_  
 1. When you have a cold?  
 2. Occasionally apart from colds?  
 3. Most days or nights? 1. Yes \_\_\_ 2. No \_\_\_

IF YES TO 1, 2, or 3 in 35A  
 B. For how many years has this been present? Number of years \_\_\_  
 Does not apply \_\_\_

36A. Have you ever had an attack of wheezing that has made you feel short of breath? 1. Yes \_\_\_ 2. No \_\_\_

IF YES TO 36A  
 B. How old were you when you had your first such attack? Age in years \_\_\_  
 Does not apply \_\_\_

C. Have you had 2 or more such episodes? 1. Yes \_\_\_ 2. No \_\_\_  
 3. Does not apply \_\_\_

D. Have you ever required medicine or treatment? 1. Yes \_\_\_ 2. No \_\_\_  
 3. Does not apply \_\_\_

**BREATHLESSNESS**

37 If disabled from walking by any condition other than heart or lung disease, please describe and proceed to question 39A. Nature of condition(s) \_\_\_\_\_

38A. Are you troubled by shortness of breath when hurrying on the level or walking up a slight hill? 1. Yes \_\_\_ 2. No \_\_\_

**IF YES TO 38A**

B. Do you have to walk slower than people of your age on the level because of breath-illness? 1. Yes \_\_\_ 2. No \_\_\_  
 3. Does not apply \_\_\_

C. Do you ever have to stop for breath when walking at your own pace on the level? 1. Yes \_\_\_ 2. No \_\_\_  
 3. Does not apply \_\_\_

D. Do you ever have to stop for breath after walking about 100 yards (or after a few minutes on the level)? 1. Yes \_\_\_ 2. No \_\_\_  
 3. Does not apply \_\_\_

E. Are you too breathless to leave the house or breathless on dressing or climbing one flight of stairs? 1. Yes \_\_\_ 2. No \_\_\_  
 3. Does not apply \_\_\_

**TOBACCO SMOKING**

39A. Have you ever smoked cigarettes? (No means less than 20 packs of cigarettes or 12 oz. of tobacco in a lifetime or less than 1 cigarette a day for 1 year.) 1. Yes \_\_\_ 2. No \_\_\_

**IF YES TO 39A**

B. 130 You now smoke cigarettes (as of . . . month ago) 1. Yes \_\_\_ 2. No \_\_\_  
 3. Does not apply \_\_\_

C. How old were you when you first Started regular cigarette smoking? Age in years \_\_\_  
 Does not apply \_\_\_

D. If you have stopped smoking cigarettes completely, how old were you when you stopped? Age stopped \_\_\_  
 Check if still smoking \_\_\_  
 Does not apply \_\_\_

E. How many cigarettes do you smoke per day now? Cigarettes per day \_\_\_  
 Does not apply \_\_\_

F. On the average of the entire time you smoked, how many cigarettes did you smoke per day? cigarettes per day \_\_\_  
 Does not apply \_\_\_

G. Do or did you inhale the cigarette smoke? 1. Does not apply \_\_\_  
 2. Not at all \_\_\_  
 3. Slightly \_\_\_  
 4. Moderately \_\_\_  
 5. Deeply \_\_\_

40A. Have you ever smoked a pipe regularly? (Yes means more than 12 oz. of tobacco in a lifetime.) 1. Yes \_\_\_ 2. No \_\_\_

IF YES TO 40A:  
FOR PERSONS WHO HAVE EVER SMOKED A PIPE

- B. 1. How old were you when you started to smoke a pipe regularly? Age
2. If you have stopped smoking a pipe completely, how old were you when you stopped? Age stopped       
Check if still smoking pipe       
Does not apply
- C. On the average over the entire time you smoked a pipe, how much pipe tobacco did YOU smoke per week?      oz. per week (a standard pouch of tobacco contains 1 1/2 oz.)  
Does not apply
- D. How much pipe tobacco are you smoking now? oz. per week       
Not currently smoking a pipe
- E. Do you or did you inhale the pipe smoke?  
1. Never smoked       
2. Not at all       
3. Slightly       
4. Moderately       
5. Deeply
- 41A. Have you ever smoked cigars regularly? (Yes means more than 1 cigar a week for a year) 1. Yes      2. No

IF YES TO 41A  
PERSONS WHO HAVE EVER SMOKED CIGARS

- B. 1. How old were you when you started smoking cigars regularly? Age
2. If You have stopped smoking cigars completely, how old were you when You stopped. Age stopped       
Check if still smoking cigars       
Does not apply
- C. On the average over the entire time you smoked cigars, how many cigars did You smoke per week? Cigars per week       
Does not apply
- D. How many cigars are you smoking per week now? Cigars per week       
Check if not smoking cigars currently
- E. Do or did you inhale the cigar smoke?  
1. Never smoked       
2. Not at all       
3. Slightly       
4. Moderately       
5. Deeply

Signature \_\_\_\_\_ Date \_\_\_\_\_

13. RECENT MEDICAL HISTORY

- 13A. Do YOU consider yourself to be in good health? Yes      NO       
If No, state reason \_\_\_\_\_
- 13B. In the past year, have you developed: Yes      NO       
Epilepsy?       
Rheumatic fever?       
Kidney disease?       
Bladder disease?       
Diabetes?       
Jaundice?       
Cancer?

14. CHEST COLDS AND CHEST ILLNESSES

- 14A. If you get a cold, does it usually go to your chest? (usually means more than 1/2 the time) 1. Yes      2. No       
3. Don't get colds
- 15A. During the past year, have you had any chest illnesses that have kept you off work, indoors at home, or in bed? 1. Yes      2. No       
3. Does Not Apply

IF YES TO 15A:

150. Did you produce phlegm with any of these chest illnesses? 1. Yes      2. No       
3. Does Not Apply
- 15C. In the past year, how many such illnesses with (increased) phlegm did you have which lasted a week or more? Number of illnesses       
No such illnesses

16. RESPIRATORY SYSTEM

- In the past year have You had:
- |                 | Yes or No   | Further Comment on Positive Answers |
|-----------------|-------------|-------------------------------------|
| Asthma          | <u>    </u> |                                     |
| Bronchitis      | <u>    </u> |                                     |
| Hay Fever       | <u>    </u> |                                     |
| Other Allergies | <u>    </u> |                                     |

Part 2  
PERIODIC MEDICAL QUESTIONNAIRE

1. NAME \_\_\_\_\_
2. SOCIAL SECURITY #
3. CLOCK NUMBER
4. PRESENT OCCUPATION \_\_\_\_\_
5. PLANT \_\_\_\_\_
6. ADDRESS \_\_\_\_\_
7. \_\_\_\_\_ (Zip Code) \_\_\_\_\_
8. TELEPHONE NUMBER \_\_\_\_\_
9. INTERVIEWER \_\_\_\_\_
10. DATE \_\_\_\_\_
11. what is your marital status? 1. Single      4. Separated/ Divorced       
2. Married       
3. Widowed
12. OCCUPATIONAL HISTORY
- 12A. In the past year, did you work full time (30 hours per week or more) for 6 months or more? 1. Yes      2. No
- IF YES TO 12A:
- 12B. In the past year, did you work in a dusty job? 1. Yes      2. No       
3. Does Not Apply
- 12C. Was dust exposure: 1. Mild      2. Modetate      3. Severe
- 12D. In the past year, were you exposed to gas or chemical fumes in your work? 1. Y e s      2. No
- 12E. Was exposure: 1. Mild      2. Moderate      3. Severe
- 12F. In the past year, what was your:  
1. Job/occupation? \_\_\_\_\_  
2. Position/job title? \_\_\_\_\_

- |   | Yes or No   | Further Comment on Positive Answers                  |
|---|-------------|--|
| Pneumonia   | <u>    </u> |  |
| Tuberculosis  | <u>    </u> |  |
| Chest Surgery   | <u>    </u> |  |
| Other Lung Problems   | <u>    </u> |  |
| Heart Disease   | <u>    </u> |  |
| Do You have:  |             |  |
|   | Yes or No   | Further Comment on Positive Answers                  |
| Frequent colds  | <u>    </u> |  |
| Chronic cough   | <u>    </u> |  |
| Shortness of breath when walking or climbing one flight or stairs | <u>    </u> |  |
| Do you:   |             |  |
| Wheeze  | <u>    </u> |  |
| Cough up phlegm   | <u>    </u> |  |
| smoke cigarettes  | <u>    </u> | Packs per day <u>    </u> How many Years <u>    </u> |

Date \_\_\_\_\_ Signature \_\_\_\_\_

Appendix E to§1926.58—interpretation and Classification of Chest Roentgenograms-Mandatory

(a) Chest roentgenograms shall be interpreted and classified in accordance with a professionally accepted classification system and recorded on a Roentgenographic Interpretation Form. \*Form CSD/NIOSH (M) 2.8.

(b) Roentgenograms shall be interpreted and classified only by a B-reader, a board eligible/certified radiologist, or an experienced physician with known expertise in pneumoconioses.

(c) All interpreters, whenever interpreting chest roentgenograms made under this section, shall have immediately available for reference a complete set of the ILO-U/C International Classification of Radiographs for Pneumoconioses, 1980.

Appendix F to 1928.68-Work Practices and Engineering Controls for Major Asbestos Removal, Renovation, and Demolition Operations-Non-Mandatory

This is a non-mandatory appendix designed to provide guidelines to assist employers in complying with the requirements of 29 CFR 1928.58. Specifically, this appendix describes the equipment, methods, and procedures that should be used in major asbestos removal projects conducted to abate a recognized asbestos hazard or in preparation for building renovation or demolition. These projects require the construction of negative-pressure temporary enclosures to contain the asbestos material and to prevent the exposure of bystanders and other employees at the worksite. Paragraph (e)(6) of the standard requires that “. . . [W]henever feasible, the employer shall establish negative-pressure enclosures before commencing asbestos removal, demolition, or renovation operations.” Employers should also be aware that, when conducting asbestos removal projects, they may be required under the National Emissions Standards for Hazardous Air Pollutants (NESHAPS), 40 CFR Part 81, Subpart M, or EPA regulations under the Clear Water Act.

Construction of a negative-pressure enclosure is a simple but time-consuming process that requires careful preparation and execution; however, if the procedures below are followed, contractors should be assured of achieving a temporary barricade that will protect employees and others outside the enclosure from exposure to asbestos and minimize to the extent possible the exposure of asbestos workers inside the barrier as well.

The equipment and materials required to construct these barriers are readily available

and easily installed and used. In addition to an enclosure around the removal site, the standard requires employers to provide hygiene facilities that ensure that their asbestos contaminated employees do not leave the work site with asbestos on their persons or clothing the construction of these facilities is also described below. The steps in the process of preparing the asbestos removal site, building the enclosure, constructing hygiene facilities, removing the asbestos-containing material, and restoring the site include:

- (1) Planning the removal project;
- (2) Procuring the necessary materials and equipment;
- (3) Preparing the work area;
- (4) Removing the asbestos-containing material;
- (5) Cleaning the work area: and
- (6) Disposing of the asbestos-containing waste.

*Planning the Removal Project*

The planning of an asbestos removal project is critical to completing the project safely and cost-effectively. A written asbestos removal plan should be prepared that describes the equipment and procedures that will be used throughout the project. The asbestos abatement plan will aid not only in executing the project but also in complying with the reporting requirements of the USEPA asbestos regulations (40 CFR 61, Subpart M), which call for specific information such as a description of control methods and control equipment to be used and the disposal sites the contractor proposes to use to dispose of the asbestos containing materials.

The asbestos abatement plan should contain the following information:

- A physical description of the work area:
  - A description of the approximate amount of material to be removed;
  - A schedule for turning off and sealing existing ventilation systems;
  - Personnel hygiene procedures;
  - Labeling procedures:
    - A description of personal protective equipment and clothing to be worn by employees;
    - A description of the local exhaust ventilation systems to be used;
  - A description of work practices to be

observed by employees:

- A description of the methods to be used to remove the asbestos-containing material:
  - The wetting agent to be used;
  - A description of the sealant to be used at the end of the project;
  - An air monitoring plan
  - A description of the method to be used to transport waste material: and
  - The location of the dump site.

*Materials and Equipment Necessary for Asbestos Removal*

Although individual asbestos removal projects vary in terms of the equipment required to accomplish the removal of the material, some equipment and materials are common to most asbestos removal operations. Equipment and materials that should be available at the beginning of each project are: (1) rolls of polyethylene sheeting (z) rolls of gray duct tape or clear plastic tape; (3) HEPA filtered vacuum(s); (4) HEPA-filtered portable ventilation system(s); (5) a wetting agent (6) an airless sprayer; (7) a portable shower unit; (8) appropriate respirators; (9) disposable coveralls; (10) signs and labels; (11) pre-printed disposal bags; and (12) a manometer or pressure gauge.

**Rolls of Polyethylene Plastic and Tape.** Rolls of polyethylene plastic (6 mil in thickness) should be available to construct the asbestos removal enclosure and to seal windows, doors, ventilation systems, wall penetrations, and ceilings and floors in the work area. Gray duct tape or clear plastic tape should be used to seal the edges of the plastic and to seal any holes in the plastic enclosure. Polyethylene plastic sheeting can be purchased in rolls up to 12-20 feet in width and up to 100 feet in length.

**HEPA-Filtered Vacuum.** A HEPA-filtered vacuum is essential for cleaning the work area after the asbestos has been removed. Such vacuums are designed to be used with a HEPA [High Efficiency Particulate Air] filter, which is capable of removing 99.97 percent of the asbestos particles from the air. Various sizes and capacities of HEPA vacuums are available. One manufacturer, Nilfisk of America, Inc.\*, produces three models that range in capacity from 5.25 gallons to 17 gallons [see Figure F-1]. All of these models are portable, and all have long hoses capable

\* Mention of trade names or commercial products does not constitute endorsement or recommendation for use.

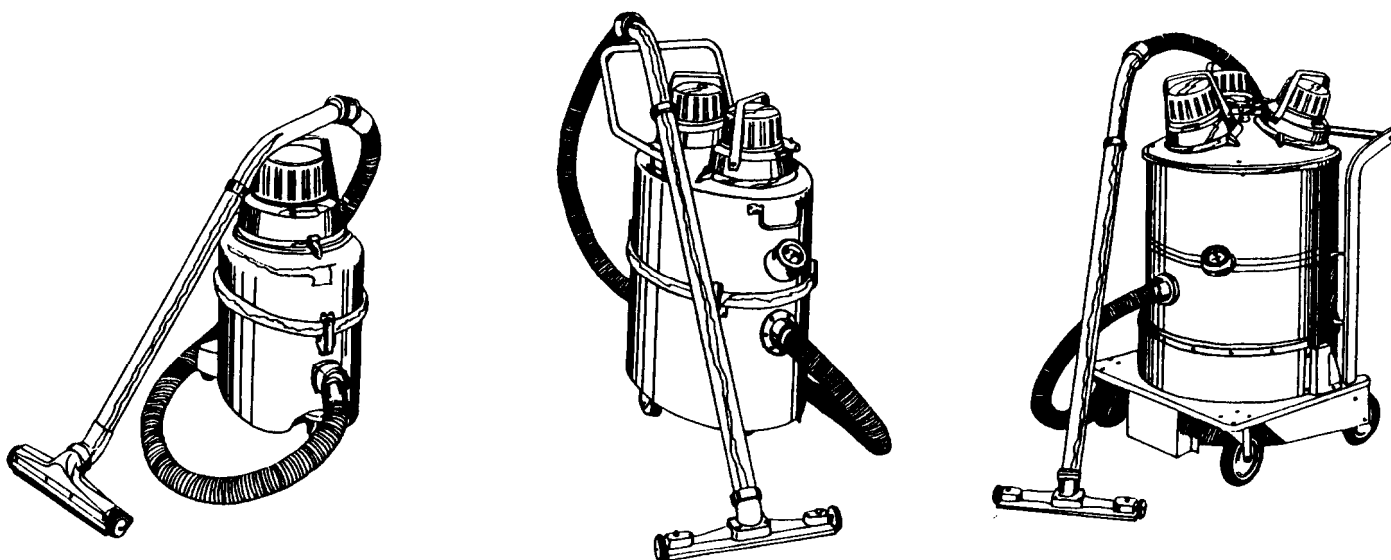

Source: Product Catalog, Asbestos Control Technologies, Inc., Maple Shade, N.J., 1985.

Figure F-1. HEPA Filtered Vacuums

of reaching out-of-the-way places, such as areas above ceiling tiles, behind pipes, etc.

**Exhaust Air Filtration System.** A portable ventilation system is necessary to create a negative pressure within the asbestos removal enclosure. Such units are equipped with a HEPA filter and are designed to exhaust and clean the air inside the enclosure before exhausting it to the outside of the enclosure (See Figure F-2). Systems are available from several manufacturers. One supplier, Micro-Trap, Inc.,<sup>1</sup> has two ventilation units that range in capacity from 600 cubic feet per minute (CFM) to 1,700 CFM. According to the manufacturer's literature, Micro-Trap<sup>®</sup> units filter particles of 0.3 micron in size with an efficiency of 99.99 percent. The number and capacity of units required to ventilate an enclosure depend on the size of the area to be ventilated.

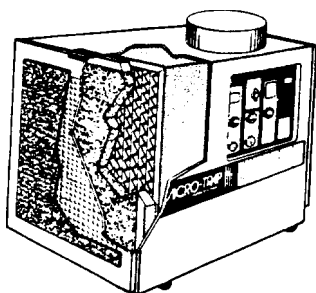

Source: Product Catalog, Asbestos Control Technologies, Inc., Maple Shade, N.J., 1985.

Figure F-2. Portable Exhaust Ventilation System with HEPA Filter

**Wetting Agents.** Wetting agents (surfactants) are added to water [which is then called amended water] and used to soak asbestos-containing materials: amended water penetrates more effectively than plain water and permits more thorough soaking of the asbestos-containing materials. Wetting

the asbestos-containing material reduces the number of fibers that will break free and become airborne when the asbestos-containing material is handled or otherwise disturbed. Asbestos-containing materials should be thoroughly soaked before removal is attempted the dislodged material should feel spongy to the touch. Wetting agents are generally prepared by mixing 1 to 3 ounces of wetting agent to 5 gallons of water.

One type of asbestos, amosite, is relatively resistant to soaking, either with plain or amended water. The work practices of choice when working with amosite containing material are to soak the material as much as possible and then to bag it for disposal immediately after removal, so that the material has no time to dry and be ground into smaller particles that are more likely to liberate airborne asbestos.

In a very limited number of situations, it may not be possible to wet the asbestos-containing material before removing it. Examples of such rare situations are: (1) Removal of asbestos material from a "live" electrical box that was oversprayed with the material when the rest of the area was sprayed with asbestos-containing coating and (2) removing asbestos-containing insulation from a live steam pipe. In both of these situations, the preferred approach would be to turn off the electricity or steam, respectively, to permit wet removal methods to be used. However, where removal work must be performed during working hours, i.e., when normal operations cannot be disrupted, the asbestos-containing material must be removed dry. Immediate bagging is then the only method of minimizing the amount of airborne asbestos generated.

**Airless Sprayer.** Airless sprayers are used to apply amended water to asbestos-containing materials. Airless sprayers allow the amended water to be applied in a fine spray that minimizes the release of asbestos fibers by reducing the impact of the spray on the material to be removed. Airless sprayers

are inexpensive and readily available.

**Portable Shower.** Unless the site has available a permanent shower facility that is contiguous to the removal area, a portable shower system is necessary to permit employees to clean themselves after exposure to asbestos and to remove any asbestos contamination from their hair and bodies. Taking a shower prevents employees from leaving the work area with asbestos on their clothes and thus prevents the spread of asbestos contamination to areas outside the asbestos removal area. This measure also protects members of the families of asbestos workers from possible exposure to asbestos. Showers should be supplied with warm water and a drain. A shower water filtration system to filter asbestos fibers from the shower water is recommended. Portable shower units are readily available, inexpensive, and easy to install and transport.

**Respirators.** Employees involved in asbestos removal projects should be provided with appropriate NIOSH-approved respirators. Selection of the appropriate respirator should be based on the concentration of asbestos fibers in the work area. If the concentration of asbestos fibers is unknown, employees should be provided with respirators that will provide protection against the highest concentration of asbestos fibers that can reasonably be expected to exist in the work area. For most work within an enclosure, employees should wear half-mask dual-filter cartridge respirators. Disposable face mask respirators (single-use) should not be used to protect employers from exposure to asbestos fibers.

**Disposable Coveralls.** Employees involved in asbestos removal operations should be provided with disposable impervious coveralls that are equipped with head and foot covers. Such coveralls are typically made of Tyvek.<sup>1</sup> The coverall has a zipper

<sup>1</sup>Mention of trade names or commercial products does not constitute endorsement or recommendation for use.

front and elastic wrists and ankles.

**Signs and Labels.** Before work begins, a supply of signs to demarcate the entrance to the work area should be obtained. Signs are available that have the wording required by the final OSHA standard. The required labels are also commercially available as press-an labels and pre-printed on the 6-mil polyethylene plastic bags used to dispose of asbestos-containing waste material.

#### Preparing the Work Area

Preparation for constructing negative-pressure enclosures should begin with the removal of all movable objects from the work area, e.g., desks, chairs, rugs, and light fixtures, to ensure that these objects do not become contaminated with asbestos. When movable objects are contaminated or are suspected of being contaminated, they should be vacuumed with a HEPA vacuum and cleaned with amended water, unless they are made of material that will be damaged by the wetting agent; wiping with plain water is recommended in those cases where amended water will damage the object. Before the asbestos removal work begins, objects that cannot be removed from the work area should be covered with a 6-mil-thick polyethylene plastic sheeting that is securely taped with duct tape or plastic tape to achieve an air-tight seal around the object.

#### Constructing the Enclosure

When all objects have either been removed from the work area or covered with plastic, all penetrations of the floor, walls, and ceiling should be sealed with 6-mil polyethylene plastic and tape to prevent airborne asbestos from escaping into areas outside the work area or from lodging in cracks around the penetrations. Penetrations that require sealing are typically found around electrical conduits, telephone wires, and water supply and drain pipes. A single entrance to be used for access and egress to the work area should be selected, and all other doors and windows should be sealed with tape or be covered with 6-mil polyethylene plastic sheeting and securely taped. Covering windows and unnecessary doors with a layer of polyethylene before covering the walls provides a second layer of protection and saves time in installation because it reduces the number of edges that must be cut and taped. All other surfaces such as support columns, ledges, pipes, and other surfaces should also be covered with polyethylene plastic sheeting and taped before the walls themselves are completely covered with sheeting.

Next a thin layer of spray adhesive should be sprayed along the top of all walls surrounding the enclosed work area, close to the wall-ceiling interface, and a layer of polyethylene plastic sheeting should be stuck to this adhesive and taped. The entire inside surfaces of all wall areas are covered in this manner, and the sheeting over the walls is extended across the floor area until it meets in the center of the area, where it is taped to form a single layer of material encasing the entire room except for the ceiling. A final layer of plastic sheeting is then laid across

the plastic-covered floor area and up the walls to a level of 2 feet or so; this layer provides a second protective layer of plastic sheeting over the floor, which can then be removed and disposed of easily after the asbestos-containing material that has dropped to the floor has been bagged and removed.

#### Building Hygiene Facilities

Paragraph (j) of the final standard mandates that employers involved in asbestos removal, demolition, or renovation operations provide their employees with hygiene facilities to be used to decontaminate asbestos-exposed workers, equipment, and clothing before such employees leave the work area. These decontamination facilities consist of:

- (1) A clean change room
- (2) A shower; and
- (3) An equipment room.

The clean change room is an area in which employees remove their street clothes and don their respirators and disposable protective clothing. The clean room should have hooks on the wall or be equipped with lockers for the storage of workers' clothing and personal articles. Extra disposable coveralls and towels can also be stored in the clean change room.

The shower should be contiguous with both the clean and dirty change room (see Figure F-3) and should be used by all workers leaving the work area. The shower should also be used to clean asbestos-contaminated equipment and materials, such as the outsides of asbestos waste bags and hand tools used in the removal process.

taped together from a double flap or barrier between the equipment room and the work area and between the shower and the clean change room (see Figure F-4).

When feasible, the clean change room, shower, and equipment room should be contiguous and adjacent to the negative-pressure enclosure surrounding the removal area. In the overwhelming number of cases, hygiene facilities can be built contiguous to the negative-pressure enclosure. In some cases, however, hygiene facilities may have to be located on another floor of the building where removal of asbestos-containing materials is taking place. In these instances, the hygiene facilities can in effect be made to be contiguous to the work area by constructing a polyethylene plastic "tunnel" from the work area to the hygiene facilities. Such a tunnel can be made even in cases where the hygiene facilities are located several floors above or below the work area; the tunnel begins with a double flap door at the enclosure, extends through the exit from the floor, continues down the necessary number of flights of stairs and goes through a double-flap entrance to the hygiene facilities, which have been prepared as described above. The tunnel is constructed of 2-inch by 4-inch lumber or aluminum struts and covered with 6-mil-thick polyethylene plastic sheeting.

In the rare instances when there is not enough space to permit any hygiene facilities to be built at the work site, employees should be directed to change into a clean disposable worksuit immediately after exiting the enclosure (without removing their respirators) and to proceed immediately to

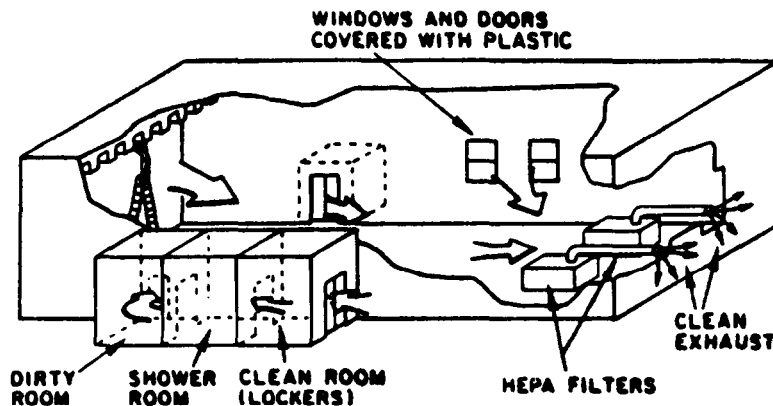

Source: EPA 1985. Asbestos Waste Management Guidance (EPA/530-SW-85-007).

Figure F-3. Cutaway View of Enclosure and Hygiene Facilities

The equipment room (also called the dirty change room) is the area where workers remove their protective coveralls and where equipment that is to be used in the work area can be stored. The equipment room should be lined with 6-mil-thick polyethylene plastic sheeting in the same way as was done in the work area enclosure. Two layers of 6-mil polyethylene plastic sheeting that are not

the shower. Alternatively, employees could be directed to vacuum their disposable coveralls with a HEPA-filtered vacuum before proceeding to a shower located a distance from the enclosure.

The clean room, shower, and equipment room must be sealed completely to ensure that the sole source of air flow through these areas originates from uncontaminated areas outside the asbestos removal, demolition, or

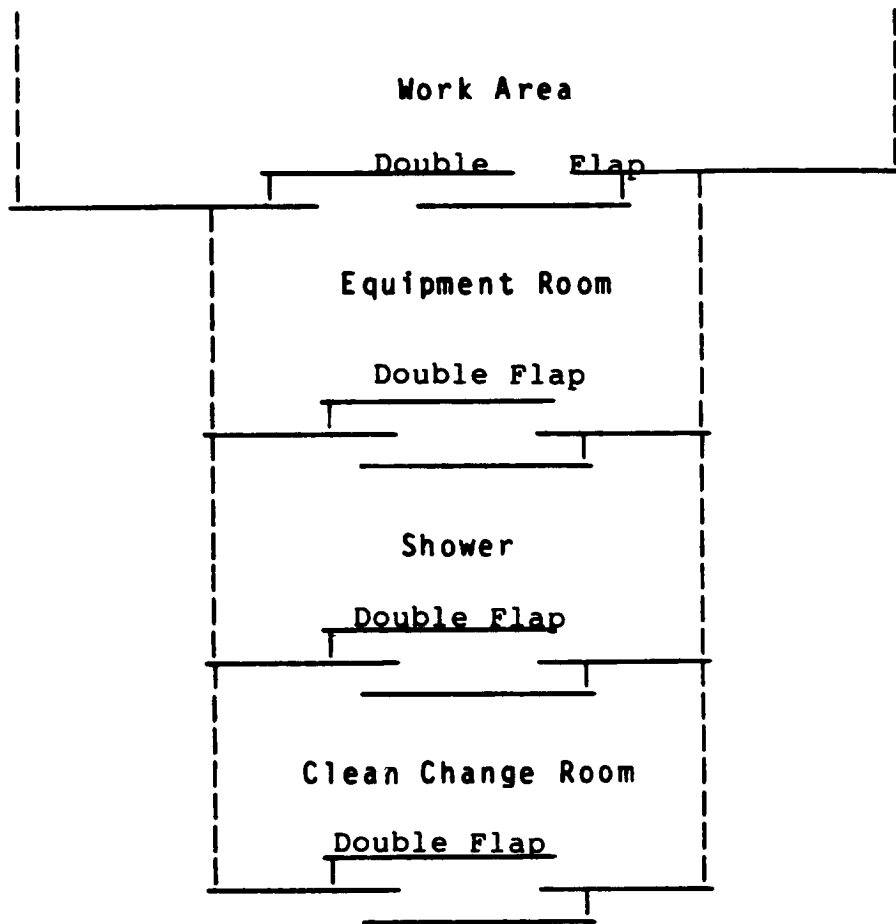

Figure F-4. Typical Hygiene Facility Layout

renovation enclosure. The shower must be drained properly after each use to ensure that contaminated water is not released to uncontaminated areas. If waste water is inadvertently released, it should be cleaned up as soon as possible to prevent any asbestos in the water from drying and becoming airborne in areas outside the work area.

*Establishing Negative Pressure Within the Enclosure*

After construction of the enclosure is completed, a ventilation system(s) should be installed to create a negative pressure within the enclosure with respect to the area outside the enclosure. Such ventilation systems must be equipped with HEPA filters to prevent the release of asbestos fibers to the environment outside the enclosure and should be operated 24 hours per day during the entire project until the final cleanup is completed and the results of final air samples are received from the laboratory. A sufficient amount of air should be exhausted to create a pressure of  $-0.02$  inches of water within the enclosure with respect to the area outside the enclosure.

These ventilation systems should exhaust the HEPA-filtered clean air outside the building in which the asbestos removal, demolition, or renovation is taking place (see

Figure F-5). If access to the outside is not available, the ventilation system can exhaust the HEPA-filtered asbestos-free air to an area within the building that is as far away as possible from the enclosure. Care should be taken to ensure that the clean air is released either to an asbestos-free area or in such a way as not to disturb any asbestos-containing materials.

A manometer or pressure gauge for measuring the negative pressure within the enclosure should be installed and should be monitored frequently throughout all work shifts during which asbestos removal, demolition, or renovation takes place. Several types of manometers and pressure gauges are available for this purpose.

All asbestos removal, renovation, and demolition operations should have a program for monitoring the concentration of airborne asbestos and employee exposures to asbestos. Area samples should be collected inside the enclosure (approximately four samples for 5000 square feet of enclosure area). At least two samples should be collected outside the work area, one at the entrance to the clean change room and one at the exhaust of the portable ventilation system. In addition, several breathing zone samples should be collected from those workers who can reasonably be expected to have the highest potential exposure to

asbestos.

*Removing Asbestos Materials*

Paragraph (e)(6)(ii) requires that employers involved in asbestos removal, demolition, or renovation operations designate a competent person to:

- (1) Set up the enclosure;
- (2) Ensure the integrity of the enclosure;
- (3) Control entry to and exit from the enclosure;
- (4) Supervise all employee exposure monitoring required by this section;
- (5) Ensure the use of protective clothing and equipment;
- (6) Ensure that employees are trained in the use of engineering controls, work practices, and personal protective equipment;
- (7) Ensure the use of hygiene facilities and the observance of proper decontamination procedures; and
- (6) Ensure that engineering controls are functioning properly.

The competent person will generally be a Certified Industrial Hygienist, an industrial hygienist with training and experience in the handling of asbestos, or a person who has such training and experience as a result of on-the-job training and experience.

Ensuring the integrity of the enclosure is accomplished by inspecting the enclosure before asbestos removal work begins and prior to each work shift throughout the entire period work is being conducted in the enclosure. The inspection should be conducted by locating all areas where air might escape from the enclosure: this is best accomplished by running a hand over all seams in the plastic enclosure to ensure that no seams are ripped and the tape is securely in place.

The competent person should also ensure that all unauthorized personnel do not enter the enclosure and that all employees and other personnel who enter the enclosure have the proper protective clothing and equipment. He or she should also ensure that all employees and other personnel who enter the enclosure use the hygiene facilities and observe the proper decontamination procedures (described below).

Proper work practices are necessary during asbestos removal, demolition, and renovation to ensure that the concentration of asbestos fibers inside the enclosure remains as low as possible. One of the most important work practices is to wet the asbestos-containing material before it is disturbed. After the asbestos-containing material is thoroughly wetted, it should be removed by scraping (as in the case of sprayed-on or troweled-on ceiling material) or removed by cutting the metal bands or wire mesh that support the asbestos-containing material on boilers or pipes. Any residue that remains on the surface of the object from which asbestos is being removed should be wire brushed and wet wiped.

Bagging asbestos waste material promptly after its removal is another work practice control that is effective in reducing the airborne concentration of asbestos within the

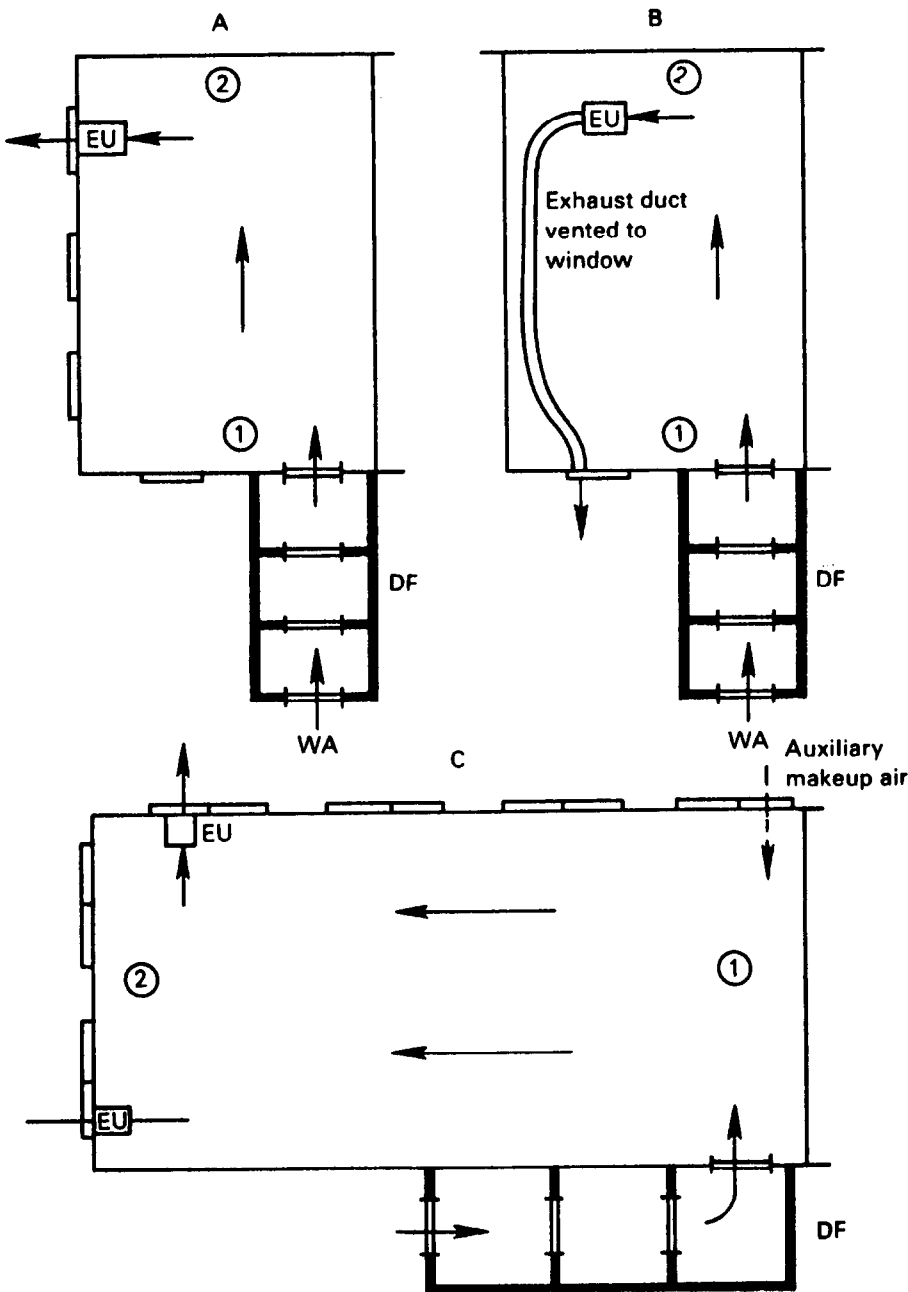

Source: EPA 1985. Guidance for Controlling Asbestos-Containing materials in Buildings (EPA 560/5-85-024).

Figure F-5. Examples of Negative pressure Systems. DF, Decontamination Facility; EU, Exhaust Unit; WA, Worker Access; A, Single-room work area with multiple windows; B, Single-room work area with single window near entrance; C, Large single-room work area with windows and auxiliary makeup air source (dotted arrow). Arrows denote direction of air flow. Circled numbers indicate progression of removal sequence.

enclosure. Whenever possible, the asbestos should be removed and placed directly into bags for disposal rather than dropping the material to the floor and picking up all of the material when the removal is complete. If a

significant amount of time elapses between the time that the material is removed and the time it is bagged, the asbestos material is likely to dry out and generate asbestos-laden dust when it is disturbed by people working within the enclosure. Any asbestos-

contaminated supplies and equipment that cannot be decontaminated should be disposed of in pre-labeled bags; items in this category include plastic sheeting, disposable work clothing, respirator cartridges, and contaminated wash water.

A checklist is one of the most effective methods of ensuring adequate surveillance of the integrity of the asbestos removal enclosure. Such a checklist is shown in Figure F-6. Filling out the checklist at the beginning of each shift in which asbestos removal is being performed will serve to document that all the necessary precautions will be taken during the asbestos removal work. The checklist contains entries for ensuring that:

- The work area enclosure is complete;
- The negative-pressure system is in operation
- Necessary signs and labels are used;
- Appropriate work practices are used
- Necessary protective clothing and equipment are used and
- Appropriate decontamination procedures are being followed.

#### Cleaning the Work Area

After all of the asbestos-containing material is removed and bagged, the entire work area should be cleaned until it is free of all visible asbestos dust. All surfaces from which asbestos has been removed should be cleaned by wire brushing the surfaces, HEPA vacuuming these surfaces, and wiping them with amended water. The inside of the plastic enclosure should be vacuumed with a HEPA vacuum and wet wiped until there is no visible dust in the enclosure. Particular attention should be given to small horizontal surfaces such as pipes, electrical conduits, lights, and support tracks for drop ceilings. All such surfaces should be free of visible dust before the final air samples are collected.

Additional sampling should be conducted inside the enclosure after the cleanup of the work area has been completed. Approximately four area samples should be collected for each 5000 square feet of enclosure area. The enclosure should not be dismantled unless the final samples show asbestos concentrations of less than the final standard's action level. EPA recommends that a clearance level of 0.01 f/cc be achieved before cleanup is considered complete.

A clearance checklist is an effective method of ensuring that all surfaces are adequately cleaned and the enclosure is ready to be dismantled. Figure F-7 shows a checklist that can be used during the final inspection phase of asbestos abatement, removal, or renovation operations.

Asbestos Removal, Renovation, and  
Demolition Checklist

Date: \_\_\_\_\_ Location: \_\_\_\_\_

Supervisor \_\_\_\_\_ Project # \_\_\_\_\_  
Work Area (sq. ft.) \_\_\_\_\_

|      |  | Yes   | No    |
|------|--|-------|-------|
| I.   | Work site barrier                          |       |       |
|      | Floor covered                              | _____ | _____ |
|      | Walls covered                              | _____ | _____ |
|      | Area ventilation off                       | _____ | _____ |
|      | All edges sealed                           | _____ | _____ |
|      | Penetrations sealed                        | _____ | _____ |
|      | Entry curtains                             | _____ | _____ |
| II.  | Negative Air Pressure                      |       |       |
|      | HEPA Vac _____ Ventilation system _____    |       |       |
|      | Constant operation                         | _____ | _____ |
|      | Negative pressure achieved                 | _____ | _____ |
| III. | Signs                                      |       |       |
|      | Work area entrance                         | _____ | _____ |
|      | Bags labeled                               | _____ | _____ |
| IV.  | Work Practices                             |       |       |
|      | Removed material promptly bagged           | _____ | _____ |
|      | Material worked wet                        | _____ | _____ |
|      | HEPA vacuum used                           | _____ | _____ |
|      | No smoking                                 | _____ | _____ |
|      | No eating, drinking                        | _____ | _____ |
|      | Work area cleaned after completion         | _____ | _____ |
|      | Personnel decontaminated each<br>departure | _____ | _____ |
| V.   | Protective Equipment                       |       |       |
|      | Disposable clothing used one time          | _____ | _____ |
|      | Proper NIOSH-approved respirators          | _____ | _____ |
| VII. | Showers                                    |       |       |
|      | On site                                    | _____ | _____ |
|      | Functioning                                | _____ | _____ |
|      | Soap and towels                            | _____ | _____ |
|      | Used by all personnel                      | _____ | _____ |

Figure F-6. Checklist



**Final Inspection of Asbestos Removal, Renovation,  
and Demolition Projects**

Date: \_\_\_\_\_  
 Project: \_\_\_\_\_  
 Location: \_\_\_\_\_  
 Building: \_\_\_\_\_

**CHECKLIST:**

| Residual dust on:        | Yes   | No    |               | Yes   | No    |
|--------------------------|-------|-------|---------------|-------|-------|
| a. Floor                 | _____ | _____ | e. Horizontal | _____ | _____ |
| b. Horizontal surfaces   | _____ | _____ | f. Pipes      | _____ | _____ |
| c. Pipes                 | _____ | _____ | g. Ducts      | _____ | _____ |
| d. Ventilation equipment | _____ | _____ | h. Register   | _____ | _____ |
|                          |       |       | i. Lights     | _____ | _____ |

**FIELD NOTES:**

Record any problems encountered here.

\_\_\_\_\_

\_\_\_\_\_

\_\_\_\_\_

\_\_\_\_\_

\_\_\_\_\_

\_\_\_\_\_

\_\_\_\_\_

\_\_\_\_\_

\_\_\_\_\_

\_\_\_\_\_

**FINAL AIR SAMPLE RESULTS:** \_\_\_\_\_

\_\_\_\_\_

\_\_\_\_\_

Figure F-7. Clearance Checklist

BILLING CODE 4510-26-C

Appendix G to § 1926.58—Work Practices and Engineering Controls for Small-Scale, Short-Duration Asbestos Renovation and Maintenance Activities-Non-Mandatory

This appendix is not mandatory, in that construction industry employers may choose to comply with all of the requirements of OSHA's final rule for occupational exposure to asbestos in the construction industry, § 1926.58. However, employers wishing to be exempted from the requirements of paragraphs (e)(6) and (f)(2)(ii)(B) of § 1926.58 shall comply with the provisions of this appendix when performing small-scale, short-duration renovation or maintenance activities. OSHA anticipates that employers in the electrical, carpentry, utility, plumbing, and interior construction trades may wish to avail themselves of the final standards exemptions for small-scale, short-duration renovation and maintenance operations.

*Definition of Small-Scale, Short-Duration Activities*

For the purposes of this appendix, small-scale, short-duration renovation and

maintenance activities are tasks such as, but not limited to:

- Removal of asbestos-containing insulation on pipes;
- Removal of small quantities of asbestos-containing insulation on beams or above ceilings;
- Replacement of an asbestos-containing gasket on a valve;
- Installation or removal of a small section of drywall;
- Installation of electrical conduits through or proximate to asbestos-containing materials.

Evidence in the record (see the Summary and Explanation section of the preamble for paragraph (g), Methods of Compliance, for specific citations) suggests that the use of certain engineering and work practice controls is capable of reducing employee exposures to asbestos to levels below the final standard's action level (0.1 f/cc). Several controls and work practices, used either singly or in combination, can be employed effectively to reduce asbestos exposures during small maintenance and

renovation operations. These include:

- Wet methods;
  - Removal methods
- Use of Glove bags
- Removal of entire asbestos insulated pipes or structures
- Use of mini-enclosures
- Enclosure of asbestos materials; and
  - Maintenance programs.
- This appendix describes these controls and work practices in detail.

*Preparation of the Area Before Renovation or Maintenance Activities*

The first step in preparing to perform a small-scale, short-duration asbestos renovation or maintenance task, regardless of the abatement method that will be used, is the removal from the work area of all objects that are movable to protect them from asbestos contamination. Objects that cannot be removed must be covered completely with a 6-mil-thick polyethylene plastic sheeting before the task begins. If objects have already been contaminated, they should be thoroughly cleaned with a High Efficiency Particulate Air (HEPA) filtered vacuum or be wet wiped before they are removed from the work area or completely encased in the plastic.

*Wet Methods*

Whenever feasible, and regardless of the abatement method to be used (e.g., removal, enclosure, use of glove bags), wet methods must be used during small-scale, short duration maintenance and renovation activities that involve disturbing asbestos-containing materials. Handling asbestos materials wet is one of the most reliable methods of ensuring that asbestos fibers do not become airborne, and this practice should therefore be used whenever feasible. As discussed in the Summary and Explanation section of the preamble for paragraph (g), Methods of Compliance, wet methods can be used in the great majority of workplace situations. Only in cases where asbestos work must be performed on live electrical equipment, on live steam lines, or in other areas where water will seriously damage materials or equipment may dry removal be performed. Amended water or another wetting agent should be applied by means of an airless sprayer to minimize the extent to which the asbestos-containing material is disturbed.

Asbestos-containing materials should be wetted from the initiation of the maintenance or renovation operation and wetting agents should be used continually throughout the work period to ensure that any dry asbestos-containing material exposed in the course of the work is wet and remains wet until final disposal.

*Removal of Small Amount of Asbestos-Containing Materials*

Several methods can be used to remove small amounts of asbestos-containing materials during small-scale, short-duration renovation or maintenance tasks. These include the use of glove bags, the removal of an entire asbestos-covered pipe or structure,

and the construction of mini-enclosures. The procedures that employers must use for each of these operations if they wish to avail themselves of the final rule's exemptions are described in the following sections.

### Glove Bags

As discussed in the Summary and Explanation section of the preamble for paragraph (g), Methods of Compliance, evidence in the record indicate that the use of glove bags to enclose the work area during small-scale, short-duration maintenance or renovation activities will result in employee exposures to asbestos that are below the final standard's action level of 0.1 f/cc. This appendix provides requirements for glove-bag procedures to be followed by employers wishing to avail themselves of the standards exemptions for each activities. OSHA has determined that the use of these procedures will reduce the 8 hour time weighted average [TWA] exposures of employees involved in these work operations to levels below the action level and will thus provide a degree of employee protection equivalent to that provided by compliance with all provisions of the final rule.

**Glove Bag Installation.** Glove bags are approximately 40-inch-wide times 64-inch-long bags fitted with arms through which the work can be performed (see Figure G-1(A)). When properly installed and used, they permit workers to remain completely isolated from the asbestos material removed or replaced inside the bag. Glove bags can thus provide a flexible, easily installed, and quickly dismantled temporary small work area enclosure that is ideal for small-scale asbestos renovation or maintenance jobs.

These bags are single use control devices that are disposed of at the end of each job. The bags are made of transparent 6-mil-thick polyethylene plastic with arms of Tyvek \* material (the same material used to make the disposable protective suite used in major asbestos removal, renovation, and demolition operations and in protective gloves). Glove bags are readily available from safety supply stores or specialty asbestos removal supply houses. Glove bags come pre-labeled with the asbestos warning label prescribed by OSHA and EPA for bags used to dispose of asbestos waste.

**Glove Bag Equipment and Supplies.** Supplies and materials that are necessary to use glove bags effectively include:

- (1) Tape to seal the glove bag to the area from which asbestos is to be removed
- (2) Amended water or other wetting agents;
- (3) An airless sprayer for the application of the wetting agent;

\* Mention of trade names or commercial products does not constitute endorsement or recommendation for use.

- (4) Bridging encapsulant (a paste-like substance for coating asbestos) to seal the rough edges of any asbestos-containing materials that remain within the glove bag at the points of attachment after the rest of the asbestos has been removed

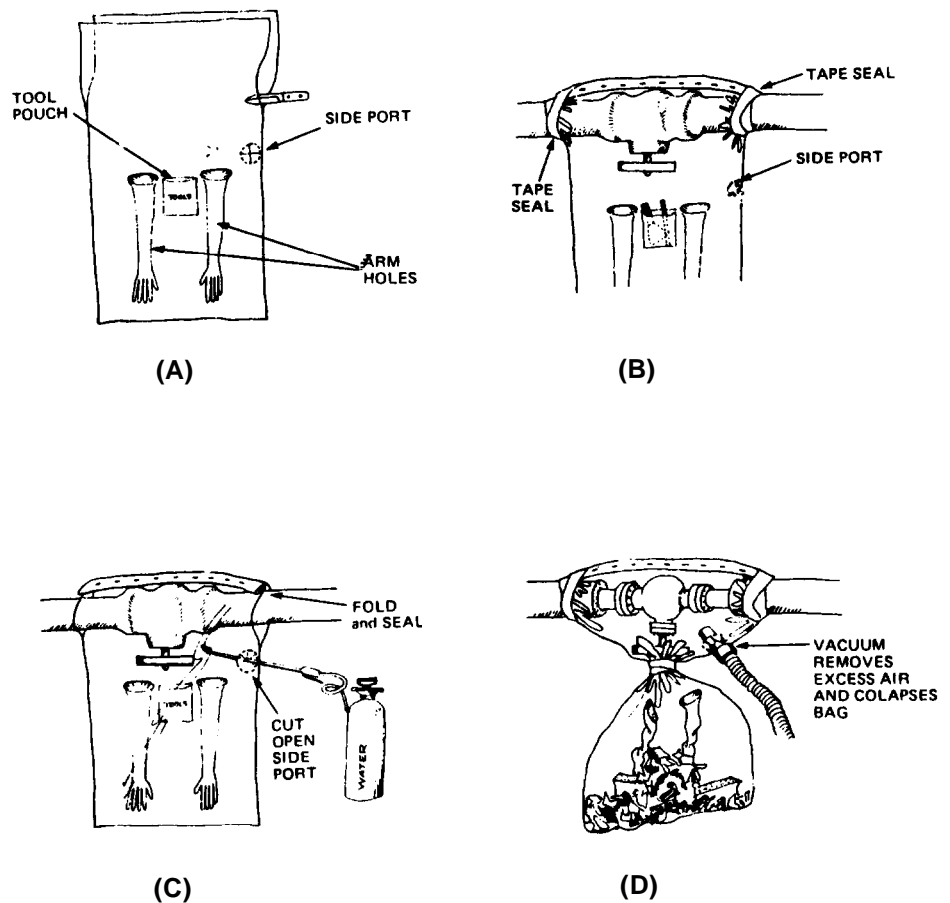

Figure G-1. Diagrams Showing Proper Use of Glove Bags in Small-Scale, Short-Duration Maintenance and Renovation Operations.

- (5) Tools such as razor knives, nips, and wire brushes (or other tools suitable for cutting wire, etc.);

- (6) A HEPA filter-equipped vacuum for evacuating the glove bag [to minimize the release of asbestos fibers) during removal of the bag from the work area and for cleaning any material that may have escaped during the installation of the glove bag; and

- (7) HEPA-equipped dust cartridge respirators for use by the employees involved in the removal of asbestos with the glove bag.

**Glove Bag Work Practices.** The proper use of glove bags requires the following steps:

- (1) Glove bags must be installed so that they completely cover the pipe or other structure where asbestos work is to be done. Glove bags are installed by cutting the sides of the glove bag to fit the size of the pipe from which asbestos is to be removed. The glove bag is attached to the pipe by folding the open edges together and securely sealing them with tape. All openings in the glove bag must be sealed with duct tape or equivalent material. The bottom seam of the glove bag must also be sealed with duct tape or equivalent to prevent any leakage from the bag that may result from a defect in the bottom seam (Figure G-1(B)).

- (2) The employee who is performing the asbestos removal with the glove bag must don a half mask dual-cartridge HEPA-equipped respirator; respirators should be worn by employees who are in close contact with the glove bag and who may thus be exposed as a result of small gaps in the seams of the bag or holes punched through the bag by a razor knife or a piece of wire mesh.

- (3) The removed asbestos material from the pipe or other surface that has fallen into the enclosed bag must be thoroughly wetted with a wetting agent (applied with an airless sprayer through the pre-cut port provided in meet gloves bags or applied through a small hole cut in the bag) (Figure G-1(C)).

- (4) Once the asbestos material has been thoroughly wetted, it can be removed from the pipe, beam or other surface. The choice of tool to use to remove the asbestos-containing material depends on the type of material to be removed. Asbestos-containing materials are generally covered with painted canvas and/or wire mesh. Painted canvas can be cut with a razor knife and peeled away from the asbestos-containing material underneath. Once the canvas has been peeled away, the asbestos-containing material underneath may

be dry, in which case it should be re-sprayed with a wetting agent to ensure that it generates as little dust as possible when removed. If the asbestos-containing material is covered with wire mesh, the mesh should be cut with nips, tin snips, or other appropriate tool and removed.

A wetting agent must then be used to spray any layer of dry material that is exposed beneath the mesh, the surface of the stripped underlying structure, and the inside of the glove bag.

(5) After removal of the layer of asbestos-containing material, the pipe or surface from which asbestos has been removed must be thoroughly cleaned with a wire brush and wet wiped with a wetting agent until no traces of the asbestos containing material can be seen.

(6) Any asbestos containing insulation edges that have been exposed as a result of the removal or maintenance activity must be encapsulated with bridging encapsulant to ensure that the edges do not release asbestos fibers to the atmosphere after the glove bag has been removed.

(7) When the asbestos removal and encapsulation have been completed, a vacuum hose from a HEPA filtered vacuum must be inserted into the glove bag through the port to remove any air in the bag that may contain asbestos fibers. When the air has been removed from the bag, the bag should be squeezed tightly (as close to the top as possible), twisted, and sealed with tape, to keep the asbestos materials safely in the bottom of the bag. The HEPA vacuum can then be removed from the bag and the glove bag itself can be removed from the work area to be disposed of properly [Figure G-1(D)].

#### Mini-Enclosures

In some instances, such as removal of asbestos from a small ventilation system or from a short length of duct, a glove bag may not be either large enough or of the proper shape to enclose the work area. In such cases, a mini-enclosure can be built around the area where small-scale, short-duration asbestos maintenance or renovation work is to be performed (Figure G-2). Such an enclosure should be constructed of 6-mil-thick polyethylene plastic sheeting and can be small enough to restrict entry to the asbestos work area to one worker.

For example, a mini-enclosure can be built in a small utility closet when asbestos-containing duct covering is to be removed. The enclosure is constructed by:

- (1) Affixing plastic sheeting to the walls with spray adhesive and tape;
- (2) Covering the floor with plastic and sealing the plastic covering the floor to the plastic on the walls,
- (3) Sealing any penetrations such as pipes or electrical conduits with tape; and
- [4] Constructing a small change room (approximately 3 feet square) made of 6-mil-thick polyethylene plastic supported by 2-inch by 4-inch lumber [the plastic should be attached to the lumber supports with staples or spray adhesive and tape].

The change room should be contiguous to

#### Top View

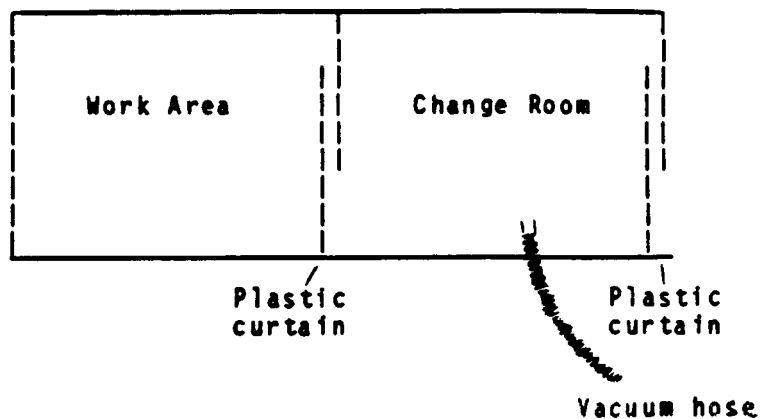

#### Side View

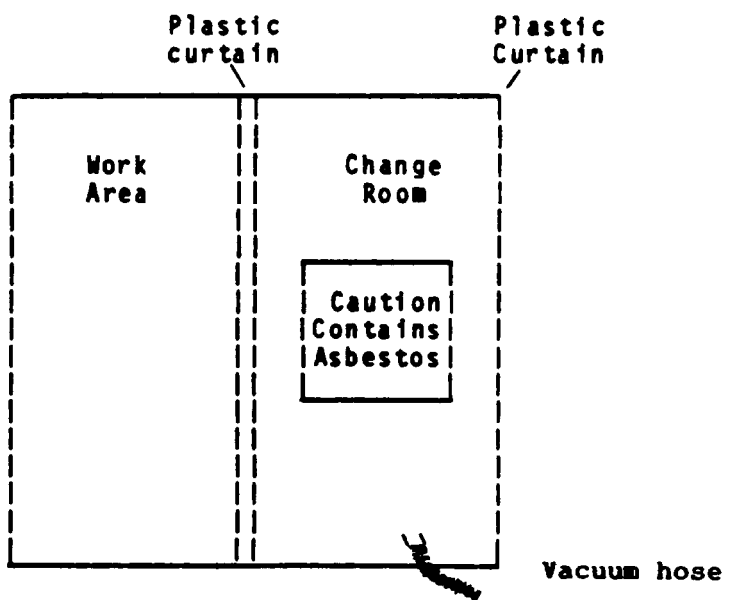

Figure G-2, Schematic of Mini-enclosure

the mini enclosure, and is necessary to allow the worker to vacuum off his protective coveralls and remove them before leaving the work area. While inside the enclosure, the worker should wear Tyvek<sup>1</sup> disposable coveralls and use the appropriate HEPA filtered dual cartridge respiratory protection.

The advantages of mini-enclosures are that they limit the spread of asbestos contamination, reduce the potential exposure of bystanders and other workers who may be working in adjacent areas, and are quick and easy to install. The disadvantage of mini-enclosures is that they may be too small to contain the equipment necessary to create a negative pressure within the enclosure; however, the double layer of plastic sheeting will serve to restrict the release of asbestos fibers to the area outside the enclosure.

#### Removal of Entire Structures

When pipes are insulated with asbestos-

containing materials, removal of the entire pipe may be more protective, easier, and more cost-effective than stripping the asbestos insulation from the pipe. Before such a pipe is cut, the asbestos-containing insulation must be wrapped with 6-oz polyethylene plastic and securely sealed with duct tape or equivalent. This plastic covering will prevent asbestos fibers from becoming airborne as a result of the vibration created by the power saws used to cut the pipe. If possible, the pipes should be cut at locations that are not insulated to avoid disturbing the asbestos. If a pipe is completely insulated with asbestos-containing materials, small sections should be stripped using the glove-bag method described above before the pipe is cut at the stripped sections.

#### Enclosure

The decision to enclose rather than remove asbestos-containing material from an area

depends on the building owner's preference, i.e., for removal or containment. Owners consider such factors as cost effectiveness, the physical configuration of the work area, and the amount of traffic in the area when determining which abatement method to use.

If the owner chooses to enclose the structure rather than to remove the asbestos-containing material insulating it, a solid structure (airtight walls and ceilings) must be built around the asbestos covered pipe or structure to prevent the release of asbestos-containing materials into the area beyond the enclosure and to prevent disturbing these materials by casual contact during future maintenance operations.

Such a permanent (i.e., for the life of the building) enclosure should be built of new construction materials and should be impact resistant and airtight. Enclosure walls should be made of tongue-and-groove boards, boards with spine joints, or gypsum boards having taped seams. The underlying structure must be able to support the weight of the enclosure. (Suspended ceilings with laid in panels do not provide airtight enclosures and should not be used to enclose structures covered with asbestos-containing materials.) All joints between the walls and ceiling of the enclosure should be caulked to prevent the escape of asbestos fibers. During the installation of enclosures, tools that are used (such as drills or rivet tools) should be equipped with HEPA-filtered vacuums. Before constructing the enclosure, all electrical conduits, telephone lines, recessed lights, and pipes in the area to be enclosed should be moved to ensure that the enclosure will not have to be re-opened later for routine or emergency maintenance. If such lights or other equipment cannot be moved to a new location for logistic reasons, or if moving them will disturb the asbestos-containing materials, removal rather than enclosure of the asbestos-containing materials is the appropriate control method to use.

### Maintenance Program

An asbestos maintenance program must be initiated in all facilities that have asbestos-containing materials. Such a program should include:

- Development of an inventory of all asbestos-containing materials in the facility;
- Periodic examination of all asbestos-containing materials to detect deterioration;
- Written procedures for handling asbestos materials during the performance of small-scale, short-duration maintenance and renovation activities;
- Written procedures for asbestos disposal; and
- Written procedures for dealing with asbestos-related emergencies.

Members of the building's maintenance engineering staff (electricians, heating/ air conditioning engineers, plumbers, etc.) who may be required to handle asbestos-containing materials should be trained in safe procedures. Such training should include at a minimum:

- Information regarding types of asbestos and its various uses and forms;
- Information on the health effects associated with asbestos exposure;

- Descriptions of the proper methods of handling asbestos-containing materials; and
- Information on the use of HEPA-equipped dual cartridge respiratory and other personal protection during maintenance activities.

### Prohibited Activities

The training program for the maintenance engineering staff should describe methods of handling asbestos-containing materials as well as routine maintenance activities that are prohibited when asbestos-containing materials are involved. For example, maintenance staff employees should be instructed:

- Not** to drill holes in asbestos-containing materials;
- Not** to hang plants or pictures on structures covered with asbestos-containing materials;
- Not** to sand asbestos-containing floor tile;
- Not** to damage asbestos-containing materials while moving furniture or other objects;
- Not** to install curtains, drapes, or dividers in such a way that they damage asbestos-containing materials;
- Not** to dust floors, ceilings, moldings or other surfaces in asbestos-contaminated environments with a dry brush or sweep with a dry broom
- Not** to use an ordinary vacuum to clean up asbestos-containing debris;
- Not** to remove ceiling tiles below asbestos-containing materials without wearing the proper respiratory protection, clearing the area of other people, and observing asbestos removal waste disposal procedures;
- Not** to remove ventilation system filters dry; and
- Not** to shake ventilation system filters.

<sup>1</sup>Mention of trade names or commercial products does not constitute endorsement or recommendation for use.

### Appendix H to §1926.58—Substance Technical Information for Asbestos–Non-Mandatory

#### 1. Substance Identification

A. Substance: "Asbestos" is the name of a class of magnesium-silicate minerals that occur in fibrous form. Minerals that are included in this group are chrysotile, crocidolite, amosite, tremolite asbestos, anthophyllite asbestos, and actinolite asbestos.

B. Asbestos, tremolite, anthophyllite, and actinolite are used in the manufacture of heat-resistant clothing, automatize brake and clutch linings, and a variety of building materials including floor tiles, roofing felts, ceiling tiles, asbestos-cement pipe and sheet, and fire-resistant drywall. Asbestos is also present in pipe and boiler insulation materials, and in sprayed-on materials located on beams, in crawlspaces, and between walls.

C. The potential for a product containing

asbestos, tremolite, anthophyllite, and actinolite to release breathable fibers depends on its degree of friability. Friable means that the material can be crumbled with hand pressure and is therefore likely to emit fibers. The fibrous or fluffy sprayed-on materials used for fireproofing, insulation, or sound proofing are considered to be friable, and they readily release airborne fibers if disturbed. Materials such as vinyl-asbestos floor tile or roofing felts are considered nonfriable and generally do not emit airborne fibers unless subjected to sanding or sawing operations. Asbestos-cement pipe or sheet can emit airborne fibers if the materials are cut or sawed, or if they are broken during demolition operations.

D. Permissible exposure: Exposure to airborne asbestos, tremolite, anthophyllite, and actinolite fibers may not exceed 0.2 fibers per cubic centimeter of air [0.2 f/cc] averaged over the 8-hour workday.

### II. Health Hazard Data

A. Asbestos, tremolite, anthophyllite, and actinolite can cause disabling respiratory disease and various types of cancers if the fibers are inhaled. Inhaling or ingesting fibers from contaminated clothing or skin can also result in these diseases. The symptoms of these diseases generally do not appear far 20 or more years after initial exposure.

B. Exposure to asbestos, tremolite, anthophyllite, and actinolite has been shown to cause lung cancer, mesothelioma, and cancer of the stomach and colon. Mesothelioma is a rare cancer of the thin membrane lining of the chest and abdomen. Symptoms of mesothelioma include shortness of breath, pain in the walls of the chest, and/or abdominal pain.

### III. Respirator and Protective Clothing

A. Respirator: You are required to wear a respirator when performing tasks that result in asbestos, tremolite, anthophyllite, and actinolite exposure that exceeds the permissible exposure limit (PEL) of 0.2 f/cc. These conditions can occur while your employer is in the process of installing engineering controls to reduce asbestos, tremolite, anthophyllite, and actinolite exposure, or where engineering controls are not feasible to reduce asbestos, tremolite, anthophyllite, and actinolite exposure. Air-purifying respirators equipped with a high-efficiency particulate air (HEPA) filter can be used where airborne asbestos, tremolite, anthophyllite, and actinolite fiber concentrations do not exceed 2 f/cc; otherwise, air-supplied, positive-pressure, full facepiece respirator must be used. Disposable respirators or dust masks are not permitted to be used for asbestos, tremolite, anthophyllite, and actinolite work. For effective protection, respirators must fit your face and head snugly. Your employer is required to conduct fit tests when you are first assigned a respirator and every 6 months thereafter. Respirators should not be loosened or removed in work situations where their use is required.

B. Protective Clothing You are required to

wear protective clothing in work areas where asbestos, tremolite, anthophyllite, and actinolite fiber concentrations exceed the permissible exposure limit (PEL) of 0.2 f/cc to prevent contamination of the skin. Where protective clothing is required, your employer must provide you with clean garments. Unless you are working on a large asbestos, tremolite, anthophyllite, and actinolite removal or demolition project, your employer must also provide a change room and separate lockers for your street clothes and contaminated work clothes. If you are working on a large asbestos, tremolite, anthophyllite, and actinolite removal or demolition project, and where it is feasible to do so, your employer must provide a clean room, shower, and decontamination room contiguous to the work area. When leaving the work area, you must remove contaminated clothing before proceeding to the shower. If the shower is not adjacent to the work area, you must vacuum your clothing before proceeding to the change room and shower. To prevent inhaling fibers in contaminated change rooms and showers, leave your respirator on until you leave the shower and enter the clean change room.

#### IV. Disposal Procedures and Cleanup

A. Wastes that are generated by processes where asbestos, tremolite, anthophyllite, and actinolite is present include:

1. Empty asbestos, tremolite, anthophyllite, and actinolite shipping containers.
2. process wastes such as cuttings, trimmings, or reject material.
3. Housekeeping waste from sweeping or vacuuming.
4. Asbestos, tremolite, anthophyllite, and actinolite fireproofing or insulating material that is removed from buildings.
5. Building products that contain asbestos, tremolite, anthophyllite, and actinolite removed during building renovation or demolition.
6. Contaminated disposable protective clothing.

B. Empty shipping bags can be flattened under exhaust hoods and packed into airtight containers for disposal. Empty shipping drums are difficult to clean and should be sealed.

C. Vacuum logs or deposable paper filters should not be cleaned, but should be sprayed with a fine water mist and placed into a labeled waste container.

D. Process waste and housekeeping waste should be wetted with water or a mixture of water and surfactant prior to packaging in disposable containers.

E. Material containing asbestos, tremolite, anthophyllite, and actinolite that is removed from buildings must be disposed of in leak-tight 6-roil thick plastic bags, plastic-lined cardboard containers, or plastic-lined metal containers. These wastes, which are removed while wet, should be sealed in containers before they dry out to minimize the release of asbestos, tremolite, anthophyllite, and actinolite fibers during handling.

#### V. Access to Information

A. Each year, your employer is required to inform you of the information contained in this standard and appendices for asbestos, tremolite, anthophyllite, and actinolite. In addition, your employer must instruct you in the proper work practices for handling materials containing asbestos, tremolite, anthophyllite, and actinolite, and the correct use of protective equipment.

B. Your employer is required to determine whether you are being exposed to asbestos, tremolite, anthophyllite, and actinolite. You or your representative has the right to observe employee measurements and to record the results obtained. Your employer is required to inform you of your exposure, and, if you are exposed above the permissible limit, he or she is required to inform you of the actions that are being taken to reduce your exposure to within the permissible limit.

C. Your employer is required to keep records of your exposures and medical examinations. These exposure records must be kept for at least thirty (30) years. Medical records must be kept for the period of your employment plus thirty (30) years.

D. Your employer is required to release your exposure and medical records to your physician or designated representative upon your written request.

#### **Appendix I to §1926.58—Medical Surveillance Guidelines for Asbestos Tremolite, Anthophyllite, and Actinolite Non-Mandatory**

##### 1. Route of Entry Inhalation, Ingestion

##### II. Toxicology

Clinical evidence of the adverse effects associated with exposure to asbestos, tremolite, anthophyllite, and actinolite, is present in the form of several well-conducted epidemiological studies of occupationally exposed workers, family contacts of workers, and persons living near asbestos, tremolite, anthophyllite, and actinolite mines. These studies have shown a definite association between exposure to asbestos, tremolite, anthophyllite, and actinolite and an increased incidence of lung cancer, pleural and peritoneal mesothelioma, gastrointestinal cancer, and asbestosis. The latter is a disabling fibrotic lung disease that is caused only by exposure to asbestos. Exposure to asbestos, tremolite, anthophyllite, and actinolite has also been associated with an increased incidence of esophageal, kidney, laryngeal, pharyngeal, and buccal cavity cancers. As with other known chronic occupational diseases, disease associated with asbestos, tremolite, anthophyllite, and actinolite generally appears about 20 years following the first occurrence of exposure: There are no known acute effects associated with exposure to asbestos, tremolite, anthophyllite, and actinolite.

Epidemiological studies indicate that the risk of lung cancer among exposed workers who smoke cigarettes is greatly increased over the risk of lung cancer among non-exposed smokers or exposed nonsmokers. These studies suggest that cessation of

smoking will reduce the risk of lung cancer for a person exposed to asbestos, tremolite, anthophyllite, and actinolite but will not reduce it to the same level of risk as that existing for an exposed worker who has never smoked.

#### III. Signs and Symptoms of Exposure-Related Disease

The signs and symptoms of lung cancer or gastrointestinal cancer induced by exposure to asbestos, tremolite, anthophyllite, and actinolite are not unique, except that a chest X-ray of an exposed patient with lung cancer may show pleural plaques, pleural calcification, or pleural fibrosis. Symptoms characteristic of mesothelioma include shortness of breath, pain in the walls of the chest, or abdominal pain. Mesothelioma has a much longer latency period compared with lung cancer (40 years versus 15-20 years), and mesothelioma is therefore more likely to be found among workers who were first exposed to asbestos at an early age. Mesothelioma is always fatal.

Asbestosis is pulmonary fibrosis caused by the accumulation of asbestos fibers in the lungs. Symptoms include shortness of breath, coughing, fatigue, and vague feelings of sickness. When the fibrosis worsens, shortness of breath occurs even at rest. The diagnosis of asbestosis is based on a history of exposure to asbestos, the presence of characteristic radiologic changes, end-inspiratory crackles (rales), and other clinical features of fibrosing lung disease. Pleural plaques and thickening are observed on X-rays taken during the early stages of the disease. Asbestosis is often a progressive disease even in the absence of continued exposure, although this appears to be a highly individualized characteristic. In severe cases, death may be caused by respiratory or cardiac failure.

#### IV. Surveillance and Preventive Considerations

As noted above, exposure to asbestos, tremolite, anthophyllite, and actinolite has been linked to an increased risk of lung cancer, mesothelioma, gastrointestinal cancer, and asbestosis among occupationally exposed workers. Adequate screening tests to determine an employee's potential for developing serious chronic diseases, such as cancer, from exposure to asbestos, tremolite, anthophyllite, and actinolite do not presently exist. However, some tests, particularly chest X-rays and pulmonary function tests, may indicate that an employee has been overexposed to asbestos, tremolite, anthophyllite, and actinolite, increasing his or her risk of developing exposure-related chronic diseases. It is important for the physician to become familiar with the operating conditions in which occupational exposure to asbestos, tremolite, anthophyllite, and actinolite is likely to occur. This is particularly important in evaluating medical and work histories and in conducting physical examinations. When an active employee has been identified as having been overexposed to asbestos, tremolite, anthophyllite, and actinolite, measures taken

by the employer to eliminate or mitigate further exposure should also lower the risk of serious long-term consequences.

The employer is required to institute a medical surveillance program for all employees who are or will be exposed to asbestos, tremolite, anthophyllite, and actinolite at or above the action level (0.1 fiber per cubic centimeter of air) for 30 or more days per year and for all employees who are assigned to wear a negative-pressure respirator. All examinations and procedures must be performed by or under the supervision of a licensed physician, at a reasonable time and place, and at no cost to the employee.

Although broad latitude is given to the physician in prescribing specific tests to be included in the medical surveillance program, OSHA requires inclusion of the following elements in the routine examination

(i) Medical and work histories with special emphasis directed to symptoms of the respiratory system, cardiovascular system, and digestive tract.

(ii) Completion of the respiratory disease questionnaire contained in Appendix D.

(iii) A physical examination including a chest roentgenogram and pulmonary function

test that includes measurement of the employee's forced vital capacity [PVC] and forced expiratory volume at one second [FEV].

(iv) Any laboratory or other test that the examining physician deems by sound medical practice to be necessary.

The employer is required to make the prescribed tests available at least annually to those employees covered more often than specified if recommended by the examining physician and upon termination of employment.

The employer is required to provide the physician with the following information: A copy of this standard and appendices; a description of the employee's duties as they relate to asbestos exposure; the employee's representative level of exposure to asbestos, tremolite, anthophyllite, and actinolite; a description of any personal protective and respiratory equipment used and information from previous medical examinations of the affected employee that is not otherwise available to the physician. Making this information available to the physician will aid in the evaluation of the employee's health in relation to assigned duties and fitness to wear personal protective equipment, if required.

The employer is required to obtain a written opinion from the examining physician containing the results of the medical examination; the physician's opinion as to whether the employee has any detected medical conditions that would place the employee at an increased risk of exposure-related disease; any recommended limitations on the employee or on the use of personal protective equipment; and a statement that the employee has been informed by the physician of the results of the medical examination and of any medical conditions related to asbestos, tremolite, anthophyllite, and actinolite exposure that require further explanation or treatment. This written opinion must not reveal specific findings or diagnoses unrelated to exposure to asbestos, tremolite, anthophyllite, and actinolite, and a copy of the opinion must be provided to the affected employee.

## Appendix A2. Occupational Safety and Health Administration (OSHA) Asbestos Regulations for General Industry (29 CFR 1910.1001)

### § 1910.1001 Asbestos, tremolite, anthophyllite, and actinolite.

(a) *Scope and application.* (1) This section applies to all occupational exposures to asbestos, tremolite, anthophyllite, and actinolite, in all industries covered by the Occupational Safety and Health Act, except as provided in paragraph (a)(2) of this section.

(z) This section does not apply to construction work as defined in 29 CFR 1910.12(b). [Exposure to asbestos, tremolite, anthophyllite, and actinolite in construction work is covered by 29 CFR 1926.58.]

(b) *Definitions.* "Action level" means an airborne concentration of asbestos, tremolite, anthophyllite, actinolite, or a combination of these minerals, of 0.1 fiber per cubic centimeter (f/cc) of air calculated as an eight (8)—hour time-weighted average.

"Asbestos" includes chrysotile, amosite, crocidolite, tremolite asbestos, anthophyllite asbestos, actinolite asbestos, and any of these minerals that have been chemically treated and/or altered,

"Assistant Secretary" means the Assistant Secretary of Labor for Occupational Safety and Health, U.S. Department of Labor, or designee.

"Authorized person" means any person authorized by the employer and required by work duties to be present in regulated areas.

"Director" means the Director of the National Institute for Occupational Safety and Health, U.S. Department of Health and Human Services, or designee.

"Employee exposure" means that exposure to airborne asbestos, tremolite, anthophyllite, actinolite, or a combination of these minerals that would occur if the employee were not using respiratory protective equipment.

"Fiber" means a particulate form of asbestos, tremolite, anthophyllite, or actinolite, 5 micrometers or longer, with a length-to-diameter ratio of at least 3 to 1.

"High-efficiency particulate air (HEPA) filter" means a filter capable of trapping and retaining at least 99.97 percent of 0.3 micrometer diameter mono-disperse particles.

"Regulated area" means an area established by the employer to demarcate areas where airborne concentrations of asbestos, tremolite,

anthophyllite, actinolite, or a combination of these minerals exceed, or can reasonably be expected to exceed, the permissible exposure limit.

"Tremolite, anthophyllite, or actinolite" means the non-asbestos form of these minerals, and any of these minerals that have been chemically treated and/or altered.

(c) *Permissible exposure limit (PEL).* The employer shall ensure that no employee is exposed to an airborne concentration of asbestos, tremolite, anthophyllite, actinolite, or a combination of these minerals in excess of 0.2 fiber per cubic centimeter of air as an eight (8)-hour time-weighted average (TWA) as determined by the method prescribed in Appendix A of this section, or by an equivalent method.

(d) *Exposure monitoring.*—(1) *General.* (i) Determinations of employee exposure shall be made from breathing zone air samples that are representative of the 8-hour TWA of each employee.

(ii) Representative 8-hour TWA employee exposures shall be determined on the basis of one or more samples representing full-shift exposures for each shift for each employee in each job classification in each work area.

(2) *Initial monitoring.* (i) Each employer who has a workplace or work operation covered by this standard, except as provided for in paragraphs (d)(2)(ii) and (d)(2) (iii) of this section, shall perform initial monitoring of employees who are, or may reasonably be expected to be exposed to airborne concentrations at or above the action level.

(ii) Where the employer has monitored after December 20, 1985, and the monitoring satisfies all other requirements of this section, the employer may rely on such earlier monitoring results to satisfy the requirements of paragraph (d)(2) [i] of this section.

(iii) Where the employer has relied upon objective data that demonstrates that asbestos, tremolite, anthophyllite, actinolite, or a combination of these minerals is not capable of being released in airborne concentrations at or above the action level under the expected conditions of processing, use, or handling, then no initial monitoring is required.

(3) *Monitoring frequency (periodic monitoring) and patterns.* After the initial determinations required by

paragraph (d)(2)(i) of this section, samples shall be of such frequency and pattern as to represent with reasonable accuracy the levels of exposure of the employees. In no case shall sampling be at intervals greater than six months for employees whose exposures may reasonably be foreseen to exceed the action level.

(4) *Changes in monitoring frequency.* If either the initial or the periodic monitoring required by paragraphs (d)(2) and (d)(3) of this section statistically indicates that employee exposures are below the action level, the employer may discontinue the monitoring for those employees whose exposures are represented by such monitoring.

(5) *Additional monitoring.* Notwithstanding the provisions of paragraphs (d)(2)(ii) and (d)(4) of this section, the employer shall institute the exposure monitoring required under paragraphs [d)(2)(i) and (d)(3) of this section whenever there has been a change in the production, process, control equipment, personnel or work practices that may result in new or additional exposures above the action level or when the employer has any reason to suspect that a change may result in new or additional exposures above the action level.

(6) *Method of monitoring.* (i) All samples taken to satisfy the monitoring requirements of paragraph (d) shall be personal samples collected following the procedures specified in Appendix A.

(ii) All samples taken to satisfy the monitoring requirements of paragraph (d) shall be evaluated using the OSHA Reference Method (ORM) specified in Appendix A of this section, or an equivalent counting method.

(iii) If an equivalent method to the ORM is used, the employer shall ensure that the method meets the following criteria:

[A] Replicate exposure data used to establish equivalency are collected in side-by-side field and laboratory comparisons; and

[B] The comparison indicates that 90% of the samples collected in the range 0.5 to 2.0 times the permissible limit have an accuracy range of plus or minus 25 percent of the ORM results with a 95% confidence level as demonstrated by a statistically valid protocol; and

[C] The equivalent method is documented and the results of the comparison testing are maintained,

(iv) To satisfy the monitoring requirements of paragraph (d) of this section, employers must use the results of monitoring analysis performed by laboratories which have instituted quality assurance programs that include the elements as prescribed in Appendix A.

(7) *Employee notification of monitoring results.* (i) The employer shall, within 15 working days after the receipt of the results of any monitoring performed under the standard, notify the affected employees of these results in writing either individually or by posting of results in an appropriate location that is accessible to affected employees.

(ii) The written notification required by paragraph (d)(7)(i) of this section shall contain the corrective action being taken by the employer to reduce employee exposure to or below the PEL, wherever monitoring results indicated that the PEL had been exceeded.

(e) *Regulated Areas.* -(1)

*Establishment.* The employer shall establish regulated areas wherever airborne concentrations of asbestos, tremolite, anthophyllite, actinolite, or a combination of these minerals are in excess of the permissible exposure limit prescribed in paragraph (c) of this section.

(2) *Demarcation.* Regulated areas shall be demarcated from the rest of the workplace in any manner that minimizes the number of persons who will be exposed to asbestos, tremolite, anthophyllite, or actinolite.

(3) *Access.* Access to regulated areas shall be limited to authorized persons or to persons authorized by the Act or regulations issued pursuant thereto.

(4) *Provision of respirators.* Each person entering a regulated area shall be supplied with and required to use a respirator, selected in accordance with paragraph (g)(2) of this section.

(5) *Prohibited activities.* The employer shall ensure that employees do not eat, drink, smoke, chew tobacco or gum, or apply cosmetics in the regulated areas.

(f) *Methods of compliance.* -(1)

*Engineering controls and work practices.* (i) The employer shall institute engineering controls and work practices to reduce and maintain employee exposure to or below the exposure limit prescribed in paragraph (c) of this section, except to the extent that such controls are not feasible.

(ii) Wherever the feasible engineering controls and work practices that can be instituted are not sufficient to reduce

employee exposure to or below the permissible exposure limit prescribed in paragraph (c) of this section, the employer shall use them to reduce employee exposure to the lowest levels achievable by these controls and shall supplement them by the use of respiratory protection that complies with the requirements of paragraph (g) of this section.

(iii) For the following operations, wherever feasible engineering controls and work practices that can be instituted are not sufficient to reduce the employee exposure to or below the permissible exposure limit prescribed in paragraph (c) of this section, the employer shall use them to reduce employee exposure to or below 0.5 fiber per cubic centimeter of air (as an eight-hour time-weighted average) and shall supplement them by the use of any combination of respiratory protection that complies with the requirements of paragraph (g) of this section, work practices and feasible engineering controls that will reduce employee exposure to or below the permissible exposure limit prescribed in paragraph (c) of this section: Coupling cutoff in primary asbestos cement pipe manufacturing sanding in primary and secondary asbestos cement sheet manufacturing grinding in primary and secondary friction product manufacturing carding and spinning in dry textile processes; and grinding and sanding in primary plastics manufacturing.

(iv) Local exhaust ventilation. Local exhaust ventilation and dust collection systems shall be designed, constructed, installed, and maintained in accordance with good practices such as those found in the American National Standard Fundamentals Governing the Design and Operation of Local Exhaust Systems, ANSI Z9.2-1979.

(v) Particular tools. All hand-operated and power-operated tools which would produce or release fibers of asbestos, tremolite, anthophyllite, actinolite, or a combination of these minerals so as to expose employees to levels in excess of the exposure limit prescribed in paragraph (c) of this section, such as, but not limited to, saws, scorers, abrasive wheels, and drills, shall be provided with local exhaust ventilation systems which comply with paragraph (f)(l)(iv) of this section.

(vi) Wet methods. Insofar as practicable, asbestos, tremolite, anthophyllite, or actinolite shall be handled, mixed, applied, removed, cut, scored, or otherwise worked in a wet

state sufficient to prevent the emission of airborne fibers so as to expose employees to levels in excess of the exposure limit prescribed in paragraph (c) of this section, unless the usefulness of the product would be diminished thereby.

(vii) Materials containing asbestos, tremolite, anthophyllite, or actinolite shall not be applied by spray methods.

(viii) Particular products and operations. No asbestos cement, mortar, coating, grout, plaster, or similar material containing asbestos, tremolite, anthophyllite, or actinolite shall be removed from bags, cartons, or other containers in which they are shipped, without being either wetted, or enclosed, or ventilated so as to prevent effectively the release of airborne fibers of asbestos, tremolite, anthophyllite, actinolite, or a combination of these minerals so as to expose employees to levels in excess of the limit prescribed in paragraph (c) of this section.

(ix) Compressed air. Compressed air shall not be used to remove asbestos, tremolite, anthophyllite, or actinolite or materials containing asbestos, tremolite, anthophyllite, or actinolite, unless the compressed air is used in conjunction with a ventilation system designed to capture the dust cloud created by the compressed air.

(2) *Compliance program.* (i) Where the PEL is exceeded, the employer shall establish and implement a written program to reduce employee exposure to or below the limit by means of engineering and work practice controls as required by paragraph (f)(1) of this section, and by the use of respiratory protection where required or permitted under this section.

(ii) Such programs shall be reviewed and updated as necessary to reflect significant changes in the status of the employer's compliance program.

(iii) Written programs shall be submitted upon request for examination and copying to the Assistant Secretary, the Director, affected employees and designated employee representatives.

(iv) The employer shall not use employee rotation as a means of compliance with the PEL.

(g) *Respiratory protection* -(1) *General.* The employer shall provide respirators, and ensure that they are used, where required by this section. Respirators shall be used in the following circumstances:

(i) During the interval necessary to install or implement feasible engineering and work practice controls;

(ii) In work operations, such as



maintenance and repair activities, or other activities for which engineering and work practice controls are not feasible;

(iii) In work situations where feasible engineering and work practice controls are not yet sufficient to reduce exposure to or below the exposure limit; and

(iv) In emergencies.

(2) *Respirator selection.* (i) Where respirators are required under this section, the employer shall select and provide, at no cost to the employee, the appropriate respirator as specified in Table 1. The employer shall select respirators from among those jointly approved as being acceptable for protection by the Mine Safety and Health Administration (MSHA) and by the National Institute for Occupational Safety and Health (NIOSH) under the provisions of 30 CFR Part 11.

(ii) The employer shall provide a powered, air-purifying respirator in lieu of any negative pressure respirator specified in Table 1 whenever:

(A) An employee chooses to use this type of respirator and

(B) This respirator will provide adequate protection to the employee.

TABLE 1.—RESPIRATORY PROTECTION FOR ASBESTOS, TREMOLITE, ANTHOPHYLLITE, AND ACTINOLITE FIBERS

| Airborne concentration of asbestos, tremolite, anthophyllite, actinolite, or a combination of these minerals | Required respirator   |
|--|---|
| Not in excess of 2 f/cc (10 X PEL).  | 1. Half-mask air-purifying respirator equipped with high-efficiency filters.  |
| Not in excess of 10 f/cc (50 X PEL).   | 1. Full facepiece air-purifying respirator equipped with high-efficiency filters.   |
| Not in excess of 20 f/cc (100 X PEL).  | 1. Any powered air-purifying respirator equipped with high-efficiency filters.<br>2. Any supplied-air respirator operated in continuous flow mode.          |
| Not in excess of 200 f/l cc (1000 X PEL).  | 1. Full facepiece supplied-air respirator operated in pressure demand mode.   |
| Greater than 200 f/cc (> 1,000 x PEL) or concentration.  | 1. Full facepiece supplied air respirator operated in pressure demand mode equipped with an auxiliary positive pressure self-contained breathing apparatus. |

NOTE: a. Respirators assigned for higher environmental concentrations may be used at lower concentrations.

b. A high-efficiency filter means a filter that is at least 99.97 percent efficient against mono-dispersed particles of 0.3 micrometers or larger.

(3) *Respirator program.* (i) Where respiratory protection is required, the employer shall institute a respirator program in accordance with 29 CFR 1910.134(b), (d), (e), and (f).

(ii) The employer shall permit each employee who uses a filter respirator to change the filter elements whenever an increase in breathing resistance is

detected and shall maintain an adequate supply of filter elements for this purpose.

(iii) Employees who wear respirators shall, be permitted to leave the regulated area to wash their faces and respirator facepieces whenever necessary to prevent skin irritation associated with respirator use.

(iv) No employee shall be assigned to tasks requiring the use of respirators if, based upon his or her most recent examination, an examining physician determines that the employee will be unable to function normally wearing a respirator, or that the safety or health of the employee or other employees will be impaired by the use of a respirator. Such employee shall be assigned to another job or given the opportunity to transfer to a different position whose duties he or she is able to perform with the same employer, in the same geographical area and with the same seniority, status, and rate of pay the employee had just prior to such transfer, if such a different position is available.

(4) *Respirator fit testing.* (i) The employer shall ensure that the respirator issued to the employee exhibits the least possible facepiece leakage and that the respirator is fitted properly.

(ii) For each employee wearing negative pressure respirators, employers shall perform either quantitative or qualitative face fit tests at the time of initial fitting and at least every six months thereafter. The qualitative fit tests may be used only for testing the fit of half-mask respirators where they are permitted to be worn, and shall be conducted in accordance with Appendix C. The tests shall be used to select facepieces that provide the required protection as prescribed in Table L

(h) *Protective work clothing and equipment—(1) Provision and use.* If an employee is exposed to asbestos, tremolite, anthophyllite, actinolite, or a combination of these minerals above the PEL, or where the possibility of eye irritation exists, the employer shall provide at no cost to the employee and ensure that the employee uses appropriate protective work clothing and equipment such as, but not limited to:

(i) Coveralls or similar full-body work clothing;

(ii) Gloves, head coverings, and foot coverings; and

(iii) Face shields, vented goggles, or other appropriate protective equipment which complies with §1910.133 of this Part.

(2) *Removal and storage.* (i) The

employer shall ensure that employees remove work clothing contaminated with asbestos, tremolite, anthophyllite, or actinolite only in change rooms provided in accordance with paragraph (i)(1) of this section.

(ii) The employer shall ensure that no employee takes contaminated work clothing out of the change room, except those employees authorized to do so for the purpose of laundering, maintenance, or disposal.

(iii) Contaminated work clothing shall be placed and stored in closed containers which prevent dispersion of the asbestos, tremolite, anthophyllite, and actinolite outside the container.

(iv) Containers of contaminated protective devices or work clothing which are to be taken out of change rooms or the workplace for cleaning, maintenance or disposal, shall bear labels in accordance with paragraph (j)(2) of this section.

(3) *Cleaning and replacement.* (i) The employer shall clean, launder, repair, or replace protective clothing and equipment required by this paragraph to maintain their effectiveness. The employer shall provide clean protective clothing and equipment at least weekly to each affected employee.

(ii) The employer shall prohibit the removal of asbestos, tremolite, anthophyllite, and actinolite from protective clothing and equipment by blowing or shaking.

(iii) Laundering of contaminated clothing shall be done so as to prevent the release of airborne fibers of asbestos, tremolite, anthophyllite, actinolite, or a combination of these minerals in excess of the permissible exposure limit prescribed in paragraph (c) of this section.

(iv) Any employer who gives contaminated clothing to another person for laundering shall inform such person of the requirement in paragraph (h)(3)(iii) of this section to effectively prevent the release of airborne fibers of asbestos, tremolite, anthophyllite, actinolite, or a combination of these minerals in excess of the permissible exposure limit.

(v) The employer shall inform any person who launders or cleans protective clothing or equipment contaminated with asbestos, tremolite, anthophyllite, or actinolite, of the potentially harmful effects of exposure to asbestos, tremolite, anthophyllite, or actinolite.

(vi) Contaminated clothing shall be transported in sealed impermeable bags, or other closed, impermeable containers, and labeled in accordance with

paragraph (j) of this section.

(i) *Hygiene facilities and practices*—  
(1) *Change rooms.* (i) The employer shall provide clean change rooms for employees who work in areas where their airborne exposure to asbestos, tremolite, anthophyllite, actinolite, or a combination of these minerals is above the permissible exposure limit.

(ii) The employer shall ensure that change rooms are in accordance with § 1910.141(e) of this part, and are equipped with two separate lockers or storage facilities, so separated as to prevent contamination of the employee's street clothes from his protective work clothing and equipment.

(2) *Showers.* (i) The employer shall ensure that employees who work in areas where their airborne exposure is above the permissible exposure limit shower at the end of the work shift.

(ii) The employer shall provide shower facilities which comply with § 1910.141 (d)(3) of this part.

(iii) The employer shall ensure that employees who are required to shower pursuant to paragraph (i)(2)(i) of this section do not leave the workplace wearing any clothing or equipment worn during the work shift.

(3) *Lunchrooms.* (i) The employer shall provide lunchroom facilities for employees who work in areas where their airborne exposure is above the permissible exposure limit.

(ii) The employer shall ensure that lunchroom facilities have a positive pressure, filtered air supply, and are readily accessible to employees.

(iii) The employer shall ensure that employees who work in areas where their airborne exposure is above the permissible exposure limit wash their hands and faces prior to eating, drinking or smoking.

(iv) The employer shall ensure that employees do not enter lunchroom facilities with protective work clothing or equipment unless surface asbestos, tremolite, anthophyllite, and actinolite fibers have been removed from the clothing or equipment by vacuuming or other method that removes dust without causing the asbestos, tremolite, anthophyllite, or actinolite to become airborne.

(j) *Communication of hazards to employees*—(1) *Warning signs.* (i) Posting. Warning signs shall be provided and displayed at each regulated area. In addition, warning signs shall be posted at all approaches to regulated areas so that an employee may read the signs and take necessary protective steps before entering the area.

(ii) Sign specifications. The warning signs required by paragraph (j)(1)(i) of this section shall bear the following information:

DANGER  
ASBESTOS  
CANCER AND LUNG DISEASE  
HAZARD  
AUTHORIZED PERSONNEL ONLY  
RESPIRATORS AND PROTECTIVE  
CLOTHING  
ARE REQUIRED IN THIS AREA

(iii) Where minerals in the regulated area are only tremolite, anthophyllite or actinolite, the employer may replace the term "asbestos" with the appropriate mineral name.

(2) *Warning labels.* (i) Labeling. Warning labels shall be affixed to all raw materials, mixtures, scrap, waste, debris, and other products containing asbestos, tremolite, anthophyllite, or actinolite fibers, or to their containers.

(ii) Label specifications. The labels shall comply with the requirements of 29 CFR 1910.1200(f) of OSHA's Hazard Communication standard, and shall include the following information:

DANGER  
CONTAINS ASBESTOS FIBERS  
AVOID CREATING DUST  
CANCER AND LUNG DISEASE  
HAZARD

(iii) Where minerals to be labeled are only tremolite, anthophyllite, or actinolite, the employer may replace the term "asbestos" with the appropriate mineral name.

(3) *Material safety data sheets.* Employers who are manufacturers or importers of asbestos, tremolite, anthophyllite, or actinolite or asbestos, tremolite, anthophyllite, or actinolite products shall comply with the requirements regarding development of material safety data sheets as specified in 29 CFR 1910.1200(g) of OSHA's Hazard Communication standard, except as provided by paragraph (j)(4) of this section.

(4) The provisions for labels required by paragraph (j)(2) or for material safety data sheets required by paragraph (j)(3) do not apply where:

(i) Asbestos, tremolite, anthophyllite, or actinolite fibers have been modified by a bonding agent, coating, binder, or other material provided that the manufacturer can demonstrate that during any reasonably foreseeable use, handling, storage, disposal, processing, or transportation, no airborne concentrations of fibers of asbestos, tremolite, anthophyllite, actinolite, or a

combination of these minerals in excess of the action level will be released or

(ii) Asbestos, tremolite, anthophyllite, actinolite, or a combination of these minerals is present in a product in concentrations less than 0.1%.

(5) *Employee information and training.* (i) The employer shall institute a training program for all employees who are exposed to airborne concentrations of asbestos, tremolite, anthophyllite, actinolite, or a combination of these minerals at or above the action level ensure their participation in the program.

(ii) Training shall be provided prior to or at the time of initial assignment and at least annually thereafter.

(iii) The training program shall be conducted in a manner which the employee is able to understand. The employer shall ensure that each employee is informed of the following:

(A) The health effect associated with asbestos, tremolite, anthophyllite, or actinolite exposure;

(B) The relationship between smoking and exposure to asbestos, tremolite, anthophyllite, and actinolite in producing lung cancer;

(C) The quantity, location, manner of use, release, and storage of asbestos, tremolite, anthophyllite, or actinolite, and the specific nature of operations which could result in exposure to asbestos, tremolite, anthophyllite, or actinolite;

(D) The engineering controls and work practices associated with the employee's job assignment;

(E) The specific procedures implemented to protect employees from exposure to asbestos, tremolite, anthophyllite, or actinolite, such as appropriate work practices, emergency and clean-up procedures, and personal protective equipment to be used;

(F) The purpose, proper use, and limitations of respirators and protective clothing;

(G) The purpose and a description of the medical surveillance program required by paragraph [1] of this section

(H) A review of this standard, including appendices.

(iv) Access to information and training materials.

(A) The employer shall make a copy of this standard and its appendices readily available without cost to all affected employees.

(B) The employer shall provide, upon request, all materials relating to the employee information and training program to the Assistant Secretary and the training program to the Assistant

Secretary and the Director.

(k) *Housekeeping.* (1) All surfaces shall be maintained as free as practicable of accumulations of dusts and waste containing asbestos, tremolite, anthophyllite, or actinolite.

(2) All spills and sudden releases of material containing asbestos, tremolite, anthophyllite, or actinolite shall be cleaned up as soon as possible.

(3) Surfaces contaminated with asbestos, tremolite, anthophyllite, or actinolite may not be cleaned by the use of compressed air.

(4) Vacuuming. HEPA-filtered vacuuming equipment shall be used for vacuuming. The equipment shall be used and emptied in a manner which minimizes the reentry of asbestos, tremolite, anthophyllite, or actinolite into the workplace.

(5) Shoveling, dry sweeping and dry clean-up of asbestos, tremolite, anthophyllite, or actinolite may be used only where vacuuming and/or wet cleaning-are not feasible.

(6) Waste disposal. Waste, scrap, debris, bags, containers, equipment, and clothing contaminated with asbestos, tremolite, anthophyllite, or actinolite consigned for disposal, shall be collected and disposed of in sealed impermeable bags, or other closed, impermeable containers.

(1) *Medical surveillance-(1) General.*-(i) *Employees covered.* The employer shall institute a medical surveillance program for all employees who are or will be exposed to airborne concentrations of fibers of asbestos, tremolite, anthophyllite, actinolite, or a combination of these minerals at or above the action level.

(ii) *Examination by a physician.* (A) The employer shall ensure that all medical examinations and procedures are performed by or under the supervision of a licensed physician, and shall be provided without cost to the employee and at a reasonable time and place.

(B) Persons other than licensed physicians, who administer the pulmonary function testing required by this section, shall complete a training course in spirometry sponsored by an appropriate academic or professional institution.

(2) *Preplacement examinations.* (i) Before an employee is assigned to an occupation exposed to airborne concentrations of asbestos, tremolite, anthophyllite, or actinolite fibers, a preplacement medical examination shall be provided or made available by the employer.

(ii) Such examination shall include, as a minimum, a medical and work history: A complete physical examination of all systems with emphasis on the respiratory system, the cardiovascular system and digestive tract; completion of the respiratory disease standardized questionnaire in Appendix D, Part 1; a chest roentgenogram (posterior-anterior 14x17 inches); pulmonary function tests to include forced vital capacity (PVC) and forced expiratory volume at 1 second (FEV<sub>1.0</sub>); and any additional tests deemed appropriate by the examining physician. Interpretation and classification of chest roentgenograms shall be conducted in accordance with Appendix E.

(3) *Periodic examinations.* (i) Periodic medical examinations shall be made available annually.

(ii) The scope of the medical examination shall be in conformance with the protocol established in paragraph (1)(2)(ii), except that the frequency of chest roentgenograms shall be conducted in accordance with Table 2, and the abbreviated standardized questionnaire contained in Appendix D, Part 2, shall be administered to the employee.

(4) *Termination of employment examinations.* (i) The employer shall provide, or make available, a termination of employment medical examination for any employee who has been exposed to airborne concentrations of fibers of asbestos, tremolite, anthophyllite, actinolite, or a combination of these minerals at or above the action level.

(ii) The medical examination shall be in accordance with the requirements of the periodic examinations stipulated in paragraph (1)(3) of this section, and shall be given within 30 calendar days before or after the date of termination of employment.

(5) *Recent examinations.* No medical examination is required of any

employee, if adequate records show that the employee has been examined in accordance with any of the preceding paragraphs [(1)(2)-(1)(4)] within the past 1 year period.

(6) *Information provided to the physician.* The employer shall provide the following information to the examining physician:

(i) A copy of this standard and Appendices D and E,

(ii) A description of the affected employee's duties as they relate to the employee's exposure.

(iii) The employee's representative exposure level or anticipated exposure level.

(iv) A description of any personal protective and respiratory equipment used or to be used.

(v) Information from previous medical examinations of the affected employee that is not otherwise available to the examining physician.

(7) *Physician 'e written opinion.* (i) The employer shall obtain a written signed opinion from the examining physician. This written opinion shall contain the results of the medical examination and shall include:

(A) The physician's opinion as to whether the employee has any detected medical conditions that would place the employee at an increased risk of material health impairment from exposure to asbestos, tremolite, anthophyllite, or actinolite;

(B) Any recommended limitations on the employee or upon the use of personal protective equipment such as clothing or respirators; and

(C) A statement that the employee has been informed by the physician of the results of the medical examination and of any medical conditions resulting from asbestos, tremolite, anthophyllite, or actinolite exposure that require further explanation or treatment.

(ii) The employer shall instruct the physician not to reveal in the written opinion given to the employer specific findings or diagnoses unrelated to occupational exposure to asbestos, tremolite, anthophyllite, or actinolite.

(iii) The employer shall provide a copy of the physician's written opinion to the affected employee within 30 days from its receipt.

(m) *Recordkeeping.*-(1) *Exposure measurements.* (i) The employer shall keep an accurate record of all measurements taken to monitor employee exposure to asbestos, tremolite, anthophyllite, or actinolite as prescribed in paragraph (d) of this

TABLE 2.—FREQUENCY OF CHEST ROENTGENOGRAMS

| Years since first exposure | Age of employee |               |                |
|----------------------------|-----------------|---------------|----------------|
|                            | 15 to 35        | 35+ to 45     | 45+            |
| 0 to 10.....               | Every 5 years   | Every 5 years | Every 5 years. |
| 10+.....                   | Every 5 years   | Every 2 years | Every 1 year.  |

section.

(ii) This record shall include at least the following information:

(A) The date of measurement

(B) The operation involving exposure to asbestos, tremolite, anthophyllite, or actinolite which is being monitored

(C) Sampling and analytical methods used and evidence of their accuracy;

(D) Number, duration, and results of samples taken;

(E) Type of respiratory protective devices worn, if any and

(F) Name, social security number and exposure of the employees whose exposure are represented.

(iii) The employer shall maintain this record for at least thirty (30) years, in accordance with 29 CFR 1910.20.

(2) *Objective data for exempted operations.*

(i) Where the processing, use, or handling of products made from or containing asbestos, tremolite, anthophyllite, or actinolite is exempted from other requirements of this section under paragraph (d)(2) (iii) of this section, the employer shall establish and maintain an accurate record of objective data reasonably relied upon in support of the exemption.

(ii) The record shall include at least the following:

(A) The product qualifying for exemption;

(B) The source of the objective data;

(C) The testing protocol, results of testing, and/or analysis of the material for the release of asbestos, tremolite, anthophyllite, or actinolite;

(D) A description of the operation exempted and how the data support the exemption and

(E) Other data relevant to the operations, materials, processing, or employee exposures covered by the exemption.

(iii) The employer shall maintain this record for the duration of the employer's reliance upon such objective data.

Note.—The employer may utilize the services of competent organizations such as industry trade associations and employee associations to maintain the records required by this section.

(3) *Medical surveillance.* (i) The employer shall establish and maintain an accurate record for each employee subject to medical surveillance by paragraph 1(I) [i] of this section, in accordance with 29 CFR 1910.20.

(ii) The record shall include at least the following information

(A) The name and social security number of the employee;

(B) Physician's written opinions;

(C) Any employee medical complaints

related to exposure to asbestos, tremolite, anthophyllite, or actinolite; and

(D) A copy of the information provided to the physician as required by paragraph 1(6) of this section.

(iii) The employer shall ensure that this record is maintained for the duration of employment plus thirty (30) years, in accordance with 29 CFR 1910.20.

(4) *Training.* The employer shall maintain all employee training records for one (1) year beyond the last date of employment of that employee.

(5) *Availability.* (i) The employer, upon written request, shall make all records required to be maintained by this section available to the Assistant Secretary and the Director for examination and copying.

(ii) The employer, upon request shall make any exposure records required by paragraph (m)(1) of this section available for examination and copying to affected employees, former employees, designated representatives and the Assistant Secretary, in accordance with 29 CFR 1910.20 (a)-(e) and (g)-(i).

(iii) The employer, upon request, shall make employee medical records required by paragraph (m)(2) of this section available for examination and copying to the subject employee, to anyone having the specific written consent of the subject employee, and the Assistant Secretary, in accordance with 29 CFR 1910.20.

(6) *Transfer of records.* (i) The employer shall comply with the requirements concerning transfer of records set forth in 29 CFR 1910.20(h).

(ii) Whenever the employer ceases to do business and there is no successor employer to receive and retain the records for the prescribed period, the employer shall notify the Director at least 90 days prior to disposal of records and, upon request, transmit them to the Director,

(n) *Observation of monitoring—(1)*

*Employee observation.* The employer shall provide affected employees or their designated representatives an opportunity to observe any monitoring of employee exposure to asbestos, tremolite, anthophyllite, or actinolite conducted in accordance with paragraph (d) of this section.

(2) *Observation procedures.* When observation of the monitoring of employee exposure to asbestos, tremolite, anthophyllite, or actinolite requires entry into an area where the

use of protective clothing or equipment is required, the observer shall be provided with and be required to use such clothing and equipment and shall comply with all other applicable safety and health procedures,

(o) *Dates—(1) Effective date.* This standard shall become effective July 21, 1986. The requirements of the asbestos standard issued in June 1972 (37 FR 11318), as amended, and published in 29 CFR 1910.1001 (1985) remain in effect until compliance is achieved with the parallel provisions of this standard.

(2) *Start-up dates.* All obligations of this standard commence on the effective date except as follows:

(i) *Exposure monitoring.* Initial monitoring required by paragraph (d)(2) of this section shall be completed as soon as possible but no later than October 20, 1986.

(ii) *Regulated areas.* Regulated areas required to be established by paragraph (e) of this section as a result of initial monitoring shall be set up as soon as possible after the results of that monitoring are known and not later than November 17, 1988.

(iii) *Respiratory protection.* Respiratory protection required by paragraph (g) of this section shall be provided as soon as possible but no later than the following schedule:

(A) Employees whose 6-hour TWA exposure exceeds 2 fibers/cc—July 21, 1966.

(B) Employees whose 6-hour TWA exposure exceeds the PEL but is less than 2 fibers/cc—November 17, 1986.

(C) Powered air-purifying respirators provided under paragraph (g)(2)(ii)—January 16, 1987.

(iv) *Hygiene and lunchroom facilities.* Construction plans for changerooms, showers, lavatories, and lunchroom facilities shall be completed no later than January 16, 1982 and these facilities shall be constructed and in use no later than July 20, 1987. However, if as part of the compliance plan it is predicted by an independent engineering firm that engineering controls and work practices will reduce exposures below the permissible exposure limit by July 20, 1988, for affected employees, then such facilities need not be completed until 1 year after the engineering controls are completed, if such controls have not in fact succeeded in reducing exposure to below the permissible exposure limit.

(v) *Employee information and training.* Employee information and training required by paragraph (j)(5) of

this section shall be provided as soon as possible but no later than October 20, 1966.

(vi) *Medical surveillance.* Medical examinations required by paragraph [1] of this section shall be provided as soon as possible but no later than November 17, 1986.

(vii) *Compliance program.* Written compliance programs required by paragraph (f)(2) of this section as a

result of initial monitoring shall be completed and available for inspection and copying as soon as possible but no later than July 20, 1967.

(viii) *Methods of compliance.* The engineering and work practice controls as required by paragraph (f)(1) shall be implemented as soon as possible but no later than July 20, 1988,

(P) *Appendices.* (1) Appendices A, C, D, and E to this section are incorporated

as part of this section and the contents of these Appendices are mandatory

(2) Appendices B, F, G and H to this section are informational and are not intended to create any additional obligations not otherwise imposed or to detract from any existing obligations.

---

**NOTE: The Appendices to 29 CFR 1910.1001 have not been reproduced since they are largely identical to the appendices to 29 CFR 1926.58 which are reproduced on pages 51 to 73. Appendices A-E are identical for both standards. Appendix F of 1910.1001 deals with automotive brake repair, and was omitted as irrelevant to the scope of this guide. Appendices G and H to 29 CFR 1910.1001 are identical to appendices H and I of 29 CFR 1926.58.**

---

## **Appendix A3. Occupational Safety and Health Administration (OSHA) Respiratory Protection (29 CFR 1910.134)**

### **1910.134 RESPIRATORY PROTECTION**

#### **(a) PERMISSIBLE PRACTICE**

- (1) In the control of those occupational diseases caused by breathing air contaminated with harmful dusts, fogs, fumes, mists, gases, smokes, sprays, or vapors, the primary objective shall be to prevent atmospheric contamination. This shall be accomplished as far as feasible by accepted engineering control measures (for example, enclosure or confinement of the operation, general and local ventilation, and substitution of less toxic materials). When effective engineering controls are not feasible, or while they are being instituted, appropriate respirators shall be used pursuant to the following requirements.
- (2) Respirators shall be provided by the employer when such equipment is necessary to protect the health of the employee. The employer shall provide the respirators which are applicable and suitable for the purpose intended. The employer shall be responsible for the establishment and maintenance of a respiratory protective program which shall include the requirements outlined in paragraph (b) of this section.
- (3) The employee shall use the provided respiratory protection in accordance with instructions and training received.

#### **(b) REQUIREMENTS FOR A MINIMAL ACCEPTABLE PROGRAM**

- (1) Written standard operating procedures governing the selection and use of respirators shall be established.
- (2) Respirators shall be selected on the basis of hazards to which the worker is exposed.
- (3) The user shall be instructed and trained in the proper use of respirators and their limitations.
- (4) Where practicable, the respirators should be assigned to individual workers for their exclusive use.
- (5) Respirators shall be regularly cleaned and disinfected. Those issued for the exclusive use of one worker should be cleaned after each day's use, or more often if necessary. Those used by more than one worker shall be thoroughly cleaned and disinfected after each use.
- (6) Respirators shall be stored in a convenient, clean, and sanitary location.
- (7) Respirators used routinely shall be inspected during cleaning. Worn or deteriorated parts shall be replaced. Respirators for emergency use such as self-contained devices shall be thoroughly inspected at least once a month and after each use.
- (8) Appropriate surveillance of work area conditions and degree of employee exposure or stress shall be maintained.
- (9) There shall be regular inspection and evaluation to determine the continued effectiveness of the program.
- (10) Persons should not be assigned to tasks requiring use of respirators unless it has been determined that they are physically able to perform the work and use the equipment. The local physician shall determine what health and physical conditions are pertinent. The respirator user's medical status should be reviewed periodically (for instance, annually).
- (11) Approved or accepted respirators shall be used when they are available. The respirator furnished shall provide adequate respiratory protection against the particular hazard for which it is designed in accordance with standards established by competent authorities. The U.S. Department of Interior, Bureau of Mines, and the U.S. Department of Agriculture are recognized as such authorities. Although respirators listed by the U.S. Department of Agriculture continue to be acceptable for protection against specified pesticides, the U.S. Department of the Interior, Bureau of Mines, is the agency now responsible for testing and approving pesticide respirators.

### (c) SELECTION OF RESPIRATORS

*Proper selection of respirators shall be made according to the guidance of American National Standard Practices for Respiratory Protection Z88.2-1969.*

### (d) AIR QUALITY

- (1) Compressed air, compressed oxygen, liquid air, and liquid oxygen used for respiration shall be of high purity. Oxygen shall meet the requirements of the United States Pharmacopoeia for medical or breathing oxygen. Breathing air shall meet at least the requirements of the specification for Grade D breathing air as described in Compressed Gas Association Commodity Specification G-7.1-1966. Compressed oxygen shall not be used in supplied-air respirators or in open circuit self-contained breathing apparatus that have previously used compressed air. Oxygen must never be used with air line respirators.
- (2) Breathing air may be supplied to respirators from cylinders or air compressors.
  - (i) Cylinders shall be tested and maintained as prescribed in the Shipping Container Specification Regulations of the Department of Transportation (49 CFR Part 178).
  - (ii) The compressor for supplying air shall be equipped with necessary safety and standby devices. A breathing air-type compressor shall be used. Compressors shall be constructed and situated so as to avoid entry of contaminated air into the system and suitable in-line air-purifying sorbent beds and filters installed to further assure breathing air quality. A receiver of sufficient capacity to enable the respirator wearer to escape from a contaminated atmosphere in event of compressor failure, and alarms to indicate compressor failure and overheating shall be installed in the system. If an oil-lubricated compressor is used, it shall have a high-temperature or carbon monoxide alarm, or both. If only a high-temperature alarm is used, the air from the compressor shall be frequently tested for carbon monoxide to insure that it meets the specifications in paragraph (d)(1) of this section.
- (3) Air line couplings shall be incompatible with outlets for other gas systems to prevent inadvertent servicing of air line respirators with nonrespirable gases or oxygen.
- (4) Breathing gas containers shall be marked in accordance with American National Standard Method of Marking Portable Compressed Gas Containers to Identify the Material Contained, 248.1-1954; Federal Specification BB-A-1034a, June 21, 1968, Air, Compressed for Breathing Purposes; or Interim Federal Specification GG-B-00675b, April 27, 1965, Breathing Apparatus, Self-Contained.

### (e) USE OF RESPIRATORS

- (1) Standard procedures shall be developed for respirator use. These should include all information and guidance necessary for their proper selection, use, and care. Possible emergency and routine uses of respirators should be anticipated and planned for.
- (2) *The* correct respirator shall be specified for each job. The respirator type is usually specified in the work procedures by a qualified individual supervising the respiratory protective program. The individual issuing them shall be adequately instructed to insure that the correct respirator is issued. Each respirator permanently assigned to an individual should be durably marked to indicate to whom it was assigned. This mark shall not affect the respirator performance in any way. The date of issuance should be recorded.
- (3) Written procedures shall be prepared covering safe use of respirators in dangerous atmospheres that might be encountered in normal operations or in emergencies. Personnel shall be familiar with these procedures and the available respirators.
  - (i) In areas where the wearer, with failure of the respirator, could be overcome by a toxic or oxygen deficient atmosphere, at least one additional man shall be present. Communications (visual, voice, or signal line) shall be maintained between both or all individuals present. Planning shall be such that one individual will be unaffected by any likely incident and have

the proper rescue equipment to be able to assist the other(s) in case of emergency.

- (ii) When self-contained breathing apparatus or hose masks with blowers are used in atmospheres immediately dangerous to life or health, standby men must be present with suitable rescue equipment.
  - (iii) Persons using air line respirators in atmospheres immediately hazardous to life or health shall be equipped with safety harnesses and safety lines for lifting or removing persons from hazardous atmospheres or other and equivalent provisions for the rescue of persons from hazardous atmospheres shall be used. A standby man or men with suitable self-contained breathing apparatus shall be at the nearest fresh air base for emergency rescue.
- (4) Respiratory protection is no better than the respirator in use, even though it is worn conscientiously. Frequent random inspections shall be conducted by a qualified individual to assure that respirators are properly selected, used, cleaned, and maintained.
- (5) For safe use of any respirator, it is essential that the user be properly instructed in its selection, use, and maintenance. Both supervisors and workers shall be so instructed by competent persons. Training shall provide the men an opportunity to handle the respirator, have it fitted properly, test its face-piece-to-face seal, wear it in normal air for a long familiarity period, and, finally, to wear it in a test atmosphere.
- (i) Every respirator wearer shall receive fitting instructions including demonstrations and practice in how the respirator should be worn, how to adjust it, and how to determine if it fits properly. Respirators shall not be worn when conditions prevent a good face seal. Such conditions may be a growth of beard, sideburns, a skull cap that projects under the facepiece, or temple pieces on glasses. Also, the absence of one or both dentures can seriously affect the fit of a facepiece. The worker's diligence in observing these factors shall be evaluated by periodic check. To assure proper protection, the facepiece fit shall be checked by the wearer each time he puts on the respirator. This maybe done by following the manufacturer's facepiece fitting instructions.
  - (ii) Providing respiratory protection for individuals wearing corrective glasses is a serious problem. A proper seal cannot be established if the temple bars of eye glasses extend through the sealing edge of the full facepiece. As a temporary measure, glasses with short temple bars or without temple bars may be taped to the wearer's head. Wearing of contact lenses in contaminated atmospheres with a respirator shall not be allowed. Systems have been developed for mounting corrective lenses inside full facepieces. When a workman must wear corrective lenses as part of the facepiece, the facepiece and lenses shall be fitted by qualified individuals to provide good vision, comfort, and a gas-tight seal.
  - (iii) If corrective spectacles or goggles are required, they shall be worn so as not to affect the fit of the facepiece. Proper selection of equipment will minimize or avoid this problem.

#### **(f) MAINTENANCE AND CARE OF RESPIRATORS**

- (1) A program for maintenance and care of respirators shall be adjusted to the type of plant, working conditions, and hazards involved, and shall include the following basic services:
- (i) Inspection for defects (including a leak check),
  - (ii) Cleaning and disinfecting,
  - (iii) Repair,
  - (iv) Storage
- Equipment shall be properly maintained to retain its original effectiveness.
- (2) (i) All respirators shall be inspected routinely before and after each use. A respirator that is not routinely used but is kept ready for emergency use shall be inspected after each use and at least monthly to assure that it is in satisfactory working condition. .



- (ii) Self-containing breathing apparatus shall be inspected monthly. Air and oxygen cylinders shall be fully charged according to the manufacturer's instructions. It shall be determined that the regulator and warning devices function properly.
  - (iii) Respirator inspection shall include a check of the tightness of connections and the condition of the facepiece, headbands, valves, connecting tube, and canisters. Rubber or elastomer parts shall be inspected for pliability and signs of deterioration. Stretching and manipulating rubber or elastomer parts with a massaging action will keep them pliable and flexible and prevent them from taking a set during storage.
  - (iv) A record shall be kept of inspection dates and findings for respirators maintained for emergency use.
- (3) Routinely used respirators shall be collected, cleaned, and disinfected as frequently as necessary to insure that proper protection is provided for the wearer. Each worker should be briefed on the cleaning procedure and be assured that he will always receive a clean and disinfected respirator. Such assurances are of greatest significance when respirators are not individually assigned to workers. Respirators maintained for emergency use shall be cleaned and disinfected after each use.
- (4) Replacement or repairs shall be done only by experienced persons with parts designed for the respirator. No attempt shall be made to replace components or to make adjustment or repairs beyond the manufacturer's recommendations. Reducing or admission valves or regulators shall be returned to the manufacturer or to a trained technician for adjustment or repair.
- (5) (i) After inspection, cleaning, and necessary repair, respirators shall be stored to protect against dust, sunlight, heat, extreme cold, excessive moisture, or damaging chemicals. Respirators placed at stations and work areas for emergency use should be quickly accessible at all times and should be stored in compartments built for the purpose. The compartments should be clearly marked. Routinely used respirators, such as dust respirators, maybe placed in plastic bags. Respirators should not be stored in such places as lockers or toolboxes unless they are in carrying cases or cartons.
- (ii) Respirators should be packed or stored so that the facepiece and exhalation valve will rest in a normal position and function will not be impaired by the elastomer setting in an abnormal position.
- (iii) Instructions for proper storage of emergency respirators, such as gas masks and self-contained breathing apparatus, are found in "use and care" instructions usually mounted inside the carrying case lid.

**(g) IDENTIFICATION OF GAS MASK CANISTERS**

- (1) The primary means of identifying a gas mask canister shall be by means of properly worded labels. The secondary means of identifying a gas mask canister shall be by a color code.
- (2) All who issue or use gas masks falling within the scope of this section shall see that all gas masks canisters purchased or used by them are properly labeled and colored in accordance with these requirements before they are placed in service and that the labels and colors are properly maintained at all times thereafter until the canisters have completely served their purpose.
- (3) **On** each canister shall appear in bold letters the following:
- (i) Canister for \_\_\_\_\_  
 (Name for atmospheric contaminant)  
 or  
 Type N Gas Mask Canister
  - (ii) In addition, essentially the following wording shall appear beneath the appropriate phrase on the canister label: "For respiratory protection in atmosphere containing not more than \_\_\_\_\_ percent by volume of \_\_\_\_\_"  
 (Name of atmospheric contaminant)

- (4) Canisters having a special high-efficiency filter for protection against radionuclides and other highly toxic particulate shall be labeled with a statement of the type and degree of protection afforded by the filter. The label shall be affixed to the neck end of, or to the gray stripe which is around and near the top of, the canister. The degree of protection shall be marked as the percent of penetration of the canister by a 0.3-micron-diameter dioctyl phthalate (DOP) smoke at a flow rate of 85 liters per minute.
- (5) Each canister shall have a label warning that gas masks should be used only in atmospheres containing sufficient oxygen to support life (at least 16 percent by volume), since gas mask canisters are only designed to neutralize or remove contaminants from the air.
- (6) Each gas mask canister shall be painted a distinctive color or combination of colors indicated in Table I-1. All colors used shall be such that they are clearly identifiable by the user and clearly distinguishable from one another. The color coating used shall offer a high degree of resistance to chipping, scaling, peeling, blistering, fading, and the effects of the ordinary atmospheres to which they may be exposed under normal conditions of storage and use. Appropriately colored pressure sensitive tape may be used for the stripes.

Table I-1.

| ATMOSPHERIC CONTAMINANTS TO BE PROTECTED AGAINST  | COLORS ASSIGNED*   |
|---|--|
| Acid gases . . . . .  | White  |
| Hydrocyanic acid gas . . . . .  | White with 1/2 inch green stripe completely around the canister near the bottom  |
| Chlorine gas . . . . .  | White with 1/2 inch yellow stripe completely around the canister near the bottom   |
| Organic vapors . . . . .  | Black  |
| Ammonia Gas . . . . .   | Green  |
| Acid gases and ammonia gas..... . . . .   | Green with 1/2 inch white stripe completely around the canister near the bottom  |
| Carbon monoxide . . . . .   | Blue   |
| Acid gases and organic vapors . . . . .   | Yellow   |
| Hydrocyanic acid gas and chloropicrin vapor . . . . .   | Yellow with 1/2 inch blue stripe completely around the canister near the bottom  |
| Acid gases, organic vapors, and ammonia gases. . . . .  | Brown  |
| Radioactive materials, excepting tritium and noble gases  | Purple (Magenta)   |
| Particulate (dusts, fumes, mists, fogs, or smokes) in combination with any of the above gases or vapors . . | Canister color for contaminant, as designated above, with 1/2 inch gray strip completely around the canister near the top. |
| All of the above atmospheric contaminants . . . . .   | Red with 1/2 inch gray stripe completely around the canister near the top.   |

\* Gray shall not be assigned as the main color for a canister designed to remove acids or vapors.  
 NOTE: Orange shall be used as a complete body, or stripe color to represent gases not included in this table. The user will need to refer to the canister label to determine the degree of protection the canister will afford.  
 (Secs. 4(b)(2), 6(b) and 8(c), 84 Stat. 1592,1593,1596,29 U.S.C. 653,655, 657; Secretary of Labor's Order No. 8-76 (41 FR 25059); 29 CFR Part 1911)  
 (39 FR 23502, June 27, 1974, as amended at 43 FR 49748, Oct. 24, 1978)

## **Appendix A4. Environmental Protection Agency Regulations Governing Asbestos Abatement Projects (40 CFR 763.120,121)**

### **SUBPART G — ASBESTOS ABATEMENT PROJECTS**

#### **763.120 SCOPE**

- (a) This part establishes requirements which must be followed during asbestos abatement projects, which include any activity involving the removal, enclosure, or encapsulation of any material containing more than 1 percent asbestos by weight which, when dry, may be crumbled, pulverized, or reduced to powder by hand pressure.
- (b) This part applies to all employers of State and local government employees not covered by the Asbestos Standard of the Occupational Safety and Health Administration (OSHA), 29 CFR 1910.1001, or an Asbestos Standard adopted by a State as part of a State plan approved by OSHA under section 18 of the Occupational Safety and Health Act. The rule covers the employees of those employers. The employer is the public department, agency, or entity which hires the employee. This includes, but is not limited to the following examples of public entities: any State, County, City, or other local governmental entity which operates or administers schools, a department of health or human services, a library, a police department, a fire department, or similar public service agencies or offices.

#### **763.121 REGULATORY REQUIREMENTS**

##### **(a) Definitions**

For the purpose of this section:

- (1) "Asbestos" means "the asbestiform varieties of chrysotile (serpentine); crocidolite (riebeckite); amosite (cummingtonite-grunerite); tremolite; anthophyllite, and actinolite."
- (2) "Asbestos fibers" means asbestos fibers longer than 5 micrometers.

##### **(b) Permissible exposure to airborne concentrations of asbestos fibers.**

###### **(1) Reserved**

(2) **Standard effective July 12, 1985.** The 8-hour time-weighted average airborne concentrations of asbestos fibers to which any employee may be exposed shall not exceed two fibers, longer than 5 micrometers, per cubic centimeter of air, as determined by the method prescribed in paragraph (e) of this section.

(3) **Ceiling concentration.** No employee shall be exposed at any time to airborne concentrations of asbestos fibers in excess of 10 fibers, longer than 5 micrometers, per cubic centimeter of air, as determined by the method prescribed in paragraph (e) of this section.

##### **(c) Methods of compliance**

###### **(1) Engineering methods**

(i) **Engineering controls.** Engineering controls, such as, but not limited to, isolation, enclosure, exhaust ventilation, and dust collection, shall be used to meet the exposure limits prescribed in paragraph (b) of this section.

###### **(ii) Local exhaust ventilation.**

(A) Local exhaust ventilation and dust collection systems shall be designed, constructed, installed, and maintained in accordance with the American National Standard Fundamentals Governing the Design and Operation of Local Exhaust Systems, ANSI Z9.2-1979, (Revision of ANSI Z9.2-1971 ) which is incorporated by reference herein.

(B) ANSI Z9.2-1979 is available for inspection at the Office of the Federal Register Information Center, Rm. 8301, 1100 L St., NW., Washington, DC 20408. This incorporation by reference was approved by the Director of the Office of the Federal Register. This material is incorporated as it exists on the date of approval and a notice of any change in this material will be published in the Federal Register. Copies of the incorporated material may be obtained from the Document Control Officer (TS-793 ), Office of Toxic Substances, EPA, Rm. 107,401 M St., SW., Washington, DC 20460, and from the American National Standards Institute, 1430 Broadway, New York, NY, 10018 (212-354-3473).

(iii) *Particular tools*. All hand-operated and power-operated tools which may produce or release asbestos fibers in excess of the exposure limits prescribed in paragraph (b) of this section, such as, but not limited to, saws, scorers, abrasive wheels, and drills, shall be provided with local exhaust ventilation systems in accordance with paragraph (c) (1) (ii) of this section.

(2) **Work practices** —

(i) *Wet methods*. Insofar as practicable, asbestos shall be handled, mixed, applied, removed, cut, scored, or otherwise worked in a wet state sufficient to prevent the emission of airborne fibers in excess of the exposure limits prescribed in paragraph (b) of this section, unless the usefulness of the product would be diminished thereby.

(ii) *Particular products and operations*. No asbestos cement, mortar, coating, grout, plaster, or similar material containing asbestos shall be removed from bags, cartons, or other containers in which they are shipped, without being either wetted, or enclosed, or ventilated so as to prevent effectively the release of airborne asbestos fibers in excess of the limits prescribed in paragraph (b) of this section,

(iii) *Spraying, demolition, or removal* Employees engaged in the spraying of asbestos, the removal, or demolition of pipes, structures, or equipment covered or insulated with asbestos, and in the removal or demolition of asbestos insulation or coverings shall be provided with respiratory equipment in accordance with paragraph (d) (2) (iii) of this section and with special clothing in accordance with paragraph (d) (3) of this section.

(d) **Personal protective equipment**

(1) Compliance with the exposure limits prescribed by paragraph (b) of this section may not be achieved by the use of respirators or shift rotation of employees, except:

(i) During the time period necessary to install the engineering controls and to institute the work practices required by paragraph (c) of this section;

(ii) In work situations in which the methods prescribed in paragraph (c) of this section are either technically not feasible or feasible to an extent insufficient to reduce the airborne concentrations of asbestos fibers below the limits prescribed by paragraph (b) of this section; or

(iii) In emergencies.

(2) Where a respirator is permitted by paragraph (d)(1) of this section, it shall be selected from among those approved by the Bureau of Mines, Department of the Interior, or the National Institute for Occupational Safety and Health, Department of Health, Education, and Welfare, under the provisions of 30 CFR Part 11 (37 FR 6244, Mar. 25, 1972), and shall be used in accordance with paragraph (d)(2)(i), (ii), (iii), and (iv) of this section.

(i) *Air purifying respirators*. A reusable or single use air purifying respirator, or a respirator described in paragraph (d)(2)(ii) or (iii) of this section, shall be used to reduce the concentrations of airborne asbestos fibers in the respirator below the exposure limits prescribed in paragraph (b) of this section, when the ceiling or the 8-hour time-weighted average airborne concentrations of asbestos fibers are reasonably expected to exceed no more than 10 times those limits.

- (ii) *Powered air purifying respirators.* A full facepiece powered air purifying respirator, or a powered air purifying respirator, or a respirator described in paragraph (d)(2) (iii) of this section, shall be used to reduce the concentrations of airborne asbestos fibers in the respirator below the exposure limits prescribed in paragraph (b) of this section, when the ceiling or the 8-hour time-weighted average concentrations of asbestos fibers are reasonably *expected* to exceed 10 times, but not 100 times, those limits.
  - (iii) *Type "C" supplied-air respirators, continuous flow or pressure-demand class.* A type "C" continuous flow or pressure-demand, supplied-air respirator shall be used to reduce the concentrations of airborne asbestos fibers in the respirator below the exposure limits prescribed in paragraph (b) of this section, when the ceiling or the 8-hour time-weighted average airborne concentrations of asbestos fibers are reasonably expected to exceed 100 times those limits.
  - (iv) *Establishment of a respirator program.*
    - (A) The employer shall establish a respirator program in accordance with the requirements of the American National Standard Practices for Respiratory Protection, ANSI Z88.2-1980 (Revision of ANSI Z88.2-1969), which is incorporated by reference herein.
    - (B) ANSI 2%8.2-1980 is available for inspection at the Office of the Federal Register Information Center, Rm. 8301, 1100 L St., NW., Washington, DC 20408. This incorporation by reference was approved by the Director of the Office of the Federal Register. This material is incorporated as it exists on the date of approval and a notice of any change in this material will be published in the Federal Register. Copies of the incorporated material may be obtained from the Document Control Officer (TS-793), Office of Toxic Substances, EPA, Rm. 107,401 M St., SW., Washington, DC 20460, and from the American National Standards Institute, 1430 Broadway, New York, NY 10018, (212-354-3473).
    - (C) No employee shall be assigned to tasks requiring the use of respirators if, based upon his most recent examination, an examining physician determines that the employee will be unable to function normally wearing a respirator, or that the safety or health of the employee or other employees will be impaired by his use of a respirator. Such employee shall be rotated to another job or given the opportunity to transfer to a different position whose duties he is able to perform with the same employer, in the same geographical area and with the same seniority, status, and rate of pay he had just prior to such transfer, if such a different position is available.
- (3) ***Special Clothing.*** The employer shall provide, and require the use of, special clothing, such as coveralls or similar whole body clothing, head coverings, gloves and foot coverings for any employee exposed to airborne concentrations of asbestos fibers, which exceed the ceiling level prescribed in paragraph (b) of this section.
- (4) ***Change rooms.***
- (i) At any fixed place of employment exposed to airborne concentrations of asbestos fibers in excess of the exposure limits prescribed in paragraph (b) of this section, the employer shall provide change rooms for employees working regularly at the place.
  - (ii) *Clothes lockers.* The employer shall provide two separate lockers or containers for each employee, so separated or isolated as to prevent contamination of the employee's street clothes from his work clothes.
  - (iii) *Laundering.*
    - (A) Laundering of asbestos contaminated clothing shall be done so as to prevent the release of airborne asbestos fibers in excess of the exposure limits prescribed in paragraph (b) of this section.
    - (B) Any employer who gives asbestos contaminated clothing to another person for laundering shall inform such person of the requirement in paragraph (d)(4) (iii)(A) of this section to effectively prevent the release of airborne asbestos fibers in excess of the exposure limits prescribed in paragraph (b) of this section.

(C) Contaminated clothing shall be transported in sealed impermeable bags, or other closed, impermeable containers, and labeled in accordance with paragraph (g) of this section.

(e) **Method of measurement.** All determinations of airborne concentrations of asbestos fibers shall be made by the membrane filter method at 400 - 450 x (magnification)(4 millimeter objective) with phase contrast illumination.

**(f) Monitoring**

(1) *Initial determinations.* Every employer shall cause every place of employment where asbestos fibers are released to be monitored in such a way as to determine whether every employee's exposure to asbestos fibers is below the limits prescribed in paragraph (b) of this section. If the limits are exceeded, the employer shall immediately undertake a compliance program in accordance with paragraph (c) of this section.

(2) *Personal monitoring.*

(i) Samples shall be collected from within the breathing zone of the employees, on membrane filters of 0.8 micrometer porosity mounted in an open-face filter holder. Samples shall be taken for the determination of the 8-hour time-weighted average airborne concentrations and of the ceiling concentrations of asbestos fibers.

(ii) *Sampling frequency and patterns.* After the initial determinations required by paragraph (f)(1) of this section, samples shall be of such frequency and pattern as to represent with reasonable accuracy the levels of exposure of employees.

(3) *Environmental monitoring.*

(i) Samples shall be collected from areas of a work environment which are representative of the airborne concentrations of asbestos fibers which may reach the breathing zone of employees. Samples shall be collected on a membrane filter of 0.8 micrometer porosity mounted in an open-face filter holder. Samples shall be taken for the determination of the 8-hour time-weighted average airborne concentrations and of the ceiling concentrations of asbestos fibers.

(ii) *Sampling frequency and patterns.* After the initial determinations required by paragraph (f) (1) of this section, samples shall be of such frequency and pattern as to represent with reasonable accuracy the levels of exposure of the employees.

(4) *Employee observation of monitoring.* Affected employees, or their representatives, shall be given a reasonable opportunity to observe any monitoring required by this paragraph and shall have access to the records thereof.

**(g) Caution signs and labels**

(1) Caution signs.

(i) *Posting.* Caution signs shall be provided and displayed at each location where airborne concentrations of asbestos fibers may in excess of the exposure limits prescribed in paragraph (b) of this section. Signs shall be posted at such a distance from such a location so that an employee may read the signs and take necessary protective steps before entering the area marked by the signs. Signs shall be posted at all approaches to areas containing excessive concentrations of airborne asbestos fibers.

(ii) *Sign specifications.* The warning signs required by paragraph (g)(1)(i) of this section shall conform to the requirements of 20"x14" vertical format signs specified in 29 CFR 1910.145 (d)(4), and to this paragraph (g)(1) (ii). The signs shall display the following legend in the lower panel, with letter sizes and styles of a visibility at least equal to that specified in this paragraph (g)(1)(ii).

| LEGEND   | NOTATION                        |
|--|---------------------------------|
| Asbestos . . . . .   | 1" Saris Serif, Gothic or Block |
| Dust Hazard . . . . .  | ¾" Saris Serif, Gothic or Block |
| Avoid Breathing Dust . . . . .                                       | ¼" Gothic                       |
| Wear Assigned Protective Equipment. . . . .                          | ¼" Gothic                       |
| Do Not Remain in Area Unless Your Work Requires It . . . . .         | ¼" Gothic                       |
| Breathing Asbestos Dust<br>May be Hazardous to Your Health . . . . . | 14 Point Gothic                 |

Spacing between lines shall be at least equal to the height of the upper of any two lines.

**(2) Caution labels,**

- (i) **Labeling.** Caution labels shall be affixed to all raw materials, mixtures, scrap, waste, debris, and other products containing asbestos fibers, or to their containers, except that no label is required where asbestos fibers have been modified by a bonding agent, coating, binder, or other material so that during any reasonably foreseeable use, handling, storage, disposal, processing, or transportation, no airborne concentrations of asbestos fibers in excess of the exposure limits prescribed in paragraph (b) of this section will be released.
- (ii) **Label specifications.** The caution labels required by paragraph (g)(2)(i) of this section shall be printed in letters of sufficient size and contrast to be readily visible and legible. The label shall state:

CONTAINS ASBESTOS FIBERS  
AVOID CREATING DUST  
BREATHING ASBESTOS DUST MAY CAUSE  
SERIOUS BODILY HARM

**(h) Housekeeping**

- (1) **Cleaning.** All external surfaces in any place of employment shall be maintained free of accumulations of asbestos fibers if, with their dispersion, there would be an excessive concentration.
- (2) **Waste disposal.** Asbestos waste, scrap, debris, bags, containers, equipment, and asbestos-contaminated clothing, consigned for disposal, which may produce in any reasonably foreseeable use, handling, storage, processing, disposal, or transportation airborne concentrations of asbestos fibers in excess of the exposure limits prescribed in paragraph (b) of this section shall be collected and dispose of in sealed impermeable bags, or other closed, impermeable containers.

**(i) Recordkeeping**

- (1) **Exposure records,** Every employer shall maintain records of any personal or environmental monitoring required by this section. Records shall be maintained for a period of at least 20 years and shall be made available upon request to the Environmental Protection Agency, the Assistant Secretary of Labor for Occupational Safety and Health, the Director of the National Institute for Occupational Safety and Health, and to authorized representatives of either.
- (2) **Employee access.** Every employee and former employee shall have reasonable access to any record required to be maintained by paragraph (i)(1) of this section, which indicates the employee's own exposure to asbestos fibers.



- (3) **Employee notification.** Any employee found to have been exposed at any time to airborne concentrations of asbestos fibers in excess of the limits prescribed in paragraph (b) of this section shall be notified in writing of the exposure as soon as practicable but not later than 5 days of the finding. The employee shall also be timely notified of the corrective action being taken.

**(j) Medical examinations**

- (1) **General.** The employer shall provide or make available at his cost, medical examinations relative to exposure to asbestos required by this paragraph.
- (2) **Preplacement.** The employer shall provide or make available to each of his employees, with 30 calendar days following his first employment in an occupation exposed to airborne concentrations of asbestos fibers, a comprehensive medical examination, which shall include, as a minimum, a chest roentgenogram (posterior-anterior 14 x 17 inches), a history to elicit symptomatology of respiratory disease, and pulmonary function tests to include forced vital capacity (FVC) and forced expiratory volume at 1 second (FEV 1.0)
- (3) **Annual examinations.** On or before July 14, 1986, and at least annually thereafter, every employer shall provide, or make available, comprehensive medical examinations to each of his employees engaged in occupations exposed to airborne concentrations of asbestos fibers. Such annual examination shall include, as a minimum, a chest roentgenogram (posterior-anterior 14 x 17 inches), a history to elicit symptomatology of respiratory disease, and pulmonary function tests to include forced vital capacity (FVC) and forced expiratory volume at 1 second (FEV 1.0).
- (4) **Termination of employment.** The employer shall provide, or make available, within 30 calendar days before or after the termination of employment of any employee engaged in an occupation exposed to airborne concentrations of asbestos fibers, a comprehensive medical examination which shall include, as a minimum, a chest roentgenogram (posterior-anterior 14 x 17 inches), a history to elicit symptomatology of respiratory disease, and pulmonary function tests to include forced vital capacity (FVC) and forced expiratory volume at 1 second (FEV 1.0 ).
- (5) **Recent examinations.** No medical examination is required of any employee, if adequate records show that the employee has been examined in accordance with this paragraph within the past 1-year period.

**(6) Medical records.**

- (i) **Maintenance.** Employers of employees examined pursuant to this paragraph shall cause to be maintained complete and accurate records of all such medical examinations. Records shall be retained by employers for at least 20 years.
- (i) **Access.** The contents of the records of the medical examinations required by this paragraph shall be made available, for inspection and copying, to the Environmental Protection Agency, the Assistant Secretary of Labor for Occupational Safety and Health, the Director of NIOSH, to authorized physicians and medical consultants of either of them, and, upon the request of an employee or former employee, to this physician. Any physician who conducts a medical examination required by this paragraph shall furnish to the employer of the examined employee all the information specifically required by this paragraph, and any other medical information related to occupational exposure to asbestos fibers.

**Appendix B.**  
**Sample MSHA/NIOSH**  
**Approval Labels**

Figure B1. Sample MSHA/NIOSH Approval Label for Pressure Demand SCBA.

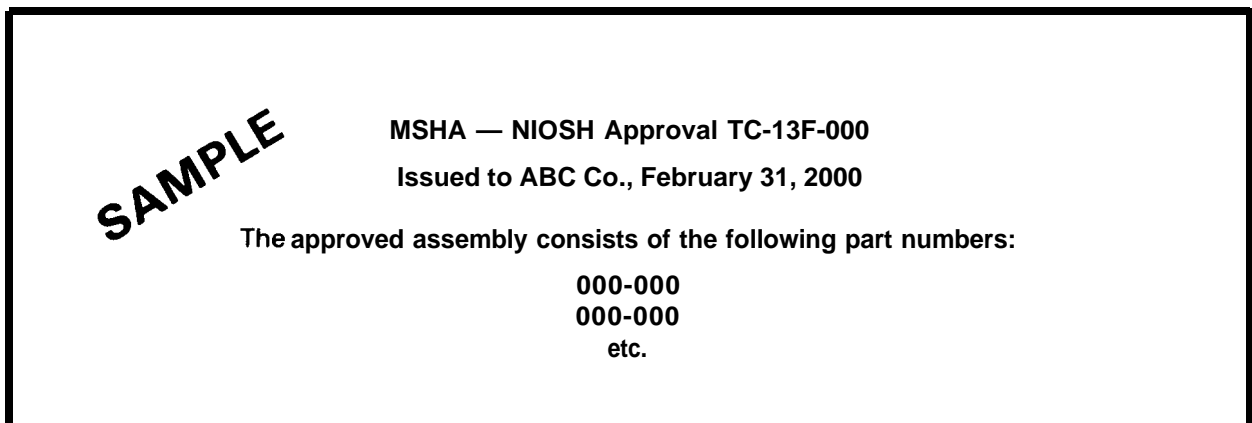

Figure B2. Sample MSHA/NIOSH Approval Label  
for Pressure-Demand SAR

PERMISSIBLE  
**Combination Ten Minute Self-Contained Compressed Air  
Breathing Apparatus for Escape Only  
Pressure Demand Type C Supplied Air Respirator**

MINE SAFETY AND HEALTH ADMINISTRATION  
NATIONAL INSTITUTE FOR OCCUPATIONAL  
SAFETY AND HEALTH

**APPROVAL NO. TC-13F-000**

ISSUED TO  
**ABC Company  
Anywhere, U.S.A.**

LIMITATIONS

Approved for respiratory protection during entry and escape from oxygen deficient atmospheres, gas, and vapors, when using air-line air supply. Approved for escape only, when using self-contained air supply. Approved for use at temperatures above -25°F.

Approved only when compressed air reservoir is fully changed with air meeting the requirements of the Compressed Air Gas Association Specifications G-7-1 for type 1, Grade D air, or equivalent specifications. The containers shall meet applicable DOT specifications.

This approval applies only when the device is supplied with respirable breathing air through 12.5 to 300 feet of hose at air pressures between 78 and 80 pounds per square inch gage or from self-contained air supply. If the supplied-air fails, open cylinder valve and proceed to fresh air immediately.

CAUTION

Use with adequate skin protection when worn in gases and vapors that poison by skin absorption (for example: hydrocyanic-acid gas). In making renewals and repairs, parts identical with those furnished by the manufacturer under the pertinent approval shall be maintained. This respirator shall be selected, fitted, used, and maintained in accordance with Mine Safety and Health Administration, and other applicable regulations.

**SAMPLE**

**MSHA — NIOSH Approval TC-13F-000**  
issued to ABC Company, February 31, 2000

The approval assembly consists of the following part numbers:

000-000  
000-000  
etc.

**SAMPLE**

**Appendix C.**  
**Selected NIOSH Respirator**  
**User Notices**



Centers for Disease Control  
National Institute for Occupational  
Safety and Health - ALOSH  
944 Chestnut Ridge Road  
Morgantown, WV 28505-2888

January 17, 1986

RESPIRATOR USERS NOTICE

Inspection of Certain Aluminum Cylinders for Breathing-gas Pressure

The light weight and high charging pressure of aluminum cylinders have resulted in their widespread acceptance and use with self-contained breathing apparatus (SCBA). The National Institute for Occupational Safety and Health (NIOSH) estimates that more than half of the SCBA of 30- and 60-minute duration in regular use today are equipped with aluminum cylinders.

Since first receiving reports of defective fiber-glass wrapped aluminum cylinders in 1983, NIOSH has advised users of potential hazards associated with use of certain fiber-glass wrapped aluminum cylinders. At this time, NIOSH believes there is sufficient evidence to warrant issuance of this NOTICE regarding inspection of fiber-glass wrapped aluminum cylinders.

The presently available evidence indicates that fiber-glass wrapped aluminum cylinders manufactured under Department of Transportation (DOT) exemptions DOT-E 7235 and DOT-E 8059 (including 2216 and 4500 psi) may, upon aging, develop neck cracks and may leak breathing gas during storage and use. This may result in significant loss of breathing gas from an unattended cylinder. If undetected, this loss of breathing gas could be dangerous to the user.

Based on this, NIOSH recommends that where SCBA are equipped with fiber-glass wrapped aluminum cylinders, inspection for cylinder pressure should be made at least weekly, for stored units. When used on a daily basis, as in fire fighting, cylinder pressure should be checked daily and immediately before use.

If a leak is suspected, the cylinder and cylinder valve should be tested as prescribed in American National Standard, Z88.5-1981, Practices for Respiratory Protection for the Fire Service, Section 6.2.4.2.

Leaks in cylinders should be reported to the SCBA manufacturer who will, in turn report them to the cylinder manufacturer. The numbers and charging pressures of leaking cylinders should also be reported to DOT (Mr. Art Mallen, DOT Office of Hazardous Materials, 400 7th St. SW, Washington, DC 20590) and to NIOSH (Mr. John Moran at the address shown at the top of this letter).

Aluminum cylinders used with SCBA, with exemption numbers other than DOT-E 7235 and DOT-E 8059 are not covered in this notice. Self-contained self rescuers used in mines are also not included.

MORE

R E M I N D E R

January 17, 1986

Manufacturers of MSHA/NIOSH-approved SCBA  
Incorporating DOT-E 7235 4500 Fiber-glass Wrapped Aluminum Cylinders

The following manufacturers incorporate DOT-E 7235 4500 cylinders in their MSHA/NIOSH-approved SCBA:

- o Bendix
- o Clifton Precision
- o Draeger
- o Siebe German
- o Scott
- o U.S.D. (SurvivAir)

DOT-E 7235 4500 cylinders must be retrofitted by Luxfer (Telephone: 714-684-5110) with steel neck rings, to prevent explosive rupture. DOT regulations prohibit charging of any DOT-E 7235 4500 cylinder that has not been fitted with a steel neck ring. Any apparatus utilizing a DOT-E 7235 4500 cylinder without a neck ring, is considered unapproved by MSHA/NIOSH.

Change in Address of Manufacturer's Contact

The following address change has been reported to NIOSH for manufacturer's personnel who are responsible for handling reports of problems with MSHA/NIOSH-approved respirators:

Clifton Precision: New Address: 750 West Sproul Road, Springfield, PA  
19064-4084  
Contact: Mr. Martin Ziegler

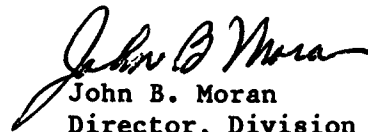
  
John B. Moran

Director, Division of Safety Research



Centers for Disease Control  
National Institute for Occupational  
Safety and Health - ALOSH  
944 Chestnut Ridge Road  
Morgantown, WV 26505-2888

June 28, 1985

RESPIRATOR USERS NOTICE

Use and Maintenance of Pressure-demand  
Self-contained Breathing Apparatus

Since July 1, 1983, the Occupational Safety and Health Administration (OSHA) Fire Brigade Standard, Title 29, Code of Federal Regulations, Part 1910.156, has required that pressure-demand or other positive pressure self-contained breathing apparatus be worn by fire brigade members performing interior structural fire fighting. Although this standard is only applicable to all industrial fire brigades and to municipal fire departments in states with state-OSHA plans, other fire service organizations and industrial users of self-contained breathing apparatus (SCBA) have also recognized the superior protective capabilities of positive-pressure SCBA. As a result, there has been a steady change from demand to pressure-demand SCBA in the United States.

To provide the increased respiratory protection afforded by pressure-demand SCBA, it is generally necessary to increase the static pressure within the facepiece. The complex mechanics necessary to maintain this increased pressure and to control air flow when the facepiece is removed, together with the wearer's physiological response to the pressure-demand system, have presented problems to SCBA users.

Pressure demand SCBA requires more careful maintenance and different training, than is required for demand SCBA. Manufacturers have been providing maintenance and use instructions and training for purchasers of pressure-demand SCBA. The National Institute for Occupational Safety and Health (NIOSH) recommends that users of pressure-demand SCBA read those instructions, follow them carefully in apparatus use and maintenance, and take advantage of the manufacturer's training assistance. In addition to the manufacturers, training courses are offered by *Fire Service* organizations and by private organizations.

In the area of pressure-demand SCBA maintenance and repair, NIOSH strongly recommends that users have this service performed by a manufacturer-trained representative. This service is required to assure continued safe performance of pressure-demand SCBA.

Please advise NIOSH of any problems encountered in maintenance and use of pressure-demand self-contained breathing apparatus. Call the NIOSH Respirator Problem Coordinator, (304) 291-4595 (FTS 923-4595).



Use and Maintenance of Pressure-Demand SCBA/Page 2

To assist you, NIOSH has prepared the following list of manufacturer's and fire service organization personnel who can provide further information on pressure-demand breathing apparatus training:

Clifton Precision  
5100 State Road  
Drexel Hill, PA 19026  
Mr. Robert Gray (215) 622-1718

North Safety Equipment  
2000 Plainfield Pike  
Cranston, RI 02920  
Mr. Richard T. Flynn (401) 943-4400

Globe Safety Equipment, Inc.  
P.O. Box 7248  
Dayton, OH 45407  
Mr. Steven Bates (513) 224-7468

Rexnord  
45 Great Valley Parkway  
Malvern, PA 19355  
Mr. Justin Mills (215) 647-7200 \*

International Safety Instruments, Inc.  
P.O. Box 846  
Lawrenceville, GA 30246  
Mr. Donald Dawson (404) 962-2552

Scott Aviation  
225 Erie Street  
Lancaster, NY 14086  
Mr. Dennis Browner (716) 683-5100

MSA  
600 Penn Center Boulevard  
Pittsburgh, PA 15235  
Mr. Jay Mears (412) 273-5145

U.S.D.  
3323 West Warner Avenue  
Santa Ana, CA 92702  
Mr. Brian Miller (714) 241-4601

National Draeger, Inc.  
P.O. Box 120  
Pittsburgh, PA 15230  
Mr. Les Boord/Ms. Karen Cox/Mr. Richard Weaver (412) 787-8383

International Association of Fire Chiefs  
1329 18th Street, NW  
Washington, DC 20036  
Mr. Jan Thomas (202) 833-3420

International Association of Fire Fighters  
1750 New York Avenue, NW  
Washington, DC 20006  
Mr. Richard Duffy (202) 737-8484

International Society of Fire Service Instructors  
20 Main Street  
Ashland, MA 01721  
Mr. Ed McCormack (617) 881-5800

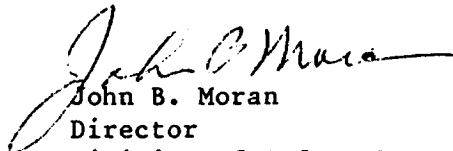
  
John B. Moran  
Director  
Division of Safety Research

\* New contact for reporting respirator problems (replaced Mr. John Moffa)



Centers for Disease Control  
National Institute for Occupational  
Safety and Health - ALOSH  
944 Chestnut Ridge Road  
Morgantown, WV 28505-2888

November 6, 1984

## RESPIRATOR USERS ' NOTICE

### USE OF UNAPPROVED SUBASSEMBLIES

The National Institute for Occupational Safety and Health (NIOSH) has received many questions and complaints in regard to interchangeability of respirator subassemblies and unapproved modifications to MSHA/NIOSH certified respirators. Further, some problems reported to NIOSH have, upon investigation, been found to have been caused by user's modifying certified respirators which have resulted in the modified respirator failing to perform as anticipated, thus jeopardizing the respirator user.

MSHA/NIOSH respirator certification regulations, Title 30 Code of Federal Regulations Part 11 (30 CFR 11), state that approved respirators are ones that "are maintained in an approved condition and are the same in all respects as those respirators for which a certificate has been issued." [30 CFR 11, 11.2(b)] In addition, the regulations permit NIOSH/MSHA to only approve complete respirator assemblies and prohibit the approval of respirator subassemblies such as cylinders or air supply hoses. These requirements are intended to insure that one manufacturer has overall control and responsibility for the integrity of the approved respirator.

In some cases even minor modifications to respirators may make significant changes in the performance of the respirator. Manufacturers who modify certified respirators must test the modification to determine if the respirator continues to meet the minimum requirements of 30 CFR 11, and must submit the modifications to NIOSH. A user who modifies a certified respirator may not be able to determine whether a change will decrease respiratory protection. Several cases have been reported to NIOSH where unapproved modifications or use of an unapproved subassembly have resulted in respirator failures. Therefore, users of NIOSH/MSHA approved respirators are cautioned against Interchanging subassemblies or making unapproved modifications to their respiratory protective devices.

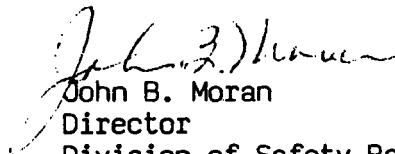
  
John B. Moran  
Director  
Division of Safety Research



Centers for Disease Control  
National Institute for Occupational  
Safety and Health - ALOSH  
944 Chestnut Ridge Road  
Morgantown, WV 26505-2888

December 16, 1983

RESPIRATOR USER'S NOTICE

Effects of Chemicals on Rubber and Plastic Parts  
of Self-contained Breathing Apparatus

The National Institute for Occupational Safety and Health (NIOSH) has received several reports of damage to parts of self-contained breathing apparatus that have apparently been exposed to concentrations of chemicals. These exposures have occurred *during* emergency response activities after accidental chemical vapor release and/or chemical discharge. The most recent report concerned a leak of dimethyl amine in Benicia, California, on August 12 and 13, 1983. Self-contained breathing apparatus and other equipment used during control of this leak were reportedly rendered unserviceable after exposure.

In view of these reports, fire fighting personnel who are engaged in emergency response activities should be equipped with proper chemical protective clothing in addition to respiratory protection. Information on the protective capabilities of such clothing should be obtained from the clothing manufacturer.

NIOSH is conducting a study of permeation of protective clothing materials by chemicals. Part of this study involves preparation of a data base of information on that subject. As part of this data base, NIOSH would appreciate receiving information on further cases of reported damage to self-contained breathing apparatus by chemicals. Reports should be addressed to the Testing and Certification Branch, Division of Safety Research, NIOSH, 944 Chestnut Ridge Road, Morgantown, WV 26505-2888. Reports should include the name of the chemical, Chemical Abstracts Service (CAS) Registry number, if known, identification and/or type of material damaged, extent of damage, and either the approximate concentration of the chemical or details of the exposure (e.g., exposure to liquid and/or vapor, temperature wind conditions, and degree of enclosure of exposure).

Thomas C. Purcell, Ph.D.  
Acting Director,  
Division of Safety Research



Centers for Disease Control  
National Institute for Occupational  
Safety and Health - ALOSH  
944 Chestnut Ridge Road  
Morgantown, WV 26505-2888

December 16, 1983

RESPIRATOR USER'S NOTICE

Effects of Heat and Flames on Rubber and Plastic  
Parts of Self-contained Breathing Apparatus

The National Institute for Occupational Safety and Health (NIOSH) has received several reports of damage to parts of self-contained breathing apparatus that have apparently been exposed to excessive heat and/or flames during fire fighting activities. A preliminary investigation of these reports indicates that development of new turnout gear for fire fighters permits them to enter and remain in higher temperatures and flame exposures. These higher temperatures and flame exposures can apparently damage some presently-used rubber and plastic parts of self-contained breathing apparatus.

NIOSH is proposing to include requirements for high-temperature performance of self-contained breathing apparatus in Title 30, Code of Federal Regulations, Part 11 (30 CFR 11), the regulations governing approval of respirators. NIOSH has been advised by self-contained breathing apparatus manufacturers that they are developing new materials with greater resistance to heat and flames. NIOSH recommends that fire fighters avoid overexposure of breathing apparatus parts to high heat and/or flames, where possible.

NIOSH requests that fire fighting personnel and others report further incidents of heat and flame damage of self-contained breathing apparatus. Such reports should be sent to the Testing and Certification Branch, Division of Safety Research, NIOSH, 944 Chestnut Ridge Road, Morgantown, WV 26505-2888.

Thomas C. Purcell, Ph.D.  
Acting Director,  
Division of Safety Research



Centers for Disease Control  
National Institute for Occupational  
Safety and Health - ALOSH  
944 Chestnut Ridge Road  
Morgantown, WV 26505-2888

March 3, 1983

RESPIRATOR INFORMATION NOTICE

ON

3M Powered Air Purifying Respirator  
3M, St. Paul, Minnesota  
Model Number: w-344  
Approval Number: TC-21C-246

Racal Powered Air Purifying Respirator  
Racal Airstream, Inc., Frederick, Maryland  
Model Number: AH3  
Approval Number: TC-21C-212

In a Respirator Information Notice dated November 15, 1982, NIOSH recommended that powered air purifying respirators (PAPRs) with high efficiency filters not be relied upon to consistently provide a workplace protection factor of 1000. That recommendation was based upon the results of the two studies of PAPRs with tight fitting facepieces described in that Notice as well as the additional NIOSH study of helmeted PAPRs described in this Notice.

The NIOSH study of helmeted PAPRs with high efficiency filters was conducted by NIOSH on the 3M W-344 PAPR and the Racal AH3 PAPR at a secondary lead smelter. In this study the challenge aerosols contained lead dust and/or lead fume.

This study produced the following preliminary results. The workplace protection factors associated with both respirator models were found to be approximately lognormally distributed. The results of the t-tests indicate that there is no significant difference ( $P < .05$ ) between the mean workplace protection factors of the 3M and Racal PAPRs under the particular circumstances of these studies. For both the 3M and Racal PAPRs, approximately 98% of the observed workplace protection factors were below 1000. Approximately 95% of the observed workplace protection factors for both the 3M and Racal PAPRs exceeded 33. The geometric mean workplace protection factor for 3M and Racal PAPRs was 182 with a geometric standard deviation of 3.2.

As stated in the November 15, 1982, Respirator Information Notice, the preliminary results of the NIOSH studies of the MSA, 3M and Racal PAPRs indicate that the protection factor expected from this class of respirators is inappropriately high.

For more information on this subject, contact Glendel J. Provost, Division of Safety Research, NIOSH, 944 Chestnut Ridge Road, Morgantown, West Virginia 26505. Commercial telephone number is (304) 291-4595 and the FTS number is 923-4595.

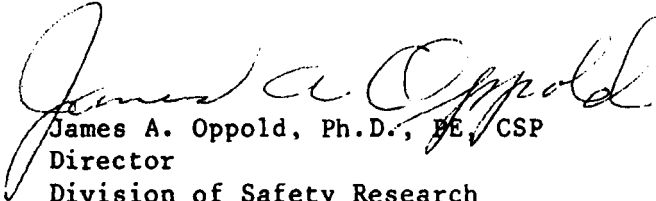

James A. Oppold, Ph.D., PE, CSP  
Director  
Division of Safety Research



Centers for Disease Control  
National Institute for Occupational  
Safety and Health - ALOSH  
844 Chestnut Ridge Road  
Morgantown, WV 26505-2888

November 15, 1982

RESPIRATOR INFORMATION NOTICE

ON

MSA Powered Air Purifying Respirator  
Mine Safety Appliance Company, Pittsburgh, PA  
Model Numbers: 463354, 466607, 466608  
Approval Number: TC-21C-186

On April 24, 1981, NIOSH issued a Respirator Information Notice which described the results of a NIOSH study of the MSA high efficiency powered air purifying respirator (PAPR) during use in a silica flour mill. The observed workplace protection factors (defined as the ratio of the concentration of contaminant outside the facepiece to the concentration of contaminant inside the facepiece measured while the respirator is worn) were significantly below the anticipated workplace protection factor of 1000. As a result, NIOSH stated that workers wearing the MSA PAPR may not receive the protection they anticipated. NIOSH stated further than the Institute had no evidence that the problem discovered in that study existed in other industries or situations of use. NIOSH also stated that the Institute would conduct further studies to evaluate the performance of the MSA PAPR against substances physically and chemically different from silica flour to determine whether results with silica flour were indicative of a problem associated with conditions of exposure or related to the malfunction of equipment.

Staff of NIOSH subsequently conducted a field evaluation of the half-mask MSA high efficiency PAPR at a primary lead smelter. The challenge aerosols contained predominantly lead dust and or lead fume. From this and other NIOSH studies, additional information has been developed and this Notice supersedes the Notice of April 24, 1981.

This field evaluation of the MSA PAPR produced the following preliminary results. The workplace protection factors associated with the respirator was found to be approximately lognormally distributed. The MSA PAPR produced a geometric mean workplace protection factor of 376 with a geometric standard deviation of 2.64 against lead fume and lead dust. Approximately 95% of the observed workplace protection factors for the MSA PAPR exceeded 77 while 84% of the observed workplace protection factors were below 1000. During this study no wearer of the MSA PAPR was exposed to concentrations of lead exceeding the permissible exposure limit (PEL).

Subsequent to issuance of the Respirator Information Notice of April 24, 1981, NIOSH and MSHA commenced proceedings to withdraw the certification of the MSA PAPR. That action was predicated upon the determination by

NIOSH that the MSA PAPR, during use in a silica flour mill, apparently did not provide the anticipated level of protection, i.e., a workplace protection factor of 1000. That action was subsequently voluntarily dismissed by the agencies pending the results of further studies. This study and additional studies of the PAPR class conducted by NIOSH indicate that the previously anticipated protection factor of 1000 expected of the entire class of PAPRs is inappropriately high. In view of this, the certification withdrawal proceedings against the MSA PAPR, which were previously dismissed will not be reinstated. However, NIOSH recommends that users of PAPRs not rely upon them to consistently provide a workplace protection factor of 1000.

The results of the additional PAPR studies will be addressed in a subsequent Respirator Information Notice. For more information on this subject, contact the Testing and Certification Branch, Division of Safety Research, NIOSH, 944 Chestnut Ridge Road, Morgantown, West Virginia 26505, (304) 291-4331.



James A. Oppold, Ph.D., PE, CSP  
Director  
Division of Safety Research



Appendix D.  
General Safety Considerations

## Appendix D. General Safety Considerations

### Ronald L. Stanevich NIOSH Division of Safety Research

This guide was primarily developed to provide recommendations concerning worker respiratory protection within the asbestos abatement industry. However, employers must not lose sight of the safety hazards their employees are exposed to in performance of their work. Asbestos abatement operations can take place in a variety of industrial, commercial and public settings. Each has unique potential safety hazards that the employer must control. However, nearly all abatement operations have some common safety hazards. With proper job planning and supervision, the employer can control both the health hazards and the safety hazards faced by their workers. The more common safety hazards associated with abatement operations and general recommendations to control them are discussed below. Sources for more specific safety information are listed to supplement and support the applicable OSHA regulatory standards.

#### 1. Elevated Work Surfaces

The nature of asbestos abatement tasks usually requires workers to work from ladders, scaffolds, manlifts, or other elevated surfaces, which creates the potential for fall injuries. Slips and falls from ladders, scaffolds, and other elevated surfaces result in a major portion of the construction industry injuries. Many of these can be prevented by implementing a few control measures:

##### A. General

- (1) Avoid use of makeshift work platforms by providing portable ladders and scaffolds.
- (2) Ensure that job-built elevated work surfaces are inspected by a competent person other than the individual who erects it.
- (3) Avoid working from elevated surfaces where possible. Consider use of wands for spraying amended water or scrapers with extended handles.

##### B. Ladders

Eighty percent of ladder-related accidents result from improper use or application.

- (1) Workers should face the ladder when climbing up, down, or working from it.
- (2) Workers should not carry objects in their hands while ascending or descending ladders. While working from a ladder they should hold on with at least one hand.
- (3) Ladders should not be used as a substitute for planks, runways, or walkboards
- (4) Ladders should be maintained in good condition. Defective ladders should be destroyed so that no one uses them by mistake.
- (5) Ladders should have safety feet in good condition to keep the ladder from slipping and cutting through polyethylene floor covers.
- (6) Ladder rungs/steps should be kept free of contaminants such as amended water and buildup of asbestos waste
- (7) Employees should work no higher than the fourth step/rung from the top of the ladder.
- (8) Employees should not attempt to "reach" distant objects from a ladder; other platforms should be used.

- (9) Wood or fiberglass ladders should be provided to help control exposure to electrical hazards.
- (10) Employees should not straddle the space between a ladder and another object.
- (11) Employees should make a visual inspection of ladders before each shift.

Additional information sources:

"Ladders" — publication no. ISBN 0-919465 -05-6

Construction Safety Association of Ontario  
74 Victoria Street  
Toronto, Ontario Canada M5C 2A5

"Safety Requirements for Portable Wood Ladders" — ANSI A1.1-1982

"Safety Requirements for Job-Made Ladders" — ANSI A14.4-1979

"Safety Requirements for Portable Reinforced Plastic Ladders" — ANSI A1.5-1982

American National Standards Institute, Inc.  
1430 Broadway  
New York, NY 10018

"Portable Ladders" — Industrial Safety Data Sheet #665

National Safety Council  
444 North Michigan Avenue  
Chicago Illinois 60611

Environmental Health and Safety Division  
Georgia Tech Research Institute  
Georgia Institute of Technology  
Atlanta, Georgia 30332

### **C. Scaffolds**

Falls from scaffolds result in about 2,000 injuries per month in the United States. These can be reduced by:

- (1) providing guardrails around the perimeter of the work surface regardless of scaffold height
- (2) securing scaffold decks against slippage
- (3) keeping scaffold uprights vertical and pinned together when stacked
- (4) ensuring vertical members are braced to keep the scaffold plumb and level
- (5) decking the entire top portion of the work surface in lieu of using minimum planking dimensions
- (6) extending planks at least 6" over their supports and cleating or restraining them from movement
- (7) ensuring that manufacturer built-in ladders are in good condition
- (8) maintaining mobile scaffold casters in good condition with position locking devices secured when employees are working from the scaffold

- (9) keeping mobile scaffolding height less than four times the minimum base dimension and with adequate cross-bracing
- (10) never interchanging scaffolding parts from different units
- (11) never using defective scaffolding
- (12) designating only “competent” persons to perform scaffolding repairs.

Additional information sources:

“Manually Propelled Mobile Ladder Stands and Scaffolds” — ANSI A92.1-1977

“Manually Propelled Elevating Work Platforms” — ANSI A92.3-1980

“Self-Propelled Elevating Work Platforms” — ANSI A92.6

American National Standards Institute, Inc.  
1430 Broadway  
New York, NY 10018

## **II. Electrical Hazards**

Asbestos abatement is often related to renovation or remodeling activities. Normally the equipment, machinery, overhead lighting fixtures, and auxiliary furnishings are removed to facilitate the abatement work. However, it is becoming more common that industrial and commercial buildings remain partially occupied while abatement operations are performed. In either situation, the abatement operator must take positive actions to protect employees from accidentally coming into contact with energized electrical circuits.

### **A. General**

- (1) Perform a pre-work walk-through of the abatement area to look for pre-existing electrical hazards involved with the work.
- (2) De-energize as many circuits as possible.
- (3) Verify that the circuits have been de-energized with a “Field Current Sensing Device” circuit tester. Either lock out/tag out all de-energized circuits to prevent them from accidentally being energized.
- (4) Use non-conductive tools such as scrapers and vacuum attachments made of wood, plastic, or rubber.
- (5) Provide workers with non-conductive rubber boots and/or gloves when work must be done around energized wiring or equipment.
- (6) Prohibit accumulation of puddles of water on the floor. Workers should be trained in the intelligent use of amended water. No water should be used around energized circuits.

### **B. Permanent Building Circuitry**

- (1) Ensure that all permanent circuits are provided with a grounding system. This can be determined with a portable ground tester.
- (2) Ensure that electrical outlets are tightly sealed and taped to avoid water spray.

- (3) Determine what equipment must remain energized during the abatement process.
- (4) Insulate or guard energized equipment and wiring from employee contact and other conductive objects.
- (5) Avoid damaging permanent building wiring during the work.
- (6) Consider dry removal methods in the vicinity of electrical equipment which must remain energized.

### **C. Temporary Power**

- (1) All temporary circuits provided by the abatement operator must be provided with a grounding system and protected by ground fault circuit interrupters.
- (2) Avoid stringing temporary wiring across floors.
- (3) Elevated wiring should not be fastened with staples, nails, or wire.
- (4) Use care not to damage the wiring insulation during installation or abatement work.

### **D. Electrical Cords and Tools**

- (1) Provide extension cords which have a ground conductor.
- (2) Ensure that cords are not damaged, contain no splices, and that the ground lug on the male plug is intact.
- (3) Position extension cords to eliminate stumbling/tripping hazards and to protect them from damage by moving scaffolds.
- (4) Provide electrical tools which are either grounded or of the double-insulated type.
- (5) Use shatterproof, guarded bulbs and heavy duty wiring for temporary lighting.
- (6) Where plugs enter receptacles, ensure that the connection is protected by use of duct tape or by other means.

Additional information sources:

“National Electrical Safety Code” — ANSI C2-1984

“National Electrical Code” — ANSI/NFPA 70-1984

American National Standards Institute, Inc.  
1430 Broadway  
New York, NY 10018

“Temporary Electric Wiring for Construction Sites” — Industrial Safety Data Sheet #515

National Safety Council  
444 North Michigan Avenue  
Chicago, Illinois 60611

### **III. Housekeeping**

Asbestos abatement operations present continuous housekeeping problems. The accumulation of asbestos and other debris on polyethylene-covered floors create employee slipping and tripping hazards. It is essential that accumulation of such debris be bagged and removed from the floor as soon as possible. Even though this activity may initially require more effort, it will make final cleanup easier and the work area safer

Additional information source:

“Supervisors Safety Manual”

National Safety Council  
444 North Michigan Avenue  
Chicago, Illinois 60611

### **IV. Emergency Planning**

The abatement operator should develop emergency procedures for fires or severely injured employees. Since abatement work areas must be sealed off, thereby blocking normal exits, the operator must familiarize the workers with procedures for safe exit in case of fire. Furthermore, the operator should develop plans for obtaining emergency aid in case of severe employee injury. The plans should be compatible with decontamination procedures yet provide for quick medical aid.

Additional information source:

Environmental Health and Safety Division  
Georgia Tech Research Institute  
Georgia Institute of Technology  
Atlanta, Georgia 30332

Appendix E.  
Heat Stress Considerations

## Appendix E. Heat Stress Considerations

Mary Kay White, Ed. D.

Donald F. Knowles

NIOSH Division of Safety Research

OSHA 1910.1001 — ASBESTOS, paragraph (h)(l) states: "If an employee is exposed to asbestos, tremolite, anthophyllite, actinolite, or a combination of these minerals above the PEL, or where the possibility of eye irritation exists, the employer shall provide at no cost to the employee and ensure that the employee uses appropriate protective work clothing and equipment such as, but not limited to: (i) Coveralls or similar full-body work clothing; (ii) Gloves, head coverings, and foot coverings; and (iii) Face shields, vented goggles, or other appropriate protective equipment which complies with §1910.133 of this Part."

NIOSH has recently published a document<sup>2</sup> which can be used for specific work site applications. Personal Protective-Equipment for Hazardous Materials Incidents: A Selection Guide includes recommendations that can be applied to asbestos abatement Procedures. Where the substance to be Protected against has been clearly identified, "disposable" coveralls of nonwoven fabric maybe recommended. These are generally one piece garments that fully cover the torso and extremities, and may or may not be coated with a plastic or rubberized barrier. These ensembles must be used with appropriate respiratory protection and include boots, boot coverings, and gloves. Helmets and/or hoods may be required as additional items.

Wearing such protective clothing interferes with the normal avenues of heat exchange between the skin and the ambient air, resulting in a greater potential for heat-induced illness and unsafe acts. NIOSH has addressed this issue in Occupational Exposure to Hot Environments: Revised Criteria 1986.<sup>3</sup> The revised document provides ways of measuring and controlling heat stress as well as methods to prevent and treat heat-related illnesses. The complexity of calculating heat exchange while wearing protective clothing is addressed in this document and recommendations for physiological monitoring are made. It should be noted that in workplaces where air and vapor impermeable clothing must be worn, the Wet Bulb Globe Thermometer (WBGT) is not the appropriate measurement of environmental heat stress. Alternatively, the dry bulb temperature or adjusted air temperature should be measured, and physiological monitoring is recommended on a time schedule as frequently as every 15 minutes.

While very little research on heat stress has been conducted to examine the specific protective clothing and respirator ensembles typically used by the asbestos abatement industry, several related studies may provide useful information for managing heat stress situations.<sup>4,9</sup> In general, this research indicates factors that contribute to worker heat stress: this includes ensemble weight (including the respiratory protective device), clothing permeability characteristics, individual work rates, and the environmental conditions.

NIOSH studies of workers wearing chemical protective clothing (CPC) and firefighters' ensembles have indicated that heat stress is a serious consideration .<sup>10</sup> Significant physiological stress was observed, even at low work intensities (30% of maximum work capacity — level walking at 3.4 miles per hour) in a neutral environment (73°F and 55% R.H.). With the chemical protective (CPC) ensemble, worker tolerance time was reduced by 56% as compared to light work clothing only. Elevated rectal temperatures (in excess of 39.0°C) were observed in three of the nine subjects. With heavier firefighters' ensemble, tolerance time was reduced by 84% as compared to light work clothing only. At higher work intensities (60% of maximum), tolerance time was decreased by as much as 96%.

Based upon this limited research, the following recommendations are made:

- (1) Select the lightest weight protective ensembles and respiratory protective devices that adequately protect the worker. This will minimize the physiological demands placed on the worker by carrying the weight of this equipment.
- (2) If available, select protective clothing made of material that will allow evaporation of water vapor, while providing skin protection from the asbestos fibers.
- (3) Reduce work rate by:
  - (a) adjusting the work/rest schedules



- (b) using automated procedures and/or mechanical assistance where possible
  - (c) minimizing the work intensity.
- (4) Educate workers on the symptoms and prevention of heat illness and schedule periodic fluid replacement breaks.<sup>11-12</sup>
- (5) Reduce heat stress by:
  - (a) providing external cooling, where possible (either through cooling garments and/or by providing cool respirable breathing air through pressure-demand air supplied respirators)
  - (b) providing multiple air changes per hour to provide negative air on asbestos abatement projects.
- (6) When conducting pipe/boiler lagging removal, ensure that steam lines are cool to minimize heat exposure from these sources.

## References

1. 29 CFR Part 1910.1001
2. NIOSH, Personal Protective Equipment for Hazardous Materials A Selection Guide, DHHS (NIOSH) Publication No. 84-114. (October 1984).
3. NIOSH, Criteria for a Recommended Standard . . . Occupational Exposure to Hot Environments, Revised Criteria 1986. DHHS (NIOSH) Publication No. 86-113. (April 1986).
4. Goldman, R. F., Tolerance Time for Work in the Heat Wearing CBR Protective Clothing. Military Medicine 128:776-786 (1 963).
5. Mihal, C. P., Jr. Effect of Heat Stress on Physiological Factors for Industrial Workers Performing Routine Work and Wearing Impermeable Vapor-Barrier Clothing. Am. Ind. Hyg. Assoc. J. 42: 97-103 (1981).
6. Raven, P. B., A. Dodson, and T.O. Davis. Stresses Involved in Wearing PVC Supplied-Air Suits: A Review. Am. Ind. Hyg. Assoc. J. 40:592-599(1979).
7. Rogan, E. An Evaluation of the Tolerance to Heat of Men Working in PVC Clothing and Air-Line Respirators (P G Report 512(5)) United Kingdom Atomic Energy Authority, Harwell (1968).
8. Shvartz, E., and D. Benor. Heat Strain in Hot and Humid Environments. Aerospace Med. 43:852-855 (1 972).
9. Thomas, N. T., J. Spencer, and B.T. Davies. A Comparison of Reactions to Industrial Protective Clothing. Ann. Occup. Hyg. 19:259-268(1976).
10. White, M. K., T.K. Hodous. Reduced Work Tolerance Associated With Wearing of Protective Clothing and Respirators. Submitted to Am. Ind. Hyg. Assoc. J. (1986).
11. White, M. K., R. Ronk. Do you have a hot and/or strenuous job? Professional Safety 27-29(1985).
12. Spain, W. H., W.M. Ewing, and E.M. Clay. Knowledge of Causes, Controls Aids Prevention of Heat Stress. NAC Journal 2(2):19-23 (Summer 1985).

## Appendix F.

Breathing Air Systems for Use with  
Pressure-Demand Supplied Air Respirators  
in Asbestos Abatement

## Table of Contents

|   |      |
|---|------|
| I. Introduction .....   | 137  |
| II. Breathing Air System .....  | 137  |
| A. Performance Requirements .....   | 1 37 |
| (1) Continuous Sufficient Supply of Grade D Breathing Air .....               | 137  |
| (a) Compression .....   | 137  |
| (b) Purification .....  | 141  |
| (c) Distribution .....  | 144  |
| (2) Adequate Reserve Air or Escape Time .....                                 | 145  |
| (3) Temperature Control of the Breathing Air .....                            | 146  |
| (4) Continuous Carbon Monoxide (CO) Monitor and Alarm .....                   | 150  |
| B. Types of Breathing Air Systems .....                                       | 152  |
| (1) The Low Pressure System .....   | 152  |
| (2) The High Pressure System .....  | 156  |
| (3) High Pressure Pre-Pumped Tanks .....                                      | 162  |
| (4) Other .....   | 163  |
| III. Cautions in the Use of Breathing Air Systems .....                       | 163  |
| IV. Cost Analysis: Supplied Air versus Air-Purifying Respirator Systems ..... | 167  |
| V. Suppliers of Breathing Air Equipment .....                                 | 173  |

## Figures and Tables

|  |     |
|--|-----|
| Figure F1. Theoretical Air Compression .....                               | 139 |
| Figure F2. Typical installation of Low Pressure Breathing Air System ..... | 148 |
| Figure F3. The Vortex Tube, its Construction and Performance .....         | 149 |
| Figure F4. Typical Low Pressure Breathing Air Purifier Assembly .....      | 154 |
| Figure F5. Typical High Pressure Breathing Air System .....                | 157 |
| Figure F6. Typical High Pressure Purifier Assembly .....                   | 160 |

## List of Tables

|   |     |
|---|-----|
| Table 1. Characteristics of Grade D and Better Breathing Air .....  | 140 |
| Table 2. Typical Pressure and Relative Adsorber Effectiveness ..... | 143 |

Breathing Air Systems for Use with  
Pressure-Demand Supplied Air Respirators  
in Asbestos Abatement

**a Technical Report**

**by**

**Clifton M. McClure**

**Consumer Fuels, Inc.  
7250 Governors Drive West  
Huntsville, Alabama 35805**

**for**

**U.S. Department of Health and Human Services  
Public Health Service  
Centers for Disease Control  
National Institute for Occupational Safety and Health  
Division of Safety Research**

## ACKNOWLEDGEMENTS

The author is indebted to the following individuals who provided invaluable suggestions during the development of this Appendix:

**William L. Bowers  
Daboco, Inc.  
3319 E. 10 Mile Rd.  
Warren, MI 48091**

**Dorothy Rushton  
Deltech Engineering, Inc.  
Century Park, Box 667  
New Castle, Delaware 19720**

# Appendix F. Breathing Air Systems for Use with Pressure-Demand Supplied Air Respirators in Asbestos Abatement

## I. INTRODUCTION

The National Institute for Occupational Safety and Health (NIOSH) and the Environmental Protection Agency (EPA) recommend that either self-contained breathing apparatus (SCBA) or combination pressure-demand supplied air respirators (SAR) with escape SCBA be used to protect workers from detectable airborne concentrations of asbestos. Since SCBA are often impractical for abatement due to their size and weight, the combined SAR/SCBA will probably offer the best protection for workers on abatement jobs. Only those respirators tested and certified by NIOSH (U.S. Department of Health and Human Services) and the Mine Safety and Health Administration (MSHA, U.S. Department of Labor) and therefore which bear the NIOSH/MSHA approval label (See Appendix B) are recommended.

As the term “supplied air” indicates, these respirators receive breathable air from an external source through a system that typically consists of compression, purification, storage, and distribution components. The subject of this Appendix is the system which produces breathable air and supplies it to the recommended respirators. The intent is to (1) acquaint employers with the characteristics of available types of breathing air systems (Part II), (2) emphasize the caution required in the use of such systems (Part III), and (3) examine the cost benefits of supplied air versus air-purifying respirator systems (Part IV). The names and addresses of suppliers of equipment used in and with breathing air systems are provided in the final section (Part V).

## II. BREATHING AIR SYSTEMS

### A. Performance Requirements

**A breathing air system must accomplish the following:**

- (1) provide a continuous sufficient supply of Grade D breathing air**
- (2) provide adequate reserve or escape time**
- (3) provide breathing air temperature control**
- (4) provide a continuous monitor and alarm against carbon monoxide (CO) in the breathing air-stream.**

#### ***(1) Continuous Sufficient Supply of Grade D Breathing Air***

**A continuous sufficient supply of breathing air means that both the air pressure and air volume requirements necessary for respirator operation are supplied directly to each respirator. Grade D breathing air is air that meets certain criteria established by the Compressed Gas Association, Inc., and is required to be used in air supplied respirators (see Table 1). Producing and supplying a continuous sufficient supply of Grade D breathing air is accomplished by the combined effect of compression, purification, and delivery processes.**

##### ***(a) Compression***

**Any person interested in specification of, purchasing, or operation of any breathing air system for use with pressure-demand supplied air respirators in asbestos removal should know the basics of air compression.**

**Theoretical Compression Process.** For a moment, let us consider the compression process apart from compressors. Forget low or high pressure or any other type of mechanical compressor. Consider only a parcel of air, A, as in Figure 1. Parcel A has a spherical diameter of about 4.0 inches, and the air is at room or ambient conditions; its pressure is about 14.7 pounds per square inch atmospheric (psia), its temperature is about 70°F.

This air parcel, as do all air parcels, carries water vapor and contaminants. In atmospheric air, water vapor is not usually considered a contaminant. In compressed air for breathing purposes, however, water vapor should be considered as a major contaminant. In order to produce breathable air, water vapor must be properly processed out of the compressed air. Water in compressed air is itself a contaminant and it traps and carries other contaminants.

If this air parcel were suddenly compressed to 100 psi over and above its ambient pressure of 14.7 psia, its absolute pressure would become 114.7 psia. The volume of the parcel of air is reduced by compression to about 1/8 of its original volume, or about one-half inch in spherical diameter.

Even with no outside heat added, because of compression the temperature of the compressed air parcel would jump to about 350°F. The water vapor and contaminants would also be compressed. Compressing air reduces its ability to hold water vapor. However, increasing the temperature increases the ability to hold water vapor. Because of these two opposite effects, the water vapor would not condense immediately upon compression, but most certainly would condense as the air temperature decreases. In a compressor, the compression itself increases contamination levels in the air. These increased contamination levels must be controlled so that they do not become a human hazard.

If the parcel of air were to be compressed to 1/300 of its initial volume, the 4-inch diameter spherical air parcel would be reduced to only 0.01 inches diameter. The air temperature in this high compression parcel would be very hot, 1500° to 2500°F. The water vapor and contaminants would also be equally highly compressed.

If either compressed air parcel in the above examples were held for a time at its higher pressure, the heat would eventually transfer out. Even in its compressed state, the initial high air temperature would decrease back toward the ambient temperature of 70°F. Once compressed air has cooled back to ambient temperature, a large amount of the water will have condensed. Condensed water can be mechanically collected and simply drained out of the air parcel. Even after all the condensation is removed, the air parcel is still saturated with the remaining water vapor. (Being saturated simply means that any further reduction in temperature of the air parcel below 70°F will also result in additional water condensation. )

After the air temperature has cooled back to 70°F, if we were then to expand the air back to its original spherical diameter of 4.0 inches, the air temperature would drop dramatically. Such a re-expansion of the air parcel would, in effect, dry the air enabling it to carry more moisture again.

There are several important things to remember about theoretical compression of air:

- Air temperature always rises with compression. The more compression, the greater the temperature rise. Even at low pressures, there are substantial temperature elevations.
- In theoretical compression, this temperature rise does not come from mechanical heating effects due to the action of pistons, vanes, compressor drive motors, etc., but only from compression.
- Compression always heats air, but the compression process can be designed to provide cooling effects in the air, This cooling is available only if sufficient heat exchanger design and time is available to remove the heat of compression from the air before delivery of the air to the workers,



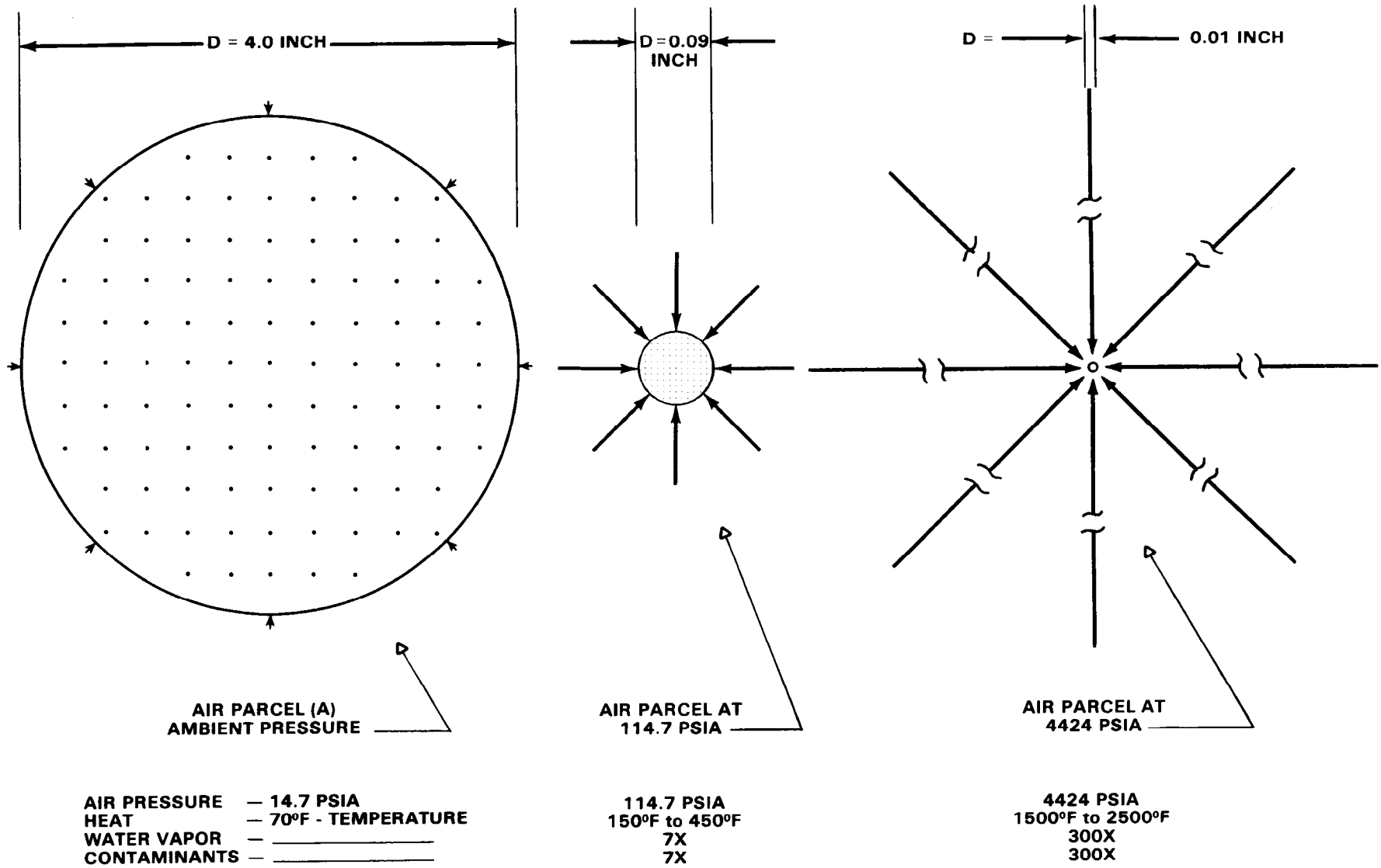

Figure F1. Theoretical Air Compression

Table 1. Characteristics of Grade D and Better Breathing Air

| Limiting Characteristics   | GRADES            |                   |                   |                   |                   |                   |
|--|-------------------|-------------------|-------------------|-------------------|-------------------|-------------------|
|  | D                 | E                 | F                 | G                 | H                 | I                 |
| % O <sub>2</sub> (v/v)<br>Balance predominately N <sub>2</sub><br>(Note 1) | atm.<br>19.5-23.5 | atm.<br>19.5-23.5 | atm.<br>19.5-23.5 | atm.<br>19.5-23.5 | atm.<br>19.5-23.5 | atm.<br>19.5-23.5 |
| Water  | note 2            | note 2            | note 2            | note 2            | note 2            | 1 -10.4'JF        |
| Hydrocarbons (condensed) in Mg/m <sup>3</sup> of gas at NTP<br>(Note 3)    | 5                 | 5                 |                   |                   |                   |                   |
| CO   | 20                | 10                | 5                 | 5                 | 5                 | 1                 |
| Odor   | *                 | *                 | *                 | *                 | *                 | *                 |
| CO <sub>2</sub>  | 1000              | 500               | 500               | 500               | 0.5               |                   |
| Gaseous Hydrocarbons (as methane)  |                   |                   | 25                | 15                | 10                | 0.5               |
| Nitrogen Dioxide   |                   |                   |                   | 2.5               | 0.5               | 0.1               |
| Nitrous Oxide  |                   |                   |                   |                   |                   | 0.1               |
| Sulfur Dioxide   |                   |                   |                   | 2.5               | 1                 | 0.1               |
| Halogenated Solvents   |                   |                   |                   | 10                | 1                 | 0.1               |
| Acetylene  |                   |                   |                   |                   |                   | 0.05              |

\*Adapted from Compressed Gas Association, Inc., Air Specification G-7. 1

[Note 1: The term “atm” (atmospheric) denotes the normal oxygen content of atmospheric air numbers indicate oxygen limits for synthesized air.

Note 2: The water content of compressed air required for a particular grade can vary from saturated to dry depending upon the intended use. If a specific water limit is required, it should be specified as a limiting dewpoint (expressed in temperature °F at one atmosphere absolute pressure) or concentration in ppm (v/v).

Note 3: No limits are given for condensed hydrocarbons beyond Grade E since gaseous hydrocarbon limits could not be met if condensed hydrocarbons were present.]

- The water vapor is also compressed, and if high temperatures are lowered, will easily condense.
- Water vapor in compressed air is a major contaminant. Condensed water in compressed air is itself a contaminant and it traps and carries other contaminants.
- Concentrations of contaminants are increased and may become hazardous unless removed.

**Practical Compression.** Real compression requires a mechanical compressor of some type. Additional heat from the drive motor and frictional heat will be added in the real compression process. In addition, the compressor will add wear particles such as metal, carbon, etc. The compressor may also add lubricant oil as either liquid oil or oil vapor. If the compressor operates at excessive temperatures, it may actually form deadly carbon monoxide (CO) within the machine, although such CO formation is rare.

A compressor may be suited for only the tasks or types of jobs for which it was originally designed and built. For instance, a compressor built to power other industrial air machines may not need heat, water, and oil removal. In fact, some compressors actually have “oilers” in the output air to increase the oil being carried in the air. A compressor whose basic design was unsuitable could easily overpower the finest air purifier assembly. Operating with such an unsuitable machine would require more frequent filter and canister replacement than normal to maintain the required air quality. The cost of maintaining the air purifier in such a case would be prohibitive. The cost of redesigning and re-building such a compressor could be more than buying a compressor of a different design.

The real effect of water as a contaminant can be understood with an example: Consider a low pressure breathing air system with a normal piston or screw-type compressor and an air purifier assembly, such as depicted in Figure 1. This actual machine is pumping 100 standard cubic feet per minute (SCFM) of air on a day when the ambient temperature is 70°F and the relative humidity is 75%. This machine will take in about 16.5 gallons of water in vapor form every 24 hours. If the machine is properly designed for breathing air applications, it will have an aftercooler to cool the air and to condense most of this water. This breathing air compressor will also have water removal traps to drain the condensate out of the machine. If the air is being cooled in the compressor aftercooler back to near ambient temperature, then about 11.5 gallons of liquid water will condense. This condensing water has many of the other contaminants entrained. This contaminated liquid water can be mechanically removed from the aftercooler drain trap. This leaves about 5.0 gallons of water as water vapor still moving with the compressor output air. Most of this 5.0 gallons of water vapor will be removed along with any other contaminants by the air purifier assembly that is downstream of the compressor.

Proper design of the compressor with sufficient intercooling, aftercooling, and proper water removal traps can mechanically remove about **65% to 90%** of all water and contaminants. Since mechanical removal methods are more or less permanent removal methods, the overall compressor design is important for final breathing air quality. The final polishing of the air quality to obtain Grade D or better will be accomplished by stages in the air purifier assembly,

#### *(b) Purification*

Ordinary compressed air cannot be used to supply breathing air to work crews working in hazardous atmospheres. Ambient breathing air, when pumped through an ordinary compressor, is not fit for human respiration. Even if the compressed air is filtered to remove dust and other particulate, it still contains the contaminants in ordinary atmospheric air, plus the localized contaminants near the compressor intake, plus any contaminants and wear particles added during compression. The compressor may add oil vapor, hydrocarbons, even carbon monoxide.

The compressor intake is especially vulnerable to all types of carbon monoxide sources. Sources of CO, such as transient vehicles and other mobile internal combustion engines, are especially hard to control on the typical asbestos abatement job.

Various contaminants are potentially present in air from ordinary compression. Where present, these contaminants are concentrated by the compression process. For these reasons, breathing apparatus will NOT provide protection unless the breathing air is purified.

Purification of air is a very precise technology which has developed over many years. Purification is considerably more than filtration. Filtration is simply capture and removal of particulate by a filter. Filtration is almost always included in the overall purification process, although it is a small part of the overall purifying process.

**Adsorption.** Purifiers are based primarily on the design and use of ADSORPTION. Adsorption of vapor and chemical contaminants is done by proper design and use of the class of materials known as adsorbers. The common adsorbers used in design of air purifier assemblies may include:

molecular sieves

silica gel

activated alumina ( $\text{Al}_2\text{O}_3$ )

activated charcoal

Adsorbers are porous type materials with large quantities of interconnected, submicroscopic internal voids, pores, or capillaries. This internal porous structure gives these adsorber materials very large surface areas in contact with the gases to which the adsorber is exposed. Adsorbers also have the property of being physiochemically “active” or can be “activated.” This means that these adsorbers can hold onto, or adsorb onto their active surfaces, various physiologically active contaminants. The adsorbant thereby effectively removes the contaminants from the air-stream and leaves the air pure and uncontaminated. These adsorbers are not all equally effective with all contaminants.

Water is an active contaminant for most adsorbers. Water is also processed in large quantities by air compression. Ninety percent of the water and entrained contaminants can regularly be removed by proper compression, cooling, and water traps, all of which are designed into the breathing air compressor section. Much of the remaining water must still be removed in order to allow adsorption of other vapor contaminants.

For the adsorber design to be effective, the appropriate types, quantities, and sequence of adsorber materials must be selected.

**Pressure Level and Adsorbers.** The effectiveness of all adsorbers increases with increasing pressure. As the pressure of the air increases, the density of the air increases. More dense air exposed to any adsorber material simply means that more of the air is pushed into more intimate contact within the adsorber. Therefore, as air pressure increases, less adsorber is needed to do the same job.

Table 2 shows the typical operating pressure range and the relative density increase for both typical types of breathing air systems for use in asbestos removal work.

Table 2. Typical Pressure and Relative Adsorber Effectiveness

| Type of Breathing Air System | Typical Pressure Range | Relative Air Density (and Adsorber Effectiveness) |
|------------------------------|------------------------|---|
| Low Pressure                 | 100-200 psi            | 6x to 12x   |
| High Pressure                | 2000-4000 psi          | 1 50X to 300X                                     |

Adsorbers must be periodically replaced. Adsorber cartridges can be equipped with a color change reaction that will show the progress of adsorber use. Such cartridges can be changed based on coloration changes through a visual canister. Adsorption canisters may also be changed on a simple operational time basis.

The Carbon Monoxide Catalyst. The action of this catalyst, which is used to eliminate carbon monoxide, is unique. On the catalyst surface, carbon monoxide, in the low concentration ranges of 10 ppm to 600 ppm, is brought into contact with oxygen in the air. These conditions cause the chemical reaction  $2\text{CO} + \text{O}_2 = 2\text{CO}_2$ . The end result is that dangerous CO is changed to  $\text{CO}_2$ , which is not harmful in these low concentrations. Theoretically, catalysts last forever, but in practice they permanently adsorb trace chemicals and become “in active.” Most manufacturers recommend yearly replacement of their catalyst-type filters.

Even very small amounts of water vapor contamination on the catalytic adsorber “poison” the catalyst and reduce its activity. For such a catalyst to operate for a reasonable period of time, the air entering the catalyst must be very dry, below 5% relative humidity.

The most effective way to dry air to these conditions is to use drying absorbents before the air reaches the catalyst. If a drying adsorber of the throwaway type were considered for use in a low pressure purifier assembly, enormous quantities of this disposable adsorber material would be required for each 8-hour shift. In order to avoid having to use such quantities of water adsorber material in the low pressure purifiers, a different design solution has been used.

The Regenerative Water Adsorber Dryer. The heatless air regenerated dryer has evolved as the simplest and most rugged method to continuously regenerate the required adsorber material. It consists of airline plumbing, two central air dryer towers, and a tower switching system. In action, this system has one tower drying the process airstream while the other tower is “off-cycle.” From 100A to 20% of the dry air output of the “on-cycle” tower (depending on system operating pressure) is split off and sent back down in reverse through the “off-cycle” tower. This regeneration air removes the water previously adsorbed in the “off-cycle” tower and is vented to the atmosphere. In this way the off-cycle adsorber material is renewed or regenerated. Every few minutes on a regular basis, the cycle switches, alternating between the two towers.

A typical adsorber design for 100 SCFM process air flow, which has 50 pounds of activated alumina in each tower, can be expected to run regeneratively for several years before this activated alumina stops being regenerated. Replacement of 100 pounds of activated alumina only one time every 5 to 7 years is inexpensive. In comparison, a single column of activated alumina in a throwaway canister design would need about 100 pounds of new activated alumina every 8 hours.

If the activated alumina regenerated dryer were the first step in the purifying process just following the breathing air compressor, it would “see” significant amounts of oil and oil vapor as well as water vapor. The regenerative dryer is based on the alternate adsorption and resorption of

water from the adsorber. In these cycling towers oil will not desorb. The regenerative dryer will operate only a few days if no oil adsorption media is placed in front of the regenerative drying section. An oil adsorption prefilter must precede the dryer towers.

The Oil Adsorption Prefilter. The active media in the oil adsorption prefilter is chosen for its ability to selectively retain oil and oil vapor. It can be formulated with a color change reaction and placed into a visual canister for visual determination of the filter media remaining. The oil vapor adsorption prefilter may quickly be saturated if “slugs” of oil and water come from the compressor. Removal of liquid “slugs” just prior to the oil prefilter is accomplished by the coalescing filter and drain trap.

The Coalescing Filter and Drain Trap. Compressors used for breathing air need great attention paid to removal of heat, which causes condensed liquids to be formed. These breathing air machines also provide special liquid removal devices called “liquid traps.” Liquids are retained in the traps and can be drained from them.

Heat exchangers and drain traps do not remove vapors. Water vapor and oil vapor move through liquid traps. Also, microscopic drops of both liquid water and liquid oil (aerosols) act similar to vapor and move through ordinary liquid traps. The coalescing element is designed to cause these aerosols to impact on a myriad of mechanical elements within the coalescing filter. This action makes big drops out of the aerosols so they can be removed.

#### Summary of Important Points About Adsorption Purification:

- Purification of air requires adsorption as well as filtration.
- Purification and adsorber design is a highly developed science. Proper design of adsorber must include:
  - proper choice of adsorber material
  - sufficient quantities of adsorber
  - proper sequencing of the correct adsorbers.
- All adsorbers must be changed periodically.
- Systems with higher working pressures will require less adsorber material to do the same job.
- A low pressure adsorber should include a regenerative dryer or enormous quantities of adsorber material will need to be replaced every eight (8) hours.

Grade D breathing air is specified by OSHA 29 CFR 1910.134(d)(1) as that listed by the Compressed Gas Association Specification G-7.1. Table 1 shows the criteria for Grade D and better breathing air. Most established American manufacturers of both high and low pressure breathing air purifying systems design and test their systems to produce Grade D or better breathing air.

#### *(c) Distribution*

Breathing air must be delivered to the respirators in a continuous and sufficient supply, which means that both air pressure and air volume requirements must be maintained through the purification and delivery processes. Required air pressure can be ensured:

- by measuring and controlling the air pressure within the air delivery system at the entrance to the respirator hoses

(Air pressure is adjusted to the required pressure specified by the manufacturer for each respirator.)

- by maintaining the required pressure under all flow conditions when all the respirators are being used.

Two factors which affect the respirator pressure during air flow are (1) the inside diameters of hoses and their connectors, and (2) the overall length of air supply hose. Respirator hose-line pressures must typically be maintained in the 65-100 pounds per square inch gauge (psig) range. The Occupational Safety and Health Administration (OSHA) and NIOSH regulations prohibit the actual hose length from the respirator manifold to exceed 300 feet in length.

in order to add low pressure supply hose beyond 300 feet, the respirator input pressure should be maintained at the required and specified value for the respirators being used. Extra large diameter supply hose from the compressor to the respirator hose manifold may allow some length increases beyond the 300 feet. The simplest method to add some extra length to the low pressure supply line is to provide a compressor with output pressure higher than the pressure required by the respirators, and to provide a regulator at the respirator manifold. This regulator functions to reduce, control, and maintain the correct respirator pressure at the inlet to the respirator hoses. An accurate pressure gauge should be located at the inlet to the respirator hoses. For increases in hose length to be acceptable, this respirator inlet pressure gauge must read the correct and required value specified for the respirators being used when under maximum flow conditions (i.e., with all available respirators in use).

An easy test of the low pressure distribution system can be conducted by:

- (1) laying out the required length of air transfer hoses
- (2) connecting all respirator manifolds
- (3) attaching the maximum number of respirator hoses and respirators to be used (up to 300 feet if needed)
- (4) pressurizing the system
- (5) with all respirators in use, then check the pressure at the respirator manifolds.

Should the pressure at the manifolds be less than the specified respirator pressure, increasing the pressure may be accomplished by using extra-large diameter supply hoses, or increasing compressor pressure combined with use of a control regulator at the respirator manifolds. If one of these methods will allow the required respirator pressure to be maintained, the extra length is acceptable for use. If the required respirator pressure cannot be maintained, the hose lengths must be shortened until the specified respirator hose pressure can be maintained.

Remember: providing a continuous and sufficient supply of breathing air is accomplished by maintaining the correct and specified respirator inlet air pressure under all airflow conditions.

## ***(2) Adequate Reserve Air or Escape Time***

Providing for adequate reserve air or escape time is a necessary and required function of the breathing air system. The OSHA Safety and Health Manual 29CFR 1910.134 (d)(2)(ii) states, "A receiver of sufficient capacity to enable the respirator wearer to escape from a contaminated atmosphere in event of compressor failure and alarms to indicate compressor failure shall be installed in the system."

This poses the question of how much reserve time, and therefore how much stored air, is necessary. If a work crew were told an escape test was going to be conducted at a specified time, such a test might show that only 10 to 20 minutes were required. The escape time required under actual workplace conditions could be considerably longer. Complex airline routing and even tangling, work on scaffolding or in restricted access areas, and the requirement for the entire work crew to take showers can all lengthen escape time. For a crew size of ten workers, actual egress times have been measured at 30 to 50 minutes and more. Therefore, for most asbestos jobs a reserve time specification of 50 minutes to one hour is needed. Certain special asbestos jobs with more complicated egress conditions may need escape time of more than one hour.

Prepumped air or air stored in a pressure container is used as the method to obtain the required escape time. However, it should be noted here that low pressure systems, with pressures up to 200 psi, are not capable of storing any appreciable escape time in any practical tank volume size. However, high pressure air storage in the 2000 psi to 4000 psi range is easily capable of meeting the required escape time and more. When high pressure tanks are used to provide one hour and more escape time, the overall tank size, weight and cost are within practical limits.

The requirement to use high pressure (2000 to 4000 psi) as the only practical reserve air storage method does not adversely affect specification, choice, or the use of low pressure breathing air systems. The cost for providing a high-pressure standby reserve system with Grade D air on a low pressure breathing air system is minimal. The high pressure breathing air tanks for this standby air reserve do not need to be purchased; rental is the normal arrangement for suppliers of such high pressure tanks. High pressure tanks are routinely available from many sources nationwide. The rental cost for such tanks is usually minimal. Suppliers can be found by search of the Yellow Pages of a local telephone book under the heading, "Gas - Industrial and Medical." Since this high pressure standby reserve should be used only for the occasional emergency compressor stoppage, the actual cost of the air used from such a standby reserve system on a jobsite should also be minimal.

Cost considerations for the in-line reserve or escape air on a high pressure breathing air system are even lower. The in-line air storage bank provides more than sufficient escape time.

### ***(3) Temperature Control of the Breathing Air***

Asbestos removal during warm weather can create extremely hot working environments for abatement workers. Typically, the heating, ventilation, and air conditioning is shut down, and the building is then sealed off with plastic sheeting on all wall, overhead, and floor surfaces. This increases the retention of heat in the workplace. Then, water sprays are introduced into this hot workplace in order to minimize the airborne fibers. Such sprays create high humidities that reduce or eliminate the normal external body heat removal method of sweat evaporation. It is not at all unusual to see workplace ambient temperatures of 120° to 130°F with relative humidities in the 90% - 100% range.

The worker has other additional adverse personal circumstances. The asbestos worker is clothed with disposable garments which are very hot to wear. Although these garments are light in weight, they are made of material which is of low permeability. Such garments restrict local body air movement and, therefore, the transfer of heat from the body.

Asbestos removal work is hard physical labor. In many instances, this labor is performed from precarious or dangerous work positions, such as high upon movable scaffolding, or in the crawl space above lightweight ceiling grids where temporary flooring is placed.

It is in this hot and difficult workplace that the respiratory protective system must be used. If a low quality supplied air system is introduced, it typically may bring hot, humid, foul-smelling air, or even air that is dangerous to breathe. In such a case, it is no wonder that the worker may dislike the respiratory protective device and remove it whenever possible.



However, a supplied air system which delivers cooled, high quality breathing air, can provide the worker with relief against body heat buildup in such hot environments. Under these circumstances the respirator may even become equipment preferred by the worker.

Where hot environmental conditions exist, the asbestos worker should be provided with some type of personal cooling. The available choices of personal cooling depend on which type of breathing air system is being used. Hot air is produced in the compression process of all three basic types of breathing air systems--low pressure, high pressure, and prepumped high pressure tank systems. The already hot general working conditions of the asbestos workplace make it intolerable to deliver hot breathing air to the worker. Unless some temperature control is placed within the breathing air system to reduce and control the compressed air temperature and remove all condensable before the air is admitted to the air purifier, the air quality will also be unreliable. Reduction of temperature and removal of condensate before the air enters the purifier system are vital to ensure air quality, even if expensive and otherwise adequate purification systems are used.

Three methods of personal cooling that are in breathing air systems are the after cooler (air-cooled or water-cooled), the Vortex tube, and adiabatic cooling.

**The Aftercooler.** Hot compressed air exiting a compressor may be cooled by using an aftercooler or heat exchanger. These heat exchangers may transfer the heat either to the ambient air (air-cooled) or to locally available cold water (water-cooled). Figure 2 shows the correct location of such aftercoolers within the overall breathing air processing system. For the downstream air purifier assembly to function properly and give good control to process high quality breathing air, excess heat, condensates, water, and oil must be removed. This is accomplished by first removing heat, and then removing the condensed water and oil. These are two vital sequential steps that must be taken before air is admitted to any purifier assembly or supplied to any worker.

The efficiency of the air-cooled aftercooler will be affected by the ambient air temperature. Because of this fact, the air-cooled aftercooler will not function as efficiently on the hottest days, when worker cooling is most needed. Therefore, the best type of aftercooler choice to ensure that worker cooling is available when needed may be the water-cooled aftercooler.

**The Vortex Tube.** The Vortex Tube (for cooling or heating) is another available method of worker temperature control (See Figure 3). The Vortex Tube is a very simple device. It is a tube of approximately ½ to 1 inch diameter and perhaps 6 to 12 inches in length. The Vortex tube is simple, lightweight, and inexpensive. Air is admitted into the side of the tube and split into two separate airstreams, each exiting at opposite ends of the tube. One airstream is hot, the other is cold. Either of these two airstreams may be directed into the worker's disposable suitor hood to provide external temperature control to the worker.

The only disadvantage of the Vortex tube is that it uses a comparatively high volume of air, approximately 15 to 20 cfm per worker. Compared to the air used by a pressure-demand type respirator, each vortex tube will use as much air as would be needed to supply 4 or 5 pressure-demand respirators. Therefore, the use of vortex worker cooling will increase the size and cost of both the compressor and the breathing air purifier.

**Adiabatic Cooling.** Adiabatic cooling is available when sufficient cooling capacity has been designed into each of the multistage compression steps found internally in the high pressure compressor. Provided that the high pressure compressor cooling design is adequate, cool or ambient temperature air will be produced at the high pressure compressor outlet. This air is carried into the in-line air reserve tanks and then into the asbestos work area via high pressure lines to an air control panel. The air pressure regulator on this panel reduces the high pressure air from pressures of 1000 to 4000 psig down to the required respirator line pressure (typically in the 65 to 100 psig range). The air temperature also drops dramatically with this air expansion at the control panel and the resulting cold air is directed into the respirator lines at the panel.

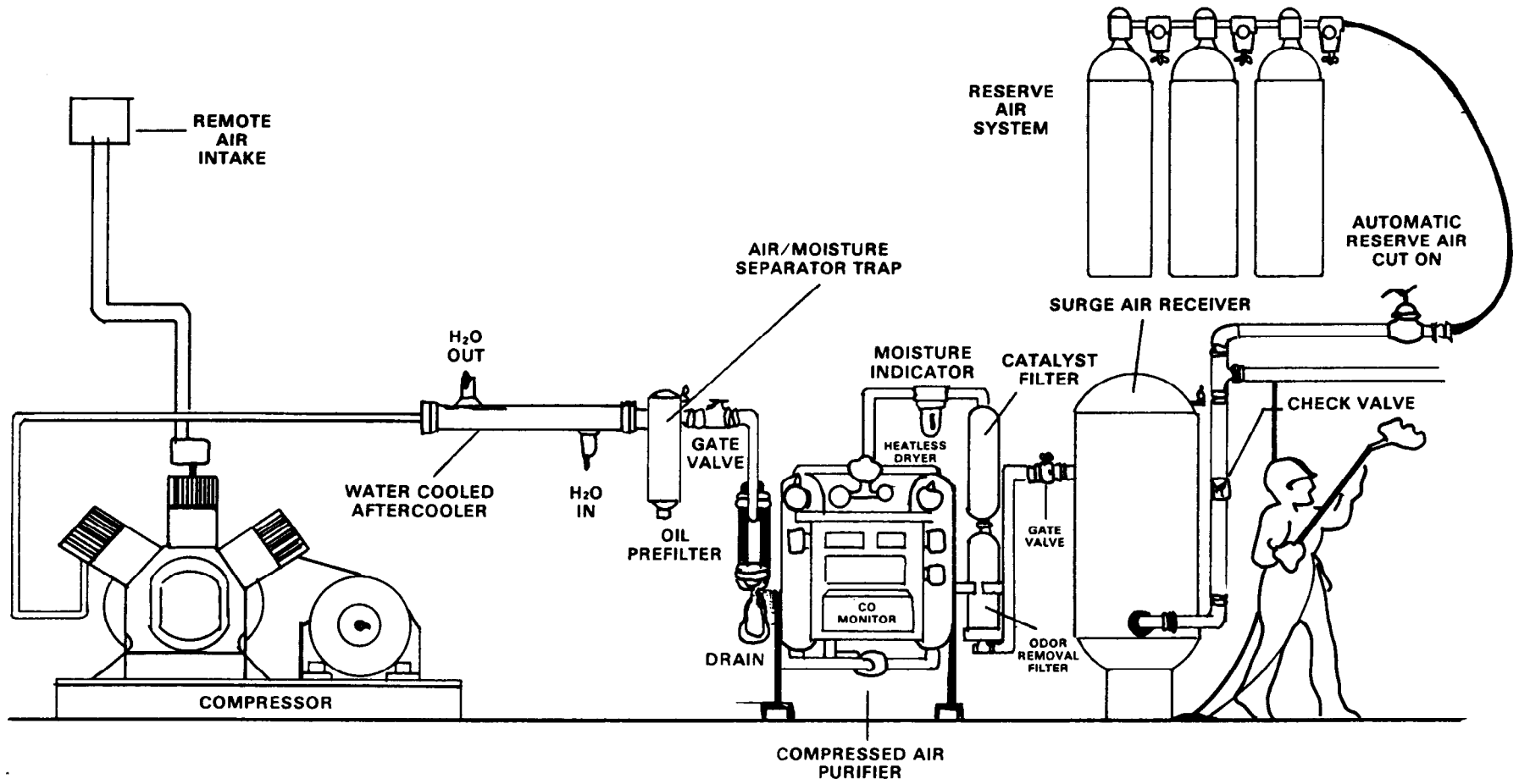
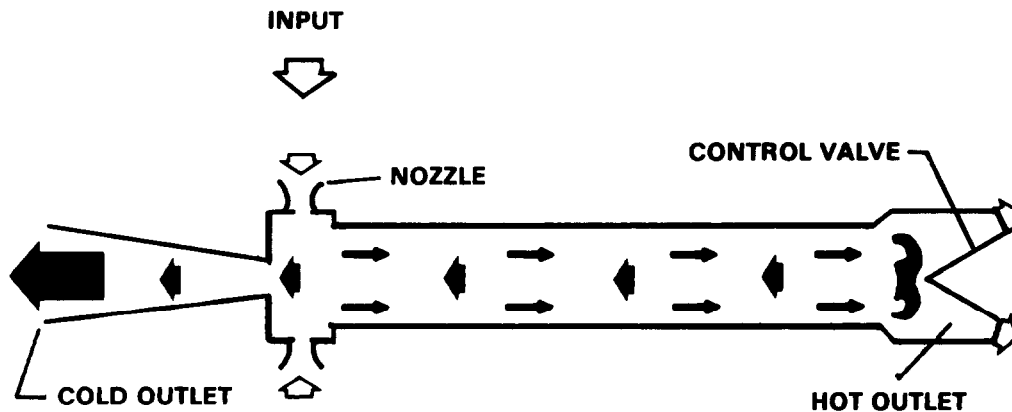

Figure F2. Typical Installation of Low Pressure Breathing Air System



SCHEMATIC DRAWING OF A VORTEX TUBE

### WHAT IS A VORTEX TUBE?

The Vortex tube is a device capable of converting an ordinary supply of compressed air into two streams, one hot and one cold. The proportions of hot and cold flow and their temperatures can be varied over a wide range. All of this is accomplished without moving parts using only compressed air as a source of power.

The temperature differences in the hot and cold outputs can be striking. With a 100 psig compressed air source, the Vortex tube can be adjusted to cool the air as much as 100° below inlet air temperature.

### HOW DOES IT WORK?

The compressed air first enters nozzles which inject it at sonic speed circumferentially into the vortex generation chamber. Spinning as fast as one million revolutions per minute, the vortex moves through the tube toward the hot outlet. Air near the surface of the tube becomes hot and some of it leaves through the control valve at the hot end. The control valve imposes enough pressure on the vortex to force some of the air to the center and back through the tube to the cold end. This air becomes very cold in the process and leaves the tube through the cold outlet.

Figure F3. The Vortex Tube, Its Construction and Performance

Adiabatic cooling is very simple, lightweight, and reliable provided the compressor has been initially designed to be adequate for such cooling:

In the typical asbestos worksite, cold breathing air will aid in cooling the asbestos worker. Normal external body cooling methods have been reduced due to the previously described working conditions, while body core cooling effects of breathing cool air have not been changed. Cooling methods using cool or cold breathing air can also be used incidentally to provide cool air externally to the worker. This can be accomplished simply by directing the cool exhaust from the respirator exhalation valve down inside the asbestos worker's disposable garment. Workers generally are observed to accomplish this added cooling without special instruction or added personal equipment. With a high pressure breathing air system, a single user of a pressure-demand full facepiece type respirator (with built-in adiabatic cooling) may use a total of only 4 standard cubic feet per minute (SCFM).

When asbestos abatement is accomplished in extremely cold environments, there may be a need to provide heat to the breathing air. Heat exchangers with a warm water heat source can be used to heat and control the breathing air being delivered to the respirator hoses. Supplemental heating or cooling may be used with any type breathing air system.

#### *(4) Continuous Carbon Monoxide (CO) Monitor and Alarm*

Providing a continuous CO monitor and alarm is a requirement of law and of common sense. Carbon monoxide monitors and alarms are available from many sources. A list of sources is included in Part V of this Appendix. The CO monitor should be purchased as a part of the overall breathing air system or breathing air purifier assembly. Proper choice of CO monitor and correct installation in the system are aided by the system manufacturer. Since CO monitor and alarm systems can malfunction, employers may find it prudent to install two such systems to ensure continued protection in case of failure.

Manufacturers of carbon monoxide monitors have available two basic types of sensors. One sensor type is specific or sensitive only to carbon monoxide. This sensor will ignore all other trace chemicals and alarm only in the presence of CO. The monitors based on a CO-specific sensor are usually more expensive. The other type of sensor also will alarm in the presence of carbon monoxide, but it is a non-specific sensor and may also give alarms in the presence of trace chemicals when carbon monoxide is not actually present. Non-specific systems are usually less expensive.

Some manufacturers tend to recommend the non-specific type sensor for inclusion in the asbestos removal air system. Non-specific sensors may give more alarms. The reasoning behind recommending the non-specific type is that other potentially harmful chemicals are being detected when this system gives such an alarm. For instance, off-gassing of certain synthetic compressor lubricants not recommended for use as lubricants in breathing air compressors may cause such non-CO alarms. The breathing air system would be protected against an "unfamiliar" rental compressor in which such adverse synthetic lubricants had been used by the action of such alarms.

On the other hand, the occurrence of numerous alarms will disrupt the asbestos worksite and could significantly increase the cost of removal or make job completion difficult. Such excessive alarms also create a "cry wolf" attitude in the workforce, leading to a disregard for the alarm. Disregard for the CO alarm is a very dangerous practice and MUST be avoided. Therefore, the CO monitor must be kept in calibration and all alarms equally respected. Immediate air quality samples may be taken during the alarm to verify the absence or presence of CO. Should numerous alarms be experienced, the possible sources for other chemicals being detected by the alarm should be found and eliminated.

If CO alarms continue after efforts at finding a local fix, contact the CO monitor manufacturer for aid. In this case, consider with the manufacturer or supplier of the carbon monoxide monitor

either (1) obtaining a new CO monitor of the same type, to eliminate the possibility of a mechanically or electrically malfunctioning alarm, or (2) obtaining a CO monitor and alarm from a different manufacturer.

**IF A LOW PRESSURE BREATHING AIR SYSTEM IS BEING USED WHEN THE ALARM SOUNDS:**

When the alarm sounds, the breathing air system should immediately be switched to the high pressure standby air reserve system. Depending on the capacity of the reserve system, the workers should exit the toxic removal zone. Typically, one 220 standard cubic foot tank will provide one man equipped with a 4.0 SCFM pressure-demand respirator with fifty-five minutes of escape time.

The outside supervisors should check and make certain all workers are exiting. All respirators should be accounted for and verified as no longer in use.

With sufficient high pressure reserve or when using a high pressure breathing air system with sufficient in-line reserve capacity, CO alarms and unexpected compressor shutdown can often be handled without disruptions in the asbestos removal work.

Remember, air being processed in a low pressure air system is almost immediately being delivered to and breathed by the workers. Therefore, when using the low pressure system, there is an immediate need for switchover to the high-pressure reserve air when the CO alarm sounds. If only the minimum high pressure reserve is available, the workers should exit the area. If additional reserve air capacity is available, the workers should exit when the reserve supply approaches the minimum acceptable amount.

When using a high pressure breathing air system with an in-line high pressure air storage bank, the compressed air from the compressor is delayed and diluted by the action of the in-line storage bank before being delivered to the workers. When the CO alarm sounds in a high pressure breathing air system, the stored air at the moment of the alarm has previously been processed through the CO monitor, and is already guaranteed to be Grade D quality. The air in the in-line air bank therefore remains available for the workers' continued use.

**IF A HIGH PRESSURE BREATHING AIR SYSTEM IS BEING USED WHEN THE ALARM SOUNDS:**

Immediately stop the air flow from the compressor into the in-line reserve air bank by shutting the output air valve. [Note: If so arranged, this step may be automatically accomplished through relays in the CO monitor.]

Immediately provide a gas sample test for CO in the supply output from the air bank to the workers. (See discussion of the gas detection method which follows).

If the sample test shows no carbon monoxide in the air from the air bank going to the workers, then the workers may continue to work. They may work as long as no further air from the compressor is being admitted into the air bank, and provided more air time is stored in the bank than the required one hour reserve time. When and if the one hour reserve level is reached, the workers should be removed.

A study of formation of carbon monoxide in breathing air compressors was done by Lawrence Livermore Laboratory in 1978\*. Two separate conclusions from this study which are of particular significance for breathing air systems used in asbestos removal are as follows:

- "Exhaust gases from combustion engines are the major threat to the quality of compressed air." (p. 6)

---

\*Formation of Carbon Monoxide in Air Compressors, Lawrence Livermore Laboratory, T.M. Distler, July 26, 1978, 94550 Contract No. W-7405-Eng-48

- “The preceding observations [of the study] indicate that a high temperature shut-off or alarm, as one of the options specified by OSHA, does not significantly protect against CO contamination of compressed air. In the event of local overheating in a compressor, the effectiveness of a temperature sensor would depend on its placement near the hot spot. The oil reservoir, because of its much lower temperature, is unreliable as an indicator of overheating. Therefore, a high-temperature alarm or shut-off device should not be considered as a substitute for CO monitoring.” (p. 7)

**Gas Detector Tubes.** As previously noted, when a CO alarm sounds in a high pressure system, a gas sample test for CO in the supply output from the air back to workers should be done immediately. Whether a low pressure or a high pressure breathing air system is in use, after all workers have exited, and all respirators have been accounted for, air testing should be conducted to determine if CO was present or not.

Although direct reading CO monitors are available, a less expensive and simple to use on-site air analysis method can be used to provide a positive backup analysis method in case a CO alarm is activated. This method uses preset chemical color change analysis. The analysis chemicals are precharged and sealed into small glass tubes. Different tubes are available for many different gases. A small case contains several sets of tubes and the constant volume sampling pump. Other tubes useful on an asbestos jobsite include those which indicate oxygen and carbon dioxide. These tubes are simple to use. The ends are broken off a tube and the tube is inserted into the pump. Operating the hand pump draws a measured volume of air sample through the tube. The results are read directly on a scale on the tube.

Practice samples taken on two known CO sources can be used to verify the detection of CO using detector tubes. Cigarette smoke can be used as a common type of low-level carbon monoxide sample test. Exhaust from an idling, non-catalytic-equipped automobile, truck, or other engine is a second example, this time of high CO content. Taking these two known CO-content samples on a CO tube will educate the crew as to what the abnormal CO reading actually looks like on the tube. The usual CO sample results on a high quality breathing air is zero CO.

Periodic gas tube sampling results should be permanently logged. This provides an additional record of the air quality on the job site.

## B. Types of Breathing Air Systems

There are three (3) general types of breathing air systems potentially available for use in asbestos removal. These general types are categorized according to the pressure levels at which they are designed to operate:

- (1) the low pressure system
- (2) the high pressure system
- (3) high pressure pre-pumped tanks

### (1) *The Low Pressure System*

The typical low pressure system is shown in Figure 2. This system consists of:

- (a) a low pressure compressor
- (b) an aftercooler assembly with water removal traps
- (c) an air purifier assembly
- (d) a standby high pressure air reserve assembly

(e) a surge-tank or in-line air volume tank

(f) a distribution hose and distribution manifold with connections for respirator hose lines.

*(a) A Low Pressure Breathing Air Compressor*

The low pressure breathing air compressor produces pressures between 100 and 200 psi. It has sufficient flow capacity to provide the flow needed for the respirators being used. The compressor should also be equipped with sufficient interstage and aftercooling capacity to reduce the air temperature to within 10°F of the ambient air temperature. The low pressure compressor should be equipped with suitable moisture removal traps to be able to remove 60% to 85% of the water/oil condensed within the machine. Water removal may be either automatic and continuous or manual and periodic.

*(b) An Aftercooler Assembly with Water Removal Traps*

The aftercooler assembly is used immediately following the low pressure breathing air compressor. The aftercooler and its water trap may be incorporated physically in the compressor. The purpose of the aftercooler assembly is to guarantee that the air temperature is reduced to within 100°F of ambient air temperature. Such a reduction in temperature forces condensation of water/oil in the airstream. The cyclone-type water separator or water trap is also a part of the aftercooler. This separator or water trap is used to allow removal of the water/oil mixtures condensed by the action of the aftercooler in the airstream.

Aftercoolers may either be ambient air-cooled or water-cooled. Ambient air aftercoolers will not function as well on the hottest days, when the most worker cooling is needed. Water-cooled aftercoolers may work best on the low pressure system.

*(c) An Air Purifier Assembly*

The purpose of this purifier network (see Figure 4) is to polish the air to at least the required Grade D air quality.

The air inlet is on the upper left of the diagram. The air path is actually downward into the prefilter, and the first active element encountered by the air is an added water coalescing element in the down tubes and bottom of this prefilter. Water is mechanically collected on this coalescing section of the prefilter and drains downward into the water removal trap. Water can be drained automatically or through a manual valve added to the bottom of this trap.

[IMPORTANT NOTE: ALL CONDENSED WATER AND OIL MUST BE DRAINED AND REMOVED FROM THE AIR ADMITTED INTO THIS PREFILTER. If proper reduction of air temperature and proper removal of condensate is not accomplished at the entrance to the prefilter, the breathing air purifier may not function as well as expected and may require more filter replacements.]

The air continues moving upward through the prefilter and into the oil removal section of the prefilter. At the lowest visual level in the prefilter there is a red color-match band. Oil vapors are adsorbed by the filter media, beginning just above the red band. Oil adsorption causes a red color change in the originally white filter material above the red color-match band. As additional air quantities are passed through the prefilter, this color change will progress upward inside the prefilter material as the filter material adsorbs the oil from the airstream. When the color change approaches the top of the prefilter material, the prefilter should be changed. The above description is typical of the visual or color-change method of notice of need for filter change, which is used by several manufacturers in many types of adsorption filters.

[IMPORTANT NOTE: Some low pressure compressors that may be available for local rental may be built and set up to power industrial machines. Industrial machines such as air tools, jack-hammers, roadwork earth drills, and other such machines have very different

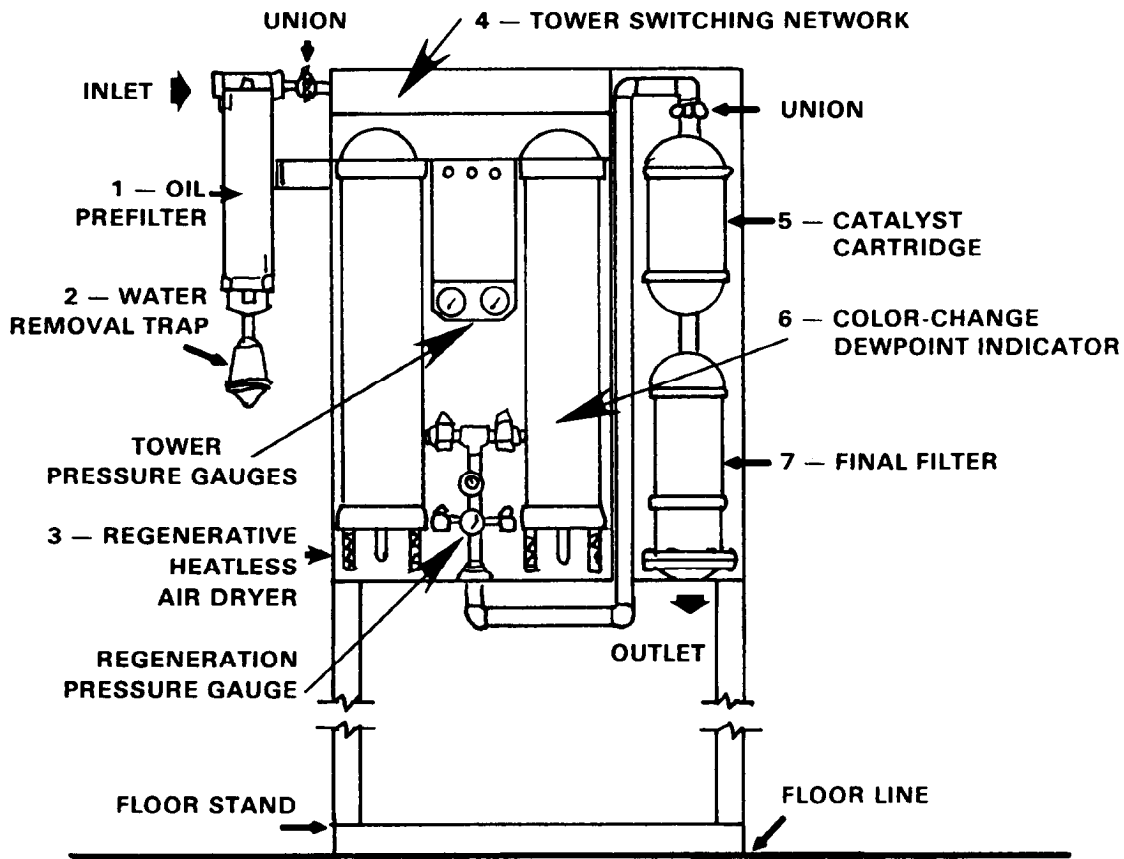

1. Oil Prefilter — removes oil mist, particulate, and entrained water. Color-change replacement notice
2. Water Removal Draintrap — removes condensed water-oil mixtures
3. Dual Regenerative Heatless Air Drying Towers — reduce water vapor content; action is to regenerate its own adsorber material
4. Tower Switching Network — acts with plumbing to provide timed dryer tower switching to effect regeneration
5. Catalyst Cartridge — removes CO by catalytic conversion to CO<sub>2</sub>
6. Color Change Dewpoint Indicator — Color change visually shows the performance of the drying towers
7. Final Filter - effects odor removal

Figure F4. Typical Low Pressure Breathing Air Purifier Assembly



requirements from a compressor required to produce breathing air. Industrial machines may require a high oil content in the **airstream**. Industrial oiling requirements may be designed to be met directly in the compressor output or may be met by the addition of airline oilers. In such cases where a high oil content is found in the air, the solution is to either remove airline oilers downstream of the compressor outlet, or change to a different and suitable compressor that has low oil output.]

**Air processed through the active prefilter passes into the dual dryer tower assembly, into the air-switching plumbing circuit assembly. This air-switching circuit simply directs the air into the heatless air dryer assembly. There are two of these drying towers. Each tower is alternately either on-line, drying the air, or off-line being regenerated.**

**The regeneration of the off-duty tower is accomplished by taking a percentage of the dry air from the output of the on-duty drying tower and running it in a reverse direction through the off-duty tower. The dewpoint of the drying air and also the amount of air to be diverted to drying the off-cycle tower is determined by the setting of the regeneration pressure gauge.**

**The breathing air purifier shown in Figure 4 has visual moisture indicators in each drying tower. These indicators change color in the presence of moisture. Observation of these color-change indicators allows the operator to observe the functioning of the drying operation. During operation the on-cycle tower will begin to absorb water. After approximately 2½ minutes the system will switch, the now dry off-cycle tower will become the functioning tower, and the on-cycle tower will go over to off-cycle as it begins to be de-adsorbed or regenerated.**

**Over a period of years in normal operation the ability of the towers to be regenerated decreases. Calorimetric indicators are available to indicate when the adsorber material in these towers must be replaced.**

**[IMPORTANT NOTE: The drying action of these towers depends on water adsorption and water de-adsorption. If the system is operated with a depleted **prefilter**, oil may be passed into the drying towers. The activated alumina in the drying towers will adsorb oil and therefore will provide a backup to the function of oil removal normally accomplished by the **prefilter**. However, oil adsorbed in the drying towers will not be desorbed in the towers. Therefore oil passing through a saturated **prefilter** will effectively ruin the water drying function of part or all of the tower and result in shorter-than-expected drying media lifetime and more frequent tower media replacement.]**

**Air from the dryer towers now enters the CO catalyst. This catalyst changes harmful CO to CO<sub>2</sub>. The catalyst can process up to 400 ppm inlet CO and still keep the output air below the required 20 ppm limit.**

**[Note: A carbon monoxide continuous monitor and alarm is required on all breathing air systems used in asbestos removal work, even if a CO catalyst is also used.]**

**Periodic replacement of the CO catalyst is recommended by all purifier manufacturers.**

**Air now flows to the final adsorber canister where odors are removed by activated charcoal. This canister is usually replaced on a recommended interval basis. This final canister may also contain a particle filter which prevents adsorber particles from passing downstream.**

**The low pressure breathing air compressor plus the described breathing air purifier is time-proven and will deliver high quality breathing air.**

#### ***(d) A Standby High Pressure Reserve System***

**The only effective method to store sufficient air for an industrial sized asbestos removal work crew is through the use of high pressure storage tanks. Such tanks are available for rental at low rates, and they can be delivered directly to the asbestos abatement worksite.**

The standby reserve system functions by sensing both the line air pressure and the air quality provided by the compressor and breathing air system. Should the compressor fail and the line air pressure begin to drop or should CO levels exceed 20 ppm, the standby reserve sensing system detects dropping pressure or presence of CO and starts to supply pressure from the reserve air system. This pressure supply is automatic and immediate, and functions to continuously provide sufficient air to operate the respirators.

There are two operational notes that must be included in the startup and shutdown checklist for the operator of this system:

**On Startup of the Low Pressure Breathing Air System:**

**(1) Start the low pressure breathing air compressor and verify air delivery at full pressure.**

**(2) Only then turn each reserve air tank on.**

**On Shutdown after workers have exited:**

**(1) Turn OFF each reserve air tank valve.**

**(2) Only then go through the procedures to shut down the breathing air compressor.**

Operating any standby reserve air system without including the directions listed above could cause inadvertent loss of air from the reserve system. This could result in low or zero reserve air in the standby reserve air tanks when it is really needed.

***(e) A Surge Tank or In-line Air Volume Tank***

A surge tank provides air storage capacity so that peak flow conditions will not deplete the air supply.

***(f) A Distribution Hose and Manifold with Connections for Respirator Hose Lines***

Once air is processed through the low pressure air purifier it is directed into the delivery air line and is immediately available to the worker.

**(2) *The High Pressure System***

The high pressure breathing air system (Figure 5) is composed of four major components:

**(a) a high pressure compressor**

**(b) an air purifier assembly**

**(c) a high pressure air storage bank**

**(d) a high pressure control and distribution panel**

***(a) A High Pressure Compressor***

The function of the high pressure compressor is the same as that in the low pressure system. The low pressure compressor utilized one or two successive compression steps or stages to compress the air up to 100 to 200 psi. The high pressure machine pumps the air to pressures of 2000 to 4000 psi utilizing from 3 to 5 successive stages of compression.

Each time the air is processed through a compression stage, its density and its pressure are increased, and its volume is decreased. The air temperature increases sharply through each

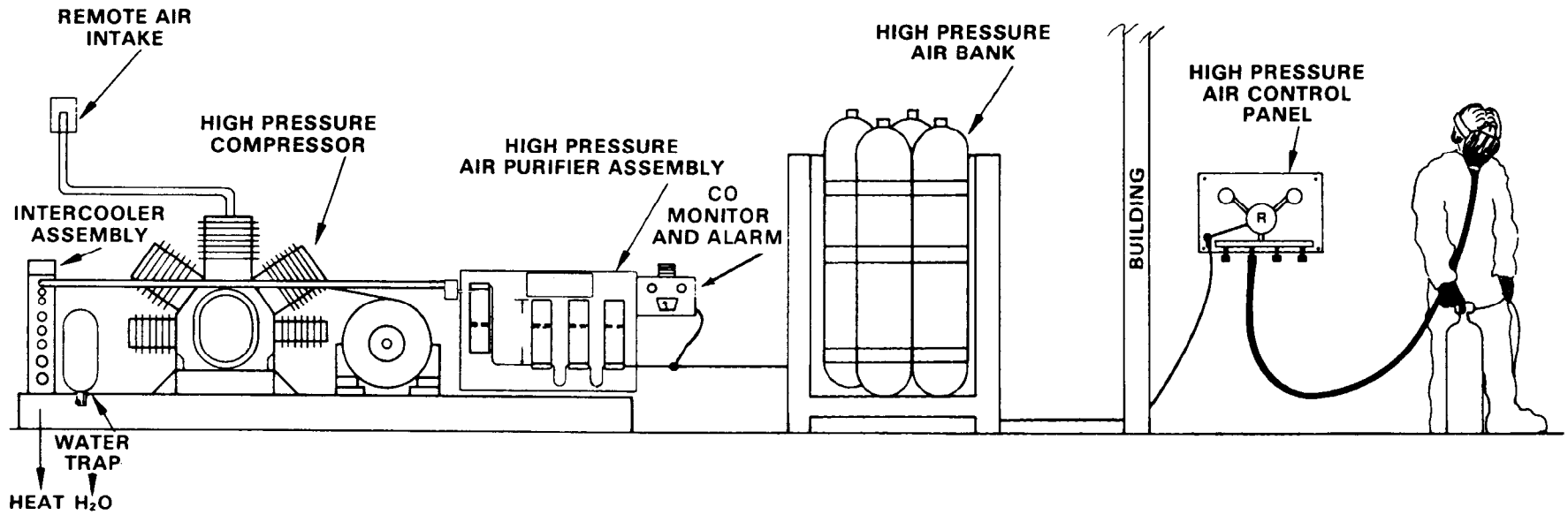

Figure F5. Typical High Pressure Breathing Air System

compression stage due to the adiabatic process. Following each stage of compression, the air is put through an intercooler that transfers considerable heat out of the air. Once the compressed air temperature is brought down, it cannot hold the moisture that it carried before that stage of compression, and the water vapor and other vapors condense. Following each intercooler stage is a cyclone-type liquid trap. The liquid trap is a vertical cylinder with a drain valve in the bottom. The air is introduced tangentially near the top of the trap, and creates a spinning vortex within the trap. The higher density condensed liquids are thrown against the cylinder walls of the trap. They drain down along the walls of the trap and can be removed from the compressor through the drain valve in the bottom. Even though water has been condensed and removed, the air is saturated. In this state, further compression or cooling will be able to remove additional water. This will be done in the following stages.

The air from the preceding compressor stage is now carried into the intake of the next compressor state. Here it is again compressed, cooled, and water is again extracted. This process of compression, cooling, and condensate removal is repeated for every succeeding state within the high pressure compressor. High pressure makes it possible to take out considerably more heat from the air than could be extracted by low pressure compression. The same is true for moisture removal within the high pressure machine. It is capable of removing much more of the water vapor that was originally being carried by the air than if the air were only compressed to a lower pressure in a single or dual state compressor.

Heat and water removal inside the compressor, by intercoolers and drain traps, is done by mechanical methods. Mechanical removal methods are more or less permanent removal methods. These methods do not require replacement adsorber cartridges nor the maintenance associated with such cartridge changes. Very high percentages of condensates are capable of being mechanically removed in high pressure processing. The result of such processing is to reduce the water vapor and other contaminants that must be removed by the following adsorber purifier.

Therefore, one of the major effects of high pressure mechanical processing in the breathing air compressor is to reduce the required size and weight of adsorbent material needed in the following high pressure purifier assembly.

#### *(b) The Air Purifier Assembly*

The high pressure purifier assembly is made up of an aftercooler, a combination coalescing filter/drain trap, and a number of successive purifier containers that hold adsorber materials.

The function of the aftercooler is similar to that of the intercoolers. Following the aftercooler, the air is put through a combination mechanical coalescing filter element/drain trap. Vapor is not removed in mechanical drain traps. There are some very tiny drops of condensed materials, called aerosols (water, oil, etc.) which act almost like vapor and also move through ordinary drain traps. In order to mechanically remove these aerosols, they are forced, in the coalescing element, to impact or squeeze together and to form big drops out of the aerosols. These coalesced liquid drops can now be drained from the air stream.

The air now moves into the adsorber section of the purifier.

Adsorber materials to be used in high pressure adsorber chambers are the same as used in low pressure designs:

- molecular sieves

- silica gel

- activated alumina ( $\text{Al}_2\text{O}_3$ )

- activated charcoal.

At this point the engineer or designer of the high pressure purifier assembly has two major advantages over designing for low pressure air purification: (1) more condensate and contaminants have already been mechanically removed within the high pressure compressor section, and (2) the density of the air is much higher. Higher density air means that any given amount of adsorber will be more effective and will process more air. Both of these facts add to a reduction in the required adsorber needed.

There is a third factor in the overall high pressure design which also allows for a reduction in the required adsorber material. One major action of the in-line high pressure storage bank is to allow a smaller compressor to be used. The high-pressure in-line air bank allows the designer to reduce compressor output, size, weight, and horsepower. Therefore overall cost of this system is reduced. Costs for the high pressure system are lower both in initial purchase and in operating costs, than if the designer were operating without the in-line high pressure air storage bank.

The combination of:

- more condensate mechanically removed by the high pressure compressor
- increased adsorber effectiveness due to higher density of air
- lower air flowrates needed because of the combination of the high pressure compressor and in-line air storage bank

make possible the use of simpler, smaller, and less costly adsorber purifiers to process the high pressure air.

As with low pressure breathing air systems, high pressure regenerative adsorber systems are available, but their high initial cost make them unattractive to the engineer/designer. They are generally not included in high pressure assemblies processing breathing air for asbestos work crews.

Following the coalescing filter trap, there are usually two (2) to four (4) successive additional disposable adsorber containers. These are usually replaced on a machine time basis, but color change or other indicators are available. Since cartridges cannot regenerate themselves it is especially important that they are changed on a regular and scheduled basis. Failure to do so could allow desiccants to reach saturation and permit contaminants to enter and contaminate the high pressure storage bank system. Atypical high pressure purifier assembly, consisting of an inlet coalescing drain trap and three successive replaceable adsorber containers, is shown in Figure 6.

Continous CO Monitor and Alarm. Air passing from the high pressure purifier should be continuously monitored by an electric carbon monoxide alarm. Should any carbon monoxide be produced in the compressor or induced into the compressor air intake, it will be detected by the CO monitor. The CO alarm will visually and/or audibly warn if the CO level goes above 20 ppm. Visual warning is accomplished by meter and by a green/red system of lights. High decibel audible alarms are also available.

CO monitors can be adjusted to alarm at different levels of CO present. In order to meet the requirements of "Grade D" air, no more than 20 ppm are allowed.

#### *(c) The High Pressure In-line Air Storage Bank*

High quality air, Grade D or better, is now pumped directly into the high pressure storage bank. The function of this high pressure storage bank is to act as an air reservoir, so that:

- the peak air flow demands can be met without concern for or limitation by the maximum compressor output

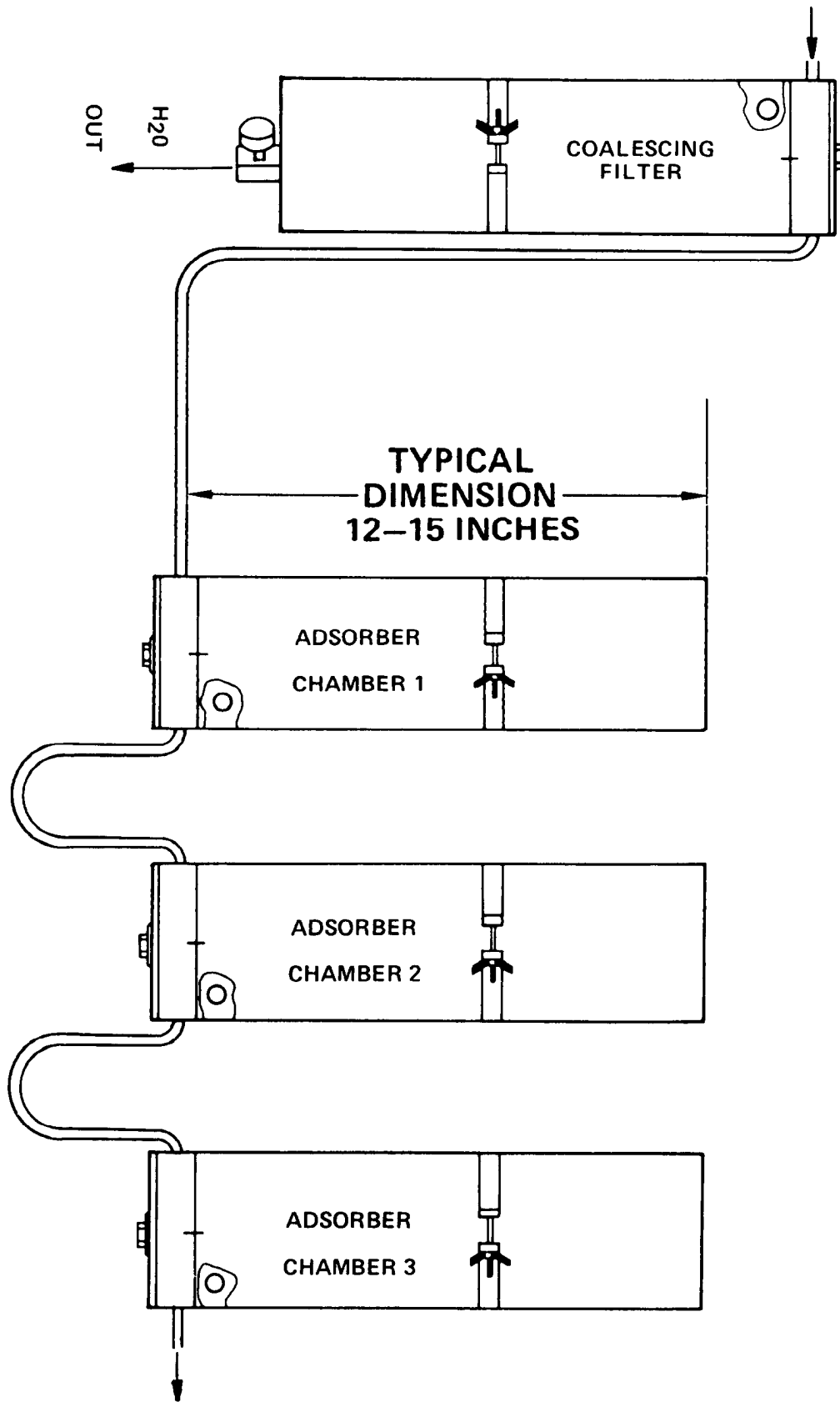

Figure F6. Typical High **Pressure** Purifier Assembly

- the compressor and purifier can be sized for lower flowrates than the peak flowrates required
- in emergency compressor conditions, such as power failure, compressor stoppage, etc. the work crew air supply remains uninterrupted for at least one hour
- greater capacity (typically three to six hours) than the minimum required for escape (one hour) can be used to allow routine or emergency maintenance of the system to be accomplished without interrupting the work crew.

**Air Reservoir for Peak Flow.** A compressor pumping directly to a large work crew is analogous to a water pump pumping without a water reservoir. The direct supply water pump must be sized to meet the peak flow demands. Water systems include a water storage reservoir so that the peak flows are supplied by the reservoir, while the water pump operates over longer periods of lower flow to maintain the reservoir level. This pump/storage design method is done more than just for convenience; it is done also for cost reasons. Even small community water systems would require prohibitively sized water pumps, if only direct supply from the water pump was used. Therefore the function of large storage capacities is included in all municipal water systems. We see large water tanks located strategically around cities.

**Air Reservoir to Lower Costs.** Air storage is different from storage of water. Water density is the same for all water pumps, while air density is a function of air pressure. Low pressures simply do not have enough density to store air effectively. Therefore low pressure air compressors must deliver and use the air almost immediately, since no effective storage is available. Higher pressure increases air density. Increased air density makes possible the compressor/storage combination which can more effectively accomplish the air supply to large crews. Therefore smaller, lighter weight, lower horsepower and lower cost high pressure air compressors can compress air into and maintain the high pressure reservoir. The high pressure reservoir can supply peak flowrates without being limited by lower maximum compressor flowrates.

The major reason for the use of in-line high pressure air storage is economic. The in-line high pressure air storage bank allows a lower cost of smaller high pressure compressor to provide breathing air to a large asbestos removal work crew. Without the in-line air storage bank, a larger and more costly air compressor and larger and more costly air purifier assembly would be needed to support the same crew.

Reserve air time in excess of one to one and a half hours is also available from the high pressure system. Extra time above the one hour escape time may be called the working reserve. Working reserve time, stored in a high pressure storage bank, is very valuable in that unscheduled or scheduled maintenance can be done without interrupting the work crew.

**Air Reservoir for Emergency Conditions.** The working reserve allows the severity of emergency conditions to be lessened. For instance, an inadvertent compressor stoppage with a low pressure system requires an immediate switchover to the high pressure air reserve. A normally open air valve is held closed until switchover is required to provide adequate egress time. The reserve air tanks must be fully charged. It is recommended that a low pressure sensor and alarm be used to monitor the standby reserve. In the high pressure system with in-line storage and reserve, the worker does not enter the toxic zone in the first place unless he is drawing air from the reserve air bank. Both outside and inside toxic zone pressure gauges show at all times the number of hours of reserve time for any crew size. Should the power fail and the high pressure compressor stop, there is no requirement for a switch to operate in order for the "reserve air" to be brought on line.

The working reserve also decreases the severity of the other conditions which might constitute real emergency conditions in other systems. For instance, consider that the CO alarm sounds. The CO alarm has auxiliary relays which can be used in the high pressure system to protect the air previously stored in the air bank. (Likewise, such relays can switch the low pressure system over to the reserve air bank.) It does this by providing power to close the air valve on the compressor output (high pressure system) or open the air valve to the backup reserve bottles (low pressure system). At the first moment of alarm, this valve is shut. Also, for both high and low pressure systems, manual valving on the compressor output can be used to shut off flow upon CO alarm. With Grade D air stored in the air bank, there is no CO emergency for the inside workers. The outside supervisors and outside workers can deal with this alarm as a potential CO problem. The inside workers are using the previously processed air stored in the bank, which will supply them for the next several hours. The problem can be identified and the condition corrected.

#### ***(d) A High Pressure Control and Distribution Panel***

Air is delivered into the toxic zone from the high pressure air bank through small high pressure lines. These lines may be flexible or solid high pressure lines and may be several hundred feet in length. This high pressure line is led into the building to a lightweight air control and air distribution panel. The panel has a high pressure gauge that may be marked off in pressure units or it may be rated in time units (hours) for any size work crew. Each worker attached by respirator hose to this panel can at all times see exactly how much working reserve time (and escape time) is available.

As with the low pressure breathing air system manifold, this panel also contains a regulator and low pressure gauge. The regulator sets, controls and maintains the respirator hose-line pressure to a precise value. Momentary fluctuations in the low pressure hose lines are removed by the action of the regulator. The regulator holds the respirator hose-line pressure at a constant value, which allows for more consistent respirator performance.

Respirator low pressure hose-line lengths are still limited to not more than 300 feet.

**Filling SCBA Tanks.** If equipped with filling devices, high pressure SCBA tanks can be filled from any part of a high pressure system.

**Worker Cooling with the High Pressure Breathing Air System.** Providing worker cooling is a consistent problem in asbestos removal work. Both the high and low pressure breathing air systems have built-in worker cooling. Because of its higher-working pressures, high pressure cooling is more noticeable. The air supplied to the air panel is at high pressure and is also at ambient temperature (2000 to 4000 psi and about 70°- 85°F). The air panel regulator reduces this pressure to 80 to 100 psi. When this pressure reduction takes place, the air temperature drops 25° to 40°F or more. This cold low pressure air is supplied to the respirator hose lines. These hose lines may moderate the air temperature somewhat, but the result is that very desirable cold air is available for the worker to breathe. This adiabatic method of cooling is reliable, lightweight, and requires no added heat exchanger or other worker or work area equipment. It does not increase airflow requirements, and adds no cooling air burden to the compressor designer's air supply requirements.

#### ***(3) High Pressure Pre-Pumped Tanks***

Sufficient breathing air for small jobs may be supplied by using pre-pumped high pressure air. There are two different choices of supply:

- rental cylinders from commercial speciality gas suppliers (This is the same source used to provide the high pressure standby air reserve.)
- the pre-pumped in-line reserve air bank from a high pressure breathing air system.



Either of these air sources can supply a small crew of one to four workers with enough air for one to three days. Operating in this manner, no electrical, gasoline, or diesel power is required at the jobsite. The pre-pumped air has already been processed through a CO monitor; therefore, job-site monitoring is not required. Special designs of larger air storage banks are possible so that this simple method of operation can be extended for larger crews and for longer times. A single high pressure air source located either at a major job site or at home base can function effectively to support one or more additional off-site jobs.

#### **(4) Other**

**The Non-Lubricated Compressor.** There are certain models of industrial-crew sized compressors which use solid state lubrication, rather than liquid lubrication. These machines, if recommended by the manufacturer, can be used to pump air for human consumption. Most of these special machines are more expensive than their oil-lubricated equivalents. They generally have to be rebuilt with less running time than the oil lubricated models.

The majority of breathing air around the world is pumped from oil-lubricated machines, and purified to Grade D air using the adsorber technology described in this report. Whether high or low pressure air, whether commercial divers, sport divers, industrial plant breathing apparatus, fire and rescue crews, all use Grade D air produced from adsorption-based air purifiers.

Unless there is a very special reason, and unless the extra cost can be justified, there is no need to operate the special class of non-lubricated compressor.

**The Ambient Air Pump.** The ambient air pump is a low power (½ hp. to 5 hp.) pump. These pumps take ambient air and supply it to the respirator through the appropriate hose line. They are not intended to improve the quality of the air being pumped.

Ambient air pumps provide an output air pressure in a range from 8 psig to 30 psig. They do not provide sufficient pressure to operate any currently approved NIOSH/MSHA pressure-demand combination SAR/SCBA respirator. Therefore, ambient air pumps cannot be used with the respirator recommended by NIOSH for use in asbestos abatement operations.

#### **(5) Use of Breathing Air Systems in Multi-story Buildings**

Large and heavy breathing air system components, including the compressor, the air-purification system, and the reserve air tanks, are best located on ground or basement floor levels. The lightweight components, such as the feed air lines and air distribution manifolds or air panels, are all that is necessary to install at upper floor levels.

The respirator manufacturers' specified pressure for the respirators being used must be maintained at all times at the inlet to the respirator hose. The Occupational Safety and Health Administration (OSHA) and NIOSH regulations prohibit the actual hose length to exceed 300 feet in length.

The simplest method to provide the manufacturer-specified pressure on the upper floor level is to provide a ground level compressor with output pressure sufficiently higher than the pressure required by the respirator, and use a control regulator on the respirator manifold. Highest compressor output pressures will achieve satisfactory performance at the highest floor level.

### **III. CAUTIONS IN THE USE OF BREATHING AIR SYSTEMS**

- 1. Gross contaminations of the inlet air to the air compressor will adversely affect purifier performance. Therefore,**

CAUTION: The compressor intake should be properly located to intake ordinary uncontaminated ambient air.

2. Inlet air must not be oxygen deficient. No breathing air system will increase the oxygen content of the intake air being processed. Therefore,

**CAUTION:** The compressor intake should be located to ensure that air with normal ambient air oxygen content (19.5% - 23.5%) is always available.

3. The inlet to the compressor should be located away from known or mobile (transient) sources of carbon monoxide. That is, it should be located away from and protected from the engine exhaust of any diesel or gasoline drive compressor, or away from the exhaust from automobiles, trucks, lawnmowers, and other mobile (transient) internal combustion engines. Therefore,

**CAUTION:** The compressor intake should be remotely located from the compressor and all possible mobile exhausts to ensure that carbon monoxide (CO) is excluded from the intake. The intake should be remotely plumbed to a safe position at each worksite.

4. The potential for carbon monoxide poisoning through the intake of the compressor of the breathing air system is high enough so that further protection from carbon monoxide is required by OSHA regulation. Such additional CO protection should be part of any breathing air system at any asbestos removal worksite.

The General Industry OSHA Safety and Health Standards (29 CFR 1910.134), states "If an oil lubricated compressor is used, it shall have a high-temperature or carbon monoxide alarm, or both. If only a high-temperature alarm is used, the air from the compressor shall be frequently tested for carbon monoxide to insure that it meets the specifications."

Since the asbestos removal workplace is usually a temporary worksite, the expectation is that mobile sources of carbon monoxide may pose more hazard than in a permanent worksite. If carbon monoxide is introduced into the intake it will NOT be detected by a high temperature alarm. Therefore, due to the conditions at the asbestos removal worksite, the recommendation is made that additional protection from carbon monoxide be provided by a continuous carbon monoxide monitor with alarm. This choice of a continuous carbon monoxide monitor and alarm is the preferred choice rather than using a high temperature alarm on the compressor.

Catalysts that under ideal conditions can cause oxidation of carbon monoxide to the less dangerous carbon dioxide (CO<sub>2</sub>) are a feature to help protect against carbon monoxide in breathing air. However, OSHA requires the protection of a monitor and alarm against CO in the breathing air. Therefore,

**CAUTION:** A continuous carbon monoxide monitor and alarm should be installed and functioning in the compressor output breathing air stream.

5. When operating a diesel or gasoline driven compressor, additional precautions should be taken to plumb both compressor intake and exhaust away from the compressor and into a safe location. Therefore,

**CAUTION:** Any internal combustion engine-driven compressor should also have the exhaust line plumbed to a safe location, as well as having the intake line plumbed to a safe (separate) location.

6. An open-ended or broken pneumatic line or hose may create a hose "whipping" or moving hose hazard. Therefore all pneumatic lines, low or high pressure, should be restrained. Simple and inexpensive restraints such as sandbags are usually sufficient. Therefore,

**CAUTION:** Air supply hose or lines should be restrained every 15 feet of their length. (This does not include the length of hose from the distribution manifold to the respirator.)

7. Asbestos removal worksites create the possible hazard of airborne toxic fibers. Therefore standard practices to contain these fibers must be used. The compressor is a concentrator of any airborne contaminants. The compressor intake inlet and the entire length of intake hose should be free of airborne asbestos fiber contamination. Therefore,

CAUTION: The compressor intake point and intake hose should never be operated in air contaminated with asbestos fibers. The compressor and air intake hose should be located in a clean air environment outside the asbestos work zone.

8. Compressor oil suitable for use in breathing air applications should be used. **The only proper source for such oil type recommendation is the manufacturer of the breathing air compressor or breathing air system. Therefore,**

CAUTION: Use only compressor oil suitable for use in breathing air applications,  
**and**

CAUTION: The recommendation for oil suitable for use in compressors for breathing air applications should only be made by the compressor or breathing air system manufacturer.

9. **The user of any breathing air system should recognize the importance of running the system at the correct design conditions. The heat, moisture and oil removal abilities designed within the compressor are important. If the high air temperatures generated by compression are not reduced, the water/oil vapors will not be condensed and therefore may pass through the water traps without being removed. This circumstance may present an overload of water/oil to any breathing air purification assembly that follows the compressor and aftercooler. Such purifier assembly overload will cause the adsorber assemblies within the purifier assembly to be replaced on a more frequent than normal schedule. Unnecessary canister replacement increases the expense of maintaining the breathing air purifier. Therefore,**

CAUTION: Compressors equipped with breathing air purifier assemblies should be used, Breathing air purifier assemblies should be used as designed and not overloaded.

10. **Pure oxygen gas must not be pumped by or utilized in a breathing air system for use with air supplied respirators. Only air is pumped by these systems. Pure oxygen gas is never to be used in the standby escape time or reserve air system. Only compressed air is used in the standby reserve air system. Pure oxygen is not to be supplied from any source into the respirator systems used in asbestos removal. Therefore,**

CAUTION: Never use pure oxygen gas in any part of the gas supply system supplying the air supplied respirators. Respirators are supplied only with Grade D air.

- 11: **High pressure air reserve bottles are, and all compressed air systems have, pressurized vessels. Therefore, an explosive hazard potential exists.**

CAUTION: Before starting and operating a compressor and purifier system, inspect all system components for structural damage which could result in an explosion. Inspect safety relief valves carefully, and verify that they are in good working order.

#### IV. COST ANALYSIS: COMBINATION SUPPLIED AIR VERSUS AIR-PURIFYING RESPIRATOR SYSTEMS

This part of the Appendix presents an analysis of the comparative **cost of equipping equal sized crews with combination supplied air respirator/breathing air systems versus air-purifying respirators.**

**Some important conclusions of this cost comparison, which follows in detail, are:**

- (1) A breathing air supply system used with pressure-demand, combination supplied air respirators, is considerably lower in cost than an air-purifying respirator system.**
- (2) The initial cost of outfitting an asbestos removal crew is lower when equipped with air-purifying respirators than the initial cost of obtaining a breathing air system and equipping the same crew with pressure demand combination supplied air respirators.**
- (3) The yearly cost for the asbestos removal crew equipped with air-purifying respirators is much higher than the same size crew equipped with the breathing air system and combination supplied air respirators. This higher yearly cost is the result of the recurring daily costs of the required replacement filters for the air-purifying respirators.**
- (4) The higher initial cost of the pressure-demand combination supplied air respirators and breathing air system over the cost of the air-purifying respirators is usually returned to the owner of the breathing air system within only 6 months to one year of operational use.**
- (5) Following this short time of operational use, the pressure-demand combination supplied air respirators with the breathing systems continue to save the owner the cost of the entire system approximately every 6 months to one year throughout its subsequent operational lifetime.**

---

**\*Based on the average yearly cost of \$20,509.00 of the Supplied Air System.**

## RESULTS COMPARATIVE INITIAL COSTS

### Crew Size 15 Workers All Cases

|  |                        |
|--|------------------------|
| <b>I. Initial cost full facepiece PAPR-HEPA</b>  | 8,985.00               |
| <b>II. Initial cost full facepiece negative pressure</b>                                   | 1,425.00               |
| <b>III. Initial cost breathing air system with pressure demand combination respirators</b> | 26,000.00 to 38,000.00 |

[NOTE: Low pressure rental breathing air compressors have not been calculated; however, they are sometimes locally available. If rental compressors were calculated, it would reduce the initial purchase cost and increase the yearly costs of the low pressure breathing air system in this comparative study. High pressure breathing air compressors are not generally available for rent.]

## RESULTS COMPARATIVE YEARLY COSTS

|  |  |
|--|--|
| <b>I. Full facepiece positive pressure air purifying powered air high efficiency particulate filtration respirator (PAPR-HEPA)</b> | <b>\$57,030.00 to \$110,168.00/yr.</b> |
| <b>II. Full facepiece negative pressure air purifying respirator</b>   | <b>30,617.00 to 60,617.00/yr.</b>      |
| <b>III. Breathing air system with full facepiece pressure demand combination respirators</b>                                       | <b>18,709.00 to 22,309.00/yr.</b>      |

### Conclusion:

**On a yearly cost basis, breathing air systems cost considerably less than air purifying replaceable filter respirators. The higher yearly costs of the replaceable filter air purifying respirators are due almost entirely to the recurring daily costs of replacement filter canisters.**

**COSTS OF FULL FACEPIECE POSITIVE PRESSURE DEMAND AIR-PURIFYING HIGH EFFICIENCY PARTICULATE FILTER TYPE RESPIRATORS (PAPR-HEPA)**

**Initial Purchase:**

**15 each PAPR-HEPA at \$599.00 each \$8,985.00**

**Yearly cost:**

**Amortize in three years \$2,995.00/yr.**

**Unscheduled maintenance at 10% per year 898.00/yr.**

**Scheduled maintenance for HEPA cartridge replacement at \$14.17/day or \$28.35/day based on one shift per day, 5 days per week, for 50 weeks per year or 250 days per year 53,137.00/yr. to 106,275.00/yr.**

**TOTAL COSTS YEARLY \$57,030.00 to \$110,168.00**

[NOTE: Inclusion of the air purifying respirator types in this comparative cost study should not be inferred as a recommendation for their suitability for use in any given asbestos removal circumstance. Breathing air systems, either low pressure (100 to 200 psi) or high pressure (2000 psi or more), used with pressure-demand full-facepiece respirators, or pressure-demand self-contained breathing apparatus provide higher levels of protection and the high reliability needed for asbestos removal.]

**COSTS OF FULL FACEPIECE NEGATIVE PRESSURE AIR-PURIFYING RESPIRATORS**

**Initial purchase:**

**15 each negative pressure full facepiece respirators at \$95.00 \$1,425.00**

**Yearly cost:**

**Amortize in three years \$475.00/yr.**

**Unscheduled maintenance at 10% per year 142.00/yr.**

**Scheduled maintenance for daily replacement of filter canisters averaging either \$8.00 or \$16.00 per man per pay day for 250 days 30,000.00/yr. to 60,000.00/yr.**

**TOTAL COSTS YEARLY \$30,617.00 to \$60,617.00**

[NOTE: Inclusion of the air purifying respirator types in this comparative cost study should not be inferred as a recommendation for their suitability for use in any given asbestos removal circumstance. Breathing air systems, either low pressure (100 to 200 psi) or high pressure (2000 psi or more), used with pressure-demand full-facepiece respirators, or pressure-demand self-contained breathing apparatus provide higher levels of protection and the high reliability needed for asbestos removal.]

**COSTS OF BREATHING AIR SYSTEM WITH FULL FACEPIECE COMBINATION  
PRESSURE DEMAND RESPIRATORS**

**Initial purchase:**

|   |                           |
|---|---------------------------|
| Breathing air compressor  | \$8,000.00 to \$12,000.00 |
| Air purifier system   | \$9,000.00 to \$17,000.00 |
| 15 each combination respirators complete with fittings and hoses at \$600.00 each | 9,000.00                  |

**Yearly costs:**

|   |                              |
|---|------------------------------|
| Cost of compressor operation at 21 C/1000 SCFM                                      | \$6,623.00/yr.*              |
| Purge air costs at 21¢/1000 SCFM  | \$1,325.00/yr.*              |
| Amortize breathing air system in five years   | \$3,400.00 to \$5,800.00/yr. |
| Unscheduled maintenance at 10% per year   | \$2,598.00 to \$3,798.00/yr. |
| Scheduled maintenance for breathing air purifying canister replacement* (see below) | \$1,763.00/yr.               |
| Amortize respirators three years  | \$3,000.00/yr                |

---

**TOTAL COSTS YEARLY:** **\$18,709.00/yr. to \$22,309.00/yr.**

**\* Scheduled maintenance:**

|   |                       |
|---|-----------------------|
| Oil purifier prefilter 6x per year at \$60.00-80.00                     | \$480.00/yr.          |
| A <sub>1</sub> O <sub>3</sub> dryer towers 1x every 3 years at \$100.00 | \$33.00/yr.           |
| CO catalyst filter 1x per year at \$750.00-\$1,800.00                   | \$1,800.00/yr.        |
| Odor removal charcoal filter 2x per year at \$90.00-120.00              | \$240.00/yr.          |
| <b>Total scheduled maintenance per year</b>                             | <b>\$1,763.00/yr.</b> |

---

\*The cost figures given above represent "worst case" estimates because they are based on 24-hour day, 365-day year operations (8760 hours/yr.). Actual costs will be proportionately less depending upon actual use.

Appendix G.

Transcript of NIOSH Testimony Given to  
the U.S. Department of Labor at a Public Hearing  
on Occupational Exposure to Asbestos  
held on June 21, 1984



V. SUPPLIERS OF BREATHING AIR EQUIPMENT

**INCLUDING SUPPLIERS OF  
High and Low Pressure Breathing Air Compressors  
High and Low Pressure Breathing Air Purifiers  
Carbon Monoxide Monitors  
Gas Detection Tubes  
Heat Exchangers  
Particle Filters  
Vortex Tubes**

**American Bristol Industries  
1600 West 240th Street  
Harbor City, California 80710**

**Asbestos Control Technology  
P.O. Box 183  
Maple Shade, New Jersey 08052**

**Atlas Copco Turbonetics  
20 School Road  
Voorheesville, New York 12186**

**Bauer  
1328 Azalea Garden Drive  
Norfolk, Virginia 23502**

**E. D. Bullard Co.  
2680 Bridgeway  
Sausalito, California 94965**

**Consumer Fuels, Inc.  
7250 Governors Drive West  
Huntsville, Alabama 35805**

**Critical Services, Inc.  
2828 Broad  
Houston, Texas 77087**

**Control Resource Systems, Inc.  
670 Mariner Drive  
Michigan City, Indiana 46360**

**Ingersol Rand  
11 Greenway Plaza  
Houston, Texas 77046**

**Joy Manufacturing Company  
Montgomery Industrial Park  
Montgomeryville, Pennsylvania 18936**

**3M Company  
3M Center Building 230-B  
St. Paul, Minnesota 55101**

**Daboco, Inc.  
3319 E. Ten Mile  
Warren, Michigan 48091**

**Davey Compressor Company  
11060 Kenwood Road  
Cincinnati, Ohio 45242**

**Deltech Engineering, Inc.  
Century Park, P.O. Box 667  
New Castle, DE 19720**

**Dynamation, Inc.  
3748 Plaza Drive  
Ann Arbor, Michigan 48104**

**Dynatech Frontier, Inc.  
5655 Kircher Blvd. NE  
Albuquerque, New Mexico 87109**

**Enmet Corporation  
2307 South Industrial Highway  
Ann Arbor, Michigan 48104**

**Hankison Corporation  
1000 Philadelphia Street  
Cannonsburg, Pennsylvania 15317**

**Industrial Pump & Compressor  
12014 Chain Lake Road  
Snohomish, Washington 98290**

**Industrial Safety Products  
1502 Telegraph Road  
Mobile, Alabama 36611**

**Rix Industries  
6460 Hollis Street  
Emeryville, California 94608**

**Sullair Corporation  
3700 East Michigan Blvd.  
Michigan City, Indiana 46360-9990**

**Mine Safety Appliances Company  
600 Penn Center Blvd.  
Pittsburgh, Pennsylvania 15235**

**National Draeger  
101 Technology Drive  
Pittsburgh, Pennsylvania 15235**

**North Safety Equipment  
2000 Plainfield Pike  
Cranston, Rhode Island 02816**

**RhineAir, Inc.  
8402 Magnolia Avenue  
Santee, California 92071**

**Racal Airstream Inc.  
7209A Grove Road  
Frederick, Maryland 21701**

**Vortec Corporation  
10125 Carver Road  
Cincinnati, Ohio 45242**

**Willson Safety Products  
2nd and Washington Streets  
P.O. Box 622  
Reading, Pennsylvania 19603**

Appendix G. Statement of  
The National Institute for Occupational Safety and Health  
The Public Hearing on Occupational Exposure to Asbestos  
June 21, 1984

I am Richard A. Lemen, Director of the Division of Standards Development and Technology Transfer (DSDTT) of the National Institute for Occupational Safety and Health (NIOSH). With me today are senior staff from NIOSH research Divisions; each of whom has expertise in various aspects of the asbestos problem. Our purpose for appearing at this hearing is to support OSHA's efforts to promulgate a new standard for asbestos.

The United States Public Health Service first published a study describing the adverse effects of exposure to asbestos in the asbestos textile industry in 1938 and recommended a guidance concentration to protect workers from adverse effects of asbestos. This concentration was 5 million particles per cubic foot of air (mppcf). This recommendation was not officially adopted until 1960, under the Longshoremen's Act, administered by the Department of Labor. This standard remained in effect until 1969 when the Department of Labor lowered it to 2 mppcf or 12 fibers/ml under the Walsh-Healey Act.

In November 1971, the Director of the newly created NIOSH, an agency of the USPHS, in a letter to the Assistant Secretary of Labor for OSHA recommended a reduction of the then current asbestos standard from 12,000,000 to 5,000,000 fibers greater than 5 microns in length per cubic meter of air (12 fibers/ml to 5 fibers/ml) as an 8-hour time weighted average (TWA). In December of 1971 OSHA issued an emergency temporary standard specifying an 8-hour TWA permissible exposure limit (PEL) of 5,000,000 fibers per cubic meter greater than 5 microns in length per cubic meter of air. Concentrations above 5,000,000 fibers per cubic meter but not to exceed 10,000,000 fibers per cubic meter were permitted for up to 15 minutes in an hour for as many as 5 hours in an 8-hour day. That standard specified respirator use where engineering controls were not feasible (36 FR 23207).

Subsequently, on February 25, 1972 NIOSH submitted a Criteria for a Recommended Standard . . . Occupational Exposure to Asbestos to OSHA. This NIOSH criteria document recommended an 8 hour TWA of 2,000,000 fibers per cubic meter based on a count of fibers greater than 5 microns in length as determined by the phase contrast microscope. Peak exposures for any 15 minute sampling period at greater than 10,000,000 fibers greater than 5 microns per cubic meter of air would not be permitted. Periodic medical examinations were also required, and respirator types were specified for various concentrations in excess of the TWA. Under the NIOSH recommended standard, it was also required that workers be informed of the hazards of working with asbestos, symptoms of diseases, and precautions to be taken to reduce the risk of adverse effects. On June 7, 1972, OSHA issued a final asbestos standard having an initial PEL of 5,000,000 fibers per cubic meter to take effect immediately and a reduced PEL of 2,000,000 fibers per cubic meter to take effect on July 1, 1976. In this OSHA standard, engineering controls were required to meet the PEL and only limited use of respirators was permitted during installation of engineering controls or when engineering controls were not feasible or during emergencies. Labels were also required.

In December 1976, NIOSH submitted a revised recommended asbestos standard to OSHA recommending that the current 2,000,000 fibers per cubic meter standard was inadequate to protect against asbestos-related disease. Since phase contrast microscopy was the only generally available and practical analytical technique at that time, the concentration recommended by NIOSH was 100,000 fibers |5um in length/m<sup>3</sup> (0.1 fibers/cc) as an 8-hour TWA with peak concentrations not exceeding 500,000 fibers |5um in length/m<sup>3</sup> (0.5 fibers/cc) as determined in a 15 minute sampling period. This new recommendation was intended to protect against the non-carcinogenic effects of asbestos and to lower the carcinogenic risk since cancer risks had been demonstrated at all fiber concentrations studied to that date. The available data at that time provided no evidence for a threshold of response or for a "safe" level of asbestos exposure. To date no new evidence would disprove this.

In the fall of 1979, at the request of the Assistant Secretary of Labor for Occupational Safety and Health and the Director of NIOSH, a joint NIOSH/OSHA working group on asbestos was established. In

November 1980 the committee's report was released. The working group was requested to review the existing scientific information concerning asbestos-related disease and assess the adequacy of the current OSHA standard of 2,000,000 fibers greater than 5 microns in length per cubic meter of air. This NIOSH/OSHA committee reviewed previous NIOSH criteria documents, the report of the British Advisory Committee on Asbestos (completed in 1979), and the 1977 International Agency for Research on Cancer (IARC) monograph on the carcinogenic hazards of asbestos. Among the recommendations made by the joint committee was a recommended definition of asbestos for regulatory purposes.

Asbestos is defined to be chrysolites, crocidolite, and fibrous cummingtonite-grunerite including amosite, fibrous tremolite, fibrous actinolite, and fibrous anthophyllite. The fibrosity of the above minerals is ascertained on a microscopic level with fibers defined to be particles with an aspect ratio of 3 to 1 or larger.

At present, NIOSH knows of no compelling scientific argument upon which to change this definition.

The committee also recommended sampling and analytical techniques for airborne asbestos and concluded that using these techniques would permit airborne asbestos to be accurately quantitated to 100,000 fibers greater than 5 urn in length per cubic meter averaged over an 8-hour workday; the joint committee recommended that this be the occupational standard for asbestos exposure in the workplace. A modification to this recommendation will be presented in the final recommendations of this testimony,

In addition, the joint committee stated that "Regardless of the choice of a permissible exposure limit, the best engineering controls and work practices should be instituted, and protective clothing and hygiene facilities should be provided, and their use required of all workers exposed to asbestos." The committee further emphasized that "Respirators are not a suitable substitute" for these control measures." The joint committee also concluded that ". . . even where exposure is controlled to levels below 100,000 fibers, [sic] there is no scientific basis for concluding that all asbestos-related cancers would be prevented." In addition, the joint committee also recommended provisions for medical surveillance. Because of the widespread current and past uses of asbestos products in the maritime and construction industries, the joint committee stated that ". . . it is vital that any new asbestos standard address these industry sectors as well as other workplaces with employees exposed to asbestos." The joint committee further recommended that:

". . . manufacturers of asbestos-containing products such as construction materials should perform detailed monitoring of exposures which could result from all foreseeable uses of their products, including misuse. This monitoring should include electron microscopy to identify fiber type, mix and exposures to fibers less than 5 urn in length. This monitoring data should accompany these products downstream so the users not only know that asbestos exposures may occur, but also know the nature of potential exposures. This monitoring data could, if appropriate, avoid the need for small employers who use asbestos-containing products to have to conduct monitoring on their own." NIOSH supports the OSHA position that any excursion about the PEL should verify the fiber type by electron microscopy.

Also, the joint committee urged that ". . . because cigarette smoking enhances the carcinogenic effect of asbestos exposure on the lung, particular emphasis should be placed on this in any educational program developed under a new standard."

NIOSH continues to believe that both asbestos and smoking are independently capable of increasing the risk of lung cancer mortality. When exposure to both occurs, the combined effect with respect to lung cancer appears to be multiplicative rather than additive. From the evidence presented, we may conclude that asbestos is a carcinogen capable of causing, independent of smoking, lung cancer and mesothelioma.

Finally, the joint committee stated that ". . . due to the fact that other agencies regulate occupational exposures to asbestos (such as the Mine Safety and Health Administration), these agencies should be urged to participate in the development of a new standard and adopt this new standard."

NIOSH continues to recommend a revised asbestos standard. It is our contention that there is no safe concentration of exposure to asbestos. Any standard, no matter how low the concentration, will not ensure absolute protection for all workers from developing cancer as a result of their occupational exposure; however, lower concentrations of exposure carry lower risks. This is consistent with the conclusions of the NIOSH 1976 criteria document and the joint NIOSH/OSHA report of 1980. This is also consistent with the conclusion of the Consumer Product Safety Commission (CPSC) Chronic Hazard Advisory Panel on Asbestos in 1983. They concluded that "on scientific grounds and as a matter of public health prudence, the Commission should regard asbestos at all levels of exposure as a potential human carcinogen." The CPSC report all concluded that:

All major fiber types studied (i.e., chrysotile, amosite, crocidolite) appear to be capable of causing lung cancer and all except anthophyllite, pleural mesothelioma in humans.

This is consistent with the joint NIOSH/OSHA report which stated that:

"On the basis of available information, the committee concludes that there is no scientific basis for differentiating between asbestos fiber types for regulatory purposes."

This statement by the joint NIOSH/OSHA committee continues to be NIOSH policy today and is supported in our written comments to the docket.

#### DOSE-RESPONSE RELATIONSHIPS

The available evidence indicates that larger doses of asbestos will produce greater biological effects than smaller doses. Although there appears to be little dispute that a larger dose of asbestos poses a health risk, the exact nature of the dose-response relationship for lung cancer mortality is subject to considerable debate. This is primarily because of the uncertainty of exposure estimation. Methods of measuring asbestos concentrations have changed over time. Sampling instrument (thermal precipitation versus midget impinger versus membrane filter), location of sampling (personal versus area), dust counting (particles versus actual fibers), and evaluation techniques (whole fields versus eyepiece graticule) have all changed. As a result, conversion of asbestos concentrations obtained by one method to those obtained by another is far from simple and is subject to considerable error. Another factor which may lead to differences of opinion on the exact shape of the dose-response curve is the measure of the dose. The commonly used measures are cumulative dose and the duration of employment. Since using cumulative dose as a measure of exposure gives equal weight to the concentrations of asbestos experienced in each year of exposure, exposures that occurred many years ago are implicitly considered to be as important as recent exposure. This assumption is unrealistic for the chronic diseases having a long latency period. Duration of employment has also been used as a measure of exposure with the assumption that increasing the exposure duration approximates increasing the dose. This procedure has the same problem as using the cumulative dose. Furthermore, in the absence of reliable past exposure data, the duration of employment may not be directly proportional to the total dose of asbestos.

Data available to date provide no evidence for the existence of a threshold level. Virtually all levels of asbestos exposure studied to date demonstrated an excess of asbestos-related disease.

#### ASBESTOS SAMPLING AND ANALYSIS AND RECOMMENDED EXPOSURE LIMIT

In the 1980 NIOSH/OSHA publication Workplace Exposure to Asbestos; Review and Recommendations we presented and evaluated several methods for sampling and analysis of asbestos that had been developed since the publication of the NIOSH criteria document on asbestos. Based upon that evaluation, it was concluded that: "The phase contrast method is clearly capable of measuring airborne fiber levels down to 0.1 fibers/cc . . ."

We also recognized that phase contrast microscopy lacked specificity when asbestos and non-asbestos fibers occurred in the same environment. To cope with the problem of specificity we concluded: "The most likely choice for fiber identification in airborne dust samples is electron microscopy where both electron diffraction and microchemical analysis may be used to identify fibers. "

We also concluded that it is reasonable that such determinations only need be made for a sample which is statistically significantly above the blank with subsequent determinations made only upon process or product modifications

In making a recommendation for an occupational exposure limit for asbestos, NIOSH's ultimate goal is to eliminate asbestos exposures. However, we realize that at this point in time such a recommendation is neither feasible nor practicable due in part to limitations imposed by currently accepted methods of sampling and analysis.

Since 1980, NIOSH has developed modifications to our existing phase contrast method for asbestos determination. By employing this modified method (NIOSH Method 7400), it is possible to measure personal asbestos exposure at concentrations as low as 20,000 fibers per cubic meter of air (when a 2 cubic meter air sample is collected). However, in some sampling locations the filter may become so loaded with non-asbestos particulate that accurate counting may not be possible,

It is assumed that NIOSH Method 7400 will be used for monitoring, which requires a minimum fiber loading of 100 f/mm<sup>2</sup>. This method is able to achieve precision which meets the established NIOSH accuracy standard of 12.8% RSD, at an exposure limit of 100,000 fibers/ins determined as an 8 hour TWA in a 400 liter sample. Using the new method 7400 it is also possible to measure 50,000 fibers per cubic meter with an overall precision of 20% RSD and to measure 20,000 fiber per cubic meter at 30% RSD using a 400-L air sample.

NIOSH and others have recommended exposure limits for asbestos based on 8-hour time weighted average concentrations. While this is a well understood practice, we cannot find compelling arguments to prevent a recommendation based on alternative sampling periods. In fact, such an approach may provide more protection than an 8-hour based sampling period that allows short term exposures 6 or 10 times greater than the 8-hour exposure limits being considered by OSHA. Furthermore, since there is uncertainty regarding the cumulative dose required to initiate disease, it seems reasonable to make every attempt to control exposures to as narrow a range of concentrations as possible. We believe that one way to accomplish this may be by restricting the period over which workplace concentrations can be averaged. Four liter per minute personal sampling pumps are presently available which would allow a sampling time of 100 minutes. NIOSH is currently evaluating this information.

We recognize that there will be certain situations in which overloading of the filter at this flow rate may be of concern. In those situations, the judgement of the professional taking the sample must be applied to determine a more appropriate sampling time keeping in mind the requirement that a minimum fiber density of 100 fibers per square millimeter is required to achieve the NIOSH acceptable precision at a concentration of 100,000 fibers/cubic meter of air.

Finally, we still believe that there are occasions such as mixed fiber exposures where fiber specificity is necessary. Therefore, we recommend the use of electron microscopy in the event of process or product modification, in mixed fiber exposures or when there are other reasons for characterization of fiber type.

#### Control of Exposures:

Effective control involves a system of engineering, work practice, personal protection, and monitoring/feedback measures, with engineering as the preferred control measure by professional occupational safety and health professionals. There are clear advantages to using engineering measures to prevent or contain emissions at the source. Effective containment prevents problems associated with house-keeping and with secondary workplace emissions from settled dust; it also prevents the prospect of emitting asbestos into the environment outside of the workplace. Thus, it addresses both occupational and public health concerns simultaneously.

The proposed OSHA requirement that engineering and work practice measures be used to meet a 2,000,000 fibers/m<sup>3</sup> level is consistent with effective containment. However, the additional proposed provision of compliance by respiratory protection below this level is not consistent with source containment, especially since engineering measures may in fact be able to control to well below 2,000,000 fibers/m<sup>3</sup> (as discussed below). Proposed blanket exemptions for intermittent exposures without regard to feasibility are also not consistent with source containment. Worker rotation as a compliance measure must be forbidden given the lack of a safe threshold for lung cancer caused by asbestos.

Potential asbestos exposures can be divided into two broad categories. The first involves the inclusion of asbestos in products which are currently being developed or manufactured (e.g., brake shoes, thermal insulation, floor tile, cement pipe) and additional handling of these products (e.g., replacement of brake shoes). The second involves construction activities, which consist principally of tearout or maintenance of previously installed asbestos in buildings or factories, and demolition of these buildings.

In the first case (currently manufactured products) the recommended control strategy is to modify the product so that asbestos or a substitute is not required at all. The continued use of large quantities of asbestos presents the prospect of large scale introduction of asbestos into the workplace, and ultimately into the environment as these products are used and disposed of. Rajhans and Bragg discuss substitutes such as: alkaline resistant glass fiber for asbestos in cement; iron or plastic pipe for cement pipe; steel and glass fiber composites (still under development) for brakes; fibrous glass and various refractories for thermal insulation. The Royal Commission Report for Ontario Canada states that, "in 1980, semi-metallic disc pads were used on the front brakes of approximately half of all new North American vehicles, and it is expected that this fraction will approach 100 percent by 1985." Further, they report that, for packing materials, "New packing materials appear to be more than viable alternatives (to asbestos), offering less abrasion and thus lower operating and maintenance costs. It appears that only sales and engineering resistance stand in the way of a total switchover to non-asbestos packings." For asbestos-cement pipe, they report that, "for most applications at least one alternative to asbestos-cement pipe will offer satisfactory performance, and main factor of choice is economics." For plastic fillers, they report that, "substitutes are economically competitive with asbestos and yield satisfactory product qualities." They report that more work may be necessary to provide completely acceptable non-asbestos substitutes for floor tile and roof coatings or paints.

Where asbestos is used, rigorous engineering source controls should be employed. Bragg stated that "Emptying asbestos out of bags, or debagging, is one of the most difficult processes to control." Bragg indicates that even if substitutes are not available, engineering containment measures should generally suffice to keep exposures at or below 500,000 fibers per cubic meter for most manufacturing operations using asbestos. NIOSH has studied controls for two of the most difficult operations involving asbestos processing. NIOSH found exposure levels around 200,000 fiber per cubic meter at an asbestos debagging operation which used an automated debagger. Furthermore, the exposures that did occur in the NIOSH study seemed to be from contaminated incoming bags rather than from the debagger itself. Newly available automated debaggers with improved bag disposal combined with improved cleaning of incoming bags may offer even further exposure reductions.

NIOSH also found exposures of 100,000 fibers per cubic meter at a well controlled asbestos bag filling operation. Therefore, the blanket OSHA exemption of engineering measures for control below 2,000,000 fibers per cubic meter is not warranted for the manufacture of asbestos-containing products.

In the second case (tearout and maintenance), rigorous engineering and work practice containment measures are available. Techniques such as wetting, local exhaust, and HEPA filtration are appropriate. Workforce mobility and rapidly changing worksites in construction activities complicate both engineering and environmental/medical monitoring activities and may justify separate standard for this industry. In general, NIOSH feels that there is a need for a validation, specification and uniform enforcement of specific engineering and work practice controls in asbestos-related construction activities. It is important that competing bidders be required to address a minimum level of safe performance, since the growth and highly competitive nature of the asbestos removal industry has resulted in strong incentives to cut costs.

## RESPIRATORS

Respirators can effectively reduce employee exposures to asbestos. However, a number of problems must be overcome before any confidence can be given to using respirators as a solution to preventing excessive exposures. Some of the problems include:

- Whether or not single-use or dust and mist respirators can provide adequate protection for cancer-causing agents such as asbestos.
- Discomfort associated with wearing respirators including dermatitis, heat, difficulty in breathing, callouses, and feelings of claustrophobia.
- Need for adequate fit testing and addressing fit problems with workers who are not clean-shaven.
- Physiologic stress and drying of breathing passages and sinuses associated with wearing respiratory protective devices.

These problems can exist even when the proper respirator has been selected and an adequate respiratory protection program including training is in place. If a respirator training program does not exist, the chances of respirators providing adequate protection are much less.

NIOSH has stressed that worker exposures to airborne contaminants should be controlled through permanent engineering controls. However, prior to the installation of or during the malfunction or maintenance of engineering controls, for certain short-term intermittent exposures, and for certain operations that are performed at constantly changing locations, a need for respirators does exist. Because respirators are and will be selected and used in industry, NIOSH wants to ensure that the respirators will be used correctly and that the quality of each respirator produced will meet certain criteria. Proposed blanket exemptions for intermittent exposures without regard to feasibility of engineering controls are also not consistent with source containment.

The position of the Institute with respect to the following specific concerns is as follows:

- Use of single-use or dust and mist respirators for protection against asbestos

Under Title 30, Code of Federal Regulations, Part 11 (30 CFR 11), NIOSH is required to test and certify respirators within the categories specified therein when such devices are submitted to NIOSH by applicants. Currently, 30 CFR 11, Subpart K defines a number of dust, fume, and mist respirators which may be used for protection against certain hazardous particulate atmospheres. Among the respirators defined in Subpart K are single-use dust respirators designed as respiratory protection against pneumoconiosis - producing and fibrosis-producing dusts, or dusts and mists. The Subpart goes on to list asbestos as one of the dusts against which the single-use dust respirator is designed to protect [Subpart K, sec. 11.1 30(h)]. Though at the time of the promulgation of Subpart K, it may have been assumed appropriate to list asbestos as a fibrosis-producing particulate against which the single-use disposable respirator could be reasonably expected to provide adequate protection, NIOSH is no longer confident that such an assumption is reasonable because asbestos is also potent carcinogen. The Current requirements of 30 CFR 11 for approval of a single-use dust respirator or dust and mist respirator do not include any tests with a fibrous challenge.

NIOSH is currently in the process of undertaking a comprehensive revision of 30 CFR 11 and intends to address the issue of appropriate respiratory protection for use against asbestos and to require that any respirator for which such approval is sought be proven to provide effective protection against asbestos. NIOSH may change the regulations included in 30 CFR 11 only in accordance with procedures set forth in the Administrative Procedures Act. In the interim, NIOSH will continue to approve single-use and replaceable dust/mist respirators for use against asbestos when such approvals are applied for only because of the legal requirement in the current approval regulations. However, NIOSH does not recommend



the use of such respirators where exposures to asbestos may occur on the basis that such is not a prudent occupational health risk

- Finally, we want to reiterate our position that we recommend a quantitative respirator fit testing program as previously stated in comments on the proposed lead standard

### MEDICAL SURVEILLANCE PROGRAMS FOR ASBESTOS EXPOSED WORKERS

One of the principal questions of considerable public health importance is “Can we develop valid and reliable medical screening and biological monitoring tests to recognize the early effects of exposures to occupational hazards at reversible or treatable stages in order to complement and evaluate the effectiveness of environmental monitoring and control measures?” (Orchard, 1980; Becklake, 1982).

Recent reviews of available epidemiological literature indicate that withdrawal from asbestos exposure will not ensure protection against progression of existing or development of asbestos-related disease (Becklake, 1982; NIOSH/College of American Pathologists Pneumoconiosis Committee, 1982; Craighead et al., 1982). Few would disagree with the view expressed by Dr. Hans Weill that radiographic evidence of diffuse pulmonary fibrosis should lead to the prudent course of avoiding further exposure (to asbestos) (Weill, 1980). However, it is uncertain whether medical removal protection should also be recommended for workers who exhibit only limited “benign” pleural abnormalities. Nor is it known whether removal from exposure will also favorably influence the risk of developing bronchogenic lung cancer or pleural mesothelioma (Orchard, 1980; Becklake, 1982; NIOSH/College of American Pathologists Pneumoconiosis Committee, 1982; American Thoracic Society 1983).

Exposure rate and cumulative dose appear to be the relevant parameters governing development of asbestosis and bronchogenic carcinoma. Therefore, while medical removal may not diminish the worker’s lifetime risk of development of nononcogenic or oncogenic asbestos-related diseases, continued exposure will surely increase the risk (Becklake, 1982). For a worker who has evidence of asbestos exposure related pleural or interstitial abnormalities with or without associated impairment or disability, the effectiveness of medical removal as a method of reducing that worker’s lifetime risk of pleural mesothelioma is even less certain since the risk of developing mesothelioma is related to the time since first exposure, even for brief low level exposures (Day et al., 1980; National Research Council, 1984). In addition, the lifetime risk of developing pleural mesothelioma among asbestos exposed workers who smoke cigarettes is not diminished by cessation of cigarette smoking (National Research Council, 1984).

Recent updates have been published concerning the principles and criteria which should underlie the design, conduct, interpretation, and evaluation of screening and surveillance programs for respiratory disease and cancer (American Thoracic Society, 1982; American Thoracic Society, 1983; Ferris, 1978; Coles et al., 1980; Halperin et al., 1984). Given the current state of knowledge, routine periodic chest X-rays and spirometric lung function tests do not meet the most crucial criteria for determining the suitability of screening tests for early recognition and primary prevention of any asbestos-related diseases.

Although these diseases are eminently preventable by eliminating or limiting exposures to asbestos, they are not curable nor amenable to secondary preventive measures in affected individuals (Becklake, 1982; NIOSH/College of American Pathologists Pneumoconiosis Committee, 1982; Craighead et al., 1982). By the time these diseases are clinically detected among individual members of an asbestos exposed workforce by routine periodic screening, it is unlikely that the affected worker, or that worker’s similarly exposed co-workers, will derive any primary preventive benefits. It maybe of little consolation that recently hired workers may benefit from the resulting reductions in their future exposures.

While currently available screening tests may detect asbestos-related abnormalities among asymptomatic asbestos exposed workers years before pulmonary impairment, disability, or death occur, medical removal of these workers for exposure to asbestos may not be effective in preventing development of cancer or non-carcinogen disease. However, cessation of cigarette smoking among

asbestos exposed workers with or without detectable evidence of asbestos-related pulmonary abnormalities does appear to effectively lower the overall risk of premature disability and death in these individuals (Becklake, 1982; NIOSH/College of American Pathologists Pneuconiosis Committee, 1982; Craighead et al., 1982; Weill, 1980; Day et al., 1980).

## RECOMMENDATIONS FOR SURVEILLANCE

The existing OSHA standard for occupational exposures to asbestos was not designed to protect all exposed workers from the risks of developing asbestos-related cancer diseases (NIOSH/OSHA Asbestos Work Group, 1980). In fact, it may not have been adequate to protect all workers from developing nononcogenic asbestos-related diseases (Becklake, 1982; NIOSH/College of American Pathologists Pneuconiosis Committee, 1982; Craighead et al., 1982; NIOSH/OSHA Asbestos Work Group, 1980).

The proposed OSHA standard is intended to reduce the risk to workers of developing asbestos-related disease based on consideration of (a) the estimated probability of developing significant disease following a given cumulative exposure; (b) a comparison of the risk estimate with the health and safety risks experienced among workers in a variety of non-asbestos producing or using industries; (c) the technical limits of reliable sampling and analysis; (d) the technical feasibility of measures to reduce asbestos exposure.

Thus, some proportion of asbestos exposed workers may still develop asbestos-related cancer diseases even if all workplaces are in compliance with the proposed standard. As with all extrapolative estimates of risk, we know there is a great deal of uncertainty regarding the true risk among asbestos exposed workers. Ideally, a well designed medical surveillance program would help quantify the risk and, therefore, reduce the uncertainty of the estimate. Unfortunately, we cannot find any medical evidence that the medical surveillance provision of the proposed rule will provide additional protection to asbestos exposed workers.

OSHA's reason for requiring periodic chest X-rays and pulmonary function testing for asbestos exposed workers is to:

1. Detect early pleural or interstitial effects of asbestos exposure
2. Prevent the progression of non-oncogenic disease or the development of oncogenic disease by removing the affected worker from further exposure or by reducing that worker's future exposure.

While we believe that these goals are highly desirable, we do not believe that they can be accomplished using the medical surveillance program being considered by OSHA.

If in the final rule OSHA maintains its requirement for employers to obtain routine periodic chest X-rays and pulmonary function tests for asbestos exposed workers; it seems appropriate that the following should then also be required:

1. Both screening tests should be conducted, at initiation of employment and thereafter every 5 years for the first 15 years, and thereafter every 2 years, using the standardized guidelines for instrumentation, training, and interpretation of recognized expert authorities (American Thoracic Society, 1982; American Thoracic Society, 1983; Feris, 1978; International Labour Office, 1980; Guidotti et al., 1983).
2. Cigarette smoking should not be permitted at worksites because of the known synergistic effects of cigarette smoking and lung cancer.
3. The results of required screening tests should be reported to OSHA without personal identification within 2 months of the performance of the tests in order to enable OSHA to evaluate over time the effectiveness of the medical surveillance and environmental control provisions of this standard.

4. Some consideration must be given to mandatory followup of all workers with any asbestos exposure. This is necessary because of the prolonged latency period of most asbestos-related diseases and the uncertainty surrounding the cumulative dose needed to initiate the disease process.
5. Routine periodic stool guaiac, sputum cytology, and bronchoalveolar lavage tests are not recommended as screening procedures based on the current state of knowledge concerning their diagnostic value in massive screening programs. However, their use on an individual basis should be left to the discretion of the examining physician.

#### **SUMMARY OF NIOSH RECOMMENDATIONS**

NIOSH urges that the objective or goal is to eliminate asbestos exposures. Where asbestos exposures cannot be eliminated, they must be controlled to the lowest level possible. A significant consideration in establishing a permissible exposure limit should be the lowest level of exposure which can be accurately measured using currently available analytical techniques. At present this level would be 100,000 fibers greater than 5 microns in length per cubic meter, as determined in a sample collected over any 100 minute period at a flow rate of 4L/min using the NIOSH analytical method 7400. However, the presence of background dust in high sample volumes maybe the limiting factor which may complicate the analysis under these sampling conditions. In making a recommendation for an occupational exposure limit for asbestos, NIOSH's ultimate goal is to eliminate asbestos exposures. However, we realize that at this point in time such a recommendation is neither feasible nor practicable due in part to limitations imposed by currently accepted methods of sampling and analysis. At this time in order to achieve precision which meets the established NIOSH accuracy standard of 12.8% RSD an exposure limit of 100,000 fibers/m<sup>3</sup> determined as an 8 hour TWA in a 400 liter sample is maintained. Since asbestos is a recognized carcinogen, NIOSH does not recommend the use of air purifying respirators for protection against asbestos.

The position OSHA is considering of permitting only the use of high efficiency air-purifying respirators, although an improvement over the old standard, may not adequately protect exposed workers.

|   |  |   |
|---|--|---|
| <b>REPORT DOCUMENTATION PAGE</b>  | 1. REPORT No.<br><b>EPA 560-0 PTS-86-001</b>         | 2.<br>3. Recipient's Accession No.  |
| 4. Title and Subtitle<br><b>A Guide to Respiratory Protection<br/>for the Asbestos Abatement Industry</b>   |  | 5. Report Date<br><b>April 1986</b>   |
| 7. Author(s)<br><b>Gary P. Noonan, Herbert I. Linn, and Laurence D. Reed</b>  |  | 6.<br>8. Performing Organization Rept. No.  |
| 9. Performing Organization Name and Address<br><b>National Institute for Occupational Safety and Health<br/>944 Chestnut Ridge Road<br/>Morgantown, West Virginia 26505</b>   |  | 10. Project/Task/Work Unit No.<br>11. Contract(C) or Grant(G) No.<br>(c)<br><b>DW75931135-01-1</b><br>(G) |
| 12. Sponsoring Organization Name and Address<br><b>U.S. EPA Asbestos Action Program<br/>Office of Pesticides and Toxic Substances<br/>401 M Street, S.W.<br/>Washington, D.C. 20460</b>   |  | 13. Type of Report & Period Covered<br><b>Final</b><br>14.  |
| 15. Supplementary Notes<br><br><b>Prepared by NIOSH for the U.S. EPA</b>  |  |   |
| 16. Abstract (Limit: 200words)<br><br><b>This guide provides practical guidance for selection and use of respiratory protection to persons who work in asbestos abatement operations or other activities, such as maintenance or repair, where exposure or the potential for exposure to asbestos exists. This guide recommends controlling exposures to the lowest level possible as determined by the most sensitive and reliable monitoring methods. The guide' has five parts. Part I is an introduction to the hazards associated with airborne asbestos and to the issues involving respiratory protection against asbestos. Part II presents a model respiratory protection program for the asbestos industry which both satisfies current Federal regulations and incorporates the most current information on appropriate respirators for use against airborne asbestos fibers. Part III contains a checklist for developing or evaluating a respiratory protection program. Part IV presents information on breathing air systems for supplied-air respirators. Part V lists sources of help for problems involving respirator use.</b> |  |   |
| 17. Document Analysis a. Descriptors<br><br>b. Identifiers/Open-Ended Terms<br><b>Asbestos<br/>Asbestos Abatement<br/>Respirators<br/>Respiratory Protection</b><br><br>c. COSATI Field/Group   |  |   |
| 18. Availability Statement  | 19. Security Class (This Report)<br><b>Unlimited</b> | 21. No. of Pages  |
|   | 20. Security Class (This Page)<br><b>Unlimited</b>   | 22. Price   |



United States  
Environmental Protection  
Agency **TS 788**  
Washington, DC 20460

Official Business  
Penalty for Private Use  
\$300