

Fire Service Features

of Buildings and Fire Protection Systems





Occupational Safety and Health Act of 1970

“To assure safe and healthful working conditions for working men and women; by authorizing enforcement of the standards developed under the Act; by assisting and encouraging the States in their efforts to assure safe and healthful working conditions; by providing for research, information, education, and training in the field of occupational safety and health.”

This publication provides a general overview of a particular standards-related topic. This publication does not alter or determine compliance responsibilities which are set forth in OSHA standards and the *Occupational Safety and Health Act*. Moreover, because interpretations and enforcement policy may change over time, for additional guidance on OSHA compliance requirements the reader should consult current administrative interpretations and decisions by the Occupational Safety and Health Review Commission and the courts.

Material contained in this publication is in the public domain and may be reproduced, fully or partially, without permission. Source credit is requested but not required.

This information will be made available to sensory-impaired individuals upon request. Voice phone: (202) 693-1999; teletypewriter (TTY) number: 1-877-889-5627.

This guidance document is not a standard or regulation, and it creates no new legal obligations. It contains recommendations as well as descriptions of mandatory safety and health standards. The recommendations are advisory in nature, informational in content, and are intended to assist employers in providing a safe and healthful workplace. The Occupational Safety and Health Act requires employers to comply with safety and health standards and regulations promulgated by OSHA or by a state with an OSHA-approved state plan. In addition, the Act's General Duty Clause, Section 5(a)(1), requires employers to provide their employees with a workplace free from recognized hazards likely to cause death or serious physical harm.

Cover photo: Vito Maggiolo

Fire Service Features

of Buildings and Fire Protection Systems

**Occupational Safety and Health Administration
U.S. Department of Labor**



OSHA 3256-09R 2015

ACKNOWLEDGMENTS

OSHA wishes to express its appreciation to the following individuals for their significant contributions to this manual.

The following persons provided a courtesy technical review:

David M. Banwarth, P.E.
David M. Banwarth Associates, LLC

James (Jamie) Barton, CFPS
Fire Inspector, Gaithersburg, MD Fire Marshal's Office
Captain (retired), Montgomery County Fire & Rescue Service, MD.

Jeffrey Cisney, Fire Protection Engineer
General Services Administration
Former firefighter, College Park Volunteer Fire Department, MD.

Ed Claridge, Beca Ltd. New Zealand

Samuel S. Dannaway, P.E.
President and Chief Fire Protection Engineer, S. S. Dannaway Associates, Inc.
Former volunteer firefighter, Prince Georges County, MD.

Robert J. Davidson
Managing Partner, Davidson Code Concepts, LLC
Fire Marshal (retired), South Brunswick, NJ.

Sean DeCrane, Battalion Chief
Director of Training
Cleveland Division of Fire
IAFF - ICC Codes Representative

John August Denhardt, P.E.
Strickland Fire Protection

Gregory Havel
Deputy Chief (retired) Town of Burlington Fire Department, WI.
Adjunct Instructor, Gateway Technical College
Safety Director, Scherrer Construction Co., Inc.;
Burlington, WI.

Ivan J. Humberson, P.E.
Fire Marshal, City of Gaithersburg, MD.
Former Volunteer Firefighter, Prince Georges and Frederick Counties, MD.

Greg Jakubowski, P.E., CSP, FSFPE
Principal - Fire Planning Associates
Pennsylvania State Fire Instructor
Chief, Linghocken Fire Co., Bucks County, PA.

Chris Jelenewicz, P.E.
Society of Fire Protection Engineers
Fire Chief (retired) Chillum-Adelphi Volunteer Fire Department, MD.

Bruce E. Johnson
International Code Council

Steve Kerber
Director, UL Firefighter Safety Research Institute
Past Deputy Chief and Life Member, College Park Volunteer Fire Department, MD.

Thomas Platt, P.E.
Fire Protection Engineer, U.S. Government
Lieutenant, College Park Volunteer Fire Department, MD.

Edward J. Prendergast, P.E.
Chicago Fire Department (retired)

Martin C. Smith, SET
President and CEO, Alarm Tech Solutions, LLC

Jim Tidwell
Tidwell Code Consulting
Fire Chief (retired) Fort Worth Fire Department, TX.

Steven Venditti, P.E.
Associate Manager, Rolf Jensen and Associates
Former Lieutenant, College Park Volunteer Fire Department, MD.

The following persons and organizations contributed photographs or diagrams for this manual:

Alarm Tech Solutions, LLC
Dave Banwarth
Mike Carroll
Jeff Cisney
Clayton Fire Company #1, DE
Cleveland Division of Fire
College Park Volunteer Fire Department, MD
Federal Emergency Management Agency
Glen Ellman
Mike Eversole
John Guyton
International Code Council
Greg Havel
Neal Hobbs
Ivan Humberson
Morgan Hurley
Gaithersburg City Fire Marshal, MD
Greg Jakubowski
Vito Maggiolo (including cover photo)
National Fire Protection Association
National Institute for Occupational Safety and Health
National Institute of Standards and Technology
Odessa Fire Company, DE
Dave Polikoff, Battalion Chief, Montgomery County Fire and Rescue Service, MD
David Purcell
Gene Shaner
Michael Schwartzberg
Martin C. Smith
Scott Stookey
Tempe Fire Department, AZ
United States Fire Administration

TABLE OF CONTENTS

- Chapter 1 Introduction 1
 - Purpose 1
 - Scope 2
 - Manual Organization and Use 3
 - Terminology 4
 - Glossary of Acronyms and Terms 4
- Chapter 2 Fire Service Primer 5
 - Challenges 5
 - Organization 6
 - Apparatus 7
 - Emergency Operations 8
 - How Stakeholders Can Help 10
- Chapter 3 Fire Apparatus Access 13
 - Extent and Number 13
 - Dimensions 14
 - Turnarounds 16
 - Design 16
 - Security 17
 - Traffic Calming Features 18
- Chapter 4 Water Supply 20
 - Fire Flow 21
 - Fire Pumps 22
 - Fire Hydrant Features 23
 - Fire Hydrant Placement 24
- Chapter 5 Premises Identification 29
- Chapter 6 Firefighter Access 32
 - Site Access 32
 - Key Boxes 32
 - Entry Points 33
 - Room and Floor Designations 34
 - Interior Access 36
 - Stairs 36
 - Stair Capacity 37

Elevators	38
Utility and Equipment Identification	40
Chapter 7 Hazards to Firefighters	42
Building Information	42
Hazardous Materials	43
Lightweight Construction	44
Shaftways	46
Rooftop Hazards	47
Energy Conservation and Alternative Energy Features	47
Chapter 8 Sprinkler Systems	51
Zoning	51
Control Valves	52
Partial Sprinkler Systems	55
Unwanted Alarms.....	56
Chapter 9 Standpipe Systems.....	58
System Design	59
Pressure-Regulating Devices	61
Fire Hose Connections	62
Fire Attack from Stairs.....	65
Isolation Valves	67
Chapter 10 Fire Department Connections	69
Quantity	69
Inlets	70
Location	71
Position	73
Marking and Signage.....	74
Chapter 11 Fire Alarm and Communication Systems	77
Zoning and Annunciation	78
Graphic Displays	81
Fire Service Notification	83
Unwanted Alarms.....	84
Occupant Notification.....	85
Fire Department Communication Systems	87
Fire Command Centers	88

Chapter 12 Other Systems.....	91
Firefighter Radio Signal Enhancement Systems	91
Firefighter Air Replenishment Systems	92
Backup Power Systems	95
Firefighter Emergency Power Outlet Systems	96
Smoke Control and Ventilation Systems	96
Chapter 13 Building Phases	101
Concept and Design	101
Construction.....	103
Occupancy.....	107
Maintenance and Use	108
Demolition.....	110
ANNEX A Coordination Checklist.....	112
Workers’ Rights.....	114
OSHA Assistance, Services and Programs	114
NIOSH Health Hazard Evaluation Program.....	116
OSHA Regional Offices	117
How to Contact OSHA.....	118

This manual is advisory in nature and informational in content. It is not a standard or a regulation, and it neither creates new legal obligations nor alters existing obligations created by OSHA standards or the *Occupational Safety and Health Act* (OSH Act).

Employers are required to comply with hazard-specific safety and health standards as issued and enforced either by the Occupational Safety and Health Administration (OSHA) or by one of the 27 OSHA-approved State Plans. State Plans have and enforce their own occupational safety and health standards that are required to be at least as effective as OSHA's, but may have different or additional requirements. A list of the State Plans and more information is available at: www.osha.gov/dcsp/osp.

In addition, Section 5(a)(1) of the OSH Act, the General Duty Clause, requires employers to provide their employees with a workplace free from recognized hazards likely to cause death or serious physical harm. Employers can be cited for violating the General Duty Clause if there is such a recognized hazard, and they do not take reasonable steps to prevent or abate the hazard. However, the failure to implement any of the recommendations in this manual is not, in itself, a violation of the General Duty Clause. Citations can only be based on standards, regulations, or the General Duty Clause.

This manual does not supersede or substitute for any local or state laws, codes, ordinances, regulations, or amendments thereto. This document shall only be used as a nonbinding supplement to a jurisdiction's requirements.

CHAPTER 1 INTRODUCTION

Purpose

The purpose of this manual is to increase the safety of emergency responders and building occupants by providing information about how firefighters typically interact with building features and fire protection systems during fires (figure 1.1) and similar emergencies. By better understanding the needs of the fire service, designers and code officials can work together to streamline fire service emergency operations within the built environment.



Photo: G. Elman

Figure 1.1 Firefighters attacking a building fire.

Originally published in 2006, this manual cited specific criteria for many of the building features discussed and code references. This document avoids such specifics and instead provides a general discussion of each feature, followed by a series of questions to ask and a list of resources to help users answer them. Editions are not listed for the resources such as codes and standards that are regularly updated. Two new chapters have been added

on water supply and building phases and topics on energy conservation, emergency power, and room and floor numbering are now included.

The combined efforts of designers, code officials, and related stakeholders can result in safer workplaces for firefighters. When designs are tailored to better meet emergency service operational needs, the time and complexity needed to mitigate an incident is often reduced. Designers in this manual can include architects, engineers, planners, and design technicians. Code officials can include fire marshals, fire inspectors, fire prevention officers, building inspectors, and plan reviewers. Other stakeholders include building owners and developers, security professionals, and construction professionals.

The faster the fire service can respond, enter, locate the emergency incident, and safely operate in or near a building, the sooner they can usually resolve the incident in a safe manner. This, in turn, will likely increase the safety of building occupants (workers, residents, and visitors), reduce property damage, and limit related indirect losses. Therefore, both building occupants as well as fire service employees will realize the benefits of this document in terms of reasonably safe working conditions as intended by the *Occupational Safety and Health Act of 1970*.

The model building codes used in the United States — The *International Building Code* and the National Fire Protection Association's (NFPA) 5000 — include firefighter safety within their scope. Designers and code officials therefore bear some responsibility for the safety of firefighters dealing with emergencies in buildings that these specialists design or approve, respectively. Users of NFPA's *Life Safety Code* should note that firefighter safety is not specifically stated as part of its scope, which is one reason it would not substitute for a building code.

The building code responsibility for firefighter protection applies equally to prescriptive and performance-based design. However, a higher level of knowledge regarding fire service operations would likely be needed to meet this responsibility in a performance-based design scenario. Only with a thorough understanding of how the fire service interacts with all building features and systems during an emergency can a designer evaluate and ensure the safety of firefighters.

Many portions of the prescriptive codes and standards governing buildings and fire protection systems allow for design variations. The resulting flexibility permits the selection of a variety of design options. This manual discusses how the fire service interacts with different building features to help designers select options that may streamline fire service operations.

Designers routinely consider the needs and comfort of their clients when arranging a building's layout and systems. Within the framework of codes and standards, design options may be developed to benefit a particular owner, occupant, or user. For example, a building code would typically dictate the minimum number of lavatories and water fountains. However, the location, distribution, and types of such facilities are left up to the designer in consultation with the client.

The application of fire protection features in buildings is similar. For instance, a code may require the installation of a fire department connection for a sprinkler system or an annunciator for a fire alarm system. However, there may be little or no guidance as to the location, position, features, or marking of such devices. This manual discusses such features, lists questions to ask, and provides resources to help answer these questions. Primarily, these questions will be addressed by local and state fire codes, the code officials administering these codes, and emergency response personnel in the

affected jurisdiction. Designers should consider code officials and emergency responders as stakeholders — just as they would building owners or occupants.

Scope

This publication is to be used voluntarily, as a companion to mandatory and advisory provisions in fire codes, building codes, life safety codes, safety regulations, and standards for fire protection systems. The material contained in this document focuses on ways that stakeholders listed above can contribute to the efficiency of operations during emergency incidents in both new and existing structures. Proper design and approval should be followed by suitable installation, inspection, testing, and maintenance.

The material in this document is applicable to all types of fire service organizations, including fire brigades and fire departments, and will help emergency responders at incidents other than fires — hazardous materials releases, emergency medical care, explosions, collapses, and entrapments.

Users of this manual must understand its limitations. It is intended to supplement rather than substitute for codes and standards. For example, there are entire standards and books written about sprinkler, standpipe, and fire alarm design. However, this document covers only the portions of those systems with which the fire service interacts and suggests design choices that will help streamline and support fire service operations.

The concepts discussed here will apply to most facilities but do not cover every possible type of building, facility, or hazard. Therefore, designers and code officials should seek additional specific guidance from code officials and emergency responders regarding specialized facilities such as tunnels, transit systems, underground structures, and about the handling of highly hazardous chemicals.

Manual Organization and Use

Chapter 2 of this manual presents an introduction to the fire service which is important for all users of this publication. The remaining chapters include a narrative describing specific building features and how the fire service uses or interacts with them. Depending on a designer's field of practice, one or more of these chapters may be applicable. Boxes at the end of each chapter list specific questions that designers and code officials should consider for each topic, followed by resources that may help answer those questions. The **Annex** section contains a checklist to facilitate coordination with emergency responders on the topics addressed in this document.

Readers should recognize that this manual was developed during 2013–2015. Its contents reflect the state of the art at that time. It is possible — in fact, likely — that building features, materials, systems, and methods to assist the fire service will continue to change in the future. Technology will continue to evolve. Material in this publication is not intended to discourage the use of the latest technology, provided that adequate data demonstrates that it provides equivalent or superior protection for firefighters.

Along with the general considerations contained in this manual, designers and code officials should seek out and follow the specific advice of emergency responders. In some cases, the fire service will have statutory code enforcement authority to take part in the plan review, permit process, and inspections of these facilities or to approve some features of the building or site. Whether or not the fire service is involved in the code enforcement process, designers and code officials can only obtain all pertinent information if they consult appropriate response personnel. Consultation among appropriate

stakeholders should begin at an early stage in the design process when changes are easier to make and are less costly.

There are several ways for code officials and emergency responders to disseminate or incorporate the information in this manual. Simply sharing the general information is a great start. Developing a handout or doing a presentation based on this document that is specific to a particular jurisdiction, with specific dimensions and other criteria, is a more effective strategy. The recommendations can also serve as a basis for local code amendments which carry the force of law, in which case the provisions would need to be revised from advisory language to enforceable mandatory language.

Codes and standards typically include an equivalency clause that permits code officials to allow alternatives to strict compliance, as long as the prescribed level of safety is not diminished. In some cases, a higher level of safety for firefighters can be achieved through this process, and perhaps even at a lower cost. For example, when fire service radio signals are inadequate within an existing building, it may be determined that portable signal enhancement devices carried by fire service vehicles are both more effective and less costly than enhancing the building's radio signal infrastructure. Equivalent alternatives and their justification should be documented so that this key information needed for safe and effective response is maintained for the life of the building.

Terminology

The terminology used in this manual is as generic as possible, based primarily on the codes and standards of the National Fire Protection Association (NFPA) and the International Code Council (ICC). For example, the term code official is used to mean any of

the following: authority having jurisdiction (an NFPA term), building code official, or fire code official (both ICC terms).

Fire service terms vary depending on where you are in the U.S. For example, this document uses the term aerial apparatus to describe a fire service vehicle with an extendable ladder or articulating boom mounted on top. Common terms for this same type of vehicle include truck, ladder, aerial, ladder truck, tower, or tower ladder. Some of these terms indicate specific types of aerial fire apparatus. In some regions, the term truck refers only to aerial apparatus, while in other areas this term could also include pumper apparatus. The term tanker means a road vehicle in some areas and a water-dropping aircraft in others.

In another example of potentially confusing terminology, fire apparatus drivers in different regions may be referred to as driver/operators, chauffeurs, or engineers. To those in the building design community, the term engineer means a person who does building design. Understanding local terminology variations is important to avoid misunderstandings.

Glossary of Acronyms and Terms

The following terms are used in multiple chapters of this manual.

<p>Apparatus: <i>fire service vehicle.</i></p> <p>Apparatus, aerial: <i>vehicle that carries a fixed extendable ladder and portable ladders.</i></p> <p>Apparatus, pumper: <i>vehicle that carries hose, a pump, and a water tank.</i></p> <p>Code Official: <i>a person legally designated to enforce a building code, a fire code, or a life safety code in a particular jurisdiction.</i></p> <p>Designer: <i>a person involved in one or more facets of creating the built environment, including architects, engineers, planners, and design technicians.</i></p> <p>Emergency responder: <i>a person designated to respond to mitigate structural fires or similar emergencies, including firefighters, HAZMAT technicians, and rescue technicians.</i></p> <p>Engine company: <i>pumper apparatus and personnel.</i></p> <p>First due unit: <i>engine company or truck company designated to respond first to an incident at a given location.</i></p> <p>HAZMAT: <i>Hazardous materials.</i></p>	<p>High-rise building: <i>qualitatively used in this manual as a building with one or more floors above the reach of fire service ladders. Many codes and standards use a more quantitative definition.</i></p> <p>Hose line, pre-connected: <i>a hose of fixed length with a nozzle attached and connected to a discharge outlet on a pumper.</i></p> <p>IBC: <i>International Building Code.</i></p> <p>ICC: <i>International Code Council.</i></p> <p>IFC: <i>International Fire Code.</i></p> <p>Ladder company: <i>aerial apparatus and personnel.</i></p> <p>NFPA: <i>National Fire Protection Association.</i></p> <p>NFPA 1: <i>Fire Code.</i></p> <p>NFPA 101: <i>Life Safety Code.</i></p> <p>NFPA 5000: <i>Building Construction and Safety Code.</i></p> <p>Pre-incident plan: <i>a compilation of information and diagrams on a specific facility to facilitate emergency operations.</i></p> <p>Truck company: <i>aerial apparatus and personnel.</i></p>
---	---

CHAPTER 2 FIRE SERVICE PRIMER

Challenges

Fire service operations take place in dangerous, time-sensitive environments (figure 2.1). A slight delay in operations, especially when the first fire apparatus are arriving and positioning, can adversely affect subsequent operations and the outcome of the incident. Delays caused by poorly located fire hydrants, confusing fire alarm system information, ineffective communication systems, or inaccessible equipment can have a ripple effect on other aspects of the operation. During these delays, the fire will likely grow exponentially, expanding the hazard for both occupants and firefighters.



Photo: M. Carroll and G. Shaner, Clayton Fire Company #1, DE, and Oeessa Fire Company, DE

Figure 2.1. Trapped firefighters being rescued from a building.

Fire service operations are performed at all times of the day or night, in any weather conditions, and frequently in unfamiliar environments. The work is mentally stressful, and physically exhausting. Crew variations (due to time off, transfers, replacements, other emergency responses, etc.) introduce additional challenges.

Firefighters' workplaces are the buildings and areas in which they deal with emergency incidents. So, they have an unlimited variety of workplaces. Without knowing the location or circumstances of the next incident, traditional risk assessments for worker safety cannot be effectively undertaken.

Risk assessment must be done in a dynamic manner. The need to carry out inherently risky fire suppression and rescue tasks must be balanced with the need to maintain firefighters' safety. In these situations, pertinent information, building protective features, and protection systems help make for a more favorable work environment for firefighters, along with proper strategy, tactics, and protective equipment.

Information is frequently limited during emergency operations. This can impact initial decisions, which in turn can affect the incident duration and outcome (figure 2.2). However, decisions must be made very quickly, despite the unknown factors at an emergency scene. These factors, many of which can be critical, include the incident origin location(s), what materials are involved or exposed, how long the incident has progressed, what directions the hazard is spreading, where the occupants are located, building construction features, and installed protection systems.

Firefighters arriving at an incident scene often see no exterior indications of fire or smoke. This occurs more frequently in newer structures that are tightly encapsulated due to modern construction techniques, stricter energy codes, and environmental features (improved weatherproofing, inoperable windows, etc.).



Photo: David Purcell, Post Road Photos

Figure 2.2. The initial hose line placement can determine the course of an incident.

Even when smoke and fire is showing from the exterior, little is immediately known about the occupants or interior conditions. Emergency scenes are often chaotic. Information given to firefighters is frequently limited, erroneous, or conflicting. Firefighters are trained to act quickly to save lives and property that are in imminent danger. Furthermore, conditions can change drastically during the time it takes firefighters to set up their equipment to attack the fire. The abilities to adapt, improvise, and foresee fire progress are key skills for successful firefighters and fire officers.

All of these challenges are magnified in high-rises, underground structures, and other large or complex buildings (figure 2.3). Many portions of these buildings are beyond the reach of ladders, making exterior access impossible and limiting firefighting and rescue operations to the interior. Firefighter escape options are also limited to internal routes. Greater time, resources, physical endurance, and dependence on elevators are required. Several crews are often needed to accomplish tasks that normally could be accomplished by one or a few firefighters — for example, an air bottle exchange and replenishment operation. A great deal of support may be necessary for basic tasks such as setting up a hose line or rescuing a trapped victim.

Trends in building construction material and contents have changed working conditions for firefighters. The Federal Emergency Management Agency (FEMA) has identified the following trends that have increased the complexity and uncertainty of fighting fires. **Chapter 7** contains a detailed discussion of several of these features.

- Lightweight construction
- Synthetic furnishings
- Residential transformations including reduced lot sizes, open floor plans, and larger concealed spaces
- Energy conservation measures including insulation, windows, doors, and rooftop gardens

- Alternative energy technology including photovoltaic systems, electric vehicles, battery storage, fuel cells, wind turbines, and smart grids

All of the above challenges may further jeopardize the safety of firefighters. Simplifying the firefighter's job in small ways will increase the level of safety for them, and for building occupants. Design features that save time or personnel can help firefighters operate in a safer manner and mitigate incidents more quickly. Any feature that provides additional information regarding the fire, the building, or its occupants can assist firefighters, as would any ways to speed the delivery of this information.



Photo: G. Ellman

Figure 2.3. Firefighters entering an occupied residential high-rise building to perform an interior attack (smoke and fire is showing from an upper floor window). In addition to heavy protective gear and breathing apparatus, they are carrying hose, extra air tanks, and other equipment.

Organization

Fire service organizations can be classified as career, volunteer, or a combination of both. Career personnel are paid for their work, while volunteer members are either unpaid or compensated in non-monetary ways. Combination organizations have both career and volunteer staff. Career organizations typically serve larger, more urban, or industrial

settings, although many smaller cities or towns have a full or partial career staff. Volunteer organizations are usually found in more suburban or rural settings, although some serve densely populated areas and have very high emergency response rates. Some areas utilize call firefighters, who are paid per response or hourly.

Perhaps a more important way to categorize fire service organizations is by whether fire stations are staffed with personnel ready to respond. Most career personnel remain in their station while on duty. Call firefighters do not remain in their station awaiting emergency calls. Most volunteers respond from home or work when they are alerted to an emergency. However, some organizations have volunteer personnel staffing their stations on shifts or living in the stations. The types of firefighters and mechanism of response are often driven by the community's call volume, budget, and the dedication and determination of its fire service members.

Another type of fire service organization is the industrial fire brigade. This is an organized group of employees trained and equipped to provide emergency services for one or several specific employers. A fire brigade can provide a full range of services (similar to a municipal fire department) or specific services such as initial fire suppression, hazardous materials mitigation, or emergency medical care. Members may be dedicated full-time to emergency operations or emergency response may be a part-time, collateral duty. The part-time members leave their primary jobs to respond.

Apparatus

The fire service response to a structure fire would normally involve a number of different units, also called companies. Fire service vehicles are called apparatus; one vehicle is sometimes referred to as a piece of apparatus. They come in a wide variety of types for specialized uses. A basic

understanding of the main types of apparatus will help designers understand some of the considerations for access and other features.

A pumper type of apparatus carries hose, a pump, and a water tank. Together with its personnel, this is called an engine company. Their main responsibility is to deliver water to the fire. Initially, the engine company may operate using the water available in their tank; however, any incidents other than small exterior fires will typically require a continuous water supply. This is done when hose lines carry water from a source of supply (fire hydrant, lake, pond, temporary basin) to the on-board pump, which then boosts the pressure to hose lines or other devices attacking the fire. Pumpers are typically equipped with a large-capacity nozzle, commonly referred to as a master stream device or deck gun, that can flow a large amount of water and is mounted on the top of the apparatus. Additionally, pumpers usually carry one or two short portable ladders.

Fire hoses are manufactured in various lengths (typically 50, 75, or 100 ft.) which must be coupled together to form hose lines. Pumpers carry hose lines of various diameter and lengths (formed with several sections). Some are used to supply water to the pumper from a water source as discussed in [Chapter 4](#). Other hose lines are used to attack fires (figure 2.4) and are usually smaller in diameter than supply hose lines.



Photo: M. Chibbaro

Figure 2.4. A pumper operating at an incident. The red hose is supplying water from a fire hydrant to the pumper. The white hose is a fire attack line.

Many pumpers have one or more preconnected hose lines comprised of a nozzle and several hose sections that remain coupled to each other and connected to a pump discharge (figure 2.5). Firefighters can quickly deploy preconnects, which are generally between 100 and 400 feet in length. They can be extended with additional hose, but this takes time — especially if the preconnect is already charged with water.



Photo: M. Chibbaro

Figure 2.5. A preconnected hose line in the front bumper of a pumper. The hose is connected to the red pump discharge outlet on the right and a nozzle is connected to the other end of the hose.

An aerial apparatus (figure 2.6) is typically equipped with a long ladder or elevating platform on top, an assortment of portable ladders (extension, roof, or folding types), and many power and hand tools. The aerial ladder/platform can extend, articulate, or both. Aerial apparatus can be straight-frame or articulating; the latter can make sharper turns but requires a tiller driver to steer the rear wheels.

An aerial apparatus along with its personnel is often called a truck (or ladder) company. They are primarily responsible for support functions, including forcible entry, search, rescue, laddering, ventilation, and utility control. If an aerial apparatus is not available, these functions must be performed by another unit. All aerial apparatus are equipped with outriggers (also called stabilizers) to provide support when the aerial ladder is extended.

A multipurpose apparatus, also called a quint, is equipped to function as a pumper or an aerial apparatus. If provided with adequate staffing and positioned properly at a fire scene, a quint can perform both functions.

Other more specialized vehicles are used by the fire service. These include rescue units, hazardous materials units, air supply units, lighting units, ambulances, and water tenders. Access for pumpers will suffice for these special units with the possible exception of large or unusual facilities. For instance, a sports arena may be designed for ambulances to enter but not fire apparatus. Where arenas are designed for large trucks to access and set up concerts, the opportunity exists for all fire apparatus to access the venue.



Photo: David Purcell, Post Road Photos

Figure 2.6. Two types of fire service aerial apparatus — one with a straight ladder (left) and the other with an elevating platform (right). The latter type of aerial apparatus is often referred to as a “tower”, “tower truck”, or “tower ladder”.

Emergency Operations

A typical emergency begins with the discovery and reporting of an incident. The time span of this phase can vary greatly,

and the fire service has no control over it. After the report is received, the information is processed and the appropriate units are alerted. Those firefighters not staffing the station (whether volunteer, paid on-call, or collateral-duty fire brigade members) must travel to the fire station. Firefighters then don their protective equipment, board the vehicles, and the response phase begins. In some organizations or scenarios, members not staffing the station may go directly to the incident scene. If the emergency is a fire, the scene is usually referred to as a fireground.

Stages of a fire emergency:

- Fire discovery
- Fire reported
- Dispatch
- Response
- Arrival and setup
- Rescue and fire attack
- Fire containment and control
- Extinguishment
- Overhaul and salvage
- Investigation



Figure 2.7. During initial operation at this structure, the first arriving engine crew is already using a fire lane, a fire hydrant, the fire department connection, and the key box. Interior operation will soon involve the alarm system, stairs, standpipe system, and other building features.

Upon arrival at an incident scene, firefighters must handle many tasks. Standard operating procedures enable firefighters to quickly assess the situation, and go into operation (figure 2.7). Rescuing occupants is the first priority,

followed by confining and extinguishing the fire. In some cases, firefighters must attack the fire in order to attempt rescues.

Engine companies, which are usually first to arrive at an incident scene, deliver water for fire extinguishment. This involves establishing a water supply from a reliable source and attacking the fire with hose lines (figures 2.2 and 2.4) or other devices.

Truck or ladder companies perform the support functions discussed above, including forcible entry and ventilation (figure 2.8). In areas without truck companies, support functions are handled by engine companies or other units such as rescue squads.



Figure 2.8. Firefighters perform vertical ventilation on a roof, relieving heat and smoke to assist interior firefighting crews. Horizontal ventilation relieves heat and smoke through windows, doors, or other wall openings.

Many fire service organizations have standard operating procedures that assign different responsibilities to different units depending on their order of arrival. Units that are expected to arrive at an emergency scene first are called first due units. Responsibilities may need to be reprioritized when one or more occupants are in need of immediate rescue. While often immediate rescue may seem to be the most critical task, attacking the fire might be a better tactic to protect trapped or incapacitated occupants.

The management of all objectives, activities and resources needed to successfully mitigate an emergency is called incident command. This begins when the first arriving

officer rapidly gathers information, which is called size-up or scene size-up. Incident command expands as additional units and chief officers arrive. Commanders base their strategy on the best information available at any given time regarding the fire, the building, and the occupants. Commanders also take into consideration the emergency resources and staffing available.

As they receive additional information, commanders may revise their strategies, including calling for additional resources. Units responding from another jurisdiction or district are referred to as mutual aid units. Units that are dispatched without being requested — usually based on inter-agency agreements — are called automatic mutual aid units. Mutual aid units will normally have longer response times than first due units.

Perhaps the most significant of the many decisions that must be made at a fire scene is whether to attack a fire from the interior (figure 1.1) or defensively from the exterior. Firefighters will often mount an interior attack to protect any remaining building occupants from the advancing fire. However, this often places the firefighters in a dangerous situation. Incident commanders and safety officers must evaluate this risk to make proper attack mode decisions, both initially and on an ongoing basis.

In other cases, due to fire advancement or building conditions, a fire must be attacked from the outside (figure 2.9). This is a critical decision, so the more accurate information firefighters have on the fire, the building, its contents, and the occupants, the more likely they are to make sound decisions on the initial fire attack mode and when to transition to another mode.

OSHA's Respiratory Protection standard contains provisions that address interior firefighting. One of these is known as the "Two In – Two Out" rule; it mandates that at least two firefighters work together (partner) to conduct

interior firefighting while at least two others remain at a safe location outside to assist or rescue the interior crew. This helps to ensure the safety of the interior firefighting team.



Photo: John Guyton

Figure 2.9. An exterior fire attack.

As operations expand, one or more larger rescue team(s) will normally stand by outside or at a staging area in a high-rise building. These are known as rapid intervention teams or rapid intervention crews. Such teams are a last resort and never a substitute for safe operations or proper building design.

As the fire incident is brought under control, several activities take place. Property that can be saved is salvaged. The structure is overhauled to find and extinguish any remaining hot spots. This may include removing building materials and opening wall cavities. An investigation is likely conducted to determine the fire's origin and cause. These activities, although dangerous and important, are less time-sensitive. As a result, they are less of a consideration for building and fire protection system designers.

How Stakeholders Can Help

Designers and code officials can provide assistance by opening the lines of communication as early as possible and continuing communication through design and construction. Remember that coordination should occur with both code officials and emergency response personnel in a given jurisdiction (figure 2.10). In some

cases, code officials have the authority and responsibility to speak for responders, but not so in other cases. The questions provided at the end of each chapter and the table in the Annex both facilitate this communication.

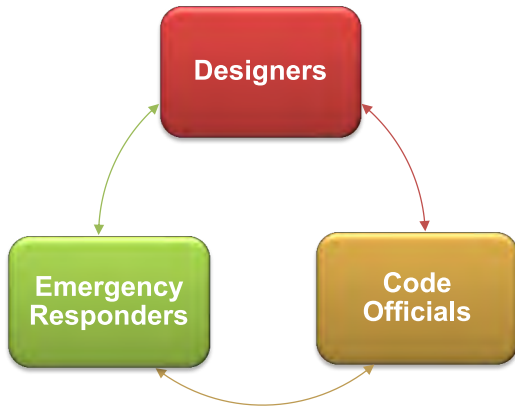

Figure 2.10. Stakeholder communication.

Although designer/responder communication is important for all systems and features discussed in this manual, codes and standards may have specific sections that require designers to obtain input from the responsible fire service. This mandatory coordination is to assure that the needs of emergency response personnel are met.

Pre-incident plans (often called pre-plans) are documents prepared by the fire service to assist in emergency operations in specific facilities. Their importance has been cited

in many National Institute for Occupational Safety and Health (NIOSH) firefighter fatality reports. Pre-incident plans should contain the location of, and information about, the fire protection features discussed in this manual. The plans are usually prepared and maintained by the engine or truck company first due at each facility. Designers can assist in pre-incident planning by providing copies of building and system plans (paper or electronic) to the fire service, subject to permission from building owners. Tools such as computerized systems can facilitate communicating pre-incident plans among all responders that may credibly respond to an emergency at a particular building.

The fire service should prepare a thorough pre-incident plan, however, the best plan cannot overcome situations where the first due unit is committed to another emergency, is out of position, out of service, or involved in training. Personnel changes can also not be foreseen, so it is risky to count on all responding personnel to be aware of the pre-incident plan. Careful design, approval, and pre-incident planning should all function together to keep firefighters safe.

Specific ways in which all stakeholders can contribute to pre-incident planning are covered in several sections in [Chapter 13](#).

Questions to Ask – Fire Service Knowledge

- Are challenges faced by the fire service understood?
- Do designers and code officials understand their role in creating workplaces for firefighters?
- Do designers understand the organization and operation of the fire service in specific project areas?
- Do designers and code officials understand the functions of different types of fire apparatus?
- Have designers begun coordinating with jurisdictional representatives early?
- Does the coordination include both code officials and emergency responders?
- How can stakeholders contribute to fire service pre-incident planning?

Resources

- The National Institute for Occupational Safety and Health conducts investigations of selected firefighter fatalities. Many of the investigation reports contain recommendations that relate to the built environment and are available at www.cdc.gov/niosh/fire.
- The UL Firefighter Safety Research Institute has produced several research reports that address aspects of firefighter safety in the built environment; available at <http://ulfirefightersafety.com>.
- The National Institute of Standards and Technology conducts research on fire protection, including firefighting technology and fire service staffing. Reports are available at www.nist.gov/fire.
- The National Institute of Standards and Technology issued extensive reports on the terrorist attacks of September 11, 2001 that are available at www.nist.gov/el/disasterstudies/wtc. This agency maintains a list of the recommendations in those reports and the resulting changes to the codes and standards. Several of these recommendations address emergency response and building design issues. This can serve as a resource for designers that want to exceed code requirements at high-risk buildings.
- The U.S. Fire Administration has reports, publications, online courses available at www.usfa.fema.gov.
- The National Fire Academy has online courses such as *Principles of Building Construction* (Q0751) available at www.usfa.fema.gov/nfa/nfaonline.
- Federal Emergency Management Agency, *Changing Severity of Home Fires Report*, available at www.usfa.fema.gov/downloads/pdf/publications/severity_home_fires_workshop.pdf.
- Polytechnic Institute of New York University, training module *Fires in Modern Lightweight Residential Construction*, available at www.poly.edu/fire/alive/alive8b.html.
- FM Global Data Sheet 1-3, *High-Rise Buildings*

CHAPTER 3

FIRE APPARATUS ACCESS

The faster the fire service can respond and set up, the sooner they can begin to mitigate an incident. This should translate into increased safety for firefighters and occupants as well as decreased property loss and indirect business loss. The time taken to set up and sustain firefighting operations can be considerable for high-rises and other complex buildings. This time can be extended when the fire location is not obvious or is remote from the arrival location.

Properly positioning fire apparatus at a fire scene can facilitate search and rescue efforts and effective use of hose streams and ladders. The more room apparatus have to operate, the more options will be available to mitigate the incident (figure 3.1). This is especially important when apparatus need to pass each other or reposition during an emergency. This chapter contains considerations to help with access and positioning fire apparatus.



Photo: M. Schwartzberg

Figure 3.1. An apartment fire where the fire apparatus access was adequate width and a proper distance from the building.

Many buildings are located on public streets that provide good access to at least one side in the case of an emergency. Others are set back from public streets and have private fire lanes. Both enable fire apparatus to approach the building and operate.

In all cases, consider the maximum practicable dimensions for design, since future apparatus purchases or mutual aid apparatus from other jurisdictions may exceed the requirements in a given jurisdiction at any given time.

Codes may contain provisions that allow reduced levels of access when approved fire sprinkler protection is provided. However, as discussed in [Chapter 1](#) of this document, fire is only one of many types of emergencies that may occur and necessitate a fire service response. These provisions should be applied carefully and with a full understanding by all stakeholders of their ramifications.

Several concerns can conflict with the need for fire apparatus access. These concerns include security needs and the desire for green space and walkability. Flexible and innovative thinking, as well as early coordination among stakeholders, can usually overcome these challenges.

Related to fire apparatus access are premises identification and firefighter access. These are covered in [Chapters 5](#) and [6](#), respectively.

Extent and Number

In some cases, one route is available for fire apparatus to reach a building. Sometimes optional (or secondary) access routes (figure 3.2) are needed for high-value or high-risk facilities or where a single access route may become impaired by factors such as traffic congestion or weather conditions.



Photo: M. Chibbaro

Figure 3.2. A secondary emergency access (foreground) supplements the main vehicle entrance/exit (background) in an apartment complex.

The next consideration is the proximity of the access to the building (figure 3.3). Traffic and parking patterns should not inhibit apparatus access. The distance from the building to a road or fire lane is sometimes referred to as the setback distance. Codes may have variations that consider building size, height, sprinkler protection, and separation from other buildings.



Photo: M. Chibbaro

Figure 3.3. An overhead view of a hotel surrounded by fire lanes.

The options available for attacking a fire increase when a building's perimeter becomes more accessible to fire apparatus. Building codes contain a concept known as frontage increase. This allows the maximum size of the building to be increased if a structure has more than a certain percentage of its perimeter on a public way or open space accessible to fire apparatus. Ideally the full perimeter would be accessible; however, this is not always feasible.

During site renovations and additions, designers should exercise particular caution to ensure that the perimeter access continues to meet applicable codes. The original building size may have been based upon a frontage increase allowance. Changing the amount of perimeter access can result in noncompliant building size without changing the building at all.

Dimensions

Width

The dimensions for roads and fire lanes that lead to a building must accommodate all apparatus that will use them. Spaces wider than the apparatus itself may be needed for several reasons. One is to enable apparatus to pass each other if necessary to facilitate developing and expanding operations. Near hydrants or other water sources, engine companies may need a wider area to facilitate hose connections, allow other fire service vehicles to pass, or permit water tenders to position alongside pumpers. Near buildings where aerial apparatus is available, accommodate the outriggers necessary to support the aerial ladder or elevating platform while in operation; this can greatly exceed the basic width of the apparatus (figure 3.4).



Photo: David Purcell, Post Road Photos

Figure 3.4. An aerial apparatus showing outriggers extended to support the aerial ladder.

The area designated as the fire lane must be maintained clear. Additional space should be provided to accommodate vehicle parking (figure 3.5), trash containers, passenger drop-off, equipment staging, and loading or unloading areas. Anticipate as many such uses as possible to prevent encroachment on the clear width of fire lanes.



Photo: M. Chibbaro

Figure 3.5. The parking spaces on the right do not reduce the width of this fire lane.

Proximity

It is important for fire apparatus to have close access to buildings to facilitate the stretching of hose lines, the use of a master stream device, or the placement of portable ladders. Long hose stretches can delay the time it takes to contain or extinguish a fire. Similarly, carrying ladders a long distance can delay access or rescue.

In areas where an aerial apparatus may respond to an emergency, roads and fire lanes should be a sufficient distance from the building to accommodate aerial ladder operation (figure 3.6). Access too far away will preclude aerial ladder reach; locations too close may cause difficulty rotating the aerial ladder and prevent it from reaching some windows. Emergency responders should specify to designers and code officials a distance that is appropriate between the building and the edge of the access road or fire lane.

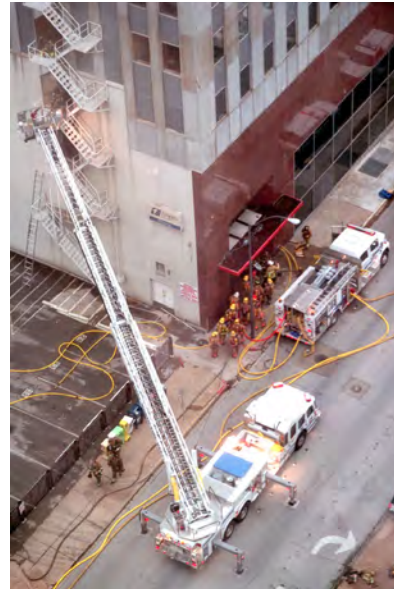

Photo: G. Ellman.

Figure 3.6. An aerial apparatus positioned at the corner of a building — a location that maximizes the number of windows that the aerial ladder can reach.

Height

All apparatus must have enough vertical clearance. Overhead obstacles such as trees or power lines can obstruct both portable and aerial ladders and should be avoided or minimized whenever possible (figure 3.7). Extra clearance should be considered in areas subject to snow accumulation.



Photo: M. Chibbaro

Figure 3.7. Lights strung across this street preclude the use of aerial ladders and limit the use of portable ladders.

Turning Radius

The minimum turning radius (inside and outside edges) for the most restrictive fire apparatus should be considered.

Turnarounds

Dead-end fire lanes or roads that exceed a certain length should have a means for fire apparatus to turn around. Turnarounds save considerable time when a fire apparatus needs to reposition during an incident. They also eliminate the need to back up a long distance. Backing up apparatus is both difficult and dangerous, particularly during an emergency situation.

There are a number of configurations that facilitate turning maneuvers. These include “T-turn” and “Y-turn” arrangements (figure 3.8) as well as round cul-de-sacs of the proper radius and width.

Design

Material

All-weather paved or concrete surfaces are the best materials for fire lanes. Some jurisdictions permit using alternative material such as grass paver blocks (figure 3.9) that allow an area to be partially landscaped. Another is subsurface construction that permits an area to be partially or fully landscaped, while being strong enough to allow fire apparatus to negotiate the area. Permeable surfaces may be an important environmental feature.

Unless their perimeter is clearly marked, it is easy for apparatus to drive off the edge of alternative materials. Over time, the access can become obscured. Also, in regions where snow accumulates, grass paver blocks and subsurface construction cannot be plowed effectively (figures 3.9 and 3.10).

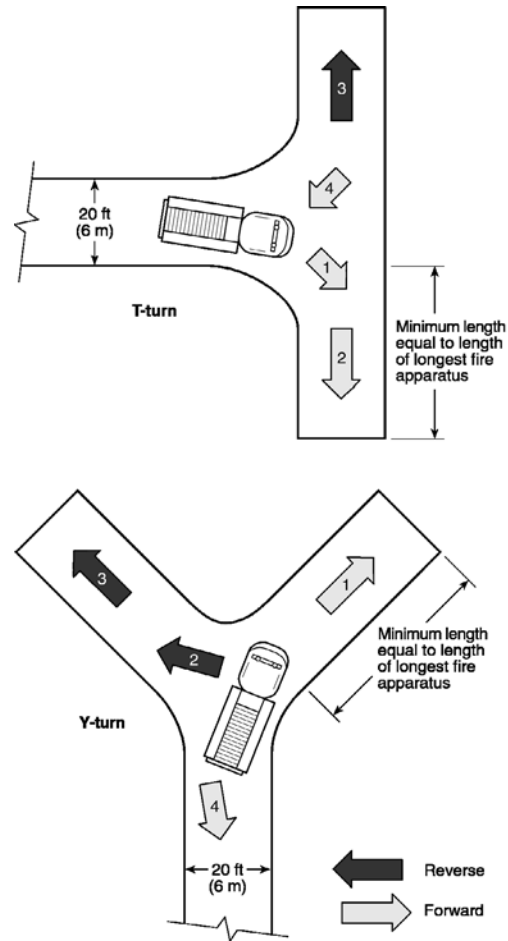

Figure 3.8. Fire apparatus “Y-” and “T-turnarounds.” Reprinted with permission from NFPA® 1-2012, *Fire Code Handbook*, Copyright ©2011, National Fire Protection Association, Quincy, MA. This reprinted material is not the complete and official position of the NFPA on the referenced subject, which is represented only by the standard in its entirety.

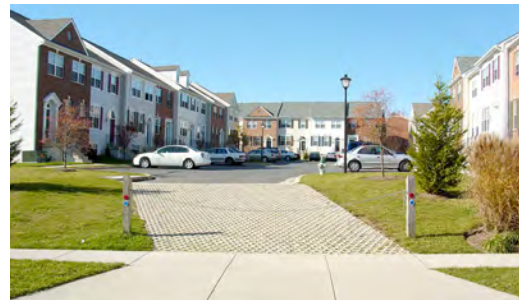

Figure 3.9. Grass paver blocks were chosen instead of paving for this fire lane. The aesthetic benefits are minimal, and the road cannot be plowed effectively.



Photo: M. Chibbaro

Figure 3.10. The same fire lane covered with snow. Access is blocked by a mound of snow plowed from the adjacent parking lot.

Where a surface is not readily identifiable by civilians as a fire lane, obstructions are more likely. Signage can help the fire lane remain clear of any items that can slow or impede responding fire apparatus.

Grade

The maximum grade (slope) must accommodate all apparatus that may respond to an emergency. When aerial apparatus is set up for operation, the vehicle body must be leveled with the outriggers. Too steep of a grade will preclude aerial ladder operation. The shallowest grade possible would allow for the most rapid setup. However, a slight grade can be beneficial to help prevent pooling of water as well as ice buildup where applicable.

Dips should be avoided to preclude damage to undercarriage components and equipment. Apparatus with long wheel-bases are particularly vulnerable to this.

Traditional curbs cannot be negotiated easily by fire apparatus. However, rolled or rounded curbs (figure 3.11) can help in several ways. They can serve as the entry to a fire lane without giving civilians the impression of a driveway. Such curbs adjacent to properly designed sidewalks can effectively increase access width without widening the width of the road or fire lane.

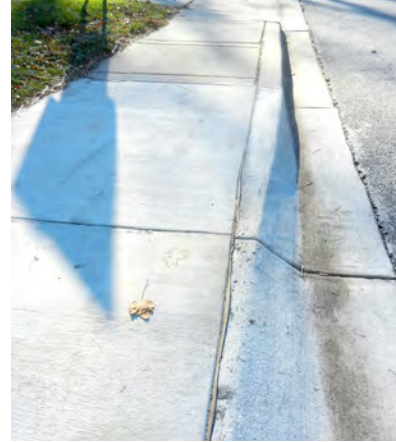

Photo: M. Chibbaro

Figure 3.11. A rolled curb at the entrance to a private fire lane from a public street.

Load

Bridges, piers, boardwalks, plazas with underground structures, and other elevated surfaces should be built to withstand the necessary fire apparatus load. Load limits should be clearly posted at all vehicle entry points.

Security

Fire lanes can be dedicated to fire service use (private), or can also serve ordinary vehicular traffic (public). Each approach has its advantages and limitations.

In public fire lanes, vehicle parking must be controlled (figure 3.12). Fire lane signage is important, both for the public and enforcement officials. Examples include signs (figure 3.13), curb painting, or curb stenciling. In areas subject to snow accumulations, curb painting or stenciling is subject to being obscured. A jurisdiction's requirements must be followed exactly to ensure that no-parking provisions are legally enforceable. However, even with the proper marking or signage, parking restrictions are often difficult to enforce.



Photo: M. Chibbaro

Figure 3.12. A public fire lane.

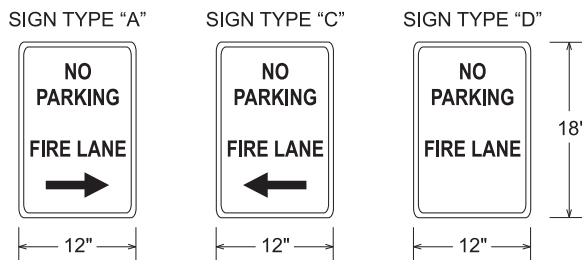

Figure 3.13. Fire lane signs. Diagram excerpted from the 2012 International Fire Code and Commentary, Copyright 2011. Washington, DC: International Code Council. Reproduced with permission. All rights reserved. [www.ICCsafef.org].

Clearly marking turnarounds is particularly important. One car can often make the entire turnaround impassible for fire apparatus.

Access to private fire lanes may be restricted by barriers such as bollards, pop-up barricades, or gates (manual or powered). These access control measures can be effective in keeping vehicular traffic out of fire lanes (figure 3.14) but can delay fire apparatus response time. During the design phase of a project, the persons responsible for security should coordinate with those who provide fire protection to help resolve concerns. Remote and automatic operators for gates address this concern. In addition, consider proper gate size, location, and swing direction.



Photo: M. Chibbaro

Figure 3.14. An entrance to a private fire lane. The delays caused by electronic gates can be minimized by providing the fire service with access cards or remote access controls.

All bollards must be removable in some fashion. Rapid removability allows quick access. Wooden bollards can be designed with cuts near their bases to allow access when apparatus bump them and break them (figure 3.15). However, the time needed to clear break-away bollards from the path of apparatus may cause delays and apparatus damage.



Photo: M. Chibbaro

Figure 3.15. Wooden break-away bollards.

Mechanisms for opening or gaining access through all apparatus access barriers should be clearly communicated to emergency responders. Pre-incident plans should document how emergency responders can open or remove access barriers.

Traffic Calming Features

Speed bumps/humps/tables, narrow road widths, curvy arrangements, and islands are traffic calming features used to control vehicular traffic speed (figure 3.16). Most

such measures that slow traffic also hinder fire apparatus access, delaying their arrival to a fire scene. Accordingly, jurisdictions may require special approval before traffic calming features can be installed.

Some special speed bump designs allow only fire apparatus to straddle bumps. All speed bumps should be painted or striped. Provide signs nearby to indicate their location, especially in climates subject to the accumulation of snow and ice.



Photo: M. Chibbaro

Figure 3.16. A traffic calming island.

Questions to Ask - Fire Apparatus Access

- Is a single approach to the building acceptable or are more required?
- How near to the building must apparatus access reach?
- How many sides of the building must have access?
- What is the maximum dead-end access before a turnaround will be required?
- What are the minimum height, width, slope, and turning radius for apparatus access?
- What distance from the building will facilitate aerial use?
- Will overhead obstructions be prohibited to facilitate aerial access?
- What material is allowed for access routes?
- Are there any building areas housing hazardous materials or processes that would require unique or special apparatus access?
- Should the access be public? If so, how will parking be controlled?
- Should the access be private? If so, what means for rapid entry will be necessary?
- Are traffic calming devices allowed or restricted?

Resources

- IFC and IBC
- NFPA 1 and 5000
- NFPA 1141, *Standard for Fire Protection Infrastructure for Land Development in Wildland, Rural, and Suburban Areas*
- Congress for the New Urbanism, *Emergency Response and Street Design Initiative*, http://cnu.org/sites/default/files/erinitiative_0.pdf
- U.S. Department of Transportation standards, include *Manual on Uniform Traffic Control Devices*, available at <http://mutcd.fhwa.dot.gov>
- American Association of State Highway Transportation Officials (AASHTO), *Standard Specification for Highway Bridges*

CHAPTER 4 WATER SUPPLY

Water is used to suppress most fires, so an adequate water supply is crucial to fire service operations (figure 4.1). The supply must deliver an adequate amount of water through a distribution system to the locations needed. The system can serve manual firefighting (typically through fire hydrants), fire standpipe systems, fire sprinkler systems, other water-based suppression systems, and non-fire needs (industrial, commercial, domestic, etc.).



Photo: David Purcell, Post Road Photos

Figure 4.1. A pumper supplying water from a fire hydrant to a fire scene.

Municipal water supply systems (including the distribution system and hydrants on public land) are generally under the jurisdiction of a local water authority. Municipal systems also feed water to private property for both fire and non-fire needs. The private property line is usually the boundary between the public portion (under the water authority) and the privately-owned portion. Property owners are primarily responsible for the private portion; however, designers and contractors share responsibility during the design and construction phases, respectively.

Private water supply systems are those contained fully on private property — for example, when the water supply consists of

an on-site tank, pump, and piping system. The on-site system may feed private fire hydrants and/or building suppression systems.

In rural and suburban areas where a municipal water supply system is not available, static water sources such as lakes, ponds, cisterns, fountains, and swimming pools are often used. Pumpers draft water from static water sources to pump water through hose lines. The capacity of static water sources should take into consideration the frequency of drought conditions in accord with applicable codes or insurance standards.

Dry fire hydrants (figure 4.2) are often provided for static water sources. These hydrants allow pumpers to quickly draft water without the need to set up suction hoses to the static water source. Fire apparatus access must permit pumpers to drive close enough to use dry hydrants or to suction water directly from the static source.



Photo: M. Chibbaro

Figure 4.2. A dry fire hydrant piped to the lake in the background.

Where an incident is remote from the water source, a shuttle is often set up. A shuttle operation involves several pumpers or tenders

filling a temporary basin at the incident scene and other pumpers drafting water from the basin to attack the fire (figure 4.3). Rural fire services often have pumpers with large-capacity tanks for initial attack or tanker vehicles that carry a large amount of water.



Photo: G. Havel

Figure 4.3. A rural water supply operation. The water tender on the left is filling the yellow portable basin. The pumper on the right is drafting water from that basin to feed hose lines.

Fire Flow

Fire flow is the rate and amount of water the fire service needs to manually extinguish anticipated fires. The fire flow must be available in excess of that required for other purposes such as industrial, commercial, and domestic water demands. Several references in the resource section at the end of this chapter include fire flow tables or charts. The minimum fire flow is typically based on factors such as building construction, building size, occupancy, and contents.

To determine the minimum required fire flow, consider adequate flow rate (gallons per minute, or gpm), sufficient pressure (pounds per square inch, or psi), and total quantity of water (gallons). The flow rate is that needed to extinguish the materials anticipated to be burning. Pressure is provided by either pumping the water (using a fire pump) or elevating it (in a tank). As the flow rate from a system increases, the available pressure will decrease unless pumps are throttled up or additional pumps are started. The

maximum flow rate available is usually given as the gpm available at 20 psi because the distribution system is subject to damage at lower pressures. The duration of an expected incident in terms of time will determine the quantity of water when multiplied by the required flow (for example: 1,500 gpm x 60 minutes = 90,000 gallons).

Water mains should be fed from two directions whenever possible. This increases reliability — for example, when flow from one direction must be shut off for repair or maintenance. Experience has also shown that dead-end piping fed from a single direction is subject to greater flow-restricting deposits due to smaller domestic flows.

Codes and installation standards for suppression systems such as sprinklers and standpipes have criteria that determine their water supply needs. The available water supply must meet the greater of the suppression system demand or the required fire flow for manual firefighting discussed above. The two are typically not additive because, for example, properly designed and installed full-coverage sprinkler systems should keep fires controlled, reducing the water needed for manual firefighting.

In some cases building and fire codes dictate certain water supply features. One example is a secondary water supply to supplement the primary supply to high-rise buildings. Another example is the use of cisterns to augment water distribution systems that are subject to earthquake damage.

Water supply systems are tested and evaluated in different ways, depending on the purpose of the evaluation (figure 4.4). Since systems may deteriorate over time in several ways, recent testing is very important for proper evaluation. Considering the possibility of future deterioration or additional demand on the system (for example, by applying a safety factor) can be equally as important.

Total fire flow for manual firefighting	Evaluated by considering the supply system in its entirety to determine its adequacy for either the building expected to need the highest demand during an incident or a particular building served by the system.
Flow and pressure available for a building's sprinkler and/or standpipe systems	Evaluated at the system supply point(s). This can be the point(s) of connection to a municipal supply system and/or an on-site supply source. In existing buildings with fire pumps, testing at the discharge side of the fire pump will yield results corrected for the pump conditions and any deterioration or obstruction upstream of that point.
Fire pumps	Evaluated by measuring the pressure boost at various flows and comparing the values obtained with the expected performance based on the pump's rated capacity or certified performance curve. This is typically done when new pumps are acceptance-tested and periodically thereafter.

Figure 4.4. Water supply evaluation.

Fire Pumps

Fire pumps are used in water distribution systems and at buildings or complexes to boost the water pressure to sprinkler and standpipe systems. The latter is necessary when the system is fed by an atmospheric (non-pressurized) water tank or when the water supply feeding the system has inadequate pressure. A fire pump may be driven by an electric motor, diesel engine, or steam turbine.

Fire pump controllers are the enclosures that contain electric circuitry and status indicators for a fire pump. They should be within sight of the fire pump motor or engine. An automatic transfer switch, which is often in a separate enclosure, transfers power to a secondary power source (when provided). Adequate space around all fire pump equipment will allow firefighter access during emergency incidents.

Fire pumps are remotely monitored for pump running, power failure, phase reversal, and controller trouble. Remote alarm signals are often incorporated into fire alarm annunciators or fire command centers to enable the fire service to quickly identify the status of a given fire pump. Designers and code officials should discuss whether these remote signals should cause an alarm condition as discussed in [Chapter 11](#).

The most desirable location for a fire pump is in a separate building. This gives firefighters easy access to the pump and its controllers while providing the most protection from fire. If locating the pump in a separate building is not possible, a fire-rated room with an outside entrance is the next best option (figure 4.5). Least preferred is an interior room, in which case a fire-rated access corridor from the exterior is crucial. Regardless of its location, label the room and how to access it so firefighters are able to quickly identify it.

Fire pumps are usually provided with a test header consisting of several male hose outlets. These can resemble fire department connection female inlets from a distance, especially when the outlets are capped. Signs can help avoid confusion with wording such as "Do Not Pump Into These Fittings".

Hose connected to test headers and charged will be rigid. To avoid obstructing firefighter access and occupant egress, position test headers so their outlets point away from egress or access doors.



Figure 4.5. An outside door to a fire pump room identified by the red sign.

Emergency responders should be trained on the operation of fire pumps. This is discussed further in [Chapter 13](#).

Fire Hydrant Features

Type

Wet barrel hydrants are used in warm climates on pressurized water distribution systems. Water remains in the barrel of the hydrant at all times. Each hose outlet is individually valved, and can therefore be operated one at a time (figure 4.6).



Figure 4.6. A wet barrel fire hydrant. The operating nut for the small hose outlet is on the right. The operating nut for the large outlet is on the rear of the hydrant.

Dry barrel hydrants (figure 4.7) are used on pressurized water distribution systems in climates subject to freezing. A valve below the frost line is activated by an operating nut on the top. When the valve is opened, water fills the hydrant body (or barrel) above it. All hose outlets on the hydrant are then pressurized concurrently. A drain is provided to allow gravity to empty the barrel of water when the valve is off. Clogged drains and poor valve seals are common reasons for hydrants to freeze and become inoperable.



Figure 4.7. A dry barrel fire hydrant.

Dry hydrants are used on static water supply sources. They facilitate pumpers drafting water from the static source (see figure 4.2).

Outlets

The size, number, and type (threaded or quick-connect) of hydrant outlets vary between jurisdictions. It is essential that the outlets match the fire service's hose couplings. If the outlets do not match the couplings, adapters can be used, but will slow the set-up time. In addition, every pumper might not carry every adapter needed if numerous outlet types are used in the region.

All hydrant outlets should be provided with protective caps to help prevent vandalism. If the outlets are threaded, caps also protect the male threads.

Typically, hydrants have a large hose outlet (4 1/2 inches is a common size) called a pumper outlet or steamer connection. They

normally also have one or more 2 1/2 inch hose outlets. Both wet-barrel type hydrants and the dry-barrel types used in areas subject to freezing have these features as shown in figures 4.6 and 4.7.

Dry hydrants (those connected to a static source such as a tank, well, or pond) usually have only a large pumper outlet as seen in figure 4.2 above. Often this outlet is 6 inches in diameter.

Marking and Signage

Several methods are used to enable firefighters to rapidly identify hydrant locations. The color used for hydrants should contrast as much as possible with the surroundings. Some jurisdictions use reflective paint on hydrants or reflective tape around them. Other jurisdictions prefer reflectors (usually blue) in the roadway in front of each hydrant; however, in cold weather climates these reflectors are often obstructed by snow.

A common way to identify hydrants in areas subject to significant snowfalls is a locator pole which is visible above the highest expected snowfall. These are reflective or contrasting in color, and some have a flag, sign, or reflector mounted on top (figure 4.7). These poles should be flexible enough to allow a hydrant wrench to be utilized on the hydrant's operating nut. Some jurisdictions or sites go so far as mounting a light (usually red or blue) above or near hydrants.

A system to indicate the flow capability of individual hydrants can facilitate fire service operations. A color-coded system is described in NFPA 291, *Recommended Practice for Fire Flow Testing and Marking of Hydrants*. Another system is simply to mark hydrants with their flow range in gpm (figure 4.8) available at 20 psi (the minimum desired pressure).



Photo: M. Chibbaro

Figure 4.8. A fire hydrant with flow indicator sign.

Security

Fire hydrant operating nuts and outlet caps are subject to theft, so jurisdictions use various means to secure the operating nuts or caps.

Fire Hydrant Placement

Spacing

The maximum distance between hydrants (typically addressed in fire codes) determines how much hose will be needed to reach a fire. Pumpers carry a limited amount of hose. Relay pumping over longer distances is possible, but introduces significant delays in delivering water to an incident scene.

Where apparatus may approach from different directions, hydrants should be placed primarily at or near intersections. It may be desirable to place them a short distance from the intersection so that pumpers do not block the intersection for other fire apparatus (figure 4.9). This would depend on where pumper intake hoses are mounted as discussed in the following section.



Photo: David Purcell, Post Road Photos

Figure 4.9. A fire hydrant located too close to an intersection can result in pumpers blocking other apparatus access.

Additional hydrants are placed within long blocks or as necessary to maintain a maximum spacing. This spacing is often based on the quantity of supply hose carried by a jurisdiction’s pumpers.

Location

Pumpers may utilize hydrants in different ways. If a hydrant is close enough to the emergency incident, a pumper can position at the hydrant and use its intake hose. These large-diameter hoses are often pre-connected to an intake on the pumper’s front bumper (see the short length of hose in figure 4.9), rear step, or side. In some urban areas, pumpers carry intake hoses long enough to reach hydrants on the opposite side of a single line of parallel parked cars.

If an incident is not in close proximity to a hydrant, longer supply hose line(s) will be needed between the hydrant and the incident scene. This can be done by manually stretching hose, but it is usually faster and more efficient for a pumper to lay hose as it proceeds. A pumper laying a supply hose line from a hydrant towards the incident scene is called a straight or forward hose lay (figures 4.10 and 4.11). The opposite — laying supply hose from an emergency scene to a hydrant farther down the street — is called a reverse lay (figure 4.12).



Photo: Tempe, AZ Fire Department

Figure 4.10. A pumper stopped to initiate a straight hose lay from a hydrant.



Photo: Tempe, AZ Fire Department

Figure 4.11. The same pumper completing the straight lay towards the fire scene, and a firefighter preparing to operate the hydrant.



Photo: Tempe, AZ Fire Department

Figure 4.12. A pumper performing a reverse hose lay from a fire scene towards a hydrant. Once the hose lay is completed, the pumper will feed water through the hose line to the portable master stream device shown on the lower right.

Fire services typically use either straight or reverse hose lays as their standard water supply procedure. Designers should take this into account when locating hydrants.

For instance, hydrants at the far end of dead-end streets will facilitate reverse lays. Hydrants at entrances to dead-end streets or building complexes will facilitate straight lays (figure 4.13).



Figure 4.13. A fire hydrant (left foreground) at the vehicle entrance to a complex of buildings.

A split lay is a combination of straight and reverse lays. When the first-arriving engine company does not pass a water source during its response, they can straight lay from any point such as a property entrance. Another engine company can reverse lay from that same point to a water source, completing the supply. The proper number and distribution of hydrants can reduce the need for split lays — which take two engine companies to accomplish — thereby making better use of resources.

Hydrants that are too close to a particular building are less likely to be used due to potential fire exposure or collapse. Consider locations with blank walls, no windows or doors, and where structural collapse is unlikely (such as building corners). A rule of thumb for collapse zone size is a horizontal

distance equal to 150 percent of the building's height. This is not a concern in urban areas where a multitude of hydrants are typically available for any given location.

Hydrant position should also take into account the location of fire department connections that feed water-based suppression systems. This is covered in detail in [Chapter 10](#).

Position and Protection

Fire hydrants that are properly positioned facilitate rapid positioning of fire apparatus and full use of hydrants. Considerations for designers include height, orientation, distance from the apparatus access, distance from surrounding obstructions, and vehicle impact protection.

Positioning of hydrants at a proper height allows rapid connection of hose lines and devices. Positioning that is too low will preclude removing outlet caps and attaching hose or other devices. These devices include special hydrant valves to facilitate the connection of multiple pumpers to one hydrant.

Hydrants with a pumper outlet should be oriented so that the outlet faces the apparatus access. This will facilitate the use of pumper intake hoses.

Proper setback distance from the apparatus access will serve two functions. A maximum distance will allow the use of intake hoses on pumpers. A minimum distance will help avoid vehicle impact, especially if the fire lane or street is not curbed. Hydrants subject to vehicle damage can also be protected by guard posts that are often called bollards (figure 4.14).

Hydrants need a clear distance to enable a hydrant wrench to be swung 360 degrees on any operating nut or cap nut (figure 4.14). Designers and code officials must consider all obstructions. Fixed obstructions include utility poles, signs, walls, vegetation, planters,

fences, pipes, poles, downspouts, built-in or heavy furniture, and vehicle impact protection bollards. Take into account potential growth of vegetation when planning for hydrant placement. Anticipate transient obstructions such as stock, merchandise, and vehicles.

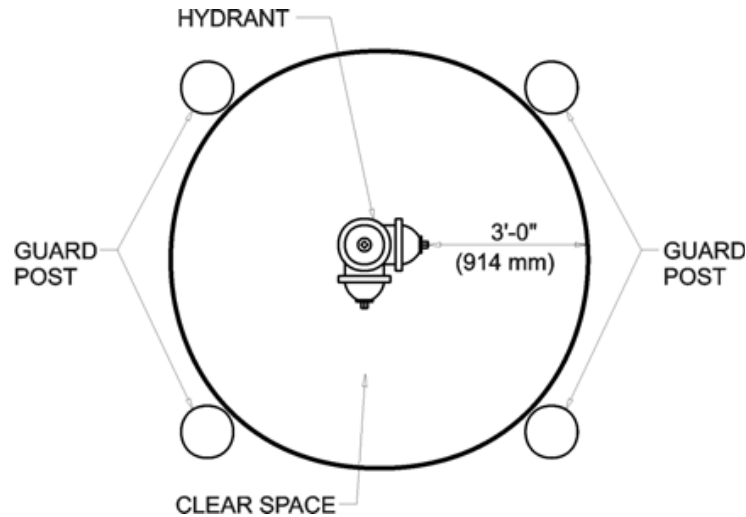

Figure 4.14. A diagram of hydrant impact protection bollards (shown as guard posts) and clearance distance. Diagram excerpted from the 2012 International Fire Code and Commentary, Copyright 2011. Washington, DC: International Code Council. Reproduced with permission. All rights reserved. [www.ICCsafes.org].

Questions to Ask – Water Supply

- Are the proper water flow, pressure, and quantity available for manual firefighting?
- Is a recent flow test used for design of sprinkler and standpipe systems? Must a safety factor be provided for future supply system changes? For future tenant renovations?
- Are fire pumps easily accessible and marked?
- Are fire pumps located where they will be protected from fire and other hazards?
- Where must the remote fire pump alarm and supervisory signals be located?
- Have fire apparatus approach directions and hose-laying procedures been considered when locating hydrants?
- Are hydrants properly positioned relative to the street or apparatus access?
- Are hydrants outside of potential collapse zones?
- Are hydrants located away from fixed, temporary, and transient obstructions?
- Are hydrant locations coordinated with FDC locations (also see [Chapter 10](#))?
- Are hydrants set at the proper height?
- Are hydrant outlets coordinated with fire service hose coupling types?
- Is vehicle impact protection (curbs, bollards, etc.) provided for hydrants?
- Will a hydrant marking or color-coding system to indicate flow be needed?
- Will hydrant locator poles be needed in areas subject to snow?
- Will hydrant outlets or operating nuts need to be locked?

Resources

- IFC
- NFPA 1
- NFPA 20, *Standard for the Installation of Stationary Pumps for Fire Protection*
- NFPA 24, *Standard for the Installation of Private Fire Service Mains and their Appurtenances*
- NFPA 291, *Recommended Practice for Fire Flow Testing and Marking of Hydrants*
- NFPA 1142, *Standard for Water Supplies for Suburban and Rural Firefighting*
- American Water Works Association standards
- U.S. Fire Administration, *Water Supply Systems and Evaluation Methods*, available at www.usfa.fema.gov/downloads/pdf/publications/water_supply_systems_volume_i.pdf
- Insurance Services Office, Inc., *Guide for Determination of Needed Fire Flow*, available at www.isomitigation.com/downloads/ppc3001.pdf
- FM Global Data Sheet 3-2, *Water Tanks for Fire Protection*
- FM Global Data Sheet 3-7, *Fire Protection Pumps*
- FM Global Data Sheet 3-10, *Installation/Maintenance of Fire Service Mains*
- Fire Protection Research Foundation, *Evaluation of Fire Flow Methodologies*, 2014, available at <http://www.nfpa.org/research/fire-protection-research-foundation/projects-reports-and-proceedings/for-emergency-responders/fireground-operations/evaluation-of-fire-flow-methodologies>
- Fire Protection Publications, Oklahoma State University, *Fire Protection Hydraulics and Water Supply Analysis*

CHAPTER 5

PREMISES IDENTIFICATION

The fire service must be able to rapidly locate and identify a specific building when an emergency incident is underway. While typically easy to locate a properly-displayed address where buildings face nearby streets, there are other instances where it is a challenge.

Assignment of address numbers and names is ordinarily the responsibility of the local jurisdiction. This can be complicated by unusually-shaped buildings or those fronting on two or more streets. It is important that the U.S. Postal Service and the local jurisdiction have the same understanding of all assigned address numbers.

Street name assignments are followed by a designator such as Street, Lane, Avenue, Boulevard, Court, Way, etc. It is important that this designator is properly assigned for each project and all records. This will help ensure proper fire service pre-incident planning and response.

Some cities have quadrant or section designators such as northwest (NW), southeast (SE), etc. Addresses may be duplicated in two or more quadrants or sections, making the full address assignment important for each project and all records.

Many jurisdictions have a minimum height requirement for address number characters, which is typically specified in building and fire codes. This can vary depending on whether the buildings are residential or other properties. Use of colors that sharply contrast with the background will increase legibility (readability).

Arabic numerals are often considered the easiest to read. If spelled-out numbers are permitted (for example, "One Hundred Twenty" instead of "120"), numerals should also be provided to allow responding firefighters to quickly locate an address.

Address numbers should be large enough to be legible from the street. Large address numbers for buildings set back from the street are helpful (figure 5.1).



Figure 5.1. A large address number.

If either obstructions or the location of the building prevent the address from being clearly visible from the street, supplemental signs should be provided (figure 5.2) in addition to displaying the address numbers on the building.



Figure 5.2. A supplemental address sign at the vehicle entrance to a building (out of view on the left) that is set far back from the public street (on the right).

A single address number will likely be sufficient even for large or long buildings — if they can be approached from a single direction. Otherwise, displaying addresses at multiple locations would be helpful.

Address numbers on the building should face the street on which the building is addressed. If one or more building entrances face a different street, it would be helpful to include both the street name and the number on each address sign (figure 5.3). This is also a good idea for rear or side entrances that face alleys or parking lots.



Figure 5.3. An address sign that includes the street name and street designator.

Rapidly locating a particular building within a building group (complex) can be particularly challenging. At the vehicle entrances to such sites, and at intersections within them, additional signs with directional arrows and/or diagrams of the buildings and access arrangement can quickly direct responding firefighters to the correct building (figures 5.4 and 5.5). Some jurisdictions may desire additional features on diagrammatic signs such as fire hydrants, fire department connections, fire alarm annunciator panels, swimming pools, and recreational courts.



Figure 5.4. A directional address sign.



Figure 5.5. A diagrammatic sign showing an entire complex of buildings and their addresses.

Building complex diagrams should be provided to the fire service. This will assist them with pre-incident planning (discussed further in [Chapter 13](#)) and the development of map books.

Consider a combined numbering scheme in complexes where buildings have several tenants with exterior entrances. The first digit(s) would be the address number and the following digit(s) would be the tenant number; for example, designation 2203-16 would be address number 2203, tenant 16. If an entire complex of buildings has a single address, a numbering scheme could coordinate building and tenant numbers; for example, designation 12-16 would be building 12, tenant 16. See the [Room and Floor Designations](#) section in Chapter 6 for a discussion of interior numbering.

Whenever possible, address numbers and any supplementary signs should be visible in all expected weather situations and all lighting conditions, including at night. Normally, site lighting is sufficient if designed with this in mind, but in some situations

supplemental illumination (lighting fixtures or reflective materials) will be needed to maximize nighttime visibility.

In areas subject to snow accumulation, addresses and supplemental signs should be positioned above the height of anticipated accumulations. A canopy or small roof may help keep the sign legible.

See the Firefighter Access section of **Chapter 6** for signage to assist the fire service in identifying interior locations and exterior entrances.

See **Chapter 11** for additional means of identifying particular addresses, sections, wings, or tenants through fire alarm remote reporting.

Questions to Ask – Premises Identification

- Are project addresses coordinated between the local jurisdiction and the U.S. Postal Service?
- Do addresses include the proper street designator? Quadrant/section designator?
- Is each building provided with a clearly legible address number in Arabic numerals?
- Are address numerals large enough and high enough to be legible from the fire apparatus access?
- Will addresses be needed at multiple points on long or large buildings?
- For entrances facing other streets, will the street name and designator be required along with the address number?
- Will supplementary signs be needed at the street for buildings set far back from the street?
- For building groups or complexes, will directional or diagrammatic signs be needed at entrances? At intersections within the complex?
- Must addresses and signs be illuminated?
- Do sign position and features take into account expected snowfall?

Resources

- IFC and IBC
- NFPA 1 and 5000
- NFPA 1141, *Standard for Fire Protection Infrastructure for Land Development in Wildland, Rural, and Suburban Areas*

CHAPTER 6

FIREFIGHTER ACCESS

Once firefighters have arrived at an emergency scene and positioned their apparatus, they perform a variety of manual tasks. These include stretching hose lines, placing ladders, forcing entry, climbing stairs, and controlling utilities. Some factors affecting firefighters' efficiency include: the distance and terrain between the apparatus access and the building; how easily they can enter the building; the building's interior layout, vertical access (stairs/elevators/ roof) and how quickly they can locate fire protection features and utilities (figure 6.1). Building designers and code officials can make a positive impact in all of these areas.



Photo: D. Polikoff

Figure 6.1. A building with poor apparatus access and challenging terrain for firefighters stretching hose lines and placing portable ladders.

Site Access

Firefighters must hand carry all equipment beyond the point where access for apparatus ends. Increased distances and steeply sloped terrain result in additional time and effort to set up ladders, hose lines, and other equipment. These delays can impact search, rescue, and suppression efforts. If the area is easy to negotiate by foot, firefighters can move relatively quickly.

Obstructions and hazards are often found around buildings that may hinder firefighter access. These include fences, landscaping, vehicles, power lines, merchandise,

storage, etc. Proper design can eliminate or minimize many of these obstructions. Give consideration to the maximum growth potential of bushes and trees.

Sloped grade adjacent to a building has two drawbacks. First, it increases the exertion required to haul hose lines and other equipment. This exertion is often complicated by inclement weather. Secondly, steep slopes can hinder and even prevent the use of portable ladders. One rule of thumb is to place the base of a portable ladder a horizontal distance away from the building equal to one-quarter of the vertical distance the ladder is extended. Accordingly, grade that is slightly sloped for a distance from the building will make ladder use easier. This distance should be at least one-quarter the length of the longest fire service portable ladder or the height of the building roof — whichever is shorter.

Key Boxes

Firefighters must enter the building at one or more points to conduct interior firefighting or rescue operations. The fire service has an array of tools to force entry into buildings. However, forcing entry takes extra time and usually causes damage.

Key boxes (also called access boxes or lock boxes) are small lockable vaults mounted on buildings (figure 6.2) or nearby (figure 6.3). The fire service retains the master key to unlock the boxes, which contain keys and key cards to the building doors, elevators, and other equipment. Some jurisdictions require listed key boxes for certain types of buildings or those with a fire alarm system; others give the code official the ability to require them when appropriate. In some jurisdictions, several sets of keys must be provided. Also, keys can be color coded for their specific use — such as access gates, elevators, fire command center, and special hazard areas (for example, swimming pools).



Photo: M. Chibbaro

Figure 6.2. A key box and sign (upper left) next to a building entrance.



Photo: M. Chibbaro

Figure 6.3. A key box on a brick pedestal. In this complex, key boxes are located next to each fire hydrant rather than at each entrance.

When building owners have the option of installing listed key boxes, they should weigh the cost against the risk of firefighters needing to force entry into their buildings along with any resulting damage. Knowledgeable designers and code officials can help educate building owners on the benefits of key boxes.

Entry Points

The primary fire service entry point should be designated early in the planning and design of a building. This may or may not be the main occupant entrance/exit. One good location may be where a permanent security station is located — so the security staff can provide information to arriving firefighters. Emergency

responders may also desire to coordinate their primary planned entry with features such as fire lanes (see [Chapter 3](#)), fire hydrants (see [Chapter 4](#)), key boxes (see previous section), fire department connections (see [Chapter 10](#)), and/or the fire alarm annunciator (see [Chapter 11](#)). Conversely, responders may not want too many features clustered near the same entrance, depending upon standard operating procedures (for example, a second-due engine company may be assigned to supply a fire department connection).

Any feature that helps speed entry into the building will facilitate emergency operations — especially those that make forcible entry unnecessary. One example is a feature that unlocks main entrance doors automatically upon fire alarm system activation.

Conversely, any feature that restricts firefighter entry should be avoided. Examples include fixed features over windows (figure 6.4).

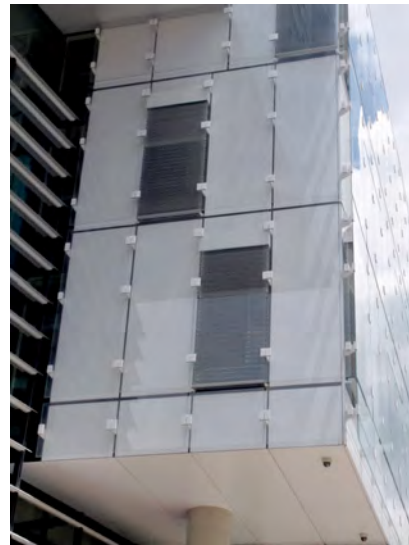

Photo: M. Chibbaro

Figure 6.4. The glass panels and sun screens surrounding this building's exterior walls would make exterior entry difficult.

First arriving firefighters will often base their point of entry on which windows have fire or smoke venting from them. In most cases, entrances that serve any particular window will be readily apparent from the outside. If

it is not obvious which doors provide access to various building areas, signs or diagrams outside each entrance door could eliminate confusion and save valuable time. The information on these signs should also be provided to the fire service for pre-incident planning (discussed further in [Chapter 13](#)).

In multi-tenant buildings, such as shopping centers and malls, tenants usually have rear exit or loading doors that firefighters use for access. Often these doors look alike, making it hard to correlate a given door with a particular tenant. This is solved by labeling rear doors on the outside with the tenant's name, address and/or suite number, in a size legible from the firefighters' vantage point (figure 6.5). Updating these signs as tenants change is important.

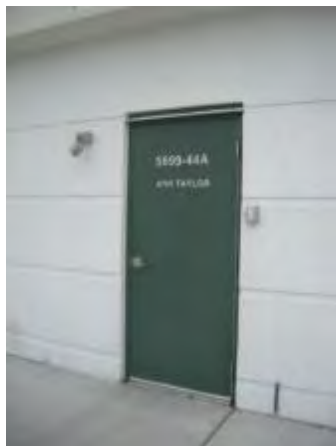

Photo: M. Chibbaro

Figure 6.5. A rear tenant door in a shopping center labeled with the address, suite number, and tenant name.

Any door that appears to be functional from the outside, but is unusable for any reason, should have a sign reading "DOOR BLOCKED" or similar wording. The lettering size should be legible from the firefighters' vantage point. If these doors are properly marked, firefighters will not waste time trying to gain entry through them.

Access via stairs is addressed in the [Stairs](#) section of this chapter, below.

Room and Floor Designations

Coordination of floor and room designations between all features is crucial. These features include stairs, elevators, fire alarm annunciators, building information signs or directories, public address systems, and all pre-incident planning documents. Consistent designations will avoid confusion, especially during time-sensitive emergency operations. Keep in mind that responders to emergency incidents unrelated to fire (such as spills or emergency medical calls) would not have the benefit of directions provided by a fire alarm annunciator, if available.

All numbering of floors and rooms should be easily readable and make common sense, even for those unfamiliar with the building. Confusing signage will delay emergency operations (figure 6.6).



Photo: M. Hurley

Figure 6.6. A confusing room number sign.

Floor numbering is particularly important for firefighter safety. Firefighters prefer to approach a fire from below because heat and smoke normally rise. The numbering scheme should be intuitive, even in situations when visibility is low and when stair level signage is not available. In such situations, firefighters may need to count stair levels to keep track of the floor they are on.

Building floors should be numbered beginning at the main entry point. If the ground-level floor is designated as “ground”, “lobby”, or anything other than “first floor”, then the next higher level should be designated as second, and so on. Confusion arises when first floor designations are used for upper levels (figure 6.7). For example, in a five-story building where the floors are designated G, 1, 2, 3, and 4, a fire on the level designated as 2 could be reported from the outside to be on the third floor. This could be dangerous as well as confusing if firefighters inadvertently make their way above the fire.



Photo: M. Chibbaro

Figure 6.7. An elevator car panel in a building with both a lobby level and first floor above it.

Another example of a confusing numbering arrangement is one with arbitrary floor numbers. For example, a hotel that starts numbering at a high number — say floor 20 is the first floor, making floor 25 the fifth floor, and so on. Conversely, a hotel above another occupancy may restart numbering on an upper floor — floors 1 through 3 may be a mall and a hotel above starts numbering at 1 again on the fourth floor. Hotels sometimes also skip 13 when numbering floors. Great confusion can arise in such circumstances with fire reporting (as in the previous paragraph) or fire command located on the exterior while crews operate on the interior.

Where entry points exist on multiple levels, consider starting the floor numbering at the primary fire service entrance even if it is not

the primary occupant or visitor entrance. Consultation with emergency responders is the only way to determine their primary entrance.

In buildings with many rooms or suites (such as apartments, hotels, and offices), room designation schemes should make it easy to find specific room numbers or to determine which direction to travel. Code officials and responders may have specific preferences. One preference could be numbers progressing higher or lower as you travel along a corridor; another could be even numbers on one side of the corridor and odd numbers on the other side. An example of a potentially confusing numbering scheme is one which proceeds in a circular fashion around the perimeter of a corridor; at any given point in such a corridor, the direction to specific room numbers would not be clear.

Where possible, room numbering should be consistent from floor to floor (i.e., rooms 212, 312, 412, etc. are located directly on top of one another. This is especially important where suites are similar such as hotels or apartments. Firefighters often investigate lower rooms or suites to determine their layout prior to initiating fire attack on a similar unit above. Where rooms or suites vary in size, consistent floor-to-floor numbering could mean skipping numbers on some floors.

Buildings with several wings introduce further challenges to room numbering. One way to handle this is to reserve certain number ranges for each wing (i.e., rooms 1 through 50 for wing A and rooms 51 through 100 for wing B). Another approach would be a four-digit number scheme where the first digit indicates floor, the second indicates wing, and the third and fourth indicate room or suite. For example, designation 9233 would mean floor 9, wing 2, room 33. Buildings with 10 or more floors would need more digits.

Interior Access

Locking arrangements can hinder or facilitate firefighter entry. For example, stair doors may all be unlocked from the inside, may all unlock automatically upon fire alarm activation, or selective re-entry may be provided at certain levels. Special door-locking arrangements such as controlled access or delayed egress locks may need special approvals or permits from code officials. Locking arrangements should be carefully coordinated with egress schemes and voice alarm systems (see [Chapter 11](#)).



Figure 6.8. A building diagram with the building features oriented properly but the text turned 90 degrees from the viewing angle.

Large, unusual, or complex buildings present a challenge to maneuvering and locating specific areas. Building directory signs with room/tenant numbers, and graphic directories of tenant/agency layout can assist the public (figure 6.8). The same diagrams may assist firefighters. They will be of additional assistance if they include information such as stair and elevator identifiers, fire protection system information, and other fire protection features (see the [Graphic Displays](#) section of Chapter 11 for a full list of possible features).

Directories should contain features to assist unfamiliar users with orientation, such as road names or a compass point. The floor label designations on the directory must be

consistent with those in the stairs, elevators, and fire alarm annunciator. Designations within floors should be descriptive of location in addition to the name of the tenant. Orient the building direction and text in the same direction as the viewing angle (figure 6.8).

Schematic floor plans showing the building layout and fire protection systems can assist the fire service. In buildings with fire command centers, the plans should be located there. In other buildings, these plans may be locked inside the fire alarm annunciator panel or control panel. Copies of these plans should also be provided to the fire service for pre-incident planning (discussed further in [Chapter 13](#)).

Stairs

Stairs, especially those enclosed with fire-rated construction, are the primary means for firefighter access to above- and below-grade floors of buildings. In some cases, stairs serve the roof level — a feature that greatly facilitates roof access for tasks such as vertical ventilation of heat and smoke.



Figure 6.9. A stair identification sign.

Identification signage inside stairs at every level (figure 6.9) is a common provision in building and fire codes. These signs assist both occupants and firefighters. The exact information required on the signs varies according to the specific code.

Information that could be included on such signs includes the stair identifier, floor level, terminus of the top and bottom, discharge level, and direction to exit/discharge. Emergency responders may prefer a specific type of stair identifier (numerical vs. letter). The floor level designations must be consistent with the elevators, building directories, and fire alarm annunciators. A directional indicator (arrow or chevron) should also be provided, especially where upward travel is required to the discharge point. It is important that these signs be located at approximately adult eye level and be visible with the stair door open or closed.

Stair signs in stairs that lead to a flat or low-pitched roof should also indicate roof access. This can be identified as “fire service access to roof” or similar wording — to prevent the public from mistaking the roof for a safe way out. Signs in stairs without roof access should indicate “no roof access” or similar wording.

In hotels or other buildings with room or suite numbers, stair signs could also include the room or suite numbers most directly accessed by each stair on every level, (i.e., second floor of stair 3 has direct access to rooms 202 through 256). The latter signage would be extremely important where certain stairs provide no access to some sections of the building.

Some stairs discharge directly to the outside and others discharge at interior locations. The exterior of all stair discharge doors, whether interior or exterior, should also be labeled so that firefighters can quickly locate them for access to other floors (figure 6.10).



Figure 6.10. Signs outside a stair discharge door indicating fire service access (right) and the levels served by the stair (left).

The illuminated exit signs that should be at stair entry doors help facilitate firefighter egress. Floor-level exit marking will help if the exit signs are obscured by smoke.

Stair Capacity

Building and fire codes require that stairs accommodate exiting occupants. Fire service personnel who may use the stairs are not typically factored into egress capacity calculations. When occupants are still exiting and firefighters are using the same stairs to enter the building (known as counter-flow), both occupant evacuation and firefighter access may take longer. This situation can be addressed by factoring the counter-flow into egress analysis — in particular for buildings with floors beyond the reach of available fire service ladders.

Furthermore, in most cases, stair capacity is calculated based on the floor with the highest occupant load. Typically, stairs are not widened as one travels in the direction of egress unless the stairs converge from both above and below. This approach assumes that people will evacuate in a phased manner, beginning with the floor(s) closest to the fire’s origin. In an immediate general evacuation, or when people from unaffected areas choose to evacuate, the increased occupant flow may slow evacuation.

Both of these bottlenecks will be made worse as the height of the building increases. Furthermore, total evacuation is an increasing consideration due to major emergency events such as terrorism and natural disasters. A designer may encounter these issues on projects for large, high-security, or high-profile facilities. Egress delays caused by either counter-flow or total evacuation can be addressed with additional egress capacity by means of additional stairs, widened stairs, or properly designed and installed occupant evacuation elevators.

Another solution to the counter-flow issue is to provide an additional stair. This gives the fire service more flexibility to choose one of the stairs for firefighting while the remaining stairs are used solely for occupant evacuation. Some codes require an additional stair in buildings over a certain height; this is an outcome of a National Institute of Standards and Technology (NIST) recommendation regarding counter-flow following the 9/11 terrorist attacks.

Owners or operators of existing high-security or high-profile facilities may incorporate full evacuation into their emergency planning without considering any increase in egress capacity. Code officials should look for such situations.

Elevators

Elevators have traditionally not been used for occupant evacuation. Two exceptions are when trained operators are available to evacuate occupants with special needs or where special features are incorporated to make some elevators safe for occupant use during an emergency (known as occupant evacuation elevators).

Building and fire codes typically require elevators to be designed for fire service use, in two phases of emergency operations. The installation standard used throughout the country for elevators is ANSI A17.1, *Safety Code for Elevators and Escalators*.

Firefighters are especially dependent on elevators in high-rise buildings. Loss of elevators due to a power outage was cited as a factor in the 1991 Meridian Plaza high-rise fire in Philadelphia, which killed three firefighters.¹

Phase 1 of elevator emergency operation consists of a recall system that sends elevators to a designated primary level — with the intent being that this occurs before a fire can affect its safe operation. The recall occurs manually upon activation of a keyed recall switch (figure 6.11) at the designated level or automatically upon activation of detectors in certain areas. These areas typically include elevator lobbies, machine rooms, machinery space, and hoistways (if the hoistways have sprinklers). If a detector is activated on the designated primary level, the elevator cars are automatically sent to an alternate floor level. In either case, the elevators are rendered unavailable to building occupants. They remain at the recall level with doors open, so the fire service can quickly determine that they are clear of occupants and then use them in a manual control (Phase 2) mode. Coordinate with both code officials and emergency responders regarding which levels to designate for primary and alternate recall.



Figure 6.11. An elevator lobby switch for manual fire service recall.

1. Federal Emergency Management Agency, "Special Report: Operational Considerations for Highrise Firefighting", USFA-TR-082, April 1996.

The designated recall level is usually the ground or entry level. This will facilitate rapid firefighter access. For buildings with entrances on multiple levels, designers and code officials should consult emergency responders about the entrance firefighters intend to use initially. The fire service may also prefer to coordinate the designated recall level with the location of the fire alarm annunciator, fire control room, and/or the sprinkler/standpipe fire department connection(s).

Phase 2 emergency operation permits the fire service to use the elevators under their manual control (figure 6.12). This phase overrides all automatic controls, including the Phase 1 recall.



Photo: M. Chibbaro

Figure 6.12. Elevator cab controls for Phase 2 firefighter operation.

Automatic power shutdown is a standard feature for elevators that have fire sprinklers located in their machine rooms, machine spaces, or hoistways. The intent is that shutdown occurs prior to, or upon, the discharge of water; this precludes water affecting the elevator circuits or braking system. Consider methods that will reduce the chances that emergency responders will be inadvertently trapped by such a

shutdown. For example, if heat detectors mounted next to each sprinkler head are used to activate the shutdown feature, consider both their temperature rating and sensitivity relative to the sprinklers. Note that in many cases sprinklers may be omitted from these areas, thereby eliminating this as a potential cause of firefighter entrapment.

Detectors in the elevator machine rooms, machine spaces, or hoistways trigger separate and distinct visible indicators at the fire alarm control unit and the fire alarm annunciator. These indicators notify firefighters that the elevators are no longer safe to use, and they also provide some warning time prior to the shutdown feature that is required with sprinkler protection. In addition, visual warning signals with fire helmet symbols are provided in elevator cabs — these flash to warn firefighters when an elevator problem is imminent.

Fire service access elevators are those specifically designed and designated for use by emergency responders. These elevators open onto fire service elevator access lobbies that provide a safe staging area for firefighters to conduct operations or for occupants to await assistance (figure 6.13). These lobbies have access to both an elevator and an exit stair with a standpipe; this increases the access and fire attack options available to firefighters. The lobbies are also fire-rated and doors to the corridor or other floor areas have viewing panels to allow both firefighters and occupants to see conditions on the opposite side of the doors. Other features are incorporated to increase reliability – for example, hardened shaft enclosures, water infiltration protection, and a prohibition of sprinklers in the hoistway, machine room, or machinery space.

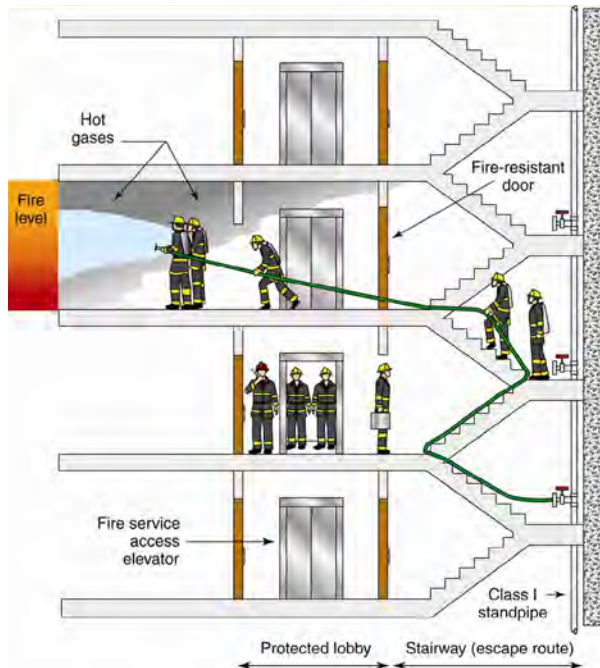

Figure 6.13. A section view of fire service access elevator lobbies. Figure excerpted from the 2012 IBC Transition from the 2006 IBC, Copyright 2012. Washington, DC: International Code Council. Reproduced with permission. All rights reserved. [www.ICCsafe.org].

Firefighters regularly respond to elevator-related emergencies such as civilians trapped in elevator cars. In some cases, the entrapped person(s) may be experiencing a medical or psychiatric emergency. Properly-trained firefighters can interact with elevator systems to mitigate such incidents. A standard elevator key has been developed to increase consistency between buildings. Labeling elevator machine rooms or machinery spaces and indicating their locations on fire alarm annunciators will facilitate access. Communication with both emergency responders and elevator code authorities may be necessary for a full understanding of proper procedures.

Utility and Equipment Identification

A routine function in any advanced fire suppression operation is to control (usually shut down) utilities to minimize hazards to firefighters. Making utilities easy to locate and identify will speed firefighters' progress. Electric, gas, and other fuel controls should be located either in dedicated rooms with marked exterior entrances (figure 6.14), or at exterior locations away from openings such as windows or doors. Several paragraphs in OSHA's electrical standards mandate signage for electrical rooms, switchgear, substations, and other equipment. OSHA's Specifications for Accident Prevention Signs and Tags standard covers signs to be used within buildings to protect workers, including firefighters.



Photo: M. Chibbaro

Figure 6.14. A room with signage indicating (top to bottom), the main electric service, the location of a secondary electric service, and the fire alarm system control panel.

Examples of such equipment include main water service, sprinkler or standpipe control valves, fire pumps, electric service, switchgear, generators, and air handling equipment. Labels on rooms containing this equipment will facilitate rapid access. Signage should be legible from the firefighters' vantage point.

Marking of fire protection system devices is discussed in more detail in **Chapters 8 through 12.**

Questions to Ask – Firefighter Access

- Does the terrain and landscaping around the building facilitate firefighting operations?
- Are all stakeholders aware of which entrance is designated as the primary fire service entry point and which features should be located there?
- Are key boxes required? Desired? At what location(s)? Which keys should they contain? How many sets? Must they be color-coded by use?
- Are floor levels designated sensibly such as limiting “first floor” designations to ground levels?
- Are floor designations coordinated between stair signs, elevators, building directories, and fire alarm annunciators?
- Are interior rooms labeled or numbered in an organized way to make them easy to find?
- Will signage be beneficial at limited access entrances?
- Are building directories needed at entrances? Should fire protection features be included?
- Are exterior entry doors labeled, especially rear or secondary entries?
- Will floor-level exit signs be needed?
- Are blocked doors provided with exterior warning signs?
- Are stair identification signs provided in each stair? Must stair identifiers be numbers or letters? Does each sign indicate whether or not roof access is available? Must room, tenant, or suite numbers served by each stair be shown?
- Are stair discharge doors marked on the discharge side?
- For unusual facilities or those which may need total evacuation, should firefighter access be augmented with widened stairs, additional stair(s), or dedicated stairs?
- Are elevators designed with recall features? Firefighter safety features? Standard elevator keys?
- Must elevator door keys or Phase II operation keys meet any specific local requirements?
- Must fire service access elevators and lobbies be provided for fire attack staging areas?
- Are rooms containing utility shutoffs, building service equipment, and fire protection equipment properly identified?

Resources

- IFC and IBC
- NFPA 1 and 5000
- Society of Fire Protection Engineers, *Human Behavior in Fire*
- ANSI A17.1, *Safety Code for Elevators and Escalators*
- NFPA 72, *Fire Alarm Code*
- NFPA 170, *Standard for Fire Safety and Emergency Symbols*
- OSHA Standard *Specifications for accident prevention signs and tags*, 29 CFR 1910.145
- OSHA Electrical standards, 29 CFR Part 1910, Subpart S

CHAPTER 7 HAZARDS TO FIREFIGHTERS

Several building features present unique or unexpected hazards to firefighters. Designers and code officials can mitigate some but not all hazards that firefighters face (figure 7.1). This chapter discusses the hazards and mitigation methods over which designers and code officials may have some control.



Photo: Glen Ellman

Figure 7.1. A firefighter bailing out of a building after running out of air.

Building Information

Several systems exist for exterior signage that contains building information specifically for firefighters. One is shown in figure 7.2; NFPA 1 contains another. Information that could be included on such a sign include construction type, presence of lightweight construction, contents hazard level, presence of fire sprinkler systems (full or partial), presence of standpipe systems, occupancy type, life safety issues, any special hazards present, and specific tactical considerations. Emergency responders must determine the appropriate tactical considerations, which may include conditions under which interior fire attack should not be undertaken. Signs should be highly visible, resistant to weather, and mounted at the main fire service entry point.

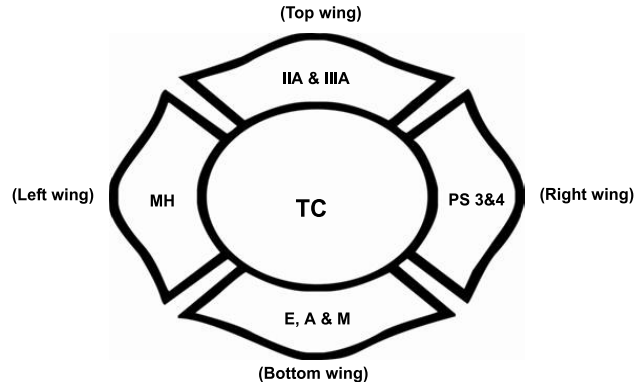

Figure 7.2. A sample sign for a building marking system. Diagram excerpted from the 2012 International Fire Code and Commentary, Copyright 2011. Washington, DC: International Code Council. Reproduced with permission. All rights reserved. [www.ICCsafe.org].

More detailed information can be placed in a locked cabinet easily accessible to firefighters (figure 7.3) or in the Fire Command Center (see Chapter 11). Include the building information listed above as well as more detailed materials such as:

- Building schematic plans
- Occupancy details such as occupant load
- Hazardous material information (see the following section)
- Hazardous operations such as MRI machines
- Building service and fire protection equipment
- Facility contact persons
- Special occupant needs



Photo: M. Chibbaro

Figure 7.3. A cabinet containing building fire safety information for the fire service. The cabinet is conveniently located just below the fire alarm annunciator.

Fire codes can list information to be provided on a Building Information Card. This can be an actual card or in electronic format. The latter makes the information very easy to access and read. The card can be located at a fire alarm annunciator, in a separate enclosure (see figure 7.3), or in a fire command center, if provided.

The preferred location for building information may be just inside or just outside the main fire service entry point. If the annunciator panel has adequate capacity, it can serve as the cabinet for building information.

Vacant buildings pose particular risks for firefighters. They are often in a deteriorated state and are sometimes structurally unstable. However, vacant does not necessarily mean unoccupied because such buildings may attract those seeking shelter or a place to perform illicit activities. These aspects complicate the decision regarding whether to attempt an interior fire attack or to fall back to an exterior attack.

Signage to quickly identify the condition of vacant buildings can provide critical information to factor into this decision. Such signage was recommended after a **2012 Philadelphia fire** that killed two firefighters. The signage should include a highly-visible symbol and any specific hazards such as holes in roofs or floors, missing stairs or steps, and unsafe fire escapes (figure 7.4).



Photo: Cleveland Division of Fire

Figure 7.4. A vacancy status sign that warns firefighters that a building is unsafe to enter. Space at the bottom of the sign is for information on specific hazards.

For any of the building information approaches in this section, information must be updated when any changes occur. Incorrect information can be more dangerous to firefighters than a lack of information. Initial information and any updates should also be shared with the fire service for pre-incident planning, which is discussed further in **Chapter 13**.

Hazardous Materials

Several federal agencies regulate hazardous materials (HAZMAT) within or near buildings, including the Occupational Safety and Health Administration (OSHA), the Environmental Protection Agency, the Department of Homeland Security, and the Bureau of Alcohol, Tobacco, Firearms, and Explosives. At the local and state levels, regulation is usually handled under the auspices of a fire code and its enforcement system and may include permitting and associated requirements.

HAZMAT information and compliance is normally handled by facility management. Building codes typically require designers to report maximum quantities of certain hazardous materials during the initial building permit application. In some cases designers and code officials may have information on hazardous materials due to the need to provide features such as fire-rated barriers, fuel tank containment, or special protection systems. Designers and code officials should be aware of the following aspects of hazardous materials for situations when they can work with building owners and emergency responders to facilitate pre-incident planning:

- HAZMAT management plan
- HAZMAT information statement, inventory, or manifest
- Facility emergency contact or liaison
- HAZMAT marking
- Flammable liquid or gas tank approval
- Permits needed for any HAZMAT

One HAZMAT marking system that has been used for several decades is outlined in NFPA 704, *Standard System for the Identification of the Hazards of Materials for Emergency Response*. NFPA 704 symbols (figure 7.5) contain numerical designations for the severity of health hazards, flammability, and instability. They also have space for special hazards such as water-incompatible material.



Figure 7.5. An NFPA 704 symbol.

OSHA's Hazard Communication standard contains a HAZMAT marking system that is based on the United Nations' Globally Harmonized System. The numerical designations are in reverse order of those in NFPA's system. A comparison of these two approaches showing OSHA's pictograms is available at www.osha.gov/Publications/HazComm_QuickCard_Pictogram.html.

Processes or equipment hazardous to firefighters should also be labeled. Examples include MRI (Magnetic Resonance Imaging) or NMR (Nuclear Magnetic Resonance) machines, operations with flash fire or explosion potential, and hazardous atmospheres. Signage is appropriate outside the entrances of spaces containing such processes or equipment. OSHA's *Specifications for Accident Prevention Signs and Tags standard* covers signs for various hazards to protect workers, including firefighters.

Accurate HAZMAT information is vital for firefighters. Hazardous materials and processes change regularly and current information enables better decision-making during an emergency incident.

Lightweight Construction

Lightweight structural components such as trusses, wood I-beams, and bar joists are routinely used in construction to span wide areas and minimize the need for vertical supports, reducing both material and construction costs (figure 7.6). Under ordinary conditions, these components work well and building codes have permitted them for many years. However, lightweight components often fail suddenly and catastrophically during fires. For example, wood and metal trusses are made of interdependent members that can all fail if one member fails. Adjacent trusses, in their weakened state, are then unable to carry the additional load and these can also fail in quick succession.

Even relatively small fires can cause failures depending on the fire's specific location in relation to the lightweight members.



Photo: M. Chibbaro

Figure 7.6. Steel bar joists.

Lightweight wood structural members such as trusses (figure 7.7) and I-beams, sometimes called engineered wood products, are combinations of smaller components that form floor or roof assemblies.² These are used as an alternative to the traditional solid (dimensional) lumber joists that would burn through more slowly and likely provide additional time for fire operations before collapse. Lightweight members have less mass in terms of extra wood not needed for structural stability. The members therefore have reduced inherent ability to provide advance warning of collapse while under attack from fire. Also, the higher surface area-to-volume ratio of trusses compared to joists allows trusses to burn more quickly than traditional lumber. In addition, the metal gusset plates that hold lightweight wood components together may fail suddenly as fire consumes the wood in which the gusset teeth are shallowly embedded. A similar outcome may occur with components glued together with adhesives.

2. Some engineered wood products replicate heavy timber structural members and have inherent fire resistance. The discussion here is limited to lightweight engineered wood products.



Photo: M. Chibbaro

Figure 7.7. The building on the right is being constructed with wood trusses. The adjacent finished building shows no indication from the exterior that wood trusses were used in its construction.

Many firefighters have been killed in collapses attributed to lightweight construction members since the 1970s. It is extremely hard for firefighters operating at a fire with lightweight members to predict the time or extent of a collapse (figure 7.8). They typically cannot see how many members are affected, which components, and to what extent. When lightweight members become unstable, they exhibit little or no warning signs of imminent collapse. Little or no time will be available for firefighters below or above such construction to evacuate or to be rescued. As a result, incident commanders and/or safety officers typically consider the presence of these members in their incident risk analysis.



Photo: G. Jakubowski

Figure 7.8. Wood trusses after an attic fire.

Marking buildings that contain lightweight structural members makes this information immediately available to the fire service. New Jersey requires a truss marking system

(figure 7.9) as a direct result of the deaths of five firefighters in Hackensack in 1988.³ Florida enacted a similar law after the deaths of two firefighters.⁴ Other jurisdictions have similar requirements.

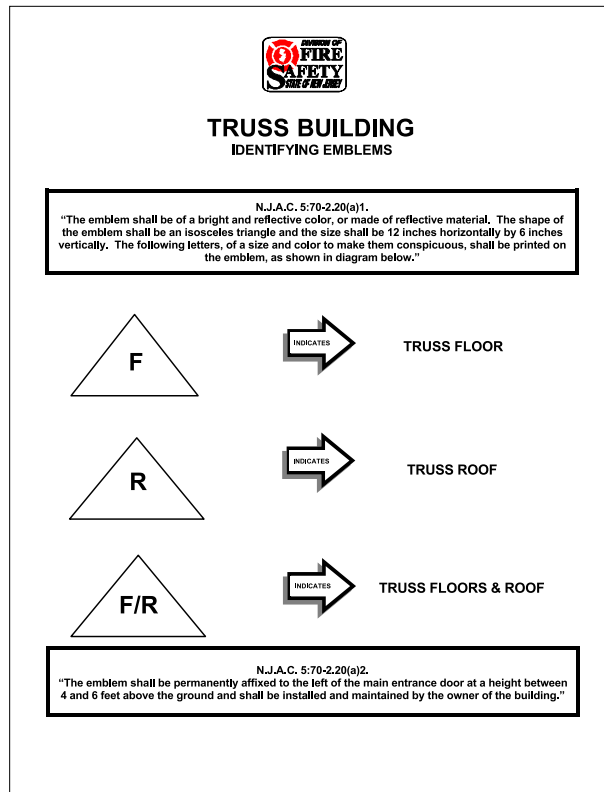

Figure 7.9. New Jersey truss building identification emblems.

One approach to protect firefighters in buildings with lightweight construction is to cover the lightweight members with a protective layer of gypsum board. Alternative methods of protection are available, but designers must ensure that such methods are listed and approved. Model codes have expanded this approach to protect firefighters in all residential buildings, including one- and two-family dwellings.

Wherever lightweight construction techniques are used, serious consideration should be given to providing sprinkler protection throughout the building, if it is

3. New Jersey Division of Fire Safety, NJAC 5:70 - 2.20(a)1 and 2.
4. Aldridge/Benge Firefighter Safety Act, Florida state Bill H727, 2008.

not already required. Sprinkler protection of combustible concealed spaces is an important feature for firefighter safety. After lightweight construction became prevalent, several codes expanded residential sprinkler system requirements – partly justified by the need for improved firefighter safety.

Shaftways

Vertical shafts within buildings sometimes have exterior openings accessible to firefighters. These doors or windows should be marked on the exterior (figure 7.10). This indicates to firefighters that this is an unsafe entry point (figure 7.11) and to make entry at other locations.



Photo: J. Cisney

Figure 7.10. Exterior shaftway marking.

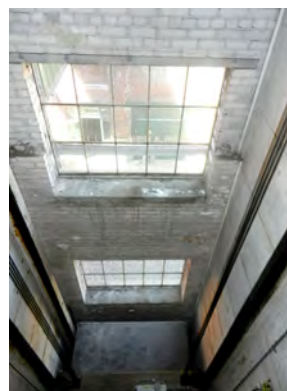

Photo: M. Chibbaro

Figure 7.11. Interior view of an elevator shaft with windows.

Often interior openings to shafts are readily identifiable. For example, ordinary elevator doors are not likely to be mistaken for anything else. However, shaftway marking

is important for other interior shaft openings that could be mistaken for ordinary doors. One example would be a ventilation shaft with full-size doors rather than access panels.

Rooftop Hazards

Skylights

Skylights are convenient places for firefighters to ventilate roofs (figure 7.12). However, a firefighter could inadvertently fall through a skylight when it is obscured by smoke or snow. In 2015, a Colorado firefighter fell through a skylight and died several weeks later. Building owners and managers are required to take precautions to prevent such falls.



Photo: M. Chibbaro

Figure 7.12. Several skylights on a roof.

OSHA's Walking-Working Surfaces standard requires guarding for skylight openings and holes. One way to accomplish this is by using a screen or cover; however, a firefighter with protective equipment and tools will likely exceed the weight capacity of the screen or cover. Furthermore, skylight covers can become brittle over time. For the protection of firefighters, a protective railing may be a more reliable guard.

Obstructions

As discussed above, firefighters often operate on roofs to accomplish tasks. This occurs frequently when visibility is limited due to darkness or smoke. When cables, wires, ropes, or other obstructions are suspended below the height of firefighters, firefighters may inadvertently walk into them,

causing injury or even a fall from the roof. Ways to mitigate this hazard include brightly-colored markings or a guard or equipment below the obstruction (figure 7.13) to preclude firefighters from contacting it.

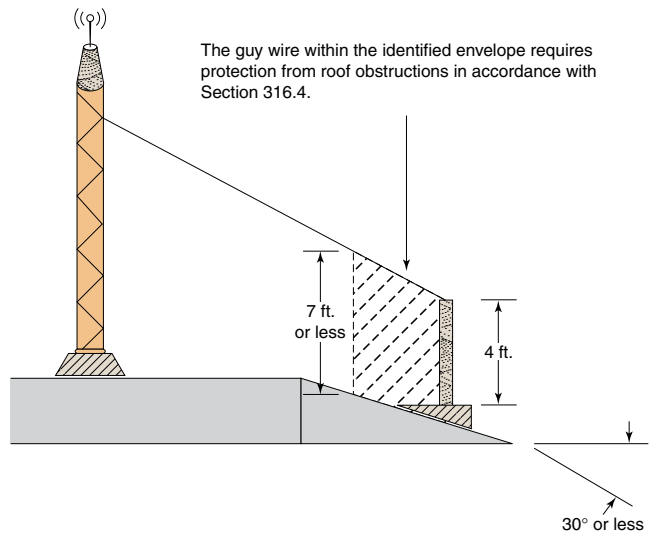

Figure 7.13. Diagram showing the area needing protection from overhead obstructions on a roof. Diagram excerpted from *Significant Changes to the 2012 International Fire Code, 2012 Edition*, Copyright 2012. Washington, DC: International Code Council. Reproduced with permission. All rights reserved. [www.ICCsafe.org].

Energy Conservation and Alternative Energy Features

Energy conservation and alternative energy features have become very important components of buildings. Associated technology has evolved rapidly. However, the risks associated with new technology should be thoroughly considered. Hazards associated with these features have arisen in several fire incidents.

A 2013 fire in an office building in Wisconsin⁵ illustrated several such hazards. Concealed spaces insulated with recycled denim material allowed a fire to spread out of the reach of the fire sprinkler system and fire service hose lines. The photovoltaic system on the roof prevented vertical

5. "Perfect Storm", B. Duval, Fire Journal, January/February 2014.

ventilation due to the electrical hazard. As the fire progressed, the photovoltaic system energized the building's metal roof and wall panels, further complicating firefighting efforts. The 18-hour firefighting operation resulted in a \$13 million dollar loss and completely depleted the town's water supply.

Photovoltaic Systems

Photovoltaic systems (figure 7.14) pose several challenges to firefighters. The electric shock hazard is complicated by the fact that electricity is usually fed in two directions; from the photovoltaic cells and from the electric service or storage batteries. What looks like a disconnect switch can simply isolate individual panels or circuits from each other, leaving both live. In some cases, scene lighting the fire service uses at night can provide enough illumination to keep the cells live. Clear warning signs and circuit marking can help firefighters operate safely around such systems, along with effective pre-incident planning. Several fire and electric code provisions provide for emergency responder safety and access.



Figure 7.14. Photovoltaic panels on a roof.

Another consideration is the difficulty to access and ventilate a roof with photovoltaic cells. It would be prudent to arrange cells to provide clear access paths (wide enough to accommodate firefighters) and clear areas

(large enough for effective ventilation at high points on the roof). Such arrangements are addressed in recent fire code revisions.

Photovoltaic panels are often mounted on roofs supported by lightweight components. This will compound the issues involving lightweight construction discussed above.

Vegetative Roof Systems

The same access and ventilation concerns arise when roofs are covered with vegetation. As with photovoltaic cells, consider space for access paths and ventilation locations (figure 7.15).



Figure 7.15. A vegetative roof system with paths that could be used for access and ventilation.

Maintenance of the landscaping is important to keep vegetation from drying out and becoming a fire hazard itself. In addition, proper maintenance of drainage systems will prevent overloading the roof. Programs for such maintenance will help ensure that maintenance continues on an ongoing basis.

Due to their weight, vegetative roof systems must be supported by substantial roof construction such as reinforced concrete. This construction is difficult or impossible for firefighters to cut for ventilation. Consider built-in vents that are manually operable from the exterior (see the **Smoke Control and Ventilation Systems** section in Chapter 12).

Other Features

Energy conservation and alternative energy technology continues to evolve at a rapid pace. Stakeholders should discuss features such as the following to facilitate emergency operations and ensure adequate firefighter protection:

- Wind turbines
- High-powered antennae
- Hydrogen fuel cell power systems
- Battery storage systems
- Nuclear power generation
- High-performance glazing
- Insulation systems

General considerations for energy conservation and alternative energy features that may assist emergency responders include:

- Notifying responders before a feature is installed and seeking their guidance

- Obtaining all required permits and inspections
- Protecting the feature with suitable fire barriers and suppression systems
- Providing remote alarms
- Providing emergency access for fire apparatus and/or firefighters
- Providing clearly-identified fuel or electric shutoffs in safe locations
- Providing warning signage and appropriate system diagrams
- Posting emergency contact information for owners and technical personnel
- Sharing information for pre-incident planning
- Training emergency responders to help them operate safely
- Maintaining the feature in good working order
- Notifying emergency responders when the feature is removed, relocated, or modified

Questions to Ask – Hazards to Firefighters

- Will a building information signage system be needed?
- Should a cabinet containing building information be provided?
- Will vacancy status signs be needed?
- Can HAZMAT information be provided to firefighters?
- Will a HAZMAT marking system be needed?
- Will lightweight construction signage be needed?
- Must lightweight construction be protected using a listed and approved method?
- Must exterior shaftway openings and interior shaftway doors be marked?
- What precautions are needed to prevent falls through skylights?
- Are rooftop obstructions marked or blocked off?
- Photovoltaic systems: have signage, circuit marking, access, and ventilation been considered?
- Vegetative roof systems: have access, ventilation, and maintenance been considered?
- Has firefighter safety been considered when implementing other energy conservation and alternative energy features?

Resources

- IFC
- NFPA 1
- NFPA 70, *National Electrical Code*
- NFPA 170, *Standard for Fire Safety and Emergency Symbols*
- NFPA 704, *Standard System for the Identification of the Hazards of Materials for Emergency Response*
- NFPA 1620, *Standard for Pre-Incident Planning*
- NFPA *Building Construction for the Fire Service*
- OSHA Standard *Walking-Working Surfaces, Guarding Floor and Wall Openings and Holes*, 29 CFR 1910.23
- OSHA Standard *Specifications for Accident Prevention Signs and Tags*, 29 CFR 1910.145
- NIST web site containing research on firefighter safety: <http://www.nist.gov/fire>
- NIOSH Publication 2005-132, *Preventing Injuries and Deaths of Fire Fighters Due to Truss System Failures*, available at www.cdc.gov/niosh/docs/2005-132
- Fire Protection Research Foundation, *National Engineered Lightweight Construction Research Project report*, 1992
- Fire Protection Research Foundation, *Fire Safety Challenges of Green Buildings*, 2012, <http://www.nfpa.org/~media/files/research/research-foundation/research-foundation-reports/building-and-life-safety/rffiresafetygreenbuildings.pdf>
- National Association of State Fire Marshals, *Bridging the Gap: Fire Safety and Green Buildings Guide* available at <http://www.firemarshalsarchives.org>
- Underwriters Laboratories Fire Safety Engineering, *Firefighter Safety and Photovoltaic Systems*, http://www.ul.com/global/documents/offerings/industries/buildingmaterials/fireservice/PV-FF_SafetyFinalReport.pdf
- Underwriters Laboratories Fire Safety Engineering, *Structural Stability of Engineered Lumber in Fire Conditions*, <http://ul.com/global/documents/offerings/industries/buildingmaterials/fireservice/NC9140-20090512-Report-Independent.pdf>
- California State Fire Marshal, *Solar Photovoltaic Installation Guide*, 2008, available at <http://osfm.fire.ca.gov/training/pdf/photovoltaics/solarphotovoltaicguideline.pdf>
- FM Global Data Sheet 1-15, *Roof Mounted Solar Photovoltaic Panels*
- FM Global Data Sheet 1-35, *Green Roof Systems*
- ANSO/ASSE A1264.1, *Safety Requirements for Workplace Walking/Working Surfaces and Their Access; Workplace, Floor, Wall, and Roof Openings; Stairs and Guardrail Systems*

CHAPTER 8

SPRINKLER SYSTEMS

Fire sprinkler systems (figure 8.1) provide early fire control or extinguishment. If properly designed, approved, installed, and maintained, sprinkler systems help to mitigate the fire hazard to both occupants and firefighters. The importance and effectiveness of sprinkler systems has been demonstrated for many years.⁶ Lack of sprinkler systems, inadequate coverage, or sprinkler impairments have been cited after many major fire incidents. For example, deficiencies in the sprinkler system of a Georgia textile recycling plant in 2007 led to one worker fatality and a challenging incident for firefighters to control, which resulted in the destruction of the plant.⁷



Photo: M. Chibbaro

Figure 8.1. A fire sprinkler system.

Building codes, fire codes, life safety codes, and owner criteria specify when to provide sprinkler systems. The code is usually a model code adopted by a jurisdiction, sometimes with local amendments. Various sections of the OSHA standards require the installation of sprinkler systems, or reference standards that contain such requirements. In addition, sprinkler systems may be required by

6. National Fire Protection Association, Fire Analysis and Research Division, *U.S. Experience with Sprinklers*, June 2013.
7. Fire Engineering, *Lessons Learned from Unsatisfactory Sprinkler Performance: An update on trends and a root cause discussion from the investigating engineer's perspective*, October 2010.

insurance carriers or provided voluntarily to reduce fire insurance premiums for buildings in which proper sprinkler coverage is provided.

Sprinkler systems should be designed to meet an installation standard. This is important for both occupants and firefighters — whether the system is mandatory or installed voluntarily. NFPA has promulgated several standards for commercial and residential sprinkler systems. These standards contain some flexibility in portions of the system that may impact the fire service. This chapter provides guidance to designers so they may exercise this flexibility to benefit fire service operations.

Designers and code officials may also refer to NFPA 13E, *Recommended Practice for Fire Department Operations in Properties Protected by Sprinkler and Standpipe Systems*. Keep in mind that any given fire service organization may follow different standard operating procedures, and communicating with local emergency responders is important.

The provisions in this chapter also apply to similar water-based suppression systems such as foam-water sprinkler systems. Standpipe systems (which are often integrated with sprinkler systems) are covered in [Chapter 9](#). Fire department connections for sprinkler systems are covered in [Chapter 10](#). Sprinkler designers should also see [Chapters 11](#) and [12](#) for special coordination considerations regarding fire alarm and smoke control systems.

For sprinkler systems to be effective, it is imperative that they are regularly inspected, tested, and maintained. Impairment programs and maintenance are covered in [Chapter 13](#).

Zoning

It is important for sprinkler designers and fire alarm designers to work together in buildings of any size or complexity. The fire alarm system will often have an annunciator to indicate the location of the alarm to the fire

service. Coordination is essential to furnish the fire service with clear information on the fire or its location.

The sprinkler piping arrangement will determine how specific a fire alarm annunciator is able to indicate water flow signals. In other than very small buildings, a separate sprinkler zone should be provided for each floor level. This will allow the fire alarm annunciator to indicate the floor level, directing the firefighters to the correct floor.

As the size of each floor increases, the amount of time it takes firefighters to search a floor to find the fire location increases. Large floor levels should be divided into zones (figure 8.2). This accomplishes two things: (1) it allows the fire alarm to indicate the fire location more specifically within a floor, and (2) it limits the system area taken out of service for maintenance, repairs, or renovations.



Figure 8.2. A sprinkler zone control station. The sign on the control valve indicates “first floor south” but there is no indication where the boundary is between south and north.

Sprinkler designers should consider firefighter access when arranging zones. As a case in point, consider an apartment building in which some individual apartments span two stories (figure 8.3). If the two-story units can only be accessed from one level, the sprinklers in both levels of those units should be zoned with the level of entry.



Figure 8.3. Some apartment units in this building span the fourth and fifth floors. Each two-story unit has a single entry door on the fourth floor.

Similar zoning challenges can arise in multi-story lobbies or in buildings where a multi-level area is adjacent to a one-level area with a high ceiling. In such scenarios, it may be clearer for fire service response if the sprinklers in the high area were zoned with the level sharing the same floor level. If you zone sprinkler piping in terms of floor level rather than ceiling level (even if this means additional piping) firefighters will know to what level they must stretch hose lines.

In buildings with standpipe systems, sprinkler systems are usually combined with them and fed by a single water supply. Typically, all sprinklers would be located downstream from a zone control valve that will shut off water to all sprinklers but not to fire hose connections. This allows the hose connections to remain available for manual fire suppression during times when one or more sprinkler zones are shut off for any reason, either before or during an emergency incident.

Control Valves

Valves that control sprinkler systems or specific zones must normally remain open. Codes often require them to be supervised electrically by the fire alarm system (see [Chapter 11](#)) or another method. Electronic supervision can help ensure that valves are returned to the open position after repair or maintenance.

Fire service personnel often need rapid access to water supply control valves. If a valve is closed when an incident occurs, it may need to be opened to permit the flow of water. Conversely, a sprinkler valve may need to be closed to assist in manual suppression efforts. At the conclusion of an incident, valves are turned off as quickly as possible to limit water damage. This also allows the fire service units to return to service as soon as possible to be available for other responses. Accordingly, careful consideration should be given to access, signage and proper pre-incident planning.

Valves can be installed for a variety of purposes, including main shutoff, zone (sectional) shutoff, fire pump bypass, pump testing, draining, and testing. Control valves are not installed in fire department connection (FDC) feed lines; this ensures that this important backup to the primary water source can never be shut down easily or inadvertently.

Labeling each valve clearly to indicate its purpose avoids confusion. This can be helpful during an emergency incident and during repair or maintenance, when a valve can inadvertently be shut off or left shut. Using descriptive labels such as “sprinkler system 12th floor” or “pump bypass — normally closed” are far better than simply “control valve.” Some jurisdictions also require color-coding of valves or valve handles.

If the area fed by a valve is not obvious, an additional diagram can provide important information. For instance, if a floor has multiple zones, each control valve sign should identify the corresponding zone, such as “12th floor east” or “zone 5-4.” A diagram of zones and the boundaries between them should be mounted adjacent to each valve (figure 8.4). This will enable firefighters to quickly determine which valve controls each specific area. It will also help prevent inadvertent maintenance/repair/renovation related shut-offs of an area not intended to be disconnected.

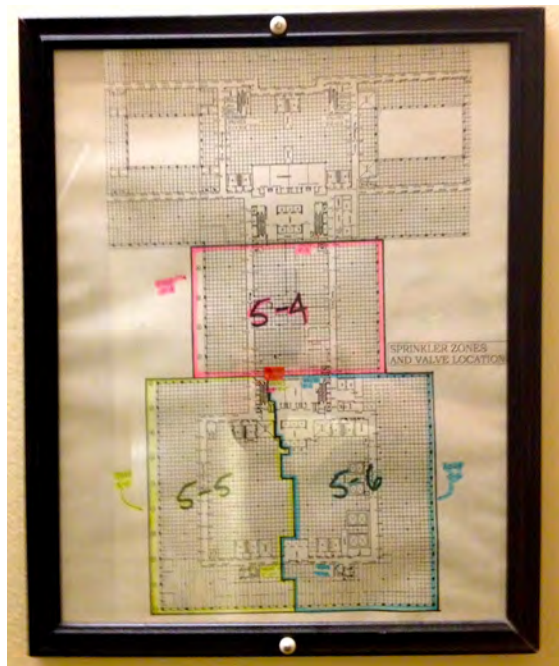

Photo: M. Chibbaro

Figure 8.4. A sprinkler zone diagram showing the outline of three zones.

The location and position of a valve will determine how easily it can be accessed during an emergency incident. Some code officials or emergency responders prefer that valves be at a height reachable without the need for a ladder. Others prefer that valves be located higher to make tampering more difficult.

On rare occasions, sprinklers will not control a fire as expected — for example, where the occupancy or storage has changed without a corresponding upgrade of the sprinkler system. In such scenarios, firefighters may need to shut off water to interior systems to conserve water for hose streams. Properly-located exterior valves, such as post indicator valves, will be accessible even during a serious fire incident. Wall-mounted valves should be positioned far enough from windows, doors, or vents (figure 8.5) to minimize the chances that fire or smoke will make them inaccessible.



Photo: M. Chibbaro

Figure 8.5. A wall control valve next to a window. Fire issuing from this window could prevent access to the valve.

Interior control valves are best located in fire-rated stairs (figure 8.6) or fire-rated rooms with exterior entrances. There they will be both readily accessible to firefighters and protected during a fire event.



Photo: M. Chibbaro

Figure 8.6. A sprinkler zone control valve in a stair enclosure.

When a water supply control valve must be located in a room, a sign outside the door helps firefighters to quickly locate it (figure 8.7). If the valve is in a concealed space, provide a sign outside the access panel – for example, “ELEVATOR SPRINKLER VALVE ABOVE”. If the concealed space is above a suspended ceiling, the appropriate place for the sign is on the fixed ceiling grid, rather than on a removable ceiling tile.



Photo: M. Chibbaro

Figure 8.7. The sign on this door indicates that a sprinkler control valve is located within the room.

In some cases, sprinkler systems are fed from two different standpipes or feed mains, in a dual feed arrangement. This redundancy may be required in very tall buildings and other high-risk occupancies. Designers may also elect this arrangement to provide a hydraulic advantage when determining pipe sizes. However, the dual valve arrangement may add confusion when a system must be shut down. Cross-reference signs should be provided at each such valve (figure 8.8) to indicate the location of the companion valve that feeds the same system.



Photo: M. Chibbaro

Figure 8.8. A sign near a sprinkler control valve indicating the location of the other valve that controls the same system.

Some jurisdictions require exterior signs that indicate the locations of interior valves. An example of wording is “Sprinkler Control Valve 15 Ft. Opposite this Sign.” The disadvantage of such signs is that they provide valuable information to potential arsonists.

Partial Sprinkler Systems

Sprinkler systems often provide full coverage for buildings. In other cases, only a portion of a building will be protected. Perhaps only an underground level or high-hazard tenant has sprinkler protection. Incident commanders will factor sprinkler coverage into their strategy. Accordingly, the locations that are sprinklered and unsprinklered in a building should be indicated in the building information or marking system used (see the **Building Information** section of Chapter 7) and on pre-incident plans. Partial system coverage should also be indicated on the fire alarm annunciator and by signage at the FDC (figure 8.9). Conversely, signs indicating full coverage might be desired for all buildings that are fully protected.



Figure 8.9. A sign indicating the areas covered by the sprinkler system that is fed by the FDC shown.

The primary purpose of residential sprinkler systems installed in multi-family occupancies under NFPA 13R is the protection of occupants' lives. These systems usually

have significant unsprinklered areas such as attics and concealed spaces. This is allowed even if the areas are built with combustible construction materials because they have a low rate of fatal fires occurring. However, fires have originated in or extended into attics and concealed spaces from the exterior, resulting in major fires with significant property losses. Buildings with NFPA 13R sprinkler systems are limited in height to four stories; however, they can be large and the type of sprinkler system will not be apparent from the exterior (figure 8.10). Signage should inform firefighters that they are operating at buildings with residential sprinkler systems. One example could be a sign at the FDC indicating “Residential Sprinkler System – Partial Coverage” or similar wording.



Figure 8.10. A building with six occupied levels from this vantage point. However, from a code standpoint, it is a four-story building because the top level is a loft and the bottom level is a basement mostly below grade. Its residential sprinkler system does not cover the combustible attic space or the truss spaces between floors.

Residential sprinkler systems installed in one- and two-family dwellings under NFPA 13D are also life safety systems with significant unsprinklered areas. However, unlike multi-family occupancies, they are recognizable and should not necessitate any special signage.

Unwanted Alarms

Unwanted sprinkler alarm scenarios involve alarm conditions without an actual emergency. Such nuisance alarms are not “false alarms” or malfunctions because the equipment usually performed as designed. Proper design, installation and approval can contribute to the reduction of unwanted nuisance alarms. This both decreases the hazards to firefighters and keeps them available for actual emergency incidents.

Water flow indicators sense the movement of water or pressure changes. Their activation triggers a water flow alarm signal to a fire alarm system or remote monitoring location. It is important that these devices operate when water is actually flowing from sprinklers rather than due to other non-emergency circumstances such as water surges. Devices such as excess pressure pumps (that maintain pressure on systems at a higher pressure than the highest expected surge) or retard chambers (that fill to accommodate expected surges) help prevent unwanted alarms.

Questions to Ask – Sprinkler Systems

- Must each floor be piped in independent zones?
- Are floors large enough to be further subdivided into zones?
- Are zones arranged with consideration of the fire service access levels?
- Are all sprinkler zones coordinated with the fire alarm design?
- Will hose connections remain in service if sprinklers are shut down?
- Are valves labeled to indicate their specific purpose or area covered?
- Are diagrams provided for floors with more than one sprinkler zone?
- Should valves be within reach from the floor below or positioned higher?
- Are valves located on the exterior where possible?
- Are exterior valves located away from doors, windows, and other openings?
- Are interior valves located in enclosed stairs where possible?
- Are valve rooms and valve access panels labeled?
- Are dual-feed systems provided with cross-reference signs?
- Is warning signage provided for partial systems?
- Are unsprinklered areas indicated on building plans and pre-incident plan documents?
- Have appropriate devices been incorporated to minimize unwanted alarms?

Resources

- IFC
- NFPA 1
- NFPA 13, *Standard for the Installation of Sprinkler Systems*
- 13D, *Standard for the Installation of Sprinkler Systems in One- and Two-Family Dwellings and Manufactured Homes*
- 13E, *Recommended Practice for Fire Department Operations in Properties Protected by Sprinkler and Standpipe Systems*
- 13R, *Standard for the Installation of Sprinkler Systems in Low-Rise Residential Occupancies*
- NFPA 25, *Standard for the Inspection, Testing, and Maintenance of Water-Based Fire Protection Systems*
- OSHA Standard *Automatic Sprinkler Systems*, 29 CFR 1910.159
- Fire Engineering, *Lessons Learned from Unsatisfactory Sprinkler Performance: An update on trends and a root cause discussion from the investigating engineer's perspective*, October 2010.

CHAPTER 9 STANDPIPE SYSTEMS

A fire standpipe system is a network of piping in tall or large structures that delivers water for manual firefighting. Water is fed into these systems either automatically through a water supply connection, manually through hose lines into a fire department connection (FDC), or both. The system piping delivers water to fire hose connections (FHCs) throughout the building, usually in enclosed or exterior stairs (figure 9.1). A properly designed, approved, and installed standpipe system precludes the need for long fire hose stretches.



Figure 9.1. An exterior dry standpipe with an FDC on the bottom and a FHC at each fire escape platform.

Firefighters can extend hose lines from FHCs for interior firefighting operations. To facilitate such operations, engine companies in jurisdictions with standpipe systems often carry bundles or packs of hose called standpipe packs (figure 9.2). In addition to hose, these standpipe packs may contain a nozzle, adapters, valve handles, a pressure gauge or piezometer, door chocks, and related equipment to allow connections to be made and to overcome problems such as vandalized systems. Some jurisdictions have required certain buildings to store caches of such equipment at strategic locations; however,

other jurisdictions have found this approach to be less reliable than depending on their emergency responder's own equipment.



Figure 9.2. A training session showing firefighters connecting hose from a standpipe pack to a FHC.

The vertical pipes that feed FHCs on multiple floors are called standpipes or risers. Pipes that feed two or more FHCs on a single floor are called horizontal standpipes. Vertical and horizontal standpipes are typically interconnected with feed main piping to form a single system (figure 9.3). This allows the FDC(s) to feed all FHCs concurrently, thereby simplifying emergency operations.

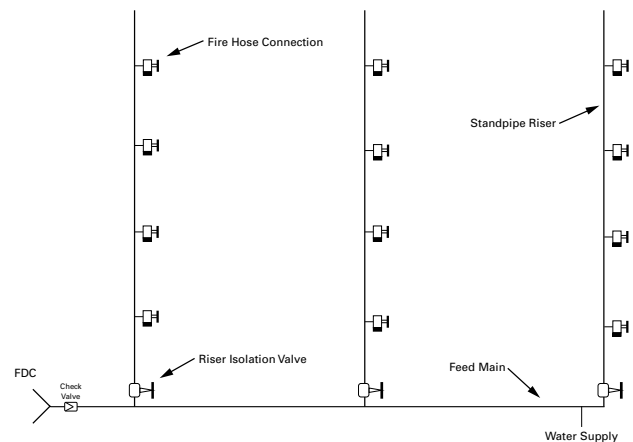

Figure 9.3. A schematic diagram of a standpipe system.

Standpipe systems are, in effect, a critical component in the supply of water to interior firefighting crews. Deficiencies can have disastrous consequences. For example,

standpipe system inadequacies were reported as a factor in the 1991 Meridian Plaza high-rise fire in Philadelphia⁸ (which killed three firefighters — figure 9.4) and the 2007 Deutsche Bank Building fire in New York City (which killed two firefighters).



Figure 9.4. The Meridian Plaza high-rise fire.

Systems are classified according to usage: fire service use (Class I), occupant use (Class II), or combined fire service and occupant use (Class III). The considerations in this chapter apply to Class I systems and fire service portions of Class III systems. Occupant use systems may only be used where the occupants are properly trained and equipped; for this reason, their use has declined.

Building codes, fire codes, life safety codes, insurance carriers, and owner criteria specify when to provide standpipe systems. The code is usually a model code adopted by a jurisdiction, sometimes with local amendments. The trigger to require a standpipe system is usually building height or floor size. Typical applications include tall buildings, shopping malls, and other buildings with a large floor area.

In some cases code officials may allow a standpipe system to substitute for fire apparatus access. One example is a side of a building with a railroad spur and no apparatus access. FHCs could be located outside each fire service access door.

8. Federal Emergency Management Agency, "Building Fire One Meridian Plaza", USFA-TR-049, February 1991.

Another example is a pier that is structurally unable to support fire apparatus access.

Fire service hose connections are also installed in sprinkler systems in some warehouses and bulk merchandising spaces. These are intended for final extinguishment, or mop-up operations rather than fire attack. They do not constitute standpipe systems and do not provide the needed flow or pressure for effective fire attack.

The installation standard for standpipe systems is NFPA 14, *Standard for the Installation of Standpipe and Hose Systems*. This standard allows options for FHCs, valves, and other design features. This chapter illustrates ways that designers can implement various options in different situations to assist the fire service.

Standpipe systems are often combined with sprinkler systems, which are covered in [Chapter 8](#). Fire department connections are covered in [Chapter 10](#). For systems to be effective, it is imperative that they be regularly inspected, tested and maintained. Impairment programs and maintenance are covered in [Chapter 13](#).

System Design

Most new standpipe systems are designed by the hydraulic calculation method. This ensures that the water supply, pipe sizes used, and pumps (if needed) will provide the necessary flow and pressure at a specified number of FHCs in the system. Where FDCs supply all or part of the standpipe demand, designers and code officials must obtain from emergency responders the worst-case estimated water supply available from pumpers that are expected to respond and feed the FDC.

It is crucial that the proper range of pressure is provided at all FHCs. Firefighters may be able to compensate for improper pressure at an FHC by either boosting the system

pressure with fire service pumpers through the FDC or by throttling down the control valve at the FHC. However, both of these approaches are last resorts and should only be needed if design or installation was inadequate or if a system deteriorated over time. Pumpers will be unable to boost pressure to compensate for any deficiencies in portions of tall standpipe systems that exceed their pumping capacity.

The selection of a minimum design pressure to be provided at FHCs must be based on accurate assumptions about the equipment used by the fire service. One common minimum design pressure is 65 psi. This is based on the friction loss through 100 ft. of 2½" hose and a smooth bore nozzle (figure 9.5) that requires a minimum pressure of 50 psi at the nozzle to be effective. Variation in equipment and procedures can render this pressure inadequate; for example, smaller diameter hose, fog or combination nozzles, and longer hose lines that are often needed to reach a fire location.



Figure 9.5. On the left is a smooth-bore nozzle that produces a solid stream. On the right is a combination nozzle that can be adjusted from a straight stream to a wide fog stream.

Another common minimum pressure — in particular those designed since the mid-1990s — is 100 psi. Since some fog or combination nozzles require 100 psi at the discharge end of the standpipe hose line, providing 100 psi at the FHC may be inadequate regardless of hose size or length

because additional pressure is needed to compensate for pressure loss through the hose line.

Remote portions of sprinklered floors may be up to 200 ft. from the closest FHC. Even longer hose lengths would be necessary where a fire must be fought from a more distant FHC due to conditions such as wind direction, ventilation paths, occupant location, and occupant egress routes.

Given these examples that illustrate how fire service equipment affects the pressure needed at FHCs, communication between designers, emergency responders, and code officials is critical. Designers and code officials should ensure that the minimum design pressure is based on a thorough understanding of fire service equipment — including hose size, hose lengths, and nozzle types. This will ensure the adequacy of fire streams for the safety of firefighters performing an interior fire attack.

In areas subject to freezing temperatures, dry type systems are used to keep water from freezing and rendering a system unusable. Heat tape and insulation of wet systems may be permissible for freeze protection; however, this option may be less effective because water is not normally flowing through the piping. Where freezing is not a concern, standpipe systems should be wet type so that water is immediately available at FHCs.

Large dry standpipe systems deserve special consideration. As the size of a dry system increases, the time required to deliver water to the remote FHC increases due to the larger pipe volume that must be filled when the system is activated. This can be mitigated by subdividing the system into smaller independent systems, or zones. However, this prevents them from being interconnected to be fed by the same FDC. See the **Quantity** section of Chapter 10 for specific considerations for signage to help alleviate potential confusion where systems are not interconnected.

Pressure-Regulating Devices

A maximum pressure limit of 175 psi is typical at FHCs on Class I and III standpipe systems. This is considered the maximum safe operating pressure of hose and devices used by firefighters. The maximum working pressure limit of many fire protection components is also 175 psi. Higher pressures will necessitate the use of pressure-regulating devices (PRDs) to restrict system pressures (figure 9.6).



Figure 9.6. An FHC equipped with a pressure-regulating device.

Proper design, installation, acceptance testing, and maintenance of PRDs is imperative so that firefighters have adequate pressure for hose streams. Problems with PRDs have been cited as factors in several major high-rise fires.⁹ For example, during the Meridian Plaza fire in Philadelphia mentioned above, failure to coordinate settings on these devices with fire service equipment resulted in inadequately low pressure for hose streams. Improper PRD settings during the 1988 First Interstate Bank building fire in Los Angeles resulted in excess pressure that made hose handling difficult and burst several hose lines.

9. Federal Emergency Management Agency, "Special Report: Operational Considerations for Highrise Firefighting", USFA-TR-082, April 1996.

PRDs fall into three categories: pressure-reducing valves (PRVs), pressure control valves, and pressure-restricting devices. Pressure-restricting devices do not limit pressure during static (non-flowing) conditions, nor do they maintain a constant discharge pressure. These devices incorporate orifice plates, mechanical pressure restrictors, or valve limiting stops. Pressure-restricting devices are not used for new Class I standpipe systems. However, designers may encounter these when redesigning existing systems — which would provide the opportunity to implement some or all of the considerations below.

PRVs and pressure control valves limit both static and residual (flowing) pressures. They are factory set to attain specific outlet pressures with specific inlet pressures. It is important for designers to specify the full range of possible inlet pressures at such valves, as well as the desired outlet pressure, so that they may be designed properly and then installed on the correct floors. Pressure fluctuations in the water supply as well as the greatest possible range of fire pump pressure capacity must be factored in.

PRVs and pressure control valves have other disadvantages. Their failure rate has been high, resulting in the addition of testing requirements (see NFPA 14 and NFPA 25). Also, many cannot be adjusted by firefighters during a fire, or they require special tools and knowledge.

One reliable means of limiting pressures in standpipe systems is to design them to eliminate the need for PRDs or limit the number of floors on which they will be needed. In shorter buildings, careful attention to the design of pumps and the maximum pressure supplied by incoming water mains can accomplish this. In taller buildings with multiple vertical standpipe zones, it may be possible to apply the same concept to the low zone. Another design option that can limit the need for PRDs is a variable-speed fire pump.

If the use of PRDs cannot be avoided, certain design features will help to balance their disadvantages. The easier the valves are to adjust in the field, the faster the fire service can overcome any unforeseen situation. However, this necessitates special training. Some jurisdictions may not want their firefighters to make such adjustments; others may prefer valves that can be easily adjusted and specify that adjustment tools and instructions be kept in a secure yet accessible location such as the fire command center or a locked cabinet near the fire alarm annunciator.

Firefighters are taught that a FHC can be used as an inlet if the FDC is not usable during an incident. This is not possible with PRDs, which permit water flow in a single direction. Standpipe systems with PRDs should incorporate a supplemental inlet at the level of fire service entry to serve as a backup to the FDC. This is especially important for systems with a single FDC. If the supplemental inlet is on the main feed piping upstream of riser isolation valves (see figure 9.3 above), it will feed all standpipe risers. Typically an extra FHC without a PRD will suffice as a supplemental inlet; however, it should be clearly marked for its purpose so that firefighters do not inadvertently use it as a hose outlet.

Fire Hose Connections

FHCs in Class I systems are typically 2½ inch threaded outlets (figure 9.7). As discussed in the [Fire Hydrant Features](#) section of Chapter 4, it is essential that hose connection type and size match those used by the fire service in the jurisdiction where the building is located. For example, incompatible hose threads were a factor in a 1992 Indianapolis, IN fire that killed two firefighters.¹⁰



Photo: M. Chibbaro

Figure 9.7. A 2½" threaded FHC. The valve is opened and closed with the red hand wheel. The hose outlet has a 2½" by 1½" reducer to facilitate the use of different hose sizes. The 1½" cap is attached to the valve body by a chain.

Location of Stair FHCs

Enclosed, fire-resistance rated stairs have traditionally been good locations for FHCs for the safety of firefighters. They can set up and begin their attack from within the protected stair enclosure. If a quick evacuation becomes necessary, the hose then functions as a lifeline, leading the firefighters back to the protection of the stairs. Disadvantages of hose lines keeping stair doors open are discussed in the following section.

Firefighters often stretch hose from a FHC below the fire floor for their protection. Below a fire is almost always a safer location than the same level or above. In stairs with intermediate landings between floors, some code officials or emergency responders may prefer that FHCs be located on the intermediate stair landings (figure 9.8). In this manner, firefighters can set up below the fire floor but need less hose compared to a FHC at the main landing a full story below the fire floor.

10. Federal Emergency Management Agency, "Indianapolis Athletic Club Fire", USFA-TR-063, February 1992.

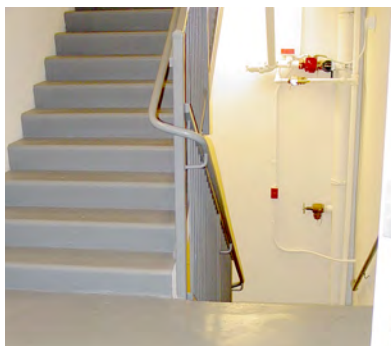

Photo: M. Chibbaro

Figure 9.8. A FHC on intermediate landing (lower right) as viewed from the main landing (foreground) where the stair entry door is located.

If FHCs are located on main landings, consider their position in relation to doors. The FHCs should not be obstructed when the doors are open. Designers should position the outlet to permit the hose line to be stretched out the door without kinking and with as little obstruction as possible to the stair. Firefighters may use the door itself as a heat shield when initially opening it.

Location of Remote FHCs

Remote FHCs are sometimes needed outside of stairs (figure 9.9) if those located within stairs are beyond a given travel distance to the farthest points of a particular floor. Consider how firefighters will access and utilize remote FHCs during a fire incident rather than solely locating them to be code compliant. Remote FHCs within rooms, suites, or tenant spaces are not likely to be used for fire attack within the same spaces. In buildings with a corridor system, the corridor walls, ceilings, doors, and other openings may be rated for fire or smoke resistance. If so, they provide some degree of protection for firefighters, although it is usually less than that provided by a stair enclosure.



Photo: M. Chibbaro

Figure 9.9. A remote FHC in a cabinet in a corridor. The sign near the floor is intended to help locate the cabinet in light smoke conditions. Note that the hose outlet is angled to facilitate connection of hose.

Remote FHCs can often be hard for firefighters to find. They should be placed as uniformly as possible on all floors to make them easier to find. Highly visible signs or other markings can assist firefighters in locating them quickly, along with notation of their locations on pre-incident plans. These may be tailored to décor or occupancy if acceptable to code officials and emergency responders. NFPA 170, *Standard for Fire Safety and Emergency Symbols*, contains symbols for marking standpipe outlets (another term for FHCs).

Location of Horizontal Exit FHCs

Horizontal exits are doors within fire-rated walls that substitute for exit stairs in some buildings. FHCs are typically placed on both sides of such doors (figure 9.10). Firefighters

use these FHCs in the same manner as stair FHCs — to stretch hose lines from one side of the horizontal exit to attack a fire on the other side. The horizontal exit wall and door provide protection just as a stair would.

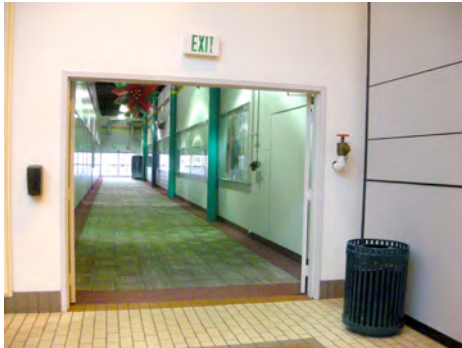

Photo: M. Chibbaro

Figure 9.10. A double set of horizontal exit doors. One FHC is shown to the right of the doors; another is on the opposite side.

Firefighters typically use a FHC on one side of a horizontal exit to attack a fire on the opposite side. The hose will then serve as a lifeline to the safe side of the wall as discussed above. For this reason, designers and code officials should remember to measure hose reach from remote locations to the FHCs on opposite sides of horizontal exit doors.

Location of Parking Garage FHCs

Parking garages deserve special consideration. Vehicle impact protection is important, especially for FHCs adjacent to drive aisles. Adequate access and marking should be provided (figure 9.11). This access path should be outside the designated parking spaces and clearly marked. If this access has the potential to be mistaken for a shopping cart storage area, consider a raised, curbed access path.

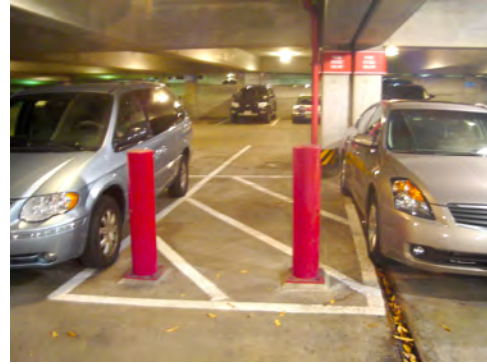

Photo: M. Chibbaro

Figure 9.11. Floor striping indicates a FHC access path in a parking garage. Bollards provide vehicle impact protection. Bright signs at the top of the columns help firefighters locate the FHC.

Exterior FHCs

Tenants or suites with exterior-only access pose yet another challenge for standpipe designers and code officials. Often they are beyond the hose reach limitation from the interior FHCs. Some jurisdictions allow this arrangement if apparatus access is nearby to permit attack hose lines to be stretched from pumpers. However, this is not an option for areas inaccessible to pumpers such as pedestrian promenades and boardwalks. In such situations, the solution for hose reach coverage is exterior FHCs (figure 9.12). In cold climates, a freeze-proof valve arrangement is necessary.



Photo: M. Chibbaro

Figure 9.12. A pedestrian promenade serving ground-floor tenant spaces with no fire apparatus access. Below the red control valve is an exterior FHC.

FHCs are also provided at access points to flat roofs in newer buildings. This allows firefighters to more easily stretch a hose line to fight a roof fire.

FHC Position

All FHCs should be positioned so that firefighters can connect hose to the outlet and operate the control valve handle while wearing heavy gloves (figure 9.13). A good height would be approximately adult waist or chest height. Emergency responders should be consulted for proper clearance from walls, cabinets, or other obstructions. Coordination is the key to preventing conflicts between features.



Photo: M. Chibbaro

Figure 9.13. A FHC in a cabinet being checked by an inspector wearing a firefighting glove.

Fire Attack from Stairs

Fire attack using hose lines from stair FHCs requires stair doors to be propped open (figure 9.14). This helps keep the hose from becoming pinched or kinked and thereby restricting water flow; however, this also allows smoke and heat to enter the stairs. Without careful coordination, occupants remaining above the level of the fire can be endangered and undesired ventilation flow paths can occur. This situation contributed to the deaths of six civilians in a stair during a 2003 fire in the Cook County Administration Building in Chicago.¹¹ Media accounts of a

11. James Lee Witt Associates, Independent Review of Cook County Administration Building Fire, 2003.

2014 New York City fire that resulted in a civilian fatality in a stair also mention this coordination issue.^{12,13}



Photo: M. Chibbaro

Figure 9.14. A training session showing a firefighter chocking open a stair door to initiate a fire attack from a stair FHC.

The conflicting needs to attack the fire and to protect remaining occupants can be challenging and difficult to manage under the best conditions. This can be complicated further by stair door locking arrangements, conflicting evacuation instructions, occupants not following evacuation instructions, the need for the fire service to operate from several stairs, or the need for total building evacuation during major incidents. Several alternative arrangements can help mitigate this dilemma.

One way of maintaining stair integrity during standpipe operations is to locate FHCs just outside stair doors instead of within stair enclosures. One disadvantage of this approach is that the fire attack must begin without the protection of the stair enclosure. Another disadvantage is a reduction in the lifeline concept described above. Some jurisdictions have allowed this arrangement if the FHCs are immediately adjacent to the stair (figure 9.15). If conditions warrant,

12. <http://www.nydailynews.com/new-york/high-rise-fire-killed-1-caused-overloaded-power-strip-article-1.1567795>

13. <http://newyork.cbslocal.com/2014/01/06/investigation-continues-into-deadly-manhattan-high-rise-fire>

hose can still be stretched through the stair from a lower level. Disadvantages should be weighed against the possible advantages of maintaining the integrity of the stair enclosure — for both occupant and firefighter protection. This approach would require specific approval of code officials in addition to coordination with emergency responders.



Photo: M. Chibbaro

Figure 9.15. A FHC on the corridor side of a stair door (on the left).

A second alternative is to provide FHCs both inside and outside the stair doors (figure 9.16). Although this provides the greatest flexibility, it adds cost. Some jurisdictions have been successful in mandating this by code amendment.

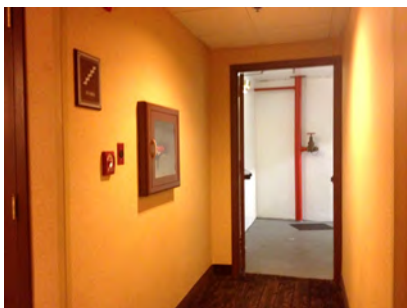

Photo: M. Chibbaro

Figure 9.16. A standpipe riser and a 2½ in. FHC are located within the stair in the background. The FHC shown in the wall cabinet outside the stair is 1½ in. This was deemed adequate for many fire situations in this fully sprinklered building.

A third approach to maintaining the integrity of stair enclosures during fire suppression operations is to place FHCs in a fire-rated

vestibule between the stairs and the building interior. Although such vestibules require additional space, they may be provided anyway for refuge areas for individuals with mobility impairments or to create smokeproof stairs (figure 9.17). A potential disadvantage of using smokeproof stair vestibules is that the air flow path (and therefore the path of heat and smoke) may be towards these vestibules during a fire.



Photo: M. Chibbaro

Figure 9.17. A standpipe riser and a FHC in a vestibule. The corridor door (foreground) can remain open for hose line use while the stair door (background) remains closed.

Another type of smokeproof stair utilizes exterior balconies between the stair and the interior (figure 9.18). These balconies allow smoke to dissipate without entering the stair. Even if both doors are open for hose line use, smoke is not likely to enter the stair.



Photo: M. Chibbaro

Figure 9.18. An exterior view of open air vestibules (arrow) between the stair and the interior of a building.

The fire service elevator lobbies discussed in the **Elevators** section of Chapter 6 provide yet another option for location of FHCs. Much like the vestibules discussed above, if FHCs are located in the lobby instead of the stair, fire attack can proceed without opening the stair door.

Isolation Valves

Each standpipe riser is provided with its own isolation valve (figure 9.19) to permit shutting off one standpipe riser without interrupting the supply to other risers (see the diagram in figure 9.3 above). This allows firefighters to shut down a standpipe riser that has a problem such as a leak, a failure, or several open FHCs. They can then use the remaining standpipe(s). These problems often arise or occur during an emergency incident rather than in advance, making it important to locate the isolation valves quickly.



Photo: M. Chibbaro

Figure 9.19. A standpipe isolation valve on a feed main (entering horizontally from the upper right) leading to a vertical standpipe riser (on the left). The valve is located within the stair enclosure to protect both the valve and the firefighters who may need to access it.

Designers and code officials should ensure that each riser isolation valve controls one entire standpipe riser. Isolation valves in the feed main piping that can shut off more than one downstream standpipe riser would not permit the isolation of one riser at a time. Conversely, each standpipe should be provided with one single isolation valve rather than multiple valves for different sections.

Where possible, the isolation valves for standpipe risers in fire-rated stairs should be within the stair enclosure for protection as discussed in the **Control Valves** section of Chapter 8 (figure 9.19). They should also be located on a level as close as possible to the fire service entry level. This may take a bit more piping if the feed main is located on a different level. However, it can facilitate rapid access to the isolation valve.

Regardless of their location, it is important for isolation valves to remain open. Codes often require them to be supervised electrically by the fire alarm system (see **Chapter 11**) or another method. Electronic supervision can help ensure that valves are returned to the open position after repair or maintenance.

Questions to Ask – Standpipe Systems

- What equipment (hose length, size, and nozzles) does the fire service use for standpipe operations?
- Is the minimum pressure at FHCs coordinated with this equipment?
- Is the maximum pressure not exceeded at any FHC?
- Has the design minimized the need for PRDs?
- Are PRDs properly designed and installed on the correct levels?
- Will PRDs need to be field adjustable? Where must adjustment tools and instructions be stored?
- Are dry standpipe systems designed to mitigate long fill times?
- Do FHC threads match the fire service hose?
- Are FHCs positioned to allow hose connection and valve handle operation with a gloved hand?
- Must stair FHCs be on main landings or intermediate landings?
- Are remote FHCs outside stairs accessible and marked?
- Are garage FHCs accessible and protected from vehicle traffic?
- Will exterior FHCs be necessary for spaces without interior access?
- Can FHCs be located to allow fire attack without compromising the stair enclosure?
- Are standpipe isolation valves located for rapid access and protection of firefighters?
- Does each standpipe isolation valve feed only one entire standpipe?
- Have emergency responders been trained on system features and operations?

Resources

- IFC
- NFPA 1
- NFPA 13E, *Recommended Practice for Fire Department Operations in Properties Protected by Sprinkler and Standpipe Systems*
- NFPA 14, *Standard for the Installation of Standpipe and Hose Systems*
- NFPA 25, *Standard for the Inspection, Testing, and Maintenance of Water-Based Fire Protection Systems*
- NFPA 170, *Standard for Fire Safety and Emergency Symbols*
- FM Global Data Sheet 3-11, *Pressure Reducing Valves for Fire Protection Service*
- FM Global Data Sheet 3-11, *Standpipe and Hose Systems*
- OSHA Standard *Standpipe and hose systems*, 29 CFR 1910.158

CHAPTER 10

FIRE DEPARTMENT CONNECTIONS

A fire department connection (FDC) enables the fire service to connect hose lines from one or more pumpers and feed water into a system to augment its automatic water supply. Systems include sprinkler systems (see [Chapter 8](#)), standpipe systems (see [Chapter 9](#)), or other water-based suppression systems. Each FDC has one or more fire hose inlets (figure 10.1). In manual dry standpipe systems, FDCs are the only water supply.



Figure 10.1. Charged hose lines connected to a wall-mounted FDC with two inlets.

The requirement to provide an FDC typically appears in the installation standard for the corresponding type of system. This chapter provides guidance on FDC quantity, number and type of inlets, location, position, marking, and signage. This guidance, together with the requirements and preferences of code officials and emergency responders, will facilitate rapid augmentation of the water supply to standpipe systems and other water-based systems.

In some cases, FDCs are not required because they would be of little or no value. Examples include very small buildings, remote buildings that are inaccessible to the fire service, and large open-sprinkler deluge systems that exceed the pumping capability of the fire service.

Impairment programs and maintenance are covered in [Chapter 13](#).

Quantity

Often a single FDC such as the one in figure 10.1 will suffice. In some cases, multiple interconnected FDCs will be provided for redundancy. For example, high-rise fire experience has shown that broken glass and debris falling from a fire area can damage hose lines. Two FDCs are therefore typically provided for each zone in high-rise buildings; this will increase the dependability of the water supply as long they are located remotely from each other. Each FDC should also be sized to independently handle the full system demand.

Another reason for multiple FDCs would be for a system with a large demand. Multiple FDCs can supply a large flow of water to a single system. Examples of buildings or uses that may have large-flow-demand systems include aircraft hangers and warehouses with high-piled storage, high-rack storage, or highly flammable materials. A single FDC with additional inlets can handle a large flow but would not provide the redundancy of multiple FDCs in different locations.

Multiple FDCs can also supply separate systems within a single building. A separate FDC could feed each separate sprinkler system. In other cases, sprinkler and standpipe systems can have separate FDCs (figure 10.2). The separate FDC arrangement precludes the possibility of two or more FDCs being out of service due to a single pipe break, leak, or other problem. However, hose lines must be fed into each separate connection that needs its supply augmented.



Photo: M. Chibbaro

Figure 10.2. Separate sprinkler and standpipe FDCs. To feed both systems, at least one hose line must be connected to at least one inlet on each of the two FDCs.

Conversely, combined FDCs allow all interconnected systems to be fed from any FDC (figure 10.3). As complexes get larger with a multitude of systems, interconnecting FDCs greatly simplifies fire service support of such systems. The disadvantage is that a single-point failure of the interconnecting piping will preclude augmentation of any system. For these reasons, preferences for FDC interconnection will vary by jurisdiction.



Photo: M. Chibbaro

Figure 10.3. A combined sprinkler and standpipe FDC.

Manual dry standpipe systems (with no permanent water supply) cannot be interconnected with automatic sprinkler systems. As discussed in the **System Design** section of Chapter 9, individual manual dry standpipe systems may intentionally be left separate in order to keep their volume down

and minimize fill time. Signage helps direct firefighters to the appropriate FDC (figure 10.4), along with proper pre-incident planning.

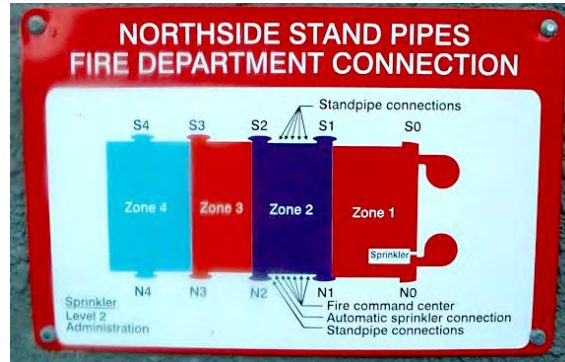

Photo: D. Banwarth

Figure 10.4. A sign indicating the areas covered by separate manual dry standpipe systems. The colors and zone numbers correspond to zones with separate FDCs.

Inlets

To permit the connection of hose lines, the inlet size and type must match the hose couplings used by the fire service. The type can be either threaded or quick-connect. Quick-connect hose inlets are usually 4 or 5 inches in size (figure 10.5) and one inlet usually suffices even for large flows.



Photo: M. Chibbaro

Figure 10.5. A quick-connect type of FDC.

In jurisdictions where the fire service uses threaded hose couplings, FDCs usually include one or more 2½-inch hose inlets. The thread type must match the hose used — usually NH Type (American National Fire Hose Connection Screw Thread). To facilitate the connection of the externally threaded (male) end of fire hose lines, threaded inlets should be the swiveling, internally threaded (female) type.

Many FDCs for threaded hose have two inlet connections (see figure 10.3 above); these are often referred to as siamese connections. A rule of thumb is to provide one inlet for each 250 gallons per minute (gpm) of system demand, rounded up to the next highest increment of 250 gpm. For example, if the system demand is 700 gpm, the designer would specify three inlets. Likewise, a system with a demand of 800 gpm would need four inlets.

When four inlets or more are needed, designers should consider placing multiple interconnected FDCs on different portions of the building. The latter scenario would provide the redundancy advantage discussed above, as well as facilitate separate pumpers feeding each FDC from different water supply points.

In areas where responding apparatus carry hose with different couplings, FDCs may be provided with both threaded and quick-connect couplings. This can be beneficial in areas with different fire service organizations providing mutual aid to each other.

Threaded hose inlets should have plugs (see figure 10.2 above) or caps (see figure 10.3 above) to help prevent damage, tampering, and infestation by animals and insects. However, plugs or caps are easy to remove and are often missing. Debris in an FDC can restrict the flow through it, cause delays while the debris is removed, or even clog the nozzle on a hose line being operated from a standpipe during a fire attack.

Lockable inlet plugs are available for increased security (figure 10.6). In some cases they will be required by code officials or emergency responders; if not, designers should find out if they are acceptable prior to specifying them. Master keys to the locks are often located in key boxes as discussed in [Chapter 6](#). Building owners may be responsible for providing keys to the fire service.

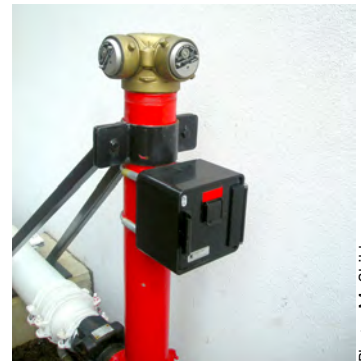

Photo: M. Chibbaro

Figure 10.6. An FDC with locked plugs. The key is in the key box below the inlets.

In some areas, theft of brass inlets and entire connections is a problem. Designers of new systems and owners of existing systems should consult code officials to determine if additional security measures are appropriate and which measures to utilize.

Location

In general, FDCs should be easily accessible to fire service pumpers and located near an adequate water supply. This will facilitate rapid backup water supply to the systems. In some jurisdictions, emergency responders are specifically responsible to approve FDC locations. Here the communication with response personnel is not only desirable — it is required.

A commonly-specified location for FDCs is the street side of buildings. The intent is to make them immediately accessible to approaching fire service pumpers. The street side is obvious in urban settings where buildings front directly onto the streets. However, for buildings set back from the street, the street side may be subject to some interpretation. In these cases, the designer should consult code officials and emergency responders about apparatus approach direction and operational procedures.



Photo: M. Chibbaro

Figure 10.7. A fire hydrant in close proximity to an FDC (near the building entrance in the background). This allows the pumper to use its large-diameter intake hose to connect to the hydrant (foreground) and a pre-connected hose line to be stretched to the FDC (center of photo). Water will be supplied from the hydrant through the intake hose, through the pumper to boost pressure, and then through the hose line into the FDC.

An important consideration is the location of FDCs in relation to nearby fire hydrants or other water supply sources, (such as ponds, lakes, or cisterns). Some jurisdictions require FDCs to be within a certain distance of the fire hydrant or other supply point. This allows a pumper to hook up directly to a hydrant with its intake hose and then use a short hose line (perhaps pre-connected) to quickly feed the FDC (figure 10.7). For example, if pumpers in a jurisdiction each carry a 150 ft.-long pre-connected hose line that can be used to supply FDCs, a maximum distance of 100 feet will enable firefighters to manually stretch this hose to the FDC regardless of the position of the pumper at the hydrant. If there are multiple FDCs, each should meet this distance requirement from separate hydrants to allow for redundant augmentation of system supply.

Some jurisdictions may prefer that FDCs be located near building entrances. This may depend upon their standard procedure and the number of responding engine companies.

Free-standing FDCs are available for situations where they are located away from buildings (figure 10.8). This option is helpful to get FDCs

close to fire hydrants and other water supply sources. It also can help facilitate fire service apparatus positioning in several ways. One example would be to enable pumpers to leave the portions of fire lanes closest to buildings available for aerial apparatus. In advanced incidents, pumpers can remain at FDCs located outside of collapse zones.



Photo: M. Chibbaro

Figure 10.8. A free-standing FDC in a parking lot island near a fire hydrant.

Free-standing FDCs have one drawback for buildings that have no below-grade levels in areas subject to freezing temperatures. The FDC feed pipe must be carefully designed for drainage into a pit with adequate capacity and acceptable maintenance access. In areas with extremely cold weather, this may not be an option acceptable to code officials.

Designers and code officials should consider site conditions leading to the FDC to make it easier for firefighters to stretch hose lines to it. Several steps, grassy areas, or low ground cover will not slow down this process. However, if a firefighter needs to negotiate walls, climb a ladder, maneuver around a fence or hedgerow, or remove an obstruction, the operation may be delayed. Designers should consider the growth potential of nearby landscaping so that the FDC remains accessible.

Fixed obstructions are easy to avoid with proper design coordination. These include walls, vegetation, planters, fences, pipes,

poles, downspouts, and built-in or heavy furniture. FDCs can even be obstructions to each other if located too close to allow connection of hose lines without kinking.

Transient or temporary obstructions are trickier but can often be foreseen. Locations that are likely to be blocked should be avoided. For example, loading docks are subject to temporary storage and vehicular traffic (figure 10.9). Another poor location would be in front of a supermarket or store where stock or carts may block the FDC at any time. This may be a good reason to deviate from the street front location, or to locate the FDC in a column abutting the road. Designers and code officials should always keep in mind how buildings will be used when people, vehicles, and objects are introduced after occupancy.



Photo: M. Chibbaro

Figure 10.9. A loading dock with merchandise.

Locate FDCs away from likely sources of fire that may make it difficult or impossible for a firefighter to stretch a hose line to it. These include fuel tanks, gas meters, and other hazardous materials and processes (figure 10.10). It is also good practice to locate FDCs away from windows, doors, or vents from which fire, heat, or smoke could be emitting. In areas subject to heavy snowfalls, FDCs should be positioned so that they are not subject to being buried under plowed snow.

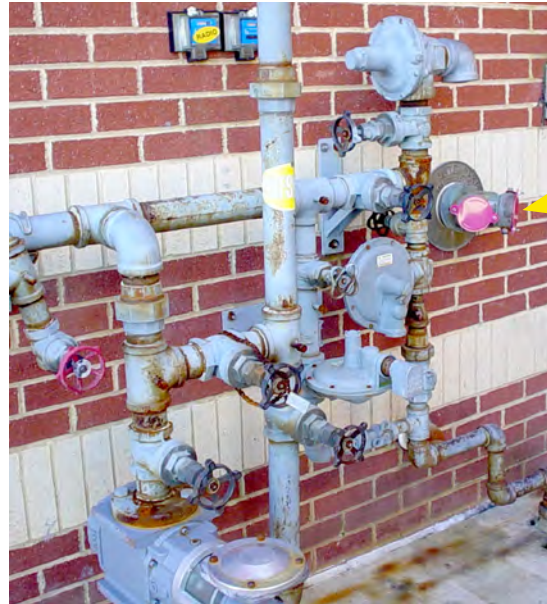

Photo: M. Chibbaro

Figure 10.10. An FDC (see arrow) located adjacent to gas service piping and a meter. The breakaway caps make it necessary for a firefighter to swing an axe or other tool to remove them. This is an accident waiting to happen that could be avoided through careful design coordination.

Position

The height at which FDCs are mounted is important to enable a firefighter to easily connect hose lines. A good height range is approximately thigh to waist level for an adult. At this range, a firefighter can cradle the hose in one hand while turning the FDC inlet fitting with the other hand (figure 10.11). Sufficient clear area around the FDC will enable a firefighter to complete this operation efficiently.



Photo: M. Chibbaro

Figure 10.11. A firefighter connecting a hose line to an FDC inlet.

If FDCs are located in landscaped areas, position the FDC based on the final grade. If the grade is built up in one area with a mound of soil or mulch to achieve the correct height, this can be inadvertently changed later by a landscaper. Or, if a platform is built to achieve the correct height, a fall hazard is created for firefighters who may be working in the dark and/or in smoky conditions (figure 10.12). These should not be considered as equivalent to positioning the FDC at a proper height above grade level.



Photo: M. Chibbaro

Figure 10.12. A platform built up to reach an FDC. This creates an unnecessary fall hazard.

Consider the locations of entrances and exits when locating FDCs. A charged hose line is very rigid and will block an outward-swinging door or pose a trip hazard. Avoid locating FDCs with their inlets pointed in the direction of doors, so that firefighter access and occupant egress is not impeded.

FDCs subject to vehicle damage should be protected by barricades such as the bollards often used near fire hydrants (see the **Fire Hydrant Placement** section of Chapter 4). Alternatives to protect wall-mounted FDCs include recessing them (figure 10.13) or providing a guard.



Photo: M. Chibbaro

Figure 10.13. An FDC recessed into a wall. Note the notch on left prevents hose lines from kinking.

Marking and Signage

Marking and signage for FDCs serve several purposes. These include helping firefighters to find the FDC and providing information about the system it feeds (type, coverage, and design). Pre-incident plans should also indicate the location of all FDCs.

Prominent marking will allow arriving firefighters to quickly locate FDCs. One example of signage can be found in NFPA 170, *Standard for Fire Safety and Emergency Symbols* (figure 10.14). Prominent signs can help greatly where the FDC is on a building set back from the street.



Photo: M. Chibbaro

Figure 10.14. An FDC sign with the NFPA 170 symbols for both sprinkler and standpipe systems.

Some jurisdictions require a light at FDCs to help firefighters identify their locations. These are particularly beneficial in the dark. Other jurisdictions, especially those prone to foggy conditions, require a strobe near the FDC that flashes upon sprinkler activation.

FDCs themselves should indicate whether the connection feeds sprinklers, standpipes, or both. The system type is usually cast with raised lettering into the plate surrounding the inlets. Color-coding is employed in some jurisdictions to differentiate system type.

Pumper operators are normally trained to supply a certain amount of water pressure to the FDC to augment the system. For example, standard procedure could be to pump sprinkler systems at 125 psi, and standpipe systems at 150 psi. This is adjusted as necessary for other floor levels or to account for different hose line configurations on standpipe systems. System demand signs can eliminate some of this estimating for pump operators and signs for special systems can also indicate tactical considerations (figure 10.15). Any additional wording to assist pumper operators can help supplement the basic standard procedures with the specific needs of each building.



Photo: G. Jakubowski

Figure 10.15. A foam-water sprinkler system FDC sign with a cautionary statement regarding the use of water.

Additional FDC signage is warranted for underground buildings such as transit system facilities. This is because the visual cues that a pump operator typically has on aboveground buildings (such as size or height), are absent. Also, smoke or fire venting provides no indication about the subsurface level where the fire is located. In

these cases, a sign indicating the maximum depth and longest horizontal run of pipe gives a pump operator an idea of the pressure needed to reach the most remote areas of the system.

In some circumstances, an FDC will feed a system covering only a portion of a building. Signage at the FDC indicating such partial protection alerts responding firefighters to this, so they may factor it into their risk analysis (figure 10.16). Signage should provide enough detail so that firefighters connecting the hose lines can identify the proper connection and extent of coverage.



Photo: M. Chibbaro

Figure 10.16. An FDC sign showing partial system coverage.

Signage is also warranted for systems that are not interconnected — to clearly indicate which FDC feeds which system(s). This can occur for the reasons discussed in this chapter's **Quantity** section above or where high-rise buildings are tall enough to need separate vertical zones. The latter should indicate the specific floors covered rather than simply indicating "high" or "low" zones.

Signage assists firefighters when it is unclear which FDC corresponds to which building. This can occur when free-standing FDCs are located far from the buildings they feed. Signage also helps when FDCs feed a building with several addresses.

Questions to Ask – Fire Department Connections

- How many FDCs should be provided?
- Should multiple FDCs be interconnected?
- Should multiple FDCs be located remotely from one another?
- What type of inlet connection and thread type will match the fire service hose?
- How many inlets are needed for each FDC, based on the system demand?
- Are inlet caps or plugs provided? Must they be lockable?
- Where should FDCs be located for quick access by the fire service?
- How close must FDCs be to a fire hydrant or other water supply?
- Have fixed, temporary, and transient obstructions been considered?
- Are FDCs located away from wall openings or hazardous materials/processes?
- At what height above finished grade should FDCs be mounted?
- Will charged hose lines feeding FDCs not block exits or entrances?
- Are FDCs positioned or protected to avoid vehicle damage?
- Are FDC locations clearly marked with signs and/or lights?
- Does each FDC clearly show the type of system it feeds?
- Will signage be needed for design details? Partial coverage? Underground facilities? To indicate building(s) covered?

Resources

- IFC
- NFPA 1
- NFPA 13, *Standard for the Installation of Sprinkler Systems*
- NFPA 13D, *Standard for the Installation of Sprinkler Systems in One- and Two-Family Dwellings and Manufactured Homes*
- NFPA 13E, *Recommended Practice for Fire Department Operations in Properties Protected by Sprinkler and Standpipe Systems*
- NFPA 13R, *Standard for the Installation of Sprinkler Systems in Low-Rise Residential Occupancies*
- NFPA 14, *Standard for the Installation of Standpipe and Hose Systems*
- OSHA Standard *Automatic Sprinkler Systems*, 29 CFR 1910.159
- NFPA 170, *Standard for Fire Safety and Emergency Symbols*
- NFPA 1963, *Standard for Fire Hose Connections*

CHAPTER 11

FIRE ALARM AND COMMUNICATION SYSTEMS

Fire alarm systems have traditionally been used in buildings to alert occupants. Modern systems are able to perform this alerting function and much more. Properly designed, approved, and installed fire alarm systems may accomplish one or more of the following:

- Warn or inform building occupants of abnormal or harmful conditions (after which they should take appropriate action — which may be sheltering in place, relocating to a refuge area, or evacuating)
- Summon assistance from appropriate entities (such as the fire service, building fire wardens, staff responders, maintenance personnel, etc.)
- Control auxiliary building fire safety devices and other systems to enhance life safety (related to elevators, air handling units, egress door locks, fire doors, fire dampers, etc.)
- Provide intelligence to responding firefighters regarding the occupants, the fire location, smoke movement, and the status of the installed fire protection systems and devices.

All the above functions are related to fire service operations during emergency incidents. Firefighters can operate more efficiently and safely when occupants are given clear direction, the correct location of the emergency is reported, staff take proper actions, the building and its components react properly, and firefighters are given clear and concise information.

To accomplish its function(s), fire alarm systems monitor alarm-initiating devices such as manual pull stations, automatic detectors, or water flow indicators. Systems can also monitor non-emergency supervisory conditions such as wiring integrity, control valve position, fire pump status, low water

level in tanks, and improper air pressure on dry suppression systems. When an input signal is received from an initiating device, the control components (figure 11.1) will trigger pre-determined outputs.



Figure 11.1. A basic fire alarm control panel with its door open, showing the wiring and the batteries for backup power. The controls and indicator lights in the center are visible when the panel door is closed and locked.

Output functions include activating audible and visual occupant notification devices sending a signal to the fire service or other authorities, displaying the location and type of the alarm or supervisory signal, and performing auxiliary building fire safety functions. Examples of auxiliary functions are elevator recall, ventilation system shutdown, smoke control activation, fire door or damper closure, and stair door unlocking. Outputs also include trouble or supervisory signals that typically notify maintenance personnel or others responsible for correcting abnormal conditions.

Before any signals are received, fire alarm systems should be in an operationally-ready mode known as normal status. Upon receipt of a signal, the system condition will change to one of the following status conditions:

- **Alarm:** An emergency condition that usually results in the activation of occupant notification devices and can also notify the fire service.

- **Supervisory:** A non-emergency condition that indicates a device or feature is not in an operationally-ready mode.
- **Trouble:** A non-emergency condition that indicates a device or feature has a fault that may prevent one or more of the system's intended functions.

Systems vary widely in complexity. A basic, fundamental system consists of a control panel, initiating devices, and notification devices that transmit a general alarm throughout a building. On the other end of the spectrum are complex selective or phased voice evacuation systems with integrated fire department communications systems.

Fire alarm technology has evolved, and will likely continue to evolve, at a rapid pace. However, many systems continue to function with older technology. As a result, designers, code officials, and emergency responders have to be familiar with various generations of technology — including systems that are hard-wired, multiplex, addressable, and wireless.

Building codes, fire codes, life safety codes, and owner criteria specify when to provide fire alarm systems. The code is usually a model code adopted by a jurisdiction, sometimes with local amendments. The trigger to require a fire alarm system is usually building size, occupancy type, and/or occupant load. In addition, certain OSHA standards mandate employee alarm systems.

The installation standard for fire alarm systems is NFPA 72, *National Fire Alarm Code*. This code, along with the fire alarm wiring portion of NFPA 70, the *National Electrical Code*, contains comprehensive requirements for design, installation, and maintenance of fire alarm and detection systems. OSHA's **Employee Alarm System standard** and **Fire Detection Systems standard** address several specific aspects of these systems. The *Americans with Disabilities Act* (1990, amended 2009) prompted changes to fire alarm systems such as the addition of visual

notification devices for the visually-impaired and lower mounting height of manual stations for the mobility-impaired.

This chapter covers fire service interaction with fire alarm systems and provides guidance to facilitate firefighters' operational efficiency. It is critical for fire alarm designers to confer with sprinkler and standpipe system designers; these systems are covered in Chapters 8 and 9, respectively. Elevator and smoke control systems, which are often interfaced with fire alarm systems, are addressed in Chapters 6 and 12, respectively. For systems to be effective they should be regularly inspected, tested, and maintained; impairment programs and maintenance are covered in Chapter 13.

Zoning and Annunciation

An annunciator panel — also called a zoning indicator panel — displays information about the location and type of alarm. This assists firefighters with their initial response and may help them track the spread of smoke or heat. The annunciated information can be displayed on the alarm system control panel for basic systems; otherwise a separate annunciator panel is provided (figure 11.2).

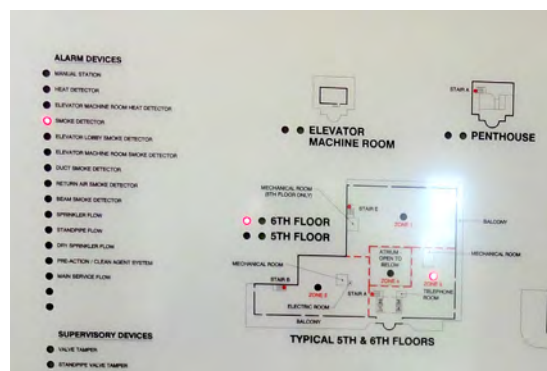

Photo: M. Smith

Figure 11.2. A close-up photo of a portion of an annunciator panel. The red lights indicate a smoke detector is in alarm mode in zone 3 on the 6th floor.

A building may have multiple annunciators to serve multiple entrances. Or, there may be different annunciators for different users —

such as the fire service, the security force, and building management. This manual focuses on annunciator features applicable to fire service use. Designers and code officials should always consult fire service response personnel on the design and location of these panels.

The location of an annunciator is critical to enable emergency responders to quickly determine the origin of the alarm and the status of related equipment. Typically, the best location is at the entrance where the fire service plans to initially respond. Keep in mind that this primary fire service entrance may not be the primary occupant or visitor entrance. Consultation with emergency responders is the only way to obtain this important piece of information.

In some large buildings, it may be beneficial to have duplicate annunciators at different locations. In buildings with a fire command center, an annunciator would be located within this room. However, depending on the room's accessibility, an additional annunciator may be appropriate at another entrance.

Each building should have its own annunciator, even if a single fire alarm control system serves multiple buildings. Fire service operations would be delayed if it were necessary for the initially-responding unit to report to a given building to check the annunciator, then relocate (or direct another unit) to investigate origination of the alarm. In large complexes, an additional master annunciator could assist the fire service in locating the building where an alarm originates.

Annunciators display information about signals in different ways:

- Directory — lamps or LEDs that are labeled with a description (figure 11.2)
- Textual (also called liquid crystal display (LCD) or alphanumeric) — static or running display that describes the signal (figure 11.3)

- Graphic — diagram showing floor layout(s), alarm information, and building information
- Computer workstation — with graphic floor plan software package



Figure 11.3 A textual-style annunciator panel with a touch-screen display.

Directory and textual annunciators are often supplemented with graphic diagrams. These diagrams and graphic annunciators are discussed in the following section. In simple systems where the control panel serves as the annunciator, its location and features should meet all annunciator requirements.

In buildings without a fire command center, the annunciator panel may store schematic building plans (see the **Fire Command Centers** section of this chapter and the **Interior Access** section of Chapter 6) to make them easily accessible to firefighters. Advance planning would ensure that the size of the panel accommodates this. A note outside the panel can indicate that it contains building plans or diagrams.

All annunciators show at least the type of alarm initiating device and the floor level where the alarm signal originated. Floor level designations must be consistent with stairs, elevators, and building directories to avoid confusion.

The larger a floor is, the longer time it will take firefighters to search for the alarm origination. Extended search times may translate into delayed fire suppression and longer times that the affected building will be evacuated or non-functional. Accordingly, large floors are typically split into two or more zones. These zones are normally limited to a maximum area as well as a maximum linear dimension.

Zone descriptors, whether they are labels next to lights or textual displays, should provide pertinent information to fire service personnel. Descriptors should be intuitive and rapidly decipherable to anyone unfamiliar with the building. For example, “pull station, dining exit” may be less intuitive than “pull station, northwest exit”, depending on the level of detail on the graphic diagram (see following section). Coded descriptors, such as WE-776, are meaningless to emergency responders. As the building, layout, tenants, or room names change, descriptors must be updated.

Flow switches or pressure switches indicate water flow. To direct firefighters to the appropriate area, it is important that the flow zone descriptor show the area covered by the sprinkler system because that is where firefighters will find the flowing sprinkler(s). The location of the switch itself is not important during an emergency incident.

Alarm devices indicate a situation requiring emergency action and normally activate evacuation signals. Examples include:

- Manual pull stations (also called pull stations or pull boxes)
- Sprinkler flow detectors
- Smoke detector (spot type or air-sampling type)
- Heat detectors
- Flame detectors
- Optical detectors

- Carbon monoxide detectors
- Dry chemical extinguishing systems
- Wet chemical extinguishing systems (typically protecting cooking equipment)
- Clean agent systems
- Carbon dioxide or other gaseous systems
 - Note: where zone sprinkler flow devices are provided to activate an alarm signal, any main or standpipe water flow indicators may be arranged to sound a supervisory signal, since they are effectively only monitoring the main feed or standpipe piping for breakage.

Smoke and heat detectors should be further identified on the annunciator by mounting location:

- Open area (ceiling)
- Underfloor
- Duct
- Air plenum
- Elevator lobby
- Elevator machine room or machinery space
- Elevator hoistway
- Stair shaft

Supervisory devices indicate abnormal conditions. They signal a need for non-emergency action, such as maintenance or repair, and they should not cause an evacuation alarm or notify the fire service. Examples include:

- Valve tamper switch (closed or partially closed water supply control valve)
- Dry sprinkler high or low air pressure switch
- Pre-action sprinkler low air pressure switch
- Water tank low temperature or low water level indicator
- Valve room low air temperature indicator

Some devices control certain building features, such as elevators, fans, doors, or

dampers. They may be shown as alarm or supervisory, depending on the preference of the code official or emergency responders. Examples include:

- Duct smoke detectors
- Air plenum smoke detectors
- Underfloor detectors
- Door closure smoke detectors
- Elevator hoistway smoke or heat detectors
- Elevator machine room or machinery space smoke or heat detectors
- Stair smoke detectors
 - Note: devices subject to frequent unwanted alarms (primarily smoke detectors in air ducts, air plenums, and elevator hoistways) are often arranged to activate a supervisory signal, since their main purpose is mechanical control rather than initiating occupant evacuation.

Status indicators give information about the condition of devices external to the alarm system. Examples include:

- Main system power on
- Main system trouble
- Fire pump running
- Fire pump fault
- Fire pump phase reversal
- Generator run
- Generator fault
- Stair doors unlocked
- Smoke control system in operation
- Elevator floor status

Controls and monitors for ancillary functions are routinely included on alarm panels or annunciators. These include:

- Fire pump start switches and indicators
- Generator start switches and indicators
- Egress or stair door unlocking switches
- Smoke control or smoke ventilation switches

Graphic Displays

Simple annunciators for small buildings will typically show alarm location in terms of floor levels only. If more specific location-related information is indicated, a graphic diagram will enable firefighters to quickly find the source of the alarm. Examples of this type of information are zone boundaries, room names, and room numbers. When an alarm originates from locations with designations such as “Zone 2 East,” “Suite 121,” or “Main Electric Room”, a diagram will help pinpoint those areas or their boundary.

The graphic display may be a separate, printed diagram mounted on the wall adjacent to the annunciator (figure 11.4). The diagram may be integrated with the annunciator, in which case it is called a “graphic annunciator” (figure 11.5). Some jurisdictions may require annunciators to be graphic type in certain situations.

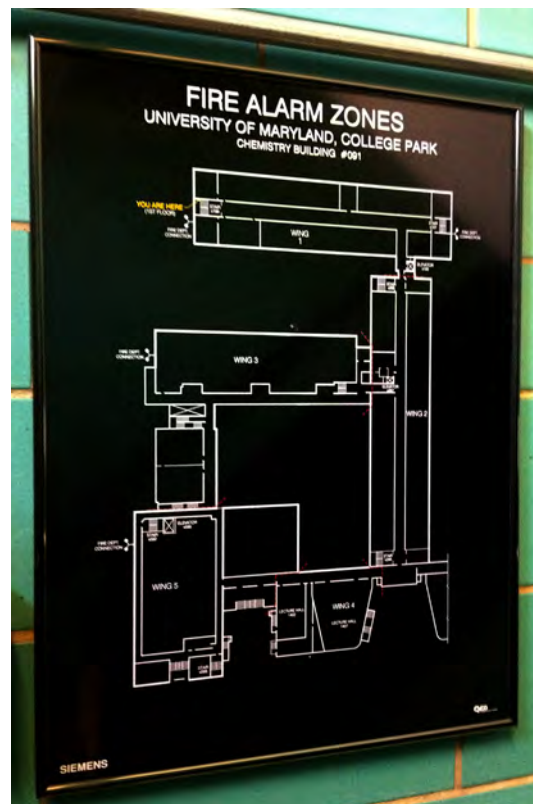

Photo: M. Chibbaro

Figure 11.4. A graphic diagram in a frame.

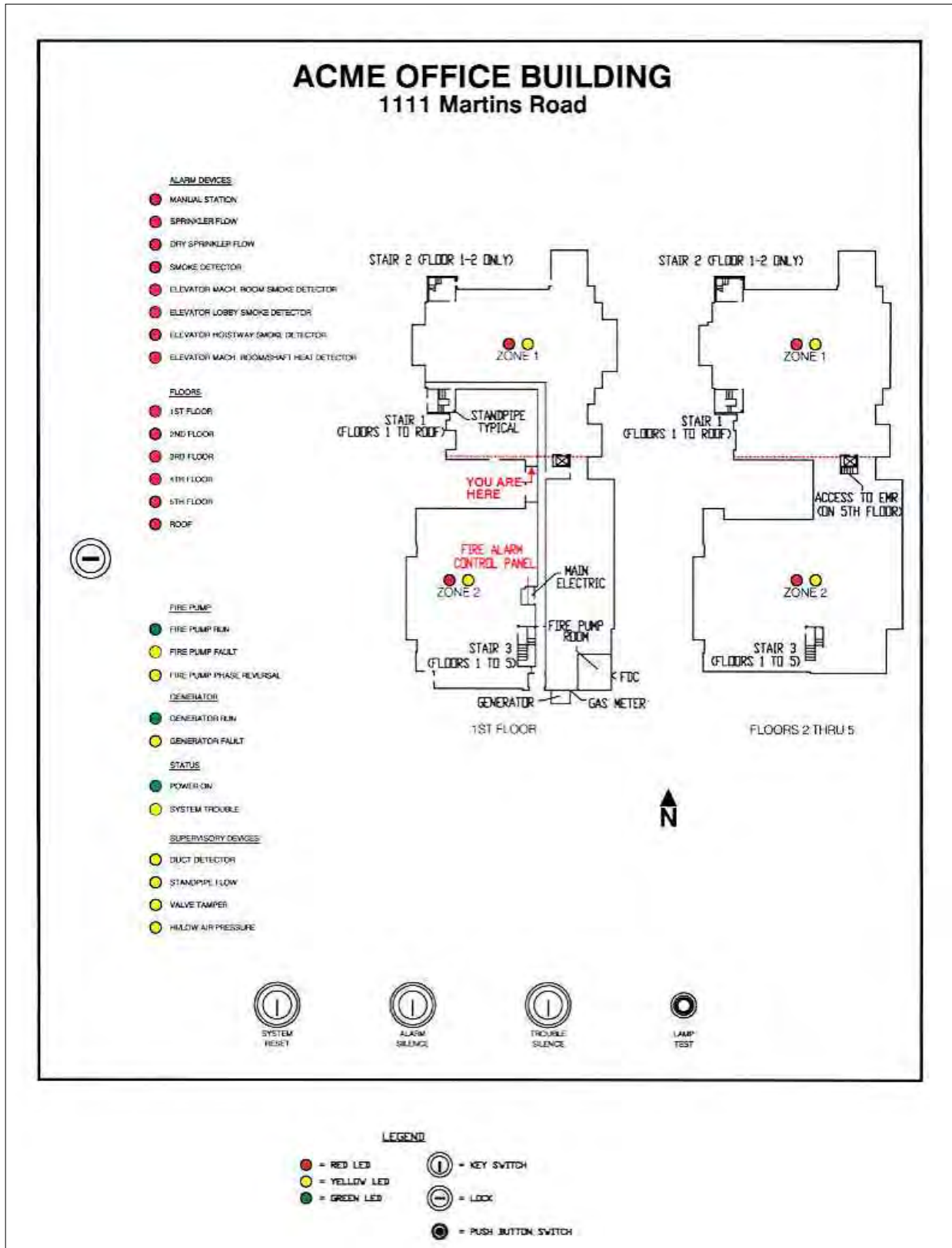

Diagram courtesy of Alarm Tech Solutions, LLC

Figure 11.5. A diagram of a well-designed graphic annunciator, with clearly organized and labeled lamps, as well as building features to assist the fire service.

The design of the diagram is very important to enable firefighters to rapidly obtain needed information. Fire services may have regulations or policies outlining their requirements or preferences. Some code officials or emergency responders require annunciators throughout their jurisdiction to have standardized features.

Proper orientation of the floor plans on the diagram will help firefighters to visually process the information it contains. When viewing the annunciator, the farthest point of the building beyond the annunciator's location should be at the top of the diagram. A "You Are Here" indicator on the floor plan shows the viewers where they are in the building.

Within the building's outline, zones are identified by the boundary lines between them. Likewise, for alarms designated by room, suite, or tenant, these specific locations are shown.

Often, sprinkler zones are allowed to be larger than zones for other alarm-initiating devices. This is because a flowing sprinkler is much easier to find than an activated heat or smoke detector. Careful coordination is important in this scenario to avoid confusion. If the sprinkler zone boundaries do not track along the other alarm zone boundaries, separate diagrams would be necessary for each.

In addition to information about floors, zones, and devices, many features of the building could be shown on the diagram. These include fire protection systems, building areas, and site features that the fire service needs to be aware of, including the following:

- Building address
- North direction arrow
- "You Are Here" indicator
- Nearby streets, especially if the building abuts more than one street
- Adjacent buildings
- Private fire apparatus access lanes

- Stairs, their identification, and the floors they serve
- Elevators, their identification, and the floors they serve
- Elevator machine rooms
- Exterior entrances
- Security, management, and maintenance offices
- Standpipe locations
- Standpipe riser isolation valves
- Sprinkler zone control valves
- Main water and sprinkler control valves
- Location of utility controls (electric, gas, fuel)
- Fire alarm control panel
- Standby generator
- Fire pumps
- Fire department connections
- Laundry rooms
- Trash or linen chutes
- Swimming pools

Designers and code officials should remember that modifications to the building or its layout may require changes to the graphic diagram. An annunciator with inaccurate information could be worse than no annunciator at all.

Engraved type graphic annunciators can be expensive to keep updated. Depending on the expected changes in a given building, it may be more appropriate and cost-effective to use an electronic annunciator that is much easier to revise. Technology is available to enable electronic annunciators to transmit their information directly to fire service apparatus via wireless communication.

Fire Service Notification

Building or fire codes may require fire alarm systems to automatically alert the responsible fire department, fire brigade, or other emergency response agency. Often an alarm service or off-site location will receive the alarm signal and then retransmit it to the response agency. Whether required or

optional, automatic fire service notification often results in the fastest response and therefore the best opportunity to affect rescues and limit property damage.

Reporting of the proper location is vital for responders. Fire alarm designers and code officials should consult emergency response personnel to determine how automatic alarms are to be reported. Considerations may include pre-incident plans, familiarity with the site, likely response direction, and location of hazardous materials.

It is crucial that the address reported to the fire service match the address where the alarm originated. If a building has multiple addresses, the one with the fire alarm annunciator or fire command center should be reported. If a building includes separate, independent annunciators, coordinate the remote signal with the correct annunciator location.

Larger buildings with multiple entrances for different sections, wings, or tenants can be confusing. If possible, remote fire service notification should include information on the section, wing, or tenant from which the alarm originates. This will help initially responding units to position properly. If the reporting system does not have this capability, another approach could be strobe lights at entrances corresponding to the alarm origination (figure 11.6).



Figure 11.6. This building has multiple tenants with different addresses fronting on two streets. Strobes outside each exterior tenant entry door indicate the tenant where an alarm originates.

Another feature to assist firefighters in multi-tenant buildings is supplemental tenant information signs (figure 11.7). These show a diagram of the overall building, the specific tenant location, a “You Are Here” indicator, and the location of other features such as the exterior entrances, the fire alarm control panel, the annunciator, and the fire department connection.

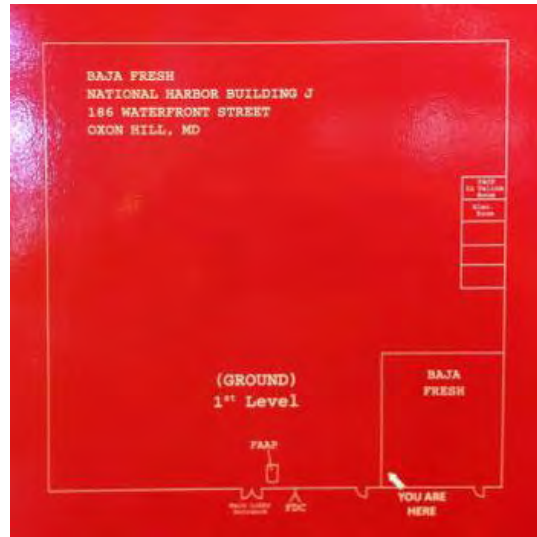

Figure 11.7. A supplemental tenant fire alarm information sign.

Unwanted Alarms

An unwanted alarm is an alarm condition that does not result from a hazardous or emergency condition. These cause the fire service to respond unnecessarily and desensitize occupants to alarm signals. Malicious alarms result from intentional acts. Unintentional (often called “good intent”) alarms occur when a person mistakenly believes a hazardous or emergency condition exists. Nuisance alarms are system responses to conditions that are not hazardous or emergency in nature. Unwanted alarms can also result from unknown or unidentified conditions. All efforts designers and code officials make to prevent any type of unwanted alarms will keep fire service responses to a minimum, thereby decreasing hazards to firefighters and keeping them available for actual emergency incidents.

Locating manual pull stations at the high point of the allowable height range will help keep small children away from them. Covers are also available (figure 11.8) that will sound a local alarm when raised to activate the pull station. These should reduce malicious alarms and are often used in schools, stores, and malls.



Photo: M. Chibbaro

Figure 11.8. A manual pull station cover.

Improperly located smoke detectors and smoke alarms will be subject to nuisance alarms. Locations likely to cause problems include those close to kitchens, air diffusers, and fans, as well as within elevator hoistways. Also, these devices are not designed for exterior use (figure 11.9). In such locations where automatic detection is required, heat detectors are often substituted.



Photo: M. Chibbaro

Figure 11.9. A smoke detector mounted in an outdoor location (an open parking garage).

Some smoke detectors have an adjustable sensitivity feature that can help prevent unwanted alarms. Sensitivity should be set very low for areas such as mechanical spaces and low for corridors and elevator lobbies. Sensitivity can be set high in rooms where the climate is highly controlled, especially if they contain high-value contents such as computer rooms.

Security alarm systems that emit smoke to confuse criminals can present a dangerous situation for firefighters. They can prompt false calls to the fire service, followed by the possibility of firefighters encountering criminal activity. Fire codes typically prohibit such systems. Where allowed, careful coordination with emergency responders would be important for their safety.

Many unwanted alarms can be traced to inadequate alarm system maintenance. Some jurisdictions assess fines for multiple responses to unwanted alarms. See [Chapter 13](#) for system maintenance and impairment programs.

Occupant Notification

The main purpose of notifying occupants of a fire or other emergency is to facilitate their appropriate reaction. The notification is often both audible and visual — the latter for occupants with hearing impairments. To successfully mitigate an incident, responding firefighters must coordinate their strategy with the actions of the occupants, provide them clear direction, and update them as the incident progresses.

Firefighters may need quick access to a fire alarm panel — to either activate or silence the occupant notification signals. Rooms or closets containing fire alarm panels should be provided with signage (figure 11.10). Directional signs could also be provided to show the direction to such rooms from the entry point.



Photo: M. Chibbaro

Figure 11.10 A sign on a door to a room containing fire alarm control panels (FACP).

Voice type alarm systems can greatly assist in the important communication between responders and occupants, but only if they are arranged to provide clear direction based on the desired egress scenario. Possible scenarios include full evacuation, partial evacuation, sheltering in place, relocation to refuge areas, or a combination of these. Occupant notification and the egress scenarios must also be coordinated with the door locking scheme, especially those doors in stairs.

Voice alarm systems automatically send a voice evacuation message to speakers — often only in selected areas of large or tall buildings. This selective evacuation is typical where general (total) evacuation is impractical, at least initially. Examples of such buildings are high-rises, hospitals, and large assembly occupancies. The voice messages can be pre-recorded or live (by properly-trained building staff).

A typical high-rise selective evacuation scenario would automatically send a pre-recorded message to the floor where the alarm originates and the adjacent floors above and below it. Another high-rise scenario could direct occupants to move to a designated refuge area or to another floor several floors below the incident.

Arriving firefighters can evacuate additional areas in a phased manner by manually activating one, several, or all floors with the manual-select switches in the command center. They can also override the pre-recorded message and broadcast live voice

announcements to any or all evacuation zones with a microphone at the command center. Visual indicators typically show which evacuation zones are activated at any given time (figure 11.11).



Photo: M. Smith

Figure 11.11. A voice alarm system panel with the door open. The microphone for live voice announcements is to the right of the red handset. The manual select switches and indicators for the different evacuation zones are shown. The red telephone handset is for the fire department communication system (see the following section) that is integrated with this panel.

The arrangement of selective evacuation notification zones depends upon the design of the building, its egress scenario, and its evacuation plan. Each floor level is typically one notification zone when the floors provide a complete fire-rated barrier. Each floor space divided by fire or smoke barriers to enable occupants to take refuge on either side would be provided with multiple notification zones. Boundaries of those zones within a given floor must coincide with those barriers.

Conversely, floors that are physically open to one another should be arranged as a single notification zone. Occupants of these floors can be exposed to the same heat and smoke conditions. Also, the single notification zone avoids the confusion possible when occupants in portions of the space hear an evacuation signal, but cannot clearly decipher it. A common example of

this situation is a series of parking garage levels connected by open ramps (figure 11.12). Such interconnected levels are often arranged as a single notification zone for the “floor, floor above, and floor below” selective evacuation scenario.



Figure 11.12. This high-rise building has three garage levels interconnected by open vehicle ramps. Those three levels have a single occupant notification zone.

Speakers are often omitted from stairs, exit passageways, and elevator cabs because occupants either spend little time in these areas, are already exiting, or will encounter others exiting. Speakers in such areas can also cause confusion because they may be heard in many other areas, including those where occupants should be remaining in place. A third issue with any alarm notification device in stairs is the negative impact on communication among firefighters using the stair for entry and staging.

However, in some special circumstances, such as very tall buildings where occupants may be in exit stairs or exit passageways for extended time frames, speakers may be provided in such areas. Speakers in each such area should be arranged as a single notification zone with manual-only selection capability for the responders staffing the fire command center.

For similar reasons, atriums and other large open spaces spanning multiple floors are challenging in buildings with selective evacuation. Again, coordination with the building’s egress scenario and evacuation

plan is important. The entire atrium will likely comprise one occupant notification zone. It may be desirable to activate only the atrium zone upon receipt of an alarm signal from within the atrium, and not from alarm signals in other areas. Designers should consider the audibility and legibility of signals in areas adjacent to the atrium to minimize occupant confusion.

Fire Department Communication Systems

Fire department communication systems are two-way telephone systems typically found in high-rise buildings. The system’s control unit has a main handset for use by the fire service commanders (figure 11.13) and is usually located in the fire command center (see the following section). Either handsets or jacks for handsets (figure 11.14) are then placed in areas of the building for firefighters to communicate with the command center.



Figure 11.13. A fire officer speaking into the main handset at the control panel for a fire department communication system. This panel also houses the portable handsets used by firefighters at remote jacks.



Figure 11.14. A firefighter training to use a handset in a remote jack located inside a stair.

If the system uses jacks, a number of portable handsets with plugs are provided in the command center for distribution to firefighters. If handsets are provided at all remote locations, portable handsets are not necessary.

Designers and code officials should plan for handsets or jacks in locations where firefighters are likely to be operating. Typical locations include each level within exit stairs, elevator cabs, elevator lobbies, elevator machine rooms or machinery spaces, fire pump rooms, emergency or standby power rooms, and areas of refuge.

In some jurisdictions, particularly for new buildings, fire service radio signal enhancement systems (see [Chapter 12](#)) may be preferred over, or allowed instead of, fire department communication systems. Firefighters are often much more comfortable using the radios they regularly use rather than a separate system they may not be familiar with or confident using. Where radio signal enhancement systems are not required, code officials may consider an equivalency or modification to allow them to substitute for the fire department communication systems discussed in this section.

Fire Command Centers

High-rise buildings often have a dedicated room or other location containing fire alarm and related fire protection and utility control equipment. Building and fire codes mandate these for newer high-rises. NFPA 72 refers to them as Fire Command Centers; other terms used include Central Control Station, Emergency Command Center, and Fire Control Room. Fire command centers provide a single location for all equipment that incident commanders would need during an emergency incident.

Items in a fire command center vary by the code(s) in effect. Equipment related to the alarm, detection, water flow, annunciation, smoke control, and communication systems are included, as are related functions

and controls such as stair unlocking, air handling systems, and emergency or standby power. Other helpful features are an outside phone line, area of refuge emergency communication equipment, video monitoring equipment, elevator emergency communication equipment, elevator status indicators, building information cards (see the [Building Information](#) section of [Chapter 7](#)), hazardous materials information, emergency contacts, schematic building plans, and a work table to facilitate referencing these materials. Furthermore, code officials or emergency responders may have requirements or preferences regarding how the various panels are arranged within the center (figure 11.15).



Photo: M. Smith

Figure 11.15. The inside of a fire command center.

The schematic building plans in the fire command center should not be detailed construction plans; rather, they should be simple firefighter-friendly plans showing features that will help firefighters determine their strategy and tactics. These features include the floor layouts, fire- and smoke-rated walls, egress and access, fire service elevator lobbies, and fire protection equipment. These same plans should also be provided to emergency responders for pre-incident planning.

Fire command centers are usually separated from other building areas by fire-rated construction. Many jurisdictions desire fire command centers to have an exterior

entrance (figure 11.16). Others permit the fire command centers to be within entrance lobbies or other approved locations. Some jurisdictions may even require underground tunnel access for protection from falling glass and debris. Regardless of location, they should be prominently marked. The center's walls and doors should have no ordinary glass windows — both for security and for protection from severe weather.



Photo: M. Chibbaro

Figure 11.16. A fire command center (right) with an outside entrance next to main building entrance (left). Note the proximity of a key box (on a pedestal) and the fire department connection.

Fire command centers must be locked for security but should not be located where they are difficult for emergency responders to access or could become inaccessible during foreseeable emergencies (figure 11.17). If a key box is provided, it should contain a control room key. It may also be desirable to arrange the fire alarm system to automatically unlock the fire control room

door and any intervening doors or gates leading to the fire service access point. These unlocking features must be balanced with security concerns.



Photo: M. Chibbaro

Figure 11.17. A fire command center (behind the red door) in a parking garage. To access this room, firefighters must make entry through a steel vehicle entry gate; however, it opens automatically upon fire alarm activation. A nearby car fire could render this room inaccessible even though its walls and door are fire-rated.

If a building has multiple fire command centers, visual indicators outside the rooms should show, at a glance, which center is active at any given time. Each fire command center should also have a visual indicator inside to show that another command center is active.

Another important consideration is the size of the room. Space is needed to accommodate a table and to access all the equipment in the room. The table is intended to help incident commanders consult plans for the building and fire protection systems. If the center is used for other purposes (such as security), additional space should be provided beyond that required or needed for the fire protection features.

Questions to Ask – Fire Alarm and Communication Systems

- Is a fire alarm annunciator needed?
- Where must the annunciator be located?
- What information must the alarm annunciator show?
- Are floor level designations coordinated with elevators and stairs?
- Must large floors be split into multiple alarm zones?
- Do sprinkler zones indicate area covered rather than location of flow indicator devices?
- What control features must be included on the annunciator?
- Must devices subject to unwanted alarms be arranged to sound supervisory signals?
- Must a graphic diagram be on or adjacent to the annunciator?
- What features must be shown on the graphic diagram?
- Is the orientation of the graphic diagram coordinated with its location in the building?
- Are separate sprinkler graphic diagrams necessary?
- Does the alarm system remotely report the correct address, location, wing, or tenant?
- Does the remote reporting direct firefighters to the entrance with the alarm annunciator or fire command center?
- Have systems been designed, and devices been located, to minimize unwanted alarms?
- Are voice alarm systems coordinated with the building egress scenario and the door locking scheme?
- Are selective evacuation zone boundaries coordinated with fire or smoke barriers?
- Should areas or floors open to one another have a single selective evacuation zone?
- How should selective evacuation notification devices be handled for elevators, stairs, and open areas such as atriums?
- Can a radio signal enhancement system substitute for a 2-way fire department communication system?
- Where must jacks or handsets be located for a fire department communication system?
- Must the fire command center be in a dedicated room? Must it have an outside entrance? How is it protected from fire and other hazards?
- What fire protection equipment must be in the fire command center?
- What supporting equipment must be in the fire command center?
- Are there preferences for how the various panels must be arranged in the fire command center?
- How large must the fire command center be?
- What visual indicators should be provided for multiple command centers?
- Have emergency responders been trained on system features and operations?

Resources

- IFC
- NFPA 1
- NFPA 70, *National Electrical Code*
- NFPA 72, *National Fire Alarm and Signaling Code*
- NFPA 170, *Standard for Fire Safety and Emergency Symbols*
- FM Global Data Sheet 5-40, *Fire Alarm Systems*
- OSHA Standard *Fire detection systems*, 29 CFR 1910.164
- OSHA Standard *Employee alarm systems*, 29 CFR 1910.165

CHAPTER 12 OTHER SYSTEMS

This chapter addresses several protection systems not covered in previous chapters. **Chapter 13** covers impairment programs and the maintenance of all systems discussed in this chapter. Emergency responders would also benefit from system installers providing them training on the operation of protection systems with which they will interact. This is discussed in more detail in **Chapter 13**.

Firefighter Radio Signal Enhancement Systems

Communication is vital during an emergency incident. Mobile radios (those mounted in vehicles) and portable radios (hand-held — figure 12.1) are used by firefighters and fire officers to transmit and receive important information such as the location of occupants or fire advancement reports. In some cases, emergency transmissions can be crucial to firefighter safety — for example, evacuation orders or mayday calls.



Photo: G. Ellman

Figure 12.1. A fire officer transmitting on a portable radio from an exterior balcony.

Radio signals are frequently unreliable inside buildings and other structures such as tunnels. Construction materials, earth, and changes in the radio frequency environment can greatly reduce the strength of radio signals. Window coverings, reflective film, photovoltaic coverings, and insulation systems can affect radio signal strength.

A firefighter who is inside and unable to transmit must relocate closer to an exterior opening (figure 12.1), move to a different floor, use an alternate means of communication, resort to runners, or relocate to enable direct voice communication. Numerous NIOSH firefighter fatality investigation reports cite inadequate communication as a factor in the outcome.¹⁴

For many years the fire service has struggled with radio communication problems in the built environment. The communication problems encountered by the Fire Department of New York at the World Trade Center on September 11, 2001 are well documented by NIST.¹⁵ The NIST report brought to the forefront several communication issues at this large scale incident. For example, after the collapse of the South Tower, many firefighters in the North Tower were unable to receive **evacuation messages**.

Unfortunately, alternate means of communication cannot always be relied upon. Cell phone signals are affected by the same factors as radio signals. Land line phones can allow firefighters to communicate with dispatchers, but not with other units. In addition, land line phone systems may be affected by the incident occurring in the building.

The **Fire Department Communication Systems** described in Chapter 11 are intended to provide a means of communication within buildings where radio transmissions are difficult. However, they are limited by the locations of phone jacks or handsets. Messages must often be relayed between the communication systems and fire service radios. Also, the maintenance of these systems is not under the control of emergency responders.

14. NIOSH Firefighter Fatality Investigation program, <http://www.cdc.gov/niosh/fire>

15. NIST World Trade Center Disaster Study, <http://www.nist.gov/el/disasterstudies/wtc>

All of these factors may delay operations, create greater challenges for firefighters, and even place firefighters in danger. Communication technology is available to improve signal transmission within buildings and allow emergency responders to use their ordinary portable radios rather than alternative communication means. Compliance could involve an installed communications infrastructure (figure 12.2).

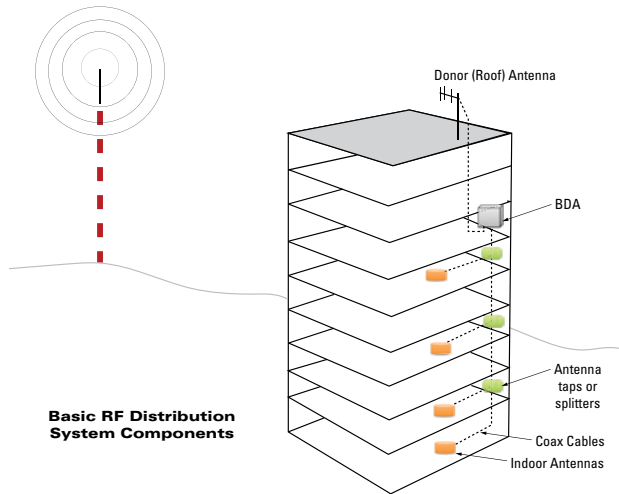

Figure 12.2. A schematic showing communication infrastructure within a building.

Passive communication infrastructure functions as a conduit that assists in the transmission of signals. For example, a passive antenna system includes both an internal and an external antenna, connected with a coaxial cable. A radiating cable, also known as leaky coax, is a network of coaxial cables with slots in the outer conductor that create a continuous antenna effect.

Active communication infrastructure involves powered signal boosters to amplify and retransmit signals. One type of signal booster is known as a bi-directional amplifier, or simply BDA. These devices amplify signals passing through the passive infrastructure. Active infrastructure can be particularly beneficial in larger, diverse areas that need a radio coverage solution.

Some fire service organizations use mobile signal boosters or repeaters. These are carried by fire service units to an incident scene. Some emergency responders and code officials prefer mobile boosters rather than the fixed signal boosters installed within buildings.

Fire codes may specify required levels of radio coverage for emergency responders — in some cases even for existing buildings. Local laws in several U.S. cities contain specific requirements for passive and/or active communication infrastructure. Any building or structure, except very small ones, can be candidates for this. High-rise buildings, large floors, and underground levels can particularly benefit from this technology. Codes or code officials may allow proof of adequate radio coverage to substitute for **Fire Department Communication Systems** as discussed in Chapter 11.

Proper system performance must be specified to help ensure proper effectiveness. Considerations include signal strength, area coverage, reliability, secondary power supply, and interference filters. Acceptance testing (upon completion) and periodic testing (ongoing) are important for reliability.

Firefighter Air Replenishment Systems

Firefighters use self-contained breathing apparatus (SCBA) for interior firefighting and other dangerous environments. SCBA air is contained in pressurized cylinders that have a limited capacity. When depleted, these air cylinders need to be refilled or replaced with full ones (figure 12.3). Some fire service organizations have specialized vehicles that contain air compressors or air refill systems known as cascade systems that refill breathing air cylinders at fire scenes.



Photo: David Purcell, Post Road Photos

Figure 12.3. An SCBA cylinder being replaced at a fire scene.

Traditionally, breathing air cylinder replacement in a tall building consists of a shuttle system. Firefighters carry full air cylinders to a staging area, where they are swapped for empty ones. Other firefighters must transport empty cylinders back to a replenishment location outside. Every firefighter performing such operations is unavailable for firefighting, rescue, and other activities.

An example of the logistical challenge is the 1988 First Interstate Bank Building high-rise fire (figure 12.4), during which 600 air cylinders were used in the hours-long firefighting operation.¹⁶ During the 1991 One Meridian Plaza high-rise fire, 100 firefighters were needed to perform support operations such as air cylinder replenishment. Three firefighters died when they ran out of air several floors above the fire. Eight additional firefighters from a search team also ran out of air but were rescued by helicopter from the roof.¹⁷



Photo: USFA

Figure 12.4. An SCBA staging area during the First Interstate Bank Building fire.

16. Fire Engineering, "The Case for Interior High-Rise Breathing Air Systems."
 17. Ibid.

A firefighter air replenishment system (FARS) is a system of piping within a tall building or a large structure that enables firefighters to refill their breathing apparatus cylinders at remote interior locations. These systems are essentially air standpipe systems that substitute for the cylinder shuttle operation described above. This makes emergency operations more efficient by reducing the time and personnel needed for logistical support. Several jurisdictions require FARS for high-rise buildings or long underground tunnels. Proper function depends upon careful design, installation, and maintenance.

A FARS consists of a piping distribution system that runs from a supply point to interior fill stations or fill panels. Fill panels contain short sections of hose with connections that fit firefighter's air cylinders (figure 12.5). Fill stations are larger rooms or closets in which cylinders are replenished. Both fill panels and stations have the necessary valves, gauges, regulators, and locks to prevent tampering. The mounting height of air hoses should facilitate easy connection of cylinders.



Photo: S. Stookey

Figure 12.5. A breathing air fill panel with its door open showing air hoses.

Typical locations for fill panels or stations are in or near stairs on every second or third floor. Emergency responders or code officials may prefer they be located just outside enclosed, fire-rated stairs. This

enables firefighters to set up a replenishment operation in safe proximity below the fire but away from the traffic within the stairs (whether firefighters or occupants). Signage within the stair enclosure can indicate the location of fill panels or stations — for example, “Breathing Air Fill Panel, Through Door and 10 Feet to the Right”. Some code officials and emergency responders may prefer that fill stations be located inside stair enclosures. This necessitates careful consideration and coordination with the emergency response procedures. Additional space may need to be allocated within stairs for refilling operations to prevent impediments to occupant egress and firefighter entry (figure 12.6).

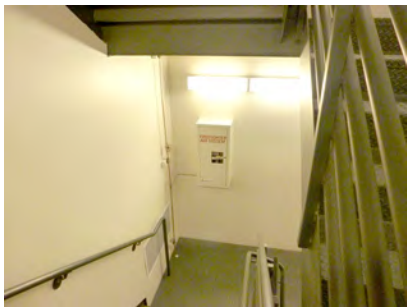

Figure 12.6. A breathing air fill panel and piping in a stair. Conducting replenishment operations within a stair may cause a traffic bottleneck.

For tunnels, designers should locate fill points a reasonable spacing apart; for example, one at each standpipe outlet or at each exit.

Two supply options are available for FARS. Where the fire service has one or more mobile air supply units, an exterior fire department connection panel (FDCP) can be provided (figure 12.7). The other option is a fixed air storage system within the building. For large buildings such as high-rises, multiple FDCPs may be provided. Some responders or code officials may desire or require both a fixed air supply and an FDCP.



Figure 12.7. An exterior FDCP being supplied by a fire service mobile air unit.

All FDCPs should be in locked, weather-resistant enclosures marked to indicate their use. Many of the design considerations in [Chapter 10](#) apply to FDCPs. All of the apparatus access considerations in [Chapter 3](#) also apply. The clear height and width would need to accommodate only the air supply unit if access is not needed for larger fire apparatus.

Reliability features are very important for FARS. The piping should stay pressurized and the system should include a low air pressure monitoring device. Continuous monitoring of critical attributes (such as oxygen content, contaminant gases, and moisture) is preferred and may be required. For adequate protection throughout an incident, all components of the system should be separated from other portions of the structure by fire-rated construction — perhaps a rating equivalent to that required for stair enclosures. All panels must be lockable, and the emergency responders should dictate key locations. Isolation valves may be needed — both for air piping risers (see the [Isolation Valves](#) section of [Chapter 9](#)) and for individual fill panels and stations. All system components, panels, and piping should be clearly marked as firefighter breathing air systems.

The performance of the entire FARS should be clearly specified. This may include the number of air cylinders to be filled simultaneously at remote locations, the fill pressure, and the

fill time. This will dictate design details such as the distribution piping size and air storage cylinder capacity. All components should be specified for use with breathing air and marked to indicate their use.

Proper design, approval, installation, testing, and maintenance are crucial for FARS. An acceptance test after installation, including air quality analyses, would serve to verify system design and installation. Ongoing periodic testing after acceptance will help ensure continued reliability.

Backup Power Systems

Building codes, fire codes, and life safety codes specify systems to provide backup power for various building features when normal utility power is out of service. Applicable consensus standards include NFPA 70, *National Electrical Code* and NFPA 110, *Standard for Emergency and Standby Power Systems*. OSHA addresses electrical systems in **Subpart S of the General Industry standards**. Several categories exist for different levels of backup power.

One category of backup system is emergency power systems. These provide backup power to systems or features that protect occupants while evacuating a building. Examples include illuminated exit signs, emergency lighting, fire alarm and detection systems, occupant-egress elevators, and electric fire pumps. Such systems and features are the first to be switched over automatically to backup power.

Many systems or features provided with emergency power have secondary roles that provide protection to emergency responders. Emergency lighting aids entering firefighters as well as exiting occupants. Fire alarm system annunciators provide critical information to firefighters. Fire pumps often feed standpipe systems as well as sprinkler systems.

A second category of backup system is legally required standby systems. These typically provide backup power to systems or

features that assist emergency responders. Examples include firefighter access elevators, lighting for fire command centers, equipment supporting smokeproof enclosures, and fixed radio signal enhancement systems. Such systems and features also automatically switch to standby power, but typically after emergency power systems are switched over.

Firefighters are particularly dependent upon systems or features classified as standby systems in high-rise buildings, as discussed in the **Challenges** section of Chapter 2. Loss of emergency power was cited as a factor in the 1991 One Meridian Plaza high-rise fire that killed three firefighters.¹⁸

A third category of backup power is optional standby systems, which provides backup power to systems and features that are important for operation of the facility but generally do not affect the safety of occupants or emergency responders. Examples include HVAC, data processing, and industrial process equipment. Such systems are typically switched to backup power manually rather than automatically.

Generators are often located outside, giving firefighters easy access while protecting the generator from a fire or other emergency within the building. If a generator must be located within a building, consider how firefighters will access it and how it will be protected from fires, flooding, and other hazards.

Generators are monitored for several conditions. Remote indications of these conditions and control features are often incorporated into fire alarm annunciators or fire command centers (see **Chapter 11**). These enable the fire service to quickly identify the generator's status or start the generator if not running.

18. Federal Emergency Management Agency, "Special Report: Operational Considerations for Highrise Firefighting", USFA-TR-082, April 1996.

Firefighter Emergency Power Outlet Systems

Firefighters regularly use electric power for lights, ventilation fans, and other tools. In large or tall buildings they must run extensive lengths of electric cords to feed equipment in remote areas of the building. A fixed, emergency power outlet system built into the building can substitute for these long cable runs, and save time and effort. This is analogous to standpipe systems substituting for long hose lays. One approach is to require an emergency power outlet system whenever standpipes are required (figure 12.8).



Figure 12.8. A firefighter emergency power outlet next to a standpipe fire hose connection.

One or more dedicated electric circuits feed a series of emergency power outlets. Electricity is fed to these circuits in one of two ways. The first arrangement is from the building's electric supply on an emergency circuit ahead of the main power shutoff. The outlets should be fed by backup power systems in buildings so equipped. The second arrangement is to provide an electrical inlet connection that would be fed by the generators on responding fire apparatus.

The plug type the fire service uses for its electrical equipment determines the outlet and inlet type (figure 12.9). The wiring methods and overcurrent protection must meet applicable standards, which may include **Subpart S of OSHA's General Industry standards** and any other local or state electrical codes in effect.



Figure 12.9. A weather-resistant outlet cover opened, showing a twist-lock type of outlet.

Typical outlet locations include every level in or near each enclosed stair, or next to each standpipe fire hose connection. Mark receptacles so that firefighters can spot them easily. For example, the designer could specify that each be painted red and labeled "For Fire Service Use Only."

Smoke Control and Ventilation Systems

Smoke control systems are mechanical systems that control the movement of smoke during a fire. System types include smoke exhaust systems (figure 12.10) and stair pressurization systems (figures 12.11 and 12.12). Other buildings may be equipped with zoned smoke control systems where zones or floors are either pressurized or exhausted to keep smoke from spreading. Building codes specify when to provide which systems. NFPA has developed three installation standards that cover various types of smoke control systems.

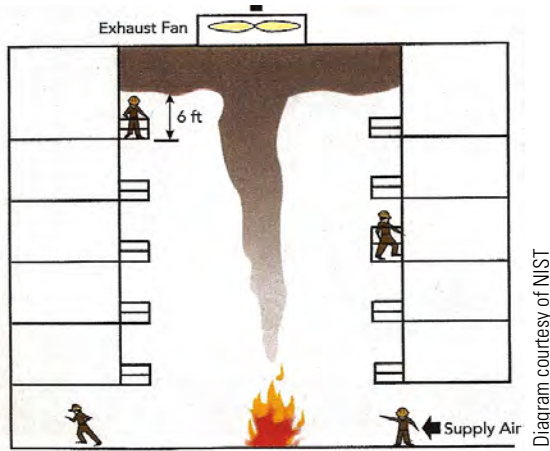

Figure 12.10. A diagram of an atrium smoke exhaust system.

Diagram courtesy of NIST

The primary purpose of most smoke control systems is to protect occupants while they are evacuating or remain in a refuge area. These systems are usually activated automatically (by detectors or suppression systems). Systems that are not zone-dependent (such as stair pressurization systems) can also be activated by manual pull stations.

The forces exerted by air movement when smoke control systems operate can result in egress doors becoming hard to open. This can be a life safety issue for both occupants and firefighters. Conversely, air flow can cause fire-rated doors to remain open when they should self-close, thereby compromising the integrity of fire barriers. Careful design must consider egress door opening force limits and fire door integrity during all system operating modes. Thorough testing should follow — to verify both proper smoke control activation and compliance with egress and fire-rating requirements.

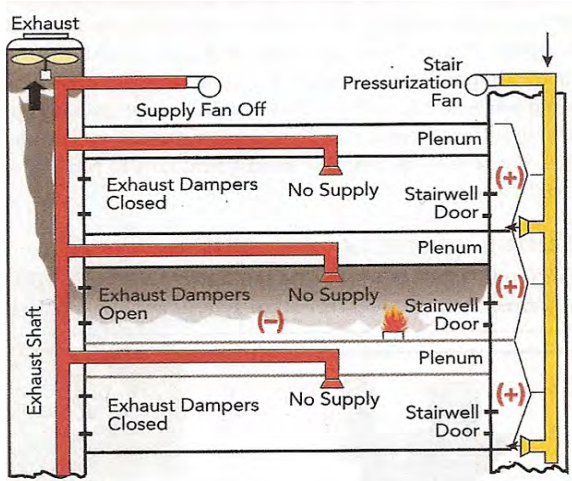

Figure 12.11. A diagram of an exhaust system (left) and a stair pressurization system (right).

Diagram courtesy of NIST

Firefighters have some level of manual control over smoke control systems during an incident. These manual controls should be designed as preferred by emergency responders. When firefighters arrive, they can assess whether the automatic modes are functioning as intended. Incident commanders may then use the manual controls to select a different mode or turn any given zone off. It is imperative that these fire service controls override any other automatic or manual controls at any other location. Also, similar to fire alarm annunciators, the fire service may have specific requirements or recommendations, and may prefer uniformity of panels within their jurisdiction.



Figure 12.12. A stair pressurization fan.

Photo: M. Smith

An easy-to-understand smoke control panel will assist a firefighter who may be trying to decipher the controls after awakening in the middle of the night. A simple, straightforward panel layout might feature a single switch for each system or zone (figure 12.13). Each

different position of the switch places the system in a specific mode; the corresponding activation or setting of the individual fans, dampers, etc. would be configured behind the scenes. For example, a stair pressurization system might contain a three-position switch for each of three modes: automatic, pressurize and off.

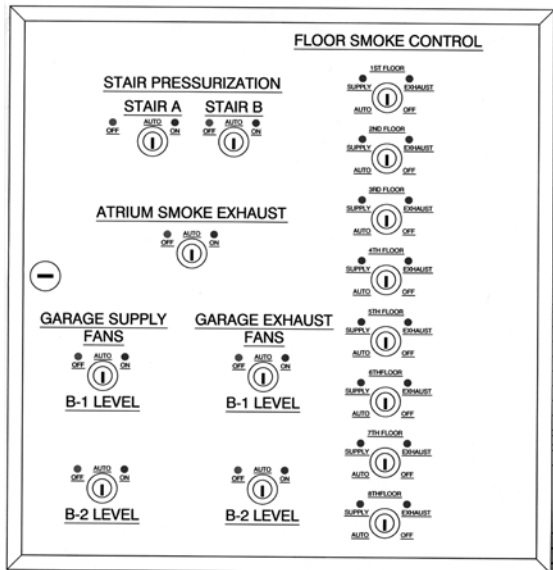

Figure 12.13. An easy-to-understand diagram of a panel for several types of smoke control systems. Each system and zone has a single, clearly labeled switch to select each mode.

Some jurisdictions may desire that smoke control panels provide visual verification that individual system components have activated. For example, indicator lights could be provided to show that each fan has activated and each damper has opened or closed, according to the system design (figure 12.14).

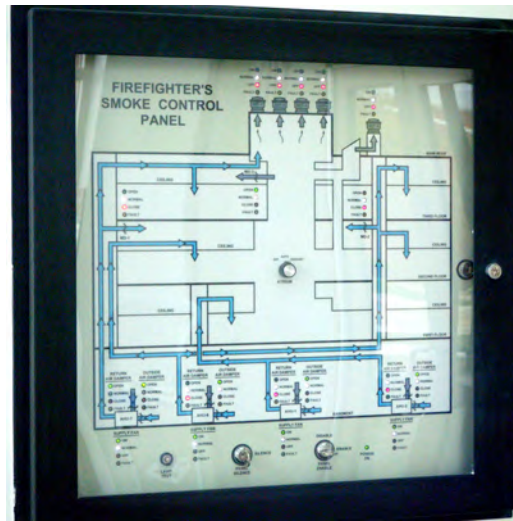

Photo: G. Havel

Figure 12.14. A panel for a smoke exhaust system in an atrium. The switch in the center allows simple control. The lights provide positive indication of the operation of individual fans and dampers.

Other jurisdictions may prefer that smoke control panels provide individual control over system devices such as fans and dampers. This level of sophistication should be accompanied by a corresponding level of training for all emergency responders who would need to use the system control panels.

Zoned smoke control systems are often arranged with each floor as a separate zone. In other cases, a floor may be split into multiple zones. These should be indicated on a graphic display, either on or adjacent to the smoke control panel. See the [Graphic Displays](#) section of Chapter 11 for additional guidance.

Smoke removal systems assist firefighters in the removal of smoke after a fire is extinguished. These are mechanical systems designed for a certain capacity without recirculating air back into the building. They are often arranged to be activated manually.

Other smoke removal features include operable windows or smoke vents (figure 12.15) distributed along walls or roofs. Windows are intended to be opened manually by firefighters. Smoke vents can be arranged to activate either manually or automatically, depending on the overall fire safety design approach in the building.



Photo: M. Chibbaro

Figure 12.15. A smoke vent at the top of a stair.

Questions to Ask - Firefighter Radio Signal Enhancement Systems

- Is fixed communications infrastructure needed?
- What is the radio system coverage of the responding fire service?
- What design and reliability criteria must be specified?

Resource

- IFC

Questions to Ask - Firefighter Air Replenishment Systems

- Will a firefighter air replenishment system be needed?
- Are fill stations or fill panels preferred? On which floors? At what locations?
- What signage is desired to indicate locations of fill stations or fill panels?
- Will fire department connection panels be needed? How many? At what locations?
- Will a fixed air supply be necessary?
- What design and reliability criteria must be specified?
- Are all panels and rooms with breathing air equipment lockable?
- Are all panels and piping marked?
- What criteria will constitute an acceptable acceptance test?
- Have emergency responders been trained on system features and operations?

Resources

- IFC
- International Association of Plumbing and Mechanical Officials, Uniform Plumbing Code, Appendix F, *Firefighter Breathing Air Replenishment Systems*

Questions to Ask – Smoke Control and Ventilation Systems

- Are smoke control switches designed for simple, straightforward operation?
- Are smoke control zones coordinated with fire/smoke barriers and other fire protection systems?
- Should smoke vents be provided?
- Must vents be manually or automatically operated?
- Where should manual vent controls be located?
- Which devices should activate automatic vents?
- Have emergency responders been trained on system features and operations?

Resources

- NFPA 92, *Standard for Smoke Control Systems*
- NFPA 92A, *Standard for Smoke Control Systems Utilizing Barriers and Pressure Differences*
- NFPA 92B, *Standard for Smoke Management Systems in Malls, Atria, and Large Spaces*
- NFPA 204, *Standard for Smoke and Heat Venting*
- OSHA *Electrical Standard*, 29 CFR 1910 Subpart S

Questions to Ask – Emergency Power Systems and Firefighter Emergency Power Outlets

- Which systems must be provided with emergency power?
- Which systems must be provided with standby power?
- Is a firefighter emergency power outlet system required?
- Will the power outlet system be fed from the building's electrical system or through a fire service inlet?
- How should the outlets be wired for reliability during an emergency?
- What plug type is used by the fire service?
- Where must outlets be located? How should they be marked?
- Have emergency responders been trained on system features and operations?

Resources

- NFPA 70, *National Electrical Code*
- NFPA 110, *Standard for Emergency and Standby Power Systems*
- OSHA *Electrical Standard*, 29 CFR Part 1910, Subpart S

CHAPTER 13

BUILDING PHASES

Fire service needs span the entire lifetime of a building. Consideration begins as early as the concept and design phase and continues through construction, when a building is occupied, and during demolition. Communication among all stakeholders is important during each phase. Stakeholders include code officials, emergency responders, design professionals (architects, engineers, planners, and design technicians), construction professionals (contractors, subcontractors, and construction managers), building owners and developers, and security professionals.

There are two general considerations for everyone involved to remember. First is the integration, throughout all building phases, of the appropriate features covered in other chapters of this manual that facilitate fire service operations. This chapter addresses how these features can be applied effectively during various phases of a building's life.

Secondly, any features that help protect workers or occupants will also reduce the frequency or severity of incidents to which the fire service must respond (figure 13.1). Accordingly, the safety and health of workers should remain a high priority for both the sake of workers and the safety of emergency responders who are called upon when an emergency occurs, whether fire-related or otherwise.



Figure 13.1. Fire service crews clearing the scene of a construction site rescue.

Concept and Design

Communication

The concept phase is the time period before any design work has begun. During this phase, a general idea of the building size and occupancy type(s) are developed. Only rather general planning of fire service features is possible. However, this is where communications among the stakeholders must begin.

Early and regular contact between designers and code authorities can establish communication that is vital to efficient incorporation of code requirements — both those that address construction hazards as well as those that apply to the finished building. Jurisdictions frequently issue amendments to the national model codes. Both the basic codes and amendments leave room for interpretation to accommodate the wide array of sites and structures. The earlier the code officials' interpretations and expectations are understood, the more efficiently the design and construction phases can proceed. This, in turn, translates into time and cost savings for the owner or developer, as well as facilitating timely incorporation of fire service features.

Designers and code officials are also encouraged to obtain emergency responders' views as early as possible. In some cases the code officials are able to speak for responders, but do not assume that is always the case. Try to learn about everyone's responsibility and authority during this phase to avoid surprises later. This will increase the chances of projects proceeding smoothly, on-time, and within budget.

Advance Planning

The subsequent construction phase will likely proceed more efficiently if designers and code officials give advance thought to how construction and occupancy will progress. Addressing these issues clearly on design and permit documents can help avoid conflicts.

Coordination in advance will help to maintain the features discussed below. These features include fire apparatus access, water supply, firefighter access, temporary standpipes, staging for combustible materials, proper locations for hazardous materials, and egress/access for partially occupied areas. Design documents should mandate proper phasing and code officials should follow up with effective enforcement. For long-term or unusual projects, a formal phasing plan may be beneficial.

Buildings or complexes that are to be initially occupied in stages will also proceed more smoothly with proper advance planning. Speculative spaces are those intended to be subdivided into separate tenants (figure 13.2). Examples include shopping centers, office buildings, or industrial complexes. Individual tenant occupancy will usually occur in stages.



Figure 13.2. A new, partially-occupied, speculative office building.

Code officials will often mandate that means of egress and protection systems be in service for occupied portions of a building. Designers can facilitate this by planning ahead. For example, a shopping center must have its water supply in place before any individual tenant can be sprinklered. This is complicated further when a single water supply or fire pump feeds several buildings. The **Occupancy** section below discusses partial occupancy in greater detail.

Subsequent sections of this chapter suggest areas where advance planning during design (and on the design and permit documents) can be beneficial. These areas include pre-incident planning, system impairment programs, and temporary features (during both construction and demolition).

Permit Process

The design phase includes the site, the building itself, utilities that serve it, features built into the building, and systems installed in it. Site plans, construction plans, and system shop drawings are developed. This phase provides the opportunity to plan for all the appropriate fire service features before construction begins. Changes made on paper are always less costly than changes only recognized as needed after construction begins.

With the exception of minor work, the design process involves a variety of professionals developing material for submission to the appropriate code officials to obtain required permits. The material (often called submittals) can include plans, specifications, and calculations. Depending on the jurisdiction, permit types may include site, building, utility, and fire protection systems. Utilities typically include gas, plumbing, electric, water, and sewer. Fire protection systems include fire alarm, detection, standpipe, sprinkler, and other suppression systems. In some cases, code officials at multiple levels (state, county, and/or city) will be involved.

Municipalities are usually responsible for utilities and systems on the public side of the property line. The design team takes responsibility for the private side of the property line. However, designers often need to know municipal capabilities; for example, the water supply available to feed a building's sprinkler or standpipe system.

In some jurisdictions, emergency responders are a mandatory part of the permit process for certain features. One common example is the location of features used by the fire service such as fire hydrants, fire alarm annunciators, fire control rooms, standpipe FHCs, or FDCs. Codes generally require coordination with emergency responders for many of the features listed in the table in [Annex A](#), below.

Application for permits usually involves submitting material to the appropriate code official. Various code officials have different responsibilities such as building, fire, electrical, etc. This permit work must often be done sequentially. For example, a sprinkler system permit will usually not be issued until after a building permit is obtained because the building permit establishes the occupancies or uses, from which the sprinkler design criteria will be derived.

The code officials will review the materials submitted and determine if they are in compliance with applicable codes and standards. Sometimes revised submissions are requested. Once the submissions are acceptable, they are approved and a permit is issued to allow the construction or system installation to begin. This approval is often subject to the completion of changes or additions that are included on the plans or otherwise transmitted to the entity that applied for the permit. These conditional comments must be addressed during construction or installation if projects are to proceed efficiently.

Construction

OSHA's construction safety and health standards apply during this phase. Local and state buildings codes usually mandate basic safety during this phase. Comprehensive guidance is contained in NFPA 241, *Standard for Safeguarding Construction, Alteration, and Demolition Operations*.

Soon after contractors are selected be sure to include them in communications with design professionals, responders, and code officials.

Early involvement minimizes surprises for all parties concerned. An on-site pre-construction meeting including these stakeholders should be conducted before construction of the building begins. Such a meeting is required in some jurisdictions. Whether required or voluntary, it allows the contractors to find out what will be expected of them by the code officials and responders as the construction proceeds. Fire codes may also require that an on-site fire prevention coordinator be designated.

Hazards

Buildings under construction or renovation likely contain a high concentration of combustible material, a wide variety of ignition sources, and an array of worker safety hazards (figure 13.3). These can result in responses to construction sites by the fire service for falls, spills, fire suppression, rescue, etc. Furthermore, the risks to firefighters during construction are greater than those in a finished building due to incomplete fire protection features and constantly changing site conditions.



Photo: M. Chibbaro

Figure 13.3. Workers on an aerial lift performing welding tasks.

Many hazardous processes and materials are introduced to the job site early in the construction phase. These may include welding, open flames, flammable liquids and gases, explosives, other hazardous materials, rubbish piles, temporary heating or electrical equipment, and temporary enclosures for heating or health hazard containment. Where possible, label all hazardous materials.

Prior to their introduction, some materials or processes may require a permit and/or notification of emergency responders. These issues emerged as significant in a 1988 incident in Missouri when a construction trailer containing explosive material detonated, killing six firefighters who were not fully informed of the material's presence.¹⁹ The potentially conflicting security concerns involving the labeling of the locations of extremely hazardous materials can be addressed by early communication between security and safety stakeholders.

Pre-Incident Planning

Pre-incident planning is the process during which the fire service learns important information about facilities in advance of an emergency. This allows them to operate more efficiently and safely when an incident does occur. Pre-incident planning begins at the construction stage. Planning is developed in cooperation with the fire service and construction professionals as the building is constructed, altered, or demolished. It is vital for building designers and developers to communicate their design intentions and building operational features to emergency responders so that they understand how the building should function and react during an emergency situation. Code officials may be in a good position to facilitate this communication.

Knowledge of the site as construction proceeds (figure 13.4) will be helpful during emergency incidents at the construction site. The fire service can learn about hazards and temporary protection features. Furthermore, seeing how a building is built provides valuable knowledge on construction and protective features that can help when a fire or other emergency occurs in a building after completion. The fire service and construction personnel should work together to facilitate site visits during various phases

19. Federal Emergency Management Agency, "Six Firefighter Fatalities in Construction Site Explosion", USFA-TR-024, November 1988, <http://www.usfa.fema.gov/downloads/pdf/publications/tr-024.pdf>

of construction. Remember to accommodate different shifts for career firefighters and convenient times for volunteer firefighters who often have other employment obligations.



Photo: M. Chibbaro

Figure 13.4. Firefighters can obtain valuable insight about construction materials and methods as a building is being built.

A convenient location on the construction site should contain items that may be needed during emergencies. These items include keys, plans, permits (hot work, HAZMAT, etc.), emergency information, spill containment kits, and other equipment for use or reference by emergency responders. The location should be readily accessible by emergency responders.

Temporary Features

During the construction phase, temporary protective features often compensate for the lack of permanent features or their incomplete nature. Access for fire apparatus and firefighters should be in place from the beginning of construction (figure 13.5). A permanent or temporary water supply is needed when the first combustible construction materials are on site.



Photo: M. Chibbaro

Figure 13.5. Temporary fire apparatus access.

Several features should progress as the building rises in height. A temporary or permanent standpipe is usually installed in tall buildings as they near a height beyond the reach of fire service ladders (figure 13.6). At least one stair should be provided as the building rises. When the building's exterior walls are in place, smoke and heat from a fire will be confined; at this time the stair should be enclosed to maintain its integrity.



Figure 13.6. A temporary FDC (see arrow) feeding a standpipe being installed as this building rises.

Temporary hoists are often used to bring workers and materials to upper floors. Temporary trash chutes may be in place to facilitate material removal, especially during renovation or demolition work. Responders need to be aware of both features before emergencies occur.

Inspection and Testing

As construction progresses, various inspections will occur at different times. Inspectors will be checking compliance with the codes in effect and the various permits issued. The approved documents for all permits must always be available on site. All appropriate contractors and subcontractors must be aware of each condition imposed by code officials. This includes any conditional comments on permits or approved plans. When neglected, these conditional comments can cause delays.

Toward the end of the construction phase, acceptance testing of systems is conducted. These tests can be performed individually or as part of full building commissioning.

Continue to involve the fire service to educate them about the systems with which they will interact (especially fire alarm, communication, and standpipe systems). Code officials can invite emergency responders to witness acceptance testing. Demonstration of systems can also be arranged as soon as possible after acceptance testing (figure 13.7). Design documents should identify the need for these important interactions with emergency responders.



Figure 13.7. Building maintenance staff familiarizing firefighters with a fire alarm system in a new building.

As construction or renovation nears completion, identify features that have not been coordinated — especially those installed late in construction. One example is security bollards that are not coordinated with fire hydrant locations. Another is fixed planters or furniture obstructing FDCs. With a large number of possible features needing coordination, all stakeholders should remain vigilant.

Information Exchange

When construction is nearing completion, as-built plans can be provided to the fire service for their use in continued pre-incident planning. These plans should include construction plans, fire protection system shop drawings, and site diagrams showing fire apparatus and firefighter access routes. Emergency responders may prefer schematic rather than detailed plans. Also check to see if responders prefer electronic or hard copies of plans.

Code officials are also in a good position to share with emergency responders a summary of important building information gleaned from the permit process (figure 13.8).

This may include information on the building, its construction, its occupancy, utilities serving it, protection features and systems, and hazardous materials and processes.

P&CA **PLANNING AND CODE ADMINISTRATION** 
City of Gaithersburg - 31 South Summit Avenue - Gaithersburg, Maryland 20877 - Telephone: (301) 258-6330 - Fax: (301) 258-6336

 - **NEW BUILDING CONSTRUCTION** - 
- **FIRE and RESCUE SERVICES INFORMATION SHEET** -

Project: Courtyard at Washingtonian

Addresses: 204 Boardwalk Place

Location Description: Project to be located adjacent to the existing Rio Mall (just to the North) and Rio Lake in the Washingtonian Waterfront.

First Due: Station 31

Occupancy Type: Mixed use [Mercantile (Retail), Assembly and Hotel]

Construction Type (Per 2000 IBC): I-A (protected noncombustible)

Number of Stories: 9

Building Height: approx. 100 feet

Floor Area: 129,907 square feet total

First Floor	=	20,876 sq. ft.
Second Floor	=	14,727 sq. ft.
Floors 3 – 9	=	13,472 sq. ft./floor

Fire Hydrant Locations: New hydrants will be located across Boardwalk Place from the building near the A/D corner, and diagonally across the intersection near the A/B corner.

General Notes: This building will be fully sprinklered and will have a Fire Alarm system. In addition, and although not required, the building will also have a Smoke Control System. The fire department connection for the Standpipe/Sprinkler system will be located on Side A near the A/D corner of the building. The main Electric room and the Fire Pump room will be accessible via exterior doors on Side C near the Side C/D corner. The gas meter will be located on Side D near the A/D corner of the building.

Ivan J. Humberson, P.E., Fire Marshal June 11, 2004

Diagram: Gaithersburg City Fire Marshal, MD

Figure 13.8. A sample of a new building information sheet prepared by a code official for transmittal to emergency responders.

Occupancy

The occupancy phase begins when code officials determine that the building is either fully code-compliant or when a portion becomes safe enough to permit occupants to move in. In reality, occupancy is often allowed pending the completion of minor punch-list items that remain to be done. In the interim, additional features may be provided or restrictions imposed to ensure a sufficient level of safety. Examples include a limitation on the occupant load or a restriction on the occupancy type (such as storage or merchandise stocking only).

Partial occupancy occurs frequently in building addition/renovation projects. Remember that speculative spaces are often initially occupied in stages (as discussed in the **Concept and Design** section above) and then partially occupied during periodic renovations of tenant spaces or common areas (figure 13.9).



Photo: M. Chibbaro

Figure 13.9. An occupied area of an existing shopping mall being renovated. Apparent deficiencies include a suspended ceiling grid without ceiling tiles, detectors and sprinklers at the future ceiling level, and protective caps on sprinkler heads.

Careful planning and attention is necessary in partial occupancy scenarios to minimize hazards to occupants, workers, and emergency responders. Considerations include fire barriers separating occupied and

unoccupied areas, completeness of the fire suppression and fire alarm systems, and all means of egress clear of any obstructions or combustible material (figure 13.10).



Photo: N. Hobbs

Figure 13.10. An exit discharge area from an occupied building. The path to safety was demolished during adjacent construction.

Often occupant egress routes and fire service access routes will be modified during construction or renovation projects. Signs will be helpful (figure 13.11) as long as they are updated for accuracy as the projects progress.

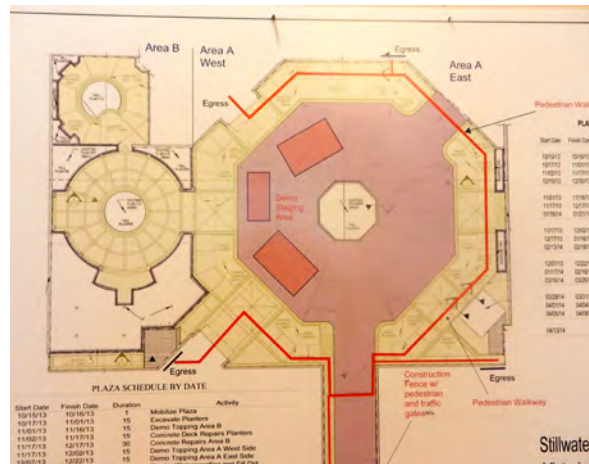

Photo: M. Chibbaro

Figure 13.11. A diagram showing temporary egress and access routes during a renovation project for a plaza between two buildings.

Temporary walkway roofs are usually provided over pedestrian areas adjacent to construction sites. When such areas also serve as means of egress from occupied buildings or areas,

consider the width needed to maintain egress capacity (figure 13.12). Egress discharges also serve as firefighter access points.



Photo: M. Chibbaro

Figure 13.12. A typical 4 ft.-wide temporary walkway (painted white) over a sidewalk adjacent to a construction site. The wide span between posts accommodates the double exit doors (shown in the center), which serve an occupied cinema.

Maintenance and Use

Pre-incident planning must continue during a building's lifetime. Conditions, features, and systems can change over time. Firefighters are regularly hired, reassigned, promoted, and retired. Accordingly, building owners, operators, and tenants should continue to facilitate regular visits by the fire service — both to help with fire service pre-incident planning and to coordinate that effort with companies' emergency preparedness.

Most fire safety features installed in buildings for the protection of occupants also serve to protect firefighters during an emergency (for example, fire barriers and suppression systems). Others are intended primarily for the use and protection of firefighters (including standpipe systems, fire alarm annunciators, and elevator emergency power). Several administrative programs will increase the chances that protective features are available when an emergency occurs.

Preventive System Maintenance

Routine preventive maintenance of fire protection systems is one such program.

Effective and ongoing maintenance will verify that systems remain in service and are capable of functioning properly. Deficiencies can be found and repaired before an emergency occurs (figure 13.13). Budget constraints may target maintenance first; therefore, code officials and emergency responders should remain vigilant.



Photo: M. Chibbaro

Figure 13.13. An FDC with a glass bottle jammed into one inlet.

Maintenance of Built-in Features

A process with effective checks and balances can help ensure that work performed in a building will not negatively impact important building features. A propped-open fire door will render a fire barrier ineffective. Utility work can result in unsealed penetrations of fire barriers (figure 13.14). Even the simple act of removing one or more tiles from a suspended ceiling can reduce the effectiveness of a fire-rated floor/ceiling assembly.



Photo: N. Hobbs

Figure 13.14. A “Do Not Penetrate” sign stenciled on a fire barrier wall above a suspended ceiling. The sign is intended to warn workers modifying the utilities located in the space above the ceiling.

Routine inspection of features by responsible parties (owners and occupants) can uncover deficiencies such as breaches of fire-rated barriers or damage to protective systems. Codes may place this responsibility on owners, who may contract with a third party to perform this service.

Impairment Programs

Impairments of fire protection systems or features can occur during maintenance and rehabilitation work, or when systems are installed on a phased basis. Regardless of the reason that a system is out of service, emergency responders should be notified when they are placed out of service and again when they are returned to service. Inoperable fire hydrants, annunciators, standpipes, etc., can cause delays in emergency operations. The fire service can compensate, at least somewhat, if they are made aware in advance. For example, rather than wasting time committing to a nearby out-of-service hydrant, firefighters can establish a water supply from a more distant in-service hydrant.

In some cases, temporary measures can be taken during impairment periods. Examples include a fire watch during a fire alarm outage and a temporary hose supply through an FDC during a water service outage.

Design documents could require notification of any impairment to the emergency responders and coordination with the code officials about any temporary protection during the time of impairment. Warning signage should be provided for systems or features that are inoperable or disabled (figure 13.15) at a location visible to responders. Impairment systems are equally as important after building occupancy.



Photo: M. Chibbaro

Figure 13.15. A sign next to an FDC indicating that the system valve is shut off.

Rehabilitation Work

Rehabilitation work, including renovations, alterations, and additions, can introduce hazards and create access issues (figure 13.16). Emergency responders must be aware of such work to factor it into their decisions and strategy during emergencies. Code officials should notify responders when a permit is issued for rehabilitation work.



Photo: M. Chibbaro

Figure 13.16. A temporary barrier covering an entire building.

Designers should remember that modifications to a building or its layout may necessitate changes to graphic diagrams, graphic annunciators, and building information diagrams. Inaccurate information can lead to poor decision-making, delays, and even strategic errors during an emergency incident.

Deteriorated Structures

Emergency responders should be notified when buildings deteriorate to the point where they are unsafe to enter (figure 13.17). Code officials can play an important part in this notification process. Warning signs as discussed in the **Building Information** section of Chapter 7 are also important.



Figure 13.17. A building deteriorated to the point that trees are growing in it and major cracks are apparent.

Vacant or abandoned buildings pose severe dangers to firefighters. For example, after two Philadelphia, PA firefighters were killed in the **2012 collapse** of such a structure, the dilapidated condition of the building was cited as a contributing factor.

Buildings condemned by code officials are usually posted with signs. Such signs should be prominently displayed. See the **Building Information** section of Chapter 7 for a discussion of marking dangerous buildings. Code officials should ensure that signs remain in place; vagrants have been known to remove signs to avoid detection.

Condemned buildings should be slated for demolition or repair as soon as possible. In the interim, they should be secured to preclude entry.

Demolition

Considerations during demolition are similar to those during the construction phase, but generally in the reverse order. Firefighters may still be called to mitigate emergencies during this phase. Two firefighters were killed at a 2007 fire during the demolition of the **Deutsche Bank Building in New York City** (figure 13.18). Factors cited included an inoperative standpipe system and maze-like conditions caused by asbestos abatement containment partitions.



Figure 13.18. The fatal 2007 fire at New York City's Deutsche Bank Building.

Depending on the structural condition, firefighters may enter a partially demolished building to mitigate an emergency. Standpipes and stairs should be maintained as the building is brought down; codes typically dictate how far below the uppermost accessible floor these features must be maintained. Fire protection systems and fire barriers should remain in place and in service as long as possible. Unprotected openings in floors are an extreme hazard for firefighters who may be working in darkness or smoky conditions. Gas and electric service should be terminated where possible, and labeled where they remain in service.

Questions to Ask – Building Phases

- Has communication with jurisdictional representatives begun as early as possible?
- Are both code officials and emergency responders in the communication loop?
- Should security professionals be consulted?
- Are fire service features accommodated during all phases of a building's life?
- Will a pre-construction meeting be held?
- Must an on-site fire prevention coordinator be designated?
- Are temporary fire service features maintained during construction and demolition?
- Are emergency responders informed about expected hazardous materials and processes?
- Are proper worker safety precautions taken during construction and demolition?
- Has the fire service been invited to conduct pre-incident planning during all phases?
- Has the fire service been invited to fire protection system acceptance testing or demonstrations?
- Are accurate as-built plans transmitted to emergency responders?
- Are accurate as-built plans maintained at the facility after occupancy?
- Have facility emergency liaisons or contacts been selected? Is this information available to emergency responders?
- Have partial occupancy precautions been taken?
- Is a program in place for inspecting building features?
- Is a preventive maintenance program in place for fire protection systems and features?
- Is an impairment program in place for fire protection systems?
- Are deteriorated and vacant buildings properly marked and secured?
- Are deteriorated buildings slated for repair or demolition as soon as possible?

Resources

- IBC
- NFPA 5000
- NFPA 241, *Standard for Safeguarding Construction, Alteration, and Demolition Operations*
- NFPA 3, *Recommended Practice on Commissioning and Integrated Testing of Fire Protection and Life Safety Systems*
- NFPA 25, *Standard for the Inspection, Testing, and Maintenance of Water-Based Fire Protection Systems*
- NFPA 1620, *Standard for Pre-Incident Planning*
- NFPA Handbook, chapter entitled *Pre-Incident Planning for Industrial and Municipal Emergency Response*
- OSHA Construction Standards, 29 CFR Part 1926
- FM Global Data Sheet 1-0, *Safeguards During Construction, Alteration and Demolition*
- FM Global Data Sheet 2-81, *Fire Protection System Inspection, Testing and Maintenance*

ANNEX A

COORDINATION CHECKLIST

The following checklist is a multidisciplinary list of items that would benefit from coordination between the following three stakeholders — designers, code officials and emergency responders (figure A.1). As discussed in [Chapter 1](#), a particular code official may or may not be able to speak for the needs of emergency responders. The coordination should occur before a building is designed or prior to a major renovation.

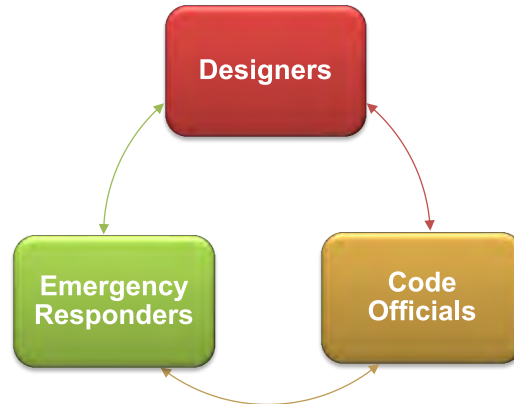

Figure A.1. Stakeholder communication

This list is not a substitute for the more specific questions that appear at the end of each chapter, which are referenced in the table. Rather, it is an overview of fire service needs in the built environment — particularly those needing coordination with emergency responders. Design professionals of various disciplines can also see where coordination among them would be beneficial. Building and fire codes include mandates for designers to coordinate some of the following items with fire service responders.

	Feature	Chapter
	Fire apparatus access — number, dimensions, proximity, material, security	3
	Water supply adequacy — total fire flow, flow testing for systems, permits needed	4
	Fire pump room — location, access, protection, remote alarms, signage	4
	Fire hydrants — outlet type, spacing, location, position, marking, access, security, vehicle impact protection, fire department connection proximity	4, 10
	Premises ID — addresses, signage	5
	Key boxes — location, keys contained	6
	Door locking arrangements — stair re-entry, access control, delayed egress	6
	Identification and signage — stairs, elevators, utilities, fire protection systems	6
	Designation of levels — coordination with stairs, elevators, building ID signs, annunciators	6, 11
	Designation of room or suite numbers	6

Feature	Chapter
Entry doors — signage at rear doors, blocked doors, utility rooms, fire protection system rooms	6, 8, 9, 11
Features required or desired to be at main fire service entrance	4, 6, 10, 11
Building plans and information — signs, cards, cabinets, command centers	7, 11
Hazardous materials — signage, manifests, permits needed	7
Underground or aboveground tanks (liquid or gas) — permits needed	7
Lightweight construction marking, shaftway marking, skylight guarding	7
Photovoltaic systems — signage, marking, access, ventilation	7
Rooftop gardens — access, maintenance, ventilation	7
Sprinkler systems — zoning, valve locations, signage, prevention of unwanted alarms, permits needed	8, 11
Standpipe systems — design pressure at fire hose connections, pumper flow and pressure available at FDC, control valve locations, hose connection locations, permits needed	9
Fire department connections — quantity, location, position, marking, access, signage, and proximity to water supply	4, 10
Fire alarm — zoning, remote reporting, automatic door unlocking, prevention of unwanted alarms, permits needed	8, 11
Fire alarm annunciator — location, orientation, content	11
Voice fire alarms — pre-recorded message details, coordination with building egress scheme, coordination with stair locking/re-entry scheme	11
Fire command center — location, protection, access, size, equipment arrangement, panel function, signage	11
Firefighter radio enhancement systems vs. two-way communication systems	11, 12
Special systems — firefighter air replenishment, backup power, smoke control, ventilation, permits needed	12
Generator room — location, access, protection, remote alarms, and signage	12
Permits needed for construction or system installation	13
Pre-construction or pre-demolition meeting with all stakeholders	13
Temporary features during construction — access, water supply, stair, standpipe, FDC	13
Fire service pre-incident planning for both the construction phase and the occupied phase — site visits, construction plans, impairments	13
Post-construction preventive maintenance and impairment programs	13

WORKERS' RIGHTS

Workers have the right to:

- Working conditions that do not pose a risk of serious harm.
- Receive information and training (in a language and vocabulary the worker understands) about workplace hazards, methods to prevent them, and the OSHA standards that apply to their workplace.
- Review records of work-related injuries and illnesses.
- File a complaint asking OSHA to inspect their workplace if they believe there is a serious hazard or that their employer is not following OSHA's rules. OSHA will keep all identities confidential.
- Exercise their rights under the law without retaliation, including reporting an injury or raising health and safety concerns with their employer or OSHA. If a worker has been retaliated against for using their rights, they must file a complaint with OSHA as soon as possible, but no later than 30 days.

For more information, see [OSHA's Workers page](#).

OSHA ASSISTANCE, SERVICES AND PROGRAMS

OSHA has a great deal of information to assist employers in complying with their responsibilities under OSHA law. Several OSHA programs and services can help employers identify and correct job hazards, as well as improve their injury and illness prevention program.

Establishing an Injury and Illness Prevention Program

The key to a safe and healthful work environment is a comprehensive injury and illness prevention program.

Injury and illness prevention programs are systems that can substantially reduce the number and severity of workplace injuries and illnesses, while reducing costs to employers. Thousands of employers across the United States already manage safety using injury and illness prevention programs, and OSHA believes that all employers can and should do the same. Thirty-four states have requirements or voluntary guidelines for workplace injury and illness prevention programs. Most successful injury and illness prevention programs are based on a common set of key elements. These include management leadership, worker participation, hazard identification, hazard prevention and control, education and training, and program evaluation and improvement. Visit OSHA's Injury and Illness Prevention Program web page at www.osha.gov/dsg/topics/safetyhealth for more information.

Compliance Assistance Specialists

OSHA has compliance assistance specialists throughout the nation located in most OSHA offices. Compliance assistance specialists can provide information to employers and workers about OSHA standards, short educational programs on specific hazards or OSHA rights and responsibilities, and information on additional compliance assistance resources. For more details, visit www.osha.gov/dcsp/compliance_assistance/cas.html or call 1-800-321-OSHA (6742) to contact your local OSHA office.

Free On-site Safety and Health Consultation Services for Small Business

OSHA's On-site Consultation Program offers free and confidential advice to small and medium-sized businesses in all states across the country, with priority given to high-hazard worksites. Each year, responding to requests from small employers looking to create or improve their safety and health management

programs, OSHA's On-site Consultation Program conducts over 29,000 visits to small business worksites covering over 1.5 million workers across the nation.

On-site consultation services are separate from enforcement and do not result in penalties or citations. Consultants from state agencies or universities work with employers to identify workplace hazards, provide advice on compliance with OSHA standards, and assist in establishing safety and health management programs.

For more information, to find the local On-site Consultation office in your state, or to request a brochure on Consultation Services, visit www.osha.gov/consultation, or call 1-800-321-OSHA (6742).

Under the consultation program, certain exemplary employers may request participation in OSHA's **Safety and Health Achievement Recognition Program (SHARP)**. Eligibility for participation includes, but is not limited to, receiving a full-service, comprehensive consultation visit, correcting all identified hazards and developing an effective safety and health management program. Worksites that receive SHARP recognition are exempt from programmed inspections during the period that the SHARP certification is valid.

Cooperative Programs

OSHA offers cooperative programs under which businesses, labor groups and other organizations can work cooperatively with OSHA. To find out more about any of the following programs, visit www.osha.gov/cooperativeprograms.

Strategic Partnerships and Alliances

The OSHA Strategic Partnerships (OSP) provide the opportunity for OSHA to partner with employers, workers, professional or trade associations, labor organizations, and/or other interested stakeholders. OSHA Partnerships

are formalized through unique agreements designed to encourage, assist, and recognize partner efforts to eliminate serious hazards and achieve model workplace safety and health practices. Through the Alliance Program, OSHA works with groups committed to worker safety and health to prevent workplace fatalities, injuries and illnesses by developing compliance assistance tools and resources to share with workers and employers, and educate workers and employers about their rights and responsibilities.

Voluntary Protection Programs (VPP)

The VPP recognize employers and workers in private industry and federal agencies who have implemented effective safety and health management programs and maintain injury and illness rates below the national average for their respective industries. In VPP, management, labor, and OSHA work cooperatively and proactively to prevent fatalities, injuries, and illnesses through a system focused on: hazard prevention and control, worksite analysis, training, and management commitment and worker involvement.

Occupational Safety and Health Training

The OSHA Training Institute in Arlington Heights, Illinois, provides basic and advanced training and education in safety and health for federal and state compliance officers, state consultants, other federal agency personnel and private sector employers, workers, and their representatives. In addition, 27 OSHA Training Institute Education Centers at 42 locations throughout the United States deliver courses on OSHA standards and occupational safety and health issues to thousands of students a year.

For more information on training, contact the OSHA Directorate of Training and Education, 2020 Arlington Heights Road, Arlington Heights, IL 60005; call 1-847-297-4810; or visit www.osha.gov/otiec.

OSHA Educational Materials

OSHA has many types of educational materials in English, Spanish, Vietnamese and other languages available in print or online. These include:

- Brochures/booklets;
- Fact Sheets;
- Guidance documents that provide detailed examinations of specific safety and health issues;
- Online Safety and Health Topics pages;
- Posters;
- Small, laminated QuickCards™ that provide brief safety and health information; and
- *QuickTakes*, OSHA's free, twice-monthly online newsletter with the latest news about OSHA initiatives and products to assist employers and workers in finding and preventing workplace hazards. To sign up for *QuickTakes* visit www.osha.gov/quicktakes.

To view materials available online or for a listing of free publications, visit www.osha.gov/publications. You can also call 1-800-321-OSHA (6742) to order publications.

Select OSHA publications are available in e-Book format. OSHA e-Books are designed to increase readability on smartphones, tablets and other mobile devices. For access, go to www.osha.gov/ebooks.

OSHA's web site also has information on job hazards and injury and illness prevention for employers and workers. To learn more about OSHA's safety and health resources online, visit www.osha.gov or www.osha.gov/html/a-z-index.html.

NIOSH HEALTH HAZARD EVALUATION PROGRAM

Getting Help with Health Hazards

The National Institute for Occupational Safety and Health (NIOSH) is a federal agency that conducts scientific and medical research on workers' safety and health. At no cost to employers or workers, NIOSH can help identify health hazards and recommend ways to reduce or eliminate those hazards in the workplace through its Health Hazard Evaluation (HHE) Program.

Workers, union representatives and employers can request a NIOSH HHE. An HHE is often requested when there is a higher than expected rate of a disease or injury in a group of workers. These situations may be the result of an unknown cause, a new hazard, or a mixture of sources. To request a NIOSH Health Hazard Evaluation go to www.cdc.gov/niosh/hhe/request.html. To find out more, in English or Spanish, about the Health Hazard Evaluation Program:

E-mail HHERequestHelp@cdc.gov or call 800-CDC-INFO (800-232-4636).

OSHA REGIONAL OFFICES

Region I

Boston Regional Office
(CT*, ME*, MA, NH, RI, VT*)
JFK Federal Building, Room E340
Boston, MA 02203
(617) 565-9860 (617) 565-9827 Fax

Region II

New York Regional Office
(NJ*, NY*, PR*, VI*)
201 Varick Street, Room 670
New York, NY 10014
(212) 337-2378 (212) 337-2371 Fax

Region III

Philadelphia Regional Office
(DE, DC, MD*, PA, VA*, WV)
The Curtis Center
170 S. Independence Mall West
Suite 740 West
Philadelphia, PA 19106-3309
(215) 861-4900 (215) 861-4904 Fax

Region IV

Atlanta Regional Office
(AL, FL, GA, KY*, MS, NC*, SC*, TN*)
61 Forsyth Street, SW, Room 6T50
Atlanta, GA 30303
(678) 237-0400 (678) 237-0447 Fax

Region V

Chicago Regional Office
(IL*, IN*, MI*, MN*, OH, WI)
230 South Dearborn Street
Room 3244
Chicago, IL 60604
(312) 353-2220 (312) 353-7774 Fax

Region VI

Dallas Regional Office
(AR, LA, NM*, OK, TX)
525 Griffin Street, Room 602
Dallas, TX 75202
(972) 850-4145 (972) 850-4149 Fax
(972) 850-4150 FSO Fax

Region VII

Kansas City Regional Office
(IA*, KS, MO, NE)
Two Pershing Square Building
2300 Main Street, Suite 1010
Kansas City, MO 64108-2416
(816) 283-8745 (816) 283-0547 Fax

Region VIII

Denver Regional Office
(CO, MT, ND, SD, UT*, WY*)
Cesar Chavez Memorial Building
1244 Speer Boulevard, Suite 551
Denver, CO 80204
(720) 264-6550 (720) 264-6585 Fax

Region IX

San Francisco Regional Office
(AZ*, CA*, HI*, NV*, and American Samoa,
Guam and the Northern Mariana Islands)
90 7th Street, Suite 18100
San Francisco, CA 94103
(415) 625-2547 (415) 625-2534 Fax

Region X

Seattle Regional Office
(AK*, ID, OR*, WA*)
300 Fifth Avenue, Suite 1280
Seattle, WA 98104
(206) 757-6700 (206) 757-6705 Fax

*These states and territories operate their own OSHA-approved job safety and health plans and cover state and local government employees as well as private sector employees. The Connecticut, Illinois, Maine, New Jersey, New York and Virgin Islands programs cover public employees only. (Private sector workers in these states are covered by Federal OSHA). States with approved programs must have standards that are identical to, or at least as effective as, the Federal OSHA standards.

Note: To get contact information for OSHA area offices, OSHA-approved state plans and OSHA consultation projects, please visit us online at www.osha.gov or call us at 1-800-321-OSHA (6742).

HOW TO CONTACT OSHA

For questions or to get information or advice, to report an emergency, fatality, inpatient hospitalization, amputation, or loss of an eye, or to file a confidential complaint, contact your nearest OSHA office, visit www.osha.gov or call OSHA at 1-800-321-OSHA (6742), TTY 1-877-889-5627.

**For assistance, contact us.
We are OSHA. We can help.**





U.S. Department of Labor

For more information:



www.osha.gov (800) 321-OSHA (6742)