

**NOT MEASUREMENT
SENSITIVE**

**DOE-HDBK-1132-99
April 1999
Reaffirmed 2014**

DOE HANDBOOK

DESIGN CONSIDERATIONS



**U.S. Department of Energy
Washington, D.C. 20585**

AREA EDCN

DISTRIBUTION STATEMENT A. Approved for public release; distribution is unlimited.

Table of Changes

Page	Paragraph	Changed	To
	Throughout	Reference citations.	Revised all reference citations throughout the Order to reflect current versions of the documents.
	Throughout	Formatting	Made editorial and formatting changes.
xv	3	Please provide suggestions for improvement and material for consideration for future revisions to the DOE Office of Environment, Safety and Health; attention: Rich Stark, DOE/EH-31	Please provide suggestions for improvement and material for consideration for future revisions to the James O'Brien, DOE Headquarters, Office of Nuclear Safety
I-6	7	Safety analyses define the functional requirements of the design, such as the type and severity of accident conditions that the confinement system must accommodate.	Safety analyses define the functional requirements of the design, such as the type and severity of accident conditions to be accommodated by the confinement system.
I-10	4	Equipment that must be located within the enclosure should be designed to allow for in-place maintenance and/or replacement.	Equipment located within the enclosure should be designed to allow for in-place maintenance and/or replacement.
I-12	11	Various types of removal and transfer systems are discussed in International Atomic Energy Agency (IAEA) Safety Series No. 30.	Deleted
I-35	1	Added	NCRP Report No. 151, <i>Structural Shielding Design and Evaluation for Megavoltage X- and Gamma-Ray Radiotherapy Facilities</i> , provides guidance regarding shielding design and evaluation for mega voltage accelerator facilities.
I-35	3	ANSI N13.2, <i>Administrative Practices in Radiation Monitoring (A Guide for Management)</i> , provides guidance for administrative practices in radiation monitoring.	Deleted
I-36	2	ANSI N13.4, American National Standard for the Specification of Portable X- or Gamma-Radiation Survey Instruments, provides guidance on personnel monitoring devices.	American National Standard N13.49-2001 (R2011), <i>Performance and Documentation of Radiological Surveys</i> , provides both specific and general guidance for facilities using radioactive material or machines producing radiation fields.

Table of Changes

Page	Paragraph	Changed	To
I-39	6	Radiation monitoring, alarm, and warning systems that must function during a loss of normal power should be provided with an emergency UPS (internal or external on-line).	Radiation monitoring, alarm, and warning systems required to function during a loss of normal power should be provided with an emergency UPS (internal or external on-line).
I-49	2	Design of materials management and storage systems should attempt to achieve inventory extension to the maximum extent possible; that is, to minimize the frequency with which inventory must be taken and reconciled.	Design of materials management and storage systems should attempt to achieve inventory extension to the maximum extent possible; that is, to minimize the frequency with which inventory and reconciliation are necessary.
I-67	2	For outdoor applications, the capacity must also include maximum predicted precipitation.	For outdoor applications, the capacity should also include maximum predicted precipitation.
I-90	2	For alloyed metals, however, additional consideration must be given to the possible leaching of impurities from the alloyed metal, even at normal room temperatures and pressures.	For alloyed metals, however, additional consideration should be given to the possible leaching of impurities from the alloyed metal, even at normal room temperatures and pressures.
I-97	2	In reality, these are the things that designers must accommodate.	In reality, these are the things that designers need to accommodate.
I-104	3	Because the true leakage rates of most tritium gloveboxes can generally be certified to be no more than 10^{-2} to 10^{-3} cm ³ /sec, the ingress of air into the box environment is a problem that must constantly be addressed.	Because the true leakage rates of most tritium gloveboxes can generally be certified to be no more than 10^{-2} to 10^{-3} cm ³ /sec, the ingress of air into the box environment is a problem to be addressed.
I-105	1	Because one of the undesired impurities will always include tritium (as T ₂ , HT, and/or HTO), the cleanup systems must always remove free tritium from the glovebox gases.	Because one of the undesired impurities will always include tritium (as T ₂ , HT, and/or HTO), the cleanup systems should remove free tritium from the glovebox gases.
I-106	1	Independent of the scale of the operation, the tritium removal systems used for these types of containment systems must be capable of a very high rate of throughput, and they should be examined with great care prior to selecting the containment systems for use.	Independent of the scale of the operation, the tritium removal systems used for these types of containment systems should be capable of a very high rate of throughput, and they should be examined with great care prior to selecting the containment systems for use.

Table of Changes

Page	Paragraph	Changed	To
I-110	1	When cleanup systems have to run for relatively long periods of time, leakage rates into and out of the glovebox in question, and leakage rates into and out of the cleanup system tend to become additional factors that must be considered in the overall design of the facility.	When cleanup systems have to run for relatively long periods of time, leakage rates into and out of the glovebox in question, and leakage rates into and out of the cleanup system tend to become additional factors to consider in the overall design of the facility.
I-119	3	In many instances, an existing DOE facility that must be decontaminated and decommissioned does not have a D&D plan and procedures in place that were implemented in the original facility design.	In many instances, an existing DOE facility that needs decontamination and decommissioning does not have a D&D plan and procedures in place that were implemented in the original facility design.
I-136	7	Each of these documents contains the technical specifications that the wastes produced must meet for acceptance of their vitrified high-level waste into the repository.	Each of these documents contains the technical specifications for acceptance of their vitrified high-level waste into the repository.
II-1	7	Certain aspects of the arrangement and layout, such as egress and access, must satisfy the building code or local code requirements.	Certain aspects of the arrangement and layout, such as egress and access, are required to satisfy the building code or local code requirements.
II-23	1	When arranged horizontally, a minimum distance of 30 inches shall be provided along one side of each tray run to allow for installation and maintenance.	When arranged horizontally, a minimum distance of 30 inches should be provided along one side of each tray run to allow for installation and maintenance.
II-23	1	When arranged vertically (trays above each other) cable trays shall have a minimum vertical spacing of 16 inches for trays which have a 3-inch loading depth and 17 inches for trays which have a 4-inch loading depth to allow for maintenance and installation and to permit the use of cable pulling equipment when required.	When arranged vertically (trays above each other) cable trays should have a minimum vertical spacing of 16 inches for trays which have a 3-inch loading depth and 17 inches for trays which have a 4-inch loading depth to allow for maintenance and installation and to permit the use of cable pulling equipment when required.

This document is available on the
Department of Energy Technical Standards Program Web page at
<http://www.hss.doe.gov/nuclearsafety/ns/techstds/>

TABLE OF CONTENTS

<u>PARAGRAPH</u>	<u>PAGE</u>
ACRONYMS AND ABBREVIATIONS	ix
FOREWORD	xiii
PART I: DESIGN CONSIDERATIONS	
INTRODUCTION	I-1
REFERENCES	I-3
SECTION 1: SYSTEMS	I-6
1.1 CONFINEMENT SYSTEMS	I-6
1.1.1 Introduction and Scope	I-6
1.1.2 General Considerations	I-7
1.1.3 Primary Confinement System	I-8
1.1.4 Secondary Confinement	I-12
1.1.5 Tertiary Confinement	I-14
1.1.6 Confinement Ventilation Systems	I-14
1.2 CONFINEMENT SYSTEM DESIGN ASPECTS BY FACILITY TYPE	I-19
1.2.1 Plutonium Processing and Handling Facilities and Plutonium Storage Facilities	I-19
1.2.2 Unirradiated Enriched Uranium Storage Facilities	I-21
1.2.3 Uranium Processing and Handling Facilities	I-22
1.2.4 Irradiated Fissile Material Storage Facilities	I-25
1.2.5 Reprocessing Facilities	I-26
1.2.6 Uranium Conversion and Recovery Facilities	I-28
1.2.7 Laboratory Facilities (Including Hot Laboratories)	I-30
1.3 EFFLUENT CONTROL AND RADIATION PROTECTION	I-33
1.3.1 Introduction and Scope	I-33
1.3.2 Shielding Design	I-34
1.3.3 Airborne Radiation Control	I-35
1.3.4 Contamination Control	I-36
1.3.5 Radiation Monitoring	I-36
1.3.6 Airborne Effluents	I-37
1.3.7 Effluent Control	I-38
1.3.8 Effluent Monitoring	I-39
SECTION 2: SPECIAL FACILITIES AND ACTIVITIES	I-40
INTRODUCTION AND SCOPE	I-40
2.1 PLUTONIUM PROCESSING AND HANDLING FACILITIES	I-40
2.1.1 Introduction	I-40
2.1.2 Design Considerations	I-40
2.2 PLUTONIUM STORAGE FACILITIES	I-50
2.2.1 Introduction	I-50
2.2.2 Design Considerations	I-50

TABLE OF CONTENTS

<u>PARAGRAPH</u>	<u>PAGE</u>
2.3 UNIRRADIATED ENRICHED URANIUM STORAGE FACILITIES.	I-52
2.3.1 Introduction	I-52
2.3.2 Design Considerations	I-52
2.4 URANIUM PROCESSING AND HANDLING FACILITIES.	I-54
2.4.1 Introduction	I-54
2.4.2 Design Considerations	I-55
2.5 IRRADIATED FISSILE MATERIAL STORAGE FACILITIES	I-56
2.5.1 Introduction	I-56
2.5.2 Design Considerations	I-57
2.6 REPROCESSING FACILITIES	I-59
2.6.1 Introduction	I-59
2.6.2 Design Considerations	I-59
2.7 URANIUM CONVERSION AND RECOVERY FACILITIES	I-61
2.7.1 Introduction.	I-61
2.7.2 Design Considerations	I-61
2.8 RADIOACTIVE LIQUID WASTE FACILITIES	I-64
2.8.1 Introduction.	I-64
2.8.2 Design Considerations	I-64
2.9 RADIOACTIVE SOLID WASTE FACILITIES.	I-71
2.9.1 Introduction.	I-71
2.9.2 Design Considerations	I-71
2.10 TRITIUM FACILITIES	I-75
2.10.1 Introduction	I-75
2.10.2 Sources of Tritium	I-76
2.10.3 The Relative Abundance of Tritium	I-78
2.10.4 The Radioactive Decay of Tritium.	I-79
2.10.5 The Chemical Properties of Tritium	I-81
2.10.6 Modeling the Behavior of Tritium	I-86
2.10.7 The Development of Tritium Technology	I-97
2.10.8 Confinement Systems vs. Containment Systems	I-99
2.10.9 Tritium Removal Systems	I-107
2.11 FUSION TEST FACILITIES.	I-114
2.11.1 Introduction	I-114
2.11.2 Design Considerations	I-114
2.12 DESIGN OF FACILITIES TO FACILITATE ULTIMATE DECONTAMINATION AND DECOMMISSIONING	I-116
2.12.1 Introduction.	I-116
2.12.2 Equipment Selection and Location.	I-116
2.12.3 Building Layout (to Facilitate Decontamination and Decommissioning)	I-117
2.12.4 Coatings to Facilitate D&D	I-118
2.13 D&D AND ENVIRONMENTAL REMEDIATION PROJECTS	I-119
2.13.1 Introduction	I-119
2.13.2 Decommissioning and Decontamination	I-121
2.13.3 Hazards Mitigation	I-125

TABLE OF CONTENTS

<u>PARAGRAPH</u>	<u>PAGE</u>
2.13.4 Summary	I-126
2.13.5 Environmental Remediation	I-127
2.14 VITRIFICATION.	I-129
2.14.1 Introduction.	I-129
2.14.2 General Vitrification Processes and Steps to Consider.....	I-129
2.14.3 Waste Extraction from Tanks	I-130
2.14.4 Feed Delivery	I-131
2.14.5 Feed Sampling	I-131
2.14.6 Feed Make-up and Chemical Addition	I-132
2.14.7 Feed Holding	I-132
2.14.8 Feed to Melter	I-133
2.14.9 Acceptable Glass Compositions.	I-133
2.14.10 Melters and Melter Behavior.....	I-133
2.14.11 Melter Life/Keeping Melters Hot/Not Cycling.....	I-134
2.14.12 Off-Gas Processing	I-135
2.14.13 Material Considerations.....	I-136
2.14.14 Process Development	I-136

PART II: GOOD PRACTICES

INTRODUCTION	II-1
1. ARCHITECTURAL CONSIDERATIONS.....	II-1
1.1 Facility Layout	II-1
1.1.1 General	II-1
1.1.2 Space Allotment	II-2
1.1.3 Hazards Separation	II-4
1.1.4 Hazardous Areas	II-4
1.2 Equipment Arrangement	II-5
1.2.1 Tanks	II-5
1.2.2 Air Compressors	II-6
1.2.3 Diesel Generators	II-6
1.2.4 Auxiliary Lifting Devices	II-7
1.2.5 Filters	II-8
1.2.6 Site Considerations for Outdoor Equipment.	II-8
1.3 Piping Design and Layout	II-8
1.3.1 General	II-8
1.3.2 Clearances	II-9
1.3.3 Vents and Drains	II-9
1.3.4 Lined Pipe	II-10
1.3.5 Freeze Protection	II-10
1.3.6 Piping at Pumps	II-10
1.3.7 Expansion Joints	II-11
1.3.8 Piping Containing Radioactive Materials	II-11
1.3.9 Valves	II-14

TABLE OF CONTENTS

<u>PARAGRAPH</u>	<u>PAGE</u>
1.4 Special Systems	II-14
1.4.1 Radioactive Waste Transfer Lines	II-14
1.4.2 High-Activity Drains	II-15
1.4.3 Non-Fire Protection Penetration Seals	II-15
1.5 Jumpers	II-16
1.5.1 General Jumper Design Considerations	II-16
1.5.2 Handling	II-16
1.5.3 Pipe Stresses	II-17
1.6 Structural Design.	II-17
1.6.1 General	II-17
1.6.2 Metals-Stainless Steel	II-17
1.6.3 Foundation Vibration	II-17
1.6.4 Loads	II-17
1.6.5 Equipment Support Resonance	II-18
1.6.6 Creep and Shrinkage	II-18
1.6.7 Environmental Concrete Storage Structures	II-18
2. ELECTRICAL SYSTEMS	II-19
2.1 Basic Electrical Materials and Methods.	II-20
2.2 Exterior Electrical Utility Service.	II-23
2.3 Special Facilities.	II-25
2.4 Interior Lighting.	II-26
2.5 Exterior Lighting	II-27
2.6 Special Systems	II-27
3. MECHANICAL SYSTEMS	II-28
3.1 Piping.	II-28
3.1.1 Piping Systems	II-28
3.1.2 Piping Design	II-29
3.1.3 Buried Pipe	II-30
3.1.4 Steam and Condensate Systems	II-30
3.1.5 Water Hammer	II-33
3.2 Purge Systems.	II-32
3.2.1 Systems Design: General Purge Systems Design Considerations	II-32
3.2.2 Components Design Considerations: Storage Tanks	II-32
3.2.3 Pressure Buildup Coils Design Considerations	II-33
3.2.4 Vaporizer Design Considerations	II-33
3.2.5 Service Piping	II-33
3.2.6 HVAC	II-33
3.3 Pumps	II-34
3.4 Valves	II-34

TABLE OF CONTENTS

<u>PARAGRAPH</u>	<u>PAGE</u>
4. INSTRUMENTATION AND CONTROLS CONSIDERATIONS	II-34
4.1 Control Centers/Control Rooms	II-34
4.2 Distributed Control Systems	II-35
4.2.1 Component Modularity	II-36
4.2.2 Input/Output Controller	II-36
4.2.3 Communications	II-36
4.2.4 Data Highways	II-36
4.2.5 Failure Mode Recovery	II-37
4.2.6 Operator Workstations	II-37
4.2.7 System Diagnostics	II-37
4.2.8 Real Time Database	II-37
4.2.9 Data Historian	II-37
4.2.10 Acceptance Tests	II-37
4.2.11 System Documentation	II-38
4.3 Programmable Logic Controller	II-38
4.4 Alarm Management	II-39
4.5 Electrical Noise and Wiring Practices	II-39
4.6 Lightning Protection for Instruments	II-40
4.7 Analyzers	II-41
4.8 Solenoid Valves	II-41
4.9 Instrument Installation	II-42
4.9.1 General	II-42
4.9.2 Instrument Location	II-42
4.9.3 Pressure Instruments	II-43
4.9.4 Temperature Instruments	II-44
4.9.5 Flow Instruments	II-44
4.9.6 Level Instruments	II-45
4.9.7 Leak Detection	II-45
4.9.8 Freeze Protection	II-45
5. MATERIALS CONSIDERATIONS	II-45
5.1 Introduction	II-45
5.2 Basic Considerations for Material Selection for Process Service	II-48
5.3 Welding, Fabrication, Examination, and Testing	II-49
5.4 Material Corrosion and Material Degradation by Radiation	II-51
ADDITIONAL REFERENCES	A-1

INTENTIONALLY BLANK

ACRONYMS

ACGIH	American Conference of Governmental Industrial Hygienists
ACI	American Concrete Institute
ADP	automated data processing
AHJ	authority having jurisdiction
ALARA	as low as reasonably achievable
ANS	American National Standards
ANSI	American National Standards Institute
ASHRAE	American Society of Heating, Refrigerating, and Air Conditioning Engineers
ASME	American Society of Mechanical Engineers
ASTM	American Society for Testing & Materials
AWG	American wire gauge
AWS	American Welding Society
BP&V	Boiler and Pressure Vessel
CAD	computer-aided design
CADD	computer-aided design and drafting
CAM	continuous air monitors
CFR	Code of Federal Regulations
D&D	decontamination and decommissioning
DC	direct current
DCS	distributed control system
DNFSB	Defense Nuclear Facilities Safety Board
DOE	Department of Energy
DOE-EM	Department of Energy, Office of Environmental Management
DOE-RW	Department of Energy, Office of Civilian Radioactive Waste Management
dpm	disintegrations per minute
ER	environmental remediation
FIPS	Federal Information Processing Standards
HEPA	high-efficiency particulate air (filter)
HID	high-intensity discharge
HPS	high-pressure sodium
HVAC	heating, ventilation, and air conditioning
I/O	input/output
IAEA	International Atomic Energy Agency
IEEE	Institute of Electrical and Electronics Engineers
IFM	irradiated fissile material
IFMSF	irradiated fissile material storage facility
ISA	International Society for Measurement and Control (formerly Instrument Society of America)
LET	linear energy transfer
MIC	microbiological-influenced corrosion
NFC	National Fire Code
NFPA	National Fire Protection Association
NPH	natural phenomena hazards

NRC	Nuclear Regulatory Commission
PLC	programmable logic controller
PPHF	plutonium processing and handling facility
PSF	plutonium storage facility
plf	pounds per linear foot
ppm	parts per million
psf	pounds per square foot
psi	pounds per square inch
psia	pounds per square inch absolute
psig	pounds per square inch gauge
PTFE	polytetrafluoroethylene
PVC	polyvinyl chloride
R.G.	Regulatory Guide
RLWF	radioactive liquid waste facility
RSWF	radioactive solid waste facility
SNM	special nuclear material
SSC	structures, systems, and components
SST	safe, secured transport
STP	standard temperature and pressure
TSR	technical safety requirement
UCRF	uranium conversion and recovery facilities
UEU	unirradiated enriched uranium
UEUSF	unirradiated enriched uranium storage facility
UMTRA	Uranium Mill Tailings Remedial Action
UPHF	uranium processing and handling facility
UPS	uninterrupted power supply

ABBREVIATIONS

Ω	resistivity
μm	micron
$^{\circ}\text{C}$	degrees Centigrade
$^{\circ}\text{F}$	degrees Fahrenheit
$^{\circ}\text{K}$	Kelvin
Ar	argon
cal	calorie
Ci	curie
cm^2	square centimeter
cm^3	cubic centimeter
D	deuterium
g	gram
H	hydrogen
H_2O	water
keV	kiloelectron volt (joule)
kVA	kilovolt-ampere
kWh	kilowatt-hour
mCi	millicurie (becquerel)
m^3	cubic meter

mg	milligram
min	minute
mm	millimeter
MW(e)	megawatt (electrical)
N ₂ O	nitrous oxide
N ₂	nitrogen
NO	nitric oxide
NO ₂	nitrogen dioxide
O ₂	oxygen
Pu(IV)	plutonium polymer
Pu ²³⁸	plutonium-238
PuF ₄	plutonium tetrafluoride
sec	second
T	tritium (the hydrogen isotope of mass-3)
UF ₆	uranium hexafluoride
UO ₂	uranium oxide

INTENTIONALLY BLANK

FOREWORD

Over a period of more than 50 years, the Department of Energy (DOE) and its predecessor agencies developed considerable experience in designing and operating nonreactor nuclear facilities of many different types. Operation of these facilities has provided valuable insight into successful designs and opportunities for improving those designs. Through the years, some of this experience and information was incorporated into DOE 6430.1A, *General Design Criteria*.

In 1996, when DOE decided to simplify and revise its directives system, DOE 6430.1A was identified for cancellation. Deemed too prescriptive, the Order was to be replaced by two performance-based Orders: DOE O 420.1, *Facility Safety* (now DOE O 420.1C), and DOE O 430.1, *Life-Cycle Asset Management* (now DOE O 430.1B Ch-2, *Real Property Asset Management*). As a result, DOE O 420.1C contains safety requirements and DOE O 430.1B contains life-cycle and programmatic requirements. In addition, Guides and other documents developed for use with DOE O 420.1C and DOE O 430.1B provide acceptable methodologies for satisfying requirements, including guidance on selecting industry codes and standards for aspects of design.

During the development of DOE O 420.1, a team visited the major DOE sites to obtain recommendations from engineering organizations regarding content and format of the new Order. One recommendation was that, although DOE 6430.1A was confusing, contradictory, dated, and too prescriptive, it contained useful information on good design practices that should not be lost. Independently, the Defense Nuclear Facilities Safety Board (DNFSB) staff made a similar suggestion. Accordingly, the purpose of this Design Considerations Handbook is to provide a compilation of DOE good practices from DOE 6430.1A in a non-mandatory fashion and to supplement them with additional lessons learned to assist current and future DOE facility designers.

Although the writers reviewed all the information not captured in DOE O 420.1 and DOE O 430.1 that was previously contained in DOE 6430.1A, certain types of information were specifically not incorporated, as listed below:

- Some of the 99 sections included requirements that address criteria for safety class structures, systems, and components (e.g., 0111-99.0.1 Structural Requirements).
- DOE O 420.1C and DOE Standard-1020-2012, *Natural Phenomena Hazards Analysis and Design Criteria for DOE Facilities* provide design evaluation guidance for natural phenomena hazards (NPH) design. Further guidance for NPH design is not included.
- Division 15 included many details of mechanical equipment design. The Design Considerations Handbook, Part II, incorporates this information only to the extent that it is not included in national codes and standards.

- DOE STD-1212-2012, *Explosives Safety*, contains authoritative guidance for explosive facilities. No information is included in the Design Considerations Handbook related to explosives and explosive facilities.
- Information related to physical protection and safeguards and security is not included.

The writers also reviewed a number of other documents, many in draft form, that provide information that may be useful in designing facilities, as well as particular components and systems. Examples of these other documents include the following:

- Report dated March 1999: “*Waste Vitrification System Lessons Learned*.”
- DOE Office of Management, *Project Management Lessons Learned*
<<http://energy.gov/management/office-management/operational-management/project-management/lessons-learned>>
- DOE Office of Management, Project Management Policy and Guidance provides a number of documents addressing asset acquisition and management < <http://energy.gov/management/office-management/operational-management/project-management/policy-and-guidance> >
- Four volumes of a Handbook developed by the Backup Power Working Group.
<<http://www.osti.gov/scitech/biblio/491576>>
- Regulatory Guides issued by the U.S. Nuclear Regulatory Commission, included those previously mentioned in DOE 6430.1A.

The information contained in the handbook is presented in differing levels of detail. The material from DOE 6430.1A has been extracted from that document, edited to remove the mandatory tone and to remove safety requirements content (which is addressed in DOE O 420.1C). Additional content has been included, when available from sources around the DOE complex, such as the tritium section (2.10), the D&D and environmental remediation section (2.13), the vitrification section (2.14), and Part II, Good Practices. No attempt has been made to edit this material to produce a document with a consistent level of detail throughout. In this regard, the handbook should be regarded as a compilation of available engineering design experience and advice. No attempt has been made to be complete and exhaustive in any one subject area. This handbook is intended for the use of designers with some level of experience as a reference to see how the designs of existing DOE nuclear facilities have addressed the special issues inherent in these facilities.

Nuclear safety design criteria requirements are contained in DOE O 420.1C. They are in the format of performance requirements rather than explicit and detailed specification requirements. Guidance on acceptable ways of satisfying the requirements of DOE O 420.1C is found in the associated Implementation Guides. Because design requirements are treated in DOE O 420.1C and because the material in this handbook is not a complete and exhaustive collection of

material that a designer would need, the contents of this handbook are not intended to be referenced as requirements. Guidance in this handbook should not be used as justification of acceptable ways of satisfying requirements. The adequacy of a design should stand on its own merits.

This handbook was prepared through the efforts of individuals from DOE Headquarters, DOE Field Offices, and contractor and subcontractor personnel. As additional relevant material is developed throughout the DOE complex and made available, revisions will be made to this handbook so that the content remains relevant and useful. Please provide suggestions for improvement and material for consideration for future revisions to the James O'Brien, DOE Headquarters, Office of Nuclear Safety.

INTENTIONALLY BLANK

PART I: DESIGN CONSIDERATIONS

INTRODUCTION

Scope. The Design Considerations Handbook includes information and suggestions for the design of systems typical to nuclear facilities, information specific to various types of special facilities, and information useful to various design disciplines.

The handbook is presented in two parts.

Part I, which addresses design considerations, includes two sections. The first addresses the design of systems typically used in nuclear facilities to control radiation or radioactive materials. Specifically, this part addresses the design of confinement systems, and radiation protection and effluent monitoring systems. The second section of Part I addresses the design of special facilities (i.e., specific types of nonreactor nuclear facilities). The specific design considerations provided in this section were developed from review of DOE 6430.1A, *General Design Criteria*, and are supplemented with specific suggestions and considerations from designers with experience designing and operating such facilities.

Part II of the Design Considerations Handbook describes good practices and design principles that should be considered in specific design disciplines, such as mechanical systems and electrical systems. These good practices are based on specific experiences in the design of nuclear facilities by design engineers with related experience. This part of the Design Considerations Handbook contains five sections, each of which applies to a particular engineering discipline.

Purpose. The purpose of this handbook is to collect and retain the non-mandatory Department of Energy (DOE) good practices from DOE 6430.1A and to supplement those practices with additional lessons learned.

Applicability. This handbook is a reference document that may be consulted during design of nonreactor nuclear facilities. Its provisions are not to be invoked as requirements. Because design requirements are treated in DOE O 420.1C and because the material in the handbook is not a complete and exhaustive collection of material that a designer would need, the contents of this handbook are not intended to be referenced as requirements. Guidance in this handbook

should not be used as justification of acceptable ways of satisfying requirements. The adequacy of a design should stand on its own merits.

REFERENCES

DOE Orders and Standards

DOE O 435.1 Chg 1 Reaffirmed 2007	<i>Radioactive Waste Management</i>
DOE G 441.1-1C (CN1)	<i>Radiation Protection Programs Guide for Use with Title 10, Code of Federal Regulations, Part 835, Occupational Radiation Protection</i>
DOE-STD-1098-2008 (CN1)	<i>Radiological Control</i>
DOE G 430.1-4	<i>Decommissioning Implementation Guide</i>
DOE-STD-1066-2012	<i>Fire Protection</i>
DOE-HDBK-1081-94	<i>Primer on Spontaneous Heating and Pyrophoricity</i>
DOE-STD-1090-2011	<i>Hoisting and Rigging Standard</i>
DOE-HDBK-1092- 2013	<i>Electrical Safety</i>
DOE HDBK-1129- 2008	<i>Tritium Handling and Safe Storage</i>
DOE-STD-1212-2012	<i>Explosives Safety</i>
DOE O 420.1C	<i>Facility Safety</i>
DOE O 430.1B Ch-2	<i>Real Property Asset Management</i>
DOE-STD-1020-2012	<i>Natural Phenomena Hazards Analysis and Design Criteria for DOE Facilities</i>
DOE-STD-3013-2012	<i>Stabilization, Packaging, and Storage of Plutonium-Bearing Materials</i>
DOE STD-3014-2006	<i>Accident Analysis for Aircraft Crash into Hazardous Facilities</i>
DOE-STD-3020-2005	<i>Specifications for HEPA Filters Used by DOE Contractors</i>
DOE-STD-3025-2007	<i>Quality Assurance Inspection and Testing of HEPA Filters</i>
DOE-HDBK-1169- 2003	<i>Nuclear Air Cleaning Handbook</i>

Other Government Documents

10 CFR 835	<i>Occupational Radiation Protection</i>
29 CFR 1910.134	<i>Respiratory Protection</i>

40 CFR 264.193	<i>Containment and Detection of Releases</i>
40 CFR 265.193	<i>Containment and Detection of Releases</i>
NRC R.G. 3.10	<i>Liquid Waste Treatment System Design Guide for Plutonium Processing and Fuel Fabrication Plants</i>
NRC R.G. 3.12	<i>General Design Guide for Ventilation Systems of Plutonium Processing and Fuel Fabrication Plants</i>
NRC R.G. 3.18	<i>Confinement Barriers and Systems for Fuel Reprocessing Plants</i>
NRC R.G. 3.20	<i>Process Off-Gas Systems for Fuel Reprocessing Plants</i>
NRC R.G. 3.32	<i>General Design Guide for Ventilation Systems for Fuel Reprocessing Plants</i>
NRC R.G. 3.54	<i>Spent Fuel Heat Generation in an Independent Spent Fuel Storage Installation</i>
NRC R.G. 8.8	<i>Information Relevant to Ensuring that Occupational Radiation Exposures at Nuclear Power Stations Will Be as Low as Is Reasonably Achievable</i>

Non-Government Documents

ACGIH 2097	<i>Industrial Ventilation: A Manual of Recommended Practice for Design</i>
ACI 224.1 R-07	<i>Causes, Evaluation, and Repair of Cracks in Concrete Structures</i>
ACI 224.2R-92 Reapproved 2008	<i>Cracking of Concrete Members in Direct Tension</i>
ACI 224.3R-95 Reapproved 2008	<i>Joints in Concrete Construction</i>
ACI 318-11	<i>Building Code Requirements for Structural Concrete and Commentary</i>
ACI 349-06	<i>Code Requirements for Nuclear Safety-Related Concrete Structures</i>
ANSI/AISC N690-12	<i>Specification for Safety-Related Steel Structures for Nuclear Facilities</i>
ANSI/ANS 6.4-2006	<i>Nuclear Analysis and Design of Concrete Radiation Shielding for Nuclear Power Plants</i>
ANSI/ANS 6.4.2-2006	<i>Specification for Radiation Shielding Materials</i>

ANSI/ANS 8.3-1997 Reaffirmed 2012	<i>Criticality Accident Alarm System</i>
ANSI/HPS N13.1- 2011	<i>Guide to Sampling Airborne Radioactive Materials in Nuclear Facilities</i>
ANSI N2.3	<i>Immediate Evacuation Signal for Use in Industrial Installations Where Radiation Exposure May Occur</i>
ANSI Z88.2	<i>Respiratory Protection</i>
ASHRAE Handbook	<i>Vol 1-4: Fundamentals, Refrigeration, HVAC Applications, and HVAC Systems and Equipment</i>
ASHRAE Std 62-2010	<i>Ventilation for Acceptable Indoor Air Quality</i>
ASME AG-1-2012	<i>Code on Nuclear Air and Gas Treatment</i>
ASME B31.3-2012	<i>Process Piping</i>
ASME B&PV	<i>ASME Boiler and Pressure Vessel Code</i>
ASME N509	<i>Nuclear Power Plant Air-Cleaning Units and Components</i>
ASME N510	<i>Testing of Nuclear Air-Treatment Systems</i>
ASME NQA-1	<i>Quality Assurance Requirements for Nuclear Facility Application</i>
ASTM A262	<i>Standard Practices for Detecting Susceptibility to Intergranular Attack in Austenitic Stainless Steels</i>
ASTM D4258-05 (2012)	<i>Standard Practice for Surface Cleaning Concrete for Coating</i>
IEEE-1023-2004	<i>Recommended Practice for the Application of Human Factors Engineering to Systems, Equipment, and Facilities of Nuclear Power Generating Stations</i>
IEEE-1185-2010	<i>Recommended Practice for Cable Installation in Generating Stations and Industrial Facilities</i>
ISA RP60.3	<i>Human Engineering for Control Centers</i>
MIL-HDBK-1007/3	<i>Soil Dynamics and Special Design Aspects</i>
NFPA 1	<i>Fire Code</i>
NFPA 101	<i>Life Safety Code</i>
Fink and Beatty	<i>Standard Handbook for Electrical Engineers</i>

SECTION 1

SYSTEMS

This section of the handbook treats systems (e.g., confinement systems, radiation protection, and effluent monitoring and controls) typically used in nuclear facilities to control radiation or radioactive material. The specifics of designing these systems are developed in an iterative fashion by considering hazards and opportunities (alternatives) for prevention and mitigation of accidents involving the hazards. This section provides information based on experience, which the designer may use when developing the design.

1.1 CONFINEMENT SYSTEMS

1.1.1 Introduction and Scope. Safety ventilation and off-gas systems are generally designed to operate in conjunction with physical barriers to form a confinement system that limits the release of radioactive or other hazardous material to the environment and prevents or minimizes the spread of contamination within the facility. Confinement systems should be designed to—

- prevent (if possible) or minimize the spread of radioactive and other hazardous materials to occupied areas;
- minimize the release of radioactive and other hazardous materials in facility effluents during normal operation and anticipated operational occurrences;
- minimize the spread of radioactive and other hazardous materials within unoccupied process areas; and
- limit the release of radioactive and other hazardous materials resulting from accidents, including those caused by severe natural phenomena and man-made events.

The specifics of confinement system design, as they relate to a particular facility, should be guided by an iterative process between safety analyses and design. Safety analyses define the functional requirements of the design, such as the type and severity of accident conditions to be accommodated by the confinement system. The design should also consider sources of functional design requirements including maintenance, operability, and process requirements. This

section discusses primary, secondary, and tertiary confinement systems, design of confinement ventilation systems, and aspects of confinement system design by nuclear facility type. The American Society of Heating, Refrigerating, and Air Conditioning Engineers (ASHRAE) *HVAC Applications Handbook* provides general information regarding heating, ventilation, and air conditioning (HVAC) design for confinement systems.

- 1.1.2 General Considerations.** Confinement system features, including confinement barriers and associated ventilation systems, are used to maintain controlled, continuous airflow from the environment into the confinement building, and then from uncontaminated areas of the building to potentially contaminated areas, and then to normally contaminated areas.

For a specific nuclear facility, the number and arrangement of confinement barriers and their design features and characteristics are determined on a case-by-case basis. Typical factors that affect confinement system design are the type, quantity, form, and conditions for dispersing the hazardous material, including the type and severity of potential accidents. In addition, alternative process and facility design features may reduce potential hazards and the resulting requirements for confinement system design. Engineering evaluations, trade-offs, and experience are used to develop a practical design that achieves confinement system objectives.

Because the number and arrangement of confinement systems required for a specific nuclear facility design cannot be predicted, this discussion describes a conservative confinement system design that uses the three principal confinement systems described below. The discussion assumes that three levels of confinement are necessary or justified. Design decisions for a specific facility should address that facility's hazards and other factors.

- Primary confinement is usually provided by piping, tanks, gloveboxes, encapsulating material, and the like, and any off-gas system that controls effluent from within the primary confinement. It confines hazardous material to the vicinity of its processing.
- Secondary confinement is usually provided by walls, floors, roofs, and associated ventilation exhaust systems of the cell or enclosure

surrounding the process material or equipment. Except for glovebox operations, the area inside this barrier provides protection for operating personnel.

- Tertiary confinement is provided by the walls, floor, roof, and associated ventilation exhaust system of the facility. Tertiary confinement provides a final barrier against release of hazardous material to the environment.

1.1.3 Primary Confinement System. Primary confinement consists of barriers, enclosures, gloveboxes, piping, vessels, tanks, and the like that contain radioactive or other hazardous material. Its primary function is to prevent release of radioactive or hazardous material to areas other than those in which processing operations are normally conducted.

Primary confinement of processes that involve readily dispersible forms of material (e.g., solutions, powder or small fragments, gases) is provided by gloveboxes or other confining enclosures. Hoods are used when hazards are acceptably low, as indicated by the quantity of the material involved, the specific operation to be performed, and the hazardous nature and chemical form of material involved. The confinement philosophy described below should be applied to any component that serves a primary confinement function, such as conveyor systems, material transfer stations, and ventilation/off-gas systems.

Breaches in the primary confinement barrier that cannot be totally avoided or ruled out (e.g., due to glove or seal failure) should be compensated for by providing adequate inflow of air or safe collection of spilled liquid. Occasional breaches required for anticipated maintenance should be made only under carefully controlled conditions. Primary confinement should provide for storage of in-process material elsewhere, temporary alternative barriers, and adequate inflow of air to provide contamination control.

The supply and exhaust ventilation system should be sized to maintain in-facility radiation doses at levels as low as reasonably achievable (ALARA) in the event of the largest credible breach. Process equipment and the process itself should be designed to minimize the probability of fire, explosion, or corrosion that might breach the confinement barrier. When handling pyrophoric forms (e.g., chips, filings, dust) of materials in the confinement enclosure, the guidance of DOE-

HDBK-1081-94, *Primer on Spontaneous Heating and Pyrophoricity*, should be considered. Halon systems should not be used with pyrophoric metals due to the oxidizing reaction between halon and hot metal.

Primary confinement barrier(s) should be provided between the process material and any auxiliary system (e.g., a cooling system) to minimize risk of material transfer to an unsafe location or introduction of an undesirable medium into the process area. Differential pressure across the barrier(s) should be used where appropriate.

The effectiveness of each confinement barrier should be checked analytically against challenges it is expected to withstand without loss of function. This applies to any form of the hazardous material (gas, liquid, or solid) and its carrying medium (i.e., airborne or spilled in a liquid).

To protect the integrity of process confinement systems, fire protection systems should include the following features:

- Automatic and redundant fire detection devices.
 - A fire-extinguishing system that actuates automatically to rapidly remove heat produced by fire to prevent or minimize pressurization of a process confinement and
 - rapidly extinguish a fire to minimize the loading of ventilation system filters with combustion products.

(See DOE-STD-1066-2012, *Fire Protection*, and DOE-STD-3020-2005, *Specifications for HEPA Filters Used by DOE Contractors*.)

- The introduction of the extinguishing agent in a way that does not result in overpressurization of the confinement barriers.
- Provisions to collect liquid agents when a wet suppression agent is used.

Enclosures (as primary confinement). Enclosures are physical barriers (e.g., cells, cubicles, gloveboxes, fume hoods, conveyor tunnels) that, together with their ventilation and operating systems, prevent the release of radioactive or other hazardous material to the work space or the environment. Accordingly, their structural and confinement integrity is a design consideration. [See the American Conference of Governmental Industrial Hygienists (ACGIH) *Industrial Ventilation: A Manual of Recommended Practice*

for Design (ACGIH 2097); American Society of Mechanical Engineers (ASME) *Code on Nuclear Air and Gas Treatment* (ASME AG-1); and the *Nuclear Air Cleaning Handbook* (DOE-HDBK-1169-2003).]

Enclosures should be designed to prevent exposure of personnel to airborne contamination and to implement ALARA concepts to minimize operator exposures. The enclosure system, including its internal and external support structures, should therefore be designed to withstand the effects of normal operating conditions, anticipated events, and accidents. Criticality considerations, when needed, should include water or other liquid sources, potential liquid level in the enclosure (during operations or fire fighting), drains to limit liquid level in the enclosure, and liquid collection in depressions, walls, and other areas.

The following additional considerations should be addressed in designing enclosures:

- Where practical, equipment not functionally required to operate directly in the presence of radioactive materials should be located outside the enclosure. Equipment located within the enclosure should be designed to allow for in-place maintenance and/or replacement.
- The design and operation of support and protection systems, such as fire protection, should not promote the failure of the enclosure system integrity or the loss of confinement.
- Noncombustible or fire-resistant, corrosion-resistant materials should be used for enclosures and, to the maximum extent practicable, for any required radiation shielding. In no case should the total combustible loading located in a fire area exceed the fire resistance rating of the structural envelope. (See National Fire Protection Association (NFPA) *Fire Protection Handbook* for guidance on the relationship of combustible loading versus fire resistance rating.)
- In conjunction with their ventilation systems, enclosures should be capable of maintaining confinement (i.e., negative pressure with respect to the surrounding operating area).
- To reduce migration of contamination, closure devices or permanent seals should be provided on entrances to and exits from piping, ducts, or conduits penetrating confinement barriers. Such closures or seals should have an integrity equal to or greater than the barrier itself.

- Where pertinent to safety, enclosure design should consider heat generation in the enclosure. Such heat sources may be from processes, lighting, chemical reactions, and the decay of radioactive material. Consideration of radioactive material as a heat source is particularly applicable to storage enclosures.
- Consideration should be given to modular construction, versatility, relocation, and incorporation of shielding. Structural support should be provided to accommodate any anticipated loading resulting from shielding. The type of shielding used and its placement should allow for adequate fire-fighting access.

Enclosure specifications should address the following standardized features, where applicable:

- Windows and mountings.
 - Windows should be appropriately sized (and as small as practicable) and located to provide operators with visual access to the enclosure interior.
 - Windows should be constructed of noncombustible or approved fire-resistant materials.
 - Resistance of the selected material to impact and radiation damage should be considered.
 - The use of Mylar™ glass laminates should be considered for use as viewing windows and lighting fixture covers in hydrofluoric acid environments.
 - Windows should be designed to minimize the risk of releasing contamination to the working area during window replacement.
 - Window material should be selected based on specific process, combustible loading, and radiological safety considerations.
- Glove ports (size, location, and height).
 - Glove ports should be located to facilitate both operations and maintenance work inside the enclosure.
 - Gloves should be flexible enough for operating personnel to access interior surfaces and equipment.

- Gloves should be designed to allow replacement without losing contamination control and with minimum exposure to the operator.
- When gloves are not in place, a noncombustible shield or cover for each glove port should be provided.
- Exhaust air filters to minimize contamination of ductwork.
- Ease of cleaning (radius corners, smooth interior and exterior surfaces, minimal protuberances, and accessibility of all parts).
- Specific coatings for boxes containing halides to permit long life and ease of decontamination.
- Adequate interior illumination (from fixtures mounted on the exterior where feasible).
- Connections for service lines, conduits, instrument leads, drains, and ductwork.
- Pressure differential monitors and heat detection.
- Fire barriers and filter installation.
- Sample removal ports for filter testing.

Consideration should be given to incorporating transfer systems (such as double-door, sealed transfer systems or chain conveyors) for removal of hazardous material from a glovebox. These systems are designed to allow entry and removal of material without breaching the integrity of the glovebox. (See DOE-HDBK-1169-2003, *Nuclear Air Cleaning Handbook*, for additional information.)

- 1.1.4 Secondary Confinement.** The secondary confinement system consists of confinement barriers and associated ventilation systems that confine any potential release of hazardous material from primary confinement. For example, when gloveboxes provide primary confinement for radioactive or hazardous material processing, the functional requirements for secondary confinement refer to the operating area boundary and the ventilation system serving the operating area.

Design features incorporated into the secondary confinement system should have been proven effective by extensive experience in similar applications or by formal prototype testing. Such design features include the following:

- Continuous monitoring capability should be provided to detect loss of proper differential pressure with respect to the process area. Operating areas should also be continuously monitored. Commensurate with the potential hazards, consideration should be given to the use of redundant sensors and alarms.
- Permanent penetrations of the secondary confinement (e.g., pipes, ducts) should have positive seals or isolation valves or double closure with controlled secondary to primary leakage on pass-through penetrations (e.g., personnel air locks and enclosed vestibules).
- Ventilation systems associated with secondary confinement should be designed with adequate capacity to provide proper direction and velocity of airflow in the event of the largest credible breach in the barrier.
- Secondary and tertiary barriers may exist in common such as a single structural envelope (e.g., walls, roof slab, floor slab), provided the barrier can withstand the effects of external events, and does not contain access ways that allow the routine transfer of personnel, equipment, or materials directly to the exterior of the facility. Access ways into the interior of the single structural envelope should be designed so that the access way is entered from another level of confinement.
- Special features (e.g., air locks, enclosed vestibules) should be considered for access through confinement barriers to minimize the impact of facility access requirements on the ventilation system and to prevent the release of radioactive airborne materials.
- The use of stack-vented rupture disks, seal pots, or bubbler traps should be considered to prevent overpressurization and potential explosive disruption of the secondary confinement system.
- When a pipe is used as the primary confinement barrier for materials, and the pipe exits a secondary confinement, the secondary confinement should be provided by a double-walled pipe or other encasement. In areas within the facility, the use of double-walled pipe should be considered. Leakage monitoring should be provided to detect leakage into the space between the primary pipe and the secondary confinement barrier. (See Resource Conservation and Recovery Act requirements in 40 Code of Federal Regulations (CFR) 264.193,

Containment and Detection of Releases, and 40 CFR 265.193, *Containment and Detection of Releases*.)

- When primary confinement includes ductwork, the considerations in the previous bullet should be applied to the ductwork. Transition from primary to secondary confinement typically occurs downstream of air cleaning devices, such as high-efficiency particulate air (HEPA) filters and adsorbers.

1.1.5 Tertiary Confinement. Tertiary confinement is provided by the building or outer structure of the facility. For some accidents, it represents the final barrier to release of hazardous material to the environment; for others, it is a barrier that protects other parts of the facility from damage.

ALARA concepts should be incorporated in tertiary confinement system design to minimize exposure to operators, the public, and the environment.

1.1.6 Confinement Ventilation Systems. The design of a confinement ventilation system ensures the desired airflow at all times and specifically when personnel access doors or hatches are open. When necessary, air locks or enclosed vestibules may be used to minimize the impact of open doors or hatches on the ventilation system and to prevent the spread of airborne contamination within the facility.

Air cleanup systems provided in confinement ventilation exhaust systems are typically used to limit the release of radioactive or other hazardous material to the environment and to minimize the spread of contamination within the facility. To the extent practical, discrete processing steps should be performed in individual process confinements to reduce the amount of hazardous material that can be released by a single or local failure of the confinement system. The following general cleanup system features should be considered, as appropriate, for ventilation system design:

- The level of radioactive material in confinement exhaust systems should be continuously monitored. Alarms should annunciate when activity levels above specified limits are detected in the exhaust stream. Appropriate manual or automatic protective features that prevent an uncontrolled release of radioactive material to the environment or workplace should be provided.
- Elevated confinement exhaust discharge locations can limit onsite doses and reduce offsite doses by enhancing atmospheric dispersion. An elevated stack should be used for confinement of exhaust discharge. Provisions should be

made to provide an adequate ventilation exhaust discharge path in the event of stack failure. The stack should be located so that it cannot fall on the facility or an adjacent facility. Alternatively, the stack may be constructed to remain functional following accidents, including those caused by severe natural phenomena and man-made external events. Stack location and height should also consider intakes on the facility and adjacent facilities to preclude uptake.

- Guidance for air sampling locations is provided in ACGIH/ASHRAE criteria. Sample collecting devices should be located as close to the sampling probe as possible. Guidance for air cleaning device test port locations is provided by ASME N510, *Testing of Nuclear Air-Treatment Systems*.
- The number of air filtration stages required for any area of a facility should be determined based on the quantity and type of radioactive materials to be confined.
- Air filtration units should be installed as close as practical to the source of contaminants to minimize the contamination of ventilation system ductwork.
- Ducts should be sized for the transport velocities needed to convey particulate contaminants to filter media while minimizing the settling of those contaminants in the ducts.
- Ducts should be welded (transverse or longitudinal). Connections to equipment should be made using companion angle flanges.
- Air filtration units should be located and provided with appropriate radiation shielding to maintain occupational doses ALARA during operations and maintenance.
- Air filtration units should be designed to facilitate recovery of fissile material and other materials capable of sustaining a chain reaction.
- The cleanup system should have installed test and measuring devices (see ASME N510) and should facilitate monitoring operations, maintenance, and periodic inspection and testing during equipment operation or shutdown, as appropriate.
- Misters to cool inlet air and demisters to prevent soaking HEPA filters should be installed. Manual control of misters from the facility control center should be

considered. The inlet should have a temperature sensor with a readout on the facility control center monitor screen.

- Where spaces, such as a control room, are to be occupied during abnormal events, filtration systems on the air inlets should be considered to protect the occupants. Control rooms should also be protected from the entry of smoke or other toxic gases through ventilation air intakes. Compressed (bottled) air storage could be used to pressurize the control room if toxic gases are present at the air intake. Alternatively, two intakes, separately located, could lessen the likelihood of toxic gas intake.
- Either HEPA filtration or fail-safe backflow prevention for process area intake ventilation systems should be provided.
- Consideration should be given to specify cadmium-free HEPA filters to avoid generating mixed waste.
- Roughing filters or prefilters upstream of a HEPA filter should be considered to maximize the useful life of the HEPA filter and to reduce radioactive waste volume.
- When ducts with fire dampers penetrate the secondary confinement, boots may be needed for the clearance between the structure and the damper sleeve.

Hot cell exhaust systems considerations are as follows:

- Exhaust prefilters and HEPA filters should be installed to facilitate filter replacement and repair. Use of a bag-in/out type filter house can lessen personnel exposures.
- Standby filters should be considered to provide backup protection and facilitate primary filter replacement without shutting down the exhaust fans. Standby filters should be installed outside the cell and sealed in an acceptable enclosure for direct maintenance. Note: Air leakage through isolation valves/dampers should be evaluated to avoid the bypassing of filtration devices; the reduction of exhaust flow from recirculation through the standby filters; the exposure of personnel changing the isolated filter elements; and the premature loading of the standby filters.

- Exhaust systems should have monitors that provide an alarm if the concentration of radioactive material in the exhaust exceeds specified limits.
- If radioiodine may be present, consideration should be given to the installation of radioiodine-absorber units.

In facilities where plutonium or enriched uranium is processed, the following are additional considerations:

- Wherever possible, the designer should provide enclosures for confining process work on plutonium and enriched uranium. When these confinement enclosures are specified and designed, consideration should be given to whether room ventilation air for either a secondary or tertiary confinement can be recirculated. If a recirculation ventilation system is provided, the design should provide a suitable means for switching from recirculation to once-through ventilation.
- If advantageous to operations, maintenance, or emergency personnel, the ventilation system should provide for independent shutdown. Such a shutdown should be considered in light of its effect on the airflow in other interfacing ventilation systems. When a system is shut down, positive means of controlling backflow of air to uncontaminated spaces should be provided by positive shutoff dampers, blind flanges, or other devices.
- Equipment to continuously monitor oxygen levels should be provided for occupied working areas of facilities equipped with significant quantities of inert or oxygen-deficient process glovebox lines. Allowable leakage rates for ductwork systems should be taken into consideration.
- The supply of air to primary confinement, such as enclosures that confine the processing of plutonium and enriched uranium, should be filtered by HEPA filters at the ventilation inlets to the enclosures and area confinement barriers to prevent the transport of radioactive contamination in the event of a flow reversal.
- If room air is recirculated, the recirculation circuit should provide at least one stage of HEPA filtration. The design should include redundant filter banks and fans. If recirculation systems are used, contaminated process enclosure air should be prevented from exhausting into the working area rooms. Process

enclosure air (from hoods, gloveboxes, etc.) should be treated and exhausted without any potential for recirculation to occupied areas.

- The designer should specify and locate components in the exhaust systems to remove radioactive materials and noxious chemicals before the air is discharged to the environment. These components should be capable of handling combustion products safely. Exhaust system design should safely direct effluents through the appropriate ventilation ducts and prevent spread beyond the physical boundary of the ventilation system until treated.
- HEPA filters should be installed at the interface between the enclosures that confine the process and the exhaust ventilation system to minimize the contamination of exhaust ductwork. Prefilters should be installed ahead of HEPA filters to reduce HEPA filter loading. The filtration system should be designed to allow reliable in-place testing of the HEPA filter and to simplify filter replacement.
- Separate exhaust ventilation system ductwork and the initial two stages of filtration should be designed for exhaust air from enclosures that confine the process (e.g., gloveboxes). These systems should maintain a negative pressure inside the enclosure with respect to the operating area. These systems should be designed to remove moisture, heat, explosive and corrosive gases, and other contaminants. These systems should also be designed to automatically provide adequate inflow of air through a credible breach in the enclosure confinement.
- Enclosures that confine the process and are supplied with gases at positive pressure should have positive-acting pressure-relief valves that relieve the exhaust system to prevent over-pressurization of the process confinement system.
- The design of air cleaning systems for normal operations, anticipated operational occurrences, and accident conditions should consider use of the following equipment as appropriate:
 - prefilters,
 - scrubbers,
 - HEPA filters,
 - sand filters,
 - glass filters,

- radioiodine absorbers,
- condenser distribution baffles, and
- pressure and flow measurement devices.

Airborne contaminant cleaning systems should be designed for convenient maintenance and the ability to decontaminate and replace components in the supply, exhaust, and cleanup systems without exposing maintenance or service personnel to hazardous materials. Filtration systems should be designed so that a bank of filters can be completely isolated from the ventilation systems during filter element replacement.

Where the confinement system's ventilation ducting penetrates fire barriers, fire dampers should be appropriately used to maintain barrier integrity. However, the closure of such dampers should not compromise confinement system functions where the loss of confinement might pose a greater threat than the spread of fire. In such cases, alternative fire protection means (e.g., duct wrapping) should be substituted for fire barrier closure. In no case should a sprinkler system be considered a fire barrier substitute. (All penetrations of a fire barrier should be sealed, including conduit, cable trays, piping, and ductwork. In the selection of seals, requirements for pressure and water-tightness should be considered.)

1.2 CONFINEMENT SYSTEM DESIGN ASPECTS BY FACILITY TYPE

The preceding discussions of primary, secondary, and tertiary confinement generally apply to all nuclear facilities. The degree of applicability should be determined on a case-by-case basis. The following discussions provide some guidance on how to make these determinations as a function of facility type.

A description of the facility types is included in Section 2. "Containment" is addressed in Section 2.10.8.

1.2.1 Plutonium Processing and Handling Facilities and Plutonium Storage Facilities (PSFs)

The degree of confinement required is generally based on the most restrictive hazards anticipated. Therefore, the type, quantity, and form (physical and chemical) of the materials to be stored should be considered. For materials in a form not readily dispersible, a single confinement barrier may be sufficient. However, for more readily dispersible materials, such as liquids and powders, and for materials with inherent dispersal mechanisms, such as pressurized cases and pyrophoric forms, multiple confinement barriers should be

considered. U.S. Nuclear Regulatory Commission (NRC) Regulatory Guide (R.G.) 3.12, “*General Design Guide for Ventilation Systems of Plutonium Processing and Fuel Fabrication Plants*,” provides useful guidance that should be considered.

Generally, for the most restrictive cases anticipated, three types of confinement systems should be considered:

- primary confinement—established by the cladding or the storage container (e.g., canning);
- secondary confinement—established by compartments with their ventilation systems; and
- tertiary or final confinement—established by the building structure and its ventilation system.

Exhaust ventilation systems are provided with HEPA filtration to minimize the release of plutonium and other hazardous material through the exhaust path. In addition, inlet ventilation to the secondary confinement systems should be provided with either HEPA filtration or fail-safe backflow prevention to minimize the release of plutonium and other hazardous materials through the inlet path.

Primary Confinement System. Cladding or storage containers typically provide primary confinement during normal operation and anticipated operational occurrences, and for accidents. Cladding or storage containers should provide corrosion-resistant confinement for fuel assemblies and to prevent an uncontrolled release of radioactive material. Special design features should be considered to provide safe introduction, removal, and handling of stored plutonium. These handling systems and equipment should be designed to protect against the dropping of storage containers, fuel assemblies, and other items onto the stored plutonium.

Secondary Confinement System. Compartments and their ventilation systems comprise the secondary confinement system. Secondary confinement barriers should have positive seals to prevent the migration of contamination. The use of positive seals should be considered for penetration of enclosures within the facility building to provide proper ventilation flow paths and to prevent the migration of contamination within the facility. Ductwork penetrations with fire

dampers need clearance between the structure and the damper sleeve. Boots may be needed.

The need for special ventilation systems for confinement purposes should be based on results of the safety analysis. In general, each compartment should be supplied with ventilation air from the building ventilation system. Each compartment should also be provided with separate exhaust ventilation handled by a system with sufficient capacity to provide adequate ventilation flow in the event of a credible breach in the compartment confinement barrier. Pressure in the compartments should be negative with respect to the building ventilation system.

Tertiary Confinement System. The facility building and its ventilation system comprise the tertiary confinement system. Penetrations of the building confinement barriers should have positive seals to prevent the migration of contamination. Air locks or enclosed vestibules should also be provided for access through confinement barriers.

- 1.2.2 Unirradiated Enriched Uranium Storage Facilities.** The following provisions are typical for an unirradiated enriched uranium storage facility (UEUSF) confinement system. The actual confinement system requirements for a specific UEUSF should be determined on a case-by-case basis.

The degree of confinement required is generally based on the most restrictive hazards anticipated. Therefore, the type, quantity, and form (physical and chemical) of the materials to be stored should be considered. For materials in a form not readily dispersible, a single confinement barrier may be sufficient. However, for more readily dispersible materials, such as liquids and powders, and for materials with inherent dispersal mechanisms, such as pressurized cases and pyrophoric forms, multiple confinement barriers should be considered.

Generally, for the most restrictive case anticipated, the use of three confinement systems should be considered. The primary confinement should be the unirradiated enriched uranium (UEU) cladding or the storage container (e.g., canning). Secondary confinement should be established by compartments with their ventilation systems. Tertiary or final confinement should be the building structure and its ventilation system.

Primary Confinement System. UEU cladding or storage containers typically provide primary confinement during normal operation, anticipated operational occurrences, and accidents. Cladding or storage containers are used to provide a corrosion-resistant confinement for the fuel assemblies and other UEU to prevent an uncontrolled release of radioactive material. Special design features should be considered to introduce, remove, and handle UEU safely. These handling systems and equipment should protect against the dropping of storage containers, UEU assemblies, and other items onto the stored UEU.

Secondary Confinement System. The compartments and their ventilation systems comprise the secondary confinement system. Penetrations of the secondary confinement barrier should have positive seals to prevent the migration of contamination. The use of positive seals should be considered for penetration of enclosures within the facility building to provide proper ventilation flow paths and to prevent the migration of contamination within the facility.

The need for special ventilation systems for confinement purposes should be determined based on the safety analysis. In general, each compartment should be supplied with ventilation air from the building ventilation system. Separate exhaust ventilation should be handled by a system with sufficient capacity to provide adequate ventilation flow in the event of a credible breach in the compartment confinement barrier. Pressure in the compartments should be negative with respect to the building ventilation system.

Tertiary Confinement System. The facility's building and ventilation system comprise the tertiary confinement system. Penetrations of the building confinement barriers should have positive seals to prevent the migration of contamination.

- 1.2.3 Uranium Processing and Handling Facilities.** The following provisions are typical for a uranium processing and handling facility (UPHF) confinement system. The actual confinement system requirements for a specific UPHF should be determined on a case-by-case basis.

Generally, facilities that process and handle UEU have used two confinement systems. The primary confinement system encloses or confines the uranium materials being fabricated and the equipment used to process the uranium. The

secondary confinement consists of the structures and associated ventilation systems that surround the operating areas that house the primary confinement system. The secondary confinement system barriers are those that separate the outside environment and free access areas, such as offices and lunch rooms, from potential contamination.

Primary Confinement System. The primary confinement system includes barriers, enclosures (including their associated ventilation or atmosphere control systems), and process piping and vessels. Its principal function is to prevent the release of hazardous substances into the operating areas. The following features should be considered in the design:

- Breaches of the primary confinement barrier (e.g., due to glove or seal failure) are acceptable if the off-gas treatment system is capable of maintaining an adequate inflow of air for the specified breach size and location. Some portions of the primary confinement may not form a complete physical enclosure. For these, primary confinement should be ensured by adequate airflow and appropriate process equipment design.
- If needed, conveyors should be used to interconnect glove holes or other primary confinement enclosures to minimize introduction and removal of materials from the system. The primary confinement system criteria should be applied to these interconnections.
- Special design features should be considered to safely introduce and remove materials from process confinements.
- Process vessels that could contain uranium should vent to the process off-gas system, which in turn should pass through pretreatment, if needed, and HEPA filtration.

Three types of metallurgical processes require special ventilation considerations:

- Processes that use volatile or easily entrained organic liquids should have a ventilation system that provides sufficient air movement around the process area to prevent exposure of personnel to the hazardous liquid or vapor. The design should incorporate roughing filters and/or other types of traps to remove entrained organic liquid droplets from the process off-gas before the off-gas enters the main ventilation. As a

result, the ventilation ducts should not become coated with the organic materials, which would create a fire hazard.

- Processes that produce either finely divided particles of metal or small metal chips should have the same kind of front-end ventilation adaptations as for hazardous vapors and liquids to prevent metal accumulations in the off-gas ducting or in the final filtration train(s). Roughing filters or centrifugal separators may be sufficient to remove metal particles from the off-gas.
- Processes that use corrosive chemicals (e.g., acids, perchlorates) should use off-gas scrubbers to preclude damage to the exhaust air cleaning system (e.g., HEPA filtration train).

Metallurgical processing equipment should have dedicated ventilation systems that exhaust to a common, final filtration train. If airborne particle capture is required, a high linear velocity will be necessary to ventilate these process areas due to the greater densities of metal particles.

Ceramic processes involve oxide powder that is finely divided. The exposure of personnel to the powder inhalation hazard should be prevented. Processes that handle bulk ceramics such as pellets are not dust-free operations and thus, adequate ventilation should be provided.

Secondary Confinement System. The secondary confinement system generally consists of the confinement barriers and associated ventilation systems that surround or confine the operating areas that house the process system and its primary confinement.

The operating area compartments should have sensors that detect releases of hazardous materials from the primary confinement system and provide appropriate alarms. Commensurate with the potential hazard, the use of redundant sensors should be considered.

Penetrations of the operating area confinement barriers should be minimized. When practical, equipment components not functionally required to operate directly in the presence of radioactive materials should be located outside the operating area compartments. Penetrations of the secondary confinement

should have positive seals to prevent the migration of contamination out of the operating area.

Each secondary confinement compartment should be supplied with ventilation air from the building ventilation system and should have exhaust ventilation with sufficient capacity to provide controlled ventilation flow as required in the event of a credible breach in the operating compartment confinement barrier. Pressure in the compartments should be negative with respect to the building ventilation system.

- 1.2.4 Irradiated Fissile Material Storage Facilities.** The following provisions are typical for an irradiated fissile material storage facility (IFMSF) confinement system. The actual confinement system requirements for a specific IFMSF should be determined on a case-by-case basis.

In general, primary confinement is the irradiated fissile material (IFM) cladding or canning. Secondary confinement is established by the facility buildings that enclose the dry storage area and/or the storage pool and auxiliary systems.

Primary Confinement System. The IFM cladding or cans, as appropriate, provide primary confinement during normal and anticipated operational occurrences. The IFM cladding or canning are used to provide a corrosion-resistant confinement for the IFM material and to prevent an uncontrolled release of radioactive material.

Secondary Confinement System. The facility building and ventilation system make up the secondary confinement system.

Penetrations of the secondary confinement barrier should have positive seals to prevent the migration of contamination. The use of positive seals should be considered for penetration of enclosures within the facility building to provide proper ventilation flow paths and to prevent the uncontrolled migration of contamination.

Ventilation systems should include inlet air filtration (roughing filters) for the main storage building to prevent dust accumulation, thus reducing the load on other filters in the facility. Recirculated air in the main storage building should be filtered through a HEPA filter to reduce the build-up of radioactive material in the air. Areas with higher potential airborne radioactive contamination (e.g., pool

water purification and waste treatment system areas) should use only once-through airflow. Supply air to these facilities should be drawn from the main storage building if such design is feasible. Exhaust air should be HEPAfiltered prior to release.

Radioiodine adsorber units, such as activated charcoal or silver zeolite, should be considered for installation in the exhaust ventilation system when radioiodine releases are possible.

Air should flow from areas of lower contamination to areas of higher contamination and areas of higher potential airborne contamination should be kept less than atmospheric pressure.

1.2.5 Reprocessing Facilities. The following provisions are typical for a reprocessing facility confinement system. Actual confinement system requirements for a specific reprocessing system should be determined on a case-by-case basis.

The degree of confinement required in various locations of the facility depends on the potential hazards associated with the process being carried out and is generally based on the most restrictive case anticipated. Design should consider the characteristics of the hazardous material involved, such as type, quantities, forms (physical and chemical), dispersibility, and energy available for dispersion.

In general, for the most restrictive case anticipated, the use of three confinement systems should be considered. In reprocessing facilities where processes require the use of corrosive or noxious materials, the process system should be totally enclosed and provided with its own ventilation system and off-gas cleanup system. In such cases, the process system should be treated as the primary confinement system. Secondary confinement should consist of the process cells and their ventilation system. Tertiary or final confinement should be the building structure and its ventilation system. In addition to these confinement systems, such features as change rooms and special access ways should be used to minimize the spread of contamination within the facility.

If heat transfer systems are used that provide circulation between radioactive and nonradioactive areas, barriers to release due to contamination of the heat

transfer fluids should be considered. Typically, confinement would be provided through the use of intermediate heat exchangers and the use of a “closed-loop” system. A leak monitoring system should be considered.

Primary Confinement System. The primary confinement system consists of process systems equipment and the associated off-gas system. Process equipment failures should not cause failure of the secondary confinement system. Process equipment should operate under process conditions that prevent or minimize the probability of explosive chemical reactions.

Secondary Confinement System. The secondary confinement system consists of the process cell barriers and the ventilation systems associated with the cells. Design should consider the following features:

- Secondary confinement areas should be equipped with sensors that detect abnormal releases of hazardous material from the primary confinement boundary and provide appropriate alarms. Commensurate with the potential hazard, the use of redundant sensors should be considered.
- Penetrations of the secondary confinement should have positive seals to prevent the migration of contamination out of the secondary confinement area.
- The ventilation system should be designed to maintain a negative differential pressure during the removal of cell covers and for normal in-leakage at cell cover joints.
- Process cells should be supplied with ventilation air from the building ventilation system and with exhaust ventilation of sufficient capacity to provide controlled ventilation flow as required in the event of a credible breach in the secondary confinement barrier.
- Pressure in the compartments should be negative with respect to the building ventilation system.
- Special features (e.g., air locks, enclosed vestibules) should be considered for access through secondary and tertiary confinement barriers.

Tertiary Confinement System. The process building and associated ventilation system comprise the tertiary confinement system. Penetrations of the building confinement barriers should have positive seals to prevent the migration of contamination.

- 1.2.6 Uranium Conversion and Recovery Facilities (UCRFs).** To the extent practical, the primary confinement system should be constructed of fire-resistant materials, and the process equipment and process being confined should be designed to prevent potential flammable or explosive conditions. Confinement enclosures for flammable metals should be designed with self-contained fire protection and extinguishing equipment; in some cases, inert atmospheres may be desirable within the enclosures.

Work that could subject personnel to possible inhalation exposures should be performed in process confinement enclosures. Gloveboxes should be the preferred enclosure, but are not always practical. Alternative systems may have to be considered.

When gloveboxes are used, their design and construction should allow replacement of parts and/or relocation of the box(es) within the facility or system(s) with a minimum of contamination or exposure.

To the extent practical, discrete processing steps should be performed in individual process confinements to reduce the amount of hazardous material that can be released by a single or local failure of the confinement system.

Process and auxiliary system differential pressure should be maintained to inhibit backflow of hazardous materials into auxiliary systems.

Generally, UCRFs have used two confinement systems. The primary confinement system encloses or confines the uranium materials being processed and the materials used to process the uranium. The secondary confinement consists of the structures and associated ventilation systems that surround the operating areas that house the primary confinement system. The operating areas include those areas that are not normally expected to become contaminated. The secondary confinement system barriers are those that separate the outside environment and free access areas, such as offices and lunch rooms, from

potential contamination. The actual confinement system requirements for a specific UCRF should be determined on a case-by-case basis.

Primary Confinement System. The primary confinement system consists of barriers, enclosures (including their associated ventilation or atmosphere control systems), process piping and vessels, and so forth. Its principal function is to prevent the release of hazardous substances into the operating areas. The following considerations should be addressed in the design of primary confinement systems for UCRFs:

- Breaches of the primary confinement barrier (e.g., due to glove or seal failure) are acceptable if the off-gas treatment system is capable of maintaining an adequate inflow of air for the specified breach size and location. Some portions of the primary confinement may not form a complete physical enclosure. For these, primary confinement function should be ensured by adequate airflow and appropriate process equipment design.
- If needed, conveyors should be used to interconnect gloveboxes or other primary confinement enclosures to minimize introduction and removal of materials from the system. The primary confinement system criteria should be applied to these interconnections.
- Special design features should be considered to safely introduce and remove materials from process confinements.
- Process vessels that could contain uranium should be vented to the process off-gas system, which should route off-gas through pretreatment, if needed, and HEPA filtration. Typical pretreatment features include cyclone dust collection systems, different types of filters, cold traps, liquid condensers, solvent adsorption systems, and aqueous solution scrubbers. Nuclear criticality safety should be considered during the design of pretreatment and HEPA filtration systems.

Secondary Confinement System. The secondary confinement system generally consists of the confinement barriers and associated ventilation systems that surround or confine the operating areas that house the process system and

its primary confinement. The following considerations should be addressed in the design of secondary confinement systems for UCRFs:

- Operating area compartments should be equipped with sensors to detect releases of hazardous materials from the primary confinement system and provide appropriate alarms. Commensurate with the potential hazard, the use of redundant sensors should be considered.
- Penetrations of the operating area confinement barriers should be minimized. When practical, equipment components not functionally required to operate directly in the presence of radioactive materials should be located outside the operating area compartments. Penetrations of the secondary confinement should have positive seals to prevent the migration of contamination out of the operating area.
- Each secondary confinement compartment should be supplied with ventilation air from the building ventilation system. Exhaust ventilation should be handled by a system with sufficient capacity to control ventilation flow as required in the event of a credible breach in the operating compartment confinement barrier. Pressure in the compartments should be negative with respect to the building ventilation system. The secondary confinement exhaust ventilation system should be equipped with HEPA filtration.

1.2.7 Laboratory Facilities (Including Hot Laboratories). The following provisions are typical for a laboratory facility confinement system. The actual confinement system requirements for a specific laboratory facility should be determined on a case-by-case basis.

If radioiodine may be present, consideration should be given to the installation of radioiodine absorber units in the exhaust ventilation/off-gas system to reduce the radioiodine concentration in the effluent.

Primary Confinement System.

- In hot laboratories, primary confinement usually consists of items such as a hot cell, glovebox, process piping, tank, fume hood, etc.; the volume enclosed is normally contaminated.

- The primary confinement volume and isolation systems, as appropriate, should be compartmentalized to isolate high-risk areas and to minimize the potential effects of accidents.
- The primary confinement system(s) should operate under process conditions that prevent or minimize the potential for explosive chemical reactions and should use ALARA design principles to minimize exposures.
- Design features for primary confinement for laboratory facilities and processes are facility-specific and should therefore incorporate the following features as appropriate:
 - Introduction and removal stations should provide for safe introduction and removal of material and maintenance equipment to and from the primary confinement.
 - Separate ventilation system or off-gas treatment system with appropriate air-cleaning capability (e.g., HEPA filtration, radioiodine absorbers, scrubbers) should be considered. The use of an inert gas atmosphere within the primary confinement is necessary when handling pyrophoric material. Special considerations should be given to systems that handle tritium (see Section 2.10, Tritium Facilities).
 - Ventilation and cleanup systems associated with the primary confinement system should not be shared with secondary and tertiary confinement systems.
 - Tanks within the primary confinement system should vent to the off-gas treatment system.
 - The operating pressure in the primary confinement system should be negative with respect to the secondary confinement.
- Gloveboxes should meet the following criteria:
 - Corrosive gases or particles from vats, scrubbers, and similar equipment should be neutralized prior to reaching HEPA off-gas filters.

- A single filtered exhaust path should be acceptable when working with low-toxicity materials that do not require dilution or continuous cooling.
- Exhaust flow rates (for air-ventilated gloveboxes) should confine in-box contaminants safely when an access port is opened or a glove ruptures.
- If the glovebox is filled with an inert atmosphere, specific design criteria for emergencies (i.e., ruptured glove) should be incorporated on a case-by-case basis (e.g., pyrophoric materials).
- Hot cells should meet the following criteria:
 - Space and equipment should be provided as needed to support accountability, process monitoring, and material control requirements.
 - Exhaust prefilters and HEPA filters should be installed to facilitate filter replacement and repair.
 - Standby filters should be incorporated for backup protection during filter changes so that filters can be changed without shutting down the exhaust fans. Standby filters should be installed outside the cell and sealed in an acceptable enclosure for direct maintenance.
 - Exhaust systems should have alarms that will annunciate if the concentration of radioactive material in the exhaust exceeds the limits specified in the facility technical safety requirement.

Secondary Confinement System. The secondary confinement system usually consists of the facility operating compartments and associated ventilation systems. The secondary confinement houses the hot cells, gloveboxes, fume hoods, etc. The following design features should be incorporated into secondary confinement systems for laboratory facilities:

- design features to minimize the potential of the spread of contamination from within the laboratory facility operating areas to areas that are not normally contaminated;

- the use of a ventilation system separate from the primary confinement ventilation system with appropriate air-cleaning capability (e.g., HEPA filtration, radioiodine absorbers, scrubbers); and
- measures to provide negative operating pressure in the secondary confinement with respect to the tertiary confinement, especially where variable flow primary confinement exhaust systems (fume hoods) are utilized.

Tertiary Confinement System. The tertiary confinement system typically is the exterior laboratory building and its associated ventilation system. It is an area that is not contaminated and houses offices and other clean laboratory facilities. The following design features should be incorporated into tertiary confinement systems for laboratory facilities:

- the use of a ventilation system separate from the primary confinement ventilation system with appropriate air-cleaning capabilities (e.g., HEPA filtration, radioiodine absorbers, scrubbers) and
- measures to maintain operating pressure in the tertiary confinement negative with respect to the atmosphere.

The secondary and tertiary confinement ventilation systems may be shared if safety analysis indicates that this type of design is acceptable.

1.3 EFFLUENT CONTROL AND RADIATION PROTECTION

1.3.1 Introduction and Scope. This section addresses aspects of facility design specifically intended to provide for effluent control and radiation worker protection. Included are shielding, radiation monitoring systems, contamination control, and effluent monitoring. This treatment is not exhaustive; many lessons learned in design have been translated into regulations, Orders, and guidance documents, especially 10 CFR 835, *Occupational Radiation Protection*; DOE G 441.1-1C (CN1), *Radiation Protection Programs Guide for Use with Title 10, Code of Federal Regulations, Part 835, Occupational Radiation Protection*, DOE-STD-1098-2008 (CN1), *Radiological Control*; and DOE O 420.1C and its guidance documents.

Design of nuclear facilities should minimize personnel exposures to external and internal radiological hazards, provide adequate radiation monitoring and alarm systems, and provide adequate space for health physics activities. Primary radiation protection should be provided through the use of engineered controls (e.g., confinement, ventilation, remote handling, equipment layout, and shielding). Additional protection for workers should be provided through an effective radiation protection program that includes implementation of ALARA concepts.

Additional considerations for specific facility types are included in this handbook; see Section 2, Special Facilities and Activities.

- 1.3.2 Shielding Design.** The shielding design basis should minimize exposure of an individual worker to ALARA levels. 10 CFR 835.1002 provides requirements in this area. In addition, appropriate shielding should be installed, if necessary, to minimize nonpenetrating external radiation exposures to the skin and lens of the eye of the worker. In most cases, the confinement barrier or process equipment provides this shielding. Shielding and other radiation protection measures should be provided for areas requiring intermittent access (e.g., to perform preventive maintenance, change components, and adjust systems and equipment). Straight-line penetration of shield walls should be avoided to prevent radiation streaming. American National Standard Institute/American Nuclear Society (ANSI/ANS-6.4-2006), *Nuclear Analysis and Design of Concrete Radiation Shielding for Nuclear Power Plants*, provides guidance regarding the design of concrete radiation shielding. ANS 6.4.2-2006, *Specification for Radiation Shielding Materials*, provides guidance regarding material specifications, where it provides a critical confinement or structural function. American Concrete Institute (ACI) 318M-11, *Building Code Requirements for Structural Concrete and Commentary*, provides general guidance for the structural design of concrete shielding. Straight-line penetration of shield walls should be avoided to prevent radiation streaming.
- Use of remote, shielded operations (i.e., through the use of handling equipment such as remote manipulators and lead glass windows) should be considered when exposures to extremities are anticipated to approach dose limits or where contaminated puncture wounds could occur.

NCRP Report No. 151, *Structural Shielding Design and Evaluation for Megavoltage X- and Gamma-Ray Radiotherapy Facilities*, provides guidance regarding shielding design and evaluation for mega voltage accelerator facilities.

- 1.3.3 Airborne Radiation Control.** Established airborne concentration limits for normal operating conditions should not be exceeded in occupied operating areas. 10 CFR 835.1002(c) provides requirements for limiting concentrations. ALARA principles should be used when designing confinement and ventilation systems to limit airborne contamination levels. Respirators should not be required during normal operations. Engineered controls and features should minimize potential inhalation of radioactive and other hazardous materials under all conditions. ASME N509, *Nuclear Power Plant Air-Cleaning Units and Components*, and ASME N510, *Testing of Nuclear Air-Treatment Systems*, provide guidance for the design and testing of nuclear facility HVAC systems.

Monitoring systems should be calibrated at least annually using appropriate national standards. Radiation monitoring, alarm, and warning systems, which are required to function during a loss of normal power, should be provided with an emergency uninterruptible power supply (UPS) (internal or external on-line) unless it can be demonstrated that these systems can tolerate a temporary loss of function without losing needed data and that they are provided with standby or emergency (switched) power. Determination of the power supply type and quality should be based on the safety classification of the monitoring system or device. The sampling motivation (vacuum) type and quality should also be based on the safety classification.

Air monitoring and warning systems should be installed in work areas where hazardous materials are stored or handled or where hazardous airborne particles or vapors may be present. Air sampling heads should be located to provide a representative sample of potential airborne radioactive or hazardous materials being breathed. ANSI/HPS N13.56-2012, *Sampling and Monitoring Releases of Airborne Radioactivity in the Workplace* provides guidance for the design of air monitoring systems.

Operation and maintenance of special facilities may lead to situations (e.g., accidents, special maintenance, and spill recovery) where air-supplied

respiratory protection is required. ANSI Z88.2, *Respiratory Protection*, and 29 CFR 1910.134, *Occupational Safety and Health Standards*, provide guidance for the design of breathing air supply systems.

- 1.3.4 Contamination Control.** Use of devices to warn personnel of possible radioactive or other hazardous contamination should be evaluated and provided in accordance with the evaluation. Personnel monitoring devices, such as hand and foot counters, should be provided in the vicinity of workstations. Installed monitors (supplemented with personal monitoring methods) should be used to monitor personnel exiting an operating area. Continuous air monitors (CAMs) should be used to detect and alarm at prescribed airborne radioactivity levels. American National Standard N13.49-2001 (R2011), *Performance and Documentation of Radiological Surveys*, provides both specific and general guidance for facilities using radioactive material or machines producing radiation fields.

Facility design should locate personnel decontamination facilities close to areas that represent potential contamination sources. Decontamination facilities should be designed to minimize the inadvertent spread of contamination during personnel decontamination activities.

Change rooms should be provided for changing into and from protective clothing. These areas should be separate for male and female workers and be located adjacent to shower facilities. Change rooms should be designed to segregate clean clothing (e.g., personal clothing) and protective clothing. Storage of contaminated protective clothing should be controlled so that contamination does not spread. Change room exhaust air should be HEPA filtered if dispersible radionuclides are handled in the process areas it serves.

- 1.3.5 Radiation Monitoring.** In the presence of ionizing radiation (due to process material, equipment, or operations), an area radiation monitoring and alarm system is used to alert personnel of unexpected increases in ionizing radiation levels. Warning and alarm systems should be designed, installed, and tested to confirm that they can be heard in the ambient conditions of the area in which they are placed. If a criticality excursion could potentially occur, including a potential for personnel exposures, nuclear accident dosimeters should be installed. ANSI/ANS 8.3-1997, Reaffirmed 2012, *Criticality Accident Alarm System*,

provides guidance for criticality accident alarms and the design of evacuation alarm systems.

In addition to a local station alarm, radiation monitoring systems (i.e., criticality alarms, CAMs, alarms associated with stack monitoring systems) should have central (i.e., control room or radiation monitoring office) readout and alarm panels that are accessible after an accident so that internal conditions can be evaluated.

1.3.6 Airborne Effluents. For nonradioactive hazardous gaseous or airborne effluents, the point of release is the point at which the effluent exits the stack, vent, or other release points.

Exhaust ducts (or stacks) that may contain radioactive airborne effluents should be provided with effluent monitoring systems. The monitoring capability should cover the range from normal effluent concentrations to the maximum concentration expected from a credible accidental release. For exhaust outlets that may contain plutonium, uranium, enriched uranium, tritium, transuranics or fission products, and other radioisotopes above ambient levels, two independent monitoring systems should be considered.

Backup capability for monitoring systems should be considered in the design of each system (e.g., redundant detectors, additional sample line ports, additional sampler trains, etc.). Continuous stack sampling and continuous radiation detection should also be considered. ANSI N13.1-2011, *Sampling and Monitoring Releases of Airborne Radioactive Substances from the Stacks and Ducts of Nuclear Facilities* provides guidance on designing sampling systems that provide accurate, representative sampling of effluent streams.

Airborne effluents from confinement areas should be exhausted through a ventilation system designed to remove hazardous particulate material, vapors, or gases. ALARA should be implemented to minimize effluent concentrations and quantities released for hazardous materials. Isokinetic sampling should be provided for effluent streams that are expected to contain particulate radionuclides. After HEPA filter installations, anisokinetic sampling may be satisfactory, due to the small particle sizes in the effluent.

Consideration should be given to including process confinement off-gas treatment systems to preclude the accumulation of potentially flammable

quantities of hydrogen generated by radiolysis or chemical reactions within process equipment. Vent streams with the potential of containing significant quantities of radioactive material should be processed by an off-gas cleanup system before being exhausted to the environment.

The following additional features should be considered in off-gas systems:

- providing vents from liquid components with traps and drains to prevent inadvertent flooding of off-gas systems;
- neutralizing corrosive gases and particles from vats, scrubbers, and similar equipment in gloveboxes before they reach the HEPA off-gas filters;
- equipping vent streams containing UF₆ with chemical traps to remove radionuclides from the gases before they are vented to the atmosphere.

The following vents are typically equipped with traps:

- purge cascade,
- cold recovery,
- buffer seal exhaust stations, and
- wet-air evaluation stations.

Consideration should also be given to the need for equipment to provide meteorological parameters (e.g., wind speed, wind direction, humidity data, and wind direction frequencies for heights related to the estimated heights at which stack effluents and cooling tower moisture will be dispersed). As necessary, installation of special equipment for stack effluent dispersal and tracking should be considered.

- 1.3.7 Effluent Control.** Generally, there will be statutory limits on facility effluents and concentrations at the point of discharge and/or the site boundary. These statutory requirements should be identified and their requirements implemented in design. Consideration should also be given to concentrations at neighboring facilities, and even to operations areas of the facility outside the building, especially for chemical releases. The design of monitoring and control systems that reduce effluents released to the environment to ALARA levels should

emphasize the use of features that employ the best technology economically available at the time of design. Confinement systems should minimize the release of radioactive and other hazardous materials in facility effluents during normal operation and anticipated operational occurrences.

1.3.8 Effluent Monitoring. Design for effluent monitoring should consider the following:

- Sampling and monitoring systems provide adequate and accurate measurements under normal operations, anticipated operational occurrences, and accident conditions. Monitoring systems should be calibrated at least annually according to appropriate national standards.
- Exhaust outlets that may contain radioisotopes other than ambient levels of those naturally occurring in the environment should be provided with monitoring systems. As necessary, special equipment for stack effluent dispersal and tracking should be considered for installation. Such monitoring provides data useful for dispersion analysis of effluent materials.
- Stack monitoring systems should have central (i.e., control room or radiation monitoring office) readout and alarm panels that are accessible after an accident to evaluate internal conditions. Such data are useful for designing the most appropriate and efficient response to a release-related incident.
- Radiation monitoring, alarm, and warning systems required to function during a loss of normal power should be provided with an emergency UPS (internal or external on-line). However, if it is demonstrated that these systems can tolerate a temporary loss of function without losing needed data and these systems are provided with standby or emergency (switched) power, the emergency UPS is not necessary. Determination of the power supply type and quality, including availability during and after events, should be based on the safety classification of the monitoring system or device. Emergency backup power systems are critical to the operation of monitoring, alarm, and warning systems in the case of a simultaneous power failure and radioactive release.

SECTION 2

SPECIAL FACILITIES AND ACTIVITIES

INTRODUCTION AND SCOPE

This section of the Design Considerations Handbook provides design principles that the facility design team should consider for special facilities. These design principles have been developed as a result of design and operating experience with such facilities. These considerations should be consulted when designing facilities whose hazards and operations are similar to those discussed in this section.

2.1 PLUTONIUM PROCESSING AND HANDLING FACILITIES.

2.1.1 Introduction. A plutonium processing and handling facility (PPHF) is typically designed for the following functions involving plutonium:

- shipping and receiving;
- storage;
- chemical processing;
- recovery of scrap/residue;
- characterization, control, and accounting; and
- management of plutonium-contaminated wastes.

Note that ^{238}Pu presents special design challenges because of its high specific activity. Those considerations are not addressed here.

2.1.2 Design Considerations. The following sections provide specific design considerations for a PPHF. The design of PPHFs should consider the following features because of the special characteristics of plutonium and other materials with high specific activity or radiotoxicity.

Shipping and Receiving. A PPHF should be sited away from highly populated areas. It should also have reasonable access to major transportation networks, such as rail systems and interstate highways while maintaining safe distance. Because many state governments have the authority to designate traffic routes for shipment of radioactive material, close coordination with state and local agencies is recommended.

The shipping and receiving area in a PPHF should accommodate the convoy of safe-secured-transport (SST), including its escort vehicles. The area should be

free of any obstacles (other buildings and structures) during loading and unloading of the plutonium payload to establish a clear line-of-sight by site security forces.

Radiation monitoring equipment should be available in the shipping and receiving area for surveying the radiation level on the surface of the SST and the containers during receipt of radioactive material from off-site. The shipping and receiving area may also be equipped with a decontamination port if a radiation survey indicates that the surface of a container is contaminated.

Storage. A PPHF should include a storage facility (such as a vault-type room) in the process area to provide storage and staging functions. The following features should be considered in the design of the storage facility:

- Operation of the storage vault should comply with the strict regulation of fire loading.
- Packaging and unpacking of plutonium in the storage vault area should provide for minimizing the build-up of packaging material.
- Storage racks and shelves should be designed and constructed to meet seismic requirements.
- Spacing between storage units should be sufficient to satisfy criticality controls.
- Layout of storage racks should minimize radiation exposure to operating personnel and provide line-of-sight by safeguards and security.
- Storage racks and shelves should be constructed of noncombustible material and designed to hold the storage containers securely in place and keep them properly separated.
- Storage vault doors, racks, and containers should be designed to accommodate the application of tamper-indicating devices.
- Design of the storage vault should facilitate the ease of performing periodic inventory.
- Pyrophoric material should not be stored in a storage vault. Plutonium metal scraps (e.g., machine turnings, shavings, and fine chips) may be

chemically reactive and should be processed to plutonium oxide before they are stored in the storage vault. [Because plutonium hydrides, carbides, oxycarbides, and nitrides are reactive and potentially pyrophoric, especially in finely divided form (powder), they should be handled in dry, inert (i.e., oxygen-free) atmosphere and should be converted to oxides for prolonged storage.]

- Plutonium oxide is formed either by the reaction of the plutonium metal with oxygen in the air or by calcining plutonium compounds, such as the peroxide, oxalate, and nitrate. Plutonium oxide is generally a chemically inert powder and insensitive to self-radiation damage. However, plutonium oxide can absorb moisture from the air (depending on calcining condition), and incompletely calcined oxide could subsequently release gases, resulting in over-pressurization (bulging) a storage can. If the plutonium compounds are not completely oxidized, the subsequent oxidation process could cause a decrease in the sealed container pressure, thereby imploding a storage can. To prevent or minimize these storage problems, plutonium oxides should be stabilized as prescribed by standards for packaging plutonium for storage.
- The use of plastic bags in bag-in/bag-out operations could cause problems if the heat generated from radioactive decay melts the plastic bags after prolonged storage. The decomposition of the plastic bags could release gases that could also bulge the can. State-of-the-art container packaging methods that either preclude or minimize the use of plastic bags should be considered, especially for long-term storage of plutonium containers.
- Design of storage tanks for aqueous plutonium solutions should consider geometrically safe configurations with respect to nuclear criticality. Plutonium polymer [Pu(IV) solid] could be formed inadvertently under conditions of transient instability, and once formed, could be difficult to destroy. Polymerization in localized areas of low acidity could also occur if an acidic plutonium solution is diluted with water or steam. The plutonium polymers could clog transfer lines, interfere with ion-exchange separations, cause foaming, and constitute a criticality hazard. Detection

of the build-up of polymers and means to remove these solids should be provided in aqueous plutonium storage systems. Prolonged solution storage of significant quantities of amorphous plutonium should be avoided.

Chemical Processing. Plutonium processing operations should be conducted in the plutonium process area of the PPHF. The initial line of defense to protect workers in a process area is the confinement system, which includes enclosures, gloveboxes, conveyor lines, the ventilation system, and process piping. The primary confinement system should be designed to minimize the impact on workers and facilities. A secondary confinement barrier enclosing the primary confinement system provides contamination protection to plant personnel outside the area of secondary confinement. A tertiary confinement system, comprised of the building structure, encloses both the primary and secondary confinement barriers as well as the offices and other support areas, providing the final barrier between the potential contamination and the outside environment. Further design considerations for confinement systems are contained in Part I, Sections 1.1 and 1.2.

The following design features should be considered for facilities that process chemicals:

- The process area should be compartmented to isolate high risk areas, thereby minimizing productivity and financial loss if an accident occurs. Movement of personnel, material, and equipment between the process area and the uncontrolled area (such as the offices) should be through a controlled access area or an air lock.
- The process area should permit ease of egress and material/equipment movement to allow rapid evacuation in the event of an accident. Consideration should be given to providing a ready room near or within the process area where maintenance, operating, and monitoring personnel could be readily available. The room should be located in a low background radiation area.
- Indicators, auxiliary units, and supporting equipment control components that do not have to be adjacent to operating/process equipment should be

installed outside the radiation or contaminated areas. Equipment that requires periodic inspection, maintenance, and testing should be located in areas with the lowest possible radiation and contaminated levels. Equipment that is expected to be contaminated during operation should have provisions for both in-place maintenance and removal to an area of low radiation for repair. Maintenance areas for repair of contaminated equipment should provide for containment or confinement of radioactive material.

- To the maximum extent practicable, the process area should provide sufficient space and versatility to accommodate equipment for programmatic changes and process modifications. It should also be designed to facilitate surveillance. Irregular plant layout (with obstacles) should be avoided where possible.

Two different types of chemistry are generally employed for plutonium processing: the aqueous chemical process and pyrochemistry. Aqueous processes that are common to the plutonium production and chemical analysis are: dissolution, precipitation, liquid-liquid extraction, and oxidation-reduction reactions.

The purex process, which has been the typical aqueous process used in plutonium production, involves the extraction and purification of plutonium with tributyl phosphate. Other processes are the production of plutonium tetrafluoride (PuF_4) and the reduction of PuF_4 using calcium and iodine. The purex process should include design features to deal with the use of flammable liquids, the potential for radiolysis, the iron catalysis of hydrogen peroxide decomposition, and the potential generation of a large volume of plutonium-contaminated wastes.

The design of facilities that employ an aqueous chemical process should consider the following features:

- Systems, structures, and components for aqueous processing should be resistant to highly corrosive liquid and entrained vapors. Depending on the process to be used, stainless steel components are acceptable for nitrate-based systems. Because stainless steel is incompatible with

chlorides, special coatings for gloveboxes (e.g., Kynar™) should be considered, along with Teflon™ or derivative polymer piping, valves, pump bodies, and vessels in systems that employ chloride chemistry. Selection of in-line process controls should consider materials compatibility. Automated ion-exchange systems have been used at Los Alamos with great success.

- The sizing of process equipment is necessarily small to accommodate nuclear criticality requirements. In-process storage of feed solutions is efficiently handled in slab tanks or hollow cylindrical tanks. Pencil tanks have also been used; however, the array of such tanks is more complicated and subject to leaks. Selection of gasket, pump, and valve material should recognize the corrosive nature of process solutions. Design of tankage should recognize the potential for post-precipitation and formation of a layer of solid precipitate on the bottom of the tank. Care should be exercised in agitating such a layer if it forms because a nuclear criticality could occur. Hence, tankage with small horizontal surfaces, such as hollow cylindrical tanks, is desirable.
- Piping and valves should be located so that flammable, explosive, or toxic gases or liquids that are necessary to the process can be isolated to prevent injuring workers if an accidental release occurs. The flammable gases should be provided by a hard-piped system with the gas supply located outside the facility in cylinders to limit the total quantity available in the event of a fire or explosion.
- Radioactive liquid piping systems should be designed to avoid notches, crevices, and rough surfaces that might retain radioactive material. The piping system that collects contaminated liquids should be designed so that effluents from leaks in the system can be collected without releasing the liquids into the personnel access areas or to the environment.
- Stainless steel should be used in radioactive waste and process system piping and equipment so that smooth, nonporous, corrosion-resistant materials are in contact with the contaminated, corrosive, and radioactive liquids. The piping system should be of welded construction whenever

practicable. Flanges should be used only when absolutely necessary for servicing.

- Piping or other conduits to convey plutonium solutions or plutonium-contaminated waste liquid should be double-walled or contained within an enclosure provided with a leak-tight barrier. Any potential leakage from the primary pipe should be collected in a geometrically safe sump or tank. Wherever possible, the piping system should be designed to avoid traps that could hold plutonium solutions.

The process and equipment supporting the pyrochemical processing of plutonium should be designed to accommodate the pyrophoricity of plutonium metal and other materials used in molten salt and molten metal processing, button break-out, and the sampling operations.

Features of the design should consider the minimization of dusting from operations. A criticality-safe service vacuum system may be used to clean up dusts.

In addition to the features described above, facilities for the chemical processing of plutonium should address the following:

- The process glovebox system should be designed to minimize moisture pickup by process materials. An inert atmosphere should be considered in gloveboxes where plutonium is processed. Bag-in/bag-out operations should be conducted without compromising glovebox atmosphere integrity.
- The airborne radioactive effluents typically associated with PPHFs are furnace off-gas, airborne dust, off-gas from solvent processes, and corrosive vapor or mists from dissolvers. The design of airborne effluent systems should consider and minimize plutonium holdup at locations in off-gas and ventilation ductwork and include provisions to detect, monitor, and recover the build-up of such material.
- The capability to service equipment should be provided. Equipment should be designed to minimize plutonium holdup. Provisions should be made to remove process material from equipment and to measure plutonium holdup with minimum downtime.

- Because of the pyrophoric nature of plutonium metal, the plutonium process/handling glovebox system should be designed to accommodate glovebox fire safety. A leak detection system should be provided to detect the inleakage of air, which could change the glovebox atmosphere and lead to a plutonium fire. Certain glovebox construction components are combustible—rubber gloves, plastic bags, polyvinyl chloride (PVC) pipes, etc. Thus, the glovebox is vulnerable to involvement in fire, which, in turn, could cause the loss of glovebox integrity.

Facility design should provide for the continuous monitoring of external radiation exposure levels in process areas (e.g., hot cells and canyons) during maintenance or repair operations. Neutron shields in the form of water jackets should be capable of being monitored for water loss.

- Gloveboxes should be equipped with quick couplings for dry chemical-type extinguishers.

Recovery of Scrap/Residue. Plutonium scrap and residue should be recovered, processed, and accounted for—to the extent practical—according to the special nuclear material (SNM) accounting requirements. To prevent the accumulation of plutonium-containing scrap or residue, space should be provided for expeditious treatment or processing of these materials to allow their return to the main process.

Plutonium could be recovered using various methods, depending on the chemical process employed. For the aqueous process, plutonium could be recovered by means of leaching and dissolution, followed by purification, evaporation, and concentration. For pyrochemistry, the recovery process would include salt flux remelting, hydriding, oxidation, and/or anion exchange.

The following features should be considered to address the recovery and handling of scrap and residue:

- Equipment for recovery and handling of scrap/residue should be designed to minimize dusting and physical losses or spillage. Vessels used for solution treatment, assay, or storage should be of geometrically safe design to preclude accidental nuclear criticality.

- Provisions should be made for crucibles and molds removed or no longer serviceable to be processed to recover or remove residual plutonium before they are discarded.
- Design should provide for the need to process plutonium scrap and residue before any subsequent disposition action is taken. Aqueous (chloride or nitrate system) and pyrochemical processing are required. Stabilization optimally involves separation of plutonium from matrix material in order to minimize the volume of material to be stored. Likewise, separation of plutonium from waste matrices will minimize the amount of transuranic waste to be shipped and placed in a waste repository. The final form of the concentrate should be a stable (but not necessarily highly purified) oxide or metal. The process includes acid dissolution (hydrochloric or nitric), some degree of purification (e.g., ion exchange), precipitation (typically as oxalate), calcining (to decompose the oxalate and produce plutonium oxide), and packaging. If a metal form is required as the end point, the temperature at which the oxalate is calcined should be kept as low as practical. Metal can be produced by direct oxide reduction with elemental calcium in a molten salt medium (calcium chloride). Means to regenerate the calcium chloride salt medium should be included in the process design.

Characterization, Control and Accounting . Chemical sampling and analyses should be provided to support process and operations in the process area of the PPHF. Techniques employed for the characterization of plutonium include: metallography, electron microscope, X-ray diffraction, chemical analysis, thermal analyses, and isotopic. The most common detection technique employed is the nondestructive assay detection system, which includes (1) radiation detection based on alpha, gamma radiation, and neutron activation, and (2) calorimetry, which measures the heat output of the radioactive materials.

Several pyrochemical processes are likely to be used in plutonium processing. Molten salt extraction is used to separate americium from plutonium in aged plutonium items. A “saltless” extraction process has been developed at Los Alamos that greatly reduces the amount of waste generated. Electrorefining is used to purify plutonium, leaving impurities behind in an anode “heel” that

requires further processing, usually by aqueous means. Relatively pure plutonium oxide can be reduced to metallic form by direct oxide reduction, which requires dissolving plutonium oxide in a calcium chloride salt and introducing metallic calcium as the reducing agent. The resulting calcium oxide can be converted to calcium chloride by reacting with a chlorinating agent. Note that the media for pyrochemistry are typically chloride salts, and require special aqueous process equipment specifications to minimize corrosion. Likewise, the crucibles used to contain the melt also should be processed into a waste form or processed for extraction of plutonium. Exhaust ventilation, handling devices, and local furnace cooling should take thermally hot operations into account.

Design of materials management and storage systems should attempt to achieve inventory extension to the maximum extent possible; that is, to minimize the frequency with which inventory and reconciliation are necessary. This can be accomplished by use of a vault system with a long-term storage vault that can be locked down for a year or more, and a day vault that contains the items that will be used within the year. Sizing of process equipment should recognize the downtime required to complete inventory actions. These actions include cleaning out process equipment, wiping down gloveboxes, consolidating materials, conducting nondestructive assays, and reconciling inventory values.

Management of Plutonium-Contaminated Wastes. Plutonium-contaminated and radioactive wastes generated from the PPHF should be managed and handled safely and effectively. The process system should be designed to minimize the generation of wastes at the source. The waste management system should be designed to limit the release of radioactive materials to the environment.

Process liquid waste should be collected in the liquid waste treatment system and contained in geometrically safe vessels for temporary storage, sampling, and neutralization. Liquid waste should be concentrated by evaporation, and off-gas from the liquid waste evaporator should be sampled for radioactive materials and hazardous chemicals before release to the environment. The concentrator bottom should be collected and solidified in containers with content meeting the waste acceptance criteria of existing or potential waste disposal site(s). Explosive

or highly flammable materials should not be stored in proximity to these wastes. U.S. NRC R.G. 3.10, *Liquid Waste Treatment System Design Guide for Plutonium Processing and Fuel Fabrication Plants*, provides useful guidance that should be considered.

2.2 **PLUTONIUM STORAGE FACILITIES.**

2.2.1 Introduction. PSFs typically contain strategic amounts of plutonium. The guidance contained in this section applies to facilities where strategic amounts of plutonium or significant quantities of other transuranic radionuclides, such as neptunium and californium, are stored. This section does not apply to “in process” or “in use” material, to material in assembly cells for use in weapons, or to material that is packaged in approved containers awaiting either transportation or disposition upon receipt.

Note that ^{238}Pu presents special design challenges because of its high specific activity. Those considerations are not addressed here.

2.2.2 Design Considerations. The design of PSFs should accommodate all planned plutonium handling and storage activities (e.g., analysis, shipping and receiving operations, packaging, and unpackaging). Provisions should be made to minimize the build-up of packaged materials or packaging materials. Receiving operations involving removal of radioactive material from protective shipping containers should be performed in an unpackaging room.

Facility design, to the maximum extent practical, should:

- provide sufficient versatility to accommodate equipment for programmatic changes and modifications and for multi-shift operations,
- provide sufficient spacing between compartments to facilitate relocation and maintenance of equipment in case of manual or automatic storage operations, and
- facilitate expeditious identification, inventory, placement, and retrieval of storage containers.

Facility layout should provide for efficient cleaning, maintenance, and ease of inspection and should consider the requirements for secure location of storage

containers, traffic control, and segregation. Door locations should be coordinated with aisles to facilitate access to stored material, for loading and unloading of material, for use of firefighting equipment, and for compliance with NFC NFPA 101, *Life Safety Code*. Bumpers should be provided where necessary to minimize potential damage to the structure of racks from handling equipment. New storage facilities should be physically separated from process operations, storage of nonnuclear materials, flammable or explosive materials or equipment, and functions not directly required for storage operations.

Combustible packaging materials should be stored in metal containers or structures outside a PSF in a location that will not endanger the storage facility or stored material if a fire occurs in the packaging material. No hazardous gases or liquids should be used in PSFs. No natural gas or other fossil fuels should be used for heating purposes unless the heating occurs in a separate building that is clearly isolated from the primary facility.

The design should provide for sufficient spacing and arrangement of compartments and/or containers to facilitate the taking of inventories. Vault doors, racks, and containers should accommodate the application of tamper-indicating devices. Adequate space for measurement should be provided for the required inventory verification and/or confirmation. An automated vault surveillance system should be provided where excessive radiation exposure would result from entry for material control and accountability purposes. The design of the vault and/or system should facilitate inventory requirements.

Those areas of the facility where SNM is stored (e.g., plutonium product storage) should be located in the least accessible (to an intrusion force) area of the plant.

Design of storage tanks for aqueous solutions of plutonium should ensure that they are geometrically favorable with respect to nuclear criticality. When there is a tendency for solids to precipitate, vessels should be instrumented to detect the build-up of solids and designed to facilitate removal of solids.

The ventilation system should be designed to provide adequate heat rejection capacity. DOE-STD-3013-2012, *Stabilization, Packaging, and Storage of Plutonium-Bearing Materials*, provides guidance regarding containers for storage of plutonium oxide and metal containing greater than 50 percent plutonium.

Suitable physical compartmentalization should be considered to limit the quantity of stored materials in each compartment to safe levels, to provide the necessary access features and controls, and satisfy loss limitation criteria.

Cautionary systems (e.g., visual or audible alarms or other warning systems) or interlocks should be considered to prevent inadvertent entry into hazardous areas. Safety alarm systems should annunciate inside and outside the PSF to identify hazardous areas to anyone present in either area. The need for visual alarm devices within the facility, in addition to audible alarm devices, should be considered.

Storage racks should be noncombustible and designed to hold storage containers securely in place, maintain proper separation of storage containers, and maintain structural integrity under normal operational conditions, anticipated events, and accident conditions.

2.3 UNIRRADIATED ENRICHED URANIUM STORAGE FACILITIES.

2.3.1 Introduction. UEUSFs are used to store unirradiated enriched uranium in a solid, liquid, or gaseous form. UEUSF activities may include shipping, receiving, handling, packaging, and unpackaging.

2.3.2 Design Considerations. The design should accomplish the following:

- Accommodate planned UEU handling and storage activities (e.g., analysis, shipping and receiving operations, packaging, and unpackaging). The build-up of packaged materials or packaging materials should be minimized. Receiving operations involving removal of radioactive material from protective shipping containers should be performed in the unpackaging room(s).
- Incorporate into the design ALARA concepts to minimize overall effects on workers, the public, and the environment.
- Provide sufficient versatility to accommodate equipment for programmatic changes, programmatic modifications, and multishift operations.

- Provide sufficient spacing between compartments to facilitate relocation and maintenance of equipment and ease of manual or automatic storage operations.
- Facilitate expeditious identification, inventory, placement, and retrieval of storage containers.
- Provide for sufficient spacing and arrangement of compartments and/or containers to facilitate the taking of inventories. Vault doors, racks, and containers should be designed to accommodate the application of tamper-indicating devices. Adequate space for measurement capability should be provided for the required inventory verification and/or confirmation. The design of the vault system should facilitate inventory requirements. Those areas of the facility where SNM is stored should be located in the least accessible area of the plant.

To expedite recovery from accidents and provide facility versatility, modular construction concepts should be used, where feasible.

No hazardous gases or liquids should be used in UEUSFs. No natural gas for heating purposes should be used unless the heating occurs in a separate building that is clearly isolated from the primary facility.

New storage facilities should be physically separated from process operations, storage of nonnuclear materials or equipment, and functions not directly required for storage operations.

Combustible packaging materials should be stored in metal containers or structures outside a UEUSF in a location that should not endanger the storage facility or stored material should a fire occur in the packaging material. The need to provide automatic fire suppression systems for these areas should be considered.

Facility layout should provide for efficient cleaning, maintenance, and ease of inspection. Layout of floor and access areas should consider the requirements for secure location of storage containers, traffic control, and segregation. Suitable physical compartmentalization should be considered to limit the quantity of stored materials in each compartment to safe levels, to provide the necessary access features and controls, and to satisfy loss limitation criteria. Bumpers should be

provided where necessary to minimize potential damage to the structure or racks from handling equipment.

Design of storage tanks for aqueous solutions of enriched uranium should ensure that they are geometrically favorable with respect to nuclear criticality safety.

When there is a tendency for solids to precipitate, vessels should be instrumented to detect the build-up of solids and designed to facilitate removal of solids.

Cautionary systems (e.g., visible or audible alarms or other warning systems) or interlocks should be considered to prevent inadvertent entry into hazardous areas. Safety alarm systems should annunciate inside and outside the UEUSF to identify hazardous areas to anyone present in either area. The need for visual alarm devices within the facility, in addition to audible alarm devices, should be considered.

Storage racks should be noncombustible and designed to hold storage containers securely in place, ensure proper separation of storage containers, and maintain structural integrity under normal operations, anticipated operational occurrences, and accident conditions.

Door locations should be coordinated with aisles to facilitate access to stored material, for loading and unloading of material, for use of firefighting equipment, and for compliance with NFC NFPA 101.

Airborne radioactive wastes associated with UEUSFs that should be considered during the design include but are not limited to the airborne releases associated with the venting of storage containers. Cladding or canning failure during dry storage is also a source of such wastes.

2.4 URANIUM PROCESSING AND HANDLING FACILITIES.

2.4.1 Introduction. A UPHF is a facility that receives feed material from sources such as a conversion facility, a reprocessing facility, or fuel/target storage material. A UPHF processes, handles, and produces products such as UO_2 , UF_6 , uranium metal, reactor fuel assemblies, target assemblies, and nuclear weapons components.

This section is not process-specific. It is applicable to facilities that handle and process uranium; however, it is principally directed at facilities that process and handle uranium enriched in ^{235}U .

2.4.2 Design Considerations. The design of processing facilities should consider inclusion of the design features described below. Design requirements vary significantly depending on the characteristics of the uranium, the type of processing and handling activities, and the characteristics of the site.

- Materials of different uranium assays should be handled in physically different trains of equipment even though duplication of equipment results. If this is not possible, the equipment should be sized for criticality control of the most restrictive condition.
- A definite isotopic specification for reactor returns should be established before facility design is started for refabrication of enriched uranium that has been irradiated and reprocessed.

Metallurgical processes and ceramic materials processing are the two principal types of processes for fabrication of uranium products. The hazards associated with each of these processes should be considered during the design of the fire protection, ventilation, and confinement systems. In addition, the chemical toxicity of uranium should be considered during the design of the facility. The design should provide specific control and isolation of flammable, toxic, and explosive gases, chemicals, and materials admitted to the areas of the facility.

- The design should provide space for shielding, both permanent and temporary, of personnel and/or remote operations of equipment and processes.
- The primary confinement system should be constructed of fire-resistant materials, and the process equipment and process being confined should be designed to prevent or minimize the probability of potential flammable or explosive conditions. Confinement enclosures for flammable metals should be designed with self-contained fire protection and extinguishing equipment; in some cases, inert atmospheres may be desirable within the enclosures.

- To the extent practical, discrete processing steps should be performed in individual process confinements to reduce the amount of hazardous material that can be released by a single or local failure of the confinement system. Process and auxiliary system differential pressure should be maintained to inhibit back-flow of hazardous materials into auxiliary systems.
- Process operations that involve oxide powder or that can generate powder or dust should be provided with special confinement to prevent the spread of contamination. Facility design should preclude the handling of uranium oxides in large open rooms.
- Airborne radioactive wastes typically associated with UPHFs that should be considered during the design include but are not limited to airborne particulate material generated by fabrication processes (e.g., airborne grinding dust). Nuclear criticality safety should be considered in the design of the airborne effluent system.
- When inert confinement system atmospheres are used, moisture removal systems should be considered to maintain long-term stability of packaged material. Small-volume process enclosures should be designed to prevent the enclosed atmosphere from being pressurized by rapid insertion of gloves into the enclosure.

2.5 **IRRADIATED FISSILE MATERIAL STORAGE FACILITIES.**

2.5.1 Introduction. IFMSFs are self-contained installations for storage of highly radioactive fissile material (e.g., spent fuel and target elements) that has been exposed to a neutron fluence, usually in a nuclear reactor. The irradiated material should be properly clad or canned when received so that leakage from the assemblies is minimized and remains within specified limits. The IFMSF stores the material in a manner that ensures the integrity of the cladding or canning. The stored material is shipped to facilities such as a hot laboratory or high-level solid radioactive waste facility.

This section applies to a water-pool type of storage facility. Dry-type and spent fuel storage facilities that are part of a reactor facility are not covered by this section.

2.5.2 Design Considerations. The design of IFMSFs should consider inclusion of the design features described below. Design requirements vary significantly depending on the characteristics of the material, the type of storage, and the characteristics of the site.

- The cooling water system for a water-pool type IFMSF should perform its required functions during normal and anticipated operating conditions and should be capable of limiting the maximum pool temperature. If pool boiling is used as an emergency cooling mechanism, the ventilation system design should consider the quantity of vapor being generated. Concrete and structural design should consider elevated temperatures. Drainage of condensate should be considered in the structure and equipment.
- If the emergency makeup system is not permanently installed, the time required to implement its operation should be conservatively less than the time required to lower the pool water level to the minimum allowable depth or raise the pool temperature to boiling.
- A pool water cleanup system should be provided to maintain water clarity, provide long-term cladding integrity, maintain structural integrity of the storage racks and other submerged structures, and minimize exposure rates and airborne contamination levels on the operating floor to ALARA levels. The piping configuration for the pool cooling water and cleanup system should be designed to eliminate the possibility of siphoning the pool water to a level below the minimum depth required for shielding and/or cooling. Cooling and cleanup systems should consider material deposition and plate-out in piping and equipment.
- The design should also consider the inclusion of filters capable of being either remotely back-flushed or designed so that cartridges can be removed directly into a shielded container. Instrumentation for periodic functional testing of the pool-water cleanup system and heat-exchanger

performance should be considered. The design should use containerized or modularized filters to reduce exposure during maintenance. Filter change-out prior to build-up of radiation levels should be considered.

- The normal water level of the storage pool should be at or near the final design grade level. The water level necessary for in-storage radiation shielding should be at or below grade.
- For water-pool type facilities, the design professional should consider providing the pool liner with a leakage collection system that will allow leakage detection and limit absorption of contaminated pool water by concrete structures.
- A system should be incorporated to detect leakage from stored IFM in the event of a cladding or canning failure that could allow the escape of fission products and other radioactive material greater than specified limits. This system should include the following:
 - Sampling of coolant allows identification of an individual leaking assembly.
 - System components, piping, and instrumentation are appropriately shielded to maintain operator exposures within guidelines and use ALARA design principles to minimize overall exposures.
 - The storage facility provides for the temporary storage of a leaky assembly. These provisions should limit the spread of contamination by a leaky assembly and provide adequate cooling and shielding of the assembly.
- The IFMSF should provide for the interim canning of leaking assemblies until disposal.
- Special design features should be considered for safe loading, removal, and handling of IFM. These systems and equipment should protect against the dropping of shipping casks, IFM assemblies, and other items onto the stored IFM. In water-pool type facilities, damage to the pool during loading and unloading operations should not allow the pool level to drop below the minimum allowable depth. Consideration should be given

to features that will prevent breaching the pool integrity if a shipping cask is dropped.

- Exhaust systems for pool areas should be HEPA-filtered. Other types of air-cleaning devices (adsorbers) should be considered.
- Airborne radioactive wastes typically associated with IFMSFs that should be considered include but are not limited to airborne releases associated with the venting of transport casks and storage vessels. Cladding or canning failure during long-term wet or dry storage is also a source of airborne radioactive wastes.
- Ventilation system design should consider the evaporation, mixing, and condensation of potentially tritiated sources in collection systems above and around pool areas.

2.6 **REPROCESSING FACILITIES.**

2.6.1 Introduction. A reprocessing facility is typically designed to recover uranium, plutonium, and other selected actinides and selected fission products from irradiated fissile fuel material and target material. The reprocessing facility is typically designed to separate these materials from each other and from any remaining actinides and fission products.

2.6.2 Design Considerations. The design of reprocessing facilities should consider inclusion of the features described below. Design requirements vary significantly depending on the material (fuel) characteristics, the reprocessing technique, and the characteristics of the site.

- Process system and auxiliary system differential pressure should be maintained to inhibit back-flow of contamination into auxiliary systems. The process equipment for transferring toxic and corrosive fluids should use vacuum and gravity where possible. Pumps and jets should have pressure capacity no greater than 10 percent above needed transfer capacity.
- The integrity of process equipment off-gas treatment systems should be ensured for normal operations, anticipated operational occurrences, and accidents.

- The use of directed airflow and back-flow prevention features to feed areas (i.e., shear and dissolver areas) should be considered.
- Mechanical chopper and dissolver off-gas and other process vents should be treated by an off-gas treatment system for removal of nuclides. As a minimum, the treatment system should be designed for particulate removal and should control the release of airborne radionuclides. In addition, the design should incorporate ALARA concepts to minimize impacts on operators and the public/environment.
- Radioiodine adsorber units in the exhaust ventilation/off-gas system should be considered to reduce the radioiodine concentration in the effluent. Additionally, these releases should be ALARA. (See ASME AG-1 for adsorber selection considerations.)

To reduce the amount of hazardous material that can be released if the process equipment fails, the following design provisions should be considered:

- grouping or compartmentalizing process equipment to form units that can isolate the process inventory into modular units;
- the capability to detect leakage from process equipment; and
- selection of the method (e.g., manual, remote-manual, or automatic) of performing corrective actions (e.g., process shutdown) according to the potential hazards associated with a particular release.

Design features that should be considered for maintenance of the confinement systems include the following:

- the use of electrical equipment that precludes or minimizes the introduction of an ignition source in flammable or potentially flammable locations;
- support and protection systems (such as fire protection systems) that do not promote the failure of the principal confinement systems; and
- provisions for sprinklers, water fog, or other suitable systems within the secondary confinement to provide for rapid heat removal and minimum

pressurization of the process cell or canyon and to minimize the loading of ventilation system filters with combustion products.

Process equipment should be designed to operate under process conditions that prevent or minimize the potential for explosive chemical reactions (e.g., solvent vapor explosions, nitrate-solvent reactions). Process system design should provide for all fission product oxidation states expected during processing (e.g., suppression of the volatilization of ruthenium or the prevention of iodate formation).

Systems should be provided to reduce the likelihood and consequences of pressurizing a primary confinement component as a result of an accident.

Airborne radioactive effluents typically associated with reprocessing facilities that should be considered during the design include but are not limited to dissolver off-gas, process vessel vents, and high-level liquid radioactive waste collection and storage tank vents. Effluent system designs should preclude the holdup or collection of fissile material and other material capable of sustaining a chain reaction in portions of the system that are not geometrically favorable. Nuclear criticality safety should be considered in the design of airborne radioactive effluent systems. U.S. NRC R.G. 3.20, *Process Off-Gas Systems for Fuel Reprocessing Plants*, and R.G. 3.32, *General Design Guide for Ventilation Systems for Fuel Reprocessing Plants*, provide useful design guidance that should be considered.

2.7 URANIUM CONVERSION AND RECOVERY FACILITIES.

2.7.1 Introduction. UCRFs receive feed materials (such as UF_6 , uranyl nitrate, or UO_3), process these materials chemically, and produce uranium metal, UO_2 , and UF_6 . Uranium recovery facilities receive and handle scrap feed materials that are of different types, shapes, sizes, uranium contents, and enrichments. The kind of scrap and therefore the process to facilitate recovery of uranium may vary daily. This section is not process-specific, but is principally directed at facilities that produce feed materials for UPHFs and those facilities that recover uranium from scrap provided by UPHFs.

2.7.2 Design Considerations. The design of UCRFs should consider the features described below. Design requirements vary significantly depending on the

material characteristics, the type of recovery and conversion processes used, and the characteristics of the site.

- The design should provide special control and isolation of flammable, toxic, and explosive gases, chemicals, and materials admitted to the areas of the facility.
- To the extent practical, the primary confinement system should be constructed of fire-resistant materials, and the process equipment and process being confined should be designed to prevent or reduce the potential for flammable or explosive conditions. Confinement enclosures for flammable metals should be designed with self-contained fire protection and extinguishing equipment; in some cases, inert atmospheres may be desirable within the enclosures.
- Work that could subject personnel to possible inhalation exposures should be performed in process confinement enclosures. Gloveboxes should be the preferred enclosure, but are not always practical. Alternative systems may have to be considered.
- To the extent practical, discrete processing steps should be performed in individual process confinements to reduce the amount of hazardous material that can be released by a single or local failure of the confinement system. Process and auxiliary system differential pressure should be maintained to inhibit back-flow of hazardous materials into auxiliary systems.
- Equipment design should include appropriate interlocks to prevent spills and cross-contamination.
- The design of process systems should minimize the production of scrap and waste.
- Geometric restrictions for nuclear criticality safety should apply to various units of equipment for the different processes used. In addition, other considerations, such as sufficient agitation in a process vessel to prevent the settling of uranium material, should be considered for nuclear criticality safety.

- Leakage of enriched uranium material from processing equipment should be prevented. Design considerations should include, but not be limited to, the use of corrosion-resistant construction materials and features less vulnerable to leakage (e.g., of flanged and/or welded construction).
- Use of thermal insulation on the equipment that processes uranium solutions of high enrichment should be minimized because it absorbs the solution in the event a leak occurs. The uranium-impregnated insulation would be subject to scrap recovery operations. Because the insulation is considered a "full reflector," the equipment together with the insulation may not be geometrically favorable for highly enriched uranium solutions.
- Storage tanks for aqueous solution of enriched uranium should be designed to ensure favorable geometry with respect to nuclear criticality safety. Where there is a tendency for solids to precipitate, vessels should be instrumented to detect settling of solids and be designed to facilitate periodic removal of solids.
- Airborne radioactive wastes typically associated with UCRFs that should be considered during the design include but are not limited to airborne particulate material generated during processing (e.g., airborne grinding dust) and vapors and gases used or generated during the processing. Nuclear criticality safety should be considered in the design of the airborne effluent system.

Uranium Conversion Facilities. Piping systems, surge vessels, and control instruments with associated piping that carry UF₆ gas should be equipped with heat tracing or heated enclosures wherever necessary to prevent solidification of UF₆. Steam may be used as the primary heating agent where low-enrichment material (less than or equal to 2 percent ²³⁵U) is involved. At higher enrichments, a dry radiant heat source should be the preferred means of supplying the heating requirements.

Uranium Recovery Facilities. The design of a uranium recovery facility should be approached on a case-by-case basis, considering possible forms of scrap and different assays of material that could be received for processing and possible

methods that could be used for enriched uranium recovery. The following design features should be considered:

- Materials of different uranium assays should be handled in physically different trains of equipment even though duplication of equipment results. If this is not possible, the equipment should be sized for criticality control of the greatest uranium enrichment.
- For enriched uranium that has been irradiated and reprocessed, a definitive isotopic specification for the uranium should be adopted before facility design is begun.
- In addition to provisions for handling uranium and other radioactive materials such as trace quantities of fission products and transuranics, the design should provide for the safe handling of other hazardous materials (e.g., acids, bases, organic solvents, fluorine, hydrogen, hydrogen fluoride, and magnesium) used or generated during recovery operations.

2.8 **RADIOACTIVE LIQUID WASTE FACILITIES.**

2.8.1 Introduction. Radioactive liquid waste facilities (RLWFs) store, treat, and dispose of radioactive liquid wastes generated by facilities and activities. This waste includes low-level, high-level, and transuranic-contaminated (to include enriched uranium and ^{233}U) waste. An RLWF may be a separate facility or an adjunct to another facility. RLWFs may include waste treatment activities that separate solid and liquid waste constituents with provisions for disposing of noncontaminated waste.

2.8.2 Design Considerations. The design of RLWFs should consider the features described below. Design requirements vary significantly depending on waste characteristics, waste management techniques, and site characteristics.

- The use of multiple barriers should be emphasized when necessary to restrict the movement of radioactive liquid waste that has the potential for human contact or for reducing groundwater quality below requirements.
- Measurement and analysis capability should be provided to determine the volume and radioactivity of wastes fed to collection tank(s). Provisions

should be made for analyzing liquids prior to transfer. Each transfer line should be identified individually. Instrumentation and control systems should be used to provide monitoring and control capabilities associated with confinement, nuclear criticality safety, and/or radiation protection.

- Individual lines should be used for each waste stream fed to central collection tanks, where necessary, to prevent chemical reactions or introduction of contaminants such as complexing agents that could interfere with waste decontamination. The use of traps in radioactive liquid waste lines should be avoided, and piping should be designed to minimize entrapment and build-up of solids in the system. Bypasses that would allow waste streams to be routed around collection tanks should be avoided. The radioactive liquid waste treatment system should contain no bypasses or drains through which waste may inadvertently be released directly to the environment.
- Basic liquid waste treatment concepts include volume reduction, immobilization of radioactive material, change of composition, and removal of radioactive material from waste. The waste treatment concept(s) for a particular application should be selected on a case-by-case basis. To the extent practical, features should be included to allow volume reduction and/or waste solidification (immobilization) to forms required for long-term isolation.
- Provisions should be made to adjust liquid waste characteristics prior to treatment to minimize adverse chemical reactions in the treatment system.
- Recirculating closed-loop cooling systems should be used for facilities and equipment associated with the storage or treatment of high-heat, high-level radioactive liquid waste.
- Provisions should be made for the continuous monitoring and recording of radioactivity, flow volume, pH, and other parameters required for material control and proper waste treatment operations while each volume of industrial waste is being received by an on-site treatment plant. This

monitoring allows optimum control of waste treatment operations and helps prevent unintended off-site releases.

- Liquid process wastes containing radioactive or other hazardous material should be collected and monitored near the source of generation before batch transfer through appropriate pipelines or tank transfer to a liquid waste treatment plant or area. Radiation, liquid level, or conductivity detectors should be provided in collection systems. Monitoring not only provides information useful for planning efficient waste treatment operations, but also can serve as an indicator of unintended fluctuations in process operations.
- The airborne radioactive waste sources typically associated with RLWFs and RSWFs that should be considered during the design include but are not limited to radioactive liquid waste process vessel vents, high-level liquid radioactive waste collection and storage tank vents, airborne effluents from process system vents, and fission product gases. Effluent system designs should preclude the holdup or collection of fissile material or other material capable of sustaining a chain reaction in portions of the system that are not geometrically favorable. Nuclear criticality safety should be considered in the design of airborne effluent systems.
- Provisions should be made to handle combustible gasses generated during waste handling and/or storage.
- Consideration should be given to condensation and deposition of aerosols formed in vent lines.

Liquid Waste Confinement Systems. The following provisions are typical for an RLWF confinement system (see Table I). The actual confinement system requirements for a specific RLWF should be determined on a case-by-case basis.

- The degree of confinement required in a RLWF is both storage-specific and process-specific, but in either case should suit the most restrictive case anticipated.

- The primary confinement system consisting of the process equipment and/or primary storage tanks should operate under process conditions that prevent or minimize the potential of explosive chemical reactions.
- Spills, overflow, or leakage from storage vessels or other primary confinement structures should be collected and retained within a suitable secondary confinement structure (e.g., secondary vessel, dike or berm, elevated threshold within a storage or process building, etc.). The secondary confinement structure should be able to retain the maximum radioactive liquid waste inventory that may be released by a spill, overflow, or leak from the primary confinement structure. For outdoor applications, the capacity should also include maximum predicted precipitation. The structure should also be designed to preclude overtopping due to wave action from the primary vessel failure and, in outdoor applications, to wind-driven wave action. The capability should exist to transfer collected liquid from the secondary confinement structure to a suitable storage location.

TABLE I. Typical confinement provisions for RLWFs.

Material being confined	Primary	Secondary	Tertiary
High-level liquid waste	Primary storage vessel ¹ or treatment system equipment ³	Secondary storage vessel ¹ or process cell	Soil barrier ² or process building ⁷
Low-level liquid waste	Storage vessel ⁴ or basin ⁶ or treatment system ⁵	Dike or berm ⁸ around vessel or dike or berm	None
Transuranic waste	Storage vessel ⁴ or treatment system ⁵	Storage building ⁷ or process building ⁷	None

¹ Double-wall underground storage tanks and transfer piping are typically used to establish primary and secondary confinement barriers. Primary storage tanks have condensers and/or filters in their vent stream. The space between tanks is also ventilated and the exhaust is filtered.

² Soil barrier is the engineered backfill material and natural setting surrounding the waste storage tanks. A monitoring capability should be available to detect leakage from the storage tanks into the soil.

³ Typical treatment equipment includes waste calciner, evaporator, or waste fractionation equipment. Treatment also occurs within the storage vessel (e.g., precipitation).

⁴ Single-wall storage tank.

⁵ Typical treatment concepts include volume reduction, immobilization of radioactive material, change of composition, and removal of radioactive material from waste.

⁶ Interim storage in retention or settling basins.

⁷ With elevated threshold or other means of confinement.

⁸ When dikes or berms are considered, use of an impervious membrane should be considered to minimize the cost of cleanup should a spill occur.

High-Level Liquid Waste Confinement. Design of a high-level liquid waste confinement system should consider the following:

- Tank and piping systems used for high-level liquid waste collection, treatment, and storage should be of welded construction to the extent practical. Construction materials should be selected to minimize all forms of corrosion. Consideration should be given to stress relieving, welding parameter controls, etc., depending on the materials used. Fatigue failure should be a design consideration where temperature cycling is required (i.e., evaporator systems, etc.).

- Potential non-uniform distribution of decay heat caused by solids in the waste should be considered in the design of storage tanks and any associated cooling system. Agitation of tank contents should be provided, when necessary, to control waste temperature.
- Double-walled piping, multi-pipe encasements, and double-walled tanks should be considered to establish the primary and secondary confinement boundaries in underground portions of high-level liquid waste systems. Provisions should be made to detect leakage from the primary confinement to the interspace.
- Installation of spare pipelines between transfer points should be considered.

Process and waste storage vessels should be vented through appropriate treatment systems that control the release of radioactive material in gaseous effluents, ensuring these releases are ALARA. Design of these systems should consider the following:

- Off-gas should be suitably pretreated upstream of off-gas treatment equipment to remove or reduce the concentration of chemicals that may adversely affect system operation.
- The venting system should prevent overpressure or vacuum conditions from occurring within vessels.
- The venting system should prevent the build-up of hydrogen from radiolysis.
- Tank overflows should be directed to collection systems.

Integrity of the primary confinement boundary should be determined by some or all of the following measures:

- vessel inventory monitoring (e.g., liquid level sensors);
- on-line leakage monitoring for the interspace of double-walled vessels (e.g., airborne activity monitors, sump level sensors, conductivity cells);
- leakage monitoring outside confinement vessels (e.g., surveillance wells to detect leakage into ground water);

- capability for periodic visual surveillance, including remote visual surveillance with closed-circuit television;
- periodic evaluation of test coupons of primary tank construction materials installed before the tank was placed in service; and
- other surveillance or testing measures, as appropriate.

Low-Level Liquid Waste Confinement. The following should apply to the low-level liquid waste confinement system:

- An impervious dike or berm around the process system should provide secondary confinement for low-level liquid wastes.
- Process and waste storage vessel vents should be provided.
- Retention basins should be lined, fenced, and posted with appropriate radiation warning signs. A system for monitoring radionuclide migration from the basin should be available.
- An impervious berm or dike should be capable of retaining the maximum radioactive liquid waste inventory that may be released by a leak or failure of a primary confinement vessel. A capability should exist to transfer waste that has leaked into the secondary confinement.
- A means of removing rain or snow from the secondary confinement area should be provided unless rain or snow is precluded from entry to the confinement area. Monitoring or testing of the removed rain or snow should be considered.

Transuranic-Contaminated Liquid Waste Confinement. The following features should be considered in the design of a transuranic-contaminated (to include enriched uranium and ²³³U) liquid waste confinement system:

- A storage or process building should provide secondary confinement for transuranic-contaminated liquid wastes.
- Tank and piping systems used for transuranic-contaminated waste collection, treatment, and storage should be of welded construction to the extent practical. Construction materials should be selected to minimize all forms of corrosion. Consideration should be given to stress relieving,

welding parameter controls, etc., depending on the materials used. Fatigue failure should be a design consideration where temperature cycling is required (i.e., evaporator systems, etc.).

- Process and waste storage vessel vents should be considered.

Nuclear criticality safety should be considered in the design of primary and secondary confinement structures and components.

2.9 RADIOACTIVE SOLID WASTE FACILITIES.

2.9.1 Introduction. Radioactive solid waste facilities (RSWFs) are used to store, treat, and dispose of the range of solid waste generated by DOE facilities and activities. This waste contains high-level, low-level, and transuranic-contaminated solid waste including radioactive-mixed waste. An RSWF may be a separate facility or an adjunct to another facility.

2.9.2 Design Considerations. The design of RSWFs should consider the design features described below. Design requirements vary significantly depending on waste characteristics, waste management techniques, and site characteristics.

- Cooling water systems or cooling air systems should be provided, where required, for facilities and equipment associated with the interim storage or treatment of high-level radioactive solid waste, and to maintain the long-term integrity of the primary confinement boundary. To the extent practical, passive cooling means should be used for air cooling systems.
- Instrumentation and control systems should be required at an RSWF to provide monitoring and control capabilities associated with confinement, nuclear criticality safety, and radiation protection.

High-Level Waste Disposal Facility Confinement. During the short-term period following emplacement when short-lived nuclides dominate the hazards associated with a disposal facility, the engineered system of barriers should remain effective and should contain the emplaced wastes. Typically, this time period is considered to include at least 300 years but not more than 1,000 years following permanent closure.

Technical criteria associated with the engineered system of barriers should address the following:

- establishment of a high-integrity confinement system during emplacement (to limit the rate of release of radionuclides from the system),
- in situ stresses affecting the engineered system of barriers,
- corrosion affecting the engineered system of barriers,
- radiological effects on barrier integrity, and
- contact with groundwater.

During the long-term period, reliance should not be placed on the engineered system of barriers to contain emplaced waste. Confinement during the long-term period should be accomplished by the geologic setting. Technical criteria associated with the geologic setting should address the following:

- leaching characteristics of waste and waste binders;
- site and soil characteristics, including fractures, porosity, hydraulic conductivity, sorption, hydraulic gradient, and thermal gradient;
- long-term geologic stability;
- groundwater travel time;
- absence of resources that would be an incentive for human intrusion; and
- stability of rock mass.

The facility should allow retrieval of wastes during the 50-year period following emplacement and before permanent closure of the facility.

Low-Level Waste Disposal Facility Confinement. Low-level solid waste that is disposed to the ground should be confined by a site-specific system of barriers that may include—but not necessarily be limited to—waste form, waste packaging, and the geologic setting.

When site permeability characteristics do not provide the required confinement capabilities, the confinement system should be augmented by the following:

- constructing low permeability walls around the low-level waste,

- lining the walls and bottom of the excavated area with low permeability material, and
- other suitable methods for reducing permeability.

Means should be provided to minimize contact of emplaced low-level waste with water. Active water-control measures should not be required following permanent closure. Typical requirements for water control are as follows:

- Placing a layer of highly permeable material (e.g., sand, gravel) beneath the low-level waste to channel any percolating water to a sump.
- Mounding the soil surface to facilitate surface water runoff.
- Use of a suitable low-permeability cover material (e.g., clay) over the disposal area to prevent contact of the waste by infiltrating rainwater. This cover material should be protected by a layer of overburden (e.g., sand, gravel, top soil).
- A site diversion system for surface water runoff during operation of the facility. (This system should not be required following site permanent closure.)
- Temporary protective covers (e.g., a tarpaulin) before the completion of the natural in-place soil barrier over the low-level waste.
- Revegetation of the overburden layer.
- Other suitable and reliable means for minimizing water contact with low-level waste.

Solid Waste Confinement Systems. The following provisions are typical for an RSWF confinement system. The actual confinement system requirements for a specific RSWF should be determined on a case-by-case basis.

- In general, the primary confinement should be the radioactive solid waste process system equipment and associated off-gas or vent systems during the treatment stage of processing. In special cases, such as RSWF where the processes or storage include corrosive or noxious materials, the radioactive solid waste process or storage system should be totally enclosed and provided with its own ventilation system and off-gas

cleanup system. In such cases, the radioactive solid waste process or storage system should be treated as the primary confinement system. Depending on the waste being processed and stored, the primary confinement and secondary confinement should consist of a site-specific engineered system of barriers (e.g., drums, liners, concrete casks).

- Secondary confinement for radioactive solid waste during treatment should consist of a process cell or building and its ventilation system; secondary confinement for radioactive solid waste during interim storage should be provided by a storage building or structure.
- Tertiary confinements are not needed in most cases for radioactive solid waste during the treatment or interim storage phase of the radioactive solid waste management process. Tertiary confinement for radioactive solid waste is typically considered to be the geologic structure of the site.
- In addition to these principal confinement systems, features such as change rooms and special access ways should be used to minimize the spread of radioactive contamination within the facility.

Primary Confinement System. The primary confinement system consists of process system equipment and its associated ventilation and off-gas system, storage containers, or other waste and site-specific engineered barriers.

Secondary Confinement System. The secondary confinement system consists of the process cell barriers and the ventilation systems associated with the cells or building, or a storage building or structure. In some cases, a drum, cask, or other waste and site-specific engineered barrier should provide secondary confinement.

- Penetrations of the secondary confinement should have positive seals to prevent migration of contamination out of the secondary confinement area.
- Process cells should be supplied with ventilation air from the building ventilation system, and should be provided with exhaust ventilation to control ventilation flow in the event of a credible breach in the secondary confinement barrier. Pressure in the compartments should be negative with respect to the building ventilation system. Special features (e.g., air

locks or enclosed vestibules) should be considered for access through secondary and tertiary confinement barriers.

Tertiary Confinement System. The natural geologic setting comprises the tertiary confinement system. The tertiary confinement system should meet the following performance objectives:

- following permanent closure, ongoing site maintenance should not be needed, and
- in the absence of unplanned natural processes or human contact with a low-level waste disposal facility, calculated contaminant levels in groundwater at the site boundary should not exceed the maximum contaminant levels established in Federal statutes.

2.10 TRITIUM FACILITIES. The DOE Tritium Focus Group has issued DOE HDBK-1129-2008, *Tritium Handling and Safe Storage*. This Handbook provides reference and background information that should be considered during the design of tritium handling and storage facilities.

2.10.1 Introduction. The design and operational philosophy of the older tritium facilities focused on worker protection. The tritium handling equipment was located in airflow hoods, and any releases from the equipment went into the ventilation system, up the stack, and directly into the environment. As long as local airflow requirements were maintained at the proper levels, exposures to workers were low to nonexistent. The high stacks maintained exposures to workers and personnel working or living downwind of such releases well below acceptable levels.

By the mid-to-late 1960s, more modern operational philosophies began to emerge. The design philosophy changed and placed the equipment that handled substantial quantities of tritium into gloveboxes; the gloveboxes in turn were equipped with their own, individualized cleanup systems. Although the initial intent of this type of change was to reduce tritium emissions to the environment to near zero by eliminating large releases, the tritium emissions were only reduced by some 10 to 25 percent. Thus, the primary lesson learned from this type of operational change strongly suggested that most tritium emissions to the

environment did not come from large releases, but from the background releases from the facilities themselves.

By the early 1970s, entirely new facility designs began to emerge. Having adapted to the lessons learned from the earlier operational changes, these newer facility designs also placed the bulk of the equipment that handled substantial quantities of tritium into gloveboxes. Rather than having individualized glovebox cleanup systems, the cleanup systems used in the newer facility designs heavily emphasized the use of a centralized cleanup system for glovebox operations. Evacuatable covers were sometimes placed over glovebox glove ports to minimize the potential for permeation from the gloveboxes to the working rooms. Additional cleanup systems were installed to handle the emissions from the glove port covers and other vacuum systems that were not compatible with the centralized glovebox cleanup system. Real-time monitoring capabilities were added to the gloveboxes and cleanup systems to track their respective reliabilities. Rapid response, real-time monitoring capabilities were added to the room air monitoring capabilities to protect the worker further. Rapid response, real-time monitoring capabilities were also added to the stack exhaust monitoring capabilities to more reliably monitor releases to the environment. And, in some cases, specialized cleanup systems were added at the room air ventilation level to allow for the cleanup of large releases into a working room, before the tritium released into the ventilation system was finally released to the stack.

With more than 25 years of operational experience with various types of newer facility designs, it is clear that the bulk of the emissions from all tritium facilities over the last 25 years have come from the background emissions of the facilities themselves.

To better understand how these emissions come about, an appreciation for the behavior of tritium in the facilities is necessary. Once understood, prospective designers and engineers will begin to understand what they can and cannot control through design innovations and techniques.

2.10.2 Sources of Tritium. Tritium is the lightest of the naturally occurring radioactive nuclides. Tritium is produced in the upper atmosphere as a result of cascade reactions between incoming cosmic rays and elemental nitrogen.

In its simplest form, this type of reaction can be written as

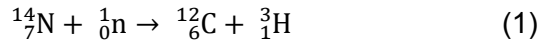

Tritium is also produced in the sun as a sub-set of the proton-proton chain of fusion reactions. Although a steady stream of tritium near the surface of the sun is ejected out into space (along with many other types of particles) on the solar wind, much larger streams are ejected out into space during solar flares and prominences. Being much more energetic than its solar wind counterparts, tritium produced in this manner is injected directly into the earth's upper atmosphere as the earth moves along in its orbit. Regardless of the method of introduction, however, estimates suggest that the natural production rate for tritium is about 4×10^6 Ci/yr, which, in turn, results in a steady-state, natural production inventory of about 7×10^7 Ci.

Tritium is also introduced into the environment through a number of man-made sources. The largest of these, atmospheric nuclear testing, added approximately 8×10^9 Ci to the environment between 1945 and 1975.

Because the half-life of tritium is relatively short, much of the tritium produced in this manner has long since decayed. However, tritium introduced into the environment as a result of atmospheric testing increased the natural background levels by more than two orders of magnitude, and, in spite of its relatively short half-life, the natural background levels of tritium in the environment will not return to normal until sometime between the years 2020 and 2030.

Tritium levels in the environment cannot truly return to background levels, however, because of a number of additional man-made sources. Tritium is also produced as a ternary fission product, within the fuel rods of nuclear reactors, at a rate of $1\text{-}2 \times 10^4$ Ci/1,000 MW(e). (Although much of the tritium produced in this manner remains trapped within the matrix of the fuel rods, estimates suggest that recovery of this tritium could reach levels of 1×10^6 Ci/yr.) Light-water and heavy-water moderated reactors produce another 500-1,000 to 1×10^6 Ci/yr, respectively, for each 1,000 MW of electrical power. Commercial producers of radioluminescent and neutron generator devices also release

about 1×10^6 Ci/yr. Thus, tritium facilities operate within a background of tritium from a variety of sources.

2.10.3 The Relative Abundance of Tritium . The isotopes of elemental hydrogen have long been recognized as being special—so special, in fact, that each has been given its own chemical name and symbol. Protium, for example, is the name given to the hydrogen isotope of mass-1, and the chemical symbol for protium is H. Deuterium is the name given to the hydrogen isotope of mass-2; the chemical symbol for deuterium is D. Tritium is the name given to the hydrogen isotope of mass-3. Its chemical symbol is T.

Protium is by far the most abundant of the hydrogen isotopes. Deuterium follows next with a relative abundance of about 1 atom of deuterium for every 6,600 atoms of protium; that is, the D to H ratio (D:H) is about 1:6,600. Tritium is the least common hydrogen isotope. The relative abundance of naturally occurring tritium (i.e., tritium produced in the upper atmosphere and tritium injected directly by the sun) has been estimated to be on the order of 1 tritium atom for every 10^{18} protium atoms. The introduction of man-made tritium into the environment, particularly as a result of atmospheric testing, has raised this level approximately one order of magnitude so that the ambient T to H ratio is now approximately 1: 10^{17} .

The names, commonly used symbols, atomic masses, and relative natural abundances of the hydrogen isotopes are summarized in Table II.

TABLE II. The isotopes of Hydrogen.

Name	Chemical Symbol	Atomic Mass	Natural Abundance (Percent)	Natural Abundance (x:H Ratio)
Protium	H	1.007 825 03	99.985 %	1:1
Deuterium	D	2.014 101 78	0.015 %	1:6,600
Tritium	T	3.016 049 26*	very low	1:10 ¹⁷

* Calculated

2.10.4 The Radioactive Decay of Tritium.

Generic. As the lightest of the pure beta emitters, tritium decays with the emission of a low-energy beta particle and an anti-neutrino; i.e.,

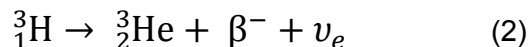

Tritium decays with a half-life of 12.3232 ± 0.0043 mean solar years or, using 365.2425 mean solar (days) per mean solar year, $4,500.96 \pm 1.57$ days. The specific activity of tritium is approximately 9,619 Ci/g, and/or 1.040×10^{-4} g/Ci. In addition, the activity density (i.e., the specific activity per unit volume) for tritium gas (T2) is 2.589 Ci/cm³, under standard temperature and pressure (STP) conditions (i.e., 1 atmosphere of pressure at 0EC), and/or 2.372 Ci/cm³ at 25EC. Under STP conditions, it can also be shown that these values translate to 58,023 Ci/g-mole and 29,012 Ci/g-atom, respectively.

Beta Emissions. Beta particles interact with matter by colliding with bound electrons in the surrounding medium. In each collision, the beta particle loses energy as electrons are stripped from molecular fragments (ionization) or promoted to an excited state (bremsstrahlung production). Because the rate of energy loss per unit path length (linear energy transfer, or LET) increases as the velocity of the beta particle slows, a distinct maximum range can be associated with beta particles of known initial energy.

The beta decay energy spectrum for tritium is shown in Figure 1. The maximum energy of the tritium beta is 18.591 ± 0.059 keV. The average energy is 5.685 ± 0.008 keV. The maximum range of the tritium beta (i.e., the mass attenuation coefficient) is 0.58 mg/cm².

The adsorption of energy from beta particles that emanate from a point source of tritium has been shown to occur nearly exponentially with distance. This is a result of the shape of the beta spectrum as it is subdivided into ranges that correspond with subgroups of initial kinetic energies. As a consequence, the fraction of energy absorbed, F, can be expressed as

$$F = 1 - e^{-(\mu/\rho)(\rho)(x)} \quad (3)$$

where μ is the mass attenuation coefficient of the surrounding material, ρ is the density of the surrounding material, and x is the thickness of the surrounding material.

For incremental energy absorption calculations, Equation (3) can be restated as

$$F = 1 - e^{-\mu x} \quad (3a)$$

where μ (i.e., the linear attenuation coefficient) is the product of the mass attenuation coefficient (μ/ρ) and the density (ρ), and x is the incremental thickness of choice. In gases at 25°C, at atmospheric pressure, for example, the linear attenuation coefficients for the gases hydrogen (H_2), nitrogen (N_2), and argon (Ar), are 1.81 cm^{-1} , 11.0 cm^{-1} , and 12.9 cm^{-1} , respectively. A 5-mm thickness of air will absorb 99.6 percent of tritium betas. A comparable thickness of hydrogen (or tritium) gas will absorb only 60 percent of the tritium betas.

Absorption coefficients for other media can be estimated by applying correction factors to the relative stopping power (the scattering probability) of the material of interest. For the most part, these will be directly proportional to ratios of electron densities. Examples of tritium beta ranges are shown in Table III. The values shown for tritium gas and for air are stated as STP values.

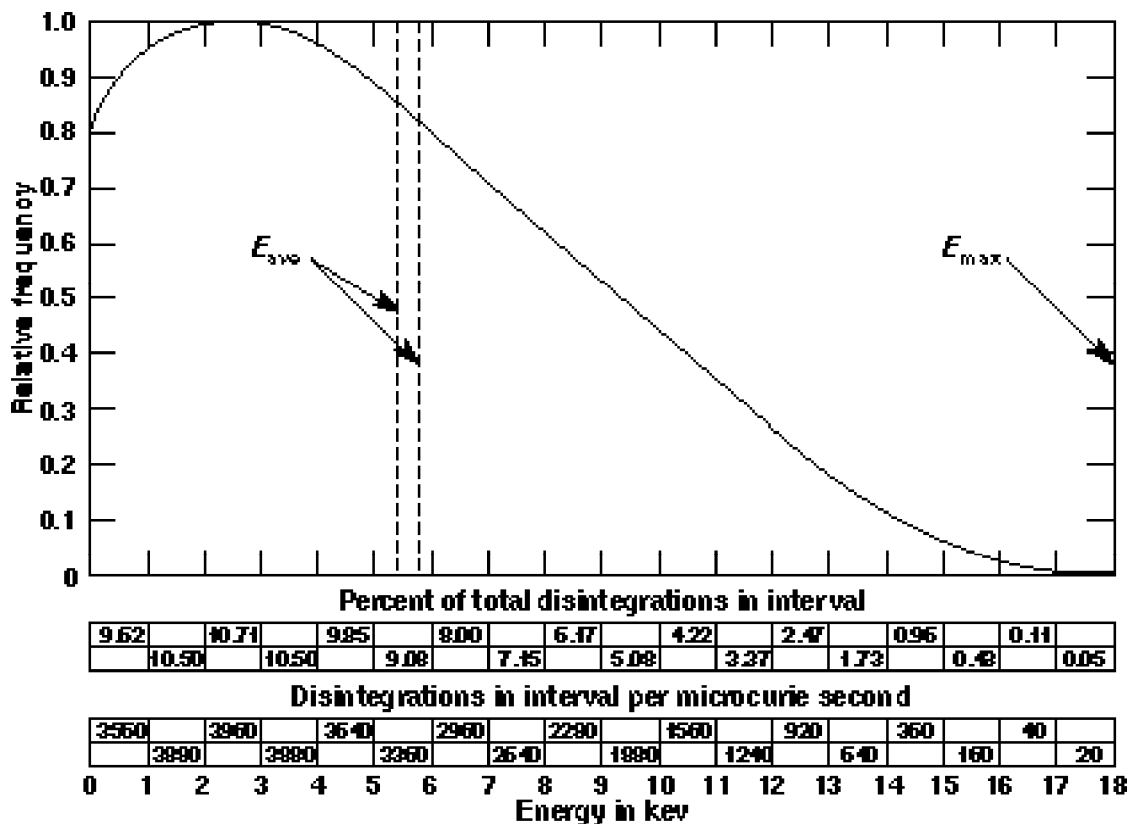

FIGURE 1. Tritium beta decay energy spectrum.

TABLE III. Approximate ranges of tritium betas.

Material	Beta Energy	Range
Tritium Gas	Average	0.26 cm
Tritium Gas	Maximum	3.2 cm
Air	Average	0.04 cm
Water (Liquid)	Average	0.42 μ m
Water (Liquid)	Maximum	5.2 μ m
Stainless Steel	Average	0.06 μ m

Photon Emissions. No nuclear electromagnetic emissions (gamma emissions) are involved in the decay scheme for tritium although it is worth noting that tritium does produce bremsstrahlung (braking radiation) as its beta particles are decelerated through interactions with nearby matter.

2.10.5 The Chemical Properties of Tritium.

Generic. Although the chemical properties of tritium have been described in great detail, three distinctive types of chemical reactions and one underlying principle in particular are worth noting here. The reaction types are solubility

reactions, exchange reactions, and radiolysis reactions. The underlying principle is Le Chatelier's Principle. An overview of these types of reactions and Le Chatelier's Principle is presented below.

Solubility Reactions. Elemental hydrogen, regardless of its form (H₂, D₂, T₂, and all combinations thereof), can be expected to dissolve to some extent in virtually all materials. On the atomic or molecular scale, hydrogen-like atoms, diatomic hydrogen-like species, or larger, hydrogen-like-bearing molecules tend to dissolve interstitially (i.e., they diffuse into the crystalline structure, locating themselves inside the normal lattice work of the internal structure). Schematically, such reactions can easily be described in terms of the generic reactions:

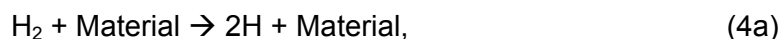

Theoretically, however, the underlying mechanics are much more complex. For example, of the generic reactions shown above, none are shown as being reversible. From a chemical perspective, none of these reactions is technically correct because, in most dissolution reactions, the solute that goes in can be expected to be the same solute that comes out. From an operational standpoint, however, experience has shown that, regardless of the tritiated compound that enters into the reaction, an HTO (i.e., a tritiated water vapor) component can be expected to come out. Presumably, this is due to catalytic effects and/or exchange effects that derive from the outward migration of the tritiated species through molecular layers of water vapor that are bound to the surface of the material.

Exchange Reactions. Driven primarily by isotope effects, exchange reactions involving tritium can be expected to occur at a relatively rapid pace. Moreover, the speed at which reactions of this type can occur can be further enhanced by the addition of energy from radioactive decay. For tritium, therefore, reactions similar to the following can be expected, and they can be expected to reach equilibrium in time frames that range from seconds to hours:

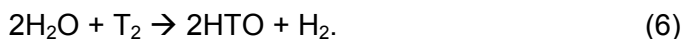
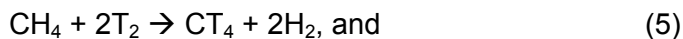

Equation (5) describes the preferential form of tritium as it exists in nature in the earth's upper atmosphere. Equation (6) describes the preferential form of tritium as it exists in nature in the earth's lower atmosphere (i.e., in a terrestrial environment).

Equation (6) is particularly important because it describes the formation of tritiated water vapor (i.e., HTO) without the involvement of free oxygen (i.e., with no O₂). A comparable reaction that would involve free oxygen would take the form of a classic inorganic chemical reaction, such as



But, because a classic inorganic chemical reaction like that depicted in Equation (7) can be expected to reach equilibrium in a time frame that ranges from many hours to several days under the conditions normally found in nature, classic inorganic chemical reactions of this type are not necessary for this discussion.

Radiolysis Reactions. It was noted previously in Section 2.10.4 that the range of the tritium beta is very short. As a consequence, it follows that virtually all of the energy involved in tritium beta decay will be deposited in the immediate vicinity of the atoms undergoing decay. When the medium surrounding the decaying atoms is tritium gas, tritiated water, or tritiated water vapor in equilibrium with its isotopic counterparts, reactions such as those presented in Equations (8) and/or (9) below can be expected to dominate. When the medium surrounding the decaying atoms is not a medium that would normally be expected to contain tritium, however, an entire spectrum of radiolysis reactions can be expected to occur.

For typical, day-to-day operations, the most common type of radiolysis reactions in the tritium community can be expected to occur at the interface between the air above a tritium contaminated surface and tritium contaminated surface itself. For these types of reactions, some of the energy involved in the tritium decay process can be expected to convert the nitrogen and oxygen components in the air immediately above the surface (i.e., the individual N₂ and O₂ components in the air) into the basic generic oxides of nitrogen, such as nitric oxide, nitrous

oxide and nitrogen peroxide (i.e., NO, N₂O, and NO₂, respectively). As the energy deposition process continues, it can also be expected that these simpler oxides will be converted into more complex oxides, such as nitrites and nitrates (i.e., NO₂s and NO₃s, respectively). Because all nitrite and nitrate compounds are readily soluble in water (and/or water vapor), it can further be expected that a relatively large percentage of the available nitrites and nitrates in the overpressure gases will be absorbed into, and/or dissolved into, the mono-molecular layers of water vapor that are actually part of the surface. (See “Modeling the Behavior of Tritium” in Section 2.10.6, below.) With the available nitrites and nitrates now an integral part of the mono-molecular layers of water vapor, it can finally be expected that the most common type of radiolysis-driven reactions should result in the gradual, low-level build-up of tritiated nitrous and nitric acids on the surfaces of most tritium contaminated materials. Over the long-term, it should further be expected that these tritiated nitrous and nitric acids will be broken down into tritiated ammonia compound dissolved into the surface bound layers of water vapor.

For the most part, this particular type of reaction sequence does not normally present itself as a problem in day-to-day tritium operations because (1) the overall production efficiency for these types of reactions is relatively low, and (2) the materials used for the construction of most tritium-handling systems are not susceptible to attack by nitrous and/or nitric acids or by tritiated ammonia compounds. By contrast, however, it should be noted that other types of radiolysis-driven reactions can be expected to occur with tritium in the presence of compounds containing chlorides and/or fluorides, and these can easily lead to chloride/fluoride induced stress corrosion cracking. (See, for example, the discussion on “Organics” in Section 2.10.6, below.)

One additional point that is worth noting about radiolysis-driven reactions is that their long-term potential for causing damage should not be underestimated. Although the overall production efficiency for these types of reactions might be expected to be relatively low, the generation of products from these types of reactions can, on the other hand, be expected to occur continuously over relatively long periods of time (i.e., 10-20 years, or more). As a consequence, the long-term effects from these types of reactions can be difficult to predict,

especially because very little is known about the long-term, synergistic effects of low-level, tritium micro-chemistry. (See Section 2.10.6.)

Le Chatelier's Principle. A chemical restatement of Newton's Third Law of Motion, Le Chatelier's Principle states that when a system at equilibrium is subjected to a perturbation, the response will be such that the system eliminates the perturbation by establishing a new equilibrium. When applied to situations like those depicted in Equations (5) and (6), Le Chatelier's Principle states that, when the background tritium levels are increased in nature (by atmospheric testing, for example), the reactions will be shifted to the right in order to adjust to the new equilibrium conditions by readjusting to the naturally occurring isotopic ratios. Thus, we get reactions of the type



The inverse situation also applies in that, when the background tritium levels are decreased in nature, the reactions will be shifted back to the left, by again readjusting to the naturally occurring isotopic ratios; i.e.,



By itself, Le Chatelier's Principle is a very powerful tool. When applied singularly, or to a sequential set of reactions like those depicted in Equations (5), (5a), and (5) again, and/or (6), (6a), and (6) again, Le Chatelier's Principle shows that exchange reactions of the types depicted above tend to behave as springs, constantly flexing back-and-forth, constantly readjusting to changing energy requirements, in a constantly changing attempt to establish a new set of equilibrium conditions.

Since elemental hydrogen, regardless of its form (H_2 , D_2 , T_2 , and all combinations thereof), can be expected to dissolve to some extent in virtually all materials, Le Chatelier's Principle can be expected to work equally as well on solubility reactions, like those shown above in the generic Equations (4a),

(4b), and (4c). These will be covered in more detail under the heading of Bulk Contamination Modeling (see below).

2.10.6 Modeling the Behavior of Tritium. Any model of the behavior of tritium starts with the assumption that all three hydrogen isotopes coexist in nature, in equilibrium with each other, in the nominal isotopic ratios described above in Table III. To this is added the consequences predicted by Le Chatelier's Principle. From both, we get the fundamental relationship,

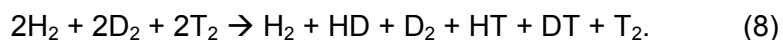

In a terrestrial environment, virtually all of the tritium that exists in nature exists as water or water vapor. Correcting this situation for the natural conversion to water and/or water vapor, Equation (8) becomes



It can also be assumed that the surfaces of all terrestrially bound objects are coated with a series of mono-molecular layers of water vapor. In the final step, it can be assumed that the innermost layers of water vapor are very tightly bound to the actual surface, that the intermediate layers of water vapor are relatively tightly to relatively loosely bound, and that the outermost layers of water vapor are very loosely bound. (See Figure 2.)

Surface Contamination Modeling. When an overpressure of tritium is added to the system (i.e., the surface, in this case), a perturbation is introduced to the system, and Le Chatelier's Principle indicates that the tritium levels in the mono-molecular layers of water will be shifted to the right; that is,



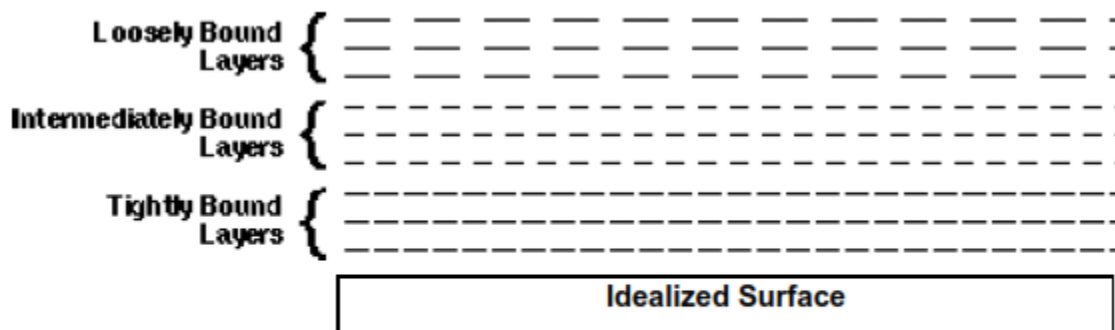
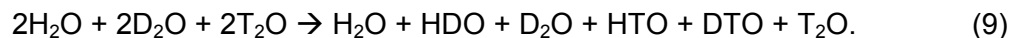

FIGURE 2. Idealized surface showing idealized mono-molecular layers of water vapor.

Tritium is incorporated first into the loosely bound, outer layers, then into the intermediate layers, and finally into the very tightly bound, near surface layers.

When the overpressure is removed, the system experiences a new perturbation. In this case, however, the perturbation is in the negative direction, and the system becomes the entity that contains the excess tritium. Le Chatelier's Principle, in this case, indicates that the tritium levels in the mono-molecular layers of water will be shifted back to the left; that is,



The tritium that had previously been incorporated into the mono-molecular layers now begins to move out of the layers, in an attempt to return to background levels.

The movement of tritium into the mono-molecular layers of water vapor is generically referred to as "plate-out." The movement of tritium out of the mono-molecular layers of water vapor is generically referred to as "outgassing."

Plate-Out Expectations. When the concentration gradients have been small and/or the exposure times have been short, only the outermost, loosely bound, mono-molecular layers of water vapor will be affected. Under such circumstances, the surface contamination levels will range from no detectable activity to very low levels; that is, up to a few tens of disintegrations per minute per 100 square centimeters (dpm/100 cm²). Since only the outermost mono-molecular layers are affected, and since these layers are easily removed by a

simple wiping, the mechanical efforts expended to perform decontamination on such surfaces will, if any, be minimal.

When the concentration gradients have been relatively large and/or the exposure times have been relatively long, the affected mono-molecular layers will range down into the intermediately bound layers (i.e., the relatively tightly to relatively loosely bound layers). Under such circumstances, the surface contamination levels will range from relatively low to relatively high (i.e., from a few hundred to a few thousand dpm/100 cm²). Because the tritium has now penetrated beyond those levels that would normally be easily removed, mechanical efforts expended to decontaminate such surfaces will be more difficult than those described above.

When the concentration gradients have been large and/or the exposure times have been long, the affected mono-molecular layers will range all the way down into the very tightly bound layers. The tritium will have penetrated down into the actual surface of the material, itself; see "Bulk Contamination Modeling," below. Under such circumstances, the surface contamination will range from relatively high to very high levels (i.e., from a few tens of thousand to several hundred thousand dpm/100 cm²), and that mechanical efforts expended to decontaminate such surfaces could be very difficult.

Outgassing Expectations. The phenomenon of outgassing is rarely a problem under the first of the exposure situations described above (i.e., situations in which the concentration gradients have been small and/or the exposure times have been short). However, when systems that have been exposed to even small amounts of tritium for long-to-very-long periods of time are suddenly introduced to room air, or any sudden change in its equilibrium situation, Reactions (5) and (6), (5a) and (6a), (8), (9), and (9a) can be thought of as springs, and the initial phenomenon of outgassing can be described as damped harmonic motion. Under such circumstances, therefore, a relatively large, initial "puff" of HTO will be released from the mono-molecular layers of water vapor, followed by a relatively long, much smaller trailing release. Because several curies of HTO can be released in a few seconds, and several tens of curies can be released in a few minutes, the speed of the "puff" portion of the release should not be underestimated. The duration of the trailing portion of the release should not be underestimated either. Depending on the concentration gradients involved

and/or the time frames involved in the plate-out portion of the exposure, the trailing portion of the release can easily last from several days to several months or even years.

As the trailing portion of the release asymptotically approaches zero, the outgassing part of the release becomes too small to measure on a real-time basis, and the tritium levels involved in any given release can only be measured by surface contamination measurement techniques. Under such circumstances, the situation reverts back to the circumstances described above under the heading of "Plate-Out Expectations." With no additional influx of tritium, tritium incorporated into all of the mono-molecular layers of water vapor will eventually return to background levels, without human intervention, regardless of the method or level of contamination.

Bulk Contamination Modeling. When an overpressure of tritium is added to the system (i.e., the surface of an idealized material), Le Chatelier's Principle indicates that the tritium levels in the mono-molecular layers of water will be shifted to the right; that is,

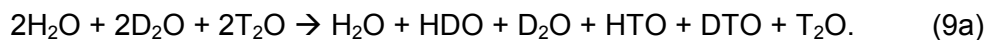

Tritium is incorporated first into the loosely bound, outer layers, then into the intermediate layers, and finally into the very tightly bound, near-surface layers. As the tritium loading in the near-surface layers builds, the disassociation processes that proceed normally as a result of the tritium decay make an overpressure of tritium available in a mono-molecular form (i.e., as T). Relative to the normal amounts of elemental hydrogen that can be expected to be dissolved in the material, the availability of excess tritium in the mono-molecular form represents a different type of perturbation on a system, and the available tritium begins to dissolve into the actual surface of the bulk material. As the local saturation sites in the actual surface of the bulk material begin to fill, the tritium dissolved in the surface begins to diffuse into the body of the bulk material; at that point, the behavior of the tritium in the body of the bulk material becomes totally dependent on the material in question.

Materials Compatibility Issues. Elemental hydrogen, regardless of its form (H₂, D₂, T₂, and all combinations thereof), can be expected to dissolve to some extent in virtually all materials. For simple solubility reactions, such as

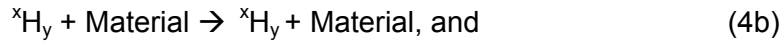
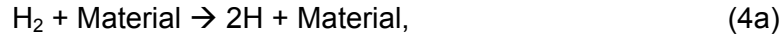

basic compatibility issues should be considered. As a general rule, the solubility of tritium in pure metals and/or ceramics should have a minimal effect, at normal room temperatures and pressures, except for the possibility of hydrogen embrittlement. For alloyed metals, such as stainless steel, similar considerations apply, again, at normal room temperatures and pressures. For alloyed metals, however, additional consideration should be given to the possible leaching of impurities from the alloyed metal, even at normal room temperatures and pressures. [In LP-50 containment vessels, for example, the formation of relatively large amounts of tritiated methane (i.e., up to 0.75 percent mole percent of CT4) has been noted after containers of high-purity tritium have been left undisturbed for several years. The formation of the tritiated methane, in this case, has long been attributed to the leaching of carbon from the body of the stainless steel containment vessel.]

Pressure Considerations. Under increased pressures (e.g., from a few tens to several hundred atmospheres), however, the general rules no longer apply for, in addition to the possibility of hydrogen embrittlement and possible leaching effects, helium embrittlement is also possible. Helium embrittlement tends to occur as a result of the dissolved tritium decaying within the body of the material, the resultant migration of the helium-3 atoms to the grain boundaries of the material, the localized agglomerations of the helium-3 atoms at the grain boundaries, and the resultant high-pressure build-ups at these localized agglomerations.

Temperature Considerations. Under increased temperature situations, the matrix of solubility considerations becomes even more complicated because virtually all solubility reactions are exponentially dependent on temperature. In

the case of diffusional flow through the walls of a containment vessel, for example, it can be assumed that steady-state permeation will have been reached when

$$\frac{D \cdot t}{L^2} = 0.45 \quad (10)$$

where D = the diffusion rate in cm^2/sec , t = the time in seconds, and L = the thickness of the diffusion barrier. For type 316 stainless steel, the value for the diffusion rate is

$$D = 4.7 \times 10^{-3} e^{(-12,900/RT)} \quad (10a)$$

and the corresponding value for R , in the appropriate units, is 1.987 cal/mole K. With a nominal wall thickness of 0.125 inches (i.e., 0.318 cm), Equation (10) indicates that it will take about 875 years to reach steady-state permeation, at a temperature of 25°C. At 100°C, the time frame will be reduced to about 11 years, and at 500°C, it only takes about 12 hours.

Organics. With the introduction of organic materials into any tritium handling system, the matrix of solubility considerations becomes complicated to its maximum extent because the simple solubility reactions, such as those shown above as Equations (4a), (4b), and (4c), are no longer working by themselves. With the availability of free tritium dissolved into the internal volume of the organic material, the molecular surroundings of the organic material see a local perturbation in their own internal systems, and Le Chatelier's Principle indicates that the system will adjust to the perturbation with the establishment of a new equilibrium. Under such circumstances, exchange reactions can be expected to dominate over simple solubility reactions, and the available tritium can be expected to replace the available protium in any—and all—available sites. Once the tritium has been incorporated into the structure of the organic material, the structure begins to break down from the inside out, primarily as a result of the tritium decay energy.

The specific activity of tritium gas at atmospheric pressure and 25°C is 2.372 Ci/cm³. The expected range of the average energy tritium beta particle in unit density material is only 0.42 μm . This means that all energy from the decay of the

dissolved tritium is deposited directly into the surrounding material. At 2.732 Ci/cm³, this becomes equivalent to 2.88×10^4 rads/hr.

The general rule for elastomers used for sealing is that total radiation levels of 10⁷ rads represent the warning point that elastomers may be losing their ability to maintain a seal. At 10⁸ rads, virtually all elastomers used for sealing lose their ability to maintain a seal. Typical failures occur as a result of compression set (i.e., the elastomer becomes brittle and loses its ability to spring back). At 10⁶ rads, on the other hand, the total damage is relatively minor, and most elastomers maintain their ability to maintain a seal. At 10⁷ rads, the ability of an elastomer to maintain a seal becomes totally dependent on the chemical compounding of the elastomer in question. It only takes about 2 weeks for an elastomer to receive 10⁷ rads at a dose rate of 2.88×10^4 rads/hr. Elastomers cannot be used for sealing where they might be exposed to high concentrations of tritium.

Similar analogies can be drawn for all organic materials. The preferred rule of thumb is the use of all organic materials should be discouraged wherever they might be exposed to tritium. Since this is neither possible nor practical, the relative radiation resistance for several elastomers, thermoplastic resins, thermosetting resins, and base oils is shown graphically in Figures 3 through 6, respectively.

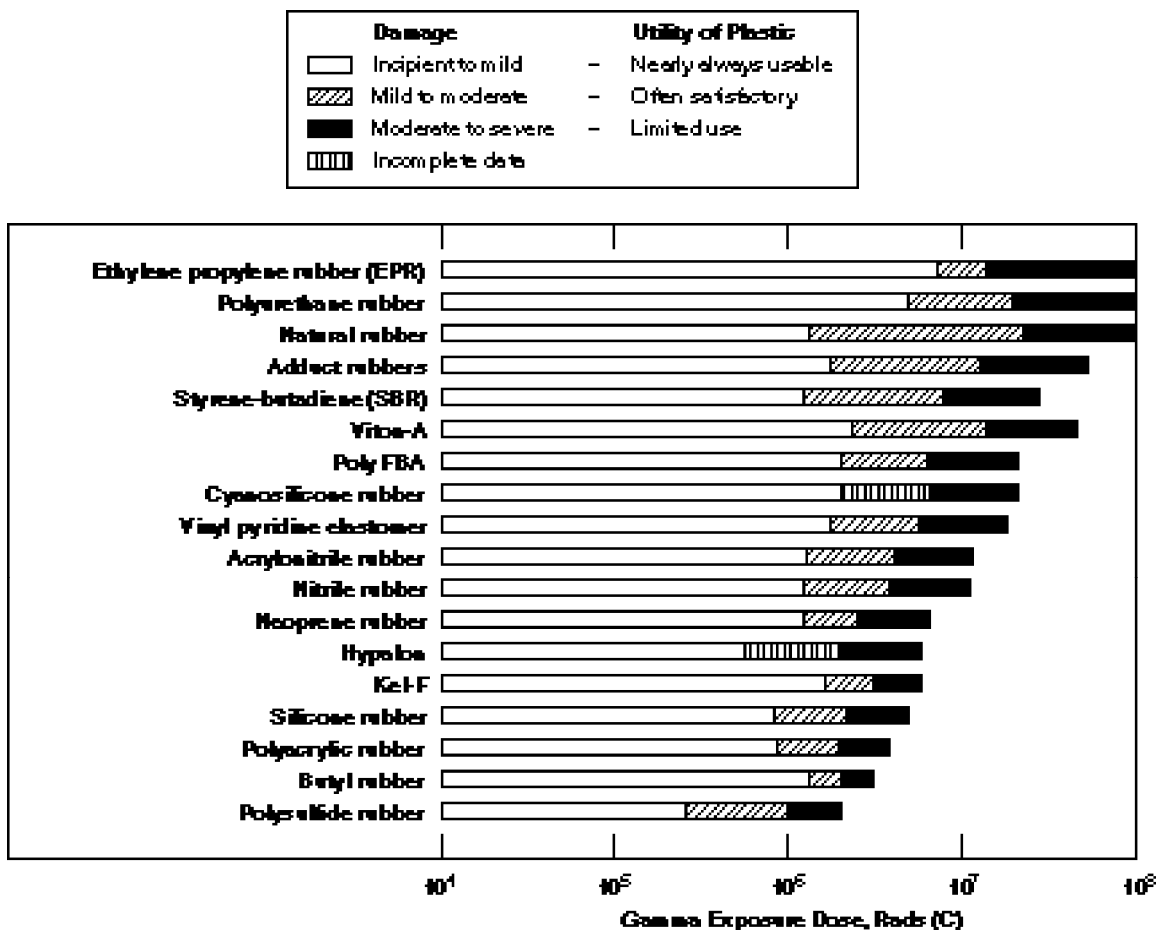

FIGURE 3. Relative radiation resistance of elastomers.

The damage done to organic materials by the presence of tritium in the internal structure of the material is not limited to the more obvious radiation damage effects. Tritium, particularly in the form of T^+ , has the insidious ability to leach impurities (and nonimpurities) out of the body of the parent material. In many cases, particularly where halogens are involved, the damage done by secondary effects such as leaching can be more destructive than the immediate effects caused by the radiation damage. In one such case, the tritium contamination normally present in heavy water up to several curies per liter was able to leach substantial amounts of chlorides out of the bodies of neoprene¹ O-rings that were used for the seals. The chlorides leached out of the O-rings were subsequently deposited into the stainless steel sealing surfaces above and below the trapped O-rings, which led directly to the introduction of chloride-induced stress-crack

¹ The proper chemical name for neoprene is "chlorobutadiene."

corrosion in the stainless steel. The operational conditions that set up the introduction of the stress-crack corrosion were moderately elevated temperatures (i.e., less than 100°C), low pressures (i.e., less than 3 atmospheres), and exposure times of 3-5 years. Fortunately, the damage was discovered before any failures occurred, the neoprene O-rings were removed, and the seal design was changed to a non-O-ring type of seal.

In a second case, six failures out of six tests occurred when high-quality Type 316 stainless steel was exposed to tritium gas in the presence of Teflon™ shavings and 500 ppm moisture. All of the failures were catastrophic, and all were the result of massively induced stress-crack corrosion. The conditions that set up the introduction of the massively induced stress-crack corrosion in this case were moderately elevated temperatures (i.e., 104°C), high pressures (i.e., 10,000 to 20,000 psi), and exposure times that ranged from 11 to 36 hours. Since the time to failure for all the tests was directly proportional to the pressure (i.e., the higher pressure tests failed more quickly than the lower pressure tests), since identical control tests with deuterium produced no failures, and since comparable testing without the Teflon™ shavings indicated no failures after 3,200 hours, it was concluded that fluorides were being leached out of the Teflon™ and deposited directly into the bodies of the stainless steel test vessels. An interesting sideline to this test is that, after the tests, the Teflon™ shavings showed no obvious signs of radiation damage (i.e., no apparent discoloration or other change from the original condition).

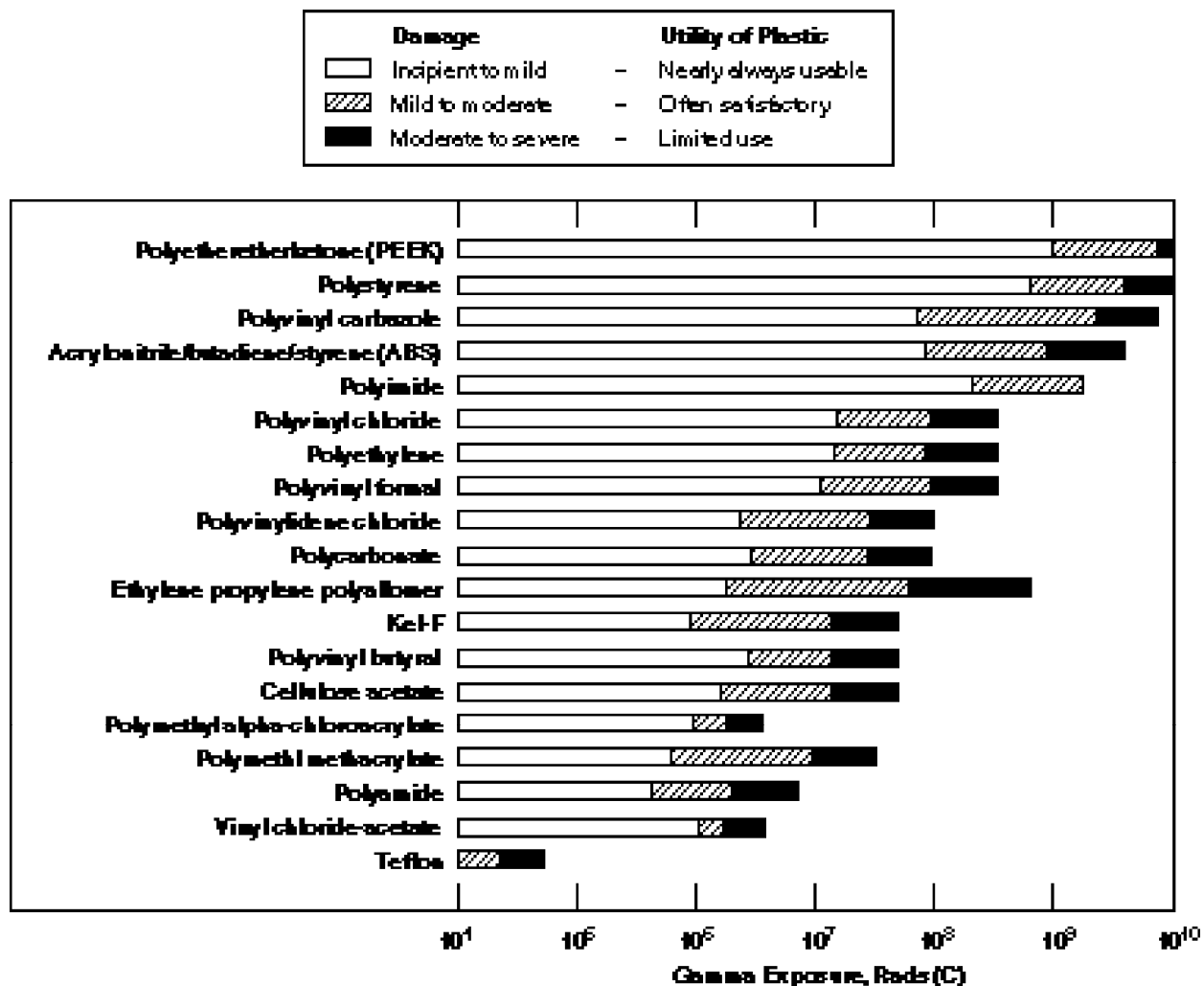

FIGURE 4. Relative radiation resistance of thermoplastic resins.

Outgassing from Bulk Materials. Discussions on the outgassing from bulk materials can be subdivided into two parts: outgassing from surfaces that have been wetted with tritium and outgassing from surfaces that have not been wetted with tritium. For surfaces that have been wetted with tritium, the behavior of the outgassing should be virtually identical to that described above. For surfaces that have not been wetted with tritium, it should be assumed that the source of the outgassing is from tritium that has been dissolved in the body of the parent material.

As the saturation level in the body of the bulk material is reached, the dissolved tritium begins to emerge from the unexposed side of the material surface, where it then begins to move through the mono-molecular layers of water vapor on that

side. In the initial stages, the pattern of the tritium moving into these mono-molecular layers tends to resemble the reverse of that described in the surface contamination model described above (i.e., the tritium is incorporated first into the very tightly bound, near-surface layers, then into the intermediate layers, and finally into the loosely bound, outer layers). As the tritium saturation levels in the body of the bulk material gradually reach steady-state, the tritium levels

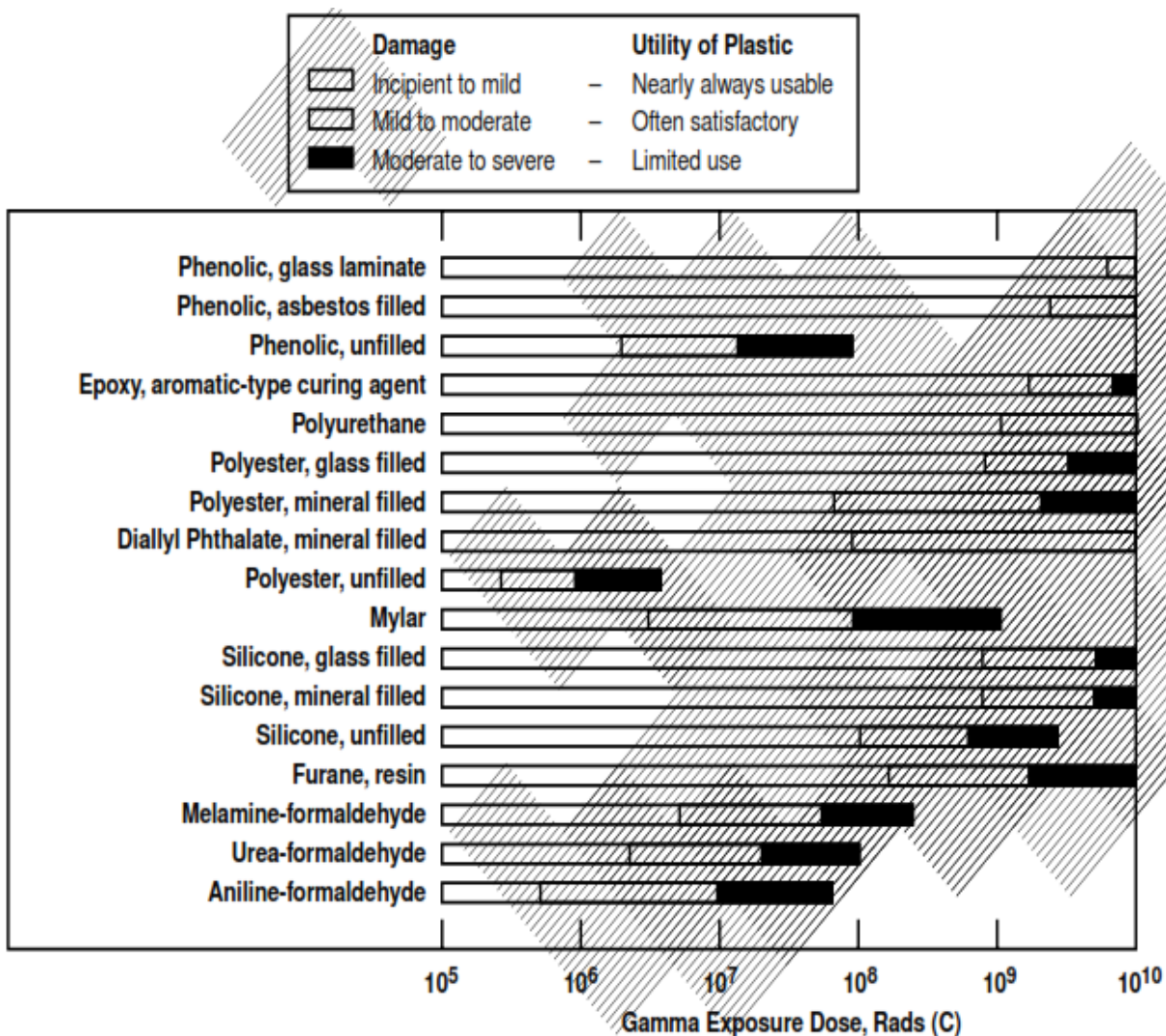

FIGURE 5. Relative radiation resistance of thermosetting resins.

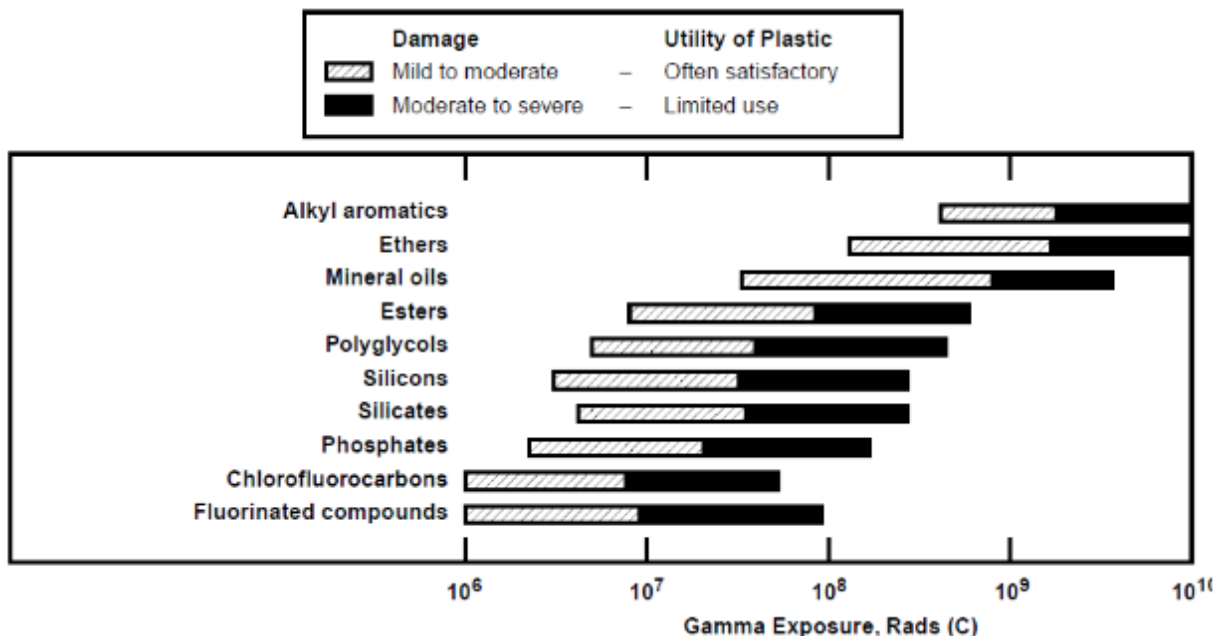

FIGURE 6. Relative radiation resistance of base oils.

moving into the mono-molecular layers gradually build over time, and the pattern slowly changes from one of a reverse surface contamination model to one of a reverse outgassing model (i.e., the level of outgassing from any given surface can be expected to increase until it too reaches a steady-state, equilibrium level with its own local environment).

2.10.7 The Development of Tritium Technology. In the preceding sections, we have taken a look at the basic physical and chemical properties of tritium that designers have to contend with but have little or no control over. In reality, these are the things that designers need to accommodate. The sections that follow describe the design and operational philosophies that have evolved over the years.

During the first two decades of the development of tritium technology, operational techniques were designed primarily to protect the worker from exposures to tritium. By the late 1950s, it had firmly been established that exposures to tritium in the form of tritiated water vapor (i.e., T_2O , or, more correctly, HTO) could be as much as 25,000 times more hazardous than

comparable exposures to tritium gas (HT, or, more correctly, T_2). Although real-time monitoring systems had been developed to detect the presence of tritium in

the working environment, the monitoring systems of the time could not differentiate between the more hazardous chemical species (HTO) and the less hazardous chemical species (HT). As a consequence, the basic philosophy for worker protection revolved around the use of high-volume-airflow, single pass ventilation systems.

The high-volume-airflow, single-pass ventilation systems of the time were intended to provide several air changes per hour, throughout an entire building, 24 hours a day, 365 days a year. (See Figure 7.) From the perspective of the building, outside air was brought into the building by the supply fans; incoming air was then conditioned for comfort, passed through the working spaces, and pushed out into the

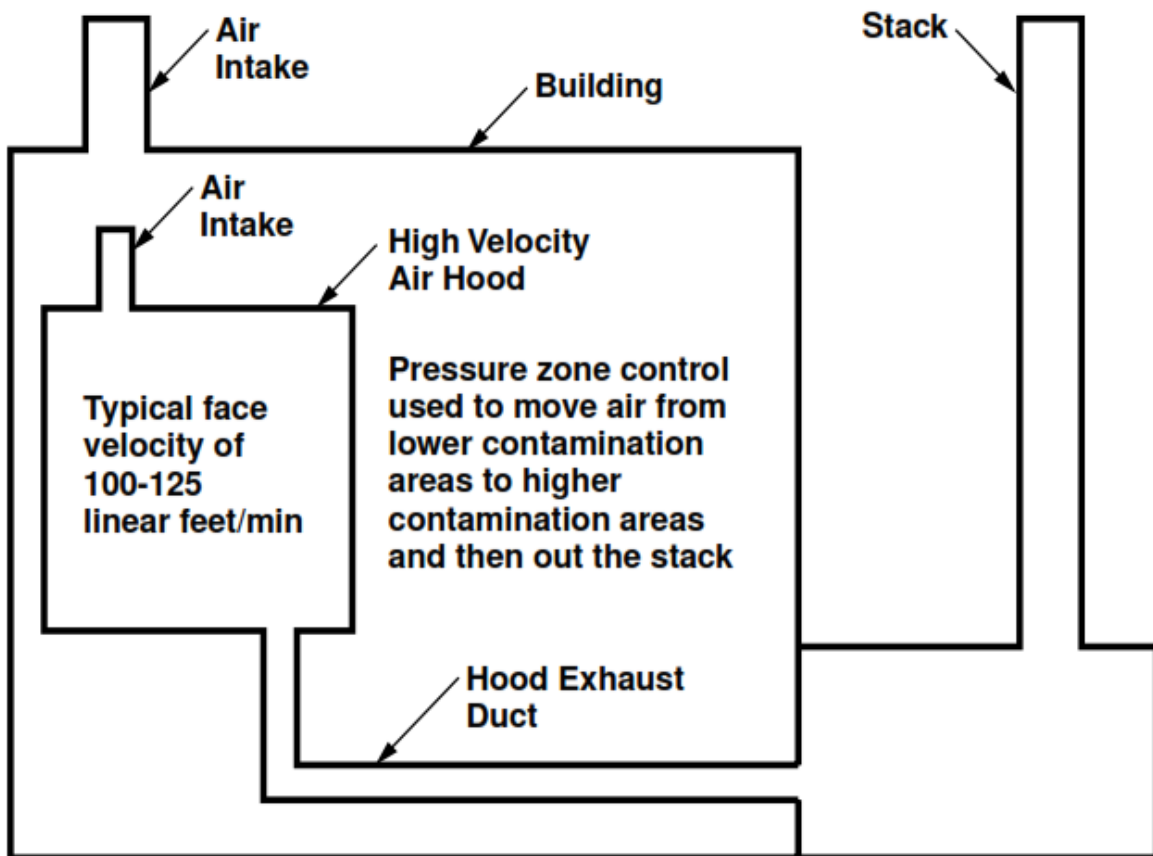

FIGURE 7. Typical tritium facility single-pass ventilation system.

environment by the exhaust fans through an elevated stack. From the perspective of the worker, individual airflow requirements were segmented—major tritium handling systems were enclosed in high velocity air hoods; work

was performed through gloves in the ventilated hood enclosure doors, or through accessible hood openings. The high air velocity hoods were maintained at a pressure that was negative with respect to the surrounding room spaces; most importantly, any tritium releases that occurred due to normal operations, component failure, and/or operator error would occur inside the hoods. The high-velocity air flowing through the building, and then through the hoods, would sweep any released tritium away from the worker.

Although this combination of single-pass ventilation systems and high air velocity hoods was used quite extensively—and quite successfully—for basic worker protection, the protection of personnel living or working downwind was dependent on the massive dilution factors that could be gained by the use of such systems.

By the end of the first decade, it gradually became obvious that the protection of personnel living or working downwind could no longer remain dependent on massive dilution factors. In their initial attempts at controlling tritium releases, a newer generation of tritium design personnel developed a plan to control releases by tightening design controls and material selection requirements. After only a few years, however, it also became obvious that the techniques developed, although helpful, would not be completely successful. While many valuable lessons were learned, tritium releases continued to occur despite more stringent design, material, and performance requirements.

By the late 1960s and early 1970s, it finally became obvious that a more realistic tritium operating philosophy would have to be developed, one that would not only protect the worker, but would also substantially increase the basic protection of the public and the environment.

2.10.8 Confinement Systems vs. Containment Systems. Within DOE, the term “confinement” has been used to describe the generic use of barriers, systems, and structures that have been specifically designed to limit the dispersion of radioactive materials within a given facility. Typical examples of confinement barriers and systems include the use of fume hoods, ventilated gloveboxes, air locks, etc.

Because most DOE facilities have, over the years, been associated with the handling of solid or particulate materials, HEPA filters have long been used on ventilation exhaust systems to minimize or eliminate the release of radioactive materials to the environment.

For tritium, however, the concept of “confinement” has little meaning because (1) tritium is a gas, (2) the use of HEPA filters on exhaust systems can do nothing to prevent the release of tritium to the environment, and (3) the classic concept of confinement, from the perspective of the facility, reduces back to the use of the high volume airflow, single pass ventilation systems described above. Thus, standard terminology has evolved that clearly differentiates between the use of “confinement” systems and the use of “containment” systems.

Primary Containment Systems. The innermost barrier that separates tritium from its immediate outside environment, primary containment systems for tritium handling typically consist of piping, valves, containment vessels, pumps, transducers, etc. Because these components can be expected to have their interior surfaces fully wetted with high concentrations of tritium gas under vacuum conditions and/or at high pressures, materials considerations become important, as do the methods of construction.

Because the primary containment system in question may or may not be situated in a secondary containment environment, the rule-of-thumb for modern primary tritium containment systems is to assume that there is no secondary containment system, and that the primary containment system is the only barrier between the tritium and the outside environment. The materials and construction issues associated with primary containment systems for tritium handling should follow the guidance set forth in the ASME *Boiler and Pressure Vessel Code* or a similar code. In most cases, the materials of choice will be a 300-series stainless steel, preferably a low carbon variety (e.g., 304L or 316L). Welding is the preferred method of construction wherever possible. Prior to being placed into service, individual portions of the system should be certified to a maximum leakage rate of 10^{-6} to 10^{-7} cm³/sec (helium), at a minimum of 125 percent of the maximum expected operating pressure.

Secondary Containment Systems. The use of secondary containment systems in the DOE tritium complex tends to vary a great deal, depending upon when the

systems were put into service and their projected use. Depending on their use, secondary containment systems can be expected to vary in complexity, from the relatively simple “jacket concept” used to house primary containment system plumbing and containment vessels, to much more complex glovebox concepts, where the gloveboxes in turn are connected to specialized cleanup systems. Depending on the amount of tritium at risk, construction requirements for secondary containment systems can also be expected to vary widely, from high-quality systems, to intermediate-quality systems, to low-quality systems. An overview of each type of system is described below, along with its intended function.

When gloveboxes are used for secondary confinement, the following design features should be considered:

- Air should not be used for the atmosphere of a recirculating tritium glovebox because of the potential for the formation of explosive mixtures of hydrogen gas. Argon or nitrogen is recommended.
- The glovebox atmosphere should be maintained at a pressure lower than that of the surroundings and diffusion-resistant material should be used to the maximum extent possible to limit tritium leakage.

High-Quality Secondary Containment Systems. A typical example of a high-quality, secondary containment system can be represented by the “jacket concept,” in which the plumbing associated with a primary containment system is completely enclosed inside an independent secondary container. High-quality, secondary containment jackets are most often used to enclose primary containment system plumbing when the primary system plumbing is used to connect systems between one glovebox and another inside a room, between one system and another inside a building, and between one system and another when the systems reside in different buildings. High-quality, secondary jackets are also used quite extensively to enclose primary-containment-system, high-pressure vessels, where the failure of the primary system vessel might be expected to release large quantities of tritium. (See, for example, Figure 8.) High-quality, secondary jackets are also used to enclose individual primary containment system components that are temperature cycled on a routine basis. In this case, however, the purpose of the high-quality secondary containment

jacket is to capture any tritium that has permeated through the walls of the primary system component as a direct result of the temperature cycling.

In each of the examples cited above, substantial amounts of tritium can be at risk at any given time. Under such circumstances, the rule-of-thumb for the design of high-quality, secondary containment systems is to assume that there is no primary containment system, and that the secondary containment system is the only barrier between the tritium and the outside environment. By default, therefore, the secondary containment system design requirements become identical to those used for primary containment systems; accordingly, the materials and construction issues associated with these types of secondary systems should also follow the guidance set forth in Section III of the *ASME Boiler and Pressure Vessel Code*.

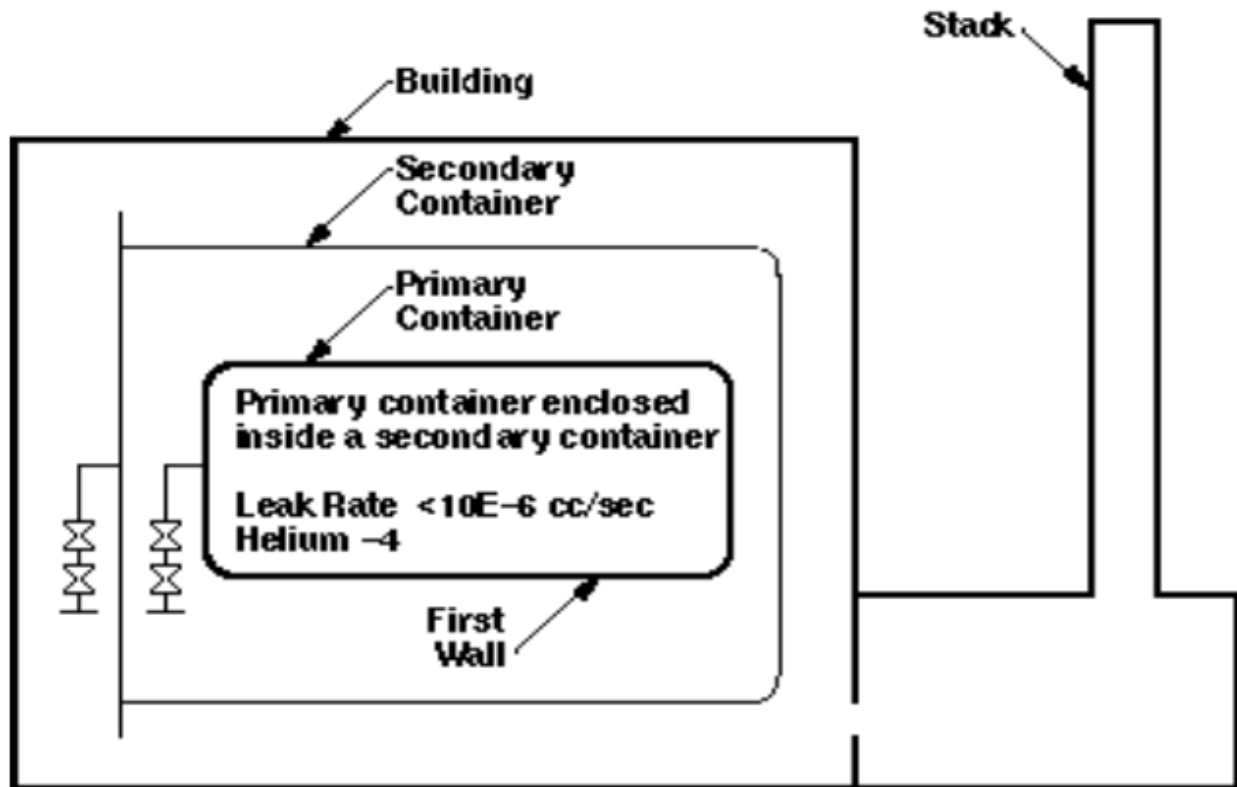

FIGURE 8. High-quality secondary containment.

From a materials and construction perspective, there should be virtually no difference between the requirements for the primary containment and secondary containment designs. In most cases, the materials of choice will be a 300-series stainless steel, preferably a low-carbon variety (e.g., 304L or 316L). Welding will

be the preferred method of construction wherever possible. Prior to being placed into service, individual portions of the system will be certified to a maximum leakage rate of 10^{-6} to 10^{-7} cm³/sec (helium), at a minimum of 125 percent of the maximum expected pressure.

From an operational perspective, however, the design philosophy should be that the void volume between the primary containment vessel outer wall and the secondary containment jacket inner wall in such systems is generally evacuated during service. Thus, if tritium is released into these secondary containers, there are no dilution gases present, and any leakage from the secondary container is in the same form as that contained in the primary container. Following a release into a high-quality system, the tritium can be recovered in almost the original purity without dilution by other gases by pumping it into another primary container. Several days can elapse during the recovery process without a significant release of tritium to the environment.

Intermediate-quality Secondary Containment Systems . It is neither practical nor possible to enclose all primary tritium systems inside high-quality, non-diluting, evacuated, secondary containers. Therefore, intermediate-quality, secondary containment systems, such as gloveboxes, are used to help minimize any tritium releases into the facility and/or out to the environment. Because gloveboxes can be constructed to accommodate all kinds of equipment, most primary containment systems are housed inside gloveboxes in modern tritium facilities. (See Figure 9.) When properly designed, gloveboxes allow access to the primary system equipment for ease of operation and maintenance. Gloveboxes are referred to as intermediate-quality systems because the design requirements do not have to meet codes and standards as stringent as the *ASME Boiler and Pressure Vessel Code*. Gloveboxes should, however, be designed in accordance with the recommendations of the American Glovebox Society.

The purpose of intermediate-quality secondary containment systems, such as gloveboxes, is to prevent the immediate release of tritium into the room or out to the environment in the event of breach of the primary containment system. Following a release into an intermediate-quality secondary containment system, the tritium is generally recovered in the tritium removal sections of the cleanup

system (see below) and several hours can elapse during the recovery process without a significant release of tritium to the room or the environment.

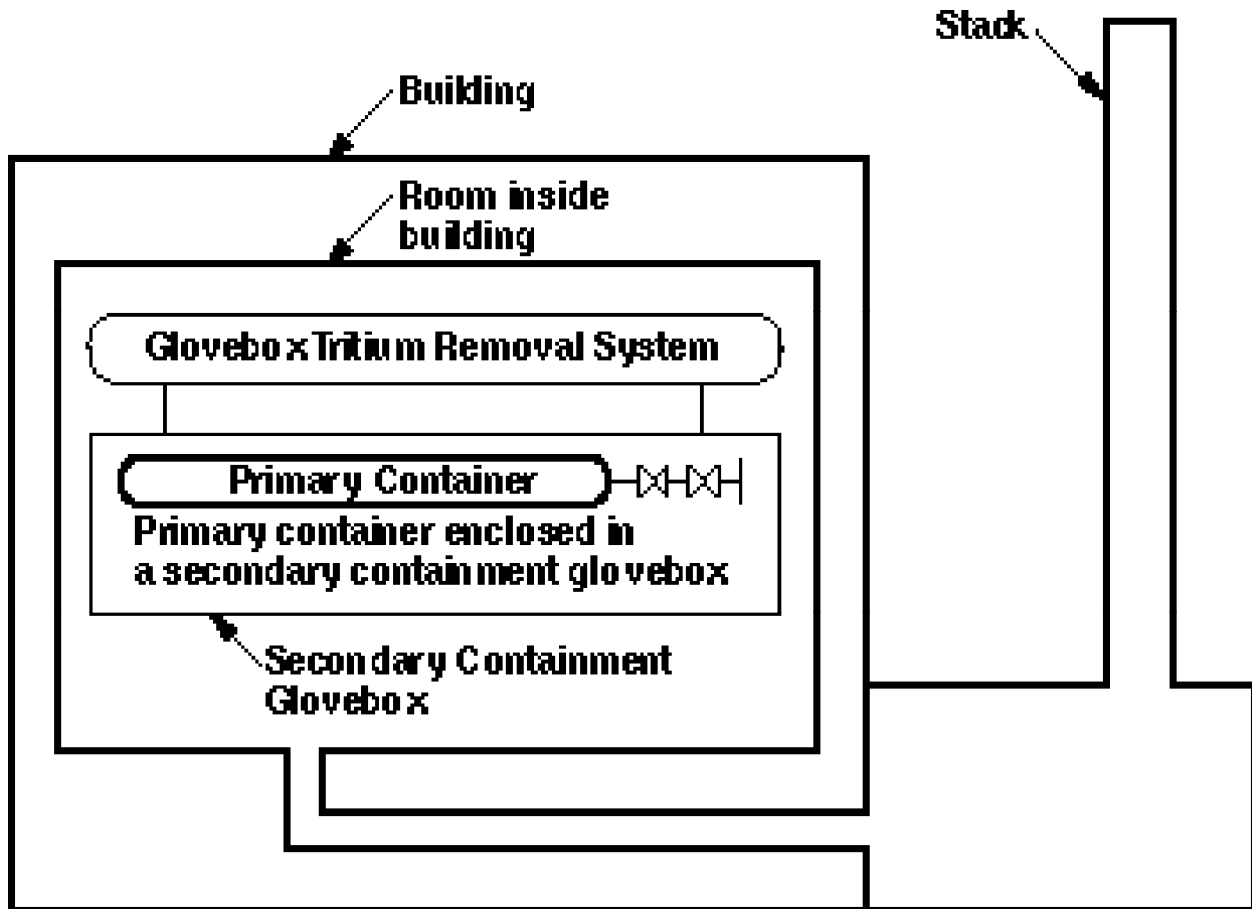

FIGURE 9. Intermediate-quality secondary containment.

In a typical working environment, tritium gloveboxes are operated at a pressure that is slightly negative with respect to the pressure in the room (i.e., on the order of a few tenths of an inch of water column). This allows for greater comfort for the worker while he or she is working through the gloveports. This is supposed to prevent the leakage of tritium from the box into the room. Tritium levels in the box are usually several orders of magnitude greater than the tritium levels in the room, and, due to the laws of partial pressures, the movement of tritium due to permeation alone will always be from the box to the room. To minimize the permeation of tritium from the box to the room, gloveports should be covered and evacuated when they are not in use.

Because the true leakage rates of most tritium gloveboxes can generally be certified to be no more than 10^{-2} to 10^{-3} cm^3/sec , the ingress of air into the box

environment is a problem to be addressed. For this reason, most tritium gloveboxes are connected to cleanup systems designed to remove undesired impurities from the glovebox gases and return clean gases back to the box. Because one of the undesired impurities will always include tritium (as T_2 , HT, and/or HTO), the cleanup systems should remove free tritium from the glovebox gases. In most cases, the cleanup systems will be designed to remove free tritium down to the part-per-million to part-per-billion level. Because this is still equivalent to tritium concentrations that range from 2.6 Ci/m^3 down to 2.6 mCi/m^3 , the return gases from such cleanup systems will never be completely devoid of free tritium. In addition, cleanup systems designed to remove free tritium from the glovebox gases are not capable of removing tritium that has plated-out on the interior surfaces of the glovebox or any of the equipment that is inside the glovebox. Thus, when the box is opened to room air for maintenance purposes, a “puff” type of tritium release will occur, such as that described previously under the heading of “Outgassing Expectations.” The chemical form of the tritium release will be as HTO.

Low-Quality Secondary Containment Systems. In some situations, tritium facilities are equipped with low-quality containment systems, such as full-scale buildings, or one or more rooms inside a building. (See Figure 10.) As a general rule, containment systems will only be installed as part of a conversion project, a retrofit project, or an add-on project, where the building or room in question was not initially intended for tritium handling.

Because the containment boundaries for systems are represented by the floors, walls, ceilings, doors, and windows of the rooms or the building in question, tritium leakage rates from containment systems cannot be stated accurately. Like the intermediate-quality secondary containment systems described above, the purpose of low-quality secondary containment systems is to prevent the immediate release of tritium to the environment in the event of a breach of the primary containment system.

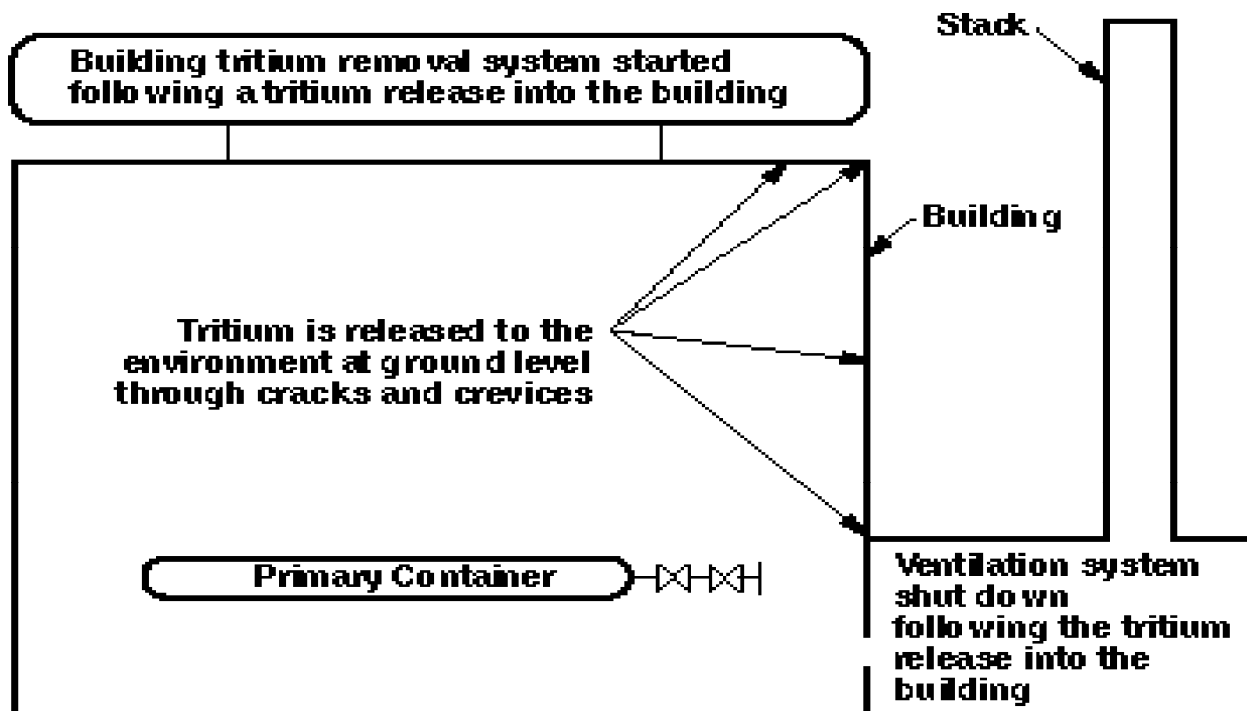

FIGURE 10. Low-quality secondary containment.

Independent of the scale of the operation, the tritium removal systems used for these types of containment systems should be capable of a very high rate of throughput, and they should be examined with great care prior to selecting the containment systems for use. For example, for a small building with a 100 m^3 volume, on the order of 20 X 18 X 10 feet, a 1-g tritium release into the building will result in a volumetric air concentration of about 100 Ci/m^3 . If the building has a true leakage rate on the order of $100 \text{ cm}^3/\text{sec}$, the tritium leakage rate out of the building will be about 0.6 Ci/min-g .

With the building ventilation system shut down, no benefits will be gained from massive dilution factors, and the tritium will be released to the environment at ground level through the walls, ceilings, doors, windows, etc., of the building. Expanding on the details, the released tritium will convert quite quickly to HTO (i.e., the more hazardous form of tritium); the tritium will thoroughly contaminate the building, adjacent rooms in the building, and the areas immediately surrounding the building. In addition, the tritium released to the environment will be poorly mixed with the environment, and, as a consequence, exposures to personnel living or working downwind could be expected to be relatively high.

In spite of their apparent drawbacks, it should be noted that low-quality containment systems *do* have a place in the broader spectrum of tritium containment strategies, particularly when used as an integral part of conversion projects, retrofit projects, or add-on projects, and particularly when other primary/secondary containment system combinations intended for use have a very low probability of release.

Tertiary Containment Systems. In most tritium facilities, the term “tertiary containment” is something of a misnomer. It usually refers to an ultraconservative approach where a high-quality primary system is housed in an intermediate-quality secondary containment system, such as a glovebox, which is equipped with a cleanup system. Both of these are then housed in a low-quality containment system, such as a room, which is independently connected to a cleanup system. In most cases, the cleanup system associated with both the glovebox and the room are the same cleanup system.

In theory, the purpose of tertiary containment systems is to prevent the immediate release of tritium to the environment in the event of a catastrophic (and simultaneous) failure of both the primary and secondary containment systems. In practice, however, these systems have never been used and, in fact, they probably should not be used in an automatic mode in the event of a catastrophic (and simultaneous) failure of both the primary and secondary containment systems. Under such circumstances, the primary emphasis should be on the health and safety of the worker, and potential rescue efforts should not be hindered by shutting down the ventilation system to those parts of the building where it is needed the most. After appropriate first-aid and rescue efforts have been completed, consideration might then be given to the use of these types of systems in a manual mode. But, as was noted in the previous section, the use of such systems can be expected to have its own undesirable effects, and the actual use of such systems could make a bad situation even worse.

2.10.9 Tritium Removal Systems. In most tritium facilities, secondary containment systems are connected to, or equipped with, tritium removal systems. The primary purpose of these removal systems is to recover any tritium that has been released from its associated primary containment system and to prevent the release of that tritium to the environment. Like the secondary containment

systems they are connected to, the operational aspects of individual tritium removal systems vary greatly among facilities, and among different types of containment systems in any single tritium facility.

The simplest type of tritium removal system can be found in those applications where high-quality primary containment systems are enclosed in high-quality secondary containment systems. In most applications, the high-quality secondary containment systems are operated under vacuum conditions when the primary and secondary containment systems are actually in service. The tritium removal systems, in this case, can be as simple as a vacuum transfer system designed to move any tritium that escapes from the primary system to an appropriate collection point for later processing. Under such circumstances, the actual transfer of the tritium can be allowed to proceed quite slowly because, at an allowable leakage rate of 10^{-6} to 10^{-7} cm³/sec from the secondary, the total leakage rate from the secondary system should be less than 0.25 Ci/day.

More complex approaches should be taken when the primary systems are enclosed in intermediate-quality, secondary containment systems (e.g., a glovebox) because, in these types of applications, the ingress of tritium into the glovebox atmosphere is not the only factor that should be considered. Additional consideration should also be given to the maintenance of the glovebox operational atmosphere, the total volume of the containment system, the total volume of the cleanup system, the ability of the cleanup system to remove tritium from the glovebox atmosphere as a function of flow rate, the overall leakage rates into and out of the glovebox, the overall leakage rates into and out of the cleanup system, and operating temperature requirements for each of the operational components.

One example of this type of cleanup system that has been used extensively in several different tritium facilities works as follows:

- (1) Tritium is released into the secondary containment system (i.e., the glovebox) as a result of a primary system failure.
- (2) The cleanup system is started and the tritium-containing gases captured in the glovebox are circulated through the cleanup system.

- (3) The cleanup system removes the tritium from the gas stream by breaking down the hydrogen (i.e., H, D, and T) containing molecules on a hot, precious metal catalyst.
- (3) The free H, D, and T atoms are recombined with oxygen in the catalytic reactor to form water vapor.
- (4) The hot water vapor is cooled to a suitable temperature by passing the gas stream through one or more heat exchangers.
- (5) The water is removed from the gas stream by passing the gas stream through molecular sieve traps. A typical example of this type of cleanup system is shown schematically in Figure 11.

Catalyst/molecular sieve tritium removal systems of this type can be very effective. Depending on the tritiated species, the reduction in tritium concentration for such systems has been measured at ratios of $10^6:1$ to $10^8:1$ when operated in a once-through flow mode, in which the gas stream passes from the glovebox, through the cleanup system, and out the stack to the environment. In most situations, these types of cleanup systems are operated in the continuous flow mode, where the gas stream is moved from the glovebox, through the cleanup system, and back to the glovebox. When operated in the continuous flow mode, these types of cleanup systems can easily reduce the tritium concentration in the gas stream to the part-per-billion level (i.e., 2.6 mCi/m^3), or lower, as long as they are operated for a sufficiently long period of time,

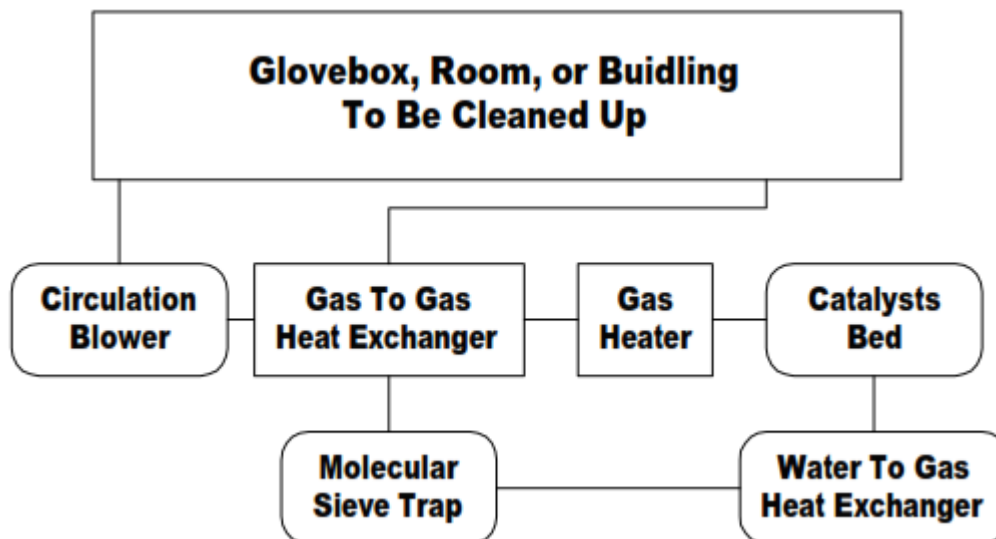

FIGURE 11. Typical tritium removal system flow schematic.

Although the operation of a typical catalyst/molecular sieve tritium removal system, like that described above, can be very effective, the operation of such systems can also have drawbacks. In the standard mode of operation, for example, little or no gas flows through either the glovebox or the cleanup system for relatively long periods of time because both sides of this type of containment scheme tend to be activated on an “on demand” basis only. A substantial drop in the catalyst bed temperature should be expected when the system is turned on (i.e., the flow on the inside of the catalyst bed goes from a static situation to several hundred cubic feet per minute in a matter of a few seconds). Under such circumstances, the temperature in the bed can easily drop below that which is required to break down tritiated methanes, and the cleanup system will have to be run long enough to allow the system temperatures to re-equilibrate. When cleanup systems have to run for relatively long periods of time, leakage rates into and out of the glovebox in question, and leakage rates into and out of the cleanup system tend to become additional factors to consider in the overall design of the facility. When the parameters are appropriately balanced, calculations indicate that the flow rates for these types of cleanup systems (i.e., high-quality primary containment system environments in combination with intermediate-quality secondary system environments) should be high enough to remove the bulk of the tritium within a few hours to a few tens of hours.

Calculations further indicate that the overall release rate to the environment will be 1 Ci for every 3 to 30 hours of operation.

When similar calculations are performed on the use of a high-quality, primary containment system in combination with a low-quality secondary system, the results indicate that the flow rates should be high enough to remove the bulk of the tritium within a few minutes to a few hours.

Double-Valve Design For Transportable Containers. The use of two valves in series on containers filled with tritium, which are to be disconnected from the tritium apparatus on a routine basis, has been in common use for several years. The idea behind this is straightforward. Valve seats fail and when the failure of a single valve seat can result in the release of significant quantities of tritium, two valves in series should be used. If a single valve is used and the valve seat develops a leak during storage, the container should be connected to a manifold, the container port uncapped, and the tritium released into the containment system through the failed valve seat.

Valve seat failure is often associated with damage to the seat caused by long exposure to tritium, especially if elastomeric seats have been used (not recommended). Double valves should be used where the container valve seat is exposed to tritium for long periods of time. Experienced tritium handlers assume that valve seats can, do, and will fail, and that they have failed until proved otherwise. Figure 12 explains how to check double valving for leakage.

Purge Ports. A "purge port" is a capped, sealed port connected through a valve to a potentially tritium-contaminated volume. The purpose of a purge port is to provide a path that can be used to remove tritium-contaminated gases from the isolation volume prior to making a line break at the component flanges to remove a component. If the tritium-contaminated gases are not removed from the isolation volume, they will be released into the containment system when the flange is unsealed to remove the component and these released gases and outgassing from the isolation volume surfaces will contaminate the containment volume gases. Following removal and replacement of a component, the port is used to leak-test the new component and the new flange seals prior to placing the new component in service.

Figure 13 is an illustration of two purge ports installed to allow evacuation of the volume and leak testing of the flanges between two sets of valves that have been placed to allow isolation and removal of a tritium-contaminated component. Note that the purge ports are part of the permanently installed system and are not part of the component. The component is isolated with two valves on each side of the component and a purge port has been installed between each set of valves. The purge port allows evacuation of the volume between the two valves to remove the tritium-contaminated gases from the isolation volume prior to removal of the component.

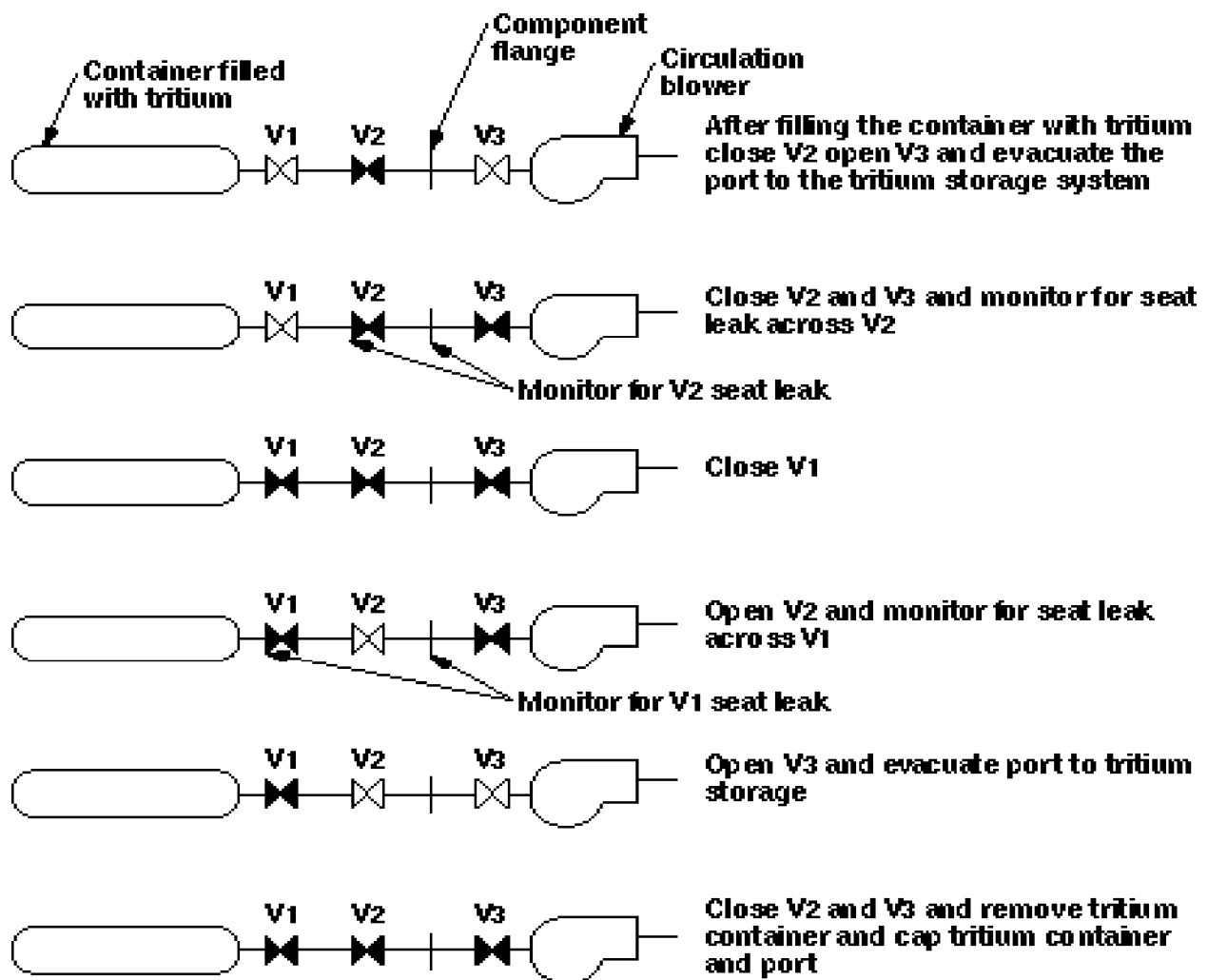

FIGURE 12. Use of double-valved containers.

In operation, the two sets of valves are closed to isolate the component from the rest of the tritium manifold. A vacuum pump is then connected to the two purge ports and the purge port valves are opened and the gases trapped between the

isolation valves is evacuated to remove the tritium-contaminated gases. In most applications, air is then allowed to enter the purged volume and the evacuation operation is then repeated.

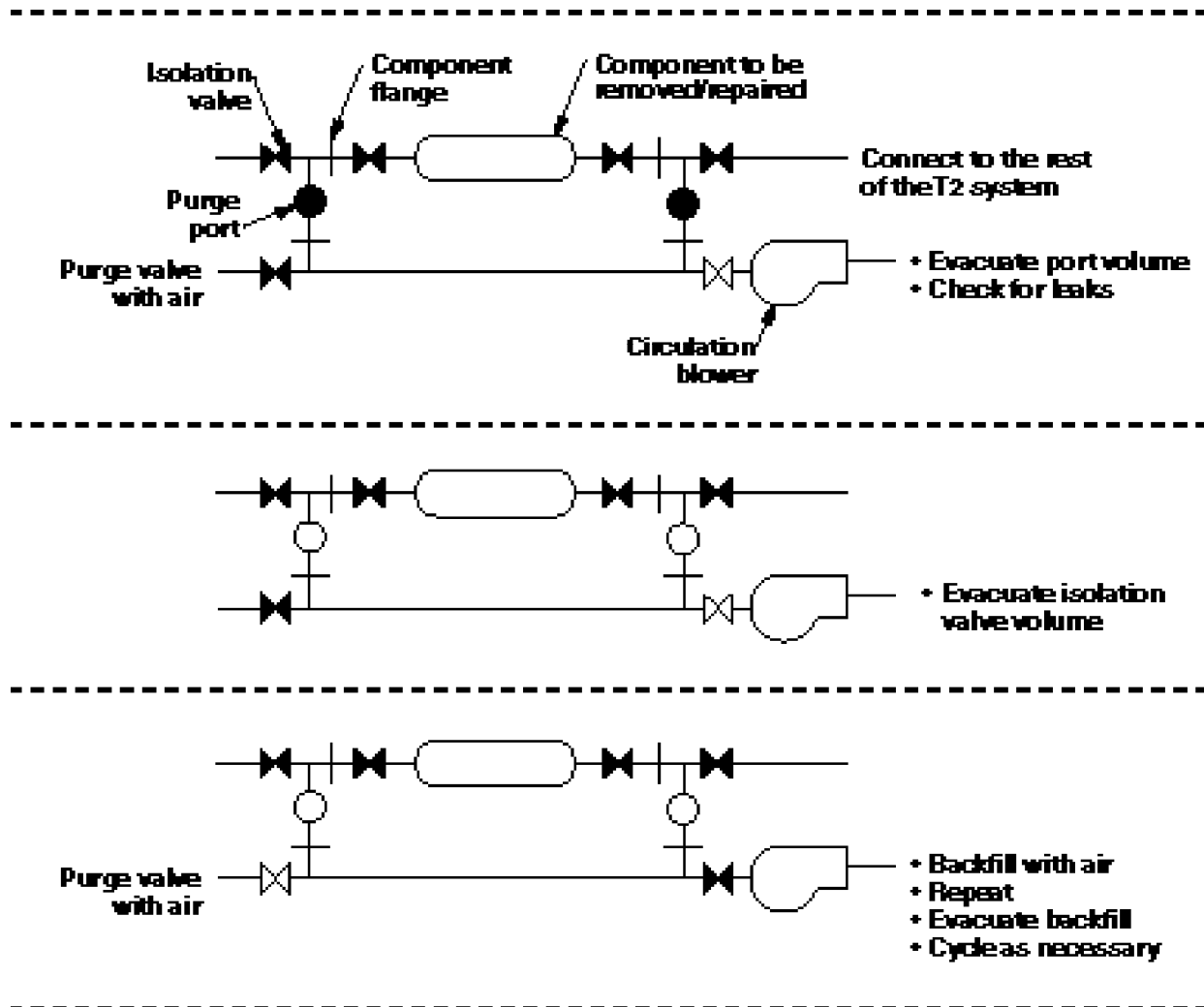

FIGURE 13. Purge ports and isolation valves.

Other gases like argon and nitrogen may be used, but in most cases air is more effective at decontaminating the surfaces. Ambient air entering the purged volume contains several thousand parts per million of normal water along with the nitrogen and oxygen. Some of the tritium and HTO on the internal surfaces of the purged volume exchanges with the hydrogen and H₂O contained in the ambient air and is pumped out during the next purge cycle.

This evacuate/backfill cycle is repeated from 3 to 6 times to remove as much of the tritium in the gases and from the surface of the volume as possible before

disconnecting the component. Three ambient air purge backfill cycles are typical and in practice more than six purge backfill cycles have not proven to be beneficial.

Designers should evaluate all maintenance operations in tritium facilities that offer a potential for significant exposure; such facilities should, where practical, be designed for remote repair or service. In those instances in which remote or enclosed maintenance cannot be achieved, a compressed-air breathing air system should be provided to support the use of supplied-air suits by maintenance personnel. However, every effort should be made to allow routine maintenance activities to be conducted without the need for supplied breathing air. Systems should be designed, to the extent practical, to minimize the conversion of elemental tritium to releasable tritium oxide, which poses a greater radiological hazard than elemental tritium. Although shielding may not be required to maintain occupational radiation exposures ALARA, shielding may be required for other radionuclides that present a direct radiation hazard. Shielding may be required in facilities that handle irradiated tritium production assemblies. Area radiation monitoring should be provided as appropriate.

2.11 FUSION TEST FACILITIES.

2.11.1 Introduction. Fusion facilities include magnetic confinement and inertial confinement fusion devices. Fusion devices range from experimental machines intended to operate below the break-even point to experimental or demonstration facilities intended to operate at or beyond the break-even point.

2.11.2 Design Considerations. The design of fusion test facilities should consider inclusion of the design features described below. Design requirements vary significantly depending on the characteristics of the test facility, the type of fuel, and the site characteristics.

Cooling systems should be provided, as required, for removal of heat from the fusion machine first wall (vacuum vessel), blanket, or other ancillary equipment.

To reduce the amount of tritium released by a single equipment failure, the design should include the following provisions, as practical:

- the capability of completely isolating areas that house equipment containing tritium from areas normally occupied by personnel,

- the capability of isolating sources of tritium, and
- the location of tritium monitors to allow the prompt detection of conditions requiring corrective or protective actions.

When the severity of accidents requires that a containment structure be used, the design pressure and temperature for fusion machine secondary confinement or containment should be determined considering the effects of energy transport and chemical reactions that may occur following the failure of a fluid system inside the containment. The containment should allow periodic leak-rate testing. To minimize the release of hazardous materials to the atmosphere, means should be provided to isolate the primary containment following accidents that release hazardous material to the containment atmosphere.

The design of fusion facilities' secondary confinement or containment where large quantities of tritium are used should consider inclusion of an emergency tritium cleanup system to mitigate the consequences of an accident involving a failure of a tritium system pressure boundary.

A secondary confinement system should be used for tritium auxiliary and other systems containing hazardous materials that are located outside the fusion machine secondary confinement building or containment structure.

The secondary confinement system should be capable of collecting and processing tritium leakage that may occur from tritium auxiliary systems.

Systems for fusion test facilities should, to the extent practical, minimize the conversion of elemental tritium to releasable tritium oxide, which poses a greater radiological hazard. Furthermore, to reduce radiation exposure due to inhalation and adsorption of tritium through the skin, the designer should consider using an independent compressed-air breathing air system to support the air-supplied suits used by personnel while maintaining tritium systems and equipment. Facility design should incorporate shielding where the potential for substantial neutron or gamma radiation may exist. Area tritium monitors should be considered.

2.12 DESIGN OF FACILITIES TO FACILITATE ULTIMATE DECONTAMINATION AND DECOMMISSIONING.

2.12.1 Introduction. Facility design should include features that will facilitate decontamination for future decommissioning, increase the potential for other uses, or both. Design of the areas in a facility that may become contaminated with radioactive or other hazardous materials under normal or abnormal operating conditions should incorporate measures to simplify future decontamination. For example, soil sampling could be considered prior to construction so that a baseline is created, against which sampling results during decommissioning can be compared.

Designs consistent with the program requirements of DOE O 435.1 Chg 1 Reaffirmed 2007, *Radioactive Waste Management*, should be developed during the planning and design phases, based upon either a proposed decommissioning method or a proposed method for conversion to other possible uses. Certain design features can readily be implemented to reduce cross-contamination of the facility and enhance the ease with which the facility can be decontaminated. For example, air filters should be strategically placed in the ventilation systems to control the spread of contamination into either the exhaust or supply ducts, depending on conditions. Walls, ceilings, and floors should be finished with easily cleaned materials; in some areas (e.g., hot cells and process equipment rooms), metal liners may be preferred. Construction joints and crevices should be caulked or sealed to prevent the accumulation of contaminated materials at inaccessible locations. The use of hazardous material should be minimized to preclude the generation of mixed waste.

The following sections address design features that should be considered for radioactive and hazardous materials processing and handling facilities.

2.12.2 Equipment Selection and Location. Equipment and configurations should be selected that preclude, to the extent practicable, the accumulation of radioactive or other hazardous materials at curves, turns, and joints in the piping, especially in hard-to-reach or inaccessible locations. The design should avoid the use of built-in crud traps, such as flanged couplings, dead legs, etc.

Construction materials and surface finishes should be considered to minimize porosity, crevices, rough machine marks, etc., to limit the possibility of tightly adherent contamination and to facilitate ease of decontamination. An example of this is electro-polished stainless steel liners.

Localized liquid transfer systems should be considered that avoid long runs of contaminated piping to the extent practical, with special attention to the design features necessary to maintain the integrity of joints in buried pipelines. Local processing (solidification) of liquid wastes should be considered when designing piping and liquid disposal systems.

The design should provide for full draining of contaminated piping systems by including the installation of low-point drains, pump drains, tank vent systems, and drain systems, and the elimination of dead legs between valves in system designs. A valuable tool in this design effort would be a 3-D computer-assisted design and drafting system to confirm that all low points can be drained and that dead legs are not designed into the system.

The design should allow access for easier dismantlement, cut-up (segmentation), removal, and packaging of contaminated equipment from the facility. Modular process equipment packages lend themselves well to this approach. The design should minimize pipe spring due to residual stress.

Lifting lugs should be considered as a part of equipment designs to better facilitate equipment removal both during maintenance and decommissioning. The ease with which a remotely operated device could be used in the rigging effort should also be considered.

2.12.3 Building Layout (to Facilitate Decontamination and Decommissioning).

Facility designs should limit the spread of contamination and simplify periodic decontamination and ultimate facility decommissioning and disposal or reuse, especially where radioactive or other hazardous materials will be used or will result from facility operations.

Areas for work with like radioactive or other hazardous materials should be located together to simplify solutions to problems of air supply and exhaust, waste disposal, decontamination, and cross-contamination. However, design criteria should specify minimum potential for cross-contamination between

radiological and hazardous materials. In addition, areas where radioactive materials are used should be designed for ease of decontamination during building use and for decommissioning at the end of the building's life cycle.

Use of modular, separable confinements for radioactive and/or hazardous materials should be considered to preclude contamination of structural components or non-process support equipment and to allow for easy removal.

The size and arrangement of corridors should accommodate movement of equipment for initial installation, facility operations, future replacement or removal, and ultimate decontamination and decommissioning (D&D) of the facility, including required equipment accessibility during decontamination.

Access to facilitate decontamination should be provided in areas most likely to become contaminated, such as crawl spaces, piping tunnels, and hatches into duct work.

Air exhaust filters, either roughing or HEPA, should be located as near to individual enclosures or equipment as reasonably possible to minimize long runs of internally contaminated ductwork.

Modularized radiation shielding, in lieu of or in addition to monolithic shielding walls, should be used for ease of maintenance and decommissioning.

2.12.4 Coatings to Facilitate D&D. To facilitate D&D, the following should be considered:

- American Society for Testing and Materials (ASTM) D4258-05 (2012), *Standard Practice for Surface Cleaning Concrete for Coating*, provides guidance for facilities that require coatings to enhance decontamination of surfaces or because of environmental conditions.
- Selection of floor and walkway coverings should consider ease of decontamination. To the extent practical, floor-to-wall interface joints should be covered for ease of decontamination.
- Bare floors, walls, and ceilings should be protected, particularly for structurally important parts of the building. Protection should be in the form of strippable or durable coatings for which effective cleaning methods have been developed.

- Surfaces in operating or process areas should have no rough or absorbent surfaces, seams, or cracks.
- For water-pool type facilities, the pool liner should be provided with a leakage detection and collection system to limit absorption of contaminated pool water by concrete structures.

2.13 D&D AND ENVIRONMENTAL REMEDIATION PROJECTS

2.13.1 Introduction. In many instances, an existing DOE facility that needs decontamination and decommissioning does not have a D&D plan and procedures in place that were implemented in the original facility design. In addition, DOE has a wide variety of facilities that will undergo D&D. These facilities are in various present-day conditions of safe layaway or operation.

Six essential functional areas should be considered during D&D plan development in order to develop a total system to solve the complex problems related to the cleanup activities associated with D&D:

- characterization,
- decontamination,
- dismantlement,
- material disposition,
- robotics, and
- regulatory compliance.

Characterization consists of four significant operational phases:

- facility characterization prior to cleanup,
- characterization during cleanup,
- characterization of waste materials, and
- site characterization after cleanup.

Each of these phases has its own unique problems and requirements and should be evaluated by the D&D plan designer to produce an efficient, economical system.

During the decontamination phase, the designer should consider various requirements and objectives in formulating the D&D plan for DOE facilities:

- permit unrestricted reuse of facility materials by recycling,
- permit reuse of the item or component in the DOE facility,
- reduce worker radiation exposure,
- avoid potential criticality accidents,
- enhance disposal, and
- separate hazardous from radioactive items and materials during decontamination.

In addition, the designer should consider several desirable objectives, which the decontamination technology and methodology should meet:

- reduction of cost,
- reduction of generated waste volumes,
- increase in productivity,
- achievement of high decontamination factors,
- capability of remote operator (if required), and
- capability for mobile operation.

During the dismantlement phase, various methodologies and site-specific requirements should be considered. The dismantlement is influenced by the type of contamination present, the level of contamination (whether remote operation is required), the facility size, and by the design features (glovebox, canyon, reactor, etc.) included in the facility.

If the designer determines that advanced, cutting-edge technology is required, operational controls should minimize spread of contaminants, generation of secondary wastes, and generation of mixed waste, and it should have ALARA features regarding worker exposures.

The area of material disposition will also require significant input by the D&D plan designer. Material disposition includes activities to recycle valuable materials for reuse and disposal of material that cannot be reused cost effectively and in a manner that protects human health and the environment. Various treatment methodologies are needed to support material disposition and should be selected by the designer to meet material disposition goals.

These methodologies include the following:

- chemical treatments,

- stabilization,
- packaging,
- refining,
- netting, and
- machining.

In addition, the D&D plan designer should investigate regulatory compliance issues. Some of these issues have various programmatic impacts, such as time constraints and procedural issues.

Environmental remediation (ER) projects are those that generally involve cleanup of soils or waste sites that are not within structures. As such, the work consists mostly of bulk moving and treating of materials. An example of this type of work is the Uranium Mill Tailings Remedial Action (UMTRA) Program. D&D projects are usually thought of in the context of work within structures. In either case, these projects often involve working with hazards that may not be completely characterized. Therefore, planning the project to minimize the work hazards is an essential part of project design. Further guidance is provided in DOE G 430.1-4, *Decommissioning Implementation Guide*.

2.13.2 Decommissioning and Decontamination. For cleanup activities, design criteria focus on mitigating hazard consequences that cannot be reduced further or eliminated before starting the cleanup. The basic safety objectives of protecting workers, onsite employees, and the public apply and form the basis for designing control features to mitigate the potential hazard consequences.

Hazard mitigation actions, such as applying a fixative to loose surface contaminants, will alter the form and decrease the dispersible fraction of hazardous dust. Sequencing the operation to specific rooms or building areas (segmenting) will limit the operational inventory. Limiting the number of simultaneous segmented cleanup operations to decrease complexity and avoid compounding hazards will also decrease the potential hazard consequences. Removing significant sources of inventory early in the operation will limit the time during which the hazard needs to be considered and will limit the releases from subsequent common cause or propagation events.

Design decisions for cleanup activities should consider the duration of the specific activity, the complexity of the activity, the hazard consequences, and the hardware salvaged for use at the next activity. Costly designs and equipment may need to be provided, even for short duration activities, for safe operation. To make these items cost effective, designs should include provisions to make the hardware portable (or at least easily salvageable). Designs should also consider modular items that can be installed with different modules to fit a particular application. The following sections address general design considerations.

D&D Hazards Reduction. Because the initial stages of decommissioning are generally hands-on operations in many facilities, personnel exposure issues should form a large part of the project planning efforts. The best hazard reduction is to remove the hazards as early as possible in the project for any type of hazard, thereby reducing the opportunity for exposure. The sections below provide specific examples of project planning, sequencing, lessons learned, or technology options that should be considered for hazards reduction in a D&D project.

Chemical Exposure. Bulk chemical removal as soon as possible in the project is usually an excellent choice from both a safety and regulatory viewpoint. Residual chemicals in piping systems and dead legs should always be drained and contained with industrial exposure; maximum expected volume issues should drive the draining and containment methods. Even “empty” systems can contain significant volumes of liquids within level, sagging, or residue dams that could be invisible from any external inspection of the systems. Application of ALARA principles to chemical hazards should be applied with the same rigor as to radiological exposure.

Operating from a position of knowledge is always preferred, but every project should be planned with some realization that exact chemical mixtures, volumes, and locations of liquids will not be known when the piping system is actually breached. The watchword for any chemical system clean-out or removal is to expect surprises.

These surprises can manifest themselves in–

- liquids found in a “drained” system,

- explosive gases found in drained systems,
- various concentrations or mixtures of the expected chemical actually found,
- crystals of evaporated chemicals rather than the liquids or vice versa, and
- salt cake or sludge-oozing liquids even after significant drying or solidification steps are undertaken.

The level of planning and control of the operation should take hazard level and exposure scenarios into account prior to the start of work. Any planning should always provide built-in contingency for the surprise that will occur during the decommissioning project.

Radioactive Material Exposure. Control of radiological exposure is well-established within any nuclear operations organization and those same principles of ALARA should be applied to the decommissioning work. The difference is that more unknowns should be expected, more scheduling options may be available to remove a source term, and the opportunities to spread contamination is greater during decontamination and piping system removal than during facility operations. In general, control techniques such as those listed below should be considered for decommissioning work:

- Removing a high-dose contributor earlier rather than shielding is preferred.
- Inhalation issues should be controlled as close to the source as possible.
- Engineering controls take precedence over protective clothing, and both methods are better than administrative controls.
- Exposure controls are needed until the waste leaves the site.
- Use of the same control mechanism for chemical and radiological exposure should be investigated and used whenever possible.

Industrial Hazards Exposure. The changing nature of any decommissioning project site demands not only good design and planning to eliminate as many hazards as possible, but constant awareness of the changing conditions and hazards present. Proper planning should sequence the work so that hands-on

work is completed in an area, or adjacent areas, before heavy equipment demolition occurs. Other considerations include—

- extremely loud operations within an area that affect workers who are otherwise not affected;
- work that may affect airflow or air quality of other facility workers;
- overly prescribed protective clothing or administrative limits (a respirator to mitigate a potential, but highly unlikely, minor exposure may introduce a very significant risk by restricting vision or aggravating heat stress issues);
- life safety escape routes, which should be reevaluated as the facility changes (what was an emergency escape path last week may be a 30-foot hole or a collapsed structure today);
- fall protection.

Many of the old DOE structures that are being decommissioned have little or no configuration management of the original electrical systems during the surveillance and maintenance period. Electrical distribution systems could have been cannibalized in the years since operations, further aggravating the situation. This being true, one of the larger industrial hazards in a decommissioning project is encountering live electrical equipment when removing equipment, cutting conduit, or excavating around a facility even after the application of lock and tags to known sources. Removing ALL electrical power prior to the start of decommissioning within a structure should be a very high concern. Removal in this case is defined as physical breaks in the circuit by wire, transformer, or breaker removal, not by open breakers since old, poorly maintained breakers could stick or malfunction. Even the task of removing ALL electrical power can be daunting. Over the years as missions change, extra or different voltage power may have been added and not documented. The review and field investigation that removes ALL power needs to ensure the safe removal of electrical equipment and wiring systems.

2.13.3 Hazards Mitigation.

Criticality Prevention. One technique that can minimize the impact of the large inventory uncertainty would be to integrate characterization data and work plans to keep the “affected” inventory less than some predetermined value by scheduling sections of the building, systems, or components to be worked at the varying times and ensuring that waste packaging and segregation and even waste storage schemes include criticality reviews. Portable neutron or alpha instrumentation and in-process active/passive neutron interrogation technologies should be added as needed to give real-time updated information of the inventory as the project or operation proceeds. A significant technical issue that should be addressed for every waste package or configuration is the way the package density or detector/target geometry affects any neutron measurement.

Electrical Power. The use of a construction-type power system to support the decommissioning work should always be considered for anything but the simplest project. The elimination of ALL power from a structure, except that which is specifically brought in on a temporary basis, greatly reduces the chances of inadvertent encounters with live electrical equipment. These temporary systems should be sized to meet the need, colored to stand out, and built to withstand the harsh environment (rain, snow, wind, and falling objects) encountered on a demolition site.

Power or energy for cleanup operations should fit the particular activity. Cleanup work is generally the primary energy source generating an airborne condition. Where loss of power could result in unacceptable releases, consideration should be given to backup power or design of the confinement system to include a passive confinement mode sufficient to reduce releases to acceptable levels when combined with work stoppage. Warning or alarm systems should be included to ensure work stoppage upon loss of active ventilation.

Confinement. The selection of the confinement system to be used during D&D operations will be dependent on the condition of the existing building and ventilation system. It is possible that the existing structure and ventilation system is adequate without change or upgrade. Where existing systems are judged to be inadequate, the designer should consider enhancing the existing system with portable ventilation and tents within the building. The tents and ventilation would

provide the active operation zoning function while the existing structure and ventilation would continue to provide the shutdown condition confinement for the remainder of the building. Care in the accident analysis and design is needed to ensure that credible accidents will not propagate beyond the work zone.

Radiation Shielding. Shielding design in cleanup activities relies on specific source reduction rather than shielding walls used in process operations. Design related to portable shielding is limited to the material (high z or low z), thickness, and features to make the shielding material easy to install, relocate, decontaminate, and remove so that it can be reused (waste minimization). The available space and shape of the object generally determines whether to shield the object or shield the worker (portable shield wall). Shielding design for buried items may have to be modular and layered because it is not always possible to determine radiation levels of buried items until they are actually uncovered.

Structural Integrity. Structures provide confinement, shielding, a stable anchor for fixed equipment, segregation or isolation, and a controlled environment (dust, humidity, and temperature control) for equipment important to safe operation. Portable equipment is generally self-standing and does not require an anchor for short-duration use. This leaves the functions of segregation and climate control. Both of these functions can be provided by a tent or, under more severe cases, sheet metal structures. The choice of structural material depends on factors such as duration of the activity, consequences of structural failure, geographical/meteorological conditions (snow or wind loading), and whether or not an existing structure is involved (D&D or soil remediation). Consideration should be given to limiting the mass of material for those structures that will be disposed of at the completion of the activity or to facilitate the ease of decontamination for those structural components that will be recovered for reuse at another activity.

2.13.4 Summary. A general D&D plan should be developed that outlines the design and operation of the activity. The plan should discuss how this combination (design and operation) will protect the worker, the public, and the environment from undue risk. General guidance is provided that suggests design features by modular, portable, and reusable characteristics to the extent safety and operational requirements will allow.

Design features provide an added resource that allows both safety and operational needs to be met. Design features mitigate the potential consequences of hazards that cannot be eliminated or reduced by other means, thus allowing operations to proceed safely. Cleanup activities should be conducted at the site of contamination using devices with design features that are flexible enough to be used at multiple sites.

The following outline demonstrates the major areas to be considered by the designer in the development of a D&D plan for a DOE facility:

- site inspection;
- site characterization;
- environmental requirements and constraints;
- predemolition planning documents;
- recommended decontamination actions/procedures;
- demolition plan:
 - demolition process,
 - demolition and disposal work breakdown structure (WBS),
 - demolition methods and equipment,
 - demolition procedure;
- disposal plan:
 - waste categories,
 - disposal methodologies,
 - post-demolition facility and land use;
- decommissioning.

2.13.5 Environmental Remediation. Specific performance objectives for ER activities should address timing, cost, exposure control, confinement, worker protection, and ALARA issues. Safety and operations then review the specific work to identify methods that eliminate or reduce the existing hazards by changing the hazards form, selecting a work sequence, or altering/eliminating energy sources while ensuring the performance objectives are met. Each hazard reduction method or combination of methods should be balanced against the performance objectives so that the end result is a safe, efficient, and effective operation. When existing hazards have been eliminated or reduced to the extent possible, the safety and operations engineer(s) work with the designer to develop design

barriers to mitigate the impact of the remaining hazard to acceptable levels while achieving the performance objectives.

One of the major hazards of soil remediation activities is fugitive dust generation (airborne contaminants) created by the cleanup activity, wind action, or a combination of both. Large area sites can involve thousands of curies of radioactivity (total quantity) when summed over the total soil volume to be remediated (even though the concentration is microcuries or even nanocuries per gram). The planning of contaminated soil site remediation activities reduces the hazard by establishing a limit of inventory available for release. Dividing the contaminated site into segments reduces the area, thereby reducing the quantity of "contaminated dust" released per unit time. Wetting the contaminated soil during cleanup activities effectively alters the contaminant particle size, thus reducing fugitive dust generation. Conducting cleanup activities during periods of low wind also reduces dust generation and transport energy. The appropriate combination of methods to reduce the hazards should be considered before considering design barriers that would mitigate hazard consequences.

Another type of ER activity is the exhumation of previously buried or otherwise disposed-of waste material. Limiting the amount of buried material removed at any one time limits the hazards associated with the activity. This limits the contaminant inventory available for accidental release.

Confinement of hazardous particles can be achieved with systems varying from general ground cover (soil cleanup) to a complex structure with multistage ventilation (stationary cleanup "treatment" center). The confinement system needed for a specific cleanup activity should consider the work to be performed, the hazard, the complexity of the activity (multiple activities simultaneously conducted at a single location), energies available, and, if the energies are present continuously or only during actual work, the cleanup rate (hazard decrease rate), and several other factors.

General soil cleanup releases are usually chronic rather than acute. For this type of activity, wind and cleanup equipment movement provide the predominant energy sources leading to the airborne dispersion of contaminants. Barriers designed to inhibit the generation of dust (wetting or fixatives) during operations

and to separate the energy from the contaminants (ground cover) during non-work periods are among the simplest forms of confinement.

Retrieval or recovery of buried waste has the potential for acute releases. Accumulation of retrieved items and in some cases individual items can contain sufficient materials to represent an accident hazard. Confinement for this type of activity could involve a vented overpack, portable hot cell, or a tent of plastic or metal construction with an associated ventilation system. Vented overpacks and hot cells provide confinement for the unusual or anticipated small percentage of packages that are uncharacteristic of the normal retrieved items. Tent confinement provides control where packages may have lost their integrity and pockets of contamination are possible or expected. Tents may also be used as weather covers for normal operation and to provide confinement only for accident conditions. The specific type of confinement used depends on the method of recovery, the type of hazard, and the confidence in the knowledge of inventory and package condition.

In cases where ER projects involve temporary structures for process confinement, especially when potentially high-activity buried waste is involved, some design considerations are common to both environmental restoration and D&D projects. For example, considerations related to electrical power, radiation shielding, structural integrity, and work process controls, are discussed in the preceding section on D&D projects.

2.14 VITRIFICATION.

2.14.1 Introduction. The process of vitrification is the melting and fusing of materials to produce a glass. It is one of the preferred treatment options for many types of hazardous and radiological waste. The general design considerations in developing a vitrification plant are discussed below.

2.14.2 General Vitrification Processes and Steps to Consider. Waste composition may make material more or less amenable to the use of vitrification as a treatment technique. It affects pretreatment required and influences the transport of material within a vitrification plant. Characteristics to consider include the following:

Physical Characteristics. Physical characteristics of the waste material, including whether the material is in solution, a slurry, or a solid, influences transport within the plant and the material's ability to form a homogenous mixture with glass formers. Imposed constraints on transport, mixing, melting the material, and the need for pre-treatment are all considerations subject to physical characteristics of the waste.

Chemical Characteristics. Certain chemicals (notably sulfur) are incompatible with vitrification and if present influences the amount of final waste produced. Other chemicals may be volatile and very difficult to retain in the glass product. Factors like pH may complicate the process of mixing a final feed material, due to rheological considerations or corrosion.

Radiological Characteristics. The radiological characteristics dictate shielding requirements, remote operations, off-gas processing, and possibly, a requirement for criticality controls.

2.14.3 Waste Extraction from Tanks. Waste extraction from tanks is the first step in the actual vitrification process. (Some in situ vitrification techniques eliminate this and many other steps discussed below, but this technology is not generally used and may often be judged unsuitable for a specific problem.) The removal of waste from tanks is the first of the process steps in moving the material toward vitrification. Some of the considerations include the following:

Pretreatment in the tank may allow adjustment of an undesirable physical or chemical characteristic to make the waste material more compatible with and amenable to future processing. Pretreatment can include pH adjustment, size reduction, mixing, and the decant and processing of dilute waste solutions on the surface of more concentrated waste deposits.

Based on Composition, experience at many radioactive waste storage facilities suggests the composition of tank wastes may make extraction techniques and extraction technology key concerns. Precipitates, agglomerates, and foreign material such as gravel have been key considerations in influencing the design of removal systems; subsequently, these considerations influence the design of facilities to process the waste. The facility design should consider the potential needs of further processing extracted material and the potential for the waste to

change significantly over the life of the facility as different methods are employed for the extraction of bulk waste versus residual waste.

Based on Tank Configuration, access may be difficult and may influence removal techniques, requiring sluicers, mixing systems, etc.

Pumping techniques should consider the slurry nature of the material, both from a pickup perspective (getting the material into the pump) and the transport through piping to a processing facility.

Mixing/Homogeneity has influence in the process and process plant equipment design. In cases where feed material is very consistent, less concentration on sampling techniques and feed composition adjustment is required. If the material is nearly all in solution, less attention to slurry handling is necessary.

2.14.4 Feed Delivery. In addition to the technical considerations of pumping the material, there are operational considerations in regard to coordination of the transfer of feed material. The melter feed process necessitates a “batch feed” type system, which allows the melter to operate in a continuous feed manner with parallel processing of a new feed batch. Multiple tanks are required for a batch feed system with a minimum requirement for two tanks. One tank is required to contain the waste material for at least one feed batch. The second tank is required to mix the glass formers, other chemicals required for the waste form, and the waste material being processed. Usually the feed tank will be significantly larger than the tank in the vitrification plant receiving the waste. Adequate operational communication and interlocks to prevent tank overfill are important considerations.

2.14.5 Feed Sampling. One of the first steps in the actual vitrification process is to maintain melter feed material within an appropriate process range. This may be for glass quality reasons but is also very important to prevent unusual reactions in the melter.

The sampling process should adequately address the number and volume of samples to be collected. Often several samples may be needed to support a given laboratory analysis and the statistical evaluation of the results.

The sampling process often has many manual steps and is, therefore, error prone, particularly when slurry feeds are involved. Design should minimize the

potential for error, providing reliable indications to operators and minimizing the number of manual steps. To ensure that the sample system does not introduce additional process errors, consideration should also be given to ensuring the pumping system for taking samples has the same operational characteristics as the pumping system feeding the melter.

Slurry Handling is of concern throughout the feed preparation of most facilities. Slurries present particular issues in line sizing, flow rates, valve operations, flushing allowances, and designs that accommodate plug clearing operations. These should be considered when developing slurry sampling provisions.

Consistency of Waste Feed should be considered in developing sampling plans and systems. The feed make up process will generally require accurate measurement of all species significant to melter and possibly waste form behavior. The feed make-up, as discussed above, is generally a batch process; the vessel in which the feed is being prepared should be well mixed to avoid composition errors that could damage the melter.

2.14.6 Feed Make-up and Chemical Addition. Feed make-up and chemical addition may require concentration and then addition of chemicals needed to meet target melter feed compositions. If the feed material is very well characterized and homogeneous, the chemicals can be added in advance and provided in the form of glass frit. If there is potential for variation, a chemical batching system that can handle specific recipes is required. The system may need to handle solids, liquids, and slurries, depending on the target feed composition. Generally, the chemical additions should be made up in a separate tank and batch-transferred into the feed tank. This recommendation derives from unique requirements for contamination control and batch quality control for high-level waste vitrification. There may be more innovative approaches for other waste types.

Accurate measurements of tank volumes and fluid density have proven very important in the feed make-up process. Special attention should be given to these areas for batch make-up tanks.

2.14.7 Feed Holding. Melters generally perform longer and best when operated as close to steady-state as possible. Enough feed should be prepared to support that objective while the next batch of feed is being prepared. Vessel sizing should

consider the potential throughput, as well as the time necessary to prepare batches. In estimating those times, analytical turnaround times for process samples should not be discounted. They can and have been a large part of the time required to make feed.

Mixing the feed holding tank is a necessary design feature to maintain consistent feed material to the melter.

Re-suspension should be considered when developing the mixing system.

Vessel Erosion allowance should be factored into the hold vessel design, based on the feed material and the mixing system potential to abrade the tank wall.

2.14.8 Feed to Melter. Like the sampling system, the melter feed system moves homogeneous feed from the hold tank to the melter. Also as noted earlier, selecting a pumping system similar to the one from the sampling system will provide some degree of consistency between the samples and the actual feed to the melter. The feed system should consider the need for flushing and plug-clearing capabilities, particularly at the melter discharge point. Experience has shown the potential for high temperatures to dry out and accumulate feed material at this point.

2.14.9 Acceptable Glass Compositions. Acceptable glass compositions with respect to melter behavior are those compositions exhibiting properties amenable to proper melter operation and longevity. These properties include glass viscosity at operating temperature, liquidous temperature, glass electrical resistivity at operating temperature, and glass transition temperature. The actual values for these parameters depend on the melter technology employed. In addition, the following compositions should be avoided: those that exhibit behaviors such as foaming in either the cold cap during drying or in the glass melt pool and those with unfavorable Redox behavior (i.e., precipitation of metals during melting) or explosive gas generation (i.e., hydrogen evolution).

Acceptable glass properties and behaviors should be generally identified early in the project and promulgated through the process development phase.

2.14.10 Melters and Melter Behavior. Melters vary in size, configuration, and heating source. The large-scale, high-level waste melters in the DOE system are joule heated, by passing current through the actual glass melt. RF and gas-fired

melting have also been proposed. The melter's configuration usually requires two chambers.

The first is a refractory chamber surrounding a glass melt "pool," where some mixing occurs either by natural convection or as enhanced with air bubblers; feed material is supplied from the top. This feed material usually forms a "cold cap" on top of the molten glass, melting into the glass pool as it is heated by convective currents rising from below. The melter feed will off-gas as the cold cap dries out and heats and as volatile elements are driven out of the glass itself. Off-gas will vary depending on the makeup of the feed material; it should be accommodated and treated in some type of off-gas system. The second chamber is a heated discharge cavity through which the molten glass can flow into a canister.

2.14.11 Melter Life/Keeping Melters Hot/Not Cycling. Melter life is dependent largely on how the melter is operated during its productive life. Operating temperatures of vitrification melters range between 1050 and 1250°C. These temperatures present special design considerations for any metals used in melter fabrication.

The melter is usually heated through infrared heaters in both melter chambers. The heaters in the glass "pool" chamber are for startup only and are shut down once the glass becomes molten and joule heating can be activated. Melters should be brought up to operating temperature in a controlled manner at an average heat-up rate of approximately 10°C per hour.

Exact heat-up rates are a function of the materials used and will vary accordingly. Refractories can be heated at much faster rates than the metals (50°C per hour). Heat-up rates should be developed around stress/strain curves plotted as a function of temperature for the specific metal used. Once the operating temperature is reached, it is good operating practice to keep the melter at temperature and eliminate thermal cycling. For maintenance or other considerations that cannot be avoided, it will become necessary during the melter operating life to reduce the temperature of the melter. Design planning should accommodate these instances to minimize the number of occurrences and the amount of cool down and reheat required. When reheating, a slow, controlled reheat is recommended.

Glass Pouring is usually accomplished by air lift over a weir into a heated discharge chamber with a pour trough that directs the flow into the top of a canister.

Design Considerations in High-Temperature Devices include methods to accommodate the expansion and movement of materials during heat-up, the possibility of auxiliary cooling of the outer structural shell, selection of materials for low expansion coefficients, and the selection of materials for corrosive resistance at operating temperatures the component will actually experience.

Penetrations/Sleeves through the melter shell will usually encounter the largest temperature differentials during normal operation. Special consideration should be afforded the selection of materials for corrosive-resistant properties and strength characteristics at the operating temperatures involved. In some cases, the use of a sacrificial inner liner material may be worthwhile, keeping in mind that the details of remote replacement of the component will have to be a part of the design.

Warping and Alignments are critical concerns in melter design. Because of the operating temperatures involved, materials are going to distort. Selection of materials, innovative use of refractories, and the ability to cool areas of the melter that are not integral to the glass melting function can be used to minimize warping. Movement of materials during heat-up is a reality that should be factored into the design.

2.14.12 Off-Gas Processing. Off-gas from melter- and canister-filling operations should be processed through some type of off-gas collection and treatment system. The collection portion of typical systems includes a ducted suction arrangement to maintain a slightly negative pressure on the melter “pool” chamber and the discharge cavity, which in turn interfaces with the canister filling operation. The amount of actual airflow from these areas should be balanced against loss of heat from both melter chambers and effects on the glass discharge stream while maintaining adequate collection of the off-gas stream. For example, excess airflow from the discharge chamber can affect the glass pour stream by causing wavering, a less viscose glass stream, and the formation of glass “bird nests” in the canisters being filled.

The treatment portion of the off-gas system typically consists of air scrubbers and HEPA filtration for particulate removal plus nitrous oxide reduction through addition of ammonia in the presence of a catalyst.

2.14.13 Material Considerations. The chemical make-up of the off-gas stream requires special attention. Typically, resistance to the corrosive characteristics of the off-gas will dictate the types of materials used in the system. Material selections typically include the 300 series of stainless steels, Inconel, TM and Hastalloy.TM

2.14.14 Process Development. Vitrification development is the process by which a recipe and protocol are developed for the manufacture of an acceptable high-level waste product. In particular, this activity focuses on developing and refining the process for manufacturing the vitrified high-level waste into a glass matrix exclusive of the canister. The development process focuses primarily on two areas:

- identification and development of the final waste glass product composition and
- development of the process for achieving the final waste glass product given the available technology.

Development of the final waste glass product composition, frequently referred to as the “target composition,” is driven by a number of factors, including regulatory performance specifications, behavior of the target composition in the melter, and compatibility with the melter technology.

Regulatory requirements are issued through various DOE Offices including the Office of Civilian Radioactive Waste Management (DOE-RW) and Office of Environmental Management (DOE-EM). Those offices, respectively, promulgate their requirements in the Waste Acceptance System Requirements Document and Waste Acceptance Product Specifications for Vitrified High-Level Waste Forms. Each of these documents contains the technical specifications for acceptance of their vitrified high-level waste into the repository. As such, among other characteristics, target compositions exhibit the characteristics necessary for meeting these technical specifications. With respect to the glass waste form, these specifications address the chemical composition, radionuclide inventory,

product consistency, phase stability, and hazardous waste. Additionally, the specifications provide requirements for the high-level waste Canisters and Canistered Waste Form.

The behavior of the target composition in the melter and its compatibility with the technology addresses the issues of foaming, melt rate, precipitation of metals, viscosity, mixing behavior, temperature, and corrosiveness. Because these issues relate to melter technology, they represent the practical aspects of preparing an acceptable glass in compliance with regulations, given the technology.

Development of the process for manufacturing the final waste glass product involves generating data associated with the behavior of the various feed streams. Data required to develop predictive models can aid in product and production control. Data for models include pH, viscosity, rheology, off-gas, and redox.

Typically, the development program should follow a strategy of—

- identifying various sets or families of potential glass target compositions that meet regulatory specifications;
- identifying and further developing a subset of glass target compositions that will be compatible and processable through a melter;
- choosing a preferred or reference composition on which front-end process development and control schemes are developed.

The strategy uses a combination of laboratory crucible testing, small melter scale-up, and full-process scale-up to obtain data and develop empirical relationships necessary for predicting process behavior and glass product performance.

INTENTIONALLY BLANK

PART II: GOOD PRACTICES

INTRODUCTION

The following sections address discipline-oriented engineering good practices. The following ground rules were applied in compiling and editing this material:

- It should not duplicate or conflict with material already treated in national codes and standards.
- Where national codes and standards treat the subpart area, the material should be good practice extensions of the provisions of the codes and standards.
- Where no applicable codes and standards exist, the information should represent the good practice knowledge of experienced engineers.

It was not always possible to adhere to these ground rules, especially in avoiding the repetition of material from national codes and standards, but hopefully any such departures from the ground rules are limited.

1. ARCHITECTURAL CONSIDERATIONS

This section contains information on general facility layout, equipment arrangement, piping design and layout, and special systems common to DOE nuclear facilities. These considerations include both nuclear and nonnuclear criteria that are recognized as good practice but are generally not included in national codes and standards.

The design of the plant arrangement should be based on the functional requirements of the facilities and the lessons learned from past operational and maintenance experience. Certain aspects of the arrangement and layout, such as egress and access, are required to satisfy the building code or local code requirements. Other requirements, such as bend radius of pipes, location of fire walls, and separation requirements, should also be code-dependent; technical information is available to address these issues.

Other aspects of the layout, such as relative location and orientation of a piece of equipment, size and location of ductwork, accessibility, etc., are based on operational and maintenance experience.

1.1 Facility Layout.

1.1.1 General. Because processing steps are most often contained in individual process rooms or cells, it is usually a good practice to separate general office areas from

nonreactor nuclear facilities. Some of the reasons for this are the risk of radioactive contamination, the need for separate heating and ventilation systems, and differing code requirements based on occupancy.

Facilities and building services are planned to achieve maximum flexibility and ease of access. Priority in design is given to gravity-flow piped services and utilities, large air distribution, and exhaust duct headers. When developing the general arrangement consider the following:

- Adequate space for convenient access to each component (including piping, wiring, control tubing, etc.) during maintenance and inspection that does not require major disassembly.
- Zones (space) in vertical and horizontal service chases.
- Service header sizes;
- Minimizing utility runs by grouping like functions, such as laboratories, toilet rooms, and equipment rooms.
- Minimizing exterior and interior penetrations through building elements (i.e., walls, floors, roofs, etc.).
- Minimizing the amount of floor space devoted to circulation, such as vestibules, corridors, stairs.
- Minimizing the diversity, and therefore the cost, of such architectural elements as doors, windows, and finish materials. As much as possible, use identical elements throughout.
- Reasonable uniformity in the arrangement and orientation of duplicate or similar components and systems to facilitate maintenance.

For facilities built to handle or store Category I and II Special Nuclear Material, security provisions should be considered early during the design phase because physical delay designed and built into the facility may affect layout.

1.1.2 Space Allotment. The following should be considered regarding space allotment:

- To facilitate component removal:

- identify a plan for penetration or openings for component removal and methods to be used for component removal and replacement;
 - maintain open space (vertical/horizontal) for removal and replacement;
 - identify provisions for rigging and handling components;
 - provide lifting and/or trolley beams where necessary to avoid “jerry-rig” setups.
- Minimize auxiliary space allotments consistent with operational efficiency. Consider the hazards of radioactive and nonradioactive materials stored (e.g., radiation and criticality of nuclear materials), fire fighting capabilities, and contamination control in determining the location of storage areas or vaults.
 - Physically separate storage facilities for radioactive materials from process operations, areas for the storage of nonnuclear materials or equipment, and functions not directly required for storage operations. Provide suitable physical compartmentalization, to limit the quantities of stored materials in each compartment to safe levels.
 - Generally, establish a clear height of 9 feet, with floor-to-floor height not exceeding 12 feet except where specific functions require special ventilation systems or where high-bay space is required for engineering development, semi-works, other equipment, or similar functional use.
 - Where economical, use suspended ceilings to reduce HVAC loads and energy costs, to provide required acoustical properties, and to facilitate the maintenance of acceptable levels of cleanliness.
 - Where an acceptable working environment can be provided by careful layout of exposed framing, piping, and ducts, design roof or overhead floor construction to eliminate the need for ceiling finish (other than painting) or applied or integral acoustical treatment.
 - Provide vertical chases with suitable access doors or removable panels for access to valves, dampers, and other equipment.

- Isolate compressed gas cylinders in a special hazardous materials storage room on an outside wall of the facility building with separate ventilation and access from outside and inside the building.
- Design facility layout to provide specific control and isolation of quantities of flammable, toxic, and explosive gases, chemicals, and other hazardous material admitted to the facility.
- When designing for a radioactive environment, provide additional space for temporary shielding or for additional shielding in the event radiation levels are higher than anticipated.

1.1.3 Hazards Separation. Hazards separation design considerations include establishing the attendant degree of risk, and taking into account the potential for cross-contamination.

Nuclear Facility Building Layout. In addition to the usual industrial safety required in a nuclear facility, the following features should be considered:

- Rectangular and windowless storage buildings should be used, where practical.
- Provide for efficient cleaning, maintenance, and ease of inspection in the facility layout.
- Consider occupancy time, spacing, remote handling equipment, and shielding.
- Air locks or enclosed vestibules should be considered for access through confinement barriers.

1.1.4 Hazardous Areas.

Alarms and Interlocks. Provide sufficient alarms and interlocks in hazardous areas, such as radioactive spaces or spaces with inert atmospheres. Prevent inadvertent entry into hazardous areas by providing cautionary systems or interlocks. Additional considerations include—

- Consider automatic monitoring and alarm devices to detect the presence of significant levels or increases of radioactivity or other hazardous materials.

- Consider the need for visual alarm devices within the special facility in addition to audible alarm devices.
- Provide criticality alarms or evacuation alarms to preclude or minimize exposures outside the facility.

Emergency Access. Consider access by emergency personnel from the exterior to ensure that access by emergency personnel will not endanger such personnel or result in a public hazard, while maintaining any required confinement or containment using air locks or other features.

Controlled Access. Control access to hazardous areas by means of locked gates, doors, or other physical barriers to ensure both the safety of personnel and effective administration and control of facilities.

Access and Egress. Locate support areas (e.g., the radiological control office) near the exit from the process area for normal and emergency access, egress, and internal traffic flow. A defect of past designs has been inadequate space at exit areas for personnel circulation, removal of protective clothing and equipment, monitoring equipment, and proper egress. Space near the exit area for temporary storage of maintenance tools and equipment is desirable in some facilities. Standard design practice is to direct normal routes of egress through exits that contain monitoring stations.

Chemical Toxicity. Evaluate the need for chemical toxicity protection, as well as radiation protection, since chemical toxicity exposure will often be the controlling factor in the event of an accident (for example, when compared to an accident involving UEU).

1.2 **Equipment Arrangement.**

1.2.1 **Tanks.**

- Shop-fabricated tanks should be a maximum of 12 feet in diameter to permit rail shipment with a preferred ratio of overall length to diameter of 2D to 4D. The maximum ratio of length to diameter is 6D.
- Lube oil storage tanks should be located in a fire-rated room fitted with a sliding fire door or outside if the tanks are over 5,000 gallons. The door

entrance can be elevated to create a diked area within the room capable of containing the volume of lube oil stored in the tank. All lube oil equipment should be located within this room. The room should include a sump, sump pump, and associated warning devices. Underground tanks should be double-lined with a low-point sump having a fluid detection device. The sump should be pumped to an oily water separator.

- Condensate storage tanks are usually located outdoors, as close as possible to their points of connection to the condensate system. Elevation of these tanks should provide sufficient net positive suction head at any connected pump suction. If these tanks are located within a radiological area, they should be placed in a diked area to control contamination.

1.2.2 Air Compressors.

- Air compressors, including their associated after coolers, air receivers, and air dryers should be located on a concrete floor, close to an outside air source.
- Air compressors should be enclosed to reduce noise levels.
- The inlet air to the compressor should be kept away from any volatile or hazardous gas sources such as hydrogen bottles or engine exhaust.
- Depending upon the maintenance requirements of compressors, a monorail with a manual or electric hoist, or a bridge crane with electric trolley and hoist can be provided.
- A laydown area should be provided for maintenance and removal of parts from the compressor.

1.2.3 Diesel Generators.

- Diesel generators are generally located outside, in their own weather-tight enclosure. When diesel generators are located inside, the engine exhaust silencers may be located inside the room or on the building roof; in either case, the silencers should be accessible for inspection.
- Due to the noise and vibration levels in these rooms, the diesel engine controls should be located in a separate room.

- Diesel engine air intakes should not be located near any volatile gas sources and the bottom of the intake should be a minimum of 20 feet above grade.
- For indoor location of diesel generator units, an overhead bridge crane sized to lift the generator should be provided for maintenance. Alternately, a rigging beam over each generator may be used.

1.2.4 Auxiliary Lifting Devices. Hoisting, lifting, and rigging are an integral part of operations at DOE facilities. This section provides general guidelines to be considered for plant layout and arrangement for the selection and application of auxiliary lifting devices. Additional guidance is provided in DOE-STD-1090-2011, *Hoisting and Rigging*.

Bridge Cranes. Bridge cranes rated up to 75-ton capacity should be used in such areas as workshops, drum storage areas, radioactive machine shops, and for the maintenance of individual pieces of equipment. Hoists should be used with bridge cranes to increase the crane use. Crane clearance requirements and the limits on hook travel are special considerations to be looked into when selecting bridge cranes.

Hoists. Hoists are available with electric, pneumatic, or manual operators. The following provides guidance on the selection of a hoist.

- Electric hoists should be considered for the following:
 - loads of 5 tons or more,
 - lifts of more than 12 feet,
 - hoisting speeds of more than 4 feet per minute,
 - operating cycles of more than once per month.
- Manual hoists should be considered for the following:
 - loads of less than 5 tons,
 - loads up to 24 tons, which are acceptable if the operating cycle is not more than once per year,
 - lifts of less than 12 feet,
 - loads for which electric power is not readily available,
 - loads for which space availability prevents the use of electric hoists,

– environments are detrimental to the use of electric components.

- Pneumatic hoists should be considered in assembly bays and cells.

Forklifts.

- Forklift access should be provided throughout facilities.
- When small changes in floor elevations occur, ramps, in lieu of stairs, will permit forklift travel.
- Forklift access ways should be sized to provide clearance for a 1500-pound capacity unit.

1.2.5 Filters. This section provides guidelines for the layout and arrangement of nuclear radioactive filters with emphasis on the methods of servicing, removing, and handling the filter cartridges.

- Filters with replaceable cartridges should be located at floor level below grade in close proximity to the solid waste handling and storage area.
- Filters should be arranged in a row along an exterior wall and in separate cells with common shield walls between them. This allows use of the structural exterior wall as a shield and permits the use of a single rigging beam for cartridge removal.

1.2.6 Site Considerations for Outdoor Equipment. Important factors to be considered in the site location of outdoor equipment are summarized below:

- Tanks or equipment requiring frequent supplies should be located no more than 10 feet from access roads used by delivery trucks.
- Outdoor equipment should not be located near power lines, flammable, and combustible liquid lines.

1.3 Piping Design and Layout. The following design guidelines should be considered in the physical routing and design of piping systems. These guidelines are a compilation of design, construction, startup, and operating experiences.

1.3.1 General.

- Where continuous services are required, service headers should be looped and appropriately valved to maintain service during routine maintenance or system modification.

- Service piping should be extended from horizontal service headers. Piping should be located outside of hazardous areas whenever possible to reduce personnel exposure during maintenance.
- Adjacent facility walls and floors should not be penetrated in cases where routine maintenance or alterations of service piping would result in undesirable curtailment or interruption of operations in other adjacent facilities.

1.3.2 **Clearances.**

- Adequate clearances should be provided between pipe and other piping systems, ductwork, structural steel and concrete, equipment, and cable trays to permit interference-free erection and allow for maintenance and in-service inspection and reduces the possibility of impact during a seismic event.
- Proper clearances will allow for the removal of valves and other equipment. Piping should not be routed across floors, walkways, or working spaces if that location could be a hazard.
- Overhead clearance to the bottom of piping or pipe racks should address the following guidelines:
 - 7 feet, 6 inches over walkways inside buildings,
 - 15 feet elevated yard piping and/or pipe racks over roadways,
 - 22 feet over railroad tracks.

1.3.3 **Vents and Drains.** Vents and drains facilitate the filling, hydrostatic testing, and draining of piping systems. The following guidelines provide the piping system with adequate venting and draining.

- Where possible, the piping system should be designed with only one high point and one low point; vent and drain connections should be provided at these locations.
- Liquid systems 2.5 inches and larger in diameter should be vented and drained at all high and low points.

- Liquid systems 2 inches and smaller in diameter should be vented and drained at the highest and lowest points in the system. Piping of this size self-purges any intermediate high and low points.
- In steam, air, and gas systems, the blowdown connections at all low points may serve as drains and the branch connections off the top of piping headers may serve as vents.
- Vent and drain connections are not required when their function is filled by system branch connections, equipment vents, and drains or instrument connections.

1.3.4 Lined Pipe. Special considerations should be given to the design of piping systems lined with materials such as rubber, cement, glass, or epoxy. The following guidelines should be considered in the fabrication and erection of such piping systems:

- Maximum spool lengths of lined pipe vary among suppliers.
- The method of joining may be flanged, mechanical joint, screwed, or welded prior to lining. Welding after the lining is installed is generally not permitted.
- When using butterfly valves, consider a potential interference between the valve disk and lining material, which decreases the inside diameter of the pipe.

1.3.5 Freeze Protection. In cold climates external piping should be provided with freeze protection. Preventing piping systems from freezing can eliminate costly repairs and system outages. Freeze protection typically consists of either steam or electric heat tracing. Economic considerations dictate which method is selected.

- Avoid routing piping along the inside of exterior building walls or un-insulated siding in cold climates. Where possible, route piping near radiant heat sources to prevent freezing.
- Review the location of steam relief valve vent stacks to ensure that the condensing vapor does not cause ice to form on nearby equipment, walkways, or roads.
- Consider local area frost penetration when designing underground piping.

1.3.6 Piping at Pumps. Piping configurations at pumps require special considerations to ensure the safe and effective operation of the pump.

- Proper piping layout permits both the suction and the discharge pipes to be supported independently of the pump so that little load is transmitted to the pump casing.
- Reductions in pipe size at the pump should be made with an eccentric reducer flat side up.
- Startup strainers necessary near pumps should have adequate space for installation.

1.3.7 Expansion Joints. Metallic or rubber bellows-type expansion joints should be used in the design of piping systems in the following instances:

- to absorb the thermally induced dimensional changes in the piping system;
- to minimize the stresses and moments in the system;
- to minimize the loads imposed on equipment nozzles;
- to reduce the recurring problem of rotating equipment misalignment due to nozzle loads, particularly at pumps;
- where space is inadequate for a conventional flexible piping arrangement;
- where a conventional piping arrangement would result in excessive pressure drop in the system;
- where the economics favor the expansion joint over a conventional piping arrangement;
- to compensate for differential expansion of a pipe within a pipe or at flued heads.

1.3.8 Piping Containing Radioactive Materials. The routing of piping containing radioactive materials should consider the reduction of exposure levels to ALARA.

- Piping that contains radioactive materials should not be routed through corridors. If necessary, shielding should be provided for the entire exposed run.

- Piping that contains radioactive materials should be routed close to the floor, along walls, and away from the normal access areas to facilitate cleanup in case of failure.
- Equipment or components in the room may be used as a shield. Piping that contains low or moderately radioactive material can be used to shield piping that contains highly radioactive material.
- Shielded pipe chases or trenches should be used wherever possible.
- Multiple blockouts may be used for piping containing low or moderately radioactive material. It is recommended that piping containing highly radioactive material should have individual pipe penetrations.
- Pipe penetrations should be located so that no direct lines of sight exist from any source of radiation in a compartment to personnel in an adjacent compartment or corridor.
- Isolation valves should be provided where radioactive material passes through compartments or rooms.
- Piping that contains radioactive material should be routed so that no direct lines-of-sight exist through doorways or labyrinths.
- In occupied areas, wall, ceiling, and floor penetrations should be provided shielding from piping containing radioactive materials.
- Valves requiring frequent operation may be fitted with remote mechanical reach rods.
- Remote valve operators should be located externally to the compartment housing the valve.
- Stagnant or low-point pockets should be avoided in any radioactive piping system.
- Restricting orifices or metering plates in piping systems containing radioactive materials should be located in vertical runs. They can be located in horizontal runs if drains are provided on both sides of the instrument.

- The piping system should be designed to preclude solids from settling in the piping.
- Process lines should be free-draining to prevent fluid accumulation in traps. In cases where low points or traps cannot be prevented by design, a drain and collection system should be provided at each low point.
- Encasement piping should drain into the process pit in which it terminates.
- Encasement piping for process lines connecting valve pits or diversion boxes should be equipped with leak detection systems. In cases where more than one pipeline terminates in a valve pit or diversion box, the leak detection system should be designed with the capability of identifying which line is leaking.
- Primary process piping and encasement piping should be provided with capabilities for periodic pressure testing. The design should restrict the use of freeze plugs for pressure testing.
- Transfer lines terminating at a tank should be provided with pressure testing capabilities.
- Primary and secondary piping should be supported and anchored. Supports should be adequate to carry the weight of the lines and maintain proper alignment.
- Pipe guides and anchors should be provided to keep pipes in accurate alignment; direct the expansion movement; and prevent buckling, swaying, and undue strain. Spider-type supports should be provided inside the encasement piping to permit leak detection.
- Process piping carrying radioactive material should be buried underground or otherwise shielded to provide radiation protection.
- Process piping should be equipped with valves at appropriate locations to facilitate maintenance within ALARA guidelines.
- Piping and equipment containing radioactive material should be designed for ease of decontamination during operations and for ease of decommissioning after the building life cycle.

1.3.9 Valves. Valves should be located in systems to provide proper isolation for maintenance tasks, normal operations, and reduced radiation exposure. Consideration should also be given to provide future expansion of the system without major system outages.

- Particular attention to valve installation and positioning is recommended to avoid head and knee injuries, eye injuries (due to the presence of valve stems in the horizontal plane at eye level), and dripping hazards.
- Valve access is best accomplished in the natural routing of pipe from point to point, avoiding the use of vertical loops and pockets. Control valves should be located adjacent to walkways wherever possible. (Access platforms should be provided where valves are otherwise inaccessible.)
- Only infrequently operated valves should be located so that the bottom of the handwheel is more than 6 feet, 6 inches above a floor or platform.
- A minimum of 4 inches of knuckle clearance is recommended around handwheels.
- Chain-wheel operators can be used as long as they do not present a hazard to operating personnel.
- Control valves should be located near the operating equipment to be observed while on local manual control.
- Control valve manifolds should have a minimum of at least three diameters of straight pipe both upstream and downstream of the control valve.
- Concentric reducers are recommended to make size reductions at the control valve.

1.4 Special Systems.

1.4.1 Radioactive Waste Transfer Lines. During the design of radioactive waste transfer systems, the following items deserve special consideration to reduce personnel exposure and the spread of contamination:

- leak detection boxes,

- valve boxes,
- drain-line plug assemblies, and
- seal plate locations for pressure testing.

1.4.2 High-Activity Drains. During the design of high-activity drain systems, the following items deserve special consideration to reduce personnel exposure and the spread of contamination:

- leak detection,
- vacuum systems, and
- double containment.

1.4.3 Non-Fire Protection Penetration Seals.

Air and Water Seals.

- Determine the project criteria for the degree of water and air pressure retention and acceptable leakage rates at penetrations. Past project criteria have sometimes imposed unrealistic goals such as zero leakage. Criteria should be based on calculations or safety analyses that can be documented.
- Select penetration sealant material based on satisfactory performance of sealant in meeting project water and air retention criteria, compatibility of sealant with adjacent materials and constructibility.

Radiation Shielding Seals.

- Determine the project criteria for the degree of radiation shielding required at penetrations. Provide calculations to support the shielding criteria.
- Select penetration sealant material based on satisfactory performance of sealant in meeting project radiation shielding criteria, life expectancy of sealant in radiation environment compatibility with adjacent materials, and constructibility.

- Consider external mechanical loads on penetrating element (pipe, etc.) and differential movement between penetrating element and structure that may cause the seal to fail or be dislodged.

1.5 **Jumpers.**

1.5.1 General Jumper Design Considerations. Chemical processing vessels in nonreactor nuclear facilities often are located in areas of high radiation with very limited access capabilities. In order to transport process materials as well as the services required for the process, pipes are fabricated with the capability of being installed remotely by cranes. Such pipes are called jumpers. Jumper design requires many special considerations in addition to normal needs, which are discussed in this section.

- Pipe jumpers are installed by remotely operated cranes between the vessel nozzles and wall nozzles by means of connector blocks. The installation is performed by using an impact wrench mounted on the crane hook. Since the installation is performed by the operator at a remote location, the tolerances are evaluated based on:
 - the ability to remotely lower the pipe into the connected nozzles (i.e., tighter clearance tolerances make the installation process more difficult);
 - the ability to install a leak-tight joint (i.e., though higher clearances make installation easier, the dimensional mismatch makes the gasket sealing more difficult);
 - fabrication tolerances of the vessel nozzles and wall nozzles (i.e., based on operating plant experiences at various facilities, a tolerance of $\pm 1/16$ inch is normally used in jumpers).
- The vessel nozzle tolerances are determined by evaluating the tolerance stackup of various components.

1.5.2 Handling. In contrast to normal piping installation where the construction crew is able to guide the piping into installation positions, jumpers are placed into installation position by a remotely operated crane. An accurate determination of the jumper dead weight and center of gravity is performed, and the jumper lifting

bail is located appropriately. It is advisable to verify the balance of the jumper prior to actual installation, because it may require additional counterweights to achieve the balance.

Inherent flexibility of the jumper configuration is needed for proper jumper operation. The slope of a process jumper is also important to minimize the potential for contamination during handling. Maximum deflections are 1.5 inches for process jumpers and 0.7 inches for electrical jumpers.

- 1.5.3 Pipe Stresses.** Evaluation of jumpers includes determination of stresses and deflections in the installed position as well as during handling. Handling stresses and deflections are important because they impose a constraint on jumper remotability. This is because a jumper with excessive deflection has a potential for binding at the connector block. Also, handling stresses often suggest that the pipe jumpers be stiffened by additional longitudinally mounted structural members.

1.6 Structural Design.

- 1.6.1 General.** Structural engineering evaluations deal with the determination of strength and deformation of members based on loads imposed by environmental conditions. Building codes, DOE Orders, and Executive Orders are concerned with the health and safety of the public and the economical construction of new and existing facilities.
- 1.6.2 Metals-Stainless Steel.** Useful information not covered in normal structural codes is available in AISC N690-12, *Specification for Safety-Related Steel Structures for Nuclear Facilities*.
- 1.6.3 Foundation Vibration.** Guidance for the analysis of foundation vibrations, design to avoid resonance, and vibration and shock isolation may be found in MIL-HDBK-1007/3, *Soil Dynamics and Special Design Aspects*.
- 1.6.4 Loads.**
- Ceiling and Roof Loads.** Many buildings are subject to unanticipated additional ceiling-roof equipment loads. Give consideration to providing for a future 10-20 psf additional structural loading.

Partition Weights. Consider an allowance for the weights of partitions, where partitions are likely to be rearranged, added, or relocated:

- For partition weights of 150 plf or less, use an equivalent uniform dead load of 20 psf.
- For partition weights above 150 plf, consider actual linear loads.
- Partitions that are likely to be rearranged or relocated can be calculated as live loads for load factor design.

Lateral Loads on Partitions. Consider a minimum live load of 5 psf applied laterally for design of interior walls, permanent partitions, and temporary partitions that exceed 6 feet in height, except where earthquake or other lateral loads are greater.

Wind Loads on Building Additions. Consider building additions to be designed as parts of a totally new building without regard to shielding from the original building and without regard to lesser wind resistance for which the original building may have been designed. The original portion of the building may require strengthening due to an increase in the wind loads.

- 1.6.5 Equipment Support Resonance.** Equipment supports are designed to avoid resonance resulting from the harmony between the natural frequency of the structure and the operating frequency of reciprocating or rotating equipment supported on the structure. Resonance effects may be minimized by designing equipment isolation supports to reduce the dynamic transmission of the applied load to as low a level as can be economically achieved.
- 1.6.6 Creep and Shrinkage.** Concrete and masonry structures should be investigated for stresses and deformations induced by creep and shrinkage.
- 1.6.7 Environmental Concrete Storage Structures.** Environmental concrete storage structures for containment, treatment, or transmission of water, wastewater, and low-, intermediate-, and high-level radioactive wastes or other fluids should be designed and constructed to be watertight, with minimal or no cracks.

ACI addresses this aspect through attention to detailing. Controlling cracks is described in ACI 224.1 R-07, *Causes, Evaluation, and Repair of Cracks in Concrete Structures*; ACI 224.2R-92 Reapproved 2004, *Cracking of Concrete*

Members in Direct Tension; and ACI 224.3R-95 Reapproved 2008, *Joints in Concrete Construction*. Some special concrete mixes are available to minimize cracks. These include shrinkage-compensating concrete and a special mix using ground granulated blast-furnace slag and fly ash. In general, these mixes, combined with proper construction techniques, can be used to control cracks in the concrete.

Two additional factors should be considered while designing environmental concrete structures to help control cracks and improve water tightness: rebar spacing and water - cementitious ratio.

2. ELECTRICAL SYSTEMS

This section contains design considerations useful to electrical design personnel involved in designing power, lighting, and special systems within DOE nuclear facilities. This guidance represents good design practices based on lessons learned from various design, construction, startup, and operations experiences. General electrical guidance is provided in DOE-HDBK-1092-2013, *Electrical Safety*.

The following factors should be considered in the design of electrical systems:

- number of required operating personnel;
- number and types of processes to be operated;
- duties of operating personnel;
- control panel and consoles arrangement;
- operator man-machine interface;
- instrument equipment functions;
- testing considerations;
- maintenance considerations;
- aesthetics;
- lighting methods and intensities;
- communications facilities;
- control center location relative to the rest of the plant;
- control center access and egress pathways;
- security and safety considerations;
- office and utility room requirements;

- computer room;
- software engineering area;
- ambient noise levels and abatement devices;
- HVAC requirements—ambient temperature, air quality, and humidity;
- fire protection requirements;
- wiring methods and requirements (including fiber optics);
- static electricity discharge requirements;
- grounding requirements;
- essential documents storage and reference area;
- electromagnetic compatibility;
- reliability;
- power requirements;
- human factors/ergonomics (see Institute of Electrical and Electronics Engineers (IEEE)-1023-2004, *Recommended Practice for the Application of Human Factors Engineering to Systems, Equipment, and Facilities of Nuclear Power Generating Stations*, and International Society for Measurement and Control (ISA) RP60.3, *Human Engineering for Control Centers*);
- the need for uninterruptible power supplies; and
- the need for DC sources.

2.1 **Basic Electrical Materials and Methods.**

- Standard off-the-shelf electrical materials and equipment used on installations are acceptable if they have been tested and labeled by a nationally recognized testing laboratory (international standards organization or recognized testing agency). If no products are listed or labeled, evaluation and approval by the authority having jurisdiction (AHJ) (usually the site safety department) for the subject facility should be adequate. On-site acceptance testing is recommended for each major electrical component and system.
- The use of electrical metallic tubing should be avoided in areas where it may be subject to severe physical damage. Conduits encased in concrete ductlines should be PVC.

- Flexible conduit is recommended for conduit connections to equipment subject to vibration. Use of liquid-tight-flexible metallic conduit with suitable fittings for outdoor installations subject to vibration is also recommended.
- Aluminum conduit is preferred in atmospheres where steel conduit is unsuitable; for example, exposed conduit runs in damp or wet areas, such as cooling tower areas. Copper-free aluminum conduit and fittings are preferred. Aluminum conduit should not be used underground or be encased in concrete.
- If dissimilar conduit materials are used, dielectric couplings should be considered.
- Steel conduits are recommended to route power cables to motors supplied from variable-frequency controllers to minimize noise to and from adjacent circuits. Variable-frequency controllers should be specified to include electrical filters.
- In general, copper conductors are preferred for interior electrical systems, but aluminum conductors, size No. 4 American wire gauge (AWG) and larger, may be used where appropriate.
- A minimum wire size of No. 12 AWG is recommended for lighting and receptacle branch circuits. This recommendation is based on the branch circuit overcurrent device rating of 20 amperes or less.
- All receptacles with their power source, including UPS-critical circuits, should be labeled. Electrical penetrations through a fire barrier should have an approved fire barrier seal. Penetrations through confinements should be designed to minimize leakage.
- Each DOE facility should consider establishing a standard color-code system to distinctly identify unground phase conductors by voltage level. The following scheme is typical:

Color coding for 120/240V single-phase systems

- Ungrounded conductor Black
- Ungrounded conductor Red

Color coding for 208Y/120V three-phase systems

- Phase “A” Ungrounded conductor Black
- Phase “B” Ungrounded conductor Red

- Phase “C” Ungrounded conductor Blue

Color coding for 480Y/277V three-phase systems

- Phase “A” Ungrounded conductor Brown
- Phase “B” Ungrounded conductor Orange
- Phase “C” Ungrounded conductor Yellow

Color coding for 480V corner-grounded (B-Phase) Delta three-phase systems

- Phase “A” Ungrounded Conductor Brown
- Phase “B” Grounded Conductor Gray
- Phase “C” Ungrounded Conductor Yellow

- Branch circuits for 120V lighting and receptacles are recommended to be two-wire circuits with a separate ground wire. Use of common neutral conductors for several branch circuits is not a good practice.
- When cable trays are used, the following guidelines should be considered for design/installation:
 - Use cable trays for large, multiple-cable applications in both interior and exterior locations.
 - Arrange cable tray runs in stacks by descending voltage levels with the highest voltage at the top.
 - Consider the minimum bending radius of all medium-voltage cables to be routed through the tray system during the selection of the cable tray bending radius (horizontal and vertical).
 - Consider the location of monorails, equipment removal spaces, and floor hatches in the layout design so that raceways do not interfere with equipment removal.
 - Use of drip shields where piping lines cross over cable trays.
 - Cable trays should be located away from heat sources such as steam lines and hot process piping wherever possible. When locating cable trays away from heat sources is not possible, analyses may be required to determine if high-temperature cable and/or heat shielding may be required. Cable trays should also be located away from potential fire hazards such as lube oil and fuel oil storage tanks.

- Raceways which require multiple cable trays may be installed in a vertical or horizontal (side by side) arrangement as required by the facility configuration. When arranged horizontally, a minimum distance of 30 inches should be provided along one side of each tray run to allow for installation and maintenance. When two trays are run side by side, the access space may be common. When arranged vertically (trays above each other) cable trays should have a minimum vertical spacing of 16 inches for trays which have a 3-inch loading depth and 17 inches for trays which have a 4-inch loading depth to allow for maintenance and installation and to permit the use of cable pulling equipment when required.
- For modifications of existing facilities, existing raceways may be used, where feasible, to install new cables. The following guidelines should be considered to prevent cable damage:
 - Additional new cables should not exceed the allowable raceway fill guidelines of IEEE-1185-2010, *Recommended Practice for Cable Installation in Generating Stations and Industrial Facilities*.
 - When power cables are added, evaluate the current capacity of all cables (existing and new) within the raceway.
 - Minimum bending radius of new cables should not be violated when pulled through existing raceways.
 - Evaluate the conduit and tray support system to stay within design loads when new cables are added.
 - When pulling cables in existing trays, refer to IEEE-1185-2010 for guidance for avoiding damage to cables.

2.2 Exterior Electrical Utility Service.

- Demand and diversity factors should be considered in calculating service capacity, substation, and feeder loads. Actual demand data should be used, or the latest edition of *Standard Handbook for Electrical Engineers* by Fink and Beatty should be referenced to obtain typical demand and diversity factors for industrial loads.

- Loads that require a high degree of service reliability may be accommodated by redundant services from the utility or a single service supplied from a loop-type transmission/distribution system having sectionalizing features. Reliability analysis is recommended to ensure the facility production targets are met.
- It is essential to maintain the appropriate power factor at the service connection to the utility in order to save demand charges, when tariff is based on kWh and kVA demand. Cost studies are recommended to arrive at the optimum kVAR rating of power factor correction capacitors.
- Single-pole structures are preferred in most applications. Joint use of poles for power and communication circuits is permissible, provided safe clearances are maintained in accordance with the National Electric Safety Code. High-load clearance to power lines should be considered during the design, depending on the site requirements. Power lines in the vicinity of helipad or emergency operation centers, where helicopters may be in use, require aviation warning markers.
- In congested areas and where required for safety and service continuity, primary and secondary distribution circuits should be placed underground in duct banks or direct-buried. Ductbanks should be encased in concrete and further reinforced if a road crossing is anticipated. A good design practice on new installations is to allow 25 percent spare ducts in a duct bank for future use.
- Cable pulling tension and sidewall pressure should be calculated when the potential for damage exists.
- In general, direct buried cable should be avoided. In certain circumstances, it is economical to design and install direct buried cable depending on the importance of the intended service and the security required for these circuits. The installation depth of the cable and other safety aspects should meet the requirements of Section 35 of IEEE C2-2012, *National Electrical Safety Code*. The following considerations are related to this type of installation:
 - The back-fill material should be sand- or rock-free, screened back fill, which is free from rotting wood or organic matter that might attract termites.

- A 3-inch thick (minimum) protective concrete tile or other protective means should be placed 6 to 8 inches above the cable to warn of buried cable below.
- Underground cables and/or duct systems are provided with physical protection and identification (e.g., the top surface of a concrete duct bank may be pigmented with red concrete dye).
- Electrical energy metering is recommended at each substation rated 500 kVA or larger capacity. Kilowatt hour meters with demand indicators should be considered in the overall facility load management system.
- If open wire distribution systems are being used, lightning protection should be considered. On multi-grounded neutral systems, arresters installed on all three phases at prescribed intervals may provide adequate protection. If the distribution system is a single-point impedance grounded system, installation of a static wire system with multiple grounding and surge arresters on all three phases at prescribed intervals should be considered. Surge arresters should also be installed on pad-mounted distribution transformers at their primary terminals.
- When open wire lines supplying power to high-reliability loads are extended outside process areas that require high reliability, installation of automatic reclosers should be considered outside the high reliability areas and properly coordinated to limit supply interruptions.

2.3 **Special Facilities.**

Emergency Preparedness Facilities. Reliability, flexibility for operations, and safety of personnel should be considered in the design of electrical distribution systems for emergency preparedness facilities. Standby power sources capable of supporting full operation of emergency loads for a minimum of 24 hours or for a period specified by the design authority should be included in the design basis. Special-purpose receptacles used to power equipment should have permanent labels to mark voltage, amperage, number of phases, power source, etc.

Telecommunication Facilities. Design of power distribution to essential equipment should consider uninterruptible power sources or emergency backup power sources.

Design coordination with equipment system specialists and DOE security personnel is essential to determine the load demand. A plug-in connection to a portable generator should be considered.

Automated Data Processing (ADP) Centers. Guidelines on electrical power for ADP installations are provided in Federal Information Processing Standards Publication, FIPS PUB 94.

Radio Control Centers. In determining power supply requirements, it is reasonable to assume that all the transmitters are keyed simultaneously while associated receivers and other equipment and building services are in operation.

2.4 **Interior Lighting.**

- Fluorescent and high-intensity discharge (HID) lamps are preferred. When HID lighting is used indoors, color rendition effects on visual and health safety should be evaluated. Glare and shadows in fixture layouts should be minimized. Additional standby lighting may be necessary to meet emergency lighting requirements. The stroboscopic effect from discharge lighting should be corrected, especially in areas where rotating machinery is present. Fluorescent or HID lighting fixtures equipped with energy-efficient and high-power-factor ballasts should be considered. In addition, energy-saving lighting controls should be considered for new lighting systems.
- Emergency lighting units in nonhazardous areas should be connected via a cord and plug for ease of maintenance. A simplex-type receptacle, preferably a twist-lock type, should be provided for such a connection.
- Lighting fixture types, location, and illumination levels should be coordinated with the equipment and functions of telecommunication, alarm, and ADP centers to provide required illumination without—
 - interfering with prompt identification of self-illuminating indicating devices,
 - creating reflecting glare that might detract from adequate observation of essential equipment,
 - creating detrimental electrical or electromagnetic interference to proper operation of equipment.

2.5 Exterior Lighting.

- High-pressure sodium lighting fixtures with built-in photocell control and high power-factor ballasts should be used for outdoor lighting. Where required by design considerations (e.g., security, street, and fence lighting circuits), contactor control with a combination of timer and photocell should be considered. The designer should also consider using a backup power source with automatic transfer switch for street and fence lighting.
- In the vicinity of heliports operated by protective force personnel, or near observatories, light glare should be minimized by selecting the proper fixture.
- The installation of aviation warning lights on tall structures adjacent to heliports should be considered.

2.6 Special Systems.

- Standby or emergency power systems should be used to support systems or equipment components whose operating continuity is determined to be vital by the design authority for protection of health, life, property, and safeguards and security systems.
- Optional standby systems should be used to power production process operations if the design authority determines that the process will become unstable or that a severe monetary loss will result.
- The design authority should specify the length of time the emergency power source is required to maintain full operation of emergency loads. Such power sources should include built-in features to facilitate operational testing on a periodic basis to verify readiness.
- The source of emergency power may be gasoline engines, batteries, uninterruptible power supplies (UPSs), diesel engines, fuel cells, propane engines, hydropower, or gas turbines as determined by capacity, starting duty, and the life-cycle cost analysis. Steam turbine generators should be used if steam is being produced for on-site processes.
- In many facilities, there are critical loads that are sensitive to fluctuations in the power supply. There are also loads that should be served continuously if the

normal supply is lost or interrupted. Typically, the following loads may be sensitive to power interruptions and should be powered by a UPS. UPSs can utilize converters or batteries. Batteries may be used to provide emergency power in special facilities like telecommunication, alarm, and radio repeater stations. Rechargeable batteries are recommended and should be maintained fully charged at all times by float chargers. A design provision is recommended for a portable emergency generator hook-up during an extended, planned outage of the normal service to the battery charger.

3. MECHANICAL SYSTEMS

This section describes design considerations useful to mechanical design personnel involved in the design of piping and air pollution control systems within DOE nuclear facilities. The guidance represents good design practices and lessons learned from various design, construction, startup, and operations experiences.

3.1 Piping.

3.1.1 Piping Systems.

- Selection of an appropriate corrosion/erosion allowance is vital to the service life of the system. Consideration of effects of temperature and fluid velocities is very important in selecting and sizing the system properly. For example, carbon steel piping may be acceptable for sulfuric acid when the concentrations are above 93 percent, flow rates are below 3 feet/sec, and the temperature is below 122°F.
- Piping systems that perform safety-related functions are to be designed and fabricated to more rigorous standards than other fluid service piping. In accordance with ASME B31.3, *Process Piping*, Category M Fluid Service may be designated for design, material and component selection, fabrication and erection, and examination and inspection of these systems. Certified Material Test Reports for material and components provide additional assurance for these piping systems.
- Piping systems that handle radioactive fluids require special design considerations. Regardless of design pressures and temperatures, these

systems should be categorized as Normal Fluid Service, at a minimum, in accordance with ASME B31.3 for design, material and component selection, fabrication and erection, and examination and inspection. Additional requirements should be added as determined necessary by engineering design.

- Maintenance activities that involve repairs, replacements, and modifications to existing piping systems should be performed in compliance with the original code of record used in the original design and installation of these systems.
- Process piping with surface temperatures exceeding 200°F that penetrates concrete walls, floors, and ceilings should be installed through sleeves with insulation.
- Piping and equipment with surface temperatures higher than 140°F and accessible from normal work areas, platforms, and access ways should be insulated for personnel protection.
- Excessive fluid velocities should be avoided in systems with condensed liquids. Line losses rise dramatically with greater fluid velocities and the potential to create undesirable vibrations increases.
- Domestic water should be supplied by a separate service line. Combined fire protection and potable water service or combined process water and potable water systems should be avoided,
- Backflow preventers and air gaps should be considered to prevent cross-connection of potable water supplies. Vacuum breakers should be considered to prevent back siphoning.
- In the design of supports for piping in compressible flow service, the weight of the line filled with water for hydrostatic testing should be considered.

3.1.2 Piping Design.

- To protect against differential settlement or seismic activity, the design should include suitable flexibility at building interfaces.

- To avoid excessive system vibration, components that create large pressure drops, such as valves and orifices, should be designed to minimize the effects of cavitation and flashing.
- To minimize the potential for costly evaluation of equipment nozzles, the piping loads on equipment nozzles (e.g., vessels, heat exchangers, pumps, etc.) should be conservatively estimated for the initial design of this type of equipment.
- The mid-span deflection due to dead weight loading should be limited to no more than 1/8 inch for lines that are required to drain. For lines that are not required to drain, deflection should be limited to 1/2 inch.

3.1.3 Buried Pipe.

- The trench for installation of buried piping should be of sufficient width and depth to provide necessary bedding and cover, depending on traffic volume to facilitate joining, trapping, and future maintenance concerns.
- As applicable, analysis of buried piping should consider soil, surface, internal pressure, thermal growth, soil settlement, water hammer, and seismic loads.
- Underground piping should be buried beneath the frost line. If conditions do not allow this, heat tracing and insulation should be used.
- Primary and secondary piping should be supported and anchored. Supports should be adequate to carry the weight of the lines and maintain proper alignment.
- Pipe guides and anchors should be provided to keep pipes in accurate alignment; direct the expansion movement; and prevent buckling, swaying, and undue strain. Spider-type supports should be provided inside the encasement piping to permit lead detection.

3.1.4 Steam and Condensate Systems.

- Steam lines should slope 1/8 inch per foot in the direction of steam flow. Lines with lesser slopes should have provisions for slower warm-up to

allow condensate time to flow to the traps. Condensate removal provisions should also be placed at shorter intervals to reduce accumulation of condensate.

- Each low point should have a steam trap and free blow with drainage provisions to a lower elevation. If condensate from steam traps discharges into a common header, a check valve is typically located downstream of each trap. The maximum backpressure that is possible in the header is normally designed to not impede the flow of condensate.
- Drip legs should include a steam trap and blowdown drains. For steam lines less than 3 inches, the drip should be the same diameter as the run pipe and the blowdown line and valve should be at least 1/2 inch.
- Blowdown (free blow) lines are normally sized to accommodate all condensation developed during steam line warm up.
- Provisions should be made to drain condensate from the upstream side of isolation valves. Small bypass lines can be installed around pressure reduction stations and around larger isolation valves. Condensate drainage from each drip leg is typically adequate for drainage of all condensate from the full-open warm-up bypass valve. Bypass valves are normally sized to not exceed the flow capacity of the downstream drip legs to handle the condensate collection during the initial startup of the steam system.
- Steam header control valves and pressure regulators should be provided with upstream strainers. Pressure regulators should have upstream drip legs and manual bypass lines.
- Steam traps should provide adequate capacity to accommodate condensation loads during warm-up as well as during normal operation and to compensate for line size, length, and insulation type and thickness. Traps for end user equipment (e.g., heating coils) normally accommodate full condensate load from the equipment warm-up in order to be considered automatic draining.

- Arimid fiber gasket material should not be used in any steam or condensate service.

3.1.5 **Water Hammer.**

- Various devices can be used to protect piping systems from damage caused by severe hydraulic transients. Check valves, standpipes, and accumulators can prevent the occurrence or reduce the effect of a transient event.
- Vacuum-breaker valves should be used in situations where water-column separation can occur. Check valves (preferably titling disc) can also be used to prevent column separation in the event of power loss.

3.2 Purge Systems. Chemical processing vessels in nonreactor facilities often handle materials that are both flammable and potentially explosive. An effective way of controlling the potential for fire and explosions in these vessels is either to control the fuel in the tank by diluting and sweeping the vapor space with purge gas or to limit the oxygen content in the vapor space by blanketing with an inert gas. The type of purge gas used depends on the chemical constituents of the vessel contents. Though air purge is used in nonflammable mixtures, nitrogen purging of vessels is the most widely used method in nonreactor facilities and is the primary subject of discussion in this section.

3.2.1 Systems Design: General Purge Systems Design Considerations. Nitrogen systems are normally delivered as packaged systems that include the liquid nitrogen storage tank with appropriate pressure build-up and economizer circuits, ambient vaporizers, interconnecting piping, and discharge pressure regulators to maintain delivery at customer-required pressures. Procurement of a standard, packaged system on a performance-based specification should be considered; however, upgrading of individual components may be required in certain cases where the failure of the inert gas supply to vessels causes undesired vapor space mixtures to form.

3.2.2 Components Design Considerations: Storage Tanks. Liquid nitrogen storage tanks normally are furnished to operate up to 250 psig saturation pressure. The appropriate operating pressure selected should be based on the following factors:

- delivery pressure at the process vessels;
- storage capacity required (i.e., the higher saturation pressure, the lower the volume of free gas available per unit liquid volume);
- length of service piping from vaporizer to use point (i.e., the longer the piping, the higher the transport losses);
- safety consideration of high-pressure storage (see *ASME Boiler and Pressure Vessel Code*, Section VIII).

3.2.3 Pressure Buildup Coils Design Considerations. Pressure build-up coils in tanks automatically maintain the station pressure through tank pressure excursions. Materials used in the coils should be selected based on evaluation of material strength and heat transfer capabilities.

3.2.4 Vaporizer Design Considerations. Although various kinds of vaporizers are available in the market, ambient vaporizers are the most commonly used. The vaporizer selection should be based on careful evaluation of the following factors:

- ambient conditions,
- material properties,
- structural loading criteria, and
- location (i.e., free versus obstructed airflow).

3.2.5 Service Piping. The temperature of the gas outlet is an important factor in selecting pipe materials for nitrogen service piping. The vaporizers are flow rated based on an industry standard of about 10 to 20°F below the ambient conditions: the lesser the flow, the warmer the outlet gas. Items that affect the heat transfer of the units are the position of the sun, ambient temperature, airflow around the units, and relative humidity. Due to the low outlet temperature of the vaporizer, the liquid nitrogen piping to the pressure regulator is normally low-temperature piping.

3.2.6 HVAC. HVAC equipment should be sized to satisfy the building heating and cooling requirements and to meet the general equipment design and selection criteria contained in ASHRAE handbooks.

3.3 Pumps. Positive displacement pumps should be considered for use in the following situations; high pressure and low flow, high-viscosity fluids, suspended solids, self-priming, two-phase-flow, and constant flow at variable system pressure.

3.4 Valves.

- Gate valves are unsuitable for throttling and should be used in the full open or closed position.
- Globe valves should be used primarily for throttling service only unless system flow reverses, and the globe valve serves as a stop valve.
- Simple check valves without external actuation should never be used as stop valves and should be used as flow reversal preventers.
- Butterfly valves should be used for stop valves or for throttling purposes in water systems.
- Ball valves should be used for bubble-tight stop valves in relatively clean fluid services.
- Plug valves can be used for bubble-tight stop valves in a variety of fluid services.
- Diaphragm valves are used as stop valves in variety of services from clean to dirty fluids including liquids with suspended solids and scale-forming liquids.

4. INSTRUMENTATION AND CONTROLS CONSIDERATIONS

This section contains design considerations useful to instrumentation and control design personnel. Data and digital control systems are undergoing dramatic changes as workstations and electronic storage media become less expensive. The guidance in this section is based on experience with existing instrumentation and control systems. The designers of new facilities should consider the use of “best available” proven technology for new instrumentation and control systems.

4.1 Control Centers/Control Rooms. Control centers or control rooms play a vital role in the operation of a facility. The following factors should be addressed in the design of a control center or control room:

- number of required operating personnel;
- number and types of processes to be operated;
- duties of operating personnel;

- control panel and consoles arrangement;
- operator man-machine interface;
- instrument equipment functions;
- testing considerations;
- maintenance considerations;
- aesthetics;
- lighting methods and intensities;
- communications facilities;
- control center location relative to the rest of the plant;
- control center access and egress pathways;
- security and safety considerations;
- office and utility room requirements;
- computer room;
- software engineering area;
- ambient noise levels and abatement devices;
- HVAC requirements-ambient temperature, air quality, and humidity;
- fire protection requirements;
- wiring methods and requirements (including fiber optics);
- static electricity discharge requirements;
- grounding requirements;
- essential documents storage and reference area;
- electromagnetic compatibility;
- human factors/ergonomics (see IEEE-1023-2004, ISA RP60.3);
- reliability; and
- power requirements.

To increase the reliability of control systems, redundancy of primary control system components (power supplies, controllers, input/output modules, communication lines, etc.) should be considered. Facility failure studies can be useful in defining control system redundancy needs.

4.2 Distributed Control Systems (DCSs). The following should be considered for specifying or purchasing a DCS.

- 4.2.1 Component Modularity.** System components are generally standardized, modular, and of plug-in construction, so that any module may easily be removed from the system and replaced without breaking or making solder-type modified, or serviced without affecting any other drop (except from loss of data from the drop being serviced). Modularity also allows easy expansion from a small system to a large system and reduces spare inventory.
- 4.2.2 Input/Output Controller.** Input/output controllers consist of intelligent modules, each performing a dedicated function. Modules are chosen to meet the specific function including input/output mix, redundancy, geographic distribution, and process requirements. Capability should be provided in the controller to perform logic functions that will eliminate the need for separate programmable logic controllers (PLCs). On critical processes, the use of backup power supplies, redundant controller, and input/output cards should be considered. Also, these controllers should be located as near as possible to the process to reduce the cost of cable installation.
- 4.2.3 Communications.** Communication networks in the system provide high-speed, secure controller information exchange, as well as an open network for standard computing hardware access where appropriate. Communications between individual modules should be via local, independent buses that allow complete integration of the family of modules. Open system capabilities may also allow third-party software to be an integral part of the system.
- 4.2.4 Data Highways.** For critical applications, redundant data highways should be considered. Failure of one data highway should be transparent to the system and should not affect system performance. An alarm message that would activate upon failure of a redundant highway should be considered at the operations station. Fiber optics may be useful in this application for its immunity to noise and electrical fault isolation. Wide band width, high reliability, and noise resistance should make fiber optic networks an attractive component of many complex control systems. Redundant computer controls and uninterruptible power sources should make these new technology control systems much more accurate and reliable than traditional analog systems.

- 4.2.5 Failure Mode Recovery.** The system should be designed so that it is capable of completely recovering from plant power loss without manual intervention. System software necessary for computer reboot and operation should be stored in nonvolatile memory.
- 4.2.6 Operator Workstations.** Operator workstations should have access to the communications bus so that if one goes out of service, another can assume the functions of the disabled unit. In general, response time from the completion of a user inquiry to the completion of resulting display should be 2 seconds. The availability of easy-to-use graphical interface makes plant operation safer and more economical. Graphics displays should be user-configurable. Designers should consider using high-resolution workstations, the ability of the workstations to be scaled, and color vector graphics that are configured with a computer-aided design (CAD)-type drawing package.
- 4.2.7 System Diagnostics.** Consideration should be given to providing self-diagnostics on all circuits (to the smallest replaceable plug-in module or component) and reporting failures to the operator workstations to indicate the source of the failure.
- 4.2.8 Real Time Database.** The data base should be hierarchical in structure to match the controller database. Capability to exchange data with standard third party applications should be provided.
- 4.2.9 Data Historian.** For trending purposes, the designer should consider use of a data historian capable of recording both process and system events and off-loading the records to permanent storage or other computer systems. Data compression algorithms may be used to minimize long-term storage requirements.
- 4.2.10 Acceptance Tests.** Various system hardware and software acceptance tests should be performed and documented both at the vendor's shop and at the site to confirm system requirements. These tests can reveal premature hardware failures and system configuration inadequacies. They also provide a starting point for plant operators' training.

4.2.11 System Documentation. Proper vendor hardware, software, and system configuration documentation should be obtained to keep the system in operation after it has been installed. On-line documentation retrieval systems should be considered.

4.3 Programmable Logic Controller. Functional differences between PLC and DCS have been narrowing over a period of time. PLCs have evolved into units offering many of the functions traditionally reserved for DCSs. DCS has also taken advantage of new technology and incorporated functions like relay ladder logic, function blocks, and structured text programming that have traditionally been performed by PLCs. The following systems issues should be considered in deciding whether to use DCS or PLCs:

- In large processes that require producing multiple products and/or batches, including recipe management, the DCS outperforms the PLC. However, in small, dedicated batch production with limited recipes, where batch management is not critical, PLCs may be a cost-effective and practical solution.
- Initial hardware and software costs are invariably less for PLCs than for DCSs. However, for a large system that requires heavy integration and custom programming, PLC software cost may be higher and may cancel initial cost savings.
- DCS networks are designed to offer high availability and full redundancy in all systems components, with no single point of failure. Tight coupling between operator interface, controllers, and system software provides greater security and assurance that all components work well together.
- The PLC is predominantly used as embedded automation by the original equipment manufacturer because of its flexible application and low hardware cost. Most small machine operations cannot support an expensive DCS solution.
- DCSs offer a single, unified, system-wide global database and superior peer-to-peer communications. By virtue of their configurations, PLCs require a third-party, PC-based software package (which is generally included with the PLC) to provide the user with a working operator interface.
- DCS offers single source, system-wide support through available service contracts with dedicated field service personnel. On the other hand, PLC

manufacturers generally do not provide total system service, especially when a facility uses different PLC manufacturers. The user should support the system or find a qualified system integrator to provide similar service and support.

- Hybrid PLC-DCS control systems may be considered where DCS provides analog control and operator interface, and PLC provides digital control for motor and air operated valves, etc.

4.4 Alarm Management. The following guidelines for alarm selection strategy should be considered:

- Provide a systematic approach for identifying, verifying, prioritizing, and documenting the requirements for process alarms.
- Provide capability of alarm pattern recognition and suppression of alarms by group, status, function, or mode.
- Provide an alarm only when the operator is required to take action to avert an abnormal event. Other information and status can be presented to the operator in the form of an alert or advisory notice, but should not sound an alarm. Alarms should be presented to the operator in an organized and optimized manner to reduce the confusion caused by multiple alarms.
- To prevent a single event from causing a cascading of alarms, report alarms hierarchically to the operator.
- Provide capability to advise the operator of the appropriate response to an alarm or to trigger an automatic response.
- Consider use of “dark board” concept for management of alarms.

4.5 Electrical Noise and Wiring Practices. When designing wiring systems, consider the following:

- Electrostatic interference occurs when a conductor acquires an unwanted electrical charge from an adjoining electrical field. An electrostatic shield, such as braided copper wire or aluminum foil wrap, is effective in reducing interference coupling. Because the shield has high capacitance to the wiring it encloses, the shield should be properly grounded or it will become a means of coupling interference to the signal. Conduit normally should be grounded at support points

because the conduit is likely to be at a lower potential with respect to ground than any external wiring. The thickness of the shield is less important than shield discontinuities, such as seams and holes. For this reason, flexible conduit with openings between segments is not desirable.

- Electromagnetic interference is created when a conductor is located within a varying magnetic field. This may occur when a conductor carrying an electrical current is adjacent to another current-carrying conductor. Signal circuits are generally in the 4–20 milliamp range and are susceptible to distortion. Of particular concern is the interference caused by inrush current to a solenoid conductor's capacitance. The inrush current appears as a high frequency spike. This spike is magnetically coupled into all adjacent conductors via inductive coupling.
- Twisting of conductors is effective in rejecting interference induced by magnetic fields. Twisted pairs should be used not only on vulnerable circuits for protection, but on offending circuits as well, for prevention. As the strength of the magnetic field near a wire varies inversely with the distance from the wire, physical separation of signal circuits from control or power circuits is recommended. To a lesser degree, steel tray or conduit provides protection from magnetic interference. The steel used in rigid conduit and tray construction is not normally of sufficiently low reluctance to be very effective.
- Crosstalk may occur when different AC signals are transmitted within the same cable or adjoining cables. A workable solution to prevent crosstalk is to isolate the paired circuits by shielding each pair and grounding the shields.

4.6 Lightning Protection for Instruments.

- In general, most instruments are located in a structure or building. Lightning protection for instrumentation begins with the lightning protection system of this structure or building. To provide adequate lightning protection from a direct or near lightning strike, a low impedance lightning protection system should be considered. This low impedance lightning protection system provides a path of lower resistance to earth ground, thereby providing protection for the instruments and equipment within the protection/shielded zone.

- The lightning protection system should be separate from the building grounding system.
- Another issue to consider when providing lightning protection for instruments is to ensure the instruments and associated cables contained in the structure or building would not be exposed to different ground potentials during a lightning strike. This should be achieved by bonding all conduits, cable trays, and shields of cables to a single ground reference point. This ground reference point should be connected to the electrodes of the structure or building grounding system.
- Where lightning strikes are more prevalent, other lightning dispersion or elimination methods should be considered.
- Surge protection should be considered for more sensitive instruments and instrument cable runs between the buildings.
- Fiber optic links should be used between sensors located in lightning prone areas and the associated analyzers/transmitters.

4.7 Analyzers.

- When selecting analyzers, sample characteristics including quantity and type of chemical components should be considered carefully.
- To prevent sample contamination, avoid sharing of sample lines between different analyzers.
- Where available, use of automatic calibration feature is desirable to counter drift in analyzer performance.
- Proper sampling conditioning is important for satisfactory operation of an analyzer.

4.8 Solenoid Valves. Two methods are usually employed to operate solenoid valves: direct and pilot-operated. Direct operators are those in which the force of the coil core directly opens or closes the valve. The force required to operate the valve is directly proportional to the valve's orifice and line pressure. As the size and line pressure increases, the size of the coil and core increases accordingly. To avoid this limitation, pilot-operated solenoid valves may be used.

The use of pilot-operated solenoid valves is limited in two ways: by the maximum differential pressure and by the minimum amount of differential pressure required to operate the valve. Operational failure may result if either is ignored in the application. For example, three-way solenoid valves are often used to direct an air supply to, or exhaust the air from, a pneumatic valve operator. If valve position is critical, two solenoid valves in the air supply line should be considered, especially when priority interlocks are necessary. Proper function may not occur if the solenoid valve's minimum required differential pressure is ignored. In critical cases, the application should be tested for the various operating modes and the solenoid valve manufacturer consulted regarding the product's capabilities.

4.9 Instrument Installation. This section provides guidance for the installation of field instrumentation, its associated tubing and location, and specific details about commonly used pressure, level, flow, and temperature instruments.

4.9.1 General. Impulse tubing and valve material may differ from piping of the process system they serve, but generally they equal or exceed the parameters of the process system with respect to material, temperature, and pressure ratings.

- Consider the use of expansion loop or flexible metal hoses on impulse and sample lines where thermal or seismic movement is a concern.
- Provide sensing lines with continuous slope to promote their being either full or free of liquid as appropriate. The recommended slope is 1 inch per foot. For instruments sensing steam up to 20 psia, the recommended minimum slope is 2 inches per foot.
- Prevent instrument tubing from coming in contact with structural steel and concrete (painted or unpainted) surfaces of building members, except for penetrations requiring closure. For tubing below 200°F, grout may be used for penetrations.
- Tubing installed in exposed locations subject to accidental crushing or damage should be protected by structural channels or tube track. This type of protection should not render the tubing and fittings inaccessible.
- Capillary tubing sealed to the instrument by the manufacturer should not be cut during or after installation unless specifically required by the

installation drawing or manufacturer's instruction (e.g., capillary system through a penetration).

4.9.2 Instrument Location. When locating instruments consider the following:

- routing of sensing lines from the process tap to the instrument;
- sensing line penetration through walls and floors;
- space requirements for installation, operation, maintenance, calibration, replacement, accessibility, and electrical flexible conduit installation;
- vibration-free mounting on available structures;
- interference with other commodities;
- environmental conditions (radiation, temperature, moisture, noise, etc.).

To provide sufficient slope requirements and thus avoid gas and liquid pocketing in sensing lines, the required instrument location relative to its process connection should be as follows:

Fluid	Instrument Location Elevation
Liquid	Below line connection
Slurry	Below line connection
Steam over 20 psia	Below line connection
Steam under 20 psia	Above line connection
Gas	Above line connection

Instruments that cannot be connected with proper slope should be provided with accessible vent and drain points.

- Vent and drain connections for hazardous or radioactive processes should have provisions for safe disposal of fluid.
- Where practicable, instrument mounting heights should be 4 feet, 6 inches from the floor.

4.9.3 Pressure Instruments.

- Condensate pots are not necessary for a sensing element that has a negligible dynamic displacement (e.g., a force-balance transmitter). If displacement is not negligible and process fluid is steam, other

condensable fluid, or other fluid that may flash, condensate pots should be used. If condensate pots are used, their volume should be at least three times the volume of the displaced volume.

- Pulsation dampers should be used on all pulsating services, such as reciprocating pumps and compressors or other applications where severe service from pulsating pressure is anticipated.
- Diaphragm seals should be provided where—
 - corrosive material is being measured and suitable element material is not available;
 - material with a freezing temperature higher than the minimum ambient temperature is being measured; and
 - material contains solid matter that could plug the instrument.
- Gauges should not be installed adjacent to sources of heat that could potentially raise their temperature to above 200°F.
- Gauges on gas and vapor services should be installed above the process tap. If it is necessary to install gauges on gas or vapor services below the process tap, they may need to be heat traced and insulated to prevent condensation.
- A pair of differential pressure sensing lines may need an equalizing valve to prevent over-pressurization of the instrument and a drain valve on one line.

4.9.4 Temperature Instruments. Temperature instruments should be installed in a thermowell to allow removal without process disturbance. Adequate space should be provided to allow removal of thermocouples, resistance temperature detectors, thermal bulbs, or indicators.

4.9.5 Flow Instruments.

- Differential pressure sensing lines should be run together to the extent practical to keep both lines at the same temperature and with no hydraulic head difference between the lines. If they are insulated, they should be insulated together.

- Differential pressure transmitters vented to the atmosphere should have the vent connection hard-tubed without a valve and turned down. For outdoor applications, an insect screen should be considered.

4.9.6 Liquid Level Instruments.

- Liquid level instrument connections should be made directly to the vessel and not on flow lines.
- The lower instrument connection should be on the side of the vessel. Bottom connections are not recommended because of the possibility of trapping solids in the sensing lines.
- A stilling well is preferred where displacement or float-type elements are located inside a vessel subject to turbulence.
- Differential pressure-level instruments should be located below the process connection on the vessel unless a gas purge or compensated isolation chamber is used.
- Liquid level devices should be placed away from areas of turbulence to prevent inaccurate level measurement.

4.9.7 Leak Detection. Conductivity probes should be protected from freezing conditions. A film of ice over the probe could render the leak detection system inoperable.

4.9.8 Freeze Protection. Consider the need for freeze protection during design to prevent instrumentation systems from freezing, to ensure reliable performance under adverse weather conditions, and when handling high-freeze-point materials. Insufficient protection causes instrument malfunction and maintenance to be performed under adverse conditions.

5. MATERIALS CONSIDERATIONS

5.1 Introduction. Factors that should be considered in the selection of a material for use in a component include assessment of the following:

- physical, chemical, electrical, and mechanical properties;

- weldability,
- availability in forms, shapes, sizes, and colors
- insurability, reliability, and safety;
- economics, cost/benefit, and initial/life-cycle cost;
- effects of the environment on workers and the public; and
- normal operating conditions, anticipated events, and accidents.

Factors that should be considered are contained in the design codes, such as those produced by ASME, American Welding Society, ANSI, and IEEE. The economics of a material selection includes its initial cost and its life-cycle cost. Economic considerations include the following:

- a clear definition of expected component performance, including degradation and failure modes;
- the required service life, and
- the anticipated inspection, testing, and maintenance required to sustain component performance at a defined level.

The insurability aspects of materials selection relate to the safety and reliability issues of a component. Each of these aspects of material selection is relatively easy to determine because of the codes and the government and insurance regulations that apply. However, taking only these issues into account in a materials selection process has not prevented failures or poor performance of components.

Premature component failure and poor performance are often the result of materials being selected without an adequate evaluation of all the failure modes applicable to a component and the materials of construction. In general, mechanical design codes have been excellent in preventing failure due to mechanical design. Component failures due to rupture, overload, or cyclic loading have steadily decreased and in some applications have been totally designed out of the component. The majority of the failures and poor component performance that occur are due to age-related degradation. The effects of thermal aging, radiation, corrosion, erosion, cyclic fatigue, and instability of the material should be taken into account. Cable products should be manufactured in accordance with Insulated Cable Engineering Association requirements.

The responsibility of accounting for age-related degradation is with the design engineer, who often does not have sufficient information to determine the level and types of age-related degradation that apply.

Typical age-related degradation phenomena include for metallic materials the following:

- general corrosion,
- pitting attack,
- intergranular corrosion,
- stress corrosion,
- galvanic corrosion,
- crevice corrosion,
- erosion corrosion,
- microbiological-influenced corrosion, and
- internal oxidation.

Of these age-related degradation mechanisms, only the general corrosion mechanism can be addressed by the “make thicker” approach. Each of the remaining mechanisms is materials-dependent and may be affected by the following:

- specific metal chemistry,
- metallurgy (which is different from the chemistry), including metallurgical phases, local composition variations, nonmetallic inclusions, etc., and
- fabrication processes, such as heat treatment, machining, pickling, bending, and welding.

Not all metals are susceptible to all the age-related mechanisms identified above. The susceptibility depends on the particular alloy, metallurgy, processing parameters, and environments involved. Therefore, an acceptable metallic selection process considers the following:

- all possible degradation and failure modes in addition to mechanical failures,
- metallurgy and fabrication processes,

- availability of adequate data support and service experience for the specific application, and
- alloy composition.

Nonmetallic materials are susceptible to thermal, cyclic, chemical, mechanical, humidity, and radiation age-related degradation. An acceptable nonmetallic material selection process considers, at least the following:

- thermal properties, including temperature stability;
- chemical properties, stability/resistance to chemicals;
- radiation resistance;
- electrical properties;
- physical properties, including water/moisture absorption, odor;
- mechanical properties;
- thermosetting or thermoplastic;
- flammability rating; and
- optical properties, transparent, translucent, or opaque.
- An acceptable materials selection process evaluates at least the performance, maintenance, service life, quality control requirements, life-cycle cost, inspection, and reliability requirements necessary to minimize/prevent component failure or degradation from all known mechanisms. This involves a literature review, tests, weldability, code approval, availability of product forms and an industrial base, identification of the critical parameters and limits, and properly prepared material specifications that address the applicable failure and degradation mechanisms.

5.2 Basic Considerations for Material Selection for Process Service. When determining an appropriate material for a specific process service, the following considerations should be evaluated:

- Establish the design life and performance requirements for process system components such as vessels, tanks, heat exchangers, piping, valves, and pumps.

- Define the expected or actual stream analysis of the process flow. The stream analysis should include constituent partial pressures, percent chemical species by weight/volume, flow velocities, and contaminant levels. Possible upset conditions, including startup and shutdown environmental conditions, should be considered.
- Define the expected operating pressures and temperatures of the process streams. Startup and shutdown conditions, as well as possible special operating conditions like steam-out cleaning of equipment, should be considered. Possible brittle fracture and fatigue failure of materials should be considered.
- Identify the desired material mechanical properties. The mechanical properties to consider include tensile and yield strength at design temperature, hardness, fatigue strength, creep strength, toughness, desired wear, and corrosion resistance.
- Establish the calculated or expected design radiation dose over the design life of the system. This is important for polymeric materials, which include thermosets, thermoplastics, and elastomers due to possible degradation effects. Additionally, consideration of detrimental off-gassing from nonmetallic materials in tritium service should be included.
- Define the expected environmental conditions. Likely conditions to be considered are embedment in soil or concrete, exposure to corrosive atmospheres, use of thermal insulation, or attachment of electrical or steam-heat tracing.
- Determine the need for material decontamination if the process service is radioactive. Consideration should be included for enhanced surface finishes or materials suitable for decontamination solutions.
- Identify any historical materials documenting performance experience with similar process streams and operating conditions. Successful past usage may indicate suitable service, but careful comparison of the process conditions should be considered.

5.3 Welding, Fabrication, Examination, and Testing. Fabrication processes, including welding, forming (hot and cold), bending, threading, etc., should be controlled or

restricted based on the type of material used and the intended process service. The following factors should be addressed:

- Certain metallic materials may be susceptible to cracking during or following welding. For example, aluminum bronzes and some aluminum alloys may suffer hot cracking (cracking during solidification); chromium molybdenum alloys are air-hardenable and may need elevated preheat temperatures to avoid weld-metal and heat-affected-zone cracking. It is important to distinguish between weld-deposit cracking and heat-affected zone or base-metal cracking.
- Some process services may require special heat treatments to reduce the risks of stress-corrosion cracking. For example, a heat treatment may be required for carbon-steel welds and cold bends in carbon steel exposed to caustics, hydrogen sulfide, or amines.
- Welding, hot forming, and heat treatment operations on certain materials may degrade their corrosion resistance. Austenitic stainless steels and some nickel alloys are examples of materials that can become susceptible to stress-corrosion cracking in certain environments as a result of these operations. Limitations and controls on welding and hot forming operations may be needed. Additionally, special heat treatment may be required to prevent stress-corrosion cracking.
- Welding process restrictions may be needed for certain materials. For example, welded fabrications are not normally used for cast irons due to their hardenability and tendency to crack during welding. Other examples include quenched and tempered alloy steels, which may need restrictive heat input limitations during welding to maintain adequate strength.
- Some welding processes may not be suitable for certain materials or material thicknesses. An example is restriction of the gas metal arc welding process used on thin materials when the short circuit mode of transfer is used. This limitation reduces the possibility of lack of fusion defects caused by this low heat, input welding process.
- When welding is required on austenitic stainless steels, it may be advisable to use only the low-carbon grades (e.g., 304L, 316L, etc.) or controlled heat input weld processes to reduce susceptibility to intergranular-corrosion or intergranular-stress-corrosion cracking.

- Certain contaminants on materials may be harmful during welding and should be controlled. Zinc and other low-melting-point metals embrittle austenitic stainless steel and nickel-based alloys during welding. Welding of zinc-coated materials to austenitic stainless steels or nickel-based alloys will lead to weld-metal or base-metal cracking. This problem may occur even if the zinc coating has been mechanically removed. Use of an uncoated transition piece is recommended.
- Special welding techniques to provide oxide-free welds should be considered for materials in tritium service. The technique may include special cleaning prior to and after welding and adhering to special welding parameters.
- It is a good practice to use qualified welding procedures and qualified welding personnel for all welded fabrication. Additionally, it is good practice to use written procedures to perform other special processes, such as heat treating, forming, bending, nondestructive examinations, and leak testing.

5.4 Material Corrosion and Material Degradation by Radiation. Corrosion and radiation degradation of materials can be a serious problem. Mitigation of corrosion and material susceptibility to radiation degradation is an important design consideration. Factors to be considered for the control of corrosion and radiation degradation are as follows:

- Limitations on the halogen content of materials that contact austenitic stainless steels during fabrication, testing, shipping, and storage should be considered. Austenitic stainless steels are susceptible to corrosive/pitting attacks by halogens. Types of materials that should be considered for halogen limits are cleaning agents, labels, markers, coatings, lubricants, insulations, oils, adhesives, sealants, gaskets, wrapping, packaging, and packing materials.
- Corrosion testing of austenitic stainless steels and nickel-based alloys should be considered for process services that cause intergranular attack. For example, hot nitric and formic acids are process services that cause intergranular attack of stainless steels and nickel-based alloys. ASTM A262, *Standard Practices for Detecting Susceptibility to Intergranular Attack in Austenitic Stainless Steels*, provides guidance in how to perform these types of tests.
- For buried metallic structures, use of cathodic protection, external coatings, hydrophobic backfill materials, or combinations of these are good practices for reducing or eliminating corrosion concerns in corrosive soils. Cathodic protection

systems should be installed at the same time as the structure being protected and activated as soon as feasible. Delays in installation and activation of a cathodic protection system may lead to early corrosion problems.

- Use of internal cathodic protection systems and/or coating of the inside of metallic water storage tanks should be considered depending on water corrosivity. Determination of water corrosivity (calcium and sodium content) is recommended in order to make an adequate determination.
- Possible microbiological-influenced corrosion (MIC) of piping systems conveying natural waters or tanks containing natural waters should be considered. The common type of organisms that cause MIC are sulfate-reducing and iron- and manganese-reducing bacteria. Both ferrous and nonferrous metals can be affected and may suffer pitting or under-deposit corrosion.
- Dissimilar metal connections in certain environments may be prone to accelerated corrosion (galvanic corrosion). Analysis of the process conditions, including the external conditions and the particular metals in contact, should be considered to avoid excessive corrosion of the materials.
- Corrosion caused by trapped moisture under insulation in outdoor piping and vessels may be a problem. Operating temperatures, intermittent service conditions, system layout, weatherproofing, and system orientation are all factors to be considered to avoid the problem. External coatings on the piping and vessels should be considered to reduce the risk.
- Aluminum and aluminum alloys to be embedded in concrete should be isolated from the concrete material to reduce corrosion concerns. The isolation may be accomplished by coatings or separating materials.
- Limiting the use of polymeric and fiberglass materials should be considered if there is possible exposure to organic compounds, such as solvents and aromatic hydrocarbons. Polymeric materials and certain resins in fiberglass materials may be susceptible to degradation by the organic compounds. Organic compounds in the parts per million range may cause degradation, so careful analysis of the process conditions should be performed. In addition, polymeric materials may be susceptible to environmental stress cracking when exposed to organic compounds and strong bases.

- Limitations on the use of polymeric materials exposed to ionizing radiation should be considered due to possible degradation. Radiation degradation includes detrimental changes in hardness, elongation, tensile strength, impact resistance, and discoloration. Most polymeric materials are suitable for cumulative radiation exposures of less than 1×10^4 rads in air. Most thermoplastics (with the exception of Teflon™ polytetrafluoroethylene (PTFE) and a few others) are suitable up to 1×10^6 rads and may be usable up to 1×10^7 rads. Thermosetting polymers, such as epoxies and phenolics, and aromatic thermoplastics, such as polystyrene, polyketones, and polyimides, exhibit resistance to levels up to 10^9 rads in air. Numerous reference materials provide data on threshold radiation damage of polymeric materials.
- Figures 3, 4, 5, and 6 in Section 2.10.6 of Part I provide information regarding the effects of gamma radiation on polymeric materials.
- The effect of heat treatment, microstructure, and composition of alloy materials should be considered. For example, a sensitized microstructure is required for nickel alloys under high-temperature-reducing conditions to prevent stress corrosion cracking, while austenitic stainless steel requires an unsensitized microstructure. In addition, radiation-induced stress corrosion cracking of austenitic stainless steel can be reduced by imposing special composition requirements of residual elements.

INTENTIONALLY BLANK

ADDITIONAL REFERENCES

DOE Orders and Standards

- DOE-STD-1020-2012 *Natural Phenomena Hazards Analysis and Design Criteria for DOE Facilities*
- DOE STD-3014-2006 *Accident Analysis for Aircraft Crash into Hazardous Facilities*
- DOE-STD-3025-2007 *Quality Assurance Inspection and Testing of HEPA Filters*

Other Government Documents

- NRC R.G. 3.54 *Spent Fuel Heat Generation in an Independent Spent Fuel Storage Installation*
- NRC R.G. 8.8 *Information Relevant to Ensuring that Occupational Radiation Exposures at Nuclear Power Stations Will Be as Low as Is Reasonably Achievable*

Non-Government Documents

- ACI 349-06 *Code Requirements for Nuclear Safety Related Concrete Structures*
- ASHRAE Handbook *Vol 1-4: Fundamentals, Refrigeration, HVAC Applications, and HVAC Systems and Equipment*
- ASHRAE Std-62-2010 *Ventilation for Acceptable Indoor Air Quality*
- NCRP Report No. 151 *Structural Shielding Design and Evaluation for Megavoltage X- and Gamma-Ray Radiotherapy Facilities*
- ANSI/HPS N13.56-2012 *Sampling and Monitoring Releases of Airborne Radioactivity in the Workplace*

INTENTIONALLY BLANK

CONCLUDING MATERIAL

Standards Manager:

DOE-HS-30

Review Activity:

DOE	Field Offices
DP	SR
EM	ID
SC	HAN
FM	LANL
NE	SAND
RW	AL
NN	RL
	OAKLAND
	OR

Preparing Activity:

HS-31

Project Number:

EDCN-0001