

# **GREENING FEDERAL FACILITIES**

**An Energy, Environmental, and Economic Resource Guide  
for Federal Facility Managers and Designers**

**SECOND EDITION**



# Greening Federal Facilities

## **An Energy, Environmental, and Economic Resource Guide for Federal Facility Managers and Designers**

SECOND EDITION

*“Then I say the earth belongs to each ...  
generation during its course, fully and in its own right,  
no generation can contract debts greater than may be  
paid during the course of its own existence.”*

Thomas Jefferson, September 6, 1789

*Produced for:*

U.S. Department of Energy  
Office of Energy Efficiency and Renewable Energy  
Federal Energy Management Program

*Produced by:*

BuildingGreen, Inc., Brattleboro, Vermont

*Under:*

NREL Subcontract No. AAR-0-29469-01  
DOE Prime Contract No. DE-AC36-99GO10337

*Edited by:*

Alex Wilson, BuildingGreen, Inc.

*Design and Imagesetting by:*

Joy Wallens-Penford

May 2001

# Contents

About the Contributing Organizations .....	iv
Acknowledgments .....	v
Executive Summary .....	vii

## **Part I RATIONALE**

1.1 A Tour of the Guide .....	2
1.2 Purpose .....	4
1.3 Current Federal Regulations .....	6

## **Part II ENVIRONMENTAL AND ENERGY DECISION-MAKING**

2.1 Green Teams – Innovations in Planning, Design, and Operation .....	10
2.2 Economic and Environmental Analysis ..	12
2.3 Green Procurement .....	14
2.4 Alternative Financing .....	16

## **Part III SITE AND LANDSCAPE ISSUES**

3.1 Land-Use Planning and Transportation ...	20
3.2 Site Selection and Site Planning .....	22
3.3 Building Placement and Orientation on a Site .....	24
3.4 General Landscaping Principles .....	26
3.5 Stormwater Management .....	28
3.6 Plantings in the Sustainable Landscape ..	30
3.7 Water Use in the Landscape .....	32
3.8 Chemical Use in the Landscape .....	34

## **Part IV BUILDING DESIGN**

4.1 Integrated Building Design .....	38
4.1.1 Passive Solar Design .....	40
4.1.2 Daylighting Design .....	42
4.1.3 Natural Ventilation .....	44
4.2 Building Envelope .....	46
4.2.1 Windows and Glazing Systems ...	48
4.2.2 Insulation .....	50

## **Part V ENERGY SYSTEMS**

5.1 Energy and Conservation Issues .....	54
5.2 HVAC Systems .....	56
5.2.1 Boilers .....	58
5.2.2 Air Distribution Systems .....	60
5.2.3 Chillers .....	62
5.2.4 Absorption Cooling .....	66
5.2.5 Desiccant Dehumidification .....	68
5.2.6 Ground-Source Heat Pumps .....	70
5.2.7 HVAC Technologies to Consider ...	72
5.3 Water Heating .....	74
5.3.1 Heat-Recovery Water Heating ....	76
5.3.2 Solar Water Heating .....	78
5.4 Lighting .....	80
5.4.1 Linear Fluorescent Lighting .....	82
5.4.2 Electronic Ballasts .....	84
5.4.3 Compact Fluorescent Lighting ...	86
5.4.4 Lighting Controls .....	88
5.4.5 Exterior Lighting .....	90
5.5 Office, Food Service, and Laundry Equipment .....	92

5.5.1	Office Equipment .....	94
5.5.2	Food Service/Laundry Equipment ..	96
5.6	Energy Management .....	98
5.6.1	Energy Management and Control Systems .....	100
5.6.2	Managing Utility Costs .....	102
5.7	Electric Motors and Drives .....	104
5.7.1	High-Efficiency Motors .....	106
5.7.2	Variable-Frequency Drives .....	108
5.7.3	Power Factor Correction .....	110
5.7.4	Energy-Efficient Elevators .....	112
5.8	Electrical Power Systems .....	114
5.8.1	Power Systems Analysis .....	116
5.8.2	Transformers .....	118
5.8.3	Microturbines .....	120
5.8.4	Fuel Cells .....	122
5.8.5	Photovoltaics .....	124
5.8.6	Wind Energy .....	126
5.8.7	Biomass Energy Systems .....	128
5.8.8	Combined Heat and Power .....	130

## **Part VI**

### **WATER AND WASTEWATER**

6.1	Water Management .....	134
6.2	Toilets and Urinals .....	136
6.3	Showers, Faucets, and Drinking Fountains .....	138
6.4	Electronic Controls for Plumbing Fixtures .....	140
6.5	Reclaimed Water .....	142
6.6	Graywater Collection and Use .....	144
6.7	Rainwater Harvesting .....	146
6.8	On-site Wastewater Treatment Systems .....	148

## **Part VII**

### **MATERIALS, WASTE MANAGEMENT, AND RECYCLING**

7.1	Material Selection .....	152
7.1.1	Writing Green Specifications ....	154
7.1.2	Structural Building Components	156
7.1.3	Wood Products .....	158
7.1.4	Low-Slope Roofing .....	160
7.1.5	Floor Coverings .....	162
7.1.6	Paints and Wall Coverings .....	164
7.1.7	Contract Furnishings .....	166
7.2	Operational Waste Reduction and Recycling .....	168
7.3	Construction Waste Management .....	170
7.4	Deconstruction .....	172

## **Part VIII**

### **INDOOR ENVIRONMENTAL QUALITY**

8.1	Indoor Air Quality .....	176
8.2	Controlling Soil Gases .....	178
8.3	Controlling Biological Contaminants ..	180
8.4	Productivity in the Workplace .....	182
8.5	Noise Control and Privacy .....	184

## **Part IX**

### **MANAGING BUILDINGS**

9.1	The Role of Operations & Maintenance (O&M) .....	188
9.2	Building Commissioning .....	190
9.3	Maintaining Healthy Indoor Environments .....	192
9.4	Leased Buildings .....	194
9.5	Measuring and Monitoring Benefits ...	196
9.6	Setting Standards and Training .....	198
9.7	Employee Incentive Programs .....	200

## About the Contributing Organizations

**U.S. Department of Energy** – The U.S. Department of Energy (DOE) contributes to the welfare of the Nation by providing resources to achieve efficiency in energy use, diversity of energy sources, a more productive and competitive economy, improved environmental quality, and a secure national defense. DOE provides scientific and technical information and educational resources to Federal agencies and the public.

**Office of Energy Efficiency and Renewable Energy** – DOE’s Office of Energy Efficiency and Renewable Energy leads the Nation to a stronger economy, a cleaner environment, and a more secure future through the development and deployment of sustainable energy technologies.

**Federal Energy Management Program** – The Federal Energy Management Program (FEMP) reduces the cost of government by advancing energy efficiency, water conservation, and the use of solar and other renewable energy. FEMP accomplishes its mission by creating partnerships, leveraging resources, transferring technology, and providing training and support. Each of these activities is directly related to achieving not only the goals set forth in legislation and Executive Orders, but also those that are inherent in sound management of Federal financial and personnel resources.

**BuildingGreen, Inc.** – BuildingGreen, Inc., provides information on green building to architects, builders, facility owners, and facility managers. BuildingGreen publishes the monthly newsletter *Environmental Building News*; the *Green Building Advisor*, a software tool for identifying strategies for greening buildings; and *GreenSpec*, a directory of green building products.

**ENSAR Group, Inc.** – ENSAR Group, Inc., is an international design consulting firm, based in Boulder, Colorado, specializing in sustainable building development. ENSAR has led the design of many extremely energy-efficient federal buildings. ENSAR coordinates many sustainable design activities, including the development of this publication.

**Greening America** – Greening America is a nonprofit foundation that educates the public and private sectors about energy-efficient and environmentally sound design, innovation, and technology. Greening America, which had its genesis in the Greening of the White House, produces videos, publications, online technical resources, and other materials that show practical examples of how sound energy and environmental decision-making makes good economic sense.

**Sustainable Systems, Inc.** – Sustainable Systems, Inc., is a consulting firm that is dedicated to implementing the principles of sustainability in development. Multi-disciplinary teams of technical professionals, social scientists, economists, and business administrators address problems—from community development to technological issues—from the viewpoint of minimizing the resource and environmental impacts of the activities of its clients, without compromising quality of life.

### Disclaimer

This document was prepared by BuildingGreen, Inc., under the direction of ENSAR Group, Inc., and the U.S. Department of Energy. A significant portion of the content was drawn from the First Edition of *Greening Federal Facilities*, which was produced by Greening America and written by Sustainable Systems, Inc. Any opinions, findings, conclusions, or recommendations expressed herein do not necessarily reflect the views of DOE, BuildingGreen, ENSAR Group, Greening America, or Sustainable Systems. Neither DOE, BuildingGreen, ENSAR Group, Greening America, or Sustainable Systems, nor any of their employees, makes any warranty, express or implied, or assumes any legal liability or responsibility for the accuracy, completeness, or usefulness of any information, apparatus, product, or process disclosed, or represents that its use would not infringe on privately owned rights. Reference herein to any specific commercial product, process, or service by trade name, trademark, manufacturer, or otherwise, does not constitute or imply an endorsement, recommendation, or favoring by DOE, BuildingGreen, ENSAR Group, Greening America, or Sustainable Systems.

# Acknowledgments

**Greening Federal Facilities** is the result of the dedicated efforts of many individuals and organizations. We gratefully acknowledge and thank the following for their commitment to the success of this resource guide.

## PROGRAM MANAGERS:

*Federal Energy Management Program*

Elizabeth Shearer, *Director* (Second Edition)

Mark Ginsberg, *Former Director* (First Edition)

Anne Sprunt Crawley, *Program Manager*

*National Renewable Energy Laboratory*

Andy Walker

*ENSAR Group, Inc.*

Gregory Franta, FAIA

*BuildingGreen, Inc.*

Alex Wilson

*Greening America* (First Edition)

Carl Costello

*Sustainable Systems, Inc.* (First Edition)

Charles Kibert

## CONTRIBUTORS:

Terry Brennan, *Camroden Associates*

Nancy Clanton, *Clanton Engineering, Inc.*

Roger Courtenay, *EDAW*

Greg Franta, *ENSAR Group, Inc.*

Brad Guy, *Sustainable Systems, Inc.*

Doug Hornbeck, *Sustainable Systems, Inc.*

Charles Kibert, *Sustainable Systems, Inc.*

Gail Lindsey, *Design Harmony, Inc.*

Nadav Malin, *BuildingGreen, Inc.*

Peter Rumsey and Leslie Hummel, *Supersymmetry USA*

Joel Ann Todd, *The Scientific Consulting Group, Inc.*

Peter Warshall, *Peter Warshall and Associates*

Alex Wilson, *BuildingGreen, Inc., Editor*

Peter Yost, *BuildingGreen, Inc.*

## REVIEWERS:

Richard (Tim) Arthurs, *U.S. Department of State*

Fred Beason, *U.S. Air Force*

Thomas Bee, *U.S. Department of Defense*

Robert Billick, *U.S. Department of Defense*

Frank Bishop, *National Association of State Energy Officers*

William Brodt, *National Institutes of Health*

William Browning, *Rocky Mountain Institute*

James Buckley, *Chugach Electric*

James Buczek, *U.S. Department of Defense*

Ed Cannon, *National Renewable Energy Laboratory*

Nancy Carlisle, *National Renewable Energy Laboratory*

Millard Carr, *U.S. Department of Defense*

Charles Claar, *International Facility Managers Association*

Nancy Clanton, *Clanton Engineering*

James Crawford, *ASHRAE*

Louis D'Angelo, *U.S. Department of Energy*

Norman Dean, *Green Seal, Inc.*

André Desjarlais, *Oak Ridge National Laboratory*

Eric Dunham, *U.S. General Services Administration*

Patrina Eiffert, *Solar and Wind Energy Specialist*

Neal Elliott, *American Council for an Energy Efficient Economy*

Helen English, *Sustainable Buildings Industry Council*

Larry Farwell, *Water Reuse Specialist*

S. Richard Fedrizzi, *U.S. Green Building Council*

Trudy Forsyth, *National Renewable Energy Laboratory*

Sieglinde Fuller, *National Institute of Standards and Technology*

Harry T. Gordon, *The American Institute of Architects*

Jim Green, *National Renewable Energy Laboratory*

Thomas Hall, *U.S. Department of Energy*

Jeffrey Harris, *Lawrence Berkeley National Laboratory*

James Hill, *National Institute of Standards and Technology*

Adam Hinge, *Sustainable Energy Partnerships*

Kathryn Houser, *Sustainable Living Alliance*

Bill Howe, *FT Energy/E Source, Inc.*

David Hunt, *Pacific Northwest National Laboratory*

Kevin Hydes, *Keen Engineering*

Arun Jhaveri, *U.S. Department of Energy*

Greg Kats, *U.S. Department of Energy*

Sandra Kloth, *International Facility Managers Association*

Martin Kurtovich, *U.S. Department of Energy*

Pat Ledonne, *U.S. Department of Energy*

Russell Leslie, *RPI Lighting Research Center*

Leonard LeVee, *National Association of Vertical Transportation Professionals*

Suzanne LeViseur, *Blue Heron Consulting, Inc.*

David Lewis, *ASHRAE*  
Stan Lindgren, *Electric Power Research Institute*  
Edward Murtagh, *U.S. Department of Agriculture*  
Aimee McKane, *Lawrence Berkeley National Laboratory*  
Fran McPoland, *Office of the Federal Environmental Executive*  
Jack Nichols, *Direct Fire Technical, Inc.*  
Kathy O'Dell, *National Renewable Energy Laboratory*  
Annette Osso, *Public Technology, Inc.*  
Steven Parker, *Pacific Northwest National Laboratory*  
Jim Patchett, *Conservation Design Forum*  
Richard Pinkham, *Rocky Mountain Institute*  
Paula Pitchford, *National Renewable Energy Laboratory*  
Marsha Prillwitz, *U.S. Bureau of Reclamation*  
Bill Sandusky, *Pacific Northwest National Laboratory*  
Dale Sartor, *Lawrence Berkeley National Laboratory*  
Michael Shepard, *FT Energy/E Source, Inc.*

Bahman Sheikh, *Water Reuse Specialist*  
Michael Shincovich, *U.S. Department of Energy*  
Sheri Sorenson, *U.S. Department of Defense*  
Kim Sorvig, *University of New Mexico*  
Steve Strong, *Solar Design Associates*  
Stephanie Tanner, *National Renewable Energy Laboratory*  
Michael Tinkelman, *Electric Power Research Institute*  
Otto Van Geet, *National Renewable Energy Laboratory*  
Carmine Vasile, *WaterFilm Energy, Inc.*  
Andy Walker, *National Renewable Energy Laboratory*  
Steve Williford, *U.S. General Services Administration*  
Philip Wirdzek, *U.S. Environmental Protection Agency*  
James Woods, *U.S. Department of Commerce*  
Paul Wormser, *Solar Design Associates*  
Debra Yap, *U.S. General Services Administration*  
Mia Zmud, *U.S. Environmental Protection Agency*

# Executive Summary

*Greening Federal Facilities, Second Edition*, is a nuts-and-bolts resource guide designed to increase energy and resource efficiency, cut waste, and improve the performance of Federal buildings and facilities. It is intended primarily for Federal facility managers, who administer more resources and have more impact on the environment than any other group in the world. Collectively, they are a powerful force for introducing improvements, and they set an example for the rest of the economy.

This guide highlights practical actions that facility managers, planners, and design and construction staff can take to save energy and money, improve the comfort and productivity of employees, and benefit the environment. The guide is one more step in a national effort to promote energy efficiency and sustainable actions in the nation's 500,000 Federal buildings and facilities.

Executive Order 13123, Section 403(d), instructs Federal agencies to develop sustainable design principles and use them in planning and building new facilities. This order also instructs agencies to optimize life-cycle costs and other environmental and energy costs associated with the construction, life-cycle operation, and decommissioning of a facility. The order's chief goals are to reduce the greenhouse gas emissions associated with Federal facility energy use by 30% by 2010 in comparison to 1990 levels, to reduce energy consumption by 35% between 1985 and 2010, and to increase water conservation and the cost-effective use of renewable energy.

The U.S. Department of Energy's (DOE) Federal Energy Management Program (FEMP) has supported several Federal facilities working to meet these goals through a process called *greening*. The Pentagon, the Naval Support Activity Mid-South in Millington, Tennessee, the Presidio of San Francisco, and Grand Canyon, Yellowstone, and other national parks are some of the many facilities that have well-organized, ongoing greening programs based on comprehensive, facility-wide planning activities. And on May 3, 2001, President George W. Bush announced that the Chief of Staff would review energy usage in the White House, which has also adopted energy-efficient practices. "Since I've asked other agencies to review their policy, I'm going to ask the White House to do the same. We want to be good, efficient users of energy in the White House," President Bush said.

FEMP's experience in helping to transfer the energy and environmental technologies used in the government's greening projects is summarized in this introductory guide. *Greening Federal Facilities* describes a wide range of effective actions that include selecting nonpolluting materials, recycling, conserving energy and water, improving landscaping, and purchasing energy-efficient lighting, heating, and cooling equipment. The guide highlights best practices to:

- Invest in improvements that have quick paybacks and make economic sense;
- Increase the productivity, comfort, and health of employees and building occupants;
- Maximize innovative financing and partnering opportunities;
- Facilitate interagency cooperation;
- Work within the ongoing operations and procedures of facilities management staff; and
- Reduce environmental impacts.

To produce *Greening Federal Facilities*, FEMP assembled an interagency team consisting of experts within DOE, the Department of Defense, the General Services Administration, the Environmental Protection Agency, the Office of the Federal Environmental Executive, and other agencies. FEMP also received considerable support from Greening America, ENSAR Group, Inc., BuildingGreen, Inc., and a team of experts from DOE's Lawrence Berkeley National Laboratory, National Renewable Energy Laboratory, and Pacific Northwest National Laboratory. An advisory group included dozens of leading private-sector experts in architecture, engineering, building operations, and energy and environmental management.

As a result, this guide concentrates on actions that are practical and cost-effective. *Greening Federal Facilities* reflects a long-standing commitment to make government work better and cost less, to use the Federal government's enormous purchasing power to stimulate markets for American energy and environmental technologies, and to save taxpayers money by reducing materials costs, waste disposal costs, and utility bills.





**Part I**  
**RATIONALE**

<b>SECTION</b>	<b>PAGE</b>
1.1 A Tour of the Guide .....	2
1.2 Purpose .....	4
1.3 Current Federal Regulations .....	6

This section describes how *Greening Federal Facilities* is organized and how you as a facility manager or designer can extract information from the guide as efficiently as possible to aid in your decision-making.

The guide emphasizes opportunities in ongoing operations, but this second edition adds more information for project designers. Thus, the guide now provides a starting place for comprehensive information for greening the entire facility—for new projects or renovations as well as ongoing operations of existing facilities. It can serve as a resource for greening information and principles for small design projects that may not go beyond the facility or base for design. For all sections, we encourage users to follow up on the references and go well beyond the ideas and actions introduced.

## Why this guide is particularly useful to facility managers

*Greening Federal Facilities* identifies “opportunities” as focal points for helping facility managers to make changes that will make their operations more sustainable. An opportunity identifies ways to use a particular technology or practice to make major positive changes in a facility to reduce energy use and environmental impacts. A good example of an opportunity is roof repair. The need to replace a roof presents opportunities to increase insulation levels, to install skylights for daylighting, and even to help control stormwater runoff. These opportunities for *Greening Federal Facilities* are described in each technology or design practice section.

## How this guide is organized

The guide is organized into nine major parts:

**Part I – Rationale and Basics** defines the playing field for facility managers and reviews the relevant Federal laws, regulations, and Executive Orders that are helping to drive the greening of Federal facilities.

**Part II – Environmental and Energy Decision-Making** introduces the critically important process of *integration* in design, and reviews economic and environmental analysis, procurement practices, and financing—information that a facility manager can use to justify difficult and sometimes expensive decisions in an era of tight budgets.

**Part III – Site and Landscape Issues** examines the macro scale—how a facility fits into the broader land-use context of the region in a manner that minimizes environmental impact—and addresses specific greening measures relating to the site and landscape.

**Part IV – Building Design** covers design practices to maximize building energy performance, to minimize energy use, and to make use of renewable energy systems, including solar thermal energy, passive solar energy, wind energy, and daylighting. While these measures are often geared to new construction, they will also be useful for existing facilities undergoing significant modifications or renovations.

**Part V – Energy Systems** addresses a wide range of specific technologies and products that can be used to reduce energy use in buildings and make use of renewable power systems; 36 sections provide concise summaries of greening opportunities.

**Part VI – Water and Wastewater** examines water systems and opportunities for conserving this increasingly precious resource—from toilet selection to rain-water harvesting.

**Part VII – Materials, Waste Management, and Recycling** presents information on materials that are specified and used in Federal facilities—from structural building components to floor coverings to furnishings—as well as the management of waste, including ultimate decommissioning and deconstruction of buildings when their useful life is over.

**Part VIII – Indoor Environmental Quality** examines issues relating to the health and productivity of people living and working in Federal housing and other buildings.

**Part IX – Managing Buildings** addresses commissioning, the importance of ongoing maintenance to ensure healthy indoor environments, special considerations relating to leased buildings, and various employee training measures and incentives to help ensure that green facilities will remain green throughout their lifetime.

## What the icons mean

The guide is organized with the help of icons to direct you to particularly pertinent information. These icons are used as the situation dictates and are reasonably self-explanatory.



Tip



Cost Information



Cautionary Note



Example

**Examples** show concrete instances of exactly how particular greening strategies have been successfully used. Look for the “file folder” icon to find these examples; check the Web site listed below for more details on these and other projects.

**References** and **Contacts** in the printed version of this guide will direct you to a few of the key information sources you can use to implement specific technologies and design practices. These information sources are limited because of space constraints. Please see also “Greening Initiatives” at [www.eren.doe.gov/femp/](http://www.eren.doe.gov/femp/) for more information.

# 1.2

## Purpose

*Greening Federal Facilities* is a resource guide for Federal facility managers and designers to assist them in reducing energy consumption and costs, improving the working environment of those facilities, and reducing the environmental impacts of their operations. Showcase initiatives such as *The Greening of the White House* serve as models for initiating environmental and energy upgrades for Federal facilities.

**Sustainability** is a term that covers the wide range of actions needed to reduce the impact of the built environment on the natural environment and, with respect to this guide, is synonymous with “greening.” At its heart, sustainability is about leaving a high quality of life for future generations. For our society to be sustainable, we must (1) use all resources (energy, water, material, and land) efficiently and minimize waste; (2) protect the natural environment, the source of all our resources; and (3) create a healthy built environment for future generations. This guide concentrates on sustainable building and facility actions that are practical and cost-effective.

**This guide was developed by the U.S. Department of Energy (DOE) Federal Energy Management Program (FEMP)** and places key energy and environmental information, along with appropriate economic data, at the fingertips of facility managers and designers to assist in their decision-making. The guide provides a quick introduction to the many technologies and practices involved in greening efforts. It suggests actions that are likely to be successful as first steps in saving energy, water, and resources. Each section is condensed and identifies additional resources to consult for detailed information. *Greening Federal Facilities* emphasizes preventing waste and pollution instead of focusing on the compliance process.

Federal facility managers should be aware that Section 504 of Executive Order 13123 requires the Department of Defense (DOD) and the General Services Administration (GSA) to issue sustainable design and development principles for new construction. These principles and guidance are available and being embedded in the *Whole Building Design Guide* Web site.

### Issues

**So who are these facility managers and why are they important?** Facility managers are the people who manage several hundred thousand facilities worldwide on behalf of the United States. They can be in-house energy managers, solid waste managers, or others with similar responsibilities. In the DOD, they are the Base Civil Engineers (BCE) and Directors of Engineering and Housing (DEH). They are middle-level managers with huge responsibilities and declining human and financial resources. Some facility manager facts for consideration:



#### DID YOU KNOW?

The cost of operating an average Federal building, including the amortized construction cost, is about \$15 per square foot (\$160/m<sup>2</sup>) per year. The cost of the Federal government employees in these buildings is on the order of \$315 per square foot (\$3,390/m<sup>2</sup>) per year. The meaning of this factor of 20 difference between building and occupant costs is clear. If you increase the productivity of the work force by a mere 5% by improving the working environment, the resulting annual savings will exceed the annual cost of building ownership and operation! This guide shows facility managers how to make these positive changes—saving energy, increasing productivity, and greatly reducing facility environmental impacts.

Cost of building per year .....	\$15/sq ft (\$161/m <sup>2</sup> )
Employee cost per year .....	\$315/sq ft (\$3,390/m <sup>2</sup> )
5% productivity improvement .....	\$16/sq ft (\$172/m <sup>2</sup> )

- The Federal facility manager community operates and maintains more than 500,000 buildings owned and leased by the Federal Government.
- The area of these buildings is in excess of 3 billion square feet (275 million m<sup>2</sup>) of floor space.
- These buildings are the homes, working places, and support systems for almost two million Federal workers and many contract staff. They comprise everything from office buildings to power plants and include aircraft hangers, libraries, hospitals, tourist attractions, and prisons.
- These Federal buildings consume in excess of 60 billion kilowatt-hours of energy each year, at a cost of more than \$3.5 billion.
- The water utilized by these buildings and other facilities is staggering in quantity—several hundred cubic miles each year!
- Facility managers purchase billions of dollars of materials annually for operations, maintenance, repair, and renovation. Their procurement decisions dramatically affect the types of products created and manufactured by a wide range of businesses—from paper products to steel panels, from cleaning fluids to hydraulic fluids, and from medicines to pesticides.

**The bottom line is this:** Federal facility managers probably manage more resources and have more impact on the environment than any other group in the world. Entire changes in direction relative to energy and environmental quality are possible through their collective action.

This guide is designed to provide facility managers with the information they need to make wise energy and environmental decisions that not only reduce energy consumption and protect the environment, but also save money and improve the productivity of Federal workers.

**What are the potential savings that facility managers can produce** to both reduce costs and U.S. dependence on foreign energy sources? The Electric Power Research Institute (EPRI) estimates that an aggressive drive to reduce energy costs can reduce electricity use by 24–44%. The Rocky Mountain Institute goes even further and claims potential cost-effective electricity savings of 75%!



## THE KEY PRINCIPLES

The key principles for facility managers to follow to reduce energy and environmental impacts of their operations are:

- **Minimize life-cycle costs** through resource management.
- **Reduce resource consumption:** energy, water, land, materials.
- **Reduce resource waste:** energy, water, materials.
- **Increase equipment and system efficiency:** no-cost or low-cost tune-ups, modifications, replacement.
- **Emphasize source and waste reduction** to all facility users.
- **Create healthy environments** for Federal workers by improving indoor air, light, noise, temperature, humidity.

## Contacts

Federal greening initiatives, including the online version of this guide and *The Greening of the White House*, are located on the Internet at [www.eren.doe.gov/femp/](http://www.eren.doe.gov/femp/).

The *Whole Building Design Guide* can be found at [www.wbdg.org](http://www.wbdg.org).

The FEMP Help Desk at (800) DOE-EREC (363-3732) offers technical support on a wide range of topics to assist facility managers in greening their facilities.

A set of Federal laws, Executive Orders, and Executive Memoranda direct Federal Government facility managers to reduce the energy and environmental impacts of the buildings they manage. These laws and regulations require facility managers to be proactive in their efforts to reduce resource consumption, to reuse and recycle materials, and to dramatically reduce the impacts of Federal Government activities on the environment. **Laws** are the will of the American people expressed through their elected representatives. **Executive Orders** are the President's directives to the agencies. **Regulations** establish procedures and criteria by which decisions shall be made and actions carried out. Laws, Executive Orders, and Regulations all provide a facility manager with the foundation, justification, and mandate to conduct projects designed to improve the energy and environmental performance of their facilities. In this section, the major Federal laws, Executive Orders, and regulations governing energy and environmental actions, together with their important provisions, are listed in reverse chronological order.

## Federal Laws

**Energy Policy Act of 1992 (EPACT).** By amending the National Energy Conservation Policy Act (NECPA), this Act increased conservation and energy-efficiency requirements for the government and consumers. Specifically, it required Federal agencies to reduce per-square-foot energy consumption 20% by 2000 compared to a 1985 baseline; it provided authorization for DOE to issue rules and guidance on Energy Savings Performance Contracts (ESPCs) for Federal agencies; it authorized agencies to participate in utility incentive programs; it required Federal agencies to train and utilize energy managers; it directed the Office of Management and Budget to issue guidelines for accurate assessment of energy consumption by Federal buildings; and it directed GSA to report annually on estimated energy costs for leased space.

**Federal Energy Management Improvement Act (FEMIA) of 1988.** By amending NECPA, this Act mandated a 10% reduction in per-square-foot energy use by Federal buildings between 1985 and 1995, marking the first time that Congress specified the level of savings that had to be achieved.

**Comprehensive Omnibus Budget Reconciliation Act (COBRA) of 1985.** COBRA, a one-year funding bill, provided Federal agencies with an alternative source of funding for energy-efficiency investments. For the first time, agencies were encouraged to seek private financing and implementation of energy-efficiency projects through "shared energy savings" (SES) contracts.

**National Energy Conservation Policy Act (NECPA) of 1978.** NECPA specified the use of a life-cycle costing methodology as the basis for energy procurement policy and specified the rate for retrofit of Federal buildings with cost-effective energy measures. Title V of NECPA was codified as the *Federal Energy Initiative*.

**Resource Conservation and Recovery Act (RCRA) of 1976.** RCRA 6002 established a Federal mandate to "Buy Recycled." RCRA 1008 and 6004 require all Federal agencies generating solid waste to take action to recover it.

**Energy Policy and Conservation Act (EPCA) of 1975.** EPCA was the first major piece of legislation to address Federal energy management. This law directed the President to develop a comprehensive energy management plan. EPCA has largely been superseded by later legislation.

## Executive Orders

**Executive Order 13149,** "Greening the Government through Federal Fleet and Transportation Efficiency," April 21, 2000. This order requires Federal agencies to reduce petroleum use 20% by 2005 compared with 1999 levels. Agencies can accomplish these reductions through the use of more fuel-efficient vehicles, use of alternative-fuel vehicles, reducing vehicle miles traveled, increasing vehicle load factors, and decreasing fleet size.

**Executive Order 13148,** "Greening the Government through Leadership in Environmental Management," April 21, 2000. This order includes requirements for Federal agencies to integrate environmental management into decision making, conduct compliance audits, emphasize pollution prevention, reduce use and releases of toxic chemicals, reduce use of ozone-depleting substances, and use environmentally sound landscaping techniques.

**Executive Order 13134,** "Developing and Promoting Biobased Products and Bioenergy," August 12, 1999. This order is designed to stimulate creation and early adoption of technologies needed to make biobased products and bioenergy cost-competitive. It establishes an Interagency Council, as well as groups within the U.S. Department of Agriculture (USDA) and DOE, to develop a strategic plan for development and use of biobased products and bioenergy.

**Executive Order 13123,** "Greening the Government through Energy-Efficient Management," June 3, 1999. This order is designed to improve energy management

in the Federal government, thereby saving taxpayer dollars and reducing emissions that contribute to air pollution and global climate change. Specific requirements include a 30% reduction of greenhouse gas emissions attributed to facility energy use by 2010 compared to 1990 levels; a 30% reduction of energy use per gross square foot by 2005 and a 35% reduction by 2010 compared to 1985 levels; use of renewable energy and support for the Million Solar Roofs Initiative; and water conservation.

**Executive Order 13101**, “Greening the Government through Waste Prevention, Recycling, and Federal Acquisition,” September 14, 1998. This order created a Steering Committee and a Federal Environmental Executive. It requires EPA to update the *Comprehensive Procurement Guideline* and publish *Recovered Materials Advisory Notices*; develop guidance on environmentally preferable purchasing; and assist agencies in conducting pilot projects using these guidelines. It requires the USDA to prepare a list of Biobased Products and encourages Federal agencies to consider purchasing these products.

**Executive Order 12902**, “Energy Efficiency and Water Conservation at Federal Facilities,” March 8, 1994. (Superseded by Executive Order 13123.) For Federal agencies this order required a 30% reduction in per-gross-square-foot energy consumption by 2005 compared to 1985, a 20% increase in energy efficiency in industrial facilities by 2005 compared to 1990, implementation of all cost-effective water conservation projects, and the procurement of products in the top 25% of their class in energy efficiency. Compliance was required only if cost-effective options were available.

**Executive Order 12873**, “Federal Acquisition, Recycling, and Waste Prevention,” October 20, 1993. (Superseded by Executive Order 13101.) This order addressed the government’s purchasing power, incorporated environmental considerations into decision making, and encouraged waste prevention and recycling in daily operations. Specific targets were not included.

**Executive Order 12856**, “Federal Compliance with Right-to-Know Laws and Pollution Prevention Requirements,” August 4, 1993. This order explains how Federal agencies are to comply with Emergency Planning and Community Right-to-Know (EPCRA) reporting requirements and offers “leadership options” for Federal agencies in meeting the goals of the Order.

**Executive Order 12845**, “Requiring Agencies to Purchase Energy-Efficient Computer Equipment,” April 21, 1993. (Superseded by Executive Order 13123.) This order required all Federal agency acquisitions of microcomputers, monitors, and printers to meet Environmental Protection Agency (EPA) ENERGY STAR® requirements for energy efficiency, including low-power standby features as defined by EPA ENERGY STAR Standards. Agencies were directed to make Federal users

aware of the economic and environmental benefits of energy-saving equipment through information and training classes.

**Executive Order 12844**, “Federal Use of Alternative Fueled Vehicles,” April 21, 1993. This order requires the Federal government to adopt aggressive plans to acquire, subject to availability of funds and considering life-cycle costs, alternative-fueled vehicles, in numbers that exceed by 50% the requirements for 1993 through 1995 set forth in the Energy Policy Act of 1992.

**Executive Order 12843**, “Procurement Requirements and Policies for Federal Agencies for Ozone-Depleting Substances,” April 21, 1993. This order requires Federal agencies to maximize the use of safe alternatives to ozone-depleting substances by: (1) revising procurement practices; (2) modifying specifications and contracts that require the use of ozone-depleting substances; (3) substituting non-ozone-depleting substances to the extent economically practicable; and (4) disseminating information on successful efforts to phase out ozone-depleting substances.

**Executive Order 12759**, “Federal Energy Management,” April 17, 1991. (Superseded by Executive Order 12902.) This order extended the FEMIA energy reduction requirements for Federal buildings to 2000, requiring a 20% reduction in per-square-foot energy usage from 1985 levels.

## Executive Memoranda

**Executive Memorandum** on “Cutting Greenhouse Gases through Energy Savings Performance Contracts,” July 25, 1998. This directs Federal agencies to make greater use of ESPCs in meeting the goals of Executive Order 12902.

**Executive Memorandum** on “Environmentally and Economically Beneficial Practices on Federal Landscaped Grounds,” April 26, 1994. Requires Federal grounds and Federally funded projects, where cost-effective and practicable, to use regionally native plants for landscaping. It also requires facility managers to promote construction practices that minimize adverse effects on the natural habitat; minimize use of fertilizers and pesticides; use integrated pest management techniques; and recycle green waste. Water-efficient practices, such as minimizing runoff, using mulches, irrigating using efficient systems, and performing water audits, are also required. Agencies must also establish areas that demonstrate these principles.

## Code of Federal Regulations

**10 CFR 435** establishes performance standards to be used in the design of new Federal commercial and multifamily high-rise buildings. Some of the guidelines are relevant to retrofits.



## 1.3

# Current Federal Regulations

**10 CFR 436** establishes procedures for determining the life-cycle cost-effectiveness of energy conservation measures, and for setting priorities for energy conservation measures in retrofits of existing Federal buildings. Subpart B establishes an ESPC program to accelerate investment in cost-effective energy conservation measures in Federal buildings.

## Regulations and Guidelines

**Comprehensive Procurement Guidelines.** These guidelines describe minimum recycled content for a variety of products used in construction, offices, and other Federal activities.

**Environmentally Preferable Purchasing Guidance,** August 20, 1999. EPA guidance is based on five

principles: (1) include environmental considerations as part of the normal purchasing process; (2) emphasize pollution prevention early in the purchasing process; (3) examine multiple environmental attributes throughout a product's life cycle; (4) compare environmental impacts when selecting products; and (5) make purchasing decisions based on accurate and meaningful information about environmental performance of products and services.

## References

For more information on Federal rules and regulations relative to energy and environmental actions, contact FEMP's Help Desk at (800) DOE-EREC (363-3732), and see the FEMP Web site, [www.eren.doe.gov/femp/](http://www.eren.doe.gov/femp/).

**Part II**  
**ENVIRONMENTAL AND ENERGY  
DECISION-MAKING**

<b>SECTION</b>	<b>PAGE</b>
<b>2.1 Green Teams – Innovations in Planning, Design, and Operation .....</b>	<b>10</b>
<b>2.2 Economic and Environmental Analysis .....</b>	<b>12</b>
<b>2.3 Green Procurement .....</b>	<b>14</b>
<b>2.4 Alternative Financing .....</b>	<b>16</b>

## 2.1

# Green Teams – Innovations in Planning, Design, and Operation

Buildings or facilities that can be called *green* are different from conventional facilities. How these facilities differ from the norm can vary. They may be built on previously developed *brownfield* (actually or apparently contaminated) sites. They may limit all development impacts to a small portion of a site and maintain the rest as open space. They may have adapted an older building in a particularly responsible way. Nearly all are more frugal in their energy use. Most use water more efficiently. Often materials are carefully selected to minimize *life-cycle* environmental impacts, or the facility may simply be operated in an environmentally responsible manner.

How these facilities got to be “green” differs greatly from project to project, but a lot of it has to do with *process*. Most successful green facilities are developed or renovated with a process that is far from “business as usual.” With a major renovation or new building project, it is a process that includes teamwork among many different players—from architects and engineers to contractors and facility managers. Often there are participants on the team with special expertise in green development. Almost always there is a strong focus on *integration* in this planning and design process, and a desire to find creative solutions to design challenges that yield multiple benefits—for example, a design strategy that at once reduces material use during construction, saves energy during facility operation, and results in a healthier working environment. The integrated design team working on a green facility nearly always has an attitude about “making it happen” and doing so in a way that keeps environmental impacts to a minimum throughout sitework, construction, and operation.

Creating greener facilities is not limited to new buildings or major renovations. Many green principles can be applied to any project. The “Greening of the White House” project, for example, established processes and procedures that will influence ongoing operations and renovations—as those renovations are done.

## Opportunities

With new facilities and major renovations, developing greening goals and design program criteria *before* beginning the actual design is one of the most effective

strategies for achieving sustainability goals with federal projects. Thus, when the architects, planners, engineers, and other participants start developing concepts early in the design process, they are already integrating solutions—and moving toward designs that will likely be both high-performance and sustainable.

## Technical Information

**The first step is to establish goals** or requirements that the project achieve certain levels of environmental and energy performance. The basis for much of this is laid out in Executive Orders, Congressional acts, specific agency mandates, and other policies that are already in place for Federal facilities. Going beyond the minimum environmental and energy requirements for a facility necessitates setting additional goals. This may reference standardized green criteria—for example, achieving a “Silver” rating with the U.S. Green Building Council’s LEED rating system for commercial buildings—or specific criteria may be developed just for the project in question. Within a particular agency, environmental goals for facilities may evolve over time as experience grows—with each project being greener than the previous one. Of course, all of these green goals must support the other needs relating to function, aesthetics, security, cost, and schedule. The challenge is in integrating the environmental goals without compromising any of the primary project needs and objectives (see diagram below).

**Selecting a team** with solid experience in green design is critically important in achieving the environmental and energy goals established for a project. (Whether the goals come first or the team comes first

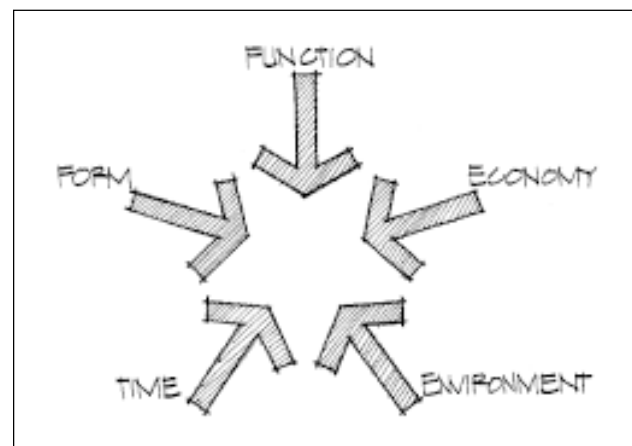

Source: ENSAR Group

will vary by project.) Specifically, the team should include facility representatives (including, for example, the project manager when new construction or major renovation is involved, the facility manager, in-house design and engineering personnel, and other employees to provide breadth), and may include—as needed—architects, engineers, planners, landscape architects, interior designers, energy and sustainable design consultants, community representatives, regulatory officials, and other stakeholders in the project. With new buildings or major renovations, the integrated design team should, to the extent possible, be composed of individuals from within the design and engineering firms hired for the project and from the agency for which the facility is being built or renovated (the client). Outside green expertise is often also needed, but this requirement should disappear over time as more design firms, engineering companies, and agencies build up in-house expertise in green design and development.

The request for proposals (RFP) for building design services should clearly state an intention to select an architectural and engineering (A&E) team with the capability and experience to deliver green buildings as evidenced by successful completed—and monitored—projects. The statement of work for the project should include periodic meetings for team integration and the work of researching and evaluating numerous design options.

**Greening “charrettes”** (focused peer reviews or brainstorming sessions) are effective means of launching and maintaining the green planning process for a facility. Charrettes usually involve the interdisciplinary planning and design team discussed above. Charrette goals are aggressive and push participants to think “outside the box.” These charrettes should have:

- Clear goals and background information;
- The full team (see above)—or at least those team members on-board at the time a charrette is held;
- An agenda that provides for an in-depth introduction (sometimes almost an educational session about the project and sustainable design strategies), break-out groups to address specific design issues in depth, and plenty of whole-group interaction time;



Source: ENSAR Group

- Facilities and logistics that encourage a productive process;
- Good documentation during and after the charrette (this should be specifically budgeted for);
- Follow-up with a series of design and analysis activities; and
- Additional charrettes, workshops, or interdisciplinary design sessions as appropriate for the specific project.

Greening charrettes provide opportunities to work together as a team. This process, in and of itself, may be one of the best things that can be done for the project. Having a whole team seeking ways to achieve project goals can accomplish remarkable things, especially when contrasted with a more conventional process in which interdisciplinary participation more often comes up with reasons why something *can't* be done.

With new buildings or major renovations, this integration can work within a normal design/bid/build process, as well as with design/build contracts. Sound leadership, clearly defined goals articulated in requests for proposals, and cooperative participation in the process will provide effective results.

## References

*Environmental Design Charrette Workbook*, available in print and online from The American Institute of Architects, (888) 272-4115; [www.e-architect.com/pia/pubs/cote.asp](http://www.e-architect.com/pia/pubs/cote.asp).

*Whole Building Design Guide*, available online at [www.wbdg.org](http://www.wbdg.org).

# Economic and Environmental Analysis

Decisions to make changes that improve the energy performance or reduce the environmental impacts of a facility require close attention to economics as well as sustainability. Several key methods can be used for conducting economic analyses to support these decisions. The most important economic analysis method for Federal facility managers and designers, and required by 10 CFR 436, is *Life-Cycle Costing (LCC)*, an adaptation of Cost-Benefit Analysis to applications where benefits are primarily cost reductions. The method discounts future cash flows to their present value in order to compare the life-cycle cost of different options. LCC is particularly important in analyzing the economics of decisions regarding buildings, since buildings and their associated components often have long life cycles. As a result, the benefits (or disadvantages) accrue over a long period of time. If the action leads to reduced costs over its lifetime, it can pay back any additional costs required to take the action and then save money over the long term. Many energy efficiency and water conservation measures might appear to “cost more” than their alternatives if only first costs are considered; through life-cycle costing, these measures often demonstrate that they save money. The regulation 10 CFR 436 requires Federal managers to base decisions on LCC and directs the National Institute of Standards and Technology (NIST) and DOE to provide a standard set of methods and economic parameters such as discount rate.

## Technical Information

**Life-Cycle Costing** analyzes the design of, or changes to, facilities, buildings, or building systems, including initial costs, maintenance costs, repair costs, replacement costs, energy and water costs, and other significant costs over the assumed life of the measure or facility. The method combines all costs into net annual amounts, discounts them, usually to *present value*, and sums them to arrive at total LCC.

**Environmental Life-Cycle Assessment (LCA)** is used to analyze the potential environmental impacts that are associated with the entire life cycle of a product, from the raw materials to final disposal of the

product after its use. This is sometimes called “cradle-to-grave” or “cradle-to-cradle” analysis. It is useful for understanding the advantages and disadvantages of products from an environmental point of view. The strength of LCA is its comprehensive approach; instead of choosing a product based only on its energy efficiency or recycled content, LCA provides information on the full range of environmental attributes. Unlike LCC, which expresses the outcome in a single monetary unit, LCA expresses the results in energy units, mass units of pollutants, potential impacts, and other units. Some LCA practitioners think that a single, simple representation of the outcome, such as a single dollar figure, is not possible.

## ECONOMIC ANALYSIS TOOLS

Several readily available tools can be used to perform an economic analysis for use in the decision-making process.

**The National Institute of Standards and Technology’s Building Life-Cycle Cost (BLCC)** computer program provides an economic analysis of proposed capital investments that are expected to reduce long-term operating costs of buildings or building systems. BLCC also calculates annual and life-cycle CO<sub>2</sub>, SO<sub>2</sub>, and NO<sub>x</sub> emissions for building energy systems. BLCC is based on the ASTM standard life-cycle cost approach and is designed to comply with 10 CFR 436.

In addition to comparing two or more alternatives on an LCC basis, BLCC computes the net savings, savings-to-investment ratio, adjusted internal rate of return, and years to payback.

**The Society for Environmental Toxicology and Chemistry (SETAC) has published guidelines and resources for environmental LCA.** This methodology is widely accepted.

**NIST has also developed a computer program for associating economics and selected environmental impacts** for building products. Building for Environmental and Economic Sustainability (BEES) synthesizes LCA and LCC measures into an overall performance measure.



## LIFE-CYCLE COST ANALYSIS PARAMETERS

- Project Initial Cost
- Annual O&M Costs
- Non-Annually Recurring O&M Costs
- Energy and Water Quantities and Costs
- Salvage Value
- Type of Analysis: Federal, military, private sector
- Treatment of Inflation: constant or current dollars
- Base Date: the date to which all future costs are discounted
- Service Date: the date at which the facility will be occupied or the system put into service
- Study Period: usually the life of the facility or product (40-yr. max. for buildings, 25-yr. max. for mechanical equipment)
- Discount Rate: the investor's opportunity cost, or the minimum acceptable rate-of-return, published annually by NIST
- Energy Cost Escalation Rates: the inflation rates for electricity, gas, oil, coal, and gasoline, published annually by NIST
- Applicable Tax Rates: for private-sector analyses

## References

*Life-Cycle Costing Manual for the Federal Energy Management Program* (NIST Handbook 135) and *Annual Supplement (ASHB) of Energy Price Indices and Discount Factors*. A guide to understanding the LCC methodology and criteria established by FEMP for the economic evaluation of energy and water conservation and renewable energy projects in Federal buildings. Available from the FEMP Help Desk (HB 135) or downloadable from the DOE FEMP Web site (ASHB).

*BLCC4 - Building Life-Cycle Cost (BLCC) – Computer Program, User's Guide and Reference Manual*, (NIST IR 5185-2). This program is updated annually on April 1 with current FEMP discount rates and DOE energy price escalation forecasts. It is available free of charge from the FEMP Help Desk or can be downloaded from the DOE FEMP Web site.

Three video training films offering an introduction to FEMP life-cycle costing methods are available from Video Transfer Inc.: (1) "An Introduction to Life-Cycle Cost Analysis," (2) "Uncertainty and Risk," and (3) "Choosing Economic Valuation Methods." For ordering information, contact VTI at 5709-B Arundel Ave., Rockville, MD 20852 or at (301) 881-0270.

Training workshops on the life-cycle cost method and the use of BLCC and associated programs are offered in various locations throughout the country. Contact the FEMP Help Desk or go to the FEMP Web site.

## Contacts

The FEMP Help Desk at (800) DOE-EREC (363-3732) or FEMP's Web site: [www.eren.doe.gov/femp/](http://www.eren.doe.gov/femp/).

NIST Office of Applied Economics: (301) 975-6132, (301) 975-5337 (fax); [www.bfrl.nist.gov/oe.html](http://www.bfrl.nist.gov/oe.html).

Information about Product Life-Cycle Assessment is available from the Society for Environmental Toxicology and Chemistry, Pensacola, FL; (904) 465-1500; [www.setac.org](http://www.setac.org). The SETAC LCA methodology is the most widely accepted procedure for determining the environmental impacts of materials or products.

Federal facility managers are required to comply with numerous Executive Orders and individual agency or departmental policies that are designed to encourage green procurement of everything from computer equipment to building materials to A&E services. Resources and references are available to assist in identifying and buying greener products and services within the constraints and requirements that apply to Federal procurement. In addition to meeting requirements, the Federal government can use its buying power to encourage product stewardship programs (for example, by purchasing third-party-certified wood products, leasing rather than purchasing long-life products, and participating in manufacturer “take-back” programs for end-of-life recycling of products) and to further the use of renewable energy sources (for example, purchasing “green electricity” from power companies that offer it).

### Opportunities

The Federal government is the world’s largest single buyer of many products. By providing a large, reliable market for green products and services, Federal purchasing helps to lower the costs of these products and services for all consumers. In addition, by demonstrating the effectiveness, feasibility, and value of these products and services, Federal agencies provide a model for other government purchasers as well as the private sector. As a result, Federal facility managers play a vital role in developing the market for green products and services. The Federal government also plays an important role in encouraging A&E firms to build their capabilities in green design; several Federal agencies have built expertise in sustainable design into their procurement criteria, thus bringing mainstream firms into the green building field. Procuring “green electricity” (which is generated from renewable energy sources) provides a high-visibility and relatively easy way to help make a facility greener. Some utility companies are now offering green electricity at a relatively modest premium that many Federal facility managers will find affordable. Deregulation is expected to significantly expand green electricity options.

### Technical Information

Relevant requirements for Federal procurements include:

- Executive Order 13123, “Greening the Government Through Efficient Energy Management”
- Executive Order 13101, “Greening the Government Through Waste Prevention, Recycling, and Federal Acquisition”
- Executive Order 12902, “Energy Efficiency and Water Conservation at Federal Facilities”
- Executive Order 12873, “Federal Acquisition, Recycling, and Waste Prevention”
- Executive Order 12843, “Procurement Requirements and Policies for Federal Agencies for Ozone-Depleting Substances”
- Executive Memorandum, “Environmental and Economically Beneficial Practices on Federal Landscaped Grounds”
- Energy Policy Act of 1992
- Federal Acquisition Regulation Part 23, Environment, Conservation, Occupational Safety, and Drug-Free Workplace
- Comprehensive Procurement Guidelines for Procurement of Products Containing Recovered Materials, applicable to agencies purchasing \$10,000 or more of a designated product.

More detailed descriptions of these and other requirements are contained in *Section 1.3 – Current Federal Regulations*.

In addition to these requirements, other considerations for greener procurement of products and services include the following:

- In some cases, procurement can be linked to “take back” programs, in which materials salvaged from demolition can be returned for refurbishing, re-manufacture, or recycling. For example, at least one large ceiling tile manufacturer has implemented such a program.
- At least one carpet manufacturer offers an option to lease carpet rather than purchase it, and a large manufacturer of heating, ventilating, and air-conditioning (HVAC) equipment is expected to launch

a leasing program. Under these leases, the manufacturer provides a service—covering the floor or chilling water, for example—and takes responsibility for replacing worn material or equipment as needed.

- *Integrated design* is the key to the most cost-effective green procurement strategy. By exploring the interactions among various design options and purchases, we can often identify first-cost savings for certain products that can be applied to purchases of other, more expensive, items, so that total project costs are no higher. For example, increases in energy efficiency (through improvements in the building envelope) might enable the HVAC equipment to be downsized, with an accompanying reduction in HVAC cost that can finance potentially higher cost windows, insulation, and other envelope features. See *Section 4.1 – Integrated Building Design*.
- Decisions about which products are “greenest” will vary from one site or location to another based on what is produced locally as well as which designs and products are best suited to the opportunities and constraints of the site and location.

Green procurement involves contracting for A&E and other consulting services as well as purchasing of products and services. Traditional Federal contracting has been based on selecting the lowest-cost (sometimes least-qualified) bidder, with no requirements for experience or expertise in green design. Some agencies are changing their process and criteria for procurement of A&E services to incorporate green features. Innovations include:

- Incorporating specific criteria into procurement language—the Navy now requires all A&E firms to demonstrate qualifications in sustainable design.
- Using performance contracts.
- Using incentive contracts—the Pentagon promoted the use of environmentally preferable materials in a recent repaving of its parking lots by offering up to a 10% incentive for the contractor to identify and use preferable products, defined by specific attributes. (See *Paving the Road to Success*, EPA publication 742-R-97-007.)
- Using design-build contracts instead of design-bid-build to establish performance goals, encourage incorporation of new materials and technologies, and facilitate integrated design during the early stages of the project.

## References and Contacts

The Federal Procurement Challenge is a voluntary, government-wide program. Begun in 1995, the program has attracted 22 Federal agencies, representing over 95% of Federal purchasing power. These agencies committed themselves to provide leadership by purchasing products that are in the upper 25% of energy efficiency for all similar products when they are cost-effective. FEMP supports Challenge participants with technical support, product efficiency recommendations (including fact sheets), software, basic ordering agreements for specific energy-saving products and services, and assistance in using ESPCs to finance specific purchases and initiatives.

DOE issues *Product Energy-Efficiency Recommendations* for products. The *Recommendations* are easy-to-use, two-page summaries that provide Federal buyers with information on efficiency, cost-effectiveness, buyer tips, and additional sources of information. They can be obtained through the FEMP Help Desk or Web site.

The *Comprehensive Procurement Guidelines*, associated *Recovered Materials Advisory Notices*, and *Fact Sheets* can be obtained through the EPA Web site ([www.epa.gov](http://www.epa.gov)).

Copies of Executive Orders can be obtained through the White House Web site ([www.whitehouse.gov](http://www.whitehouse.gov)).

The GSA highlights “environmentally preferable” products on its Planet GSA Web site ([hydra.gsa.gov/](http://hydra.gsa.gov/)) and in its supply schedule.

The *GreenSpec* product directory includes comprehensive listings for over 1,200 green building products selected by the publishers of *Environmental Building News* ([www.greenspec.com](http://www.greenspec.com), [www.BuildingGreen.com](http://www.BuildingGreen.com)).

The *Harris Directory* is a computer database of recycled and other pollution-preventing materials ([www.harrisdirectory.com](http://www.harrisdirectory.com)).

The *REDI Guide* is a Web-based database of green products and materials ([www.oikos.com](http://www.oikos.com)).

The Certified Forest Products Council provides a database of certified wood products ([www.certifiedwood.org](http://www.certifiedwood.org)).



Historically, Federal appropriations have provided the bulk of financing for Federal facility projects. In an era of steady or decreasing Federal budgets, however, funds are not always available from direct appropriations, and financing greening projects might present a challenge. In some cases, there is no cost for these projects—green materials, systems, or procedures can often be substituted for their less-green counterparts at no cost. In other cases, immediate savings from integrated design will pay for the cost of greening projects. In many cases, however, an initial investment will be needed to support improvement projects. There are a variety of approaches that Federal facility managers can use to finance greening efforts.

## Opportunities

When considering greening strategies, the team should look for synergies that yield reductions in both first costs and life-cycle costs. If it is possible to downsize HVAC equipment as a result of reduced cooling or heating loads or to reduce landfilling costs by reusing demolition waste, the amount of necessary financing will be reduced. (See *Section 4.1 – Integrated Building Design* for more information on saving money through integration.)

## Technical Information

**FEMP offers technical assistance, training, and guidance manuals** to assist Federal agencies in identifying, evaluating, and selecting financing mechanisms. Additional information on these mechanisms, training opportunities, and resource materials are available on the FEMP Web site.

**Energy Savings Performance Contracts (ESPCs)**, authorized by the Energy Policy Act of 1992, allow *Energy Service Companies (ESCOs)* to assume the capital costs of installing renewable-energy systems or systems for conserving energy or water. ESPCs can be used for leased or owned facilities. There are two main types of ESPCs. Under a *Site-Specific ESPC*, the energy service company guarantees a fixed amount of energy cost savings throughout the life of the contract with the facility (up to 25 years), and payments to the ESCO must be less than cost savings in energy and related operations and maintenance (O&M). Agencies retain the remainder of the cost savings for themselves. *Regional Super ESPCs* (established by DOE) or *Area-wide ESPCs* (established by the Army) are similar to conventional, site-specific ESPCs except that they are designed to encompass more than one site. Furthermore, under these *Indefinite Delivery–Indefinite Quantity* contracts, facilities within a defined geographic area can take advantage of streamlined procedures by issuing a site-specific delivery order within an established contract vehicle. This saves time and resources that would have been needed to plan and issue

a competitive procurement. In addition to the Regional Super ESPCs, there are also *Technology-Specific Super ESPCs* that cover the entire nation for procuring specific technologies, such as solar-thermal concentrating systems, photovoltaics, and ground-source heat pumps. The legislation authorizing ESPCs also requires that performance be verified; FEMP provides guidance regarding measurement and verification (see the FEMP Web site).

**Utility Incentive Programs** provide another possible source of project financing. Utility programs may include rebates, shared savings programs, partnership programs, and technical assistance. (Some utility programs are in flux because of the uncertainty surrounding deregulation of the industry.) In efforts to address this new competitive market, FEMP has established a Federal Utility Partnership Working Group; GSA has established area-wide utility contracts to cover energy audits, designs, construction, operations, and maintenance; and DOD has developed a model agreement with the Edison Electric Institute (EEI) to expedite contracting between DOD and EEI. In one example of such a partnership, FEMP developed a three-way partnership to finance electrical equipment upgrades at Fort Lewis, Washington. Under this agreement, Tacoma Public Utilities managed the work by the energy services company and paid for 85% of the cost; Fort Lewis paid for 15%. Tacoma Public Utilities plans to recoup its investment by selling unused energy to the Bonneville Power Administration. Fort Lewis will realize a \$700,000 annual savings for its \$1.8 million investment.

## References

FEMP offers several resources to assist agencies in considering and obtaining alternative financing. Documents and information on other resources are available through the FEMP Web site ([www.eren.doe.gov/femp/](http://www.eren.doe.gov/femp/)). These resources include (1) *Energy Savings Performance Contracts or Utility Energy Services Contracts: Guidance on Choosing a Financing Option*; (2) workshops for Federal employees with information they need to participate in the Super ESPC Program; (3) seminars for the private sector on ESPCs; (4) Super ESPC delivery order guidelines; (5) *Practical Guide to Savings and Payments in Super ESPCs*; (6) tools for regional and technology-specific ESPCs; (7) two classroom courses on utility incentives, one to present a detailed review of financing options and one on deregulation effects and how to handle competitive power procurements; (8) a Utility Action Kit to assist energy managers in implementing projects; (9) model documents, such as the EEI/DOD Model Agreement; and (10) measurement and verification guidelines.

## Contacts

U.S. Department of Energy, FEMP Help Desk, (800) DOE-EREC (363-3732), and see the list of DOE Regional Office contacts on the FEMP Web site, [www.eren.doe.gov/femp/](http://www.eren.doe.gov/femp/).



**Part III**  
**SITE AND LANDSCAPE ISSUES**

<b>SECTION</b>	<b>PAGE</b>
3.1 Land-Use Planning and Transportation .....	20
3.2 Site Selection.....	22
3.3 Building Placement and Orientation on a Site ...	24
3.4 General Landscaping Principles .....	26
3.5 Stormwater Management .....	28
3.6 Plantings in the Sustainable Landscape.....	30
3.7 Water Use in the Landscape .....	32
3.8 Chemical Use in the Landscape .....	34

## 3.1

# Land-Use Planning and Transportation

Promoting and encouraging modes of transportation other than the single-occupancy vehicle is the key to greening Federal facilities with respect to land-use planning for transportation. While the National Environmental Policy Act (NEPA) process for Federal facility development typically considers the compatibility of candidate sites with responsible transportation management goals, there is also much that can be done at existing facilities within typical planning “life cycles” to improve relative greenness. Promoting and creating incentives for public transportation, improving conditions for other modes of commuting, and retrofitting parking areas to be more environmentally responsible are among the possible improvements.

Land-use planning for transportation begins with the choice of site or property for development. Federal facilities are typically planned today to take advantage of existing or proposed public transportation systems. Keeping intense development closer to public transportation opportunities generally can save outlying and less-accessible areas for other uses or for preservation and protection.

Land-use planning has as its basis the idea that the use of land can be efficiently carried out to meet human needs and can be responsibly planned to conserve the finite resource base that it represents. With such a large proportion of our land devoted to, or influenced by, transportation, this is an extremely important area of attention.

## Opportunities

When we can influence the development process prior to site selection and acquisition, there is tremendous opportunity to create facilities with far more responsible land-use and transportation components than are typical. Only rarely, however, can we influence decisions at such a macro scale. Usually, we have to work with a site that has already been selected, or—even more commonly—we have to work with existing facilities. Here we have greening opportunities of two kinds. One has to do with providing for, and creating incentives for, alternative transportation methods: bicycle, carpooling and public transit. The comfort and safety of these alternative transportation modes play a large role in breaking reliance on the single-occupant automobile. The second opportunity lies in how parking, typically the first- or second-largest land use, can be made more environmentally responsible.

## Technical Information

Suggested practices for greening transportation to and from Federal facilities and dealing more responsibly with land use within a facility are addressed below.

### OPPORTUNITIES OTHER THAN THE AUTOMOBILE

Many people avoid anything other than commuting by automobile because of the difficulties associated with changing one’s mode of transportation. Providing amenities on site that foster and facilitate people’s use of public transit (including approaches like the “Kiss and Ride” program in the Washington, D.C., area), ride-sharing, carpooling, vanpooling, and other multi-occupant modes of commuting can reduce the land area necessary for parking and vehicle circulation at a facility. Try to develop a traffic management plan that:

- Works with public transit systems to encourage and promote their use;
- Provides incentives or “perks” to employees for ride-sharing and use of public transit—incentives might include privileged parking locations for vans, vehicles for ride-sharing, and bus passes, often provided at volume discounts by bus systems to large employers;
- Comfortably accommodates other modes of transportation on site, perhaps at the expense of convenient, close-in parking;
- Lowers the number of employees arriving in single-occupancy vehicles by encouraging other modes of transportation;
- Proactively works with the local municipality to provide safe pedestrian crossings on adjacent streets, and on routes leading to and from public transit stops or facilities (examine TEA-21 and other Federal alternative transportation funding mechanisms that might improve access to public transit); and
- Provides shuttle service to and from airports, train stations, light rail stops, and even bus stops (examine private/public partnership opportunities for multiple-user benefits).

For bicyclists and pedestrians:

- Provide safe and clearly defined pathways across and around the facility, including all entrances;

- Provide pedestrian-friendly access to public transit/transportation, including all-weather shelters and well-lighted, secure facilities and routes;
- Provide bicycle parking and locking facilities near supervised or well-used public areas that are well-lighted and secure—perhaps even inside or at least under shelter;
- Provide designated on-site bicycling routes that are user-friendly; and
- Provide shower facilities for bicycle and pedestrian commuters.



The National Institutes of Health (NIH), in Bethesda, Maryland, has contracted for parking spaces at facilities located several miles from the campus. Employees have the option of parking at one of those locations and riding a shuttle bus to the campus. The park-and-ride system shortens the employees' trips and reduces the number of parking spaces that would otherwise have to be provided on campus. About 500 employees, out of 9,000 who drive, were using this option in 2000.

## PARKING INFRASTRUCTURE

Parking can be the single biggest user of land area at a facility. Anything that can reduce the area devoted to parking results in a reduction of polluted surface runoff (stormwater), greater groundwater recharge, more green area for employee recreation, a reduction in localized warming from parking lots (“urban heat island” effect), and improved air quality from more oxygen-producing plants. Practices that can create more environmentally responsible surface parking include the following:

- Lay out surface parking lots to allow for sheetlike drainage to infiltration and bioremediation strips and swales, minimizing points of concentration and piped flow, and maximizing groundwater recharge and pollutant removal (see *Section 3.5 – Stormwater Management*).
- Lay out parking lots to minimize changes to the topography (and therefore impacts on groundwater and soil regimes) by planning parking aisles that run parallel to the topographic contours, by leaving sloped areas between parking terraces, and by making runoff more sheetlike and less concentrated.
- Plant windrows and hedgerows of trees to lessen the microclimatic impact of solar radiation absorption of large dark surfaces of asphalt paving. This can also improve comfort and reduce automobile air-conditioning use when employees get in their cars.
- Plan and design stormwater detention/retention facilities that are aesthetically attractive and environmentally responsible by using pond aeration and by establishing planted littoral (shoreline) shelves at the water’s edge to support water-loving plant species that, in turn, can improve water quality.
- Consider the use of above- or below-ground parking structures when climate, space limitations, or other needs (such as stormwater management and protection of sensitive wetland habitat) suggest it. While parking structures tend to be built for only one purpose and one general category of size of vehicle, keep in mind that, with the pace of technological change, the needs and design requirements of these facilities may significantly change in the future. Designing parking structures for adaptability is advisable. Also consider features like natural-gas fueling and electric-vehicle recharging.
- Public/private partnerships for parking structures—particularly when planned with corporate neighbors—can provide incentive-based opportunities for the private sector. Building parking facilities that allow weekend or off-peak usage by others should also be considered—the objective being to get the most use out of the investment and possibly realize broader benefits to both the community and the facility.

## References

- Ewing, Reid, *Best Development Practices*, American Planning Association, Washington, DC, 1996.
- Schwarz, Loring, ed., *Greenways: A Guide to Planning, Design, and Development*, Island Press, Washington, DC, 1996.
- Childs, Mark, *Parking Spaces: A Design, Implementation, and Use Manual for Architects, Planners, and Engineers*, McGraw-Hill, New York, NY, 1999.

## Contacts

American Planning Association, 122 South Michigan Avenue, Suite 1600, Chicago, IL 60603; (312) 431-9100, (312) 431-9985 (fax); [www.planning.org](http://www.planning.org).

*Site selection* refers to the choice of a site; *site planning* refers to the laying out of proposed uses within property boundaries. The *siting* of structures on a particular site is a subset of site planning but is addressed in *Section 3.3 – Building Placement and Orientation on a Site*. Both site selection and site planning have a major impact on the relative “greenness” of any Federal facility being planned. Site selection includes such issues as transportation and travel distances for building occupants, impacts on wildlife corridors, and impacts on the hydrology (stormwater flows, wetlands, etc.). Decisions made during site planning will have an impact on the immediate natural community as well as on the energy consumption of buildings and the comfort of their occupants. Thoughtful placement of the building on the site promotes energy conservation by taking advantage of natural site features such as breezes, sunlight, shade, and topography. Good site planning minimizes site-clearing (saving money), and preservation of existing vegetation may provide a low-maintenance landscape that avoids supplemental irrigation and fertilizer. Mature stands of native vegetation often provide the desired energy-conserving shade and wind control that would otherwise require years to develop from expensive new plantings.

## Opportunities

Opportunities for creating greener facilities arise throughout the site selection and site planning stages of design. Try to influence the process at the very earliest stages of planning—well before a site is selected, if possible. If a site is already selected, find out what is there and try to influence both the overall site planning and the siting of specific buildings and other facilities. Site planning and building siting should be considered part of the overall building design, particularly as related to cooling-load avoidance, natural daylighting, passive solar heating, and natural ventilation.

## Technical Information

### SITE SELECTION

Select sites that reduce occupants’ dependence on automobiles. Developing an inner-city site with ready access to light rail, for example, instead of a suburban “greenfield” site can dramatically reduce the overall environmental burdens of a facility, including the impacts of a facility’s operation as well as the impacts of getting workers to and from the facility.

Avoid development that will interrupt wildlife corridors or break up contiguous natural areas. Loss of wildlife habitat is one of the most significant—and challenging—impacts of development today.

Pay attention to cultural and agricultural resources when choosing a site and avoid disruption whenever possible.

### SITE PLANNING AND FACILITY SITING

**Site inventory surveys** should be thorough and objective and include the following: geology, topography, orientation and slope aspect, soils, hydrology, vegetation, and wildlife habitat. All structures and physical construction on the site should be mapped and all prior uses noted. Vegetation surveys should show the location and character of all vegetation communities as well as important individual trees. Soil analysis based on random sampling should report soil type, soil pH, total soluble salts, and infiltration rate. Soil texture, percentage of organic matter, and water-holding capacity should also be determined. County agricultural extension offices can perform these analyses for a modest fee.

**Proximity of trees to structures** and constructed features should take into account the type of trees (deciduous vs. coniferous, for example), growth rate, life span, and ultimate canopy shape—all of which can influence both shading and solar/daylighting access. When existing tree stands are too dense, selective thinning and lifting the canopy will improve air movement, enhance ground-level vistas, and provide remaining trees with room to more fully develop. If possible, consult an arborist.

**Preserve high-quality habitat.** Strive for large contiguous natural areas that are connected by wildlife corridors. Size of habitat and corridor requirements vary widely by region and any species of particular concern. For details of habitat protection and corridor design, contact the local office of the state's natural resources department or the regional office of the U.S. Fish and Wildlife Service.

**Channel development** into areas that have already been disturbed. Existing infrastructure, facilities, and cleared areas should be preferentially used, resulting in lower development costs and leaving less-disturbed areas intact. On damaged sites, ecological restoration can become part of the development plan: revegetation, wetlands restoration, invasive species removal, and habitat reconstruction can both help the environment and foster a positive public image in the community.

**Significant wetlands** and significant uplands should be protected through careful site planning. While wetlands are designated differently by various regulatory authorities, this variability does not diminish the ecological importance of protecting and enhancing these natural features. Uplands affect wetlands and require their own forms of protection.

**Buffers should be retained** along wetlands, erosion-prone slopes, and other fragile areas or locations of special ecological importance.

**Natural drainage systems** should be used and preserved wherever possible. Site buildings, roadways, and parking so that water flowing off the developed site during extreme storm events will not cause environmental damage (see *Section 3.5 – Stormwater Management*). Also consider how drainage systems will be



Photo: Warren Gretz

*Careful use of trees around buildings, such as at this Lakewood, Colorado, municipal center, can reduce energy use by blocking unwanted solar gain.*

affected *during* construction, and avoid sites where impacts will be excessive.

**Desirable locations for driveways and parking** are generally on south-facing slopes or the south sides of buildings in snowy climates, and on the east or north sides of buildings in southern climates—the latter reducing heat buildup during hot afternoons (existing or newly planted shade trees can cool these surfaces). These needs must be balanced with other priorities, however; there are often more important considerations.

A “**wind rose**” is a **diagram** of annual wind directions and velocity for a particular region. It is useful for plotting information on winds in order to provide

natural shielding from adverse winds and to utilize favorable winds for passive cooling. Regional wind rose information is usually available from the nearest airport, reference library, or county agricultural extension office.

## References

Thompson, William, and Kim Sorvig, *Sustainable Landscape Construction: A Guide to Green Building Outdoors*, Island Press, Washington, DC, 2000.

McHarg, Ian L., *Design With Nature, 25th Anniversary Edition*, John Wiley & Sons, New York, NY, 1992.

Marsh, William M., *Landscape Planning: Environmental Applications, 3rd Edition*, John Wiley & Sons, New York, NY, 1997.



## 3.3

# Building Placement and Orientation on a Site

Where buildings are situated on a site and how they are oriented provide significant opportunities to reduce overall environmental impacts—including both direct site impacts and indirect impacts relating to energy consumption by the building(s). A well-planned and optimally oriented building relates well to its site and the climate. This maximizes opportunities for (1) passive solar heating when heating is needed, (2) solar heat gain avoidance during cooling times, (3) natural ventilation as needed, and (4) high-quality daylighting throughout the year.

### Opportunities

Carefully planned building placement should minimize stormwater runoff, minimize habitat disturbance, protect open space, reduce the risk of erosion, and save energy by providing for solar energy utilization, natural ventilation, and daylighting. These opportunities should be acted on as early as possible in the site selection and site planning process—even before pre-design so that site issues can inform the process. Some opportunities continue through design and, to a limited extent, through construction and landscaping.

### Technical Information

**Where buildings are situated** on a site can have a huge impact on the overall *greenness* of a facility. Try to *concentrate* development impacts while retaining as much undeveloped open space as possible. Locate build-

ings and roadways to minimize site disturbance, particularly where significant wetlands and wildlife habitat (including wildlife corridors) are present. Keeping buildings and infrastructure on an area of the site close to public highways and with easy access to utilities will reduce material use, minimize new impervious surfaces, and permit as much open space as possible to be retained.

**Slope and soils considerations** are very important in building and infrastructure placement. Consider both long-term stormwater management issues and short-term erosion impacts during construction. Avoid very steep slopes and those with unstable soils.

**Site plans** that consider orientation in the placement of buildings provide abundant opportunities to benefit from natural systems—bioclimatic design. The options illustrated below compare the layout for a conventional military base and one planned with solar orientation in mind. These site plans are for the same property. Site topography needs to be considered too. Slopes to the south allow for plenty of solar access, while north-facing slopes will provide good shading opportunities.

**Rectangular buildings** should be oriented with the long axis running east-west. In this configuration, east and west walls receive less direct sun in summer, so unwanted heat gain is reduced. This same configuration works well for buildings in cold climates where passive solar heat gain on the south side during the winter is desired. A long, narrow building plan also facilitates daylighting and natural ventilation.

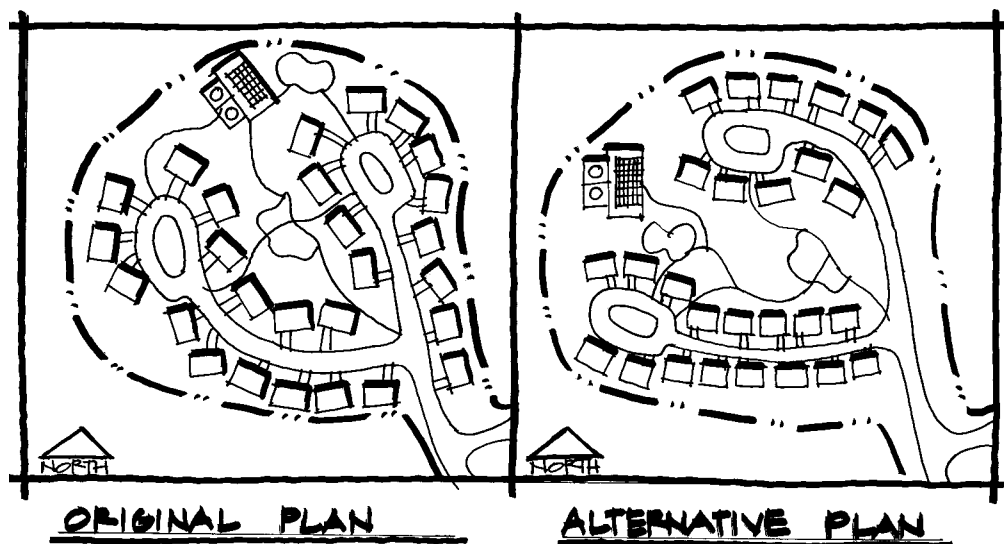

*This site plan illustrates two variations of the same military housing project. The alternative plan has excellent orientation on all buildings, the original plan doesn't.*

Source: ENSAR Group

Solar energy at various orientations at 40° latitude.

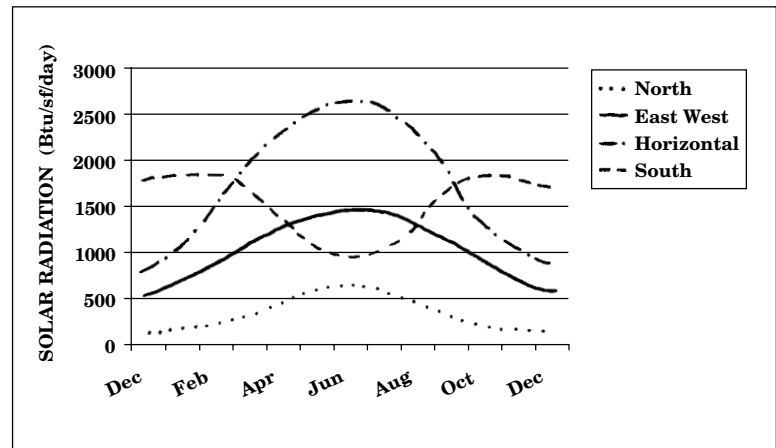

Source: ENSAR Group

**Solar energy** is both a friend and a foe of low-energy building design. The diagram above illustrates the amount of daily solar energy availability relative to orientation for each month of the year at 40° latitude. As can be seen, south-facing walls achieve the most solar gain during the winter, while the least in the summer. East and west vertical orientations and horizontal orientation (skylights) all result in more heat in the summer than winter. The optimal orientation depends upon what the application is. For example, when trying to use solar energy during the winter for passive solar heating, south-facing glazing is desired. South-facing glass is relative easy to shade with an overhang or awning during the summer to minimize solar heat gain. North-facing glass receives good daylight but relatively little direct insolation, so heat gain is less of a concern. East- and west-facing glazing is the most difficult to control (because of low sun angles) and the greatest contributors to unwanted heat gain. Daylighting can be achieved with almost any orientation, but control of natural light is critical and will depend on the glazing area, the types of glazing used, daylighting design strategies, and other key issues.

**Proximity of trees to buildings** should take into account growth rate, life span, and ultimate canopy shape. Planting decisions and decisions about which trees to leave require a careful balance between the desirable qualities of shade with the loss of future solar access. Evergreen trees may provide shade and block cold winter winds, but on the south side deciduous trees are preferred because they lose their leaves and admit more sun in the winter. When existing tree plantings are too dense, selective thinning and lifting the canopy may improve air movement, enhance ground-level vistas, and allow remaining trees better growth potential. Special care should be used in construction near trees. Important plant areas and trees to be retained should be effectively barricaded to prevent damage (at a minimum, fence off the area around

trees to the outer perimeter of branches—the “drip line”). Tunnel for utility lines instead of trenching near trees. When cutting roots and limbs, cut cleanly. Water well before major cutting to invigorate the tree. When major roots are cut, light canopy pruning will reduce transpiration stresses.

**Driveways and parking lots** should be located on the east or north side of buildings in southern climates. This reduces heat buildup during hot afternoons. Existing or newly planted shade trees can cool these surfaces. In cold climates, driveways and parking lots work better on the south and west sides of buildings to melt snow. In relatively populated (town) locations, it is generally preferable to hide parking behind buildings to present a *pedestrian-friendly* face to the community.

**Account for prevailing winds.** A *wind rose* is a diagram of annual wind directions and velocity for a particular region. It is useful for plotting information on wind in order to provide natural shielding from adverse winds in cold weather and to benefit from favorable winds for passive cooling measures. Wind rose information is usually available from airports, larger libraries, Internet sources, and county agricultural extension offices.

## References

Thompson, William, and Kim Sorvig, *Sustainable Landscape Construction: A Guide to Green Building Outdoors*, Island Press, Washington, DC, 2000.

Olgay, Victor, *Design with Climate*, Princeton University Press, Princeton, NJ, 1963.

EDAW, *Sustainable Planning: A Multi-Service Assessment*, 1999. Naval Facilities Engineering Command, Washington, DC, Contract #96-D-0103.

Good general landscaping practices increase the ecological value of landscapes while reducing energy use, minimizing or eliminating the use of harmful pesticides, minimizing the use of potable water, and decreasing stormwater runoff. Recommended practices include choosing appropriate plantings, responsibly managing water on the site—both water we add and rainfall—and choosing appropriate materials for landscape construction. Through good landscaping we can complement natural ecosystems, preserve the inherent beauty and functionality of a site, maintain and enhance wetlands and natural water flows, help building occupants appreciate nature, and educate visitors about the value of responsible landscape management. Another important benefit of “greener” landscaping can be the reduction of energy use—both directly in the maintenance program (less mowing, for example) and indirectly by reducing the “heat island effect” (regional or localized warming due to paving and other surfaces that heat up), which drives up cooling energy use.

## Opportunities

Opportunities to improve landscaping practices exist in virtually any facility with outdoor grounds. Improvements can be implemented at any time, though many are seasonal. Some landscape construction measures are most easily included during initial development of a facility.

## Technical Information

All landscapes change, grow, and evolve in a process of succession. By sensitively working with these natural dynamics, good landscaping can provide economy, efficiency, and satisfaction for the workforce.

Good general landscape principles consider site functions for humans and wildlife and anticipate cycles of use throughout the day, week, and year. They take into consideration extremes of climate, annual solar angles with patterns of light and shade, annual direction and intensity of breezes, even seasonal color of flower and leaf. A good landscape plan takes advantage of the aesthetics of site orientation and helps building occupants “celebrate” nature (which some experts suggest may have a beneficial effect on productivity in the workplace).

## PLANT MATERIALS

**Appropriate plant selection** means “using the right plant in the right place.” Native plants (or others well-adapted to local conditions) should be used whenever possible. Plant growth rate, size at maturity, life span, brittleness, and requirements for light, water, and soil pH are important factors in selecting plants—along with color, texture, scent, and seasonal characteristics. Matching plant requirements with site realities, and correctly placing appropriate plants, helps avoid expensive and time-consuming problems. Thoughtful selection and siting of trees, shrubs, and groundcovers to provide shade and lower ambient air temperature can reduce air conditioning energy use by 5–20%. The use of native and noninvasive naturalized plant materials can reduce maintenance demands. Selection of plant materials for low water consumption, as well as for disease and pest resistance, can contribute significantly to an environmentally responsible landscape.

**Allergy potential** is an important consideration with plant selection. Some plants produce copious pollen that affects building occupants who have allergies. As many as 30% of adults and 40% of children suffer from allergic rhinitis (nasal congestion and itchy eyes commonly called hay fever), a rate that has increased dramatically in recent years. Some plants are far more allergenic than others, and even within a particular species there may be big differences. With dioecious plants (separate male and female plants), for example, it is only the males that produce pollen; in cities it has been common practice to plant only male trees, because fruits are not produced that have to be cleaned up—but this exacerbates allergy problems. The Ogren Plant Allergy Scale (OPALS) has recently been published to provide guidance on plant selection—see the references in this section, and see *Section 3.6 – Plantings in the Sustainable Landscape* for more information.

**Turf grass** should be limited to recreational areas and not become the default landscape. This allows major reductions in water, chemicals, maintenance energy, pollution, noise, and labor. Where turf is used, species and cultivar selection should consider the local climate and growing conditions. Alternatives to conventional turf include low-growing ground covers, wildflower meadows, prairie ecosystems, and decorative mulches.

## WATER USE

**Efficient irrigation** is accomplished by grouping plants with similar water needs. Design irrigation systems to avoid overwatering by using ultra-low-volume distribution devices. Irrigate after on-site inspection or electronic sensing of moisture requirements, rather

than by schedule. Water requirements vary greatly by season. As the landscape matures, less irrigation is required—especially when native or well-adapted plants and thick mulches are used. Automatic irrigation controllers should have rain switches that override the “on” signal when sufficient rain has fallen or soils are moist.

**Reclaimed wastewater**, sometimes called Irrigation Quality or IQ water, is another possible source of water for irrigation. It is often available at attractive rates from some water utilities. It must be scrupulously isolated from potable water distribution, and all IQ hose bibs must be clearly marked as “nonpotable.” See *Section 6.5 – Reclaimed Water*.

**Graywater** is untreated wastewater generated within the facility from shower and bath, laundry, and bathroom sinks (not from toilets, urinals, kitchen sinks, or dishwashers). In some parts of the country, graywater can be used for below-ground irrigation. Because pathogens may be present, it should never be used for above-ground irrigation or on fruits and vegetables for human consumption. See *Section 6.6 – Graywater Collection and Use*.

**Rainwater harvesting** can often satisfy all landscape water needs while helping to reduce stormwater runoff. Careful planning is needed that considers anticipated water needs, rainfall patterns, storage requirements, maintenance of water quality, and means of distribution. See *Section 6.7 – Rainwater Harvesting*.

**Watershed management** for water quality and habitat protection/improvement should be carefully addressed on most sites. Opportunities include groundwater recharge through stormwater infiltration, grassy swales to filter and purify runoff from roads and parking lots, and responsible treatment of on-site-generated wastewater through advanced purification technologies and constructed wetlands. See *Sections 3.5 – Stormwater Management* and *6.8 – On-Site Wastewater Treatment Systems*.

## LANDSCAPE MATERIALS AND STRUCTURES

**To pave surfaces in landscaped areas**, use loose-set masonry units, flagstones, gravel, turf block, “geowebs” (flexible or rigid synthetic grid structures) planted with grass or groundcovers, crushed shells, mosaics of reused concrete slab, and forest-derived materials. A bedding of crushed, recycled concrete improves drainage and may serve as a useful application for an otherwise difficult-to-dispose-of material. Porous paving with specially formulated concrete or asphalt is appropriate for some applications. With alternatives

to pavement, consider other issues, such as the fact that crushed stone and pebble surfaces do not contribute organic matter to soils, that crushed shell surfaces may raise soil pH, and that some light-colored surfaces might reflect sunlight onto nearby plants and thus injure them.

**Mulches hold soil moisture**, reduce weed growth, slow erosion, build soil texture, increase root density by keeping soil cooler in summer and warmer in winter, and feed important soil microorganisms (which, in turn, buffer soil pH). Mulches add color, texture, contrast, and definition. They can consist of leaves; grass clippings; shredded wood from site clearing, utility, or commercial sources; pine bark; pine straw; nut hulls; or sawdust. Under deciduous trees, leaf litter eventually becomes mulch if left undisturbed. Use chipped prunings with caution—some fungi and diseases can be spread in dead wood. Cypress mulch should be avoided because its harvest depletes an important tree population.

Recycled-plastic lumber products provide an increasingly attractive alternative to pressure-treated wood and naturally rot-resistant wood from old-growth trees that are in limited supply. Both 100% recycled-plastic lumber products and recycled-plastic-wood-fiber composite lumber products are available.

## References

Thompson, William, and Kim Sorvig, *Sustainable Landscape Construction: A Guide to Green Building Outdoors*, Island Press, Washington, DC, 2000.

Ogren, Thomas, *Allergy-Free Gardening: The Revolutionary Guide to Healthy Landscaping*, Ten Speed Press, Berkeley, CA, 2000.

*Xeriscape—A Guide to Developing a Water-Wise Landscape*, Georgia Cooperative Extension Service, Atlanta, GA, 1992.

## Contacts

For local consulting on landscape and soils issues, contact your local county cooperative extension service or a local office of the Natural Resources Conservation Service.

American Society of Landscape Architects, 4401 Connecticut Avenue, NW, 5th Floor, Washington, DC 20008; (202) 686-2752; [www.asla.org](http://www.asla.org).

## 3.5

# Stormwater Management

Stormwater is precipitation that does not soak into the ground or evaporate but flows along the surface of the ground as runoff. Conventional practice for stormwater management—concentrating runoff and carrying it off a site as quickly as possible through storm sewers—causes various environmental problems, including erosion and downstream flooding, pollution loading of surface waters, and reduced groundwater recharge. Responsible management of stormwater involves a combination of strategies to reduce the amount of runoff generated, to reduce the amount of pollutants that are transported in the runoff, and to remove pollutants from that runoff. Generally, the most important management strategy for stormwater is to provide for infiltration into the ground as close as possible to where the precipitation falls.

## Opportunities

Effective stormwater management practices should be incorporated into any new development. This should start with a thorough analysis of the existing hydrology on a site and assessment of expected stormwater flows. How stormwater is handled at *existing* facilities should also be examined and improved to the extent possible—even if “problems” are not obvious. Consider opportunities for improving stormwater management practices when any of the following occur: landscape redesign or replanting, regrading of the site in any way, excavation of utilities, reroofing of buildings, street and sidewalk modifications, and replacement, addition, or resurfacing of any paved areas. Strategies for improving stormwater management can also improve wildlife habitat on a site, improve water quality in the region, and help to recharge underground aquifers. Stormwater runoff and erosion during construction are of particular concern and generally necessitate actions well beyond practices for stormwater management once the facility is developed.

## Technical Information

A **stormwater analysis** includes soil analysis, topography mapping, peak flow calculations, and examination of historical patterns of stormwater flow. It should also predict (with new facilities) or quantify (with existing facilities) the vehicular pollutants that reach the runoff stream, such as oil, gasoline, heavy

metals, detergents, and cleaners. Fertilizers, pesticides, herbicides, and other landscaping treatments also contaminate stormwater, and their quantity must be measured in the analysis.

**Establishing stormwater goals** should be done following collection of data. With new facilities, for example, a possible target might be for the development to result in no net increase in stormwater flows off the site with any storm event up to a two-year storm in magnitude.

**Avoid changes to topography, vegetation, and landforms.** Most disturbances to a site, including grading (which compacts soils) and removal or disturbance of vegetation, will increase stormwater flows by reducing the ability of soils to infiltrate rainwater. Preserving original topography is generally recommended, though recontouring land, if planned and done carefully, can also improve infiltration in some cases.

**Minimize impervious paved surfaces.** Minimize the size of parking lots and the width of roadways. Use porous paving, such as porous asphalt, porous concrete, modular block pavers, and specialized grass-paving systems.

**Separate impervious surfaces** with turf, gravel, or vegetation to increase infiltration. Avoid curbs where possible—they increase the concentration of pollutants. When there are no curbs, rainwater runs off driveways, sidewalks, and roads and goes directly into the ground.

**Consider green roofs** as a stormwater management

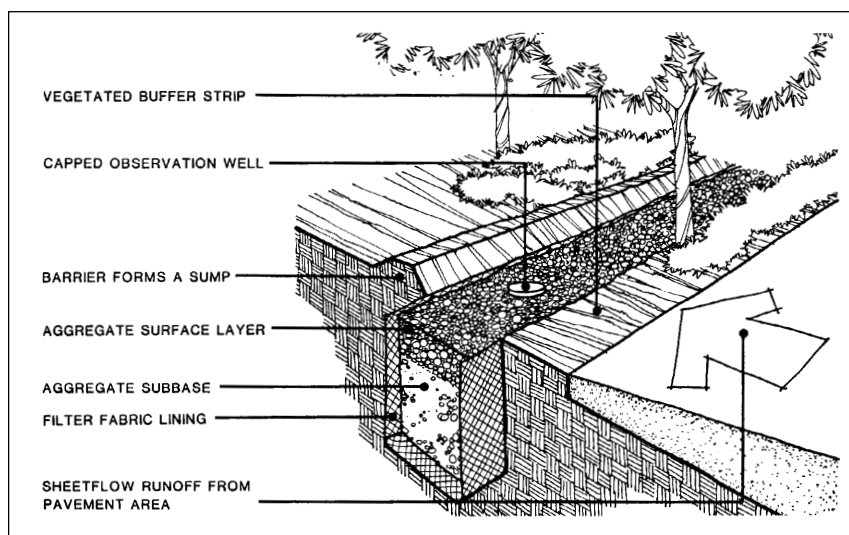

From *Stormwater Management: A Guide for Floridians* (72-page overview by the Florida Department of Environmental Regulation, 2600 Stone Road, Tallahassee, FL 32399-2400)

*Infiltration trench*

strategy. By capturing and absorbing rainfall, green (vegetated) roofs function like stormwater detention basins by slowing down the flow of runoff. *Rainwater harvesting* systems (see *Section 6.7*) can also reduce stormwater production, though the potential benefit is determined in large part by the size of the storage cistern(s).

**Reduce pollutants in stormwater.** Minimize the use of road salt, sweep streets regularly, reduce animal waste, and reduce car use. Reducing reliance on cars can be achieved through emphasis on public transportation, bicycle and pedestrian paths, and carpooling. Avoid the use of herbicides, pesticides, and fertilizers in the landscape. Discourage dumping of motor oil, antifreeze, and other hazardous wastes into storm drains—let people know through clear signage that storm drains lead directly to streams and rivers.

**Rely on natural “biofiltration” systems to remove pollutants.** Vegetated swales, vegetated infiltration basins, and constructed wetlands should be used to remove pollutants through biological action. Microorganisms and plants in the biologically active layer of soil (close to the surface) and in wetlands are highly effective at removing or detoxifying many of the pollutants in stormwater.

**Specialized mechanical means of removing stormwater pollutants** should be considered in locations where very high levels of pollutants are generated, such as fuel storage yards, filling stations, and large parking lots. Such systems require regular maintenance, however, and may not be as effective in many cases as simpler, natural systems relying on “biofiltration.”

**Manage stormwater runoff at construction sites.** Construction activities can cause high stormwater runoff, erosion, and pollution discharge into streams and rivers. Avoid soil compaction because heavily compacted soil absorbs water less efficiently. Heavily compacted areas can be made more permeable through “deep ripping.” Minimize slope modifications by designing landscapes that respect the original topography of the site, or recontour in a manner that *improves* infiltration. Ensure that heavy equipment is reliable and well maintained and does not leak hydraulic fluid, oil, or fuel. Erect temporary barriers such as straw-bale silt fences to capture sediment in runoff. Regrade and replant disturbed areas (preferably with native plants) as soon as possible.

**Infiltration beds, swales, and basins** are gently sloping vegetated surface treatments designed to allow



Clearly label stormwater sewers to discourage dumping of hazardous wastes.

Photo: Robert Day

stormwater runoff to collect and soak into the ground. Some such basins may become ponds during large storm events—like detention ponds. Pollutant removal occurs through biological activity in the top few inches of the soil (“biofiltration”) and through plant uptake of nutrients. Use of native vegetation is most effective.

**Detention ponds** are designed to temporarily hold water and release it gradually through an outlet channel. They fully drain between storms. The ability of deten-

tion ponds to remove pollutants depends on how long the stormwater is detained, what type of vegetation is established, and the amount of infiltration that occurs.

**Constructed wetlands and retention ponds** are designed to hold water at all times, with excess volume for handling water during storms. Wetland plants and associated root-zone microorganisms provide complex biological processing of nutrients, sediment, and pollutants. Both aerobic and anaerobic breakdown of nutrients and other chemicals can occur in these ecosystems.

## References

Wilson, Alex, “Stormwater Management: Environmentally Sound Approaches,” *Environmental Building News*, Vol. 3, No. 5, September-October 1994; BuildingGreen, Inc., Brattleboro, VT; (800) 861-0954; www.BuildingGreen.com.

Ferguson, Bruce, *Introduction to Stormwater: Concept, Purpose, Design*, John Wiley & Sons, New York, NY, 1998.

Thompson, William, and Kim Sorvig, *Sustainable Landscape Construction: A Guide to Green Building Outdoors*, Island Press, Washington, DC, 2000.

Ferguson, Bruce, Richard Pinkham, and Timothy Collins, *Re-Evaluating Stormwater: The Nine Mile Run Model for Restorative Development*, Rocky Mountain Institute, Snowmass, CO, 1999.

*Low-Impact Development Design Strategies*, U.S. EPA and Prince George’s County Department of Environmental Resources, 2000.

## Contacts

Center for Watershed Protection, 8391 Main Street, Ellicott City, MD 21043; (410) 461-8323, (410) 461-8324 (fax); www.cwp.org.

## 3.6

# Plantings in the Sustainable Landscape

Plant selection and placement around buildings can help us benefit from sunlight and airflow while minimizing negative impacts of those forces. Plants provide economical means of modifying microclimate and are an investment in future energy savings. They can complement design features of buildings that are intended to conserve energy or provide passive solar heating, daylighting, and natural ventilation. Carefully selected plantings can also reduce allergies in and around buildings, create vitally important wildlife habitat, minimize outdoor water requirements, provide natural erosion control, and even detoxify contaminated soils.

## Opportunities

Opportunities for sustainable landscape plantings are greatest when a new facility is being built, but there are lots of opportunities at existing facilities as well. Consider plantings whenever sitework is being done (relocation of roadways, installation of new underground utilities, expansion of a facility, etc.) as well as when landscape maintenance contracts are being reviewed—there may be opportunities to reduce maintenance costs by implementing more responsible landscaping practices. Also consider plantings when special needs arise, such as erosion problems along streams.

## Technical Information

**Trees are valuable assets** for passively enhancing the interior comfort of small and medium-sized buildings, especially in warmer climates. When planning new facilities, try to protect existing trees on the site. Once established, most trees require little maintenance. Shade and air movement modification depend on height, growth rate, seasonal leaf persistence, canopy shape and density, seasonal solar angles, wind velocity, proximity, and height of structure. Generally, trunks of trees that grow to less than 40 feet (12 m) tall can be as close as 10 feet (3 m) from walls. Trees that grow over 40 feet (12 m) should be kept further from walls. To allow air movement, lower branches near buildings should be removed as the tree grows.

**Use trees and other plantings to reduce cooling costs.** Particularly with residential and small commercial buildings, carefully situated and selected trees, shrubs, annuals, and vines can provide access to the winter sun (for passive solar heating and daylighting) while shading the building from hot summer sun. Tall deciduous trees with few low branches are effective near south-facing windows. Lower vegetation, such as tall annuals and deciduous vines, is

appropriate for west- and east-facing windows, though trees can also be appropriate. Arbors and trellises over walkways and outdoor activity areas can provide attractive, functional shade. Plants also create cooler temperatures by evaporating water from their leaves and, depending on humidity, can lower outdoor air temperature several degrees. Plantings can cut air conditioning costs by 5–20%.

**Shrubs can influence airflow.** Evergreen shrubs planted closely together and somewhat near a building wall can create a “dead-air” space around a building that reduces heat loss in winter. In summer, these same shrubs can provide cooling by evaporation and by shading the walls from early-morning and late-afternoon sun. Maintain a 2-foot (0.6 m) clear-zone between shrubs and the building walls to allow for maintenance access and to reduce mildew on exterior surfaces and insect access to the building. Where operable windows allow natural ventilation, proper pruning of shrubs will not block airflows or views.

**Avoid highly allergenic plants.** Some trees, shrubs, and herbaceous plants produce pollen or volatile organic

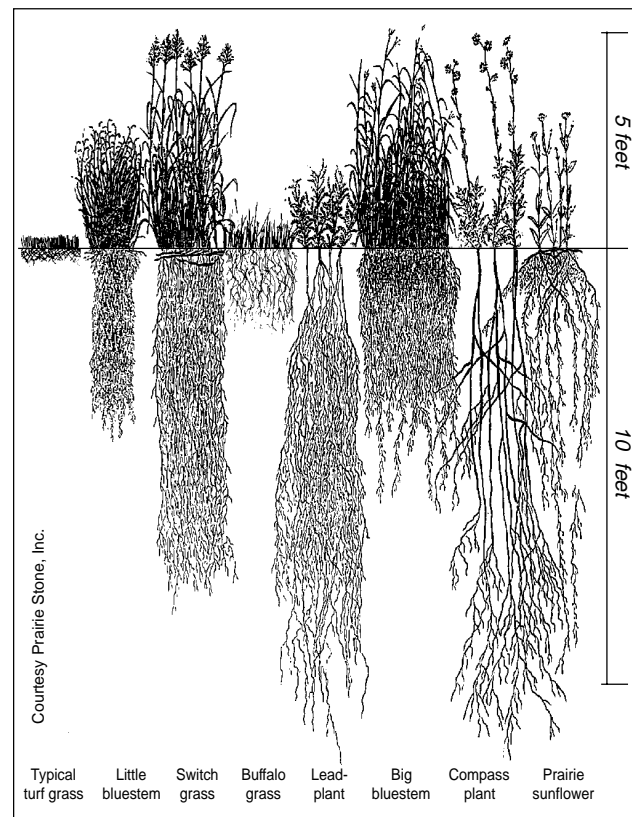

*The extensive root systems of native prairie plants are responsible for many of their advantages over conventional turf grass (far left).*

chemicals that are highly allergenic. The worst offenders tend to be the male forms of *dioecious* trees and shrubs (those with separate male and female forms, such as live oak, silver maple, pecan, and pepper tree). Ironically, it is often only the males of these species that are planted in urban areas because the females produce fruits that require more cleanup. OPALS provides 1–10 allergy-risk rankings of more than 5,000 plant species (see *Allergy-Free Gardening* in the references).

**Soils.** Heavy soil fertilization should not be required for plants that are adapted to the local soils and microclimate. Pay attention to the organic matter in soil (humus), which can be improved by incorporating leaf litter, lawn clippings, and other organic mulches. Mulches around plants also help retain moisture and keep down weeds, obviating the need for herbicides. Chipping locally derived wood waste for mulch can be less expensive than the disposal of such waste and the purchase of mulch.

**Invasiveness of plants varies by region.** Because of their potential to invade and disrupt native plant communities and create other environmental burdens, nonnative plants should be carefully evaluated; if invasive, they should not be planted and should be removed if present. While some such plants are merely discouraged, others may be strictly prohibited. Contact the nearest agricultural extension office for details.

**Weed management** is best achieved by prevention and nonchemical means. Mulch will prevent most weed seeds in the soil from germinating. Some weed seeds can be kept out by ensuring that flowers or seed heads are removed before going to seed (thistles, for example). Hand weeding is less expensive, less dangerous to workers, less noisy, and healthier for the environment than chemical treatment. See *Section 3.8 – Chemical Use in the Landscape* for more on strategies for avoiding herbicides and pesticides.

**Simple, flowing designs usually require less maintenance.** When choosing and placing plants, anticipate their mature size and form. Try to plant groups of species (natural plant communities) that are typically found in your region. Instead of conventional turf, consider “islands” of natural plantings surrounded by meadows that are occasionally mowed—but left more natural than lawns.

**Create wildlife habitat.** Designing plantings that foster biodiversity should be a consideration for any facility. With the increasing loss of open space, providing wildlife habitat and wildlife corridors in the landscaping around buildings is increasingly important ecologically. Small pockets of songbird habitat and patches of tall-grass prairie around buildings are helping to stem the decline of many threatened animals—from birds to butterflies. Select diverse native vegetation, including plants that provide forage for birds. Also consider creating wetlands that can support amphibians, wading birds, fish, and diverse natural plant communities.

**Xeriscaping** is a specialized type of landscaping and plant selection for low water use. While xeriscaping strategies are most important in dry Southwestern climates, they can be important on certain soils and in certain microclimates in many parts of the country—especially areas prone to periodic droughts. Selecting plants that are native to a particular area and adapted to the specific site conditions generally ensures survival without irrigation. Look for nurseries and seed suppliers that specialize in native and xeriscape plantings.

**Bioengineering** is a relatively new specialty of landscaping in which plants are used for erosion control and other “engineering” functions. What civil engineers generally do with rip-rap-lined channels, wire-mesh shrouded gabions, and rock fill, skilled landscapers can often do with natural, biodegradable mats, fiber-rolls, and native plantings. Bioengineered plantings along streams and rivers will become more and more effective over time at protecting the banks from erosion, while the conventionally engineered alternative breaks down over time, becoming less effective.

## References

Sauer, Leslie, *The Once and Future Forest: A Guide to Forest Restoration Strategies*, Island Press, Washington, DC, 1998.

Druse, Ken, and Margaret Roach, *The Natural Habitat Garden*, Clarkson N. Potter, Inc., New York, NY, 1994.

Ogren, Thomas, *Allergy-Free Gardening: The Revolutionary Guide to Healthy Landscaping*, Ten Speed Press, Berkeley, CA, 2000.

Sternberg, Guy, and Jim Wilson, *Landscaping with Native Trees*, Chapters Publishers, Ltd., Shelburne, VT, 1995.

Thompson, William, and Kim Sorvig, *Sustainable Landscape Construction: A Guide to Green Building Outdoors*, Island Press, Washington, DC, 2000.

*Cooling our Communities: A Guidebook on Tree Planting and Light-Colored Surfaces*, Environmental Protection Agency, Washington, DC, January 1992.

*Shading and Landscaping for Energy Efficiency*, Arizona Energy Office, Phoenix, AZ; (602) 280-1402.

## Contacts

County agricultural extension offices can provide planting information for regionally appropriate plants.

WaterWiser: The Water Efficiency Clearinghouse at [www.waterwiser.org](http://www.waterwiser.org).



Photo: [www.prairiefrontier.com](http://www.prairiefrontier.com)  
Varieties of hardy lupine can be used for displays of color in a landscape.



Water is key to the survival and prospering of plants in the landscape. Plants use water to absorb and transport nutrients, to respire, to maintain temperature balances, and to remove wastes. Water should be delivered at a rate and on a cycle appropriate to the plant materials in question. The challenge with green facilities is to use water efficiently, to avoid its use when not required, and to maintain—or even improve—water quality.

## Opportunities

Efficient water use in the landscape is best planned as part of the initial development and site planning of a facility. There are also many opportunities for improving water use at existing facilities. Irrigation infrastructure typically has to be substantially renewed every twenty to thirty years; this is a good time to thoroughly examine and improve water use and water efficiency. The availability of innovative new water sources for irrigation, such as graywater and reclaimed water, provides another opportunity for modifying a landscape irrigation system.

## Technical Information

The lawn is almost solely an American horticultural obsession. It represents an attitude toward water use and plant selection that, in many geographic areas, is out of synch with the actual cultural requirements of the plants that we typically use and the microclimate in which we expect them to grow and perform. Water plays a very large part in the support of lawns. In fact, many other equally acceptable, and equally American, planting design approaches can be implemented to benefit local and regional water conservation and quality. Responsible water use in the landscape begins and ends with the plant materials selected and designed for the facility. The five components of a facility's water regime are supply, quality, delivery (irrigation), planting design, and public awareness programs.

### WATER SUPPLY

**Pursue the use of reclaimed water for irrigation**, from local utilities and site facility utilities. This can include treated wastewater from sewage treatment plants, steam condensate, graywater, and filtered industrial-process water.

**Pay particular attention to reducing dependence on limited aquifers**, especially those in which the “fossil water” is nonrenewable or subject to very long (possibly geologically long) recharge cycles.

**Reduce dependence on river and stream water** when the downstream water supply is limited.

**Reduce dependence on water that is energy intensive to use and procure**—for instance, water that is transported long distances (whether by truck or canal). Water conservation programs in Southern California, for example, can often be justified for the energy savings alone, because huge energy expenditures are required to pump water over mountains.

**Design landscapes that rely on irrigation only during the toughest drought conditions.**

**Collect water that falls on the site or buildings for irrigation use**, either by storage and use or by site grading, which delivers site and roof waters to wider planting areas. In rainwater catchment areas for stormwater control, advantage can be taken of this *ephemeral* supply to promote water-loving and even riparian plant materials, including trees, shrubs, and groundcover.

**Develop a drought plan with the design.** To minimize drought impacts, integrate thinking about plant and soil selection, maintenance techniques, and drainage. Zoned irrigation allows irrigation of expensive-to-replace shrubs and trees, as well as cutbacks on turf that can be more easily replaced after severe droughts.

### WATER QUALITY

**Water for landscape irrigation can be much lower in quality** than potable drinking water. Alternative water sources should be investigated, especially for larger projects.

**Retain as much stormwater flow on site as possible** to minimize downstream degradation, erosion, flooding, and the need for an expensive conveyance infrastructure.

**Separate storm and sanitary sewer systems.** Design stormwater systems to reflect, as much as possible, the natural-state watershed runoff characteristics. Use detention basins to contain the overflow.

**Minimize surface and groundwater pollution** by treating (or separating pollutants from) parking lot runoff; pretreat water flowing off-site. In general, biofiltration is the best treatment option; mechanical separation makes sense only where high levels of pollutants are generated (such as fuel storage and very large parking lots).

**Organic landscaping techniques and integrated pest management (IPM) programs** can lessen soil and groundwater pollution.

**Appropriate fertilization techniques will reduce nutrient loading** in waterways, lakes, and rivers, and enhance local and regional water quality as a result.

## WATER DELIVERY AND IRRIGATION

**Reduce aerial sprinkling** by providing for the use of drip and bubbler irrigation.

**Properly zone the irrigation system** to the specific needs of plant materials and site microclimate.

**Irrigation scheduling:** Adjust the time of operation to match the current supplemental needs of the plant material. Use controller timing, system zoning, irrigation durations optimized for drip systems, and adjustment for seasonal variation. Tensiometers, when properly placed, may be used to determine irrigation demand based on soil moisture content. Photovoltaic (PV)-powered irrigation controls can also be used where electric power is not available (such as on road medians).

**Perform routine maintenance to ensure proper system functioning** and reduce the risk of water loss due to leaks.

**Maintenance:** Check the backflow preventer device annually, winterize the irrigation system, check the height of sprinklers, perform spring start-up carefully.

**Investigate the use of separate delivery systems** for potable water, reclaimed water, and other sources of irrigation water. Look for opportunities to combine large irrigated areas (parks, golf courses, etc.) on separate delivery systems.

## PLANTING DESIGN

**Reduce areas of lawn**, particularly in regions where lawn grasses are not native and where water usage is high.

**Replace lawn with shrubs, groundcovers, and mulch.**

**Mulch what you water**—water retention is much improved in mulched areas.

**Use local and regional native and (non-invasive or infertile) naturalized plant materials** appropriate to the microclimate regimes of the facility to reduce water take-up and to balance water use and soil development objectives.

**Use associated plant palettes over broader areas** to minimize the need for zoning and related controls.

**In arid regions and areas prone to drought, install xeriscape (low-water-use) landscapes** that

are appropriate to the region. In the Southwest, these might be cactus gardens in sand; in the Midwest, these might include buffalo grass lawns and tall-grass prairie meadows.

## PUBLIC AWARENESS

**Proactive public relations can be an important part of communicating the benefits** of certain actions or changes in water management that might otherwise raise questions in the community.

**Develop demonstration areas and signage programs** that make changes in landscape management visible and comprehensible to the public.

**Watering of Federal facility grounds during drought periods**, which often results in a public outcry but is important to plant viability (and generally less expensive than plant replacement), will generate less concern if there is signage indicating that watering is being done with “Recycled Water Only” (presuming that it is the case, of course!).

**Landscaping with native or more naturalized plantings can garner public support** for Federal landscaping expenditures. “Natural Revegetation Area” and similar signage will help to clarify the intent and the responsible motives at work with such landscaping practices.

**Initiate public demonstration projects**, such as xeriscape demonstration gardens, to help foster public understanding of appropriate plantings and water conservation techniques. Good demonstrations also help to show attractive landscapes and dispel “rock and cactus” stereotypes.

## References

Thompson, William, and Kim Sorvig, *Sustainable Landscape Construction: A Guide to Green Building Outdoors*, Island Press, Washington, DC, 2000.

Holmes, Roger, ed., *Taylor's Guide to Natural Gardening*, Houghton Mifflin Company, Boston, MA, 1993.

Ellefson, Connie, and Tom Stephens, *Xeriscape Gardening: Water Conservation for the American Landscape*, MacMillan Publishing Company, New York, NY, 1992.

## Contacts

American Society of Landscape Architects, 4401 Connecticut Avenue, NW, 5th Floor, Washington, DC 20008; (202) 686-2752; [www.asla.org](http://www.asla.org).

Chemical use is as old as agriculture itself and is generally taken for granted. We use chemicals to enhance plants' performance, to protect them from pests and disease, and to streamline maintenance. Originally, chemicals and compounds used to aid plant growth were biologically based or naturally occurring compounds. The majority of chemicals used today, however, are synthesized. Some of the synthetic chemicals introduced for weed and pest control following World War II were later found to cause health or environmental problems and have been eliminated. Others, while still on the market, are considered hazardous or dangerous, and their use should be limited. In selecting chemicals for use in the landscape, we should be concerned not only with performance but also with life-cycle impacts associated with production, use, and disposal.

## Opportunities

The use of chemicals to protect or improve plants is best addressed at the time plants are selected—by choosing plants not highly dependent on frequent or excessive chemical use. Certain other decisions about chemical use in the landscape—for example, to control dust, melt ice, and provide decay resistance for wood—can similarly be addressed up-front through good site planning. Formulating overall chemical-use objectives and a chemical-use plan should be done at the outset of a project.

Chemical usage can be modified after facility construction and landscaping, of course, particularly as maintenance and replacement cycles allow new routines and materials to be introduced, and as adjustments to new regulations are made.

## Technical Information

The key to responsible chemical use lies in minimizing the need for chemicals and, when needed, relying on organic, biodegradable, nontoxic, and natural products. Conventional chemical use can provide initial success but often leads to longer-term problems—for example, residues can stay in the soil for years, affecting both plant health and water quality. Increased pest resistance to chemical controls (and opening up the ecosystem to new, and potentially more harmful, pests) is a common outcome of highly chemical-dependent landscape management practices.

**Use native or noninvasive naturalized plant species and cultivars** that thrive under the specific microclimatic and soil and water conditions of various parts of the grounds, that won't need fertilizing, and that are naturally resistant to local pests and diseases.

**Ecosystem diversity enhances landscape health.** Plant many species, including species that naturally coexist as plant communities. This will provide habitat for stable populations of insects and other organisms—beneficial and harmful alike. Diversity ensures that if one pest momentarily gains the upper hand, it is unlikely to wipe out an entire planting. It also means that there are more likely to be natural predators of a particular pest species.

**Use soil and drainage designs specific to the microclimate and to planting design objectives**—provide a healthy, nontoxic growing medium.

**Whenever possible and affordable, use natural, biologically derived, organic fertilizers** instead of nonorganic, synthesized materials. Conventional (non-organic) nitrogen fertilizers, for example, are very energy-intensive to produce. In creating an energy-efficient green building, consider how energy-intensive the landscape is! Composted manure and kitchen scraps provide a very good soil amendment, and the latter can help to reduce a facility's solid waste output.

**Maintain observational and response records** of problems, solutions, and changes made to the grounds. Good records can help provide insight into new techniques, changes, and improvements that might otherwise not be identified. Plant health is a long-term, not a short-term, management issue.

**New products and families of products are arriving all the time**—from genetically modified organisms and compounds produced by genetic manipulation of plant and animal stock to growth inhibitors and species-specific attractants or baits. Some of these offer tremendous opportunity for reduced chemical use; others raise new environmental and health questions. Be aware of the chemicals you are using and whether there might be hidden risks.

### INTEGRATED PEST MANAGEMENT

IPM—using mechanical, physical, cultural, biological, and (as a last resort) least-toxic chemical means—is a fundamentally sound way of keeping pests in check. IPM has been used with success for decades, but this success requires careful planning, initial work, and the

acceptance that results are rarely immediate but will be achieved over time. The IPM approach uses known (often organic) compounds, fertilizers produced from natural materials, even beneficial insects, minerals, and salts, to achieve success. Extra up-front work to design and plan the system is a basic difference from the traditional “see the problem, open a bag, look for new problems afterward” approach. Plants and animals are healthy and necessary parts of an ecosystem—and health calls for balance, not war.

**The basic tenet of this low-chemical approach is organic, or natural** gardening and grounds maintenance—using materials derived from naturally occurring compounds and techniques of planting design and maintenance that give the best results with the least impact on the environment. This approach demonstrably creates a better environment for plants as time passes.

**Safety should always be a concern**, even with state-of-the-art IPM techniques, as some products—even natural ones—can be irritating or cause health problems upon application, even though they rapidly disperse and biodegrade after release.

**An IPM management plan should be made for the long haul**, planned for several years after implementation. Monitoring is an important part of implementing an IPM program. This can help establish (at least for an existing facility) a baseline from which to measure changes and successes. Monitoring activities typically include:

- Routine examination and journal entries recording the health of plants and any indications of disease and pests.
- Tracking of temperatures and climate indicators to predict pest insect developmental stages and emergence. Pheromone traps can be used to confirm the presence of pests and determine appropriate timing for controls.
- Identification of pest sources, nest locations, and feeding areas on site and in the surrounding neighborhood to assist in developing area-wide strategies, if possible, for control.

**A full IPM plan should incorporate**, or plan for, the use of:

- Habitat destruction or modification procedures for dealing with pest insects, at least during one stage of the life cycle. Control the development of pests

and health problems by removing potential habitat, by choosing healthy plant material, and by providing good drainage, plenty of air movement, healthy soil, effective pruning, and careful clean-up practices.

- Installation of permanent or seasonal barriers: covers, traps, and other mechanical installations that physically inhibit infestation. This practice extends as well to buildings through design and construction practices that minimize the risk of insect entry and damage.
- Controlled release of naturally occurring parasites, predators, and pathogens that can control pests.
- Naturally derived pesticides such as insecticidal soaps, horticultural oils (petroleum-based products with low toxicity that biodegrade rapidly in the soil), diatomaceous earth, and botanical pesticides (plant-derived products that are by nature toxic to selected insect pests).
- Application of minerals—such as sulfur, copper, and lime—that are useful in fighting fungal and bacterial diseases.

## References

Olkowski, William, Sheila Daar, and Helga Olkowski, *Common-Sense Pest Control*, Taunton Press, Newtown, CT, 1991.

Holmes, Roger, ed., *Taylor's Guide to Natural Gardening*, Houghton Mifflin Company, Boston, MA, 1993.

Pirone, P. P., J. R. Hartman, M. A. Sall, and T. P. Pirone, *Tree Maintenance*, Oxford University Press, 1988.

Thompson, William, and Kim Sorvig, *Sustainable Landscape Construction: A Guide to Green Building Outdoors*, Island Press, Washington, DC, 2000.

## Contacts

American Society of Landscape Architects, 4401 Connecticut Avenue, NW, 5th Floor, Washington, DC 20008; (202) 686-2752; [www.asla.org](http://www.asla.org).

Local agricultural extension offices are good sources of information on soils and regionally appropriate landscaping practices.



**Part IV**  
**BUILDING DESIGN**

<b>SECTION</b>	<b>PAGE</b>
<b>4.1 Integrated Building Design .....</b>	<b>38</b>
<b>4.1.1 Passive Solar Design .....</b>	<b>40</b>
<b>4.1.2 Daylighting Design .....</b>	<b>42</b>
<b>4.1.3 Natural Ventilation .....</b>	<b>44</b>
<b>4.2 Building Envelope .....</b>	<b>46</b>
<b>4.2.1 Windows and Glazing Systems.....</b>	<b>48</b>
<b>4.2.2 Insulation .....</b>	<b>50</b>

## 4.1

# Integrated Building Design

Integrated building design is a process of design in which multiple disciplines and seemingly unrelated aspects of design are integrated in a manner that permits synergistic benefits to be realized. The goal is to achieve high performance and multiple benefits at a lower cost than the total for all the components combined. This process often includes integrating green design strategies into conventional design criteria for building form, function, performance, and cost. A key to successful integrated building design is the participation of people from different specialties of design: general architecture, HVAC, lighting and electrical, interior design, and landscape design. By working together at key points in the design process, these participants can often identify highly attractive solutions to design needs that would otherwise not be found. In an integrated design approach, the mechanical engineer will calculate energy use and cost very early in the design, informing designers of the energy-use implications of building orientation, configuration, fenestration, mechanical systems, and lighting options.

## Opportunities

Although integrated building design can be part of almost any Federal facilities project, it is most suitable for the design of new whole buildings or significant renovation projects. Integrated building design is most effective when key issues are addressed early in the facility planning and design process. Opportunities are most easily identified through an open process of exploring how to combine low-energy-use and other greening strategies to achieve the best results.

The graph below suggests that the earlier design integration becomes a part of the process, the more successful the results will be. Conversely, if a building is designed “as usual” and then green technologies are applied to it as an afterthought, the results will probably be poorly integrated into the overall building design objectives, and the greening strategies will likely be expensive to implement.

In existing buildings, opportunities for improved building design integration exist whenever a major replacement or renovation of a building component or system is being planned. For example, if a large chiller system is to be replaced, investments in reducing the cooling loads through daylighting, improved glazing, and more efficient electric lighting may significantly reduce the size and cost of the new chiller. In some cases, cost savings from the new chiller may be greater than investments in the load-reduction strategies, so the ancillary benefits of improved lighting and lower energy consumption are obtained for free—or even at a “negative cost.”

## Technical Information

Consider integrated building design strategies for all aspects of green design: improving energy efficiency, planning a sustainable site, safeguarding water, creating healthy indoor environments, and using environmentally preferable materials. Major design issues should be considered by all members of the design team—from civil engineers to interior designers—who have common goals that were set in the building program. The procurement of A&E services should stress a

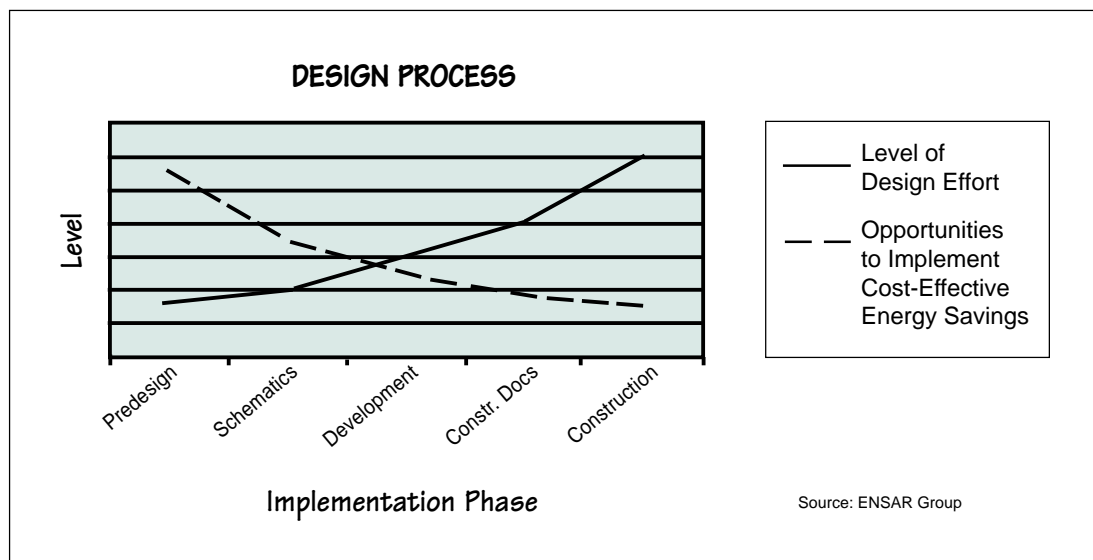



Source: ENSAR Group



The Way Station (above) is an institutional building created for mental health care in Frederick, Maryland. The integrated building design used in creating it included careful siting, climate-responsive building form, energy-efficient envelope design, daylighting, passive solar heating, cooling-load reduction strategies, high-performance glazings, high-efficiency lighting and HVAC equipment, and healthy building design strategies. The net increase in construction cost for this package of measures was \$170,000, and the annual energy savings total \$38,000—a return-on-investment of 22%.

team-building approach, and provisions for integrated design should be clearly presented in the statement of work (SOW). For example, the SOW should stipulate frequent meetings and a significant level of effort from mechanical engineers to evaluate design options.

The design and analysis process for developing integrated building designs includes:

- **Establishing a base case**—for example, a performance profile showing energy use and costs for a typical facility that complies with Federal energy standards and other measures for the project type, location, size, etc.
- **Identifying a range of solutions**—all those that appear to have potential for the specific project.
- **Evaluating the performance of individual strategies**—one by one through sensitivity analysis or a process of elimination parametrics.
- **Grouping strategies that are high performers** into different combinations to evaluate performance.

- **Selecting strategies, refining the design, and reiterating the analysis** throughout the process.

Finding the right building design recipes through an integrated design process can be challenging. At first, design teams often make incremental changes that are effective and result in high-performance buildings—and often at affordable costs. However, continuing to explore design integration opportunities can sometimes yield incredible results, in which the design team *breaks through* the cost barrier.

Whenever one green design strategy can provide more than one benefit, there is a potential for design integration. For example, windows can be highly cost-effective even when they are designed and placed to provide the multiple benefits of daylight, passive solar heating, summer-heat-gain avoidance, natural ventilation, and an attractive view. A double-loaded central corridor, common in historic buildings, provides daylight and natural ventilation to each room, and transom windows above doors provide lower levels of light and ventilation to corridors. Building envelope and lighting design strategies that significantly reduce HVAC system requirements can have remarkable results. Sometimes the most effective solutions also have the lowest construction costs, especially when they are part of an integrated design.

## References

Wilson, Alex, et al., Rocky Mountain Institute, *Green Development: Integrating Ecology and Real Estate*, John Wiley and Sons, New York, NY, 1998.

*Designing Low-Energy Buildings*, Sustainable Buildings Industry Council, Washington, DC, 1997.

*U.S. Air Force Environmentally Responsible Facilities Guide*, Government Printing Office, 1999.

Anderson, Bruce, *Solar Building Architecture*, MIT Press, Cambridge, MA, 1990.

## Contacts

Green Development Services, Rocky Mountain Institute, 1739 Snowmass Creek Road, Snowmass, CO 81654; 970/927-3807; [www.rmi.org](http://www.rmi.org).

Sustainable Buildings Industry Council, 1331 H Street, NW, Suite 1000, Washington, DC 20005; (202) 628-7400, (202) 393-5043 (fax); [www.sbicouncil.org](http://www.sbicouncil.org).



## 4.1.1 Passive Solar Design

Passive solar systems make use of natural energy flows as the primary means of harvesting solar energy. Passive solar systems can provide space heating, cooling-load avoidance, natural ventilation, water heating, and daylighting. This section focuses on passive solar heating, but the other strategies also need to be integrated and coordinated into a whole-building design. Passive solar design is an approach that integrates building components—exterior walls, windows, and building materials—to provide solar collection, heat storage, and heat distribution. Passive solar heating systems are typically categorized as sun-tempered, direct-gain, sunspaces, and thermal storage walls (Trombe walls). In most U.S. climates, passive solar design techniques can significantly reduce heating requirements for residential and small commercial buildings.

### Opportunities

New construction offers the greatest opportunity for incorporating passive solar design, but any renovation or addition to a building envelope also offers opportunities for integration of passive methods. It is important to include passive solar as early as possible in the site planning and design process, or when the addition or building is first conceived. Ideally, an energy budget is included in the building design specifications, and the RFPs require the design team to demonstrate their commitment to whole-building performance and their ability to respond to the energy targets. This commitment is emphasized during programming and throughout the design and construction process.

For retrofit projects, consider (1) daylighting strategies, such as making atria out of courtyards or adding clerestories, along with modification of the electric lighting system to ensure energy savings; (2) heat control techniques, such as adding exterior shades or overhangs; and (3) using passive solar heating strategies to allow modification of HVAC systems—perhaps down-sizing if the passive strategies reduce energy loads sufficiently.

Many buildings in the Federal inventory have passive features because they were built before modern lighting and HVAC technologies became available. When renovating older buildings, determine whether passive features that have been disabled can be revitalized.

### Technical Information

**Terminology.** *Sun tempering* is simply using windows with a size and orientation to admit a moderate amount of solar heat in winter without special measures for heat storage. *Direct gain* has more south-facing glass

in occupied spaces and thermal mass to smooth out temperature fluctuations. A *Trombe wall* puts the thermal mass (e.g., tile floors) directly behind the glazing to reduce glare and overheating in the occupied space. A *sunspace* keeps the glass and mass separate from the occupied space but allows for the transfer of useful heat into the building by convection or a common mass wall; temperatures in a sunspace are allowed to fluctuate around the comfort range.

**Highlight passive solar as a project goal.** Many agencies, including GSA and DOD, already encourage the use of passive solar design and renewables in new construction and major renovation. A good general project goal is “to produce a beautiful, sustainable, cost-effective building that meets its program, enhances productivity, and consumes as little nonrenewable energy as possible, through the use of passive solar design, energy efficiency, and the use of other renewable resources.”

**Incorporating energy performance goals into the programming documents** conveys the seriousness of energy consumption and the use of passive solar as a design issue. For small offices, warehouses, and other smaller projects—10,000 sq ft (930 m<sup>2</sup>) or less—facility managers or their contractors can develop energy budgets easily using software such as *Energy-10*. For larger multi-zone projects (for example, laboratories or high-rise office buildings), national average energy consumption data by building type can be cited as targets to be exceeded, or more complex analyses can be run by consultants. The building program should describe an articulation that allows passive solar strategies to be effective (for example, large multistory core zones are hard to reach with passive solar). The building program should also describe requirements, such as privacy and security, that may influence the type of passive solar heating system that can be used.

**Thirty to fifty percent energy cost reductions below national averages are economically realistic** in new office design if an optimum mix of energy conservation and passive solar design strategies is applied to the building design. Annual savings of \$0.45 to \$0.75 per sq ft (\$5 to \$8/m<sup>2</sup>) is a reasonable estimate of achievable cost savings.

**Passive solar design considers the synergy of different building components and systems.** For example:

- Can natural daylighting reduce the need for electric light?
- If less electric light generates less heat, will there be a lower cooling load?
- If the cooling load is lower, can the fans be smaller?

- Will natural ventilation allow fans and other cooling equipment to be turned off at times?

Passive solar design is often more challenging than designing a mechanical system to accomplish the same functions. Using the building components to regulate temperature takes a rigorous analytical approach to optimize performance while avoiding such problems as overheating and glare.



**Buildings properly designed using passive solar systems and strategies are generally more comfortable for the occupants, resulting in productivity benefits that are great relative to the building cost.**

**Generic design solutions or rules of thumb are of limited value.** Rules of thumb may be useful in anticipating system size and type, but only early in the design process. Computer simulation provides much more accurate guidance because of the complexity of system combinations and interactions. Some of the variables involved include:

- Climate (sun, wind, air temperature, and humidity);
- Building orientation (glazing and room layout);
- Building use type (occupancy schedules and use profiles);
- Lighting and daylighting (electric and natural light sources);
- Building envelope (geometry, insulation, fenestration, air leakage, ventilation, shading, thermal mass, color);
- Internal heat gains (from lighting, office equipment, machinery, and people);
- HVAC (plant, systems, and controls); and
- Energy costs (fuel source, demand charges, conversion efficiency).

An hourly simulation analysis combines all of these parameters to evaluate a single figure-of-merit, such as annual energy use or annual operating cost.

**The integrated interaction of many energy-efficient strategies** is considered in passive solar design. These include: passive solar heating, glazing, thermal mass, insulation, shading, daylighting, energy-efficient lighting, lighting controls, air-leakage control, natural ventilation, and mechanical system options such as

economizer cycle, exhaust air heat recovery, high-efficiency HVAC, HVAC controls, and evaporative cooling.



**Passive solar design is an integrated design approach optimizing total building performance rather than a single building system. This is the key to “green building” design.**

**Cost and technical analyses are conducted at the same time** in passive solar design to optimize investments for maximum energy cost savings. It is rarely feasible to meet 100% of the building load with passive solar, so an optimum design is based on minimizing life-cycle cost: the sum of solar system first-cost and life-cycle operating costs. *Means Assemblies Cost Data* is a good source of cost information for thermal storage walls (Trombe walls) and other selected strategies. It is difficult to separate the cost of many passive solar systems and components from other building costs because passive solar features serve other building functions—e.g., as windows and wall systems.



*The Trombe wall at the NREL Visitors Center in Golden, Colorado, provides passive heating and daylighting to the exhibit hall.*

Photo: Warren Gretz

## References

Olgyay, Victor, *Design with Climate: Bioclimatic Approach to Architectural Regionalism*, Princeton University Press, Princeton, NJ, 1963.

Watson, Donald, and Kenneth Labs, *Climatic Design: Energy-Efficient Building Principles and Practices*, McGraw-Hill, New York, NY, 1983.

*Designing Low-Energy Buildings*, Sustainable Buildings Industry Council, Washington, DC, 1997.

*Means Assemblies Cost Data 2000*, R. S. Means Company, Inc., Kingston, MA, 2000.

## Contacts

FEMP offers a course on passive solar design, *Designing Low-Energy Buildings*. Call (800) DOE-EREC (363-3732) for course information.

Sustainable Buildings Industry Council (SBIC), 1331 H Street, NW, Suite 1000, Washington, DC 20005 (202) 628-7400; [www.sbicouncil.org](http://www.sbicouncil.org). SBIC sponsors workshops on low-energy building design and markets *Energy-10*, the software developed by NREL to aid in the evaluation of passive measures in residential and small, single-zone commercial buildings.

## 4.1.2 Daylighting Design

Daylighting is the effective use of natural light in buildings to minimize the need for electric light during daylight hours. When properly designed, daylighting can provide high-quality architectural lighting and can balance the thermal consequences of additional glazing. Since many Federal buildings use significant energy for electric lighting (often 30 to 50% of annual energy use), daylighting can be a very important design strategy to consider.

### Opportunities

In almost all cases where lighting is needed in a building on a regular basis during the day, daylighting can be an effective solution for at least some of the lighting requirements. Daylighting should be considered in buildings such as offices, laboratories, schools, food service facilities, and other daytime-use spaces. In existing buildings, daylighting potential is greatest close to perimeter window walls.

A baseline lighting profile will help establish the potential opportunities for daylighting. The graph below illustrates the lighting profile baseline of an office building on average days for each month on a 24-hour basis. The energy saved because of daylighting is plotted in the lower negative curve. This profile indicates that daylighting provides considerable savings in this building and thus is a good candidate for further consideration.

### Technical Information

Windows are provided in most buildings for daylight, view, and architectural aesthetics, as well as to satisfy a basic human need to connect with nature. However, the art and science of designing effective, high-quality daylighting systems goes beyond simply adding windows in a wall. Glazing strategies responding to size, location, orientation, type, sun control, and building geometry all affect the quality and effectiveness of a daylighting design.

Achieving good daylighting is often more of an art than a technical, engineered solution. The eye's perception of light is a key part of visibility. The amount of light (typically measured in foot-candles) in a space is only one small part of the equation. The brightness of surfaces within the field of view directs the eye's perception of visibility. If the brightness difference (luminance ratio) of surfaces being viewed is too great, the darker areas seem underlit even when the amount of light is within desirable ranges.

The quality of daylight and the human need for connection to daylight cannot be emphasized enough. Human health and productivity can be enhanced with sound daylighting designs. Some studies have indicated significant increases in productivity (up to 15%) and reduced absenteeism for office workers through the use of effective daylighting. Recent studies in California demonstrate a strong statistical correlation between daylighting and improved sales in retail stores. Similarly, daylit classrooms are being shown to result in faster learning and healthier students.

The form-givers relating to daylighting design are building geometry (architectural form of interior spaces and the building as a whole), glazing strategies (size, orientation, type, location), daylighting controls (light shelves, blinds, fins), and surfaces (textures, colors). A double-loaded corridor provides access to daylight from one wall in each room, with a lower level of borrowed light in the central corridor.

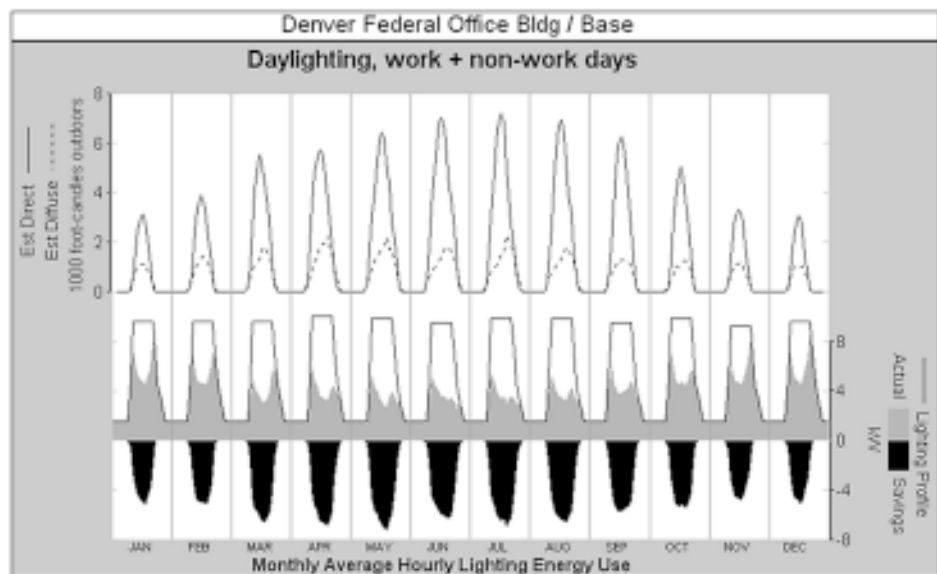

The energy saved monthly as a result of daylighting in a Denver Federal office building is shown graphically in the bottom (black) profiles.

Source: ENSAR Group



There is a tremendous amount of light outdoors, and even small windows let in enough light—an important objective is to minimize the difference between the lightest and darkest points of the room.

A key component of any daylighting strategy, particularly for a large building, is careful integration with electric lighting. After all, even the best daylighting design will save energy only if it reduces the amount of electricity used for artificial lighting. Daylight controls can dim fluorescent lighting if luminaires are fitted with dimming electronic ballasts. Controlling banks of luminaires along window walls separately from interior lights enables perimeter lights to be dimmed when natural light levels are adequate, thus yielding significant savings.

Beyond the basics, advanced daylighting systems, such as light pipes, light shelves with specular surfaces for deep directional daylighting to the building core, fiber optics, tracking daylight apertures, and other techniques can provide ample daylighting when simple approaches won't solve the problem. Most of these approaches, however, will increase overall costs.



Bring daylight in high in the space, bounce daylight off surfaces, filter daylight with vegetation and architectural components, and integrate daylighting design with electric lighting, HVAC, and architectural systems.



Avoid ceiling reflections and direct sunlight or skylight in areas where extreme brightness isn't useful.

## References

Evans, Benjamin H., AIA, *Daylight in Architecture*, McGraw-Hill, New York, NY, 1981.

Ander, Gregg D., AIA, *Daylighting: Performance and Design*, Van Nostrand Reinhold, New York, NY, 1995.



Source: ENSAR Group

*Building 33 at the Navy Shipyard in Washington, D.C., is a retrofit of a historic building where daylighting was employed through skylights and windows.*

## Contacts

Windows and Daylighting Group, Lawrence Berkeley National Laboratory, Berkeley, CA; 510/486-6845, [www.lbl.gov](http://www.lbl.gov). *Tips for Daylighting with Windows* is available as a pdf file.

Center for Buildings and Thermal Systems, National Renewable Energy Laboratory, Golden, CO; [www.nrel.gov/buildings\\_thermal/](http://www.nrel.gov/buildings_thermal/).

Daylighting Collaborative, Energy Center of Wisconsin, 595 Science Drive, Madison, WI 53711; (608) 238-4601; [www.daylighting.org](http://www.daylighting.org).

Pacific Gas & Electric Daylighting Initiative, [www.pge.com/pec/daylight/](http://www.pge.com/pec/daylight/).

## 4.1.3 Natural Ventilation

Natural ventilation is the use of wind and temperature differences to create airflows in and through buildings. These airflows may be used both for ventilation air and for passive cooling strategies. Natural ventilation is often strongly preferred by building occupants, especially if they have some control over it, as with operable windows. Studies have shown that most occupants will readily tolerate a wider range of ambient conditions if they have such control.

Before the advent of mechanical ventilation, all buildings were naturally ventilated. Since that time, climate-control expectations have risen significantly, and most building programs, codes, and regulations are based on the expectation of mechanical systems. Nevertheless, well-designed natural ventilation can often be used in conjunction with mechanical systems, creating a “mixed mode” building. Mixed-mode buildings may be designed around mechanical systems that are supplemented by natural ventilation or vice versa. The building may be designed to use both systems simultaneously or to switch from one to the other based on climate conditions or occupant demand. In a few situations, natural ventilation approaches can replace mechanical cooling and ventilation systems entirely.

### Opportunities

Buildings constructed before about 1950 were almost always designed for natural ventilation, and it often makes sense to retain that function when renovating such buildings. Building types with less stringent climate-control requirements are the best candidates for natural ventilation, whether renovated or newly designed. Temperate climates with low relative humidity, such as in the northwestern United States, are best suited to natural ventilation.

Natural ventilation is most effective in increasing occupant satisfaction when it is combined with daylighting and when occupants are at least partially in control of the conditions. Unfortunately, giving control to occupants makes energy use by mechanical systems difficult to predict. Natural ventilation is most effective as an energy conservation strategy when combined with other passive cooling and cooling load reduction strategies, such as night flushing and effective shading.

### Technical Information

There are two basic types of natural ventilation effects: buoyancy and wind. Buoyancy ventilation is more commonly referred to as temperature-induced

or stack ventilation. Wind ventilation supplies air from a positive pressure through apertures on the windward side of a building and exhausts air to a negative pressure on the leeward side. Shutters and louvers can also be positioned to maximize wind-induced airflow through the building. Airflow rate depends on the wind speed and direction as well as the size of apertures. Wind-driven turbine extractors are common in industrial buildings to provide natural ventilation.

In summer, the indoor-outdoor temperature difference is not high enough to drive buoyancy ventilation, and wind is used to supply as much fresh air as possible. In winter, however, the indoors is much warmer than outdoors, providing an opportunity for buoyancy ventilation. Also, ventilation is normally reduced to levels sufficient to remove excess moisture and pollutants in winter. For buoyancy ventilation, warm air in the roof rises and exhausts out of a high aperture, while cooler outdoor air comes in through an aperture at a lower elevation. Airflow rate depends on the size of these apertures, the height difference between them, and the indoor and outdoor temperatures. A “solar chimney” may be added to the exhaust to enhance the stack effect. An improvement sometimes used in arid climates is to add an evaporative cooler on top of a “cool tower”—this precools and pressurizes the inlet air and helps exhaust warm air high in the conditioned space or through the solar chimney.

Natural ventilation as a primary cooling and ventilation strategy is appropriate only under certain conditions. Temperate climates with low average humidity



### OBSTACLES TO THE USE OF NATURAL VENTILATION

- *Smoke control in case of fire is more difficult and may require special equipment and/or variances in codes.*
- *Outdoor noise is difficult to manage in a building that relies on operable windows or vents.*
- *Acoustic separation between spaces can be difficult to achieve.*
- *Low pressure differences often require large apertures for desired airflow rates.*
- *Outdoor air must be clean enough to introduce directly into occupied space. If filtration is required, mechanical ventilation is necessary.*



Passive down-draft cool towers at the Visitor Center in Zion National Park (in Springdale, Utah) help bring temperatures down by cooling hot air with water at the top of the tower. This cooled air then falls into the building and onto the patio.

Photo: Paul Torcellini

levels are the best candidates. In cold climates, mixed-mode buildings are viable, with natural ventilation as the primary source of outdoor air on a seasonal basis. Hot, humid climates tend to have the fewest days in which natural ventilation can be used without the risk of compromising comfort.

When natural ventilation is a priority for a new building or renovation, performance requirements should not include strict limits on acceptable indoor temperature and humidity conditions; this is because extreme weather conditions are difficult to predict. Instead, clear guidelines should be established for an allowable percentage of time to stray from certain conditions. The more broadly these conditions are defined, and the larger the acceptable amount of time out of compliance, the greater the possibilities for reducing mechanical system size and usage.

Naturally ventilated and mixed-mode buildings typically have floor plates less than 40 feet (12 m) wide—the floor plates of typical new large office buildings are too big for air to move reliably across them. Cooling-load reduction strategies—e.g., shading, heat-rejecting glazing, and the use of thermal mass to dampen temperature swings—are essential to maintaining

comfortable conditions in buildings relying on natural ventilation.

Mixed-mode buildings may be designed to switch from mechanical to natural ventilation within the same space, or they may have both types of ventilation occurring simultaneously in separate spaces. Running both natural and mechanical ventilation simultaneously in the same space will usually lead to excessive energy use, especially if mechanical cooling or heating is active. In humid climates, switching back and forth between mechanical and natural ventilation may *increase* energy use, as the mechanical cooling system has to work harder to remove latent heat (moisture) that accumulates in the air and in materials in the building.

Design for passive airflow is complex, especially in large buildings. Specialized *computational fluid dynamics* (CFD) software is valuable in understanding airflow under different conditions, but such software is expensive and time-consuming to learn. Engineering firms with expertise in natural ventilation should have CFD software or access to it. The design of simple structures, such as livestock barns, often relies on simple but effective hand calculations to size the natural ventilation apertures.

For any building type, an understanding of local climate conditions is essential for good natural ventilation design. The free *Climate Consultant* software from the University of California at Los Angeles provides graphic displays of temperature and humidity conditions for most U.S. locations. It can be downloaded from [www.aud.ucla.edu/energy-design-tools/](http://www.aud.ucla.edu/energy-design-tools/).



Mixed-mode buildings tend to be more expensive than either mechanically ventilated or naturally ventilated buildings because of the duplication of air movement systems.

## References

Allard, Francis, ed., *Natural Ventilation in Buildings*, James and James, London, 1998.

Givoni, Baruch, *Climate Considerations in Building and Urban Design*, John Wiley & Sons, New York, NY, 1998.

## 4.2

# Building Envelope

The building envelope is a critical component of any facility since it both protects the building occupants and plays a major role in regulating the indoor environment. Consisting of the building's roof, walls, windows, and doors, the envelope controls the flow of energy between the interior and exterior of the building. The building envelope can be considered the selective pathway for a building to work with the climate—responding to heating, cooling, ventilating, and natural lighting needs.

### Opportunities

**For a new project**, opportunities relating to the building envelope begin during the predesign phase of the facility. An optimal design of the building envelope may provide significant reductions in heating and cooling loads—which in turn can allow downsizing of mechanical equipment. When the right strategies are integrated through good design, the extra cost for a high-performance envelope may be paid for through savings achieved by installing smaller HVAC equipment.

**With existing facilities**, facility managers have much less opportunity to change most envelope components. Reducing outside air infiltration into the building by improving building envelope tightness is usually quite feasible. During reroofing, extra insulation can typically be added with little difficulty. Windows and insulation can be upgraded during more significant building improvements and renovations.

### Technical Information

#### WINDOWS

**Glazing systems** have a huge impact on energy consumption, and glazing modifications often present an excellent opportunity for energy improvements in a building. Appropriate glazing choices vary greatly, depending on the location of the facility, the uses of the building, and (in some cases) even the glazing's placement on the building. In hot climates, the primary strategy is to control heat gain by keeping solar energy from entering the interior space while allowing reasonable visible light transmittance for views and daylighting. Solar screens that intercept solar radiation, or films that prevent infrared and ultraviolet transmission while allowing good visibility, are useful retrofits for hot climates.

**In colder climates**, the focus shifts from keeping solar energy out of the space to reducing heat loss to the outdoors and (in some cases) allowing desirable solar radiation to enter. Windows with two or three glazing



Source: Lawrence Berkeley National Laboratory



By taking an integrated approach to combining building envelope and lighting components, even greater energy savings and increased occupant comfort can be attained. The photos above show dynamically controlled window and lighting systems implemented by the Lawrence Berkeley National Laboratory at the Oakland, California, Federal Building. The blinds adjust, and electric lights dim, in response to real-time variations in sun and sky conditions. Lighting energy savings were 20% in winter and 30–50% in summer. Overall cooling savings for the summer were 5–15%.

layers that utilize low-emissivity coatings will minimize conductive energy transmission. Filling the spaces between the glazing layers with an inert low-conductivity gas, such as argon, will further reduce heat flow. Much heat is also lost through a window's frame. For optimal energy performance, specify a low-conductivity frame material, such as wood or vinyl. If metal

frames are used, make sure the frame has thermal breaks. In addition to reducing heat loss, a good window frame will help prevent condensation—even high-performance glazings may result in condensation problems if those glazings are mounted in inappropriate frames or window sashes.

**Fenestration can be a source of discomfort** when solar gain and glare interfere with work station visibility or increase contrast and visual discomfort for occupants. Daylighting benefits will be negated if glare forces occupants to close blinds and turn on electric lights, for example, to perform visual tasks optimally.

**Facility managers should choose appropriate window technology** that is cost-effective for the climate conditions. Computer modeling, using a tool such as *DOE-2* or *Energy-10*, will help determine which glazing system is most appropriate for a particular climate. In coastal California, for example, single glazing may be all that can be economically justified, while in both hotter and colder climates, more sophisticated glazings are likely to be much more effective.

## WALLS AND ROOFS

**For buildings dominated by cooling loads**, it makes sense to provide exterior finishes with high reflectivity or wall-shading devices that reduce solar gain. Reflective roofing products help reduce cooling loads because the roof is exposed to the sun for the entire operating day. Specify roofing products that carry the ENERGY STAR® roof label—for low-slope roofing products, these have an initial reflectivity of at least 65%. ENERGY STAR roof products are widely available with single-ply roofing, as well as various other roofing systems.

**Wall shading** can reduce solar heat gain significantly—use roof overhangs, window shades, awnings, a canopy of mature trees, or other vegetative plantings, such as trellises with deciduous vines. To reduce cooling loads, wall shading on the east and west is most important, though especially for buildings with year-round cooling loads, south walls will benefit from shading as well. In new construction, providing architectural features that shade walls and glazings should be considered. In existing buildings, vegetative shading options are generally more feasible.

## INSULATION

**With new buildings**, adding more wall insulation than normal can be done for a relatively low-cost premium. Also consider thermal bridging, which can significantly degrade the rated performance of cavity-fill insulation that is used with steel framing. With steel framing, consider adding a layer of rigid insulation.

**Boosting wall insulation levels in existing buildings** is difficult without expensive building modifications. One option for existing buildings is adding an exterior insulation and finish system (EIFS) on the outside of the current building skin. With EIFS, use

only systems that include a drainage layer to accommodate small leaks that may occur over time—avoid *barrier-type* systems.

**Roof insulation** can typically be increased relatively easily during reroofing. At the time of reroofing, consider switching to a *protected-membrane* roofing system, which will allow reuse of the rigid insulation during future reroofing—thus greatly cutting down on landfill disposal.

**While we think of insulation as a strategy for cold climates**, it makes sense in cooling climates as well. The addition of insulation can significantly reduce air conditioning costs and should be considered during any major renovation project. Roofs and attics should receive priority attention for insulation retrofits because of the ease and relative low cost.

**Insulation is a guideline item under RCRA §6002** and should be purchased with recycled content. Federally funded projects are required to use insulation materials with minimum recycled content that varies depending on the type of insulation. Also consider the ozone-depletion potential of rigid insulation materials. Most extruded polystyrene and polyisocyanurate insulation is produced with ozone-depleting hydrochlorofluorocarbons (HCFCs), though ozone-safe alternatives are beginning to appear.

## Contacts

Oak Ridge National Laboratory, Bldg 3147, P.O. Box 2008 – MS6070, Oak Ridge, TN 37831; (423) 574-5207; [www.ornl.gov/roofs+walls](http://www.ornl.gov/roofs+walls). DOE *Insulation Fact Sheet* available online.

ENERGY STAR Roof Products Program, Office of Air and Radiation, U.S. Environmental Protection Agency, Washington, DC 20460; 202/564-9124; [www.epa.gov/energystar](http://www.epa.gov/energystar).



Photo: Craig Miller Productions and DOE

*Installation of light-colored roofing to better reflect sunlight and reduce interior temperature.*



## 4.2.1 Windows and Glazing Systems

Windows, and glazing systems in general, can provide daylighting, passive solar heat gain, natural ventilation, and views. Glazings can be vertical or sloped, wall-mounted or roof-mounted. While a vitally important building component, glazing systems can also be the weakest point in the building envelope—relative to heat loss, unwanted heat gain, moisture problems, and noise transmission. Through proper design, careful analysis, and proper installation, glazing systems allow buildings to work with the climate to reduce energy use as well as enhance human comfort and productivity.

### Opportunities

Opportunities to ensure that glazing systems will be effective and climate-responsive are greatest very early in the planning and design process both for new buildings and for existing buildings undergoing renovation. Renovations afford opportunities for replacing older, single-glazed, and either clear or darkly tinted windows. Window and glazing modifications can be considered independently of other building changes, but changes will be most cost-effective when carried out as part of a broader upgrade of the whole building. Improving the energy performance of windows without replacing the window units themselves may be feasible by adding shading devices on the exterior, an extra glazing layer (storm panel) on the interior or exterior, or window treatments (such as shades, drapes, shutters, or window films) on the interior.

### Technical Information

**Windows and glazings are specified** by solar heat gain coefficient (SHGC), U-factor (thermal transfer rate), air-leakage rate, visible light transmittance, and materials of construction. The glazing configuration, frame materials, and quality of construction will determine the environmental impact, maintenance, durability, and potential for disassembly for reuse or recycling at the end of its life.

**Issues to be considered in the selection of windows and glazings** include the glazing system (see below), framing materials and design, finishes used on framing components, window operation (for operable units), and how windows or glazing units are sealed at the time of installation to ensure a weather-tight envelope.

**Windows and glazings allow heat movement** via conduction across the glazing and the frame, via air leakage at the frame gaps and between the frame and wall, and via the transmission of solar and heat radiation through the glazing. Window thermal performance should be compared by using the whole-window

U-factors, as specified by the National Fenestration Rating Council (NFRC). These unit values account for the glazing, frame, and glazing spacers in insulated-glass units. The lower the U-factor ( $\text{Btu}/\text{ft}^2 \cdot \text{F} \cdot \text{hr}$ ), the better the performance. U-factor is the inverse of R-value ( $U=1/R$ ). The U-factor of double clear glazing is about 0.5 (R-value about 2).

**Types of glazing** include clear, tinted, reflective, low-emissivity (low-e), and spectrally selective. Some low-e coatings are on suspended plastic films (Heat Mirror®). There are also some advanced high-tech glazing systems available or under development, including electrochromic (tinted by applied voltage), photochromic (tinted by light intensity), thermochromic (tinted by heat), photovoltaic (power-generating), and transparent insulating.

**Low-e coatings** have revolutionized glazing design in the past twenty years, dramatically boosting energy performance. These very thin coatings of metal (typically silver or tin oxide) allow short-wavelength sunlight through but block the escape of longer-wavelength heat radiation. There are two types of low-e coatings: soft-coat (vacuum-deposited) coatings that have to be protected within a sealed insulated glass unit; and hard-coat (pyrolytic) coatings that are applied when the glass is still molten and are durable enough to be used on single-pane glazings. Soft-coat low-e coatings generally block heat loss better, but they also block more of the solar heat gain and thus aren't as good for south-facing glazing on passive solar buildings.

**Spectrally selective glazings** are a special type of glazing used mostly in commercial buildings. These should be specified in climates where solar gain in the summer creates large cooling loads and where daylight also is desired. The coatings allow visible portions of the solar energy spectrum to be transmitted, but they block infrared and ultraviolet portions of the spectrum that introduce heat primarily.

**The gap between multiple panes of glass** also influences heat flow. The space may be filled with air or a high-conductivity gas such as argon or krypton. Because these gases have lower thermal conductivity than air, they result in lower U-values. While krypton is significantly better than argon, it is also a lot more expensive and therefore rarely used. Low-conductivity gas fills are particularly important when low-e coatings are used on the glass, because the coatings result in a higher difference in temperature across the interpane space.

**In renovations**—particularly of historic buildings—aluminum, metal, and vinyl panning and receptor systems provide a weathertight, finished covering for



Photo: Warren Gretz

*NREL's Solar Energy Research Facility is designed to use natural lighting. South-, east-, and west-facing windows are specially coated with six different, graduated glazings to mitigate unwanted heat or glare from the sun. Windows facing east and west are also outfitted with "smart," motorized window shades. Each shade has a photovoltaic sensor to detect the sun's intensity and automatically raise or lower the shade to prevent glare and heat gain.*

placement over existing wood frames. This simplifies installation of new units and eliminates the removal of old frames. Separate interior or exterior glazing panels can also often be added to single-pane windows in historic buildings to boost energy performance without significantly altering the building's appearance.



Wood frames may be a better material from an environmental standpoint (if the wood is from a certified well-managed forest), but they may have greater life-cycle costs because of their shorter life, and higher maintenance costs compared with metal, vinyl (PVC), and fiberglass windows. When selecting frame materials, weight heavily the thermal performance and maintenance—not just the initial environmental impacts of the material.

**To select windows for the best overall energy performance,** first conduct an analysis that accounts for inward and outward energy flows throughout the

year. Various computer software tools can be used for this analysis, including *DOE-2* and *Energy-10*.

**Sound-control (acoustical) performance of windows** can be improved by ensuring that windows are airtight, increasing the thickness of the glass, adding additional glazing layers, and specifying *laminated* glass with a plastic interlayer.

**The choice of either fixed glazing units or operable units** should be based on site-specific and climate-specific opportunities and constraints. Casement, pivoting, and awning windows offer the greatest opening area for natural ventilation and utilize compression seals that provide the best method of sealing the joint between sash and frame. Fixed windows provide the best thermal performance because of fixed seals; these can be designed to satisfy acoustical and security concerns as well.



Glazings that insulate poorly and frames that are highly conductive will have a cold interior surface during winter months, and condensation may occur on the inside of the glass and frames. This can damage window frames, sills, wallboard, paint, and wall coverings. A more thermally efficient window and a nonconductive frame with thermal breaks are less likely to result in condensation. Avoid metal frames that lack thermal breaks.

## References

Carmody, John, Steve Selkowitz, and Lisa Hescong, *Residential Windows*, W. W. Norton & Company, New York, NY, 1996.

Franta, Greg, et al., *Glazing Design Handbook*, The American Institute of Architects, Washington, DC, 1996.

*Certified Products Directory: Energy Performance Ratings for Windows, Doors, Skylights, 9th Edition*, National Fenestration Rating Council, Washington, DC, December 1999.

## Contacts

The FEMP Help Desk, (800) DOE-EREC (363-3732) can provide window evaluation software developed by Lawrence Berkeley National Laboratory.

The National Fenestration Rating Council (NFRC), 1300 Spring Street, Suite 500, Silver Spring, MD 20910; (301) 589-6372; [www.nfrc.org](http://www.nfrc.org). (Both printed and online versions of *NFRC Certified Product Directory* are available.)

## 4.2.2 Insulation

Insulation ranks as one of the best means of saving energy in buildings, reducing utility bills, and improving air quality. Insulation provides resistance to the flow of heat from a building's exterior to its interior, and vice versa. Thermal resistance is measured in R-value, the inverse of U-factor (the measure of heat flow through a material in Btu per square foot per hour for each °F difference in temperature). Insulation is primarily either loose-fill, batt, rigid boardstock, or foamed-in-place. Along with air barriers and vapor retarders, insulation controls the passage of sensible and latent heat and prevents condensation within wall and ceiling cavities. Though we take it for granted, only since the 1950s has insulation become widely available, inexpensive, easy to install, fire-retardant, resistant to pests, and able to retain these properties over time. It represents only a small portion of building costs, but insulation has a major impact on operating costs. So, selecting the proper insulation is one of the most economical and effective ways to reduce the operating costs and environmental impacts of a Federal facility.

### Opportunities

Facility planners should specify R-values that minimize life-cycle costs for all new construction. Codes and standards dictate minimums, but it can be cost effective to use more. Improving the insulation in existing buildings, especially older ones, can also be cost effective and beneficial to occupants' health and comfort. Insulation can easily be added to attics or under floors, but retrofitting cavity insulation in walls is usually expensive and disruptive. It is less disruptive to add wall insulation on the exterior—for example, with an exterior insulation and finish system—giving a dilapidated exterior a new look. The best time to consider upgrading wall insulation is during a renovation. In reroofing, for example, insulation levels can easily be increased when exterior, low-slope insulation is being removed and reapplied (see Section 7.1.4, *Low-Slope Roofing*). Tapered insulation provides the desired slope to drains, increasing the roof membrane's life. Gasketing and caulking are integral to insulating envelopes for energy efficiency; they can be done either independently or during insulation upgrades.

### Technical Issues

**Selection issues for insulation** include R-value performance (including changes over time), environmental impacts during manufacture, recycled content, whether HCFCs were used in manufacture, durability, waste generated, and potential health hazards. The insulation selected should conform to the relevant fire

rating, pest-resistance, and product standards of ASTM and others. ASHRAE 90.1 specifies insulation requirements for various building envelope components, depending on heating degree-days and other factors.

**R-value** depends on the properties of the material, the thickness of the insulation layer, and the packing density. Though R-values per inch of thickness vary considerably, the table shows representative values for several common insulating materials.

**R-VALUES FOR SOME COMMON INSULATING MATERIALS**

Material	R-value per Inch Thickness (°F-ft <sup>2</sup> -h/Btu/inch)
Mineral Fiber	3.3 to 4.3
Glass fiber	4.0
Perlite	2.8 to 3.7
Polystyrene	3.8 (expanded) 5.0 (extruded)
Cellular Polyisocyanurate	5.6 to 7.0
Cellulose, loose fill	3.1 to 3.7
Polyurethane, spray-applied foam	5.6 to 6.2
Cotton, batt	3.4

Source: 1997 ASHRAE Fundamentals Handbook; cotton data from Environmental Building News, Vol. 9, No. 11 (November 2000).

**Minimum recycled content** of different types of insulation is specified in the recycled-content procurement guidelines of RCRA §6002. Insulation used in Federally funded projects exceeding \$10,000 must meet these standards.

**The ozone-depletion potential** of rigid boardstock and foamed-in-place insulation has been reduced by manufacturing innovations and materials. The chlorofluorocarbons (CFCs) used as blowing agents in most foam insulation have been replaced either with HCFCs, which are about 10% as damaging to ozone, or with hydrocarbons, which do not deplete ozone. The HCFC-141b used in some polyisocyanurate and spray polyurethane should be phased out by Jan. 1, 2003; the HCFC-142b used in some extruded polystyrene (XPS) should be phased out by 2020, with a production cap in 2010. Ozone-safe polyisocyanurate and spray polyurethane appeared in the late 1990s.

**Fiberglass insulation** has a high recycled glass content and includes post-industrial recycled glass cullet from window manufacturing. An increasing percentage is recycled glass from beverage containers. Some fiberglass insulation batting is encapsulated in plastic wrap. This insulation is available without a phenol formaldehyde binder.

**Mineral wool insulation** is made from either iron-ore blast furnace slag (slagwool) or natural rock (rockwool). Mineral wool is fire-resistant and effective at blocking sound.

**Cellulose insulation** contains post-consumer recycled newspaper and fire-retardant borates and ammonium sulfate.

**Cotton insulation** is made from recycled cloth. Borates are added for fire- and pest-resistance.

**Expanded polystyrene (EPS) insulation** contains no ozone-depleting substances and can be made with recycled polystyrene. Though usually produced at low density—about 1 lb/ft<sup>3</sup> (16 kg/m<sup>3</sup>)—higher density EPS is also available. In those cases, structural and R-value properties are closer to those of XPS. Below-grade EPS is widely used for insulated concrete-form products.

**Spray-in open-cell polyurethane insulation** is popular in lightframe construction. It can also be used for filling masonry block. Open-cell polyurethane contains neither ozone-depleting blowing agents nor formaldehyde.

**There are diminishing economic returns as insulation thickness increases.** Designers or facility managers should analyze life-cycle costs (LCC) to determine optimal insulation levels for minimizing LCC costs.

**Thermal bypasses** in the building can significantly reduce the effectiveness of insulation, which is why the R-value of wall insulation used with steel studs is significantly lower (see the table below).

**Settling, dust, and moisture accumulation** reduce the R-value of loose-fill and batt insulation, especially in vertical wall cavities. Skilled, careful installation should avoid or minimize problems.

**Measures to protect** both the installer and the insulation must be taken during any installation, and a

continuous barrier (e.g., drywall) should be installed between the insulation and the occupied space to protect building occupants.

**Be aware of the health hazards associated with asbestos.** Asbestos is a proven carcinogen. It is prohibited in new construction; when found in existing buildings, it is usually left in place and encapsulated. When asbestos must be removed, all regulations and methods for removal, transportation, and disposal should be followed.

**Moisture** in the exterior wall cavity occurs when water is trapped in the cavity by impermeable surfaces. Condensation can occur if the dew point temperature occurs anywhere within the cavity. Managing moisture in the building envelope requires an understanding of the climate, the drying potential of wall cavities, and the interior space conditioning method. In northern (cold) climates, the interior side of wall cavities should be less permeable than the exterior side; just the opposite is true in warm climates with mechanically cooled buildings. Using rigid insulation on the exterior side of wall framing is one effective way to deal with moisture.

## References

Lstiburek, Joseph, P. Eng., and John Carmody, *Moisture Control Handbook*, Oak Ridge National Laboratory, Oak Ridge, TN, 1991.

Wilson, Alex, “Insulation Materials: Environmental Comparisons,” *Environmental Building News*, Vol. 4, No. 1, January 1995; BuildingGreen, Inc., Brattleboro, VT.

## Contacts

Building Thermal Envelope Systems and Materials (BTESM) Program, Oak Ridge National Laboratory, P.O. Box 2008 – MS6070, Oak Ridge, TN 37831-6070; (423) 574-5207; [www.ornl.gov/walls+roofs/](http://www.ornl.gov/walls+roofs/).

## IMPACT OF FRAMING ON WALL R-VALUES

Combined Insulation & Framing R-Value			
Framing Material & Spacing	Insulation R-Value	Wood-Framed Walls	Steel-Framed Walls
2x4 16" on-center	R-11 (RSI-1.9)	R-9.0 (RSI-1.6)	R-5.5 (RSI-0.1)
	R-13 (RSI-2.3)	R-10.1 (RSI-1.8)	R-6.0 (RSI-1.0)
2x6 16" on-center	R-19 (RSI-3.3)	R-15.1 (RSI-2.7)	R-7.1 (RSI-1.2)
	R-21 (RSI-3.7)	R-16.2 (RSI-2.9)	R-7.4 (RSI-1.3)
2x6 24" on-center	R-19 (RSI-3.3)	R-16.0 (RSI-2.8)	R-8.6 (RSI-1.5)
	R-21 (RSI-3.7)	R-17.2 (RSI-3.0)	R-9.0 (RSI-1.6)

Notes: Assumes C-channel steel studs; steel-framing data from ASHRAE Standard 90.1; wood-framing values calculated using parallel-path method.

Source: *Environmental Building News*, Vol. 3, No. 4 (July/August 1994)

---

## GREENING FEDERAL FACILITIES

An Energy, Environmental, and Economic Resource Guide for Federal Facility Managers and Designers

---

### Part V

## ENERGY SYSTEMS

SECTION	PAGE
5.1 Energy and Conservation Issues .....	54
5.2 HVAC Systems .....	56
5.2.1 Boilers .....	58
5.2.2 Air Distribution Systems .....	60
5.2.3 Chillers .....	62
5.2.4 Absorption Cooling .....	66
5.2.5 Desiccant Dehumidification .....	68
5.2.6 Ground-Source Heat Pumps .....	70
5.2.7 HVAC Technologies to Consider .....	72
5.3 Water Heating .....	74
5.3.1 Heat-Recovery Water Heating .....	76
5.3.2 Solar Water Heating .....	78
5.4 Lighting .....	80
5.4.1 Linear Fluorescent Lighting .....	82
5.4.2 Electronic Ballasts .....	84
5.4.3 Compact Fluorescent Lighting .....	86
5.4.4 Lighting Controls .....	88
5.4.5 Exterior Lighting .....	90

<b>5.5</b>	<b>Office, Food Service, and Laundry Equipment ...</b>	<b>92</b>
5.5.1	Office Equipment .....	94
5.5.2	Food Service/Laundry Equipment .....	96
<b>5.6</b>	<b>Energy Management.....</b>	<b>98</b>
5.6.1	Energy Management and Control Systems .....	100
5.6.2	Managing Utility Costs .....	102
<b>5.7</b>	<b>Electric Motors and Drives .....</b>	<b>104</b>
5.7.1	High-Efficiency Drives .....	106
5.7.2	Variable-Frequency Motors .....	108
5.7.3	Power Factor Correction .....	110
5.7.4	Energy-Efficient Elevators .....	112
<b>5.8</b>	<b>Electric Power Systems .....</b>	<b>114</b>
5.8.1	Power Systems Analysis .....	116
5.8.2	Transformers .....	118
5.8.3	Microturbines .....	120
5.8.4	Fuel Cells .....	122
5.8.5	Photovoltaics .....	124
5.8.6	Wind Energy .....	126
5.8.7	Biomass Energy Systems .....	128
5.8.8	Combined Heat and Power .....	130

The Federal Government is the largest single user of energy in the United States and purchases \$10–20 billion in energy-related products each year. With ownership of more than 500,000 buildings, including 422,000 housing structures, the Federal Government has a tremendous interest in energy efficiency in buildings. The Energy Policy Act of 1992 and Executive Order 13123 set goals for energy reduction and provide some guidelines for implementing conservation measures. Annual energy use in Federal buildings has dropped from 140,000 Btu/sq ft (1,600 MJ/m<sup>2</sup>) in 1985 to 116,000 Btu/sq ft (1,300 MJ/m<sup>2</sup>) in 1997. To meet the Executive Order 13123 requirement, annual energy use must drop to 90,800 Btu/sq ft (1,000 MJ/m<sup>2</sup>) by 2010. FEMP provides information on technologies that have been proven in field testing or recommended by reliable sources, such as the DOE national laboratories.

## Opportunities

The time for planning, evaluating, and implementing is now! Facility managers should first implement energy- and demand-reducing measures in their operations and then look for opportunities to cost-effectively replace conventional technologies with ones using renewable energy sources.

Facility managers should also set goals for their operations that follow Federal mandates. Executive Order 13123 requires an energy reduction in Federal buildings of 30% by 2005 and 35% by 2010, relative to 1985. Industrial and laboratory facilities are required to reduce energy consumption by 20% by 2005 and 25% by 2010, relative to 1990. Executive Order 13123 further states that agencies shall use life-cycle cost analysis in making decisions about their investments in products, services, construction, and other projects to lower the Federal government's costs and to reduce energy consumption. When energy-consuming equipment needs replacement, guidance for purchasing products that meet or exceed Executive Order 13123 procurement goals is available through FEMP's Product Energy Efficiency Recommendations series.

## Technical Information

The *Energy Systems* section of this guide describes systems that provide key opportunities for energy savings. The following are some of these opportunities:

**Integrated design** is a process whereby the various disciplines involved in design—architect, mechanical engineer, electrical engineer, interior design professional, etc.—work together to come up with design solutions that maximize performance, energy conservation, and environmental benefits. Integrated design is an important aspect of energy conservation and equipment selection because decisions made in one area (lighting, for example) will affect others (such as chiller sizing). Refer back to *Section 4.1 – Integrated Building Design* for an overview.

**HVAC system** improvements offer tremendous potential for energy savings in most facilities. Opportunities include replacing older equipment with more efficient products, improving controls, upgrading maintenance programs, and retrofitting existing equipment to operate more efficiently. Central plants contain many interrelated components, and upgrading them takes careful planning, professional design assistance, and careful implementation. This guide covers chillers, boilers, air distribution systems, and other HVAC technologies.

**Water heating** is a major energy user in facilities with kitchens and laundries. Beyond reducing the use of hot water, various heat recovery and solar technologies can also help reduce operating costs.

**Lighting.** More than \$250 million could be saved annually if all Federal facilities upgraded to energy-efficient lighting. Light energy savings of up to 40% can be achieved in interior applications by replacing lamps and ballasts. Savings of well over 50% are possible by designing and implementing an integrated approach to lighting that includes daylighting, task lighting, and sophisticated controls.

**Office equipment** is becoming an ever greater proportion of building loads. “Green” appliances that feature automatic power shutdown and more efficient electronics can help reduce energy consumption.

**Energy Management and Control Systems (EMCSs)** are critical in avoiding energy waste and monitoring energy consumption. Control technology should be applied intelligently for each situation, and an optimized mix of local and central control should be used.

**Electric motor systems** that operate around the clock (or nearly so) consume many times their purchase price in electricity each year. This makes inefficient, large-horsepower motors excellent targets for replacement. If the driven load operates at reduced speed a majority of the time, installing electronic motor controls could reduce both energy consumption and operating costs.

**Electrical power systems** can be made more efficient through (1) maintenance practices focused on identifying potential trouble areas, such as loose electrical connections; and (2) selection of efficient electrical equipment, such as transformers. There may also be opportunities to use renewable power-generation equipment.

## Making It Happen

Carrying out energy efficiency improvements in Federal buildings is not simply about energy technologies and systems, it is also about financing and budgets. Here are a few financing strategies that can be applicable to Federal buildings. Also refer to *Section 2.4 – Alternative Financing*.

**Energy Savings Performance Contracts** provide Federal agencies with a means of increasing their investment in energy-saving technologies. Because appropriated funds are shrinking for many agencies, ESPCs enable them to secure financing from energy service contractors, or ESCOs, to identify and implement energy conservation measures. In effect, agencies can defer the initial costs of equipment and pay for the equipment through utility-bill savings. FEMP assists Federal agencies with ESPCs.

**Super ESPCs** are a facilitated form of ESPC. They are regional agreements in which delivery orders are placed against a contract with selected ESCOs. A Super ESPC allows individual facilities to negotiate contracts directly with certain competitively selected companies, greatly reducing the complexity of the ESPC process.

**Basic Ordering Agreements (BOAs)** are written understandings negotiated between GSA and a utility or other business that set contract guidelines for energy-consuming products and services. For example, the GSA Chet Holifield Federal Center in Laguna Niguel, California, contracted with its electric utility for thermal energy storage, energy-efficient chillers, variable-frequency drives, efficient motors, and lighting system retrofits. The contractor invested \$3,800,000,



Source: Farallon National Wildlife Refuge

*The U.S. Fish and Wildlife service needed a cleaner, quieter power source for the Farallon National Wildlife Refuge, 30 miles (48 km) west of San Francisco. Applied Power designed a 9.1-kW hybrid photovoltaic system to withstand the extremely corrosive island environment. Before this installation, the staff operated extremely loud, expensive diesel generators during daylight hours only.*

and the government's share of the savings is \$1,400,000 over 14 years. The GSA retains the equipment after the contract term. One prominent BOA specifying energy-efficient chillers for Federal procurement has been developed between GSA and five major chiller manufacturers in the United States. Other BOAs are being developed and will be available soon.

## References

*Architect's and Engineer's Guide to Energy Conservation in Existing Buildings* (DOE/RL/018-30P-H4), U.S. Department of Energy, Washington, DC, 1990.

*Technology Atlas Series*, E Source, Inc., Boulder, CO, 1996-97; (303) 440-8500; [www.esource.com](http://www.esource.com).

## Contacts

To access FEMP's *Product Energy-Efficient Recommendations* series or obtain more information on financing alternatives, visit the FEMP Web site at [www.eren.doe.gov/femp](http://www.eren.doe.gov/femp) or call the FEMP Help Desk at (800) DOE-EREC (363-3732).



Heating, ventilating, and air-conditioning systems can be the largest energy consumers in Federal buildings. HVAC systems provide heating, cooling, humidity control, filtration, fresh air makeup, building pressure control, and comfort control—all requiring minimal interaction between the occupants and the system. Properly designed, installed, and maintained HVAC systems are efficient, provide comfort to the occupants, and inhibit the growth of molds and fungi. Well-designed, energy-efficient HVAC systems are essential in Federal buildings and contribute to employee productivity. Boilers, air distribution systems, chillers, absorption cooling systems, desiccant dehumidification, ground-source heat pumps, and new HVAC technologies are covered in the sections that follow.

## Opportunities

Consider upgrading or replacing existing HVAC systems with more efficient ones if current equipment is old and inefficient; if loads have changed as a result of other conservation measures or changes in building occupancy; if control is poor; if implementing new ventilation standards has caused capacity problems; or if moisture or other indoor air quality problems exist. Be sure to have a plan in place for equipment change-out and failure. The phase-out of CFCs is another factor encouraging chiller replacement. In all these cases, an *integrated* approach should be utilized that looks at the entire cooling system and the entire building to take advantage of synergies that allow for *downsizing*, as well as boosting the efficiency of, a replacement chiller.

## Technical Information

Strategies for reducing HVAC operating costs in large facilities include the following:

**Reduce HVAC loads.** By reducing building loads, less heating and cooling energy is expended. Load reduction measures include adding insulation; shading harsh wind and sun exposures with trees, shade screens, awnings, or window treatments and minimizing the use of heat-producing equipment, such as office equipment and computers; daylighting; controlling interior lighting; and capturing heat from exhaust air. See *Part 4* of this guide for more on building design issues.

**Incorporate building automation/control systems.** These systems can be added or upgraded to improve the overall performance of the building, including the HVAC equipment. Perhaps the simplest measure and the first to be considered should be to ensure that HVAC systems are in “setback” mode during un-

occupied periods. Existing control systems will often accommodate this very simple measure. Sections 5.6, 5.6.1, and 5.4.4 (for lighting) address energy controls in more detail.

**Optimize for part-load conditions.** Buildings usually operate under conditions in which the full heating or cooling capacity is not required. Therefore, significant improvements in annual efficiency will result from giving special consideration to part-load conditions. Staging multiple chillers or boilers to meet varying demand greatly improves efficiencies at low and moderate building loads. Pairing *different-sized* chillers and boilers in parallel offers greater flexibility in output while maintaining top performance. Units should be staged with microprocessor controls to optimize system performance.

**Isolate off-line chillers and boilers.** In parallel systems, off-line equipment should be isolated from cooling towers and distribution loops. With reduced pumping needs, circulation pumps can be shut off or modulated with variable-speed drives.

**Use economizers.** In climates with seasons having moderate temperatures and humidity, adding air- and water-side economizer capabilities can be cost-effective. When ambient conditions permit, outside air provides space conditioning without the use of the cooling plant. To prevent the inappropriate introduction of outside air, careful attention must be given to economizer logic, controls, and maintenance. With a water-side economizer, cooling is provided by the cooling tower without the use of the chiller.

**Remember that ventilation systems have a tremendous impact on energy use** because of the high costs associated with heating or cooling outside air. Buildings should be ventilated according to ASHRAE Standard 62. The outside air requirements—15 to 20 cfm (7.1–9.5 L/s) per person in most commercial buildings—of Standard 62’s most recent version (62-1989) do not apply to buildings constructed before it was published, although for new additions of 25% or more, this “grandfathering” is not permitted by the major building codes. The indoor air quality benefits of complying with ASHRAE 62-1989, such as higher productivity and decreased sick leave, may often make the added expense worthwhile, even when not required by law.

**Upgrade cooling towers.** Large savings are possible when cooling towers are retrofitted with new fill, efficient transmissions, high-efficiency motors, and variable-frequency drives. Good water chemistry is needed to minimize the use of environmentally hazardous chemical biocides. Ozone treatments also may be useful.



*Chillers have changed dramatically in recent years. Today's models are far better for the environment than older products.*

Photo: McQuay Air Conditioning

**Interconnect mechanical rooms for greater modularity and redundancy.** This increases effective capacity while improving part-load efficiency.

### IMPORTANCE OF MAINTENANCE

Proper maintenance helps prevent loss of HVAC air balance (return, supply, and outdoor air); indoor air quality problems; improper refrigerant charge; fouling of evaporator coils by dust and debris; poor water quality in cooling towers; and water damage from condensate.

**Provide a monitoring and diagnostic capability.** An important part of maintaining the rated efficiency of equipment and optimal performance of HVAC systems is understanding how they are functioning. Incorporate systems to track performance and identify problems quickly when they occur.

**Ensure that air handlers are maintained.** To achieve better indoor air quality and reduce operating costs, steam-clean evaporator coils and air handlers at a minimum three-year rotation. Also service filters frequently.

**Service the ventilation system.** A good balance report is required. Airflows can then be periodically checked. Periodically lubricate dampers and check their operation by exercising the controls.

**Prevent or repair air distribution system leakage.** In residential and small commercial buildings, air duct leakage can be a huge energy waster. Leaks can also cause comfort and air quality problems. Check ventilation rates after duct repair to ensure that

ASHRAE standards are met and that desired pressure relationships are maintained.

**Eliminate or upgrade inefficient steam systems.** Leaks are a common problem with older central steam distribution systems. Regularly inspect for evidence of leaks; repair problems as they occur or upgrade the system.

**Check for improper refrigerant charge.** Refrigerant-based HVAC systems require precise levels of refrigerant to operate at peak capacity and efficiency, and to most effectively control interior humidity in moist climates. Loss of refrigerant charge not only wastes money but also damages the environment—most refrigerants deplete stratospheric ozone. Inspect for leaks and promptly fix problems. Consider replacing older equipment with new, more efficient, ozone-safe systems.

**Provide or consider ease of maintenance** when making any HVAC system modifications or equipment purchases. Make sure that access to filters (for cleaning or replacement), ducts (for inspection and cleaning), controls, and other system components remains easy. Label components that will need servicing, and post any necessary inspection and maintenance instructions clearly for maintenance personnel.

## References

*ASHRAE Standard 62* (ventilation), *Standard 90.1* (energy performance), others; American Society of Heating, Refrigerating and Air-Conditioning Engineers, Atlanta, GA; [www.ashrae.org](http://www.ashrae.org).

*A Design Guide for Energy-Efficient Research Laboratories*, Lawrence Berkeley National Laboratory; available online (also downloadable) at [ateam.lbl.gov/Design-Guide](http://ateam.lbl.gov/Design-Guide).

*Space Heating Technology Atlas* (1996) and *Commercial Space Cooling and Air Handling Technology Atlas* (1997), E Source, Inc., Boulder, CO; (303) 440-8500; [www.esource.com](http://www.esource.com).

## Contacts

HVAC retrofits and maintenance opportunities are thoroughly covered in the FEMP-sponsored “Trained Energy Manager” course. Contact the FEMP Help Desk at (800) DOE-EREC (363-3732) for course information.

Information about the Laboratories for the 21st Century project is online at [www.epa.gov/labs21century/](http://www.epa.gov/labs21century/).

For written material and software to assist with evaluating HVAC systems, contact the EPA ENERGY STAR® Building Hotline, (202) 775-6650; [www.energystar.gov](http://www.energystar.gov).

## 5.2.1 Boilers

Most medium-to-large facilities use boilers to generate hot water or steam for space heating, domestic water heating, food preparation, and industrial processes. For boilers to run at peak efficiency, operators must attend to boiler staging, water chemistry, pumping and boiler controls, boiler and pipe insulation, fuel-air mixtures, burn-to-load ratio, and stack temperatures.

### Opportunities

Every effort should be made to upgrade boiler systems to peak efficiency in order to reduce operating costs and environmental impacts. When replacing old equipment or installing new equipment:

- Consider the advantages of multiple boiler systems, which are more efficient than single boilers, especially under part-load conditions.
- Consider solar-assisted systems and biomass-fired boilers as alternatives to conventional boiler systems.
- Consider opportunities for cogeneration (combined heat and power), including the use of fuel cells and microturbines as the heat source.

### Technical Information

**Note recent trends in boiler systems**, which include installing multiple small boiler units, decentralizing systems, and installing direct digital control (DDC) systems, including temperature reset strategies. Because these systems capture the latent heat of vaporization from combustion water vapor, flue-gas temperatures are low enough to vent the exhaust through polyvinyl chloride (PVC) pipes; PVC resists the corrosive action of flue-gas condensate.

**Replace inefficient boilers.** In newer units, more fuel energy goes into creating heat, so both stack temperatures and excess oxygen are lower. Estimate efficiencies of existing units by measuring excess air, flue and boiler room temperatures, and percent of flue-gas oxygen and carbon dioxide. Some utilities will provide this service free of charge. Boilers are available that have efficiencies greater than 90%.

**Decentralize systems.** Several smaller units strategically located around a large facility reduce distribution losses and offer flexibility in meeting the demands of differing schedules, as well as steam pressure and heating requirements. Estimate standby losses by monitoring fuel consumption during no-load periods.

**Downsize.** Strive to lower overall heating demands through prudent application of energy conservation measures, such as increased building insulation and improved glazings. Smaller boilers may be staged to meet loads less expensively than large central plants. Many new units are designed to ease retrofit by fitting through standard doorways.

**Modernize boiler controls.** Direct digital controls consist of computers, sensors, and software that provide the real-time data needed to maximize boiler system efficiency. They allow logic-intense control functions to be carried out, such as temperature reset, optimizing fuel/air mixture based on continuous flue-gas sampling, managing combustion, controlling feedwater and drum levels, and controlling steam header pressure.

**Install an economizer.** Install a heat exchanger in the flue to preheat the boiler feedwater. Efficiency increases about 1% for every 10°F (5.5°C) increase in feedwater temperature. If you are considering an economizer, ensure (1) that the stack temperature remains higher than the acid dew point in order to prevent flue damage, and (2) that excess flue temperature is due to insufficient heat transfer surfaces in the boiler rather than scaling or other maintenance problems.

**Install an oxygen trim system.** To optimize the fuel/air ratio, these systems monitor excess oxygen in the flue gas and modulate air intake to the burners accordingly.

**Reduce excess air to boiler combustion.** The common practice of using 50–100% excess air decreases efficiency by 5%. Work with the manufacturer to determine the appropriate fuel/air mixture.

**Install air preheaters** that deliver warm air to the boiler air inlets through ducts. The source of warm air can be the boiler room ceiling, solar panels, or solar-preheat walls. Managers should check with boiler manufacturers to ensure that alterations will not adversely alter the performance, void the warranty, or create a hazardous situation.



Source: HydroTherm

*The Multi-Pulse boiler from Hydrotherm offers an annual fuel utilization efficiency (AFUE) of over 90%. Multiple units can be ganged for higher output requirements.*

**Install automatic flue dampers** to reduce the amount of boiler heat that is stripped away by natural convection in the flue after the boiler cycles off.

**Retrofit gas pilots** with electronic ignition systems, which are readily available.

**Add automatic blowdown controls.** Uncontrolled, continuous blowdown is very wasteful. A 10% blowdown on a 200 psia steam system results in a 3% efficiency loss. Add automatic blowdown controls that sense and respond to boiler water conductivity and pH.

**Add a waste heat recovery system to blowdowns.** Capturing blowdown in recovery tanks and using heat exchangers to preheat boiler feedwater can improve system efficiency by about 1%.

**Consider retrofitting boiler fire tubes with turbulators** for greater heat exchange, after checking with your boiler manufacturer. Turbulators are baffles placed in boiler tubes to increase turbulence, thereby extracting more heat from flue gases.

**Insulate boiler and boiler piping.** Reduce heat loss through boiler walls and piping by repairing or adding insulation. The addition of 1 inch (2.5 cm) of insulation can reduce heat loss by 80–90%.

## OPERATION AND MAINTENANCE

Proper operation and maintenance is the key to efficient boiler operation. Any large boiler plant should maintain logs on boiler conditions as a diagnostic tool. When performance declines, corrective action should be taken.

**Reduce soot and scale.** Deposits act as insulation on heat exchangers and allow heat to escape up the flue. If the stack temperature rises over time under the same load and fuel/air mixture, and deposits are discovered, adjust and improve water chemistry and fuel/air mixture accordingly. Periodically running the system lean can remove soot.

**Detect and repair steam leaks.** Though they are not directly boiler-related, leaks in underground distribution pipes can go undetected for years. Monitor blowdown and feedwater to help detect these leaks. Repair them promptly.



On systems operating with negative pressure, air may enter the system after combustion and give false indications of excess air measured with flue-gas oxygen.

## References

Brecher, Mark L., “Low-Pressure System Gets High Marks from College,” *Heating/Piping/Air Conditioning*, September 1994.

Payne, William, *Efficient Boiler Operations Sourcebook, 3rd Edition*, Fairmont Press, Lilburn, GA, 1991.

Washington State Energy Office, *Boiler Efficiency Operations* (WAOENG-89-24), Olympia, WA, 1989.

## 5.2.2

# Air Distribution Systems

On an annual basis, continuously operating air distribution fans can consume more electricity than chillers or boilers, which run only intermittently. High-efficiency air distribution systems can substantially reduce fan power required by an HVAC system, resulting in dramatic energy savings. Because fan power increases at the square of air speed, delivering a large mass of air at low velocity is a far more efficient design strategy than pushing air through small ducts at high velocity. Supplying only as much air as is needed to condition or ventilate a space through the use of variable-air-volume systems is more efficient than supplying a constant volume of air at all times.

## Opportunities

The largest gains in efficiency for air distribution systems are realized in the system design phase during new construction or major retrofits. Modifications to air distribution systems are difficult to make in existing buildings, except during a major renovation.

## Technical Information

Design options for improving air distribution efficiency include (1) variable-air-volume (VAV) systems, (2) VAV diffusers, (3) low-pressure-drop ducting design, (4) low-face-velocity air handlers, (5) fan sizing and variable-frequency-drive (VFD) motors, and (6) displacement-ventilation systems. These are described below.

**Deliver only the volume of air needed for conditioning the actual load.** Variable-air-volume systems offer superior energy performance compared with constant-volume systems with dual ducts or terminal reheat that use backward-inclined or airfoil fans. VAV systems are becoming an increasingly standard design practice, yet even greater efficiency gains can be made through careful selection of equipment and system design.

**Use local VAV diffusers for individual temperature control.** Temperatures across a multiroom zone in a VAV system can vary widely, causing individuals



Facility managers can evaluate the benefits of reducing the size of fan systems in facilities by running EPA's QuikFan software. The software is available to Green Lights and ENERGY STAR® Building Partners.

further from the thermostat and VAV box location to be uncomfortable. Local ceiling diffusers ducted from the VAV box to individual rooms can modulate the amount of conditioned air delivered to a space, eliminating the inefficient practice of overheating or overcooling spaces to ensure the comfort of all occupants. VAV diffusers require low duct static pressures—0.25 inches of water column (62 Pa) or less—and thus save on fan energy.

**Increase duct size to reduce duct pressure drop and fan speed.** Eliminate resistance in the duct system by improving the aerodynamics of the flow paths and avoiding sharp turns in duct routing. Increasing the size of ducting where possible allows reductions in air velocity, which in turn permit reductions in fan speed and yield substantial energy savings. Small increases in duct diameter can yield large pressure drop and fan energy savings, because the pressure drop in ducts is proportional to the inverse of duct diameter to the fifth power.

**Specify low-face-velocity air handlers—to reduce air velocity across coils.** Oversizing the air handler increases the cross-sectional area of the airflow, allowing the delivery of the same required airflow at a slower air speed for only a relatively small loss of floor space. The pressure drop across the coils decreases with the square of the air speed, allowing the use of a smaller fan and smaller VFD, thus reducing the first-costs of those components. Air traveling at a lower velocity remains in contact with cooling coils longer, allowing warmer



Source: Krantz

*Designed for use with access flooring systems, these passive air diffusers from Krantz swirl air, causing it to mix very quickly with surrounding air.*



Half-round textile ducts in the Carlsson company's dining room (in Sweden) retain their shape even when not inflated with supply air.

Source: KE Fibertec North America

chilled water temperatures. This can yield substantial compounded savings through downsizing of the chilled water plant (as long as all air-handling units in a facility are sized with these design strategies in mind).

**Size fans correctly and install VFDs on fan motors.** Replace oversized fans with units that match the load. Electronically control the fan motor's speed and torque to continually match fan speed with changing building-load conditions. Electronic control of the fan speed and airflow can replace inefficient mechanical controls, such as inlet vanes or outlet dampers. (See Section 5.7.2 – Variable-Frequency Drives.)

**Use the displacement method for special facility types.** Displacement ventilation systems can largely eliminate the need for ducting by supplying air through a floor plenum and using a ceiling plenum or ceiling ducts as the return. Raised (access) floors providing



Be certain that proper ventilation and humidity control is provided by the air distribution system even when heating and cooling loads are low. If fans are set up to respond only to space temperature requirements, space ventilation can fall below acceptable limits during mild weather. This is a very important air quality issue.



Using fabric ducting for exposed applications can help avoid duct cleaning difficulties. Conditioned supply air inflates the ducts and diffuses through the fabric into the occupied space, providing final filtration of the supply air in the process. Textile ducting can be removed and washed in conventional clothes washers at low labor costs, an important savings opportunity for sensitive areas that require frequent cleaning, such as food processing facilities.

air delivery are commonly used in Europe and rapidly gaining popularity in the United States. This design strategy is best used in (1) facilities that already include, or can accommodate, low-wall duct mounts or a floor plenum; (2) spaces with high ceilings, in which only a small band of air at the floor level needs to be conditioned for occupant comfort; (3) clean-room or laboratory spaces that require high-volume ventilation or laminar airflow; or (4) facilities in which other benefits of access floors, such as telecommunications wiring needs and high churn rate, are important. Because of the air delivery characteristics, the conditioned supply air does not have to be chilled as much, resulting in additional energy savings.

## References

*Variable Air Volume Systems: Maximum Energy Efficiency and Profits* (430-R-95-002), U.S. Environmental Protection Agency, 1995; [www.epa.gov](http://www.epa.gov).

Cler, Gerald, et al., *Commercial Space Cooling and Air Handling Technology Atlas*, E Source, Inc., Boulder, CO, 1997; (303) 440-8500; [www.esource.com](http://www.esource.com).

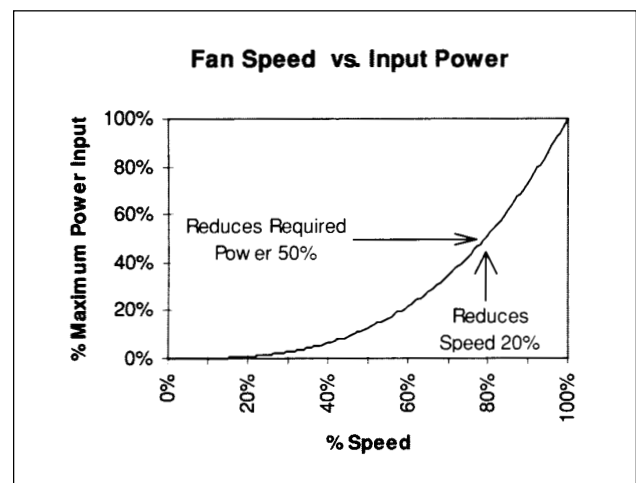

## 5.2.3 Chillers

In large Federal facilities, the equipment used to produce chilled water for HVAC systems can account for up to 35% of a facility's electrical energy use. If replacement is determined to be the most cost-effective option, there are some excellent new chillers on the market. The most efficient chillers currently available operate at efficiencies of 0.50 kilowatts per ton (kW/ton), a savings of 0.15 to 0.30 kW/ton over most existing equipment. When considering chiller types and specific products, part-load efficiencies must also be compared. If existing chiller equipment is to be kept, there are a number of measures that can be carried out to improve performance.

### Opportunities

Consider chiller replacement when existing equipment is more than ten years old and the life-cycle cost analysis confirms that replacement is worthwhile. New chillers can be 30–40% more efficient than existing equipment. First-cost and energy performance are the major components of life-cycle costing, but refrigerant fluids may also be a factor. Older chillers using CFCs may be very expensive to recharge if a refrigerant leak occurs (and loss of refrigerant is environmentally damaging).

An excellent time to consider chiller replacement is when lighting retrofits, glazing replacement, or other modifications are being done to the building that will reduce cooling loads. Conversely, when a chiller is being replaced, consider whether such energy improvements should be carried out—in some situations those energy improvements can be essentially done for free because they will be paid for from savings achieved in downsizing the chiller (see *Section 4.1 – Integrated Building Design*). Be aware that there can be lead times of six months or more for delivery of new chillers.

### Technical Information

Electric chillers use a vapor compression refrigerant cycle to transfer heat. The basic components of an electric chiller include an electric motor, refrigerant compressor, condenser, evaporator, expansion device, and

controls. Electric chiller classification is based on the type of compressor used—common types include centrifugal, screw, and reciprocating. The scroll compressor is another type frequently used for smaller applications of 20 to 60 tons. Hydraulic compressors are a fifth type (still under development).

Both the heat rejection system and building distribution loop can use water or air as the working fluid. Wet condensers usually incorporate one or several cooling towers. Evaporative condensers can be used in certain (generally dry) climates. Air-cooled condensers incorporate one or more fans to cool refrigerant coils and are common on smaller, packaged rooftop units. Air-cooled condensers may also be located remotely from the chillers.

### REFRIGERANT ISSUES

**The refrigerant issues currently facing facility managers** arise from concerns about protection of the ozone layer and the buildup of greenhouse gases in the atmosphere. The CFC refrigerants traditionally used in most large chillers were phased out of production on January 1, 1996, to protect the ozone layer. CFC chillers still in service must be (1) serviced with stockpiled refrigerants or refrigerants recovered from retired equipment; or (2) converted to HCFC-123 (for the CFC-11 chillers) or HFC-134a (for the CFC-12 chillers); or (3) replaced with new chillers using EPA-approved refrigerants.

**All refrigerants listed for chillers by the EPA Strategic New Alternatives Program (SNAP) are acceptable.** These include HCFC-22, HCFC-123, HFC-134a, and ammonia for vapor-compression chillers (see table on page 63). Under current regulations, HCFC-22 will be phased out in the year 2020. HCFC-123 will be phased out in the year 2030. Chlorine-free refrigerants, such as HFC-134a and water/lithium bromide mixtures, are not currently listed for phase-out.

**A chiller operating with a CFC refrigerant** is not directly damaging to the ozone, provided that the refrigerant is totally contained during the chiller's operational life and that the refrigerant is recovered upon retirement. If a maintenance accident or leak results in venting of the CFC refrigerant into the atmosphere, however, damage to the Earth's ozone layer occurs. This risk should be avoided whenever possible.

**Proper refrigerant handling** is a requirement for any of the options relating to chillers operating with CFC refrigerants. The three options are containment, conversion, or replacement:

- **Containing refrigerant** in existing chillers is possible with retrofit devices that ensure that refrigerant leakage is eliminated. Containment assumes that phased-out refrigerants will continue to be available by recovering refrigerants from retired systems.
- **Converting chillers** to use alternative refrigerants will lower their performance and capacity. The capacity loss may not be a problem with converted units since existing units may have been oversized when originally installed and loads may have been reduced through energy conservation activities.
- **Replacing older chillers** that contain refrigerants no longer produced is usually the best option for complying with refrigerant phaseout requirements, especially if load reductions are implemented at the same time, permitting chiller downsizing.

### SPECIFYING NEW CHILLERS

Chillers have been significantly reengineered in recent years to use new HCFC and HFC refrigerants. New machines have full-load efficiencies down to 0.50 kW/ton in the 170- to 2,300-ton range. Some have built-in refrigerant containment, are designed to leak no more than 0.1% refrigerant per year, and do not require purging.

**Other important energy efficiency improvements in new chillers** include larger heat transfer surfaces, microprocessor controls for chiller optimization, high-efficiency motors, variable-frequency drives, and optional automatic tube-cleaning systems. To facilitate replacement, new equipment is available from all manufacturers that can be unbolted for passage through conventional doors into equipment rooms. Many positive-pressure chillers are approximately one-third smaller than negative-pressure chillers of similar capacity.

**Thermal energy storage** may be added when replacing chillers and may enable the use of smaller chillers. Although this strategy does not save energy per se, operating costs may be reduced by lowering electrical demand charges and by using cheaper, off-peak electricity. Thermal storage systems commonly use one of three thermal storage media: water, eutectic salts, or ice. Volumes of these materials required for storage of 1 ton-hour of cooling are approximately 11.4, 2.5, and 1.5 ft<sup>3</sup> (0.33, 0.07, and 0.04 m<sup>3</sup>), respectively.

**Multiple chiller operations** may be made more efficient by using *unequally sized* units. With this configuration, the smallest chiller can efficiently meet light loads. The other chillers are staged to meet higher loads after the lead chiller is operating close to full capacity. If an existing chiller operates frequently at part-load conditions, it may be cost-effective to replace it with multiple chillers staged to meet varying loads.

**Double-bundle chillers** have two possible pathways for rejecting condenser heat. One pathway is a conventional cooling tower. The other pathway is heat

*(continued on next page)*

### COMPARISON OF REFRIGERANT ALTERNATIVES

Criteria	HCFC-123	HCFC-22	HFC-134a	Ammonia
Ozone-depletion potential	0.016	0.05	0	0
Global warming potential (relative to CO <sub>2</sub> )	85	1,500	1,200	0
Ideal kW/ton	0.46	0.50	0.52	0.48
Occupational risk	Low	Low	Low	Low
Flammable	No	No	No	Yes

Source: U.S. Environmental Protection Agency



## 5.2.3 Chillers (continued)

recovery for space heating or service-water heating. Candidates for these chillers are facilities in cold climates with substantial hours of simultaneous cooling and heating demands. Retrofitting existing water heating may be difficult, because of the low temperature rise available from the heat-recovery loop.

**Steam or hot water absorption chillers** use mixtures of water/lithium-bromide or ammonia/water that are heated with steam or hot water to provide the driving force for cooling. This eliminates global environmental concerns about refrigerants used in vapor-compression chillers. Double-effect absorption chillers are significantly more efficient than single-effect machines. (See *Section 5.2.4 – Absorption Cooling*.)

**Specifying and procuring chillers** should include load-reduction efforts, careful equipment sizing, and good engineering. Proper sizing is important in order to save on both initial costs and operating costs. Building loads often decrease over time as a result of conservation measures, so replacing a chiller should be accomplished only after recalculating building loads. Published standards such as ASHRAE 90.1 and DOE standards provide guidance for specifying equipment. Procuring energy-efficient, water-cooled electric chillers has been made considerably easier for facility managers through the BOA developed by DOE and GSA that specifies desired equipment parameters.

### UPGRADING EXISTING CHILLERS

A number of alterations may be considered to make existing chiller systems more energy efficient. Careful engineering is required before implementing any of these opportunities to determine the practicality and economic feasibility.

**Variable-frequency drives** provide an efficient method of reducing the capacity of centrifugal chillers and thus saving energy. Note that VFDs are typically installed at the factory. Savings can be significant, provided that (1) loads are light for many hours per year, (2) the climate does not have a constant high wet-bulb temperature, and (3) the condenser water temperature can be reset higher under low part-load conditions. (See *Section 5.7.2 – Variable-Frequency Drives*.)

**Chiller bypass** systems can be retrofitted into central plants, enabling waterside economizers to cool spaces with chillers off-line. In these systems, the cooling tower provides chilled water either directly with filtering or indirectly with a heat exchanger. These systems are applicable when (1) chilled water is required many hours per year, (2) outdoor temperatures are below 55°F (13°C), (3) air economizer cycles cannot be used, and (4) cooling loads below 55°F (13°C) do not exceed 35–50% of full design loads.

**Other conservation measures** to consider when looking at the chiller system upgrades include:

- Higher-efficiency pumps and motors;
- Operation with low condenser water temperatures;
- Low-pressure-drop evaporators and condensers (oversized chiller “barrels”);
- Interconnecting multiple chillers into a single system;
- Upgrading cooling towers; and
- Upgrading control systems (e.g., temperature reset).



**Overall HVAC system efficiency** should be considered when altering chiller settings.

The complex interrelationships of chiller system components can make it difficult for operators to understand the effects of their actions on all components of the systems. For example, one way to improve chiller efficiency is to decrease the condensing water temperature. However, this requires additional cooling tower operation that may actually increase total operating costs if taken to an extreme. In humid climates, increasing the chilled water temperature to save energy may unacceptably reduce the effective removal of humidity if the coil size is not also adjusted.

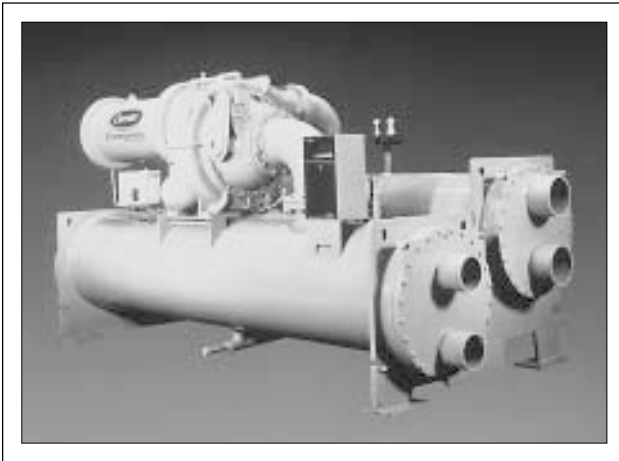

Carrier Corporation's Evergreen line of chillers was the first one specifically designed to accommodate non-ozone-depleting HFC-134a refrigerant. Source: Carrier Corporation

## References

*Energy Management: A Program to Reduce Cost and Protect the Environment*, Facility Management Division, General Services Administration, Washington, DC, 1994.

*Electric Chiller Handbook* (TR-105951s), Electric Power Research Institute, Pleasant Hill, CA, 1995; (510) 934-4212.

Fryer, Lynn, *Electric Chiller Buyer's Guide: Water-Cooled Centrifugal and Screw Chillers*, Technical Manual, E Source, Inc., Boulder, CO, 1995; (303) 440-8500; [www.esource.com](http://www.esource.com).

Cler, Gerald, et al., *Commercial Space Cooling and Air Handling Technology Atlas*, E Source, Inc., Boulder, CO, 1997 (see contact information above).

## Contacts

For more information about the Basic Ordering Agreement (BOA) for energy-efficient water-cooled chillers, contact the General Services Administration at (817) 978-2929.



## ROOFTOP RETROFITS

Many Federal buildings are cooled via roof-mounted direct-expansion (DX) air conditioners. If the individual rooftop DX units are old and inefficient, it may be possible to retrofit them to use a single high-efficiency chiller (18 or higher energy-efficiency rating [EER]). In the retrofit process, the existing evaporator coils are adapted to use glycol that is cooled by the chiller. Ice storage may be incorporated as part of the rooftop retrofit. The chiller can be operated at night to make ice, which would provide or supplement cooling during the day. This retrofit system provides an efficient means of reducing on-peak electric demand, as discussed in this section under *Thermal Storage*. FEMP estimates a very high savings potential from this system. If all rooftop DX systems used in Federal buildings were replaced by chillers, more than 50% of the electricity used by rooftop units could be saved. Available space for the chiller and, if included, ice storage, is a consideration with this type of retrofit.

On the surface, the idea of using an open flame or steam to generate cooling might appear contradictory, but the idea is actually very elegant. And it has been around for quite a while—the first patent for absorption cooling was issued in 1859 and the first system built in 1860. Absorption cooling is more common today than most people realize. Large, high-efficiency, double-effect absorption chillers using water as the refrigerant dominate the Japanese commercial air-conditioning market. While less common in the U.S., interest in absorption cooling is growing, largely as a result of deregulation in the electric power industry. The technology is even finding widespread use in hotels that use small built-in absorption refrigerators (because of their virtually silent operation) and for refrigerators in recreational vehicles (because they do not require electricity).

## Opportunities

Absorption cooling is most frequently used to air-condition large commercial buildings. Because there are no simplifying rules of thumb to help determine when absorption chillers should be used, a life-cycle cost analysis should be performed on a case-by-case basis to determine whether this is an appropriate technology. Absorption chillers may make sense in the following situations: where there are high electric demand charges, where electricity use rates are high, where summertime natural gas prices are favorable, or where utility and manufacturer rebates exist. Absorption chillers can be teamed with electric chillers in “hybrid” central plants to provide cooling at the lowest energy costs—in this case, the absorption chillers are used during the summer to avoid high electric demand charges, and the electric chillers are used during the winter when they are more economical. Because absorption chillers can make use of waste heat, they can essentially provide free cooling in certain facilities.

Absorption cooling systems can most easily be incorporated into new construction, though they can also be used as replacements for conventional electric chillers. A good time to consider absorption cooling is when an old electric chiller is due for replacement.

## Technical Information

An absorption cooling cycle is similar to a vapor-compression cycle in that it relies on the same three basic principles (1) when a liquid is heated it boils (vaporizes), and when a gas is cooled it condenses; (2) lowering the pressure above a liquid reduces its boiling point; and (3) heat flows from warmer to cooler surfaces. Instead of mechanically compressing a gas (as occurs with a vapor-compression refrigeration cycle), absorption cooling relies on a thermochemical “compressor.” Two different fluids are used, a refrigerant and an absorbent, that have high “affinity” for each other (one dissolves easily in the other). The refrigerant (usually water) can change phase easily between liquid and vapor and circulates through the system. Heat from natural gas combustion or a waste-heat source drives the process. The high affinity of the refrigerant for the absorbent (usually lithium bromide or ammonia) causes the refrigerant to boil at a lower temperature and pressure than it normally would and transfers heat from one place to another.

Absorption chillers can be direct-fired or indirect-fired, and they can be single-effect or double-effect (explanation of these differences is beyond the scope of this discussion). Double-effect absorption cycles capture some internal heat to provide part of the energy required in the generator or “desorber” to create the high-pressure refrigerant vapor. Using the heat of absorption reduces the steam or natural gas requirements and boosts system efficiency.

Absorption cooling equipment on the market ranges in capacity from less than 10 tons to over 1,500 tons (35 to 5,300 kW). Coefficients of performance (COPs) range from about 0.7 to 1.2, and electricity use ranges from 0.004 to 0.04 kW/ton of cooling. Though an electric pump is usually used (the principal exceptions being the small hotel and recreational vehicle [RV] refrigerators), pump energy requirements are relatively small because pumping a liquid to the high-side pressure requires much less electricity than does compressing a gas to the same pressure.

High-efficiency, double-effect absorption chillers are more expensive than electric-driven chillers. They require larger heat exchangers because of higher heat-rejection loads; this translates directly into higher

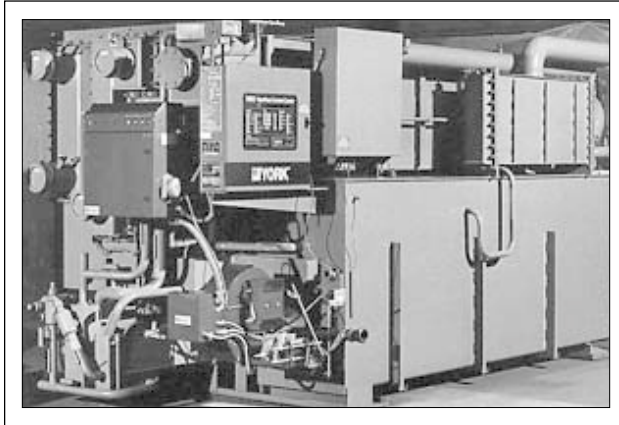

Source: American Gas Cooling Center

This York® Millennium™ Direct-Fired Double-Effect Absorption Chiller/Heater replaces an electric chiller and boiler, reducing the floor-space requirement by up to 40%.

costs. Non-energy operating and maintenance costs for electric and absorption chillers are comparable. Significant developments in controls and operating practice have led the current generation of double-effect absorption chillers to be praised by end-users for their low maintenance requirements.

The potential of absorption cooling systems to use waste heat can greatly improve their economics. Indirect-fired chillers use steam or hot water as their primary energy source, and they lend themselves to integration with on-site power generation or heat recovery from incinerators, industrial furnaces, or manufacturing equipment. Indirect-fired, double-effect absorption

chillers require steam at around 370°F and 115 psig (190°C and 900 kPa), while the less efficient (but also less expensive) single-effect chillers require hot water or steam at only 167–270°F (75–132°C). Triple-effect chillers are also available.

## References

Cler, Gerald, et al., *Commercial Space Cooling and Air Handling Technology Atlas*, E Source, Inc., Boulder, CO, 1997; (303) 440-8500; www.esource.com.

*ASHRAE Handbook: 1997 Fundamentals*, pp. 1-20, American Society of Heating, Refrigerating, and Air-Conditioning Engineers, Atlanta, GA; www.ashrae.org.

Wood, Bernard D., *Application of Thermodynamics*, Addison-Wesley Publishing Company, Reading, MA, 1982, pp. 238-257.

## Contacts

Distributed Energy Resources Program, Office of Power Technologies, EERE, U.S. Department of Energy, 1000 Independence Avenue, SW, Washington, DC 20585.

Building Equipment Research Program, Energy Division, Oak Ridge National Laboratory, Oak Ridge, TN 37831; (865) 574-2694.

American Gas Cooling Center, 400 N. Capitol Street, NW, Washington, DC 20001; (202) 824-7141, www.agcc.org.

### TYPICAL INSTALLED COSTS OF VARIOUS TYPES OF CHILLERS (\$/TON)

CHILLER TYPE	SMALL (<500 tons)	MEDIUM (500–1,000 tons)	LARGE (1,000–1,500 tons)
Electrically Driven	\$300	\$280	<\$280
Single-Effect Absorption	\$285	\$210	\$195
Double-Effect Absorption	\$600	\$525–\$550	\$460

Source: Supersymmetry USA

## 5.2.5

# Desiccant Dehumidification

Desiccants are materials that attract and hold moisture, and desiccant air-conditioning systems provide a method of drying air before it enters a conditioned space. With the high levels of fresh air now required for building ventilation, removing moisture has become increasingly important. Desiccant dehumidification systems are growing in popularity because of their ability to remove moisture from outdoor ventilation air while allowing conventional air-conditioning systems to deal primarily with control temperature (sensible cooling loads).

### Opportunities

Desiccant dehumidification is a new approach to space-conditioning that offers solutions for many of the current economic, environmental, and regulatory issues being faced by facility managers. Indoor air quality is improved through higher ventilation rates, and achieving those fresh air make-up rates becomes more feasible with desiccant systems. At “low load conditions” outdoor air used for ventilation and recirculated air from the building have to be dehumidified more than they have to be cooled.

Properly integrated desiccant dehumidification systems have become cost-effective additions to many building HVAC systems because of:

- Their ability to recover energy from conditioned air that is normally exhausted from buildings.
- The lower cost of dehumidification when low-sensible load, high-latent load conditions are met.
- The greater comfort achieved with dehumidified air.
- The promotion of gas cooling for summer air-conditioning by utilities in the form of preferential gas cooling rates.
- High electric utility demand charges, which encourage a shift away from conventional, electrically driven air-conditioning (which requires a heavy daytime loading).

Desiccant systems offer significant potential for energy savings (0.1 to 0.4 quads nationwide). They also inhibit microbiological growth by maintaining lower humidity levels. Better control of humidity prevents moisture, mildew, and rot damage to building materials.

Desiccant dehumidification is particularly attractive in applications where building exhaust air is readily available for an energy-recovery ventilator (ERV, or “passive” desiccant system) or where a source of waste heat from other building operations is available to regenerate an “active” desiccant system.

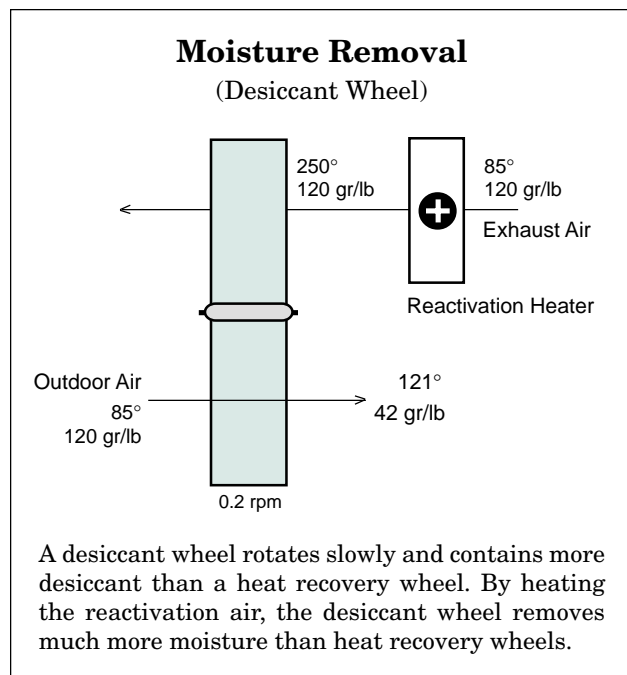
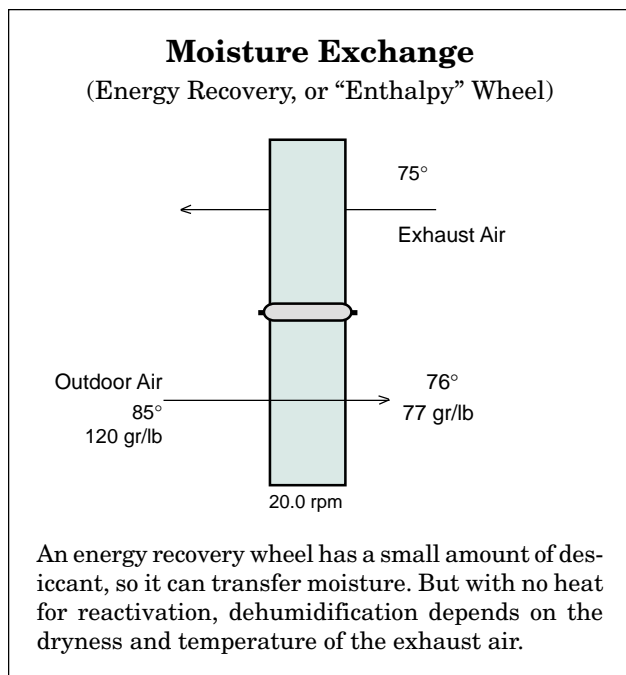

### “Passive” versus “active” desiccant wheels

Adapted from American Gas Cooling Center materials

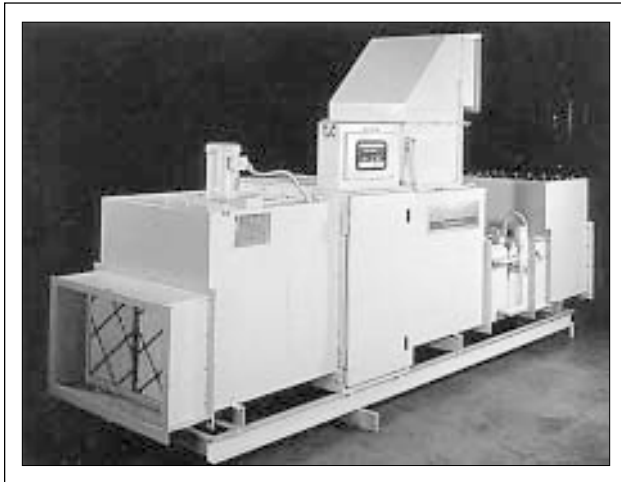

Source: American Gas Cooling Center

The DRYOMATIC Dehumidification System from the Air-flow Company may be installed indoors or outdoors.

## Technical Information

To dehumidify air streams, desiccant materials are impregnated into a lightweight honeycomb or corrugated matrix that is formed into a wheel. This wheel is rotated through a supply or process air stream on one side that is dried by the desiccant before being routed into the building. The wheel continues to rotate through a reactivation or regeneration air stream on the other side that dries out the desiccant and carries the moisture out of the building. The desiccant can be reactivated with air that is either hotter or drier than the process air.

“Passive” desiccant wheels, which are used in total ERVs and enthalpy exchangers, use dry air that is usually building exhaust air for regeneration. Passive desiccant wheels require additional fan power only to move the air and the energy contained in the exhaust air stream. However, passive desiccants cannot remove as much moisture from incoming ventilation air as active desiccant systems and are ultimately limited in *sensible* and *latent* capacity by the temperature and dryness of exhaust air leaving the building.

“Active” desiccant wheels use heated air and require a thermal energy source for regeneration. The illustration above shows the operational characteristics of active and passive desiccant wheels. The advantage of active desiccant wheels is that they dry the supply air continuously—to any desired humidity level—in all weather, regardless of the moisture content of the building’s exhaust air. They can be regenerated with

**\$** Because the sizing of desiccant systems is based on the airflow rate (cfm), costs are typically given in terms of \$/cfm. Passive desiccant system costs have been estimated by one HVAC manufacturer at \$3 to \$4/cfm. For large, active desiccant systems, the cost is usually about \$6/cfm, while smaller units (less than 5,000 cfm) may cost up to \$8/cfm. Installation costs vary according to specific site requirements.

natural gas combustion or another heat source, independent of—or in combination with—building exhaust air, which allows more installation flexibility. The regeneration process, however, requires heat input to dry the desiccant; this usually increases the operating cost of the system. Active desiccant wheels can remove much more moisture than passive systems and thus are the only desiccant approach that allows truly *independent* humidity control to any desired level.

## References

“Two-Wheel Desiccant Dehumidification System,” *Federal Technology Alert*, April 1997; [www.pnl.gov/fta/8\\_tdd.htm](http://www.pnl.gov/fta/8_tdd.htm).

“Applications Engineering Manual for Desiccant Systems,” American Gas Cooling Center, Washington, DC, 1996.

## Contacts

Distributed Energy Resources Program, Office of Power Technologies, EERE, U.S. Department of Energy, 1000 Independence Avenue, SW, Washington, DC 20585-0121.

Building Equipment Research Program, Energy Division, Oak Ridge National Laboratory, Oak Ridge, TN 37831-6070; (865) 574-2694.

American Gas Cooling Center, Inc., 400 N. Capitol Street, NW, Washington, DC 20001; (202) 824-7141; [www.agcc.org](http://www.agcc.org).

Advanced Desiccant Cooling & Dehumidification Program, National Renewable Energy Laboratory, 1617 Cole Boulevard, Golden, CO 80401; (303) 384-7527; [www.nrel.gov/desiccantcool](http://www.nrel.gov/desiccantcool).

## 5.2.6

# Ground-Source Heat Pumps

Heat pumps function by moving (or pumping) heat from one place to another. Like a standard air-conditioner, a heat pump takes heat from inside a building and dumps it outside. The difference is that a heat pump can be reversed to take heat from a heat source outside and pump it inside. Heat pumps use electricity to operate pumps that alternately evaporate and condense a refrigerant fluid to move that heat. In the heating mode, heat pumps are far more “efficient” at converting electricity into usable heat because the electricity is used to *move* heat, not to generate it.

The most common type of heat pump—an air-source heat pump—uses outside air as the *heat source* during the heating season and the *heat sink* during the air-conditioning season. *Ground-source* and *water-source* heat pumps work the same way, except that the heat source/sink is the ground, groundwater, or a body of surface water, such as a lake. (For simplicity, water-source heat pumps are often lumped with ground-source heat pumps, as is the case here.) The efficiency or *coefficient of performance* of ground-source heat pumps is significantly higher than that

of air-source heat pumps because the heat source is warmer during the heating season and the heat sink is cooler during the cooling season. Ground-source heat pumps are also known as *geothermal* heat pumps, though this is a bit of a misnomer since the ultimate heat source with most ground-source heat pumps is really solar energy—which maintains the long-term earth temperatures within the top few meters of the ground surface. Only deep-well ground-source heat pumps that benefit from much deeper earth temperatures may be actually utilizing geothermal energy.

Ground-source heat pumps are environmentally attractive because they deliver so much heat or cooling energy per unit of electricity consumed. The COP is usually 3 or higher. The best ground-source heat pumps are more efficient than high-efficiency gas combustion, even when the *source efficiency* of the electricity is taken into account.

## Opportunities

Ground-source heat pumps are generally most appropriate for residential and small commercial buildings,

such as small-town post offices. In residential and small (skin-dominated) commercial buildings, ground-source heat pumps make the most sense in mixed climates with significant heating and cooling loads because the high-cost heat pump replaces both the heating and air-conditioning system. In larger buildings (with significant internal loads), the investment in a ground-source heat pump can be justified further north because air-

conditioning loads increase with building size. *Packaged terminal heat pumps*, used in hotels and large apartment buildings, are similar except that the heat source is a continuously circulating source of chilled water—the individual water-source heat pumps provide a fully controllable source of heat or air-conditioning for individual rooms.

Because ground-source heat pumps are expensive to install in residential and small commercial buildings, it sometimes makes better economic sense to invest in energy efficiency measures that significantly reduce heating and cooling loads, then install less expensive heating and cooling equipment—the savings in equipment may be able to pay

for most of the envelope improvements (see *Section 4.1 – Integrated Building Design*). If a ground-source heat pump is to be used, plan the site work and project scheduling carefully so that the ground loop can be installed with minimum site disturbance or in an area that will be covered by a parking lot or driveway.

## Technical Information

Ground-source heat pumps are generally classified according to the type of loop used to exchange heat with the heat source/sink. Most common are closed-loop horizontal (see the illustration above) and closed-loop vertical systems. Using a body of water as the heat source/sink is very effective, but seldom available as an option. Open-loop systems are less common than closed-loop systems due to performance problems (if detritus gets into the heat pump) and risk of contaminating the water source or—in the case of well water—inadequately recharging the aquifer.

Ground-source heat pumps are complex. Basically, water or a nontoxic antifreeze-water mix is circulated through buried polyethylene or polybutylene piping.

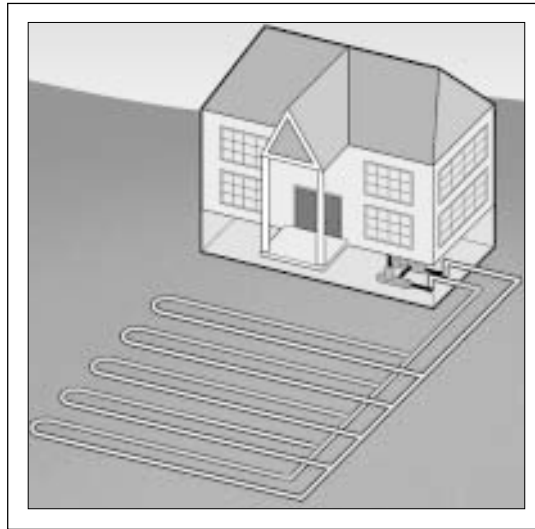



*Horizontal-loop ground-source heat pumps typically have tubing buried within the top 10 feet (3 m) of ground.*

Source: Al Paul Lefton Company

This water is then pumped through one of two heat exchangers in the heat pump. When used in the heating mode, this circulating water is pumped through the cold heat exchanger, where its heat is absorbed by evaporation of the refrigerant. The refrigerant is then pumped to the warm heat exchanger, where the refrigerant is condensed, releasing heat in the process. This sequence is reversed for operation in the cooling mode.

Direct-exchange ground-source heat pumps use copper ground-loop coils that are charged with refrigerant. This ground loop thus serves as one of the two heat exchangers in the heat pump. The overall efficiency is higher because one of the two separate heat exchangers is eliminated, but the risk of releasing the ozone-depleting refrigerant into the environment is greater. DX systems have a small market share.

 **Free Hot Water:** When used in the cooling mode, a ground-source heat pump with a desuperheater will provide free hot water. Buildings in more southern climates that use a ground-source heat pump primarily for cooling can obtain a high percentage of hot water demand in this manner. Look for a ground-source heat pump that includes a desuperheater module.

 Typical system efficiencies and costs of a number of heating, cooling, and water-heating systems for residential and light commercial buildings are shown in the table below (from EPA, 1993). Of all the systems listed, ground-source heat pumps are the most expensive to install but the least expensive to operate.

 **Improving Performance:** There are a number of ways to improve ground-source heat pump performance. Cooling-tower-supplemented systems can reduce the total size of the ground loop required to meet cooling demand. A cooling tower is added to the ground-coupled loop by means of a heat exchanger. Solar-assisted systems use solar energy to supplement heating in northern climates. Solar panels boost the temperature of the ground loop.

## References

*Space Conditioning: The Next Frontier*, U.S. Environmental Protection Agency, Washington, DC, 1993.

*Space Heating Technology Atlas*, E Source, Inc., Boulder, CO, 1996; (303) 440-8500; www.esource.com.

*GeoExchange in Federal Facilities*, Geothermal Heat Pump Consortium (see contact information below).

Malin, Nadav, and Alex Wilson, "Ground-Source Heat Pumps: Are They Green?" *Environmental Building News*, Vol. 9, No. 7/8, July 2000; BuildingGreen, Inc., Brattleboro, VT; (800) 861-0954; www.BuildingGreen.com.

## Contacts

Geothermal Heat Pump Consortium, 701 Pennsylvania Avenue, NW, Washington, DC 20004; (888) 255-4436, (202) 508-5500, (202) 508-5222 (fax); www.geoexchange.org.

U.S. Department of Energy; www.eren.doe.gov/ or www.energy.gov.

### SEASONAL PERFORMANCE FACTORS<sup>(1)</sup>

Space-Conditioning System	Heating	Cooling	Hot Water	Installed Cost	Ann. Op. Cost
Electric resistance with elec. A/C	1.00	2.3–2.6	0.90	\$5,415–5,615	\$871–2,945
Gas furnace with elec. A/C	0.64–0.87	2.3–3.2	0.56–0.60	\$5,775–7,200	\$461–1,377
Adv. oil furnace with elec. A/C	0.73	3.1–3.2	0.90	\$6,515	\$1,162–1,370
Air-source heat pump	1.6–2.9	2.3–4.3	0.90–3.1	\$5,315–10,295	\$353–2,059
Ground-source heat pump	2.7–5.4	2.8–6.0	1.2–3.0	\$7,520–10,730	\$274–1,179

1. Seasonal performance factors represent seasonal efficiencies for conventional heating and cooling systems and seasonal COPs for heat pumps. Ranges show modeled performance by EPA in different climates.

Source: U.S. Environmental Protection Agency, *Space Conditioning: The Next Frontier*, 1993



New (or generally unfamiliar) HVAC technologies can help facility managers lower energy costs, reduce environmental impacts, and enhance indoor environmental quality. Information is provided here on a number of these technologies. Some of the new technologies covered in this section of the first edition of *Greening Federal Facilities* (1997) are now in fairly widespread use and merit their own sections of the guide (ground-source heat pumps, absorption cooling, and desiccant dehumidification). Other technologies have been added to this section. Although new technologies may be available only from a single manufacturer, and although the energy performance data are sometimes limited, these systems are worth considering.

## Opportunities

Not every Federal facility will be able to try out relatively new or unfamiliar technologies, but as these systems become better known and trusted, potential applications will grow. Ventilation-preheat solar collectors are demonstrated to be highly cost-effective in hundreds of cold-climate applications. A number of the technologies described here can help control indoor humidity. In arid climates, evaporative cooling and an innovative rooftop evaporative system can be effective. Where electrical power demand costs are high, natural-gas engine-driven cooling may be appropriate.

## Technical Information

### VENTILATION-PREHEAT SOLAR COLLECTORS (TRANSPIRED AIR COLLECTORS)

This very simple solar collector passively preheats ventilation make-up air via a large, unglazed solar collector. These collectors are most effective on south-facing building facades, though significant deviation off true south (plus-or-minus about 60°) results in only minor loss of performance. The Canadian company Conservall Engineering, Inc., has pioneered this system under the tradename Solarwall. The sheet-metal collector has perforations that allow air to pass through into corrugated air channels under the outer building skin. The ventilation system air intakes are configured so that make-up air is drawn through the collector before it enters the building.

In new construction, installation costs are typically in the range of \$6 to \$7 per square foot (\$65–\$75/m<sup>2</sup>), though if the sheet metal facade replaces a more expensive facing, such as brick, there may actually be a *net reduction in cost* for this ventilation preheat system. With retrofit applications, costs are usually somewhat higher than with new construction.



Fort Carson uses a ventilation-preheat solar collector wall to warm outside fresh air before it enters an aircraft hanger. Intake air is preheated by 30–50°F (17–28°C). Such systems can reduce annual heating cost by \$1–\$3 per square foot (\$11–\$32/m<sup>2</sup>) of collector wall, depending on fuel type, significantly reducing demand on boiler systems.

### NATURAL GAS ENGINE-DRIVEN COOLING

An engine-driven cooling system is similar to a conventional electric cooling system, except that the compressor is driven by a natural gas engine rather than an electric motor. Configurations include chillers, packaged direct-expansion units, and heat pumps, usually in sizes from 200 tons to 4,000 tons. Engine-driven systems are variable-speed, have higher part-load efficiencies, generate high-temperature waste heat (that can be used), and can often reduce operating costs. Consider engine-driven natural gas cooling when electrical demand charges are high or natural gas is particularly inexpensive.

### COOLING EQUIPMENT WITH ENHANCED DEHUMIDIFICATION

Reducing indoor humidity is a prime factor in discouraging microbiological growth in the indoor environment. *Section 5.2.5* addresses desiccant dehumidification. Heat pipes can also be used to efficiently remove moisture with direct-expansion or DX cooling. Heat pipes enable DX coils to remove more moisture by pre-cooling return air. Heat absorbed by the refrigerant in the heat pipe can then be returned to the overcooled, dehumidified air coming out of the DX coils. The system is passive, eliminating the expense of active re-heat systems. Somewhat more fan energy is required to maintain duct static pressure, as is the case when any new element is added to the ventilation system, but no additional pumps or compressors are required. Increased fan energy must be considered when calculating system energy savings. Energy savings up to 30% have been reported. At least one manufacturer builds a variable-dehumidification system for DX equipment that pre-cools liquid refrigerant rather than the air stream.

### EVAPORATIVE COOLING TECHNOLOGIES

Evaporative coolers (also known as swamp coolers) have been used for many years in hot, arid parts of the



Each innovative “air tree” above provides ventilation for six offices at the National Renewable Energy Laboratory’s (NREL’s) Solar Energy Research Facility in Golden, Colorado. Air is cooled and humidified by direct evaporation, or “swamp cooling.”

Photo: Warren Gretz

country. These systems are typically roof-mounted. Cooling is provided as hot, dry outside air is blown through an evaporative media that is kept moist. *Indirect* evaporative coolers can work in climates where moist air is not wanted in the building, though efficiency is lower.

On larger buildings in hot, dry climates, the benefits of evaporative cooling can be achieved through roof-spray technology. A modified spray-irrigation system can be used on the roof to drop daytime roof-surface temperatures from 135–160°F to 85–90°F (57–71°C to 29–32°C). With a typical (poorly insulated) roof system, this can reduce interior temperatures significantly.

A newer, more innovative use of evaporative cooling is *night-sky radiant cooling*. This approach works in climates with large diurnal temperature swings and generally clear nights (such as in the Southwest). Water is sprayed onto a low-slope roof surface at night, and the water is cooled through a combination of evaporation and radiation. This process typically cools the water to 5–10°F (2.7–5.5°C) below the night air temperature. The water drains to a tank in the basement or circulates through tubing embedded in a concrete floor slab. Daytime cooling is accomplished either by circulating cooled water from the tank or through passive means from the concrete slab. Developed by the Davis Energy Group and Integrated Comfort, Inc., this NightSky™ system was used at the U.S. Customs border patrol station in Nogales, Arizona, and monitored by Pacific Northwest National Laboratory (PNNL) in 1997. The average cooling efficiency was found to be nearly 15 times greater than that of conventional compressor-based air-conditioning systems.

## REFRIGERANT SUBCOOLING

Refrigerant subcooling systems save energy in air conditioners, heat pumps, or reciprocating, screw and scroll chillers by altering the vapor-compression refrigerant cycle. Three types of refrigerant subcooling technologies are being manufactured, and each adds a heat exchanger on the liquid line after the condenser: (1) suction-line heat exchangers, which use the suction-line as a heat sink; (2) mechanical subcoolers that use a small, efficient, secondary vapor-compression system for subcooling; and (3) external heat-sink subcoolers that used a mini-cooling tower or ground-source water loop as a heat sink. Subcoolers increase energy efficiency, cooling capacity, and expansion valve performance (i.e., decrease flash gas).

Heat sink subcooling can be used (1) where units are being replaced; (2) where building expansion is planned; or (3) where current capacity is inadequate. The best applications are in climates that are hot year-round—1,200 or more base-65°F (18°C) cooling-degree days—and with DX systems. With external heat sink subcooling, condensing units and compressors should be downsized, making the technology more appropriate when existing equipment is being replaced, when construction or expansion is planned, or when current cooling capacity is inadequate. PNNL’s evaluation of subcooling in Federal facilities is contained in a *Federal Technology Alert* available from FEMP.

## References

*Space Conditioning: The Next Frontier*, U.S. Environmental Protection Agency, Washington, DC, 1993.

*Space Heating Technology Atlas* (1996) and *Commercial Space Cooling and Air Handling Technology Atlas* (1997), E Source, Inc., Boulder, CO; (303) 440-8500; [www.esource.com](http://www.esource.com).

*Natural Gas Cooling Equipment Guide*, American Gas Cooling Center, Washington, DC, 1995.

## Contacts

For information about all types of gas cooling equipment, contact the American Gas Cooling Center, 400 N. Capitol Street, NW, Washington, DC 20001; (202) 824-7141; [www.agcc.org](http://www.agcc.org).

*Federal Technology Alerts* and other publications about new HVAC technologies are available from the FEMP Help Desk at (800) DOE-EREC (363-3732), or see the FEMP Web site at [www.eren.doe.gov/femp](http://www.eren.doe.gov/femp).

Conserval Engineering, Inc., 200 Wildcat Road, Downsview, Ontario M3J 2N5, Canada; (416) 661-7057; [www.solarwall.com](http://www.solarwall.com).

Davis Energy Group, 123 C Street, Davis, CA 95616; (530) 757-4844; [www.davisenergy.com](http://www.davisenergy.com).

Hot water is used in Federal facilities for handwashing, showering, janitorial cleaning, cooking, dishwashing, and laundering. Facilities often have significant needs for hot water in one or more locations and many smaller needs scattered throughout the facility. Methods for reducing water-heating energy use include maintaining equipment, implementing water conservation, reducing hot water temperatures, reducing heat losses from the system, utilizing waste heat sources, and replacing equipment with higher-efficiency or renewable-energy systems.

## Opportunities

Reducing the demand for hot water should be the first priority, and it can be implemented at virtually any facility through efficiency measures and by matching the water temperatures to the task. Beyond that, consider upgrading to higher-efficiency water-heating equipment or shifting to other water-heating technologies whenever equipment is being replaced or major remodeling is planned. Rooftop solar water-heating equipment should be considered—especially at the time of reroofing. Heat-recovery water heating can be considered when modifying plumbing, HVAC, power-generation, or industrial-process systems that generate waste heat. Plan ahead and select a technology for use in the event that existing water-heating equipment fails; don't just replace-in-kind.

## Technical Information

### WATER HEATING TECHNOLOGIES

**Solar water heating** captures energy from the sun for heating water. These systems have improved significantly in recent years and make economic sense in many areas. See *Section 5.3.2 – Solar Water Heating*.

**Standard electric water heaters** both heat and store water in insulated storage tanks. Many older units have inadequate insulation and should be replaced or fitted with insulation jackets to improve performance.

**Tankless or demand electric water heaters** eliminate standby losses by heating water only as it is needed. They are usually located at the point of use and are convenient for remote areas having only occasional use; however, because of very high power consumption, they can increase electric demand charges.

**Steam-fired water heaters** utilize centrally produced steam for heating water. These units are popular in

commercial kitchens where steam is also used for cookers. Where boilers must be kept operating during summer months to supply small amounts of steam for kitchen purposes, changing to alternative water heating can be extremely cost-effective and possibly extend the life of the boiler.

**Standard gas-fired water heaters** use natural gas or propane burners located beneath storage tanks. Standby losses tend to be high because internal flues are uninsulated heat-exchange surfaces. Equipment should be direct-vented or sealed-combustion to minimize the risk of combustion gas spillage into the building.

**Condensing gas water heaters** have higher efficiency because the latent heat of vaporization is reclaimed from the combustion gases. Flue gases are cool enough to permit venting with special PVC pipe.

**Tankless or demand gas water heaters** are usually installed near the point of use. These are often good options for remote sites where there is adequate gas piping, pressure, and venting. Some recent developments—including higher-efficiency models with precise controllability and potential for ganging multiple units together for whole-building, staged use—are extending the practical applications for demand gas water heaters.

**Direct-fire water heaters** are gas-fired, demand water heaters for users of large quantities of potable water—up to several hundred gallons per minute. Using technology in existence since 1908, they mix the heat of combustion (not flame) directly with incoming water, achieving in excess of 98% efficiency while eliminating standby losses. Though expensive, these systems (produced by several manufacturers) can be very cost-effective for facilities using large quantities of hot water.

**Air-source heat pump water heaters** are specialized vapor-compression machines that transfer heat from the air into domestic water. Commercial kitchens and laundries are excellent opportunities because both indoor air temperatures and hot water needs are high. In the process of capturing heat, the air is both cooled and dehumidified, making space conditions more comfortable. Air-source heat pumps are recommended only if the air source is warmed by waste heat.

**Ground-source and water-source heat pump water heaters** are dedicated heat pumps that heat domestic water from energy captured from a water source. The heat source may be groundwater that is used for its stable year-round temperature, or a low-grade waste heat source. Ground-source heat pumps circulate the water through buried heat exchanger tubing.



Source: Direct Fire Technical, Inc.

---

*Though requiring a high first-cost investment, a direct-fire water heater is so energy-efficient that its payback period can be short.*

---

**Desuperheaters** are connected to air-conditioners, heat pumps, or refrigeration compressors. Hot refrigerant gas from the compressor is routed to the gas side of the unit's heat exchanger. Water is essentially heated for free whenever the air-conditioner, heat pump, or refrigerator compressor is operating. When a desuperheater is connected to a heat pump operating in *heating* mode, some of the heat pump's capacity is devoted to water heating.

**Drainline heat exchangers** are very simple, passive copper coils wrapped around wastewater drain lines. The cold-water line leading to the water heater passes through this coil, and water is preheated by hot water going down the drain. These low-cost systems are cost-effective in residential buildings (typically mounted to capture waste heat from showers). They can also work well in commercial buildings with significant hot water use.

### IMPROVING WATER HEATER PERFORMANCE AND SAVING ENERGY

**Insulate tanks and hot-water lines** that are warm to the touch. Only recently have manufacturers installed adequate amounts of insulation on water heater tanks. Hot-water lines should be continuously insulated from the heater to the end use. Cold-water lines also should be insulated near the tank to minimize

convective losses (and everywhere if high humidity is likely to cause condensation).

**Limit operating hours of circulating pumps.** Large facilities often circulate domestic hot water to speed its delivery upon demand. By turning off those pumps when facilities are not being used (nights and weekends, for example), both the cost of operating the pump and heat losses through pipe walls will be reduced.

**Install heat traps.** Heat traps are plumbing fittings that block convective heat losses from water storage tanks.

**Install water heaters near the points of most frequent use** to minimize heat losses in hot water pipes. Note, this location will not necessarily be where the most hot water is used.

**Eliminate leaks.** Delays in repairing dripping faucets not only waste water and energy but often lead to more expensive repairs because of valve stem and valve seat corrosion.

**Repair hidden waste** from failed shower diverter valves that cause a portion of the water to be dumped at a user's feet. This leakage is usually not reported to maintenance teams.

**Reduce hot water temperature.** Temperatures can be safely reduced to 140°F (60°C) for cleaning and laundering.

**Install quality low-flow fixtures.** Good-quality low-flow showerheads and faucets provide performance almost indistinguishable from that of older fixtures; avoid inexpensive models or pressure-reducing inserts that provide unsatisfactory shower performance.



Setting the water temperature too low can cause problems. Reducing the hot water set-point below 120°F (49°C) to save energy may allow *Legionella* bacteria to grow inside domestic hot water tanks.

## Contacts

The FEMP Help Desk at (800) DOE-EREC (363-3732) can provide many publications about energy-efficient water heating.

Heat recovery is the capture of energy contained in fluids or gases that would otherwise be lost from a facility. Heat sources may include heat pumps, chillers, steam condensate lines, hot air associated with kitchen and laundry facilities, power-generation equipment (such as microturbines or fuel cells), and wastewater drain lines.

## Opportunities

There are two basic requirements for heat-recovery water heating: (1) hot water demand must be great enough to justify equipment and maintenance costs, and (2) the waste heat temperature must be high enough to serve as a useful heat source. Large facilities such as hospitals and military bases often have the perfect mix of waste heat and demand for hot water to effectively use waste-heat-recovery systems for water heating. Consider heat-recovery water heating whenever adding or replacing large heating or air-conditioning equipment. For example, double-bundle chillers can easily provide for the recovery of heat normally lost to a cooling tower. The simplest heat-recovery water preheaters can even work with small commercial kitchens and housing units.

## Technical Information

**How waste heat is captured and utilized** depend upon the temperature of the waste heat source. Where water temperature of 140–180°F (60–82°C) is required, waste heat sources with higher temperatures should be used. Lower-temperature sources, such as hot kitchen air or drainline water, may require mechanical systems to concentrate the heat or supplemental heating using another fuel (i.e., the waste heat serving to *preheat* the water).

**Hot gas heat exchangers.** The refrigeration cycle of an air conditioner or heat pump provides an opportunity to recover heat for water heating. HVAC compressors concentrate heat by compressing a gaseous refrigerant. The resultant superheated gas is normally

pumped to a condenser for heat rejection. However, a hot-gas-to-water heat exchanger may be placed into the refrigerant line between the compressor and condenser coils to capture a portion of the rejected heat. In this system, water is looped between the water storage tank and the heat exchanger when the HVAC system is on. Heat pumps operating in the heating mode do not have waste heat because the hot gas is used for space heating. However, the heat pump system can still heat water more efficiently than electric resistance heating.

**Double-bundle condensers.** Some chillers have condensers that make it possible to heat water with waste heat recovery. Double-bundle condensers contain two sets of water tubes bundled within the condenser shell. Heat is rejected from the system by releasing superheated gas into the shell and removing heat as the refrigerant condenses by one of two methods. During the heating season, water pumped through the “winter bundle” absorbs heat that can be used for water heating or heating the perimeter of the building. During the cooling season, water pumped through the “summer bundle” rejects heat to the cooling tower after hot water needs are met.

**Heat from engines.** Heat exchangers can be placed on exhausts of reciprocating engines and gas turbines to capture heat for water heating or steam generation. Water jackets may also be placed on engines in order to capture heat from the engine and exhaust in series. Some of this equipment also acts as a silencer to replace or supplement noise-reduction equipment needed to meet noise-control requirements. Systems for domestic heating are unpressurized, but temperatures above 210°F (99°C) are possible with pressurized systems. Designers must be careful that the pressure drop is less than the back pressure allowed by the engine manufacturer.

**Waste heat from electrical power generation** can also be used for water heating. With fuel cells and microturbines beginning to be used for distributed power generation in buildings, for example, there are opportunities to recover the waste heat. See *Section 5.8.8 – Combined Heat and Power*.

**Heat from boiler flues.** Hot flue gases from boilers can provide a source of waste heat for a variety of uses. The most common use is for preheating boiler feed water. Heat exchangers used in flues must be constructed to withstand the highly corrosive nature of cooled flue gases.



Source: WaterFilm Energy, Inc.

*The gravity film exchange (GFX) drainline heat exchangers—technology developed under a DOE grant—make sense in facilities with significant water heating loads, such as kitchens, laundromats, prisons, and military barracks. The system shown above is being installed in a hotel.*

**Steam condensate heat exchangers.** Buildings with steam systems for space heating or kitchen facilities may recover some of the heat contained in hot condensate. Condensate is continuously formed in steam systems when steam loses heat in the distribution lines or when it performs work. A condensate receiver reduces steam to atmospheric pressure to allow reintroduction into the boiler. Condensate heat for heating water can be captured by a heat exchanger located in the condensate return before the receiver.

**Heat pump water heaters.** Rooms containing laundries and food preparation facilities are often extremely hot and uncomfortable for staff. Heat from the air can be captured for heating water by using a dedicated heat pump that mechanically concentrates the diffuse heat contained in the air. These systems are discussed in *Section 5.3 – Water Heating*.

**Refrigeration equipment.** Commercial refrigerators and freezers may be installed with condensing units at one location. This will enhance the economic feasibility of capturing heat from hot refrigerant gases for water heating.

**Drainline heat recovery.** Energy required to heat domestic water may be reduced by preheating with waste heat from drainlines. Kitchens and laundries offer the greatest opportunities for this type of heat recovery since water temperatures are fairly high and schedules are predictable. Drainline-heat-recovery systems can also work in group shower facilities (dormitories, barracks, prisons, etc.) and in residential housing units. The simplest such system has a coil of copper pipe wrapped tightly around a section of copper drainline. Cold water flowing to the water heater flows through this coil and is preheated whenever hot water is going down the drain. More complex systems with heat exchangers within the drainline must be designed to filter out waste materials or provide back-flushing to remove sediment that could cause clogging. It is also necessary to ensure that potable water is not fouled by the wastewater.

## References

“Heat Exchangers in Aggressive Environments,” Center for the Analysis and Dissemination of Demonstrated Energy Technologies (CADET), Analysis Series #16, 1995.

Vasile, C. F., “Residential Waste Water Heat Recovery System: GFX,” Center for the Analysis and Dissemination of Demonstrated Energy Technologies (CADET), No. 4, December 1997.

Heating water using the sun's energy is practical in almost any climate. Although solar systems can meet the total hot water demand in many regions of the United States during summer months, supplemental water heating is often required in winter.

## Opportunities

Many people assume that solar water heating is an option only in extremely sunny or warm climates. That is not the case. In fact, a solar water heating system might be more cost-effective in New Hampshire than in Arizona—depending on the cost of the energy being replaced. Solar water heating is easiest to justify economically when it is replacing electric water heating and when hot water demand is both high enough to justify the initial equipment investment and fairly constant throughout the week. Good candidates are laundries, hospitals, dormitories, gymnasiums, and prisons. Swimming pools are good warm-season applications—very simple, low-cost systems work very well. While costs will be lowest when solar water heating is installed during initial construction, retrofits onto existing buildings are relatively easy and can generally be done with little disturbance to building occupants.

## Technical Information

Solar thermal water heating systems come in various configurations suited for different climate zones and applications. The two basic components are collectors, usually mounted on the roof or ground, and an insulated storage tank. Active systems contain mechanical pumps for circulating the collection fluid, which is either plain water or water containing propylene glycol (nontoxic) antifreeze. Passive systems do not have pumps. The most common configurations of solar water heaters are as follows:

**Passive thermosiphoning systems** rely on the buoyancy of warm water rising from the collector to the tank, which is always located above the collector. Heat pipes—sealed tubing systems containing refrigerant—can also be used for heat transfer from panel to tank.

**Passive integral collector-storage (ICS) systems** combine collection and storage. Most common are a series of large-diameter (4-inch/100 mm) copper tubes located within an insulated box with glass cover plate. ICS systems are generally plumbed in-line with the building's tap water, so they are pressurized. Potable water enters at the bottom of the ICS collector, and warm water is drawn from the top. With ICS systems, roof structures must be strong enough to support the weight of water-filled collector tanks.

**Active direct or “open-loop” systems** are simple, very efficient, and suitable for mild and moderate climates with good water quality. In direct systems, potable water is pumped through the collector. Often, photovoltaic- (PV-)powered, DC pumps are used, providing a built-in control system—when it is sunny, water is circulated through the collector. Damage to collectors is a concern if water is hard or corrosive. Also, freeze protection is needed. Direct systems are especially applicable to swimming pool heating.

**Active indirect or “closed-loop” systems** are dependable and suitable for all climates. Indirect systems circulate nontoxic antifreeze (propylene glycol) through the closed loop, which consists of collector, piping, and heat exchanger located at the storage tank. Nontoxic antifreeze in the collector and exposed piping ensures protection from freeze damage, corrosion, and scaling. Like direct systems, indirect systems may use PV-powered pumps; otherwise, differential thermostats are typically used to turn AC pumps on and off.

### FREEZE PROTECTION

**Freeze protection** is an important consideration in all but tropical climates. Four primary strategies are used with active solar water heating:

- **Drainback systems** include a small reservoir into which water is drained from collectors and exposed piping whenever the circulating pump is turned off. This provides reliable freeze protection even when electrical power fails. It also protects the fluid from high temperatures by turning off the pump and draining the collector.
- **Draindown systems** dump water from a collector into a drain when triggered by near-freezing temperatures. They may also be manually drained in case of power failure during freezing. Draindown systems historically have been the least reliable because valves may freeze closed or become clogged with corrosion, preventing drainage.
- **Recirculation systems** utilize warm water from the storage tank to circulate into the collectors during freezing weather. They should be considered only in very mild climates.
- **Indirect systems** are filled with a nontoxic antifreeze solution all the time. They are reliable for use in any climate and are very effective at avoiding freeze damage, though if the pump fails or electricity is lost, the antifreeze may be damaged in the stagnating collector. A heat exchanger is required to heat the potable water.



Photo: Warren Gretz

*Solar water heating directly substitutes renewable energy for conventional fossil fuels or electricity. This array of parabolic trough collectors at a prison was paid for through a FEMP Energy Savings Performance Contract or ESPC.*

## SOLAR COLLECTORS

Three basic types of collectors are used for active solar water heating:

- **Flat-plate collectors** are the most common and generally consist of insulated rectangular frames containing small-diameter, fluid-filled copper tubes mounted on copper or aluminum absorber plates. Selective-surface coatings are applied to the tubing and absorber plates to emit less heat radiation. High-transmission tempered glass covers the absorber.
- **Evacuated-tube collectors** utilize a tube-within-a-tube design similar to a thermos bottle. A vacuum between the fluid-filled inner copper tube (generally with absorber fin) and glass outer tube permits maximum heat gain, minimum heat loss, and very high temperatures.
- **Parabolic trough collectors** focus sunlight onto a tube with selective-surface coating (usually contained within a vacuum tube). These systems tend to be more complex than stationary collectors because they have to track the sun as it moves across the sky, but performance is very good. They are most appropriate for large commercial installations requiring significant quantities of hot water. In addition to providing hot water, they can be used for process heat and absorption cooling. The recent development and commercialization of compound parabolic collectors promises significant improvements in performance. Because the collectors focus sunlight, they are a poor choice for cloudy climates.

**Solar systems should be tested and certified** by independent groups such as the Solar Rating and Certification Corporation (SRCC) or the Florida Solar Energy Center (FSEC).

**Colder climate zones** require more collector area and indirect systems with superior freeze-protection capabilities.

**Removing trees to provide access to sunlight** for solar collectors could be a net energy loser if there is substantially more heat gain through exposed windows and thus increased cooling loads. Site collectors carefully, and prune trees selectively.

**At times of the year when collectors harvest sunlight very efficiently**, water temperatures may be above 140°F (60°C). Ensure that mixing valves are installed to keep users from being scalded.

**On direct systems, collectors may require periodic treatment** with a nontoxic solution, such as diluted vinegar, to remove scaling buildup that inhibits heat transfer and efficiency.



The economics of installing solar water heating depend on the cost of the fuels being replaced. Hot water demand, patterns of usage, incoming water temperature, and availability of solar energy are also key considerations. Retrofitting solar water heating into existing buildings is complicated by the need to provide access for running pipes and space in mechanical rooms for larger storage tanks. Solar water heaters typically provide 40–80% of annual hot water needs.

## References

“Solar Water Heating,” *Federal Technology Alert*, Federal Energy Management Program, Department of Energy, Washington, DC, September 1995 (also available on the Web at [www.eren.doe.gov/femp/](http://www.eren.doe.gov/femp/)).

## Contacts

The FEMP Help Desk at (800) DOE-EREC (363-3732) or at [www.eren.doe.gov/femp/](http://www.eren.doe.gov/femp/) can provide technical assistance and information about financing via ESPCs.

Florida Solar Energy Center, 1679 Clearlake Road, Cocoa, FL 32922; 407/638-1000; [www.fsec.ucf.edu](http://www.fsec.ucf.edu) (Solar Rating and Certification Corporation—same address; 407/638-1537; [www.solar-rating.org](http://www.solar-rating.org)).

Center for Buildings and Thermal Systems, National Renewable Energy Laboratory, 1617 Cole Blvd., Golden, CO 80401; 303/275-3000; [www.nrel.gov/buildings\\_thermal/](http://www.nrel.gov/buildings_thermal/).



Lighting accounts for 25% of the electricity used in the Federal sector. If advanced lighting technologies and designs were implemented throughout the Federal sector, electricity use for lighting would be cut by more than 50%, electrical demand dramatically reduced, and working environments significantly improved. Lighting power densities of 2.5 watts per square foot (typical for many office buildings) can be reduced to 1 watt per square foot or even less in new buildings and major renovation by (1) optimizing the use of natural daylighting; (2) installing modern, efficient luminaires; (3) replacing ballasts and lamps with modern components; (4) replacing incandescent lamps with compact fluorescent lamps (CFLs); (5) replacing mercury vapor lamps with metal halide or fluorescent lamps (including new T-5s); (6) implementing task lighting strategies; and (7) installing state-of-the-art lighting controls.

## Opportunities

Consider making it a very high priority to retrofit the lighting system whenever undertaking renovations or new additions. Even reconfiguring workspaces (adding partitions, for example) provides an opportunity to upgrade the ceiling lighting system and add task lighting where appropriate. If the HVAC system is being upgraded or replaced, that presents another opportunity to upgrade the lighting system—in fact, the reduced cooling loads that can be achieved with state-of-the-art lighting may enable significant downsizing of chillers and even pay the full first-cost of the lighting improvements while ensuring dramatic savings in ongoing energy use. Whenever possible, incorporate daylighting strategies into a building (new or existing) and integrate the electric lighting system appropriately (see 4.1.2 – *Daylighting Design*). Replacing incandescent wall sconces, downlights, decorative pendants, and exit sign lighting with CFL units (or, in the case of exit signs, with light-emitting diode [LED]-lit units) will not only save a considerable amount of energy, it will also significantly reduce labor costs associated with relamping.

## Technical Information

### LIGHTING DESIGN ASSISTANCE

Designing a lighting system that provides visual comfort at low energy cost is more of an art than generally thought. Hire a lighting designer for both new building design and lighting retrofit projects. The designation “LC” after a consultant’s name indicates “lighting certified” by the National Council for the Qualification of Lighting Professionals—a certification program supported by DOE. With lighting retrofit projects, the lighting designer should inventory the age and type of lighting equipment, examine visual tasks in the building and changes that have occurred (such as increased use of computers), and interview workers about their satisfaction with the lighting.

### DESIGN STRATEGIES FOR IMPROVED LIGHTING

- Refer to the *IESNA Lighting Handbook – 9th Edition* (2000) for lighting quality and quantity recommendations—match lighting to tasks. An inexpensive light meter (less than \$200) can help determine whether needs are being met in existing work spaces.
- Consider brightening interior surfaces—the perception of spaciousness and the relative “cheeriness” of spaces is directly related to wall and ceiling brightness.
- Use a combination of direct and indirect lighting to minimize harsh contrasts, which can be uncomfortable and tiring.
- Consider reducing ambient light levels (or relying on natural daylight) and supplying task lighting where the light is needed.

### LIGHTING EQUIPMENT SELECTION

- Choose fixtures (luminaires) that efficiently deliver light and are well suited to the expected tasks (see 5.4.1 – *Linear Fluorescent Lighting* for more on fixture selection).
- Depending on the ceiling fixtures selected, some additional illumination on walls and ceilings may be needed to achieve adequate *vertical surface brightness*. This is particularly important with parabolic fixtures (see *Section 5.4.1*). Wall and ceiling illumination can be provided with luminaires that deliver some of their light upward, wall-wash sconces, and daylighting.

- Select fluorescent lamps with a high color rendering index (CRI) and color temperature well suited to the space and tasks.
- Install lighting control systems that will dim or turn off lights when the illumination is not needed—either because people have left the space or because of adequate daylighting. Provide manual dimming control, especially in small offices.

### TOOLS TO ASSIST IN LIGHTING DESIGN AND PRODUCT SELECTION

(see References for information on accessing the Building Energy Tools Directory)

- **Commercially available software tools**, including *Lumen-Pro*, *Radiance*, and *LightScape*, are a tremendous help in lighting design.
- **FEMP's Federal Relighting Initiative** is a program that provides facility managers with lighting evaluation tools and lighting retrofit information.
- **Lighting Technology Screening Matrix (LTSM)** software evaluates different lighting technologies on a per-fixture basis. The algorithms are based on lumen equivalents, but the user can adjust for areas that are overlit or underlit. The LTSM program is primarily a financial tool that generates a list of potentially cost-effective lighting retrofits.
- **Lighting Systems Screening Tool (LSST)** software allows managers to evaluate system retrofits on a facility-wide basis. It can either make assumptions about existing lighting for a first cut or allow more precise evaluation using actual data entered for the facility.
- **The Federal Lighting Expert (FLEX)** is an expert system that can assist facility managers in optimizing lighting retrofit projects. It is user-friendly, can be used by nonexperts, and has a product database with performance specifications and cost information.
- **The Master Specifications (Version 2.03)** is a generic specification for energy-efficient lighting systems targeted at Federal facilities. It addresses lamps, ballasts, reflectors, and luminaires. Parts of the specification can be copied verbatim to assist in the preparation of technical specifications for specific projects.



Mercury is present in all fluorescent and mercury vapor lamps, and polychlorinated biphenyls (PCBs) are in many older fluorescent ballasts. These materials can be extremely hazardous to human health and the environment and should be disposed of only through specialized recycling or hazardous disposal facilities. Never discard lamps or ballasts that do not carry labels "No PCBs" with ordinary waste.

## References

*Advanced Lighting Guidelines*, Report Number DOE/EE-0008, NTIS Order Number DE94005264, U.S. Department of Energy, Washington, DC, 1993. Provides acceptable lighting levels for various applications.

*ASHRAE Standard 90.1*, American Society of Heating, Refrigerating, and Air-Conditioning Engineers, Atlanta, GA; [www.ashrae.org](http://www.ashrae.org).

*IESNA Lighting Handbook – 9th Edition*, Illuminating Engineering Society of North America, New York, NY, 2000; (212) 248-5000; [www.iesna.org](http://www.iesna.org).

## Contacts

The FEMP Help Desk at (800) DOE-EREC (363-3732) has information about the Federal Relighting Initiative, training courses devoted to lighting technologies and techniques, and software; see also the lighting information on the Web at [www.eren.doe.gov/femp/](http://www.eren.doe.gov/femp/).

*ProjectKale* software is available from the EPA Green Lights Hotline: (202) 775-6650.

DOE's Building Energy Tools Directory offers information on over 200 software tools covering lighting and other topics. Many of these tools are free or accessible online; [www.eren.doe.gov/buildings/tools\\_directory](http://www.eren.doe.gov/buildings/tools_directory).

The National Lighting Product Information Program (NLPIP) of the Lighting Research Center at Rensselaer Polytechnic Institute offers independently evaluated product information, including manufacturer-specific test results on thousands of lamps, fixtures, ballasts, and controls; [www.lrc.rpi.edu](http://www.lrc.rpi.edu).

Association of Lighting and Mercury Recyclers, 2436 Foothill Blvd., Suite K, Calistoga, CA 94515; (707) 942-2197.

## 5.4.1 Linear Fluorescent Lighting

In U.S. commercial buildings, lighting accounts for 23% of total energy consumption (1995) and 46% of total electricity consumption. The vast majority of interior lighting in commercial buildings is provided with linear fluorescent fixtures (luminaires) and lamps. There have been significant improvements in fluorescent lighting technologies in recent years, including new higher-quality lamps, improved electronic ballasts, more advanced luminaires, and better controls.

### Opportunities

Whenever an interior space is being renovated or reconfigured, the lighting should be carefully examined. Changing the location of workspaces, adding or moving interior partitions, replacing ceilings, and even painting walls will alter the characteristics of, and provide an opportunity for upgrading, existing lighting. Substantial savings are often possible with reliance on task lighting where existing, uniformly lit spaces include defined task areas. When specifying systems for a new space, always require lighting to be efficient, and look for opportunities to integrate daylighting strategies.

### Technical Information

**Fluorescent lighting is the best source** for most Federal lighting applications because it is efficient and can be switched and controlled easily. Modern linear fluorescent lamps have good color rendering and are available in many styles. Lamps are classified by length, form (straight or U-bend), tube diameter (T-8, T-5, etc.), wattage, pin configuration, electrical type (rapid- or instant-start), color rendering index (CRI), and color temperature. When specifying a lighting system, be sure that the lamp and ballast are electrically matched and the lamp and fixture optically matched.

**Fluorescent lamp** diameters are measured in 1/8-in. increments—T-12s are 12/8 in. or 1-1/2 in. in diameter; T-8s are 1 in. Most fluorescent lamps are straight, though T-8s and T-5s are also available in U-bend or

folded configurations. (Until the late 1990s, T-5s were only available folded, but straight-tube T-5s are becoming more common.) Straight-tube fluorescent lamps are most often used in 1x4-, 2x4-, and 1x8-ft luminaires; folded lamps are used for smaller, square fixtures—1x1s or 2x2s. Typical linear fluorescent lamps are compared in the table below; note that efficacy (lumens per watt) is higher with smaller-diameter lamps.

**Color rendering** of fluorescent lamps is very important. Modern, efficient fluorescent lamps use rare-earth phosphors to provide good color rendition. The color rendering index describes how a light source affects the appearance of a standardized set of colored patches under standard conditions. A lamp with a CRI of 100 will not distort the appearance of the patches in comparison to a reference lamp, while a CRI of 50 will significantly distort colors. T-8 and T-5 lamps are available only with high-quality phosphors that provide CRIs greater than 80. The minimum acceptable CRI for most indoor applications is 70; levels above 80 are recommended.

**Color temperature** influences the appearance of luminaires and the general “feel” in the space. Low color temperature (e.g., 2,700K) provides a warm feel that is similar to light from incandescent lamps; 3,500K provides a balanced color; and 4,100K emits “cooler” bluish light. Standardizing the color temperature of all lamps in a room or facility is recommended.

**Specify electronic ballasts with all linear fluorescent lighting.** These are significantly more energy-efficient than magnetic ballasts and eliminate the hum and flicker associated with older fluorescent lighting. Dimming electronic ballasts are also widely available.

**Select luminaires that are appropriate for the tasks being performed.** Reflectorized and white industrial fixtures are very efficient and good for production and assembly areas but usually inappropriate for office applications. Lensed fluorescent fixtures (“prismatic lens” style) typically result in too much reflected glare off computer screens to be a good choice for today’s electronic office. In areas with extensive computer use, common practice is to install “parabolic” luminaires, which minimize high angle light that can cause reflected glare in computer screens; however, these may result in unpleasant illumination with dark ceilings and walls. Instead, for tall ceilings—over 9 ft (2.7 m) in height—use direct/indirect pendant luminaires. For lower ceilings—8 ft 6 in. (2.6 m)—consider parabolic luminaires with semi-specular louvers and provide separate wall-washing to minimize high contrast.

**Do not select luminaires based solely on efficiency.** Some of the highest-efficiency luminaires have inferior photometric performance. The most effective

### COMPARISON OF FLUORESCENT LAMPS

Lamp Type	T-12	T-12 ES	T-8	T-5*
Watts	40	34	32	54
Initial lumens	3,200	2,850	2,850	5,000
Efficacy (lm/W)	80	84	89	93
Lumen depreciation**	10%	10%	5%	5%

\* High-output T-5 in metric length  
 \*\* Change from “initial lumens” to “design lumens” Source: Philips Lighting

$$\text{Luminaire Efficiency Rating} = \frac{\text{Fixture efficiency} \times \text{Lamp lumens} \times \text{No. of lamps} \times \text{Ballast factor}}{\text{Input watts}}$$

luminaires are usually not the most efficient, but they deliver light where it is most needed and minimize glare. The new Luminaire Efficiency Rating (LER) used by some fluorescent fixture manufacturers makes it easier to compare products. Since the LER includes the effect of the lamp and ballast type as well as the optical properties of the fixture, it is a better indicator of the overall energy efficiency than simple fixture efficiency. An LER of 60 is good for a modern electronically-ballasted T-8 fluorescent fixture; 75 is very good and close to “state-of-the-art.”

**Provide for control of light levels.** One option is dual-level lighting (tandem or split-wiring) so that a 50% lighting level can be obtained when desired (check local codes). Another option is either automated or manual dimming using special ballasts and controls. Photocell-controlled dimming is particularly important if there is a significant daylighting component to the lighting design. See 5.4.4 – *Lighting Controls*.

**Replace 4-lamp T-12 luminaires** with half the number of T-8 lamps (usually in the outer lamp positions) and upgrade to electronic ballasts. A lighting designer should be consulted to evaluate the effectiveness of this strategy and the various alternatives.

**Avoid using retrofit reflectors** that fit into existing luminaires. Except in one- and two-lamp industrial strips, the white-painted inner surfaces of luminaires serve as very effective reflectors. Because highly reflective specular reflectors often produce striated patterns on surfaces being lit and cause light to “dump” beneath the fixture, they can produce worse lighting than the original diffuse reflectors.

**Avoid inappropriate retrofits.** If original lighting conditions are poor and cause visual discomfort or ineffective light use because of poorly placed fixtures, conversion to T-8s alone will not provide a satisfactory solution. Complete lighting redesign, retrofit, and even complete ceiling replacement to accommodate new lighting may be necessary. Any lighting retrofit should include a lighting design analysis.

**Avoid high-intensity discharge lighting, even with high ceilings.** Fluorescent lighting is generally far superior, less costly, easier to control, and provides better light quality than even metal halide. For very high ceilings (e.g., in gymnasiums), new high-bay luminaires using multiple T-5 lamps are proving highly successful. In most high-ceiling areas, try to provide a mix of lighting types, including indirect uplighting, downlighting, wall sconces, decorative pendants in lobby areas, etc.

**Always transport and store fluorescent lamps horizontally** to prevent phosphorus coatings from settling to the ends of the tubes.

**Recycle fluorescent lamps and ballasts.** All fluorescent lamps contain mercury, which should be kept out of landfills and municipal incinerators. Phosphor coatings also contain harmful materials that should be kept out of the waste stream. Before 1979, nearly all ballasts for fluorescent lamps contained PCBs (polychlorinated biphenyls), which are highly toxic chemicals that bioaccumulate in biological systems through the food chain. Specialized lamp and ballast disposal firms can thermally destroy PCBs and recover mercury from old lamps (see listing below).



In specifying fluorescent lamps, look for low-mercury products that will cause less of this toxic metal to enter the environment if disposal is not handled properly.

## References

*IESNA Lighting Handbook – 9th Edition*, Illuminating Engineering Society of North America, New York, NY, 2000; (212) 248-5000; [www.iesna.org](http://www.iesna.org).

Lighting guide specifications for lamps, ballasts, luminaires, and reflectors have been developed under the FEMP Federal Relighting Initiative. Software to assist in system selection and design also is available from the FEMP Help Desk at (800) DOE-EREC or from the FEMP Web site at [www.eren.doe.gov/femp/](http://www.eren.doe.gov/femp/).

The *Lighting Upgrade Manual* may be downloaded at [www.epa.gov/docs/CGDOAR/gcd\\_pubs.html#glpubs](http://www.epa.gov/docs/CGDOAR/gcd_pubs.html#glpubs).

*Lighting Waste Disposal* (6202J), U.S. Environmental Protection Agency, Office of Air and Radiation, 1994.

*Electric Utility Guide to Marketing Efficient Lighting*, Western Area Power Administration, Golden, CO, 1990; (303) 231-7504.

## Contacts

EPA Green Lights and ENERGY STAR® Programs Hotline: (202) 775-6650.

The National Lighting Product Information Program (NLPIP) of the Lighting Research Center at Rensselaer Polytechnic Institute offers independently evaluated product information, including manufacturer-specific test results on thousands of lamps, fixtures, ballasts, and controls; [www.lrc.rpi.edu](http://www.lrc.rpi.edu).

Association of Lighting and Mercury Recyclers, 2436 Foothill Blvd., Suite K, Calistoga, CA 94515; (707) 942-2197.

## 5.4.2 Electronic Ballasts

Electronic ballasts (sometimes called solid-state ballasts) are efficient replacements for standard magnetic ballasts. Since the lamp and ballast form a system, lamps are generally changed at the same time ballasts are upgraded. Used with the proper fluorescent lamps, electronic ballasts provide energy-efficient lighting while eliminating the flicker, hum, and poor color rendering associated with older fluorescent lighting. Electronic ballasts capable of driving up to four lamps are available. These will continue to drive three lamps even after one has failed. Some electronic ballasts can also be dimmed, although this generally requires an additional low-voltage control circuit.

### Opportunities

Investing in new fixtures with electronic ballasts should be considered if the existing lighting system (1) is old and prone to failure; (2) is inappropriate for current and future use; (3) is kept on for many hours per day; (4) produces flicker, glare, or other discomforts for occupants; (5) causes problems with sensitive electronics in the facility; or (6) produces lighting levels that are either too low or too high. All the fixtures in an entire area are often redone at the same time to save on installation costs and to achieve an integrated design. However, if the original fixtures are in good shape and well suited to an area's needs, it may be possible to replace just the ballasts and lamps.

### Technical Information

In 1988, only 1% of the 75.7 million ballasts shipped in the United States were electronic; in 1998, 38% of the 104 million ballasts shipped were electronic. In 2000, DOE issued a new ballast standard that will require high-efficiency electronic ballasts in all new



Ballasts manufactured before 1979 probably contain polychlorinated biphenyls. PCBs are hazardous because they cause cancer, do not readily break down in the environment, and bioaccumulate in plant and animal food chains. PCB-containing ballasts must be disposed of properly in a hazardous-waste or ballast-recycling facility. Ballast-recycling firms salvage reusable metals, reducing the volume of PCB-containing material for disposal.

commercial fixtures manufactured after April 1, 2006, and electronic ballasts for most replacement applications after July 1, 2010.

#### Ballast specifications include:

- Input voltage (usually 277 or 120 VAC)
- Number and type of lamps powered per ballast
- Power factor
- Total harmonic distortion (THD)
- Circuit type (instant-start or rapid-start; series or parallel operation)
- Lamp operating frequency (kHz)
- Ballast factor (BF)
- Ballast efficacy factor
- Minimum starting temperature
- Rated life in hours

Guidance for specifying these and other parameters is available from the National Lighting Product Information Program of the Lighting Research Center.

**Instant-start electronic ballasts** are slightly more efficient than rapid-start ballasts, but they result in some degradation of lamp life (instant-start operation generally reduces lamp life by about 25%—typically yielding a 15,000-hour life instead of 20,000 hours). Rapid-start operation is usually required for reduced-output ballasts and dimming ballasts. Parallel operation is generally preferable to series operation. If one lamp fails with a parallel-circuit ballast, the other lamp(s) will continue to operate. With series operation, neither lamp will operate if one fails.

**Dimming is available as an option** for some electronic ballasts. These are always of the rapid-start type, and the dimming ballast will generally have two extra wires for a low-voltage control signal (typically 0–10 VDC). By connecting a simple wall-mounted potentiometer to the low-voltage control wiring, an occupant can control light levels between about 10% (depending on product) and 100% of maximum light output. Alternatively, the control wires can be connected to a ceiling-mounted photocell that adjusts the electric light level to supplement available daylight, thus saving energy (see *Section 5.4.4 – Lighting Controls*).

**Power factor** indicates how effectively the input power and current are converted into usable watts of power delivered to the ballast. High-power-factor ballasts reduce current loads on building wiring and transformers. Specify high-power-factor ballasts (power factors of 0.90 or higher).

**Ballast factor** quantifies the light-producing ability of fluorescent lamps relative to a laboratory reference ballast. For electronic ballasts, the BF can range from about 0.7 to 1.5. It usually makes sense to specify a BF between 0.85 and 1.0 to maximize light output from a specific lamp/ballast combination without overdriving the lamps (which can shorten lamp life). A ballast may have one BF for standard lamps and another for energy-efficient lamps.



One way to significantly reduce energy costs in overlit spaces is to replace existing magnetic ballasts with reduced-output T-8 electronic ballasts (with a BF of 0.70) and relamp with T-8 lamps. Although the T-8 lamp output will be reduced 30% from the rated value, the new levels will be more appropriate, and more energy is saved than with “normal” BF ballasts.

**Ballast efficacy factor** is the ratio between light output (lumens) of lamps operating on a ballast divided by the input wattage to the ballast. Ballast efficacy factor is useful in comparing ballasts within a given type of lighting system—for example, for the class of 4-foot fluorescent lamps.

**Total harmonic distortion** defines the effect a device has on the ideal electrical sinusoidal waveform. Harmonics within a facility can cause problems with electronic and communications equipment, can overload transformers, and can cause unexpected loading of the neutral in a three-phase system. Although other equipment can be responsible for harmonic distortion, ballasts are often blamed for these power-quality problems. To avoid problems, specify ballasts with a THD of 20% or less. Ballasts with a THD of 5% or less are available for areas with sensitive electronic equipment or other special needs.

**Specify electronic ballasts with the following performance**, unless there is a reason to do otherwise:

- Ballast factor: 0.85 to 1.0
- Power factor: greater than 0.90
- Total harmonic distortion: less than 20%

Ballasts capable of operating four lamps can be wired to lamps in several fixtures, saving both initial equipment costs and operating costs.



Many ballasts have a minimum starting temperature rating of 50°F (10°C), and may not be suitable for unconditioned locations. Other ballasts offer low-temperature starting down to 0°F (-17°C).

## References

*Guide to Specifying High-Frequency Electronic Ballasts*, November 1996, and *Electronic Ballasts – Specifier Report*, May 2000, National Lighting Product Information Program (see contacts below). Guides available as downloadable pdf files: [www.lrc.rpi.edu/NLPIP](http://www.lrc.rpi.edu/NLPIP).

*Lighting Waste Disposal* (EPA 420-R-94-004), Office of Air and Radiation, U.S. Environmental Protection Agency, 1994.

*Energy-Efficient Lighting Catalog*, Defense Logistics Agency, 1996. A good source of equipment information.

*Lighting Technology Atlas*, E Source, Inc., Boulder, CO, 1997; (303) 440-8500; [www.esource.com](http://www.esource.com).

## Contacts

National Lighting Product Information Program, Lighting Research Center, Rensselaer Polytechnic Institute; (518) 276-8716; [www.lrc.rpi.edu/NLPIP](http://www.lrc.rpi.edu/NLPIP) (manufacturer-specific ballast data available online).

FEMP’s ballast specifications are available from the FEMP Help Desk at (800) DOE-EREC (363-3732).

EPA ENERGY STAR® Buildings/Green Lights Program Customer Service Center has information about ballast disposal at (202) 775-6650; [www.epa.gov/energystar](http://www.epa.gov/energystar).

Defense Logistics Agency, Defense Supply Center, Richmond, VA; (800) DLA-BULB; [www.dgsc.dla.mil](http://www.dgsc.dla.mil).

Association of Lighting and Mercury Recyclers, 2436 Foothill Blvd., Suite K, Calistoga, CA 94515; (707) 942-2197.



To avoid significantly reducing ballast life, promptly replace fluorescent lamps that strobe or have blackened ends.

Compact fluorescent lamps are energy-efficient, long-lasting substitutes for incandescent lamps. Introduced in the early 1980s, these lamps use only one-quarter to one-third as much energy to produce the same light output as incandescents. Because they last up to 13 times longer than incandescent lamps, CFLs also provide an attractive return on investment.

### Opportunities

Compact fluorescent lamps can be substituted for incandescent lamps in nearly all applications where incandescents are commonly used—except where directional accent lighting is required (for example, where artwork needs to be illuminated). Incandescent lamps used the most hours per day are the highest-priority candidates for replacement with CFLs; replacement can easily be justified because of the energy savings possible with any lamp used more than an hour a day. It is best to replace incandescent fixtures with those optically designed and hard-wired for CFLs. Alternatively, screw-in CFLs with integral ballasts can often be swapped for incandescent lamps, though this is not generally recommended for recessed downlights. CFLs are particularly appropriate for wall sconces, low ceiling downlights (ceilings up to 9 ft or 2.7 m), wall-washers, and decorative pendants.



Retrofit lamps that contain the lamp, ballast, and screw base all in one unit are widely available. As a rule, however, these units should be avoided for several reasons:

- They are often replaced by incandescent lamps when they fail, negating savings.
- The geometry of the bulky retrofit often makes it difficult to position the lamp in the fixture where it can achieve the best lighting output.
- The ballasts can outlast the lamps by a factor of five or more, and disposing of the ballast with the lamp is thus wasteful.
- Though this varies according to the manufacturer and the configuration, heat from an integral ballast does not dissipate well, and thus both lamp life and ballast life are reduced.
- It is easier for these relatively expensive retrofits to be stolen than for a whole new fixture to be removed.

### Technical Information

**Compact fluorescent lamps** have excellent color rendition and are available in a wide variety of sizes, shapes, and wattages. They are suitable both in new buildings and in renovations and are most appropriate for general (as opposed to directional) lighting. For dimming applications, four-pin CFLs are required. As a rule of thumb, 1 watt of compact fluorescent can replace 3 to 4 watts of incandescent lighting—e.g., a 60-watt incandescent lamp can be replaced by a 15- to 20-watt compact fluorescent lamp. The light output of fluorescent lamps is sensitive to both temperature and burning position, while that of an incandescent bulb is not—so in some fixtures CFLs will perform differently than in others. Very-low-wattage CFLs (below 13 watts) have lower efficacy than higher-wattage CFLs, poor power factor, and lower-quality phosphors; they are generally available only with magnetic ballasts.

**Fixtures for compact fluorescent lamps** come in a variety of styles to meet many lighting situations. Fixtures hard-wired for CFLs contain ballasts required to operate the lamps and special sockets to hold the lamps in the proper position. With this modular configuration, when the lamps fail, they can be replaced without having to replace the longer-life ballasts as well. CFLs are also available with integral ballasts and screw-base sockets for use in fixtures designed for standard incandescent lamps. See the cautionary note on this page regarding retrofit lamps.

**A lighting survey** is the first step in planning to replace incandescent lamps with CFLs. Although not every incandescent lamp has a compact fluorescent equivalent, facility managers can establish a plan to gradually change over to these more cost-effective alternatives. Software such as the *Lighting Technology Screening Matrix* (LTSM) and the *Lighting System Screening Tool* (LSST) can help with planning and a financial assessment. See *Section 5.4* for a description of these tools and how to obtain them.

**Rated lamp life** of CFLs is typically 10,000 hours, or 5 to 13 times longer than that for incandescent lamps. Long life helps provide a favorable life-cycle cost and labor savings for lamp replacement. However, lamp life varies considerably by manufacturer (see NLRIP Specifier Report: Screwbase CFLs) and is sensitive to how often the lamp is switched on and off. Burning life is longer if lamps burn continuously or for many hours at a time; lamp life can be much shorter if the lamp is switched on and off frequently, so be careful about using CFLs in fixtures on motion sensors that are activated frequently.



Source: Pacific Northwest National Laboratory

*The new twisted-tube compact fluorescent lamps are nearly as small as standard lightbulbs.*

**Overlighting is common**, so one-for-one replacement of incandescent lamps with their CFL equivalents may result in overlit conditions. As part of a lighting survey, it is important to determine the lowest wattage lamp that can be used for the application.



Replacing incandescent fixtures with compact fluorescent fixtures typically achieves a 35% annual return on investment.

## References

*Electric Utility Guide to Marketing Efficient Lighting* (ref. contract DE-AC65-86WA00467), Western Area Power Administration, Golden, CO, 1990.

## Contacts

Defense Logistics Agency, Defense Supply Center, Richmond, VA; (800) DLA-BULB; www.dgsc.dla.mil.

EPA Green Lights and ENERGY STAR® Programs Hotline: (888) STAR-YES.

The National Lighting Product Information Program (NLPPI) of the Lighting Research Center at Rensselaer Polytechnic Institute offers independently evaluated product information, including manufacturer-specific test results on thousands of lamps, fixtures, ballasts, and controls; www.lrc.rpi.edu.

## WHERE CFLS ARE NOT AS APPROPRIATE

Where CFLs Should Be Avoided	More Appropriate Solution
Applications where tight beam control is required	Provide low-wattage reflector-type tungsten halogen lighting.
Outdoor lighting in very cold areas	Many CFL ballasts will not operate below about 32°F (0°C). Even when low-temperature ballasts are used, lamps will not reach full brightness for several minutes in cold weather.
High-bay lighting—ceiling higher than 20 ft (6 m)	Specify linear fluorescent lighting, including high-bay luminaires using tightly packed T-5 lamps.
Medium-bay lighting—ceiling 12 to 20 ft (3.7 to 6 m)	Use a combination of direct and indirect lighting with linear fluorescents.
Exposed-lamp applications with high-wattage CFLs	High-wattage CFLs are very bright if exposed; provide some type of shielding.
Where frequent switching is required, such as with motion sensors	Frequent on-off switching will reduce lamp life of CFLs; incandescents (including halogen lamps) may be a better option.
Exit sign illumination	Replace incandescent or fluorescent lamps with LED retrofits, or replace exit signs with LED models.



**Look for applications with long burn hours.** Interior and exterior hallways and walkways provide excellent opportunities for cost-effective replacements with CFLs because these locations typically have long burn hours. Sconces containing CFLs make excellent retrofit fixtures for these applications. Make sure the lamp does not extend below the bottom of the luminaire.



The National Electric Code forbids the use of incandescent fixtures in small clothes closets and other locations where the heat from incandescent lamps can be a fire hazard. CFLs can be used in many of these applications due to their low heat generation.



When replacing incandescent lamps in recessed cans with screw-in CFLs, it is often best to use a CFL with a built-in reflector or a retrofit CFL reflector fixture.



Some lamps take a second to turn on and flicker initially; others do not. Consult your supplier about this issue.



## 5.4.4 Lighting Controls

Lighting controls enable building occupants or building managers to modify illumination levels to meet task and comfort requirements while minimizing unneeded or wasted lighting energy use. A well-designed lighting control system has the potential to reduce lighting energy use by 30–50%. Electric lighting can be controlled by giving occupants manual control over their personal lighting, by automatically controlling light levels based on occupancy or daylight levels, or by a combination of these strategies. Occupancy sensors can turn off lighting when no one is in the area. Daylight controls are better handled with dimmers than with on/off switches.

### Opportunities

Buildings where banks of electric lights are on all day, irrespective of the amount of natural daylight and occupancy, are excellent candidates for retrofitting with more sophisticated lighting controls. Rooms with window walls but no ability to control banks of luminaires along the windows are also good candidates for better controls. Whenever a building is being renovated or remodeled to the extent that the lighting is being reconfigured in any way (see *Section 5.4 – Lighting*), be sure to consider lighting controls as well. These can be combined with daylight dimming controls that set an upper lighting limit and with occupancy sensors that turn off the lights when no one is in the area. Use automatic daylight dimming or on/off controls for common and public areas. Use occupancy sensors in all areas of the building for maximum energy savings.

### Technical Information

Many types of controls not only give occupants control over their space but also respond to daylighting and occupancy through dimming and on/off controls. The key to a successful lighting control project is selecting the correct system to give occupants “control” over their lighting, as opposed to a system that takes away that control. Inappropriate lighting controls may be overridden, which results in loss of all potential energy savings.

#### MANUAL DIMMING

Manual dimming is ideal for individual offices, conference rooms, and classrooms. Lighting levels can be dimmed by the occupants according to the tasks and appearance of an area. Psychologically, manual dimming is the most successful type of control because occupants can vary their own lighting levels. Fluorescent dimming ballasts can lower the lighting power to as little as 1–10%, depending on the ballast type. Every time the lights are dimmed, energy is saved.

#### DAYLIGHT CONTROLS

Automated daylight dimming is an important lighting control strategy in spaces where there is a significant amount of natural light but where turning electric lights off altogether would be inappropriate. Thus, it is a useful strategy in perimeter areas of large open offices, lobby areas, and employee lounges. Dimming electronic ballasts reduce or increase the light output gradually as natural light level changes, almost imperceptibly. Where daylight is adequate and the light source is not easy to see from normal viewing angles, lighting can be turned off with a photosensor control.

#### OCCUPANCY SENSORS

Occupancy sensors (infrared, ultrasonic, and combination) provide an ideal way of turning lights off when no one is in the area. In order to avoid nuisance on/off



*High-quality occupancy sensors and other types of lighting controls like these are now readily available from a number of manufacturers.*

Photo: The Watt Stopper

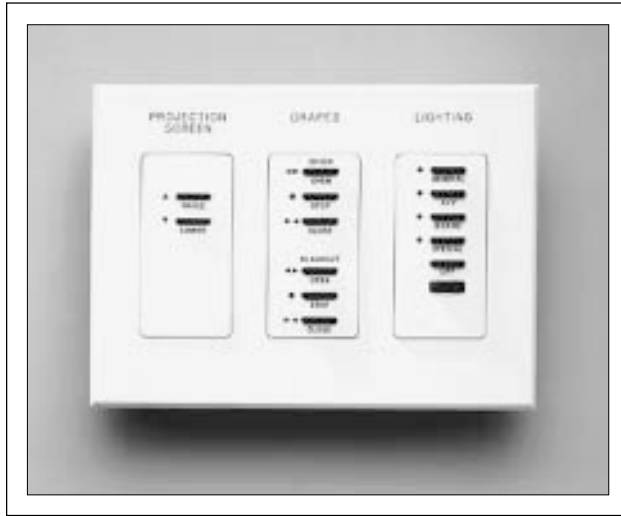

Photo: Lutron Electronics Co., Inc.

*Customized controls like these are available for controlling not only lighting but also drapes, projector screens, and other electrically operated devices.*

trippings, make sure that the occupancy sensor is specified for the type of area and its use. Consult with occupancy sensor control manufacturers to ensure the correct number, type, and mounting of occupancy sensors so they will provide proper coverage and optimal control. Specifics on the various types of occupancy sensors are as follows:

**Infrared occupancy sensors** are ideal for small enclosed rooms, such as private offices, conference rooms, small supply rooms, classrooms, and other spaces where the sensor has a “line of sight” view to occupants. Infrared sensors pick up small amounts of movement and are reliable in these small, unpartitioned situations. Wall-mounted infrared sensors are the most common.

**Ultrasonic occupancy sensors** are ideal for large open spaces and areas where partitions are present, such as open offices, large conference rooms, lecture halls, hallways, large lunchrooms, and lobbies. Ceiling-mounted ultrasonic sensors are the most common.

**Combination infrared and ultrasonic sensors** provide the most reliable system because use of both detection mechanisms overcomes the weaknesses of each.

## MANUAL DIMMING/INFRARED COMBINATION

The combination of manual dimming with occupancy sensors is another good option for small offices and conference rooms. One wall-mounted control can provide manual dimming for the occupant and still turn lights off when everyone leaves the room.

## POST-OCCUPANCY EVALUATION (FINE-TUNING CONTROLS)

It is important for users to understand how to use dimming and occupancy controls. Correctly setting sensitivities and time delays prevents nuisance on/off trippings. In addition, longer time delays are appropriate for areas that should remain lighted all day long, such as main hallways and busy restrooms, but where lighting should be turned off at the end of the day. Lights can turn on for cleaning crews and employees working in off-hour periods. Both occupancy sensors and daylight sensors need to be adjusted to provide the desired lighting levels.

## Contacts

National Dimming Initiative, (847) 390-5136. Industry initiative led by Advance Transformer.

Complete information on the ENERGY STAR® program, including the Green Lights Program, is available by calling the ENERGY STAR Hotline: (888) STAR-YES; [www.epa.gov/energystar](http://www.epa.gov/energystar) or [www.energystar.gov](http://www.energystar.gov).

The National Lighting Product Information Program (NLPPIP) of the Lighting Research Center at Rensselaer Polytechnic Institute offers independently evaluated product information, including manufacturer-specific test results on thousands of lamps, fixtures, ballasts, and controls; [www.lrc.rpi.edu](http://www.lrc.rpi.edu).

Exterior lighting improves security, enhances safety, and directs pedestrians and vehicles. It is also used in nighttime work areas, sports facilities, landscapes, and cityscapes. A wide selection of new lamps, ballasts, fixtures, and controls are available to lighting designers to replace inefficient exterior lighting systems. The use of white light sources increases nighttime visibility and maximizes peripheral vision. With any exterior lighting design it should be a high priority to avoid light pollution (the upward transmission of light) and light trespass (glare obnoxious to neighbors)—careful luminaire and lamp selection can minimize these problems.

### Opportunities

Most exterior lighting systems using incandescent, mercury vapor, or sodium lamps should be evaluated, redesigned, and replaced with new hardware using compact fluorescent or metal halide lamps. In locations with nearby astronomical observatories, low-pressure sodium lighting may be appropriate, but otherwise both low-pressure and high-pressure sodium lighting should be avoided because the poor color rendering makes night vision very inefficient. Incandescent (halogen) exterior lighting may be appropriate when used with motion sensors where instant illumination is required and the total “on” time is low.

Exterior lighting systems that currently result in inappropriate glare, light trespass, and light pollution should be replaced. A parking lot that is lighted with floodlights, for example, can be relighted with IESNA full-cutoff luminaires and appropriate low-wattage lamps.

### Technical Information

**Exterior lighting principles** should be considered when implementing any exterior lighting retrofit or new design. These principles assist in achieving energy conservation, provide superior lighting quality to users, and help preserve the night sky.

**Minimize glare.** Glare greatly detracts from nighttime visibility. If two parking lots are equally illuminated to 5 footcandles, the installation with the least glare from the fixtures will provide the greatest visibility, safety, and visual comfort. *Veiling luminance* is a numerical measure of glare and needs to be considered in roadway and parking area illumination calculations. *Light trespass potential* can also be evaluated.

**Minimize or eliminate light directed upward.** Light emitted at angles of 80° or higher (straight down is 0°) fails to produce useful illumination on horizontal surfaces in open areas such as parking lots. At these high angles light produces significant glare, light pollution, and wasted energy. Light above 90° (horizontal) is totally wasted and produces undesirable sky glow.

**Direct light only where it is needed.** New fixtures allow designers to control where light falls. By eliminating light spillage into surrounding areas, lower wattage lamps can be used. “Barn lights” that contain 175-watt mercury vapor lamps, wall packs, and floodlights are good examples of fixtures to avoid.

**Avoid overlighting.** Refer to the *IESNA Lighting Handbook – 9th Edition* (2000) for lighting quality and quantity guidelines. Minimum levels are required for different uses, with maximum to minimum uniformity requirements. Lighting quality is directly related to good uniformity, not to the number of footcandles. A good rule of thumb is that “a little light is a lot of light where there isn’t any other light.”

**Consider human usage patterns.** Where pedestrians are likely along roadways, for example, provide high-quality (white) vertical light that allows plenty of time for both pedestrians and motorists to be seen.

#### LAMP AND BALLAST SELECTION

**Mercury vapor** lights should be avoided. Replace mercury vapor lights with metal halide lights whenever possible.

**Low-pressure sodium** lamps provide the highest efficacy (lumens per watt) of any light source, but this light source is appropriate only in rare situations. The monochromatic yellow light they produce has absolutely no color rendering capability. Three cars—red, blue, and black—may all appear identical under these lights. In fact, despite the high efficacy, low-pressure sodium is actually among the least efficient nighttime light sources in terms of providing visibility. However, if astronomical observatories are nearby, low-pressure sodium may be a desirable exterior lighting option because filters for specific wavelengths can be installed on telescopes.

**High-pressure sodium** lights, though they provide significantly better light quality than low-pressure sodium, do not provide nearly as good nighttime illumination as metal halide (a much whiter light). They do offer long life, however. Many high-pressure sodium ballasts with igniters can accept metal halide lamp retrofits.



Source: Kim Lighting

*Full-cutoff luminaires direct nearly all of their light downward, thus reducing light pollution.*

**Metal halide** is generally the best option when very high levels of illumination are required. The efficacy is good and the light is very white.

**Inductive lamps** provide high-quality white light and are an increasingly attractive exterior lighting option.

**Compact fluorescent** exterior lighting is appropriate for many applications, especially along walls and in low outdoor fixtures.

**Some high-intensity discharge (HID)** ballasts incorporate control circuits that allow easy attachment of motion sensors or energy management system controls. To maximize lamp life, specify ballasts that provide the least amount of voltage variation to the lamps.

**Use HID lamps** with specific orientations rather than universal position lamps. Lamps that specify burning in the horizontal, base-up, or base-down positions can produce 10–20% more light and last up to 60% longer.

**Consider photovoltaic** lighting for remote sites not yet served by power lines. Locations requiring low levels of light that are further than 50 feet (15 m) from a power source can be good applications for PV lighting. Examples are signs and bus shelter lights (See Section 5.8.5 – *Photovoltaics*).

## CONTROL AND MAINTENANCE

**Turn off lights by 11:00 p.m.** unless they are needed for security or safety. In little-used parking areas, illumination may not be needed that late. Consider motion sensors when only brief periods of illumination are needed.

**Control of exterior lighting** may be provided by manual switches, time clocks, photocells, motion sensors, or sophisticated energy management systems. FM-frequency and satellite controls are available for very large installations. By automating controls, users need not manually switch lights on and off each night. Where time clocks are used, however, they should be periodically checked to ensure that the time is set correctly and adjusted for changes in time of sunrise and sunset. Where photocells are used, they should be very sensitive to low light levels and placed in open areas, such as on roofs. This will help to ensure that lights do not operate unnecessarily at dusk and dawn. See Section 5.4.4 – *Lighting Controls* for more information about control systems.

**Design systems to provide for cost-effective maintenance.** To reduce maintenance costs, provide long ballast and lamp lives, and provide equipment that is resistant to dirt, animal droppings, birds' nests, vandalism, and water damage.

**Relamp groups of fixtures** at the same time to reduce maintenance costs, lamp stocking, and light depreciation toward the end of lamp life.

## References

*IESNA Lighting Handbook – 9th Edition*, Illuminating Engineering Society of North America, New York, NY, 2000; (212) 248-5000; [www.iesna.org](http://www.iesna.org).

Leslie, Russell, and Paula Rodgers, *The Outdoor Lighting Pattern Book*, McGraw-Hill, New York, NY, 1996.

*Lighting for Exterior Environments (RP-33-99)*, Recommended Practice Series, Illuminating Engineering Society of North America, New York, NY, 1999.

## Contacts

International Dark-Sky Association, 3545 N. Stewart Avenue, Tucson, AZ 85716; [www.darksky.org/](http://www.darksky.org/); offers information on techniques for providing good outdoor lighting without contributing unnecessarily to light pollution.

## 5.5

# Office, Food Service, and Laundry Equipment

Some of the many different energy-consuming devices in Federal buildings are only recently beginning to receive attention relative to their power and water consumption. Office equipment, food service equipment, and laundry equipment provide excellent opportunities for reducing energy consumption. Indeed, office equipment represents the fastest growing use of electrical energy in U.S. commercial buildings. These products are discussed in general here and in more detail in the following two sections.

### Opportunities

When selecting office, food service, or laundry equipment, the facility manager may reduce energy consumption by opting for the high-efficiency, high-performance equipment described in *Section 5.5.1* and *Section 5.5.2*.

### Technical Information

**Selecting energy-efficient office equipment**—personal computers (PCs), monitors, copiers, printers, and fax machines—and turning off machines when not in use can result in enormous energy savings. A typical

PC operating 9 hours a day will use only 38% of the power consumed by a computer operating 24 hours. Power management devices on computers can reduce energy usage even further by turning down the power when the computer is not being used. Copiers, laser printers, faxes, and other office equipment can save up to 66% of their 24-hour power consumption by keeping them on only during office hours.

**EPA's ENERGY STAR® program**, which began in 1992, was reinforced by a 1993 Executive Order requiring all Federal agencies to purchase only ENERGY STAR-compliant computers. Office equipment qualifying for this program must have the capability of powering down to a low-power mode after a user-designated period of inactivity.

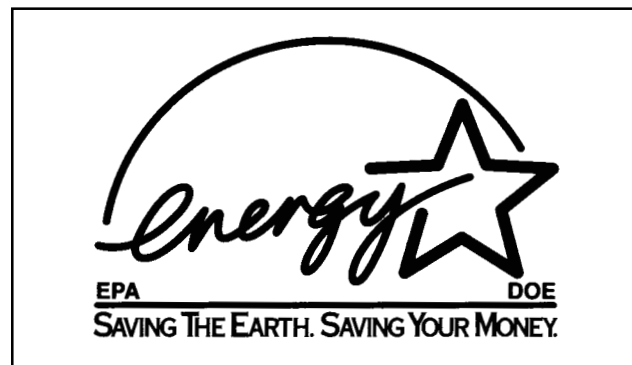

**High-capacity, multistage dishwashing machines** are designed for medium-to-large food service operations, including hospitals, colleges, prisons, hotels, and restaurants. Multistage dishwashers reuse water from the two rinse stages to prewash the dishes. In addition to the water savings, these devices save considerable amounts of detergent and rinse additives. Because of the improved design of the dishwashers, dish breakage has been reduced.



Source: Jackson MSC, Inc.

*This commercial dishwasher handles up to 57 racks per hour with a 58-second wash/rinse cycle. It uses only 1 gallon (3.8 liters) of water per rack, less than the amount required by competitive machines. In addition to savings on water and sewer charges, a built-in booster heater cost-effectively raises incoming water temperature to commercial standards—typically 180°F (82°C).*

**Before upgrading a kitchen, consider the following energy-efficient types of equipment:** infrared fryers, convection ovens (including steamer models), microwave ovens, and specialized equipment such as pizza ovens. Computerized controls can produce savings because they automatically time the cooking of certain foods. Energy-efficient exhaust hoods can provide significant savings because they use outside air rather than indoor conditioned air for ventilation. Side curtains around cooking equipment help restrict the flow of conditioned air to the outdoors. Exhaust air can be used to preheat air for HVAC purposes or to preheat water (see *Section 5.3.1 – Heat-Recovery Water Heating*).

**Microcomputers on newer-model clothes washing machines** permit precise control of water temperature and cycles. Horizontal-axis and other high-efficiency ENERGY STAR clothes washers use significantly less water and energy than conventional vertical-axis machines. Operate washers and dryers with full loads rather than partial loads in order to save energy.

**Laundry water temperatures should be reduced** to 160°F (71°C) unless prohibited by codes. Some soaps and detergents will perform at even lower temperatures, and their use is encouraged. Water temperatures should be checked with an accurate thermometer, and the equipment settings should be adjusted as needed.

## Contacts

Complete information on the ENERGY STAR program is available by calling the ENERGY STAR Hotline at (888) STAR-YES or through the ENERGY STAR Web site at [www.epa.gov/energystar](http://www.epa.gov/energystar) or [www.energystar.gov](http://www.energystar.gov).

Office equipment is the fastest-growing use of electricity in commercial buildings in the United States, accounting for 7% of all commercial-sector power consumption. We spend \$1.8 billion each year to operate office equipment in businesses and homes. ENERGY STAR® office equipment is widely available that provides users with dramatic savings compared with non-ENERGY STAR equipment—as much as 90% savings in some product areas. More than 3,300 office products are ENERGY STAR-labeled. Along with saving energy directly, this equipment can reduce air-conditioning loads, noise from fans and transformers, and electromagnetic field emissions from monitors.

## Opportunities

When new office equipment is purchased, be certain that the products are ENERGY STAR-compliant, as required by Executive Order 12845 (signed April 1993). Also, provide education about the use of office equipment for optimal energy efficiency as part of new-employee training, and send periodic reminders to employees—through e-mail or print newsletters and other in-house communication vehicles—about the use of equipment.

## Technical Information

### COMPUTERS

**To save energy used by computers and monitors, buy ENERGY STAR-listed equipment** or consider laptop computers. ENERGY STAR computers must have a power-saving mode that powers down to no more than 15% of maximum power usage. ENERGY STAR monitors power down to 15 watts or less after 15–30 minutes of inactivity, and then down to 8 watts or less after about 70 minutes of inactivity.

**Laptop computers save even more energy** than ENERGY STAR-rated desktop computers/monitors. Laptops draw only 15–25 watts during use, compared to the 150 watts used by a conventional PC and monitor, and their sleep mode typically uses just a fraction of a watt. To maximize savings with a laptop, put the AC adapter on a power strip that can be turned off (or will turn off automatically)—the transformer in the AC adapter draws power continuously, even when the laptop is not plugged into the adapter.

**ENERGY STAR computers and monitors save energy only when the energy management features are activated.** ENERGY STAR products are shipped with energy-saving features activated. Employees should be able to adjust the energy-saving features to suit their particular needs and work habits (e.g., the length of time before power-down), but discouraged from deactivating those features.



Obtaining maximum energy savings from computers that are on networks can be difficult. There are many combinations of hardware, operating systems, applications software, and peripherals that may affect the sleep mode of computers. The “failure mode” for ENERGY STAR personal computers is for the computer to stay awake, or the network management staff may simply deactivate the power management system on the computer. In contemplating large purchases of PCs, first purchase a single machine to find out whether the power management works as designed with the network and software that will be used.

**The monitors must be capable of entering a low-power state.** Monitors must be capable of being shut off by a Display Power Monitoring Signal (DPMS) signaling protocol, by a software utility, or by a special plug connected to the PC. “Universal” monitors can both accept a DPMS from a PC and run power management from a non-DPMS PC.

**Screen savers do not save energy.** There is a common misconception that screen savers reduce energy use by monitors—they do not. Automatic switching to sleep mode or manually turning monitors off is always the better energy-saving strategy.

**Turn computers and monitors off at night, on weekends, and during the day when they are not in use.** Turning computers off saves more electricity than having them in sleep mode. A 150-watt PC and monitor will cost about \$105 per year to operate if left on continually. Turning it off at night and on weekends will save about \$80 per year in energy costs. Turning it off when not in use during the day can save another \$15 per year.



*ENERGY STAR-qualified office equipment switches to low-power modes after short periods of inactivity, thereby realizing significant energy savings compared with non-ENERGY STAR models.*

Photos: [www.officecopier.com](http://www.officecopier.com)

## PRINTERS/FACSIMILE MACHINES

**ENERGY STAR printers and fax machines power down** to a maximum of 15–45 watts, depending on the output speed (pages per minute), after a predetermined period of inactivity. Ink-jet and bubble-jet printers use significantly less electricity than laser models.

**Use a network or printer-sharing switch** rather than buying one printer per worker.

**Reduce printer use** by implementing paper reduction strategies, using duplex printing features (two-sided printing), and encouraging the use of e-mail.

**Consider new printers.** Although older ENERGY STAR printers required a delay time to return to print mode, newer models return to operating mode almost immediately from low-power mode.

**Use plain-paper fax machines to save money.** Thermal fax paper is not acceptable in typical paper recycling programs. For higher-usage offices, avoid fax machines that generate substantial waste by using a film cartridge.

**Use e-mail or direct computer faxing** instead of paper faxes whenever possible.

## COPIERS

**ENERGY STAR copiers must power down** to a low-power mode after 15 minutes of inactivity and an “off-mode” of lower power use (5–20 watts) after no more than 120 minutes of inactivity. Specific ENERGY STAR standards depend on the copier speed (copies per minute). The smallest copiers (less than 20 copies per minute) do not have the intermediate low-power mode and are preset to power down to an “off mode” of no more than 5 watts after 30 minutes of inactivity.

**Copiers use more energy** than any other piece of office equipment. Be sure to buy an ENERGY STAR copier that is sized correctly for the job.

**Purchase correctly sized copiers.** A mid-volume copier installed in a low-volume office can use 70% more energy per page than an efficient low-volume copier!

**Use e-mail, Web sites, and “paperless faxing”** when possible.

**Select double-sided copying,** an important energy- and paper-saving feature. Set copiers to automatically default to duplex copying.

**Purchase paper with a high recycled content.** At a minimum, use paper meeting the required recycled content for Federal purchasing—if possible, use higher-recycled-content paper.

**Copy in batches.** Significant reduction in energy consumption can be achieved by scheduling copier projects in batches so that the printer spends far less time in high-power mode.

## References

Tiller, D. K., and G. R. Newsham, “Switch Off Your Office Equipment and Save Money,” *IEEE Industry Applications Magazine*, 2(4), 1996, pp. 17–24.

## Contacts

Complete information on the ENERGY STAR program is available by calling the ENERGY STAR hotline at (888) STAR-YES or through the ENERGY STAR Web site at [www.epa.gov/energystar](http://www.epa.gov/energystar) or [www.energystar.gov](http://www.energystar.gov).

Lawrence Berkeley National Laboratory’s Web site includes a list of resources on reducing office equipment energy use: [eetd.LBL.gov/BEA/SF/](http://eetd.LBL.gov/BEA/SF/).



Food service and laundry equipment can be some of the heaviest consumers of energy and water. New types of high-capacity, multistage dishwashing machines, high-efficiency refrigerators, advanced cooking equipment, and new clothes washers provide significant opportunities to save resources and money. In each case, heat recovery systems can be used to capture waste energy from appliances and use it to preheat air for HVAC purposes or to preheat water.

## Opportunities

Make energy efficiency and water efficiency key considerations when outfitting a new kitchen or laundry for a Federal facility, as well as when renovating these spaces or replacing individual pieces of equipment. In certain situations, replacement will be justified solely on the basis of energy savings. Also consider measures to recover waste heat at the time of new equipment selection or kitchen/laundry renovation.

## Technical Information

### DISHWASHERS

**New high-capacity**, multistage dishwashing machines are designed for medium-to-large food service operations, including hospitals, colleges, hotels, and restaurants. In addition to reducing water usage and load requirements, labor requirements for operation are reduced by 50%.

**Multistage dishwashers** reuse water from the two rinse stages to prewash dishes. In addition to reducing water consumption, these devices save a considerable amount of detergent and rinse additives. Because of their improved design, breakage is also significantly reduced.

**Power scrapers** are available for some dishwasher models that remove caked-on, dried food. This can be particularly useful when there is a significant time lag between use and washing.

**Typical throughput** of dishes in a high-capacity, multistage washing machine is 3,500 to 3,700 dishes per hour, with a conveyor speed of 5 to 6 feet (1.5 to 1.8 m) per minute.

**A recent Department of Defense cafeteria installation** of the new multistage dishwashing equipment cost \$57,800. The result was a water reduction of 500,000 gallons (1,900 m<sup>3</sup>) per year, saving \$2,000 per year. Labor savings were \$19,000 per year. The payback time for this installation was 2.7 years, and it will save almost \$500,000 over its 25-year projected life.

### REFRIGERATORS AND FREEZERS

In commissaries, refrigerators and freezers can account for up to 50% of energy consumption. Energy efficiency advances in commercial refrigeration have paralleled those in residential refrigeration since the 1970s.

**Refrigerators and freezers** are divided into medium-temperature (MT) systems—down to 20°F (-7°C)—and low-temperature (LT) systems—down to -25°F (-32°C).

**New equipment is available** with EERs of 7 to 9 for MT systems and 5 to 6 for LT systems. Replace old, inefficient systems with high-efficiency, new systems to obtain significant savings immediately.

**Relying on refrigerator cases** to cool the interior of a space is not very useful, as HVAC systems typically have EERs of 10 to 12 versus the 5 to 9 for refrigeration equipment. This translates to a difference of 40% in energy use. Air spillage from the refrigeration equipment should be minimized.

**Product literature** specifies proper operation and maintenance of refrigerators and freezers. Some of the causes of excessive energy use by these devices are controls set too low, doors that do not close properly, and worn or torn gaskets. An accurate thermometer is needed to check temperature conditions. Cleaning condenser heat transfer surfaces to remove dirt and scale is very important for proper and efficient operation. Overloading the unit may result in over- or undercooling the stored food.

### COOKING EQUIPMENT

**The key strategies for saving energy** when using cooking equipment are (1) turn equipment off when not in use, (2) use a temperature no higher than necessary, (3) match the equipment to the job, and (4) cook as efficiently as possible. The last step includes adjusting flames on ranges to just touch the bottom of cookware, avoiding unnecessary oven door openings, cooking foods with the same requirements simultaneously, and cooking in volume.

**When upgrading a kitchen**, consider the following energy-efficient types of equipment: infrared fryers, convection ovens (including steamer models), microwave ovens, and specialized equipment. Specialized equipment (such as a pizza oven) is designed to cook specific foods very efficiently. Computerized controls can also produce savings by automatically timing the cooking of certain foods.

**Energy-efficient exhaust hoods** can provide significant savings because they use outside air rather than inside conditioned air for ventilation. Side curtains



Source: Bruce Wagman Photography/Maytag

*Maytag's commercial H-axis Neptune washer uses significantly less water and energy than top-loading models.*

around cooking equipment can help restrict the flow of conditioned air to the outside. Exhaust air also can be used to preheat air for HVAC purposes or to preheat water.

## LAUNDRY EQUIPMENT

**Horizontal-axis (H-axis) washing machines** are far more energy- and water-efficient than conventional top-loading, vertical-axis machines. American manufacturers have only recently begun to reintroduce H-axis equipment for residential use. H-axis commercial equipment has been available for many years, but new products (based on residential models) have been introduced recently. One manufacturer has designed a resource-efficient vertical-axis residential washer that performs far better than typical top-loaders and meets ENERGY STAR® standards. Look for washing machines that meet ENERGY STAR requirements for water and energy savings.

**Laundry water temperatures** should be reduced to

160°F (71°C) unless prohibited by code. Some soaps and detergents perform well at lower temperatures and should be used where appropriate. Temperatures should be checked with an accurate thermometer, and equipment should be adjusted as needed.

**Microcomputers on newer-model laundry equipment** permit the precise control of water temperature, wash cycles, and drying.

**Large commercial laundries** should consider water recycling and batch tunnel washers as water-conservation measures. Continuous-batch machines conserve water and energy, as do machines that recycle the final rinse for use as the first wash on the next batch.

**Using equipment efficiently** means ensuring that washing machines and dryers are operated with full loads rather than partial loads.

**To reduce energy use by clothes washers and dishwashers:** repair leaks, insulate storage tanks and distribution piping, clean sediment out of equipment, and test/tune-up water-heating components.

## OTHER KITCHEN AND LAUNDRY IMPROVEMENTS

**Add drainline heat-recovery equipment** where practical. These units can capture a significant portion of the heat from hot water going down the drain (see Section 5.3.1 – Heat-Recovery Water Heating).

**Replace conventional garbage disposals** with pulpers. These recirculate a portion of the water instead of washing it all down the drain. Some systems allow ground-up materials to be composted instead of disposed of in the sewer system.

**Provide foot controls on sinks.** These permit easy control of sinks and can save tremendous quantities of water in situations where water is commonly left running throughout a specific task. Water can be turned on and off without changing the temperature mix.

**Install low-flow faucet tops** for sinks that provide adequate waterflow but no more than needed (see Section 6.3 – Showers, Faucets, and Drinking Fountains). Aerating devices should be avoided, particularly in health facilities, because the screens can harbor germs and pathogens. Flow restrictors should be avoided.

## References

*The Most Energy-Efficient Appliances – 1999 Edition*, American Council for an Energy-Efficient Economy (ACEEE), Washington, DC; [www.aceee.org](http://www.aceee.org).

Appropriate control systems allow facility managers to automate functions that would be impossible or impractical to control manually. Automatic controls are useful with lighting, air distribution systems, chillers, boilers, heat pumps, pumping systems, compressed air systems, water heating, and other major energy-consuming equipment. Controls may be simple and inexpensive, or complex and costly. Simple controls, including time clocks, occupancy sensors, photocells, and programmable thermostats, are discussed in this section. More sophisticated, computer-based energy management and control systems (EMCSs) that monitor hundreds or thousands of “points” throughout a facility are discussed in *Section 5.6.1*. Some control systems designed to reduce peak electrical demand and lower utility bills are covered in *Section 5.6.2 – Managing Utility Costs*. Most of the discussion on lighting controls is found in *Section 5.4.4*.



Power outages disrupt schedules of electromechanical time clocks because the time setting is lost; battery backup may be justified in locations with frequent loss of power. Daylight Savings Time shifts also require resetting of clocks.

## Opportunities

Facility managers should consider automatic controls and sensing technology when equipment can be turned on, shut off, or modulated based on schedules, temperatures, pressures, light levels, or the presence or absence of personnel. HVAC and lighting are prime candidates for automatic controls. It is easiest to add (or change) control systems when the HVAC or lighting systems are being replaced or modified in other ways, though controls can often be retrofit fairly easily.

## Technical Information

The following is general information about some of the common controls available to help reduce energy consumption.

**Time clocks** are electrical or electromechanical devices that can turn equipment on and off according to a schedule. Small loads can be switched directly, and large loads can be controlled indirectly through the use of relays. Many time clocks are 24-hour devices that repeat programs every day. Some have weekly and even annual wheels that allow more complex programming patterns. Although it will minimize wiring costs, locating time clocks near the circuits they control is not necessary. Maintenance staff must have easy access to controls to carry out preventive maintenance and to ensure that the control equipment is operating properly.

**Occupancy sensors** detect whether people are present by sensing heat (infrared), motion (ultrasonic), or sound. Some systems directly control small lighting loads at line voltage and directly replace wall switches.



Standard time clocks usually do a poor job of controlling exterior lights because they do not account for daily changes in sunset and sunrise.

Others are part of more complex systems that may include several sensors, control logic, and an interface to the load. Facilities that have EMCSs may also make use of occupancy sensors to control lights and certain HVAC operations.

**Programmable electronic thermostats** allow facility managers to reset heating and cooling setpoints for different operating modes. Daytime, nighttime, and weekends typically have different target temperatures in order to allow the building temperature to drift appropriately when unoccupied, then return automatically to occupied mode.

**Timers** are simple devices that automatically turn off loads after a predetermined number of minutes or hours. They can be used to control bathroom exhaust fans, for example, allowing moisture removal for a predetermined period of time after showering—thus eliminating the need for continuous operation. Timers are sometimes more cost-effective than occupancy sensors in controlling lighting and fan loads in areas that are used infrequently. These can either be mechanical, with spring-wound mechanisms, or electronic, with digital controls. The latter are quieter and can be programmed for different time-out periods.

**Photocells** are devices that open and close switches in response to light levels. Some photocells are not very sensitive to low light levels at dusk and dawn and may, for example, switch outdoor lights on in the evening before light is needed. This wastes energy and, in some cases, can increase demand charges. Photocells are also used to dim fluorescent lights inside buildings where electric light levels are regulated on the basis of available daylighting (see *Section 5.4.4 – Lighting Controls*).



To avoid injury, it is important to post signs indicating the control mechanism and to install disconnect switches near equipment operated by automatic controls.

**When purchasing programmable thermostats** made for use with heat pumps, ensure that they have “ramped recovery” features for heating. Ramped recovery slowly brings the building up to the target temperature without engaging the supplementary electric strip heating.

**Facility managers should document all the automatic controls in their facilities** by recording the locations of controls, the equipment being controlled, and any requirements for resetting the time or program as seasons change, as time changes for Daylight Savings, or after power outages.

**Electrically combining time clocks and photocells** may provide a good way to program the needed exterior lighting logic—for example, “on at sunset, off at 10:00 p.m.” Facilities with EMCS equipment should have no trouble implementing this type of control logic.



Sophisticated electronic controls, such as programmable thermostats and EMCSs, can be prone to problems with electrical power quality: surges, spikes, brownouts, and outages, particularly in locations distant from utility substations. Putting this equipment on circuits with surge suppression or uninterruptible power supply (UPS) may be advisable.

# Energy Management and Control Systems

An energy management and control system, or EMCS, reduces energy use in buildings by monitoring conditions and controlling energy-consuming equipment. An EMCS is typically applied to the largest electrical loads, including HVAC equipment, cooling towers, pumps, water heaters, and lighting. Control functions may include everything from basic stop/start functions to more complex chiller optimization routines. An EMCS can be used in new or existing facilities and can interface with existing controls, such as pneumatic damper actuators. EMCSs typically save money in two ways: by reducing energy use and by reducing labor costs. EMCSs can have very favorable paybacks, especially where existing control systems are lacking or have problems. By tracking system operation using an EMCS, a facility manager can perform diagnostics and optimize system performance.

## Opportunities

Facility managers should consider installing an EMCS in any facility expansion. EMCS retrofits are often justified and can involve improving chiller or boiler controls, adding economizer cycles, controlling lighting loads, and limiting electrical demand. An EMCS can be particularly reliable for very large or widely dispersed facilities. Be sure to consider adding an EMCS when modifications to HVAC and lighting systems are being considered for other reasons—such as the downsizing of mechanicals to pay for cooling-load-reduction measures. Strategies for load management are covered in *Section 5.6.2 – Managing Utility Costs*.

## Technical Information

An EMCS can perform various functions, from simple single-point control to multifunction systems with complex decision logic. Fully functional EMCSs provide the greatest potential for maximum energy and cost savings.

**Hardware varies in complexity.** Simple systems include actuators that switch or change loads according to signals from local controllers that contain control logic. More sophisticated systems add sensors or monitoring points, field termination panels for minimizing control wiring, modems, communication links, and central computers. Software often includes

sophisticated user interfaces that graphically depict equipment, sensors, and controls.

**Distributed or networked systems** combine the reliability of local controllers with the advantages of facility-wide monitoring. Centralized control provides facility engineers an immediate interface with remote equipment, allowing quick diagnosis of problems and quick response to complaints.

### FUNCTIONAL CAPABILITIES

Many scheduling, optimizing, and reporting functions are available with an EMCS:

**Start/stop controls** will limit operating hours of equipment according to predetermined schedules.

**Optimum start/stop** controls delay bringing equipment online until the latest possible time. This is particularly useful in limiting HVAC operation.

**Temperature setback/setup** saves energy by allowing building conditions to drift (within predefined limits) during unoccupied periods.

**Economizer controls** turn off chillers during mild weather and allow outside air to provide space conditioning.

**Enthalpy control** provides more sophisticated economizer control that is based on both temperature and humidity.



### HELPFUL TIPS

- Train key employees to use the EMCS once it is installed.
- Have a qualified engineering firm design specifications before bidding any EMCS.
- Require the vendor to fully demonstrate the system and all software before delivery. Videotape the demonstration and training for use during refresher training.
- Design expansions of EMCSs to have a single-user interface system in order to avoid operator confusion.



*A sophisticated energy management and control system is helping the Rockland County Community College in New York realize substantial energy savings. Dual-fuel boiler controls allow the college to switch between oil and gas, depending on current market conditions.* Source: NYSERDA

**Supply temperature reset** modulates circulating water temperature based on load sensors and program logic.

**Boiler optimization** balances fuel and combustion air according to actual heating loads.

**Duty cycling** can help reduce utility peak demand charges by turning off equipment for a predetermined percentage of time.

**Demand limiters** shed nonessential equipment, such as water heaters, to reduce peak power demand to a preset level.

**Alarm functions** alert operators to conditions outside preestablished ranges.

**Monitoring** provides the capability to track (1) equipment run-time and other parameters for proactive maintenance, and (2) energy consumption for cost containment.

**Load management controls** stage the start-up of large equipment to avoid power peaks.

## OPERATION AND MAINTENANCE

**Use in-house staff for day-to-day service** requirements, provided that they have adequate skills and are well trained. Service contracts can be very expensive and should be used only when necessary.

**Sensors should be checked and calibrated** on a regular maintenance schedule. Failed sensors and false readings can waste a considerable amount of energy.



## CAUTIONARY NOTES

- New EMCS systems will not necessarily interface properly with existing controllers and other components that are intended to remain in place.
- Be careful about buying “custom-built” systems. Purchase proven systems and software that has a good track record. Request systems with open protocols to improve compatibility with future systems.
- Sole reliance on the EMCS console can lead to misdiagnosis. For example, a temperature alarm would prompt the operator to check the position of the VAV damper for that zone. If the sensor indicated that the damper was fully open and yet the zone was too hot, the operator might reset the chilled water temperature. However, the combination of a stuck damper (cutting off airflow) and a loose damper shaft (allowing the control system to believe the damper is operating normally) might be the real problem. This situation could easily fool both the control system and the operator.

## References

“Energy Management Systems” (Technical Brief TB.EMU.121.4.87), Electric Power Research Institute, 3412 Hillview Avenue, Palo Alto, CA 94304; (650) 855-2000; [www.epri.com](http://www.epri.com). The EPRI Web site lists summaries of a large number of technical reports available on various aspects of energy management.

Utility bills for large facilities include demand charges that can amount to one-third of monthly electricity costs. Demand, measured in kilowatts, is the average electrical load over a small period of time, usually 15 or 30 minutes. Facilities are billed for the largest peak demand during the billing period. Electrical demand peaks can be lowered in several ways: shedding unneeded loads, rescheduling loads, staging equipment start-up, generating power on-site, or switching to another fuel. Keep in mind that there will be a lot of changes in the coming years as a result of utility deregulation (restructuring). In restructured power markets, some innovative market-based utility partnerships are emerging with large power users. At the same time, however, volatile energy prices are likely to be reflected in price increases to customers.

## Opportunities

Facilities with low load factors or steep load-duration curves are the best candidates for cost-effective peak shedding. Facilities using energy management and control systems may already have most of the hardware and software needed to institute a load-shedding program. As utility restructuring becomes more common, look into innovative load-shedding arrangements with utility companies—e.g., apportioning some load as interruptible and selling to the utility company the right to shed that load during peak-demand periods; such arrangements can be very attractive financially.

## Technical Information

Utility tariffs usually encourage demand control and load shifting. Facility managers should understand how their facilities are charged for power and energy (be aware that with utility restructuring, there are likely to be significant changes in the coming years). Here are three utility pricing elements common today:

- **Demand charges** are based on the highest monthly power peak, measured in kilowatts (kW). All but the smallest facilities will be billed for demand. This charge reflects the electric utility's infrastructure cost of power generation and transmission and the more expensive fuels used in peaking plants. Summer-peaking utilities tend to have higher summer demand charges, and winter-peaking utilities (increasingly rare) have higher demand charges during winter months.
- **“Demand ratchets”** are minimum demand bills based on some percentage of the highest peak power metered over the preceding year. Thus, one month's high demand can affect monthly charges for an entire year.
- **Time-of-Use (TOU) tariffs** offer discounted rates for power used at times the utility establishes as off-peak. The difference in energy charges (per kWh) between on-peak and off-peak power can be a factor of two to four.

### DEMAND SHEDDING

**Demand-shedding or peak-shaving** strategies include purchasing smaller, more efficient equipment; altering the on-times of existing equipment; switching fuels during peak periods; and generating power on site. Some popular strategies are as follows:

- **Duty-cycling** strategies attempt to limit the operation of equipment to certain times within a utility's demand period. Duty cycling has limited application because of stresses on frequently cycled equipment and the effect on the building or its systems. For instance, duty cycling of cooling tower motors would allow the chilled water temperature to rise. Cycling a ventilation fan might compromise indoor air quality or adversely affect building pressures.
- **Demand limiters** shed loads in a preestablished order when demand targets are about to be exceeded. Two main algorithms are used: simple and predictive (or slope-sensitive). Simple demand limiters can result in undesirably high load-shedding frequencies and cannot control demand closely.
- **Generators** can be used to keep equipment operating while off-grid. If the same generators provide emergency backup power, precautions must be taken to ensure that emergency power is available even during peak periods. If critical loads also contribute to facility peaks, consider shifting these loads to generator power during peak periods.
- **Dual-fuel heating and cooling** equipment can provide a nonelectric means of meeting space-conditioning requirements during times when using electricity would be expensive. For example, hybrid cooling systems, fueled by either natural gas or electricity, can dramatically lower electricity demand by using natural gas at peak hours.

- **Battery storage** generally is not cost-effective for peak reduction unless batteries are in place for other purposes. One situation where battery storage may make sense is for off-peak charging of forklifts that are used during daylight hours.
- **Thermal storage** involves storing thermal capacity generated off-peak for on-peak use. During the peak periods of the day, circulating water is cooled by ice baths or chilled water tanks (instead of chillers) to provide space or process cooling. Precooling a building at night before a predicted hot day so that chillers will not have to work as hard is another form of thermal storage. Water storage is not as common as ice storage because of the extra volumes needed to store thermal energy without phase changes.
- **Dispatchable load shedding** is a direct load-control technique in which the utility controls the times that a customer's equipment is shed under a prearranged agreement. Such arrangements can benefit both parties and justify on-site generation or alternative fuels. In some cases, the utility company may sell that additional power, taking advantage of price spikes in wholesale power markets and sharing a portion of the windfall profits with the facility. With utility restructuring, look for innovative market-based load management arrangements such as this.
- **Cogeneration** of electricity and steam from gas turbines and other power-generation technologies may be cost-effective for large facilities.

**Facilities with steep load-duration curves** are well suited for applications of peak-shaving technologies. Load-duration curves, such as the one shown in this section, are generated by sorting electrical loads recorded for each hour of the year. Data may be available from the electrical utility or from the facility's energy management system.

**Track load factors each month** to check utility demand charges. The formula for calculating the load factor is shown below. Load factors greater than 100% are impossible and indicate metering or billing problems. Load factors that suddenly deviate from historical

$$\text{Load Factor} = \frac{\text{Monthly kWh}}{\text{Monthly peak kW} \times 24 \times \text{No. of days in billing period}}$$

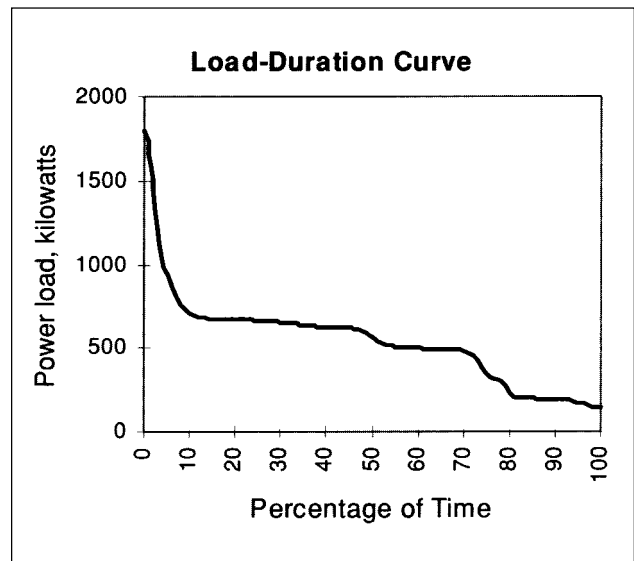

*High loads, occurring only a small percentage of the time, can lead to very high demand charges.*

values also indicate problems. If problems are found, recheck the billing information and contact the utility.

**If the facility has a high minimum-demand billing**, find out if the utility has a “ratchet release” provision to reset the minimum demand to a lower level based on measures implemented by the facility.

**With the use of daylight-linked dimmable lighting ballasts**, both lighting and subsequent chiller loads can be reduced. Allowing temperature and humidity to drift slightly is another effective strategy. According to ASHRAE, one-hour excursions out of the standard comfort envelope will be unnoticeable to most building occupants.

## Contacts

Electric Power Research Institute, 3412 Hillview Avenue, Palo Alto, CA 94304; (650) 855-2000; www.epri.com.



## 5.7

# Electric Motors and Drives

Electric motors vary greatly in performance. The selection of energy-efficient motors for HVAC equipment and other applications in existing or new facilities can greatly reduce energy consumption. Recent developments in energy-efficient motors and motor controls allow facility managers to significantly reduce energy consumption in some Federal facilities.

## Opportunities

For new facilities, high-efficiency motors should be specified during design. In existing facilities, facility managers should inventory all motors, beginning with the largest and those with the longest run-times. This inventory permits informed decision-making about replacement, either before or after motor failure. Field-testing of motors enables the facility manager to properly size replacements to match the actual driven load. The software mentioned in this section can help with this inventory.

## Technical Information

**The Motor Challenge Program** was developed by DOE to assist industrial customers in increasing their use of energy-efficient motor systems. Federal facility managers can also benefit from Motor Challenge through a special arrangement with FEMP, receiving technical assistance, training, software, and other materials.

**MotorMaster+** is a PC-based software tool that helps the user to inventory and select motors. A database of 12,000 new motors contained in the software includes horsepower, speed, enclosure type, manufacturer, model name, catalog number, voltage, nominal efficiencies at various loads, torque and current characteristics, power factor, warranty, and list price. The software allows users to simulate replacement scenarios to determine the lowest life-cycle cost options for existing motors.

**The inventory features in MotorMaster+** help facility managers track motors, including their location, and electrical measurements needed to determine loading. Developing an inventory is the first step in establishing a motor rewind/replacement policy that could

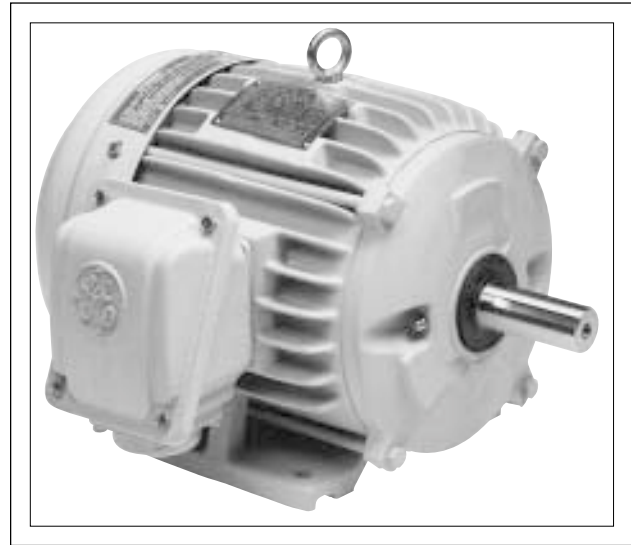

*This high-efficiency motor is designed to work with a variable-frequency drive.*

Photo: General Electric

significantly reduce operating expenses. Since motors are typically replaced or rewound when the motor fails, having an inventory will allow facility managers to quickly determine the most economical approach to take and assist in proper equipment selection. Inventoried motors also can be evaluated to set priorities for the replacement of functioning motors with premium-efficiency motors.



**Turn off unneeded motors.** Identify motors that operate unnecessarily, even for a portion of the time they are on. For example, waste may occur with multiple HVAC circulation pumps operating even when demand falls, cooling-tower fans operating when target temperatures are met, ceiling fans operating in unoccupied spaces, exhaust fans operating after ventilation needs are met, and escalators operating after closing time. In all these cases, simply turning off the motors can produce significant energy savings.

**Reduce motor system usage.** Building design, maintenance, and operation can greatly affect the run-time of motors. For example, reducing cooling loads in a building will reduce the amount of time air handler motors need to operate. The following is a list of strategies for reducing the use of motors.



## REDUCE MOTOR SYSTEM USAGE

- **Reduce loads on HVAC systems:**
  - Improve building shell energy performance.
  - Improve HVAC performance.
  - Check refrigerant charge.
- **Reduce refrigeration loads:**
  - Improve insulation.
  - Add strip curtains on doors.
  - Calibrate control setpoints.
  - Check refrigerant charge.
- **Check ventilation systems for excessive air:**
  - Reseal fan if air is excessive.
  - Downsize motors if possible.
- **Improve compressed-air systems:**
  - Locate and repair compressed-air leaks.
  - Check air-tool fittings for physical damage.
  - Turn off air to tools when not in use.
- **Repair duct leaks.**

**Sizing motors is important.** Do not assume that an existing motor is properly sized for its load, especially when replacing it. Many motors operate most efficiently at 75–85% of full-load rating. Undersizing or oversizing reduces efficiency. For large motors, facility managers may want to seek engineering help in determining the proper sizes and actual loadings of existing motors. There are several ways to estimate actual motor loading: the kilowatt technique, the amperage ratio technique, and the less-reliable slip technique. All three are supported in the *MotorMaster+* software.

**Instead of rewinding** small motors, consider replacing them with energy-efficient models. For larger motors, if rewinding offers the lowest life-cycle cost, select a rewind facility with high quality standards to ensure that motor efficiency is not adversely affected. For sizes of 10 hp or less, new motors are generally less expensive than rewinding. When standard-efficiency motors under 100 hp have failed, scrapping them is usually the most cost-effective option, provided that they have had sufficient run-time and are replaced with energy-efficient models.

## References

*Energy-Efficient Electric Motor Handbook, Revision 3*, U.S. Department of Energy, Washington, DC, 1993.

Hoslida, Robert K., “Electric Motor Do’s and Don’ts,” *Energy Engineering*, Vol. 19, No. 1.

Nadel, Steven, et al., *Energy-Efficient Motor Systems: A Handbook on Technology, Programs, and Policy Opportunities*, American Council for an Energy-Efficient Economy, Washington, DC, 1991.

*Drivepower Technology Atlas*, E Source, Inc., Boulder, CO, 1996; (303) 440-8500; [www.esource.com](http://www.esource.com).

## Contacts

FEMP offers training to facility managers on the use of *MotorMaster+* software and other motor system management topics. Contact the FEMP Help Desk at (800) DOE-EREC (363-3732), or see the FEMP Web site at [www.eren.doe.gov/femp/](http://www.eren.doe.gov/femp/).

*MotorMaster+ 3.0* can be downloaded or used online: [mm3.energy.wsu.edu/mmplus/](http://mm3.energy.wsu.edu/mmplus/).

DOE’s Motor Challenge Hotline, (800) 862-2086, provides information, software, and publications.

The Motor Challenge Web site, [www.motor.doe.gov](http://www.motor.doe.gov), includes discussion forums, frequently asked questions, and application information.

Electric motors vary greatly in performance. The selection of energy-efficient motors for HVAC equipment installed in renovation or new construction can result in greatly reduced energy consumption during their operational lifetimes. In converting electrical energy into mechanical energy, motors incur losses in several ways: electrical losses, iron (core) losses, mechanical (friction and windage) losses, and stray losses dependent on design and manufacturing. Energy-efficient motors reduce losses because of their better design, materials, and manufacturing. With proper installation, energy-efficient motors run cooler and thus can have higher service factors and longer bearing and insulation life.

## Opportunities

Facility managers should consider installing energy-efficient motors when faced with any motor purchase or repair decision. Replacing a functional motor may be justified solely on the electricity cost savings derived from an energy-efficient replacement. This is especially true if the motor runs continuously, if electricity rates or demand charges are high, if the motor is significantly oversized for the application, or if its nominal efficiency has been reduced by damage or previous rewinds. Priority opportunities are HVAC fan motors and circulation pumps. Efficient motors for other uses should also be considered.

Any time motor replacement is being considered, attention should be paid to the loads served by the motor. Improvements to the overall *system* served by the motor may reduce its load. If this is done at the time of replacement, it may be possible to purchase a smaller, less expensive motor. If it is done independently of motor replacement, the motor may be oversized for the job, so efficiency will be lower.

## Technical Information

The tips below relate to motor selection, maintenance, and possible rewinding or replacement.

### MOTOR SELECTION

**Manufacturers use many terms** to describe their most efficient motors, including adjectives such as “high,” “super,” “premium,” and “extra.” These terms create confusion when comparing motors, so purchasers should always consult the nominal efficiency rating and the minimum efficiency rating. Nominal efficiency, an average efficiency of motors of duplicate design, is

listed in the manufacturer’s literature and in the *MotorMaster+* software. Even within the group of duplicate designs, there is some variation in actual efficiencies because of variations in motor materials and manufacturing. Minimum efficiency ratings can be used as the basis for the manufacturer’s guarantee.

**To be considered energy-efficient**, a motor must meet the performance criteria published by the National Electrical Manufacturers Association (NEMA). Most manufacturers offer lines of motors that significantly exceed the NEMA-defined criteria. Table 12-10 of NEMA (Standard MG-1) delineates efficiency “bins” that form the basis of the “NEMA nominal efficiency” ratings listed on nameplates. The bins provide ranges of efficiencies, such that actual nominal efficiencies are less than or equal to NEMA nominal efficiencies. For example, a motor with an actual nominal efficiency of 92.0 would have a nameplate efficiency listed as 91.7, since the NEMA bracket is 91.7, then 92.4. This standard applies only to Design A and B motors in the horsepower range of 1 to 500. The standard does not cover other sizes and designs, including C, D, vertical, and specialty motors.

**Energy-efficient motors run cooler** and therefore tend to last longer, and they may require less maintenance. Bearing grease lasts longer at lower temperatures, lengthening the required time between regreasing. Lower temperatures translate to longer-lasting insulation. Generally, motor life doubles for each 18°F (10°C) reduction in operating temperature.

**A general guideline for selection of energy-efficient motors** is to look for models that (1) have a 1.15 service factor and (2) are designed for operation at 85% of the rated motor load.

**Speed control** is crucial in some applications. In polyphase induction motors, slip is a measure of how efficiently a motor develops torque. The lower the slip, the higher the efficiency. Less slippage in energy-efficient motors results in speeds about 1% faster than in standard counterparts, which can increase energy use in fans and pumps.

**Starting torque** for efficient motors may be lower than for standard motors. Facility managers must be careful when applying efficient motors to high-torque applications.

### MAINTENANCE

**Inspect motors for misalignment** or excessive vibration.

**Inspect wires and connections** on motors and incoming power for damage, corrosion, or looseness.

**Check motor bearings** and, on single-phase motors, check for wear on internal switches.

**Clean dirt and grease** from all motors and especially from the cooling fan and grill on totally enclosed, fan-cooled motors.

**Check for electrical power problems** that can affect the operation of energy-efficient motors. For example, plant personnel in one manufacturing operation blamed motor failures on the energy-efficient designs of their motors. However, further investigation revealed poor incoming power quality. Investigators suggested addressing the power quality instead of replacing the energy-efficient motors.

## REPLACEMENT CONSIDERATIONS

**Sizing motors is important.** Do not assume that an existing motor is properly sized for its load, especially when replacing motors. Many motors operate



**Facility managers can easily estimate** operating savings of a high-efficiency motor compared with a typical motor (or an existing motor when replacement is being considered). The following formula is used to estimate the annual operating cost of a motor based on the efficiency at rated load, partial load factor (PLF) in percent, annual operating hours, and electricity rate (see calculation example at the bottom of this page):

$$\$/\text{year efficiency} = \text{hp} \times \text{PLF} \times 0.746 \text{ kW}/\text{hp} \times \text{hours}/\text{year} \times \$/\text{kWh}$$

Managers can also use the BestPractices Program's *MotorMaster+* software to estimate operating and energy savings. FEMP offers training to facility managers on the use of *Motor-Master+* software.

most efficiently at 75–85% of full-load rating. Undersizing or oversizing reduces efficiency. For large motors, facility managers may want to seek professional help in determining proper sizes and actual loadings. There are several ways to estimate actual motor loading: the kilowatt technique, the amperage ratio technique, and the less reliable slip technique. All three are supported in the *MotorMaster+* software.

**Instead of rewinding** motors, consider replacing them with an energy-efficient version, as even high-quality rewinding will result in some loss of efficiency. For larger motors, if motor rewinding offers the lowest life-cycle cost, select a rewind facility with high quality standards to ensure that motor efficiency is not adversely affected. For sizes of 10 hp or less, new motors are generally cheaper than rewinding. It is cost-effective to scrap most standard-efficiency motors under 100 hp when they fail, provided that they have had sufficient run-time and are replaced with energy-efficient models.

## References

*MotorMaster+ 3.0* can be downloaded or used online at: [mm3.energy.wsu.edu/mmplus/](http://mm3.energy.wsu.edu/mmplus/).

Nadel, Steven, et al., *Energy-Efficient Motor Systems: A Handbook on Technology, Programs, and Policy Opportunities*, American Council for an Energy-Efficient Economy, Washington, DC, 1991.

*NEMA Standard MG-1*, National Electric Manufacturers Association, 1300 N. 17th Street, Suite 1847, Rosslyn, VA 22209; (703) 841-3200; [www.nema.org](http://www.nema.org).

Skaer, Mark, "Energy-Efficient Motors: Are They Really More Efficient?" *Air Conditioning, Heating & Refrigeration News*, 1995.

*Drivepower Technology Atlas*, E Source, Inc., Boulder, CO, 1996; (303) 440-8500; [www.esource.com](http://www.esource.com).

## Contacts

BestPractices Program, Office of Industrial Technologies, U.S. Department of Energy; (800) 862-2086; [www.oit.doe.gov](http://www.oit.doe.gov).



**Example of calculating energy cost savings from motor replacement:** Consider replacing a 20 hp motor that operates 80% loaded for 8,760 hours per year where electricity costs 5.5 cents per kilowatt-hour. Assume efficiencies are 0.88 and 0.92 for standard and energy-efficient motors, respectively. Notice that this does not include savings from reducing electrical power demand.

Standard motor:	20 hp x 0.80 x 0.746 kW/hp x 8,760 hr/yr x \$0.055 per kWh / 0.88	=	\$6,535 per year
<u>Efficient motor:</u>	20 hp x 0.80 x 0.746 kW/hp x 8,760 hr/yr x \$0.055 per kWh / 0.92	=	<u>\$6,251</u> per year
Savings:		=	\$6,535 - \$6,251 = \$ 284 per year

Variable-frequency drives, a type of variable-speed drive, are controllers that vary the speed of induction motors. VFDs save substantial energy when applied to variable-torque loads, thus reducing electricity bills for most facilities. These energy savings are possible with variable-torque loads, such as fans and pumps, because torque varies as the square of speed, and horsepower varies as the cube of speed. For example, if fan speed is reduced by 20%, motor horsepower (and energy consumption) is reduced by 50%.

VFDs generate variable voltage and frequency output in the proper volts/hertz ratio for an induction motor from the fixed utility-supplied power. VFDs can be retrofitted into existing motor systems and can operate both standard and high-efficiency motors ranging in size from 1/3 hp to several thousand hp. Unlike mechanical or hydraulic motor controllers, they can be located remotely and do not require mechanical coupling between the motor and the load. This simplifies the installation and alignment of motor systems.

### Opportunities

Variable-flow applications, where throttling or bypass devices are used to modulate flow, are good candidates for VFDs. These include centrifugal fans, pumps (centrifugal, impeller, or turbine), agitators, and axial compressors. The best applications for VFDs are large motors that can operate for many hours each year at reduced speeds. Some opportunities common in facilities include the following:

- **Variable-air-volume HVAC fans:** Airflow in older VAV systems is usually controlled by opening and closing dampers or inlet vanes. Because the systems often operate at low airflow, considerable energy savings are possible by converting to VFDs. VFDs vary motor speed in order to match fan output to varying HVAC loads, making dampers or inlet vanes superfluous.
- **Cooling tower fans:** Cooling towers may be good candidates for VFDs, because motors are large, fans often operate for long periods of time, and loads can vary both seasonally and diurnally.

- **Circulating water pumps for chillers and boilers:** Pumping systems can be made variable by sequencing fixed-speed pumps and a single variable-speed pump. This will save the cost of installing VFDs on each pump.
- **Special industrial applications:** The economics of using VFDs for applications such as grinding and materials handling, where precise speed control is required, depend on the size and run-time of the motors involved.

### Technical Information

**Three major VFD designs** are commonly used: pulse-width modulation (PWM), current source inverter (CSI), and variable voltage inverter (VVI). A fourth type, the flux vector PWM drive, is gaining popularity but is considered too expensive and sophisticated for most applications. Knowing the characteristics of the load is critical in evaluating the advantages and disadvantages of each technology.

- **Pulse-width modulation** is the dominant VFD design in the 1/2 hp to 500 hp range because of its reliability, affordability, and availability. PWM outputs emulate sinusoidal power waves by varying the width of voltage pulses in each half cycle. Advantages of PWMs are low harmonic motor heating, excellent input displacement power factor, high efficiencies at 92–96%, and ability to control multiple motor systems with a single drive.
- **Current source inverter** designs are quite reliable because of their inherent current-limiting characteristics and simple circuitry. CSIs have regenerative power capabilities, meaning that CSI drives can reverse the power flow back from the motor through the drive. However, CSIs “reflect” large amounts of power harmonics back to the source, have poor input power factors, and produce jerky motor operations (cogging) at very low speeds. CSIs are typically used for large (over 300 hp) induction and synchronous motors.
- **Voltage source inverter** designs are similar to CSI designs, but VSIs generate variable-frequency outputs to motors by regulating *voltage* rather than current. Harmonics, power factor, and cogging at low frequencies can be problems.

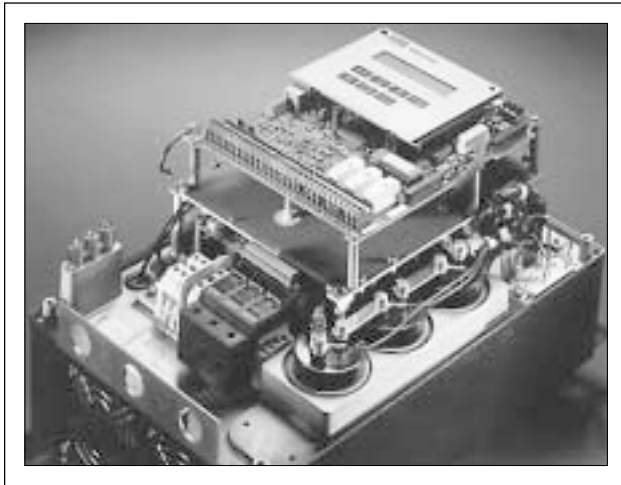

*This variable-frequency drive significantly improves overall energy efficiency.*

Source: Alpha Electrical Service

**VFDs should be properly installed** to avoid damage to their electronics. This includes proper grounding, mounting, connection, voltage, and cooling. Improper installation and start-up accounts for 50% of VFD failures. **Precautions** for specifying, installing and operating VFDs are numerous.

- **Use the VFD start-up sheet** to guide the initialization check before energizing the VFD for the first time. If a VFD is started when the load is already spinning, the VFD will try to pull the motor down to a low, soft-start frequency. This can result in high current and a trip unless special VFDs are used.
- **Always install wall-mounted units** against a smooth, flat, vertical surface, or install a piece of plywood or sheet metal to create the required cooling channels. Installing VFDs intended for wall mounting as freestanding units will interfere with the “chimney effect” cooling of the heat sink.
- **Check and monitor motors operating at low speeds** because they can suffer from reduced cooling. For maximum motor protection on motors to be run at low speeds, install thermal sensors that interlock with the VFD control circuit. Standard motor protection responds only to over-current conditions.

- **Ensure that the power voltage** supplied to VFDs is stable within plus-or-minus 10% to prevent tripping faults.
- **Separate speed control wiring**, which is often 4 mA to 20 mA or 0 VDC to 5 VDC, from other wiring to avoid erratic behavior. Parallel runs of 115 V and 24 V control wiring may cause problems.
- **Prevent damage from corrosive environments**, humidity above 95%, ambient air temperatures exceeding 104°F (40°C), and conditions where condensation occurs, as much as possible.
- **If power switching is anticipated, include this capability in the specification.** Switching from grid power to emergency power while the VFD is running is not possible with most types of VFDs.
- **Interlock the run-permissive circuit to the disconnect** if electrical disconnects are located between the VFD and motor .
- **Use “inverter duty” motors** on new installations that will have VFDs.



If a motor always operates at its rated load, a VFD will *increase energy use, as a result of electrical losses in the VFD.*

## References

ASDMaster™ software, EPRI PEAC Corporation, 942 Corridor Park Blvd., Knoxville, TN 37932; 800/982-9294; [www.epri-peac.com/asdmaster/](http://www.epri-peac.com/asdmaster/).

Murphy, Howard G., “Power Quality Issues with Adjustable Frequency Drive—Coping with Power Loss and Voltage Transients,” *Iron and Steel Engineer*, February 1994.

Induction motors, magnetic ballasts, and transformers require two types of power to operate. *Active power* (also called true or real power) produces work or heat, is used by all electrical devices, and is expressed in kilowatts. *Reactive power* is used by inductive devices to generate magnetic fields. It does not perform useful work and is expressed as kVARs (kilovolt-amps reactive). *Total power*, or apparent power, is the vector sum of active and reactive power and is expressed in kVA (kilovolt-amps). A *power factor* is the ratio of active power to total power and quantifies the portion of power used by a facility that does electrically useful work. Power companies generally charge an additional fee to facilities having power factors less than 85–95% in order to capture costs to the utility company that are not reflected by the electric energy (kWh) meter. Improving the power factor can increase current-carrying capacity, improve voltage to equipment, reduce power losses, and lower electric bills.

### Opportunities

Efforts should be made to improve power factors if (1) power factors are below 90–95% and penalties charged by the electrical utility are high, (2) electrical problems within the facility can be eliminated by improving the power factor, or (3) installing larger transformers for capacity needs can be deferred. Power factor improvements should be considered whenever electrical equipment such as motors and lighting are being upgraded or replaced.

### Technical Information

**Electric motors are large contributors to poor power factors** because many generally operate under light loads. Lower power factors do not necessarily increase peak kVA demand because of the reduction in load. For example, the power factor of an electric motor is lowest when the motor is lightly loaded. This occurs when both its power draw and contribution to the electrical peak demand is the least.

**Power factor correction capacitors** are designed to provide the reactive current needed by inductive loads. Capacitors may be installed to improve the power factor of a single load or an entire power system and come in sizes from 1 to 600 kVARs.

**Automatic power factor correcting equipment** switches banks of capacitors on- and off-line depending on the power factor. These may provide good solutions in applications where reactive loads vary in magnitude over time.

**Locate capacitors upstream of motor controllers** unless full-voltage, nonreversing, across-the-line starters are used.



Replace standard motors with energy-efficient motors that have high power factor ratings. Note that even high-efficiency motors will have poor power factors under low load conditions—and that efficiency is more important than power factor. Be sure not to sacrifice efficiency for power factor. Avoid operating equipment above its rated voltage. Minimize operation of lightly loaded or idling motors.

**Shut down a lightly loaded motor in situations where a smaller, parallel motor can do the same job.** For example, when chilled water demand drops, parallel pumps may be removed from service until loads increase.

**Be aware that installing power factor correction capacitors** on the load side of a motor-overload protection device may require reducing the overload size. The capacitor manufacturer will have tables to assist you in resizing.

**Avoid oversizing capacitors installed on the load side of motor controllers** because they can discharge into the motor when the controller is turned off. Damaging voltages may occur if kVAR current exceeds motor no-load current.

**Note that power factor correction saves money in three basic ways:**

- Avoided power factor penalties from the utility (where applicable).
- Freed capacity in supply transformers if such capacity is needed.



Photo: Northeast Power Systems, Inc.

*This automated control and protection system includes capacitor banks and harmonic filter banks.*

- Reduced I<sup>2</sup>R resistive losses in wiring, etc., provided the capacitors are located close to the inductive loads. Kilowatt-hour savings of less than 0.5% are typical, and savings of 1–2% would be the high range for typical commercial and industrial systems.



**Beware of applications where there are significant harmonics (VFDs and other nonlinear loads). The harmonics can cause resonances with the capacitors and damage them. If harmonics exist, consider harmonic filters, which also typically improve power factor.**

**Do not exceed manufacturer’s recommendation** on maximum capacitor size.

**Install high-power-factor lighting and electronic equipment.** While motors garner most of the attention regarding power quality, lighting equipment and other electronic products can also have a significant impact on power factor. With lighting, ANSI classifies ballasts with power factors above 0.90 as “high power factor” (HPF). Magnetic ballasts often have far lower

power factors (0.50 is typical with some products), as do many types of office equipment (desktop computers, monitors, laser printers, etc.). When data on power factor are available, specify and buy high-power-factor products.



**Power factor is less than one when energy is quickly stored and released in a piece of equipment so that the voltage and current are out of phase by the angle  $\Theta$ .**

$$\text{Power factor} = \frac{\text{watts}}{\text{volts} \times \text{amps}} = \text{Cos } \Theta$$

**Additional power is not consumed, but bigger wires and transformers are required to handle the additional amps needed by the load. Low power factors of large inductive loads, such as motors, can be improved by adding capacitors to the load. Current through a capacitor has the effect of cancelling out the lagging current.**

## References

*Energy-Efficient Motor Selection Handbook* (DE-B179-93-B08158), Bonneville Power Administration, 1993.

“Reducing Power Factor Cost,” *Technology Update*, Bonneville Power Administration, April 1991.

Morgan, Robert, “Improving Power Factor for Greater Efficiency,” *Electrical Construction and Maintenance*, September and November 1994.

“Power Quality,” *Lighting Answers*, Vol. 2, No. 2, February 1995; National Lighting Product Information Program, Lighting Research Center, Rensselaer Polytechnic Institute, Troy, NY; (518) 276-8716; [www.lrc.rpi.edu/NLPIP](http://www.lrc.rpi.edu/NLPIP). (This report is available as a downloadable file.)



Elevators consume a significant fraction of the total energy used in tall buildings. In low-rise and mid-rise buildings, their energy use is less substantial, but opportunities for improving conventional practices are huge. In addition to reducing energy use, newly selected elevators should minimize other environmental concerns, such as the potential for leaking hydraulic fluid, maintenance requirements, and future replacement cost.

The electricity-consuming elements of elevators are the drive/machine, car illumination (some elevator codes require this to be on all the time), and the controller. Though the illumination in infrequently used elevators can equal the drive consumption, in 99% of cases the drive is the dominant consumer.

### Opportunities

The greatest opportunity to select lost-cost, high-performance elevators is early in the design process for a new facility, because the type of elevator selected can significantly affect the space and structural requirements of the hoistway and ancillary spaces. Any time equipment needs replacing or significant maintenance, however, upgrading to more energy-efficient and environmentally friendly systems should be considered. Elevators in high-rise buildings use significant amounts of energy, so even marginal improvements in their efficiency can translate into significant savings. The most significant improvement opportunities exist in low-rise buildings because the hydraulic elevators typically installed in these facilities are the least efficient and the most problematic in terms of pollution from hydraulic fluid. Switching to a less toxic hydraulic fluid should be considered for buildings with hydraulic systems that are not candidates for replacement.

### Technical Information

Good data on the fraction of a building's energy use represented by elevators is sparse, but a typical estimate is 4–10%. A recent survey of ten high-rise residential buildings by Canada Mortgage and Housing Corporation found that the elevators' share in overall energy use was 3–9%. As with lighting, all energy used by elevators is converted into heat, so excess energy use translates into increased cooling loads as well. Elevator shafts can also be significant sources of lost heat in cold climates, due to poor airtightness and the strong upward pressure of hot air, or the stack effect.

Elevator technology is a highly specialized field, with many factors affecting comfort, safety, energy efficiency, and maintenance requirements. In very general terms, elevators for low- and mid-rise buildings are typically either hydraulic or traction (gear-driven) systems, while high-rise buildings use variable voltage-variable frequency (VVVF) controlled gearless AC-motors replacing earlier DC technology. A more recent evolution is the availability of VVVF systems for low- and mid-



Hydraulic elevators tend to increase in cost roughly in proportion to the number of stops. More sophisticated elevators, on the other hand, are only incrementally more expensive with each added stop. Consequently, in low-rise applications, high-performance elevator systems tend to cost significantly more than hydraulics do. Other factors affecting the cost comparison include the reduced cost for electrical supply and connections when the elevator's maximum draw is reduced by two-thirds. Selecting a system that does not require a machine room also reduces the cost.

---

*In the EcoSystem elevator a thin, permanent magnet motor is mounted directly to the hoisting rail. This technology offers significant energy savings compared with conventional systems.*

---

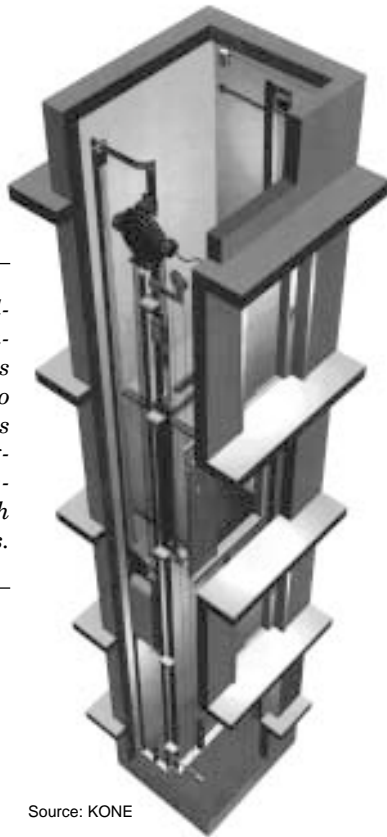

Source: KONE

rise applications, which makes the energy efficiency and comfort of that technology available to buildings that are not so tall.

While the initial cost of hydraulic elevators makes them typically the least expensive for short runs, their inefficiency and the potential for groundwater contamination from leaking hydraulic fluid make them less desirable environmentally. Conventional hydraulic elevators require that a shaft be drilled in the ground that is equivalent in depth to the height of the lift. Modified systems use a telescoping shaft or a hydraulic lift with cables to avoid the complications of the long, in-ground shaft. In addition, less toxic, vegetable-based hydraulic fluid—although costly—is available to reduce the risk of ecological and health damage.

The latest VVVF technology with a permanent-magnet, synchronous motor also offers the possibility of saving space and construction costs because, up to certain elevator load/speed values, the small motor actually fits inside the hoistway. When mounted directly on the main car guiderails, this design avoids the need for a separate machine room and reduces the structural demand on the building because the guiderails support the load of the moving car. Initially introduced only for smaller applications, this guiderail-mounted motor technology is now expanding into longer runs and larger sizes, including freight elevators.

Any elevator system with significant traffic can also benefit from a control system that provides the most cars where they will be needed while reducing unnecessary travel. Some manufacturers now offer sophisticated computerized controls capable of optimizing energy consumption in addition to reducing response and travel time, including systems based on fuzzy logic that self-adjust based on travel patterns. Simpler controls can be programmed to cut off power to some cars during low-usage periods, reducing standby energy use. Finally, cab lighting can be a large factor, as these lights are usually on all the time. Higher-efficiency lamps often also have longer service lives, which reduces the labor cost associated with lamp replacement.

## References

“New energy-efficient lift concept,” from CADDET Energy Efficiency, a program of the International Energy Agency and the Organization for Economic Cooperation and Development; [www.caddet-ee.org/techbroc/r314.htm](http://www.caddet-ee.org/techbroc/r314.htm).

“EcoSystem: A Better Elevator,” *Environmental Building News*, Vol. 8, No. 7/8, p. 7, July/August 1999; BuildingGreen, Inc., Brattleboro, VT; (800) 861-0954. This review is posted on the BuildingGreen Web site: [www.BuildingGreen.com](http://www.BuildingGreen.com).

Electricity is the largest energy source in most facilities, powering HVAC equipment, motors, lighting, water heaters, and all types of industrial, office, and residential appliances and equipment. Electricity is generated primarily from fossil fuels and nuclear power sources, which have high pollution burdens. Only about one-third of the energy in the source fuels is delivered to the end user as electricity; the rest is lost to inefficiencies in generation and transmission of the power. With deregulation of the electric utilities, many new procurement options are becoming available, including the possibility of buying green energy from non-polluting, renewable sources. The focus of this section is on procuring electricity from green sources and on ways to transfer it efficiently from delivery point at the facility to points of use. Further analysis of power systems is presented in *Section 5.8.1*, transformers are addressed in *Section 5.8.2*, and combined heat and power is addressed in *Section 5.8.8*.

## Opportunities

Evaluate the pollution burden associated with electricity that a facility is using or considering for purchase, and seek opportunities to purchase green power. Consider the efficiency, reliability, and maintenance requirements of power systems whenever installing, renovating, or replacing equipment. There are opportunities within the facility's distribution system to save energy, increase equipment life, and reduce unscheduled outages. In some cases, efficiency improvements may be significant enough to justify replacement even if current equipment is still serviceable.

## Technical Information

Efforts to reduce the environmental impact of electricity systems at any facility should include two parallel efforts: improving utilization efficiency on site and procuring green power.

### UTILIZATION EFFICIENCY

**Electric utility bills** include both energy charges in kilowatt-hours and power demand charges in kilowatts. Rates may vary by season and time of day. Opportunities for improving the efficiencies of electrical power systems include evaluating and correcting voltage imbalances, voltage deviations, poor connections, undersized conductors, poor power factors, insulation leakage, and harmonics. Components to check in a maintenance program include transformers, conductors, switchgear, distribution panels, and connections at loads and elsewhere. Utilities penalize facilities with low power factors that require the utility to provide power-factor compensations.

Voltage imbalances are problematic differences between relative voltage levels among the three phases in part or all of a facility. Voltage imbalances result in preventable energy waste, excessive equipment wear, and premature equipment failure. Power demands on all three power phases should be virtually equal in order to maintain equal voltages in all phases. Problems with conductors, connections, and transformer settings may cause imbalances in any facility; however, supplying single-phase needs while maintaining three-phase balance is a challenge.



Avoid imbalance in supply circuits by distributing single-phase loads such as lighting, single-phase motors, resistance heating, and plugloads among phases.

**Designate or hire a Resource Efficiency Manager** who will find and address power imbalances, suboptimal equipment, and other inefficiencies. The more critical the equipment, the more maintenance resources should be devoted to it. Maintenance programs for electrical distribution systems may be reactive, preventive, predictive, or proactive. With good recordkeeping, a manager can develop the tools needed for at least a predictive if not a highly proactive maintenance program.



Photo: Warren Gretz

*This substation at the Palm Springs wind farm ties wind-produced electricity into the power grid.*

## GREEN POWER

The restructuring of the electric utility industry has created an opportunity for companies to offer electricity from renewable and nonpolluting sources to customers in states that have embraced deregulation. In many other states, where utilities are still regulated, green pricing is available as an option for customers who wish to pay a premium to support clean electricity sources. Executive Order 13123 directs Federal agencies to include provisions for the purchase of electricity from renewable energy sources in their

## MAINTENANCE TYPE AND PHILOSOPHY

**REACTIVE:** Repairs are made or components are replaced only upon failure.

**PREVENTIVE:** Includes inspecting, diagnosing, and servicing electrical systems to minimize future equipment problems or failures.

**PREDICTIVE:** Uses tests to predict the required service intervals, and targets equipment with the greatest service needs.

**PROACTIVE:** Employs failure analysis and predictive analysis as feedback to improve maintenance practices.

requests for bids whenever procuring electricity. A number of funding mechanisms are available to pay the premium associated with green power. See FEMP's Utility Market Restructuring Web site for current information.

Because of the complex nature of the electric transmission and distribution system, and the varying definitions of "green" and "renewable" energy, there has been some confusion and misinformation in the green electricity marketplace. In response to this problem, the Center for Resource Solutions, a San Francisco-based nonprofit organization, has developed the Green-e Renewable Electricity Program to certify green power providers that meet its criteria. Green electricity providers being considered for a contract should be accredited as such by the appropriate state board and should carry the Green-e certification. The Center for Resource Solutions also has a parallel program to accredit green pricing programs from regulated utilities.

## References

Total Efficiency Network, Washington State University Energy Program; (888) 634-2558; [www.energy.wsu.edu/ten/](http://www.energy.wsu.edu/ten/).

FEMP's Utility Market Restructuring Web site: [www.femp-restructuring.org/](http://www.femp-restructuring.org/).

## Contacts

Center for Resource Solutions, Presidio Building 49, P.O. Box 29512, San Francisco, CA 94129; (415) 561-2100, (415) 561-2105 (fax); [www.resource-solutions.org](http://www.resource-solutions.org).

Analysis of electrical power systems may uncover energy waste, fire hazards, and impending equipment failure. A well-executed analysis requires planning and lays the foundation for ongoing reliability-based maintenance.

## Opportunities

The best time to initiate preventive maintenance on electrical systems is before failures occur. Regular maintenance will help uncover hidden problems, allow timely repair, and avoid the unexpected disruption of system failure. In a new facility, maintenance should begin from the outset. In existing facilities, it is never too late to start a regular electrical system maintenance program.

## Technical Information

“Tune-ups” for electrical power systems yield both direct and indirect efficiency improvements, and they can increase the reliability of equipment. Direct improvements result from correcting leaks to ground and cutting resistive ( $I^2R$ ) losses in the distribution components. Indirect improvements result from improving the efficiency of equipment that previously operated with poor quality input power, such as three-phase motors operating with phase-to-phase voltage imbalances.

**Establish a preventive maintenance program** that includes good recordkeeping. The following procedures should be followed when possible:

- Document system components and electrical loads. Start with available drawings and other documentation. Update this documentation to “as-built” and keep files current.
- Inspect components, noting discoloration, deformation, damage, hot odors, noise, or vibration.
- Manually operate all switches and disconnects on a monthly schedule to help eliminate corrosion.

- Conduct a regime of electrical tests designed to identify actual and potential problems. This may include contact condition assessment with a voltage-drop survey, infrared thermography, power factor assessment, or voltage assessment to determine imbalances and deviations from target voltages.
- Consider a proactive maintenance program with the predictive elements discussed in *Section 5.8 – Electrical Power Systems*.



When conducting electrical assessments, be aware of varying conditions. Power quality may change greatly at night or at other times because of changes in loads.



Facility managers increasingly find that reliability-centered maintenance can save money, reduce energy consumption, and reduce downtime. A lumber/plywood facility in Oregon projected \$125,000 in potential savings by instituting an electrical system preventive maintenance program. Estimating actual savings is difficult, however, because of the uncertainty about when failures will occur, what equipment will be damaged, and how long problems will last.

## References

*IEEE Recommended Practice for Protection and Coordination of Industrial and Commercial Power Systems* (ANSI/IEEE Standard 242-1986), Institute of Electrical and Electronics Engineers, 1986; Publications Office, Los Alamitos, CA: (800) 272-6657; [www.ieee.org](http://www.ieee.org).

*Keeping the Spark in Your Electrical System: An Industrial Electrical Distribution Maintenance Guidebook* (WSEO 93-15), Washington State Energy Office, Olympia, WA, 1995.



Source: FLIR Systems

*Infrared thermography can quickly identify electrical power system problems and should be included in a proactive maintenance program. Apart from the costly inefficiency of wasted power, this faulty electrical connection would eventually have resulted in total failure once the melting point was reached.*

## TROUBLESHOOTING FOR POWER SYSTEMS

PROBLEM	COMMON CAUSES	POSSIBLE EFFECTS	SOLUTIONS
Voltage imbalances or differences between relative voltage levels among the three phases in all or part of a facility	Improper transformer tap settings, one single-phase transformer on a polyphase system, single-phase loads not balanced among phases, poor connections, bad conductors, transformer grounds or faults	Motor vibration, premature motor failure, energy waste (a 5% imbalance causes a 40% increase in motor losses)	Balance loads among phases.
Voltage deviations (voltages too low or high)	Improper transformer settings, incorrect selection of motors, e.g., a 230/208 motor (which is actually 230-volt rated) on a 208-volt circuit	Reduced efficiency, power factor, and equipment life; increased temperature	Check and correct transformer settings, motor ratings, and motor input voltages.
Poor connections (may be in distribution or at connected loads)	Loose bus bar connections, loose cable connections, corroded connections, poor crimps, loose or worn contactors, corrosion or dirt in disconnects	Energy waste, heat generation, failure at connection site, voltage drops or imbalances	Use IR camera to locate hot-spots and correct.
Undersized conductors	Facilities expanding beyond original designs, poor power factor	Voltage drop, energy waste	Reduce the load through conservation load scheduling.
Insulation leakage	Degradation over time due to extreme temperatures, abrasion, moisture, chemicals, or use of conductor insulation inappropriate for conditions	Breaker trip failure, current leakage to ground or to another phase, variable energy waste	Replace conductors, insulators.
Low power factor	Inductive loads such as motors, transformers, and lighting ballasts; nonlinear loads such as most electronic equipment loads	Reduction in current-carrying capacity of wiring, voltage regulation effectiveness, and equipment life; increase in utility costs	Add capacitors to counteract reactive loads (see <i>Section 5.7.3 – Power Factor Correction</i> ).
Harmonics (nonsinusoidal voltage and/or current wave forms)	Office electronics, telephone PBXs, uninterruptible power supplies, variable-frequency drives, high-intensity discharge lighting, and electronic and core-coil ballasts	Overheating of neutral conductors, motors, transformers, switch gear; voltage drop, low power factors, reduced capacity	Choose equipment carefully. Isolate sensitive electronics from noisy circuits.

## 5.8.2 Transformers

Customer-owned transformers allow facilities to purchase power at lower costs and then step down electric utility power distribution line voltages to lower secondary voltages needed for internal applications. Transformers commonly used for powering large facilities are either liquid-filled, dry-type, or epoxy cast resin. Liquid-filled transformers may be pole-mounted for overhead distribution, pad-mounted for underground feed in and out, or station-class for lineup application with switchgear. Dry-type transformers are used both in medium-voltage applications, such as substations, and in low-voltage (less than 600-volt primary) step-down applications, such as plugloads and lighting. Dry-type transformers are typically located inside buildings away from harsh environments. Proper transformer selection is important to ensure robust application and to minimize the potential for catastrophic failure. Energy efficiency considerations are particularly important and can result in rapid recovery of incremental investments.

### Opportunities

Purchase energy-efficient transformers and practice good installation techniques whenever replacing or adding new equipment. Conduct proactive transformer maintenance along with other electrical maintenance functions.

### Technical Information

**Efficiencies of low-voltage dry-type transformers**, designed only for temperature rises, will range from 95% to 98%, with core losses caused by magnetizing and coil losses caused by impedance and resistance. NEMA Standard TP 1-1996 was established to define energy-efficient liquid and dry-type transformers. TP 1-compliant transformers will range from a low of 97.0% efficiency for 15 kVA dry-type to 98.9% efficient for 1,000 kVA low-voltage dry-type. Medium-voltage dry-type transformers, designed to meet the NEMA Standard, will range from 96.8% efficiency at 15 kVA to 99.1% efficiency at 2,500 kVA. Low-voltage dry-type transformers meeting the TP 1-1996 requirements also qualify for an ENERGYSTAR® label. When purchasing transformers, look for those with high efficiency ratings that meet your needs. Be sure to obtain all transformer loss information from the manufacturer and match the transformer to the load profile. Manufacturers trade off coil losses (most significant at full load) with core losses (most significant at low load). Consequently, a low-temperature-rise unit that operates very efficiently at high load may be inefficient at low load.



Each year, according to insurance industry figures, more than 100 incidents of electrical and fire damage are caused by inadequate transformer maintenance, resulting in \$10 million in losses.

**Disconnect the primary side of transformers not serving active loads.** Transformers consume power even when loads are switched off or disconnected. Disconnecting the primary side of transformers to reduce transformer standby losses is safe, provided that critical equipment such as clocks, fire alarms, and heating control circuits are not affected.

**For three-phase transformers, ensure that the voltage of each phase is balanced** with others to within the minimum transformer step. If this fails to yield equal tap settings, redistribution of the loads is needed.



---

*Though not particularly glamorous in appearance, this Honeywell TranStar, the first ultra-low-loss transformer available in North America, achieves 98.5% efficiency at 35% load unit and could save users up to \$3,500 each year.*

---

Source: Honeywell

**Reduce acoustical noise** from pad-mounted transformers through proper design. In areas where personnel might be affected by the 60 Hz hum of power transformers, use isolators to reduce transmission to the building's structural components. Install isolators between the transformer core and housing, and also between the housing and the building structure.

**Visually inspect transformers** to verify that oil is contained and that connections appear to be sound.

**Scan temperatures of transformers** using infrared thermography to determine points of energy waste and pending failure. Criteria for assessment include ambient air temperature, rated-rise of similar transformers under the same conditions, and an absolute maximum allowable temperature.

**Maintain balanced voltage** with polyphase transformers by maintaining equal tap settings. Balance single-phase loads among phases to keep voltages within 1% of the average.

**Be careful when connecting single-phase** transformers to a three-phase system. If the load is large, a three-phase transformer should be used and the single-phase loads should be balanced.

**Cooling oil in old transformers may** contain polychlorinated biphenyls. PCBs are hazardous, cancer-causing agents that must not be released into the environment. Use extreme care to avoid spillage when replacing PCB-containing transformers. Collect oils for recycling or disposal at an approved hazardous waste facility. Follow applicable safety and environmental protection standards for handling and disposal.

## References

*Guide for Determining Energy Efficiency for Distribution Transformers.* NEMA Standards Publication TP 1-1996, National Electrical Manufacturers Association (NEMA), Rosslyn, VA; [www.nema.org](http://www.nema.org).

"Honeywell TranStar Transformer Offers Significant Savings," *Environmental Building News*, Vol. 9, No., 7/8, July/August 2000; BuildingGreen, Inc., Brattleboro, VT; (800) 861-0954; [www.BuildingGreen.com](http://www.BuildingGreen.com).

## Contacts

Consortium for Energy Efficiency, Inc., One State Street, Suite 1400, Boston, MA 02109; (617) 589-3949; [www.CEEforMT.org](http://www.CEEforMT.org).

U.S. Environmental Protection Agency ENERGY STAR Program; (888) STAR-YES; [www.epa.gov/appdstar/transform/](http://www.epa.gov/appdstar/transform/).



## 5.8.3 Microturbines

Microturbines are emerging as a very promising technology for power generation at the scale of 25 to 300 kW. A handful of companies have introduced—or will soon introduce—these small, self-contained gas-turbines for utility distributed-power applications and self-contained power systems at manufacturing plants, hospitals, data processing centers, and other commercial-scale facilities.

### Opportunities

Microturbines should be considered for power generation in the following situations:

- When the reliability of the power supply is extremely important;
- When grid-supplied power is limited or very costly (whether from kWh usage, time-of-use, or demand charges);
- When power quality is a concern either because of problems with grid-supplied electricity or because of particular needs for the facility;
- When utility companies require distributed generation capacity to meet remote power-user demands; and
- When thermal energy needs (for heating, absorption cooling, water heating, and industrial processes) can be matched with electricity generation.

---

*Microturbines like this work like jet engines but produce electricity instead of thrust. Capstone's products have one moving part and operate with air bearings.*

---

From an environmental standpoint, the potential of producing both heat and electricity—combined-heat-and-power (CHP) or cogeneration—with microturbines is particularly exciting. CHP systems provide an opportunity to dramatically increase the overall efficiency of delivered energy—by 25–30% with the microturbine alone to well over 50% when waste heat is utilized.

### Technical Information

Microturbines, or turbogenerators as they are sometimes called, evolved out of turbocharger technology that is used to boost power output in cars, trucks, propeller-driven airplanes, and jet aircraft. The first microturbines were developed in the 1960s by Allison Engine Company (a division of Rolls-Royce) and used on a test basis to power several Greyhound buses. The fuel (usually natural gas, but also such fuels as propane, methane, landfill gas, gasified biomass, gasoline, and diesel) is superheated and burned. Combustion gases power a turbine, spinning the shaft extremely rapidly—up to 100,000 revolutions per minute (rpm). This spinning shaft, in turn, powers a high-speed generator, producing electricity. Waste heat can be extracted from the exhaust and used. However, current microturbines offer no improvements in efficiency or emissions over larger turbines.

While the commercialization of microturbines is just beginning, the Gas Technology Institute expects com-

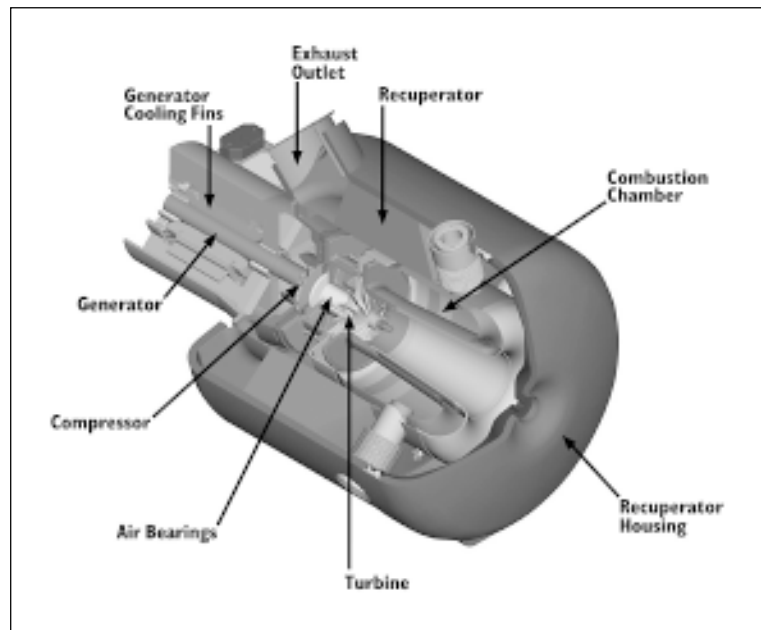

Source: Capstone Turbine Corporation



Source: Capstone Turbine Corporation

*The Underwriters Laboratory (UL)-rated Capstone MicroTurbine™ Model 330 produces 25–30 kW of electricity and can be configured for cogeneration.*

mercial products to have an operating life of 25,000 to 50,000 hours, very low polluting emissions (nitrous oxide [NO<sub>x</sub>], levels of 9 to 42 parts per million), and a purchase price of \$600 to \$1,200 per kW. Unlike most of the larger gas turbines used for utility power generation that are custom-made for the application, microturbines will be mass-produced, off-the-shelf items. They are being designed to have very few moving parts (often only one!), in comparison to the many hundreds of parts for reciprocating engines that have generally served this power-generation market. The simple design and the use of air bearings contribute to quiet operation—typically less than 70 dB at 10 feet (3 m)—and long service life between overhauls. The use of ceramics in turbine manufacture may further improve durability and performance in the future.

Among the active developers of microturbines are Honeywell (previously AlliedSignal Power Systems), Capstone Turbine Corporation, Allison Engine Company, NREC Energy Systems (a division of Ingersoll-Rand Co.), and Elliot Energy Systems (which is teaming up with GE Power Systems and NICOR). Among the first products to be introduced, the Capstone MicroTurbine™ Model 330 burns natural gas and produces 25–30 kW at approximately 27% efficiency with less than 9 ppm of NO<sub>x</sub>. The 1,050-pound (476 kg) unit stands just over 6 feet (1.8 m) tall and looks somewhat like an oversized computer (see photo).

## TINY MICROTURBINES

Another class of microturbines—very small units with outputs sometimes measured in watts rather than kilowatts—is being developed primarily for military applications. These units will provide portable power to soldiers for radios, GPS equipment, and battlefield computers. Going the furthest with this concept, the Massachusetts Institute of Technology has designed a tiny, flat microturbine under 1/2 in. (12 mm) in diameter, 1/8 in. (3 mm) long, and weighing just a gram, with a turbine speed of 1.4 million rpm, fuel consumption of a gram per hour, and output of 10 to 20 watts! As these products evolve, they may find applications in houses and small commercial buildings. A shoebox-sized microturbine might someday be able to power a house and heat its water.



*The Gas Research Institute projects that microturbines will cost \$600 to \$1,200 per kW to install. Some other organizations project costs as low as \$225 per kW, with a delivered electricity cost below 5¢ per kWh, including amortized equipment costs. For facilities with time-of-day electricity pricing or high demand charges, microturbine costs can be repaid much more quickly than the 5¢/kWh cost might imply. Using cogenerated heat can further improve the economics of microturbines.*

## Contacts

Distributed Power Coalition of America, 10 G Street, NE, Suite 700, Washington, DC 20002; (202) 216-5944, (202) 216-0874 (fax); [www.dpc.org](http://www.dpc.org).

Advanced Turbine Systems Program, Office of Industrial Technologies, U.S. Department of Energy, Washington, DC; OIT Resource Center: (202) 586-2090; [www.oit.doe.gov/cogen/](http://www.oit.doe.gov/cogen/).

Energy Conversion Program, Gas Technology Institute (formerly Gas Research Institute), 8600 W. Bryn Mawr Avenue, Chicago, IL 60631; (773) 399-8352, (773) 864-3551 (fax); [www.gri.org](http://www.gri.org).

## 5.8.4 Fuel Cells

Fuel cells generate electricity by converting chemical energy into electrical power with few moving parts. Power generation by means of fuel cells is a rapidly emerging technology that provides electricity with high efficiency and little noise. Fuel cells produce no noxious gases that produce acid rain, no particulate pollutants that foul the air, no unburned hydrocarbons during normal operation, and proportionately less carbon dioxide (CO<sub>2</sub>) than other, less efficient technologies. Fuel cells provide the opportunity to make the transition from fossil fuels, such as natural gas, methane, and liquid hydrocarbons, to what many consider to be the fuel of the future: hydrogen.

### Opportunities

At costs up to \$3,000 to \$4,000 per kW, fuel cells are not for everybody. While DOD and others estimate that the installed cost of a fuel cell will have to drop to \$1,500 per kW before they will be widely used for most applications, they are already cost-effective in situations where very clean power and reliable backup energy supplies are essential. Fuel cells generate cleaner power than is generally available from the utility grid, so facilities with equipment that is sensitive to current and voltage variations can use fuel cells effectively. Hospitals, data centers, and other mission-critical facilities can obtain fuel cells to provide emergency power and then use them to meet a portion of their everyday base load as well. Remote sites without access to the utility grid are also good candidates for fuel cells. Facilities that can make effective use of waste heat can use that free energy to help offset the devices' higher cost.

### Technical Information

Fuel cells are electrochemical engines that convert the chemical energy of a fuel and an oxidant—hydrogen and oxygen—directly into electricity. The oxygen used in the fuel cell is atmospheric oxygen, and the hydrogen is either elemental hydrogen or hydrogen extracted from hydrocarbon fuels using a device called a *reformer*. Water is the only significant by-product of a fuel cell's operation. Because nearly all fuel cells in use or under development today rely on hydrocarbon fuels as their source of hydrogen, however, CO<sub>2</sub> and other air pollutants are emitted from the reformer.

The fuel cell's principal components are catalytically activated electrodes for the fuel (anode), the oxidant (cathode), and an electrolyte to conduct ions between the two electrodes. Because the operating conditions of the fuel cell are largely determined by the electrolyte, fuel cells are classified by the type of electrolyte.

### Four leading fuel cell technologies are being developed at present:

**Phosphoric acid** fuel cells (PAFC) have an acid electrolyte and are the most highly developed fuel cells. These operate at relatively low temperatures, around 400°F (200°C), are commercially available, and have thermal output that can be used in cogeneration applications. DOD has been testing 200-kW PAFCs at various facilities since 1993, with generally positive results (see box, next page). The first 1-MW system is currently installed and being tested at a U.S. Postal Service mail distribution center in Anchorage, Alaska (see photograph).

**Proton exchange membrane** (PEM) fuel cells are well suited to residential, light commercial, and mobile applications requiring relatively compact power systems. The electrochemistry of PEM fuel cells is similar to that of phosphoric acid fuel cells. They operate in the same pressure range but at a much lower temperature, about 175°F (80°C). Their very low thermal and noise signatures may make them especially useful for replacing military generator sets.

Fuel cells using a **molten carbonate** (MCFC) electrolyte are relatively high-temperature units, operating at higher than 1100°F (600°C). Current MCFCs are being designed for applications on the order of 250 kW to 5 MW. The high-temperature exhaust gases can be used in a combined-cycle (cogeneration) system, creating an overall efficiency of about 80%.

**Solid oxide** (SOFC) electrolyte fuel cells are also high-temperature devices, operating at 1100 to 1800°F (600 to 1000°C). At these temperatures, a natural gas-powered fuel cell does not require a reformer. The solid construction of the SOFC fuel cell prevents some of the corrosion problems of liquid-electrolyte fuel cells. SOFC cogeneration power systems are expected to provide electric power at efficiencies close to 50% and useful steam or hot water at about 40% of rated power, raising the overall effectiveness of the system. A variety of 20- to 125-kW SOFC units have been tested, and units up to 1 MW are planned for preproduction release.

---

*The U.S. Postal Service distribution center in Anchorage, Alaska, is powered by five 200-kW fuel cells as part of the DOD Fuel Cell Demonstration Program.*

---

**Fuel cells are inherently less polluting** than conventional fossil-fuel technologies and are more efficient in producing electricity. They produce almost no harmful air or water emissions. The principal by-product is water. However, PAFC, MCFC, and PEM fuel cells have inherent maintenance problems related to water issues. Make-up water supply is required, and—depending on the mineral content—a water treatment system may also be required.

The footprint of a 200-kW PAFC unit is about 200 ft<sup>2</sup> (20 m<sup>2</sup>), while the footprint of a 2.85-MW MCFC plant is about 4,500 ft<sup>2</sup> (450 m<sup>2</sup>). For many types of fuel cell power plants, stack and fuel processor units must be replaced every 5 to 10 years, requiring a shutdown of several days. Current cost estimates for this are up to half the cost of the fuel cell plant.

## References

Fuel Cells for Buildings program; U.S. Department of Energy; [www.pnl.gov/fuelcells/](http://www.pnl.gov/fuelcells/).

Wilson, Alex, and Nadav Malin, "Fuel Cells: A Primer on the Coming Hydrogen Economy," *Environmental Building News*, Vol. 8, No. 4, April 1999; Building-Green, Inc., Brattleboro, VT; (800) 861-0954; [www.BuildingGreen.com](http://www.BuildingGreen.com).

## Contacts

Facilities Division, Energy Branch, U.S. Army Construction Engineering Research Lab; (217) 373-7214; [www.dodfuelcell.com](http://www.dodfuelcell.com).

Electrochemical Technology Program, Argonne National Laboratory, U.S. Department of Energy; (630) 252-2000; [www.anl.gov](http://www.anl.gov).



Source: U.S. Postal Service



**DOD Fuel Cell Demonstration Program:** Since Fiscal Years 1993 and 1994, the U.S. Army's Construction Engineering Research Laboratory has overseen the installation and operation of 30 PAFC fuel cells made by ONSI Corporation at facilities across the nation. Installation and maintenance were included in the contract, thus providing an opportunity for ONSI to learn how its units work in the field. This process has led to several refinements to ONSI's standard PA25 fuel cell.

As of April 1, 2000, the 30 fuel cells had generated a total of 95,000 MWh of electricity and provided  $181 \times 10^9$  Btu in thermal energy. The displaced cost for this energy is \$3.8 million. Avoided air emissions include 182 tons of nitrous oxides, 390 tons of sulfur oxides, and 15 tons of carbon monoxide. DOD is considering following this program with tests of several other fuel cell technologies.

## 5.8.5 Photovoltaics

Photovoltaic, or PV, cells are semiconductor devices that convert sunlight into electricity. They have no moving parts. Energy storage, if needed, is provided with batteries. PV modules are successfully providing electricity at hundreds of thousands of installations throughout the world. Especially exciting are building-integrated photovoltaic (BIPV) technologies that integrate PV directly into building materials, such as semitransparent insulated glass windows, skylights, spandrel panels, flexible shingles, and raised-seam metal roofing.

### Opportunities

Photovoltaic systems are cost-effective in small applications removed from utility power. It costs less to serve a small load with PV than to install a power line, even on a first-cost basis. PV prices have historically declined about 5% per year, and PV systems are typically less expensive than operating a stand-alone generator in a remote location. Consider replacing small (less than 10 hp) generators with PV, especially in environmentally sensitive areas where maintenance and fuel spills are a concern. Increasingly, PV is being considered as a source of electrical energy for buildings—even those with ready access to utility power—with the PV system integrated into the building envelope.

### Technical Information

At the heart of all PV systems is the photovoltaic cell. *Crystalline PV cells* are made from thin circular or rectangular silicon wafers sliced from single-crystal or polycrystalline silicon stock. Wafers are doped either with boron or phosphorus to provide them with special charge properties and are sandwiched together to create cells. Most crystalline PV cells are on the order of 8 to 17 mils thick and typically 12–14% efficient.

With thin-film PV cells, the semiconductor material is deposited directly onto a glass, plastic, or metal substrate in a very thin layer (usually less than 5 microns thick), thus dramatically reducing the amount of material used. Thin-film cells are produced today with one to three layers of amorphous (noncrystalline) silicon, very thin layers of crystalline silicon, or more exotic materials such as cadmium telluride or copper indium diselenide. Most thin-film PV cells are 5–10% efficient in converting sunlight to electricity.

*Modules* are produced by wiring PV cells together and sealing them between layers of protective materials—usually glass. For BIPV applications, crystalline cells can be custom-colored (standard colors are dark gray to deep blue) and spaced to allow light transmission between cells, and modules can measure up to about 30 sq ft (2.8 m<sup>2</sup>) in area. Thin-film modules typically

are a uniform gray color and can be semitransparent.

Modules, in turn, are assembled into *PV systems*, which can be either stand-alone or utility-interactive, as described below.

#### STAND-ALONE PV SYSTEMS

Stand-alone PV systems can be set up to function in several ways:

- **A direct-coupled system** is the simplest version and consists of photovoltaic cells driving a DC load with no battery storage. Loads such as water pumps, ventilation fans, and special DC refrigerators are good applications.
- **Battery storage systems to drive DC loads** store the PV-produced energy until it is needed—for example, to power navigation aids at night. The simplest version drives DC loads only and requires a battery with charge control to prevent overcharging.
- **Battery storage systems to drive AC loads** have a charge controller and an inverter (which changes DC to AC) to power connected AC loads. Hybrid systems may have one or more additional energy sources, such as a wind turbine or diesel generator.

Typical stand-alone applications include remote residential lighting and home power, emergency communications, irrigation systems for agriculture, microwave repeaters, cathodic protection for bridges and pipelines, navigation aids, security systems, meteorological stations, remote area lighting, and signboard lighting. There are hundreds of thousands of stand-alone PV systems worldwide.

#### UTILITY-INTERACTIVE PV SYSTEMS

Utility-interactive or grid-connected systems require an interactive inverter to operate with the grid. The PV power is first delivered to the load, and then extra electricity is sent to the grid. The inverter matches the output power to the phase and frequency of the grid. Some considerations are as follows:

- **Net metering**, legislated in a majority of states for residential-scale systems, allows the electric meter to literally spin backwards, giving full retail credit for electrical energy exported to the grid.
- **The Public Utilities Regulatory Policy Act (PURPA)** requires utilities to interconnect to any qualified facility. However, the facility must pay for the interconnection.
- **Technical and operating issues** that must be coordinated with the utility are metering, safety, equipment protection, service reliability, and power

quality. IEEE standards address interconnection with the utilities; UL standards apply to inverter and PV module performance and safety; the National Electrical Code governs wiring issues.

- **For situations in which the reliability of grid power is in doubt**, the PV system can be designed to automatically replace it during outages.
- **When planning a utility-interactive system**, be sure to check into metering options, buy and sell rates for power, outdoor disconnect requirements, insurance requirements, and other interconnection costs.



**Building-Integrated Photovoltaics systems combine electricity generation with other building envelope functions. A skylight, for example, can both provide daylighting and generate electricity. Spandrel panels in commercial buildings can be power-producing with little, if any, change in appearance. Raised-seam metal roofing and even shingles can serve a dual purpose: shedding rain and generating electricity. BIPV systems often have significant economic advantages over electricity-only PV systems because the BIPV modules are used in place of a building element.**

## PV SYSTEM DESIGN AND INSTALLATION

PV system design and installation can be complex. This is particularly true for utility-interactive systems and hybrid systems with supplemental power generation. System designers should be familiar with PV and balance-of-system equipment, as well as all applicable codes and regulatory issues. With BIPV systems, architectural expertise is needed to ensure proper integration with the building and satisfaction of building envelope requirements. Hiring experienced, fully qualified PV system designers is key to satisfactory performance, easy maintenance, and long system life.



**In 1970, PV cells cost more than \$1,000 per peak watt of power and were used mostly for exotic applications, such as spacecraft power systems. Prices today are under \$4 per peak watt, wholesale, for standard modules. Complete stand-alone systems typically range between \$6 and \$12 per peak watt; BIPV systems range from \$7 to \$15 per peak watt but often earn a credit by replacing conventional building materials.**



Source: Craig Miller Productions and DOE

*The swimming and diving facility built for the 1996 Summer Olympics uses photovoltaics (front) to produce electricity and a solar-thermal system (back) to heat pool water. Both systems reduce demand on the local utility and result in significant annual energy and cost savings.*

## STORAGE SYSTEMS

Storage systems for PV arrays make it possible to use captured energy at night or whenever the PV system can't meet the load. A typical storage system is a set of batteries sized to accommodate the PV input as well as the load demand.

When selecting a battery system, the designer needs to consider cyclic and calendar life, daily depth of discharge, temperature and environmental conditions, off-gassing characteristics, size and weight, cost, warranty, availability, reputation of the manufacturer, maintenance requirements, and terminal configuration.

Batteries often contain hazardous materials; the proper use and care of batteries should be a priority throughout their life cycle, including disposal.

## References

*Photovoltaic Fundamentals* (DOE/CH10093-117), National Renewable Energy Laboratory, U.S. Department of Energy, revised February 1996.

*Photovoltaic System Design Manual* (FSC-GP-31-86), Florida Solar Energy Center, Cocoa, FL, revised April 1996.

## Contacts

Contact the FEMP Help Desk, (800) DOE-EREC (363-3732), or see the FEMP Web site, [www.eren.doe/femp/](http://www.eren.doe/femp/).

Solar Energy Industries Association, 1616 H Street, NW, 8th Floor, Washington, DC 20006; (202) 628-7745, (202) 628-7779 (fax); [www.seia.org](http://www.seia.org).

## 5.8.6

# Wind Energy

Wind energy may be the biggest success story in the arena of alternative or renewable energy systems. Worldwide, wind energy capacity more than tripled over the past 10 years to exceed 10,000 MW by the end of 1999. About 2,500 MW of that capacity is installed in the United States. Over the past 20 years, the cost of producing wind energy has come down from 40 cents per kWh to approximately 3 to 5 cents per kWh for bulk power. The National Renewable Energy Laboratory's National Wind Technology Center (NWTC), located near Boulder, Colorado, supports the research and development of wind energy through a collaborative effort among industry, utilities, environmental groups, and others. NREL researchers predict that near-future design improvements will lower production costs to as little as 2.5 cents per kWh, making wind energy cost-competitive with conventional fuels. Many people are forecasting that wind energy will be the cheapest electricity available from any source within the next 10 to 15 years.

## Opportunities

In mid-1999, the U.S. Government made a firm commitment to:

- Use wind power to supply at least 5% of the nation's electricity needs by the year 2020;
- Double the number of states that have more than 20 MW of wind capacity by 2005; and
- Increase to 5% the Federal Government's use of wind-generated electricity by 2010.

Today's wind turbines are versatile, modular sources of electricity. Small turbines—500 watts to 100 kW—can supply enough electricity to power remote sites, small homes, or business. Large, utility-scale turbines—250 kW and larger—can provide enough electricity to power hundreds of homes and businesses.

Wind energy may be an excellent choice for providing power to facilities if:

- Renewable energy incentives (rebates, tax credits, etc.) are offered;
- The power producer can participate in a production tax credit for renewable energy, established under the Energy Policy Act of 1992;
- Net metering is available in the state or utility district;
- Electricity costs in the area exceed 8 to 12 cents per kWh;
- Diesel or other fossil fuels have to be transported to the site for remote power production;
- The facility is not in compliance with air-pollution regulations; or
- The facility is attempting to meet clean energy goals.

## Technical Information

Since earliest recorded history, wind power has been used to move ships, grind grain, and pump water. Today, wind power is also being used to provide electricity to homes, schools, businesses, and entire communities.

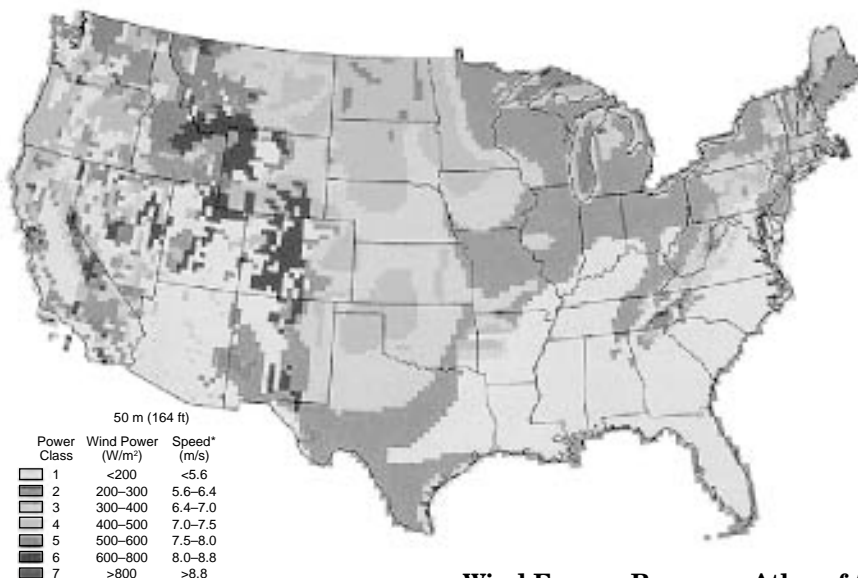

Wind Energy Resource Atlas of the United States

Map 2-6: Annual average wind resource estimates in the contiguous United States.

*A year of data collection may be necessary to obtain accurate information on wind speeds in a given location or to increase the confidence level in wind data before beginning a project. Equipment to accomplish this can be installed in one day and costs \$1,500 to \$3,000. FEMP also has a CD-ROM containing wind speeds throughout the United States.*

---

*This 6-MW wind farm at Searsburg, Vermont, provides emission-free, renewable energy to more than 2,000 households. This installation was funded by the DOE Turbine Development Program. Photo: Green Mountain Power Corp.*

---



More than half the United States has wind resources that could support the development of utility-scale wind power plants, and most states have enough wind to at least support small-scale wind systems. An annual average wind speed in excess of 8 miles per hour (12.9 km/h) is required for small-scale systems to be economical, and annual average wind speeds of at least 11.5 to 12.5 miles per hour (18.5 to 20 km/h) are required for utility-scale turbines.

**The power available from wind** is proportional to the cube of its speed. At double the wind speed, power generated increases by a factor of 8. Therefore, a wind turbine operating in 11.8 mph (19 km/h) wind can generate 29% more electricity than one operating in 11.2 mph (18 km/h) wind.

**Most wind turbines are horizontal-axis machines**, with turning blades that resemble propellers. Utility-scale turbines are often grouped together to form a single wind power plant, or *wind farm*, to generate bulk electrical power. Wind turbines are available in a variety of sizes and power ratings. A small home-sized wind machine has blades between 3 and 25 feet (0.9–7.6 m) in diameter and stands upwards of 30 feet (9 m) high. The largest machine stands 20 stories high and has blades that span the length of a football field.

**Approximately 50 acres (20 hectares) of land are required per MW for each utility-scale turbine.** However, much of the land is actually unoccupied and can be used for farming, ranching, and other activities.

**Hybrid wind/diesel systems** that combine a wind turbine with a diesel generator provide reliable, economical power. A more sophisticated hybrid system combining wind turbines, photovoltaic (solar electric) panels, and diesel generators provides backup power during low-wind periods, has the ability to supply peak loads under any conditions, and has lower diesel fuel consumption than simpler wind/diesel systems.

**Wind energy systems help the U.S. economy** by avoiding the external or societal costs associated with conventional energy sources—namely, the trade deficit from importing foreign oil and other fuels, the health and environmental costs of pollution, and the cost of

depleted resources. Wind energy is a reliable domestic resource that provides more jobs per dollar invested than any other conventional power technology—more than five times that from coal or nuclear power. Wind turbine and component manufacturers contribute directly to the economies of most states, creating thousands of jobs for Americans.

**A wind energy production tax credit** was established under the Energy Policy Act of 1992 as a means of stimulating wind energy development and making wind energy more competitive with conventional energy sources. The tax credit amounts to 1.5 cents per kWh (adjusted for inflation) for electricity produced using wind resources.

It therefore rewards actual electricity generation, rather than equipment installation, and is an important factor in setting the price of long-term wind energy contracts. The credit applies to the first 10 years of production for wind turbines installed between December 31, 1993, and December 31, 2001.

**The downsides of wind-turbine-generated electricity** include negative visual impacts and occasional bird fatalities. Efforts are being made to mitigate both of these effects. Using turbines of the same size with uniform spacing and analyzing visual impacts with computer simulations can greatly improve the appearance of a wind farm. The National Audubon Society and others are working with the American Wind Energy Association, DOE, and NREL to minimize bird fatalities.

**Although wind turbines generate some noise**, a 300 kW turbine creates only 45 dB of noise at a distance of about 650 feet (200 m). This noise is usually masked completely by background noise or the natural sound of the wind.

## Contacts

American Wind Energy Association, 122 C Street, NW, Suite 380, Washington, DC 20001; (202) 383-2504, (202) 383-2505 (fax); [www.awea.org](http://www.awea.org).

National Wind Technology Center, National Renewable Energy Laboratory, 1617 Cole Blvd., Golden, CO 80401; (303) 384-6900; [www.nrel.gov/wind/](http://www.nrel.gov/wind/).

Wind Program, Office of Energy Efficiency and Renewable Energy, U.S. Department of Energy; [www.eren.doe.gov/wind/](http://www.eren.doe.gov/wind/).

Wind Powering America, U.S. Department of Energy; [www.eren.doe.gov/windpoweringamerica/](http://www.eren.doe.gov/windpoweringamerica/).



Using biomass as an energy source goes back thousands of years; it was our principal energy source until the 1800s. Biomass is organic matter, such as wood, agricultural crops, and animal waste. In essence, biomass is a form of stored solar energy—produced when plants use energy from the sun to convert air and carbon dioxide into plant tissue through photosynthesis. Energy can be derived from biomass by burning it directly, by converting it into energy-rich gases (gasification) that can fuel advanced gas turbines or fuel cells, and by converting it into liquid fuels (biofuels) that can fuel vehicles and other power-supply equipment. Using combined heat-and-power (cogeneration) systems and the most advanced biomass power-generation equipment, we could achieve total efficiencies of more than 80%.

From an environmental standpoint, biomass energy systems are attractive for several reasons:

- Biomass combustion is climate-neutral, since growing new biomass removes as much (or more) carbon dioxide from the atmosphere as the burning of it releases into the atmosphere.
- The production of certain biomass fuels can reduce pollution risks—for example, the capture of landfill gas (mostly methane) that would contribute to global climate change and the conversion of livestock waste into methane.
- Mixing biomass with coal in coal-fired power plants (co-firing) can reduce polluting emissions.
- Growing perennial biomass fuels instead of cultivated agricultural crops on steep, erosion-prone soils and on buffer strips along waterways can prevent siltation of surface waters and help to prevent runoff of agricultural chemicals and fertilizers.

## Opportunities

Biomass energy systems should be considered for facilities with on-site electricity generation, especially when the waste heat from that power generation can be used for industrial processes or district heating (combined heat and power). Biomass energy is most feasible when there is an on-site (or nearby) source, such as waste wood from furniture manufacturing, agricultural crop residues, or a landfill with recoverable methane. Federal facilities can also support biomass energy use through green power purchasing programs in which biomass comprises part of the utility company's power generation mix.

## Technical Information

Biomass can be used as an energy source in a number of different ways. These are as follows:

**Co-firing:** Adding a small percentage of biomass to the fuel supply of a coal-fired power plant—referred to as co-firing—is the easiest short-term option for increasing our use of biomass in power production. Co-firing up to 15% of the fuel mix is currently being done in six U.S. power plants, mostly using wood residues. One coal power plant demonstrated co-firing at 40% biomass substitution for coal. Through co-firing in the nation's coal-fired power plants, which have a combined capacity of 310 gigawatts (GW), biomass could supply 20 to 30 GW by the year 2020, according to the DOE BioPower Program.

**Direct combustion** of biomass is already widely practiced in certain industries, including lumber mills, furniture and millwork factories, and sugar mills (which produce bagasse as a by-product). In a direct-combustion facility, the biomass is typically burned in a large boiler, producing steam that drives a Rankine-cycle generator. This is much the same process used in coal-fired power plants, though the fuel-handling equipment is different. Most direct-combustion power plants are small (less than 25 MW) and operate at efficiencies of about 20%.

**Gasification:** Rather than simply burning biomass, a more efficient and cleaner way to extract heat energy from it is through gasification. In this process, biomass is heated in an oxygen-starved environment, which breaks down the biomass into its chemical constitu-



*NREL worked with state, community, business, and utility partners to assist in the development of the 50-MW McNeil Generating Station in Burlington, Vermont, which uses wood fuel to produce electricity (cooling towers and excess steam are shown here).*

Photo: Dave Parsons

ents and produces *biogas*. This biogas can then be used as fuel in a high-efficiency gas turbine. Sophisticated *gasification combined cycle* (GCC) systems include a gas-turbine topping cycle and a steam-turbine bottoming cycle to achieve efficiencies nearly double those of direct combustion (37% vs. 20%).

**Anaerobic digestion:** Another way to produce energy from biomass is to anaerobically digest organic matter to generate methane, which can then be burned as fuel. Anaerobic (meaning oxygen-starved) digesters can be used to produce methane from municipal sewage treatment plants, livestock manure tanks, and other nutri-

ent-rich organic matter. In Gronigen, Holland, a biomass digester system has recently been installed that digests the organic component of municipal solid waste to generate 2.5 MW of electricity.

**Biofuels:** The final approach described for converting biomass into usable energy is to produce liquid fuel from organic matter. Biofuels, as defined by the DOE Biofuels Program, are alcohols, ethers, esters, and other chemicals made from cellulosic biomass. While biofuels can be burned to generate electricity, most of the focus is on biofuels for transportation, especially ethanol and biodiesel. More than 1.5 billion gallons (5.7 billion liters) of ethanol—derived from biomass through a fermentation process—are added to gasoline each year to improve vehicle performance and reduce air pollution. Alcohol is typically used in a 10% blend with gasoline. Biodiesel is an ester that can be made from a variety of vegetable oils and animal fats. Roughly 30 million gallons (113.5 million liters) of U.S. biodiesel are produced annually; most of that is used in a 20% blend with conventional diesel fuel.

## References

Numerous documents are available on the BioPower and Biofuels Web sites listed below.

## Contacts

Biomass Power Program, National Renewable Energy Laboratory, Golden, CO; [www.eren.doe.gov/biopower/](http://www.eren.doe.gov/biopower/).

National Biofuels Program, National Renewable Energy Laboratory, Golden, CO; [www.biofuels.nrel.gov](http://www.biofuels.nrel.gov).

Combined heat and power, or CHP, is the joint production of both heat (usually steam or hot water) and electricity from a single fuel source. Conventional U.S. power production converts roughly one-third of the Btu from the primary energy source (e.g., coal or natural gas) into electricity; most of the rest is lost as waste heat. Collecting and making productive use of that waste heat can result in total efficiencies over 70%. Combined heat and power is often referred to as *cogeneration*. Many commercial CHP systems go even further, producing electricity, steam, and chilled water from the heat. This is often referred to as *trigeneration*.

## Opportunities

Combined heat and power systems can be implemented on many different levels. At the largest scale, utility power production can be developed in such a way that cogenerated steam is distributed to nearby energy users through a district energy system. Such CHP systems are operating successfully in Boston, Philadelphia, Trenton, St. Louis, and Oklahoma City. In Philadelphia, for example, a CHP plant produces up to 150 MW of electricity while providing steam for 375 district-heating customers that include 70% of the city's downtown commercial buildings and institutional facilities. At the other end of the scale, single buildings can use CHP systems to generate their own electricity while providing thermal energy for internal uses. Between these two extremes, CHP is widely used in industrial facilities that have significant electricity and steam requirements *and* a ready source of fuel—for example, wood products companies and petroleum refineries. CHP systems are also increasingly used at multibuilding institutional facilities, such as universities and hospital complexes.

For single-building applications, CHP systems make the most sense where electric rates and electric demand charges are high. Sometimes opportunities for CHP can be found when the local utility company is looking to bolster its grid through distributed power production or when there is a need for greater reliability than the utility can provide. The best time to consider CHP for a facility is during the initial planning of new buildings and when major upgrades are planned for HVAC systems. Replacing electric chillers with absorption cooling or engine-driven chillers, for example, presents an excellent opportunity for CHP.

## Technical Information

**Thermal-energy losses from power plants** in the U.S. currently total approximately 23 quads (one quad is  $10^{15}$  Btu)—more than one-quarter of total U.S. energy consumption and equal to the total amount of energy spent on transportation.

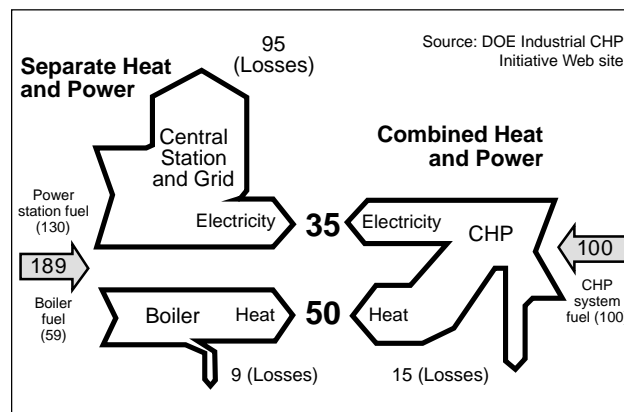

*Combined heat and power is compared with conventional power generation and heat production in this schematic. The total energy inputs required to produce 35 units of electricity and 50 units of heat are indicated for conventional electricity generation, boilers, and a cogeneration system. Cogeneration offers significant energy savings.*

**For CHP to succeed in buildings**, two things are required: (1) an electricity-generation technology that produces excess heat, and (2) a use for the cogenerated heat.

**Power-generation technologies** that can be used on a small scale in CHP systems include advanced turbine systems, reciprocating spark-ignition (Otto cycle) engines, reciprocating compression-ignition (Diesel cycle) engines, microturbines, and fuel cells.

**Practical uses for cogenerated thermal energy** in buildings include direct space heating, water heating, absorption chillers, engine-driven chillers, desiccant dehumidification, compressed air, and industrial processes.

**Total efficiencies of CHP systems** can easily exceed 70%, and efficiencies as high as 90% have been achieved.

**Regulatory and market hurdles for CHP** include utility interconnection standards, high and often prohibitive utility charges for having backup power available



Photo: Massachusetts Institute of Technology

The air intake for the cogeneration plant at MIT in Cambridge, Massachusetts is pictured above. Waste heat from the gas turbine produces steam for the university.



In the late 1980s, the Massachusetts Institute of Technology (MIT) was spending \$14 million per year on energy—oil and gas for their district-heating steam plant and electricity purchased from the local utility company. Facing rising electricity costs, growth in demand, and a need for more reliable power, MIT decided to install a CHP system. The 22-MW CHP system meets 94% of the university's electricity, heating, and cooling needs. It reduces annual energy costs by 40% and polluting emissions by 45%.

to facilities with on-site power production, unreasonably long depreciation standards for on-site generation, and environmental regulations that do not fairly take into account reductions in polluting emissions that occur beyond the plant being permitted.

**Electric industry restructuring (deregulation)** is expected to open up new opportunities for CHP by removing barriers that have existed in the current utility system.

**The CHP Challenge** announced by DOE in 1998 set a goal of doubling by 2010 the amount of U.S. power generated using CHP systems—an increase of 50 GW.

**Energy service companies** and energy service providers (ESPs) are becoming one-stop providers of heat and power—a trend that is likely to continue. ESCOs and ESPs simplify and reduce the risk of CHP development, particularly for larger projects.

**The environmental benefits** of meeting the CHP Challenge will include annual reductions of air emissions as follows: 150 million tons of CO<sub>2</sub>, one million tons of SO<sub>2</sub>, and one-half million tons of NO<sub>x</sub>.

## References

*Combined Heat and Power*, Special Supplement to *Energy Matters*, available online at [www.oit.doe.gov/bestpractices/](http://www.oit.doe.gov/bestpractices/).

Elliott, R. Neal, and Mark Spurr, *Combined Heat and Power: Capturing Wasted Energy*, American Council for an Energy-Efficient Economy, Washington, DC, 1999. Executive summary available online, along with other reference materials, at [aceee.org/chp/](http://aceee.org/chp/).

*Combined Heat and Power: A Vision for the Future of CHP in the U.S. in 2020*, U.S. CHP Association, 1999. Available online at [www.nemw.org/uschpa/](http://www.nemw.org/uschpa/).

*Buildings Cooling, Heating, and Power Vision*, U.S. Department of Energy, 1999. Available online, along with other reference materials, at [www.bchp.org](http://www.bchp.org).

## Contacts

Office of Power Technologies, U.S. Department of Energy, Washington, DC; (202) 586-6074; [www.oit.doe.gov/chpchallenge/](http://www.oit.doe.gov/chpchallenge/) and [www.eren.doe.gov/distributedpower/](http://www.eren.doe.gov/distributedpower/). Numerous fact sheets and reports available, as well as a Web-based software tool to help assess the feasibility of CHP systems for specific applications.

U.S. Combined Heat and Power Association, c/o Northeast-Midwest Institute, 218 D Street, SE, Washington, DC 20003; 202/544-5200; [www.nemw.org/uschpa/](http://www.nemw.org/uschpa/) (includes links to major corporate stakeholders).

Distributed Power Coalition of America, 10 G Street, NE, Suite 700, Washington, DC 20002; (202) 216-5944; [www.dpc.org](http://www.dpc.org).

Gas Technology Institute (formerly Gas Research Institute), 8600 W. Bryn Mawr Avenue, Chicago, IL 60631; (773) 399-8100; [www.gri.org](http://www.gri.org).



**Part VI**  
**WATER AND WASTEWATER**

<b>SECTION</b>	<b>PAGE</b>
6.1 Water Management .....	134
6.2 Toilets and Urinals .....	136
6.3 Showers, Faucets, and Drinking Fountains .....	138
6.4 Electronic Controls for Plumbing Fixtures .....	140
6.5 Reclaimed Water .....	142
6.6 Graywater Collection and Use .....	144
6.7 Rainwater Harvesting .....	146
6.8 On-Site Wastewater Treatment Systems .....	148

## 6.1

# Water Management

The goal of effective water management is to reduce water consumption without compromising the performance of equipment and fixtures. Using water more efficiently is a green strategy for several reasons: it reduces pressure on sometimes-limited water resources, reduces the amount of energy and chemicals used for water and wastewater treatment, and, to the extent that the use of *hot* water is reduced, increases energy savings—with associated environmental benefits. In addition to these benefits, water conservation in Federal facilities saves tax dollars. Facility managers should conduct comprehensive audits of water use in all buildings and landscapes under their supervision. Not only is this an excellent idea, it is mandated by Executive Order 12902, “Energy Efficiency and Water Conservation at Federal Facilities.” The water audit should be accompanied by an examination of available water management techniques and be followed by implementation and monitoring of appropriate measures.

## Opportunities

Water management techniques can and should be implemented in all Federal facilities. These techniques include (1) reducing losses by repairing leaky faucets and pipes; (2) reducing the overall amount of water consumed (replacing toilets with low-flush models, for example); (3) finding more sustainable sources of fresh water (rainwater harvesting, for example); (4) managing water more responsibly after use (using graywater for irrigation, for example, and more responsible wastewater treatment); (5) where appropriate, enforcing conservation-based water pricing; and (6) forming partnerships with local utilities. Water management also involves emergency planning for droughts and implementation of those plans when conditions require. Most water management strategies can be implemented at any time, although a few—such as installation of an alternative wastewater treatment system—are far more easily done during major building renovations or as part of new construction. An important integration opportunity is to reduce hot water use, which both reduces overall water consumption and saves energy.

## Technical Information

**Water use in the United States** has more than doubled in the past half-century—from about 180 billion gallons (680 billion liters) a day in 1950 to more than 400 billion gallons (1.5 trillion liters) a day in 1995. Federal agencies collectively spend more than \$500 million annually on water and sewer costs.

**Replacing old plumbing fixtures** can save huge quantities of water. The standards established for water consumption by the Energy Policy Act restrict showerheads

Water Use in Commercial Buildings

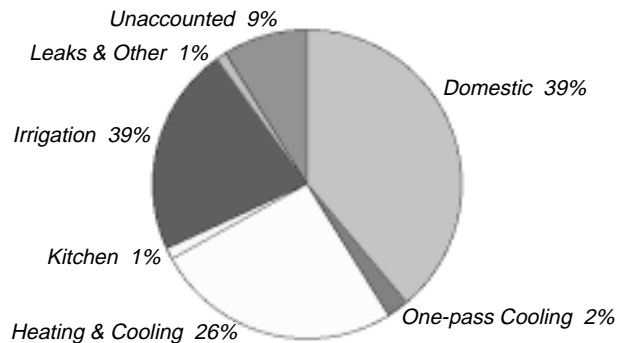

to 2.5 gallons (9.5 liters) per minute, urinals to 1 gallon (3.8 liters) per flush, faucets to 2.2 gallons (8.3 liters) per minute at 60 psi (410 kPa), and toilets to 1.6 gallons (6 liters) per flush at 80 psi (550 kPa).

**Water management measures that are cost-effective**—that is, with a payback of 10 years or less—can be implemented immediately. Note that the true cost of water must include costs to heat, cool, and pump it; costs of treatment before use (such as softening or filtration); and costs to treat or dispose of wastewater. Dollar savings from reduced water and energy use as a result of water conservation projects can be substantial.

**A successful water management program** begins with the development of a comprehensive plan that includes a thorough analysis of water use throughout a facility (see “Eight Steps to a Successful Water Management Plan”) and a review of the relationship between the facility and water supplier (typically, a municipal utility company).



In 1992 the Nuclear Regulatory Commission’s Phillips Building saved 1.4 million gallons (6.4 million liters) of water compared with usage for the previous year. This was achieved by replacing many plumbing fixtures that were more than 30 years old and retrofitting other fixtures to improve efficiency—sometimes at very low cost. One hundred faucets were retrofitted with new seats and washers, for example, at a cost of about \$1,000. Monthly inspections ensure the continuation of this very successful program. How did it get started? It began with a water management plan similar to the one outlined on the next page.

## EIGHT STEPS TO A SUCCESSFUL WATER MANAGEMENT PLAN

- 1. Gather information.** Start with the facility floor plan, operating schedules, number of employees and visitors, and maintenance/janitorial schedules. List all fixtures and the manufacturers' data on rated flow rates. Determine outdoor water applications, quantity, and schedule. Obtain utility name and water/sewer bills for at least the past two years. Check meter calibration results to adjust quantities, if necessary.
- 2. Conduct a comprehensive facility survey.** A basic water audit can be completed by qualified staff using published tools and fixture-use assumptions; a more complete audit may require assistance from water efficiency professionals.
- 3. Explore and evaluate water management options.** With a water audit in hand, determine whether fixture replacement and changes in maintenance procedures are needed. Just a single constantly running toilet, for example, can waste 6,000 gallons (23,000 liters) per day!
- 4. Conduct life-cycle cost analyses and explore financing options.** Total water cost must include water purchased from utilities, pumping energy, pretreating, water heating and cooling, chemical treatments (e.g., cooling towers), and sewer costs. Use the NIST BLCC program to compare alternative plans. Where appropriate, consider the GSA Federal Buildings Fund if there are energy savings involved. Check into utility programs or ESPCs with private firms. Review the water utility's rate structure and determine whether it encourages conservation.
- 5. Develop a water management plan and work schedule.** Set priorities for the changes to be made based on current water use, occupant needs, and life-cycle cost analysis. Determine the schedule of implementation and associated funding.
- 6. Inform building occupants about water management.** Send a letter to everyone telling them about the plan. Post signs near equipment to make occupants aware of water savings initiatives. Set up a "hotline" to report leaks or other wastes of water. Start a water information section in an in-house newsletter detailing water savings.
- 7. Implement the water management plan.** Check with contractors to ensure that work is going as planned. Check bills to verify consumption reductions as the program evolves. Immediately address problems that arise for users.
- 8. Monitor the water management plan.** Carefully check to ensure that savings are occurring. Make regular contact with the operating and maintenance staff to insure their active participation.

The following sections of this guide address more specific aspects of water conservation, as well as innovative water source and wastewater treatment options.



More than 300 Waterless urinals like this, made by the Waterless Company of Del Mar, California, were installed at the Jet Propulsion Laboratory in Barstow, California. The urinals have reduced annual water consumption by 13 million gallons (49 million liters), saving \$52,000 per year in water and sewer costs. A lightweight biodegradable oil in the sophisticated



Source: The Waterless Co.

EcoTrap® allows urine to pass through while serving as a trap to block odors from entering the restroom. The oil is replenished on a regular maintenance schedule based on usage.

## References

*Water Management: A Comprehensive Approach for Facility Managers*, General Services Administration, Washington, DC, 1995.

*Water Audits and Leak Detection*, American Water Works Association, Denver, CO, 1997; (703) 684-2492.

*Facility Manager's Guide to Water Management and Water Efficiency Manual for Commercial, Industrial, and Institutional Facilities*. Though regional (Arizona and North Carolina, respectively), both reports are useful and can be downloaded as pdf files from the WaterWiser Web site ([www.waterwiser.org](http://www.waterwiser.org)).

## Contacts

Water management training courses are offered by FEMP. *WATERGY, A Water and Energy Conservation Model for Federal Facilities* is also available to aid in water conservation audits. Call the FEMP Help Desk, (800) DOE-EREC (363-3732), and see the FEMP Web site, [www.eren.doe.gov/femp/](http://www.eren.doe.gov/femp/).



## 6.2

# Toilets and Urinals

There are three common varieties of toilets: gravity flow, (siphon-jet) flush valve, and pressurized tank systems. Similarly, there are four common varieties of urinals: the siphonic jet urinal, washout/wash-down urinals, blowout urinals, and waterless urinals. All of these must meet Federal water efficiency standards, though waterless urinals go far beyond the conservation minimums. Composting toilets also use no water, but potential applications are generally limited to national park facilities and small highway rest stops.

## Opportunities

The vast majority of toilets and urinals in Federal facilities were installed at a time when there was little or no regard for using water efficiently. Consequently, there are ample opportunities to make significant savings in water usage. Complete replacement is the desired option. Retrofit of existing toilets and urinals is a second choice that may be more attractive if there are budget constraints. While retrofits reduce the amount of water used per flush, most fixtures were not designed to use reduced amounts of water and their performance may suffer. Only complete replacement of porcelain fixtures ensures that, even with less water, they can still perform efficiently and effectively.

## Technical Information

**Toilets account for almost half of a typical building's water consumption.** Americans flush about 4.8 billion gallons (18.2 billion liters) of water down toilets each day, according to the U.S. Environmental Protection Agency. According to the Plumbing Foundation, replacing all existing toilets with 1.6 gallons (6 liters) per flush, ultra-low-flow (ULF) models would save almost 5,500 gallons (25,000 liters) of water per person each year. A widespread toilet replacement program in New York City apartment buildings found an average 29% reduction in total water use for the buildings studied. The entire program, in which 1.3 million toilets were replaced, is estimated to be saving 60–80 million gallons (230–300 million liters) per day.

There is a common perception that ULF toilets do not perform adequately. A number of early 1.6-gallons-per-flush (gpf) (6-liter) gravity-flush toilets that were simply adapted from 3.5-gpf (16-liter) models—rather

than being designed from the ground up to operate effectively with the ULF volume—performed very poorly, and some low-cost toilets today still suffer from that problem. But studies show that most 1.6-gpf (6-liter) toilets work very well. Where flush performance is a particular concern, or water conservation beyond that of a 1.6-gpf (6-liter) model is required, pressurized-tank toilets, vacuum toilets, and dual-flush toilets should be considered. Carefully choose toilet models based on recommendations from industry surveys or experienced plumbers and facility managers. You may also want to contact some managers of facilities that have already installed the toilets under consideration.

While some retrofit options for toilets reduce water use (see next page), none of these modifications will perform as effectively or use as little water as quality toilets manufactured after January 1, 1994. These retrofits will merely allow the fixture to operate using less water until it is replaced.

Even greater water conservation can be achieved in certain (limited) applications with composting toilets. Because of the size of composting tanks, lack of knowledge about performance, local regulatory restrictions, and higher first-costs, composting toilets are rarely an option except in certain unique applications, such as national park facilities. Composting toilets are being used very successfully, for example, at Grand Canyon National Park.

With urinals, water conservation well beyond the standard 1.0-gpf (4.5-liter) performance for new products can be obtained using waterless urinals. These products, available from The Waterless Company, use a special trap with a lightweight biodegradable oil that lets urine and water pass through but prevents odors from escaping into the restroom; there are no valves to fail, and clogging does not cause flooding. Three Waterless

### PROJECTED WATER SAVINGS FROM INSTALLING WATERLESS URINALS

Building Type	No. Males	No. Urinals	Uses/Day	Gal/Flush	Days/Year	Ann. Water Savings/Gallons	Ann. Water Savings/Urinal Liters
Small Office	25	1	3	3.0	260	58,500	220,000
New const.	25	1	3	1.0	260	19,500	73,800
Restaurant	150	3	1	3.0	360	54,000	204,000
New const.	150	3	1	1.0	360	18,000	68,100
School	300	10	2	3.0	185	33,300	126,000
New const.	300	10	2	1.0	185	11,100	42,000

Source: *Environmental Building News*, February 1998.

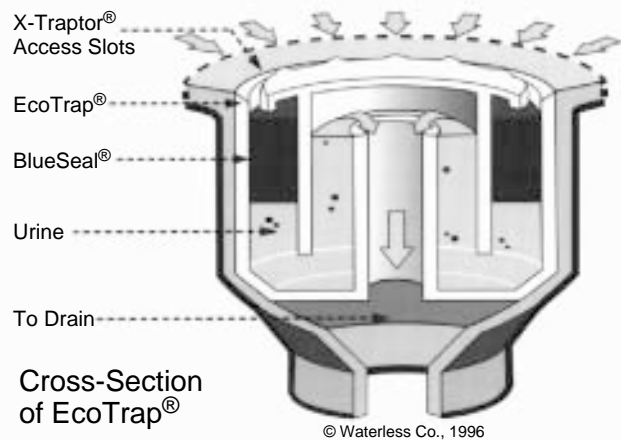

*The low-specific-gravity BlueSeal® fluid in this Waterless Urinal allows urine to pass through while serving as a trap to block odors from entering the restroom.*

urinals at the Bureau of Recreation's Glen Canyon Visitor Center are saving an estimated 225,000 gallons (850,000 liters) of water per year, according to *Environmental Building News* (February 1998). Furthermore, installing those urinals enabled the Bureau to avoid spending \$600,000 to expand its on-site sewage treatment capacity. Projected water savings from waterless urinals in different types of facilities are shown in the table on page 136—both for retrofits and new construction.

## TOILET AND URINAL RETROFITS

**Adjust the flush valve to reduce the water used per flush** without impeding waste removal or violating the manufacturer's requirements.

**Regularly check for leaks** and periodically replace valves and ballcocks. Use toilet cleaners that are not highly corrosive to flapper valves.

**Check water pressure** to ensure that the pressure is proper for optimal toilet or urinal operation.

**Early closure devices** can save 1 to 2 gallons (4.5 to 9 liters) per flush. These devices cause the same force to be exerted with each flush but with half the water.

**Dual-flush adapters** can be used with some toilets; these allow two types of flushes, saving up to 1.2 gallons (5.5 liters) per flush. One flush is standard and removes solids; the second is smaller and removes paper and liquids.

**Toilet refill diverters** are extremely low-cost devices that balance the flow of refill water in gravity-flush toilets. With most toilets, the bowl fills a lot faster than the tank, and excess water in the bowl simply flows down the drain—this occurs even in 1.6-gpf (6-liter) toilets. Products made by the Fuller Group of Marietta, Georgia, and Niagara Conservation Corp. of Cedar

Knolls, New Jersey, divert most of the bowl-refill water into the tank, typically saving 1/2 to 1 gallon (2 to 4 liters) per flush on an older toilet and about 1/4 gallon (1 liter) on a new toilet. *Environmental Building News* (March 1999) reported that the Marriott Corporation has installed the Fuller AquaSaver product on 280,000 of their 480,000 toilets and is saving \$3.4 million per year in water bills.

**For siphonic jet urinals**, retrofit with infrared sensors to eliminate double flushing, or replace. Choose 0.5-gpf (1.9-liter) models instead of 1.0-gpf (3.8-liter) models for greater savings.

**Blowout urinals**, which discharge at intervals as the water tank reaches a given level, can be modified (with sensors) to function only when the building is occupied.



Displacement devices, such as bags or bottles, and toilet dams are not recommended for 5-gpf (23-liter) or 3.5-gpf (16-liter) toilets because they can compromise flushing performance, resulting in double-flushing or increased need for cleaning. Early-closure flappers work better but must be properly calibrated.



The Prince Kuhio Federal Building and Post Office in Honolulu is a 10-story building housing 1,400 employees. A complete toilet and urinal replacement program is saving 8.8 million gallons (40 million liters) of water there annually. With the total cost of replacement estimated to be about \$235,000, annual savings in sewer and water bills are about \$31,000.

## References

"Water Saving Restroom Fixtures," Federal Energy Management Program, U.S. Department of Energy, 1995. This publication and the *WATERGY* software, which quickly screens facility water consumption, are available by calling the FEMP Help Desk, (800) DOE-EREC (363-3732); also see the FEMP Web site, [www.eren.doe.gov/femp/](http://www.eren.doe.gov/femp/).

The WaterWiser Web site includes hundreds of useful links on water conservation practices and products: [www.waterwiser.org](http://www.waterwiser.org).

Wilson, Alex, "Big Savings from Waterless Urinal," *Environmental Building News*, Vol. 7, No. 2, February 1998; BuildingGreen, Inc., Brattleboro, VT; (800) 861-0954; [www.BuildingGreen.com](http://www.BuildingGreen.com).

# Showers, Faucets, and Drinking Fountains

According to the water efficiency plumbing standards of the Energy Policy Act of 1992, new showerheads and faucets must have a maximum flow rate of 2.5 gallons per minute (gpm) at 80 psi (9.5 liters per minute at 550 kPa). Many new products are available (at widely varying prices) to achieve this reduced flow rate. Although drinking fountains are not regulated by the government, they should be included in water management programs.

## Opportunities

It is becoming common for showers to be installed in office buildings, reflecting the trend toward healthier life-styles, commuting by bicycle or foot, and exercise programs. Military and national park housing, of course, contains large numbers of showers and faucets. There are many shower and faucet retrofits for achieving (or exceeding) the water conservation standards that provide rapid payback. The fact that water-efficient showerheads and faucets also save energy (by reducing hot water use) makes them attractive energy retrofit options as well.

## Technical Information

Equipment selection and water conservation retrofit options for showers, faucets, and drinking fountains are as follows:

### SHOWERS

**A conventional showerhead** is rated to use 3 to 7 gallons (11 to 27 liters) per minute at normal water pressure, about 80 psi (550 kPa). A 5-minute shower with a conventional showerhead typically consumes 15 to 35 gallons (60 to 130 liters) of water.

**High-quality replacement showerheads** that deliver 1.0 to 2.5 gallons (3.8 to 9.5 liters) per minute can save many gallons per shower when used to replace conventional showerheads. Products vary in price from \$3 to \$95—and many good models are available for \$10 to \$20. A variety of spray patterns are available, ranging from misty to pounding and massaging. They typically have narrow spray jets and a greater mix of air and water than conventional showerheads, enabling them to provide what feels like a full-volume shower while using far less water. Facility managers should consult *Consumer Reports* or other objective comparisons of different models before making large purchases.

**Flow regulators** on the shower controls and temporary cutoff buttons or levers incorporated into the showerhead reduce or stop water flow when the individual is soaping or shampooing, further lowering water use. When the water flow is reactivated, it emerges at the same temperature, eliminating the need to remix the hot and cold water.

**Flow restrictors are washer-like disks** that fit inside showerheads, and they are tempting retrofits. However, flow restrictors provide poor water pressure in most showerheads. Flow-restrictor disks were given away by many water conservation programs, leading to poor acceptance of water conservation in general. Permanent water savings are better provided through the installation of well-engineered showerheads.



The actual amount of water savings from showerhead retrofits is difficult to establish because savings tests are often performed at full flow, while users often do not operate showers at maximum flow. There is also a high variability in shower length.

### FAUCETS

**Federal facilities** deal with three kinds of faucets: bathroom (residential or institutional), kitchen (residential or institutional), and industrial/workroom. Flow rates and operation of these three types of faucets differ. Bathrooms need no more than 1.5 gallons (5.7 liters) per minute, for example, while residential kitchens rarely need less than 2.5 gallons (9.5 liters) per minute. Institutional bathroom faucets may include automated controls and premixed temperatures. Institutional kitchen faucets may include special features such as swivel-heads and foot-activated on/off controls.

**Older faucets** with flow rates of 3 to 5 gallons (11 to 19 liters) per minute waste tremendous quantities of water. Federal guidelines mandate that all lavatory and kitchen faucets and replacement faucet tips (including aerators) manufactured after January 1, 1994, consume no more than 2.5 gallons (9.5 liters) per minute at 80 psi (550 kPa). Metered-valve faucets are restricted to a 0.25-gallon (0.95 liters) per cycle discharge after this date.

**Variations in water pressure** are problematic for water management programs. Pressure-compensating



Photo: Pedal Valves, Inc.

*By making it easy to run water only when it is actually being used, foot-pedal controllers save a surprising amount of water and energy.*

faucets can be used to automatically maintain 2.5 gallons (9.5 liters) per minute at varying water pressures.

**With manual-valve faucets**, replacing the screw-in tip of the faucet is all that is usually necessary to reduce water use. While faucet aerators that mix air into the water stream are commonly used in residential faucets, they are specifically prohibited in health facilities because they can harbor germs and pathogens. Use nonaerating, low-flow faucet tips (including those providing a smooth, laminar stream of water). These devices are inexpensive. Choose 2.2- to 2.5- gpm (8.3- to 9.5-liter) devices for kitchens. In washrooms, 0.5- to 1.25-gpm (1.9- to 4.7-liter) models will often prove adequate for personal washing purposes.

**Metered-valve faucets** deliver a preset amount of water and then shut off. For water management purposes, the preset amount of water can be reduced by adjusting the flow valve. The Americans with Disabilities Act requires a 10-second minimum on-cycle time.

**Foot controls** for kitchen faucets provide both water savings and hands-free convenience. The hot-water mix is set and the foot valve turns the water on and off at the set temperature.

**Hot-water recirculation systems** reduce water wasted while users wait for water to warm up as it flows from the faucet. To prevent these water-saving systems from wasting large amounts of energy, hot-water pipes should be well-insulated.

**Electronic faucet controls** are discussed in *Section 6.4 – Electronic Controls for Plumbing Fixtures*. To maximize water savings, choose the lowest-water-use models—typically 0.5 gpm (1.9 liters per minute).



**Repair leaky faucets:** Institute a regular maintenance program to ensure that leaky faucets are regularly inspected and immediately repaired. A single leaky faucet (one drip per second) will waste 8.6 gallons (33 liters) of water per day. The thinnest stream of water running continuously will waste 43 gallons (160 liters) per day.

## DRINKING FOUNTAINS

**Self-contained drinking fountains** have an internal refrigeration system. Adjusting the exit water temperature to 70°F (21°C) versus the typical 65°F (18°C) will result in substantial energy savings. Insulate the piping, chiller, and storage tank to save energy. If appropriate, add an automatic timer to shut off the unit during evenings and weekends.

**Remote chillers or central systems** are used in some facilities to supply cold drinking water to multiple locations. To conserve energy, the temperature can be raised from 65°F to 70°F (18°C to 21°C); piping should be well insulated, and a timer can be used to turn off the unit when the building is unoccupied.

**Metering faucets** are priced at \$100 to \$150. Sensor-operated metering faucets cost between \$260 and \$310. Sensor faucets require either electrical wiring for the connection of AC power or regular replacement of battery power supplies.

## Contacts

American Water Works Association, 6666 W. Quincy Avenue, Denver, CO 80235; (800) 559-9855, (303) 794-6303 (fax); WaterWiser Web site: [www.waterwiser.org](http://www.waterwiser.org).

Water Efficiency Program, Office of Wastewater Management (4204), U.S. Environmental Protection Agency, 401 M Street, SW, Washington, DC 20460; (202) 260-7288 or (202) 260-7259; [www.epa.gov/OWM/genwave.htm](http://www.epa.gov/OWM/genwave.htm).

# Electronic Controls for Plumbing Fixtures

Automated controls for faucets, toilets, and urinals help address occupants' concerns about disease transmission via contact with bathroom surfaces and fixtures—they can also reduce water consumption. These controls are rapidly gaining popularity in all types of commercial and institutional facilities, though the driver is generally hygiene rather than water or energy savings.

## Opportunities

Electronic controls can be installed with new plumbing fixtures or retrofitted onto many types of existing fixtures. Potential water savings are greater with retrofits because current fixtures generally do not meet water-conservation standards unless they are upgraded as part of the retrofit. Though water savings depend greatly on the type of facility and the particular controls used, some facilities report a 70% savings. This type of on-demand system can also produce proportional savings in water heating (for faucets) and sewage treatment.

## Technical Information

Electronic controls for plumbing fixtures usually function by transmitting a continuous beam of infrared (IR) light. With faucet controls, when a user interrupts this IR beam, a solenoid is activated, turning on the water flow. Dual-beam IR sensors or multispectrum sensors are generally recommended because they perform better for users with dark skin. With toilets and urinals, the flush is actuated when the user moves away and the IR beam is no longer blocked. The cost of automated-control fixtures is quite high.

**Some brands of no-hands faucets** are equipped with timers to defeat attempts to alter their operation or to provide a maximum on-cycle—usually 30 seconds.

**Depending on the faucet, a 10-second handwash typical of an electronic unit** will consume as little as 1-1/3 cups (0.3 liters) of water. A 10-second cycle is required as a minimum by the Americans with

Disabilities Act. Choose the lowest-flow faucet valves available—typically 0.5 gpm (1.9 liters per minute).

**Electronic controls can also be used** for other purposes in restrooms. Sensor-operated hand dryers are very hygienic and save energy (compared with conventional electric hand dryers) by automatically shutting off when the user steps away. Soap dispensers can be electronically controlled. Electronic door openers can be employed to further reduce contact with bathroom surfaces. Even showers are now sometimes being controlled with electronic sensors—for example, in prisons and military barracks.

**Electronic fixtures are particularly useful for handicapped installations** and hospitals, greatly reducing the need to manipulate awkward fixture handles and removing the possibility of scalding caused by improper water control.

**No-touch faucets** are available with (1) the sensor mounted in the wall behind the sink, (2) the sensor integrated into the faucet, and (3) the sensor mounted in an existing hot- or cold-water handle hole and the faucet body in the center hole. For new installations, the first or second option is usually best; for retrofit installations, the last option may be the only one feasible.

**At sports facilities** where urinals experience heavy use, the entire restroom can be set up and treated as if it were a single fixture. Traffic can be detected and the urinals flushed periodically based on traffic rather than per person. This can significantly reduce water use.

**Computer controls** can be used to coordinate water usage to divert water for fire protection when necessary.

**Thermostatic valves** can be used with electronic faucets to deliver water at a preset temperature. Reducing hot water saves a significant amount of energy.

**A 24-volt transformer** operating off a 120-volt AC power supply is typically used, at least with new installations. The transformer should be UL-listed, and for security reasons the transformer and the solenoid valve should be remotely located in a chase.

**Many commercial faucets can be retrofitted very quickly**, requiring just 7 to 9 minutes per fixture, according to Sloan Valve, a supplier of electronic plumbing fixture controls.

---

*Electronic faucet controls offer the convenience and sanitary benefits of hands-free operation. If the system is properly set up, significant water and energy savings are achieved.*

---

**Battery-powered controls** are often used for retrofit applications because connecting AC electricity to each fixture can be costly. For battery-controlled units, most manufacturers recommend standard alkaline batteries, which last two to three years with typical usage; lithium batteries require less frequent replacement (they can last up to five years), but they are more expensive. In heavy usage areas, such as airports, battery-powered controls are not recommended because of the need for frequent replacement.

**For battery-powered controls**, provide a plan for proper disposal of used batteries.

**For hospitals or other medical facilities**, electronic fixtures should be used to the maximum extent possible because they can help health care professionals meet the Occupational Safety and Health Administration (OSHA) protocols for handwashing after patient contact.

**Automated faucets** are much easier to clean since there are no handles in the way. The industrial-grade solenoid valves used in these devices are far more durable than their mechanical counterparts and are virtually unaffected by chemicals and other constituents of the water supply.

**Some manufacturers estimate a payback period** of less than 6 months when a conventional fixture is replaced with an electronic one. With faucets, this includes savings in water, energy, and maintenance. With toilets and urinals, some of the water savings may be attributable to reduced incidence of intentional multiple-flushing—a common practice with toilets and urinals.



Photo: Sloan Valve



Careful calibration is required with some electronic controls to prevent (or lessen the likelihood of) unintentional multiple flushes—which can happen, for example, in airport toilet stalls when they are used for changing clothes.

## References

Marsch, Donald R., “Getting a Hand on No-Hands Fixtures,” *The Construction Specifier*, August 1990, pp. 61–66.

American Water Works Association, 6666 W. Quincy Avenue, Denver, CO 80235; (800) 559-9855, (303) 794-6303 (fax); WaterWiser Web site: [www.waterwiser.org](http://www.waterwiser.org).

Reclaimed or recycled water is water from a wastewater treatment plant (WWTP) that has been treated and can be used for nonpotable uses such as landscape irrigation, cooling towers, industrial process uses, toilet flushing, and fire protection. In some areas of the United States, reclaimed water may be referred to as Irrigation Quality or “IQ” water, but potential uses can extend well beyond irrigation. In fact, with higher levels of treatment, such as reverse osmosis, using reclaimed water as a *potable* source is technically and economically feasible. New technological breakthroughs in membrane filtration and combined biological and filtration treatment offer unprecedented opportunities for water recycling, especially in isolated locations and regions where the water supply is severely limited.

Per capita water use in the United States has quadrupled since the beginning of the 20th century. Americans typically consume between 60 and 200 gallons (230 to 760 liters) per capita each day. The use of reclaimed water for nonpotable purposes can greatly reduce the demand on potable water sources—this use is encouraged by diverse organizations such as FEMP, EPA, and the American Water Works Association (AWWA). Municipal wastewater reuse now amounts to about 4.8 billion gallons (18 million m<sup>3</sup>) per day (about 1% of all freshwater withdrawals). Industrial wastewater reuse is far greater—about 865 billion gallons (3.2 billion m<sup>3</sup>) per day.

## Opportunities

Facility managers with buildings in areas of chronic water shortage should check with their local water utility and inquire whether they have a program to provide reclaimed water to the building’s location. Reclaimed water programs are particularly popular in California, Florida, Arizona, Nevada, and Texas. There are a host of potential applications for reclaimed water: landscaping, golf course, or agricultural irrigation; decorative features such as fountains; cooling tower makeup; boiler feed; once-through cooling; concrete mixing; snowmaking; and fire main water. Making use of reclaimed water is easiest if planned for at the

outset of building a new facility, but major renovations or changes to a facility’s plumbing system provide opportunities as well. For certain uses, such as landscape irrigation, required modifications to the plumbing system might be quite modest. Note that the use of reclaimed water may be restricted by state and local regulations. If the government facility or base has its own WWTP, there may be an opportunity to modify it to provide *on-site* reclaimed water.

## Technical Information

**For a successful reclaimed water project**, one or more of the following ingredients are required: (1) high-cost water or a need to extend the drinking water supply, (2) local public policy encouraging or mandating water conservation, (3) availability of high-quality effluent from a WWTP, and (4) recognition of environmental or other nontangible benefits of water reuse.

**Technologies vary with end-uses.** In general, tertiary or advanced secondary treatment is required, either of which usually includes a combination of coagulation, flocculation, sedimentation, and filtration. Virus inactivation is attained by granular carbon adsorption plus chlorination, or by reverse osmosis, ozonation, or UV exposure.

**Dual water systems** are beginning to appear in some parts of the country where the water supply is limited, such as southern California. Office buildings may have two water lines coming in—one for “fresh” water and the other for reclaimed water. The former is for all potable uses, the latter for nonpotable uses.

**Piping and valves used in reclaimed water** systems should be color-coded with purple tags or tape. This minimizes piping identification problems and cross-connection problems when installing systems. Liberal use of warning signs at all meters, valves, and fixtures is also recommended. Note that potable water mains are usually color-coded blue, while sanitary sewers are green.

Reclaimed water should be maintained at 10 psi (70 kPa) lower pressure than potable water mains to prevent backflow and siphonage in the event of accidental cross-connection. Although it is feasible to use backflow prevention devices for safety, it is imperative never to connect reclaimed and potable water piping directly. One additional precaution is to run reclaimed water

mains at least 12 in. (30 cm) lower (in elevation) than potable water mains, and separate them from potable or sewer mains by a minimum of 10 ft (3 m) horizontally.

**Reclamation can be complex** when the water supplier and the wastewater utility are not the same. In addition, issues of water ownership arise when discharged wastewater is withdrawn from one use to accommodate another.



The quality of reclaimed water must be reviewed in order to ensure that there will be no adverse effects from long-term use, such as landscape damage caused by salt buildup, specific ion toxicity, and nutrient buildup.



In St. Petersburg, Florida, more than 5,500 acres (2,200 hectares) of green-space are irrigated with reclaimed water. More than 7,300 customers are served with reclaimed water by the water utility, and usage averages 20 million gallons (76,000 m<sup>3</sup>) per day. The water is supplied to commercial and residential customers via a “third” main consisting of more than 80 miles (130 km) of piping that ranges from 2 to 48 in. (5 to 122 cm) in diameter. The system also serves 289 fire hydrants and numerous building fire protection systems. The William C. Cramer Federal Building, operated by the GSA, is connected to this system. The building saved 1.4 million gallons (5,300 m<sup>3</sup>) of fresh water in 1992. Built in 1967 and housing 900 employees, it has more than 15,000 square feet (1,400 m<sup>2</sup>) of turf, 17 trees, and hundreds of shrubs. This successful use of reclaimed water for irrigation has prompted the GSA Field Office Manager, John F. Bennett, to plan the use of reclaimed water for cooling tower makeup water.



Although water prices vary greatly around the country, reclaimed water costs significantly less than potable water. For example, in Jupiter, Florida, the price of potable water is now \$1.70/1,000 gallons (\$0.45/m<sup>3</sup>) versus \$0.26/1,000 gallons (\$0.07/m<sup>3</sup>) for reclaimed water. Similar pricing differences occur wherever reclaimed water is available.

## References

Crook, James, et al., *Guidelines for Water Reuse*, Camp Dresser & McKee, Inc., Cambridge, MA, 1992.

*Proceedings of the Urban and Agricultural Water Reuse Conference, 28 June–1 July 1992, Orlando, FL*, Water Environment Federation, Alexandria, VA, 1992.

*Water Reuse: Manual of Practice* (2nd Edition, SM-3), Water Pollution Control Federation, Alexandria, VA, 1989.

Asano, Takasi, ed., *Wastewater Reclamation and Reuse*, Vol. 10 in *Water Quality Management*, Technomic Publishing Company, Lancaster, PA, 1998; [www.techpub.com](http://www.techpub.com).

## Contacts

Water Environment Federation, 601 Wythe Street, Alexandria, VA 22314; (800) 666-0206; [www.wef.org](http://www.wef.org).

American Water Works Association, 6666 W. Quincy Avenue, Denver, CO 80235; (800) 559-9855, (303) 794-6303 (fax); Water Wiser Web Site: [www.waterwiser.org](http://www.waterwiser.org).

WaterReuse Association, 915 L Street, Suite 1000, Sacramento, CA 95814; (916) 442-2746. Washington, DC office: 4748 N. 40th Street, Arlington, VA 22207; (703) 536-7533. Offers public information packet designed for use in education and public outreach.



# 6.6

## Graywater Collection and Use

Graywater reuse is an increasingly accepted practice to (1) provide irrigation water and some fertilizer to landscapes, (2) reduce wastewater loads to sewage systems, (3) improve the effectiveness of on-site wastewater disposal, and (4) reduce pressure on limited potable water resources in some communities, especially during drought crises. The State of California now allows graywater systems, and various municipalities and utility districts have passed specific graywater ordinances.

### Opportunities

The primary motivation for installing graywater systems has been the ability to irrigate landscapes during dry seasons and times of more extreme drought. The installation of graywater systems requires modifications to existing plumbing systems and the addition of certain components. In new construction, it is relatively easy to incorporate a graywater system. Retrofitting such systems in existing buildings will be easiest when plumbing modifications are already planned. Buildings with basements or crawl spaces are far more amenable to plumbing system retrofits than those with slab-on-grade construction (where piping runs under the slab). Currently, the separation and use of graywater is not permitted in many parts of the country; be sure such a system is acceptable to local building officials before moving ahead with design and construction. Even if this is not permitted by code, it may make sense during new construction to install plumbing in such a way that a graywater system can be added later. Graywater collection and use can be especially important in buildings served by composting toilets.

### Technical Information

#### TERMINOLOGY

*Graywater* is usually defined as water from showers, bathtubs, bathroom sinks, washing machines, and drinking fountains. It may also include condensation pan water from refrigeration equipment and air-conditioners, hot tub drainwater, pond and fountain drainwater, and cistern drainwater. Graywater contains a minimum amount of contamination and can be reused for certain landscape applications. Although this is still being debated by public health officials, no case of illness has ever been traced to graywater reuse. Graywater is distinguished from *blackwater*, which is usually defined as heavily soiled water from toilets and

urinals. Wastewater from kitchen sinks and dishwashers is occasionally included with “graywater,” but more commonly it is lumped with blackwater because it contains oil, grease, and food scraps, which can burden the treatment and disposal processes. Both graywater and blackwater contain pathogens—humans should avoid contact with either—but blackwater is considered a much higher risk medium for the transmission of waterborne diseases. Though they are not blackwater, the following water sources should not be included in graywater that is to be used for irrigation: garden and greenhouse sinks, water softener backflush, floor drains, and swimming pool water. In buildings served exclusively by composting toilets and thus producing no true blackwater, it may be necessary to include kitchen wastewater in the graywater by taking special precautions to eliminate organic matter.

Note that graywater is very different from reclaimed wastewater, which is covered in *Section 6.5*. Reclaimed, treated wastewater can be used for other applications, such as toilet flushing and above-ground irrigation, which are not permitted with untreated graywater.

#### GRAYWATER COLLECTION

Graywater collection involves separating graywater from all other sources of wastewater in a building—including wastewater from toilets, urinals, dishwashers,

### CALIFORNIA REGULATIONS FOR GRAYWATER SETBACKS

Minimum Horizontal Distance From:	Surge Tank (feet) (meters)		Irrigation Field (feet) (meters)	
Buildings or structures	5	1.5	8	2.4
Property lines	5	1.5	5	1.5
Water supply wells	50	15.2	100	30.5
Streams and lakes	50	15.2	50	15.2
Seepage pits or cesspools	5	1.5	5	1.5
Disposal field and 100% expansion area	5	1.5	4	1.2
Septic tank	0	0.0	5	1.5
On-site domestic water service line	5	1.5	5	1.5
Pressure public water main	10	3.0	10	3.0
Water ditches	50	15.2	50	15.2

Note: Some variations and exceptions apply; see specific regulations.

and kitchen sinks. Graywater waste lines should run to a central location in the basement or crawl space where a surge tank can collect and hold the water until it drains or is pumped into the below-ground irrigation lines. It is very important to provide an overflow from the graywater collection system that feeds directly into the sewer line in case filters get clogged or some other problem occurs. A controllable valve should also be included so that graywater can be shunted into the sewer line when the area(s) being irrigated become too wet or other reasons preclude the use of graywater (see cautionary note on protecting plants).

Graywater should not be stored for extended periods of time before use. Decomposition of the organic material in the water by microorganisms will quickly use up available oxygen, and anaerobic bacteria will take over, producing a foul smell. Some graywater systems are designed to dose irrigation pipes with a large, sudden flow of water instead of allowing the water to trickle out as soon as it enters the surge tank. For the dosing systems, holding the water for some amount of time will be necessary, but this should be limited to no more than a few hours, if possible.

If a filter is used in the graywater system, it should be one that is easy to clean or self-cleaning. Filter maintenance is one of the biggest problems with many graywater systems.

### GRAYWATER DISPOSAL

For complete protection from pathogens, graywater should flow by gravity or be pumped to a below-ground disposed field (subsurface irrigation). Perforated plastic pipe—3 in. (76 mm) minimum diameter—is called for in California's graywater regulations, though with filtering, smaller-diameter drip irrigation tubing can also be used. The California standards require that untreated graywater be disposed of at least 9 in. (about 230 mm) below the surface of the ground.

Some graywater systems discharge into planter beds—sometimes even beds located inside buildings. Some ready-made systems are available by mail order, but these should be modified for specific soil and climate conditions.

As a general rule, graywater can be used for subsurface irrigation of lawns, flowers, trees, and shrubs but should not be used for vegetable gardens. Drip irrigation systems have not yet proven to be effective for graywater discharge because of clogging or maintenance costs.



Do not connect roof drains, downspouts, or patio runoff to a graywater system.



For optimal breakdown of organic matter in the graywater, the discharge should be in the biologically active portion of the ground (near the surface), so do not bury irrigation pipes too deeply.

### MAINTENANCE

A maintenance program for graywater systems should include (1) inspecting the system for leaks and blockages, (2) cleaning or replacing any filters bimonthly or as recommended by the manufacturer or designer, (3) periodically flushing the entire system if called for by the manufacturer or designer, and (4) regularly inspecting the ground being irrigated to make sure that not too much water is being delivered (in which case, graywater should be shunted into the sewage line).



To protect plants being irrigated with graywater, it is important to control what cleaning and washing chemicals are used in the building. Avoid powdered detergents, which tend to be high in sodium and salts (liquid detergents are better); avoid boron, which can be toxic to some plants; and avoid chlorine bleach, caustic drain cleaners, petroleum distillates, and other chemicals with unknown effects on plants. In homes where cloth diapers are being rinsed or washed and in buildings where contagious illnesses are present, it is advisable to send graywater into the sewage line instead of collecting it for reuse.

### References

*Graywater Guide*, California Department of Water Resources, Attn: Publications Office, P.O. Box 942836, Sacramento, CA 94236; (916) 653-1097; [www.dwr.water.ca.gov](http://www.dwr.water.ca.gov). Introduction to graywater collection and use, as well as details on California's graywater regulations.

Ludwig, Art, *Create an Oasis With Greywater* (2000) and *Builder's Greywater Guide* (1999), Oasis Design, Santa Barbara, CA; (805) 967-9956; [www.oasisdesign.net](http://www.oasisdesign.net).

*Water Management: A Comprehensive Approach for Facility Managers*, General Services Administration, 1995. For ordering information, call (202) 219-0062.

## 6.7

# Rainwater Harvesting

Rainwater harvesting refers to the collection, storage, and use of rainwater. Most systems use the roof surface as the collection area and a large galvanized steel, fiberglass, polyethylene, or ferro-cement tank as the storage cistern. When the water is to be used just for landscape irrigation, only sediment filtration is typically required. When water is being collected and stored for potable uses, additional measures are required to purify the water and ensure its safety. Rainwater harvesting offers several important environmental benefits, including reduced pressure on limited water supplies and reduced stormwater runoff and flooding. It can also be a better-quality source of water than conventional sources. After purification, rainwater is usually very safe and of high quality. “Hardness” (mineral content) is low, and in areas with groundwater that is polluted, hazardous (from arsenic or other natural toxins), saline, or hard, properly purified rainwater may be a higher-quality and safer source of drinking water than water pumped out of the ground.

## Opportunities

Consider rainwater harvesting in the following situations: (1) locations where aquifer-based water supplies are very limited or ecologically fragile (i.e., where excessive pumping of groundwater can lower the water table, threatening ecologically valuable surface waters and springs); (2) where pumped groundwater is polluted or excessively mineralized (hard) and requires extensive treatment; and (3) where stormwater runoff is a major concern. Installation of a rainwater harvesting system will be easiest if planned for in the design of a new building or considered when reroofing is planned. Though rainwater harvesting is feasible on commercial as well as residential buildings, commercial applications may be more restricted in many locations—uses may, in fact, be limited to landscape irrigation or cooling-tower use. To be viable as the sole water source for residential and small commercial applications, an average annual rainfall of at least 24 in. (600 mm) is generally required; if total annual rainfall is less than about 40 in. (1 m) per year or highly seasonal, aggressive water conservation measures will probably be required.

## Technical Information

A typical rainwater harvesting system designed for potable uses has seven primary components; one of these—the roof-wash system (number 2)—may be eliminated in systems not used for potable water:

- 1. Catchment area.** With most rainwater harvesting systems, the catchment area is the building’s roof. The best roof surface for rainwater harvesting does not support biological growth (algae, mold, moss, etc.), is fairly smooth so that pollutants deposited on the roof are quickly removed by the “roof-wash” system, and should have minimal overhanging tree branches above it. Galvanized metal is the roofing material most commonly used for rainwater harvesting.
- 2. Roof-wash system.** This is a system for keeping dust and pollutants that have settled on the roof out of the cistern. It is *necessary* for systems used as a source of potable water but also recommended for other systems since it keeps potential contaminants out of the tank. A roof-wash system is designed to purge the initial water flowing off a roof during rainfall.
- 3. Prestorage filtration.** To keep large particulates, leaves, and other debris out of the cistern, a domed, stainless-steel screen should be secured over each

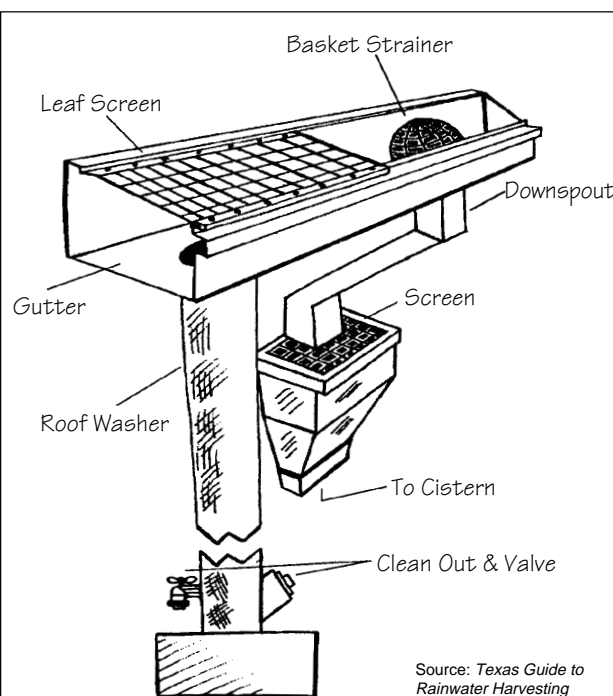

*This schematic shows the primary means of keeping leaves and pollutants out of a rainwater cistern. The roof washer fills with the first 10–20 gallons of rainfall. After it fills, water flows to a downspout leading to the cistern. After the rain ends, the roof washer is drained—or the valve can be left open slightly so that water trickles out, even during a rainstorm.*

inlet leading to the cistern. Leaf guards over gutters can be added in areas with significant windblown debris or overhanging trees.

4. **Rainwater conveyance.** This is the system of gutters, downspouts, and (generally plastic) pipes used to carry water from the roof to the cistern.
5. **Cistern.** This is usually the largest single investment required for a rainwater harvesting system. Typical materials used include galvanized steel, concrete, ferro-cement, fiberglass, polyethylene, and durable wood (e.g., redwood or cypress). Costs and expected lifetimes vary considerably among these options. Tanks may be located in a basement, buried outdoors, or located above ground outdoors. Light should be kept out to prevent algae growth. Cistern capacity should be sized to meet expected demand. Particularly for systems designed as the sole water supply, sizing should be modeled on the basis of 30-year precipitation records, with sufficient storage to meet demand during times of the year having little or no rainfall.
6. **Water delivery.** A pump is generally required to deliver water from the cistern to its point of use, though gravity-fed systems are occasionally possible with appropriate placement of system components.
7. **Water treatment system.** To protect plumbing and irrigation lines (especially with drip irrigation), water should be filtered through sediment cartridges to remove particulates, preferably down to 5 microns. For systems providing potable water, additional treatment is required to ensure a safe water supply. This can be provided with microfiltration, UV sterilization, reverse osmosis, or ozonation

**\$** Costs of rainwater harvesting systems vary widely, from almost nothing (for a simple rain barrel beneath a downspout) to more than \$75,000 (for a large commercial system). The greatest variability in cost has to do with the choice of a cistern. A typical rule of thumb is \$1.00 per gallon (\$264/m<sup>3</sup>) of storage capacity for systems under 10,000 gallons, and \$0.50 per gallon (\$132/m<sup>3</sup>) for larger systems.



The town of Volcano on the Island of Hawaii is an ideal location for rainwater harvesting. Being volcanic, the land is extremely porous, so pockets of groundwater (aquifers) generally do not exist or are extremely deep. But there is plenty of rainfall—more than 60 in. (1.5 m) per year. As a result, nearly all buildings in the town, including the post office (above), harvest rainwater as their primary water source.

(or a combination of those methods). With some systems, higher levels of treatment are provided only at a single faucet where potable water is drawn. (If not all faucets in a building are delivering fully purified potable water, be sure to educate building occupants as to where water for drinking or cooking should be drawn.)

## References

*Texas Guide to Rainwater Harvesting*, Texas Water Development Board in cooperation with the Center for Maximum Potential Building Systems. Available from the Texas Water Development Board, P.O. Box 13231, Austin, TX 78711; (512) 463-7847; or downloadable online at [www.twdb.state.tx.us/assistance/conservation/Rain.htm](http://www.twdb.state.tx.us/assistance/conservation/Rain.htm).

## Contacts

Center for Maximum Potential Building Systems, 8604 F.M. 969, Austin, TX 78724; (512) 928-4786; [www.cmpbs.org](http://www.cmpbs.org).

# On-site Wastewater Treatment Systems

When the collection, treatment, and discharge (or reuse) of wastewater occurs on or near the site where the wastewater has been generated, it is called an “on-site” system. These systems are distinguished from a “centralized” system that has an extensive network of collection pipes feeding a central sewage treatment plant—an approach that relies on energy- and chemical-intensive treatment methods to quickly process large volumes of wastewater. On-site wastewater systems are typically designed to handle a few hundred to a few hundred thousand gallons per day. On-site technologies can range from compost privies in national forests, to high-tech membrane-filtration systems that recycle wastewater for toilet flushing in large buildings, to sophisticated yet elegant designs that use ecosystems, such as constructed wetlands, to treat wastewater. On-site treatment can reduce construction, operations, and maintenance costs while conserving resources and providing an aesthetically and ecologically attractive feature for the facility.

## Opportunities

On-site wastewater treatment should be considered (1) when the Federal facility is distant from an existing treatment plant or sewer main, (2) when sewage treatment capacity is severely limited, (3) when topography necessitates expensive pumping and excavation, and (4) when the system can serve multiple functions. On-site systems are particularly suited for semi-arid and arid regions, and for locations that require riparian restoration, groundwater recharge, an increase in surface-water flow, on-site fire control storage, or irrigation of nearby landscapes (such as golf courses). When water is at a premium, treatment and reuse for toilet flushing and other purposes can be cheaper if handled on site. Many Federal facilities are part of larger communities that wish to manage sprawl, and on-site facilities are often the best option for serving a diverse matrix of greenbelts and developed areas. On-site systems can also provide safety advantages in difficult ecological conditions such as areas subject to earthquakes, slope movement, and rapid, repeated changes of grade (hilly areas). Keep in mind, however, that local codes and building departments may prohibit certain on-site wastewater treatment systems, or require costly and time-consuming permitting processes (because these systems are new and often poorly understood).

## Technical Information

With almost all small-volume on-site wastewater systems, the flow first enters a septic (or Imhoff) tank for primary treatment. Secondary, or more advanced, treatment can be handled by:

- Modified septic tanks with an anaerobic/aerobic treatment device or a specially equipped aerobic tank;
- Specially designed filters, such as intermittent or recirculating sand filters;
- Constructed wetlands that rely on algae, microbes, macrophytic plants such as water hyacinths or bulrushes, and other organisms for wastewater treatment; or
- Membrane filtration (micro-, nano-, or ultra-filtration and reverse osmosis).

Very small daily volumes can also be treated on site by composting toilets and proper management of the resultant (composted) solids.

Most on-site wastewater systems utilize evapo-transpiration by plants for “disposal” of a portion of the treated effluent—this process “treats” the wastewater as well as disposing of it. At times, it is impossible to distinguish treatment from disposal and reuse processes. An on-site system may perform multiple tasks simultaneously—for example, a constructed wetland also provides wildlife habitat and recreational opportunities. Treatment/disposal/reuse options include the following:

- Shallow sand-filled beds and trenches that provide near-surface irrigation;
- Mound systems with vegetation;
- Wetlands (marshes) that discharge to connected riparian habitats;
- On-surface irrigation with restricted public access.
- After disinfection, treated effluent can be used for spray irrigation and nonpotable uses such as toilet flushing, steam heating, and industrial or coolant feedwaters (see *Section 6.5 – Reclaimed Water*).

An on-site wastewater management district is an organizational framework for community or larger-scale facilities such as military bases. Recent technical advances have helped make on-site districts more feasible. These include improved septic tanks; larger-volume

septic tanks fed from multiple sources via small-diameter sewers; and low-cost septic tank innovations—especially in-tank effluent filters and pressure-dosing pumps and chambers—that improve soil-based treatment and water-holding capacity, thereby extending drainfield longevity. In-tank modifications also improve flow through small-diameter sewers, which, in turn, reduce the required earthwork, materials, and energy costs.

Typical cluster-systems, managed by on-site districts, include the following:

- Septic tanks with effluent filters and small-diameter sewers for gravity-delivery to an on-site treatment facility;
- Septic tanks with pressure sewer lines for collection in hilly areas (STEP systems);
- Septic tanks with grinder pump and pressure sewer lines that actually begin to “pretreat” sewage before delivery to the on-site treatment facility; and
- Vacuum sewers with extensive in-line oxidation and pretreatment—these are more expensive but appropriate for areas subject to earthquakes and slope movement.

Another important addition to the on-site management toolkit is membrane filtration. Though energy-intensive, membrane filtration is appropriate for situations in which the wastewater may contain hazardous components—for example, low-level radioactive pollutants in wastewater from military facilities, nitrocellulose from ammunitions plants, or other contaminants in bilge water from ships and submarines. Membrane filtration can also be considered in areas lacking acreage for biological treatment, such as urban locations.



**Peak usage periods, such as Labor Day or Memorial Day in Federal parks or visitors' day in prisons, require special attention. Holding tanks are a cost-effective component that feeds the on-site treatment system at a later time and at rates optimal for biological or soil treatment.**

**With soil-based treatment systems, the wettest season places limits on how much effluent can be effectively treated and discharged (hydraulic assimilation capacity). In biologically reliant systems, the coldest months can slow treatment processes.**



**Steps to Choosing a Technology: Federal facilities vary widely and include research facilities, prisons, military bases, office buildings, employee homes, and trailside comfort stations. Before deciding on a treatment option, characterize the waste and wastewater. Then set out ideal environmental goals and carefully evaluate the site. Finally, keeping in mind the water quality, site, and cost considerations, work with a knowledgeable engineer to examine and select from the menu of available technologies.**



**Retrofitting: Many existing on-site systems do not meet modern engineering standards. Retrofitting septic tanks with effluent filters and pressure-dosing pumps should be considered an option. Constructing artificial soil profiles and/or diverting graywater for on-site irrigation or riparian restoration may be appropriate alternatives for overloaded systems.**

## References

Crites, Ron, and George Tchobanoglous, *Small and Decentralized Wastewater Management Systems*, McGraw-Hill, New York, NY, 1998.

Jordan, E. J., and P. R. Senthilnathan, *Advanced Wastewater Treatment with Integrated Membrane Biosystems*, 1996. Available from: Zenon, P.O. Box 1285, Ann Arbor, MI 48106; (303) 769-0700.

## Contacts

The Consortium of Institutes for Decentralized Wastewater Treatment; [www.dal.ca/~cwrs/cdwt/](http://www.dal.ca/~cwrs/cdwt/).

EPA Center for Environmental Research Information, 26 W. Martin Luther King Drive, Cincinnati, OH 45268; (513) 569-7562. Publishes: *Onsite Wastewater Treatment and Disposal Systems Design Manual* and *Alternative Sewer Systems Design Manual*.

EPA National Small Flows Clearinghouse, P.O. Box 6064, Morgantown, WV 26506; (800) 624-8301; [www.estd.wvu.edu/nsfc/](http://www.estd.wvu.edu/nsfc/).



**Part VII**  
**MATERIALS, WASTE MANAGEMENT,  
AND RECYCLING**

<b>SECTION</b>	<b>PAGE</b>
<b>7.1 Material Selection .....</b>	<b>152</b>
<b>7.1.1 Writing Green Specifications .....</b>	<b>154</b>
<b>7.1.2 Structural Building Components .....</b>	<b>156</b>
<b>7.1.3 Wood Products .....</b>	<b>158</b>
<b>7.1.4 Low-Slope Roofing .....</b>	<b>160</b>
<b>7.1.5 Floor Coverings .....</b>	<b>162</b>
<b>7.1.6 Paint and Wall Coverings .....</b>	<b>164</b>
<b>7.7.7 Contract Furnishings .....</b>	<b>166</b>
<b>7.2 Operational Waste Reduction and Recycling .....</b>	<b>168</b>
<b>7.3 Construction Waste Management .....</b>	<b>170</b>
<b>7.4 Deconstruction .....</b>	<b>172</b>



# 7.1

# Material Selection

According to the Worldwatch Institute, building construction consumes about 40% of the raw materials used worldwide. Roughly three billion tons ( $2.7 \times 10^{12}$  kg) of stone, sand, minerals, wood, petroleum, and other materials are extracted and processed into construction materials with a range of environmental consequences. These impacts include land disturbances and habitat loss for mining and logging, solid waste from by-products, and energy use for all stages of the process. Materials can also have a significant impact on the healthiness of the indoor environment. Greening requires a consideration of all these effects alongside the traditional factors of cost, performance, and esthetics. Fortunately, environmentally preferable options, as well as tools and information resources for identifying those options, are becoming more widely available all the time.

## Opportunities

Any renovation or addition presents an opportunity to make environmentally sound material selections. Initial assessments as to the sustainability of likely materials should begin very early in the design process, to help target key areas for improvement. The selection of healthy materials that release low levels of volatile organic compounds is especially important—and easiest to justify economically—during renovations or remodeling in an occupied building. Occupancy of the facility should also be considered: using healthy materials may be a higher priority in a day-care facility or residence than in a well-ventilated industrial facility, for example.

## Technical Information

Because materials may have environmental impacts associated with any stage of their production, use, and disposal, a holistic assessment of their entire life cycle is important when selecting them. There is an evolving field of study called “life-cycle assessment” (LCA) (not to be confused with life-cycle costing) that takes this approach. This assessment is based on a life-cycle inventory, which quantifies all significant inputs and outputs at each stage in a material’s cycle. Inputs include raw materials, energy, and water used in the process. Outputs include the useful product itself, along with solid waste from by-products, releases to water, and air emissions.

Performing a full LCA is very complex and time-consuming, but resources that streamline the process and provide guidance are increasingly available. These include written reports summarizing the LCA of various materials, articles that describe specific products from an LCA perspective, and even software tools that display life-cycle inventory information from internal databases.

While information sources are improving, so are the materials themselves. New products that offer dramatic environmental advantages are introduced frequently. Many conventional products are exhibiting improvements as well—industry-wide these are incremental, but over time they become significant. For example, older “wet-process” cement kilns are being phased out in favor of new “dry-process” kilns with precalciner chambers. The new facilities use only half as

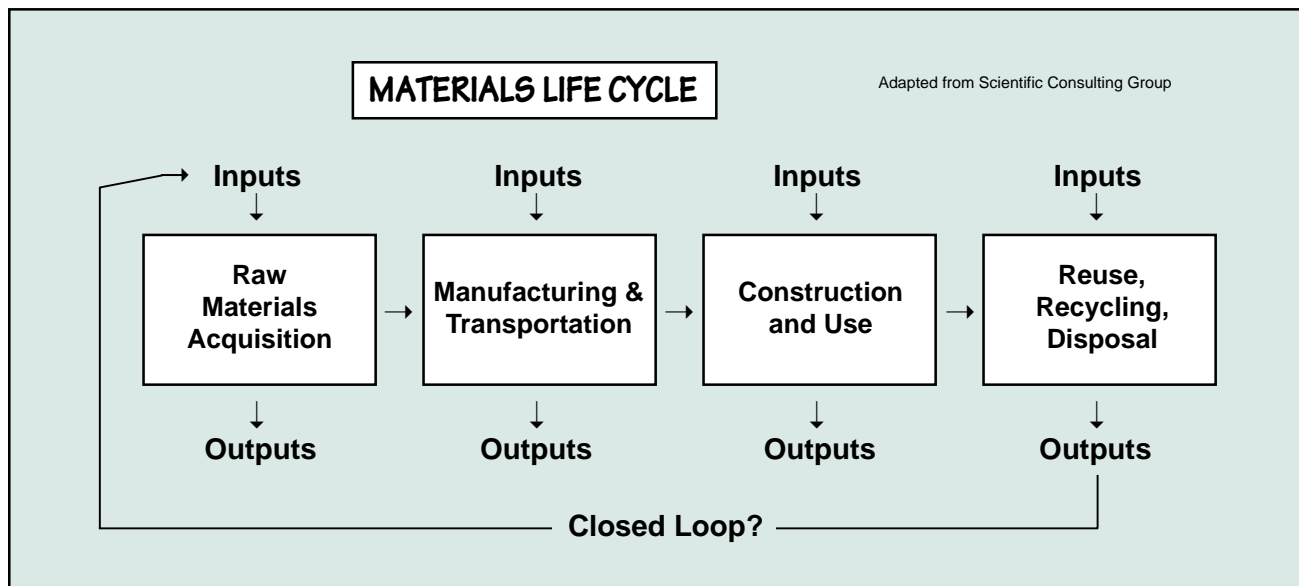



## SAVING MONEY WITH GREENER PAVING

In June 1997, D-M&S, Inc., was awarded a five-year, \$1 million-per-year DOD contract to maintain and repair parking lots and access roads at the Pentagon and three other facilities. The contract included an incentive, in the form of a 2% allowable price differential, for the use of optional products with specified environmental attributes. The contractor was able to identify many products meeting and exceeding the environmental goals, including some with superior performance characteristics that it is now using as a matter of course. Additionally,

the total cost of the contract, including the incentive payments, is significantly lower than that of comparable parking lot repair projects.

Materials used as of August 1998 include:

- 3,328 tons (3,019 tonnes) of recycled asphalt;
- 1,031 tons (935 tonnes) of recycled concrete;
- 300 cubic yards (229 m<sup>3</sup>) of concrete containing recovered materials;
- 3,558 linear feet of low-VOC\* paint (<50 g/l);
- 24,324 ft<sup>2</sup> (2,259 m<sup>2</sup>) of low-VOC concrete curing compound.

\*volatile organic compounds

Source: EPA742-R-96/007

much energy to produce cement. Even more dramatic, however, is the increasing use of industrial waste products, such as coal fly ash, to replace some of the cement in concrete.

## References

*GreenSpec: The Environmental Building News Product Directory and Guideline Specifications*, BuildingGreen, Inc., Brattleboro, VT; (800) 861-0954; www.greenspec.com.

Spiegel, Ross, and Dru Meadows, *Green Building Materials: A Guide to Product Selection and Specification*, John Wiley & Sons, New York, NY, 1999.

*EBN Archives* CD-ROM (contains detailed articles assessing many materials), BuildingGreen, Inc., Brattleboro, VT; (800) 861-0954; www.BuildingGreen.com.

*Building Environmental and Economic Sustainability* (BEES) 2.0, National Institute of Standards and Technology; www.nist.gov.

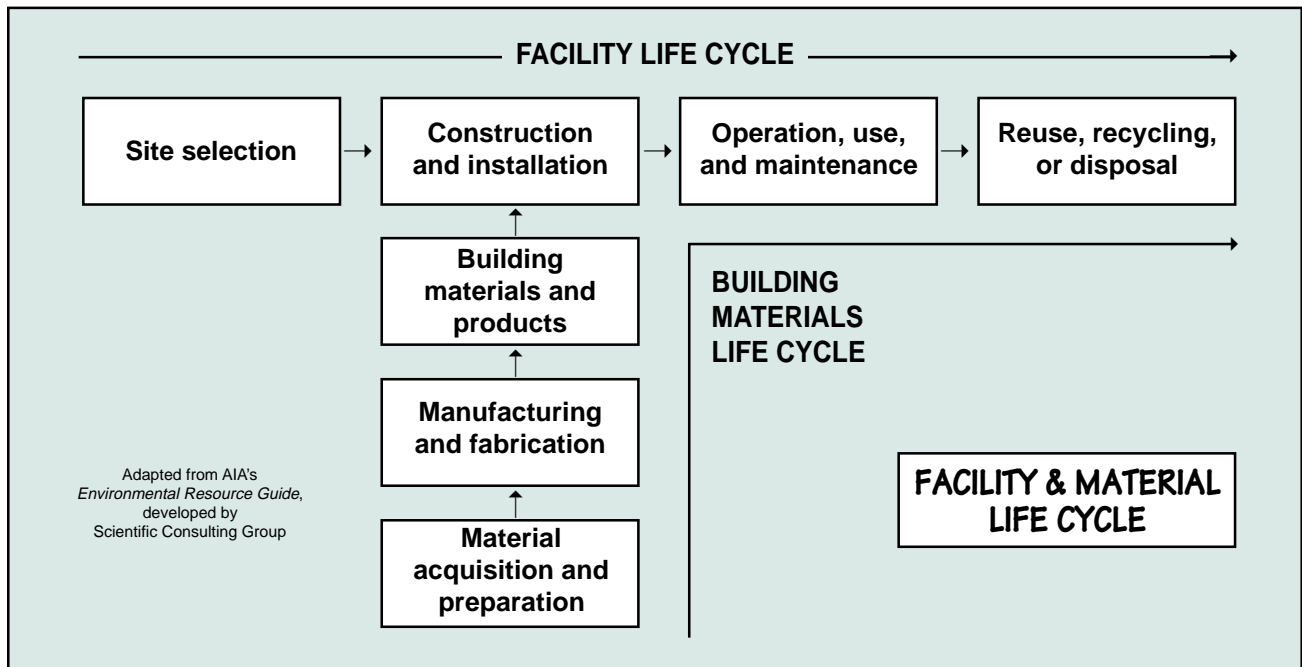

## 7.1.1

# Writing Green Specifications

A key component to greening Federal facilities is writing green specifications for projects. Green specifications are integrated throughout construction documents in order to implement environmentally sound construction processes, design intent, and material selection.

## Opportunities

Even though specifications are part of the construction documents for projects, opportunities to influence the content start at project conception. When the project is first defined—before beginning the design and selecting architectural/engineering (A&E) firms—many specific targets, procedures, and design intents can be identified. These include building performance targets, construction management procedures, recycled content goals, and site-impact limits.

It is all about communication. Federal facility managers, designers, and representatives need to clearly articulate green goals and any predetermined green attributes to the design professionals. The design professionals need to describe the green specs effectively for the building contractors, subcontractors, and materials suppliers. The specifications accompanying the drawings need to fully describe the project, materials, and construction details.

During the early design phases, design professionals should be creating outline specifications that will reinforce the project goals. Then, at the construction documents phase, explicit green specifications with lists of products and execution techniques must be described—even more carefully than with standard practice because green building is different.

Since the actual writing of green specifications for construction is normally in the hands of design professionals serving as consultants to the government—rather than in the hands of the Federal facility managers and representatives—clear guidance about project goals must be conveyed from the Federal agency to the consulting architects and engineers.

## Technical Information

Following World War II, Federal government architects wanted a standard format for construction specifications; this led to the creation of the Construction Specifications Institute in 1948. The CSI MasterFormat™ is a common organization of construction specifications for both public and private facilities. The format is organized into 16 divisions, with 1 covering General Administration, and 2 through 16 covering specific building systems and/or components. Within each of the divisions, specifications information is organized into three topics: General, Products, and Execution. Green

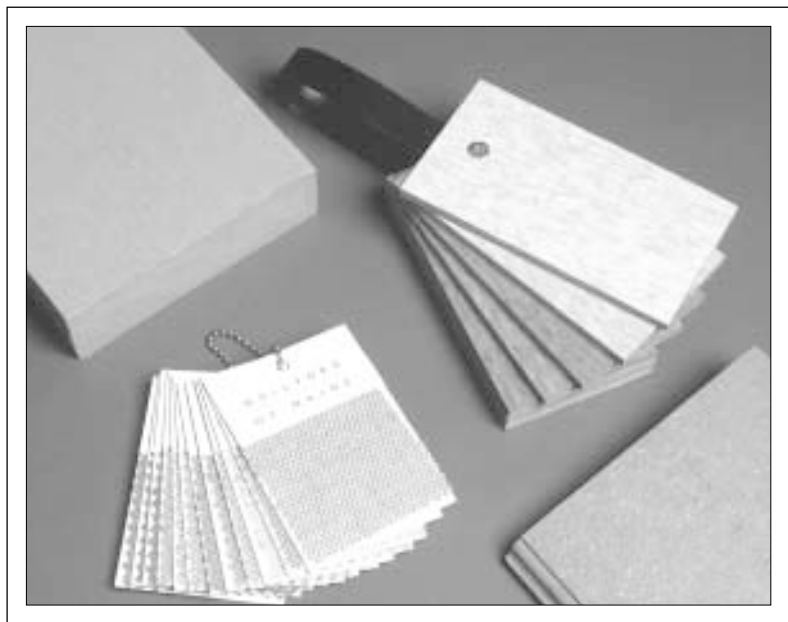

Photo: BuildingGreen, Inc.



Photo: BuildingGreen, Inc.

specifications can and should be integrated throughout these three topics for each of the 16 divisions.

Division 1, General Requirements, encompasses the overall intent relating to green technologies. This is the place to describe the construction waste management plan and the general procedure for accepting “alternates” that may have similar or better green performance than products specified later on.

Divisions 2 through 16 describe each building component in general, products, and execution. For example, in Division 8, windows are described in terms of thermal performance—use this section to set the performance requirements for the glazing and window units. Finishes are described in Division 9—use this section to establish recycled content, maximum levels of volatile organic compounds (VOCs), and other green attributes.



Be sure to link the general material descriptions with the Products and Execution components of the specifications.



With most Federal government projects, it is necessary to specify products that can be supplied by at least 3 manufacturers.

## References

Spiegel, Ross, and Dru Meadows, *Green Building Materials: A Guide to Product Selection and Specification*, John Wiley & Sons, New York, NY, 1999.

Mendler, Sandra F., AIA, and William Odell, AIA, *The HOK Guidebook to Sustainable Design*, John Wiley & Sons, New York, NY, 2000.

*MasterFormat™*, The Construction Specifications Institute, Alexandria, VA, 1999.

*GreenSpec: The Environmental Building News Product Directory and Guideline Specifications*, BuildingGreen, Inc., Brattleboro, VT, 1999; (800) 861-0954; [www.greenspec.com](http://www.greenspec.com).

Nearly all large buildings are constructed of steel and concrete. In smaller buildings, masonry and wood are also common as structural components. Each of these materials has its own environmental profile with distinct opportunities for environmental improvements, both in terms of how the materials are specified and how they are used in the design.

Because structure plays a critical role in a building, the conventional performance parameters of function and durability are particularly important from an environmental perspective. Of all building components, structural elements are the most difficult to repair or replace, so if they are not built for longevity, the entire building may need to be prematurely replaced, causing extra environmental impacts. As a result, choosing structural components for a green building requires a careful assessment of both function and materials.

## Opportunities

Structural components require more material than any other element in most buildings. Because they are used in such quantity, the environmental burdens associated with these materials are magnified. Conversely, opportunities to benefit from green strategies are also significant. Choices regarding structural materials are generally limited to new construction, and the ramifications of those choices will extend through the life of the building.

In terms of integration with general green design strategies, two important considerations affect the selection and design of structural components:

- Structural materials may provide finished surfaces that can remain exposed either on the interior or exterior of the building. This approach can save money and reduce environmental burdens by leaving off entire layers of finish materials, each with its own maintenance and replacement requirements.
- Structural components should be designed for adaptability to changing demands on the space, ranging from minor modifications to a complete change in function. For example, large spaces with high ceilings can be designed to accommodate the future addition of an intermediate story if the space were to be converted into smaller offices or dwelling units.

## Technical Information

Comparing the environmental impacts of different structural systems requires the balancing of many variables, including life-cycle impacts of the materials (see *Section 7.1 – Material Selection*), clear spans and structural loads, durability, and impact on the thermal performance of the building envelope. Each of the four common structural materials—steel, concrete, masonry, and wood—is appropriate for certain applications. Of the four, wood typically uses the least energy, causes the least pollution from manufacturing, and has the best thermal performance. In situations in which wood is suitable structurally—and as long as it is not harvested from old-growth or sensitive forests—wood is often the best choice.

Regardless of the choice of material, designs that utilize the material most efficiently are better in terms of reducing impacts associated with production. Considerations and opportunities specific to each material are described below.

**Structural steel** used in construction may come from large integrated mills that make steel from iron ore in a blast furnace or from mini-mills that use electric arc furnaces to make new steel from scrap iron and steel. Many fewer environmental burdens are associated with steel from mini-mills because it is almost 100% recycled and much less energy is used in the manufacturing process. Scrap is also used in integrated mills but at a much lower volume (20–30% of the material).

Steel structures that are bolted together rather than welded will be easier to disassemble in the future, which may allow components to be reused. Because of its high rate of thermal transfer, care should be taken to avoid creating unwanted thermal bridges through a building envelope when using steel.

**Concrete** consists primarily of large and small mineral aggregates (stone and sand), Portland cement, and water, with various admixtures and (usually) steel reinforcing. Of these components, Portland cement has the most significant environmental burdens by far, chiefly in the form of CO<sub>2</sub> emissions, which contribute to global warming. Producing cement from limestone releases about one ton of CO<sub>2</sub> for each ton of cement. About half of these emissions come from the fossil fuels used to generate heat, and the other half from the limestone itself. As a result, using pozzolanic materials, such as coal fly ash, as a partial substitute for cement in the concrete mix has great environmental benefit. Using coal fly ash also affects many performance parameters of the concrete, generally for the better.



Source: North American Steel Framing Alliance

---

*Steel framing can protect against insect damage and rot in residential and light-commercial buildings, but care must be taken to avoid excessive heat loss (and heat gain) caused by thermal bridging.*

---

For structural wall systems in small and mid-size buildings, wall form systems that remain in place as part of the wall and provide thermal insulation are an option. These may be made of polystyrene foam, or a cementitious matrix of recycled polystyrene beads or wood fibers. The latter material can be left exposed in industrial buildings and provides excellent sound absorption.

**Masonry** comes in many different materials and shapes, although cement masonry units (CMUs) are by far the most common. CMUs share many of the same issues as concrete, and CMU buildings often use significant amounts of concrete as grout. As with concrete, coal fly ash may be used instead of some cement in the manufacture of CMUs. CMUs alone are poor thermal insulators, so additional insulation, usually in the form of rigid foam insulation between the CMU wall and a finish surface, is generally required. While such insulation is critical for comfort and reducing energy use, it also adds to the environmental burdens associated with manufacturing the wall system. Autoclaved aerated concrete is a type of masonry block that provides some thermal insulation—about R-1 per inch. Masonry systems do not provide support for floor or roof decks, so they must be coupled with other structural components.

**Environmental considerations associated with wood products** are covered in *Section 7.1.3*. Solid wood as a structural material is appropriate only for

small buildings without large clear spans, as large loads and spans require very large members that are available only from precious, mature trees. For larger spans, engineered wood products, such as glulams and laminated veneer lumber, are viable options. Along with overall environmental impacts, the adhesives used to make these products must also be considered.

## References

*EBN Archives* CD-ROM (contains detailed articles on concrete, wood, and light framing), BuildingGreen, Inc., Brattleboro, VT; (800) 861-0954; [www.BuildingGreen.com](http://www.BuildingGreen.com).

Demkin, Joseph, AIA, ed., *Environmental Resource Guide*, John Wiley & Sons, New York, NY, 1999.

## Contacts

The ATHENA Sustainable Materials Institute, [www.athenaSMI.ca](http://www.athenaSMI.ca).

## 7.1.3 Wood Products

Wood products have the potential to be among our greenest building materials. After all, the primary energy source going into the production of wood fiber is the sun—through photosynthesis. If we could be confident that the forests from which we derive our wood products were well managed, wood would be an obvious environmental choice. Along with considering the source of wood, we should also consider how efficiently the wood is used and—with manufactured products—whether harmful offgassing could occur.

### Opportunities

Wherever wood is being used in a building, there is an opportunity to advance good forest management by specifying certified wood products. When wood is being used for framing—more common in residential and light commercial buildings—there is an opportunity to utilize this resource in a more efficient manner than usual, and there is opportunity to influence how effectively the building envelope will be insulated. With the specification of manufactured wood products—from subflooring to furniture—there is opportunity to influence the indoor air quality of the completed building by selecting products made with binders that release little or no formaldehyde.

### Technical Information

**Forest certification:** The best way to ensure that wood used in a building is from well-managed forest operations is to specify third-party-certified wood. Currently the only way to ensure that wood being used in a building is from a well-managed forest is to insist on certification based on standards developed by the Forest Stewardship Council (FSC). This independent forest certification program was founded in 1992 to encourage more responsible forestry and provide a mechanism for buyers of wood to influence forestry through their purchasing decisions. FSC developed international standards for responsible forest management and set up a program to accredit companies or organizations that would actually certify forest operations.

At present there are two U.S. organizations accredited by FSC to certify forests: SmartWood, of Burlington, Vermont, and Scientific Certification Systems, Inc., of Oakland, California. This certification process involves bringing outside forestry experts in to examine how the forest is being managed, then rating it. FSC standards also provide for chain-of-custody certification for tracking wood from FSC-certified forest

operations so that buyers can be assured that labeled wood products have actually come from well-managed forests. At the end of 1999 there were 4.9 million acres (2 million ha) of FSC-certified private and public forest in the United States, and 44 million acres (17.8 million ha) worldwide.



*The Forest Stewardship Council developed criteria for forest certification and chain-of-custody certification of forest products. This logo is used on FSC-certified products.*

**Using wood efficiently:** While the source of wood is very important from an environmental standpoint, so too is the efficiency with which we use it. In residential and light-commercial buildings, wood-frame construction is very common. A typical house uses roughly 15,000 board feet (35.4 m<sup>3</sup>) of wood in the framing lumber, plywood, particleboard, trim, and millwork. Nationwide, some 35 billion board feet (82.6 million m<sup>3</sup>) of framing lumber is used annually, according to the U.S. Census Bureau.

*Advanced framing* is a building technique that makes more efficient use of lumber. Sometimes referred to as “optimal-value engineering,” this system differs from conventional framing significantly: it features wider spacing of wall studs, fewer studs at corners, single top plates with trusses aligned directly above wall studs, and less lumber around door and window openings. Combined, these advanced framing techniques can reduce wood use by 25% or more, while improving the energy performance of insulated walls and roofs (because insulation insulates better than wood). Supporting drywall corners with drywall clips instead of nailing or screwing them into the framing also reduces cracking—one of the most common causes of callbacks for builders.

**Engineered wood products:** Another way builders are using wood fiber more efficiently is through the use of engineered lumber products. Instead of using large-dimension, solid-wood framing members, engineered wood is made by taking small pieces of wood and gluing them together into structural products. The first such product was plywood, introduced around

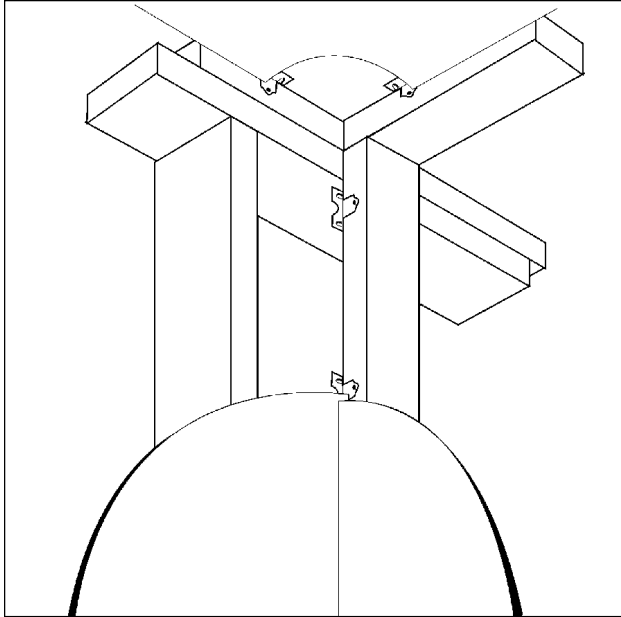

Adapted from NY-STAR Builder's Field Guide

Wood use in framing can be minimized by installing dry-wall stops at the ceiling, at exterior corners, and where interior partitions meet exterior walls.

1900. Glue-laminated beams (glulams) appeared soon after. Newer products, including oriented strand board (OSB), wood I-joists, laminated-veneer lumber, parallel-strand lumber, and laminated-strand lumber, carry these ideas further. Wood I-beams, made largely from small-diameter, low-grade trees such as aspen, are now used in over 60% of homes, where they are lighter, stronger, more dimensionally stable, and faster to install than solid dimension lumber.

**Formaldehyde emissions:** Manufactured wood products, including plywood, OSB, engineered lumber, particleboard, and medium-density fiberboard (MDF), require binders to hold veneers, strands, or particles of wood together. Three types of binders are commonly used in these products: phenol formaldehyde, urea formaldehyde, and polymeric methyl diisocyanate (PMDI), a type of polyurethane.

Of these, urea formaldehyde, used in interior-grade products (particleboard, MDF, paneling, and hardwood plywood) releases the greatest amount of formaldehyde, a suspected carcinogen and known respiratory irritant. While manufacturers have succeeded in dramatically reducing formaldehyde emissions from urea formaldehyde binders in recent decades, this is still a significant concern, especially among people with chemical sensitivities. Phenol formaldehyde binder, used in most exterior-grade structural manufactured wood products, locks up the formaldehyde much more tightly than does urea formaldehyde, so significantly less formaldehyde is

released, but it still occurs. Only PMDI releases no formaldehyde. Although PMDI is quite toxic at the manufacturing plant, once cured it is highly stable.



**Straw Particleboard:** Among manufactured “wood” products, one of the greenest isn’t made of wood at all—but of straw, an agricultural waste product. Until recently, most straw was burned in the fields, but that practice has been banned in many areas because of air pollution and safety concerns. Only a portion of the straw can be plowed back into the ground without robbing the soil of nitrogen. As a result, a huge quantity of straw is available. Some of it is being turned into high-quality particleboard suitable for furniture and other applications in which wood particleboard and MDF are typically used. All straw particleboard is made with PMDI resins that do not release formaldehyde.

## References

*Cost-Effective Home Building: A Design and Construction Handbook*, NAHB Research Center, Upper Marlboro, MD, 1994.

*Efficient Wood Use in Residential Construction: A Practical Guide to Saving Wood, Money and Forests*, Natural Resources Defense Council, New York, NY, 1998.

ForestWorld.com, Inc., Colchester, VT. Offers a useful Web site with extensive discussion of forest certification issues and links to more than 6,000 other forest industry-related sites; [www.forestworld.com](http://www.forestworld.com).

“Straw: The Next Great Building Material?,” *Environmental Building News*, Vol. 4, No. 3, May/June 1995, BuildingGreen, Inc., Brattleboro, VT; (800) 861-0954; [www.BuildingGreen.com](http://www.BuildingGreen.com).

## Contacts

Certified Forest Products Council, 14780 SW Osprey Drive, Suite 285, Beaverton, OR 97007; (503) 590-6600, (503) 590-6655 (fax); [www.certifiedwood.org](http://www.certifiedwood.org).



Roofing serves the vital function of protecting a building from the elements—such as precipitation, of course, but also unwanted heat and cold. Roofing must serve its protective function dependably, yet roofing materials are exposed to the harshest environment of any building component: harsh ultraviolet light, intense heat, plummeting nighttime temperatures, widely fluctuating moisture conditions, freeze-thaw cycles, damage from hail, and so forth. It is no wonder that most low-slope roofs last only 10 to 20 years. Vast quantities of roofing are installed on commercial buildings each year—most of it after failing roofing materials are removed. Only a tiny percentage of the old roofing removed each year is recycled. Even worse, with the most common type of commercial roofing, the rigid-foam roof insulation is destroyed in the process of reroofing. Among building materials, low-slope roofing is one of the most environmentally damaging, and greening the roofs of commercial buildings is among the most difficult challenges in environmentally responsible design and construction.

## Opportunities

*Environmental Building News* estimates that there are 1,400 square miles (3,625 km<sup>2</sup>) of low-slope roofing (an area larger than the state of Rhode Island) on the nation's 4.8 million commercial buildings. Three-quarters of the roofing installed each year is reroofing installed on older buildings. While roofing choices must, of course, be considered during the design of new buildings, there will also be opportunities for installing more environmentally responsible products during reroofing rather than simply replacing a failed roof with more of the same. Be sure to consider the integration of roofing, roof insulation, cooling load avoidance, and moisture-control detailing with all reroofing jobs.

## Technical Information

**Consider the roof system as a whole.** In new buildings consider, for example, whether the roofing and decking can be combined into one system. This is becoming an attractive option with some new low-slope, structural metal roofing systems that eliminate the need for roof decking.

**Choose a protected-membrane roof.** With a protected-membrane roof, the waterproof roof membrane is installed directly on the roof deck, then rigid-foam roof insulation is loose-laid on top, and the insulation is protected by ballast. This configuration both increases the roof membrane life by protecting it from UV exposure and allows the rigid insulation to be salvaged and reused during reroofing.

**Specify nonhalogenated roof membranes.** Polyvinyl chloride roof membranes are fire-resistant and durable, but in the event of a fully engaged building fire, toxic hydrochloric acid is produced as well as such persistent organic pollutants as dioxin. Some thermoplastic olefin (TPO) membranes gain their fire resistance with bromine, which may be as environmentally damaging as chlorine in the event of a fire. Often, nonhalogenated roof membranes can meet fire code only if they are covered with protective ballast (such as stone or concrete tile).



*When the roof membrane was replaced on the Mount Washington Visitor Center in New Hampshire, the Styrofoam<sup>®</sup> insulation was able to be reused because it was a protected-membrane roof.*

Source: Dow Chemical

## GARDEN ROOF™

"EXTENSIVE" VEGETATION  
SUBSTRATE SOIL  
SYSTEMFILTER SF  
FLORADRAIN 40  
MOISTURE MAT SSM45  
HYDRODRAIN  
STYROFOAM®  
ROOT STOP WSF 40  
HYDROFLEX 30  
MM6125-EV  
SURFACE CONDITIONER



Source: Hydrotech

*The Garden Roof system from Hydrotech and ZinCo offers a sophisticated collection of components for protecting the roof against moisture penetration, draining excess rainwater, retaining water for irrigating the roof, and keeping plant roots away from the roof membrane.*

**Integrate rainwater harvesting into the roof design.** Rainwater can be collected off roofs for landscape irrigation, nonpotable uses (e.g., toilet flushing), and even—with proper treatment—potable uses. Collection of rainwater also helps reduce stormwater runoff and downstream flooding. See *Section 6.7 – Rainwater Harvesting*.

**Consider a green roof.** One of the most exciting options for a green building is a green roof—a roof that is planted with vegetation. These are increasingly being proposed both as a strategy for controlling stormwater runoff (they can detain as much as three-quarters of the rainfall from a storm) and for cooling urban heat islands. Planting roofs with native, drought-tolerant grasses or prairie vegetation is often the best environmental solution. Newly available European components are making green roofs more feasible than ever.

**Select reflective roof membranes.** The ENERGY STAR® Roof Products program labels low-slope roofing products with an initial reflectivity of 65% or higher and a three-year aged reflectivity of 50% or higher. There are now more than 100 partners in the program, including manufacturers of both low-slope and steep-slope roofing products. Reflective roofs can dramatically reduce heat gain in commercial buildings. They can also help to reduce the regional warming that occurs in urban areas with lots of roof area and pavement (the *urban heat island* effect).

**Specify recyclable roofing whenever possible.** Thermoplastic roofing products (PVC and TPO) are generally recyclable; ethylene propylene diene monomer (EPDM), bitumen, and modified bitumen generally are not.

**Specify non-ozone-depleting roof insulation.** Avoid polyisocyanurate or extruded polystyrene insulation unless the manufacturer can verify that it was not made with ozone-depleting HCFCs. Expanded polystyrene, some polyisocyanurate, and rigid mineral wool or fiberglass boardstock do not deplete ozone. Do not skimp on insulation levels.

**Recycle old roofing.** A few companies will recycle PVC and TPO roof membranes as well as polystyrene insulation removed during reroofing. When the recycling of roofing is required by Federal building specifications, additional options will become available for this more responsible means of disposal.

**Consider using the roof for PV power generation.**

Several companies now produce roofing materials that are also photovoltaic panels. Building-integrated PV is growing tremendously, and roofing products are an obvious first choice. Most such products are designed for steep-slope roofing (PV shingles and standing-seam metal roofing with applied thin-film PV modules), but even low-slope roofing can be used for PV arrays (see *Section 5.8.5 – Photovoltaics* for more information).

## References

*GreenSpec: The Environmental Building News Product Directory and Guideline Specifications*, BuildingGreen, Inc., Brattleboro, VT, 1999; (800) 861-0954; [www.greenspec.com](http://www.greenspec.com).

Wilson, Alex, "Low-Slope Roofing: Prospects Looking Up," *Environmental Building News*, Vol. 7, No. 10, November 1998, BuildingGreen, Inc., Brattleboro, VT; (800) 861-0954; [www.BuildingGreen.com](http://www.BuildingGreen.com).

## Contacts

ENERGY STAR Roof Products Program, EPA Office of Air and Radiation, Washington, DC; (888) STAR-YES, (202) 564-9124; [www.energystar.gov](http://www.energystar.gov).

## 7.1.5 Floor Coverings

Floor coverings encompass an enormous range of materials, including textiles, hard surface materials, and resilient materials. Floor coverings must be able to withstand varying amounts of foot and wheel traffic without premature degradation. The conventional criteria for floor-covering material selection include wear resistance, slip resistance, noise control, and aesthetics. Environmental considerations for floor coverings include the resource efficiency of the source materials, the additives used to install and finish them, their impact on indoor air quality, and their potential for disposal or recycling at the end of their useful life. Floor coverings can be integral to the building floor structure, mechanically fastened, or chemically bonded.

### Opportunities

Depending upon the ease of removal, durability, amount of traffic, and changes in space usage, opportunities for replacing floor coverings can occur relatively often during the life cycle of a building. Even when replacement is not an option, careful cleaning and maintenance can increase longevity and reduce possible health hazards related to flooring.

### Technical Information

**Carpet** is the most common floor covering in office settings, and its environmental implications include the use of resources, maintenance practices, and indoor air quality (IAQ). The odor of new carpet is a by-product of the styrene butadiene latex (4-PC) commonly used to adhere face fibers to backing materials and the adhesives used to install carpets. In recent years, latex manufacturers and the carpet industry have significantly reduced 4-PC and other VOC emissions from carpeting. Look for carpet, cushions, and adhesives that carry the Carpet & Rug Institute's (CRI's) green IAQ label, ensuring a low-emitting product. Carpets that cover large interior surfaces also provide "sinks" for the absorption of VOCs from other sources.

Odors, as well as dust and allergens, can be minimized with regular vacuuming and extraction cleaning. CRI identifies vacuum cleaners that have been tested for soil removal and dust containment with the green IAQ label; using these vacuum cleaners regularly provides a cleaner indoor environment.

The EPA's guideline for purchasing polyester carpet for light- and moderate-wear uses is 100% polyethylene terephthalate (PET) from recycled plastic soda bottles. In addition, nylon carpets are available with 25% recycled nylon fibers. Recycled content is also available in backing materials. Several companies make carpet cushions of recycled and natural materials

Many carpet manufacturers participate in programs that collect used carpet for recycling into new carpet and other products. When specifying carpet for a new facility, give preference to manufacturers that guarantee they will help recycle the carpet later on.

such as recycled post-industrial fibers, recycled polyurethane, jute, and hair.

For glue-down installations, use adhesives and seam sealers with the lowest possible VOC levels. Alternatives to glue-down include carpet tiles with peel-and-stick backings or mechanical fasteners using hook-and-loop tape (Velcro™). In residential and hospitality settings, installation using tackless strips at the perimeter is common. Carpet tiles can be replaced when soiled or damaged. Fusion-bonded carpets use heat instead of adhesives to bond the face fiber to the primary backing, which reduces VOCs.

Minimize the risk of indoor air quality problems by installing carpet in accordance with CRI guidelines (CR-104). These guidelines instruct installers to make sure that fresh or forced air is circulating during installations and for a few hours afterward to protect highly sensitive people in the area. Some managers require suppliers to unroll and air out carpets in the warehouse before bringing them into the building. Carpets should never be installed where moisture and organic matter can contaminate them.

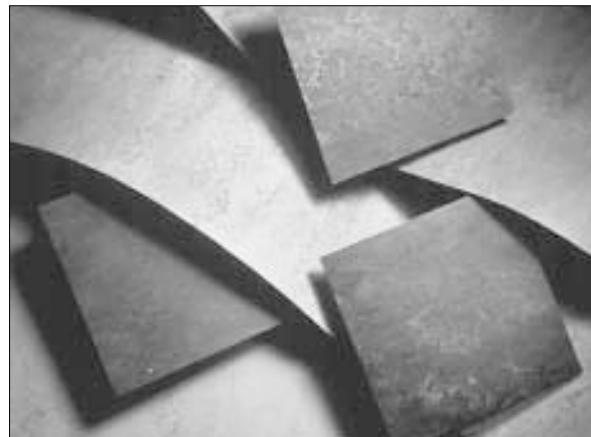

Source: Forbo Industries

*First manufactured in the 1860s, linoleum is a natural material made primarily from linseed oil, pine rosin, sawdust, cork dust, limestone, and jute. Today's products come in many colors and patterns for creative flooring options.*

Carpet mats are especially appropriate outside entrances, to catch dirt and moisture from outside. Mats should be cleaned or exchanged regularly.

Carpet that has become wet should not be allowed to remain that way for long; it should either be dried completely or removed. Although carpet is not a food source for biological organisms, mildew and mold can grow in the moist, soiled areas.



Install walk-off mats and/or grates at all entries with heavy traffic. Mats or grates greatly reduce the amount of sand, grit, and hydrocarbon pollutants tracked into the building. Reducing sand and grit will increase the longevity of all floor coverings and increase cleaning intervals. Reducing tracked-in contaminants also improves indoor air quality.

Some manufacturers provide extended services for installation, maintenance, and removal. For a monthly fee, the manufacturer takes responsibility for maintenance and replacement as needed. Leased carpet can have the lowest first-cost and may be the most likely to be recycled.

**Resilient flooring includes vinyl, linoleum, rubber, and cork.** These are available in rolls or tiles and require adhesives for installation. They are typically composites with several layers: facing, body, and backing. Linoleum is made from renewable, nontoxic materials. The linoleic acid from the flax seed oxidizes gradually over a long period of time. This oxidation helps prevent microbial growth and makes the material harder over time. It also releases a natural VOC that some people find objectionable at high concentrations. Linoleum also has naturally occurring antistatic properties, making it good for rooms with sensitive electronic equipment. Rubber flooring can have a high recycled content, although some recycled rubber products may offgas VOCs. Cork is an excellent sound-absorbing material and is recyclable. Adhesives for each product must be specifically formulated for the flooring material substrate being installed.

**Cementitious materials** provide opportunities for integrating the floor finish with the building structure. They provide durability, low maintenance, and an opportunity to use recycled materials, as in terrazzo-type finishes.

**Ceramic tile** can be made from recycled glass or recycled mine tailings. Glazes are typically energy-intensive and produce pollutants in their manufacture. Thin-set mortar and grout for tile installation often contain latex additives, which increase the flexibility and durability of the installation but also offgas VOCs.

**Natural stone such as slate, granite, and marble** from regional sources can help create a sense of place



Source: Interface

*Solenium carpet tiles from Interface are a sandwich of very different materials designed to come apart for recycling.*

and save transportation costs. Cementitious mortars and grouts reduce the VOCs associated with other types of flooring.

**Wood floors** provide the environmental benefits of a renewable and long-lasting material, and they can be disassembled and reused or recycled at the end of their useful life. (See *Section 7.1.3* for environmentally preferable wood choices.) Wood flooring requires periodic refinishing, however, which can be a source of VOC emissions. Laminates minimize the use of nonrenewable resources by bonding a thin, resilient surface onto a strong, high-density fiberboard made of recycled wood.

## References

*GreenSpec: The Environmental Building News Product Directory and Guideline Specifications*, Building-Green, Inc., Brattleboro, VT, 1999; (800) 861-0954; [www.greenspec.com](http://www.greenspec.com).

Demkin, Joseph, AIA, ed., *Environmental Resource Guide*, John Wiley & Sons, New York, NY, 1999.

“Aberdeen/Green Seal Environmental Standard for Certification of Commercial Adhesives,” Green Seal, Inc., Washington, DC; (202) 872-6400, (202) 872-4324 (fax); [www.greenseal.org](http://www.greenseal.org).

*CRI Indoor Air Quality Testing Program*, for carpet, cushion, floor-covering adhesives, and vacuum cleaners; for information, call (800) 882-8846.

*CRI-104, Standard for Installation of Commercial Carpet*, available from the Carpet & Rug Institute.

## Contacts

The Carpet & Rug Institute, P.O. Box 2048, Dalton, GA 30722; (800) 882-8846, (706) 278-8835 (fax); [www.carpet-rug.com](http://www.carpet-rug.com).

## 7.1.6 Paints and Wall Coverings

An enormous range of paints and wall coverings are available, but the market is increasingly dominated by just two: latex paint and vinyl wall covering. The most significant environmental concern with most wall coverings is their potential for emitting volatile organic compounds, or VOCs. Also, by affecting the ability of moisture to migrate through a wall surface, coatings and wall coverings can affect the potential for condensation and microbial growth in buildings. Other considerations include the raw materials used to make the products, additives used to install and finish them, durability, and disposal or recycling at the end of their useful life.

### Opportunities

Low-VOC, even zero-VOC, paints and adhesives are a good choice in most situations to protect the health of installers and avoid the buildup of contaminants in a building. When recoating or repapering walls in occupied facilities, however, zero-VOC coatings are especially useful. They can be applied adjacent to occupied spaces during regular business hours with minimal disruption or complaints, continued staff productivity, and little or no need for overtime pay.

### Technical Information

**Light-colored surfaces**, regardless of the material, can save energy by reducing the amount of light that must be introduced to illuminate the space. Carefully designed horizontal surfaces and ceilings can bounce daylight from perimeter windows or interior skylights deep into the building (see *Section 4.1.2 – Daylighting Design*).

**Paints** are composed of three main constituents: carriers, binders, and the pigments that give them their color. Water-based or latex paints use water as the carrier, acrylic or polyvinyl acetate latex as the binder, and various mineral and organic pigments; the primary white pigment is titanium dioxide. Latex paints also require additives to prevent the growth of mildew, both in the can and on the painted surface. Oil-based paints traditionally use some kind of solvent as the carrier (although this practice is increasingly rare because of air quality regulations), alkyd resins as the binder, and pigments similar to those in latex paints.

As of September 1999, Federal air quality standards restrict VOC levels in most flat paints to 250 grams per liter, and in nonflat paints to 380 grams per liter. Some jurisdictions restrict allowable VOC levels even further. Such regulations are effectively eliminating oil-based paints as a viable option for most applications. Even where oil-based paints are still available, they may be reformulated to meet the new regulations, and these new formulations may not perform as well as the originals.

Even though they do not use solvents as the carrier, most latex paints contain some solvents to emulsify the binder, so they still emit VOCs. In response to health and odor concerns, nearly every major paint manufacturer also offers a line of “low-free” or “zero-VOC” paints. Some paints that are nominally zero-VOC still use a solvent-based pigmenting system, so saturated colors in these paint lines may contain significant levels of VOCs.

For applications where peak performance and color selection are not critical, there are “recycled” paints made largely of leftover paint collected from consumers or industrial users. Depending on the source, these recycled paints may be more or less carefully tested and reprocessed to provide consistent performance characteristics. For obvious reasons, recycled paint is not as available in white as it is in browns and grays.

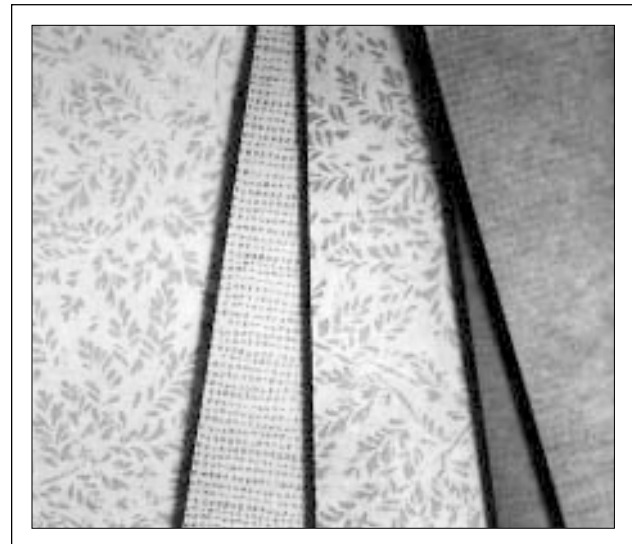

Source: Innovations in Wallcoverings, Inc.

*Introduced in 1999, the Allegory® commercial wall coverings are composed of 50% wood fiber and 50% spun-woven polyester with inks that contain no heavy metals or formaldehyde. Though they are not scrubbable, their moisture-permeability will cut down on mold problems that can occur with vinyl wall coverings in humid environments.*



Source: Sherwin-Williams

Although zero-VOC paints are considered a niche market—with strong interest from specifiers but slow-growing awareness on the part of consumers—most major manufacturers now have their own line.

**Traditional wallpaper** has been all-but-replaced with vinyl wall coverings because of the latter's superior durability and cleanability. Vinyl wall coverings provide moisture resistance for "wet" areas such as restrooms and food preparation areas. Vinyl, or PVC, is produced from vinyl chloride, which is a known carcinogen. Vinyl wall coverings also can be a source of VOC emissions from the plasticizers used to make the material flexible. Vinyl wall covering should be avoided in hot, humid climates, where cool indoor temperatures can cause condensation on the back of the wall covering.

**Wall covering application systems** can be water-based or solvent-based, strippable or nonstrippable. Strippable wallpapers allow for the removal of wall coverings without energy-intensive stripping processes. Water-based adhesives contain lower VOC levels than solvent-based adhesives but potentially perform less effectively; therefore, they require more attention to the weight of the paper, location, and quality of installation for their successful use.

**Fabric wall coverings can adsorb and rerelease VOCs**, depending on their area, porosity, and texture. The integration of low-maintenance, durable wall coverings with acoustical performance requires consideration of the wall construction, geometry, height, and location.

**Facility managers should ensure scheduling of drying times** for wet-applied finishing materials, such as paints and adhesives, to avoid the accumulation of VOCs in the interior environment and protect installers and occupants from high levels of exposure. Renovations that occur adjacent to occupied spaces have the potential to allow the infiltration of VOCs from work areas to occupied spaces. Facility managers can ensure that precautions are taken to seal off work

spaces from occupied space and to isolate entrances and storage areas from occupied spaces. During application of any VOC-releasing product, direct-to-outdoors ventilation should be provided to prevent distribution of VOCs throughout the facility. Under no circumstances should VOC-laden air be circulated through a central air distribution system.

## References

*GreenSpec: The Environmental Building News Product Directory and Guideline Specifications*, Building-Green, Inc., Brattleboro, VT, 1999; (800) 861-0954; [www.greenspec.com](http://www.greenspec.com).

Demkin, Joseph, AIA, ed., *Environmental Resource Guide*, John Wiley & Sons, New York, NY, 1999.

## Contacts

Aberdeen Proving Ground Pollution Prevention Program, [www.apg.army.mil/AP2G/index.htm](http://www.apg.army.mil/AP2G/index.htm).

Green Seal, Inc., Washington, DC; (202) 872-6400, (202) 872-4324 (fax); [www.greenseal.org](http://www.greenseal.org). Provides green labeling standards for paints (GS-11) and anticorrosive paints (GS-03).



The Department of the Army's Aberdeen Proving Ground worked with the nonprofit ecolabelling organization Green Seal, Inc., and Dynamac, Inc., to identify environmentally preferable paints for use on site. Based on Green Seal's consensus-based standards, appropriate thresholds were determined for VOC levels, and toxic constituents that should be avoided were identified. For 178 paints in use at the Proving Ground, Green Seal first reviewed Material Safety Data Sheets and then tested promising products for VOCs and toxins. As a result of this process, 24 paints were recommended as environmentally responsible choices. They represented flat, semigloss, and gloss finishes for both indoor and outdoor use.

The selection of furnishings—including workstations, cubicle partitions, chairs, desks, filing cabinets, window treatments, and other interior furniture—should consider many of the environmental issues raised by other products, such as life-cycle environmental impacts and effects on indoor air quality. In recent years, some manufacturers have taken steps to address environmental concerns by using materials with lower VOC emissions and higher recycled content, specifying wood from sustainably managed forests, and extending the useful life of products through reconditioning and remanufacturing. In addition, building owners and tenants are taking advantage of the adaptability of some types of furnishings and planning for future reconfigurations.

## Opportunities

Renovation or reconfiguration of space, as well as moving into new space, provides opportunities for greening furnishings. These opportunities include the following:

- Salvaging, reconditioning, and reusing furnishings;
- Ordering new furnishings that have environmentally preferable attributes, such as high recycled content, low or no VOC emissions, and certified wood;
- Using furnishings that are designed for future flexibility and adaptability; and
- Increasing personal control over space conditioning, lighting, acoustics, and other elements.

*Polyesters are popular workstation panel fabrics because they are inexpensive, have inherent fire-retardant properties (usually not requiring further chemical treatments for flame resistance), and are easy to clean. The DesignTex Play it Again Sam polyester workstation panel fabric shown here is made from 100% recycled PET soda bottles.*

Photo: DesignTex

## Technical Information

**Fabrics** are used in upholstery, window treatments, workstations, and systems furniture. Issues to consider in choosing fabric are the environmental impacts of manufacturing the fabric, the potential for offgassing of chemicals, the potential for acting as a “sink” for chemicals (adsorbing chemicals on the surface and later releasing them back into the air), and the need for cleaning to prevent the buildup of dust and molds. Polyester fabrics are made from petroleum and natural gas, thus contributing to the depletion of this resource; wool production raises environmental issues regarding overgrazing, pesticides, and insect infestations; and cotton production involves a considerable amount of pesticides and soil depletion. Conventional dyes and fabric treatments can be toxic.



Innovative fabric lines include the William McDonough Fabric Collection and Recycled-PET Workstation Fabric from DesignTex, a Steelcase Design Partnership company. The McDonough Collection is a blend of wool and the plant fiber ramie. The company worked with sheep farmers to encourage low-impact grazing and the use of alternatives to toxic “dips,” and had a chemical company develop dyes that contained no hazardous ingredients or by-products. The PET fabric, called “Play it Again Sam,” uses no virgin materials but does use conventional dyes.



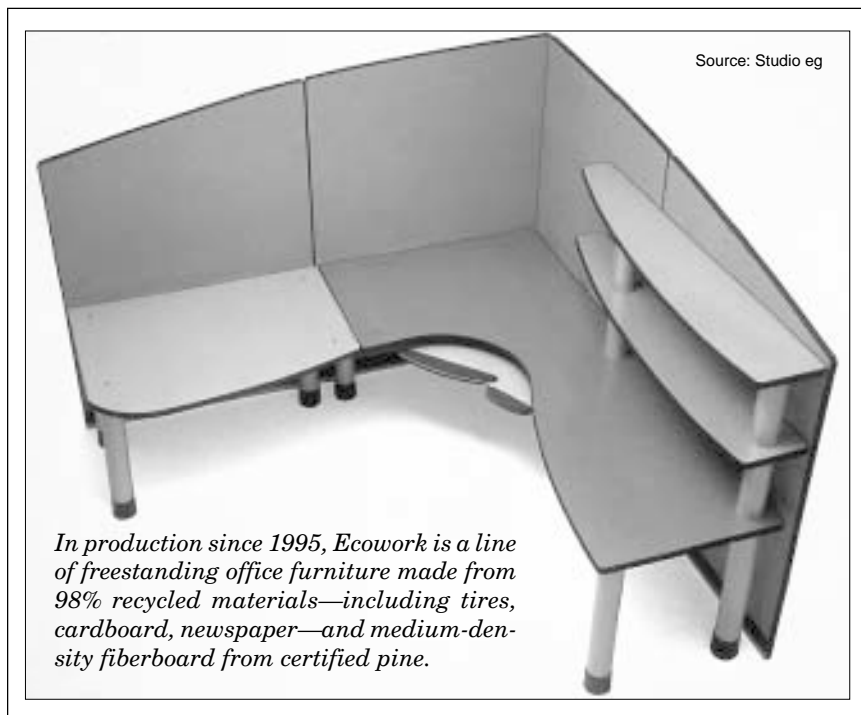

**Furniture.** Many options are available for greening furniture selections. Salvaging and reusing furniture often has the lowest environmental impact; many companies refurbish and sell furniture. Steelcase and Herman Miller have furniture lines that are easily disassembled for recycling. The use of recycled steel and aluminum is relatively common, but manufacturers may not know the specifics of recycled content. Metal parts finished with powder coatings or no finish at all have lower environmental impacts than those finished with solvent-based spray paint. Wood furniture should be made from wood that is harvested from sustainably managed forests, as certified under Forest Stewardship Council guidelines, or that is reclaimed/salvaged.

**Modular systems furniture** is available in “environmental” lines that offer reclaimed or refurbished units and units made from recycled materials, low-VOC fabrics and composite woods, and natural fibers. Systems furniture offers several benefits for indoor environmental quality. It is flexible, allowing for easy (and low-cost) reconfiguration to meet changing needs without demolition and resulting waste. If the panel height of a partition is kept relatively low, daylight can penetrate into the space, reducing electric lighting requirements, and air can circulate more freely.

**Cabinetry** is often a source of indoor air quality problems because of its use of conventional composite wood products with urea formaldehyde binders. Neil Kelly Signature Cabinets has introduced a new line made

with certified wood, environmentally friendly finishes (such as natural oil/wax), and nonformaldehyde medium-density fiberboard.

**Indoor air quality testing** is now possible using relatively affordable kits from such companies as Air Quality Sciences (AQS) of Atlanta, Georgia. The AQS kit measures formaldehyde levels and total VOCs, lists the three primary VOCs detected, and enables mold and particulate samples to be collected for AQS laboratory analysis. Users might need assistance from an expert to interpret the results.

**Access floors** often can be selected along with furnishings. Access floors with modular systems furnishings provide maximum flexibility for electricity and tele-

communications cable distribution and for greater personal control over environmental conditions. The use of *Personal Environmental Monitors* or similar systems enable individuals to regulate comfort conditions at each workstation.

## Resources

*GreenSpec: The Environmental Building News Product Directory and Guideline Specifications*, Building-Green, Inc., Brattleboro, VT, 1999; (800) 861-0954; [www.greenspec.com](http://www.greenspec.com).



## 7.2

# Operational Waste Reduction and Recycling

Commercial buildings, including Federal facilities, generate nearly 90 million tons of municipal solid waste per year (EPA, 1999). On September 14, 1998, Executive Order 13101, *Greening the Government Through Waste Prevention, Recycling, and Federal Acquisition*, was issued to further expand and strengthen the Federal government's commitment to recycling and to purchasing recycled-content and environmentally preferable products. Federal facilities have the potential to conserve natural resources—from energy to water to the trees that are made into office paper—by the way in which buildings are operated, provisioned, and serviced. The three-R hierarchy of resource conservation—Reduce, Reuse, Recycle—can reduce overall waste and save money as well. Recycling helps keep financial resources within a community—producing jobs and generating other economic benefits. Strong, proactive recycling programs at government facilities also serve as an important model for the communities where they are located and can project a positive public image.

### Opportunities

There are few aspects of facility management in which opportunities for operational waste reduction and recycling do not exist. Opportunities are particularly great in the areas of building and equipment maintenance, office operation, housekeeping, and waste management services.

Building and equipment maintenance is, by definition, involved in waste reduction. Well-maintained buildings and equipment prolong service life and reduce the waste associated with production of the new and disposal of the old. Maintenance activities do, however, generate waste, particularly potentially hazardous waste such as used motor oil, waste hydraulic and cooling fluids, and solvents. All these materials can be recycled and, in fact, their hazardous contents often favor recycling over disposal.

Waste reduction and recycling associated with business operations involving paper, cardboard, glass, metals, and plastics require a coordinated effort among office, cleaning, and waste management personnel and services. Strategies for office waste and recycling are a key component of EPA's WasteWise program (see box, next page). A growing number of Federal WasteWise partners—more than 40 to date—and award winners demonstrate the tremendous opportunities and savings associated with operational waste reduction and recycling.



Source: Windsor Barrel Works

*Installation of 95%-recycled-content collection barrels at Mount Rushmore National Park (in configurations like these from the Denver Zoo) has resulted in recycling of more than 90% of the aluminum cans that two million annual visitors used to throw in the trash.*

### Technical Information

Both EPA's WasteWise program and the *Greening the Government* initiative provide excellent resources for, and success stories of, operational waste reduction and recycling. While factors such as facility location, local waste disposal costs, existing recycling markets, and quantities of materials generated all have an impact on the recycling opportunities for a given facility, several key elements of a waste reduction and recycling program will help to ensure success:

- **Comprehensive planning:** Every aspect of a facility's operation should be included in a program so that each waste material is treated in the same manner throughout the facility.
- **Buy-in throughout facility:** No program for waste reduction and recycling can succeed without the full knowledge and support of all staff. Implementation must be as comprehensive as the program.
- **Recognition:** Let staff know the impacts—both in terms of natural resources and dollar savings—of their reduction and recycling efforts; consider an awards program.
- **Feedback:** Every program has to be tailored both to the existing conditions at a facility and to future

changes. Provide an easy feedback mechanism so that the waste reduction and recycling program responds to “ground-level” conditions.



**1999 WasteWise Award Winner: U.S. Postal Service, Northeast Area**—The U.S. Postal Service Northeast Area’s 74,135 employees in 3,114 post offices throughout the New England states and upstate New York continued to demonstrate their strong commitment to reducing the generation of undeliverable standard mail throughout 1998. The Postal Service reduced 1,087 tons of bulk mail and saved \$76,000 by promoting the national change of address program to major mailers. It also reduced the generation of solid waste at 25 vehicle maintenance and 29 processing and distribution facilities by 50% over fiscal year 1992 generation rates.

#### 1998 WasteWise Accomplishments

Waste Prevented .....	1,087 tons
Recycling Collection .....	44,175 tons
Recycled-Content Purchases .....	415 tons
Total Cost Savings .....	\$2,378,700

## RECYCLING OF SPECIFIC MATERIALS

**Metals:** Steel, copper, aluminum, brass, mercury, and zinc from appliances, light fixtures, cladding, flashings, plumbing, wiring, and structural materials are easily recyclable, and doing so can usually generate revenue.

**Paper and cardboard:** Paper and cardboard constitute the single largest component of municipal landfill waste; both are easily recycled. The price of recycled paper products fluctuates widely, depending on supply and demand as well as pricing of virgin wood fiber. Materials made from recycled paper include new office paper and cardboard, cellulose insulation, sound insulation board, drywall facing, and certain wallpapers.

**Plastics:** Certain plastics are recycled widely. For ease of recycling, different types of plastic resin need to be kept separate; in fact, small amounts of one type of plastic, such as PVC, can damage equipment used to recycle other types of plastic. Composite materials are more difficult to recycle. Recycled plastics are used in producing waste receptacles, office accessories, and weather-resistant outdoor lumber products used for landscaping and furniture.

**Glass:** Glass beverage containers are easy to recycle in any facility with food services. Window glass cannot be recycled with beverage glass, because of differences

in the formulation; it is generally recycled only at window glass factories. Beverage container glass is recycled into fiberglass insulation—all major manufacturers now use at least 30% recycled glass—and asphalt shingles, concrete aggregate, brick, and ceramic tile. Glass cullet has also been used for drainage fill.

**Rubber:** Tires and other rubber products can be recycled into flooring materials, low-grade industrial uses, road surfacing, speed bumps, and parking wheel stops.

**Fluorescent lamps and office equipment:** Fluorescent lamps contain mercury and should always be recycled through specialized facilities (see Contacts). Obsolete office equipment can be donated to nonprofit organizations for reuse or can be recycled, depending on its age and quality.

**Compost:** Organic matter generated from food services and landscaping operations should be composted if possible. This not only reduces landfilling but also provides a high-grade soil amendment for landscaping.



Provide waste collection areas for recyclables in any building or facility. In large, multistory buildings this may include specialized chutes and bins for recyclables. Separate storage areas should be provided for each different material collected. Planning for storage and handling of recyclables as part of the design of a facility is strongly advised.

## References

*Greening the Government: A Guide to Implementing Executive Order 13101*, Office of the Federal Environmental Executive; [www.ofee.gov/](http://www.ofee.gov/).

WasteWise Publications: [www.epa.gov/wastewise/pub.htm](http://www.epa.gov/wastewise/pub.htm).

## Contacts

Office of the Federal Environmental Executive, Mail Code 1600S, Ariel Rios Building, 1200 Pennsylvania Avenue, NW, Washington, DC 20460; (202) 564-1297.

WasteWise Program (5306W), U.S. Environmental Protection Agency, 401 M Street, SW, Washington, DC 20460; (800) EPA-WISE.

Association of Lighting and Mercury Recyclers, 2436 Foothill Blvd., Suite K, Calistoga, CA 94515; (707) 942-2197.

## 7.3

# Construction Waste Management

According to a recent EPA study, construction and demolition (C&D) waste totaled more than 135 million tons (122.5 million tonnes) in the U.S. in 1998; about 77 million tons (69.9 million tonnes) resulted from commercial work alone. Per-square-foot waste generation ranges from about 4 pounds (19.5 kg/m<sup>2</sup>) for new construction and renovation to about 155 pounds (757 kg/m<sup>2</sup>) for building demolition. On many construction projects, recyclable materials such as wood, concrete and masonry, metals, and drywall make up as much as 75% of the total waste stream, presenting opportunities for significant waste diversion. As more C&D landfills reach capacity, new ones become increasingly difficult to site, and as more municipal waste landfills exclude C&D waste, tipping fees will continue to rise. Construction waste—and costs—can be managed just like any other part of the construction process, with positive environmental impacts on land and water resources.

## Opportunities

C&D waste management takes advantage of opportunities for source reduction, materials reuse, and waste recycling. Source reduction is most relevant to new construction and large renovation projects and involves reduced “waste factors” on materials ordering, tighter contract language assigning waste management responsibilities among trade contractors, and value-engineering of building design and components. During renovation and demolition, building components that still have functional value can be reemployed on the current project, stored for use on a future project, or sold on the ever-growing salvage market. And recycling of building materials can be accomplished whenever sufficient quantities can be collected and markets are readily available.

### AVERAGE COMPOSITION OF WASTE FROM 19 INDUSTRIAL/COMMERCIAL DEMOLITION PROJECTS IN THE NORTHWEST AREA

Type of Material	Totals Tons	Average Percent
Wood	28,000	15.5
Roofing	1,400	0.8
Concrete	120,300	66.8
Brick	2,200	1.2
Scrap Iron	8,700	4.8
Asphalt	3,200	1.8
Landfill Debris	16,400	9.1
<b>Total Tons</b>	<b>180,200</b>	<b>100.0</b>
Total Tons (17 buildings) *	167,200	
Building Size (square feet) *	2,204,000	
<b>Average generation rate *</b>	<b>151.7 lb/sq ft</b>	
* Building sizes available for 17 of the 19 projects.		

Source: R.W. Rhine Inc., Tacoma, WA; adapted from Table A-18 in *Characterization of Building-Related Construction and Demolition Debris in the United States* (EPA530-R-98-010)

## Technical Information

Some key elements of C&D waste management include the following:

- **Waste assessment:** On any project, knowing ahead of time what type and quantity of materials will be generated can make lining up reduction, reuse, and recycling easier. Conduct your own audit or refer to existing audits (see Reference 1).
- **Contract language:** If all your trade contracts explicitly address waste management, contractors will know from the start how to handle your requirements for reuse and recycling (see Reference 2).
- **“Take-back” policies:** From acoustic ceiling tiles and cardboard packaging to carpeting and clean cut-off drywall, manufacturers’ systems for accepting suitable materials back into production are growing. Check with distributors and manufacturers about this before your project begins.
- **On-site recycling:** Recent research has added clean wood and drywall cut-off waste to concrete and masonry as waste materials suitable for grinding and use on the job site. Wood chips can be used for erosion control or mulch, and ground drywall as a soil amendment (see Reference 3).
- **Recycling systems:** Job-site recycling can be set up for commingled recovery (all waste goes into one container for processing), source separation (separate labeled bins for each recycled material and one for waste) or staged pickup (recycler times the pickup according to stage of construction to keep materials separated for recovery) (see Reference 4). Investigate options available in your area before your project begins.
- **Hazardous materials:** First, minimize hazmat generation by specifying nontoxic materials, particularly with the finishing (paints, stains, and coatings), plumbing (adhesives), and foundation (form-releasing agents) trades. Second, make sure that trade contractors identify all the hazardous materials they generate and document their plans for safe and compliant disposal.
- **Local resources:** Many local offices of solid waste or recycling have developed resources (handbooks, directories, Web sites) for C&D waste recovery. Contact local and state offices for local resources, including outlets, contractors, and related businesses.



Photo: Benchmark Contractors, Inc.

*Good signage is critical to effective on-site source separation for C&D waste recovery.*

## References

*Characterization of Building-Related Construction and Demolition Debris in the United States*, EPA530-R-98-010 (see Tables A-11 through A-18), June 1998. Prepared for EPA by Franklin Associates.

Kincaid, Judith E., Cheryl Walker, and Greg Flynn, *WasteSpec: Model Specifications for Construction Waste Reduction, Reuse, and Recycling*, Triangle J Council of Governments, July 1995; [www.tjcog.dst.nc.us](http://www.tjcog.dst.nc.us).

Yost, Peter, and Eric Lund, *On-site Grinding of Residential Construction Debris: The Indiana Grinder Pilot*, NAHB Research Center, Upper Marlboro, MD, July 1999.

Yost, Peter, and Eric Lund, *Residential Construction Waste Management: A Builder's Guide*, NAHB Research Center, Upper Marlboro, MD, 1996.

## Contacts

EPA Office of Solid Waste, Washington, DC; (703) 308-7200; [www.epa.gov/swerrims/](http://www.epa.gov/swerrims/).

California Integrated Waste Management Board, Sacramento, CA; (916) 255-2296; [www.ciwmb.ca.gov](http://www.ciwmb.ca.gov).

Deconstruction is a new term for an old process: building disassembly and material salvage. Deconstruction can range from “soft-stripping” of building components, such as mechanical equipment or hardwood flooring, to structural recovery of floor and wall assemblies. If the removal of a building can be planned and implemented carefully (as it was designed and built), deconstruction can greatly reduce landfill disposal as well as the resource use associated with the production of new building materials. EPA estimated in 1998 that 44,000 commercial buildings and 245,000 houses are demolished annually in the United States, accounting for 65 million tons (59 million tonnes) of material. If just half of those buildings were deconstructed, and only 10% of the materials salvaged from the ones being deconstructed, more than 3 million tons (2.7 million tonnes) of demolition waste could be kept out of landfills each year.

## Opportunities

When a building reaches the end of its useful life, renovating the structure for reuse is always preferable to taking it down. If reuse is not possible, however, consider deconstruction rather than demolition, as there are lots of opportunities for waste reduction, reuse, and recycling of building materials and components. Deconstruction offers a double environmental benefit—when building materials or components are *salvaged for reuse*, landfill disposal is avoided and natural resources are conserved (by avoiding the production of new materials or components).

Deconstruction should be considered when one or more of the following conditions exist:

- Adaptive reuse of the building is not an option.
- The building is “designed for disassembly”—from precast-concrete double-T beams to pre-engineered metal buildings.
- The building contains high-value items such as “antique” brick, hardwood flooring, large-dimension structural timbers, modern mechanical equipment, and specialty masonry, woodwork, or metalwork.
- Adequate time exists to accommodate the lengthier process of disassembly.
- Local salvage markets exist or regional/national markets can be identified.
- Materials or components can be reused in-house, eliminating the need to identify markets.

- Salvaged components or materials can be specified by the A&E firm in the redevelopment taking place on the site where the building to be removed stands.
- The added labor costs of manual disassembly can be subsidized by a worker-training program.
- Local landfill tipping fees are high enough to push reuse as a cost-avoidance strategy.

## Technical Information

Successful deconstruction requires careful planning. Recommended procedures or elements include:

**Detailed building assessment:** When a building slated for demolition is assessed for environmental hazards (lead-based paint, asbestos, PCBs, etc.), it can also be assessed for salvage potential. While full structural salvage might be appropriate only in very specific situations (see list above), less extensive levels of deconstruction should be considered for almost any building. (See the references for an example of a building materials inventory form.)

**Contract language:** The best mechanism for encouraging deconstruction is to specify materials recovery (reuse and recycling of building materials and components) in both the building-removal bidding and in the property-redevelopment process. Sources of model contract language are listed in the references.

**Identification of used building material markets:** A good way to support high rates of materials recovery is to provide potential bidders with as much market information as possible. For local resources, use the “Yellow Pages” and contact the local recycling office or coordinator. An increasingly useful regional and national resource is the Internet. A list of Internet-based used building material exchanges is listed in the references, and general Internet auction sites, such as [www.freemarkets.com](http://www.freemarkets.com), should also be considered.

**Training programs:** Check with local construction trade

### GENERATION OF DEMOLITION DEBRIS IN THE U.S.

Building Type	Demolitions per year	Average Bldg. Size sq. ft. (m <sup>2</sup> )	Average Generation Rate lbs/sq. ft. (kg/m <sup>2</sup> )	Total tons (tonnes)
Residential	245,000	1,396 (130)	115 (560)	19.7 (20) million
Nonresidential	43,795	13,300 (1,235)	155 (755)	45.1 (45.8) million
TOTAL	288,795	—	—	64.8 (65.8) million

Source: Tables 5 and 6, *Characterization of Building-Related Construction and Demolition Debris in the United States*, U.S. EPA, 1998.

unions or vocational schools on their needs for identifying and qualifying construction workers. An excellent way to both identify individuals with an aptitude for construction and familiarize them with how buildings are put together is to teach them how to take buildings apart. While incorporating a training program into the demolition schedule can be challenging, it can provide a labor subsidy that enables a level of disassembly far greater than might otherwise be possible.

**Permit process:** In some cases it is possible to compensate for the additional time that deconstruction usually requires by obtaining faster approvals for other aspects of the redevelopment process. Check with local regulatory authorities to find out if there is an opportunity for a *time benefit* to the contractor to offset the time penalty that deconstruction is likely to entail.



The salvage and reuse of some building materials and components—older, non-1.6-gpf (6-liters-per-flush) toilets, single-glazed windows, and trim materials with lead-based paint, for example—need to be done with great care or not at all. For materials or components with poor resource efficiency or environmental and health risks, follow special procedures for appropriate reuse—for example, using salvaged windows for interior transom windows. Make sure that the reuse of vintage materials represents a real environmental gain.

## References

*A Guide to Deconstruction: An overview of deconstruction with a focus on Community Development Opportunities*, prepared by the NAHB Research Center for the U.S. Department of Housing and Urban Development, February 2000. Downloadable from the HUD Web site at [www.hud.gov:80/deconstr.pdf](http://www.hud.gov:80/deconstr.pdf).

Kincaid, Judith E., Cheryl Walker, and Greg Flynn, *WasteSpec: Model Specifications for Construction Waste Reduction, Reuse, and Recycling*, Triangle J Council of Governments, July 1995; [www.tjcog.dst.nc.us](http://www.tjcog.dst.nc.us).

Yost, Peter, “Deconstruction: Back to the Future for Buildings?” *Environmental Building News*, Vol. 9, No. 5, May 2000, BuildingGreen, Inc., Brattleboro, VT 05301; (800) 861-0954; [www.BuildingGreen.com](http://www.BuildingGreen.com).

An example of a Building Materials Inventory Form may be found in Appendix B of “Deconstruction – Building Disassembly and Material Salvage: The Riverdale Case Study,” NAHB Research Center, Upper Marlboro, MD, 1997; downloadable from the Web at either [www.nahbrc.org](http://www.nahbrc.org) or [www.smartgrowth.org](http://www.smartgrowth.org).

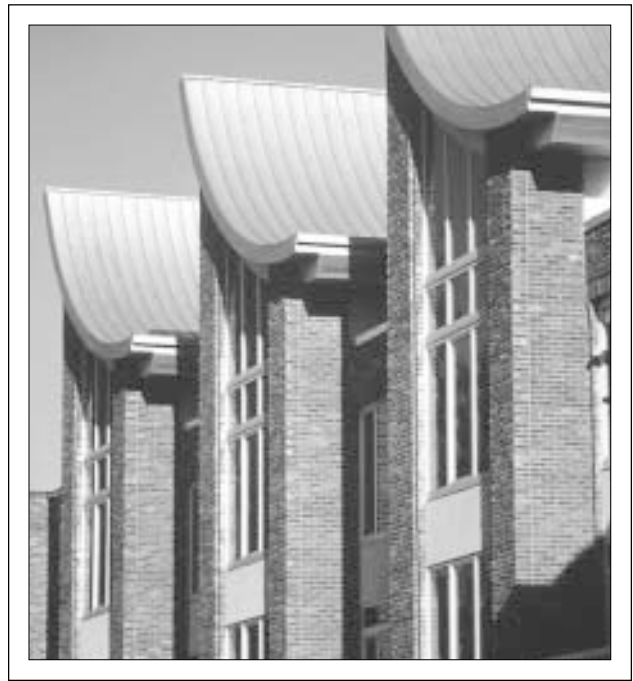

Source: Greater Vancouver Regional District

*The C. K. Choi Building at the University of British Columbia features the extensive use of salvaged materials, including brick from a road in Yaletown, Vancouver.*

See these resources for model contract language:

- UC–Santa Cruz Extension, Business Environmental Assistance Center, (800) 799-2322, and the Fort Ord Reuse Authority, (408) 883-3672.
- East Bay Conversion and Reinvestment Commission, (510) 834-6928.
- Defense Construction Canada, (613) 998-0468 (fax). The bid document includes an evaluation matrix for received bids.

## Contacts

U.S. Environmental Protection Agency, Washington, DC; (202) 260-4048; [www.epa.gov](http://www.epa.gov).

Department of Housing and Urban Development, Washington, DC; (202) 708-1112; [www.hud.gov](http://www.hud.gov).

The Used Building Materials Association represents U.S. and Canadian building salvage firms and used building materials retailers; [www.ubma.org](http://www.ubma.org).

The following sites are for used building material exchanges or retail operations:

[www.greenguide.com](http://www.greenguide.com)  
[www.rbme.com](http://www.rbme.com)  
[www.recycle.net/recycle/build/](http://www.recycle.net/recycle/build/)  
[www.renovators-resource.com](http://www.renovators-resource.com)  
[www.afandpa.org/Recycling/Wood/Search.htm](http://www.afandpa.org/Recycling/Wood/Search.htm)  
[www.goodwood.org/goodwood/](http://www.goodwood.org/goodwood/)  
[www.woodexchange.com](http://www.woodexchange.com)



**Part VIII**  
**INDOOR ENVIRONMENTAL QUALITY**

<b>SECTION</b>	<b>PAGE</b>
8.1 Indoor Air Quality .....	176
8.2 Controlling Soil Gases .....	178
8.3 Controlling Biological Contaminants .....	180
8.4 Productivity in the Workplace .....	182
8.5 Noise Control and Privacy .....	184



EPA has determined that the average U.S. citizen today spends 90% of his or her time indoors, and indoor air pollution levels can be up to 96 times greater than outdoor pollution levels. This makes indoor air quality, or IAQ, one of the greatest health concerns in this country. Poor air quality can have a significant impact on workers' health and productivity.

## Opportunities

IAQ problems can be caused (or avoided) at virtually any stage in the design, construction, and operation of any facility. During *building design*, such issues as roof overhangs (to keep out rain), location of outside air inlet ports, glazing specifications (relative to potential condensation and mold growth), formaldehyde content of cabinetry, and entryway design to hold down tracked-in pollutants all can influence IAQ. During *construction*, such issues as wall system detailing to keep out wind-driven rain and practices to remove VOCs released from new building materials will affect IAQ. During *operation and maintenance*, such issues as the choice of cleaning agents, regulation of tobacco smoking, and maintenance of filters in air handlers affect IAQ.

Facility managers should not wait to address IAQ risks until problems arise. Become proactive in identifying and solving potential problems *before* they occur. Involve workers in the solution and take their complaints about IAQ seriously. Consider IAQ when renovating spaces, maintaining HVAC and other equipment, or contracting for janitorial services.

## Technical Information

The three concepts below are often used to describe IAQ problems:

- **Sick building syndrome (SBS)** is a condition in which a significant number of building occupants (sometimes defined as at least 20%) display symptoms of illness for an extended period of time, and the source of these illnesses cannot be positively identified.
- **Building-related illness (BRI)** refers to symptoms of a diagnosable illness that can be attributed directly to a defined IAQ pollution source.
- **Multiple chemical sensitivity (MCS)** is a condition in which a person is sensitive to a number of chemicals, all at very low concentrations. This condition is not well understood but is often attributed to high levels of exposure to certain chemicals.

Other IAQ problems do not clearly fall into these three categories, however. Asthma and allergies (including allergic rhinitis—hay fever), for example, are very common and can be medically diagnosed, but there are many triggers, which vary widely from person to person; as a result, the source of particular triggers is not always easily identified.

### IAQ SOURCES

Many factors can cause—or contribute to—IAQ problems. Sometimes it is a *combination* of different factors that causes problems—though any one of those factors, by itself, does not cause problems. Among these potential factors are the following:

**Biological contaminants**—including molds, bacteria, and dust mites—can result from roof leaks, water vapor entry from basements, inadequate drainage around buildings, leaking pipes, condensation from air-conditioning equipment, and the pests in a building (rodents, insects, etc.). Relative humidity that consistently exceeds 50% should be avoided. Bioaerosols emitted from certain organisms are recognized as a very significant problem. Some molds are particularly toxic, such as *Stachybotrys atra*, which has been implicated in infant deaths in Ohio.

**Volatile organic compounds**, or VOCs, can cause IAQ problems, particularly in new (or newly remodeled) buildings. Common sources of VOCs are paints, carpeting (especially carpet backings and adhesives), furnishings, and chemicals (such as solvents and cleaning agents).

**Combustion by-products** can create hazardous conditions if allowed to enter or accumulate in a building. Improper ventilation, inoperative or undersized exhaust fans, poor placement of ventilation air supply ports, and improper pressurization of the building can all lead to a buildup of combustion gases.

**Particulates** from a number of sources can cause IAQ problems. These include fiber shedding from fiberglass or mineral-wool insulation, ductboard, and mineral-fiber acoustic ceiling tiles; heavy metals and other compounds tracked into a building by employees or visitors; and soot from combustion devices.

### CONTROLLING IAQ PROBLEMS

Avoiding or minimizing IAQ problems involves a seven-part strategy:

1. **Keep the building dry**—this is arguably the most important strategy, especially in quite humid regions of the country.

2. **Keep the building clean and pest-free**—for example, install a track-off system to capture particulates that might enter from outdoors.
3. **Avoid potential contaminant sources**—for example, particleboard and MDF products that offgas formaldehyde, adhesives, solvent-based cleaning agents, and sources of combustion gases.
4. **Reduce unplanned airflows**—these can result from unbalanced HVAC systems, the stack effect, or depressurization in buildings; and they can enable air pollutants to enter from outdoors (combustion gases, pollen), as well as moisture and radon or other soil gases through the floor slab or basement walls, for example.
5. **Provide exhaust ventilation** for unavoidable, strong, stationary pollution sources—these include photocopiers and laser printers in offices, cooking equipment, restrooms, and designated smoking areas.
6. **Provide filtered dilution ventilation** for people, interior finishes, and furnishings in a building—mechanical ventilation is necessary in most buildings to meet minimum ASHRAE standards.
7. **Educate designers, builders, and building occupants**—education is critical in minimizing the risk of creating IAQ problems, identifying problems as they occur, and effectively dealing with those problems.

A few specific recommendations for avoiding IAQ problems are provided in the list at right.

## References

*Building Air Quality: A Guide for Building Owners and Facility Managers*, EPA/400/1-91/033, DHHS (NIOSH) Publication No. 91-114, U.S. Environmental Protection Agency, Washington, DC, December 1991; [www.epa.gov](http://www.epa.gov).

*Ventilation for Acceptable Indoor Air Quality* (Standard 62-1989), American Society of Heating, Refrigeration, and Air Conditioning Engineers (ASHRAE), Atlanta, GA; [www.ashrae.org](http://www.ashrae.org).

*Indoor Environment Business*, monthly independent trade newspaper, IAQ Publications, Inc., Bethesda, MD; [www.iaqpubs.com](http://www.iaqpubs.com).

*IAQ Guidelines for Occupied Buildings Under Construction*, SMACNA, 1995; [www.smacna.org/iaq.cfm](http://www.smacna.org/iaq.cfm).

## A SAMPLING OF SPECIFIC MEASURES THAT PREVENT IAQ PROBLEMS

- **Air handlers** should be easy to clean and tightly sealed, have a minimum of joints and other dust catchers, and have effective filters.
- **Inspection of air handlers** should be made easier by good access doors and light- or white-colored surfaces inside the air handlers.
- **Condensate pans** inside air handlers should drain fully, and debris should be removed from the pans regularly.
- **Fresh air intakes** should be inspected to ensure that poor-quality air is not drawn into the building from “short circuits” between exhaust and air intakes or as a result of site-specific conditions such as wind. Look for standing water on the roof, bird feces or nests, and proximity to cooling towers, parking areas, waste stacks, exhaust vents, loading docks, and other nearby sources of contamination.
- **Ducts** should be easily cleaned, should be installed without interior insulation, and generally should be air-sealed; textile ducts, while not air-sealed, are the easiest to clean.
- **Floor drains** should be refilled periodically to prevent sewer gas from entering the building through dry traps.
- **Wall-to-wall carpeting** should be minimized and the use of carpet adhesives eliminated; install only products that meet the Carpet & Rug Institute IAQ standard.
- **Paints and adhesives** should contain no—or very low—VOCs. Interior painting should be done during unoccupied periods, such as weekends. Adequate “airing out” should be done to remove the majority of the VOCs from the air before re-occupancy.
- **Durable and easily cleaned building materials** should be used to eliminate the need for strong cleaning chemicals. For example, ceramic tile makes a good substitute for carpeting in entry areas and hallways.
- **Vinyl wall coverings** should not be used on interior surfaces of exterior walls where moisture from wall cavities can condense on the back of the vinyl and harbor mold.
- **“Wet” applied** and formaldehyde-containing wall coverings should be minimized.
- **Ventilation, temperature, and humidity** should comply with ASHRAE Standards 62-1989 and 55-94.
- **Isolate renovation work areas** with plastic sheeting. Tape off HVAC ductwork in renovation work areas to prevent dust and debris from entering the ducts.
- **Newly installed materials**, such as carpets and other flooring products, should be “aired out” before installation.

The entry into buildings of soil gases—including, but by no means limited to, radon—is an important area of concern. The few studies that have investigated soil gas entry report that 1–20% of the outdoor air entering buildings enters from below grade. Some gases, such as radon and hydrocarbons (from fuel or chemical spills), are health and safety risks to building occupants. Others, principally water vapor, may put the building at risk or cause secondary IAQ problems such as mold growth. Controlling soil gases is an important priority to ensure a safe working or living environment. Fortunately, the strategies for keeping soil gases out are relatively easy.

## Opportunities

Soil gases are very easy to control in new buildings through proper design and construction practices. Specific measures for soil gas control should be included in all new buildings, but they are especially important in areas known to have high soil radon levels, on brown-field sites, and on land previously used for agriculture. In existing buildings, dealing with soil gas problems is more difficult and more expensive—but still doable. Before investing in a soil-gas remediation program in an existing building, however, test the area carefully to determine the type and extent of the contamination.

## Technical Information

In order for radon or other soil gases from an underground source to end up in a building, there must be a way for the soil gases to enter (passageways) and a driving force to bring them in. The driving force is usually a combination of differences in air pressure (air-flow through the below-grade material) and differences in contaminant concentrations. Passages include pores in the soil matrix, fissures and cracks in the underlying bedrock, porous fill around buildings, and cracks and holes in the building foundation walls and floor.

The most common driving force is negative pressure in the building. Exhaust fans, the stack effect, or air-handler returns may create negative pressure in the basement or crawl space that draws air from the soil into the building. Natural systems can also be the driving force. For example, a low-pressure weather system accompanied by a heavy rain may force the soil air mass to equalize with atmospheric air through a building. Rapidly rising water tables displace a large amount of soil air, generating positive pressure in the soil around a building. Air moves easily through gravel and rock that is fractured or has been dissolved by water, so pressure differentials can move large amounts of underground air and soil gases.

## UNDERSTANDING SOIL GASES

The soil air contaminants we know the most about are radon, vapors from petroleum products, gases released by other volatile compounds, gases released by anaerobic or aerobic decomposition of carbon-containing materials, and water vapor.

Radon is a radioactive gas released when radium, a trace element in many soils, undergoes nuclear decay. These decay products include radon and various other radioactive “daughter products” from the breakdown of radon. The only known health effect from exposure to radon and its short-lived decay products is an increased risk of lung cancer. Radon is the only carcinogen that is documented with human exposures at levels that may actually occur in buildings. It is classified by the EPA as a Group 1 (known human) carcinogen and is considered the second leading cause of lung cancer in the United States (after tobacco).

Gasoline and fuel oil are the most common sources of below-grade petroleum vapors. These hydrocarbons can get into the soil through spills, leaks, and intentional dumping. Gasoline fumes present an explosion hazard at levels of 14,000 ppm; fuel oil vapors entering a building are not generally explosive. Petroleum products contain a host of other compounds, including benzene, toluene, ethyl-benzene and xylenes (collectively referred to as BTEX). Although there are many other compounds released by petroleum products, these BTEX compounds are always present and pose substantial health risks; they can be detected very easily with portable, relatively inexpensive equipment.

Nonpetroleum VOCs disposed of underground or present in contaminated groundwater can be a big problem if they make their way into buildings. The best known example is the contamination at Love Canal in New York State. Common VOC soil gases include solvents, thinners, and de-icers—the constituents are as varied as the activities that produced them. A wide variety of short-term and long-term health effects could result from exposure to VOCs, depending on the contaminant(s) involved.

Buried materials that contain carbon are often decomposed by bacteria or fungi. Fungi most commonly digest organic matter in the presence of oxygen (aerobic decomposition), while bacteria generally operate in the absence of oxygen (anaerobic decomposition). Gases released by aerobic decomposition are primarily carbon dioxide, water vapor, and trace VOCs; the associated smell is often described as “moldy,” “musty,” or “earthy.” Compounds released by anaerobic bacterial decomposition include methane, nitrogen, hydrogen, and sulfur compounds—and the associated smell can

be very bad (often described as “old socks,” “locker room,” “rotten food,” and “sewer gases”). Landfills contain a lot of buried organic matter that decomposes anaerobically, producing methane. Methane reaches explosive concentrations at 40,000 to 150,000 ppm, depending on the temperature and oxygen content. Such explosions have occurred at landfill sites. Buildings near landfills may end up with high methane levels—rarely at explosive concentrations but often at levels where the methane and associated gases can cause “nuisance odor” and health risks.

Water vapor is not itself a contaminant, but it creates an environment that can support populations of fungi, bacteria, mites, insects, or rodents. Potentially high levels of water vapor can enter a building from the ground. Whether this water vapor becomes a problem depends on the rate at which it is being added to and removed from the building by other means. Some studies have shown that strategies to keep soil gases out of buildings can significantly reduce indoor humidity levels.

### DEALING WITH SOIL GASES

A two-prong approach is recommended: prevent soil gas entry and provide dilution ventilation air as called for by codes or professional guidelines.

Preventing soil air entry is the primary control method. It solves soil gas problems that would be impractical to solve using ventilation alone. To prevent soil air entry:

- Provide a relatively airtight foundation;
- Avoid depressurization of the building through improperly balanced exhaust fans and air-handling equipment or through the stack effect (most pronounced in tall buildings);
- Provide a highly permeable layer of material beneath the building (e.g., crushed stone) that can be easily depressurized; and
- Install a passive stack that runs from the subslab layer through the heated part of the building to the outdoors.

The last two of these steps will create a low-air-pressure zone beneath the foundation that will intercept soil air and divert it through the passive stack. In the event that the passive stack is not powerful enough to keep problem gases out of the building, the stack can be powered with an in-line fan. Detailed correctly, a very small fan can treat a large footprint. In research conducted by the EPA, a single stack using a 90-watt

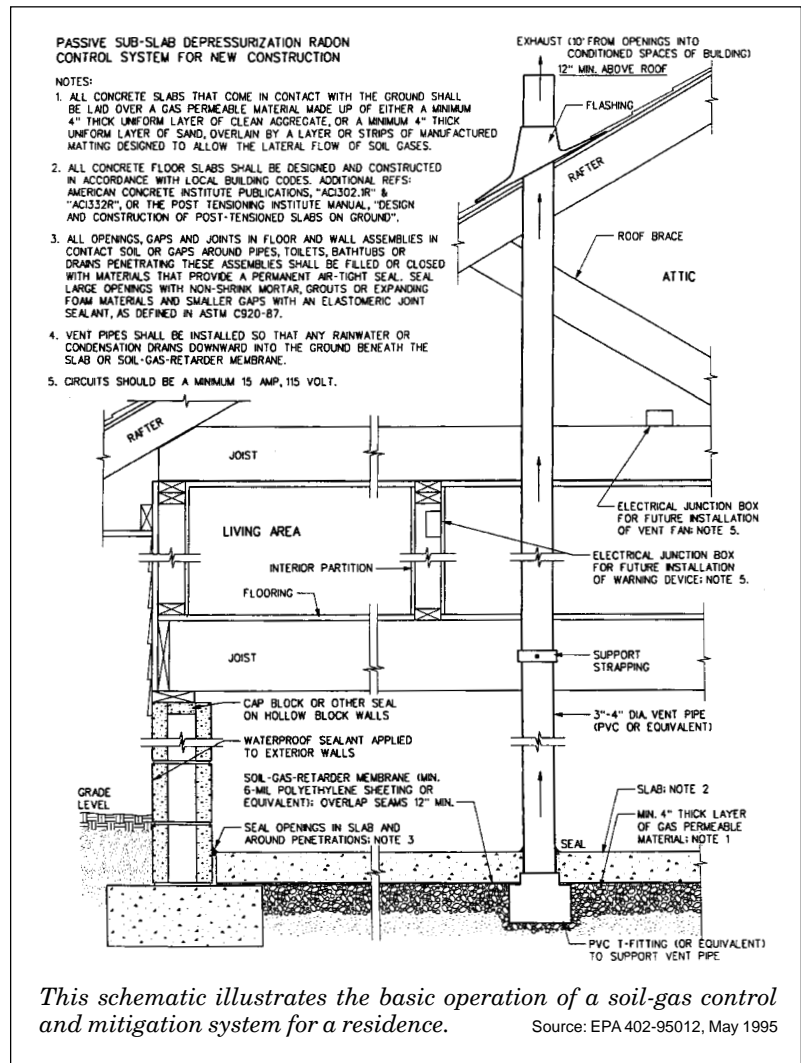

fan has depressurized the drainage layer beneath a 100,000-square-foot (9,300 m<sup>2</sup>) slab.

## References

“Radon and Other Soil Gases: Dealing with the Hazards from Below,” *Environmental Building News*, Vol. 7, No. 7, July/August 1998, BuildingGreen, Inc., Brattleboro, VT; (800) 861-0954; [www.BuildingGreen.com](http://www.BuildingGreen.com).

*Radon Prevention in the Design and Construction of Schools and Other Large Buildings* (EPA/625/R-92/016), U.S. Environmental Protection Agency, Washington, DC, 1993; [www.epa.gov/iaq](http://www.epa.gov/iaq).

*Soil Gases and Housing: A Guide for Municipalities*, Canada Mortgage and Housing Corporation, Ottawa, ON, 1993.

## Contacts

Indoor Environments Division, U.S. Environmental Protection Agency, MC 660 4J, 401 M Street, SW, Washington, DC 20460; (202) 564-9456; [www.epa.gov/iaq](http://www.epa.gov/iaq).

# Controlling Biological Contaminants

Biological contaminants are particles or gases that originate with something that is—or once was—alive. Sometimes, as in the case of pathogens, the entire organism is the contaminant; in other situations the contaminant is produced by the organism—directly or indirectly. Organisms that are the source of biological contaminants may reside inside the building or outside. The contaminants may be released in the building, be tracked in on the feet of people or pets, or be carried in with infiltration or ventilation air. Biological contaminants that may cause physiological problems for people include odors, irritants, allergens, toxins, and pathogens. People in the building are not the only ones at risk. Organisms or contaminants released by them may decompose or corrode building components and damage electronic equipment.

## Opportunities

Deal with existing problems first. Moisture problems are the precursor to nearly all pest, fungal, and environmental bacteria problems. If there are moisture problems in the building, these should be first on the list of priorities for correction. Mold should not be growing inside buildings. If there is mold or fungal growth, respond quickly and safely to clean it up and prevent a recurrence. The next priority is pest animals. The Executive Memorandum on “Environmentally and Economically Beneficial Practices on Federal Landscaped Grounds” (April 16, 1994) requires the use of integrated pest management, or IPM, practices when they are cost-effective and practical. Many Federal agencies developed and adopted IPM policies for their buildings and landscapes before and since this memorandum. If an IPM program is not in effect, begin to develop and implement one.

## Technical Information

Living things in buildings fall into two categories: invited and uninvited. This is an important distinction, because the primary control mechanisms are quite different. The invited are the building’s occupants. Contaminants released by these occupants must be controlled with personal hygiene, cleaning, filtration, and dilution by outdoor air. The uninvited biological organisms we may have to deal with, however, include the following:

- Mammals – rats, mice, bats, raccoons and skunks;
- Birds – pigeons, starlings;

- Reptiles – lizards, snakes;
- Arthropods – roaches, ants, termites, wasps, bees, carpet beetles, mites, spiders;
- Fungi – penicillium, aspergillus, cladosporium, fusarium;
- Bacteria – environmental and pathogenic; and
- Viruses – pathogenic.

The contaminants released by these organisms consist largely of the following: dander (skin or scale flakes), feces, urine, spores, hyphae, metabolites, and viable bacteria or viruses. Allergic response to alien protein in these contaminants is probably the most frequent effect encountered. The most dangerous effect is exposure to pathogens that can be passed by airborne transmission. Electronic equipment is sensitive to contaminants, especially the acidic ones found in feces and urine. Pollen is not usually lumped with biological contaminants in buildings, but it can get into buildings and commonly causes allergic responses.

Tracked-in dirt is a significant source of biological contaminants. Fungal spores are the most abundant contaminant in this category—large enough to have settled outside but small enough to become airborne for a time when disturbed indoors. Exclusion is the first line of defense for tracked-in contaminants.

The smallest biological contaminants enter by means of outdoor air. They consist primarily of fungal spores, insect parts, pollen, and metabolic gases. Generally, an especially strong outdoor source is required to cause an indoor problem, such as downwind of a composting facility or a swamp—though pollen is a seasonal problem in many areas. Contaminated outdoor air may be actively drawn in through the intakes of the ventilation system, or passively drawn in through infiltration as a result of depressurization caused by mechanical equipment, the stack effect, or wind.

### CONTROLLING BIOLOGICAL CONTAMINANTS

Several strategies must be used to minimize exposure to biological contaminants while also minimizing exposure to biocides. Controlling contaminants released by organisms inside the building is accomplished using IPM methods for the animals and moisture control for the fungi and environmental bacteria.

**Integrated pest management** for animals consists of the following steps:

### 1. Keep them out.

- Landscape the building to eliminate easy pest access to the building (overhanging tree branches, shrubbery in direct contact with the building, etc.).
- Seal the exterior walls, foundations, and roofs against pest entry.
- Seal gaps around wiring and plumbing that provide passage between food, water, and living habitat.

### 2. Reduce food and water sources.

- Establish and enforce a food policy and a cleaning policy that minimize food scraps in the building.
- Repair rain and plumbing leaks quickly.
- Keep soil moisture and groundwater out of the building.
- Prevent condensation on cool surfaces, such as windows (better-insulating glazings and edge spacers may be required).

### 3. Reduce pesticide exposures.

- Respond to pest problems when they occur, rather than providing regular applications.
- Select least-toxic pesticides that target the problem species.
- Use treatment methods that target individual species and nests.
- Avoid spraying pesticides when possible (traps and baits are preferred).

**Fungal contamination** should be addressed as follows:

#### 1. Identify problems.

- Determine the extent of moisture damage and fungal contamination.
- Figure out the moisture dynamics causing the problem.
- During the initial investigation, ensure appropriate containment and protection of workers.

#### 2. Dry the affected area.

#### 3. Implement an effective long-term solution.

- Eliminate moisture sources through roof repair, flashing modification, installation of a drainage layer beneath cladding, and control of soil moisture entry.
- Develop a long-term fungal cleanup plan.
- Implement containment and worker protection procedures.
- Discard materials that are not worth saving.
- Decontaminate materials that can be saved.
- Implement repairs and program changes to prevent a recurrence of the problem(s).

- Tracked-in contaminants are among the simplest to control. Up to 85% of tracked-in contaminants can be caught at the entry using effective track-off mats that are cleaned daily. Vacuuming with machines that indicate when dust has been collected greatly reduces the amount of contaminants on hard-surface floors and in carpet.

## References

### INTEGRATED PEST MANAGEMENT

Olkowski, William, Sheila Daar, Helga Olkowski, *Common-sense Pest Control*, Taunton Press, Newtown, CT, 1991.

Olkowski, William, Sheila Daar, Helga Olkowski, *IPM for Schools: A How-to Manual*, U.S. Environmental Protection Agency (Document #909-B-97-001), 1997.

*Model Pesticide Reduction Plan*, The Air Force Center for Environmental Excellence/Environmental Quality Directorate, 1996.

### FUNGAL CONTAMINATION

*Bioaerosols: Assessment and Control*, American Conference of Governmental Industrial Hygienists, 1999.

*Standard and Reference Guide for professional Water Damage Restoration IICRC S500*, Institute of Inspection, Cleaning and Restoration Certification, 1999.

### MOISTURE CONTROL

Lstiburek, Joseph, and John Carmody, *Moisture Control Handbook*, Van Nostrand Reinhold, New York, NY, 1993.

### CLEANING MANAGEMENT

Roberts, J. W., D. E. Camaan, T. M. Spittler, "Reducing Lead exposure from Remodeling and Soil Track-in in Older Homes," *Proceedings of the Annual Meeting of the Air and Waste Management Association* (#15:134.2), 1991.

## Contacts

General Services Administration, National Capital Region Building Services, Integrated Pest Management; (202)708-6948; see Web site at [ncr.gsa.gov/Services/RealEstate/building.asp](http://ncr.gsa.gov/Services/RealEstate/building.asp).

U.S. Environmental Protection Agency, Indoor Environments Division, Mail Code 660 4J, 401 M Street, SW, Washington DC 20460; (202) 564-9456; [www.epa.gov](http://www.epa.gov).

The Air Force Center for Environmental Excellence, Environmental Quality Directorate, 3207 North Road, Brooks Air Force Base, TX 78235; (210) 536-5135.

Productivity involves the health, comfort, and well-being of people living and working in Federal facilities as well as how those factors affect their performance. Maximizing health and productivity through proper building design is increasingly recognized as a critical aspect of sustainability and global competitiveness. The economic impacts of productivity are much greater than commonly assumed, even among building professionals. A productivity increase of just 1% can completely offset a building's entire energy bill. Thus, while it may sometimes be difficult to defend certain green design investments (such as daylighting, natural ventilation, and passive solar heating) solely on the basis of energy savings, these investments may be easily justified when their effects on productivity are considered.

## Opportunities

Human health and productivity can be maximized when the project team addresses the following issues in an integrated manner at the beginning of a project:

- Thermal comfort (HVAC design);
- Indoor air quality (interior finish materials, construction detailing, and HVAC design);
- Visual comfort (daylighting);
- Acoustic comfort (site placement and interior materials and systems);
- Ergonomic comfort (furniture selection);
- Connection to nature (windows for view, interior landscapes); and
- Potential for both privacy and networking (space configurations).

Opportunities for boosting productivity should be considered whenever significant renovation or reconfiguration is being done in a facility. Some productivity-enhancing measures can be implemented even when major modifications to the building are not being done. The widest range of strategies and most comprehensive measures to boost productivity can be incorporated into *new* buildings, especially if addressing productivity is a high priority right from the start.

## Technical Information

Our understanding of productivity and all the factors that influence it is still growing. Members of the integrated design team for a project should keep abreast of the latest findings regarding the productivity benefits of building design and construction strategies,

such as daylighting (see box below). They should also be aware of the added benefits most such strategies offer in reducing energy consumption and improving the overall environmental performance of a building.



**Daylighting and Productivity:** Detailed, statistically rigorous evidence that daylighting helps boost human performance has long been claimed, but most evidence has been anecdotal or of limited statistical significance. That has changed. Two recent studies conducted by the Heschong Mahone Group of Fair Oaks, California, for Pacific Gas and Electric demonstrate that daylighting can measurably benefit productivity. One study found a dramatic improvement in sales performance in retail stores with natural daylighting; another found that elementary school students in daylit classrooms learned faster than students in rooms lit only by electric lighting (see Section 4.1.2 – Daylighting Design). Explanations for these results range from improved visibility and enhanced moods to better and more attentive service by employees and teachers. Studies and findings in other areas of human health and productivity are being examined at the Carnegie Mellon Center for Building Performance and Diagnostics and several other institutions.

Strategies that can maximize human health and productivity should be addressed at each stage of a project. At the outset, potential outside influences at a site should be considered, such as outdoor air quality and proximity to sources of noise (e.g., flight paths, highways, industrial facilities). These site characteristics should be taken into account in the building design to minimize negative impacts on building occupants.

High levels of ventilation, good air distribution, and thermal comfort can be addressed during design and then be specified, implemented, and ultimately tested before occupancy. Daylighting, careful selection of materials and cleaning products, contaminant isolation (to avoid noxious odors), and minimization of noise are most effectively addressed during the design phase.

Construction scheduling, detailing, and installation techniques are extremely important. In particular,

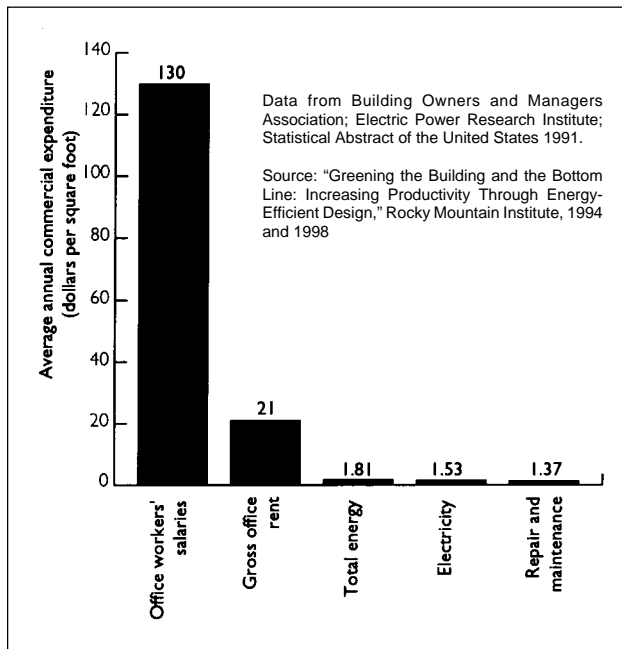

While a great deal of attention has been focused on reducing energy costs in commercial buildings, even a very small improvement in productivity can offset the entire energy bill of a facility. Some studies have found 5–15% improvements in productivity as a result of green design.

preventing construction conditions and practices that can cause wet materials and mold growth should be a high priority. Delay installing highly absorptive materials, such as fabrics and upholstery, until building products that may offgas VOCs have been in place for a while. Avoid using a building's permanent ventilation system during painting, floor finishing, carpet installation, and other procedures that may release high quantities of VOCs—because those VOCs may get into the ventilation system and then be released into the building when it is occupied.

Post-occupancy considerations, such as permanent air quality monitoring systems with feedback mechanisms and responsible O&M procedures, also play an important role in maximizing health and productivity. These should be given serious attention in the design process.

Access floors and individual controls that function well with them are good examples of design for productivity. Access floor systems provide a floor cavity that serves both as a place to run wiring and as a plenum for conditioned air delivery. An access floor greatly improves the ability to reconfigure workspaces over time (saving many thousands of dollars for a facility with a high churn rate). Access floors enhance comfort by allowing workers to individually control the diffusers that deliver conditioned air beneath the floor—the diffuser openings can be enlarged easily, for example, if the employee wants to boost airflow to keep his or her space cooler. Personal workstations with integrated

environmental controls work very well with access floors. Occupancy sensors in workstations can further reduce energy use by turning equipment off when workstations are unoccupied. Individualized controls can be coordinated with natural and mechanical heating and cooling systems, daylighting, and operable windows for effective thermal, visual, and acoustic comfort.

## ENVIRONMENTAL IMPLICATIONS

Several strategies that increase health and productivity have direct impacts on larger environmental considerations. For example, daylighting design with high-performance electric lighting improves occupants' performance while conserving energy. High-performance glazings specified to enhance occupants' thermal comfort also conserve energy.

Finally, human health and performance can be enhanced by avoiding materials with high levels of VOCs and other indoor pollutants. Such pollutants are commonly introduced in paints, adhesives, sealants, cleaning products, and carpeting, as well as manufactured wood products produced with medium-density fiberboard or particleboard.

## References

*Whole Building Design Guide*, [www.wbdg.org/productive/](http://www.wbdg.org/productive/).

Heerwagen, Judith H., et al., "A Tale of Two Buildings: Biophilia and the Benefits of Green Design," paper presented at the U.S. Green Building Council's Third Annual Conference, 1996.

Romm, Joseph J., *Lean and Clean Management: How to Boost Products and Productivity by Reducing Pollution*, Kodansha America Press, New York, NY, 1994.

Wise, James, "Measuring the Occupant Benefits of Green Buildings," *Proceedings of the Human Factors and Ergonomics Society 41st Annual Meeting*, 1997.

Romm, Joseph J., and William D. Browning, "Greening the Building and the Bottom Line: Increasing Productivity Through Energy-Efficient Design," Rocky Mountain Institute, Snowmass, CO, 1994, revised 1998; posted online at [www.rmi.org/images/other/GDS-GBBL.pdf](http://www.rmi.org/images/other/GDS-GBBL.pdf).

## Contacts

Center for Building Performance and Diagnostics, The Intelligent Workplace, 415 MMCH, Carnegie Mellon University, 5000 Forbes Avenue, Pittsburgh, PA 15213; (412) 268-2350, (412) 268-6129 (fax); [www.arc.cmu.edu/cbpd/](http://www.arc.cmu.edu/cbpd/).



Like air quality and lighting, a good acoustic environment is essential in maintaining a high level of satisfaction and morale among workers. Ideally, offices and other workspaces should be free of noise and audible information that distracts them from the tasks at hand. Additionally, acoustic privacy is necessary for some tasks. Noise and distracting sounds can come from both indoor and outdoor sources. They may be continuous and irritating, such as the buzz of magnetic ballasts, or they may be sporadic, such as an occasional loud voice. Speech is the most prolific and disruptive noise in most offices because it can be difficult to ignore.

## Opportunities

Noise can be controlled most effectively, and at the least expense, if it is considered alongside other building performance parameters early in the design of a new building or renovation. During the schematic design it is possible, for example, to provide maximum separation between sources of noise and the spaces that have the greatest need for quiet. In addition, choices regarding the degree of acoustic dampening and isolation between spaces can also affect options for air distribution, lighting, and other systems. For example, indirect lighting schemes supplemented by task lighting reflect less sound than recessed troffers with plastic covers, and they may be easier to justify in a budget if their acoustic benefits are also taken into account.

In an existing facility, the impact of changes on the noise level in adjacent spaces should be considered whenever mechanical or electrical equipment is being serviced or replaced. Regular maintenance can help keep machines running quietly and efficiently.

## Technical Information

Concepts important in addressing acoustical problems in buildings include the following:

- **Background noise** is needed to provide some masking of sound, but too much noise is stressful and can make it difficult to hear conversations or other communications. Noise criteria (NC) have been used to rate sources of background noise in the past. More recently, room criteria (RC) have become widespread as a rating system for overall noise levels. Studies have shown that an RC rating between 35 and 45 will usually provide speech privacy in open-plan settings, while ratings below 35 will not.

- **Speech privacy potential (SPP)** quantifies the percentage of words that can be understood from an adjacent conversation and is related to sound isolation and background noise. SPP is directly proportional to occupant satisfaction, and GSA recommends a minimum value of 60 for SPP in open offices; an SPP of 70 is considered good for closed-office plans. GSA-sponsored research for open office areas revealed that speech privacy can be improved either by increasing the sound attenuation between workstations or by increasing the background noise. Another measure of speech privacy is the articulation index (AI), which ranges from 0 (speech not at all intelligible) to 1.0 (fully intelligible).

Basic principles of sound control include these:

- Reducing noise at its source.
- Blocking noise transmission.
- Absorbing noise.
- Masking noise.
- Active noise cancellation.

**Reducing noise at its source** is an important first step in addressing internally generated sounds. Noise from mechanical and electrical equipment is a release of energy that is not contributing to the intended tasks, and as a result it is a symptom of inefficiency in the system. In some cases, reduced noise may be a contributing factor that can help justify the selection of higher-efficiency equipment. Air-handler noise transmission can be reduced by providing flexible connections between the air handler and ductwork and by using duct liners. Carpets are effective at preventing footfall noise from pedestrian traffic through a space.

**Blocking noise transmission** is achieved primarily with high-mass barriers that are rated by sound transmission class (STC). Both internally generated and exterior noises can be controlled to some extent in this way. For exterior noise, a high-mass, airtight building shell is important. Windows tend to be a weak link in this respect. Double-glazed windows are more effective with a wide space between the panes, or with sulfur hexafluoride (SF<sub>6</sub>) gas fill. The need for noise control makes it particularly difficult to use natural ventilation or operable windows for buildings in noisy settings. Natural earth berms and other massive external barriers can also be effective at managing noise from highways or other nearby sources.

Barriers are also important to control the transmission of conversation and other indoor noises. In open office systems, partitions lower than 50 in. (1.3 m) in height are largely ineffective, while those over 70 in.

(1.8 m) are subject to diminishing returns. Minimizing spaces below dividers and at their joints is also important. In the case of full-wall partitions, airtightness is important to minimize sound leakage. In some cases it may be advisable to extend interior partitions past the suspended ceiling and up to the slab above, but such extensions complicate air distribution and other systems. One solution is use slab-to-slab partitions between adjacent offices but not between offices and corridors. Adding a foil backing to suspended ceiling tiles will also reduce the sound transmitted through the ceiling.

**Absorbing noise** is an essential component of any office noise-management plan. Reflective surfaces allow noises to travel over a significantly greater distance, and sound levels tend to be much higher. Absorption in ceilings, in furniture panels, on the floors, and on walls (where necessary) helps to lower noise levels and reduce the distance over which sound travels. Of these surfaces, acoustical ceilings and workstation dividers tend to be most effective at absorbing sound.

The noise reduction coefficient (NRC) is a measure of how effective a material is at absorbing sound. NRC ratings range from nearly 0 for a hard, reflective material to 1.0 for a highly absorptive material. Effective ceiling tiles should have an NRC rating close to 0.9.

**Sound-masking systems** artificially raise the background noise level to maintain speech privacy. Unlike older “white noise” generators, modern systems adjust sounds levels at various frequencies to meet acoustical objectives, while remaining relatively unobtrusive to occupants. The systems consist of an array of speakers that are usually located above a suspended ceiling on a 15-foot (5-meter) grid. The speakers project sound upwards so that it is reflected off the underside of the slab above. Although high-tech, such masking systems are often more cost-effective than alternative means of increasing acoustic privacy and reducing distractions. A good sound-masking system should reduce distractions as much as if the STC rating of the sound barriers was increased by 10 points.

**Active noise cancellation** (ANC) systems consist of microphones that receive the target noise and speakers that create an identical sound field 180 degrees out of phase with the original noise. The sound field created effectively reduces the effect of the offending noise but does not cancel it. Some ANC systems are made for use in HVAC ductwork to prevent problem noise from disturbing occupants. Active noise cancellation only works for low-frequency constant noises (such as that of generators and motors) when both the

## SOUND INTENSITY LEVELS OF TYPICAL NOISES

Sound Pressure (Pa)	Sound Intensity (W/m <sup>2</sup> )	Decibels (dB)	Noise in the Environment
63.2	10	130	Threshold of pain
20	1	120	Near a jet aircraft at take-off
6.32	0.1	110	Riveting machine
2.0	0.10	100	Pneumatic hammer
0.632	0.001	90	Diesel truck at 50 ft (15 m)
0.2	0.0001	80	Shouting at 3 ft (1 m)
0.0632	1 x 10 <sup>-5</sup>	70	Busy office
0.02	1 x 10 <sup>-6</sup>	60	Conversational speech at 3 ft (1 m)
0.00632	1 x 10 <sup>-7</sup>	50	Quiet urban area during daytime
0.002	1 x 10 <sup>-8</sup>	40	Quiet urban area at night
0.000632	1 x 10 <sup>-9</sup>	30	Quiet suburban area at night
0.0002	1 x 10 <sup>-10</sup>	20	Quiet countryside
0.000632	1 x 10 <sup>-11</sup>	10	Human breathing
0.00002	1 x 10 <sup>-12</sup>	0	Threshold of audibility

Loudness or noise can be measured in various units. The decibel scale provides a convenient way to express this. Note that the quietest sound we can hear is one ten-trillionth (1x10<sup>-13</sup>) as loud as the most intense noise we experience.

Adapted from: *Architectural Acoustics: Principles and Design* by Madan Mehta, Jim Johnson, and Jorge Rocafort (Prentice-Hall, Upper Saddle River, NJ, 1999)

noise source and the listener are stationary. It has little or no application to office environments but may be useful in certain specialized facilities.

## References

Harris, C. M., *Noise Control in Buildings: A Guide for Architects and Engineers*, McGraw-Hill, New York, NY, 1994.

“It’s a Matter of Balance: New Understandings of Open-Plan Acoustics,” research paper, Herman Miller, Inc., 2000; posted online at [www.hermanmiller.com/us/index.bbk/5525](http://www.hermanmiller.com/us/index.bbk/5525).

Egan, David M., with Steven Haas and Christopher Jaffe, Ph.D., “Acoustics: Theory and Applications,” *Time-Saver Standards for Architectural Design Data: Seventh Edition* (Donald Watson, FAIA, et al., editors), McGraw-Hill, New York, NY, 1997.

## Contacts

National Council of Acoustical Consultants, Springfield, NJ; (201) 564-5859.



**Part IX**  
**MANAGING BUILDINGS**

<b>SECTION</b>	<b>PAGE</b>
<b>9.1 The Role of Operations &amp; Maintenance (O&amp;M) ...</b>	<b>188</b>
<b>9.2 Building Commissioning .....</b>	<b>190</b>
<b>9.3 Maintaining Healthy Indoor Environments .....</b>	<b>192</b>
<b>9.4 Leased Buildings .....</b>	<b>194</b>
<b>9.5 Measuring and Monitoring Benefits .....</b>	<b>196</b>
<b>9.6 Setting Standards and Training .....</b>	<b>198</b>
<b>9.7 Employee Incentive Programs .....</b>	<b>200</b>

# The Role of Operations & Maintenance (O&M)

The best efforts to reduce negative environmental impacts in the built environment are doomed to failure unless well-crafted operations and maintenance (O&M) procedures are implemented. Furthermore, even the best O&M procedures are of no use unless they are understood and followed by building O&M personnel. Facility managers play the key role in ensuring that this happens. An “integrated team” approach can be a big help. In this process, O&M personnel are active participants in the design of a facility and the development of O&M procedures. This “integrated team” promotes useful procedures that are efficient and—most important—faithfully executed. Addressing O&M considerations at the start of a project can contribute greatly to improved working environments, higher productivity, and reduced energy and resource costs. The following sections of this guide provide a variety of O&M information on the important systems typically found in Federal facilities. Other O&M-related information also can be found in various places in the earlier sections of this guide.

## Opportunities

There are tremendous opportunities in most existing buildings and facilities to improve O&M procedures and make them more environmentally responsible. With new buildings, there are opportunities during design and construction to facilitate easy, low-environmental-impact O&M. With all buildings there are opportunities to derive multiple benefits. Energy savings and improved indoor air quality can be achieved by tuning up older oil-fired boilers, for example. Improved indoor air quality and less hazardous effluent from a building can be achieved by switching to more benign cleaning chemicals. If implemented effectively, the multiple benefits of O&M practices should include reduced operating costs.

## Technical Information

To create an effective O&M program, the following general procedures should be followed:

- Ensure that up-to-date operational procedures and manuals are available.
- Obtain up-to-date documentation on all building systems, including system drawings.
- Implement preventive maintenance programs complete with maintenance schedules and records of all maintenance performed for all building equipment and systems.
- Create a well-trained maintenance staff and offer professional development and training opportunities for each staff member.
- Implement a monitoring program that tracks and documents building systems performance to identify and diagnose potential problems and track the effectiveness of the O&M program. Include cost and performance tracking in this analysis.

Specific elements of an effective O&M program are addressed as follows:

**HVAC systems and equipment:** Energy consumption and conservation are tied heavily to O&M procedures. HVAC equipment must be well maintained for the complex array of chillers, boilers, air handlers, controls, and other hardware to function at peak performance. Easy access to HVAC systems for ongoing maintenance and repair is critical (be sure that this is considered during design). A well-thought-out, well-executed O&M program can provide huge savings in equipment and energy costs.



By installing a state-of-the-art O&M monitoring system in early 1993, the Marine Corps Air/Ground Combat Center at Twenty-Nine Palms, California was able to increase its hot water plant capacity by 30% and eliminate the need for a \$1.5 million boiler installation. This artificial-intelligence-based system saved \$138,000 in natural gas costs during its first year of operation, and its advanced diagnostic system reduces plant maintenance costs by up to 30%.



Source: Donald Hadley, Pacific Northwest National Laboratory

*Monitoring building performance is an important part of operations and maintenance. The technician in this photograph is installing an energy performance sensor in a data logger at U.S. Navy Headquarters Building 33.*

**IAQ systems and equipment:** Air ventilation and distribution systems should be well maintained and frequently checked for optimal performance. Coordination between air distribution systems and furniture layouts is especially important. In addition, regular inspection for biological and chemical contaminants is crucial. Poor IAQ lowers productivity, can cause illness, and has resulted in numerous lawsuits.

**Cleaning equipment and products:** Using biodegradable and least-toxic cleaning products and equipment can reduce both O&M costs and pollution to air and wastewater streams while improving both indoor air quality and worker productivity. The need for chemical cleaning products can also be reduced through environmentally conscious design and material choices. New requirements for cleaning contracts must be clearly specified. EPA has a Web site devoted to environmentally preferable cleaning products.

**Materials:** This aspect of O&M procedures received scant attention until major concerns about the handling and disposal of hazardous materials came to light. Now, facilities must maintain an attentive and proactive stance with regard to the environmental impacts of their material choices. Every day new products, systems, and equipment become available that have fewer adverse environmental impacts. All these choices should be carefully scrutinized in terms of O&M.

**Water fixtures and systems:** Routine inspections and maintenance programs for water fixtures and systems are crucial. Population growth and development have reduced the availability of high-quality, potable water in many regions of the country. Along with increased water prices, reduced supply often leads to usage restrictions. An O&M program will reduce operating costs when it verifies that fixtures and systems are functioning effectively and ensures that leaks or components are quickly repaired.

**Waste systems:** Recycling and waste-reduction programs and their supporting hardware need frequent attention and maintenance in order to function at peak performance.

**Landscape maintenance:** Use of native plantings can reduce landscape O&M requirements and costs significantly. Although natural vegetation may take several years to become established, once it is established there is usually less need for water. Integrated pest management can also reduce overall O&M costs by reducing the need for hazardous chemicals and pesticides.

## References

Meador, Richard, "Maintaining the Solution to Operations and Maintenance Efficiency Improvement," *Proceedings of the World Energy Engineering Congress, Atlanta*, Association of Energy Engineers, 1995.

U.S. EPA Environmentally Preferable Cleaning Products; [www.epa.gov/opptintr/epp/cleaners/select](http://www.epa.gov/opptintr/epp/cleaners/select).

## Contacts

Information on, and Web links to, commissioning and O&M print resources and training opportunities are available from Portland Energy Conservation, Inc., 921 SW Washington Street, Suite 312, Portland OR 97205; (503) 248-4636, (503) 295-0820 (fax); [www.peci.org](http://www.peci.org).

FEMP offers an Operations & Maintenance Management course. Contact the Help Desk at (800) DOE-EREC (363-3732) or check for training dates on the Web: [www.eren.doe.gov/femp/resources/training/fy2001\\_om.html](http://www.eren.doe.gov/femp/resources/training/fy2001_om.html).

Building commissioning involves documenting the owner's goals and needs for a facility and then ensuring that those goals are being met. In large, complex facilities, effective commissioning can help ensure that all performance goals are met, often resulting in a showcase facility. Commissioning may be limited to specific systems, such as HVAC or building automation, or it may cover the entire project. Commissioning traditionally involves comprehensive testing of an existing facility or a new facility after construction is completed, simulating a complete range of outside conditions and operating modes to verify performance. More recently, however, the involvement of commissioning agents or authorities has extended from the predesign into the post-occupancy phases of the project.

## Opportunities

Some degree of commissioning is worthwhile in nearly every project, though the importance of commissioning increases as facilities get more complex or experience higher demands on mechanical and electrical systems. Large, mixed-use facilities are important commissioning targets, as are those with laboratories, assembly halls, and other large ventilation loads. Buildings in hot and humid climates or very cold climates are especially susceptible to serious problems if they are not properly commissioned. Facilities that are experiencing comfort problems, excessive energy use, or premature deterioration are high-priority commissioning targets. Within a new or existing facility, any systems that have historically been troublesome to O&M staff in similar facilities should be targeted for specific attention during commissioning.

The earlier in the design process it begins, the better are the chances that commissioning will be an integral and effective part of the design and construction process. The opportunities for the designer are many and include defining a holistic approach to sustainable design that includes energy efficiency, environmental pollution prevention, and economic cost-effectiveness from a life-cycle cost viewpoint. The scope of work for the building commissioning should be integrated into the project's goals for performance, quality control, and innovations.

*Recommissioning* is recommended periodically during the operation of a building—just as periodic tune-ups are recommended for automobiles. A good time to carry out recommissioning is during any renovation work, during tenant changeover, or during periods of light usage—such as during the summer for school facilities.

## Technical Information

Good commissioning agents are professionals with broad expertise and the training to look at buildings as complex, interconnected systems. When they participate throughout an entire design process, they can offer invaluable suggestions, not only for avoiding problems but also for exploiting potential synergies between different building systems to optimize performance at least cost. If the commissioning agents are versed in the strategies and technologies of sustainable design, they may be well positioned to monitor and document the compliance of a facility with the requirements of a green building rating system, such as LEED™ (Leadership in Energy and Environmental Design) from the U.S. Green Building Council.

A commissioning agent or authority may be hired by the owner as an autonomous agent working alongside the designers and contractors, or commissioning may be contracted as an additional service from a design-build or construction management provider. Regardless of the specific contractual arrangements, provisions must be made with other participants in the design and construction process to facilitate their cooperation with the commissioning process. A-E firms and contractors must be paid for their time and effort to produce timely and complete documentation and to resolve any concerns that are raised during the commissioning process. Ideally, these arrangements should be spelled out before the design phase begins, so that the lines of communication are clear.

### COSTS OF COMMISSIONING, NEW CONSTRUCTION

Commissioning Scope	Cost
All Mechanical and Electrical Building Systems	0.5–1.5% of total construction cost
HVAC and Automated Control Systems	1.5–2.5% of mechanical system cost
Electrical Systems Commissioning	1.0–1.5% of electrical system cost
Energy-Efficiency Measures	\$0.23–0.28/ft <sup>2</sup> (\$2.48–\$3.01/m <sup>2</sup> )
Source: Portland Energy Conservation Inc., as published in <i>Building Commissioning Guide</i> version 2.2 from the U.S. General Services Administration and the U.S. Department of Energy, July 30, 1998.	



Source: Portland Energy Conservation, Inc.

*During the commissioning of a new facility, the agents discovered that this outdoor photocell controlling the exterior and parking lot lighting had been sprayed with paint and did not function properly.*

Conventional testing, adjusting, and balancing (TAB) that is typically performed on newly installed HVAC systems is not a substitute for comprehensive commissioning. TAB merely checks and adjusts flows under standard conditions; it does not thoroughly test the systems under all projected operating conditions, nor does it check that the systems as designed and installed will satisfy the owner's requirements for the space.

Sophisticated computer modeling is increasingly able to describe the conditions that equipment and systems *should* be creating, which then simplifies on-site verification efforts. One such tool, the Information Monitoring and Diagnostic System, is currently being tested by researchers at Lawrence Berkeley National Laboratory.



**The economics of commissioning are very favorable. In an existing facility, commissioning and then resolving problems usually has a simple payback of a year or less in energy savings alone. In new construction, commissioning helps bring projects in on schedule and within budget without sacrificing quality or performance. The earlier commissioning begins (in the design and construction process), the greater the benefits tend to be. Commissioning can also save money by avoiding unnecessary redesigns, contractor requests-for-information, and contractor callbacks.**

Building on the success and insights of commissioning during design and construction, the practices of *continuous building commissioning* and *recommissioning* are gaining popularity. Continuous commissioning involves ongoing monitoring and testing of systems as part of a regular maintenance plan to ensure optimum performance and enhance longevity. Recommissioning is a less regular examination of building operations that is similar to the initial commissioning that follows building completion. Both procedures are attempts to keep buildings operating as they were designed.



**When commissioning an existing facility or a new facility after construction, people responsible for O&M should be included in the process. In existing facilities, they may have knowledge about undocumented problems and modifications. In both existing and new facilities, testing the systems through all conditions and performance parameters is an excellent training opportunity for O&M staff. If staff are unavailable or frequent turnover is likely, key aspects of the commissioning process should be captured on videotape as a training resource.**

## References

Heinz, John, P.E., *Building Commissioning Handbook*, APPA Publications, Alexandria, VA, 1996; (703) 549-2772.

Odom, J. David, and George DuBose, *Commissioning Buildings in Hot, Humid Climates*, September 1999, CH2M-HILL, Inc., Orlando, FL; (407) 423-0030.

DOE FEMP/GSA Building Commissioning Guidelines; [www.eren.doe.gov/femp/techassist/bldguide.pdf](http://www.eren.doe.gov/femp/techassist/bldguide.pdf).

## Contacts

Building Commissioning Association, P.O. Box 158, La Conner, WA 98257; (360) 466-5611; [www.bxca.org](http://www.bxca.org).

Florida Design Initiative, Total Building Commissioning Web site: [sustainable.state.fl.us/fdi/edesign/resource/totalbcx/index.html](http://sustainable.state.fl.us/fdi/edesign/resource/totalbcx/index.html).

Portland Energy Conservation, Inc., 921 SW Washington, Suite 312, Portland, OR 97205; (503) 248-4636; [www.peci.org](http://www.peci.org).



# Maintaining Healthy Indoor Environments

Perhaps there is no more visible and important issue facing facility managers today than that of indoor environmental quality. Employees who remain healthy will be more productive and lose fewer workdays to illness. Conversely, buildings that make employees sick may be very expensive—not only direct expenses to fix problems but also indirect expenses such as legal fees and payments to settle lawsuits. O&M procedures play a very important role in this—a healthy indoor environment cannot be sustained without careful attention to how the facility is operated and maintained, including routine cleaning procedures.

## Opportunities

Good O&M procedures are essential to creating and maintaining a healthy interior environment. Attention to O&M can actually reverse poor working conditions and greatly improve the workspaces of the Federal work force. Areas needing attention include indoor climate conditions, moisture control, HVAC system performance, lighting quality, acoustics, pest control, and cleaning procedures. Most changes in building management can be made at any time. A few changes, such as relamping and noise mitigation, are most easily accomplished during building renovation or reconfiguration of spaces.

## Technical Information

**What makes a healthy indoor environment?** Many factors keep the interiors of buildings healthy, including the following:

- Proper temperature control;
- Proper humidity control;
- Adequate removal of stale indoor air and introduction of fresh outside air (ventilation);
- Low VOC emissions within buildings;

- Control of what gets brought into buildings—from particulates tracked in on employees' shoes to pollen or vehicle exhaust entering through the ventilation system, to perfumes worn by employees;
- Avoidance of chemical-intensive pest control within buildings;
- Proper cleaning procedures, including the selection of cleaning chemicals and the performance of vacuum cleaners;
- Avoidance of mold- and mildew-producing conditions, which generally involve high humidity levels or water leaks; and
- Strict controls on smoking within or immediately outside buildings.

Note that nearly all of these conditions can be either maintained or reversed through O&M procedures.

**HVAC and indoor environmental health** are tightly interconnected. Proper maintenance will ensure that HVAC systems continue to function over their operational lives as intended by the designer. Controls, including dampers and their pneumatic or electric motors, must be checked periodically to ensure their proper operation. Filters have to be serviced or replaced at regular intervals. Flow rates of chilled water, hot water, cooling-tower water, and other fluids have to be monitored to maintain their design values.

**Volatile organic compounds** are usually the most significant chemical source of IAQ problems. When operating and maintaining buildings, all materials used in maintenance should be scrutinized for their emissions. Sources of high-VOC emissions include cleaning solvents, floor waxes and finishes, carpet shampoos, paints, and varnishes. As noted in the *Materials Selection Issues* and *Indoor Air Quality* sections of this guide, more and more zero-VOC or low-VOC products are becoming available all the time, and many are specifically marketed for their IAQ benefits.

**Biological contaminants and bioaerosols** emitted from some organisms can sometimes be the greatest IAQ problem in buildings—and are among the most difficult to control. These biological contaminants include molds and mildews, bacteria, dust mites, insects,

and rodents. Avoiding conditions conducive to the growth of these organisms should be a high priority. Most important in this regard is the control of moisture. Any leaks in plumbing or the weathertight envelope should be promptly fixed. Glazings and other building components that permit condensation on interior surfaces should be replaced or retrofit with more energy-conserving products. The seepage or wicking of moisture from the ground or from surface drainage should be stopped by changing drainage patterns around buildings or modifying basement floor and wall systems. Indoor relative humidity levels should be maintained below 50%—and in some regions, even lower.

**A well-designed track-off system** should be provided at all building entrances. Tracked-in particulates, heavy metals, mold spores, pesticides, and other chemicals can be significant sources of IAQ problems, and they can be relatively easily controlled with a three-level track-off system that provides coarser-to-finer particulate removal as people enter the building. Ideally at least 15 feet (4.6 m) of track-off system should be provided.

**Cleaning procedures** can have significant impacts on indoor environmental health. First, lack of cleaning allows the buildup of dirt and dust, which can become airborne for a variety of reasons—not the least of which is the movement of people through the building. Second, attention should be given to the types of cleaners being used, including disinfectants, waxes, polishes, and cleaning solutions; some of these merely contribute unpleasant odors, while others emit compounds that can make people feel sick. Third, vacuum cleaners should adequately contain fine particulates—HEPA filtration is most effective (or central vacuum systems that vent to the outdoors). Fourth, provide ongoing training and education for maintenance and custodial staff on product evaluation and practices to maintain good indoor environmental quality.

**Pest control** is a very important issue in many parts of the country and one that can have significant impacts on indoor environmental quality. Avoid plantings right against buildings, contain food to designated areas with resilient or hard-surface flooring that can easily be cleaned, avoid moisture problems (see above), and practice integrated pest management when pest problems do arise.

**Other considerations for healthy indoor environments include** the quality of lighting in buildings, connections to the outdoors, and the control of distracting noises.

**The General Services Administration maintains an active program to reduce toxic chemical use** in Federal buildings—both to avoid indoor environmental quality problems and to minimize environmental releases and off-site transfers of toxic chemicals. GSA's New Item Program promotes pollution prevention technologies and environmentally beneficial products and services, including cleaning products.

## References

*GreenSpec: The Environmental Building News Product Directory and Guideline Specifications*, Building-Green, Inc., Brattleboro, VT, 1999; (800) 861-0954; [www.greenspec.com](http://www.greenspec.com).

*IEQ Strategies*, monthly newsletter, Cutter Information Corp., Arlington, MA; (800) 888-1816; [www.cutter.com/energy/](http://www.cutter.com/energy/).

Bazerghi, H., and C. Arnoult, *Practical Maintenance for Good Indoor Air Quality*, Association Quebecoise pour la Maitrise de l'Energie, 1989.

Olkowski, William, Sheila Daar, and Helga Olkowski, *Common-Sense Pest Control*, Taunton Press, Newtown, CT, 1991.

*Environmental Products Guide* (RCPG-0001). Catalog of environmentally oriented products (paper, paints, cleaning products, etc.) available through the GSA Federal Supply Service system; (817) 334-5215, (817) 334-5227 (fax); [www.gsa.gov](http://www.gsa.gov).

Although many buildings occupied by the Federal workforce are leased, greening actions can be taken during the development and negotiation of the lease as well as after it is signed. These actions can affect the build-out/fit-out and furnishing of the leased space as well as O&M procedures after occupancy. It is best to introduce green concepts during the earliest stages of building selection and lease negotiation. The range of actions that can be taken by facility managers may be limited by lease agreements; however, even with these constraints, many O&M procedures can be implemented to improve the environmental performance of these buildings. The O&M issues with leased buildings are virtually identical to those of owned buildings.

## Opportunities

Many of the opportunities outlined in other sections of this guide should be considered for leased buildings. For example, before leasing a building, an agency can conduct a detailed survey of all energy and environmental issues to select a building that is—or can become—a high-performance building, and to identify strategies for greening the facility. A green team should be formed to participate in the lease negotiations to ensure that appropriate strategies are incorporated. Before occupancy, the team or a commissioning agent should ensure that the systems operate as specified.

## Technical Information

**Model lease provisions:** Executive Order 13123 (June 3, 1999) calls for agencies entering into leases, including the renegotiation or extension of existing leases, to incorporate lease provisions that encourage energy and water efficiency wherever life-cycle cost-effective. Build-to-suit lease solicitations shall contain criteria encouraging sustainable design and development, energy efficiency, and verification of building performance. Agencies shall include a preference for buildings having the ENERGY STAR® building label in their selection criteria for acquiring leased buildings. In addition, all agencies shall encourage lessors to apply for the ENERGY STAR building label and to explore and implement projects that would reduce costs to the

Federal Government, including projects carried out through the lessors' Energy Savings Performance Contracts or utility energy-efficiency service contracts.

**Financing mechanisms:** Executive Order 13123 also charges that agencies shall maximize their use of available alternative financing contracting mechanisms, including Energy Savings Performance Contracts and utility energy-efficiency service contracts, when life-cycle cost-effective, to reduce energy use and cost in their facilities and operations. Energy Savings Performance Contracts, which are authorized under the National Energy Conservation Policy Act, as modified by the Energy Policy Act of 1992, and utility energy-efficiency service contracts provide significant opportunities for making Federal facilities more energy-efficient at no net cost to taxpayers.

Agency managers should work with their procurement officials to identify and eliminate internal regulations, procedures, and other barriers to implementation of this order.

### LEASED BUILDING ISSUES

**Indoor air quality:** One of the greatest contributors to poor indoor environmental quality and poor health is an improperly designed, sized, installed, and maintained HVAC system. Along with addressing equipment selection when that is an option, the facility manager should address HVAC maintenance: filter changing, control system inspection, air/water system balancing, etc. Interior finishes can also cause air quality problems. With leased space, look for low-emission materials, especially paints, wall coverings, carpets and carpet padding, adhesives, sealants, varnishes, particle-board, and furnishings. Require low-VOC materials in the lease terms; most are cost-competitive with traditional materials. Other requirements can include staging the construction so that VOC-emitting materials are applied before materials that act as "sinks" (such as carpet) are installed; flush-out of the space before occupancy; and thorough cleaning of ductwork that might have become contaminated during construction. The facility manager should monitor and verify that the building air quality complies with all regulatory and contractual requirements.

**Energy consumption:** Depending on the lease provisions, energy consumption of the building can vary greatly. An agency leasing an entire building may be

in a position to require substantial upgrades, including modifications to the HVAC system, addition of an energy management system, installation of improved T-8 fluorescent lighting, and so forth—all of which can dramatically affect operational costs. With energy upgrades, care should be taken to ensure that all the ramifications of system changes are considered and the potential benefits realized. For example, extensive lighting retrofits or glazing replacements can significantly reduce HVAC loads, enabling chillers to be downsized. Even when total energy use is not reduced, changes in electric demand profiles can result in significant dollar savings, depending on utility pricing.

**Water use:** Older leased buildings probably have old plumbing fixtures that use considerably more water than today's standards. During renovations of restrooms, replace fixtures (or valves) with low-flow products—when upgrading faucets and urinals, products can be installed that significantly exceed water conservation standards (see *Sections 6.2* and *6.3*). Ensuring that malfunctioning and leaking fixtures are quickly repaired can greatly reduce water consumption. A Water Management Plan, as described in *Section 6.1*, can be the basis for such improvements.

**Materials:** In addition to specifying low-VOC finishes, requirements can include salvage or recycling of materials being removed during renovation; *reuse* of certain existing materials (such as ceiling grid systems, doors, and wood flooring.); installation of materials with high recycled content (such as carpet and insulation); the use of natural and biobased products (such as natural-fiber upholstery and straw particleboard); and the use of only *certified* wood products when wood is specified.

**Recycling programs:** Reducing the environmental impacts of Federal buildings, whether leased or owned, can be helped greatly by controlling the generation of waste. Paper waste accounts for the greatest quantity of solid waste generated. The implementation of recycling programs is fairly straightforward, though facility managers need to ensure that programs are being successfully carried out and that materials collected for recycling are actually being recycled.

**Transportation:** Access to public transportation should be considered when selecting a building. Reducing the need for employees to use private automobiles can significantly improve the overall greenness of a facility.

In negotiating parking spaces in the lease, preferred parking for carpools can be included as well as secure bicycle storage. Consider offering employee incentives to encourage commuting by other than private automobiles—and reduce the amount of parking required.

## BEFORE LEASING A BUILDING . . .

Planet GSA is a site dedicated to greening Federal facilities and operations. Review information provided there and contact the GSA to help specify the full set of energy, water, HVAC, and other requirements for the leased space. In addition, review case studies of other public buildings that have negotiated greener leases, such as the Pennsylvania Department of Environmental Protection and the U.S. Environmental Protection Agency.

It is becoming increasingly feasible to require green elements in leases of public buildings. The U.S. Green Building Council is developing a LEED rating system for Commercial Interiors and Renovations that will be helpful in guiding negotiations and design. A&E firms designing the build-out or fit-out of Federal facilities should have experience and expertise in *integrated design* so that they can bring this capability to bear.

## References

*Energy Efficient Leased-Space Toolbook*, Federal Energy Management Program, U.S. Department of Energy, Washington, DC. Available from the FEMP Help Desk at (800) DOE-EREC.

The Department of Environmental Protection, Commonwealth of Pennsylvania, offers a free video on the design and construction of “Pennsylvania’s first green building”; P.O. Box 2063, Harrisburg, PA 17105; (717) 787-4190; [www.dep.state.pa.us](http://www.dep.state.pa.us). Two informative handbooks—*Guidelines for High-Performance Green Buildings* and *Model Green Office Leasing Specifications*—can be downloaded from the Governor’s Green Government Council Web site at [www.gggc.state.pa.us/publicn/default.htm](http://www.gggc.state.pa.us/publicn/default.htm).

Planet GSA, General Services Administration; [hydra.gsa.gov/planetgsa/](http://hydra.gsa.gov/planetgsa/).

# Measuring and Monitoring Benefits

When an organization makes a commitment giving higher priority to reducing energy costs and protecting the environment, it is important to measure the results of these efforts. Senior managers need this information to justify budgets for capital improvements to produce long-term benefits and to determine the benefits received from these investments. These measurements can provide feedback on whether investments are producing the anticipated benefits. If they are not, monitoring may identify reasons for the shortfalls and help facility managers improve performance with other projects.

Some of these measurements are relatively easy to quantify. For example, energy and water quantities and associated costs are provided monthly to the facility manager, and the cost-benefit of some energy and water reduction measures can be readily determined from those bills. Levels of specific indoor air pollutants can be measured, but the cost-benefit determination is less straightforward. Many issues are not so readily quantified—for example: durability, maintenance, drought-tolerant landscaping, and indoor environmental quality. For projects financed by Energy Savings Performance Contracts, or ESPCs, an annual verification of cost savings is required by statute. Instrumentation and measurements play a role throughout the process, from measuring baseline energy use, to commissioning new systems, to optimizing long-term performance and serving as the basis of performance metrics and contractor payments.

## Technical Information

The *FEMP Measurement and Verification (M&V) Guidelines* provide methods for quantifying the savings resulting from the installation of energy conservation measures. The *M&V Guide* helps to verify energy savings at minimum cost, and it is intended to be used with ESPCs and utility program projects discussed in *Section 2.3 – Green Procurement* and *2.4 – Alternative Financing*. The *M&V Guide* was developed by FEMP in parallel with the North American Energy

Monitoring and Verification Protocol (NEMVP), ensuring consistency for companies doing business with both the public and the private sectors. More recently, both efforts have resulted in the publishing of the International Performance Measurement and Verification Protocol (IPMVP).

The IPMVP provides a wide range of M&V alternatives, including stipulation based on engineering calculations, metering, and using the results of a short-term test to calibrate computer models. In general, more detailed and labor-intensive efforts yield more information, but the value of the information must be weighed against the cost of the M&V program. Simple, low-cost measurements are often adequate and cost-effective. Energy management system tracking features are an effective way to collect consumption and demand information. Factors affecting the costs of measurement and verification include these:

- The number of energy measures implemented;
- The size and complexity of energy conservation measures;
- The interactions between energy conservation measures; and
- The issue of how risk is allocated between the owner and the contractor in a performance contract.

The appropriate M&V strategy can be determined by assessing the project's complexity and the way risk is allocated between an energy service company and its customer. Risk allocation refers to whether the contractor (a) is responsible only for equipment performance (efficiency), or (b) also bears some risk related to operational factors, such as uncertainty in the load. In an ESPC, the M&V program would evaluate all measures of performance in the contract. For example, a lighting contract might include measurements of both electric power consumption and lighting levels.

**Electrical energy:** Determining electrical energy consumption is relatively straightforward, and an ordinary electrical meter is adequate for simple daily, weekly, or other longer electrical energy determinations. If consumption versus time is required, either the manual method of taking frequent meter readings or automated data collection is necessary. For the collection of time-based information, split-core current transducers and power transducers can be installed without disconnecting power. Data loggers can be used to collect data, which can then be downloaded as needed.



Photo: Warren Gretz

*Careful monitoring of building performance is a key component of effective energy management for any facility.*

**Electrical demand:** Time-based information is essential if electrical demand is to be determined. For this purpose, it is essential to have the appropriate software to determine the “peak” value. The peak can be a time-averaged value over a sliding 15- or 30-minute time frame in which single or multiple spikes are not indicative of the peak as measured by the local utility. Others simply measure the highest demand in a month and base demand charges on that value.

**Chilled water and hot water:** Btu meters can be installed to determine the energy consumption of HVAC equipment lines: chilled water, hot water, and steam. Simple, reasonably accurate meters can be installed “hot,” that is, without needing to turn off the system.

**Indoor environmental quality (IEQ):** Measuring the benefits of IEQ is difficult but not impossible. IEQ is an aggregate of the environment created by air quality, light, noise, temperature, and humidity conditions. Indoor air quality has received the most attention recently, but the other factors are also important contributors to the sense of well-being of facility occupants. There are methods and instrumentation for measuring pollution levels (including carbon dioxide, carbon monoxide, volatile organics, ozone, particulates, and other air emissions), light levels, noise levels, and indices of comfort, such as mean radiant temperature. Employees can be surveyed to determine their reactions to their indoor environment and their perceptions of its effects on their performance and sense of satisfaction.

It is also important to assess objectively the impacts on employees’ performance of measures designed to improve IEQ. Although these measures are more indirect,

some of the statistics that may be examined include absenteeism, sick days, and drops in productivity. To make sense of this information, the data must be collected for a significant period of time—both before and after the changes. The Rocky Mountain Institute and Pacific Gas and Electric have conducted several studies linking improvements in IEQ to improvements in productivity. In most Federal facilities, the cost-per-square-foot of the workforce is 20 times greater than the cost-per-square-foot of the building. This huge difference readily demonstrates that investments in IEQ that improve productivity are likely to be rapidly recovered. *Section 8.4 – Productivity in the Workplace* provides more information on this topic.

## References

Romm, Joseph J., *Lean and Clean Management: How to Boost Profit and Productivity by Reducing Pollution*, Kodansha America Press, New York, NY, 1994.

Fryer, Lynn, “Tapping the Value of Energy Use Data: New Tools and Techniques,” E Source Strategic Memo, E Source, Inc., Boulder, CO, March 1996; [www.esource.com](http://www.esource.com).

The FEMP *M&V Guide* and the NEMVP are available through the FEMP Help Desk, (800) DOE-EREC (363-3732), or on the FEMP Web site: [www.eren.doe.gov/femp/](http://www.eren.doe.gov/femp/).

## Contacts

For additional information on the Federal *M&V Guide*, call the FEMP Help Desk, (800) DOE-EREC (363-3732), and see [www.eren.doe.gov/femp/](http://www.eren.doe.gov/femp/).

To download the *M&V Guide*, visit the Lawrence Berkeley National Laboratory (LBNL) Web site at [www.lbl.gov](http://www.lbl.gov).

To reduce the negative environmental impacts of Federal facilities, we must change the various standards, operational procedures, and other documents that define how these facilities are designed and managed. To ensure that these modified standards are followed, a comprehensive training program to disseminate and explain them must be implemented. The contents of this guide can be used as material for this training and can be supplemented with a wide range of government, private-sector, and academic information resources concerning environmental issues as they relate to the design and maintenance of the built environment.

## Setting Standards

Leadership by example is imperative to inspire the deep changes required to shift to low consumption and efficient utilization of resources, low waste, and the creation of healthy interior environments. The organizational culture must be transformed to one that has fully internalized the benefits of this shift. A change of this magnitude demands firm commitment and leadership from senior management; consequently, it is imperative that management be educated and informed, permitting a top-down change in culture.

Facility managers and others are required to follow a wide array of standards and mandatory regulations from various authorities. There are also a number of suggested green standards and rating systems. It is often difficult to grasp the wide range of requirements and potential solutions available. Even more critical and difficult are the financial issues associated with change. Only an integrated design team—facility managers, planners, architects, engineers, and others—can collectively create an overall blueprint and critical path for an effective, resource-efficient organization. Appropriate standards must be set that not only meet and integrate the requirements of existing standards but

also “raise the bar” still higher whenever possible. In addition, “champions” must be identified within the team that will be responsible for specific goals and objectives. In order to meet and maintain the standards set, a continual and consistent feedback loop of priorities, evaluation, and course corrections is needed from this integrated design team.

*Section 1.3* of this guide outlines the major Federal laws and Executive Orders that require the reduction of environmental impacts by Federal facilities. These should be of prime importance when writing standards for facilities. Coordinating Federal laws and Executive Orders with assessment tools and green building rating systems would be extremely informative and useful. Facility managers should also be aware of the voluntary LEED™ (Leadership in Energy and Environmental Design) Building Rating System developed by the U.S. Green Building Council. A number of Federal agencies, including the Navy, are adopting LEED as a target for environmental performance of new and renovated facilities. Through the LEED program, commercial buildings receive points for various energy and environmental features—ranging from energy performance and water efficiency to the control of light pollution, protection of local ecosystems, and use of certified well-managed wood.

## Training

High-quality training programs are key to changing the behavior of the wide range of people involved in the design and management of Federal facilities. The training must be interesting, fun, relevant, up-to-date, and tailored to the specific audience. It should be action-oriented and hands-on whenever possible. The participants should be from diverse disciplines, and the training should emphasize integrated design and an integrated team approach. If the training is successful, participants will take the information and put it into action—incorporating sustainable design concepts into everyday choices.

As is the case with many other issues, the quality and quantity of the training provided often depends on funds. In any organization’s budgeting process, setting aside resources for education and training is essential, because the success of the organization depends on its employees having the most up-to-date information regarding their particular work, trade, or discipline. It pays to find the best delivery system possible,

whether it be from the government, private organizations specializing in training, industry, universities, or professional associations.

For training to be effective it must have the backing of top management, it must be delivered periodically to continually reinforce high-priority ideas, and it must always be relevant. The best trainers are not only highly knowledgeable but also creative and imaginative. Expert trainers maintain high interest levels, and their information is more likely to be retained. Here are several key components for effective sustainable design training:

**Videotapes** make training more interesting and varied at minimal cost. The American Institute of Architects offers videotapes on specific topics, such as energy, site planning, and materials. Videotapes that give an overview of sustainable design, such as “Greening the Red, White, and Blue” from the Department of Defense, are highly effective, not only for training but also for management briefings.

**Endorsement statements** on sustainable design by high-ranking officials are effective and inspiring. These statements can either be part of videotapes shown to participants or statements given in the training introductions.

**Case studies** are valuable training aids. A combination of diverse, in-depth case studies that encompass a wide variety of specific concepts show how these concepts can be implemented in real-world situations.

**Process issues:** Current design and development processes of Federal facilities should be reviewed in an attempt to locate opportunities and obstacles related to sustainable design. Ways to implement an integrated team approach should also be sought. Establishing a clear process outline during training, noting “points of opportunity and obstacles,” will allow participants to create realistic plans of action for sustainable design.

**Hands-on exercises** focusing on realistic situations provide participants with practical experience that can easily be implemented back at their offices.

**Resources and tools:** Introducing Web sites, magazines, books, journals, technical publications, and CD-ROMs during training can provide useful follow-up information for further study. In addition, providing information about green building rating systems and assessment tools such as LEED is extremely important.

## References

*Introduction to Federal Energy Management* (CD-ROM), Federal Energy Management Program, U.S. Department of Energy, 1997 (CD-ROM of FEMP case studies also available).

Department of Defense Sustainable Training Regime, a two-and-a-half-day course with workbook and video; (757) 322-4200.

“Greening the Red, White, and Blue” video and Training Program for DOD; [www.defenselink.mil/](http://www.defenselink.mil/).

*Building Connections* Video Teleconference Series (four topics: Energy, Materials, Sustainable Communities, and Case Studies). Available from The American Institute of Architects, Washington, DC; (888) 272-4115; [www.e-architect.com/pia/pubs/cote.asp](http://www.e-architect.com/pia/pubs/cote.asp).

“The Story of Pennsylvania’s First Green Building: DEP South Central Office Building”, video, 1999. Available free from the Pennsylvania Department of Environmental Protection, P.O. Box 2063, Harrisburg, PA 17105; (717) 787-4190; [www.dep.state.pa.us](http://www.dep.state.pa.us).

## Contacts

Copies of the *FEMP Training Catalog* are available from the Help Desk, (800) DOE-EREC (363-3732); various training resources, including a schedule of upcoming FEMP courses, are available online at [www.eren.doe.gov/femp/resources/training/femptraining.html](http://www.eren.doe.gov/femp/resources/training/femptraining.html).

FEMP’s Training Course Locator System, (202) 586-5772, provides information about training offered by other government agencies, universities, and private-sector organizations.

U.S. Green Building Council, 1015 18th Street, NW, Suite 805, Washington, DC 20036; (202) 828-7422; [www.usgbc.org](http://www.usgbc.org).



Incentive programs are an excellent way to produce change in an organization, increase enthusiasm, and obtain buy-in concerning green ideas and practices. Rewarding with tangible benefits those who take the time and effort to put forward good ideas not only encourages the continuation of this behavior but also helps motivate others to perform in a similar fashion. The Federal government has a long and successful history of incentive programs aimed to motivate its workforce to save money. More recent versions provide financial incentives for suggestions that could lead to cost savings due to reductions in water, energy, and resource consumption. A sophisticated incentive program can dramatically help reduce the environmental impacts of a facility.

## Opportunities

When trying to implement a broad range of environmental actions to “green” facilities and operations, the integrated design team can use incentive programs to motivate and inspire in order to achieve high levels of success in greening efforts. Incentives other than simple monetary rewards (such as using cost savings to further other quality-of-life aspects) should be considered.

## Technical Information

The integrated design team members should become aware of existing incentive programs created by utility companies and others. Green building rating programs can be used as incentives by providing recognition for the environmental performance of a facility. These programs can be folded into a site-specific plan created by the design team. Here are several key incentives for the integrated design team to consider:

---

*The Bachelor Enlisted Quarters at the Great Lakes Naval Training Center in Illinois was one of the first LEED-rated building projects. Notable green features include energy-efficient design, recycled-content and indigenous materials, increased glazing for daylight, and commissioning of the facility.*

---

**Utility incentive programs** include rebates, customized services, bidding programs, and other offerings. In utility incentive bidding programs, tenants, owners, utilities, and energy service companies work together as a team to create energy-efficient systems.

Group incentive programs can be just as important as individual incentive programs. For example, in DOD, groups can use up to 40% of the savings from their energy conservation efforts for quality-of-life improvements at military bases and other facilities.

The Energy Policy Act of 1992 offers Federal agencies the opportunity to participate in any and all electric and gas utility incentive programs that the utilities offer to their non-Federal customers.

**Contract incentives:** To encourage environmental initiatives in such areas as environmentally preferable purchasing, contract language can be written that provides financial incentives to contractors for improved environmental material selection and product procurement, as the Pentagon parking lot project demonstrates.

**Green building rating system incentives:** Rating systems such as LEED™ recognize high-performance buildings by awarding points and “levels” (certified, silver, gold, and platinum) for green design initiatives. Used as an incentive program, the rating system assists the design team in setting green priorities in order to receive recognition and added value.

**Annual awards programs** that recognize outstanding achievements in sustainable design have been established by DOE FEMP, DOD, AIA, and others. These awards can act as incentives to the integrated design team, inspiring and motivating their actions and choices.



Photo: Wight & Company

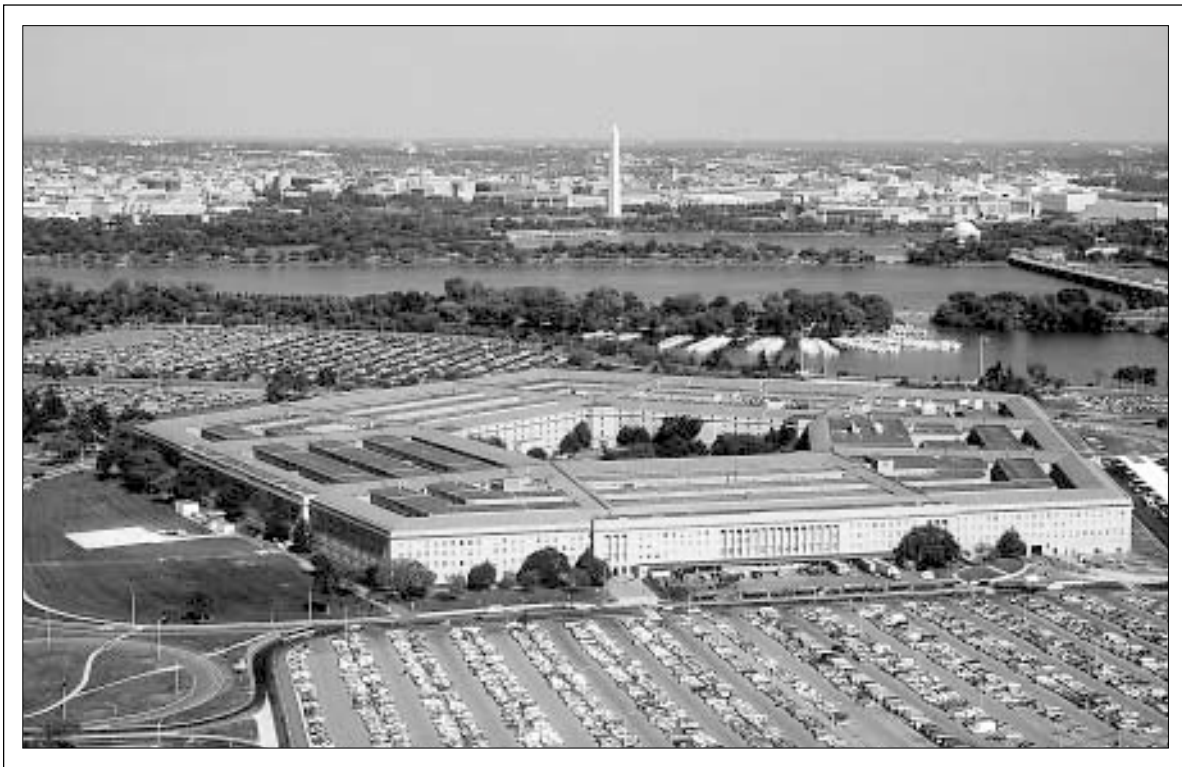

Photo: Master Sgt. Ken Hammond, U.S. Air Force

*At the Pentagon, more convenient parking is designated for carpools—one of many innovative ideas implemented there.*

The annual Federal Energy and Water Management Awards are presented by DOE in conjunction with the Federal Interagency Energy Policy Committee (the “656” Committee). The program recognizes outstanding achievements in the efficient use of water and energy, the use of renewable energy sources, and cost-beneficial landscaping practices by the Federal government. Renewable measures include, but are not limited to, photovoltaics, solar thermal systems, passive solar design, biomass energy, wind systems, geothermal heat pumps, and low-head hydro dams. FEMP coordinates this program for the Federal government. The American Institute of Architects recognizes the “Top Ten” sustainable design projects in the United States, annually on Earth Day, while DOD has an Energy and Environment Awards Program for military bases.

**Employee suggestions:** The standard Federal suggestion program is an excellent vehicle for garnering input from employees regarding the greening of facility operations. This program could be enhanced by linking suggestions or the implementation of suggestions with tangible incentives for employees. To broaden participation, it should be promoted in newsletters, classes,

and training sessions—especially those addressing energy and environmental problems.

## References

*Paving the Road to Success* (EPA 742-R-97-007); *Defending the Environment at the Department of Defense: Using Environmentally Preferable Purchasing Procedures to Maintain the Pentagon and Other DOD Facilities* (EPA742-R-99-002). Copies of these and other EPP case studies and guidance can be ordered from the Pollution Prevention Information Clearing House (PPIC); (202) 260-1023; [www.epa.gov/opptintr/epp/](http://www.epa.gov/opptintr/epp/).

## Contacts

For information on the FEMP Awards Program, call the FEMP Help Desk at (800) DOE-EREC (363-3732).

U.S. Green Building Council, 1015 18th Street, NW, Suite 805, Washington, DC 20036; (202) 828-7422; [www.usgbc.org](http://www.usgbc.org).

