

UNIFIED FACILITIES CRITERIA (UFC)

O&M MANUAL: STANDARD PRACTICE FOR FLEXIBLE PAVEMENTS



UNIFIED FACILITIES CRITERIA (UFC)

O&M MANUAL: STANDARD PRACTICE FOR FLEXIBLE PAVEMENTS

Any copyrighted material included in this UFC is identified at its point of use. Use of the copyrighted material apart from this UFC must have the permission of the copyright holder.

Use of the name or mark of any specific manufacturer, commercial product, commodity, or service in this UFC does not imply endorsement by the Department of Defense.

U.S. ARMY CORPS OF ENGINEERS (Preparing Activity)

NAVAL FACILITIES ENGINEERING COMMAND

AIR FORCE CIVIL ENGINEER CENTER

Record of Changes (changes are indicated by \1\ ... /1/)

Change No.	Date	Location

This UFC supersedes UFC 3-250-03, dated 15 May 2001, Air Force ETL 01-7, dated 5 June 2017, and Air Force ETL 01-9, dated 17 July 2001.

FOREWORD

The Unified Facilities Criteria (UFC) system is prescribed by MIL-STD 3007 and provides planning, design, construction, sustainment, restoration, and modernization criteria, and applies to the Military Departments, the Defense Agencies, and the DoD Field Activities in accordance with [USD\(AT&L\) Memorandum](#) dated 29 May 2002. UFC is used for all DoD projects and work for other customers where appropriate. All construction outside of the United States is also governed by Status of Forces Agreements (SOFA), Host Nation Funded Construction Agreements (HNFA), and in some instances, Bilateral Infrastructure Agreements (BIA). Therefore, the acquisition team must ensure compliance with the more stringent of the UFC, the SOFA, the HNFA, and the BIA, as applicable.

UFC are living documents and is periodically reviewed, updated, and made available to users as part of the Services' responsibility for providing technical criteria for military construction. Headquarters, U.S. Army Corps of Engineers (HQUSACE), Naval Facilities Engineering Command (NAVFAC), and Air Force Civil Engineer Center (AFCEC) are responsible for administration of the UFC system. Defense agencies should contact the preparing service for document interpretation and improvements. Technical content of UFC is the responsibility of the cognizant DoD working group. Recommended changes with supporting rationale should be sent to the respective service proponent office by the following electronic form: [Criteria Change Request \(CCR\)](#). The form is also accessible from the Internet sites listed below.

UFC are effective upon issuance and are distributed only in electronic media from the following source:

- Whole Building Design Guide web site <http://dod.wbdg.org/>.

Refer to UFC 1-200-01, *DoD Building Code (General Building Requirements)*, for implementation of new issuances on projects.

AUTHORIZED BY:



LARRY D. McCALLISTER, PhD, PE,
PMP, SES
Chief, Engineering and Construction
Directorate of Civil Works
U.S. Army Corps of Engineers



JOSEPH E. GOTT, P.E.
Chief Engineer
Naval Facilities Engineering Command



EDWIN H. OSHIBA, SES, DAF
Director
Air Force Civil Engineer Center



MICHAEL McANDREW
Deputy Assistant Secretary of Defense
(Facilities Investment and Management)
Office of the Assistant Secretary of Defense
(Energy, Installations, and Environment)

UNIFIED FACILITIES CRITERIA (UFC)
REVISION SUMMARY SHEET

Document: UFC 3-250-03, *O&M Manual: Standard Practice For Flexible Pavements*

Superseding: UFC 3-250-03, *Standard Practice Manual for Flexible Pavements*, 15 May 2001; AF ETL 01-7, *Large Aggregate Asphalt Mixtures*, 5 Jun 2017; and AF ETL 01-9, *Procedures to Retard Reflective Cracking*, 17 Jun 2001.

Description: This UFC provides guidance for the preparation of drawings and specifications for road and airfield flexible pavements using asphalt cement materials. It also provides useful information for design engineers, laboratory personnel, and project managers concerning mix design, materials, production, and placement of the various asphalt mixtures.

Reasons for Document: This UFC provides engineers with current changes in technology to outline materials, equipment, techniques, and cautions required to produce a cost-effective and durable flexible asphalt pavement. Additionally, a number of editorial changes were needed to improve readability. Figures and tables were also improved.

Impact: Cost impact is negligible; improved guidance results in improved performance and reduced life cycle cost.

Unification Issues: None

TABLE OF CONTENTS

CHAPTER 1 INTRODUCTION	1
1-1 PURPOSE.....	1
1-2 SCOPE.....	1
1-3 REFERENCES.....	1
1-4 UNITS OF MEASURE.....	1
1-5 SPECIAL TERMS.....	1
1-6 BACKGROUND.....	1
1-7 SAFETY CONSIDERATIONS.....	2
CHAPTER 2 HOT-MIX ASPHALT.....	3
2-1 INTRODUCTION.....	3
2-1.1 Advantages.....	3
2-1.2 Gradations and Layer Thickness.....	3
2-1.3 Uses.....	5
2-2 EQUIPMENT.....	5
2-2.1 Plant Equipment.....	5
2-2.1.1 Batch Plant.....	6
2-2.1.2 Drum Mix Plant.....	8
2-2.1.3 Asphalt Mixture Storage Silo.....	10
2-2.2 Placement Equipment.....	10
2-2.2.1 Asphalt Spreader (Paver).....	10
2-2.2.2 Material Transfer Vehicle.....	11
2-2.2.3 Joint Heaters.....	11
2-2.2.4 Asphalt Distributor.....	12
2-2.2.5 Rollers.....	12
2-3 MATERIALS.....	13
2-3.1 Asphalt Materials.....	13
2-3.1.2 Performance Graded (PG) Asphalt Cements.....	14
2-3.1.3 Classification Method for PG Graded Asphalt Cements.....	14
2-3.1.4 Asphalt Cement Selection by Temperature Region.....	16
2-3.2 Aggregates.....	20
2-3.2.1 Sieve Analysis.....	20
2-3.2.2 Specific Gravity.....	20
2-3.2.3 Abrasion and Impact Resistance of Coarse Aggregate.....	20
2-3.2.4 Soundness Test.....	20
2-3.2.5 Percent Crushed Pieces.....	20
2-3.2.6 Particle Shape.....	21
2-3.2.7 Clay Lumps and Friable Particles.....	21

2-3.2.8	Sand Equivalent.....	21
2-3.2.9	Natural Sand Content.....	21
2-3.2.10	Fine Aggregate Angularity.....	21
2-3.2.11	Voids in Mineral Aggregate (VMA).....	22
2-3.3	Mineral Fillers.....	22
2-3.3.1	Addition of Mineral Filler.....	22
2-3.4	Antistrip Agents.....	23
2-3.4.1	Recommended Antistrip Agent.....	23
2-3.5	Antifoam Agents.....	23
2-4	DENSE-GRADED HMA.....	24
2-4.1.1	Aggregate Considerations.....	24
2-4.2	Marshall Mix Design.....	24
2-4.2.1	Contractor-provided Job Mix Formula (JMF).....	24
2-4.2.2	Procedure.....	25
2-4.2.3	Preparation of Test Specimens.....	25
2-4.2.4	Asphalt Contents for Specimens.....	29
2-4.2.5	Selection of Design Compaction Method.....	29
2-4.2.6	Tabulation of Data.....	29
2-4.2.7	Relationship of Test Properties to Asphalt Cement Content.....	30
2-4.2.8	Requirement for Additional Test Specimens.....	36
2-4.2.9	Importance of Asphalt Content.....	38
2-4.2.10	Determination Optimum Asphalt Content & Acceptability of Mix...	38
2-4.2.11	Dust/Asphalt Ratio.....	38
2-4.2.12	Moisture Susceptibility.....	40
2-4.2.13	Superpave Mix Design.....	40
2-4.3	Mixture Control.....	41
2-4.3.1	JMF Production at Asphalt Plant.....	41
2-4.3.2	Asphalt Plant Laboratory Burden.....	41
2-4.3.3	Mix Adjustments.....	42
2-4.3.4	Production & Laydown Quality Control & Quality Assurance.....	42
2-4.4	Significance of Changes in Mixture Properties.....	46
2-4.4.1	Hot-bin Gradations.....	48
2-4.4.2	Construction Control.....	48
2-4.4.3	Pavement Sampling.....	48
2-4.4.4	Testing Pavement Samples.....	48
2-4.4.5	Density Data.....	49
2-4.4.6	Pavement Imperfections and Probable Causes.....	49
2-5	POROUS FRICTION COURSE.....	49

2-5.1	Materials.....	49
2-5.1.1	Aggregates.....	49
2-5.1.2	Asphalt Cement.....	51
2-5.2	Mixture Design.	51
2-5.2.1	Proportioning of Aggregates.	51
2-5.2.2	Fiber Stabilizers.	51
2-5.2.3	Asphalt Content.....	53
2-5.2.4	K _c Factor.....	53
2-5.2.5	Mixing Temperature.	54
2-5.3	Plant Control.....	54
2-5.3.1	Plant Laboratory.....	54
2-5.3.2	Sieve Analysis.....	54
2-5.3.3	Asphalt Content Tests.....	54
2-5.3.4	Mix Proportions.	54
2-5.3.5	Controlling Plant Production.....	55
2-5.4	Construction.	55
2-5.4.1	Pavement Control.	55
2-5.4.2	Pavement Sampling.....	55
2-5.4.3	Storage Silos.....	55
2-5.4.4	Pavement Operations under Normal Conditions.....	55
2-6	STONE MATRIX ASPHALT.....	55
2-6.1	Materials.....	56
2-6.1.1	Aggregates.....	56
2-6.1.2	Filler.	56
2-6.1.3	Stabilizer.	56
2-6.1.4	Asphalt.	58
2-6.2	Mixture Design.	58
2-6.2.1	SMA Draindown Test.	59
2-6.2.2	JMF Requirements.....	59
2-6.3	Mixing Plants.	60
2-6.3.1	Batch Plants.....	61
2-6.3.2	Drum-Mix Plants.....	61
2-6.3.3	Mixing Time.....	61
2-6.3.4	Storage.	61
2-6.4	Test Section.	61
2-6.5	Placement.	61
2-6.5.1	Equipment.....	61
2-6.5.2	Surface Preparation.....	62

2-6.5.3	Paving.....	62
2-6.5.4	Compaction.....	62
2-7	WARM-MIX ASPHALT.....	62
CHAPTER 3	SPRAY APPLICATIONS.....	65
3-1	INTRODUCTION.....	65
3-2	PRIME COAT.....	65
3-2.1	Materials.....	66
3-2.1.1	Asphalt.....	66
3-2.1.2	Prime Coats.....	66
3-2.2	Application Rate.....	67
3-2.3	Placement.....	68
3-2.4	Control.....	68
3-3	TACK COAT.....	68
3-3.1	Materials.....	68
3-3.2	Application Rate.....	69
3-3.3	Placement.....	69
3-3.4	Control.....	70
3-4	FOG SEALS.....	70
3-4.1	Materials.....	70
3-4.2	Application Rate.....	71
3-4.3	Placement.....	71
3-5	REJUVENATION.....	71
3-5.1	Testing.....	71
3-5.2	Materials.....	72
3-5.3	Application Rate.....	72
3-5.4	Placement.....	72
3-5.5	Control.....	73
3-5.6	Skid Resistance.....	73
CHAPTER 4	SEAL COATS.....	75
4-1	INTRODUCTION.....	75
4-2	SINGLE AND DOUBLE BITUMINOUS SURFACE TREATMENTS.....	75
4-2.1	Materials.....	75
4-2.1.1	Binder.....	75
4-2.1.2	Aggregates.....	77
4-2.2	Design.....	77
4-2.3	Construction.....	78
4-2.3.1	Equipment.....	79
4-2.3.2	Surface Preparation.....	79

4-2.3.3	Application.	79
4-2.3.4	Control.	79
4-3	SLURRY SEAL.	80
4-3.1	Equipment.	80
4-3.2	Material Requirements.	80
4-3.2.1	Emulsion.	80
4-3.2.2	Aggregate.	81
4-3.2.3	Mineral Filler.....	81
4-3.2.4	Water.	82
4-3.3	Design.	82
4-3.4	Factors Affecting Design.	82
4-3.5	Surface Preparation.....	83
4-3.6	Application.....	83
4-3.6.1	Joints.....	83
4-3.6.2	Hand Application.	84
4-3.7	Curing.....	84
4-3.8	Rolling.	84
4-4	FUEL-RESISTANT SEALER.	84
4-4.1	Areas of Application.....	84
4-4.2	Considerations for Use.....	84
4-4.3	Material Requirements.	85
4-4.3.1	Coal-tar Emulsion.....	85
4-4.3.2	Aggregates.....	85
4-4.3.3	Water.	85
4-4.3.4	Additives.	85
4-4.4	Design.	86
4-4.4.1	Application Rate.....	86
4-4.4.2	Requirements.....	86
4-4.5	Equipment.	87
4-4.6	Surface Preparation.....	87
4-4.7	Application.....	87
4-4.8	Curing.....	88
4-5	MICRO-SURFACING.	88
4-5.1	Equipment.	88
4-5.2	Material Requirements.	88
4-5.2.1	Emulsion.	88
4-5.2.2	Additives.	89
4-5.2.3	Aggregates.....	89

4-5.2.4	Water.	89
4-5.3	Design.	90
4-5.3.1	Mix Characteristics.	90
4-5.3.2	Determination of Optimum Asphalt Content.	92
4-5.4	Surface Preparation.	95
4-5.5	Application.	95
CHAPTER 5	ASPHALT STABILIZATION.	97
5-1	INTRODUCTION.	97
5-2	MATERIALS.	97
5-2.1	Soil/Aggregate.	97
5-2.2	Asphalt.	97
5-3	COMPOSITION AND MIXTURE.	97
5-4	CONSTRUCTION.	97
5-5	DRAINAGE LAYERS.	98
5-5.1	Design.	98
5-5.2	Construction.	98
CHAPTER 6	MISCELLANEOUS MIXTURES.	99
6-1	RECYCLED ASPHALT MIXTURES.	99
6-2	SAND-ASPHALT MIXTURES.	99
6-2.1	Advantages and Disadvantages.	99
6-2.2	Uses.	99
6-3	SHEET ASPHALT.	100
6-4	ROCK ASPHALT.	100
6-4.1	Advantages and Disadvantages.	100
6-4.2	Uses.	100
6-5	COLD-MIX ASPHALT.	100
6-5.1	Design.	101
6-5.1.1	Preliminary Work.	101
6-5.1.2	Materials.	101
6-5.1.3	Design.	103
6-5.2	Plant Mix.	104
6-5.2.1	Plant Operation.	104
6-5.2.2	Plant Laboratory.	105
6-5.2.3	Adjusting Mix Proportions.	106
6-5.2.4	Preparation of Construction Specifications.	106
6-5.3	Road Mix.	107
6-5.3.1	Advantages and Disadvantages.	107
6-5.3.2	Uses.	107

CHAPTER 7 RESIN MODIFIED PAVEMENT (RMP)	109
7-1. overview.	109
7-2 MATERIALS	110
7-2.1 Open-Graded Asphalt Mixture	110
7-2.1.1 Aggregates.....	110
7-2.1.2 Asphalt Cement.....	110
7-2.2 Cement Slurry Grout.....	111
7-2.2.1 Aggregate.	111
7-2.2.2 Filler.	111
7-2.2.3 Cement.	111
7-2.2.4 Cross Polymer Resin Additive.....	111
7-3 MIXTURE DESIGN.	111
7-3.1 Open-Graded Asphalt Mixture.....	111
7-3.2 Cement Grout.....	113
7-4 EQUIPMENT.	114
7-4.1 Rollers.	114
7-4.2 Hand Tools.....	114
7-5 PLACEMENT.	114
7-5.1 Open-Graded Asphalt Mixture.....	114
7-5.2 Cement Slurry Grout.....	115
7-5.2.1 Mixing and Transport.	115
7-5.2.2 Placement.	115
7-5.2.3 Covering Pavement Surface.	116
APPENDIX A REFERENCES	117
APPENDIX B BEST PRACTICES	123
APPENDIX C GLOSSARY	129

FIGURES

Figure 2-1 Batch Plant (Courtesy of National Asphalt Pavement Association (NAPA))	6
Figure 2-2 Drum Mix Plant (Courtesy of NAPA)	9
Figure 2-3 Minimum Anticipated Pavement Temperature as a Function of DFI	19
Figure 2-4 Gradation Curves for Stockpile Samples	27
Figure 2-5 Gradation Curves for Bin Samples	28
Figure 2-6(a-f) Asphalt Paving Mix Design for Typical Mix	33
Figure 2-7 Mat Density Control Chart	46
Figure 2.8 Types of HMA Deficiencies and Probable Causes	47
Figure 2-9 Types of HMA Pavement Imperfections and Probable Causes	50
Figure 4-1 Classification of Mix Systems by Cohesion Test Curves	91

Figure 4-2 Mineral Filler Content Optimization “Benedict Curve” 91
 Figure 4-3 Determination of Optimum Asphalt Content 93

TABLES

Table 2-1 Aggregate Gradations for HMA Pavements..... 4
 Table 2-2 Specification References for Asphalt Materials 14
 Table 2-3 Asphalt Binder Base Grade Selection Criteria Based on Pavement
 Temperature Index* 16
 Table 2-4 Example PTI Data 17
 Table 2-5 Asphalt Cement Selection Criteria Based on Design Air-freezing
 Index* 19
 Table 2-6 Computation of Properties of Asphalt Mixtures..... 31
 Table 2-7 Minimum Percent Voids in Mineral Aggregate (VMA)..... 36
 Table 2-8 Design Criteria 39
 Table 2-9 Determination of Optimum Asphalt Content¹ 40
 Table 2-10 Evaluation for Acceptability of Design Mix..... 40
 Table 2-11 Lot Density as a Percent of Laboratory Density 45
 Table 2-12 Aggregate Gradation for PFCs 51
 Table 2-13 SMA Gradation Guideline (after NAPA 1999*) 52
 Table 2-14 Recommended SMA Coarse and Fine Aggregate Properties
 (after NAPA 1999)..... 53
 Table 2-15 Properties of Cellulose Fibers (after NAPA 1999) 57
 Table 2-16 Properties of Mineral Fibers¹ (after NAPA 1999) 58
 Table 2-17. SMA Mix Design Requirements (after NAPA 1995) 59
 Table 3-1 Prime Coat Materials..... 66
 Table 3-2 Tack Coat Materials and Spray Application Temperatures 69
 Table 4-1 Surface Treatment Asphalt Materials 76
 Table 4-2 Gradations for SBST 78
 Table 4-3 Gradations for DBST..... 78
 Table 4-4 Slurry Seal Aggregate Gradations..... 82
 Table 4-5 FRS Minimum Application Rates and Corresponding Aggregate
 Gradations 86
 Table 4-6 Physical Properties of Sealer Mixtures 87
 Table 4-7 Gradation Types for Micro-Surfacing..... 89
 Table 6-1 Typical¹ Aggregate Gradations for Plant-Mix Cold-Laid Asphalt
 Mixtures 102
 Table 6-2 Selection of Asphalt Type and Grade..... 103
 Table 6-3 Selection of Optimum Asphalt Content 104
 Table 6-4 Mixing Temperatures for Asphalt Materials..... 105
 Table 7-1 Aggregate Physical Properties 110
 Table 7-2 Gradation Limits for Open-Graded Asphalt Mixture 110
 Table 7-3 Aggregate Gradation for Slurry Grout..... 111
 Table 7-4 Resin Modified Cement Slurry Grout Mixture Proportions 113
 Table 7-5 Slurry Grout Viscosity.....114

Table B-1	Factors Used in Calculating Surface Area of Slurry	
	Seal Aggregate	124
Table B-2	Surface Area Calculation.....	126
Table B-3	Kerosene Absorption Calculation	126
Table B-4	Product and Vendor Information	128

This Page Intentionally Left Blank

CHAPTER 1 INTRODUCTION

1-1 PURPOSE.

This UFC provides guidance for the preparation of drawings and specifications for road and airfield flexible pavements using asphalt cement materials. The term “asphalt” is used herein instead of bitumen or bituminous (a generic term for both asphalt and tar materials) because asphalt is the material typically used in pavement construction. In the past, tar or coal tar was used only in instances where fuel resistance was required. Due to problems with emissions, tar is no longer used in flexible pavement construction except occasionally as a sealer. This UFC also provides useful information for design engineers, laboratory personnel, and project managers concerning mix design, materials, production, and placement of the various asphalt mixtures.

1-2 SCOPE.

This UFC prescribes materials, mix design procedures, and construction practices for flexible pavements.

1-3 REFERENCES.

Appendix A contains a list of references cited within this UFC.

1-4 UNITS OF MEASURE.

The primary system of measurement used in this UFC is the International System of Units (SI). In some cases, inch-pound (IP) measurements are the governing critical values because of applicable codes, accepted standards, industry practices, or other considerations where the IP measurements govern. The IP value is shown in parentheses following a comparable SI value.

1-5 SPECIAL TERMS.

Special terms used in this UFC are explained in Appendix C.

1-6 BACKGROUND.

Asphalt mixtures (hot-, cold-, and warm-mix asphalt and other asphalt surfaces) provide a resilient, relatively waterproof, load-distributing medium that protects the base course and underlying pavement structure from the harmful effects of water and abrasion from traffic. Asphalt pavements wear, weather, and deteriorate from aging; therefore, maintenance of these pavements extends pavement life. The flexibility of asphalt mixtures allows a pavement structure to adjust slightly to consolidation of underlying layers or deflection due to load without affecting pavement performance. Flexible pavements also allow stage construction and use a range of construction materials, often leading to substantial savings through the use of locally available materials. Additional pavement courses are placed on existing pavements to provide additional

structural strength as total loads increase or as traffic intensity increases. Design and construct the economical pavement that satisfy the objective of long pavement life.

1-7 SAFETY CONSIDERATIONS.

Department of Defense's (DoD) objective is to construct pavements that provides traffic safety. A non-skid surface is essential, and grade control is required to provide rapid removal of surface water to minimize the potential for hydroplaning. All pavement surfaces normally exhibit a sufficiently coarse texture to provide skid resistance. Avoid aggregate types known to have a history of polishing because they are probably the greatest cause of low skid resistance, prevalent in surface treatments and seal coats. Avoid aggregates having friable particles, as these tend to break down and form foreign object debris (FOD). Construction techniques are important for surface treatments and seal coats to ensure good bond between the asphalt and aggregate, providing aggregate retention. Pavement surfacing such as sealers that do not include aggregate are not applied in areas of high-speed traffic.

CHAPTER 2 HOT-MIX ASPHALT

2-1 INTRODUCTION.

Hot-mix asphalt (HMA) is often used for high-performance pavements. Select the degree of performance required based on traffic conditions and the availability of materials. HMA mixtures consist of mineral aggregate and asphalt cement. These HMA mixtures are meet the design requirements for airfield pavements, roads and streets, and storage areas. In general, from 4 to 6.5 percent asphalt cement content is required for asphalt base, intermediate courses, and surface courses and 5 to 7 percent asphalt cement content for porous friction course (PFC) and stone matrix asphalt (SMA); however, determine the optimum asphalt content according to mix design procedures. The term “hot-mix asphalt” refers to any hot asphalt mixture produced in a hot-mix plant; however, unless referred to directly by a specific name, it refers to dense-graded HMA with aggregate gradations shown in Table 2-1. Much of the information discussed in this section is found in report AATP 05-01 developed by Auburn University.

2-1.1 Advantages.

The hot-mix method of preparing paving mixtures provides for thorough coating of the aggregates with a uniform film of asphalt cement and accurate control of aggregate sizes and quantity of asphalt cement. Hot-mix pavements require no curing period after being laid and are used as soon as the pavement has cooled. Roll the paving mixture to compact the mix while it is sufficiently hot because rolling is ineffective after the mixture has cooled, making the mix design density unachievable. Hot-mix asphalt pavements are constructed rapidly minimizing the probability of damage to the HMA due to weather conditions that occur immediately after construction is completed. Immediately after adequate rolling and a cooling period, the pavement has a high degree of stability from the interlocking of the coarse and fine aggregate and adhesion of the asphalt cement, as well as a high resistance to moisture penetration and frost damage.

2-1.2 Gradations and Layer Thickness.

Selection of a gradation from Table 2-1 is based on the layer thickness of the HMA to be placed and the need to limit aggregate segregation. Segregation occurs more quickly in mixes with coarser aggregates; therefore, do not use aggregate gradation No. 1 on the surface. Ensure the layer thickness for gradation No.1 is at least 57 millimeters (2.25 inches), the layer thickness for gradation No. 2 is at least 37.5 millimeters (1.5 inches), and the layer thickness for gradation No. 3 is at least 28.5 millimeters (1.1 inches). Use 25-millimeter- (1 inch) thick layers of HMA only in unusual situations, such as level courses, since these thin layers tend to cool quickly and are difficult to place and compact properly. The preferred thickness of the surface layer for an airfield pavement is 51 millimeters (2 inches). Design and/or construct underlying layers with a thickness no greater than 76 millimeters (3 inches). The thickness of underlying layers is determined by the total designed thickness of the asphalt mixture. Surface layers for airfields are not less than 37.5 millimeters (1.5 inches) thick.

Table 2-1 Aggregate Gradations for HMA Pavements

Sieve Size, mm	Gradation 1 19 mm Nominal Max Agg Size by Mass	Gradation 2 12.5 mm Nominal Max Agg Size by Mass	Gradation 3 9.5 mm Nominal Max Agg Size by Mass
25.0	100	–	–
19.0	90-100	100	–
12.5	68-88	90-100	100
9.5	60-82	69-89	90-100
4.75	45-67	53-73	58-78
2.36	32-54	38-60	40-60
1.18	22-44	26-48	28-48
0.60	15-35	18-38	18-38
0.30	9-25	11-27	11-27
0.15	6-18	6-18	6-18
0.075	3-6	3-6	3-6
Sieve Size, inch	Gradation 1 3/4 inch Nominal Max Agg Size by Mass	Gradation 2 1/2 inch Nominal Max Agg Size by Mass	Gradation 3 3/8 inch Nominal Max Agg Size by Mass
1	100	–	–
3/4	90-100	100	–
1/2	68-88	90-100	100
3/8	60-82	69-89	90-100
No. 4	45-67	53-73	58-78
No. 8	32-54	38-60	40-60
No. 16	22-44	26-48	28-48
No. 30	15-35	18-38	18-38
No. 50	9-25	11-27	11-27
No. 100	6-18	6-18	6-18
No. 200	3-6	3-6	3-6

When a leveling course is applied, ensure layers are at least 37.5 millimeters (1.5 inches) thick except in areas where it is tapered to tie into the underlying layer. Ensure areas of leveling course that require tapering (it's better not to use tapering techniques) of the mix are at least 19 millimeters (0.75 inch) thick in the thinnest part of the taper to allow sufficient thickness for minimal compaction. Before overlaying, mill the asphalt surface to a grade resulting in no need for a leveling course. This allows each layer to be placed at a constant thickness throughout which is preferred.

Mixes with maximum aggregate size tend to have lower optimum asphalt content so these mixes are potentially a little cheaper for the contractor to produce but these mixes are more difficult to handle and compact and tend to segregate during handling. Use gradation 2 for all surface course mixtures for airfields unless the thickness is less than 37.5 millimeters (1.5 inches); in this case, use gradation 3. Provide good justification to use asphalt layer thicknesses less than 37.5 millimeters (1.5 inches). Use gradation 2 for intermediate layers as well unless the layer thickness exceeds 57 millimeters (2.25 inches); then gradation 1 is allowed to be used. Use gradation 3 for shoulders and for any layer that is constructed less than 37.5 millimeters (1.5 inches) thick.

2-1.3 Uses.

If properly designed, HMA paving mixtures are used for an asphalt base course, intermediate course, surface course, porous friction or stone matrix asphalt course. Wheel loads, wheel spacing, tire pressures, intensity of traffic, and subgrade strength (California Bearing Ratio (CBR)) dictate the thickness of the pavement (UFC 3-260-02). For airfield pavement applications, HMA is used for intermediate and surface courses on types A, B, C, and D traffic areas, blast areas, and any other areas (including non-traffic) where their use is economical. The four types of airfield traffic areas (A, B, C, and D) and their relationship to other methods of traffic area nomenclature are described in UFC 3-260-02. HMA is often used on any road or street, classification A through F. PFCs have been used in the past to prevent hydroplaning but have not been used in recent years on airfields primarily due to potential for raveling of the surface resulting in FOD. Gain approval from the Pavements Discipline Working Group (DWG) or their designated representative before using a PFC on an airfield. Grooving is used on runways in place of PFCs to facilitate removal of the water from the pavement surface. SMA is used in applications requiring a rut- and abrasion-resistant surfacing. SMA mixtures are more expensive than HMA, so they are not used. Areas subjected to fuel spills require an application of a fuel-resistant sealer to protect the HMA pavement or the use of a fuel resistant binder. When possible, investigate the use of a rigid pavement for areas with expected fuel spillage.

HMA is used for new construction and for rehabilitating existing pavements. For new construction it is important to ensure that the existing subgrade meets the strength requirements used for design. It is also essential that the quality of materials in the subbase and base courses meet the design requirements. Ensure a condition survey of existing pavements is made in order to develop a design for existing pavement repairs. During construction, it is essential that the design for materials and thicknesses be followed. Immediately address any construction issues prior to placement of material to avoid ultimately having to remove and replace such.

2-2 EQUIPMENT.

2-2.1 Plant Equipment.

The purpose of an asphalt plant is to produce the mixture using mix design proportions of aggregate materials and asphalt cement and mix the materials so that all aggregates

are thoroughly coated and the mixture is uniform throughout. HMA is produced in both batch and drum mix asphalt plants. Drum mix plants are common in the U.S. Either type of asphalt plant is used to produce high quality HMA. Initiate asphalt mixture quality control at the aggregate stockpiles. Manage each aggregate stockpile to prevent segregation or mixing with adjacent stockpiles or contamination from other materials including underlying material.

2-2.1.1 Batch Plant.

The components of a batch plant are illustrated in Figure 2-1. Cold feed hoppers have individual feeders for each of the aggregates used in the mixture. Set feeders so that the desired percentage of each aggregate as specified in the job mix formula is fed into the plant. Rate of feed is controlled by the gate opening, belt speed, or other methods, depending on the type of cold feed. If aggregate feeders are not set as specified in the job mix formula, the following problems occur:

- a. One of the aggregate hot bins overflows with material while another hot bin runs low on material.
- b. The gradation of the aggregate in the mix being produced does not meet the design gradation.
- c. The amount of natural sand varies from the design proportion and exceeds the amount allowed in the specifications.

Figure 2-1 Batch Plant

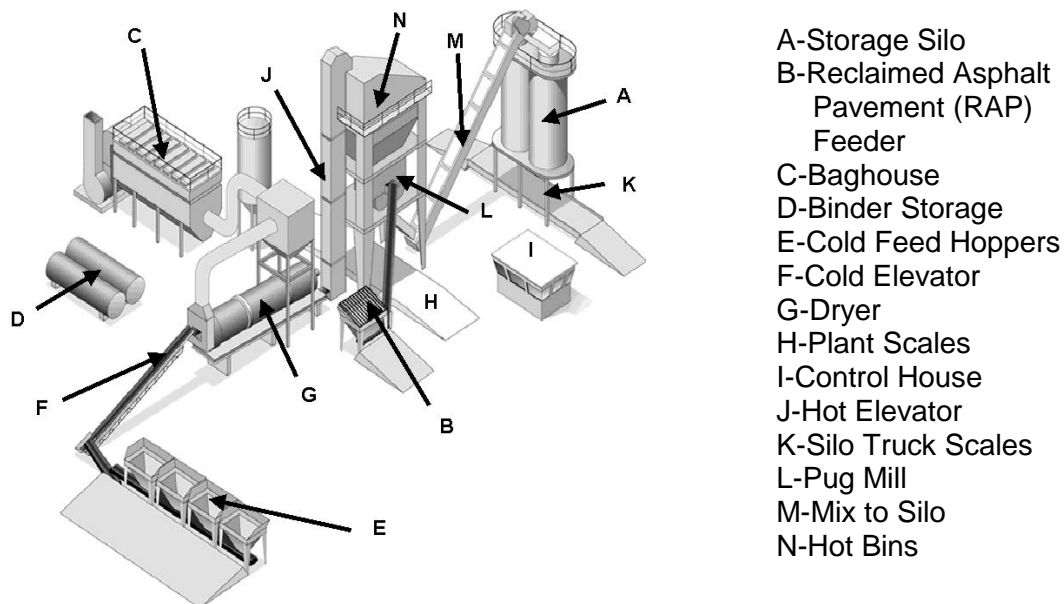

(Courtesy of National Asphalt Pavement Association (NAPA))

2-2.1.1.1 Cold Feed Bins.

Before the start of a project, calibrate the cold feed bins so that each bin feeds the desired rate of material. The cold feed calibration involves feeding one aggregate at a time onto a belt that is common to all aggregates. Determine the speed of this belt prior to calibration of the feeders. One way to do this is to divide the belt length by the time required for one revolution. After the material is fed onto the belt, completely remove and weigh the material over a given length (for example; 2 meters (6.5 feet)). To convert the weight of the sample taken to kilograms per hour (pounds per hour) and later to metric tons (tons) per hour, use the following relationship:

$$R = \frac{3600 WS}{L}$$

Where:

R = rate of feed, kilograms per hour (pounds per hour)

W = weight of sample, kilograms (pounds)

S = speed of belt, meters per second (feet per second)

L = length of belt sampled, meters (feet)

Feed each aggregate at four to five different feeder settings and determine the rate of feed for each setting. Develop a plot of this data showing the relationship between the rate of feed (kilograms or metric tons (pounds or tons) per hour) and the feeder setting (gate opening, feeder belt speed, or other method for setting the aggregate feeder) for each aggregate. Use these plots to set each cold feed bin to feed at the desired rate.

2-2.1.1.2 Dryer.

After the aggregate cold feed bins have been properly set, the aggregate feeders are set to provide the desired percentages, and the aggregate is fed up the cold elevator and through the dryer. The dryer removes the moisture from the aggregate down to less than 0.5% and heats the aggregate to the desired temperature for mixing and handling.

2-2.1.1.3 Dust Collector.

A dust collector collects the dust created in the dryer and at other plant locations and adds all or any portion of it back into the mix at the hot elevator. Ensure the plant has the capability to remove any desired portion of the collected dust or to return it back to the mixture.

2-2.1.1.4 Screens.

The aggregate exits the dryer and is carried, along with the returned dust, up the hot elevator, over the screening deck, and into the hot bins. Screen sizes are selected such that the oversize material is rejected and the remaining aggregates are separated into various sizes. Ideally, select the screen sizes so that the amount of material going into each hot bin is proportional to the relative volume of that hot bin. For example, suppose that hot bin No. 1 has a volume of 3 cubic meters (4 cubic yards), hot bin No. 2 has a volume of 1.5 cubic meters (2 cubic yards), and hot bin No. 3 has a volume of 1.5 cubic

meters (2 cubic yards). Select screens so that 50 percent of the material goes into bin No. 1, 25 percent into bin No. 2, and 25 percent into bin No. 3. This is not done for each mix since it takes effort to change the screens and asphalt batch plants produce a range of mixes during a normal workday.

2-2.1.1.5 Hot Bins.

Determine the percentage of each hot bin to be used in the mixture. Take samples of each hot bin and the gradation for each sample determined. Select the percentage of each bin so that the gradation of the combined materials from the hot bins is equal to the gradation of the job-mix formula (JMF). Variations occur in the combined hot bin gradation and that sent through the drier due to possible aggregate degradation or loss of fines in the dust collection system; however, ensure the gradation of the blended aggregate is equal to that originally developed in the mix design.

2-2.1.1.6 Mixer.

After the cold feed and hot bins are properly set, the combined aggregate from the hot bins is mixed with the approved mix design amount of asphalt binder. Select the mixing time, 5 seconds for dry mixing and 25 to 40 seconds for wet mixing, so that all aggregate particles are coated. Ensure the plant produces a uniform asphalt mixture having approved mix design aggregate gradation, asphalt content, and temperature. The batch plant weighs in approved mix design percentage of the various nominal size aggregates stored in the hot bins and asphalt binder to produce a batch of material that is then mixed in a pugmill.

2-2.1.1.7 Storage Silo.

A storage silo is not required in a batch plant but almost all asphalt plants have one or more storage silos to temporarily store material during production. Ensure the storage silo in a batch plant meets the same requirements as that for a drum mix plant discussed below.

2-2.1.2 Drum Mix Plant.

The drum mix plant is illustrated in Figure 2-2. The drum mix plant is generally produces HMA at a higher production rate compared to a batch plant. When a drum mix plant is used, the gradation is completely controlled at the cold feed bins since no additional screening of the mixture occurs. The asphalt cement is either added to the aggregate while inside the drum or added to the aggregate immediately after passing through the drum. This plant type is used to readily produce HMA containing reclaimed asphalt pavement as well as HMA containing no reclaimed asphalt pavement.

Figure 2-2 Drum Mix Plant

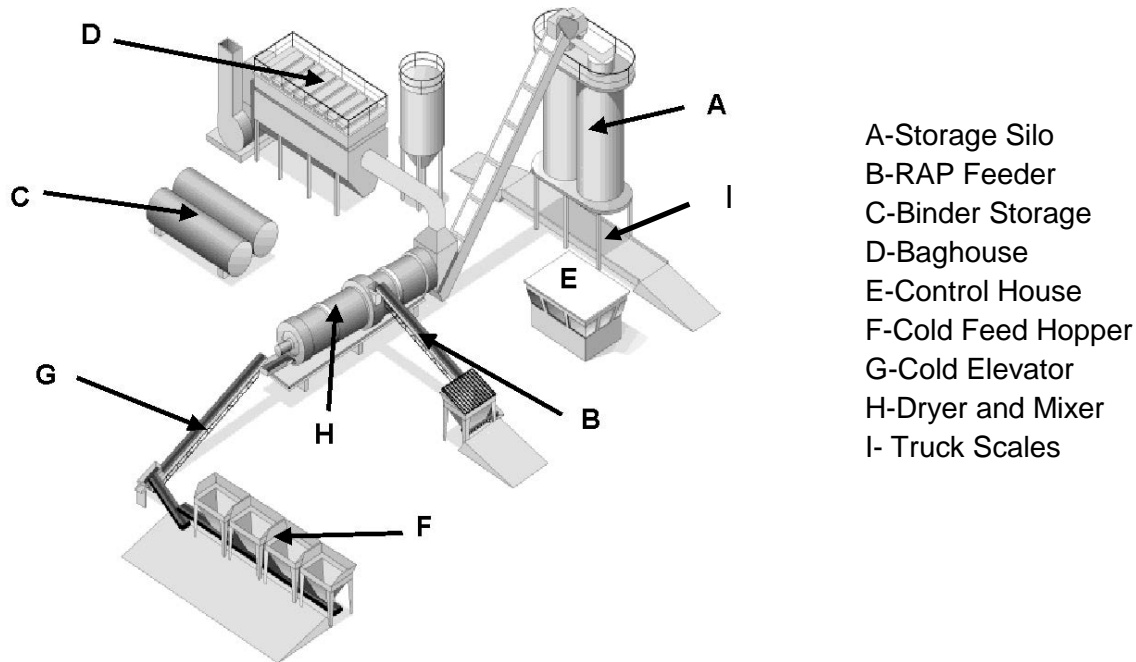

(Courtesy of NAPA)

2-2.1.2.1 Cold Feed Bin

The cold feed bins in a drum mix plant are set up much the same way as for the batch plant, but the drum mix plant has a weight sensor on the aggregate feed belt that weighs the aggregate on the run prior to being fed into the dryer. Adjust this aggregate weight based on moisture content since there is moisture in the aggregate that is removed during the drying process. The asphalt pump adds binder based on the belt-measured weight of aggregate which is more asphalt binder than desired unless the aggregate weight is corrected based on the measure moisture content.

2-2.1.2.2 Dryer.

For the drum mix plant, the burner for the dryer is normally located on the high side (parallel flow) or the low side (counter flow) of the drum. In the parallel flow dryer, the aggregate enters the dryer on the high end of the drum and helps to shield the asphalt binder being added inside the drum from direct contact with the flame. The asphalt cement is added to the dryer at the midpoint to two-thirds the length to prevent close contact with the flame, which causes over-heating and damage to the asphalt binder. A counter-flow drum mix plant has the burner on the low end of the drum and is more energy efficient than a conventional drum mixer and produces less emissions during plant operations. With a counter flow plant, various techniques are used to protect the asphalt from the flame as it passes through the plant. Examples of techniques used include double barrels (where the aggregate is heated in the inner drum and the asphalt cement is added in the outside drum), coaters (where the asphalt cement is added to

the aggregate after it passes through the dryer), and heat shields (shield the asphalt cement from the flame).

2-2.1.2.3 Dust Collector.

The dust collector in a drum mix plant operates similar to that in a batch plant.

2-2.1.3 Asphalt Mixture Storage Silo.

Asphalt storage silos are used to store HMA mixture before loading it onto trucks. Ensure the storage silo volume is maintained for the drum mix plants continuous flow production. The silos allow plants to run continuously even when there is a temporary shortage of trucks. Material is stored in silos for short periods of time, but if stored too long, the material cools excessively or oxidizes excessively, causing the asphalt binder to become hard and brittle. The asphalt binder has the potential to drain from the aggregate during long-term storage. This draindown is more likely to occur with mixes having high coarse aggregate content such as open-graded friction course and stone matrix asphalt. Hence for these mixture types storing the mixture in the silo for more than 30 minutes is not allowed.

Meet the stored mixture specification requirements when sampled and tested after storage. As a general rule, HMA dense-graded mixtures are not stored more than 3 hours in a non-insulated storage silo or for more than 8 hours in an insulated storage silo. If segregation of aggregate or draindown of asphalt binder occurs in the silo, disallow use of the silo or make changes in the equipment or process to prevent segregation and draindown.

2-2.2 Placement Equipment.

2-2.2.1 Asphalt Spreader (Paver).

2-2.2.1.1 Types of Spreaders.

An asphalt spreader is used to place mixture types, such as hot mix, cold mix, and base course material. Spreaders currently in use operate on either tracks or rubber tires, and have a vibrating screed to strike off and smooth the paving mixture. Spreaders use a tamping bar in conjunction with the screed, or an oscillating screed with a vibrating compactor, and others use a vibrating screed for both strike-off and initial compaction. Conventional paving machines are place HMA, provided these machines are maintained in good mechanical condition, kept adjusted, and operated by experienced personnel. Poor pavement surfaces result if the screed plates are worn or rusty or if the tamping bars (when used) are worn or not properly adjusted.

2-2.2.1.2 Automatic Grade Control.

Ensure asphalt spreaders have a means of automatically controlling the grade. In many cases the grade of the base course or underlying layers is controlled and the desired thickness of asphalt mixture is placed resulting in the desired grade on the surface. When directly controlling grade of an asphalt layer, grade control is used on both sides

of the paver for the first pass. For additional passes, the existing edge is matched on one side of the paver while grade control is used on the opposite side of the paver. For roads, slope control in the paver is often used to control the desired grade. In this case one side of the paver matches the existing pavement and the opposite side is controlled by setting the screed of the paver to provide the desired slope. Controlling the grade by utilizing the transverse slope with the paving machine is not acceptable when multiple lanes are to be placed since the error using the transverse slope approach increases as the number of lanes placed is increased. Methods of grade control that have been used include stringline, laser, and Global Positioning System (GPS)/automation. The asphalt mixture is placed to a desired grade with the asphalt paver but after compaction the mix rolls down 20 to 25 percent of the loose thickness. Hence, if 63.5 millimeters (2.5 inches) of loose mix is placed, this results in 51 millimeters (2.0 inches) of mix after compaction. This results in the initial placement of the asphalt mixture being 13 millimeters (0.5 inch) higher than the desired grade after compaction.

2-2.2.2 Material Transfer Vehicle.

Segregation and lack of smoothness are problems that occur on many paving projects. The use of a material transfer vehicle (MTV) has been shown to minimize segregation and improve pavement smoothness. The MTV is used to transfer the HMA paving mixture from the transport truck to the hopper of the paver. These devices hold a substantial amount of paving mixture, allowing more freedom in mixture transport, and they remix the paving mixture to help reduce segregation that often occurs during placement. In addition to helping prevent segregation, the MTV improves pavement smoothness by allowing a paver to operate continuously (less stopping and starting) without having to be concerned with trucking operations. MTVs receive mixtures directly into a hopper from dump trucks. State's Department of Transportation (DOT) require that an MTV be used on critical projects, such as interstate highways, so MTVs are readily available. All MTVs are not the same. MTVs work better for reducing segregation and improving performance. As a minimum, specify an MTV that has an articulating arm and one that is self-propelled and operated independently from the paver. Ensure the MTV has remixing capability to minimize segregation. There are many machines that simply transfer the mix from the truck to the paver. Many of these do not remix the asphalt mixture. One method of remixing is to have an auger inside the MTV that has auger blades at varying spacing (closer together near the end and further apart near the middle of the auger where the material is fed to the paver) which results in mixing of the materials as they are being fed to the paver.

2-2.2.3 Joint Heaters.

Joint-heating devices that are attached to asphalt spreaders have been used on a number of HMA construction projects. The joint heaters are used to heat the edge of an adjacent pavement lane during placement so that a hot joint is obtained. The hot joint allows for higher compaction. Experience with joint heaters has shown that there is a danger of overheating the existing asphalt mixture. Accordingly, do not use joint heaters on airfields.

2-2.2.4 Asphalt Distributor.

Asphalt distributors are used to apply asphalt material evenly over a pavement surface. Clean the openings of all nozzles of any blockages. Ensure nozzles are the same size and turned at the same angle with reference to the spray bar to produce a uniform fan of bituminous material. The height of the spray bar above the surface being sprayed is important for uniform application. When the bar is too high or too low, a difference in application rate across the spray bar occurs, causing streaking. Adjust the height of the spray bar so that a double or triple overlap of the spray fan is obtained. The Asphalt Institute's Manual Series No. 19 (MS-19) offers guidance for calibrating and checking application equipment. American Society for Testing and Materials (ASTM) Standard D2995 (ASTM D2995) details a method for the determination of the application rate of asphalt (bituminous) distributors. Fully calibrate a distributor before being allowed to be used on a project.

2-2.2.5 Rollers.

A number of roller types are used for paving operations. Rollers used to compact asphalt mixtures are static steel-wheel, vibratory steel-wheel, and rubber-tired rollers. Occasionally rollers have a steel drum on one end of the roller and rubber tires on the other end of the roller. These types of rollers are not allowed for use on HMA because the rubber tires tend to pick up the asphalt mixture resulting in damage to the HMA surface.

2-2.2.5.1 Static Steel-Wheel Rollers.

Static steel-wheel rollers are available in two-wheel (tandem) and three-wheel (tricycle) versions. These two wheel tandem rollers are used for finish rolling but have been used for breakdown rolling as well. Static steel-wheel rollers leave a smooth finish on the pavement surface, but excessive rolling with steel wheel rollers results in lateral movement of the mixture as it's being rolled, causing surface cracking and a general loss in density. Equip these rollers with a system for watering the drums and ensure they have scrapers to remove any material that sticks to the drums. The three-wheel rollers, tricycle rollers, are not used as often, partially due to their tendency to push and shove the asphalt mixture, which results in surface problems.

2-2.2.5.2 Vibratory Steel-Wheel Rollers.

Vibratory steel-wheel rollers are commonly used for breakdown and intermediate rolling of HMA mixtures. They consist of dual-drum vibration, single-drum vibration and single-drum static, or single-drum vibration and rubber tires on the rear axle; however, use of rubber tires on the vibratory steel wheel rollers for asphalt is not normally recommended due to the potential for pickup of the HMA. These vibratory steel wheel rollers are used for breakdown, intermediate, and finish rolling. Breakdown rolling is performed in either static or vibratory mode, although almost everyone now uses a vibratory roller for breakdown rolling. Intermediate rolling is almost always performed in the vibratory mode, while finish rolling is performed in the static mode. Limited data that indicates that excessive rolling with a vibratory roller results in bleeding of the asphalt surface

resulting in excessive loss of friction. Therefore, limit the maximum number of passes to three in the vibratory mode. Ensure the vibratory roller has a watering system along with scrapers on the steel drums. Although the vibratory roller is used for intermediate rolling, it does not replace a rubber-tired roller.

2-2.2.5.3 Rubber-Tire Rollers.

Rubber-tired rollers are used commonly for intermediate rolling of HMA mixtures. They are also used as breakdown rollers when mixtures are excessively tender. Whether used as breakdown or intermediate rollers, these rollers provide for an increase in compaction and produce a watertight surface. Ensure a rubber-tired roller consisting of nine tires, four on one end of the roller and five on the end of the roller and with a minimum total mass load of 18,180 kilograms (40,000 pounds) or 2,020 kilograms (4,440 pounds) per tire and a minimum tire inflation pressure of 620 kilopascals (90 pounds per square inch (psi)), is available for construction of heavy-duty pavements on roads or airfields. Ensure the rubber-tired roller has a watering system for the tires and has scrapers and pads in good shape to prevent accumulation of materials on tires. Commercially available products are available that when applied to the rubber tires keep the HMA mixture from sticking to tires. An effective method for preventing pickup is to get the tires hot and keep them hot. In cold climates or in windy conditions, apply skirts to protect the tires from excessive cooling caused by wind. While roller types are not in the specifications, it is recommended that a rubber-tired roller be included in the train of rollers for compaction of all heavy-duty HMA pavements, and these rubber tire rollers have tires containing the minimum pressures and weights as described above. The rated weight for a rubber tire roller is the loaded weight for the roller. If the roller is not filled with ballast (sand and water), the weight is less than the rated weight. If the actual weight of the roller is needed, weigh it. Rubber tire rollers always yield the best results for longitudinal cold joints and transvers transition joints between asphalt and concrete vs. vibratory or non-vibratory steel rollers.

2-2.2.5.4 Operation of Rollers.

Operate rollers at or below a rate of 4.8 to 8 kilometers per hour (3 to 5 miles per hour) (fast walking speed). Ensure starts and stops are gradual to avoid damaging the freshly laid mixture. Quick turns or any turns that cause cracking on freshly laid mixture is not allowed.

2-3 MATERIALS.

2-3.1 Asphalt Materials.

Asphalt materials used in hot-mix paving operations include the products conforming to the specifications listed in Table 2-2. Asphalt cements for use in pavement design and construction are graded or classified in one of two ways. They are graded on the basis of penetration (ASTM D946) or by the performance grading system (ASTM D6373). Currently, in the continental United States (CONUS) and many other countries, the performance grading system is used; however, in many countries, penetration grades of asphalt are obtained more easily. If performance graded asphalt is available, specify it

for any airfield project. In general, use the softest grade of asphalt cement consistent with traffic and climate. Base selecting a grade of asphalt cement on several considerations, such as climate, traffic conditions, economics of asphalt availability, and previous regional experiences. Traffic conditions and economic considerations vary from project to project, but environmental conditions and regional experiences are normally similar. For example, in warm and hot regions, primarily select a grade of asphalt cement to ensure that the mix is stable during the summer months, and in cold regions, primarily select a grade of asphalt cement to ensure that the mix is not prone to cracking during winter months. These requirements are discussed in the following subparagraphs.

Table 2-2 Specification References for Asphalt Materials

Bitumen Type	Specification
Asphalt cement (performance-graded asphalt binder)	ASTM D6373
Asphalt cement (penetration-graded)	ASTM D946
Cutback asphalt (slow-curing type)	ASTM D2026
Cutback asphalt (medium-curing type)	ASTM D2027
Cutback asphalt (rapid-curing type)	ASTM D2028
Asphalt, emulsified (anionic)	ASTM D977
Asphalt, emulsified (cationic)	ASTM D2397

2-3.1.2 Performance Graded (PG) Asphalt Cements.

The performance grading system (ASTM D6373) classifies asphalt binders using performance-related properties according to the upper and lower temperatures that are expected during the life of the pavement. American Association of State Highway and Transportation Officials (AASHTO) R29 provides information for grading or verifying the performance grade of asphalt cement. PG asphalts have replaced penetration- and viscosity-graded asphalts in the United States. Unlike the viscosity and penetration grading systems, the performance grading system is used to classify unmodified as well as polymer modified asphalt binders.

2-3.1.3 Classification Method for PG Graded Asphalt Cements.

Specify PG graded asphalt binders wherever available. Consider the same PG binder grade as that used by the state highway department in the specific geographic area as the base grade for the project (e.g., the PG grade specified in that specific location for dense-graded mixes on highways with design equivalent single axle loads (ESAL) less than 10 million). The exception is that grades with low temperature requirements higher than PG XX-22 are not to be used (e.g., PG XX-16 or PG XX-10), unless the engineer or the local DOT has had successful experience with these grades.

Rutting is not a problem on airport runways but there have been issues on taxiways where the traffic is slower moving. At airfields with a history of stacking on ends of runways and taxiway areas, rutting has occurred due to the slow speed of loading on the pavement. If there has been rutting on the project or if stacking occurs regularly during the design life of the project, then apply the following grade "bumping" for the top 125 millimeters (5 inches) of paving in the end of runway and taxiway areas: for aircraft tire pressure between 0.7 and 1.4 megapascals (100 and 200 psi), increase the high temperature grade by one grade; for aircraft tire pressure greater than 1.4 megapascals (200 psi), increase the high temperature grade by two grades. For those projects used by aircraft and missions intended to primarily support air operations on ships, a high temperature increase of two grades is required for all HMA projects.

PG grades are provided in 6 degree increments, for example PG 64-22, PG 70-22, PG 76-22 on the high temperature side and PG 64-22, PG 64-28 on the low temperature side. However, many state DOTs, in the southern climates, have selected a mid-range grade on the high end, PG 67-22, as the primary grade of asphalt binder to use. When in these states specify the mid-range grade, PG 67-22, unless the high temperature grade needs to be bumped to be more resistant to rutting.

Polymer-modified asphalt (PMA) has been shown to perform well for improving the resistance to rutting. Using PMA results in a bumped grade of asphalt binder. When bumping the high temperature grade, ensure the low temperature grade remains the same as that for the base grade asphalt. A rule of thumb is that any asphalt binder, having the sum of the high and low temperature grades exceeding 90, is likely to contain a polymer. For example a PG 64-22 has a sum of 86 and this is likely not modified; however, a PG 76-22 has a sum of 98 and this asphalt binder is almost certainly modified. Changing from a PG 64-22 to a PG 76-22 provide much improved resistance to rutting but substantially increase the cost of the asphalt mixture (by 15%, but this varies considerably).

2-3.1.3.1 Polymer Modification of Asphalts.

Many polymers greatly improve the stiffness and flow characteristics of asphalts at high temperatures and are being demonstrated in pavement applications to significantly reduce rutting where this has been a problem in the past. These modified mixtures are produced at higher mixing temperatures to facilitate mixing, placement, and compaction. Polymers improve the low temperature characteristics of an asphalt binder and improve the ability of the pavement to resist low temperature cracking.

Many agencies bump the grade of asphalt binder to provide a binder that is more resistant to rutting and to help ensure that the binder contains a polymer. This bumping results when the high temperature grade is increased. For example, the grade of asphalt binder to be used in a certain area is identified as PG 64-22. However, to minimize rutting potential and to help ensure that a polymer is used, the agency elects to bump the grade to a PG 76-22. This provides increased stiffness at high temperatures without increasing the stiffness at low temperatures thus producing a more rut resistant mixture without increasing the potential for cracking. When the PG

grade is bumped, the agency desires that a polymer be used in the binder. However, the grade is bumped in other ways, such as air blowing, but the asphalt binder won't perform as well when a polymer is used to bump the binder grade.

Ensure that a polymer is used to bump the asphalt binder grade by modifying the binder specification. The modifications to the binder specifications that have been used include, but are not limited to, elastic recovery, forced ductility, phase angle requirement. This has resulted in agencies adopting different requirements thus creating a problem for asphalt binder producers. As a result there has been a lot of work to standardize the binder test to ensure polymer modification resulting in development of the multiple stress creep recovery (MSCR) test. This test is being finalized and is eventually a part of the binder specification requirements but is not yet included as part of the specifications. If the PG binder grade is bumped, it is recommended that additional PG binder requirements (PG plus) specified by the local state DOT be adopted as part of the binder specification. Once the MSCR test procedure is completed and adopted as a part of the ASTM binder specifications, it becomes part of the requirements.

2-3.1.4 Asphalt Cement Selection by Temperature Region.

2-3.1.4.1 Determining the Temperature Region.

Table 2-3 gives guidance for selecting penetration-graded and performance graded asphalt binder by temperature region. When local experience suggests a specific grade of asphalt binder be used, local experience controls. For example, in the U.S., the local state DOT has requirements for selecting the grade of asphalt binder to use. If local experience cannot be used, climatological data are required to provide input into the selection method. First, average monthly maximum temperature data are required to compute a pavement temperature index (PTI). When project locations have average monthly maximum temperatures above 23.9 degrees Celsius (C) (75 degrees Fahrenheit (F)), the PTI is defined as the sum of the monthly increments exceeding 23.9 degrees C (75 degrees F). Conversely, when no average monthly temperature exceeds 23.9 degrees C (75 degrees F), the PTI is defined as the difference between the highest average maximum temperature for the warmest month and 23.9 degrees C (75 degrees F).

Table 2-3 Asphalt Binder Base Grade Selection Criteria Based on Pavement Temperature Index*

Pavement Temperature Index, Cumulative °C (°F)	Temperature Region	Asphalt Cement Selection Criteria
< 16.7 (30)	Cold	120-150 penetration, PG (52,58)-xx**
16.7–44.4 (30–80)	Warm	85–100 penetration, PG 64-(22 or 28)
> 44.4 (80)	Hot	60–70 penetration, PG (64, 70 or 76)-22

*Use only if there is no local guidance on asphalt cement grade to use)

**Use cold region requirements described in paragraph 2-3.1.3.3 for low temperature grade.

2-3.1.4.2 Example of Calculations for PTI.

This example shows the method for calculating the PTI for two construction sites. The average monthly maximum temperature and the difference above 23.9 degrees C (75 degrees F) for Site A and Site B are provided in Table 2-4.

Table 2-4 Example PTI Data

Month	Site A		Site B	
	Average Maximum Temperature °C (°F)	Difference Above 23.9 °C (75 °F)	Average Maximum Temperature °C (°F)	Difference Above 23.9 °C (75 °F)
January	15.8 (60.4)	--	-1.2 (29.8)	--
February	20.3 (68.5)	--	-2.3 (27.9)	--
March	23.2 (73.8)	--	6.1 (43.0)	--
April	26.6 (79.9)	2.7 (4.9)	14.6 (58.3)	--
May	31.4 (88.5)	7.5 (13.5)	19.6 (67.3)	--
June	34.7 (94.5)	10.8 (19.5)	21.3 (70.3)	--
July	36.4 (97.5)	12.5 (22.5)	25.0 (77.0)	1.1 (2.0)
August	33.3 (91.9)	9.4 (16.9)	23.4 (74.1)	--
September	32.3 (90.1)	8.4 (15.1)	19.4 (66.9)	--
October	26.8 (80.2)	2.9 (5.2)	14.2 (57.6)	--
November	23.3 (73.9)	--	6.3 (43.3)	--
December	15.7 (60.3)	--	2.7 (36.9)	--
Cumulative Total		54.2 (97.6)		1.1 (2.0)

The temperature index at these sites is the sum of the increments of average monthly maximums above 23.9 degrees C (75 degrees F); therefore, these are the PTIs for each site:

Site A = 54.2, cumulative degrees Celsius (97.6 cumulative degrees Fahrenheit).
Site B = 1.1, cumulative degrees Celsius (2.0 cumulative degrees Fahrenheit).

Based on the criteria in Table 2-3, Site A is a hot region, and Site B is a cold region.

2-3.1.4.3 Cold Region Requirements -- Determining the Design Air-Freezing Index.

When it is determined that a project exist in a cold region, as defined in Table 2-3, additional climate data are required. For the project area under consideration, a design air-freezing index (DFI) is also required to meet cold region requirements. (Reference UFC 3-260-02 for determination of DFI.) DFIs are used to differentiate between climates

in cold temperature regions. A DFI of 1,667 degree Celsius-days or 3,000 degree Fahrenheit-days (degree-days) is used as the delineation between moderately cold and severely cold (extremely cold) climates. Moderately cold climates have DFIs up to 1,667 degree-days, and severely cold climates have DFIs greater than 1,667 degree-days. After the DFI is determined, select the grade of asphalt from Table 2-5. The minimum pavement temperature is estimated as a function of DFI as shown in Figure 2-3. Knowing the minimum pavement temperature is helpful in selecting the best low temperature grade of the asphalt binder. Ensure the low temperature grade is lower than the estimated low temperature from the figure. For example if the estimated low pavement temperature is -26 degrees C (-14.8 degrees F) then the PG grade is -28 or lower.

2-3.1.4.4 Examples of Asphalt Cement Selection in the Three Regions.

- a. **Asphalt cement selection in a hot region.** A parking lot is to be built in a region that has a PTI of 54.4, cumulative degrees Celsius (97.6, cumulative degrees Fahrenheit). Assume that the DOT requires a grade of PG 67-22 for routine traffic and PG 76-22 for heavy traffic such as an Interstate Highway. In this case select a PG 67-22 or select a PG 76-22 in areas of known potential rutting issues such as slow moving airfield traffic areas including taxiways and runway ends and roads with high volume and/or slow moving traffic.

If no local guidance is available use Table 2-3 for selecting the asphalt cement grade. An asphalt cement that is graded as a 60-70 penetration or use a PG (64, 70, 76)-22. If rutting has been a problem or if aircraft stacking is expected then PG 76-22 is preferred. However, if this is for shoulder or other areas with little or no traffic, select PG 64-22. A PG 70-22 works reasonably well in traffic or non-traffic areas.
- b. **Asphalt cement selection in a warm region.** A street is to be constructed in a region that has a PTI of 23.3, cumulative degrees Celsius (42, cumulative degrees Fahrenheit). Based on Table 2-3, select 85-100 penetration asphalt cement or PG 64-(22, 28) unless local guidance suggests a different grade. The -28 is more resistant to cracking and the -22 is more economical.
- c. **Asphalt cement selection in a cold region.** Construct a heavy-duty open storage area (design index of 0) for use by 22,680-kilogram (50,000-pound) forklift trucks in a region with a PTI of 1.1, cumulative degrees Celsius (2, cumulative degrees Fahrenheit) and a DFI of 1,278 degree Celsius-days (2,300 degree Fahrenheit-days) calculated using UFC 3-260-02. Use penetration 120-150 if penetration graded asphalt is used or use PG (52, 58)-(28, 34) based on Tables 2-3 and 2-5. Again use local guidance for selecting grade of asphalt binder if available. Grade 58 is more resistant to rutting and Grade -34 is more resistant to cracking.

Table 2-5 Asphalt Cement Selection Criteria Based on Design Air-freezing Index*

Pavement Temperature Index, Cumulative °C (°F)	Temperature Region	Asphalt Cement Selection Criteria
< 1,667 (3,000)	Moderately Cold	PG (52, 58)-(28, 34)
> 1,667 (3,000)	Severely Cold	PG(52, 58)-(34, 40)

*Use only if there is no local guidance on asphalt cement grade to use)

Figure 2-3 Minimum Anticipated Pavement Temperature as a Function of DFI

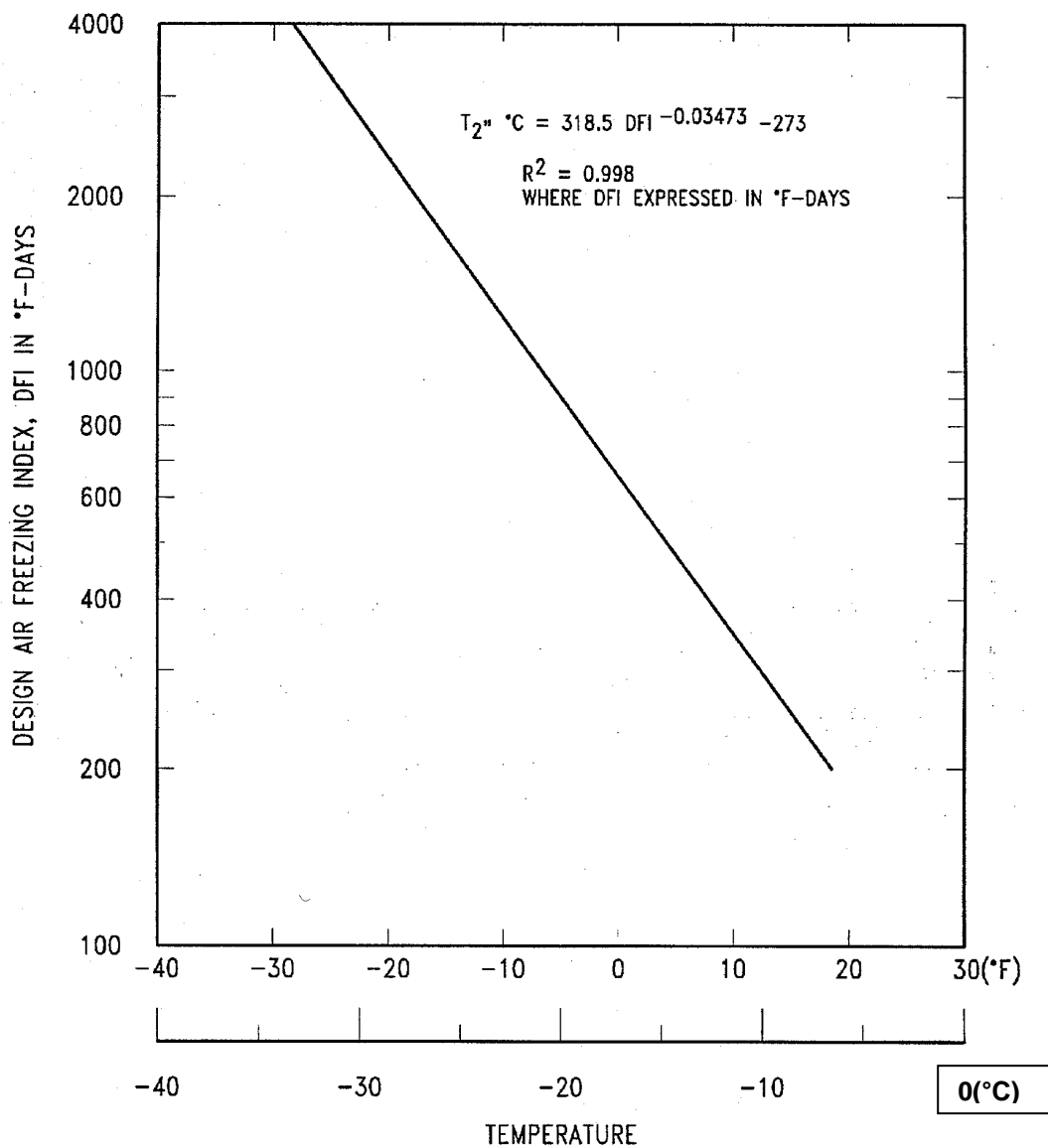

2-3.2 Aggregates.

Use clean, hard, and durable aggregates for use in HMA. Angular aggregates provide more stable HMA mixtures than do rounded aggregates. Natural sands and gravels tend to be rounded and need to be limited or the gravel crushed to provide angular properties. Remove the fine aggregate from the source stone material before crushing to remove soft particles and potential clay balls that develop in the seams of the rock. Remove the fine aggregate from the gravel source before crushing to remove potential soft particles and clay balls, and to ensure that after crushing, particles are fractured and angular.

2-3.2.1 Sieve Analysis.

Subject aggregates to be used in a paving mix, as listed in Table 2-1, to a sieve analysis. From an aggregate's grading curve, an experienced engineer obtains information concerning the suitability of the aggregate for a paving mix, the quantity of asphalt cement required, and whether to add mineral filler. Conducted sieve analyses of fine and coarse aggregates according to ASTM C136. Washed sieve analysis are needed to get accurate measure of dust but for quality control (QC) testing during construction dry gradations are conducted to reduce test time. Use washed gradations for acceptance testing.

2-3.2.2 Specific Gravity.

Bulk specific gravity values for aggregates used in paving mixture are required in the computation of percent VMA. The method to determine the bulk specific gravity of aggregate is provided in ASTM C127 for coarse aggregate and ASTM C128 for fine aggregate.

2-3.2.3 Abrasion and Impact Resistance of Coarse Aggregate.

The determination of percent loss for coarse aggregates is not required if the aggregate has been found to meet the project mix design by previous tests or performance; however, test coarse aggregates obtained from new or doubtful deposits for resistance to degradation by evaluating the conformance to specification requirements for percent loss as measured using the Los Angeles Abrasion Machine (ASTM C131).

2-3.2.4 Soundness Test.

The soundness test is used where damage from freezing is a potential problem. Do not perform the soundness test on aggregate that has been found to meet the mix design by previous tests or performance data; however, aggregate obtained from new or doubtful deposits is tested for conformance to specification requirements using the sodium sulfate or magnesium sulfate solution tests (ASTM C88).

2-3.2.5 Percent Crushed Pieces.

Ensure the percentage of crushed pieces in both the coarse aggregate and fine aggregate fractions are sufficiently high to promote stability in the HMA mix design. Use

CRD-C 171 to determine the percentage of crushed aggregate particles for coarse aggregate (particles retained on a 4.75 millimeter (No. 4) sieve). Ensure a description for a crushed face and the required percentage of crushed aggregate particles is specified in the contract specifications. Natural gravels require crushing to produce the mix design percentage of fractured faces. Crushed stone, on the other hand, almost always meet the fractured face requirement.

2-3.2.6 Particle Shape.

The particle shape of crushed aggregates is required to be essentially cubical. Flat and elongated aggregate particles are susceptible to breakage under compaction and subsequent traffic. This breakdown of aggregate results in a change in volumetric properties of the mixture often resulting in a mix that does not meet the specification requirements. Determine the quantity of flat and elongated particles for conformance to specification requirements using ASTM D4791.

2-3.2.7 Clay Lumps and Friable Particles.

Some aggregates tend to have clay balls and soft particles. This test requirement (ASTM C142) evaluates the aggregate to ensure that aggregate containing clay balls or other friable particles that tend to breakdown during handling or during traffic is not allowed in the asphalt mixture. While these particles don't normally result in disintegration of the pavement, they do result in blemishes that are unsightly and lead to FOD which is a significant problem for airfield pavements.

2-3.2.8 Sand Equivalent.

Some aggregates contain a significant amount of clay particles distributed throughout the aggregate. These particles that are not identified in the clay lumps and friable particles test present a problem. The sand equivalent test (ASTM D2419) evaluates a fine aggregate to determine the ratio between sand size and clay size particles. When a fine aggregate fails the sand equivalent test, it is not acceptable for use.

2-3.2.9 Natural Sand Content.

Natural sand is defined as any fine aggregate material that occurs naturally and has not been crushed. Natural sands tend to be rounded particles which, when used in excess, cause instability in the HMA mixture. The limit of 15 percent natural (uncrushed) sand in airfield mixtures assures a strong and stable pavement under aircraft. Natural sand also tends to have a smooth surface often resulting in poor bond between the asphalt binder and the sand particles. When reclaimed asphalt pavement (RAP) is used, determine the amount of natural sand in the RAP and included in the total amount of natural sand in the recycled mixture.

2-3.2.10 Fine Aggregate Angularity.

The fine aggregate angularity (FAA) test method (ASTM C1252, Method A) measures the uncompacted void content in the fine aggregate portion of a mix and is related to the angularity of the fine aggregate portion of the mixture. Generally crushed fine

aggregates have an FAA value greater than 45 while natural sands have FAA values between the high 30s and the low 40s. The minimum specified value of FAA is 45 unless local experience indicates that aggregates with a lower value provide better performance. Occasionally, the FAA of a fine aggregate portion of the total aggregate is less than 45 even when it contains 100 percent crushed stone particles.

2-3.2.11 Voids in Mineral Aggregate (VMA).

The VMA is the volume of intergranular void space between the aggregate particles of a compacted paving mixture expressed as a percent of the total volume; it includes the air voids and the volume of the asphalt not absorbed into the aggregates. While VMA is not an aggregate property, it is a measure of the packing ability of an aggregate. The VMA is a function of bulk specific gravity of the aggregate, bulk specific gravity of the mix, asphalt content, and specific gravity of the asphalt binder. The VMA requirement is used to establish the minimum amount of asphalt binder added to the asphalt mix design. Without the VMA requirement, laboratories design asphalt mixes to have less asphalt binder to reduce mix cost. These low asphalt content mixes are difficult to place and compact and often result in reduced pavement durability. The VMA requirement indirectly controls the minimum asphalt content.

2-3.2.12 Combining Aggregates.

When asphalt mixtures are produced, combine aggregates from two or more sources. This UFC provides methods and procedures for determining the aggregate blend available and prescribes the asphalt content for the aggregate blend. Whenever an asphalt mixture does not meet established criteria, improve the gradation of the aggregate, use another aggregate, or make adjustments in the mix. Option choice is a matter of engineering judgment by the contractor and involves an analysis of the available aggregate supplies and costs.

2-3.3 Mineral Fillers.

Mineral filler refers to the material passing the 0.075 mm (No. 200) sieve. Most asphalt mixtures have enough mineral filler in the crushed aggregates and no additional filler is required. In fact, many mixtures have too much filler in the aggregates and procedures have to be used to waste some of the filler prior to or during the plant production operations. Some mineral fillers are more desirable to use in asphalt paving mixtures than others. For example, fine sands are less suitable fillers than limestone filler or some other by-product of crushed stone. Design asphalt pavement mixtures using commercial fillers that conform to ASTM D242.

2-3.3.1 Addition of Mineral Filler.

Additional filler is seldom needed in asphalt mixtures since the aggregates typically contain sufficient filler. The quantity of mineral filler to be added or removed depends on the amount of filler naturally present in the aggregate. In most cases the amount of filler in the aggregate produces a mixture meeting the specification requirements. With some aggregates, washing is performed to remove the excess filler in the aggregate

before producing an asphalt mixture. High filler contents reduce the VMA in the mixture making it difficult to meet the specification requirements for VMA. The addition of satisfactory mineral filler, when needed, results in lower optimum asphalt content and increased stability of a paving mixture. Mixtures with low filler contents typically require additional asphalt binder to fill the voids resulting in a mixture that tends to be less stable if the filler is too low. Higher amounts of filler result in lower optimum asphalt content and reduced film thickness causing loss in mixture durability. Practical considerations and optimum performance usually dictate quantities of approximately 5-6 percent passing the 0.075 mm (No. 200) sieve for HMA and approximately 10 percent passing for sand-asphalt mixtures.

2-3.4 Antistrip Agents.

Several antistrip agents have been used successfully to reduce the probability of the asphalt stripping from the aggregate. Antistrip agents are added to the asphalt binder before it leaves the refinery, while others are added directly into the mixer as mineral filler. Hydrated lime is a commonly used antistrip agent and is one material with a history of success in preventing stripping. The liquid antistrip agents are easier to work with since these materials are mixed into the asphalt at the refinery and don't require any extra effort by the contractor. When hydrated lime is added at the plant, have a silo to hold the lime and meter it into the mix thus requiring more effort by the contractor. Other available antistripping agents fall into these general groups: cationic surfactants, iron naphthenate, organosilane, and Portland cement. The tensile strength ratio (TSR) (ASTM D4867/D4867M) is used to evaluate the stripping property of a dense-graded asphalt mixture.

2-3.4.1 Recommended Antistrip Agent.

The recommended procedure for improving the resistance of an aggregate to stripping is to add 1 percent by weight hydrated lime to the mixture. Include this 1 percent lime in the determination of the aggregate gradation. Exact amounts are determined through trial and error on test specimens with various amounts of antistripping materials. Research has shown that lime provides better resistance to stripping than other materials. Some state DOTs are considered lime states and others are not. When in a state that does not use lime, local contractors are not set up to add lime increasing cost to set up equipment to store lime and feed it into the mix.

2-3.5 Antifoam Agents.

Silicone additives or modifiers reduce foaming of asphalt mixes when they come in contact with moisture. Silicone additives have been used successfully to suppress foaming of asphalt in asphalt plants. The silicone that has been used for this purpose is mixed at a rate of 1 milliliter per 640 liters (1 ounce per 5,000 gallons) of asphalt binder. The recommended range is also given as 1 to 2 parts per million. Silicones have been used to reduce the hardening of HMA while it is in storage silos. Silicone additives have successfully prevented slumping of mixes in trucks, which occurs when the hot-mix gradation is such that the mix traps escaping steam. In addition, silicones have provided better finishing qualities to pavement mixtures. These qualities include improved

workability, reduced tearing during placement, and a reduction in the amount of effort required for compaction. Testing by several agencies has revealed no detrimental effects on the properties of asphalts when silicone is used in the recommended concentrations. Silicones are persistent materials, and their effects potentially carry over from one tank of asphalt to another. Mixing and control is best achieved by addition of the silicone at the refinery. (If silicone is added to the asphalt binder to prevent foaming, the asphalt binder cannot be used with the foaming process to produce warm mix asphalt).

2-4 DENSE-GRADED HMA.

Dense-graded HMA consists of a mixture of well-graded aggregate and asphalt cement. The HMA is produced at a central plant, laid to the desired grade with an asphalt spreader, and compacted with steel wheel and rubber tire rollers. HMA provides a high-strength, water resistant, smooth riding surface.

2-4.1.1 Aggregate Considerations.

Dense-graded HMA mixtures have several aggregate requirements and considerations. For airfield mixtures that support high-pressure tires, ensure the percentage of natural sand does not exceed 15 percent of the combined weight of the total aggregate. This percentage is 25 percent for roadway (low-pressure) mixtures, but needs to be validated with the mix design. The amount of filler that exists naturally in aggregates is sufficient to produce HMA meeting the mix design but needs to be validated. Usually, practical considerations and optimum performance dictate 5 to 6 percent filler, which is almost always available in the aggregates being used. Ensure the aggregates used meet the specification requirements for the aggregate properties discussed in paragraph 2.3.2.

2-4.2 Marshall Mix Design.

2-4.2.1 Contractor-provided Job Mix Formula (JMF).

Current practice is for the contractor to design the mixture and develop the JMF for the aggregates and asphalt used in the paving project. Supply a sufficient amount of aggregate and asphalt to the contracting officer or the contracting officer's representative for possible verification tests. If verification tests are not performed, keep these material samples until the project is completed and accepted. Ensure the JMF supplied contains, as a minimum, the following information:

- Percent passing each sieve size for each aggregate and combined gradation.
- Optimum asphalt content.
- Percent of each aggregate and mineral filler to be used.
- Asphalt penetration grade, or performance grade.
- Number of blows of hammer per side of molded specimen (if Superpave is used, then show the number of gyrations).

- Laboratory mixing temperature.
- Lab compaction temperature.
- Temperature-viscosity relationship of the asphalt cement.
- Plot of the combined gradation on the 0.45 power gradation chart, stating the nominal maximum size.
- Graphical plots of stability, flow, air voids, VMA, and unit weight versus asphalt content.
- Bulk specific gravity and absorption of each aggregate.
- Percent natural sand.
- Coarse aggregate test results including: Los Angeles (LA) abrasion, sulfate soundness, percent fractured faces, flat and elongated particles, clay lumps and friable particles.
- Fine aggregate test results including: sand equivalent, uncompacted void content, clay lumps and friable particles.
- Tensile strength ratio and wet/dry specimen test results.
- Antistrip agent (if required) and amount.
- List of all modifiers and amounts.
- Percentage and properties (asphalt content, binder properties, and aggregate properties) of RAP in accordance with specifications when RAP is used.

The JMF likely needs to be adjusted based on plant-produced materials but only adjusted within the limits allowed in the specifications. Adjustments that exceed these specified limits are not be performed without a revised mixture design. Adjust the JMF only when changes in materials or procedures occur or to improve the JMF. It is common to adjust the mix design after construction of the test section and as needed during mixture production.

2-4.2.2 Procedure.

Laboratory tests are conducted on laboratory-compacted samples compacted with the effort identified in the specifications. These samples are tested to identify air voids, voids filled with asphalt, and VMA. Based on these properties (primarily air voids) the optimum asphalt content is selected. A final selection of aggregate blend and asphalt content is based on these data with due consideration to relative costs of the various mixes. The procedure set forth in paragraph 2-4.2.3 apply directly to all mixes containing not more than 10 percent by weight of total aggregate retained on the 25-millimeter (1-inch) sieve.

2-4.2.3 Preparation of Test Specimens.

Selection of materials for use in designing the paving mix is addressed in section 2-3. As an example, suppose that an aggregate gradation for a hot-mix design is required to

meet the requirements of the 19-millimeter (3/4-inch) maximum (high-pressure) aggregate gradation band (gradation No. 2, 12.5 mm [1/2 inch] nominal) shown in Table 2-1. Design data are required on this blend. The initial mix design tests is usually conducted in a central testing laboratory on samples of stockpile materials taken by the laboratory. The procedure for proportioning stockpile samples to produce a blend of materials to meet a specified gradation is outlined in paragraphs 2-4.2.3.1 and 2-4.2.3.2. Adjustments to the mix design is based on samples taken from the asphalt plant and is usually conducted in a field laboratory near the plant.

2-4.2.3.1 Proportioning of Stockpile Samples.

As a preliminary step in mixture design and manufacture, determine the proportions of the different available stockpiled materials required to produce the mix design gradation of aggregate. This step is required to determine whether a blend is produced meeting the mix design and, if so, determine the proportion of each aggregate to be fed from the cold feeder bins into the dryer. Sieve analyses are conducted on material from each of the stockpiles, and the data are shown graphically in Figure 2-4. Another method of plotting or graphically illustrating the data is through the use of the 0.45 power curve. This was developed in the early 1960's by the Federal Highway Administration (FHWA) using a formula developed in a study by Fuller and Thompson. The equation developed by Fuller is:

$$P = 100 (d/D)^n$$

where d is the opening of the sieve size in question, P is the total percent passing or finer than the sieve, D is the maximum size of the aggregate, and n is equal to 0.45. The FHWA recommends that this chart be used as part of the hot-mix design process. Combine the four aggregate fractions to produce the desired blend. The estimated percentage of each fraction needed to produce this blend is determined by trial-and-error calculations. Normally, two or three trials are required to obtain the desired blended gradation.

2-4.2.3.2 Proportioning of Bin Samples from Batch Plants.

Once it is demonstrated that a blend is prepared from the available materials, samples of these materials are processed through the asphalt plant for verification of the mix design or during construction of the test section. Conduct sieve analyses for each batch of processed aggregate. The data are shown graphically in Figure 2-5. Blend the hot-bin aggregates to produce the same gradation as that produced in the JMF. The percentage of each bin is estimated, and calculations are made to determine the gradation produced from these estimated percentages. The gradation of this recombined blend is then checked against the desired gradation. Two or three trials are usually sufficient to produce a combined mixture having a gradation equal to the job mix formula. This step is not needed when a drum mix plant is used since the aggregate is not rescreened in the plant.

Figure 2-4 Gradation Curves for Stockpile Samples

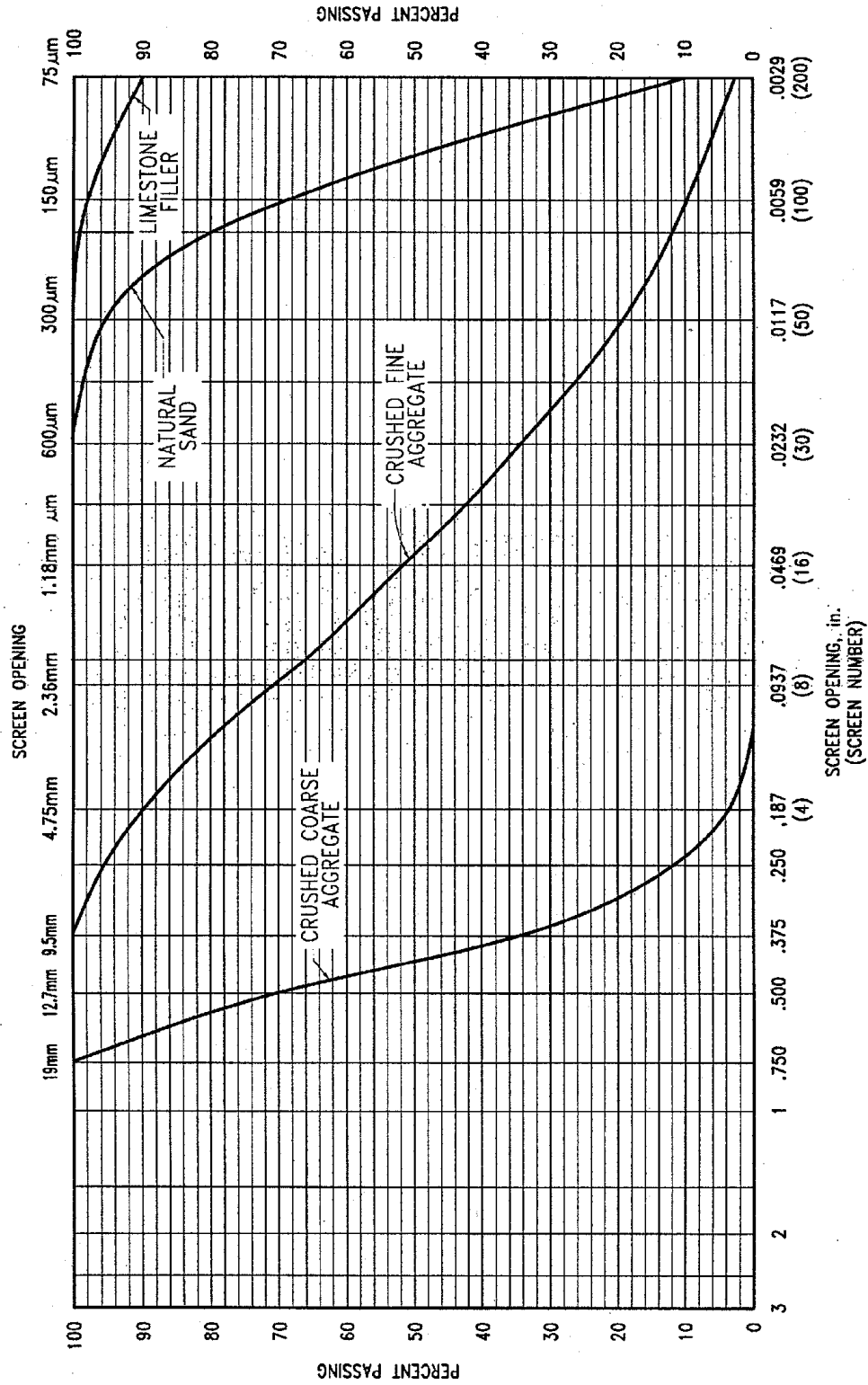
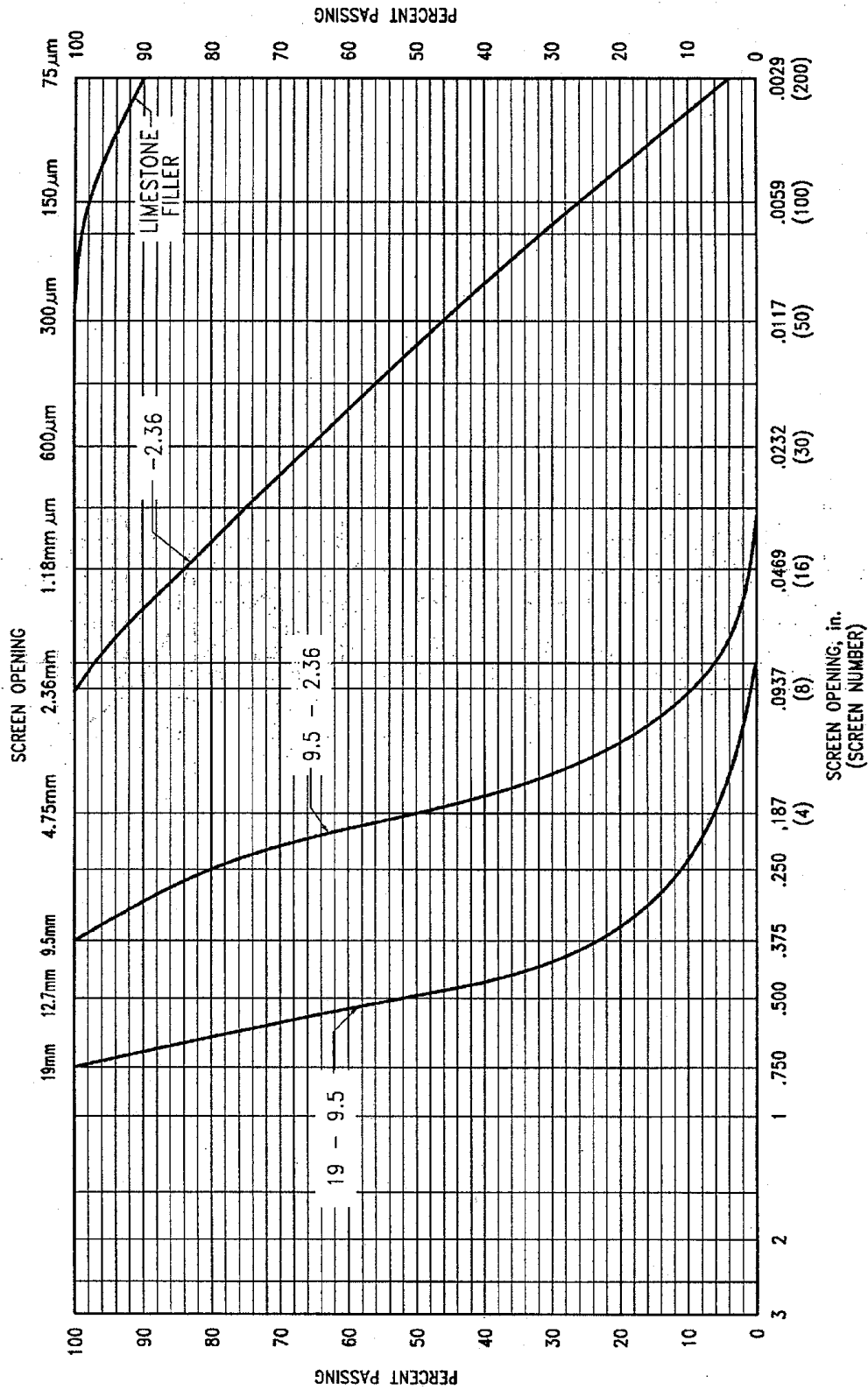

Figure 2-5 Gradation Curves for Bin Samples



2-4.2.4 Asphalt Contents for Specimens.

The quantity of asphalt binder required for an aggregate is important to ensure performance. Procedures are described in paragraph 2-4.2.5. Normally, to start the laboratory tests, an estimate is made of the optimum amount of asphalt binder based on total weight of mix. Laboratory tests usually are conducted for a minimum of five asphalt contents: two above, two below, and one near the estimated optimum asphalt content. Incremental changes of 1 percent of asphalt are used for preliminary work, but increments of 0.5 percent are used for final design.

2-4.2.5 Selection of Design Compaction Method.

DoD use the Marshall mix design method. Specifications have also been prepared for using Superpave mix design procedures which use the Superpave Gyratory Compactor. Procedures for conducting the Marshall mix design tests are described in the Asphalt Institute's Manual Series No. 2 (MS-2) and CRD-C649. The primary difference between the Marshall method and the Superpave method is the method of compaction. A Marshall hammer is used for the Marshall method and a gyratory compactor is used for the Superpave method.

When using CRD-C649, establish the mixing temperature to provide the asphalt binder with a kinematic viscosity of 280 ± 30 centistokes, determined according to the procedure provided in ASTM D2493. A manual hammer is required. When a mechanical hammer is used, calibrate it to provide the same specified density as that obtained with the effort with a manual hammer. It is easier to use a manual hammer for mix design and to use a mechanical hammer once full scale production begins. Compact samples produced at the asphalt plant using 50/75 blows as specified with a manual hammer and a variable number of blows with a mechanical hammer. Then select the number of blows required with the mechanical hammer to produce the specified density equal to that with the required number of blows with the manual hammer. Use this correlation only on the one project and not on additional projects since the correlation varies for different mixes. Verify the accuracy of the calibration weekly during the conduct of the project.

2-4.2.6 Tabulation of Data.

After selecting the laboratory design method and preparing test specimens, tabulate the data on forms similar to those shown in MS-2 or CRD-C649 and CRD-C650 for the Marshall procedure and for Superpave. Arranging data as shown in Table 2-6 facilitates tabulation of specimen test property data. Other material properties needed to make calculations include the bulk specific gravity of the aggregate, which is 2.700 (for this example), and the specific gravity of asphalt binder, which is 1.02 (for this example). Make plots of data from Table 2-6 for stability, flow, unit weight, percent voids total mix (VTM), percent VMA, and percent voids filled with asphalt (VFA) as shown in Figure 2-6(a-f). The desired values of VMA depend on the size of the aggregate particles in the mixture as shown in Table 2-6. The average actual specific gravity of the mixture is obtained for each set of test specimens, as shown in column G of Table 2-6. The unit weight values are determined in accordance with ASTM D2726 and provided in grams per cubic centimeter (g/cm^3) at 25 degrees C (77 degrees F). At this

temperature, the average values are multiplied by 997 to convert to kilograms per cubic meter (kg/m^3) (62.24 to obtain the density conversion in pounds per cubic foot (lb/ft^3)). Enter these data in column M. Plot the density conversion values as shown in Figure 2-6, and draw the best-fit smooth curve. The data from columns J, K, and L are used to plot curves for percent VTM, VMA, and VFA, respectively, in Figure 2-6. The corrected (converted) stability values in column O and the flow values in column P of Table 2-6 are plotted on Figure 2-6 to evaluate the stability and flow properties of the mixture. For Superpave, flow and stability are not used.

2-4.2.7 Relationship of Test Properties to Asphalt Cement Content.

Test property curves, plotted as described in paragraph 2-4.2.6, have been found to follow a reasonably consistent pattern for mixes made with non-modified grades of asphalt cement. Polymer-modified asphalt cements exhibit less consistent trends. Standard trends shown in Figures 2-6 (a-f) are noted in the following sub-paragraphs:

2-4.2.7.1 Flow.

The flow value increases at an increasing rate with increasing asphalt content. Flow is part of Marshall procedure but not used in Superpave.

2-4.2.7.2 Stability.

The Marshall stability increases with increasing asphalt content up to a point, after which it decreases. Stability is part of Marshall procedure but not used in Superpave.

2-4.2.7.3 Unit Weight.

The curve for unit weight of total mix is similar to the curve for stability, except that the peak of the unit-weight curve is normally at a slightly higher asphalt content than the peak of the stability curve.

2-4.2.7.4 VTM.

VTM decreases with increasing asphalt content. The void content of the compacted mix approaches a minimum void content as the asphalt content of the mix is increased.

2-4.2.7.5 VMA.

The VMA decreases with increasing asphalt content as the mixture becomes better lubricated and easier to compact. As the asphalt content continues to increase, the asphalt occupies space and begins to push apart aggregate particles, thereby increasing the VMA.

2-4.2.7.6 VFA.

The percent VFA increases with increasing asphalt content and approaches a maximum value in much the same manner as the VTM (above) approaches a minimum value.

Table 2-6 Computation of Properties of Asphalt Mixtures (page 1 of 2)

Specimen No.	Asphalt Cement %	Weight - Grams			Volume cc	Specific Gravity		Voids - Percent			Unit Weight Total Mix kg/m ³ (lb/ft ³)	Stability - N (lb)		Flow of Units of 0.25 mm (0.01 in.)
		In Air	In Water	SSD		Actual	Theo	Total Mix	VMA	Filled		Measured	Converted	
A	B	C	D	E	F	G	H	J	K	L	M	N	O	P
						Note 1		Note 1	Note 1	Note 1	Note 1		Note 2	
A-3.5	1	3.5	1228.3	719.3	1231.3	512.0	2.399					8985 (2020)	8985 (2020)	11
	2		1219.5	716.2	1223.5	507.3	2.404					8283 (1862)	8612 (1936)	10
	3		1205.5	708.3	1208.5	500.2	2.410					8100 (1821)	8425 (1894)	8
	4		1206.2	714.4	1212.2	497.8	2.423					8416 (1892)	8754 (1968)	8
	Avg						2.409	2.579	6.6	15.2	69.7	2,402 (149.9)	8694 (1954)	9
A-4.0	1	4.0	1276.9	751.3	1280.9	529.6	2.411					9386 (2110)	9012 (2026)	10
	2		1252.6	736.3	1255.6	519.3	2.412					9008 (2025)	9008 (2025)	9
	3		1243.5	734.0	1246.8	512.8	2.425					8874 (1995)	8874 (1995)	9
	4		1230.4	726.8	1234.4	507.6	2.424					8985 (2020)	9346 (2101)	9
	Avg						2.418	2.559	5.5	14.9	73.0	2,411 (150.5)	9060 (2037)	9
A-4.5	1	4.5	1254.4	741.2	1257.4	516.2	2.430					9119 (2050)	9119 (2050)	12
	2		1238.3	729.0	1240.5	511.5	2.421					9319 (2095)	9319 (2095)	9
	3		1239.0	727.1	1241.2	514.1	2.410					9386 (2110)	9386 (2110)	10
	4		1273.5	754.4	1275.9	521.5	2.442					9097 (2045)	9097 (2045)	10
	Avg						2.426	2.539	4.5	14.6	76.4	2,419 (151.0)	9230 (2075)	10
Sp. Gr. of Bit. = 1.020														

- No flow or stability results when Superpave used.

Figure 2-6(a-f) Asphalt Paving Mix Design for Typical Mix

Figure 2-6a VTM vs. Asphalt Content

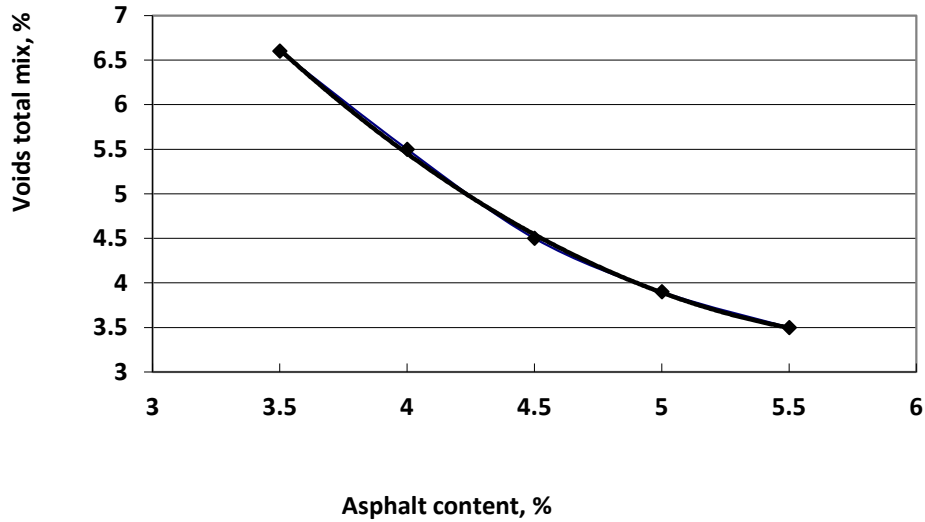

Figure 2-6b Unit Weight vs. Asphalt Content

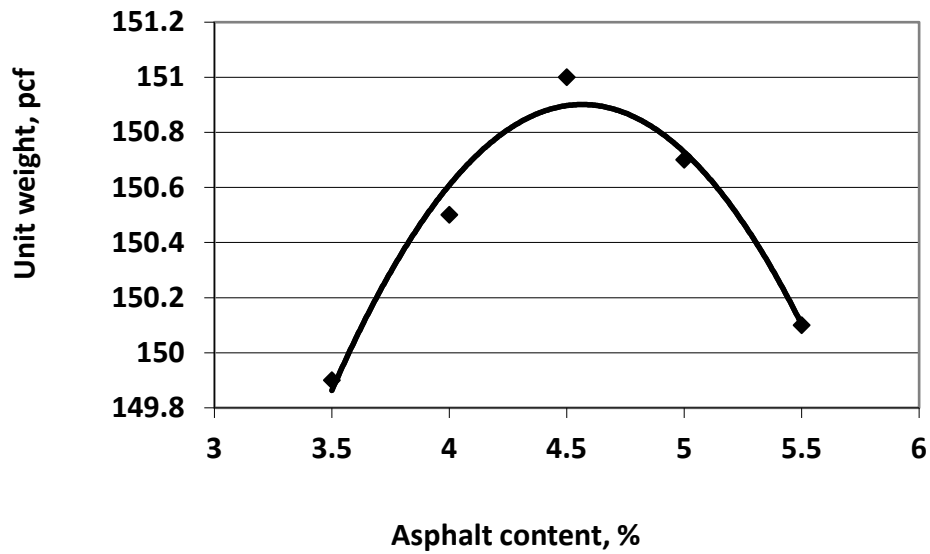

Figure 2-6c VMA vs. Asphalt Content

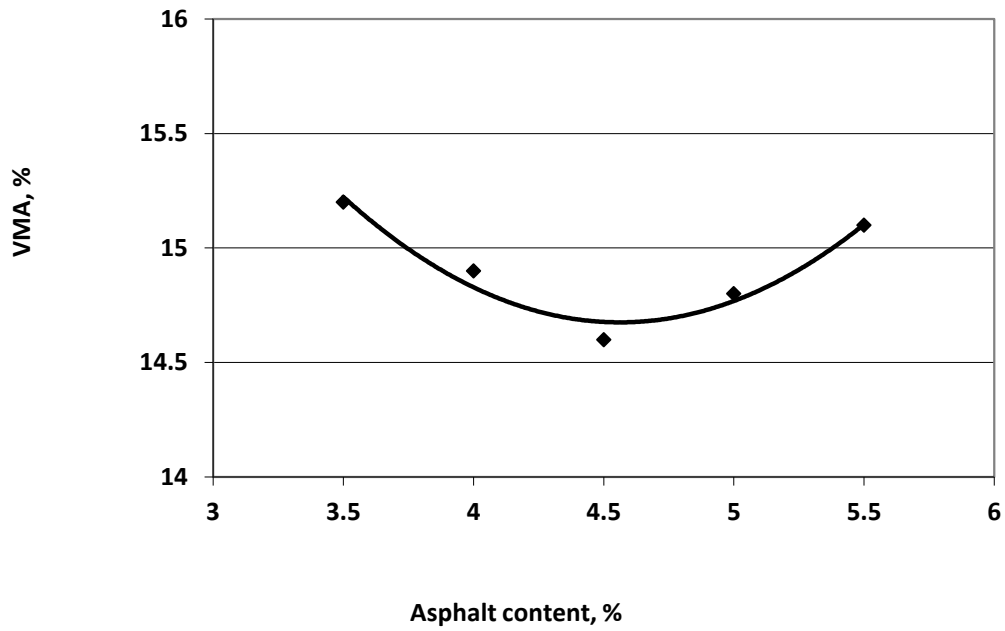

Figure 2-6d Voids Filled vs. Asphalt Content

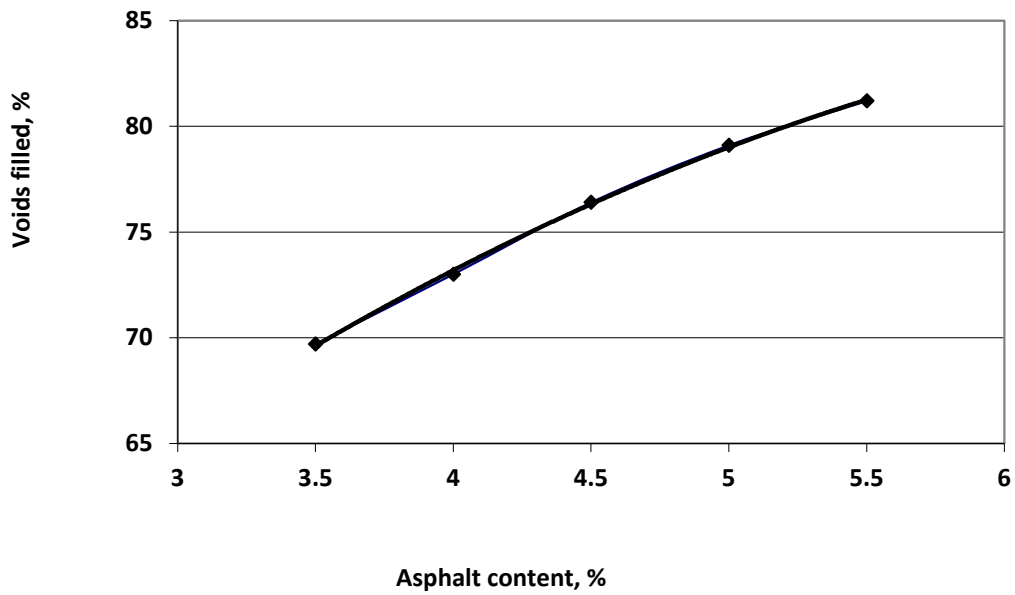

Figure 2-6e Stability vs. Asphalt Content

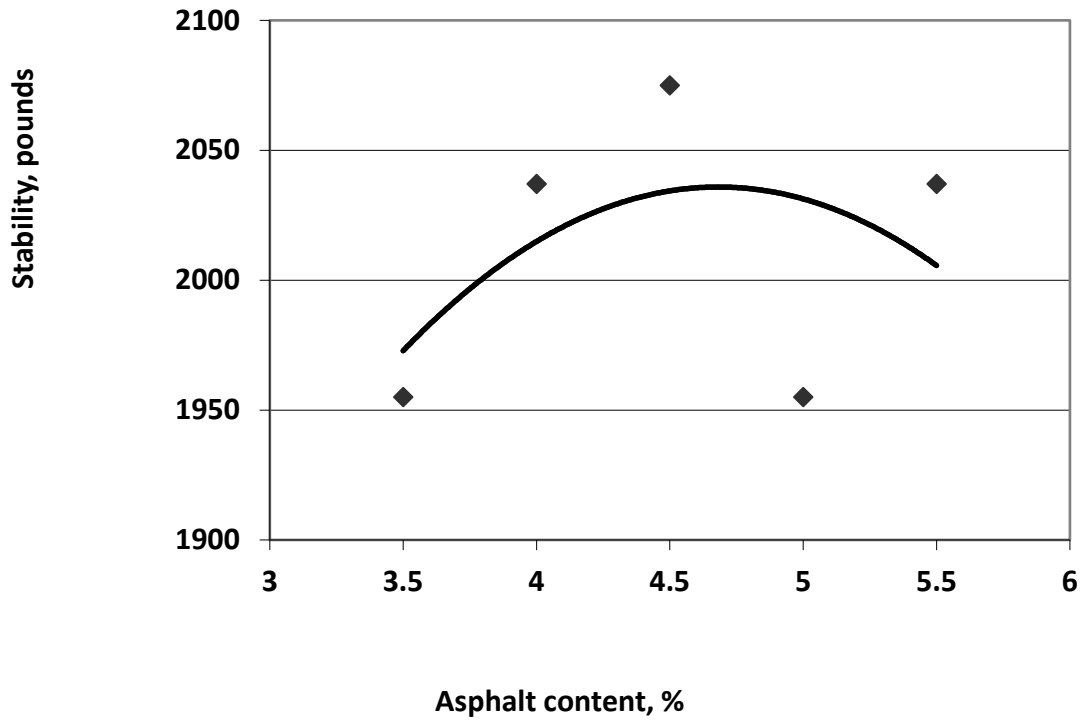

Figure 2-6f Flow vs. Asphalt Content

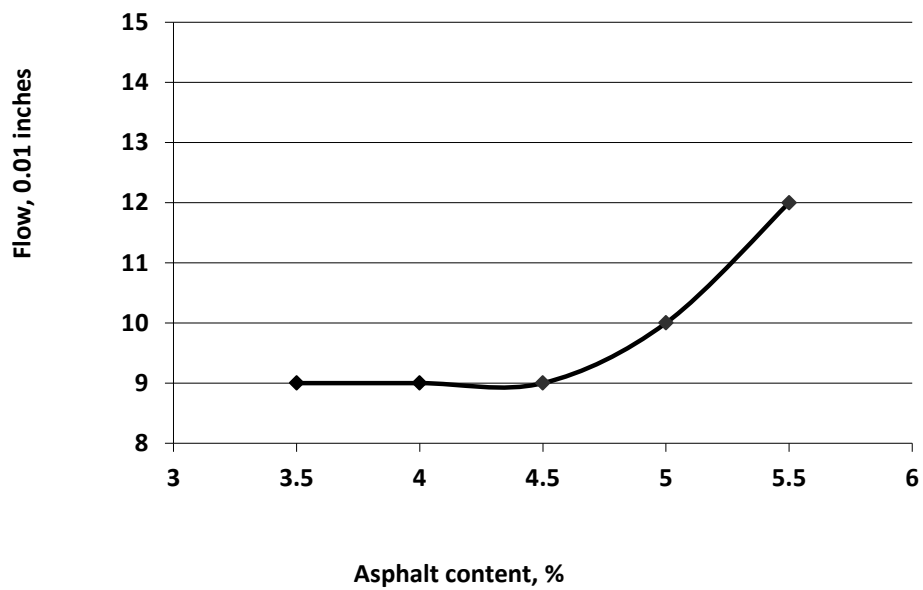

Table 2-7 Minimum Percent Voids in Mineral Aggregate (VMA)

Gradation Type¹	Minimum VMA, percent
Gradation 1, 25 mm (1-in.) maximum particle size	13.0
Gradation 2, 19 mm (3/4-in.) maximum particle size	14.0
Gradation 3, 12.5 mm (1/2-in.) maximum particle size	15.0
¹ Gradation designations given in Unified Facilities Guide Specification (UFGS) 32 12 15.13	

2-4.2.8 Requirement for Additional Test Specimens.

The curves in Figure 2-6 are typical of those normally obtained when non-modified grades of asphalt cement are used with aggregate mixes. Some aggregate blends furnish erratic data that make plotting the typical curves difficult. In these cases, an increase in the number of specimens tested at each asphalt content normally results in data that plots as typical curves.

2-4.2.8.1 Equations Used for Calculation of Mixture Properties.

These are the mixture properties:

- G_b = specific gravity of binder, ASTM D70
- G_{sb} = bulk specific gravity of aggregate, ASTM C127 and C128
- P_b = percent of total asphalt by weight
- G_{mb} = bulk specific gravity of mixture, ASTM D2726
- G_{mm} = theoretical maximum specific gravity of mixture, ASTM D2041
- V_v = air voids in mixture, percent of total mixture
- VMA = voids in mineral aggregate, percent of total mixture
- VFA = voids filled with asphalt
- W_{dry} = weight of sample after compaction in dry condition
- $W_{submerged}$ = weight of sample submerged in water for 3 to 5 minutes
- W_{SSD} = weight after removing from water and blotting dry, often called the saturated surface dry (SSD) weight

Determination of bulk specific gravity of mixture: $G_{mb} = \frac{W_{dry}}{W(SSD) - W(submerged)}$

Determination of air voids: $V_v = 100(1 - \frac{G_{mb}}{G_{mm}})$

Determination of VMA: $VMA = 100 - \left(\frac{G_{mb}(1 - P_b)}{G_{sb}} \right) 100$

Determination of VFA: $VFA = \frac{100(VMA - V_v)}{VMA}$

2-4.2.8.2 Determination of Stability and Flow

Stability and flow are determined by measuring the load and deformation of a sample at failure (ASTM D6927). The adjusted stability is needed to correct samples that are taller or shorter than 6.35 centimeters (2.5 inches) in height to get an equivalent stability to that of a 6.35 centimeters (2.5-inch)-tall sample. The stability is the load to failure, and the flow is the deformation at failure. The samples are corrected for height based on the height of the sample or the volume of the sample, which is determined when evaluating the volumetric properties of the mixture.

Example: Using the data for Specimen No. 1 at 5.0 percent asphalt in Table 2-6, the calculations are shown below for determining the mixture properties. The specific gravity of the binder is known to be 1.02. The bulk specific gravity of the aggregate is 2.70. A sample of the loose mix is obtained and the theoretical maximum density (TMD) is determined. For this example, the theoretical maximum density was determined to be 2.519. Samples of the remaining mixture are compacted using a specified effort and the mixture properties determined. After compaction, the sample is weighed dry, weighed while submerged in water, and weighed in a SSD condition after being removed from the water bath and the surface water blotted.

The sample volume is determined by:

$$Volume = W_{ssd} - W_{submerged} = 1240.2 - 729.3 = 510.9 \text{ cc}$$

The bulk specific gravity of the sample is determined by:

$$G_{mb} = \frac{W_{dry}}{W(SSD) - W(submerged)}$$

$$G_{mb} = \frac{1237.9}{1240.2 - 729.3}$$

$$G_{mb} = 2.423$$

Multiply this bulk specific gravity by 62.24 (since the test is conducted at 25 degrees C (77 degrees F)) to convert to pounds per cubic foot.

The VTM is determined to be:

$$V_v = 100 \left(1 - \frac{G_{mb}}{G_{mm}} \right)$$

$$V_v = 100 \left(1 - \frac{2.423}{2.519} \right)$$

$$V_v = 3.8 \text{ percent}$$

The VMA is determined to be:

$$VMA = 100 - \left(\frac{G_{mb}(1-Pb)}{G_{sb}} \right) 100$$

$$VMA = 100 - \frac{2.423(1-0.05)}{2.70} 100$$

$$VMA = 14.8 \text{ percent}$$

The VFA is determined to be:

$$VFA = \frac{100(VMA - V_v)}{VMA}$$

$$VFA = \frac{14.7 - 3.8}{14.7}$$

$$VFA = 79.6 \text{ percent}$$

2-4.2.9 Importance of Asphalt Content.

Previous testing has indicated that optimum asphalt content is an important factor in meeting the specified design of an asphalt paving mixture. Extensive research has resulted in criteria for determining the optimum asphalt content for a given blend of aggregates. Criteria have also been established to determine whether the aggregate furnishes the design paving mix at the selected optimum asphalt content.

2-4.2.10 Determination Optimum Asphalt Content & Acceptability of Mix.

The data plotted in graphical form in Figure 2-6(a-f) is used to illustrate the determination of optimum asphalt content. In addition to the data from Figure 2-6, optimum asphalt content and acceptability of the mix are determined based on Table 2-8. Separate criteria are shown for use where specimens were prepared with 50- or 75-blow compactive efforts. As shown in Table 2-9, the optimum asphalt content is determined at 4 percent air voids for surface or intermediate mixtures and is determined to be 4.9 percent. Table 2-10 shows that at the optimum bitumen content of 4.9 percent, this mixture meets the minimum criteria for acceptability of the mix for a 75-blow compactive effort.

2-4.2.11 Dust/Asphalt Ratio

One check of the design mixture is the dust proportion. This is the ratio of the mass of the aggregate passing the 0.075 mm (No. 200) sieve, divided by the effective asphalt content, in percent of total mass of the mixture. The normal range is 0.8 to 1.2. The ratio is intended to ensure that dust is added to the mix to provide good stability but not so much that results in excessively low asphalt content and subsequent durability problems.

Table 2-8 Design Criteria

Section 1. Procedure for Determining Optimum Asphalt Content					
Property	Point of Curve				
	Type of Mix	50 Blows	75 Blows	50 Gyration	75 Gyration
Marshall stability	HMA surface or intermediate course	NA	NA	NA	NA
	Sand asphalt	NA	NA	NA	NA
Unit weight	HMA surface or intermediate course	NA	NA	NA	NA
	Sand asphalt	NA	NA	NA	NA
Flow	HMA surface or Intermediate course	NA	NA	NA	NA
	Sand asphalt	NA	NA	NA	NA
Percent ^b VTM	HMA surface or intermediate course	4	4	4	4
	Sand asphalt	6	NA	6	NA
Percent ^b VMA	HMA surface or intermediate course	NA	NA	NA	NA
	Sand asphalt	NA	NA	NA	NA
Percent ^b VFA	HMA surface or intermediate course	NA	NA	NA	NA
	Sand asphalt	NA	NA	NA	NA
Section 2. Procedure for Determining Acceptability of Mix					
Test Property	Criteria				
	Type of Mix	50 Blows	75 Blows	50 Gyration	75 Gyration
Marshall stability	HMA surface or intermediate course	6.0 kN (1350 lbf) or higher	8.0 kN (1800 lbf) or higher	NA	NA
	Sand asphalt	500 lbf or higher	NA	NA	NA
Unit weight	--	NA	NA	NA	NA
Flow	HMA surface or intermediate course	20 (0.25 mm (0.01 in.)) or less	16 (0.25 mm (0.01 in.)) or less	NA	NA
	Sand asphalt	20 (0.25 mm (0.01 in.)) or less	NA	NA	NA
Percent ^b VTM	HMA surface or intermediate course	3–5 percent	3–5 percent	3-5 percent	3-5 percent
	Sand asphalt	5–7 percent	NA	5-7 percent	NA
Percent VMA	HMA surface or intermediate course	See Table 2-7	See Table 2-7	See Table 2-7	See Table 2-7
	Sand asphalt	NA	NA	NA	NA
Percent VFA	HMA surface or intermediate course	75–85 percent	70–80 percent	75-85 percent	70-80 percent
	Sand asphalt	65–75 percent	NA	65-75 percent	NA

^a Sand asphalt is not to be used for pavements having traffic with tire pressures above 690 kPa (100 psi).
^b The theoretical maximum specific gravity is determined by the use of ASTM D2041.

Table 2-9 Determination of Optimum Asphalt Content¹

Criteria	Asphalt Content, Percent
Flow curve	NA
Stability curve	NA
Unit-weight curve	NA
4 percent air voids from VTM curve	4.9
VMA curve	NA
VFA curve	NA

¹ Based on data in Figure 2-6.

Table 2-10 Evaluation for Acceptability of Design Mix

Test Property	4.9 Percent Asphalt	Criteria for Acceptability
Flow 0.025 centimeters (0.01 inch)	10	< 16
Stability, kN (lbf)	9.0 (2,030)	> 8.0 (1,800)
Percent VTM	4.0	3–5 percent (HMA)
Percent VMA	14.8	14 min
Percent total VFA	78	70–80 percent (HMA)

2-4.2.12 Moisture Susceptibility.

The final evaluation of the design mixture involves a test for moisture susceptibility. The TSR of the mixture at the selected optimum is performed according to ASTM D4867. A TSR value of less than 75 percent requires the use of an antistripping additive in the mixture.

2-4.2.13 Superpave Mix Design.

Superpave mix design is acceptable for airfield pavements. UFGS 32 12 15.13 provides for use of Superpave mix design as an option for the designer. Marshall mix design and Superpave mix design share common guidance. The aggregate and asphalt binder requirements are the same whether Marshall or Superpave is used. A difference is the way samples are compacted. For Marshall, samples are compacted with a Marshall hammer. For Superpave, samples are compacted with a Superpave gyratory compactor. Samples for Marshall are 102 millimeters in diameter (4 inches) and 64 millimeters tall (2.5 inches). For Superpave, samples are 150 millimeters in diameter (6 inches) and 115 millimeters tall (4.6 inches); hence, sample material is larger for a Superpave mix design than for a Marshall mix design. For Superpave, the

number of gyrations is set at 75 for high tire pressures greater than 1380 kPa (200 psi) and 50 for low tire pressures for less than 1380 kPa (200 psi).

The asphalt content is varied in 0.5 percent increments just as with Marshall mix design. Stability and flow tests are not conducted for Superpave designed mixes. Plots of the data that obtained with a Superpave mix design are provided in Figure 2-6, a-d. The quality of the mix is based on air voids, VMA, and voids filled with asphalt. The specification requirements for air voids, VMA, and voids filled with asphalt are the same for Superpave as for Marshall. These properties are determined for Superpave mixtures in the same way that they are determined for Marshall mixes. The optimum asphalt content is selected at 4 percent air voids. Moisture susceptibility testing is performed to ensure acceptability of the mixture, just like with Marshall.

Hence, the Superpave mix design and Marshall mix design procedures are almost identical except for the type of compactor used, the size of sample, and the fact that flow and stability are not part of the Superpave mix design procedure. The Superpave mix design compactive effort (number of gyrations) was selected to match that for Marshall (75 blows with Marshall hammer is equal to 75 gyrations with the Superpave gyratory machine and 50 blows with the Marshall hammer is equal to 50 gyrations with the Superpave gyratory machine). Hence for a specific aggregate, it is expected that the mix design provide the same results whether using Marshall or Superpave.

2-4.3 Mixture Control.

2-4.3.1 JMF Production at Asphalt Plant.

After the aggregate and asphalt binder qualities have been determined to meet the required mix design has been completed, the next step is to ensure that the JMF is produced at the asphalt plant. To evaluate the quality of the material produced and to ensure the required paving mixture is produced, a complete plant laboratory is required. Locate the laboratory at the plant site and ensure it contains the same equipment as that listed in MS-2 or CRD-C649 and CRD-C650. Because of the capacity of asphalt plants, assign at least two technicians to conduct control tests; otherwise, all testing cannot be completed in a timely manner.

2-4.3.2 Asphalt Plant Laboratory Burden.

The heaviest demands on plant laboratory facilities occur at the initiation of plant production. Feed aggregates and asphalt binder through the plant at a relatively constant rate and at the correct proportions. The gradation of the aggregate supplied by the plant often does not precisely reproduce the job mix formula developed in mix design. This often requires that the job mix formula be modified slightly. The specifications provide guidance on how much the mix is modified without requiring a new mix design. Feed the aggregates and asphalt binder through the plant at a constant rate to obtain efficient plant operation and to produce a mixture conforming to requirements.

2-4.3.3 Mix Adjustments.

The aggregates obtained from the hot bins of batch plants cannot be proportioned to exactly reproduce the gradation of the aggregate used in the laboratory design. Similarly, the gradation of the aggregates that have passed through a drum-mixer plant do not entirely duplicate the gradation used in the mixture design. This occurs because fines are generated during handling and production operations. Usually only slight adjustments are required to the original mix design and a completely new design is not required. If the change in gradation is substantial to prevent the contractor from meeting the mix design gradation (i.e., the gradation does not meet the job mix formula), it is necessary to adjust or redesign the mix using plant-produced aggregates. Specimens are prepared and tested for the new design in the same manner as for the original design tests. The optimum asphalt content and acceptability of the mix produced by the plant are determined. Perform sufficient additional tests to establish the optimum asphalt requirements and to ensure that the mix meets the applicable criteria.

2-4.3.4 Production & Laydown Quality Control & Quality Assurance.

Control several items routinely during the production and laydown operation to provide the specified pavement. As part of the quality control program, test for and control, at a minimum, asphalt content, aggregate gradation, temperatures, aggregate moisture, moisture in the asphalt mixture, laboratory air voids, VMA, stability, flow, in-place density, grade, and smoothness. As part of a quality assurance program, test mixture items including: aggregate gradation, asphalt content, voids, and VMA. The laydown items include density, smoothness, and final grade. Measure and analyze these items statistically. These items are air voids, density (mat and joint), and final grade. When these items do not meet the specified requirements, the contract unit price is reduced or the mixture is rejected. Projects of less than 1,000 metric tons (1,000 tons) of hot-mix are constructed without the pay reduction clause for economic reasons.

2-4.3.4.1 QA Methodology.

To evaluate the quality of a job, the work is divided into lots. Each lot is considered as a separate job and as such is evaluated solely on the test results for that lot. Ensure a lot does not exceed 2,000 metric tons (2,000 tons) of production or one normal day's production. Subdivide the lot into four equal sublots, and take a random sample from each subplot for evaluation of air voids, asphalt content, and density. The random subplot sample for these properties includes one sample of uncompacted asphalt mixture, one field core from a pavement joint area, and one field core from the compacted HMA.

ASTM D3665 provides detailed information on how to determine sampling locations within a subplot. As an example, suppose that 1,000 metric tons (1,100 tons) (one lot) of HMA were placed in two adjacent lanes, one lane 2,000 meters (6,600 feet) long and the other 1,000 meters (3,300 feet) long. The width of each paving lane was 3 meters (10 feet). The joint length between the two lanes is 1,000 meters (3,300 feet); thus, one

sample is taken at random for each 250 meters (825 feet) of joint length to evaluate joint density. The total length of the two lanes is 3,000 meters (9,900 feet); therefore, take one random sample from the mat for each 750 meters (2,475 feet) of HMA. Ensure the mat core samples are at least 0.3 meter (1 foot) away from any joint, the effective width of the paving lanes is 2.4 meters (8 feet). Obtain two random numbers and multiply the first one times the length and the second times the width to give the location for the core within the subplot. In this case, with random numbers of 0.108 and 0.485, the location of the core from the beginning of the subplot is 750 meters (2,500 feet) \times 0.108 = 81 meters (270 feet) and 2.7 meters (9 feet) \times 0.485 = 1.31 meters (4.3 feet) from 0.3 meter (1 foot) inside the designated left or right edge of the pavement. The random samples do not have to be precisely located, but it is important that the procedure being used to locate the sampling location is based on a standard form of measurement and is not affected by surface appearance.

2-4.3.4.2 QC Methodology.

The asphalt content and aggregate gradation is determined from samples of the asphalt mix taken between the production and the laydown operation. It is preferred that samples be taken from the back of loaded trucks before they leave the asphalt plant. It is also acceptable to take samples from other locations such as truck at laydown site or from behind the paver. Take samples from the paver hopper or at the paver auger during production. This is not acceptable since this practice is unsafe and it is extremely difficult to obtain a sample in this way. ASTM D979 and D3665 provide information needed for obtaining samples.

If a lot size equal to 1,000 metric tons (1,000 tons) is selected, ensure a sample of asphalt mix is taken for each 250 metric tons (250 tons) produced. Obtain a random number of each 250 metric tons (250 tons) produced. As an example, suppose that a random number is selected between 1 and 250 and is determined to be 200. This selection means that the 200th ton batched is sampled.

2-4.3.4.3 Air Void and Asphalt Content Deviations from JMF.

After the four asphalt contents and corresponding void values are determined for a lot, these results are compared with the JMF and the absolute difference is determined. Suppose the design air void content is 4.0 percent and the four air void contents of the sampled mixtures are determined to be 3.5, 3.0, 4.0, and 3.7. The mean absolute deviation from the JMF is determined to be:

$$\text{Mean absolute deviation} = (0.5+1.0+0.0+0.3)/4 = 0.45$$

The same procedure is used to determine the mean absolute deviation for asphalt content. After the mean absolute deviation is determined for the air void content and asphalt content for a lot, the maximum percent payment for that lot is determined from the tables provided in the specification requirements.

2-4.3.4.4 Density Measurements.

Determine density within the mat and at the joints between mats. Density measurements for acceptance is measured from cores taken from the pavement. Density gauges are not acceptable for acceptance testing. Obtain one sample in the mat and one in the joint for each subplot. The total linear length of joint constructed for a given lot is divided into quarters and one random sample taken for each subplot. These sample locations are determined in a similar way as that for aggregate gradation and asphalt content. Take all mat samples at least 0.3 meter (1 foot) from the edge of mat or joint. Use ASTM D3665 to determine sample locations in the mat and joint. ASTM D5361 provides information on obtaining the pavement sample.

The mat density and joint density for each subplot is expressed as a percentage of the theoretical maximum density (TMD) for that subplot. When a joint core sample is taken across two sublots, the density is determined using an average of the TMD for each of the two sublots. Suppose that the TMD for four consecutive sublots within a lot was 2,408 kilograms per cubic meter, 2,398 kilograms per cubic meter, 2,389 kilograms per cubic meter, and 2,421 kilograms per cubic meter, yielding an average TMD value of 2,404 kilograms per cubic meter. Further assume that the corresponding four subplot mat samples have individual densities of 2,324 kilograms per cubic meter, 2,356 kilograms per cubic meter, 2,348 kilograms per cubic meter, and 2,373 kilograms per cubic meter, and that the four corresponding subplot joint samples have individual densities of 2,311 kilograms per cubic meter, 2,324 kilograms per cubic meter, 2,343 kilograms per cubic meter, and 2,325 kilograms per cubic meter. Based on these results, the mat lot density is determined as:

$$\text{Mat density} = \frac{2,324 + 2,356 + 2,348 + 2,373}{4(2,404)} = 97.8 \text{ percent}$$

and the average joint density is:

$$\text{Joint density} = \frac{2,311 + 2,324 + 2,343 + 2,325}{4(2,404)} = 96.8 \text{ percent .}$$

The average density in the mat and the average density in the joint are used along with the tables in the specifications to determine the maximum percent payment for the lot of material being evaluated.

2-4.3.4.5 Evaluation of Grade and Smoothness.

The surface of the completed pavement is evaluated on a systematic basis to determine the acceptability of grade and smoothness. The results are compared with the specification requirements to determine the percent payment for grade and smoothness.

2-4.3.4.6 Quality Control Charts.

To properly evaluate the quality control of a mixture and maintain up-to-date records of test results, maintain control charts. It is recommended that the control charts be plotted for the critical sieves in the gradation requirements. The critical sieves include the 4.75 millimeters (No. 4) and 75 micrometers (No. 200) sieves. The plots are also to be made for asphalt content, laboratory density, stability, flow, VTM, VFA, mat density, and joint density. Make a plot of individual values and for the running average of four samples.

Subparagraphs a through c provide an example of the use of control charts. Assume that the density results shown in Table 2-11 were obtained from the in-place mat.

Table 2-11 Lot Density as a Percent of Laboratory Density

Lot 1	Lot 2	Lot 3	Lot 4	Lot 5
95.2	98.4	99.5	98.1	100.0
96.4	99.1	98.0	96.8	99.1
97.8	97.3	97.5	99.8	98.3
96.6	98.1	98.3	98.6	98.9
Average				
96.5	98.2	98.3	98.3	99.1

- a. Figure 2-7 shows the control charts for mat density. The first test result obtained is plotted in Figure 2-7, a. Note that this measurement falls below the desired range. At this point, it is concluded that the process is out of control; thus, stop the operation until the cause of the deficiency is identified and corrected.
- b. The second, third, and fourth samples are those obtained after corrections to the process, and they are higher but still below the desired range. At this point, the weight of the rubber-tired roller used to compact the mat was increased from 18 to 22.5 metric tons (18 to 22 tons), and the tire pressure was increased from 480 to 620 kilopascals (70 to 90 psi). After these changes, the density results were within the desired range.
- c. The moving average is determined for the last four samples tested (Figure 2-7, b). Plotting the moving average smoothes out the plot of individual values and allows trends to be spotted more readily.

Figure 2-7 Mat Density Control Chart

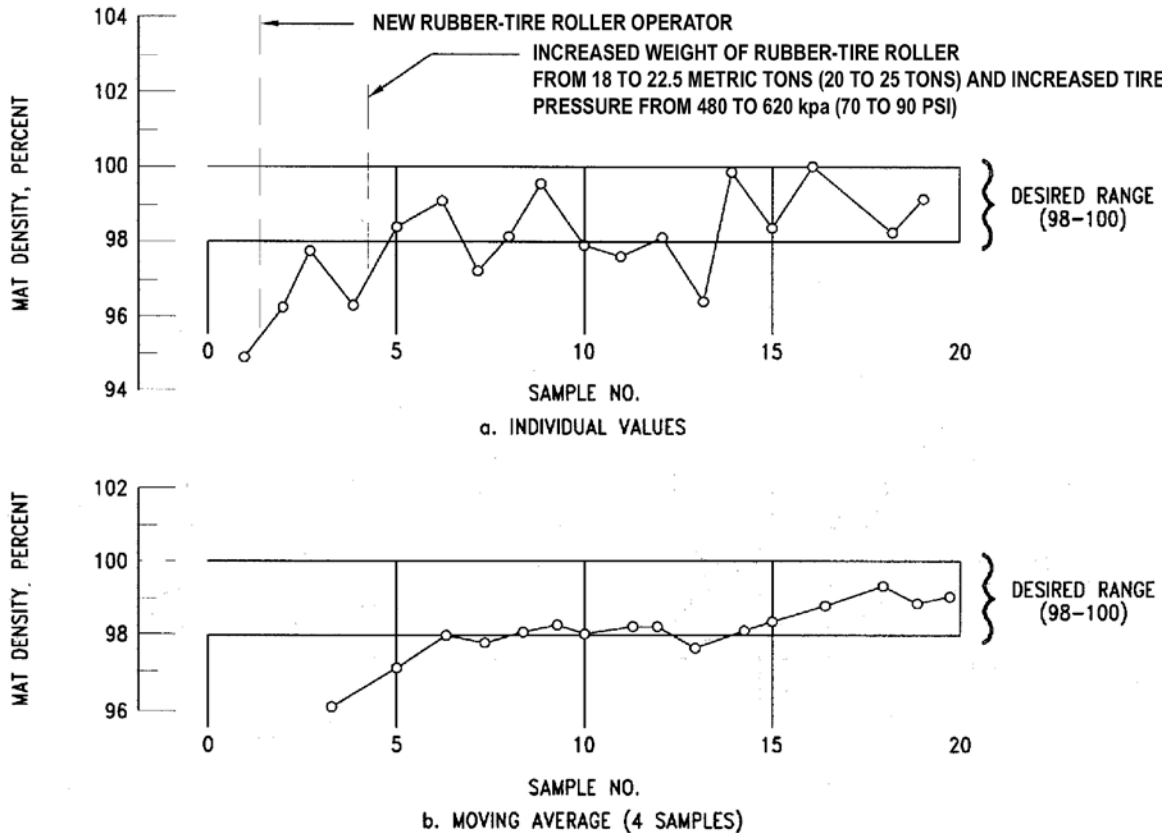

2-4.4 Significance of Changes in Mixture Properties.

As a general rule, most of the QC test results (for example, air voids, VMA, asphalt content, gradation) are obtainable quickly and are reasonably reliable indicators of the consistency of the plant-produced mix. A measurable change in these properties or properties outside the specified limits indicates that there is a mixture problem. A review of the control charts normally indicates the problem. Adjust mix proportions whenever any test property consistently falls outside of the specified tolerances. In the case of batch plants, the use of faulty scales and the failure of the operator to accurately weigh the required proportions of materials are common causes for paving-mixture deficiencies. Improper weighing or faulty scales need to be detected readily and corrective measures taken by maintaining a close check of load weights. Figure 2-8 lists other probable causes of paving-mixture deficiencies. For drum mix plants, a mixture problem typically is an indication that the rate of feed of one or more of the materials into the plant is incorrect.

Figure 2-8 Types of HMA Deficiencies and Probable Causes

Item	1	2	3	4	5	6	7	8	9	10	11	12	13	14	15	16	17	18	19	20	21	22	23	24	25	26	27	28
Aggregate scales out of adjustment																												
Bitumen scales out of adjustment in bin																												
Lack of proper weighing by operator																												
Bitumen temperature too high																												
Improper dryer operation																												
Too little bitumen																												
Too much bitumen																												
Sampling method not uniform																												
Bin overflow moisture content not uniform																												
Bin overflow pipes not uniform																												
Leaky bins																												
Segregation of aggregate in bins																												
Mixing line not uniform																												
Mineral filler feed not uniform																												
Aggregate temperature too high																												
Temperature mechanism too high																												
Improper feed of aggregate to dryer																												
Overloaded dryer capacity																												
Faulty screen operation																												
Improper set on pug mill																												
Bitumen and aggregate feed out of adjustment																												
Bitumen pump not functioning properly																												
Aggregate gates not properly set																												
Types of Deficiencies That May Be Encountered in Producing Hot Plant Mix Paving Mixtures																												
Bitumen content fails to check job-mix formula																												
Gradation fails to check job-mix formula																												
Poorly mixed loads																												
Fat, rich mixtures																												
Lean or burned mixtures																												
Mixture temperature fails to check job mix																												
Smoking loads																												
Steaming loads																												
Overweight or underweight loads																												
Lack of uniformity of mixtures in loads																												

Items 6 to 23 are applicable to all types of plants. Items 1 to 5 and items 24 to 28 are applicable to batch plants and volumetric plants, respectively.

2-4.4.1 Hot-bin Gradations.

When batch plants are used, conduct the hot-bin gradation tests at least once daily during operation. Determine hot-bin gradations on all bins in conjunction with sampling of the pavement mixture. Determine washed sieve analyses initially.

2-4.4.2 Construction Control.

Well-designed mixes are compacted by adequate field rolling to about 98 percent or greater of the density obtained by compacting specimens with previously specified laboratory procedures (or at least 94 percent of theoretical maximum density). Roll asphalt intermediate, base course, or surface course mixes until the density specified is met.

2-4.4.3 Pavement Sampling.

Take samples for determining pavement density and thickness either with a coring machine (with a core barrel nominal diameter of at least 100 millimeters (4 inches)) or by cutting out a section of pavement at least 100 millimeters (4 inches) square with a concrete saw. When the compacted thickness of the pavement is less than 50 millimeters (2 inches), use a 150-millimeter (6-inch) -diameter core barrel to obtain the sample. Ensure these samples include the entire thickness of the layer of asphalt mixture being evaluated. Take density samples of each day's production and have delivered to the project laboratory by noon of the following day, and make the density determinations by the end of the day. Any changes in placing technique to obtain the required density is made immediately prior to placing additional pavement.

2-4.4.4 Testing Pavement Samples.

Prepare pavement samples for testing by carefully removing all particles of base material or other foreign matter. Carefully trim broken or damaged edges of sawed samples for density tests carefully from the sample. Take thickness measurements before separating the sample into layers. Split a sample consisting of an intermediate course and surface course at the interface of these layers before testing. Usually these courses are separated with only a few blows of a sharp-edged chisel at the interface. When possible, use a concrete table saw to separate layers of pavement. This is true when the underlying surface was a milled layer or the asphalt was placed directly on a crushed stone base. Eliminating excess tack, uncoated aggregate, and voids from the bottom of a core sample greatly increase the accuracy of density measurements. Determine the density of the sawed samples by weighing them in air and in water and as described in paragraphs 2-4.2.6 and 2-4.2.8. Discard samples from which density measurements are desired if damage is apparent. Take additional samples from the same subplot.

Nuclear gauges and other nondestructive density tests are currently being used to check the density of HMA. These methods are fast, but the results are often questionable. Factors that affect the results of density measurements with the nondestructive gauges are the thickness of the asphalt mixture, the density of the

material below the asphalt mixture, moisture, and smoothness at the test location. The nondestructive density gauges are useful for developing roller patterns, but conduct density tests for acceptance by removing samples from the pavement and weighing them in air and water to determine density.

2-4.4.5 Density Data.

Density data obtained from specimens in the manner described in paragraphs 2-4.2.6 and 2-4.2.8 is compared with the average laboratory density or theoretical maximum density for the same lot.

2-4.4.6 Pavement Imperfections and Probable Causes.

Pavement imperfections result from not following specified laying and rolling operations as well as not meeting specified mix designs or faulty plant operation. These imperfections are controlled only by inspection. Figure 2-9 presents these potential pavement imperfections result.

2-5 POROUS FRICTION COURSE.

A PFC is an open-graded, free-draining asphalt paving mixture that is placed on an existing pavement to minimize hydroplaning and to improve skid resistance in wet weather. PFC is just another name for open-graded friction course (OGFC) used by many state DOT agencies. Do not use this surface for low-speed applications or in areas subjected to tank traffic. The thickness of the finished course varies from approximately 19 millimeters (3/4 inch) to 25 millimeters (1 inch). A PFC has a coarse surface texture and is sufficiently porous to permit drainage of water internally as well as along the surface. A combination of water pressure relief through the internal and surface voids and the rough surface texture promotes tire-to-aggregate contact. PFC paving mixtures are produced in HMA plants and placed with conventional asphalt paving machines. Place them on pavements that are in good condition. Similar to Section 2-1.2, determine if a leveling course is required to achieve the desired surface conditions before construction of the PFC. Due to performance issues, FOD potential, PFCs have not been used on airfields in recent years.

2-5.1 Materials.

2-5.1.1 Aggregates.

High-quality aggregates are required for PFCs with a maximum Los Angeles (LA) abrasion loss (ASTM C131) of 25 percent and 40 percent for high and low tire pressure loadings, respectively. A crushed aggregate is required and has a minimum of 90 percent by total weight of aggregate with one crushed face and 70 percent with two crushed faces. Specify antistripping agents when required. Design, specify and use an antistripping agent not only in the PFC but also in the underlying HMA layer regardless of the results from the TSR test (ASTM D4867/D4867M). Table 2-12 presents the aggregate gradation requirements for PFCs.

Figure 2-9 Types of HMA Pavement Imperfections and Probable Causes

Probable Causes of Imperfections in Finished Pavements	Types of Pavement Imperfections That May Be Encountered in Laying Hot Plant Mix Paving Mixtures										
	Bleeding	Brown, dead appearance	Poor surface texture	Rough uneven surface	Uneven joints	Roller marks	Shoving	Waves	Cracking	Honeycomb	Tearing of surface during laying
Excessive primecoat											
Improper proportioning											
Unsatistactory batches in load											
Excessive segregation in laying											
Inadequate rolling											
Poor spreader operation											
Mixture too hot or burned											
Mixture too cold											
Rolling mixture when too hot											
Rolling mixture when too cold											
Poorly graded mixture											
Unusable basecourse											
Excess basecourse											
Roller allowance for compaction											
Mixture standing on hot pavement											
Lack of bitumen in hot pavement											
Excess of bitumen in mixture											
Inadequate cross rolling											
Not cut back to uniform thickness											
Excessive moisture in mixture											

Table 2-12 Aggregate Gradation for PFCs

Sieve Designation (Square Openings)	Percent Passing by Weight of Total Aggregates	
	Gradation "A" 19 mm (3/4-inch) Maximum (Compacted Nominal Thickness, 25 mm, 1 inch)	Gradation "B" 12.5 mm (1/2-inch) Maximum (Compacted Nominal Thickness, 19 mm, 3/4 inch)
19 mm (3/4 inch)	100	100
12.5 mm (1/2 inch)	70–100	100
9.5 mm (3/8 inch)	35–75	80–100
4.75 mm (No. 4)	25–40	25–40
2.36 mm (No. 8)	10–20	10–20
600 µm (No. 30)	3–10	3–10
75 µm (No. 200)	0–5	0–5

2-5.1.2 Asphalt Cement.

Test requirements for asphalt cements are outlined in specifications (ASTM D946, D3381, D6373, or AASHTO M320). Guidance on the selection of an asphalt type is provided in section 2-3.1. Historically, many PFCs were constructed using modified asphalt to improve the ability of the asphalt to hold the aggregate in place and reduce oxidation deterioration in the porous mat. When using PFC, specify polymer modified asphalt cement.

2-5.2 Mixture Design.

2-5.2.1 Proportioning of Aggregates.

For PFC use polymer modified asphalt and fibers. The modified asphalt and fibers help to reduce draindown when storing for a short period of time and during haul to the paving site. Select the aggregate gradation from Table 2-12.

2-5.2.2 Fiber Stabilizers.

Tables 2-13 and 2-14 provide the requirements and test procedures to be used with cellulose and mineral fibers, respectively. The dosage rates normally used for cellulose fibers is 0.3 percent by weight of the total mix and for mineral fibers is 0.4 percent by weight of the total mix. The recommended tolerance for the fibers is 10 percent of the required fiber weight.

Table 2-13 Properties of Cellulose Fibers (after NAPA 1999)

Properties	Requirement
Sieve Analysis Method A, Alpine Sieve ¹ Analysis Fiber length Passing 150 μm (No. 100) sieve Method B, Mesh Screen ² Analysis Fiber length Passing 850 μm (No. 20) sieve 425 μm (No. 40) sieve 106 μm (No. 140) sieve	 6 mm (0.25 in.) (max.) 70% (±10%) 6 mm (0.25 in.) (max.) 85% (±10%) 65% (±10%) 30% (±10%)
Ash Content ³	18% (±5%) non-volatiles
pH ⁴	7.5 (±1.0)
Oil Absorption ⁵	5.0 (±1.0) (times fiber weight)
Moisture Content ⁶	< 5% (by weight)
<p>¹ Method A, Alpine Sieve Analysis. This test is performed using an Alpine air jet sieve (Type 200 LS). A representative 5-gram (0.18 oz) sample of fiber is sieved for 14 minutes at a controlled vacuum of 75 kPa (11 psi). The portion remaining on the screen is weighed.</p> <p>² Method B, Mesh Screen Analysis. This test is performed using standard 850, 425, 250, 180, 150, 106 μm (No. 20, 40, 60, 80, 100, 140) sieves, nylon brushes, and a shaker. A representative 10-gram sample of fiber is sieved using a shaker and two nylon brushes on each screen. The amount retained on each sieve is weighed and the percentage passing calculated. Repeatability of this method is suspect and needs to be verified.</p> <p>³ Ash Content. A representative 2- to 3-gram (0.07 – 0.11 oz) sample of fiber is placed in a tared crucible and heated between 595 and 650 degrees C (1100 and 1200 degrees F) for not less than 2 hours. The crucible and ash are cooled in a desiccator and reweighed.</p> <p>⁴ pH Test. Five grams (0.18 oz) of fiber is added to 100 ml (0.106 quarts) of distilled water, stirred, and let sit for 30 minutes. The pH is determined with a probe calibrated with pH 7.0 buffer.</p> <p>⁵ Oil Absorption Test. Five grams(0.18 oz) of fiber is accurately weighed and suspended in an excess of mineral spirits for not less than 5 minutes to ensure total saturation. It is then placed in a screen mesh strainer (0.5 square millimeter [7.75 x 10⁻⁴ square inch] hole size) and shaken on a wrist action shaker for 10 minutes, 3.2 centimeter (1.25 inch) motion at 240 shakes per minute). The shaken mass is then transferred without touching, to a tared container and weighed. Results are reported as the amount (number of times its own weight) the fibers absorb.</p> <p>⁶ Moisture Content. Ten grams (0.35 oz) of fiber is weighed and placed in a 121 degrees C (250 degrees F) forced air oven for 2 hours. The sample is then reweighed immediately upon removal from the oven.</p>	

Table 2-14 Properties of Mineral Fibers¹ (after NAPA 1999)

	Properties	Requirement
Sieve Analysis	Fiber length ²	6 mm (0.25 in.) max. mean test value
	Thickness ³	5 μm (0.0002 in.) max. mean test value
Shot Content ⁴	250 μm (No. 60) sieve	95 percent passing (min.)
	63 μm (No. 230)	65 percent passing (min.)
<p>¹ The European experience and development of the above criteria are based on the use of <u>basalt</u> mineral fibers.</p> <p>² The fiber length is determined according to the Bauer-McNett fractionation.</p> <p>³ The fiber diameter is determined by measuring at least 200 fibers in a phase contract microscope.</p> <p>⁴ Shot content is a measure of non-fibrous material. The shot content is determined on vibrating sieves. Two sieves, 250 μm (No. 60) and 63 μm (No. 230), are used; for additional information see ASTM C612.</p>		

2-5.2.3 Asphalt Content.

The asphalt content of PFCs is expressed as a percentage of the total mix by weight. A surface area constant, K_c , as described in the centrifuge kerosene equivalent (CKE) test (ASTM D5148), is used to determine the optimum asphalt content. The K_c value is used in the relation $2K_c+4.0$ to determine the estimate of asphalt (EOA). This asphalt content is valid for aggregates with an apparent specific gravity in the range of 2.60 to 2.80 and with a water absorption value less than 2.50 percent when tested by ASTM C127 for coarse aggregate and ASTM C128 for fine aggregate. A slight increase in asphalt content (up to 0.5 percent) is required when the absorption is greater than 2.50 percent. The EOA is inversely proportional to the specific gravity of the aggregate, ensure adjustments are made when the specific gravity is outside of the 2.60 to 2.80 range.

2-5.2.4 K_c Factor.

The K_c factor indicates the relative particle roughness and surface capacity based on the porosity of the aggregate to be used for the PFC. The K_c factor is determined from the percent of Society of Automotive Engineers (SAE) 10 oil retained, which represents the total effect of the coarse aggregate's absorptive properties and surface roughness. The K_c factor is determined from that portion of the aggregate sample that passes the 9.5-millimeter (3/8-inch) sieve and is retained on the 4.75-millimeter (No. 4) sieve using the procedure described in ASTM D5148. If the specific gravity for the aggregate is greater than 2.70 or less than 2.60, apply a correction to oil retained using the formula given in ASTM D5148. No correction need be applied for asphalt viscosity.

2-5.2.5 Mixing Temperature.

Mixing temperature to provide an asphalt viscosity of 275 ± 25 centistokes is obtained by evaluating the temperature-viscosity relationship for the type of asphalt selected at a minimum of three temperatures (ASTM D2170 and ASTM D2171). ASTM D2493 provides details for plotting this information on a graph with temperature versus log viscosity. Plotting this information normally results in a straight-line relationship, and the temperature for the correct viscosity is chosen from the graph.

2-5.3 Plant Control.

2-5.3.1 Plant Laboratory.

A plant laboratory is needed to ensure that the aggregate is properly graded and the mix contains the prescribed percentage of asphalt binder. Locate the laboratory at the plant to minimize the time between production and testing.

2-5.3.2 Sieve Analysis.

Conduct all sieve analyses by the method described in ASTM C136. Recommended sieve sizes for plant sieve analysis are: 19 millimeter (3/4 inch), 12.5 millimeter (1/2 inch), 9.5 millimeter (3/8 inch), 4.75 millimeter (No. 4), 2.36 millimeter (No. 8), 600 micrometers (No. 30), and 75 micrometers (No. 200). For batch-mix plants, accomplish sieve analyses on material from each plant hot bin. Obtain samples for these sieve analyses after a few tons of aggregate have been processed through the dryer and screens so that the sample is representative. For drum mixers, make the sieve analysis directly from the cold feeds. Final mix proportions are determined on the basis of these analyses. For both types of plants, aggregate gradations will also be conducted on the aggregate recovered from the asphalt mixture.

2-5.3.3 Asphalt Content Tests.

Accomplish extraction tests in accordance with ASTM D2172. A nuclear gauge is used to determine the asphalt content, when tested in accordance with ASTM D4125, provided the gauge is calibrated. The asphalt content is also determined by the ignition method in accordance with ASTM D6307. Follow procedures specified in ASTM D5444 for sieve analysis. If the nuclear gauge is used to measure asphalt content, there is no way to recover the aggregate from the mixture for testing.

2-5.3.4 Mix Proportions.

Adjust mix proportions whenever tests indicate that specified tolerances are not being met. In the case of batch plants, common causes for mixture deficiencies are faulty scales and the failure of the operator to accurately weigh the required proportions of materials. Detect failure of accurate weighing or faulty scales and take corrective measures by maintaining a close check of load weights. Figure 2-8 presents other probable causes of mixture deficiencies due to plant operations.

2-5.3.5 Controlling Plant Production.

Normally the plant inspector obtains a sample of the PFC mix after the plant has been in production for 30 minutes. Test the sample as rapidly as possible for compliance with gradation and asphalt content requirements. If plant is too far from the construction site, draindown potentially occurs during haul due to the extended period of haul time.

2-5.4 Construction.

2-5.4.1 Pavement Control.

A PFC pavement has no density requirements. A characteristic of this overlay is its rapid cooling. If minimum asphalt drainage is desired, ensure the roller closely follows the paver to initially set the PFC so that asphalt drainage is minimized. If drainage in the truck or the paver causes a rich spot (excess asphalt cement) in the pavement, and warm weather conditions exist (high temperatures), rolling is delayed to allow the asphalt to drain into the PFC. Two passes with a 10-metric ton (10-ton) steel-wheel roller (in static mode if a vibratory roller) is required to properly seat the PFC mix.

2-5.4.2 Pavement Sampling.

Samples for determining thickness (ASTM D979) are taken either with a coring machine or by cutting out a sample of pavement at least 100 millimeters (4 inches) square with a concrete saw. Ensure the sample includes the entire thickness of the PFC.

2-5.4.3 Storage Silos.

Avoid storage of PFC mix whenever possible; the maximum allowable storage time under any circumstance is not to exceed 1 hour. Excessive storage time allows the asphalt to drain, causing segregation of the mixture. Coordination between the plant and the laydown operations eliminates the need for extended storage.

2-5.4.4 Pavement Operations under Normal Conditions.

Guide specifications do not permit placement of PFC when the surface temperature of the existing pavement is below 16 degrees C (60 degrees F). Ensure the contractor applies the specified rolling before the mixture becomes too cool to be properly seated. Generally, perform all rolling before the PFC mixture cools to 80 degrees C (175 degrees F). A PFC cools quickly because of the thin layer of material and high void content in the thin PFC layer.

2-6 STONE MATRIX ASPHALT.

SMA is a mixture of aggregate, mineral filler, asphalt cement, and a stabilizer (modified asphalt with or without the addition of cellulose or mineral fiber). SMA is designed to minimize rutting and abrasions even under high loads and high tire pressures. SMA mixtures depend on aggregate-to-aggregate contact to support traffic loads, therefore their mix design requires a higher percentage of coarse aggregate than HMA. Excess fine aggregate or too much mastic prevents the coarse aggregate particles from

obtaining full contact and therefore lowers the mixture's resistance to rutting. The high void content of the mix is occupied by fine aggregate, mineral filler, asphalt cement, and a stabilizer (polymer, cellulose, or mineral fiber), which forms a mastic portion of the SMA mixture. This mastic stabilizes the coarse aggregate and reduces the final air voids in the SMA to 3 to 4 percent. SMA is comparable to HMA in regards to structural design, mix design, and construction. SMA originated in Europe and has recently been placed by state and federal agencies on projects throughout the country. The design and construction of SMA pavements are described in this chapter.

2-6.1 Materials.

2-6.1.1 Aggregates.

The gradation used for SMA is gap-graded for the coarse aggregate retained on the 4.75-millimeter (No. 4) sieve. This coarse aggregate makes up from 72 to 80 percent of the aggregate in the mix. Ensure 100 percent of the coarse aggregate passes the 19-millimeter (3/4-inch) sieve, and the amount of the fine material passing the 75-micrometer (No. 200) sieve is from 8 to 10 percent. Table 2-15 lists the gradation as recommended by the NAPA and FHWA. This gradation is based on the recommendations of a technical working group jointly representing NAPA and FHWA that reviewed the performance of SMA mixtures in place. Table 2-16 lists the recommended coarse and fine aggregate properties for SMA. Another test that is often used for airfield specs is ASTM C142, *Clay Lumps and Friable Particles*, which might be used in place of ASTM D3744, coarse and fine durability index.

2-6.1.2 Filler.

As presented in Table 2-15 for SMA mixtures, the recommended amount of aggregate filler (dust) passing the 75-micrometers (No. 200) sieve is 8 to 10 percent. This amount of filler in the SMA is higher than that usually found in dense-graded HMA. The amount of filler is important in obtaining the desired mixture air voids and in affecting the optimum asphalt content. The SMA asphalt content is sensitive to the aggregate fines and filler content. SMA mixtures commonly employ a filler-to-asphalt ratio of 1.5 and higher. In contrast, conventional dense-graded hot mix recommends a filler-to-asphalt ratio of less than 1.2. A well-graded filler with less than 20 percent of the total filler smaller than 20 micrometers (0.001 inch) is required. Commercial fillers are added by mineral filler feeder systems. Fly ash, limestone dust, and other types of rock dust have been used successfully as fillers for SMA applications.

2-6.1.3 Stabilizer.

There is a tendency for the asphalt binder to drain from the aggregate during storage, transportation, or placement because of the high asphalt content in the mix, the thick asphalt coating on the coarse aggregate, and the high voids in the aggregate skeleton. To reduce this drainage potential, stabilizers are used to stiffen the mastic or to increase the asphalt binder viscosity. These stabilizers are categorized into two groups: (1) either cellulose fibers or mineral fibers, and (2) polymers. When SMA has been placed with a

combination of fibers and asphalt polymer, the fibers have been shown to perform better at reducing draindown than polymers.

Table 2-15 SMA Gradation Guideline (after NAPA 1999*)

Sieve Size	Percent Passing
19 mm (3/4 in.)	100
12.7 mm (1/2 in.)	85–95
9.5 mm (3/8 in.)	75 maximum
4.75 mm (No. 4)	20–28
2.36 mm (No. 8)	16–24
600 μm (No. 30)	12–16
300 μm (No. 50)	12–15
75 μm (No. 200)	8–10
*National Asphalt Pavement Association, publication QIP-122	

2-6.1.3.1 Fiber Stabilizers.

Tables 2-13 and 2-14 provide the requirements and test procedures to be used with cellulose and mineral fibers, respectively. The dosage rates normally used for cellulose fibers is 0.3 percent by weight of the total mix and for mineral fibers is 0.4 percent by weight of the total mix. The recommended tolerance for the fibers is 10 percent of the required fiber weight.

2-6.1.3.2 Asphalt-Polymer Stabilizers.

SMA mixtures have been placed using a polymer to modify the asphalt cement and stabilize the mixture so that fibers are not required. There have also been instances where a polymer and a fiber have been used in conjunction to stabilize SMA mixtures. Follow the manufacturer's design and construction recommendations when the standard SMA guidelines are not applicable for asphalt-polymer stabilizers.

**Table 2-16 Recommended SMA Coarse and Fine Aggregate Properties
(after NAPA 1999)**

Property	Specifications	Requirement
Coarse aggregate:		
LA abrasion, %	ASTM C131, AASHTO T96	30 max.
Flat and elongated, +No. 4 3 to 1 (length to thickness), % 5 to 1 (length to thickness), %	ASTM D4791	20 max. 5 max.
Fractured faces, +No. 4 One fractured face, % Two fractured faces, %	CRD-C171	100 min. 90 min.
Absorption, %	ASTM C127, AASHTO T85	2 max.
Coarse and fine durability index	ASTM D3744, AASHTO T210	40 min.
Sulfate soundness loss, 5 cycles Sodium sulfate, % or Magnesium sulfate, %	ASTM C88, AASHTO T104	15 max. 20 max.
Fine aggregate:		
Crushed manufactured fines, %		100 min.
Sulfate soundness loss, 5 cycles Sodium sulfate, %		15 max.
Liquid limit	ASTM D4318, AASHTO T89	25 max.

2-6.1.4 Asphalt.

Ensure the asphalt cement complies with the requirements of ASTM D946, ASTM D3381, or ASTM D6373, and the asphalt cement used is the grade normally used in the area by the local DOT or on previous Department of Defense (DoD) projects. When using ASTM D6373, the grade is normally bumped to be equal to that specified for heavy traffic. Ensure the temperature of the asphalt cement at the time of mixing is that required to achieve a viscosity of 170±20 centistokes. Where polymer modified asphalt cement is used, manufacturer's recommendations for mixing temperature are to be followed.

2-6.2 Mixture Design.

Determine optimum asphalt content with procedures similar to those outlined in section 2-4.3. Table 2-17 contains the recommended mix design requirements for SMA, which are based on the requirements in AASHTO MP8.

Table 2-17. SMA Mix Design Requirements (after NAPA 1995)

Design Parameter	Value
Marshall ¹	
(1) VTM, percent ²	3–4
(2) Asphalt content, percent ³	6.0 min.
(3) VMA ⁴	17 min.
(4) Stability, N (lbf)	6200 (1400) suggested minimum
(5) Flow, 0.25 mm (0.01 in.)	8–16
(6) Compaction, number of blows on each side of test specimen	50
(7) Draindown, percent ⁵	0.3 max. (1 hour reading)
¹ Marshall procedures are in accordance with AASHTO T245 (ASTM D6927). ² VTM (voids in total mix or air voids) is based on AASHTO T166, T209 (ASTM D2041), and T269 (ASTM D3203). Maximum density is based on AASHTO T209 (ASTM D2041). ³ Based on weight of total mix. ⁴ VMA (see Asphalt Institute MS-2). ⁵ ASTM D6390	

2-6.2.1 SMA Draindown Test.

For the purpose of this test method (ASTM D6390), draindown is considered to be that portion of the asphalt cement that separates itself from a sample of uncompacted SMA mixture as a whole and is deposited outside the wire basket during the test. This test method is used to determine whether the amount of draindown measured for a given SMA mixture is within acceptable levels. This test method also provides an evaluation of the draindown potential of an SMA mixture produced in the field.

2-6.2.2 JMF Requirements.

It is the contractor's responsibility to ensure that, in addition to meeting the aggregate gradation requirements, the produced material provides an asphalt mixture that conforms to the applicable design parameters listed in Table 2-17. Submit in writing the proposed JMF in accordance with contract specifications, including:

- a. The percentage (in units of 1 percent) of aggregate passing each specified sieve (except the 75-micrometer (No. 200) sieve), based on the total dry weight of aggregate as determined by ASTM C117 and C136.
- b. The percentage (in units of 1/10th of 1 percent) of aggregate passing the 75-micrometer (No. 200) sieve, based on the dry weight of aggregate as determined by ASTM C117.

- c. The percentage (in units of 1/10th of 1 percent) of aggregate finer than 0.020 millimeter (7.87×10^{-4} inch) in size, based on the dry weight of aggregate as determined by AASHTO T 88-13 (2017).
- d. The percentage (in units of 1/10th of 1 percent) of asphalt material to be added based upon the total weight of mixture.
- e. The proposed percentage of each stockpile to be used, the average gradation of each stockpile, and the proposed target value for each sieve size. Ensure the target values and the combined average gradation of all the stockpiles when combined in accordance with the contractor's recommended stockpile combinations are within the gradation ranges for the designated grading in Table 2-12.
- f. The type and amount by weight of mix of stabilizer additive to be used.
- g. Additional information required as part of the JMF includes:
 - (1) The material sources for all ingredients.
 - (2) The material properties, as listed, for all ingredients:
 - (a) The specific gravities of the individual aggregates and asphalt.
 - (b) The LA abrasion of the aggregates.
 - (c) The sand equivalent value of the combined aggregate.
 - (d) The flat and elongated percent of the coarse aggregate (3-to-1 and 5-to-1 ratios) retained above the 4.75 millimeter (No. 4) sieve.
 - (e) The plasticity index of the aggregate.
 - (f) The absorption of the aggregates.
 - (g) The asphalt temperature/viscosity curves.
 - (3) The mixing temperature.
 - (4) The mix design test property values and curves used to develop the job mix in accordance with those provided for HMA in this chapter and also in the Asphalt Institute's MS-2.
 - (5) The plot of the gradation on the FHWA 0.45 power gradation chart.

2-6.3 Mixing Plants.

SMA has been mixed in both batch and drum-mix plants. However, make required adaptations to meet the SMA components mix design.

2-6.3.1 Batch Plants.

The mineral filler is added directly into the weigh hopper. Batch plants have an existing mechanism for accomplishing this; however, attention is required to assure accurate proportioning of the amounts of filler required for SMA. The fiber is also added directly into the weigh hopper, which occurs when the hot aggregate is also being placed into the hopper. An alternative method of adding the fibers directly to the pugmill as the hot aggregates are added has also been used successfully.

2-6.3.2 Drum-Mix Plants.

The mineral filler is added directly into the drum mixer. Attention is required to assure accurate proportioning of the amounts of filler added. The fiber is also added directly into the drum mixer. A separate feeding system is usually employed, in the case of loose fibers. Ensure these fibers are added to the aggregates to avoid direct contact with the burner flame.

2-6.3.3 Mixing Time.

The time required to mix SMA is usually greater than that to mix dense-graded HMA. For batch plants, the dry-mixing time is increased from 5 to 15 seconds, and wet-mixing is increased at least 5 seconds for cellulose fibers and up to 5 seconds for mineral fibers.

2-6.3.4 Storage.

Temporary (less than 1 hour) storage of SMA in surge bins is used only for balanced production capacity. Limit storage in heated and insulated storage bins to 4 hours unless laboratory testing indicates that additional time is acceptable. Base acceptability on no adverse changes in binder properties and excessive draindown not occurring. Do not store mixture overnight.

2-6.4 Test Section.

The construction of a test section is important to allow examination of the contractor's mixing and placement procedures. This is true if the contractor has not had experience in mixing or placing SMA.

2-6.5 Placement.

2-6.5.1 Equipment.

The trucks, pavers, distributors, and other general equipment are the same as those used for any asphalt concrete (AC) construction. Only steel-wheel rollers are used for SMA. Rubber-tire rollers are not used since they tend to pick up the rich mix excessively. Vibratory rollers are used, but take care to prevent breakdown (fracture) of the aggregate.

2-6.5.2 Surface Preparation.

Clean the surface of all loose or deleterious material. Apply a tack coat as described in section 3-3. A minimum atmospheric temperature of 7 degrees C (45 degrees F) and rising is required at the time of placement.

2-6.5.3 Paving.

Ensure the SMA mixture, when delivered to the paver, is at a temperature sufficiently high for good compaction but not so high as to damage the asphalt binder. Never exceed 177 degrees C (350 degrees F) for the mixture temperature.

2-6.5.4 Compaction.

Compact the SMA to a minimum of 94 percent of maximum theoretical density. Use steel-wheel rollers for rolling. Vibratory rollers are used provided that the aggregate is not excessively crushed. Rubber-tire rollers do not perform well with SMA due to the high amounts of asphalt cement in the mixture causing asphalt buildup on the wheels. Continue rolling until the required density is obtained. This is usually controlled through the use of a nuclear density gauge. Due to the amount of binder coating the aggregate particles, it is important that the roller drums be properly moistened with water containing small amounts of detergent to prevent adhesion. Ensure traffic remains off the SMA surface until it has cooled below a minimum of 60 degrees C (140 degrees F). One method that has been used to increase the rate of cooling to allow for earlier trafficking is flooding with water from a truck after the completion of all rolling.

2-7 WARM-MIX ASPHALT.

In recent years, processes that allow mixtures to be constructed at lower temperatures have been developed, and these lower temperature mixtures are referred to as warm-mix asphalt. A number of processes have been used, but specific processes are not discussed here. These processes allow the asphalt mixture to be mixed and placed at temperatures of 132 degrees C (270 degrees F) down to 110 degrees C (230 degrees F). The techniques involve using additives to change the viscosity of the asphalt at the higher temperatures or a foaming process. Generally, these warm mixes meets the requirements for HMA. While there has been little use on airfields, there has been significant use on highways. It is anticipated that use of warm-mix asphalt (WMA) increases significantly on airfields in future years. Early performance of WMA has been good. Use UFGS 32 12 15.13 as the guide specification for WMA. Prior to using WMA, contact the Pavements Discipline Working Group (DWG) or their designated representative.

The primary purpose of WMA is to reduce emissions during production. The additional cost for producing WMA is often offset by the savings in fuel cost. Hence, WMA potentially is a little lower cost than HMA or it might be a little higher depending on location and other factors. Besides reducing emissions, WMA also has other benefits including improved workability and ability to provide a mixture easier to compact during cooler weather. There have been a number of studies for roads and for airfields comparing the performance of WMA and HMA. So far, studies have shown that WMA and HMA have similar performance characteristics. One thing that has to be monitored, when WMA is used just as with HMA, is the moisture in the mix. Since mix temperatures are lower with WMA, the amount of moisture tends to be a little higher as specified in the mix design. So far, this has not been a significant problem but it is one that has to be monitored.

There are approximately 30 products/techniques for producing WMA. All of these have not been determined to be viable for airfields. UFGS 32 12 15.16 provides an approach for determining viable products. There are no significant differences in production, placement, and compaction of WMA and HMA.

This Page Intentionally Left Blank

CHAPTER 3 SPRAY APPLICATIONS

3-1 INTRODUCTION.

“Spray application” is a term used to describe many different types of asphalt applications. An economical maintenance and repair method for flexible pavements is accomplished using spray applications of an asphalt material. When properly constructed, asphalt spray applications are economical as well as long lasting and are beneficial in treating or improving the pavement condition and increasing the life of the pavement. Where additional thickness is needed to increase the structural strength of pavements, spray applications are not considered helpful because they don’t contribute the structural strength. The different types of spray applications to be discussed in detail in this chapter are prime coats, tack coats, and fog seals and rejuvenators.

Note: The main cause for concern with fog seals and rejuvenators is reduced skid resistance, which is discussed in detail in sections 3-4 and 3-5. The amount of application is greater in lower-trafficked areas, such as pavement shoulders, the outer edges of runway and taxi pavements, and parking areas. Application rates are greatest where traffic, such as high-speed traffic, is not expected to occur. Due to a possible decrease in skid resistance, obtain approval from the Pavements Discipline Working Group (DWG) or their designated representative prior to using fog seals and rejuvenators.

3-2 PRIME COAT.

Asphalt prime coat consists of a low-viscosity liquid asphalt material applied by a pressure distributor to an unbound base course before placement of a HMA pavement. The purposes of the prime coat are to prevent lateral movement of the unbound base during pavement construction, to waterproof during pavement construction, and to form a tight, tough base to which an asphalt pavement adheres. To accomplish these purposes, ensure the prime material penetrates into the unbound base and fills the void spaces. A completed unbound base is susceptible to serious damage from rain, wind, and traffic. A prime coat is insurance against this water and traffic damage. Apply prime coat material to a dust-free, unbound base as soon as the base has been thoroughly compacted and before construction or other traffic loosens surface material in the compacted base. For best penetration of emulsions, the application of water (saturation or ponding) improves the watability of the emulsion and improves penetration. Allow sufficient time to permit prime material to penetrate thoroughly into the compacted base. In instances where construction of an asphalt layer is to follow in less than 7 days upon completion of base course compaction, the application of a prime coat is not mandatory if it improves construction scheduling, but the use of a prime coat is preferred. When construction of an asphalt layer does not occur for at least 7 days, the compacted base is primed. Whether the compacted base is primed or not, take steps to protect the surface from any damage (e.g., from water, traffic) until an asphalt layer is placed. Generally, it is required that a prime coat be allowed to cure for 48 hours to withstand construction traffic, and cool or wet weather further increases the required time. Construction traffic on an uncured or improperly cured prime coat causes base

movement. Local conditions, local experience, the type of base material, and the type of prime coat material available are all to be considered when deciding on the application of a prime coat.

3-2.1 Materials.

3-2.1.1 Asphalt.

Use low-viscosity asphalt material as prime material, but ensure the selection of type and grade is given consideration. These following items are consider in selecting the priming material:

- Air temperature
- Humidity
- Void content of the base course
- Curing time of the prime material
- Environmental restrictions
- Available materials

3-2.1.2 Prime Coats.

Recommended priming materials include emulsified asphalts and cutback (liquid) asphalt. Table 3-1 shows the recommended types and grades.

Table 3-1 Prime Coat Materials

Type	Grade
Cutback	SC-70
	SC-250
	MC-30
	MC-70
	MC-250
	RC-70
	RC-250
Emulsion	SS-1
	SS-1h
	CSS-1
	CSS-1h

A prime coat works only if it penetrates into the base course. Open-textured (high void content) bases are primed easily, but a tight surface (low voids) cannot be penetrated readily. In cases of low voids, consider the less viscous cutbacks such as RC-70, MC-30, MC-70, and SC-70. If penetration does not occur, an asphalt film is left on the

surface of the base, causing slippage of the bituminous surface during and after construction. Use caution in using RC-70 or RC-250 because the solvent in the cutback evaporates rapidly or is absorbed by the base course fines and leaves an asphalt film on the surface. Undiluted emulsions cause asphalt film problems if the base course surface is tight. When emulsions are used for prime coat it is recommended that the emulsion be diluted with 1 part water to 1 part emulsion. Generally, cutback asphalts penetrate better and are better prime coat materials than asphalt emulsions. However, many areas do not allow the use of cutback asphalts. Also, emulsions are specially formulated to improve their penetrating ability. So, many asphalt suppliers produce an asphalt emulsion that is specially formulated for prime coats.

3-2.1.2.1 Influence of Weather.

Weather influences the choice of the correct priming materials. Since emulsions are dependent on the evaporation of water for curing, low temperature or high humidity slow or stop the curing process. Cutbacks are not as dependent on weather conditions as emulsions. In cold weather, however, the rapid-curing cutbacks (RCs) cure quicker than the slower curing cutbacks (MCs and SCs).

3-2.1.2.2 Considerations for Use of Cutbacks.

Cutback materials are available in locations throughout the United States and the world. Environmental, safety, and cost considerations have led to increased use of emulsions as prime coat materials. Environmental restrictions, under certain conditions, have begun to limit the use of cutback prime coat materials. This plus concerns that flammability and the cost of cutbacks have led to an increased used of asphalt emulsion prime coats. Dilute asphalt emulsions with water before applying as a prime coat, and exercise handling and storage considerations to prevent freezing, settling, and breaking.

3-2.2 Application Rate.

Prime coats are usually applied in quantities of 0.45 to 1.13 liters per square meter (0.10 to 0.25 gallons per square yard) of residual asphalt. The optimum amount of prime is highly dependent on the plasticity index of the base material, the amount of fines in the base, the nature of the fines, the tightness of the surface, and the moisture content of the base; therefore, determine the optimum amount of prime required by field trial. Test sections at various application rates are recommended for determining the optimum amount of prime. After 48 hours of curing, if there is free or excess bitumen on the surface or if the base continues to appear shiny, the base is probably overprimed. Generally, the prime is absorbed into the base within 2 to 3 hours. When excessive prime is used, the surplus probably is absorbed into the overlying asphalt layers. In turn, the absorption of the excess contributes to pavement slippage or rutting. Where excessive prime is applied, blot the excess with an application of clean fine sand or mineral dust. The ideal end result is to obtain maximum penetration without leaving free prime on the surface.

3-2.3 Placement.

Lightly broom surfaces to be primed that contain appreciable amounts of loose material or are dusty. A dusty surface cause prime to “freckle,” that is, have areas with no prime and adjacent areas with drops of excess prime. A light application of water just before applying the prime aids in reducing freckles and getting good distribution of the prime. Ensure the primer is uniformly applied with a pressure distributor at the required application rate and at the specified temperature for the asphalt used. The minimum curing time varies according to the grade and type of asphalt being used, the nature of the base, the temperature, and the humidity, but curing takes place within 48 hours.

3-2.4 Control.

Since prime coat material is applied with a pressure distributor, calibrate and check the distributor for the specified application rate before applying the prime. ASTM D2995 offers a method for determining the application rate of bituminous distributors. In addition, ensure all nozzles are free and open, the same size, and to the same angle in reference to the spray bar to produce a uniform fan of prime. The height of the spray bar above the surface is important because a bar too high or too low gives an unequal application across the spray bar, causing streaking. Ensure the height of the spray bar is such that a double or triple lap of the spray fan is obtained.

3-3 TACK COAT.

A tack coat is a light application of asphalt material to an existing paved surface immediately prior to placing the next pavement layer or course. The purpose of the tack coat is to provide a bond between the two pavement layers. The tack coat is applied by pressure distributor to cleaned surfaces. Apply the tack coat in a light and uniform application.

3-3.1 Materials.

Emulsions are common types of asphalt material used as tack, but cutbacks and asphalt cements are also used. For tack coats, the asphalt emulsion is not to be diluted. Obtain the correct spraying viscosities (temperatures) for the type of material used. Recommended tack coat materials and spray application temperatures are shown in Table 3-2. Cutbacks and emulsions are sprayed at low temperatures, but asphalt cements require considerable heating to reach a viscosity for spraying. A tack coat is always to be used when adding an asphalt mixture on top of a bound layer such as HMA or Portland cement concrete (PCC).

In cold weather, cutbacks are used with less concern than with emulsions; however, concerns with cutbacks, as mentioned before for prime coats, make them unavailable. Use of an emulsion requires that consideration be given to weather conditions, storage and handling requirements, and curing time. Ensure all tack coats are completely cured before placing the new pavement layer.

3-3.2 Application Rate.

Tack coats are usually applied in quantities of 0.23 to 0.68 liter per square meter (0.05 to 0.15 gallon per square yard) of residual asphalt, but adjust the exact quantities to suit field conditions. Light applications are preferred since heavy applications cause serious pavement slippage and bleeding problems; however, failure to use any tack coat also causes pavement slippage problems.

Table 3-2 Tack Coat Materials and Spray Application Temperatures

Type	Grade	Application Temperature °C (°F)
Cutback	RC-70	49-93(120–200)
	RC-250	74-121(165–250)
Emulsion	RS-1	21-60(70–140)
	MS-1	21-71(70–160)
	HFMS-1	21-71(70–160)
	SS-1	21-71(70–160)
	SS-1h	21-71(70–160)
	CRS-1	52-85(125–185)
	CSS-1	21-71(70–160)
	CSS-1h	21-71(70–160)
Asphalt cement	200–300 pen	129(265)+
	120–150 pen	132(270)+
	85–100 pen	138(280)+
	AC-2.5	132(270)+
	AC-5	138(280)+
	AC-10	138(280)+
	AR-1000	135(275)+
	AR-2000	141(285)+
	AR-4000	143(290)+
PG 58-22, 64-22	143(290)+	

3-3.3 Placement.

Apply tack coats to clean, dust-free asphalt pavement courses prior to placement of the overlying pavement layer. Apply the tack coat immediately before placement of the

overlay; therefore, unless an asphalt cement is used, allow the tack coat time to cure. A tack coat is required on a base course when the prime coat on that surface has been subjected to construction traffic or other traffic. Use a pressure distributor to apply tack coats at an application temperature that produces a viscosity between 10 and 60 seconds, Saybolt Furol, or between 20 and 120 centistokes, kinematic viscosity. The suggested spray application temperatures in degrees Fahrenheit for tack coat materials are shown in Table 3-2. When an even or uniform coating is not obtained, an improved coverage is possible by making several passes over the freshly applied tack coat with a pneumatic-tired roller. However, take steps to ensure a uniform application from the asphalt distributor. Ensure the tack coat is completely cured (volatiles or water evaporated) before the overlying layer is placed. A properly cured surface feels tacky. Plan work so that the amount of tack coat placed on the surface is equal to the amount required for one day of operation. Keep all nonessential traffic off the tack coat so that dust, mud, or sand is not tracked onto the surface. There are tack coats that are tack free when cured. These products were developed to prevent tracking of the tack by the trucks to areas outside the work area. Guidance for using these products is provided in UFGS 32 12 13.

3-3.4 Control.

The control of tack coat application is the same as that for prime coat application, as discussed in paragraph 3-2.2.

3-4 FOG SEALS.

A fog seal is a light spray application of diluted emulsified asphalt to an existing asphalt pavement surface. Fog seals are used to maintain old pavements, reduce raveling, waterproof, and in general extend the life of existing pavements. Fog seals are good for treating pavements that carry little or no traffic; however, there are several considerations when using fog seals:

- The pavement skid resistance is possibly reduced.
- The pavement air voids or permeability is possibly reduced.
- Close the pavement to traffic for 12 to 24 hours to allow for curing of the seal material.

3-4.1 Materials

In the past, asphalt emulsions and cutbacks were used for fog seals, but in recent years, the materials used are emulsions and rejuvenators. The emulsions often used are SS-1, SS-1h, CSS-1, and CSS-1h. Use only slow-setting emulsions, to allow for maximum penetration of the asphalt into the pavement. Several products are marketed as rejuvenators; they are proprietary products and their use is discussed in section 3-5.

3-4.2 Application Rate.

The application and dilution rate for fog seal varies with the absorption characteristics of the existing pavement surface. Rates vary between 0.14 to 0.36 liters per square meter (0.03 to 0.08 gallons per square yard of residual asphalt). Place test sections on the pavement to determine the best application rate. Adjust the application rate so that the pavement does not become slick or unstable and does not have excess free material on the surface after curing 12 to 24 hours. Asphalt emulsion are applied at full strength or are diluted as much as 1 part emulsion to 5 parts or more of water; however, normal application dilution is 1 part emulsion to 1 part water. Evaluate the amount of dilution for each job using a test section similar to application rate.

3-4.3 Placement.

Use only a pressure distributor that has been calibrated to deliver the fog seal at the specified rate to apply the seal material. Clean all surfaces to which the seal is applied. Apply the fog seal when the ambient temperature is above 4.5 degrees C (40 degrees F), but warmer temperatures are preferable because the material breaks and cure faster. The seal material is applied to a damp pavement if the dilution material is water, but ensure the pavement is not be too wet or the seal does not break properly and does not penetrate into the pavement. Blot excess seal left on the surface with clean sand and broom.

3-5 REJUVENATION.

Rejuvenation is the spray application of a material on an asphalt surface for the purpose of rejuvenating an aged asphalt cement binder. This rejuvenation is intended to extend the life of the asphalt pavement by softening or rejuvenating the surface asphalt toward the properties it had shortly after construction. The application of a rejuvenator is effective when the pavement has not aged to the point at which block cracking or substantial raveling has occurred. Depending on the climatic conditions, pavement rejuvenation is required within 3 to 6 years after placement. Rejuvenators are spray applied to the pavement surface and allowed to penetrate into the pavement. Rejuvenators are not to be used on runways without fine aggregate cover due to their tendency to reduce the surface friction. Obtain approval from the Pavements Discipline Working Group (DWG) or their designated representative prior to the use of rejuvenators or rejuvenators-sealers on airfields.

3-5.1 Testing.

Test results have shown that the viscosity test is effective in determining a change in asphalt properties compared to a penetration test. The viscosity test identifies changes in asphalt properties regardless of amount of rejuvenator applied, while the penetration test potentially identifies no change in asphalt property. The dynamic shear rheometer (DSR) test method is also used to produce results for evaluation; however, while the test requires less asphalt than the other methods, current extraction methods normally

recover the amount of material required to perform the preferred viscosity test. If the DSR test method is used, select the phase angle test parameter for comparison since it has been shown to be statistically consistent that the G^* parameter.

3-5.2 Materials.

Rejuvenation materials are not currently specified by ASTM or any other organization. The various rejuvenators available are proprietary products. Available rejuvenator materials are classified into two major types according to their major components, either asphalt or coal tar bases. Ensure the rejuvenator selected for use has a proven record of performance; however, if performance data on a rejuvenator are not available, apply the rejuvenator to a test area on the pavement and evaluated to determine its potential performance. Fog spray applications of emulsified asphalt cannot be considered to act as a rejuvenator as they don't normally have significant penetration into the pavement surface.

3-5.3 Application Rate.

The rate of application varies greatly with the condition, dry, oxidized, and open-textured, of the pavement surface. Ensure the application rate of total liquid is within the range of 0.18 to 0.9 liters per square meter (0.04 to 0.2 gallons per square yard). The application rate is selected as the amount of material that is absorbed into the pavement surface within 12 to 24 hours of application depending on the trafficking needs of the rejuvenated pavement. Follow the manufacturer's recommendations concerning dilution and other factors. Depending on the amount of solids or residual material within the rejuvenator, as evidenced by materials remaining on the pavement surface after curing, sand-sized aggregate are used to provide initial skid resistance after placement. The rejuvenators that leave material on the surface to hold aggregate are also classified or referred to as rejuvenator-sealer because they rejuvenate the surface asphalt and also, at least temporarily, seal the pavement surface. Coal tar- and asphalt-based rejuvenator-sealers leave residue on the pavement surface to hold aggregate for at least a short time. The sand used is a fine-grained aggregate that passes the 1.18 mm (No. 16) and usually the 600 μm (No. 30) sieve. The amount of aggregate applied varies with the type of rejuvenator-sealer and the condition of the pavement surface, usually within the range of 0.27 to 0.54 kilogram per square meter (0.5 to 1.0 pound per square yard).

3-5.4 Placement.

Prior to placement of the rejuvenator, thoroughly clean all the loose material from the pavement surface. Rejuvenators are usually placed with an asphalt distributor truck or any other type of specially designed application spray vehicle. Manufacturers and contractors have added a feature to immediately apply aggregate directly on top of the rejuvenator (rejuvenator-sealer). Follow manufacturer recommendations concerning application temperature and dilution of the material. When a rejuvenator is applied to the pavement, ensure clean dry sand is available to blot areas that received too much rejuvenator. Spread the sand evenly over these areas, broom into a pile, and remove.

Rolling the pavement surface with a rubber tire roller 1 or 2 days after rejuvenator has been applied helps to knead and close hairline cracks. The minimum application temperature is normally 10 degrees C (50 degrees F); however, temperatures at or above 21 degrees C (70 degrees F) results in improved penetration and curing.

3-5.5 Control.

Calibrate the asphalt distributor and check all nozzles according to ASTM D2995. When a rejuvenator-sealer is applied, the aggregate distribution system is calibrated and checked according to ASTM D5624. Conduct test sections of the pavement to be rejuvenated to test various application rates and the function of the distribution equipment.

3-5.6 Skid Resistance.

Rejuvenators normally reduce the skid resistance of treated pavement surfaces. Any excess rejuvenator that is not removed reduces skid resistance. Rejuvenator materials, when applied in the correct amounts, have skid resistance values approaching pretreatment values within a few days. Rejuvenator-sealer materials, those leaving substantial amounts of material on the pavement surface, provide skid resistance values when the application of aggregate has been applied to them. As the rejuvenator-sealer cures and traffic is applied, this thin layer of sand is worn off along with the material, and the skid resistance approaches that of the untreated pavement.

This Page Intentionally Left Blank

CHAPTER 4 SEAL COATS

4-1 INTRODUCTION.

Seal coats are one of several types of applications that consist of a relatively thin layer of aggregate cemented together with an asphalt (bituminous) material. The types of seal coats addressed in this chapter include surface treatments, slurry seals, fuel-resistant sealers, and micro-surfacing. Seal coats are widely used because of their low cost and usefulness in light to medium traffic roadways and parking areas. These treatments are normally used to seal or waterproof the pavement, provide wear resistance, and increase skid resistance. All seal coats are relatively thin coatings of material and do not add structurally to the pavement. Contact Pavements Discipline Working Group (DWG) or their designated representative prior to using surface treatments on airfield pavements due to FOD potential. Surface treatments have a FOD potential in that they use aggregate particles that are 9.5 to 19 millimeters (3/8 to 3/4 inches) in diameter. Slurry seals and micro-surfacing use aggregates with maximum sized particles less than 4.75 millimeter (No. 4) in diameter and fuel-resistant sealers use sand sized particles less than 1.18 millimeter (No. 16) in diameter. The major FOD potential from slurry seals, micro-surfacing, and fuel-resistant sealers occur when sections of the seals were not completely bonded to the underlying HMA. The individual aggregate particles are too small (1.18 to 19 millimeters) to cause a potential FOD threat.

4-2 SINGLE AND DOUBLE BITUMINOUS SURFACE TREATMENTS.

A single bituminous surface treatment (SBST) consists of an application of bituminous material on a prepared surface followed immediately by a single layer of cover aggregate. "Chip seal" is a commonly used term for the same process. Double bituminous surface treatment (DBST) is similar to a SBST except that two applications of bitumen and cover aggregate are used. The first application of aggregate uses a coarser aggregate than the second application and usually determines the DBST thickness. The second application of aggregate partially fills the surface voids and keys into the aggregate in the first aggregate course. SBSTs and DBSTs are used on prepared base courses and on new or old pavements. The DBSTs with additional layers are used to provide greater wearing resistance and potential structural strengthening (minimal).

4-2.1 Materials.

4-2.1.1 Binder.

The functions of the asphalt binder are to hold the aggregate in place, bond it to the underlying surface, and seal the underlying surface to prevent the entrance of moisture and air. The binders specified for SBST and DBST are cutback asphalts, emulsified asphalts, and asphalt cements. The types and grades are shown in Table 4-1. ASTM D1369 also provides a list of binder materials based on aggregate size and expected temperatures at application.

Table 4-1 Surface Treatment Asphalt Materials

Type	Grade
Cutback (seldom used currently due to environmental issues)	RC-250
	RC-800
	RC-3000
Emulsion	RS-1
	RS-2
	CRS-1
	CRS-2
Asphalt cement	120–150 pen
	200–300 pen
	AC-2.5
	AC-5
	PG 58-22
	PG 64-22

4-2.1.1.1 Selecting Type and Grade.

Select the type and grade of binder carefully. Consider these factors:

- Climatic conditions.
- Curing time of the binder.
- Environmental restrictions.
- Available materials.
- Temperature of the surface.
- Condition of the surface.
- Condition of the aggregate.

4-2.1.1.2 Cutback Asphalts.

Historically, rapid-curing cutback asphalts were used for surface treatments. RC-250 was used when cooler temperatures were anticipated and RC-3000 when warmer temperatures were anticipated. Currently, environmental requirements limit the availability of cutback asphalts, and as a result, emulsified asphalt binders are widely used binders.

4-2.1.1.3 Emulsions.

Emulsions require handling and storage considerations to prevent freezing, settling, and premature breaking, but they are applied with little or no additional heating. In selecting the type of emulsion, consider the compatibility of the aggregate and emulsion. As a general rule, anionic emulsions adhere better to limestone and other aggregates composed of predominantly calcium minerals. Cationic emulsions adhere better to aggregates high in silica, such as chert and quartz gravels. Cationic and anionic emulsions both adhere well to damp aggregates.

4-2.1.1.4 Asphalt Cements.

Asphalt cements harden quickly so that the cover aggregate is held in place better than other binders provided the asphalt cement does not chill before the cover aggregate is applied. Chilling of the binder before applying the aggregate is one major disadvantage with asphalt cement binders. To ensure good bond, the aggregates are often heated when asphalt cements are used. Another disadvantage with the use of asphalt cements is the high amount of heat required for spraying. Because of the difficulties encountered with asphalt cements, carefully consider using cutbacks or emulsions instead of asphalt cement.

4-2.1.2 Aggregates.

The aggregate has an effect on the degree of wear resistance, riding quality, and skid resistance of the surface treatment. Use only clean, dry, aggregate fragments that are free from dust or dried films of harmful material. Ensure the aggregate has a single-size (uniform) gradation and is composed of hard, angular, polish-resistant material. Flat and elongated aggregate particles and wet or dusty aggregates are not used. Quantities of moisture up to 1 percent do not create a problem, in warm weather, but dust prevents the adhesion of the binder to the aggregate. When an emulsion is used as the binder, aggregate with up to 3 percent moisture are commonly used. ASTM D1139 offers additional physical requirements for aggregates to be used in surface treatments.

Tables 4-2 and 4-3 provide the recommended aggregate gradations for SBST and DBST, respectively. The correlating size number designation from ASTM D448 is also provided. For DBST, gradation Nos. 1 and 2 and gradation Nos. 3 and 4 from Table 4-3 is used in combination.

4-2.2 Design.

The type and amount of aggregate and bitumen to be used for surface treatments is determined in accordance with ASTM D1369. This standard provides guidance on typical rates of aggregate and bitumen for the various types of surface treatments, and cites other ASTM standards that are applicable for measuring both bituminous and aggregate quantities. D1369 lists recommended grades of various asphalt and tar materials for use with surface treatments. Similar guidance is also available in the Asphalt Institute's Educational Series No. 11 (ES-11) and ES-12.

Table 4-2 Gradations for SBST

Sieve Size	Percent Passing by Weight, Gradation Designation		
	No. 1 (No. 6 ¹)	No. 2 (No. 7 ¹)	No. 3 (No. 8 ¹)
25 mm (1 in.)	100	--	--
19 mm (3/4 in.)	90–100	100	--
12.5 mm (1/2 in.)	20–55	90–100	100
9.5 mm (3/8 in.)	0–15	40–70	85–100
4.75 mm (No. 4)	0–5	0–15	10–30
2.36 mm (No. 8)	--	0–5	0–10
1.18 mm (No. 16)	--	--	0–5

¹ Number size designations from ASTM D448.

Table 4-3 Gradations for DBST

Sieve Size	Percent Passing by Weight, Gradation Designation			
	No. 1 (No. 6 ¹) (First Spreading)	No. 2 (No. 8 ¹) (Second Spreading)	No. 3 (No. 7 ¹) (First Spreading)	No. 4 (No. 9 ¹) (Second Spreading)
25 mm (1 in.)	100	--	--	--
19 mm (3/4 in.)	90–100	--	100	--
12.5 mm (1/2 in.)	20–55	100	90–100	--
9.5 mm (3/8 in.)	0–15	85–100	40–70	100
4.75 mm (No. 4)	0–5	10–30	0–15	85–100
2.36 mm (No. 8)	--	0–10	0–5	10–40
1.18 mm (No. 16)	--	0–5	--	0–10
300 μm (No. 50)	--	--	--	0–5

¹ Number size designation from ASTM D448.

4-2.3 Construction.

Field construction practices determine the success or failure of a well-designed surface treatment; therefore, equipment, surface preparation, and construction techniques are important.

4-2.3.1 Equipment.

Among the equipment used in placing a surface treatment, the asphalt distributor and the aggregate spreader are important. Aggregate spreaders are used during the construction of bituminous surface treatments to apply the aggregate to the surface being treated. Design and calibrate the spreader to apply a predetermined amount of aggregate uniformly over the surface. Aggregate spreaders are self-propelled; others are propelled by the truck hauling the aggregate. The self-propelled aggregate spreaders are desirable because they allow for a uniform application of material and a smoother operation. Ensure calibration and operation of the distributor and aggregate spreader meet the specified results.

4-2.3.2 Surface Preparation.

Without surface preparation, the life expectancy of a pavement is reduced; therefore, repair all soft or failed areas and remove all loose material, dirt, and vegetation prior to placing the surface treatment. Also sand or remove a bleeding surface before construction of the surface treatment.

4-2.3.3 Application.

Give attention to the application rates of both binder and aggregate. Too much binder causes bleeding or low skid resistance, and too little binder results in the loss of cover aggregate. Apply 5 to 10 percent excess aggregate, although too much aggregate results in a waste of materials and damage to windshields.

Apply the aggregate immediately after the binder application to obtain a good bond between asphalt and aggregate. Rolling with a rubber-tired roller immediately after applying the aggregate seats the aggregate in the binder and improve the bond.

4-2.3.4 Control.

Since the distributor and aggregate spreader are important for the successful application of materials, calibrate and check them to ensure that the specified application rate is obtained. ASTM D2995 offers a method for determining the application rate of asphalt (bituminous) distributors. In addition, ensure all nozzles are free and open, the same size, and at the same angle with reference to the spray bar to produce a uniform fan of asphalt. The height of the spray bar above the surface is important. A bar too high or too low produces a variable application across the spray bar, causing streaking. Ensure the height of the spray bar is such that a double or triple lap of the spray fan is obtained. ASTM D5624 offers a method for determining the application rate of aggregate transversely across the width of the spreader.

A test section is another method to evaluate the construction techniques and the application rates required for surface treatment. Construct at least one test section before allowing surface treatment applications on a full scale.

4-3 SLURRY SEAL.

A slurry seal is a mixture of asphalt emulsion, well-graded fine aggregate, water, and mineral filler. These materials are combined in proportions to produce a homogeneous, fluid-like slurry. Ensure the consistency of the slurry is spreadable to be squeegeed over an existing pavement surface. A thick, sealed surface results after evaporation of the water and curing of the mix. When properly designed, constructed, and cured, the slurry seal improves the qualities of an existing pavement surface, but the structural strength of the pavement structure is not significantly improved. Slurry seals are used to protect worn, weathered, or cracked pavements from the adverse effects of weather conditions and traffic wear. With use of aggregates, the slurry seal is also used to reduce skid or slipperiness problems. Slurry seals have application to roads and streets, parking lots, and bridge decks. This type of seal coat is best suited for pavements that are not subjected to heavy traffic. Because aircraft normally causes a rapid deterioration of the slurry seal and there is a high potential for FOD, do not apply slurry seals to airfields.

4-3.1 Equipment.

Various types of equipment are needed on a slurry seal project, but the basic pieces of equipment required include a truck-mounted continuous-mix slurry machine, spreader box, power broom, front-end loader, distributor, and pneumatic-tired roller. The truck-mounted continuous-mix slurry machine, which serves as a portable mixing plant, is an important piece of equipment. It is the only type of mixing equipment recommended for mixing a slurry seal. A slurry seal machine is used to mix aggregate, filler, asphalt emulsion, and water in the correct proportions and to uniformly apply the material to the surface to be sealed. The slurry seal machine contains storage for the aggregate, filler, emulsion, and water. Before use, calibrate and set the machine to deliver the job materials in the correct proportions. The machine manufacturer's instructions usually offer the best guidance for calibrating the slurry machine; however, a calibration method based on a revolution counter is applicable to all machines. By attaching a revolution counter to any shaft that is mechanically interlocked with the emulsion pump, water pump, fines feeder, and aggregate conveyor, the relative quantities of each of these components per revolution is determined for various gate openings, metering valve openings, or sprocket sizes. The materials are mixed and deposited into a squeegee box, which applies the slurry seal onto the surface at a thickness equal to the maximum aggregate size.

4-3.2 Material Requirements.

4-3.2.1 Emulsion.

The binder used in a slurry seal is asphalt emulsion. The emulsion is often either slow-set anionic (SS-1 or SS-1h) or slow-set cationic (CSS-1 or CSS-1h). The slow-set emulsions are best suited for slurry seals, but quick-set emulsions are specifically designed for slurry seals. The use of quick-set emulsions requires that an experienced slurry seal contractor perform the job because of the amount of time available for handling the slurry seal before it cures. Slow-set cationic emulsions cure faster than slow-set anionic emulsions because the curing process is partly a chemical reaction that

expels water from the mix. Anionic emulsions cure primarily by evaporation of the water from the mix; therefore, they are greatly influenced by weather conditions. Low temperatures, high humidity, or rain slows or stops the curing process. Emulsion break; that is, the asphalt separates from the water upon contact with certain types of aggregates. If a break occurs, change either the emulsion or aggregate type.

Aggregates have a slightly negative or positive charge. A cationic emulsion bonds better with a negatively charged aggregate and an anionic emulsion bonds better with a positively charged aggregate. Aggregates that have a minimum charge, and in this case, an anionic or cationic aggregate works.

4-3.2.2 Aggregate.

Give close attention to the aggregate as well as the emulsion used in a slurry seal. Clean all aggregates, and crush the particles to produce an angular shape. Do not use aggregates that contain plastic fines. These fines absorb excessive amounts of emulsion, not allowing the required amounts of binder to coat the remaining aggregate. The fines also promote low-wear characteristics and premature break of the emulsion. Better performance is expected from slurry seals that are produced using crushed aggregate. Natural sands such as dune, river, and beach sands and other rounded aggregates tend to have poor skid resistance and wear characteristics and therefore do not use these in slurry seal coatings.

4-3.2.2.1 Gradations for Aggregates.

Ensure the aggregates are dense-graded so that the particles lock themselves together. Table 4-4 shows the gradations for use with slurry seals. Gradation type 1 is normally used for filling and sealing cracks in a pavement surface, and it provides a thin wearing surface. Gradation type 2 is widely used, and is used to fill voids, correct moderate surface irregularities, seal cracks, and provide a wearing surface for traffic. Aggregate gradation type 3 assures a thicker seal and provides a coarser surface texture. This gradation might be used as the first course in a two-course slurry seal surface treatment.

4-3.2.3 Mineral Filler.

When stability or segregation problems occur, mineral filler at a rate of 0.5 to 4.0 percent by weight of the total mixture is used to solve the problem. When mineral filler is needed, Portland cement (PC) or hydrated lime (HL) is often used in slurry seals. The filler is used to improve the mix stability, that is, to suspend heavier aggregate particles throughout the slurry seal mixture, to reduce segregation of materials, and to meet gradation requirements. Take care to ensure that the fines content, including mineral filler, does not exceed the gradation limits. Excessive fines or mineral filler causes shrinkage cracking to occur in the seal coat.

4-3.2.4 Water.

Water controls the workability of the slurry seal mixture. Ensure the mixture contains the required amount of water to produce a smooth, creamy, homogeneous, fluid-like appearance. If more water is used than required, the resultant mixture is soupy, and segregation or bleeding of the mixture occurs. On the other hand, if less water is used than required, the slurry mixture is stiff and neither spreads smoothly nor performs. Use only potable water in a slurry seal mixture.

Table 4-4 Slurry Seal Aggregate Gradations

Sieve Size	Percent Passing		
	Type 1	Type 2	Type 3
9.5 mm (3/8 in.)	–	100	100
4.75 mm (No. 4)	100	90–100	70–90
2.36 mm (No. 8)	90–100	65–90	45–70
1.18 mm (No. 16)	65–90	45–70	28–50
600 μm (No. 30)	40–65	30–50	19–34
300 μm (No. 50)	25–42	18–30	12–25
150 μm (No. 100)	15–30	10–21	7–18
75 μm (No. 200)	10–20	5–15	5–15

4-3.3 Design.

The method of developing a JMF for slurry seals selects the optimum asphalt content based on a desired film thickness of asphalt and the absorption characteristics of the aggregate. The water and mineral filler content requirements are determined by a cone test, and the wear characteristics are determined by the wet track abrasion test (WTAT) as described in ASTM D3910. Appendix C contains a summary design method and an example problem for slurry seals. The method is intended to furnish a starting point for field application. Adjust the proportions of the mixture to field conditions; however, construct a field test section using the laboratory-developed JMF.

4-3.4 Factors Affecting Design.

Consider these important factors before using a slurry seal:

- The cost of placing a slurry seal is relatively small, but this mixture does not provide additional strength to the pavement and does wear rapidly under a high volume of traffic.
- Slurry seal fills and seals many surface cracks.
- Slurry seals are used to seal a pavement surface to retard oxidation and raveling or to provide a thin (6-millimeter (1/4-inch)) wearing surface.

- Skid resistance is improved if crushed aggregates are used in the mix.
- Uncured slurry seal is adversely affected by changes in weather conditions.
- Close treated pavement to traffic to allow the slurry seal to cure (sometimes as long as 24 hours, but usually 6 hours).
- Slurry seal is better suited for a pavement subjected to low or moderate traffic because heavy traffic causes a rapid deterioration of the thin layer.
- Only structurally sound pavements are suited for a slurry seal.
- Design and application are important for meeting job required job performance.
- Generally, slurry seals have a three- to five-year life.
- Slurry seals fills cracks and coats the surface of the pavement to a depth of 3 to 6 millimeters (1/8 to 1/4 inch).

4-3.5 Surface Preparation.

Without surface preparation, the life expectancy of a slurry seal surface is reduced. Remove all loose material (including loose or flaky paint), dirt, and vegetation. Treat cracks wider than 3 millimeters (1/8 inch) before applying the seal coat. After the surface is cleaned, apply a light tack coat to improve the bond and to reduce the asphalt absorption of the old surface.

4-3.6 Application.

The surface texture of the fresh slurry seal is affected by the condition of the flexible lining of the spreader box, fragments of cured slurry adhering to the edges of the lining or to the squeegee, and the condition of the burlap drag. Worn lining results in an uneven thickness of the seal coat. Fragments of cured slurry seal or aggregate particles caught in the lining produce gouges and streaks. Wash or replace the burlap drag as needed to ensure that accumulations or crusts of mix do not cause scars or streaks. Empty and clean the mesh basket screen that is hung at the end of the discharge chute. Check the slurry seal for lumps or balling, which is caused by inadequate mixing or premature break of the asphalt emulsion. Deviation of the mix from the specified gradation potentially results in a product not meeting required job performance.

4-3.6.1 Joints.

Whenever possible, make joints while the slurry seal mixture applied in the first pass is still semi-fluid and workable. If operations preclude fresh working joints, allow the previously laid pass to set and cure sufficiently to support the spreader box without scarring, tearing, or being scraped from the pavement surface.

4-3.6.2 Hand Application.

Give close attention to spreading of the slurry seal mixture by hand squeegee. Overworking causes partial breaking of the emulsion before the final spreading is completed, which results in a nonuniform material that has poor appearance and durability.

4-3.7 Curing.

Slurry seals, depending on the emulsion characteristics in relation to the aggregate with which the emulsion is used, cure primarily by evaporation of water from the surface, by deposition of asphalt on the aggregate that frees the water, or by a combination of both. If curing is from the surface downward, the surface presents a cured appearance, but the material below possibly is still uncured. Therefore, assure thorough curing of the slurry seal before traffic is permitted.

4-3.8 Rolling.

Rolling is advantageous in reducing voids in the slurry seal, smoothing out surface irregularities, and increasing the resistance to water. Begin rolling as soon as the slurry seal has cured to support the roller without any pickup of the slurry seal mixture. Use a rubber-tired roller for rolling the slurry seal mixture.

4-4 FUEL-RESISTANT SEALER.

Fuel-resistant sealer (FRS) material is a combination of coal-tar emulsion, fine aggregate, water, and occasionally other additives. These materials are mixed in batches and applied to HMA surfaces by hand, sprayer, or mechanical squeegee. Coal-tar emulsion binder provides a fuel-resistant surface, and the fine aggregate provides skid resistance. The FRS is placed in thin layers, usually 2 millimeters (1/16 inch) or less. Particle size affects the minimum thickness that is applied by squeegee. An FRS does not significantly enhance the structural strength of the pavement structure.

4-4.1 Areas of Application.

Apply FRS to any HMA surface subjected to fuel drippage or spillage. This includes vehicle maintenance and parking areas.

4-4.2 Considerations for Use.

Important factors to consider before using an FRS:

- Use FRS only where a fuel-resistant surface is required.
- FRSs do not have as long a service life as surface treatments with asphalt cement binder, but they last up to 4 years, depending on traffic and climate conditions.

- Parking areas with low vehicle turnover or low usage rates (therefore lower instances of fuel spillage) are better served with a single or double bituminous surface treatment or a slurry seal.
- FRSs provides a seal to protect the underlying HMA pavement to retard oxidation and weathering.
- Close the pavement to traffic during the curing of FRS layers (usually 4 to 8 hours).
- Uncured FRS is adversely affected by changes in weather conditions such as rain or freezing temperatures.
- Only structurally sound pavements are suited for an FRS.
- Mixture design and application are important for obtaining a required job performance.

4-4.3 Material Requirements.

4-4.3.1 Coal-tar Emulsion.

The binder material used in an FRS is a coal-tar emulsion. The coal-tar emulsion is usually specified as having to meet the requirements of ASTM D5727.

4-4.3.2 Aggregates.

Ensure aggregates are either natural or manufactured angular aggregate, are clean, free of organic and other objectionable material, and meet the gradation requirements in Table 4-5.

4-4.3.3 Water.

Use only potable water in an FRS mixture. Determine the amount of water required from laboratory testing prior to construction. Additional water normally is required under high temperature pavement conditions.

4-4.3.4 Additives.

Additives used in FRSs include various types of polymer and silicon materials. These materials are added to the FRS mixture in the field or added to the coal-tar emulsion during the emulsifying process. The polymer materials often used are latex combinations of acrylonitrile and butadiene. Ensure additives used are compatible with the coal-tar emulsion.

Table 4-5 FRS Minimum Application Rates and Corresponding Aggregate Gradations

Gradation Type		Coarse	Medium	Fine
Minimum Application Rate, L/m ² (gal/yd ²)		1.35 (0.3)	1.0 (0.22)	0.72 (0.16)
Sieve Size	1.18 mm (No. 16)	100	100	100
	850 μm (No. 20)	85–100	98–100	100
	600 μm (No. 30)	25–85	85–100	98–100
	425 μm (No. 40)	5–25	25–85	85–100
	300 μm (No. 50)	2–10	5–25	25–85
	212 μm (No. 70)	---	2–10	5–25
	150 μm (No. 100)	0–2	0–4	2–10
	106 μm (No. 140)	--	0–2	0–2

4-4.4 Design.

Historically, the design of FRS mixtures has been based on the selection of materials (sand, water, and additives) from an allowable range based on a gallon of coal-tar emulsion. The current guide specification requires that the final FRS mixture developed be required to meet two test requirements. These tests are curing time and resistance to kerosene.

4-4.4.1 Application Rate.

The rate of application of sealer depends, to a great extent, on the gradation of the aggregate used. The coarser the gradation, the thicker the application required. This ensures that the aggregate is embedded in the sealer and does not wear off under traffic. The rates given are for general guidance and vary depending on the final proportions (solids content) of the sealer that is applied. Recent research suggests that thinner coatings of FRS are not as susceptible to cracking with age; therefore, when possible, use the fine gradation (smaller size aggregate particle). This decreases the occurrence of cracking and increases the life span of the FRS.

4-4.4.2 Requirements.

The FRS mixture is required to meet the requirements provided in Table 4-6. Ensure the amount of sand added to the FRS mixture does not exceed 480 to 720 grams per liter (4 to 6 pounds per gallon) of coal-tar emulsion. Sand loads of greater amounts are not normally fuel resistant and fail the resistance to kerosene test.

Table 4-6 Physical Properties of Sealer Mixtures

Property	Requirement	Referenced ASTM Test Method
Curing time, firm set	8 hours maximum	D2939
Resistance to kerosene	No penetration or loss of adhesion	D2939

4-4.5 Equipment.

Various types of hand-held squeegees, brooms, and other non-mechanical equipment are needed on the typical FRS project. Depending on the job size, they are completed with only mixers sized to job size and hand-held squeegees; however, the basic equipment required for mechanical application on an FRS project includes a truck-mounted batch-mix machine, squeegee blades, power broom, and front-end loader or fork truck. The truck-mounted batch-mix machine is where the FRS mixtures are proportioned and mixed and then taken to the project site and applied to the pavement surface. FRS mixtures are always batch mixed and then applied, unlike slurry seals that are made in a continuous mix operation. The batch-mix machine usually has a manufacturer-supplied calibration sheet showing the number of gallons per depth in the tank. The depth is usually monitored with a marked dipstick. The squeegee blades apply the FRS material to the pavement surface. The power broom cleans the pavement surface prior to application. The front-end loader is used for aggregate handling; however, a forklift is often needed because bagged and manufactured aggregate is often used.

4-4.6 Surface Preparation.

Remove all loose material from the pavement surface prior to application of the FRS. Clean and seal cracks wider than 3 millimeters (1/8 inch) or with vegetation prior to application of the FRS.

4-4.7 Application.

After sufficient mixing, pour the FRS mixture directly on the pavement surface and squeegee across the pavement surface. In hot weather conditions where the pavement surface gets hot, applying a fog spray of water prior to application of the FRS material assists in bonding the FRS to the pavement surface. Use a minimum of two applications of the FRS material to eliminate the possibility of any continuous, full-depth voids in the FRS. When possible, make each additional application perpendicular to the previous one. Whenever possible, place consecutive lanes while the sealer mixture applied in the first lane is still semi-fluid and workable. If operations preclude fresh working joints, allow the previously laid pass to set and cure sufficiently so that it is not scarred, torn, or scraped from the pavement surface during the placement of the adjoining pass.

4-4.8 Curing.

FRSs cure by evaporation of the water from the sealed pavement surface. Sunlight and warmer temperatures increase the rate of curing. Curing time varies from 2 to 24 hours depending on the thickness of FRS applied and the existing climatic conditions. Ensure FRSs are not applied when freezing temperatures (<0 degrees C, <32 degrees F) are possible within the required curing time.

4-5 MICRO-SURFACING.

Micro-surfacing, also known as micro-texturing, macro-seal, or macro-pavement, is a latex-modified asphalt emulsion slurry paving system. This system was originally developed in West Germany in the 1970's and has been used in the United States since 1980. The total system consists of a latex-modified asphalt emulsion, a chemical set control additive, high-quality crushed aggregate and mineral filler (usually Type 1 Portland cement), and water.

4-5.1 Equipment.

Some of the methods of mixing and application are similar to those of a slurry seal. Equipment such as brooms, loaders, and asphalt distributors are the same as for a slurry seal. However, other equipment required for mixing and application of micro-surfacing mixtures are different than those required for slurry seals. Mixing is accomplished in a multi-bladed, twin-shaft, pugmill mixer. Application equipment with constant agitation within the slurry box is required to achieve a uniform placement of slurry. Micro-surfacing mixtures are placed with self-propelled mixing and placement vehicles. These vehicles have bins and tanks to carry all the aggregate, filler, asphalt emulsion, water, and additives required to make the mixture. Two basic types of vehicles are used to place micro-surfacing -- those that do so with the help of nurse or resupply trucks and those that place and then leave for resupply. These vehicles have the ability to apply a fog spray of water to the pavement directly in front of the spreader box. The spreader box contains blades to continually agitate the slurry. On relatively smooth surfaces, the rear seal is rubber and acts as a strike-off (screed). On rough surfaces, normally a steel strike-off is used to form an intermediate leveling course, with another slurry then placed over the leveling course. Rut boxes are used to fill ruts in individual traffic lanes. These boxes are V-shaped, with the point of the V toward the rear of the box. They have two shafts with multiple blades on each side of the V to continuously agitate the slurry. The box is designed to push aggregate to the center and is equipped with two metal leveling plates and a rubber strike-off.

4-5.2 Material Requirements.

4-5.2.1 Emulsion.

The binder used in micro-surfacing is a latex-modified asphalt emulsion. The base asphalt emulsion used is normally a cationic slow-setting emulsion with a hard base asphalt (CSS-1H) as specified in ASTM D2397. The latex polymer is combined with the

asphalt cement during the emulsifying process, at a rate of 3.0 percent by weight of residual material.

4-5.2.2 Additives.

Liquid additives are added during the field mixing process to provide control of the set properties of the micro-surface mixture. The amount of additive used increases with decreasing temperatures. This is because the additive acts to cause the emulsion to break or cure faster. Obtain these additives from the emulsion manufacturer to assure compatibility with all components of the mixture.

4-5.2.3 Aggregates.

Ensure the aggregate used is a high-quality, 100 percent crushed aggregate. Aggregates previously used for micro-texturing include granite, flint, slag, limestone, basalt, chert, and gravel. The aggregate is required to meet one of the gradation types listed in Table 4-7. The gradations used for micro-surfacing are the same as those of an asphalt slurry seal, except that type 1, the finest gradation used for a slurry seal (Table 4-4), is not used for micro-surfacing.

Table 4-7 Gradation Types for Micro-Surfacing

Sieve Size	Type 2 Percent Passing	Type 3 Percent Passing
9.5 mm (3/8 in.)	100	100
4.75 mm (No. 4)	90–100	70–90
2.36 mm (No. 8)	65–90	45–70
1.18 mm (No. 16)	45–70	28–50
600 μm (No. 30)	30–50	19–34
300 μm (No. 50)	18–30	12–25
150 μm (No. 100)	10–21	7–18
75 μm (No. 200)	5–15	5–15

Mineral filler is added to the mixture to obtain the desired dispersion (reduce segregation) and working characteristics (speed-up or slow-down the rate of cure of the system) of the micro-surfaced mixture. Determine the amount of mineral filler added from laboratory testing, normally not to exceed 3.0 percent of the weight of the aggregate. Mineral filler is non-air entrained Portland cement, hydrated lime, or another mineral additive.

4-5.2.4 Water.

Use potable water free of soluble salts or any other harmful materials. Limit the amount of water used to that required to produce a mixture of the desired consistency. The amount of water required increases slightly with increasing temperatures.

4-5.3 Design.

A method of mix design for military pavements has not been developed. Instead, procedures developed by the International Slurry Surfacing Association (ISSA) are recommended for use and are detailed here. These procedures are broken down into three parts. The first is the evaluation of materials to verify that they meet the requirements described in section 4-5.2. These materials include the aggregates and the polymer-modified asphalt cement. The second part involves testing the effects of mixing and application characteristics, water content, filler, and additives, and determining the optimum asphalt content through the preparation of trial mixes. The third part involves performance-related tests on the mixture to ensure good long-term performance. ASTM D6372 provides information on standard practices in the design, testing, and construction of micro-surfacing.

4-5.3.1 Mix Characteristics.

Trial mixes are used to determine if the emulsion and aggregate are compatible, if a mineral filler or field control additive is needed, and if used, the concentration and the range of water that produces homogeneous mixtures. Trial mixes are also prepared to determine the optimum filler content and the effects of mineral filler on wet cohesion. These mixes are prepared with constant asphalt emulsion contents and incremental changes in the amount of mineral filler, usually either hydrated lime or Portland cement. Once the desirable mineral filler content has been determined, trial mixes are again prepared, this time keeping the mineral filler content constant and making incremental changes in the asphalt emulsion content.

4-5.3.1.1 Cohesion Test (ISSA Technical Bulletin 139 (TB-139)).

The cohesion test is the method used to classify the set and traffic time of micro-surfacing systems. The cohesion tester is a power steering simulator that measures the torque required to tear apart a 6- or 8-millimeter-thick (0.236- or 0.315-inch-thick) by 60-millimeter (2.36-inch) in diameter specimen under the action of a 32-millimeter-diameter (1.26-inch-diameter) rubber foot loaded to 200 kilopascals (4,177 pounds per square foot). A system is defined as "quick set" if it develops a torque value of 12 to 13 kilograms per centimeter (67.1 to 72.6 pounds per inch) within 20 to 30 minutes. A torque of 12 to 13 kilograms per centimeter (67.1 to 72.6 pounds per inch) is considered the cohesion value at which the mixture is set, water-resistant, and cannot be remixed. A system is defined as "quick traffic" if the mixture develops 20 to 21 kilograms per centimeter (111.9 to 117.6 pounds per inch) torque within 60 minutes. At 20 to 21 kilograms per centimeter (111.9 to 117.6 pounds per inch), sufficient cohesion has developed to allow rolling traffic. Figure 4-1 provides a method to classify various slurry seals and micro-surfacing systems. All micro-surfacing mixtures are designed as quick set, quick traffic systems. Cohesion test results are also used to optimize mineral filler by the use of the "Benedict Curve" (see Figure 4-2), in which the effect of an incremental addition of mineral filler versus cohesion is plotted. The optimum filler content is the value that gives the highest cohesion value. The shape of the curve shows the sensitivity of the system to changes in mineral filler. This helps determine the range of mineral filler that give acceptable laboratory results.

Figure 4-1 Classification of Mix Systems by Cohesion Test Curves

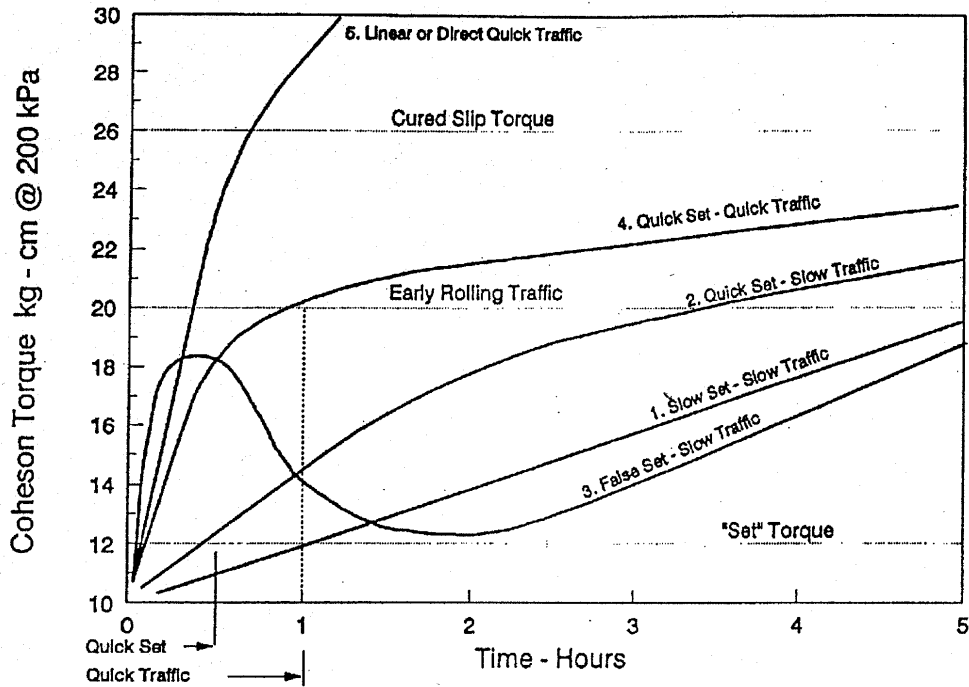
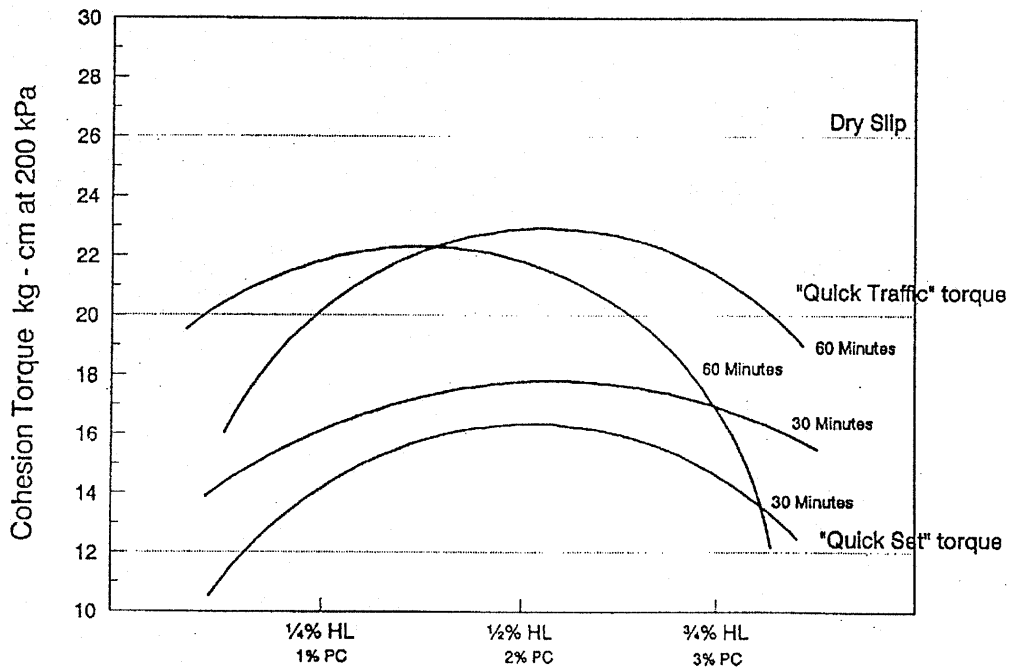

Figure 4-2 Mineral Filler Content Optimization "Benedict Curve"



4-5.3.1.2 Stripping.

Two tests used to evaluate the potential for stripping are: the Wet Stripping Test (ISSA TB-114) and the Boiling Test (ISSA TB-149). The Wet Stripping Test is performed on 60 degrees C (140 degrees F) cured cohesion specimens that are boiled in water for 3 minutes to determine the asphalt adhesion to the aggregate. A coating retention of 90 percent or greater is considered meeting required specifications, with 75 to 90 percent being marginal and less than 75 percent not meeting required specifications. The Boiling Test is similar to the Wet Stripping Test. Either test is also used as an early compatibility indicator test.

4-5.3.2 Determination of Optimum Asphalt Content.

There are several ways to determine the optimum asphalt cement content. One way is to use ISSA test procedures, and another is to use a modified Marshall procedure. A few states also specify requirements for Hveem stability test.

4-5.3.2.1 ISSA Procedure.

The optimum asphalt content is determined from ISSA procedures by graphically combining the results of a WTAT and a loaded wheel test (LWT). Figure 4-3 (a, b, and c) shows how the optimum asphalt content along with an acceptable range is determined by graphically combining WTAT and LWT data. Ensure the minimum and maximum asphalt content falls within the range usually provided in the specification. The ISSA recommends that residual asphalt content be within a range of 5.5 to 9.5 percent.

- a. **Wet Track Abrasion Test (ASTM D3910/ISSA TB-100).** This test determines the abrasion resistance of micro-surfacing mixture relative to asphalt content and is one of two ISSA tests used for determining optimum asphalt content. This test simulates wet abrasive conditions such as vehicle cornering and braking. A prepared and cured sample of mixture 6 millimeters (0.24 inch) thick by 280 millimeters (11.0 inches) in diameter that has been soaked for periods of either 1 hour or 6 days is immersed in a 25 degrees C (77 degrees F) water pan and is wet abraded by a rotating weighted (2.3-kilogram [5.1 pounds]) rubber hose for 5 minutes. The abraded specimen is dried to 60 degrees C (140 degrees F) and weighed. The maximum allowed weight losses for 1-hour and 6-day soaks are 0.54 kilogram per square meter (0.11 pound per square foot) and 0.8 kilogram per square meter (0.16 pound per square foot), respectively. Asphalt contents that result in these weight losses are considered the minimum asphalt contents. The WTAT on a 6-day soaked sample is not required; however, due to the increased severity of the 6-day soak, it is preferred by laboratories and user agencies for predicting the performance of the system.
- b. **Loaded Wheel Test (ISSA TB-109).** This test is used to determine the maximum asphalt content to avoid asphalt flushing in micro-surfacing

systems. This is accomplished by specifying and measuring fine sand that adheres to the sample subjected to simulated wheel loadings. The ISSA recommends a maximum sand adhesion value of 0.54 kilogram per square meter (0.11 pound per square foot) for heavy traffic loadings. If the sand adhesion is below this maximum value, mixture bleeding does not occur. In this test, a 50-millimeter-wide (1.97-inch-wide) by 375-millimeter-long (14.76-inch-long) specimen of desired thickness (25 percent thicker than the coarsest particle) is fastened to the mounting plate and is compacted with one thousand 57-kilogram (125.6-pound) cycles at 25 degrees C (77 degrees F). At the end of compaction, the specimen is washed, and then dried at 60 degrees C (140 degrees F) to a constant weight. A measured quantity of sand is then placed on the sample, and the LWT is repeated for a specified (usually 100) number of cycles. The specimen is then removed and weighed. The increase in weight due to sand adhesion is noted.

Figure 4-3 Determination of Optimum Asphalt Content

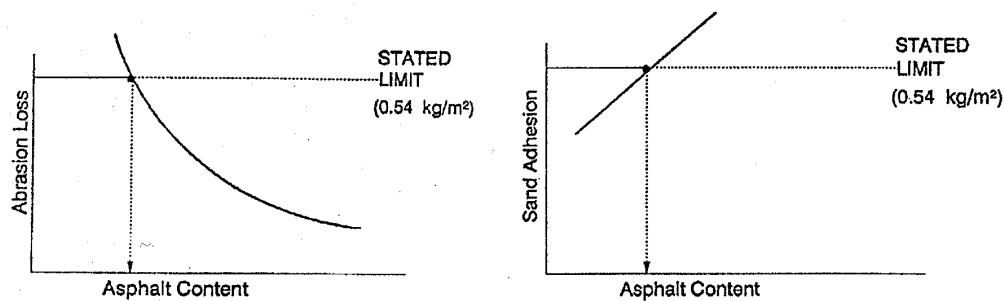

(a) *Minimum asphalt content by wet track abrasion test*

(b) *Maximum asphalt content by loaded wheel test*

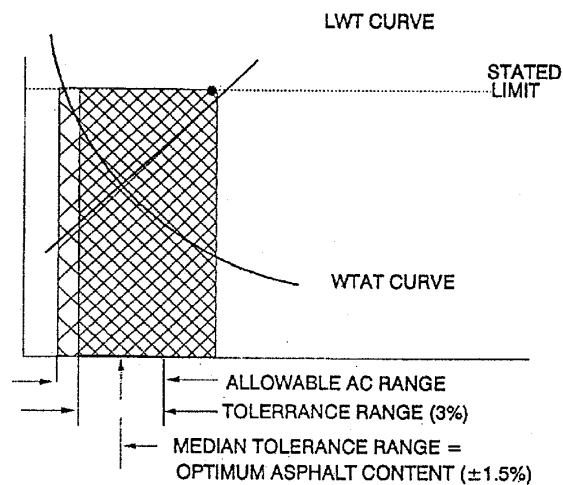

(c) *Combined WTAT and LWT curves*

4-5.3.2.2 Marshall Procedure (Modified CRD-C649 or ASTM D6927).

The Marshall HMA mixture criteria is used to determine the optimum asphalt content. Since these are cold polymer-modified emulsion systems, the stability and flow test procedures have been modified to allow for air and low temperature drying (at least 3 days of air curing, 18 to 20 hours of drying in an oven at 60 degrees C (140 degrees F) before compaction at 135 degrees C (275 degrees F)). The mixes are usually compacted with 50 blows per side. Under this procedure, several test specimens are prepared for combinations of aggregate and asphalt content. The asphalt contents are selected to provide VTM of 4.5 to 5.5 percent. The compacted test specimens are tested for the bulk specific gravity (ASTM D2726), stability, and flow values. Finally, the optimum asphalt cement content is determined using results from these tests. For thin micro-surfacing applications, the stability is not considered a primary factor in determining the optimum asphalt cement content. The surface characteristics of aggregates require adjustments in the VTM requirement to achieve the desired flow values.

4-5.3.2.3 Design Limitations.

- a. **ISSA Design.** Torque values are measured in the laboratory under specific conditions; no correlation has been established with pavement performance in the field. Perform the mixing and wet cohesion test at various moisture contents, relative humidity, and temperatures to simulate the expected field conditions. In addition, it has been reported that aggregates that met ISSA torque standards for 60 minutes have failed to meet the torque values for 30 minutes. Laboratories also use a subjective analysis to determine torque. The sample is examined after the torque is applied, and if it fails, the torque value is determined from a visual examination of the condition of the sample; however, this analysis appears to negate the objectivity of the cohesion test. This indicates an area where the industry reexamines its procedures for cohesion tests and consider the effect of various aggregates on test results. The WTAT was correlated to field performance for only 6-millimeter (0.24-inch) thickness and Type 2 gradation. Accordingly, values of 0.54 kilogram per square meter (0.11 pound per square foot) are not used for other thicknesses and aggregate gradations. Further tests are needed to verify or establish new values. Also, limestone materials meet the WTAT standard for 1-hour soak periods but fail to meet maximum abrasion loss when a sample with a 6-day soak is tested. While the WTAT on a 6-day soak specimen is used for information only, industries review and adjust their current design standards. The reproducibility of the LWT is questionable. The arm that moves the wheel does not stay horizontal, but rather moves up and down during the test. This changes the pressure on the sample. Modify the arm to stay horizontal. At the present time, the weights used to apply pressure are bags of lead shot. These bags shift during the test and affect the applied pressure. Plates that are attached to the machine replace the bags. Sample preparation has been

shown to affect the LWT results by a factor of as much as two. The test specimen flushes if water levels are not carefully controlled. This condition affects the sand adhesion. Improve current laboratory procedures for sample preparation so that samples are molded consistently. For aggregates, the LWT has shown to permit excessive amounts of binder, resulting in unacceptable mixtures. This is true for applications in high shear areas such as intersections. Performance data indicates that mixtures produced with these aggregates using a lower binder content (than required by the LWT) have performed well in extending the pavement service life. The specific gravity specification is subjective due to the sampling procedure. The entire LWT specimen is weighed wet and dry to obtain the specific gravity. After compaction, the same test is repeated. The problem is that only 50 to 60 percent of the specimen is compacted. Variations in the specific gravities of samples also skew LWT results.

- b. **Marshall Design.** The applicability of this HMA test for micro-surfacing is questionable. The Marshall series uses specimens of varying asphalt contents that are dried, reheated to 135 degrees C (275 degrees F), and compacted to low void content. Micro-surfacing mixtures do not reach low void levels during the life of the mixture. Field observation has noted air voids of 10 to 15 percent after 1 to 2 years of placement. There is a need to correlate the voids measured during the design using the Marshall method with the actual field voids. One materials laboratory that has developed a cold Marshall test procedure to estimate field voids is currently correlating the field voids with the voids obtained by the modified HMA procedure. The HMA samples are prepared by compacting in a mold. Also, for reliable results, cure the sample in a uniformly distributed film throughout the thickness of the lift.

4-5.4 Surface Preparation.

Ensure the pavement surface has all loose material removed prior to application of the micro-surfacing material. Repair any structurally deficient pavement areas. Clean and seal cracks wider than 3 millimeters (1/8 inch) or filled with vegetation prior to application of the micro-surfacing.

4-5.5 Application.

Apply a tack coat to the pavement surface prior to application of the micro-surfacing. Immediately prior to application, wet the pavement surface with a water fogging. This fogging leaves the surface damp but with no free water. Ensure the minimum thickness of micro-surfacing material application at least exceeds the maximum nominal size of the aggregate in the mixture (usually 1¼ to 1½ times the maximum nominal size). This relates to minimum thicknesses of from 10 to 13 millimeters (3/8 to slightly over 1/2 inch). Where wheel ruts exceed 6 millimeters (1/4 inch) in depth, place a separate rut-filling layer prior to the complete overlay. The emulsion is usually heated to within 27 to 49 degrees C (80 to 120 degrees F) prior to mixing. Micro-surfacing applications

are designed to be opened to traffic within 1 hour after placement. Temperature and humidity are the controlling factors for curing micro-surfacing after placement. As the temperature increases and the humidity decreases, the cure time decreases.

Construction of a test section is very important for micro-surfacing due to changes in field conditions from lab conditions. Micro-surfacing is a quick-set system; therefore, changes or variations in field conditions require moisture, additive, or basic mix design changes to meet field conditions. Where possible, accomplish placement utilizing “nurse trucks” to allow for continuous placement. Nurse trucks are vehicles that are intended to carry aggregate, emulsion, and water to the application vehicle, whereby application of the micro-surfacing is a continuous operation. Whenever placement of the micro-surfacing is stopped, lift and clean the spreader box and ensure the transverse joint is squared. Paper strips or metal flashing is used to improve transverse joints. Construct longitudinal joints with a 50-millimeter (2-inch) overlap to assure complete coverage and to reduce rigid development. Use of an operator to control the rate of material flow along with careful control of the placement vehicle’s speed allows for accurate placement of the micro-surfacing.

CHAPTER 5 ASPHALT STABILIZATION

5-1 INTRODUCTION.

This chapter contains information for use of asphalt cement for stabilization of soil/aggregate materials and on stabilization of drainage layers. When any subsurface layer receives an asphalt treatment, the treatment is considered asphalt stabilization. In general, asphalt stabilization is utilized where good base course materials are not readily available and where the existing subgrade materials are sands or silts which meet design requirements for stabilization. Asphalt stabilization is used when a drainage layer is trafficked with construction equipment. UFC 3-250-11 contains detailed information on the design and construction of asphalt stabilized soils.

5-2 MATERIALS.

5-2.1 Soil/Aggregate.

There are a number of requirements for determining soil suitability for asphalt stabilization. The stabilization of fine-grained soils depends on the plasticity characteristics and amount of material passing the 75 μm (No. 200) sieve. Recommended gradations of materials for various types of asphalt stabilization are given in UFC 3-250-11. Soils with high plasticity are not stabilized with asphalt because of difficulty in thoroughly mixing the asphalt into the soil. These soils are only stabilized if pretreated with lime or cement to decrease the plasticity of the soil.

5-2.2 Asphalt.

The asphalt used for stabilization is either emulsified or cutback asphalt. Normally, the emulsions used are slow setting (SS) or possibly some medium setting (MS) emulsions. Rapid set (RS) emulsions are not used. Any type of cutback from rapid (RC) to medium (MC) to slow (SC) cure is used for asphalt stabilization. The use of emulsions versus cutbacks is dependent on the availability of materials, soil type, climate, and construction practice. The availability of cutbacks is limited in areas due to environmental concerns.

5-3 COMPOSITION AND MIXTURE.

For stabilized materials, the type of asphalt used is as important as how much is used. UFC 3-250-11 contains information on the type and amount of liquid asphalt to use. Design procedures for determining optimum asphalt content are given for both cutback and emulsified asphalts.

5-4 CONSTRUCTION.

Methods and procedures for constructing asphalt-stabilized materials are given in UFC 3-250-11.

5-5 DRAINAGE LAYERS.

Guidance for the design and construction of subsurface drainage features is given in FAA Advisory Circular 150/5320-5E, *Airport Drainage Design*. Open graded material (OGM) is the drainage feature that normally requires stabilization for construction stability or for structural strength to serve as a base for a flexible pavement.

5-5.1 Design.

Ensure the amount of asphalt used coats the aggregate and holds it in place but does not fill any voids. Normally 2 to 2.5 percent (by weight of total mixture) asphalt is sufficient for stabilization. As a rule, the more open graded the material is, the lower the asphalt content required for stabilization. The asphalt used is similar to the grade normally used in that location. Use a higher viscosity (stiffer) asphalt to provide increased stability.

5-5.2 Construction.

Place a stabilized OGM with a paver to minimize segregation and achieve the design grade and thickness. Usually asphalt cement is used as the binder and the OGM is run through a HMA plant to achieve required coating and to allow for placement. Liquid asphalts (emulsions or cutbacks) are used if conditions warrant. An OGM requires rolling the mixture only to seat the aggregate in place.

CHAPTER 6 MISCELLANEOUS MIXTURES

6-1 RECYCLED ASPHALT MIXTURES.

See UFC 3-250-07.

6-2 SAND-ASPHALT MIXTURES.

In regions such as coastal areas where sand of good quality (clean and angular) is the only local aggregate available, the sand is used to produce an economical base or surface course. Sand mixtures, produced from these clean angular sands, are considered for paving roads and streets where light loads are anticipated and where considerable savings are realized by using locally available sand. Mineral filler is often added to increase the density and stability of the mixture, but mineral filler is omitted in designing sand-asphalt mixtures for asphalt-stabilized base courses. Asphalt cement, cutback asphalt, or emulsified asphalt is used for binder. Cold-laid asphalt mixtures are mixed at a central plant, mixed with a travel plant, or mixed in place. HMA is mixed at a central plant. Sand mixes are fine textured, dense, and relatively impermeable. The stability and durability of the sand mixes depend on the quality and grading of the fine aggregate, the amount and grade of asphalt binder, and the degree of control exercised in construction operations. Ensure the sand is sufficiently well-graded to meet the specified aggregate requirements for the type of course to be constructed and is free from excessive amounts of foreign matter. In many cases, the design gradation is obtained by selecting and blending locally available sands.

6-2.1 Advantages and Disadvantages.

Sand-asphalt mixes are produced with locally available materials at a relatively low cost; however, the use of sand mixes is limited due to their relative lack of strength and durability. Sand asphalt mixtures normally require a relatively high asphalt content thus resulting in a high mixture cost.

6-2.2 Uses.

Sand mixes are not to be used as surface or intermediate courses for airfield and heliport pavements designed for high-pressure tires or for pavements designed for solid-rubber tires, steel wheels, or tracked vehicles. High-pressure truck tires and all-terrain vehicle (ATV) tires are not to be allowed on sand-asphalt mixes. Sand mixes are considered for asphalt-stabilized base courses for all types of traffic areas and for any course in non-traffic areas. Sand mixes are considered for surface and intermediate courses for pavements subjected to low-pressure tires (690 kilopascals (100 psi) or less) and low traffic volumes. In this case, make and test trial mixes in the laboratory. Sand-asphalt mixes have been used to provide temporary travel paths for construction vehicles over completed AC pavements. Ensure the maximum sized aggregate particle are 9.5 millimeters (3/8 inch) or less to prevent the traffic from making indentations on the underlying AC pavement.

6-3 SHEET ASPHALT.

Sheet asphalt is a refined type of hot sand-asphalt pavement in which the grading, quality of sand, amount of mineral filler, and asphalt cement content are carefully controlled. The percentage of asphalt required is higher than that used for sand asphalt. Sheet asphalt provides a smooth, impermeable, homogeneous surface course that gives the best service when traffic is spread evenly over the pavement. Normally, sheet asphalt is used for surface courses only and is constructed 38 to 50 millimeters (1½ to 2 inches) thick over an intermediate course.

6-4 ROCK ASPHALT.

Rock asphalt pavement is composed of crushed, natural asphalt-impregnated limestone or sandstone, or a combination of these, used alone or mixed with additional asphalt or flux oil. Rock asphalt pavement is laid cold in the same manner as cold-laid asphalt mixture. Rock asphalt is used only in surface courses for roads and are not to be constructed over 37.5 and 50.0 millimeters (1½ and 2 inches) thick for blended and fluxed rock-asphalt, respectively. Kentucky, Alabama, Texas, New Mexico, Oklahoma and Utah have natural rock-asphalt deposits where paving material is produced commercially. The character and quantity of the aggregate and asphalt in the material vary among the different deposits and vary within the same deposit. Rock asphalt pavement is prepared by blending into the natural asphalt a crushed impregnated limestone or sandstone or a combination of the two in proportions to produce a properly graded mixture with a specified asphalt content. Ensure the natural rock asphalt is enriched (that is, add more asphalt to the mixture) if the material does not contain asphalt in its natural state to produce a mixture meeting design requirements. Hot mixes are produced by heating crushed limestone impregnated with relatively hard asphalt, alone or with added sand, and mixing with additional asphalt cement in a conventional plant.

6-4.1 Advantages and Disadvantages.

The advantages and disadvantages are the same as those for plant-mix cold-laid asphalt mixtures. In addition, the use of rock asphalt pavement reduces cost because this mixture already contains binder material.

6-4.2 Uses.

Rock asphalt pavements are used for roads and streets not subjected to traffic by tracked vehicles. Rock asphalts are used as the aggregate in slurry seals, but only use predominantly sandstone rock asphalts in slurry since limestone rock asphalts polish under traffic and thus produce a slick pavement surface.

6-5 COLD-MIX ASPHALT.

Cold-mix asphalt pavements are used as a low-cost surface for low-volume roads or as a base course for high-volume roads and airfields. While cold mixes do not provide pavements with the same quality as hot mixes, cold mixes do perform for the purposes

intended. Cold mixes are capable of being stored for several months and are useful for patching. Because fuel is not needed to heat cold mixes, these pavements are constructed at lower cost than hot mixes. Two disadvantages of using cold mixes are that usually a lower density is obtained in cold mixes than in the construction of hot mixes and that a curing period is needed to allow water or volatiles to evaporate so that shear strength is obtained.

6-5.1 Design.

6-5.1.1 Preliminary Work.

The first step in designing a paving mixture is to make a survey to ensure that the materials needed are available in quantities meeting job requirements and their use is economical in the pavement construction. Obtain sufficient samples of material during the survey to accomplish the tests described in this section of this UFC. Materials normally required for the paving mix are coarse aggregate, fine aggregate, mineral filler, and bitumen.

6-5.1.1.1 Sampling.

Test reports reflecting the results of sampling and testing of the aggregates and bituminous materials are prepared. Conduct a gradation analysis on the aggregates to determine whether the aggregates when blended meet the contract gradation specifications. Furnish representative samples of materials for laboratory testing. Divide samples into sizes meeting testing requirements in the laboratory, in a way that represents field conditions. Sufficient quantities of materials are obtained at the time of sampling to meet the ASTM requirements and for laboratory pavement design tests described in this section of this UFC. Normally, aggregates that produces 90 kilograms (200 pounds) of the desired gradation and 19 liters (5 gallons) of bitumen is sufficient for these tests.

6-5.1.2 Materials.

6-5.1.2.1 Tests on Aggregates.

Ensure aggregates for use in an asphalt mixture are clean, hard, and durable. Angular aggregates provide an increased stability in pavements compared to rounded aggregates. Tests of aggregates required in the design of HMA mixtures are also applicable to the cold-mix type. Table 6-1 lists typical aggregate gradation requirements for both dense- and open-graded mixtures. The gradation used depends on the application and the binder. Dense-graded mixtures are used in most applications; open-graded mixtures provide more workability in colder weather. Many proprietary cold-patch materials use an open grading along with a modified binder. The dense-graded aggregate gradations correspond to those recommended in this text for hot-mix, hot-laid asphalt mixtures, which are provided in Table 2-1 for HMA.

Generally, combine aggregates for paving mixes from a minimum of two stockpiles. Mathematical equations are available for making such combinations but are not presented in this UFC because they are lengthy and because trial-and-error procedures are normally easier. The method of combining stockpile sample gradations is described in section 2-4 on dense-graded HMA. Ensure the gradation of the aggregate falls within the limits of the gradation for the project specifications, such as those provided in Table 6-1. Ensure the final gradation presents a smooth curve when plotted with sieve size versus percent passing.

Table 6-1 Typical¹ Aggregate Gradations for Plant-Mix Cold-Laid Asphalt Mixtures

Sieve Size	Percent Passing Sieve by Weight			
	Dense-Graded		Open-Graded	
12.5 mm (1/2 in.)	100	--	100	100
9.5 mm (3/8 in.)	86±9	100	90–100	90–100
4.75 mm (No. 4)	66±9	85±9	20–55	40–75
2.36 mm (No. 8)	53±9	71±9	5–30	25–55
1.18 mm (No. 16)	41±9	57±9	0–10	10–30
600 µm (No. 30)	31±9	43±9	---	---
300 µm (No. 50)	21±8	31±8	0–5	3–15
150 µm (No. 100)	13±6	19±6	---	---
75 µm (No. 200)	4.5±1.5	6±3	0–2	0–6

¹ Actual gradations used depend on the application; open gradations provide for greater workability in colder weather.

6-5.1.2.2 Tests on Asphalt Cement.

Know the specific gravity of the asphalt cement to determine the percent by volume of bituminous materials in the mix. Because only the residual asphalt is used in calculating the percent binder, the amount of residual asphalt cement in cutback asphalts and asphalt emulsions are determined as specified in ASTM D402 and ASTM D244 for cutback and emulsified asphalts, respectively. Determine the specific gravity of the residual asphalt as described in ASTM D70.

In addition to cutback asphalts and emulsified asphalts, cold-mix asphalt pavements are made with asphalt cement and liquefier (cutback) produced to meet a project's design requirements. This cutback asphalt is produced, usually for remote projects, by using kerosene to liquefy an asphalt cement. The type of asphalt cement used to make this liquid binder is varied easily to meet various climate conditions. The cutback binder produced has a relatively long shelf life, depending on the amount of cutback material (kerosene) that is added. When cutback asphalts are contained in a single tank, then only the standard pipelines and spray bar are required. Additional equipment is used for

handling the kerosene and asphalt cement when this type of cutback binder is produced. Asphalt emulsions are advantageous in that damp aggregate is allowed to be used in the mixing process, whereas dry aggregates are required for the other binder materials. Normally, mixes made with asphalt emulsions cannot be stockpiled unless the emulsion has been specifically formulated for stockpiling purposes. The choice of asphalt material type depends primarily on economics and the type of equipment to be used. Table 6-2 provides a guide to the selection of the type and grade of asphalt cement. The table provides information on asphalt for mixes to be used immediately and on asphalt for mixes to be stockpiled for later use.

Table 6-2 Selection of Asphalt Type and Grade

Asphalt Parameter	Climatic Conditions During Construction or Storage		
	Cold (less than 16 °C, 60 °F)	Moderate (16–27 °C, 60–80 °F)	Hot (above 27 °C, 80 °F)
Kerosene, liters/metric ton (gallons/ton mix) to asphalt cement	8.3 (18.8 ¹) (2.0 (4.5 ¹)) added to AC-20, 85–100 pen, and PG 58-22	7.1 (15.4 ¹) (1.7 (3.7 ¹)) added to AC-20, 85–100 pen, and PG 58-22	6.3 (12.5 ¹) (1.5 (3.0 ¹)) added to AC-20, 85–100 pen, and PG 58-22
Cutback asphalts	RC-70–RC-250	RC-250–RC-800	RC-800–RC-3000
Emulsified asphalts ²	MS-2h SS-1h	MS-2–MS-2h SS-1–SS-1h	MS-2 SS-1
Note: RC = rapid curing; MS = medium set; SS = slow set. ¹ Amount of kerosene to be added when mixture is to be stockpiled for future use. ² Emulsified asphalts are available that are specifically formulated for stockpile use.			

6-5.1.3 Design.

The following procedure is recommended for determining the amount of asphalt cement to be used in the paving mix for cold-mix pavements. This procedure is applicable only for dense-graded mixtures. This design procedure is similar to the procedure used for designing HMA mixes for roads and streets. Laboratory equipment and test procedures are required to conform to CRD-C 649 and CRD-C 650. There is no widely accepted standard method for the design of all types of cold mixes. The Asphalt Institute provides information on design and construction procedures for cold mixes in MS-14. Information specific to emulsions is available in MS-19. Base the selection of the design method on past experience and local practices.

6-5.1.3.1 Asphalt Contents for Specimens.

The quantity of asphalt cement required for an aggregate is an important factor in the design of a paving mixture. To start the laboratory tests, make an estimate of the optimum amount of asphalt cement for the aggregate to be tested. Laboratory tests normally are conducted for a minimum of five asphalt cement contents: two above, two

below, and one at the estimated optimum content. Incremental changes of 1 percent are used for preliminary work, but increments of 0.5 percent are used where the optimum asphalt cement content is known and for final designs.

6-5.1.3.2 Proportioning of Aggregates.

As a preliminary step in mixture design and manufacture, determine the proportions of the different available stockpiled materials required to produce the desired gradation of aggregate. This step determines whether a blend is produced meeting design requirements and, if so, the proportion of aggregates to be fed from the cold feeders into the dryer. Sieve analyses are conducted on material from each of the stockpiles. The aggregates are combined as described in CHAPTER 2. After a blend has been prepared from the available materials meeting design requirements, samples of these materials are processed for use in the laboratory design tests as specified in CRD-C 649.

6-5.1.3.3 Determination of Optimum Asphalt Cement Content.

The optimum asphalt cement content is taken as the average of the asphalt contents corresponding to the mix properties in Table 6-7. The optimum asphalt cement content is the amount of asphalt cement that is incorporated into the mix. The percent of cutback asphalts and emulsified asphalts are corrected to give a residual asphalt content equal to the optimum asphalt content determined by the tests. Because all of the volatiles do not evaporate, decrease slightly the amount of bitumen to be added as determined by this mix design procedure. When the asphalt cement and kerosene-type mix is to be used, add the desired amount of kerosene to the actual paving mix in addition to the optimum asphalt content determined from the laboratory design.

Table 6-3 Selection of Optimum Asphalt Content

Mix Property	Value for Determining Optimum Asphalt Content
Unit weight of mix, lb/ft ³	Peak of curve
VTM, percent	4±1
VFA, percent	75±5

6-5.2 Plant Mix.

Quality control is increased for mixtures produced in a plant Vs mixtures mixed in place in the field. This increased control results in a much tighter gradation and binder content control, although overall costs are greater compared to in-place mixing.

6-5.2.1 Plant Operation.

The plant operation varies with the type of asphalt material used in the mix. For mixes using asphalt cement and kerosene, introduce the kerosene and asphalt cement onto the aggregate at different times. Drying of the aggregate is not a design requirement

with asphalt emulsions, but for cutback binders, heat the aggregates. Ensure aggregates are not hotter than 93 degrees C (200 degrees F) when mixed with RC cutback asphalts and not hotter than 121 degrees C (250 degrees F) for mixing with MC grades or asphalt cement and kerosene. Ensure the asphalt materials are in the temperature ranges provided in Table 6-8 when introduced into the pugmill.

Table 6-4 Mixing Temperatures for Asphalt Materials

Bituminous Material Type	Grade	Temperature Range, °C (°F)
Emulsified asphalts	MS-2	38–71 (100–160)
	MS-2h	38–71 (100–160)
	SS-1	24–54 (75–130)
	SS-1h	24–54 (75–130)
Cutback asphalts (not used much due to environmental issues)	RC-70	38–57 (100–135)
	RC-250	57–79 (135–175)
	RC-800	77–96 (170–205)
	MC-70	38–57 (100–135)
	MC-250	57–79 (135–175)
	MC-800	77–96 (170–205)
Note: MC = medium curing; RC = rapid curing; MS = medium set; and SS = slow set.		

6-5.2.2 Plant Laboratory.

Use of a plant laboratory ensures that the aggregate meets design gradation requirements and that the mix contains the prescribed percentage of asphalt material. The plant laboratory contains this major equipment:

- a. A hand- or power-driven mechanical sieve shaker. The sieve shaker is required to have a capacity of not less than eight full-height, 200-millimeter (8-inch) -diameter sieves.
- b. A full-height, 200-millimeter (8-inch) -diameter sieve for each of the following sieve openings: 12.5 millimeter (1/2 inch), 9.5 millimeter (3/8 inch), 4.75 millimeter (No. 4), 2.36 millimeter (No. 8), 1.18 millimeter (No. 16), 600 micrometer (No. 30), 300 micrometer (No. 50), 150 micrometer (No. 100), and 75 micrometer (No. 200). The sieves are required to have square openings and conform to the requirements of ASTM E11.
- c. An extractor or ignition test for measuring bitumen content within close tolerances.
- d. A balance having a capacity of 2 kilograms (4.4 pounds) and sensitive to 0.1 gram (0.0035 ounce).

- e. Marshall equipment for compacting and testing samples to verify mixture design.

6-5.2.3 Adjusting Mix Proportions.

Adjust mix proportions whenever tests indicate that specified tolerances are not being met. Fully automated plants produce consistent mixtures, provided that the equipment is calibrated and in good working condition. Variations in weighing techniques or faulty scales are detected readily and corrective measures taken by maintaining a close check on load weights. Ensure the total weight of each load of mixture produced only varies between plus or minus 2 percent from the total of the batch weights dumped into the truck.

6-5.2.4 Preparation of Construction Specifications.

6-5.2.4.1 Specifications.

Cold-laid asphalt mixtures are produced according to the provisions of guide specifications except when mix quantities, less than 100 metric tons (100 tons), are specified for limited use in repairs. In these cases, the procedures specified in the guide specification are not economical. When such an exception is allowed, locally available cold-laid bituminous mix produced according to local state highway department specifications are used. Contact the Pavements Discipline Working Group (DWG) or their designated representative for these exceptions. When the quantity equals or exceeds 100 metric tons (100 tons), approval from the Pavements DWG or their designated representative is required. Provide a copy of the specification or reference thereto and information regarding traffic conditions and facilities to be paved to facilitate discussions

6-5.2.4.2 Placing.

Although closer control of layer thickness and better prevention of segregation of the mix is achieved with a mechanical spreader, a motor grader is desirable for spreading plant-mix cold-laid pavements. Aeration of the mix to remove volatile material is often required to bring the mix to the design condition for compaction. A motor grader aerates the mix by blading it back and forth across the roadbed.

6-5.2.4.3 Compaction of Mixture.

At the time of compaction, the asphalt material in the mixture is required to provide the specified amount of cohesion so that the design density is reached. Cohesion of the mixture is controlled by the type of asphalt material, volatile content, and temperature of the mixture. Low cohesion causes the mix to be unstable under the roller, while high cohesion causes the mix to be too stiff to be compacted. Compact the mixture as soon as it supports the roller without undue displacement.

6-5.3 Road Mix.

Asphalt road mixes are normally mixed in place by travel plants or common types of road-building equipment, such as blade graders, disk harrows, drags, and pressure distributors. When allowed by design, the existing subgrade materials, loosened existing subgrade materials blended with imported materials, or properly processed imported materials placed on the existing base or subgrade have been used as aggregate in road mixes. When the amount of material passing the 75 microns (No. 200) sieve exceeds 20 percent, processing with asphalt is difficult and this material benefits from the addition of imported materials. A wide range of aggregates are used, and the gradation requirements are less strict than those for hot or cold plant-mixed types. The bitumen is often applied by a pressure distributor to the processed aggregate on the base or subgrade and then thoroughly mixed with the aggregate. A travel-type mixing plant combines the aggregates with an asphalt material and continuously discharges the mixture at the rear of the machine as the plant travels along the strip being paved. Using a travel plant permits accurate proportioning of the bitumen and aggregate and produces a uniform and higher quality mixture vs. a mixed-in-place method. Further, because viscous types of cutback asphalt are used, the curing time is reduced. Curing is usually required to reduce the volatiles in the cutback asphalt or water in the asphalt emulsion prior to spreading and compacting because excessive amounts of volatiles and water affect the compatibility of the mixture and the stability of the finished pavement. Manipulation with blades or other road machines speed curing.

6-5.3.1 Advantages and Disadvantages.

Much less equipment is required for construction using asphalt road mix than is required using AC, thus resulting in cost savings. Using locally available materials also results in significant cost savings. Asphalt road mix, however, does not have the strength or durability of HMA. The road-mix type of pavement provides an economical means of obtaining a surface for roads and streets when the required amount of pavement is small, when the natural soil meets aggregate design requirements, or when aggregates meeting design requirements are nearby. Apply seal coats with aggregate cover as a part of road-mix construction since road mixes are often open graded or of relatively low density and are therefore susceptible to oxidation and abrasion.

6-5.3.2 Uses.

When an asphalt road mix is properly designed and constructed on an existing subgrade meeting design requirements or using locally available aggregates, the quality of road-mix construction approaches that of cold mix produced in a central plant. Road mix is used for intermediate or surface courses, but because of the less accurate control, road mix is often considered inferior to plant mixtures. Road mix is not allowed for use above the base course for airfields. Road mix is used as a wearing course for temporary roads and streets or as the first step in stage construction for permanent roads and streets when these are to be supplemented by plant-mix surfaces as the demands of traffic increase and warrant the increased thickness. Seal coats reduce infiltration of air and water and thus improve the durability of road-mix pavements.

This Page Intentionally Left Blank

CHAPTER 7 RESIN MODIFIED PAVEMENT (RMP)

7-1. OVERVIEW.

RMP is a tough and durable surfacing material that combines the flexible characteristics of HMA with the fuel, abrasion, and wear resistance of PCC. RMP is best described as a cross between AC and PCC and is categorized between these two common types of paving materials. RMP is basically an open-graded AC mixture containing 25 to 35 percent voids that are filled with a resin modified Portland cement grout. The open-graded asphalt mixture and resin modified cement grout are produced and placed separately. The production of the materials and the mixture requirements for both the open-graded asphalt mixture and the cement grout differ slightly from conventional procedures. The open-graded asphalt mixture is designed to be the support layer and to determine the thickness of the RMP, which is 50 millimeters (2 inches). The open-graded mixture is placed with standard AC paving equipment but is not compacted. After placement, the open-graded asphalt material is simply smoothed over with a steel-wheel roller, a 3-metric ton (3-ton) maximum. Compaction of the open-graded AC material adversely decrease the voids and hinder grout penetration. After the asphalt mixture has cooled, the cement grout is poured onto the open-graded asphalt material and squeegeed over the surface. The cement grout is then vibrated into the voids with the steel-wheel roller to ensure full penetration of the grout. This process of grout application and vibration continues until all voids are filled with grout, which essentially completes the construction process.

RMP was developed in France in the 1960's as a fuel and abrasion resistant surfacing material. The RMP, or Salviacim® process as it is known in Europe, was developed by the French construction company, Jean Lefebvre Enterprises, as a cost-effective alternative to PCC. The RMP process has been used on various types of pavements, including warehouse floors, tank hardstands and roads, and aircraft parking aprons. This surfacing material is best suited for pavements that are subjected to abrasive traffic, heavy static point loads, heavy fuel spillage, and channelized traffic. RMP has been constructed successfully in numerous countries, including France, Great Britain, South Africa, Japan, Australia, Saudi Arabia, and the United States.

7-2 MATERIALS

7-2.1 Open-Graded Asphalt Mixture

7-2.1.1 Aggregates

The required aggregate physical properties and the gradation limits for aggregates in the open-graded asphalt portion of RMP are listed in Table 7-1 and Table 7-2, respectively.

Table 7-1 Aggregate Physical Properties

Test	Specification Requirements
LA Abrasion (ASTM C131)	< 40 percent
Percent Fractured faces +4.75 mm (No. 4)	> 70 percent
-4.75 mm (No. 4)	> 70 percent
Percent flat and elongated (ASTM D4791)	< 8 percent

Table 7-2 Gradation Limits for Open-Graded Asphalt Mixture

Sieve Size	Specified Limits, Percent Passing
19 mm (3/4 inch)	100
12.5 mm (1/2 inch)	54–76
9.5 mm (3/8 inch)	38–60
4.75 mm (No. 4)	10–26
2.36 mm (No. 8)	8–16
600 μm (No. 30)	4–10
75 μm (No. 200)	1–3

7-2.1.2 Asphalt Cement.

The asphalt cement used is required to be of the same grade as that normally used in the area. When possible, specify the stiffest (highest viscosity) asphalt cement available in that area to assist in providing a stable surface for the subsequent grouting operations. Ensure the asphalt cement meets the requirements of ASTM D946, ASTM D3381, or ASTM D6373/AASHTO M 320.

7-2.2 Cement Slurry Grout.

7-2.2.1 Aggregate.

The cement slurry grout requires silica sand meeting the gradation provided in Table 7-3. Silica sand is specified because of its soundness and durability. Ensure the silica sand meets the requirements for wear and soundness specified for the aggregate in the open-graded AC. Deviations from these aggregate requirements have resulted in significant constructability problems in the past. To date, no problems or distresses associated with possible alkali-silica reactivity (ASR) have been reported in any RMP. No information has been found on investigations of this possible phenomenon.

Table 7-3 Aggregate Gradation for Slurry Grout

Sieve Size	Percentage by Weight Passing Sieves
1.18 mm (No. 16)	100
600 μm (No. 30)	95–100
75 μm (No. 200)	0–2

7-2.2.2 Filler.

Normally, filler or material passing the 75 μm (No. 200) sieve is present in the aggregate used in the cement grout. When additional filler is required, ensure it is a Class F (ASTM C618) fly ash with a limit on the calcium oxide content of 5 percent by weight maximum. Ensure the fly ash has a minimum of 95 percent by weight of material passing the 75 micron (No. 200) sieve.

7-2.2.3 Cement.

Ensure the Portland cement used conforms to ASTM C150. Ensure the Portland cement used is Type I, II, III, or IV. Type I cement is commonly used for RMP applications. The other types are used where moderate to high sulfate resistance or high early strength is required.

7-2.2.4 Cross Polymer Resin Additive.

Cross polymer resin additives are available on the commercial market, Table B-4. Typical composition is five parts water, two parts cross polymer resin of styrene and butadiene, and one part water reducing agent. This product is used as a plasticizing and strengthening agent.

7-3 MIXTURE DESIGN.

7-3.1 Open-Graded Asphalt Mixture.

The optimum asphalt content for the open-graded asphalt mixture is determined through a modified Marshall mix design procedure. Marshall laboratory samples

152.4 millimeters (6 inches) in diameter by 63.5 millimeters (2½ inches) in height are produced using the determined JMF aggregate gradation and a series of asphalt contents ranging below and above an estimated optimum asphalt content value. The estimated optimum asphalt content is determined using a procedure developed in France and based on aggregate properties. The procedure is outlined below:

$$\text{Optimum asphalt content} = 3.25 \alpha \Sigma_{0.2}$$

where

$$\alpha = \frac{2.65}{SG} \text{ where SG = apparent specific gravity of the combined aggregates}$$

$$\Sigma = \text{conventional specific surface area}$$

$$= 0.21G + 5.4S + 7.2s + 135f$$

$$G = \text{percentage of material retained on the 4.75 millimeter (No. 4) sieve}$$

$$S = \text{percentage of material passing the 4.75 millimeter (No. 4) sieve and retained on the 600 } \mu\text{m (No. 30) sieve}$$

$$s = \text{percentage of material passing the 600 } \mu\text{m (No. 30) sieve and retained on the 75 } \mu\text{m (No. 200) sieve}$$

$$f = \text{percentage of material passing 75 } \mu\text{m (No. 200) sieve}$$

If, for example, the estimated optimum asphalt content calculated for a given aggregate gradation was 4.2 percent, then the asphalt contents used for the subsequent laboratory Marshall sample evaluation normally is 3.8, 4.0, 4.2, 4.4, and 4.6 percent. The 152.4-millimeter (6-inch) -diameter Marshall samples are compacted in the laboratory using a 4.536-kilogram (10-pound) hand hammer with a 152.4-millimeter (6-inch) -diameter impact plate. The samples are compacted at 121 degrees C (250 degrees F) using 25 blows on one side of the sample. Three samples are produced for each of the five asphalt contents used, and the resulting average voids data of percentage of VTM and voids filled are used to finalize the selection of optimum asphalt content. As a general rule, as the percent of asphalt increases, the VTM fluctuates over a relatively small range. Also, the voids filled increase slowly until the percentage shows a significant increase, indicating that further increases in asphalt content are working to fill the void spaces rather than coating the aggregate particles. This is an undesirable condition since an excess amount of asphalt cement in the RMP void structure hinders the slurry grout's penetration upon its application. Ensure the asphalt content selected is below the point where voids filled shows a significant increase and where the VTM is within the 25 to 35 percent range of values. The VTM of laboratory specimens and field cores prior to grouting are calculated using this formula:

$$VTM = \left[100 - \frac{WT_{air} (1)}{Volume SG_T} \times 100 \right]$$

Where:

- VTM* = voids total mix
WT_{air} = dry weight of specimen
Volume = $\pi/4 D^2 H$ (measured)
D = diameter
H = height
SG_T = theoretical specific gravity

7-3.2 Cement Grout.

The slurry grout JMF is developed using the range of properties listed in Table 7-4. Using these proportions, the following procedure is used. The slurry grout samples are prepared in the laboratory by first dry mixing the cement, sand, and fly ash in a blender until they are thoroughly mixed. Then the specified amount of water is added meeting viscosity requirements, and the grout mixture is blended for 5 minutes. After this 5-minute mixing period, the cross polymer resin additive is added and mixed with the grout for an additional 3 minutes. Immediately after the 3-minute mixing period, the grout is poured into the Marsh flow cone and tested for viscosity. A Marsh cone has dimensions of 155 millimeters (6.2 inches) base inside diameter, tapering 315 millimeters (12.6 inches) to a tip inside diameter of 10 millimeters (0.4 inch). The 10-millimeter (0.4-inch) -diameter neck has a length of 60 millimeters (2.4 inches). The viscosity, in seconds, is measured for each sample, and three different batches of each blend are tested to obtain an average viscosity value. The requirements for viscosity of the grout are provided in Table 7-5. The individual components of the grout are adjusted within the prescribed tolerances listed in Table 7-4 to obtain a desired grout viscosity.

Table 7-4 Resin Modified Cement Slurry Grout Mixture Proportions

Material	Percent by Weight
Silica sand	16–20
Fly ash	16–20
Water	22–26
Type I cement	34–40
Cross polymer resin	2.5–3.5

Table 7-5 Slurry Grout Viscosity

Time Elapsed After Addition of Polymer	Viscosity (Marsh Cone Flow Time)
0–30 minutes	8–10 seconds
After 30 minutes	9–11 seconds

7-4 EQUIPMENT.

The equipment used to place, transport, and mix the open-graded asphalt mixture is the same as that used to place dense-graded asphalt mixture, except for smaller steel-wheel rollers. This equipment includes sweepers, distributors, pavers, AC plants, and transport trucks. The equipment used to place the cement slurry grout consists of transit trucks, vibratory steel-wheel rollers, and hand tools.

7-4.1 Rollers.

The rollers used to seat the open-graded asphalt mixture and to vibrate the cement slurry grout into the open-graded mixture are (3 metric tons (3 tons) maximum) vibratory rollers. These rollers are used in the static mode only while seating the open-graded asphalt mixture and in the vibratory mode while placing the cement grout. During placing of the grout, ensure that a minimum of two vibratory rollers are available at the job site in case of breakdowns.

7-4.2 Hand Tools.

Hand squeegees are used to spread the cement grout over the pavement surface during application and to remove excess grout from the pavement surface once the grout application is completed. Hand brooms are used to smooth the texture of the joints during grout application and are used to roughen the texture of the entire grouted pavement surface immediately after the grout application.

7-5 PLACEMENT.

7-5.1 Open-Graded Asphalt Mixture.

The open-graded mix is mixed, transported, and placed by the same methods and procedures used to place dense-graded asphalt mixture. A light tack coat of asphalt material is first applied on the existing AC on which the RMP is to be placed. After the mixture has been placed with a standard asphalt paver, the mixture is not compacted but is rolled to seat or smooth the surface. This is accomplished with a (3-metric ton (3-ton) maximum) tandem steel-wheel roller once the freshly placed open-graded asphalt layer has cooled to 71 degrees C (160 degrees F). Only use a vibratory roller of this size when it is operated in the static mode, in other words the vibratory mode of vibration is turned off. One pass of the roller is usually sufficient for seating. With another single pass, the same or a similar-sized roller is used as a finishing roller to

remove roller marks once the asphalt layer has cooled to 38 degrees C (100 degrees F).

7-5.2 Cement Slurry Grout.

7-5.2.1 Mixing and Transport.

The slurry grout is mixed in either a batch plant, portable mixer, or in a ready-mix truck. The cross polymer resin is added to the mixture after all other ingredients have been mixed thoroughly. Generally, add the cross polymer resin to the grout mixture at the batch plant if the haul distance is less than 30 minutes. If the haul distance is greater than 30 minutes, add the cross polymer resin to the grout mixture at the job site. When using ready-mix trucks for transporting slurry grout, mix the grout mixture thoroughly at the job site immediately before application for a minimum of 10 minutes. Thorough mixing is best accomplished by rotating the mixing drum at the maximum allowable revolutions per minute. The final control on the acceptability of the mixing process is the mixing of a consistent grout that meets the viscosity requirements.

7-5.2.2 Placement.

7-5.2.2.1 Application of Grout.

Ensure the surface temperature of the bituminous mixture is less than 38 degrees C (100 degrees F) before the application of grout. On hot days, this requires the use of a fog spray of water to reduce the temperature immediately prior to grouting. Do not use excessive amounts of water, which causes ponding. Test each batch of grout at the job site immediately before placement and use in the finished product only if the batch meets the viscosity requirements listed in Table 7-5. The cement grout is poured over the bituminous mixture from the ready-mix truck by means of a pivoting delivery chute and then spread around with the hand squeegees. Ensure the application of the cement grout is sufficient to fill the internal voids of the open-graded bituminous mixture. 10 to 13 kilograms (22 to 28 pounds) of mixed slurry grout fills 0.8 square meter (1 square yard) for each 25 millimeters (1 inch) of thickness of open-graded asphalt mixture with 25 to 35 percent VTM. Begin the grouting operation at the lowest side of the sloped cross-section and proceed from the low side to the high side. Note that slopes up to 2 percent are considered the practical limit for RMP. Sections with slopes up to 5 percent have been placed, but excess handwork and grout overruns are expected at slopes greater than 2 percent. Place the slurry grout in successive paving lanes with a maximum width of 6 meters (20 feet). The use of 50-millimeter (2-inch) by 100-millimeter (4-inch) strips of lumber as wooden battens separating each of the grouting lanes and the RMP from adjacent pavements facilitates an orderly grouting operation. Secure the wooden battens to the surface of the bituminous mixture before grout application to help prevent excessive grout runoff and to prevent overworking the grouting crew. Ensure the grouting operation is in the same direction as the paving operation for the open-graded bituminous mixture. Use the small, 3-metric ton (3-ton) maximum tandem steel-wheel roller (vibratory mode) passing over the grout-covered bituminous mixture to promote full penetration of the slurry grout into the void spaces. Once the open-graded layer is fully saturated with grout, all excess grout is removed by

squeegeeing. This process exposes the rough surface of the open-graded material and improve skid resistance.

7-5.2.2.2 Joints.

Make the formation of all joints between successive lanes of RMP in such a manner as to ensure a continuous bond between the paving lanes. Remove the wooden battens as soon as the grout has been applied to the surrounding area and the area underneath them vibrated or reworked with additional grout and hand brooms to assure full penetration and smoothness in these joint areas. There are no time restrictions for placing successive lanes of grout to create joints. Ensure all RMP joints have the same texture, density, and smoothness as other sections of the course. Saw cut the joints between the RMP and any surrounding pavement surfaced with PCC to the full depth of the RMP thickness and filled with a joint sealant material meeting project specifications. Curing.

Curing of a new RMP surface is accomplished with a light coating of a white-pigmented, membrane-forming curing compound. Apply the curing compound to the finished pavement surface while the surface is still damp but without excessive moisture on the surface, normally within 2 hours of the completed slurry grout application. Apply curing compound with a pressurized spraying machine, using one or two coats with a total application rate of 4.5 square meters per liter (183.4 square feet per gallon).

7-5.2.3 Covering Pavement Surface.

7-5.2.3.1 Prior to Grouting.

Protect the pavement and its appurtenances prior to grouting against contamination from mud, dirt, windblown debris, waterborne material, or any other contamination that enters the void spaces of the open-graded asphalt mixture before grout application. Protection against contamination by keeping the construction site clean and free of such contaminants and by covering the pavement prior to grouting with a protective material such as rolled polyethylene sheeting. The sheeting is mounted on either the paver or a separate movable bridge from which it is unrolled without dragging over the pavement surface.

7-5.2.3.2 After Grouting.

Protect the pavement and its appurtenances against both public traffic and traffic caused by the contractor's employees and agents for a period of 14 to 21 days. This time period depends on the environmental conditions during curing, with 14 days required for warm and dry weather curing and 21 days required for cool and damp weather curing. To properly protect the pavement against the effects of rain before the pavement is sufficiently hardened (the first 24 to 48 hours), materials for the protection of the edges and surfaces of the unhardened RMP are required to be available, at all times,. Use the same protective materials and method of application as described in paragraph 7-5.2.3.1. When rain appears imminent, stop all paving operations, and cover the surface of the hardened RMP with protective covering.

APPENDIX A REFERENCES

U.S. ARMY CORPS OF ENGINEERS

<http://wbdg.org/ffc/army-coe/standards>

U.S. Army Corps of Engineers Handbook for Cement and Concrete (CRD)

CRD-C649-95, *Standard Test Method for Unit Weight, Marshall Stability, and Flow of Bituminous Mixtures*

CRD-C650-95, *Standard Test Method for Density and Percent Voids in Compacted Bituminous Paving Mixtures*

CRD-C171-94, *Standard Test Method for Determining Percentage of Crushed Particles in Aggregate*

UNIFIED FACILITIES CRITERIA

http://www.wbdg.org/ccb/browse_cat.php?o=29&c=4

3-250-07, *Standard Practice for Pavement Recycling*

3-250-11, *Soil Stabilization for Pavements*

3-260-02, *Pavement Design for Airfields*

UNIFIED FACILITIES GUIDE SPECIFICATIONS

<https://www.wbdg.org/ffc/dod/unified-facilities-guide-specifications-ufgs>

32 12 13, *Bituminous Tack and Prime Coats*

32 12 15.13, *Asphalt Paving for Airfields*

32 12 15.16, *Warm Mix Asphalt Airfield Paving*

AIRFIELD ASPHALT PAVEMENT TECHNOLOGY PROGRAM

<https://eng.auburn.edu/research/centers/ncat/files/aaptp/Report.Final.05-01.pdf>

AAPT 05-01, *Airfield Asphalt Pavement Construction Best Practices Manual*

AMERICAN ASSOCIATION OF STATE HIGHWAY AND TRANSPORTATION OFFICIALS

<https://bookstore.transportation.org/>

M320-17-UL, *Standard Specification for Performance-Graded Asphalt Binder*

MP-8, *Standard Specification for Stone Matrix Asphalt (SMA)*

R029-15-UL, *Standard Practice for Grading or Verifying the Performance Grade (PG) of an Asphalt Binder*

T088-13-UL, *Standard Method of Test for Particle Size Analysis of Soils*

T089-13-UL, *Standard Method of Test for Determining the Liquid Limit of Soils*

T096-02-UL, *Standard Method of Test for Resistance to Degradation of Small-Size Coarse Aggregate by Abrasion and Impact in the Los Angeles Machine*

T104-99-UL, *Standard Method of Test for Soundness of Aggregate by Use of Sodium Sulfate or Magnesium Sulfate*

T166-16-UL, *Standard Method of Test for Bulk Specific Gravity (G_{mb}) of Compacted Hot Mix Asphalt (HMA) Using Saturated Surface-Dry Specimens*

T209-12-UL, *Standard Method of Test for Theoretical Maximum Specific Gravity (G_{mm}) and Density of Hot Mix Asphalt (HMA)*

T210-15-UL, *Standard Method of Test for Aggregate Durability Index*

T245-15-UL, *Standard Method of Test for Resistance to Plastic Flow of Asphalt Mixtures Using Marshall Apparatus*

T269-14-UL, *Standard Method of Test for Percent Air Voids in Compacted Dense and Open Asphalt Mixtures*

ASPHALT INSTITUTE

<http://www.asphaltinstitute.org/>

ES-11, *Asphalt Surface Treatments Specifications*

ES-12, *Asphalt Surface Treatments – Construction Techniques*

MS-2, *Asphalt Mix Design Methods*

MS-14, *Asphalt Cold Mix Manual*

MS-19, *Basic Asphalt Emulsion Manual*

AMERICAN SOCIETY FOR TESTING AND MATERIALS

www.astm.org

C88-13, *Standard Test Method for Soundness of Aggregates by Use of Sodium Sulfate or Magnesium Sulfate*

C117-17, *Standard Test Method for Materials Finer than 75- μ m (No. 200) Sieve in Mineral Aggregates by Washing*

- C127-15, *Standard Test Method for Density, Relative Density (Specific Gravity), and Absorption of Coarse Aggregate*
- C128-15, *Standard Test Method for Relative Density (Specific Gravity) and Absorption of Fine Aggregate*
- C131/C131M-14, *Standard Test Method for Resistance to Degradation of Small-Size Coarse Aggregate by Abrasion and Impact in the Los Angeles Machine*
- C136/C136M-14, *Standard Test Method for Sieve Analysis of Fine and Coarse Aggregates*
- C142/C142M-17, *Standard Test Method for Clay Lumps and Friable Particles in Aggregates*
- C150/C150M-17, *Standard Specification for Portland Cement*
- C612-14, *Standard Specification for Mineral Fiber Block and Board Thermal Insulation*
- C618-17a, *Standard Specification for Coal Fly Ash and Raw or Calcined Natural Pozzolan for Use in Concrete*
- C1252-17, *Standard Test Methods for Uncompacted Void Content of Fine Aggregate (as Influenced by Particle Shape, Surface Texture, and Grading)*
- D70-17, *Standard Test Method for Density of Semi-Solid Bituminous Materials (Pycnometer Method)*
- D242/D242M-09, *Standard Specification for Mineral Filler for Bituminous Paving Mixtures*
- D244-09, *Standard Test Methods and Practices for Emulsified Asphalts*
- D402/D402M-14, *Standard Test Method for Distillation of Cutback Asphalt*
- D448-12, *Standard Classification for Sizes of Aggregate for Road and Bridge Construction*
- D946/D946M-15, *Standard Specification for Penetration-Graded Asphalt Binder for Use in Pavement Construction*
- D977-17, *Standard Specification for Emulsified Asphalt*
- D979/D979M-15, *Standard Practice for Sampling Bituminous Paving Mixtures*
- D1139/D1139M-15, *Standard Specification for Aggregate for Single or Multiple Bituminous Surface Treatments*

- D1369-84(2012), *Standard Practice for Quantities of Materials for Bituminous Surface Treatments*
- D2026/D2026M-15, *Standard Specification for Cutback Asphalt (Slow-Curing Type)*
- D2027/D2027M-13, *Standard Specification for Cutback Asphalt (Medium-Curing Type)*
- D2028/D2028M-15, *Standard Specification for Cutback Asphalt (Rapid-Curing Type)*
- D2041/D2041M-11, *Standard Test Method for Theoretical Maximum Specific Gravity and Density of Bituminous Paving Mixtures*
- D2170/D2170M-10, *Standard Test Method for Kinematic Viscosity of Asphalts (Bitumens)*
- D2171/D2171M-10, *Standard Test Method for Viscosity of Asphalts by Vacuum Capillary Viscometer*
- D2172/D2172M-17, *Standard Test Methods for Quantitative Extraction of Asphalt Binder From Asphalt Mixtures*
- D2397/D2397M-17, *Standard Specification for Cationic Emulsified Asphalt*
- D2419-14, *Standard Test Method for Sand Equivalent Value of Soils and Fine Aggregate*
- D2493/D2493M-16, *Standard Practice for Viscosity-Temperature Chart for Asphalt Binders*
- D2726/D2726M-17, *Standard Test Method for Bulk Specific Gravity and Density of Non-Absorptive Compacted Asphalt Mixtures*
- D2995-14, *Standard Practice for Estimating Application Rate and Residual Application Rate of Bituminous Distributors*
- D3203/D3023M-17, *Standard Test Method for Percent Air Voids in Compacted Asphalt Mixtures*
- D3381/D3381M-13, *Standard Specification for Viscosity-Graded Asphalt Cement for Use in Pavement Construction*
- D3665-12, *Standard Practice for Random Sampling of Construction Materials*
- D3744/D3744M-11a, *Standard Test Method for Aggregate Durability Index*
- D3910-15, *Standard Practices for Design, Testing, and Construction of Slurry Seal*
- D4125/D4125M-10, *Standard Test Methods for Asphalt Content of Bituminous Mixtures by the Nuclear Method*

D4318-17, *Standard Test Methods for Liquid Limit, Plastic Limit, and Plasticity Index of Soils*

D4791-10, *Standard Test Method for Flat Particles, Elongated Particles, or Flat and Elongated Particles in Coarse Aggregate*

D4867/D4867M-09, *Standard Test Method for Effect of Moisture on Asphalt Concrete Paving Mixtures*

D5148-10, *Standard Test Method for Centrifuge Kerosine Equivalent*

D5361/D5361M-16, *Standard Practice for Sampling Compacted Asphalt Mixtures for Laboratory Testing*

D5444-15, *Standard Test Method for Mechanical Size Analysis of Extracted Aggregate*

D5624-13, *Standard Practice for Determining the Transverse-Aggregate Spread Rate for Surface Treatment Applications*

D5727/D5727M-00, *Standard Specification for Emulsified Refined Coal Tar (Mineral Colloid Type)*

D6307-16, *Standard Test Method for Asphalt Content of Asphalt Mixture by Ignition Method*

D6372-15, *Standard Practice for Design, Testing, and Construction of Micro-Surfacing*

D6373-16, *Standard Specification for Performance Graded Asphalt Binder*

D6390-11, *Standard Test Method for Determination of Draindown Characteristics in Uncompacted Asphalt Mixtures*

D6927-15, *Standard Test Method for Marshall Stability and Flow of Asphalt Mixtures*

INTERNATIONAL SLURRY SURFACING ASSOCIATION

www.slurry.org/

TB-100, *Laboratory Test Method for Wet Track Abrasion of Slurry Surfacing Systems*

TB-109, *Test Method for Measurement of Excess Asphalt In Bituminous Mixtures by Use of a Loaded Wheel Tester and Sand Adhesion*

TB-114, *Test Method for Wet Stripping of Cured Slurry Surfacing Mixtures*

TB-149, *Test Method for Boiling Compatibility of Slurry Seal Mixes*

NATIONAL ASPHALT PAVEMENT ASSOCIATION

QIP-122E, *Designing and Constructing SMA Mixtures - State of the Practice*,
<http://store.asphalt pavement.org/index.php?productID=776>

APPENDIX B BEST PRACTICES

B-1 SUMMARY OF DESIGN METHODS FOR SLURRY SEALS

B-1.1 INTRODUCTION

The design method for determining the emulsion requirement consists of determining the surface area of the job aggregate and calculating the amount of asphalt required to coat the surface area with a film thickness of 8 microns (3.15×10^{-4} inch). The absorption characteristics of the aggregate are determined using the CKE test. The total asphalt is the asphalt required for coating the aggregate plus the required due to aggregate absorption.

The water required for a given mixture is determined by a cone test as described in ASTM D3910. Water is added to a slurry mixture until a flow of 25.4 millimeters (1 inch) is obtained on a reference plate. Ensure the consistency of the mixture when the 25.4-millimeter (1-inch) flow is obtained is such that there is no segregation in the mixture. Portland cement or hydrated lime is added to aid in overcoming the segregation; the cone test serves as an aid for determining the amount of Portland cement or hydrated lime required in the mixture.

B-1.2 SURFACE AREA DESIGN METHOD

The surface area design method includes three considerations: the calculation of the amount of asphalt required to coat the surface area of the job aggregate, the absorption characteristics of the aggregate, and the total asphalt content.

B-1.2.1 Surface Area Asphalt Calculation

The surface area of the job aggregate is determined by multiplying the percent of aggregate passing a given sieve by a surface area factor based on the sieve size. The surface area of the aggregate is determined for each particle size (group) and then summed to obtain the total surface area. The surface area units are given in square meters per kilogram (feet per pound) of aggregate. The surface area factors are shown in Table B-1. The total surface area (SA) is then corrected to obtain a corrected surface area (CSA): $CSA = SA \times 2.65 / ASG$, where ASG is the apparent specific gravity of the aggregate. When the surface area and the desired bitumen film thickness are known, the volume of asphalt required and thus the percent by weight of asphalt required is obtained. Equation B-1 is the equation for calculation of the percent asphalt by weight to provide a desired film thickness:

$$SAA = \begin{array}{l} \text{Metric: } CSA \times t \times 0.99941 \times SG_A \\ \text{U.S. Customary: } CSA \times t \times 0.02047 \times SG_A \end{array}$$

Where:

SAA = asphalt content to cover surface area of aggregate, t micrometers thick, percent of dry aggregate weight

CSA = corrected surface area, square meters per kilogram (feet per pound) of dry aggregate

T = asphalt film thickness, micrometers

SGA = specific gravity of the asphalt

0.99941 (0.02047) = conversion coefficient for the units of the equation

If the specific gravity of the asphalt is not known, the asphalt required to coat the aggregate is calculated by assuming $SG_A = 1.0$. The error that results from assuming $SG_A = 1.0$ does not greatly affect the final design requirements.

Table B-1 Factors Used in Calculating Surface Area of Slurry Seal Aggregate

Sieve Size	Surface Area Factors	
	Square Meters per Kilogram of Aggregate	Square Feet per Pound of Aggregate
9.5 mm (3/8 in.)	0.4	2
4.75 mm (No. 4)	0.4	2
2.36 mm (No. 8)	0.8	4
1.18 mm (No. 16)	1.6	8
600 μm (No. 30)	2.9	14
300 μm (No. 50)	6.1	30
150 μm (No. 100)	12.2	60
75 μm (No. 200)	32.8	160

B-1.2.2 Aggregate Absorption

The absorption requirements of the aggregate are determined by using the CKE described in ASTM D5148. In this test, 100 grams (0.22 pounds) of 4.75-millimeter (No. 4) material is centrifuged in the presence of kerosene for 2 minutes. The amount of kerosene retained by the aggregate is assumed to be the amount of asphalt that the aggregate absorbs. The kerosene absorbed (KA) by the aggregate is converted to a percentage of the dry weight of the aggregate.

B-1.2.3 Total Asphalt Content

The total asphalt requirement is obtained by adding the percent asphalt required for the film thickness and the percent asphalt required for absorption. All percentages are based on the dry weight of the aggregate. The total is obtained using equations B-2 and B-3:

$$AR = SAA + KA$$

$$AR = \begin{array}{l} \text{Metric: } (CSA \times t \times 0.99941 \times SG_A) + KA \\ \text{U.S. Customary: } (CSA \times t \times 0.02047 \times SG_A) + KA \end{array}$$

Where:

AR = total asphalt required, percent of dry aggregate weight

KA = kerosene absorbed, percent of dry aggregate weight

The required percentage of emulsion is calculated by dividing the total asphalt required for the aggregate by the percentage of asphalt residue in the emulsion. A sample calculation for determining the asphalt content is presented in section B-1.4.

B-1.3 CONE TEST

The cone test is used to determine the amount of water required to form a workable mixture as described in ASTM D3910. This test uses the sand absorption cone described in ASTM C128. The cone is placed over a base plate. The base plate has concentric circles inscribed in diameters that are equal to the large end of the cone and increase proportionally outward. The radius of each circle increases in 12.7-millimeter (1/2-inch) increments. The cone is loosely filled with a slurry mixture, struck off, and then removed to allow the slurry mixture to “flow” over the base plate. A mixture with a flow of 25.4 millimeters (1 inch) is considered to contain the right amount of water for field workability. Mixtures that do not flow 25.4 millimeters (1 inch) require additional water to obtain the desired flow. If the flow cannot be obtained without segregation of the mixture, the addition of 0.5 to 4 percent Portland cement or hydrated lime helps to reduce the segregation. Flows greater than 25.4 millimeters (1 inch) indicate excess water or segregation.

If Portland cement or hydrated lime is added to reduce segregation and its addition has not been included in the design gradation, correct the total bitumen content of the mixture to include the effects of the Portland cement or hydrated lime. As a rule, increase the asphalt content by 0.6 percent for every percent of additional Portland cement or hydrated lime added to the mixture.

B-1.4 SAMPLE CALCULATION OF ASPHALT REQUIREMENTS FOR A SLURRY SEAL AGGREGATE

B-1.4.1 Surface Area Calculation

The ASG equals 2.96, and the aggregate gradation includes 2 percent Portland cement.

Table B-2 Surface Area Calculation

Sieve Size	Percent Passing	Surface Area Factor square meters per kilogram (square feet per pound) of Aggregate	Surface Area square meters per kilogram (square feet per pound) of Aggregate
9.5 mm (3/8 in.)	100	0.00409 (0.02)	0.409 (2.00)
4.75 mm (No. 4)	99.5	0.00409 (0.02)	0.407 (1.99)
2.36 mm (No. 8)	95.6	0.00819 (0.04)	0.783 (3.82)
1.18 mm (No. 16)	77.8	0.01639 (0.08)	1.275 (6.22)
600 μm (No. 30)	52.0	0.02867 (0.14)	1.491 (7.28)
300 μm (No. 50)	24.5	0.06144 (0.30)	1.505 (7.35)
150 μm (No. 100)	10.7	0.12289 (0.60)	1.315 (6.42)
75 μm (No. 200)	6.4	0.32771 (1.60)	2.097 (10.24)
Total SA			9.282 (45.32)

The corrected SA (CSA) = $SA \times 2.65 / 2.96 = 8.310$ square meters per kilogram (40.57 square feet per pound) of aggregate.

B-1.4.2 Kerosene Absorption Calculation

The aggregate gradation includes 2 percent Portland cement.

Table B-3 Kerosene Absorption Calculation

Cup No. (a)	Tare Weight Grams (b)	Sample Weight Grams (c)	Weight before Centrifuging Grams (d = b+c)	Weight after Centrifuging Grams (e)	KA Percent (f = e - d)
1	215.3	100.0	315.3	321.0	5.7
2	215.9	100.0	315.9	321.6	5.7
Average KA					5.7

B-1.4.3 Total Asphalt Requirements

These factors are involved in calculating the asphalt contents:

- Asphalt = SS-lh asphalt emulsion
- Design film thickness (t) = 8 micrometers
- Apparent specific gravity of aggregate (ASG) = 2.96
- Specific gravity of asphalt (SG_A) = 1.028
- Kerosene absorption (KA) = 5.7 percent
- Corrected surface area (CSA) =
- Metric: 8.310 square meters per kilogram of aggregate
- U.S. Customary: 40.57 square feet per pound of aggregate
- Total asphalt required (AR) =
- Metric: $(CSA \times t \times SG_A \times 0.99941) + KA$
- U.S. Customary: $(CSA \times t \times SG_A \times 0.02047) + KA$
- Metric: $(8.310 \times 8 \times 1.028 \times 0.99941) + 5.7 = 6.83 + 5.7 = 12.53$ percent.
- U.S. Customary: $(40.57 \times 8 \times 1.028 \times 0.02047) + 5.7 = 6.83 + 5.7 =$
- 12.53 percent
- AR = 12.53 percent of dry aggregate weight
- Residue asphalt content in emulsion = 63 percent by weight
- Emulsion required = $\frac{AR \times 100}{\text{Residue asphalt content in emulsion}}$
- Emulsion required = $\frac{12.53 \times 100}{63} = 19.9$ percent of dry aggregate weight,
that is, 19.9 kilograms of emulsion is required for every 100 kilograms of dry aggregate, or in inch-pound units, 19.9 pounds of emulsion is required for every 100 pounds of dry aggregate

B-2 POTENTIAL VENDORS

A list of potential vendors is summarized in Table B-1 to assist in the procurement of products. It is not intended to be a complete listing of vendors as there are numerous large and small companies that provide a wide range of materials for dust abatement. Inclusion on this list does not represent endorsement of any kind. The list is provided to assist the soldiers, sailors, marines, and airmen working in the field. Complete a small test section prior to using each product to evaluate the effectiveness and determine the placement details.

Table B-4 Product and Vendor Information

Vendor	Products	Website
Alyan Corporation	Prosalvia-7 (PL7)	http://www.alyancorp.com/

APPENDIX C GLOSSARY

C-1

ACRONYMS

AAPTP	Airfield Asphalt Pavement Technology Program
AASHTO	American Association of State Highway and Transportation Officials
AC	asphalt concrete
ASG	apparent specific gravity
ASR	alkali-silica reactivity
ASTM	American Society for Testing and Material
ATV	all-terrain vehicle
C	Celsius
CBR	California Bearing Ratio
CKE	centrifuge kerosene equivalent
CONUS	continental United States
CRD	Concrete Research Division
CSA	corrected surface area
cSt	centistoke
DBST	double bituminous surface treatment
DFI	design air-freezing index
DoD	Department of Defense
DOT	Department of Transportation
DSR	dynamic shear rheometer
EOA	estimate of asphalt
ERDC	U.S. Army Engineer Research and Development Center
ES	Educational Series
ESAL	equivalent single axle load

F	Fahrenheit
FAA	fine aggregate angularity
FAA	Federal Aviation Administration
FOD	foreign object debris
ft	foot, feet
FHWA	Federal Highway Administration
FRS	fuel-resistant sealer
gal	gallon
g/cm ³	grams per cubic centimeter
gal/yd ²	gallons per square yard
GPS	Global Positioning System
HL	hydrated lime
in.	inch
ISSA	International Slurry Surfacing Association
JMF	job-mix formula
KA	kerosene absorption
K _c	surface area constant
kg	kilogram
kg/m ³	kilograms per cubic meter
kN	kilonewton
kPa	kilopascal
L	liter
LA	Los Angeles
L/m ²	liters per square meter
lb	pound

lb/ft ³	pounds per cubic foot
LWT	loaded wheel test
m	meter
MAJCOM	major command (Air Force)
max, max.	maximum
MC	medium curing
µm	micrometer
min.	minimum
min	minute
mm	millimeter
MS	medium setting
MSCR	multiple stress creep recovery
MS	Manual Series (Asphalt Institute)
MTV	material transfer vehicle
N	newton
NA	not applicable
NAPA	National Asphalt Pavement Association
NAVFAC	Naval Facilities Engineering Command
No.	number
OGFC	open-graded friction course
OGM	open-graded material
P	poise
PC	Portland cement
PCC	Portland cement concrete
pcf	pounds per cubic foot

pen	penetration
PFC	porous friction course
PG	performance graded
PL7	Prosalvia L7
PMA	polymer-modified asphalt
psi	pounds per square inch
PTI	pavement temperature index
QA	quality assurance
QC	quality control
RAP	reclaimed asphalt pavement
RC	rapid curing
RMP	resin modified pavement
RS	rapid set
SA	surface area
SAE	Society of Automotive Engineers
SBST	single bituminous surface treatment
SC	slow-curing
SI	International System of Units
SMA	stone matrix asphalt
SS	slow setting
SSD	saturated surface dry
TB	technical bulletin
TM	technical manual
TMD	theoretical maximum density
TSR	tensile strength ratio

UFC	Unified Facilities Criteria
U.S.	United States
USACE	U.S. Army <i>Corps of Engineers</i>
TSMCX	USACE Transportation Systems Center
UFGS	Unified Facilities Guide Specification
VFA	voids filled with asphalt
VMA	voids in mineral aggregate
VTM	voids in total mix
WES	Waterways Experiment Station (USACE ERDC)
WMA	warm mix asphalt
WTAT	wet track abrasion test

C-2 DEFINITION OF TERMS

Common terms related to AC pavements are not defined here since they are found in flexible pavement references, primarily in ASTM D8. The terms defined for this UFC have definitions that have not been universally accepted or that have limited usage.

asphalt base course: A minimum of one course of asphalt mixture placed on a subbase or subgrade to serve as a base course. This mixture is called a black base. An asphalt base course is covered with an intermediate course and surface course.

coarse aggregate: The aggregate retained on the 4.75-millimeter (No. 4) sieve as described in ASTM E11.

cold-mix recycling: Involves reclaiming all of the existing bituminous pavement by breaking it to a maximum particle size of 4 centimeters (1½ inch), mixing it with virgin materials, if needed, and reusing the mixture as a pavement material. Cold-mix recycling material is used to surface secondary roads, if a seal coat is applied, and as a base course for high-quality pavements.

components of a compacted bituminous mixture: A given volume of compacted bituminous concrete consists of air, bitumen, and aggregate.

fine aggregate: Aggregate passing the 4.75-millimeter (No. 4) sieve and retained on the 75 µm (No. 200) sieve, often referred to as sand. Natural sand (fine aggregate) is that material found naturally and not manufactured by crushing.

flow: The deformation, measured in 25 hundredths-of-a-millimeter (hundredths-of-an-inch), that occurs in a compacted specimen of a paving mixture at the point at which maximum load begins to decrease when the specimen is subjected to the Marshall stability test.

hot-mix recycling: Process that involves removing the existing HMA, crushing it, and mixing it in a hot-mix plant with new aggregate, asphalt, and recycling agent, when required. The recycled HMA is designed for use in all types of pavements. Crushed PCC has also been used as aggregate for hot recycled mixtures.

intermediate course: That portion of a pavement placed on the base course to serve as a leveling or transition layer between the base and surface courses. Intermediate courses are called leveling or binder courses.

Marshall stability value: The maximum load in newtons (pounds) that is applied to a specimen of AC paving mixture when tested in the Marshall apparatus.

mastic asphalt: Mastic asphalt is an HMA mixture of fine aggregate and asphalt cement forming a mixture free of voids.

micro-surfacing: Micro-surfacing is the process of applying a latex-modified asphalt emulsion slurry to an existing pavement surface. The slurry is mixed and applied

similarly to asphalt slurry seals, except for the specially-designed mixing and constant agitation application equipment required by the latex modifier. Micro-surfacing applications contain larger aggregate particles than conventional asphalt slurry seals. Micro-surfacing is used to fill ruts or for re-establishing skid resistance. Curing is normally completed in 1 to several hours depending on weather conditions.

mineral filler: Mineral aggregate particles passing a 75 micrometer (No. 200) sieve or commercially available materials such as lime or cement.

optimum asphalt content: The asphalt content of a paving mixture determined by the Marshall or gyratory methods of design that satisfies the applicable pavement mix design criteria.

percent VFA: Percentage of the VMA in the compacted aggregate mass that is filled with asphalt.

$$\text{VFA} = \frac{V_{\text{bitumen}}}{V_{\text{air}} + V_{\text{bitumen}}} \times 100$$

percent VMA: Percentage of the compacted bituminous mixture not occupied by the aggregate. The percentage of VTM plus the percentage of asphalt cement by total volume is equal to VMA.

$$\text{VMA} = \frac{V_{\text{air}} + V_{\text{bitumen}}}{V_{\text{total}}} \times 100$$

percent VTM: Percentage of the compacted AC mixture not occupied by the aggregate or asphalt cement.

$$\text{VTM} = \frac{V_{\text{air}}}{V_{\text{total}}} \times 100$$

porous friction course (PFC): An open-graded, free-draining asphalt paving mixture that is placed on an existing pavement to minimize hydroplaning and to improve skid resistance in wet weather. The course is placed in a layer usually varying from 20 to 25 millimeters (3/4 to 1-inch) in thickness. PFC paving mixtures are produced in asphalt hot-mix plants and placed with conventional asphalt paving machines.

resin-modified pavement (RMP): A composite pavement surfacing that uses a unique combination of HMA and PCC materials in the same layer. The RMP material is described as an open-graded AC mixture containing 25 to 35 percent voids that are filled with a resin-modified Portland cement grout. An RMP layer is 5 centimeters (2 inches) thick and has a surface appearance similar to a rough-textured PCC.

stone matrix asphalt (SMA): SMA, which is also referred to as stone mastic asphalt, is a mixture of aggregate, mineral filler, polymer-modified asphalt cement, and a mineral

or cellulose fiber. SMA is designed to prevent rutting and abrasion under high loads or high tire pressures.

surface course: The top course of an AC pavement. The surface course is referred to as the wearing course by many pavement engineers.

surface recycling: Repaving, heater-planing-scarifying, cold milling, and rejuvenating are methods of surface recycling that are used to increase skid resistance, decrease permeability to air and water, and improve properties of the asphalt binder. Depending on the process used, surface recycling modifies from 5 to 50 millimeters (1/4 to 2 inches) of the pavement surface. Surface recycling does not increase the strength of the pavement. The cost to scarify and rejuvenate pavement is the same as the cost of an additional 25 millimeters (1 inch) of overlay, but the benefits of the scarification and rejuvenation usually exceed the benefits of the additional 25 millimeters (1 inch) of overlay.

warm-mix asphalt: Asphalt mixture that has been treated through additives or foaming to allow the mixture to be mixed, placed, and compacted at lower temperatures than HMA.