

# **UNIFIED FACILITIES CRITERIA (UFC)**

---

## **FOUNDATIONS FOR STRUCTURES: ARCTIC AND SUBARCTIC CONSTRUCTION**



**APPROVED FOR PUBLIC RELEASE; DISTRIBUTION UNLIMITED**

## UNIFIED FACILITIES CRITERIA (UFC)

### FOUNDATIONS FOR STRUCTURES: ARCTIC AND SUBARCTIC CONSTRUCTION

Any copyrighted material included in this UFC is identified at its point of use. Use of the copyrighted material apart from this UFC must have the permission of the copyright holder.

U.S. ARMY CORPS OF ENGINEERS (Preparing Activity)

NAVAL FACILITIES ENGINEERING COMMAND

AIR FORCE CIVIL ENGINEER SUPPORT AGENCY

Record of Changes (changes are indicated by \1\ ... /1/)

Change No.	Date	Location

---

This UFC supersedes TM 5-852-4, dated 15 October 1983. The format of this UFC does not conform to UFC 1-300-01; however, the format will be adjusted to conform at the next revision. The body of this UFC is the previous TM 5-852-4, dated 15 October 1983.

## FOREWORD

\1\

The Unified Facilities Criteria (UFC) system is prescribed by MIL-STD 3007 and provides planning, design, construction, sustainment, restoration, and modernization criteria, and applies to the Military Departments, the Defense Agencies, and the DoD Field Activities in accordance with [USD\(AT&L\) Memorandum](#) dated 29 May 2002. UFC will be used for all DoD projects and work for other customers where appropriate. All construction outside of the United States is also governed by Status of forces Agreements (SOFA), Host Nation Funded Construction Agreements (HNFA), and in some instances, Bilateral Infrastructure Agreements (BIA.) Therefore, the acquisition team must ensure compliance with the more stringent of the UFC, the SOFA, the HNFA, and the BIA, as applicable.

UFC are living documents and will be periodically reviewed, updated, and made available to users as part of the Services' responsibility for providing technical criteria for military construction. Headquarters, U.S. Army Corps of Engineers (HQUSACE), Naval Facilities Engineering Command (NAVFAC), and Air Force Civil Engineer Support Agency (AFCEA) are responsible for administration of the UFC system. Defense agencies should contact the preparing service for document interpretation and improvements. Technical content of UFC is the responsibility of the cognizant DoD working group. Recommended changes with supporting rationale should be sent to the respective service proponent office by the following electronic form: [Criteria Change Request \(CCR\)](#). The form is also accessible from the Internet sites listed below.

UFC are effective upon issuance and are distributed only in electronic media from the following source:

- Whole Building Design Guide web site <http://dod.wbdg.org/>.

Hard copies of UFC printed from electronic media should be checked against the current electronic version prior to use to ensure that they are current.

AUTHORIZED BY:

  
DONALD L. BASHAM, P.E.  
Chief, Engineering and Construction  
U.S. Army Corps of Engineers

  
DR. JAMES W. WRIGHT, P.E.  
Chief Engineer  
Naval Facilities Engineering Command

  
KATHLEEN I. FERGUSON, P.E.  
The Deputy Civil Engineer  
DCS/Installations & Logistics  
Department of the Air Force

  
Dr. GET W. MOY, P.E.  
Director, Installations Requirements and  
Management  
Office of the Deputy Under Secretary of Defense  
(Installations and Environment)

ARMY  
AIR FORCE

TM 5-852-4  
AFM 88-19, Chap. 4

---

ARCTIC AND SUBARCTIC  
CONSTRUCTION FOUNDATIONS  
FOR STRUCTURES

---

DEPARTMENT OF THE ARMY AND THE AIR FORCE

OCTOBER 1983

INACTIVE

### REPRODUCTION AUTHORIZATION/RESTRICTIONS

This manual has been prepared by or for the Government and, except to the extent indicated below, is public property and not subject to copyright.

Copyrighted material included in the manual has been used with the knowledge and permission of the proprietors and is acknowledged as such at point of use. Anyone wishing to make further use of any copyrighted material, by itself and apart from this text, should seek necessary permission directly from the proprietors.

Reprints or republications of the manual should include a credit substantially as follows: "Joint Departments of the Army and the Air Force, USA, Technical Manual TM 5-852-4/AFM 88-19, Chap. 4, Arctic and Subarctic Construction, Foundations for Structures, 15 October 1983."

If the reprint or republication includes copyrighted material, the credit should also state: "Anyone wishing to make further use of copyrighted material, by itself and apart from this text, should seek necessary permission directly from the proprietors."

INACTIVE

**ARCTIC AND SUBARCTIC CONSTRUCTION  
FOUNDATIONS FOR STRUCTURES**

Chapter		Paragraph	Page
1.	INTRODUCTION		
	Purpose and scope .....	1-1	1-1
	Environmental conditions in the Arctic and Subarctic.....	1-2	1-1
2.	BASIC CONSIDERATIONS AFFECTING FOUNDATION DESIGN		
	Thermal effects .....	2-1	2-1
	Seasonal frost heave and settlement.....	2-2	2-3
	Groundwater .....	2-3	2-5
	Effect of surcharge.....	2-4	2-8
	Foundation materials .....	2-5	2-11
	Structural materials.....	2-6	2-26
3.	SITE INVESTIGATIONS		
	General.....	3-1	3-1
	Remote sensing and geophysical investigation.....	3-2	3-1
	Detailed direct site exploration .....	3-3	3-2
	Site technical data.....	3-4	3-3
4.	FOUNDATION DESIGN		
	Selection of foundation type.....	4-1	4-1
	Control of heat transfer and degradation.....	4-2	4-6
	Control of movement and distortion from freeze and thaw .....	4-3	4-59
	Allowable design stresses on basis of ultimate strength .....	4-4	4-72
	Estimation of creep deformation .....	4-5	4-77
	Dynamic loading .....	4-6	4-83
	Design of footing, rafts and piers .....	4-7	4-92
	Piling.....	4-8	4-109
	Grade beams .....	4-9	4-144
	Walls and retaining structures.....	4-10	4-144
	Tower foundations .....	4-11	4-147
	Bridge foundations.....	4-12	4-152
	Culverts .....	4-13	4-155
	Anchorage.....	4-14	4-156
	Foundations for non-heated facilities .....	4-15	4-158
	Utilidor and pipeline foundations.....	4-16	4-160
	Connections of utilities to buildings .....	4-17	4-160
	Drainage around structures.....	4-18	4-160
	Stability of slopes during thaw.....	4-19	4-164
5.	SURVEY DATUM POINTS		
	Permanent datum points.....	5-1	5-1
	Temporary datum points .....	5-2	5-3
6.	CONSTRUCTION CONSIDERATIONS		
	Effect of construction procedures on design .....	6-1	6-1
	Excavation .....	6-2	6-1
	Excavation .....	6-2	6-1
	Embankment and backfill.....	6-3	6-3
	Placing concrete under freezing conditions.....	6-4	6-4
	Protection against the environment.....	6-5	6-11
7.	MONITORING PERFORMANCE		
	General.....	7-1	7-1
	Inspections.....	7-2	7-1
	Vertical movement measurement.....	7-3	7-1
	Temperature sensing .....	7-4	7-1
	Other systems for freeze and thaw monitoring.....	7-5	7-3
	Monitoring groundwater .....	7-6	7-4

\*This manual supersedes TM 5-852-4, October 1954.

Appendix A. REFERENCES..... A-1  
 B. BIBLIOGRAPHY..... B-1

**LIST OF TABLES**

Table 1-1. Stages of Relative Human Comfort and the Environmental Effects of Atmospheric Cooling..... 1-7  
 2-1. Approximate Coefficients of Linear Thermal Expansion per °C..... 2-3  
 2-2. Specific Gravity and Strength of Wood..... 2-28  
 2-3. Moisture Distribution in Cellular Glass after 20 Years Burial in the Annual Frost Zone, Fairbanks, Alaska..... 2-40  
 3-1. Example of Settlement Estimate-Location A, figure 3-7..... 3-11  
 4-1. n-Factors for Freeze and Thaw (Ratio of Surface Index to Air Index)..... 4-8  
 4-2. Thaw Penetration Beneath a Slab-on-Grade Building Constructed on Permafrost..... 4-17  
 4-3. Recommended Perimeter Insulation for Various Design Winter Temperatures..... 4-56  
 4-4. Allowable Design Cohesive Stress for Saturated Frozen Soils in T/ft' on Basis of Ultimate Strength ..... 4-79  
 4-5. Constants for Equation ..... 4-82  
 4-6. P-wave Velocities in Permafrost..... 4-87  
 4-7. Computation of Temperature Below Top of Permafrost..... 4-101  
 4-8. Settlement Computations ..... 4-105  
 4-9. Stress Distribution Beneath the Uniformly Loaded Area..... 4-108  
 4-10. Settlement Computations ..... 4-110  
 6-1. Effect of Temperature of Materials on Temperature of Various Freshly Mixed Concretes..... 6-5  
 6-2. Insulation Requirements for Concrete Walls and for Concrete Slabs and Canal Linings Placed on the Ground..... 6-9

**LIST OF FIGURES**

Figure 1-1. Meteorological data and ground isotherms, Fort Yukon, Alaska..... 1-2  
 1-2. Freeze or thaw penetration vs mean annual temperature..... 1-3  
 1-3. Typical temperature gradients under permafrost conditions, Kotzebue Air Force Station, Alaska ..... 1-4  
 1-4. Typical temperature gradients in the ground..... 1-5  
 2-1. Thermal conductivity vs density and porosity of typical materials ..... 2-2  
 2-2. Ice wedges in polygonal ground area..... 2-4  
 2-3. Moisture content changes caused by freezing..... 2-6  
 2-4. Generalization of changing ground conditions as freezing penetrates into the annual frost zone..... 2-7  
 2-5. Plan an elevation of surcharge field experiment, Fairbanks, Alaska..... 2-7  
 2-6. Heave vs frost penetration for various applied loadings, surcharge field experiment..... 2-8  
 2-7. Heave vs frost penetration for various total stresses, surcharge field experiment ..... 2-9  
 2-8. Comparison of laboratory and field measurements of effects of surcharge ..... 2-10  
 2-9. Maximum frost heave pressures..... 2-11  
 2-10. Summary of maximum stress in compression vs temperature..... 2-14  
 2-11. Summary of soil characteristics ..... 2-15  
 2-12. Summary of maximum stress in tension vs temperature ..... 2-18  
 2-13. Summary of maximum shear stress of frozen soil vs temperature..... 2-19  
 2-14. Effect of rate of stress application on failure strength ..... 2-20  
 2-15. Plastic deformation of frozen soils under constant compressive stress ..... 2-21  
 2-16. Compressive strength vs ice content, Manchester fine sand..... 2-22  
 2-17. Longitudinal and torsional wave velocity, dynamic moduli of elasticity and rigidity, Poisson's ratio vs temperature..... 2-23  
 2-18. Typical record of ice in permafrost..... 2-25  
 2-19. Influence of moisture and temperature on strength of wood..... 2-29  
 2-20. Effect of temperature on strength of wood..... 2-30  
 2-21. Toughness shown in flexure test ..... 2-31  
 2-22. Effect of temperature on flexure properties and of temperature and moisture content on modulus of elasticity of wood.. 2-32  
 2-23. Effect of concrete mix and moisture conditions on strength of concrete at low temperatures ..... 2-34  
 2-24. Moisture absorption of insulation board by soaking in water..... 2-36  
 2-25. Internal moisture distribution in insulation board under different test conditions ..... 2-37  
 3-1. Required extent of explorations for large structure ..... 3-3  
 3-2. Typical exploration log..... 3-6  
 3-3. Dry density and water content vs depth for a soil exploration in permafrost ..... 3-7  
 3-4. Thaw-consolidation test on undisturbed sample..... 3-8  
 3-5. Consolidation test results for undisturbed samples from two drill holes at same site..... 3-9  
 3-6. Intergranular pressure vs depth for three explorations at same site ..... 3-10  
 3-7. Estimated settlement vs depth of thaw for different explorations at the same time..... 3-10  
 3-8. Pattern of cracks in taxiway pavement, Elmendorf AFB, Alaska..... 3-13  
 3-9. Soil profile, south wall of trench near south edge of taxiway, Elmendorf AFB, Alaska ..... 3-14  
 4-1. Design of foundations in areas of deep frost penetration and permafrost..... 4-1  
 4-2. Design alternatives..... 4-2  
 4-3. Thawing of permafrost under 3 story, reinforced concrete, 500-man barracks, Fairbanks, Alaska..... 4-3

LIST OF FIGURES CONT.

Figure	4-4. Approximate depth of thaw or freeze vs air thawing or freezing index and n-factor for various homogeneous soils.....	page 4-9
	4-5. Thaw progression under undisturbed surface, Camp TUTO (near Thule Air Base), Greenland.....	4-11
	4-6. Thaw vs time, Canadian locations.....	4-12
	4-7. Depth of thaw vs air thawing index for unpaved surfaces.....	4-14
	4-8. Thaw depth as affected by runway construction on permafrost.....	4-15
	4-9. Effect of heated structure size on depth and rate of thaw.....	4-16
	4-10. Degradation of permafrost under five-story reinforced concrete structure, Fairbanks, Alaska.....	4-18
	4-11. Permafrost degradation under 16-ft-square heated test buildings without air space, beginning at end of construction....	4-19
	4-12. Typical foundation thaw near Fairbanks, Alaska.....	4-20
	4-13. Typical design for light structure with air space and gravel mat.....	4-22
	4-14. Foundation in permafrost area for men's barracks, Thule, Greenland.....	4-22
	4-15. Post and pad type foundation for composite building, Fort Yukon, Alaska.....	4-23
	4-16. Footing on permafrost foundation, Bethel, Alaska.....	4-24
	4-17. Footings on permafrost.....	4-25
	4-18. Typical ventilated foundation design for structures supported on piles.....	4-26
	4-19. Wood pile foundation for small residences, Fairbanks, Alaska.....	4-27
	4-20. Typical pile foundation for light utility building, Fairbanks, Alaska.....	4-28
	4-21. Steel pile foundation for utility building showing sunshade, Bethel, Alaska.....	4-29
	4-22. Foundation for men's club, Thule, Greenland.....	4-30
	4-23. Two story steel frame building on footings and piers at Churchill, Manitoba, Canada.....	4-31
	4-24. Utility and maintenance building, Fairbanks, Alaska.....	4-32
	4-25. Ducted foundation for garage, Fairbanks, Alaska.....	4-33
	4-26. Pan duct foundation, Thule, Greenland.....	4-34
	4-27. Typical pan duct foundation, showing section at plenum chamber and at interior column for warehouse, Sondrestrom AB, Greenland.....	4-35
	4-28. Foundation details and maximum thaw penetration for selected years, hangar at Thule, Greenland.....	4-37
	4-29. Schematic of ducted foundation.....	4-41
	4-30. Properties of dry air at atmospheric pressure.....	4-43
	4-31. Flow net, concrete slab on grade, uninsulated.....	4-47
	4-32. Flow net, concrete slab on grade, insulated.....	4-47
	4-33. Flow net, extrapolated from field measurements, with 1-1/2-in. cellular glass insulation, 36 in. long in vertical position....	4-48
	4-34. Floor temperature 6 in. from wall vs daily average air temperature measured at Loring AFB, Maine.....	4-49
	4-35. Comparison of predicted and measured floor temperatures for a concrete slab on gravel with vertical insulation.....	4-50
	4-36. Thermal resistance vs design winter temperature for, various vertical lengths of insulation for kitchens and mess halls (from electrical analog analyses).....	4-51
	4-37. Thermal resistance vs design winter temperatures for two vertical lengths of insulation for barrack buildings (from electrical analog analyses).....	4-54
	4-38. Wood frame residence 32 x 32 ft on rigid concrete raft foundation, Fairbanks, Alaska.....	4-60
	4-39. Wood frame residence 32 x 32 ft on wood pile foundation, Fairbanks, Alaska.....	4-62
	4-40. Wood frame garage, 32 x 32 on rigid concrete raft foundation, Fairbanks, Alaska.....	4-64
	4-41. Vertical movement of 50-ft single span bridge on pile-supported concrete abutments, east-west road near Fairbanks, Alaska.....	4-65
	4-42. Frost action effects.....	4-66
	4-43. Average heave vs. time.....	4-67
	4-44. Test observations, 1962-63, 8-in. steel pipe pile placed with silt-water slurry in dry-augered hole.....	4-69
	4-45. Test observations 1962-63, creosoted timber pile.....	4-70
	4-46. Heave isolation.....	4-72
	4-47. Frozen soil creep tests, unconfined compression, Manchester fine sand.....	4-73
	4-48. Variation of ultimate strength ratios with temperature for various rates of loading.....	4-74
	4-49. Unconfined compression creep curves for frozen Ottawa sand at 29°F.....	4-74
	4-50. Ultimate strength vs time to failure for Ottawa sand (20-30 mesh) at various temperatures, comparing test data with computed values.....	4-75
	4-51. Mohr's envelopes for frozen sand (Ottawa sand, 20-30 mesh).....	4-76
	4-52. Stress and time to failure in creep.....	4-78
	4-53. Mohr envelopes for frozen soils under moderately rapid loading, from tension and unconfined compression tests.....	4-80
	4-54. Frozen soil creep test on Manchester fine sand, unconfined compression, 200 psi at 15 °F.....	4-84
	4-55. Frozen soil creep tests on Manchester fine sand, unconfined compression, 15 °F.....	4-84
	4-56. Complex dynamic Young's modulus vs volume ice/volume soil ratio for frozen saturated, non-plastic soils.....	4-88
	4-57. Complex dynamic shear modulus vs ice saturation.....	4-89
	4-58. Complex dynamic Young's modulus vs ice saturation.....	4-90
	4-59. Complex dynamic shear modulus vs dynamic stress at constant frequency (500 Hz), temperature 15 °F.....	4-91



LIST OF FIGURES CONT.

	page
Figure 4-60. Complex dynamic shear modulus vs frequency at constant dynamic stress (1.0 psi), temperature 15 °F .....	4-91
4-61. Bearing capacity formulas .....	4-93
4-62. Boring log and soils condition .....	4-96
4-63. Case of isolated square footing .....	4-97
4-64. Vertical stress at centerline .....	4-99
4-65. Temperature distribution for permafrost below footing .....	4-101
4-66. Conditions for creep analysis .....	4-104
4-67. Unconfined compression creep test - data for Zone B .....	4-106
4-68. Conditions for bearing capacity analysis of square raft .....	4-107
4-69. Frozen soil - diagrams of temperature and stress distribution .....	4-109
4-70. Latent heat of slurry backfill .....	4-115
4-71. General solution of slurry freezeback rate .....	4-117
4-72. Specific solution of slurry freezeback rate .....	4-118
4-73. Natural freezeback of piles in permafrost during winter and summer .....	4-119
4-74. Compressor for artificial freezeback of piles .....	4-120
4-75. Refrigeration coils on timber piles for artificial freezeback .....	4-121
4-76. Influence of slurry on temperature of permafrost between piles .....	4-123
4-77. Stresses acting on piling for typical permafrost condition .....	4-128
4-78. Response of frozen silt to loading conditions in unconfined compression .....	4-130
4-79. Load, strain and stress distribution for pile in permafrost with zero load at tip .....	4-130
4-80. Load test of steel pipe pile .....	4-132
4-81. Load distribution along pile during test, strain-gage instrumented pile .....	4-133
4-82. Tangential adfreeze bond strengths vs temperature for silt-water slurried 8.625-in.-O.D. steel pipe piles in permafrost averaged over 18 to 21 ft embedded lengths in permafrost .....	4-134
4-83. Example of computation of sustainable load capacity of pile in permafrost .....	4-136
4-84. Load-settlement test, 10-kip increments .....	4-141
4-85. Effect of rate of loading and temperature on adfreeze strength of steel pipe piles .....	4-142
4-86. Load settlement test, single increment .....	4-143
4-87. Walls and abutments .....	4-145
4-88. Thickness of non-frost-susceptible backfill behind concrete walls .....	4-146
4-89. Granular pad tower foundations .....	4-148
4-90. Foundation designs employing minimum or no NFS granular borrowed material .....	4-149
4-91. Effects of granular mats on frost penetration and heave .....	4-150
4-92. Geologic sections at two Alaska railroad bridges in Goldstream Valley near Fairbanks, Alaska .....	4-153
4-93. Mechanics of anchor failure in frozen soils .....	4-157
4-94. Failure planes for batter and vertical anchor installation .....	4-157
4-95. Typical foundation design for unheated buildings over frost-susceptible soil in deep seasonal frost or permafrost areas .....	4-159
4-96. Exterior apron design .....	4-161
4-97. Utility connections to buildings .....	4-162
4-98. Slopes in frost and permafrost areas .....	4-165
4-99. Ice exposed in vertical cut for Trans-Alaska Pipeline Access Road between Livengood and the Yukon River, Alaska, April 1970 .....	4-167
4-100. Slope resulting from melting of ice in vertical cut face during one summer, Trans-Alaska Pipeline Access Road between Livengood and the Yukon River, Alaska, August 1970 .....	4-168
5-1. Recommended permanent benchmark .....	5-2
7-1. Permafrost and frost probing techniques .....	4-4
7-2. Electrical resistance gage for determination of frost penetration .....	7-6

## CHAPTER 1 INTRODUCTION

### 1-1. Purpose and scope.

a. This manual provides criteria and guidance for design of foundations for structures for military facilities in arctic and subarctic regions.

b. To facilitate the use of this manual, superscript numbers are used to refer to Appendix A-References. These references have been divided into publications required to use the manual (Required Publications) and additional related publications (Related Publications.)

### 1-2. Environmental conditions in the Arctic and Subarctic.

The design, construction and maintenance of foundations are all affected by the special environmental conditions found in the Arctic and Subarctic<sup>109, 110</sup>. (Superscript numbers indicate references listed in app A.) These conditions typically include the following, as applicable:

Seasonal freezing and thawing of ground with attendant frost heaving and other effects.

Occurrence of permanently frozen ground subject to thawing and subsidence during and following construction.

Special physical behavior and properties of frozen soil, rock, and construction materials at low temperatures and under freeze-thaw action.

Difficulty of excavating and handling frozen ground.

Poor drainage and possible excess of water during thaw caused by the presence of impervious frozen ground at shallow depths.

Thermal stresses and cracking.

Ice uplift and thrust action.

Limited availability of natural construction materials, support facilities, and labor.

Adverse conditions of temperature, wind, precipitation, distance, accessibility, working seasons, and cost.

While these factors are important in many other types of construction such as pavements<sup>6</sup> and utilities<sup>3</sup>, they merit separate consideration for foundations for structures.

a. *Temperature.* The single most important factor contributing to the existence of these adverse conditions in the northern regions is the prevailing low air temperatures, demonstrated not only in the intensity and duration of cold in winter itself but also in the low mean annual temperatures.

(1) In general, mean annual temperatures decrease with increasing latitude or elevation, and the amplitude of the annual air temperature cycle generally decreases as large bodies of water or oceans are approached. Under natural conditions, mean annual ground temperatures are usually 2 °F to 5 °F higher than mean annual air temperatures, though deviations are sometimes outside this range. The difference between air and ground temperatures is attributable primarily to additional heat input from absorption of solar radiation at the ground surface in the summer, to restriction of heat loss by the insulating effect of a snow cover during the winter months, and to the normal temperature difference which occurs in heat flow across a solid/gas interface. Mean annual air temperatures in the Northern Hemisphere are shown in TM 5-852-1<sup>9</sup>.

(2) Air temperatures in arctic environments may range from highs of 75 °F to 85 °F in the summer to lows of -50°F to -75 °F during the coldest winter months. It is not uncommon for air temperatures to remain below -30°F for a week or more at many locations in Alaska and in fact air temperatures have remained below -50°F for as much as several weeks. A typical record of air temperatures for a one-year period at Fort Yukon is shown in figure 1-1, along with other data, including ground temperatures.

b. *Front conditions.*

(1). Seasonal frost areas are those areas where significant freezing occurs during the winter season but without development of permafrost. In North America significant seasonal frost occurs about 1 year in 10 in northern Texas. A little farther to the north it is experienced every year. As indicated in figure 1-2, depth of seasonal freezing increases northward with decreasing mean annual air temperature until permafrost is encountered. With still further decrease of mean annual temperature, the zone subject to annual freezing and thawing becomes progressively thinner<sup>164</sup>

(2) Permafrost areas<sup>174</sup> are those in which perennially frozen ground is found. In North America permafrost is found principally north of latitudes 55° to 65°, although patches of permafrost are found much farther south on mountains where the temperature conditions are sufficiently low, including some mountains in the United States. The depth to the surface of permafrost is dependent primarily on the magnitude of the air thawing index, the radiational input to the surface (as controlled by such factors as latitude, amount of cloudiness, degree of shading or exposure, vegetation, and surface color), and the water content and dry unit weight of the soil.

(a) *In zones of continuous permafrost, frozen*

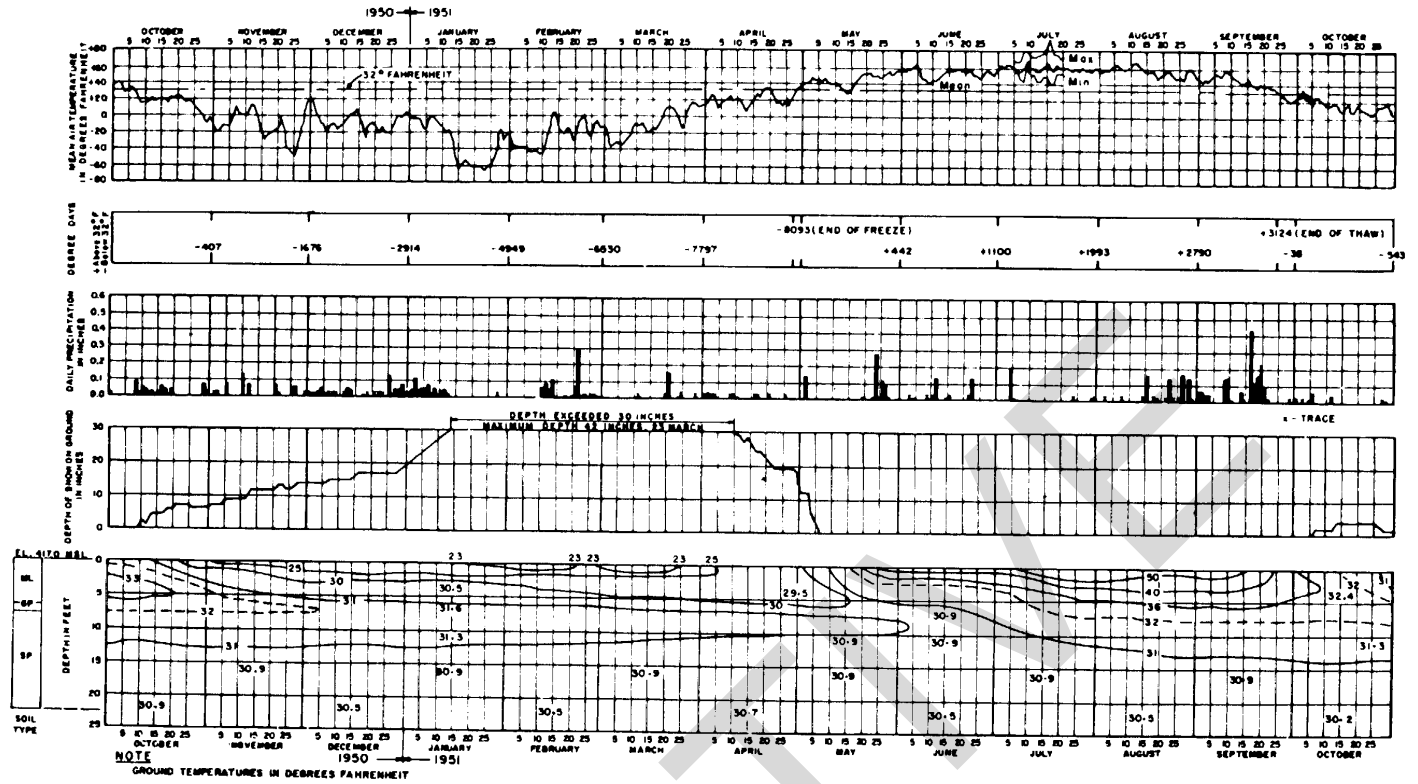

U. S. Army Corps of Engineers

Figure 1-1. Meteorological data and ground isotherms, Fort Yukon, Alaska<sup>99</sup>

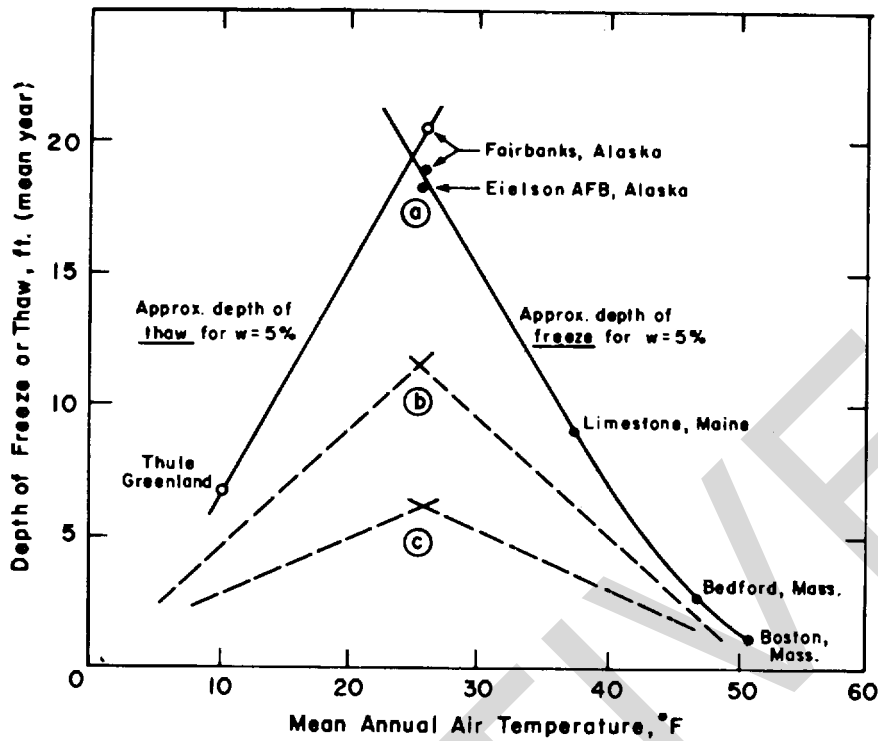

(a) For bituminous paved areas over well drained gravel, kept clear of snow.  
 (b) a (c) Typical for other soil, moisture and surface conditions.

U. S. Army Corps of Engineers

Figure 1-2. Freeze or thaw penetration vs mean annual temperature <sup>164</sup>.

ground is absent only at a few widely scattered locations, as at the bottom of lakes and rivers.

(b) In zones of discontinuous permafrost, permafrost is found intermittently in various degrees. There may be discontinuities in both horizontal and vertical extents.

(c) The boundaries between zones of continuous permafrost, discontinuous permafrost, and seasonal frost without permafrost are poorly defined. Distinctions between continuous and discontinuous permafrost, in particular, are somewhat arbitrary.

(d) Definitions of specialized terms, more detailed discussions on seasonal frost and permafrost, and the approximate extent of continuous and discontinuous permafrost in the Northern Hemisphere are given in TM 5-852-1 0 general provisions.

c. *Thermal regime in the ground.* As shown in figure 1-3, temperatures below the ground surface vary with the seasons. The annual ground temperature fluctuation decreases in amplitude with depth and lags in

time behind the air temperature variations occurring at the surface <sup>197</sup>. The decrease of annual amplitude with depth is illustrated in a more general way in figure 1-4. Below a depth in the range of 30 to 60 feet, the amplitude of annual temperature variation becomes small and the temperature gradient corresponding to the normal flow of heat outward from the interior of the earth becomes discernible. When the ground temperature curve with depth at its warmest extreme is below freezing over a portion of its length, as in figure 1-4, a permafrost condition exists. When the curve shows ground temperatures entirely above freezing at its warmest extreme, but freezing does occur at its coldest extreme, only seasonal frost conditions exist. A seasonal freeze and thaw zone, called the "annual frost zone," occurs even in the permafrost areas, except at very extreme locations where the air temperatures remain well below freezing even in the summer. The annual frost zone is usually not more than 10 feet thick, but it may exceed 20 feet.

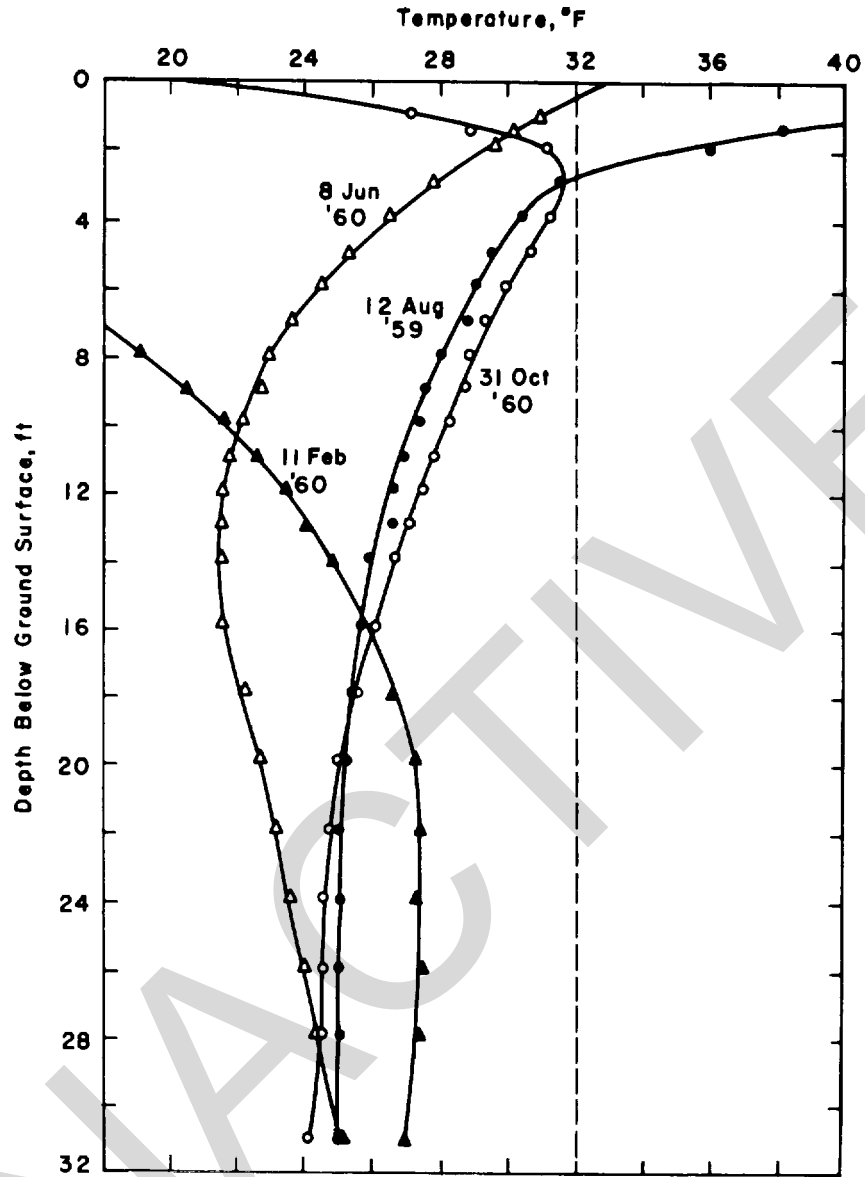

U. S. Army Corps of Engineers

Figure 1-3. Typical temperature gradients under permafrost conditions, Kotzebue Air Force Station, Alaska.

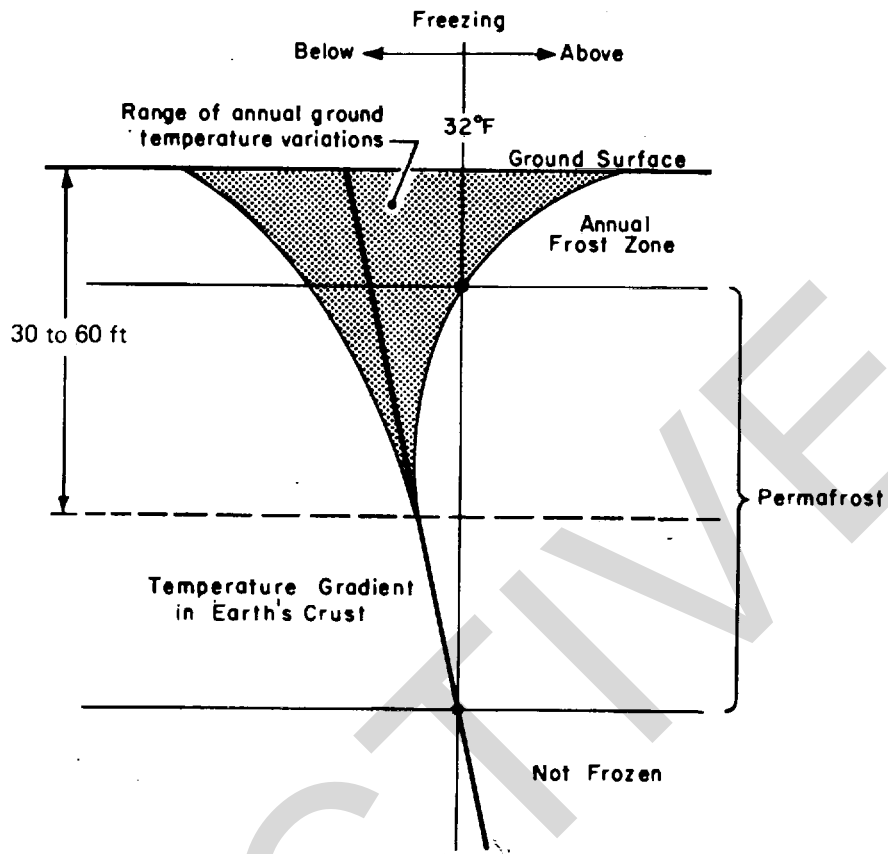

U. S. Army Corps of Engineers

Figure 1-4. Typical temperature gradients in the ground.

Under conditions of natural cover in very cold areas, its thickness may be as little as 1 foot or less; thickness may vary over a wide range even in a relatively limited geographical area.

(1) Seasonal variations in properties and behavior of foundation materials are caused primarily by the freezing, thawing, and redistribution of water contained in the ground and by the variations of stress-strain characteristics and thermal properties with temperature. The water may be present in the voids before freezing or may be drawn to the freezing plane during the freezing process and released during thawing. Seasonal changes are also produced by shrinkage and expansion caused by temperature changes.

(2) Below the zone of seasonal effects the temperature gradient usually averages 1 °F for 40 to 50 feet of depth, although it may range from about 1 °F in 15 ft to 1 °F in 135 feet. Since foundation work rarely extends below a depth of about 30 feet, most foundation design is concerned with the environmental effects encountered in the upper 30 ft.

(3) The penetration of freezing temperatures into the ground depends upon such factors as weather, radiation, surface conditions, insulating or other special courses, soil properties and soil moisture.<sup>43, 83, 181, 185</sup> The most important weather conditions are air temperatures and length of freezing season. These may be combined into indices, based upon accumulated degree-days as explained in TM 5-852-1/AFM 88-19, Chapter 1<sup>10</sup>.

(4) It is important to note that the indices found from weather records are for the air about 4-1/2 feet above ground. The value at the ground surface, which determines frost effects is usually different, being generally higher for thawing and lower for freezing, and is the composite result of many influencing variables, some of which have been mentioned in (3) above. The *surface index*, which is the index determined for temperatures immediately below the surface, is  $n$  times the air index, where  $n$  is the *correction factor*. For paved surfaces kept cleared of snow and ice,  $n$  may usually be taken as 0.7 for freezing. Other values are given in chapter 2. Turf, moss, other vegetative cover and snow cover with reduce the  $n$  value for temperatures at the soil surface in relation to air temperatures, and hence frost penetration will be less for the same air freezing index.

(5) TM 5-852-1/AFM 88-19, Chapter 1<sup>10</sup> gives the approximate distribution of mean air-freezing and air-thawing intensities in North America. More detailed information for northern Canada is given by Thompson.<sup>199</sup> As demonstrated by Gilman,<sup>64</sup> highly useful summaries for local areas can be prepared when sufficient weather data are available. Calculation methods for determining the freezing and thawing

conditions which may be anticipated for specific situations, more detailed explanation of the factors influencing freeze and thaw penetration, and typical values of  $n$  are presented in TM 5-852-6/AFM 88-19, Chapter 6<sup>14</sup>.

(6) Because temperature inversions and steep temperature gradients are common in levels of the atmosphere nearest the ground, temperature differentials of as much as 50°F may be found at a given time at different local topographical positions. Within the range of ground elevations subject to temperature inversions, mean temperatures may actually increase rather than decrease with increasing elevation. For such reasons, it is important to determine design indices for the specific site topographic position.

(7) Anything which is done in the course of construction is likely to alter the temperature conditions at the surface of the ground and, as a consequence, to change the thickness of the annual frost zone and the depth to the top of permafrost, and ultimately, possible even to affect the existence of the permafrost.

d. *Wind and other factors.* Mean annual wind speeds for most arctic and subarctic locations are usually of the order of 5 to 10 mph except in coastal areas where the mean is usually 10 to 20 mph. In mountainous regions wind speeds are generally greater than those in the plains. Local katabatic winds with velocities up to 100 mph or more are not uncommon, particularly along sea coasts. Even though velocities of arctic winds as a whole tend to be low, combination of very cold temperatures with wind causes extremely large heat losses from buildings, equipment, and personnel in winter. Wind chill values representing the combined effects of wind and temperature are given in TM 5-852-1/AFM 88-19, Chapter 1<sup>10</sup>. Table 1-1 relates wind chill values to human working conditions. Drifting and blowing of snow often creates major construction and operational problems, even where the actual precipitation is very low. It is of fundamental importance to anticipate such problems in planning and design stages. It is often possible to reduce greatly adverse effects of drifting and blowing snow by proper site selection and layout alone.

e. *Solar radiation.* As previously indicated, solar radiation is an important factor in the thermal stability of foundations in arctic and subarctic areas. Net summer radiational input into the ground may range from almost nothing in very cloudy or shaded locations to a predominant part of the summer heat flow at others. It is a function of latitude, cloud cover, time of year, time of day, atmospheric conditions, wind speed, subsurface thermal properties, degree of shading, if any, and aspect, albedo and roughness characteristics of the surface<sup>88</sup>.

Table 1-1. Stages of Relative Human Comfort and the Environmental Effects of Atmospheric Cooling.

Effects of Atmospheric Cooling.

<u>Wind chill factor (kg cal/m<sup>2</sup> hr)</u>	<u>Relative comfort</u>
600	Conditions considered as comfortable when men are dressed in wool underwear, socks, mitts, ski boots, ski headband, and thin cotton windbreaker suits, and while skiing over snow at about 3 mph (metabolic output about 200 kg cal/m <sup>2</sup> hr).
1000	Pleasant conditions for travel cease on foggy and overcast days.
1200	Pleasant conditions for travel cease on clear sunlit days.
1400	Freezing of human flesh begins, depending upon the degree of activity, the amount of solar radiation, and the character of the skin and circulation.
1600	Travel and life in temporary shelter very disagreeable.
1900	Conditions reached in the darkness of mid-winter. Exposed areas of face freeze within less than a minute for the average individual. Travel dangerous.
2300	Exposed areas of the face freeze within less than 1/2 minute for the average individual.



## CHAPTER 2

### BASIC CONSIDERATIONS AFFECTIVE FOUNDATION DESIGN

#### 2-1. Thermal effects.

a. As indicated in chapter 1, ground temperatures and presence or absence of permafrost are the product of many interacting variables. In addition to reflecting the effects of such factors as snow cover, air temperatures, and net radiation flux, the natural ground temperatures of a specific area can be related to the recent history of the terrain. For example, in flood plains of meandering streams permafrost may be absent in areas which were under water in recent decades and present elsewhere. Again, destruction of vegetation by forest fires in past years may have produced special subsurface temperature conditions.

b. The fundamental properties of soil or rock which determine the depths to which freezing and thawing temperatures will penetrate below the ground surface under given temperature differentials over a given time are the thermal conductivity, the volumetric specific heat capacity, and the volumetric latent heat of fusion<sup>30</sup>. These factors, defined in TM 5-852-6/AFM 88-19, Chapter 6<sup>14</sup>, vary in turn with type of material, density, and moisture content. Figure 2-1 shown typical values of thermal conductivity vs dry unit weight and porosity. More detailed plots are presented in TM 5-852-6/AFM 88-19, Chapter 6<sup>14</sup>. The specific heat of most dry soils near the freezing point may be assumed to be 0.17 Btu/lb°F. Specific heats of other construction materials are given in TM 5-852-6/AFM 88-19, Chapter 6<sup>14</sup>.

c. Permafrost will thaw when sufficient heat is transferred to it from the underside of a structure. The rate of thaw depends on the temperature of the building, the insulation in the floor, air space or ventilation provisions, layers of special material (such as gravel) on the ground, and the natural characteristics (such as moisture content and temperature) in the annual frost zone and permafrost. Insulation retards and reduces but cannot prevent heat flow from the structure. Thaw will progress in permafrost below a heated structure unless provisions are made for removing the escaping heat such as by an air space beneath the building, natural or forced circulation in ducts, or even artificial refrigeration. During the winter, such a system must provide sufficient cooling and refreezing of any foundation material warmed or thawed during the summer so that progressive thermal changes and degradation will not occur.

d. Ground temperatures influence bearing and adfreeze strengths and creep rates of the permafrost. Normally, in areas of discontinuous permafrost, where the most difficult foundation engineering problems are encountered, the mean annual temperature of the

permafrost is not far below freezing. Here tangential adfreeze and other strength values are low, and creep rates are high. In far northern areas of continuous permafrost and lower ground temperatures, strength values and creep factors are more favorable.

e. Ground temperatures and relative thermal stability at sites in permafrost areas are important not only in determining the amount and rate of progression of permafrost degradation which may be initiated by construction, but also the rate of creep closure of underground openings and the extent and dimensions of protective measures such as ventilated foundations or refrigeration, which are required for heat producing facilities. Ground temperatures influence installation procedures and the rate of freezback of slurried piles. The dynamic response characteristics of foundations are also a function of ground temperatures.

f. Thaw of permafrost from below will result if a long-duration increase occurs in the surface ground temperature. This may be visualized by assuming that the entire temperature gradient curve in figure 1-4 is moved to the right. However, as Terzaghi<sup>197</sup> has shown, the natural heat flow out of the earth can at most produce only quite slow upward thaw of permafrost, that is, somewhat under 2 cm/yr for permafrost containing 30 percent ice by volume. If a normally developed and stable geothermal gradient exists in the permafrost and the foundation is designed to maintain original permafrost temperatures, there will be no thaw from below. If the permafrost is in process of warming from prior colder climatic conditions or is even in an isothermal condition at the thawing temperature, as may sometimes happen, thaw will occur from below at rates up to the maximum possible under the geothermal gradient existing in the sub-permafrost materials. In any case, thaw of permafrost from below is not normally a significant factor in design of foundations for structures, except that a flow of warm sub-permafrost groundwater might rarely present a special situation.

g. Designers must also keep in mind that both manufactured and natural construction materials experience significant linear and volumetric changes with changes in temperature. Linear coefficients of thermal expansion for some common materials are shown in table 2-1. Note particularly that values for asphalt and ice are much higher than for soil or rock. The higher the percentages of asphalt or ice the greater the degree of

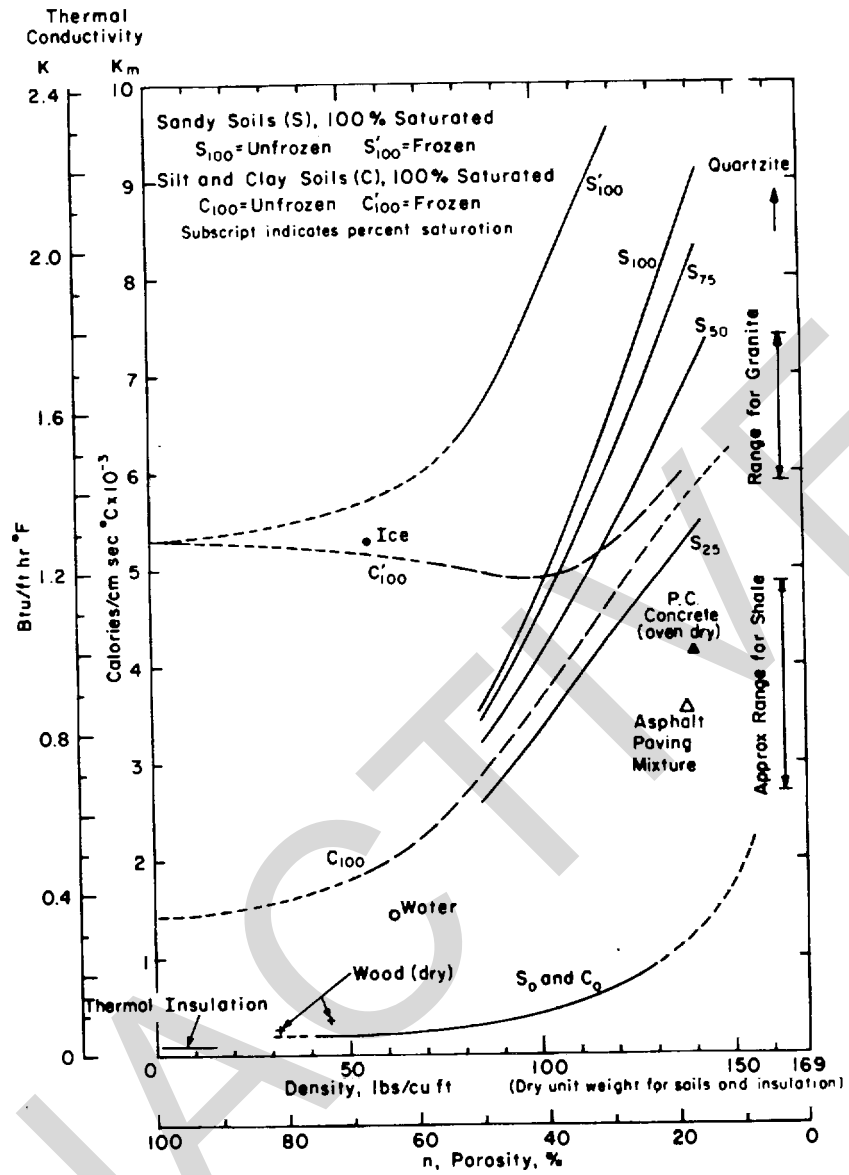

U. S. Army Corps of Engineers

Figure 2-1. Thermal conductivity vs density and porosity of typical materials<sup>58</sup>.

Table 2-1. Approximate Coefficients of Linear Thermal Expansion per°C.

	<u>x 10<sup>-6</sup></u>
Granite and slate	8
Portland cement concrete	10
Soil (109 lb/ft <sup>3</sup> , 23 % water content, +20 to -160°C)	22
Ice	51
Steel	12
Copper	14-17
Aluminum	18-23
Sulfur	64
Coal tar pitch	160
Asphalt	215
Roofing felt	11-33
Built-up roofing membranes	15-53
Bakelite	22-33
Some other plastics	35-90
Wood (pine), parallel to fiber	5.4
Wood (pine), perpendicular to fiber	34

Note: The coefficient of cubical expansion may be taken as three times the linear coefficient.

shrinkage with lowering temperature.

*h.* The ground surface experiences substantial contraction as it is cooled in the fall and winter months, resulting in cracking of the surface<sup>207</sup>. In arctic and subarctic areas patterned ground is formed<sup>160, 206</sup>, with ice wedges at the boundaries of the resulting polygons, as illustrated in figure 2-2. (For additional information on surficial features such as patterned ground, see TM 5-852-8<sup>17</sup>.) In far northern areas the maximum surface cracking effects tend to develop in the spring, even as late as May or June, as the effects of the winter low temperatures reach substantial depths below the surface. Shrinkage cracking of flexible pavements is observed in all cold regions and ground cracking has been observed in seasonal frost areas as well as the permafrost regions<sup>207</sup>. During the summer and fall, expansion of the warming ground may exert substantial horizontal thrust if cracks have become filled with soil or ice. Any construction features embedded in the layers of ground subject to these seasonal thermal contraction or expansion effects, or supported on them, may in consequence have stresses imposed upon them. Where items such as power cables or pipes cross contraction cracks, stresses may be sufficient to rupture or damage these members. Structures supported above the surface may also experience such effects if the strains are differential and if these can be transmitted through the supporting members. Structures of sufficient

strength may also serve to alter and control contraction cracking of the ground.

*i.* Thus, foundation materials and structures in arctic and subarctic regions must be viewed as subject to continual changes in conditions and in their states of stress and strain. It must be the designer's objective to keep such movements and stresses within acceptable limits and without progressive changes detrimental to the facility.

**2-2. Seasonal frost heave and settlement.**

*a.* Frost heave may be anticipated whenever freezing temperatures advance into frost-susceptible soil and adequate moisture is available, provided it is not restrained by a countermeasure. Seasonal heave and settlement of frost-susceptible soils occur in both permafrost and seasonal frost regions in the surface strata subject to cyclic freezing and thawing. Heave or settlement may also occur on a nonseasonal basis if progressive freezing or thawing is caused in the foundation.

*b.* During the freezing process the normal moisture of the soil, and that drawn up from greater depths, is converted into ice as crystals, lenses or other forms. In

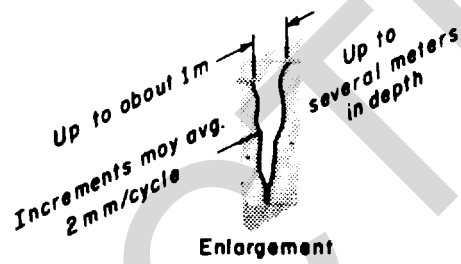
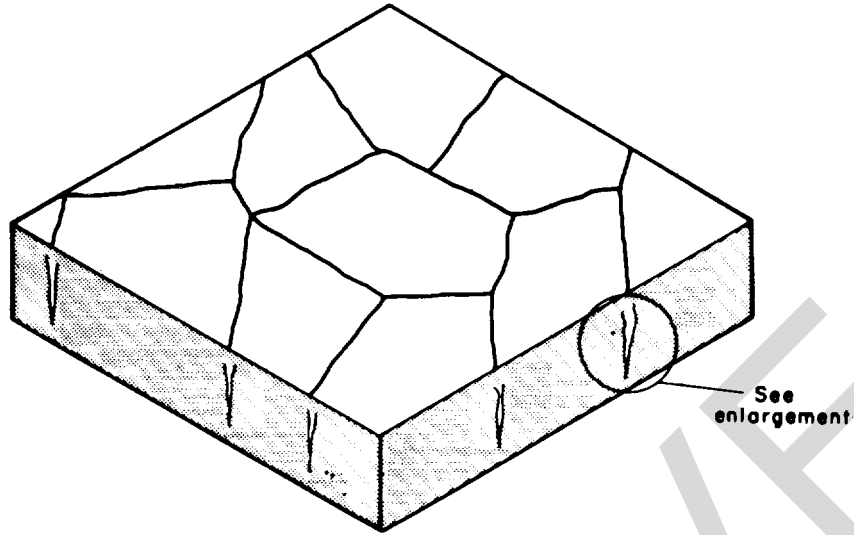

U. S. Army Corps of Engineers

Figure 2-2. Ice wedges in polygonal ground area.

frost-susceptible soils the formation of ice lenses at (and in the finer-grained soils behind) the freezing plane during the freezing process tends to produce an upward movement or heaving of the soil mass. Ice segregation is most commonly in the form of lenses and layers oriented principally at right angles to the direction of heat flow; the surface heave is approximately equal to the total thickness of the ice layers. The raising or heaving of the ground surface in a freezing season may vary from nothing in confined, well-drained non-frost-susceptible sands and gravels to a foot or more in saturated, frost-susceptible silts and some clays if there is an unlimited supply of moisture. The magnitude of seasonal heaving is dependent upon such factors as rate and duration of frost penetration, soil type and effective pore size, surcharge, and availability of moisture<sup>40,59,60</sup>. Figure 2-3 illustrates, in a laboratory freezing test, the typical gain in moisture content in upper layers of soil, with withdrawal of moisture from lower strata even though water was provided at the base. In frost-susceptible soils, ice segregation can occur by such withdrawal of moisture from lower layers even without an outside source of moisture.

c. Clean GW, GP, SW, and SP gravels and sands with a negligible percentage of material smaller than 0.02 mm are so relatively nonheaving that foundation design on such materials is usually not governed by seasonal frost effects. (Frost susceptibility criteria are discussed in more detail in TM 5-818-26). If saturated, it is possible for such soil to heave a small amount on freezing because of the expansion of water on changing to ice. However, if the expansion of the water which freezes can be balanced by movement of an equal volume of unfrozen water away from the freezing plane, there will be negligible expansion of nominally confined non-frost-susceptible materials. The same expansion relief can be obtained in non-frost-susceptible soils by a condition of partial saturation. Superficial fluffing of the surface of unconfined, relatively clean sands and gravels is frequently observed, but this effect is small to negligible when these materials are confined. In permafrost areas, however, the fact that the foundation materials are non-frost-susceptible does not justify assuming, without investigation, that ground ice masses are not present or that settlement on thawing will not occur.

d. When fine-grained soils thaw, water tends to be released by melting of segregated ice more rapidly than it can be drained away or redistributed in the thawed soil. This results in a very wet, soft condition of the soil, with substantial loss in shear strength. The shear strength of the thawed soil is dependent upon the same factors as would apply under non-frost-related conditions but is very difficult to measure meaningfully by conventional approaches.

### 2-3. Groundwater.

a. If a freezing soil has no access to free water beyond that contained in the voids of the soil immediately below the plane of freezing, frost heave will necessarily be limited. However, if free water can be easily drawn to the plane of freezing from an appreciable distance below the plane of freezing or from an underlying aquifer, heave can be large. A water table within 5 feet of the plane of freezing is favorable for significant frost heave<sup>6</sup>. However, lowering of a water table to even great depth cannot be depended upon to eliminate frost heave; the percentage of water that can be drained by gravity from most frost-susceptible soils is limited and may be negligible". The remaining water in the voids will still be available to migrate to the plane of freezing. In permafrost areas the supply of water available to feed growing ice lenses tends to be limited because of the presence of the underlying impermeable permafrost layer, usually at relatively shallow depths, and maximum heave may thus be (but is not necessarily) less than under otherwise similar conditions in seasonal frost areas. Uplift forces on structures may nevertheless be more difficult to counteract in these more northerly cold regions because of lower soil temperatures and consequently higher effective tangential adfreeze strength values.

b. As illustrated in figure 2-4, the water table may disappear rapidly in the first part of the freezing period as water is withdrawn from the unfrozen layers of soil to form ice lenses at the plane of freezing. However, even when the free water table disappears a substantial volume of water remains still available, and ice segregation and frost heave may continue for many weeks thereafter, while availability of moisture, surcharge weight at the freezing plane and rate of frost penetration are progressively changing. Full saturation is not necessary for ice segregation in fine-grained soils, though below about 70 percent saturation some soils do not heave significantly. Perched water tables can be as important as base groundwater tables.

c. Susceptibility of the soil to particle break-down under freeze-thaw cycles is a function not only of the durability characteristics of the particles themselves (which can be evaluated by standard laboratory tests), but also of the degree of saturation. For building stone and mineral aggregate it has been found that 87 percent saturation of the material itself is a good maximum if the stone or aggregate (or concrete made therefrom) is to resist freeze-thaw damage (communication from K.B. Woods). Thus, the degree of natural drainage existing in foundation soils during freeze-thaw cycles may be an important design consideration if particle degradation may significantly affect the long range performance of the construction.

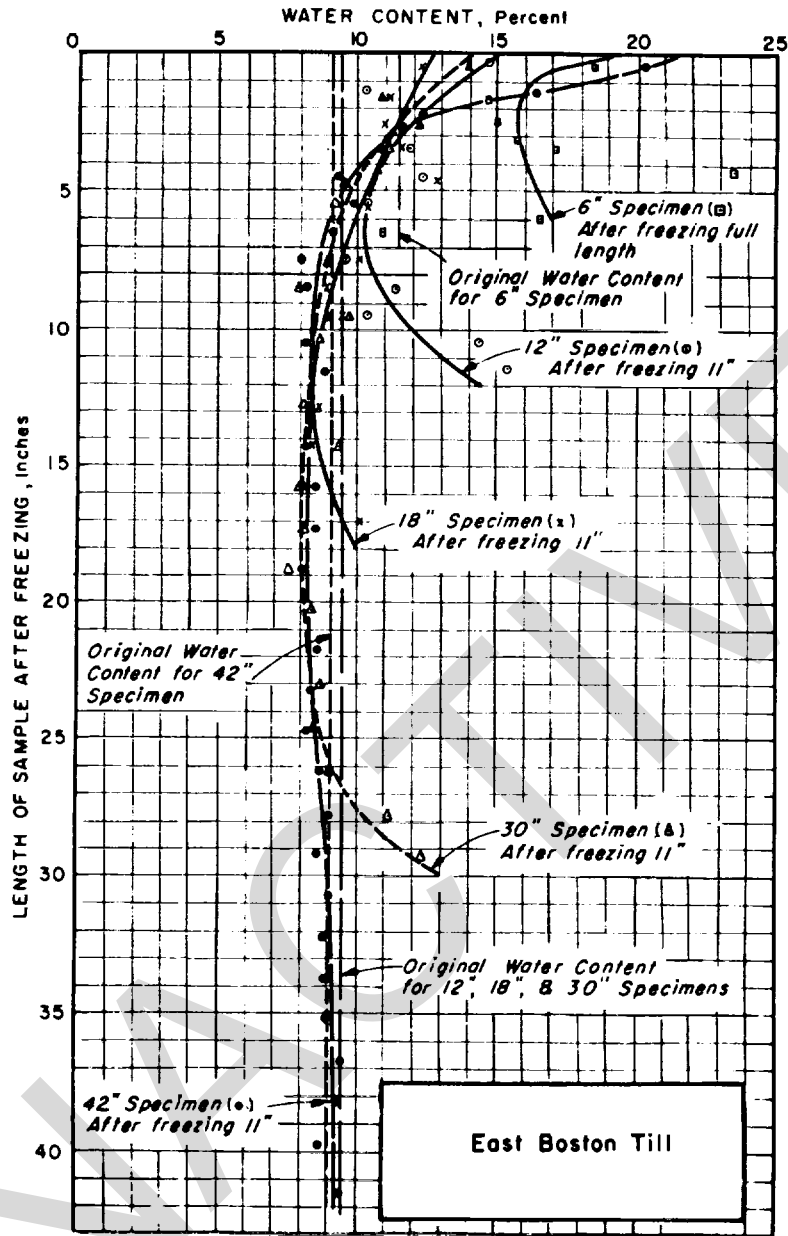

U. S. Army Corps of Engineers

Figure 2-3. Moisture content changes caused by freezing<sup>40</sup>. Water available at base of specimen during test. See figure 2-11 for soil characteristics.

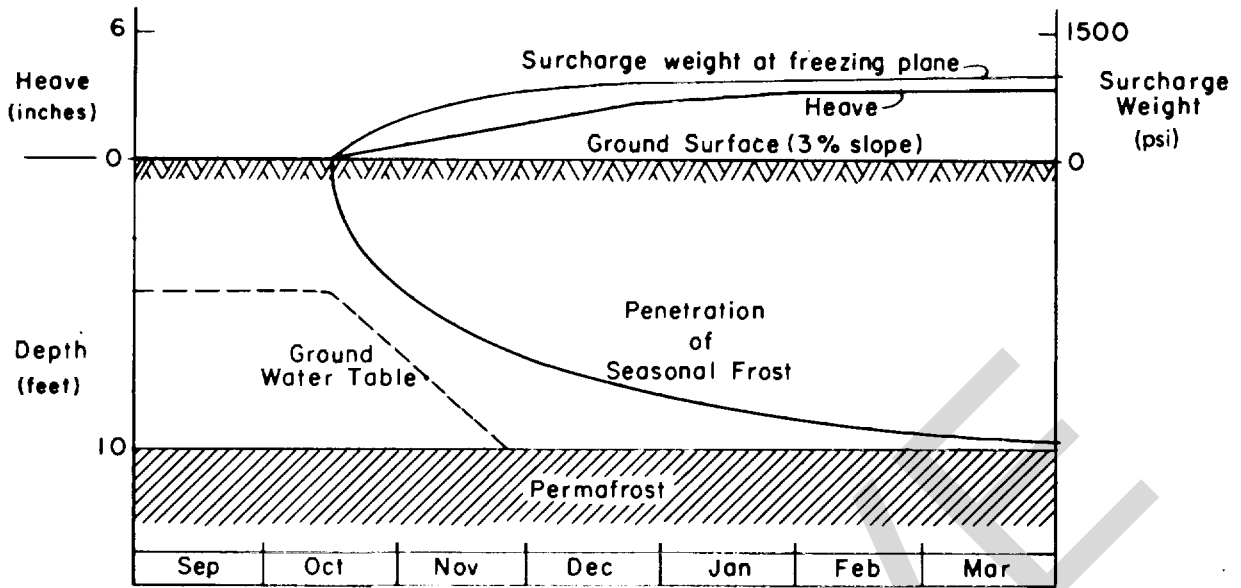

U. S. Army Corps of Engineers

Figure 2-4. Generalization of changing ground conditions as freezing penetrates into the annual frost zone<sup>35</sup>.

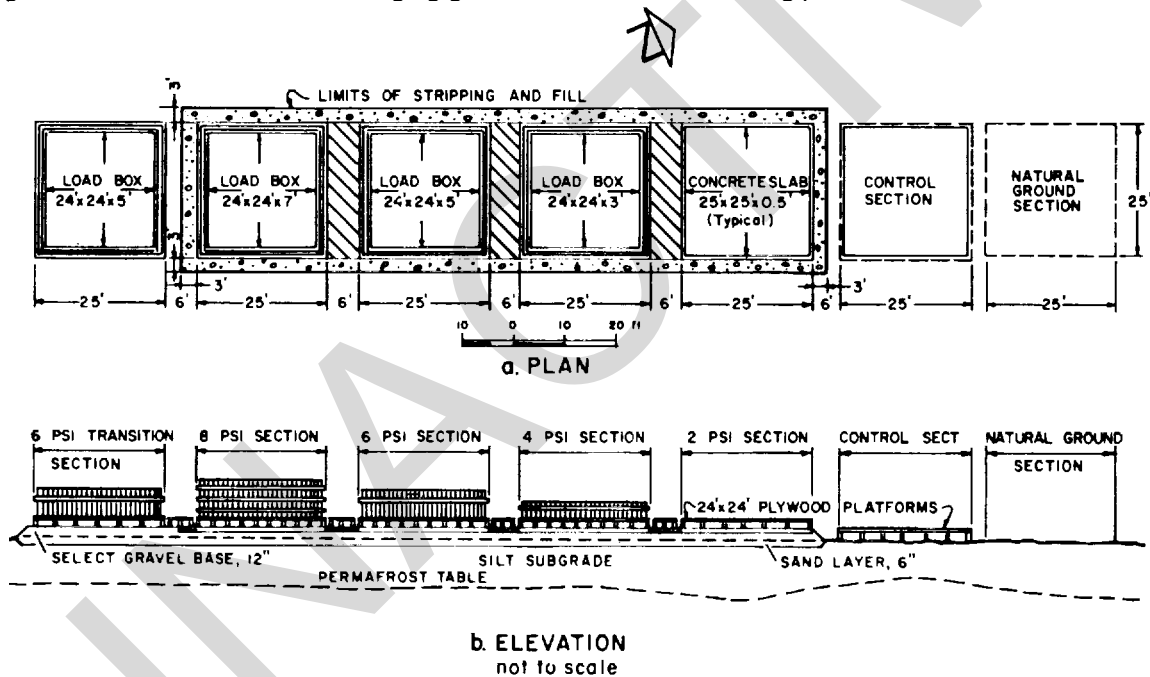

Notes

- Concrete transition sections, shown as crosshatched on plan, were separated from main slabs by one inch expansion joints, and were covered by 6x24-ft plywood platforms.
- All slabs were reinforced with 616 welded wire mesh.
- Transition section, 6 psi, constructed 2 years after original sections
- The groundwater table was at or only slightly below ground surface at the beginning of each freezing season.

U. S. Army Corps of Engineers

Figure 2-5. Plan and elevation of surcharge field experiment, Fairbanks, Alaska<sup>28</sup>.

d. The water content of a soil exerts a substantial effect upon the depth of freeze or thaw penetration which will occur with a given surface freezing or thawing index. An increase in moisture content tends to reduce penetration by increasing the volumetric latent heat of fusion, as well as the volumetric specific heat capacity. While increase in moisture content also increases thermal conductivity, the effect of latent heat of fusion tends to be predominant.

**2-4. Effect of surcharge.**

a. It has been demonstrated beyond question in both laboratory and field experiments that the rate of frost heaving is decreased by increase of loading on the freezing plane<sup>28,125,166</sup> and that frost heaving can be entirely restrained if sufficient pressure is applied<sup>66</sup>. In foundation design the heave-reducing effect of load may be readily taken advantage of by placing mats of non-frost-susceptible materials on the surface of frost-susceptible soils to reduce the magnitude of seasonal frost heaving. Where the depth of winter freezing is not limited by the presence of underlying permafrost, the heave-reducing effect of such mats is not solely the effect of load; it is also partly a result of the reduction of subgrade frost penetration. The load imposed by the structure and foundation members also contributes to heave reduction.

b. In a field experiment on a silt subgrade near Fairbanks, Alaska, a series of 25-foot-square areas were loaded to values ranging from 0 to 8 psi as shown in figure 2-5<sup>28</sup>. Ventilation ducts were incorporated in the construction so as to achieve essentially equal depths of subgrade frost penetration in the test sections. As shown in figure 2-6 the seasonal maximum frost heave in this field experiment was reduced from about 0.5 feet to about 0.3 feet with only a 2-psi applied surcharge load and to less than 0.1 feet with an 8-psi applied load.

c. Figure 2-7 presents the same data in the form of total stress at the freezing interface (which includes weight of both frozen soil and applied surcharge) versus seasonal heave and frost penetration. This type of presentation is more basic than that in figure 2-6 because it takes into account the total stress against which ice segregation is acting at any point during the freezing. These data indicate that for 5 ft of seasonal subgrade frost penetration an increase in total stress at the freeze/thaw interface from 4 to 10 psi reduced seasonal frost heave from 0.4 to 0.15 feet.

d. On the plot of rate of heave versus applied loading

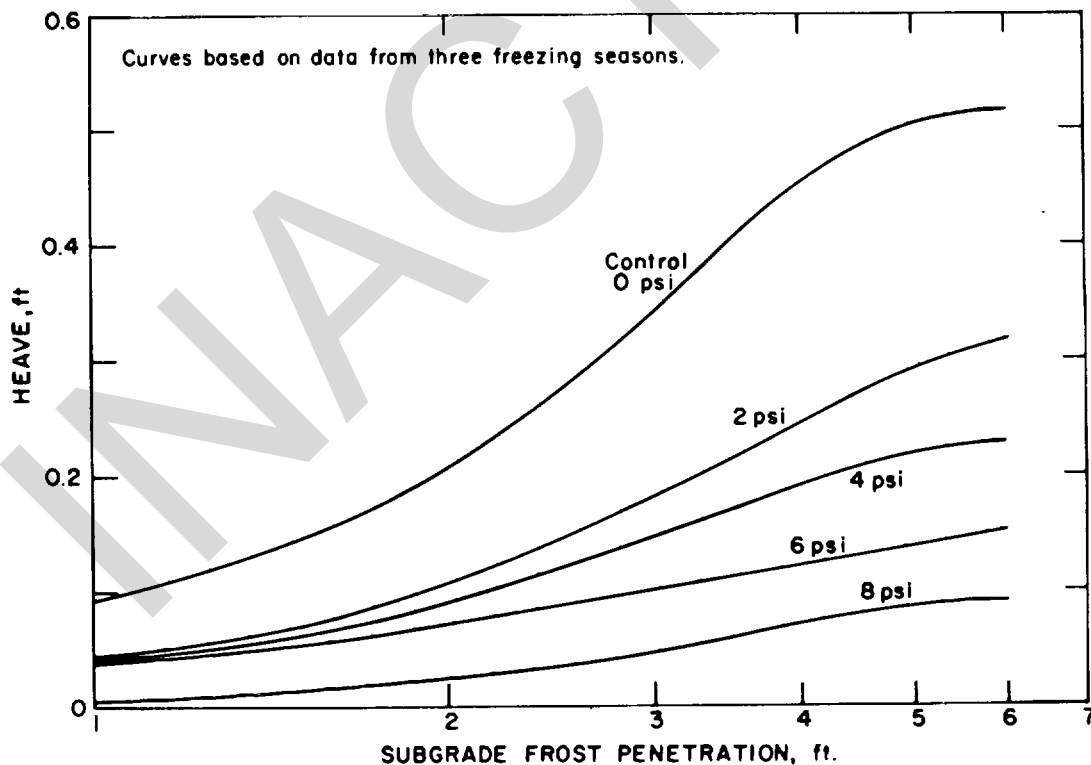

U. S. Army Corps of Engineers

Figure 2-6. Heave vs frost penetration for various applied loadings, surcharge field experiment". See figure 2-5 for plan and elevation of test installation.



in figure 2-8, comparison is made between laboratory and field test results for silt soils. While the results of the two types of experiment correspond approximately in magnitude, the laboratory tests indicate a more rapid lowering of the rate of heave with increase in surcharge than the field tests. It is believed that this may have been caused by edge effects in the small laboratory specimens; the field values are unquestionably more representative of real construction situations.

e. Also shown in figure 2-8 are laboratory results for WASHO clay (liquid limit = 37.0 percent, plasticity index = 13.0 percent). The flatter curve indicates less rapid reduction of heave with increase in applied load than in the laboratory tests on silts<sup>40</sup>. No quantitative field-scale test on a clay subgrade has been

performed and the field quantitative validity of this WASHO clay curve has not been proved; however, there is no question that clays should be less affected by surcharge than silts (see, for example, fig 2-9a). While laboratory data are available on several soils, little reliable field information is available on effect of surcharge for other soils than the Fairbanks silt. Therefore, where advantage is taken of the effect of surcharge and where justified by the scope and details of the construction project, test footings of prototype dimensions using the actual proposed loadings should be constructed in order to obtain data on actual frost heave values which will occur. This is important not only because of the differing behaviors

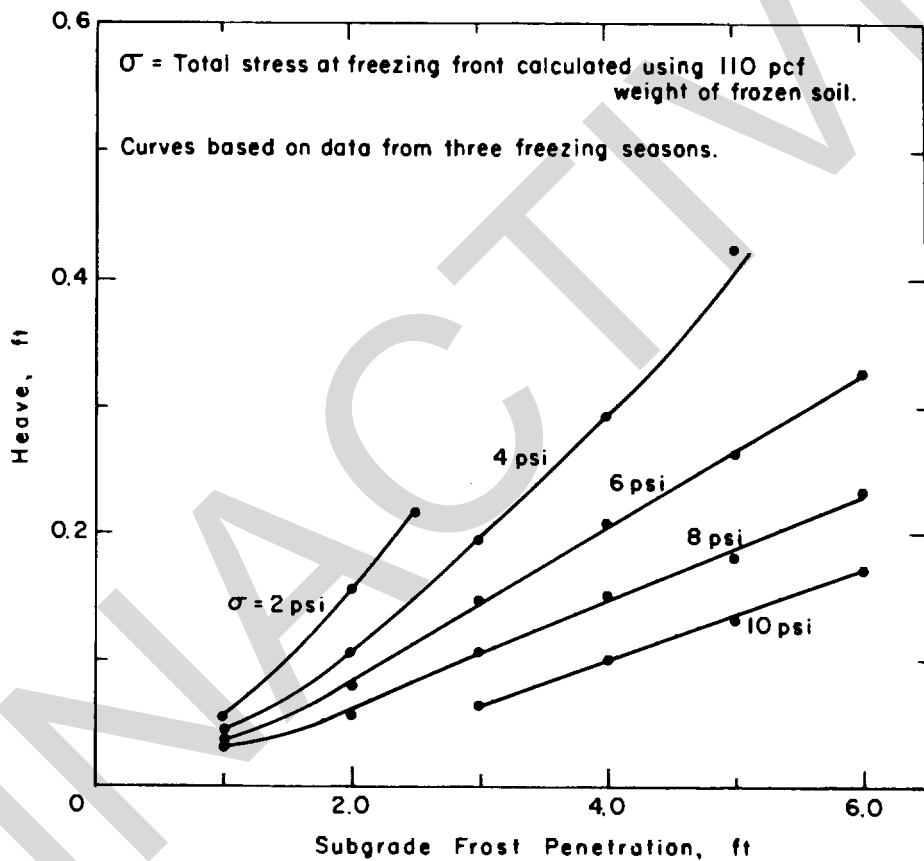

U. S. Army Corps of Engineers

Figure 2-7. Heave vs frost penetration for various total stresses, surcharge field experiment". See figure 2-5 for plan and elevation of test in stallion.

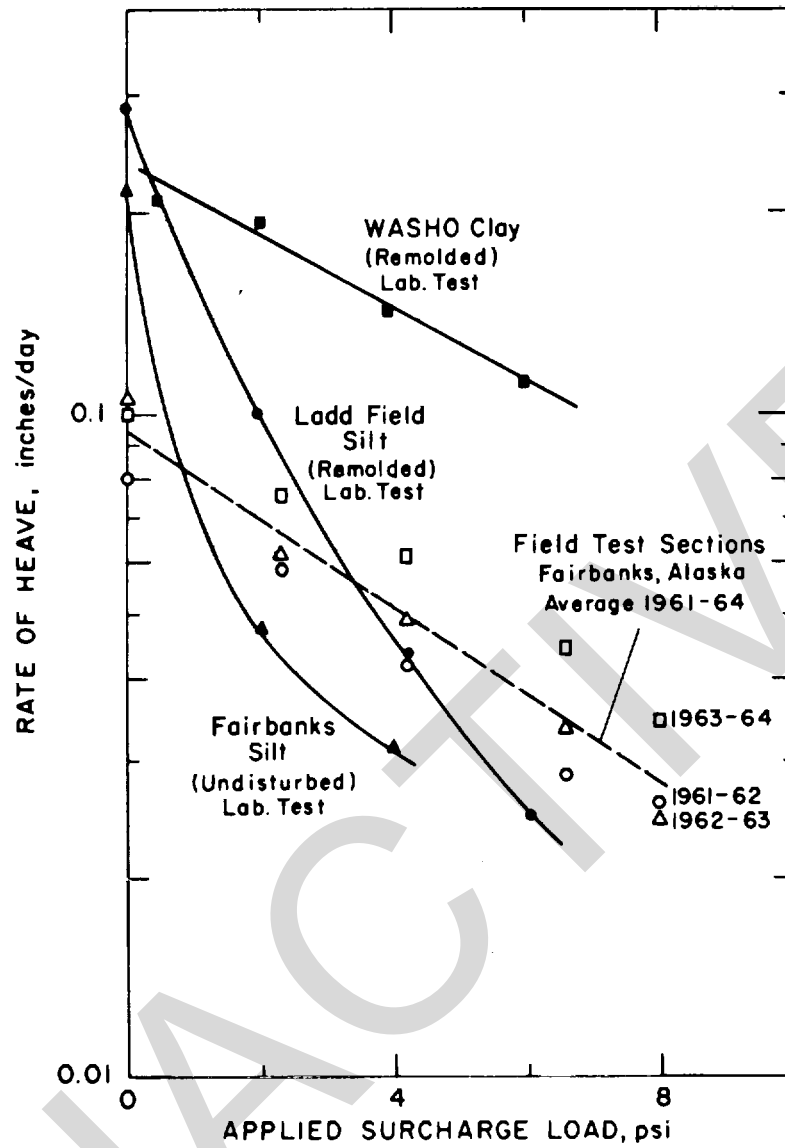

U. S. Army Corps of Engineers

Figure 2-8. Comparison of laboratory and field measurements of effects of surcharge<sup>28,40</sup>.

of different soil types but also because variations in climatic and groundwater conditions may also be expected to affect the field behavior.

f. In laboratory freezing experiments, heaving pressures of the magnitudes shown in figure 2-9 have been measured under conditions of essentially complete restraint. Therefore, if foundation loadings at the freezing plane equal or exceed these pressures, heave will be prevented completely. For many engineering structures such as pavements, such complete prevention is unnecessary and uneconomical. For structures particularly sensitive to movement, however, complete prevention may be essential, and in some cases it may be feasible to achieve this result by providing sufficient foundation loading, allowable foundation bearing values permitting. However, uplift computations cannot be made simply by applying the pressures of figure 2-9 to the areas of direct foundation loading, as frost heave uplift acts on the base of a frozen slab of soil whose effective area may be much greater than the area of the structure foundation, as illustrated in figure 4-42a. The heave-reducing effect of surcharge is presently taken

into account in the limited subgrade frost penetration method of pavement design (see TM 5-818-2<sup>6</sup>). This approach to limiting differential movements due to frost heaving is also applicable to unheated warehouses, POL facilities and transmission towers, and may enter into the design of many other types of facilities.

**2-5. Foundation materials.**

a. Soils.

(1) Permafrost soils cover the entire range from very coarse, bouldery glacial drift through gravels, sands, silts and clays to organic soils. Slightly undersaturated coarse, bouldery frozen soils at low temperature, such as are encountered in northern Greenland, behave in excavation and tunneling as if they are granite<sup>24</sup>. At the other extreme, in fat clays at temperatures not far below the freezing point, only a relatively small percentage of the soil water may actually be frozen, and the behavior of such soil may be only slightly altered by the freezing temperatures. In some

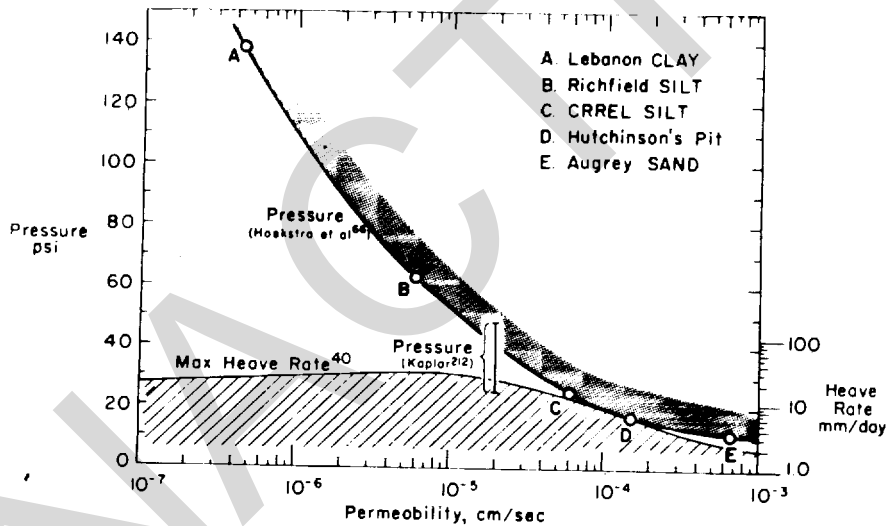

U. S. Army Corps of Engineers

Figure 2-9a. Maximum Frost Heave Pressures. (Pressure and Heave vs Permeability.)

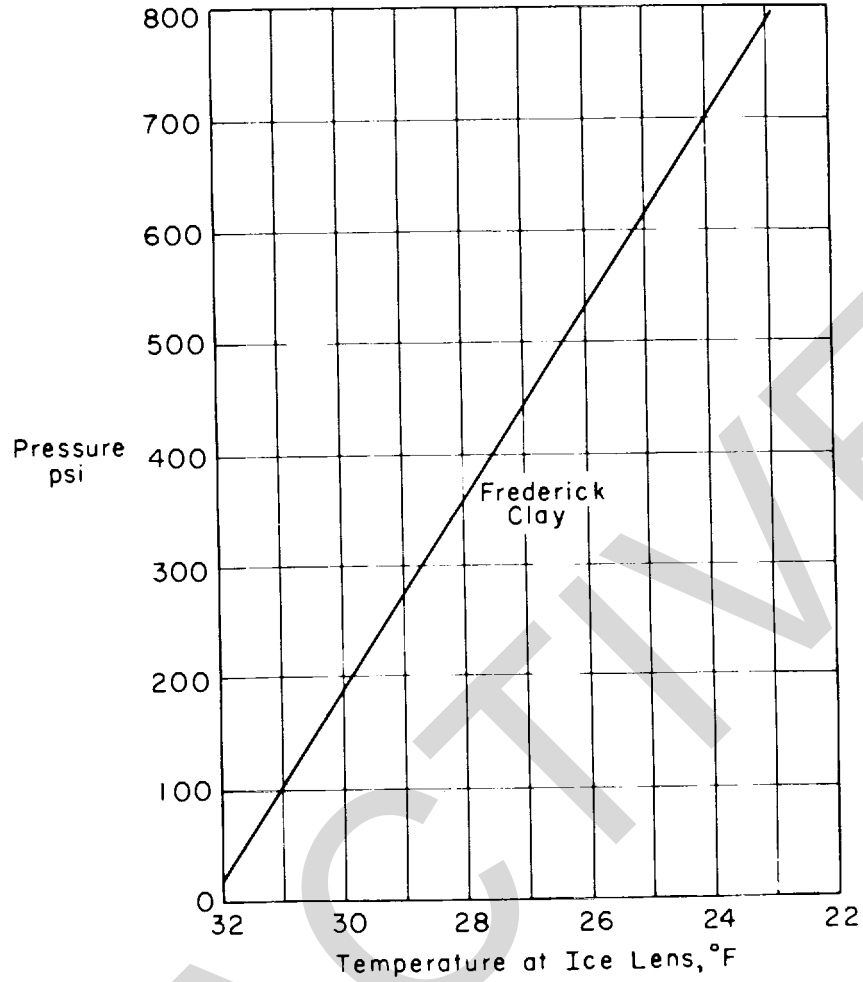

U. S. Army Corps of Engineers

Figure 2-9b. Maximum Frost Heave Pressures. (Temperature at Growing Ice Lens vs Maximum Pressure Developed at that Depth.<sup>213</sup>.)

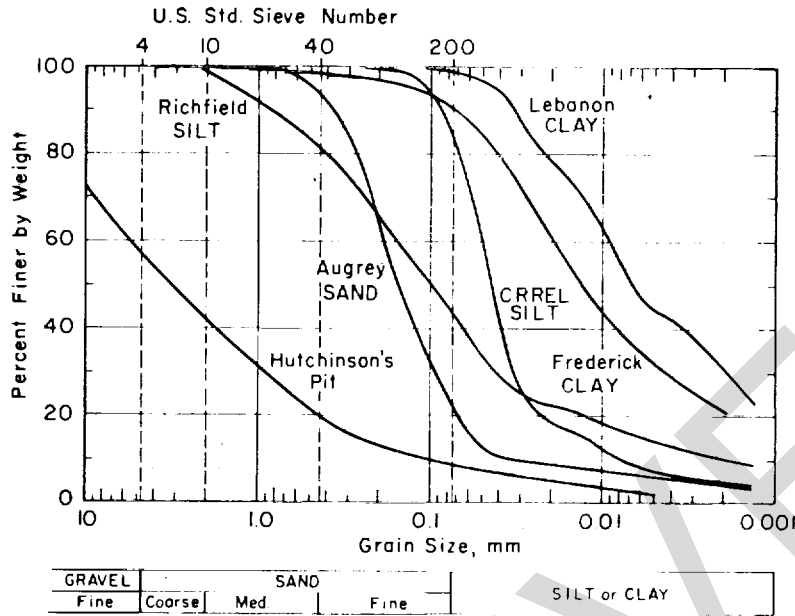

U. S. Army Corps of Engineers

Figure 2-9c. Maximum Frost Heave Pressures. (Grain, Size Distribution, of Soils.)

areas, layers of salty groundwater and unfrozen strata may be encountered in the soils<sup>208</sup>. Methane pockets are common because of entrapment by the impervious frozen soil, and animal and vegetative remains are often found surprisingly intact, their decomposition rates slowed in the permafrost. Organic soils are common, both in permafrost and seasonal frost zones. Organic soils range from only slightly organic mineral soil to 100 percent organic muskeg or peat. They cover about 10 percent of the land area of Alaska and present both transportation and construction obstacles<sup>189</sup>.

(2) Figure 2-10 shows typical compressive strength values for nine types of frozen soil including peat, in laboratory tests performed at 400 psi/min rate of stress increase. Properties of these soils are summarized in figure 2-11. Figure 2-12 presents a similar summary for tension tests performed on these soils at a rate of stress increase of 40 psi/min. Figure 2-13 shows a summary for shear tests performed at a rate of stress increase of 100 psi/min.

(3) Strength properties of frozen soils are

dependent on such variables as gradation, density, degree of saturation, ice content, temperature, percentage of moisture in specimen frozen, dissolved solids, and rate of loading. Available data on effect of rate of loading on strength of frozen materials are summarized in figure 2-14. Frozen soils characteristically exhibit creep at stresses as low as 5 to 10 percent of the rupture strength in rapid loading<sup>53,187</sup>. Typical creep relationships are shown in figure 2-15.

(4) The effect of ice content on the compressive strength of Manchester fine sand is shown in figure 2-16.

(5) Values of dynamic moduli and Poisson's ratio determined by flexural vibration are summarized in figure 2-17<sup>68</sup>. See also paragraph 4-6. Values of adfreeze strength for tangential shear on various materials are discussed in paragraph 4-8.

(6) It will be apparent from the information presented above that it is not feasible to give categorical

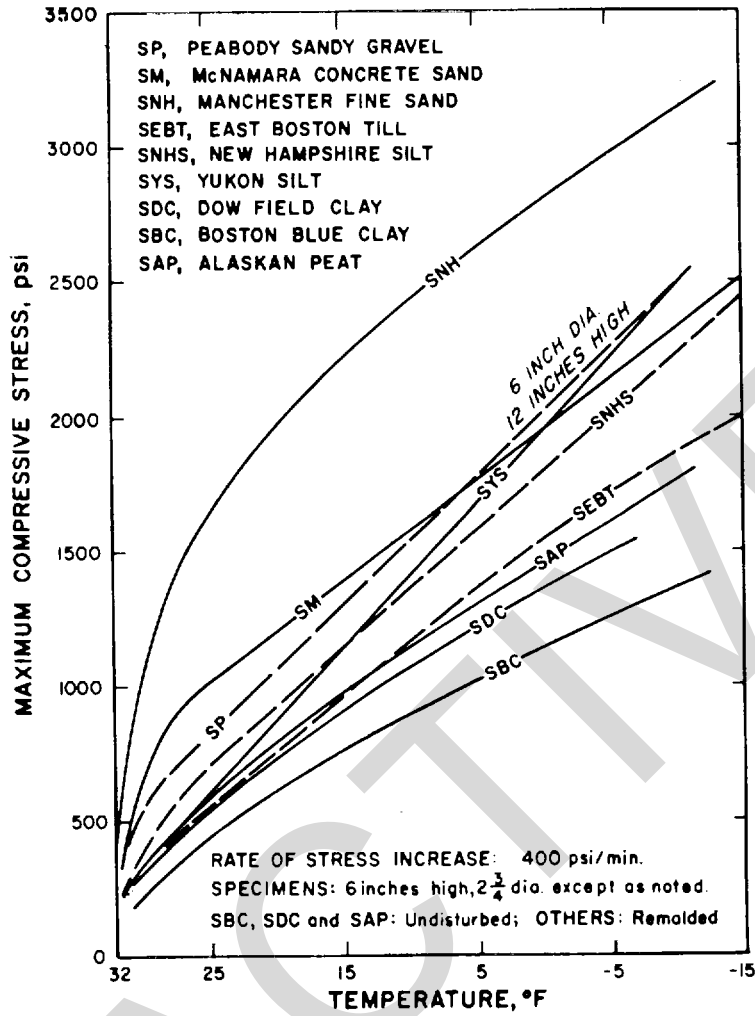

U. S. Army Corps of Engineers

Figure 2-10. Summary of maximum stress in compression vs temperature. See figure 2-11 for soil characteristics<sup>34</sup>.

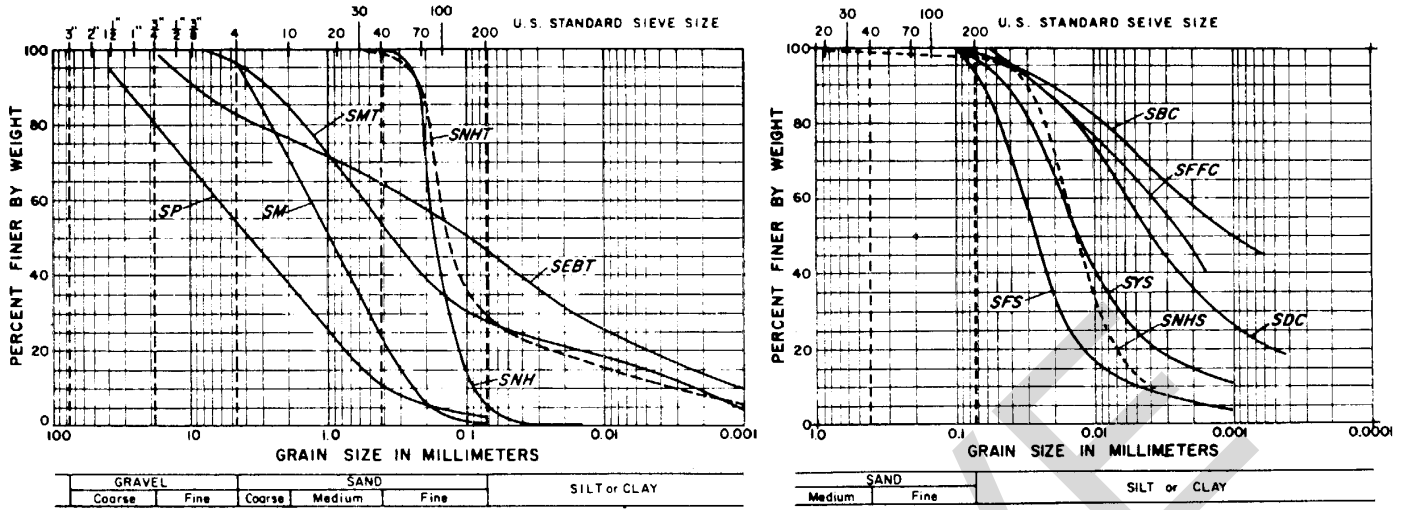

U. S. Army Corps of Engineers

Figure 2-11a. Summary of Soil Characteristics<sup>34</sup> (Gradations)

SOIL SYMBOL	NAME	SOURCE	DEPARTMENT OF THE ARMY UNIFIED SOIL CLASSIFICATION				ATTENDING LIMITS			COMPACTION CHARACTERISTICS		TYPICAL PROPERTIES OF SPECIMENS BEFORE FREEZING (4)					MAX. UNCONFINED COMPRESSIVE STRENGTH	DIRECTIONAL ANGLES OF INTERNAL FRICTION - φ
			DESCRIPTION	GROUP SYMBOL	LIQUID LIMIT	PLASTICITY INDEX	SHRINKAGE LIMIT	SPECIFIC GRAVITY	MAX. DRY UNIT WT.	OPTIMUM MOISTURE CONSTANT	SIZE		DWT. UNIT WT.	FLUID RATIO	COEFF. OF PERMEABILITY			
											NO. 10	NO. 20				pcf		
SP	Peabody Gravelly Sand	Peabody, Mass.	Bank run gravelly SAND	SP		non-plastic	-	2.72	134 (1)	-	6.00	12	175	0.356	120.0	-	-	
SM	McManara Concrete Sand	Needham, Mass.	SAND, brown, angular, processed for concrete.	SP		non-plastic	-	2.72	123 (1)	-	2.75	6	117	0.456	84.0	-	39	
SMH	Manchester Fine Sand	Manchester, N. H.	Uniform, fine SAND, light brown, clean.	SP		non-plastic	-	2.68	106 (1)	-	2.75	6	101	0.658	59.0	-	25	
SMF	Blend, McManara Concrete Sand and East Boston Till	SM blended with 35% minus 40 mesh S&F	Silty SAND	SM		non-plastic	-	2.72	142 (2)	6.8	2.75	6	135	0.262	0.002	-	38	
SMFT	Blend, Manchester Fine Sand and East Boston Till	SMH blended with 35% minus 40 mesh S&F	Silty SAND	SM		non-plastic	-	2.72	128 (2)	9.2	2.75	6	121	0.398	0.106	-	32	
SMFT	East Boston Till (-3/4")	East Boston, Mass.	Clayey, gravelly SAND (glacial till)	SC	21	7	-	2.76	137 (2)	8.1	2.75	6	130	0.327	0.006	-	28	
SMMS	New Hampshire Silt (S)	Manchester, N. H.	Light gray brown, inorganic clayey SILT	CI-ML	26	5	-	2.70	107 (2)	15.6	2.75	6	102	0.653	0.032	-	30	
MFS	Fairbanks Silt	Fairbanks, Alaska	Brown and gray SILT, contains traces of mica and some organic matter.	ML-OL	28	4	-	2.68	112 (2)	15.7	2.75	6	105	0.590	0.168	-	32	
STB	Tukon Silt	Whitehorse, Yukon Territory, Canada	Gray, well graded, inorganic clayey SILT	CI-ML	28	9	-	2.73	121 (3)	12.8	2.75	6	115	0.479	0.007	-	38	
SOC	Low Field Clay	Low Air Force Base Bangor, Me.	Very stiff, lean CLAY, some fractures, brown organic stain and trace of fine roots.	CL	34	17	20	2.79	-	-	2.75	6	100	0.738	0.004	38.1	-	
SBC	Boston Blue Clay	No. Cambridge, Mass.	Stiff lean CLAY, relatively homogeneous and free of fractures and warps.	CL	47	27	22	2.81	-	-	2.75	6	85	1.057	0.002	21.9	-	
SFPC	Fargo Clay	Fargo, North Dakota	Dark gray, friable, highly plastic homogeneous fat CLAY, with honey-comb structure (organic content 8%)	CH-OH	68	46	15	2.76	-	-	2.75	6	87	0.980	0.035	9.2	-	
SAP	Alaskan Peat	Fairbanks, Alaska	Dark brown to black PeAT; fibrous, partially decomposed (organic content 82 percent)	Pt		Tests inapplicable		1.52	-	-	2.75	6	-	-	-	-	-	

NOTES: (1) Provenience Vibrated Density (2) Modified AASHTO Density (3) Standard Proctor Density (4) All specimens de-aired and saturated at 60°F prior to freezing. In saturation procedure, vacuum applied at top with water supplied at bottom for minimum of 12 hrs for non-frost-susceptible soils and 24 hrs for frost-susceptible soils.

U. S. Army Corps of Engineers

U. S. Army Corps of Engineers

Figure 2-11b. Summary of Soil Characteristics (Void Ratio vs Coefficient of Permeability)



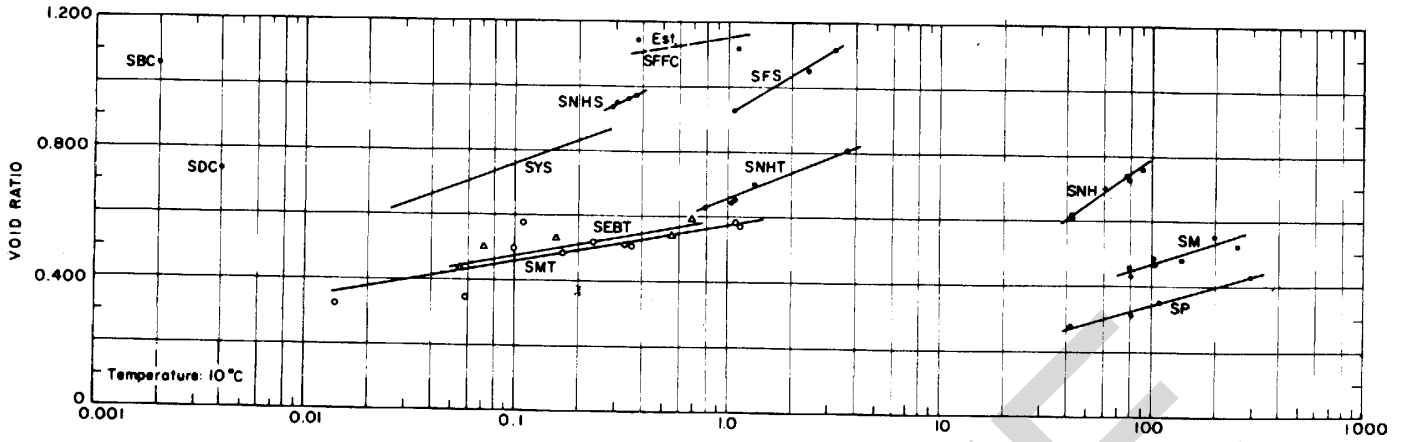

U. S. Army Corps of Engineers

Figure 2-11c. Summary of Soil Characteristics. (Soils Test Data)

SM.....	McNamere Concrete Sd	SFS.....	Fairbanks Silt
SNH.....	Manchester Fine Sand	SYS.....	Yukon Silt
SMT.....	Blend, SM and SEBT	SBC.....	Boston Blue Clay
SNHT.....	Blend, SNH and SEBT	SFFC.....	Fargo Cloy
SEBT.....	East Boston Till	SAP.....	Alaskan Peat
SNHS.....	New Hampshire Silt	SI.....	Artificially-Frozen Ice

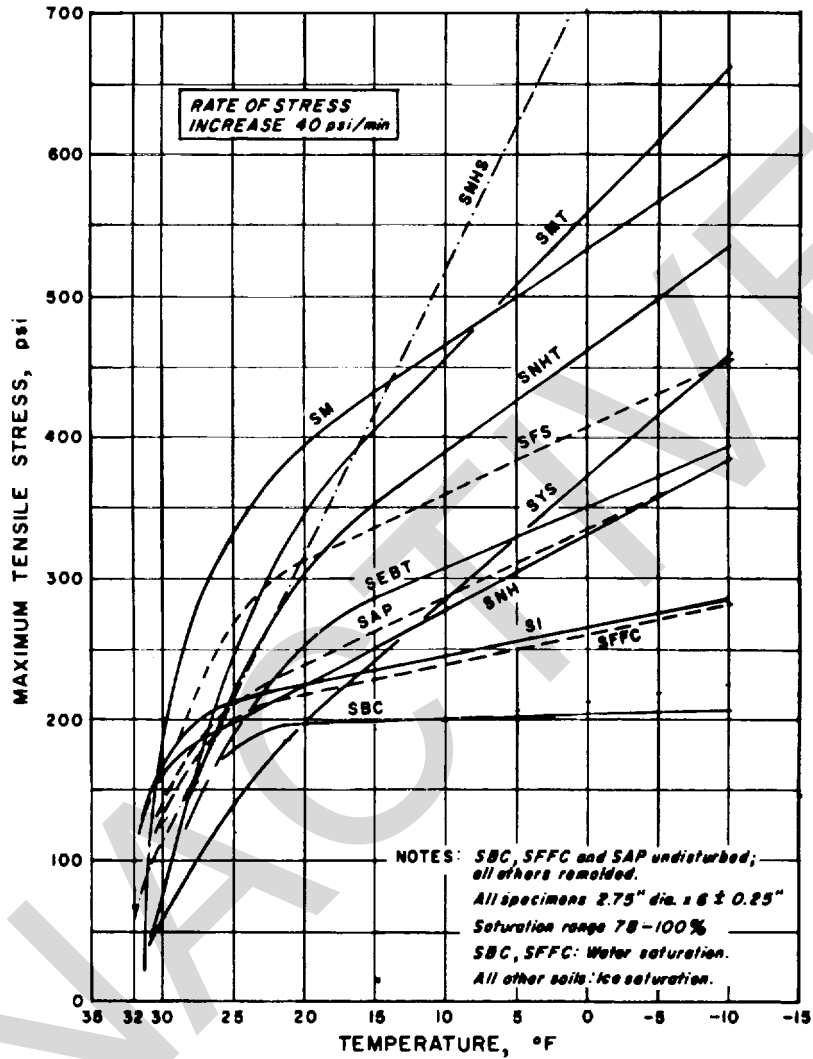

U. S. Army Corps of Engineers

Figure 2-12. Summary of maximum stress in tension vs temperature. See figure 2-11 for soil characteristics<sup>34</sup>.

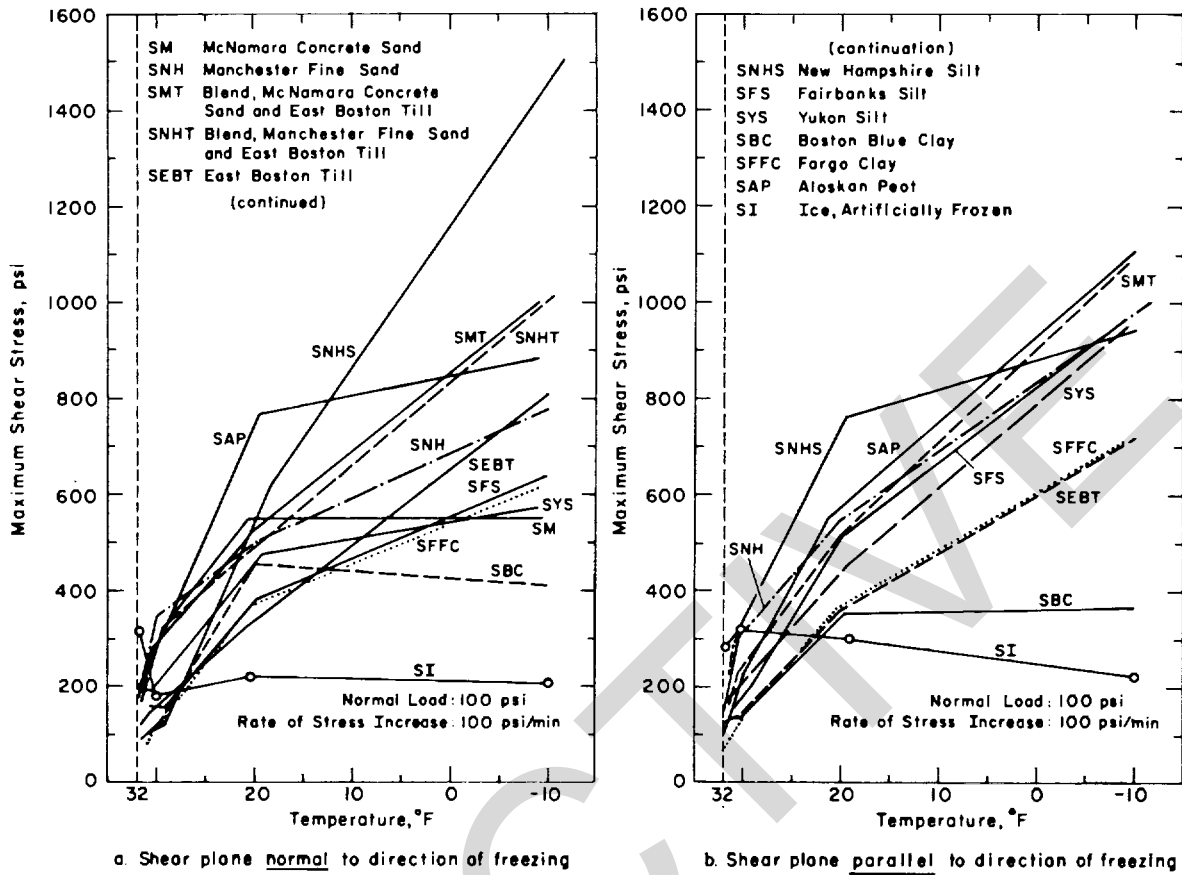
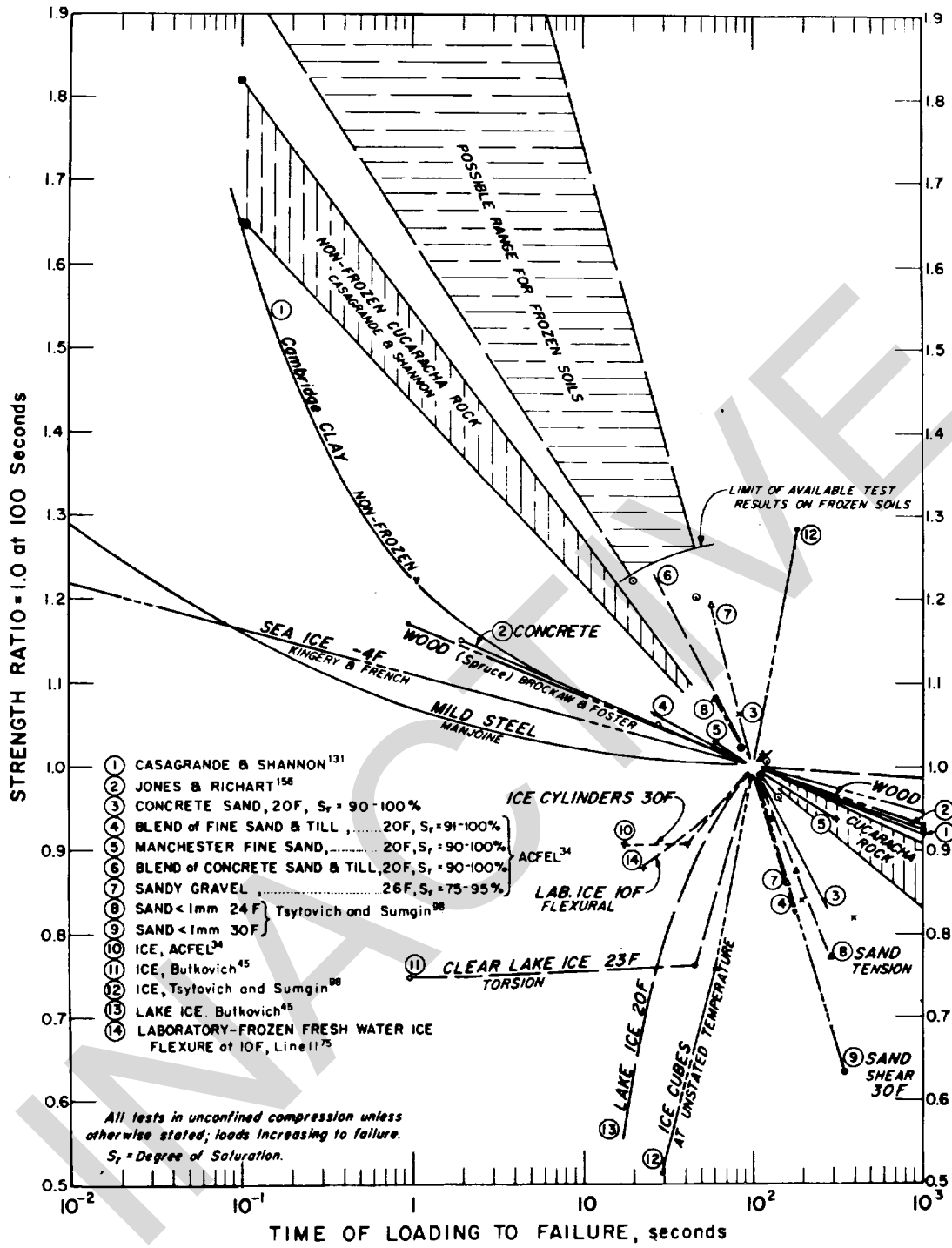
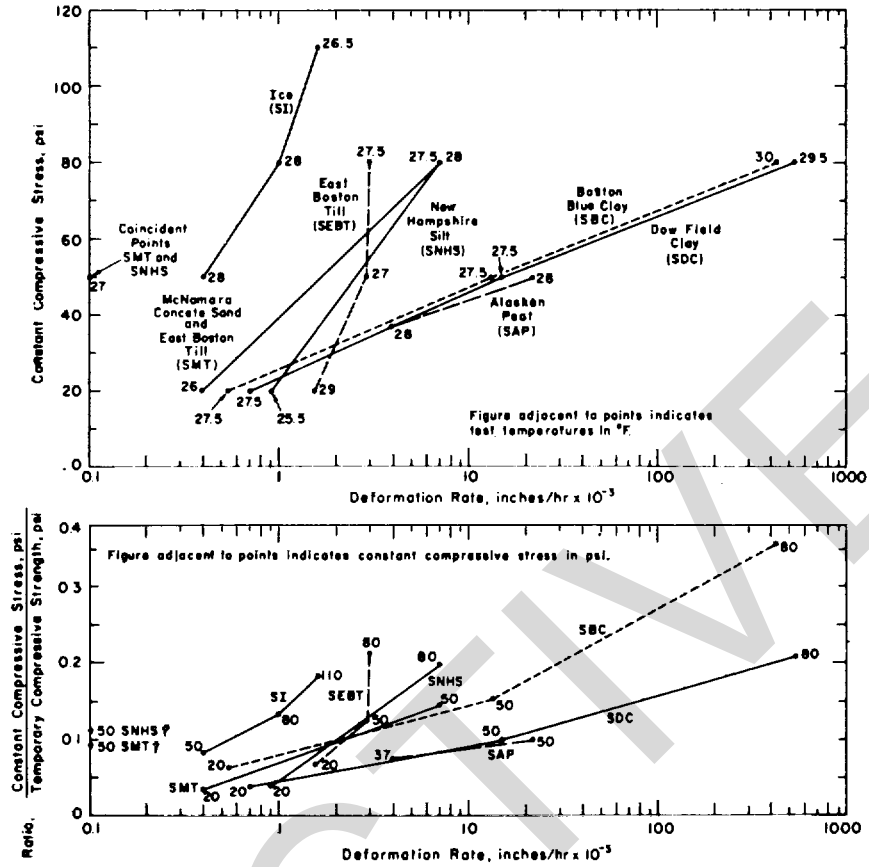

Figure 2-13. Summary of maximum shear stress of frozen soil vs temperature. See figure 2-11 for soil characteristics<sup>34</sup>.



U. S. Army Corps of Engineers

Figure 2-14. Effect of rate of stress application on failure strength<sup>69</sup>.



U. S. Army Corps of Engineers

Figure 2-15. Plastic deformation of frozen soils under constant compressive stress. See figure 2-11 for soil characteristics<sup>33</sup>.

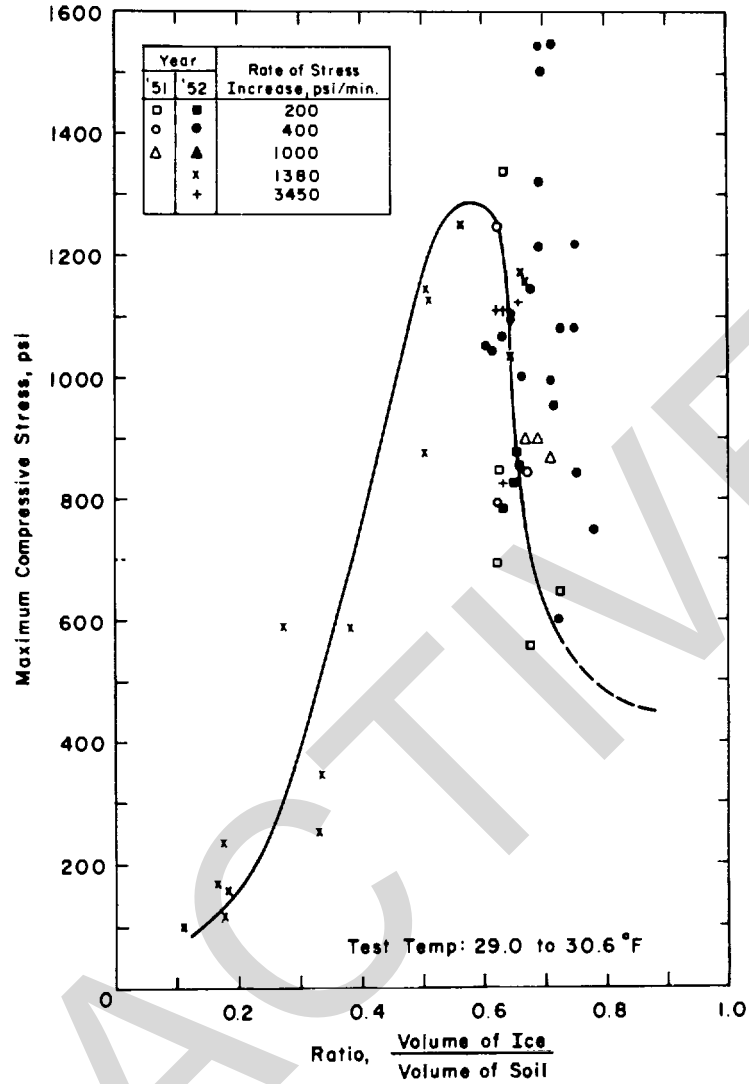

U. S. Army Corps of Engineers

Figure 2-16. Compressive strength vs ice content, Manchester fine sand<sup>34</sup>.

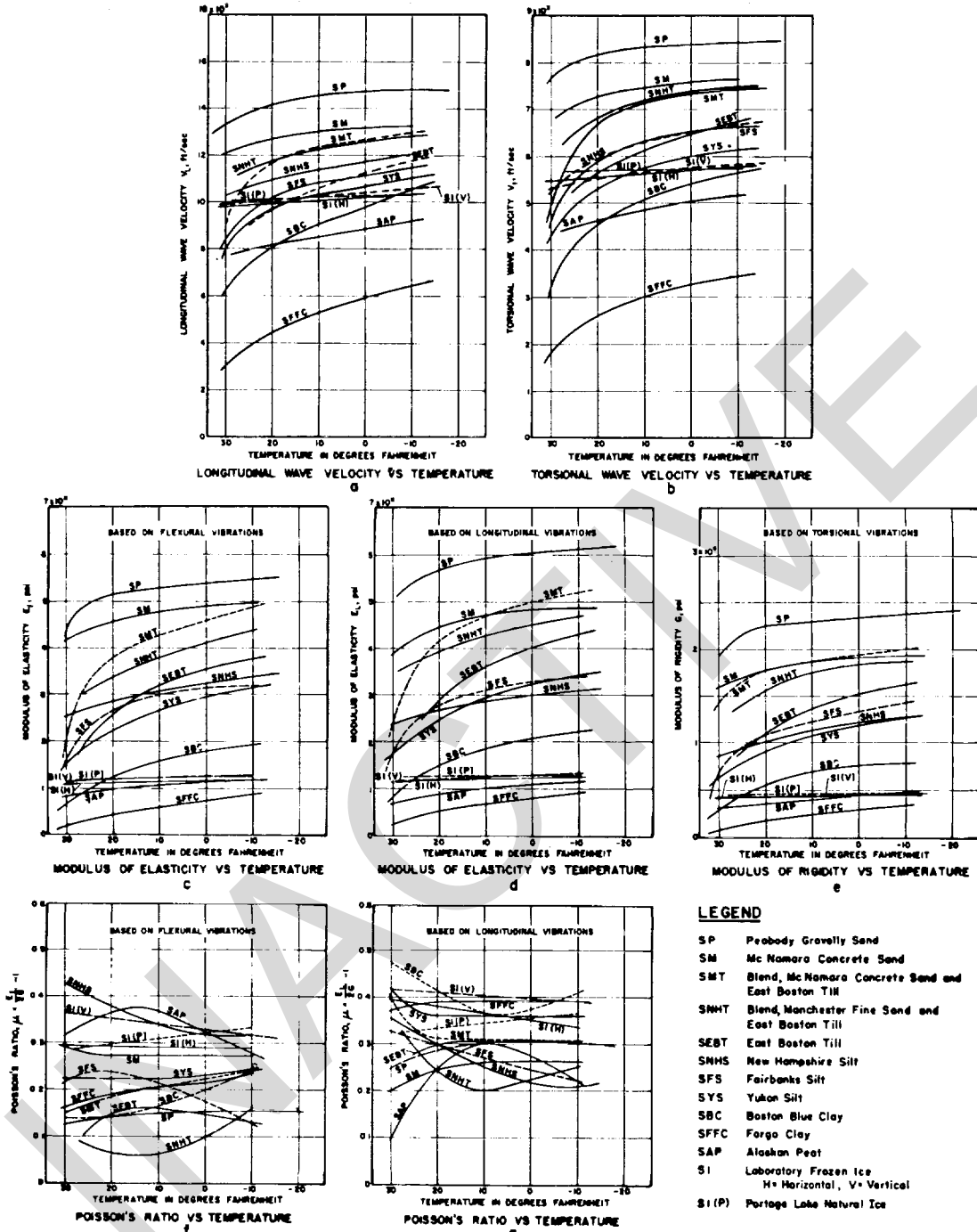

U. S. Army Corps of Engineers

Figure 2-17. Longitudinal and torsional wave velocity, dynamic moduli of elasticity and rigidity, Poisson's ratio vs temperature. Each curve represents test results of two to six specimens. See figure 2-11 for soil characteristics<sup>68</sup>.

property values which are typical for frozen soils under all conditions.

*b. Ground ice.* When ice is found in permafrost in sufficient amounts that significant settlement would occur upon thawing, it may have originated by the conventional ice segregation process with ice lensing primarily parallel to the ground surface as the permafrost was gradually developed in the geologic past; it may have been formed as vertical ice wedges in the horizontal contraction-expansion process which results in the typical patterned ground features so evident in far northern areas; it may be "fossil ice" buried by landslides or other events and preserved as permafrost; or all three of these types may occur together. Often several soil formations of different ages may be superimposed one on another, each containing ground ice. Figure 2-18 shows a typical cross section in silt near Fairbanks, Alaska; note that ice concentrations do not necessarily decrease with depth, contrary to a frequent assumption.

(1) In the annual frost zone, ice is of the common ice segregation type; small amounts of ice may also be found in shrinkage cracks. Ice formations in this zone disappear every summer and are formed anew in the winter. Substantial ice concentrations are frequently found on permafrost at the bottom of the annual thaw zone which thaw only in occasional very warm summers.

(2) Occasionally bodies of permafrost may be encountered (such as near the top of a high, well-drained bluff) which are less than 100 percent saturated; such permafrost may lack some of the detrimental characteristics associated with ground ice. However, if ground ice exists in strata at lower levels in the foundation and thaw may reach the ice during the life of the structure, this must be taken into account in the design.

(3) Ice masses in clean, granular deposits are not uncommon in the Arctic because of the severe environment, but their occurrence is less common in the Subarctic. U.S. Army Engineer District, Alaska, personnel have reported the occurrence of major ice inclusions in gravels at Cape Lisburne, Alaska, and at Gambel on St. Lawrence Island off the coast of Alaska, and others have reported ice wedges and masses in gravels at Barrow and Umiat, Alaska, and Inuvik, N.W.T., Canada. Church, Pewe and Andresen<sup>46</sup>, in their study of patterned ground in the Donnelly Dome area near Ft. Greely, Alaska, found evidence that ice wedges had formed in the outwash gravels of the area during a period colder than at present and subsequently thawed during a period warmer than now exists. Similar evidence has been observed at Clear, Alaska. Thus, the possibility should be considered that, even in the Subarctic, ice wedges formed in clean granular materials in a previous colder climatic period may be found preserved by overlying accumulations of soil which have

protected the ice from thawing, or by other especially favorable local conditions. The possibility of such ice will be greater, the colder the climate of the location.

(4) Open-work gravel containing clear ice tends to give a visual impression that substantial settlement of this material may occur on thaw, but close examinations of random samples of such material near Fairbanks, Alaska, have shown particle-to-particle contacts, and no actual thaw-settlement difficulties with such soils have thus far been reported. On the other hand, personnel of the Alaska District, Corps of Engineers, report that many ice-saturated gravel deposits do not show particle-to-particle contact, and that tests of sands have shown consolidation on thaw. It may be visualized that if permafrost is formed in clean, granular, non-frost-susceptible material by continuous downward advance of the freezing front under conditions permitting escape of any excess water then there may be no separation of the soil particles which would lead to consolidation on thaw. However, if opportunity for escape of excess water is lacking, either in the original freezing or in refreezing from a partially degraded condition, as from a climatic warming interval, then a bulked condition will exist in the zone of water entrapment; this zone may be horizontally discontinuous. Finally, even essentially clean deposits may develop some ice segregation during downward freezing if even thin inclusions of fine material are present, or possibly if the freezing front advances very slowly or is stationary. Thus, no simple generalizations are safe.

(5) In borderline permafrost areas remnants of permafrost containing ground ice may sometimes be found at depths such as 25 to 40 ft, with non-frozen soils both above and below. Such was the experience in deep granular deposits at Clear, Alaska. Extensive exploration is required to locate these remnants when they occur as small, scattered bodies.

(6) If fine-grained soils containing ground ice are excavated, very wet, liquid-soft material unusable for earth fill and incapable of supporting equipment may result on thaw. From coarse, free-draining granular soils and broken rock, however, thaw-water may escape almost as rapidly as thaw occurs. The settlement of foundations from degradation of permafrost and the development of frost heave in the annual frost zone both typically occur differentially between points across the foundation. The thawing of polygon ice wedges such as shown by figures 2-2 and 2-18 may tend to develop cavern-like voids in the foundation which may lead not only to sudden and dangerous collapses but also to development of underground drainageways which may serve to extend thaw. Loess-type frozen soils may be particularly susceptible to subsidence and erosion on thaw. Where foundations include anchorages in permafrost, thaw may lead to anchorage failures.



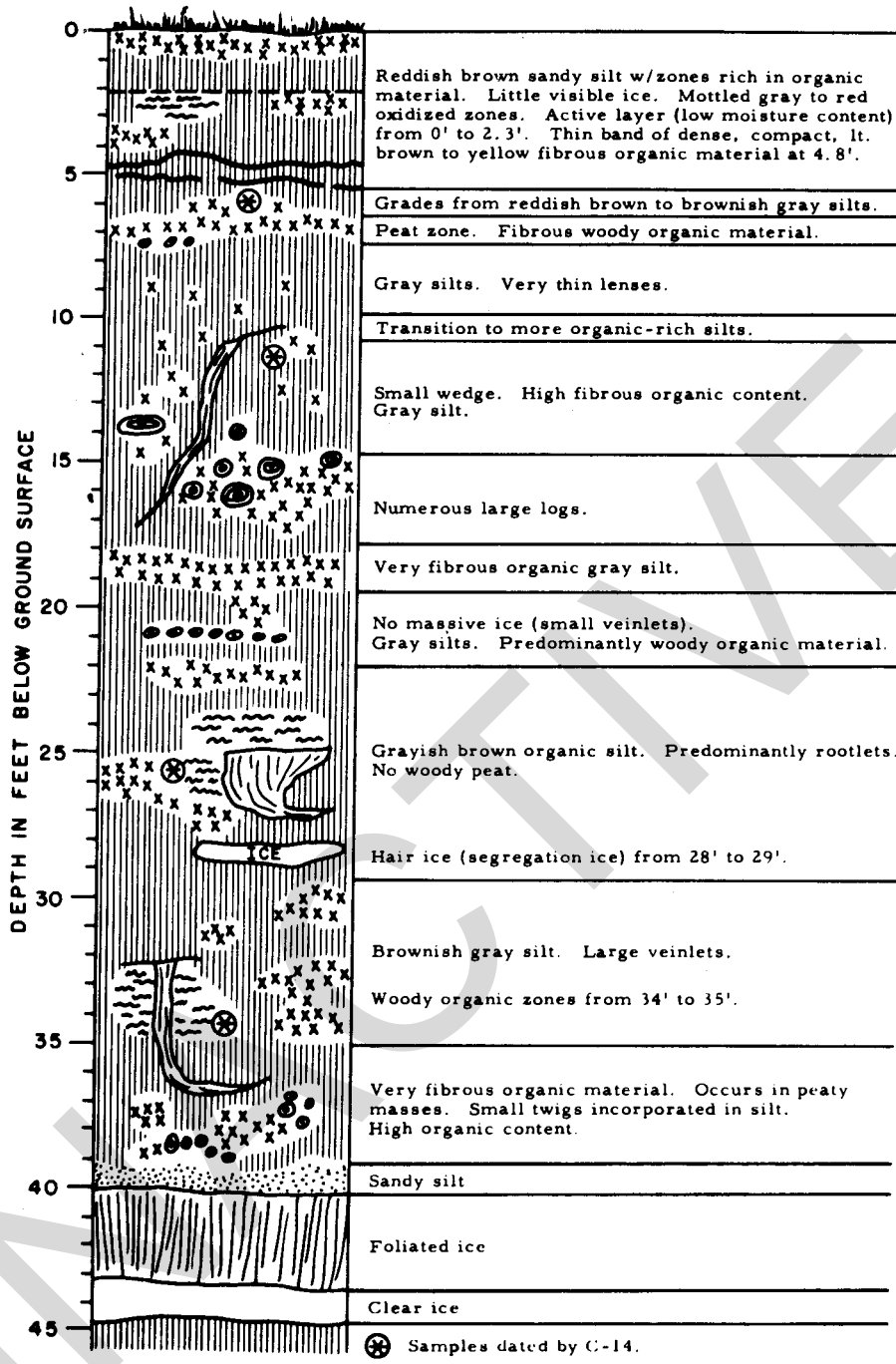

Legend

- xxx Organic zones
- ⊗ Logs, branches, twigs
- ~ Noticeable areas of ice lensing
- ⊗ 7000 Samples of organic material radiocarbon dated and approximate age

U. S. Army Corps of Engineers

Figure 2-18. Typical record of ice in permafrost<sup>89</sup>.

(7) For engineering purposes it is very important to know whether significant settlement will take place upon thawing of the frozen soil. If the ice present will produce more water upon melting than can be retained within the voids of the soil after thaw, then the material is thaw-unstable to a degree that is dependent upon the amount of excess ice and the soil density. If all the melt water can be absorbed by the soil voids without significant settlement, then the soil can be considered thaw stable. Thaw-consolidation computations are outlined in chapter 3.

*c. Rock.* Bedrock should never be assumed free of ice if the melting of such ice is possible and the consequences significant. Numerous cases are on record where this assumption was made and substantial volumes of ice were later found to be present in the bedrock. At Thule, Greenland, this situation resulted in substantial settlement of a building; required repair measures included installation of artificial refrigeration in the foundation on a permanent basis. At the same location the disappearance of water from a drainage ditch cut in shale resulted in discovery of ice layers up to 20 inches thick in the rock which were being melted by the drainage waters<sup>76</sup>. The only safe approach is to carry subsurface explorations into bedrock, obtaining undisturbed frozen cores which will reveal the exact thicknesses of any ice strata present.

(1) Structurally, the frozen water in bedrock fissures adds substantially to the competence of the rock, so long as the ice remains frozen. At Yellowknife, NWT, Canada, it has been stated that in mining of ore by the stoppage process, excavations can safely be made in 300 foot lifts whereas the standard height in unfrozen rock in Canada is 150 feet. Blasting specialists responsible for mining of iron ore at Knob Lake, Quebec, Canada, have stated that three times as much powder is required for blasting of ore rock containing 10 percent ice as for blasting of unfrozen deposits". On the other hand, ore containing this much moisture is very wet when thawed and very substantial problems have been encountered in handling, transporting and using such material.

(2) Bedrock is frequently a source of severe frost heave because of mud seams in the rock or concentrations of fines at or near the rock surface in combination with the ability of fissures in the rock to supply large quantities of water for ice segregation.

## 2-6. Structural materials.

Foundations of structures in areas of deep seasonal frost and permafrost tend to experience larger and less predictable tensile, compressive, and shear stresses than in more temperate regions as a result of thermal expansion and contraction effects, unstable conditions during and after the construction period, and seasonal frost action. The properties and behavior of structural

materials used in the foundations are also affected by the low temperature conditions. Materials susceptible to brittle fracture at low temperatures should not be specified for conditions where they may fail. Consideration must be given to logistics, supply, costs and problems of field fabrication and erection. Shop fabrication may be found more economical than field fabrication in spite of greater logistics problems. Availability of local materials must also be considered. Native materials are often scarce and not very suitable and construction practices may differ because of transportation problems, equipment and labor available and severe weather. The relative cost and availability of all construction materials must be established early in the design; this will influence the selection of the foundation type to be used.

*a. Wood.* Wood is a satisfactory and widely used construction material because of availability, low thermal conductivity, adequate durability, when selectively used and treated if required, flexibility, unimpaired strength at low temperature, low weight and availability. However, in many arctic and subarctic areas it may be as unavailable as any other construction material. Even when timber is obtainable in the Subarctic, available sizes may be limited and quality low.

(1) A principal use of timber in foundations is in piling. Spread footings have been frequently made of wood. Heavy timbers are widely used for distributing structure loads onto piles or other principal supporting members. Timber is also useful as a semi-insulating pad under a concrete footing. Rock fill wood cribs are useful for many purposes. Although timber piles have lower thermal conductivity than concrete or steel piles, this is usually a negligible advantage for the thermal stability of foundations. It may be assumed that no decay will occur in portions of piles embedded in permafrost. Within the annual frost zone, temperatures are low throughout the year and below freezing temperatures prevail for many months; groundwater is often near the surface throughout the year. These factors slow decay below ground, though not guaranteeing against it. At the ground line, however, experience shows that, except in the high Arctic, timber members may be destroyed in only a few years even where the mean annual precipitation is low. While wood piles therefore need preservative treatment above the permafrost table, a coating of creosote on the portion of a pile embedded in permafrost reduces the tangential shear stress which can be developed below that which would apply for bare wood. In theory then, only the upper parts of wood piles should be so treated. However, no method exists for pressure creosoting only part of a pile. Therefore when wood piles require pressure treatment, the entire length must be treated and tangential adfreeze working stresses

must be established at sufficiently low values to reflect the presence of the surface coating of treatment material. Wood piles which are embedded entirely in permafrost (capped at the permafrost table) need not be treated.

(2) One of the most important properties influencing strength of wood, especially at low temperatures, is the moisture content. Table 2-2 presents the relationships of specific gravity and various strength properties of wood at room temperature, based on average results of tests on a large number of species. As illustrated in figure 2-19 compressive strength tests at 44°F show higher values at all moisture contents than tests at 68 °F with a maximum at approximately 82 percent. Tests conducted by Kollman<sup>159</sup> as shown in figures 2-20 and 2-21 indicate nearly straight line increases of compressive strength and toughness ratio with decreasing temperatures over a wide range. These effects are proportional to density. Experiments at the Forest Products Laboratory with Sitka Spruce and Douglas Fir showed an increase in bending strength of about 1½ to 2½ in the cold to room-temperature strength ratio. Figure 2-22a shows the effect of temperature on the modulus of rupture and modulus of elasticity of three species of wood tested in flexure and figure 2-22b shows the effect of temperature and moisture content on the modulus of elasticity of plywood. One of the special characteristics of wood in the frozen state is that failure is often sudden, without the usual audible advance warning of overloading. Such failure occurs violently with a loud report and separation of the parts is complete.

(3) Wood piles cannot be driven into permafrost by hammer; this may dictate the use of steel instead of wood piles. Wood and steel must both be protected from the possibility of fire damage which is a problem of major concern in remote cold areas. (See TM 5-852-9/AFM 88-19, Chap. 9<sup>16</sup>.)

*b. Metals.* The predominant problem encountered with use of metal in cold regions is cold embrittlement fracture. Generally speaking, as temperature is lowered the hardness, yield strength, modulus of elasticity, and endurance limit of most metals and alloys increase. However, many of these same metals become embrittled at reduced temperatures and will shatter or fracture when subjected to stresses (especially due to impact) that would be allowable at normal temperatures. Characteristic of this type of failure is lack of deformation or prior indication of failure.

(1) A relatively small group of pure metals remains ductile at low temperature, including nickel, copper, aluminum, lead and silver. Several other metals such as magnesium, zinc and beryllium are brittle, with little ductility even at room or slightly higher temperatures. The behavior of ferrous metals covers a very broad range of possibilities. The brittleness of carbon steels increases with the carbon content (up to

0.25 percent), and higher carbon steels may be expected to be brittle. Although special alloy steel is not likely to find application in foundation work, it may be noted that addition of nickel in the amount of 2-¼/4 percent will ensure satisfactory properties of steel to temperatures of -50°F and additional amounts up to 9 percent will increase the range to -320°F. Almost all aluminum and titanium alloys can be used at low temperatures (except high strength aluminum in which stress concentrations are likely to occur) and essentially all nickel and copper base alloys. However, because the properties of zinc and its alloys are adversely affected by low temperature, brass, a zinc-copper alloy, is unsuitable for low temperature use. Parts made from brass have been known to shatter under normal handling techniques. Galvanizing has shown cracking and spalling when subjected to cold in arctic areas if the coating was too thick.

(2) Cold embrittlement susceptibility of the steels used should be known, and the possible effects of the temperature extremes and types of loads which will be experienced during both construction and subsequent operation should be examined. As evidenced by years of experience with mild steels in structures throughout Alaska, it should not be necessary to use special alloys in structures and foundations when the number of fatigue cycles or dynamic stress level is low. However, the possibility of brittle fracture in either structural components or construction equipment under other conditions including the construction phase must always be kept in mind. For example, components of excavating equipment often fail when operated at extremely low temperatures unless they are kept heated or are made of special, higher cost steels.

(3) Steel piles can be driven successfully into permafrost composed of fine-grained soil (sand, silt or clay) at soil temperatures down to about 25 F. Steel pipe piles, 6 inches in diameter (schedule 80), were driven with a diesel pile hammer to a depth of 21 feet into the silt-ice soil at the Kotzebue Air Force Station in the late winter with soil temperatures approximately as indicated in figure 1-3 for 11 February 1960. Compressed air, diesel and vibratory hammers have been used successfully,<sup>47,48,49,134</sup>. Examination of steel pipe and H-piles installed for periods of 8-11 years at the U.S. Army CRREL field station at Fairbanks, Alaska, showed that the length of pile embedded in permafrost was unaffected by corrosion and only insignificant effects were observed in the annual thaw zone<sup>183,184</sup>. Protective coating of steel in the annual frost zone, therefore, is optional; it may be needed only under special local conditions. Paint or similar protective coatings reduce the potential tangential shear which can be developed between frozen soil and pile surfaces and care must be taken that such materials are not applied below the level

Table 2-2. Specific Gravity and Strength of Wood<sup>43</sup>

Specific gravity of typical species at 12% moisture content are:

Ponderosa pine	0.40	Western hemlock	0.48
Loblolly pine	0.51	Eastern hemlock	0.41
Sitka spruce	0.40	Lodgepole pine	0.41
Douglas-fir, coast type	0.48	Engelmann spruce	0.34
White fir	0.37	Alaska cedar	0.44

(Forest Products Laboratory,  
U.S. Department of Agriculture)  
Specific Gravity-Strength Relation

	<u>Green wood</u>	<u>Air-dry wood (12% moisture content)</u>
Static bending:		
Fiber stress at proportional limit, psi	10,200G <sup>1.25</sup>	16,700G <sup>1.25</sup>
Modulus of rupture, psi	17,600G <sup>1.25</sup>	25,700G <sup>1.25</sup>
Work to maximum load, in. lb/in. <sup>3</sup>	35.6G <sup>1.75</sup>	32.4G <sup>1.75</sup>
Total work, in. lb/in. <sup>3</sup>	103G <sup>2</sup>	72.7G <sup>2</sup>
Modulus of elasticity, 1000 psi	2,360G	2,800G
Impact bending, height of drop causing complete failure, in.		
	114G <sup>1.75</sup>	94.6G <sup>1.75</sup>
Compression parallel to grain:		
Fiber stress at proportional limit, psi	5,250G	8,750G
Maximum crushing strength, psi	6,730G	12,200G
Modulus of elasticity, 1000 psi	2,910G	3,380G
Compression perpendicular to grain, fiber stress at proportional limit, psi		
	3,000G <sup>2.25</sup>	4,630G <sup>2.25</sup>
Hardness:		
End, lb	3,740G <sup>2.25</sup>	4,800G <sup>2.25</sup>
Side, lb	3,420G <sup>2.25</sup>	3,770G <sup>2.25</sup>

\*The properties and values should be read as equations: for example, modulus of rupture for green wood = 17,600G<sup>1.25</sup> where G represents the specific gravity of oven-dry wood, based on the volume at the moisture condition indicated.

(Courtesy of Forest Products Laboratory USDA)

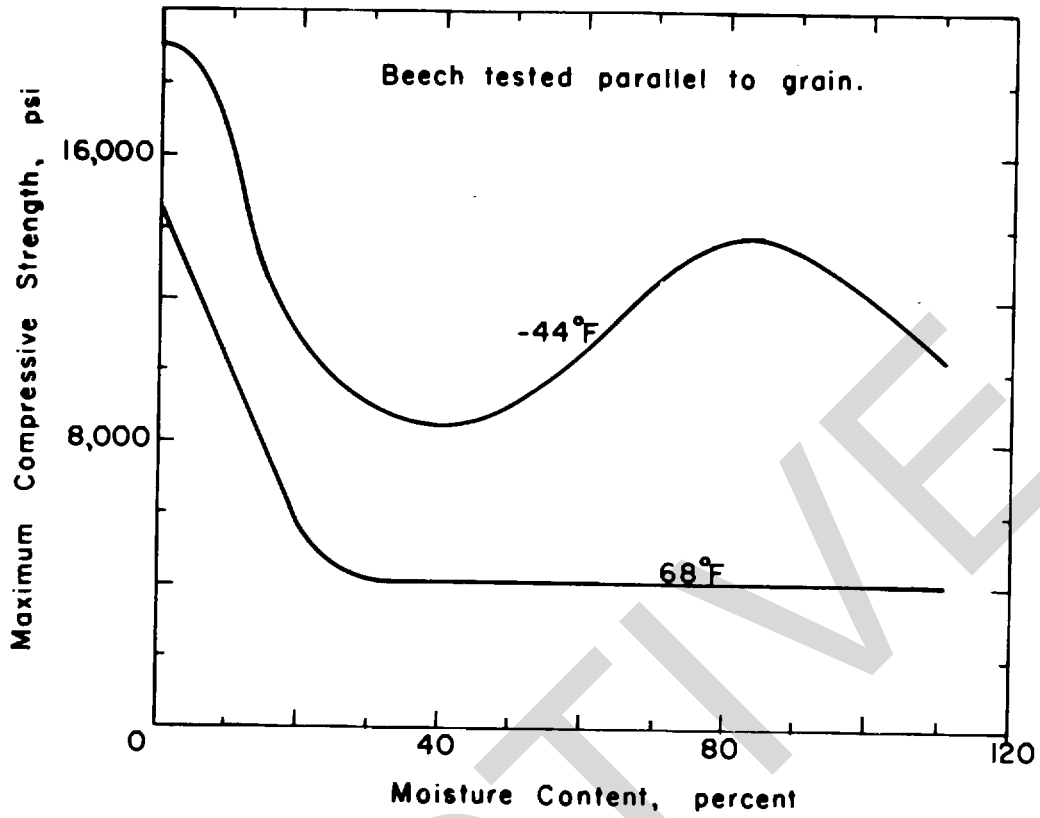

Figure 2-19. Influence of moisture and temperature on strength of wood. (Adapted from Kollman<sup>159</sup> by Boiler<sup>127</sup>.)

(Courtesy of Advisory Board on Quartermaster Research and Development, NAS-NRC)

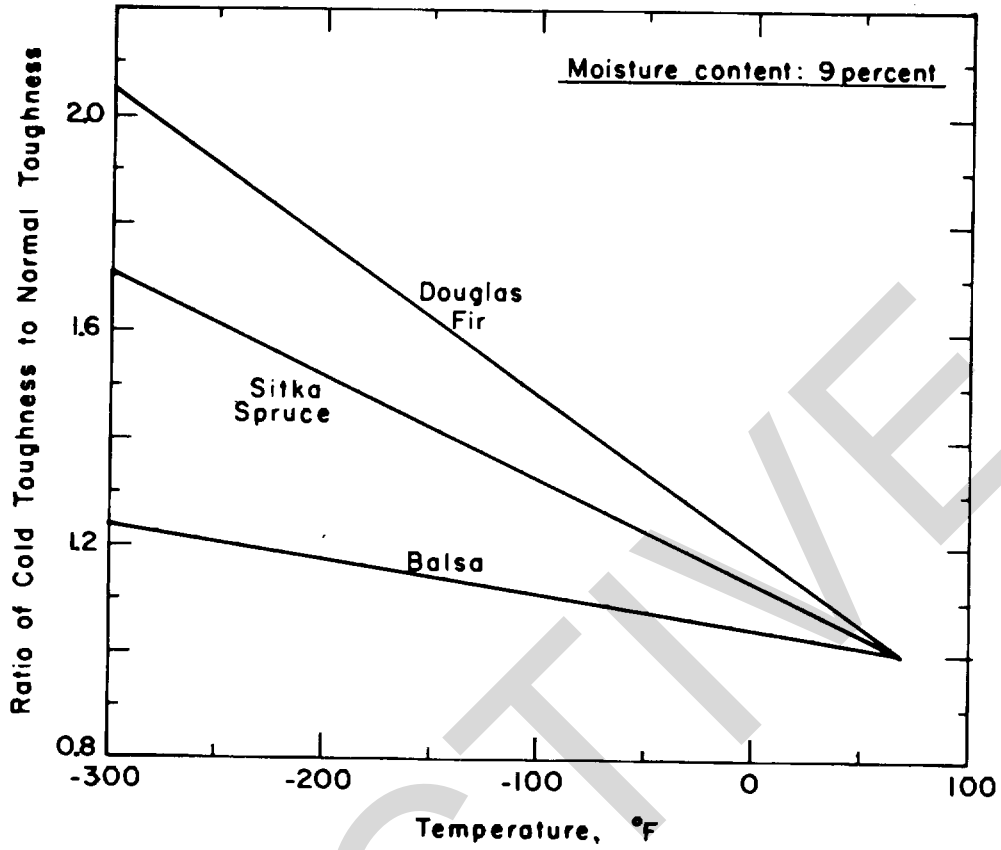

Figure 2-20. Effect of temperature on strength of wood. (Adapted from Kollman<sup>159</sup> by Boiler<sup>127</sup>.)

(Courtesy of Advisory Board on Quartermaster Research and Development, NAS -NRC)

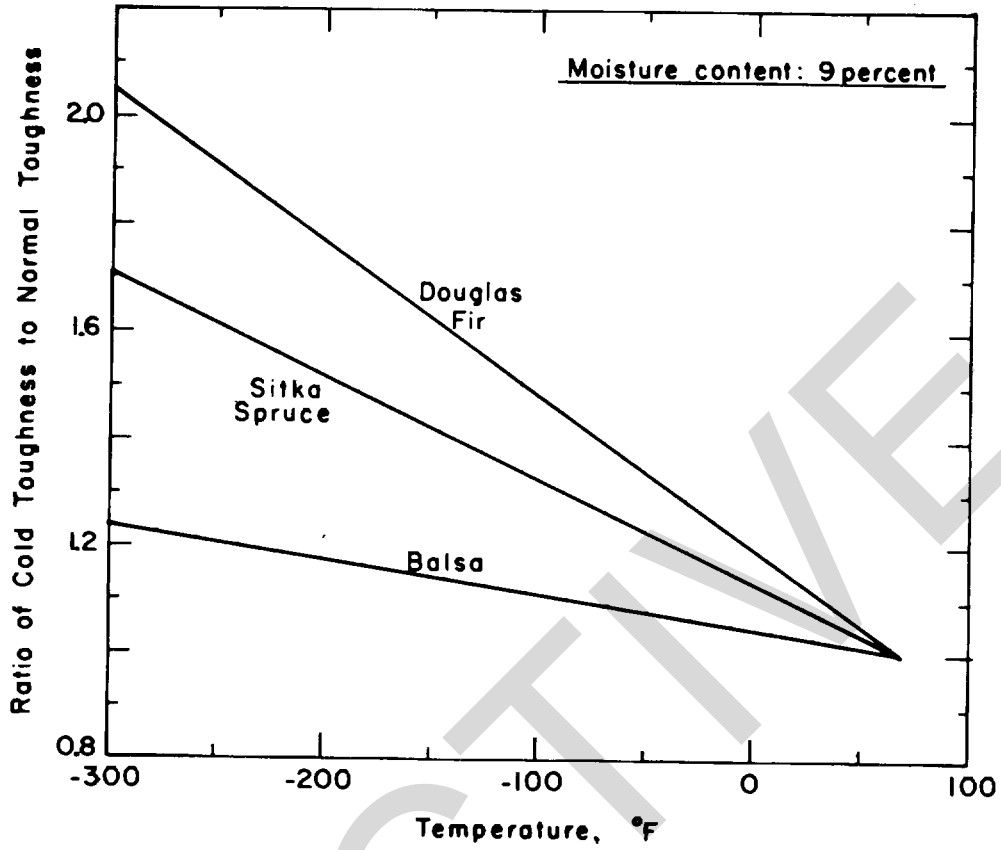

Figure 2-21. Toughness shown in flexure test<sup>127</sup>. 'est

(Courtesy of Advisory Board on Quartermaster Research and Development, NAS-NRC)

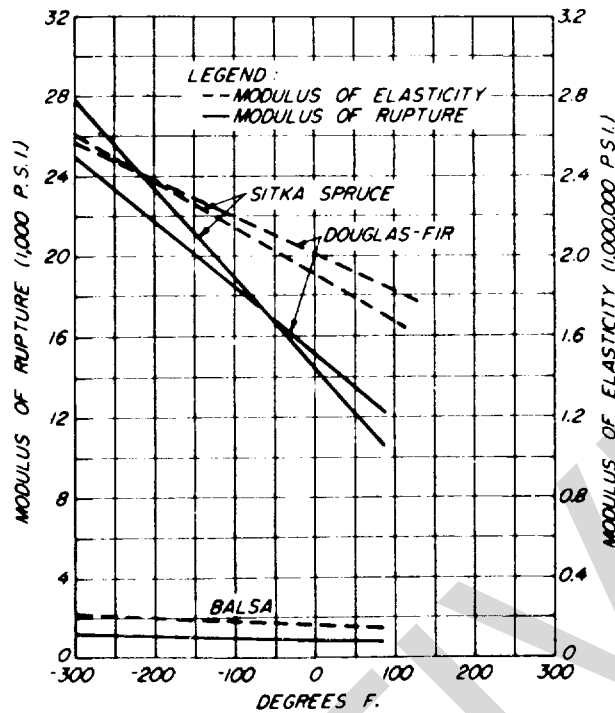

Figure 2-22a. Effect on Flexure Properties and of Temperature and Moisture Content on Modulus of Elasticity of Wood (Effect of Temperature on Flexure Properties, Moisture Content = 9 percent for Three Species of Wood)

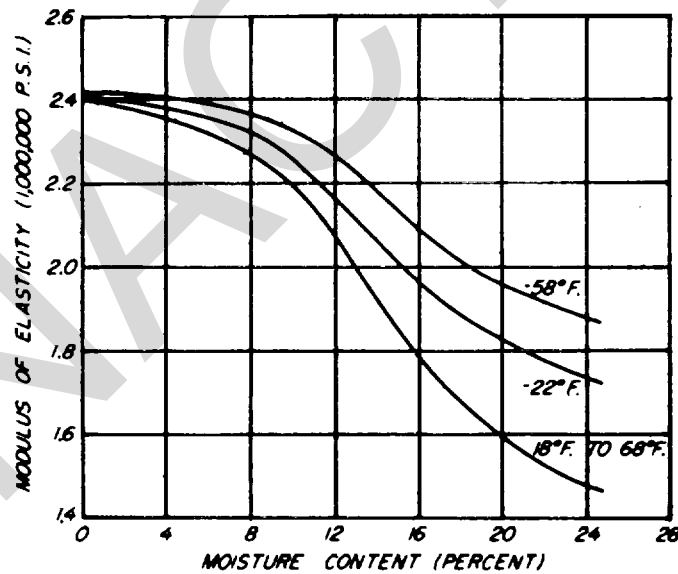

Figure 2-22b. Effect of Temperature on Flexure Properties and of Temperature and Moisture Content on Modulus of Elasticity of Wood (Effect of Temperature and Moisture Content on Modulus of Elasticity of Plywood Specimens - from Bending Tests. (Adapted from Kollman<sup>159</sup> by Boller<sup>127</sup>.)

(Courtesy of Advisory Board on Quartermaster Research and Development, NAS-NRC)



of the permafrost table which will exist after construction<sup>23</sup>. Protective coatings which are brittle or which have linear shrinkage coefficients widely different from steel should be avoided.

c. *Concrete and masonry.* Portland cement concrete is an extremely useful material in the cold regions. Gravel and sand deposits and/or rock exposures are usually readily available (though this is not necessarily so). With proper processing of these deposits and with suitable water available, only the cement and air entraining component has to be imported. Good concrete is durable and presents no fire hazard. Because concrete needs to be warm during mixing, placement and curing and because it generates heat internally for a considerable time, difficulties arise when concrete is to be placed on or near Permafrost (See TM 5-852-6<sup>14</sup> for computations on heat of hydration and its effects.)

(1) Concrete which is exposed to freezing at very early periods may be damaged sufficiently to seriously lower the strength and durability which otherwise will be attainable. It is necessary, therefore, in all cases to carefully protect concrete against freezing for the first 48 hours and for such additional time as may be needed to meet minimum strength and curing criteria (para 6-4). Beyond this critical point, concrete hardens very slowly at low temperatures, and below freezing there is almost no increase in strength or hardness. Concrete which has been kept at a low temperature for a period may resume hydration and strength gain at an increased rate when favorable conditions are provided. If subjected to large drops in temperature at early periods cracking may occur, particularly if some degree of restraint exists against shrinkage. However, concrete also shrinks and cracks if cured quickly by too much heat. Some research has been done to develop concretes which will set and gain strength at below freezing temperatures". However, these depend on use of salt admixtures. They have not yet been tried in actual construction and the possible effects of the salts on long range strength and durability are unknown. They should be used with caution in reinforced or pre-stressed concrete because of corrosion hazard and never in the presence of zinc or aluminum.

(2) Freezing and thawing cycles in completely cured good quality air-entrained concrete are not generally harmful but if the concrete is below standard or if especially adverse factors exist at the time of the freezing thaw cycles the effects may be serious. Concrete which will be exposed to frost action should have durable aggregates, 4 to 7 percent entrained air depending on aggregate gradation, proper consistency for good placement without segregation, adequate curing, and best possible drainage afterwards. Concrete which is saturated prior to freezing tends to be more susceptible to freeze-thaw damage. For large or critical exposed structures, investigation and testing of available aggregates including freeze-thaw testing, petrographic

analysis, and detailed mix-design studies are justified. Frost action is less detrimental in areas which are so cold that materials remain frozen throughout the winter than in warmer areas where frequent freeze-thaw cycles occur during the winter months.

(3) Tests performed by Monfore and Lentz<sup>173</sup> to determine the suitability of concrete for use in underground storage structures for liquefied natural gas ascertained the characteristics of concrete in very cold temperatures down to -250 °F (-157 °C). Sand and gravel mixes with three different cement contents and one using expanded shale for aggregate were used. All samples employed air entrainment in amounts varying from 5.3 to 7.8 percent. Test temperatures ranged from + 75 to -250 °F ( + 24 to -157 °C). Proceeding down through the temperature range, Young's modulus increased approximately 50 percent for the saturated samples, increased only 8 percent for those stored at 50 percent relative humidity, and remained the same for the oven-dried. Poisson's ration remained essentially unchanged throughout the temperature range at approximately 0.22. Over the 325 °F (181 °C) range, the contraction of the samples was in the neighborhood of  $1.4 \times 10^{-3}$  in./in. Compression tests showed an increase in strength with an increase in the cement factor. Strength curves for various cement contents exhibited similar trends with temperature (fig. 2-23a). The compressive strength of the samples with 5.5 bags/yd' cement content showed little change from + 75 to + 40 °F (+24 to + 4 °C) at about 5000 psi. At +40°F (+4°C) an upward trend started, reaching a maximum of approximately 18,000 psi at -150°F (-101 °C). This overall increase in strength is due to moisture within the samples (fig. 2-23b). Tests on oven-dry samples showed an increase in strength of 20 percent from +75 to -150°F (-101 °C), 50 percent moist samples gained only slightly more, while 100 percent moist samples increased by 240 percent.

(4) Precast and prestressed reinforced concrete may be used for foundations as well as structures in arctic regions but special care must be taken where frost heave, settlement or freeze-thaw under moist conditions may occur. Heave may, for example, produce tensile stresses and cracking in reinforced concrete bearing piles. While precast reinforced concrete sectional buildings have been used successfully, exposed joints in such construction may be very carefully sealed and drainage must be provided where joints can be damaged by freezing of accumulated water within the joints.

(5) Unless favorable foundation conditions exist or can be provided, concrete block or brick masonry construction should be avoided because of its poor ability to tolerate differential movements. When masonry is used for interior work, environmental protection must be

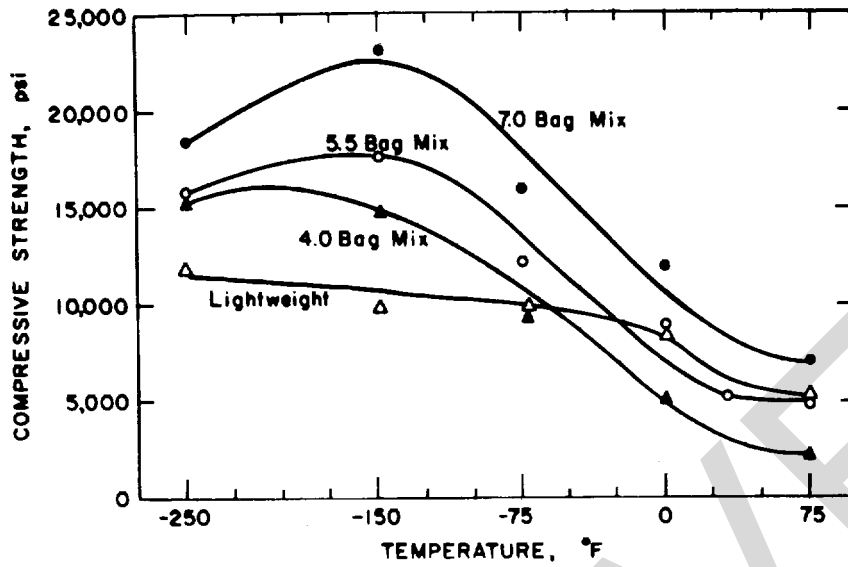

(Courtesy of Portland Cement Association)

Figure 2-23a. Effect of Concrete Mix and Moisture Conditions on Strength of Concrete at Low Temperatures<sup>173</sup>. (Effect of Concrete Mix (Moist Concrete).)

(Courtesy of Portland Cement Association)

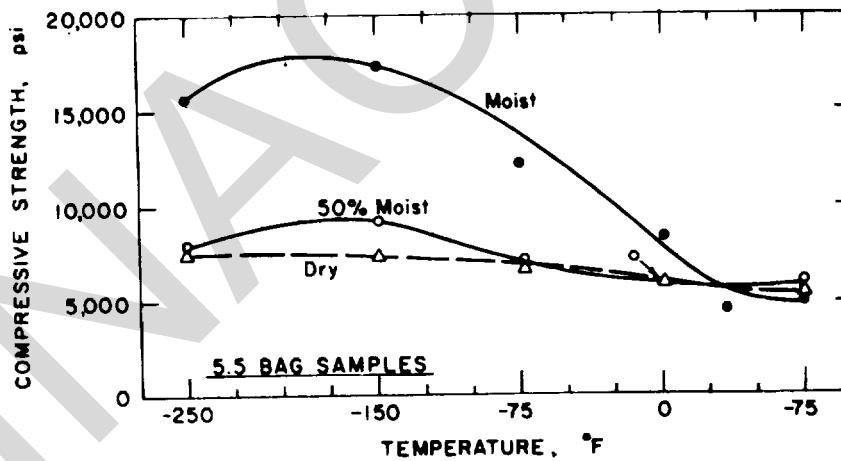
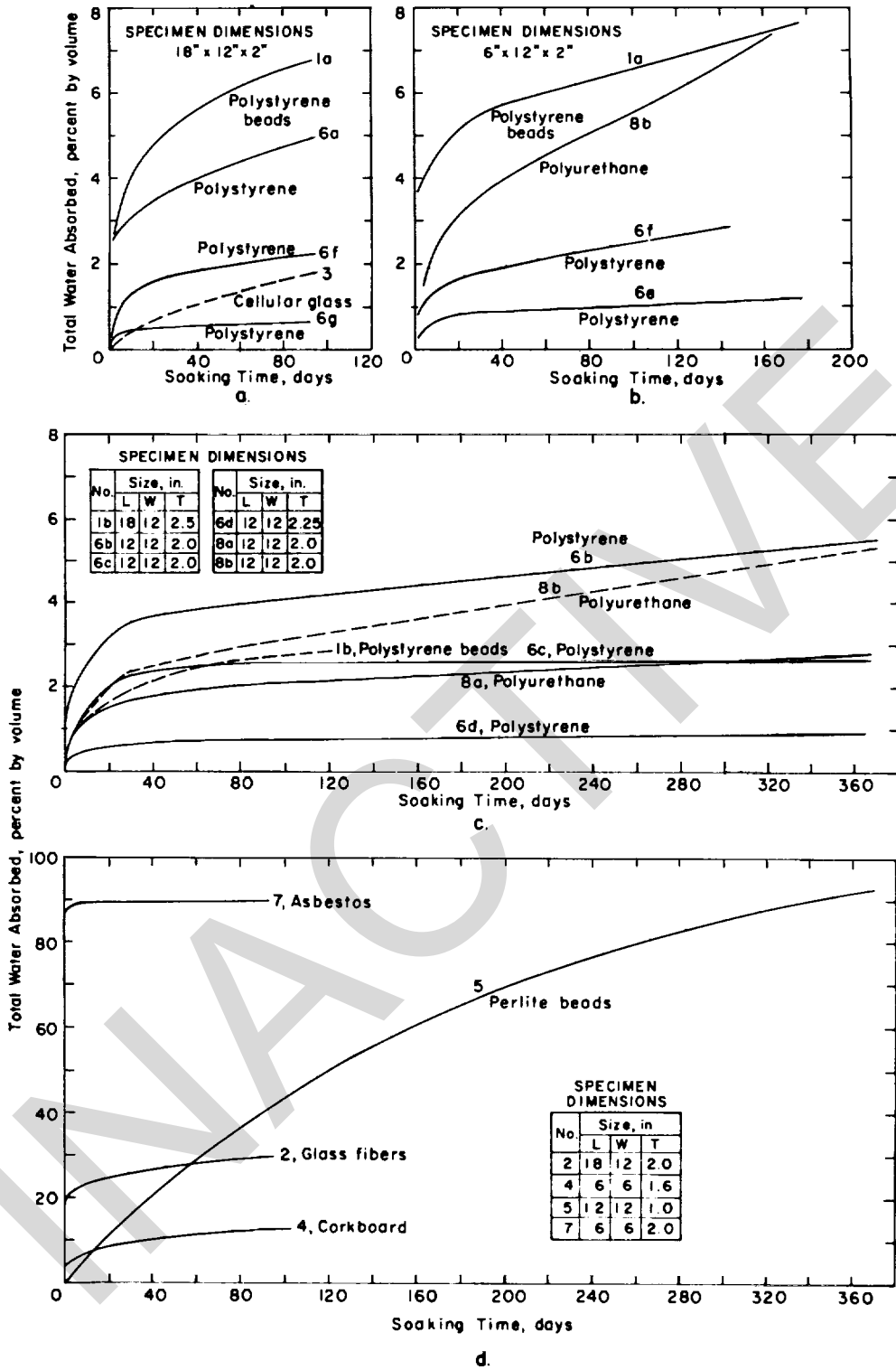

Figure 2-23b. Effect of Concrete Mix and Moisture Conditions on Strength of Concrete at Low Temperatures<sup>173</sup>. (Effect of Moisture Conditions.)

provided during the construction period. For exterior applications, the additional possibility of freeze-thaw damage during the life of the structure must be anticipated. Bricks which will be in contact with frozen soil should be of SW (ASTM) grade or equivalent. The mortar must be durable and moisture resistant.

*d. Thermal insulating materials.* Thermal conductivity values of construction materials are usually given for the dry condition. However, many of these materials lose much of their insulation value if they become wet. Many insulating materials will absorb significant amounts of water (fig. 2-24 and 2-25)<sup>70,71,139</sup> and care should be exercised to select insulation material for underground use which will absorb minimum moisture and to allow in the design for the degree of insulation impairment from moisture which is expected over the life of the facility. Cellular insulations exhibit extremely varied performance and must be examined closely before acceptance for specific installation usages; details of manufacture may significantly affect moisture absorption rates. Cellular glass has performed fairly well, though not perfectly, in maintaining its low conductivity in wet ground<sup>42,80</sup>. Both laboratory and field experiments show that cellular glass experiences slow but progressive deterioration under wet freeze-thaw conditions. Table 2-3 shows field test data. Figure 2-25d illustrates the effect of freeze-thaw on moisture absorption by various board-type insulations, but since exposure to freeze-thaw in presence of water causes some cell damage in cellular insulations, thermal conductivity tests, after freeze-thaw cycles, are

considered a better determination of performance than total amount of moisture absorption after freeze-thaw, especially in those which absorb a great deal of moisture. Vermiculite concrete or other forms of lightweight concrete which will gradually absorb substantial amounts of moisture when placed underground are unsuitable as insulating material in below-surface construction. To prolong effectiveness of insulation underground, it should be placed in positions offering minimum exposure to moisture and to moist freeze-thaw conditions. Thus, from the point of view of maintaining insulation effectiveness, incorporating insulation within a concrete foundation slab is preferable to placing the insulation in the ground below the slab. In usages where complete moisture protection can be readily provided, such as under the floor of a structure, any commercial insulation or insulating composition suitable for general building usage may be employed provided it meets other applicable requirements such as bearing capacity or compression criteria. Thermal properties of a number of materials are given in TM 5-852-6/AFM 88-19, Chapter 6<sup>14</sup>. Insulation only slows down rate of heat conduction; it cannot prevent heat flow. When thick gravel pads contain some moisture, they provide nonfrost-susceptible thermal buffers or heat sinks in which freezing and thawing are absorbed with minimum detrimental effects; if freeze and thaw should penetrate somewhat into the soil below such a gravel pad, the gravel layer helps to minimize frost heave and to smooth out any differential heave or settlement which may occur.



U. S. Army Corps of Engineers

Figure 2-24. Moisture absorption of insulation board by soaking in water<sup>93</sup>. See figure 2-25 for index of insulating materials.

No	Board Composition	Approx Density $\rho$ pcf
1a	Fused expanded polystyrene beads	0.9
1b	" " "	1.6
2	Glass fibers, sandwich	9.5
3	Cellular glass	9.2
4	Corkboard	15.0
5	Perlite beads with organic fiber	10.7
6a	Polystyrene, extruded	1.7
6b	" " "	1.9
6c	" " "	2.0
6d	" " "	2.5
6e	" " "	2.5
6f	" " "	3.1
6g	" " "	3.6
7	Asbestos with binder	14.8
8a	Polyurethane	1.9
8b	" " "	2.2

All insulations were plant manufactured

U. S. Army Corps of Engineers

Figure 2-25a. Internal moisture distribution in insulation board under different rest conditions. (Index for insulating materials)

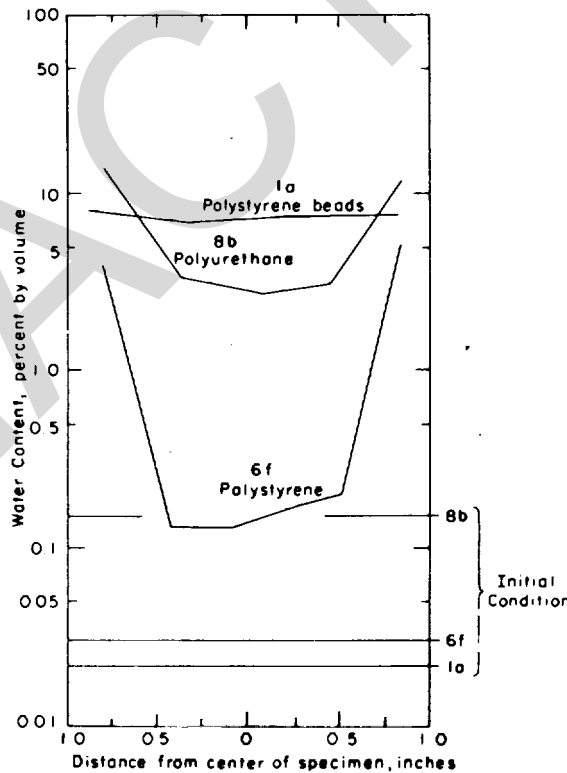

U. S. Army Corps of Engineers

Figure 2-25b. Internal moisture distribution in insulation board under different test conditions. (After 18 months in water)

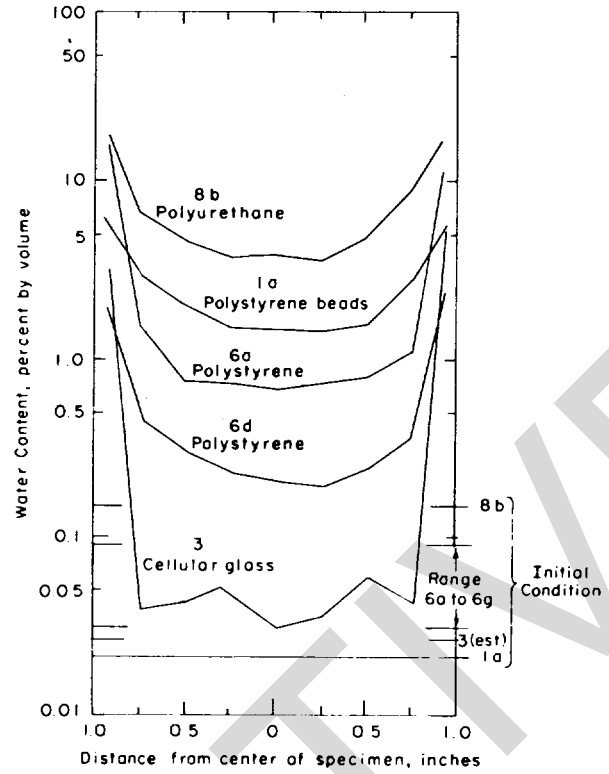

U. S. Army Corps of Engineers

Figure 2-25c. Internal moisture distribution in insulation board under different test conditions. (After 34 months embedment in moist silt)

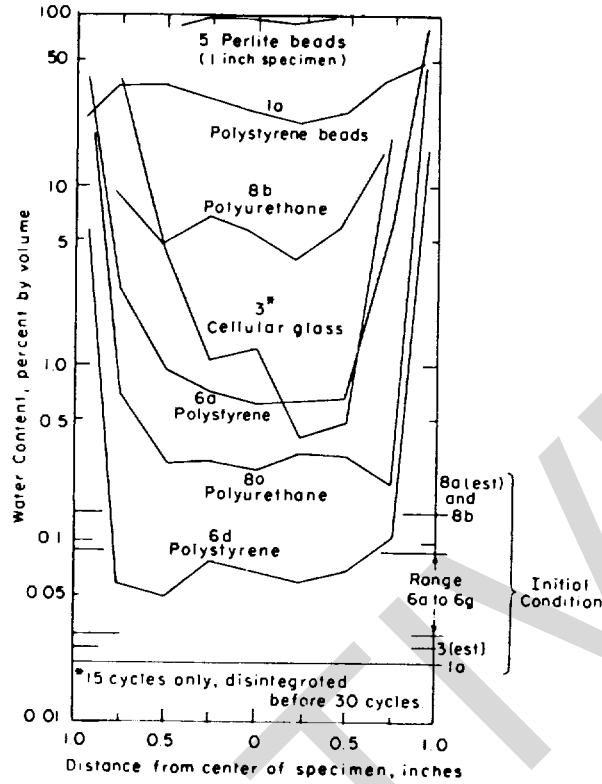

U. S. Army Corps of Engineers

Figure 2-25d. Internal moisture distribution in insulation board under different test conditions. (After 30 freeze-thaw cycles (over approximately a 30-day period) with specimen immersed in water)

Table 2-3. Moisture Distribution in Cellular Glass after 20 Years Burial in the Annual Frost Zone, Fairbanks, Alaska"

Test	0 - 1"	1 - 2"	2 - 3"	3 - 4"	4 - 5"	5 - 6"
<u>Area</u>	<u>%</u>	<u>%</u>	<u>%</u>	<u>%</u>	<u>%</u>	<u>%</u>
RN-5	117.0 85.0	0.7 0.1	1.4 5.8			
RN-6	115.5 76.5	2.1 4.4	2.1 5.3	103.2 26.0	104.3 0.3	1.8 0.6
RN-11	55.5 64.7	1.4 2.2	12.4 5.3	35.5 5.0	1.8 1.5	1.3 4.4

Notes on Tests Performed at 20 Years:

1. Each test section was 50 ft square, asphalt-surfaced with the insulating layer in the middle of a 4 to 4.5-ft-thick gravel layer on a silt subgrade. The insulation in RN-5 consisted of one 3-in. layer of 12-in. by 15-in. blocks, coated with tar top and bottom, and with joints sealed by tar. The insulation in RN-6 and RN-11 was made up of two 3-in. layers of 12-in. by 15-in. blocks, coated with tar between layers, and with Joints staggered and sealed by tar.
2. Two samples of insulation from each test section were tested for moisture content as percent of dry weight. Data are shown for each of the two samples.
3. Before moisture measurement, sand and tar were trimmed from the samples. Samples were sliced into approximately 1-in.-thick layers. 0-1 in. is the first 1-in. horizontal layer of cellular glass from the top; 1 to 2 in. the second and so on.
4. Large discrepancies are noted between values for the top inch of the bottom (3 - 4 in.) layer of cellular glass in RN-6 and RN-11 and for the 4 to 5 in. layer in RN-6. This was possibly caused by water passing through the joints between blocks and lying between layers where the tar bond is broken.
5. It was noted that cell walls had deteriorated in the upper 1/4 in. to 1/2 in. of the blocks to the extent that the cell walls could be easily broken by finger pressure.



## CHAPTER 3 SITE INVESTIGATIONS

### 3-1. General.

a. The site data needed for design of foundations in cold regions include the same information as would be required in temperate regions, but with additional requirements imposed by the special climatic conditions. Also the remoteness of the site often imposes additional requirements<sup>155</sup>. Subject to design policies, general criteria, cost limitations and the constantly changing state-of-the-art, site information needed for design of foundations in cold regions may be summarized as follows:

- Climate (general and local).
- Physiography and geology, including topography and surface cover.
- Subsurface conditions.
- Thermal regime.
- Hydrology and drainage.
- Materials of construction.
- Transportation facilities and access.
- Construction cost factors.

b. Availability of labor, construction equipment and supplies. Must of the information needed for foundation design must be obtained as a part of the over-all facility design. However, some elements of needed information pertain specifically to foundations.

c. By giving adequate attention to subsurface conditions during the site selection stage, foundation design problems and facility costs can often be greatly reduced. When facilities can be sited on deposits of deep, free-draining, non-frost-susceptible granular materials, design, construction, maintenance, and operational problems are all minimized.

d. When a facility such as a power transmission line or long pipeline covers an extended area, not only may a variety of foundation conditions be encountered but also a considerable range of ground temperatures and permafrost conditions. In such cases it will be uneconomical to develop an individual design specifically for each structure or portion of the facility. Instead, the terrain may be divided into areas of like foundation conditions, and standard designs prepared which will be suitable over each of these areas. Also, a number of standard designs may be prepared to cover the range of conditions, the particular design for each facility element to be field-selected in accordance with the conditions actually encountered.

### 3-2. Remote sensing and geophysical investigation.

a. Aerial investigation techniques are especially valuable during the selection of the site location itself. At times communications or other requirements may closely dictate the choice of the facility

site. Often, however, the opposite is true and site selection may involve hundreds or even thousands of square miles of potential terrain. In such cases, remote sensing and geophysical techniques may provide the only economical approach. State-of-the-art reviews are continued in publications by Ferrians and Hobson<sup>142</sup> and Linell and Johnston<sup>165</sup>. Use of conventional aerial photographic techniques for terrain and site investigation in arctic and subarctic areas began in the late 1940's and the results were reported by Frost<sup>62</sup>. The U.S. Army Corps of Engineers has included summaries of these techniques in two Engineering Manuals. Aerial photography and photo interpretation are invaluable in obtaining much of the needed site information and should be employed routinely as part of design studies. Information obtained by aerial photography should be tied in with coordinated ground investigations. The ground studies will provide reference data and accuracy checks of the aerially obtained data and should extend this information in the detail necessary for actual design. The accelerating development of northern North America in recent years has greatly spurred practical use of these techniques, particularly in connection with investigations for several pipelines<sup>172</sup>.

b. Color and infrared photography, and radar and other special forms of sensing techniques may also be employed. Rinker and Frost have recently discussed the application of various type of remote sensing to environmental studies in the Arctic<sup>182</sup>. Haugen et al.<sup>151</sup> and Ferrians<sup>141</sup> are currently investigating potentials for satellite acquisition of data under the Earth Resources Technology Satellite (ERTS) program, obtaining information on such surface details as vegetation, snow and ice cover, ground temperatures, geomorphic and other evidences of permafrost, stream levels, sedimentation patterns, and forest fires. Electromagnetic sensing systems, both airborne and surface operated, have been shown capable of distinguishing with depth materials such as soils, ice and rock having different electrical properties,<sup>142,144,147</sup> to depths of 15 meters or more in frozen ground. Although not yet routinely used, such equipment is in a state of rapid and continuing development. Garg<sup>147</sup> and Hunter<sup>152</sup> have reported that both resistivity and refraction types of conventional geophysical systems have utility in permafrost areas, and Roethlisberger<sup>84</sup> has summarized the state-of-the-art of seismic exploration in cold regions. Development of acoustic reflection type sounding equipment for use in permafrost areas is in a very early state of development. Greene<sup>149,163</sup> and LeSchack<sup>162,163</sup> have concluded that infrared sensing techniques can provide useful infor-

mation on permafrost conditions. Ferrians and Hobson<sup>142</sup> have reviewed the currently available information on applicability of bore hole logging methods in permafrost areas. Williams and VanEverdingen<sup>209</sup> have also concluded that borehole geophysical logging methods can yield valid geophysical logs in frozen unconsolidated deposits and that interpretation is possible in terms of bulk density, moisture content and other characteristics.

### 3-3. Detailed direct site exploration.

Guidance for foundation investigation is given in TM 5-852-2/AFM 88-19, Chapter 2<sup>11</sup> and TM 5-818-1/AFM 88-3, Chapter 7<sup>5</sup> and is also discussed in Terzaghi and Peck<sup>198</sup>. Detailed direct investigations of site conditions are required at structure sites. Positive knowledge of subsurface conditions is as important in foundation design as is knowledge of properties of construction materials in design of above-surface structures.

a. Extent of exploration. The number and extent of direct site explorations should be sufficient to determine in detail the occurrence and extent of permafrost, ground ice, including ice wedges, moisture contents and ground water, temperature conditions in the ground, and the characteristics and properties of frozen materials, soil and rock. It is desirable that the personnel who make the actual site investigations proceed in very close communication with the design engineers so that a continuous process of feedback and adjustment of the investigation program can be maintained; as a minimum, the field personnel must be aware of the features which are important in foundation design in general and of criteria applicable for the particular facility.

(1) A thorough soil investigation should be conducted for all new construction. Sites with granular soils free of ice masses are highly desirable for siting of structures, and although sands or gravels of soil groups GW, GP, SW, and SP are generally free of segregated ice, this is not necessarily true in all cases. Granular soils often occur as a cap over finer grained soils containing ground ice and superficial investigations based only upon the nature of the surface materials may lead to very serious problems, possibly many years after completion of construction. Buried ice wedges, old stream channels, and peat deposits containing excess ice may be present. As figure 3-1 suggests, a single shallow exploration, or a few widely scattered ones may fail to reveal the true subsurface conditions. Experience also shows that bedrock often contains substantial masses of ice which would produce substantial settlement on thaw; bed rock thus cannot automatically be assumed to provide a sound foundation. Bedrock should be explored by core boring methods to obtain undisturbed frozen cores whenever this possibility would be a factor in the foundation design.

(2) Explorations at the structure site should extend to a depth at least equal to the least width of the foundation, unless icefree bedrock is encountered at shallower depth. In addition, the explorations should encompass any foundation materials subject to possible thaw during the anticipated life of the structure, as illustrated in figure 3-1. For structures with pile foundations, the explorations should establish the nature of materials in which the piles will be supported.

b. Techniques of subsurface exploration. Frozen soil may have compressive strength as great as that of lean concrete (para 2-5). Frozen glacial till at very low temperatures has been described as behaving exactly like granite in excavation and tunnelling work. These properties make subsurface exploration in frozen materials considerable more difficult than in unfrozen soils and sometimes have led to accomplishment of less subsurface exploration than needed, with disastrous results. Persons responsible for subsurface exploration, therefore, should be prepared to bring extra money, effort, talent, and equipment to bear on the problem.

(1) Deep core drilling using refrigerated drilling fluid to prevent melting of ice in the cores gives the best results under the widest range of materials up to and including frozen soils containing particles up to boulder size and frozen bedrock.<sup>153,161</sup> Cores obtained by this procedure are nearly completely undisturbed and can be subjected to the widest range of laboratory tests. They permit ice formations to be inspected and measured accurately after removal of the drilling-fluid-saturated out surface. Cores should be photographed for record purposes when appropriate, and when low temperature storage cannot be provided. In fine grained soils above 25° F, drive sampling is feasible<sup>55</sup> and is often considerably simpler, cheaper, and more rapid. Samples obtained by this procedure are somewhat disturbed but they still permit accurate detection of ground ice and accurate moisture content determinations on specimens. Examination and sampling of natural and man-made exposures in the general site area may be helpful but care is necessary to avoid being misled by sloughing of the face or by rapid melting and disappearance of ice when air temperatures are above freezing.

(2) Test pits are also widely useful, especially in shallow granular deposits intended for borrow. For frozen soils, which do not contain very many cobbles and boulders, truck mounted power augers using tungsten carbide cutting teeth provide excellent service where classification, gradation and rough ice content information will be sufficient; this procedure is very useful for expansion of subsurface information where critical details have already been established by more widely spaced undisturbed core drilling techniques. In both seasonal frost and permafrost areas a saturated

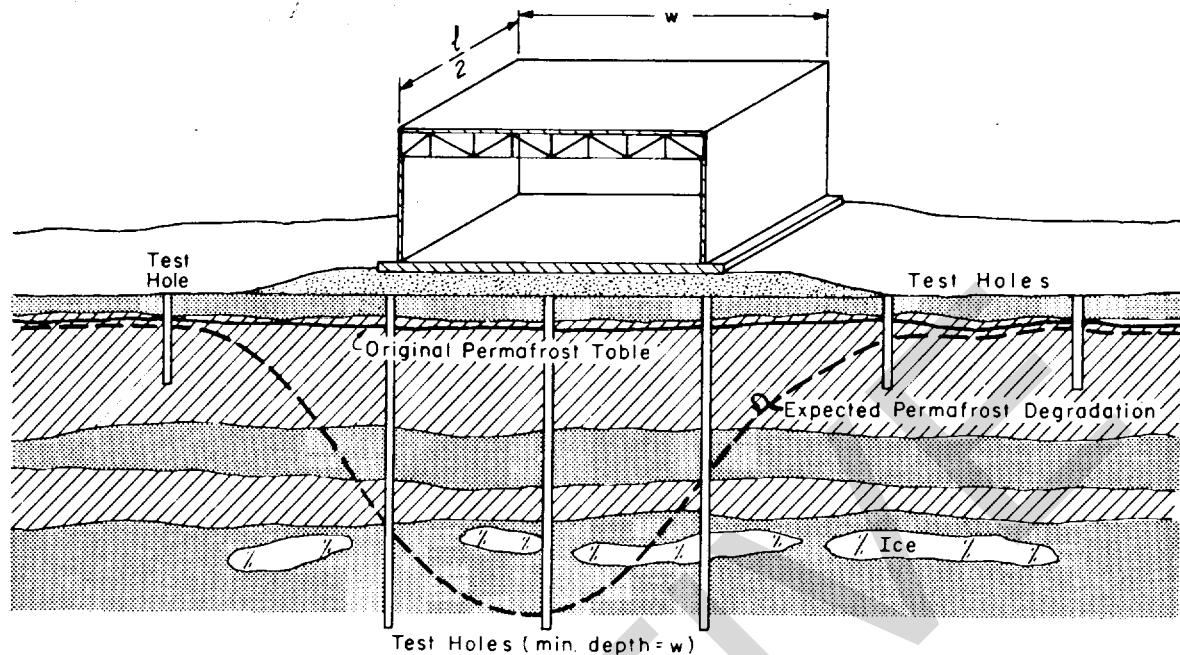

U. S. Army Corps of Engineers

Figure 3-1. Required extent of explorations for large structure.

condition is common in the upper layers of soil during the thaw season so long as the underlying layer is frozen impervious soil. Normally, borings must be cased through this saturated thawed layer. It is frequently found that explorations are most easily carried out during the colder part of the year, when water areas and the annual frost zone are solidly frozen, rather than during the summer.

*c. Special investigations.* Special investigations may be necessary for unusual projects; for example, the installation of a nuclear power plant may require installation of temperature sensing equipment on a much more elaborate scale than for an ordinary structure. Again, for structures in which the dynamic response of the foundation is important, measurements may be required of dynamic modulus and wave propagation velocities in the field and in the laboratory. In other cases creep deformation of electrical properties of the foundation (such as for grounding of antennas) may be critical. Installation of test piles may be required during the site investigation or early construction phases in order to determine optimum methods of installation and the actual allowable loadings and performance of piles. Sometimes other field experiments may be required in order to determine if new or untried construction methods are feasible under the particular soil and temperature conditions.

**3-4. Site technical data.** Careful collection of data as outlined in the following paragraphs of this Chapter as

applicable will provide a reliable picture of the natural subsurface conditions existing at a specific site and will provide a solid base of information for consideration of design options and performance of most design analyses. Additional special technical data development may be required, depending on the specific type of foundation design to be explored. This may involve either laboratory or field tests, or both. Field tests must normally be performed at the naturally occurring field ground temperatures; if the tests cannot be performed at the critical design temperatures because of time or other requirements, the results must be adjusted or extrapolated to these temperature conditions. Laboratory tests may be performed at coldroom or test chamber temperatures which are representative controlling field conditions and also permit economical investigation of the effects of full ranges of conditions. If the general site conditions have become clearly established in previous design studies at the particular location, foundation studies for subsequent facilities construction may often be less extensive and may in fact sometimes consist mainly of verification explorations. General information requirements for site selection and development have been outlined in preceding paragraphs and are given in detail in TM 5-852-2/AFM 88-19, Chapter 2<sup>11</sup>. The following discussion is limited to specialized

aspects of cold regions foundation design for a specific facility.

a. *Climatic data.* Some climatic data such as temperature information will provide direct input to the technical foundation design. Other data will provide indirect input, such as weather conditions which will be experienced during the construction period, including the lengths of the outdoor working seasons and of the specific periods over which protection against adverse temperature conditions will be required. Freeze and thaw indexes are essential for computing depths of freeze and thaw and for estimating degradation or aggradation. Precipitation is an indicator of both outdoor working conditions and of surface and subsurface drainage conditions. Snowfall amounts, the frequency and intensity of snow drifting, snow depths, and the frequency and intensity of icing conditions are all important input elements affecting directly or indirectly the foundation design. The deposit of ice and snow may frequently impose severe loads on structures and foundations. It is important to tabulate liquid and solid types of precipitation separately. When snow drifting patterns may be important to the operation and maintenance of the facility, it is desirable to obtain aerial photographs in the spring after initial thaw has started to delineate sharply the natural patterns of seasonal accumulation. Information on wind directions and velocities and the frequency of storms is essential in design of structures and it is one of the determinants of foundation design loading values. In mountain areas, structures may require design for velocities as high as 200 to 250 mpg, imposing severe foundation stability requirements. Often foundation uplift forces produced by wind on specialized structures such as antennas offer the most critical foundation design problems in permafrost areas. If added footing weight and size or added depth of footing burial is required to resist uplift, this may result in substantial revisions of the ultimate design. Combinations of severe climatic conditions must also be investigated. For example, severe icing conditions combined with high wind may be critical for a radio transmission tower. When there are no weather records from a station near the proposed site, it will be necessary to estimate conditions at the site from weather records at the nearest available locations, taking into account such factors as latitude, elevation, exposure, and nearness to water bodies. Experience shows that this estimation is difficult to accomplish with accuracy. Therefore, whenever the time and nature of the job permit, arrangements should be made for collection of at least elementary weather data at the site itself at the earliest possible time; even records for part of a year may give invaluable checks on the accuracy of estimates. Sometimes design, maintenance and/or operational difficulties may be substantially simplified by

small, local adjustments of site location based on detailed knowledge of local conditions.

(1) Specific weather information useful in foundation design includes mean, minimum, and maximum daily air temperatures; precipitation (liquid and solid); snow and ice depth on the ground; wind velocity and direction; and frequency of storms or severe combinations of conditions. Air temperatures are the most important data; they are obtainable with a simple recorded needing a minimum of attention.

(2) Even observations for a limited period such as a month, when compared with simultaneous observations at the nearest regular weather stations, will give valuable clues concerning the air temperature regime of the structure site.

(3) Equipment, installation and observational procedures should be in accordance with the guidance of the National Oceanic and Atmospheric Administration Federal Meteorological Handbook No. 2, Substation Observations<sup>178</sup>. Greater technical detail is available in Handbook No. 1, Surface Observations<sup>177</sup>.

b. *Subsurface thermal regime.* Ground temperatures with depth have been recorded for numerous specific locations in North America and Greenland, including a number of stations in Alaska<sup>10,25,29,37,99,101,102</sup>. Data from such observations and air temperature records, together with detailed data on topography, elevation, snowfall and other site data, permit approximate preliminary estimates of ground temperatures at new sites. However, it is very easy for such estimates to be considerable in error unless all pertinent factors are accurately perceived and evaluated. For example, permafrost is found in the valley bottoms in the Fairbanks, Alaska, area but is absent in valley bottoms in the Knob Lake, Quebec, area in spite of a lower mean annual temperature. One key reason for this is the much heavier snowfall in the latter area. Again, at Kotzebue, Alaska, mean ground temperature in the gravel spit on which the village is located is about 29.7 °F but it is about 24.5 °F in the silt and clay bluffs which are at only slightly higher elevation but are more removed from direct contact with the effects of the ocean.

(1) At new sites, ground temperature and freeze and thaw penetration information should be obtained as early as possible in the site investigations, in sufficient detail to demonstrate or verify the subsurface thermal regime. Copper-constantan thermocouples installed in foundation exploration holes or in holes drilled for this specific purpose provide the simplest means of measuring subsurface temperatures. Readings with an absolute accuracy of about  $\pm 0.4^{\circ}\text{C}$  ( $3/4^{\circ}\text{F}$ ) may be obtained manually using a portable potentiometer. When greater precision is needed than is obtainable with thermocouples, thermistors of a select type, glass-bead encased and properly calibrated, should be employed. Careful techniques can readily produce data from ther-

mistors accurate to  $\pm 0.01$  °C (0.02 °F), although under field conditions with less than fully experienced observers, a lower order of accuracy may be obtained. A more detailed discussion of temperature sensors is presented in chapter 7 (para 7-4). To obtain a good measure of the mean annual ground temperature, at least one temperature installation should extend to a depth of about 30 feet. Readings during the period of thermal stabilization following installation should be discounted. Readings during the summer and fall when readings in the upper part of the foundation are at their warmest are most important. One or more of these assemblies should be installed in areas which will not be disturbed by the construction, in order to serve as a control against which ground temperatures in the construction area during and after construction may be compared.

(2) The maximum seasonal depth of thaw penetration can be readily measured at the end of summer or in early fall by probing, test pitting or other means, correlated with soil temperature readings.

(3) Thermocouple and thermistor assemblies are usually prefabricated in protective plastic tubing before delivery to the site. Recommended principles and techniques of subsurface temperature measurement are presented in a paper by Sohlberg;g2 his report includes an extensive bibliography.

c. *Physiography and geology.* Even if only a single structure is involved, physiographic and geologic information on the general area should be established. Information on the surrounding terrain will often be invaluable in interpretation of the detailed exploration results at the site itself. Bedrock exposures, glacial landforms, alluvial deposits and similar features should be known. Surface cover conditions of the site should also be recorded and are essential for estimating the extent of change in thermal regime which will be produced by the construction. Topographic data are an essential requirement.

d. *Identification and classification of foundation materials.* The most important single step in foundation investigations is the accurate description and classification of the exploration materials in accordance with the Unified Soil Classification System MIL-STD 619B including the frozen soil classification system.<sup>167</sup> The frozen soil portion of this system has been devised on the basis of experience of United States and Canadian organizations.

(1) The frozen soil classification system provides information on the factors of appearance and physical properties which are essential guides to the nature and behavior of the material in the frozen state and to the changes which may occur upon thawing. It is independent of geologic history or mode of origin on the materials and can be used with any types of samples which show the natural structure of the materials, such as specimens recovered from drill holes or test pits, or frozen in the laboratory. Unfrozen soils and the soil

phase of the frozen materials should first be identified; the material characteristics resulting from the frozen state are then added to the soil description as appropriate. Important ice strata found in the foundation are then described separately.

(2) Frozen soils are divided into two major groups: soils in which segregated ice is not visible to the naked eye, and soils in which segregated ice is visible. The visual division is not necessarily determinative for thaw settlement potential. The boundaries between frozen and unfrozen strata should be carefully recorded, particularly in marginal permafrost areas. Surface cover materials should be included in the exploration records and should be described especially carefully. Tests in the field and/or laboratory such as for soil gradation and Atterberg Limits may be employed as needed to supplement the field identification.

(3) The result will be an exploration log of the type illustrated in figure 3-2, where an obvious thaw settlement potential exists, as revealed by the ice layer from 7.7 to 9.1 feet. This information may by itself decisively limit the design options and determine the needs for further foundation data.

e. *Density and moisture content.* The dry unit weight and natural moisture contents of both frozen and unfrozen core samples or frozen lumps should be determined. The bulk densities of representative frozen core samples or frozen lumps should be first obtained. Then the sample should be melted and the dry weight of solids and the moisture content as a percent of dry unit weight obtained. This will give a plot of dry unit weight and moisture content vs. depth as shown in figure 3-3. From knowledge of the common moisture content ranges for the foundation materials encountered and from the number and thicknesses of ice layers encountered, the existence of a potential settlement problem in thawing may be immediately apparent if amounts of ice are appreciable. However, quantitative analysis of the amount of settlement which will occur can readily be made through the procedures outlined in f below.

(1) The maximum heave that can occur as a result of in-place freezing of the water present in the voids of a non-frost-susceptible soil (without ice segregation) may be computed by the following formula:

$$\Delta H = 0.144w\lambda_d H \times 10^{-4} \text{ (Equation 1)}$$

where

$\Delta H$  = frost heave, ft

w = water content, percent of dry weight of soil

$\lambda_d$  = dry unit weight of soil, lb/ft<sup>3</sup>

H = thickness of deposit, ft.

(2) The expansion on freezing of non-frost-susceptible soil is negligible under nominal confinement

		SOIL DESCRIPTION	ICE FEATURES
(E1. 963.2)	0.0	OL Organic, sandy SILT, not frozen	None
	1.5	GW Brown, well-graded, sandy GRAVEL med, compact, moist, not frozen	None
	1.8	GW Nf Brown, well-graded, sandy GRAVEL frozen, poorly bonded	No visible segregation, negligible thin ice film on gravel sizes and within larger voids
	3.7	GW Nbn Brown, well-graded, sandy GRAVEL frozen, poorly bonded	No visible segregation
	5.4	ML Vs Black, micaceous, sand SILT frozen	Stratified horizontal ice lenses average 4" in horizontal extent, hairline to 1/4" in thickness, 1/2" to 3/4" spacing. Visible excess ice approx 20% of total volume. Ice lenses hard, clear, colorless
	7.7	Ice	Hard, slightly cloudy, colorless, few scattered inclusions of silty SAND
	9.1	Pt Dark brown PEAT frozen, well-bonded high degree of saturation	Approx 5% visible ice
	10.5	MH Vr Light brown SILT frozen	Irregularly oriented ice lenses and layers 1/4" to 3/4" thick on random pattern grid approx 3" to 4" spacing. Visible ice approx 10% of total volume. Ice moderately soft, porous, gray-white
	14.3	B e d r o c k	
	16.0	Laminated SHALE Top few feet weathered	1/16" thick ice lenses in fissures to 16.0'. None below
	20.6	Bottom of exploration	

DEPTH, ft.

Heavy bar shown from 1.8 to 16.0 ft indicates frozen soil.

U. S. Army Corps of Engineers

U. S. Army Corps of Engineers

Figure 3-2. Typical exploration log.

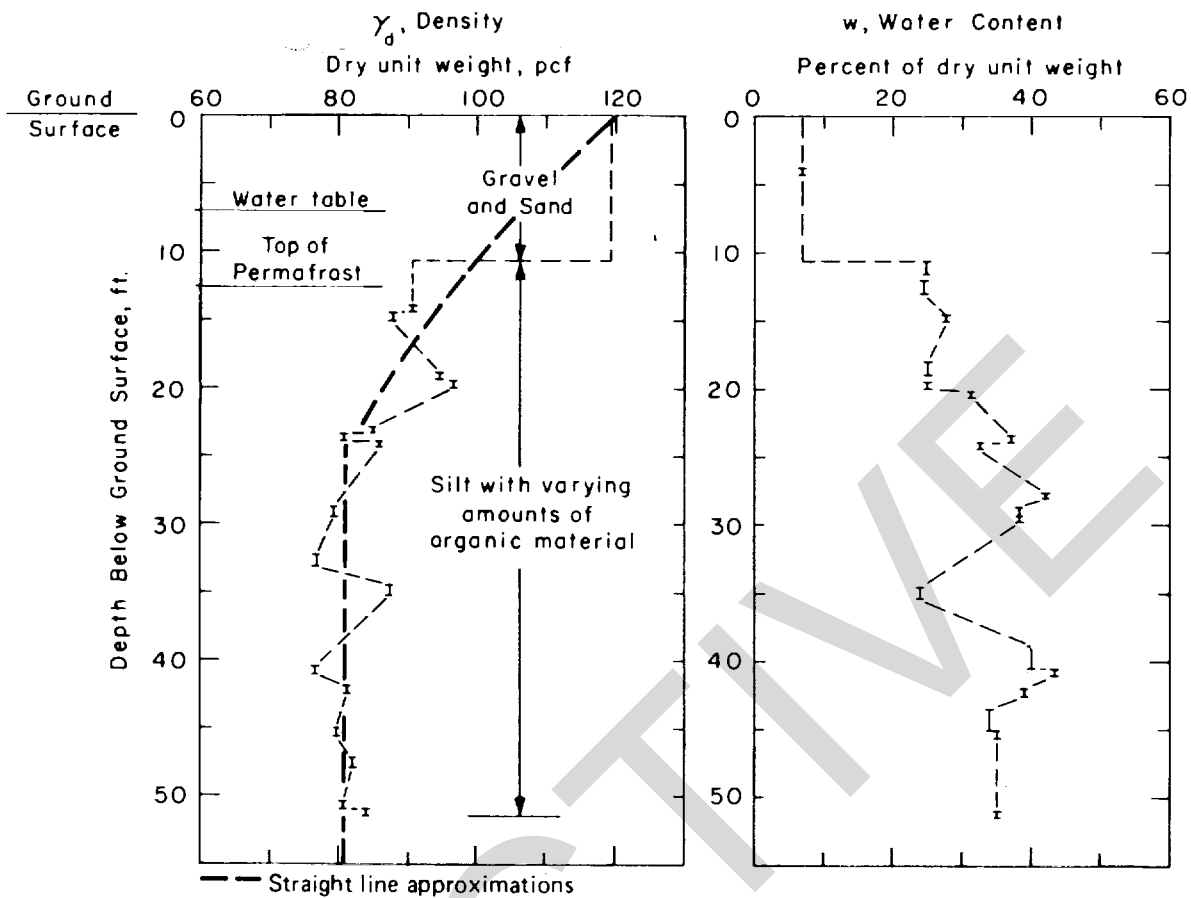

U. S. Army Corps of Engineers

Figure 3-3. Dry density and water content vs. depth for a soil exploration in permafrost.

if it is sufficiently well-trained so that the excess volume of water corresponding to the expansion of water upon freezing can escape. The top few inches of soil, under less than 1 psi of confining pressure, may "fluff" during freezing; this is usually of negligible practical importance except to trafficability in the thawing season. However, because natural soil may not be completely non-frost-susceptible and because drainage below the plane of freezing may not always be perfect, freezing of upper layers of soil may have made them less compact than underlying materials. This effect may extend as deep as 30 feet.

f. *Thaw-consolidation and settlement.* When quantitative data are needed on the amount of settlement which will occur on thaw under the foundation stresses which will exist after construction, rapid estimates may be made by cumulatively measuring amounts of ice visible in core samples or in test pit or excavation exposures. If amounts of ice are substantial these results may be determinative. For less clear-cut

situations, such as where ice is relatively uniformly distributed through the soil rather than occurring as individual ice layers, where clear ice is apparent but there still may be direct particle to particle contact in the soil structure, or where swelling rather than reduction in volume may occur, thaw consolidation tests would be performed on frozen, undisturbed samples. Crory<sup>135</sup> and others have discussed test procedures and analyses. Two methods of performing such thaw consolidation tests are available. In one, frozen core samples are trimmed under coldroom conditions to fit a standard soil consolidometer apparatus.<sup>135</sup> An initial compressive stress, nominally 1 psi, is applied to the frozen specimen; it is then allowed to thaw and consolidate (or swell) under this stress to determine the consolidation which is attributable primarily to the ice content of the specimen. Consolidation is allowed to continue until at least primary consolidation is complete. Secondary consolidation may rarely have to be taken into account. Successive in-

crements of load are then applied in accordance with conventional test procedures to develop plots of pressure versus void ratio as illustrated in figure 3-4 or pressure versus settlement strain as illustrated by figure 3-5 to encompass the stress level which may be expected in the foundation. The amount of settlement which may be expected at the level in the foundation represented by the specimen may then be computed from the volume change information. Note in figure 3-5b that the initial compressions of samples which are thawed after application of the initial load were much more than for the samples thawed *prior* to application of the initial load. Where time-rate of consolidation information is needed it can be computed from the individual incremental compression versus time records.

(1) As an expedient method to obtain a measure of the volume reduction which may occur on thawing of materials which cannot conveniently be trimmed to fit into a standard consolidometer, a lump of the frozen material may be placed into a bag of thin rubber together with a length of tubing attached to a porous stone or other drainage medium. After evacuation of the rubber bag sufficient to bring it into intimate and complete contact with the frozen soil, the initial volume of the bag and sample should be determined. The specimen should then be thawed under about 1 psi vacuum pressure differential with drainage of the excess water permitted to occur through the tubing. The volume change of bag plus sample should

be measured when thaw is complete and again after completion of each successive consolidation pressure increment which can then be effected under external pressure. The resulting volume change information may be taken as indicative of the amount of settlement which will occur on thaw. The lump method is not suitable for depth-time rates of consolidation as the lengths of drainage paths are indeterminate. The results may also involve some error from the fact that the consolidation effected is not unidirectional nor related to foundation strata in the same manner as in the actual foundation. However, since a large portion of the consolidation may commonly be that resulting from the thaw of ice, as illustrated in figure 3-5, the test may be a quite useful indicator.

(2) From plots of soil density with depth and with addition of structure load stresses, the relationship of intergranular pressure with depth for the design condition should be established as illustrated in figure 3-6. Using this information and the pressure versus void ratio or pressure versus settlement strain consolidation data, and cumulatively summing the amounts of settlement associated with increasing increments of thaw depth, curves of estimated settlement vs. depth of thaw may be estimated, as illustrated in figure 3-7 and table 3-1 for individual locations. If the foundation materials

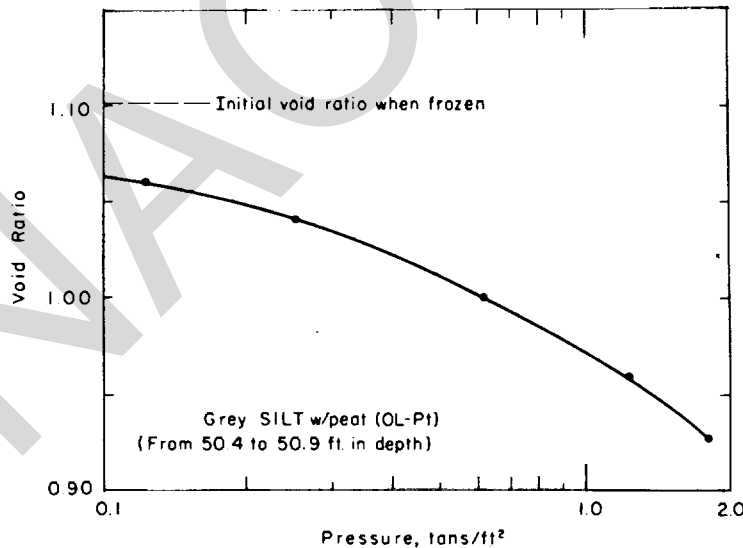

U. S. Army Corps of Engineers

Figure 3-4. Thaw-consolidation test on undisturbed sample.



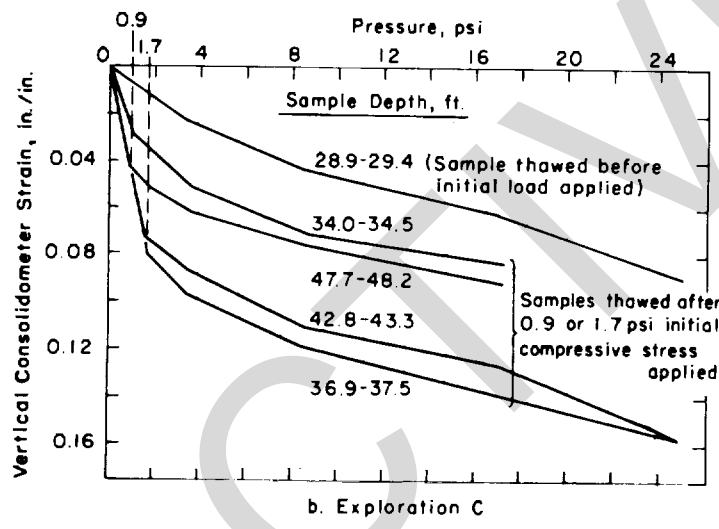
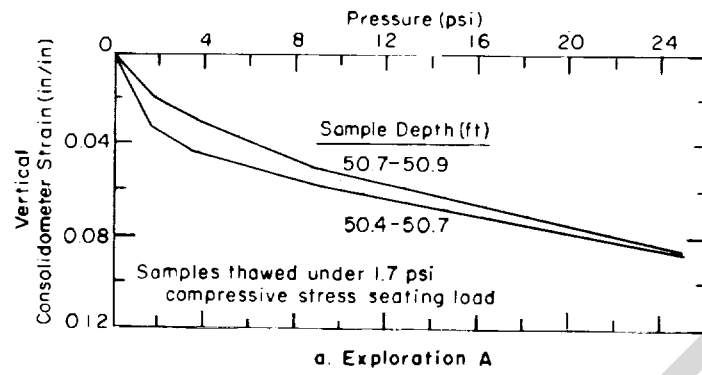

U. S. Army Corps of Engineers

Figure 3-5. Consolidation test results for undisturbed samples from two drill holes at same site. Tests performed using fixed ring consolidometer. Specimen diameter 2.5 in., height 0.8 in..

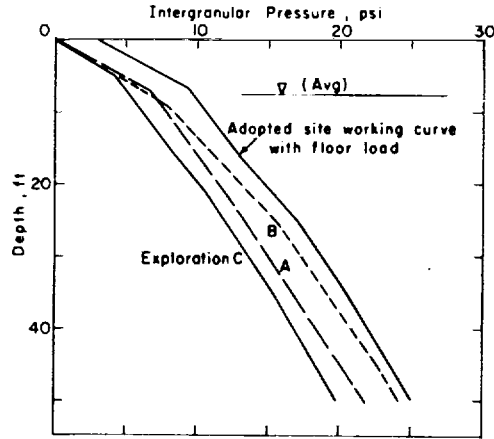

Figure 3-6. Intergranular pressure vs. depth for three explorations at same site. Site work curve based on average of A, B and C, to which was added a 2-psi floor load. Curve A was computed from density data in soils of figure 3-3, using straight line approximations.

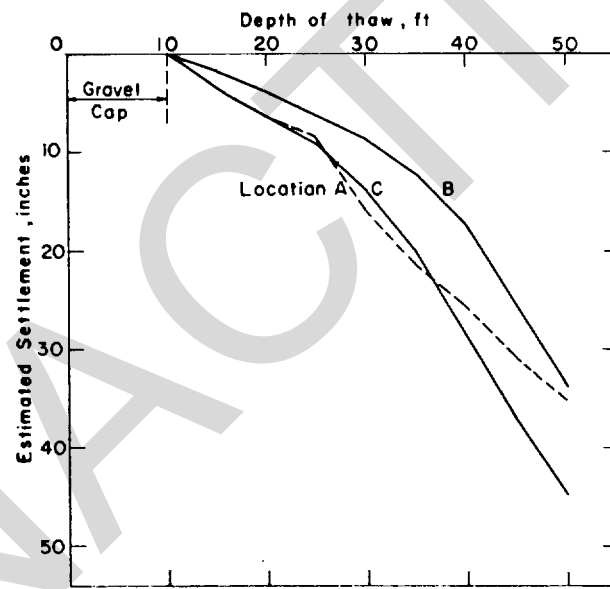

Figure 3-7. Estimated settlement vs. depth of thaw for different explorations at the same time.

U. S. Army Corps of Engineers

Table 3-1. Example of Settlement Estimate - Location A, figure 3-7.

Depth (ft)	Average pressure (psi)	Strain (in./in.)	Settlement of layer (in.)	Cumulative settlement (in.)
10-15	11.6	0.0064	3.84	3.84
15-20	13.6	0.036	2.16	6.00
20-25	15.8	0.0425	2.55	8.55
25-30	17.8	0.124	7.44	15.99
30-35	19.6	0.088	5.28	21.27
35-40	21.2	0.071	4.26	25.53
40-45	22.8	0.089	5.34	30.87
45-50	24.3	0.070	4.20	35.07

- Notes:
1. Values for average pressure determined from "Adopted Site Working Curve" in Figure 3-6.
  2. Values of strain for first five layers taken from plots of pressure vs strain in Figure 3-5a for Exploration A. Values for three lower layers determined from similar plots not shown.

may be expected to consolidate nearly as rapidly as thaw progresses, the rate of settlement will correspond closely in time with the rate of thaw. Because the thaw front under a heated structure advances more rapidly at the center than under the edges, as illustrated in figure 4-9, the actual distribution of settlement displacement across the foundation normally will develop in a dish shape.

*g. Thermal properties.* The basic thermal properties of soils and other construction materials pertinent to foundation design are specific heat, thermal conductivity and latent heat of fusion. Satisfactory values of thermal conductivity and specific heat of these materials for design computations are available in tables and charts of TM 5-852-6,<sup>14</sup> the values for soils and rock being based primarily on investigations by Kersten." Because special equipment is required, special measurement of properties for design purposes is not recommended for normal design situations.

(1) If performance of thermal conductivity tests is required, however, it is recommended that the guarded hot plate method be used, ASTM C 177,<sup>119</sup> with equipment modified to maintain specimen temperatures below freezing. CRREL has test

apparatus of this type and has performed research on thermal properties of construction materials at below freezing temperatures.<sup>71</sup> Thermal conductivity probes have been extensively investigated<sup>108,171</sup> but procedures which will produce reliable results under all conditions have thus far not been developed.

(2) The thermal conductivity of soil is dependent upon a number of factors such as density; moisture content; particle shape; temperature; solid frozen, unfrozen, or partially frozen. The latent heat of fusion of soil is dependent upon the amount of water in the voids which actually freezes. The specific heat capacities of soils may be adequately computed by summing the specific heat capacities of each constituent, multiplied by its respective mass fraction, taking into account moisture phase proportions. Anderson and Tice<sup>123</sup> have made detailed investigations of the unfrozen water contents in frozen soils and Anderson and Morgenstern<sup>121</sup> have recently summarized other related fundamental thermal research since 1963.

*h. Ground water records.* Knowledge of surface and

subsurface drainage and water table conditions of the general area is needed for accurate design. Under bodies of water, the permafrost table may be depressed or permafrost may be absent, particularly in marginal permafrost areas, and subsurface movement of moisture through these unfrozen zones may be an important factor influencing the thermal stability of the foundation. It may also be possible to exploit such zones as water supply sources.<sup>191,209</sup> When residual thaw zones carrying subsurface drainage develop, the thaw zones tend to deepen and channelize and when these develop near a foundation, they may threaten its stability. Even where moisture-bearing residual or permanent perched thaw zones do not exist, substantial quantities of water and heat may be transported by subsurface flow in the annual frost zone in the summer. Thus sufficient information is needed so that both surface and subsurface drainage conditions within the vicinity of the structure and foundation after construction can be anticipated.

(1) Ground water levels encountered in subsurface explorations should be recorded routinely, whether in seasonal frost or permafrost areas. In the saturated silty soils common in permafrost areas, as illustrated in figure 2-4, the ground water table in the annual frost zone may drop rapidly during the fall and early winter and disappear well before annual freezing reaches permafrost level. However, as further illustrated in figure 2-4, frost heave may continue almost up to the time freeze-up is complete because, in frost-susceptible finegrained soils, 95 percent or higher degree of saturation may still prevail at the moment when removal of moisture causes a free water table to disappear. In permafrost areas the absence of a water table in the annual frost zone in the freezing season should not be taken to indicate that high ground water will not exist in summer.

(2) Ground water considerations are further discussed in Chapter 4 (paras 4-12 and 4-18) and Chapter 7 (para 7-6).

*i. Frost susceptibility.* Criteria for susceptibility of soils to ice segregation based upon the percentage of grains finer than 0.02 mm by weight are outlined in TM 5-818-2<sup>6</sup>. While 3 percent finer than 0.02 mm is the most common dividing line between soils susceptible and not susceptible to ice segregation, frost heave and subsequent thaw weakening, and is used widely in pavement engineering, this is a very rough measure, an engineering rule of thumb, signifying not zero frost susceptibility but a level which is acceptably small for most engineering requirements under average conditions. For a specific soil, the actual limiting criterion for frost susceptibility may be either below or above this value. For borderline materials or where a measurement of frost susceptibility is essential, freezing tests will be carried out under the supervision of the U.S. Army Cold Regions Research and Engineering Laboratory,

Hanover, New Hampshire. Because of possible serious structural and operational effects of differential frost heave, the site investigations should ascertain the horizontal variability of frost heave potential under the structure. Variation may occur from point to point as a result of differences in soil type, properties or profile, or in moisture availability. Figure 3-8 illustrates a special case of such variability which resulted in serious cracking, in the first winter, of a new rigid pavement at the west end of the East-West taxiway at Elmendorf AFB, Anchorage, Alaska, with 72 inches combined thickness of pavement and non-frost-susceptible base over the natural soil subgrade. Maximum heave was about 0.4 feet. The pattern of cracking shown in figure 3-8, which also continued out through the unpaved shoulders, directly corresponded with a pattern of extreme subgrade soil variation. The soil conditions are illustrated by a profile recorded in a trench dug parallel to the south edge of the taxiway, (fig. 3-9). The Alaska District, Corps of Engineers, concluded that the alternating strata of sands and silts had been contorted by glacial shoving into their near-vertical positions. It will be apparent that design of structure foundations on such soils would require special attention to the subsurface details.

*j. Frost heave field observations.* It is often necessary or useful to have quantitative information on the amount of frost heave which occurs at a project site. Since heave and settlement are cyclic, the amount of frost heave can be determined by measuring either total heave, which occurs during fall and winter, or total thaw settlement, which occurs in spring and summer. Aitken<sup>2</sup> describes one type of apparatus used in measuring frost heave of the ground surface. Where roads exist, the amount of heave may be determinable at fixed structures such as bridge abutments or culverts. Effects of frost heave or frost thrust can often be discerned by the evidence of frost jacking out of the ground or tilting of insufficiently anchored and inadequately constructed facilities. In summer, mud lines may often be discerned on surfaces of piles or structures as the heaved surface recedes with thaw. Thaw consolidation tests can also be performed on cores of frozen materials obtained from the annual frost zone after maximum winter freeze had occurred. Where some frost heaving of the facility under design is to be permitted, as for a transmission tower, but the amount must be limited, the design predictions may be verified by constructing a prototype foundation without superstructure but with equivalent ground cover, loading it, and observing its performance through a freezing season.

*k. Creep and solifluction.* Slope creep is extremely slow downslope movement of surficial soil or rock debris, usually imperceptible except by long-term obser-

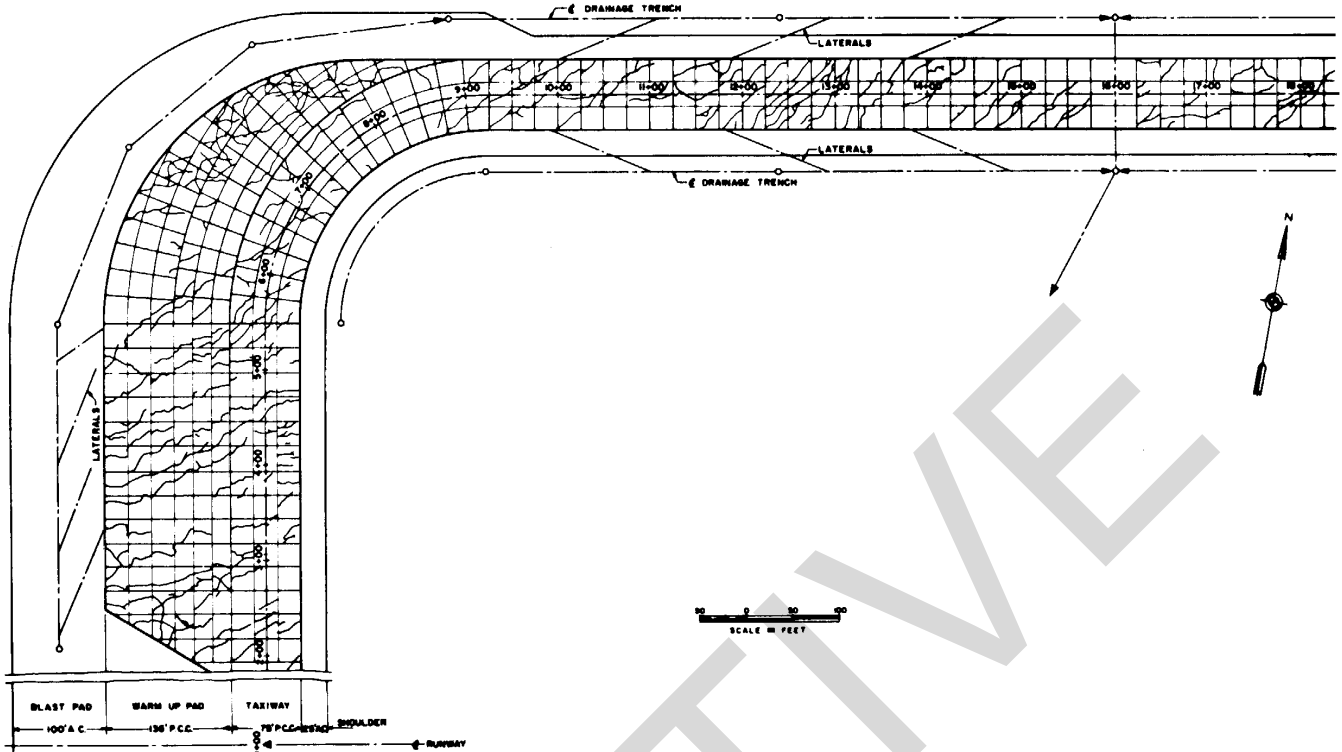

U. S. Army Corps of Engineers

U.S. Army Corps of Engineers

Figure 3-8. Pattern of cracks in taxiway pavement, Elmendorf AFB, Alaska

vation, and solifluction is the perceptible slow downslope flow of saturated nonfrozen soil over a base of impervious or frozen material. Creep may be frost creep, resulting from progressive effects of cyclic frost heave and settling, or may be simply extremely slow continuing deformation of frozen or unfrozen materials under stress. When siting of a facility in a location possibly susceptible to such conditions is contemplated, careful study of the terrain should be made for possible evidences of such movements. Where movement is suspected but is not obvious it may be necessary to install movement points on the slope in question and obtain actual measurements by careful surveying techniques. If either visual observation or measurements indicate a problem exists, the site should be avoided if at all possible, because stabilization or protective measures against such movements are likely to be extremely expensive or even impractical. Obvious evidences of slope instability are the bending of vegetation growth patterns out of the normal vertical position, lobe-like thrusts of material over downslope material, traces of sloughs or actual slides and displacements of roads or other facilities from their original alignments. Most such evidences are even more readily revealed by air photos than by on-the-surface inspection.

*I. Other data.* The availability and quality of gravel, sand, rock, water for portland cement concrete, usable local timber, and needed fill and backfill materials should be established. It is impossible to develop realistic cost estimates for the construction unless this is done.

(1) The availability of existing or potential transport facilities, means of access, sources of labor, and sources of construction equipment and supplies must be determined. These data may be controlling the decisions on type of foundation design to be employed.

(2) More detailed guidance for general site investigations is contained in TM 5-852-2/AFM 88-19, Chapter 2<sup>11</sup>.

(3) Design technical data in the following categories are discussed separately in the paragraphs indicated:

- Soil strength tests (compression, tension, shear), paragraphs 2-5, 4-4, 4-5, 4-8
- Pile load tests, paragraph 4-8
- Bearing test, paragraph 4-5
- Anchor tests, paragraph 4-14
- Dynamic response tests (moduli, wave propagation), paragraphs 2-5, 4-6
- Lateral pressures, paragraphs 4-3, 4-10

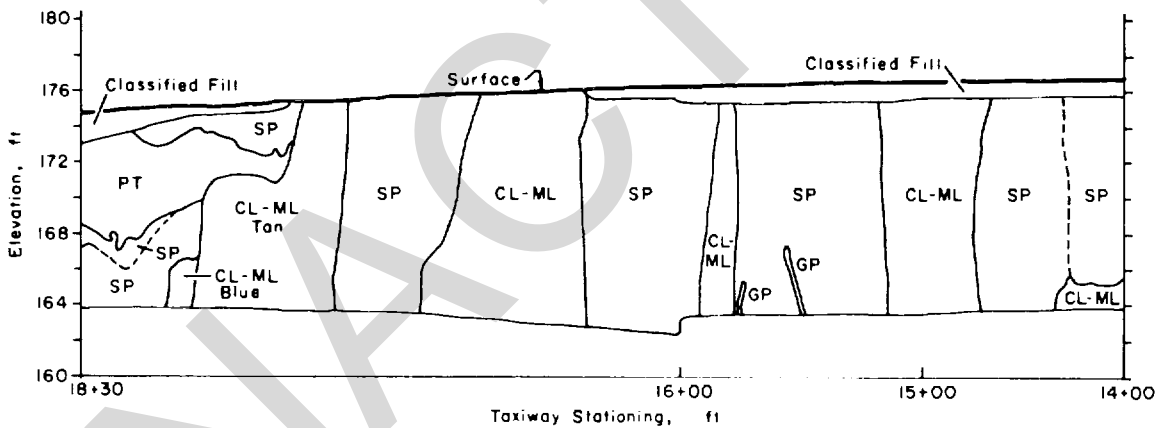

U. S. Army Corps of Engineers.

Figure 3-9. Soil profile, south wall of trench near south edge of taxiway, Elmendorf AFB, Alaska.

CHAPTER 4  
FOUNDATION DESIGN

**4-1. Selection of foundation type.** As illustrated figure 4-1, site data, engineering policies, general and environmental criteria, cost limitations, knowledge of the state-of-the-art, and specific facility requirements are used to develop the engineering design. Cost comparisons should be made for realistically competitive alternate designs. Feedback may occur at all stages of the procedure, resulting in a new or modified approaches, design refinements and revised cost estimates, within constraints established by the basic data. Selection is finally made of the foundation type which most effectively meets requirements at minimum cost, and design drawings and specifications are completed for this type. Accurate cost estimates require full development of the design details covered in succeeding chapters of the manual, as applicable. However, the designer should begin to make at least rough cost estimates early in the design process in order to insure that efforts are applied along avenues most likely to produce economical results. In subarctic areas without permafrost, procedures for selection of

foundation type are similar to those in seasonal frost areas of the temperate zones except that difficulties and expense involved in preventing uplift or thrust damage from frost heave, as by placing footing below the annual frost zone, are intensified. In permafrost areas, however, the selection of foundation type is more complex; it is rarely practical here to carry footings below the zone of frozen ground and additional factors must be considered in design<sup>86,201</sup>. The principal foundation design options for foundations on permafrost are illustrated in figure 4-2. For areas of deep frost penetration without permafrost the design alternatives are similar, except that the possibility of permafrost degradation does not have to be considered.

a. *Construction when foundation supporting conditions will not be adversely affected by thaw.*

(1) Whenever possible, structures in arctic and subarctic areas should be located on clean, granular, non-frost-susceptible materials or rock which are free of ground ice. In absence of subsurface exploration, per-

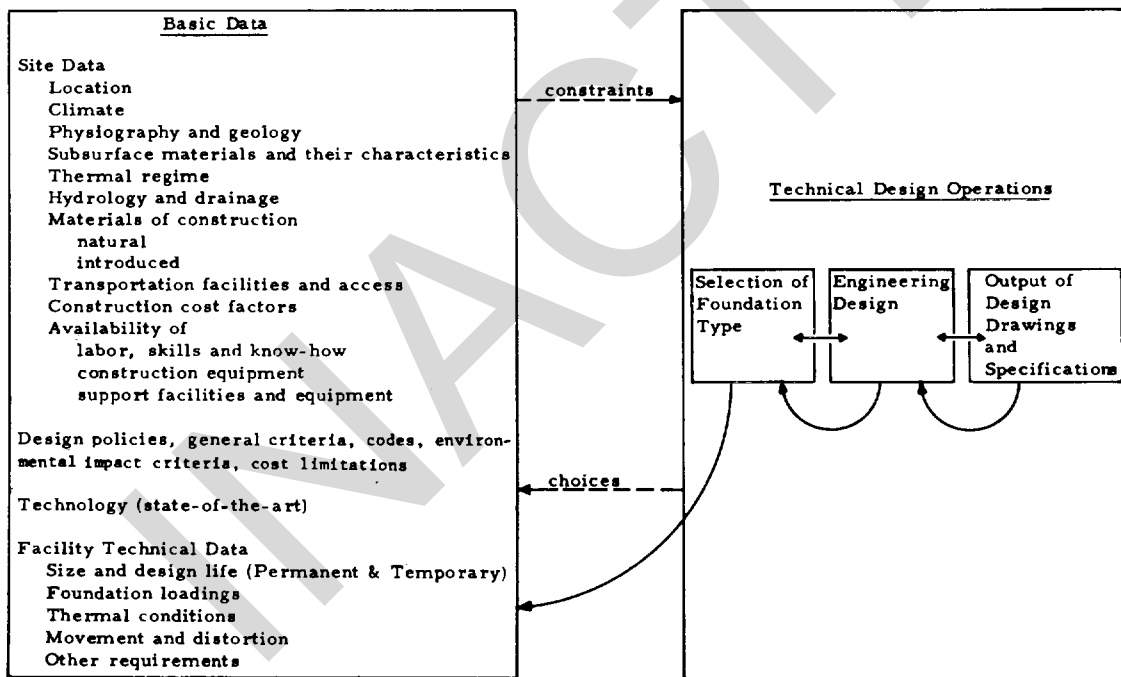

U. S. Army Corps of Engineers

Figure 4-1. Design of foundations in areas of deep frost penetration and permafrost.

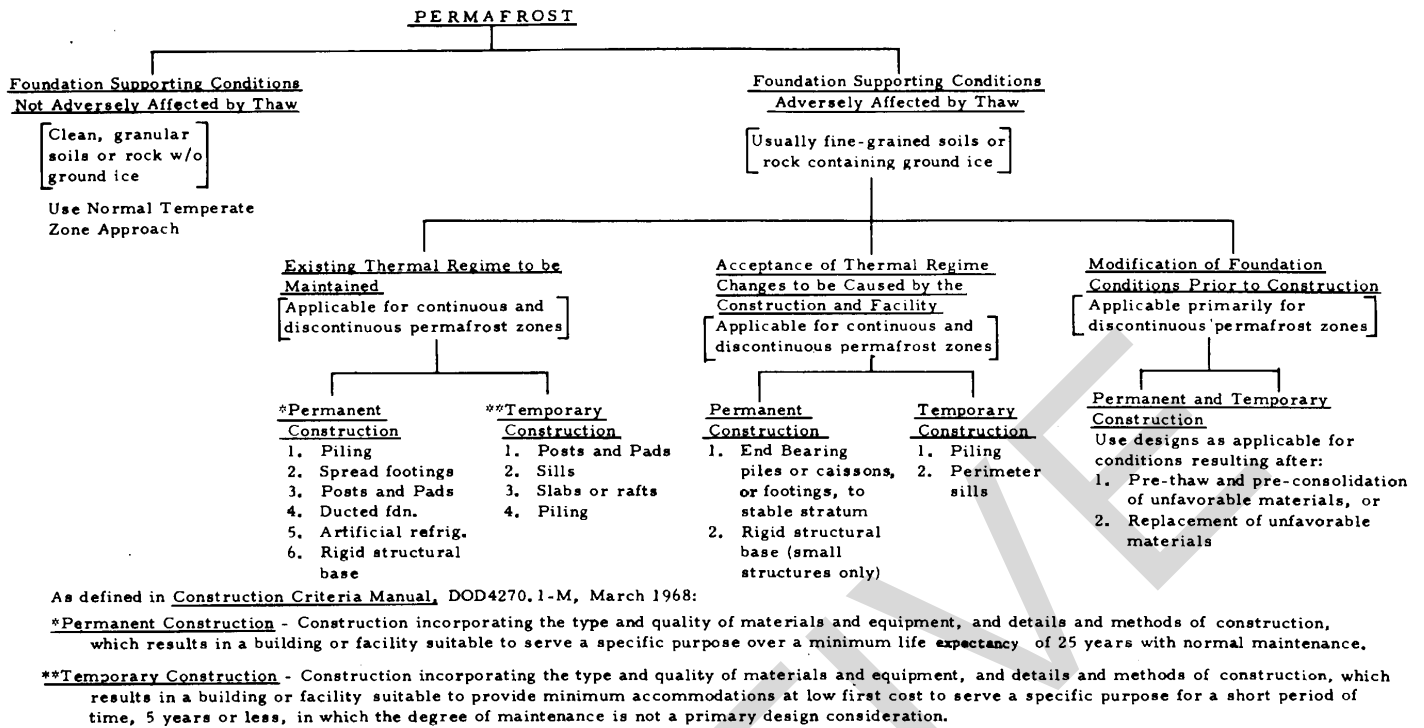

U. S. Army Corps of Engineers

Figure 4-2. Design alternatives.



manently frozen sands, gravels, and bedrock cannot be automatically assumed to be free of ice inclusions such as lenses or wedges (para 2-5). However, such foundation materials, free of excess ice, do occur frequently, as in important areas of interior Alaska. When clean sands and gravels, or bedrock free of ground ice, are present, foundation design can frequently be identical with temperate zone practice, even though the foundation materials are frozen below the foundation level. Seasonal frost heave and settlement are comparatively small or negligible in clean, granular, non-frost-susceptible materials under nominal confinement. When such materials thaw they remain relatively stable and retain good bearing characteristics. The tendency of freedraining sand and gravel deposits to have low ground water levels, within limits set by surrounding terrain, contributes to their general desirability as

construction sites. It is possible that local sand and gravel deposits may be found quite loose or containing ground ice due to various causes, such as silt inclusions within the soil mass, and some settlements may occur at such points if thawed materials are reconsolidated under the effects of loading and/or vibrations. Whether or not such conditions are present in significant degree must be determined in the course of the site investigations, and whether or not they need be taken into account in the design and construction will depend in part on the type and importance of the structure. Often, measures to preserve permafrost are unnecessary in construction on deep, clean sand and gravel deposits. Figure 4-3 shows, for example, the very minor settlement which accompanied thaw progression under a three story reinforced concrete

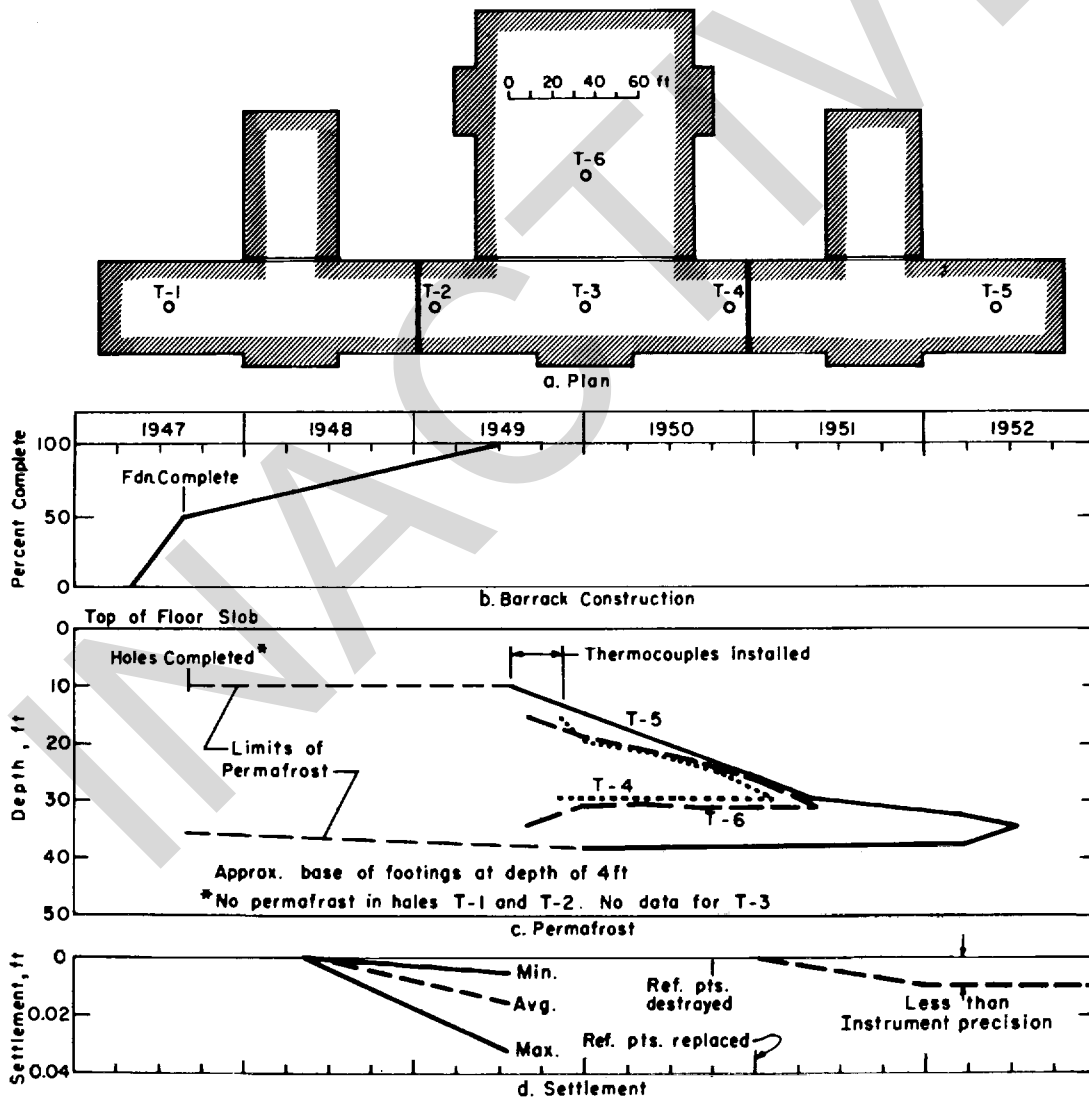

U. S. Army Corps of Engineers

Figure 4-3. Thawing of permafrost under 3 story, reinforced concrete, 500-man barracks, Fairbanks, Alaska. Reference points consisted of bolts installed in outer side of foundation wall above ground<sup>100</sup>.

building at Ft Wainwright (Ladd AFB), Fairbanks, Alaska.<sup>100</sup> No adverse effects could be detected. The settlement indicated by the earlier set of reference points in figure 4-3d may be attributed to compression of 2 to 6 feet of gravel backfill which had been placed beneath the footings and of the 3 to 4 feet of underlying gravelly soil which was at that time thawed to a depth of 10 feet. In special cases, such as of very important or critical structures which can tolerate only minute settlement or which transmit significant vibratory stresses to the foundation, or where effects of thaw after construction would be otherwise unacceptable, it may be necessary to employ pre-thawing (b below) followed by foundation soil consolidation and/or stabilization in accordance with the same principles and techniques as applicable under similar situations in non-frost areas.

(2) In some cases, in areas of low precipitation, fine-grained soils may be encountered which are free of ground ice and sufficiently dry and compact so that they may in theory be treated in the same way as granular non-frost-susceptible soils. However, the possibility that moisture may be introduced into such soils later, during or following construction such as from roof drains, dry wells or condensate discharge, must be considered.

*b. Construction when foundation supporting conditions will be adversely affected by thaw.* Permafrost in which the soil is fine-textured or contains significant fractions of silt or clay frequently contains significant amounts of ground ice in various forms such as lenses, veins, or wedges. Bedrock also often contains substantial ground ice. Any change from natural conditions which results in a warming of the ground can result in progressive lowering of the permafrost table over a period of years, known as degradation. Thawing of high ice content materials may produce large volume reduction and settlement of overlying soil and structures. Consolidating soils may have greatly reduced shear strength. Degradation subsidence in soils containing ground ice is almost invariably differential and hence potentially very damaging to a structure. The local thaw-depression produced in the permafrost will tend to form a collection sump for ground water, and underground components of the construction may encounter a difficult water control problem. Under some conditions lateral soil movements may develop. Degradation may occur not only from building heat but also from solar heating, in positions which sunlight can reach, from ground water flow, and from heat from underground utility lines. During the winter, seasonal freezing of frost-susceptible materials may produce substantial frost heaving. For locations in areas of fine textured soils, design should consider the following alternatives, as shown in figure 4-2.

Maintenance of existing thermal regime. Acceptance of the changes in the thermal regime and foundation conditions which will be caused by the construction and facility and

allowance for these in design. Modification of foundation conditions prior to construction. This includes the alternatives of removing and replacing unacceptable foundation conditions, and thawing to eliminate permafrost.

The principles of these three alternative methods are explained in the following paragraphs.

(1) *Existing thermal regime to be maintained.*

(a) This design approach is applicable for both continuous and discontinuous permafrost zones.

(b) In surface construction, it is possible to utilize the low temperatures of the freezing season to maintain permanent frozen soil conditions in the finegrained soil at and below the depth of the foundation support by providing for circulation of cold winter air through a foundation ventilation system or by some other method of foundation cooling. In some circumstances artificial refrigeration systems may be necessary.

(c) In order for natural cooling methods to be practical, it is necessary to cool the upper foundation soils sufficiently during the winter so that the foundation materials thawed in the preceding summer will be completely refrozen, progressive annual lowering of the permafrost table will be prevented, and there will be sufficient "storage of cold" so that maximum temperatures of permafrost do not exceed limits for safe foundation support. The latent heat of fusion of the ice produced by the winter refreezing of the moisture contained in the upper soil layers will be a major factor in restricting summer thaw to a shallow depth. When seasonal frost heave and settlement of the soil under the structure must be controlled and summer thaw must be prevented from reaching into underlying unsatisfactory foundation materials, sufficient thickness of non-frost-susceptible granular material should be placed to achieve the desired effect. The flow of heat from a building to the permafrost is retarded, and the refreezing of foundation materials aided, by placing insulation between the floor of the building and the underlying foundation ventilation or cooling system.

(d) To minimize disturbance of the subsurface thermal regime, the existing vegetative cover and seasonal frost zone material should be protected and preserved in non-work area. In the areas of actual construction, however, a mat of granular non-frost-susceptible material should be placed over soft vegetative cover to serve as a working surface, unless the work can be accomplished in winter without essential damage to the surface materials. Since it is generally not feasible to remove such a mat later and restore the vegetative cover to its original condition, the mat should

be designed as a permanent feature of the facilities. Mat thickness criteria are discussed in paragraph 4-2. Many types of fibrous organic surface layers when of sufficient thickness will support a few coverages of light construction equipment, but low-strength surface materials may require end-dumping techniques even to enable placement of the working mat. However, such mat or fill is not by itself a complete design solution when placed over frozen, highly compressible or high ice content deposits if there is any possibility of subsequent permafrost degradation. In order to estimate the structural properties of the permafrost in its frozen state, the temperatures at which it will be maintained must be estimated.

(e) It will be apparent that maintenance of the existing thermal regime is much easier to achieve in areas of continuous permafrost where permafrost temperatures are low than in the discontinuous and borderline permafrost areas where there is less margin of safety and greater care is required in design analysis.

(2) Acceptance of thermal regime changes to be caused by the construction and facility.

(a) This design approach is applicable for both continuous and discontinuous permafrost zones.

(b) If small progressive thawing is anticipated in the permafrost, settlement of structures may be avoided by supporting them on piles which are frozen into permafrost to a depth that is well below the level of anticipated degradation during the planned life of the structures and that is also sufficiently deep to resist any heaving forces during winter periods; it is approach is usually only used for temporary structures such as construction camp buildings and the possibility of unacceptable environmental impact must be considered. Piles or caissons may also be designed for end bearing on icefree bedrock or other firm, stable underlying formation. This method is particularly feasible when the finegrained foundation soils containing ground ice form a relatively shallow cap. Designing for end-bearing is a very good approach for bridge piers or similar structures where foundation ventilation or similar systems are not practical. It must be kept in mind that once a residual thaw zone has developed as a result of the construction, the temperature of the underlying permafrost, and its structural capacities for members such as piles, will be seriously altered.

(3) *Modification of foundation conditions prior to construction.*

(a) This design approach is applicable almost solely in the discontinuous or borderline permafrost areas. It has only very limited applicability for areas of continuous, low-temperature permafrost.

(b) Under this alternative, one procedure would be to compute the expected final extent of thawed or unfrozen foundation materials produced by

construction and subsequent facility operation and to pre-thaw and pre-consolidate the foundation within this zone. Thawing techniques are discussed in paragraph 6-2. One major disadvantage of this scheme lies in the difficulty of accurately anticipating the new thermal regime or thaw bulb position that will be stable, particularly if permafrost is too thick to be thawed completely through; continuing thaw of permafrost could result in settlement, but refreezing at the boundaries of pre-thawing would tend to produce heave. If only a relatively shallow layer of frozen fine-grained soil exists in or on an otherwise satisfactory granular foundation, the scheme may be more practical. The Corps of Engineers has constructed successfully performing facilities at both Anchorage and Fairbanks, Alaska, in which the major portions of frost-susceptible soils have been prethawed, consolidated and utilized in place with adequate heat permitted to escape to insure continuous thawed conditions. However, even under relatively favorable conditions, refreezing of the foundation when the building is vacated and heating discontinued for an extended period can cause major facility damage under this scheme. Because possible changes in building usage over long periods are relatively unpredictable and communication of requirements for continuous facility heating to successor occupants cannot be relied upon, this approach should not be used except with specific approval of HQDA (DAEN-ECE-G), WASH DC 20314.

(c) The same risk also occurs if a foundation cooling system is installed to stabilize the thawed regime of a foundation where degradation has already been experienced. At a regional school at Glenallen, Alaska, frost heave and structural difficulties, including differential movement of 2 inches, were apparently caused by operation of a mechanical refrigeration system for cooling under-floor air at temperatures low enough to cause progressive refreezing of underlying thawed soil.<sup>111</sup>

(d) Where the fine-grained settlement susceptible permafrost soils are limited to a relatively shallow upper layer, say up to about 20 ft thick, and clean, granular, non-settlement-susceptible soils underlie, it may be feasible to remove the undesirable soils and replace them with compacted fill of clean, granular soils. Design and construction may then follow normal temperate zone techniques. The U.S. Army Engineer District, Alaska, has used this technique successfully at Fairbanks, Alaska.

(e) Occasionally it may be possible to alter surface conditions at a construction site up to several years in advance so that adjustment of the thermal balance may occur naturally over a long time.

(f) Where permafrost is to be pre-thawed, the relative density of the soil in place, after thaw, should be

estimated together with related effects of the changes on subdrainage in the area and the thermal regime in the ground.

(g) Preferred practice is to aim as closely as practicable at the method in (1) above, but with knowledge that construction must inevitably effect some changes in accordance with the method in (2) above. Under the latter, design should aim at making the changes in thermal regime determinate. Where conditions are favorable, the method in (3) above may sometimes obviate the need for special foundation structural design, although the requisite conditions for employing this technique occur somewhat rarely.

(h) Unless foundation soils are clean granular materials which will not produce significant frost heave or settlement with fluctuations of thermal regime, it is accepted practice to support structures either entirely on top of the annual frost zone or entirely in the underlying permafrost zone using piles or other means to transmit structure loads through the annual frost zone.

*c. Simplified example of selection of foundation type in an area of discontinuous permafrost.*

(1) *Facility Requirements*

One story permanent facility, above surface. 250 lb/ft<sup>2</sup> minimum floor load capacity.

72° F normal room temperature.

No special thermal loads.

(2) *Site Data*

Within 5 miles of a city, in discontinuous permafrost region.

Construction materials, labor, equipment, transportation all readily available.

Clean, bank run gravel borrow available 3 miles from site.

Mean permafrost temperature 300F.

Thawing index = 5700.

Permafrost thickness = 200 ft continuous over site.

Overburden: 5 ft silt, non-plastic ML-Vs, over clean, frozen, thaw-stable sandy gravels, GW-Nbn, extending to bedrock at 210 feet.

No ice wedges. Anticipated settlement of silt on thaw = 1 1/2 in./ft.

(3) Since there is only 5 feet of thaw-susceptible over-burden, floor loading is high, and gravel is available, the silt should be removed and replaced with gravel, and a slab-on-grade type foundation should be employed. For a facility in which a more modest floor load capacity would be acceptable, a basement-type construction might be considered since this would avoid the hauling, spreading and compaction of gravel. However, a basement water problem might be encountered if thaw water were unable to drain naturally from the thaw bulb which will develop under the structure.

*d. Simplified example of selection of foundation type in an area of continuous permafrost.*

(1) *Facility Requirements*

One story permanent facility, above surface.

40 lb/ft<sup>2</sup> floor load capacity.

72°F room temperature, year-round No special thermal loads.

(2) *Site Data* Very remote site, continuous permafrost.

No local trained labor or materials.

Mean permafrost temperature + 12° F.

Thawing index = 700.

Freezing index = 8000.

Permafrost thickness = 1700 feet.

Overburden: 90 ft glacial till, silty gravel GMVr, containing ice wedges, over bedrock.

Anticipated settlement of overburden on thaw = 2 in./ft of thaw depth.

(3) Because permafrost is very deep and continuous, as well as containing substantial ground ice, the alternative "Modification of Foundation Conditions Prior to Construction" (fig. 4-2) is impractical and inapplicable. Permafrost temperature is low enough so that a thermally stable design is readily achievable. Under the foundation conditions, the alternative "Acceptance of Thermal Regime Changes to be Caused by Construction and Facility" is impractical for a permanent facility. Therefore, the possible designs shown under "Existing Thermal Regime to be Maintained" should be considered. For the light floor loading the ducted foundation and the rigid structural base options are too heavy and costly and are inappropriate. Since there is no special thermal load, permafrost temperature is low, and the structure is above-surface and can have a ventilated foundation, there is no need for artificial refrigeration. Therefore, design alternatives for permanent type foundation are piling, spread footings, and post and pad. Choice can be made on basis of cost after development of details for each of these types to the degree needed for resolution.

**4-2. Control of heat transfer and degradation.**

*a. General.*

(1) Frost and permafrost conditions, thermal regime in the ground and effects of heat from facilities have been discussed in general terms in paragraphs 1-2 and 2-1. Beneath and surrounding a foundation on frozen soil, the degree of disturbance of the normal thermal regime brought about by construction depends upon such factors as construction methods, exposure, drainage, snow cover and drifting, and extent of disturbance or change of the original surface cover, in addition to normal heat loss from the structure which may reach the ground. These factors must be taken into account in estimating both the immediate and long term stability of the struc-

ture foundation. Changes in the thermal regime in turn produce corresponding changes in such factors as the strength and creep properties of the foundation media and subsurface drainage. These factors are of far greater importance to foundation stability in the marginal areas of relatively warm, discontinuous permafrost than in the areas of either cold, continuous permafrost or of deep seasonal frost.

(2) In both seasonal frost and permafrost areas, heat flow should also be considered in relation to discomfort. From cool floors, the cost in added fuel requirements of undue heat loss, and the possible desirability of some heat loss to assist in protecting against frost heave of footings.

(3) Large heat-producing structures, particularly steam and power plants, present an especially serious foundation design problem because of the potential large and continuous flow of heat to the foundation. Heavy floor loadings often associated with such facilities may make it expensive to provide ventilation beneath the floor. The problem is commonly further complicated when severe dynamic loadings occur, such as from generator equipment. In addition, proper operation of such a plant may be seriously impaired by any differential floor movements. For these reasons, such structures should, whenever possible, be located on non-frost-susceptible granular soils in which effects of thawing or frost action will not be detrimental (making sure that the granular soil is not simply a relatively shallow layer covering fine-grained soils containing ground ice). At heat producing facilities it is essential to make specific provisions for disposal of warm water waste so that degradation of permafrost will not be caused by discharge of such water under or adjacent to the foundation. Care must be taken to avoid leakage from water or steam distribution lines and of deflection against the ground of warm air from facility ventilating systems. Whenever possible, heat producing plants should be housed in independently located buildings if they might be sources of differential thawing and subsidence for connected or closely adjacent facilities.

(4) Thermal stability and potential frost action in foundations of unheated facilities such as bridge piers, storage igloos, tower footings, loading platforms, and exterior shelter areas must also be analyzed carefully. In seasonal frost areas absence of an artificial heat source in an unheated facility, combined in some facilities with the shading effect of the upper parts of the structure, will usually result in maximum potential frost penetration, maximum frost adhesion to the foundation, and maximum tendency toward frost heave. In permafrost areas, on the other hand, thermal stability of the permafrost is much easier to achieve in foundations of unheated than heated facilities.

(5) The designer must keep in mind that disturbance of the natural ground surface by construction

efforts will normally cause some change in the position of the permafrost table, even though a continuously degrading condition may not be produced. In borderline permafrost areas it may be necessary to use vegetation, reflective paint, or shading devices to assist in obtaining a stable permafrost condition for the new construction.

(6) Serious difficulties may also occur if facilities in permafrost areas designed for no heat or a relatively low heating level are converted to higher heating temperatures; the results may be degradation of permafrost and foundation settlement. During design the possibility of future higher heating temperatures in facilities must be examined; if there is substantial probability of such future conversion, design for the higher temperature levels should be seriously considered.

(7) POL and water tanks should have ventilated foundations when located on permafrost subject to settlement on thaw. Water storage tanks are always kept above freezing and if placed directly on the ground, would cause continuous heat input into a frozen foundation even though insulated. POL may be loaded into storage tanks at relatively elevated temperatures, giving off considerable heat while cooling; also heavy oils may have to be heated for pumping.

(8) In pile foundations the piles themselves are also potential conductors of heat from the building or from warm air or sunlight to which they are exposed in the summer into the foundation but this is seldom a real problem because most conducted heat is diffused from the pile into the air ventilation space in winter or into the annual freeze and thaw zone, within a distance of 2 or 3 diameters along the pile. Probing and test pitting have shown slightly deeper summer thaw directly adjacent to unpainted steel piles which are exposed above ground to heating by both direct sunlight and air, but the amount has not been found to exceed about 12 to 18 inches in depth for piles properly installed and is generally much less. However, even this effect can be minimized with skirting, white paint or radiation shields where needed as discussed in f below.

(9) Care should be taken in designing foundations for refrigerated warehouses, refrigerated fuel tanks or similar foundations to avoid frost heave from progressive freezing of underlying soils. Such effects may take years to become evident. It should be noted that insulation only slows such effects; it does not prevent them.

(10) Detailed procedures for foundation thermal computations are presented in TM 5-852-6/AFM 88-19, Chapter 6<sup>14</sup>.

*b. Estimation of ordinary freeze and thaw penetration.*

(1) Design depth of frost penetration.

(a) In areas of seasonal frost conditions, the

design depth of seasonal frost penetration for situations not affected by heat from a structure should preferably be the maximum found by actual measurement under conditions representative of those for the facility design, or by computations if measurements are not available. When measurements are available, they will frequently need to be adjusted by computations to the equivalent of the freezing index selected as the basis for design, as measurements may not be available for a winter having a severity equivalent to that value. The air freezing index to be used in the estimate of frost penetration should be selected on the basis of the expected life of the structure and its type. For average permanent structures, the air freezing index for the coldest year in 30 should be used; this is more conservative than the coldest-year-in-ten (or average of 3 coldest in 30) criterion used for pavement

design because permanent buildings and other structures are less tolerant of vertical movement than pavements. For structures of a temporary nature or otherwise tolerant of some foundation movement, the air freezing index for the coldest year in ten or even the mean air freezing index may be used, as may be most applicable.

(b) For average conditions, the air freezing or thawing index can be converted to surface index by multiplying it by the appropriate n factor from table 4-1.

(c) The frost penetration can then be computed using the detailed guidance given in TM 5-852-6/AFM 88-19, Chapter 6<sup>14</sup>. Approximate values of frost penetration may also be estimated from figure 4-4b for

Table 4-1. n - Factors for Freeze and Thaw (Ratio of Surface Index to Air Index)<sup>14</sup>

Type of Surface (a)	For Freezing Conditions	For Thawing Conditions
Snow Surface	1.0	-
Portland Cement Concrete	0.75	1.5
Bituminous Pavement	0.7	1.6 to 2+ (b)
Bare Soil	0.7	1.4 to 2+ (b)
Shaded Surface	0.9	1.0
Turf	0.5	0.8
Tree- covered	0.3(c)	0.4

- (a) Surface exposed directly to sun and/or air without any overlying dust, soil, snow or ice, except as noted otherwise, and with no building heat involved.
- (b) Use lowest value except in extremely high latitudes or at high elevations where a major proportion of summer heating is from solar radiation.
- (c) Data from Fairbanks, Alaska, for single season with normal snow cover permitted to accumulate.

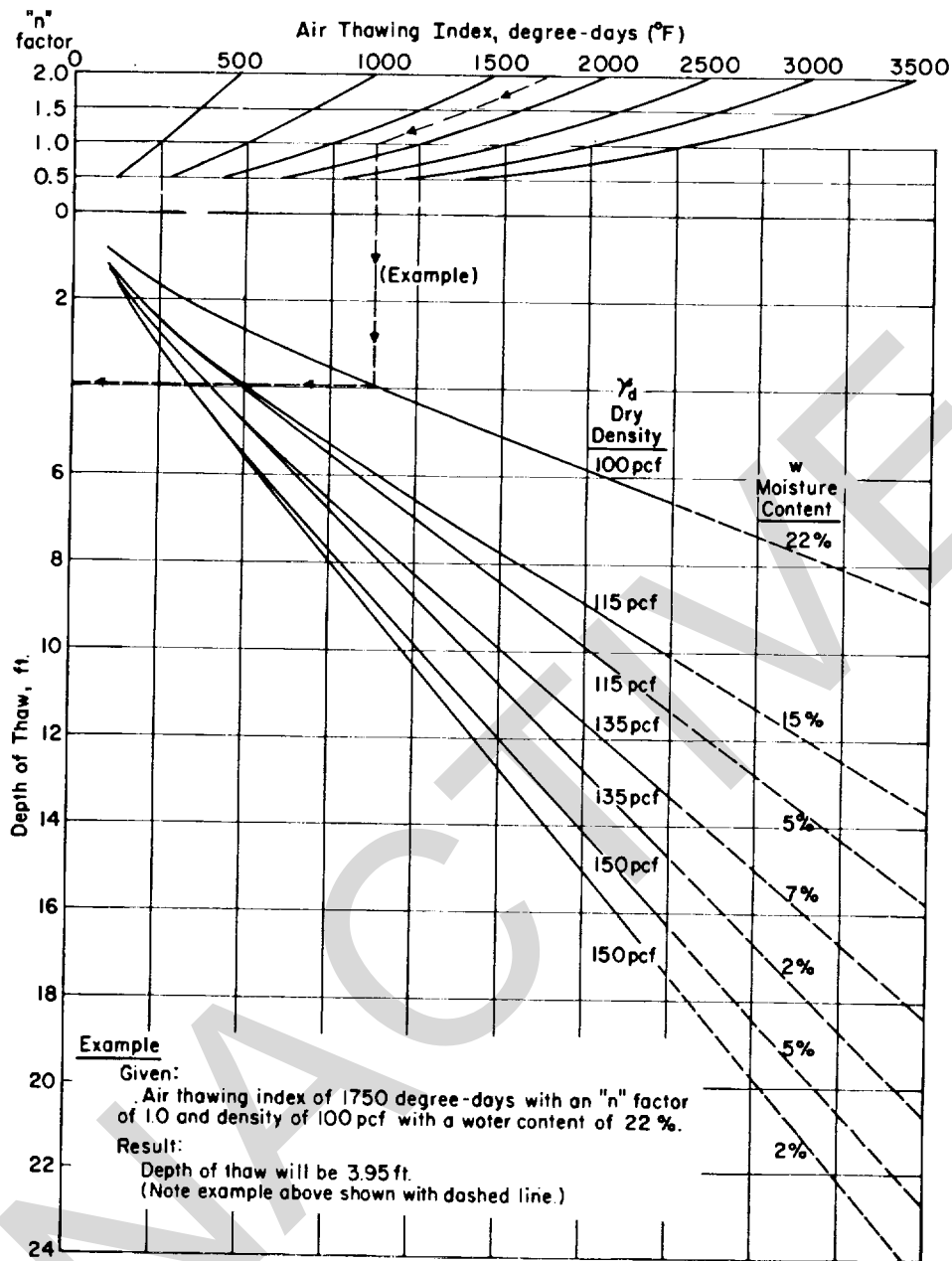

U. S. Army Corps of Engineers

Figure 4-4a. Approximate depth of thaw or freeze vs air thawing or freezing index and n-factor for various homogeneous soils. In calculations for the curves, thermal conductivities for frozen and thawed states have been averaged together. Because the actual effective thermal conductivity may not be equal to this average value during either freezing or thawing, precise agreement between measured and predicted values should not be anticipated. However, deviations due to this approximation should not exceed those arising from other causes. Curves developed from calculations based on procedures in TM 5-852-6<sup>14</sup>. (Air thawing index vs depth of thaw.)

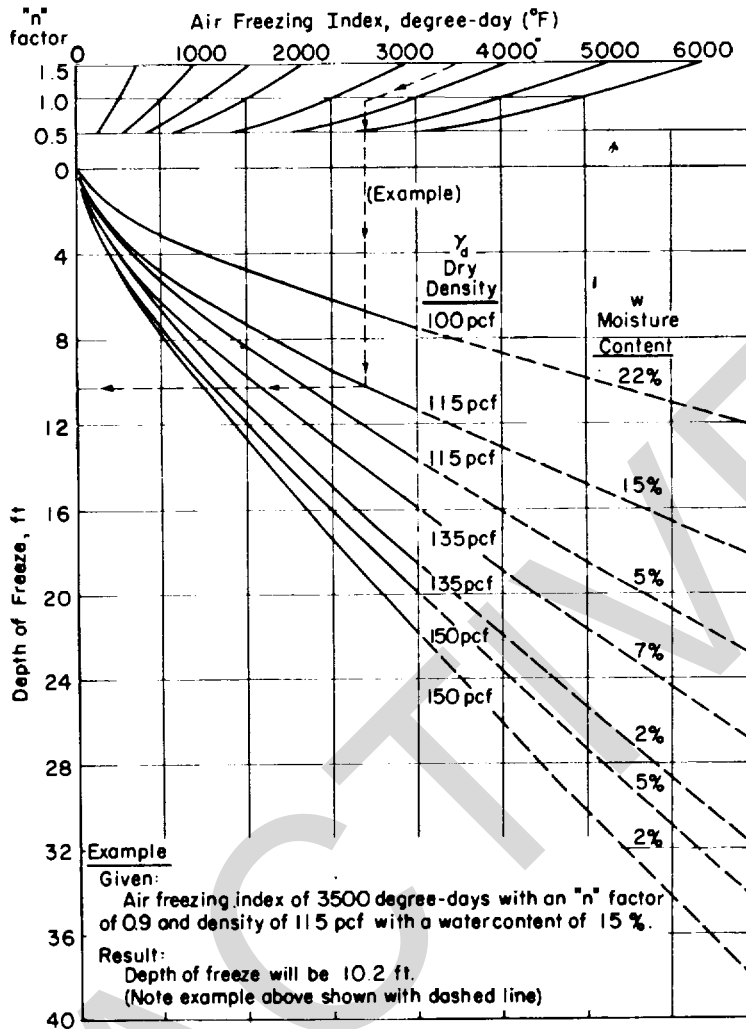

U. S. Army Corps of Engineers

Figure 4-4b. Approximate depth of thaw or freeze vs air thawing or freezing index and n-factor for various homogeneous soils. In calculations for the curves, thermal conductivities for frozen and thawed states have been averaged together. Because the actual effective thermal conductivity may not be equal to this average value during either freezing or thawing, precise agreement between measured and predicted values should not be anticipated. However, deviations due to this approximation should not exceed those arising from other causes. Curves developed from calculations based on procedures in TM 5-852-6<sup>14</sup>. (Air freezing index vs depth of freeze.)



soils of the density and moisture content ranges there represented. For paved areas kept free of snow, depth of frost penetration may also be estimated from TM 5-818-21 or TM 5-852-3<sup>12</sup>, entering the appropriate chart with air freezing index directly.

(d) For given soil conditions, the greatest depth of penetration will be for paved areas not affected by any artificial heat, shaded from the sun, and kept cleared of snow. For heated buildings, both slab on grade and basemented, the heat flowing outward from the foundation tends to modify frost penetration next to the foundation wall. However, a variety of possible situations exists. A building with a basement offers a different condition than one with slab-on-grade construction, and use of insulation or firming on basement or perimeter walls will change heat flow.

(e) Penetration depths for paved areas will nearly always need to be determined by computation rather than from measurements. A deep snow cover may entirely prevent frost penetration; however, the effect of snow cover should usually be disregarded for design purposes, as snowfall may be very small or negligible in the years when temperatures are coldest. Turf, muskeg, and other vegetative covers also help substantially to reduce frost penetration. Some additional guidance on effects of surface conditions is contained in TM 5-852-6/AFM 88-19, Chapter 6<sup>14</sup>.

(f) In the more developed parts of the cold regions, the building codes of most cities specify minimum footing depth, based on many years of local experience; these depths are invariably less than the maximum observed frost penetrations. The code values should not be assumed to represent actual frost

penetration depths. Such local code values have been selected to give generally suitable results for the types of construction, soil moisture, density, and surface cover conditions, severity of freezing conditions, and building heating conditions which are common in the area. Unfortunately, specific information on how these factors are represented in the code values is seldom available. The code values may be inadequate or inapplicable under conditions which differ from those assumed in formulating the code, especially for unheated facilities, insulated foundations, or especially cold winters. Building codes in the Middle and North Atlantic States and Canada frequently specify minimum footing depths in the range of 3 to 5 feet. If frost penetrations of this order of magnitude occur with fine silt and clay type soils, 30 to 100 percent greater frost penetration may occur in well-drained gravels under the same conditions. With good soil data and a knowledge of local conditions, computed values for ordinary frost penetration, unaffected by building heat, may be expected to be adequately reliable, even though the freezing index may have to be estimated from weather data from nearby stations. In remote areas, reliance on computation of the design frost depth for the specific local conditions at the proposed structure location may be the only practicable or possible procedure, as opposed to reliance on measurements.

(2) Design depth of thaw penetration. Seasonal thaw penetration in permafrost areas typically begins in May or June and reaches maximum depth in the ground in the period July September, as illustrated in figures 4-5 and 4-6. Under paved areas exposed to sunshine, particularly black bituminous pavements,

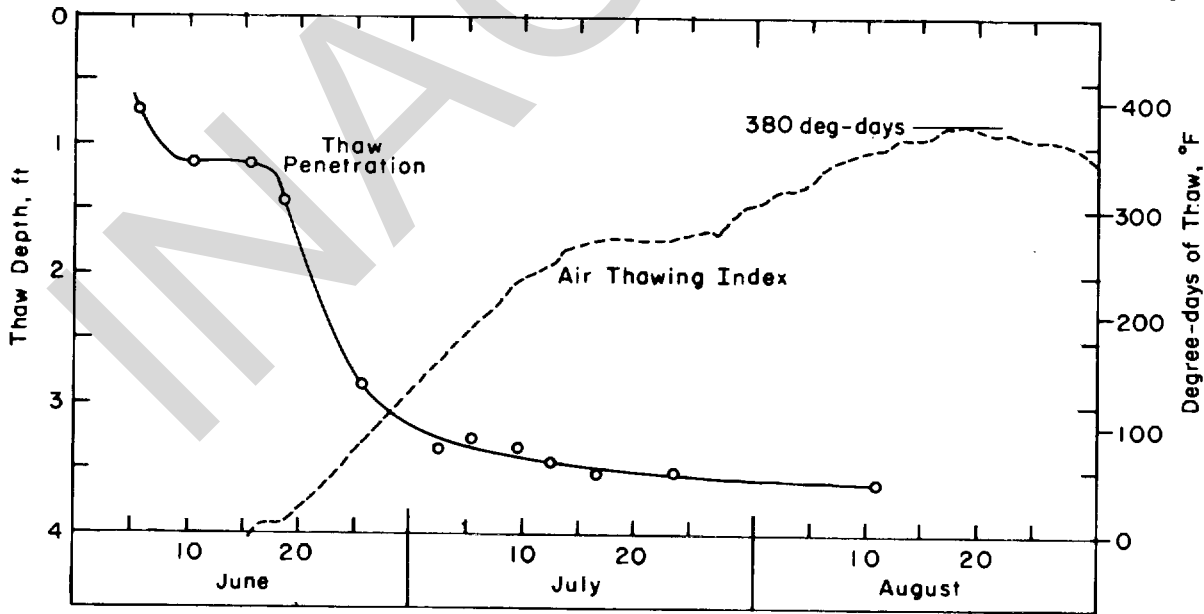

U. S. Army Corps of Engineers

Figure 4-5. Thaw progression under undisturbed surface, Camp TUTO (near Thule air Base), Greenland. Soils data: average gradation SC, clayey sand; dry unit weight 120124 lb/ft<sup>3</sup>; moisture content 8-12 percent, essentially no vegetative cover on surface (by CRREL).

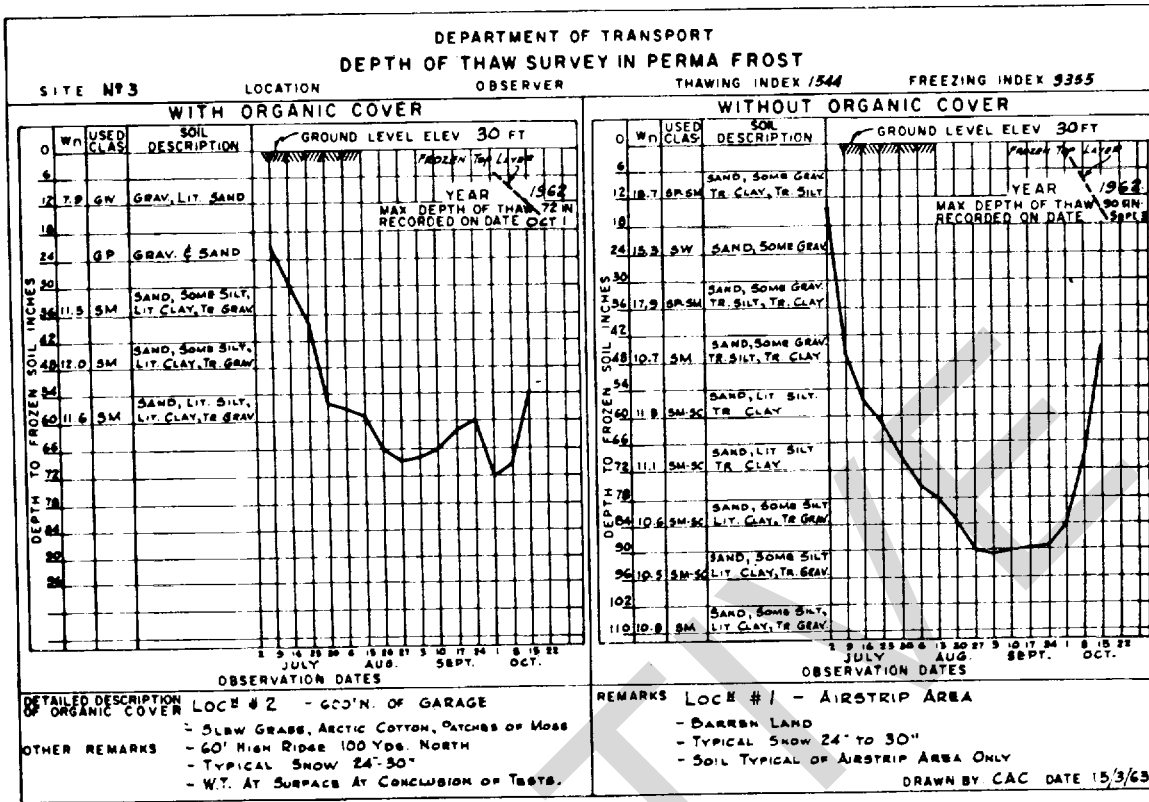
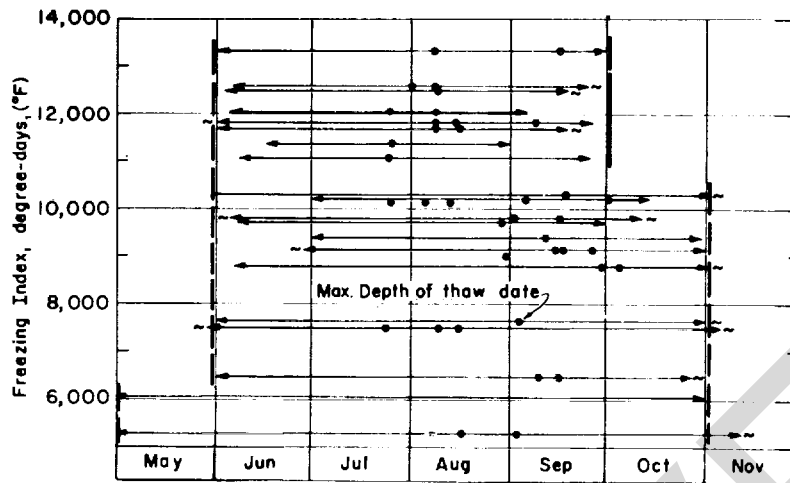

Figure 4-6a. Thaw vs time. Canadian locations (after Sebastyan<sup>188</sup>). (Depth of thaw survey in permafrost, Canadian location)

(Courtesy of Building Research Advisory Board, NAS-NRC)



(Courtesy of Building Research Advisory Board, NAS-NRC)

Figure 4-6b. Thaw vs time, Canadian locations (after Sebastyan<sup>188</sup>). (Period of thaw vs freezing index. Data based on depth of thaw determined by soundings at 38 locations in northern Canada.)

seasonal thaw penetration in high density, extremely well-drained granular materials may be substantial and in marginal permafrost areas may reach as much as 20 feet. Thaw depths under non-paved areas reach typical values as illustrated in figure 4-7 and thaw may vary seasonally from place to place on an airfield site as shown in figure 4-8. The air thawing index to be used in the estimate of seasonal thaw penetration should be established on the same statistical basis as outlined in (1) above for seasonal frost penetration. The air thawing index can be converted to surface thawing index by multiplying it by the appropriate thawing-conditions n-factor from table 4-1. The thaw penetration can then be computed using the detailed guidance given in TM 5-852-6/AFM 88-19, Chapter 6<sup>14</sup>. Approximate values of thaw penetration may also be estimated from figure 4-4a for soils of the density and moisture content ranges there represented. If average annual depth of thaw exceeds average annual freeze depth, degradation of the permafrost will result.

c. Estimation and control of thaw or freeze beneath structures on permafrost.

(1) General.

(a) Heat flow from the structure is a major consideration in the design of a foundation in a northern area. Only when no settlement or other adverse effects will result can heat flow from the structure to the underlying ground be ignored as a factor in the long term structural stability.

(b) Figure 4-9 presents an idealized diagram of the effect of size on both total depth of thaw and rate of thaw under a heated structure placed directly on frozen material. Thawing of uniformly distributed

ground ice under a uniformly heated structure proceeds most rapidly near the center of the structure and more slowly at the perimeters, tending to produce a bulb-shaped thaw front and dish-shaped settlement surface. Interior footings in such a structure tend to settle progressively in the same dish-shape, at about the same rate as the melting of the ice. However, a rigid foundation slab tends to develop a space under it, at least for a time, after which abrupt collapse may occur. The larger the structure the larger the potential ultimate depth of thaw; however, in initial stages of thaw, the rate of thaw advance under the center of the structure is not a function of structure size. For small temporary buildings it is seldom necessary to completely preclude differential seasonal movements even though it may be relatively easy to do this; most construction camp buildings, for example, can be maintained easily and the movements brought about by frost action and thaw can be equalized by the use of jacks and shims.

(c) For large structures intended for long term use, maintenance requirements must be kept at a much lower level, consequences of progressive thawing may be more severe, and achievement of adequate ground cooling and thaw depth control with a foundation ventilation system is more difficult.

(2) Building floor placed on ground. When the floor of a heated building is placed directly on the ground over permafrost, the depth of thaw is determined by the same method as that used to solve a multilayer problem when the surface is exposed to atmospheric effects, as explained in TM 5-852-6/AFM 88-19, Chapter 6<sup>14</sup>, except that the thawing index is replaced by the product of the time and the differential between the

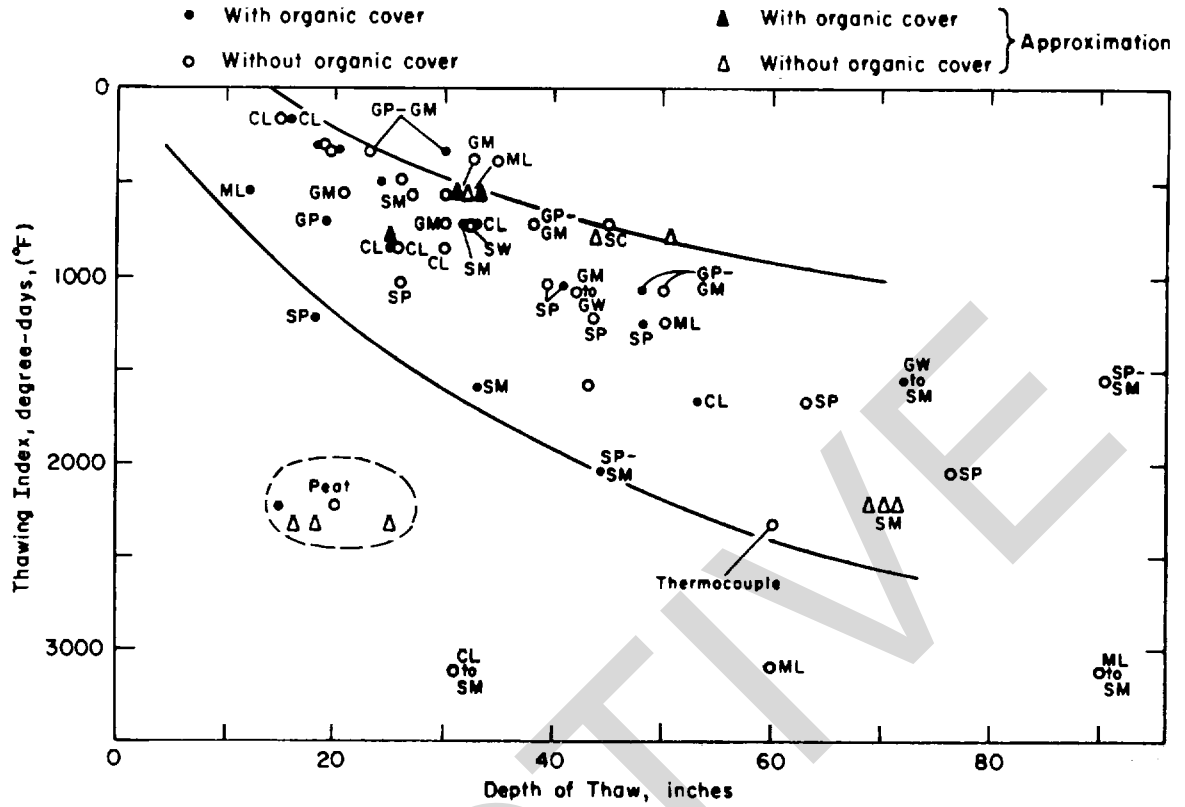

Figure 4-7. Depth of thaw vs air thawing index for unpaved surfaces. Data based on depth of thaw determination by sounding at 62 locations in the Canadian North<sup>188</sup>.

(Courtesy of Building Research Advisory Board, NAS-NRC)

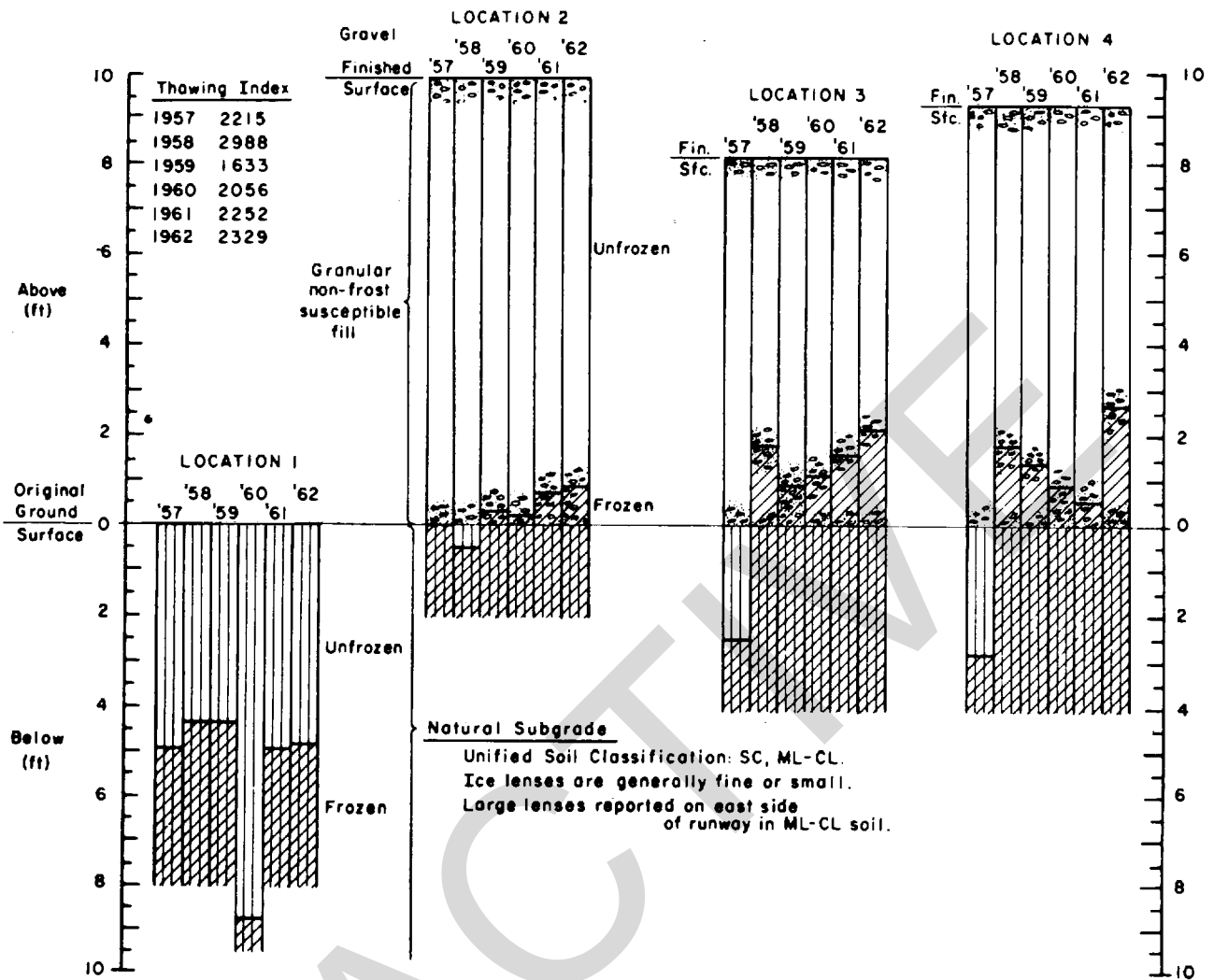
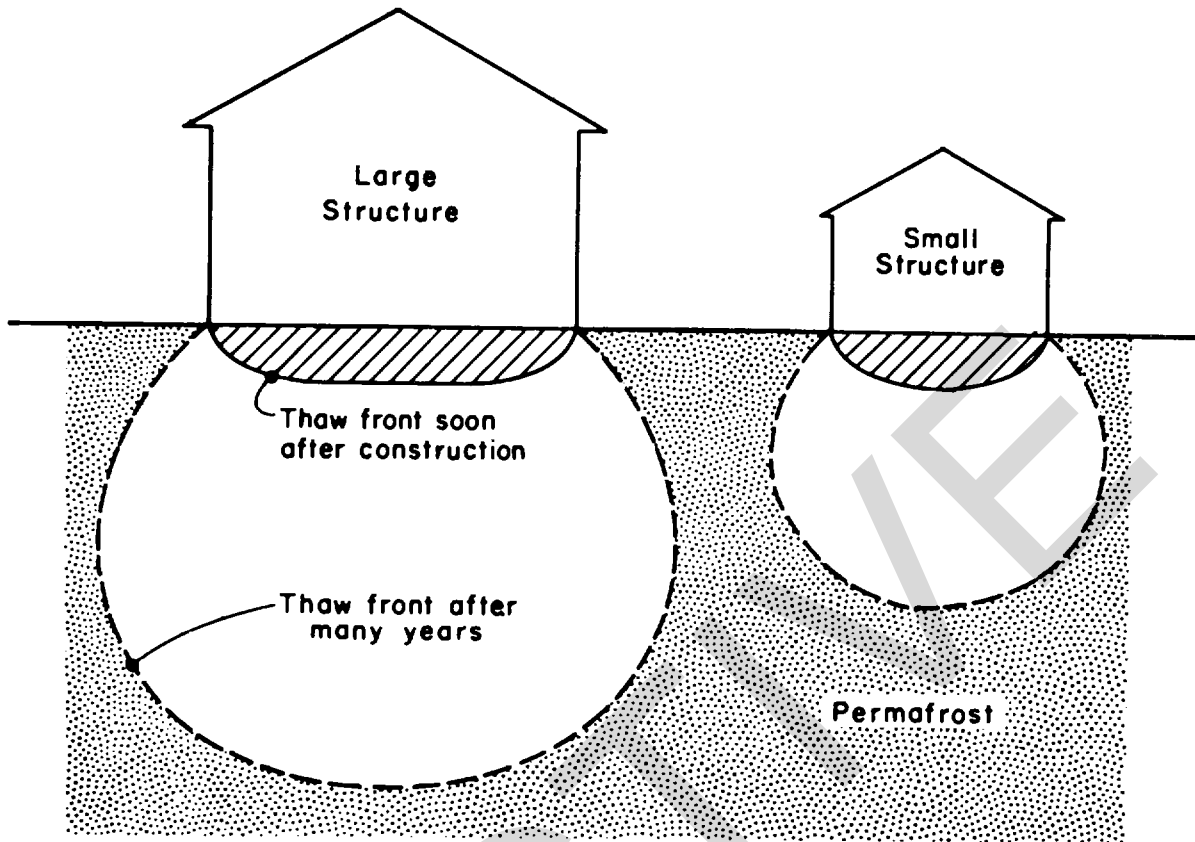

Figure 4-8. Thaw depth as affected by runway construction on permafrost<sup>188</sup>.

(Courtesy of Building Research Advisory Board, NAS-NRC)



U. S. Army Corps of Engineers

Figure 4-9. Effect of heated structure size on depth and rate of thaw.

building floor temperature and 32 °F.

(a) Example: Estimate the depth of thaw after a period of one year for a building floor consisting of 8 inches of concrete, 4 inches of cellular glass insulation, and 6 inches of concrete, placed directly on a 5-feetthick sand pad overlying permanently frozen silt for the following conditions:

Mean annual temperature (MAT), 20 F.

Building floor temperature, 65 °F.

Sand pad: Dry unit weight  $\gamma_d = 72 \text{ lb/ft}^3$ ,  $w = 45$  percent.

Concrete: Coefficient of thermal conductivity,  $K = 1.0 \text{ Btu/ft hr } ^\circ\text{F}$ ; Volumetric heat capacity,  $C = 30 \text{ Btu/ft}^3 \text{ } ^\circ\text{F}$ .

Insulation:  $K = 0.033 \text{ Btu/ft hr } ^\circ\text{F}$ ,  $C = 1.5 \text{ Btu/ft}^3 \text{ } ^\circ\text{F}$ .

The resistances of the three floor layers are in series, and the floor resistance  $R_f$  is the sum of the three layer resistances ( $d =$  thickness of layer in feet).

$$R_v = \frac{d}{k} = \frac{8}{(12)(1.0)} + \frac{4}{(12)(0.033)} + \frac{6}{(12)(1.0)} = 11.2 \text{ ft}^2 \text{ hr } ^\circ\text{F/Btu}$$

The average volumetric heat capacity of the floor system is

$$C_f = \frac{(30)(8) + (1.5)(4) + (30)(6)}{8+4+6} = 23.7 \text{ Btu/ft}^3 \text{ } ^\circ\text{F}$$

The solution to this problem (table 4-2) predicts a total thaw depth of 7.8 feet. This solution did not consider edge effects; i.e., a long narrow building will have less depth of thaw than a square building with the same floor area because of the difference in lateral heat flow.

(b) Figures 4-3, 4-10, 4-11 and 4-12a show measured rates of thaw beneath buildings placed direct-

Table 4-2. Thaw Penetration Beneath a Slab-on-Grade Building Constructed on Permafrost<sup>14</sup>

Layer	$\gamma_d$	w	d	$\Sigma d$	C	K	L	Ld	$\Sigma Ld$	$\bar{L}$	Cd	$\Sigma Cd$	$\bar{C}$	$\mu$	$\lambda$	$\lambda^2$	$R_n$	$\Sigma R$	$\Sigma R \frac{R}{Z}$	nI	$\Sigma nI$
Floor	--	--	1.5	1.5	24	--	0	0	0	0	36	--	--	--	--	--	11.20	0	5.60	--	--
Sand	133	5.0	5.0	6.5	28	1.54	960	4,800	4,800	738	140	176	27	1.21	0.68	0.463	3.25	11.20	12.82	5,540	5,540
Silt a	72	45.0	1.5	8.0	37	0.90	4,650	6,970	11,770	1,470	55	231	29	0.65	0.77	0.593	1.67	14.45	15.29	7,480	13,020
Silt b	72	45.0	1.3	7.8	37	0.90	4,650	6,050	10,850	1,390	48	224	29	0.69	0.765	0.586	1.44	14.45	15.17	6,520	12,060

Where: L = volumetric latent heat of fusion = 144  $\gamma_d \frac{w}{100}$  (see Figure 8, TM5-852-6<sup>14</sup>)

$$\bar{L} = \Sigma Ld / \Sigma d$$

$$\bar{C} = \Sigma Cd / \Sigma d$$

$$\mu = V_o \left( \frac{\bar{C}}{L} \right) \text{ and } V_o = 65 - 32 = 33$$

$\lambda$  determined from Figure 13, TM5-852-6, using  $\mu$  and  $\alpha$

$$\alpha = \frac{V_o}{V_g}, V_o = \text{initial temperature differential} = 32 - \text{M.A.T.} = 12$$

$$\alpha = \frac{12}{33} = 0.364$$

$$nI = \frac{Ld}{24\lambda^2} \left( \Sigma R + \frac{R_n}{Z} \right)$$

Computations for Thaw Penetration:

Surface thawing index (nI) = 33 x 365 = 12,050 degree-days

$$nI (\text{Sand}) = \frac{4,800}{24(0.463)} (12.82) = 5,540 \text{ degree-days}$$

$$nI (\text{Silt a}) = \frac{6,970}{24(0.593)} (15.29) = 7,480 \text{ degree-days}$$

$$nI (\text{Silt b}) = \frac{6,050}{24(0.586)} (15.17) = 6,520 \text{ degree-days}$$

Total Thaw Penetration = 7.8 ft.

U. S. Army Corps of Engineers

U. S. Army Corps of Engineers

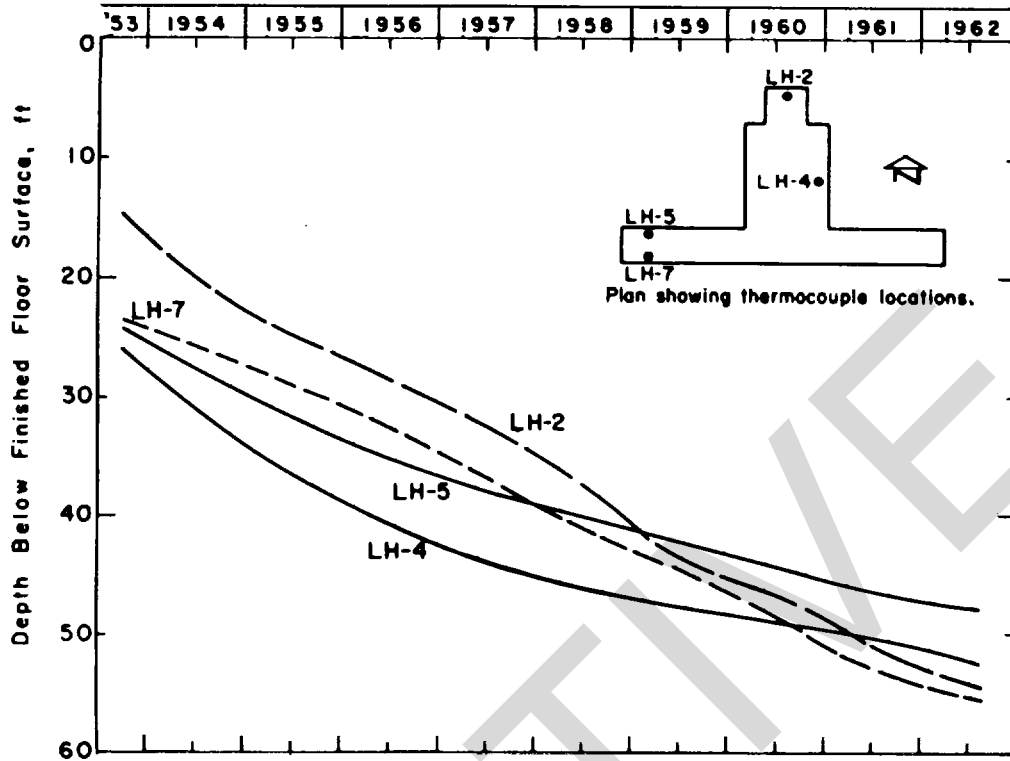

U. S. Army Corps of Engineers

Figure 4-10. Degradation of permafrost under five-story reinforced concrete structure, Fairbanks, Alaska. Foundation: perimeter wall footing wallfooting and interior spreadfootings; uninsulated basement floor 3 to 6 feet below ground surface. Soil types: sandy gravels to silty sands.



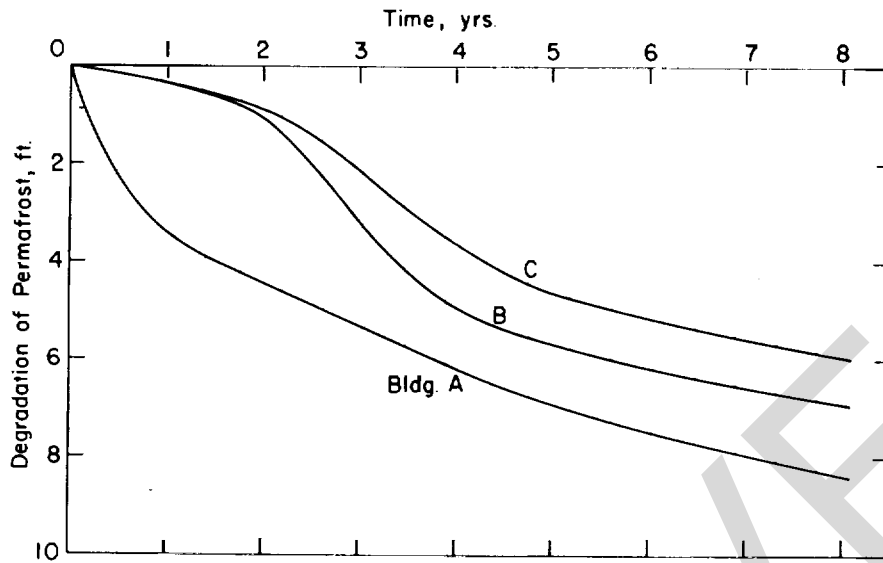

		Bldg A	Bldg B	Bldg C
Foundation	Floor	4 in. concrete slab	Wood floor with 4 in. batt insul.	Wood floor with 4 in. batt insul.
	Mat	4 ft gravel	2 ft gravel	2 ft gravel over 6 in. eell concrete over 2 ft gravel
Conditions at end of construction	Thaw depth in silt	4.6 ft	2.9 ft	3.5 ft
	Depth to permafrost (from top of gravel fill)	8.6 ft	4.9 ft	8.0 ft

U. S. Army Corps of Engineers

U. S. Army Corps of Engineers

Figure 4-11. Permafrost degradation under 16-foot-square heated test buildings without air space, beginning at end of construction. Table shows foundation conditions. See figure 4-19 for site conditions.

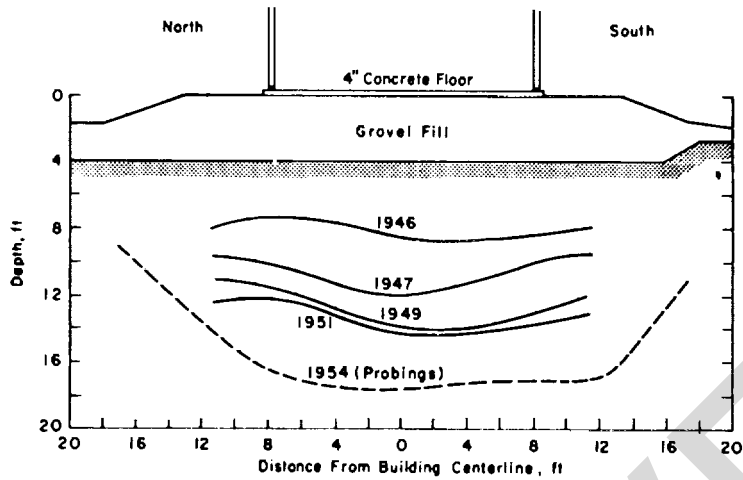

U. S. Army Corps of Engineers

Figure 4-12a. Typical foundation thaw near Fairbanks, Alaska. See figure 4-19 for "Site Conditions."

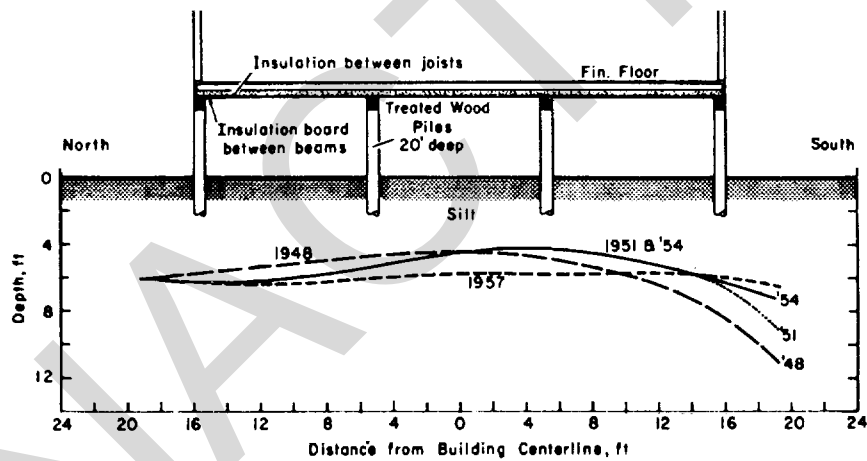

U. S. Army Corps of Engineers

Figure 4-12b. Typical foundation thaw near Fairbanks, Alaska (Permafrost Degradation Under heated building (32 x 32ft) supported by piles over airspace.)

ly on the ground, over permafrost. Figures 4-3 and 4-10 show data for large reinforced concrete structures, 3 stories and 5 stories, respectively, erected on clean, granular frozen soils which did not contain ice in such form as to cause significant settlement on thawing. Figure 4-11 shows the effects of various combinations of insulation and granular mat on thawing beneath small experimental buildings supported over frozen silt containing much ice. Insulation held back degradation initially but had little effect later. Figure 4-12 compares the continuing degradation under a small building without foundation ventilation with the thermal stability achieved by supporting a structure on piles with an airspace.

(3) *Ventilated foundations.* The most widely employed, effective and economical means of maintaining a stable thermal regime in permafrost under a heated structure is by use of a ventilated foundation. In such a foundation, provision is made for either open or ducted circulation of cold winter air between the insulated floor and the underlying ground. The air circulation serves to carry away heat both from the foundation and from the overlying building, freezing back the upper layers of soil which were thawed in the preceding summer.

(a) Cold air passing through a simple air space beneath a building or through a ducted foundation ventilation system is gradually warmed, reaching the outlet side with a reduced air freezing index. Thus, freezeback in a ventilated foundation tends to progress from the intake toward the outlet side, as indicated by the asymmetrical curve of thaw penetration depth in figure 4-28. In summer also, thaw tends to occur progressively across the foundation in the direction of air flow. The freezing index at the outlet must be sufficient to counteract the thawing index at that point in order to insure annual freezeback of foundation soils. In borderline discontinuous permafrost areas, this freezeback is more difficult to achieve than in colder climates and in these areas it may set a positive limit on the feasible width of buildings for a given type of ventilated foundation design. Even under calm conditions, air circulation will be induced by heating of the air below a building from both the ground and the building. Stacks or chimneys may be used where appropriate to induce increased circulation and they may be found to be a positive requirement. The stack or chimney height and the floor insulation are both very important variables in the foundation design. Increasing insulation thickness will permit lowering the stack or chimney height for the same insulation; increase in stack height will increase the air flow. Potential permafrost degradation problems from flow of ground water in the annual zone must be carefully investigated<sup>200</sup>.

(b) The simplest means of implementing foundation ventilation is by providing an open air space under the entire building, with the

structure supported on piling in permafrost, columns supported on footings in permafrost, or posts and pads over a gravel layer, as illustrated by figures 4-13 through 4-23. For structures whose narrow width is not more than 20 feet, the air space should technically not be less than 18 inches and where the narrow building width is between 20 to 50 feet not less than 30 inches. However, since access to the air space may be required for foundation adjustments such as jacking or shimming, for inspection or repair of utilities, or for other reasons, the actual depth of the space should be enough so that it may serve as a crawl space, nominally 30 to 36 inches minimum, regardless of size of structure. Beams, sills and other supporting members may occupy part of this space provided all parts of the foundation are accessible for maintenance, free paths of air circulation across the width of the foundation are maintained, and paths for direct conduction of heat from the building into the foundation are kept minimal. In areas subject to snow drifting, too little clearance, excessive numbers of piles or excessive depth of framing members will reduce air velocities and permit drifting and snow accumulation under buildings. For very wide structures or where access to the air space is restricted, induced air circulation by the use of plenums and/or stacks or chimneys, or, less likely, by use of fans, may be required.

(c) When large buildings with heavy floor loads, such as hangars, garages and warehouses, make provision of an open air space difficult, use of ventilation ducts below the insulated floor should be considered. Examples of such designs are shown in figures 4-24 through 4-28. Thermal calculation procedures for ducted foundations are outlined in TM 5-852-4/AFM 88-19, Chapter 6<sup>14</sup>. Ducted foundations are normally much more expensive than open air-space foundations, because of the relatively large volume of concrete and numbers of construction steps involved and because of the cost of pans, pipes, plywood or other special duct-forming items left in place when these materials are used. The design shown in figure 4-24, which makes extensive use of simple prefabricated members, demonstrates an effort to reduce the cost of ducted foundations. Because of the susceptibility to damage of ducted type construction from vertical movements, special care must be taken that the underlying gravel mat is of adequate thickness so that freeze and thaw will remain within non-frost-susceptible materials to eliminate seasonal heave and settlement.

(d) Ventilating foundation design should incorporate a safety factor which provides for complete freezeback of the underlying soil 30 days before the end of the freezing season, using the minimum site freezing index and allowing for any greater freezeback requirement which may exist at the perimeter of the founda-

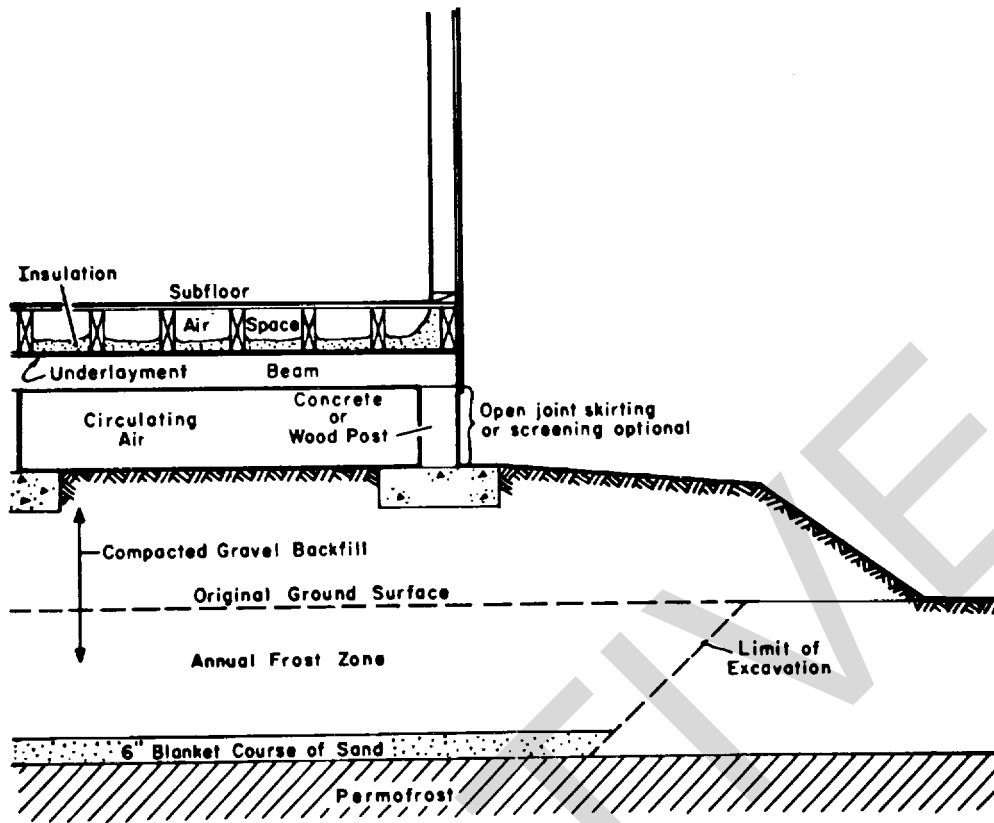

U. S. Army Corps of Engineers

Figure 4-13. Typical design for light structure with air space and gravel mat (by CRREL).

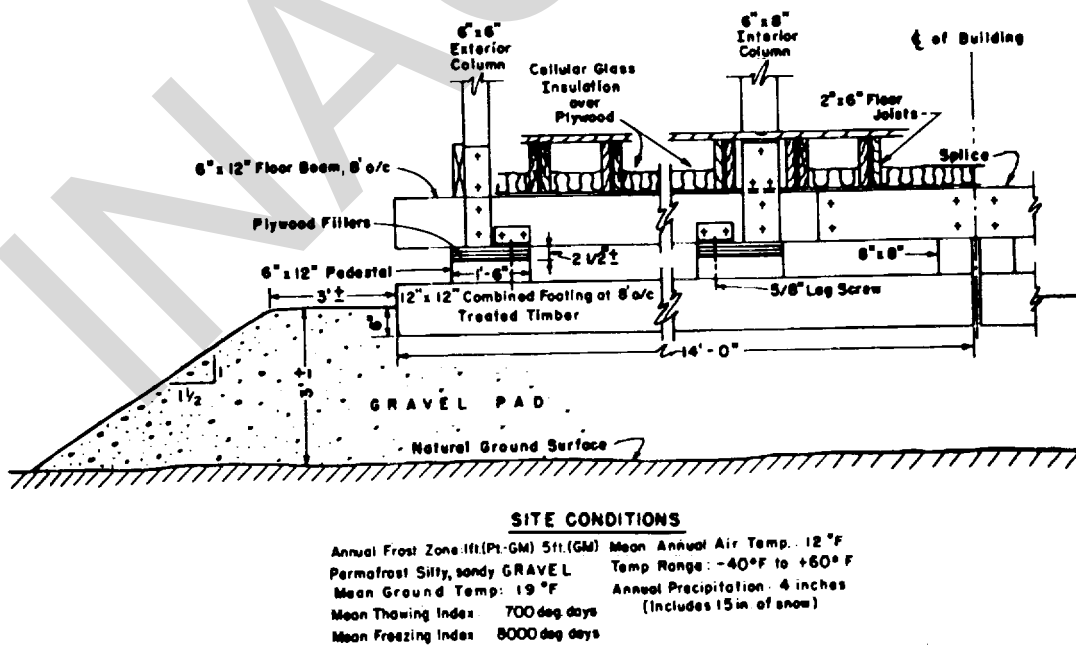
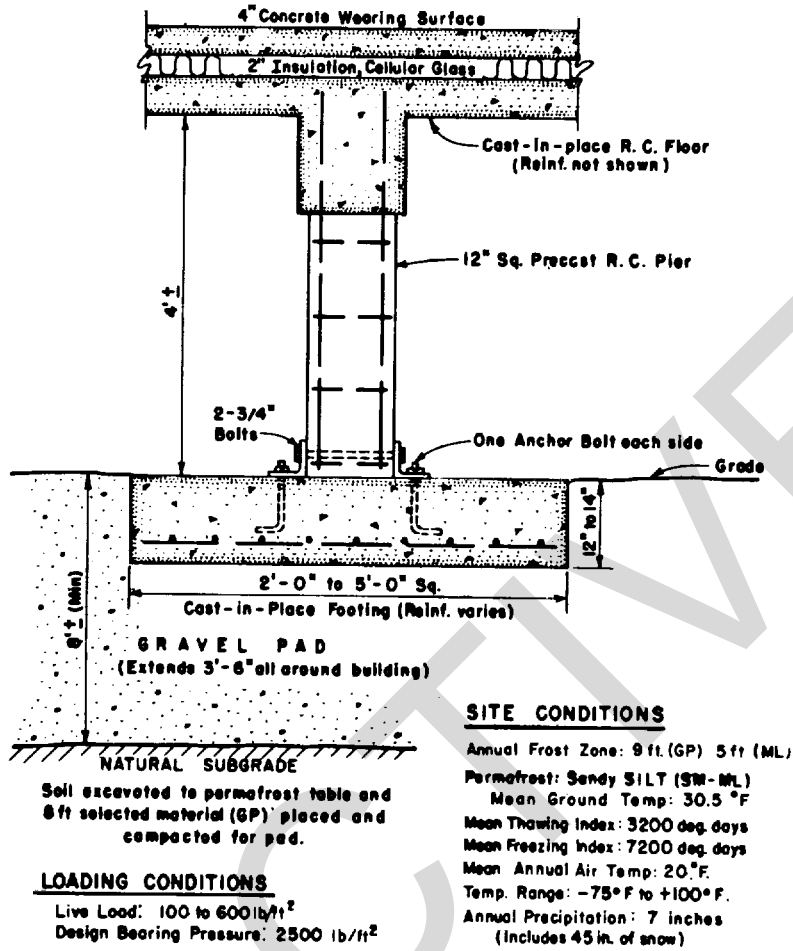
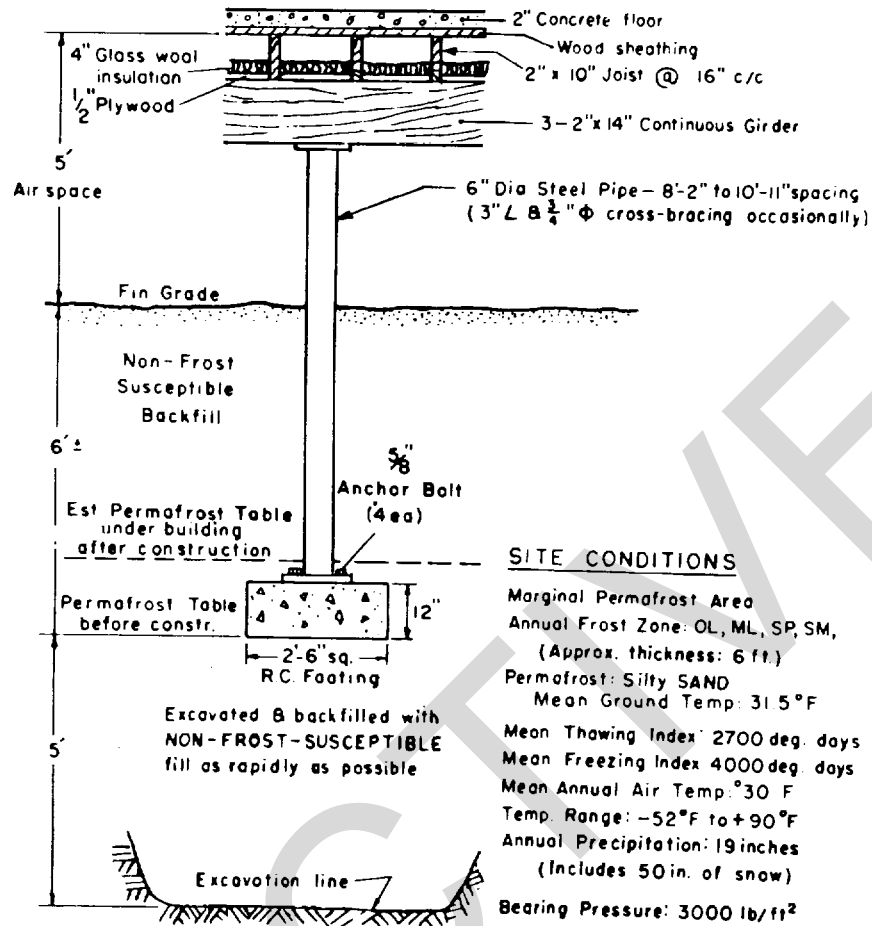

Figure 4-14. Foundation in permafrost area for men's barracks, Thule, Greenland<sup>86</sup>.



U. S. Army Corps of Engineers

Figure 4-15. Post and pad type foundation for composite building, Fort Yukon, Alaska<sup>86</sup>.



U. S. Army Corps of Engineers

Figure 4-16. Footing on permafrost foundation, Bethel, Alaska<sup>86</sup>.

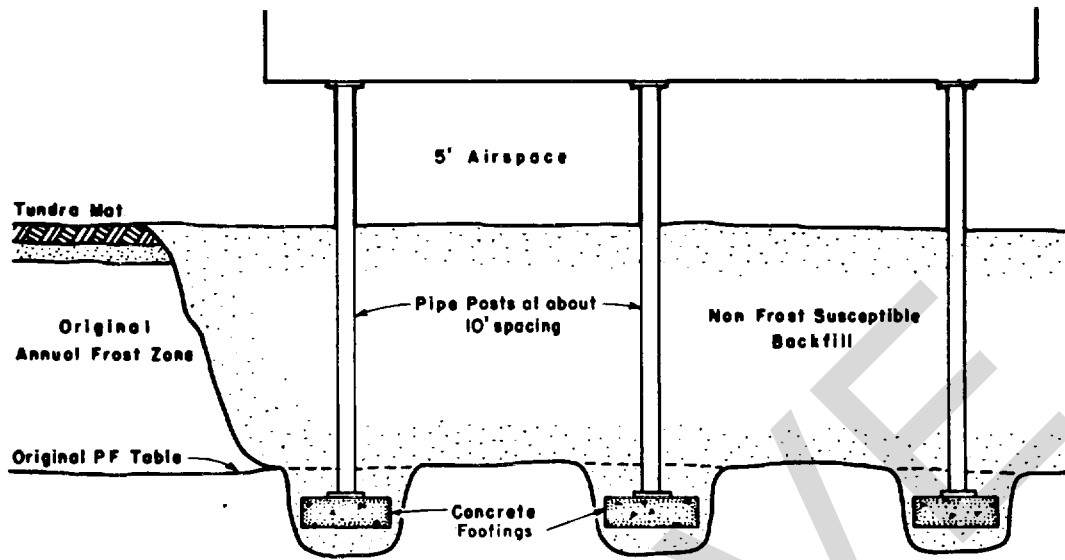

U. S. Army Corps of Engineers

Figure 4-17. Footings on permafrost.

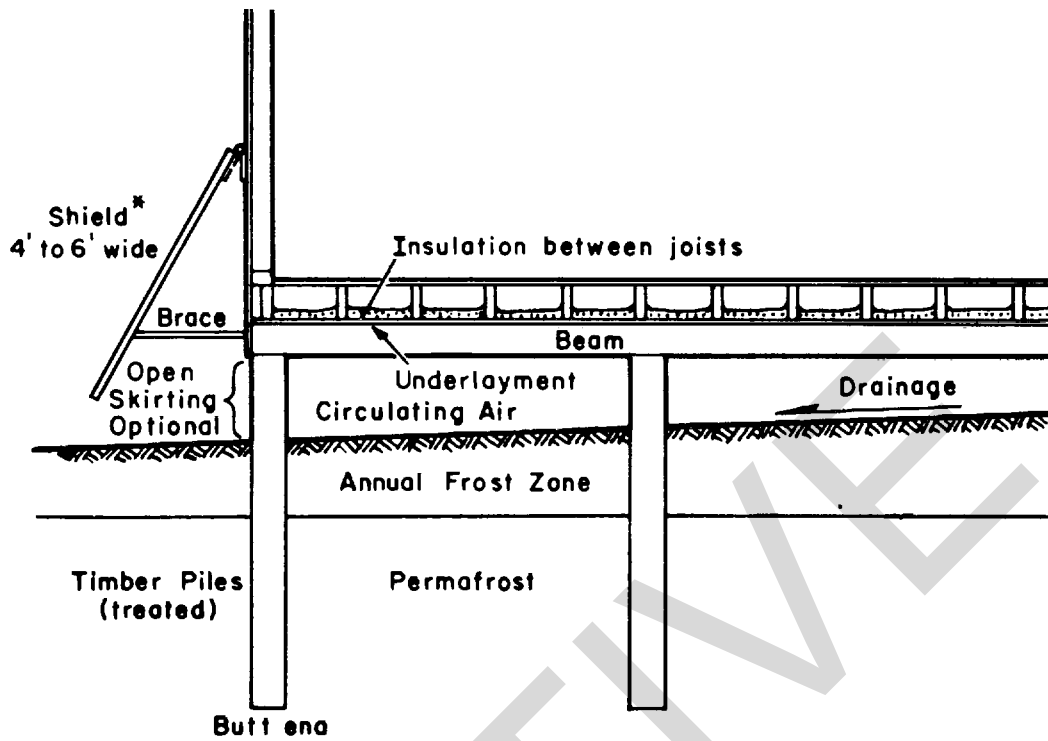

\*When necessary, detachable hinged, vented shield may be placed on building walls with southerly to westerly exposures to shade foundation perimeter during summer seasons.

U. S. Army Corps of Engineers

Figure 4-18. Typical ventilated foundation design for structure supported on piles.



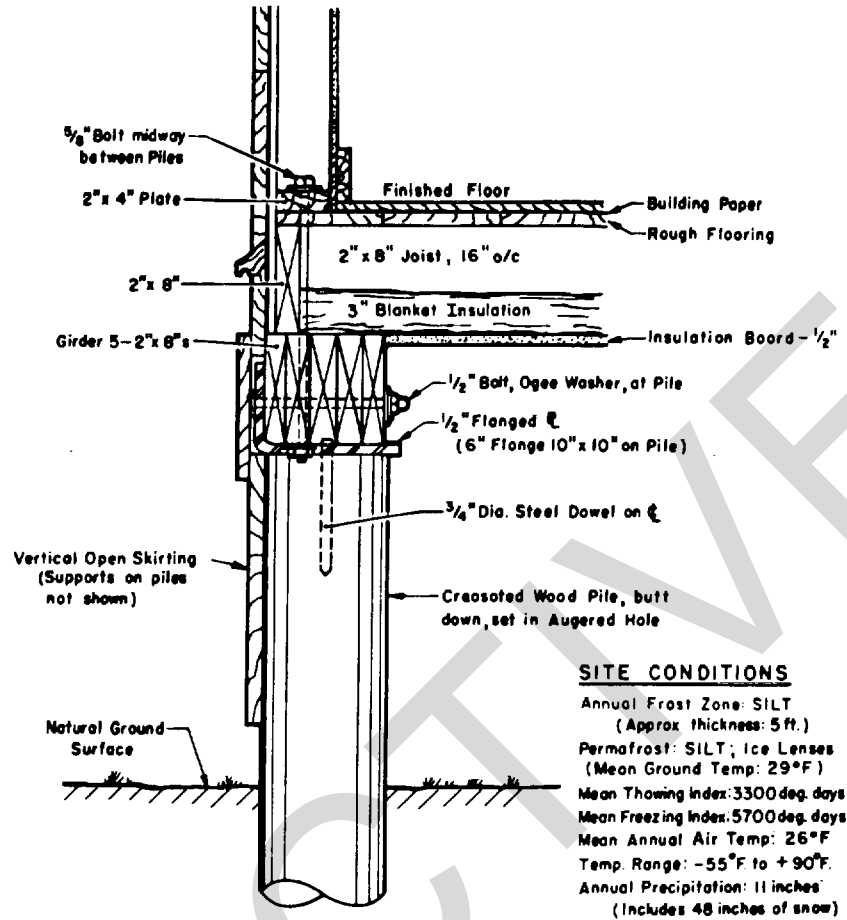

U. S. Army Corps of Engineers

Figure 4-19. Woodpile foundation for small residences, Fairbanks, Alaska.

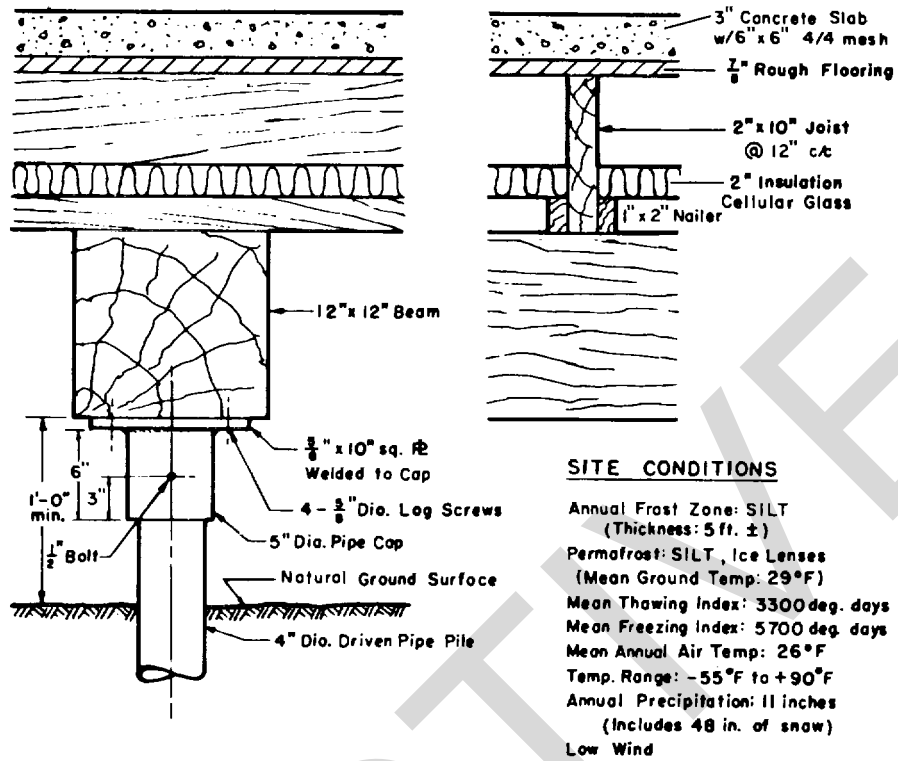

U. S. Army Corps of Engineers

Figure 4-20. Typical pile foundation for light utility building, Fairbanks, Alaska.

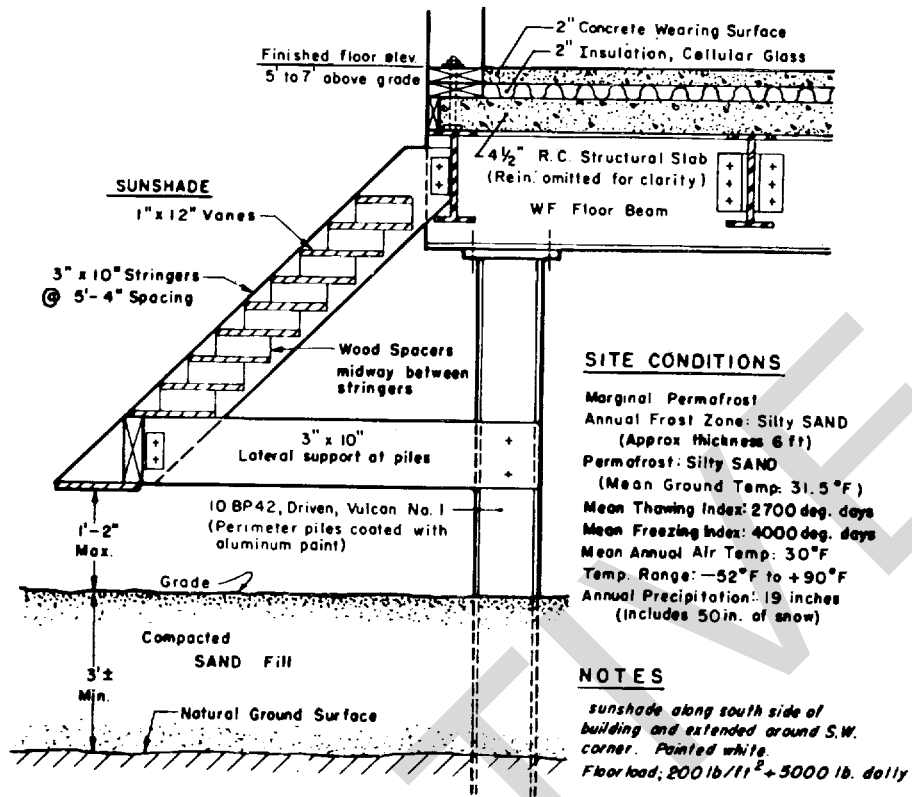

U. S. Army Corps of Engineers

Figure 4-21. Steel pile foundation for utility building showing sunshade, Bethel, Alaska.

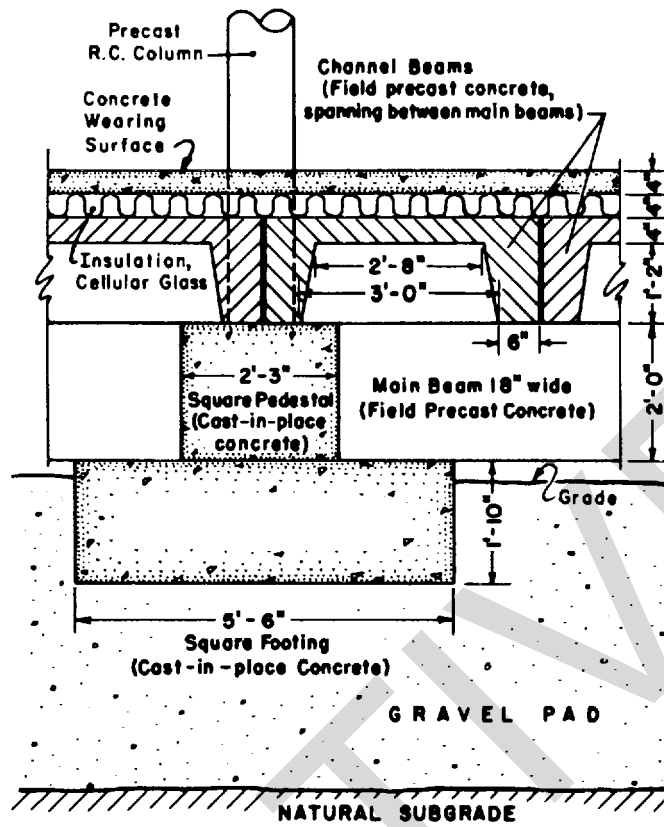

Steel reinforcement in concrete omitted for clarity

**SITE CONDITIONS**

Annual Frost Zone: 1ft.(Pt-GM) 5ft.(GM)	Mean Annual Air Temp: 12°F
Permafrost: Silty, sandy GRAVEL	Temp. Range: -40°F to +60°F
Mean Ground Temp: 19°F	Annual Precipitation: 4 inches
Mean Thawing Index: 700 deg. days	(Includes 15 in. of snow)
Mean Freezing Index: 8000 deg. days	

U. S. Army Corps of Engineers

Figure 4-22. Foundation for men's club, Thule, Greenland.

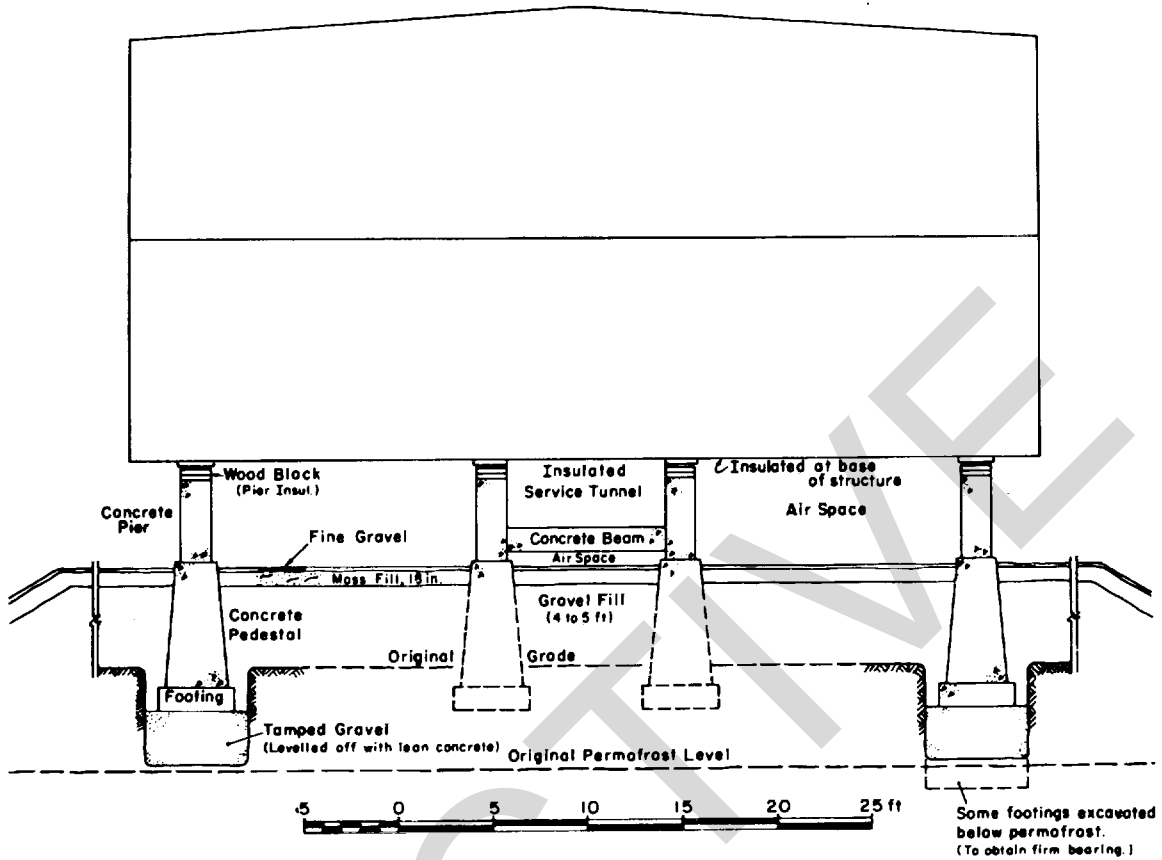

(Courtesy of American Society of Civil Engineers)

(Courtesy of American Society of Civil Engineers)

Figure 4-23. Two story steel frame building on footings and piers at Churchill, Manitoba, Canada<sup>138</sup>. Subgrade is sand and silt interspersed with gravel and large boulders.

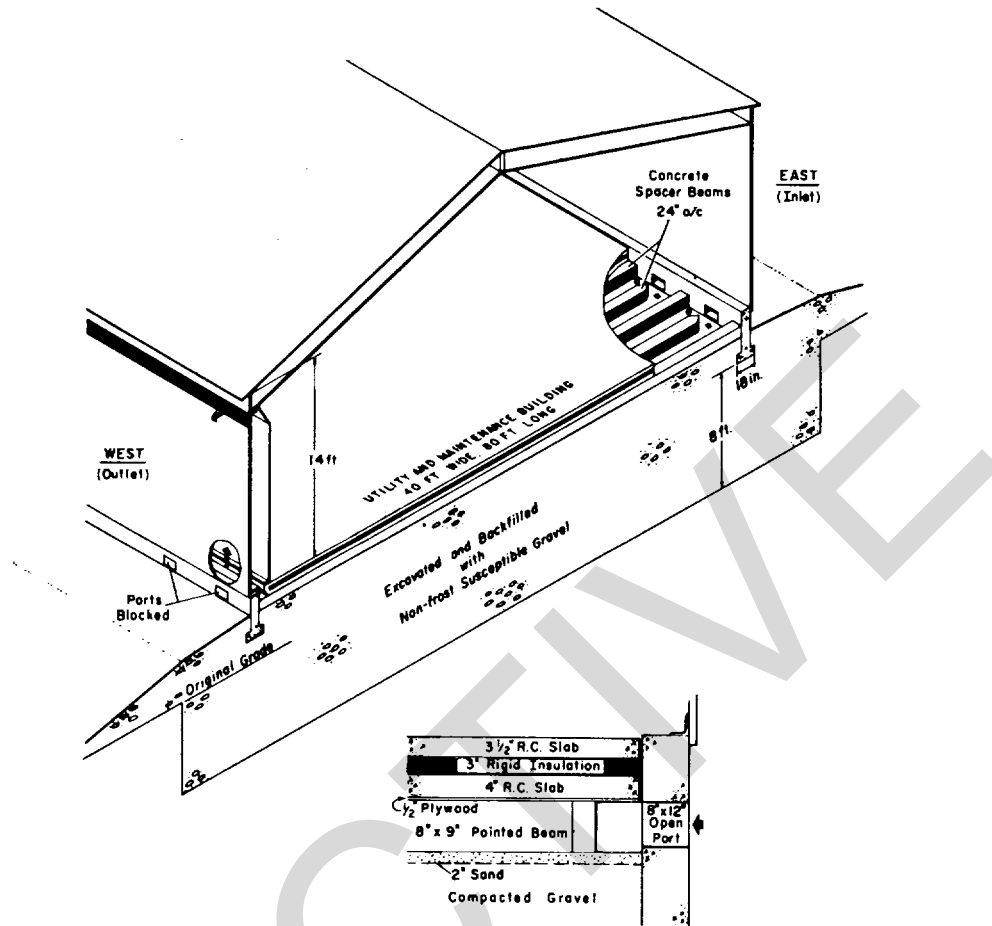

U. S. Army Corps of Engineers

Figure 4-24. Utility and maintenance building, Fairbanks, Alaska (by CRREL). See figure 4-25 for site conditions.

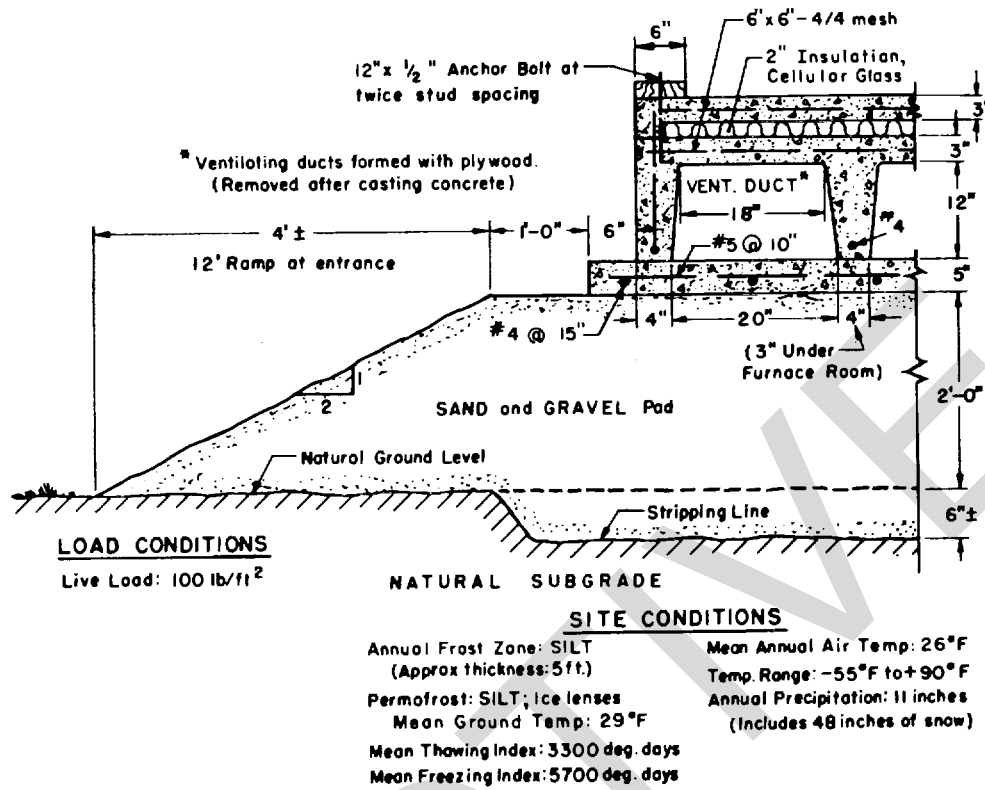

U. S. Army Corps of Engineers

Figure 4-25. Ducted foundation for garage, Fairbanks, Alaska<sup>86</sup>.

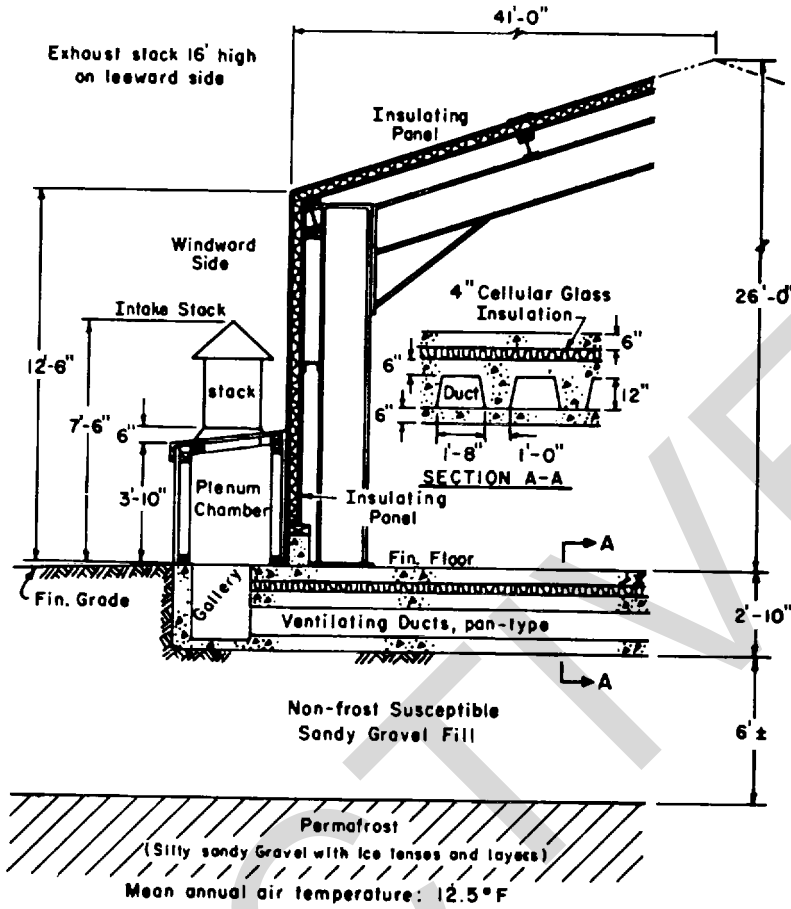

U. S. Army Corps of Engineers

Figure 4-26. Pan duct foundation, Thule, Greenland<sup>86</sup>. See figure 4-22 for site conditions.



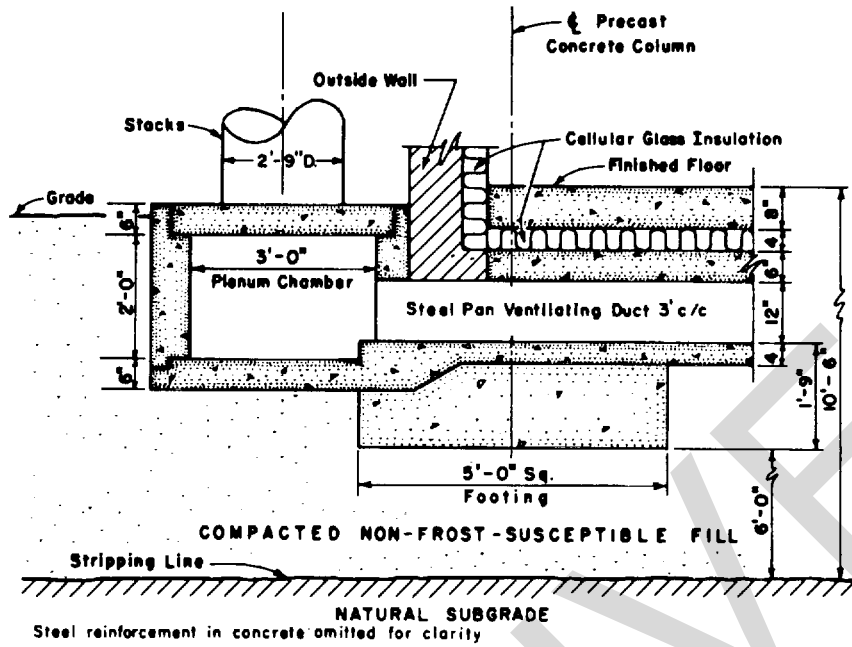

U. S. Army Corps of Engineers

U. S. Army Corps of Engineers

Figure 4-27a. Typical Pan Duct Foundation, Showing Section at Plenum chamber and at Interior Column for Warehouse, Sondrestrom AB, Greenland (Section at Plenum Chamber)

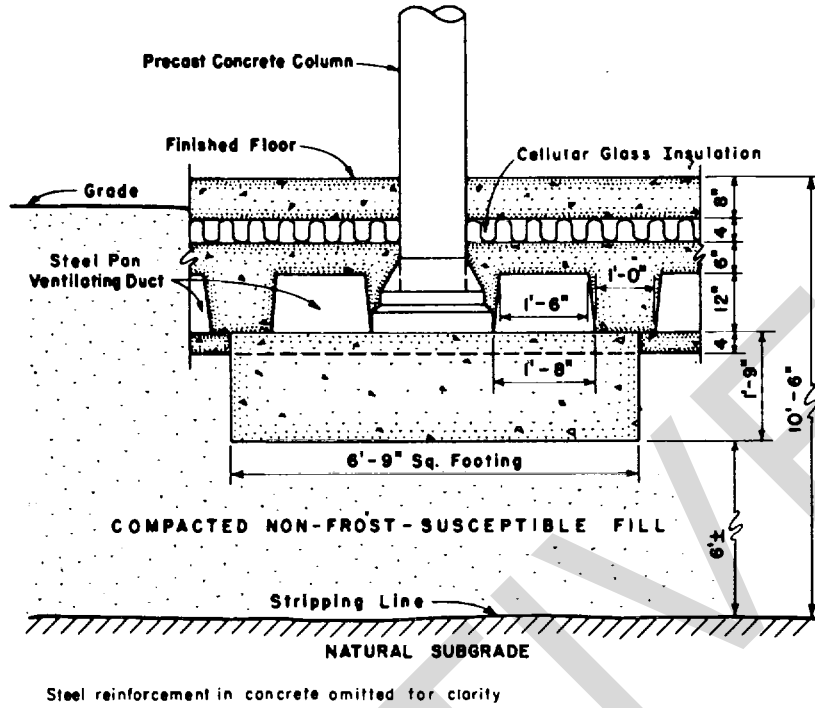

SITE CONDITIONS

Annual Frost Zone SILT to silty SAND  
 (Approx. thickness: 8 ft.)  
 Permafrost GRAVEL through SAND to SILT  
 Mean Ground Temp. 27°F  
 Mean Thawing Index. 1900 deg. days  
 Mean Freezing Index 5100 deg. days  
 Mean Annual Air Temp. 24°F  
 Temp Range -49°F to +73° F  
 Annual Precipitation 5 inches

LOADING CONDITIONS

Live LOAD. 250 lb/ft<sup>2</sup>  
 Design Footing Bearing Pressure: 4000 lb/ft<sup>2</sup>

U. S. Army Corps of Engineers

Figure 4-27b. Typical Pan Duct Foundation, Showing Section at Plenum Chamber and at Interior Column for Warehouse, Sondrestrom AB, Greenland (Section at Interior column)

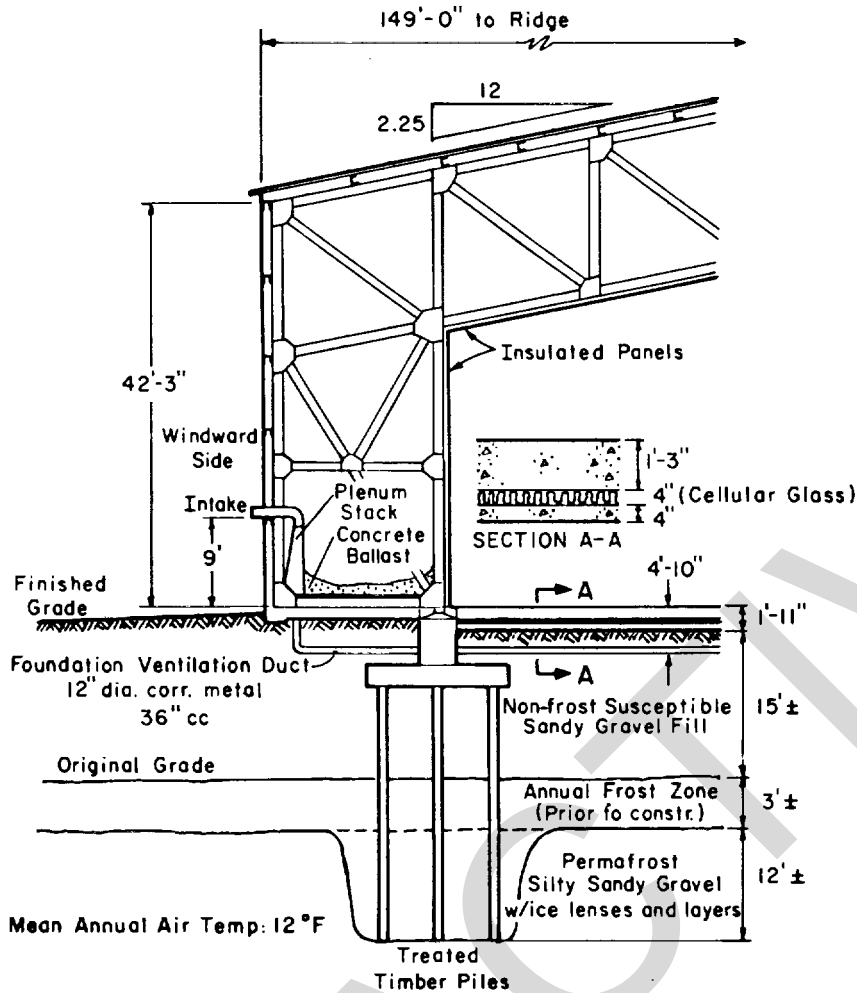

U. S. Army Corps of Engineers

Figure 4-28a. Foundation Details and Maximum Thaw Penetration for Selected Years, Hangar at Thule, Greenland (Deep air duct foundation details. Forced circulation by fans may be required where natural draft is not sufficient. Exhaust for cooling duct is located on leeward side, 32 feet above grade. One plenum stack for each six or seven ducts. Arch tie rod omitted for clarity.)

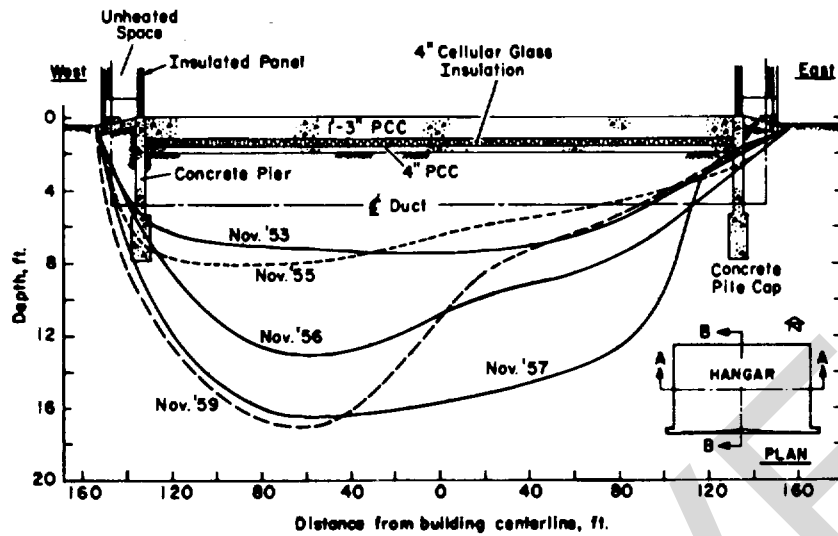

U. S. Army Corps of Engineers

Figure 4-28b. Foundation details and maximum thaw penetration for selected years, hangar at Thule, Greenland (Longitudinal section A-A parallel to 12-inches-diameter corrugated metal cooling ducts)

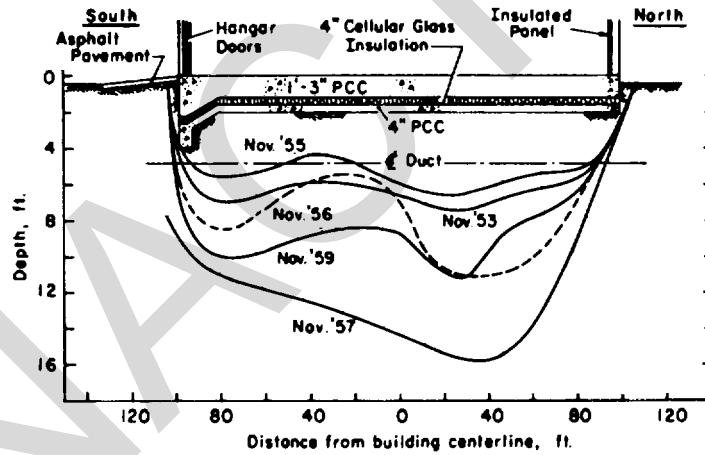

U. S. Army Corps of Engineers

Figure 4-28c. Foundation details and maximum thaw penetration for selected years, hangar at Thule, Greenland. (Transverse section B-B perpendicular to 12-inches-diameter corrugated metal cooling ducts)

tion. Since only about 5 percent of the freezing index is usually accumulated in the last 30 days of the freezing season, this is a very modest factor of safety. At one subarctic site, the complete freezeback of the soil on the downwind side of a building with ducted foundation was not completed until after the soil immediately under the foundation slab commenced its summer thaw. A slight increase in the building's interior operating temperature could have serious consequences under such a situation, not only because of the risk of permafrost degradation but also because of the possible lowering of pile supporting capacity if the structure is pile-supported.

(e) Experience has shown that it is desirable that ventilated foundations be sufficiently elevated, positioned and sloped relative to the surrounding terrain to avoid accumulation of surface water, to drain away in summer thaw water from any accumulations of ice and snow from the preceding winter and to prevent lateral migration of water through the annual thaw zone. Figure 4-25 illustrates an elevated ducted foundation. Such ducts are also more immune to blocking with soil accumulations.

(f) Ducts depressed below the ground surface as in figures 4-26, 4-27 and 4-28 are likely to collect water from the ground or ice and soil from snow and dust infiltration, which restrict or block air flow through the ducts. If ground water rises to the duct level, soil may also be piped into the ducts. Blockage is often unnoticed until after water in the ducts has frozen. Such obstructions are very difficult to remove. Steam thawing may be required to open them; this is not only somewhat complicated but may also cause thermal damage unless carefully controlled. Condensation of ice crystals in the ducts from moist air may also block the ventilating ducts if they are kept in operation when air temperatures become higher than the temperatures of the duct walls in the spring. Tobiasson<sup>200</sup> has pointed out that for below-grade duct systems, manifolds and perhaps the ducts themselves should be large enough to permit entry of maintenance personnel for inspection and removal of blockage, and provisions should be incorporated to minimize the amount of snow infiltration and to remove any material which does enter. Experience indicates that when plenum and/or stacks or chimneys, as illustrated in figures 4-24, 4-26, 4-27 and 4-28, are needed to increase air flow by the stack effect or to raise intakes and outlets sufficiently to be above maximum snow accumulation levels, a chimney space incorporated so as to take advantage of the building heat, as in figure 4-24, is preferable to independent exterior exhaust stacks in which cooling of the rising air tends to diminish the draft.<sup>200</sup> Insulation of the stacks can reduce this difference. Systems should be free of air leaks to insure maximum circulation effectiveness.

(g) Blower systems may be used when conditions require increased volume of air

circulation in ducts, but at the expense of increased mechanical complexity, increased operating costs, and necessity for alertness to make sure the system is turned on and off and the air flow controls set correctly at proper times (see further discussion of this point later in this chapter).

(h) Part or all of the air space of a ventilated foundation has sometimes been used for unheated storage purposes, particularly when extra height of air space has resulted from variations of the natural topography. However, air circulation at the ground and foundation freezeback are easily impaired by such storage, and extra accumulation of snow may be induced.

(i) In ducted foundations of the general types shown in figures 4-25 and 4-27, the vertical concrete sections between individual ducts should be kept relatively thin in order to minimize conduction of heat through these members directly to the foundation. In pile foundations, conduction of heat into the ground by the piles should be minimized by techniques described in *f* below.

(j) Experience has shown that where blowing or drifting snow occurs in winter it is very important to align and locate the structure so as to minimize snow drifting which may in any way affect the structure. Unless ventilation openings of foundations are placed and oriented so that they will not become blocked by snow, the snow drifting may restrict or prevent necessary seasonal freezeback of the foundation. Size and shape of structures and position with respect to prevailing wind and to other structures, to fences and vegetation affecting wind flow, and to adjacent snow removal operations are very important in determining snow drift patterns. Everything else being equal, maximum drifting tends to occur on windward and lee sides of obstructions. However, even if access of winter air to the foundation is completely shut off by snow on the windward and lee sides, ventilating action of an open air space type foundation may still be satisfactory if the other two sides remain open and so long as drifting of snow into open space under the building itself remains insufficient to significantly insulate the foundation materials against freezeback. Open air space type foundations subject to drifting therefore should be designed and oriented to depend on air flow through the foundation at right angles to the wind direction; the shortest dimension of the foundation should then be at right angles to the prevailing wind. Provisions should also be made against other possible problems such as blocking of ground level ventilation intakes or outlets by accumulation of snow next to the foundation from roof discharge or from snow plowing operations. If snow blockage problems cannot be practically avoided through adjustment of orientation and location, use of

flatter roof pitch or greater overhang, or other means, it may be necessary to employ plenum chambers and stacks or chimneys as shown in figures 4-26, 4-27 and 4-28. If other considerations should make it essential to rely on ventilation flow parallel with the predominant wind direction and it is not feasible to elevate the intake and exhaust sufficiently, fences or shrubbery may be installed upwind of the structure to induce drifting at that position and thus to minimize drifting close to the building itself. Sometimes snow ridges pushed by snow plowing operations may be counted on to induce drifting in desired locations. Extreme distance of drifting behind a snow fence is about 25 times the height of fence. Principles of snow drift control have been outlined by Mellor<sup>77</sup>. The use of completely closed skirting around foundations constructed with open air spaces must be avoided. Open picket-type skirting around foundations has been successfully used to permit ventilation, while preventing significant snowdrifting under the building, keeping children and animals out of the air space, and beneficially modifying the overall architectural appearance of the building. If used, such skirting should be elevated sufficiently above the ground to avoid damage due to frost heaving. Wire mesh may also be employed over openings to foundation air spaces but the mesh openings should not be smaller than about 2 inches.

(k) For maximum effectiveness a foundation cooling system utilizing natural low winter temperatures should be shut off in the spring when air temperatures reach such a level that circulation of the ambient air through the system would add to the summer heat input into the foundation. Turning off the system in the spring and turning it on again in the fall is necessary for systems using forced circulation, or stack or chimney systems. However, experience shows that when such a system is dependent upon manual opening or closing of ports or dampers, or turning electrical switches on or off, and these operations are required only twice a year, the necessary actions may be forgotten or may be carried out incorrectly. Experience also shows that system operating manuals are easily misplaced. Therefore, whenever possible, designs should be selected which are automatic in operation and do not require specific manual actions. Fail-safe differential thermostat control systems can reduce these problems, but still require dependable power supply, checking for proper operation of controls, and resetting of circuit breakers. Reliability becomes less in relatively complex systems which involve numerous dampers, blowers or other elements. Therefore, simple ventilated foundations or through-duct systems of the type illustrated in figure 4-25 which are entirely free of control mechanisms requiring setting are far preferable. Where required, operating directions for dampers, switches, etc. should be stenciled directly adjacent to the particular control element to ensure that

the necessary guidance is available when needed. If dampers are installed they should be placed on the upwind side<sup>200</sup>. Eliminating downwind dampers allows convection currents to remove warm air from ducts even with the upwind damper closed. Buildings with ventilated foundations have greater potential rates of heat loss in winter than structures resting directly on the ground because they are exposed to the cold air on all their surfaces. Special care is therefore required in insulation and heating. This is further discussed in d below.

(l) If snow drifting is not a problem or if the intake and exhaust can be elevated so that snow drifting will not interfere with air flow, structure orientation should be such that maximum velocity and effectiveness of air circulation will be obtained, combining both thermal and wind-induced effects. If wind is of significant strength and consistency in direction during the freezing season it is then desirable to orient air intakes into the wind and to configure the exhaust end of the system to maximize wind-induced suction, whether wind-induced draft is taken into account in design computations or not. In many areas, however, this may not be practical because winter winds are too light or too variable in direction and velocity; in such cases possible benefits from wind-induced drafts should be ignored in developing the system design. Where wind-blown precipitation comes from variable directions, rotating wind-oriented ventilator units may be employed at tops of exhaust stacks to minimize snow ingestion and maximize draft. Exhausts should terminate at positions on the lee side of the building.

(m) Thermal analysis of simple ventilated foundation. The depth of thaw under an open air space type ventilated foundation may be approximated from figure 4-4a for certain homogeneous soil and moisture content conditions. For situations not covered by figure 4-4a, the depth of thaw should be calculated by means of the modified Berggren equation for either a homogeneous or multilayered system as applicable, using procedures outlined in TM 5-852-6/AFM 88-19, Chapter 6<sup>14</sup>. An n-factor of 1.0 is applicable for determining the surface thawing index of the shaded area under the building, under either approach.

(n) Thermal analysis of ducted foundation. No simple mathematical expression exists to analyze the heat flow in the case of a ventilated floor system consisting of a duct or pipe system installed within or at some depth beneath the floor, with air circulation induced by stack effect. The depth to which freezing temperatures will penetrate is computed by means of the modified Berggren equation except that the air-freezing index at the outlet governs. The index is influenced by a number of design variables, i.e., average daily air

temperatures, inside building temperatures, floor and duct or pipe system design, temperature and velocity of air in the system, and stack height. Cold air passing through the ducts acquires heat from the duct walls and experiences a temperature rise longitudinally along the duct with a reduction in air-freezing index at the outlet. Field observations indicated the inlet air-freezing index to closely approximate the site air-freezing index. The freezing index at the outlet should be sufficient to counteract the thawing index and insure freeze back of foundation soils.

Example: Determine the required thickness of a gravel pad beneath the floor section shown in figure 4-29

to contain all thaw penetration and the required stack height to insure freezeback of the pad on the outlet side of the ducts for the following conditions:

Duct length  $l$ , 220 feet.

Gravel pad:  $\gamma_d = 125 \text{ lb/ft}^3$ ,  $w = 2.5$  percent.

Outlet mean annual temperature, 32 °F. (This is a conservative assumption.)

Minimum site freezing index, 4,000 degree-days.

Freezing season, 215 days.

Thawing season, 150 days (period during which ducts are closed).

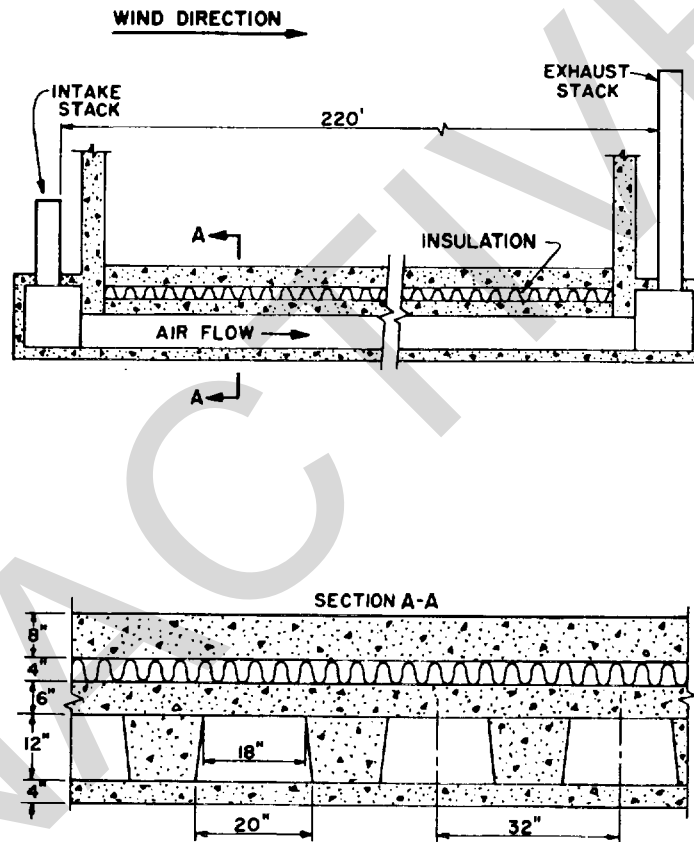

U. S. Army Corps of Engineers

Figure 4-29. Schematic of ducted foundation<sup>14</sup>.

Building temperature, 60 OF.  
 Thermal conductivity of concrete,  $K_c = 1.0$  Btu/ft hr°F.  
 Thermal conductivity of insulation,  $K_i = 0.033$  Btu/ft hr °F.

Other data required for solution are obtainable from TM 5-852-6/AFM 88-19, Chapter 6" or are introduced later. The thickness of gravel pad required is determined by the following equation (derived from the modified Berggren equation):

$$X = KR_f \left( \sqrt{1 + \frac{48\lambda^2 I_f}{KLR_f^2}} - 1 \right)$$

where

**K** = average thermal conductivity of gravel  
 =  $1/2 (K_u + K_f)$   
 =  $1/2 (0.7 + 1.0)$   
 =  $0.85$  Btu/ft hr °F

\* $R_f$  = thermal resistance of floor system  
 =  $\frac{\text{thickness layer}}{K}$   
 =  $\frac{18}{12(1.0)} + \frac{4}{12(0.033)} + \frac{12}{12(1.0)} = 12.5$  ft<sup>2</sup> hr°F/Btu

(In the computations, the dead airspace is assumed equivalent to the thermal resistance of concrete of the same thickness.)

**λ** = factor in modified Berggren equation  
 =  $0.97$  (this is a conservative assumption).

**I<sub>f</sub>** = thawing index at floor surface  
 =  $(60 - 32)(150) = 4,200$  degree-days.

**L** = latent heat of gravel =  $144 \lambda_d \frac{w}{100}$   
 $144(125)(0.025) = 450$  Btu/ft<sup>3</sup>.

Then

$$x = (0.85)(12.5) \left( \sqrt{1 + \frac{(48)(0.97)^2(4,200)}{(0.85)(450)(12.5)^2}} - 1 \right) = 11.0 \text{ ft.}$$

Thus, the total amount of heat to be removed from the gravel pad by cold-air ventilation during the freezing season with ducts open is equal to the latent and sensible heat contained in the thawed pad. The heat content per square foot of pad is determined as follows:

Latent heat =  $(X)(L) = (11.0)(450) = 4,950$  Btu/ft<sup>2</sup>.

\* $R_f$  = Reciprocal of time rate of heat flow through a unit area of a given temperature difference per unit thickness

Sensible heat (10% of latent heat, based upon experience)

$$= 495 \text{ Btu/ft}^2$$

Total heat content  
 =  $5,445$  Btu/ft<sup>2</sup>.

The ducts will be open during the freezing season (215 days), and the average rate of heat flow from the gravel during this season is equal to  $5,445/(215 \times 24) = 1.0$  Btu/ft<sup>2</sup> hr. The average thawing index at the surface of the pad is

$$\frac{IX^2}{48\lambda^2 K} = \frac{(450)(11.0)^2}{(48)(0.97)^2(0.85)} = 1,420 \text{ degree-days}$$

This thawing index must be compensated by an equal freezing index at the duct outlet on the surface of the pad to assure freezeback. The average pad surface temperature at the outlet equals the ratio

$$\frac{\text{Required freezing index}}{\text{Length of freezing season}} = \frac{1,420}{215} = 6.6^\circ\text{F below } 32^\circ\text{F or } 25.4^\circ\text{F.}$$

The inlet air during the freezing season has an average temperature of

$$\frac{\text{Air-freezing index}}{\text{Length of freezing season}} = \frac{4,000}{215} = 18.6^\circ\text{F below } 32^\circ\text{F or } 13.4^\circ\text{F.}$$

Therefore, the average permissible temperature rise TR along the duct is  $(25.4 - 13.4) = 12.0$  F.

The heat flowing from the floor surface to the duct air during the winter is equal to the temperature difference between the floor and duct air divided by the thermal resistance between them. The thermal resistance

$$R = \frac{X_c}{K_c} + \frac{X_i}{K_i} + \frac{1}{h_{rc}} = \frac{14}{(12)(1.0)} + \frac{4}{(12)(0.033)} + \frac{1}{1.0} = 12.3 \text{ hr ft}^2 \text{ }^\circ\text{F/Btu}$$

where

**X<sub>c</sub>** = thickness of concrete, feet.  
**X<sub>i</sub>** = thickness of insulation, feet.  
**h<sub>rc</sub>** = surface transfer coefficient between duct wall and duct air.

where

(For practical design purposes  $h_{rc} = 1.0$  Btu/ft<sup>2</sup> hr °F, and represents the combined effect of convection and radiation. At much higher air velocities, this value will be slightly larger; however, using a value of 1.0 will lead to conservative designs.)

The average heat flow between the floor and inlet duct air is  $[(60 - 13.4)/12.3] = 3.8$  Btu/ft<sup>2</sup> hr, and between the floor and outlet duct air is  $[(60 - 25.4)/12.3] = 2.8$  Btu/ft<sup>2</sup> hr. Thus, the average rate of heat flow from the floor to the duct air is  $[(3.8 + 2.8)/2] = 3.3$  Btu/ft<sup>2</sup> V hr. As previously calculated the average heat flow from



the gravel pad to the duct air is 1.0 Btu/ft<sup>2</sup> hr. The total heat flow X to the duct air from the floor and gravel pad is (3.3 + 1.0) = 4.3 Btu/ft<sup>2</sup> hr. The heat flow to the duct air must equal the heat removed by the duct air.

Heat added = heat removed

$$\phi l m = 60V A_d \rho C_p T_R$$

Thus, the average duct air velocity required to extract this quantity (4.3 Btu/ft<sup>2</sup> hr) of heat is determined by the equation as shown below.

- Ø = total heat flow to duct air, 4.3. Btu/ft<sup>2</sup> hr
- l = length of duct, 220 ft

$$V = \frac{\phi l m}{60 A_d \rho C_p T_R} \text{ ft/min}$$

$$v = \frac{(4.3) (220) (2.66)}{(60) (1.58) (0.083) (0.24) (12.0)} = 111 \text{ ft/min.}$$

- m = duct spacing, 2.66 ft
- A<sub>d</sub> = cross sectional area of duct, 1.58 ft<sup>2</sup>
- ρ = density of air, 0.083 lb/ft<sup>3</sup> (fig. 4-30)
- C<sub>p</sub> = specific heat of air at constant pressure, 0.24 Btu/lb °F
- T<sub>R</sub> = temperature rise in duct air, 12°F.

Substitution of appropriate values gives a required air velocity.

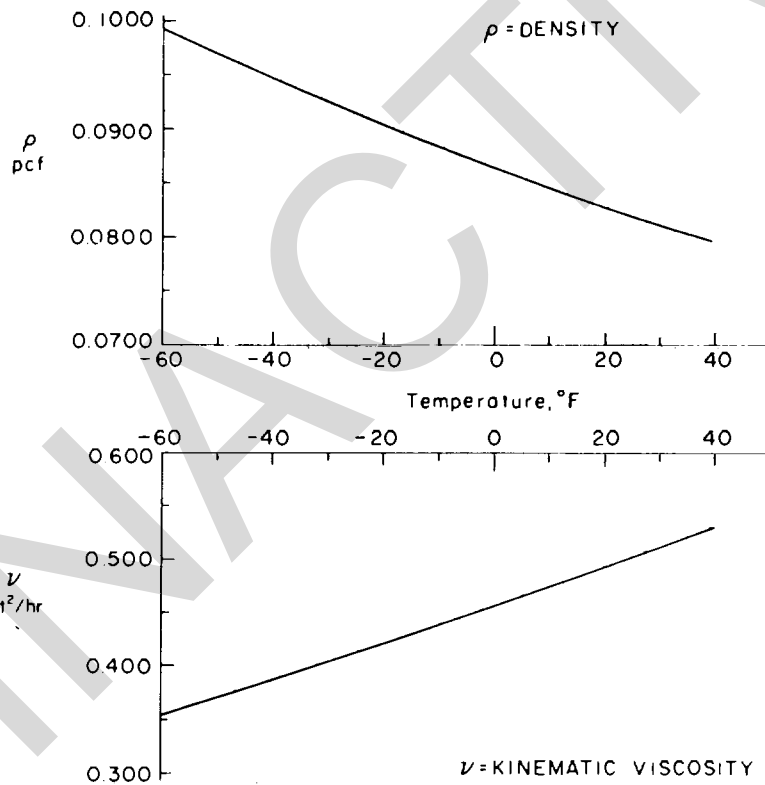

U. S. Army Corps of Engineers

Figure 4-30. Properties of dry air at atmospheric pressure<sup>14</sup>.

The required airflow is obtained by a stack or chimney effect which is related to the stack height. The stack height is determined by the equation

$$h_d = h_v + h_f$$

where

$$h_d = \frac{\rho \epsilon H (T_c - T_o)}{5.2(T_c + 460)} \text{ in. of water natural draft head (ASHRAE Guide}^{117}\text{).}$$

$\rho$  = density of air at average duct temperature, lb/ft<sup>3</sup>

$\epsilon$  = efficiency of stack system, percent (this factor provides for friction losses within the chimney; ASHRAE Guide<sup>117</sup>)

H = stack height, feet

$T_o$  = temperature of air surrounding stack, °F

$T_c$  = temperature of air in stack, °F

$$h_v = \left( \frac{v}{4,000} \right)^2 \text{ in. of water (velocity head)}$$

V = velocity of duct air, ft/min

$$h_f = f' \left( \frac{\ell_e}{D_e} \right) h_v \text{ in. of water (friction head)}$$

$f'$  = friction factor, dimensionless

$\ell_e$  = equivalent duct length, feet.

$D_e$  = equivalent duct diameter, feet.

The technique used to calculate the friction head is as follows:

$$D_e = \frac{4 (\text{cross-sectional area of duct, ft}^2)}{\text{perimeter of duct, ft}}$$

$$= \frac{4 (1.58)}{\frac{2}{12} \frac{18 + 20}{2} + 12}$$

$$= 1.22 \text{ ft (ASHRAE Guide}^{117}\text{).}$$

The equivalent length of the duct is equal to the actual length  $\ell$  plus an allowance  $\ell_b$  for bends and entry and exit. Each right-angle bend has the effect of adding approximately 65 diameters to the length of the duct, and entry and exit effect about 10 diameters (ASHRAE Guide<sup>117</sup>). The total allowance  $\ell_b$  for these effects is  $[2(65 + 10)] = 150$  diameters which is added to the length of the straight duct. The estimated length of straight duct  $\ell_s$  is:

$$\begin{aligned} &5 \text{ feet (assumed inlet open length)} \\ &220 \text{ feet (length of duct beneath floor)} \\ &\frac{15}{240} \text{ feet (assumed stack height)} \end{aligned}$$

$$\ell_e = \ell_s + \ell_b$$

$$\ell_e = 240 + (150 \times 1.22) = 423 \text{ feet.}$$

The friction factor  $f'$  is a function of Reynolds number  $N_R$  and the ratio  $e/D_e$ .

A reasonable absolute roughness factor  $e$  of the concrete duct surface is 0.001 ft, based on field observations. Suggested values of  $e$  for other types of surfaces are given in the ASHRAE Guide<sup>117</sup>. The effect of minor variations in  $e$  on the friction factor is small as noted by examining the equation below used to calculate the friction factor  $f'$

Reynolds number is obtained from the equation

$$N_R = v \frac{a' + 0.25 D_e}{\nu}$$

Where

$$N_R = \frac{(111 \times 60) (1.0 + 0.25 \times 1.22)}{0.49} = 17,700$$

$v$  = average duct velocity, ft/hr

$a'$  = shortest dimension, feet

$\nu$  = kinematic viscosity, ft<sup>2</sup>/hr at 19.°F. (fig. 4-30).

The friction factor  $f'$  is obtained by solving the equation

$$\begin{aligned} f' &= 0.0055 \left[ 1 + \left( 20,000 \times \frac{e}{D_e} + \frac{10^6}{N_R} \right)^{1/3} \right] \text{ (ASHRAE Guide}^{117}\text{)} \\ &= 0.0055 \left[ 1 + \left( 20,000 \times \frac{0.001}{1.22} + \frac{10^6}{17,700} \right)^{1/3} \right] = 0.0285 \end{aligned}$$

Therefore the friction head

$$\begin{aligned} h_f &= f' \times \frac{\ell_e}{D_e} \times h_v \\ &= 0.0285 \times \frac{423}{1.22} \times h_v \\ &= 9.8 h_v \end{aligned}$$

The draft head required to provide the desired velocity head and overcome the friction head is furnished by the chimney or stack effect.

The draft head  $h_d$  is obtained as follows:

$$\begin{aligned} h_d &= h_v + h_f = h_v + 9.8 h_v \\ &= 10.8 h_v \\ &= 10.8 \left( \frac{v}{4,000} \right)^2 \\ &= 10.8 \left( \frac{111}{4,000} \right)^2 \\ &= 8.31 \times 10^{-3} \text{ in. of water} \end{aligned}$$

The stack height required to produce this draft head is

$$\begin{aligned}
 H &= \frac{5.2h_d(T_e + 460)}{\rho \epsilon (T_c - T_o)} \\
 &= \frac{(5.2)(8.31 \times 10^{-3})(25.4 + 460)}{(0.083)(0.80)(25.4 - 13.4)} \\
 &= 26 \text{ ft.}
 \end{aligned}$$

where

$$\rho = 0.083 \text{ lb/ft}^3$$

$$T_c = 25.4^\circ\text{F}$$

$$T_o = 13.4^\circ\text{F}$$

$\epsilon = 80$  percent (found to be reasonable design value based on observations over an entire season)

$$h_d = 8.31 \times 10^{-3} \text{ in. of water}$$

If the stack height is too high for the structure, a greater thickness of foundation insulation could be used. In this example the effect of increasing the insulation thickness by one-half would result in lowering the stack height by five-eighths.

The first approximated stack height is next incorporated in the calculation of the length of straight duct  $l_s$ , and the newly obtained  $l_e$  is used to recalculate the friction head  $h_f$ . By iteration, the final calculated stack height is found to be 26.5 feet.

The stack height is an important variable as an increase in stack height will increase the duct airflow. Circulation of air through the ducts results from a density difference between the air inside the duct and that outside the building; a pressure reduction at the outlet end due to the stack effect; a positive pressure head at the inlet end when wind blows directly into the intake stack opening; and a negative pressure head at the outlet when wind passes over the exhaust stack opening. If reliance is placed upon wind-induced draft for part of the required winter cooling, minimum wind conditions should be assumed in order to assure freezeback even in the least favorable winter. Vents should be cowled to take advantage of any available velocity head provided by the wind and as previously noted should be positioned to minimize snow infiltration. If sufficient air cannot be drawn through the ducts by natural draft, consideration may be given to such alternatives as placing the exhaust stacks at the center of the building with intakes both sides, in order to reduce the effective duct length, or

using a mechanical blower system to increase air circulation (however, see discussion of disadvantages of latter systems in (k) above. In order to minimize air flow resistances and to avoid differences in heat removal effectiveness between different parts of the foundation duct system, the number of ducts connected together through plenums into a single pair of intake and outlet stacks should not exceed three to five. Thus, an average foundation of this type may have numerous intake and outlet stacks. A chamber extending the length of the structure and open to the atmosphere along its length as shown in figure 4-24 may provide an acceptable alternative. Plenum chambers should be designed so as to permit ready access to the ends of the ducts for cleanout or other maintenance.

*d. Foundation insulation.* Foundation insulation may be used to control heat flow for the following objectives.

- To control frost penetration and heave.
- To reduce rates of thaw of permafrost and settlement.
- For heating economy.
- For comfort.
- To control condensation.

(1) The general properties of insulating materials which are pertinent to construction under cold climatic conditions have been reviewed in paragraph 2-6d. Insulation used in foundations must satisfy the following performance criteria:

- Provide required thermal insulating properties.
- Provide adequate bearing capacity for static and dynamic loads which may be imposed.
- Resist loss of thermal insulating properties and bearing capacity with time under the effects of moisture, ice and cyclic freeze thaw.

(2) Insulation can reduce quantity of heat flow but cannot prevent it entirely. Insulation should not be depended upon by itself to prevent thaw of permafrost under a continuously heated building or to prevent frost penetration under a continuously refrigerated warehouse or other structure.

(3) Where comfort is involved, as in quarters buildings, the insulation thickness should not be less than that required to maintain floor surface temperature at satisfactory comfort levels under design minimum winter temperature conditions. Floor temperature must also be maintained above the dew point of the interior air under these conditions; moist floors are not only unpleasant for personnel but may present hazards of slipperiness or sanitation. Much of the problem of cold floor discomfort in cold regions originates from cold air drainage from inadequately insulated ceilings, exterior walls, windows and doors. However, discomfort may be experienced even where these factors are absent, such as in interior rooms,

because the floor must necessarily be colder than the air above it whenever there is downward flow of heat through the floor, out of the building; otherwise heat flow would not occur. It is therefore most important for ventilated foundations of all types that adequate floor insulation be employed, together with a heating system that delivers enough heat near the floor to counteract so far as possible the effect of the heat transmission through the floor, as well as the effects of downdrafts from cold exterior surfaces. Systems which heat the floor itself can eliminate discomfort from heat loss through the floor but thus far have not been widely used because of cost.

(4) Some typical insulation designs which have been used in actual structures in Alaska and Greenland are shown in figures 4-15, 4-19 through 4-22 and 4-24 through 4-28. In general, the insulation amounts shown in these figures have provided only marginal comfort under winter conditions.

(5) When insulating materials are used in foundations, conditions may be extremely adverse for satisfactory performance of these materials. In insulation is installed below ground level under wet conditions, its value may be reduced or lost as a result of absorption of moisture (para 2-6d). If exposed to cyclic freeze-thaw, progressive physical breakdown of the insulating material may occur, again with increase of moisture content and with loss of thermal insulating and strength properties. In addition to use for controlling flow of heat from buildings into the foundations, insulating material may be used below ground level for a number of miscellaneous purposes such as to reduce the thickness of fill required to prevent freezing and thawing temperatures from penetrating into underlying frost-susceptible soil, to thermally protect buried pipelines or utilidors, or to control freeze and thaw penetration under and around bridge piers, grade beams, culverts or paved surfaces. In any such applications where detrimental moisture, ice, or freeze-thaw effects may be encountered, great care must be exercised in specifying type, placement and protection of insulation.

(6) Only closed-cell types of insulation should be used underground. Cellular glass may be used under high ground moisture conditions if it will be either continuously frozen or continuously thawed. Under these conditions no separate moisture barrier or protective membrane for the cellular glass is required. Cellular glass should not be used where it would be subject to cyclic freeze-thaw in presence of moisture. Where cyclic freeze-thaw in presence of moist (but not immersed) conditions is anticipated, it is recommended that only foam plastic closed-cell types of insulation, protected against absorption of moisture by a self-membrane or by sealed heavy polyethylene sheeting or equal, should be used. In soils of permanently very low moisture content, not subject to cyclic freeze-thaw, and

protected against moisture infiltration and condensation or seepage by an overlying slab and/or other means, any closed-cell type insulation which has high integral resistance to moisture absorption may be used. Unless continuously frozen, installation of any type insulation where it will be below the water table should be avoided. Instead, alternatives should be sought, such as construction of the facility on a well-drained granular embankment where the insulation can be protected against moisture by the shelter of the structure itself and/or by embedment in high quality impervious concrete when appropriate.

(7) When insulation is used in a facility such as a hangar floor, where live loads occur, it must be placed at sufficient depth so that concentrated live load stresses will be reduced sufficiently to be within the allowable bearing values for the particular insulation used. At the same time the maximum allowable depth of insulation placement established by the live load stress in combination with the increase of overburden pressure with depth must not be exceeded.

(8) *Insulation of ventilated and ducted foundations.*

(a) For structures with open airspaces such as shown in figures 4-13 through 4-23 and ducted foundations such as shown in figures 4-24 through 4-28 insulation should be installed above the airspace or ducting system. This will not only minimize the amount of heat which must be removed by the foundation ventilation system but will provide excellent protection for the insulating material against moisture and freeze-thaw effects. Heat losses may be computed by the procedures of the ASHRAE Guide<sup>17</sup>.

(b) For ducted foundations, trial computations for various alternative duct system and insulation design combinations will yield data on insulation requirements for foundation thermal stability. Computations of thicknesses required to maintain comfortable floor temperatures and to prevent condensation will provide additional input. From these data, a decision on insulation thickness can be made.

(c) For open airspace type ventilated foundations, comfort and heating economy will usually determine insulation thickness requirements.

(9) *Insulation of slab on grade and basemented foundations.*

(a) These types of construction are suitable for use in seasonal frost areas and thaw-stable permafrost without detrimental ground ice. Because of the susceptibility of insulating materials to moisture, ice and freeze-thaw effects, sufficient elevation above the natural terrain should be provided in such foundations, together with drainage, so that exposure of insulation to these adverse effects will be minimized. It should be noted that even where permafrost foundation materials

are thaw-stable clean sands and gravels, the construction of a basement which will be kept at above freezing temperatures will tend to produce a sump in the frozen materials in which thaw water will tend to collect, causing a basement drainage problem.

(b) Two types of concrete floors are used in basementless houses: unheated floors relying for warmth on heat delivered above floor level, and heated floors containing heated pipes, ducts, or other integral heating system to constitute a radiant slab (panel heating). Thermal analysis should be made in accordance with recommendations contained in the latest edition of the ASHRAE Guide<sup>1</sup>.

(c) Edge insulation for non-radiant concrete floor slabs on grade may serve the functions of preventing excessive heat losses at edges of floor slabs, maintaining comfortable floor temperatures for building occupants, and preventing condensation on floor surfaces adjacent to exterior walls.

(d) As shown in figure 4-31, the maximum rate of heat loss from an uninsulated non-radiant floor slab occurs at the edge, tending to result in an uncomfortably cold floor along the building perimeter.

Condensation on the floor may result if the relative humidity is sufficiently high. Areas such as kitchens and mess halls where high relative humidity can normally be expected are more susceptible to condensation than areas such as warehouses and living quarters. A relatively small amount of insulation properly placed can reduce these adverse effects significantly.

(e) Edge insulation for slab-on-grade construction may be installed either horizontally as in figure 4-32 or vertically as in figure 4-33 with approximately equal results. The flow nets in figures 4-32 and 4-33 are theoretical, for assumed steady state heat flow conditions, seldom if ever fully realized in the field. The flow net in figure 4-33 is based on thermocouple measurements from an actual foundation, with some extrapolation. Since footings of slab-on-grade type buildings in frost areas are normally placed several feet deep in the ground in order to be below the seasonal frost line, the insulation is easily installed on the four-

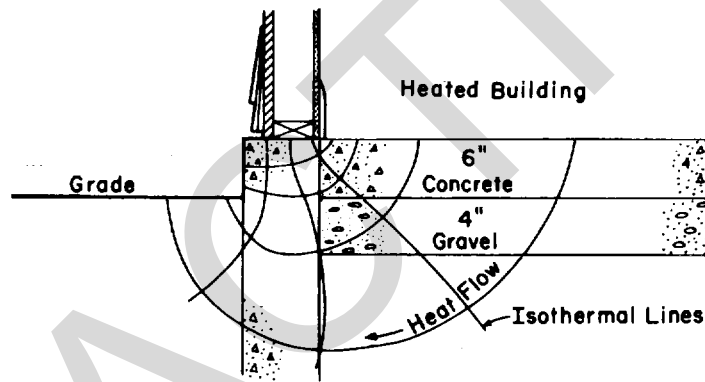

Figure 4-31. Flow net, concrete slab on grade, uninsulated<sup>41</sup>.

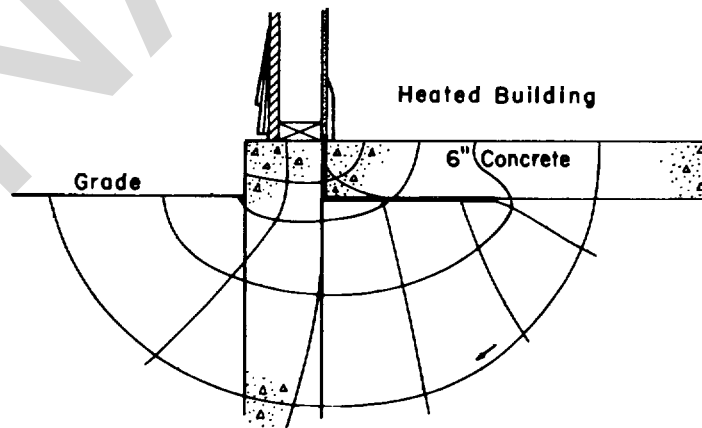
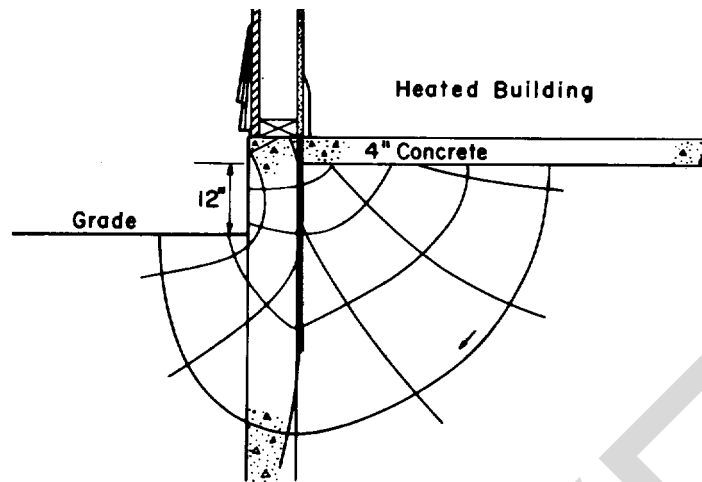

Figure 4-32. Flow net, concrete slab on grade, insulated<sup>41</sup>.



U. S. Army Corps of Engineers

Figure 4-33. Flow net, extrapolated from field measurements, with 1-1/2-inches cellular glass insulation, 36 inches long in vertical position<sup>41</sup>.

dition wall. If placed horizontally under the slab, difficulty and expense are involved in leveling the base course sufficiently to provide uniform support under the insulation, particularly when the material contains gravel and cobble sizes. Because the compressive characteristics of the insulation are normally different than for the soil which underlies the slab in noninsulated portions of the foundation, non-uniform support tends to result, which is conducive to cracking of the slab, particularly if the slab is heavily loaded. This problem is avoided in the vertical type of insulation. Again the possibility of frost heave is reduced with the vertical insulation since flow net analysis (fig. 4-32 and 4-33) shows that the horizontal insulation gives greater opportunity for frost penetration under the floor slab. The vertical insulation can also be inserted as a single piece whereas the horizontal type requires a joint where the insulation meets the vertical piece placed between the wall and the slab. If both horizontal and vertical insulation should be used, the result would be a more complicated and expensive installation without corresponding gain in effectiveness. While placing vertical insulation on the exterior rather than the interior side of the slab-on-grade foundation wall would appear to offer some advantages, such as reduction of thermal stresses in the wall, it also presents the disadvantages for the insulation of more severe conditions of moisture, freeze-thaw and possibly frost heave. Also, in a design situation such as shown in figure 4-33, the insulation would have to be exposed above the grade level in order to attain continuity with the building insulation and this would be susceptible to damage. Therefore, placement on the interior face is recommended.

(f) From the condensation standpoint there seems to be normally no advantage in extending the insulation to the depth of maximum seasonal frost penetration since extending the insulation below the depth of balanced design<sup>(1)</sup> has relatively little effect upon the floor slab temperatures. However, if there is a possibility of freezing of the soil under the slab adjacent to the inside face of the foundation wall as estimated by flow net analysis, insulation should be carried as necessary toward the maximum depth of freezing unless the soil and/or moisture conditions are such that no frost heave expansion can occur. Even slight heaving at the edge of the floor may result in cracking of the floor slab and may break any utilities passing through the slab. Usually, such depth-of-freezing insulation need only be of nominal thickness below the upper 2 or 3 feet. Measurements of actual frost penetration and temperatures under existing buildings in the area may be helpful when in doubt.

(g) Freezing may penetrate within the foundation wall of the slab-on-grade construction and cause difficulty if the building is not heated to normal temperatures or is not heated at all, if backfill of low insulating value, such as free draining gravel or crushed stone, is used on the outside of the foundation wall, or if insulation is insufficient for the conditions. For best resistance to frost penetration, the exterior backfill should consist of a relatively fine-grained and moist soil. A substantial snow cover on the ground adjacent to

<sup>(1)</sup>Balanced design is considered to exist where resistance to heat flow at the edge of the floor slab is the same whether the heat flows through the insulation or around the lower edge of the insulation.

the building will minimize frost penetration but usually cannot be relied on for design purposes. In some winters snow cover at time of maximum freezing conditions may be very small. Again snow will be absent if sidewalks are placed adjacent to the outside of the foundation wall and are kept shoveled or plowed and possibly if a large roof overhang is used. Sometimes wind patterns near the building may blow the area adjacent to the foundation wall essentially free of snow cover.

(h) Insulation should be specified in depths corresponding to commercially available dimensions. Avoidance of the necessity for field cutting is especially advantageous if factory-enclosed insulation board is available, since a minimum of on-the-job membrane resealing is then required. A record of actual

measured floor temperatures 6 in. from the inside wall of the structure shown in figure 4-33 is presented in figure 4-34<sup>41</sup>. Because the external temperature varied constantly during the period of observation, true steady state conditions were not achieved. Figure 4-35 shows floor temperatures vs distance from the interior wall determined by actual measurement at the same Loring AFB building, compared with results predicted by flow net analysis and electrical analog analysis and with adjusted comparative data from National Bureau of Standards studies. The actual measured values show more rapid drop in floor temperature as the exterior wall is approached than is predicted by the flow net and electric analog analyses. This difference is believed to be the

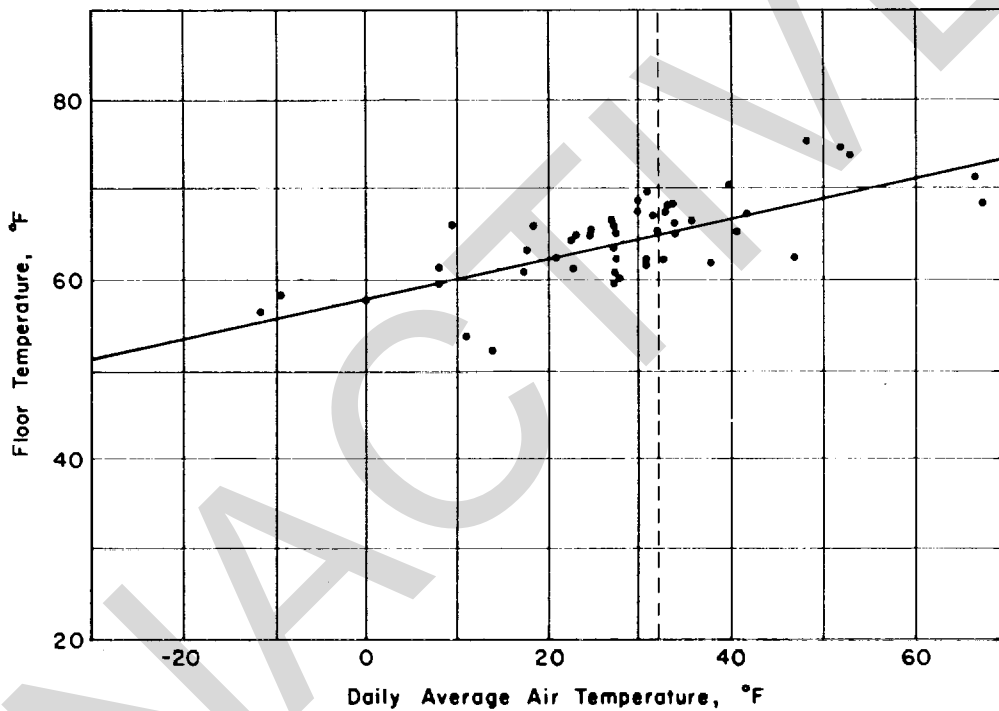

U. S. Army Corps of Engineers

Figure 4-34. Floor temperature 6 in. from wall vs daily average air temperature measured at Loring AFB, Maine<sup>41</sup>. (Concrete slab 12 inches above grade; insulation is cellular glass 1 1/2 inches thick, 36 inches vertical length.)

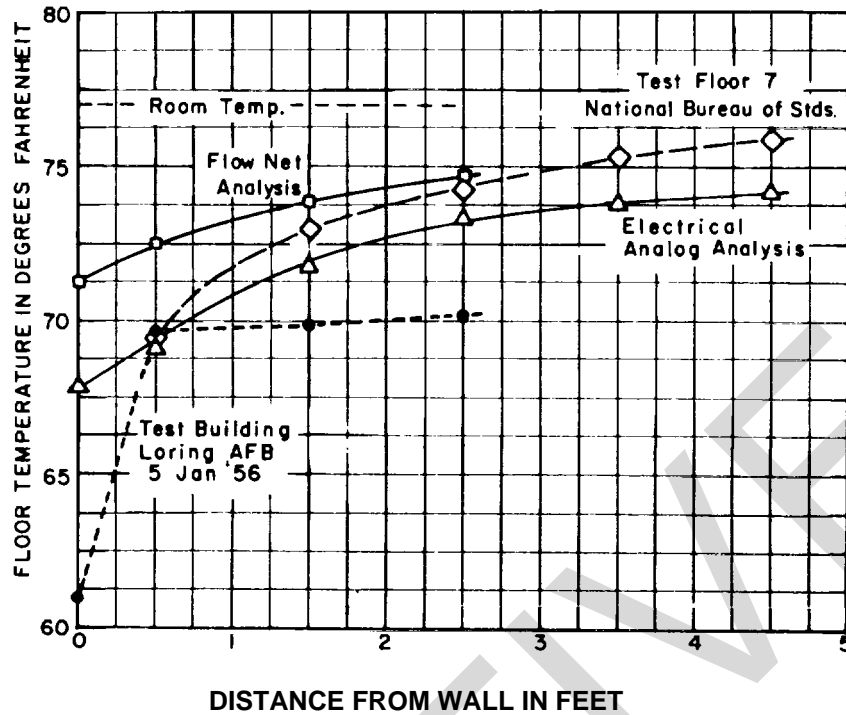

U. S. Army Corps of Engineers

Figure 4-35. Comparison of predicted and measured floor temperatures for a concrete slab on gravel with vertical insulation (same case as fig 4-33<sup>41</sup>). Insulation 1 1/2-inches x 36 inches cellular glass except 3/4-inches x 18-inches rubber board for Test Floor 7. Room temperature 77°F. Outside temperature 32°F except 35°F in Loring AFB measurements. Data for test floor 7<sup>204</sup> adjusted from lower room temperature of 70°F by adding 7°F to all temperatures (from Government sources).

result partly of simplifications in the assumed boundary conditions for the flow net and electrical analog analyses, partly of such factors as localized cooling by the downward movement to the floor of cold air on the inside face of the exterior wall of the field test facility, and partly of the fact that the analytical approaches assume steady state conditions but these are probably never achieved in the field situation.

(i) If it is assumed that the air temperature in a mess hall or kitchen is 70 °F and the relative humidity is 70 percent, the floor surface temperature can not be lower than 60°F if the floor is to remain condensation free. For quarters or similar areas, a relative humidity of 40 percent and air temperature of 70°F will allow floor surface temperature to drop to 45 OF without condensation. Using these criteria, the curves of required insulation thermal resistance versus design winter 4-50 temperature in figures 4-36 and 4-37

were developed from theoretical studies of heat flow by an electrical analog method, verified in part by field data. Both figures show curves for no condensation over 6 in. from the edge of the wall. Recommended practice for insulation of concrete slab-on-grade structures is presented in table 4-3.

(j) Basements are desirable in areas of deep seasonal frost because heat losses tend to prevent or reduce frost grip on perimeter walls and foundations; however, a basement or underground facility in permafrost may be a source of structurally dangerous heat loss. Heat losses and wall and floor surface temperatures in partial or full basement or below-grade heated spaces may be calculated by procedures outlined in the ASHRAE Guide<sup>117</sup>, extrapolated as necessary to arctic and subarctic temperature ranges, and insulation



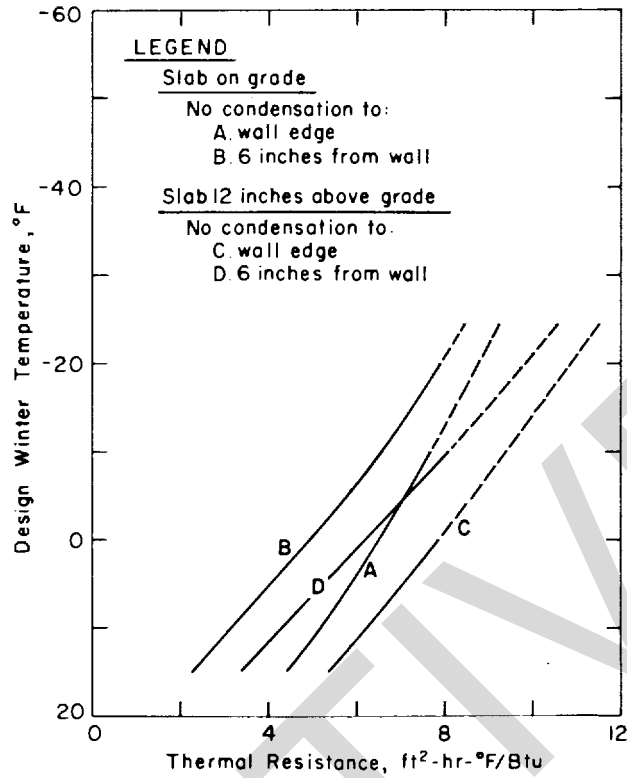

U. S. Army Corps of Engineers

Figure 4-36a. Thermal resistance vs design winter temperature for various vertical lengths of insulation for kitchens and mess halls (from electrical analog analyses)<sup>41</sup>. (length 24 inches)

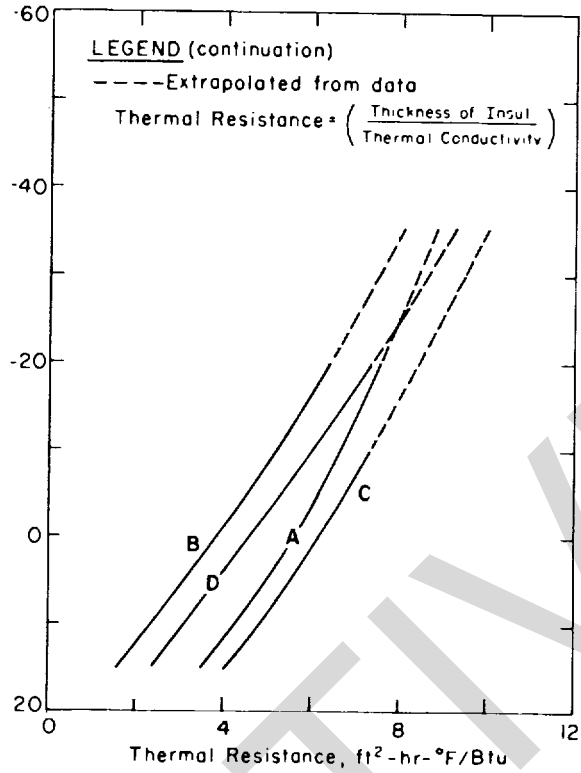

U. S. Army Corps of Engineers

Figure 4-36b. Thermal resistance vs design winter temperature for various vertical lengths of insulation for Kitchens and Mess Halls (from Electrical Analog Analyses)<sup>41</sup> (length 36 inches)

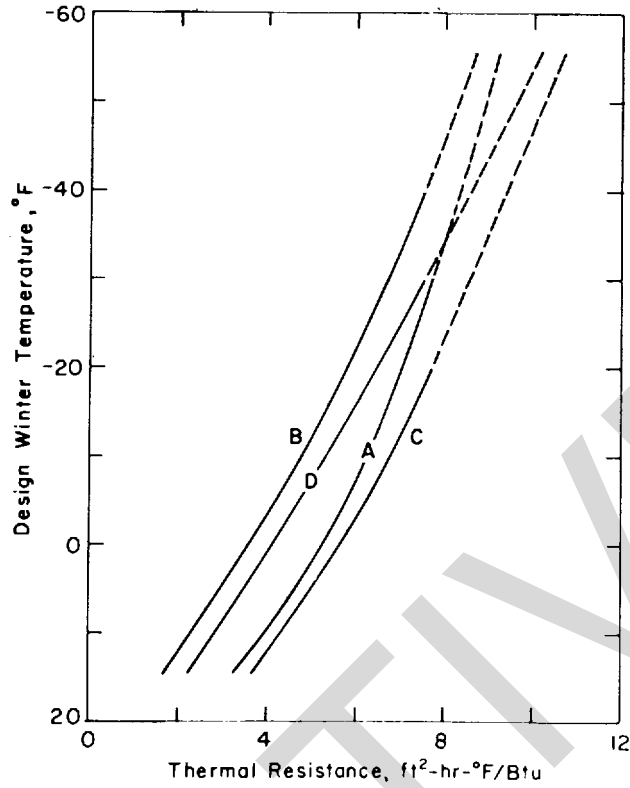

U. S. Army Corps of Engineers

Figure 4-36c. Thermal resistance vs design temperature for various vertical lengths of insulation for Kitchens and Mess Halls (from Electrical analog Analyses)<sup>41</sup> (length 48 inches)

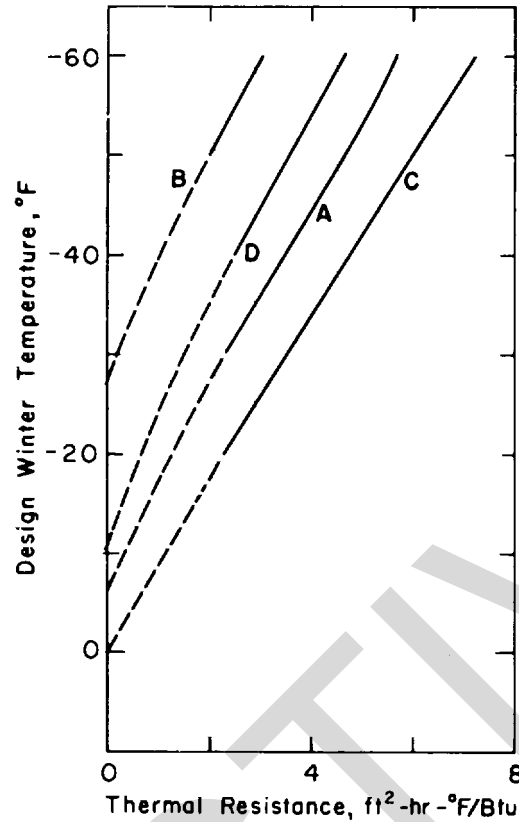

U. S. Army Corps of Engineers

Figure 4-37a. Thermal resistance vs design winter temperatures for two vertical lengths of insulation for barrack buildings (from electrical analog analyses)<sup>41</sup>. See figure 4-36 for legend. Note: TM 5-810-1<sup>4</sup>, Mechanical Design-Heating, Ventilating and Air Conditioning, states: "1-03 OUTSIDE DESIGN TEMPERATURES. The outside heating design temperature should be determined in accordance with TM 5-785/AFM 88-29. Winter design for military installations will normally be based on the 97-1/2 percent dry-bulb temperatures tabulated in TM 5-785/AFM 88-29 and defined therein under 'General Information'." TM 5-785/AFM 88-29, defines this temperature as the dry bulb temperature which is equalled or exceeded 97-1/2 percent of the time, on the average during the coldest three consecutive months. (Length 12 inches)

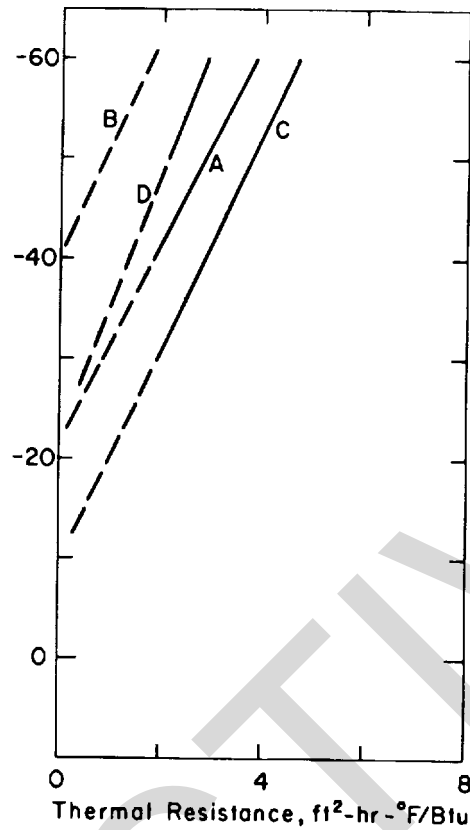

Army Corps of Engineers

Figure 4-37a. Thermal resistance vs. design winter temperatures for two vertical lengths of insulation for barrack buildings (from electrical analog analyses)<sup>4</sup>. See figure 4-36 for legend. Note: TM 5-810-1, Mechanical Design-Heating, Ventilating and Air Conditioning, states: "1-03 OUTSIDE DESIGN TEMPERATURES. The outside heating design temperature should be determined in accordance with TM 5-785/AFM 88-29. Winter design for military installations will normally be based on the 9742 percent dry-bulb temperatures tabulated in TM 5-785/AFM 88-29 and defined therein under 'General Information'. " TM 5-785/AFM 88-29, defines this temperature as the dry bulb temperature which is equaled or exceeded 97% percent of the time, on the average during the coldest three consecutive months. (Length 24 inches).

Table 4-3. Recommended Perimeter Insulation for Various Design Winter Temperatures

Structure Usage	Floor Surface Moisture to be Permitted	Elevation of Bottom of Floor Slab	Design Winter Temperature											
			0°F		-10°F		-20°F		-30°F		-40°F		-50°F	
			Vertical Length <sup>a</sup>	Thermal Resistance	Vertical Length	Thermal Resistance	Vertical Length	Thermal Resistance	Vertical Length	Thermal Resistance	Vertical Length	Thermal Resistance	Vertical Length	Thermal Resistance
Barracks, administrative buildings, etc. not subject to high humidity in winter. (Dew point temperature = 45°F.)	No condensation to wall edge	On grade	--	--	12"	1	12"	2	12"	3	24"	2	24"	3
		12" above grade	--	--	12"	1	12"	3	12"	4	24"	3	24"	4
	No condensation to 6" from wall	On grade	--	--	--	--	--	--	--	--	12"	1	12"	2
		12" above grade	--	--	--	--	12"	1	12"	2	12"	3	12"	4
Kitchens, mess halls, etc. subject to high humidity in winter. (Dew point temperature = 60°F.)	No condensation to wall edge	On grade	24"	7	24"	8	36"	8	36"	9	48"	9	48"	9
		12" above grade	24"	8	24"	10	36"	9	36"	10	48"	10	48"	11
	No condensation to 6" from wall	On grade	24"	5	24"	7	36"	7	36"	8	48"	8	48"	9
		12" above grade	24"	7	24"	8	36"	8	36"	9	48"	9	48"	10

NOTES:

- Only insulating materials that are not adversely affected by moisture and freezing or that are adequately protected against the moisture should be used.
  - Thermal resistance =  $\frac{\text{Thickness of insulation}}{\text{Thermal conductivity, K, of insulation}}$  with units,  $\text{ft}^2\text{-hr-}^\circ\text{F}/\text{BTU}$ . For insulation with  $K = 0.5 \text{ BTU}/\text{ft}^2\text{-hr-}^\circ\text{F}/\text{in.}$ , one inch thickness has a Thermal Resistance =  $1/0.5 = 2 \text{ ft}^2\text{-hr-}^\circ\text{F}/\text{BTU}$ .
  - "Design Winter Temperature" is defined as the temperature equaled or exceeded during 97 1/2% of the hours in December, January and February.
- \* From top of floor slab.

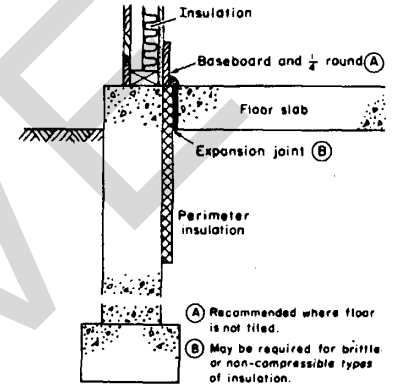

requirements, if any, may be computed as necessary. It should be kept in mind that if heat escaping through the foundation walls of an uninsulated basement is sufficient, it may prevent soil freezing at the outer face of the wall but if insulation is then added on these walls soil adfreeze may occur, with possible risk of frost heave in frost-susceptible soils.

(k) If a basement is completely below grade and is not heated, the temperature in the basement normally will range between that in the rooms and that of the ground. The exact temperature which will naturally exist in an unheated basement or in crawl spaces below floors is indeterminate and depends on such things as the proportion of basement which is below ground, the number and size of windows or wall vents, the amount of warm piping present, the extent of piping or floor insulation, and the heat given off by a basement heating plant. If the floor in the space above is at all cold, the using service or resident will try to increase the floor temperature where it is not difficult to do so. It is necessary, therefore, for the design engineer to evaluate the probable conditions carefully and to make a realistic basement or crawl space design temperature assumption in accordance with his best judgment.

e. *Granular mats.*

(1) In areas of both deep seasonal frost and permafrost, a mat of non-frost-susceptible granular material placed at the start of the field construction effort on the areas of planned construction serves to moderate and control seasonal freeze and thaw effects in the foundation soils, to provide stable foundation support and to provide a working platform on which construction equipment and personnel may move and operate with minimum difficulty regardless of seasonal conditions. The mat becomes the locus of part or all of the seasonal freeze and thaw action, reducing or eliminating these effects in the underlying in-place materials. Its thermal function is more nearly that of a heat sink than of an insulator, dampening the effects of seasonal fluctuations relative to the subgrade. The mat reduces the magnitude of any seasonal frost heave in underlying materials through its surcharge effect. It is usually convenient to place the mat at the start of the construction so as to serve both working platform and structure foundation purposes.

(2) To insure a dry, stable working surface during upward flow of melted water in the thaw period, the mat materials must be sufficiently pervious to bleed water away laterally without its emerging on the surface (TM 5-820-2/AFM 88-5, Chap. 2<sup>8</sup>). The mat is most commonly composed of clean, well-graded bank run gravel of 2 and 3 inches maximum size, offering good compaction, trafficability and drainage characteristics. Where such material is not available, alternatives such as crushed rock or clean sand with a soil-cement surface will have to be considered. Materials should contain

sufficient sand sizes to retain some moisture; this will help to control thaw and freeze penetration. If a very coarse gravelly mat material is to be placed over a fine-grained subgrade, a sub-base of 6 in. minimum thickness of clean, non-frost-susceptible sand should be placed directly on the subgrade in order to minimize the possibility of upward intrusion of fines into the mat during thaw periods. Increased volumetric latent heat of fusion corresponding to the higher moisture-holding capacity of this sand will also help reduce freeze and thaw penetration into the subgrade.

(3) When the mat is needed only as a construction working platform, and control of freeze and thaw penetration into the subgrade is not a factor, the mat is made only thick enough to carry the loadings which may be applied to it during actual facility construction, during critical periods of reduced subgrade strength. For this purpose, thicknesses should be determined from the flexible pavement design curves given in TM 5-818-2<sup>6</sup> or TM 5-852-3<sup>12</sup>. However, under summer soft ground conditions as much as 3 ft of material may need to be placed by end dumping and spread in one layer simply to support the hauling equipment initially. If compressible materials underlie, even more may be needed to meet design grades. Under other conditions, as where the natural soils are free draining sands and gravels, little or no mat may be needed except to provide, through elevation, a well-drained surface during unfavorable periods of the year, to provide a uniform work platform level, or to minimize snow accumulation problems.

(4) Figures 4-16, 4-17, 4-21 and 4-23 illustrate use of mats to provide thermal protection to the foundation. Figures 4-13, 4-14, 4-15, 4-22 and 4-24 through 4-27 illustrate use of mats additionally to provide stable bearing support for footings and rafts. Figure 4-28 shows both thermal protection of a pile foundation supported in the natural ground and support of the hangar pavement on the gravel mat. When used for foundation support the mat should be designed with sufficient thickness to achieve any needed heave reduction through its surcharge effect. For temporary facilities or for light flexible structures, complete frost heave control may not be necessary or economical. For facilities which require a foundation free from any frost heave or thaw settlement effects the mat should be made thick enough so that seasonal freeze and thaw are kept within the mat if the subgrade conditions are unfavorable. Required thicknesses for thermal control should be computed by procedures outlined in TM 5-852-6/AFM 88-19, Chapter 6<sup>14</sup>. Approximate values may be estimated from figure 4-4. If thicknesses are excessive, alternative foundation design approaches must be investigated. It should be kept in mind that during the thawing season building heat may add to the thawing in-

dex of air passing through a ventilation space so long as the air temperature is below the building temperature even though the temperature differential is smaller and the thawing index increase is of smaller magnitude than the freezing index decrease in winter.

(5) The surface of the mat should extend outside the perimeter of the structure or any foundation members at least a distance of 5 feet before sloping down to the ground surface. In addition, greater width should be added for walkways or vehicular traffic or to handle construction equipment where required.

(6) Allowable bearing values for footings and sills supported on granular mats vary from 2,000 psf on shallow, poorly graded sandy mat materials to 6,000 psf on deeper, well-graded gravels and clean crushed rock. Thickness of granular material between footing and underlying natural soil must be sufficient to reduce concentrated stresses on the natural soils to tolerable levels, as discussed in paragraph 4-4.

*f. Protection against solar radiation thermal effects.*

(1) Solar radiation is a major factor in the thawing of frozen ground, particularly at very high latitudes. A very substantial proportion of the heat received in summer in those regions comes from this source.

(2) Because the portion of a granular foundation mat extending beyond the building perimeter tends to absorb substantial solar heat, thaw of permafrost under this extension, unless full protection against combined heat input is provided, may cause settlement of this portion of the mat in time. At the extreme perimeter of the mat where it is tapered down to the natural ground surface, the plane of seasonal thaw penetration tends to be depressed because of the thinned granular cover. On south-and west-facing embankment edges the effect is intensified by increased solar heat absorption. Settlement or even sloughing of the embankment edge may result, and ponding of water on thaw-depressed natural ground at the toe of the slope may further intensify the condition by increasing the absorption of solar radiation. Possible adverse effects on the construction and possible increased maintenance requirements from these perimeter conditions should be anticipated in the design. Typical provisions include extension of the mat sufficiently far beyond the structure foundations so that the latter cannot be affected by thaw settlements, including those from surface and subsurface drainage of thaw water; re-forming of the embankment cross-section with additional material from time to time during the life of the facility so as to gradually build up extra thickness of granular material at thaw-settlement locations; and use of heat-absorptive or heat-reflective coverings. The area of mat exposed to solar heat input is sometimes covered with moss or peat to minimize these effects, but because of the fire hazard contributed by the dry organic material in summer, it is

policy to avoid this in Army construction except for the outermost edge of the mat contiguous with the natural terrain, where the organic material can reasonably be expected to support a live vegetative cover. Another solution is to provide a more reflective surface by using a light-colored reflective aggregate cover, if available, by spraying with whitewash or a very light spray coating of white paint, or by constructing white painted pavement in the proper position near the structure. Such methods will only be successful after construction activities have ended and accumulation of dirt and dust on the surface has ceased. An insulating course in the ground may sometimes be used to slow rate of thaw. Positive but potentially expensive solutions which shade both the granular pad close to the structure and the piles at the perimeter are special hinged plywood panels which can be extended from the side of the structure as shown in figure 4-18, or timber vanes as shown in figure 4-19; while acting as sunshades, these do not interfere with the flow of ventilating air under the structure. Actually, simple white painted moisture-durable panels of metal or wood or other material can be used, even if only laid on the ground surface in the critical locations and anchored down. Vegetation also can be an effective agent for control of radiation effects but may not be feasible within the time frame available or under the site climatic conditions. Experience indicates that protection is usually needed only on the south and west sides of structures, although facilities located well north of the Arctic Circle may in fact receive substantial sunlight on all sides during the height of summer. Areas of a well ventilated foundation which are fully shaded by the structure against sunlight may experience a rise of the permafrost table following construction. Cantilevering the edge of the structure beyond piling, post or column supports so as to provide positive shade for the foundation will help to assure maximum foundation stability on permafrost.

(3) Individual sun shades are sometimes used on the upper column part of an isolated steel pile. These consist of sheet metal enclosures, usually of aluminum alloy or reflective-painted light gauge steel. Care must be taken in fastening them to the column as wind damage has sometimes occurred. The air-space between enclosure and column plus the reflective surface of the enclosure is very efficient.

(4) Another expedient is to increase the pile length by about 2 feet to ensure adequate bond length in permafrost when summer heat may increase the thaw depth by up to 12 to 18 inches around a steel pile.

(5) Probably the simplest, yet adequate, approach for controlling direct radiation absorption by piling which may be exposed to the sun is to paint the exposed portions with a highly reflective white paint.



**4-3. Control of movement and distortion from freeze and thaw.** The foundation design engineer must establish the amounts of movement and distortion which may be tolerated in the structure supported by the foundation and must develop his design to meet these criteria. Foundation design must interrelate with design of the structure.

a. Movement and distortion may arise from seasonal upward and downward displacements, from progressive settlement arising from degradation of permafrost, from horizontal seasonal shrinkage and expansion caused by temperature changes, and from creep, flow, or sliding of material on slopes. Detrimental effects may consist of the following:

Tilting of floors

Jamming of doors and windows

Cracks and separations in floors, walls and ceilings

Breaking of glass Complete disorientation of structural stresses

Structural failures

Shearing of utilities within structure, at structure perimeter, and in the ground

Damage to installed equipment or interference with its operation

b. Small flexible buildings on posts and pads can easily tolerate several inches of seasonal movement provided the differential between various parts of the foundation is not excessive and provided utility connections have the requisite flexibility. Post and pad, footing and column, and simple pile foundations such as illustrated in figures 4-13 through 4-20 are generally satisfactory for such relatively light structures. However, permanent structures should be designed to be free from both seasonal and progressive movements or distortions during the life of the facility, except for the normal cyclic effects caused by seasonal expansion and contraction of ground and structural elements. For certain technically complex facilities such as radar or communications installations which can tolerate only minute movement, exceptionally stringent foundation stability and response requirements may be established.

c. As foundation loadings increase, support members must be more closely spaced and/or have heavier cross-sections, and footings must have larger areas, with less and less space between footings. Figures 4-21 through 4-23 show designs of higher load capacity. Where these systems may become uneconomical, designs such as the systems shown in figures 4-24 through 4-28, capable of very high unit loadings, should be considered. As a last resort, where even such air ducts cannot be incorporated into the foundation, tubing systems through which liquid refrigerant is circulated may need to be used in the foundation. The magnitude of the foundation loading will have an influence on the type of material used, and will determine the size and arrangement of foundation components. The relative in-place costs of materials such as wood, steel and concrete must be known for

accurate economic evaluation of optional approaches. The geometrics, size and loading of the members of the foundation will determine the upward heave force and displacement pattern and adfreeze stresses developed. The foundation, structure, and loading will react, in turn, to restrict the amounts of actual heave displacement which can occur.

d. Wood frame structures have relatively high flexibility and capability for adjustment to differential foundation movements. They have often continued to give acceptable service even under conditions of such severe distortion that doors have required substantial trimming in order to open and close, window glass has required replacement with plastic film to reduce breakage, and floors have become conspicuously unlevel. Steel frame structures usually are highly suitable for modern military facilities, are highly reliable and versatile, and offer excellent long term service capability. They are more rigid than wood frame structures but more tolerant of movement than reinforced concrete and masonry. Both pad supported and fixed types of foundations may be used for wood and steel structures. Concrete and masonry exhibit in the cold regions about the same responses to distortion as in temperate or tropic areas. Foundations which provide complete freedom from cracking or distortion of the structure are required for concrete or masonry structures.

e. If the foundation materials are thaw-stable, clean, non-frost-susceptible granular soil or ice-free sound bedrock, the same type of foundations may be considered as would be employed in the temperate zones.

f. Figure 4-38 shows a typical record of permafrost degradation and vertical movements of a small wooden building constructed with a "floating" foundation consisting of a rigid concrete raft on a gravel pad. This particular design is not an economical one; it was constructed as an experiment,"". Although regular seasonal vertical movements occurred and there was gradual progressive degradation of permafrost at the warmer southwesterly side of the foundation which received maximum sunlight in the summer, resulting in tilting, the building itself performed excellently. warmer southwesterly side of the foundation which received maximum sunlight in the summer, resulting in tilting, the building itself performed excellently.

g. Figure 4-39 shows displacements for a small wooden building supported on wood piles embedded in permafrost,"". In this case, 1 of the 20 supporting piles failed to achieve freeze-back in permafrost and continued to heave progressively upward. Distortion of the wooden building of more than 6 inches occurred before the top of the pile was sawed off and a jack in

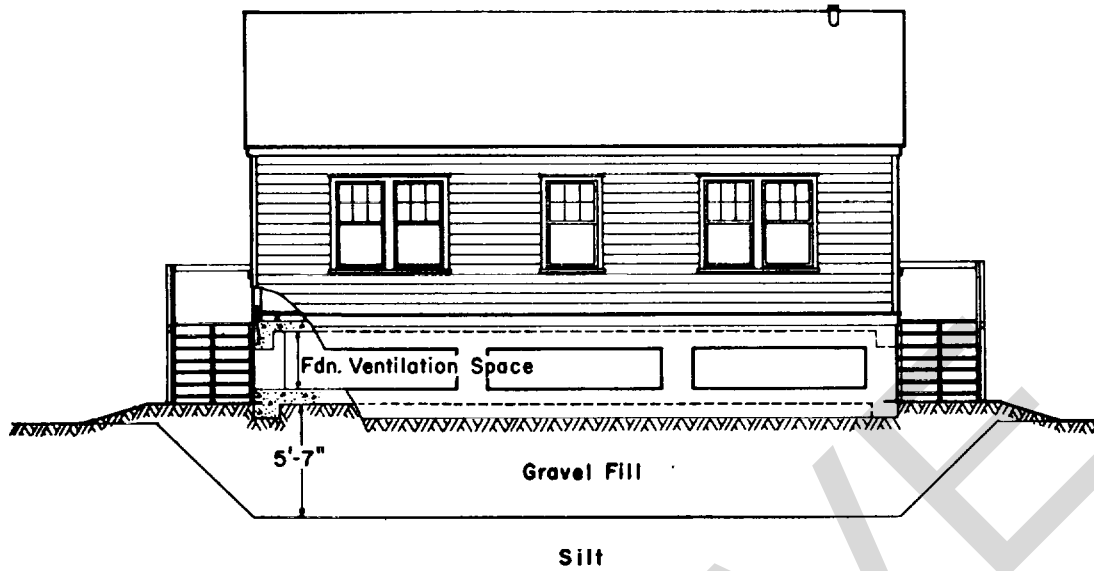

U. S. Army Corps of Engineers

Figure 4-38a. Wood frame residence 32 x 32 feet on rigid concrete raft foundation, Fairbanks, Alaska (South side Elevation)

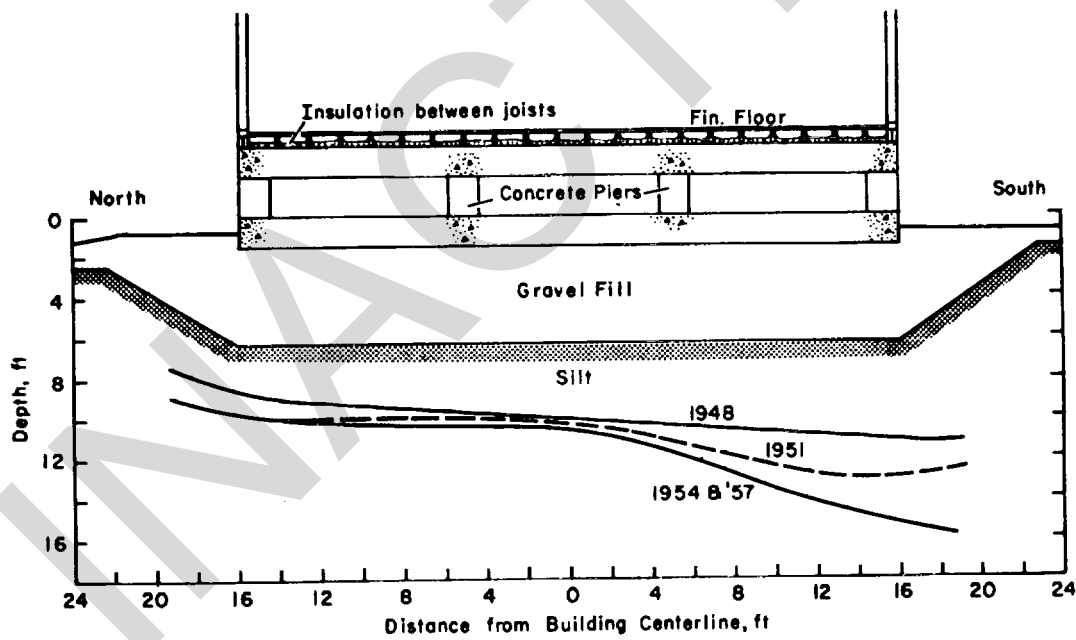

U. S. Army Corps of Engineers

Figure 4-38b. Wood frame residence 32 x 32 feet on rigid concrete raft foundation, Fairbanks, Alaska (Degradation of permafrost on N-S centerline, 1948-1957)

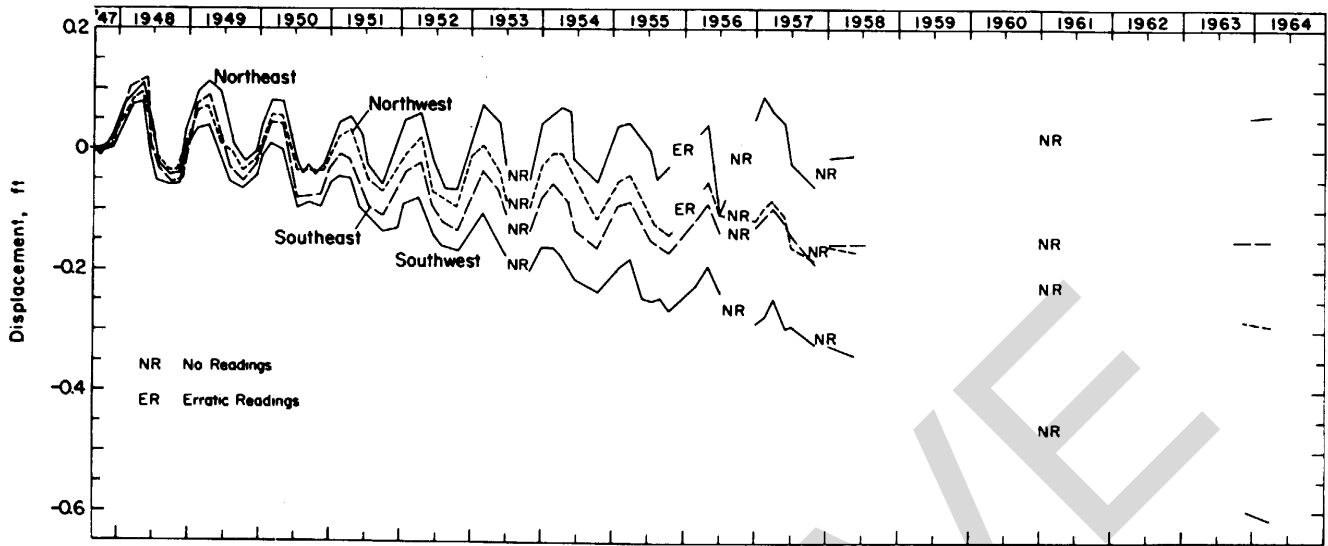

U. S. Army Corps of Engineers

Figure 4-38c. Wood frame residence 32 x 32 feet on rigid concrete raft foundation, Fairbanks, Alaska (Displacement of corners, 1947-1964)

serted. The building is still giving good service more than 20 years after erection although the one jack requires periodic adjustment and occasionally an additional section has to be removed from the top of the pile. In figure 4-39 the rapid jacking out of the ground of porch posts embedded only in the annual frost zone is contrasted with the performance of the permafrost embedded piles supporting the building itself. These porches became unusable and had to be reconstructed.

h. Figure 4-40 shows the rapid settlement of a wooden garage building on a grossly inadequately ventilated foundation, "0. The greater displacement of the west side as compared to the east may have resulted from the effect of the late afternoon sun on the west side. Degradation of the permafrost was finally nearly arrested by discontinuing heating of the building. In spite of extreme differential distortion of the building it was then used for some years for storage with very little further distress. It was finally moved to a new foundation and reconditioned; it is still in use more than 20 years after its original construction.

i. Power transmission line towers can often tolerate several inches of upward and downward seasonal movement (depending on the tower design) provided there is no progressive tilting, heave or settlement. Therefore, it is often possible for such towers to be economically supported on footings resting on pads of free-draining granular materials. Radar or

communication antenna towers, however, must usually maintain fixed orientations at all times and normally require fixed types of foundations. Bridge piers and abutments are normally thought of as fixed types of structures but recent observations of such construction in Alaska have shown that considerable seasonal movements may occur<sup>48</sup>. Figure 4-41 shows observed movements of a bridge pier in central Alaska. Nevertheless, such facilities must be designed for permanent stability, accepting small cyclic seasonal deflections due to thermal stresses. Water and POL storage tanks may accept considerable movement and distortion if properly constructed and may therefore be supported either on "floating" or fixed types of foundations, provided long range thermal stability is assumed.

j. When components such as exterior loading platforms, porches or unheated wings are attached to heated structures which are stable supported, the potential exists for severe differential movements between the facility components (fig 4-39). Such conditions must be carefully studied and precautions must be taken in design to ensure that structural damage will not occur. To achieve this, the foundation of the attached or unheated facilities should be provided with the same

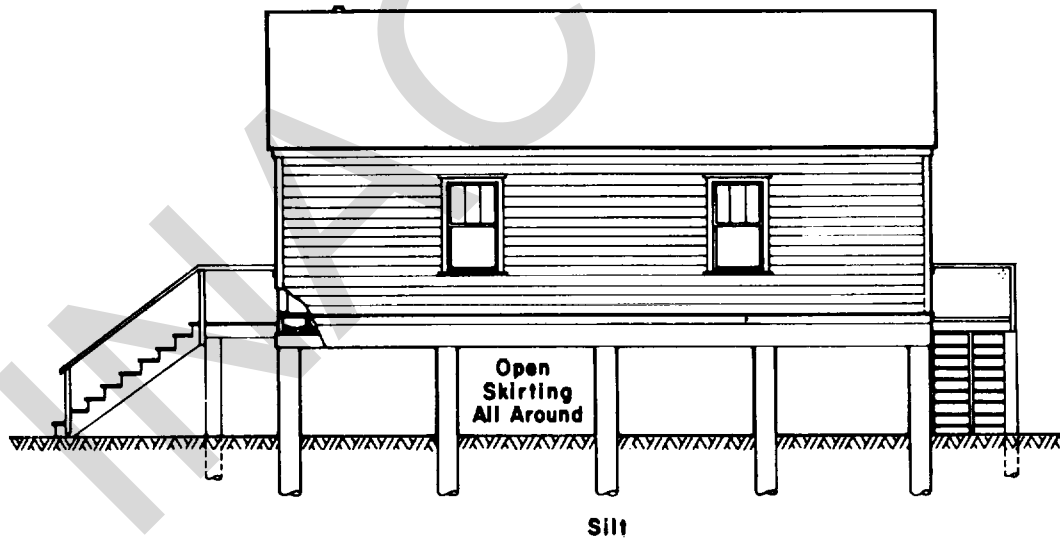

U. S. Army Corps of Engineers

Figure 4-39a. Wood frame residence 32 x 32 feet on wood pile foundation, Fairbanks, Alaska<sup>73,180</sup>. See figure 4-25 for site conditions. See figure 4-12b for degradation of permafrost, 1948-1957. (North side elevation.)

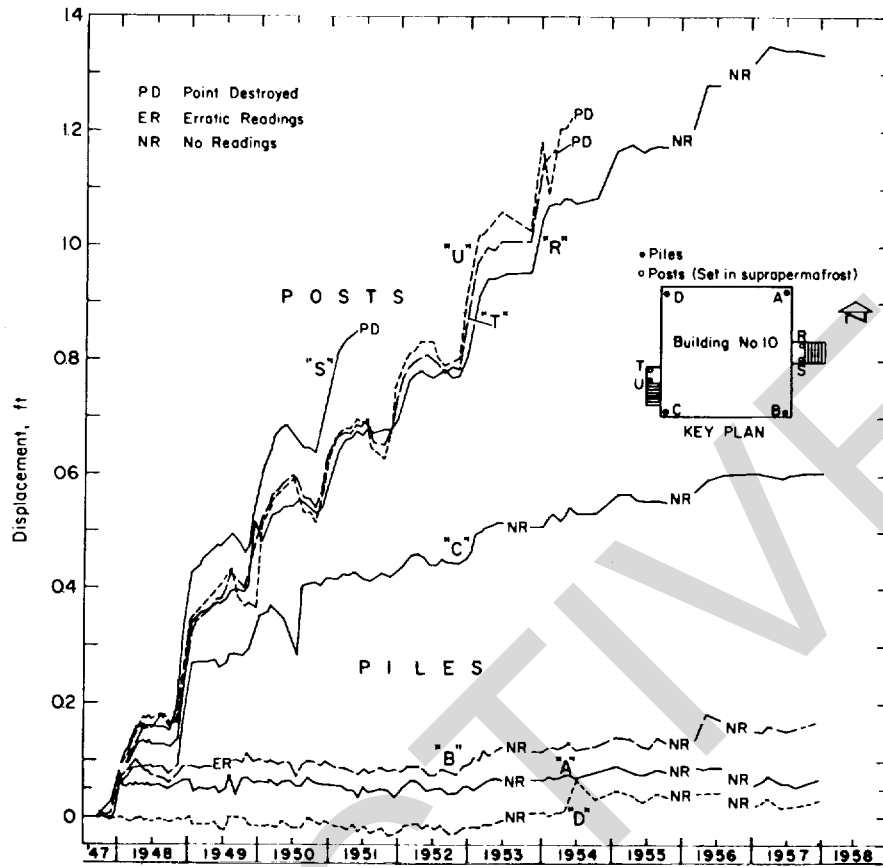

U. S. Army Corps of Engineers

Figure 4-39b. Wood frame residence 32 x 32 feet on woodpile foundation, Fairbanks, Alaska (Displacement of piles and posts, 1947-1958.)

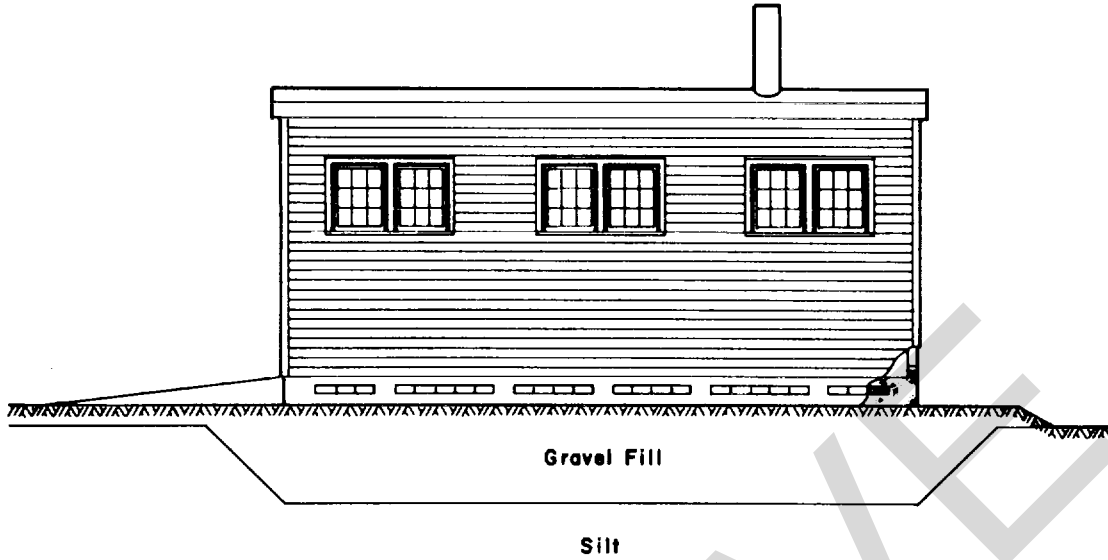

U. S. Army Corps of Engineers

Figure 4-40a. Wood frame garage, 32 x 32 feet on rigid concrete raft foundation, Fairbanks, Alaska<sup>73,188</sup>. See figure 4-25 for site conditions. (East side elevation.)

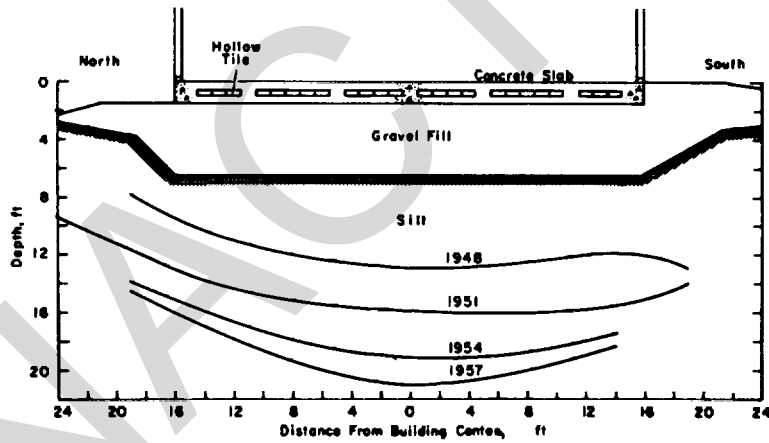
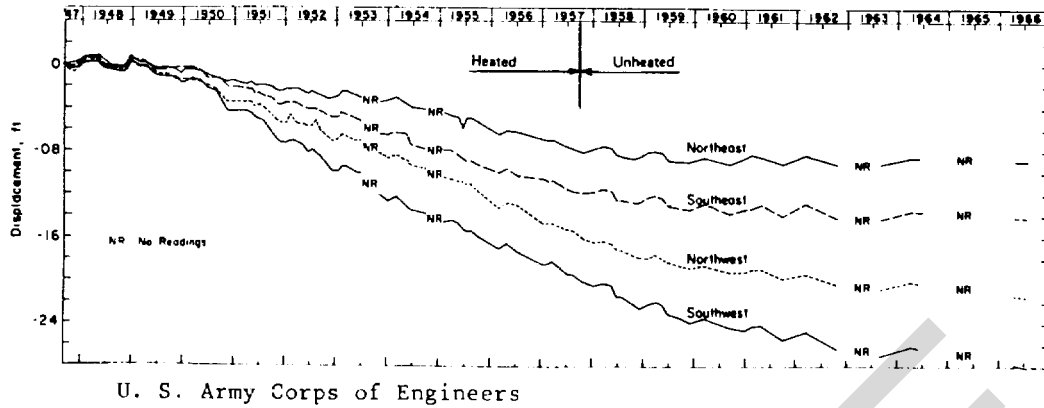
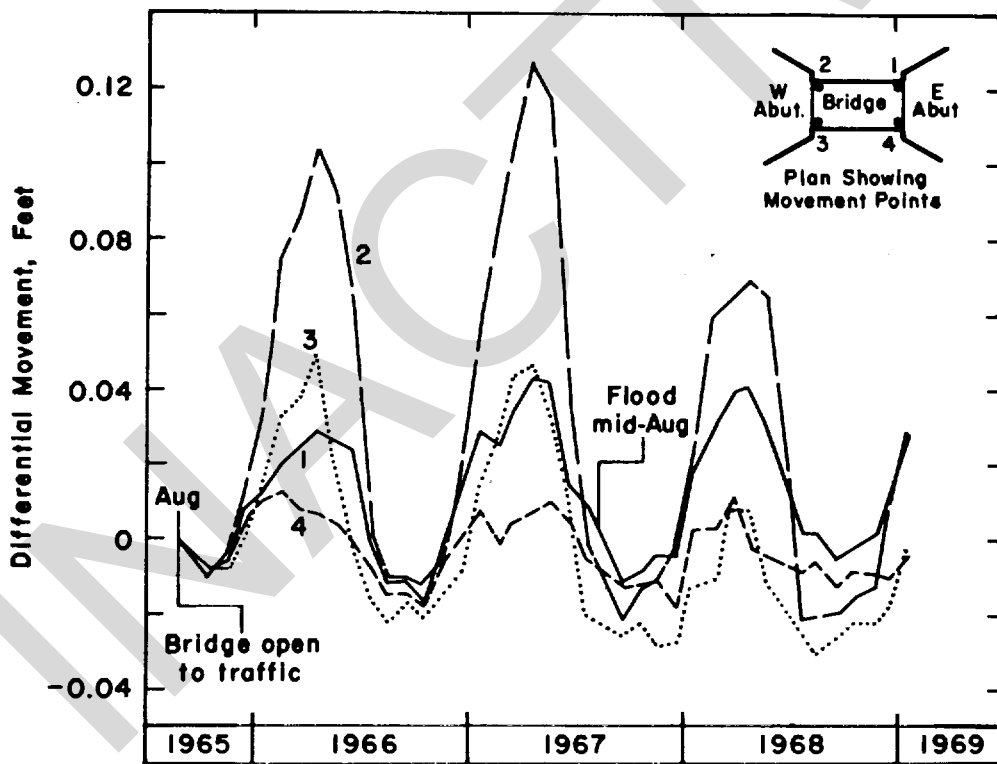

Figure 4-40b. Wood frame garage 32x 32 feet on rigid concrete raft foundation Fairbanks, Alaska (Degradation of permafrost on N-S centerline, 1948-1957)



U. S. Army Corps of Engineers

Figure 4-40c. Wood frame garage, 32x 32 feet on rigid concrete raft foundation, Fairbanks, Alaska (Displacement of corners, 1947-1966)



U. S. Army Corps of Engineers

Figure 4-41. Vertical movement of 50-foot single span bridge on pile-supported concrete abutments, east-west road near Fairbanks, Alaska<sup>48</sup>. (Initial foundation conditions: each abutment supported on four 10BP57 H-piles driven 28 feet into 4 to 6 feet unfrozen gravel fill, 15 feet frozen silt and 7 to 9 feet frozen gravel; permafrost degrading slowly since construction.)

degree of stability, with respect to frost heave or thaw settlement, as the main or heated parts of the structures.

k. *Control of settlements which may result from thaw.* Thaw penetration beneath a slab or foundation readily occurs non-uniformly. The resulting differential stresses and strains may cause distortion and cracking in the slab, foundation and structure. If thaw is rapid and imposed loadings are high, displacement of over-stressed, thaw-weakened foundation soil is possible. Under dynamic loading, pumping and mud boils are possible. Thaw water may emerge upward. These thaw settlement problems should be avoided by adopting the proper foundation design approach for the conditions and by designing for full thermal stability control, using the principles presented in paragraphs 4-1 and 4-2. If damaging thaw settlements should start to occur, a mechanical refrigeration system may have to be installed in the foundation or a continual program of jacking and shimming will have to be adopted together with installation of flexible utility connections.

l. *Control of frost heave and frost thrust.* When estimation of the depth of seasonal frost penetration and evaluation of frost uplift or thrust forces indicate potential problems, they must be taken fully into

account in design and measures taken as necessary to avoid detrimental effects from either the structural stresses developed by the frost forces or from the resulting deformations.

(1) In the case of slab or footing foundations the heaving thrust of underlying frost-susceptible soils may act directly upward against the base of the foundation as illustrated in figure 4-42a or laterally against foundation walls as in figure 4-42b. Piers, posts, piles, or entire foundations surrounded by frost-susceptible soils are also subject to frost heaving as the ground adjacent to lateral surfaces is displaced annually as shown in figure 4-42c. Should the soil conditions, moisture availability, loading or frost penetration vary under the foundation the frost heaving effects will be non-uniform. To illustrate the problems involved, figure 4-43 shows the heave of floor slabs in wing hangars at Loring AFB, Maine". Through a combination of sufficient clearance of the slab around the interior columns and sufficient anchorage of the column footings, no movement of the

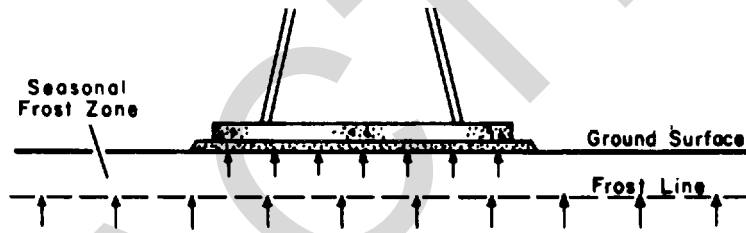

Figure 4-42a. Frost Action Effects (Heaving of soil in seasonal frost zone causing direct upward thrust on overlying structural elements.)

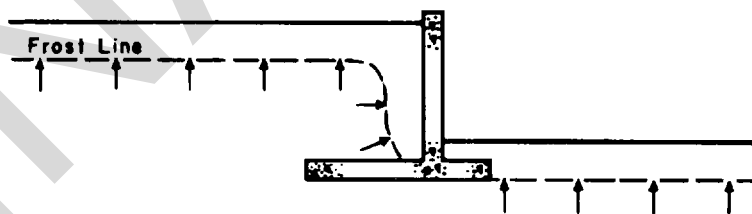
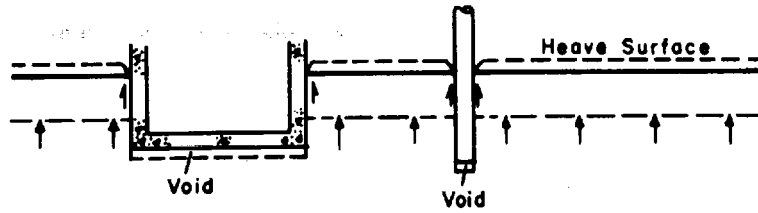

Figure 4-42b. Frost Action Effects (Freezing of frost-susceptible soil behind walls causing thrust perpendicular to freezing front.)





U. S. Army Corps of Engineers

Figure 4-42c. Frost Action Effects (Force at base of freezing interface tends to lift entire frozen slab, applying jacking forces to lateral surfaces of embedded structures, creating voids underneath. Structures may not return to original positions on thawing.)

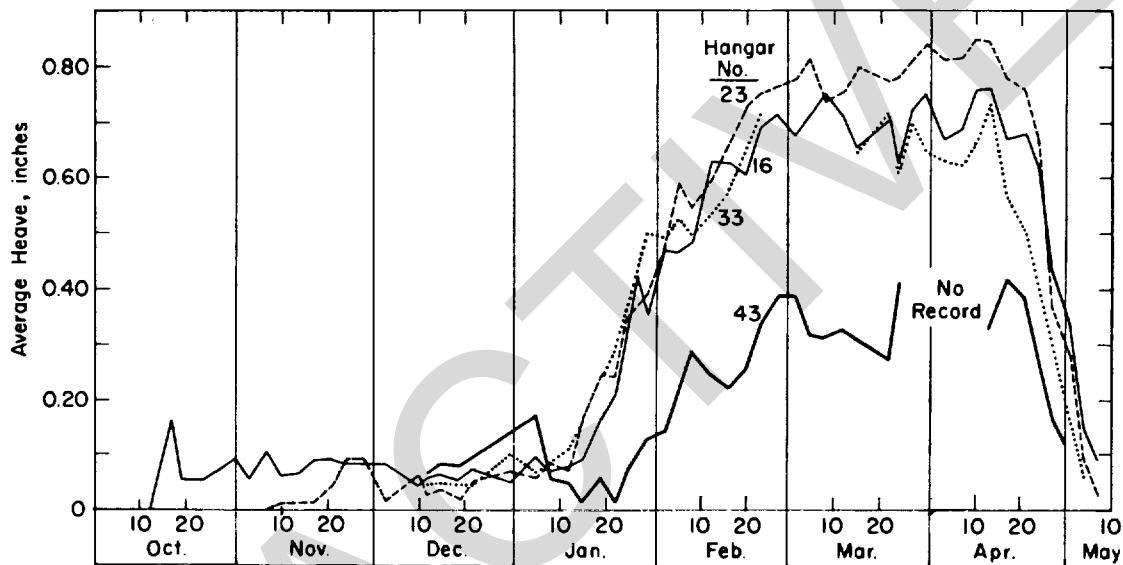

U. S. Army Corps of Engineers

Figure 4-43. Average heave vs. time. Floors of unheated wing hangars, Loring AFB, Limestone, Maine<sup>38</sup>.

columns resulted and the slabs returned to their original grades in the spring. Figures 4-44 and 4-45 show the magnitude of heave forces actually developed on plain steel pipe and creosoted wood piles at Fairbanks, Alaska<sup>51</sup>.

(2) By a nominal estimate of the effective area of the slab of seasonally frozen soil which contributes to heave or thrust forces on a structure and by use of the maximum heave pressure data presented in figure 2-9, and discussed in paragraph 2-4, a rough approximation of the total heave or thrust forces on a given structure can be made. A comparison of these forces with structural foundation loadings or passive resistive forces will give an indication of their relative balance. By laboratory tests<sup>40, 66</sup>, using either undisturbed or remolded materials as applicable for the particular frostsusceptible soil involved and by more rigorous analysis of the interaction of the structure and frost forces, a more accurate estimate is possible in theory. However, because of the many variables of soil conditions, moisture availability and frost penetration, precise quantitative predictions are not usually practical in the present state-of-the-art.

(3) When frost penetrates downward along vertical faces of walls, footings and piles in contact with earth, as illustrated in figure 4-42c, an adfreeze bond develops between the soil and the concrete, wood or other material of the foundation. If the soil is frost susceptible and heaves, the wall or footing tends to be lifted with the layer of frozen soil because of this adhesion. The weight of the structure at the same time tends to restrict frost heaving, the reduction diminishing with distance from the face. The maximum upward force which can be exerted on the structure is usually not limited by the uplift force which can be developed at the plane of freezing, but by the unit tangential adfreeze bond strength and the area of adfreeze contact on the wall, footing or pile itself. The total uplift force which is thus imparted to the structure is a function of the thickness of the frozen layer; the total force increases as the depth of frost penetration and the total bond contact area increase.

(4) The tangential shear stress which can be developed under a given rate of loading, or allowed in design, on the surface of adfreeze is limited by creep, which occurs down to stresses as low as 5 to 10 percent of the rupture strength measured under relatively rapid loading. Tangential shear stress is a function of such factors as the temperature, surface material (as concrete, steel, wood or paint), presence of salt or other chemicals in the soil moisture, direction and sequence of freezing, and rate and duration of loading. Tangential shear stress values are discussed in paragraph 4-8. In the present state of knowledge, dean metal, untreated smooth wood or smooth concrete surfaces may all be assumed to have similar adfreeze bond potentials. Rough concrete and rough wood (timber) have greater

potential; however, potential for increasing tangential shear strength by increasing roughness is limited by the shear strength of the adjacent frozen soil. Creosoted wood, steel with a mill varnish or red lead or other coating substances have the least adfreeze bond potential.

(5) In tests in a permafrost area at Fairbanks, Alaska, average maximum adfreeze bond stresses as high as 60 psi have been measured on uncoated steel piles embedded in a silt, under natural freezing conditions. Since this is an average value over the area of adfreeze, higher unit values undoubtedly were developed in the coldest upper levels of the seasonal frost zone. Values decreased rapidly when the rate of advance of the freezing plane slowed, as stress relaxation occurred in creep. Thus, any design measure which results in slower frost penetration, and/or higher temperatures at the adfreeze bond surface and smaller bond area will lower peak adfreeze bond forces and increase probability of stability against frost heave. The same is not necessarily true of direct uplift as illustrated in figure 4-42a or of frost thrust as illustrated in figure 4-42b, as direct forces may remain high so long as ice segregation is occurring, even with a stationary position of the freezing plane.

(6) When a structure is permitted to "float" on the annual frost zone as in figure 4-42a, detrimental frost effects can be best avoided, first by minimizing the magnitudes of seasonal displacement through the heave reducing effect of a surcharge provided by a non-frostsusceptible granular mat and, second, by insuring uniformity of the remaining frost effects through (a) selection of sites with as nearly uniform soil conditions as possible, (b) careful control of thickness, soil characteristics, and drainage of the mat, (c) extending the mat a sufficient distance beyond the structure perimeter so that possible edge effects on footings are minimized, and (d) providing supplementary shading of the foundation if appropriate.

(7) A situation similar to that shown in figure 4-42a may develop inadvertently in temporarily exposed footing or foundations on frost-susceptible materials during construction if adequate protection against winter frost heaving is not provided. In two documented cases, at Anchorage, Alaska; and at a group of mid-western construction sites, erected but incomplete structures were bodily lifted as much as 4 to 6 inches by frost action before the heaving was noticed<sup>148</sup>. In the case of the mid-western installations tilting due to differential heaving also occurred. At both locations the foundation soils were allowed to thaw gradually and evenly; the foundations returned essentially to their design grades and the structures were completed successfully. In an inverse case, frost heave of various parts of an Alaskan schoolhouse was caused when artificial refrigeration

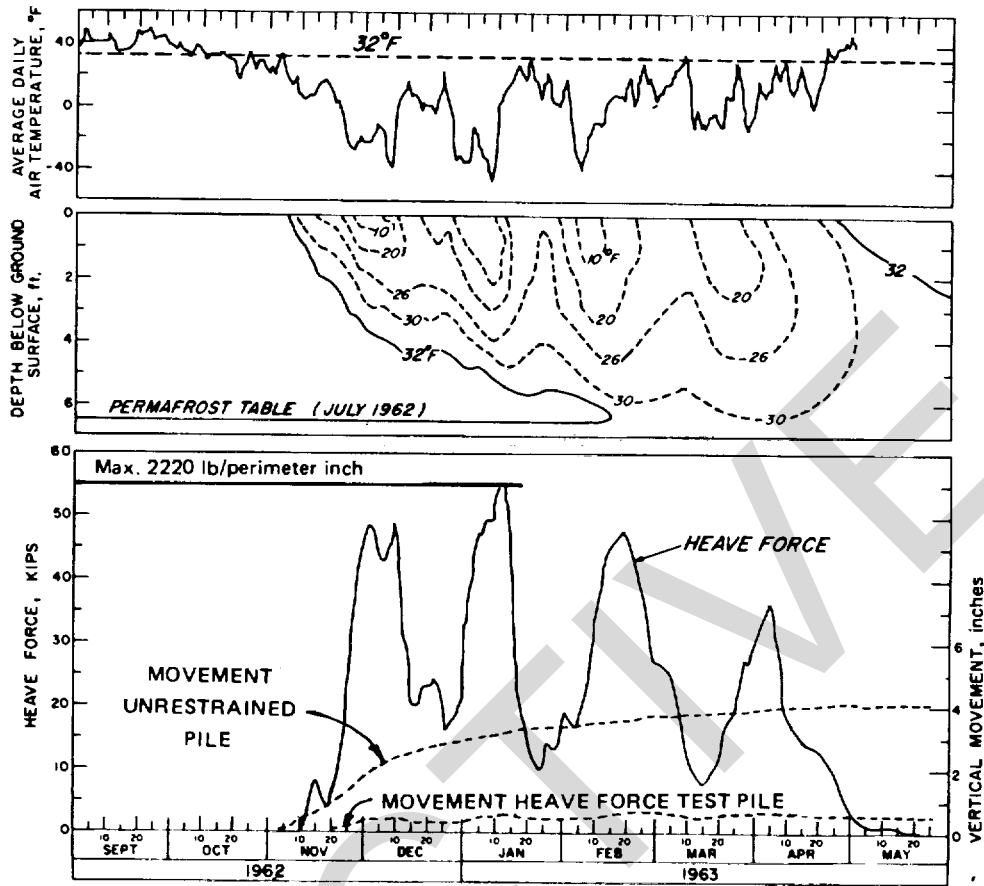

U. S. Army Corps of Engineers

Figure 4-44. Test observations, 1962-63, 8-inch steel pipe pile, placed with silt-water slurry in dry-augered hole<sup>51</sup>. "Heave force test pile" was restrained in order to obtain force measurements, permitting only the minimal movement shown. "Unrestrained pile"<sup>55</sup> was an identical pile allowed to heave freely with no imposed vertical loading.

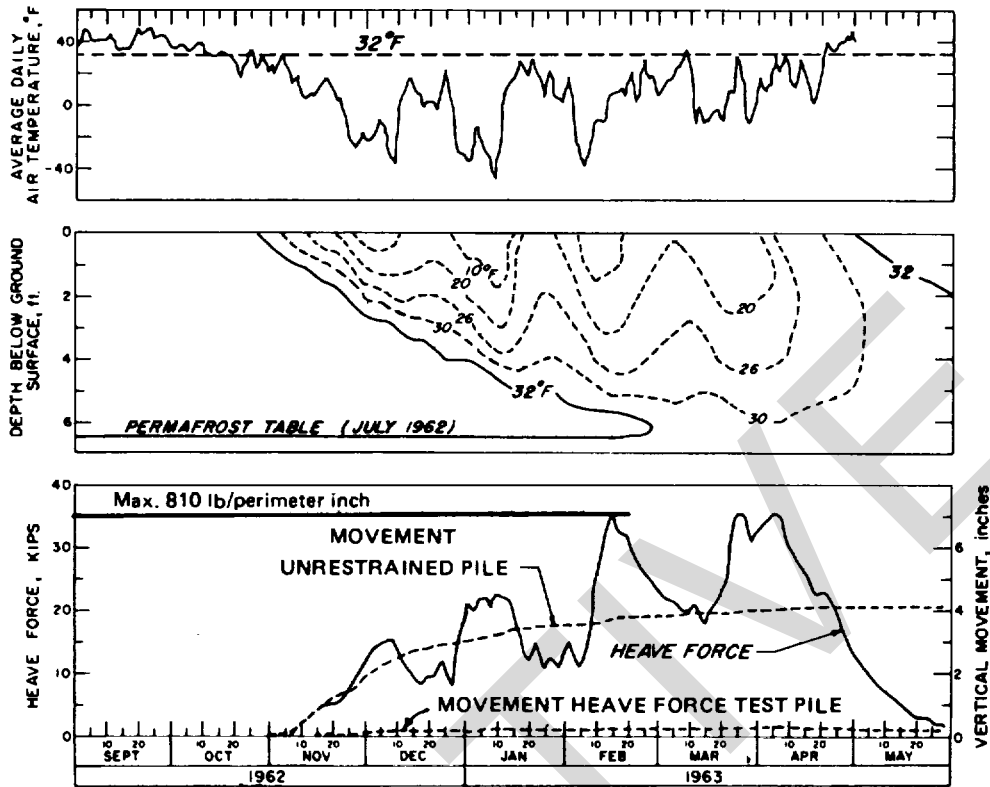

U. S. Army Corps of Engineers

U. S. Army Corps of Engineers

Figure 4-45. Test observations, 1962-63, creosoted timber pile, average diameter. Heave force pile, 14 in.; unrestrained pile, 12 in. Placed with sill-water slurry in dry-augered hole<sup>51</sup>. "Heave force test pile" was restrained in order to obtain force measurements, permitting only the minimal movement shown. "Unrestrained pile" was an identical pile allowed to heave freely with no imposed vertical loading.

was employed to control degradation of permafrost under the structure<sup>111</sup>.

(8) Foundations of the type shown in figure 4-42a are relatively immune to progressive frost action effects as the foundation readily returns each summer to its original position. However, foundations of the types illustrated in figures 4-42b and c are susceptible to possible progressive jacking by frost action. In these designs, irrecoverable deflections must be positively prevented.

(9) Where fixed type foundations are used as in figure 4-42c, detrimental frost action effects can be controlled by placing non-frost-susceptible soils in the annual frost zone to avoid frost heave problems; providing sufficient embedment or anchorage to resist movement under the heaving forces (sufficient integral strength must also be provided in foundation members to ensure such forces); providing sufficient loading on the foundation to counterbalance heaving forces; isolating foundation members from uplift forces by various means; or in seasonal frost areas by taking advantage of natural heat losses to minimize adfreeze and/or frost heave (here however, the possibility of future standby deactivation of the structure without heat must be considered).

(10) A non-frost-susceptible foundation mat or backfill can be of substantial help in achieving desired control. In addition to providing material which in itself will not impart frost heaving forces to the foundation, the mat will impose a surcharge on the underlying soils to reduce frost heaving and provide a useful thermal barrier which will avoid the extremely low temperatures in the potentially adhering frost-susceptible underlying soils. Maintaining warmer (though still below freezing) temperatures decreases the adfreeze strength of the insitu soils.

(11) All forces which might distort the supported structure must be carefully anticipated. As discussed elsewhere some types of foundations are self-adjusting for non-uniformities of frost heave.

(12) Thermal piles offer increased anchorage against frost heaving through lowering of pile surface temperatures in permafrost. Self-refrigerating thermal piles also tend to reduce depth of summer thaw and furnish heat to the annual frost zone during the period of frost heaving, thereby reducing the adfreeze bond stress in the zone of frost jacking.

(13) Various methods of isolation are available to reduce the extremely high adfreeze strength and upward forces imposed on piling, footings and other foundations by frost heaving.

(14) Heave force isolation of piles is required when there is insufficient length of pile in permafrost, particularly when warm permafrost is present. This condition is particularly common when bedrock or another bearing stratum exists at relatively shallow

depths. The bearing stratum can competently support the live and dead loads on a pile but cannot provide sufficient anchorage to resist frost heaving forces unless the pile is anchored at considerable additional expense. Such conditions are quite common at bridges, where the thermal regime of the permafrost is influenced by the stream. In other situations, such as piles or poles which are lightly loaded or carry only transient loads, the depth of embedment in permafrost required solely to resist the frost heave forces may produce uneconomical design. Isolation may also be more economical in seasonal frost areas.

(15) Heave force isolation may be accomplished by casing the pile or foundation member or backfilling around the foundation member with treated soil. The annulus between pile and casing is normally filled with an oil-wax mixture which has a thick consistency, as shown in figure 4-46a. Simple casings within the annual frost zone normally will be jacked progressively out of the ground by frost action. Therefore, plates or flanges should be employed at the bottom of the casings to resist casing heave.

(16) To avoid the difficulties and costs involved with casing, a premixed backfill of soil, oil and wax may be used to reduce frost heave thrust on the upper sections of the pile to acceptably low values, as shown in figure 4-46b. This method of heave isolation offers a somewhat greater lateral pile support than the casing and oil-wax method shown in figure 4-46a.

(17) Coating the pile length in the annual frost zone with low friction material, as well as creosoting", may temporarily reduce frost heaving but must not be relied on for this purpose in permanent construction. Chemical additives have also been added to the active zone immediately around piles but were not found to be significant or of sufficient life to reduce heaving. Various methods of providing additional shear strength or anchorage in permafrost have been studied to combat frost heaving of lightly loaded piles but were found to be only partially effective. Some of the methods investigated including notching the pile, driving railroad spikes in timber piles, welding angle iron on flanges of steel piles and providing plates on the base of various pile types.

(18) While a large surface area in permafrost is desired to provide a greater capacity, the section of pile passing through the active layer should be as small as possible. Changes in pile cross sections or surface areas available may be accomplished by the use of composite piles. Care should be taken in using composite piles to ensure that the pile has adequate strength to resist tension. Reducing the surface area of timber piles in the annual frost zone may be accomplished by placing timber piles butt down. In addition to a small cross section in

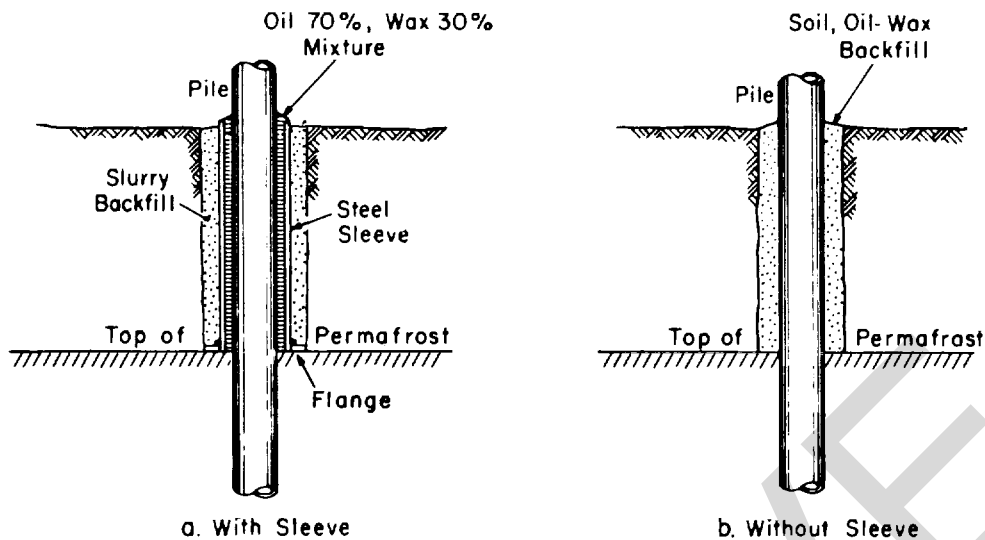

U. S. Army Corps of Engineers

Figure 4-46. Heave isolation (by CRREL).

the annual frost zone, timber piles placed in this manner have a preferred batter to further reduce frost thrust together with improved anchorage.

**4-4. Allowable design stresses on basis of ultimate strength.** Ultimate strength and deformation characteristics of any particular saturated frozen soil depend primarily upon its temperature relative to 32 ° and the period of time that the soil will be subjected to a given stress. The ultimate strength increases as the temperature decreases.

a. There are two primary reasons for the increase in strength: first, the solidification by freezing of an increasing proportion of the water in the voids as the temperature drops (this is of importance primarily in fine-grained soils, especially in the temperature range between 32°F and 0°F); and secondly, the increase in strength of the ice fraction with decrease in temperature. In addition, there is the possibility of a contribution resulting from soil matrix consolidation due to ice segregation". The ultimate strength of frozen soil also decreases with increase in the length of time over which a constant stress must be resisted. The dependence of ultimate strength of frozen soil on temperature and time-duration of constant stress application is shown in a plot of unconfined compressive strength vs. temperature for a saturated frozen fine sand (fig. 4-47)<sup>87</sup>. It should be

noted that for a given reduction of temperature, the increase in long-term strength is smaller in magnitude than the increase in short-term strength; however, the proportionate increases are comparable, as shown in figure 4-48.

b. The decrease in strength with increase in time over which a constant stress must be resisted is further illustrated in the unconfined compression test results shown in figures 4-49 and 4-50 for frozen saturated Ottawa sand. The family of experimental curves in figure 4-49 show creep curves for different applied constant stresses at 29°F. Proceeding from high to the lower stresses, the slopes of the curves decrease until the lower curve approaches a nearly horizontal straight line. The latter curve, which corresponds to the maximum stress that the soil can resist indefinitely, is considered the long-term strength of the soil.

c. The plot of time to ultimate failure vs. ultimate strength (fig. 4-50) indicates that for this particular frozen soil the long-term strength at 25 °F is in the order of about 20 percent of that determined from a standard test for unconfined compressive strength. Tests on silts

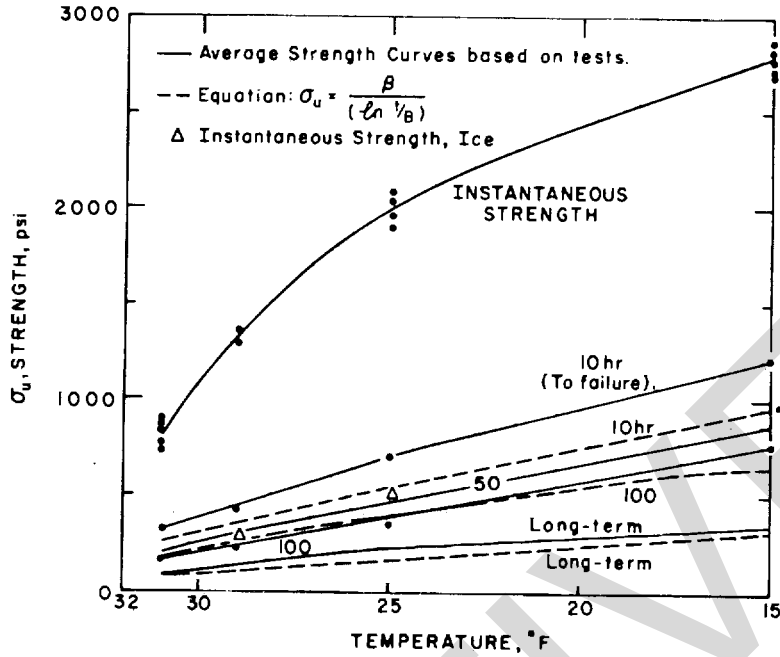

U. S. Army Corps of Engineers

Figure 4-47. Frozen soil creep tests, unconfined compression, Manchester fine sand<sup>87</sup>. Instantaneous strength is maximum stress determined by loading specimen at a constant strain rate of 0.033/min. Long-term strength is maximum stress that the frozen soil can withstand indefinitely and exhibit either a zero or continually decreasing strain rate with time.

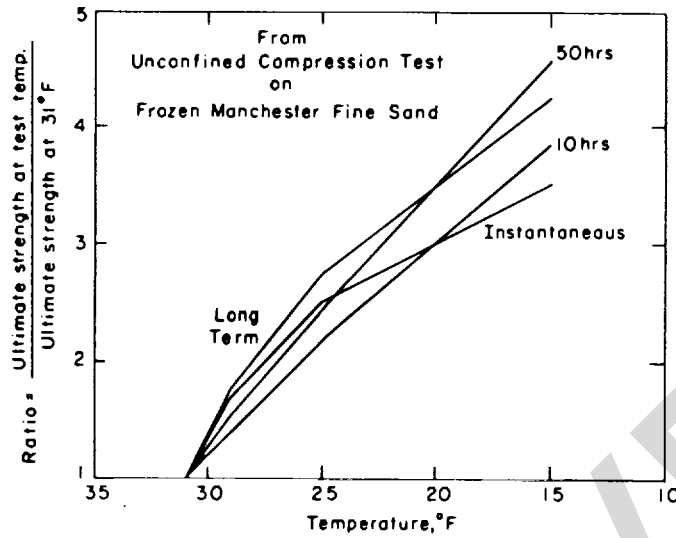

U. S. Army Corps of Engineers

Figure 4-48. Variation of ultimate strength ratios with temperature for various rates of loading (computed from data in fig 4-47).

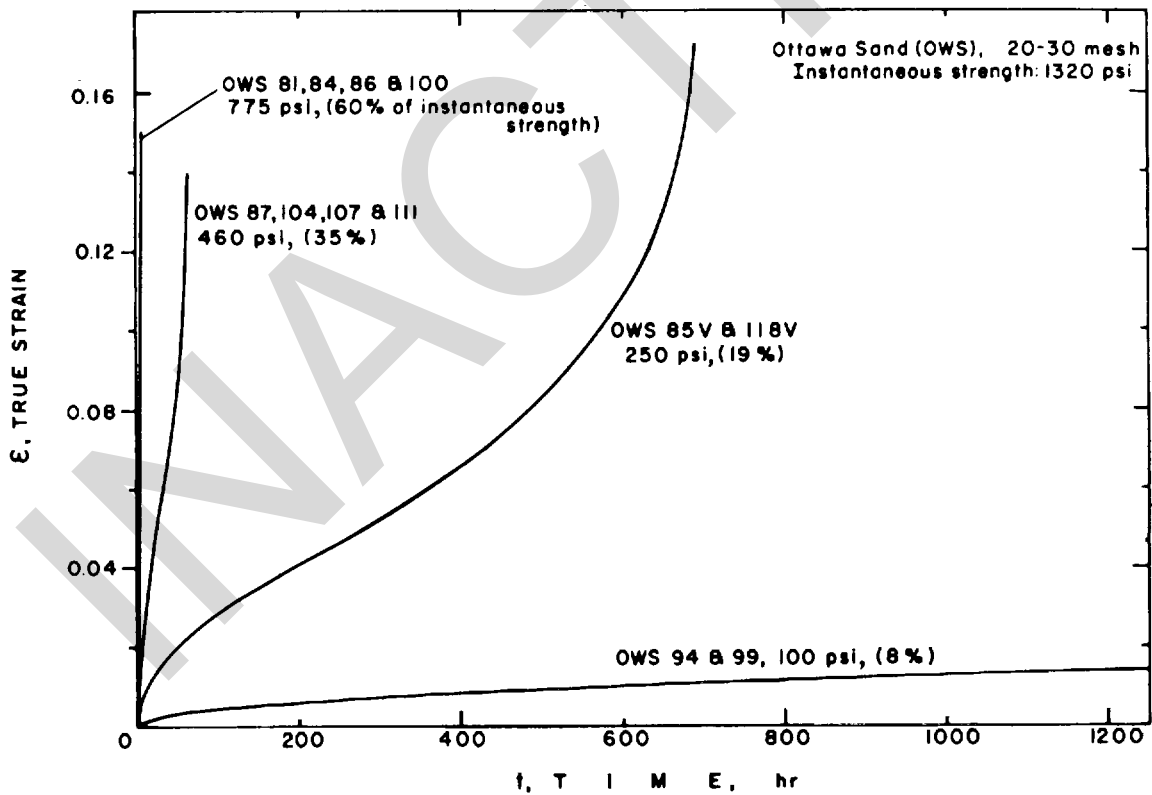

U. S. Army Corps of Engineers

Figure 4-49. Unconfined compression creep curves for frozen Ottawa sand at 29°F<sup>87</sup>.



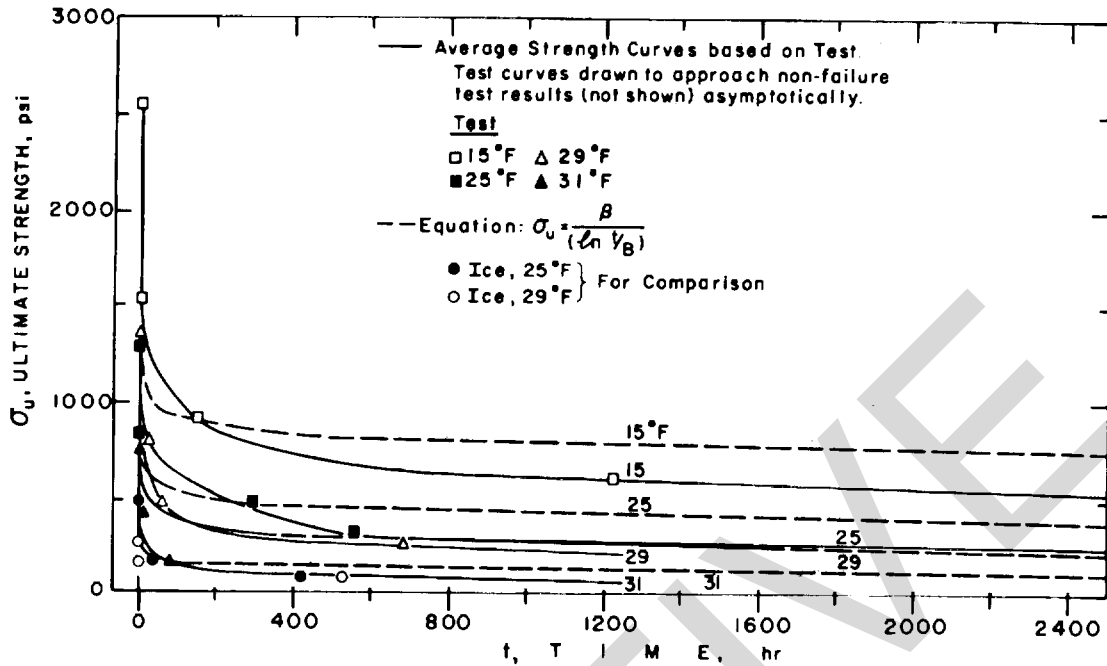

U. S. Army Corps of Engineers

Figure 4-50. Ultimate strength vs. time to failure for Ottawa sand (20-30 mesh) at various temperatures, comparing test data with computed values<sup>87</sup>.

and clays indicate that the long-term strength level can be as low as 5 to 10 percent of that determined from a standard test for compressive strength.

d. The load carrying capacity of frozen soil is essentially determined by its shear strength and within certain limits the relationship between shear strength and normal pressure may be written as:

$$(Equation 2) \quad s = c + p \tan \phi$$

where  $c$  = cohesion, which is dependent upon both temperature and time

$\phi$  = angle of internal friction

$p$  = total normal stress.

e. To show graphically how shear strength varies with time, Mohr's envelopes for frozen sand are shown in figure 4-51. The envelopes are plots of the ultimate shear strength vs. normal stress for different rates of applied strain in controlled strain rate type triaxial tests. Two characteristics are of interest here. First, the ultimate shear strength is less for the low strain rates than for the higher ones; and secondly, the envelopes

are noticeably curved, that is, shear strength is not directly proportional to normal stress. Therefore, when testing frozen soil for shear strength, the tests must be performed using a normal stress near the value to which the in-situ material will be subjected and large extrapolations of the shear envelopes should be avoided. It is permissible and conservative to use a secant to the envelope if a straight line relationship between the shear and normal stress is desired, provided the secant intersects the envelope at the in-situ stress value.

f. Experimental work indicates that long-term shear strength of saturated frozen soils can be determined for practical purposes by the equation:

$$\sigma_t = \frac{\beta}{1n(t/B)} \text{ (by Vialov) (Equation 3)}$$

where  $\sigma_t$  = the constant stress level at which failure will occur at time  $t$  in psi

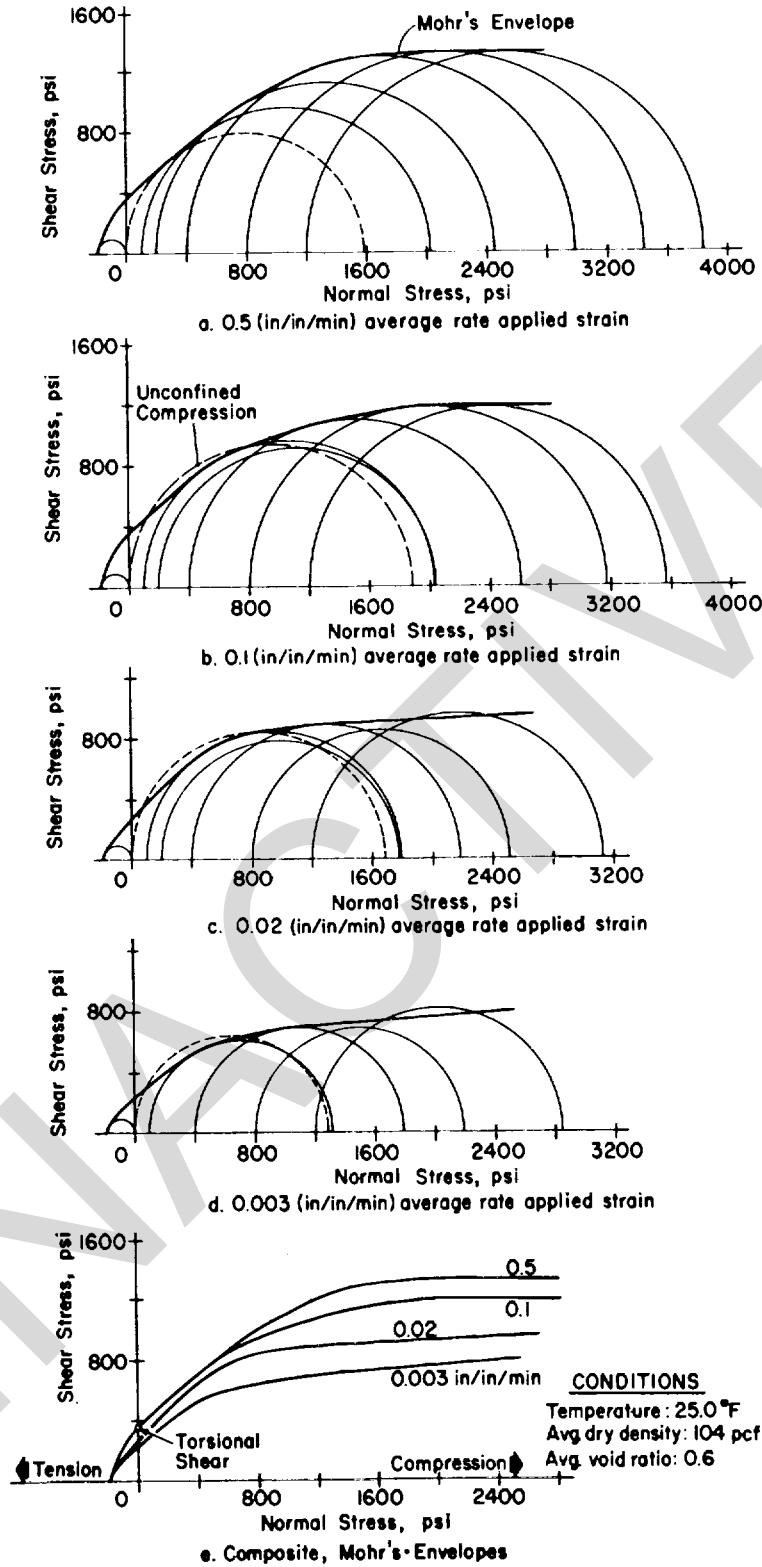

U. S. Army Corps of Engineers

Figure 4-51. Mohr's envelopes for frozen sand (Ottawa sand, 20 - 30 mesh).

$t$  = period of time after application of stress ( $\sigma_i$ ) that failure will occur, hour  
 $\beta$  and  $B$  are soil constants that are temperature dependent.

g. It should be noted that equation 3 is an empirical relationship for creep strength and it is not valid for small values of  $t$  since the strength would become infinite when time approaches zero. For practical applications of equation 3, the value of  $t$  should not be less than, say, one minute.

h. One method of determining the ultimate bearing capacity of a foundation on permafrost is to assume that frozen soil is a purely cohesive material and use an appropriate foundation bearing capacity equation.

i. This assumption is conservative since the internal friction term ( $p \tan \phi$  of equation 2) is assumed to be zero. Internal friction can contribute substantial shear resistance in some frozen soils, such as unsaturated frozen soils; however, the determination of the value of  $\phi$  requires that triaxial creep tests or similar tests be performed for the specific in-situ conditions under consideration, whereas a value for the cohesion factor can be determined by relatively simple unconfined compression creep tests using procedures described below. For footings, the equations developed by L. Prandtl and K. Terzaghi can be applied using a cohesion value thus determined. This method is particularly appropriate for frozen silts and clays and can be readily applied also to frozen fine-to medium-grained saturated sands. For frozen gravels and tills somewhat greater difficulty is involved.

j. To determine the strength value of the frozen soils for use in equation 3, a minimum of two unconfined compression creep test are required on undisturbed soil samples of each type of foundation soil. These tests must be conducted near the estimated temperature or maximum seasonal temperature (critical temperature) of the natural foundation soil. To expedite the creep testing, one of the creep tests should be performed at a stress level of about 60 percent of the conventional unconfined compressive strength and a second test near the 40 percent strength at the critical temperature. In general, the test at the 60 percent stress level should require less than eight hours to perform; the test at 40 percent stress level may require as much as three days. Using the period of time required for each of the two test samples to fail and the corresponding applied creep stress for each test, the constants  $B$  and  $\beta$  can be evaluated by substituting twice into equation 3 and solving the simultaneous equations. By substituting the estimated design life of the structure into equation 3 (unless specific justification exists for assuming a different life span, a 25-year life should be used for a permanent structure), a value of  $\sigma_{ult}$  is determined. A nomogram<sup>6</sup> to solve equation 3

is shown in figure 4-52 with an illustration of its use and may be used as a check on these computations. The nomogram is limited in its application to situations where the shortest duration of test is longer than one hour. Since the cohesive strength is about one-half the unconfined compressive strength, the value of ultimate cohesive strength is one-half the  $\sigma_{ult}$  so determined. The value of ultimate cohesive strength must still be reduced by an appropriate factor of safety. Factors recommended in TM 5-818-1/AFM-88-3, Chapter 7<sup>5</sup> should be used.

k. Allowable long-term cohesive stresses for a few specific frozen soils are listed in table 4-4. These stresses include a factor of safety of 2.0. The degrees of reduction involved in these stress values from short-term strength results may be visualized in figure 4-53 which shows Mohr's envelopes for six frozen mineral soils, frozen peat and ice, based on tension and unconfined compression tests. The 1 T/ft<sup>2</sup> allowable design stress for Manchester fine sand at 31.0 °F is indicated on the ordinate of the left hand diagram and may be compared with the envelope for the same material. The 2.0 T/ft<sup>2</sup> allowable design stress for the same soil at 29° F is shown on the right hand diagram. It is emphasized that values in table 4-4 are given for general guidance and that cohesive stress values for the specific foundation soil under consideration should be determined by test procedures previously outlined.

l. When foundations are supported on soils containing large size particles, such as gravel or glacial till, the working design strength will depend on the amount of ice present. If there is a substantial amount of segregated or excess ice, the behavior of the material should be assumed to correspond to that of the frozen fine fractions of the soil, or of ice. If the soils are under-saturated or the voids are completely filled but there is no excess ice and full particle to particle contact exists, the soils may be expected to behave like unfrozen soils with normal void ratio at relatively low stress levels. These stress levels do not disturb essentially the original particle to particle bridging, which the ice here helps to maintain. However, creep behavior should be expected at higher stress levels which involve sufficient strain deformation to force the ice matrix into positive response. It should be kept in mind that in frozen soils the volume changes which in unfrozen soils attend shearing deformation are essentially prevented, thus greatly modifying shear response.

#### 4-5. Estimation of creep deformation.

a. Determination of the bearing capacity of frozen foundation material on the basis of ultimate strength as described in the preceding section will not necessarily insure satisfactory performance, because unacceptable progressive creep deformation may occur. As described

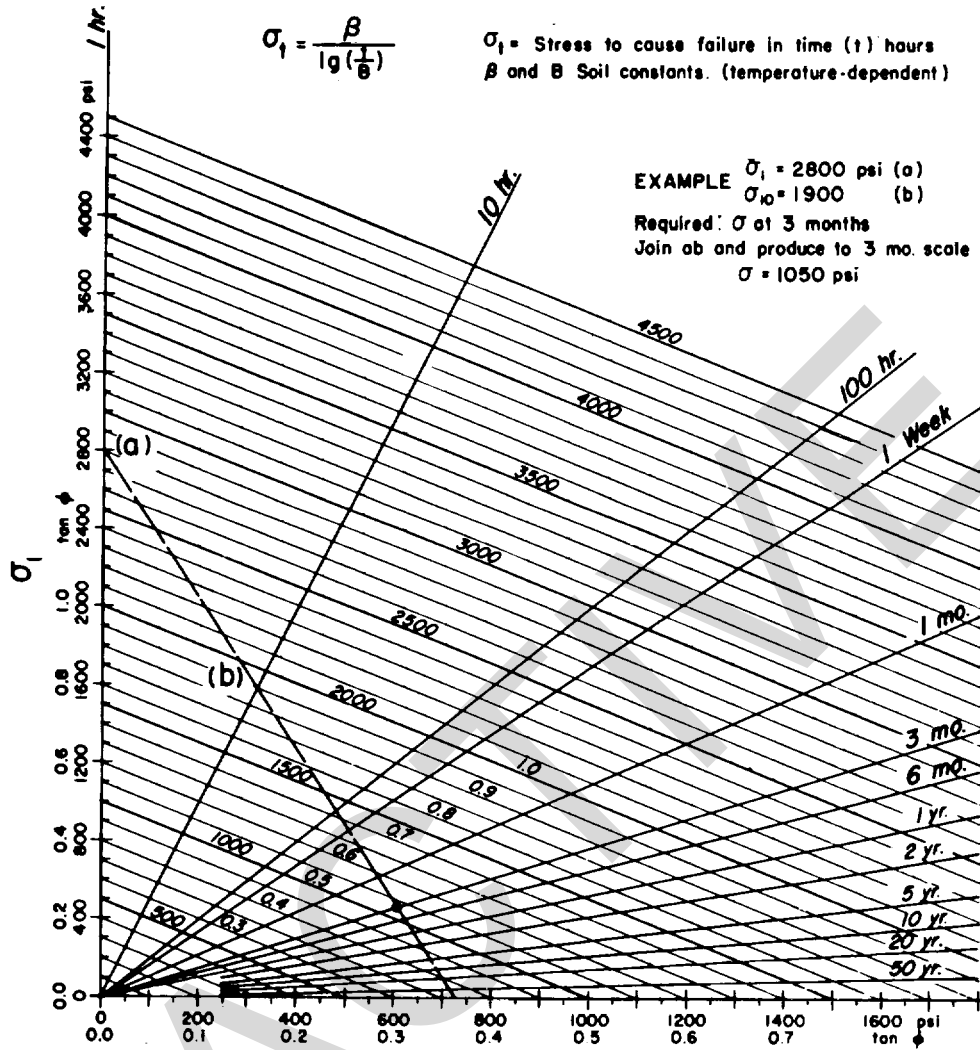

U. S. Army Corps of Engineers

Figure 4-52. Stress and time to failure in creep<sup>186</sup>.

Table 4-4. Allowable Design Cohesive Stress for Saturated Frozen Soil in  $T/ff^2$  on Basis of Ultimate Strength.

The values for stress shown include a safety factor of 2.0. The stress values should only be used where cohesion is the sole factor involved.

U. S. Army Corps of Engineers Frozen Soil	Critical (highest) temperature of frozen soil beneath base of the foundation			
	310°F	290°F	25°F	150°F
Saturated Ottawa sand <sup>87</sup> (20-30)	1.0	2.5	4.5	10.0
Manchester fine sand <sup>87</sup> (Saturated uniform fine sand)	1.0	2.0	3.5	6.0
Hanover silt (Saturated silt, ML, non-plastic, no visible ice lenses, $w \leq 35\%$ ) (Unpublished CRREL data) -	0.6	1.5	3.0	5.5
Suffield clay (Saturated clay, CL; LL 35, PL 20; no visible ice lenses, $w < 40\%$ ) (Unpublished CRREL data)	0.5	1.0	2.5	5.0

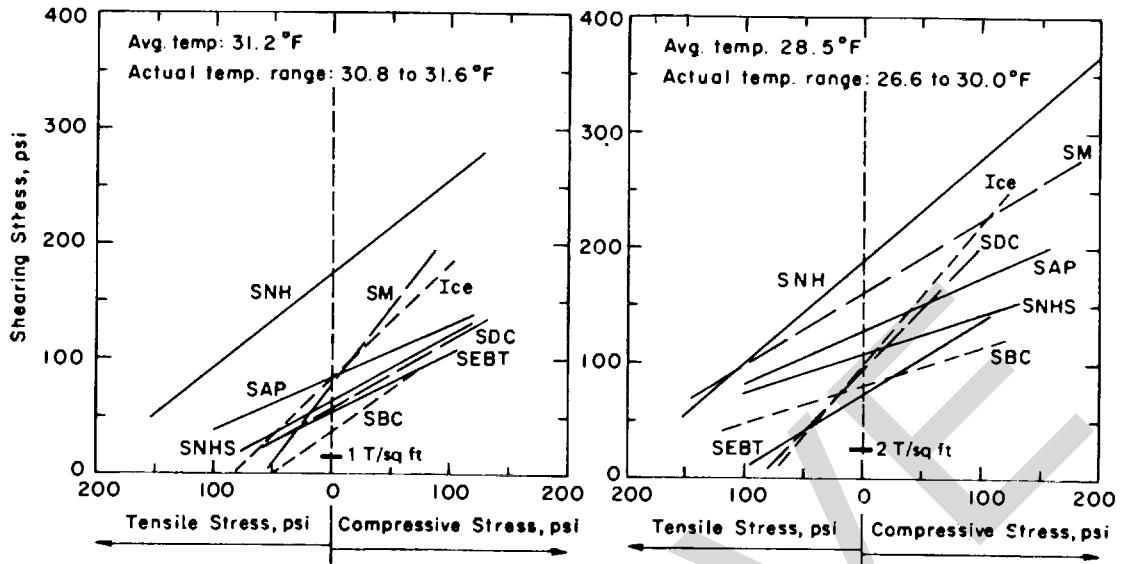

1. Gradations and other characteristics of these soils are shown in figure 2-11.
2. Rate of stress increase in unconfined compression tests, 400 psi/min. Rate of stress increase in tension tests, 40 psi/min.
3. Insufficient data available to show probable curvature of envelopes.
4. Average degree of saturation:

- SNH, Manchester Fine Sand, 84%
- SM, McNamara Concrete Sand, 89%
- SNHS, New Hampshire Silt, 88%
- SEBT, East Boston Till, 93%
- SAP, Alaskan Peat, 98%
- SBC, Boston Blue Clay, 98%
- SDC, Dow Field Clay, 98%

U. S. Army Corps of Engineers

Figure 4-53. Mohr envelopes for frozen soils under moderately rapid loading, from tension and unconfined compression tests<sup>33</sup>.

in paragraphs 2-5a and 4-4 and as illustrated in figures 2-15, 4-49 and 4-50, frozen soils and ice exhibit creep characteristics under long term loads down to at least as low as 5 to 10 percent of their rupture strengths under relatively rapid loading. When slow, progressive movement occurs in foundations on saturated frozen soil in absence of thawing, it is generally the result of creep. Creep is a time dependent shear phenomenon in which the total volume of the stressed material remains constant; i.e. the stressed soil flows rather than consolidates. In TM 5-852-1/AFM 88-19, Chapter 1, slope creep is defined as "extremely slow downslope movement of surficial soil or rock debris, usually imperceptible except by long-term observation." In that case the movement usually involves freeze or thaw action in strata near the surface and downslope movement of seasonally thawed soil, together with creep of frozen materials when stress and temperature conditions favor this. For creep of frozen material, the ice filling the soil voids may be considered to be a fluid of extremely high viscosity. Within normal pressure and time frame, consolidation of soil can only occur if air or other gas voids are present in the soil mass or if part of the soil moisture is not frozen.

b. In general, present design practice is to avoid the problem of creep in frozen soil foundations either by supporting footings on mats of well drained non-frost-susceptible gravel or other material which spread stresses sufficiently so that stresses on underlying confined frozen materials are conservatively low, or by placing foundations at a sufficient depth in the ground so that the overburden pressure effectively minimizes foundation-induced creep.

c. When analysis indicates that a footing, raft, pier or similar foundation designed on the basis of ultimate strength with recommended factor of safety will develop unacceptable creep deformation over the life of the facility, the design must be revised to bring the deformation within acceptable limits.

d. Various empirical equations have been proposed for the prediction of creep of frozen soil in unconfined compression. At the present time, these equations do not take into account the complex stress and deformation conditions of the soil beneath a foundation. For the first approximation of the amount of creep that may be expected, the following empirical equation similar to Vialov<sup>107</sup> may be applied to a foundation:

$$\text{strain} = E = \frac{\sigma t^\lambda}{w(0 + 1)^k} + E_0 \quad (\text{Equation 4})$$

where:

- σ = stress in the material under consideration, psi
- t = time that stress is to act, hr
- θ = number of degrees below the freezing point of water, °F

ε<sub>0</sub> = strain that occurs immediately upon application of stress (this term can be neglected for the purpose of estimating creep)

m, λ, w, k = constants that depend on properties of material.

Typical values for m, λ, w, and k for equation 4 are given for specific soils in table 4-5. These values were derived empirically by laboratory tests demanding quite precise measurements of the absolute values of strain and requiring several tests for evaluation of the constants. Care must be taken to use the proper units consistent with those given in the table.

e. A conservative method for estimating the vertical creep of a foundation is to assume that the foundation is supported by a column of frozen soil having a height equal to 1/2 times the least plan dimension of the foundation and apply equation 4 to compute the strain and hence the deformation of the soil column. In applying equation 4, values for stress and temperature are assumed to be constant for the period of time under consideration. The average temperature of the column of permafrost for the critical period of the year can be projected from ground temperature records or from on-the-spot temperature measurements. The critical period of the year is that time of year when permafrost temperatures beneath the foundation are warmest. The magnitude and distribution of stress under the foundation can be approximated by using elastic theory, as outlined TM 5-818-1/AFM 88-3, Chapter 7<sup>5</sup>. Since magnitude of stress decreases with depth, it is necessary to use an equivalent constant stress in order to apply equation 4. A closer approximation of the amount of creep can be obtained by dividing the soil beneath the foundation into an arbitrary number of horizontal zones and using an average constant stress and temperature for each zone. Using these average values and the thickness of each zone, equation 4 can be used to estimate the vertical deformation of each zone. The total deformation will be the sum of the deformations of all the zones. Where the soil is stratified, the boundaries of some of the zones should be coincident with the stratum interfaces.

f. It is emphasized that this procedure will give only an order of magnitude of the amount of creep and the constants in table 4-5 apply only for the specific soils listed and are given only as a guide.

g. A second, more accurate, method of predicting creep requires performance of unconfined compression creep tests on undisturbed samples of the foundation soil at the design stress level and at the predicted temperatures of the foundation soil and application of the following empirical equations:

Table 4-5. Constants for Equation 4 (by CRREL and ref 107)

All constants are dimensionless except that the units of  $w$  for the equation to be dimensionally correct are:  $[\text{psi}(\text{hr})^{\lambda}]^{\omega} F^k$ .

Frozen Soil	$m$	$\lambda$	$\omega$	$k$
Saturated Ottawa sand* (20-30 mesh)	0.78	0.35	5500	0.97
Manchester fine sand* (saturated uniform fine sand, 40-200 mesh)	0.38	0.24	285	0.97
Suffield clay* (saturated clay*, CL, LL 35, PL 20, no visible ice lenses, $w < 40\%$ )	0.42	0.14	93	1.0
Hanover silt* (saturated silt, ML, non-plastic, no visible ice lenses, $w < 35\%$ )	0.49	0.074	570	0.76
Callovian sandy loam** (sandy silt, ML)	0.27	0.10	90	0.89
Bat-baioss clay**	0.4	0.18	130	0.97

\*Data from laboratory tests, CRREL.

\*\*Data from Vialov et al. (1962), Ch. V.<sup>107</sup>

U. S. Army Corps of Engineers

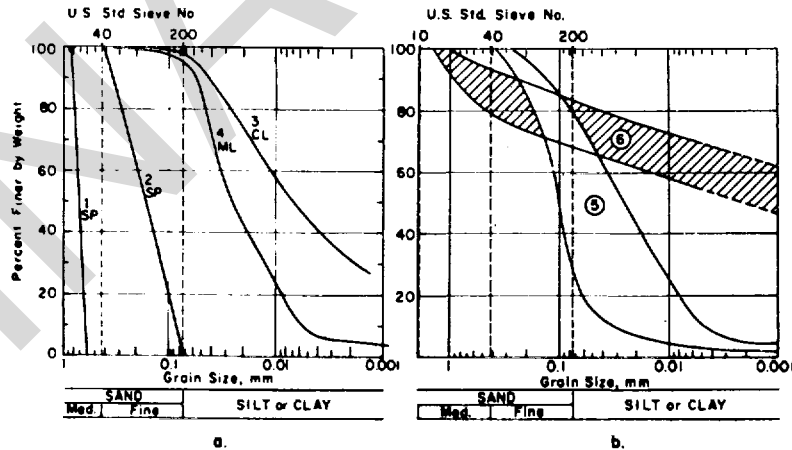

No	Description	Nat w %	LL	PL	PI
1	Ottawa SAND (20-30)	—	—	—	—
2	Manchester fine SAND	—	—	—	—
3	Suffield CLAY	—	35	20	15
4	Hanover SILT	31	Non-plastic		
5	Callovian Sandy LOAM	26	25-36	21-30	4-7
6	Bat Baioss	20-24	23-58	14-21	9-31



$$\frac{1}{t} = \left( \frac{\dot{\epsilon}}{\epsilon_1} \right)^M \text{ or } \dot{\epsilon} = \dot{\epsilon}_1 t^{-1/M} \quad (\text{Equation 5})$$

By integration

$$\epsilon = \dot{\epsilon}_1 \left( \frac{M}{M-1} \right) \left( t^{\frac{M-1}{M}} - 1 \right) + \epsilon_0 \quad (\text{Equation 6})$$

when M is greater than zero and not equal to one,

or,  $\epsilon = \dot{\epsilon}_1 \ln t + \epsilon_0$  when M is equal to one,

where

$\epsilon$  = strain total

$\dot{\epsilon}$  = strain rate

$\dot{\epsilon}_1$  = strain rate 1 hour after stress is applied

$\epsilon_0$  = initial strain that occurs at the time of load application.  $\epsilon_0$  can be neglected for the purpose of evaluating creep.

M = slope of the log 1/t vs log strain rate plot

An illustration of the use of this method is given in paragraph 4-7b(2).

*h.* The third and probably most accurate method of predicting creep is to run a field test on a prototype or large size model of the foundation under consideration and apply equation 6. The field test should be performed on the model using the same configuration, soil pressure and soil temperatures as for the foundation to be constructed, and on the same frozen soil. The design stress should be applied to the model as nearly instantaneously as possible but without impact. (One method of applying the load is to release the hydraulic pressure from jacks in a manner so as to quickly transfer a dead weight load from the jacks to the model foundation.) After the full load is applied, the deformation of the model should be recorded at frequent intervals to define the time vs. deformation curve for a period of eight hours. The elevation should be recorded before loading and immediately after loading. (The difference between these two readings gives an estimate of the instantaneous deformation that occurs during load, i.e.  $\epsilon_0$ .) Using the time after load application as time zero, then deformation readings should be taken at times 1, 2, 3, 4, 5, 10, 20, 30 minutes, 1 hour, and every hour, until 8 hours have elapsed.

*i.* Using the data obtained from the model tests, the values of  $\epsilon$ , and M in equation 6 can be determined graphically. One technique is to use the slopes of the tangents to the deformation vs. time curve on arithmetic coordinates at times of 1/2 hour and 1 hour after stress application (see figure 4-54) for details). A second technique is to determine the rate of deformation of the foundation at several times and plot log  $\epsilon$  vs. log 1/t curve for the 8 hours of the test. The slope of this curve is the value of M. The value of  $\epsilon_1$  can be read from the

curve directly, i.e., at 1 hour; see figure 4-55 for details. The foundation soil temperature is nearly constant and is the same for the model as for the foundation during the critical period of the year (defined above). The test is performed in in-situ soil that the structure foundation is to be founded on and that the same soil conditions extend at least to a depth equal to the smaller dimension of the entire foundation. The model dimensions are large enough to minimize the edge and side effects.

*k.* The various test requirements may make this approach difficult to employ; the soil temperature requirements, for example, may substantially restrict the time of year within which the field tests may be performed.

*l.* It must be emphasized that the methods and ideas presented here for predicting creep of frozen soils are still under investigation.

*m.* Where the tolerable foundation movement is very small, a special investigation for the determination of creep deformation may be required.

#### 4-6. Dynamic loading.

##### *a. General.*

(1) Foundations supported on frozen ground, ice or snow may be affected by high stress type dynamic loadings such as shock loadings from high yield explosions, by lower stress pulse type loadings as from earthquakes or impacts, or by relatively low stress, relatively low frequency, steady-state vibrations. In general, the same design procedures used for non-frozen soil conditions are applicable to frozen soils. Design criteria are given in TM 5-809-10/AFM 88-3, Chapter 13<sup>3</sup>, TM 5-856-4<sup>18</sup>, and EM 1110-345-310<sup>20</sup>. These manuals also contain references to sources of data on the general behavior and properties of non-frozen soils under dynamic load and discuss types of laboratory and field tests available. However, design criteria, test techniques and methods of analysis are not yet firmly established for engineering problems of dynamic loading of foundations. Therefore, HQDA (DAEN-ECE-G), WASH DC 20314 or HQUSAF/PREE, WASH, DC should be notified upon initiation of design and should participate in establishing criteria and approach and in planning field and/or laboratory tests.

(2) All design approaches require knowledge of the response characteristics of the foundation materials, frozen or non-frozen, under the particular load involved. As dynamic loadings occur in a range of stresses, frequencies and types (shock, pulse, steady-state vibrations, etc.) and the response of the soil varies depending upon the load characteristics, the required data must be obtained from tests that produce the same responses as the actual load. Different design criteria are used for the

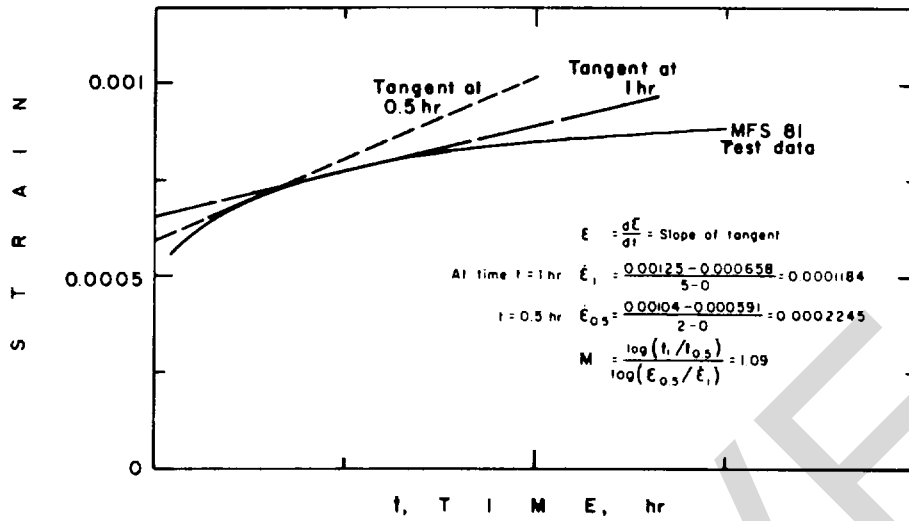

U. S. Army Corps of Engineers

Figure 4-54. Frozen soil creep test on Manchester fine sand, unconfined compression, 200 psi at 15°F<sup>87</sup>.

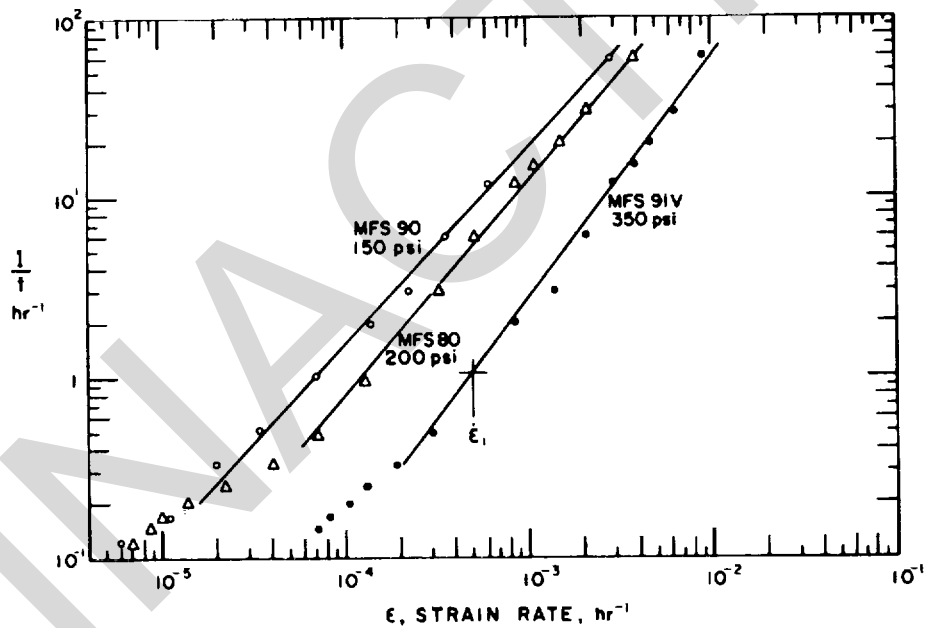

U. S. Army Corps of Engineers

Figure 4-55. Frozen soil creep tests on Manchester fine sand, unconfined compression, 15°F<sup>87</sup>.

different types of dynamic loading and different parameters are required. Such properties as module, damping ability, and velocity of propagation vary significantly with such factors as dynamic stress, strain, frequency, temperature, and soil type and condition.

b. *Determination of response characteristics of foundation materials.* The testing of frozen materials under dynamic loading has been only recently explored and relatively few published data are available. Some data are shown in figure 2-17. It will usually be necessary to conduct a test program for the particular site and the particular soils involved.

(1) In-situ tests. Two methods are available. In a procedure described in a Waterways Experiment Station paper a vibrator is placed on the surface and operated at a range of frequencies<sup>106</sup>. The characteristics of the wave are measured, yielding a relationship between shear modulus and depth. Various seismic procedures may also be used<sup>84,124,75</sup>.

(2) Laboratory tests. Few laboratories are presently equipped to test frozen soils under dynamic loads, but suitable techniques are available. Foundation analysis for high stress, shock type loads requires knowledge of the equation of state for the condition of interest so that the conservation of energy laws may be applied. Test techniques yielding pressure-volume-temperature relationships for frozen soils have been described in several papers<sup>32,63,128,170,176</sup>. Design analysis for low stress, steady-state vibration type loading requires values for deformation moduli, velocity of wave propagation, and internal damping for the particular soil. Kaplar<sup>68</sup> and Stevens<sup>93</sup> have described two test techniques. The first of these techniques yields moduli of elasticity and rigidity, longitudinal and torsional velocities of wave propagation, and Poisson's ratio. The second technique uses viscoelastic theory and yields complex Young's moduli, dilatational and shear velocities and internal damping factor expressed as the tangent of the lag angle between stress and strain<sup>93,94</sup>. The latter value may be expressed as an attenuation coefficient. (Consider a plane wave passing through a solid. If the displacement amplitude at a distance from the source is  $A_{19}$  and at a distance,  $X_1$  farther along is  $A_{25}$  then:  $A_2 = A_1 e^{-\alpha x}$ , and  $\alpha$  is the attenuation coefficient. It is a property of the material.) If damping is small as it usually is in frozen soils, the complex modulus does not differ significantly from the elastic modulus.

c. *The response of frozen materials to dynamic loads.* In general, frozen soils are more brittle, are stiffer (that is, have higher moduli) and have less damping capacity than non-frozen soils. However, these properties vary widely, primarily with temperature, with ice volume/s oil volume ratio, soil type, load characteristics, and degrees of ice saturation and segregation. The classification system for frozen soils describes frozen soils in terms of the most fundamental of these parameters. Rock also tends to be stiffer when

frozen. Possibly both non-frozen and frozen materials may be present in a foundation, complicating the problem.

(1) *High stress dynamic loads.* While high stress loads may result from a variety of causes, most available design criteria have been developed for the case of protection of a structure against the shock loadings imposed by explosions. Design of the structure, including the foundation, for stresses resulting from explosions is covered in TM 5-856-4<sup>18</sup>. In general, the pressures resulting from an air blast are more critical to surface facilities than ground transmitted shock waves, and the question of the response of the soil does then not particularly enter the problem. However, if the structure is underground or the shock source is in the ground, then consideration must be given to the characteristics of the stress wave propagating through the ground and, in the cold regions, through frozen materials. The theory employed and general approach to the problem are given in TM 5-856-4. If the stress involved is sufficiently low or such that a change in state of the material does not occur, the required soil properties may be obtained as discussed in (3) below. If a change in-state does occur, as is possible in shock type loads, then the pressure-density-temperature relationship for the particular material must be obtained<sup>32,63,67,90,121,176</sup>.

(2) Dynamic loads imposed by earthquakes.

(a) TM 5-809-10/AFM 88-3, Chapter 13<sup>3</sup>, presents criteria for design of structures against earthquake damage, including earthquake intensities for design purposes for the state of Alaska and some other cold regions locations. Recent suggested procedures for earthquake design employ response spectrum techniques wherein the response of the structure in each mode is considered and total response is obtained by combining the separate modal responses. An example of the application of this technique has been presented by Severn and Taylor<sup>190</sup>.

(b) All design techniques employed for nonfrozen soil conditions are applicable to frozen soil conditions, but the response of frozen soils to earthquake load may obviously be quite different. Of primary concern is the brittleness, greater stiffness and overall rocklike behavior of frozen soil as compared with nonfrozen soil. Stress wave velocities are much higher and damping is generally lower in the frozen soil. Propagation of the stress wave through permafrost may be faster and of higher intensity than for non-frozen soils.

(c) The U.S. Geological Survey has reported observations, on the Alaskan earthquake of 1964<sup>201</sup>. Seasonally frozen soil on the surface acted as a more or less rigid blanket over the underlying non-frozen soil. Where the blanket was 2 or 3 feet thick, cracks of a brittle nature occurred, sometimes forming large slabs of

frozen soil. In some cases a pumping action resulted, wherein non-frozen soil and debris were ejected through the cracks in the frozen soil layer. There was mention, in a few cases, of sliding occurring along the interface of the frozen and non-frozen layers.

(d) The design engineer should visualize the possible effects of an earthquake on the foundation, whether it may involve sliding of slabs of frozen soil in winter, sliding of saturated thawed soil over permafrost in summer, or other effect and should avoid any situations or actions which may be hazardous or imprudent.

(3) *Low stress, vibratory loads.*

(a) Design of foundations for radar towers with rotating antennas and structures supporting heavy machinery, turbines, generators, and the like, must consider the response of the foundation and soil mass to the vibration. Evaluation of natural foundation frequency, displacements and settlement may be required. The critical situation may be a condition of resonance which can produce unacceptable displacements and settlements and/or interfere with the operation of the facility. EM 1110-345-3102o gives a design procedure for predicting the resonant frequency and displacement under vibratory loads. Three modes of motion are treated: vertical movement, rotation about a vertical axis, and rocking about a horizontal axis. The equations are based on the elastic half-space concept. Damping is that involved in dissipation of energy with distance; damping as a result of the viscous or internal friction properties of the material is not accounted for. However, as internal damping is small for many soils, especially frozen soils, the procedure is adequate for most cases. A value for the shear modulus of the soil is required. Young's modulus and Poisson's ratio may also be used. The elastic half-space method assumes that the soil mass is more-or-less homogeneous and isotropic. If the soil mass radically departs from the condition, as in the case of a strongly layered soil, a partially frozen condition or similar situation, special design procedures must be employed. Computer codes for calculation are available and two dimensional computer codes are in the state-of-the-art. However, the required properties of the soils are not always directly available from test. This is especially true of frozen soils. Most material property inputs are based on one dimensional plane strain tests. It is seldom possible to exactly reproduce in tests the complex stress and deformation states which govern actual behavior under dynamic loads. Therefore, engineering judgment based on broad experience and knowledge must be employed in choosing test procedures and in analyzing test results to select suitable values for use in computer solutions.

(b) The response of frozen soils to vibratory loads varies with the stress, strain, and frequency imposed by the load, with exterior influences such as temperature and confining pressure, and with the soil characteristics such as void ratio, ice volume/soil volume ratio, degree of ice saturation and soil type.

Testing to date has not established definitive relationships with these variables but data indicating general trends are available.

(c) Measurements of velocity of the dilatational wave have been made using seismic methods. Table 4-6 lists velocities for a variety of frozen soils and rocks. If Poisson's ratio is known or assumed, Young's modulus may be calculated from such velocities as follows:

$$E = \frac{V_c^2 (1 + \nu) (1 - 2\nu)}{1 - \nu} \rho \quad (\text{Equation 7})$$

where:  $V_c$  = P-wave velocity  
 $\nu$  = Poisson's ratio  
 $\rho$  = mass density

**(d) As the seismic method uses very high rise times, modulus values must be considered as upper limits.**

(e) Figure 2-17 shows dynamic moduli and Poisson's ratio determined by Kaplan for various frozen soils at various temperatures". It will be noted that the stiffness decreases drastically as temperature rises and approaches 32 °F. The test procedure used in this case did not allow measurement of internal damping as a material property. No variation of modulus and velocity with frequency or stress level was determined and test frequencies ranged from 830 to 4000 Hz. Stress levels were unknown but were low, such as to give a linear response.

(f) The decrease in stiffness with rising temperature emphasizes the possibility that energy dissipation into the soil may raise the temperature sufficiently to alter the foundation response or even its stability. A pile embedded in frozen soil and depending for its bearing capacity on the adhesive strength between the soil and pile may, under steady-state prolonged vibration, dissipate energy into the soil sufficiently to raise the temperature. The state-of-the-art does not currently allow calculation of energy dissipation into the soil and temperature rise at the soil/pile interface under a given dynamic load. However, the designer should consider the possibility.

(g) Figures 4-56 through 4-60 illustrate the effect of ice volume/soil volume ratio, degree of ice saturation, frequency and stress on the modulus. Complete data including the complex Young's and shear moduli, the corresponding velocity of wave propagation, Poisson's ratio, damping expressed as the tangent of the lag angle between stress and strain, and the attenuation coefficient have been reported by CRREL<sup>176</sup>.

Table 4-6. P-wave Velocities in Permafrost (after Barnes<sup>1</sup> with some Additions)

Rock Types	Locality and Reference	Seismic Velocity				Est. Ground Temp. °C
		(10 <sup>3</sup> ft/sec)		(km/sec)		
		Frozen	Unfrozen	Frozen	Unfrozen	
<b>Quaternary sediments</b>						
Silt and organic matter	Fairbanks Area, Alaska <sup>a</sup>	5-10	1.8-4	1.5-3.0	0.6-1.2	-1
Alluvial clay	Northway, Alaska <sup>b</sup>	7.8		2.4		-2
Silt and gravel	Fairbanks Area, Alaska <sup>c</sup>	7.7-10		2.3-3.0		-1
Aeolian sand	Tetlin Junction, Alaska <sup>c</sup>	8		2.4		-3
Floodplain alluvium	Fairbanks Area, Alaska <sup>c</sup>	8-14	6.1-7	2.4-4.3	1.9-2.1	-1
Tundra silts, sands, and peats (Gubik Formation, probably saline)	Barrow Area, NPR-4, Alaska (Woolson 1962)	8-8.8		2.4-2.7		-9
(Gubik Formation, probably saline)	Skull Cliff Area, NPR-4, Alaska (Woolson 1962)	7.4-8.9		2.3-2.7		-9
(Gubik Formation, less saline)	Topagoruk Area, NPR-4, Alaska (Woolson 1962)	8-12		2.4-3.7		-9
Gravel	Fairbanks Area, Alaska <sup>a</sup>	13.0-15.2	6-7.5	4.0-4.6	1.8-2.3	-1
Outwash gravel	Tanacross, Alaska <sup>c</sup>	7.6-10		2.3-3.0		-3
Glacier moraine <sup>b</sup>	Delta Junction, Alaska <sup>c</sup>	7.6-13.2		2.3-4.0		-2
Unclassified sediments	Isachsen, Canada (Hobson 1962)	8.8		2.7		-10
Glacier outwash	Thule, Greenland (Roethlisberger 1961, 1961a)	14.9-15.5		4.5-4.7		-11
Glacier till	Thule, Greenland (Roethlisberger 1961, 1961a)	15.4-16.0		4.7-4.8		-11
Glacier till	McMurdo Sound, Antarctica (Bell 1966)	9.8-13.8	1.6-5	3.0-4.3	0.5-1.5	-20
Loess (dry)	McMurdo Sound, Antarctica (Bell 1966)		1		0.3	-20
Exfoliated granite (dry)	McMurdo Sound, Antarctica (Bell 1966)		4		1.2	-20
Shattered rock (dry)	McMurdo Sound, Antarctica (Bell 1966)		2.6-8		0.8-2.5	-20
<b>Mesozoic sediments</b>						
Mudstone (Ogotoruk Formation) <sup>d</sup>	Ogotoruk Creek, Alaska (Barnes 1960)	14.2	11 <sup>d</sup>	4.3	3.4 <sup>d</sup>	-5
Mudstone (Ogotoruk Formation) <sup>d, e</sup>	Ogotoruk Creek, Alaska (Barnes 1960)	13.2		4.0		-5
Shale and siltstone (Schrader Bluff Formation) <sup>f</sup>	Fish Creek Test Well 1, NPR-4, Alaska (Chalmers 1949)	8.9-9.8	6.6-7.6	2.7-3.0	2.0-2.3	-8
Shale and sandstone (Chandler Formation) <sup>e, f</sup>	Umiat Test Well 2, NPR-4, Alaska (Legge 1947/48)	12.7		3.9		-7
Shale and sandstone (Nanushuk Group) <sup>e, g</sup>	Simpson and Minga Wells, NPR-4, Alaska (Wiancko 1950)	8.1-8.4	5-7	2.5-2.6	1.5-2.1	-9
Sandstone (Colville Group)	Umiat Area, NPR-4, Alaska (Woolson 1962)	10.7		3.3		-7
Sandstone and shale (Nanushuk and Colville Group)	Meade-Oumalik Area, NPR-4, Alaska (Woolson 1962)	10-14		3.0-4.3		-9
Sandstone (Isachsen Formation)	Isachsen, Canada (Hobson 1962)	11.1		3.4		-10
<b>Paleozoic and older sediments</b>						
Shale (Dundas Formation)	Thule, Greenland (Roethlisberger 1961, 1961a)	12.5-15		3.8-4.6		-11
Sandstone (Narsarsuaq Formation)	Thule, Greenland (Roethlisberger 1961, 1961a)	17.0-17.4		5.2-5.3		-11
Quartzite (Wolstenholme Formation)	Thule, Greenland (Roethlisberger 1961, 1961a)	18.4-19		5.6-5.8		-11
Dolomite (Narsarsuaq Formation)	Thule, Greenland (Roethlisberger 1961, 1961a)	18.9-19.3		5.8-5.9		-11
<b>Metamorphic rocks</b>						
Schist (Birch Creek Schist)	Fairbanks Area, Alaska <sup>a</sup>	13-16		4.0-4.9		-1
Gneiss	Thule, Greenland (Roethlisberger 1961, 1961a)	20-20.8		6.0-6.3		-11

<sup>a</sup> Obtained from H.G. Taylor, 1938, Report on geophysical work by the seismic method in placer deposits of Fairbanks District of Alaska, unpublished report to U.S. Smelting, Refining & Mining Co.  
<sup>b</sup> Unpublished data from J.H. Swartz and E.R. Shephard, U.S. Geol. Survey, 1946  
<sup>c</sup> Data by author in 1952  
<sup>d</sup> The Materials Testing Laboratory, U.S. Army Engineer District, Alaska, tested cores from this well and found that 5 porosity measurements averaged 6.4% and that dynamic measurements on unfrozen cores gave elastic moduli which may be used to compute a velocity in the unfrozen rocks of about 11,000 fps  
<sup>e</sup> Measurements by velocity logs of wells; rest measured by refraction  
<sup>f</sup> Porosity measurements of 44 cores from Umiat Test Well #2 averaged 13.5% (Collins 1958)  
<sup>g</sup> Porosity measurements of 15 cores from Simpson Test Well #1 averaged 30.8% (Robinson 1959)

(Courtesy of Building Research Advisory Board, NAS-NRC)

For these data, the test technique employed was that given by Stevens<sup>93</sup>. Complex moduli may be used as equivalent to elastic moduli when damping is normally small.

(h) As shown in figure 4-56, complex Young's modulus of 100 percent ice-saturated, non-plastic frozen soils increases sharply as the ice volume/soil volume ratio decreases. As the ratio increases the modulus approaches that of ice. The relationship shown does not appear to apply for plastic soils.

(i) Figures 4-57 and 4-58 show the relationships of complex shear and Young's moduli to percent ice saturation. The moduli decrease rapidly with decrease in percent saturation, obviously approaching the moduli in a non-frozen state.

(j) Figures 4-59 and 4-60 show the relationship between shear modulus, stress level, and frequency.

Within the test ranges the relative effects are small except for partially saturated clay. However, the effect of stress and/or frequency on the shear modulus could be significant for stresses and/or frequencies outside these test ranges. Therefore, these relationships are sufficiently important to warrant consideration when choosing a modulus for design.

(k) Smith<sup>91</sup> has published data on properties of snow and ice under vibrating loads.

(l) The data presented in this manual and in the reference publications serve only as a guide and it will be necessary in most problem cases to carry out a test program covering the range of soil conditions, test freq

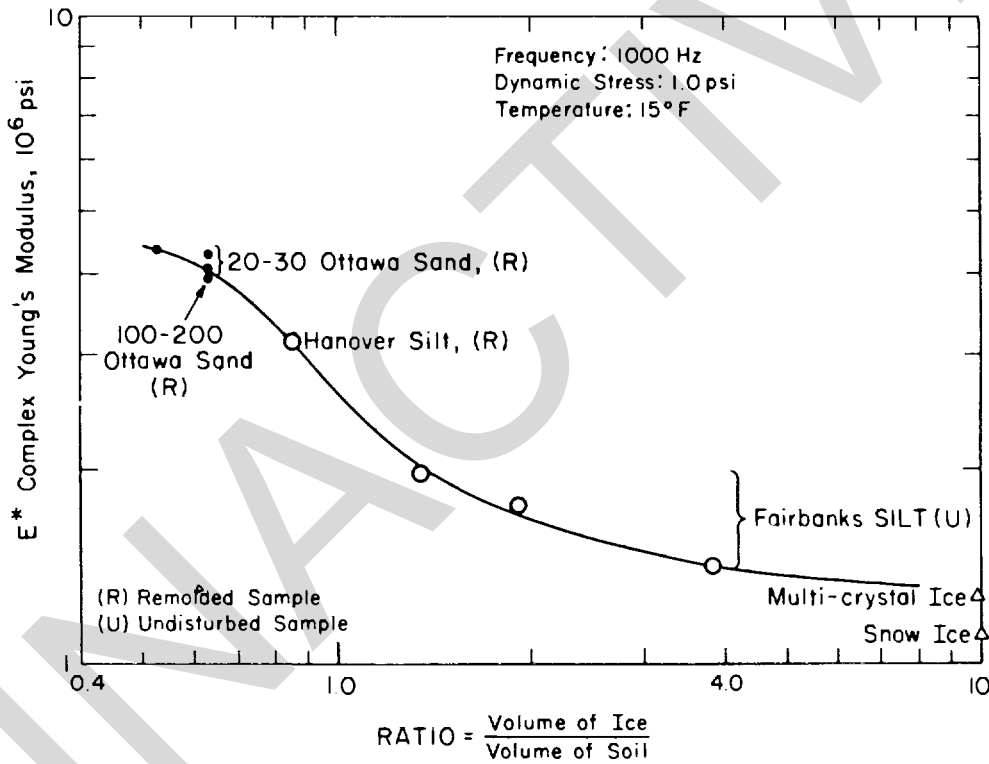

U. S. Army Corps of Engineers

Figure 4-56. Complex dynamic Young's modulus vs. volume ice/volume soil ratio for frozen saturated, non-plastic soils.

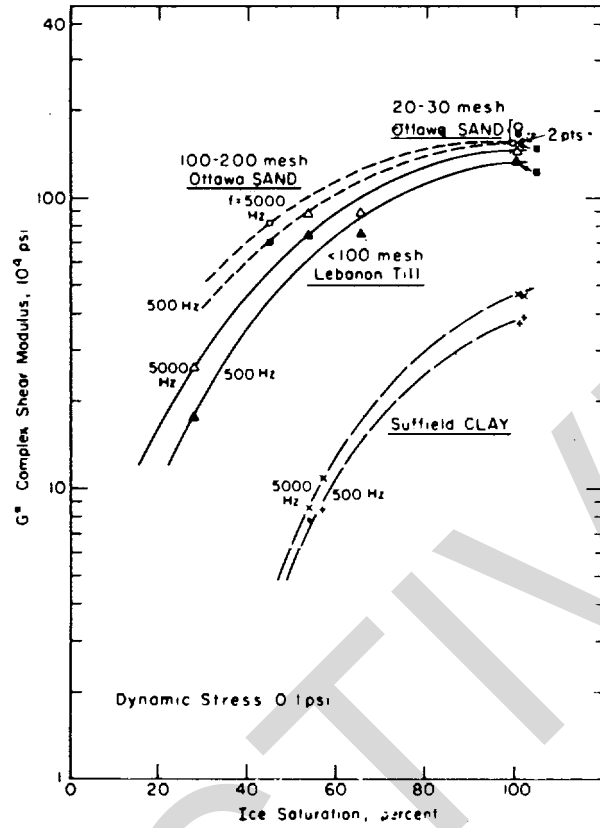

U. S. Army Corps of Engineers

Figure 4-57. Complex dynamic shear modulus vs. ice saturation.

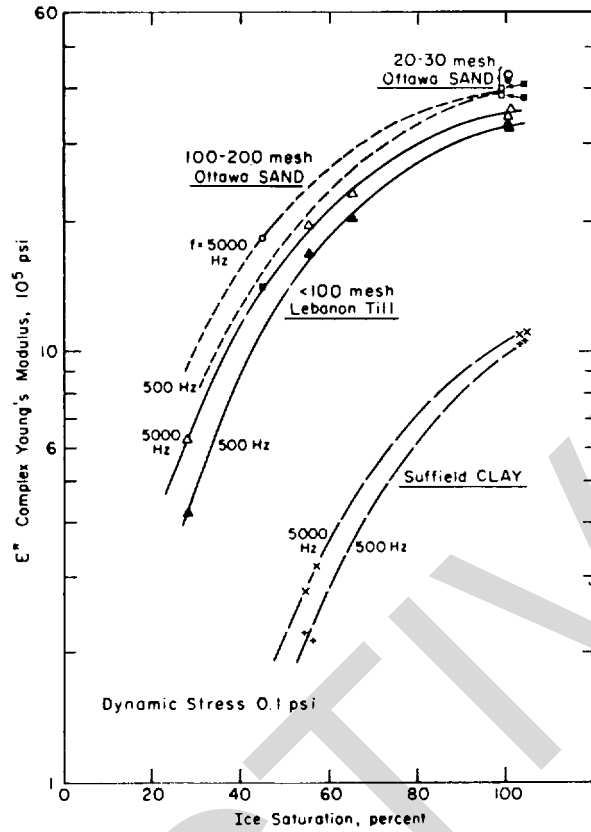

U. S. Army Corps of Engineers

Figure 4-58. Complex dynamic Young's modulus vs. ice saturation.



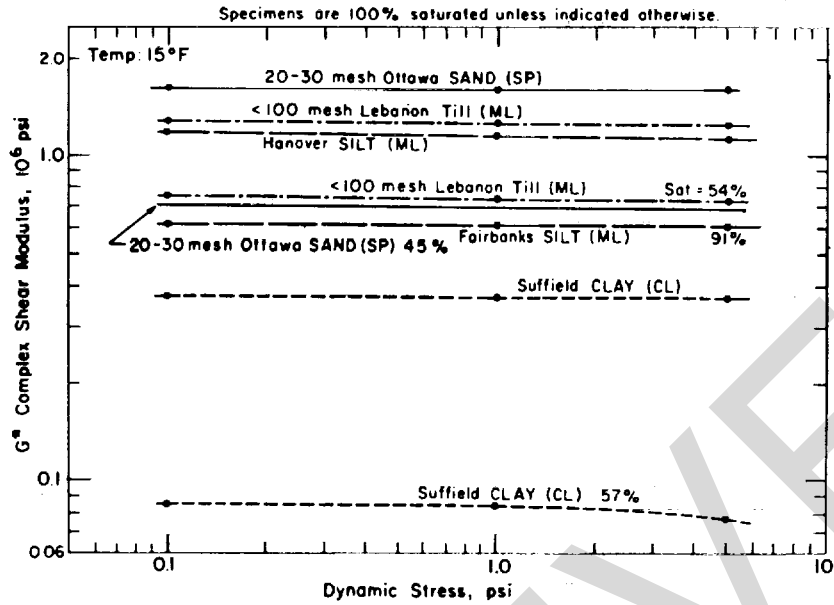
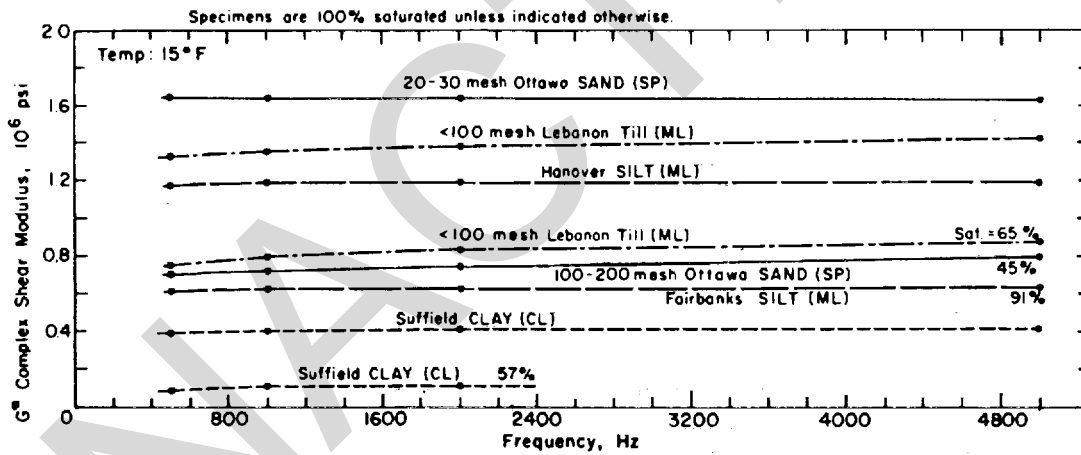

Figure 4-59. Complex dynamic shear modulus vs. dynamic stress at constant frequency (500 Hz), temperature 15 °F (by CRREL).



U. S. Army Corps of Engineers

Figure 4-60. Complex dynamic shear modulus vs. frequency at constant dynamic stress (1.0 psi), temperature 15°F (by CRREL).

nuencies, stress levels, and temperatures, applicable for the specific site.

#### 4-7. Design of footings, rafts and piers.

a. *General.* Footings, rafts and piers are considered together in this section because they share the common characteristic of developing load supporting capacity through the bearing of a horizontal surface of adequate dimensions on the supporting soil stratum.

(1) Suitable foundations of these types should:

- (a) be safe with respect to bearing capacity failure
- (b) keep displacement, settlement, heaving, or creep deformations, and, when required, resonant frequency within acceptable limits.
- (c) be economical to construct and maintain.

(2) Foundation design must satisfy all three of these criteria. However, in some cases one or two of the criteria may have predominant importance.

(3) A *footing* is an enlargement of a column or wall to distribute concentrated loads over sufficient area so that allowable pressure on the soil will not be exceeded. A spread footing, individual column footing, or isolated footing is usually an individual square or circular footing placed beneath a column or post. A combined footing is a footing carrying more than one column or post. A footing that supports a wall is a continuous or wall footing. A shallow footing is a footing whose width is equal to or greater than the vertical distance between the surface of the ground and the base of the footing. A sill or mud sill is a structural piece such as a timber which rests directly on the soil and supports the structure.

(4) With proper design care all these types can be used successfully for arctic and subarctic structure foundations under the particular conditions to which they are suited, although they may not always be as economical as alternatives such as piles. Individual column footings are preferred to continuous footings because of the greater risk of structural foundation damage for the continuous type of footing in frost areas. Examples of all these footing types are shown in figures 4-13 through 4-17, 4-22 through 4-24 and 4-27. As illustrated by these figures, footings on frost-susceptible permafrost soils may be placed at the surface of foundation gravel mats as in figures 4-13 through 4-15, and may be placed within the gravel mat as in figure 4-24, or may be placed below the depth of maximum seasonal thaw which will exist after construction, as illustrated in figures 4-16, 4-17 or 4-23. In the latter case a granular layer of clean gravel or sand should be used immediately below the footing to provide a suitable working and placement surface; it may also serve to reduce bearing pressures on the underlying materials.

During construction in warm weather this granular layer also provides some protection of underlying thaw susceptible permafrost during the footing installation.

(5) For frost-susceptible soils in seasonal frost areas footings should normally be supported below the depth of seasonal frost penetration, whether the structure is heated or not. While it is true that such footing depth may appear unnecessary for many types of heated structures in seasonal frost areas because of the protective effect of heat losses into the ground, it is unrealistic to assume that a facility will continue to be heated if it is placed on standby status at some future date. Placement of a non-frost-susceptible fill of sufficient depth on the site would avoid this requirement.

(6) If foundation soils are clean, granular and nonfrost-susceptible, conventional temperate zone foundation practice may be used in both seasonal frost and permafrost areas and footings should be placed at a minimum depth of 4 feet. This depth is recommended in order to minimize seasonal thermal and mechanical effects, such as seasonal expansion and contraction, which are most intense in the upper layers of the ground and tend to impose stresses on the structure.

(7) A variation of the continuous footing is the sill or mud sill type foundation, usually used for small structures having light floor loads or for temporary buildings. If only small-dimension sill members are used, without ventilation, this option is limited to nonthaw-susceptible granular foundation materials or under less favorable foundation conditions to very temporary use beneath small structures with the aid of a granular mat to distribute differential movements and jacking and shimming provisions to allow adjustment of differential movements. However, the latter usage is not recommended, even for temporary construction facilities, unless heated. If large dimension sills are used, marginal ventilated foundation designs are possible for small structures, as by using through beams across the minimum dimension of the structure.

(8) A *raft or mat foundation* is a combined footing which covers the entire area beneath the structure and supports the walls and structural columns. It is usually employed where heavy floor loads are required, such as in hangars, garages and warehouses. It acts as a unit and minimizes differential movements which could occur in the use of individual footings. As employed in permafrost areas, ordinary raft foundations are reinforced concrete slabs on gravel mats, as illustrated in figures 4-25 and 4-26, employing various means of insulation and ventilation or refrigeration between the floor and the underlying gravel mat (paras 4-2c and 4-2d). Care must be taken to insure that all parts of the foundation are protected by insulation and cooling provisions, including areas beneath the walls.

(9) In an intermediate type of foundation, a slab is used to support heavy floor loads, but the support

Strip footing:  $q_u = \frac{Q}{B} = cN_c + \gamma DN_q + 0.5\gamma BN_\gamma$

Rectangular footing:  $q_u = \frac{Q}{BL} = cN_c \left(1 + 0.3 \frac{B}{L}\right) + \gamma DN_q + 0.4\gamma BN_\gamma$

Circular footing:  $q_u = \frac{Q}{\pi R^2} = 1.3cN_c + \gamma DN_q + 0.6\gamma RN_\gamma$

where:  $Q$  = total load bearing capacity of footing, lb.  
 $q_u$  = ultimate bearing capacity, psf  
 $c$  = allowable long-term cohesion (see paragraph 4-4)  
 $\gamma$  = unit weight of soil  
 $L$  = length of footing

$N_c, N_q, N_\gamma$  = dimensionless bearing capacity factors

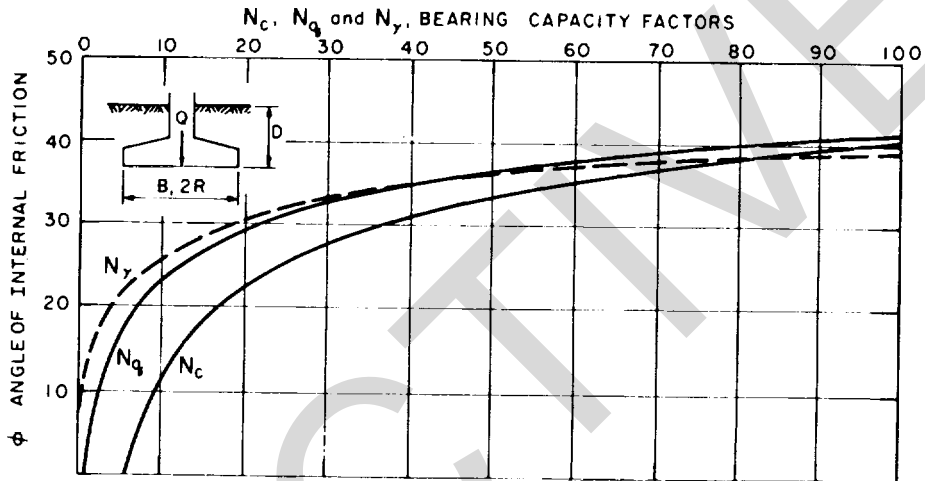

U. S. Army Corps of Engineers

Figure 4-61a. Bearing capacity formulas<sup>5</sup>. (Ultimate bearing capacity of shallow foundations under vertical centric loads.)

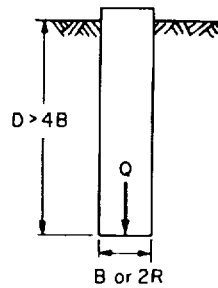

Strip loading:  $\frac{Q}{L} = cBN_c + \gamma DB + 2Df_s$

Square loading:  $Q = cB^2N_c + \gamma DB^2 + 4BDf_s$

Circular loading:  $Q = c\pi R^2N_c + \gamma D\pi R^2 + 2\pi RDf_s$

Notes:

1. Bearing capacity factors  $N_c$  for foundations in  $\phi = 0^\circ$  material:

B/L	$N_c$
1 (square or circle)	9.0
0.5	8.2
0 (strip footing)	7.5

2. Bearing capacity factors based on a smooth base (base shear stress = 0) and D/B greater than 4.
3. The skin friction  $f_s$  should not exceed the minimum sustained tangential adfreeze bond strengths recommended in paragraph 4-8f(1).

U. S. Army Corps of Engineers

Figure 4-61b. Bearing capacity formulas<sup>1</sup>. (Ultimate bearing capacity of deep foundations in c- $\phi$  material.)

system for wall and column loads is separate, as illustrated in figures 4-24, 4-27 and 4-28. Choice may depend on either structural or economic factors, or both.

(10) A pier is a prismatic or cylindrical column that serves, like a pile or pile cluster, to transfer load to a suitable bearing stratum at depth, as illustrated in figure 4-61b. It may be noted in figure 4-61b that the bearing capacity increases as the square of the radius of the pier in two of the three factors making up the total bearing for the circular pier, thus suggesting rapid increase of bearing capacity with diameter of pier.

(11) However, it should also be noted that the ultimate frost heaving force which can be developed on a pier or on the stem of a footing is a function of the surface area of the member in contact with the seasonally frozen ground and hence of the diameter of a cylindrical member. The frost heaving force is capable of fracturing members which are weak in tension and which are solidly anchored below the seasonal frost zone. Footing or pier members in the seasonal frost zone which may be placed in tension by frost heave forces should be made strong enough to resist such

tensile stresses. The amount of steel reinforcement in concrete members should be sufficient to prevent cracking of concrete and the consequent exposure of steel to moisture. To prevent foundation uplift, bases of footings should be large enough to resist frost heave uplift through passive soil reaction of the base projections against overlying materials, or pier-type foundations should extend to sufficient depth to resist such uplift through skin friction or adfreeze bond on lateral surfaces. Uplift resistance contributed by dead load from structure and weight of foundation should be taken into account. When practical, surfaces in contact with the frozen soil may be battered so that heave of the frozen layer will tend to reduce the contact and thereby minimize heaving forces. It is also desirable that vertical foundation members extending upward through the annual frost zone from underlying pads be as small in cross section as possible to minimize the total heave seasonal frost zone during thaw, care must be taken to avoid column instability in thinned-down members. Frost heave forces may be estimated as described in paragraph 4-31.

force. Of course, if foundation members are isolated from the annual frost zone by methods as described in paragraph 4-31 such requirements are reduced. Since negligible lateral support may be provided in the

(12) Innumerable variations and combinations of structural designs of foundation members are possible. Piers may be stepped, tapered or made hollow, footings and columns may be combined in the form of pedestals, etc. It is not possible to anticipate and give guidance for all such variations. However, the principles outlined herein may be combined as needed to fit any situation.

(13) Allowable bearing values for shallow footings and sills supported on well-drained granular mats may be based on unfrozen strengths of these materials. The thickness of granular material between footing and underlying natural soil must, however, be sufficient to reduce concentrated stresses on the natural soil to tolerable levels.

(14) Allowable bearing values for footings, rafts and piers supported on frozen materials should be determined using analytical procedures and factors of safety outlined in TM 5-818-1/AFM 88-3, Chapter 7<sup>5</sup> (F.S. = 2.0 for dead load plus normal live load and 1.5 for dead load plus maximum live load) and the design strength values determined as described in paragraph 4-4 for ultimate strength analysis, assuming that control against degradation of permafrost has been carefully provided in the design. Since most footings supported on permafrost are placed near the top of permafrost where ground temperature may rise fairly close to 32 °F in summer and fall, soil design values within 1° to 3 °F of 32 °F are usually applicable. Stresses in the weakest underlying strata must be kept within tolerable levels. Creep deformations estimated in accordance with paragraph 4-5 may also exert overriding control over allowable bearing values.

(15) Those of the analytical bearing capacity analyses presented in TM 5-818-1/AFM 88-3, Chapter 7<sup>5</sup> which are most typically applicable for frozen materials are illustrated in figure 4-61, covering shallow and deep foundations.

(16) For computation of bearing capacity of unfrozen soils and for detailed general guidance, reference should be made to applicable procedures outlined in TM 5-818-1/AFM 88-3, Chapter 7<sup>5</sup>.

(17) Design bearing pressures of 2500, 3000 and 4000 psf on frozen soils have been used satisfactorily in the designs shown in figures 4-15, 4-16 and 4-27, respectively. A bearing pressure of 12,000 psf has been used satisfactorily on very bouldery till with estimated highest soil temperature at the base of the footing of 25 °F, near Thule AB, Greenland<sup>86</sup>.

(18) Settlement of footings on permafrost from pressure melting or extrusion of ice from soil voids should be assumed negligible under normal footing loadings. A footing bearing value of 3600 psf, for example, corresponds to 25 psi. In terms of melting

point lowering this corresponds to only about 1/40°F. As indicated in figures 2-12, 2-15 and 4-53, the potential strength and deformation properties of ice are such that strata of hard, high-density ice in the foundation may exhibit better bearing characteristics than may frozen soils, especially at temperatures above about 25°F. However, porous ice may be compressible.

(19) Design procedure for predicting the resonant frequency and displacement under vibratory loads is given in EM 1110-345-310<sup>20</sup>.

(20) Design guidance with respect to other aspects of footing, raft and pier design are presented in other paragraphs of this manual as follows:

Settlement analysis, paragraph 3-4f

Thermal stability analysis and control, paragraph 4-2

Control of movement and distortion from freeze and thaw, paragraph 4-3

Estimation of creep deformation, paragraph 4-5

b. *Illustrative examples for the design of footings in permafrost.*

(1) *Steps required for design of footings on permafrost.* Determine required depth of footing (a above); determine the temperature distribution in the permafrost with respect to the base of the footing, for the critical period of the year; check the bearing capacity of a trial footing size in this critical period of the year using standard soil mechanics theory (a above) with properties of the frozen soil determined by field or laboratory tests (see chap 3); adjust the footing dimensions to obtain the desired factor of safety; and make a settlement analysis. Determine the distribution of the imposed vertical stress with depth beneath the footing. Compute the deformation of a free standing column of frozen soil, using creep equations and constants obtained from laboratory unconfined compression creep tests (para 4-5). If the estimated settlement is excessive, enlarge the footing or otherwise revise the design to reduce the estimated settlement to a tolerable amount.

(2) *Example of design of an isolated square footing.*

(a) Assumptions:

Permanent structure, 25-year life  
Soil conditions as shown in boring log (fig. 4-62)

Properties of the 2-foot-thick organic sandy silt layer (fig. 4-62) essentially the same as for the underlying sandy silt

Footing design of general type shown in figure 4-63

Column load 150 tons

Required factor of safety with respect to ultimate bearing capacity = 2.0

Air space provided between building floor

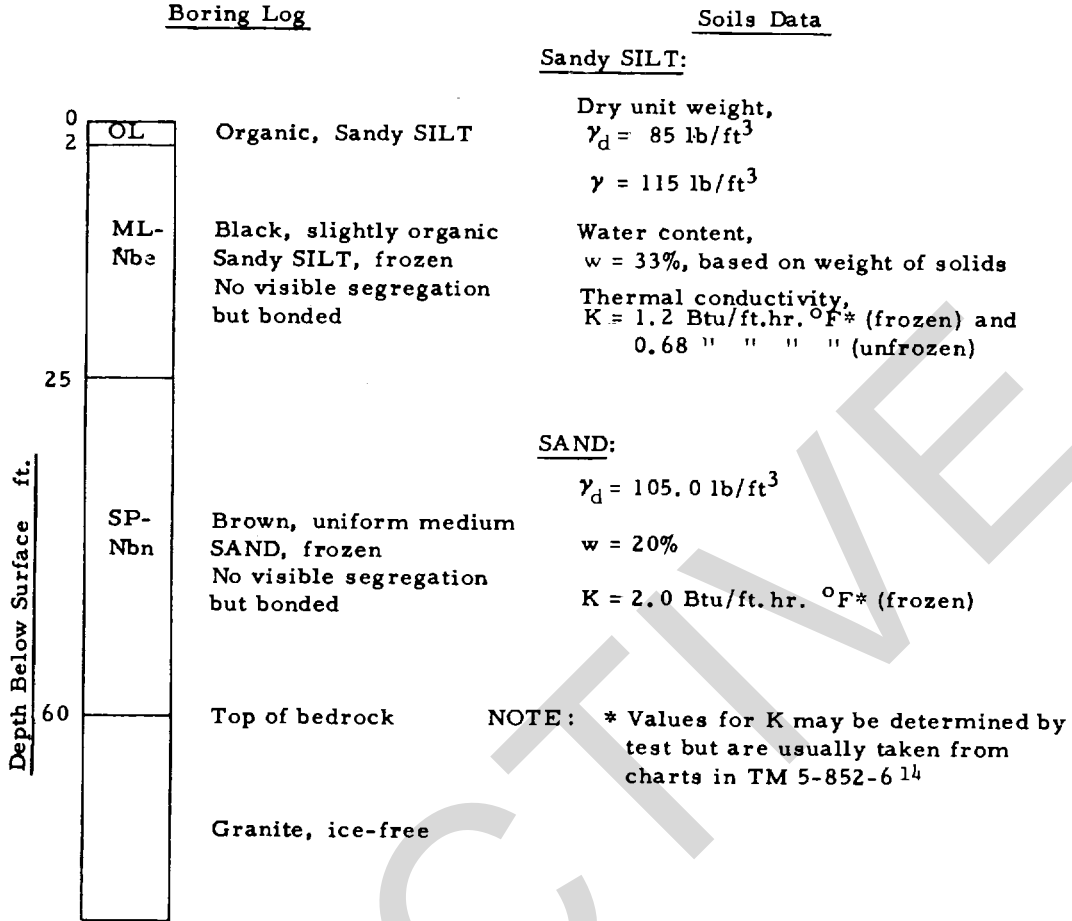

U. S. Army Corps of Engineers

Figure 4-62. Boring log and soils condition (by CRREL).

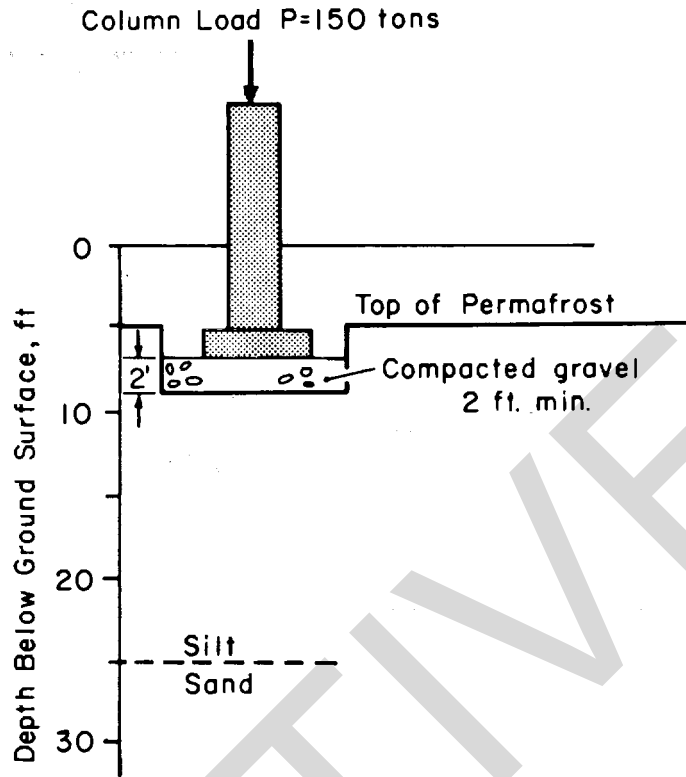

U. S. Army Corps of Engineers

Figure 4-63. Case of isolated square footing (by CRREL)

and ground surface  
 Mean annual air temperature (MAT) = 23°F.  
 Ground temperature below zone of seasonal variations (at 50 feet, measured) = 27 °F.  
 Design air thawing index, I = 2900  
 Length of thawing season, t = 150 days  
 Conversion factor for air thawing index to surface thawing index, n = 1.0 for building-shaded area (see table 4-1 and TM 5-852-6), dimensionless. (Note that this factor does not apply for the freezing period or for the overall annual heat exchange.)

(b) Determining required depth of footing. The footing should be founded below the top of permafrost for stable bearing. To establish this position the depth of seasonal thaw must be determined. If previous measurements of depth of thaw are available, these should be used, adjusted if necessary to correspond with the design air thawing index condition.

Otherwise the thaw depth should be determined by computation using procedures and terminology of TM 5-852-6/AFM 88-19, Chapter 6".  
 As indicated in TM 5-852-6/AFM 88-19, Chapter 6 use the equation,

$$X = \frac{\lambda \sqrt{48KnI}}{L}$$

where

- X = depth of thaw, ft
- L = volumetric latent heat of fusion, Btu/ft<sup>3</sup>
- λ = a coefficient which takes into consideration the effect of temperature changes in the soil mass (other factors are as previously defined)
- λ = is determined from TM 5-852-6/AFM 88-19, Chapter 6, figure 13, using values of α and μ calculated as follows:

$$\text{Thermal ration } \alpha = \left| \frac{v_o}{v_s} \right|$$

Average thaw-season surface temperature differential

$$v_s = \frac{nl}{t} = \frac{(1.0)(2900)}{150} = 19.3 \text{ (above } 32^\circ\text{F)}$$

Initial temperature differential

$$V_o = \text{MAT} - 32 = 23 - 32 = 9^\circ\text{F (below } 32^\circ\text{F)}$$

$$\alpha = \frac{9}{19.3} = 0.47$$

Fusion parameter  $\mu = v_s$

Average volumetric heat capacity,  $C = \lambda d (c + 0.75 w/100)$

For silt: Dry unit weight,  $\lambda d = 85 \text{ lb/ft}^3$ .

Moisture content of soil (percent of dry weight),  $w = 33$  percent

Specific heat of dry soil,  $c = 0.17$ .

(Average value for near  $32^\circ\text{F}$ ; TM 5-852-6/AFM 88-19, Chap 6<sup>14</sup>)

$$C = 85[0.17 + 0.75 (33/100)] = 35.5 \text{ Btu/ft}^3$$

$$L = 144 (\lambda d) (w/100) = 144 (85) (33/100) = 4050 \text{ Btu/ft}^3$$

$\lambda = 0.88$  (from TM 5-852-6/AFM 88-19, Chap 6, fig. 13)

Since the annual thaw zone includes both frozen and unfrozen soil except at the start and the end of the thawing season, an average value of thermal conductivity,  $K$ , is the best approximation for this condition. Select individual  $K$  values from figures 3 and 4 of TM 5-852-6 (they may also be determined by test). These have been shown in figure 4-62. Then,  $K_{ave} = \frac{1}{2}[K_{unfroz} + K_{froz}] = \frac{1}{2}[0.68 + 1.2] = 0.94 \text{ Btu/ft hr}$

$$\text{Estimated depth of thaw } X = \frac{\lambda \sqrt{48knl}}{L} = \frac{0.88 \sqrt{48(0.94)(1.0)(2900)}}{4050}$$

The footing should be founded a foot or more below the top of the permafrost, depending on the reliability of the data used in the estimate and the degree of confidence that the assumed thermal regime will be maintained. In this case, a depth of 7 feet is used with a footing design of the general type shown in figure 4-63. Because stresses are most intense within about one to one and one-half diameters below the base of the footing, as shown in figure 4-64, temperatures within this depth are most critical. By placing high-bearing value material within the most critical part of this depth, as illustrated by the gravel in figure 4-63, design certainty can be increased.

At the perimeter of the building where transition occurs from the shaded, cooler interior surface under the building to the unshaded natural ground surface, the building should cantilever out beyond the footings or special shading should be provided for sufficient distance

to ensure maintenance of design ground temperature conditions under the footings. Ground temperatures under individual footings should be as nearly the same as possible in order to obtain uniform support. By successfully achieving an  $n = 1.0$  condition for the actual foundation support area, for the thaw season, the permafrost table may be expected to become somewhat higher under the building than under adjacent non-shaded areas.

(c) Determining temperature distribution with depth below base of footing for critical period of year. Given that the highest temperature at the top of permafrost is  $32^\circ\text{F}$  and the permafrost temperature at a depth below the influence of annual temperature fluctuations is  $27^\circ\text{F}$  it is assumed that erection and operation of the structure does not significantly affect the mean annual temperature at the latter depth. Studies of field data show that the temperature of permafrost,  $T_x$  at depth  $X$  below the permafrost table may be determined from the expression:

$$T_x = 32 - (A_o - A_x)$$

where:

$A_o$  = amplitude of temperature wave that the top of permafrost above the temperature at the depth of no annual variation.

In this case,

$$A_o = 32 + 27 = 5^\circ\text{F}$$

and from p. 36, TM 5-852-6/AFM 88-19, Chapter 6

$$A_x = A_o \exp(-X\sqrt{\pi/ap})$$

where:

$a$  = thermal diffusivity =  $K/C$

$P$  = period of sine wave, 365 days

The footing size is in this case assumed to be small enough so that the foundation temperatures are not significantly affected by the differing thermal properties of the footing and underlying gravel.

For frozen silt:

$$K = 1.2 \text{ Btu/ft hr } ^\circ\text{F}$$

$$C = \gamma (c + 0.5 w/100) = 85 (0.17 + 0.5 (33/100)) = 28.5 \text{ Btu/ft}^3$$

$$a_{\text{silt}} = K/C = \frac{1.2}{28.5} = 0.042 \text{ ft}^2/\text{hr} = 1.01 \text{ ft}^2/\text{day}$$

$$A_x = 5 \exp(-X \sqrt{\pi/(1.01)(365)}) = 5e^{-0.0923X}$$

and

$$T_x = 32 - (5 - 5e^{-0.0923X}) = 32 - 5 + 5e^{-0.0923X} = 27 + 5e^{-0.0923X}$$



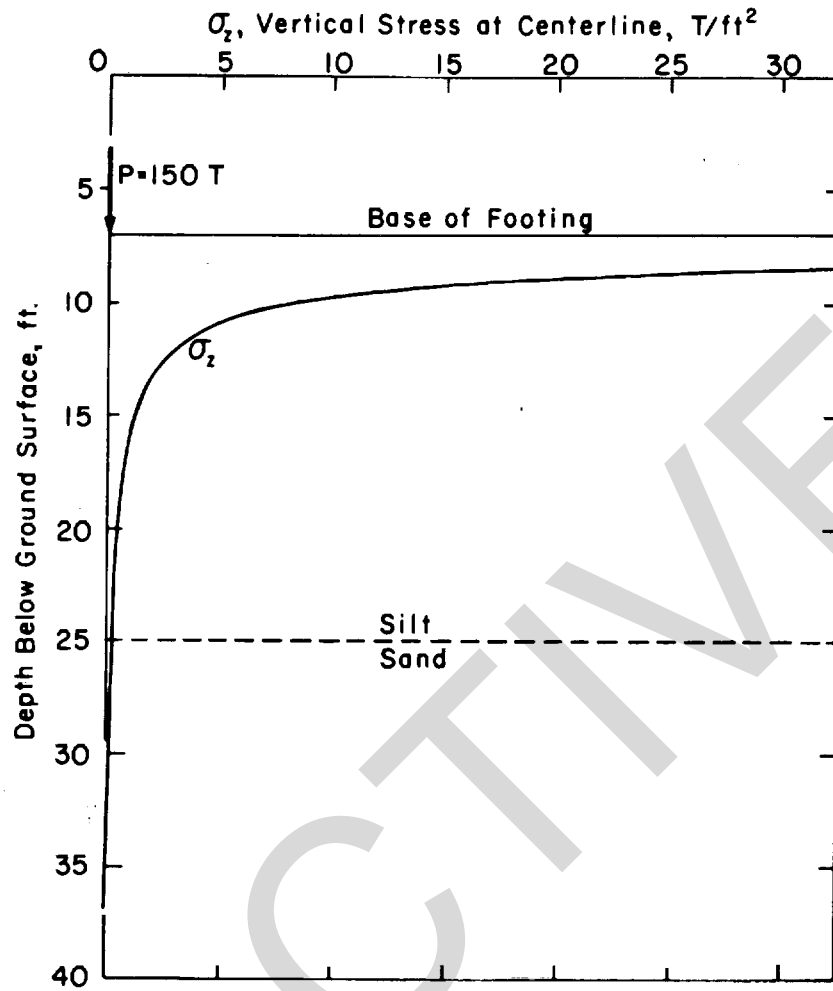

U. S. Army Corps of Engineers

Figure 4-64. Vertical stress at centerline (by CRREL).

The equation for  $T_x$  predicts the maximum temperatures occurring at particular depths. These maximum temperatures do not occur simultaneously but the assumption that they do is conservative for this situation.

The diffusivity of the sand is greater than that of the silt, which will induce higher temperatures in the sand layer than would result if all the soil were silt. An adjustment can be made for the layered soil condition by using the procedure outlined below. To determine temperature distribution with depth in the sand, it is necessary to convert the sand layer to an equivalent silt layer. From page 38, TM 5-852-6/AFM 88-19, Chapter 6<sup>14</sup>, the thicknesses are proportional to the square roots of the thermal diffusivities.

Diffusivity for silt,

$$a_{\text{silt}} = 1.01 \text{ ft}^2/\text{day}$$

Diffusivity for sand,

$$C_{\text{sand}} = \gamma_d [c + 0.5 (w/100)] = 105. [0.17 + 0.5 \frac{(20)}{(100)}]$$

$$C_{\text{sand}} = 28.3 \text{ Btu/ft}^3 \text{ } ^\circ\text{F}$$

$$K_{\text{sand}} = 2.0 \text{ Btu/ft}^3 \text{ hr } ^\circ\text{F (frozen)}$$

$$a_{\text{sand}} = K/C = \frac{2.0}{28.3} = 0.0706 \text{ ft}^2/\text{hr} = 1.7 \text{ ft}^2/\text{day}$$

$$\text{Ratio} = \frac{\sqrt{a_{\text{silt}}}}{\sqrt{a_{\text{sand}}}} = \sqrt{\frac{1.01}{1.7}} = 0.77$$

i.e. 1 foot of sand is equivalent to 0.77 foot of silt, as regards temperature penetration under transient conditions.

Values of  $T_x$  are computed for the entire depth of possible interest assuming silt, and depth adjustments are then applied in the sand layers. Computations for selected depths are shown in table 4-7 and the temperature distribution with depth is illustrated in figure 4-65. For use in settlement computations, a simplified temperature distribution is also shown in the figure.

(d) Checking bearing capacity in critical period of year. Use equation:

$$q_u = 1.3c N_c + \gamma D N_q + 0.4\gamma B N_\gamma$$

from figure 4-61, using terminology thereon, or from TM 5-818-1/AFM 88-3, Chapter 7<sup>5</sup>, for square footings.

Neglecting internal friction ( $\phi = 0$  and  $N_\gamma = 0$ )

$$q_u = 1.3c N_c + \gamma D N_q$$

From figures 4-61 and 4-62.

$$\begin{aligned} N_c &= 5.7 \\ N_q &= 1.0 \\ \gamma &= 115 \text{ lb/ft}^3 \\ D &= 7 \text{ ft (at base of footing)} \end{aligned}$$

The cohesion,  $c$ , of the frozen silt must be determined from creep test data at about 30°F (average temperature in the top 2 feet of silt as shown in fig 4-65.) Take failure cohesion at 25 years.

Unconfined compressive strength determined by conventional laboratory test is

$$q_w = 450 \text{ psi} = 32.4 \text{ T/ft}^2$$

Results of laboratory unconfined compression creep tests are:

Percent of $q_w$	Applied Creep Stress	Time of Failure
60	270 psi (19.4 T/ft <sup>2</sup> )	$t_f = 0.027 \text{ hr}$
40	180 psi (13.0 T/ft <sup>2</sup> )	$t_f = 0.24 \text{ hr}$

Using equation 3 (para 4-4):

$$\begin{aligned} \sigma_{\text{ult}} &= \frac{\beta}{\ln(t_f/B)} = \frac{\beta}{\ln t_f - \ln B} \\ \ln B &= \ln t_f - \frac{\beta}{\sigma_{\text{ult}}} \end{aligned}$$

Substituting:

$$\ln B = \ln 0.027 - \frac{\beta}{270}$$

and

$$\ln B = \ln 0.24 - \frac{\beta}{180}$$

Solving for  $B$  and  $\beta$  and substituting back,

$$\sigma_{\text{ult}} = \frac{1180}{\ln t_f} = 6.67$$

For failure time of 25 years =  $2 \times 10^5 \text{ hr}$ :

$$\sigma_{\text{ult}} = \frac{1180}{\ln 2 \times 10^5 + 6.67} = 62.2 \text{ psi}$$

$$\text{Cohesion } \sigma_{\text{ult}} = \frac{62.2}{2} = 31.1 \text{ psi} = 2.2 \text{ T/ft}^2.$$

Since the gravel layer beneath the footing is a high bearing value material, using  $D = 7$  feet for depth of footing might be too conservative. However, using  $D = 9$  feet at the base of the gravel layer might not be conservative enough. Therefore, both values will be checked below to determine the effect on indicated capacity. For  $D = 7$  feet, Ultimate Bearing Capacity,  $q_u = 1.3 c N_c + \gamma D N_q$

$$q_u = 1.3 (2.2) (5.7) + \frac{(115)(7)(1.0)}{2000} = 16.3 + 0.4$$

$$q_u = 16.7 \text{ T/ft}^2$$

Table 4-7. Computation of Temperature Below Top of Permafrost.

Depth Below Top of Permafrost		0.0923X	$e^{-0.0923X}$	$5e^{-0.0923X}$	Temperature, $T_X$ $= (27 + 5e^{-0.0923X})$ (°F)
In Silt, X (ft)	In Sand, X' (ft)				
0	-	0.0	1.0	5.0	32.0
1	-	0.0923	0.912	4.56	31.6
2	-	0.184	0.832	4.16	31.2 <b>Base of footing</b>
3	-	0.277	0.76	3.80	30.8
4	-	0.369	0.69	3.45	30.4 <b>Bottom of gravel layer</b>
5	-	0.461	0.63	3.15	30.1 <b>Silt</b>
6	-	0.554	0.58	2.90	29.9 "
7	-	0.646	0.52	2.60	29.6 "
10	-	0.923	0.39	1.95	28.9 "
12	-	1.11	0.33	1.65	28.6 "
15	-	1.38	0.25	1.26	28.2 "
20	-	1.85	0.157	0.78	27.8 <b>Bottom of silt layer</b>
(25)	26.5	2.31	0.099	0.49	27.4 <b>Sand</b>
(30)	33.0	2.76	0.062	0.31	27.3 "
(35)	39.5	3.23	0.039	0.20	27.2 "
(40)	46.0	3.69	0.025	0.12	27.1 "
(50)	59.0	4.61	0.010	0.05	27.0 "

NOTE: The temperature distribution in the silt layer is the same as if all the soil were silt and the temperature distribution in the sand is obtained by first computing the temperature as if the layer were silt and then adjusting the depths beneath the silt-sand interface, In this case:

$$X' = \frac{-1}{0.77} (X-20) + 20 = \text{Actual distance from top of permafrost to point in sand}$$

U. S. Army Corps of Engineers

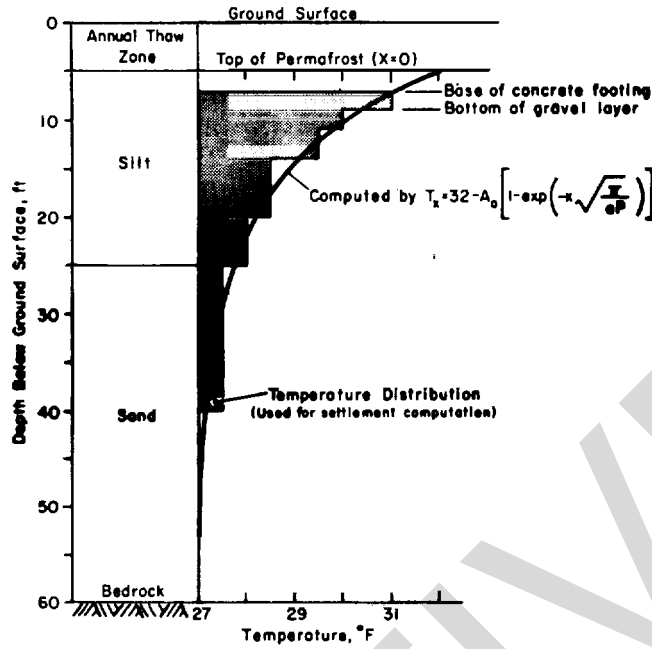

U. S. Army Corps of Engineers

Figure 4-65. Temperature distribution for permafrost below footing. Temperature distribution should be checked by measurement (e.g. by thermocouples if possible.)

$$\text{For } D = 9 \text{ feet, } q_u = 1.3 (2.2) (5.7) + \frac{(115)(9)(1.0)}{2000} = 16.3 + 0.5$$

$$q_u = 16.8 \text{ T/ft}^2$$

The difference is not significant and the lower of the two,

$$q_u = 16.7 \text{ T/ft}^2, \text{ will be used.}$$

$$\text{Total Bearing Capacity} = q_u \times \text{area of footing}$$

Using 4 feet  $\times$  4 feet footing:

$$\text{Capacity} = 16.7 \times (4 \times 4) = 267 \text{ T.}$$

$$\text{Factor of Safety FS} = \frac{\text{Total Bearing Capacity}}{\text{Design Footing Load}} = \frac{267}{150}$$

$$= 1.78 (< 2).$$

Therefore use 4-1/2 ft  $\times$  4-1/2 ft footing which gives:

$$\text{Total Bearing Capacity} = 16.7 \times (4-1/2 \times 4-1/2) = 338 \text{ T.}$$

$$\text{Factor of Safety} = \frac{338}{150} = 2.25 (> 2) \text{ OK.}$$

(e) *Making settlement estimate.* Consider the isolated footing as a point load near the surface of a semi-infinite solid (conservative assumption because of depth and increased bearing area).

1. Stress distribution. For simplicity, use Boussinesq's equation for point load. (See Terzaghi and Peck<sup>198</sup>, 2<sup>nd</sup> Ed., p. 271.)

Vertical stress

$$\sigma_z = \frac{3P}{2\pi} \frac{1}{z^2} = \frac{3(150)}{2\pi} \frac{1}{z^2} = \frac{71.7}{z^2}$$

where  $z$  = distance below base of footing.

The computed stress distribution is shown in figure 4-64.

2. Creep settlement computation.

Assume:

Load  $P$  is distributed uniformly over the end of a soil column with cross section equal to the base area of the footing with stress decreasing progressively in the column to the depth where the stress is negligible, as indicated in figure 4-66.

Vertical movement is the result of unconfined compression creep of the frozen column of soil directly beneath the footing. (This assumption is on the safe side since creep-reducing effects of lateral confinement are neglected.)

Total creep movement is the sum of the creep of all the zones of soil in the soil column.

Creep in the compacted gravel is neglected.

Temperature distribution is as shown in figure 4-65 and as computed in table 4-7. (The approximate distribution assumed for computation is also shown in fig 4-66).

The amount of creep deformation can be estimated by the following methods:

By using constants from table 4-5 and equation 4 from paragraph 4-5.

By performing unconfined compression creep tests on undistributed samples of the foundation soil and using equation 6 of paragraph 4-5.

The first method will give a rough estimate. An example of computations by this method using values from table 4-5 for a silt similar to the soil under the footing, at about the same water content, is shown in table 4-8. Use of a value of 25 years of time,  $t$ , in these computations is a simplification and quite conservative in that it assumes that ground temperatures remain throughout the year at the same level as during the "critical period." Since ground temperatures are somewhat colder during a considerable portion of the year, it is clear that the length of time required to attain the settlements computed in table 4-8 (and in table 4-10 as well) is somewhat longer than the 25 years. Computing the settlement using the coldest temperatures to be anticipated during the year (24°F for Zone A, etc.), with all other factors the same, results in a 25-yr settlement of 0.2 in., 1/5 that determined in table 4-8.

The second method gives a more accurate prediction for the specific case. The unconfined compression creep tests should be performed at the design stress level and at the predicted temperature of the foundation soil. A plot of unconfined compression creep test results for a silt at 29.5°F under applied stress of 50 psi (3.6 T/ft<sup>2</sup>) and a sample computation are shown in figure 4-67 (for Zone B).

Using equation 6 and the data from the test, the relationship between strain and time becomes, for Zone B:

$$\text{Strain, } \epsilon = 4.55 \times 10^{-4} [t^{0.099} - 1] + 0.00051$$

A similar relationship must be obtained by tests performed on soil from each zone in the "soil column" beneath the footing for the critical temperature and the stress conditions that exist

The sum of the deformations from all the zones for a given time will constitute the estimate of the total settlement.

$$\text{For demonstration purposes assume time, } t = 25 \text{ yr}$$

$$\approx 2 \times 10^5 \text{ hr.}$$

$$\text{Zone A, Strain, } \epsilon = 4.55 \times 10^{-4} + 6.68 \times 10^{-5} = 8.84 \times 10^{-5}$$

Creep test not performed on Zone C at required temperature; strain data interpolated from a general formula and average values to complete example.

Deformation:

Zone A,  $0.0313 \times 2 \text{ ft} = 0.0626 \text{ ft}$   
 Zone B,  $0.00158 \times 3 \text{ ft} = 0.0047 \text{ ft}$   
 Zone C,  $0.0000884 \times 6 \text{ ft} = 0.0005 \text{ ft}$   
 TOTAL =  $0.0678 \text{ ft} = 0.81$   
 Say 1 in., at end of 25 years.

The details for the field test of the third method are given in paragraph 4-5. Actual data for a field test under the conditions assumed in this example are not available. As indicated in paragraph 4-5, the various requirements for the field test make this approach difficult to employ and the designer will generally have to rely on laboratory unconfined compression creep tests in estimating creep deformation.

(3) Example of design of a uniformly loaded square raft foundation.

Assumptions: assume the same soil conditions as shown in figure 4-62 and a foundation of the general type shown in figure 4-68.

Determining required depth of base of raft. The analysis is the same as for the isolated square footing in the preceding example.

Determining the temperature distribution with depth below foundation for critical period of year. The analysis is the same as for the isolated square footing in the preceding example.

Checking bearing capacity in critical period of year.

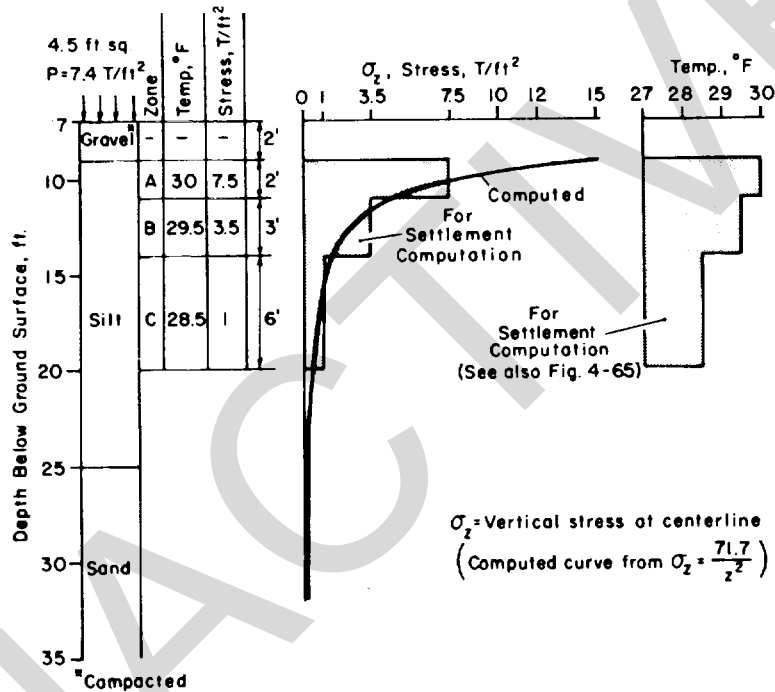

U. S. Army Corps of Engineers

Figure 4-66. Conditions for creep analysis.

Table 4-8. Settlement Computations

Zone	Zone Thick. (H) (ft)	Soil Type	$\theta$ ( $^{\circ}$ F)	Vert. Stress. $\sigma_z$ (psi)	STRAIN, $\epsilon(t) = \left[ \frac{\sigma t^\lambda}{\omega(\theta + 10)^k} \right]^{1/m} + \epsilon_0^*$		Strain Period of Loading $t=25\text{yr} \approx 2 \times 10^5 \text{hr}$	Deformation	
					(ft)	(in)			
A	2	Silt	2	104	$\left[ \frac{104t^{.074}}{570(2+1)^{.76}} \right]^{1/.49} = \left[ 0.079t^{.074} \right]^{1/.49} = 0.0057 t^{.151}$	0.036	0.072	0.864	
B	3	Silt	2.5	49	$\left[ \frac{49t^{.074}}{570(2.5+1)^{.76}} \right]^{1/.49} = \left[ 0.033t^{.074} \right]^{1/.49} = 0.0010 t^{.151}$	0.0063	0.019	0.228	
C	6	Silt	3.5	14	$\left[ \frac{14t^{.074}}{570(3.5+1)^{.76}} \right]^{1/.49} = \left[ 0.008t^{.074} \right]^{1/.49} = 0.000053t^{.151}$	0.00034	0.002	0.024	
<b>TOTAL =</b>							0.093 ft	1.12"	

Values for Constants  
From Table 4-V:

Silt

- $m = 0.49$
- $\lambda = 0.074$
- $\omega = 570 \text{ (psi (hr}^\lambda\text{))} / \text{ } ^{\circ}\text{F}^k$
- $k = 0.76$
- $\theta = (32^{\circ} - \text{Temp. of soil})^{\circ}\text{F}$

\* The term,  $\epsilon_0$ , can be neglected for estimating creep.

If a settlement of 1 1/4" can not be tolerated, the footing should be enlarged to reduce the stresses or the foundation redesigned.

TOTAL SETTLEMENT IN 25 YR OF ABOUT 1 1/4 INCHES

U. S. Army Corps of Engineers

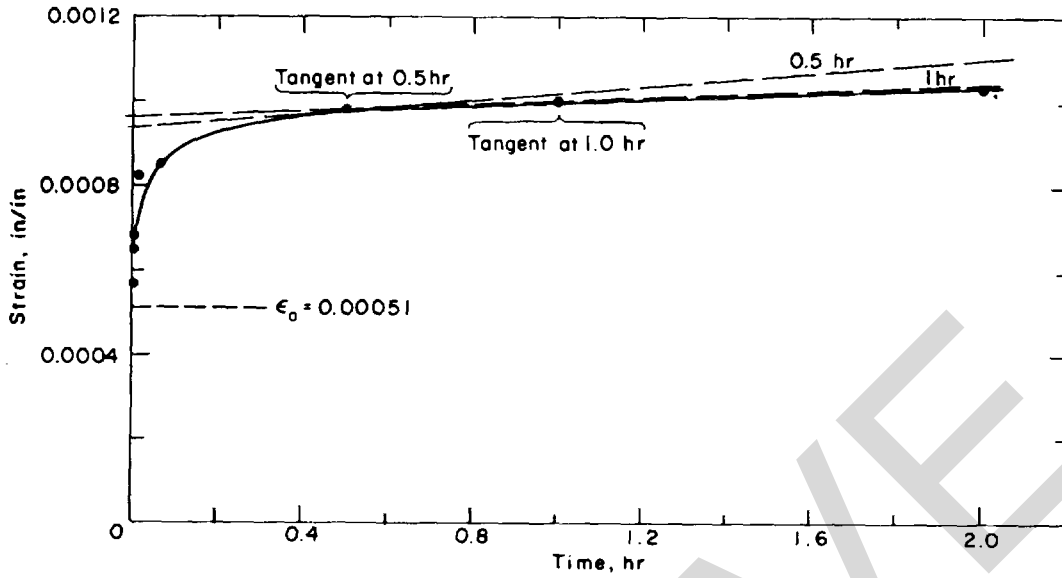

$$\dot{\epsilon} = \frac{d\epsilon}{dt} = \text{slope of tangent at time, } t = 1 \text{ hr and } 0.5 \text{ hr}$$

$$t = 1 \text{ hr, } \dot{\epsilon}_1 = \frac{0.00105 - 0.000961}{2.0} = 0.000045$$

$$t = 0.5 \text{ hr, } \dot{\epsilon}_{0.5} = \frac{0.00110 - 0.000933}{2.0} = 0.000083$$

$$M = \frac{\log(t_1/t_{0.5})}{\log(\dot{\epsilon}_{0.5}/\dot{\epsilon}_1)} = \frac{\log 1/0.5}{\log 0.000083/0.000045} = \frac{\log 2}{\log 1.8} = 1.11$$

$$\text{then } \epsilon = \dot{\epsilon}_1 \left( \frac{M}{M-1} \right) [t^{(M-1/M)} - 1] + \epsilon_0 = 4.5 \times 10^{-5} \times (10.1) [t^{0.099} - 1] + \epsilon_0$$

$$\epsilon = 4.55 \times 10^{-4} [t^{0.099} - 1] + 0.00051$$

U. S. Army Corps of Engineers

Figure 4-67. Unconfined compression creep test - data for Zone B. Specimen No. HAS-83. Applied stress 50 psi. Test temperature 29.5°F.



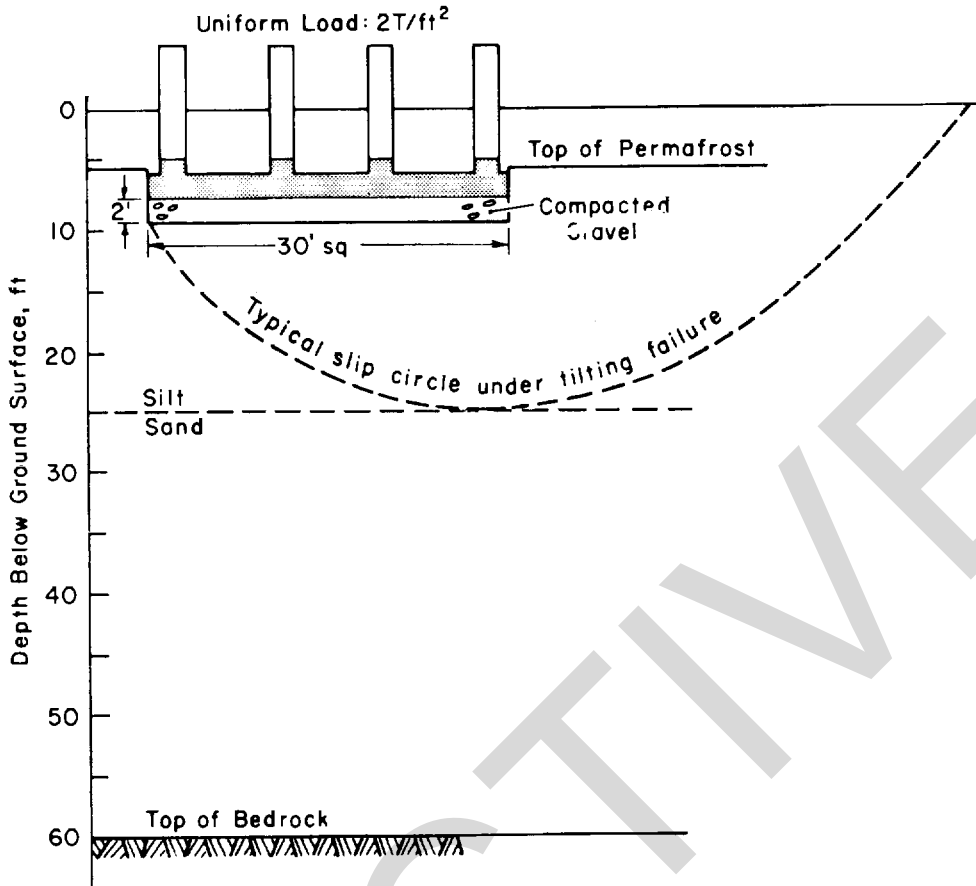

U. S. Army Corps of Engineers

Figure 4-68. Conditions for bearing capacity analysis of square raft (by CRREL). Desired factor of safety = 2.0. A uniform load can be assumed for closely spaced individual footings or piers, or the area beneath piling.

$$q_u = 1.3 c N_c + \gamma D N_q + 0.4 \gamma B N_7$$

The value of "c" varies at different depths with the soil temperature and the soil type. A failure surface can be assumed as shown in figure 4-68 and a "weighted" value for "c" used, e.g.

$$c_{wt} = \frac{\sum_{1}^n c_n \times ARC_n}{\sum_{1}^n ARC_n}$$

$c_n$  = cohesion for zone n

$ARC_n$  = arc length contained in zone n

A conservative procedure is to use the smallest cohesion of the soil zones involved. Neglecting internal friction ( $N_x = 0$ )

- $N_c = 5.7$
- $N_q = 1.0$
- $D = 7$

$$q_u = 1.3 c(5.7) + \frac{115(7)(1.0)}{2000}$$

$$q_u = 1.3 c (5.7) + 2000$$

$$q_u = 7.41 c + 0.40$$

Using cohesive stress of 2.0 T/fr' for silt at 30°F (from table 4-4 in paragraph 4-4, neglecting safety factor):

$$q_u = 7.41 (2.0) + 0.40 = 14.82 + 0.40 = 15.22 \text{ T/ft}^2$$

$$FS = \frac{15.22(30 \times 30)}{2(30 \times 30)} = 7.61 (>2)$$

This is very safe, but creep settlement may govern.

Making creep settlement estimate. Using charts from TM 5-818-1<sup>5</sup> for uniform load (based on Boussinesq equations) the stress distribution beneath the centerline of the footing ( $\delta_z$ ) is tabulated in table 4-9 and shown in figure 4-69 ( $\delta_z$  = increase in the stress in the soil — neglect weight of soil).

Table 4-9. Stress Distribution Beneath the Uniformly Loaded Area.

Loaded Area.

a. Under center, b=15 ft.

$z$ Depth below footing, ft	$\frac{b}{z}$	$f(m,n)$ from chart	Stress, T/ft <sup>2</sup> $a_z = 4xf(m,n) \times 2T/ft^2$
60	0.25	0.027	0.22
50	0.30	0.038	0.30
42.8	0.35	0.048	0.38
37.5	0.40	0.06	0.48
33.3	0.45	0.072	0.58
30.0	0.5	0.084	0.67
20.0	0.75	0.136	1.09
15.0	1.0	0.175	1.40
10.0	1.5	0.216	1.73
7.5	2.0	0.232	1.86
6.0	2.5	0.24	1.92
4.28	3.5	0.245	1.96
3.75	4.0	0.247	2.00

b. Under corner, b=30 ft.

$z$ Depth below footing, ft	$\frac{b}{z}$	$f(m,n)$ from chart	Stress, T/ft <sup>2</sup> $a_z = 4xf(m,n) \times 2T/ft^2$
60	0.5	0.085	0.17
50	0.6	0.107	0.21
42.8	0.7	0.128	0.25
37.5	0.8	0.146	0.29
33.3	0.9	0.162	0.32
30.0	1.0	0.175	0.35
20.0	1.5	0.216	0.43
15.0	2.0	0.232	0.46
10.0	3.0	0.244	0.49
7.5	4.0	0.247	0.49
6.0	5.0	0.248	0.50
4.28	7.0	0.250	0.50
3.75	8.0	0.250	0.50

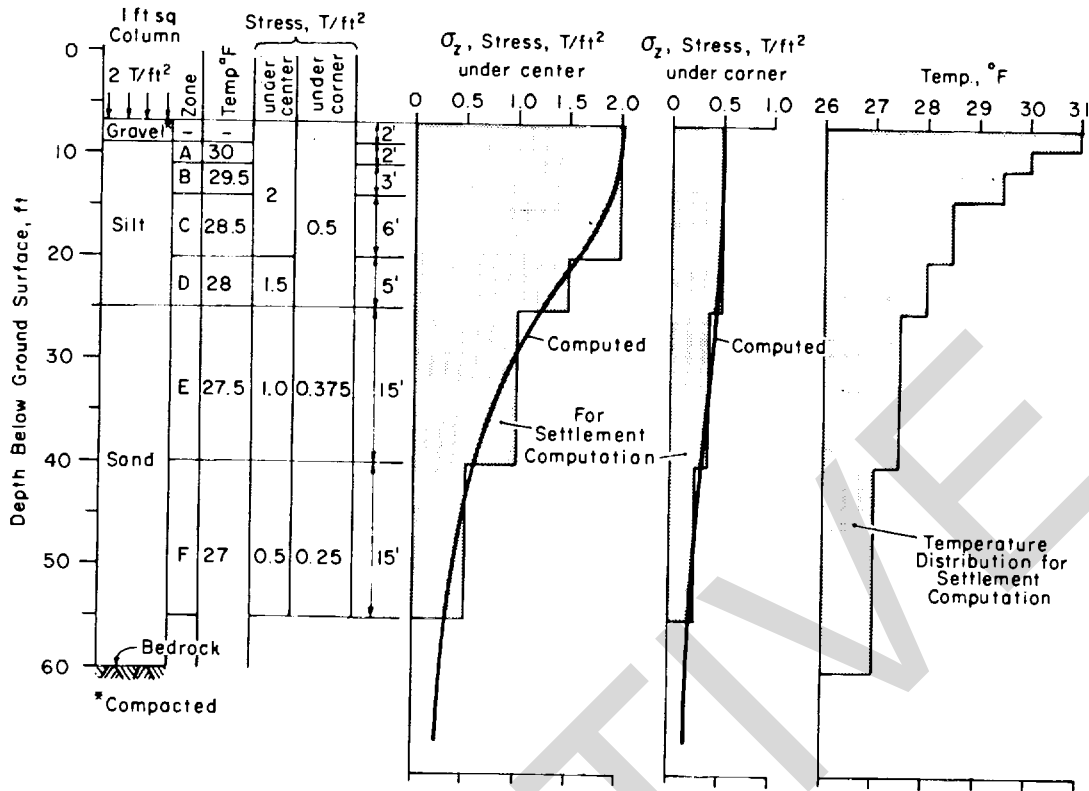

U. S. Army Corps of Engineers

Figure 4-69. Frozen soil column - diagrams of temperature and stress distribution.

Creep settlement deformations are computed using the stress and temperature distributions shown in figure 4-69. The height of the column of soil to be analyzed is determined by the stress and temperature distributions. The height of the column is assumed to extend to a depth where the magnitude of the stress is so small that the contribution to creep deformation below this point can be neglected. The cross-sectional area of the soil column is taken as the load area (i.e., the area of the footing). The column of soil used in the settlement estimate is shown in figure 4-69. The computed temperature distribution from table 4-7 and the computed stress distribution below the center of the foundation from table 4-9 are shown as smooth curves in figure 4-69. The rectangular shaded areas represent the approximate stress and temperature distributions used in the settlement computations. Table 4-10 shows the detailed computations for the settlements at the center and at the corner of the foundation at the end of 25 years, assuming it is flexible. If this differential settlement is not tolerable it will be necessary to increase the area of the footing or change the configuration or

type of foundation. Of course, the revised design will require repetition of the settlement computations.

**4-8. Piling.**

a. *General.* Piling offers many advantages where construction is on frost-susceptible foundation soils in areas of deep seasonal frost penetration or permafrost with high ice content". Pile foundations can be constructed with minimum disturbance to the thermal regime and can isolate the structure from the seasonal heave and subsidence movements of the annual frost zone and from at least limited degradation of the permafrost. The structure load is transferred by the pile to depths where soil supporting strength remains relatively stable through the life of the structure. General information on engineering and design of pile structures and foundations is contained in EM 1110-2-29062<sup>20</sup> and TM 5-818-1/AFM 88-3, Chapter 7<sup>5</sup>, and the references cited therein.

b. *Pile types.* Pile materials may be timber, concrete, or steel. Composite piles may be profitably used to pro

Table 4-10. Settlement Computations (by CRREL)

$$\text{STRAIN } \epsilon(t) = \left[ \frac{\sigma_z \lambda}{\omega (\theta + 1)^k} \right]^{1/m} + \epsilon_0$$

Zone	Zone Thick. (H) (ft)	Soil Type	Degree Freez. $\theta$ °F	Vert. Stress $\sigma_z$		Strain (Period of Loading $t=25\text{yr}=2 \times 10^5\text{hr}$ )	Deformation		
				Ctr.	Corner		Center (ft)	Corner (ft)	
A	2	Silt	2	28	7	$\left[ \frac{28t \cdot 0.074}{570(2+1)^{.76}} \right]^{1/.49} = \left[ 0.0213t \cdot 0.074 \right]^{1/.49} = 0.00038t^{.151}$	0.0024	$x(7/28)^{1/.49} = 0.00026$	
B	3	Silt	2.5	28	7	$\left[ \frac{28t \cdot 0.074}{570(2.5+1)^{.76}} \right]^{1/.49} = \left[ 0.0190t \cdot 0.074 \right]^{1/.49} = 0.00030t^{.151}$	0.0019	$x(7/28)^{1/.49} = 0.00034$	
C	6	Silt	3.5	28	7	$\left[ \frac{28t \cdot 0.074}{570(3.5+1)^{.76}} \right]^{1/.49} = \left[ 0.0156t \cdot 0.074 \right]^{1/.49} = 0.00021t^{.151}$	0.0013	$x(7/28)^{1/.49} = 0.00046$	
D	5	Silt	4	21	7	$\left[ \frac{21t \cdot 0.074}{570(4+1)^{.76}} \right]^{1/.49} = \left[ 0.0108t \cdot 0.074 \right]^{1/.49} = 0.00010t^{.151}$	0.0006	$x(7/21)^{1/.49} = 0.0002$	
E	15	Sand	4.5	14	5.2	$\left[ \frac{14t \cdot .35}{5500(4.5+1)^{.97}} \right]^{1/.78} = \left[ 0.0005t \cdot .35 \right]^{1/.78} = 0.00006t^{.448}$	0.0142	$x(5.2/14)^{1/.78} = 0.060$	
F	15	Sand	5	7	3.5	$\left[ \frac{7t \cdot .35}{5500(5+1)^{.97}} \right]^{1/.78} = \left[ 0.0002t \cdot .35 \right]^{1/.78} = 0.000018t^{.448}$	0.0043	$x(3.5/7)^{1/.78} = 0.041$	
TOTAL =							0.299'	3.6"	0.102' 1.2"

\* The term  $\epsilon_0$  can be neglected for estimating creep.

Values for constants from Table 4-V.

Silt  
 $m = 0.49$   
 $\lambda = 0.074$   
 $\omega = 570 [\text{psi}(\text{hr})^\lambda] / \sigma_F^k$   
 $k = 0.76$

Sand  
 $m = 0.78$   
 $\lambda = 0.35$   
 $\omega = 5500 [\text{psi}(\text{hr})^\lambda] / \sigma_F^k$   
 $k = 0.97$

Estimated Total Settlement in 25 yrs.

At center of loaded area	= 3.6
At corner of loaded area	= 1.2
Differential Settlement	= 2.4"

vide a large surface area and holding capacity within the permafrost but with a small circumference and area exposed to heaving forces within the annual frost zone. Composite piles employing wood as either the upper or lower member are not recommended unless there is no possibility that frost heave forces will act on the pile, because of the difficulty of providing a joint capable of resisting high tension forces under the effects of heaving. The type of pile selected will depend on initial costs, shipping costs, installation method, load levels, resistance to corrosion, difficulty in splicing or cost and difficulty of providing installation equipment, labor availability and other factors. Displacement piles, which densify or force aside a relatively large volume of soil as they are driven, can be used only in thawed soils.

(1) **Timberpiles.** Timber piles are normally less expensive than other types, easy to handle and normally readily available in lengths from 30 to 70 feet. Timber piles frozen into saturated permafrost soils are durable for centuries. Their structural characteristics are discussed in paragraph 2-6. The maximum allowable average compressive stresses on the cross section of round or square timber piles are given in TM 5-818-1/AFM 88-3, Chapter 7<sup>5</sup>.

(2) **Steel piles.** H-piles and pipe piles are the most useful types of steel piles, although box sections and angles have been used. Pipe or shell piles filled with concrete or sand may be used in some designs to provide high load capacity. Pipe piles that are capped or closed-ended at the bottom may be installed in pre-made holes but cannot be driven in permafrost as displacement piles. Open-ended steel pipe and H-piles can be driven in great lengths, can be readily cut off or made longer and can carry high loads. The average compressive stress on steel pipe and H-piles under the design load should not exceed 9000 psi<sup>120</sup>. For steel shells less than 1/10 in. in thickness, no contribution to bearing capacity from the shell should be credited. For steel shells 1/10 inch thick or greater, stress should not exceed 9000 psi<sup>120</sup>. Laboratory investigations should be made of the soils and water to which steel piles will be exposed to determine if corrosion will be a problem<sup>183,184</sup>. If corrosion protection is required, steel piles should be protected by a coal-tar preservative over a lead based primer from the pile cap to not more than 5 feet below the long term permafrost table. No corrosion protection is required, nor should it be used, below the latter depth in frozen soils. Reduction of the potential adfreeze bond may be expected as a result of shear failure in the coatings applied to the pile surface<sup>23</sup>. Any portion so coated extending below the permafrost table should be discounted in computing bearing capacity or frost heave resistance.

(3) **Concrete piles.**

(a) Concrete piles should not be used under conditions where frost heave forces may produce

tensile stresses sufficient to crack the piles and expose the reinforcing steel to corrosion. Steel in lightly reinforced and lightly loaded concrete piles may be stretched and substantially by frost heave forces, causing multiple cracking. The upward forces may be double the design loadings, causing complete stress reversal. Therefore, if the piles will be subject to heave forces, careful analysis should be made to insure that the amount of reinforcing steel in combination with structural loading is sufficient to prevent cracking. Prestensioned precast piles may be advantageous.

(b) Cast-in-place concrete piles should not in general be used in permafrost because of the hazards of either thawing the permafrost or freezing of the concrete. When such piles may be required in special cases, approval of HQDA (DAEN-ECE-G), WASH DC 20314 or HQUSAF/PREE, WASH, DC should be obtained based on field test evidence.

(c) The average compressive stress on any cross section of a pile should be in accordance with requirements in TM 5-818-1/AFM 88-3, Chapter 7<sup>5</sup>.

(d) Precast piles may be round, square, multisided or double T's. Handling, transporting and cutoff of concrete piles may be relatively expensive.

(4) **Special types of piles.**

(a) To assist freezeback at time of installation and to increase the degree of thermal stability under service conditions during period of below-freezing weather, several special types of metal pipe piles may be considered. Such piles, called as a group thermal piles, including self-refrigerated piles, serve not only to carry structural loads, but also to remove heat from the ground surrounding the embedded portion of the pile, and move it upward to the surface where it is dissipated to the atmosphere. In some cases only the heat removal function may be needed.

(b) In the two-phase system which operates on an evaporation-condensation cycle, analogous to a steam heating system with gravity condensate return, the pile is charged with propane, carbon dioxide or other suitable evaporative material". Evaporation of this material by heat flow from the ground and its condensation in the portion of the pile exposed to cold winter temperatures above the ground surface provides the heat transfer mechanism. Finned radiation surfaces are commonly employed above ground. Condensate returns by gravity to the liquid reservoir at the lower end of the pile.

(c) In the single-phase system or liquid convection cell, analogous to a gravity hot water heating system, the pile is completely filled with a suitable nonfreezing fluid, and heat is moved upward from the ground by a natural circulation induced by a density gradient of fluid resulting from the temperature dif

ference between the exposed top and the embedded bottom of the pile in winter<sup>145</sup>.

(d) Both the above systems are self-initiating systems. They automatically cease operation when air temperatures become warmer than those around the lower part of the pile. They are intended to require no operating attention once properly installed. Patents have been obtained for proprietary systems in both areas.

(e) In a fluid forced circulation system, analogous to a circulated hot water heating system, a pump is used to circulate a nonfreezing liquid or gas through the pile and through a surface heat exchanger exposed to the atmosphere in winter, or through a mechanically refrigerated heat exchanger without regard to season. The refrigerated fluid is usually introduced at the bottom of the pile through a central inner pipe and then flows upward in contact with the inner wall of the pile. The same objective may be gained by circulation of refrigerated fluid through tubing attached to the exterior of the pile for artificial freezeback as described in d (3) below. The refrigeration may be temporary for the purpose of achieving initial freezeback during construction or may be permanent where required by the design thermal conditions. Direct circulation of cold winter air through a pipe pile by a simple fan has been shown to be very effective in principle, but it is possible the circulation may be rapidly blocked by frost accumulation if the system is under unfavorable conditions; this alternative is therefore not recommended for permanent construction in the present state-of-the-art.

(f) Thermal piles which depend on seasonal dissipation of heat to the cold winter air may be expected to show a temperature drop effect to about 8 to 10 feet radius by the time above-freezing air temperatures arrive in the spring. At least a small depression of ground temperature should remain through the fall from this effect, in order for the piles to achieve their long range purpose. Piles which use artificial refrigeration can keep the ground refrigerated in all seasons.

(g) An essential requirement of all closed system thermal piles is freedom from leakage. Leakage of liquid containing antifreeze may seriously and permanently degrade the ad freeze bond strength of the pile. Leakage of gas through fittings, welds or porous metal may quickly make the system inoperative. All such installations must therefore be very carefully pressure tested to detect any leakage. All thermal pile units using liquefied petroleum products must be constructed to meet the standards of the National Fire Protection Association NFPA 58-1979 Standard for the Storage and Handling of Liquefied Petroleum Gases and the ASME Section VIII-1977 Pressure Vessels Division 1. Methods of computing heat transfer by thermal piles are presented in e below.

c. *Pile emplacement methods.* Many of the earlier foundations in permafrost used local timber, installed in steam or water-thawed holes to depths which rarely exceeded 20 feet. Normally the piles were pushed or lightly driven into the pre-thawed holes. They often required restraint to prevent flotation. Pile length and spacing tended to be dictated by structural requirements of the building rather than by pile bearing capacity or by the ability of the permafrost to accept the heat introduced during the installation. Pile installation techniques now utilize modern drilling or driving techniques and effectively minimize permafrost thermal disturbance. Installation methods are determined by ground temperatures, the type of soil, the required depth of embedment, the type of pile, and the difficulty and cost of mobilizing the required equipment and personnel at the site. Installation methods which may be considered are as follows: (1) Installation in dry augered holes.

(a) Holes for the piles may be drilled in permafrost by using earth augers with bits specially designed for frozen ground<sup>37,74,80,133,211</sup>. Two-foot-diameter holes can be advanced at rates up to about 1 ft/min in frozen silt or clay depending on type of bit, ground temperature and size of equipment. Holes up to 4 feet or more in diameter can be drilled readily in such soil. Advantages include minimum required effort and equipment, accurate positioning and alignment, and accurate control of hole dimensions and therefore of heat input into the permafrost. Drilling is easily carried out under winter conditions when the frozen ground surface permits ready mobility, without the problems of handling water or steam under freezing air temperatures. However, the method is not likely to be feasible in coarse, bouldery frozen soils. The holes may be drilled oversized and wood or pipe piles may be driven into the holes. However, more commonly the holes are drilled oversized and soil-water slurry is placed in the annular space around the pile and allowed to freeze back as described below.

(b) The mixture of soil and water (slurry) used to fill the annulus between augered hole and pile can often transfer the imposed pile loads to the surrounding frozen soil more effectively than the original in-situ soils. The auger-slurry method is easily adapted to production methods the auger followed by a pile-placing crane, followed by a slurry crew. If surface water is not entering the augered holes which would require relatively quick action, they may be covered with plywood, or by other methods, until pile placement is convenient. This will permit each crew to work independently. Silt from borrow or from the pile hole excavation can be used for the slurry, as well as gravelly sand, sand or silty

sand. Clays are difficult to mix and place and do not achieve good adfreeze strength values. Gravel, unsaturated soils or only water (ice) should not be used for backfill. Concrete should not be used to backfill around piles in drilled or augered holes in permanently frozen ground. Organic matter (peat) should not be permitted in the material used for preparation of the slurry. Strength and creep properties of slurries are discussed in more detail in f(l) below.

(c) Slurries are normally prepared in portable concrete mixers by adding sufficient water to bring the slurry within a prescribed range of water content. The mix water temperature may be warm or even heated when using frozen cuttings. When thawed borrow material is used water is chilled by the addition of snow and/or ice. When mixed, slurry temperature should under no circumstances exceed 40 °F. The slurry should have the consistency of 6 inches slump concrete, the consistency being specified and monitored by field inspectors using a calibrated container from which the acceptable range of wet unit weights can be quickly determined. Normally the mixing crew can reproduce the desired consistency quite easily after establishing the appearance and viscosity during the first or second batch. Methods for control of components may be similar to those used in concrete batching. Based on past experience, continuous inspection of the mixing operation should be made to insure that no more water than necessary to saturate the soil and to produce the desired consistency of the slurry is used and that temperature of the mix is kept low.

(d) The slurry is normally placed by direct backfilling by wheelbarrow on small jobs or by the use of concrete buckets with cranes on large jobs. Tremie pipes or direct pumping may be advantageously used on some jobs but during cold weather, operations are often a source of major trouble because of freezing. Normally the pile after being centered and plumbed in the hole is backfilled with the slurry in one continuous operation. It is very important that the material be vibrated with a small diameter concrete spud vibrator and rodded to ensure that there are no bridging and no voids left along the pile, which can often happen when backfilling around cylindrical piles, especially if tremie pipe is not used. Care should be taken during placement of the slurry to avoid moving or bending the pile by placing the slurry too fast from only one side. Small form vibrators may also be attached directly to the pile to aid in uniform flow around the pile during backfilling and to hasten consolidation of the backfill. Rapping the sides of the pile with a sledge hammer also aids the backfilling and consolidation.

(e) Timber piles quite often float or rise up when backfilled with silt-water slurries and must be restrained or weighted. Anchoring timber piles may also be accomplished by backfilling only a portion of the

hole depth and permitting the lower portion to freeze back before completing the backfill. Care must be taken not to coat the pile or hole wall with the slurry above the level of the backfill since it will freeze in place, and tend to prevent complete filling of the voids when the final lift is placed later. To avoid flotation no additional slurry backfill should be placed around the pile until the pile has frozen solidly in place.

(f) Backfilling may also be accomplished by filling the hole with silt-water slurry, just prior to placing the pile, sufficiently to bring the slurry to the surface when the pile is inserted to proper depth. Piles thus placed are more difficult to plumb and position but when such factors are not critical this method is much faster. H-piles are easily placed by this method; timber and closed-end pipe piles have a strong tendency to float. Such prior backfilling of holes should not be attempted when using sand backfills unless the piles are to be driven into the unfrozen slurry.

(g) Normally no attempt is made to completely clean or to bell the bottom of augered holes, some loose cuttings always remaining. Bottom portions of holes drilled too deep can be backfilled as necessary with sand or gravel slurry while the pile is suspended in the hole. The pile may be dropped a short distance to compact the cuttings or backfill. Piles (except H-piles) should not be placed closer than 1 inch to the walls of augered or drilled holes.

(h) To minimize the amount of heat to be introduced into the ground by the slurry, the annular space is made only just large enough to allow the slurry to be efficiently placed and vibrated with a small diameter concrete vibrator. Vibration is needed to insure that the space will be completely filled without air entrapment. Except for H-piles, a minimum of about 3 inches oversize in diameter is required to permit use of a 1-inch-diameter vibrator in the annular space. Additional allowance is usually made because of the difficulty of achieving exact centering of the pile in the hole and because of pile irregularities such as lack of straightness. A hole size 4 to 6 inches larger than the pile diameter commonly has been used, but it should be kept as small as practical for the particular situation.

(2) *Installation in bored holes.* Holes for the piles may also be made by rotary or churn drilling, or even by drive coring under some conditions, using various bits, drive barrels, etc., and removing frozen materials with air, water and/or mechanical systems<sup>55,74,153</sup>. Procedures are otherwise the same as for dry augered holes. By proper selection of equipment, any type of frozen ground may be handled. Use of water or warm air for removal of cuttings may introduce undesirable quantities of heat into the permafrost and must be carefully controlled.

(3) *Installation by driving.*

(a) Conventional or modified pile driving procedures including diesel and vibratory hammers may be used to drive open-ended steel pipe and H-section to depths up to 50 or more feet in frozen ground composed of silty sand or finer-grained soils, at ground temperatures above about 25°F<sup>48,49,55,74,169</sup>. Some experience indicates that, under favorable conditions, heavy pipe and H-sections can be driven into ground at lower temperatures, as described in paragraph 2-6. Although the pile is heated by the driving action and a thin zone of soil may be thawed at the soil/pile interface, the amount of heat thus introduced into the permafrost is usually negligibly small and freezeback is normally complete within 15 to 30 minutes after completion of driving. Because no drilling of pile holes is required, because no slurring is involved, and because total installation equipment can be minimal, this installation technique can be even simpler than the dry augered hole technique. However, the procedure is limited to steel pipe and H-piles, and it is necessary to make certain that sufficient driving energy is available to reach the depths of penetration needed for bearing and to resist frost heave. Templates should be used to assure accurate placement of piles.

(h) The smallest H section to be considered for driving in frozen soil should normally not be smaller than 10BP42 and the rated hammer energy should not be less than 25,000 ft-lb. When piles are driven with conventional or vibratory hammers, advance should be continuous, since there is a negligible amount of heat evolved, and stops longer than 5-10 minutes can permit freezeback to the extent that resumption of driving will be impossible, or possible only after a prolonged period of heavy driving. Necessity for stops to weld on additional lengths should be avoided. The use of chemicals, jetting or steaming should not be permitted during driving although the pile may be preheated (particularly lower half) as it enters the ground to minimize side friction during pile penetration.

(4) *Installation by steam or water thawing.* Until the early 1950's, piles were traditionally installed in permafrost by prethawing the ground at the pile locations by steam points before driving. An alternative was water thawing. However, these techniques have the disadvantage of introducing so much heat into the ground that freezeback may be almost indefinitely delayed. This involves not only the volume of permafrost thawed by the steam or water, which is difficult to control, but also the warming of a large volume of surrounding frozen material. The result may be failure to develop adequate bearing capacity and/or progressive working of the piles out of the ground by frost heave with consequent damage to supported structures. Many such failures have occurred. Therefore, steam or water thawing should not be used in any area where the mean annual permafrost temperature is greater than 20°F and

may be used in colder heat input into the ground if alternative methods of installation are not feasible.

d. *Freezeback of conventional piles.*

(1) General.

(a) Piles and anchors in permanently frozen ground attain their holding capacities only after they are frozen solidly in place. Pile-supporting capacity in permafrost is dependent primarily on the strength of the adfreeze bond between the permafrost and the pile surface. The strength of the bond is a function of temperature and is at its lowest and most critical value in the fall and early winter when permafrost temperatures at the levels in which the piles are supported are at their warmest. Therefore, any unnecessary transfer of heat from the structure to the foundation will tend to have an adverse effect on the supporting capacity. In far northern areas the reserves of supporting capacity and stability may be so large that small variations in heat input to the foundation will be of little consequence; in marginal permafrost areas, however, the effect of even small unanticipated heat inputs may be extremely critical.

(b) Freezeback of slurry or otherwise thawed soil surrounding piles must be assured before imposing any load upon the pile. Thus, in addition to the time required to install the pile, the construction schedule depends on the time required for freezeback of the pile. If foundation piles are installed well in advance of the structural construction or if the permafrost temperature is well below freezing, there may be adequate time available for natural freezeback by permafrost. If the construction time is short and the work is to be continuous or if the permafrost temperature is warm, use of artificial refrigeration or thermal piles may be required. Thus, the foundation thermal conditions may determine both the design and the method of construction to be employed.

(c) In order to measure the rate and effectiveness of freezeback of slurried piles, and to permit monitoring of subsequent foundation performance, thermocouple or thermistor assemblies should be attached to representative piles or thermistor assemblies should be attached to representative piles in the foundation. When artificial freezeback is employed using tubing attached to the pile exterior, the temperature sensors should be placed midway between tubes where freezeback will be longest delayed. A control thermocouple assembly installed at an adjacent undisturbed area and in equilibrium with the ground temperatures is essential for comparison with temperatures at the piles. To avoid conflicts all monitoring equipment should be provided, installed and observed by the Government.

(d) Since fine-grained soils tend to freeze or thaw at temperature levels depressed below 32 °F,



theoretical computations of freezeback and pile spacing involving such materials should use the actual freezing or thawing temperatures, rather than 32 °F. This is especially important when normal permafrost temperatures exceed about 29 °F to 300°F. If either the slurry material or the permafrost is other than silt, sand or gravel in which practically all the moisture freezes at the nucleation temperature, the volumetric latent heat of the slurry and/or the volumetric heat capacity of the permafrost within the range of the placement, freezeback, and thermal adjustment temperatures will have to be determined by test. The freezing characteristics of the soil can be ascertained in the laboratory by generating a cooling curve with time<sup>160</sup> or by calorimetry; they can also be inferred from study of natural in-ground temperatures during seasonal freeze-thaw flux. In important projects, test piles instrumented with thermocouples or other temperature indicating devices should be used to verify the freezeback potential of the permafrost prior to actual construction. Since test conditions can seldom be identical with the actual construction ground temperatures, the results must usually be analytically transformed to the construction conditions.

(2) *Natural freezeback.*

(a) Soil-water slurries placed in drilled or augered holes introduce heat, which in natural freezeback is conducted into the surrounding permafrost. The heat content of the water, soil, and pile can be computed, if the water content and dry unit weight of the slurry are known or determined by experiment. Slurry placed at temperatures from 32 °F to 40 °F, under normal conditions, has a total heat content above 32°F of less than 200 Btu/ft<sup>3</sup>; this is small enough to be merely approximated and added to the latent heat in the computation procedures outlined below.

(b) The latent heat per foot of pile length is computed by the equations shown in figure 4-70. Note that the latent heat is governed only by the volume of slurry, the water content (w) and dry unit weight (d). Thus, the heat input into the permafrost can be minimized by control of the dimensions of the annulus (which is also a function of the type of pile) and by selection and control of the slurry. Simple comparisons of the amount of latent heat per unit volume of slurry can be made using the following equation, assuming all the water freezes:

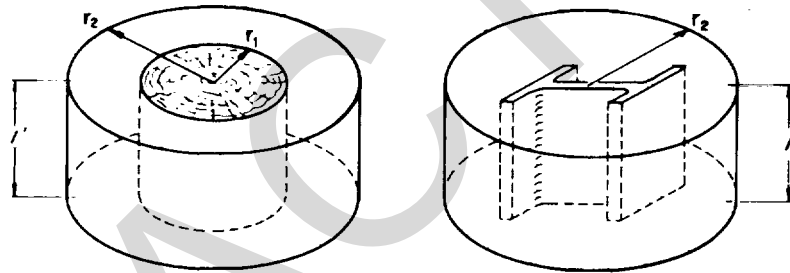

$$Q = \pi L(r_2^2 - r_1^2)w\gamma_d \text{ or } Q = L(\pi r_2^2 - A)w\gamma_d$$

where L = Latent heat of water  
 $r_2$  = Radius of hole  
 $r_1$  = Radius of pile  
 A = Cross sectional area of H-pile  
 w = Water content, percent dry weight/100  
 $\gamma_d$  = Dry unit weight of slurry.

U. S. Army Corps of Engineers

Figure 4-70. Latent heat of slurry backfill<sup>134</sup>.

$$Q = L w \gamma d \text{ (Equation 8)}$$

where

L = latent heat, 144 Btu/lb of water

w = water content, expressed as decimal

$\lambda d$  = dry unit weight, lb/ft<sup>3</sup>.

Examples are as follows:

For w = 80 %,  $\lambda d = 53$ ,  $Q = 144 (0.80)(53) = 6100 \text{ Btu/ft}^3$

For w = 40%,  $\lambda d = 80$ ,  $Q = 144 (0.40)(80) = 460 \text{ Btu/ft}^3$

For w = 19%7,  $\lambda d = 109$ ,  $Q = 144 (0.19)(109) = 3140 \text{ Btu/ft}^3$

(c) Thus, a silt slurry or one with an excess of water may introduce considerably more heat than a sand slurry or one in which the amount of water is carefully controlled.

(d) When the slurry moisture content is carefully controlled, the slurry will retain relatively uniform characteristics after freezing. However, if the slurry has an excess of water, consolidation of the soil component may result in separation of excess water from the slurry. Even while freezeback is proceeding inward from the wall of the hole, bridging of the soil in the relatively narrow annular space may result in formation of essentially soil-free slugs of water between masses of consolidated slurry. Because of their high heat content, the water inclusions will freeze back more slowly than the consolidated slurry. If the water inclusions occur within the annual thaw zone, they may thaw and escape to the surface in subsequent seasonal thawing, even though frozen initially, and settlement of the overlying slurry may then occur, requiring backfilling of the resulting depression around the pile.

(e) Freezeback of slurry proceeds primarily from the wall of the hole inward toward the pile. If the pile itself is below freezing temperature, freezing may also occur from the pile surface outward, particularly if the pile is a pipe type open at the surface to admit air at low temperatures. When the slurry is composed of frost susceptible fine-grained soil, multiple small ice lenses will form during freezeback; these are oriented vertically, parallel to the wall of the hole. An annular layer of ice normally forms at the contact between the slurry and the wall of the hole, sometimes as much as an inch thick; this has no significant effect upon the pile bearing capacity. A similar layer of ice may also form on the surface of the pile; because the ability of the material at this contact surface to endure tangential shear stresses is controlling in determining allowable pile bearing capacity, the occurrence of such an ice layer may be significant. If piles of any type are placed during below freezing air temperatures by the slurry method it should be assumed, unless evidence can be presented to the contrary, that an ice layer, however thin, will form on the surface of the pile. In such cases it will be necessary to

assume allowable tangential adfreeze bond stress corresponding to whichever is the weaker, under the critical permafrost design temperature, of pure ice or consolidated slurry. (For further discussion of strength of ice vs. strength of frozen soil, see f(1) below.) This problem will not arise when piles are installed in permafrost by driving.

(f) While it may be possible to avoid formation of an ice layer on the pile during installation at low temperatures by use of non-frost-susceptible slurry a number of problems may cause difficulty in achieving this result. In the first place, a slurry conforming to the common definition of non-frost-susceptible material presented in TM 5-818-2<sup>6</sup> is not necessarily completely non-frost-susceptible. That criterion assumes that a certain low level of frost susceptibility is tolerable in pavement applications and is based upon freezing rates experienced under pavements. Validity of the criterion for slurry freezeback conditions has not been investigated. Also, under field conditions it may be difficult to insure that some contamination with fines may not occur from contact of the above-freezing slurry with the wall of the drilled hole, or from other sources.

(g) Some test pits made around piles which have been in place a year or more have shown a layer of ice on the pile extending from the ground surface through the annual thaw zone, attributed to segregated freezing of seasonally thawed moisture. Such an ice layer limited to the annual thaw zone is not significant in terms of the pile bearing capacity.

(h) Measurements on 8-inch steel pipe piles exposed to the atmosphere and sunlight above the ground in a region of borderline permafrost have shown that thawing may typically reach several inches below the top of permafrost immediately adjacent to the pile surface at a location where the permafrost table is 3.8 feet below the ground surface. An additional few inches may have especially low tangential adfreeze bond strengths. Therefore, the assumed effective length of embedment in permafrost of all properly installed dark-surfaced piles exposed to sunlight should be reduced by a nominal 15 inches. No reduction is required for piles completely shaded, shielded, or painted a highly reflective white, regardless of type of pile. For piles improperly installed, as by uncontrolled steam thawing, no valid guidance can be given.

(i) Knowledge of ground temperature with depth is essential to estimate the freezeback time and overall effect of the installation on the permafrost. Plots showing seasonal variation of depths of isotherms in the ground or plots of temperature with depth may be used to select the optimum installation period for rapid freezeback. Available methods of computing natural freezeback of piles in permafrost assume the slurried pile to be a finite cylindrical heat source inside a semi-

infinite medium, with a suddenly applied constant temperature (32°F) source which dissipates heat only in a radial direction into frozen ground of a known initial temperature<sup>14,134</sup>. The general solution for the natural freezeback problem, based upon latent heat content of the slurry, is shown in figure 4-71.

(j) To determine the time required for freezeback at different permafrost temperatures, it is easier to use a specific solution similar to that shown in figure 4-72, prepared from the general solution. The specific solution is computed using the known or estimated thermal conductivity and volumetric heat capacity of the permafrost and the diameter of the hole to be used. As previously noted, allowance for any heat content of the slurry above 32°F may be made with sufficient accuracy by adding this heat content to the volumetric latent heat, Q; this assumes that the placement temperature of the slurry is controlled below about 40°F. The specific solution in figure 4-72 clearly demonstrates the effect of latent heat of slurry and initial

permafrost temperature on the time required for freezeback.

While not specifically shown in figure 4-72, months may be required to freeze back slurries of 10,000 Btu/ft<sup>3</sup> or more volumetric heat capacity at permafrost temperatures between 30" and 32°F. Under otherwise identical conditions, a sand-water slurry in 28 °F permafrost could freeze back in 2 or 3 days while a siltwater slurry would take 10 to 11 days; however, in 31.5 °F permafrost, a freezeback time of about 16 days would be required for the same sand-water slurry and about 130 days for the same silt-water slurry. Thus, for given pile spacings careful selection of the pile type, hole size, slurry material, and installation season, plus careful control of water content, can substantially reduce the amount of heat which must be absorbed by the permafrost and the time required for freezeback.

(k) The preceding general and specific solutions

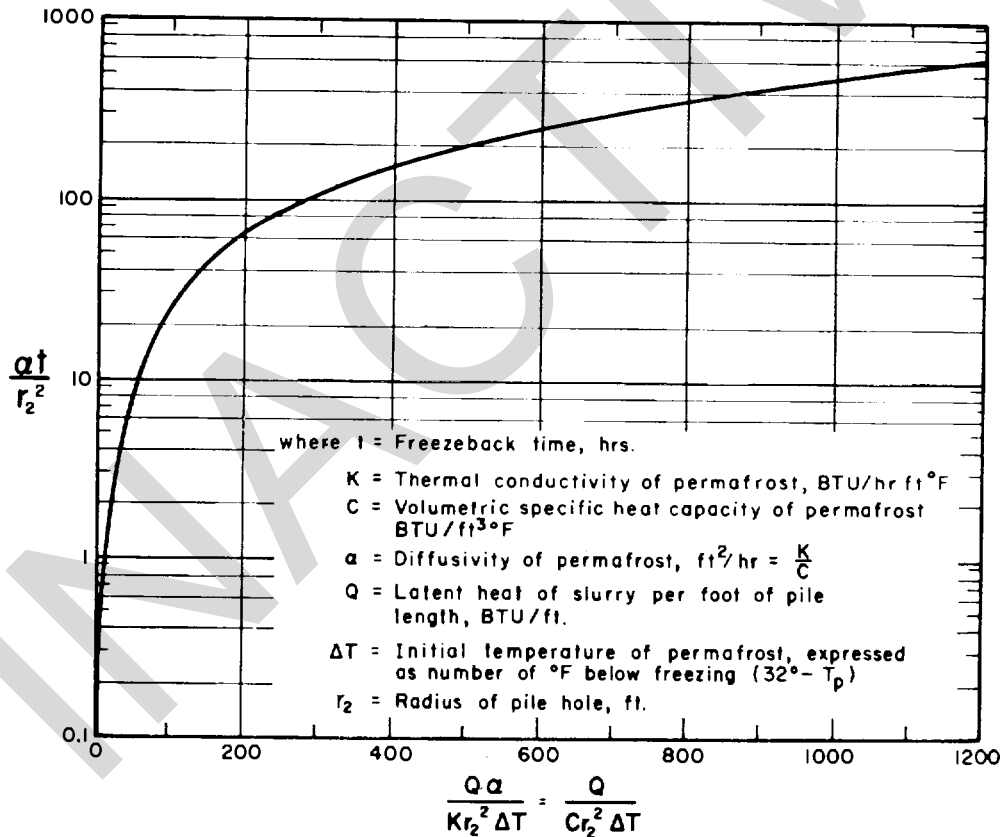

U. S. Army Corps of Engineers

Figure 4-71. General solution of slurry freezeback rate<sup>134</sup>.

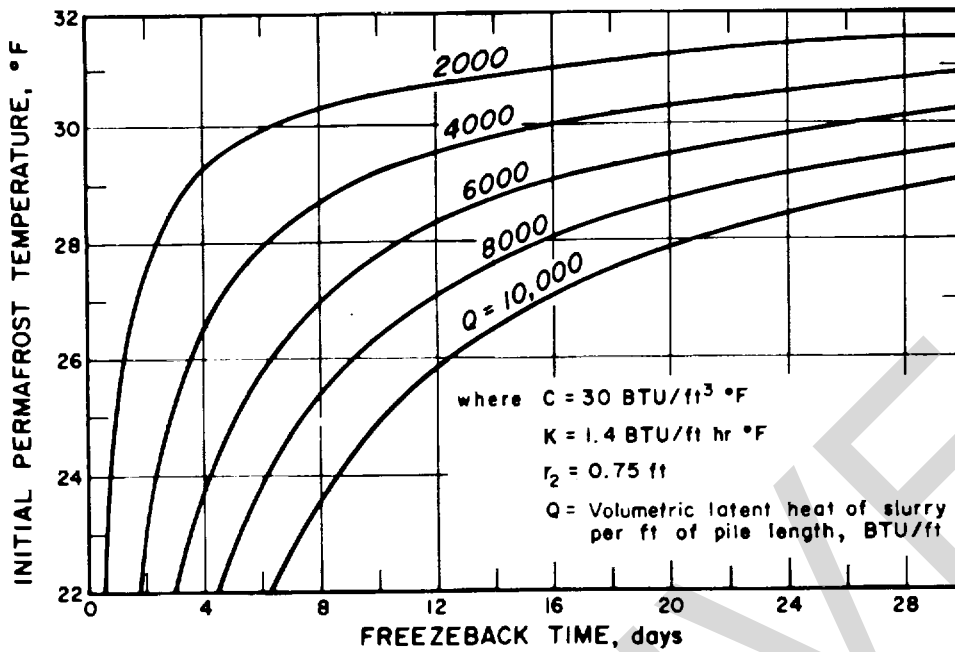

U. S. Army Corps of Engineers

Figure 4-72. Specific solution of slurry freezeback rate<sup>134</sup>.

assume the slurry heat to be conducted only in a horizontal radial direction. The actual heat paths during summer and winter are approximately as shown in figure 4-73. However, while freezeback time may be increased or decreased by deviations of heat flow from the horizontal, and adjustment of the assumed "effective" temperature of the permafrost may sometimes be necessary to allow for this effect, the increase in freezeback time which may be caused by proximity between adjacent piles is a more dominant consideration ((4) below), everything else being equal.

(3) Artificial freezeback.

(a) When ground temperatures are too warm or the amount of heat introduced is too great to accomplish natural freezeback of slurry within the planned construction period, artificial refrigeration must

be used to accomplish the desired freezing of the backfill. The artificial freezing may be accomplished by circulation of refrigerating fluid through longitudinal or spiral steel or copper tubing attached to the pile, or by use of thermal piles as described in e below. Brine or glycol solutions and ambient air have all been used as the circulating fluid. However, the use of propane or other refrigerants of similar characteristics has been found to be the most efficient and economical. Propane has the disadvantage of flammability. The refrigerant may be circulated through piles either individually or in series, using a portable compressor, as shown in figures 4-74 and 4-75. The size of the compressor depends on the number of piles to be frozen and the amount of heat to be removed from the slurry. Pipe size, exposure area per foot of pile length, and rate of circulation are other

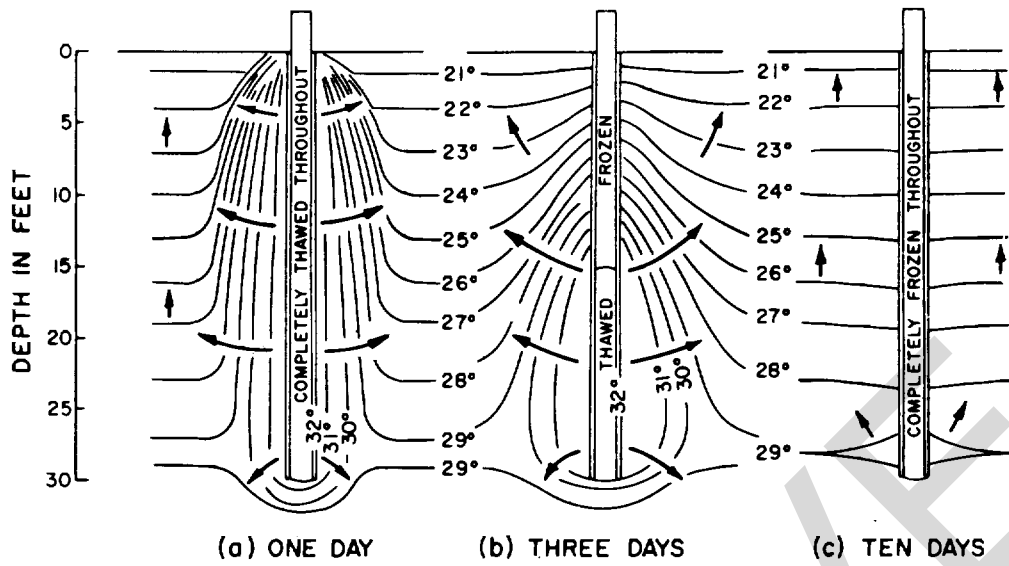

**a. LATE WINTER**

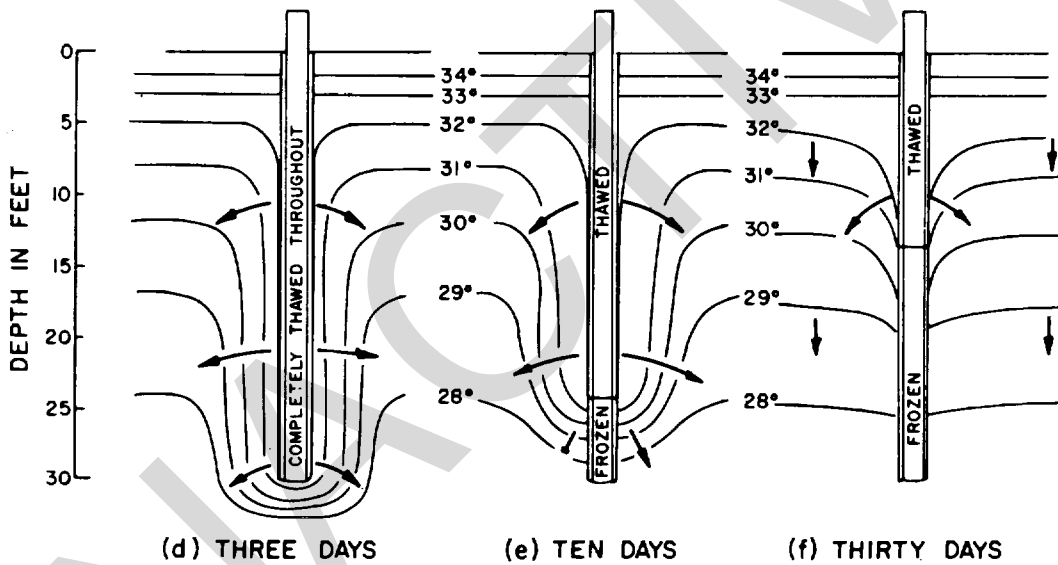

**b. LATE SUMMER**

U. S. Army Corps of Engineers

Figure 4-73. Natural freezeback of piles in permafrost during winter and summer<sup>134</sup>.

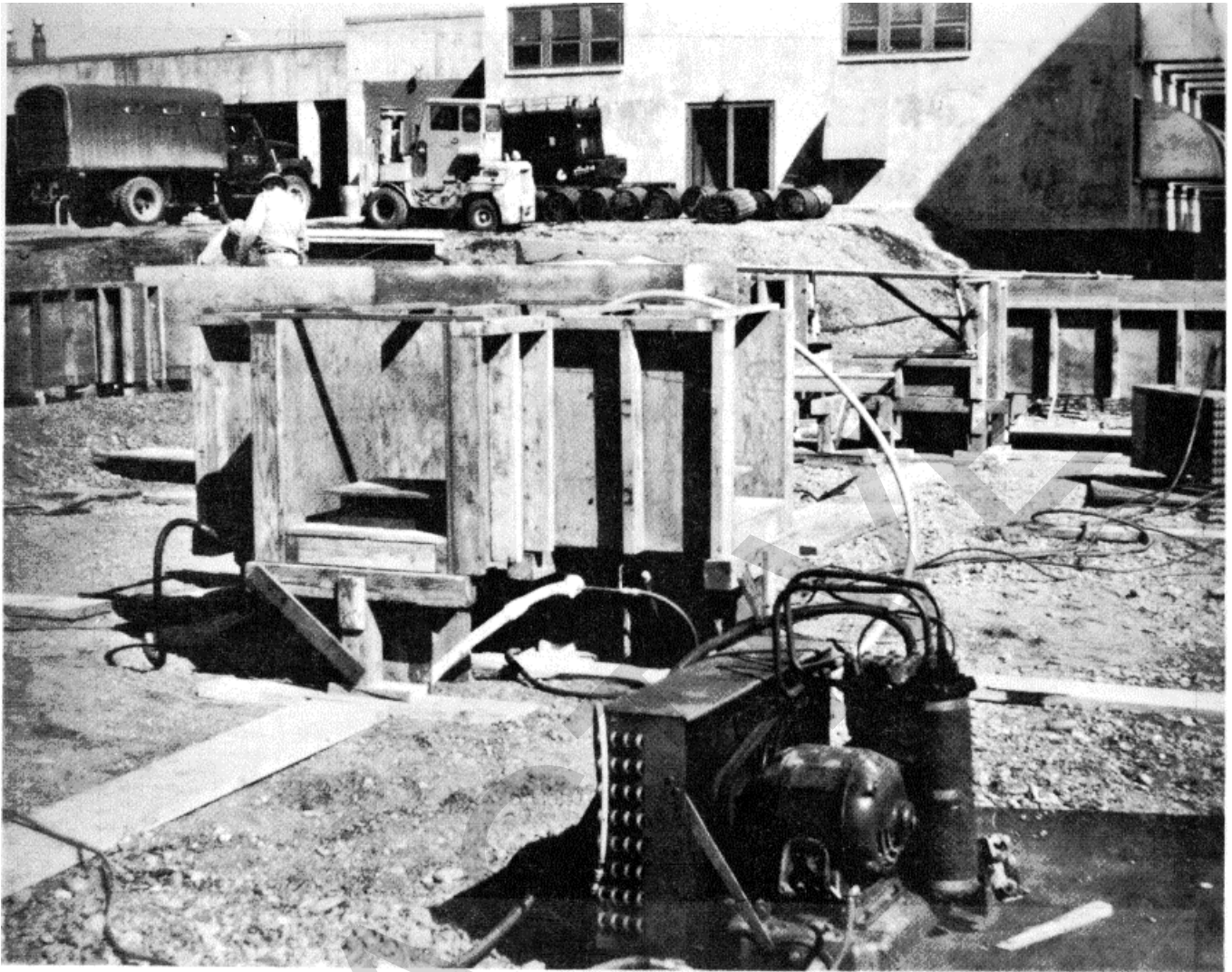

*Figure 4-74. Compressor for artificial freezeback of piles.*



*Figure 4-75. Refrigeration coils on timber piles for artificial freezeback.*

parameters influencing the rate of freezeback. Method of computing freezeback time for a given refrigeration capacity is given in TM 5-852-6/AFM 88-19, Chap 6<sup>14</sup>. By limiting the time between slurry placement and start of refrigeration to less than a day, the heat gain by the surrounding permafrost can be minimized. Establishment of a proper freezeback criterion is very important. Very low temperatures can be produced at a given moment close to the refrigerant tubing but the soil may still be unfrozen several inches away. Therefore, the duration of the refrigeration period should be established as that which when suspended for 24 hours will produce frozen ground temperature at the critical freezeback location no greater than the normal ground temperature at that position. The controlling depth where the freezeback is slowest is often about 20 feet, but may be anywhere between the top of permafrost and the bottom of the pile. Temperatures may also need to be monitored simultaneously at two or more different depths for control. When the required period of refrigeration has been established for one or more monitored piles, it is thereafter necessary to monitor freezeback on only a limited number of selected production piles for spot check purposes. Careful records should be kept of the freezing plant and ground temperature observations.

(b) Unless refrigeration is to remain permanently in operation, refrigerant tubes on the piles should be filled with arctic engine oil chilled to below existing ground temperatures and sealed when the refrigeration period is completed. Should refrigeration be required at a later date, oil can be removed and the refrigeration system reactivated with minimum effort; in the interim, the oil provides protection against corrosion and ice blockage.

(c) Internal refrigeration of pipe or other hollow piles can be accomplished by use of automatic or forced circulation thermal piles as described in e below.

(d) Artificial freezeback can also be accomplished by the evaporation and expansion from the liquid or solid state of gases vented to the atmosphere. Such gases include nitrogen, carbon dioxide, propane and other similar materials. Dry ice has, for example, been placed in pipe piles to effect rapid freezeback. Such means of rapid freezeback are usually too expensive for use in large installations but can be effectively employed in small installations.

(4) Relation of pile spacing to freezeback.

(a) The spacing of piles is normally based on structural requirements of the floor system or on the need to provide a sufficient number of piles to support relatively large concentrated vertical loads. Consideration of pile spacing in early phases of the structural design may make it possible to provide sufficient distance between piles so that in permafrost areas natural freezeback can be utilized to effect substantial savings.

(b) Driven piles, which introduce negligible amounts of heat, have no critical spacing other than that required to facilitate movement and operation of the driving equipment or that introduced by possible group action effect in the foundation.

(c) Slurried piles, however, produce an overall rise in permafrost temperature<sup>134</sup>. The effect of pile spacing on permafrost temperature rise at different slurry heat values is illustrated in figure 4-76. The relationship between temperature rise and slurry heat, as influenced by the volumetric heat capacity of the permafrost and spacing, is given by the equations in the figure. If the rise in permafrost temperature ( $\Delta T$ ) indicated by figure 4-76 should exceed the difference between the freezing point and the initial permafrost temperature ( $T_f - T_p$ ) the permafrost can not freeze more than the amount of slurry water which will raise the permafrost temperature to its thawing point. Heat exchange cannot occur when permafrost and slurry are at the same temperature. The remaining slurry will not freeze until the surrounding permafrost becomes colder. Actual freezing or thawing temperatures of the materials should be used in the analysis where these differ from 32°F.

(d) No factor of safety is incorporated in the pile spacing effect equations and chart presented in figure -I 4-76. Therefore, it is essential that temperature indicating devices be required as part of the design to verify freezeback during construction (again taking into account the freezing characteristics of the soil).

(5) *Period of installation.*

(a) The natural freezing rate of slurried piles is primarily dependent on initial ground temperatures of the permafrost and the spacing of the piles<sup>134,137</sup>. As illustrated in figures 1-1 and 1-3, the coldest ground temperatures are experienced in the spring. In areas of marginal permafrost, permafrost temperatures are so high that there is insufficient "reserve of cold" in the permafrost to insure natural freezeback of slurried piles except in spring (approximately February, March, April and May). If slurried piles must be installed in marginal permafrost areas at other times of the year, artificial refrigeration must be employed to insure slurry freezeback. If freezeback is not completed before the refreezing of the annual frost zone starts in the fall, and frost heaving occurs, the adfreeze bonding required for support of the design load may never be achieved. On the other hand, steel piles may usually be installed in fine-grained permafrost soils by driving at any time of the year in these areas without freezeback problems. Where permafrost temperatures are below about 25°F, installation by driving will usually be impractical, thus - requiring a slurried type of installation. However, at



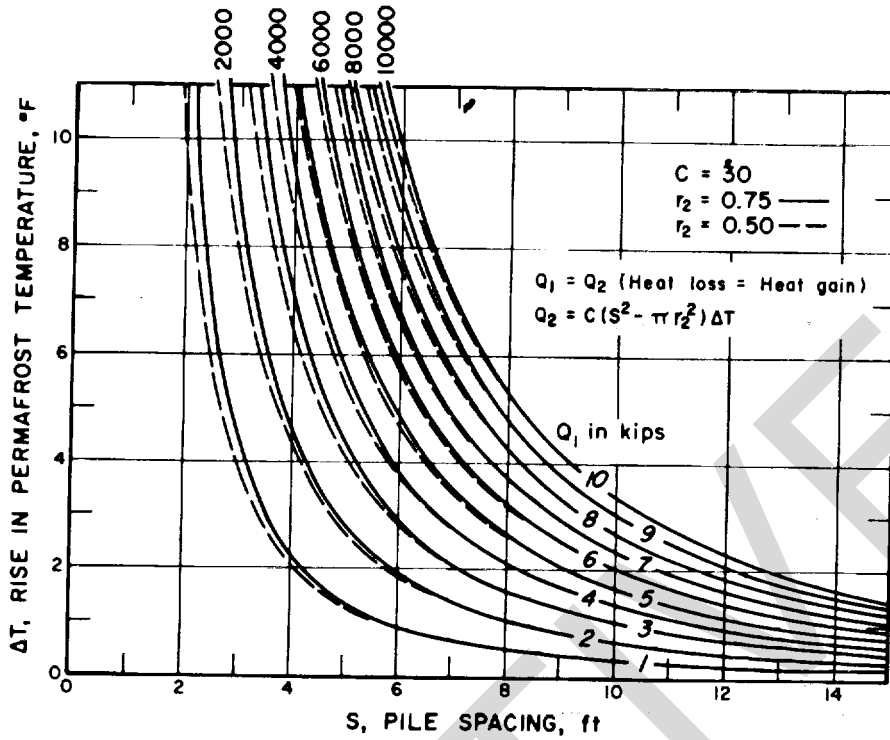

where  $Q$  = Latent heat of slurry, BTU/ft of pile length  
 $C$  = Volumetric heat capacity of permafrost, BTU/ft<sup>3</sup> °F  
 $S$  = Pile spacing, ft.  
 $r_2$  = Radius of pile hole, ft.  
 $\Delta T$  = Rise in temperature of permafrost, °F.

Figure 4-76. Influence of slurry on temperature of permafrost between piles<sup>134</sup>.

such temperatures problems of slurry freezeback are greatly reduced. If augering is accomplished prior to start of thaw in spring or early summer, the holes normally require no casing and are not subject to filling with melt water. Augering cold frozen soils requires no additional power; in fact cold frozen cuttings are easier to displace at the surface when spin-removed and are easier to shovel or scoop up for removal or use in the slurry. Snow on the ground surface may be partially or completely removed, but compacted snow offers a good working surface which helps to protect vegetative cover. Compaction of snow greatly reduces the insulation value of the snow cover, permitting colder temperatures to develop in late winter.

(b) Most construction contracts involving slurried piles are awarded so as to permit the contractor to install piles in late winter or spring, thereby allowing the work to progress throughout the summer, with the structure being closed in against weather by late fall. If the pile installation is done in summer and fall the

work tends to be hampered by ground water, sloughing of soils in holes, slow freezeback, and a loss of equipment mobility on the ground surface unless a granular mat is placed. Even though the ground surface may be frozen in fall, a residual thaw zone may still be present well into the winter, possibly requiring a casing to seal off ground water and sloughing soil. Early winter is also unfavorable because air temperatures are often uncomfortable, there is minimum daylight for work, and ground temperatures in the permafrost are near their warmest.

(c) On the other hand, piles which are to be driven into frozen soil can be best driven in the early winter. In the spring, open-ended pipe piles are somewhat more difficult to drive than in the early winter because of colder permafrost temperatures, the presence of the seasonal frost layer and the tendency of the soil plug developed inside the pipe to wedge against the sides. This wedging action can develop to an extent

that the effort required to advance the pile is similar to that required for a closed-end pipe pile and may make it impossible to advance the pile at all. Normally H piles require less additional effort in the spring as compared to fall.

(d) The design engineer should therefore carefully consider the period of installation with respect to mobilization, transportation, work and equipment efficiency, ground water and soil problems when augering as well as the attendant freezeback time. Since the problems associated with the installations at different periods of the year will be reflected in the quotations.

e. Heat transfer by thermal piles.

(1) Two-phase thermal piles.

(a) As previously noted, the two-phase system operates on an evaporation-condensation cycle wherein the vapor condenses on the inner walls of the pipe pile and flows down the pipe walls to mix with the liquid phase. The requirement for spontaneous operation of the device is that the temperature in the upper reaches of the interior wall must be colder than the saturation temperature of the vapor. The selection of the refrigerant should consider such factors as its vapor pressure, vapor density, and flammability. A refrigerant having a low vapor pressure at a given temperature will tend to minimize the leakage potential and to simplify sealing. A high liquid density at a given temperature will tend to increase the gravity forces which remove the liquid condensate after its formation on the upper walls of the pile. Although the thermodynamics of the internal pipe refrigerant are important, particularly the thermal resistance of the condensate film which varies in thickness along the interior pipe wall, the governing resistance (exclusive of the freezing soil surrounding the pile) may be assumed to be the air boundary layer on the pile's exterior surface. This is particularly true for conditions of heat transfer from the exposed portion of the pile by essentially natural convection. On this assumption, rate of heat transfer to the exterior from the exposed surfaces of a two-phase thermal pile may be estimated using the following equation: further, assuming that; the pipe and soil are in intimate contact along the entire buried portion; the pipe relies solely upon heat dissipation from its vertically oriented surface i.e., no horizontal piping connections at the surface) and; the pile is of sufficient diameter so that the upward vapor flow and downward condensate flow do not impede their mutual development:

$$\Delta T = T_v - T_a, \text{ } ^\circ\text{F}$$

$$T_v = \text{refrigerant vapor temperature, } ^\circ\text{F}$$

$$T_a = \text{ambient air temperature, } ^\circ\text{F}$$

$$A_l = \text{surface area of pile exposed to air per lineal foot, } \text{ft}^2$$

$L_a$  = length of pile exposed to air, ft

(b) The addition of fins to the pile improves its heat transfer capability. An indication of this improvement can be determined for a *unit length of pile per fin* by:

$$q_o = 2 \delta K_1 N \Delta T \tanh (Nw + \sqrt{Nu}) \quad (\text{Equation 10})$$

where

$$\sqrt{Nu} \leq 1/2$$

$\delta$  = half thickness of fin, ft

$K_1$  = thermal conductivity of fin material, Btu/ft hr  $^\circ\text{F}$

$$N = \sqrt{h_c / K_1} \delta$$

$w$  = width of fin, ft

$$Nu = \text{Nusselt number} = \frac{h_c \delta}{K_1}$$

(c) For the case of unfinned piles, natural convection (no wind), and assuming that turbulent conditions generally prevail, the equation  $q = hc A \Delta T = hc A (T_v - T_a)$  (equation 9) is modified by introducing:

$$h_c = C_1 K_{\text{air}} a (T_v - T_a)^{1/3} \quad (\text{Equation 11})$$

where:

$C_1$  = constant = 0.13 (vertical cylinder)

$K_{\text{air}}$  = thermal conductivity of air at temperature

$$T_m = 1/2 (T_v + T_a), \text{ Btu/ft hr } ^\circ\text{F}$$

$a = g \beta \rho c_p / \mu K_{\text{air}}, 1/\text{ft}^3 \text{ } ^\circ\text{F}$  (see table below)

where:

$a$  is determined for the mean temperature condition,  $T_m$

$g$  = acceleration of gravity, ft/sec<sup>2</sup>

$\beta$  = coefficient of expansion for air, 1/ $^\circ\text{F}_{\text{abs}}$

$\rho$  = air density, lb/ft<sup>3</sup>

$c_p$  = specific heat of air at constant pressure, Btu/lbm  $^\circ\text{F}$

$\mu$  = absolute viscosity of air, lb<sub>m</sub>/ft hr

Thus, for unfinned piles, natural convection, no wind:

$$q = 0.13 K_{air} a^{1/3} A (T_v - T_a)^{4/3}$$

(d) For the case of unfinned piles, forced convection, induced either naturally by wind or mechanically, the surface transfer coefficient is modified and the equation is:

$$q = h_c A (T_v - T_a) = \frac{K_{air}}{D} (0.82) \frac{VD\rho}{\mu} 0.585 A(T_v - T_a)$$

where:

V = wind velocity, ft/hr

D = outer diameter of pile, ft

Values of factors  $\rho$ ,  $\mu$ , a and  $K_{air}$  for various values of  $T_m$  are given below:

$T_m$ (°F)	$\rho$ (lb/ft <sup>3</sup> )	$\mu$ (lb <sub>m</sub> /ft hr)	a (1/ft <sup>3</sup> °F)	$K_{air}$ (Btu/ft hr)
32	.0807	.0417	$2.21 \times 10^6$	.0140
20	.0827	.0408	$2.50 \times 10^6$	.0136
0	.0863	.0394	$3.00 \times 10^6$	.0131
-10	.0882	.0387	$3.47 \times 10^6$	.0129
-20	.0902	.0380	$3.93 \times 10^6$	.0126
-30	.0923	.0373	$4.53 \times 10^6$	.0123
-40	.0945	.0366	$5.21 \times 10^6$	.0121
-50	.0968	.0358	$5.74 \times 10^6$	.0118
-60	.0992	.0351	$6.47 \times 10^6$	.0115
-70	.1018	.0344	$7.24 \times 10^6$	.0113

(f) Computation of heat transfer during freezeback. The thermal pile may be used to accelerate freezeback of the slurry in a preaugered hole. It would thus tend to supplement the in-situ permafrost's freezeback capability. As noted in figure 4-72, a wet slurry of 10,000 Btu/ft in a relatively warm permafrost at 28°F would require about 20 days to freeze back naturally for the numerical values assumed in that example. An indication of the reduction in freezeback time afforded by the thermal pile is developed below.

(g) Example. Assuming a pile length of 20 feet below ground surface (i.e., including the annual frost zone), this represents a total of 200,000 Btu's of latent heat to be-removed during slurry freezeback. Further, assuming that an unfinned pile is placed during the late fall when the average daily air temperature is 20°F and no wind exists, the following estimation of freezeback under the thermal pile mechanism may be made:

$$q = 0.13 K_{air} a^{1/3} A (T_v - T_a)^{4/3}$$

$T_v = 32^\circ\text{F}$  (assumed to be the temperature of slurry during freeze-up)

$T_a = 20^\circ\text{F}$

$K_{air} = 0.0138 \text{ Btu/ft hr } ^\circ\text{F for } T_m = 1/2 (T_v + T_a)$

= 26 F (from table)

$a = 2.35 \times 10^6/\text{ft}^3 \text{ } ^\circ\text{F for } T_m = 26^\circ\text{F}$   
(from table)

From a pile of 1 foot nominal diameter, the cooling area,  $A_t$ , is  $(\pi \times 1.062) = 3.33 \text{ ft}^2/\text{lineal foot}$ . Thus:

$$q = (0.13) (0.0138) (2.35 \times 10^6)^{1/3} (3.33) (32-20)^{4/3} = 21.8 \text{ Btu/Ain ft hr}$$

(h) The freezeback time, relying exclusively on the thermal pile effect, for a pile length,  $L_a$ , of 4 feet exposed to the air is:

$$\frac{200,000 \text{ Btu}}{21.8 \times 4 \times 24} = 96 \text{ days}$$

(i) This assumes that none of the slurry heat is extracted by the surrounding permafrost, which, of course, is not the case. During the 20-day period required to naturally freeze back the slurry, heat removal via the thermal pile effect is  $(21.8 \times 4 \times 20 \times 24) = 42,000 \text{ Btu}$ . This represents 2100 Btu/lineal ft of pile. Again referring to figure 4-72 and using a volumetric latent heat of slurry of  $(10,000 / 2100) = 7900 \text{ Btu per lineal foot}$ , it is noted that 7900 Btu can be removed in about 15.5 days. Thus, the thermal pile will influence freezeback over a shorter time than 20 days and by successive approximations the appropriate freezeback time is established. In 16.5 days, the thermal pile extracts 1740 Btu/ft and about  $(10,000 / 1740) = 5747 \text{ Btu/ft}$  is dissipated into the permafrost in the same time interval (fig. 4-72). This represents a reduction in freezeback time of about 17 percent.

(j) Had the air temperature averaged 0 F, rather than 20°F, the thermal pile heat removal rate would have increased to 81 Btu/lineal ft hr and the overall freezeback time would have been reduced to about 10 days (a 50% reduction in time). It should be noted that these calculations assume that heat is also extracted by the pile from that portion of the slurry in the annual frost zone. If the pile is placed at the end of the winter, the annual frost zone will be at a lower temperature than the permafrost and thus more slurry heat will be removed per linear foot by the surrounding ground in the annual frost layer than is the than is the case in the permafrost zone. Thus, the procedure will tend to estimate the freezeback benefit of the thermal pile somewhat conservatively. However, the opposite situation develops should the pile be placed at the end of the summer period when the active zone is above freezing. At this time a large percentage of the pile's heat sink ability is used to extract heat from the annual frost zone.

(k) The above calculations neglected any consideration of the thermal benefit of finning the pile. A 1/4-inch-thick, 6-inch-wide fin of 4-foot length would dissipate 6.2 Btu/lin ft hr at 20 F air temperature and 20.7 Btu/lin ft hr at 0°F. The use of four fins would have the effect of essentially doubling the heat transfer rate from a cylindrical surface. The use of six fins, a number commonly used, would reduce the freezeback time from 16.5 and 10 days to 12 and 6 days for ambient air temperatures of 20 °F and 0 °F respectively.

(l) The above example assumed that the air would be quiescent during the freezeback period; the effect of an average wind of only 2 mph is considered next:

$$q = K_{air} \frac{(0.282)}{D} \left( \frac{VD}{\nu} \right)^{0.585} A_L (T_v - T_a)$$

where:

- $\rho = 0.0817 \text{ lb/ft}^3$  at 26°F (from table in (g) above)
- $\nu = 0.0412 \text{ lb/ft hr}$  at 26°F (from table in (g) above)
- $V = 2 \text{ mph} \times 5280 = 10569 \text{ ft/hr}$

substituting:

$$q = \left( \frac{0.0138}{1.062} \right) (0.282) \left( \frac{10,569 \times 1.062 \times 0.0817}{0.0412} \right)^{0.585} \quad (3.33) \quad (32-20)$$

= 51 Btu/lin. ft hr for  $T_a = 20^\circ\text{F}$ .

(m) The freezeback time is reduced from 20 to about 12 days, representing a reduction of 40% from the natural freezeback time without thermal pile assistance. Had the temperature averaged 0 °F, the time would be reduced by about 60% to 7-3/4 days. These results are tabulated below:

Wind	Freezeback Time (Days)			
	Without Fins		With Fins (6)	
	20°F	0°F	20°F	0°F
0 mph	16 1/2	10	12	6
2 mph	12	7 3/4	--	--
5 mph	9 1/2	5	--	--

Natural Freezeback Time 20 days (Permafrost at 28 °F)

(n) As indicated by these calculations, the amount of surface area presented to the cold outside air is critical and thus it is essential that snow (which is a rather good insulator) not be allowed to impede heat transfer from the pile. Heat transfer by the emission of long-wave radiation from the pile will accelerate the heat transfer process while absorption of solar radiation tends to retard heat transfer. The use of high albedo paint to reflect the incoming solar radiation is a common practice.

(o) Computation of heat transfer in service. An indication of the magnitude of temperature depression below the mean temperature of the ground surrounding the pile is useful in appraising the potential adfreeze strength provided by the thermal pile. This problem is best solved by means of a finite difference

approach utilizing a digital computer. However, some useful relationships can be obtained via a steady state analysis assuming that the mean ground temperature,  $T_g$ , remains unchanged at a distance of ten radii from the pile.

The heat removed by the pile is:

$$q = h_c A_L (T_v - T_a) L_a$$

while the heat input from the soil is:

$$q = \frac{2.73 K_s (T_g - T_v) L_s}{\log (r_2/r_1)} \quad (\text{Equation 12})$$

where:

$h_c, A_L, L_a, T_v, T_a$  were defined above

$L_s =$  length of pile exposed to soil, ft

$K_s =$  frozen soil thermal conductivity, Btu/ft hr °F

$r_1 =$  radius of pile

$r_2 = 10 r_1$

$T_g =$  ground temperature at  $r_2$

These two heat flow rates are equal.

$$h_c A_L (T_v - T_a) L_a = 2.73 K_s (T_g - T_v) L_s$$

Thus:

$$T_v = \frac{2.73 K_s (L_s/L_a) T_g + h_c A_L T_a}{2.73 K_s (L_s/L_a) + h_c A_L} \quad (\text{Equation 13})$$

For the sample problem above in which the average wind speed was 2 mph, it is estimated that the permafrost temperature would be depressed from 28 °F to about 19° at the pile/soil interface.

(2) Single-phase piles.

(a) As previously described, the single phase system, or convection cell, operates by virtue of a density gradient induced by temperature difference between the above-ground (exposed to air) and the below-ground portions of the pile. Such systems may use a confined liquid, or gas, or ambient air as the heat transfer medium within the pile. As the fluid extracts heat from the soil surrounding the pile, its density decreases, thereby causing the fluid to rise and be replaced by overlying cooler fluid. Heat exchange to the atmosphere is accomplished either through the pile wall for liquid systems or by

direct mixing for air systems. Successful operation of this concept requires use of plumbing within the pile which physically separates the warm and cold fluid columns. As air temperatures increase above ground temperatures, the convective process is stopped, thereby preventing induction of warm ground temperatures. It should be noted that when ambient air is used as the heat transfer medium, summer winds may cause undesirable air flow within the pile and necessitate the use of positive shutoffs.

(b) Although a potentially simpler, essentially unpressurized system, the thermal efficiency of the natural convection, single-phase pile is less than that for two-phase systems owing to the increased internal resistance associated with for the liquid-filled pile: primarily the mass flow of the liquid with some contribution due to the liquid side boundary layer thermal resistance in the portion of the pile exposed to air and for the ambient air-filled pile: the low volumetric heat capacity of the air at low rates. Some laboratory studies reported by Johnson<sup>11</sup> indicated that for liquid-filled (both water-ethyl alcohol and trichloroethylene), 2-inch and 4-inch model piles, a 5° to 15 °F temperature difference between air and the material to be cooled was necessary to achieve any heat transfer over a range of air flow from 0 to 40 mph; this indicates the influence of inertia forces which must be overcome to permit development of fluid flow.

(c) There are few heat transfer field data available for this type of pile system at time of preparation of this publication.

(3) Forced circulation piles.

(a) In some cases it may be necessary to install artificial refrigeration pipe or tubing on the pile to accelerate slurry freezeback time and to have such refrigeration available in the event that permafrost temperatures rise to unacceptable levels after construction. The thermal pile technique is restricted to that period of the year when air temperatures are low and normally cannot be used to accelerate freezeback during the summer period. The following example shows calculations required to determine the amount of heat to be extracted from the ground.

(b) Example. It is assumed that the average volume of slurry backfill for a group of piles is 31 feet<sup>3</sup> each. The slurry is placed at an average temperature 40 °F and must be frozen to 23 °F. A silt-water slurry of 80 lb/ft<sup>3</sup> dry weight and 40 percent water content is used as backfill material, and an available refrigeration unit is capable of removing 225,000 Btu/hr. Calculate the length of time required to freeze back a cluster of 20 piles.

$$\begin{aligned} &\text{Volumetric latent heat of backfill} \\ L &= (144 \times 80 \times 0.40) = 4,600 \text{ Btu/ft}^3 \\ &\text{Volumetric heat capacity of frozen backfill} \\ C_f &= 80 [0.17 + (0.5 \times 0.4)] = 29.6 \text{ Btu/ft}^3 \text{ } ^\circ\text{F} \end{aligned}$$

Volumetric heat capacity of thawed backfill  
 $C_u = 80 [0.17 + (1.0 \times 0.4)] = 45.6 \text{ Btu/ft}^3 \text{ } ^\circ\text{F}$   
 Heat required to depress the slurry temperature to the freezing point:

$$45.6 \times 31 (40 - 32) = 11,310 \text{ Btu/pile}$$

Heat required to freeze slurry:

$$31 \times 4,600 = 142,600 \text{ Btu/pile}$$

Heat required to depress the slurry temperature from the freezing point to 23 °F:

$$29.6 \times 31 (32 - 23) = 8,260 \text{ Btu/pile}$$

Total heat to be extracted from the slurry:

$$20(11,310 + 142,600 + 8,260) = 3,243,000 \text{ Btu}$$

Time required for artificial freezeback excluding allowances for system losses

$$3,243,000/225,000 = 14.4 \text{ hr (with losses allow 20 hr)}$$

(c) The maximum operating temperature for the coolant is usually set 10 F below the desired in-situ permafrost temperature and the temperature rise in the system should be fixed at 5 °F or less. Thus, for this example, the maximum temperature is (23 - 10) = 13°F and a difference of 5 °F would place the lowest temperature at 8 °F. The coolant freezing point should be at least 10F below this minimum. If it is likely that the air temperature will fall below this freezing point during the refrigeration operation, then the low air temperature would establish the freezing point for the coolant.

(d) Allowing a temperature rise of 4°F in the refrigerant and selecting a 21 percent sodium chloride brine, the required circulation rate is:

$$\frac{225,000}{60 \times 0.799 \times 4 \times 1.169 \times 62 \cdot \text{h}/7.5} = 120.6 \text{ gpm}$$

(e) Using 3/4-inch black pipe on the pile, the rate of circulation is in the order of 1 ft/sec, which should be considered as an upper limit. This size pipe or tubing is most commonly used.

(f) The brine temperature will average 11°F which will result in a temperature difference between the surrounding soil of (40 - 11) = 29°F at completion of the refrigeration cycle.

(g) It is essential that temperature sensors be used to insure that proper freezeback rates and temperatures are obtained.

(h) Should the option of forced circulation of a gas or liquid within a closed metal pile be considered, the computation procedures outlined above may be adapted, the case being technically comparable to the freezing points used for stabilization of ground in construction or for stabilizing foundations experiencing permafrost degradation. However, so far as is known this approach has not been used except experimentally in conventional foundation bearing piles in North

America.

f. *Design depth of pile embedment.* Pile foundations must be designed for sufficient depth of embedment to support the imposed loads in adfreeze bond without objectionable displacement under the warmest ground temperatures expected, unless suitable end bearing on ice-free bedrock or other reliable strata can be obtained. The piles must also be capable of resisting the additional down drag of negative skin friction from consolidating fill or thawed foundation soils and must provide sufficient anchorage and tensile strength to prevent upward displacement and pile structural failure from frost heave forces in the annual frost zone in winter. The forces acting on a pile in permafrost during freezing

and thawing seasons are shown in figure 4-77. During spring and early summer, piles have greatest potential bearing capacity in adfreeze bond because of the low permafrost temperatures during the period<sup>133</sup>. When the zone of annual thaw and freeze is in the process of refreezing, the extremely low temperatures in the frozen soil near the ground surface cause much higher adfreeze bond strengths in this area. During the same period of seasonal freezing, ground temperatures along the pile length in permafrost are at their warmest and the corresponding permafrost adfreeze strengths are at their weakest. Unless the pile is adequately embedded in the permafrost and capable of mobilizing sufficient resistance in adfreeze bond, the pile will heave if an up-

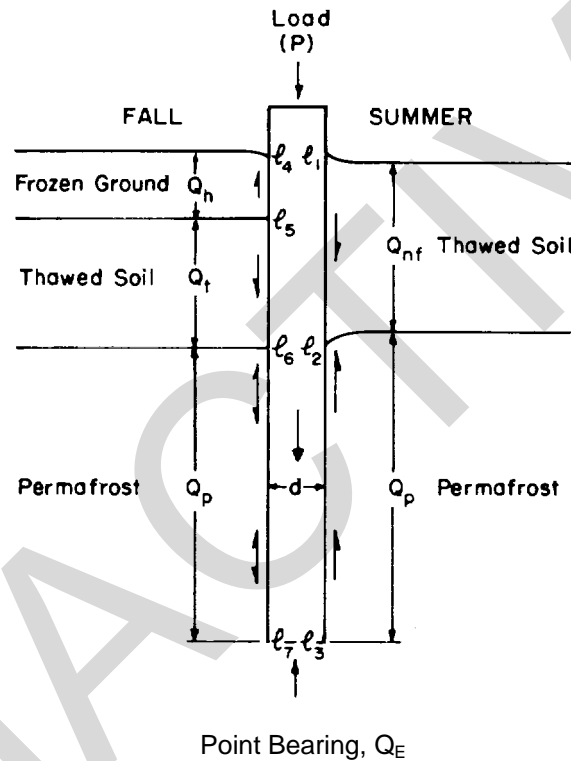

U. S. Army Corps of Engineers

Figure 4-77. Stresses acting on piling for typical permafrost condition<sup>134</sup>.

ward frost heave thrust occurs exceeding the combined weight of the pile, load on the pile, negative skin friction in thawed zone(s) and the adhesion in the permafrost.

(1) *Friction piles.*

(a) Analytical considerations and methods of making preliminary estimates of bearing capacity of piles which develop their support in skin friction along their surfaces are discussed in this paragraph. Bearing capacity of such piles should be calculated for the ground conditions which exist in the most critical period of the year. In permafrost areas this will usually be late summer through early winter when permafrost temperatures at the depths of primary load support are at their warmest. Allowable downward load on piles supported in adfreeze bond in permafrost should be computed in accordance with equation 14 (see right-hand side of fig. 4-77):

$$Q_a = \frac{1}{FS} (Q_p \pm Q_{nf}) \quad \text{(Equation 14)}$$

where

- $Q_a$  = Allowable design load on pile
- FS = Factor of safety
- $Q_p$  = Maximum load which may be developed in tangential bond between pile and permafrost,

$$\int_{l_2}^{l_3} f_a dA_p$$

where

- $A_p$  = surface area of pile in permafrost
- $f_a$  = maximum tangential adfreeze bond stress which may be developed between frozen soil and pile, a function primarily of temperature, everything else being equal.
- $Q_{nf}$  = Maximum skin friction force from thawed soil on pile. Under normal summer conditions this will be a negative force, acting downward:

$$= \int_{l_1}^{l_2} f_s dA_t$$

where

- $A_t$  = surface area of pile in thawed soil
- $f_s$  = sum of unit friction and adhesion between thawed soil and pile

(b) As with footings, allowable loadings of piles in frozen ground are determined by creep deformation which occurs under steady loadings at stress levels well below the rupture levels measured in ordinary relatively rapid tests to failure. A creep deformation rate of only 0.01 in./day will result in 3.65 inches of settlement per year or about 3 feet in 10 years, which is wholly unacceptable for permanent type structures. Creep occurs in the adfreeze bond zone at the contact surface between the pile and the frozen ground and is attended by punching at the pile tip if the pile is overloaded. The stress-strain behavior of frozen soil in unconfined compression tests may be used to illustrate the deformation phenomena associated with support of loads on piles in frozen ground. Response of frozen silt to various conditions of loading is shown diagrammatically in figure 4-78 (the same relationships are represented in another form in fig 4-47). Elastic behavior is limited to a negligibly small portion of the stress-strain curve. Nonelastic deformation begins only a short distance from the origin and increases with increase in stress. At rapid rates of loading or at low temperatures, the stress-strain curves are relatively steep, relatively high stress levels are reached, and the deformation ends in brittle-type rupture, as shown by the two left-hand curves in figure 4-78. At slow rates of loading and warmer permafrost temperatures the curves are flatter, lower stress levels are reached, and deformation continues plastically to large strain values. If rate of applied strain is reduced at a point such as A, the stress intensity will tend to relax as indicated by curve AB to a stress level compatible with the new, lower rate of strain. In saturated, fine-grained frozen soils the peak and ultimate strengths tend to be virtually identical when loading rate is at a level producing extended deformation, as shown by the two right-hand curves in figure 4-78. Peak stresses higher than ultimate strength values are observed in saturated, granular frozen soils, even for slow rates of loading, but such soils less frequently require pile-type foundations.

(c) Figure 4-79 illustrates diagrammatically the manner in which load applied at the top of a pile is transmitted with time into relatively warm permafrost. For simplicity, load is assumed carried solely in skin friction in permafrost with zero load on the tip of the pile. Conditions are shown in figure 4-79 for three separate times after instantaneous application of load:  $t_1$  represents a time immediately after load application,  $t_2$  represents a time intermediate between  $t_1$  and  $t_3$  and  $t_3$  represents time when complete stress-strain adjustment has occurred under the applied load. Immediately after load application, load transfer to permafrost is concentrated in upper sections of the pile. Load transfer to lower parts of the pile is at that time restricted because shortening of the pile in compression is restrain-

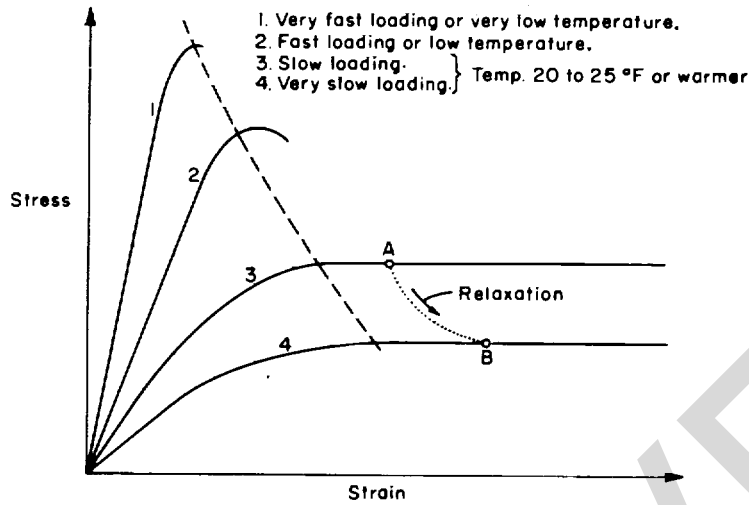
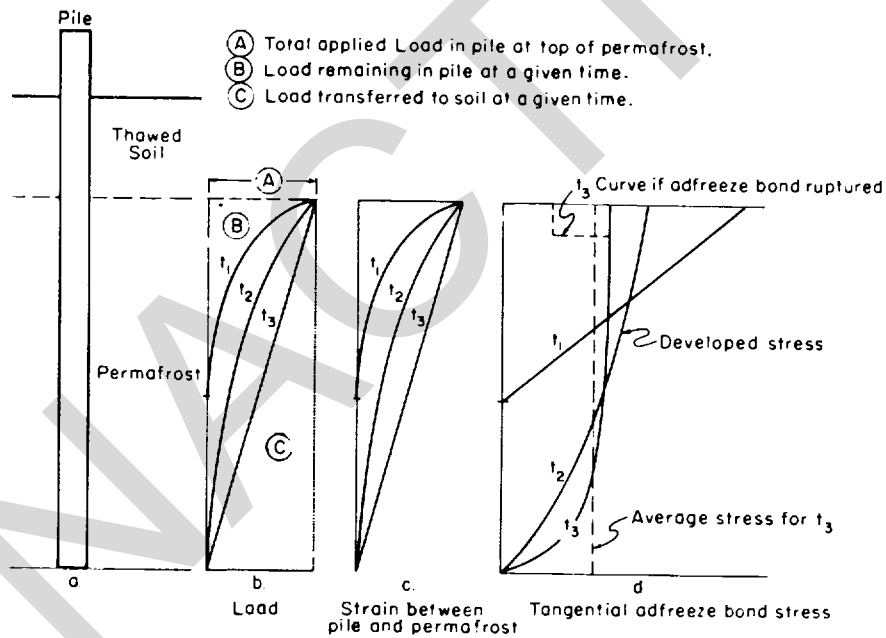

Figure 4-78. Response of frozen silt to loading conditions in unconfined compression (by CRREL).



U. S. Army Corps of Engineers

Figure 4-79. Load, strain and stress distribution for pile in permafrost with zero load at tip.



ed by the surrounding frozen ground. As yield occurs in the permafrost and the adfreeze bond, more and more compressive strain develops in the pile with depth, progressively readjusting the pattern of load transfer from pile to soil, the strain at the pile-permafrost interface, and the tangential adfreeze bond stress. As shown in diagrams b. and c. in figure 4-79, the final distributions of load and strain along the embedded length of pile in permafrost at time  $t$ , are approximately triangular. An assumed pattern of adfreeze bond stress is shown in diagram d. of figure 4-79. As also shown in this diagram, the adfreeze bond may be ruptured as a result of excessive stress or excessive rate or magnitude of strain, beginning at the top of permafrost. The stress strain-time relationship and possibility for bond rupture are affected not only by the behavior characteristics of the frozen soil and the adfreeze bond zone, but also by the deformation characteristics of the pile. Piles which exhibit high deformation per unit length under load or which are especially long are more susceptible to such bond rupture.

(d) That a triangular distribution of load and strain over the depth of embedment, reducing to zero load at the tip, may be reasonably assumed as a basis for design in relatively warm permafrost is demonstrated in figure 4-80, which shows load-deflection data from a compression load test to failure on an 8-inch pipe pile compared with deflection computed on the basis of the triangular load distribution assumption. The degree of correspondence appears especially satisfactory when account is taken of the fact that application of factor of safety in the design will place working loads in the area of best agreement. It must be recognized that even though the load was added slowly over more than two weeks, in the test shown in figure 4-80, the stress-strain adjustment under each 10-kip increment was not 100 percent complete. In the test illustrated in figure 4-81, measured distributions of strain in an 8-inch. I-beam pile with 10-foot embedment in permafrost under various levels of imposed loading also show the general triangular pattern<sup>83</sup>.

(e) For friction type piles of average lengths, bearing on the tip is small enough so that it can be ignored if the tip diameter is relatively small (of the order of 6 inches) or if the pile is placed in a dry-augered hole which is not flat-bottomed and/or if loose auger cuttings are unavoidably left at the bottom of the hole, thus requiring appreciable strain at the tip before full end bearing can be achieved. If the tip diameter is relatively large and if full positive end contact is assured, results obtained by ignoring the load on the tip may be too conservative. In such case, the pile tip load may be computed as the sum of the first two factors in the applicable equation of figure 4-61b.

(f) Effective unit values of the strength of adfreeze bond between frozen soils and foundation piles under long term loading depend primarily on such factors as the type of soil, the moisture

content, the chemical composition of the pore water, the temperature, and the surface condition, shape and length of the pile. With augered and slurried piles some control can be effected over the adfreeze bond strength that can be developed, by controlling the type of pile material and surface, the soil type and moisture content of the slurry, the mode of freezing, and the characteristics of the water used to make the slurry. With driven steel piles such control is not possible except for removal of oil, paint, rust or scale from the pile surface before driving; however, there is no freezeback delay or uncertainty, a common problem with slurried piles.

(g) Experimentally determined values of average sustained and average peak adfreeze bond strengths for frozen slurries made with silt of low organic content in contact with steel pipe piles of 18 to 21-foot lengths (in frozen soil) are shown in figure 4-82. Factors for adjusting the curves for different types of piling and slurry backfill, based on field and laboratory testing, are also shown in the figure. (The curve "Average Sustainable Adfreeze Strength" with the appropriate correction factor for variation in pile and/or slurry type and with a procedure to be illustrated later may be used for preliminary design and planning of pile load tests.) Because shear strain along the surface of a loaded pile varies along the length, decreasing downward from a maximum at the ground surface, as has been illustrated in figure 4-79, such values measured on full scale piles represent averages over wide ranges of development of the stress-strain curve. The average values are therefore always less than the potential maximum adfreeze bond stress. Average adfreeze bond strengths at ultimate pile bearing capacity are about 40 percent greater than average sustainable adfreeze bond strengths used in design (before application of any factor of safety).

(h) Adfreeze bond strengths and creep properties of slurry may range from those characteristic of freshwater ice, through those of frozen sands, silts, clays and organic soils at various moisture contents (depending on the type of material selected, the water content at freezeback, and the manner of freezing) to those of the same soils unfrozen, if freezeback is incomplete or if permafrost degradation should occur. In temperature ranges a few degrees below 32 °F, slurries in which the ice fraction predominates may show better structural performance than slurries of some soils in which the soil fraction is more predominant, if the solute content of the added water is relatively low, depending on the soil type. As shown in figures 2-12 and 2-13, ice has relatively high ultimate strength compared to most frozen soils at temperatures immediately

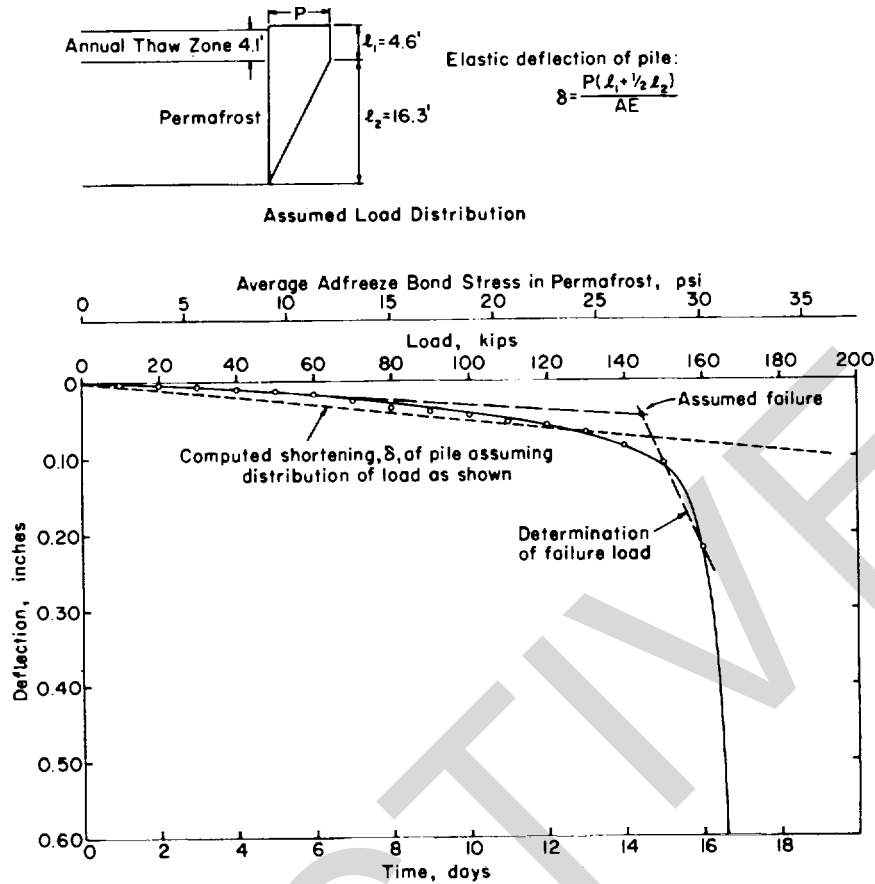

Pile type: 8-in. pipe, 36 lb/ft  
 Pile length: 20.9 ft  
 Length below surface: 20.4 ft  
 Embedment in frozen soil: 16.1 ft  
 Soil profile: 0-1 ft peat, 1-20.4 ft (bottom of pile) silt  
 Backfill around pile: silt-water slurry  
 Avg temp of frozen soil: 29.2°F  
 Test performed: July 1958  
 Loading schedule: 10-kip increments applied at 24-hr intervals. The deflection shown for an increment is that observed just prior to application of next increment.  
 Note: Pile not isolated from soil in thaw zone.

COMPUTATION OF ALLOWABLE DESIGN LOAD

Failure load = 147 kips  
 Surface area of pile in permafrost = 5230 in.<sup>2</sup>  
 Average adfreeze bond stress at failure = 147 kips/5230 in.<sup>2</sup> = 28.1 psi  
 Adjusting for 10 kips per day rate of loading (by interpolation, Figure 4-85), average adfreeze bond stress at failure = 21.5 psi  
 Assuming failure stress is 40% greater than average sustainable stress, average sustainable adfreeze strength = 21.5/1.4 = 15.3 psi  
 Sustainable pile load capacity = 15.3 psi x 5230 in.<sup>2</sup> = 80 kips  
 Using a factor of safety = 2.5, allowable design load = adjusted failure load/FS = 21.5 x 5230/2.5 = 45,000.1b

U. S. Army Corps of Engineers

Figure 4-80. Load test of steel pipe pile.

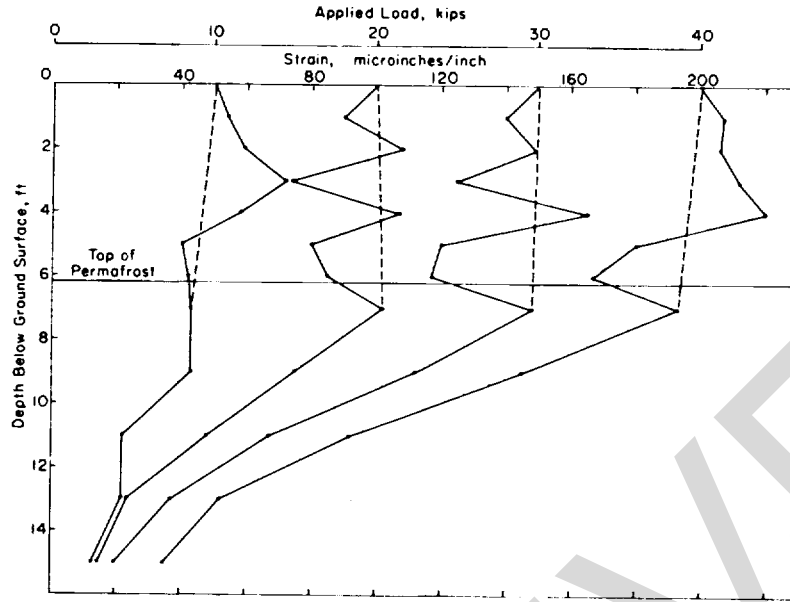

Pile type 8-in. I-beam, 18.4 lb/ft  
 (bottom of pile) silt  
 Pile length 16.8 ft  
 Length below surface. 16.1 ft  
 Embedment in frozen soil 9.9 ft  
 Loading schedule 5-kip increments applied at 30-minute intervals to total load of

Soil profile, 0-1 ft peat, 1-16.1 ft  
 Backfill around pile Silt-water slurry  
 Avg temp of frozen soil. 30.8°F  
 Test performed December 1961

U. S. Army Corps of Engineers

Figure 4-81. Load distribution along pile during test, strain-gage instrumented pile. Frost penetration of about 1 foot occurred adjacent to pile prior to test. Adfreeze bond of frost broken at surface and use of heating devices on ground surface prevented additional frost penetration.

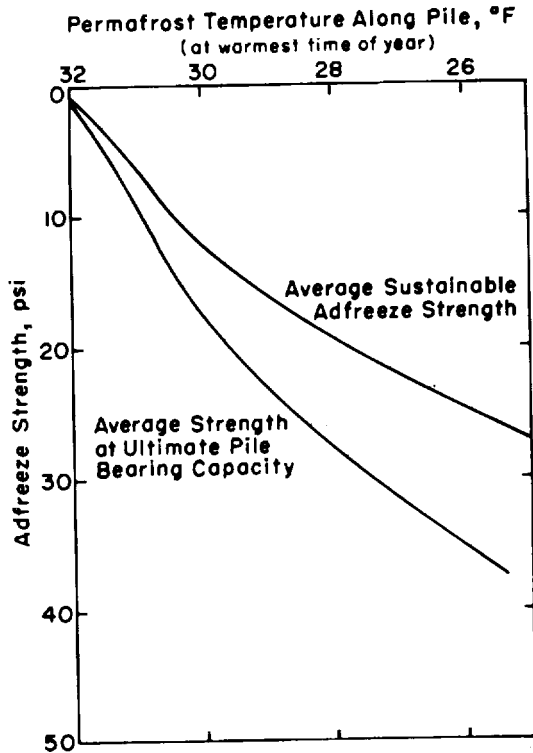

Type of pile	Slurry soil	
	Silt	Sand
Steel	1.0	1.5
Concrete	1.5	1.5
Wood, untreated or lightly creosoted	1.5	1.5
Wood, medium creosoted (no surface film)	1.0	1.5
Wood, coal tar-treated (heavily coated)	0.8	0.8

- Notes:
1. Applies only for soil temperatures down to about 25° F.
  2. Where factor is the same for silt and sand, the surface coating on the pile controls, regardless of type of slurry. In the remaining factors the pile is capable of generating sufficient bond so that the slurry material controls.
  3. Gradations typical of soils used for slurry backfill are shown in Figure 2-11 as follows:  
 Silt - SFS, Fairbanks silt  
 Sand - SM, McNamara concrete sand
  4. Pile load tests performed using 10 kips/day load increment were adjusted to 10 kips/3 day increment to obtain curves shown.
  5. Clays and highly organic soils should be expected to have lower adfreeze bond strengths.

Correction factors for type of pile and slurry backfill (using steel in slurry of low-organic silt as 1.0)

U. S. Army Corps of Engineers

Figure 4-82. Tangential adfreeze bond strengths vs. temperature for silt-water slurried 8.625-inches-O.D. steel pipe piles in permafrost averaged over 18 to 21 feet embedded lengths in permafrost<sup>134</sup>.

below freezing when load is increased relatively rapidly to failure, but most frozen soils exceed the strength of ice at lower temperatures. At a temperature of about 30 °F, freshwater ice, frozen concrete sand and fine sand have shear strengths of about the same magnitude, but frozen silt is significantly weaker. With lowering of temperature, ice does not gain further shear strength, but the frozen soils do. At temperatures between 30° and 25 °F, shear strength of sands may exceed that of silt by 33 percent to more than 100 percent. At a temperature of about 20°F sands and silt may have about equal shear strengths, but these may exceed the shear strength of ice substantially. As temperatures fall below 200°F, silt continues to increase in shear strength at a rate which is much more rapid than for sand. In absence of reliable direct adfreeze bond strength data, shear strength

behavior is considered the most nearly analogous characteristic. Also, as illustrated by figure 2-15, hard, sound freshwater ice shows a lower rate of creep deformation than frozen soils, at least in the temperature range above about 26 F; data are not available for lower temperatures, or for lower temperatures, or for ice which is porous or contains significant amounts of impurities. However, the much more rapid rates of freezeback obtainable with minimum moisture content slurries offer a significant construction advantage<sup>134</sup>. Concrete sand also will usually contain few soluble materials to alter freezing temperature of the pore water.

(i) The use of steel H-type piles or other irregular section piles, which have considerably more surface area than a comparable-size circular pile, will not result in

proportionately greater pile load capacity simply because of this increased surface. Although extraction tests to failure of H-piles show that such piles come out clean, i.e., without soil included between the flanges, the included perimeter should be used in design rather than the actual surface, since yield in creep will tend to occur on that basis.

(1) Available data indicate that when steel piles are driven into permafrost by conventional methods, adfreeze bond over the pile surface area is less complete than is possible with a properly placed slurry backfill. This conclusion is based both upon load tests and inspection, for evidences of contact, of piles which have been completely extracted. Therefore, the allowable load-bearing capacity of a conventionally driven steel pipe pile should be reduced to 75 percent of that for a slurried pile in which the slurry is made from the same foundation soil mixed with fresh water. For H-type and other irregular section piles, the reduction should be less since the pile surface area allowable is partly direct pile soil contact surface and partly surface through frozen soil as computed for the included perimeter. For example, the allowable load bearing capacity for a driven 10 inches by 10 inches steel H-pile would be 87.5 percent of that for a slurried pile, if the sustainable creep strength of the soil is approximately the same as the unreduced adfreeze strength between soil and steel. However, if a pile is driven by a method which generates enough heat to produce a slurry film on the entire pile surface in permafrost, no reduction is needed.

(k) The possibility must be considered that the natural foundation soil may have sufficiently low shear strength, as compared with the adfreeze bond strength at the slurry/pile interface, to be the controlling factor in determining the load-carrying capacity. However, since the perimeter of the drilled or augered pile hole is ordinarily a minimum of 30 to 50 percent greater than the perimeter of the pile itself, the natural frozen ground would have to be much weaker than the strength at the slurry/pile interface for the strength of the natural soil to be controlling. This is very unlikely if the slurry is made from the natural foundation soil. However, it may occur if select slurry backfill is used. It is possible to intentionally make the augered hole larger than needed for pile placement purposes alone, in order to decrease stress at the outside perimeter of the slurry cylinder when this condition may apply. However, the resulting increase in slurry volume would significantly retard freezeback time.

(1) For preliminary design purposes, the average sustainable adfreeze strength values in figure 4-82, adjusted by the appropriate factor if necessary, should be used. Normal negative frictional resistance values (combined friction and cohesion) for unfrozen soil may be determined from guidance given in TM 5-818-

1/AFM88-3, Chapter 7. Full-scale load tests performed on piles installed by the planned construction procedures best integrate the variables involved. Figure 4-80 shows an example of such a test, though the interval between load increments is less than the 10 kips per three days which is recommended (see below). However, if sufficient time is unavailable in the construction schedule, such deviation may sometimes have to be accepted and corrected for as indicated in the "Computation of Allowable Design Load" in figure 4-80. If these tests cannot be performed at the design ground temperature (as is frequently the case for field tests), they may be adjusted to the design temperature by using the applicable curve in figure 4-82 for guidance and assuming that the strength for the test case varies as a fixed percentage of this curve with temperature.

(m) Since the effective unit adfreeze bond strengths are directly related to permafrost temperatures, reasonably accurate assessment of the permafrost temperatures with depth, for the life of the structure, is required. The warmest temperatures with depth to be experienced in the life of the structure should be used for design. For ventilated pile foundations this normally will occur in the early part of each winter. If a residual thaw zone should exist or develop, there will be no seasonal variation in permafrost temperatures and the permafrost will tend to eventually reach a thawing condition"; in such a case the recommended procedure is to design for thawed-condition skin friction values. If the permafrost or slurry contains excess moisture in the form of ice, these values will tend to be on the low side for the type of soil involved, and negative friction forces may need to be considered. However, since thaw at depth in the ground is usually slow, consolidation will normally occur in small annual increments.

(n) If permafrost temperatures in the seasonal period selected for design are essentially uniform with depth, the permafrost supporting capacity may be estimated (using fig. 4-82) by simply multiplying the total surface area of the part of the pile in permafrost by the average sustainable tangential adfreeze bond strength at that temperature, applying a correction factor for the type of pile surface and slurry if necessary. Should the ground temperatures vary appreciably with depth, a more refined computation of the permafrost supporting capacity may be made by plotting, first the variation of average sustainable bond stress with temperature, then temperature with depth, then the average sustainable bond stress for the applicable temperature with depth, and finally the sustainable adfreeze bond load capacity per foot with depth. By determining the area under the latter curve as shown in the right hand diagram of figure 4-83, the potential pile load capacity is obtained.

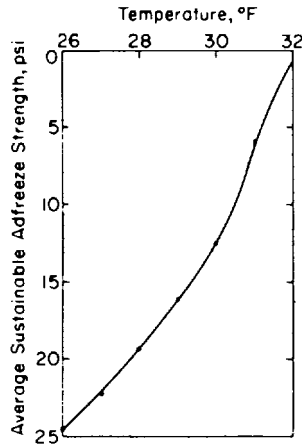

U. S. Army Corps of Engineers

Figure 4-83a. Example of computation of sustainable load capacity of pile in permafrost. (Average sustainable and adfreeze strength vs. temperature. Values taken from figure 4-82. If an estimate is desired of the load capacity of the pile at failure, values from the curve "Average strength at Ultimate Pile Bearing Capacity" in figure 4-82 should be used.)

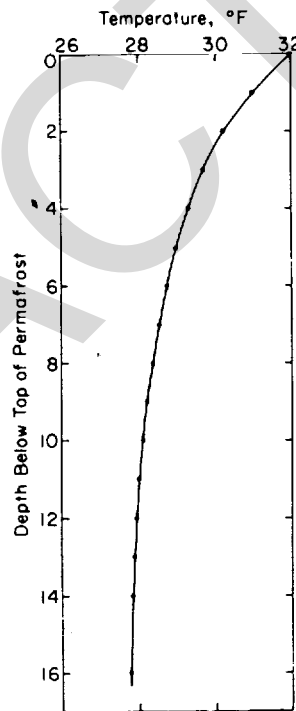

U. S. Army Corps of Engineers

Figure 4-83b. Example of computation of sustainable load capacity of pile in permafrost. (Temperature vs. depth below top of permafrost, warmest time of year.)

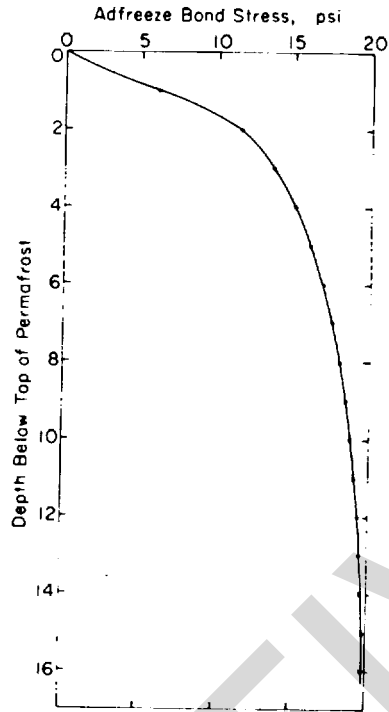

U. S. Army Corps of Engineers

Figure 4-83c. Example of computation of sustainable load capacity of pile in permafrost. (Average sustainable adfreeze strength for applicable temperature at depth below top of permafrost.)

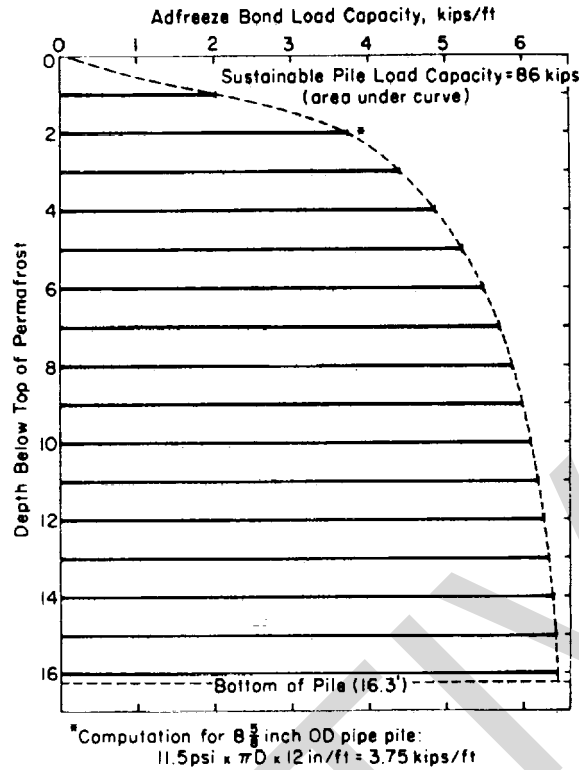

Figure 4-83d. Example of computation of sustainable load capacity of pile in permafrost. (Adfreeze bond load capacity vs. depth below top of permafrost)

(o) Within reasonable limits a deflection of the pile relative to the surrounding permafrost, which exceeds the minimum strain required to develop peak adfreeze bond stress at the top of permafrost, is normal and acceptable in permafrost at a temperature of about 20° to 25 °F or warmer, provided opportunity for gradual development of this displacement by creep is available. The curves for slow loading shown in figure 4-78 typify this condition. However, the possibility of complete rupture of the adfreeze bond in upper permafrost strata must be considered and special analysis should be made when considering piles of significantly more than 30 foot embedment in permafrost, or if the temperature of the permafrost when loads are applied is colder than about 20 °F, or full design load is suddenly applied on the pile. The criteria in this manual are based on experience with piles of conventional lengths of permafrost embedment, that is 15 to 30 feet in permafrost at temperatures of 20° to 25°F or warmer, under gradual application of load.

(p) In permafrost of low and very low temperatures (colder than about 20°F) unit adfreeze bond strengths are higher, allowable deflections are lower, optimum pile lengths are less, possibility for rupture of the adfreeze bond is increased, and the patterns of distribution of load, strain, and stress along the embedded length of pile may differ from the pattern

which has been described above because the stress-strain behavior typified by the two left-hand curves in figure 4-78 will apply rather than the extended-strain type behavior shown in the two right-hand curves of that figure. Even though higher stress levels can be accepted under rapid loading, reduced capacity for readjustment by creep may nullify this.

(q) The computation of the allowable load on the pile should be completed using equation 14 above and factor of safety from h below. TM 5-818-1/AFM 88-3, Chapter 7 may be referred to for guidance concerning skin friction of thawed soil.

(2) End bearing piles. As described in the preceding paragraph, the point bearing ( $Q_e$  in fig. 4-77) may often be assumed negligible. However, if a firm, reliable bearing stratum such as ice-free bedrock is within economical depth, the bearing capacity can be augmented by or solely derived from end bearing. Design procedures for end bearing piles should be the same as in temperate zone practice (TM 5-818-1/AFM 88-3, Chap. 7' and/or EM 1110-2-2906<sup>20</sup>) except that safety against frost heave must be assured in accordance with the following paragraph. Drilling and anchoring of



the piles into the bearing stratum may be required.

(3) *Pile safety against frost heave.*

(a) Analysis must be made to assure that the pile is safe against frost heaving under the normal sustained dead load, or when not loaded if this can occur during a freezing period. The latter is most likely to happen during construction.

(b) For heave stability a satisfactory relationship as expressed in the following equation must be maintained under the most unfavorable conditions (see lefthand side of fig. 4-77):

$$Q_h = \frac{1}{FS} (Q_L + Q_p + Q_t) \quad (\text{Equation 15})$$

where

$$Q_h = \text{frost heave force} = \int_{l_4}^{l_5} f_h dA_n$$

where

- $A_n$  = surface area of pile in seasonally frozen ground
- $f_h$  = adfreeze bond stress mobilized between frozen soil and pile by heave
- $Q_L$  = effective load of structure, P, and pile, W
- $Q_p$  = same as in equation 14 above, acting from  $l_6$  to  $l_7$ , but stress mobilized in opposite direction
- $Q_t$  = skin friction of thawed soil on pile

$$= \int_{l_5}^{l_6} f_s dA_t$$

If the pile can experience loading in tension from the structure the equation must be adjusted accordingly. The nature and mechanism of the heave phenomenon and values of frost uplift pressures which can act at the plane of freezing are discussed in paragraphs 2-2 and 2-4. The effects of frost heave on engineering structures and methods of controlling these effects are discussed in paragraph 4-3. Because a pile in tension contracts in the transverse direction, there is a tendency for skin friction under high tensile load to be less than in compression. As shown in figures 4-44 and 4-45, peak frost heave forces have been measured of 55,800 lb or 2220 lb per perimeter-inch for an 8 inch steel pipe pile and 35,60 lb or 809 lb per perimeter-inch for a creosoted timber pile, both in frozen silt slurry. For steel piles in silt with ample moisture available, an average value of  $f_h$  of 40 psi should be assumed to act over the full depth of seasonal freezing; in the coldest upper strata of seasonally frozen

soil, local tangential shear stresses on the surface of the pile may be substantially higher. For other pile and soil types the 40 psi value may be adjusted proportionately to factors noted in figure 4-82. Experience shows that the surface of the pile within the annual thaw zone will often show a thin coating of ice which may possibly control the observed behavior of the system. Although clays are capable of producing considerably higher heaving pressures than silt (see fig. 2-9), values of  $f_h$  for clays should be less than for silt because of the limited heave rates possible with these low permeability soils and because of their weaker adfreeze bond potentials.

(c) The holding force in permafrost,  $Q_p$ , should be computed as in (l) above using average sustainable adfreeze strength. A factor of safety must be applied as outlined in paragraph h below.

(d) If the capacity of the pile is insufficient to resist the frost thrust,  $Q_h$ , the pile must be redesigned to provide greater loading, increased embedment or holding power in permafrost, or a combination of these alternatives, or one of the heave force isolation methods discussed in paragraph 4-3 may be restored to. Where frost heave is possible, wood piles should be installed butt down to increase safety against heave. Piles which heave as the result of frost action destroy the adhesive bond of permafrost. Once broken this bond does not readily reheel and as little as 1/2 or less of the potential adfreeze bond strength may be available to support the imposed load and to resist further heaving in subsequent years.

(4) Tension loading. It may sometimes be desirable to use piles in frozen ground to resist tension or uplift loads. Their advantage usually is their low cost. However, the use of friction piles in frozen ground to carry permanent tension loads should be approached with great caution for the following reasons: friction piles in frozen ground have inherent potential to fail progressively in creep; piles in tension tend to experience reduction in friction by transverse contraction under load; frost heave forces act in the same direction as the applied stress; permafrost degradation or even warming of ground temperatures during the life of the structure may lead to failure; developing failure under a structure, if observed, may be very difficult to correct; and failure, if it occurs, may be accelerative and catastrophic. Some of these adverse factors can be eliminated by careful design. For example by means of a rod passing through the pile it can be placed in compression rather than tension; in such case it may be better designated as an anchorage than as a pile. Ample factors of safety can also be employed. However, in lieu of friction piles positive gravity or mechanical type anchorages which insure mobilization of the required mass of soil and are less sensitive to design, construction and

operational deficiencies and uncertainties can be used. For short-term, intermittent tension loading, as from wind, the problem is less critical; in this case the pile may be designed by adaptation of the procedure outlined in the previous paragraph for safety against frost heave. Again, however, the designer must make sure that there is no possibility of unacceptable degradation or warming of the ground during the life of the facility, either from natural conditions or from improper practices on the part of the facility operators, and a very conservative approach must be taken. The decision may rest in considerable part upon how serious would be the probable consequences of a failure.

*g. Load testing of piles in permafrost.*

(1) Pile testing in permafrost may be required or desirable to obtain data needed for design, to verify design assumptions, and/or to evaluate various alternative designs. In addition to more or less conventional load settlement and extraction pile tests, cyclic, long term static load or lateral load tests may be needed under some conditions<sup>134,168</sup>. In addition to the direct load capacity value of the pile test data, considerable useful collateral information can be derived in the course of performing a pile test program. Such information may cover rates and times required for freezeback; ease of driving, augering or drilling; techniques and problems of mixing and placing slurry backfill, and supplementary foundation soil information (as from auger cuttings). The pile load tests should normally be performed during the facility design studies. However, they may also be performed at the start of the foundation construction if their function is to verify design assumptions, provided opportunity for design adjustment exists.

(2) While a pile load test set-up may be based on the general methods outlined in ASTM D1143<sup>118</sup>, the following special procedures must be followed in testing piles in frozen ground.

(3) All vertical instrumentation supports shall be 2-inches or larger pipes driven 20 or more feet into frozen soil and cased if necessary to isolate them from frost heave. All instrumentation pipes shall be 8 or more feet from test and anchor piles or load platform supports. In addition to checking observations with an engineer's level, the motion of the test pile under load shall be frequently monitored by dial gages having 0.001 inch subdivisions and having 2 or more inches of travel. At least three such dials shall be used on round piles, at 120° intervals, and four dials on other piles. All dials shall be equally spaced and equi-distant from the pile center, on a common horizontal plane. The dial gage support beam shall be roller-supported at one end to avoid bending of the beam as a result of thermal expansion and contraction forces. During the loading and unloading of the pile the dials shall be observed at

sufficient time intervals to permit the plotting of accurate settlement vs. time and settlement vs. load data to 0.001 inch. The dial gages and their supports shall be completely protected from direct sunlight, and from precipitation and wind, by a suitable shelter. The shelter must be ventable to minimize the build-up of heat during the day. As nearly uniform temperature as practicable should be sought within the shelter. Air temperatures within the shelter shall be observed at least hourly at the instrumentation level. Ground temperatures with depth at test piles shall be monitored daily to establish the rate of freezeback following installation and the temperature conditions in the surrounding ground during the load testing period. In winter, local heating shall be used as necessary to avoid the possibility of frost formation on instruments and consequent malfunction (ordinary electric light bulbs are often the most convenient source of such heat). All load increments shall be added with care to avoid producing impact overload.

(4) For a site where little or no previous pile bearing capacity information is available, a minimum of one exploratory pile load test and one verification pile load test (see below) should be performed during design investigations. Only a verification pile load test during design or at start of construction may be necessary if previous pile bearing capacity information is available for the construction site or the soil formation, or if the job is small and a conservative value has been assumed for design load in lieu of making detailed pile bearing studies. Verification pile load tests should be made in the construction stage on all major projects.

(5) In exploratory pile load tests the load is increased progressively in relatively small increments in order to define changes of a pile response with load with reasonable accuracy. To obtain an estimate of pile load capacity, figure 4-82 should be used along with the procedure illustrated in steps from left to right in figure 4-83. A standard increment of 10 kips is assumed in the following discussion. Loading should be continued to failure, normally defined to occur when the gross settlement reaches 1.5 inch, or to 2 /z times the anticipated design load. One example of such a load test, in which a loading rate of 10 kips per day was employed, has been shown in figure 4-79. Figure 4-84 shows results of another test in which load increments were added at the much slower rate of 10 kips every 4 days, except for a number of loads which were held for longer periods, up to 12 days. Figure 4-84 has been prepared with an expanded vertical scale in order to show the deflections which occurred under the individual load increments. The cumulative deflection curve AC shows about 0.16 inch greater deflection at the maximum load than that (at point B) computed from the assumed load distribution pattern, shown on the figure. This difference cor-

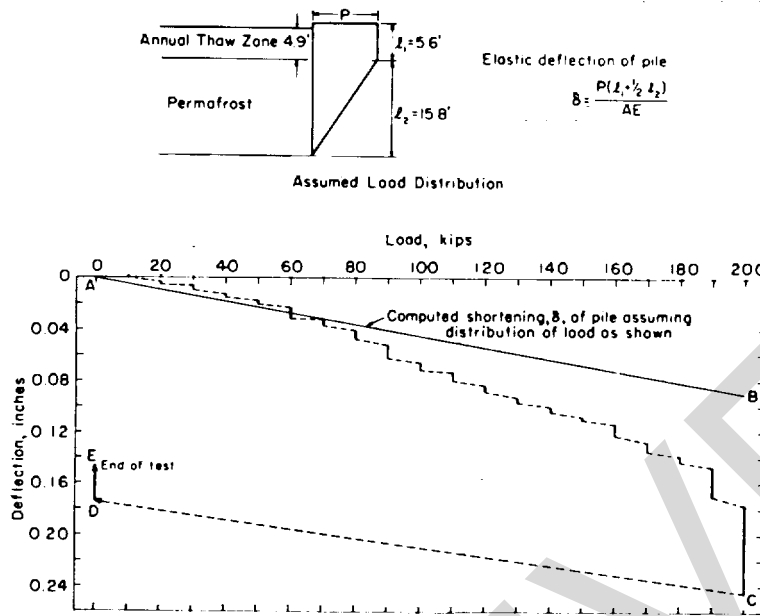

Pile type: 10BP42

Pile length 21.4 ft  
 Length of pile below surface: 20.7 ft  
 Pile embedment in frozen soil 15.8 ft  
 Pile cased through active zone.

Soil profile 0-1 ft peat, 1-20.7 ft  
 (bottom of pile silt)  
 Backfill around pile silt-water slurry  
 Avg temp of frozen soil 28°F  
 Test performed Feb-May 1961

Loading schedule: 10-kip increments at 4-day intervals except load held at 90 kips for 8 days, at 130 kips for 6 days, at 160 kips for 8 days, at 170 kips for 5 days, at 190 kips for 12 days, and at 200 kips for 9 days. Test terminated due to failure of hydraulic jack and zero load rebound observed for 3 days.

U. S. Army Corps of Engineers

Figure 4-84. Load-settlement test. 10-kip increments.

responds approximately with the permafrost displacement remaining at point E after removal of the load, C to D, and completion of rebound. At a practical working load of about 72 kips, obtained by dividing the ultimate load (as defined at the end of this paragraph) of about 180 kips by a factor of safety of 2.5, relatively good correspondence may be observed between the computed elastic deflection (curve AB) and the observed deflection (AC).

(6) To provide meaningful test data, the false capacities achieved by rapid rates of loading should be avoided by limiting the rate of load increase. The required time interval between load increments increases with increase in length of pile embedment, decrease of permafrost temperature, and increase in relative intensity of loading. For piles of less than about 20 feet embedment, in permafrost warmer than about 24 F load increments should be maintained for at least 72 hours. It is simplest to use a uniform period between additions of

load increments throughout each test. For longer piles or lower permafrost temperatures, it may be necessary to use longer time intervals; this must be determined by test. Figure 4-85 shows the effect of time between load increments on tangential adfreeze bond failure stress on 6-inch steel pipe piles of 11 to 12 feet embedment in permafrost installed in augered holes backfilled with siltwater slurry, tested at permafrost temperatures down to 23.5 °F. It will be apparent that for 10,000-lb increments held less than about 72 hours, measured bond strength values for these piles tend to be too high, requiring application for correction factors obtained from these curves to reduce the results to long term values. Similar relationships may be assumed to apply for other types of piles. Thus, the observed ultimate adfreeze bond strength obtained in the load test on a steel pile shown in figure 4-81 is too high because the 10-kip increments

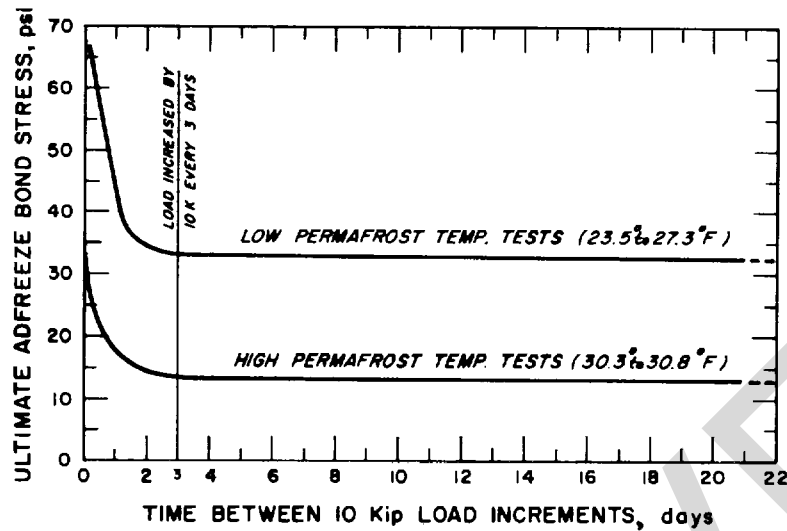

U. S. Army Corps of Engineers

Figure 4-85. Effect of rate of loading and temperature on adfreeze strength of steel pipe piles<sup>134</sup>. Curves based on tests of 6 inch steel pipe piles installed in augered holes backfilled with silt-water slurry at Fairbanks, Alaska. Embedment of piles in permafrost varied from 10.9 to 12.0 ft.

were only held one day. However, that obtained in the test shown in figure 4-84 with each increment held at least four days requires no correction. A continuous record of deformations should be obtained under each load increment and continuing deformation rates at ends of the increment periods should be plotted against load to assist in determination of the load level at which excessive creep deformations begin. However, it should be kept in mind that stress redistribution along the length of the pile under an increment of load may continue far beyond a period of even three days and that such readings should not be assumed to quantitatively represent creep rates under long term steady load. The load may be completely removed at intervals during the test and the rebound of the pile noted. The rebound of the pile after the maximum load had been released should be observed for at least 24 hours. The deformation of the pile after rebound (point E in fig. 4-84) is known as the net or plastic deformation. The algebraic difference between the total deformation and the net settlement (difference in deflection between C and E in fig. 4-84) is known as the elastic deformation of the pile and soil. The net or plastic deformation of piles in permafrost rarely exceeds 0.50 inch before complete failure of the pile.

(7) As shown in figure 4-84, analysis is aided by comparing the observed deformations with the computed pile shortening. Comparison may also be

made with equivalent end bearing piles. Such analyses give indications of the length of pile actively supporting load and assist in recognition of failure situations.

(8) A value of failure or ultimate load should be determined from the load test results. A number of common criteria for selection of failure load are listed in TM 5-818-1/AFM 88-3, Chapter 7<sup>5</sup>. The most appropriate of these for tests in frozen ground is that which defines the failure or ultimate load as the load indicated by intersection of tangent lines drawn through the initial, flatter portion of the load-deformation curve and through the steeper part of the same curve. Adjustment to the critical design temperature should then be made if required, using the data shown in figure 4-82 and the allowable design load should be computed by application of a factor of safety as indicated in h below.

(9) If the length of time required to perform an exploratory load test as described is unacceptable, an alternative approach is to perform simultaneously several verification pile load tests as described below, with load values selected so as to positively bracket and establish the acceptable design load.

(10) In verification pile load tests the pile may be loaded to the design load in a single increment and then to 2 1/2 times the design load in a second increment, all other requirements remaining the same as for an ex-

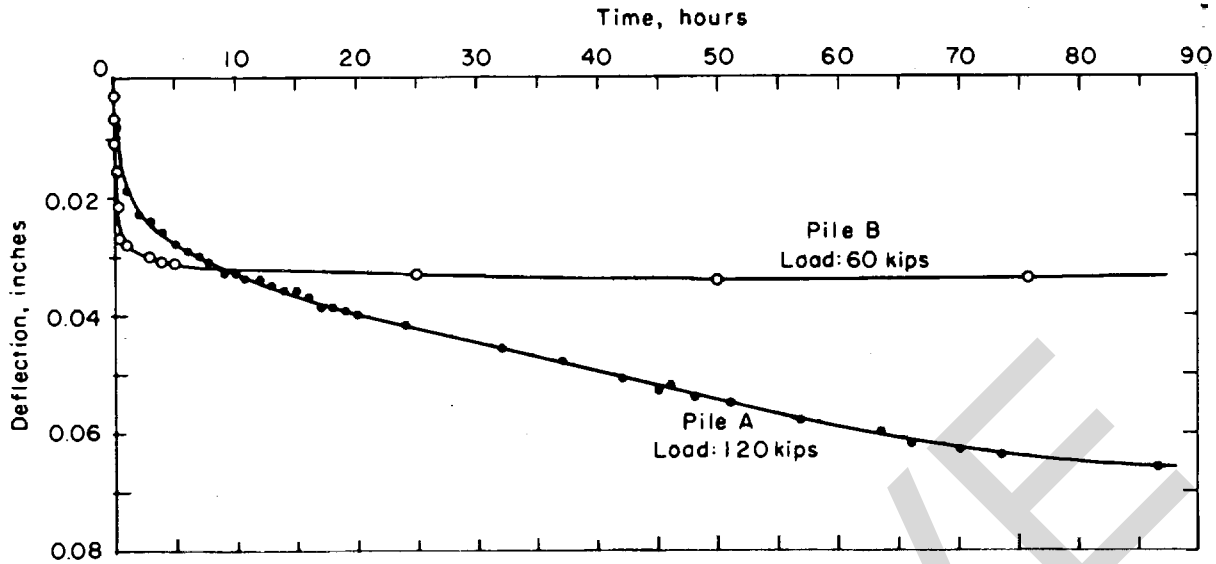

	Pile A	Pile B
Pile type:	Wood, butt down	Wood, tip down
Avg pile diameter:	11 in.	12 in.
Pile length:	34.5 ft	21.4 ft
Length of pile below surface:	31.0 ft	21.0 ft
Pile embedment in frozen soil:	31.0 ft	16.5 ft
Backfill around pile:	Silt-water slurry	Silt-water slurry
Soil profile:	0-1.6 ft gravel fill 1.6-3.3 ft peat 3.3-15 ft silt 15-31 ft ice	0.0-1.0 ft peat 1.0-21 ft silt
Avg temp of frozen soil:	24°F	30.4°F
Test performed:	Oct 1955	Nov-Dec 1958

U. S. Army Corps of Engineers

Figure 4-86. Load settlement test. single increment<sup>37</sup>.

ploratory load test. Two examples of deflection measured under single-increment loads are shown in figure 4-86. The much longer stress adjustment time required for the longer pile A, loaded to 120 kips and embedded in 24 F permafrost, as compared to the shorter pile B, loaded to 60 kips and embedded in 30.4°F permafrost, is readily apparent. If significant continuing deflection is still occurring 72 hours after application of the design load increment, observations should be continued until a firm conclusion can be drawn as to whether or not the pile will be safe against excessive creep deformation under the design load. It is not

necessary for the rate of deflection to drop entirely to zero. Normally proof of safe bearing capacity will not be a problem because the design load, which includes a factor of safety, will be conservatively low. Application of the second increment, increasing the load to 2 ½ times the design load, is intended primarily to provide a further check on the validity of the design load. Deflection measurements normally need not extend beyond 72 hours for this second increment, regardless of rate of continuing deflection. Intermediate increments of load between these two may be used if time and other constraints permit.

*h. Factors of safety.*

(1) On the basis of failure load determination from pile loading tests (g(5) above) the factor of safety of friction type piles against ultimate failure should be at least 2.5 for dead load plus normal live load and 2.0 for dead load plus maximum live load. Since ultimate adfreeze bond strength is about 1.4 times the sustainable, the factor of safety of 2.5 provides a factor of safety of about 2.5 divided by 1.4 equal to 1.79 with respect to the sustainable strength, on a gross basis. When the allowable design load in equation 14 is computed analytically (f(1) above) the gross factor of safety against ultimate failure contained in the resultant value  $Q_a$  should not be less than 3.0. These criteria apply for piles of average length of embedment in permafrost, i.e., 15 to 35 feet.

(2) Factors of safety for end bearing piles should be the same as in TM 5-818-1/AFM 88-3, Chapter 75.

(3) Because, as shown in figures 4-44 and 4-45, peak frost heave forces act for only a fraction of the year, avoidance of rupture of the adfreeze bond in permafrost under peak stresses is a more critical problem in considering pile safety against heave than is progressive upward movement under stresses of creep levels. The same is true for piles subject to intermittent external tension loads. If rupture of the bond occurs, major upward displacement may be expected, which, as noted in f(3) above, is not likely to stabilize. These types of loading are also less predictable in magnitude than downward compression type loadings. Under intermittent tension or frost heave loading of piles, factors of safety of 2.5 and 3.9 with respect to failure loads determined by tests and by computations, respectively, should be applied in equation 15 to forestall failure. These values should also be used for other types of foundations when critical stressing is in tangential shear of adfreeze bond.

**4-9. Grade Beams.** Grade beams or similar horizontal structural members placed at or just below ground level, which may be subject to uplift, should be avoided when frost-susceptible soils are involved. Instead, full foundation type walls should be substituted. In theory, an alternate procedure is to replace the soil at the grade-beam location for the full frost depth with non-frost-susceptible material for sufficient width so that the non-heaving soil under the beam will not be carried up by heave of the adjacent soil. However, no rational procedure for determining the required width of non-frost-susceptible material is yet available.

**4-10. Walls and retaining structures.**

a. Bridge abutments, retaining walls, bulkheads and similar structures with unheated foundations are susceptible to frost heave, settlement and overturning forces, when the requisite soil, moisture and freezing conditions are present. They are subject to

upward frost thrust acting directly against horizontal foundation surfaces and on vertical surfaces by adfreeze bond of the seasonal frost layer to the structure. They are also subject to lateral thrust from laterally acting frost heave forces; as indicated in figure 4-42, frost heave develops in a direction directly opposite to the direction of frost penetration. If freezing temperatures penetrate through a vertical face, such as a wall, water migration, ice lensing and frost thrust will be oriented in relation to the vertical surface in the same manner as they are to a horizontal surface when frost penetration is downward. The force developed can be sufficient to move or break the wall. Progressive small movements, year after year, can produce substantial permanent tilt, because forces during the thawing period do not act to return the structure toward its original position, as is the case, for example, for pavements. For these reasons, the design of walls and retaining structures requires even more care than the design of conventional footings. The most satisfactory method is to place a backfill of non-frost susceptible material directly behind and adjacent to the wall structure, as shown in figure 4-87a, b, to a thickness equal to the depth of frost penetration, using, if necessary, a 12-inch filter layer next to the finegrained backfill. If differential frost heave would cause a problem on the ground surface at the edge of the nonfrost-susceptible backfill, the latter should be tapered out over sufficient distance to eliminate the problem. Positive drainage of the backfill should be provided; however, the possibility that the drainage system may be blocked by freezing during a significant part of the year must be taken into account in the hydrostatic pressure design assumptions for wall stability analysis.

b. The chart shown in figure 4-88 may be used to estimate the depth of backfill required behind concrete walls in order to confine seasonal freezing to the backfill. For average wall conditions (assuming essentially vertical wall faces) with average exposure to the sun, a surface freezing index equal to 0.9 of the air freezing index should be used. The n-factor of 0.9 is greater than the 0.7 used for pavements kept cleared of snow because of the more positive freedom from the insulating effects of snow and ice, because of 3-dimensional cooling effects associated with a wall and embankment, and because of increased cooling effects of wind. If the wall receives no sunshine during the freezing period, is exposed to substantial wind and remains free of snow or ice, an n-factor of 1.0 should be used. If the wall is located in a southerly latitude, has a southerly exposure and therefore receives much sunshine, the n-factor may be as low as 0.5 to 0.7; however, in very high latitudes, the net radiational heat input may be very small or negative and the n-factor may be 0.7 to 0.9.

The chart may also be used for estimating the depth of frost penetration vertically into granular soil below a

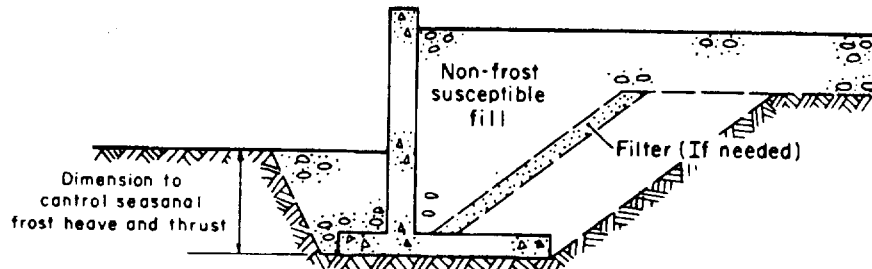

a. Counter fort wall

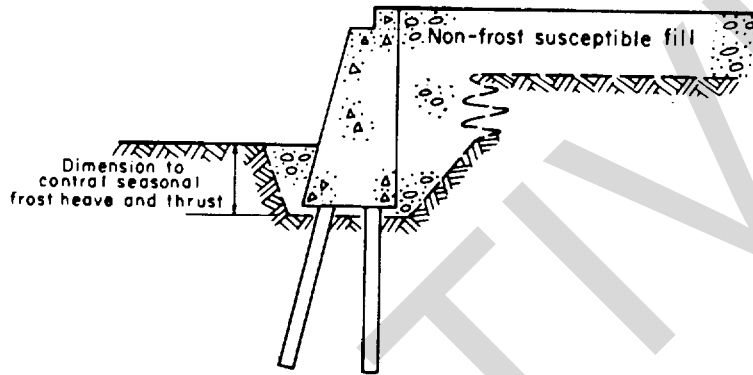

b. Pile-supported wall

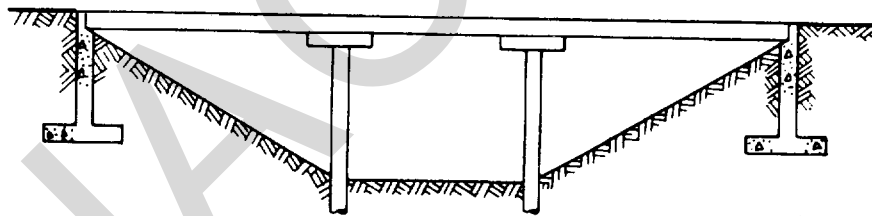

c. Wingless abutments

U. S. Army Corps of Engineers

Figure 4-87. Walls and abutments.

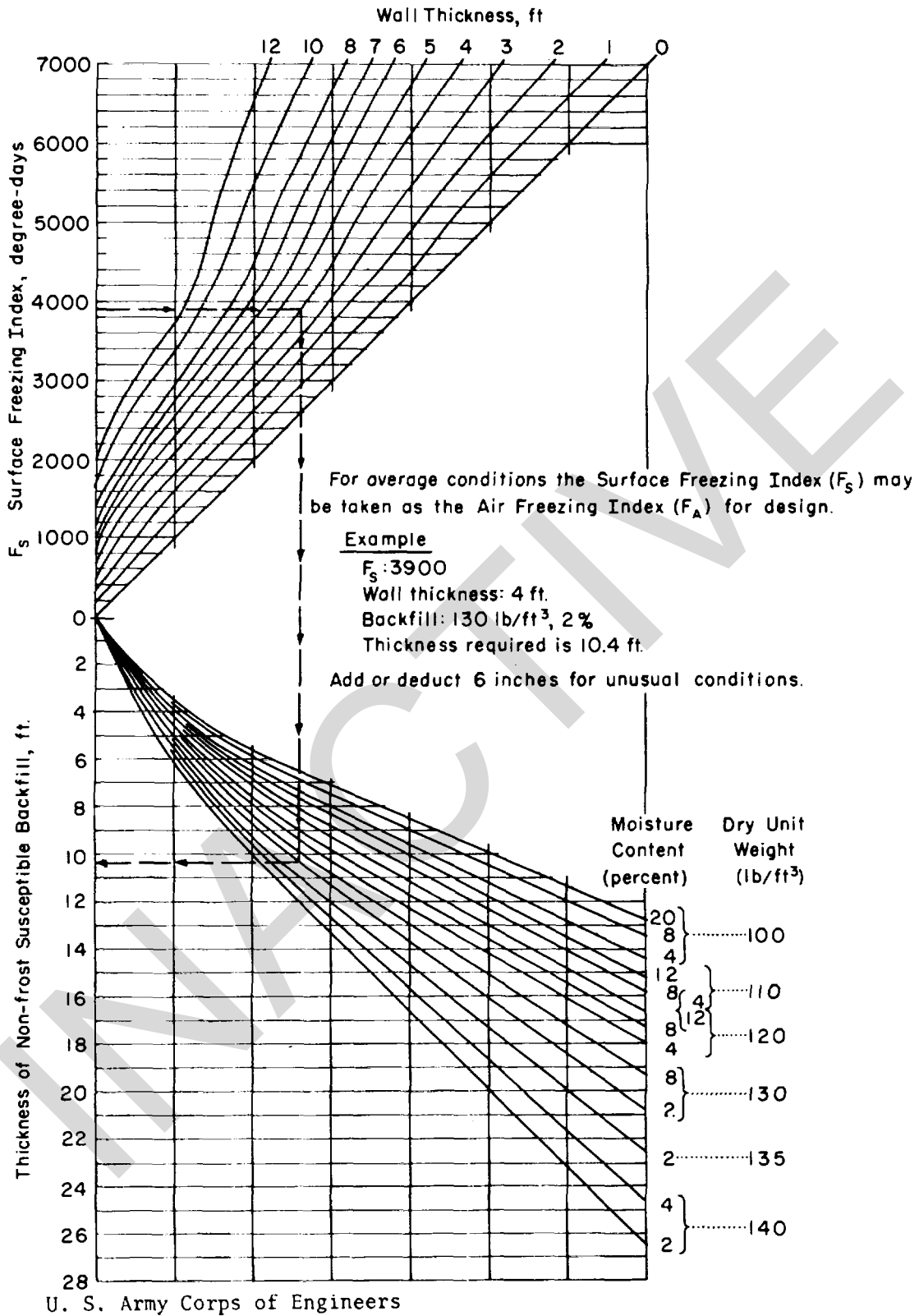

U. S. Army Corps of Engineers

Figure 4-88. Thickness of non-frost-susceptible backfill behind concrete walls.



snow-free horizontal ground surface; for bare ground, for example, the surface freezing index would be taken as 0.7 of the air freezing index and the chart would be entered with zero wall thickness. If it is necessary for a wall or retaining structure to be in contact with frost susceptible soil over all or part of its height under conditions where freezing direction is vertical rather than lateral, some modification of frost uplift may be provided by battering the face of the structure as much as possible. Heaving soil will then tend to break contact with the wall as it is lifted and thus limit the area of adfreeze contact. It should not be assumed that this will eliminate uplift forces. Anchorage against the uplift forces should be provided by such means as extending the batter well down below the zone of frost penetration. and/or by using an adequately widespread base. In any case, sufficient reinforcing steel must be incorporated in the concrete to sustain tensile forces developed therein without cracking of the concrete in tension by extension of the reinforcement.

c. In lieu of placing the base of the wall deep enough in the ground so that freezing cannot penetrate under it into frost-susceptible soils, it may sometimes be feasible to support the structure on piles just above the ground, "daylighting" the base sufficiently to provide room for upward expansion of the heaving soil. However, risk is then present that this space may be eliminated by settlement, or by deposition of material within the gap by water or wind, and be unable to function when needed. This is particularly true if the structure is a bridge pier subject to movement and deposition of material by stream flow.

d. Figure 4-87c shows a type of design which minimizes many of the problems inherent in wing or box type bridge abutments. Although it may require special attention to slope stability and erosion control and it requires a longer supported span, it reduces the frost design problems of retaining structures to a minimum and offers much in simplicity.

e. Stability of walls and retaining structures may be computed using earth pressure analytical techniques as presented in TM 5-818-1<sup>5</sup>.

#### **4-11. Tower foundations.**

a. Towers for transmission lines, communication antennas, cableways or other purposes are commonly either self-supporting as shown schematically in the left hand diagrams of figures 4-89 and 4-90 or guyed as indicated in the right hand diagrams of figure 4-89 and the right hand portions of figure 4-90a,b. When bank-run gravel is available, designs of the types shown in Figure 4-89 may be considered. Figure 4-90 shows a number of possible types of foundations requiring little or no granular non-frost-susceptible material.

b. A tower supported on top of the annual frost zone will experience frost heave if the freezing soil is frostsusceptible and moisture is available. Depending on the design and purpose of the tower, the seasonal

vertical movement may or may not be detrimental. If the heave is differential between footings supporting the tower, the tower will tip and/or the structure will be unevenly stressed. For a radar or communication tower, loss of orientation may be critical. If the tower is guyed, the guys and/or the guy anchors may be overstressed. Some may become slack. Differential footing settlements may occur during thaw-weakening in spring. If the tower is on a slope, progressive downslope movement may occur with successive cycles of freeze-thaw.

c. Granular material may be used as illustrated by figures 4-89 and 4-91 to control or even eliminate detrimental vertical movement. The simplest approach, as shown in figures 4-89a,b, is to support the tower on a granular mat placed on the surface. Because of the intensity of the winter cold, it is usually impractical in arctic and subarctic regions to attempt to make the mat thick enough to completely prevent frost penetration or heave in the underlying frost-susceptible material, particularly when the mat is naturally well-drained, as in figures 4-89a,b, though this may be possible in some seasonal frost areas. However, as described in paragraph 2-5, the magnitude of frost heave may be substantially reduced by a relatively modest surcharge, consisting of the weight of the gravel plus the load from the structure. For some situations, the thickness of gravel may therefore merely need to be made sufficient to reduce frost heave to an acceptable level, assuming the design is not sensitive to possible differential effects.

d. In the type of design shown in figure 4-89b, the footings are placed at the natural ground surface instead of on the mat. If the mat densities and thicknesses are the same, the potential for heave reduction by surcharge will be the same in figure 4-89a and b. However, safety against overturning of the self-supporting tower will be greater in figure 4-89b because of the load of the mat on the footings. There is greater possibility in figure 4-89b that the soil under the footing may be overstressed during spring thaw weakening. To reduce this possibility, as well as to provide a working surface and to make sure that footings will not get "hung up" and fail to settle completely back to original position on thaw, it is desirable to specify a shallow granular pad immediately below the footing as shown in figure 4-89b. More steel is required in the figure 4-89b scheme than in the figure 4-89a design, placement of gravel around the structural members requires special care, and protection of the buried steel against corrosion is more complicated; this scheme is thus more expensive.

e. If in the figure 4-89b design the footings were to

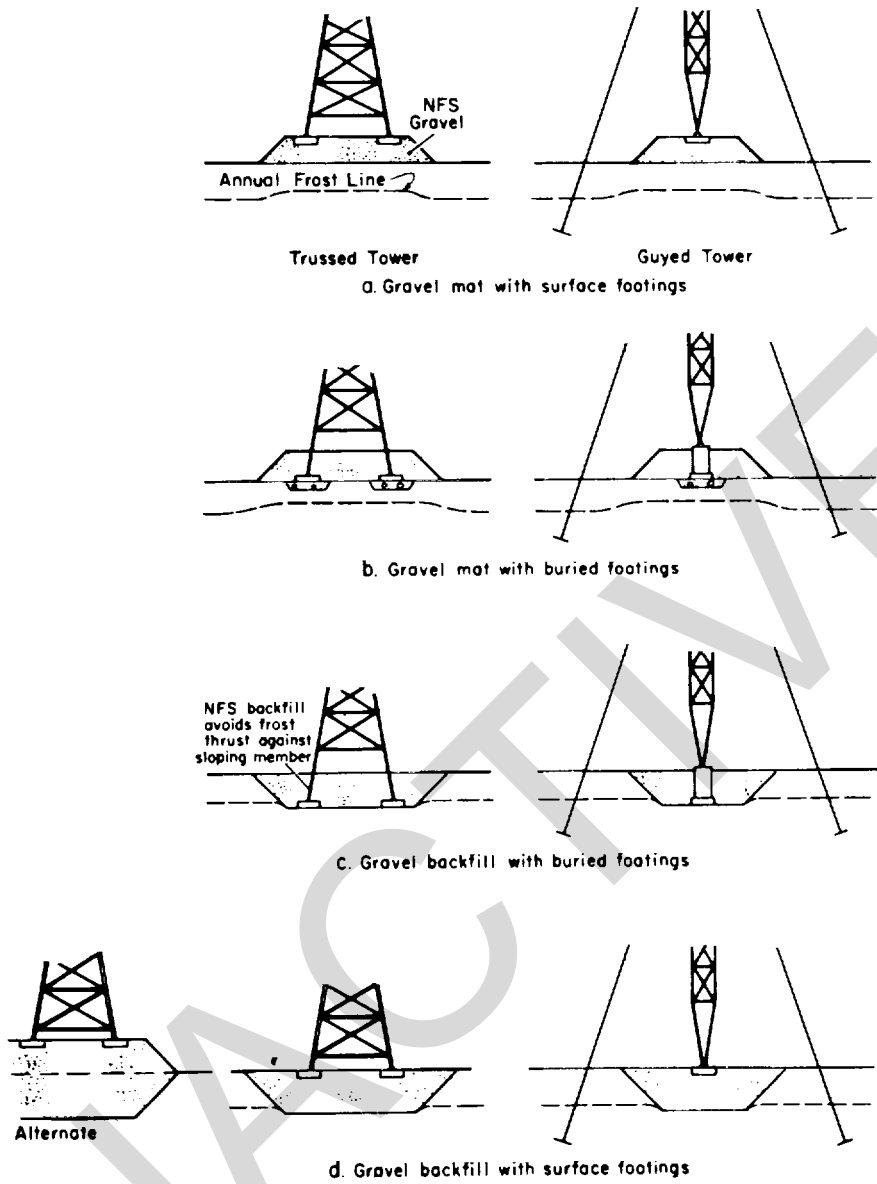

U. S. Army Corps of Engineers

Figure 4-89. Granular pad tower foundation.

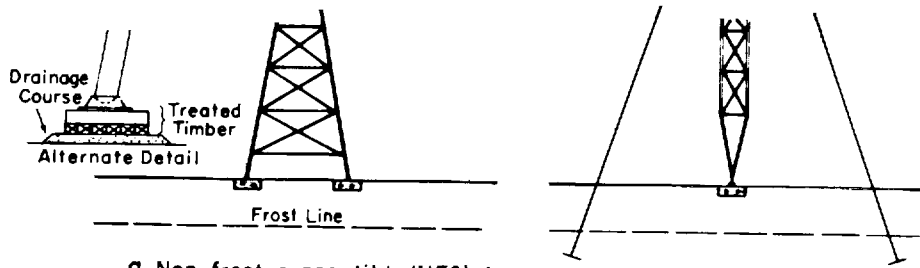

d. Non-frost-susceptible (NFS) foundation with shallow footings.

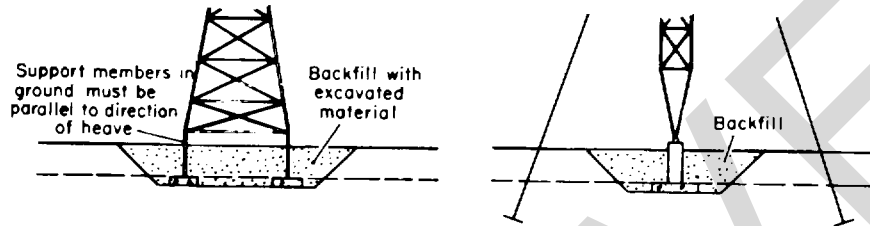

b. Frost susceptible foundation with footings below frost line.

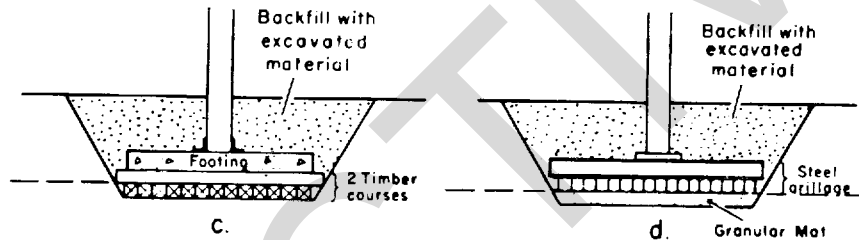

c.

d.

Alternate foundation details.

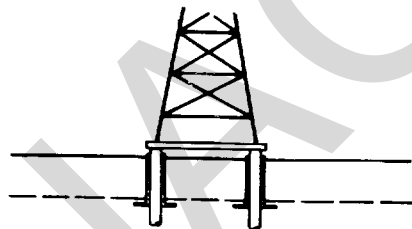

e. Pile foundation

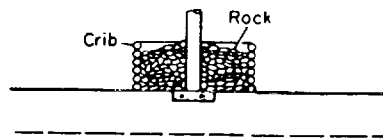

f. Crib foundation

U. S. Army Corps of Engineers

Figure 4-90. Foundation designs employing minimum or no NFS granular borrowed material (both are frost-susceptible foundation).

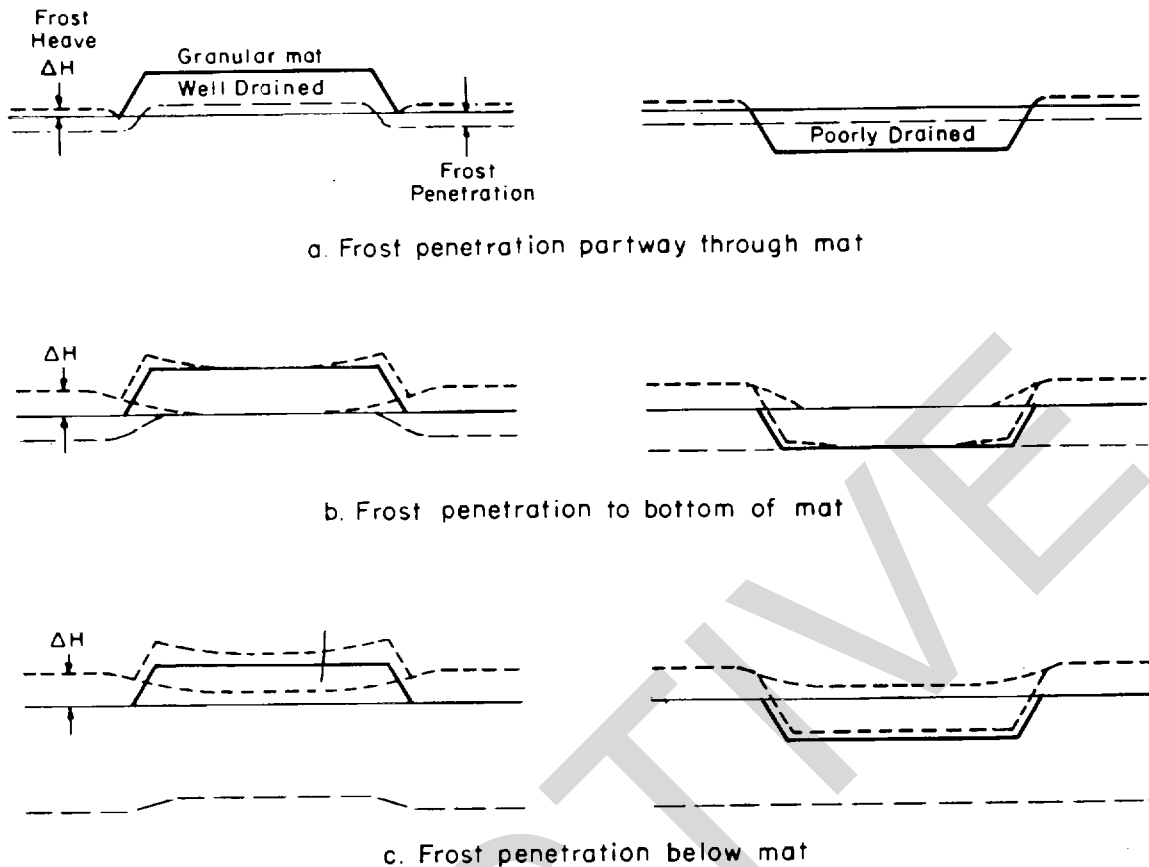

U. S. Army Corps of Engineers

Figure 4-91. Effects of granular mats on frost penetration and heave.

be placed within the frost heaving material, the possibility would exist that the footing would be moved progressively upward with successive annual cycles of freeze and thaw, in the same way that boulders work upward in the seasonal frost zone. Therefore, where foundation soils are frost-susceptible, footings must be placed either on top of the frost-susceptible material or granular mat or below the zone of seasonal frost, never in between. If in the case shown in figure 4-89b, the footings were to be placed below the seasonal frost zone, care would have to be taken that the direction of frost heave and the axes of the structural members within the annual frost zone had the same orientation so that the heaving soil could "slide" on the structural members. In hilly country this requirement might be impossible to achieve. Of course, the structural members would also have to be free of projections or obstructions and would have to be designed, together

with the footings, to resist the heave forces generated in them.

f. The same concepts as involved in figure 4-89b are also represented in the approach shown in figure 4-89c. On the plus side, the latter design offers the additional advantages that moisture content of the granular fill will tend to be higher and the total seasonal frost penetration less than in the figure 4-89b case, because of the poorer NFS drainage situation, the footings rest on material not subject to freeze and thaw which thus will retain its bearing capacity and snow cover will develop relatively normally because through the year the backfill is flush with the surrounding ground. However, the scheme has the inherent disadvantages that the additional cost of excavation and removal of material in the annual frost zone is bound to make this scheme more

expensive than that in figure 4-89b (which in turn is more costly than that in fig 4-89a), and unless the mat is of substantial diameter there is a real possibility that the frozen moist granular mat, forming a relatively continuous slab with the adjacent frozen soils, may be lifted by heave of these surrounding soils. If such lifting is possible, careful analysis of possible frost heaving forces on the bottom structural members of the tower or of possible lifting of the tower itself will be required.

*g.* The center and right hand diagrams in figure 4-89d show the same mat and footing arrangements as in figure 4-89a except that the mat is placed below the surface, to gain the advantages of higher moisture retention potential and corresponding reduced frost penetration. The disadvantages are the same as explained above for figure 4-89c except that possible heave forces on the non-perpendicular bottom structural members are avoided. The self-supporting design also lacks the added safety against overturning provided by load of the mat on the footings. The left hand diagram of figure 4-89d illustrates how the design might be further combined with the mat in figure 4-89a to further increase the surcharge and better control frost penetration.

*h.* The development of frost penetration and frost heave in above-surface and below-surface granular mats is illustrated diagrammatically in figure 4-91 for three relative depths of frost penetration, disregarding possible effects from non-uniform snow cover. In figure 4-91a, freezing has only partially penetrated the mat and there is no frost heave in the interior of the mat. In figure 4-91b, frost penetration has reached the bottom of the mat but frost heave of the mat is confined to the shoulders. In figure 4-91c frost has penetrated below the mat; the entire mat has lifted and the surface is dish shaped. At the same time heave of the natural ground tends to be restrained near the mat; heave at the mat is less than it would have been without the mat. Because the transition zone conditions at the boundary of the mat develop gradually over the winter, upward bending of the frozen granular material may occur by creep.

*i.* It will be apparent from these diagrams that tower footings should be located a prudent distance away from the mat boundaries in order to minimize frost heave problems. No tower footing edge should be closer than 5 feet to the top edge of the granular embankment under average conditions.

*j.* Although some guidance in selection of mat thickness is given in paragraphs 2-4, 4-2b, and 4-2e, it is difficult to estimate the actual maximum frost heave accurately, even at the center of the mat, in the present state-of-the-art. For example, the projection of a mat above the surface, as shown in figure 4-89a, will affect the thickness and uniformity of snow cover developed locally, but the exact effect of the variable snow

accumulation on frost penetration under the interior of the mat is difficult to predict. It is even more difficult to predict effects in the perimeter transition zone. For both above-surface and below-surface mats there is at present no rational technique for analytically determining the pattern of vertical deformation in this zone or of the diameter of mat required to isolate the footings from the upward thrust of the surrounding frost heaving materials.

*k.* Therefore, for designs which require frost heave to be predicted with a high degree of confidence, prototype/scale test installations should be constructed under representative field conditions; heave and frost penetration should be measured on these in at least one winter, correlated with soil moisture and freezing conditions, and projected to the worst anticipated winter conditions during the life of the structure.

*l.* Figure 4-90a shows, schematically, tower foundation designs for non-frost-susceptible foundation materials using surface footings. Since these are little affected by freeze and thaw except for thermal contraction and expansion of the ground surface, foundation designs may be essentially the same as in non-frost areas.

*m.* In figure 4-90b, footings in a frost-susceptible foundation are shown placed at a level below the zone of seasonal freeze and thaw. In seasonal frost areas, these footings may rest directly on natural soil. In permafrost areas a granular working surface of nominal thickness should be employed directly under the footing. By backfilling over the footings with the same material as that removed, the depth of seasonal frost penetration under the tower will experience minimum change from the natural conditions, the major remaining cause of difference then being the effects of destruction of the surface vegetation during construction. If the soils have high moisture holding capacities, the depth of frost penetration, and hence the needed depth of excavation, will be a minimum. As shown in figure 4-90b, however, the structural members passing through the frost zone must parallel the direction of frost heave; this requirement may make this type design impractical in hilly country. Sometimes it may be possible to modify the topography locally, in the area of the foundation, sufficiently so that all frost penetration will be vertical.

*n.* Figures 4-90c and d show details of two possible alternate footings. Figure 4-90c illustrates the use of two timber courses to provide a firm, semi-insulating working surface and footing base. In some areas, timber may be more readily available and more easily handled than gravel. Figure 4-90d shows a steel grillage resting on a shallow gravel working course. If the backfill is frost-susceptible, frost heave forces acting on the vertical member of the foundation in figures 4-90c and d must be analyzed and the footings designed so that they

offer adequate resistance against being pulled upward in winter.

*o.* Figure 4-90e illustrates a pile foundation with flanged sleeves to isolate the piles from frost heave forces. The sleeves may be omitted if adequate pile embedment in permafrost or other provisions against uplift are provided. Sleeves and other techniques for providing heave force isolation are discussed in greater detail in paragraph 4-3/.

*p.* The timber crib foundation shown in figure 4-90f has been used successfully for pole lines in difficult marginal permafrost terrain. Pole lines are further discussed in TM 5-852-5<sup>13</sup>.

#### 4-12. Bridge foundations.

*a.* Foundations of bridges which do not cross water bodies should be designed using the previously described criteria for walls and retaining structures (para 410), footings and piers (para 4-7), and piling (para 4-8), as applicable.

*b.* Bridges over water bodies in permafrost areas tend to involve difficult special problems because the permafrost conditions are substantially altered near and under the water. As shown in figure 4-92, the permafrost table tends to be depressed under a water body; under a major water body, permafrost may be absent except very close to the shore. Temperatures of permafrost near and under the water also tend to be warmer; especially in areas of marginal permafrost, permafrost temperatures at the ground levels in which foundations are supported may be very close to or at the melting point. Water moving in thaw zones beneath and adjacent to the water body may cause an extremely complex and uncertain thermal regime pattern. Little or no capacity for natural freezeback of piles may be available and the tangential adfreeze strength that can be safely relied on may be very low. Footing-type foundations encounter substantial risk of settlement from slight changes in the subsurface thermal regime.

*c.* For all these reasons highway and railroad bridge foundations in permafrost areas have been a continuing source of difficulties. In marginal permafrost areas, designs of stable piers and abutments are among the most challenging engineering problems which may be encountered in permafrost areas. In order to support these facilities on relatively stable frozen materials, pile foundations are commonly employed<sup>48,50</sup>. However, because of uncertain or incomplete freezeback, the frequency of serious frost heaving of pile bridge foundations has been very high. On the Alaska Railroad for example, wood piling of many of the bridges is heaved every year. Pewe<sup>180</sup> has reported that this heave reaches as much as 14 in./yr and the elevation of the track is seriously disturbed, making necessary reduction of speed to avoid uncoupling of cars or shifting of cargo. Tops of piles are trimmed off each summer, resulting in

progressive reduction of embedded length. Maintenance requirements are substantial and periodic replacement of piling and even changes of alignment are required. At some bridge sites, the stubs of several "generations" of piling which have been successively abandoned may be seen, *d.* Especially careful and detailed subsurface exploration should be carried out at proposed bridge locations to assure the most favorable bridge alignment and positioning of the foundations and to provide the information required for thorough and painstaking foundation design of these vital facilities. Positions of the permafrost table and any residual thaw zones should be carefully determined. The amount of any excess ice in the ground should be carefully ascertained using refrigerated drilling techniques, and the subsurface temperature conditions, should be determined.

*e.* The presence of frozen ground should not be assumed to preclude scour; fine-grained permafrost soils are often very highly susceptible to erosion upon thaw and the effects of floods may be substantial, particularly directly adjacent to piers placed in the streams. Also, the gouging action of floating ice often has a powerful eroding effect on stream banks. Since stream flow and thermal regime patterns may change substantially and unpredictably over the life of a bridge, and hydrologic data are often grossly inadequate, bridge foundations should be placed at depths which are conservatively safe with respect to usual criteria for safety against undercutting. Stationary ice sheets<sup>78</sup>, ice jams, and ice sheets and ice cakes moving with various velocities of flowing water or blown by wind and with various angles of attack, can exert very substantial pressures on foundations placed in the water. Foundations and piers should be positioned and shaped so as to minimize the effects that these forces can exert on exposed members of the foundation and designed with sufficient armor and strength to resist the forces which may then still occur. Michel<sup>78,79</sup> and Dunham<sup>140</sup> present useful discussions of this problem. Davis has reported on rock fill and sheet pile construction exposed to sea ice in Thule Harbor<sup>54</sup>. Techniques for design of structures against ice forces are in early stages of development.

*f.* Icing or the progressive accumulation of ice in winter by freezing of seepage or stream flow on the surface is unlikely to contribute any structural loadings to the foundation if the ice rests directly on the ground, although it may significantly reduce the hydraulic capacity of the bridge opening. However, if the ice build-up occurs on floating ice, a downward thrust on the foundation may be exerted in winter because of

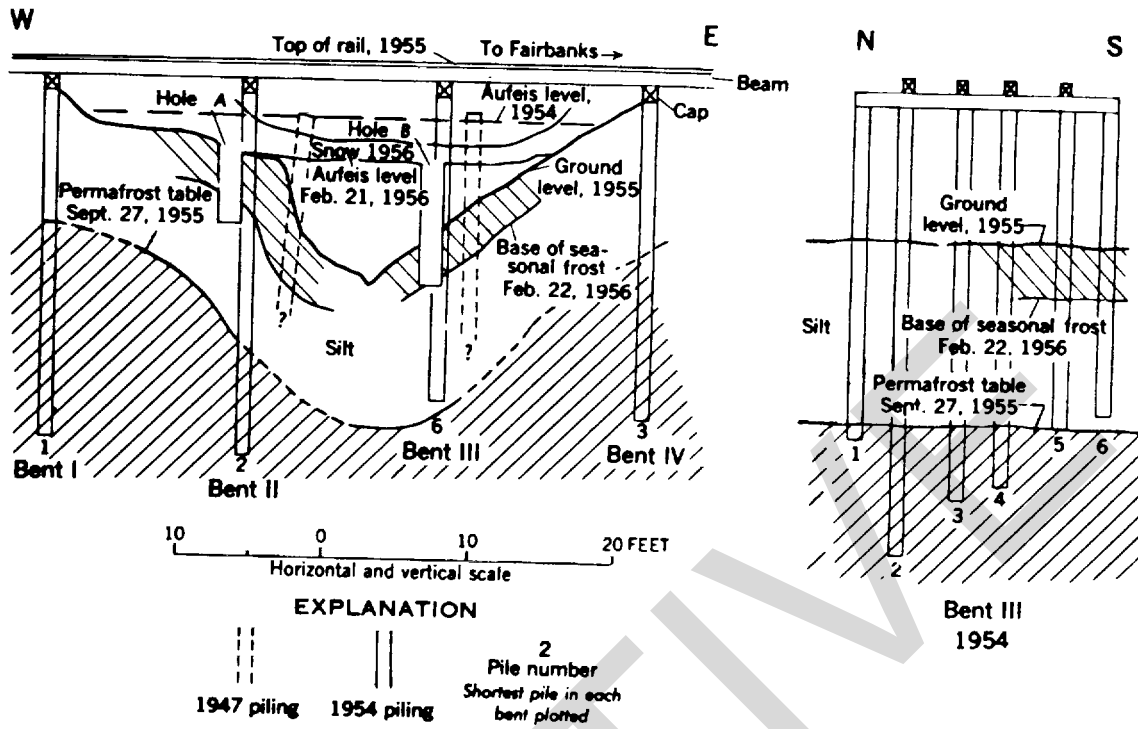

(Courtesy of U.S. Geological Survey)

Figure 4-92a. Geologic sections at two Alaska railroad bridges in Goldstream Valley near Fairbanks, Alaska. (From Pewe<sup>180</sup>.) (Milepost 456.7.)

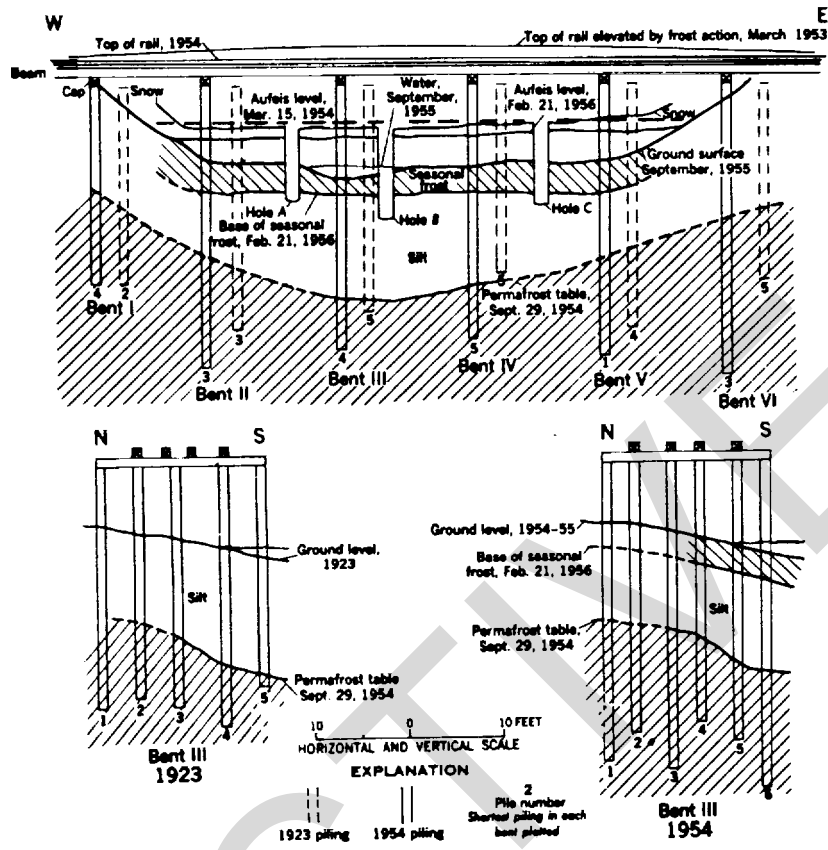

(Courtesy of U.S. Geological Survey)

Figure 4-92b. Geological sections at two Alaska railroad bridges in Goldstream Valley near Fairbanks, Alaska. (From Pewel<sup>180</sup>.) (Milepost 458.4.)



adherence of the ice to the pier, either from the increasing accumulation of ice above the water level or by lowering of the water level with decreasing stream flow. On the other hand, raising of the water level in the spring can cause a large upward thrust on the pier from the buoyancy of ice adhering to the pier or bearing against connecting members. In tidal areas the adherence of sea ice sheets to piers or piles at low tide may not only cause spalling or other direct structural damage but may cause them to be jacked up by the buoyant force of the ice in the succeeding high tide. In coastal Connecticut, piles for a waterfront structure were pulled out of the ground in one winter by this action. When such uplift is possible, piers, caissons, or piles should be kept entirely smooth, without projection or cross-bracing, in the levels at which ice may act, and must have sufficient depth of embedment or other anchorage to resist such uplift forces as can develop.

*g.* If the foundation is supported on frozen ground, short duration forces such as wind gusts are likely to be of little consequence because design for long term stability will have automatically introduced large factors of safety relative to short term loadings. However, any loadings which can act relatively consistently over substantial periods must be taken into account in the design load assumptions. In all cases careful analysis of frost heaving forces is required (para 4-31) and a safety factor against heave must be provided (para 4-8h). As shown in figure 4-41, which represents a relatively stable bridge for subarctic conditions, bridge foundations tend to be continuously in motion due to seasonal effects. If progressive frost heave occurs, or if allowable bearing stresses are overestimated and settlement occurs, movements may be progressive and much greater in magnitude, as well as differential. Because of these ever-present possibilities, types of bridge span structures which are especially sensitive to foundation movements should not be employed in arctic and subarctic areas unless stable foundations can be provided with complete certainty.

#### **4-13. Culverts.**

*a.* Criteria for design of flexible and rigid pipe culverts, for required depths of placement of culverts and of required depths of cover below pavements are given in TM 5-820-2/AFM 88-5, Chapter 1<sup>8</sup> and TM 5-820-3/AFM 88-5, Chapter 3<sup>9</sup>. The problem of icing in culverts is discussed in TM 5-852-7/AFM 88-19, Chapter 7<sup>17</sup>.

*b.* The problems of thermal stability of culvert foundations are somewhat similar to those of bridges in that the presence and flow of water causes a special thermal regime under the structure. If the culvert is a large one and carries water flow during most of the year, the frost penetration pattern may be substantially altered locally. If the culvert is constructed in a natural drainageway, a special, relatively stable thermal pattern

may already exist before construction and a condition of substantial seepage flow through the soil under the culvert location may already have been established. For this reason a natural drainage site is nearly always preferable. If the culvert is cut into an area which has not previously carried such flow, a new thermal regime will begin to develop; if the culvert is cut into permafrost containing ground ice, thaw will occur in summer into the soil surrounding the culvert structure from the effects of both the heat in the water flowing at the bottom of the culvert and the exposure to above-freezing air temperatures. Since the surface of ponded water exposed to the sun in arctic and subarctic areas may reach temperatures as high as about 70°F in the summer, heat input from the water may be substantial. If permafrost containing ground ice underlies the culvert, catastrophic settlement can be produced in a single summer. Not only may the culvert structure be damaged by loss of support, but the water may begin to pass under the structure instead of through it, leading to even more rapid collapse. If the flow is derived primarily from snow melt or emergence of seepage from thawing ground, it may be close to 32 F. If the water before reaching the culvert is experiencing net heat loss by radiation to the sky, it may even contain frazil ice particles.

*c.* In truly arctic areas it is possible to construct a stable culvert cut into permafrost by placing sufficient non-frost-susceptible backfill under and around the culvert structure so that thaw will be confined to this material in summer, with thawed material refreezing in the following winter. Required depth of gravel may be computed by analysis methods outlined in TM 852-6/AFM 88-19, Chapter 6". It will be necessary to determine not only the shaded air temperature but also the temperature of the water flowing in summer in the culvert and to compute thaw penetrations separately for these conditions using techniques for two-dimensional radial heat flow analysis. The only accurate way of determining the temperature of water which is flowing in a culvert is by actual measurement during a summer season. When in doubt, the designer should make certain that any error is on the safe side. Insulation may sometimes be economically substituted for part of the non-frost-susceptible material. In marginal permafrost areas, however, it may not be possible to achieve essentially complete freeze-back in winter and thaw will then be progressive. Insulation can slow but not prevent this. In this case, if unacceptable settlement would otherwise result, the designer should consider use of only established drainageways where reasonable thermal stability has been naturally achieved, use of pile-supported bridges instead of culverts, or complete excavation of the thaw-susceptible materials and replace

ment with non-frost-susceptible material. For nonpermanent facilities it may sometimes be necessary to accept heavy maintenance costs, however.

d. If foundation soils are susceptible to settlement on thaw, thermal analysis should be made of the proposed culvert, adapting the methods of TM 5-852-6/AFM 88-19, Chapter 6<sup>14</sup>. The final design should provide a thermally stable condition.

e. Headwalls of culverts may be heaved, undercut, tilted and fractured by frost action unless properly designed and constructed. They should be designed using the same structural approaches as outlined in paragraph 4-10, and with conventional provisions against piping through unfrozen material under the culvert.

#### 4-14. Anchorages.

a. Economical construction of anchors in frozen ground is a difficult and challenging problem because of the marked tendency for anchors to yield and creep when anchoring in a frozen soils' and also because of frost heave forces within the annual frost zone. While anchors in frozen soil may be capable of sustaining relatively high, short-duration loads without difficulty, they can exhibit unacceptable yield and creep under much lower long-term loadings. The latter is most pronounced when frozen ground temperatures are only slightly below the freezing point. Possible long term or transient changes in thermal regime must be carefully evaluated.

b. Laboratory experiments have shown that plate type anchors entirely in frozen soil (no thawed layer at the surface) fail in two distinct modes depending on the depth of burial. When the ratio of depth below surface divided by diameter of plate is greater than six, failure of the anchor occurs by punching of the plate on a cylindrical surface through the overlying material in a manner similar to that by which an overstressed footing may punch downward into a foundation. This is illustrated in b through f of figure 4-93. At stresses less than those which will produce rupture under relatively rapid loading, creep deformation will occur under long term loading in the same manner as described for footings in paragraph 4-7. When the plate is buried less than six times the diameter of the plate below the surface, failure may be expected to take place by punching out of a truncated cone of material starting at the plate and widening out at a 30° angle from the vertical, as shown in figure 4-93g. As this cone approaches the ground surface, the angle may change abruptly to perhaps 20° with the ground surface. However, it is conservative to assume in the analysis that the 30° angle continues to the surface. If the anchor acts at an angle with the ground surface, the failure surface may be expected to be altered as illustrated in figure 4-94.

c. Therefore, plate type anchors may be analyzed in the same manner as footings when the

depth of burial in frozen material exceeds six times the plate diameter; soil stresses on the anchor rod should be included in the analysis. Anchors closer to the surface than six times the diameter of the plate may be analyzed in terms of stresses on an assumed 30° truncated cone. In both cases, the presence of a thawed layer at the surface, of distinctly different characteristics from the underlying frozen material, will usually require that it be handled as a separate element within the analysis.

d. Conventional plate, screw-in type or various patented earth anchors can be installed in inclined or vertical augered holes in permafrost with slurry or backfill of soil-water mixture, compacted moist soil, or crushed rock. The capacity of such anchors is greatly increased by freezing and keeping the backfill frozen. If the anchor relies significantly upon the strength and resistance of thawed soil after installation, all efforts should be directed to selection of the most suitable backfill and the attainment of good compactive effort.

e. In recent years, special helical anchors have been developed for installation in permafrost. These anchors often have multiple helixes increasing in diameter from the bottom and are designed to resist the large torques required for installation in frozen soil by truck-or crane-mounted power equipment. Conventional helical anchors used for unfrozen soils may fail during installation by shearing the rod from the helix.

f. The design capacities for the various sizes and shapes of commercial earth anchors, as published in various tables in handbooks or manufacturers' literature for a range of unfrozen soils, should be reduced by 75 percent for anchors in thawed soil above permafrost. Unless protected in the annual frost zone by anti-heave devices or treated backfill, all anchors embedded in permafrost should be designed so that the anchor rod is capable of resisting 60 psi of frost thrust within that part of the rod which will be in the annual frost layer, and a total frost uplift force would be computed by assuming the average of 40 psi acting over the depth of the annual frost zone; the latter should be added to the design tensile load imposed on the anchor. For anti-heave protection, see paragraph 4-31. Provisions should be made for adjusting the tension of guy lines in both summer and winter, since the pole, tower or structure being guyed and anchored may experience heave or settlement quite different from that of the anchor(s).

g. Conventional metal expanding anchors should not be used in frozen soil or in rock containing ice as the extremely high local stresses developed with such anchors cause rapid plastic deformation and creep in the ice component. Only anchors which develop very low level

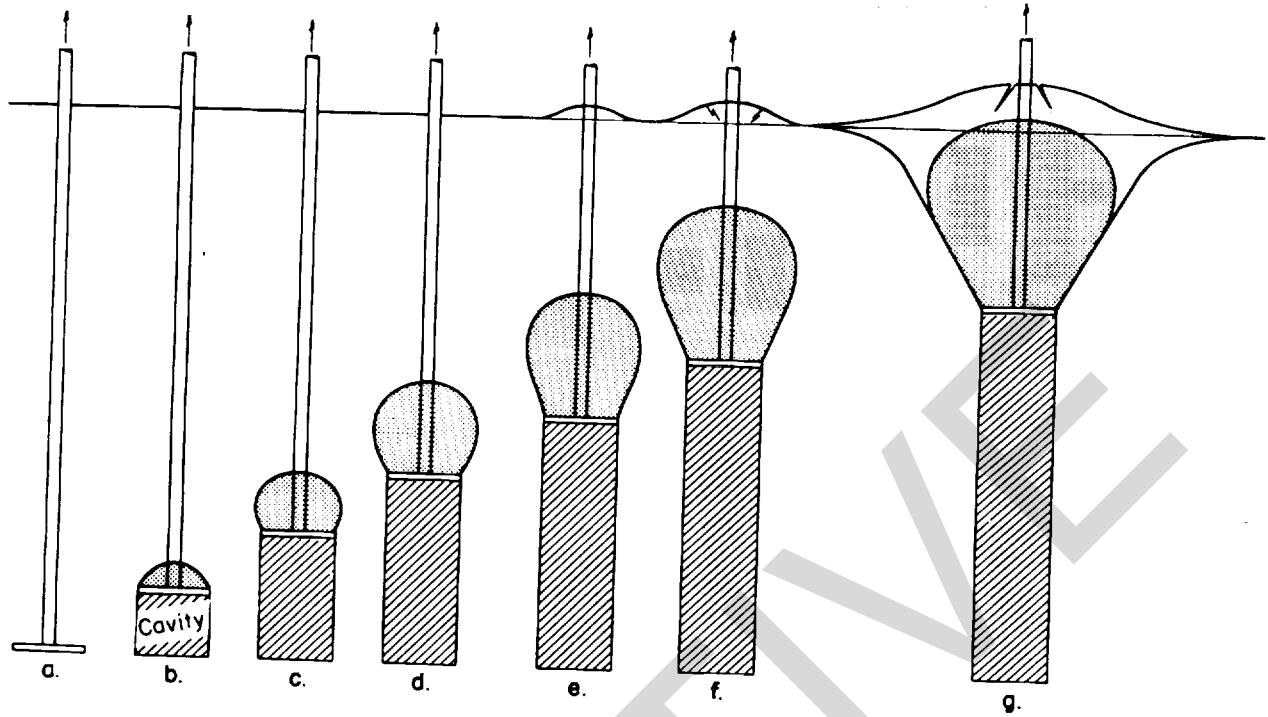

U. S. Army Corps of Engineers

Figure 4-93. Mechanics of anchor failure in frozen soils.

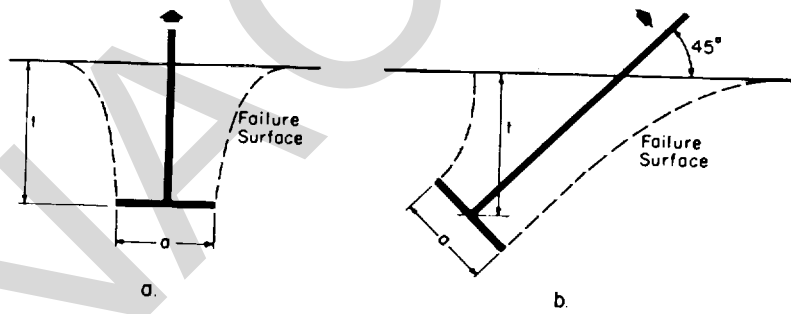

U. S. Army Corps of Engineers

Figure 4-94. Failure planes for batter and vertical anchor installation.

stresses over a relatively large area should be used. These are essentially the same principles as used in design of pile foundations in frozen ground (para 4-8).

*h.* Grouted anchors may be set in ice-free rock in conventional drill holes. The drill holes will require preheating before grouting if the rock is frozen. Grouted anchors may be installed in ice-free rock without preheating if the rock is warmer than 30°F, if high-early or other fast setting cements are used, provided the temperature of the ground is greater than 60°F at the time of placement and the annular thickness of the grout around the anchor rod is at least 2 1/2 inches (i.e., diameter of hole 6 inches or greater for 1-inch rod). Enlarged bells may be augered and integrally poured with the normal grouted rod anchors to provide additional anchor capacity. Because of the low ground temperatures, lead was used to grout anchorages into bedrock during construction of a major antenna at Thule, Greenland, in the 1950's to avoid the uncertainties of using portland cement mortar under these conditions. However, such practice is not recommended today in light of present techniques and capabilities for analyzing such problems.

*i.* Mass-gravity anchors have the advantage in cold regions that they are positive, can always be counted on, and are free of the risk of creep. However, if placed on top of frost-susceptible soils, the risk of frost heave and consequent variable anchor tension must be considered. Mass-gravity anchors are particularly suitable where clean, granular or even bouldery soils exist which can be easily excavated and handled for complete or partial burial of cast-in-place or precast anchor units. Deadmen can also be advantageously used to bear against frozen soil, but excavation costs are usually quite high.

*j.* In permafrost areas it is usually preferable to install anchors in the winter in order to cause as little permanent thermal disturbance of the permafrost as possible while at the same time assuring rapid development of the design anchor capacity.

*k.* For permanent anchors in frozen ground, design should be predicated on whichever is controlling: ultimate strength or holding creep within acceptable limits. Factors of safety should not be less than those specified in paragraphs 4-4 or 4-8h depending on the type of stressing. Failure of an anchor by pull-out is more likely to be catastrophic than the failure of a footing in settlement would be. Therefore, the factor of safety against actual pull-out should also be at least equivalent to the factor of safety in the supported structure based on ultimate strength.

#### **4-15. Foundations for non-heated facilities.**

Foundations of non-heated facilities may involve special design problems, considerations or requirements.

##### *a. Non-heated buildings.*

(1) Temperatures at floor level in an unheated building will depend on such factors as roof and wall insulation, degree of ventilation, roof and wall exterior reflectivity, and seasonal percent sunshine and are best determined experimentally in comparable buildings in the same area. Temperatures at floor level in an unheated building fully open to the outside air may usually be assumed to average the same as standard shaded meteorological station air temperatures. For this situation, slab-on-grade construction without insulation can be employed if a mat of non-frost-susceptible material is used, as illustrated in figure 4-95, sufficiently thick to contain seasonal freeze and thaw. With modification of the thickness of the non-frost susceptible mat as required by local climate, and possibly radiant heat input through windows, this design can be used under any building in any seasonal frost area or under any fully ventilated, unheated building in any frost area. Closed unheated buildings with no more than nominal ventilation tend to have warmer average annual temperatures, particularly from absorption of solar heat in summer. This is qualitatively illustrated in figure 4-40. Degradation of permafrost under this closed, insulated building (with ineffective foundation ventilation system) only slowly decreased after discontinuance of heating. If the average annual temperature in the building is warm enough to cause degradation of permafrost, the design in figure 4-95 will no longer be suitable if the foundation soils will settle significantly on thaw. Temperatures in an unheated earth-covered igloo or below-ground structure may usually be assumed to average the same as the ground temperatures at the average depth of the facility. The possibility that lighting or other electrical facilities and body heat may introduce significant amounts of heat into closed facilities should be considered.

(2) Where non-frost-susceptible material is scarce or expensive or where very deep frost penetration would require an uneconomical thickness of mat, the following alternatives to the designs in figure 4-95 may be considered.

(a) Use of under-slab insulation to reduce the thickness of non-frost-susceptible fill required.

(b) Use of a structural floor supported by footings or piles sufficiently above the ground so that it will be isolated from frost heave. This system can also be used to provide foundation ventilation to insure the coldest possible temperature conditions at the ground surface.

(c) Use of a gravel floor of nominal thickness directly on the natural soil, accepting resultant frost heave.

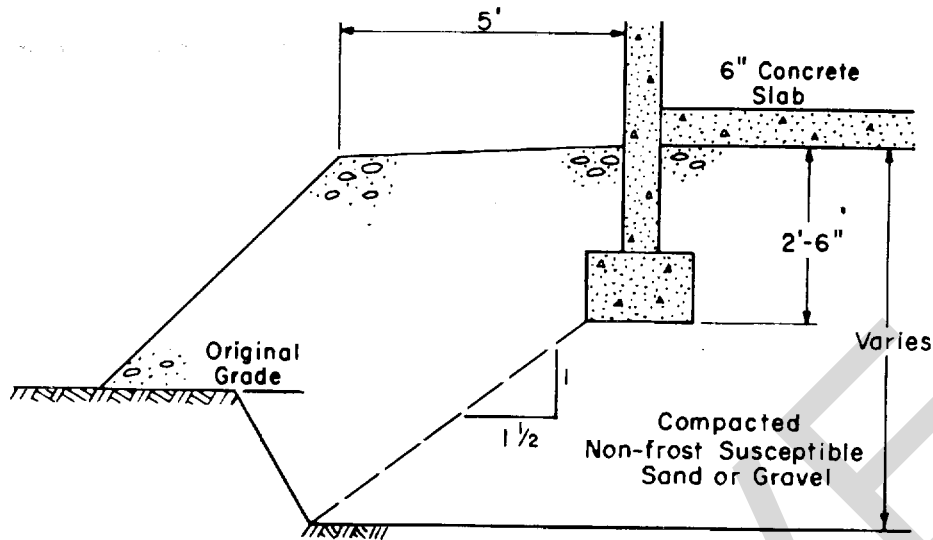

U. S. Army Corps of Engineers

Figure 4-95. Typical foundation design for unheated buildings overfrost-susceptible soil in deep seasonal frost or permafrost areas.

(d) Use of a mesh-reinforced concrete floor slab with sufficient non-frost-susceptible material to reduce total heave to about 1 inch (assume 1/2 of this differential), accepting some slab movement and fine cracks.

b. Exterior footings and piles.

(1) Footings and piles placed on the exterior of heated buildings for support of porches, roof extensions and unheated connecting corridors, and which receive none of the heating benefits experienced by the main foundation, are subject to full frost-heave effects. In fact, because snow cover may be absent, frost penetration may be more than it is farther from the building where snow is allowed to accumulate. The importance of adequate provisions against heave of such footings is frequently overlooked, perhaps in part because the construction measures required seem out of proportion to the importance or construction cost of the facilities involved. However, the cost of repair measures for structural damage, blocked roof drainage, broken glass and distorted structures may substantially exceed the cost of adequate initial protection against heave.

(2) Foundations of this type should be constructed in accordance with the principles outlined in paragraphs 4-3, 4-7 and 4-8. If only small pipe columns are required, they may be installed inside protective casings extending through the annual frost zone with the space between casing and column filled with an oil-wax mixture which will permit free relative vertical movement of the casing and column but prevent entry of water and dirt; the casing should have an external flange at its bottom end to minimize its tendency to gradually work out of the ground. The flange should be strong enough

to resist an adfreeze uplift force on the outside of the casing of magnitude as indicated in paragraph 4-8. If the casing and oil wax are not used, the column should be fastened to a plate or footing of size sufficient to develop the passive resistance required to counter the frost heaving forces.

c. Exterior aprons.

(1) When an exterior unheated loading platform, apron, or transition pavement over frost-susceptible soil is connected to a structure which is heated or is otherwise protected against frost heave, difficulties frequently arise. As indicated in figure 4-96a, heave may cause an unacceptable, abrupt displacement of the apron at the junction with the building and may block outward opening doors. It may also cause structural damage, interfere with drainage and thus cause icing. A pad of non-frost-susceptible soil placed under the apron to the full depth of frost penetration and tapered in thickness as shown in figure 4-96b or c will eliminate this difficulty if the material can be kept well drained. If the nonsusceptible material cannot be drained and becomes saturated, however, some uplift can still occur as a result of expansion of water which is trapped in the voids, on freezing. This heave may still be sufficient to block outward-opening doors if the fill is deep or is borderline in its non-frost-susceptibility and clearances are insufficient. In this case, it may be necessary to construct all or part of the apron in the form of a structural slab supported on one side of the foundation wall of the building, and, on the other, on footing, beam, or pile support, as shown in figure 4-96d, with sufficient space under the slab so that the heaving soil will not come in

contact with it. If a beam supported near the surface is used and the outer edge of the slab is heaved then hinge action will occur at the inner edge, but there will be no step displacement. In some cases, a layer of insulation under the slab may assist in providing the most economical solution. Another alternative way of allowing for minor heave is to provide a downward step as small as 2 to 4 inches with the apron left free to heave.

(2) In extreme climates it is considered preferable to hand doors of heated dwellings to open inward because of the possibility of blocking of doors by heave of exterior aprons, stairs, or platforms, or by heavy snow or ice, even though this is contrary to conventional fire safety regulations.

#### **4-16. Utilidor and pipeline foundations.**

Methods of supporting utilidors and pipelines above and below ground are discussed in TM 5-852-5/AFM 88-19, Chapter 5<sup>13</sup>. Techniques for design of the pile or other types of foundation construction and support described therein should be in accordance with the provisions of this manual.

#### **4-17. Connection of utilities to buildings.**

a. The manner and depth at which utilities (water, sewer, electric, communications, etc.) approach and enter building below ground may be a factor in foundation design. It is important that provisions be made so that utility lines will not be sheared by heave or settlement where they pass through foundation walls and that lines carrying water will not freeze. In purely seasonal frost areas, water lines 6 inches or less in diameter should be laid with invert 6 inches below the computed maximum frost penetration depth. Larger water pipes should be laid so that the top of the pipe is at the computed maximum frost penetration depth. In areas of very deep frost penetration it may be more economical, if the soils are non-frost-susceptible, to place the entire system of water pipes at nominal depth and provide continuous circulation and heat during the freezing season; for some situations insulation may also be used effectively if it is protected against moisture absorption. Because of wide variations in operating conditions, it is difficult to give a simple rule for determining the minimum depth of sewer pipes to prevent freezing. However, pipes located according to the above criteria for water pipes should nearly always be safe, as sewage leaving a building is normally appreciably warmer than the water supply entering the building. However, when water supply lines are allowed to waste continuously into sewer lines in extremely cold periods to prevent water line freeze-ups, the sewage flow may be abnormally cold. Factors affecting design of sewer lines with respect to freezing conditions are outlined in TM 5-852-5/AFM 88-19, Chapter 5<sup>3</sup> and TM

b. As illustrated in figure 4-97a, utility lines passing through the seasonal frost zone should be

oriented parallel to the direction in which frost heave acts. Anchored frost isolation sleeves should be installed if materials are frost-susceptible. When utility lines enter a facility laterally below ground level as in figure 4-97b, they should be placed below the anticipated depth of seasonal frost penetration to avoid shear at the interface. When backfill is placed under utility lines it of course must be compacted in accordance with standard provisions to avoid settlement. However, precautions must be taken to prevent freezing and ice segregation in such fill during placement if the soil will later thaw. It is impractical to attempt to estimate the amount of such frost heaving and to pre-position utility lines in order to allow for consequent later settlement on thaw.

c. In permafrost areas utility lines most commonly run above the ground surface and connections into buildings are relatively easily effected, although specific provisions to permit relative movement are often needed. If placement of utility lines below ground is desired in permafrost areas the possibility of shearing of the lines by relative movement at the foundation wall must be considered. If the utility line is laid within permafrost, the possibility that permafrost degradation and foundation settlement may later occur must be carefully examined. If placement of the utility line in the annual frost zone overlying permafrost is considered, both thaw settlement and frost heave effects may have to be contended with, depending on the type of soil. If there is any possibility that such a below-ground utility line may be subject to shearing action at the foundation line, it must either be laid within a surrounding conduit of large enough diameter to isolate it from any possible shearing action or it must be brought above the ground outside the foundation and enter the building through a conventional above-ground connection.

#### **4-18. Drainage around structures.**

a. Considerable permafrost thaw damage can be caused to foundations by seemingly insignificant amounts of water entering or moving through unfrozen ground under and near structures. Where groundwater flow is a potential threat to thermal stability of foundations, a substantial analysis of groundwater flow may be required, including possibly the use of dye to trace directions and velocities. In fine-grained soils, seepage flow is slow and may amount to only a few inches or feet per year, but in coarse gravels flow in the annual thaw zone as high as about 2500 ft/hr has been measured<sup>105</sup>. If such groundwater flow is in contact with a source of warm water such as a lake or pond, substantial disruption of thermal regimes and melting of permafrost may result. Water temperatures at the surfaces of shallow ponds and lakes in permafrost areas have

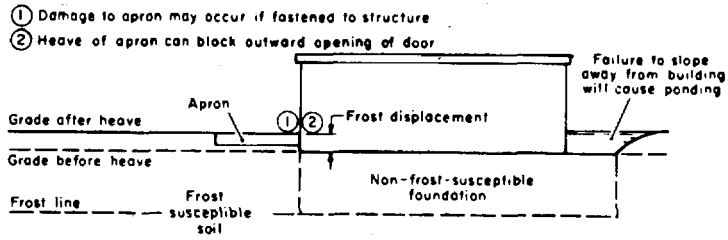

a. Unacceptable design

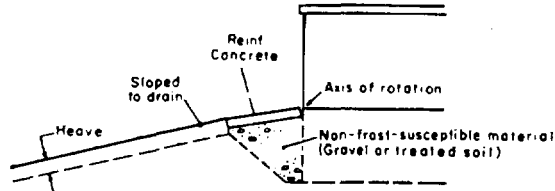

b. Alternate design No. 1

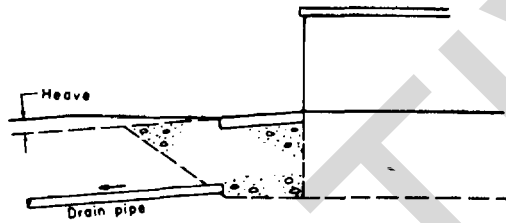

c. Alternate design No. 2

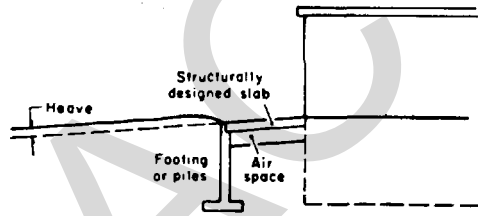

d. Alternate design No. 3

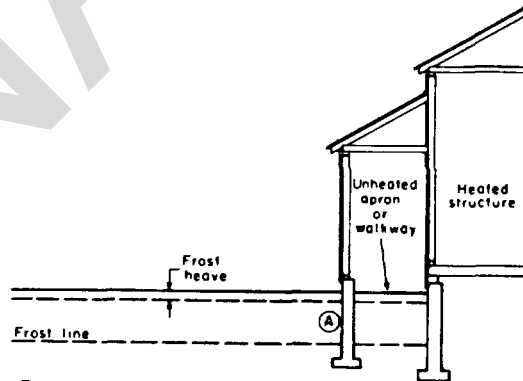

A Anchor to footing below frost line, use anchored sleeve, special low friction backfill or non-frost susceptible fill.

e. Connected exterior unheated facility

U. S. Army Corps of Engineers

Figure 4-96. Exterior apron design.

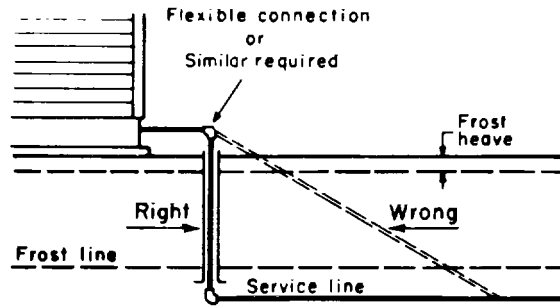

U. S. Army Corps of Engineers

Figure 4-97a. Utility connections to buildings. (Unheated facility on apron. Use flanged or otherwise anchored sleeve, special low friction backfill or non-frost-susceptible fill over sufficient area to prevent heave stressing of service line.)

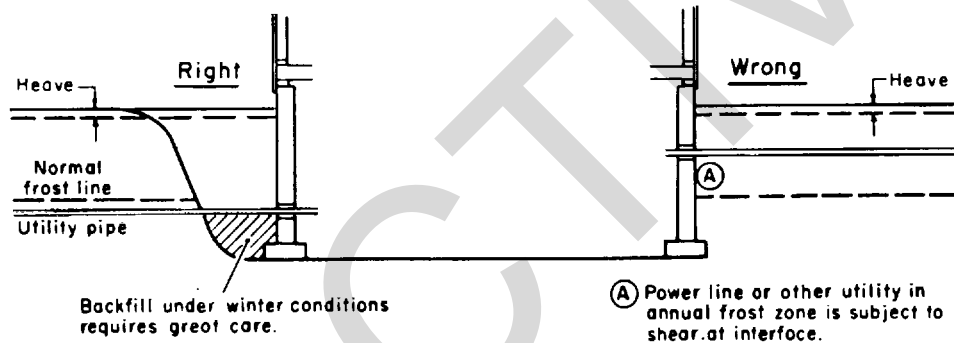

U. S. Army Corps of Engineers

Figure 4-97b. Utility connections to buildings. (Lateral utility connections.)



been measured as high as 70°F in the summer. Because of its high specific heat, even relatively cold water may have significant thawing capacity as demonstrated by the use of cold water to pre-thaw gravels and to remove frozen silt by sluicing in gold mining operations. In the warmer permafrost areas thaw zones readily develop under surface drainage channels; even temporary wastage of water on the surface during construction may produce thaw zones 10 or 20 feet deep which may remain unfrozen for decades thereafter. Wells drilled through permafrost should not be allowed to discharge indiscriminately on the ground surface in permafrost areas. Water absorbs solar radiation much more effectively than soil. Therefore, care must be taken in permafrost areas to slope surfaces at and near facilities so that surface water from snow melt or rainfall is drained away and ponding is positively prevented. Wastewater from buildings, particularly hot water such as waste steam condensate, must never be allowed to discharge on or into the ground near a permafrost foundation, even in small amounts. Good surface drainage is also important in seasonal frost areas to minimize frost action. In permafrost areas, natural subsurface seepage patterns in the annual thaw zone should be considered during site selection to avoid problem locations. However, it may also be possible to modify or control subsurface flow by judicious use of techniques for locally raising the permafrost table at critical locations, such as by placement of fill or use of shading or reflective surface color. One of the benefits sought from painting the runway white at Thule, Greenland, was the diversion of summer seepage flow in the annual thaw zone by raising of the permafrost table under the pavement to act as a dam<sup>105</sup>.

b. Steam, water, and sewer lines must be kept completely tight. At an Alaskan facility minor leakage from an overhead steam line and resultant slow drip of condensate at the edge of the foundation contributed to thaw of permafrost to about 18 feet over a relatively short period.

c. Drainage ditches cut into ground underlain by permafrost containing ground ice or into permafrost itself should be avoided if at all possible because of the settlement and ground instability problems which will result from thawing. Thawing of ice wedges may lead surface drainage in unplanned directions. Undercutting and sloughing of drainage ditch slopes may cause silting and other problems. In soils or rocks capable of bridging, sing-holes and underground drainage channels may develop which may endanger even somewhat distant foundations. Under some conditions, it may be advisable to allow natural stabilization of the drainage effects to occur. This stabilization will occur most easily if ditches can be made shallow, penetrating only part of the annual thaw zone, rather than narrow and deep, TM

5-852-4/AFM 88-19, Chap. 4 even though shallow, wide ditches are more susceptible to icing. A 10 percent transverse slope should be used on the bottom of the ditch. When cutting into permafrost containing ground ice cannot be avoided and natural stabilization will not occur, cannot be relied on, or would involve unacceptable settlements and/or erosion, it may be possible to over-excavate the ditch and backfill to the desired cross-section with non-frost susceptible material of sufficient thickness to prevent summer thaw from reaching the underlying ice. On the other hand, it may be found that ditching at the site is simply impractical. An alternative then is to place the basic facilities on fill so that all need for cutting into permafrost is avoided.

d. Ditches in permafrost areas should be as short as possible. A reasonable slope is 0.003. Minimum width should be about 2 feet at the bottom with the actual width made sufficient to handle spring run-off. Side slopes of 1 on 2 are usually suitable. Where seepage into the ditch from side slopes will cause erosion and sloughing, where sloughing will occur as a result of thaw-weakening in spring and summer, or where control of permafrost degradation is required, blankets of free granular, non-frost-susceptible material may be employed on the slopes as discussed in paragraph 4-19.

e. Subsurface drainage systems, including trench drains, are not usually practical in areas of deep seasonal frost or permafrost unless they can be placed in ground which will be unfrozen at the time they need to function.

f. If cellars or basements are attempted under heated buildings in permafrost containing ground ice, the gradual melting of ice under and around the warm cellar will cause settlement not only of the building foundations but also of the surrounding ground. The results will be development of a dish-shaped depression surrounding and under the facility and an increasingly difficult water control problem in the cellar, which becomes in effect a sump for both surface run-off and permafrost melt water. An ordinary drain trenched from the cellar to a low point would soon freeze. Therefore, an endless problem of pumping and disposal of seepage water may be presented to which there is no good solution.

g. Drainage from flat roofs has often been piped down through the interior of buildings and into dry wells outside the foundation. Such systems have a history of problems in winter. The dry well and pipe drainage system outside the building commonly freezes up, and water backs up within the pipe inside the building. In summer, however, the contrary problem may exist of some local thawing of permafrost near the dry well from discharge of relatively warm water, heated on the roof. No good solutions to this roof

drainage problem presently exist except discharge into the building sewer system in permafrost areas or, in seasonal frost areas, discharge into the ground at sufficient depth to be below the zone of freezing.

#### 4-19. Stability of slopes during thaw.

##### a. Frost sloughing in areas of seasonal frost.

(1) In seasonal frost areas slopes composed of finegrained soils tend to experience "frost sloughing," as illustrated in figure 4-98a, during spring thaw. The sloughing occurs when the ice-filled soil thaws relatively rapidly. Impervious underlying frozen material prevents drainage of excess water in that direction. The resulting very wet, low shear strength soil therefore slumps or flows downward as illustrated in figure 4-98a. The effect can be intensified by earthquake accelerations. Emerging excess water may also move some soil downward by erosion. The phenomenon occurs typically in frost-susceptible fine-grained soils under conditions where sufficient moisture is available to build up substantial excess water in the annual frost zone in the form of ice lenses.

(2) Frost-sloughing is more common in cut slopes than fills because of the greater availability of moisture. However, it is not uncommon in embankments, especially if the slopes are made very steep. It is also more common and more severe on north-facing than south-facing slopes (in the Northern Hemisphere), probably because north-facing slopes tend to be wetter and although onset of thaw is delayed, its progress is fast once it starts. In wet cuts in which seepage emerges from the face, sloughing and erosion may also occur during non-frost periods.

(3) Slope flattening can control frost sloughing but may be very costly or not feasible. Drainage to reduce the amount of moisture available for ice segregation usually provides only partially effective control, especially when soils have strong horizontal stratification, and may be very expensive. Turf helps to control sloughing but its effects is marginal. Both the frost and non-frost types of slope problems can be controlled by blanketing the slope with granular pervious material as illustrated in figure 4-98c. The blanket material should be graded to act as a filter but also be sufficiently coarse-grained so that slow seepage can emerge from it without movement of particles. At the toe of slope the blanket should be carried a short distance below the adjacent surface as shown in figure 4-98c to avoid supporting the toe on material which will experience sufficient frost weakening in spring and to avoid loss of support under the toe by seepage erosion of fine-grained soil. The blanket functions in several different ways. It serves as a surcharge weight to reduce the amount of ice segregation per unit volume and hence the volume of water to be released from the frozen frost-susceptible material in spring. It serves as a semi-insulating layer, to reduce the amount of frost penetration

into the frost susceptible material and to slow rate of thaw into this material in spring. Its loading effect serves to assist reconsolidation of frost-loosened material. It serves as a relatively high strength reinforcing material within the zone potentially involved in the sliding action. It also provides drainage. Because it is designed as a filter, seepage may emerge through it without loss of fine particles from the frost-susceptible zone or plugging of the voids in the blanket material.

(4) Successful use of both cinders and bank-run gravel as the blanketing material has been reported in numerous cases. However, gravel will be the normal blanketing material in arctic and subarctic areas. Good quality crusher run rock can also be used.

(5) Where frost and ordinary seepage sloughing and erosion of slopes are definitely anticipated in seasonal frost areas, protective blankets should be specified as part of the original design when they provide the most cost-effective approach. Although the blankets require initial extra expense, as compared with untreated slopes, maintenance costs resulting from unstable slopes can be eliminated. Blankets may also be used to correct unanticipated problems, but added expense to prepare the sloughed face of the slope will then be involved. Blanket thickness should be between 6 inches and 30 inches, with the larger thicknesses used for the most severe cases. In most cases 18 inches or 24 inches will be needed. Opportunity to use as little as 6 inches is expected to be rare in arctic and subarctic areas. Vertical to near-vertical slopes have been tried in highway cuts in Alaska in search of a more economical but still satisfactory solution. The wind-deposited silts in Alaska, when free of ground ice, have significant loess or loess-like properties and in areas of low precipitation have appreciable capacity for standing vertically for heights of 20 feet or more. However, a number of problems have been observed<sup>52</sup>. These include a tendency for spalling to occur in slabs about 4 in. thick, more on south-facing slopes than on north, attributable to such causes as moisture fluctuations and thermal stresses, collapse from undercutting by erosion or by loss of toe stability from moisture at the ditch level, and erosion or gulying from the top of slope downward, caused by discharge of surface run-off over the top during periods of heavy precipitation or snow melt. If the ditch must carry drainage flow, the slope is especially vulnerable and blockage of drainage by collapse materials may cause secondary damage. Slumping onto the roadway may be possible. Drifted snow and snow cast by snow removal equipment can cause a wet condition on thawing, not only in the ditch but to some extent on the face itself. Low precipitation with long periods of dry weather does not insure against occurrence of wet conditions at some period of the year. In-

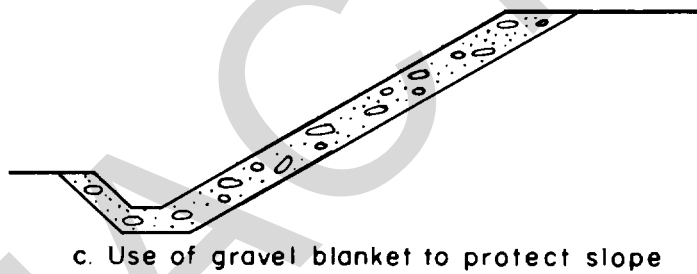
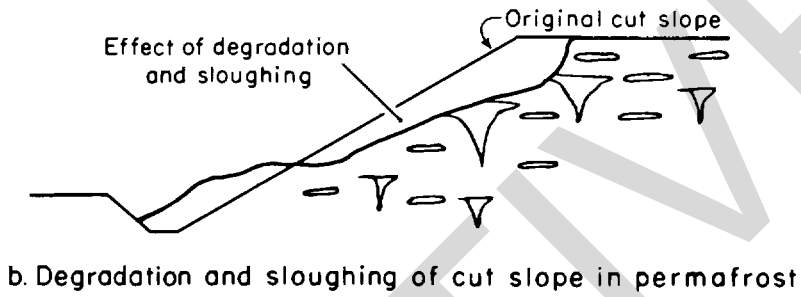
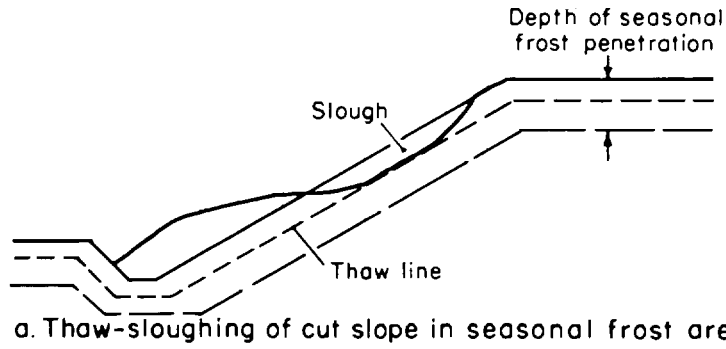

U. S. Army Corps of Engineers

Figure 4-98. Slopes in frost and permafrost areas.

intercepting ditches above the top of cut can control discharge of moisture over the top, and may be needed regardless of degree of slope, but the consequences of seepage of water from the ditches into the soil directly behind the face may be more severe with the steep slopes. In fine-grained soil, especially silts, great care is required to avoid gullyng and progressive soil erosion where the surface vegetative mat is cut, as by an intercepting ditch or at the cut slope, and surface flow of water occurs. Such erosion can involve large areas and must be corrected in its earliest stages. The savings in initial construction costs obtained by employing nearly vertical slopes as opposed to conventional flatter slopes must be balanced against such extra costs as providing wider ditch area to allow for spalling, erosion and sloughing, placing gravel or crushed rock at the toe when needed to insure stability at the ditch level, and maintenance efforts for periodic clean up and removal of slope-wasting materials, restoration of drainage, etc., which are not required when positive slope stability is provided at the start.

b. *Sloughing and thaw settlement in areas of permafrost.*

(1) When a cut is made in permafrost containing substantial amounts of ground ice, frost-sloughing and seepage erosion effects are intensified because of the potentially much larger volumes and deeper extent of deposits of ice and because of the irregular general settlement of the slope which may occur when this ice melts, as illustrated in figure 4-98b. If it is necessary to produce a reasonably stable slope during the initial construction, the amount of protective earth covering which will develop as permafrost degrades should be evaluated and a blanket thickness adopted which will not only control sloughing and erosion but ultimately limit further permafrost degradation. This will require the initial cut to be made with more or less conventional side slopes. The blanket should cover the full height of the cut slope.

(2) If the excess ice content of the natural soil is relatively low, the same protective blanket criteria as presented above for areas of seasonal frost should be used, except that blanket thicknesses should be in the range of 18 to 36 inches. As ice masses melt and drain away, the blanket may develop an irregular surface, but so long as the blanket remains intact, it will retain its function. Except in most northerly areas, it will seldom be economical to place sufficient thickness of blanket to contain thaw within the blanket. Some redressing of the slope may be done if needed, in future years.

(3) If the ice content of the permafrost is higher and the sloughing penetrates deep it may be necessary to use up to 3 to 5 feet of blanket material. This was done successfully to stabilize a sloughing slope in silt at the CRREL tunnel in permafrost at Fox, Alaska, for construction of the tunnel portal.

(4) If the excess ice content is very high it may be necessary to ultimately place a very substantial blanket designed to make up for the low amount of soil naturally present in the slope. Since relatively fine-grained moisture-holding soil is more effective than gravel for this purpose, the blanket may in this case consist of two layers an underlying zone of random fill and an overlying granular blanket not exceeding 3 to 5 feet in thickness. When possible, it is advantageous under these conditions to make the initial cut slope quite steep and to allow natural degradation and build-up of protective cover to occur for up to several years before placing the final protective blanket. Required combined thicknesses of blanket materials and natural cover for complete thermal stability may be computed as described in paragraph 4-2.

(5) Under conditions where a lengthy period of slope adjustment is acceptable, initial construction cost may be significantly reduced by going even further and making cuts with vertical or near-vertical slopes with wider than normal ditches, leaving the natural cover undisturbed and allowing the slope to seek a relatively stable condition by natural processes, at expense of greater maintenance costs. This method was tried in 1970 along the Trans-Alaska Pipeline Access Road from Livengood to the Yukon River, Alaska<sup>195</sup>. Cut faces contained up to 70 percent ice, as illustrated by figure 4-99. During summers following construction, melting of the ice caused the cut faces to assume quite irregular but gradually flatter slopes, accompanied by dropping of the organic mat and thawed soil down over the initially exposed ground ice to provide a progressively increasing thickness of protective cover as shown in figure 4-100. Considerable sloughing and down-slope erosion of fine-grained soils developed. Study of silt faces cut by gold mining operations in the Fairbanks area indicates that in areas of relatively warm permafrost, slope instability and adjustment under this approach may continue for many years or indefinitely, even after moderate-size trees have grown on the slope. Where significant ice is present, the slope may become very rough and unsightly. Periodic removal of silt from ditches and drainageways will be needed. If road-way ditches are allowed to fill, not only will drainage fail to function properly but snow and ice control in winter may become more difficult. Silt in run-off may also cause undesirable or unacceptable environmental effects unless it is prevented from entering streams which receive the drainage discharge. Where slopes are high the possibility that sloughing or slides may encroach on the pavement must be considered. Progressive gullyng and erosion where the cut slope intercepts surface drainageways must be corrected expeditiously. Ultimately, the natural stabilization processes may have to be supplemented.



*Figure 4-99. Ice exposed in vertical cut for Trans-Alaska Pipeline Access Road between Livengood and the Yukon River, Alaska, April 1970.*



*Figure 4-100. Slope resulting from melting of ice in vertical cut face during one summer, Trans-Alaska Pipeline Access Road between Livengood and the Yukon River, Alaska, August 1970.*

## CHAPTER 5 SURVEY DATUM POINTS

### 5-1. Permanent datum points.

a. The establishment of reliable permanent (10 years) datum points for survey measurements in seasonal frost and permafrost areas often requires substantial effort and care<sup>19</sup>. In northern areas, conventional types of benchmarks, satisfactory in warm climates, are subject to frost heave and/or thaw settlement which may produce many inches of seasonal movement, often progressive. Trees, boulders and even foundations of structures may move seasonally. Even benchmarks placed in bedrock cannot necessarily be relied on as rock often contains mud seams which can produce frost heave and ice layers which will cause settlement on thaw. The problem of frost heave is most difficult in those northern areas that have very deep annual frost penetration because it is necessary to support the datum points at very substantial depths in the ground to assure stability; also the magnitudes of frost heave forces in these areas are potentially very large.

b. Movements can result not only from simple frost heave but also from the soil volume changes attending the horizontal and vertical moisture movements which accompany frost action, from the expansion and contraction caused by the annual variation of temperatures within freezing or frozen soil and from solifluction and other types of downslope movement. Moisture movements during freezing may actually cause lowering of surfaces of some soils. The effects of contraction and expansion are not simply lateral; because temperature gradients with depth cause differential dimensional changes, bending tends to occur with complex combinations of vertical and horizontal movement.

c. Permafrost areas containing patterned ground and ice wedges should be assumed especially unfavorable. Areas showing evidences of solifluction or slope movement should be avoided whenever possible. If datum points must be placed in such areas they should be tied in to more stable points and rechecked often enough so that movements with time can be known.

d. Care should be taken to locate benchmarks away from potential thawing influences such as buildings, roads and streams.

e. In order to establish a reliable datum point in a seasonal frost or permafrost area firm support must be provided in stable material below the annual frost zone and the supporting rod must be isolated from the effects of frost action where it passes through the annual frost zone. As shown in figure 5-1, this isolation can be provided by an outer casing, with the space between the rod and casing filled with a viscous substance which has very low relative shear strength at all temperatures yet is

solid enough at summer temperatures to keep water and soil from entering and accumulating in the annular space. For a permanent datum point, this space should extend at least 1 to 3 feet below the predicted annual frost zone depth after construction, depending on the estimate confidence, to make sure that no frost heave forces can act on the datum rod. The rod should extend sufficient additional distance below this point so that the rod will be stably supported, taking into account the sometimes substantial length of unsupported rod within the casing. For relatively shallow annual frost zones the rod embedment should be at least 5 feet; for longer unsupported lengths it should be more.

f. Permanent datum points in deep seasonal frost or borderline permafrost areas should desirably employ a standard weight pipe of minimum 2 inch nominal diameter for the datum point rod because of the relatively long unsupported length through the deep layer of seasonal freezing. The outer casing should be large enough to allow at least 1 inch of space between the datum rod and the casing, for effective placement of oil, wax, or other substances and for positive clearance. Before placement of the viscous material the space between the datum rod and the outer casing should be carefully checked to make sure that the space is free of soil over 100 percent of the length of the outer casing, that there is no water at the bottom and that the rod and casing are not in contact with each other. Otherwise, a plug of ice or frozen soil or friction might transmit drag from the outer casing to the datum rod. The top surface of the viscous material may be given additional protection against water or soil infiltration by a suitable light cover of fabric, plywood or metal.

g. It is recommended that a standard floor flange or welded flat plate be fitted to the bottom of the rod, the datum point hole being drilled large enough to permit this. This will help to stabilize the rod against movement even if skin friction on the embedded portion of the rod should prove inadequate. Other types of projections can be fitted to the length of rod below the casing for the same purposes. Holes or slots are also sometimes cut in pipe-type datum point rods into which slurry will penetrate, helping to increase holding power. The casing should also have an external flange at its lower end to control the tendency for the casing to be jacked progressively out of the ground by frost heaving. For a permanent benchmark, this flange should be designed to develop and withstand full passive forces equal to the

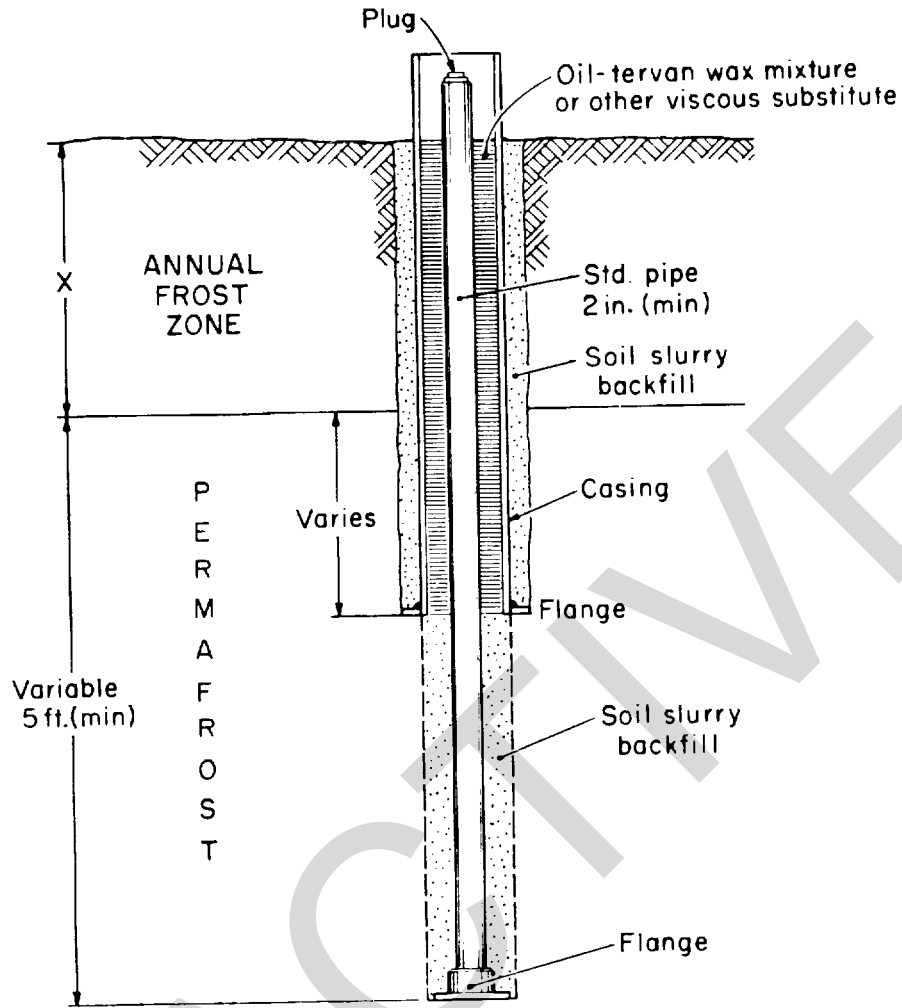

U. S. Army Corps of Engineers

Figure 5-1. Recommended permanent benchmark<sup>39</sup>.



maximum frost heave force which can be developed on the casing.

*h.* For permanent type datum points requiring very high precision, the casing and viscous backfill should extend to a depth below which the annual temperature variation is 2 °F or less, usually about 30 feet in northern areas. For extreme precision, a special study of requirements for attaining needed stability may be required. Black<sup>126</sup> has suggested that in areas such as the northern part of Alaska the datum point may have to be supported at as deep as 65 feet (20 m) to obtain high stability.

*i.* The natural thermal regime and the method of placing a datum point are important factors in datum point performance. In permafrost areas, casing anchorage and datum rod stability depend on achieving rapid and thorough refreezing during installation and maintaining this during the life of the datum point. Disturbance of the thermal regime may interfere with this, particularly in marginal permafrost areas.

*j.* Dry augering or refrigerated fluid mechanical drilling create the least disturbance of frozen soil and permit much more rapid freezeback of the backfill material than steam thawing or drilling methods using warm fluids. This is of utmost importance in the more southerly areas where permafrost is near the thawing point (32 °F). Mechanical drilling may be the only practical method where bouldery soils or bedrock are involved. On the other hand, test pit installation, though very laborious, may sometimes be found the most practical approach in remote areas inaccessible for suitable drilling equipment. In all permafrost areas, freezeback of slurried-in datum points can usually be expected to be complete in not over two weeks, often, much less, provided dry or refrigerated-fluid drilling methods are used, the annular space is not over 1 1/2 to 3 inches and the slurry temperature when placed is not more than a few degrees above 32 °F, except that in marginal permafrost areas this applies only during the period of February to early June, when temperatures in the upper permafrost are depressed. Refreezing times for slurries can be estimated using the procedures outlined in paragraph 4-8d. Because refreezing does not always occur at a uniform rate around the embedded rod or pipe, some bending or small displacement may occur during this process. Therefore, the datum point should not be used as a reference point until refreeze is complete.

*k.* The viscous substance placed in the annular space between the casing and the benchmark rod may be a heavy grease, a special oil-wax mixture such as 70 percent Mentor 29 oil with 30 percent Amber Tervan wax or Socony Mobil Cerise AA by weight, or

other viscous material or mixture which will be firm enough at normal summer temperatures to support gravel or sand particles on the surface yet transmit negligible frost heave forces to the datum rod in winter. If oil-wax mixture is used, the oil and wax should be heated separately to about 200°F, then mixed. The mixture then may be poured into the annular space while it is still warm enough for easy placement.

## 5-2. Temporary datum points.

*a.* Since these need to be stable only for limited periods of time, less elaborate precautions are required than for permanent installations. However, even though shorter times are involved, stability requirements may be just as stringent. Thus, a stable temporary benchmark must be solidly anchored in stable ground and must be isolated from the effects of seasonal frost heave or thaw-settlement forces during its period of use, in accordance with the same principles as for permanent benchmarks. However, it may be feasible to use a smaller flange or no flange on the casing. For example, an unflanged casing embedded 2 ft below the annual frost zone and which may heave 8 in./yr can be expected to protect the benchmark from heave for at least 3 years.

*b.* For construction projects of limited duration it may suffice to install a temporary benchmark by hand augering or test pitting to below the depth of seasonal frost and then driving a relatively small diameter rod into the underlying material for sufficient depth to obtain stable embedment, placing an unflanged casing around the rod, backfilling on the outside with soil and placing the oil-wax or other mixture in the annular space. Small diameter pilot auger holes may be employed to facilitate driving. Hand-sledge driving is of limited effectiveness; a heavy weight (up to about 350 lb) operated with a tripod and winch will extend effectiveness. Driving should be assumed impractical in other than in warm (above 25 F), fine-grained frozen soils. Freezeback of datum points driven into permafrost may be assumed almost instantaneous because of the relatively small amount of heat to be dissipated. Often these operations may be carried out easily after the end of the summer thaw (though ground water may cause problems). Even if the casing is frost heaved several inches in winter the point may remain stable long enough to get the job completed.

*c.* On the other hand, when extended post construction performance feedback measurements on the structure are to be made, one or more permanent type datum reference points should be installed.

## CHAPTER 6 CONSTRUCTION CONSIDERATIONS

### 6-1. Effect of construction procedures on design.

a. Design decisions must be approached not as isolated technical questions but as a system of interrelated elements under broad design, construction, operational and maintenance facility requirements.

b. The tentative construction schedule and procedures should be kept in mind during all phases of the design procedure and should provide input influencing design decisions. The facility location and its environment, the relative urgency of the project and of desired completion data to meet user needs and the type and scope of the effort will indicate the type and amount of construction to be accomplished under adverse seasonal conditions. The progress and efficiency of the work during such periods will depend on how well the designer has anticipated and adapted the design to the conditions.

c. Site accessibility and working conditions may affect choice of type of foundations. Access to remote sites by sea or river may be possible only during a short period in the summer. In permafrost areas overland access may be possible only in winter after the annual thaw zone has solidly refrozen. Aircraft landing facilities may severely restrict the size and type of aircraft which can land at the site. This may limit the sizes and types of construction equipment which can be brought in by air. For small to moderate size construction jobs, the cost of improving the aircraft landing facilities may be prohibitive. Landings on ice cannot be made during the ice break-up and early freeze-up periods. Heavy aircraft cannot land on floating ice until middle or even late winter. Tractor train operations on ice are similarly limited. Access roads and granular working mats may be easy to place in winter when the terrain is frozen but much more difficult to construct in summer. On the other hand, if the facility construction is small and can be completed in winter, roads and working mats may not be needed at all except for facility operational purposes. Under proper scheduling, pile installation equipment can work on compacted snow or frozen ground in late winter or early spring at maximum efficiency, without the use of granular work mats. As described in paragraph 4-8d, this same period of maximum cooling of the ground in depth (February through May) is the most effective time for installation of slurried piles intended to freeze back naturally. However, if it is not possible to install the piles in the critical months and it is a marginal permafrost area, it will be necessary to use artificial refrigeration to assist freezeback or to choose another type of foundation, and this must be reflected in the plans, specifications and cost estimates. As has been

described by Dickens and Gray<sup>138</sup>, it is possible to construct footing type foundations in the summer months with satisfactory results; however, such type construction may involve quite different labor, materials, and equipment requirements with different transportation, housing, maintenance and supply problems than would apply in winter.

d. Through proper design and construction, a foundation may be installed in permafrost with minimum disturbance to the thermal regime and with rapid healing of thermal damage caused by construction. However, the construction procedure adopted will be a major factor in determining the amount of environmental damage and therefore the damage-corrective provisions in the plans and specifications, as well as costs.

### 6-2. Excavation.

a. In permafrost areas, excavation should be avoided as much as possible in the foundation design because of the increased disturbance of the thermal regime and the increased effort required when frozen ground must be handled. During the summer, excavations in finegrained permafrost for placement of footings may experience very rapid thaw and softening on exposure and it is almost impossible to install footings and to complete backfill under these conditions without experiencing at least some short-term settlement of the base of the footing, even though gravel fill or insulation is placed quickly at the bottom of the excavation to minimize this effect. Therefore, such excavations are much more easily accomplished when air temperatures are below freezing, preferably in the early fall when the annual frost zone is completely thawed and most easily excavated through. At subarctic locations, excavation of soil above the permafrost table may not be a major problem during the early part of the freezing season, especially if ground-freezing is minimized by an insulating cover of snow, moss, or other material. As the winter progresses and depth of freezing increases, excavation becomes more difficult, unless the excavated materials are very coarse and well-drained. Winter construction involving excavation is handicapped by frozen ground conditions, the difficulties of operation of equipment and handling of frozen materials at very low temperatures, reduction of daylight hours and work season, and lowered worker efficiency at low temperatures.

b. Special equipment such as heavy rippers, systematic drilling and blasting or possibly pre-thawing of

the frozen layer may be required to accomplish the work. Where excavation is in permafrost, this situation applies year-round. Frozen soils may have strength properties equivalent to those of lean concrete at only moderately low temperatures; at very low temperatures the compressive strength may exceed 3,000 psi. Excavation of frozen soils at low temperatures may be comparable to excavating concrete of low to moderate strength. Frozen rock is stronger than when unfrozen. By comparison ice may be comparatively easy to excavate. A special problem is introduced by the tendency of frozen excavated materials of appreciable moisture content to adhere to equipment surfaces at below-freezing temperatures or to exhibit fluid or semi-fluid properties when thawed. A number of research studies have been performed on methods of penetrating, disengaging and handling frozen materials<sup>56,57,81,96,97</sup>. Near-surface frozen materials may be easier to excavate or penetrate in the summer months. However, excavation in winter is in some aspects easier than in summer, because drainage and dewatering problems are reduced or eliminated. If shaped up prior to the first freeze, haul roads become as smooth and strong as pavement when frozen, requiring little maintenance except snow plowing.

c. Excavation at the face of the pit with a dipper shovel is less affected by winter weather than excavation by scrapers, although when the seasonal frost layer reaches a thickness of perhaps 1 1/2 to 2 feet the soil may form slabs large enough to break a shovel boom unless the operator is careful. Various types of trench cutting equipment, as well as drop and pneumatic hammers, may be used for cutting through or breaking up frozen soil in small areas. A snow cover over the area to be excavated limits the depth of frost penetration, especially if the ground is covered early enough in the season and the snow is undisturbed. In the lower latitudes of the cold regions, black polyethylene sheeting placed over limited areas has been found effective in limiting freezing or promoting thawing by its absorption of solar radiation. Each day the surface cover should be removed only in the areas which are to be worked in that day. In addition, for local areas the ground may be covered with hot sand and tarpaulins or treated with salt and covered with hay and tarpaulins 3 or 4 days before excavation. Salt in the soil moisture lowers its freezing point. Fires may also be built over the areas to be thawed. This method is slow and inefficient but has been used to thaw up to 2 or 3 feet of frozen ground.

d. In the early winter, borrow areas, once opened, must be worked continuously from day to day or the frozen material will build up in thickness and be difficult to remove as well as present the problem of frozen inclusions in the fill. As the winter progresses and depth of freezing increases, excavating becomes more difficult and may require special equipment or possibly pre thawing of the frozen layer to accomplish the work.

e. Handling of frozen soil from excavations is often a problem because of the tendency of frozen lumps to freeze to each other or to the handling equipment when temperatures are between about 15° and 32 F, or to thaw into mud in above-freezing temperatures.

f. Excavation of borrow areas in frozen soil in the spring and summer can also be accomplished by removal of thawed material periodically to promote thawing of underlying layers. On the other hand, if such incremental thaw depths of wet, soft materials are allowed to become deep enough to interfere with movement of construction equipment, construction may be seriously delayed or halted.

g. Frozen ground, including frozen soil and highly fissured frozen bedrock, often can be broken more economically and faster with a heavy bulldozer equipped with a sturdy ripper than with the use of explosives if a large area has to be excavated and the ground temperature is marginal (30 ° to 32 °F). Operation over a large area allows maximum assistance to be gained from daily thaw increments in summer.

h. Deep formations of frozen material can be thawed to assist excavation. Cold water pumped into jets, placed in a grid fashion at 12 to 16-foot spacing, has been used successfully in thawing operations and is the most economical technique. Hot water and steam jets may also be used in a similar manner. Small electrically heated probes have local value. When excavation of permafrost is required, the surface should be stripped early in the summer to expose the frozen material. Stripping of vegetative cover and removal of the annual thaw zone material in late summer or early fall will permit excavation to start at the permafrost table at the start of the following thaw season rather than at the top of the then frozen annual thaw zone, but removal of the overlying cover will have caused more intensive cooling of the permafrost during the winter, tending to slow the daily rate of excavation. In areas where the annual thaw zone is 12 to 18 inches under moss surface cover, 3 to 5 inches of thawed materials may be removed each day during the warm months and 25 feet may be excavated in a 100-day summer operation<sup>114</sup>. At bases where long-range construction plans are known, it may be desirable, under certain conditions, to clear, strip, and provide drainage of future construction sites where permafrost excavation will be required as far in advance of construction as possible to minimize possible future subsidence and to make excavation easier. However, pre-thawing of finegrained soils to appreciable depth is likely to be impractical; for example, it may produce too soft or liquid a condition for the available construction equipment to operate effectively. Any introduction of heat into permafrost must be very carefully controlled and is general-

ly inadvisable at a structure site.

*i.* Rock excavation presents no more difficult a problem at air temperatures between 32° and 0°F than at temperatures above freezing, except that rock containing appreciable moisture is likely to be difficult to transport and handle between 15 ° and 32°F because of its tendency to freeze to surfaces. Blasting and mucking operations should be coordinated because the blasted rock, providing many channels for moisture penetration such as from snow or rain, can freeze into a mass which must be reblasted. As noted above, large rippers may be effective in some rock. Rock, if in large pieces or without moisture, seldom freezes to truck bodies; however, this can be a major problem with moist soil or rock containing fines, especially if hauled a considerable distance. To control this, many contractors in Canada have equipped their dump truck bodies with muffler extension pipes to heat the bodies with otherwise lost engine heat.

### **6-3. Embankment and backfill.**

*a.* All personnel responsible for design and construction of projects to be constructed in cold climates should be aware of the extent to which construction of embankments, fills, and backfill may at the same time be both possible and limited. On the one hand, placement of embankments may be accomplished most readily in winter when the ground is frozen, if the natural surface is impassable in the summer, provided suitable fill materials are used. On the other hand, construction of load-bearing fill which will be used to support an overlying facility may be difficult to accomplish successfully in the winter season because of the problems of freezing of moist material before it can be compacted or of excluding lumps of frozen materials which may result in later thaw-settlement. It is impossible to compact most soils to specified densities with available equipment and techniques when the soil temperature drops below about 30°F, that is, after the soil has frozen. However, successful embankment, fill, or backfill placement under winter conditions, at very low ambient temperatures, has been accomplished by stockpiling very clean, gravelly materials in the summer months in such a way as to promote drainage to very low water contents; such material can be handled and placed with effectiveness acceptable for many purposes under the coldest temperatures. It is possible that dry, clean gravels may also sometimes be found naturally at very low moisture contents in the borrow pit. Dry, crushed or broken rock may be placed even more effectively under all temperatures. In one especially urgent situation a compacted fill foundation for a large structure was built in mid-winter by the expedient use of a very large inflated shelter into which frozen borrow was trucked, spread in shallow layers, each of which was TM 5-852-4/AFM 88-19, Chap. 4 allowed to thaw, then compacted by

conventional procedures before spreading of the next layer of frozen material. The Corps of Engineers Alaska District reports that by using procedures designed to insure the most favorable results, moist thawed silts have been borrowed and placed at 95 percent of modified AASHTO density during 0° to 30°F weather using heavy vibratory compactors. They suggest that vibratory grid roller or vibratory sheepsfoot compaction should be most effective. Similar experiences have been reported in New England with sheepsfoot roller compaction using rapid processing to achieve compaction before significant freezing. Others have concluded that the minimum practical and economical temperature for placing common backfill is about 20 °F and for placing granular materials, 15°F<sup>13</sup>. Success is any of the recorded cases of successful below-freezing embankment placement has depended on one or more of the following alternatives: rapid and continuous placement so as to achieve compaction before freezing, use of CaCl<sub>2</sub>, added in advance, to lower the freezing temperature, or use of dry, cohesionless, non-frost susceptible materials.

*b.* During freezing weather, earth handling and placement of ordinary soils should be continuous to avoid formation of thick layers of frozen material which will not thaw quickly if incorporated into the embankment. The foundation or surface of the fill should be checked for frozen material before proceeding with the next lift. All frozen material should be removed. It should not be disced in place. If poor-drainage material is used, the temperature of the material should be above freezing and it should be placed and compacted at the proper moisture content. The fill should than either be protected from freezing or all frozen material removed before additional backfill is placed. Under no circumstances should frozen material, from stockpile or borrow, be placed in fill or backfill which is to be compacted to a specified density. Extreme precautions should be taken regarding the possible entrance of excess water from wastewater, curing water, or during thaws into areas of compacted fill. The use of additives, such as calcium chloride, will lower the freezing temperature of soil, but they will ordinarily also change the compaction and moisture requirements'. Experience with salt has been mixed. Therefore, additives should not be used unless a prior laboratory study of compaction and additive percentage requirements is made. If used, additives must be incorporated before freezing.

*c.* Although construction schedules may necessitate the placement of permanent fill or backfill during or immediately preceding periods of freezing weather, every effort should be made, whenever construction schedules permit, to schedule placement of backfill in periods of favorable weather conditions.

d. In permafrost areas, deep fills constructed with thawed materials may require up to many years to freeze to the ultimate thermally stable condition, if placed by single-step construction. When this slow, long-term freezing is likely to result in undesirable frost heaving, consideration should be given to placement of fill in annual increments, each of which will freeze completely during the winter following its placement. The result will be a more immediately stable foundation, upon completion. An example of this procedure was the two stage construction of a runway extension embankment at Sondrestrom Air Base, Greenland<sup>103</sup>. Inorganic soils are very often covered with living "tundra mat," a mantle of moss and peat. In permafrost areas this material should usually be left in place during the placement of fill, thus preserving to a limited extent its value as an insulating layer. The natural cover around a construction site should be protected from disturbance by construction equipment, to minimize subsequent degradation. Cutting of the tundra mat by heavy tracked vehicles is a common source of local thawing and subsequent ponding of water, erosion and degradation of permafrost.

e. The design should take into account the possible frost heave of backfill and the effect of such heave on footings, structural elements, utility connections and walls. Backfill adjacent to walls should be non-frost susceptible in situations where frost heave or frost thrust damage might otherwise occur.

f. Determination of construction material availability is an essential element in the design effort. If special materials such as non-frost-susceptible backfill are only accessible at specific times of the year, this may be a critical factor in design decisions.

#### 6-4. Placing concrete under freezing air or ground temperature.

a. *General.* Under freezing conditions, concrete placement should conform to standard procedures, but additional special precautions should be employed as needed to assure good results<sup>22,115,203</sup>.

(1) As a general rule, concrete should not be placed in direct contact with ground or rock at temperatures below 33 °F. If the concrete section is thin and the temperature of the ground well below freezing, the concrete may freeze or at least may not set and harden properly. If the concrete section is massive, its heat of hydration will generate ample heat for strength gain and prevention of freezing but this heat may at the same time thaw the ground for some depth and this may result in settlement and formation of voids even while work is in progress, if ground ice is present. The concrete may be fractured, foundation bearing capacity may be reduced, and it may become impossible to maintain foundation grade lines. Thaw water may pipe up through the fresh concrete before set if a pressure

head can develop, destroying its water-tightness. If the section is heavy enough so that only a thin layer of poor mortar is produced on the face of the concrete by the low temperatures, it may sometimes be acceptable to place concrete directly against frozen soil, provided the soil supporting the foundation is not susceptible to settlement on thaw. When underlying soils contain sufficient ice so that settlement will occur on thaw, special pads of wood, gravel and/or rigid insulating material or their combinations, of adequate bearing strength, should be used between the frozen ground and the concrete course to protect the frozen ground from thawing and to aid in retention of heat by the concrete. Wherever concrete must rest on or adjacent to frozen soil, strong consideration should be given to the use of precast sections to avoid the problems of protection, to insure quality construction and to minimize work schedule problems. On important work, refrigeration pipes placed within a granular course have been employed to maintain the 32 °F point on the temperature gradient at the proper position between the underlying permafrost and overlying newly cast concrete. Electrical heating cable may also be used where supply of heat is necessary. Artificial refrigeration placed within the concrete has much more limited utility, as such refrigeration cannot be turned on until the concrete has gained minimum required strength and in this time excessive thaw settlement of underlying materials may occur if ground ice is present.

(2) Plans to protect fresh concrete from freezing and to maintain temperature at not less than the specified permissible minimum should be made well in advance of expected freezing temperatures. All necessary equipment and materials should be ready for use at the site of the work before concrete placing is permitted. It is too late to start assembling protective devices and materials after concrete placing has commenced and the temperature begins to approach the freezing point. The complications which these measures introduce can be greatly reduced by maximum employment of prefabricated components and members.

(3) "Concrete which is not allowed to freeze and which is placed at low temperatures above freezing, and receives long-time natural curing, develops higher ultimate strength, greater durability, and less thermal cracking than similar concrete placed at higher temperatures. A high concrete temperature as placed will impair these good properties, although it may expedite small jobs and finishing in cold weather."<sup>115</sup> Concrete mixed and placed at a high temperature also requires excessive mixing, requires a higher water content to maintain a specified consistency, and usually results in quick setting. Rapid moisture loss from hot concrete surfaces or high temperature differentials at the surface may cause shrinkage cracking. Heating the

materials to inordinately high temperatures before mixing or over-zealous use of hot air blowers to protect against freezing are, therefore, not proper solutions to cold weather concreting. Rather the materials should be heated to maintain a concrete placing temperature not less than shown in table 6-1, but not over 70°F after placing. The air, water, and forms in contact with the concrete surfaces should be maintained at not less than 50 °F throughout the curing period specified for the type of cement used in the concrete. Accurate periodic concrete temperature readings should be taken during setting and curing to obtain a quantitative measure of the actual degree of protection afforded. Ice or snow on reinforcing steel and within forms must be removed before placing concrete. Hot air heaters of various types or live steam may be employed to warm reinforcement, forms or ground just before concrete is placed.

b. *Air entraining agents.* An approved air entraining agent should be used to produce a proper number, size and spacing of air bubbles in concrete which will be exposed to weathering. Concrete must have a satisfactory entrained air-void system in order to resist freezing and thawing if the concrete is in an environment where critical saturation with water may exist at the time freezing may occur. If the environment is quite severe, the concrete should be protected from freezing until it has matured sufficiently to have developed a compressive strength such as would be indicated by test of 6-inch by 12-inch cylinders of 4000 to 4500 psi. If the air-entraining agent is either an approved air-entraining addition to the cement or an air-entraining admixture incorporated into the concrete mixture at the time of batching, it may be assumed with normal concrete mixtures that the air-void system will be adequate, provided the

Table 6-1. Effect of Temperature of Materials on Temperature of Various Freshly Mixed Concrete<sup>203</sup>

Subject to controlling criterion that the thickness of section shall not be less than 5 times the maximum size of rock.

[Temperatures in degrees F]

		Thin sections								Mass concrete							
		¾ inch				1½ inches				3 inches				6 inches			
Approximate maximum size of rock		40 percent				35 percent				30 percent				25 percent			
Approximate percent of sand		1,200 pounds				1,100 pounds				1,000 pounds				900 pounds			
Weight of sand for batch		1,800 pounds				2,100 pounds				2,400 pounds				2,700 pounds			
Weight of rock for batch		300 pounds				250 pounds				200 pounds				150 pounds			
Weight of water for batch		600 pounds				500 pounds				400 pounds				300 pounds			
Weight of cement for batch																	
Minimum temperature of fresh concrete AFTER PLACING and for first 72 hours		55				50				45				40			
Minimum temperature of fresh concrete AS MIXED, for weather. <sup>1</sup>	Above 30° F	60				55				50				45			
	0 to 30° F	65				60				55				50			
	Below 0° F	70				65				60				55			
Minimum temperature of materials to produce indicated temperature of freshly mixed concrete.	Cement <sup>2</sup>	35	10	10	-10	35	10	10	-10	35	10	10	-10	35	10	10	-10
	Added water	140	140	140	140	140	140	140	140	140	140	140	140	140	140	140	140
	Aggregate water <sup>4</sup>	38	95	50	61	35	100	46	55	33	105	43	52	33	113	40	48
	Sand	38	95	50	61	35	100	46	55	33	105	43	52	33	113	40	48
Rock	38	10	50	61	35	10	46	55	33	10	43	52	33	10	40	48	
Temperature of freshly mixed concrete	60	65	65	70	55	60	60	65	50	55	55	60	46	50	50	55	
Maximum allowable GRADUAL drop in temperature in 24 hours at end of protection, degrees F	50				40				30				20				

<sup>1</sup> Rock at temperatures below freezing is assumed to be surface dry and free of ice.  
<sup>2</sup> For colder weather, a greater margin is provided between temperature of concrete as mixed and the required minimum temperature of fresh concrete in place.  
<sup>3</sup> Cement temperature has been considered the same as that of average air and of unheated materials.  
<sup>4</sup> The amount of free water in the aggregate has been assumed equal to one-fourth of the mix water.

(Courtesy of Bureau of Reclamation, U.S. Dept of Interior)

air content of the freshly mixed concrete meets the requirements of the applicable specifications. Specifications are generally based on the concept of having an air content in the mortar fraction of approximately 9 percent; hence, the total air content of the concrete that should be obtained diminishes as the proportion of mortar diminishes, which it will do as the quantity of aggregate increases as the maximum size of aggregate increases.

c. *High early strength cement.* The alternative use of high early strength cement, Type III, is generally permitted by the specifications. As the name implies, high early strength cement increases the rate at which concrete gains strength, thereby reducing the length of time that the concrete surfaces must be protected. Therefore, its use is beneficial, either alone or as a supplement to heated materials during cold weather. The same end result can usually be obtained by increasing the cement factor for Type I and II cement by about 30 percent. However, shrinkage characteristics may not permit this addition.

d. *Accelerators.* The permissible substitution of high early strength cement, Type III (except when Type V is specified), will produce the desired acceleration of the rate at which the concrete gains strength more positively than a chemical accelerator. "Calcium chloride, other salts or other chemicals in the mix in permissible amounts will not lower the freezing point of concrete to any significant degree. To avoid use of harmful materials, any such attempt to protect concrete from freezing should not be permitted." However, calcium chloride may sometimes be needed as an accelerating agent, and when its use is approved, not more than 2 percent of calcium chloride, by weight of the cement, should be allowed. The calcium chloride should be measured accurately and added to the batch in solution in a portion of the mixing water with an acceptable commercially manufactured automatic dispenser<sup>22</sup>. The following precautions must be observed in use of calcium chloride:

1. It must not be used where sulphate resistance cement (Type V) is specified. Type III cement with a limitation of 5 percent tricalcium aluminate may be used where sulphate resistance is needed.
2. It must not be added directly to the mixing water in the dry state; it should be added in solution only.
3. It must not be used in prestressed concrete.
4. It must not be used where zinc or aluminum is present or when subject to sulphate conditions contained in the aggregate or present in the environment.

e. *Heating the materials.*

(1) It is not difficult to maintain the temperature of freshly mixed concrete within a ten degree range above the minimum temperature specified and desired. Although it is difficult to heat aggregates uniformly or to a predetermined temperature, the temperature of the mixing water can be adjusted readily by blending hot water or steam with cold water to maintain the temperature of the freshly mixed concrete within the desired 10 °F range.

(2) Making the basic assumption that the specific heat of both the cement and aggregate can be accurately enough represented by the factor 0.22 (0.2 may be used for rapid field computation) and knowing that the specific heat of water is 1, reasonably accurate estimates of temperature of freshly mixed concrete can be made from the following equation:<sup>20</sup>

$$T = \frac{0.22 (T_a W_a + T_c W_c + T_m W_m)}{0.22 (W_a + W_c) + W_f + W_m} \quad (\text{Equation 16})$$

T = Temperature of concrete, °F.

T<sub>c</sub> = Temperature of cement, °F.

T<sub>m</sub> = Temperature of mixing water, °F.

T<sub>f</sub> = Temperature of free moisture in aggregates, °F.

T<sub>a</sub> = Temperature of aggregate, °F.

W<sub>c</sub> = Weight of cement, lbs.

W<sub>m</sub> = Weight of mixing water, lbs.

W<sub>f</sub> = Weight of free moisture in aggregates, lbs.

W<sub>a</sub> = Weight of aggregates, lbs.

(The temperature of all water including the moisture in the aggregates must be above 32°F, as ice absorbs 144 Btu's of heat per pound in melting and has a specific heat of only 0.5.) The above equation does not take into account any heat loss to the air during mixing, transporting, and placing or any heat gain in hydration of the cement. Based on temperatures computed from this equation (using 0.2 for specific heat of cement and aggregate), table 6-1 from the Bureau of Reclamation Concrete Manual<sup>203</sup> shows the effect of temperature of materials on temperature of various freshly mixed concretes.

(3) Cement as taken from usual storage is rarely under 32°F. Heating cement should not be used as a method of raising the concrete temperature. Cement containing frozen lumps should not be used since the chunks indicate the presence of moisture.

(4) Heating the mixing water is generally considered the most practical and efficient means for obtaining the desired placing temperature of concrete dur-

ing cold weather. Water is not only easy to heat, but each pound of water has roughly 4 1/2 times as many heat units per degree Fahrenheit as are stored in a pound of aggregate or cement. Mixing water is usually heated in auxiliary tanks connected to the water measuring tank. Heating can be accomplished most rapidly by injecting live steam into the water; however, electric and oil or gas burning heaters are acceptable. The mixing water should be heated under such control and in such quantity and the storage tanks and lines should be insulated to the degree that no appreciable fluctuation of the temperature can occur.

(5) Cement coming in contact with hot water or hot aggregate may experience flash set. To avoid the possibility of flash set when either aggregate or water is heated to a temperature in excess of 100°F, water and aggregate should come together first in the mixer in such a way that the high temperature of one or the other is reduced before cement is admitted. If the mixer is loaded in this sequence, water temperature up to the boiling point may be used, provided aggregate is cold enough to reduce temperature of the mixture of water and aggregate to appreciably less than 100°F; in fact, this temperature should rarely exceed 60° to 80°F<sup>115</sup>.

(6) When air temperature is below freezing often one or more of the aggregates, as well as the water, must be heated to produce the desired minimum temperature of the freshly mixed concrete. The heating of all the aggregates is the more desirable method since it insures that no ice, snow or frozen chunks are present. However, if the coarse aggregate is dry and free of ice, snow, or frozen chunks, the heating of only the sand and water may be sufficient to produce the desired temperature.

(7) Heating aggregates can be accomplished most satisfactorily by the use of steam in a closed system of coils in the aggregate storage bins. A closed system of steam coils tends to dry the aggregates and bring about a uniform moisture content. Open steam jets should be avoided if possible because of the resulting fluctuation in moisture content of the materials so heated. If, however, emergency conditions require the thawing of fairly large quantities of aggregates at extremely low temperatures, or if railroad car or truck loads of aggregates must be thawed before unloading, then steam jets may be the only practical method. In such instances, thawing should be accomplished as far in advance of batching as possible, the car or truck loads unloaded and stockpiled, and thereafter the steam should be cut to the minimum that will prevent freezing and the stockpiles covered with tarpaulins to help maintain a uniform temperature, promote a more uniform moisture content, and prevent the formation of a frozen crust on the surface of the stockpiles. Variations in the moisture content and temperature of the aggregates after thawing with steam jets will require control of the

total mixing water on an individual batch adjustment basis which is difficult to obtain. Heated air in pipes, or hot water in a closed system of coils, have also been used to keep aggregates ice-free.

(8) Whatever method is used, the average temperature of an individual batch of aggregates should not exceed 150 °F<sup>115</sup> and no aggregate should be heated above 212°F<sup>115</sup> as such a temperature may cause incipient cracking of the aggregate".

f. Mixing, transporting and placing. The mixing, transportation, and placement of concrete should be accomplished with the minimum possible temperature loss<sup>179</sup>. The batching plant, or the batching and mixing plant, if the concrete is centrally mixed, should be made heatable, if possible, or at least must be protected from the wind. The transporting and mixing, if not centrally mixed, and the placing must be done as quickly as possible so as not to allow the concrete to cool below the desired placing temperature. The heat losses during mixing, transporting, and placing are difficult to determine with any degree of accuracy; however, authoritative sources indicate hourly temperature losses as high as 15 percent of the difference between concrete and surrounding air temperature during this period. Consideration should be given to large transport volumes and insulated and covered transport vehicles to keep this temperature loss to a minimum. Protection from the wind during placement will also materially reduce the heat loss through convection.

g. Protection of concrete in the curing period. Protection required for concrete during the curing period will range from none in on-surface construction in summer to use of insulated forms, heated covers or complete heated enclosures, depending on the severity of environmental conditions and the nature of the item involved. Problems such as work protection and heating of materials can often be minimized through proper schedule planning. Since most of the heat of hydration of cement is developed in the first few days after mixing, protection is intended primarily to conserve the heat being developed and quick application of protection for the freshly placed concrete is therefore of primary importance.

(1) *Insulation.* Forms preferably should be well insulated before concrete is placed. Unformed surfaces, and uninsulated formed surfaces, should either be covered with adequate insulating blankets or covered by vented shelters heated to maintain the desired temperatures. The thickness of the insulating blanket to be used against the forms or against the surface of the concrete must be adequate to maintain the desired temperature of the concrete under the extremes of low temperature and concurrent wind conditions to be expected during the curing period. Efforts to protect in-



adequately insulated concrete surfaces after the onset of extreme low temperatures are seldom successful due to the press of other work during such critical periods. It should be remembered that, to be effective, the insulating material must be kept in close contact with the concrete or formed surface and air should not be permitted to circulate between it and the concrete. Particular attention should be given to assure that edges and corners are provided with extra protection. Protection of the insulating material with heavy moisture proof canvas or plastic sheeting from wind, rain, snow, or other wetting is essential. The insulation should have a conductance of not more than 0.25 Btu/hr-ft<sup>2</sup>-°F and should be maintained in such a condition that this value is not exceeded during the period of protection. As a general rule, concrete includes in forms and/or adequate protective insulation<sup>202</sup> will not lose enough moisture to require additional curing water. Table 6-2 from the Bureau of Reclamation Concrete Manual<sup>203</sup> is a useful guide to insulated forms using bat or blanket insulation. Polystyrene or polyurethane foam equivalents require less thickness than bat or blanket insulation and are more suitable for re-use. On larger projects special commercial insulated forms of plywood and foamed plastic board may be considered. Various substitute materials as well as foamed-in-place techniques may be used. Insulation can usually suffice without supplementary heat down to an ambient air temperature of, say, 25°F; this value, and also rule-of-thumb temperature estimates, involve considerable uncertainty because convection losses depend strongly on wind speed and because such variables as type of cement and the thickness of concrete section are also involved.

(2) Heating of forms. Below about 25 °F ambient temperature, heat is advisable, together with the insulation. Forms may be heated by steam jacketing or electrically. A recent product for efficient electrical heating consists of panels of woven glass, coated with graphite and impregnated with epoxy resin. The panels are readily incorporated into the insulation of the formwork or may be sandwiched with plastic protection.

(3) Heated enclosures. A number of types of heated enclosures may be used to protect concrete from loss of heat. Live steam is considered the best heating agent since it also insures that the exposed concrete surfaces are not subjected to moisture evaporation<sup>132</sup>. The enclosures must be reasonably tight and securely braced against wind and snow loading with particular care given to tightness of openings in the enclosure. The use of hot air blowers is the second best method of heating the air in an enclosure. Rapid drying of the concrete surface will result from hot air, however, and the curing surfaces must be kept damp. The use of open fires and salamanders, while still in somewhat general use, should be avoided wherever possible due to possible damage to concrete from direct exposure to

heat and from strong CO<sub>2</sub> atmosphere<sup>157</sup>. The harmful effects of CO<sub>2</sub> can be avoided by the use of heaters which do not create combustion gases in the heated area or by the removal of gases from oil burning heaters through proper venting to the atmosphere. Membrane curing compound applied to exposed surfaces of concrete is helpful for preventing detrimental effects of CO<sub>2</sub> but should not be used as a substitute for venting oil burning heaters. Heaters also create severe safety problems due to the hazards of fire and asphyxiation. Passage of electric current through the concrete or reinforcement for heating purposes is a Soviet technique that has serious complications and drawbacks in danger to personnel and possible local overheating of concrete; it is not recommended. Any mechanical devices used to maintain heat after placing should be backed up by standby equipment.

*h. Protection after the curing period.* After the specified curing and protection period, the insulation and forms or the enclosure should be removed only after careful review of the temperature observations made and recorded throughout the period and the results of the test specimens. When it is assured that the concrete has attained the desired strength, the protective and curing measures may be discontinued. Rapid chilling of the concrete surface must be avoided to preclude shrinkage cracking and serious damage to the structure. Care should be used to avoid the rapid exposure of large areas of fresh concrete to low ambient temperatures. This can be accomplished by the gradual removal of the forms in the presence of a source of heat, the dissipation of which is prevented by tarpaulins or similar sheltering devices, by removal of forms and immediate application of insulation, by slow reduction of heat supplied to enclosures, and preferably by delaying removal of forms or other protection until suitable temperatures prevail. The time, trouble, and expense of heating the materials, and using protective measures during the mixing, transporting, placing and curing of the concrete will be wasted if the stability, durability and soundness of the structure are jeopardized by a lack of concern at this last stage. The temperature of the concrete should not be allowed to decrease at a rate of more than 2 °F/hr.

*i. Temperature records.* A comprehensive temperature record should be kept during and after the period of protection and included in the permanent records of the job. The temperature of the heated and unheated materials and the freshly mixed concrete should be a part of this record. It is desirable to obtain the temperature history of the interior concrete for each part of the structure during and after the necessary period of protection and until the concrete temperature stabilizes. This can best be accomplished with thermocouples; however, the embedment of this-walled

Table 6-2. Insulation Requirements for Concrete Walls and for Concrete Slabs and Canal Linings Placed on the Ground<sup>203</sup>

**A. Concrete walls; concrete placed at 50F.**

Wall thickness, feet	Minimum air temperature allowable for these thicknesses of commercial blanket or bat insulation, degrees F			
	0.5 inch	1.0 inch	1.5 inches	2.0 inches
<b>Cement content—300 pounds per cubic yard</b>				
0.5 .....	47	41	33	28
1.0 .....	41	29	17	5
1.5 .....	35	19	0	-17
2.0 .....	34	14	-9	-29
3.0 .....	31	8	-15	-35
4.0 .....	30	6	-18	-39
5.0 .....	30	5	-21	-43
<b>Cement content—400 pounds per cubic yard</b>				
0.5 .....	46	38	28	21
1.0 .....	38	22	6	-11
1.5 .....	31	8	-16	-39
2.0 .....	28	2	-26	-53
3.0 .....	25	-6	-36	
4.0 .....	23	-8	-41	
5.0 .....	23	-10	-45	
<b>Cement content—500 pounds per cubic yard</b>				
0.5 .....	45	35	22	14
1.0 .....	35	15	-5	-26
1.5 .....	27	-3	-33	-65
2.0 .....	23	-10	-50	
3.0 .....	18	-20		
4.0 .....	17	-23		
5.0 .....	16	-25		
<b>Cement content—600 pounds per cubic yard</b>				
0.5 .....	44	32	16	6
1.0 .....	32	8	-16	-41
1.5 .....	21	-14	-50	-89
2.0 .....	18	-22		
3.0 .....	12	-34		
4.0 .....	11	-38		
5.0 .....	10	-40		

Table 6-2. (cont.)

Slab thickness, feet	Minimum air temperature allowable for these thicknesses of commercial blanket or bat insulation, degrees F			
	0.5 inch	1.0 inch	1.5 inches	2.0 inches
<b>Cement content—300 pounds per cubic yard</b>				
0.333	( <sup>1</sup> )	( <sup>1</sup> )	( <sup>1</sup> )	( <sup>1</sup> )
0.667	( <sup>1</sup> )	( <sup>1</sup> )	( <sup>1</sup> )	( <sup>1</sup> )
1.0	47	42	35	29
1.5	37	19	-1	-21
2.0	26	-5	-37	-70
2.5	16	-27	-72	
3.0	6	-51		
<b>Cement content—400 pounds per cubic yard</b>				
0.333	( <sup>1</sup> )	( <sup>1</sup> )	( <sup>1</sup> )	( <sup>1</sup> )
0.667	50	49	47	46
1.0	42	30	17	5
1.5	29	1	-27	-56
2.0	16	-28	-72	-117
2.5	3	-58		
3.0	-10	-86		
<b>Cement content—500 pounds per cubic yard</b>				
0.333	( <sup>1</sup> )	( <sup>1</sup> )	( <sup>1</sup> )	( <sup>1</sup> )
0.667	47	42	35	30
1.0	37	19	0	-19
1.5	21	-16	-54	-92
2.0	5	-51		
2.5	-13			
3.0	-26			
<b>Cement content—600 pounds per cubic yard</b>				
0.333	( <sup>1</sup> )	( <sup>1</sup> )	( <sup>1</sup> )	( <sup>1</sup> )
0.667	43	34	24	14
1.0	31	7	-18	-42
1.5	13	-33	-80	-127
2.0	-5	-74		
2.5	-22			
3.0	-42			

Slab thickness, feet	Minimum air temperature allowable for these thicknesses of commercial blanket or bat insulation, degrees F			
	0.5 inch	1.0 inch	1.5 inches	2.0 inches
<b>Cement content—300 pounds per cubic yard</b>				
0.333	( <sup>1</sup> )	( <sup>1</sup> )	( <sup>1</sup> )	( <sup>1</sup> )
0.667	49	47	44	42
1.0	43	33	22	12
1.5	33	12	-10	-33
2.0	24	-9	-43	-77
2.5	14	-31	-76	
3.0	5	-52		
<b>Cement content—400 pounds per cubic yard</b>				
0.333	( <sup>1</sup> )	( <sup>1</sup> )	( <sup>1</sup> )	( <sup>1</sup> )
0.667	46	40	32	26
1.0	37	22	5	-12
1.5	25	-5	-37	-68
2.0	13	-32	-78	
2.5	1	-59		
3.0	-11			
<b>Cement content—500 pounds per cubic yard</b>				
0.333	( <sup>1</sup> )	( <sup>1</sup> )	( <sup>1</sup> )	( <sup>1</sup> )
0.667	42	32	21	10
1.0	32	10	-13	-35
1.5	17	-23	-63	-103
2.0	3	-55		
2.5	-12			
3.0	-27			
<b>Cement content—600 pounds per cubic yard</b>				
0.333	( <sup>1</sup> )	( <sup>1</sup> )	48	48
0.667	39	24	9	-5
1.0	27	-1	-31	-59
1.5	10	-40	-90	-139
2.0	-8	-78		
2.5	-25			
3.0	-43			

<sup>1</sup> Owing to influence of cold subgrade on canal linings and other thin slabs, insulation alone will not maintain the temperature of concrete at the specified 50° F minimum for the first 72 hours after placing in cold weather. At such placements, additional heat is necessary to maintain required temperatures in the concrete by using higher placing temperatures, by preheating the ground, by placing electric resistance wire under the insulation, or by other means, depending on the severity of the prevailing weather. Where it is impracticable to supply such additional heat, insulation mats may prevent the concrete from freezing, but as the concrete temperature will probably fall below 50° F, the period of protection should be increased to obtain concrete strengths at the end of the protection period equivalent to the strength of concrete protected at 50° F for 72 hours.

copper tubing into which a common thermometer can be inserted will give fair results. The temperature of the concrete surfaces, the air temperature of any protective enclosure and the outside air temperature should be taken at least twice daily and recorded. Additional readings should be taken whenever the situation warrants. The humidity of heated enclosures should also be recorded. The surface temperature of the concrete should be taken in numerous places including edges and corners. Surface temperature of satisfactory accuracy can generally be obtained by placing a thermometer against the surface under a cover of insulating material until it registers a constant temperature.

### 6-5. Protection against the environment.

*a. General.* While it is true that most foundation construction is accomplished in summer in order to provide prepared support so that structures may be erected without seasonal constraints, it is often necessary to extend foundation work into winter seasons. Provisions for protection of construction against winter conditions should be initiated well before the first heavy frost or snowfall and in far northern locations they should be ready at all times. While weather records can indicate the probable date of first freezing temperatures and snow, the possibility of a significantly earlier date should be assumed. Adequate and timely protection of work can often save the expense of removing and replacing damaged material and equipment. Often enclosures for winter protection can be advantageously employed to protect the work also from sun, precipitation, dust, heat and wind, and to provide conditions for maximum worker efficiency.

*b. Barriers against temperature, precipitation and wind.*

(1) the protection required for winter construction varies with the construction material, the severity of the weather, and the duration and type of the work. As noted in the preceding section, uninsulated forms with tarpaulins and availability of temporary heat if needed may be adequate for some phases of work; others may require insulated forms with supplementary heat. Temporary portable shelters or enclosures may be utilized to enclose all or a portion of the work-9,'94'. Such protection permits the contractor to maintain schedules irrespective of weather and ensures maximum quality and productivity. The efficiency of men, unhampered by extra clothes and the effects of the elements, is often a prime consideration in selecting the type of enclosure to be used.

(2) Enclosures may consist of light portable buildings skidded to or erected over the work site, airinflated shelters, or timber or metal framing covered with transparent plastic films, tarpaulins or canvas, plywood or building board. In addition to cost, enclosure selection should consider amount of light desired, effect of wind and snow, heating, ventilation,

portability or reusability, and access openings for equipment and personnel. Winds in excess of 100 mph are common in some areas. Where drifting snow and high winds are prevalent, even the smallest openings must be avoided to prevent filling of the enclosed space with snow. Enclosures or shelters may be self-supporting or extensions to the existing structural framework. Enclosed scaffolds, suspended from outriggers, provide a convenient and easily moved shelter for workmen and material. Standard sections of tubular scaffolding can also be covered to provide an economical shelter, particularly for structures four or five stories in height. Buildings designed as prefabricated structural shells that can be erected on prepared foundations in a matter of hours or at most a few days under even the worst outdoor conditions appear to offer distinct advantages, as interior finishing can thereafter proceed in comfort, with the aid of temporary heat, without need for any special enclosure; the building shell serves as its own protective enclosure.

*c. Heating and light for winter work.*

(1) In addition to enclosing the work for winter protection, heat must be supplied to protect new concrete from freezing, thaw out and warm aggregates and prevent frost heaving, as well as provide an efficiently comfortable environment for workmen. Like shelters, heating requirements depend on the scope of work to be performed. Heaters range from steam boilers, warm air units and electrical space heaters to oil or gas-fired salamanders. The most commonly used heaters are oilfired space heaters producing up to 800,000 Btu/hr.

(2) While it is desirable to maintain some degree of full-time surveillance on all heating equipment, cokeburning equipment should never be left unattended. Adequate ventilation should be provided for all heating units except electrical ones for the health and safety of workmen and because of fire and other hazards. Some heaters (e.g., those using solid fuels) produce sulfurous acid which produces excessive corrosion. Carbon dioxide, which is produced by all fuel burning units, can damage new concrete". Improper combustion such as from clogging of fuel nozzles in oil-fired units, especially types not vented outside the enclosure, can badly contaminate the enclosure space with soot or atomized but unburned fuel as well as produce carbon monoxide. Infrared lamps have been used to keep fresh concrete from freezing. The lamps can be easily positioned and when arranged in a reflector in banks of three to five bulbs can protect a considerable area. With any type of warm air or radiant heating system it is especially important that proper moisture and humidity conditions be maintained at the surface of the concrete and that the concrete not be overheated. Electricity can also be used to

protect concrete by comparatively low temperature heating grids within the insulated form or by the direct burial of heating cables within the concrete. The cables are cut off after the concrete has cured. Heating tapes controlled by a rheostat are particularly useful at exposed corners, tops of walls and other thin sections which are susceptible to rapid cooling.

(3) Ordinary light bulbs are often utilized to provide some heat in addition to their prime use as a source of light. Since both safety and worker efficiency are directly related to illumination, it is imperative that sufficient lighting be provided. This is especially true in winter when sunshine is at a minimum and if the enclosure further reduces any natural lighting. On small construction jobs five to ten 100-watt bulbs are sufficient illumination for 1000 ft<sup>2</sup> of area.

*d. Fire hazards.* Fire is a major hazard in arctic and subarctic construction. The use of temporary heaters within an often-confined work area enclosed with or containing many combustible materials can be a potential fire danger. Heating equipment should be maintained and continually inspected to ensure proper functioning. Heating units should be carefully positioned away from formwork, tarpaulins and other combustibles and securely mounted or placed. Electrical heating is often advantageous on small jobs because of easy automated control and greater fire safety, even though cost may be greater. Non-combustible materials should be selected where feasible. Tarpaulins should be flame-proofed and secured from heavy winds. Firefighting equipment should be strategically placed both inside and outside of the enclosure and building at all times for quick access. When insulation can be used to avoid or reduce heating requirements, it may be possible to reduce risk of fire.

*e. Protection of fills, backfill and embankments.* Winter protection of fills, backfills and embankments is usually only justified for such purposes as (a) temporary prevention of freezing pending foundation or other emplacement or (b) protection of underlying construction such as utility pipes when construction is incomplete. A covering of peat or loose earth is ordinarily the best means of protecting the backfill from freezing. Loose rock backfill is ordinarily too porous to provide much protection against freezing. If loose earth is used, building paper, straw, or some other easily identifiable material can be placed on top of the compacted backfill so that the limits of the temporary fill

can readily be determined at the time of removal. Careful records should be kept of all such temporary fills which must be removed before backfilling operations are resumed. A checklist should be maintained to insure that all temporary fills are removed at the beginning of the following construction sequence. After such insulating temporary fills are removed, the density of the underlying compacted fill should be checked carefully before backfilling operations are resumed. Any previously compacted backfill which has lost its specified density due to freezing should be removed or recompacted.

*f. Foundation protection.* The need to protect the foundation against frost heave or thaw settlement during construction is sometimes overlooked". When frost-susceptible soils are present, it is essential that the foundation be protected until the backfill is in place and, if heat in the structure is depended upon to prevent frost action, until heat is available. Methods which may be used to provide protection of foundations against frost heave in seasonal frost areas include the following, individually or in combinations, as appropriate:

Cover of earth, hay, sawdust, peat or other indigenous material.

Directly applied bat, blanket or foam insulation.

Insulated structural enclosure or tentage.

Cover of polyethylene sheeting or special fabric inflated by hot air blower.

Saturation of foundation soils with salt solution to prevent freezing.

Flooding of foundation with water to a depth of a foot or more greater than the normal ice thickness for the area.

Hot air, steam, or electrical heat.

Methods to prevent or minimize degradation of permafrost have been discussed in previous sections and include: Scheduling work in periods of below freezing air temperatures.

Covering permafrost with protective fill or backfill.

Shading or enclosure.

Insulation.

Artificial refrigeration.

## CHAPTER 7 MONITORING PERFORMANCE

### 7-1. General.

a. Although periodic visual inspections are an essential part of performance monitoring, destructive trends may be present for several years before visual signs of foundation distress appear. Gradual warming of frozen soil has little effect on performance until the melting point is reached. Severe damage can then rapidly develop if the foundation has high ice content. Exceptional weather conditions or changes in operation may also induce more abrupt deviations. By installing instrumentation, such efforts can be detected and stopped before damage results. If distress does occur, instrumentation provides the evidence needed to establish the source of the problem which otherwise must be defined by deductive reasoning, a process of limited value where unique foundation conditions are encountered.

b. Where possible, basic instrumentation for monitoring the performance of a foundation and structure should be installed prior to construction in conjunction with the program of subsurface exploration. Frost-free benchmarks, temperature sensors, frost gauges, water wells and other devices installed in drill holes at that time will define the undisturbed conditions as well as any subsequent changes caused by the facility. Additional instrumentation should be installed during the construction. The type and amount of instrumentation and the observational frequency depend on the type of building and foundation, its purpose, and the subsurface and environmental conditions.

c. In 1943 Dr. Karl Terzaghi<sup>196</sup> wrote: "Records with potentially valuable information have become worthless on account of a few omissions which escaped attention at the time the record was filed. Others have never served a useful purpose because the data were so poorly presented and cumbersome that no one could afford the time to unravel and digest them." Consequently, well organized systems for data collection and analysis should be established at the time instrumentation is installed and summary data reports prepared periodically. Photographs taken before, during, and after construction are often useful. Broad comparisons and evaluations on a regional or extra-agency basis also provide extremely valuable input for development of new and improved criteria. Copies of such data and reports should be submitted to CRREL for incorporation into its records under its mission of obtaining performance feedback, maintaining cognizance and disseminating information on cold regions science and engineering.

**7-2. Inspections.** Periodic inspection of the performance of facilities is essential to detect possible

evidences of foundation distress. Written and photographic records of inspections should be maintained so that the development of problems can be fixed in time. Additional instrumentation should be installed when needed to assist inspection. A brittle plaster patch (tell-tale) placed over a crack will indicate if movements are continuing. Mechanical and electrical strain gages may also be considered. Inspection of interconnecting utilities and adjacent areas is also important because leaks in utility lines, insufficient surface drainage provisions, disruption of natural ground water, thermal disturbance and other factors may cause unanticipated problems.

### 7-3. Vertical movement measurement.

a. Measurement points should be installed at the key points on the foundation so that frost heave or settlement deflections can be monitored. The points should be established during construction and their elevations referenced to a frost-free stable benchmark (Chap 5) located some distance away in an undisturbed area. If an adequate benchmark is unavailable, the relative elevations of points on the structure should at least be measured. Since it is not always possible to predict potential problem areas, the elevation of numerous points on and around the foundation should be established initially. Subsequent surveys need not be as comprehensive. If foundation movements do occur, the pattern of measurement points can then be adjusted as needed. Allowance should be made for removal, blockage and damage to points during the life of the structure by establishing enough points so as not to be too dependent on any one.

b. Although expensive, manometer systems are occasionally used to measure the relative elevation of points on a structure<sup>130</sup>. By interconnecting the upper ends of the manometers with a hose, variations in atmospheric pressure from one point to the next can be eliminated. To avoid introducing errors caused by variations of liquid density with temperature, the manometers should be maintained at the same temperature, or temperatures should be measured and corrections applied.

c. Under some conditions, such as where soil creep is occurring, measurement of horizontal components of movement may also be needed.

**7-4. Temperature sensing.** Where remote sensing of temperature is necessary electrical systems are generally required. These are the most versatile and most frequently used systems for monitoring freeze and thaw conditions in the ground. Either thermocouples or

thermistors may be used. The choice is based chiefly on the degree of precision required. Sohlberg<sup>92</sup> presents a comprehensive analysis of the basic systems and their sub-features. Thermohms, which are wound wire resistors that experience resistance change with temperature, have been used extensively in the past but are now little used because of their expense and because their substantial size, their volumetric heat capacity, and their heat conductance capacity in both probe and cable present substantial potentials for error in temperature measurements.

*a. Thermocouples.*

(1) In essence, a thermocouple is a very weak battery created simply by joining wires of two dissimilar metals. The strength of this "battery" changes with changing temperature and by measuring the small voltage produced the temperature at the bimetallic junction can be determined. When an electrical circuit consisting of two dissimilar wires is closed at both ends, two thermocouples are created. They are in electrically opposite directions and if the two junctions are at the same temperature, the voltage produced by one offsets that produced by the other. If the two junctions are not at the same temperature, a net voltage difference is produced. Consequently, it is not the temperature at a single thermoelectric junction that is measured but rather the difference in temperature between two junctions. Thermocouple circuits are generally arranged so that one of the junctions (the sensor) is placed at the point where an unknown temperature is to be measured and the other (the reference) is placed in a mixture of ice and water which maintains itself at 0 °C (32 °F). The difference in emf is usually measured by millivolt potentiometer together with an unsaturated mercurycadmium standard cell voltage reference. An electronic null detector should be used with the potentiometer. The two dissimilar wires commonly used are copper and constantan. Tables are available<sup>2</sup> for converting voltage readings obtained on a precision potentiometer for these wires when the reference junction is maintained at 0°C (32 °F). If field measurements on a top quality installation are obtained carefully, with first rate equipment, the temperatures can be obtained within about 0.4 C (3/4 F) (+) of the true values. If the measurements on a given thermocouple assembly are all made in a single operation over a reasonably short period of time, so that temperatures do not change significantly, the relative temperatures indicated between the thermocouples can be correct within much closer limits. Often differences in temperature between various points are much more important and useful than actual temperature levels. Since the nucleation temperature is usually displaced below 32 °F in finegrained soils, the positions of interfaces between frozen and unfrozen materials are usually more accurately determined by changes in slope of the curve of ground temperatures vs. depth than by

the positions of the 3-°F isotherm. To take maximum advantage of this situation, differential values of emf between sensor thermocouples may be measured directly. Since experience indicates that the accuracy level of portable potentiometer field work is about + 0.1 to 0.2 F ( ± 0.1 °C), differential temperature measurements may approach this degree of accuracy on an individual assembly if all other sources of error, including thermocouple wire characteristics, influence the apparent emf's from all thermocouples equally. To enhance the probability of the latter situation, it is desirable that all the thermocouples in a given assembly be made from the same run of thermocouple wire. Thus, in actual frozen ground measurements, thermocouples may often be used to greater advantage than their capacity to yield true temperatures would suggest, so long as temperature gradients are reasonably pronounced.

(2) Thermocouples are relatively simple and cheap compared to other electrical ground temperature measurement systems. They give good results when temperature gradients are large enough so that very high precision in individual readings is not needed. Their disadvantages include the problems of making and maintaining ice baths and of using and protecting standard cells under winter conditions. In order to obtain reliable temperature measurements, any potentiometer should be maintained at a temperature above 0 °F and the ice bath container kept above 3' °F. This is best accomplished in the field in winter by placing the potentiometer in a shock-mounted heated (electric or exhaust gas) enclosure in an oversnow or other vehicle and making provision for the observer to carry the ice bath container and the potentiometer batteries and standard cell beneath his parka connected to the potentiometer by extension leads. The leads from the thermocouple cable can then be fitted with a suitable connector and attached directly to a mating connector on the potentiometer enclosure. The thermal gradient across the signal load connector will cause a zero offset but the amount of this offset can be easily determined by connecting the input terminals on the potentiometer together with a short length of wire and reading the offset voltage.

*b. Thermistors.* When greater precision is needed than is obtainable with thermocouples, thermistors of a select type, stabilized and properly calibrated, should be used.

(1) Thermistors are semiconductors consisting of compounds of various metal oxides which exhibit extremely large changes in resistance with temperature change. Resistance variation with temperature is approximately exponential and a fairly elaborate calibration procedure is required. Sohlberg<sup>92</sup> has described such a procedure. A Wheatstone bridge is used to

measure the thermistor resistances and the calibration curve used to convert to temperature. Thermistor systems are complex to fabricate and cost more than thermocouples but careful field fabrication, installation and observation techniques can produce results repeatable to better than 0.01 °C (0.02 °F) and accurate to better than 0.05 C (0.09 F). Where slight temperature changes are critical their extra expense may be justified. However, in foundation work the added precision often may not be usable to real advantage. Experience has shown that uncalibrated thermistors with direct reading instruments are seldom accurate to 1 IF. An assembly intended for underground installation must be very carefully protected against moisture, because variations of moisture content within the system would change resistances in both the bead and the insulation and hence the apparent temperatures. Thermistors of the type contained within a shock resistant glass bead protective cover should be used and the connecting system of wires and insulations should be assembled with elaborate precautions against moisture penetration. Because thermistors are also pressure sensitive, the thermistor beads must be surrounded by protective metal sleeves or other enclosures within the assembly when pressures such as from freezing of soil or water may occur. Possible errors caused by resistances of leads and contacts in the circuits must be avoided. The thermistors must be stabilized by an accelerated aging process at temperatures well above the operating range and thermal stress adjusted by cycling to temperatures below those expected in application.

(2) Thermistors eliminate the ice bath problems of thermocouples and the problem of thermal gradients across the signal lead connector, making field observational techniques less complex. However, a heated shock-mounted enclosure is still required to house the Wheatstone bridge, in the same manner as for the potentiometer for thermocouples, for reliable field results. Care must be taken to control the amount of current put through the thermistor during the Wheatstone bridge measurements so as not to change its resistance by more than the accuracy of measurement required. In precise work, errors due to thermocouples in the system must be avoided by proper observational techniques.

**7-5. Other systems for freeze and thaw monitoring.** Several systems other than thermocouples or thermistors are possible for locating the interface between frozen and unfrozen materials and may under some conditions be used in their place. Some of these do not require the assumption of a freezing temperature but determine the interface directly.

*a. Probing.* In summer, a steel rod can be driven through unfrozen soil in the annual thaw zone until it encounters underlying permafrost. Several methods of driving may be used. In soft, fine-grained soils a

sharpened ¼ to ½-in.-diameter steel rod can be pushed down to as much as 15 feet<sup>55</sup> with the help of a pair of clamp-grip pliers as illustrated in figure 7-1a. By making a hole part way by some method, hand probing can be extended further. In slightly stiffer soils a sledgehammer may be needed. Hand augering or test pitting may also be used. For soils in which manual methods of penetration are difficult or impossible, or when a frozen layer must be penetrated, a drill rod or other rod can be driven by a pneumatic drill. Regular exploration, auger or other power-operated drill rigs may also be used. The interface between a frozen layer and an underlying unfrozen layer will usually be detectable by the decrease in resistance to penetration. However, if there is question, the scheme shown in figure 7-1b may be tried, raising the L-shaped rod in contact with the wall of the bore hole until the interface is felt.

*b. Soil electrical resistance.* When a soil freezes, a large increase in its electrical resistance occurs. This resistance can be measured between copper or conductive epoxy electrodes on the outside surface of a nonconductive pipe which is buried vertically in the soil. The variation of soil resistance with depth determined with this device delineates frozen and unfrozen strata. A schematic of a device developed by Aitken at CRREL<sup>6</sup> together with typical electrical resistance data are shown in figure 7-2. The CRREL tests were accomplished successfully using a low level direct current system. In some soil conditions it might be necessary to make an a-c resistance measurement to avoid polarization at the electrodes.

*c. Seismic.* The rigidity and consequently the seismic velocity of soil increases when it is frozen. Consequently, conventional refraction seismic surveys can be used to determine the depth to frozen ground below unfrozen material in the same fashion that bedrock is delineated. For relatively shallow annual thaw zone depths, special seismic equipment capable of handling extremely short refraction time intervals must be used. However, the thickness of a frozen layer (annual frost or permafrost) cannot be determined by refraction seismic methods. Reflection type equipment is currently being tested for use in permafrost areas<sup>84,85,124</sup>.

*d.* Color change of material within a tube inserted into the ground. If a sealed tube filled with moist sand is inserted into the ground inside of a fixed outer tube, sealed at the bottom, positions of frozen and unfrozen zones in the ground can be determined at any desired time by withdrawal and inspection of the tube. Dyes such as methyl blue or fluorescein are used to intensify the color difference. Devices of this type have been investigated or used in Alaska by the Permafrost Division



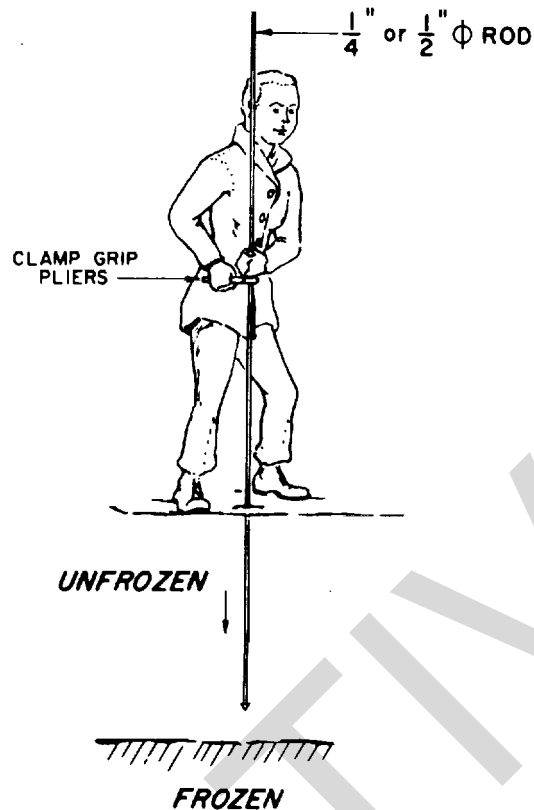

U. S. Army Corps of Engineers

Figure 7-1a. Permafrost and frost probing techniques (by CRREL).

(Probing to frozen ground.) of the Corps of Engineers (in the early 1950's), in Greenland by the Arctic Construction and Frost Effects Laboratory (in the mid-1950's), in a number of North American locations by CRREL (in the late 60's)<sup>44</sup>, in Scandinavia as reported by Gandahl<sup>16</sup>, and in Canada by the Saskatchewan Dept. of Highways<sup>116</sup> and the Division of Building Research, National Research Council of Canada. Advantages are simplicity, economy, and avoidance of electrical complexities. Potential disadvantages are (a) lack of thermal correspondence of the sand in the tube with the surrounding soil, with resultant errors, (b) expansion of the inner tube and inability to withdraw it under certain freezing conditions, and (c) lack of detailed thermal gradient data.

#### 7-6. Monitoring groundwater.

a. Simple observation wells have generally proven to be the most reliable method of monitoring groundwater elevations. To prevent cutoff of water by

frozen zones the entire length of the casing should be perforated. Since frost action can progressively lift the casing, heave prevention measures should be employed (chap 5).

b. In the fall the elevation of groundwater begins to decrease as soon as the ground begins to freeze (fig. 2-4)<sup>35</sup>. Water standing in an observation well freezes at the top when the frost line reaches it. Because the ice is frozen to the pipe it does not drop with subsequent lowering of the water table. It has been observed that after ice in such wells is cut through at a later date, the water in the well drops below the level of freezing as suction is released and thereafter remains unfrozen (provided the well is covered) unless the frost line reaches the new depth. Consequently, adequate time should be provided for equilibrium to develop once the ice is cut and the suction released, before readings are accepted as valid.

c. A water level indicator device utilizing an electrical contact and visual or audible signal is recommended for measuring the water table position in the well and may be obtained from soils testing equipment suppliers. For very shallow depths a tape or ruler may suffice. To prevent freezing, kerosene has been added in wells to displace a portion of the water column. Air pressure has also been used with limited success in sealed wells to force the water below the frost line. Since the pressure is released when a reading is taken, this method is useful only in highly permeable soils where stability is rapidly achieved. After the measurement is made, the well is again pressurized<sup>65</sup>. Williams and vanEvarding<sup>209</sup> have reviewed the state-of-the-art of groundwater measurement in permafrost regions, including use of soil moisture cells. However,

under the severe condition, encountered on construction projects, moisture cells may not always perform reliably<sup>37</sup>.

d. In areas of seasonal frost, electrical resistance gages and various types of pore pressure measuring equipment (piezometers) can also be employed, provided that the sensing element is located below the maximum depth of frost penetration. Freezing of water in the tubing of standpipe type piezometers can be a problem. Carlson, Kane and Bowers<sup>129</sup> and Slaughter and Kane<sup>192</sup> have reported on use of piezometers in recent groundwater studies in central Alaska. Dye solutions can be used to trace the paths and quantity of groundwater flows. This technique was successfully used to study ground flow in the annual thaw zone at Thule AB<sup>105</sup>.

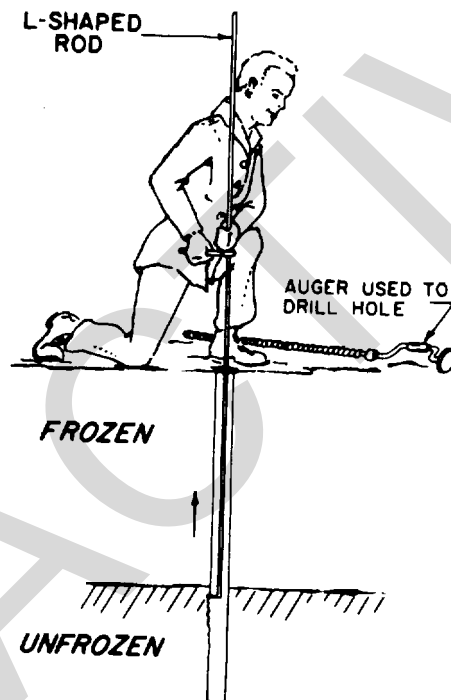

U. S. Army Corps of Engineers

Figure 7-1b. Permafrost and frost probing techniques. (Probing through frozen ground.)

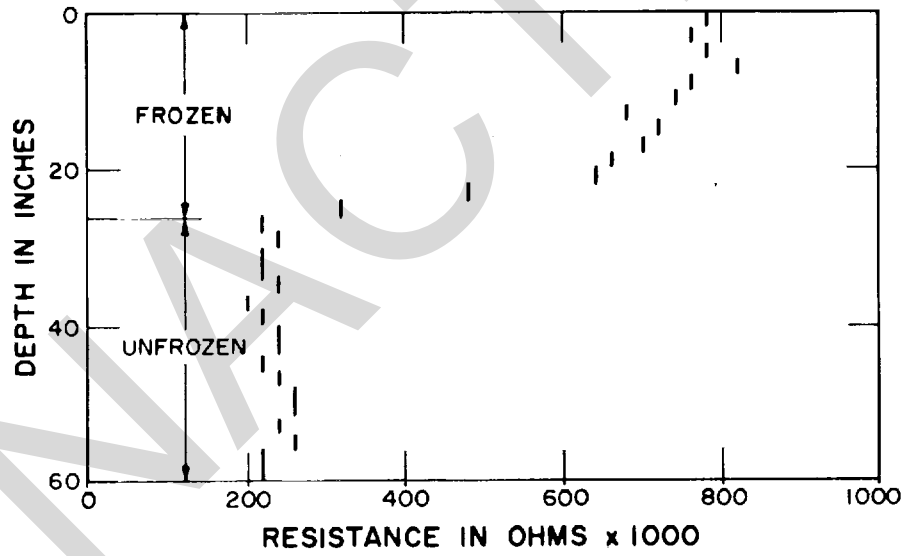
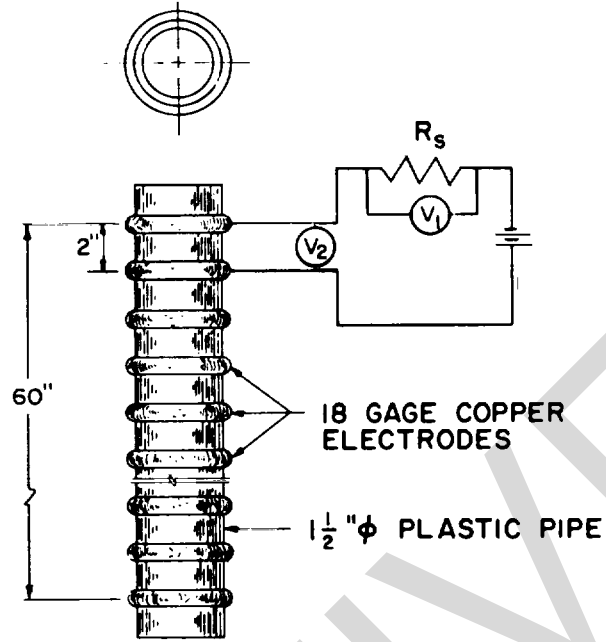

U. S. Army Corps of Engineers

Figure 7-2. Electrical resistance gage for determination of frost penetration (by CRREL).

**APPENDIX A  
REFERENCES**

**REQUIRED PUBLICATIONS**

**Government Publications**

**Department of Defense, Military Standard**

1. MIL-STD-619

Unified Soil Classification System for Roads, Airfields, Embankments and Foundations (Include system for frozen soils.)

**Departments of the Army and Air Force**

**Technical Manuals**

2. TM 5-785/AFM 88-29/NAVFAC P-89
3. TM 5-809-10/AFM 88-3, Chap. 13
4. TM 5-810-1
5. TM 5-818-1/AFM 88-3, Chap. 7
  
6. TM 5-818-2
7. TM 5-818-4/AFM 88-5, Chap. 5
8. TM 5-820-2/AFM 88-5, Chap. 2
  
9. TM 5-820-3
  
10. TM 5-852-1/AFM 88-19, Chap. 1
11. TM 5-852-2/AFM 88-19, Chap. 2
  
12. TM 5-852-3
13. TM 5-852-5/AFM 88-19, Chap. 5
14. TM 5-852-6/AFM 88-19, Chap. 6
  
15. TM 5-852-7/AFM 88-19, Chap. 7
  
16. TM 5-852-9/AFM 88-19, Chap. 9
17. TM 5-852-8
  
18. TM 5-856-4
  
19. TM 5-805-1/AFM 88-3, Chap. 6

Engineering Weather Data  
 Seismic Design for Buildings  
 Mechanical Design: Heating, Ventilating and Air Conditioning  
 Soils and Geology: Procedures for Foundation Designs of Buildings and other Structures (except Hydraulic Structures)  
 Soils and Geology: Pavement Design for Frost Conditions  
 Soils and Geology: Backfill for Subsurface Structures.  
 Drainage and Erosion Control: Subsurface Drainage Facilities for Airfield Pavements.  
 Drainage and Erosion-Control Structures for Airfields and Heliports  
 Arctic and Subarctic Construction-General Provisions  
 Arctic and Subarctic Construction, Site Selection and Development  
 Arctic and Subarctic Construction: Runway and Road Design  
 Arctic and Subarctic Construction: Utilities  
 Arctic and Subarctic Construction Calculation Methods for Determination of Depths of Freeze and Thaw in Soils  
 Surface Drainage for Airfields and Heliports in Arctic and Subarctic Regions  
 Arctic and Subarctic Construction: Buildings  
 Arctic and Subarctic Construction; Terrain Evaluation in Arctic and Subarctic Regions  
 Engineering and Design: Design of Structures to Resist the Effects of Atomic Weapons: Structural Elements Subjected to Dynamic Loads  
 Standard Practice for Concrete for Military Structures.

**RELATED PUBLICATIONS**

**U.S. Army Corps of Engineers**

**Engineer Manuals**

20. EM 1110-2-2906
21. EM 1110-345-310
22. U.S. Army Corps of Engineers Ballistic Missile Construction Office

Design of Pile Structures and Foundations  
 Foundations Subject to Vibratory Loads  
 Ballistic Missile and Space Facility Design and Construction Handbook. Chapter XIII, Cold Weather Concrete and Backfill Operation at ICBM Sites, Los Angeles, California, 1961

**Department of the Army  
Technical Reports**

23. Aamot, H.W.C., *Dynamic Pile Foundation Measurements*, Barter Island, Alaska. U.S. Army Cold Regions Research and Engineering Laboratory (CRREL) Special Report 75, 1966.
24. Abel, J.F., Jr., *Permafrost Tunnel*, Camp TUTO, Greenland. U.S. Army Snow, Ice and Permafrost Research Establishment (SIPRE) Technical Report 73, 1960.
25. Aitken, G.W., *Ground Temperature Observations*, Galena, McGrath, Big Delta, Barrow, Gulkana, Northway and Kotzebue, Alaska. CRREL Technical Reports 102-108, 1963-65.
26. *Performance of a Prototype DC Resistance Frost Penetration Gage*. CRREL Technical Note, 1963.
27. *Temperature-Millivolt Conversion Tables, Copper Constantan Thermocouples, 32 F Reference Temperature*. CRREL Special Report 108, 1966.
28. *Reduction in Frost Heave by Surcharge Load*. CRREL Technical Report 184, 1974.
29. Aitken, G.W. and Fulwider, C.W., *Ground Temperature Observations*, Aniak, Alaska. CRREL Technical Report 101, 1962.
30. Aldrich, H.P. and Paynter, H.M., *Analytical Studies of Freezing and Thawing of Soils*. U.S. Army Arctic Construction and Frost Effects Laboratory (ACFEL2) Technical Report 42.
31. Anderson, D.M. and Hoekstra, P., *Migration and Crystallization of Interlamellar Water during Freezing and Thawing of Wyoming Bentonite*. CRREL Research Report 192, 1965.
32. Anderson, G.D., *The Equation of State of Ice and Composite Frozen Soil Material*. CRREL Research Report 257, 1968.
33. Arctic Construction and Frost Effects Laboratory (ACFEL), *Investigation of Description, Classification and Strength Properties of Frozen Soils, FY 1951*. ACFEL Technical Report 40/SIPRE Technical Report 8, 1952.
34. ACFEL, *Investigation of the Strength Properties of Frozen Soils, FY 1952, FY 1953*. ACFEL Technical Reports 44 and 48 (Drafts), 1953, 1954.
35. *Ground Water Studies*. Fairbanks Permafrost Research Area. CRREL Internal Report 40, 1954.
36. *Interim Report of Observations on Hangar 7A-4, Thule AB*. CRREL Files 1955.
37. *Freezeback Control and Pile Testing*, Kotzebue Air Force Station, Alaska. ACFEL Technical Report 66, 1957.
38. *Investigation of Frost Heave in Unheated Wing Hangars*. CRREL Files, 1957.
39. *Permanent Benchmarks in Permafrozen Fine-Grained Soils*. ACFEL Miscellaneous Paper 17, 1957.
40. ACFEL, *Cold Room Studies, Third Interim Report of Investigations*. ACFEL Technical Report 43, 1958.
41. *Perimeter Insulation for Slab-on-Grade Buildings*. ACFEL Internal Report (CRREL Files), 1961.
42. Banfield, A.F. and Csergei, H.P., *Results of Sampling Insulating Layers in Runway Test Sections*, Alaska Field Station. CRREL files.
43. Berg, R.L., *Energy Balance on a Paved Surface*. CRREL Technical Report 226, 1974.
44. Brown, J. and Rickard, W., *A Modified Freeze-Thaw Depth Indicator*. CRREL Technical Note 52, 1968.
45. Butkovich, T.R., *Ultimate Strength of Ice*. SIPRE Research Report 11, 1954.
46. Church, R.E., Pewe, T.L. and Andresen, M.J., *Origin and Environmental Significance of Large-Scale Patterned Ground, Donnelly Dome Area, Alaska*. CRREL Research Report 159, 1965.
47. Croy, F.E., *Test of Vibratory Pile Driving*. CRREL Files, 1966.
48. *Bridge Foundations in Permafrost Areas*, Goldstream Creek, Fairbanks, Alaska. CRREL Technical Report 180, 1968.
49. *Installation of Driven Test Piles in Permafrost at Bethel Air Force Station*, Alaska. CRREL Technical Report 139, 1973.
50. *Bridge Foundations in Permafrost Areas*, Moose and Spinach Creeks, Fairbanks, Alaska. CRREL Technical Report 266, 1975.
51. Croy, F.E. and Reed, R.E., *Measurement of Frost Heaving Forces on Piles*. CRREL Technical Report 145, 1965.
52. Croy, F.E. and Tizzard, W.J., *Some Limited Observations of Highway Cuts on the New Defense Access Road to Murphy Dome*, Alaska. CRREL Technical Note, 1965.
53. *Installation and Testing of Earth Anchors at Fairbanks, Alaska*. CRREL Draft Report, 1965.

Function of the former Arctic Construction and Frost Effects Laboratory (ACFEL) and the Snow, Ice and Permafrost Research Establishment (SIPRE) were transferred to the U.S. Army Cold Regions Research and Engineering Laboratory (CRREL) in 1961.

<sup>2</sup>Functions of the former Arctic Construction and Frost Effects Laboratory (ACFEL) and USA Snow, Ice and Permafrost Research Establishment (SIPRE) were transferred to USA Cold Regions Research and Engineering Laboratory (USACRREL) in 1961.

54. Davis, R.M., *Design, Construction and Performance Data of Utility Systems*, Thule Air Base. CRREL Special Report 95, 1966.
55. Davis, R.M. and Kitze, F.F., *Soil Sampling and Drilling Near Fairbanks, Alaska Equipment and Procedures*. CRREL Technical Report 191, 1967.
56. Foster-Miller Associates, Inc., *Final Phase I Report on an Investigation of Methods of Conveying Snow, Ice and/or Frozen Ground from an Excavation to a Disposal Area*. CRREL Internal Report 23, 1967.
57. *Development of Fundamental Concepts for the Rapid Disengagement of Frozen Soil*. CRREL Technical Report 233, 1973.
58. *Frost Effects Laboratory', Addendum No. 1, 1945-1947 Report on Frost Investigation, 1944-1945*. ACFEL Technical Report 24, 1949.
59. *Cold Room Studies, Interim Report 1949-1950*. ACFEL Technical Report 33, 1950.
60. *Cold Room Studies, Second Interim Report of Investigations, FY 1950 and 1951*. ACFEL Technical Report 36, 1951.
61. *Insulation of Concrete Floor Slabs on Grade (Preliminary Report)*. ACFEL Miscellaneous Paper 3, 1952.
62. Frost, R.E., *Evaluation of Soils and Permafrost Conditions in the Territory of Alaska by Means of Aerial Photographs*. ACFEL Technical Report 34, 1950.
63. Fyfe, T.M., *Dynamic Testing of Frozen Soil Samples with an Exploding Wire System*. Mathematical Sciences Northwest, Inc., Rpt. 68-53-1 for CRREL, 1968.
64. Gilman, G., *The Freezing Index in New England*. CRREL Special Report 63, 1964.
65. *Displacement Method for Ground Water Observations During Freezing Periods*. CRREL Internal Report 39, 1967.
66. Hoekstra, P., Chamberlain, E.J. and Frate, A., *Frost-Heaving Pressures*. CRREL Research Report 176, 1965.
67. Joachim, C.E., *Shock Transmission through Ice and Snow*. U.S. Army Waterways Experiment Station Technical Report 1-794, 1967.
68. Kaplar, C.W., *Laboratory Determination of the Dynamic Moduli of Frozen Soil and of Ice*. CRREL Research Report 163, 1969.
69. *Some Strength Properties of Frozen Soil and Effect of Loading Rate*. CRREL Special Report 159, 1971.
70. *Moisture and Freeze-Thaw Effects on Rigid Thermal Insulations*. CRREL Technical Report 249, 1974.
71. Kaplar, C.W. and Wieselquist, K., *Summary Report of Laboratory Studies Performed under Projects SP 15 and SP 48, Materials in Cold Climates*. CRREL Internal Report 46, 1968.
72. Kersten, M.S., *Laboratory Research for the Determination of the Thermal Properties of Soils*. ACFEL Technical Report 23, 1949.
73. Kersten, M.S., and Lobacz, E.F., *A Study of Building Foundations*. ACFEL Miscellaneous Paper 22, 1958.
74. Kitze, F.F., *Installation of Piles in Permafrost*. ACFEL Miscellaneous Paper 18, 1957.
75. Linell, K.A., *Use of Ice as a Load Supporting Surface*. ACFEL Miscellaneous Paper 19, 1958.
76. McAnerney, J.M., *Investigations of Subsurface Drainage at the BMEWS Facility, Thule, Greenland*. CRREL Special Report 111, 1968.
77. Mellor, M., *Blowing Snow*. CRREL Monograph III-A3c, 1965.
78. Michel, B., *Ice Pressure on Engineering Structures*. CRREL Monograph III-B1b, 1970.
79. *Winter Regime of Rivers and Lakes*. CRREL Monograph III-B1a, 1971.
80. Permafrost Division, St. Paul District, CE, *Investigation of Military Construction in Arctic and Subarctic Regions, Comprehensive Report, 1945-1948*. ACFEL Technical Report 28, 1950.
81. Quinn, W.F., McAnerney, J. and Hawkes, I., *Blasting Frozen Ground with Compressed Air*. CRREL Miscellaneous Publications 279, 1969.
82. Reed, R.E., *Refrigeration of a Pipe Pile by Air Circulation*. CRREL Technical Report 156, 1966.
83. Huck, R., *Strain Gage Instrumented Piles in Permafrost*. CRREL Special Report 144 (unpublished).
84. Roethlisberger, H., *Seismic Exploration in Cold Regions*. CRREL Monograph II-A2a, 1972
85. *Application of Seismic Refraction Soundings in Permafrost Near Thule, Greenland*. CRREL Technical Report 81, 1961.
86. Sanger, F.J., *Foundations of Structures in Cold Regions*. CRREL Monograph III-C4, 1969.
87. Sayles, F.H., *Creep of Frozen Sands*. CRREL Technical Report 190, 1968.
88. Scott, R.F., *Heat Exchange at the Ground Surface*, CRREL Monograph II-A1, 1964.

<sup>3</sup>The Frost Effects Laboratory and the Permafrost Division, U.S. Army Engineer District, St. Paul, were combined in 1953 to form the Arctic Construction and Frost Effects Laboratory (ACFEL), U.S. Army Engineer Division, New England, and see note 2.

89. Sellman, P.V., *Geology of the USACRREL Permafrost Tunnel, Fairbanks, Alaska*. CRREL Technical Report 199, 1967.
90. Smith, J.L., *Shock Tube Experiments on Snow*. CRREL Technical Report 218, 1969.
91. Smith, N., *Determining the Dynamic Properties of Snow and Ice by Forced Vibration*. CCREL Technical Report 216, 1969.
92. Sohlberg, E.T., *Surface Temperature Measurements*. CCREL Internal Report 485, 1976.
93. Stevens, H.W., *Measurement of the Complex Moduli and Damping of Soils under Dynamic Loads; Laboratory Test Apparatus, Procedure and Analysis*. CRREL Technical Report 173, 1966.
94. *The Response of Frozen Soils to Vibratory Loads*. CRREL Technical Report 265, 1975.
95. Stormer, C.D., *Cold Concrete*. CRREL Technical Report 220, 1970.
96. Swinzow, G.K., *Tunneling in Permafrost II*. CRREL Technical Report 91, 1964.
97. *Permafrost Tunneling by a Continuous Mechanical Method*. CRREL Technical Report 221, 1970.
98. Tsytovich, N.A. and Sumgin, M.I., *Principles of Mechanics of Frozen Ground*. Akad. Nauk SSSR, 1937. USA SIPRE Translation 19, 1959.
99. U.S. Army Cold Regions Research and Engineering Laboratory (CRREL), *Ground Temperature Observations, Fort Yukon, Alaska*. CRREL Technical Report 100, 1962.
100. CRREL, *Thaw Penetration and Subsidence, 500-Man Barracks, Ladd AFB*. CRREL Internal Report 12, 1966.
101. *Ground Temperature Observations, Bettles, Tanana and Unalakleet, Alaska*. CRREL Internal Report 489, 490, 491, 1976.
102. *Ground Temperature Observations, Aishihik, N. W. T., Canada; Summit, Wainwright, Fairbanks, Anchorage, Noime, Pt. Lay, Shunghak and Wales, Alaska*. CRREL File reports, 1966.
103. U.S. Army Engineer District, Eastern Ocean, *Stability and Settlement Analysis, Runway Extension, Sondrestrom AB (BW-8)*. Technical Report No. ENG-436, prepared by J.F. Haley, Consulting Foundation Engineer, for Metcalf and Eddy and Alfred Hopkins and Associates, New York, N.Y., 1957.
104. *Greenland Completion Report, 1951-1955*. Prepared by Metcalf & Eddy and Lapierre, Litchfield and Partners, Engineer and Architect, New York, N.Y.
105. *Airfield Drainage Investigation, Thule AB, FY 1958*. Technical Report No. ENG-455, prepared by Metcalf and Eddy and LaPierre, Litchfield, Boston, Mass., 1958.
106. U.S. Army Waterways Experiment Station, *A Procedure for Determining Elastic Moduli of Soils by Field Vibratory Techniques*. Miscellaneous Paper No. 4-577, 1963.
107. Vialov, S.S., *The Strength and Creep of Frozen Soils and Calculations for Ice-Soil Retaining Structures*. Akad. Nauk SSSR, 1962. CRREL Translation 76, 1965.
108. Wechsler, A.E., *Development of Thermal Conductivity Probes for Soils and Insulations*. CRREL Technical Report 182, 1966.
109. Wilson, C., *Climatology of the Cold Regions. Introduction and Northern Hemisphere 1*. CRREL Monograph I-A3a, 1967.
110. *Climatology of the Cold Regions. Northern Hemisphere II*. CRREL Monograph I-A3b, 1969.
111. Woods, K.B., Fadum, R., Assur, A., Boyd, W.K., Linell, K.A. and Sterrett, K., *Alaska Trip Report*. CRREL Files, 1967.
112. Woods, K.B., Linell, K.A. and Crory, F.E., *Alaska-Canada Trip Report*. CRREL Files, 1963.
113. Yoakum D., *A Survey of Winter Construction Practices: Earthwork, Concrete and Asphalt*. CRREL Special Report 76, 1966.

**Department of the Navy  
Technical Report**

114. Arctic Engineering. Technical Publication NAVDOCKS TP-PW-1 1, 1955.
115. American Concrete Institute, *Cold Weather Concreting*. ACI 306 R-78.
116. American Society of Civil Engineers, *Ice Pressure Against Dams: A Symposium*. Bertil Lofquist, A.D. Hogg, G.E. Monfore and discussion paper 2656, *Transactions*, ASCE, Vol. 119, 1954.
117. American Society of Heating, Refrigerating and Air-Conditioning Engineers, *ASHRAE Handbook and Product Directory*. ASHRAE, New York, 1976, 1977, 1978, 1979.
118. American Society for Testing and Materials, *Piles Under Axial Compressive Load*. ASTM D 1143-74.
119. American Society for Testing and Materials, *Steady-State Thermal Transmission Properties by Means of the Guarded Hot Plate*. ASTM C 177-76.

120. American Standards Association, Inc., *American Standard Building Code Requirements for Excavations and Foundations, LA56.1-1952*. Sponsored by American Society of Civil Engineers, 1953.
121. Anderson, D.M. and Morgenstern, N.R., "Physics, Chemistry and Mechanics of Frozen Ground A Review." *In Permafrost: The North American Contribution to the Second International Conference, Yakutsk*. National Academy of Science National Academy of Engineering National Research Council, Washington, D.C., 1973.
122. *Low Temperature Phases of Interfacial Water in Clay-Water Systems*. Soil Sci. Soc. Am. Proc., Vol 35, No. 1, pp. 47-54, 1971.
123. Anderson, D.M. and Tice, A.R., *Predicting Unfrozen Water Contents in Frozen Soils from Surface Area Measurements*. In Highway Research Board Symposium on Frost Action in Soils, Highway Research Record No. 393. 1972.
124. Barnes, D.F., *Geophysical Methods for Delineating Permafrost*. In Permafrost: Proceedings, International Conference, Purdue University. National Academy of Sciences National Research Council Pub. No. 1287, pp. 349-355, 1963.
125. Beskow, G., *Soil Freezing and Frost Heaving with Special Applications to Roads and Railroads*. The Swedish Geological Society, 26th Yearbook, No. 3, Series C, No. 375, 1935. Translated by J.O. Osterberg, Northwestern University Technological Institute, 1947.
126. Black, R.F., *Some Problems in Engineering Geology Caused by Permafrost in the Arctic Coastal Plain, Northern Alaska*. Arctic, Vol. 10, pp. 230-240, 1957.
127. Boller, K.H. *Strength of Wood at Low Temperatures*. In Low Temperature Test Methods and Standards for Containers A Symposium. Advisory Board on Quartermaster Research and Development, NAS-NRC, Washington, pp. 65-76, 1954.
128. Butkovich, T.R., *Frozen Earth Materials as Seismic Decoupling Materials*. Lawrence Radiation Laboratory, University of California, Report TID-4500, 1968.
129. Carlson, R.F., Kane, D.L. and Bowers, C.E., *Groundwater Pore Pressures Adjacent to Subarctic Streams*. In Permafrost: The North American Contribution to the Second International Conference, Yakutsk. NAS-NAE-NRC, Washington, D.C., 1973.
130. Casagrande, A. and Fadum, R.E., *Application of Soil Mechanics in Designing Building Foundations*. Tran. ASCE, Vol. 109, pp. 383-490, 1944.
131. Casagrande, A. and Shannon, W.L., *Research on Stress-Deformation and Strength Characteristics of Soft Rocks under Transient Loading*. Soil Mechanics 1 Series 31, Graduate School of Engineering, Harvard University, 1947-48.
132. Crane, C.O., *Steam Curing Protects Winter Concreting*. J. Am. Concrete Inst., Vol. 22, pp. 214-216, 1950.
133. Croy, F.E., *Pile Construction in Permafrost*. Proc. ASCE, Vol. 86, No. SM4, pp. 87-94, 1960. (Discussion of J.A Pihlainen, Ibid, Proc. ASCE, Vol. 85, No. SM6, December 1959, pp. 75-95.)
134. *Pile Foundations in Permafrost*. In Permafrost: Proceedings, International Conference, Purdue University. NAS-NRC Pub. No. 1287, pp. 467-472, 1963.
135. *Settlement Associated with Thawing of Permafrost*. In Permafrost: The North American Contribution to the International Conference, Yakutsk. NAS-NAE-NRC, Washington, D.C., 1973.
136. Culley, R.W., *Frost Penetration in Saskatchewan Pavements*. Dept. of Highways, Saskatchewan, Canada, Technical Report 6, 1967.
137. Dias, W.C. and Freedman, S., Discussion: *Pile Foundations in Permafrost*, by F.E. Croy. In Permafrost: Proceedings, International Conference, Purdue University. NAS-NRC Pub. No. 1287, pp. 442-474, 1963.
138. Dickens, H.B. and Gray, D.M., *Experience with a Pier-Supported Building over Permafrost*. Proc. ASCE, J. Soil Mech. Fdn. Div., No. 86, pp. 1-14, 1960.
139. Dow Chemical Co., *Water Accumulation in Styrofoam*. Report No. 2560-722E, 1966.
140. Dunham, J.W., *Pile Foundations for Buildings*. Proc. ASCE, J. Soil Mech. Fdn. Div., No. 80, 1954.
141. Ferriars, O.J., Jr., *ERTS and Arctic Engineering Geology in Alaska*. In Summaries, Proc. 8th International Symposium on Remote Sensing of Environment. University of Michigan, Ann Arbor, Michigan, pp. 153-154, 1972.
142. Ferriars, O.J., Jr. and Hobson, G.D., *Mapping and Predicting Permafrost in North America: A review, 1963-1973*. In Permafrost: The North American Contribution to the Second International Conference, Yakutsk. NAS-NAE-NRC, Washington, D.C., 1973.
143. Forest Products Laboratory, *Wood Handbook*. U.S. Dept. of Agriculture Handbook No. 72, 1955.
144. Frischknecht, F.C. and Stanley, W.D., *Airborne and Ground Electrical Resistivity Studies Along Proposed TAPS Route*. In 2nd International Symposium on Arctic Geology, San Francisco. Am. Assoc. Petrol. Geol., Tulsa, Oklahoma, 1971.



145. Fryer, M.W., *The Liquid Convection Cell; A Study in Natural Convection*. University of Alaska Environmental Laboratory, 1967.
146. Gandahl, Rune, *Determination of the Depth of Soil Freezing with a New Frost Meter (text in Swedish)*. Statensvaginstitut, Stockholm, Rapport 30, 1957.
147. Garg, O., *In Situ Physicomechanical Properties of Permafrost Using Geophysical Techniques*. In Permafrost: The North American Contribution to the Second International Conference, Yakutsk. NAS-NAE-NRC, Washington, D.C., 1973.
148. Gerdine, L.A., *Frost Displacement of Missile Structures*. ASCE Structural Engineering Conference, Seattle, Preprint No. 511, 1967.
149. Greene, G.W., *The Application of Infrared Remote Sensing Techniques to Permafrost-Related Engineering Problems*. In 2nd International symposium on Arctic Geology, San Francisco. Am. Assoc. Petrol. Geol., Tulsa, Oklahoma, Program Abstr., p. 59-61, 1971.
150. *Applications of Infrared Remote Sensing Methods to Geological and Engineering Problems of the Arctic*. In Annual Earth Resource Program Review, 4th, Houston, Texas. NASA-MSR, p. 36, 1972.
151. Haugen, R.K., McKim, H.L., Gatto, L.W. and Anderson, D.M., *Cold Regions Environmental Analysis Based on ERTS-I Imagery*. In Proc. 8th International Symposium on Remote Sensing of Environment. University of Michigan, Ann Arbor, Michigan, 1972.
152. Hunter, J.A., *The Application of Shallow Seismic Methods to Mapping of Frozen Surficial Materials*. In Permafrost: The North American Contribution to the Second International Conference, Yakutsk. NAS-NAE-NRC, Washington, D.C., 1973.
153. Hvorslev, M.J. and Goode, T.B., *Core Drilling in Frozen Soils*. In Permafrost: Proceedings, International Conference, Purdue University. NAS-NRC Pub. No. 1287, pp. 364-371, 1963.
154. Johnson, P.R., *Empirical Heat Transfer Rates of Small, Long and Balch Thermal Piles and Thermalconvection Loops*. Institute of Arctic Environmental Engineering, University of Alaska, Report 7102, 1971.
155. Johnston, G.H., *Engineering Site Investigations in Permafrost Areas*. In Permafrost: Proceedings, International Conference, Purdue University. NAS-NRC Pub. No. 1287, pp. 371-374, 1973.
156. Jones, P.G. and Richart, F.E., *Effect of Testing Speed on Strength and Elastic Properties of Concrete*. Proc. ASTM, Vol. 37, II, 1936.
157. Kauer, J.A. and Freeman, R.L., *Effect of Carbon Dioxide on Fresh Concrete*. J. Am. Concrete Inst., Vol 27, No. 4, pp. 447-454, 1955.
158. Klieger, P., *Effect of Mixing and Curing Temperature on Concrete Strength*. Portland Cement Association Bulletin 103, 1958.
159. Kollman, F., *Mechanical Characteristics of Various Moist Woods within Temperature Gradients from -200 Degrees to + 200 Degrees C*. Translation, U.S. National Advisory Com. Aeronaut. Tech. Memo. 984, 1941.
160. Lachenbruch, A.H., *Construction Theory of Ice-Wedge Polygons. A Qualitative Discussion*. In Permafrost: Proceedings, International Conference, Purdue University. NAS-NRC Pub. No. 1287, pp. 63-71, 1963.
161. Lange, G.R., *Refrigerated Fluids for Drilling and Coring in Permafrost*. In Permafrost: Proceedings, International Conference, Purdue University. NAS-NRC Pub. No. 1287, pp. 375-380.
162. LeSchack, L.A. and Morse, F.A., *Dual-Channel Airborne I-R Scanning for Detection of Ice in Permafrost*. Alaska Preliminary Results. Am. Coc. Photog. Proc., Vol. 38, pp. 213-238, 1972.
163. LeShack, L.A., *Airborne Dual-Channel Infrared Scanning to Detect Massive Ice in Permafrost*. In Permafrost: The North American Contribution to the Second International Conference, Yakutsk. NAS-NAE-NRC, Washington, D.C., 1973.
164. Linell, K.A., *Airfields on Permafrost*. Proc. ASCE, J. Air Transport Div., Vol. 83, No. 1, pp. 1326-1 to 1326-15, 1957. (Also ACFEL Miscellaneous Paper 20, 1956.)
165. Linell, K.A. and Johnston, G.H., *Engineering Design and Construction in Permafrost Regions: A Review*. In Permafrost: The North American Contribution to the Second International Conference, Yakutsk. NAS-NAE-NRC, Washington, D.C., 1973.
166. Linell, K.A. and Kaplar, C.W., *The Factor of Soil and Material Type in Frost Action*. HRB Bull. No. 225, Highway Pavement Design in Frost Areas, 1959, (Also ACFEL Miscellaneous Paper 21, 1959.)
167. *Description and Classification of Frozen Soil*. In Permafrost: Proceedings, International Conference, Purdue University. NAS-NRC Pub. No. 1287, pp. 481-486, 1963.
168. Linell, K.A., Crory, F.E., Haley, J.F. and Pickering, C.A., Jr., Discussion: *Timber Piles in Permafrost at an Alaska Radar Station*, by W.C. Jensen. Proc. ASCE, J. Soil Mech. Fdn. Div., Vol. 88, pp. 141-153, 1962.

169. Long, E.L., *Permafrost Design and Construction Within the Alaska District*, Corps of Engineers. ASCE Conf., Fairbanks, Alaska, 1957.
170. Louie, N.A., *Equation of State of Frozen Soil Material*. Shock Hydrodynamics, Inc., Report No. SH2155-08, 1968.
171. McGaw, R., *Thermal Conductivity of Compacted Sand/Ice Mixtures*. Highway Record, No. 215.
172. Mollard, J.D., *Air Photo Terrain Classification and Mapping for Northern Feasibility Studies*. Proc. Canadian Northern Pipeline Research Conference, pp. 105-127. Assoc. Com. Geotech. Res. Tech. Memo. 104, National Research Council of Canada, Ottawa, 1972.
173. Monfore, G.E. and Lentz, A.E., *Physical Properties of Concrete at Very Low Temperatures*. Portland Cement Association Bulletin 145, May 1962.
174. Muller, S.W., *Permafrost of Permanently Frozen Ground and Related Engineering Problems*. J.W. Edwards, Inc., Ann Arbor, Michigan, 1947.
175. Naar, J., *A Source Book of Underground Phenomena and Effects of Nuclear Explosions: Part One, Theory of Directly Induced Ground Motion*. DASA-1285 (1), 1964.
176. Nakano, Y. and Froula, N.H., *Sound and Shock Transmission in Frozen Soils*. In Permafrost: The North American Contribution to the Second International Conference, Yakutsk. NAS-NAE-NRC, Washington, D.C., pp. 359-369, 1973.
177. National Oceanic and Atmospheric Administration, *Surface Observations*. Federal Meteorological Handbook No. 1 (formerly Circular N), 1970.
178. *Substation Observations*. Federal Meteorological Handbook No. 2 (formerly Circular B), 1970.
179. National Ready Mixed Concrete Association, *Cold Weather Ready Mixed Concrete*. Publication 34, 1960.
180. Pewe, T.L. and Paige, R.A., *Frost Heaving of Piles with an Example from Fairbanks, Alaska*. U.S. Geological Survey Bulletin No. 1111-1, 1963.
181. Quinn, W.F. and Lobacz, E.F., *Frost Penetration Beneath Concrete Slabs Maintained Free of Snow and Ice, with and without Insulation*. HRB Bulletin No. 331, pp. 98-115, 1962.
182. Rinker, J.N. and Frost, R.E., *Application of Remote Sensing to Arctic Environmental Studies*. In The Use of Remote Sensing in Conservation, Development, and Management of the Natural Resources of the State of Alaska. Dept. Econ. Devel., Juneau, Alaska, pp. 105-116, 1970.
183. Romanoff, M., *Corrosion of Steel Piling in Soils*. J. Res., NBS, Vol. 66c, No. 3, 1962.
184. *Corrosion Evaluation of Steel Test Piles Exposed to Permafrost Soils*. In Proceedings, 25th Conf. of the Nat. Assoc. of Corrosion Engineers. Houston, Texas, pp. 6-13, 1969.
185. Sanger, F.J., *Degree-Days and Heat Conduction in Soils*. In Permafrost: Proceedings, International Conference, Purdue University. NAS-NRC Pub. No. 1287, pp. 253-262, 1963.
186. Discussion: Section 6, *Physico-Mechanical Properties of Frozen Ground*. In Permafrost: Proceedings, International Conference, Purdue University. NAS-NRC Pub. No. 1287, pp. 341-342, 1963.
187. Sanger, F.J. and Kaplar, C.W., *Plastic Deformation of Frozen Soils*. In Permafrost: Proceedings, International Conference, Purdue University. NAS-NRC Pub. No. 1287, pp. 305-315, 1963.
188. Sebastyan, C.Y., *Preliminary Site Investigation for the Foundation of Structures and Pavements in Permafrost*. In Permafrost: Proceedings, International Conference, Purdue University. NAS-NRC Pub. No. 1287, pp. 387-394, 1963.
189. Sellmann, P.V., *Properties and Distribution of Organic Deposits in Two Characteristic Peat Environments in Alaska*. In Proc. 3rd International Peat Congress, Quebec. National Research Council of Canada, Ottawa, pp. 157-162, 1968.
190. Severn, R.T. and Taylor, P.R., *Earthquake Effects on an Arch Dam by Response Spectra Methods*. In Proc. Symposium on Vibration in Civil Engineering, British National Section of the International Association for Earthquake Engineering. Butterworth and Co. Ltd., London, 1966.
191. Sherman, R.G., *A Groundwater Supply for an Oil Camp Near Prudhoe Bay*. In Permafrost: The North American Contribution to the Second International Conference, Yakutsk. NAS-NAE-NRC, Washington, D.C., 1973.
192. Slaughter, C.W. and Kane, D.L., *Recharge of a Central Alaska Lake by Sub-permafrost Groundwater*. In Permafrost: The North American Contribution to the Second International Conference, Yakutsk. NAS-NAE-NRC, Washington, D.C., 1973.
193. Smith, A.W., *A Plastic Shelter for House Building in Winter*. Division of Building Research, National Research Council, Canada, Technical Paper No. 59, 1959.

194. *Building in Winter with the Aid of Enclosures*. Division of Building Research, National Research Council, Canada, Technical Paper No. 85, 1960.
195. Smith, N. and Berg, R., *Encountering Massive Ground Ice During Road Construction, Central Alaska*. In *Permafrost: The North American Contribution to the Second International Conference*, Yakutsk NAS-NAE-NRC, Washington, D.C., pp. 730-736, 1973.
196. Terzaghi, K., *Recording Results of Field Tests on Soils*. Civil engineering, Vol. 13, No. 12, pp. 585-587, 1943.
197. *Permafrost*. J. Boston Soc. Civil Engineer, Vol. 39, No. 1, pp. 1-50, 1952.
198. Terzaghi, K. and Peck, R.B., *Soil Mechanics in Engineering Practice*. Wiley, New York, 1967.
199. Thompson, H.A., *Air Temperature in Northern Canada with Emphasis on Freezing and Thawing Indexes*. In *Permafrost: Proceedings, International Conference*, Purdue University. NAS-NRC Pub. No. 1287, pp. 272-280, 1963.
200. Tobiasson, W., *Performance of the Thule Hangar Cooling Systems*. In *Permafrost: The North American Contribution to the Second International Conference*, Yakutsk. NAS-NAE-NRC, Washington, D.C., 1973.
201. Tsytovich, N.A., *Bases and Foundations on Frozen Soils*. HRB Special Report No. 59, 1960.
202. Tuthill, L.H. and others, *Insulation for Protection of New Concrete in Winter*. J. Am Concrete Inst., Vol. 23, pp. 232-272, 1951.
203. U.S. Bureau of Reclamation, *Concrete Manual*, 7th Ed., 1966.
204. U.S. Bureau of Standards, *Effect of Edge Insulation upon Temperature and Condensation of Concrete Slab Floors*. Building Materials and Structures Report 138, 1953.
205. U.S. Geological Survey, *The Alaskan Earthquake*. USGS Professional Paper 541, Investigations and Reconstruction, Effects on Communities, Valdez, GSP542B and Whittier, GSP542C.
206. Washburn, A.L., *Classification of Patterned Ground and Review of Suggested Origins*. Bull. Geol. Soc. Am., Vol. 67, No. 7, pp. 823-865, 1965.
207. Washburn, A.L., Smith, D.D. and Goodard, R.H., *Frost Cracking in a Middle-Latitude Climate*. Biuletyn Peryglacjalny (Lodz), No. 12, pp. 1751-189, 1963.
208. Williams, J.R., *Ground Water in Permafrost Regions, An Annotated Bibliography*. U.S. Geological Survey, Water Supply Paper 1972, 1965.
209. Williams, J.R. and vanEverdingen, R.O., *Groundwater Investigations in Permafrost Regions of North America: A Review*. In *Permafrost: The North American Contribution to the Second International Conference*, Yakutsk. NAS-NAE-NRC, Washington, D.C., 1973.
210. Woods, H., *Durability of Concrete Construction*. American Concrete Institute and Iowa State University Press, Monograph No. 4, 1968.
211. Anon., *Frozen in Place Piles Support Air Force Building in Alaska*. Construction Methods and Equipment, June 1956, pp. 62-64.
212. Kaplar, C.W., *Some Experiments to Measure Frost Heaving Force in a Silt*. CRREL Technical Note, 1965.
213. Keune, R. and Hoekstra, P., *Calculating the Amount of Unfrozen Water in Frozen Ground from Moisture Characteristic Curves*. CRREL Special Report 114, 1967.

**APPENDIX B  
BIBLIOGRAPHY**

**Departments of the Army and Air Force  
Technical Manual**

TM 5-809-3/NAVFAC DM-2.9/AFM 88-3,  
Chap. 3

Masonry Structural Design for Buildings

**U.S. Army Corps of Engineers  
Engineer Manual**

EM 1110-2-1906

Laboratory Soil Testing.

**Guide Specification**

CEGS-04200

Masonry.

**Department of the Army  
Technical Reports**

Crory, F.E., *Pile Foundations in Discontinuous Permafrost Areas*. U.S. Army Cold Regions Research and Engineering Laboratory Special Report 79, 1967.

Fulwider, C.W. and Stearman, J.H., *Bibliography on Winter construction, 1940-1967*. CRREL Special Report 83, 1966.

Kaplar, C.W., *Some Experiments to Measure Frost Heaving Force in a Silt*. CRREL Technical Note, 1965.

Keune, R. and Hoekstra, P., *Calculating the Amount of Unfrozen Water in Frozen Ground from Moisture Characteristic Curves*. CRREL Special Report 114, 1967.

Kitze, F.F., *Some Experiments in Drive Sampling of Frozen Ground*. Arctic Construction and Frost Effects Laboratory, Miscellaneous Paper 16, 1956.

Linell, K.A., *Pavement Design for Areas of Deep Frost Penetration*. CRREL Miscellaneous Paper, 1969.

Nakaya, U., *Viscoelastic Properties of Snow and Ice from the Greenland Ice Cap*. U.S. Army Snow, Ice and Permafrost Research Establishment Research Report 46, 1959.

Stearns, S.R., *Selected Aspects of Geology and Physiography of the Cold Regions*. CRREL Monograph I-A1, 1956.

Stearns, S.R., *Permafrost (Perennially Frozen Ground)*. CRREL Monograph I-A2, 1966.

U.S. Army Engineer Waterways Experiment Station, *The Unified Soil Classification System*. Technical Report 3-357, 1953.

Woods, K.B. and Linell, K.A., *Alaska-Canada Trip Report*. CRREL Files, 1965.

Woods, K.B., Pringle, T.B. and Linell, K.A., *Alaska Trip Report*. CRREL Files, 1960.

**Department of the Air Force**

**Technical Report**

Newark, N.M. and Haltiwanger, J.D., *Principles and Practices for Design of Hardened Structures*. U.S. Air Force Special Weapons Center Technical Documentary Report No. AFSW-TDY-62-138, 1962.

**Other Technical Publications**

American Concrete Institute, *Durability of Concrete Construction*. H. Woods Monograph No. 4, American Concrete Institute and Iowa State University Press, 1968.

Balch, J.C., *Soil Refrigeration System*. Patent No. 3,200,470, U.S. Patent Office, 1965.

Brown, R.J.E., *The Distribution of Permafrost and its Relation to Air Temperature in Canada and the USSR*. Arctic, Vol. 13, No. 3, pp. 163-177, 1960.

Brown, R.J.E., *Relation Between Mean Annual Air and Ground Temperatures in the Permafrost Region of Canada*. In Permafrost: Proceedings, International Conference, Purdue University. National Academy of Sciences - National Research Council Pu. No. 1287, pp. 241-247, 1963.

Chellis, R.D., *Pile Foundations*. McGraw-Hill, New York, 2nd. Ed., 1961.

- Constantino, C.J., Wachowski, A. and Barnwell, V.L., *Finite Element Solution for Wave Propagation in Layered Media Caused by a Nuclear Detonation*. In Proceedings, Symposium on Wave Propagation and Dynamic Properties of Earth Materials. University of New Mexico Press, Albuquerque, N.M., 1967.
- Crocker, C.R., *Winter Construction*. Division of Building Research, National Research Council, Canada, Technical Paper No. 49, 1958.
- Cranberg, H.B., *Indirect Mapping of Snowcover for Permafrost Prediction at Schefferville, Quebec, Canada*. In Permafrost: The North American Contribution to the Second International Conference, Yakutsk. National Academy of Sciences-National Academy of Engineering National Research Council, Washington, D.C. 1973.
- Hennion, F.B., *Frost and Permafrost Definitions*. Highway Research Board Bulletin, No. 111, pp. 107-110, 1955.
- Hoekstra, P. and McNeill, D., *Electromagnetic Probing of Permafrost*. In Permafrost: The North American Contribution to the Second International Conference, Yakutsk. NAS-NAE-NRC, Washington, D.C., 1973.
- Hopkins, D.M., Karlstrom, T.N.V. and others, *Permafrost and Ground Water in Alaska*. U.S. Geological Survey Professional Paper No. 264-F, 1955.
- Krieth, F., Heat Transfer. International Textbook Co., Scranton, Pa., 1965 Linell, K.A., *Frost Action and Permafrost*. In Highway Engineering Handbook (K.B. Woods, Ed.), Section 13. McGraw-Hill, N.Y., pp. 13-1 to 13-35.
- Lobacz, E.F. and Quinn, W.F., *Thermal Regime Beneath Buildings constructed on Permafrost*. In Permafrost: Proceedings, International Conference, Purdue University. NAS-NRC Pub. No. 1287, pp. 247-252, 1963.
- Long, E.L., *The Long Thermopile*. In Permafrost: Proceedings, International Conference, Purdue University. NAS-NRC Pub. No. 1287, pp. 487-491, 1963.
- Long, E.L., *Means for Maintaining Permafrost Foundations*. Patent No. 3,217,791, U.S. Patent Office.
- Melnikov, P.I., Vyalov, V.A. and others, *Pile Foundations in Permafrost*. In Permafrost: Proceedings, International Conference, Purdue University. NAS-NRC Pub. No. 1287, pp. 542-547, 1963.
- National Research Council of Canada, *Proceedings of the Canadian Regional Permafrost Conference, 1 and 2 December 1964* (R.J.E. Brown, Ed.). Ottawa, Canada.
- Pearson, H., How Raber and Kief *Drilled 900 Holes in Permafrost in the Arctic in Midwinter*. Pacific Builder and Engineer, Vol. 62, No. 11, pp. 58-59, 1956.
- Penner, E., *Frost Heaving Forces in Leda Clay*. Canadian Geotechnical Journal, Vol. 7, No. 1, pp. 8-16, 1970.
- Penner, E. and Gold, L.W., *Transfer of Heaving Forces by Adfreezing to Columns and Foundation Walls in Frost Susceptible Soils*. Canadian Geotechnical Journal, Vol. 8, No. 4, pp. 514-526, 1971.
- Pihlainen, J.A., *Pile Construction in Permafrost*. Proceedings American Society of Civil Engineers, Vol. 85, No. SM6, pp. 75-95, 1959.
- Portland Cement Association, Structural Bureau, *Cold Weather Concreting*, ST94-3, 1966.
- RILEM Symposium, *Winter Concreting: Theory and Practice*. Danish National Institute of Building Research, 1956.
- Roberts, P.W. and Cooke, F.A., *Arctic Tower Foundations Frozen into Permafrost*. Engineering News-Record, Vol. 44, No. 6, pp. 38-39.
- Terzaghi, K., *Theoretical Soil Mechanics*. Wiley, New York, 1943.
- Thomas, M.K., *Climatological Atlas of Canada*. National Research Council, Canada. National Research Council, Canada, No. 3151, and Division of Building Research, No. 41, 1953.
- Yoakum, D., *Winter Construction - Earthwork and Foundations*. ASCE Structural Engineering Conference, Seattle, Preprint No. 510, 1967.

The proponent agency of this Pamphlet is the Office of the Chief of Engineers, United States Army. Users are invited to send comments and suggested improvements on DA Form 2028 (Recommended Changes to Publications and Blank Forms) direct to HQDA (DAEN-ECE-G), WASH DC 20314.

By Order of the Secretaries of the Army and the Air Force:

ROBERT M. JOYCE  
Major General, United States Army  
The Adjutant General

Official:  
JAMES H. DELANEY  
Colonel, United States Air Force  
Director of Administration

JOHN A. WICKHAM, JR.  
General, United States Army  
Official: Chief of Staff

CHARLES A. GABRIEL  
General, United States Air Force  
Chief of Staff

*Distribution:*

Army: To be distributed in accordance with DA Form 12-34B, requirements for TM 5-800 Series: Engineering and Design for Real Property Facilities.  
Air Force: F

☆ U. S. GOVERNMENT PRINTING OFFICE: 1983-705-046/436

RECOMMENDED CHANGES TO EQUIPMENT TECHNICAL PUBLICATIONS



## SOMETHING WRONG WITH THIS PUBLICATION?

THEN... JOT DOWN THE DOPE ABOUT IT ON THIS FORM, CAREFULLY TEAR IT OUT, FOLD IT AND DROP IT IN THE MAIL!

FROM: (PRINT YOUR UNIT'S COMPLETE ADDRESS)

---

DATE SENT

PUBLICATION NUMBER

PUBLICATION DATE

PUBLICATION TITLE

BE EXACT... PIN-POINT WHERE IT IS				IN THIS SPACE TELL WHAT IS WRONG AND WHAT SHOULD BE DONE ABOUT IT:
PAGE NO.	PARA-GRAPH	FIGURE NO.	TABLE NO.	

PRINTED NAME, GRADE OR TITLE, AND TELEPHONE NUMBER

SIGN HERE:

TEAR ALONG PERFORATED LINE

**DA** FORM 2028-2  
JUL 79

PREVIOUS EDITIONS ARE OBSOLETE.

P.S.—IF YOUR OUTFIT WANTS TO KNOW ABOUT YOUR RECOMMENDATION MAKE A CARBON COPY OF THIS AND GIVE IT TO YOUR HEADQUARTERS.

INACTIVE