

UNIFIED FACILITIES CRITERIA (UFC)

SECURITY ENGINEERING: ENTRY CONTROL FACILITIES / ACCESS CONTROL POINTS



DISTRIBUTION STATEMENT A: Approved for Public Release;
Distribution unlimited.

UNIFIED FACILITIES CRITERIA (UFC)

SECURITY ENGINEERING: ENTRY CONTROL FACILITIES / ACCESS CONTROL POINTS

Any copyrighted material included in this UFC is identified at its point of use. Use of the copyrighted material apart from this UFC must have the permission of the copyright holder.

U.S. ARMY CORPS OF ENGINEERS

NAVAL FACILITIES ENGINEERING COMMAND (Preparing Activity)

AIR FORCE CIVIL ENGINEER SUPPORT AGENCY

Record of Changes (changes are indicated by \1\ ... /1/)

Change No.	Date	Location

This UFC supersedes Naval Facilities Engineering Command (NAVFAC) Interim Technical Guidance (ITG) FY03-03, *Entry Control Facilities*, dated 20 Feb 2003

FOREWORD

The Unified Facilities Criteria (UFC) system is prescribed by MIL-STD 3007 and provides planning, design, construction, sustainment, restoration, and modernization criteria, and applies to the Military Departments, the Defense Agencies, and the DoD Field Activities in accordance with [USD\(AT&L\) Memorandum](#) dated 29 May 2002. UFC will be used for all DoD projects and work for other customers where appropriate. All construction outside of the United States is also governed by Status of forces Agreements (SOFA), Host Nation Funded Construction Agreements (HNFA), and in some instances, Bilateral Infrastructure Agreements (BIA.) Therefore, the acquisition team must ensure compliance with the more stringent of the UFC, the SOFA, the HNFA, and the BIA, as applicable.

UFC are living documents and will be periodically reviewed, updated, and made available to users as part of the Services' responsibility for providing technical criteria for military construction. Headquarters, U.S. Army Corps of Engineers (HQUSACE), Naval Facilities Engineering Command (NAVFAC), and Air Force Civil Engineer Support Agency (AFCEA) are responsible for administration of the UFC system. Defense agencies should contact the preparing service for document interpretation and improvements. Technical content of UFC is the responsibility of the cognizant DoD working group. Recommended changes with supporting rationale should be sent to the respective service proponent office by the following electronic form: [Criteria Change Request \(CCR\)](#). The form is also accessible from the Internet sites listed below.

UFC are effective upon issuance and are distributed only in electronic media from the following source:

- Whole Building Design Guide web site <http://dod.wbdg.org/>.

Hard copies of UFC printed from electronic media should be checked against the current electronic version prior to use to ensure that they are current.

AUTHORIZED BY:



DONALD L. BASHAM, P.E.
Chief, Engineering and Construction
U.S. Army Corps of Engineers



DR. JAMES W. WRIGHT, P.E.
Chief Engineer
Naval Facilities Engineering Command



KATHLEEN I. FERGUSON, P.E.
The Deputy Civil Engineer
DCS/Installations & Logistics
Department of the Air Force



Dr. GET W. MOY, P.E.
Director, Installations Requirements and
Management
Office of the Deputy Under Secretary of Defense
(Installations and Environment)

Unified Facilities Criteria (UFC)
New Document Summary Sheet

Subject: UFC 4-022-01, Security Engineering: Entry Control Facilities/Access Control Points

Cancel: Naval Facilities Engineering Command (NAVFAC) Interim Technical Guidance (ITG) FY03-03, *Entry Control Facilities*, 20 FEB 2003

Document Description and Need:

- **Purpose:** This UFC presents a unified approach to the design of Entry Control Facilities (ECFs). The term “Entry Control Facilities” encompasses the overall layout, organization, infrastructure, and facilities of an entry control point or access control point. ECF is synonymous with the term Access Control Point (ACP) used in some Service publications. This UFC identifies design features necessary to ensure that infrastructure constructed today will have the flexibility to support future technologies, a changing threat environment, and changes in operations.
- **Application and Use:** Commanders, security personnel, planners, designers, architects, and engineers should use this UFC when designing primary and secondary ECFs of an installation. A limited-use ECF, which is open only occasionally, may not require the same level of infrastructure. Technical information considered generally known to professional designers, architects, or engineers or readily available in existing technical references (Unified Facility Criteria, Military Handbooks, Technical Manuals, etc.) has not been included.
- **Need:** This UFC is one of a series of security engineering Unified Facilities Criteria that cover minimum standards, planning, preliminary design, and detailed design for security and antiterrorism. The manuals in this series are designed to be used sequentially by a diverse audience to facilitate development of projects throughout the design cycle. The manuals in this series include the following:
 - **DoD Minimum Antiterrorism Standards for Buildings.**
 - **Security Engineering Facilities Planning Manual.**
 - **Security Engineering Facilities Design Manual.**
 - **Security Engineering Support Manuals.**

UFC 4-022-01 falls into the category of an “engineering support manual”.

Impact:

- Creates a single source reference for the design of entry control facilities and access control points for DoD installations.
- Entry control facilities ensure the proper level of access control for all DOD personnel, visitors, and commercial traffic to an installation. The objective of an ECF is to secure the installation from unauthorized access and intercept contraband (weapons, explosives, drugs, classified material, etc.) while maximizing vehicular traffic flow. Design considerations, in order of priority, are: Security, Safety, Capacity, and Image.
- Other services (Army/Air Force) Impacts:

- **Department of Air Force:** The Air Force Security Forces and the Air Force Center for Environmental Excellence Design Group released the Entry Control Facilities Design Guide in February 2003 which served to some extent in the development of this UFC. Apply the requirements of any previous design guides and this UFC. Ensure the MORE STRINGENT criteria is incorporated in the project.
- **Department of Army:** Requirements concerning Access Control Point Policy and physical security for the Department of Army can be found in Army Regulation (AR) 190-13, *Army Physical Security Program*. In addition, a Facility Design Team (FDT) under the Department of the Army Facilities Standardization Program will develop and issue a standard design titled *Access Control Points for U.S. Army Installations*. These standard designs will meet the requirements of this criteria and AR 190-13.
- **Department of Navy – Marine Corp:** MCO P5530.14 *Marine Corps Physical Security Program* provides guidance on the requirements for installation access control, perimeter barriers, vehicle barriers, and protective lighting.
- No adverse impacts on environmental, sustainability, or constructability policies or practices.
- This new document will provide a design of an entry control facility (ECF) so that persons and vehicles entering and leaving the facility do so in a safe and orderly manner to protect themselves, security personnel, and pedestrians from harm.
- This new document will provide a design of an entry control facility (ECF) that will maximize the flow of traffic without compromising safety, security, or causing undue delays that may affect installation operations or off-installation public highway users.

CONTENTS

CONTENTS	I
1 INTRODUCTION	1-1
1-1 PURPOSE	1-1
1-2 SCOPE AND USE OF GUIDANCE	1-1
1-3 ENTRY CONTROL FACILITY MISSION AND PRIORITIES	1-1
1-3.1 Security	1-2
1-3.2 Safety	1-2
1-3.3 Capacity	1-2
1-3.4 Image	1-2
1-4 SECURITY ENGINEERING UFC SERIES	1-2
2 EXISTING REQUIREMENTS AND GUIDANCE	2-1
2-1 DOD REQUIREMENTS	2-1
2-1.1 DOD 5200.8-R Physical Security Program	2-1
2-1.2 DOD 2000.12 DOD Antiterrorism Force Protection (ATFP) Program	2-1
2-1.3 DOD 2000.16 DOD Antiterrorism Standards	2-1
2-1.4 UFC 4-010-01 DOD Minimum Antiterrorism Standards for Buildings	2-1
2-2 SERVICE REQUIREMENTS	2-2
2-2.1 Department of Air Force	2-2
2-2.2 Department of Army	2-2
2-2.3 Department of Navy	2-2
2-3 COMBATANT COMMANDER REQUIREMENTS	2-2
2-4 INSTALLATION SPECIFIC REQUIREMENTS	2-3
2-5 FORCE PROTECTION CONDITION (FPCON) LEVELS	2-3
2-6 RANDOM ANTITERRORISM MEASURES (RAM)	2-4
2-7 EXISTING DESIGN GUIDANCE	2-4
3 ECF CLASSIFICATIONS AND FUNCTION	3-6
3-1 ECF USE CLASSIFICATIONS	3-6
3-2 ECF FUNCTION CLASSIFICATION	3-6
3-2.1 Multi-Function ECFs	3-7
3-3 ECF FUNCTIONAL DIAGRAMS	3-7
4 PLANNING AND SITE SELECTION CRITERIA	4-10
4-1 PLANNING	4-10
4-2 SITE SELECTION CRITERIA	4-10
4-2.1 User Demand	4-10
4-2.2 Existing Terrain and Available Space	4-10
4-2.3 Future Development Plans	4-11
4-2.4 Compatible Land Use	4-11
4-2.5 Environmental Constraints	4-11
4-2.6 Location	4-11
5 ORGANIZATION AND OPERATION OF AN ECF	5-1
5-1 ECF ZONES	5-1

5-1.1	<i>Approach Zone</i>	5-1
5-1.2	<i>Access Control Zone</i>	5-2
5-1.3	<i>Response Zone</i>	5-3
5-1.4	<i>Safety Zone</i>	5-4
6	DESIGN GUIDELINES	6-1
6-1	INTRODUCTION	6-1
6-2	GENERAL LAYOUT REQUIREMENTS.....	6-1
6-2.1	<i>Layout Guidelines for the Approach Zone</i>	6-1
6-2.2	<i>Layout Guidelines for the Access Control Zone</i>	6-2
6-2.3	<i>Layout Guidelines for the Response Zone</i>	6-6
6-3	CONTAINMENT AND CONTROL OF VEHICLES	6-9
6-3.1	<i>Roadway Containment</i>	6-9
6-3.2	<i>Final Denial Barrier</i>	6-10
6-3.3	<i>Controls for Active Vehicle Barriers</i>	6-11
6-4	VEHICLE INSPECTION CAPABILITY	6-12
6-4.1	<i>Location of Inspection Area</i>	6-12
6-4.2	<i>Geometric Design of Inspection Areas</i>	6-14
6-4.3	<i>Location and Support for Inspection Equipment</i>	6-14
6-5	CAPABILITY TO REJECT UNAUTHORIZED VEHICLES	6-15
6-6	GEOMETRIC DESIGN OF ROADWAYS.....	6-15
6-6.1	<i>Channelization Islands</i>	6-15
6-6.2	<i>Medians</i>	6-16
6-6.3	<i>Travel Lane Width</i>	6-16
6-6.4	<i>Inspection Areas</i>	6-17
6-6.5	<i>Curbs and Gutters/Shoulders</i>	6-17
6-6.6	<i>Transitions and Tapers</i>	6-18
6-6.7	<i>Roadside Safety</i>	6-18
6-6.8	<i>Lateral Clearances</i>	6-18
6-6.9	<i>Vertical Clearances</i>	6-19
6-6.10	<i>Corner Radii</i>	6-19
6-7	TRAFFIC CONSIDERATIONS.....	6-19
6-7.1	<i>Capacity</i>	6-19
6-7.2	<i>Adequate Lanes</i>	6-20
6-8	TRAFFIC CONTROL	6-21
6-8.1	<i>Speed Limit</i>	6-21
6-8.2	<i>Signage</i>	6-22
6-8.3	<i>Markings</i>	6-23
6-8.4	<i>Traffic Control Devices</i>	6-24
6-9	GUARD FACILITY DESIGN CRITERIA.....	6-24
6-9.1	<i>General</i>	6-24
6-9.2	<i>Gatehouse</i>	6-25
6-9.3	<i>Sentry/Guard Booth</i>	6-26
6-9.4	<i>Overwatch Position</i>	6-26
6-9.5	<i>Overhead Canopy</i>	6-27
6-9.6	<i>Common Requirements</i>	6-28
6-10	ELECTRICAL POWER REQUIREMENTS	6-30
6-10.1	<i>Alternate Electrical Power Source</i>	6-31

6-10.2	<i>Uninterruptible Power Supply</i>	6-31
6-10.3	<i>Infrastructure</i>	6-31
6-10.4	<i>General</i>	6-32
6-11	COMMUNICATIONS AND INFORMATION TECHNOLOGY	6-33
6-12	CLOSED CIRCUIT TELEVISION (CCTV).....	6-34
6-13	WATER / WASTEWATER.....	6-34
6-14	EXTERIOR LIGHTING	6-34
6-14.1	<i>Approach and Response Zone Lighting</i>	6-35
6-14.2	<i>Access Control Zone Lighting</i>	6-35
6-14.3	<i>Lighting Level and Quality</i>	6-35
6-14.4	<i>Restrike or Restart Capability</i>	6-36
6-14.5	<i>General Requirements</i>	6-37
6-15	PERIMETER FENCE AND GATE	6-37
6-16	PERSONNEL PROTECTION.....	6-37
6-17	VISITORS CENTER DESIGN CRITERIA.....	6-38
6-17.1	<i>Waiting Area</i>	6-39
6-17.2	<i>Parking</i>	6-39
6-17.3	<i>Service Counter</i>	6-39
6-17.4	<i>Administration Office</i>	6-40
6-17.5	<i>Break Room</i>	6-40
6-17.6	<i>Restrooms</i>	6-40
6-17.7	<i>Environmental Control</i>	6-40
6-18	PEDESTRIAN CONSIDERATIONS	6-40
6-19	PARKING	6-41
6-20	AESTHETICS.....	6-41
6-21	LANDSCAPING.....	6-41
6-22	CONSTRUCTION PHASING	6-41
7	LARGE COMMERCIAL VEHICLE AND TRUCK INSPECTION FACILITIES	7-1
7-1	INTRODUCTION	7-1
7-2	MISSION AND OPERATION	7-1
7-3	INSPECTION EQUIPMENT	7-1
7-3.1	<i>Under Vehicle Lighting System</i>	7-1
7-3.2	<i>CCTV Under Vehicle Search Systems (UVSS)</i>	7-2
7-3.3	<i>Cargo and Vehicle Inspection Systems</i>	7-2
7-4	LAYOUT.....	7-14
7-4.1	<i>Geometric Design of Roadways</i>	7-19
7-5	FACILITIES.....	7-19
7-5.1	<i>Inspection Office</i>	7-19
7-5.2	<i>Occupant Shelter</i>	7-20
7-5.3	<i>Cargo Handling Equipment and Storage</i>	7-20
7-6	ADDITIONAL DESIGN GUIDELINES	7-20
7-6.1	<i>Electrical Power Requirements</i>	7-20
7-6.2	<i>Exterior Lighting</i>	7-20
7-6.3	<i>Perimeter Fence and Gate</i>	7-21
8	NOTIONAL LAYOUTS	8-1
8-1	GENERAL.....	8-1

9 REFERENCES..... 9-1

TABLES

Table 2-1 FPCON Descriptions (ref. DoD O-2000.12-H)..... 2-3
Table 2-2 Existing Design Guidance Relating to ECF 2-5
Table 3-1 ECF Use Classifications..... 3-6
Table 6-1 Estimated Vehicle Throughput (SDDCTEA Data except as noted) 6-21
Table 6-2 Thickness of Common Materials for Resistance Against UL 752 Level III . 6-29
Table 6-3 Thickness of Common Materials for Resistance Against UL 752 Level V .. 6-29
Table 6-4 Minimum Exterior Illuminances 6-36
Table 7-1 Sample Power Requirements for Fixed Inspection Systems..... 7-10

FIGURES

Figure 3-1 Visitors/DoD Personnel ECF – Functional Relationships..... 3-8
Figure 3-2 DoD/Authorized Personnel Only ECF – Functional Relationships 3-8
Figure 3-3 Commercial Gate: Functional Relationships 3-9
Figure 5-1 Entry Control Facility Zones 5-1
Figure 6-1 Access Control Zone Operated by Security Personnel 6-4
Figure 6-2 Access Control Zone Operated by Automated Equipment..... 6-4
Figure 6-3 Access Control Zone with Pull-Off Area for Each Inbound Lane..... 6-5
Figure 6-4 Access Control Zone with Single Pull-Off Area for all Inbound Lanes..... 6-5
Figure 6-5 Notional Layout using Pull-Off/Alternate Inspection 6-14
Figure 6-6 Example Speed Hump Profile 6-24
Figure 6-7 Typical Locations for Provision of Future Power/Control Connections..... 6-33
Figure 6-8 Visitors Center: Notional Layout..... 6-39
Figure 7-1 MobileSearch Advanced X-Ray Portable Inspection System..... 7-5
Figure 7-2 Mobile VACIS – Gamma Ray Imaging System 7-5
Figure 7-3 Example Exclusion Zones for Mobile Inspection Systems 7-6
Figure 7-4 VACIS II - Gamma Ray Imaging System 7-8
Figure 7-5 Portal VACIS - Gamma Ray Imaging System..... 7-8
Figure 7-6 Shaped Energy ISO Search X-Ray Inspection System..... 7-9
Figure 7-7 VACIS II - Gamma Ray Imaging System Exclusion Zones 7-11
Figure 7-8 VACIS II - Gamma Ray Imaging System Exclusion Zones 7-12
Figure 7-9 Shaped Energy ISO Search X-Ray System Radiation Levels..... 7-13
Figure 7-10 Large Vehicle Inspection Facility - Mobile Imaging Systems..... 7-16
Figure 7-11 Large Vehicle Inspection Facility - Fixed Imaging System 7-17
Figure 7-12 Large Vehicle Inspection Facility - Portal Imaging System..... 7-18
Figure 8-1 Visitors/DoD Personnel ECF 8-1
Figure 8-2 DoD/Authorized Personnel Only ECF 8-1
Figure 8-3 Commercial/Large Vehicle ECF 8-2
Figure 8-4 Combined Commercial/Visitors/DoD Alternative Gate 8-2
Figure 8-5 Visitors/DoD Personnel Gate – Restricted Real Estate Option 8-3
Figure 8-6 DoD/Authorized Personnel ECF 8-3
Figure 8-7 Combined POV and Commercial Vehicle ECF - Restricted Real Estate ... 8-4
Figure 8-8 Combined POV/Commercial Vehicle/Visitor’s Center 8-4
Figure 8-9 Combined POV/Commercial Vehicle/Visitor’s Center 8-5

1 INTRODUCTION

1-1 PURPOSE

This UFC presents a unified approach to the design of Entry Control Facilities (ECFs). The term “Entry Control Facilities” encompasses the overall layout, organization, infrastructure, and facilities of an entry control point or access control point. ECF is synonymous with the term Access Control Point (ACP) used in some Service publications. This UFC identifies design features necessary to ensure that infrastructure constructed today will have the flexibility to support future technologies, a changing threat environment and changes in operations.

The examples provided in this UFC are for illustration only and should be modified and adapted to satisfy installation specific constraints. This UFC is not intended to address procedural issues such as tactics and techniques, however a well-designed ECF can enhance and improve operations.

1-2 SCOPE AND USE OF GUIDANCE

Commanders, security personnel, planners, designers, architects and engineers should use this UFC when designing primary and secondary ECFs of an installation. A limited-use ECF, which is open only occasionally, may not require the same level of infrastructure. Technical information considered generally known to professional designers, architects, or engineers or readily available in existing technical references (Unified Facility Criteria, Military Handbooks, Technical Manuals, etc.) has not been included.

Note: Where one or more Service's criteria vary from the other Services' criteria, it is noted in the text with the **SE** (Service Exception) symbol. Within the symbol, the Service the exception is applicable for will be indicated by “A” for Department of Army, “AF” for Department of Air Force, “N” for Department of Navy, and “MC” for Department of Navy – Marine Corps.

1-3 ENTRY CONTROL FACILITY MISSION AND PRIORITIES

Entry control facilities ensure the proper level of access control for all DOD personnel, visitors, and commercial traffic to an installation. The objective of an ECF is to secure the installation from unauthorized access and intercept contraband (weapons, explosives, drugs, classified material, etc.) while maximizing vehicular traffic flow. Design considerations, in order of priority, are:

1. Security
2. Safety
3. Capacity
4. Image

1-3.1 Security

It is well established that installations should focus first on threats that can be mitigated at the first line of defense – the installation perimeter. ECF and the access control they provide are extremely important to defense-in-depth and effective risk mitigation.

The first priority of an ECF is to maintain perimeter security. The ECF:

- is a part of the installation perimeter and a legal line of demarcation;
- must accommodate Random Antiterrorism Measures (RAM), for sustained operations;
- must be able to operate at all FPCONs, including 100% vehicle inspections; and
- must have security features that protect against vehicle-borne threats and illegal entry.

1-3.2 Safety

ECFs must have a working environment that is both safe and comfortable for Security Forces personnel. Security Forces safety includes provisions for personal protection against attack and errant drivers; consider climate, location, and orientation.

Design the ECF so that persons and vehicles entering and leaving the facility do so in a safe and orderly manner to protect themselves, security personnel, and pedestrians from harm.

1-3.3 Capacity

Design the ECF to maximize the flow of traffic without compromising safety, security, or causing undue delays that may affect installation operations or off-installation public highway users.

1-3.4 Image

Design the ECF to impart an immediate impression of professionalism and convey the DOD's commitment to the protection and safety of DOD personnel and the security of its facilities and resources.

1-4 SECURITY ENGINEERING UFC SERIES

This UFC is one of a series of security engineering Unified Facilities Criteria that cover minimum standards, planning, preliminary design, and detailed design for security and antiterrorism. The manuals in this series are designed to be used sequentially by a diverse audience to facilitate development of projects throughout the design cycle. The manuals in this series include the following:

- **DoD Minimum Antiterrorism Standards for Buildings.** UFC 4-010-01 *DoD Minimum Antiterrorism Standards for Buildings* and 4-010-02 *DoD Minimum*

Standoff Distances for Buildings establish standards that provide minimum levels of protection against terrorist attacks for the occupants of all DoD inhabited buildings. Those UFC are intended to be used by security and antiterrorism personnel and design teams to identify the minimum requirements that must be incorporated into the design of all new construction and major renovations of inhabited DoD buildings. They also include recommendations that should be, but are not required to be, incorporated into all such buildings.

- **Security Engineering Facilities Planning Manual.** UFC 4-020-01 *Security Engineering Facilities Planning Manual* presents processes for developing the design criteria necessary to incorporate security and antiterrorism features into DoD facilities and for identifying the cost implications of applying those design criteria. Those design criteria may be limited to the requirements of the minimum standards, or they may include protection of assets other than those addressed in the minimum standards (people), aggressor tactics that are not addressed in the minimum standards, or levels of protection beyond those required by the minimum standards. The cost implications for security and antiterrorism are addressed as cost increases over conventional construction for common construction types. The changes in construction represented by those cost increases are tabulated for reference, but they represent only representative construction that will meet the requirements of the design criteria. The manual also includes a means to assess the tradeoffs between cost and risk. The Security Engineering Planning Manual is intended to be used by planners as well as security and antiterrorism personnel with support from planning team members.
- **Security Engineering Facilities Design Manual.** UFC 4-020-02 *Security Engineering Facilities Design Manual* provides interdisciplinary design guidance for developing preliminary systems of protective measures to implement the design criteria established using UFC 4-020-01. Those protective measures include building and site elements, equipment, and the supporting manpower and procedures necessary to make them all work as a system. The information in UFC 4-020-02 is in sufficient detail to support concept level project development, and as such can provide a good basis for a more detailed design. The manual also provides a process for assessing the impact of protective measures on risk. The primary audience for the Security Engineering Design Manual is the design team, but it can also be used by security and antiterrorism personnel.
- **Security Engineering Support Manuals.** In addition to the standards, planning, and design UFC mentioned above, there is a series of additional UFC that provide detailed design guidance for developing final designs based on the preliminary designs developed using UFC 4-020-02. These support manuals provide specialized, discipline specific design guidance. Some address specific tactics such as direct fire weapons, forced entry, or airborne contamination. Others address limited aspects of design such as resistance to progressive collapse or design of portions of buildings such as mailrooms. Still others address details of designs for specific protective measures such as vehicle

barriers or fences. The Security Engineering Support Manuals are intended to be used by the design team during the development of final design packages.

CANCELLED

2 EXISTING REQUIREMENTS AND GUIDANCE

2-1 DOD REQUIREMENTS

There are several instructions and publications within the Department of Defense that establish required access control procedures for an installation, objectives of an entry control facility, and the responsibility for the operation of the facility.

2-1.1 DOD 5200.8-R *Physical Security Program*

This regulation requires DOD Components to determine the necessary access control based on the requirements of a developed physical security program. It also requires the evaluation of automated entry control systems or access devices, where necessary. Emergency planning is specified to include establishment of a system for positive identification of personnel and equipment authorized to enter and exit the installation and maintenance of adequate physical barriers that will be deployed to control access to the installation. Planning will also include increasing vigilance and access restrictions during higher force protection conditions.

2-1.2 DOD 2000.12 *DOD Antiterrorism (AT) Program*

This directive provides DOD policies for ATFP and assigns responsibilities for implementing the procedures for the DOD ATFP Program. It authorized the publication of DOD O-2000.16 as the DOD standards for ATFP and DOD O-2000.12-H *DOD Antiterrorism Handbook* as guidance for the DOD standards. DOD O-2000.12H defines the DOD Force Protection Condition (FPCON) System, which describes the potential threat levels and the applicable FPCON measures to be enacted for each level. It also requires Commanders to develop and implement Random Antiterrorism Measures (RAM) as an integral part of their AT Program.

2-1.3 DOD 2000.16 *DOD Antiterrorism Standards*

This instruction and service directives require the installation or activity Commanding Officer to define the access control measures at installations. Additionally DOD 2000.16 requires Commanders at all levels to develop and implement a comprehensive Antiterrorism (AT) Program, which should define the necessary action sets, including identification and inspection procedures, at each of the potential Force Protection Condition (FPCON) levels.

2-1.4 UFC 4-010-01 *DOD Minimum Antiterrorism Standards for Buildings*

This UFC was issued under the authority of DOD 2000.16, which requires DOD Components to adopt and adhere to common criteria and minimum construction standards to mitigate antiterrorism vulnerabilities and terrorist threats. The minimum standards are based on the assumption that larger amounts of explosive will be detected and denied entry at the controlled perimeter of an installation. It is, therefore, critical that the infrastructure and operating procedures at the Entry Control Facility are capable of that mission.

2-2 SERVICE REQUIREMENTS

2-2.1 Department of Air Force

The Air Force Security Forces and the Air Force Center for Environmental Excellence Design Group released the Entry Control Facilities Design Guide in February 2003 which served to some extent in the development of this UFC. Apply the requirements of any previous design guides and this UFC. Ensure the MORE STRINGENT criteria is incorporated in the project.

2-2.2 Department of Army

Requirements concerning Access Control Point Policy and physical security for the Department of Army can be found in Army Regulation (AR) 190-13, *Army Physical Security Program*. In addition, a Facility Design Team (FDT) under the Department of the Army Facilities Standardization Program will develop and issue a standard design titled *Access Control Points for U.S. Army Installations*. These standard designs will meet the requirements of this criteria and AR 190-13.

2-2.3 Department of Navy

The Naval Facilities Engineering Command (NAVFAC) issued *Interim Technical Guidance (ITG) FY03-03 Entry Control Facilities*, on 20 Feb 2003. This UFC supersedes that publication.

OPNAV 5530.14D *Navy Physical Security Manual*, Chapter 10 identifies the requirements for installation access and circulation control. Section 1001 specifies that each installation or separate activity Commanding Officer must clearly define the access control measures required to safeguard facilities and ensure accomplishment of the mission. Among the policies, it is specified that the procedures to control access to installations must include using a defense-in-depth concept and establish positive access control measures at entry control points to installations. OPNAV 5530.14D further specifies the minimum access control measures based on FPCON and the service level for the installation.

2-2.3.1 Department of Navy - Marine Corps

MCO P5530.14 *Marine Corps Physical Security Program* provides guidance on the requirements for installation access control, perimeter barriers, vehicle barriers, and protective lighting.

2-3 COMBATANT COMMANDER REQUIREMENTS

Some combatant commanders have issued requirements for entry control procedures for installations within their area of responsibility. Ensure any such requirements are incorporated in addition to the requirements found in this UFC. Resolve any differences

in the requirements for the design of an ECF by applying the most stringent requirement.

2-4 INSTALLATION SPECIFIC REQUIREMENTS

As required by DOD 2000.16 and service directives, each installation will have an Antiterrorism Plan. The plan provides procedures and recommendations for reducing risk and vulnerability of DOD personnel, their family members, facilities, and assets from acts of terrorism. The FPCON and RAM specified in an AT Plan and their impact on ECF operations and design is discussed in detail in the following sections.

2-5 FORCE PROTECTION CONDITION (FPCON) LEVELS

The level of identification and inspection requirements at an ECF will vary depending on the FPCON level. Table 2-1 shows the FPCON applications and descriptions, and provides guidance on the expected capabilities and impacts associated with the FPCON levels.

Table 2-1 FPCON Descriptions (ref. DoD O-2000.12-H)

FPCON	Application	Description
NORMAL	Applies when a general threat of possible terrorist activity exists but warrants only a routine security posture.	The baseline posture.
ALPHA	Applies when there is a general threat of possible terrorist activity against personnel and installations, the nature and extent of which are unpredictable.	The measures must be capable of being maintained indefinitely.
BRAVO	Applies when an increased and more predictable threat of terrorist activity exists.	The measures must be capable of being maintained for weeks without causing undue hardship or extreme traffic delays, affecting operational capability, or aggravating relations with local authorities.
CHARLIE	Applies when an incident occurs or intelligence is received indicating some form of terrorist action against personnel and installations is imminent.	Implementation of this measure for more than a short period may create hardship and affect the peacetime activities of the unit and its personnel.
DELTA	Applies in the immediate area where a terrorist attack has occurred or when intelligence has been received that terrorist action against a specific location is likely. Normally, FPCON DELTA is declared as a localized warning.	Measures to be implemented in response to local warning and not intended to be sustained for lengthy periods of time.

It is important to understand the required operations and anticipated traffic volume during all FPCONs as outlined in the Installation's AT Plan. In accordance with DOD O-2000.12-H, the security measures employed during FPCON Bravo must be capable of being maintained for weeks without causing undue hardship, affecting operational capability, or aggravating relations with local authorities. Therefore, an ECF designed in accordance with this UFC should be capable of supporting the security measures employed during FPCON Normal, Alpha, and Bravo, including any Random Antiterrorism Measures employed in accordance with the Installation AT Plan. For shorter durations, the ECF should be designed to support operations at FPCONs Charlie and Delta, which includes 100% vehicle inspections. At FPCONs Charlie and Delta, traffic congestion is expected and can be relieved by authorizing entry to mission-essential personnel only. Other methods of reducing traffic congestion at higher level FPCONs involve the use of procedural rather than design elements and are not covered here.

2-6 RANDOM ANTITERRORISM MEASURES (RAM)

Implementing RAM involves identifying at any FPCON a set of measures extracted from higher FPCONs or specific measures prescribed by the Installation Commander to be employed in addition to the basic FPCON measures already in place. Therefore, the level of identification and inspection at the Entry Control Facility will vary depending on the FPCON and the use of RAM. The RAM will be identified in the Installation AT Plan. Each installation will have an AT Officer, who maintains the AT Plan.

RAM can include, but are not limited to:

- Erection of barriers and obstacles to control traffic flow;
- Vehicle, cargo, and personnel searches; and
- Variations in security routines.

2-7 EXISTING DESIGN GUIDANCE

Table 2-2 provides a summary of the design guidance and criteria available for infrastructure issues related to an ECF. Where differences exist between the references in Table 2-2 and this UFC, the UFC governs.

Table 2-2 Existing Design Guidance Relating to ECF

Subject	Document(s)
Exterior Security Lighting	IESNA HB-9 <i>Lighting Handbook</i> IESNA G-1-03 <i>Guideline for Security Lighting for People, Property, and Public Spaces</i>
Exterior CCTV and IDS	UFC 4-012-17 <i>Security Engineering: Design of Electronic Security Systems</i>
Vehicle Barriers	UFC 4-022-02 <i>Security Engineering: Design and Selection of Vehicle Barriers</i>
Guard Facilities	UFC 4-022-03 <i>Security Engineering: Design of Security Fencing, Gates, Barriers, and Guard Facilities</i> UFC 4-024-10 <i>Security Engineering: Design of Buildings to Resist Forced Entry</i> UFC 4-023-07 <i>Security Engineering: Design to Resist Direct Fire Weapons Effects</i>
Traffic and Highway Design Considerations	MTMCTEA (now SDDCTEA) Bulletins <i>Traffic and Safety Engineering for Better Entry Control Facilities</i> - SDDCTEA GDHS-4, <i>A Policy on Geometric Design of Highways and Streets</i> – AASHTO RSDG-3, <i>Roadside Design Guide</i> – AASHTO <i>Manual of Uniform Traffic Control Devices for Streets and Highways</i> (MUTCD)- USDOT/FHWA <i>Standard Highway Signs</i> – USDOT/FHWA <i>Traffic Engineering Handbook</i> – ITE <i>Traffic Control Devices Handbook</i> - ITE

3 ECF CLASSIFICATIONS AND FUNCTION

3-1 ECF USE CLASSIFICATIONS

ECFs are classified based on the intended function and anticipated usage of the ECF. The four “use” classifications are outlined in Table 3-1. The use classification is a function of the type of traffic, hours of operation, and FPCON considerations.

Table 3-1 ECF Use Classifications

Use Classification	Operational Hours	FPCON Considerations	Preferred Operation
Primary	24/7 Open continuously	Open thru FPCON Delta	Vehicle registration/visitor pass capacity. Regular operations, visitors with authorization. Could also be designated as truck and delivery gate.
Secondary	Regular hours, closed at times	Potentially closed at or above FPCON Charlie	Regular operations, visitors with authorization. Could also be designated as truck and delivery gate.
Limited Use	Only opened for special purposes	Closed at most times	Tactical vehicles, HAZMAT, special events, etc.
Pedestrian Access	Varies	Potentially closed at or above FPCON Charlie	Personnel only. Could be located near installation housing areas, near schools, or as part of a Primary or Secondary ECF.

The guidance contained in this UFC is intended for primary and secondary ECFs. Limited-use ECFs or internal/restricted area ECFs may require significantly less infrastructure due to reduced operations.

3-2 ECF FUNCTION CLASSIFICATION

An ECF can have many functions. Not all functions are required at every ECF. Functions for each ECF are based on the installation’s mission, AT Plan, ECF use classification, and land area. Functions may change to meet the demands of higher FPCON levels. The basic functions associated with an ECF are:

- Processing visitors
- Vehicle ID checks
- Personnel ID checks

- Privately Owned Vehicle (POV) Inspections
- Commercial/Large Vehicle Inspections

3-2.1 Multi-Function ECFs

When an installation has a limited number of access points, functional requirements may be combined at the ECF. For example, an installation with only one ECF may combine all of the above functions, or may use a centralized truck inspection facility that is separate from the ECFs or the installation. A large installation may designate one ECF for truck inspection and commercial vehicle access only. Not requiring support for all functions at each ECF will reduce the infrastructure requirements. Additionally, when designating the functions for all ECFs at an installation, give consideration to the requirements to support oversized, atypical vehicles such as those frequently encountered during construction operations or during mobilization of military vehicles and equipment. These atypical vehicles should be supported by at least one limited use or primary/secondary ECF, which may require modifications such as wider lanes, limiting the use of channelization islands, or limiting potential obstructions.

When possible separate truck and passenger vehicle traffic. For traffic lanes that require speed management to delay a high performance passenger vehicle, exclude truck traffic from these lanes. The effectiveness of most speed management techniques for passenger vehicles decreases when trucks must use the same lanes. Also, search requirements differ significantly for trucks and passenger vehicles. Consider separate search facilities for those types of traffic to avoid congestion and improve efficiency of search guards during higher FPCON.

3-3 ECF FUNCTIONAL DIAGRAMS

The functional diagrams shown in Figures 3-1 through 3-3 illustrate general relationships and desired adjacencies for different types of ECFs. These can be modified based on installation or site-specific requirements for an ECF.

Figure 3-1 Visitors/DoD Personnel ECF – Functional Relationships

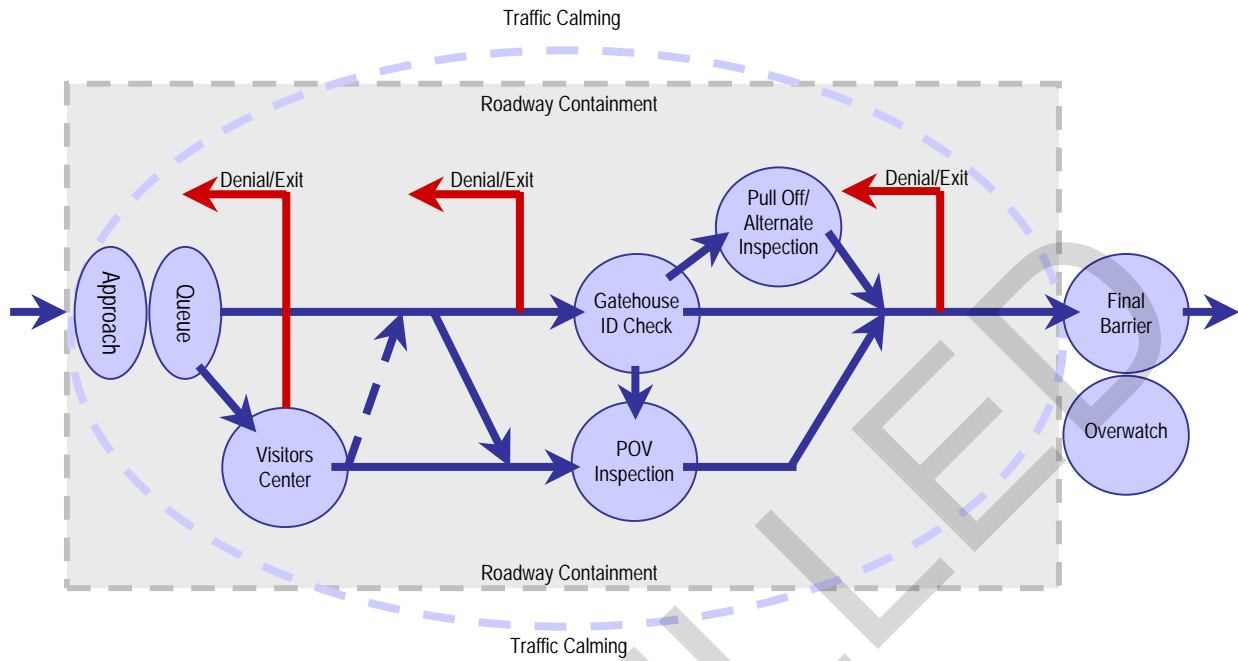

Figure 3-2 DoD/Authorized Personnel Only ECF – Functional Relationships

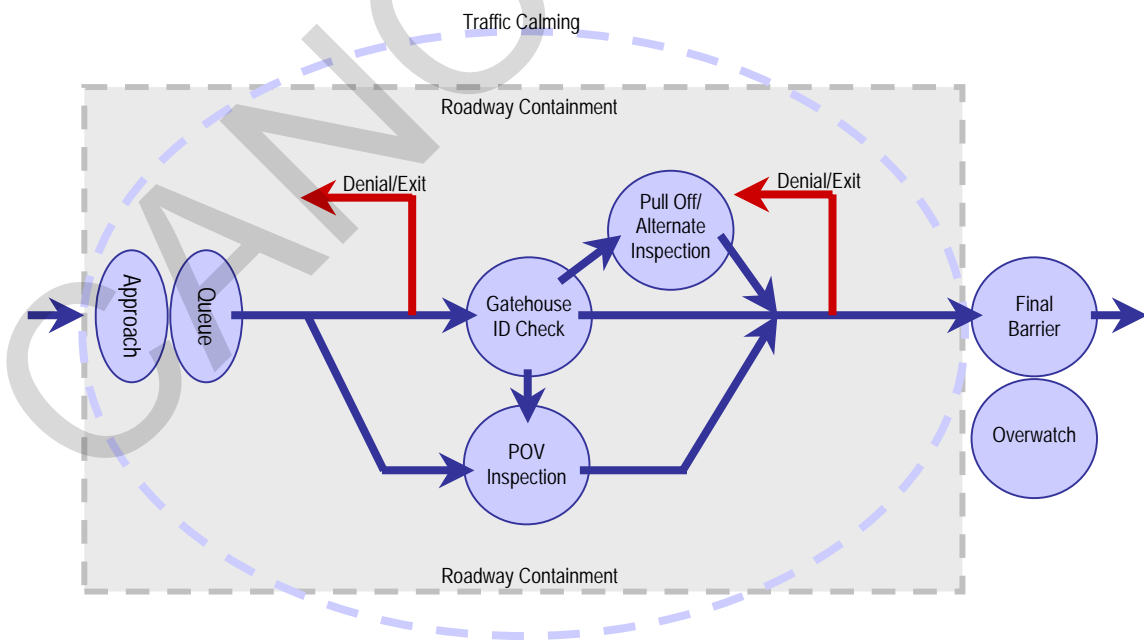
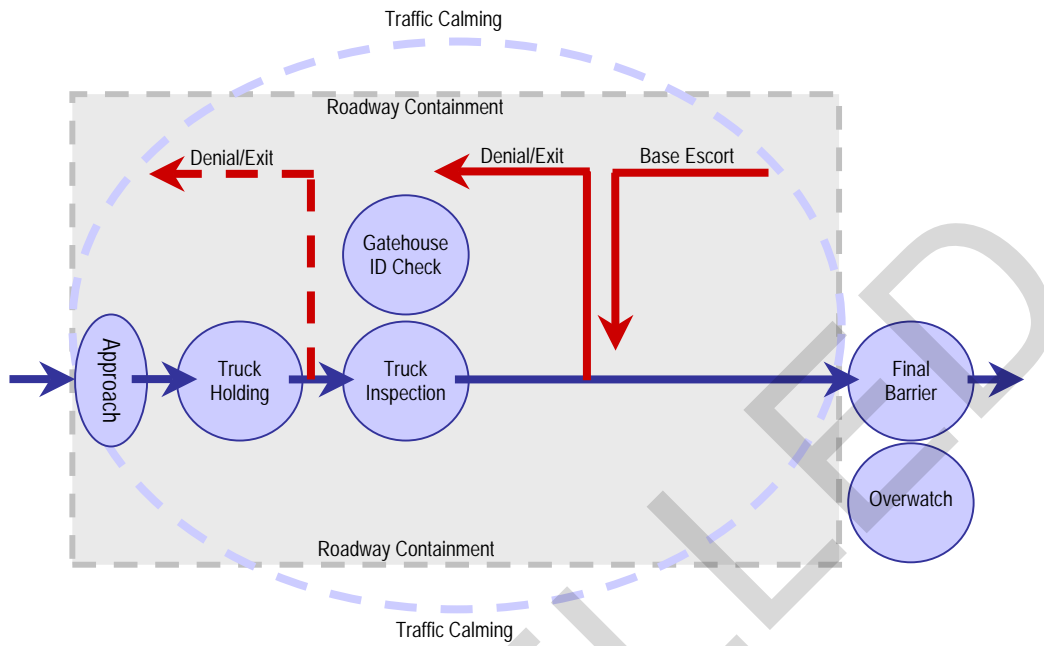

Figure 3-3 Commercial Gate: Functional Relationships



4 PLANNING AND SITE SELECTION CRITERIA

4-1 PLANNING

The following groups should be involved in the planning and design of an ECF:

- Security forces (operations, security, crime prevention, personnel security, and communications security,)
- Installation facility and traffic engineering representatives,
- Installation AT Officer,
- Communications Officers,
- Safety Officers, and
- Local, state, Federal, or host nation officials to ensure integrity of restrictive access to the installation and reduce the potential adverse effects on surrounding communities.

4-2 SITE SELECTION CRITERIA

4-2.1 User Demand

Site selection for a new ECF starts with an extensive evaluation of the anticipated demand for access to the installation, an analysis of traffic origin and destination, and an analysis of the capability of the surrounding road network to tie in to the ECF, including its capacity to handle additional traffic. Analyses of traffic patterns at installation entry points should include the local Department of Transportation, since any traffic changes will likely have some effect or impact on civilian traffic patterns.

For additional guidance in capacity and traffic safety operations at Entry Control Facilities, refer to *Traffic and Safety Engineering for Better Entry Control Facilities* by Military Surface Deployment and Distribution Command Transportation Engineering Agency (SDDCTEA).

4-2.2 Existing Terrain and Available Space

The existing terrain can have a significant impact on the suitability of a potential ECF site. Flat terrain is generally preferred. A gentle rise in elevation up to the gatehouse allows for a clear view of arriving vehicles, which helps entry control personnel monitor potential threats.

ECF spatial requirements vary depending on the type, the traffic demand, and the security measures necessary. The installation should have a corridor (tract of land for the ECF) at least 140 feet (43 m) wide for collector streets (2,000 to 8,000 vehicles per day) and 180 feet (55 m) wide for arterial streets (8,000 – 25,000 vehicles per day). These corridors should have a dedicated right-of-way protected from encroachment by buildings, trees, and other objects. This will provide a safe, clear roadway and accommodate future expansion. Space must also be available for the other ECF elements. The amount of space required depends on the layout selected in accordance

with this UFC and should include space for parking, buffer and transitional space between ECF elements, and surrounding land use.

4-2.3 **Future Development Plans**

Carefully evaluate future development plans for the installation and the surrounding community when selecting a site for a new ECF or modifying existing facilities. All ECF development plans should accommodate future modifications necessitated by increased demand or revised security measures.

4-2.4 **Compatible Land Use**

Do not locate ECFs near restricted/clear zones, protection-level resources, and identified vulnerable assets. Locate ECFs away from housing, school, and commercial areas, both on and off installation, to avoid interference with pedestrians, parked cars, and driveways. See paragraph 5-1.4 for additional information on assessing a safe zone surrounding an ECF.

4-2.5 **Environmental Constraints**

Consider the impact to existing environmental systems as well as constraints that may prohibit development in certain areas, including wetlands, protected habitats and resources, and restoration sites.

4-2.6 **Location**

Comply with the requirements of UFC 4-010-01. Give special attention to the requirements for parking and roadway projects, which are necessary even if the project is not associated with a building renovation, modification, repair, or restoration.

5 ORGANIZATION AND OPERATION OF AN ECF

5-1 ECF ZONES

An ECF can be subdivided into four zones, each encompassing specific functions and operations. Beginning at the installation property boundary, the zones include the approach zone, access control zone, response zone, and the safety zone. Specific components are used within each zone to conduct the necessary operations (*Securing U.S. Army Site Access Points*). The location of each zone of the ECF is illustrated in Figure 5-1.

Figure 5-1 Entry Control Facility Zones

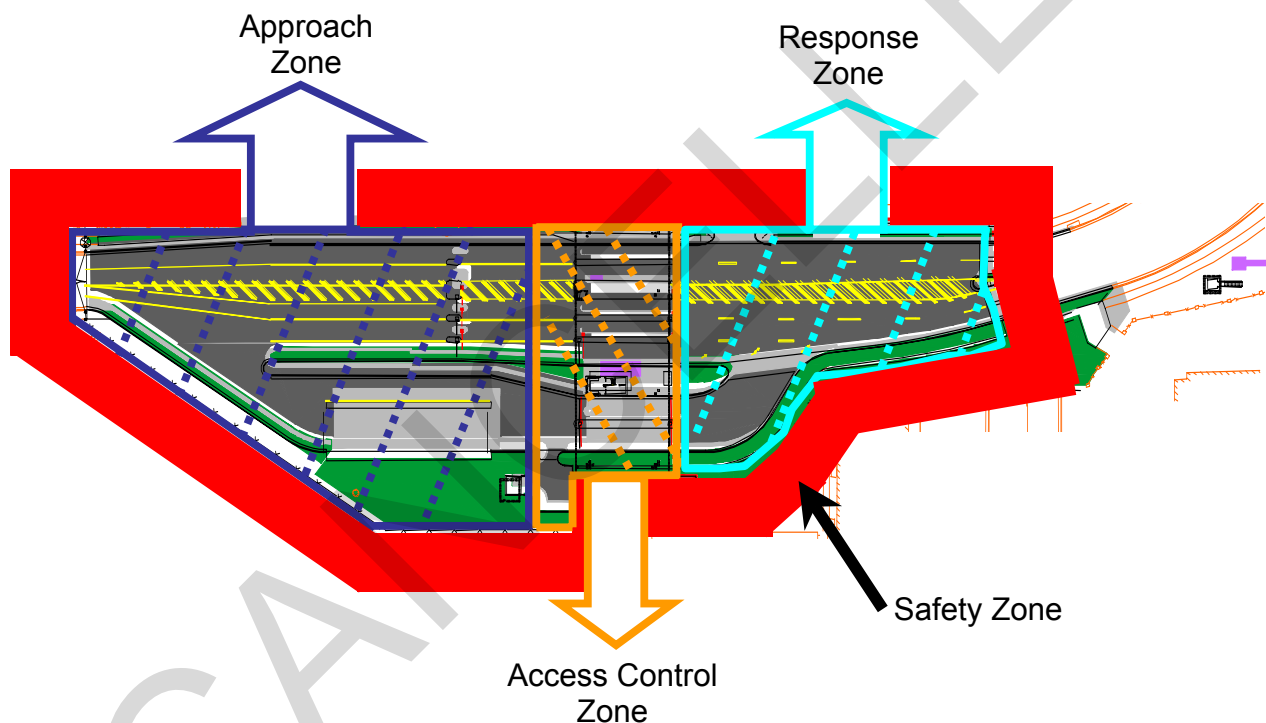

5-1.1 Approach Zone

The Approach Zone lies between the installation boundary and the Access Control Zone. It is the interface between the off-facility road network and the facility, and the area all vehicles must traverse before reaching the actual checkpoint.

5-1.1.1 Design Elements

The Approach Zone should include design elements to support the following functions and operations (*Securing U.S. Army Site Access Points*):

- Reduce the speed of incoming vehicles to, or below, the design speed of the ECF;

- Perform sorting of traffic by vehicle type, e.g. sorting trucks or visitors into the proper lane before reaching the inspection area or checkpoint;
- Provide adequate stacking distance for vehicles waiting for entry, especially during times of peak demand, to ensure minimal impact on traffic approaching the installation and on traffic safety operations of adjacent public highways; and
- Provide the first opportunity to identify potential threat vehicles, including those attempting entry through the outbound lanes of traffic.

Roadway layout and traffic control devices such as signs, variable message systems, signals, and lane control markings should be utilized to perform these functions. Drivers should be notified of the upcoming access control point, the proper speed to travel, and proper lane to utilize.

5-1.1.2 Size of the Approach Zone

The length of the Approach Zone is based on available land, distance required for queuing and performing traffic sorting, and the space required to create additional lanes of traffic without queuing excessively onto adjacent public highways (*Securing U.S. Army Site Access Points*). The design should also support measures that may be needed during higher FPCON levels, the use of RAMS at lower FPCON levels, and the temporary placement of traffic barriers as specified in the Installation AT Plan to constrain and slow traffic. Space may also be required to support traffic calming techniques to mitigate high-speed threats.

5-1.2 Access Control Zone

The Access Control Zone is the main body of the ECF and includes guard facilities and traffic management equipment used by the security forces. The design of the Access Control Zone should be flexible enough to ensure the infrastructure can support future inspection demands, access control equipment, and technologies.

When designing the Access Control Zone, consider the requirements to process the following types of vehicles depending on the intended functions of the ECF (see Section 3-2) (*Securing U.S. Army Site Access Points*):

- POV of authorized personnel,
- Government vehicles,
- Visitor vehicles,
- Military convoys,
- Delivery vans, trucks, and buses

5-1.2.1 Typical Operations in the Access Control Zone

Most installations conduct identification procedures manually and require both vehicle and personnel identification. Security personnel generally conduct these procedures in Access Control Zones at FPCON Bravo and below:

- Verification of vehicle decals;
- Verification of personnel identification;

- General surveillance of the vehicle and its contents; and
- Random, complete inspections of the vehicle and contents.

Most installations issue visitor and/or vehicle passes at a centralized visitor's center.

5-1.2.2 Inspection and Control of Vehicles

The frequency of complete inspections is dependent on the FPCON level, the use of RAM, or the suspicions raised from general surveillance. Design inspection areas to accommodate one or more vehicles requiring detailed inspection. Consider monitoring and control of both inbound and outbound traffic. At high FPCONs, installations may conduct vehicle checks or check visitor passes as personnel are leaving the installation

If a vehicle is denied entry during identification checks, the access control zone must have room for that vehicle to be re-directed to exit the installation. Traffic arms can be used to control traffic when a vehicle is being rejected from the ECF.

5-1.2.3 Tandem Processing

Installations may use tandem processing, with two or more security personnel posted to each lane of traffic, to increase the throughput of an ECF. It has been estimated that tandem processing may improve capacity by up to 50% per lane (*Traffic Engineering and Highway Safety Bulletin: Gates Revisited*). This additional capacity may be critical during increased FPCON levels or during the use of RAM. Therefore, design Access Control Zones to support tandem processing.

5-1.2.4 Support for Automation

In addition to supporting manual procedures, design the Access Control Zone to accommodate automated identification systems. In order to use automated systems, vehicles will need to be channeled to the proper locations. Design automated operations to mimic current identification procedures by requiring identification of both vehicles and personnel. Pilot projects have been initiated to test potential technologies, and it is anticipated that the use of automated verification and identification procedures will become more widespread.

Where the automated system is known, design the Access Control Zone to provide the necessary infrastructure to support the system. If the exact type of automated equipment and procedures used for vehicle or personnel identification is unknown, provide a flexible layout and electrical power infrastructure to support the future installation of an automated system with limited disruption to operations of the ECF.

5-1.3 Response Zone

The Response Zone is the area extending from the end of the Access Control Zone to the final denial barrier (*Securing U.S. Army Site Access Points*). This zone defines the end of the ECF. Design the Response Zone so that the security forces have time to react to a threat, operate the final denial barriers, and close the ECF if necessary.

5-1.4 Safety Zone

A terrorist vehicle could explode inside the contained area of the ECF. Consider the effects an explosion may have on nearby personnel, buildings, or assets. The safety zone extends from the passive and active barriers in all directions to protect installation personnel from an explosion at the vehicle barricade (*Securing U.S. Army Site Access Points*). Determine the acceptable standoff distance or safety zone by the expected weight of the explosive charge and the facility or asset to be protected. Another consideration in the development of the safety zone is any exclusion zones, which may be required to minimize radiation exposure from x-ray, gamma ray, or similar inspection equipment. Exclusion zones are discussed in Chapter 7.

UFC 4-022-02 provides a thorough discussion of determining the proper standoff distances associated with planning of vehicle barriers. Based on the assumed explosive weight, injury levels can be predicted based on distance from the explosion. The user must make decisions based on the risk involved and the probability that an incident would take place. Consider high value assets such as mission critical, high profile facilities or facilities close to the ECF with a high concentration of personnel as high risk. If an adequate safety zone or standoff distance cannot be achieved to produce acceptable damage and injury levels, evaluate other alternatives or the decision must be made to accept additional risk.

6 DESIGN GUIDELINES

6-1 INTRODUCTION

The following design considerations are provided for ECFs controlling DOD Personnel Only (Authorized Vehicles), DOD Personnel / Visitors, and Commercial / Large Vehicles with a separate centralized inspection facility. For a Large Vehicle Inspection Facility follow the additional guidelines in Chapter 7 which reflect the unique requirements of supporting inspection functions for these types of vehicles.

6-2 GENERAL LAYOUT REQUIREMENTS

This section reviews the general layout requirements and design guidelines for the various zones of an entry control facility. Further details concerning specific elements are provided in later sections.

Many of these design guidelines are illustrated in Figures 6-1 through 6-4. Figure 6-1 illustrates an ECF with manual identification and inspection procedures. Figure 6-2 illustrates the same ECF operating using an automated access control system. Figures 6-3 and 6-4 illustrate alternative layouts of the access control zone using pull-off inspection areas in lieu of a separate inspection lane.

6-2.1 Layout Guidelines for the Approach Zone

Design the approach to the installation to accommodate peak traffic demand without impeding traffic flow in the surrounding road network. Additional traffic considerations are discussed in later sections. See *Traffic and Safety Engineering for Better Entry Control Facilities* for design guidance concerning traffic demand and lane capacity.

Base the layout of the approach zone on the following guidelines:

1. Maximize the length of the approach zone, to provide optimal stacking distance for the traffic queue.
2. Reversible lanes can increase throughput and flexibility where space is unavailable for additional lanes.
3. Sort traffic by vehicle type. For example - use the farthest right lane for truck traffic. Rejection of these vehicles requires additional space for their larger turning radii.
4. Separating vehicles with varying inspection requirements can also increase throughput. For example - authorized personnel could use a separate lane with automated equipment.

6-2.1.1 Traffic Calming

Traffic calming, or speed management, can be utilized for inbound lanes to control vehicle speed and slow incoming vehicles before they reach the gate so that SF personnel have adequate time to respond to unauthorized activities. This includes provisions for restricting traffic flow approaching the access control zone (ID check area) during increased FPCONs. Appropriate traffic calming measures include:

- Road alignment (circle, serpentine) (ensure that any curves are adequate to support the design vehicles, recommend minimum of AASHTO WB-50 (WB-15m));
- Drop-in or retractable bollards (to cause serpentine traffic flow);
- Gates or barriers that redirect traffic (may be moveable manually or mechanically if not in use);
- Speed humps or speed tables; and
- Pavement texture.

Additional information on traffic calming can be found in *Traffic Engineering and Highway Safety Bulletin: Traffic Calming*; *Traffic Calming, State of the Practice*; and at <http://www.ite.org/traffic/index.html>.

6-2.1.2 Temporary Measures

Temporary barriers may be required by the installation's AT Plan for certain FPCONs. These may include jersey barriers, water-filled plastic barriers, or similar obstructions to reduce the number of lanes and reduce the speed of oncoming traffic. Incorporate design details to support the installation of temporary barriers. This may include pre-positioned sleeves or anchors to secure temporary bollards, etc. Any obstructions in the roadway must be clearly marked and identified with Type III Barricade markings, retroreflective red and retroreflective white stripings, in accordance with the MUTCD. For additional guidance for temporary traffic control measures, refer to *Traffic and Safety Engineering for Better Entry Control Facilities*.

6-2.2 Layout Guidelines for the Access Control Zone

Design the access control zone to manage authorized vehicles and personnel, to reject unauthorized vehicles, and minimize the adverse impacts on traffic.

Base the layout of the access control zone on the following guidelines.

1. Provide infrastructure to support manual and automated identification and inspection procedures for the inbound lanes. Configure the access control zone to support tandem processing.
2. Where outbound lanes are designed to be reversible, security regulations periodically require the inspection of exiting vehicles, or there is a potential for automated monitoring of exiting vehicles as part of an automated access control system infrastructure to support manual and automated identification procedures should be provided.
3. The main identification area should be covered with an overhead canopy to protect against inclement weather, facilitate identification and inspection procedures, and provide a platform for lighting and CCTV. See paragraph 6-9.5 for further canopy requirements.
4. As illustrated by the functional diagrams shown in Figures 3-1 through 3-3 there may be the need for several rejection points from an ECF. Provide a minimum

of one rejection point, however, two rejection points are recommended. One should occur prior to the central identification area / gatehouse and the other should occur after this point. Where only one rejection point is possible, the rejection should occur following the identification area.

5. Provide a channelization island between all inbound lanes or outbound lanes designed as reversible lanes in the identification area.

N Provide primary channelization islands in between each inbound and outbound traffic lane in the Access Control Zone. The island is required in the outbound lanes due to security regulations that may periodically require the inspection of exiting vehicles and also due to the potential for automated access control, which may be used to monitor and identify exiting vehicles. Also a secondary channelization island should be provided prior to the first rejection point in the Access Control Zone for inbound traffic. This island should support potential future automated access control systems.

6. Each ECF should have a minimum of one gatehouse. Provide additional sentry/guard booths if required. The gatehouse can be centrally located on a median, or may be positioned to the side of the ECF. Guard facility requirements are further discussed in paragraph 6-9.

CANCELLED

Figure 6-1 Access Control Zone Operated by Security Personnel

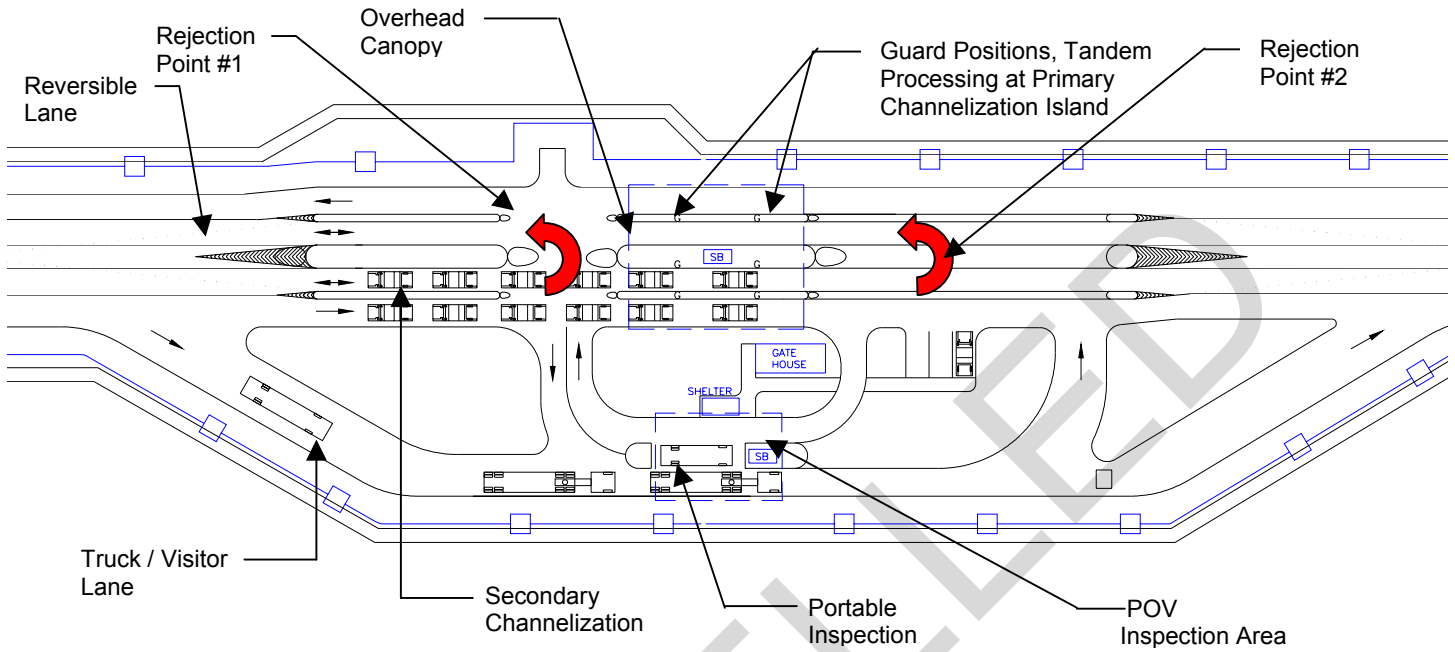

Figure 6-2 Access Control Zone Operated by Automated Equipment

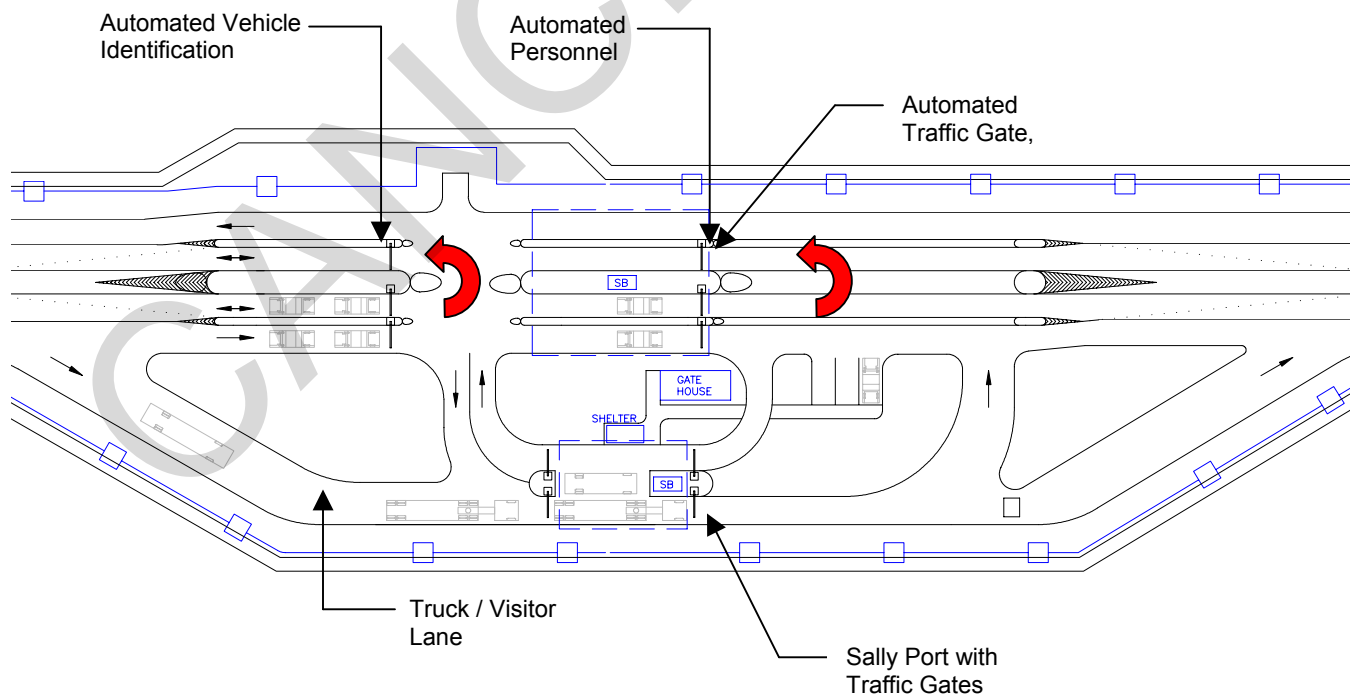

Figure 6-3
Access Control Zone with Pull-Off Area for Each Inbound Lane

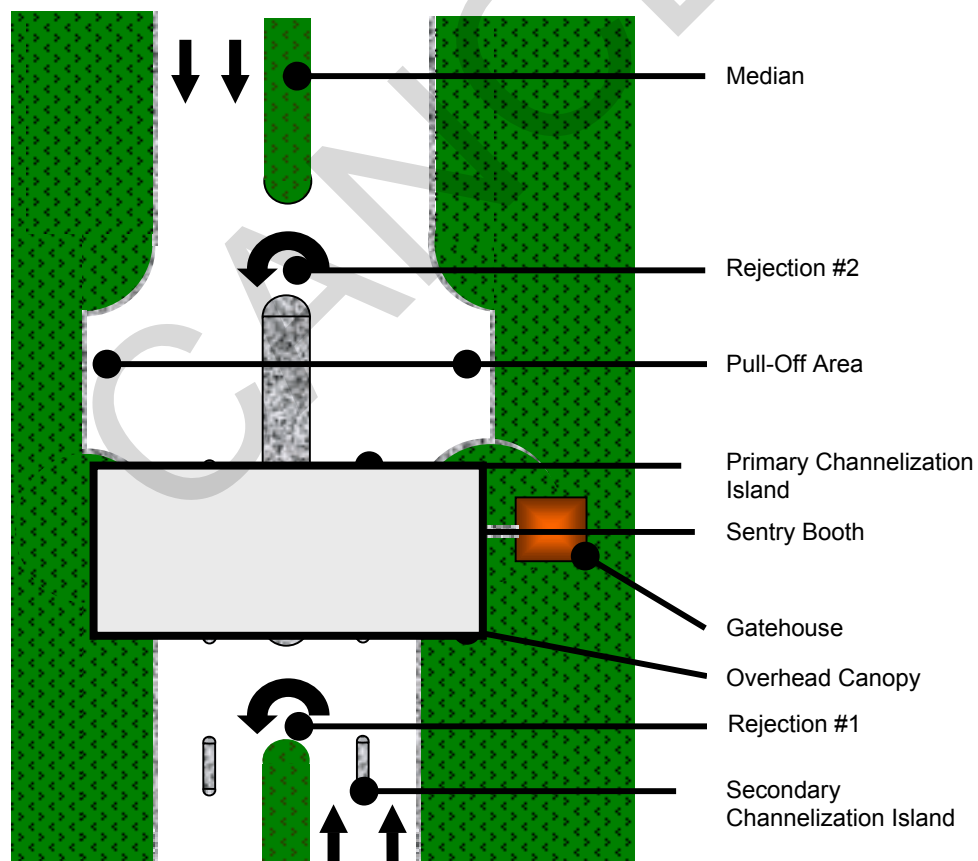
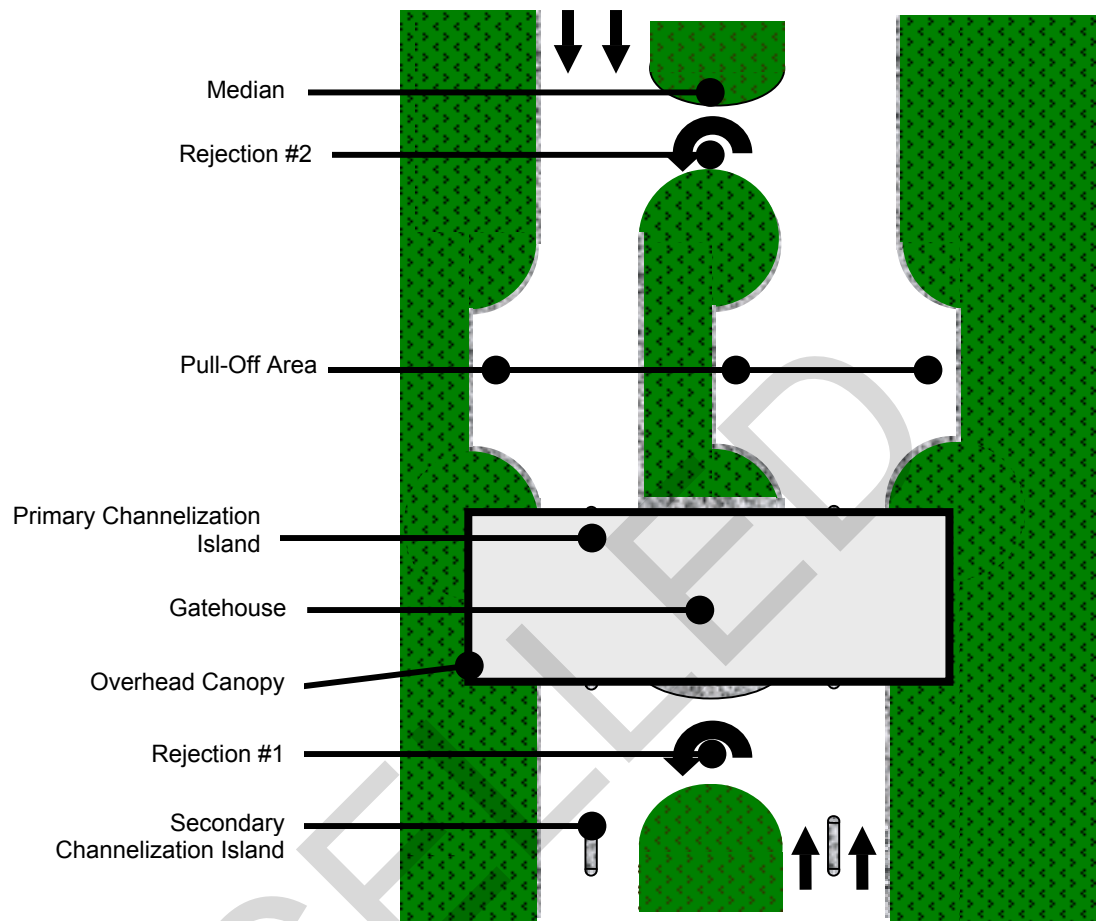

Figure 6-4
Access Control Zone with Single Pull-Off Area for all Inbound Lanes

6-2.3 Layout Guidelines for the Response Zone

Design the response zone with a sufficient length to provide adequate reaction time for security personnel to respond to a threat. Provide final denial barriers at the termination of the ECF to provide the capability to stop threat vehicles from using high-speed attacks to gain entry to the installation. The necessary length of the response zone and location of the final denial barriers is based on the provision of adequate response time.

6-2.3.1 Determining Length of Response Zone

Response time is the time required for complete activation of the final denial barriers once a threat is detected. This implies the distance required to provide an adequate response time is measured from a starting position where it can be assumed detection, i.e. assessment of the threat, has already occurred. The length of the response zone is calculated based on the velocity of the threat vehicle when it is detected, the subsequent rate of acceleration, and the response time. The location of the threat vehicle when first detected is based on the threat scenario and site plan. The rate of acceleration is dependent on the type of vehicle. Generally, the acceleration capabilities of threat vehicles are known.

The length of the response zone can be minimized, or the available response time increased, by using passive barriers or roadway layout to control the velocity of vehicles as they travel the Approach and Response Zones. It is recommended that roadway layout features such as reverse curves (S-curves) be used to reduce the maximum velocity of traffic. UFC 4-022-02 provides guidance on determining the maximum attainable velocity including curved paths.

6-2.3.1.1 Threat Scenarios.

Consider all scenarios when designing the Response Zone, determine which scenario governs, and verify the adequacy of the response time and final denial barrier selected. As a minimum, consider the following three threat scenarios.

- High-speed attack - A vehicle approaches the ECF at a moderate or high rate of speed. The attack can initiate outside of the ECF or at any point within the Approach Zone. The vehicle will be detected early due to the high-speed approach; but the high speed and subsequent acceleration may not allow security personnel enough response time to activate the final denial barrier.
- The appearance of legitimacy until the Access Control Zone - A potential threat vehicle approaches the ECF to attempt covert entry. The vehicle will approach at a slow speed or stop to offer false credentials or a suspect vehicle attempts to circumvent security from inspection or rejection lane. A suspect vehicle that is rejected or directed to proceed to the inspection area, may initially indicate compliance, however, once away from the guard attempt to enter the installation. In this case, the threat is not detected until the vehicle proceeds past the rejection lane or past the inspection area. In this scenario, the vehicle is closer to the final denial barrier when detection occurs, but the vehicle is moving at a low velocity and must then accelerate towards the barrier.

6-2.3.1.2 Response Time

The response time includes the time for security personnel to react to a threat and initiate the activation of the barrier system and the time for the selected barrier system to fully deploy and close the roadway. The time for the barrier system to deploy will be based on the operational characteristics of the final denial barrier selected; however, in no case must the time be taken less than 2 seconds. The time for the barrier system to deploy should include the time for sequencing traffic signals where they are employed as a safety measure. The time for security personnel to react to a threat and initiate the response is dependent on the standard operating procedures and location of emergency operation controls. The time assumed for the reaction of personnel will be determined based on the specific conditions and layout of the ECF, however, it should not be taken to be less than 3 seconds. When evaluating the threat scenario associated with vehicles traveling to or from the inspection area, the reaction time for personnel may be reduced to 1 second if approved by the security personnel and if the standard operating procedure includes personnel on standby at the barrier activation controls when a suspect vehicle is traveling to the inspection area or being rejected. The following examples illustrate the calculation of the required length of the response zone.

Example 6-1:

Given:

- High speed attack scenario - Vehicles enter the installation from a right or left hand turn that limits the speed of incoming vehicles to a maximum of 20 mph (32 km/hr)
- The approach zone is 250 ft (76.2 m) long, flat, and straight
- Security personnel are provided automatic warning of speeding vehicles 100 ft (30.5 m) prior to the checkpoint and the speed limit is 20 mph (32 km/hr) in the ECF. The over speed detection is set at 35 mph (56 km/hr), with the first loop 100 ft (30.5m) from the start of the approach zone and the second loop 50 ft (15.23 m) from the first.
- A threat assessment indicates high performance vehicles (acceleration rate of 11.3 ft/sec² (3.44 m/sec²)) could be used in an attack
- The final denial barrier takes 3 seconds to fully deploy when the emergency fast operation (EFO) is triggered. Based on the location of EFO controls, security personnel may take as long as 4 seconds to trigger the final denial barrier once the threat is detected.

Solution:

The initial velocity when the vehicle enters the approach zone is 20 mph (32 km/hr.) The acceleration rate is taken as 11.3 ft/sec² (3.44 meter/sec².) Determine the vehicle speed at the time the first detector is reached:

$v_f^2 = v_i^2 + 2as$, where v_f = final velocity, v_i = initial velocity, a = acceleration, and s = distance traveled. Therefore,

$$v_f = \sqrt{\left(8.889 \frac{\text{meter}}{\text{sec}}\right)^2 + 2 \cdot (3.44 \frac{\text{meter}}{\text{sec}^2}) \cdot (30.5\text{m})} = 17 \frac{\text{meter}}{\text{sec}} = 61.2 \frac{\text{km}}{\text{hr}} = 38 \frac{\text{miles}}{\text{hr}}$$

The velocity at the second detector loop can be found to be 19.84 meter/sec = 71.4 km/hr (44.4 mph). The detection loop will alarm since the velocity exceeds the minimum setting. The response time is equal to the sum of the barrier and security personnel reaction times, which equals 7 seconds. Since the roadway is flat and straight, the distance traveled in 7 seconds can be calculated with the following formula: $s = \frac{1}{2} \cdot a_o \cdot t^2 + v_o \cdot t$ where, s = distance traveled; t = response time; v_o = initial velocity (at detection); a_o = acceleration

$$\text{Therefore, } s = \frac{1}{2} \cdot (3.44 \frac{\text{meter}}{\text{sec}^2}) \cdot (7 \text{ sec})^2 + (19.84 \frac{\text{meter}}{\text{sec}}) \cdot (7 \text{ sec}) = 223.2 \text{ meter} = 732.3 \text{ feet}$$

Since the attack is detected 30.5 meters prior to the checkpoint, the final minimum length of the response zone is 223.2 meters – 30.5 meters = 192.7 meters (632.3 feet).

If and there is an additional 4 second delay following the EFO being triggered for safety and signals prior to the barrier deploying, the total response time is increased to 11 seconds. This would increase the minimum length of the response zone to 396 meters (1300 feet).

Example 6-2:

Given:

- Assume the conditions given in Example 6-1, with the addition of a S-curve or speed control device in the response zone. The speed control area begins 50 ft (15.24 m) past the end of the access control zone and it limits the maximum velocity of vehicles to 25 mph (40 km/h).
- The speed control device controls the speed of the vehicle for the first 150 ft (45.72 m) of the response zone. The maneuvers added by the speed control device add 50 feet (15.24 m) of additional path for the vehicle to traverse.
- The threat vehicle is traveling at the maximum velocity allowed by speed control measures

Solution:

The vehicle cannot enter the response zone at a speed greater than 40 km/h, therefore for the first 200 ft (61 m), the vehicle will be traveling approximately 40 km/h. When the added length of travel is added for maneuvering, the total distance traveled to reach the end of the speed control area is 250 ft (76.2 m). At 40 km/h (11.2 m/s), it will take 6.8 seconds to reach the end of the speed control area. Using the same formula as utilized in Example 6-1 the distance traveled in the remaining 0.19 seconds until the response time is complete:

$$s = \frac{1}{2} \cdot (3.44 \frac{\text{meter}}{\text{sec}^2}) \cdot (0.19 \text{ sec})^2 + (11.2 \frac{\text{meter}}{\text{sec}}) \cdot (0.19 \text{ sec}) = 2.19 \text{ meters} = 7.19 \text{ feet}$$

Therefore the total distance traveled in the 7-second response time and the required length of the response zone is 257.2 ft (78.39m). This is a 375 ft (114 m) reduction in the size of the response zone compared to Example 6-1, achieved by using speed management immediately following the access control zone.

When designing a Response Zone, maximize the response time by lengthening the Response Zone, which will increase the distance between the Access Control Zone and the final denial barrier. In certain instances, there may not be enough space available to provide an acceptable response time. In those cases, it may be necessary to operate the facility with barriers normally in the activated or “up” position blocking traffic. The barriers are then only lowered for authorized vehicles. It may also be necessary to incorporate sally ports to provide adequate security. UFC 4-022-02 will provide additional guidance in estimating the activation time for final denial barrier systems and determining the available response time for a given layout.

6-3 CONTAINMENT AND CONTROL OF VEHICLES

Full containment and control of vehicles is required for all ECFs. The design of an ECF should ensure that vehicles are contained through an arrangement of passive and active vehicle barrier systems. Both types of vehicle barriers, passive and active, can be fixed or movable. Active barriers require some action, either by personnel, equipment, or both, to prevent entry of a vehicle. Passive barriers are used to direct and channel the flow of traffic in the desired direction. UFC 4-022-02 provides additional discussion of the selection and application of active and passive vehicle barriers.

The passive and active vehicle barrier systems are designed based on their capacity to stop threat vehicles. The design basis threat will be determined by a site-specific threat assessment or specified by the installation. Some Services may establish minimum barrier capacities or specify threat vehicles for primary and secondary ECFs. The velocity of the threat vehicle will be determined based on vehicle characteristics and the roadway layout. For non-perpendicular approaches, the necessary barrier capacity should be based on the specified weight of the threat vehicle, the maximum attainable velocity, and the angle of approach. The allowable penetration following impact should be based on site considerations and the proximity of inhabited facilities or high value assets. For barriers provided in addition to the containment and final denial barriers, such as barriers used for control in inspection areas, the capacity will be specified by the installation. Further information concerning design and specification of active vehicle barrier systems is provided in UFC 4-022-02.

N It is recommended that the barrier capacity should be based on a vehicle with a 15,000 lb (6800 kg) gross weight at the maximum attainable velocity based on the roadway layout.

6-3.1 Roadway Containment.

Roadway containment is necessary to prevent inbound vehicles from unauthorized access and must extend from the installation perimeter to the final denial barrier in order to be effective. Passive vehicle barriers should encompass a contiguous perimeter around the ECF, with the final denial barriers completing the containment. The barriers should be arranged to ensure that a vehicle couldn't circumvent the ECF once the vehicle has entered.

Containment may consist of either natural or constructed barriers. Natural barriers may be a dense tree stand, berms, or drainage ditches on either side of the roadway. Berms and ditches must have slopes effective at preventing vehicles from passing. Constructed containment may include cable-reinforced fencing, concrete walls, etc. Consider the potential debris hazard produced by passive barrier systems exposed to blast during a potential attack and the effect on any nearby buildings or assets. The aesthetics and design of the barrier system should be consistent with the installation's exterior architectural plan and the surrounding architectural and landscape features. Breaks in the passive barrier system for pedestrian access to the ECF should not exceed 3.3 feet (1 m) in width for traffic having a 90-degree approach and 4.1 ft (1.25 m) in width for traffic paralleling the barrier.

AF Air Force guidance suggests that higher curbs, a minimum of 18 in (457mm) high, are a low-cost means to prevent motorists from leaving a road to bypass security or to access a sensitive area of the installation.

6-3.2 Final Denial Barrier

The purpose of the final denial barrier is to stop unauthorized vehicles from entering the installation. Some individuals who attempt to enter the installation without authorization are lost, confused, or inattentive, but there are also those whose intent is to "run the gate." A properly designed final denial barrier will take into account both groups, minimizing the risk to individuals who have made an honest mistake and providing a properly designed barrier (based on the specified threat) to stop those with hostile intentions.

Final denial barriers are active vehicle barriers. ECFs should be provided with final denial barriers to enable the ECF to be closed and to prevent a threat vehicle from breaching the security. As discussed in 6-2.3.1, determination of the location of the final denial barriers depends on the response time required between the detection of threat and the deployment of the final denial barriers. Provide final denial barriers in the incoming and outgoing lanes in order to prevent threat vehicles from using the outgoing lanes to gain access to the installation (*Securing U.S. Army Site Access Points*).

Provide active barrier systems with a normal operating mode that moves the barrier between open and closed positions at a relatively slow pace. In addition the barrier should have an emergency activation or emergency fast operation (EFO) mode, which deploys the barrier at an accelerated, shortened time in the event of an attack or threat. In all cases an alarm signal must be transmitted to the installation central security monitoring facility indicating an emergency activation of the active vehicle barriers.

6-3.2.1 Design and Safety Considerations

Ensure that vehicle barriers are planned and constructed in accordance with UFC 4-022-02 including all necessary safety measures. Safety devices associated with active vehicle barriers are covered in UFGS 02840 *Active Vehicle Barriers*. The design and operation of the ECF should include provisions to protect innocent users of the ECF from operation of the final denial barrier whether deployment is accidental, during a test,

or during an actual response to a threat. Where possible, incorporate an appropriate delay time (minimum of 4 seconds) into the barrier control sequence to allow sequencing of traffic signals and lights at the final denial barrier to allow vehicles approaching the barrier to either clear it or stop safely in front of it before it deploys. Automatic detection loops embedded in the pavement around the active vehicle barrier system can be used to avoid deployment of the vehicle barrier when an authorized vehicle is within the loop detection zone and the barrier is activated.

During emergency barrier activation, a barrier would not initially activate if the detection loop indicates the presence of a vehicle. In order to avoid tailgating to defeat the barriers, it may be necessary to activate the barrier as soon as that first vehicle clears the loop, regardless of whether a second vehicle enters the presence loop. It may also be necessary to activate the barriers once the maximum allowable delay time has been reached even if the detection loop indicates a vehicle is in the presence zone. Place warning lights at all active vehicle barriers. When the active vehicle barrier is in the closed position (stopping vehicle flow), a red stoplight should be used. At all other times a yellow flashing light should be used (*Securing U.S. Army Site Access Points*.) Consider other safety measures that provide protection for innocent motorists from barrier activation such as non-lethal active vehicle barrier systems that reduce the risk of injury and level of damage, requiring vehicles to stop prior to the active vehicle barriers in conjunction with providing vehicle detection loops and controls and providing additional channelization in front of each barrier, or utilizing speed management techniques to control the velocity of traffic. Further information on traffic safety considerations related to active vehicle barriers including the use of traffic signals and sequencing can be found in *Traffic and Safety Engineering for Better Entry Control Facilities*.

Active vehicle barrier systems can require significant maintenance. To facilitate maintenance and reduce costs it is desirable that the types of vehicle barriers be minimized at each installation or within a region.

6-3.3 Controls for Active Vehicle Barriers

Locate the main, multi-function control panel for the active vehicle barrier systems in the gatehouse. The control panel should require a key for normal operation and control all lanes. Provide a separate emergency control on the panel to initiate the emergency fast operation (EFO) mode of the final denial barriers in all entrance and exit lanes. A tamperproof, emergency activation control for the final denial barriers should be located, as a minimum, at each guard facility or post (channelization island, gatehouse, sentry/guard booth, and overwatch position). The emergency activation control will trigger the accelerated deployment function of the barrier system. Providing redundant control will reduce reaction time and increase the effectiveness of response. All activation controls, including individual emergency activation controls, should be protected from inadvertent use by a shield or cover.

The active vehicle barrier control system should be designed such that deactivation of the final denial barriers, after an emergency activation is triggered at the master panel or other locations, requires a key or similar device. This prevents a

potential attacker from opening the final denial barrier if the security personnel are incapacitated during an attack. The emergency deactivation key should be kept by the duty officer or in a central location and should be different than the key required for normal operation of the master control panel. Controls located in the overwatch position should be capable of being secured when the position is not manned.

Most active barrier systems are capable of being operated through several devices such as push button switches, wired and wireless hand operated switches, computer control systems, and radar or detection loop monitoring excessive speed or unauthorized entry. Due to the dangers associated with activation of a barrier system and the potential for false alarms, in no case should activation of the barrier system be triggered through automatic detection and response. All control systems should be based on the actions of the security personnel manning the entry control facility (such as push button or hand operated switches). This will provide an opportunity for security personnel to distinguish confused, inattentive, or drunk drivers from potential terrorists attempting forced entry (*Securing U.S. Army Site Access Points.*)

Automatic detection equipment such as detection loops or radar for excessive speed or wrong direction of travel could be utilized for warning security personnel of potential threats. Final selection of control systems should follow the guidance in UFC 4-022-02 and the preferences of the user.

Limitations on the maximum speed serve to reduce the potential for fatalities. For this reason, the speed of traffic in the ECF should be kept to the minimum necessary to maintain the flow of traffic.

6-4 VEHICLE INSPECTION CAPABILITY

Vehicles are inspected in accordance with local directives, from random inspections to inspections of all vehicles entering the installation. Once vehicles have been inspected, they do not have to pass through the ID check station; the exit lane from the inspection area may bypass entry control and merge into other inbound traffic downstream. Active barriers and procedures should be in place to prevent unauthorized vehicles from bypassing entry control.

6-4.1 Location of Inspection Area

Since vehicle content inspection can be time consuming, during periods of random vehicle content inspection it is important to allow the inspection to occur without impeding the flow of traffic through the entry control facility. One study showed that random in-lane inspections of approximately 1 in 30 vehicles consumed 27 minutes per lane per hour based on a typical inspection time of 2 to 3 minutes per vehicle. If the inspections were removed from the roadway, the installation could process vehicles for the full hour, rather than 33 minutes. This would represent a 182 percent increase in the available processing time and increase the processing rate from 321 vehicles per hour per lane to 584 vehicles per hour per lane (*Traffic Engineering and Highway Safety Bulletin: Gates Revisited.*)

Separating the inspection area can be accomplished through the use of a separate inspection lane, a pull-off area, or dedicating a lane as dual purpose such as visitor and inspection. To the extent possible, the inspection area should not be immediately adjacent to inbound traffic lanes. While this separation is primarily for safety reasons, some screening of the inspection procedure from public view is also desired. This can be accomplished with appropriate landscape plantings.

The inspection area can occur prior or adjacent to the ID check area. Where the inspection area occurs before the checkpoint, it should be possible to direct suspect vehicles to the area from the checkpoint or a pull-off/alternate inspection area should be provided. The pull-off area provides an area just beyond the ID check area and gatehouse where alternate inspections can be conducted, ID discrepancies addressed, or driver's questions answered. There should be a pull-off area on the exit lane where vehicle inspections can be conducted. This configuration is illustrated in Figure 6-5, where the main inspection area occurs prior to the ID check area.

CANCELLED

Figure 6-5 Notional Layout using Pull-Off/Alternate Inspection

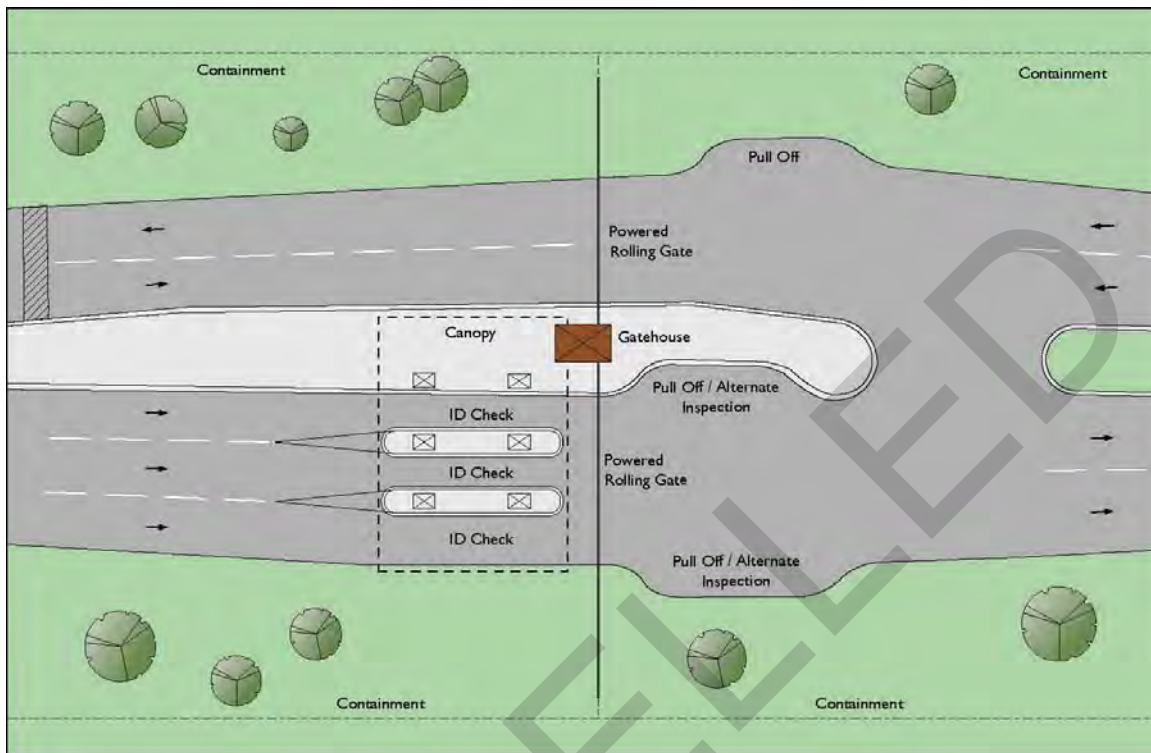

A driver waiting area should be provided if local inspection procedures and equipment require that the driver be separated from the vehicle for some length of time. Provide seating for two (2) occupants per vehicle undergoing inspection. A small shelter, similar to a bus shelter should be provided, to protect vehicle occupants from inclement weather, and moving vehicles.

6-4.2 Geometric Design of Inspection Areas

Paragraph 6-6.4 provides design guidelines concerning the geometric design of general inspection areas. Chapter 7 provides additional design guidelines for large vehicle inspection areas. Consider centralizing the large vehicle inspections by designing a dedicated ECF or design a separate large vehicle inspection area at one of the installation's primary ECFs. See Chapter 7 for more information on inspection of large commercial vehicles.

6-4.3 Location and Support for Inspection Equipment

Most vehicle inspections are conducted with manual procedures using tools or hand-held detectors. Provide space required to store this equipment and to conduct battery-charging operations. Other types of search equipment are of a more permanent nature, and require planning for their deployment. Items in this category include high-energy methods for conducting imaging searches, and certain automated search methods for

both vehicles and pedestrians. Some examples of these technologies are x-ray, ion mobility spectroscopy, gamma ray imaging, and neutron analysis.

Chapter 7 discusses high throughput, high-energy equipment used for truck inspection and also provides additional information including layout considerations. The inspection equipment may be mobile or a fixed installation. Mobile units can be randomly used at any ECFs that have the required space for operation. Either a fixed or mobile unit could be used on a continuous basis at a large vehicle inspection facility. The design of the Access Control Zone should include provisions for the future incorporation of these large scanning devices where possible. The design should include space for vehicle inspection equipment and provide utility conduits to the anticipated location for future use.

6-5 CAPABILITY TO REJECT UNAUTHORIZED VEHICLES

Inevitably, unauthorized vehicles will enter the ECF and the design should support rejecting these vehicles. Minimize the impact on traffic. Vehicles denied entry might be required to cross several lanes of incoming and outbound traffic to exit the ECF. These vehicles will require assistance to exit quickly. The assistance will be from security personnel directing traffic or, if the ECF is automated, through the use of traffic gates to stop normal traffic.

The roadway should be designed to have the required turning radius to allow a single movement for the vehicle to be redirected. Consider the need for re-directing, without major traffic disruptions, a large vehicle that mistakenly enters the wrong ECF. Where possible, the ECF will accommodate the turning radii of AASHTO WB-50 (WB-15m) to limit the time necessary for the reject vehicle to leave the entry control facility. If space is unavailable to support a single movement, consider the impact on the flow of traffic while a vehicle makes a three-point turn or similar movement. If the impact is infrequent or acceptable, or large vehicles are not expected at the ECF, then the required space can be minimized. As illustrated by the functional diagrams, Figures 3-1 through 3-3, two rejection points should be provided; one prior to the central identification area / gatehouse and the other after this point. Provide a minimum of one rejection point prior to the final denial barrier.

6-6 GEOMETRIC DESIGN OF ROADWAYS

Base the design of the roadways in the ECF on the latest edition of the GDHS-4 except as modified in this UFC. See Chapter 7 for requirements specific to large vehicle inspection operations and facilities. Additionally, consider the requirements to support oversized, atypical vehicles such as those frequently encountered during construction operations or during mobilization of military vehicles and equipment.

Traffic and Safety Engineering for Better Entry Control Facilities provides additional guidance on geometric design of roadways for Entry Control Facilities.

6-6.1 Channelization Islands

Channelization islands provide a safe position for security personnel and serve as a location to install present or future access control devices. A primary channelization island should be provided between each incoming traffic lane in the Access Control Zone (including potential reversible lanes). The proper path through and around raised islands should be readily visible through the use of approach pavement markings. This is especially important for an ECF, where there may be several islands for security personnel performing ID checks and monitoring installation traffic. The island should be raised, supported by a curb. The colors, line widths, and other design features of the markings must adhere to the MUTCD.

The minimum primary channelization island should be 3 ft (914 mm) wide, 6 in (160 mm) high and 50 ft (15.2 m) long, although a length of 70 ft (21.3 m) is recommended. The minimum length is required in order to support tandem processing. Where facilities are located on an island, design the island to provide a minimum of 3 ft (914 mm) clear on each side of the facility. The primary channelization islands should have crash protection in accordance with paragraph 6-16.

A/N Provide secondary channelization islands. The secondary island should be a minimum of 3 ft (914 mm) in wide, 6 in (160 mm) in high and 10 ft (3 m) long.

6-6.2 Medians

Medians are constructed to:

- Separate opposite traffic flows;
- Provide a protected zone for left or U turns;
- Minimize headlight glare;
- Create an open green space for landscaping;
- Provide space for signs; and
- Provide space for a guard facilities

Medians can greatly improve the safety of the roadway. Medians can be either raised, flushed, or depressed depending on the required functions per *Traffic and Highway Engineering*. A flushed median could be used to facilitate the operation of reversible lanes. A raised median surrounded by a curb should be utilized in the access control zone for the central identification island. The minimum recommended median width is 12 ft (3.6 m). The desired median width is 30 ft (9.14 m), which protects vehicles making left or U-turns. If the median is to provide turnaround capability for larger trucks, it should be a minimum of 40 ft (12.19 m) wide. Automated access control systems may be installed in the median as in the channelization island. Therefore, medians should have infrastructure to support this potential.

AF Minimum median width should be 16 ft (4.88 m).

6-6.3 Travel Lane Width

The minimum lane width is 10 ft (3.0 m). The preferred lane width is 12 ft (3.6 m). Lanes approaching the gate should be 12 ft (3.6 m) wide, plus another 2 ft (0.61 m) on

each side for the curb and gutter. If moderate-to-heavy bicycle traffic is expected, lane widths of 15 ft (4.57 m) to 17 ft (5.18 m) are recommended.

Consider narrowing the lanes at the gatehouse/guard facilities to 10 ft (3.0 m) wide to slow motorists down and place them close to the ID checker. If this is done, at least one inbound lane, usually the outer lane, at multi-lane gates should be 12 ft (3.6 m) wide to accommodate larger, wider vehicles. Also consider other potential impacts of narrow lanes, such as:

- Narrow lanes are highly restrictive to large vehicles, including some emergency vehicles;
- Narrow lanes can impact traffic flow; when the lane width is less than 12 ft (3.6 m) motorists drive very cautiously and also tend to increase the spacing between vehicles (*Traffic and Highway Engineering*); and
- Consider snow removal requirements and address required width between ID check islands for snow removal equipment.

6-6.4 Inspection Areas

Inspection and search areas should have sufficient area to safely move vehicles from the lanes of traffic to conduct thorough vehicle inspections. Consider the space required for maneuvering robotic inspection and disposal equipment.

For lanes or pull-off areas used for random inspection purposes, the minimum width is 18 ft (5.5 m) to facilitate the safe inspection of vehicles. The length of a pull-off area or inspection area should be a minimum of 40 ft (12.2 m) or the length required to support the largest expected vehicle at the ECF, whichever is larger.

AF Provide the following inspection areas: For standard vehicles, provide 15 x 25 ft (4.5 x 7.2 m) inspection bays that can be enclosed, if necessary, to protect inspection equipment in the event of bad weather. For commercial vehicles, size inspection areas to be a minimum of 18 x 80 ft (5.5 x 24.4 m) x 17 ft 6 in (5.4 m) high that can be enclosed to protect inspection equipment in the event of bad weather. Pull-off areas should accommodate one to three parallel-parked vehicles, and be located both sides of the entry lanes.

6-6.5 Curbs and Gutters/Shoulders

Shoulders are desirable to accommodate disabled or stopped vehicles. However, curbs and gutters are preferable in areas where lane control is desired and to improve safety. Therefore, consider shoulders only for use in the approach and response zones. Curbs and gutters are required in the access control zone and around all channelization islands.

6-6.5.1 Curbs and Gutters

Curbs are primarily intended to contain vehicles within the roadway and to provide an elevated platform for personnel who must stand close to the moving vehicles. A curb height of 6 in (152mm) is recommended in the access control zone. Curbs where ID checks are performed can be 9 in (229mm) high to increase the safety for entry

controllers. However, this curb height can place the checkers too high above the seated drivers. Therefore, if curbs higher than 6 in (152mm) are used, provide “curb cuts” or a step down to position security personnel at the proper working level.

If a gutter has a different color and texture than the road surface and has a longitudinal joint, it should not be considered part of the travel lane width. One exception to this is the total lane width at ID checkpoints, which should be either 10 feet (3.04 m) or 12 feet (3.66 m), as previously identified.

6-6.5.2 Shoulders

Shoulders are discouraged near an ECF because motorists tend to go faster where there are shoulders. Shoulders also make it harder to constrain and control the movement of vehicles. If used, shoulders should be 6 ft (1.83 m) to 8 ft (2.44 m) wide, and all fixed objects, such as signs, trees, and posts, should be at least 6 ft (1.83 m) from the edge of the shoulder or 12 ft (3.65 m), from the edge of the travel lane. Where a road edge changes from a shoulder to a curb, the transition area should be gradual, with a minimum taper ratio of 10 to 1, to give the driver time to react.

6-6.6 Transitions and Tapers

When lanes are redirected, dropped, or added, provide proper transitions to enhance traffic flow and ensure safety (*Traffic Engineering and Highway Safety Bulletin: Traffic Engineering for Better Gates.*) The transition allows drivers the opportunity to recognize the change and react appropriately. A common flaw is that road transitions are often too short. At a minimum, provide transitions to redirect lanes at channelization islands. Lane tapers allow drivers to respond to a change in road alignment. Tapers should be used when lanes are separated on the approach to a gate island or lanes on a road are added or dropped before or after a gatehouse. *Traffic and Safety Engineering for Better Entry Control Facilities* provides transition and taper length criteria.

6-6.7 Roadside Safety

Determine barrier end treatments and the need for crash cushions in accordance with RSDG-3, *Roadside Design Guide*, latest edition. Transportation Research Board National Cooperative Highway Research Program (TRB NCHRP), Report 350 “Recommended Procedures for the Safety Performance Evaluation of Highway Features” provides guidelines on testing and evaluating safety features, as well as providing a basis for formulating performance specifications for safety features.

6-6.8 Lateral Clearances

Lateral obstructions present a safety hazard and tend to negatively impact traffic flow. The negative effects are eliminated or reduced if the object is less than 6 in (152 mm) high or located at least 6 ft (1.8 m) from the edge of the roadway (*Traffic and Highway Engineering.*) Ideally the lateral clearance would be greater. Therefore, the location of lateral obstructions in the approach and response zones, including the passive vehicle barriers, should be a minimum of 6 ft (1.8 m) from the edge of roadway.

It is recommended that passive vehicle barriers defining the boundary of the ECF be located 12 ft (3.6 m) from the edge of road. Where passive vehicle barriers must extend close to the active vehicle barriers at the end of the response zone to maintain containment, this minimum is not applicable.

Additionally, in the Access Control Zone, the location of facilities and access control equipment will likely provide less lateral clearance. Where possible, maintain a minimum lateral clearance of 2 ft (610 mm) in the access control zone to allow security personnel to pass between the obstruction and the roadway. Maintain a minimum lateral clearance of 3 ft (914 mm) between facilities and the roadway.

6-6.9 Vertical Clearances

AASHTO standards indicate a minimum vertical clearance of 14 ft (4.3 m) for highways or 16 ft (4.9 m) for freeways or arterials. Provide a minimum vertical clearance of 14 ft 6 in (4.41 m) for general use and 17 ft 6 in (5.4 m) in commercial vehicle inspection areas or where a large number of over-height vehicles are expected.

N In order to support potential over-height vehicles or future pavement overlays, a minimum vertical clearance of 17 ft (5.2 m) should be maintained throughout the ECF.

6-6.10 Corner Radii

The radius of a corner or turning lane depends on the largest vehicle expected to use the lane and the average turning speeds, which will be quite low around an ECF. Other factors to consider include the available right-of-way, the angle of the intersection, and pedestrian activity. The following minimum inside radii should be used.

- Locations serving only passenger vehicles, 15 ft (4.57 m) to 30 ft (9.14 m), preferred is 20 ft (6.1 m).
- Corners where RVs, SUVs, or similar vehicles turn, 35 ft (10.67 m).
- Intersections where large trucks (WB-50) including semi-trailers (WB-67) turn, 50 ft (15.24 m).
- Turnarounds for large trucks, 65 ft (19.81 m).

6-7 TRAFFIC CONSIDERATIONS

The effect of an entry control facility design on the surrounding roadways and intersections is of paramount concern. If congestion occurs, and there is inadequate stacking distance, the queues may extend into adjacent intersections or cause congestion on feeder roads. Additionally, the stopped vehicles become a target of opportunity themselves. The design of a modification or renovation of an existing ECF should improve the throughput of the ECF, and as a minimum not reduce the throughput. Additional guidance on traffic considerations at Entry Control Facilities can be found in *Traffic and Safety Engineering for Better Entry Control Facilities*.

6-7.1 Capacity

The design capacity is based on the peak hour traffic volume that the entry control point would handle without unreasonable congestion. Consider both current and future traffic demands, where the design demand is the peak hour traffic volume, such as the morning rush hour. If the rate of vehicles arriving at an entry control facility exceeds the rate of processing, then congestion will occur (*Traffic Engineering and Highway Safety Bulletin: Traffic Engineering For Better Gates.*) As discussed in paragraph 2-5, the FPCON has a great effect on the processing time per vehicle and the traffic volume due to changes in the inspection procedures and the number of authorized vehicles. The traffic design of the ECF will consider the operations at all FPCONs. However, since some disruption in the level of service is expected at high FPCON(s) (Charlie or Delta), design the ECF to eliminate congestion at FPCON Bravo and below.

At FPCON Charlie and Delta, some congestion may occur but this is sometimes offset by the installation also reducing the population seeking to enter the installation to mission essential personnel only. Where possible, minimize the congestion during FPCON Charlie or Delta. If the final capacity achieved at an entry control point is below the expected peak hour traffic volume, congestion can also be reduced by implementing staggered work hours, encouraging carpooling, adding lanes, and/or tandem processing (multiple identification checks per lane) (*Traffic Engineering and Highway Safety Bulletin: Traffic Engineering For Better Gates.*) *Traffic Engineering and Highway Safety Bulletin: Gates Revisited* estimates that tandem processing may improve capacity by up to 50% per lane. Therefore, design all entry control points to support tandem processing. It may also be possible to design lanes to be reversible such that outbound lanes can be used for incoming traffic during periods of peak volume. However, give priority to maximizing the number of lanes prior to utilizing reversible lanes.

6-7.2 Adequate Lanes

The number of lanes planned for an entry control point should be sufficient to handle the expected volume of traffic, especially during times of peak demand such as morning rush hour. If necessary and possible, increase the number of lanes to increase the throughput of the entry control point. To aid in the determination of the required number of lanes, Table 6-1 provides reference information concerning the approximate throughput of entry control points during different levels of identification.

Table 6-1 Estimated Vehicle Throughput (SDDCTEA Data except as noted)

Identification Type	Assumed FPCON	Capacity (vehicles/lane/hour)	
		Single Processor	Tandem Processing
No Direct Checks	NA	600-800	600-800
Vehicle Identification Only	ALPHA	400-600	400-600
Vehicle and Driver/Occupant Identification	BRAVO/BRAVO+	300-400	450-600
Complete Vehicle Inspection	DELTA	20-120, typ. 60	20-120, typ. 60
Traffic Arm w/ Card Reader	NA	150 ⁽²⁾	NA

6-8 TRAFFIC CONTROL

Signs, markings and signals are necessary to perform traffic control and satisfy regulatory requirements and should be provided in accordance with Service guidance and the MUTCD. Due to the increase in use of automation and channelization of traffic, guide signs in the approach zone will become increasingly important to indicate lane use and direct traffic into the appropriate lanes.

Limited use of signs in all zones and especially in the access control zone is strongly encouraged. Signs in the Access Control Zone may obstruct the guard's view of approaching traffic. Use overhead guide signs when the gate has three or more lanes, with varying functional use in each lane (*Traffic Engineering and Highway Safety Bulletin: Traffic Engineering for Better Gates.*) Ensure position of signage does not interfere with visibility of security personnel, especially the overwatch position. Vehicles approaching the ECF should be informed of their approach to a restricted area. This may require coordinating signage on feeder roads with state or local officials.

Traffic and Safety Engineering for Better Entry Control Facilities provides additional information on traffic control at Entry Control Facilities.

6-8.1 Speed Limit

It is also desirable to manage the speed of traffic in inbound and outbound lanes of the ECF for safety. Clearly post the speed limit in the ECF. Use geometric roadway layout features or other traffic control devices such as "rumble strips" or warning strips, caution signs, or traffic or flashing lights in the response zone to manage the speed of traffic and increase awareness of the final denial barrier system.

The speed limit should be 25 mph (40 km/hr) or below throughout the ECF to protect security personnel and to minimize the potential for accidental impact with vehicle barricades. This speed limit also applies to the outbound lanes as they approach the vehicle barricades. Any deployed active vehicle barrier system has the potential to be lethal. Limitations on the maximum speed serve to reduce the potential for injuries or fatalities.

6-8.2 Signage

Prepare a comprehensive signage plan for each ECF that is compatible with the installation's signage program and complies with local standards. The plan should include the following types of signs.

- Traffic Regulatory and Directional Signs, which control traffic flow and direct vehicles to specific gates, ID check lanes or the Visitors Center.
- Entry Control Procedures Signs, which explain current ID check procedures for drivers; display of current FPCON status should follow Service guidelines.
- Variable Message Signs (VMS) at the ECF that provide the ability to inform motorists of roadway status or other general information per *Traffic Engineering and Highway Safety Bulletin: Traffic Engineering for Better Gates*. Locate these signs inside the installation and at least 200 ft (61 m) beyond the ID check area.
- Warning signs, markings, object markings and delineators indicate hazards to users.

These signs will reduce conflict between approaching vehicles and improve the flow of traffic through the ECF. Minimize the use of signs to prevent the obstruction of the lines of sight for security personnel. When signs are required they should be located to provide the least obstruction to the lines of sight of security personnel.

Provide signage in accordance with Service regulations and the MUTCD. Additional information on the standard size and shapes of markings and signs can be found in the latest edition of the Federal Highway Administration's *Standard Highway Signs*.

Examples of signage, which could be used in an ECF, are provided below. Use of signs should be consistent with the MUTCD. Sign designations in accordance with the latest edition of the *Standard Highway Signs* are provided in parentheses.

Approach Zone

Inbound Traffic

- Reduce Speed Ahead (R2-5a)
- Speed Limit Sign (R2-1)
- Trucks Use Right Lane (R4-5 or R4-6) (if applicable)

Outbound Traffic

- Do Not Enter (RS-1), at end of transition
- One Way (R6-1 or R6-2), at end of transition

Both Directions

- Road Closed (R11-2) Secured to both sides of gate
- Type III Barricade marking signs, (3 per lane) Secured to both sides of gate at installation perimeter (horizontally)

Access Control Zone

- Guide signs indicating lane use (One per lane)
- Type 1 Object marking signs on barriers for personnel protection

Response Zone

Outbound Traffic

- Reduce Speed Ahead (R2-5a)
- Speed Limit Sign (R2-1)
- Warning signs should be placed a minimum of 100 feet before the final denial barrier, if the final denial barrier signal is not visible.

Inbound Traffic

- Do Not Enter (RS-1), for inbound traffic at end of transition
- One Way (R6-1 or R6-2) for inbound traffic at end of transition
- Warning signs should be placed a minimum of 100 feet before the final denial barrier, if the final denial barrier signal is not visible.

AF Comply with UFC 3-120-01 *Air Force Sign Standard* and USAF symbol guidelines at <http://www.af.mil/airforcestory/guidelines.shtml> regarding signage for all new construction and renovation projects. These guidelines now mandate that base identification signs show only the USAF symbol and the name of the base or installation.

N Provide signage in accordance with OPNAV 5530.14D *Navy Physical Security Manual* at the entrance to the ECF.

A Facility identification signs must meet the requirements in the Installation Design Standards.

6-8.3 Markings

The following guidelines are provided for markings in the ECF.

- Provide individual broken lane lines for each lane.
- Consider dotted transition lines for reversible lanes.
- Consider the use of double yellow broken lines on both sides of a reversible lane.
- Provide, repair, or upgrade crosswalks impacted by the ECF.
- Use solid yellow lines, delineators and chevron markings to indicate obstructions between lanes traveling in different directions and reversible lanes.

- Use solid white lines, delineators, and chevron markings to indicate obstructions between lanes traveling in the same direction.
- Use solid lines to prevent changing lanes just before and just after the elevated islands.
- Provide symbols to indicate the appropriate turning movements.
- Use black to outline the pavement marking where light-colored pavements do not provide sufficient contrast with the markings.

6-8.4 Traffic Control Devices

As a minimum, consider “rumble strips” at the entrance to the ECF (beginning of the approach zone) to alert vehicles entering the installation, and prior to the active barriers in the outbound lanes to alert exiting vehicles. When using rumble strips, consider the effects of the tire noise generated on nearby facilities or operations.

The use of speed bumps is prohibited. Speed humps as illustrated in Figure 6-6 may be used. See *Traffic Engineering and Highway Safety Bulletin: Traffic Calming and Traffic Calming, State of the Practice* for guidelines on the use of speed humps.

Figure 6-6 Example Speed Hump Profile

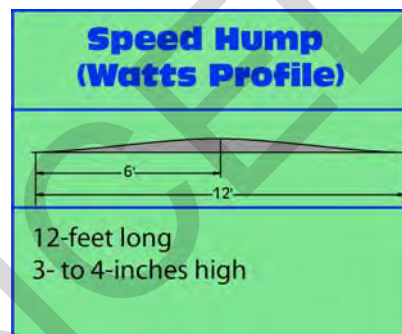

Use guardrails, or equivalent, to transition from shoulder to passive vehicle barriers. Where final denial barriers or traffic arms are used, provide red and white reflectorized striping on arms or surfaces. Warning signals should be provided prior to all active vehicle barriers in each direction. The warning signals should have red and yellow lights with the yellow light having the ability to flash. When the active vehicle barrier is deployed to stop vehicle flow, a red stoplight will be used. At other times a yellow flashing light will be used.

6-9 GUARD FACILITY DESIGN CRITERIA

This section outlines design guidelines for the various facilities associated with an ECF. Specific design criteria for each facility type are first reviewed, and then common requirements for all guard facilities are discussed.

6-9.1 General

The guard facilities at the ECF should provide a comfortable, safe working environment for security personnel. Generally, a single gatehouse centered in the entry control

facility may be utilized, or alternatively the gatehouse or sentry booth may be located to the side of the roadway. The gatehouse could also be located after the last rejection point (turn-around) to give security personnel in the gatehouse an overall view of the Access Control Zone operations and vehicles directed to the rejection point or vehicle inspection area. If the gatehouse is located to the side of the roadway or after the last rejection point, consider providing a sentry booth in the central island of the access control zone or in between entry lanes to provide easily accessible shelter and protection for the guards operating the ECF.

Since guard facilities are located in the immediate vicinity of the explosive threats they are trying to prevent from entering the installation, it is impractical and impossible to provide protection from the possible effects of an explosive device. In addition, the occupancy of the facilities is typically below the threshold for the requirements of UFC 4-010-01. Therefore, no protective design elements are required for guard facilities to mitigate the effects of an explosive device. Paragraph 6-9.6.2, discusses protection from other potential threats and tactics.

UFC 4-022-03 provides additional guidance on the design of sentry/guard booths, gatehouses, and guard towers. The sentry booth and gatehouse may be a site-built or prefabricated structure if allowed by the installation architectural guidelines. The basic considerations in determining the size of the facility are number of personnel assigned during normal operations, space required for electronic and electrical equipment, mechanical equipment, and counter or work space. The appearance of the guard facilities should be in accordance with the installation exterior architectural plan. Maximize visibility from the facilities. Provide access from the guard facilities to the pedestrian walkways entering the ECF. When properly documented in accordance with Service requirements that only able-bodied security personnel utilize guard facilities, the facilities are not required to meet [Americans with Disabilities Act Accessibility Guidelines \(ADAAG\)](#) requirements.

N MC Plan guard facilities in accordance with NAVFAC P-80.

Where guard facilities are located near the roadway, provide a minimum platform width of 3 ft (914 mm) behind the curb. This width is the minimum necessary for security personnel to stand post adjacent to the facility, therefore additional platform width is recommended to provide additional safety through increased lateral clearance and space for security personnel carrying weapons or equipment.

In addition to the guard facilities, a shelter should be provided near any inspection lane for occupants of a vehicle that is to be searched. The shelter should be similar to a bus stop shelter, with see-thru walls to allow security personnel to observe the vehicle occupants at all times.

6-9.2 Gatehouse

The gatehouse serves as the central control center for the ECF and provides shelter for security personnel. Every ECF should have a gatehouse, designed to support three to five security personnel. As the control center, the gatehouse controls the vehicle

barricades, traffic control devices, access controls, and lighting. Do not locate controls for other aspects of an installation security system in the gatehouse or other facilities associated with an ECF. Locate the installation security center or emergency control center within the controlled perimeter of the installation. The gatehouse should serve only as the control center for equipment associated with the ECF.

Base the design of the gatehouse on consideration of the following equipment and functions:

- Communications equipment;
- Electronic control panels for all current or anticipated future automated gates, barriers, or alarms;
- Monitor stations for closed circuit television or computer monitors associated with automation controls;
- An electrical room for the main electric panelboards;
- Storage for traffic control devices, weapons, and personnel equipment including vehicle inspection kits and the storage of personal protective equipment for CBR exposure;
- Computer servers for future automated identification systems;
- Counter or work space; and
- A unisex restroom.

6-9.3 Sentry/Guard Booth

The sentry/guard booth is located in a median strip or channelization island between traffic lanes. The booth provides one or two guards with protection against the weather and potential threats (*Securing U.S. Army Site Access Points*.) It should have space allotted for electronic control panels for gate automation equipment, workspace incorporating space for computer monitors, and an electrical panelboard. It should be possible to enter or exit the booth from either side of the structure.

6-9.4 Overwatch Position

Many installations desire additional position(s) for security personnel to facilitate a response to a threat. These positions are normally placed in the response zone to facilitate surveillance and armed response. This position may be fixed or temporary/portable. Manning of the overwatch position will be in accordance with the installation physical security plans. Design the facility to permit security personnel to respond to any attackers from a protected position (*Securing U.S. Army Site Access Points*.) A permanent facility will normally be site-built. The position should be provided with emergency fast operation (EFO) controls to activate the active vehicle barrier system. Provide an enunciator in the overwatch position to alert security personnel of the duress alarm being triggered at the other guard facilities. Maximize visibility from the facility, with a minimum of 180-degree visibility. The overwatch position should have a direct line of sight to the access control zone of the ECF including identification and inspection areas.

The location of the overwatch position should also be designed to afford personnel the ability to assess the threat, initiate alarms, activate the barrier system (if other personnel

are incapacitated), and respond to the attack with force if necessary and authorized. Therefore the overwatch position should be located to provide a minimum of four (4) seconds of reaction time from the time a threat is detected or an alarm is initiated. The threat scenarios and guidelines for assessing the required response time and the distance required in order to provide sufficient response time are discussed in paragraph 6-2.3.1.

In most cases the overwatch position will be located at or near the end of the response zone in order to provide sufficient distance for this response. Coordinate the facility location with security personnel to ensure proper line of fire and safety considerations. If required, elevate the facility to aid the observation of incoming traffic and reduce incidental/collateral damage by creating a plunging fire scenario.

If the overwatch position is established as a temporary facility; an asphalt or otherwise paved pad should be provided at the overwatch location, to accommodate a security forces vehicle or temporary facility during increased FPCONs. An utilities communications stub should be provided for this facility.

6-9.5 Overhead Canopy

Providing an overhead canopy at the access control area can improve lighting, protect the guards and drivers from inclement weather, and serve as a platform for traffic control devices, signage, and security equipment (*Traffic Engineering and Highway Safety Bulletin: Traffic Engineering For Better Gates.*) An overhead canopy should be provided for all posts routinely occupied by security personnel and the inspection lanes unless directed by the installation not to provide the canopy over a portion or all of the posts. Where outbound lanes are designed to be reversible or inspection activities occur in the outbound lanes, consider extending the canopy over the entire access control area, providing protection for all potential security personnel positions.

Provide lane control signals in all lanes (inbound and outbound), similar to toll collection or parking facilities, to inform incoming vehicles of the current lane configuration. Provide lane control signals for outbound traffic where reversible lanes are utilized.

The overhead canopy also serves as a platform for lighting and security equipment. Design the canopy to support the future installation of closed circuit television (CCTV) cameras over each lane for inspection purposes or general observation.

The minimum clear height should be 17 ft (5.2 m) to support common vehicle heights and facilitate use of the overhead canopy for lighting or security equipment. The clear height is measured from the pavement to the lowest point on the overhead canopy including light fixtures and other equipment.

The architectural appearance of the canopy should match surrounding features and meet the requirements of the installation exterior architectural plan. Avoid the use of structural elements that could obstruct visibility for entry controllers.

Provide a minimum clear height of 14 ft 6 in (4.41 m) for emergency response vehicle access. Fans or other type of air circulation device should be provided (if not provided for individual sentry/guard booths). The minimum clear height is 17 feet 6 in (5.4 m) for commercial vehicle inspection areas.

A ACP canopies should have a minimum vertical clearance of 14.5 ft (4.41 m) unless a large number of over-height trucks are expected, then 17 ft (5.2 m). Canopies at Truck/Commercial Vehicle Only ACPs should have a minimum clearance of 17 feet (5.2 m).

6-9.6 Common Requirements

This section outlines the requirements that are common to all guard facilities.

6-9.6.1 Construction

Design the facilities as required in UFC 1-200-01 *Design: General Building Requirements* and UFC 3-310-01 *Design: Load Assumptions for Buildings*. Consider the corrosion resistance and maintenance requirements of the guard facilities, especially pre-manufactured facilities, due to the perils of environmental exposure commonly encountered at some installations and the high visibility of these structures.

6-9.6.2 Physical Security and Protective Design

Determine the required physical security design features in accordance with installation requirements and UFC 4-020-01. Threats that may commonly be considered include forced entry and ballistic attack. Provide ballistic protection equivalent to UL 752 Level III (formerly SPSA) for all guard facilities as a minimum. Provide this protection in the design and construction of the exterior envelope including windows, doors, walls, and other equipment. It is not required for openings or penetrations for weapons in guard facilities, such as the overwatch position. Another consideration in establishing the minimum level of ballistic protection is ensuring protection from the weapons carried by security personnel at the ECF. Table 6-2 provides examples of the wall thickness required for commonly encountered materials to provide an adequate ballistic resistance against UL 752 Level III. Additional information and guidance can be found in UFC 4-023-04 *Design to Resist Direct Fire Weapons Effects*.

AF Construction of guard facilities should meet the minimum ballistic requirements of UL 752 Level V. See Table 6-3.

Table 6-2 Thickness of Common Materials for Resistance Against UL 752 Level III

Wall Material	Wall Thickness
Concrete Masonry (Grouted)	6 in (152 mm)*
Brick	6 in (152 mm)*
Reinforced Concrete (3000 psi)	4 in (102 mm)
Steel Plate (mild)	9/16 in (14.3 mm)
Steel Plate (armor)	7/16 in (11.1 mm)

*Nominal thickness (Reference TM5-853-2)

AF

Table 6-3 Thickness of Common Materials for Resistance Against UL 752 Level V

Wall Material	Wall Thickness
Concrete Masonry (Grouted)	4 in (102 mm)*
Brick	4 in (102 mm)*
Reinforced Concrete (3000 psi)	2.5 in (63.5 mm)
Steel Plate (mild)	5/16 in (8 mm)
Steel Plate (armor)	1/4 in (6 mm)

*Nominal thickness (Reference TM5-853-2)

Some mechanical equipment installed in the exterior envelope of a guard facility may not be capable of providing sufficient ballistic resistance. Therefore, locate the equipment to minimize potential exposure to projectile penetration or provide ballistic hardened equipment and/or louvers. As an example, it may be prudent to install the HVAC equipment on the roof of the gatehouse or sentry booth to reduce penetrations in the walls. Provide roof ballistic protection only where there are sightlines to the roof.

6-9.6.3 Windows and Glazing

Provide limited view window glazing. Glazing should limit viewing into the facility to the extent possible without restricting views out of the facility during day and night operations. The intent is to reduce the visible signature of security personnel, as seen from the outside of the gatehouse, without reducing the ability of security personnel to see out. The IESNA HB-9 suggests specular-reflecting, low transmission glazing at a tilted angle can be used in the windows to limit view into the guard facilities from the exterior.

See paragraph 6-9.6.2 for ballistic resistance requirements. Any windows provided in the overwatch positions should not interfere with the capability to respond to an attack. Therefore, any windows should be capable of being fully opened/removed quickly or have a substantial gun port to enable unobstructed line of fire from the position. Without these capabilities the overwatch positions should have no windows in the exterior wall openings. If ballistic resistant glazing is maintained for some portion or all of an opening, consider the visibility through the glazing after it has been impacted during an attack. Some ballistic resistant glazing materials provide better visibility characteristics after impact than others.

6-9.6.4 Floors/Walkways

The finished floor elevation should be 6 in (152 mm) or more above grade or the adjacent walkways, unless the facility is located on a raised island. If the facility is on an island, the minimum finished floor elevation will be the elevation of the island. Provide floors and walkways with anti-skid surfaces. Anti-fatigue mats should be provided at all security personnel posts to relieve fatigue and discomfort from standing for long periods of time.

6-9.6.5 Environmental Control

Provide heating and cooling appropriate for personnel, the electronic and electrical systems or fixtures, and the security support equipment. The HVAC requirements should be based on existing service design guidance and installation requirements. Consider protection from chemical or biological agents used during an attack based on the anticipated threats. However, due to the small size of the facility, comprehensive protection is often not feasible. In order to limit airborne contamination and maximize the time for security personnel to shelter in place in order to initiate a response, utilize protective gear, and respond to an attack, the design of the HVAC system should include minimum measures such as those outlined in UFC 4-010-01. Design features include elevated air intakes, emergency air distribution shutoff switch (or easily accessible controls), and the use of gasketed doors and windows to minimize air leakage.

6-9.6.6 Interior Lighting

The interior lighting should be diffused lighting and should be provided with dimmer controls to aid with night vision and reduce the ability of those outside the guard facility to see inside. The interior lighting should be connected to the backup power source. As discussed in the IESNA HB-9, the illuminance inside the guard facility should be limited to the minimum required for comfortable completion of the expected tasks and functions. As indicated in Figure 29-17 of the IESNA HB-9, the recommended average illuminance for the gatehouse is 30 footcandles (300 lx) on the work plane in the gatehouse. Additional recommendations from the HB-9, include providing well-shielded task luminaires to avoid reflections on monitors and windows. Also providing specular-reflecting, low transmission glass at a tilted angle and painting the inside of the gatehouse dark colors limit the view into the guard facility. Consider providing magenta filters for interior lighting to lessen the impact of interior lighting on the night vision of security personnel. See paragraph 6-14 for exterior lighting considerations

6-10 ELECTRICAL POWER REQUIREMENTS

Electrical design should consider current power demands as well as the communication and power requirements for future traffic control devices, identification equipment, and other devices associated with potential automation of the ECF. Coordinate power requirements for vehicle barrier systems with the manufacturer. Barriers may require three phase, 220-volt service.

6-10.1 Alternate Electrical Power Source

Each ECF should have an alternate electrical power source. In the event of a loss of the primary electrical source, a reliable alternate power source is necessary to ensure continuous operation of the ECF. Use a standby generator or other equivalent means as the alternate electrical power source. Provide either automatic or manual starting of the generator and load transfer depending on the permissible duration of the electrical power outage per TM 5-811-1, *Electrical Power Supply and Distribution*. In some cases, installations may specify the use of portable generators in addition to stationary auxiliary electrical power sources. Where portable units are utilized, provide a suitable location and a power connection point. Equipment on back-up power should include gatehouse interior and exterior lighting, canopy lighting, exterior lighting in the Access Control Zone, roadway lighting within 100 ft (30.3m) of both sides of the Access Control Zone, roadway lighting at the vehicle barrier location(s), exterior lighting at the search area(s), traffic control arms, the active vehicle barrier charging motor (if applicable), and the uninterruptible power supply (UPS). The generator should be provided with sufficient fuel to provide back-up power for a period of at least twelve (12) hours or as required to support the installation's plan for refueling operations. If a fixed generator is provided, auto-start capability should be provided.

6-10.2 Uninterruptible Power Supply

In order to maintain security and barrier safety functions, provide an uninterruptible power supply (UPS) for use during generator starting and load transfer. The UPS system supports computerized equipment to avoid power disruption. As a minimum, provide UPS for the following: Primary communications system, duress alarm system, computers, CCTV systems, Intrusion Detection Systems (IDS), Enunciator, and Access Control Equipment including active vehicle barrier controls, barrier activation device (for emergency close), any traffic arms used for safety at the active vehicle barrier, traffic sensors, and barrier signals and warning lights. UPS will not normally be used for security lighting per TM 5-811-1. Due to the power requirements and nonlinear nature of lighting, avoid placing lighting loads on the UPS. Provide limited lighting at the control consoles in the gatehouse, inspection office, and overwatch position with stand-alone emergency lights. If the installation requires the use of UPS to support lighting, the design should clearly identify the nonlinear nature and switching patterns of the load to be served per TM 5-811-1. It may be desirable to place limited lighting on UPS to avoid restrike concerns; see paragraph 6-14 for further information.

6-10.3 Infrastructure

Frequently, new underground utilities for existing site elements must be placed within the right-of-way. New security systems and technology must also be installed. Such construction can disrupt traffic and interfere with the function of the ECF and thus pose a security risk. This can be a significant problem at an ECF that is frequently one of the most congested and critical areas on an installation, but for security reasons often has poor or no alternative routings.

To minimize the problem posed by such construction, anticipate future requirements in the design. To facilitate the installation of future electronic systems, spare duct bank and conduit should be run in a similar manner to that shown in Figure 6-7. At a minimum, provide a system of underground concrete-encased PVC duct bank and fiberglass/ composite hand-holes for distribution of power, control, and communications/data wiring from the ECF control center (gatehouse) to each remote device. If no detailed locations are pre-determined for remote devices, provide two hand-holes located at either end of each primary channelization island, one at each secondary channelization island, and similarly in the median. The layout should assume that in the future an automation device will be positioned prior to the rejection point located before the main identification checkpoint. Consider the possibility of access control systems being used for recording outbound lane activity in addition to inbound traffic identification.

6-10.4 General

Separate power and communications wiring in accordance with the *National Electrical Code (NFPA 70)* and the *National Electrical Safety Code (IEEE C2)*. Space should be reserved in the gatehouse for the controls and electric panel boards associated with the future control systems. The sites of ECFs are commonly congested and limited in size. Therefore, provide transformers with less flammable insulating fluid in order to facilitate the placement of the transformer closer to structures located in the ECF.

Figure 6-7 Typical Locations for Provision of Future Power/Control Connections

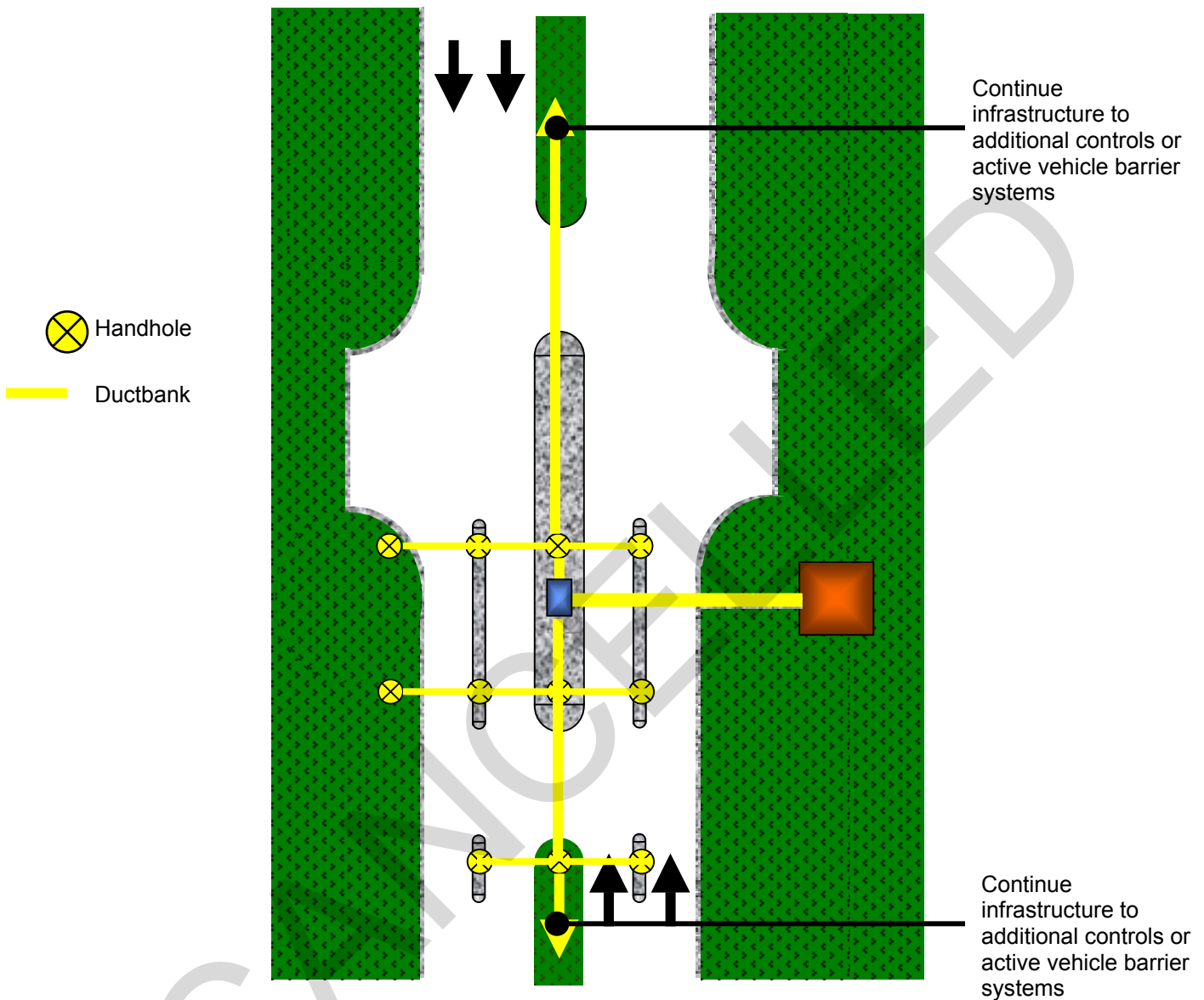

6-11 COMMUNICATIONS AND INFORMATION TECHNOLOGY

Each ECF should have at least two means of communication from the ECF to a central monitoring point, e.g. telephone, data or radio. Coordinate the requirements for radio-based communication with the installation. Some installations may require an emergency ring down telephone, which provides a direct, hard-wired duress alarm to the installation emergency dispatch or control center.

Provide a central duress alarm, which signals the installation emergency control center, dispatch center, or similar designated location in each gatehouse, sentry/guard booth, search area, and overwatch position. The duress alarm should be silent in the ECF to avoid alerting aggressors of its activation.

The ECF should be capable of connecting to installation-wide, information technology systems. If no installation wide data cabling system exists, this capability can be achieved through the use of the telephone system.

As discussed in the paragraph 6-10, to facilitate the installation of the electronic systems, run spare duct bank and conduit in a similar manner to that shown in Figure 6-7.

N Provide telecommunications capability for all guard facilities. Each guard facility should have provisions for connection to the installation wide computer network, as well to a central server to be located in the gatehouse.

AF As a minimum, provide telecommunications to inspection areas and visitor's centers. Overwatch positions will have telecommunication capability if required by the MAJCOM. Local Area Network (LAN) capability should be provided for inspection areas, visitor's centers, and locations utilizing Smart Gate technology.

6-12 **CLOSED CIRCUIT TELEVISION (CCTV)**

ECFs should be equipped with a CCTV system. The system should be equipped with digital video recording capability for 24 hours and 7 days a week operation. Camera(s) should provide an overwatch perspective of ECF operations to include the access control area, vehicle search areas, final denial barriers, and pedestrian access points. Each inbound lane of traffic should be equipped with cameras capable of reading license plates and viewing drivers in the identification check areas and search areas. The CCTV system should be monitored in the gatehouse, inspection office, and the Installation's Central Security Monitoring Station (MP Desk, 911 Desk, Installation Emergency Operations Center (EOC), etc.).

6-13 **WATER / WASTEWATER**

Provide water and waste system service for general use and for the unisex restroom in the gatehouse. If it is technically impossible or economically infeasible to provide these utilities to an ECF due to site constraints, the installation may wave the requirement to provide the water and waste utilities.

6-14 **EXTERIOR LIGHTING**

There are several references that discuss site lighting for general security purposes and entry control facilities (see *Traffic Engineering and Highway Safety Bulletin: Traffic Engineering for Better Gates*, IESNA HB-9, and TM 5-811-1). As indicated in TM 5-811-1, the quantity and quality of illumination will conform to the latest edition of the IESNA HB-9, except as modified in this UFC. The design should also follow the recommendations of IESNA G-1-03. Within the ECF, the lighting requirements vary depending on the zone of the entry control point.

6-14.1 Approach and Response Zone Lighting

The approach and response zones require typical roadway lighting. The roadway lighting should provide enough intensity so that pedestrians, security personnel, islands, signage, and other hazards are visible (*Traffic Engineering and Highway Safety Bulletin: Traffic Engineering for Better Gates.*) The lighting should not be directed in the driver's eyes and it should not backlight important signage. Table 6-4 provides the suggested minimum illuminances for the various areas of an ECF.

Transitional lighting is necessary on approaches to the entry control point so that drivers are not blinded during arrival and departure per IESNA HB-9. As discussed in the IESNA HB-9, a "visually safe installation must be free of glare and of uncontrolled, large differences in luminances. Maximum luminance ratios are important in order to avoid temporary reductions in visibility because of changes in readaptation when alternately looking at areas of widely different brightnesses." Follow the guidance provided in the IESNA HB-9 for limiting glare and adaptation effects. The illumination level should be reduced by 50 percent within the average distance traveled in 15 seconds in order to create proper transitional lighting. As an example, at an ECF with a speed limit of 25 mph (40 km/ph) where the illumination level is 4 foot-candles, the illumination level should be 2 foot-candles at 550 ft (168 m) and 1 foot-candle at 1,100 ft (334 m). A third transition is not needed. Actual lighting locations must be determined on a case-by-case basis and depend on the height, light source, and lens distribution.

6-14.2 Access Control Zone Lighting

In the Access Control Zone, area lighting is provided in the vicinity of the facilities. This lighting should be provided at a higher level as indicated in Table 6-4, to facilitate identification and inspection procedures. The lighting needs to illuminate the exterior and interior of a vehicle to facilitate identification of the occupants and the vehicle contents. Good vertical illuminance facilitates the identification and inspection procedures per IESNA HB-9. Lighting levels above those indicated in Table 6-4, may be appropriate where practical and desired. However, careful consideration of the potential adaptation problems and the design of the lighting of surrounding areas are required for the safety of traffic and security personnel.

It may also be necessary to provide additional task lighting in the ID and inspection areas to support adequate identification of vehicle occupants and contents. Such lighting should be directed transverse to the roadway; it will then illuminate the roadway in front of the gatehouse, the driver, and the guard. Per IESNA HB-9, lighting may also be mounted at or below pavement level to facilitate under vehicle inspection or associated with under vehicle inspection systems (see Section 7-3).

6-14.3 Lighting Level and Quality

As discussed in the IESNA HB-9, the light source spectral power distribution is important for identification and inspection tasks such as seeing hair, eye, clothing, complexion, and vehicle colors. The ability to identify colors accurately and confidently is determined by the light source spectral power distribution and the illuminance level. This capability is commonly referred to as color rendition and is measured by the color

rendition index (CRI). To ensure appropriate color rendition, use a light source with CRI greater than or equal to 65 in the ID check areas, and use any nominally white light source (CRI greater than or equal to 50) at the illuminances typically encountered in the remaining areas of an ECF.

When closed circuit television (CCTV) is used as part of the security operations, it is important to coordinate the lighting and CCTV system (TM 5-811-1.) TM 5-811-1 and the IESNA G-1-03 provide further information on designing lighting systems for use with CCTV.

Table 6-4 Minimum Exterior Illuminances

Application	Minimum Illuminance, footcandles (lx) at Ground Level*	Notes
Approach Zone and Response Zone Search Area Parking and Roadways	3 (30) Secondary Gates 3 (30) Primary Gates AF 4 (40) Primary Gates	Illuminance on the pavement and sidewalks Average to minimum levels shall not exceed 4:1
Access Control Zone Search Areas	5 (50) in general area 10 (100) or twice the immediate surrounding areas, whichever is greater at ID checking areas AF 20 (200) in ID checking areas under the canopy, and 30 (300) is required at the point of contact using additional task lighting	Average to minimum levels shall not exceed 3:1 In immediate area where identification and inspection occur. Also vert. Illuminance = 25% of horizontal illuminance should be provided at the level of the vehicle driver. AF This level of lighting is only required for the Air Force
*Ground level is defined as 6 in (150 mm) above ground level		

6-14.4 Restrike or Restart Capability

Another important consideration in the design of the site lighting, is the restart or restrike time for the selected lamps. Restart occurs when a lamp experiences a loss of power and there is a time delay before backup power restores power to the lamp and the subsequent restrike or restart of the lamp. Coordinate the restart capability with the user. As an example, high intensity discharge (HID) lamps are more energy conserving

than incandescent lamps, however, they require several minutes to warm up and restart after power is interrupted. This period of time, which could be 15 to 20 minutes, is unsatisfactory for security operations. The installation should designate the maximum acceptable period for which loss of illumination can be tolerated, however, without specific data two (2) minutes is considered the maximum outage period acceptable per TM 5-811-1. The selection of light sources, especially in the Access Control Zone, should include an evaluation of restart or restrike time. It may be necessary to provide lamps and auxiliary equipment for rapid startup and restrike to provide minimal adequate lighting in the event of a power interruption.

6-14.5 General Requirements

Provide the ECF with multiple, redundant luminaires to ensure the loss of a single luminaire does not seriously degrade the total available lighting available for security personnel.

The lighting at the ECF should be designed as controlled lighting, to reduce light pollution and increase traffic safety. Glare projection or glare lighting should be avoided where a safety hazard would be created. Use luminaires that are classified as cutoff or semi-cutoff.

Where an ECF includes modifications to the installation perimeter lighting system refer to IESNA HB-9 and TM 5-811-1 for guidance on the design of installation perimeter lighting.

6-15 PERIMETER FENCE AND GATE

The ECF typically begins at the installation perimeter. In most cases the perimeter is defined and secured with a fence. Each ECF should have a gate enabling the ECF to be closed at the installation perimeter when not in use. This gate should be reinforced with cables to increase resistance to a moving vehicle threat. In addition, the gate must have Type III Barricade markings in accordance with MUTCD (3 per lane) secured to the gate horizontally. This configuration enables a reduced potential penetration, maximizes standoff, and prevents entry of pedestrians during periods when the ECF is not in use.

A The fence gates at ACPs must maintain an equivalent level of security as the adjacent fence/barriers.

6-16 PERSONNEL PROTECTION

Design the ECF to ensure safety of the security personnel operating the access control zone. All ECF facilities, or other manned posts, should be afforded crash protection (from traffic in either direction). Passive barriers such as bollards, reinforced concrete walls or knee-walls, or crash cushions should be used to protect personnel standing on the traffic islands.

One example of a barrier system would be a short, concrete bull nose wall at the beginning and end of an elevated island. By elevating the personnel on an island, they are protected from accidental impact during identification checks. The bull nose is designed to protect the personnel from potential injury caused by a vehicle leaving the roadway or lane. This type of system not only enhances the safety of security personnel, but it also offers the personnel cover in the event of an attack. Another example would be providing 9 in (229 mm) high curbs where ID checks are performed to increase the safety for entry controllers. However, if crash cushions or concrete deflections are constructed in advance of these positions, the curbs should be 6 in (152mm) high so that the checkers are not too high above the seated drivers.

See the *RSDG-3* for further information concerning barriers and crash cushions. The maximum height of crash protection barriers will be 3 ft (1 m) or the elevation of the guard facility window sills, whichever is less, to avoid conflicts with traffic or guard sightlines.

6-17 VISITORS CENTER DESIGN CRITERIA

The Visitors Center should support processing 12 to 20 visitors per hour per processor. Peak hourly requirements at the installation determine the required processing capacity. Design the visitor center in accordance with UFC 1-200-01 , UFC 3-310-01 and UFC 4-010-01 . As a public facility, the visitor center must comply with the [ADAAG](#). The following sections outline the considerations for the design of a Visitors Center. Figure 6-8 illustrates a notional layout of a visitor's center.

- **N** ● **MC** The Visitor Center should be planned in accordance with NAVFAC P-80.

Figure 6-8 Visitors Center: Notional Layout

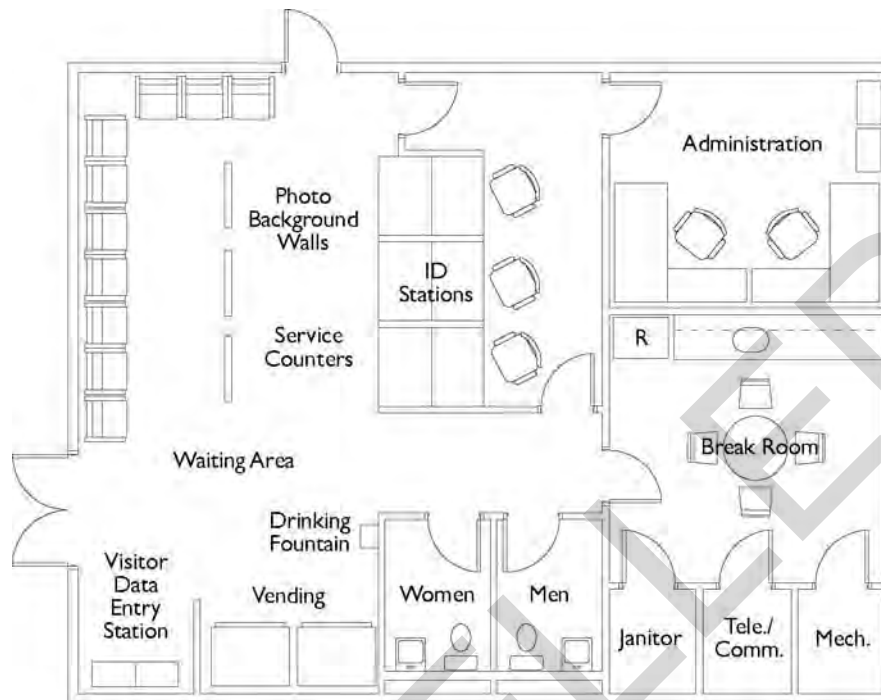

6-17.1 Waiting Area

- Provide a comfortable environment with adequate seating for visitors to await processing (based on peak hourly requirements.)
- Provide a water fountain.
- Provide a vestibule if required by local climatic conditions.

AF The following additional requirements apply to Air Force installations:

- Provide a TV with cable service.
- Provide an area for vending machines that is accessible to visitors.
- Provide a designated area for a computer station to be used by visitors to enter registration information. This computer station should network from each processing station to the office area so that registration information can be accessed.

6-17.2 Parking

Provide adequate parking based on typical peak volume. Provide reserved parking spaces for a minimum of two SF personnel vehicles. Provide Reserved Handicapped parking spaces ADAAG.

6-17.3 Service Counter

- Include sufficient desktop work surfaces and countertop space for one to three processing stations, depending on the size of the installation and anticipated maximum processing requirements. Allow three to five minutes per person for

processing. Assume that approximately 12-20 people can be processed each hour on average per processing station.

- Include a computer station with networking and Internet access for each processing station.
- Provide photo ID capability at each processing station. Install a photo backdrop. Provide wiring at each processing station for a duress alarm.

6-17.4 Administration Office

- Provide an enclosed office for two workstations and a filing cabinet.
- Provide video surveillance equipment for the interior and exterior areas of the Visitors Center.
- Provide Internet connectivity, telecommunications, a closed-circuit television system, and a radio battery recharging area.

6-17.5 Break Room

- Locate the break room so that it is out of the direct line of sight of the waiting/seating area.
- Provide a refrigerator, microwave, and sink.
- Provide seating for four SF personnel.

6-17.6 Restrooms

- Provide men's and women's restrooms for public and security personnel use per ADAAG requirements. Provide accommodations for baby-changing stations in each restroom.

6-17.7 Environmental Control

Provide heating and cooling appropriate for personnel, the electronic and electrical systems or fixtures, and the security support equipment. The HVAC requirements should be based on existing service design guidance and installation requirements.

6-18 PEDESTRIAN CONSIDERATIONS

Some installations have a significant pedestrian volume. When pedestrian access control is required, ensure that proper sidewalk and safety provisions direct pedestrian traffic to the Access Control Zone and separate it from vehicular traffic. Design pedestrian access to ensure security personnel maintain visual contact with the pedestrians as they approach the ECF. Plan sidewalks to integrate into the existing site layout and accommodate new facilities. Breaks may be provided in the passive barriers surrounding the ECF to allow pedestrian access to the ECF. Any break in the passive barrier should not exceed 3 ft (1 m) in width. Provide sidewalks with a minimum width of 4 ft (1.2 m). Crosswalks should be 6 ft (1.8 m) in wide.

Where warranted based on pedestrian usage, incorporate turnstiles or similar devices that can be automated to facilitate authorized access control. Ensure turnstiles

incorporate access control systems or are capable of being upgraded in the future. Other considerations in the selection of turnstiles or similar access control devices include the control of potential tailgating and the likelihood that personnel will have equipment or luggage, which may require additional space in the turnstile. Consider if pedestrian inspection areas will be required based on pedestrian demand and any requirement to search personnel and packages. Design elements for pedestrians should be compliant with ADAAG requirements.

6-19 **PARKING**

Incorporate parking in the design of the Access Control Zone to support security vehicles and vehicles associated with shift changes of security personnel. Where an ECF includes a Visitor Center and more than two visitors will be concurrently processed on a routine basis, an off-street parking lot is required. Locate spaces to minimize the walking distance and potential interference with moving or parked vehicles. In addition, consider the requirements of UFC 4-010-01 and incorporate as necessary.

6-20 **AESTHETICS**

Entry control facilities provide the first public impression of the installation. They must present the proper appearance for visitors, employees, and military personnel. The layout, landscaping, and architecture of the facilities are factors in this image. The architectural design of the facilities will comply with the installation or command's architectural design standards.

6-21 **LANDSCAPING**

Landscaping can greatly improve the aesthetics of the ECF and the impressions of personnel and visitors. Include line-of-sight considerations in the landscape design. It is important that the line-of-sight of security personnel through the ECF not be impeded. This includes consideration of overwatch positions, which require an adequate and acceptable line-of-fire. Landscaping can also provide natural features that can act as passive vehicle barriers to provide containment of vehicles through the ECF. Ditches, berms, slope-cuts, and other natural features can be designed as passive vehicle barriers. In addition, the existing natural terrain may be impassable by vehicles and incorporated into the design. Examples of using natural terrain would be using bounding wetlands, dense forest, etc. as passive barriers. The use of the natural terrain and landscaping aids in integrating the ECF into the existing landscape, improves aesthetics and image, and is encouraged.

6-22 **CONSTRUCTION PHASING**

If the project involves the modification of an existing entry control facility, pay considerable attention to the phasing of construction. In most cases, it is desirable to minimize the interruption of the entry control facility operations especially during periods of peak demand.

7 LARGE COMMERCIAL VEHICLE AND TRUCK INSPECTION FACILITIES

7-1 INTRODUCTION

A large vehicle inspection facility may be a separate centralized facility or combined into the functions of a commercial/large vehicle ECF as indicated in the function diagram in Figure 3-3. The following guidelines are intended to provide general considerations in the design of such an inspection facility.

7-2 MISSION AND OPERATION

An installation large vehicle inspection facility is intended to be the single point of inspection for all large commercial and truck traffic intending to enter the installation. It is envisioned that once a vehicle is inspected and authorized to access an installation, that the vehicle may be tracked and monitored until it enters and exits the installation.

7-3 INSPECTION EQUIPMENT

Base the design of the large vehicle inspection station on the use of large vehicle inspection equipment. Some examples of these technologies are x-ray, ion mobility spectrometry, gamma ray imaging, and neutron analysis. Since many of these devices are not currently deployed, the design should include space for vehicle inspection equipment and provide utility conduits to the anticipated location for future use. The inspection equipment may be a mobile or fixed installation. It should be noted that some detection equipment is built-in to a large, drive-through structure. If this type of equipment is anticipated, then this could be coordinated and incorporated into the inspection office and overhead canopy facilities.

In addition, many installations desire CCTV inspection of the top and underside of vehicles. Mount these cameras on the overhead canopy and in the pavement below the vehicle. As a minimum, the inspection facility should possess the infrastructure to support the installation of CCTV inspection equipment, including adequate lighting to illuminate the underside of the vehicles during inspection. Some installations may also consider the use of vehicle inspection pits, although this type of facility is not recommended due to commonly encountered soil conditions and anticipated operational safety issues. The following sections contain information on various inspection related devices in order to facilitate the layout of the truck inspection facility and the determination of the required infrastructure to support inspection equipment. **Inclusion of any equipment in this section does not constitute an endorsement. The equipment shown is for illustration purposes only.**

7-3.1 Under Vehicle Lighting System

These are systems used to illuminate the underside or other areas of a vehicle. The quality of light is as important as the quantity. The system should aim to eliminate shadows and create contrast. The systems are typically low cost, about \$5000 for an effective system

7-3.2 CCTV Under Vehicle Search Systems (UVSS)

Several companies have developed fixed and portable CCTV systems for facilitating under vehicle search. This technology is meant to enhance or replace existing inspection techniques such as manual inspection using mirrors or accessing the underside of the vehicle from an inspection pit. Contact the manufacturers of these systems to ensure proper installation and operation of this equipment. The effectiveness of these systems has not been fully assessed and results of initial testing vary. Therefore, the use of CCTV UVSS should be in accordance with Service guidelines.

If a CCTV UVSS is utilized, evaluate the following considerations and guidelines.

- Consider maintenance requirements. Is the equipment self-cleaning?
- If installed below grade, is the enclosure waterproof? Is the vault and equipment designed to support large vehicle loading?
- Install the system far enough in advance of the access control point so that the largest vehicle can pass over the equipment without entering the installation.
- Drainage should be established such that water drains away from the equipment.
- When providing drains from the equipment enclosure, provide backflow prevention valves to prevent water from entering the vault. Ensure any water that may be captured in the vault will not drain through control conduit to the control center.
- The electrical circuit serving the equipment should be a ground fault interrupt (GFI) circuit.
- Monitoring area should be free of glare.
- Vehicle speed should be kept below 15 mph (24.1 km/h) to ensure adequate performance.
- Where exposed to freezing temperatures, the equipment installation should include heaters.

7-3.3 Cargo and Vehicle Inspection Systems

There are many types of automated inspection equipment for large vehicle or cargo inspection. Some of the types available, which provide an image of the contents of a vehicle or container, include X-ray and Gamma Ray inspection systems. There are other systems available, such as neutron or vapor/particle analysis, which aim to detect the common chemical elements associated with explosives or other contraband. Currently the most commonly used equipment is imaging systems. Generally, this equipment can be categorized into mobile and fixed installations. Many installations are considering procuring mobile systems that afford the possibility of varying the location of the equipment amongst various entry control facilities. Installations that plan centralized truck inspection facilities should consider a fixed installation, which potentially has an increased throughput and a reduced space requirement. Due to the wide-ranging requirements for the different manufactured systems, it is not possible to provide detailed guidance that will support all types of this equipment. However, this section will attempt to identify the important infrastructure considerations associated with both

mobile and fixed x-ray/gamma-ray inspection systems. Several manufacturers were consulted to obtain the data used to develop the following guidelines. However, consult with manufacturers of these systems during the design of an entry control facility to ensure data concerning operational considerations is current and the best available.

These systems offer the ability to inspect vehicles or containers without removing the cargo. The equipment typically consists of a transmitter (x-ray or gamma ray) and a detector on the opposite side of the target vehicle. Gamma ray systems utilize a low-level, gamma-ray radiation source to generate a beam of gamma rays to penetrate the object. The detectors on the opposite side then measure the amount of gamma ray absorption. This data is then translated into an image of the contents of the vehicle or container. X-ray systems typically utilize electro-mechanical equipment to generate X-rays to penetrate the object. Detectors on the opposite side then record the x-ray transmission, which is then translated into an image. The MobileSearch and Shaped Energy ISO Search systems (discussed below) also include a detector on the transmission side of the unit that detects the x-ray reflections, which occur from organic materials, producing a second type of image of the contents.

7-3.3.1 Safety and Regulatory Considerations

Due to the use of gamma or x-ray radiation, there are safety and regulatory considerations in the use of these systems. The requirements vary depending on the system. Normally an exclusion zone, an area where personnel are not permitted during operation of the equipment, is established within and around the inspection equipment. The region outside of the exclusion zone is considered safe for personnel during scanning operations. The size of the exclusion zone varies greatly depending on the type of equipment.

Nuclear Regulatory Commission regulations state that radiation dose limits in Public-Uncontrolled areas are 2 mR in any hour or 100 mR in any year. Therefore depending on the characteristics of the source, the frequency of scans, and the expected occupancies, the exclusion zone can vary. Additionally, a shielding wall can be constructed to reduce the dose substantially. Some x-ray systems have qualified as a "cabinet x-ray system" in accordance with FDA regulations or similar standards, meaning minimal shielding is required and the exclusion zone does not extend outside of the footprint of the inspection area. In order to qualify for this designation, FDA regulations require an emission limit of 0.5 mR per hour at 2 in (5 cm) from the surface of the cabinet. Other regulatory considerations are that systems utilizing radioactive sources may require operation under a radiation materials license held and administered by the owner of the equipment (the installation) and a permit for operation may be required.

7-3.3.2 Mobile Vehicle Inspection Systems (Imaging)

There are several truck-based, mobile large vehicle or container inspection systems currently available. Two examples are illustrated in Figures 7-1 and 7-2. These systems utilize a boom type arm to form an inspection tunnel. In no case are the vehicle operators to remain in the vehicle during a scan. The operator is either to exit the vehicle or the vehicle is positioned such that the operator is outside the scan area

prior to the scan initiating. In order to properly plan the required space for this type of equipment, the detailed operational procedures must be reviewed. The MobileSearch system is designed to acquire images by traveling at a constant velocity past any number of parked vehicles in a line. This is accomplished using an electric secondary drive motor that propels the vehicle at a constant velocity. The MobileSearch system is capable of scanning only on the “driver’s side” of the MobileSearch vehicle. The maximum height of the boom is 16 ft 6 in (5.03 m), with a maximum scanned vehicle dimension of 8 ft 6 in (2.59m) wide x 14 ft (4.27 m) high. The width of the equipment with boom and stairs deployed is 25 ft (7.62 m).

CANCELLED

Figure 7-1 MobileSearch Advanced X-Ray Portable Inspection System

(Photos Courtesy of American Science and Engineering, Inc.)

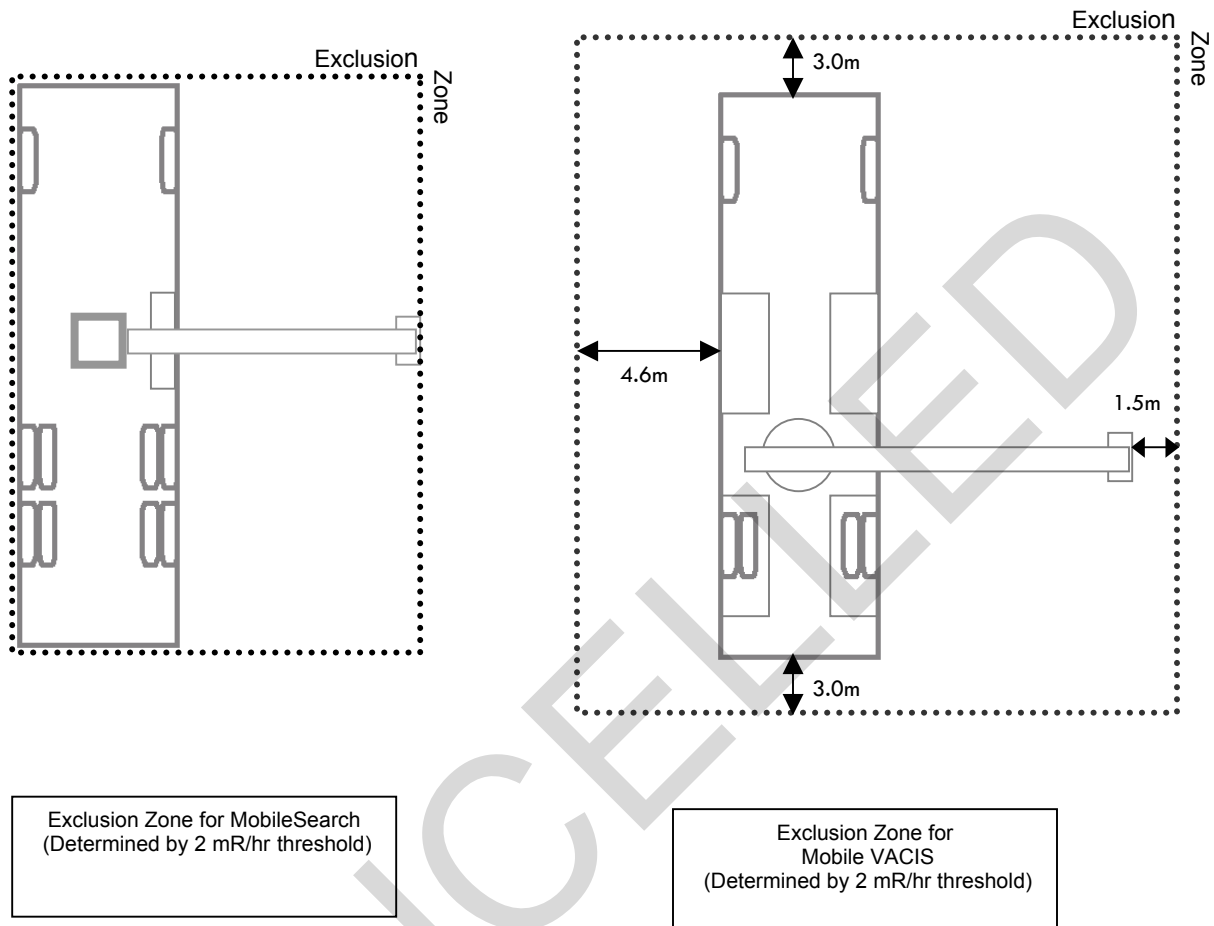

Figure 7-2 Mobile VACIS – Gamma Ray Imaging System

(Photos Courtesy of Science Applications International Corporation, Inc.)



Figure 7-3 Example Exclusion Zones for Mobile Inspection Systems



The Mobile VACIS system is designed to acquire images by either traveling past a stationary vehicle or in a pass-through mode as a moving vehicle passes through the scan area. Additionally, the system can conduct operations on either side of the VACIS vehicle. The vehicle requires a clear height of 20 ft (6.1 m) and a surface grade of less than 5%. The exclusion zone for each system is illustrated in figure 7-3. Note that this information was based on available manufacturer literature and it must be verified with the manufacturer of the specific system anticipated. Also these exclusion zones are based on the 2mR in any one-hour dose limit. Therefore, the manufacturers should be contacted for the radiation rate data beyond the exclusion zone to determine the zone appropriate for a specific application. The 100 mR per year limit may govern the location of a permanent facility. Since the portable units are entirely self-contained they require no land based power or other facilities. If an entry control facility or truck inspection station design is to incorporate a portable vehicle inspection system similar to those illustrated above, but *the system is unspecified* the following recommendations regarding site development should be followed.

- Provide a 35 ft (10.7 m) wide x 110 ft (33.5 m) long paved inspection area for use by the portable equipment. This provides enough width for the inspection system and the lane of travel for the vehicles to be inspected. The length is

sufficient to allow the inspection system to scan a large stationary vehicle and maneuver.

- To increase throughput, provide a longer inspection lane for operation of a portable system that scans stationary vehicles. This will allow the system to scan several vehicles at one time.
- Provide no canopy over the inspection area planned or dedicated for use by the portable equipment unless the clear height is a minimum of 22 ft (6.7 m).
- Site all permanent facilities or guard posts such that they would remain outside of the exclusion zone. A shielding wall may be required if there are occupied buildings or areas near the detector.
- Site all permanent facilities such that they are not in the direction of travel of the radiation beam unless the distance between the inspection vehicle and the facility is at least 300 ft (90m.) The intent is to insure that the 100 mR / year radiation dose limit is not exceeded for personnel who may be in the direction of travel of the radiation. This distance can be reduced to 75.5 ft (23 m) if a 12 in (305 mm) wide x 8 ft (2.4 m) high (minimum) concrete shielding wall is provided between the radiation source and any facility of concern. The determination of exclusion zones should also consider oblique scan angles, which some inspection systems can employ.

7-3.3.3 Fixed / Portable Vehicle X-Ray Inspection Systems (Imaging)

There is a wide range of fixed vehicle inspection systems. The systems operate in a manner very similar to the mobile systems. The types of systems can be categorized as follows:

- Stationary Target Vehicle - transmission source and detector travel past the target on a rail system or similar platform;
- Controlled Target Vehicle - vehicle is moved through a fixed inspection system on a platen or gantry transport, on a rail system, or similar device; and
- A Portal system - with a fixed inspection system where vehicles pass-through the equipment

Examples of these systems are illustrated in Figures 7-4 to 7-6. The space requirements vary from minimal for the portal system to significant for a transport or stationary vehicle system. As encountered for the mobile inspection systems, exclusion zones may be required for the fixed systems. For illustration purposes, the exclusion zones and/or radiation levels associated with the SAIC VACIS II and AS&E Shaped Energy ISO Search systems are provided in Figures 7-7 to 7-9. Note that the VACIS II exclusion zones depend on the type of radioactive isotope used and the presence of a shielding wall. Some systems have no exclusion zone outside of the actual scan area. In no case are the vehicle operators to remain in the vehicle during a scan. The operator is either to exit the vehicle or the vehicle is positioned such that the operator is outside the scan area prior to the scan initiating.



Figure 7-4 VACIS II - Gamma Ray Imaging System

(Photos Courtesy of Science Applications International Corporation, Inc.)

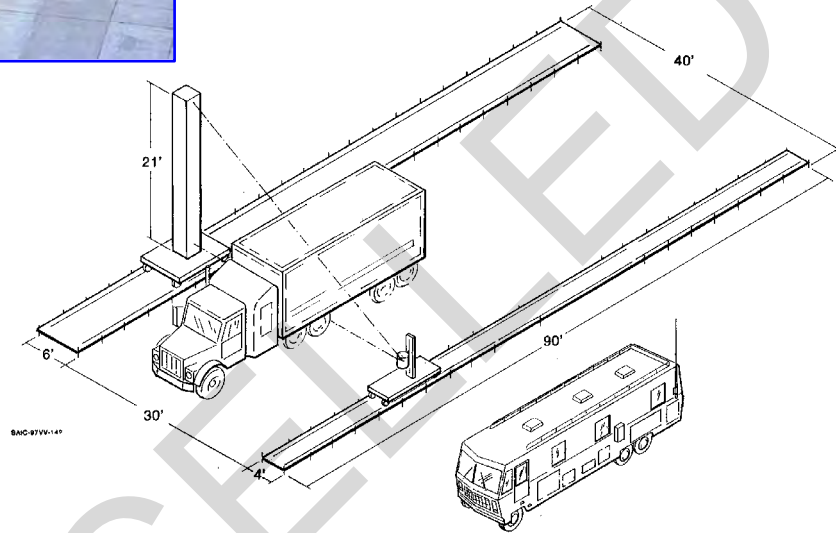
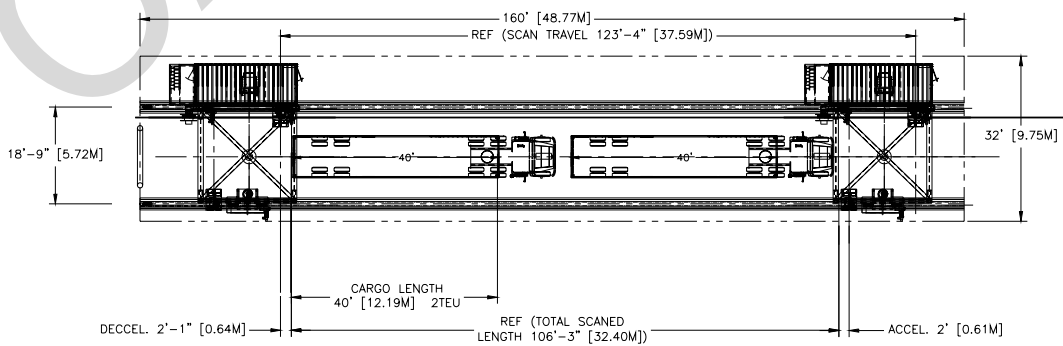
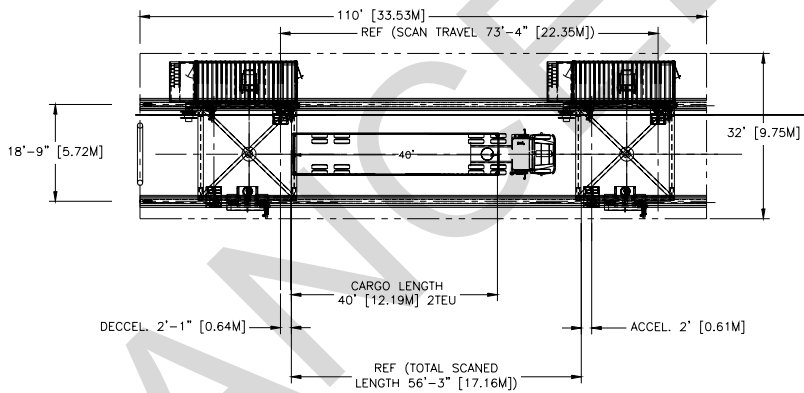

Figure 7-5 Portal VACIS - Gamma Ray Imaging System

(Photos Courtesy of Science Applications International Corporation, Inc.)



Figure 7-6 Shaped Energy ISO Search X-Ray Inspection System
(Rendering and Drawings Courtesy of American Science and Engineering, Inc.)



7-3.3.3.1 Power Requirements for Fixed/Portable Inspection Equipment

The power requirements of fixed/portable systems vary widely depending on the system type. Gamma-ray systems use a radioactive source to generate the transmission rays. This requires less power compared to an X-ray system, which generates the x-ray transmission using electro-mechanical means. Table 7-1 illustrates the potential power requirements.

Table 7-1 Sample Power Requirements for Fixed Inspection Systems

Inspection System	Power Requirements	Notes
AS&E Shaped Energy ISOsearch X-ray Inspection System	100 kVA site power	Includes power to inspection equipment and power for gantry transport
SAIC Portal VACIS	3 kVA <u>per lane</u> 120/240 VAC	
SAIC VACIS II (track system)	30A , 220-240 VAC	Documentation indicates 5kW of backup power is sufficient for the VACIS II system components, additional power required for operating booth, HVAC, etc.

If an inspection system is specified, consult with the manufacturer concerning the latest requirements for power. If no inspection system is specified, however, the future inclusion of a system is likely, the design of the electrical power system should consider an allowance to provide sufficient site power to support this future requirement.

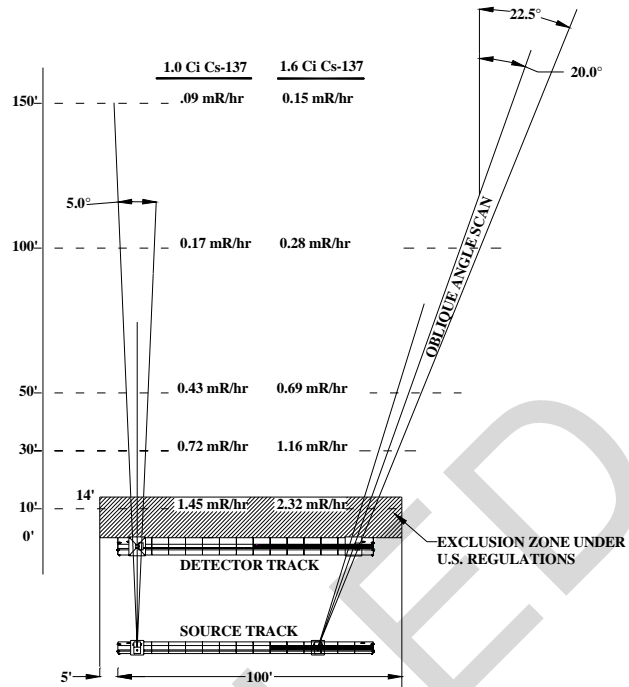

NOTE: EXCLUSION ZONE PERIMETER SHOWN FOR TYPICAL U.S. INSTALLATION FOR 1.6 Ci SOURCE AT 2.0 mR/hr LIMIT.

**Figure 7-7 VACIS II -
Gamma Ray Imaging
System Exclusion Zones**

Cesium Source with and without
Shielding Wall

(Courtesy of Science
Applications International
Corporation, Inc.)

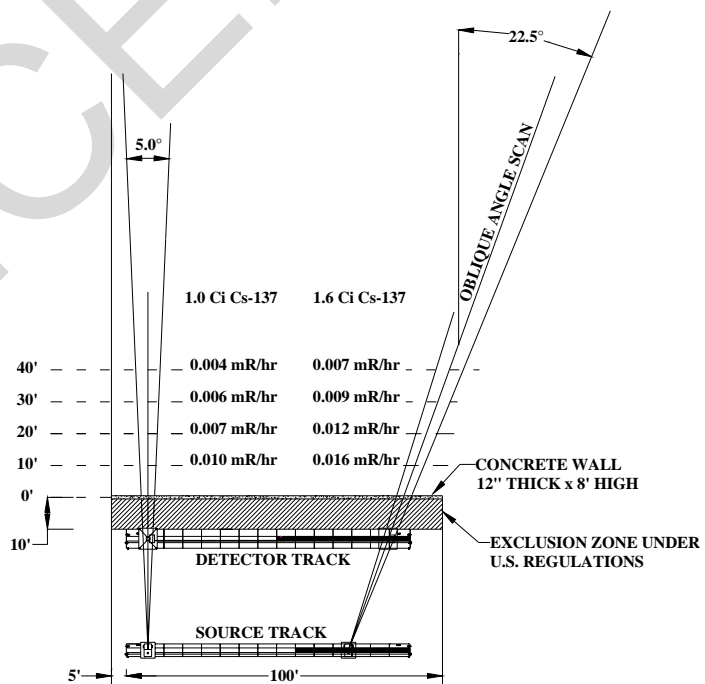

NOTE: Value at wall rear for 1.0 Ci Cs source is 0.015 mR/hr.
Value at wall rear for 1.6 Ci Cs source is 0.023 mR/hr.

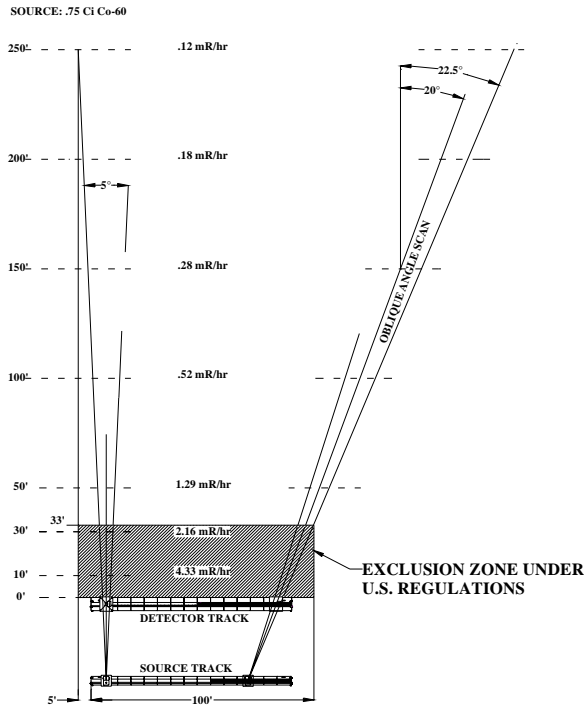

NOTE: THE EXCLUSION ZONE PERIMETER SHOWN IS BASED ON THE U.S. STANDARD OF A 2 mR/hr LIMIT.

Figure 7-8 VACIS II - Gamma Ray Imaging System Exclusion Zones

Cobalt Source with and without Shielding Wall

(Courtesy of Science Applications International Corporation, Inc.)

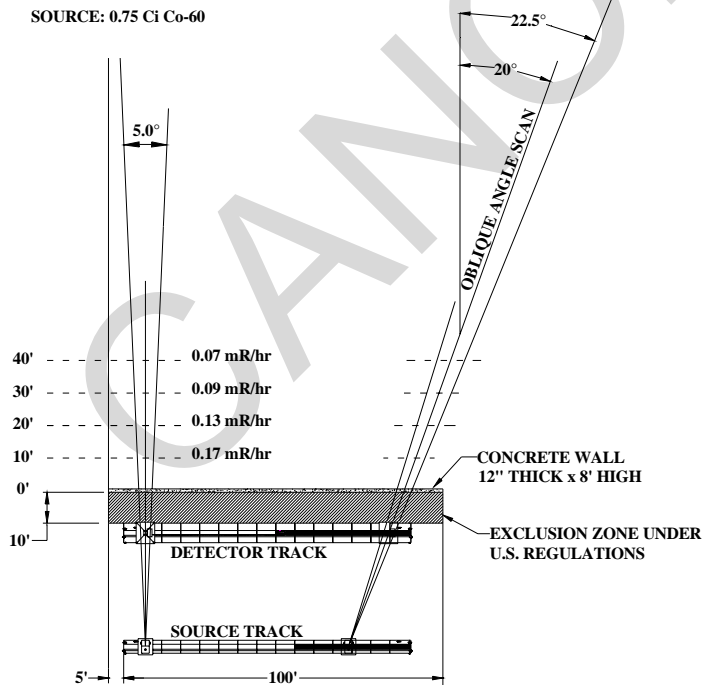

NOTE: Value at wall rear is 0.255 mR/hr.

Figure 7-9 Shaped Energy ISO Search X-Ray System Radiation Levels
(Courtesy of American Science and Engineering, Inc.)

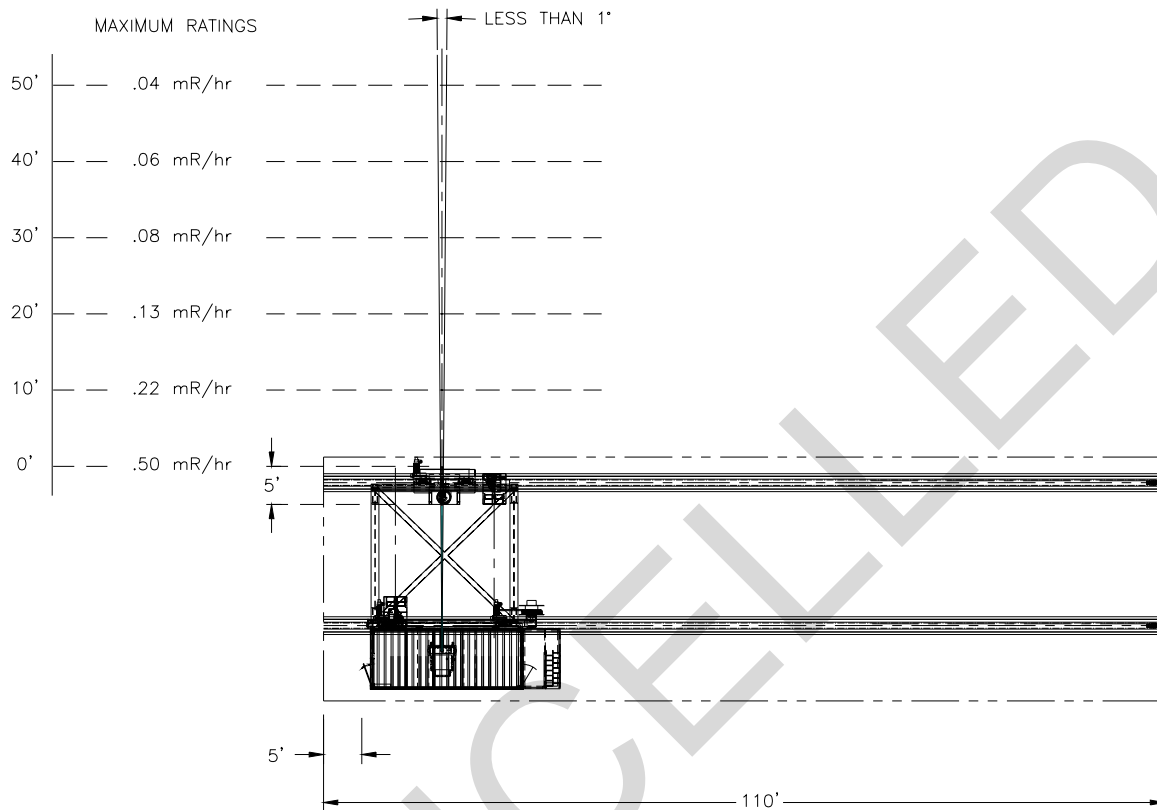

7-3.3.3.2 Space Requirements for Fixed/Portable System

The space requirements of these systems also vary greatly. Systems that require a stationary vehicle or move the vehicle on a rail or platen system passed fixed detectors require the most space. A portal system requires minimal space. If an entry control facility or truck inspection station design is to incorporate a fixed vehicle inspection system similar to those illustrated above, but if the *system is unspecified* the following recommendations regarding site development should be followed.

- Provide a 35 ft (10.7 m) wide x 110 ft (33.5 m) long paved inspection area for use by the fixed equipment. This provides enough width for the inspection system and the length of travel for the equipment or a platen/gantry system. The length is sufficient to allow the inspection system to scan a large stationary vehicle and maneuver.
- To increase throughput, provide a longer inspection lane for operation of a portable system that scans stationary vehicles, allowing the system to scan several vehicles at one time.
- Provide no canopy over the inspection lanes dedicated for use by the fixed equipment unless the clear height is a minimum of 22 ft (6.7 m). This is

conservative since some systems will operate with a clear height of 15 feet (4.57 m) and could be installed under a canopy.

- Consider provisions for automated inspection equipment to be installed prior to the main inspection area. It is often desirable to complete any automated inspection such as UVSS or imaging prior to arriving at the main, covered inspection area for identification and further inspection tasks. Therefore these functions should precede the final inspection area. Most inspection systems are designed to be outside and do not require shelter from the weather.
- Site all permanent facilities or guard posts such that they would remain outside of the exclusion zone. A shielding wall may be required if there are occupied buildings or areas near the detector.
- Site all permanent facilities such that they are not in the direction of travel of the transmission beam unless the distance between the inspection vehicle and the facility is at least 300 ft (90m.) The intent is to insure that the 100 mR / year radiation dose limit is not exceeded for personnel who may be in the direction of travel of the radiation. This distance can be reduced if a shielding wall meeting manufacturer's guidance is provided between the radiation source and any facility of concern.
- Provide channelization islands a minimum of 5 ft (1.5 m) wide to support the future installation of a portal inspection system.

Paragraph 7-4 provides layout design recommendations intended to provide flexibility for the future inclusion of these systems.

7-4 LAYOUT

The layout of the large vehicle inspection facility is extremely important to ensure the facility will function properly. The civil design should consider the turning radius and other operating characteristics of the expected vehicle types. In addition, the facility should have multiple lanes of inspection to support different vehicle types, or varying inspection levels. The design should have adequate stacking distances for the anticipated queue and parking for vehicles to be inspected and security vehicles. Size parking areas for the range of expected vehicles and consider the anticipated volume of vehicles to be inspected.

Consider providing a "sally port" in the inspection area. A "sally port" configuration is created through the use of vehicle barricades or traffic gates. These barriers are intended to confine the vehicle during inspection until it is determined that the vehicle is authorized to proceed or if the vehicle is denied admission to the installation. The barriers can also be used to aid in positioning the vehicle relative to inspection equipment.

Some installations may require screening of the inspection operations from the remaining portions of the ECF. Screening may increase safety and shields the inspection procedures from public view to prevent visual surveillance from unauthorized personnel. As discussed in section 7-3, the inspection equipment can have a significant impact on the layout of a truck inspection facility. It is difficult to develop a layout that can support all potential types of automated inspection equipment. If the installation

specifies the anticipated inspection systems, then the layout can be customized. If the specific system is not identified, but the use of imaging or related inspection equipment is anticipated, the layout should facilitate the future incorporation of this equipment. Figures 7-10 through 7-12 illustrate the incorporation of several types of inspection equipment into the layout of a large vehicle inspection facility. As illustrated, it is possible to provide areas for future equipment or as a minimum reserve space for the equipment when developing the site plan for an inspection facility. The following sections provide further detailed design guidance.

CANCELLED

Figure 7-10 Large Vehicle Inspection Facility - Mobile Imaging Systems

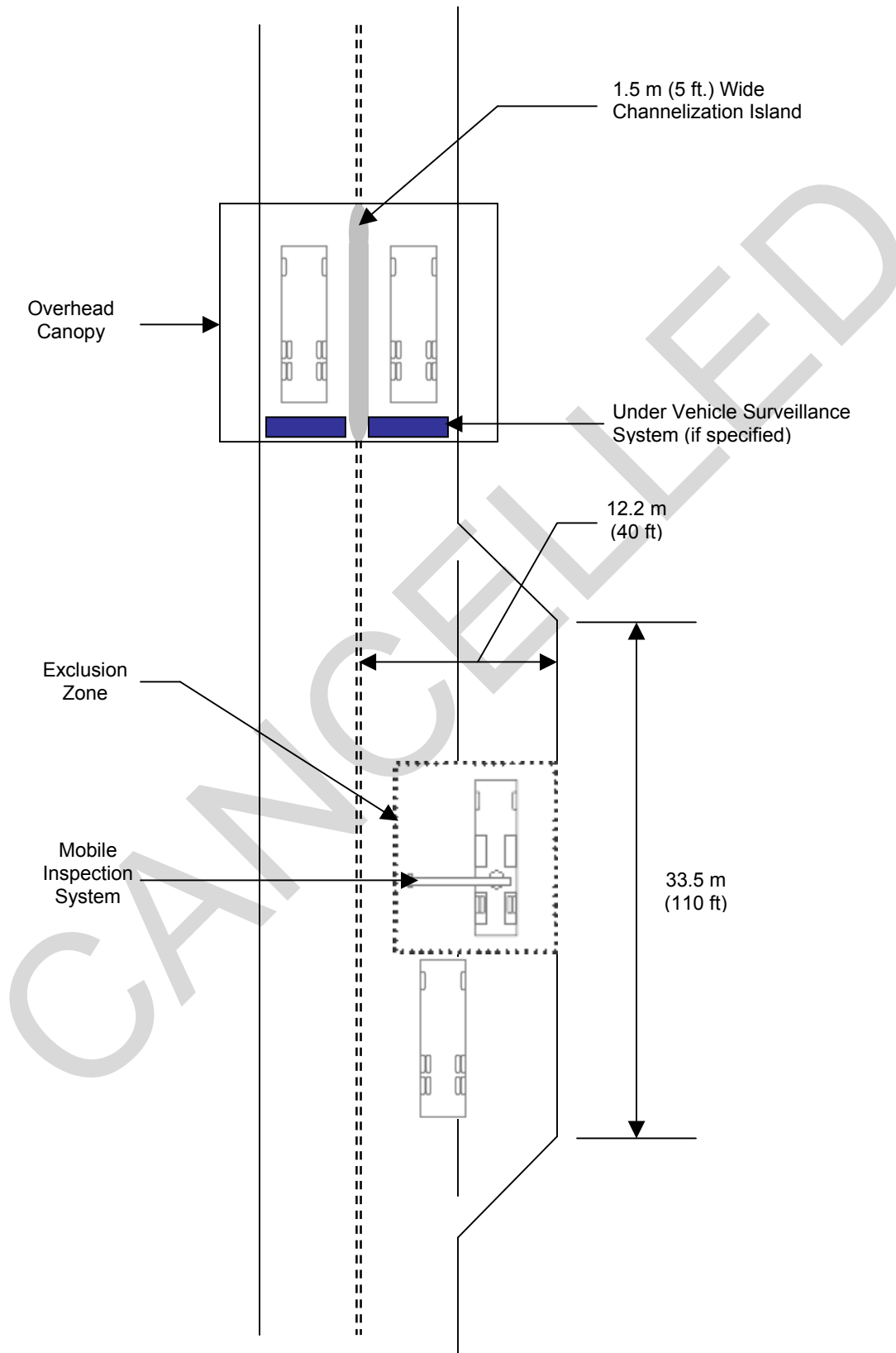

Figure 7-11 Large Vehicle Inspection Facility - Fixed Imaging System

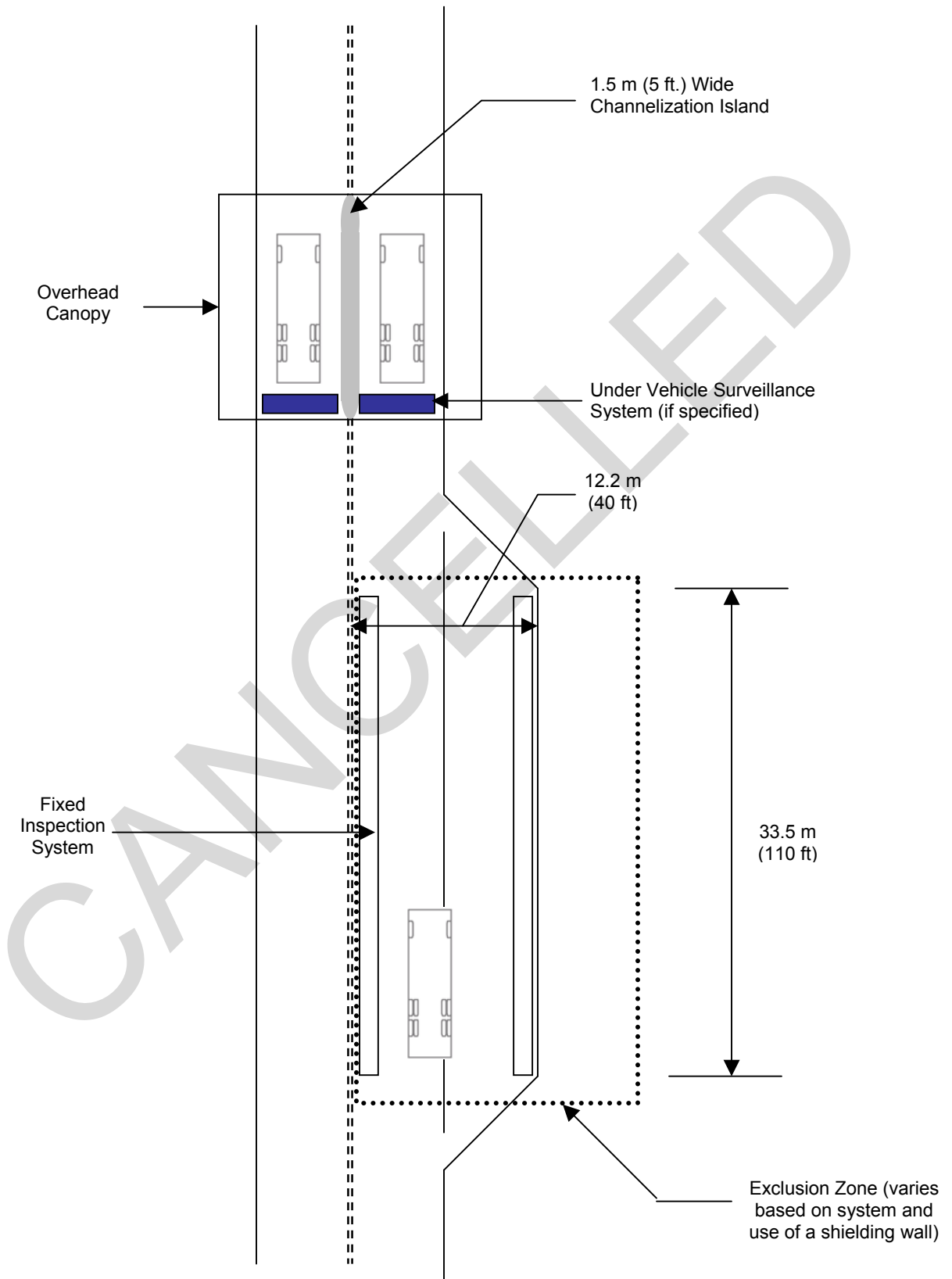
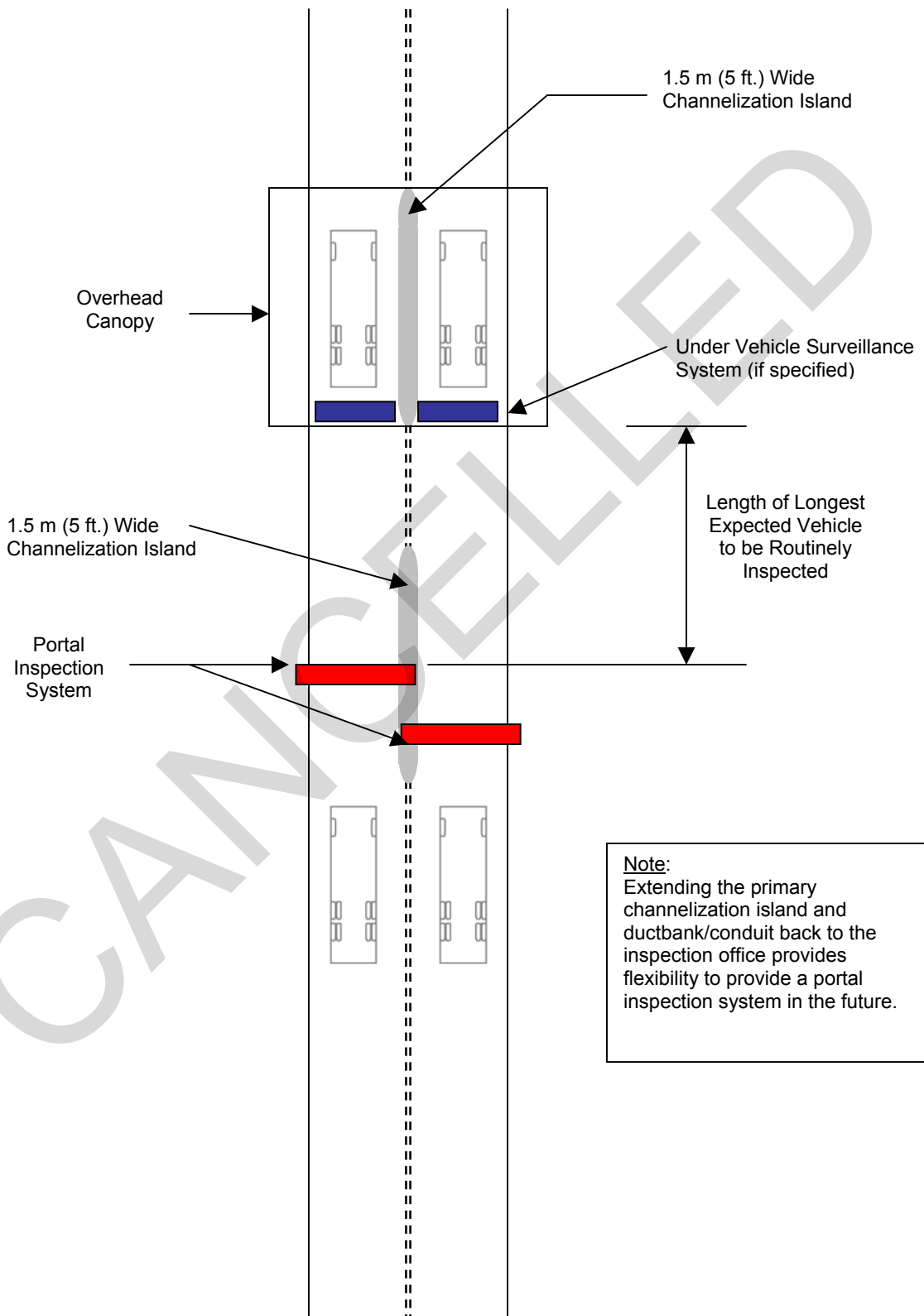

Figure 7-12 Large Vehicle Inspection Facility - Portal Imaging System



7-4.1 Geometric Design of Roadways

Design roadways in a Large Vehicle Inspection Facility in accordance with the guidelines provided in Section 6-6 and the latest edition of the AASHTO Policy on Geometric Design of Highways and Streets except as modified in this section. Additionally, consider the requirements to support oversized, atypical vehicles such as those frequently encountered during construction operations.

7-4.1.1 Channelization Islands

The minimum raised channelization island should be 5 ft (1.5 m) wide, 6 in (152 mm) high and 50 ft (15.2 m) long. A channelization island should be provided between each incoming traffic lane. These islands provide a safe position for security personnel and a location to mount present/future vehicle inspection devices.

7-4.1.2 Lane Width

The minimum lane width should be 16 ft (4.9 m) in the inspection area. A preferred lane width of 18 ft (5.5 m) is recommended. The increased lane widths are required to facilitate manual inspection procedures and to support the potential for future automated inspection technology. Outside of the inspection area, the minimum lane width facilitating the flow of traffic and other operations, is 12 ft (3.6 m).

AF Inspection areas should be a minimum of 18 x 80 ft (5.5 x 24.4 m) x 17 feet 6 in (5.4 m) high that can be enclosed to protect inspection equipment in the event of bad weather.

7-4.1.3 Vertical Clearances

In order to support potential over height vehicles or future pavement overlays a minimum vertical clearance of 17 ft (5.2 m) should be maintained throughout the inspection facility. Higher clearance may be desirable for inspection equipment.

AF Provide a minimum clear height of 17 ft 6 in (5.4 m).

7-5 FACILITIES

Develop facilities in accordance with the guidelines provided in paragraph 6-9 except as modified in the following sections.

7-5.1 Inspection Office

The inspection office serves as the central control center for the truck inspection station and provides shelter for security personnel. Every truck inspection station should have an inspection office. As the control center, the inspection office controls the vehicle barricades, traffic control devices, access controls, and lighting. The office should include space for the following equipment and functions:

- Support 3 to 5 security personnel;
- Communications equipment;
- Electronic control panels for all current or anticipated future automated gates or barriers;
- Monitor stations for CCTV or computer monitors associated with automation controls, UVSS, and imaging systems;
- An electrical room for the main electric panelboards and electronic controls;
- Locker storage for traffic control devices, weapons, and personnel equipment including vehicle inspection kits and the pre-positioning of personal protective equipment for CBR exposure;
- Space for storing and charging batteries for communication and/or inspection equipment;
- Computer servers for future automated identification systems;
- Counter or work space;
- A unisex restroom; and
- Waiting / Processing Area for Vehicle Occupants.

7-5.2 **Occupant Shelter**

Shelter for the vehicle occupants can be provided in a separate shelter similar to those specified for ECFs, or within the inspection office as specified in section 7-5.1.

7-5.3 **Cargo Handling Equipment and Storage**

Although advanced inspection equipment is designed to inspect the contents of a suspect vehicle without opening or removing the cargo, it is anticipated that removal of cargo will be necessary at times for a complete inspection. In addition, current inspection procedures frequently require the removal of all or portions of the cargo in the suspect vehicle. Therefore the truck inspection station should have cargo handling equipment and storage areas to provide temporary storage of material removed from suspect vehicles. The size of this area should be based on the anticipated demand.

7-6 **ADDITIONAL DESIGN GUIDELINES**

Follow the requirements and guidelines in paragraphs 6-9 through 6-21, as modified in the following sections, for the design of the large vehicle inspection facility.

7-6.1 **Electrical Power Requirements**

Electrical design should consider current power demands as well as the power requirements for future traffic control devices, identification equipment, and other devices associated with potential automation of the inspection station. This includes an allowance for the power demands of future vehicle inspection equipment, such as fixed large vehicle x-ray devices. See paragraph 7-3 for additional information concerning vehicle inspection equipment.

7-6.2 **Exterior Lighting**

IESNA HB-9 and TM 5-811-1 discuss exterior lighting for general security purposes. The parking and roadway areas of the truck inspection station should have a minimum illumination of 3 footcandle (30 lux). The areas where the actual inspections take place should be illuminated to a minimum of 10 footcandle (100 lux).

It may also be necessary to provide additional task lighting in the ID and inspection areas to support adequate identification of vehicle occupants and contents. Lighting may also be mounted at or below pavement level to facilitate under vehicle inspection or associated with under vehicle inspection systems (see paragraph 7-3).

AF The Air Force requires 202 footcandle (200 lux) in inspection areas, and 30 footcandle (300 lux) is required at the point of contact using additional task lighting.

7-6.3 Perimeter Fence and Gate

Where the inspection facility is part of a Commercial/Large Vehicle ECF, each ECF should have a gate enabling the ECF to be closed at the installation perimeter when not in use. This gate should be reinforced with cables, as indicated in UFC 4-022-02, to increase resistance to a moving vehicle threat. In addition the gate must have Type III Barricade in accordance with MUTCD (3 per lane) secured to the gate horizontally. This configuration enables a reduced potential penetration and maximizes standoff when the ECF is not in use.

Secure a centralized truck inspection facility located off installation with a security fence in accordance with service regulations, including a gate enabling the inspection facility to be closed at the perimeter of the site when not in use.

8 NOTIONAL LAYOUTS

8-1 GENERAL

The notional site layouts in this chapter illustrate general relationships and desired adjacencies for each type of ECF. These illustrations are not drawn to any scale and are not intended to depict the importance or size of each element.

Figure 8-1 Visitors/DoD Personnel ECF

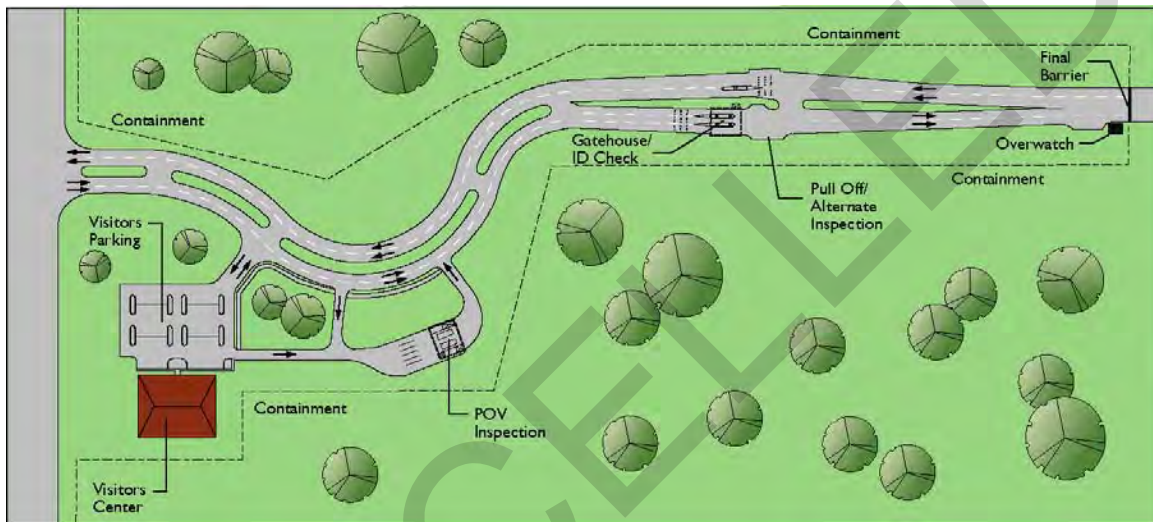

Figure 8-2 DoD/Authorized Personnel Only ECF

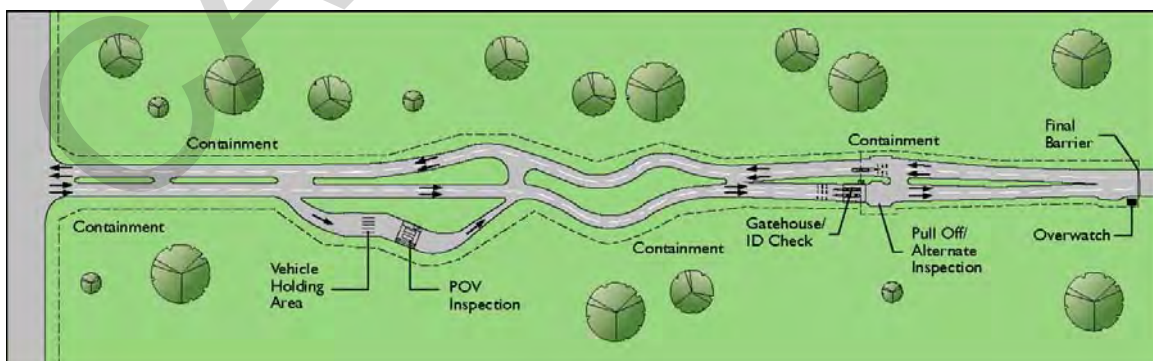

Figure 8-3 Commercial/Large Vehicle ECF

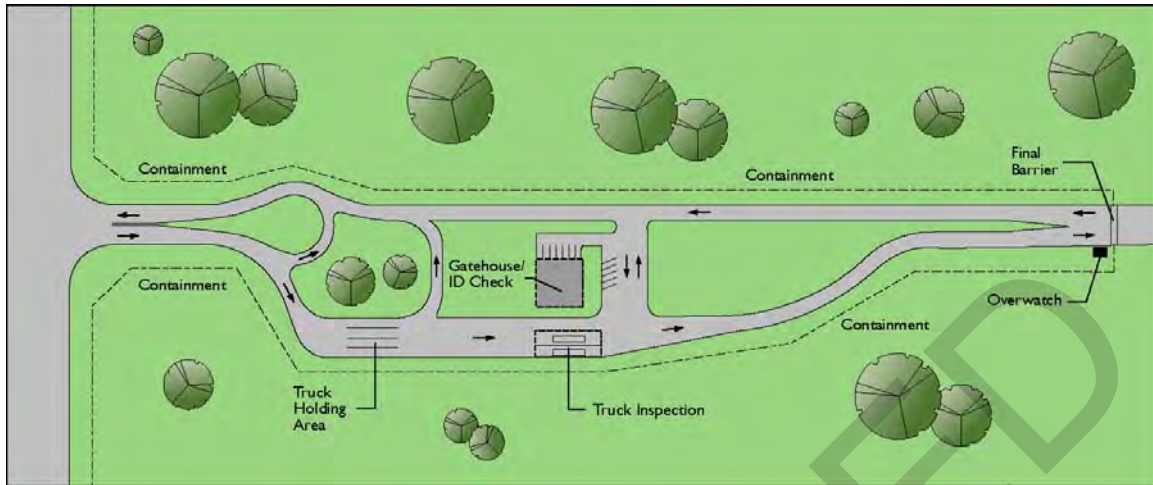

Figure 8-4 Combined Commercial/Visitors/DoD Alternative Gate

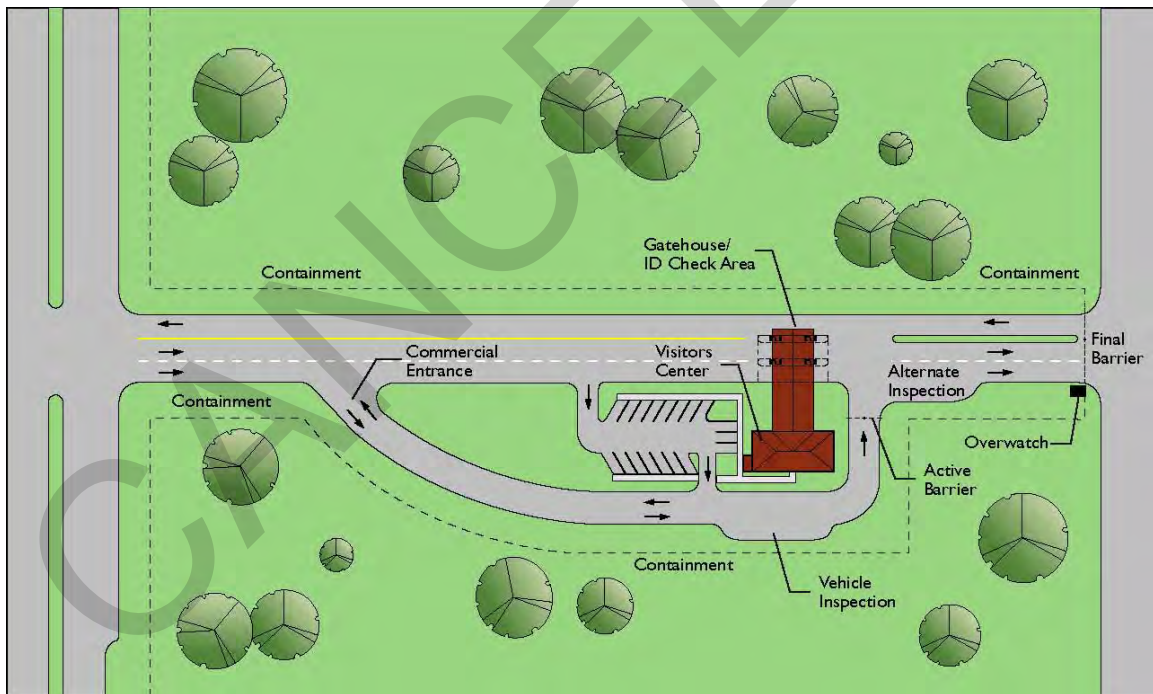

Figure 8-5 Visitors/DoD Personnel Gate – Restricted Real Estate Option

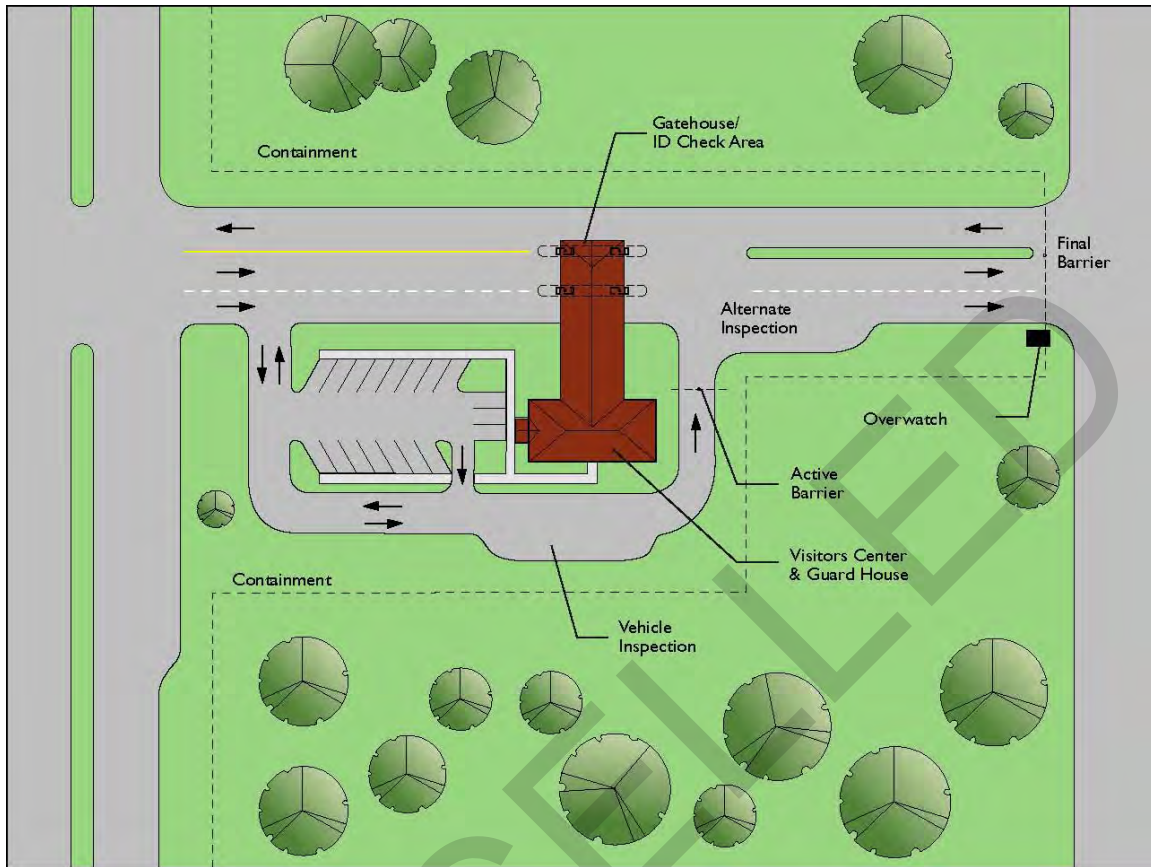

Figure 8-6 DoD/Authorized Personnel ECF

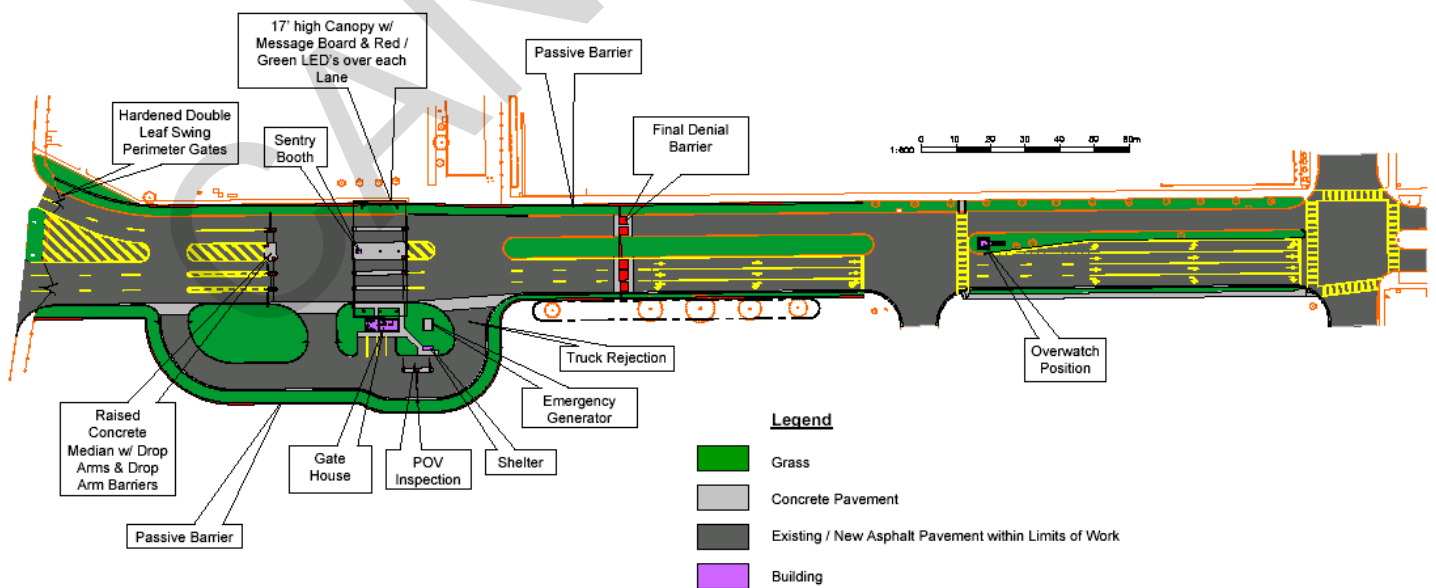

Figure 8-7 Combined POV and Commercial Vehicle ECF - Restricted Real Estate

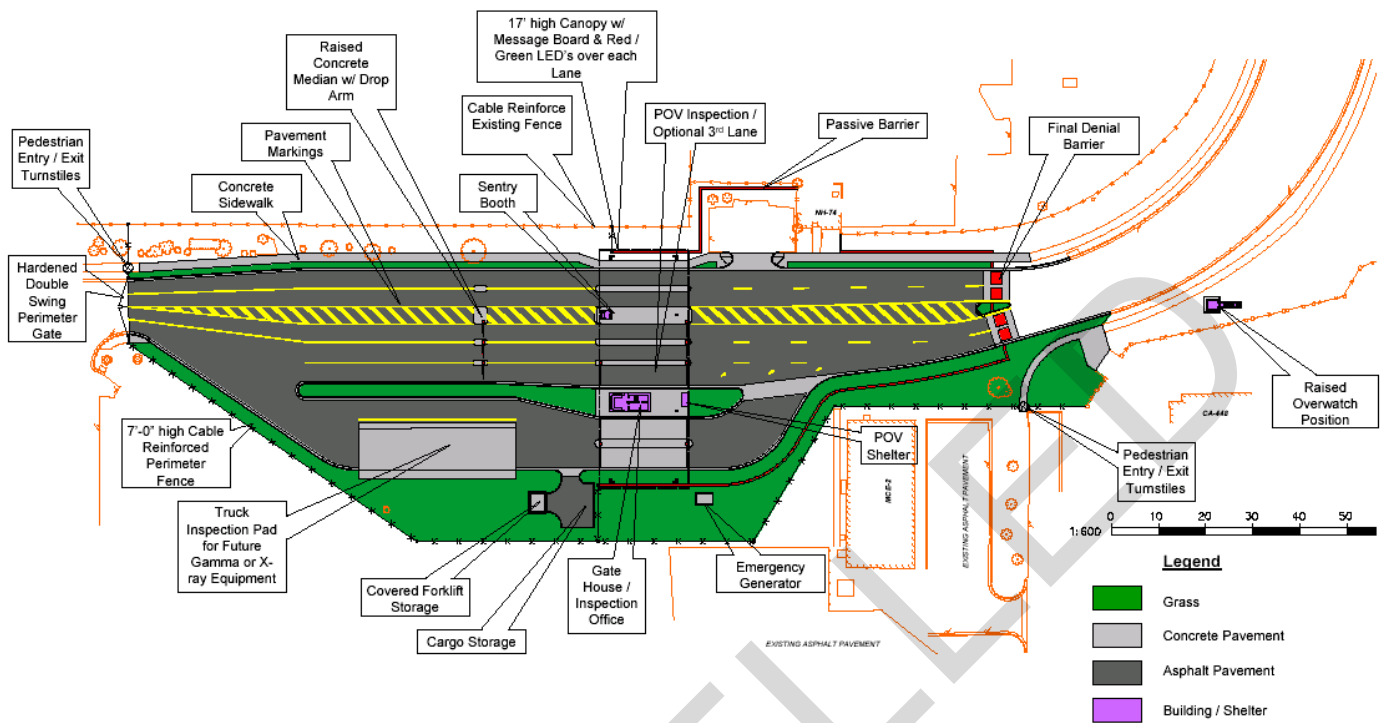

Figure 8-8 Combined POV/Commercial Vehicle/Visitor's Center

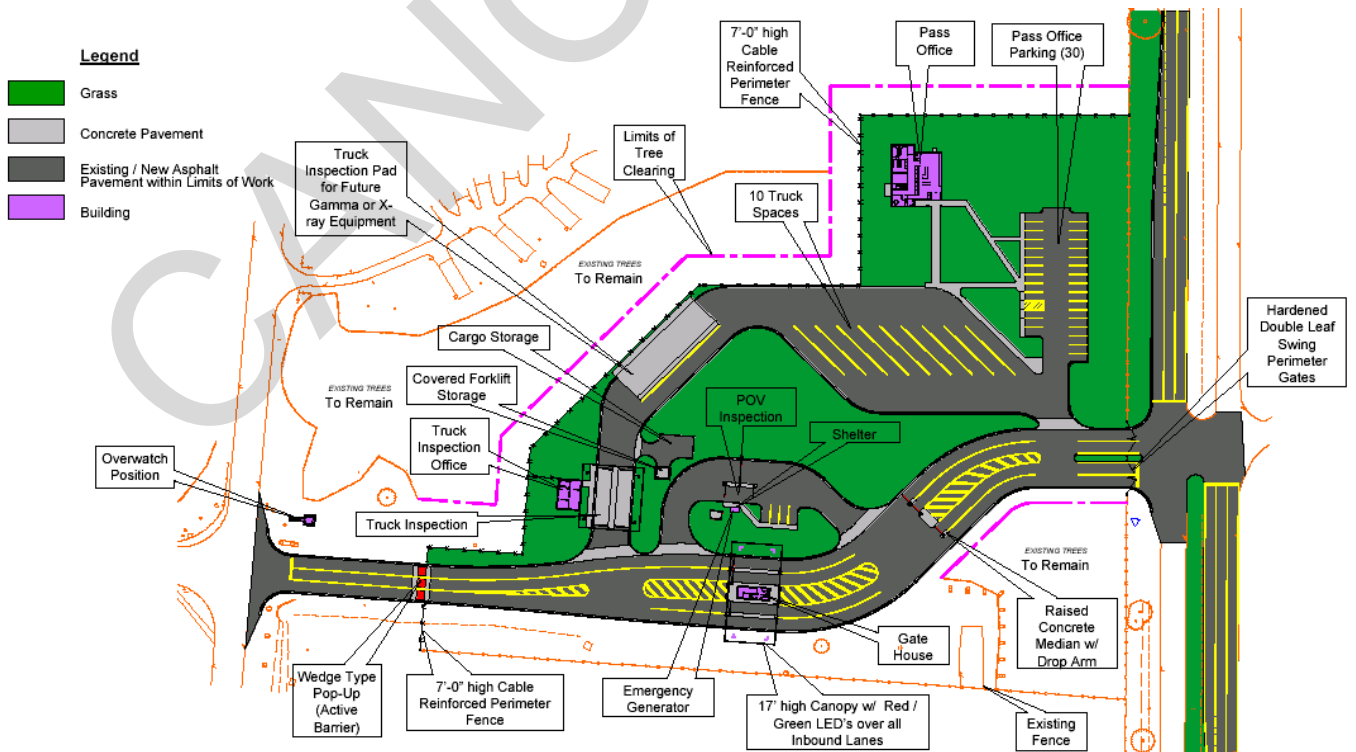
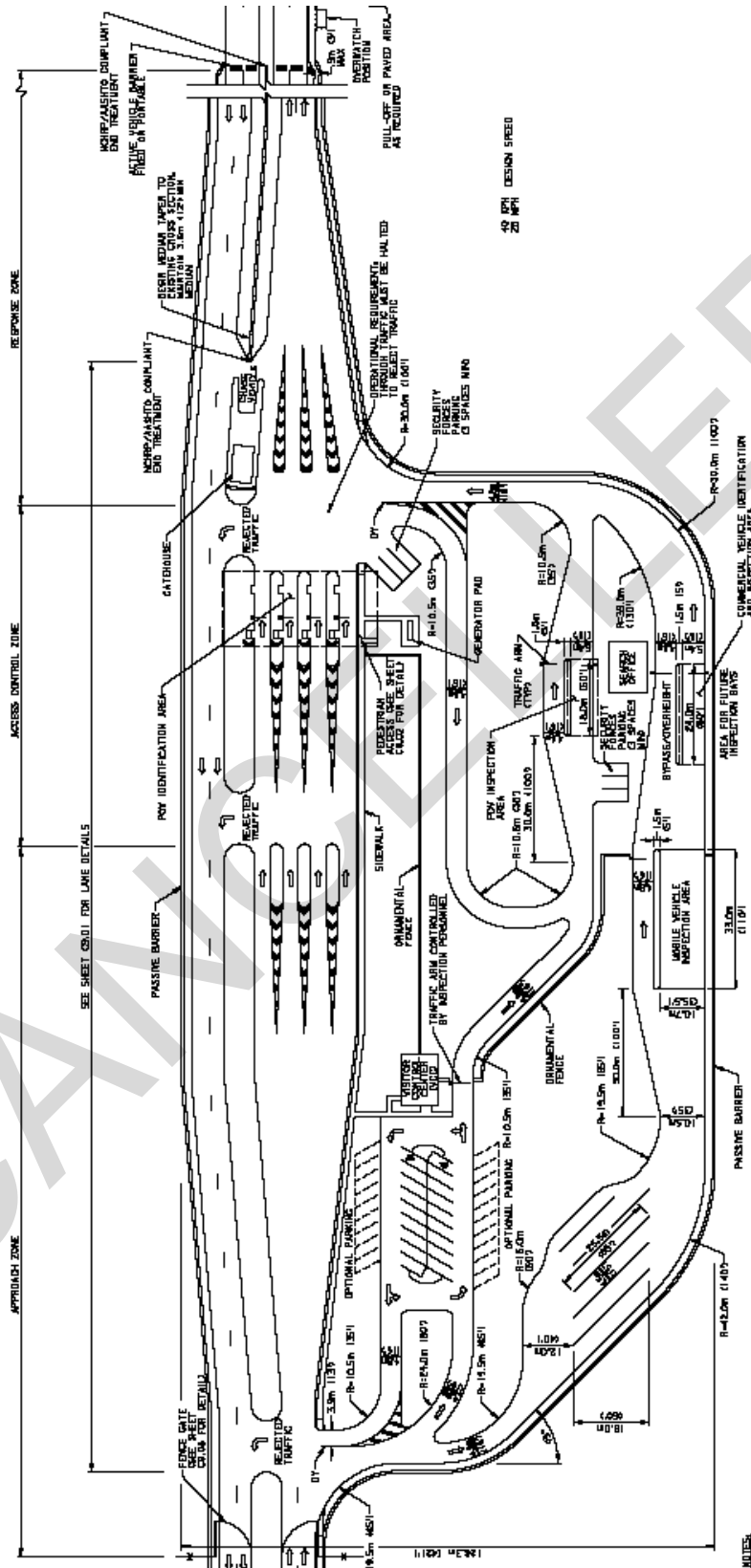

Figure 8-9 Combined POV/Commercial Vehicle/Visitor's Center



9 REFERENCES

- Access Control Points for U.S. Army installations*, United States Army Corps of Engineers (USACE)
- ADAAG, *Americans with Disabilities Act Accessibility Guidelines*, Architectural and Transportation Barriers Compliance Board, 1331 F. Street W, Suite 1000, Washington DC, 20004-1111, (202) 272-0080, <http://www.access-board.gov/>
- AIR FORCE LINK, <http://www.af.mil/library/symbol/>, *United States Air Force symbol guidelines*, Air Force Office of National Outreach and Communications Division, (703) 697-5630
- AR 190-13, *Army Physical Security Program*,
- DOD 2000.12, *DOD Antiterrorism (AT) Program*, Department of Defense
- DOD 2000.16, *DOD Antiterrorism Standards*,
- DOD 5200.8R, *Physical Security Program*,
- DOD O 2000.12-H, *DOD Antiterrorism Handbook*,
- Entry Control Facilities Design Guide*, February 2003, Air Force Civil Engineer Support Agency, 139 Barnes Drive Suite 1, Tyndall AFB, FL 32403-5319, 850-283-6101, <http://www.afcesa.af.mil/>
- G-1, *Guideline on Security Lighting for People, Property and Public Spaces*, Illuminating Engineering Society of North America (IESNA), 120 Wall St, Floor 17, New York, NY, 10005, 212-248-5000, 2003. <http://www.iesna.org>
- GDHS-4, *A Policy on Geometric Design of Highways and Streets*, American Association of State Highway and Transportation Officials (AASHTO), 444 North Capitol Street, NW, Suite 249, Washington, DC 20001, 202-624-5800, <http://www.aashto.org/>.
- HB-9, *Lighting Handbook*. Illuminating Engineering Society of North America (IESNA), 120 Wall St, Floor 17, New York, NY, 10005, 212-248-5000, 2000. 9th ed. <http://www.iesna.org>
- IEEE C2, *National Electrical Safety Code*, Institute of Electrical and Electronic Engineers (IEEE), 3 Park Ave, 17th Floor, New York, New York, 10016-5997, 212-419-7900, <http://www.ieee.org/>.
- ITG FY03-03, *Interim Technical Guidance: Entry Control Facilities*, Engineering Innovation and Criteria Office, NAVFAC, 6506 Hampton, Blvd, Norfolk, VA 23508, 757-322-4200, <http://www.wbdg.org/ndbm>, 20 Feb 2003
- MCO P5530.14, *Marine Corps Physical Security Program*,

MUTCD, *Manual of Uniform Traffic Control Devices*,

NFPA 70, *National Electrical Code*, National Fire Prevention Association, 1
Batterymarch Park, Quincy, MA, 02169-7471, 617-770-3000, <http://www.nfpa.org/>.

OPNAV 5530.14D, *Navy Physical Security Manual*, SECNAV/OPNAV Directives
Control Office, N09B15, Washington Navy Yard, Bldg. 36, 720 Kennon Street, SE,
Rm 203, Washington Navy Yard, DC 20374-5074, (202) 433-4934/5/6,
<http://neds.nebt.daps.mil/usndirs.htm>

P-80, *Facility Planning Criteria for Navy and Marine Corps Shore Installations*, Naval
Facilities Engineering Command, 1322 Patterson Ave, Suite 1000, Washington, DC,
20374, <http://www.navfac.navy.mil/>

Report 350, "Recommended Procedures for the Safety Performance Evaluation of
Highway Features," Transportation Research Board National Cooperative Highway
Research Program (TRB NCHRP,) Keck Center of the National Academies,
Transportation Research Board, 500 Fifth Street, NW, Washington, DC 20001, (202)
334-2934, <http://www.trb.org/>

RSDG-3, *Roadside Design Guide*, American Association of State Highway and
Transportation Officials (AASHTO), 444 North Capitol Street, NW, Suite 249,
Washington, DC 20001, 202-624-5800, <http://www.aashto.org/>.

"Securing Installations Against Car-Bomb Attack." *Securing U.S. Army Site Access
Points*. Webb, William. Davis, Michael., ed. Proceedings of Conference; 1986 May
15-17; Washington D.C. Alexandria, VA SIACA 433-542

Standard Highway Signs, Federal Highway Administration, United States Department of
Transportation, Washington, DC, (202)-366-0660, <http://www.fhwa.dot.gov/>

TM 5-811-1, *Electrical Power Supply and Distribution*. Office of the Chief of Engineers,
U.S. Army. Washington, DC: U.S. G.P.O.:1995-386-731:210

TM 5-853-2, *Security Engineering Concept Design*. United States Corps of Engineers
(USACE,) Huntsville, AL, <http://www.hnd.usace.army.mil/techinfo/>

Traffic and Highway Engineering. Garber, Nicholas J; Hoel, Lester A. New York: West
Publishing Company; 1988

Traffic and Safety Engineering for Better Entry Control Facilities. SDDCTEA. Newport
News, VA: Military Surface Deployment and Distribution Command Transportation
Engineering Agency (SDDCTEA), 2004. <http://www.tea.army.mil>

TRAFFIC CALMING FOR COMMUNITIES, <http://www.ite.org/traffic/index.html>, Institute
of Transportation Engineers (ITE,) 1099 14th Street, NW, Suite 300 West,
Washington, DC , 20005-3438 USA, Phone: (202) 289-0222

Traffic Calming, State of the Practice. Institute of Transportation Engineers, FHWA. Washington, D.C: ITE/FHWA, 1999. <http://www.ite.org>

Traffic Engineering Handbook, Institute of Transportation Engineers (ITE,) 1099 14th Street, NW, Suite 300 West, Washington, DC , 20005-3438 USA, Phone: (202) 289-0222, <http://www.ite.org/>

Traffic Control Devices handbook, Institute of Transportation Engineers (ITE,) 1099 14th Street, NW, Suite 300 West, Washington, DC , 20005-3438 USA, Phone: (202) 289-0222, <http://www.ite.org/>

Traffic Engineering & Highway Safety Bulletin: Gates Revisited. Allred, Paul; Quesenberry, Richard; Sumark, Rick. Newport News, VA: Military Traffic Management Command Transportation Engineering Agency; 2003.) <http://www.tea.army.mil>

Traffic Engineering & Highway Safety Bulletin: Traffic Calming. Allred, Paul; Quesenberry, Richard; Sumark, Rick, Gannett Fleming. Newport News, VA: Military Traffic Management Command Transportation Engineering Agency; 2003.) <http://www.tea.army.mil>

Traffic Engineering & Highway Safety Bulletin: Traffic Engineering For Better Gates. Allred, Paul; Quesenberry, Richard; Sumark, Rick. Newport News, VA: Military Traffic Management Command Transportation Engineering Agency; 2001.) <http://www.tea.army.mil>

UFC 1-200-01, *Design: General Building Requirements*, Tri-Service Engineering Senior Executive Panel, <http://dod.wbdg.org/>

UFC 3-120-01, *Air Force Sign Standard*, Tri-Service Engineering Senior Executive Panel, <http://dod.wbdg.org/>

UFC 3-310-01, *Design: Load Assumptions for Buildings*, Tri-Service Engineering Senior Executive Panel, <http://dod.wbdg.org/>

UFC 4-010-01, *DOD Minimum Antiterrorism Standards for Buildings*, Tri-Service Engineering Senior Executive Panel, <http://dod.wbdg.org/>

UFC 4-010-02, *DOD Minimum Standoff Distances for Buildings*, Tri-Service Engineering Senior Executive Panel, <http://dod.wbdg.org/>

UFC 4-020-01, *Security Engineering Planning Manual*, Tri-Service Engineering Senior Executive Panel, <http://dod.wbdg.org/>

UFC 4-020-02, *Security Engineering Design Manual*, Tri-Service Engineering Senior Executive Panel, <http://dod.wbdg.org/>

UFC 4-021-02, *Security Engineering: Design of Electronic Security Systems*, Tri-Service Engineering Senior Executive Panel, <http://dod.wbdg.org/>

UFC 4-022-02, *Security Engineering: Design and Selection of Vehicle Barriers*, Tri-Service Engineering Senior Executive Panel, <http://dod.wbdg.org/>

UFC 4-022-03, *Security Engineering: Design of Security Fencing, Gates, Barriers and Guard Facilities*, Tri-Service Engineering Senior Executive Panel, <http://dod.wbdg.org/>

UFC 4-023-07, *Design to Resist Direct Fire Weapons Effects*, Tri-Service Engineering Senior Executive Panel, <http://dod.wbdg.org/>

UFC 4-024-10, *Security Engineering: Design of Buildings to Resist Forced Entry*, Tri-Service Engineering Senior Executive Panel, <http://dod.wbdg.org/>

UFGS 02840, *Active Vehicle Barriers*, Tri-Service Engineering Senior Executive Panel, <http://dod.wbdg.org/>

CANCELLED