

# UNIFIED FACILITIES CRITERIA (UFC)

---

## OPERATION AND MAINTENANCE: ELECTRICAL SAFETY



## UNIFIED FACILITIES CRITERIA (UFC)

### OPERATION AND MAINTENANCE: ELECTRICAL SAFETY

Any copyrighted material included in this UFC is identified at its point of use. Use of the copyrighted material apart from this UFC must have the permission of the copyright holder.

U.S. ARMY CORPS OF ENGINEERS

NAVAL FACILITIES ENGINEERING COMMAND (Preparing Activity)

AIR FORCE CIVIL ENGINEER CENTER

Record of Changes (changes are indicated by \1\ ... /1/)

Change No.	Date	Location
<u>1</u>	<u>21 Feb 2018</u>	<u>Paragraph 1-5</u>
<u>2</u>	<u>31 Oct 2019</u>	<u>Miscellaneous changes throughout document to update arc flash requirements to comply with the latest NFPA 70E version. Reference updates and changes within tables are not marked with a /2/.</u>

---

This UFC supersedes UFC 3-560-01, Electrical Safety, O&M, dated 14 April 2015, with Change 5 and all preceding changes.

CANCELLED

## FOREWORD

The Unified Facilities Criteria (UFC) system is prescribed by MIL-STD 3007 and provides planning, design, construction, sustainment, restoration, and modernization criteria, and applies to the Military Departments, the Defense Agencies, and the DoD Field Activities in accordance with [USD \(AT&L\) Memorandum](#) dated 29 May 2002. UFC will be used for all DoD projects and work for other customers where appropriate. All construction outside of the United States is also governed by Status of Forces Agreements (SOFA), Host Nation Funded Construction Agreements (HNFA), and in some instances, Bilateral Infrastructure Agreements (BIA.) Therefore, the acquisition team must ensure compliance with the most stringent of the UFC, the SOFA, the HNFA, and the BIA, as applicable.

UFC are living documents and will be periodically reviewed, updated, and made available to users as part of the Services' responsibility for providing technical criteria for military construction. Headquarters, U.S. Army Corps of Engineers (HQUSACE), Naval Facilities Engineering Command (NAVFAC), and Air Force Civil Engineer Center (AFCEC) are responsible for administration of the UFC system. Defense agencies should contact the preparing service for document interpretation and improvements. Technical content of UFC is the responsibility of the cognizant DoD working group. Recommended changes with supporting rationale should be sent to the respective service proponent office by the following electronic form: [Criteria Change Request](#). The form is also accessible from the Internet sites listed below.

UFC are effective upon issuance and are distributed only in electronic media from the following source:

- Whole Building Design Guide web site <http://dod.wbdg.org/>.

Refer to UFC 1-200-01, *DoD Building Code (General Building Requirements)*, for implementation of new issuances on projects.

### AUTHORIZED BY:



LARRY D. McCALLISTER, PhD, PE,  
PMP, SES  
Chief, Engineering and Construction  
Directorate of Civil Works  
U.S. Army Corps of Engineers



JOSEPH E. GOTT, P.E.  
Chief Engineer  
Naval Facilities Engineering Command



EDWIN H. OSHIBA, SES, DAF  
Director  
Air Force Civil Engineer Center



MICHAEL MCANDREW  
Deputy Assistant Secretary of Defense  
(Facilities Investment and Management)  
Office of the Assistant Secretary of Defense  
(Energy, Installations, and Environment)

## UNIFIED FACILITIES CRITERIA (UFC) SUMMARY SHEET

**Document:** UFC 3-560-01, Operation and Maintenance: Electrical Safety

**Superseding:**

- UFC 3-560-01, *Electrical Safety, O&M, Change 5.*

The following documents were superseded by the original issuance of UFC 3-560-01 in 2006.

- Air Force Manual 32-1185, *Electrical Worker Safety*. This manual was prepared in draft form, but was not issued.
- TM 5-682, *Facilities Engineering, Electrical Facilities Safety*.
- UFC 3-560-10N (previously MIL-HDBK-1025/10), *Safety Of Electrical Transmission And Distribution Systems*.
- Draft UFC 3-560-02, *Electrical Safety*. This document was made mandatory guidance by Air Force Engineering Technical Letter (ETL) 04-15, *Electrical Safety Guidance*

**Description:** This UFC 3-560-01 incorporates tri-service requirements into one unified document and provides electrical safety requirements for all electrical work activities.

**Reasons for Document:**

- Provide guidance for all aspects of electrical safety.
- Conform UFC criteria to recently issued industry standards.
- Clarify work requirements for unique activities.

**Impact:** There are cost impacts associated with the required use of personal protective equipment (PPE). The new requirements associated with working on exposed, energized circuits involve additional safety precautions. However, the following benefits will be realized.

- Electrical safety criteria are more consistent with industry standards and OSHA requirements.
- Personnel working on electrical systems have improved guidance to ensure a safer working environment.

**Unification Issues:**

- Paragraph 1-4.3 Service-Specific Criteria, lists service specific documents that add additional safety requirements to this UFC. In several places in this UFC these documents are referenced for the technical subject being discussed. As

an example, in Chapter 8 Energized Work, in sub-paragraphs 8-5, 8-6, and 8-7 additional requirements are listed for the Navy, Air Force and Army, respectively. These requirements, in general, incorporate the documents from Paragraph 1-4.3.

- Chapter 12 Shore-to-Ship Electrical Power Connections has Navy specific criteria requirements.

CANCELLED

**TABLE OF CONTENTS**

CHAPTER 1 INTRODUCTION..... 1

1-1 PURPOSE.....1

1-2 SCOPE.....1

1-2.1 Need.....1

1-2.2 Familiarity and Requirements.....1

1-2.3 Mishap Prevention.....1

1-2.4 Unclear Conditions.....2

1-2.5 Applicability.....2

1-2.6 Work Type.....3

1-2.7 Occupational Safety and Health Administration (OSHA).....3

1-3 REFERENCES.....3

1-4 CODES, STANDARDS, AND PUBLICATIONS.....3

1-4.1 Applicable Documents.....3

1-4.2 NFPA 70E and IEEE C2 Applicability.....4

1-4.3 Service-Specific Criteria.....4

1-5 ELECTRICAL SYSTEM MAINTENANCE AND TESTING.....5

1-6 WAIVER AND EXEMPTION PROCESS.....5

1-7 VARIANCES FROM NORMAL SAFETY PRACTICES.....5

1-8 WARNINGS AND NOTES.....5

1-8.1 Warning.....5

1-8.2 Note.....5

1-9 ELECTRICAL HAZARDS.....6

1-9.1 Electrical Shock Dangers and Effects.....6

1-9.2 Danger from Electrical Arc Flash and Arc Blast Hazards.....8

1-9.3 Workplace Dangers.....8

1-9.4 Health Hazards of Asbestos.....8

1-10 MISHAP RESPONSE.....9

1-10.1 Knowing What to Do.....9

1-10.2 Work Injuries and Mishap Reports.....9

1-10.3 First Aid Supplies.....10

1-10.4 Automatic External Defibrillators (AEDs).....10

1-11 COMMUNICATIONS.....10

1-12 ARC FLASH WARNING LABELS.....11

1-12.1 General Arc Flash Label.....12

1-12.2 General Arc Flash Label That Refers to OSHA.....12

1-12.3	Detailed Arc Flash Label.....	13
1-12.4	Arc Flash Label That Refers to a Separate Calculation.....	18
1-12.5	Arc Flash Label for Existing Equipment Without Maintenance or Testing.....	18
1-12.6	Arc Flash Label for Locations Identified to Be Greater Than 40 cal/cm <sup>2</sup> .....	19
<b>CHAPTER 2 WORKER/CREW RESPONSIBILITIES.....</b>		<b>20</b>
2-1	<b>LEVELS OF RESPONSIBILITY.....</b>	<b>20</b>
2-2	<b>ELECTRICAL WORKER QUALIFICATIONS.....</b>	<b>20</b>
2-2.1	Qualified Persons.....	20
2-2.2	Unqualified Person.....	21
2-2.3	Type of Training.....	21
2-2.4	Cardiopulmonary Resuscitation (CPR) and First Aid Training.....	21
2-2.5	Rescue Training.....	22
2-2.6	Training Documentation.....	22
2-3	<b>SAFETY MEETINGS.....</b>	<b>22</b>
2-3.1	Scheduled Meetings.....	22
2-3.2	Job Briefing/Tailgate Meetings.....	22
2-4	<b>WORK SITE SAFETY.....</b>	<b>23</b>
2-5	<b>JOB HAZARD ANALYSIS/JOB SAFETY ANALYSIS.....</b>	<b>24</b>
2-6	<b>SAFETY COMPLIANCE.....</b>	<b>25</b>
2-6.1	Carelessness.....	25
2-6.2	Interpretation.....	25
2-6.3	Violations.....	25
<b>CHAPTER 3 PRE-SITE SAFETY MANAGEMENT.....</b>		<b>26</b>
3-1	<b>WORK LOCATION SAFETY REQUIREMENTS.....</b>	<b>26</b>
3-1.1	Working Near Energized Circuits.....	26
3-1.2	Work Location.....	29
3-2	<b>PUBLIC SAFETY.....</b>	<b>30</b>
3-2.1	Warning Devices.....	30
3-2.2	Flagmen.....	30
3-2.3	Excavations.....	30
3-3	<b>NUMBER OF WORKERS REQUIRED.....</b>	<b>32</b>
3-4	<b>VERIFYING SYSTEM AND EQUIPMENT PROVISIONS.....</b>	<b>33</b>
<b>CHAPTER 4 ARC FLASH PERSONAL PROTECTIVE EQUIPMENT (PPE).....</b>		<b>34</b>
4-1	<b>PPE FOR ARC FLASH PROTECTION.....</b>	<b>34</b>
4-1.1	Applicability.....	34



4-1.2	NFPA 70E PPE Summary. ....	35
4-1.3	Minimum PPE Clothing Requirements. ....	38
4-1.4	Job-Site PPE Clothing Requirements. ....	38
4-1.5	Required PPE Level Per Arc Flash Category. ....	39
4-1.6	Air Force Military Uniforms. ....	40
4-1.7	Additional PPE Clothing Requirements. ....	41
4-1.8	Clothing Prohibitions. ....	41
4-2	ARC FLASH RISK ASSESSMENT. ....	42
4-2.1	Arc Flash Risk Assessments Based on Tables. ....	43
4-2.2	Facility Manager Authorized Tasks. ....	56
4-2.3	Arc Flash PPE Requirements for Low Voltage Control Circuits. ....	56
CHAPTER 5 WORK AREA PROTECTIVE EQUIPMENT AND TOOLS .....		57
5-1	INSPECTION OF APPAREL, TOOLS, AND MATERIALS HANDLING EQUIPMENT. 57	
5-2	RUBBER PROTECTIVE EQUIPMENT. ....	58
5-2.1	Job Requirements. ....	58
5-2.2	Use of Rubber Protective Equipment. ....	58
5-2.3	Use of Rubber Gloves. ....	59
5-2.4	Use of Rubber Sleeves. ....	60
5-2.5	Care and Inspection of Rubber Protective Equipment. ....	60
5-2.6	Test Intervals for Rubber Protective Equipment. ....	61
5-3	INSULATED HAND TOOLS AND HANDLING EQUIPMENT. ....	62
5-4	LIVE-LINE (HOT-LINE) TOOLS. ....	62
5-4.1	Manufacture. ....	63
5-4.2	Authorized Types of Tools. ....	63
5-4.3	Records. ....	63
5-4.4	Tool Cleaning Before Use. ....	63
5-4.5	Tool Inspection After Cleaning and Before Use. ....	63
5-4.6	Other Conditions for Removal from Service. ....	64
5-4.7	Returning a Tool to Service. ....	64
5-4.8	Waxing. ....	64
5-4.9	Repairs and Refinishing. ....	64
5-4.10	Wet Electrical Testing. ....	64
5-4.11	Precautions for Shop or Field Testing. ....	65
5-4.12	Transportation. ....	65
5-4.13	Storage. ....	65

5-4.14	Use of Live-Line Tools.....	66
5-5	SKIN PROTECTION.....	66
5-6	POLE/TREE CLIMBING AND FALL PROTECTION.....	67
5-6.1	Personal Protective Equipment.....	67
5-6.2	Climbing Personal Protective Equipment.....	67
5-6.3	Fall Protection Personal Protective Equipment.....	67
5-7	ELECTRICAL TESTING DEVICES.....	68
5-7.1	Electrical Testing Device Calibration.....	68
5-7.2	Voltage Detectors.....	69
5-7.3	Phasing Testers.....	69
5-7.4	Line Fault Locators.....	70
5-7.5	Insulator Testers.....	70
5-7.6	Leakage-Current Monitors.....	71
5-7.7	Combustible Gas/Oxygen Detectors.....	71
CHAPTER 6 ENERGY CONTROL (LOCKOUT/TAGOUT).....		72
6-1	SERVICE-SPECIFIC CRITERIA.....	72
6-2	ADDITIONAL CRITERIA FOR ELECTRICAL EQUIPMENT.....	72
CHAPTER 7 TEMPORARY PROTECTIVE GROUNDING.....		73
7-1	TEMPORARY GROUNDING.....	73
7-1.1	Testing.....	73
7-1.2	Installation Criteria.....	73
7-1.3	Temporary Grounding System Components.....	74
7-1.4	Equipotential Zone.....	76
7-1.5	Ground Connection and Electrodes.....	76
7-2	TEMPORARY GROUNDING OF SUBSTATION CURRENT-CARRYING EQUIPMENT COMPONENTS.....	76
7-3	AERIAL LIFT TRUCK VEHICLE GROUNDING.....	79
7-4	TEMPORARY GROUNDING OF UNDERGROUND LINES.....	80
7-5	OPENING OR SPLICING DEENERGIZED CONDUCTORS.....	81
7-6	GROUNDING FOR STRINGING AND REMOVING LINES.....	81
7-7	TEMPORARY GROUNDING OF AERIAL LINES.....	83
7-8	PLACEMENT OF GROUNDS.....	83
CHAPTER 8 ENERGIZED WORK.....		85
8-1	WORK ON ENERGIZED CIRCUITS.....	85
8-2	EXAMPLES OF ENERGIZED WORK.....	85
8-3	ENERGIZED ELECTRICAL WORK PERMIT.....	89

8-3.1	Normal Operation of Electrical Equipment. ....	89
8-3.2	Prohibitions to Energized Work.....	89
8-3.3	Energized Electrical Work Permit. ....	89
8-3.4	Exemptions to Energized Electrical Work Permit. ....	90
8-4	STANDARD OPERATING PROCEDURES FOR ENERGIZED ELECTRICAL WORK PERMITS.....	91
8-4.1	OVERVIEW.....	91
8-5	APPLICABILITY FOR THE NAVY.....	92
8-5.1	Navy Energized Electrical Work Permit.....	92
8-5.2	NAVFAC Standard Operating Procedures (SOPs).....	93
8-5.3	SOP Priority.....	93
8-5.4	SOP Approval and Training. ....	93
8-6	APPLICABILITY FOR THE AIR FORCE.....	94
8-7	APPLICABILITY FOR THE ARMY.....	94
8-8	CATEGORIES OF WORK. ....	94
8-8.1	Workers at Ground Potential.....	94
8-8.2	Workers at Intermediate Potential.....	94
8-8.3	Workers at Line Potential.....	94
8-9	ENERGIZED WORK RULES. ....	94
8-9.1	Permitted Work.....	95
8-9.2	Personal Protective Equipment and Clothing.....	95
8-9.3	Statement of Qualifications.....	95
8-9.4	Work Methods for Voltage Levels. ....	95
8-9.5	Pre-Work Procedures. ....	97
8-9.6	General Job-in-Progress Procedures.....	98
	CHAPTER 9 SUBSTATIONS AND SWITCHGEAR.....	100
9-1	SUBSTATION WORK.....	100
9-1.1	Purpose of Substation. ....	100
9-1.2	Diagrams and Schematics.....	100
9-1.3	Engineering Guidance. ....	100
9-1.4	System Operation.....	100
9-1.5	Abnormal Conditions. ....	101
9-1.6	Defective Equipment.....	101
9-2	SWITCHING. ....	102
9-2.1	Air Switches.....	102
9-2.2	Oil Switches.....	103

9-2.3	SF <sub>6</sub> Switches. ....	104
9-2.4	Oil-Filled Vacuum Switches. ....	104
9-3	FUSES.....	104
9-3.1	Characteristics.....	104
9-3.2	Fuse Handling. ....	105
9-3.3	Operation of Energized Fuses. ....	105
9-3.4	Open Fuse Holder. ....	105
9-3.5	Closed-Position Fuse Locking. ....	105
9-3.6	Bypassing.....	105
9-4	ENERGY STORING PROTECTIVE DEVICES. ....	105
9-4.1	Electrical Charge. ....	105
9-4.2	Surge Arresters. ....	106
9-4.3	Choke Coils. ....	106
9-4.4	Capacitors. ....	106
9-4.5	Coupling Capacitors. ....	107
9-5	INSTRUMENT TRANSFORMERS.....	107
9-5.1	Potential (Voltage) Transformers (PT). ....	107
9-5.2	Current Transformers (CT). ....	109
9-6	POWER TRANSFORMERS AND REGULATORS.....	109
9-6.1	Transformers (Power and Distribution). ....	109
9-6.2	Voltage Regulators. ....	110
9-7	METALCLAD SWITCHGEAR. ....	110
9-8	STATIONARY BATTERIES. ....	112
9-8.1	Basis for Safety Requirements. ....	112
9-8.2	Applicable Industry Standards. ....	112
9-8.3	Protective Equipment.....	113
9-8.4	Safety Precautions. ....	113
9-9	INSULATING OIL HANDLING OPERATIONS. ....	114
CHAPTER 10 UNDERGROUND LINES .....		115
10-1	AUTHORIZED WORK ACTIVITIES INSIDE CONFINED SPACES CONTAINING ENERGIZED ELECTRICAL CIRCUITS.....	115
10-1.1	Inspection-Only Access in Manholes Containing Energized Circuits.....	115
10-1.2	Work Inside Manholes Containing Energized Circuits.....	116
10-1.3	All Other Work Inside Manholes Containing Energized Circuits. ....	117
10-1.4	Switching Activities Inside Manholes Containing Energized Circuits. ....	117
10-2	CABLE PULLING.....	118

10-3	BURIED ELECTRICAL CABLES. ....	118
CHAPTER 11	LOW-VOLTAGE INTERIOR SYSTEMS .....	119
11-1	WORKING ON INDOOR EQUIPMENT.....	119
11-1.1	Restricted Space.....	119
11-1.2	Grounding Systems.....	119
11-1.3	Disconnection of Power Sources.....	119
11-1.4	Related Building Systems.....	119
11-2	LOW-VOLTAGE SYSTEMS.....	119
11-2.1	Overview.....	119
11-2.2	Battery Room Hazards.....	120
11-2.3	Fire Alarm Systems.....	120
11-2.4	Solid-State Equipment.....	120
11-2.5	Low-Voltage Work Precautions.....	120
11-3	ROTATING MACHINERY.....	122
11-3.1	Hazards of Rotating Machinery.....	122
11-3.2	Motors and Generators.....	122
CHAPTER 12	SHORE-TO-SHIP ELECTRICAL POWER CONNECTIONS.....	123
12-1	CONNECT/DISCONNECT SERVICES.....	123
12-2	SPECIFIC SHORE-TO-SHIP ELECTRICAL SYSTEM SAFETY.....	123
12-2.1	Unusual Shore-to-Ship System Hazards.....	123
12-2.2	Split Personnel Responsibilities.....	123
12-2.3	Portable Power Cable and Outlet Safety Assurance.....	124
12-2.4	Electrical Equipment Accessibility and Working Space.....	124
12-2.5	Readily Accessible.....	124
12-2.6	Working Space.....	124
12-3	SPECIALIZED SHORE-TO-SHIP SYSTEM TRAINING.....	125
12-4	SHIP'S MAIN ELECTRICAL SERVICE COMPONENTS.....	125
12-4.1	Shore High-Voltage Distribution System.....	125
12-4.2	Pier Substations.....	126
12-4.3	Ship-to-Shore Pier Electrical Outlet Assemblies.....	129
12-4.4	Shore-to-Ship Power Cables and Connectors.....	131
12-4.5	Pier High-Voltage (4,160 Volt) Electrical Outlet Assemblies.....	133
12-4.6	Low-Voltage Terminations.....	133
APPENDIX A	REFERENCES .....	135
APPENDIX B	ELECTRICAL TASK RISK ASSESSMENT CHECKLIST .....	138

APPENDIX C SAMPLE SOP – VOLTAGE AND CURRENT DIAGNOSTIC MEASUREMENTS ..... 141

APPENDIX D SAMPLE SOP – WORKING ON STATIONARY BATTERY SYSTEMS ..... 151

APPENDIX E SAMPLE SOP – INSERTING OR REMOVING (RACKING) CIRCUIT BREAKERS TO/FROM AN ENERGIZED BUS..... 159

APPENDIX F SAMPLE SOP – FUSED CUTOUPS: OPENING, CLOSING, OR REPLACING FUSES..... 169

APPENDIX G SAMPLE SOP – CONNECTING/DISCONNECTING LOADBREAK ELBOWS . 176

APPENDIX H SAMPLE SOP – ELECTRICAL MANHOLE/VAULT ENTRY ..... 184

APPENDIX I SAMPLE SOP – PROHIBITED ENERGIZED WORK ACTIVITIES..... 191

APPENDIX J LOCKOUT/TAGOUT GUIDANCE..... 196

J-1 SAFE CLEARANCE (SWITCHING ORDER) AND LOCKOUT/TAGOUT PROCEDURES..... 196

J-1.1 Development of Procedures. .... 197

J-1.2 Lockout..... 197

J-1.3 Tagouts. .... 198

J-1.4 Preparation of the Safe Clearance Form (Switching Order). .... 198

J-1.5 Issue (Approval) of the Safe Clearance Form (Switching Order)..... 198

J-1.6 Safe Clearance Form Description..... 199

J-1.7 Lockout and Tagout Precautions. .... 201

J-2 ENERGY CONTROL (LOCKOUT/TAGOUT). .... 202

J-2.1 Low-Voltage Levels. .... 202

J-2.2 High-Voltage Levels. .... 202

APPENDIX K GLOSSARY ..... 204

**FIGURES**

Figure 1-1. Ground Potential Gradient ..... 6

Figure 1-2. Current Path Flow ..... 7

Figure 1-3 Typical Arc Flash Warning Label ..... 12

Figure 1-4 General Arc Flash Label That Refers to OSHA..... 13

Figure 1-5 Typical Calibration or Maintenance Stickers ..... 14

Figure 1-6 NFPA 70E Handbook Arc Flash Incident Energy Warning Label..... 16

Figure 1-7 Typical Detailed Arc Flash Warning Label ..... 16

Figure 1-8 NFPA 70E Handbook Arc Flash PPE Category Warning Label..... 17

Figure 1-9 Arc Flash Warning Label Referring to a Separate Calculation..... 18

Figure 1-10 Arc Flash Danger Label for Equipment Without Documented Maintenance and Testing ..... 19

Figure 1-11 Arc Flash Danger Label for Locations Identified to Be Greater Than 40 cal/cm<sup>2</sup> ..... 19

Figure 3-1. Approach Limits ..... 26

Figure 4-2. Personal Protective Equipment for Working on a Pole ..... 67

Figure 4-3. Types of Fall Protection ..... 67

Figure 5-2. Phasing Check Using Hot-Stick Phasing Testers ..... 70

Figure 7-1. Substation Temporary Grounding ..... 77

Figure 7-2. Insulated and Uninsulated Aerial Lift Vehicle Grounding Connections ..... 80

Figure 7-3. Underground System Grounding Sets ..... 80

Figure 7-4. Using a Conductive or Insulating Platform for Opening/Closing Deenergized Overhead Conductors ..... 81

Figure 7-5. Composite Stringing/Removing Temporary Protective Grounds on Overhead Conductor Lines ..... 82

Figure 12-1. Electrical Connection Outlet Assembly with a 15 kV Receptacle ..... 126

Figure 12-2. Close-Up of Electrical Connection Outlet Assembly ..... 127

Figure 12-3. Inside a Pier Vault Housing a Substation ..... 127

Figure 12-4. Skid-Mounted Substation ..... 128

Figure 12-5. Skid-Mounted Substation with Single-Pole Connections ..... 128

Figure 12-6. Double-Deck Pier Switchgear ..... 129

Figure 12-7. 480 Volt Pier Electrical Outlet Assembly Without Cable Connections ..... 130

Figure 12-8. 4.16 kV Pier Electrical Outlet Assembly and Outlets – Existing Installations ..... 130

Figure 12-9. 4.16 kV Pier Electrical Outlet Assembly and Outlets – Newer Designs .. 131

Figure 12-10. 480 Volt Pier Electrical Outlet Assembly and Cable Connections ..... 131

Figure 12-11. 480 Volt Shore-Cable to Ship-Cable with Single-Pole Connection ..... 132

Figure 12-12. 480 Volt Shore-Cable to Ship-Cable Plug and Receptacle Connection In Place ..... 132

Figure 12-13. 480 Volt Shore-Cable to Ship-Cable Splice Connection in Place ..... 133

Figure 12-14. High-Voltage Shore Receptacle ..... 133

Figure 12-15. Low-Voltage (480 Volt) Shore Receptacle ..... 134

**TABLES**

Table 1-1. Effect of 60-Hertz Current on Humans ..... 7

Table 1-2. Typical Hazards ..... 8

Table 1-3. Precautionary Steps to Minimize Asbestos Exposure ..... 9

Table 1-4. Knowing What to Do ..... 9

Table 2-1. Levels of Safety Accountability ..... 20

Table 2-2. Prohibited Actions ..... 23

Table 2-3. Unsafe Worker Indications ..... 23

Table 2-4. Pre-Site Job Requirements ..... 23

Table 2-5. Significant Unsafe Actions and Conditions ..... 24

Table 2-6. Job Hazard Analysis (JHA)/Job Safety Analysis (JSA) ..... 25

Table 3-1. Qualified Worker Minimum Approach Distances – AC Systems ..... 28

Table 3-2. Qualified Worker Minimum Approach Distances – DC Systems ..... 29

Table 3-3. Altitude Correction Factors ..... 29

Table 3-4. Excavation Pre-Survey Checklist ..... 31

Table 3-5. Performing Excavations ..... 31

Table 3-6. Backfilling ..... 31

Table 3-7. Damage During Backfilling of Trenching .....	32
Table 3-8. Jobs Acceptable For One Electrical Worker.....	32
Table 3-9. Jobs Requiring Two Electrical Workers.....	32
Table 3-10. Jobs Working In Confined Spaces That May Require More Than Two Workers.....	33
Table 4-1. NFPA 70E PPE Criteria – Category Method .....	35
Table 4-2. NFPA 70E PPE Criteria – Incident Energy Analysis Method.....	37
Table 4-3. Required PPE Per Arc Flash Category .....	39
Table 4-4. Required PPE Per Available Incident Energy.....	40
Table 4-5. Arc Flash Hazard Identification .....	45
Table 4-6. Arc Flash PPE Category Classifications for Alternating Current (AC) Systems on Grade .....	49
Table 4-7. Arc Flash PPE Category Classifications for Direct Current (DC) Systems..	51
Table 4-8. Additional Work Tasks and Associated PPE Requirements.....	52
Table 4-9. Requirements for Aerial (Overhead) Systems and Equipment.....	55
Table 5-1. Rubber Insulating Equipment Voltage Requirements.....	59
Table 5-2. Rubber Insulating Equipment Test Intervals.....	62
Table 7-1. Maximum Fault Current Capability for Grounding Cables <sup>1</sup> .....	75
Table 7-2. Temporary Ground Rod Minimum Requirements.....	75
Table 7-3. Substation Protective Grounding Procedures .....	77
Table 7-4. Grounding of Substation Equipment .....	78
Table 7-5. Grounding of Equipment During Oil Handling .....	78
Table 7-6. Procedures for Grounding Insulated and Uninsulated Aerial Lift Trucks .....	79
Table 7-7. Stringing/Removing Conductor Ground Locations .....	82
Table 7-8. Conductor Ground Location After Pulling .....	83
Table 7-9. Temporary Grounding Connection/Removal Procedures.....	84
Table 8-1. Typical Energized Work Activities on Interior Electrical Systems .....	85
Table 8-2. Typical Energized Work Activities on Exterior Electrical Systems.....	87
Table 8-1. Approved Energized Overhead Line Work Methods by Voltage Class .....	96
Table 8-2. Insulating Tools for Electrical Workers .....	96
Table 8-3. Insulating Overhead Line Plastic Guards/Platforms for Electrical Workers .	97
Table 8-4. Pre-Work Procedures – Overhead Line .....	98
Table 8-5. Energized Work Precautions – Overhead Line .....	98
Table 8-6. Voltage Level Work Procedures – Overhead Line .....	99
Table B-1 Electrical Task Risk Assessment Checklist.....	138
Table J-1 Lockout/Tagout Sequence.....	197



## CHAPTER 1 INTRODUCTION

### 1-1 PURPOSE.

This Unified Facilities Criteria (UFC) provides safety requirements for electrical workers. The requirements address various aspects associated with work safety for electrical workers. Wherever specific instructions are provided, the emphasis is on the job safety requirements; additional work instructions will likely be necessary related to the actual work being performed.

### 1-2 SCOPE.

This UFC provides safety requirements and guidance for anyone working on or near electrical components rated at 50 volts or above in facilities and related infrastructure. The scope includes electrical substations and switching stations, the associated distribution systems, and extending to electrical distribution systems inside facilities, including electrical equipment covered by UFC 3-501-01.

For the purposes of this UFC, low voltage is defined as 1,000 volts or less. Voltages higher than 1,000 volts are referred to as high voltage. Refer to the Glossary for definitions.

*Note: The prior edition of this UFC designated 600 volts as the upper limit for low voltage because this voltage was considered the highest low voltage that would be typically encountered. The designation of 1,000 volts as low voltage has been chosen to be consistent with NFPA 70E and NFPA 70. However, NFPA 70E provides the same approach distances for voltages between 751 volts to 15 kV, and refers to voltage above 600 volts as medium voltage in its Annex D. NFPA 70 provides different requirements for voltages below 600 volts, between 600 and 1,000 volts, and above 1,000 volts.*

#### 1-2.1 Need.

Electrical personnel involved in operating and maintaining electrical facilities can be injured and equipment can be damaged whenever electrical systems and components are not handled safely. The adoption and enforcement of safe electrical practices will reduce the hazards to personnel.

#### 1-2.2 Familiarity and Requirements.

Each worker must understand and apply those safety requirements of this UFC that apply to the work performed. This safety manual must be readily available to each worker for reference and study.

#### 1-2.3 Mishap Prevention.

Mishap prevention is a basic responsibility of every worker. Personal safety, fellow workers' safety, and the general public's safety depend upon compliance with this manual's requirements. Safety takes precedence over work production.

#### 1-2.4 **Unclear Conditions.**

If this UFC does not cover a specific working condition or job requirements are unclear, workers must obtain clear instructions from an authorized individual-in-charge before proceeding with the work.

#### 1-2.5 **Applicability.**

##### 1-2.5.1 **Facilities and Related Infrastructure.**

This UFC applies primarily to maintenance workers involved in electrical work at DoD facilities and related infrastructure. This UFC covers the authorized individual-in-charge, crew members, and qualified and unqualified electrical workers. The authorized individual-in-charge might be a supervisor, a foreman, or a lead electrical worker depending upon local policy. This UFC applies to operations, maintenance, and construction functions. It also applies to design functions when on project sites. Construction activities performed by contractors are subject to the requirements of this UFC only when required by appropriate contract documents. It is more common for contracted construction to have EM 385-1-1, *Safety and Health Requirements*, specified.

*Note: For Navy electronics personnel/operations, follow the guidance outlined in SPAWARINST 5100.9D, Navy Shore Electronics Safety Precautions.*

##### 1-2.5.2 **OCONUS Locations.**

Facilities located outside of the United States must also comply with the applicable host nation standards; refer to UFC 3-510-01 for additional information. Different voltages, frequencies, and grounding conventions often apply in other host nations; however, follow the design principles provided in this UFC to the extent practical.

##### 1-2.5.3 **Contingency Tactical Locations.**

Although the principles of electrical safety apply to work on any electrical system, this UFC does not apply to the following:

- Forward operating base.
- Contingency operating base.
- Other temporarily manned contingency tactical locations.

Refer to service-specific documents for requirements.

##### 1-2.5.4 **Privatized Systems.**

This UFC does not apply to electrical equipment and electrical systems owned ~~and~~ maintained ~~by~~ by other organizations outside DoD. Non-DoD organizations may typically be the local utility.

## 1-2.6 **Work Type.**

The type of work covered includes electrical construction, installation, maintenance, operation, repair, and testing of base and facility electrical systems.

## 1-2.7 **Occupational Safety and Health Administration (OSHA).**

Comply with OSHA requirements, as applicable.

## 1-3 **REFERENCES.**

Appendix A contains a list of references used in this UFC.

## 1-4 **CODES, STANDARDS, AND PUBLICATIONS.**

### 1-4.1 **Applicable Documents.**

Several codes, standards, and regulations apply to basic electrical practices; these documents cover electrical work rules, safety procedures, and requirements for electrical installations. Comply with all applicable provisions of the current issues of these consensus standards as follows and as noted elsewhere in this document. The applicable documents include:

- 29 CFR 1910, *Occupational Safety and Health, General Industry Standards.*
- 29 CFR 1915, *Occupational Safety and Health Standards for Shipyard Employment.*
- 29 CFR 1926, *Occupational Safety and Health, Safety and Health Regulations for Construction.*
- ANSI/NETA ATS, *Acceptance Testing Specifications for Electrical Power Distribution Equipment and Systems.*
- ANSI/NETA MTS, *Maintenance Testing Specifications for Electrical Power Distribution Equipment and Systems.*
- IEEE C2, *National Electrical Safety Code (NESC).*
- IEEE 1584, *IEEE Guide for Performing Arc-Flash Hazard Calculations.*
- NFPA 70, National Fire Protection Association (NFPA), *National Electrical Code (NEC).*
- NFPA 70B, *Electrical Equipment Maintenance.*
- NFPA 70E, *Electrical Safety in the Workplace.*

Note: Wherever NFPA 70E is referenced in this UFC, the reference refers to the 2018/2/ edition of NFPA 70E.

#### 1-4.2 **NFPA 70E and IEEE C2 Applicability.**

For this document, specifically for arc flash related criteria issues mainly identified in Chapter 3 (Pre-Site Safety Management), and Chapter 4 (Protective Clothing and Personal Protective Equipment), the equipment operating voltage of 1,000 volts is the delineation point (demarcation point) between the two main applicable consensus standards, NFPA 70E and IEEE C2 (NESC) as follows.

##### 1-4.2.1 **NFPA 70E.**

Readily accessible equipment, for all voltage levels, mounted within an enclosure (arc in a box) on grade, below grade, or in close proximity and maintained from grade, falls under the general arc flash requirements of NFPA 70E (listed in Table 4-2) and Additional Work Tasks (provided in Table 4-3).

##### 1-4.2.2 **IEEE C2.**

Address aerial (overhead) systems and equipment in accordance with the general arc flash requirements of IEEE C2 (NESC) as identified by Additional Work Tasks (Table 4-6) and Table 4-7. Table 4-7 is a modified version of IEEE C2 (NESC) Table 410-2.

#### 1-4.3 **Service-Specific Criteria.**

Each service has its own documents and criteria relating to occupational safety and health. Refer to the following documents as applicable for the issuing and endorsing services:

##### **Navy**

OPNAVINST 5100.23G CH-1, *Navy Safety and Occupational Health Program Manual.*

NAVFACINST 5100.12, *NAVFACENGCOCOM Safety & Health Program.*

##### **Army**

EM 385-1-1, *Safety and Health Requirements.*

Department of the Army Pamphlet (DA PAM) 385-10, *Army Safety Program.*

DA PAM 385-26, *The Army Electrical Safety Program.*

##### **Air Force**

AFI 91-203, *Air Force Consolidated Occupational Safety Instruction.*

AFI 32-1064, *Electrical Safe Practices.*

**1-5 ELECTRICAL SYSTEM MAINTENANCE AND TESTING.**

NFPA 70E addresses the role of electrical system maintenance and testing as part of an electrical safety program. NFPA 70E-2018 Article 110.1 (C) states, “*The electrical safety program shall include elements that consider condition of maintenance of electrical equipment and systems.*” NFPA 70E-2018 Article 205.3 states, “*Electrical equipment shall be maintained in accordance with manufacturers’ instructions or industry consensus standards to reduce the risk associated with failure. The equipment owner or the owner’s designated representative shall be responsible for maintenance of the electrical equipment and documentation.*”

An electrical safety program does not comply with NFPA 70E if it fails to perform maintenance and testing of electrical equipment in accordance with established industry standards or manufacturer’s recommendations. Apply ANSI/NETA MTS or NFPA 70B for the maintenance and testing of electrical system equipment, and for additional guidance, reference TM 5-683/NAVFAC MO 116/AFJMAN 32-1083, *Facility Engineering Electrical Interior Facilities*.

**1-6 WAIVER AND EXEMPTION PROCESS.**

MIL-STD 3007 provides the waiver and exemption process for deviations from this UFC.

**1-7 VARIANCES FROM NORMAL SAFETY PRACTICES.**

The safety requirements of this UFC apply to most commonly encountered working conditions. Occasionally, there might be a need to vary work practices from these requirements due to unusual or abnormal conditions. An example might be to permit work on energized equipment. In these cases, the authorized individual-in-charge must analyze and discuss alternatives with the crew prior to commencing work. Obtain required approvals according to local directives.

**1-8 WARNINGS AND NOTES.**

The following definitions apply to “Warnings,” and “Notes” found throughout this UFC.

**1-8.1 Warning.**

An operating procedure, practice, or condition that might result in injury or death or equipment damage if not carefully observed or followed.

**WARNING**

**1-8.2 Note.**

An operating procedure, practice, or condition that is essential to emphasize.

*Note: This is an example of a note.*

## 1-9 ELECTRICAL HAZARDS.

Electrical hazards include electrical shock, electrical arc flash, and electrical arc blast. These electrical hazards are particularly dangerous because the human body usually does not sense electrical energy until contact is made and significant injury has already occurred. Workers must always be aware of the location of energized equipment and its voltage level at each job site. Additionally, workers must be aware of the possible sources of electrical feedback from other energized power sources into the work site. These hazards must be determined before starting work. Pre-job planning must include engineering guidance in understanding the system's operation and review of up-to-date single line and schematic as-built drawings. All apparel, tools, and other equipment required for worker safety must be identified and available before beginning the job.

### 1-9.1 Electrical Shock Dangers and Effects.

Electric shock results from setting up an electric current path within the human body. The current flows because there is a potential gradient (voltage difference) between an energized object and the grounded worker. Figure 1-1 shows potential gradients and the safe area or equipotential zone which has no potential gradient. Figure 1-2 indicates current flow paths. Table 1-1 indicates the effects of 60-hertz current on humans.

**Figure 1-1. Ground Potential Gradient**

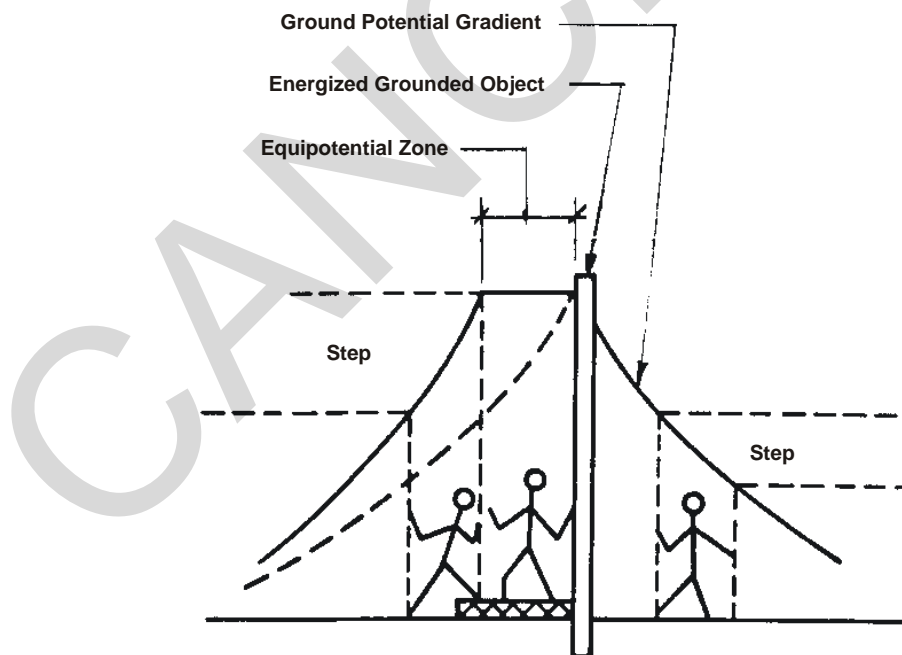

Figure 1-2. Current Path Flow

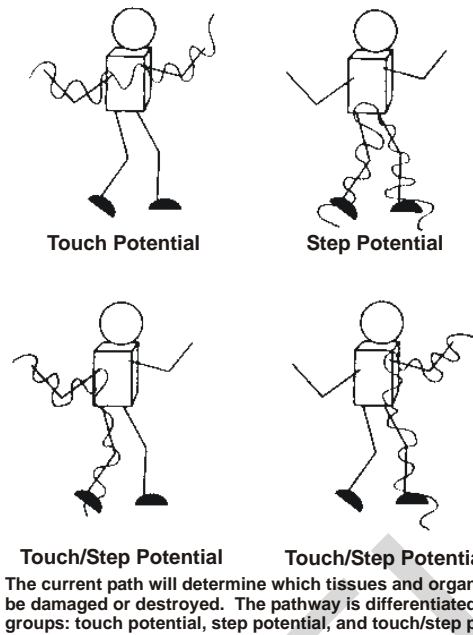

Table 1-1. Effect of 60-Hertz Current on Humans

Effect	Milliamperes	
	Men	Women <sup>1</sup>
Slight sensation on hand	0.4	0.3
Perception threshold	1.1	0.7
Shock, not painful and muscular control not lost	1.8	1.2
Painful shock, painful but muscular control not lost	9	6
Painful shock let-go threshold	16	10.5
Painful and severe shock, muscular contractions, breathing difficult	23	15
Ventricular fibrillation, threshold	75	75
Ventricular fibrillation, fatal (usually fatal for shock duration of 5 seconds or longer)	235	235
Heart paralysis (no ventricular fibrillation), threshold (usually not fatal; heart often restarts after short shocks)	4,000	4,000
Tissue burning (usually not fatal unless vital organs damaged)	5,000	5,000

<sup>1</sup>The current values for women are lower because women typically have less body mass than men.

### 1-9.2 Danger from Electrical Arc Flash and Arc Blast Hazards.

This UFC addresses arc flash criteria for electrical safety. Arcs result from the passage of electric current through air; the air failing as an insulator, but serving as a conducting medium. Blasts result when the metal at the arc site expands and vaporizes. High energy arcs can be fatal even at distances of 10 ft (3.0 m) or more.

### 1-9.3 Workplace Dangers.

Table 1-2 indicates typical hazards that can be found in enclosures, enclosed areas, or confined work spaces. Check the applicable safety data sheets (SDS).

**Table 1-2. Typical Hazards**

Hazard	Source
Asbestos	Insulation, underground manholes, under houses; crawl spaces, old electric equipment, fire protecting tape, duct banks, arc chutes/shields, cables, and wiring
Polychlorinated biphenyl (PCB)	Old liquid-filled transformers, capacitors, ballasts, lead-sheathed cables
Sulfur hexafluoride (SF6)	Toxic decomposition products from electric arcs or faults acting on SF6 insulation
Combustible gases	Sewer or natural gas accumulations or from outgassing of lead-acid batteries
Carbon monoxide	Cable faults, combustion engine exhausts
Inadequate oxygen	Displaced by heavier-than-air gases
Lead	Outer sheath of lead covered conductors.

### 1-9.4 Health Hazards of Asbestos.

Asbestos is a known human carcinogen. Its primary route of entry to the body is by inhalation; however, exposure can occur by ingestion. Asbestos is not absorbed through the skin. The diseases caused by long term exposure to asbestos are: cancer of the lungs, pleura sack surrounding the lungs, bronchus, oropharynx, stomach, and colon. Symptoms are shortness of breath, dry cough, and clubbing of the fingers. These symptoms generally do not show up for 20 years or more after initial exposure. The potential for a material containing asbestos to release breathable fibers depends on the material's degree of friability. Friable means that the material can be crumbled with hand pressure. When working around materials suspected of containing asbestos, it is important not to bump, brush or disturb the materials in any way. Wetting the materials can help to reduce the emission of fibers. Refer to Table 1-3.

*Note: Employees who are not qualified to work with asbestos are not to handle or remove materials containing asbestos fibers. Refer to 29 CFR 1910.1001 (Asbestos) or*



29 CFR 1926.1101 (Asbestos) for worker qualifications and requirements for handling asbestos containing materials.

**Table 1-3. Precautionary Steps to Minimize Asbestos Exposure**

1. Prior to disturbance, have unknown material tested for asbestos.
2. Keep unknown fibers off clothing. Wear disposable coveralls.
3. Wear proper respiratory protection: either full face or half face respirators with P-100 Filter if working with fibrous materials.
4. After working with materials, wash hands prior to eating, drinking or taking a break.

## 1-10 MISHAP RESPONSE.

Each worker must know what to do when a mishap occurs. Additionally, each worker must know how to report injuries and other mishaps.

### 1-10.1 Knowing What to Do.

Table 1-4 summarizes the first aid knowledge required of each worker. As a preplanning aid, prepare an emergency telephone number list to include the location and telephone numbers of the nearest ambulance or emergency medical treatment responders, the nearest hospital with an emergency room, the nearest helicopter evacuation service, and the nearest burn trauma center. A medical professional must evaluate all shock victims for treatment and medical follow-up.

**Table 1-4. Knowing What to Do**

Item	Instructions/Training
First aid/CPR	How to control bleeding and apply artificial respiration and cardiopulmonary resuscitation (CPR). How to provide pole top and manhole rescues of mishap victims. Familiarity with electric shock symptoms.
Medical provisions	Location, contents, and use of first aid kits and where located in electric line and aerial lift vehicles. How to get medical assistance.

### 1-10.2 Work Injuries and Mishap Reports.

Report injuries, including minor injuries, to your immediate supervisor. Every mishap involving personnel injury, property damage, or near misses must be investigated to determine the cause and the corrective action needed to prevent recurrence. Cognizant safety personnel conduct investigations. The safety staff must be notified of all mishaps that involve personnel injuries or property damage.

### 1-10.3 **First Aid Supplies.**

#### 1-10.3.1 **Storage and Inspection.**

Place first aid supplies in weatherproof containers if the supplies could be exposed to the weather. Maintain each first aid kit readily available for use, and inspect frequently (at least annually) to ensure expended items are replaced.

#### 1-10.3.2 **Contents.**

An example of the minimal contents of a generic first aid kit is described in American National Standard (ANSI) Z308.1, *Minimum Requirements for Workplace First-Aid Kits and Supplies*. The contents of the kit listed in the ANSI standard is adequate for small worksites. When larger operations or multiple operations are being conducted at the same location, determine the need for additional first aid kits at the worksite, additional types of first aid equipment and supplies and additional quantities and types of supplies and equipment in the first aid kits.

### 1-10.4 **Automatic External Defibrillators (AEDs).**

Where emergency medical assistance is not available within four minutes, the use of AEDs may be warranted. Prior to agencies/activities purchasing AEDs, effective written programs must be established. At a minimum, address the following:

- Coordination with private sector and/or DoD medical facilities, fire departments, emergency responders.
- Training.
- Placement and availability of properly trained employees.
- Equipment maintenance.
- Legal issues.

*Note: For the Air Force, refer to AFI 32-1064 for requirements on AED training, including certification requirements.*

## 1-11 **COMMUNICATIONS.**

All employees participating in a work procedure must be in constant voice contact with all other members involved in that procedure. The ability of work crew, work leader, and/or supervisor to communicate during circuit isolation, maintenance, troubleshooting and restoration is essential. Accordingly, provide each employee with a personal communication device (radio or cellular phone) and with each assigned a unique caller identification.

## 1-12 ARC FLASH WARNING LABELS.

Provide arc flash warning labels on electrical equipment likely to require examination, servicing, or maintenance while energized. Some typical types of equipment include pad-mounted transformers, switchgear, switchboards, panelboards, disconnect switches, industrial control panels, meter socket enclosures, and motor control centers that are in other than dwelling occupancies.

*Note: Determine if the Activity has an arc flash risk assessment program, and if so, coordinate on which label format will be used.*

*Note: For Army projects, comply with DA PAM 385-26, The Army Electrical Safety Program, and provide arc flash labels in accordance with NFPA 70E.*

*Note: AutoCAD format and Adobe PDF format files are available at [http://www.wbdg.org/ccb/NAVGRAPH/arc\\_flash\\_warning\\_labels.zip](http://www.wbdg.org/ccb/NAVGRAPH/arc_flash_warning_labels.zip).*

*2\Note: In the 2018 update to IEEE 1584, the requirement was added to account for factors such as enclosure dimensions and electrode configurations when performing incident energy calculations. As a result, equipment such as motor control centers, which house branch circuit overcurrent protective devices within separate enclosed cubicles, may produce unique arc flash risk analysis results for each cubicle. Once the incident energy calculations have been performed for all cubicles on a piece of equipment such as this, as an alternative to applying labels to each cubicle, it is acceptable to generate a 'Worst Case' label which can be used to represent all branch circuit cubicles. 'Worst Case' branch circuit cubicle labels should only be used with the written approval of the equipment owner and/or the entity responsible for maintaining the equipment. When 'Worst Case' branch circuit cubicle labels are used, separate unique labels must still be applied to any cubicles housing the equipment's main overcurrent device(s) or tie breakers. Any 'Worst Case' branch circuit cubicle labels should be conspicuously located on the equipment and should contain wording which clearly indicates which cubicles the label applies to.121*

The following sections list the types of arc flash label formats that have been approved. These include:

- General label.
- General label referring to OSHA.
- Detailed label, compliant with NFPA 70E.
- General label that refers to a separate arc flash calculation for requirements.
- Label for equipment that has not received adequate maintenance or testing.

- Label for equipment where an arc flash calculation identifies an available incident energy greater than 40 cal/cm<sup>2</sup>.

### 1-12.1 General Arc Flash Label.

Provide labels in accordance with the format shown in Figure 1-3.

*Note: Do not use this label for Army projects.*

**Figure 1-3 Typical Arc Flash Warning Label**

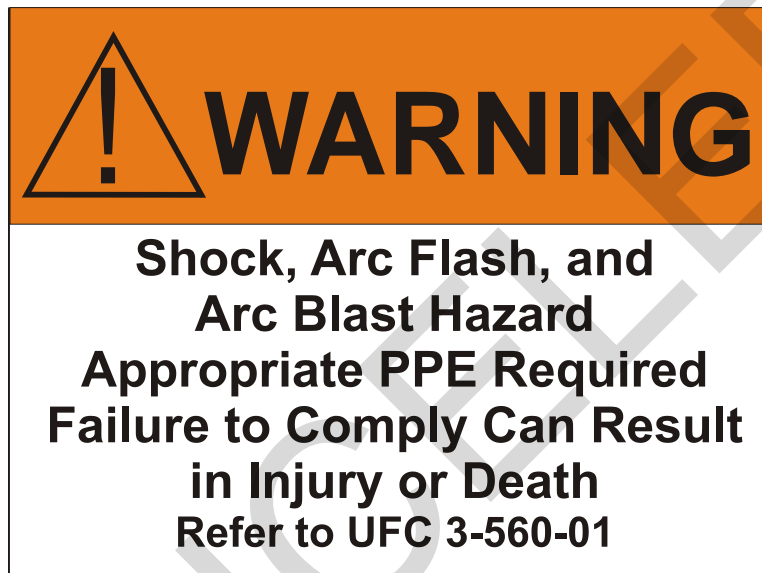

*Note: As part of the original development of UFC 3-501-01, Electrical Engineering, and UFC 3-560-01, Operation and Maintenance: Electrical Safety, the Tri-Service Electrical Working Group (TSEWG) deliberately specified general arc flash warning labels rather than the detailed arc flash warning labels specified by NFPA 70E. The detailed label information specified by NFPA 70E was considered inappropriate for the following reasons:*

- *∇\The equipment is in poor condition.\2/*
- *∇\Routine testing and maintenance does not occur or cannot be verified to have occurred.\2/*
- *∇\Detailed incident energy calculations cannot reasonably be assumed to be updated on a routine basis as requirement by NFPA 70E.\2/*

### 1-12.2 General Arc Flash Label That Refers to OSHA.

OSHA requires protection from the incident energy of an arcing fault. But, neither 29 CFR 1910 nor 29 CFR 1926 require an arc flash label. As published, the OSHA requirements do not discuss labels at all. The Federal Register publication (April 11,

2014) of the revised 29 CFR Parts 1910 and 1926 discusses why OSHA does not require arc flash labels.

A general arc flash label that refers to OSHA requirements is allowed. Figure 1-4 provides an example.

*Note: Do not use this label for Army projects.*

**Figure 1-4 General Arc Flash Label That Refers to OSHA**

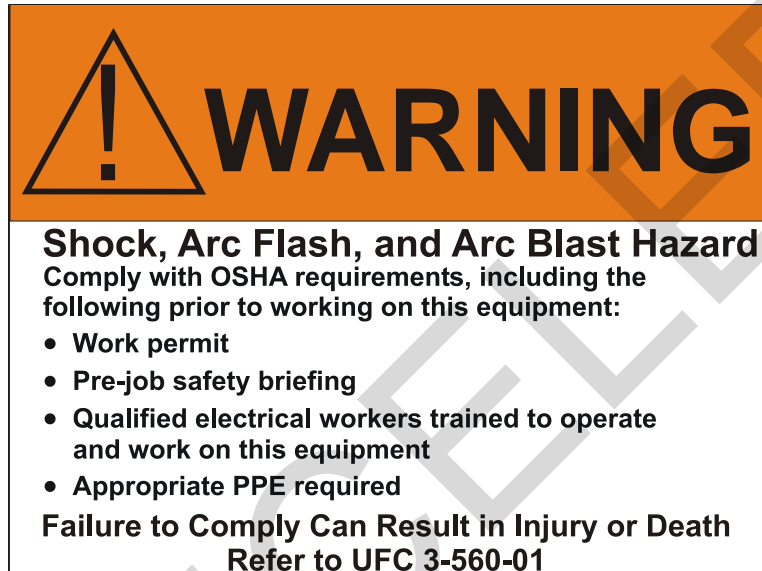

### 1-12.3 Detailed Arc Flash Label.

For new and existing installations, a detailed label is only authorized if the Activity has an arc flash risk assessment program that includes documented periodic maintenance and testing. New installations must also have been commissioned in accordance with NETA Acceptance Test Specifications.

*Note: an Activity may have two distinct arc flash risk assessment programs in place: one for the medium voltage distribution (utility) part of the electrical distribution system and one for low voltage systems inside facilities.*

If the following types of equipment are credited for clearing an arcing fault as part of an arc flash study, the equipment must have commissioning performed in accordance with NETA ATS if new, and periodic maintenance and testing performed in accordance with NETA MTS or NFPA 70B if existing:

- Medium voltage power circuit breakers.
- Medium voltage pad-mounted switchgear.
- Low voltage power circuit breakers.

- Overcurrent protective relays.
- Switchboards and panelboards – main circuit breaker at each location and all circuit breakers rated for 225 amperes, or higher (molded case circuit breakers and insulated case circuit breakers).
- Electronic trip units associated with the above equipment.

*Note: Coordinate with activity to ensure funding is available for the above maintenance and testing.*

### 1-12.3.1 Documentation of Commissioning and Maintenance/Testing.

Confirmation of commissioning and maintenance/testing consists of calibration or maintenance stickers applied to the equipment and a documented report of the maintenance and testing that was completed. Coordinate with the Activity maintenance personnel to identify the required format and content to be provided on a calibration or maintenance sticker. Figure 1-5 shows typical calibration or maintenance stickers. As a minimum, provide the following information:

- Company or organization that performed the testing.
- Date of test.
- Initials of person who performed the test.
- Date due.

**Figure 1-5 Typical Calibration or Maintenance Stickers**



### 1-12.3.2 Arc Flash Label Content.

NFPA 70E specifies the following information to be included on a detailed arc flash label:

- Nominal system voltage.
- Arc flash boundary.
- At least one of the following:

- a) Available incident energy and the corresponding working distance, or the arc flash PPE category in NFPA 70E Table 130.7(C)(15)(a) or 130.7(C)(15)(b) for the equipment, but not both.
- b) Minimum arc rating of clothing.
- c) Site-specific level of PPE.

*Note: Site-specific level of PPE is an identified requirement in NFPA 70E if it is more restrictive than item a) above. Annotate the label appropriately. This could occur based on an Activity specific issue, where the Activity is adding the additional requirement. An example of this is shown in Figure 1-8 below.*

In addition to the above information specified by NFPA 70E, include the following information on a detailed label:

- Equipment identification number.
- Date of arc flash calculation.

If the arc flash results can vary as a result of different operating or switching modes, include this information in the detailed label.

### 1-12.3.3 Arc Flash Label Examples.

Figure 1-6 shows the detailed label provided by the NFPA 70E Handbook which displays the calculated available incident energy. Figure 1-7 shows a typical detailed label based on the required minimum arc rating of clothing PPE. The arc flash label format can be modified provided that the required information is included.

121

Figure 1-6 NFPA 70E Handbook Arc Flash Incident Energy Warning Label

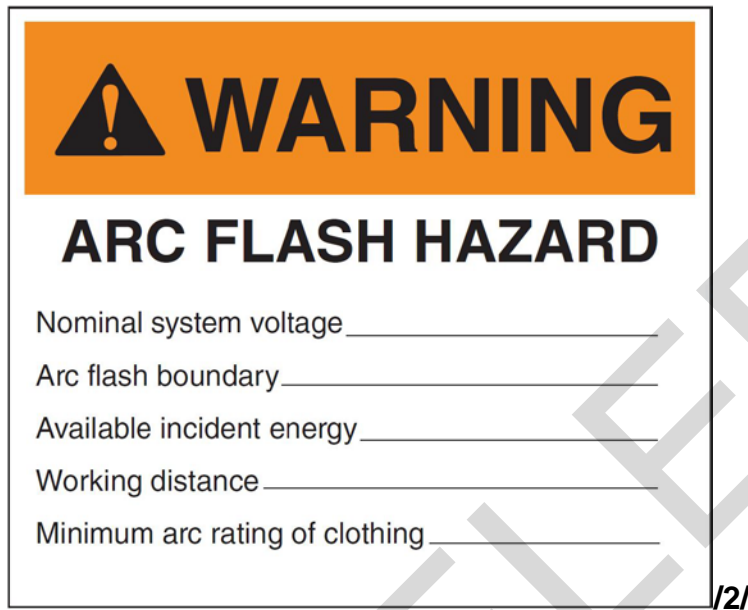
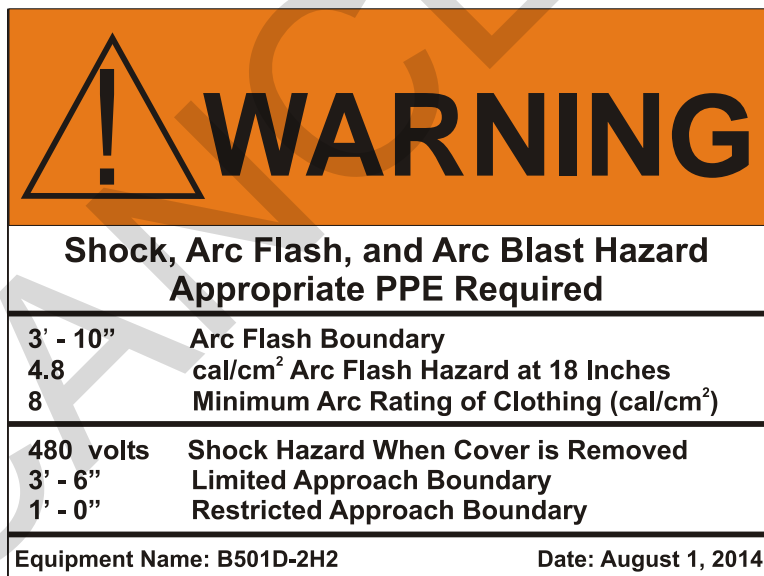

Figure 1-7 Typical Detailed Arc Flash Warning Label



1-12.3.4 Arc Flash Labels Based on NFPA 70E Tables.

Detailed labels based on NFPA 70E Table 130.7(C)(15)(a) or 130.7(C)(15)(b) can be installed if the following conditions have been verified and documented:

- The available short circuit is less than stated in the table.
- The upstream protective device is identified and confirmed to trip within the clearing time stated in the table.



- Maintenance and testing of the upstream protective device in accordance with NETA MTS or NFPA 70B has been confirmed to be adequate and current. Typically, this equipment would have calibration or maintenance stickers applied with a documented report of the maintenance and testing that was completed.

Figure 1-8 shows the detailed label provided by the NFPA 70E Handbook which displays the PPE category.

**Figure 1-8 NFPA 70E Handbook Arc Flash PPE Category Warning Label**

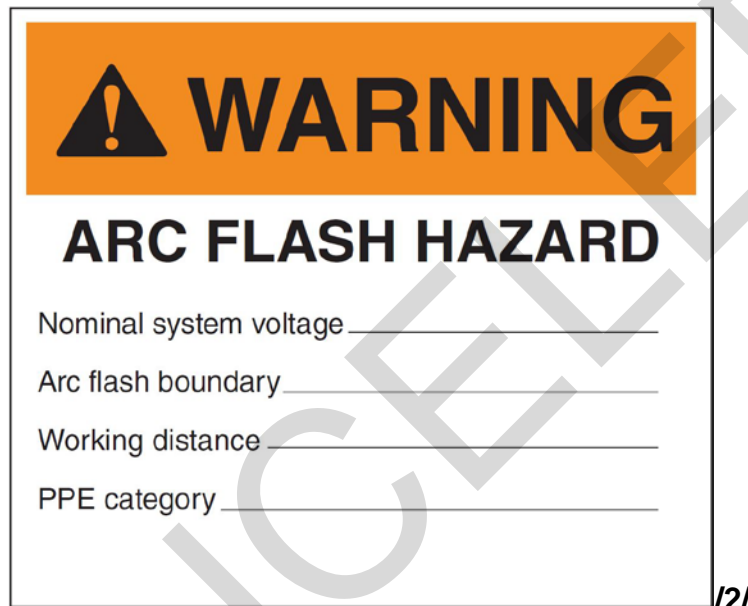

### 1-12.3.5 Arc Flash Label Updates.

Document the method of calculating and the data to support the information for the label. Once installed, a detailed label must be removed or replaced with a new label containing updated information under any of the following conditions:

- Whenever a review of the arc flash risk assessment identifies a change that renders the label inaccurate. This includes:
  - System design changes that affect short circuit values or electrical coordination.
  - Circuit breaker trip setting changes.
- More than five years passes without maintenance and testing in accordance with NETA MTS or NFPA 70B.
- More than five years passes without a review of the arc flash risk assessment for accuracy.

#### 1-12.4 Arc Flash Label That Refers to a Separate Calculation.

In supervised industrial installations where conditions of maintenance and engineering supervision ensure that only qualified persons monitor and service the system, instead of a detailed label as specified by NFPA 70E and addressed above in Section 1-12.3, the arc flash label is allowed to refer to an arc flash calculation where the required arc flash parameters can be obtained. Figure 1-9 shows an example. The advantage of this approach is that the calculation can be periodically revised without requiring physical relabeling of the equipment.

*Note: Do not use this label for Army projects.*

**Figure 1-9 Arc Flash Warning Label Referring to a Separate Calculation**



#### 1-12.5 Arc Flash Label for Existing Equipment Without Maintenance or Testing.

Arc flash calculation results are based on proper operation of upstream protective devices in accordance with their published time-current curves. Periodic maintenance and testing of electrical equipment is essential to confirming this proper operation. Use the standard label provided in Figure 1-10 for the following equipment locations:

- New installations that did not include commissioning in accordance with NETA ATS.
- Existing installations without maintenance and testing in accordance with NETA MTS or NFPA 70B in the last five years.

Figure 1-10 Arc Flash Danger Label for Equipment Without Documented Maintenance and Testing



1-12.6 **Arc Flash Label for Locations Identified to Be Greater Than 40 cal/cm<sup>2</sup>.**

Use a label similar to the following if the arc flash calculation identifies a location with an available incident energy greater than 40 cal/cm<sup>2</sup>.

Figure 1-11 Arc Flash Danger Label for Locations Identified to Be Greater Than 40 cal/cm<sup>2</sup>

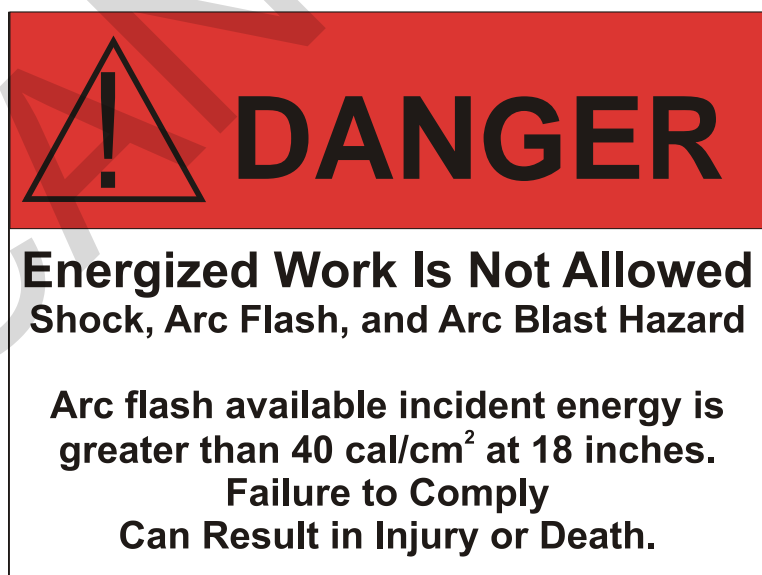

**CHAPTER 2 WORKER/CREW RESPONSIBILITIES****2-1 LEVELS OF RESPONSIBILITY.**

Operation and maintenance of electrical distribution systems are a single work group responsibility. The same personnel will frequently perform both functions. All personnel are responsible for safety at all times. Table 2-1 lists the level of accountability for each job function.

*Note: The titles and responsibilities listed in Table 2-1 are typical assignments for electrical workers at most facilities or organizations. However, titles and responsibilities might be assigned differently in accordance with local directives.*

**Table 2-1. Levels of Safety Accountability**

<b>Title</b>	<b>Accountability</b>
Installation commander	Ultimate safety accountability
Base civil engineer	Base systems safety accountability
Electric supervisor (if assigned)	Systems safety accountability
Supervisor/lead electrical worker	Systems safety and specific work task safety
Crew members	Crew members' safety accountability is limited to doing only work for which they are qualified

**2-2 ELECTRICAL WORKER QUALIFICATIONS.**

Qualifications for electrical workers are normally established locally. Workers are classified as *Qualified* or *Unqualified*.

**2-2.1 Qualified Persons.**

One who has skills and knowledge related to the construction and operation of the electrical equipment and installations and has received safety training to recognize and avoid the hazards involved. This includes :

- The skills and techniques necessary to distinguish exposed live parts from other parts of electric equipment.
- The skills and techniques necessary to determine the nominal voltage of exposed live parts.
- Skills and techniques regarding how to select and use a voltage detector and phase meter.
- The clearance distances and the corresponding voltages to which the qualified person will be exposed.

## 2-2.2 Unqualified Person.

An unqualified person is any person who is not a qualified person.

## 2-2.3 Type of Training.

Training can be in the classroom or on-the-job, or a combination of the two. Determine the degree of training based on the risk to the employee. As a minimum, the employee must demonstrate to their supervisor or designated representatives, the capability, knowledge and skills to understand and apply the controls required by their exposures, and that they can safely complete their assigned tasks. Each employee's possession of the necessary skills, knowledge and abilities must be determined by written or verbal tests, in conjunction with functional tests. Develop and use lesson plans or Standard Operating Procedures. Training may be contracted from outside sources, which include certified training facilities and utility companies.

*Note 1: Whether an employee is considered to be a “qualified person” depends upon various circumstances in the workplace. For example, it is possible and, in fact, likely for an individual to be considered “qualified” with regard to certain equipment in the workplace, but “unqualified” as to other equipment.*

*Note 2: An employee who is undergoing on-the-job training and who, in the course of such training, has demonstrated an ability to perform duties safely at his or her level of training and who is under the direct supervision of a qualified person is considered to be a qualified person for the performance of those duties.*

## 2-2.4 Cardiopulmonary Resuscitation (CPR) and First Aid Training.

Provide first aid and CPR training to employees exposed at or above 50 volts and those trades listed in Section 4-1.1. Consider including automated external defibrillator (AED) training as part of this training. First aid training is primarily received through the American Red Cross, the American Heart Association, the National Safety Council, or other private institutions. Obtain refresher training annually to maintain CPR certifications. Train employees responsible for responding to medical emergencies in the use of an AED if the emergency response plan includes the use of this device.

When employees are performing work on or associated with exposed lines or equipment energized at 50 volts or more, persons trained in first aid and CPR must be available as follows:

- For field work involving two or more employees at a work location, ensure at least two trained persons are available. Refer to Section 3-3 for those jobs requiring at least two employees.
- For fixed work locations such as generating stations, provide a sufficient number of trained persons to ensure that each employee exposed to electric shock can be reached within 4 minutes by a trained person. However, where the existing number of employees is insufficient to meet

this requirement (at a remote substation, for example), train all employees at the work location.

### 2-2.5 **Rescue Training.**

All workers engaged in electrical work must receive training in methods of release from the energized conductor and in methods of rescue from poles, structures, manholes, aerial baskets, confined spaces, and other field work areas as applicable to the facility or installation.

### 2-2.6 **Training Documentation.**

Document that each employee has received the required training. Complete this documentation when the employee demonstrates proficiency in the work practices involved and maintain the documentation for the duration of the employee's employment. Include each employee's name and dates of training in the documentation file. Verify at least annually that training is current for each employee.

## 2-3 **SAFETY MEETINGS.**

Safety meetings must consist of scheduled meetings for all personnel and job briefing/tailgate meetings as needed for specific jobs.

### 2-3.1 **Scheduled Meetings.**

Schedule safety meetings in accordance with local policy. Twice a month is recommended, but once a month is the minimum; less frequent meetings tend to de-emphasize the importance of safety. Supervisory personnel must conduct these meetings, but encourage other knowledgeable individuals to conduct training on specialized topics.

### 2-3.2 **Job Briefing/Tailgate Meetings.**

Meetings at the job site prior to the commencement of work are commonly called tailgate meetings. This meeting covers all aspects of the planned work, site hazards, safety precautions to be followed, special precautions, energy source controls, and personal protective equipment. The individual in charge must conduct the job brief and must ensure that each crew member understands the precautions to be observed and the procedures to be followed. Tailgate meetings are also recommended at the beginning of each work shift for longer duration jobs so that all crew members understand what is to be done, how to accomplish the job, safety hazards present, and methods used to provide worker protection.

Refer to NFPA 70E Annex I for a typical job briefing and planning checklist. Individual services also have Standard Operating Procedures or other information that provides job briefing checklists.

**2-4 WORK SITE SAFETY.**

Maintaining acceptable work site safety involves proper behavior, good housekeeping, maintenance of protective measures, and avoiding unsafe actions. The following tables provide examples and are not all inclusive. Table 2-2 lists prohibited actions. Report indications of unsafe worker actions listed in Table 2-3. Verify that pre-site job requirements listed in Table 2-4 are met. Significant unsafe actions and conditions are listed in Table 2-5.

**Table 2-2. Prohibited Actions**

Taking chances
Playing jokes
Carelessness
Smoking
Use of intoxicants or drugs
Throwing material
Quarreling
Disobedience
Unnecessary talking or noise
Working while ill or under emotional stress

**Table 2-3. Unsafe Worker Indications**

Lacks information
Lacks skills
Lacks experience
Unaware of safe practices
Does not realize danger

**Table 2-4. Pre-Site Job Requirements**

Regular safety meetings
Job hazard analysis if safe clearance ( <i>Chapter 6</i> ) requires it or if energized line work ( <i>Chapter 8</i> ) will be done
Written work procedures covering existing conditions
Job briefing/tailgate briefings

**Table 2-5. Significant Unsafe Actions and Conditions**

<b>Unsafe Actions</b>
Operating without authority; failure to secure or warn others
Operating or working at unsafe speeds
Making safety devices inoperative without proper authorization
Using unsafe equipment (hands instead of equipment) or equipment unsafely
Taking unsafe positions or postures
Working on moving or dangerous equipment
Distracting, teasing, abusing, startling
Failing to use safe attire or personal protective devices
Failing to lock-out and tag deenergized circuits
Failure to follow established safety policies
Carelessness
Defacing identifying markings on equipment
<b>Unsafe Conditions</b>
Improperly guarded facilities
Defects of facilities
Hazardous arrangement or procedure
Improper ventilation
Improper illumination
Unsafe dress or apparel

**2-5 JOB HAZARD ANALYSIS/JOB SAFETY ANALYSIS.**

Written work procedures must be prepared for unusual or complicated work activities. Table 2-6 lists the minimum requirements for a job hazard analysis or job safety analysis.



**Table 2-6. Job Hazard Analysis (JHA)/Job Safety Analysis (JSA)**

Identification of the work site
Description of the work to be done
Specific hazards and how to minimize or eliminate them by use of safety equipment
Use of proper arc flash and shock hazard personal protective equipment (PPE)
Instructions covering special practices for grounding, unusual equipment and tools, and first aid requirements for hazardous materials
Sequence of major steps or a detailed step-by-step work listing
A JHA or JSA, and written standard operating procedure

## **2-6 SAFETY COMPLIANCE.**

A requirement of employment is compliance with safety requirements. Workers must not perform work they consider unduly hazardous based on their own capabilities; they are not trained or qualified to perform; or when they are not properly protected from injury. In a case where the safety requirements are not clear, the worker must obtain direction from the authorized individual-in-charge.

### **2-6.1 Carelessness.**

A worker must challenge a fellow worker who violates any of these rules or works in an unsafe manner, and must promptly report any violations of safety requirements to the authorized individual-in-charge.

### **2-6.2 Interpretation.**

In any case where rules are not clear ask the foreman or supervisor for an interpretation.

### **2-6.3 Violations.**

Each safety rule must be strictly enforced. Workers failing to observe the rules can be subject to penalties. Supervisors must follow appropriate guidelines and ensure the severity of the penalty is related to the seriousness of the offense.

## CHAPTER 3 PRE-SITE SAFETY MANAGEMENT

### 3-1 WORK LOCATION SAFETY REQUIREMENTS.

The location and the public access to the work site impose additional protective or regulatory requirements.

#### 3-1.1 Working Near Energized Circuits.

Perform electrical maintenance near energized circuits with rubber blankets or other suitable guards as a safety measure. Minor work (such as cutting weeds, taking oil samples, or securing nameplate data) when done near energized apparatus or conductors located on or near the ground may be performed when workers maintain the unqualified worker minimum approach distances, as appropriate.

##### 3-1.1.1 Minimum Approach Distances.

Figure 3-1 shows a general layout of the various approach limits. Each boundary is defined following Figure 3-1.

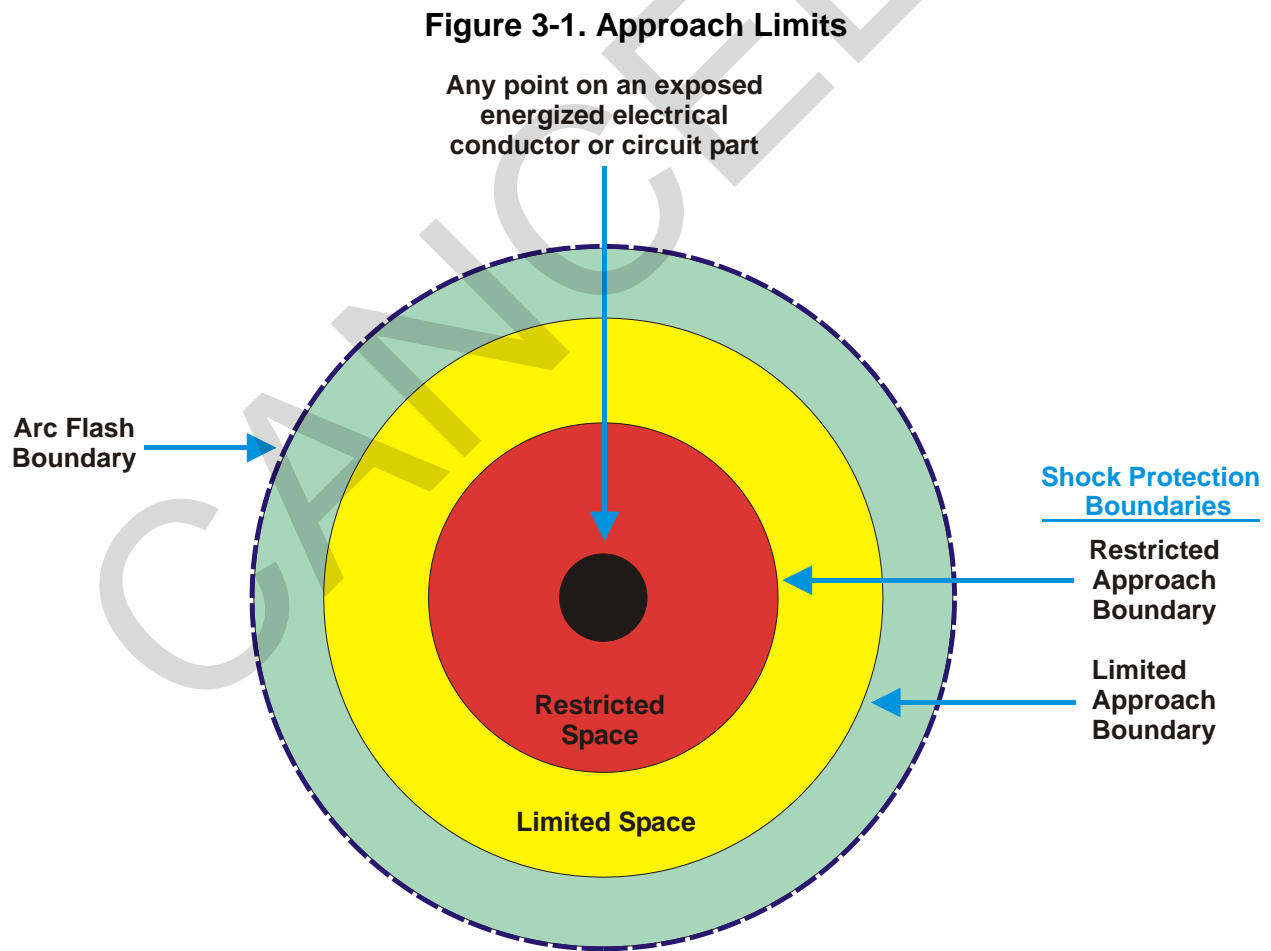

### **3-1.1.1.1 Arc Flash Boundary.**

The distance from an arc source (energized exposed equipment) at which the potential incident heat energy from an arcing fault on the surface of the skin is  $1.2 \text{ cal/cm}^2$  ( $5 \text{ J/cm}^2$ ). Within this boundary, workers are required to wear appropriate personal protective equipment (PPE) clothing. Only qualified workers wearing appropriate PPE are permitted to be within this boundary.

### **3-1.1.1.2 Limited Approach Boundary.**

A shock protection boundary to be crossed by only qualified persons (at a distance from a live part) that is not to be crossed by unqualified persons.

If there is a need for an unqualified person(s) to cross the limited approach boundary, a qualified person must advise him or her of the possible hazards and continuously escort the unqualified person(s) while inside the limited approach boundary. Under no circumstance is the escorted unqualified person(s) allowed to cross the restricted approach boundary.

### **3-1.1.1.3 Restricted Approach Boundary.**

A shock protection boundary to be crossed by only qualified persons (at a distance from a live part) that, due to its proximity to a shock hazard, requires the use of shock protection techniques and equipment when crossed.

### **3-1.1.2 Minimum Approach Distance for Unqualified Workers.**

Only workers qualified by electrical training can work in areas on or with unguarded, uninsulated energized lines or parts of equipment operating at 50 volts or more. All electric lines and equipment will be treated as energized unless they are placed in an electrically safe working condition, including grounding in accordance with Chapter 7. The minimum approach distance refers to the shortest possible distance between energized electrical lines or apparatus and any part of a worker's body and tools or material being handled.

*Note: an unqualified person can enter a limited approach boundary only under the conditions stated in Section 3-1.1.1.2.*

### **3-1.1.3 Minimum Approach Distances.**

Table 3-1 lists the minimum approach distances from exposed alternating current energized parts within which a qualified worker may not approach without the use of personal protective equipment appropriate for the potential electrical hazards, or place any conductive object without an approved insulating handle, unless certain other work techniques are used (such as isolation, insulation, shielding, or guarding). Table 3-2 provides similar information for direct current systems.

**Table 3-1. Qualified Worker Minimum Approach Distances – AC Systems**

Nominal System Voltage Range Phase to Phase (1)	Limited Approach Boundary		Restricted Approach Boundary (2) (3)
	Exposed Movable Conductor	Exposed Fixed Circuit Part	Includes Standard Inadvertent Movement Adder
<50 V	Not specified.	Not specified.	Not specified.
50 V to 150 V	10 ft 0 in (3.0 m)	3 ft 6 in (1.0 m)	Avoid contact
>151 V to 750 V	10 ft 0 in (3.0 m)	3 ft 6 in (1.0 m)	1 ft 0 in (0.3 m)
>750 V to 15 kV	10 ft 0 in (3.0 m)	5 ft 0 in (1.5 m)	2 ft 2 in (0.7 m)
>15 kV to 36 kV	10 ft 0 in (3.0 m)	6 ft 0 in (1.8 m)	2 ft 9 in (0.8 m)
>36 kV to 46 kV	10 ft 0 in (3.0 m)	8 ft 0 in (2.5 m)	2 ft 9 in (0.8 m)
>46 kV to 72.5 kV	10 ft 0 in (3.0 m)	8 ft 0 in (2.5 m)	3 ft 6 in (1.0 m)
>72.5 kV to 121 kV	10 ft 8 in (3.3 m)	8 ft 0 in (2.5 m)	3 ft 6 in (1.0 m)
>121 kV to 145 kV	11 ft 0 in (3.4 m)	10 ft 0 in (3.0 m)	3 ft 10 in (1.2 m)

*Notes for Table 3-1:*

1. For single phase systems  $\sqrt{2}$  above 250 volts,  $\sqrt{2}$  select the range that is equal to the system's maximum phase to ground voltage times 1.732.
2. The restricted approach boundary is defined as the distance between energized parts and grounded objects without insulation, isolation, or guards.
3. The restricted approach distance applied to hot sticks is the distance between a worker's hand and the working end of the stick.
4. Only qualified workers wearing appropriate PPE are permitted to be within the arc flash boundary. The arc flash boundary is determined by an arc flash analysis. Refer to Chapter 4 for PPE requirements for the intended work location.
5.  $\sqrt{2}$  Refer to NFPA 70E for AC voltages above 145 kV.  $\sqrt{2}$

**Table 3-2. Qualified Worker Minimum Approach Distances – DC Systems**

Nominal System Voltage Range Phase to Phase (1)	Limited Approach Boundary		Restricted Approach Boundary
	Exposed Movable Conductor	Exposed Fixed Circuit Part	Includes Reduced Inadvertent Movement Adder
<50 V	Not specified	Not specified	Not specified
50 V to 300 V	10 ft 0 in (3.0 m)	3 ft 6 in (1.0 m)	Avoid contact
>300 V to 1 kV	10 ft 0 in (3.0 m)	3 ft 6 in (1.0 m)	1 ft 0 in (0.3 m)

Notes for Table 3-2:

1. Refer to NFPA 70E for DC voltages above 1,000 V.

**3-1.1.4 Altitude Correction for Minimum Approach Distances.**

Refer to Table 3-3 for altitude correction factors for work performed at elevations greater than 3,000 ft (914 m); the minimum approach distance is determined by multiplying the distances in Table 3-1 by the appropriate correction factor from Table 3-3.

**Table 3-3. Altitude Correction Factors**

Altitude		Correction Factor	Altitude		Correction Factor
Feet	Meters		Feet	Meters	
3,000	900	1.00	10,000	3,000	1.20
4,000	1,200	1.02	12,000	3,600	1.25
5,000	1,500	1.05	14,000	4,200	1.30
6,000	1,800	1.08	16,000	4,800	1.35
7,000	2,100	1.11	18,000	5,400	1.39
8,000	2,400	1.14	20,000	6,000	1.44
9,000	2,700	1.17			

**3-1.2 Work Location.**

The location of the work will determine whether climbing or confined space training along with fall and/or respiratory protection are mandatory (refer to Chapter 4). Safety standards require protection from excessive noise and provision of minimum illumination at any applicable work site.

### 3-1.2.1 **Noise.**

Follow local procedures regarding hearing protection. Wherever hazardous noise area signs are posted, hearing protection must be used as prescribed.

### 3-1.2.2 **Minimum Illumination.**

Do not reach blindly into areas that might contain exposed energized electrical conductors or circuit parts where an electrical hazard exists. Ensure the working area has adequate illumination. Provide temporary lighting where natural or installed artificial illumination is not sufficient. Survey facility electrical equipment rooms to determine if lighting has been connected to a timer/motion control device. Ensure timers/motion control devices are disengaged prior to beginning any electrical work operations.

Where lack of illumination or an obstruction precludes observation of the work to be performed, do not perform any task within the limited approach boundary of energized electrical conductors or circuit parts operating at 50 volts or more or where an electrical hazard exists.

## 3-2 **PUBLIC SAFETY.**

Protect the public around the work area by safely guiding unqualified personnel and traffic away from workers, equipment, and excavations.

### 3-2.1 **Warning Devices.**

Locate appropriate barriers, warning signs, traffic cones, and lights at approaches to and at work areas, excavations, open manholes, parked equipment, and other hazards. Take special precautions for any areas where reduced visibility occurs, such as night operations or in fog. Immediately remove warning devices after removal of hazards and equipment. Provide flagmen if there is any doubt as to whether the warning devices will be adequate as controls, such as in areas with obstructed vehicular traffic.

### 3-2.2 **Flagmen.**

Flagmen must be used whenever there is any doubt of the effectiveness of warning devices. This often occurs on busy roadways or during commuting hours on less traveled streets. Flagmen must wear brightly colored and highly reflective warning vests.

### 3-2.3 **Excavations.**

Provide barricades around every excavation area. Keep warning barricade (cones, tape, and other items providing no physical protection) 5 ft (1.5 m) from the excavation. A protective barricade may be placed closer since it provides both a warning and physical protection. Protective barricades must have a withstand rating of at least 200 lb (90 kg) in any direction with minimal deflection. Never enter an excavation deeper than 4 ft (1.6 m) which does not have a safe access-way, which has not been inspected by a competent person before allowing an entrance, or which has equipment

working next to the edge. Comply with requirements stated in 29 CFR 1926, Subpart P, (Excavations). Identify underground lines and services prior to starting excavations. The following tables provide additional guidance.

**Table 3-4. Excavation Pre-Survey Checklist**

Location	Checklist Items
Prior to leaving the shop.	<ol style="list-style-type: none"> <li>1. Ensure location of underground cables has been established.</li> <li>2. Verify that field sketch is available.</li> <li>3. Obtain as-built/maps from facility owner(s).</li> <li>4. Have subsurface facility engineering performed.</li> <li>5. Conduct pre-construction meetings with facility owner(s).</li> <li>6. Site and Safety Plan or Job Hazardous Analysis/Job Safety Analysis.</li> </ol>
On the job site.	<ol style="list-style-type: none"> <li>1. Check for field sketch.</li> <li>2. Verify all facility marks on ground.</li> <li>3. Verify all service feeds from houses or buildings. Verify all are marked or noted above ground. Draw sketch. Check for: pedestals, risers, and new trench lines.</li> <li>4. Verify position of dig area to sketch.</li> <li>5. Check for private facilities not marked.</li> <li>6. Advise facilities owner of excavation.</li> </ol>

**Table 3-5. Performing Excavations**

1. Maintain 24 in (610 mm) from marks. If digging within 24 in (610 mm), hand dig to expose and verify lines.
2. Expose all major facilities within 5 ft (1.5 m) of work area.
3. If paralleling: expose to verify location and depth of facilities every 100 ft (30.5 m).
4. Hand dig within 5 ft (1.5 m) of pedestals, risers, meters, flags, whiskers, etc.
5. Bore away from facilities.
6. Verify depth of any facilities boring across, change route or depth as required.
7. Do not place excavation dirt on locate marks, flags, whiskers, etc.
8. Support all lines exposed during excavation to avoid kinks or other damage.

**Table 3-6. Backfilling**

1. Prior to backfilling, contact facility owner to inspect exposed facility.
2. "Shade" all lines placed or exposed with good fill dirt.
3. Verify all fill dirt is free from rocks, cable trash, and large dirt clods.
4. No cable or personal trash may be backfilled into the trench.

**Table 3-7. Damage During Backfilling of Trenching**

1. If damage involves a potential risk of life, health or significant property damage, call 911 or local emergency response number.
2. All damage, including kinking or sheath damage, must be reported immediately to a supervisor and facility owner or operator.
3. Photograph the damage.
4. If a water line, other than a main, attempt to stop the damage.
5. If a gas or power line, evacuate the area, if necessary, and notify others working in the area.
6. Complete damage investigation report.

**3-3 NUMBER OF WORKERS REQUIRED.**

All work must be performed with a sufficient number of workers to provide a safe working environment. 29 CFR 1910.269 (*Electrical power generation, transmission, and distribution*) requires more than one worker where the hazard exposure of the work is considered to be significantly reduced by the presence of additional workers. The following tables provide specific requirements:

**Table 3-8. Jobs Acceptable For One Electrical Worker**

1. Work on systems in an electrically safe work condition with nominal system voltages of 600 volts ac or 250 volts dc, or less.
2. Routine electrical measurements on energized systems with nominal system voltages of 600 volts ac or 250 volts dc, or less.
3. Routine operation of metal-enclosed switchgear with nominal system voltages of 600 volts ac or 250 volts dc, or less.
4. Routine operation of metal-enclosed switchgear and pad mounted switches with nominal systems voltages greater than 600 volts ac if the activity responsible can demonstrate that conditions at the site allow this work to be performed safely.
5. Routine electrical measurements or switching using gloves and live-line tools if the worker is positioned out of reach or possible contact with energized parts.
6. Emergency repair work to safeguard the general public, if previously authorized.

**Table 3-9. Jobs Requiring Two Electrical Workers**

Hazard Exposure	Working On
Installation, removal, or repair when working on or near lines or parts energized at:	
<ol style="list-style-type: none"> <li>1. Voltages of 600 volts ac or 250 volts dc, or less.</li> </ol>	<ul style="list-style-type: none"> <li>• Installing portable monitoring equipment if it requires 1) removing covers on panels rated for greater than 240 volts or 2) disturbing circuit conductors.</li> </ul>



<p>2. Greater than 600 volts ac or 250 volts dc.</p>	<ul style="list-style-type: none"> <li>• Energized lines.</li> <li>• Deenergized lines with possible energized parts contact.</li> <li>• Equipment with possible energized line contact.</li> <li>• Mechanical equipment operation (except insulated aerial lifts) near energized parts.</li> <li>• Operation of insulated aerial lifts (bucket trucks).</li> <li>• Other work with equal or greater hazard exposure.</li> </ul>
--	--

**Table 3-10. Jobs Working In Confined Spaces That May Require More Than Two Workers**

Hazard Exposure	Additional Worker Requirement
<p>Installation, removal, or repair when working in a confined space. Manhole or vault requirements are generally classified as confined spaces.</p>	<ol style="list-style-type: none"> <li>1. An attendant with first-aid and CPR training will be available on the surface in the immediate vicinity.</li> <li>2. If a hazard exists within the space, or a hazard exists or is created because of traffic patterns outside the space, the attendant may not enter the confined space.</li> <li>3. If the restrictions of Item 2 above do not apply, the attendant may enter the confined space to provide assistance, but only for a brief period (other than in an emergency). For extended periods of assistance, a second worker in addition to the attendant is required.</li> </ol> <p>For the Air Force, a minimum of three personnel must be present for manhole or vault entry.</p>

**3-4 VERIFYING SYSTEM AND EQUIPMENT PROVISIONS.**

Be familiar with the electrical system to be worked on by reviewing the system's single line diagram. Check out the equipment needed such as insulating tools, hot sticks, and grounding cables.

## CHAPTER 4 ARC FLASH PERSONAL PROTECTIVE EQUIPMENT (PPE)

This chapter addresses the requirements for arc flash risk assessments and the associated personal protective equipment (PPE) criteria.

### 4-1 PPE FOR ARC FLASH PROTECTION.

#### 4-1.1 Applicability.

PPE that provides appropriate arc flash protection is required for all personnel working on or near exposed energized electrical equipment operating at 50 volts or more. Depending on the work location and activity, these requirements might include but are not limited to the following types of workers:

- Boiler plant operator or mechanic.
- Construction inspector.
- Electrical engineer.
- Electrical engineering technician.
- Electronic industrial controls mechanic.
- Electrical Power Controller (EPC).
- Elevator technician.
- Emergency/standby generator technician.
- Heating, ventilation, and air conditioning technician.
- High-voltage electrician.
- Industrial equipment mechanic.
- Liquid oxygen maintenance personnel.
- Low-voltage electrician.
- Maintenance mechanics.
- Mechanical engineer.
- Project manager.
- Ship-to-shore electrician.

- Utility system workers.

#### 4-1.2 NFPA 70E PPE Summary.

The PPE to be used for a piece of equipment must be determined by an arc flash risk analysis using either the incident energy analysis method or the PPE category method, but not both. Table 4-1 provides the NFPA 70E criteria for PPE as it relates to arc flash risk assessments performed using the PPE category method. Table 4-2 provides the NFPA 70E criteria for PPE as it relates to arc flash risk assessments performed using the incident energy analysis method. The results of an incident energy analysis to specify a PPE category in Table 4-1 shall not be permitted./2/

**Table 4-1. NFPA 70E PPE Criteria – Category Method**

PPE Category	PPE
0 (≤1.2 cal/cm <sup>2</sup> )	Outside the arc flash boundary and not defined by NFPA 70E. See Note 1.
1 (≤4 cal/cm <sup>2</sup> )	<p><b><u>Arc-Rated Clothing, Minimum Arc Rating of 4 cal/cm<sup>2</sup> (see Note 1)</u></b>            Arc-rated long-sleeve shirt and pants or arc-rated coverall            Arc-rated face shield (see Note 2) or arc flash suit hood            Arc-rated jacket, parka, rainwear, or hard hat liner (AN)</p> <p><b><u>Protective Equipment</u></b>            Hard hat (AR)            Safety glasses or safety goggles (SR)            Hearing protection (ear canal inserts) \2\ (see Note 3)/2/            Heavy duty leather gloves (see Note 4)            Leather footwear (AN)</p>
2 (≤8 cal/cm <sup>2</sup> )	<p><b><u>Arc-Rated Clothing, Minimum Arc Rating of 8 cal/cm<sup>2</sup></u></b>            Arc-rated long-sleeve shirt and pants or arc-rated coverall            Arc-rated flash suit hood or arc-rated face shield (see Note 2) and arc-rated balaclava            Arc-rated jacket, parka, rainwear, or hard hat liner (AN)</p> <p><b><u>Protective Equipment</u></b>            Hard hat (AR)            Safety glasses or safety goggles (SR)            Hearing protection (ear canal inserts) \2\ (see Note 3)/2/            Heavy duty leather gloves (see Note 4)            Leather footwear</p>

PPE Category	PPE
3 ( $\leq 25$ cal/cm <sup>2</sup> )	<p><b><u>Arc-Rated Clothing Selected so That the System Arc Rating Meets the Required Minimum Arc Rating of 25 cal/cm<sup>2</sup></u></b></p> <p>Arc-rated long-sleeve shirt (AR)            Arc-rated pants (AR)            Arc-rated coverall (AR)            Arc-rated arc flash suit jacket (AR)            Arc-rated arc flash suit pants (AR)            Arc-rated arc flash suit hood            Arc-rated gloves <math>\sqrt{2}</math>(see Note 4)/2/            Arc-rated jacket, parka, rainwear, or hard hat liner (AN)</p> <p><b><u>Protective Equipment</u></b></p> <p>Hard hat            Safety glasses or safety goggles (SR)            Hearing protection (ear canal inserts) <math>\sqrt{2}</math>(see Note 3)/2/            Leather footwear</p>
4 ( $\leq 40$ cal/cm <sup>2</sup> )	<p><b><u>Arc-Rated Clothing Selected so That the System Arc Rating Meets the Required Minimum Arc Rating of 40 cal/cm<sup>2</sup></u></b></p> <p>Arc-rated long-sleeve shirt (AR)            Arc-rated pants (AR)            Arc-rated coverall (AR)            Arc-rated arc flash suit jacket (AR)            Arc-rated arc flash suit pants (AR)            Arc-rated arc flash suit hood            Arc-rated gloves <math>\sqrt{2}</math>(see Note 4)/2/            Arc-rated jacket, parka, rainwear, or hard hat liner (AN)</p> <p><b><u>Protective Equipment</u></b></p> <p>Hard hat            Safety glasses or safety goggles (SR)            Hearing protection (ear canal inserts) <math>\sqrt{2}</math>(see Note 3)/2/            Leather footwear</p>

AN: as needed (optional). AR: as required. SR: selection required.

Notes:

1. Refer to Table 4-3 for minimum PPE clothing requirements.
2. Face shields are to have wrap-around guarding to protect not only the face but also the forehead, ears, and neck. Use an arc-rated balaclava with an arc-rated face shield when the back of the head is within the arc flash boundary. As an alternative, an arc-rated arc flash suit hood can be worn instead of an arc-rated face shield and balaclava.

3. ~~2~~ Other types of hearing protection are permitted to be used in lieu of or in addition to ear canal inserts provided they are worn under an arc-rated arc flash suit hood.
4. If rubber insulating gloves with leather protectors are used, additional leather or arc-rated gloves are not required. The combination of rubber insulating gloves with leather protectors satisfies the arc flash protection requirement.

**Table 4-2. NFPA 70E PPE Criteria – Incident Energy Analysis Method**

Incident Energy	PPE
0-1.2 cal/cm <sup>2</sup>	Outside the arc flash boundary and not defined by NFPA 70E. See Note 1.
1.2-12 cal/cm <sup>2</sup>	Arc-rated clothing with an arc rating equal to or greater than the estimated incident energy (see Note 2) Long-sleeve shirt and pants or coverall or arc flash suit (SR) Arc-rated face shield and arc-rated balaclava or arc flash suit hood (SR) (see Note 3) Arc-rated outerwear (e.g., jacket, parka, rainwear, hard hat liner) (AN) Heavy-duty leather gloves, arc-rated gloves, or rubber insulating gloves with leather protectors (SR) (see Note 4) Hard hat Safety glasses or safety goggles (SR) Hearing protection Leather footwear
>12 cal/cm <sup>2</sup>	Arc-rated clothing with an arc rating equal to or greater than the estimated incident energy (see Note 2) Long-sleeve shirt and pants or coverall or arc flash suit (SR) Arc-rated arc flash suit hood Arc-rated outerwear (e.g., jacket, parka, rainwear, hard hat liner) (AN) Arc-rated gloves or rubber insulating gloves with leather protectors (SR) (see Note 4) Hard hat Safety glasses or safety goggles (SR) Hearing protection Leather footwear

AN: as needed (optional). AR: as required. SR: selection required.

*Notes:*

1. Refer to Table 4-4 for minimum PPE clothing requirements.
2. Arc ratings can be for a single layer, such as an arc-rated shirt and pants or a coverall, or for an arc flash suit or a multi-layer system if tested as a combination consisting of an arc-rated shirt and pants, coverall, and arc flash suit.

3. *Face shields with a wrap-around guarding to protect the face, chin, forehead, ears, and neck area are required by NFPA 70E Article 130.7(C)(10)(c). Where the back of the head is inside the arc flash boundary, a balaclava or an arc flash hood shall be required for full head and neck protection.*
4. *Rubber insulating gloves with leather protectors provide arc flash protection in addition to shock protection. Higher class rubber insulating gloves with leather protectors, due to their increased material thickness, provide increased arc flash protection.*

#### 4-1.3 Minimum PPE Clothing Requirements.

Any worker whose normal job includes working on or near exposed electrical equipment must wear to work as a minimum:

- Arc-rated shirt (long-sleeve) and pants (or arc-rated coveralls) with minimum arc rating of 8 cal/cm<sup>2</sup> (33.47 J/cm<sup>2</sup>).
- Cotton or natural fiber underwear (conventional short sleeve t-shirt and briefs/shorts). Do not include any organizational or other insignias or decals on t-shirts.
- Leather electrical hazard-rated (EH) footwear. *Note: High voltage linemen are not required to wear EH work footwear while climbing.*

#### 4-1.4 Job-Site PPE Clothing Requirements.

Any employee who goes to a job site that involves working on or near exposed electrical equipment must wear all of the following (with the exception of gloves which will be dictated by the work task in Table 4-2) as a minimum:

- Arc-rated shirt (long-sleeve) and pants (or arc-rated coveralls) with minimum arc rating of 8 cal/cm<sup>2</sup> (33.47 J/cm<sup>2</sup>).
- Cotton or natural fiber underwear (conventional short sleeve t-shirt and briefs/shorts). Do not include any organizational or other insignias or decals on t-shirts.
- Leather electrical hazard-rated (EH) footwear. *Note: High voltage linemen are not required to wear EH footwear while climbing.*
- Safety glasses (ANSI Z87.1) with side shields. Wear safety goggles (ANSI Z87.1) over metal frame and non-safety glasses.
- Hardhat (ISEA Z89.1 Type 1 Class E approved). Long hair must be secured under the hardhat. For cold weather operations, insulated hard hat liner must be arc rated. For work tasks classified as Category 2 or

higher, an insulated hard hat liner does not satisfy the requirement for a sock/balaclava worn under the face shield.

- Wear leather work gloves for work tasks classified as Category 1 or 2. Wear arc-rated gloves for work tasks classified as Category 3 or 4. Voltage rated gloves with leather protectors are equivalent to arc-rated gloves. Rubber glove protectors must not be used as work gloves.
- Hearing protection using ear-canal inserts is required whenever working within the arc flash boundary. Hearing protection is also required in accordance with local procedures and whenever the sound level exceeds 84 decibels or 140 decibels peak sound level pressure for impulse or impact noise, regardless of the exposure duration. Wear a combination of insert type and circumaural types of hearing protectors (double protection) when sound levels exceed 104 db(A).

#### 4-1.5 Required PPE Level Per Arc Flash Risk Analysis.

Table 4-3 provides the required minimum PPE level to be worn as a function of the arc flash PPE category. Table 4-4 provides the required minimum PPE level to be worn as determined by an incident energy analysis. The results of an incident energy analysis to specify a PPE category in Table 4-3 shall not be permitted./2/

**Table 4-3. Required PPE Per Arc Flash Category**

Arc Flash PPE Category	General PPE Description <small>(See notes)</small>	Required Minimum PPE Arc Rating [cal/cm <sup>2</sup> (J/cm <sup>2</sup> )]
0	Comply with Section 4-1.4.	8 (33.47)
1	Comply with Section 4-1.4 for clothing requirements and Table 4-1 for face shield requirements.	8 (33.47)
2	Comply with Table 4-1.	8 (33.47)
3	Comply with Table 4-1.	25 (104.60)
4	Comply with Table 4-1.	40 (167.36)

*Note 1. NFPA 70E discontinued the use of Category 0, which is defined as an incident energy of less than 1.2 cal/cm<sup>2</sup> (5 J/cm<sup>2</sup>). This level of incident energy is also referred to as the arc flash boundary.*

*Note 2. Voltage rated gloves with leather protectors must be used in accordance with NFPA 70E and as specified elsewhere in this UFC.*

*Note 3. For cold weather operations, an insulated hard hat liner must be arc rated. For work tasks classified as Category 2 or higher, an insulated hard hat liner does not satisfy the requirement for a sock/balaclava worn under the face shield.*

Note 4. Comply with Section 4-2.2 when operating branch circuit breakers rated for 30 amperes or less used for lighting and general purpose receptacles.

Note 5. For Air Force military qualified electrical personnel performing Category 0 tasks, comply with Section 4-1.6.

**Table 4-4. Required PPE Per Available Incident Energy**

Available Incident Energy	General PPE Description <small>(See notes)</small>	Required Minimum PPE Arc Rating [cal/cm <sup>2</sup> (J/cm <sup>2</sup> )]
0-1.2 cal/cm <sup>2</sup>	Comply with Section 4-1.4.	8 (33.47)
1.2-8 cal/cm <sup>2</sup>	Comply with Section 4-1.4 for clothing requirements and Table 4-2 for face shield requirements.	8 (33.47)
8-12 cal/cm <sup>2</sup>	Comply with Table 4-2.	As determined by incident energy analysis
>12 cal/cm <sup>2</sup>	Comply with Table 4-2.	As determined by incident energy analysis

Note 1. NFPA 70E does not provide PPE requirements for under 1.2 cal/cm<sup>2</sup> (5 J/cm<sup>2</sup>). This level of incident energy is also referred to as the arc flash boundary.

Note 2. Voltage rated gloves with leather protectors must be used in accordance with NFPA 70E and as specified elsewhere in this UFC.

Note 3. An insulated hard hat liner does not satisfy the requirement for a sock/balaclava worn under the face shield.

Note 4. Comply with Section 4-2.2 when operating branch circuit breakers rated for 30 amperes or less used for lighting and general purpose receptacles.

Note 5. For Air Force military qualified electrical personnel performing 0-1.2 cal/cm<sup>2</sup> tasks, comply with Section 4-1.6.

#### 4-1.6 Air Force Military Uniforms.

For the Air Force, refer to AFI 32-1064, *Electrical Safe Practices*, Attachment 2 for proper wear of military uniforms while working on or near exposed electrical equipment.

At forward deployed locations, Mission Oriented Protective Postures equipment may directly conflict with PPE/clothing requirements for performing electrical work on or near energized circuits. For this and other contingency or wartime operations when special chemical, biological, or radiological clothing is required, the Base Civil Engineer may



waive or modify requirements in this chapter, but only after evaluating all safety alternatives with mission requirements.

#### 4-1.7 **Additional PPE Clothing Requirements.**

Wear arc flash rated clothing properly inside the arc flash boundary. This includes:

- Long sleeves must be rolled down and buttoned.
- The top button of shirts, coveralls, and jackets must be fastened.
- Tuck shirts into the trousers.
- Shorts are prohibited and trousers must extend the full length of the leg.
- Garments with exposed metallic fasteners must not be worn, unless the garments are properly arc rated.
- Garments, including safety harnesses, worn over arc flash rated protective clothing must be arc flash rated.

#### 4-1.8 **Clothing Prohibitions.**

The following is prohibited:

- Do not wear conductive articles of jewelry (including but not limited to cloth with conductive thread, metal frame glasses, metal headgear, wristbands, watch chains, rings, bracelets, necklaces, body jewelry and piercings) within the restricted approach boundary or where they present an electrical contact hazard with exposed energized electrical conductors or circuit parts.
- Do not wear clothing that could increase the extent of injuries when exposed to electric arcs or open flames. Clothing made from acetate, nylon, polyester, and rayon, either alone or in blends, cannot be worn as undergarments when working on or near energized equipment of greater than 50 V. Military clothing such as DCUs, field jackets, field jacket liners, Gortex jackets and pants, Gortex fleece liners, nylon cold weather gloves, nylon upper combat boots, chemical warfare suits, winter parkas, winter parka pants, all are polyester blend materials and not allowed to be worn when working on or near energized equipment of greater than 50 V. Shorts are prohibited and trousers must extend the full length of the leg.
- Do not wear anything made of celluloid or other flammable plastic when working near electric arcs or open flames. This may include cap visors, collars, and cuff protectors.

- Do not wear loose clothing, dangling sleeves, or neckties when working on or near moving machinery.
- Do not wear garments equipped with metal slides or zipper fasteners, unless the slide or fastener is effectively covered.
- Do not wear coveralls half-dressed where the top-half is wrapped around the waist area.
- Do not wear clothing in a way in which it was unintended to be worn, such as an arc-rated shirt tied around waist with the sleeves.

#### 4-2 ARC FLASH RISK ASSESSMENT.

Perform and document an arc flash risk assessment in accordance with NFPA 70E, Article 130.5 or IEEE C2 Paragraph 410.A.3.a, to determine the available incident energy at the intended work location.

**2**When conducting arc flash risk assessments in accordance with NFPA 70E, incident energy calculations must be performed in accordance with the latest edition of IEEE 1584. **2**

*Note: Refer to Section 1-4.2 for the delineation between NFPA 70E and IEEE C2.*

Include the following in an arc flash risk assessment:

- a. Determine if an arc flash hazard exists. If an arc flash hazard exists, include the following in the arc flash risk assessment:
  - Appropriate safety-related work practices.
  - The PPE to be used within the arc flash boundary.
- b. Update the arc flash risk assessment when a major modification or renovation takes place. Review the arc flash risk assessment periodically, at intervals not to exceed 5 years, to account for changes in the electrical distribution system that could affect the results of the arc flash risk assessment. Typical changes that could affect the arc flash risk assessment include:
  - System design changes that affect short circuit values or electrical coordination.
  - Protective relay and circuit breaker trip setting changes.

- Revisions to NFPA 70E, IEEE 1584, or IEEE C2 that affect the arc flash calculation methodology or allowed assumptions in the methodology.
  - Lack of maintenance and testing for the protective equipment credited by the arc flash calculations.
- c. Take into consideration the design of the overcurrent protective device and its opening time, including its condition of maintenance.

*Note: Improper or inadequate maintenance can result in increased opening time of the overcurrent protective device, thus increasing the incident energy. Where equipment is not properly installed or maintained, PPE selection based on incident energy analysis or the PPE category method may not provide adequate protection from arc flash hazards.*

#### 4-2.1 Arc Flash Risk Assessments Based on Tables.

If incident energy calculations cannot be performed in support of an arc flash risk assessment, utilize the following tables. A documented arc flash risk assessment must be performed for any condition not covered by these tables. Arc flash risk assessments shall be performed using Tables 4-5, 4-6, and 4-7 only as a short term solution until an arc flash risk assessment can be performed using an incident energy analysis. Arc flash risk assessments performed using Tables 4-5, 4-6, and 4-7 are only permitted for tasks which are included in Table 4-5 and for equipment and parameters included in Table 4-6 or Table 4-7. Interpolation or extrapolation of parameters not included in these tables is prohibited.

- a. Table 4-5 has been developed utilizing NFPA 70E-2018 Table 130.5(C). This table determines if arc flash PPE is required for the intended energized work activity.
- b. Table 4-6 has been developed utilizing NFPA 70E-2018 Table 130.7(C)(15)(a). Once it has been determined that arc flash PPE is required, Table 4-6 provides guidance regarding the PPE arc flash category.
- c. Table 4-7 has been developed utilizing NFPA 70E-2018 Table 130.7(C)(15)(b). The arc flash PPE category depends on the battery voltage and the available short circuit current.
- d. Table 4-8 addresses specific service SOPs. Table 4-8 takes precedence over Tables 4-5, 4-6, and 4-7 for any conflicts (interpretation or comparisons) between the tables.
- e. Table 4-9 provides the arc flash PPE requirements for overhead distribution work and is based on IEEE C2. Refer to the notes below Table 4-9 for additional information.

- f. Tools used as part of the task must be rated for the line-to-line voltage of the energized equipment.

CANCELLED

**Table 4-5. Arc Flash Hazard Identification**

Task	Equipment Condition	Likelihood of Occurance (see Note)
<ul style="list-style-type: none"> <li>• Reading a panel meter while operating a meter switch.</li> <li>• Performing infrared thermography and other non-contact inspections outside the restricted approach boundary. This activity does not include opening of doors or covers.</li> <li>• Working on control circuits with exposed energized electrical conductors and circuit parts, nominal 125 volts ac or dc, or below without any other exposed energized equipment over nominal 125 volts ac or dc, including opening of hinged covers to gain access.</li> <li>• Examination of insulated cable with no manipulation of cable.</li> <li>• For dc systems, insertion or removal of individual cells or multi-cell units of a battery system in an open rack.</li> <li>• For dc systems, maintenance on a single cell of a battery system or multi-cell units in an open rack.</li> </ul>	Any	No

CANCELED

Task	Equipment Condition	Likelihood of Occurance (see Note)
<ul style="list-style-type: none"> <li>• For ac systems, work on energized electrical conductors and circuit parts, including voltage testing.</li> <li>• For dc systems, working on energized electrical conductors and circuit parts of series-connected battery cells, including voltage testing.</li> <li>• Removal or installation of CBs or switches.</li> <li>• Opening hinged door(s) or cover(s) or removal of bolted covers (to expose bare, energized electrical conductors and circuit parts). For dc systems, this includes bolted covers, such as battery terminal covers.</li> <li>• Application of temporary protective grounding equipment, after voltage test.</li> <li>• Working on control circuits with exposed energized electrical conductors and circuit parts, greater than 120 volts.</li> <li>• Insertion or removal of individual starter buckets from motor control center (MCC).</li> <li>• Insertion or removal (racking) of circuit breakers (CBs) or starters from cubicles, doors open or closed.</li> <li>• Insertion or removal of plug-in devices into or from busways.</li> <li>• Examination of insulated cable with manipulation of cable.</li> <li>• Working on exposed energized electrical conductors and circuit parts of equipment directly supplied by a panelboard or motor control center.</li> <li>• Insertion or removal of revenue meters (kW-hour, at primary voltage and current).</li> <li>• Removal of battery conductive intercell connector covers.</li> <li>• For dc systems, working on exposed energized electrical conductors and circuit parts of utilization equipment directly supplied by a dc source.</li> <li>• Opening voltage transformer or control power transformer compartments.</li> <li>• Operation of outdoor disconnect switch (hookstick operated) at 1 kV through 15 kV.</li> <li>• Operation of outdoor disconnect switch (gang-operated, from grade) at 1 kV through 15 kV.</li> </ul>	Any	Yes

Task	Equipment Condition	Likelihood of Occurance (see Note)
<ul style="list-style-type: none"> <li>• Operation of a CB, switch, contactor, or starter.</li> <li>• Voltage testing on individual battery cells or individual multi-cell units.</li> <li>• Removal or installation of covers for equipment such as wireways, junction boxes, and cable trays that does not expose bare, energized electrical conductors and circuit parts.</li> <li>• Opening a panelboard hinged door or cover to access dead front overcurrent devices.</li> <li>• Removal of battery nonconductive intercell connector covers.</li> </ul>	Normal	No
<ul style="list-style-type: none"> <li>• Maintenance and testing on individual battery cells or individual multi-cell units in an open rack</li> <li>• Insertion or removal of individual cells or multi-cell units of a battery system in an open rack.</li> <li>• Arc-resistant switchgear Type 1 or 2 (for clearing times of less than 0.5 sec with a prospective fault current not to exceed the arc-resistant rating of the equipment) and metal enclosed interrupter switchgear, fused or unfused of arc resistant type construction, 1 kV through 15 kV.</li> <li>• Insertion or removal (racking) of CBs from cubicles;</li> <li>• Insertion or removal (racking) of ground and test device; or</li> <li>• Insertion or removal (racking) of voltage transformers on or off the bus.</li> <li>• Equipment condition considered to be “normal” if all of the following circumstances apply:               <ol style="list-style-type: none"> <li>1. The equipment is properly installed in accordance with the manufacturer’s recommendations and applicable industry codes and standards.</li> <li>2. The equipment is properly maintained in accordance with the manufacturer’s recommendations and applicable industry codes and standards.</li> <li>3. The equipment is used in accordance with instructions included in the listing and labeling and in accordance with manufacturer’s instructions.</li> <li>4. Equipment doors are closed and secured.</li> <li>5. Equipment covers are in place and secured.</li> <li>6. There is no evidence of impending failure such as arcing, overheating, loose or bound equipment parts, visible damage, or deterioration.</li> </ol> </li> </ul>	Abnormal	Yes

*Note: The two components of risk are the likelihood of occurrence of injury or damage to health and the severity of injury or damage to health that results from a hazard. Risk assessment is an overall process that involves estimating both the likelihood of occurrence and severity to determine if additional protective measures are required. The estimate of the likelihood of occurrence contained in this table does not cover every possible condition or situation, nor does it address severity of injury or damage to health. Where this table identifies “No” as an estimate of likelihood of occurrence, it means that an arc flash incident is not likely to occur. Where this table identifies “Yes” as an estimate of likelihood of occurrence, it means that additional protective measures are required to be selected and implemented according to the hierarchy of risk control identified in NFPA 70E Article 110.1(H).*

CANCELLED



**Table 4-6. Arc Flash PPE Category Classifications for Alternating Current (AC) Systems on Grade**

Equipment	Arc Flash PPE Category	Arc Flash Boundary
Panelboards or other equipment rated 240 V and below. Parameters: Maximum of 25 kA short-circuit current available; maximum of 0.03 sec. (2 cycles) fault clearing time; working distance 455 mm (18 in.).	1	19 in (485 mm)
Panelboards or other equipment rated >240 V and up to 600 V. Parameters: Maximum of 25 kA short-circuit current available; maximum of 0.03 sec. (2 cycles) fault clearing time; working distance 455 mm (18 in.).	2	3 ft (900 mm)
600-V class motor control centers (MCCs). Parameters: Maximum of 65 kA short-circuit current available; maximum of 0.03 sec. (2 cycles) fault clearing time; working distance 455 mm (18 in.).	2	5 ft (1.5 m)
600-V class motor control centers (MCCs). Parameters: Maximum of 42 kA short-circuit current available; maximum of 0.33 sec. (20 cycles) fault clearing time; working distance 455 mm (18 in.).	4	14 ft (4.3 m)
600-V class switchgear (with power circuit breakers or fused switches) and 600 V class switchboards. Parameters: Maximum of 35 kA short-circuit current available; maximum of up to 0.5 sec. (30 cycles) fault clearing time; working distance 455 mm (18 in.).	4	20 ft (6 m)
Other 600-V class (277 V through 600 V, nominal) equipment. Parameters: Maximum of 65 kA short circuit current available; maximum of 0.03 sec. (2 cycles) fault clearing time; working distance 455 mm (18 in.).	2	5 ft (1.5 m)
NEMA E2 (fused contactor) motor starters, 2.3 kV through 7.2 kV. Parameters: Maximum of 35 kA short-circuit current available; maximum of up to 0.24 sec. (15 cycles) fault clearing time; working distance 910 mm (36 in.).	4	40 ft (12 m)
Metal-clad switchgear, 1 kV through 15 kV. Parameters: Maximum of 35 kA short circuit current available; maximum of 0.24 sec. (15 cycles) fault clearing time; working distance 910 mm (36 in.).	4	40 ft (12 m)

Equipment	Arc Flash PPE Category	Arc Flash Boundary
Arc-resistant switchgear 1 kV through 15 kV [for clearing times of < 0.5 sec (30 cycles) with an available fault current not to exceed the arc-resistant rating of the equipment], and metal enclosed interrupter switchgear, fused or unfused of arc-resistant-type construction, 1 kV through 15 kV.	N/A (Doors closed)	N/A (Doors closed)
Arc-resistant switchgear 1 kV through 15 kV [for clearing times of < 0.5 sec (30 cycles) with an available fault current not to exceed the arc-resistant rating of the equipment], and metal enclosed interrupter switchgear, fused or unfused of arc-resistant-type construction, 1 kV through 15 kV. Parameters: Maximum of 35 kA short-circuit current available; maximum of up to 0.24 sec (15 cycles) fault clearing time; working distance 910 mm (36 in.)	4 (Doors open)	40 ft (12 m)
Other equipment 1 kV through 15 kV. Parameters: Maximum of 35 kA short-circuit current available; maximum of up to 0.24 sec. (15 cycles) fault clearing time; minimum working distance 910 mm (36 in.).	4	40 ft (12 m)

*Note 1. Refer to NFPA 70E for additional limitations regarding the use of the above table.*

**Table 4-7. Arc Flash PPE Category Classifications for Direct Current (DC) Systems**

Equipment	Arc Flash PPE Category	Arc Flash Boundary
Storage batteries, dc switchboards, and other dc supply sources Parameters: $100\text{ V} \leq \text{Voltage} \leq 250\text{ V}$ Maximum arc duration and working distance: 2 sec @ 18 in.		
Short-circuit current < 4 kA	2	3 ft
$4\text{ kA} \leq \text{short-circuit current} < 7\text{ kA}$	2	4 ft
$7\text{ kA} \leq \text{short-circuit current} < 15\text{ kA}$	3	6 ft
Storage batteries, dc switchboards, and other dc supply sources Parameters: $250\text{ V} < \text{Voltage} \leq 600\text{ V}$ Maximum arc duration and working distance: 2 sec @ 18 in.		
Short-circuit current < 1.5 kA	2	3 ft
$1.5\text{ kA} \leq \text{short-circuit current} < 3\text{ kA}$	2	4 ft
$3\text{ kA} \leq \text{short-circuit current} < 7\text{ kA}$	3	6 ft
$7\text{ kA} \leq \text{short-circuit current} < 10\text{ kA}$	4	8 ft

*Note 1. Refer to NFPA 70E for additional limitations regarding the use of the above table.*

*Note 2. Obtain the available short circuit current for a particular battery from the manufacturer or the manufacturer's manual for the battery. If this information is not available, estimate the available short circuit current for a lead acid battery from the battery performance data sheet as 10 times the 1 minute ampere capability of the cell (at 77°F (25°C) to 1.75 V per cell).*

**Table 4-8. Additional Work Tasks and Associated PPE Requirements**

<b>Voltage</b>	<b>Task</b>	<b>Modifications and Clarifications to NFPA 70E Tables</b>	<b>V-Rated Gloves</b>	<b>V-Rated Tools</b>
< 600 V	Overhead line work, including lighting.	Comply with Section 4-1.4 and arc-rated safety harness (see Note 1)	Y	Y
> 600 V	Overhead line work (specific tasks of gang-operated switch operation, phasing/voltage/current testing, installing or removing safety grounds, and installing/removing mechanical type live-line clamps/stirrups) at hot stick distance (> 6 ft (2 m)).	Comply with Section 4-1.4 and arc-rated safety harness with lanyard	Y	Y (Note 2)
> 600 V	Overhead line work (specific tasks of disconnect switch operation, fused cutout operation, and replacing fuses) at hot stick distance (> 6 ft (2 m)).	Category 2 and arc-rated safety harness with lanyard	Y	Y (Note 2)
< 600 V	Underground line work (excluding underground structures), including lighting.	Comply with Section 4-1.4	Y	Y
> 600 V	Underground structures (manhole or vault) with no known problems: Routine cable inspection without touching or otherwise disturbing cables.	Comply with Section 4-1.4 and arc-rated safety harness with lanyard	Y	Y
> 600 V	Underground structures (manhole or vault) with no known problems:  Splicing deenergized cables in structure with energized cables.	Comply with Section 4-1.4 and arc-rated safety harness with lanyard.  Any work task associated with adjusting, moving, or disturbing energized cables requires that power be secured (circuit opened) prior to beginning the task. See Chapter 10 for additional guidance.	N	N
> 600 V	Operating (open/close) SF6, vacuum and air pad-mounted switches (dead front).	Category 2	Y	N

Voltage	Task	Modifications and Clarifications to NFPA 70E Tables	V-Rated Gloves	V-Rated Tools
> 600 V	Operating (open/close) SF6, vacuum and air pad-mounted switches (live front) at hot stick distance (> 4 ft (1.25 m)).	Category 2	Y	Y (Note 2)
> 600 V	Operating (open/close) oil switches.	Must remotely operate from >20 ft (6.1 m) and comply with Section 4-1.4.	Y	N
> 600 V	Oil fused cutouts.	Category 2 Must deenergize upstream before operating cutout.	Y	N
> 600 V	Operating (open/close) oil immersed loadbreak 3-phase gang operated or single-phase pad mount transformer switches at hot stick distance and removal of load-break elbows from various equipment (> 4 ft (1.25 m)).	Category 2	Y	Y (Note 2)
> 600 V	Phasing circuits from grade (ground) at hot stick distance (> 6 ft (2 m)).	Category 2	Y	Y (Note 2)
> 600 V	Overhead series lighting at hot stick distance (> 6 ft (2 m)).	Category 2	Y	Y (Note 2)
> 600 V	Fusing: Operation of fused cutouts (or replacing fuses in fused cutouts) mounted inside a vault or building at hot stick distance (> 4 ft (1.25 m)).	Category 4	Y	Y (Note 2)
> 600 V	Fusing: Replacing fuses in pad mounted transformers or pad mounted switches at hot stick distance (> 4 ft (1.25 m)).	Category 2  Must deenergize transformer before replacing fuses.	Y	Y (Note 2)
> 600 V	Disconnecting /shorting/and grounding capacitor banks at hot stick distance (> 4 ft (1.25 m)).	Category 4	Y	Y (Note 2)
< 600 V	Ship to shore – voltage testing, testing shore power receptacle cover interlock switches and shore power receptacle interlock switches.	Category 4	Y	N
> 600 V	Ship to shore – voltage testing, application of safety grounds at hot stick distance (> 4 ft (1.25 m)).	Category 4	Y	Y (Note 2)

Voltage	Task	Modifications and Clarifications to NFPA 70E Tables	V-Rated Gloves	V-Rated Tools
> 600 V	Hi-potential testing.	Comply with Section 4-1.4.	Y	N
> 600 V	Application of safety grounds from grade (ground) at hot stick distance (>6ft (2m)) in outdoor substations.	Category 4	Y	Y (Note 2)
> 600 V	Spiking a deenergized cable to ground with a remote hydraulic spiking tool. See Note 3.	Comply with Section 4-1.4.	N	N
> 600 V	Cutting a deenergized cable with a remote hydraulic guillotine cutter. See Note 3.	Comply with Section 4-1.4.	N	N

*Note 1. Treat voltage of circuits (less than 600 V) as that of the highest voltage occupying one or more poles on which the circuit is run.*

*Note 2. Live-line tools (minimum length as indicated) must be used.*

*Note 3. For manhole work, keep workers outside manhole for this task. For direct buried cables, keep workers more than 20 ft (6.1 m) away from task.*

**Table 4-9. Requirements for Aerial (Overhead) Systems and Equipment**

Phase-to-Phase Voltage (kV)	Fault Current (kA)	Category 0	Category 2
		Maximum Clearing Time (cycles)	Maximum Clearing Time (cycles)
1.1 to 15	5	320.0	2,134.0
	10	125.0	830.0
	15	69.0	460.2
	20	44.7	297.7
15.1 to 25	5	189.6	1264.0
	10	78.0	519.8
	15	45.2	301.0
	20	30.2	201.0
25.1 to 36	5	141.3	942.0
	10	59.7	398.0
	15	35.4	235.7
	20	24.0	160.0
36.1 to 46	5	107.4	716.0
	10	46.1	307.0
	15	28.3	188.5
	20	20.2	134.7

*Note 1. These calculations are based on open air phase-to-ground. This table is not intended for phase-to-phase arcs or enclosed arcs (arc in a box).*

*Note 2. These calculations are based on a 72-inch distance from the arc to the employee and arc gaps as follows: 1 kV to 15 kV = 5.08 cm (2 in), 15.1 kV to 25 kV = 10.16 cm (4 in), 25.1 kV to 36 kV = 15.24 cm (6 in), 36.1 kV to 46 kV = 22.86 cm (9 in). See IEEE 4.*

*Note 3. These calculations were derived using a commercially available computer software program. Other methods are available to estimate arc exposure values and may yield slightly different but equally acceptable results.*

*Note 4. The use of the table in the selection of clothing is intended to reduce the amount of injury but may not prevent all burns.*

*Note 5. The table identifies Category 0 and Category 2 levels. Refer to Section 4-1.5 for associated PPE requirements.*

*Note 6. The maximum clearing time applies to the upstream protective device(s) that provides circuit protection for the intended work location.*

#### 4-2.2 Facility Manager Authorized Tasks.

Facility Managers and Building Monitors are permitted to perform the following tasks on switchboards and panelboards rated for less than 600 volts while wearing a minimum of 8 cal/cm<sup>2</sup> (33.47 J/cm<sup>2</sup>) coveralls, leather gloves, and safety glasses:

- Opening and closing circuit breakers rated for 30 amperes or less for the purpose of circuit identification and panelboard labeling, including ground fault circuit interrupter and arc fault circuit interrupter testing.
- Operating SWD or HID rated circuit breakers used for lighting control.
- Resetting a branch circuit breaker rated for 30 amperes or less used for lighting and general purpose receptacles after a known equipment or circuit overload and the overload has been removed. If circuit breaker fails to close or immediately trips after resetting, call a qualified electrical worker to investigate.

*Note: If the reason for a tripped circuit breaker cannot be determined to be because of an overload, do not reclose the circuit breaker. Call a qualified electrical worker to investigate.*

#### 4-2.3 Arc Flash PPE Requirements for Low Voltage Control Circuits.

Arc flash PPE clothing is optional for work on control circuits rated for 120 volts, or less, if the control circuit is provided with upstream fusing rated for 30 amperes or less. The restricted approach boundary is "Avoid Contact" at 150 volts or less and voltage rated gloves are optional for work near 120 volt control circuits. Personnel working on these energized control circuits are required to be trained and designated as a qualified electrical worker in accordance with Section 2-2 for the activities that might be performed on an energized control circuit.

The following are examples of systems that might include these low-voltage control circuits:

- Elevator systems.
- HVAC systems.
- Fire alarm systems.
- Diesel generator control circuits.
- SCADA control circuits.



## CHAPTER 5 WORK AREA PROTECTIVE EQUIPMENT AND TOOLS

This chapter addresses the work area protective equipment that supports electrical construction and maintenance, and the associated requirements for their inspection and use. Refer to manufacturer's specific instructions when available.

### 5-1 INSPECTION OF APPAREL, TOOLS, AND MATERIALS HANDLING EQUIPMENT.

All apparel, tools, and equipment used on the job must comply with this UFC, as well as the applicable service and OSHA requirements. Regular inspections are also necessary to prevent the use of defective items on the job. The authorized individual-in-charge may, regardless of ownership, prohibit the use of any equipment on the job which could be considered unsafe. Complete inspections as follows:

- An initial inspection of tools brought on the job by a new worker must be made by the authorized individual-in-charge. Use is permitted only if the tools are in good condition and conform to requirements of this UFC.
- Inspections of tools and equipment used by an individual worker may be made by the authorized individual-in-charge at any time.
- Before a job is started, each worker must inspect protective apparel, tools, ladders, scaffolds, ropes, and other materials handling equipment to be used. All items must be suitable for their intended uses and in good material condition.
- Use of employee-owned test equipment is prohibited.

Consider the following when selecting and using apparel:

- Maintenance of the garment – some garments may be marked for professional cleaning/dry cleaning only with home/shop laundry prohibited.
- Durability – ability and process to remove stain/oils.
- Wear ability – sizing.
- Repair – procedures utilizing proper materials.
- Intended use – based upon arc flash analysis and manufacturer's recommendations.
- Projected life of the product.
- Limitations of the garment – limited washings, as specified by the manufacturer.

- Training.
- Take care to ensure all garments meet and are labeled in accordance with ASTM F1506, *Standard Performance Specification for Flame Resistant Textile Materials for Wearing Apparel for use by Electrical Workers Exposed to Momentary Electric Arc and Related Thermal Hazards*.

## **5-2 RUBBER PROTECTIVE EQUIPMENT.**

Rubber protective equipment consists of gloves, sleeves, blankets, and insulator hoods. Ensure all items meet or exceed the requirements of the applicable ASTM F18 series standards.

### **5-2.1 Job Requirements.**

The authorized individual-in-charge must determine the necessary type and amount of protective equipment required on the job. Inspect rubber goods before use. Destroy any item found to be defective. Each line truck and service/trouble truck that is required to carry protective equipment, must carry enough protective equipment rated at or above the voltages that could be encountered.

Keep rubber goods inside of a bag, box, or container designed for and used exclusively for them. Transport rubber goods in a manner protected from light, temperature extremes, excessive humidity, ozone, and other injurious substances and conditions. Transport rubber goods in their natural shape, not folded, creased, inside out, compressed, or in any manner that will cause stretching or compression.

### **5-2.2 Use of Rubber Protective Equipment.**

Rubber or other approved protective equipment must be used on all conductors or energized parts, which could be contacted by a worker climbing to or reaching from a work position. Rubber or other approved protective equipment must be rated for the voltage encountered. Table 5-1 provides the OSHA 29 CFR 1910.137 voltage and proof test requirements for rubber insulating equipment. Table 5-2 provides the rubber insulating equipment test intervals.

**Table 5-1. Rubber Insulating Equipment Voltage Requirements**

Class of Equipment	Color Label	Maximum Use (AC Volts)	Proof Test (AC Volts)	Retest Voltage (DC or AC – Average)	Minimum Distance <sup>1</sup> in Inches (Millimeters)
00	Beige	500	2,500	10,000	1 (25)
0	Red	1,000	5,000	20,000	1 (25)
1	White	7,500	10,000	40,000	1 (25)
2	Yellow	17,000	20,000	50,000	2 (50)
3	Green	26,500	30,000	60,000	3 (75)
4	Orange	36,000	40,000	70,000	4 (100)

*1 – Wear leather protectors over rubber gloves. Minimum distance is the minimum length that the exposed rubber glove must extend beyond the leather protector.*

Observe the following precautions:

- Position protective equipment to protect workers against unforeseen hazards such as slipping, cutting out, leaning back, or falling.
- Protective equipment must be placed by working from a level below the wires or insulators on the pole or structure, beginning with those nearest the climbing space, and covering the live parts in the order of their distance away from the climbing space.
- Cover other points of contact, such as grounded guys, equipment, and secondary wires to provide complete protection.
- The removal of protective equipment must be done with equal care, working below the level of wires and insulators. The order of removal must be the reverse of the order of placement.

### 5-2.3 Use of Rubber Gloves.

Wear rubber gloves with leather protectors suitable for the purpose when climbing or working on installations or structures in the vicinity of live circuits, or in the vicinity of any wire or equipment that may become energized by remote or accidental means.

Observe the following:

- Do not use rubber gloves without leather protector gloves over them.
- Before putting on rubber gloves, give each glove an air test to detect cuts and weak spots. This is accomplished by rolling up the glove tightly beginning at the gauntlet end. Listen and feel for air escaping through the palm, thumb, or fingers. Gloves that show weak spots or air leakage must

be destroyed. It is recommended that one or more fingers of a defective glove be immediately cut off to ensure no other worker inadvertently uses the glove.

- Liners are available for use inside the rubber gloves to absorb perspiration.
- Use only the gloves assigned, except in case of emergency.
- Keep sleeves of wearing apparel tucked inside the cuffs of the rubber gloves.
- Put on rubber gloves (and sleeves if needed) before being within reach of the restricted approach boundary of the energized conductors.
- Do not remove gloves or sleeves until out of reach of the restricted approach boundary of energized conductors.

*Note: Work involving overhead work in a bucket truck is treated differently regarding when to put on and remove rubber gloves. Put on rubber gloves before bucket departure from the cradle and do not remove rubber gloves until the bucket has been returned to the cradle.*

#### 5-2.4 Use of Rubber Sleeves.

Wear rubber sleeves whenever there is a possibility of arms coming within the restricted approach boundary specified in Table 3-1. Rubber sleeves are normally worn in conjunction with rubber glove work. Wear rubber sleeves when performing energized-line pole or bucket work within contact distance of an energized line.

#### 5-2.5 Care and Inspection of Rubber Protective Equipment.

Inspect rubber protective equipment before each day's use and immediately following any incident that can reasonably be suspected of having caused damage. Protective equipment must not be stored in a sharply bent position or exposed to the sun's rays, light, or heat.

##### 5-2.5.1 General Care.

Wipe dry all protective equipment before storing. Protect it from contact with oil, paint, creosote, kerosene, gasoline, acids, and other harmful materials. Rubber protective equipment must be turned in to an experienced testing laboratory for cleaning, inspection, and electrical tests. Shorter inspection periods must be considered where equipment is used frequently. Refer to Table 5-2 for required test intervals.

##### 5-2.5.2 Care of Rubber Gloves.

When not in use, rubber gloves must be carried in glove bags. When in use, take the following precautions:

- Rubber gloves must be washed when tested at an approved laboratory, and kept free from embedded foreign matter.
- Powder specifically designed for protective rubber gloves can be used after washing rubber gloves to avoid skin irritation and to prevent the rubber from sticking together.
- Store rubber gloves with the fingers up to allow perspiration to drain/dry from the gloves.

#### 5-2.5.3 **Care of Rubber Blankets and Sleeves.**

Roll, never fold, rubber blankets and sleeves. When being rolled, their surfaces must be brushed clean to prevent dirt from becoming embedded in the surface of the rubber. Do not wear climbers when standing on rubber blankets.

#### 5-2.5.4 **Inspection of Rubber Blankets and Sleeves.**

Inspect rubber blankets and sleeves immediately before each use. Items with cracks, holes, snags, blisters, or other defects must be discarded.

#### 5-2.5.5 **Inspection of Insulator Hoods.**

Inspect hoods immediately before use. Examine hoods before each use to ensure that there are no defects, and determine if they are suitable for further use.

#### 5-2.5.6 **Care of Insulator Hoods.**

Line hoods must be air dried. Store hoods in compartments so that no part is strained or distorted.

#### 5-2.6 **Test Intervals for Rubber Protective Equipment.**

Rubber protective equipment must be subjected to periodic electrical tests. Table 5-2 provides the OSHA 29 CFR 1910.137 required test intervals for rubber insulating equipment. Consider shorter inspection periods where equipment is used frequently.

**Table 5-2. Rubber Insulating Equipment Test Intervals**

Type of Equipment	Test Frequency
Rubber insulating covers	Upon indication that insulating value is suspect
Rubber insulating blankets	Before first issue and every 12 months thereafter
Rubber insulating gloves	Before first issue and every 6 months thereafter
Rubber insulating sleeves	Before first issue and every 12 months thereafter

*Note: If the insulating equipment has been electrically tested, but not issued for service, it may not be placed into service unless it has been electrically tested within the previous 12 months. For rubber insulating gloves, the following examples describe when gloves must be removed from service or retested:*

- *Gloves tested on January 1, 2016 and issued after six months in storage on July 1, 2016. The gloves must be removed from service by January 1, 2017. This is both 6 months from the issue date and 12 months from the test date.*
- *Gloves tested on January 1, 2016 and issued shortly after on February 1, 2016. The gloves must be removed from service by August 1, 2016. This is 6 months from the issue date but less than 12 months from the test date.*
- *Gloves tested on January 1, 2016 and issued later in the year on October 1, 2016. The gloves must be removed from service by January 1, 2017. This is only 2 months from the issue date but 12 months from the test date.*

### **5-3 INSULATED HAND TOOLS AND HANDLING EQUIPMENT.**

When working near exposed energized conductors or circuit parts, use insulated tools or handling equipment if the tools or handling equipment might make contact with such conductors or parts. If the insulating capability of insulated tools or handling equipment is subject to damage, protect the insulating material during storage.

### **5-4 LIVE-LINE (HOT-LINE) TOOLS.**

Live-line tools are only as safe as their continued care and inspection make them. ANSI/IEEE 516 and ASTM F3121/F3121M-16 provide additional information on maintenance and testing. ANSI/IEEE 935 is the guide to be used for tool terminology.

#### 5-4.1 **Manufacture.**

Tools must be manufactured to meet ASTM F18 series specifications as appropriate to the device and material. The insulating tool portion must be made of fiberglass-reinforced plastic (FRP). FRP must be used as it does not absorb moisture, is impervious to oil-borne materials and solvents, is stronger, and is a better insulator than wood. Like any insulator, FRP must be kept clean and dry to maintain its insulating ability. Use only live-line tools that have a manufacturer's certification as having been tested to meet the following minimum acceptance requirements:

##### 5-4.1.1 **FRP.**

A FRP tool must have withstood 100,000 V ac per ft (305 mm) of length for 5 minutes.

##### 5-4.1.2 **Wood.**

Wooden tools are not authorized for use.

#### 5-4.2 **Authorized Types of Tools.**

All tools must be FRP tools. Replace existing wooden tools with new FRP tools.

#### 5-4.3 **Records.**

Records must be maintained for all live-line tools to demonstrate satisfactory accomplishment of laboratory and shop testing.

#### 5-4.4 **Tool Cleaning Before Use.**

A live-line tool must be wiped clean before each day's use and visually inspected for cleanliness and a glossy surface. Clean live-line tools with a clean absorbent paper towel or cloth and then wipe with a clean, dry cloth (a silicone-treated cloth is also permitted). Never use cloths that have been washed in harsh solvents, soap or detergents. Residues could be left on the tool that may be conductive. Abrasives could damage the surface gloss of the tool (thus permitting water to "wet-out" or "sheet" on the surface of the tool if later exposed to rain or heavy fog). If the surface of the tool is not glossy, or any contamination is present after wiping that could adversely affect the insulating qualities of the tool, the tool must be removed from service and tested before being returned to service.

#### 5-4.5 **Tool Inspection After Cleaning and Before Use.**

After each cleaning and before use, a live-line tool must be visually inspected for defects. If any defect is present that could adversely affect the insulating qualities of the tool, the tool must be removed from service and tested before being returned to service. The following field observations warrant removing a tool from service:

- Evidence of an electrically overstressed tool, such as: electrical tracking; burn marks; or blisters caused from heat.

- Evidence of a mechanically overstressed tool, such as: damaged, bent, warped, worn or cracked components; deep cuts, scratches, nicks, gouges, dents or delamination in the tool surface; or deterioration of the tool's glossy surface.

#### 5-4.6 **Other Conditions for Removal from Service.**

A live-line tool must be removed from service if one or more of the following conditions are detected:

- It fails to pass an electrical wet test during laboratory, shop, or field-testing.
- If a tingling or fuzzy sensation is felt when the tool is in contact with energized conductors or hardware.
- If a tool has been dropped from a significant height (such as from an overhead line or a structure) or subjected to impact such that internal structural damage is suspected.

#### 5-4.7 **Returning a Tool to Service.**

A tool may not be returned to service until the tool has been examined, cleaned, and repaired (if necessary), and electrically tested.

#### 5-4.8 **Waxing.**

Waxing is not necessary after every use but only as needed. Use cleaning and waxing kits manufactured for live-line tools and follow directions for their use. All live-line tools must be electrically tested under wet conditions before being returned to service after any waxing.

#### 5-4.9 **Repairs and Refinishing.**

Only competent personnel must make repairs, including any necessary refinishing. Generally, if there is no roughness on the surface and the live-line tool meets electrical tests, there is no need for repair. Small surface ruptures and small voids beneath the surface may need repair and refinishing. Refinishing of FRP tools typically includes abrasive smoothing of the surface and application of a clear epoxy coat. FRP tools must be electrically wet tested before returning to service after repair or refinishing.

#### 5-4.10 **Wet Electrical Testing.**

FRP tools must be submitted to a wet electrical test at not more than 2-year intervals, and after any repair or refinishing. This test must be performed over the entire working length of the tool. Use of either of two procedures is acceptable to complete these tests:



- Laboratory testing in accordance with ASTM F3121/F3121M-16. FRP tools require an application of 75,000 V (ac) per ft (305 mm) for one minute.
- Shop or field testing using calibrated test equipment, such as the Hubbell Chance Wet/Dry Hot Stick Tester.

#### 5-4.11 **Precautions for Shop or Field Testing.**

Follow the manufacturer's instructions and comply with the following precautions:

- Use demineralized water (such as sold in local grocery stores), if available. Otherwise use clean water of conductivity of 3.0 micromho-centimeters or less at room temperature.
- Support the tool in a horizontal position during the test.
- Avoid over-wetting. Use a mist applicator (such as a laundry-type spray bottle) and spray the test section until drops just start to run down the surface. If too much water is sprayed on the tool, water can collect in a line of drops at the undersurface, producing a false rejection because of flashover or high leakage current.
- Take overlapping readings from one end of the tool to the other but do not slide the tester on the tool. Lift up the tester before moving it. This can prevent streaks that can cause a false rejection.
- Rotate the tool 90 degrees and again test the tool from end to end. Continue in this manner until four different positions around the tool circumference have been tested.

#### 5-4.12 **Transportation.**

Live-line tools must be transported with care and protected from mechanical damage. Exposure to inclement weather must be avoided. Containers must prevent damage to insulating surfaces from abrasive surfaces and bumping motions, and to minimize contamination buildup. In house fabricated containers made from PVC pipe and fittings provide excellent protection for live line tools. Special PVC fittings are also available from vendor for this purpose.

#### 5-4.13 **Storage.**

Live-line tools transported on vehicles can be stored in bins or racks. If possible avoid locations subject to temperature changes because this can permit the formation of condensation. Place tools in protective covers that are furnished with the tools. Store tools in bins and racks, constructed to prevent damage to insulating surfaces, away from dirt, moisture and sunlight (and other sources of ultraviolet light). In house

fabricated containers made from PVC pipe and fittings provide excellent protection for live line tools. Special PVC fittings are also available from vendors for this purpose.

#### 5-4.14 Use of Live-Line Tools.

When using live-line tools, workers must use voltage rated gloves and not place their hands closer than is absolutely necessary to energized conductors or equipment or to the metal parts of the tool, and in no case closer than the restricted approach boundary specified in Table 3-1. Additional requirements on the use of live-line tools include:

- If tools used have quick-change heads, they must not be used without a “quick change safety clip”.
- Approved blocks, ropes, slings and other tackle used in live-line tool work must not be used for any other purpose and must be kept clean, dry and free from contamination.
- Live-line tools being used to spread or raise conductors must be securely fastened and must not be held by workers except as necessary to secure or release them.
- Live-line tools must be hung on a hand line or approved tool hanger, if possible. Do not hang a tool on a conductor or bond wire.
- Never lay live-line tools on the ground. When brought to the worksite, place tools on portable racks or lay them on clean, dry tarpaulins or plastic sheeting.
- Do not use live-line tools in rain or heavy fog except in an emergency as directed by the authorized individual-in-charge. In no case must they be used when conditions permit formation of rivulets of water along the tool. After completing the job, make sure the tools are wiped dry before returning them to storage.

#### 5-5 SKIN PROTECTION.

Provide protection for the worker’s skin from toxic and irritant substances where there is a possibility they can occur at the job site. Ensure workers prevent injury by wearing suitable protective clothing. Keep protective ointments, proper cleaners for the skin, and appropriate first aid remedies on hand. Ensure protective ointments are not of a type that can damage rubber protective apparel. Keep emergency water sources on hand for flushing of irritant substances which could spill on the body, such as battery acid when working in a battery room. Keep sun-blocking ointments on hand when working outdoors.

## 5-6 POLE/TREE CLIMBING AND FALL PROTECTION.

### 5-6.1 Personal Protective Equipment.

Pole and tree climbing requires additional personal protective equipment to prevent falls. Items appropriate for work on a wood pole are shown in Figure 4-2.

**Figure 4-2. Personal Protective Equipment for Working on a Pole**

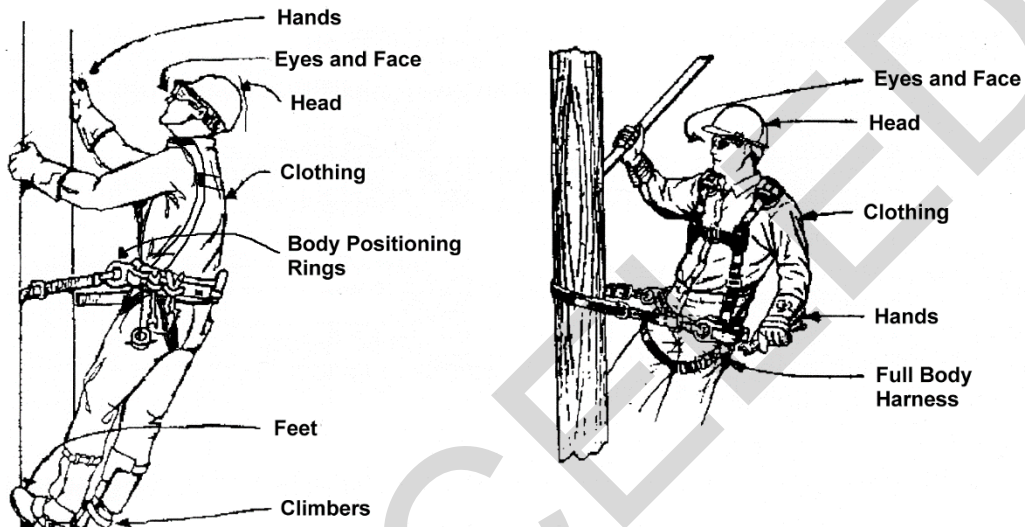



### 5-6.2 Climbing Personal Protective Equipment.

Use climbers meeting ASTM F887, *Specifications for Personal Climbing Equipment*.

### 5-6.3 Fall Protection Personal Protective Equipment.

Use of fall protection equipment is required in all instances while climbing or changing positions on poles or towers. Four types of fall protection are used to handle various fall situations as shown in Figure 4-3. Fall arrest equipment is effective only if adequate anchoring has been identified by a qualified person.

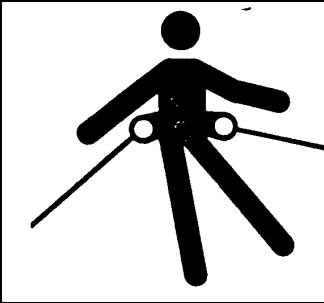
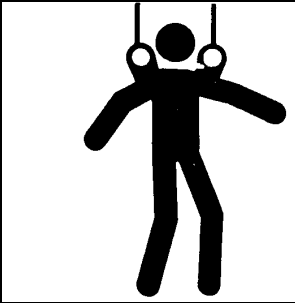
**Figure 4-3. Types of Fall Protection**

			
Positioning Rings on Full Body Harness	Retrieval	Suspension	Fall arrest
Leaves hands free while positioning a worker.	Allows emergency retrieval from a confined space.	Leaves hands free and supports a worker.	For arresting a fall from an elevated position.
Use on wood pole.	Use in a manhole.	Use on structures.	With anchor points.

Positioning, retrieval, and suspension fall protection must support worker's weight plus any additional load. This type of protection does not provide fall arrest. Fall arrest must be added if it is determined that there is a fall arrest anchor point capable of meeting fall arrest requirements. Fall arrest protection requires an anchor point capable of supporting 5,000 lb (2,250 kg) plus a connection device. Protection must provide an adequate free fall distance of 6 ft (1.8 m) or with a deceleration unit a fall distance of 9.5 ft (2.8 m).

## 5-7 ELECTRICAL TESTING DEVICES.

Electrical testing devices are necessary to ensure maintenance of electric lines can be accomplished safely. This section covers testers that are considered necessary for normal safety considerations. Always use testing devices in accordance with the manufacturer's recommendations, and with the appropriate personal protection. Live-line tools may also be needed.

Note: For the Air Force, proximity voltage detectors are not to be used solely to verify deenergized conditions. Direct contact voltage meters must be used. Capacitive voltage test point meters are considered direct contact voltage meters when used in accordance with the manufacturer's criteria.

### 5-7.1 Electrical Testing Device Calibration.

Maintain a calibration program which assures that all applicable testing devices are maintained within rated accuracy. Ensure the accuracy is traceable to the National Institute of Standards and Technology. Maintain a testing device calibration frequency schedule not to exceed 12 months. Provide visible dated calibration labels on all test equipment. Keep up-to-date records that indicate dates and test results of the electrical devices calibrated.

When a device is not being used for NETA type testing, then as an exception to annual certification, the following apply:

- Analog low-voltage multimeters are not allowed.
- Digital multimeters, such as a Fluke, used to verify the absence or existence of voltage do not require annual certification. However, if the device shows any signs of defective operation including failure of any segment of a display element, immediately remove it from service. If the device is sent out for repair, obtain a calibration certification before placing it back in service.
- Meters used for a specific purpose, such as voltage detectors, ampere meters, or phase check meters, do not require annual certification. However, if the device shows any signs of defective operation including failure of any segment of a display element, immediately remove it from service. If the device is sent out for repair, obtain a calibration certification before placing it back in service.

#### 5-7.2 **Voltage Detectors.**

Voltage detectors (meters) are used to determine whether the line or device is energized or deenergized. The user must understand how to select the proper voltage detector (meter) for the application and where and how the detectors can be used. Some detectors cannot be used to detect or measure voltages on cables with metallic sheaths or semiconductor coatings. Some detectors cannot be used on ungrounded circuits or to detect lower voltages.

#### 5-7.3 **Phasing Testers.**

Use phasing testers to determine the phase relationships and approximate voltages on energized lines and cables. Prior to paralleling two circuits, determine the correct connection for each conductor by checking the voltage level between that conductor and all other conductors. The voltage across corresponding lines or phases must be zero. A typical phasing tester consists of two high-resistance units on hot sticks connected through a voltmeter. Refer to Figure 5-2 for connections. If potential transformers are available, a voltmeter can be used to measure voltages by connecting a voltmeter between the two sides. If the lines are in phase, the voltmeter will register zero.

Figure 5-2. Phasing Check Using Hot-Stick Phasing Testers

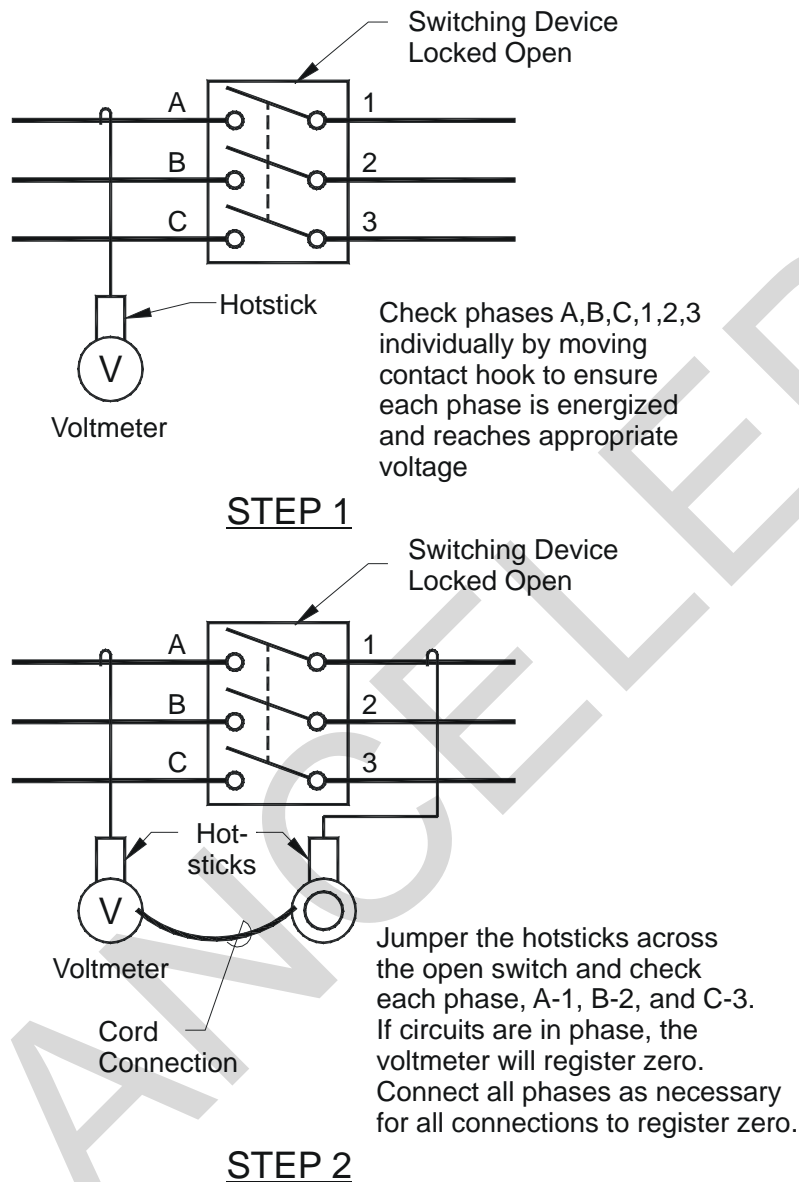

5-7.4 **Line Fault Locators.**

Use line fault locators on underground lines up to 34.5 kilovolts to determine the location of line faults.

5-7.5 **Insulator Testers.**

Use insulator testers to measure the potential across each insulator in a suspect string of cap and pin insulators. They can be used without interrupting service.

**5-7.6 Leakage-Current Monitors.**

The leakage current that can occur from overcurrent conditions on insulated ladder and truck booms must be monitored for worker safety. Leakage current flows along the surface of tools or equipment due to the properties of the device's surface and surface deposits. The permissible leakage current on aerial lifts is one microampere per kilovolt ac or 0.5 microamperes per kilovolt dc. Adverse weather conditions derate the normal dielectric quality of air which results in a greater leakage current. Periodic testing is required. The use of a monitor on an aerial lift providing a continuous display of leakage current is recommended. Set the monitor to sound an alarm at a pre-set leakage current level to alert workers of danger.

**5-7.7 Combustible Gas/Oxygen Detectors.**

Portable monitors provide visual and audible warnings of explosive atmospheres and/or low oxygen levels which often occur in confined spaces. A continuous reading is given of any gas concentration ranging from 0 to 100 percent of the lower explosive level (LEL) and 0 to 25 percent of the oxygen level. A detector can be used to check battery rooms where ventilation is suspect. Determine if a hazardous atmosphere exists before entering a confined space. Hazardous atmospheres include: a contaminant concentration 10 percent or more of its lower flammability limit; oxygen concentration less than 19.5 percent by volume; and oxygen concentration more than 23 percent by volume, particularly if oil mist or other combustible materials are present.

**CHAPTER 6 ENERGY CONTROL (LOCKOUT/TAGOUT)****6-1 SERVICE-SPECIFIC CRITERIA**

Comply with the energy control (lockout and tagout) requirements specified in the following documents:

**Navy**

OPNAVINST 5100.23G CH-1, *Navy Safety and Occupational Health Program Manual*.

**Army**

EM 385-1-1, *Safety and Health Requirements*.

Department of the Army Pamphlet (DA PAM) 385-10, *Army Safety Program*.

DA PAM 385-26, *The Army Electrical Safety Program*.

**Air Force**

AFI 91-203, *Air Force Consolidated Occupational Safety Instruction*.

AFI 32-1064, *Electrical Safe Practices*.

**6-2 ADDITIONAL CRITERIA FOR ELECTRICAL EQUIPMENT**

Refer to Appendix J for additional information regarding lockout/tagout for electrical equipment.



## CHAPTER 7 TEMPORARY PROTECTIVE GROUNDING

### 7-1 TEMPORARY GROUNDING.

Temporary grounding is provided to protect workers engaged in deenergized electric line maintenance. In addition, lines and equipment are protected. Unsafe potentials can occur on the line from static charge buildup, induced voltages through magnetic and capacitive coupling from nearby energized lines, and accidental energizing of the line. The temporary grounding will cause an inadvertently energized line to become deenergized through the action of ground fault relays, and will drain off induced voltages. Provide protective grounds with an impedance low enough to cause immediate operation of protective devices in case of accidental energizing of the lines or equipment. Further information on temporary grounding may be found in IEEE Standard 1048, *Guide for Protective Grounding of Power Lines*, and IEEE 1246, *Guide for Temporary Protective Grounding Systems Used in Substations*.

For 600 volts and below, temporary grounding must be installed on lines and equipment to be worked on, unless the authorized individual-in-charge determines that temporary grounding is not practical. The authorized individual-in-charge must explain to the work crew the reasons for not installing temporary grounding. If it is not practical or possible to install temporary grounding then other methods of protection must be provided, such as circuit breakers racked out to the disconnected position, removal of fuses from disconnect switches, disconnect conductors from terminals to isolate the circuit or equipment being worked on, or other methods.

#### 7-1.1 Testing.

Test the line to be sure it is deenergized before installing protective grounds.

#### **WARNING**

Place protective grounds on the disconnected lines or equipment to be worked on in accordance with 29 CFR 1910.269(n), Grounding for Protection of Employees. However, if it can be demonstrated that installation of a ground is impracticable or that the conditions resulting from the installation of a ground would present greater hazards than working without grounds, the lines and equipment may be treated as deenergized provided all of the following conditions are met.

1. The lines and equipment have been deenergized.
2. There is no possibility of contact with another energized source.
3. The hazard of induced voltage is not present.

#### 7-1.2 Installation Criteria.

A good temporary ground provides adequate current-carrying capacity and a low-resistance path to the reference ground, and is connected at the proper points with

clean tight joints. If the temporary ground is not installed correctly, a worker might feel secure but not actually be protected. When connecting grounds to conductors, maintain the minimum approach distances specified in Table 3-1 from energized lines, using live-line tools as required. Place grounds as close to the equipment/work as practical to minimize the inductive voltage loop formed by the ground cable and the worker. To avoid hazardous touch and step potentials, persons on the ground within the work area must stay at least 10 ft (3.0 m) from any protective grounds or devices, and from vehicles bonded to them. If this is not feasible, workers must wear insulated footwear or use other protective measures to minimize the hazard.

### 7-1.3 Temporary Grounding System Components.

Use system application (overhead, underground, substation) sets with ASTM F 855, *Temporary Grounding Systems to be Used on De-Energized Electric Power Lines and Equipment*, grounding jumpers (clamps, ferrules, and 600 volt jacketed elastomer flexible cable). Store in accordance with the requirements for electrical tools and rubber protective equipment. Assemble grounding sets and jumpers in a workbench environment and test annually using an instrument specifically designed to test grounding equipment.

#### 7-1.3.1 Clamps.

Use the alloy (copper or aluminum) matching the conductor or device to which it is attached and meeting or exceeding the current-carrying capacity of the associated cable. Use smooth jaw clamps on buses to avoid surface marring. Use serrated clamp jaws to bite through corrosion products for attachment to conductors or metal products. Self-cleaning jaws are recommended for use on aluminum. Never use live-line clamps for grounding.

#### 7-1.3.2 Cable.

Cables will be preferably ASTM F855, Type I, of a minimum 2/0 AWG copper and be able to withstand the available fault currents for 15 cycles for substation use and for 30 cycles for line use. Sharp bends and continuous flexing of cable can break conductor strands. Excessive cable lengths must be avoided as this increases resistance, and twists and coils also reduce their current-carrying capacity. As a general rule, limit the length of grounding cables to 30 ft (9 m) for line use and 40 ft (12 m) for substation use. Derate the Table 7-1 fault current capability by 10 percent when using multiple ground cables (which must all be of the same size and length). Verify cables prepared by facility personnel for grounding applications are highly flexible and rugged.

**Table 7-1. Maximum Fault Current Capability for Grounding Cables<sup>1</sup>**

Cable Size (AWG)	Fault Time (Cycles)	RMS Amperes (Copper)
2/0	15	27,000
	30	20,000
3/0	15	36,000
	30	25,000
4/0	15	43,000
	30	30,000

<sup>1</sup>These current values are the “withstand rating” currents for grounding cables and cables as per *ASTM F 855*. These values are about 70 percent of the fusing (melting) currents for new copper conductors. They represent a current that a cable is capable of conducting without being damaged sufficiently to prevent reuse.

**7-1.3.3 Ferrules.**

Use ASTM F855, Type IV (stud copper base compression type) when installed on grounding cables by facility personnel. Use ferrules with a filler compound vent hole at the bottom of the cable so that employees can visually check that the cable is fully inserted into the ferrule. Install clear heat shrink over a portion of the ferrule to minimize strand breakage caused by bending. In all cases, follow the manufacturer’s recommendations. Do not use aluminum alloy ferrules as they will not provide a lasting snug fit. Check for tightness periodically.

**7-1.3.4 Grounding Cluster Bars.**

Use to connect phase and neutral conductor jumper cables to the selected method of providing a ground electrode. Cluster bars must have an attached bonding lead. Provide temporary ground rods as stated in Table 7-2.

**Table 7-2. Temporary Ground Rod Minimum Requirements**

<p>1. Single rod installed to a depth of 5 ft (1.5 m) below grade.</p> <ul style="list-style-type: none"> <li>• A minimum 5/8 in (16 mm) diameter bronze, copper, or copper-weld rod at least 6 ft (1.8 m) long.</li> <li>• A 6 ft (1.8 m), screw-type ground rod, consisting of a minimum 5/8 in (16 mm) diameter copper-weld shaft with a bronze auger bit and bronze T-handle, tightly connected to the rod.</li> </ul>
<p>2. Additional rods to provide a total of 5 ft (1.5 m) below grade where required.</p> <ul style="list-style-type: none"> <li>• Install 6 to 8 ft (1.8 to 2.4 m) apart while maintaining the 10 ft (3.0 m) step and touch potential clearance.</li> <li>• Bond all rods together prior to installing other electrode connections.</li> </ul>

#### 7-1.4 **Equipotential Zone.**

All metal within reach must be at the same (zero or minimum) potential with reference to ground in order to safely protect the workers. Install and connect grounding and bonding conductors in a proper manner to provide an equipotential zone of protection for workers.

#### 7-1.5 **Ground Connection and Electrodes.**

Temporary grounds must be connected to the permanent ground of the structure or pole, to another grounding electrode or grounded conductor. This may be the neutral conductor, or an overhead ground wire, or the station ground, or one or more temporarily driven ground rods, driven so at least 6 ft (1.8 m) of the ground rod is in contact with moist soil. Additionally, any metallic object that is a good conductor, such as an anchor rod or permanent ground rod, which extends several feet into the ground, may be used for the connection if sufficiently low ground resistance is determined. When connecting to a metal pole or structure, always verify it has an unbroken connection to its permanent ground rod. In areas accessible to unqualified persons, provide a barricade for the ground rod as a physical and visual barrier to prevent anyone from approaching within the minimum approach distances specified in Table 3-1.

#### 7-2 **TEMPORARY GROUNDING OF SUBSTATION CURRENT-CARRYING EQUIPMENT COMPONENTS.**

Ground deenergized current-carrying components of substation equipment before approaching them within the minimum distances specified in Table 3-1. Place grounds as close to the equipment/work as practical to minimize the inductive voltage loop formed by the ground cable and the worker. Special precautions are needed during oil handling. Refer to Figure 7-1, and Tables 7-3 and 7-4. Refer to Table 7-5 if oil handling is involved.

Figure 7-1. Substation Temporary Grounding

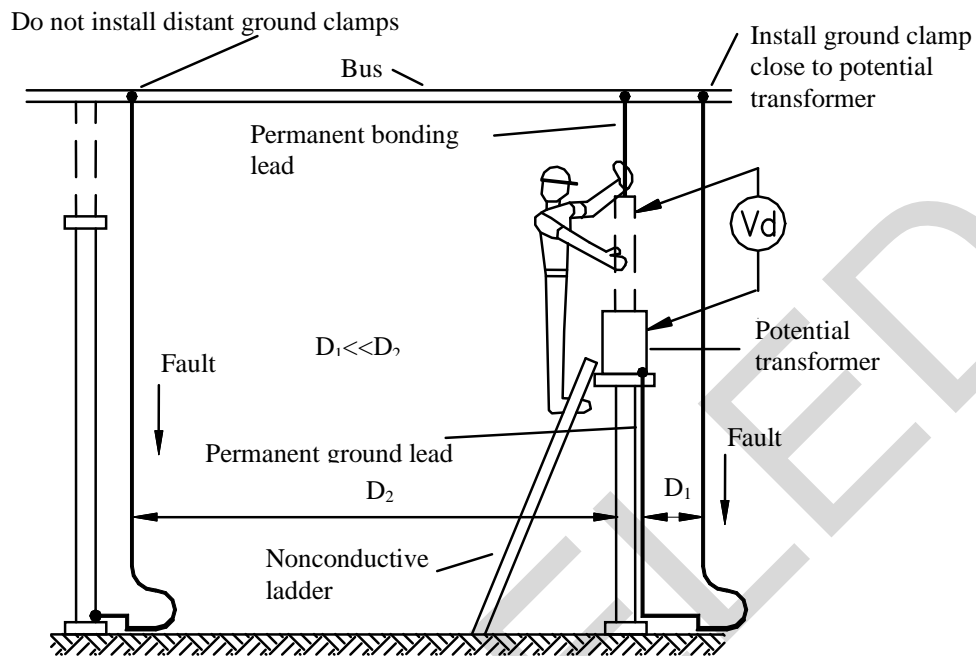

Table 7-3. Substation Protective Grounding Procedures

1	Check validity of permanent equipment grounds.
2	Install a protective ground cable and bond to a grounded structure member or to a common copper equipment bushing lead for equipment being worked on.
3	Apply personal protective grounds before working within Table 3-1 minimum approach distances on substation equipment including: <ul style="list-style-type: none"> <li>• Bushings</li> <li>• Buses</li> <li>• Capacitors</li> <li>• Circuit breakers</li> <li>• Instrument transformers</li> <li>• Power transformers</li> <li>• Switches</li> <li>• Surge arrestors</li> </ul>

**Table 7-4. Grounding of Substation Equipment**

1	Grounds must be in place before a tank is opened and the insulating medium (oil/gas) is changed. This does not apply to sampling when using a sampling valve.
2	Switches may not be used to maintain personal ground continuity except when the switch is specifically designed for that purpose.
3	Allow at least 5 minutes between opening of the capacitor switching devices and the closing of the ground switch on a fully charged capacitor bank. wait at least 5 minutes after the ground switch is closed before installing protective grounds. Maintain a capacitor bank deenergized for at least 5 minutes before re-energizing it. Include the time limits required for these maneuvers in switching orders involving capacitor banks.
4	Disconnect and discharge surge arrestors using grounding cables.
5	Do not work on grounding transformers unless they are in an electrically safe work condition. Isolate phase reactors from all energized sources and ground them before starting work on them.
6	Disconnect bushing leads from bushing terminals as necessary to permit equipment testing that requires the equipment to be ungrounded. Use a hot stick to connect test equipment and re-establish the ground as soon as the test is completed. Following an applied potential test ("Hi-Pot"), ensure the ground remains in place for a period at least two times the duration of the test period. Follow the manufacturer's recommendations for work clearances and grounding instructions for the test equipment
7	Install separate grounds for each isolated section of the deenergized circuit if a hazard exists when working in a deenergized area of a substation where there are one or more physical breaks in the electrical circuit.

**Table 7-5. Grounding of Equipment During Oil Handling**

1	Bond apparatus tanks, conductive hoses, pumping or filtering equipment, drums, tank cars, trucks, and portable storage tanks to the station ground mat. Connect the vehicle end first and disconnect it last to prevent possible arcs near the vehicle.
2	Bond exposed conductors, such as transformer or circuit breaker bushings, or coil ends or transformers where bushings have been physically removed, to the same grounding point.

**7-3 AERIAL LIFT TRUCK VEHICLE GROUNDING.**

Ground and bond each vehicle being used at the job site when any parts of it will come within the minimum approach distances of Table 3-1. When in transit or when parked with no load and all booms lowered, the vehicle may be ungrounded if it is located outside the restricted approach boundary. Ensure the workers and the vehicle operator are aware of step and touch potential hazards near vehicles as well as near permanent and temporary ground rods and electrodes. Diggers, cranes, and other work vehicles must be bonded, if practical, to the common temporary or permanent ground electrode provided when performing work on deenergized circuits. Ground vehicles in accordance with Table 7-6 and Figure 7-2.

**Table 7-6. Procedures for Grounding Insulated and Uninsulated Aerial Lift Trucks**

Grounding	Procedure
Insulated boom vehicles	Bond the vehicle to a separate driven ground rod located about midway on one side and as close to the vehicle as practical. If possible, keep insulated vehicles and their ground rods at least 10 ft (3.0 m) away from the structure grounding system to minimize step and touch potentials. If workers can simultaneously contact two or more separately grounded systems, the systems will be bonded together.
Uninsulated boom and other electrical work vehicles	Bond the uninsulated boom and all other vehicles directly involved in electrical work to the grounded system using a grounding cable rated for the maximum available fault current.
Tensioning vehicles	Vehicles used to pull and hold tension on the conductor or overhead ground wire must be properly bonded to a structure ground or a temporary ground rod. Stay on the vehicle or at least 10 ft (3.0 m) away from the vehicle ground when possible.

Figure 7-2. Insulated and Uninsulated Aerial Lift Vehicle Grounding Connections

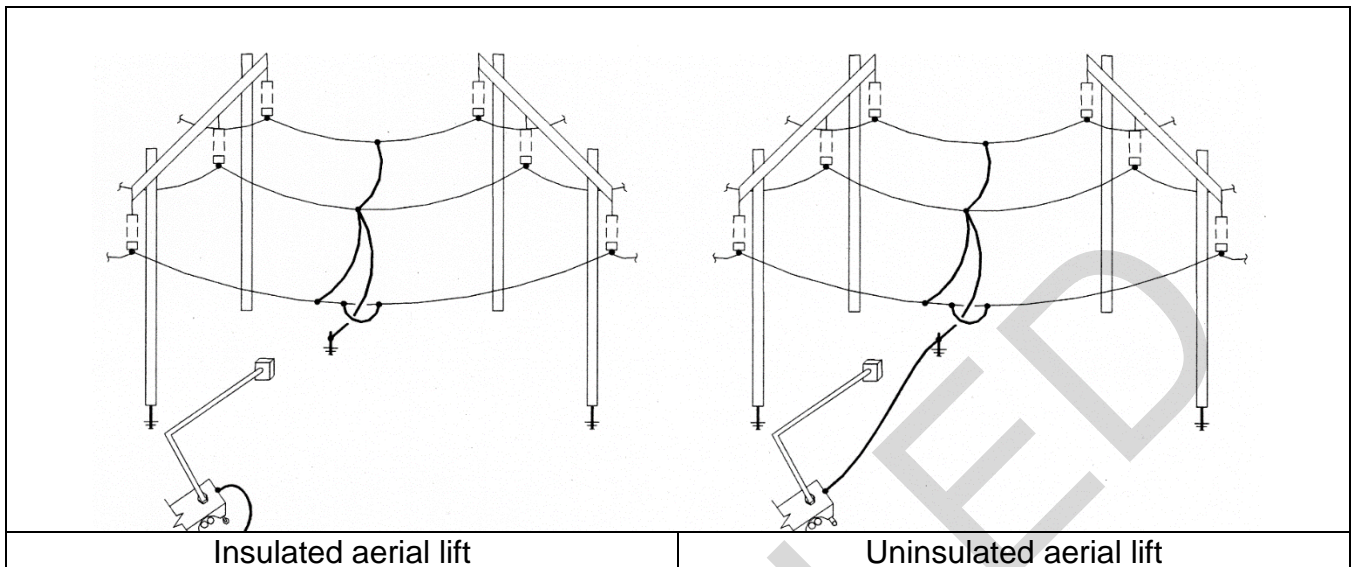

**7-4 TEMPORARY GROUNDING OF UNDERGROUND LINES.**

Ground all possible sources of power (including transformer backfeed). If the application of grounds is considered to increase the work hazard, then the grounding method will require additional evaluation and approval in accordance with Chapter 8. Install protective grounds at equipment terminations or ground by spiking cable (using an approved tool) prior to work on the cable. Use approved ground sets of the type shown on Figure 7-3.

Figure 7-3. Underground System Grounding Sets

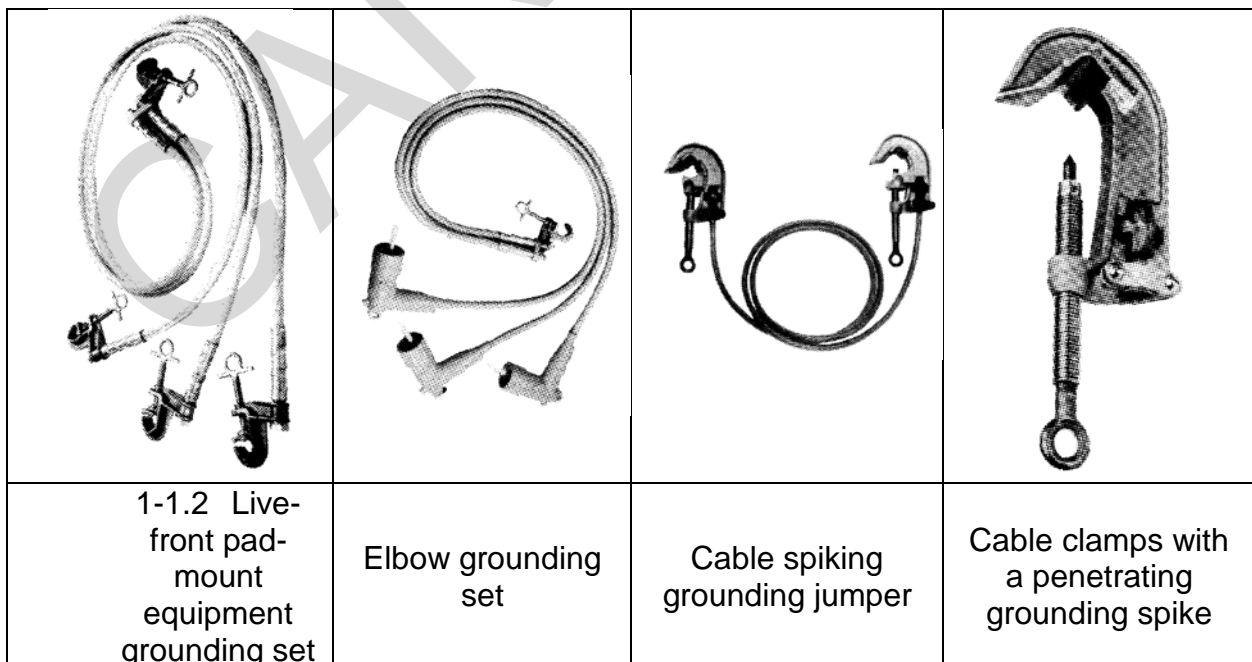



**7-5 OPENING OR SPLICING DEENERGIZED CONDUCTORS.**

Conductors may be spliced at ground level, from aerial lift equipment utilizing ground mats (uninsulated aerial lifts), or from insulating platforms (insulated aerial lifts). Grounding for conductive or insulating platforms is shown on Figure 7-4. Install all grounding jumpers with hot sticks. Ground any mobile equipment. Stay 10 ft (3.0 m) away from grounded items and step onto equipment or platforms as quickly as possible to minimize any adverse step and touch potentials.

**Figure 7-4. Using a Conductive or Insulating Platform for Opening/Closing Deenergized Overhead Conductors**

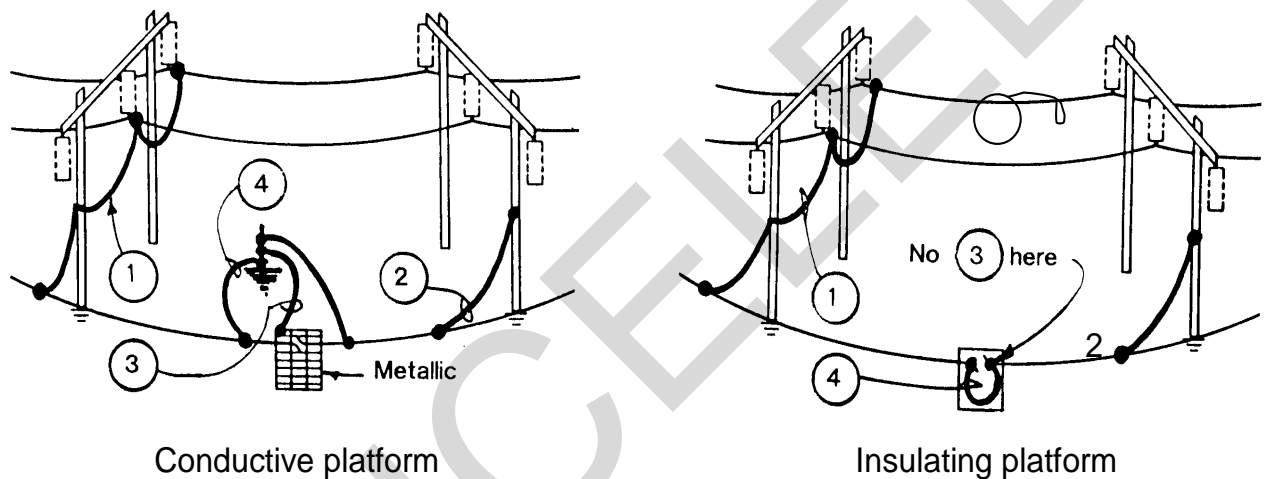

1. Three-phase ground all conductors and structure on one side of the work.
2. Single-phase ground work on conductor and structure on the other side of the work.
3. Ground conductive platform but not insulating platform.
4. Maintain integrity of conductor connection.

**7-6 GROUNDING FOR STRINGING AND REMOVING LINES.**

Locate grounds to meet requirements of Table 7-7 and Figure 7-5. After conductor pulling, locate grounds in accordance with Table 7-8. Stay 10 ft (3.0 m) away from grounded items and step onto equipment or platforms as quickly as possible to minimize any adverse step and touch potentials.

Figure 7-5. Composite Stringing/Removing Temporary Protective Grounds on Overhead Conductor Lines

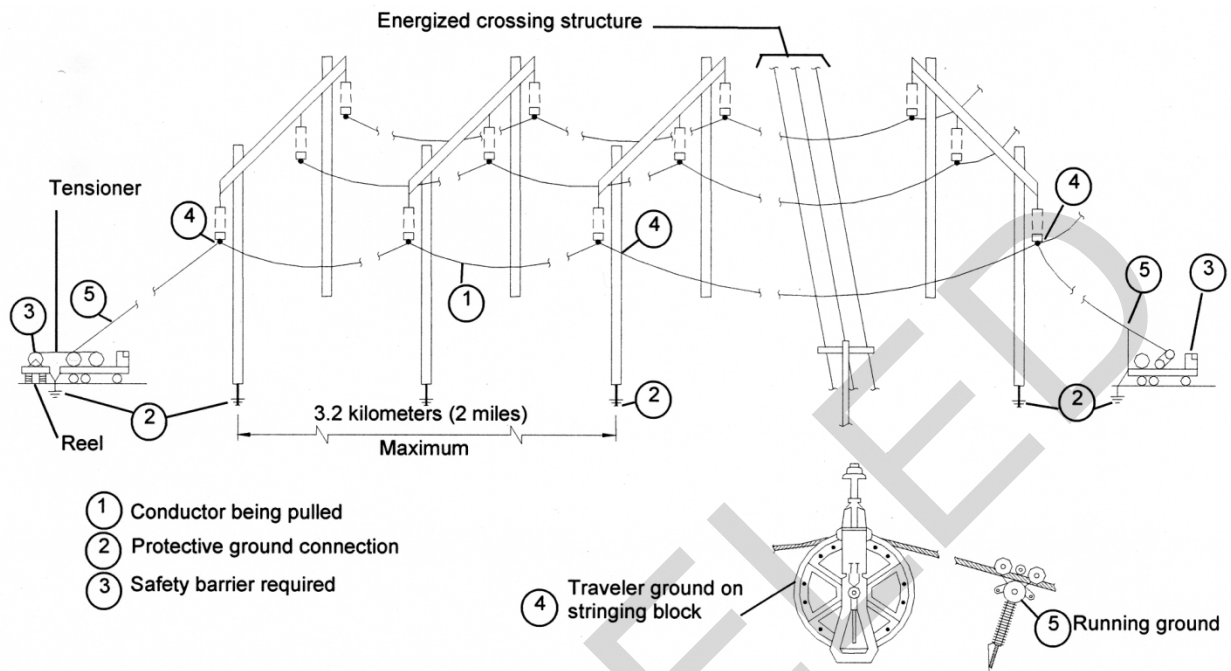

Table 7-7. Stringing/Removing Conductor Ground Locations

1	Ground all stringing equipment such as reel stands, pullers, tensioners, and other devices.
2	Provide a safety barrier around the equipment.
3	Install a running ground between pulling and tensioning equipment and their adjacent structures. <i>Note: "Running grounds" only work on bare conductors. If using insulated conductors (aerial cable or tree wire for example), the pulling cart and the tensioning cart will need to be grounded and all personnel working are required to wear voltage rated gloves.</i>
4	Ground stringing blocks at first and last structures, and at least every 2 miles (3.2 km) in between.
5	Ground stringing blocks at each structure on both sides of an energized circuit being crossed. If the design of the circuit interrupting devices protecting the lines so permits, the automated reclosing feature of those devices must be made inoperative and tagged out.

**Table 7-8. Conductor Ground Location After Pulling**

1	Ground at each structure next to intermediate deadends of the stringing operation.
2	Ground at each structure where and while work (including clipping-in) is being performed on or near the conductor.
3	Remove grounds as the last phase of finished aerial installation.

**7-7 TEMPORARY GROUNDING OF AERIAL LINES.**

Ground by installing an overhead distribution grounding set. The grounding set provides a parallel low-level (milliohm) resistance path which limits the current flow through the worker to a very low (safe) value (milliamperes) thus limiting the potential across the worker to a safe value. If the ground resistance were in series with the worker life-endangering currents could flow through the worker under fault conditions. Avoid any ground connection which could provide violent whipping from wind action. Double-point grounds are sometimes utilized but single-point (equipotential) grounding is the preferred method. If double-point grounding is necessary, install the temporary grounds at least one span away from the work site because the grounding cables may violently move during a fault condition.

**7-8 PLACEMENT OF GROUNDS.**

Install grounds as close as possible to the work. Temporary grounding connection/removal procedures will be in accordance with Table 7-9. Never approach closer than distances specified in Table 3-1 until after the line/equipment has been isolated, deenergized, tested, and properly grounded. Afterwards, avoid coming closer than 10 ft (3.0 m) to minimize the hazard from step and touch potentials. Such potential differences occur from items such as down guys, ground rods, maintenance vehicles, and structure legs or ground wires during the period in which they are bonded to temporary grounds. When it is absolutely necessary to work on or near these features, use bonded conductive or insulated platforms, or approved insulated footwear to minimize the hazard from step and touch potentials. Bond separately grounded systems together if they can be simultaneously contacted.

**Table 7-9. Temporary Grounding Connection/Removal Procedures**

1	Select a ground electrode using either an established ground at the structure or a temporarily driven ground rod. Minimize the impedance and do not introduce a hazardous potential difference.
2	Test the deenergized line/equipment for voltage by an approved tester. Test each phase conductor or circuit part both phase-to-phase and phase-to-ground. Before and after each test, determine that the voltage detector is operating satisfactorily. The test also determines if any energized condition exists as a result of inadvertently induced voltage or unrelated voltage backfeed.
3	Visually inspect ground equipment. Check mechanical connections for tightness. Clean clamp jaws and conductor surfaces. Clean not earlier than 5 minutes before connection using a wire brush attached to a live-line tool. Use of self-cleaning equipment is also acceptable.
4	Make the ground end clamp of each grounding cable the first connection made and the last to be removed. Hot sticks will be used if the grounded system and worker are at different potentials.
5	The conductor-end clamps of each grounding cable will always be connected last and removed first by hot sticks. Apply to the nearest conductor first and proceed outward or upward until all phases have been connected. Remove in reverse order. The practice of physically holding the temporary grounding cable with gloved hand while attaching the temporary ground connector, in order to lighten the weight on the head of the stick, is strictly prohibited. The practice of holding the hot stick near the head of the hot stick to lighten the weight on the head of the stick is also prohibited. Instead, have a co-worker assist in installing heavy cables by holding the cable with another hot stick, or by using a "shepherd hook" with a pulley and a nonconductive rope to hoist the grounding cable into position.

**CHAPTER 8 ENERGIZED WORK****8-1 WORK ON ENERGIZED CIRCUITS.**

Do not work on energized electrical circuits operating at 50 V or more except when required to support a critical mission, prevent human injury, or protect property.

In all instances of work on energized electrical circuits, workers must be qualified for energized line work and all required protective equipment and special tools must be available at the work site. OSHA 29 CFR 1910.333 limits work on live energized electrical equipment as follows: *“Live parts to which an employee may be exposed shall be deenergized before the employee works on or near them, unless the employer can demonstrate that deenergizing introduces additional or increased hazards or is not feasible due to equipment design or operational limitations.”*

**WARNING**

Only workers qualified by electrical training can work in areas on or with unguarded, uninsulated energized lines or parts of equipment operating at 50 V or more. All electric lines and equipment will be treated as energized unless deenergized, locked, tagged, and tested for no voltage. In addition, provide grounding in accordance with Chapter 7. Maintain the specified minimum approach distances specified in Table 3-1 based on the voltage range. The arc flash boundary distance requires the wearing of arc rated clothing. No energized work can be performed during adverse weather conditions (ice storms, high winds, and electric storms) unless there is an emergency and the work has been approved by the designated authority. Any relaxation of these electrical safety requirements in the interest of mission continuation places both the electrical workers and the mission at risk.

**8-2 EXAMPLES OF ENERGIZED WORK.**

Tables 8-1 and 8-2 provide examples of energized work activities that might be performed. Comments are provided in the tables regarding each energized work activity.

**Table 8-1. Typical Energized Work Activities on Interior Electrical Systems**

<b>Activity on Energized Electrical Equipment</b>	<b>Comments</b>
Circuit switching (on or off) – low voltage.	This is considered by NFPA 70E as normal operation of electrical equipment.
Circuit switching (on or off) – medium voltage.	This is considered by NFPA 70E as normal operation of electrical equipment.

Activity on Energized Electrical Equipment	Comments
Troubleshooting – low voltage.	This is considered by NFPA 70E as an activity that does not require an energized electrical work permit.
Troubleshooting – medium voltage.	This is considered by NFPA 70E as an activity that does not require an energized electrical work permit.
Voltage testing – low voltage.	This is considered by NFPA 70E as an activity that does not require an energized electrical work permit.
Voltage testing – medium voltage.	This is considered by NFPA 70E as an activity that does not require an energized electrical work permit.
Remove bolted covers of energized equipment – low voltage.	This is the type of activity that might require an energized electrical work permit.
Remove bolted covers of energized equipment – medium voltage.	This is the type of activity that might require an energized electrical work permit.
Install or remove data logger from a low voltage panel.	This is the type of activity that might require an energized electrical work permit and is a good candidate for a Standard Operating Procedure.
Racking power circuit breakers manually (in or out) – low voltage.	This is the type of activity that might require an energized electrical work permit and is a good candidate for a Standard Operating Procedure.
Racking power circuit breakers manually (in or out) – medium voltage.	This is the type of activity that might require an energized electrical work permit and is a good candidate for a Standard Operating Procedure.
Racking power circuit breakers with remote mechanism (in or out) – low voltage.	A case could be made that this is not energized work in that the employee is a safe distance away from the work activity.
Racking power circuit breakers with remote mechanism (in or out) – medium voltage.	A case could be made that this is not energized work in that the employee is a safe distance away from the work activity.
Conductor termination into energized panel or switchboard.	This activity does not satisfy the OSHA requirement of “...unless the employer can demonstrate that deenergizing introduces additional or increased hazards or is not feasible due to equipment design or operational limitations”.
Replace lighting ballasts while energized.	This activity does not satisfy the OSHA requirement of “...unless the employer can demonstrate that deenergizing introduces additional or increased hazards or is not feasible due to equipment design or operational limitations”.

Activity on Energized Electrical Equipment	Comments
Replace lighting fixtures while energized.	This activity does not satisfy the OSHA requirement of "...unless the employer can demonstrate that deenergizing introduces additional or increased hazards or is not feasible due to equipment design or operational limitations".
Installing receptacles while energized.	This activity does not satisfy the OSHA requirement of "...unless the employer can demonstrate that deenergizing introduces additional or increased hazards or is not feasible due to equipment design or operational limitations".
Circuit breaker installation into energized panel – low voltage.	This activity does not satisfy the OSHA requirement of "...unless the employer can demonstrate that deenergizing introduces additional or increased hazards or is not feasible due to equipment design or operational limitations".

#### Batteries and Backup Power Systems

Stationary battery maintenance.	This is the type of activity that might require an energized electrical work permit or a Standard Operating Procedure.
Stationary battery replacement, including individual cells or modules.	This is the type of activity that might require an energized electrical work permit or a Standard Operating Procedure.
Automatic transfer switches – inspection and exercising while energized.	This is the type of activity that might require an energized electrical work permit or a Standard Operating Procedure.
UPS inspection and maintenance	This is the type of activity that might require an energized electrical work permit or a Standard Operating Procedure.

**Table 8-2. Typical Energized Work Activities on Exterior Electrical Systems**

Activity on Energized Electrical Equipment	Comments
<b>Overhead Distribution</b>	
Opening or closing gang-operated air break switches	Routine activity that can be controlled by a Standard Operating Procedure.
Opening or closing single pole switches	Routine activity that can be controlled by a Standard Operating Procedure.
Opening or closing fused cutouts, including refusing.	Routine activity that can be controlled by a Standard Operating Procedure.

Activity on Energized Electrical Equipment	Comments
Voltage testing, phase rotation testing, and current measurements.	Routine activity that can be controlled by a Standard Operating Procedure. Voltage testing is also part of applying temporary grounding equipment.
Replace pole-mounted equipment, including cross-arms, conductors, transformers, switches, surge arresters, etc.	Routine activity for an electric utility. Not a routine activity at most military installations.
<b>Underground Distribution</b>	
Opening or closing switches, VFIs, or fused compartments on pad-mounted switchgear.	Routine activity that can be controlled by a Standard Operating Procedure.
Removing or inserting load break elbows.	Routine activity that can be controlled by a Standard Operating Procedure.
Voltage testing, phase rotation testing, and current measurements.	Routine activity that can be controlled by a Standard Operating Procedure. Voltage testing is also part of applying temporary grounding equipment.
<b>Electrical Manholes and Vaults</b>	
Entry into manhole containing energized circuits for insulated cable examination.	<p>Arc flash calculation methodology does not address the unique configuration of an electrical manhole in which an arcing fault occurs inside a small enclosed space that also contains the worker. Additional precautions are necessary.</p> <p>An IEEE interpretation, dated 14 January 2009, regarding IEEE C2 (National Electrical Safety Code) Rule 410A3, confirms that the phrase “on or near energized parts or equipment” applies to energized insulated conductors inside manholes. IEEE C2 Rule 443 does allow a qualified employee, working alone, to enter a manhole where energized cables or equipment are in service for the purpose of inspection, housekeeping, taking readings, or similar work if such work can be performed safely.</p>
Entry into manhole containing energized circuits for circuit installation/relocation.	See above.
Spicing electrical conductors.	See above.



## 8-3 ENERGIZED ELECTRICAL WORK PERMIT.

### 8-3.1 Normal Operation of Electrical Equipment.

Normal operation of electrical equipment, such as circuit breaker operation, does not require an energized electrical work permit if all of the following conditions are met:

- The equipment is properly installed. The phrase *properly installed* means that the equipment is installed in accordance with applicable industry codes and standards (such as NFPA 70) and the manufacturer's recommendations,
- The equipment is properly maintained. The phrase *properly maintained* means that the equipment has been maintained in accordance with the manufacturer's recommendations and applicable industry codes and standards, such as NFPA 70B or NETA MTS.
- All equipment doors are closed and secured.
- All equipment covers are in place and secured.
- There is no evidence of impending failure. The phrase *evidence of impending failure* means that there is evidence such as arcing, overheating, loose or bound equipment parts, visible damage, or deterioration.

### 8-3.2 Prohibitions to Energized Work.

Energized work is prohibited for the following conditions:

- Energized work on equipment or systems with a nominal voltage above 34.5 kV.
- Energized work on medium voltage systems that have not received adequate maintenance and testing.
- Energized work on low voltage systems that have not received adequate maintenance and testing.

An energized electrical work permit is not authorized if there is no assurance that the electrical distribution system is capable of responding as required to overcurrent or arc flash events.

### 8-3.3 Energized Electrical Work Permit.

An energized electrical work permit is required under the following conditions:

- When work is performed within the restricted approach boundary.

- When an employee interacts with the equipment when conductors or circuit parts are not exposed but an increased likelihood of injury from an exposure to an arc flash hazard exists. An example of this condition is racking (inserting or removing) a circuit breaker into or out of an energized switchgear bus.

Determine appropriate safety-related work practices before any person is exposed to the electrical hazards involved by using both shock risk assessment and arc flash risk assessment. Only qualified persons are permitted to work on electrical conductors or circuit parts that have not been put into an electrically safe work condition. Energized electrical work permits must be prepared in advance in accordance with NFPA 70E and, as a minimum, include:

- Description of the circuit and equipment to be worked on and their location.
- Justification for why the work must be performed in an energized condition.
- Description of safe work practices to be employed.
- Results of the electrical task risk assessment, which includes:
  - Results of the shock risk assessment, including voltage level, limited approach boundary, restricted approach boundary, and necessary personal protective equipment.
  - Results of the arc flash risk assessment, including 1) available incident energy at the intended working distance or arc flash PPE category, 2) necessary PPE to protect against the hazard, and 3) arc flash boundary.
- Means employed to restrict the access of unqualified persons from the work area.
- Evidence of completion of a job briefing, including a discussion of any job-specific hazards
- Energized work approval.

Appendix B provides an example of an electrical task risk assessment checklist that can be used in support of preparing the energized electrical work permit.

#### 8-3.4 Exemptions to Energized Electrical Work Permit.

An energized electrical work permit is not required if a qualified person is provided with and uses appropriate safe work practices and PPE under the following conditions:

- Testing, troubleshooting, and voltage measuring.

- Thermography and visual inspections if the restricted approach boundary is not crossed.
- Access to and egress from an area with energized electrical equipment if no electrical work is performed and the restricted approach boundary is not crossed.
- General housekeeping and miscellaneous non-electrical tasks if the restricted approach boundary is not crossed.

## **8-4 STANDARD OPERATING PROCEDURES FOR ENERGIZED ELECTRICAL WORK PERMITS.**

### **8-4.1 OVERVIEW.**

Standard Operating Procedures (SOPs) are recommended as a means of satisfying the energized electrical work permit requirements of this UFC. The preferred work approach is to establish an electrically safe work condition by deenergizing the equipment before allowing work. However, there are routine activities on the primary distribution system that involve energized work.

Done properly, an energized electrical work permit is a time-consuming detailed evaluation of the work to be done and the safety precautions that are required to ensure the work is performed safely. For specified tasks, an SOP is a pre-approved energized electrical work permit that can simplify the preparation for an energized work activity while still complying with mandated regulations and industry standards.

#### **8-4.1.1 SOP Limitations.**

SOPs are recommended for electrical-related work activities that might be performed routinely. Unusual or non-routine work activities that involve working on or near energized electrical equipment require an energized electrical work permit.

An SOP is a pre-approved energized electrical work permit rather than a detailed technical procedure. The SOP assumes that the qualified electrical worker is proficient in the technical aspects of the designated work activity and the SOP focuses on the safety aspects that would be typically included in an energized electrical work permit.

#### **8-4.1.2 Items to Address in an SOP.**

Develop SOPs by a risk assessment based upon job hazard analyses (JHA) using Operational Risk Management (ORM) principles. Include the following in an SOP:

- The purpose of the SOP.
- References and definitions appropriate for the work activity.
- The hazards that will be avoided by using the SOP.

- Specific procedures that will be used to reduce/minimize/eliminate the hazards.
- Potential energy sources, including limits of approach.
- Specific required training/certifications.
- Number of required employees.
- Rescue procedures and equipment.
- Potential incident energy level exposure.
- Appropriate personal protective equipment (PPE) such as arc rated clothing, face shields, and electrical gloves for exposure level.
- Management approvals.

Include an electrical task risk assessment as part of the SOP development in support of its specified work scope and associated electrical safety requirements. Refer to the appendices for examples of SOPs that might be appropriate for working on the primary distribution system. These sample SOPs are provided for reference; modify them as necessary for the installation, the allowed work practices, and the qualifications of the personnel.

## **8-5 APPLICABILITY FOR THE NAVY.**

### **8-5.1 Navy Energized Electrical Work Permit.**

For the Navy, all energized work requires written, job specific procedures approved, in writing, by the Commanding Officer/Executive Officer and considered necessary to support a critical mission, prevent human injury, or protect property. "Gloving" above 600 volts is not authorized for Navy personnel. In addition, Navy personnel are not authorized to perform energized overhead distribution (pole line) work above 600 volts with the following exceptions (these exceptions must be performed as required in the task specific SOP, which includes using the appropriate PPE and live line tools):

- a. Comply with Section 4-1.4 and arc rated safety harness with lanyard:
  - Gang operated switch operation.
  - Phasing tests.
  - Voltage tests.
  - Current tests (with hook sensing head ammeter).
  - Installing and removing temporary protective grounds.

- Installing and removing mechanical stirrups and live-line clamps.
- b. Comply with Category 2 and arc rated safety harness with lanyard (*Note: Where limited visibility, due to environmental conditions (night time, rain, wind) will possibly create a greater hazard, a face shield is not mandatory. Remainder of PPE (including safety goggles and balaclava with hardhat), is required*):
  - Disconnect switch operation.
  - Opening or closing fused cutouts.
  - Replacing fuses.

#### 8-5.2 **NAVFAC Standard Operating Procedures (SOPs).**

Develop SOPs based upon job hazard analyses (JHA) using Operational Risk Management (ORM) principles. SOPs must ensure compliance with the codes, standards and regulations identified in Section 1-4. Address the purpose of the SOP, the hazards that will be avoided by using the SOP, specific procedures that will be used to reduce/minimize/eliminate the hazards, potential energy sources, specific required training/certifications, rescue procedures and equipment, and appropriate personal protective equipment (PPE) such as arc rated clothing, face shields, and electrical gloves.

#### 8-5.3 **SOP Priority.**

Priorities for the development of SOPs are:

- The hazard may cause death, serious injury, or loss of a facility.
- May cause major injury, severe illness, or major property damage.
- May cause minor injury, minor illness, or minor property damage.

#### 8-5.4 **SOP Approval and Training.**

Following completion of the JHA and development of the SOP, route SOPs through the appropriate chain-of-command and the Activity Safety Office for review and approval. Upon completion of this process, train employees on the SOP and maintain a training record by the supervisor.

SOPs that have been issued by NAVFAC Activities are available for review at the Enterprise Safety Applications Management System (ESAMS) at the following:

[https://esams.cniv.navy.mil/ESAMS\\_GEN\\_2/LoginESAMS.aspx](https://esams.cniv.navy.mil/ESAMS_GEN_2/LoginESAMS.aspx).

## **8-6 APPLICABILITY FOR THE AIR FORCE.**

For the Air Force, all energized work must be authorized by the authority referenced in AFI 32-1064, *Electrical Safe Practices*, and considered necessary to support a critical mission, prevent human injury, or protect property. Energized electrical work permits are required in advance of work and require as a minimum those items contained in AFI 32-1064. "Gloving" above 600 volts is not authorized for Air Force personnel.

## **8-7 APPLICABILITY FOR THE ARMY.**

For the Army, all energized work must be authorized in accordance with DA PAM 385-26, *The Army Electrical Safety Program*.

## **8-8 CATEGORIES OF WORK.**

The approved work procedures to be used for work on energized circuits depend on the potentials at which the worker operates. These include:

### **8-8.1 Workers at Ground Potential.**

Workers located on a structure supporting the conductor, on other work platforms, or standing on the ground (earth) remain essentially at ground potential when using tools and equipment. Apply the lockout/tagout program with temporary grounding to ensure that an appropriate ground potential and equipotential work zone is maintained.

### **8-8.2 Workers at Intermediate Potential.**

Workers are isolated from grounded objects by insulating means, such as an aerial lift, an insulating ladder or platform, or insulating mat and they work with insulated tools and equipment. Specific approval is required for this work.

### **8-8.3 Workers at Line Potential.**

Workers are bonded to the energized device on which work is to be performed and are insulated from grounded objects and other energized devices that are at a different potential. This is commonly known as the barehand technique and is prohibited.

## **8-9 ENERGIZED WORK RULES.**

With the use of various types of aerial equipment and live-line tools, it is possible to perform many operations in the maintenance of overhead distribution lines while these lines are energized. Exact compliance with safety precautions is particularly important for energized work, and personnel engaged in this type of work must be trained and qualified in the procedures and the use of tools and equipment. Trained personnel must be familiar with ANSI/IEEE 516, *Guide for Maintenance Methods on Energized Power-lines*, and ANSI/IEEE 935, *Guide on Terminology for Tools and Equipment to Be Used in Live Line Working*. The "Lineman's and Cableman's Handbook" also provides pictorial data on many of the tools, equipment, and techniques used for energized work operations.

**8-9.1 Permitted Work.**

Energized work must not be performed at any facility without written authorization.

**8-9.2 Personal Protective Equipment and Clothing.**

Refer to Chapter 4 to determine the protective equipment and clothing that will be required.

**8-9.3 Statement of Qualifications.**

Each worker authorized to perform work on energized lines or equipment must be qualified and covered by a written statement that indicates the highest voltage on which the individual is authorized to work. Local policy must establish who can issue the statement of qualification. Electricians in upgrade training must work under the direct supervision of a qualified person.

**8-9.4 Work Methods for Voltage Levels.**

Energized work methods and the minimum approach distances must be in accordance with this UFC. For overhead line work, use the approved energized work methods given in Table 8-1 while maintaining the minimum approach distances given in Table 3-1. Use insulated (rubber) goods meeting the requirements of ASTM F 18 standards with color coding meeting the requirements of Table 5-1. Use leather protectors over rubber gloves. Use insulating tools meeting the requirements of Table 8-2 and insulating plastic guard equipment meeting the requirements of Table 8-3. The use of live-line tools without gloves to detect tool deterioration is prohibited. Use voltage-rated gloves with live-line tools. Review instructions and regulations detailing correct use and maintenance of such tools/equipment as a part of the work procedures. At least two workers, fully qualified for the voltage range (including other conductors within reach), must be available. See exceptions in Table 3-9.

**Table 8-1. Approved Energized Overhead Line Work Methods by Voltage Class**

Nominal AC Voltage Level	Work Method
Up to 600 volts	Use of live-line tools from electrically insulated aerial lift bucket or platform (intermediate protection) or use of live-line tools from structure mounting or an aerial lift bucket (ground potential).
>600 to 7.5 kilovolts	Use of live-line tools from electrically insulated aerial lift bucket or platform (intermediate protection) or use of live-line tools from structure mounting or an aerial lift bucket (ground potential).
>7.5 to 15 kilovolts	Use of live-line tools from electrically insulated aerial lift bucket or platform (intermediate protection) or use of live-line tools from structure mounting or an aerial lift bucket (ground potential).
>15 to 36 kilovolts	Use of live-line tools from an electrically insulated aerial lift bucket (intermediate potential).
>36 to 70 kilovolts	This work can only be performed by personnel specifically trained in the hazards associated with voltages in this range.
>70 to 230 kilovolts	This work can only be performed by personnel specifically trained in the hazards associated with voltages in this range.

**Table 8-2. Insulating Tools for Electrical Workers**

Standards			
<i>ASTM F711, Specification for Fiberglass Reinforced Plastic (FRP) Rod and Tube Used in Live-Line Tools.</i>			
<i>ASTM F3121/F3121M-16, Standard Guide for In-Service Maintenance and Electrical Testing of Hand-Held Live-Line Insulating Tools (Fiberglass-Reinforced Plastic (FRP)).</i>			
Minimum Test Values			
Tool Material	OSHA Acceptance <sup>1</sup>	IEEE In-Service <sup>2</sup>	Use
Fiberglass reinforced plastic (FRP)	100 kV/ft (0.3 m)	75 kV/ft (0.3 m)	Preferred <sup>3</sup>

Notes for Table 8-2:

1. Test values manufacturers must certify for acceptance by buyer.
2. Test values required after acceptance and tested after use in the field.
3. All new tools will be FRP. Replace wood live-line tools with FRP tools immediately; permanently remove the wood tools from service and destroy.



**Table 8-3. Insulating Overhead Line Plastic Guards/Platforms for Electrical Workers**

Standards						
<i>ASTM F-712, Test Methods for Electrically Insulating Plastic Guard Equipment for Protection of Workers</i>						
<i>ASTM F-968, Specification for Electrically Insulating Plastic Guard Equipment for Protection of Workers</i>						
<i>ASTM F-1564, Specification for Structure Mounted Insulating Work Platforms for Electrical Workers</i>						
Common Classifications for Plastic Guards						
Installation	Conductors		Structure/Apparatus		Special	
<ul style="list-style-type: none"> <li>Attached hot stick</li> <li>Eye for removable hot stick</li> <li>Rope loop or equivalent for gloving or hot stick</li> </ul>	<ul style="list-style-type: none"> <li>Line guards</li> <li>Line guard connectors</li> <li>Insulator covers</li> <li>Deadend covers</li> <li>Bus guards</li> <li>Bus "T" guards</li> </ul>	<ul style="list-style-type: none"> <li>Pole guards</li> <li>Ridge pin covers</li> <li>Switchblade covers</li> <li>Arm guards</li> <li>Cutout covers</li> <li>Crossarm guards</li> </ul>	<ul style="list-style-type: none"> <li>Shape</li> <li>Size</li> <li>Attachment</li> <li>More stringent electrical requirements</li> </ul>			
Guard Rating for Accidental Brush Contact						
Class	Maximum Use Rating kV (60 Hz)		Proof Test Withstand Voltage (In-Service Testing)		Duration, Minutes	Criteria
	Phase-to-Phase <sup>1</sup>	Phase-to-Ground	Phase-to-Ground kV 60 Hz	dc		
2	14.6	8.4	13.0	18	1	No flashover other than momentary as a result of too close spacing of electrode
3	26.4	15.3	24.0	34	1	
4	36.6	21.1	32.0	45	1	
5	48.3	27.0	42.0	60	0.5	
6	72.5	41.8	64.0	91	0.25	

*Notes for Table 8-3:*

- Cover-up materials are tested at values greater than the maximum use phase-to-ground values. The maximum use phase-to-phase values relate to guarded-phase-to-guarded-phase. The units are not rated for bare-phase-to-guarded-phase potentials.*

**8-9.5 Pre-Work Procedures.**

Do not start work until the requirements of Table 8-4 have been completed.

**Table 8-4. Pre-Work Procedures – Overhead Line**

1. Determine existing conditions and complete a job hazard analysis (see Chapter 2).
2. Determine the voltage rating of circuits to be worked on, distances to other energized lines, and location of work. Evaluate the following: <ol style="list-style-type: none"> <li>If aerial lift equipment can be used.</li> <li>What personnel qualifications are needed for the work.</li> <li>If special equipment, tools, or hazard protection are needed.</li> </ol>
3. Prepare a written standard operating procedure.
4. Obtain energized work approval/permit (permissible work for all services is discussed in Chapter 8).
5. Review work and safety precautions with the crew before work begins (including tailgate briefing).
6. Inspect tools/equipment before starting work.

**8-9.6 General Job-in-Progress Procedures.**

Observe the precautions given in Table 8-5 before proceeding with the procedures provided in Table 8-6.

**Table 8-5. Energized Work Precautions – Overhead Line**

1. Check that circuit automatic reclosing devices have been made inoperative and tagged out while work is being performed. For the Navy, use a Special Instruction tag or a Hold tag.
2. Do not allow items of a voltage class lower than required for the work to be available to the workers at the work site.
3. Exercise special care when working in the proximity of equipment such as fuses, surge arresters, and similar equipment, or where conductor checks indicate burns or other defects in conductors, tie wires, and insulators. Procedures may require that some equipment be bypassed for the duration of the work.
4. Comply with adverse weather and number of qualified worker requirements.

**Table 8-6. Voltage Level Work Procedures – Overhead Line**

<b>600 Volts and Below</b>
1. Ground vehicles and aerial lifts in the vicinity of the work site.
2. Cover with approved protective equipment, or isolate with suitable barriers, energized phase and neutral wires, ground wires, messengers, and guy wires in the vicinity of the work. Apply covering to the nearest and lowest conductor first and remove in reverse order. Refer to Chapter 7.
3. Refer to Table 8-3 for work methods.
4. Rubber gloves with leather protectors will be worn when entering the restricted approach boundary of Table 3-1 and removed only after leaving that area..
5. Protective equipment and vehicle grounds will be removed at the end of each workday.
6. Perform work on only one conductor at a time.
7. Tape or otherwise protect splices. Secure loose ends of conductors.
<b>601 to 15,000 Volts</b>
1. Ground vehicles and aerial lifts in the vicinity of the work site.
2. Cover with approved protective equipment, or isolate with suitable barriers, energized phase and neutral wires, ground wires, messengers, and guy wires in the vicinity of the work. Apply covering to the nearest and lowest conductor first and remove in reverse order. Refer to Chapter 7.
3. Use approved live-line tools where required by Table 8-3.
4. Rubber gloves with leather protectors will be worn when entering the restricted approach boundary of Table 3-1 and removed only after leaving that area..
5. Protective equipment and vehicle grounds will be removed at the end of each workday.
6. Work performed must be under the direct supervision of a qualified work leader devoting full time and attention to the workers and the safety of their work.
7. Perform work on only one conductor at a time, although it is recognized that three-phase lifting tools may be used.
<b>Above 15,000 to 230,000 Volts</b>
1. Except for the replacement of fuses and switching, work on energized lines or apparatus at this voltage range must be performed by personnel specifically trained in the hazards associated with voltages in this range. Follow the requirements of Table 8-3.
2. Energized work above 36,000 volts will be done by personnel specifically trained in the hazards associated with voltages in this range.

**CHAPTER 9 SUBSTATIONS AND SWITCHGEAR****9-1 SUBSTATION WORK.****9-1.1 Purpose of Substation.**

A substation provides a protected area for switching power circuits and may include transforming power from one voltage to another. For the purposes of this UFC, substation refers to substations and switching stations. A substation presents an inherent safety hazard because usually only some portions of the substation apparatus can be deenergized for maintenance. For safe operation and maintenance, a thorough knowledge of the substation, including aerial and underground line connections, is necessary. Systems are designed to be safe to operate if maintained properly. Operating safely requires maintenance to be done in a manner that eliminates risks and requires knowledge of the work area, its hazards, and its design basis.

**9-1.2 Diagrams and Schematics.**

Electrical diagrams and schematics of the substations must be available and up-to-date. Diagrams and schematics must be studied to understand the operation of the systems and the location and connections of all circuits. Protective devices, alarms, and interlocking circuits all are intended to protect the system. The electrical worker must understand where, why, how, and when blocking protective devices can maintain safe working conditions.

**9-1.3 Engineering Guidance.**

Diagrams and schematics must be kept up to date under the supervision of the facility's engineering staff. Engineering staff guidance must be sought when performing maintenance on complex systems. Engineering input is mandatory if the maintenance work involves additions or changes to the power and control systems involved.

**9-1.4 System Operation.**

System single line diagrams must be permanently mounted at each substation. When Safe Clearance switching operations are performed, mimic buses on switchgear can be helpful as a visual indication of the lines or equipment being operated.

**9-1.4.1 Protective Devices.**

Protective devices within the system, such as relays, circuit breakers, and fuses, must retain, respectively, their correct coordination settings or be of the proper size and type. Always record previous data so that unintended changes in system coordination are not made.

#### 9-1.4.2 Alarms.

System alarms, if blocked during maintenance, must be returned to their correct operating condition at the completion of the maintenance.

#### 9-1.4.3 Interlocking.

Interlocking is used to maintain proper electrical operation in the case of a circuit loss or switching change. Interlocking provisions must be fully understood so to eliminate the danger of electrical feedback from another source, possible paralleling of two unsynchronized sources, or other unsafe operations. Interlocks, if bypassed during maintenance, must only be done by qualified persons and must be returned to their correct operating condition at the completion of the maintenance.

#### 9-1.5 Abnormal Conditions.

Maintenance accomplished after the occurrence of fault conditions that interrupted normal service imposes higher than usual maintenance risks. Faulty energized equipment and lines must always be placed in an electrically safe work condition before any work is done. All abnormal operating equipment and electrical components must be deenergized, locked and tagged tested, and grounded or isolated (whichever is applicable).

#### 9-1.6 Defective Equipment.

Electrical apparatus found to be in a dangerous condition or not working properly must be removed from service immediately and tagged. Subsequently, a complete report on the defective equipment must be provided by the worker to the authorized individual-in-charge, the same day if feasible. Perform the following:

- Defective equipment removed from service, such as: distribution, potential, and current transformers; capacitors; and surge (lightning) arresters must positively be identified by an authorized and qualified individual before they are put in storage. Existing defective equipment in storage or at any other location must also be clearly identifiable.
- Identify defective equipment by painting a large red "X" on the body (not on the top) of the equipment. The red X must remain on such equipment until it has been repaired or until it has been properly disposed of. Local policy may dictate use of their preferred defective equipment identification marking.
- It must be considered a serious neglect of duty, and willful disobedience of instructions for a worker to deface in any way the identification marking on defective equipment or to place such equipment in service while so identified. The worker in charge of repairing any piece of defective equipment must be the only person authorized to remove the defective markings, and then only after all repairs have been made and the equipment has passed all required testing.

## 9-2 SWITCHING.

Opening or closing a power switch can expose the electrical worker to some degree of hazard. A mishap might occur if a switch is closed when a fault is still present on the line. To prevent a mishap, the authorized individual must prepare a switching sequence and identify all load isolation requirements. All switches operated in the switching sequence must be correctly identified. The electrical worker will review the manufacturer's operation manual for any switch that is unfamiliar, and all safety steps listed in the operation manual will be accomplished before opening or closing the switch.

### WARNING

Switches can fail during switching operations, creating arc flash hazards. Wear arc rated clothing and/or switching suits during these operations in accordance with Chapter 4 requirements.

For the Navy, switching operations above 600 volts require a Switching Order. Switching operations include changing the position of circuit breakers, fused equipment, switches, and other devices.

### 9-2.1 Air Switches.

Many air switches cannot be opened if there is a load on the line, a large magnetizing current from a transformer, or a heavy charging current from an unloaded transmission line. Understand the interrupting capability of each switch being operated.

#### 9-2.1.1 Disconnect Switches.

Disconnect switches of the non-load break-type must not be used to interrupt loads and magnetizing currents, unless an engineering review has determined the disconnect switch can safely interrupt the actual current. Switch sticks will be used when necessary to provide the minimum working and clear hot stick distances. Assume disconnect switches are of the non-load break-type unless you have positive proof otherwise. Operate non-load break-type switches on the following basis:

- Disconnect switches can be used to open an energized line when not under load.
- Disconnect switches can be used to open sections of deenergized lines where these lines parallel other high-voltage lines. Use caution because induced voltages can build up in the deenergized line and create dangerous switching conditions.
- Evaluate the hazard before using disconnect switches to open a tie line or to break two parallel high-voltage lines.

### 9-2.1.2 **Airbreak Switches.**

Gang-operated airbreak switches equipped with arcing horns may be rated for load-break operation, or they may only be rated for interrupting the magnetizing current of transformers or the charging current of lines, or to make and break line parallels.

Operates these switches as follows:

- Provide ground mats for the operator to stand on for all substation airbreak switches when operating. Either fixed or portable small iron-mesh mats must be used. The mats must be electrically connected to the operating rod and the substation ground grid to equalize the ground gradient and prevent any potential differences in case of insulation failure or flashover.
- Appropriate arc flash rated personal protective equipment, rubber gloves, and hot sticks must be used when operating airbreak switches.
- The hinges of airbreak switches must be sufficiently stiff (and kept in this condition) so that after the blades have been turned into the open position they will not accidentally fall back on their line-side energized clips.
- The switch must be inspected after it has been opened to see that all blades have opened the proper distance. Single-throw airbreak switches must be opened to the maximum amount. Double-throw airbreak switches must be opened so that the blades clear both sides of the switch by the same amount.
- Install locks on all airbreak switch-operating mechanisms. Airbreak switches will be kept locked except when opening or shutting the switch..

### 9-2.1.3 **Interrupter Switches.**

Interrupter switches are designed to be opened under load. Metal-enclosed interrupter switches have sometimes been used in place of circuit breakers as a more economical switching method.

### 9-2.1.4 **Inching.**

The method of opening manually operated non-load break-type disconnects in a gradual manner is called inching, when the operator believes there is no load current. If a small arc occurs from the charging current, it has been assumed that a cautious opening would allow the arc to be broken; however, inching is dangerous and is prohibited.

### 9-2.2 **Oil Switches.**

The consequences of operating a faulty oil switch, or closing into a faulted circuit with an oil switch are likely to be catastrophic and, often fatal. Switching procedures will be used to make sure that no energized oil switch is operated while workers are in the

vicinity. Unless the switch has been equipped for remote operation (at least 20 ft (6.1 m)) away, the switch must be completely deenergized by an upstream device before switching. The switch must be locked out and tagged out before allowing maintenance. In addition, do not operate any energized high-voltage oil switch unless routine maintenance has been performed within the past year.

The switch must be deenergized at the nearest upstream device following the lockout/tagout procedures of Chapter 6. Once maintenance has been performed on the switch, the switch can be considered operational following the guidelines of this section. Oil switches must incorporate a mechanical stop to prevent inadvertent operation to ground. Any abnormalities or defects discovered in any oil switch must be reported to an authorized individual.

### 9-2.3 **SF<sub>6</sub> Switches.**

Follow all precautions specified by the manufacturer. Inspect the switch before operating it for any signs of degradation, such as low SF<sub>6</sub> pressure or signs of SF<sub>6</sub> leakage (accumulation of powder around seals). Verify that the SF<sub>6</sub> pressure gauge is in the green zone before operating the switch; operating a switch with low SF<sub>6</sub> pressure can result in internal flashovers that will damage the equipment and cause personal injury. Before energizing the switchgear for first use, verify that the shipping caps on all bushings and bushing wells have been replaced with elbows or insulated protective covers or plugs. The switchgear must be deenergized and grounded prior to conducting any maintenance, SF<sub>6</sub> sampling, or SF<sub>6</sub> filling procedures.

### 9-2.4 **Oil-Filled Vacuum Switches.**

Follow all precautions specified by the manufacturer. Inspect the switch before operating it for any signs of degradation, such as oil leakage; operating a switch without oil can result in internal flashovers that will damage the equipment and cause personal injury. Before energizing the switchgear for first use, verify that the shipping caps on all bushings and bushing wells have been replaced with elbows or insulated protective covers or plugs. The switchgear must be in an electrically safe work condition prior to conducting any maintenance, oil sampling, or oil filling procedures.

## 9-3 **FUSES.**

### **WARNING**

Fuses might fail during handling if energized, creating arc flash hazards. Wear arc rated clothing or switching suits when changing energized fuses in accordance with Chapter 4 requirements.

### 9-3.1 **Characteristics.**

A fuse is a single-phase device. Fuses can be subject to partial melting or damage by currents that might not have been of sufficient magnitude to blow the fuse.



### 9-3.2 Fuse Handling.

Fuses must normally not be handled, except when they need to be replaced. Pull them briskly, and remove completely. Use safety glasses and face shields when replacing fuses in primary fuse cutouts, do not use your free arm in an attempt to shield your eyes from possible flashes. The worker changing the fuses must stand firmly on a level surface. Where operating in an elevated position, the worker will be secured with a safety lanyard/harness to prevent a slip and fall if there is a flash. Use live-line tools to remove energized fuses. Whenever possible, deenergize the circuit before removing a fuse.

### 9-3.3 Operation of Energized Fuses.

Open all lines protected with energized fuses in the same manner as for air switches. Deenergize non-load-break type installations. For load-break installations, wait for a short time after fuse replacement in order to allow the fuse to interrupt any fault condition that might remain prior to the fuse replacement.

### 9-3.4 Open Fuse Holder.

Do not leave outdoor fuse holders open for an extended period of time. Water damage/moisture or warping could make closing them dangerous, or degrade their protective ability.

### 9-3.5 Closed-Position Fuse Locking.

Follow the fuse or switch manufacturer's instructions, as appropriate, to be sure that the fuse is securely locked, latched, and held fast in a closed position.

### 9-3.6 Bypassing.

Do not bridge fuses or fuse cutouts internally.

## 9-4 ENERGY STORING PROTECTIVE DEVICES.

### 9-4.1 Electrical Charge.

#### **WARNING**

Protective devices such as surge arresters, choke coils, and capacitors store electrical charges as a byproduct of their protective mechanism. This stored charge must be discharged to ground before such devices can be considered deenergized. Always wear appropriately rated personal protective equipment, including eye/face protection when deenergizing or energizing these devices., and use appropriate PPE in accordance with Chapter 4 requirements.

#### 9-4.2 **Surge Arresters.**

A surge arrester limits overvoltages and bypasses the related current surge to a ground system that absorbs most of the energy. An overvoltage condition can be caused by a fault in the electrical system, a lightning strike, or a surge voltage related to load switching. All surge arrester equipment must be considered as loaded to full circuit potential, unless it is positively disconnected from the circuit. Be sure the permanent ground conductor is intact before any work is performed.

- High-voltage substation and at-grade surge arresters must always be provided with screens or fences to prevent possible contact while parts of the surge arresters may be live. The screen or fence must have a gate large enough to permit the removal of individual units. The gate must be provided with a lock and an authorized person must keep the key.
- Surge arresters must never be touched or approached, unless they are completely disconnected from all live lines and live equipment, and all parts have been discharged to ground and effectively grounded.
- Horn gap switches must be fully opened and completely separated from all live lines and equipment whenever it is necessary to work near a surge arrester.
- If the first attempt to disconnect a surge arrester is unsuccessful, wait 2 or 3 minutes before making another attempt so not to cause an internal fault.

#### 9-4.3 **Choke Coils.**

Choke coils are inductors that operate in a manner similar to surge arresters, except that they operate on over-frequency rather than over-voltage.

#### 9-4.4 **Capacitors.**

Capacitors consist of an electrical condenser housed in a suitable container. Power capacitors are used to provide power factor correction. Coupling capacitors are used for coupling communication circuits to metering circuits. Because capacitors can hold their charge, they are not electrically deenergized immediately after being disconnected from an energized line. Capacitors on electric lines must be provided with discharge devices to discharge the voltage to 50 V or less, within 5 minutes after the capacitors have been completely disconnected from the circuit. Wear appropriate levels of PPE identified in Chapter 4.

- Discharge circuits are intended to discharge capacitors after the circuit is deenergized. Since there could be no indication that the circuit is burned out or otherwise not functioning, always assume capacitors are fully charged until tested.

- Line capacitors removed from service for any purpose must be considered at full or higher voltage, until the terminals have been shorted together and discharged by an approved method. Do not short terminals until capacitors have been deenergized for at least 5 minutes to allow time for the voltage level to reduce.
- It is not safe to use fuses or disconnect switches to disconnect large capacitor banks (above 60 kilovolt-reactive single-phase, or 180 kilovolt-reactive three-phase). Circuit breakers or switches designed specifically for this purpose must be used.
- After disconnecting all capacitor banks, wait 5 minutes. Short together and ground all terminals; ensure the neutral is grounded. All operations must be performed using rubber gloves and a hot stick.
- Grounds and terminal shorts on capacitors must be left on until the work is completed.
- Barricade the work area as a safety measure for other workers, when working on or testing capacitors in the shop.
- Capacitors made before 1979 usually contained PCBs. Follow precautions for hazardous materials if the case is ruptured or any liquid is visible on the outside of the case.

#### 9-4.5 **Coupling Capacitors.**

These capacitors have a high impedance, which results in a long discharge period. This characteristic of coupling capacitors is typically overlooked, which makes them particularly hazardous to personnel if not properly grounded. To minimize shock hazard follow the precautions below:

- A coupling capacitor must always have a shorting wire installed.
- During maintenance, a grounding wire must be connected to each exposed metal terminal that a worker could contact. Grounding wires must be left in place for the entire duration of maintenance.

### 9-5 **INSTRUMENT TRANSFORMERS.**

#### 9-5.1 **Potential (Voltage) Transformers (PT).**

PTs provide a means of obtaining a low voltage from a higher voltage circuit. They are designed and selected to operate within certain accuracy limits and burdens. Replacement transformers must have characteristics identical with the original units. The case and one of the windings of the low-voltage side of voltage transformers must always be grounded before energizing the transformer.

Be aware of the following hazards inherent in the maintenance and removal of these units:

- If the secondary windings are inadvertently shorted together when the primary windings are energized, a very high current will flow causing the windings to quickly overheat. This may also create an arc flash hazard to anyone in the vicinity of the transformer.
- On most modern switchgear, a drawout arrangement automatically disconnects and grounds the transformers when access to the fuses is necessary.
- On older obsolete switchgear, fuse replacement is potentially dangerous when the primary circuit to the transformer remains energized. Follow these additional safety precautions.
  - The authorized individual-in-charge will give specific instructions for replacing a blown primary winding fuse on a potential transformer located within switchgear and whenever it is not possible to use a standard 6 ft (1.8 m) fuse puller.
  - If a circuit breaker or sectionalizing switch is not installed to isolate a potential transformer, the worker must report the situation to the authorized individual-in-charge before replacing the fuse. The authorized individual-in-charge will arrange for deenergizing the primary circuit. Replacing a primary fuse when the potential transformer is not isolated is particularly hazardous, and requires specific approval.
  - When disconnecting the primary service to the transformer, verify the absence of voltage using a suitably rated voltmeter (a handheld test meter with a high-voltage probe is not acceptable). Lamps can be used in addition; however, note that a non-illuminated lamp, connected on the low-voltage side of a voltage transformer, is not an adequate indication that the primary side of the transformer is deenergized.
  - The secondary fuses must also be removed before replacing the primary fuse, and then reinstalled before the transformer is reenergized.
- While the transformer is deenergized, the worker must visually inspect for obvious symptoms of trouble such as a smoked or burned case, a damaged bushing, or a damaged fuseholder.

## 9-5.2 Current Transformers (CT).

### **WARNING**

The most serious hazard associated with the maintenance of CTs occurs when the secondary side is opened while the primary side is energized. This causes a very high voltage to develop in the secondary winding, which both stresses the insulation and presents an extreme personnel hazard. The secondary circuit of a current transformer must never be opened while the primary side is energized; however, the secondary leads can be shorted together without damage to the transformer.

Before opening the secondary circuits of any energized current transformer, the secondary leads must be shorted together and grounded. The location of the short and ground is preferably located at the transformer secondary terminals, but can be at any point between the current transformer and the location at which the secondary circuit is to be opened.

Current transformer cases and secondary circuits must be grounded before energizing any current transformer.

## 9-6 POWER TRANSFORMERS AND REGULATORS.

### 9-6.1 Transformers (Power and Distribution).

Consider all transformers energized and at full voltage, unless they are disconnected from primary and secondary wires or disconnected from the primary wires and all phases shorted together and grounded. The secondary neutral normally is sufficient as a ground, provided that there is a grounding conductor interconnected with the common neutral, the transformer case, and a ground electrode. Always check continuity of the ground connection.

### **WARNING**

Do not remove transformer covers or handhole plates, or allow any work to be done on the inside of transformers until the following instructions have been completed.

Observe the following precautions:

- When transformers are installed or replaced, check the secondary terminals for correct voltage and for phase rotation (if applicable).
- When transformers are installed, and before they are energized, the ground connection must first be made to the case and to the neutral, when applicable.

- When removing transformers, case and neutral grounds must be disconnected last.
- When working on or near an energized three-phase, wye-connected transformer or transformer bank, verify the transformer neutral is properly grounded.
- Never operate no-load (or manual) tap changers when the transformer is energized. Only load-tap-changing (LTC) type tap changers can be operated when the transformer is energized. When reenergizing a transformer after changing the position of manual tap changers, maintain the minimum approach distances specified in Table 3-1 with all required personal protective equipment until it is determined the internal switching was successful.
- If necessary to relieve pressure on a transformer, the pipe plug, pressure relief device, or inspection cover plate must be loosened slowly so the internal pressure of the transformer can dissipate gradually.
- Pressure relief valves must never be opened when there is precipitation or high humidity, except on failed transformers and when re-fusing.
- Never draw an oil sample, open a pressure relief valve, or otherwise open a transformer when there is an internal vacuum on an energized transformer. Doing so can cause an explosion.
- Transformers or tanks must not be entered unless forced ventilation or an air supply is used to maintain a minimum oxygen level of 19.5 percent by volume in the work area.
- Energized pad-mounted transformers and associated equipment must be locked or otherwise secured when unattended.

#### 9-6.2 **Voltage Regulators.**

Voltage regulators are normally installed with bypass and disconnect switches. Never open or close a regulator bypass switch, unless the regulator is set on its neutral position and the control switch is open, or the automatic control feature is inactivated in accordance with the manufacturer's recommendations.

When regulators are maintained as spares in substations, their bushings must be short-circuited and grounded.

#### 9-7 **METALCLAD SWITCHGEAR.**

Operate and maintain metalclad switchgear according to manufacturer's instructions and the guidance provided in this section. Perform the following prior to drawout (rack

out) of a circuit breaker operating mechanism. Always rack out the switchgear breaker whenever there is work on the circuit originating from that switchgear breaker.

- In a confined space, such as pier vaults, the switchgear must be deenergized. Ground where possible. In other than confined spaces and vaults, consider deenergizing the switchgear from an upstream location. Utilize remote racking mechanisms when available, to rack breakers in and out. Wear appropriate PPE in accordance with Chapter 4.
- Open the circuit breaker.
- Discharge the stored-energy mechanism, if provided.
- Check that protective interlocks are functioning to protect against closed-position circuit breaker rack out.
- Ensure that all workers in the vicinity know the circuit breaker is being racked out.
- Access to switchgear terminals through portholes for maintenance in circuit breaker cells is limited to the following.
  - When both sets of terminals in a cell are deenergized (i.e., line and load, or bus to bus).
  - After both sets of terminals are deenergized, access to switchgear terminals through the portholes is permitted for cleaning, inspecting, and routine maintenance of terminals and bushings.
- A manufacturer-approved ground and test device can be used for access to terminals for procedures such as the application of protective grounds, phase identification on deenergized circuits, or phasing tests on live circuits. Use of this device avoids the hazardous operation of opening and shutting the shutters of a high-voltage switchgear cell. It can be an extremely hazardous device if not used according to manufacturer's instructions. Such devices are not permitted for Navy installations.
  - Do not install the device with ground cables already connected. Connect ground cables after installing the device.
  - Shut all access doors on the device while installing and removing the device. Use padlocks on any door where studs are intended to remain energized and access is not needed for testing.
  - After installing the device, verify by using a voltage detector that exposed studs are deenergized.

- For the Navy, a manufacturer-approved grounding breaker can be used for access to the terminals for procedures of connecting temporary protective grounds to ground the main bus, ground the incoming lines or ground both the main bus and the incoming lines.
- For the Navy, phasing tests on circuits must be accomplished by using ground ball studs on outgoing cable termination pads or synchronizing check controls in conjunction with ground ball studs on outgoing cable termination pads. It is no longer permissible to conduct phasing tests using the shutters of a high-voltage switchgear cell. Retrofit existing equipment during preventive maintenance cycles.

## **9-8 STATIONARY BATTERIES.**

### **9-8.1 Basis for Safety Requirements.**

Batteries and DC system components are different from AC electrical system equipment. Batteries contain acid, which is harmful to skin and eyes, and the electrical shock hazards associated with DC power can be more severe than those associated with AC power for equivalent voltages and currents. Only authorized personnel who have been familiarized, trained, and qualified on battery fundamentals and maintenance procedures are allowed to perform maintenance-related activities on a battery.

In addition to substation applications, the requirements of this section apply to all stationary battery applications, including engine starting, UPS, and other backup power applications.

### **9-8.2 Applicable Industry Standards.**

The following industry standards provide the most complete safety standards for stationary batteries and DC systems. Refer to the appropriate document for the type of battery used in a particular application.

- IEEE 450, *Maintenance, Testing, and Replacement of Vented Lead-Acid Batteries for Stationary Applications.*
- IEEE 484, *Installation Design and Installation of Vented Lead-Acid Batteries for Stationary Applications.*
- IEEE 1106, *Installation Maintenance, Testing, and Replacement of Vented Nickel-Cadmium Batteries for Stationary Applications.*
- IEEE 1187, *Installation Design and Installation of Valve Regulated Lead-Acid Batteries for Stationary Applications.*
- IEEE 1188, *Maintenance, Testing and Replacement of Valve Regulated Lead-Acid Batteries for Stationary Applications.*
- IEEE 1578, *Stationary Battery Spill Containment and Management.*



- NFPA 70E, *Electrical Safety in the Workplace, Chapter 2, Article 240, Batteries and Battery Rooms.*

### 9-8.3 Protective Equipment.

The following equipment must be available for the safe handling of the battery and protection of personnel:

- Safety glasses with side shields, goggles, and/or face shields.
- Acid-resistant gloves.
- Protective aprons and safety footwear.
- Portable or stationary water facilities for rinsing eyes and skin in case of contact with acid electrolyte.
- Class C fire extinguisher.
- For lead acid batteries, bicarbonate of soda to neutralize any acid spillage (1 lb/gal or 0.1 kg/L of water).
- Adequately insulated tools.
- Lifting devices of adequate capacity, when required.

### 9-8.4 Safety Precautions.

#### **WARNING**

Stationary batteries generate a direct current (DC) voltage, which is particularly dangerous with respect to electrical safety. Exercise extreme caution whenever working on battery systems.

Observe the following safety precautions:

- Wear proper safety clothing to prevent contact with acid or live electrical connections. Whenever working on or near batteries, wear a rubber apron and rubber gloves. Ensure goggles and face shields are available for personnel.
- Use only insulated tools in the battery area to prevent accidental shorting across battery connections. Never lay tools or other metal objects on cells; shorting, explosion, or personal injury could result. As a general rule, ensure the length of the exposed metal for any tool is less than the distance between the positive and negative posts of each cell.

- Wear only nonconductive hard hats near batteries. Metal hard hats can fall across the battery terminals or connections and create short circuits.
- Remove all jewelry, wristwatches, or clothing with metal parts that could come into contact with the battery terminals.
- Do not make or break series connections within an operating group of cells. Before proceeding, open the battery system circuit breaker to minimize the possibility of arcing
- Vented lead acid, vented nickel cadmium batteries and valve-regulated lead acid (VRLA) batteries can generate hydrogen gas that, in sufficient concentrations, can be explosive if ignited. Never bring burning materials such as lighted matches, cigarettes, or sparks of any kind near the battery. Avoid the use of spark-producing equipment near batteries. Residual gases can remain within cells during storage and shipment. Smoking is not permitted in battery rooms or near stationary batteries. Take these precautions at all times while handling batteries.
- Ensure that the exit from the battery area is unobstructed.
- Minimize access to the battery by personnel unaware of battery safety precautions.
- Ensure that the battery area is suitably illuminated.
- Keep the battery and adjacent area clear of all tools and other foreign objects.
- Avoid static buildup by having personnel contact ground periodically while working on batteries.

## 9-9 INSULATING OIL HANDLING OPERATIONS.

Place oil insulated equipment in an electrically safe work condition before starting any oil handling procedure. Observe the following additional precautions during oil filtering, oil reclaiming, and other oil-handling operations:

- Always place potential and current transformers in an electrically safe work condition before taking oil samples.
- Have appropriate types and sizes of fire extinguishers readily available.
- Once all equipment has been placed in an electrically safe work condition and insulating oil handling operations is to begin, don an approved disposable coverall. Use extreme caution to ensure that oil does not contaminate arc-rated PPE. Immediately remove from service arc-rated PPE that has become contaminated.

## CHAPTER 10 UNDERGROUND LINES

This chapter applies to work in manholes, vaults, and handholes; work on duct lines, trenches, and underground cables; and work on ground-mounted and underground equipment associated with underground electrical lines.

*Note: An IEEE interpretation, dated 14 January 2009, regarding IEEE C2 (National Electrical Safety Code) Rule 410A3, confirms that the phrase “on or near energized parts or equipment” applies to energized insulated conductors inside manholes. IEEE C2 Rule 443 does allow a qualified employee, working alone, to enter a manhole where energized cables or equipment are in service for the purpose of inspection, housekeeping, taking readings, or similar work if such work can be performed safely.*

### 10-1 AUTHORIZED WORK ACTIVITIES INSIDE CONFINED SPACES CONTAINING ENERGIZED ELECTRICAL CIRCUITS.

Deenergize all equipment inside an underground structure (including manholes and vaults) operating at high voltage levels before allowing entry into the underground structure. This includes insulated conductors. If the equipment inside the manhole cannot be deenergized, apply the guidance provided in the following sections. If a cable in an underground structure has one or more abnormalities that could lead to or be an indication of an impending fault, the defective cable must be deenergized before any employee can enter the manhole.

*Note: Abnormalities such as oil or compound leaking from cable or joints, broken cable sheaths or joint sleeves, hot localized surface temperatures of cables or joints, or joints that are swollen beyond normal tolerance are presumed to lead to or be an indication of an impending fault.*

An arc flash event inside an electrical manhole or vault is considered potentially more severe than arcing faults in equipment above grade. IEEE 1584 provides arc flash analysis methods for two configurations: a three-phase arc in open air and a three-phase arc in a box in which the worker is located just outside the box. For work inside an electrical manhole, the IEEE 1584 methodology, as well as an NFPA 70E alternate method, does not apply, in that the worker is located within the box, which is not a configuration covered by IEEE 1584. An arc flash risk assessment must consider that, if an arcing fault occurs, the electrical worker will be located within the plasma cloud inside a constrained environment.

#### 10-1.1 Inspection-Only Access in Manholes Containing Energized Circuits.

*Note: Entry into a manhole or vault containing energized circuits is not permitted for inspection activities if problems are suspected inside the manhole, such as conductor damage associated with a short circuit.*

*Note: Standing water is permitted for inspection activities provided that the standing water level is below energized and installed conductors and associated cable rack arm.*

Inspection-only access to a manhole or vault containing energized circuits can be authorized by an energized electrical work permit or a standard operating procedure (SOP) for the purpose of examining insulated cable, equipment, or accomplishing other inspections not requiring touching or disturbing the energized conductors or equipment. The following are examples of the types of activities that are considered inspection-only access:

- Manhole and sump inspection.
- Sump cleaning.
- Inspection of conductors and splices, without touching or disturbing the conductors.
- Inspection of any equipment installed in the manhole.
- Installation of conduit plugs on spare conduits, provided that conductors inside the manhole will not be touched or disturbed.

Comply with Table 4-6 Additional Work Tasks and Associated PPE Requirements for the minimum PPE for this activity. Before entering, visually confirm that the manhole can be entered and the intended activity can be accomplished without disturbing energized conductors.

#### 10-1.2 **Work Inside Manholes Containing Energized Circuits.**

*Note: Entry into a manhole or vault containing energized circuits is not permitted for work activities if problems are suspected inside the manhole, such as conductor damage associated with a short circuit.*

*Note: Standing water is permitted for the specified work activities provided that the standing water level is below energized and installed conductors and associated cable rack arm.*

*Note: Reracking energized conductors is not permitted. The circuits must be deenergized before the conductors can be disturbed.*

Access to a manhole or vault containing energized circuits to perform specific work activities can be authorized by an energized electrical work permit or a standard operating procedure (SOP). The following are examples of the types of work that can be performed:

- Removing conduit plugs.
- Spare conduit inspection using fish tape, boroscope, or other devices.
- Splicing deenergized conductors. When splicing deenergized conductors, confirm that an 18-inch (0.5-meter) safe working distance from other energized conductors or equipment can be maintained during the work.

- Pulling new conductors in spare conduits.
- Removing abandoned (deenergized) circuits, including associated equipment, if nearby energized circuits are not disturbed.

Comply with Table 4-6 Additional Work Tasks and Associated PPE Requirements for the minimum PPE for this activity. Before entering, visually confirm that the manhole can be entered and the intended activity can be accomplished without disturbing energized conductors.

### 10-1.3 All Other Work Inside Manholes Containing Energized Circuits.

*Note:* Standing water is permitted for the specified work activities provided that the standing water level is below energized and installed conductors and associated cable rack arm.

All other work not covered by Section 10-1.1 or 10-1.2 require a job-specific energized electrical work permit in accordance with Chapter 8. In addition to the requirements provided in Chapter 8, include the following in the energized electrical work permit:

- Description of manhole and its configuration.
- Description of planned work activities.
- Electrical shock and arc flash risk assessment.

*Note: Electrical analysis software packages that perform arc flash calculations do not account for an electrical manhole configuration in which the electrical worker is inside an enclosed area rather than standing adjacent to an enclosure. Increase the arc flash PPE requirements by a minimum of one (1) arc flash hazard category above the arc flash calculation result.*

- Required PPE.
- Minimum number of qualified electrical workers.
- Means to restrict unqualified persons from the work area.
- Rescue plan.

### 10-1.4 Switching Activities Inside Manholes Containing Energized Circuits.

Do not switch or rack energized equipment in or out of switchgear in an underground structure. Observe the following:

- Secure, whenever feasible, all electrical power prior to start of work in electrical vaults, manholes and other confined or enclosed spaces.

- When absolutely not feasible to secure the power in these locations, refer to Chapter 8 for requirements.

## **10-2 CABLE PULLING.**

Observe the following:

- Do not handle pull-wires or pulling-lines within reaching distance of blocks, sheaves, winch drums, and take-up reels.
- Do not remain in a manhole during pulling operations.
- Do not use wire rope to pull cable in a duct already occupied by conductors.
- Use a nonmetallic duct fishing wire or device when fishing ducts containing energized conductors.
- Always fish ducts in the direction that presents the least hazard. Consider stationing a worker at each end when fishing ducts.

## **10-3 BURIED ELECTRICAL CABLES.**

Observe the following:

- Use area utility maps to locate existing buried cables and nearby utilities as accurately as possible. Locate/scope for buried cables along any intended digging areas. Obtain digging permits, as required.
- Use extreme care when excavating near or exposing direct-burial electric underground cables. If the depth of all direct-burial cables is definitely known, power digging equipment can be used for excavating all but the last 12 in (305 mm) of cover over the cables. The remaining cover must be removed by use of hand-digging tools with FRP handles. Where the depth of direct-burial cables is not established, power-digging equipment must not be used, except to break and remove the surface pavement.
- Do not use probe rods or bars to locate any underground direct-burial cables.
- Take extreme care to avoid damaging the cable insulation when uncovering direct-burial cables.
- Protect all exposed cables against damage in a work area with boards or other nonconductive materials. Utilize suitable nonflammable protective material when it is necessary to weld adjacent to cables.
- Do not stand, sit, kneel, or lean on unprotected direct-burial cables.

## CHAPTER 11 LOW-VOLTAGE INTERIOR SYSTEMS

### 11-1 WORKING ON INDOOR EQUIPMENT.

#### 11-1.1 Restricted Space.

Be alert that older installations might not meet current NEC clearance and entrance requirements for electrical rooms. Where installations do not conform to current NEC/OSHA requirements, additional safety precautions and instruction must be provided to maintenance workers. Give special attention to the guarding of live parts where current NEC clearances are not met. Ensure that unobstructed emergency exit routes are provided.

#### 11-1.2 Grounding Systems.

Verify that existing permanent electrical system grounds are adequate for personnel protective grounding, and provide additional temporary grounding as necessary.

#### 11-1.3 Disconnection of Power Sources.

Be sure to check single line diagrams and verify that all inputs and interconnections to any electric power source are locked and tagged open. Verify single line diagram connections with the actual line connections of the applicable equipment.

#### 11-1.4 Related Building Systems.

Do not disable or work on any fire protection and fire alarm systems without prior notification and approval of the local fire department. If the room's ventilation system is affected by the work, ensure that adequate temporary ventilation is provided.

### 11-2 LOW-VOLTAGE SYSTEMS.

Complete any work with only qualified electrical workers with training and experience on low-voltage circuits. Electrical workers must be familiar with NFPA 70 requirements and must have work experience with low-voltage systems. Inform the foreman when installations do not meet the requirements of applicable codes and standards. Electrical workers must understand electrical safety requirements for low-voltage systems. In many cases, contract personnel or specially trained workers will repair complex controls and special equipment.

#### 11-2.1 Overview.

Consult the manufacturer's instruction manual if available for the apparatus before starting work.

Unless specifically approved in accordance with Chapter 8, work is not permitted on energized circuits. Use temporary ground wires to drain off induced voltages and

currents from live circuits, stored energy devices, and equipment metal guards before starting work.

#### 11-2.2 **Battery Room Hazards.**

The battery safety rules provided in Section 9-8 apply to low-voltage systems.

#### 11-2.3 **Fire Alarm Systems.**

Maintaining fire alarm systems with their appropriate safety requirements requires special training and must be in accordance with UFC 3-601-02, *Operations and Maintenance: Inspection, Testing and Maintenance of Fire Protection Systems*. Workers must have completed one or more of the following certifications or specialized training.

- Factory trained and certified, or
- Certified by the National Institute for Certification in Engineering Technologies (Fire Alarm Systems), or
- Certified by the International Municipal Signaling Association (Fire Alarm Systems), or
- Certified by state or local authority, or
- Trained and qualified by an organization listed by a nationally recognized testing laboratory for the servicing of fire alarm systems.

#### 11-2.4 **Solid-State Equipment.**

Adjustable-speed motor controllers, frequency converters, and uninterruptible power supply (UPS) equipment are complex solid-state devices that must generally be maintained by manufacturers or specially trained contract personnel. Facility personnel are not normally trained for such work. Even after initial training, maintenance work is usually done on such an infrequent basis that workers must not be considered qualified. Facilities with these installations must contain cautionary labeling to warn workers of the electric shock dangers involved in operating and maintaining these types of equipment.

#### 11-2.5 **Low-Voltage Work Precautions.**

Observe the following:

- Assume all parts of an electric circuit are energized until an electrically safe working condition has been established.
- Use only insulated hand tools when working on equipment where the tool could contact an energized source of 50 V or higher.



**CAUTION**

Older plastic or rubber coated tools are often not certified by the manufacturer for insulating ability, and the coating is only provided as a comfort feature for the user. If the tool has not been tested, it must be assumed to not meet OSHA requirements for use of insulated hand tools.

- Unless specific permission is provided, no work will be performed on energized electrical circuits or equipment operating at more than 50 V phase-to-phase. Follow the safe clearance requirements of Chapter 6. If work is performed on live energized circuits, select the appropriate personal protective equipment in accordance with the criteria provided in Chapter 4.
- When working on or near energized circuits, workers must stand on a dry surface.
- If using fish tape near energized parts, cover live parts with rubber equipment.
- If working near running machinery, use extreme care and provide barricades, if necessary.
- Place all tools clear of machinery before starting machinery. Never use a wrench on running machinery.
- Provide adequate illumination.
- Wear safety goggles when soldering joints or tinning lugs on connectors.
- Remove tripping hazards before starting work and do not work on slippery surfaces.
- Tape or cover bare or exposed places on one energized conductor before exposing another energized conductor. Never leave joints or loose ends of wire untapped or otherwise unprotected.
- An open knife switch can be hazardous because of the exposure to live parts and because of the arc formed when the switch is opened. Only use knife switches that are enclosed in grounded metal cabinets having the control lever operable from outside the cabinet. Install a knife switch so that the blades are deenergized when the switch is open and oriented so that gravity will not tend to close the switch.
- Provide fuses and circuit breakers in accordance with NFPA 70, properly sized to protect the downstream conductors and equipment. Substitution of conductors for fuses is not permitted. Remove fuses only after opening

the upstream disconnect device. Use an insulated fuse puller. Use an insulated fuse puller and PPE in accordance with Chapter 4.

- Use properly grounded portable electric tools, particularly in damp locations or near grounded equipment or piping. Do not open a ground connection to a water pipe or ground rod until the ground wire has been disconnected at the equipment.

## **11-3 ROTATING MACHINERY.**

### **11-3.1 Hazards of Rotating Machinery.**

Ensure guards are provided to protect workers from accidental contact with live electrical parts, rotating parts, and hot machine surfaces. Be aware that rotation can loosen grounding connections, hold-down bolts, and fray flexible or cord connections. Be alert to sparking of brushes and insulation failures that may cause flame or molten metal to be ejected from open type motors or generators. Interior electrical work often must be done in close proximity of rotating electrical equipment such as motors and generators. Do not operate rotating machinery without protective guards.

### **11-3.2 Motors and Generators.**

After work has been performed on circuits to rotating machines, check direction of rotation. Always take positive steps to ensure that rotating equipment under repair cannot be set into motion.

Follow appropriate mechanical safety precautions if operating a generator, including:

- Ensure engine coolant is at the proper level and has the proper amount of antifreeze. Make sure engine lubricant and fuel are at the proper levels. Check hoses for good condition.
- Ensure engine air requirements for combustion are met. Check air filters and cleaners for cleanliness and good condition.
- Verify the engine, generator, and related equipment are clean. Keep oil-soaked rags out of the generating facility to avoid a fire hazard.

**CHAPTER 12 SHORE-TO-SHIP ELECTRICAL POWER CONNECTIONS****12-1 CONNECT/DISCONNECT SERVICES.**

Shore Electric Utility Systems are utilized to provide dockside electrical service (Shore Power) to Ships operating in a cold iron mode. Shore Power Electric Utilities which connect and disconnect services, with the associated cable assemblies and cable maintenance, are provided as a reimbursable activity. Cable assemblies include all necessary components to allow connection from Facility Shore Power receptacles to Ship's or Submarine's Shore Power receptacles but may also require use of ship owned lug and bolt cable adapter assemblies, often called pigtails. The specific requirements and performance responsibilities for shore-to-ship connects are provided in Section 12-2. The step-by-step procedures for ship connects, infra-red testing of connections, and ship disconnects are developed at the local level following this UFC. Refer to Naval Engineering Training and Operating Procedure and Standard (NETOPS) #29, *Shore-to-Ship Power Connect and Disconnect Procedures*, for additional information.

SOPs that have been issued by NAVFAC Activities are available for review at the Enterprise Safety Applications Management System (ESAMS) at the following:

[https://esams.cnmc.navy.mil/ESAMS\\_GEN\\_2/LoginESAMS.aspx](https://esams.cnmc.navy.mil/ESAMS_GEN_2/LoginESAMS.aspx)

**12-2 SPECIFIC SHORE-TO-SHIP ELECTRICAL SYSTEM SAFETY.**

This section covers connection of portable power cables to shore electrical outlet assemblies and ship electrical buses. Connection is a divided responsibility between the Shore Electrical Supervisor (ES) and the Ships Electrical Officer (EO)). Follow the Standard Operating Procedure (SOP) established by the Shore ES as identified in Section 12-1.

**12-2.1 Unusual Shore-to-Ship System Hazards.**

The additional risks posed by shore-to-ship power cable connections include:

- Split personnel shore/ship responsibilities for electrical safety.
- Portable power cable and outlet safety assurance.
- Electrical equipment accessibility and working space.
- An ungrounded, adequate and correctly phased electrical power input.
- Minimizing any parallel operations.

**12-2.2 Split Personnel Responsibilities.**

It cannot be overemphasized how important standard operating procedures are in eliminating the hazards of split responsibilities between shore and ship. Training of both

shore and ship personnel is necessary to assure safety while connecting and disconnecting cables between a pier and a ship.

### 12-2.3 **Portable Power Cable and Outlet Safety Assurance.**

#### **WARNING**

Harsh waterfront environments provide salt spray, high humidity, and cold temperature conditions. All of these result in more rapid deterioration of permanent installations. Portable power cables, if not adequately barricaded are subject to damage from the wheels of vehicles used in industrial operations and improper handling. Families welcoming returning service members, DoD personnel, and contractors working on piers may not understand or recognize the dangers these energized shore power cables installed in accessible positions poses to the public.

### 12-2.4 **Electrical Equipment Accessibility and Working Space.**

#### **WARNING**

Electrical equipment in under-pier vaults that is not readily accessible might not meet current NEC working space requirements.

### 12-2.5 **Readily Accessible.**

#### **WARNING**

The NEC defines ready accessible as capable of being reached quickly for operation, renewal, or inspections, without requiring those to whom ready access is requisite to climb over or remove obstacles or to resort to portable ladders, chairs, or other such devices. Therefore all workers in vaults must satisfy all confined space requirements.

### 12-2.6 **Working Space.**

The NEC defines working space as sufficient access provided and maintained about all electric equipment to permit ready and safe operation and maintenance of such equipment. Working space in vaults has been provided in accordance with the NEC requirements applying at the time the vault was built. As with all safety aspects affecting both the general public and maintenance workers, safety requirements have become more rigorous over the years. Although current NEC requirements do not apply to vaults built to previous NEC editions, compare the NEC current requirements with actual working space provisions.

Each activity must evaluate the comparisons as to their effect on workers safety and provide SOP's as necessary to assure safe working conditions.

### **12-3 SPECIALIZED SHORE-TO-SHIP SYSTEM TRAINING.**

Train all employees whose job requires providing shore power services to understand the purpose and function of the hazardous energy control program, and the hazards they face. Verify that they demonstrate a working level knowledge of all process steps and applicable references, and complete site specific training as required.

Qualification training for the operation, maintenance, and testing of the shore power systems includes:

- Power cable/connector assemblies and extensions.
- Cable phasing and paralleling methods.
- Lock-out/tag-out procedures.
- Switching operations.
- Maintaining electrical safe working conditions.

### **12-4 SHIP'S MAIN ELECTRICAL SERVICE COMPONENTS.**

The specific safety requirements given apply to the cable assemblies from the pier's electrical outlet assemblies (commonly called "turtlebacks" on Mil-C receptacle systems, and "Connection Stations" on single pole panel mount connector systems) to the ship's electrical bus. There are other components of the shore's high-voltage electrical distribution system used to supply substations that in turn supply the pier electrical outlet assemblies. The safety requirements for the pier electrical outlet assemblies that supply line side components are covered by earlier sections. Because they are provided for ships power in addition to permanent pier electrical loads, these components are also described here to enable a clearer understanding of the dockside electrical distribution system.

#### **12-4.1 Shore High-Voltage Distribution System.**

The facility's primary electrical distribution system normally operates in the high-voltage range between 5 kV and 35 kV. For permanent pier service, dual primary feeders from the shore's primary system is preferred. Pier systems can also be furnished with single feeders. These feeders serve substations, which step down the distribution system's primary voltage to the required secondary voltage for ships electrical service of 13.2 kV, 4.16 kV or 480 volts.

## 12-4.2 Pier Substations.

Substations might consist of above ground installed on the top of a pier or units installed in vaults located under the pier. Vault substations are fed by shielded power cables installed in electrical duct. Above deck substations are skid-mounted and are supplied by either shielded power cables installed in duct or mine power cable installed on the pier connected to the electrical distribution system via cable coupler plugs to coupler receptacles in electrical connection outlet assemblies. Both types of substations may include one or more primary fused switches or be fed from a pad mount switchgear vacuum fault interrupter switch way, the step-down transformer, and secondary circuit breakers supplying the pier electrical outlet assemblies for ship-to-shore power cables. The following figures show these component elements.

**Figure 12-1. Electrical Connection Outlet Assembly with a 15 kV Receptacle**



Figure 12-2. Close-Up of Electrical Connection Outlet Assembly



Figure 12-3. Inside a Pier Vault Housing a Substation



Figure 12-4. Skid-Mounted Substation



Figure 12-5. Skid-Mounted Substation with Single-Pole Connections





**Figure 12-6. Double-Deck Pier Switchgear****12-4.3 Ship-to-Shore Pier Electrical Outlet Assemblies.**

Ships service is from pier electrical outlet assemblies that contain either multiples of single pole or three-pole, 500-ampere receptacles rated either for 450 volts ships service, 4.16 kV ships service, or 15-kV ships service as appropriate to the pier's ship electrical service requirement. Receptacles may be interlocked with their associated substation secondary circuit breaker for safety reasons. Figures 12-7 and 12-8 show three-pole outlet assemblies for 480 volt and 4.16 kV services respectively. Figure 12-9 shows the newer design for medium voltage electrical outlet assemblies.

Figure 12-7. 480 Volt Pier Electrical Outlet Assembly Without Cable Connections



Figure 12-8. 4.16 kV Pier Electrical Outlet Assembly and Outlets – Existing Installations

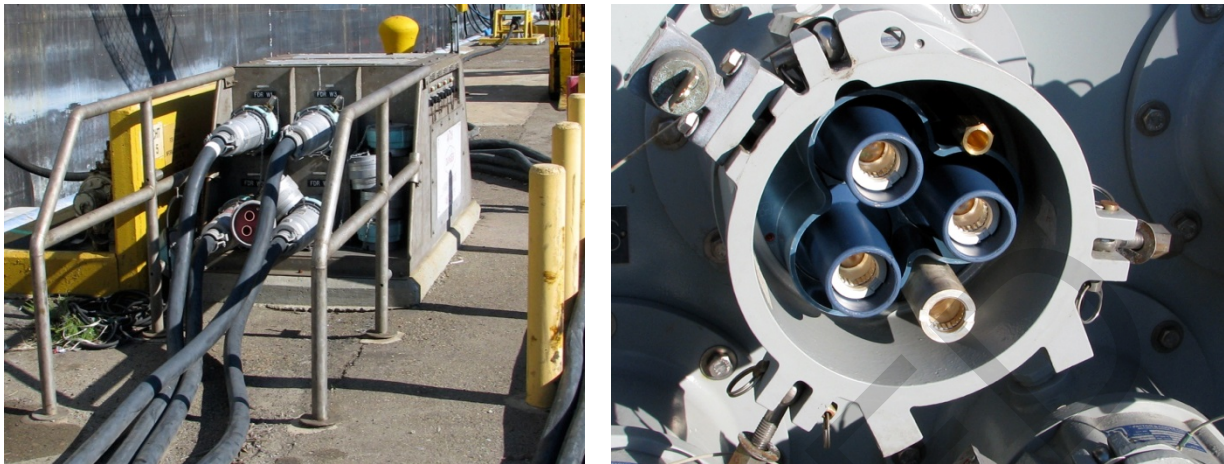

**Figure 12-9. 4.16 kV Pier Electrical Outlet Assembly and Outlets – Newer Designs**

#### 12-4.4 Shore-to-Ship Power Cables and Connectors.

Portable shore-to-ship power cables are rated 8000 volts for operating at 4160 volts, three-phase, three-wire, ac or 600 volts for operating at 450 volt, three phase, three-wire ac. Both 4160 V and 480 V shore power systems are ungrounded (the transformer neutrals are isolated from ground).

*Note: Splices are not allowed in 4.16 kV power cables. Figures 12-10 through 12-13 show examples of cables in place and various connections.*

**Figure 12-10. 480 Volt Pier Electrical Outlet Assembly and Cable Connections**

Figure 12-11. 480 Volt Shore-Cable to Ship-Cable with Single-Pole Connection



Figure 12-12. 480 Volt Shore-Cable to Ship-Cable Plug and Receptacle Connection In Place

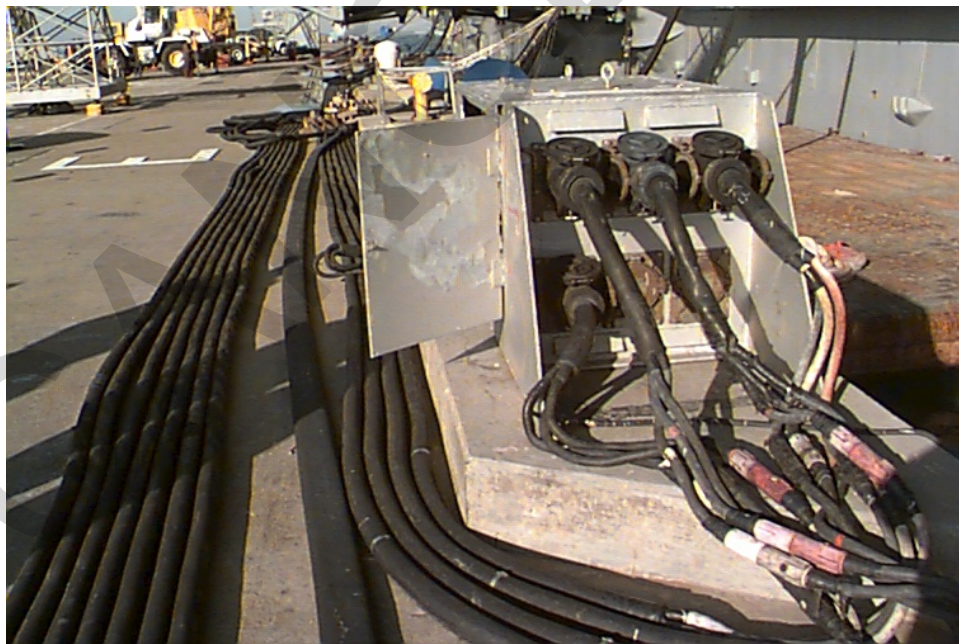

**Figure 12-13. 480 Volt Shore-Cable to Ship-Cable Splice Connection in Place****12-4.5 Pier High-Voltage (4,160 Volt) Electrical Outlet Assemblies.**

This assembly utilizes a three pole, 500-ampere, 4,160 volt receptacle with a matching plug. Units have the Mine Health Safety Administration approval, are provided with a safety interlock, and have been modified to remove a ground cable connector. Refer to Figure 12-14.

**Figure 12-14. High-Voltage Shore Receptacle****12-4.6 Low-Voltage Terminations.**

The system provides a 480 volt, three-phase, three-wire, ungrounded 60 hertz source to the ship. Refer to Figure 12-15.

Figure 12-15. Low-Voltage (480 Volt) Shore Receptacle

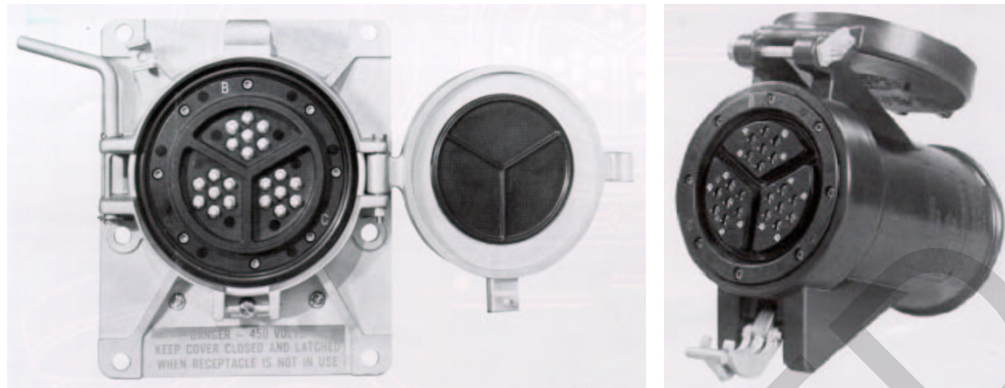

CANCELLED

**APPENDIX A REFERENCES**

**Note:** *The most recent edition of referenced publications applies, unless otherwise specified.*<sup>1</sup>

**AIR FORCE PUBLICATIONS**

AFI 32-1064, *Electrical Safe Practices.*

AFI 91-203, *Air Force Consolidated Occupational Safety Instruction.*

**DEPARTMENT OF DEFENSE PUBLICATIONS**

DTM 5-683/NAVFAC MO 116/AFJMAN 32-1083, *Facility Engineering Electrical Interior Facilities/2/*

TSEWG [TP-15: Electrical Technical Paper: Arc Flash Calculations and Detailed Arc Flash Warning Labels.](#)

UFC 3-501-01, *Electrical Engineering*

**U.S. NAVY PUBLICATIONS**

OPNAVINST 5100.23G CH-1, *Navy Safety and Occupational Health Program Manual.*

NAVFACINST 5100.12, *NAVFACENGCOM Safety & Health Program.*

Naval Engineering Training and Operating Procedure and Standard (NETOPS) #29, *Shore-to-Ship Power Connect and Disconnect Procedures.*

**U.S ARMY CORPS OF ENGINEERS PUBLICATIONS**

Engineer Memorandum (EM) 385-1-1, *Safety and Health Requirements Manual.*

Department of the Army Pamphlet (DA PAM) 385-10, *Army Safety Program.*

DA PAM 385-26, *The Army Electrical Safety Program.*

**AMERICAN NATIONAL STANDARDS INSTITUTE (ANSI)**

*Note: Many ANSI documents are sponsored or co-sponsored by other organizations, such as IEEE. Some ANSI documents are listed with the sponsoring organization.*

---

<sup>1</sup> Addresses for Non-Government standards organizations:

1. American National Standards Institute, 25 West 43<sup>rd</sup> Street, 4<sup>th</sup> Floor, New York, NY 10036
2. ASTM International, 100 Barr Harbor Drive, PO Box C700, West Conshohocken, PA 19428-2959
3. Institute of Electrical and Electronics Engineers, 3 Park Avenue, New York, NY 10016
4. International Safety Equipment Association, 1901 North Moore Street, Arlington, VA 22209-1762
5. National Fire Protection Association, One Batterymarch Park, P.O. Box 9101, Quincy, MA 02269
6. Underwriter's Laboratories, Inc., 333 Pfingston Road, Northbrook, IL 60062

ANSI/NETA ATS, *Acceptance Testing Specifications for Electrical Power Distribution Equipment and Systems.*

ANSI/NETA MTS, *Maintenance Testing Specifications for Electrical Power Distribution Equipment and Systems.*

ANSI/SIA A92.2, *Vehicle-Mounted Elevating and Rotating Aerial Devices.*

ANSI/SIA A92.3, *Manually Propelled Elevating Aerial Platforms.*

ANSI/SIA A92.5, *Boom Supported Elevating Work Platforms.*

ANSI/SIA A92.6, *Self-Propelled Elevating Work Platforms .*

ANSI Z308.1, *Minimum Requirements for Workplace First-Aid Kits and Supplies.*

### **ASTM INTERNATIONAL**

ASTM F18-Series, *Standard on Electrical Protective Equipment for Workers.*

ASTM F711, *Specification for Fiberglass Reinforced Plastic (FRP) Rod and Tube Used in Live-Line Tools.*

ASTM F855, *Specifications for Temporary Grounding Systems to be Used on De-energized Electric Power Lines and Equipment.*

ASTM F887, *Specifications for Personal Climbing Equipment.*

ASTM F1506, *Standard Performance Specification for Flame Resistant Textile Materials for Wearing Apparel for use by Electrical Workers Exposed to Momentary Electric Arc and Related Thermal Hazards.*

ASTM F3121/F3121M-16, *Standard Guide for In-Service Maintenance and Electrical Testing of Hand-Held Live-Line Insulating Tools (Fiberglass-Reinforced Plastic (FRP)).*

### **FEDERAL HIGHWAY ADMINISTRATION**

*Manual on Uniform Traffic Control Devices (MUTCD)*

### **INSTITUTE OF ELECTRICAL AND ELECTRONICS ENGINEERS (IEEE)**

IEEE C2, *National Electrical Safety Code.*

IEEE C37.20.7, *Guide for Testing Metal-Enclosed Switchgear Rated Up To 38 Kv for Internal Arcing Faults*

IEEE 100, *The Authoritative Dictionary of IEEE Standards Terms.*



IEEE 450, *Maintenance, Testing, and Replacement of Vented Lead-Acid Batteries for Stationary Applications.*

IEEE 484, *Installation Design and Installation of Vented Lead-Acid Batteries for Stationary Applications.*

IEEE 516, *Guide for Maintenance Methods on Energized Power-lines.*

ANSI/IEEE 935, *Guide on Terminology for Tools and Equipment to Be Used in Live Line Working.*

IEEE 1106, *Installation, Maintenance, Testing, and Replacement of Vented Nickel-Cadmium Batteries for Stationary Applications.*

IEEE 1187, *Installation Design and Installation of Valve Regulated Lead-Acid Batteries for Stationary Applications.*

IEEE 1188, *Maintenance, Testing and Replacement of Valve Regulated Lead-Acid Batteries for Stationary Applications.*

IEEE 1246, *Guide for Temporary Protective Grounding Systems Used in Substations.*

IEEE 1578, *Stationary Battery Spill Containment and Management.*

IEEE 1584, *Guide for Performing Arc Flash Hazard Calculations.*

#### **INTERNATIONAL SAFETY EQUIPMENT ASSOCIATION (ISEA)**

ISEA Z89.1 *Industrial Head Protection.*

#### **NATIONAL FIRE PROTECTION ASSOCIATION (NFPA)**

NFPA 70, *National Electrical Code.*

NFPA 70B, *Electrical Equipment Maintenance.*

NFPA 70E, *Electrical Safety in the Workplace.*

#### **OCCUPATIONAL SAFETY AND HEALTH ADMINISTRATION**

Note: The following OSHA regulations can be downloaded from [www.osha.gov](http://www.osha.gov).

29 CFR 1910, *Occupational Safety and Health, General Industry Standards.*

29 CFR 1915, *Occupational Safety and Health Standards for Shipyard Employment.*

29 CFR 1926, *Occupational Safety and Health, Safety and Health Regulations for Construction.*

**APPENDIX B ELECTRICAL TASK RISK ASSESSMENT CHECKLIST**

Appendix B provides an example checklist in support of the risk assessments specified by NFPA 70E. An energized electrical work permit requires a shock risk assessment and an arc flash risk assessment. Table B-1 provides an example checklist. The format and method of documentation is optional; however, any electrical task risk assessment must address the topics listed in Table B-1. References to numbered sections and tables (such as Section 4-2 or Table 4-7) apply to sections and tables in this UFC. References to lettered sections (such as Section C) apply to sections within the Electrical Task Risk Assessment Checklist.

**Table B-1 Electrical Task Risk Assessment Checklist**

Section A, Task Identification				
Facility Location:				
Equipment:				
Scope of Work/Task:				
Work Order No.				
Submitter:		Submitter Signature:		Date:
Section B, General				
<i>Mark "Y" or "N" as appropriate</i>				
No.	Item	Yes	No	Instructions
1.	Is the equipment operating at 50 volts or more or is a shock hazard present?			<i>If No, hazard analysis is not required. If Yes, proceed to Line 2.</i>
2.	Is the required working distance available?			<i>If Yes, proceed to Line 3. If No, do not proceed. Additional risk assessment is required before any work is performed.</i>
3.	Is the working space clear?			<i>If Yes, proceed to Line 4. If No, do not proceed. Additional risk assessment is required before any work is performed.</i>
4.	Was an incident energy analysis performed?			<i>If Yes, proceed to Section C. If No, proceed to Line 5.</i>
5.	Is the equipment properly installed and maintained and there is no evidence of impending failure?			<i>If Yes, arc flash PPE may not be required if doors are, and will remain, closed and secured and if covers are, and will remain, secured in place. If work will be performed on exposed energized electrical equipment as stated in Section 8-3.3, proceed to Section C. If No, arc flash PPE is required, proceed to Section C.</i>
Section C, Shock Information – All Methods				
<i>Refer to Table 3-1 or Table 3-2, as applicable, as well as Table 3-3.</i>				
6.	Phase voltage:			<i>Establish the shock boundaries</i>

	Limited Approach Boundary:		Proceed to Lines 7 and 8.	
	Restricted Approach Boundary:			
7.	Are rubber insulating gloves required for the task?		Proceed to Section D if an incident energy analysis has been or needs to be performed. Proceed to Section E if using the Arc Flash PPE Category (Table) method.	
8.	Are insulated or insulating hand tools required for the task?			
<b>Completed By:</b>		<b>Signature:</b>		<b>Date:</b>

**Section D, Arc Flash Information – Incident Energy Analysis Method (Default Method)**  
(To Be Completed by Engineering Personnel if Unknown or Not Previously Analyzed)

9.	Incident energy:	Working Distance:	Include at least one and establish the arc flash boundary. Working distance must be provided with incident energy determination. Note method used: <ul style="list-style-type: none"> <li>Section 4-2 (Based on NFPA 70E 2015 Article 130.5) for interior electrical equipment or for exterior pad-mounted equipment.</li> <li>Section 4-2 and Table 4-7 (Based on the National Electrical Safety Code) for overhead distribution.</li> </ul>	
	Level of PPE:			
	Minimum Arc-Rating of Clothing:			
	Arc Flash Boundary:			
<b>Completed By:</b>		<b>Signature:</b>		<b>Date:</b>

**Section E, Arc Flash Information – Arc Flash PPE Category Method**  
(To Be Completed by Engineering Personnel if Unknown or Not Previously Analyzed)  
Use Tables 4-5 through 4-9 as applicable

10.	Determine the available fault current and clearing times for the task			
	Available Fault Current:		Overcurrent Device Clearing Time:	
Mark "Y" or "N" as appropriate				
11.	Do the available fault current and clearing times for the task exceed the maximum allowed by Table 130.7(C)(15)(a) or 130.7(C)(15)(b)?		If <b>Yes</b> , an incident energy analysis is required. Complete Section D. If <b>No</b> , proceed to Line 12	
12.	Arc Flash Boundary:			
	Arc Flash PPE Category:		Working Distance:	
<b>Completed By:</b>		<b>Signature:</b>		<b>Date:</b>

**Section F, Confirmation of Adequate Maintenance and Testing of Overcurrent Protective Devices Credited by the Incident Energy Analysis Method or Arc Flash PPE Category Method**

13.			<i>List the overcurrent protective devices that have been credited by the arc flash analysis.</i>
14.			<i>Confirm that the above overcurrent protective devices have received adequate maintenance and testing, including the calibration dates or explain why maintenance and testing are not required, such as for protection by upstream fuses.</i>
<b>Completed By:</b>		<b>Signature:</b>	<b>Date:</b>
<b>Section G, Arc-Rated Clothing and Other PPE Information – All Methods</b>			
15.	Minimum arc rating in cal/cm <sup>2</sup> for protective clothing and other PPE		<i>Establish the required arc-rated clothing and other PPE</i>
		<p><i>In the block to the left, list the required arc-rated clothing and other PPE. Note which method used:</i></p> <p><b>Incident Energy Analysis Method:</b> Section 4-2 (Based on NFPA 70E 2018 Article 130.5)</p> <p><b>Incident Energy Analysis Method for Overhead Distribution:</b> Section 4-2 and Table 4-9 (Based on the National Electrical Safety Code)</p> <p><b>PPE Category Method:</b> Section 4-2.1 (Based on NFPA 70E 2018 Article 130.7(C)(15))</p>	
<b>Completed By:</b>		<b>Signature:</b>	<b>Date:</b>

CANCELLED

## APPENDIX C SAMPLE SOP – VOLTAGE AND CURRENT DIAGNOSTIC MEASUREMENTS

This appendix is optional and provides a typical SOP. Refer to Section 8-4 for requirements associated with SOPs.

### 1.0 Purpose.

This procedure defines the requirements for measuring voltage and current, monitoring the performance of electrical systems with data loggers, and confirming correct phase rotation. Modify this SOP as appropriate for the installation, the allowed work practices, and personnel qualifications.

This procedure can also be used as part of circuit lockout/tagout to confirm that a circuit has been deenergized.

### 2.0 Applicability.

This procedure applies to personnel that are designated as a qualified person with respect to working on or near electrical equipment rated at 50 volts or above.

### 3.0 References.

- 29 CFR 1910, *Occupational Safety and Health, General Industry Standards*
- Unified Facilities Criteria (UFC) 3-560-01, *Operation and Maintenance: Electrical Safety*
- NFPA 70E, *Electrical Safety in the Workplace*

### 4.0 Definitions.

**Arc Flash Hazard.** A dangerous condition associated with the possible release of energy caused by an electric arc.

**Arc Rating.** The value attributed to materials that describes their performance to exposure to an electrical arc discharge. The arc rating is expressed in cal/cm<sup>2</sup> and is derived from the determined value of the arc thermal performance value (ATPV) or energy of breakopen threshold (EBT) (should a material system exhibit a breakopen response below the ATPV value). Arc rating is reported as either ATPV or EBT, whichever is the lower value.

**Balaclava (Sock Hood).** An arc-rated hood that protects the neck and head except for the facial area of the eyes and nose.

**Boundary, Arc Flash.** When an arc flash hazard exists, an approach limit at a distance from a prospective arc source within which a person could receive a second degree burn if an electrical arc flash were to occur.

**Boundary, Limited Approach.** An approach limit at a distance from an exposed energized electrical conductor or circuit part within which a shock hazard exists.

**Boundary, Restricted Approach.** An approach limit at a distance from an exposed energized electrical conductor or circuit part within which there is an increased likelihood of electric shock, due to electrical arc-over combined with inadvertent movement, for personnel working in close proximity to the energized electrical conductor or circuit part.

**De-energized.** Free from any electrical connection to a source of potential difference and from electrical charge; not having a potential different from that of the earth.

**Electrical Hazard.** A dangerous condition such that contact or equipment failure can result in electric shock, arc flash burn, thermal burn, or blast.

**Electrical Safety.** Recognizing hazards associated with the use of electrical energy and taking precautions so that hazards do not cause injury or death.

**Electrically Safe Work Condition.** A state in which an electrical conductor or circuit part has been disconnected from energized parts, locked/tagged in accordance with established standards, tested to ensure the absence of voltage, and grounded if determined necessary.

**Exposed (as applied to energized electrical conductors or circuit parts).** Capable of being inadvertently touched or approached nearer than a safe distance by a person. It is applied to electrical conductors or circuit parts that are not suitably guarded, isolated, or insulated.

**Incident Energy.** The amount of thermal energy impressed on a surface, a certain distance from the source, generated during an electrical arc event. Incident energy is typically expressed in calories per square centimeter ( $\text{cal}/\text{cm}^2$ ).

**Live Line Tool.** An insulated tool that electrically insulates the worker from the energized conductor and provides physical separation from the device being operated.

**Low-Voltage.** Any voltage below 1,000 V.

**Medium Voltage.** Voltages above 1,000 and ranging to 72,500 V.

**Qualified Person.** One who has demonstrated skills and knowledge related to the construction and operation of electrical equipment and installations and has received safety training to identify and avoid the hazards involved.

**Shock Hazard.** A dangerous condition associated with the possible release of energy caused by contact or approach to energized electrical conductors or circuit parts.

**Unqualified Person.** A person who is not a qualified person.

**Working On (energized electrical conductors or circuit parts).** Intentionally coming in contact with energized electrical conductors or circuit parts with the hands, feet, or other body parts, with tools, probes, or with test equipment, regardless of the personal protective equipment (PPE) a person is wearing. There are two categories of “working on”: Diagnostic (testing) is taking readings or measurements of electrical equipment with approved test equipment that does not require making any physical change to the equipment; repair is any physical alteration of electrical equipment (such as making or tightening connections, removing or replacing components, etc.).

#### 5.0 **Training and Qualification Requirements.**

Personnel using this procedure must be trained and qualified in the following:

**Emergency response training.** Contact release. First aid, emergency response, and resuscitation.

**Qualified Person Employee training.** A qualified person must be trained and knowledgeable in the construction and operation of equipment or a specific work method and be trained to identify and avoid the electrical hazards that might be present with respect to that equipment or work method.

Document all training.

#### 6.0 **Required Approach Distances.**

Table 1 lists the minimum approach distances from exposed alternating current energized parts within which a qualified worker may not approach without the use of personal protective equipment appropriate for the potential electrical hazards, or place any conductive object without an approved insulating handle, unless certain other work techniques are used (such as isolation, insulation, shielding, or guarding). Table 2 provides similar information for direct current systems.

Table 1 Qualified Worker Minimum Approach Distances – AC Systems

Nominal System Voltage Range Phase to Phase (1)	Arc Flash Boundary	Limited Approach Boundary		Restricted Approach Boundary (3) (4)
	From Phase to Phase Voltage (5), (6)	Exposed Movable Conductor	Exposed Fixed Circuit Part	Includes Standard Inadvertent Movement Adder
50 V to 150 V	(2)	10 ft 0 in (3.0 m)	3 ft 6 in (1.0 m)	Avoid contact
>151 V to 750 V	(2)	10 ft 0 in (3.0 m)	3 ft 6 in (1.0 m)	1 ft 0 in (0.3 m)
>750 V to 15 kV	(2)	10 ft 0 in (3.0 m)	5 ft 0 in (1.5 m)	2 ft 2 in (0.7 m)
>15 kV to 36 kV	(2)	10 ft 0 in (3.0 m)	6 ft 0 in (1.8 m)	2 ft 9 in (0.8 m)
>36 kV to 46 kV	(2)	10 ft 0 in (3.0 m)	8 ft 0 in (2.5 m)	2 ft 9 in (0.8 m)
>46 kV to 72.5 kV	(2)	10 ft 0 in (3.0 m)	8 ft 0 in (2.5 m)	3 ft 6 in (1.0 m)
>72.5 kV to 121 kV	(2)	10 ft 8 in (3.3 m)	8 ft 0 in (2.5 m)	3 ft 6 in (1.0 m)
>121 kV to 145 kV	(2)	11 ft 0 in (3.4 m)	10 ft 0 in (3.0 m)	3 ft 10 in (1.2 m)

## Notes for Table 1:

1. For single phase systems  $V_{\text{max}}$  above 250 volts,  $V_{\text{max}}/2$  select the range that is equal to the system's maximum phase to ground voltage times 1.732.
2. The arc flash boundary is determined by an arc flash analysis.
3. The restricted approach boundary is defined as the distance between energized parts and grounded objects without insulation, isolation, or guards.
4. The restricted approach distance applied to hot sticks is the distance between a worker's hand and the working end of the stick.
5. Only qualified workers wearing appropriate PPE are permitted to be within the arc flash boundary.
6.  $V_{\text{max}}$  Refer to NFPA 70E for AC voltages above 145 kV.  $V_{\text{max}}$



**Table 2. Qualified Worker Minimum Approach Distances – DC Systems**

Nominal System Voltage Range	Limited Approach Boundary	Restricted Approach Boundary
	Exposed Fixed Circuit Part	Includes Reduced Inadvertent Movement Adder
<50 V	Not specified	Not specified
50 V to 300 V	3 ft 6 in (1.0 m)	Avoid contact
>300 V to 1 kV	3 ft 6 in (1.0 m)	1 ft 0 in (0.3 m)

*Notes for Table 2:*

1. *The restricted approach boundary is defined as the distance between energized parts and grounded objects without insulation, isolation, or guards.*
2. *Only qualified workers wearing appropriate PPE are permitted to be within the limited approach boundary and the arc flash boundary. The arc flash boundary is determined by calculation.*
3. *Refer to NFPA 70E for DC voltages above 1 kV.*

### 7.0 Personal Protective Equipment.

Comply with UFC 3-560-01 for PPE requirements. Perform the following:

1. Review electrical task risk assessment for this SOP for the potential incident energy level.
2. Select PPE equipment to exceed calculated potential incident energy level.

Voltage-rated gloves with leather protectors (Table 3) are required for work inside the restricted approach boundary or when handling live-line tools. Select as follows:

**Table 3 Rubber Insulating Equipment Voltage Requirements**

Class of Equipment	Color Label	Maximum Use (AC Volts)	Minimum Distance <sup>1</sup> in Inches (Millimeters)
00	Beige	500	1 (25)
0	Red	1,000	1 (25)
1	White	7,500	1 (25)
2	Yellow	17,000	2 (50)
3	Green	26,500	3 (75)
4	Orange	36,000	4 (100)

*Notes for Table 3: Wear leather protectors over rubber gloves. Minimum distance is the minimum length that the exposed rubber glove must extend beyond the leather protector.*

#### 8.0 **Low-Voltage Electrical Measurements – Voltage and Current.**

Take electrical measurements in accordance with the following procedure:

1. Conduct pre-job brief. Ensure all personnel are wearing required PPE. Confirm communication is established with all crew members, if applicable.
2. Select voltage-rated gloves with leather protectors using Table 3. Inspect voltage-rated gloves and leather protectors before use.
3. Select and inspect the tools and devices to be used for the electrical measurements. Ensure that all are rated for the voltage to be tested.
4. Check the arc flash label installed at the location where electrical measurements will be taken. **12** Before starting work, obtain and wear the correct arc-rated PPE rated at or above the incident energy or arc flash hazard category listed on the arc flash label, with a minimum rating of 8 cal/cm<sup>2</sup> or Category 2 respectively. **12**
5. Open the cabinet or enclosure where electrical measurements will be taken. Ensure PPE is worn properly before exposing energized electrical circuits. Wear voltage-rated gloves with leather protectors before entering the restricted approach distance. Only voltage-rated gloves with leather protectors are allowed inside the restricted approach distance.
6. Test the meter with a known energized source. Confirm the meter is operational and displaying correctly.
7. Apply the voltage leads of the meter to the test point on the system or device being tested to check for voltage. Check voltage on all phases.

8. If testing for current, position the meter's ammeter sensor so that the wire(s) or conductor(s) to be tested pass through the sensor. Document the current reading and repeat for all phases.
9. If voltage testing was performed to verify a deenergized circuit as part of a lockout/tagout procedure, test the meter again with a known energized source.
10. When testing is complete, restore the equipment to normal and return all devices (test equipment, PPE, and voltage-rated gloves) to their protective containers. Confirm that all tools and test equipment that were used are accounted for. If covers were removed as part of gaining access to the equipment, confirm that the covers are fully secured with no missing screws.

#### 9.0 **Medium-Voltage Electrical Measurements – Voltage and Current.**

This procedure applies to all systems with a voltage above 600 volts. Take electrical measurements in accordance with the following procedure:

1. Conduct pre-job brief. Ensure all personnel are wearing required PPE. Confirm communication is established with all crew members, if applicable.
2. Select voltage-rated gloves with leather protectors using Table 3. Inspect voltage-rated gloves and leather protectors before use.
3. Select and inspect the tools and devices to be used for the electrical measurements. Ensure that all are rated for the voltage to be tested. Confirm that live-line tools (hot sticks) have been wet tested within the last 2 years. Inspect tools before use.
4. Check the arc flash label installed at the location where electrical measurements will be taken. **2** Before starting work, obtain and wear the correct arc-rated PPE rated at or above the incident energy or arc flash hazard category listed on the arc flash label, with a minimum rating of 8 cal/cm<sup>2</sup> or Category 2 respectively. **2**
5. Open the cabinet or enclosure where electrical measurements will be taken. Ensure PPE is worn properly before exposing energized electrical circuits. Wear voltage-rated gloves with leather protectors before entering the restricted approach distance. Only the voltage-rated gloves with leather protectors are allowed inside the restricted approach distance.
6. Test the meter with a known energized source or test medium. Confirm the meter is operational and displaying correctly.
7. Apply the tip of the touch meter to the test point on the system or device being tested to check for voltage. Check voltage on all phases.
8. If testing for current, attach the clamp-on/inductive type ammeter to the insulated hot stick. Position or move the meter's ammeter sensor so that the wire(s) or conductor(s) to be tested pass through the sensor. Document the current reading and repeat for all phases.

9. If voltage testing was performed to verify a deenergized circuit as part of a lockout/tagout procedure, test the meter again with a known energized source.
10. When testing is complete, restore the equipment to normal and return all devices (test equipment, PPE, and voltage-rated gloves) to their protective containers. Confirm that all tools and test equipment that were used are accounted for. If covers were removed as part of gaining access to the equipment, confirm that the covers are fully secured with no missing screws.

#### 10.0 Low-Voltage Data Logging Electrical Measurements.

Take electrical measurements using a data logger in accordance with the following procedure:

1. Conduct pre-job brief. Ensure all personnel are wearing required PPE. Confirm communication is established with all crew members, if applicable.
2. Select voltage-rated gloves with leather protectors using Table 3. Inspect voltage-rated gloves and leather protectors before use.
3. Select and inspect the tools and devices to be used for the electrical measurements. Ensure that all are rated for the voltage to be tested. Inspect the current transformers (CTs)/clamp-on leads that will be used for testing; confirm the leads are in good condition and are fully insulated.
4. Check the arc flash label installed at the location where electrical measurements will be taken. **12** Before starting work, obtain and wear the correct arc-rated PPE rated at or above the incident energy or arc flash hazard category listed on the arc flash label, with a minimum rating of 8 cal/cm<sup>2</sup> or Category 2 respectively. **12**
5. Open the cabinet or enclosure where electrical measurements will be taken. Ensure PPE is worn properly before exposing energized electrical circuits. Wear voltage-rated gloves with leather protectors before entering the restricted approach distance. Only the voltage-rated gloves with leather protectors are allowed inside the restricted approach distance.
6. Determine where all leads will be attached.
7. Apply the voltage leads to the selected exposed energized phases.
8. Attach the CT clamp-on leads around the selected conductors.
9. After all leads are connected and confirmed to be in place, start the data logger to start monitoring.
10. While data logging is in progress, close and secure the cabinet or enclosure where the data logger leads are connected. If the cabinet or enclosure cannot be sealed because of its configuration, place warning signs around the equipment and secure the area to prevent unauthorized access.

11. When testing is complete, perform Steps 1 through 5 and reopen the cabinet or enclosure to allow access to the data logger and its leads. Stop the data logger and remove the voltage and CT clamp-on leads.
12. Close the cabinet or enclosure where measurements were taken.
13. When testing is complete, restore the equipment to normal and return all devices (test equipment, PPE, and voltage-rated gloves) to their protective containers. Confirm that all tools and test equipment that were used are accounted for. If covers were removed as part of gaining access to the equipment, confirm that the covers are fully secured with no missing screws.

#### 11.0 Low-Voltage Phase Rotation Checks.

Take phase rotation measurements in accordance with the following procedure:

1. Conduct pre-job brief. Ensure all personnel are wearing required PPE. Confirm communication is established with all crew members, if applicable.
2. Select voltage-rated gloves with leather protectors using Table 3. Inspect voltage-rated gloves and leather protectors before use.
3. Select and inspect the tools and devices to be used for the electrical measurements. Ensure that all are rated for the voltage to be tested.
4. Check the arc flash label installed at the location where electrical measurements will be taken. **2** Before starting work, obtain and wear the correct arc-rated PPE rated at or above the incident energy or arc flash hazard category listed on the arc flash label, with a minimum rating of 8 cal/cm<sup>2</sup> or Category 2 respectively. **2**
5. Open the cabinet or enclosure where electrical measurements will be taken. Ensure PPE is worn properly before exposing energized electrical circuits. Wear voltage-rated gloves with leather protectors before entering the restricted approach distance. Only the voltage-rated gloves with leather protectors are allowed inside the restricted approach distance.
6. Confirm presence of voltage in accordance with Paragraph 8 above.
7. If possible, deenergize the circuit or equipment before connecting the phase rotation meter leads. Attach the leads of the phase rotation meter to the exposed energized conductors.
8. Press the meter's actuating button, check for proper phase rotation, and release.
9. If possible, deenergize the circuit or equipment before disconnecting the phase rotation meter leads. Remove the leads.
10. When testing is complete, restore the equipment to normal and return all devices (test equipment, PPE, and voltage-rated gloves) to their protective containers.

Confirm that all tools and test equipment that were used are accounted for. If covers were removed as part of gaining access to the equipment, confirm that the covers are fully secured with no missing screws.

## 12.0 Medium-Voltage Phase Rotation Checks.

This procedure applies to all systems with a voltage above 600 volts. Take phase rotation measurements in accordance with the following procedure:

1. Conduct pre-job brief. Ensure all personnel are wearing required PPE. Confirm communication is established with all crew members, if applicable.
2. Select voltage-rated gloves with leather protectors using Table 3. Inspect voltage-rated gloves and leather protectors before use.
3. Select and inspect the tools and devices to be used for the electrical measurements. Ensure that all are rated for the voltage to be tested. Confirm that live-line tools (hot sticks) have been tested within the last 6 months. Inspect tools before use.
4. Check the arc flash label installed at the location where electrical measurements will be taken. **2** Before starting work, obtain and wear the correct arc-rated PPE rated at or above the incident energy or arc flash hazard category listed on the arc flash label, with a minimum rating of 8 cal/cm<sup>2</sup> or Category 2 respectively. **2**
5. Open the cabinet or enclosure where electrical measurements will be taken. Ensure PPE is worn properly before exposing energized electrical circuits. Wear voltage-rated gloves with leather protectors before entering the restricted approach distance. Only the voltage-rated gloves with leather protectors are allowed inside the restricted approach distance.
6. Confirm presence of voltage in accordance with Paragraph 9 above.
7. Use two personnel to hold the hot sticks for phase rotation checks. Perform dry run, with PPE, without touching the energized source. This step is performed to confirm that there is sufficient access for the task and that the two crewmembers can coordinate their movements.
8. Apply the touchmeters to the test points on the system being tested to check for proper phasing. Check all phases.
9. When testing is complete, restore the equipment to normal and return all devices (test equipment, PPE, and voltage-rated gloves) to their protective containers. Confirm that all tools and test equipment that were used are accounted for. If covers were removed as part of gaining access to the equipment, confirm that the covers are fully secured with no missing screws.

**APPENDIX D SAMPLE SOP – WORKING ON STATIONARY BATTERY SYSTEMS**

This appendix is optional and provides a typical SOP. Refer to Section 8-4 for requirements associated with SOPs.

**1.0 Purpose.**

This procedure defines the requirements for working on or near stationary battery systems and applies to the following activities:

- Battery or cell inspections.
- Battery or cell maintenance or testing.
- Battery or cell replacement.

Modify this SOP as appropriate for the installation, the allowed work practices, and personnel qualifications.

This procedure applies to stationary battery systems consisting of either nickel cadmium batteries, vented lead acid batteries, or valve-regulated lead acid (VRLA) batteries. It applies to batteries installed on battery racks or installed inside cabinets, including UPS systems.

Batteries and dc system components are different from ac electrical system equipment. Lead acid batteries contain a sulfuric acid electrolyte, which is harmful to skin and eyes, and the electrical shock hazards associated with dc power can be more severe than those associated with ac power for equivalent voltages and currents.

Batteries and cells are always energized and a fully charged stationary battery contains a tremendous amount of energy. A short circuit between the battery or cell terminals can produce explosive fault currents.

Only authorized personnel who have been familiarized and trained on battery fundamentals and maintenance procedures should be allowed to perform maintenance activities on a battery.

**2.0 Applicability.**

This procedure applies to personnel that are designated as a qualified person with respect to working on or near electrical equipment rated at 50 volts or above, including working on stationary battery systems.

**3.0 References.**

- 29 CFR 1910, *Occupational Safety and Health, General Industry Standards*
- Unified Facilities Criteria (UFC) 3-560-01, *Operation and Maintenance: Electrical Safety*

- NFPA 70E, *Electrical Safety in the Workplace*

#### 4.0 **Definitions.**

**Arc Flash Hazard.** A dangerous condition associated with the possible release of energy caused by an electric arc.

**Arc Rating.** The value attributed to materials that describes their performance to exposure to an electrical arc discharge. The arc rating is expressed in cal/cm<sup>2</sup> and is derived from the determined value of the arc thermal performance value (ATPV) or energy of breakopen threshold (EBT) (should a material system exhibit a breakopen response below the ATPV value). Arc rating is reported as either ATPV or EBT, whichever is the lower value.

**Battery.** Two or more cells connected to form one unit for producing electric energy at the required voltage and current levels.

**Battery Rack.** A structure used to support a group of cells.

**Boundary, Arc Flash.** When an arc flash hazard exists, an approach limit at a distance from a prospective arc source within which a person could receive a second degree burn if an electrical arc flash were to occur.

**Boundary, Limited Approach.** An approach limit at a distance from an exposed energized electrical conductor or circuit part within which a shock hazard exists.

**Boundary, Restricted Approach.** An approach limit at a distance from an exposed energized electrical conductor or circuit part within which there is an increased likelihood of electric shock, due to electrical arc-over combined with inadvertent movement, for personnel working in close proximity to the energized electrical conductor or circuit part.

**Cell.** An electrochemical device, composed of positive and negative plates, separator, and electrolyte, that is capable of storing electrical energy; when encased in a container and fitted with terminals, it is the basic component of a battery.

**Electrical Hazard.** A dangerous condition such that contact or equipment failure can result in electric shock, arc flash burn, thermal burn, or blast.

**Electrolyte.** The conducting medium in which the flow of electric current takes place by the migration of ions. For example, the electrolyte for a lead-acid cell is an aqueous solution of sulfuric acid.

**Electrical Safety.** Recognizing hazards associated with the use of electrical energy and taking precautions so that hazards do not cause injury or death.

**Exposed (as applied to energized electrical conductors or circuit parts).** Capable of being inadvertently touched or approached nearer than a safe distance by a person.



It is applied to electrical conductors or circuit parts that are not suitably guarded, isolated, or insulated.

**Incident Energy.** The amount of thermal energy impressed on a surface, a certain distance from the source, generated during an electrical arc event. Incident energy is typically expressed in calories per square centimeter (cal/cm<sup>2</sup>).

**Qualified Person.** One who has demonstrated skills and knowledge related to the construction and operation of electrical equipment and installations and has received safety training to identify and avoid the hazards involved.

**Shock Hazard.** A dangerous condition associated with the possible release of energy caused by contact or approach to energized electrical conductors or circuit parts.

**Unqualified Person.** A person who is not a qualified person.

**Valve-Regulated Lead-Acid (VRLA) Cell.** A lead-acid cell that is sealed with the exception of a valve that opens to the atmosphere when the internal gas pressure in the cell exceeds the atmospheric pressure by a pre-selected amount. VRLA cells provide a means of recombination of internally generated oxygen and the suppression of hydrogen gas evolution to limit water consumption.

**Vent.** A normally sealed mechanism which allows the controlled escape of gases from within a cell.

**Vented Cell.** A lead-acid cell in which the gaseous products of electrolysis and evaporation are allowed to escape to the atmosphere as they are generated. A vented cell is also referred to as a flooded cell.

**Working On (energized electrical conductors or circuit parts).** Intentionally coming in contact with energized electrical conductors or circuit parts with the hands, feet, or other body parts, with tools, probes, or with test equipment, regardless of the personal protective equipment (PPE) a person is wearing. There are two categories of “working on”: Diagnostic (testing) is taking readings or measurements of electrical equipment with approved test equipment that does not require making any physical change to the equipment; repair is any physical alteration of electrical equipment (such as making or tightening connections, removing or replacing components, etc.).

## 5.0 Training and Qualification Requirements.

Personnel using this procedure must be trained and qualified in the following:

**Emergency response training.** Contact release. First aid, emergency response, and resuscitation.

**Qualified Person Employee training.** A qualified person must be trained and knowledgeable in the construction and operation of equipment or a specific work method and be trained to identify and avoid the electrical hazards that might be present with respect to that equipment or work method.

Only authorized personnel who have been familiarized and trained on battery fundamentals and maintenance procedures should be allowed to perform maintenance or work activities on a battery.

Document all training.

## 6.0 Required Approach Distances.

Table 1 lists the minimum approach distances from exposed direct current energized parts within which a qualified worker may not approach without the use of personal protective equipment appropriate for the potential electrical hazards, or place any conductive object without an approved insulating handle, unless certain other work techniques are used (such as isolation, insulation, shielding, or guarding).

**Table 1. Qualified Worker Minimum Approach Distances – DC Systems**

Nominal System Voltage Range	Limited Approach Boundary	Restricted Approach Boundary
	Exposed Fixed Circuit Part	Includes Reduced Inadvertent Movement Adder
<50 V	Not specified	Not specified
50 V to 300 V	3 ft 6 in (1.0 m)	Avoid contact
>300 V to 1 kV	3 ft 6 in (1.0 m)	1 ft 0 in (0.3 m)

Notes for Table 1:

1. The restricted approach boundary is defined as the distance between energized parts and grounded objects without insulation, isolation, or guards.
2. Only qualified workers wearing appropriate PPE are permitted to be within the limited approach boundary and the arc flash boundary. The arc flash boundary is determined by calculation.
3. Refer to NFPA 70E for DC voltages above 1 kV.

## 7.0 Personal Protective Equipment.

Comply with UFC 3-560-01 for PPE requirements. Wear Class 0 voltage rated gloves with leather protectors for DC voltages 600 volts and below. Select arc-rated PPE in accordance with the PPE category specified in Table 2.

**Table 2. Arc Flash PPE Categories for Direct Current Systems**

Equipment	PPE Category	Arc Flash Boundary
Storage batteries, dc switchboards, and other dc supply sources Parameters: $100\text{ V} \leq \text{Voltage} < 250\text{ V}$ Maximum arc duration and working distance: 2 sec @ 18 in.		
Short-circuit current $< 4\text{ kA}$	2	3 ft
$4\text{ kA} \leq \text{short-circuit current} < 7\text{ kA}$	2	4 ft
$7\text{ kA} \leq \text{short-circuit current} < 15\text{ kA}$	3	6 ft
Storage batteries, dc switchboards, and other dc supply sources Parameters: $250\text{ V} < \text{Voltage} \leq 600\text{ V}$ Maximum arc duration and working distance: 2 sec @ 18 in.		
Short-circuit current $< 1.5\text{ kA}$	2	3 ft
$1.5\text{ kA} \leq \text{short-circuit current} < 3\text{ kA}$	2	4 ft
$3\text{ kA} \leq \text{short-circuit current} < 7\text{ kA}$	3	6 ft
$7\text{ kA} \leq \text{short-circuit current} < 10\text{ kA}$	4	8 ft

*Note: Apparel that can be expected to be exposed to battery electrolyte must meet both of the following conditions:*

- 1. Be evaluated for electrolyte protection in accordance with ASTM F1296, Standard Guide for Evaluating Chemical Protective Clothing.*
- 2. Be arc-rated in accordance with ASTM F1891, Standard Specification for Arc Rated and Flame Resistant Rainwear, or equivalent.*

*Note: Obtain the available short circuit current for a particular battery from the manufacturer. If this information is not available, estimate the available short circuit current from the battery performance data sheet as 10 times the 1 minute ampere capability of the cell (at 77°F (25°C) to 1.75 V per cell) for lead-acid batteries.*

## 8.0 **Safety Precautions.**

The following sections provide basic safety precautions for working around lead acid batteries and dc equipment.

### 8.1 **Personal Safety General Precautions.**

Batteries are inherently dangerous; they can generate lethal currents and contain acidic or caustic electrolyte. Take the following personnel safety measures should be take whenever working around batteries or other dc system equipment.

1. Lead acid batteries contain a sulfuric acid electrolyte that can cause burns and other serious injury. Avoid any skin contact with the electrolyte. In the event of skin contact with the electrolyte, flush immediately and thoroughly with water. If the electrolyte comes into contact with eyes, flush immediately with water and seek medical assistance. Be familiar with how to use emergency eyewash equipment, which should always be close at hand.
2. Neutralize sulfuric acid electrolyte spills on clothing or other material with a bicarbonate of soda (baking soda) solution (1 pound of bicarbonate of soda per gallon of water). Apply the solution to any spills until bubbling stops and rinse with clean water. .
3. Whenever working with battery electrolyte, wear a rubber apron and rubber gloves. Ensure goggles and face shields are available.
4. Batteries can generate hydrogen gas. Never bring burning materials such as matches, cigarettes, or sparks of any kind near the battery. Avoid the use of spark-producing equipment near batteries. Residual gases can remain within cells during storage and shipment. Take these precautions at all times while handling batteries.
5. Use only insulated tools in the battery area to prevent accidental shorting across battery connections. Never lay tools or other metal objects on cells; shorting, explosion, or personal injury could result. As a general rule, the length of the exposed metal for any tool should be less than the distance between the positive and negative posts of each cell.
6. Remove all jewelry, wristwatches, or clothing with metal parts that could come into contact with the battery terminals.
7. Do not make or break series connections within an operating group of cells. Before proceeding, open the battery system circuit breaker to minimize the possibility of arcing.
8. Ensure that the exit from the battery area is unobstructed.
9. Do not overheat anticorrosion grease when preparing it for battery terminations. Some compounds have a flash point as low as 90°F. Follow the manufacturer's instructions carefully.
10. Minimize access to the battery by personnel unaware of battery safety precautions.

## 8.2 **Equipment Safety General Precautions.**

The previous section summarized safety precautions applicable to personnel. Improper handling or maintenance can also damage the battery. The following summarizes common considerations for the battery.

1. Install stationary batteries only on racks designed for the types of cells to be installed. Follow the manufacturer's guidance with regard to the design and material of the battery rack.
2. Do not lift any cell by its terminal posts. Use a lifting belt, spreader board, or other device approved by the manufacturer to move cells; internal cell damage can result if the cells are mishandled.
3. Do not adjust or tamper with seal nuts around cell posts, if installed.
4. Never use solvents or unapproved greases on cells or connections. Solvents can attack and even crack the plastic cell case. Unapproved greases can also attack plastic materials on the cell. Use only clean water and the proper neutralizing compound, as necessary, to clean the battery racks and containers.
5. Do not use a steel brush, brass brush, emery cloth, sandpaper, steel wool or metal file to clean cell posts and connectors; these tools can damage the lead plating.
6. Keep battery tops clean and neutralize any spilled electrolyte to minimize the possibility of electrical shock and short circuit, and to reduce rack corrosion.
7. Use two insulated wrenches when checking the connection torque to minimize stress on the connection hardware.
8. Unless required by the manufacturer for the particular battery design, do not remove flame arrestors. Use the filling funnel to add water or check the electrolyte.
9. Provide proper support for cables connected to cell terminals. Excessive strain from improper cable arrangements can damage cell terminal posts and seals.
10. Do not use cables as handles. This practice can stress the termination points and cause terminal post seal leakage.

#### 9.0 **Working on Stationary Battery Systems.**

Perform work on or around a stationary battery in accordance with the following procedure:

1. Conduct pre-job brief; include unique precautions for working on battery and DC systems. Confirm communication is established with all crew members, if applicable.
2. Select required PPE in accordance with Table 2. Ensure all personnel are wearing required PPE.
3. Wear Class 0 voltage-rated gloves with leather protectors if working within the restricted approach boundary for battery systems rated for 300 volts or higher. Inspect voltage-rated gloves and leather protectors before use.

4. Select and inspect the tools and devices to be used for work. Ensure that all tools are insulated.
5. Perform work in accordance with the pre-job brief.

*Note: Depending on the work to be performed, a separate procedure might be required. This SOP addresses only the safety considerations for working on or near battery systems.*

6. When work is complete, restore the equipment to normal and return all devices (tools, test equipment, PPE, and voltage-rated gloves) to their protective containers. Confirm that all tools and test equipment that were used are accounted for. If covers were removed as part of gaining access to the equipment, confirm that the covers are fully secured with no missing screws.

CANCELLED

## APPENDIX E SAMPLE SOP – INSERTING OR REMOVING (RACKING) CIRCUIT BREAKERS TO/FROM AN ENERGIZED BUS

This appendix is optional and provides a typical SOP. Refer to Section 8-4 for requirements associated with SOPs.

### 1.0 Purpose.

The following is a sample SOP for racking circuit breakers in and out of switchgear. The following activities are covered by this SOP.

- Manually racking circuit breakers out of switchgear.
- Manually racking circuit breakers into switchgear.
- Racking circuit breakers out of and into switchgear using a remote racking mechanism.

The process of racking a drawout circuit breaker into and out of the connected position is one of the most frequent exercises that exposes an operator to risk. A malfunction during this operation has the potential for catastrophic consequences to equipment and personnel. Supervised, closed door circuit breaker racking is a fundamental recognized safety practice. Furthermore, older breakers are more complex and vulnerable to mechanical failures that create safety problems.

Manual racking refers to switchgear circuit breaker removal or insertion using a hand-operated racking device while standing in front of the circuit breaker. Given the potential risk, Category 4 (40 cal/cm<sup>2</sup>) PPE and voltage-rated gloves with leather protectors are specified for this activity.

Remote racking refers to switchgear circuit breaker removal or insertion using a remote racking mechanism that allows the operator to stand up to 25 feet away from the circuit breaker; Figure 1 shows an example of one type of unit. Remote racking reduces the risk of circuit breaker racking and standard Category 2 (8 cal/cm<sup>2</sup>) clothing is specified for this activity.

Figure 1. Remote Racking Mechanism



Modify this SOP as appropriate for the installation, the allowed work practices, and personnel qualifications.

## 2.0 Applicability.

This procedure applies to personnel that are designated as a qualified person with respect to working on or near electrical equipment rated at 50 volts or above.

## 3.0 References.

- 29 CFR 1910, *Occupational Safety and Health, General Industry Standards*
- Unified Facilities Criteria (UFC) 3-560-01, *Operation and Maintenance: Electrical Safety*
- NFPA 70E, *Electrical Safety in the Workplace*

## 4.0 Definitions.

**Arc Flash Hazard.** A dangerous condition associated with the possible release of energy caused by an electric arc.

**Arc Rating.** The value attributed to materials that describes their performance to exposure to an electrical arc discharge. The arc rating is expressed in cal/cm<sup>2</sup> and is derived from the determined value of the arc thermal performance value (ATPV) or energy of breakopen threshold (EBT) (should a material system exhibit a breakopen response below the ATPV value). Arc rating is reported as either ATPV or EBT, whichever is the lower value.



**Boundary, Arc Flash.** When an arc flash hazard exists, an approach limit at a distance from a prospective arc source within which a person could receive a second degree burn if an electrical arc flash were to occur.

**Boundary, Limited Approach.** An approach limit at a distance from an exposed energized electrical conductor or circuit part within which a shock hazard exists.

**Boundary, Restricted Approach.** An approach limit at a distance from an exposed energized electrical conductor or circuit part within which there is an increased likelihood of electric shock, due to electrical arc-over combined with inadvertent movement, for personnel working in close proximity to the energized electrical conductor or circuit part.

**De-energized.** Free from any electrical connection to a source of potential difference and from electrical charge; not having a potential different from that of the earth.

**Electrical Hazard.** A dangerous condition such that contact or equipment failure can result in electric shock, arc flash burn, thermal burn, or blast.

**Electrical Safety.** Recognizing hazards associated with the use of electrical energy and taking precautions so that hazards do not cause injury or death.

**Electrically Safe Work Condition.** A state in which an electrical conductor or circuit part has been disconnected from energized parts, locked/tagged in accordance with established standards, tested to ensure the absence of voltage, and grounded if determined necessary.

**Exposed (as applied to energized electrical conductors or circuit parts).** Capable of being inadvertently touched or approached nearer than a safe distance by a person. It is applied to electrical conductors or circuit parts that are not suitably guarded, isolated, or insulated.

**Incident Energy.** The amount of thermal energy impressed on a surface, a certain distance from the source, generated during an electrical arc event. Incident energy is typically expressed in calories per square centimeter ( $\text{cal}/\text{cm}^2$ ).

**Inserting (Racking In) Circuit Breaker.** The act of inserting a breaker into its cell, effectively placing it into a position to control or connect the electrical supply to the load connections mounted in the rear of the cell.

**Live Line Tool.** An insulated tool that electrically insulates the worker from the energized conductor and provides physical separation from the device being operated.

**Low-Voltage.** Any voltage below 1,000 V.

**Medium Voltage.** Voltages above 1,000 and ranging to 72,500 V.

**Qualified Person.** One who has demonstrated skills and knowledge related to the construction and operation of electrical equipment and installations and has received safety training to identify and avoid the hazards involved.

**Shock Hazard.** A dangerous condition associated with the possible release of energy caused by contact or approach to energized electrical conductors or circuit parts.

**Test Position.** Breaker position for testing the breaker operation during maintenance. When in the test position, the breaker is not connected to the line or load side stabs (bus).

**Unqualified Person.** A person who is not a qualified person.

**Working On (energized electrical conductors or circuit parts).** Intentionally coming in contact with energized electrical conductors or circuit parts with the hands, feet, or other body parts, with tools, probes, or with test equipment, regardless of the personal protective equipment (PPE) a person is wearing. There are two categories of “working on”: Diagnostic (testing) is taking readings or measurements of electrical equipment with approved test equipment that does not require making any physical change to the equipment; repair is any physical alteration of electrical equipment (such as making or tightening connections, removing or replacing components, etc.).

#### 5.0 Training and Qualification Requirements.

Personnel using this procedure must be trained and qualified in the following:

**Emergency response training.** Contact release. First aid, emergency response, and resuscitation.

**Qualified Person Employee training.** A qualified person must be trained and knowledgeable in the construction and operation of equipment or a specific work method and be trained to identify and avoid the electrical hazards that might be present with respect to that equipment or work method.

Personnel using this procedure must also be trained in circuit breaker racking, either manually or with a remote racking mechanism if available.

Document all training.

#### 6.0 Required Approach Distances.

Table 1 lists the minimum approach distances from exposed alternating current energized parts within which a qualified worker may not approach without the use of personal protective equipment appropriate for the potential electrical hazards, or place any conductive object without an approved insulating handle, unless certain other work techniques are used (such as isolation, insulation, shielding, or guarding).

*Note: Racking operations are not performed with the qualified electrical worker next to exposed energized parts. The equipment to be racked out is dead-front design.*

However, because of the higher risk associated with racking operations, observe these approach distances and wear the PPE specified in Section 7.

**Table 1 Qualified Worker Minimum Approach Distances – AC Systems**

Nominal System Voltage Range Phase to Phase (1)	Arc Flash Boundary	Limited Approach Boundary		Restricted Approach Boundary (3) (4)
	From Phase to Phase Voltage (5), (6)	Exposed Movable Conductor	Exposed Fixed Circuit Part	Includes Standard Inadvertent Movement Adder
50 V to 150 V	(2)	10 ft 0 in (3.0 m)	3 ft 6 in (1.0 m)	Avoid contact
>151 V to 750 V	(2)	10 ft 0 in (3.0 m)	3 ft 6 in (1.0 m)	1 ft 0 in (0.3 m)
>750 V to 15 kV	(2)	10 ft 0 in (3.0 m)	5 ft 0 in (1.5 m)	2 ft 2 in (0.7 m)
>15 kV to 36 kV	(2)	10 ft 0 in (3.0 m)	6 ft 0 in (1.8 m)	2 ft 9 in (0.8 m)
>36 kV to 46 kV	(2)	10 ft 0 in (3.0 m)	8 ft 0 in (2.5 m)	2 ft 9 in (0.8 m)
>46 kV to 72.5 kV	(2)	10 ft 0 in (3.0 m)	8 ft 0 in (2.5 m)	3 ft 6 in (1.0 m)
>72.5 kV to 121 kV	(2)	10 ft 8 in (3.3 m)	8 ft 0 in (2.5 m)	3 ft 6 in (1.0 m)
>121 kV to 145 kV	(2)	11 ft 0 in (3.4 m)	10 ft 0 in (3.0 m)	3 ft 10 in (1.2 m)

Notes for Table 1:

1. For single phase systems  $\sqrt{2}$  above 250 volts,  $\sqrt{2}$  select the range that is equal to the system's maximum phase to ground voltage times 1.732.
2. The arc flash boundary is determined by an arc flash analysis.
3. The restricted approach boundary is defined as the distance between energized parts and grounded objects without insulation, isolation, or guards.
4. Only qualified workers wearing appropriate PPE are permitted to be within the arc flash boundary.
5.  $\sqrt{2}$  Refer to NFPA 70E for AC voltages above 145 kV.  $\sqrt{2}$

7.0 **Personal Protective Equipment (PPE).**

Comply with UFC 3-560-01 for PPE requirements, as well as the additional requirements specified in the sections below.

7.1 **PPE for Manual Racking.**

Review electrical task risk assessment for this SOP for the potential incident energy level to confirm there are no locations with an incident energy rating above 40 cal/cm<sup>2</sup>. Wear the following arc-rated clothing, minimum of 40 cal/cm<sup>2</sup>, while performing manual racking operations:

*Note: Some locations where racking will be performed will be rated for an incident energy of less than Category 4 (40 cal/cm<sup>2</sup>) or lower. Category 4 clothing is specified for this activity because of the unique risk posed by this activity,*

*Note: The following PPE is required regardless of whether the circuit breaker compartment door is open or closed during racking.*

- Arc-rated flash suit pants and jacket.
- Arc-rated flash suit hood.
- Leather electrical hazard-rated (EH) work shoes/boots.
- Hearing protection.
- Voltage-rated gloves with leather protectors.

Select voltage-rated gloves with leather protectors (Table 2) based on the line-to-line voltage rating of the switchgear. Select as follows:

**Table 2 Rubber Insulating Equipment Voltage Requirements**

Class of Equipment	Color Label	Maximum Use (AC Volts)	Minimum Distance <sup>1</sup> in Inches (Millimeters)
00	Beige	500	1 (25)
0	Red	1,000	1 (25)
1	White	7,500	1 (25)
2	Yellow	17,000	2 (50)
3	Green	26,500	3 (75)
4	Orange	36,000	4 (100)

*Notes for Table: Wear leather protectors over rubber gloves. Minimum distance is the minimum length that the exposed rubber glove must extend beyond the leather protector.*

## 7.2 PPE for Remote Racking.

Remote racking operations will be performed with the qualified electrical worker located well outside the limited approach boundary and the arc flash boundary, which reduces the risk associated with this activity. Comply with UFC 3-560-01 for minimum arc flash clothing requirements.

## 8.0 Manual Racking.

### 8.1 Manual Racking – Breaker Removal (Rack Out) from an Energized Bus.

Perform the following steps:

1. Conduct pre-job brief and identify/confirm the circuit breaker(s) that will be operated and racked. Confirm communication is established with all crew members, if applicable.
2. Check the electrical task risk assessment for this SOP for the location where racking will occur. If the arc flash incident energy exceeds Category 4 (40 cal/cm<sup>2</sup>) at the stated working distance, stop work. The switchgear must be deenergized and placed in an electrically safe work condition before racking is allowed.
3. Ensure personnel that will perform manual racking operations are wearing PPE required by Section 7.
4. Open the circuit breaker to be racked out, using a remote control device if available.
5. Rack out the circuit breaker using the racking tool.

*Note: Count the number of revolutions required to fully rack out the circuit breaker. Use this number as a guide in the future when racking the circuit breaker back in.*

6. If circuit breaker removal is part of a lockout/tagout procedure, complete the lockout/tagout. If desired for additional confirmation of lockout/tagout, pull the control power fuses for the circuit breaker.

### 8.2 Manual Racking – Breaker Insertion (Rack In) to an Energized Bus.

Perform the following steps:

1. Conduct pre-job brief and identify/confirm the circuit breaker(s) that will be operated and racked. Confirm communication is established with all crew members, if applicable.
2. Check the electrical task risk assessment for this SOP for the location where racking will occur. If the arc flash incident energy exceeds Category 4 (40 cal/cm<sup>2</sup>) at the stated working distance, stop work. The switchgear must be deenergized and placed in an electrically safe work condition before racking is allowed.

3. Ensure personnel that will perform manual racking operations are wearing PPE required by Section 7.
4. Remove any lockout/tagout tags and locks, if applicable. If removed, replace the control power fuses for the circuit breaker.
5. Open the compartment and confirm that the circuit breaker is squarely aligned in the cell and is seated into the starting position. Visually confirm that the circuit breaker is open.
6. Rack the circuit breaker into the cell using the racking tool.

*Note: Count the number of revolutions required to fully rack in the circuit breaker. This should be the same number as was required to rack out the circuit breaker.*

7. Visually confirm the circuit breaker is racked in.
8. If needed for system operations, close the circuit breaker, using a remote control device if available.
9. Open the circuit breaker compartment door and visually confirm that the circuit breaker is closed.

#### 9.0 **Remote Racking.**

#### 9.1 **Remote Racking – Breaker Removal (Rack Out) from an Energized Bus.**

Perform the following steps:

1. Conduct pre-job brief and identify/confirm the circuit breaker(s) that will be operated and racked. Confirm communication is established with all crew members, if applicable.
2. Check the electrical task risk assessment for this SOP for the location where racking will occur. If the arc flash incident energy exceeds Category 4 ( $40 \text{ cal/cm}^2$ ) at the stated working distance, stop work. The switchgear must be deenergized and placed in an electrically safe work condition before racking is allowed.
3. Ensure personnel that will perform remote racking operations are wearing PPE required by Section 7.
4. Open the circuit breaker to be racked out, using the remote control device.
5. Align the remote racking mechanism in front of the circuit breaker and connect to the circuit breaker racking rod.
6. Set up to operate the remote racking mechanism in accordance with the manufacturer's instructions.

7. Ensure all personnel in the area are a minimum of 20 feet away from the circuit breaker to be racked.
8. Rack out the circuit breaker using the remote racking mechanism.
9. If circuit breaker removal is part of a lockout/tagout procedure, complete the lockout/tagout.

9.2            **Remote Racking – Breaker Removal (Rack Out) from an Energized Bus.**

Perform the following steps:

1. Conduct pre-job brief and identify/confirm the circuit breaker(s) that will be operated and racked. Confirm communication is established with all crew members, if applicable.
2. Check the electrical task risk assessment for this SOP for the location where racking will occur. If the arc flash incident energy exceeds Category 4 (40 cal/cm<sup>2</sup>) at the stated working distance, stop work. The switchgear must be deenergized and placed in an electrically safe work condition before racking is allowed.
3. Ensure personnel that will perform racking operations are wearing PPE required by Section 7.
4. Remove any lockout/tagout tags and locks, if applicable. If removed, replace the control power fuses for the circuit breaker.
5. Open the compartment and confirm that the circuit breaker is squarely aligned in the cell and is seated into the starting position. Visually confirm that the circuit breaker is open.
6. Align the remote racking mechanism in front of the circuit breaker and connect to the circuit breaker racking rod.
7. Set up to operate the remote racking mechanism in accordance with the manufacturer's instructions.
8. Ensure all personnel in the area are a minimum of 20 feet away from the circuit breaker to be racked.
9. Rack the circuit breaker into the cell using the remote racking mechanism.
10. Visually confirm the circuit breaker is racked in.
11. If needed for system operations, close the circuit breaker, using a remote control device if available.

12. Open the circuit breaker compartment door and visually confirm that the circuit breaker is closed.

CANCELLED



## APPENDIX F SAMPLE SOP – FUSED CUTOUTS: OPENING, CLOSING, OR REPLACING FUSES

This appendix is optional and provides a typical SOP. Refer to Section 8-4 for requirements associated with SOPs.

The following is a sample SOP for operating overhead distribution fused cutouts or replacing fuse links inside cutouts. Modify this SOP as appropriate for the installation, the allowed work practices, and personnel qualifications.

### 1.0 Purpose.

This procedure defines the requirements for opening fused cutouts, closing fused cutouts, or replacing fuse links in fused cutouts on the overhead distribution system.

### 2.0 Applicability.

This procedure applies to personnel that are designated as a qualified person with respect to working on or near primary overhead distribution systems.

### 3.0 References.

- 29 CFR 1910, *Occupational Safety and Health, General Industry Standards*
- Unified Facilities Criteria (UFC) 3-560-01, *Operation and Maintenance: Electrical Safety*
- NFPA 70E, *Electrical Safety in the Workplace*

### 4.0 Definitions.

**Arc Flash Hazard.** A dangerous condition associated with the possible release of energy caused by an electric arc.

**Arc Rating.** The value attributed to materials that describes their performance to exposure to an electrical arc discharge. The arc rating is expressed in cal/cm<sup>2</sup> and is derived from the determined value of the arc thermal performance value (ATPV) or energy of breakopen threshold (EBT) (should a material system exhibit a breakopen response below the ATPV value). Arc rating is reported as either ATPV or EBT, whichever is the lower value.

**Balaclava (Sock Hood).** An arc-rated hood that protects the neck and head except for the facial area of the eyes and nose.

**Boundary, Arc Flash.** When an arc flash hazard exists, an approach limit at a distance from a prospective arc source within which a person could receive a second degree burn if an electrical arc flash were to occur.

**Boundary, Limited Approach.** An approach limit at a distance from an exposed energized electrical conductor or circuit part within which a shock hazard exists.

**Boundary, Restricted Approach.** An approach limit at a distance from an exposed energized electrical conductor or circuit part within which there is an increased likelihood of electric shock, due to electrical arc-over combined with inadvertent movement, for personnel working in close proximity to the energized electrical conductor or circuit part.

**De-energized.** Free from any electrical connection to a source of potential difference and from electrical charge; not having a potential different from that of the earth.

**Electrical Hazard.** A dangerous condition such that contact or equipment failure can result in electric shock, arc flash burn, thermal burn, or blast.

**Electrical Safety.** Recognizing hazards associated with the use of electrical energy and taking precautions so that hazards do not cause injury or death.

**Electrically Safe Work Condition.** A state in which an electrical conductor or circuit part has been disconnected from energized parts, locked/tagged in accordance with established standards, tested to ensure the absence of voltage, and grounded if determined necessary.

**Exposed (as applied to energized electrical conductors or circuit parts).** Capable of being inadvertently touched or approached nearer than a safe distance by a person. It is applied to electrical conductors or circuit parts that are not suitably guarded, isolated, or insulated.

**Fused Cutout.** A pole mounted interrupting device, equipped with fuses, that provides a method for de-energizing and protecting downstream electrical equipment.

**Incident Energy.** The amount of thermal energy impressed on a surface, a certain distance from the source, generated during an electrical arc event. Incident energy is typically expressed in calories per square centimeter ( $\text{cal}/\text{cm}^2$ ).

**Live Line Tool.** An insulated tool that electrically insulates the worker from the energized conductor and provides physical separation from the device being operated.

**Low-Voltage.** Any voltage below 1,000 V.

**Medium Voltage.** Voltages above 1,000 and ranging to 72,500 V.

**Qualified Person.** One who has demonstrated skills and knowledge related to the construction and operation of electrical equipment and installations and has received safety training to identify and avoid the hazards involved.

**Shock Hazard.** A dangerous condition associated with the possible release of energy caused by contact or approach to energized electrical conductors or circuit parts.

**Unqualified Person.** A person who is not a qualified person.

**Working On (energized electrical conductors or circuit parts).** Intentionally coming in contact with energized electrical conductors or circuit parts with the hands, feet, or other body parts, with tools, probes, or with test equipment, regardless of the personal protective equipment (PPE) a person is wearing. There are two categories of “working on”: Diagnostic (testing) is taking readings or measurements of electrical equipment with approved test equipment that does not require making any physical change to the equipment; repair is any physical alteration of electrical equipment (such as making or tightening connections, removing or replacing components, etc.).

#### 5.0 Training and Qualification Requirements.

Personnel using this procedure must be trained and qualified in the following:

**Emergency response training.** Contact release. First aid, emergency response, and resuscitation.

**Qualified Person Employee training.** A qualified person must be trained and knowledgeable in the construction and operation of equipment or a specific work method and be trained to identify and avoid the electrical hazards that might be present with respect to that equipment or work method. For this SOP, this includes working inside an elevated bucket, handling of live-line tools, and pole-top rescue.

Document all training.

#### 6.0 Required Approach Distances.

Table 1 lists the minimum approach distances from exposed alternating current energized parts within which a qualified worker may not approach without the use of personal protective equipment appropriate for the potential electrical hazards, or place any conductive object without an approved insulating handle, unless certain other work techniques are used (such as isolation, insulation, shielding, or guarding).

Table 1 Qualified Worker Minimum Approach Distances – AC Systems

Nominal System Voltage Range Phase to Phase (1)	Arc Flash Boundary	Limited Approach Boundary		Restricted Approach Boundary (3) (4)
	From Phase to Phase Voltage (5), (6)	Exposed Movable Conductor	Exposed Fixed Circuit Part	Includes Standard Inadvertent Movement Adder
50 V to 150 V	(2)	10 ft 0 in (3.0 m)	3 ft 6 in (1.0 m)	Avoid contact
>151 V to 750 V	(2)	10 ft 0 in (3.0 m)	3 ft 6 in (1.0 m)	1 ft 0 in (0.3 m)
>750 V to 15 kV	(2)	10 ft 0 in (3.0 m)	5 ft 0 in (1.5 m)	2 ft 2 in (0.7 m)
>15 kV to 36 kV	(2)	10 ft 0 in (3.0 m)	6 ft 0 in (1.8 m)	2 ft 9 in (0.8 m)
>36 kV to 46 kV	(2)	10 ft 0 in (3.0 m)	8 ft 0 in (2.5 m)	2 ft 9 in (0.8 m)
>46 kV to 72.5 kV	(2)	10 ft 0 in (3.0 m)	8 ft 0 in (2.5 m)	3 ft 6 in (1.0 m)
>72.5 kV to 121 kV	(2)	10 ft 8 in (3.3 m)	8 ft 0 in (2.5 m)	3 ft 6 in (1.0 m)
>121 kV to 145 kV	(2)	11 ft 0 in (3.4 m)	10 ft 0 in (3.0 m)	3 ft 10 in (1.2 m)

## Notes for Table 1:

- For single phase systems  $V_{\text{max}}$  above 250 volts,  $\frac{1}{2}$  select the range that is equal to the system's maximum phase to ground voltage times 1.732.
- The arc flash boundary is determined by an arc flash analysis.
- The restricted approach boundary is defined as the distance between energized parts and grounded objects without insulation, isolation, or guards.
- The restricted approach distance applied to hot sticks is the distance between a worker's hand and the working end of the stick.
- Only qualified workers wearing appropriate PPE are permitted to be within the arc flash boundary.
- $\frac{1}{2}$  Refer to NFPA 70E for AC voltages above 145 kV.  $\frac{1}{2}$

7.0 **Personal Protective Equipment.**

Comply with UFC 3-560-01 for PPE requirements.

De-energizing equipment before opening equipment is the preferred work procedure. If mission prohibits de-energizing equipment:

1. Review electrical task risk assessment for this SOP for the potential incident energy level.
2. Select PPE equipment to exceed calculated potential incident energy level.

Voltage-rated gloves with leather protectors (Table 2) are required for work inside the restricted approach boundary or when handling live-line tools. Select as follows:

**Table 2 Rubber Insulating Equipment Voltage Requirements**

Class of Equipment	Color Label	Maximum Use (AC Volts)	Minimum Distance <sup>1</sup> in Inches (Millimeters)
00	Beige	500	1 (25)
0	Red	1,000	1 (25)
1	White	7,500	1 (25)
2	Yellow	17,000	2 (50)
3	Green	26,500	3 (75)
4	Orange	36,000	4 (100)

*Notes for Table: Wear leather protectors over rubber gloves. Minimum distance is the minimum length that the exposed rubber glove must extend beyond the leather protector.*

#### 8.0 **Opening a Fused Cutout.**

Perform the following steps:

*Note: If the overhead distribution circuit overcurrent protection includes reclosing ability, disable upstream reclosing before starting work. Enable reclosing after work is complete.*

1. Conduct pre-job brief. Ensure all personnel are wearing required PPE. Confirm communication is established with all crew members.
2. If possible, remove load from the fused cutouts by opening the secondary main breakers in all facilities supplied through the fused cutouts.
3. Select voltage-rated gloves with leather protectors using Table 2. Inspect voltage-rated gloves and leather protectors before use. Wear voltage-rated gloves with leather protectors while performing all work inside the bucket.
4. Select and inspect the live-line insulated tool (hot stick) to be used for the work. Confirm that hot sticks have been wet tested within the last 2 years. Ensure that all tools are rated for the voltage to be worked on.

5. Position the insulated bucket truck in a position as far as possible from active traffic lanes. Place cones, barricades, and traffic markers as appropriate. Turn on all warning flashers and yellow beacons (day and night).
6. Enter and maneuver the bucket close enough to reach the fused cutouts with the insulated tool without having to reach or lean outside of the bucket.
7. Grasp the hot stick with both hands and insert the working end into the pull handle on the individual fused cutout. Pull it open in one smooth motion.
8. Open the remaining fused cutouts by the same process described above.
9. If changing the fuse(s), use the hot stick to lift and remove the fuse cartridge from the fused cutouts. To install the replacement fuse cartridge, pick up the fuse cartridge with the working end of the hot stick, position the fuse, and drop into place in the fused cutout.
10. When work is complete, return all equipment (PPE, live-line tools, and voltage-rated gloves) to their protective containers. Confirm that all tools that were used are accounted for.

#### 9.0 **Closing a Fused Cutout.**

Perform the following steps:

*Note: If the overhead distribution circuit overcurrent protection includes reclosing ability, disable upstream reclosing before starting work. Enable reclosing when work is complete.*

1. Conduct pre-job brief. Ensure all personnel are wearing required PPE. Confirm communication is established with all crew members.
2. If possible, remove load from the fused cutouts by opening the secondary main breakers in all facilities supplied through the fused cutouts.
3. Select voltage-rated gloves with leather protectors using Table 2. Inspect voltage-rated gloves and leather protectors before use. Wear voltage-rated gloves with leather protectors while performing all work inside the bucket.
4. Select and inspect the live-line insulated tool (hot stick) to be used for the work. Confirm that hot sticks have been wet tested within the last 2 years. Ensure that all tools are rated for the voltage to be worked on.
5. Position the insulated bucket truck in a position as far as possible from active traffic lanes. Place cones, barricades, and traffic markers as appropriate. Turn on all warning flashers and yellow beacons (day and night).
6. Enter and maneuver the bucket close enough to reach the fused cutouts with the insulated tool without having to reach or lean outside of the bucket.

7. Grasp the hot stick with both hands and insert the working end into the pull handle on the individual fused cutout. Lift and push closed in one smooth motion.
8. Close the remaining fused cutouts by the same process described above.
9. If changing the fuse(s), use the hot stick to lift and remove the fuse cartridge from the fused cutouts. To install the replacement fuse cartridge, pick up the fuse cartridge with the working end of the hot stick, position the fuse, and drop into place in the fused cutout.
10. When work is complete, return all equipment (PPE, live-line tools, and voltage-rated gloves) to their protective containers. Confirm that all tools that were used are accounted for.
11. If load was removed from the fused cutouts by opening the secondary main breakers in facilities supplied through the fused cutouts, restore power to the facilities by closing the secondary main breakers.

CANCELLED

## APPENDIX G SAMPLE SOP – CONNECTING/DISCONNECTING LOADBREAK ELBOWS

This appendix is optional and provides a typical SOP. Refer to Section 8-4 for requirements associated with SOPs.

The following is a sample SOP for connecting or disconnecting load break elbows on an energized bus. Modify this SOP as appropriate for the installation, the allowed work practices, and personnel qualifications.

### 1.0 Purpose.

This procedure defines the requirements for or connecting or disconnecting load break elbows on an energized circuit.

### 2.0 Applicability.

This procedure applies to personnel that are designated as a qualified person with respect to working on or near primary underground distribution systems.

### 3.0 References.

- 29 CFR 1910, *Occupational Safety and Health, General Industry Standards*
- Unified Facilities Criteria (UFC) 3-560-01, *Operation and Maintenance: Electrical Safety*
- NFPA 70E, *Electrical Safety in the Workplace*

### 4.0 Definitions.

**Arc Flash Hazard.** A dangerous condition associated with the possible release of energy caused by an electric arc.

**Arc Rating.** The value attributed to materials that describes their performance to exposure to an electrical arc discharge. The arc rating is expressed in cal/cm<sup>2</sup> and is derived from the determined value of the arc thermal performance value (ATPV) or energy of breakopen threshold (EBT) (should a material system exhibit a breakopen response below the ATPV value). Arc rating is reported as either ATPV or EBT, whichever is the lower value.

**Balaclava (Sock Hood).** An arc-rated hood that protects the neck and head except for the facial area of the eyes and nose.

**Boundary, Arc Flash.** When an arc flash hazard exists, an approach limit at a distance from a prospective arc source within which a person could receive a second degree burn if an electrical arc flash were to occur.



**Boundary, Limited Approach.** An approach limit at a distance from an exposed energized electrical conductor or circuit part within which a shock hazard exists.

**Boundary, Restricted Approach.** An approach limit at a distance from an exposed energized electrical conductor or circuit part within which there is an increased likelihood of electric shock, due to electrical arc-over combined with inadvertent movement, for personnel working in close proximity to the energized electrical conductor or circuit part.

**De-energized.** Free from any electrical connection to a source of potential difference and from electrical charge; not having a potential different from that of the earth.

**Elbow.** A connector component for connecting a power conductor to a bushing, designed so that when assembled with the bushing, the axes of the conductor and bushing are perpendicular.

**Electrical Hazard.** A dangerous condition such that contact or equipment failure can result in electric shock, arc flash burn, thermal burn, or blast.

**Electrical Safety.** Recognizing hazards associated with the use of electrical energy and taking precautions so that hazards do not cause injury or death.

**Electrically Safe Work Condition.** A state in which an electrical conductor or circuit part has been disconnected from energized parts, locked/tagged in accordance with established standards, tested to ensure the absence of voltage, and grounded if determined necessary.

**Exposed (as applied to energized electrical conductors or circuit parts).** Capable of being inadvertently touched or approached nearer than a safe distance by a person. It is applied to electrical conductors or circuit parts that are not suitably guarded, isolated, or insulated.

**Incident Energy.** The amount of thermal energy impressed on a surface, a certain distance from the source, generated during an electrical arc event. Incident energy is typically expressed in calories per square centimeter ( $\text{cal}/\text{cm}^2$ ).

**Insulated Cap.** An accessory device designed to electrically insulate, electrically shield, and mechanically seal a bushing insert or integral bushing.

**Insulated Parking Bushing.** An accessory device designed to electrically insulate, electrically shield, and mechanically seal a power cable terminated with an elbow and to be installed into a parking stand.

**Live Line Tool.** An insulated tool that electrically insulates the worker from the energized conductor and provides physical separation from the device being operated.

**Loadbreak Connector.** A connector designed to close and interrupt rated load current or less on energized circuits under rated conditions.

**Low-Voltage.** Any voltage below 1,000 V.

**Medium Voltage.** Voltages above 600 and ranging to 72,500 V.

**Qualified Person.** One who has demonstrated skills and knowledge related to the construction and operation of electrical equipment and installations and has received safety training to identify and avoid the hazards involved.

**Separable Insulated Connector.** A fully insulated and shielded system for terminating an insulated power conductor to electrical apparatus, other power conductors, or both, and designed such that the electrical connection can be readily made or broken by engaging the connector at the operating interface.

**Shock Hazard.** A dangerous condition associated with the possible release of energy caused by contact or approach to energized electrical conductors or circuit parts.

**Unqualified Person.** A person who is not a qualified person.

**Working On (energized electrical conductors or circuit parts).** Intentionally coming in contact with energized electrical conductors or circuit parts with the hands, feet, or other body parts, with tools, probes, or with test equipment, regardless of the personal protective equipment (PPE) a person is wearing. There are two categories of “working on”: Diagnostic (testing) is taking readings or measurements of electrical equipment with approved test equipment that does not require making any physical change to the equipment; repair is any physical alteration of electrical equipment (such as making or tightening connections, removing or replacing components, etc.).

## 5.0 Training and Qualification Requirements.

Personnel using this procedure must be trained and qualified in the following:

**Emergency response training.** Contact release. First aid, emergency response, and resuscitation.

**Qualified Person Employee training.** A qualified person must be trained and knowledgeable in the construction and operation of equipment or a specific work method and be trained to identify and avoid the electrical hazards that might be present with respect to that equipment or work method.

Document all training.

## 6.0 Required Approach Distances.

Table 1 lists the minimum approach distances from exposed alternating current energized parts within which a qualified worker may not approach without the use of personal protective equipment appropriate for the potential electrical hazards, or place any conductive object without an approved insulating handle, unless certain other work techniques are used (such as isolation, insulation, shielding, or guarding).

**Table 1 Qualified Worker Minimum Approach Distances – AC Systems**

Nominal System Voltage Range Phase to Phase (1)	Arc Flash Boundary	Limited Approach Boundary		Restricted Approach Boundary (3) (4)
	From Phase to Phase Voltage (5), (6)	Exposed Movable Conductor	Exposed Fixed Circuit Part	Includes Standard Inadvertent Movement Adder
50 V to 150 V	(2)	10 ft 0 in (3.0 m)	3 ft 6 in (1.0 m)	Avoid contact
>151 V to 750 V	(2)	10 ft 0 in (3.0 m)	3 ft 6 in (1.0 m)	1 ft 0 in (0.3 m)
>750 V to 15 kV	(2)	10 ft 0 in (3.0 m)	5 ft 0 in (1.5 m)	2 ft 2 in (0.7 m)
>15 kV to 36 kV	(2)	10 ft 0 in (3.0 m)	6 ft 0 in (1.8 m)	2 ft 9 in (0.8 m)
>36 kV to 46 kV	(2)	10 ft 0 in (3.0 m)	8 ft 0 in (2.5 m)	2 ft 9 in (0.8 m)
>46 kV to 72.5 kV	(2)	10 ft 0 in (3.0 m)	8 ft 0 in (2.5 m)	3 ft 6 in (1.0 m)
>72.5 kV to 121 kV	(2)	10 ft 8 in (3.3 m)	8 ft 0 in (2.5 m)	3 ft 6 in (1.0 m)
>121 kV to 145 kV	(2)	11 ft 0 in (3.4 m)	10 ft 0 in (3.0 m)	3 ft 10 in (1.2 m)

*Notes for Table 1:*

1. For single phase systems  $\sqrt{2}$  above 250 volts,  $\sqrt{2}$  select the range that is equal to the system's maximum phase to ground voltage times 1.732.
2. The arc flash boundary is determined by an arc flash analysis.
3. The restricted approach boundary is defined as the distance between energized parts and grounded objects without insulation, isolation, or guards.
4. The restricted approach distance applied to hot sticks is the distance between a worker's hand and the working end of the stick.
5. Only qualified workers wearing appropriate PPE are permitted to be within the arc flash boundary.
6.  $\sqrt{2}$  Refer to NFPA 70E for AC voltages above 145 kV.  $\sqrt{2}$

**7.0 Personal Protective Equipment.**

Comply with UFC 3-560-01 for PPE requirements.

De-energizing equipment before opening equipment is the preferred work procedure. If mission prohibits de-energizing equipment:

1. Review electrical task risk assessment for this SOP for the potential incident energy level.
2. Select PPE equipment to exceed calculated potential incident energy level.

Voltage-rated gloves with leather protectors (Table 2) are required for work inside the restricted approach boundary or when handling live-line tools. Select as follows:

**Table 2 Rubber Insulating Equipment Voltage Requirements**

Class of Equipment	Color Label	Maximum Use (AC Volts)	Minimum Distance <sup>1</sup> in Inches (Millimeters)
00	Beige	500	1 (25)
0	Red	1,000	1 (25)
1	White	7,500	1 (25)
2	Yellow	17,000	2 (50)
3	Green	26,500	3 (75)
4	Orange	36,000	4 (100)

*Notes for Table: Wear leather protectors over rubber gloves. Minimum distance is the minimum length that the exposed rubber glove must extend beyond the leather protector.*

## 8.0 Precautions.

Maneuver loadbreak connectors with a fully insulated “shot gun” live-line type tool; the live-line tool length is optional provided that the resulting working distance is less than or equal to that assumed in the electrical task risk assessment developed for this SOP. Ensure the working area is clear of obstructions or contaminants that might interfere with the operation of the connector or cause it to fall into the exposed bushing well. The operating position should allow establishing a firm footing and enable grasping the live-line tool securely, while maintaining positive control over the movement of the loadbreak connector before, during, and directly after the operating sequence. Because of the control, speed, and force required to engage or disengage an elbow, certain operating positions are more advantageous than others. If there are any concerns regarding an adequate position for handling a loadbreak connector, the operation must be practiced first on a de-energized circuit.

The following lists additional precautions and limitations for handling loadbreak connectors on an energized circuit:

- Limit work to dry weather conditions. Do not operate loadbreak connectors during wet conditions.

- Loadbreak connectors can be operated inside manholes only if the work can be accomplished with the qualified electrical worker standing outside the manhole at grade.
- Operation (connecting or disconnecting) loadbreak connectors inside a manhole with the qualified electrical worker standing inside the manhole is prohibited.
- Making a connection into a suspected fault is prohibited. De-energize the circuit prior to connection.
- If a fault occurs during connection or disconnection, replace the elbow connector and the bushing.
- Never connect an energized load break elbow into a transformer that has not been tested for proper operation.
- Never connect loadbreak elbow type surge arresters into an energized transformer or circuit.
- Never use a loadbreak connector to switch energized capacitors.
- Check the appropriate manufacturer's operating instructions to confirm the device(s) is rated for energized operation, either connecting or disconnecting.

#### 9.0 **Loadbreak Operation (Connecting) at Grade.**

Perform the following steps:

*Note: This operation might be performed as part of a switching order. If so, then coordinate the Activity with the rest of the switching order.*

1. Conduct pre-job brief. Ensure all personnel are wearing required PPE. Confirm communication is established with all crew members.
2. Select voltage-rated gloves with leather protectors using Table 2. Inspect voltage-rated gloves and leather protectors before use. Wear voltage-rated gloves with leather protectors while performing all work.
3. Select and inspect the live-line insulated tool (hot stick) to be used for the work. Confirm that hot sticks have been wet tested within the last 2 years. Ensure that all tools are rated for the voltage to be worked on.
4. Ensure the area is clear of obstructions or contaminants that might interfere with the operation of the connector.
5. Open the equipment where the loadbreak connector operation will be performed.
6. Prepare the bushing for the elbow connector by removing the insulated cap. Attach the live-line tool to the insulated cap pulling eye and remove from the bushing.

7. Securely fasten a shot gun live-line tool to the load break connector pulling eye.

*Note: This procedure assumes that the loadbreak connector is on an insulated parking bushing on the apparatus parking stand before work starts.*

8. Without exerting any pulling force, slightly rotate the connector to break any surface friction prior to disconnection from the insulated parking bushing on the apparatus parking stand.
9. After establishing a firm footing and positive control of the elbow connector, withdraw the elbow from the insulated parking bushing on the apparatus parking stand with a fast, firm, and straight motion, while being careful to avoid the ground plane.
10. Place the elbow connector receptacle area over the bushing plug and insert the elbow male contact (arc flower portion) into the bushing until a slight resistance is felt. Immediately push the elbow into the locked position with a fast, firm, and straight motion. Apply sufficient force to engage the internal lock on the elbow connector and bushing interface.
11. When work is complete, return all equipment (PPE, live-line tools, and voltage-rated gloves) to their protective containers. Confirm that all tools that were used are accounted for.

#### 10.0 **Loadbreak Operation (Disconnecting) at Grade.**

Perform the following steps:

*Note: This operation might be performed as part of a switching order. If so, then coordinate the Activity with the rest of the switching order.*

1. Conduct pre-job brief. Ensure all personnel are wearing required PPE. Confirm communication is established with all crew members.
2. Select voltage-rated gloves with leather protectors using Table 2. Inspect voltage-rated gloves and leather protectors before use. Wear voltage-rated gloves with leather protectors while performing all work.
3. Select and inspect the live-line insulated tool (hot stick) to be used for the work. Confirm that hot sticks have been wet tested within the last 2 years. Ensure that all tools are rated for the voltage to be worked on.
4. Ensure the area is clear of obstructions or contaminants that might interfere with the operation of the connector.
5. Open the equipment where the loadbreak connector operation will be performed.
6. Place the insulated parking bushing on the apparatus parking stand.
7. Firmly tighten a shot gun live-line tool to the loadbreak connector pulling eye.

8. Without exerting any pulling force, slightly rotate the connector to break any surface friction prior to disconnection.
9. After establishing a firm footing and positive control of the elbow connector, withdraw the elbow from the bushing with a fast, firm, and straight motion, while being careful to avoid the ground plane.
10. Place the connector on the insulated parking bushing and secure.
11. When work is complete, return all equipment (PPE, live-line tools, and voltage-rated gloves) to their protective containers. Confirm that all tools that were used are accounted for.

CANCELLED

**APPENDIX H SAMPLE SOP – ELECTRICAL MANHOLE/VAULT ENTRY**

This appendix is optional and provides a typical SOP. Refer to Section 8-4 for requirements associated with SOPs.

**1.0 Purpose.**

This procedure defines the requirements for work performed inside electrical manholes and vaults. Modify this SOP as appropriate for the installation, the allowed work practices, and personnel qualifications.

Arc flash calculation methodology does not address the unique configuration of an electrical manhole in which an arcing fault occurs inside a small enclosed space that also contains the worker. Additional precautions are necessary.

An IEEE interpretation, dated 14 January 2009, regarding IEEE C2 (National Electrical Safety Code) Rule 410A3, confirms that the phrase “on or near energized parts or equipment” applies to energized insulated conductors inside manholes. IEEE C2 Rule 443 does allow a qualified employee, working alone, to enter a manhole where energized cables or equipment are in service for the purpose of inspection, housekeeping, taking readings, or similar work if such work can be performed safely.

In some instances, it can be difficult to deenergize all circuits inside a manhole when accomplishing repair or installation activities because of the number of circuits inside the manhole. Accordingly, this SOP provides guidance regarding the type of work activities permitted inside manholes containing energized circuits

**2.0 Applicability.**

This procedure applies to personnel that are designated as a qualified person with respect to working on or near electrical equipment rated at 50 volts or above.

**3.0 References.**

- 29 CFR 1910, *Occupational Safety and Health, General Industry Standards*
- Unified Facilities Criteria (UFC) 3-560-01, *Operation and Maintenance: Electrical Safety*
- NFPA 70E, *Electrical Safety in the Workplace*

**4.0 Definitions.**

**Arc Flash Hazard.** A dangerous condition associated with the possible release of energy caused by an electric arc.

**Arc Rating.** The value attributed to materials that describes their performance to exposure to an electrical arc discharge. The arc rating is expressed in cal/cm<sup>2</sup> and is derived from the determined value of the arc thermal performance value (ATPV) or



energy of breakopen threshold (EBT) (should a material system exhibit a breakopen response below the ATPV value). Arc rating is reported as either ATPV or EBT, whichever is the lower value.

**Boundary, Arc Flash.** When an arc flash hazard exists, an approach limit at a distance from a prospective arc source within which a person could receive a second degree burn if an electrical arc flash were to occur.

**Boundary, Limited Approach.** An approach limit at a distance from an exposed energized electrical conductor or circuit part within which a shock hazard exists.

**Boundary, Restricted Approach.** An approach limit at a distance from an exposed energized electrical conductor or circuit part within which there is an increased likelihood of electric shock, due to electrical arc-over combined with inadvertent movement, for personnel working in close proximity to the energized electrical conductor or circuit part.

**De-energized.** Free from any electrical connection to a source of potential difference and from electrical charge; not having a potential different from that of the earth.

**Electrical Hazard.** A dangerous condition such that contact or equipment failure can result in electric shock, arc flash burn, thermal burn, or blast.

**Electrical Safety.** Recognizing hazards associated with the use of electrical energy and taking precautions so that hazards do not cause injury or death.

**Electrically Safe Work Condition.** A state in which an electrical conductor or circuit part has been disconnected from energized parts, locked/tagged in accordance with established standards, tested to ensure the absence of voltage, and grounded if determined necessary.

**Exposed (as applied to energized electrical conductors or circuit parts).** Capable of being inadvertently touched or approached nearer than a safe distance by a person. It is applied to electrical conductors or circuit parts that are not suitably guarded, isolated, or insulated.

**Incident Energy.** The amount of thermal energy impressed on a surface, a certain distance from the source, generated during an electrical arc event. Incident energy is typically expressed in calories per square centimeter ( $\text{cal}/\text{cm}^2$ ).

**Low-Voltage.** Any voltage below 1,000 V.

**Medium Voltage.** Voltages above 1,000 and ranging to 72,500 V.

**Qualified Person.** One who has demonstrated skills and knowledge related to the construction and operation of electrical equipment and installations and has received safety training to identify and avoid the hazards involved.

**Shock Hazard.** A dangerous condition associated with the possible release of energy caused by contact or approach to energized electrical conductors or circuit parts.

**Unqualified Person.** A person who is not a qualified person.

**Working On (energized electrical conductors or circuit parts).** Intentionally coming in contact with energized electrical conductors or circuit parts with the hands, feet, or other body parts, with tools, probes, or with test equipment, regardless of the personal protective equipment (PPE) a person is wearing. There are two categories of “working on”: Diagnostic (testing) is taking readings or measurements of electrical equipment with approved test equipment that does not require making any physical change to the equipment; repair is any physical alteration of electrical equipment (such as making or tightening connections, removing or replacing components, etc.).

#### 5.0 Training and Qualification Requirements.

Personnel using this procedure must be trained and qualified in the following:

**Emergency response training.** Contact release. First aid, emergency response, and resuscitation.

**Qualified Person Employee training.** A qualified person must be trained and knowledgeable in the construction and operation of equipment or a specific work method and be trained to identify and avoid the electrical hazards that might be present with respect to that equipment or work method.

Document all training.

#### 6.0 Required Approach Distances.

Table 1 lists the minimum approach distances from exposed alternating current energized parts within which a qualified worker may not approach without the use of personal protective equipment appropriate for the potential electrical hazards, or place any conductive object without an approved insulating handle, unless certain other work techniques are used (such as isolation, insulation, shielding, or guarding).

Table 1 Qualified Worker Minimum Approach Distances – AC Systems

Nominal System Voltage Range Phase to Phase (1)	Arc Flash Boundary	Limited Approach Boundary		Restricted Approach Boundary (3) (4)
	From Phase to Phase Voltage (5), (6)	Exposed Movable Conductor	Exposed Fixed Circuit Part	Includes Standard Inadvertent Movement Adder
50 V to 150 V	(2)	10 ft 0 in (3.0 m)	3 ft 6 in (1.0 m)	Avoid contact
>151 V to 750 V	(2)	10 ft 0 in (3.0 m)	3 ft 6 in (1.0 m)	1 ft 0 in (0.3 m)
>750 V to 15 kV	(2)	10 ft 0 in (3.0 m)	5 ft 0 in (1.5 m)	2 ft 2 in (0.7 m)
>15 kV to 36 kV	(2)	10 ft 0 in (3.0 m)	6 ft 0 in (1.8 m)	2 ft 9 in (0.8 m)
>36 kV to 46 kV	(2)	10 ft 0 in (3.0 m)	8 ft 0 in (2.5 m)	2 ft 9 in (0.8 m)
>46 kV to 72.5 kV	(2)	10 ft 0 in (3.0 m)	8 ft 0 in (2.5 m)	3 ft 6 in (1.0 m)
>72.5 kV to 121 kV	(2)	10 ft 8 in (3.3 m)	8 ft 0 in (2.5 m)	3 ft 6 in (1.0 m)
>121 kV to 145 kV	(2)	11 ft 0 in (3.4 m)	10 ft 0 in (3.0 m)	3 ft 10 in (1.2 m)

## Notes for Table 1:

- For single phase systems  $\geq 250$  volts, select the range that is equal to the system's maximum phase to ground voltage times 1.732.
- The arc flash boundary is determined by an arc flash analysis.
- The restricted approach boundary is defined as the distance between energized parts and grounded objects without insulation, isolation, or guards.
- The restricted approach distance applied to hot sticks is the distance between a worker's hand and the working end of the stick.
- Only qualified workers wearing appropriate PPE are permitted to be within the arc flash boundary.
- Refer to NFPA 70E for AC voltages above 145 kV.

7.0 **Personal Protective Equipment.**

Comply with UFC 3-560-01 for PPE requirements. Review the electrical task risk assessment for this SOP for the potential incident energy level.

Voltage-rated gloves with leather protectors if energized circuits can be or will be touched. Select as follows:

**Table 2 Rubber Insulating Equipment Voltage Requirements**

Class of Equipment	Color Label	Maximum Use (AC Volts)	Minimum Distance <sup>1</sup> in Inches (Millimeters)
00	Beige	500	1 (25)
0	Red	1,000	1 (25)
1	White	7,500	1 (25)
2	Yellow	17,000	2 (50)
3	Green	26,500	3 (75)
4	Orange	36,000	4 (100)

*Notes for Table: Wear leather protectors over rubber gloves. Minimum distance is the minimum length that the exposed rubber glove must extend beyond the leather protector.*

#### 7.0 **Electrical Manhole Entry.**

##### 7.1 **Access for Inspection Only – No Known Problems.**

*Note: Entry into a manhole containing energized circuits is not permitted for inspection activities if problems are suspected inside the manhole, such as conductor damage associated with a short circuit.*

*Note: A small amount of standing water is permitted for inspection activities.*

The following activities are allowed:

1. Manhole and sump inspection.
2. Sump cleaning.
3. Inspection of conductors and splices, without touching or disturbing the conductors.
4. Inspection of any equipment installed in the manhole.
5. Installation of conduit plugs on spare conduits.

Perform the following steps:

1. Conduct pre-job brief. A minimum of two qualified persons are required for this activity. Confirm communication is established with all crew members, if applicable.

2. Follow all requirements for confined space entry.
3. Ensure qualified persons are wearing PPE required by Section 6.
4. Open the electrical manhole or vault. Before entering, visually confirm that the manhole can be entered and the activity can be accomplished without disturbing energized conductors.
5. One qualified person is required to remain outside the electrical manhole or vault.
6. One or more qualified persons are allowed to enter and perform the allowed activities.

#### 7.2 **Authorized Work Inside Manholes Containing Energized Circuits.**

*Note: Entry into a manhole containing energized circuits is not permitted for inspection activities if problems are suspected inside the manhole, such as conductor damage associated with a short circuit.*

*Note: No standing water is permitted for work.*

*Note: Reracking energized conductors is not permitted. The circuits must be deenergized before the conductors can be disturbed*

The following activities are allowed:

1. Removing conduit plugs.
2. Spare conduit inspection using fish tape, boroscope, or other devices.
3. Splicing deenergized conductors. When splicing deenergized conductors, confirm that an 18-inch (0.5-meter) safe working distance from other energized conductors or equipment can be maintained during the work.
4. Pulling new conductors in spare conduits.
5. Removing abandoned (deenergized) circuits, including associated equipment, if nearby energized circuits are not disturbed.

Perform the following steps:

1. Conduct pre-job brief. A minimum of two qualified persons are required for this activity. Confirm communication is established with all crew members, if applicable.
2. Follow all requirements for confined space entry.
3. Ensure qualified persons are wearing PPE required by Section 6.

4. Open the electrical manhole or vault. Before entering, visually confirm that the manhole can be entered and the planned work activity can be accomplished without disturbing energized conductors.
5. One qualified person is required to remain outside the electrical manhole or vault.
6. One or more qualified persons are allowed to enter and perform the allowed planned work activities.

### 7.3 **Other Work Inside Manholes Containing Energized Circuits.**

Other work not covered by Section 7.1 or Section 7.2 require a job-specific energized electrical work permit. Include the following in the energized electrical work permit:

1. Description of manhole and its configuration.
2. Description of planned work activities.
3. Electrical shock and arc flash risk assessment.

*Note: Electrical analysis software packages that perform arc flash calculations do not account for an electrical manhole configuration in which the electrical worker is inside an enclosed area rather than standing adjacent to an enclosure. Increase the arc flash PPE requirements by a minimum of one (1) arc flash hazard category above the arc flash calculation result.*

4. Required PPE.
5. Minimum number of qualified electrical workers.
6. Means to restrict unqualified persons from the work area.
7. Rescue plan.

**APPENDIX I SAMPLE SOP – PROHIBITED ENERGIZED WORK ACTIVITIES**

This appendix is optional and provides a typical SOP. Refer to Section 8-4 for requirements associated with SOPs.

This SOP is an example of how to prohibit certain electrical work activities if the system cannot be deenergized. Modify this SOP as appropriate for the installation, the allowed work practices, and personnel qualifications.

**1.0 Purpose.**

This procedure defines the requirements for the following activities:

- Replacing ballasts on lighting circuits.
- Replacing or installing low-voltage receptacles.
- Installing a molded case circuit breaker into a panelboard or switchboard.

The associated electrical systems must be deenergized before performing any of the above activities. The basis for this limitation includes:

Replacing lighting system ballasts, installing receptacles, or inserting molded case circuit breakers while energized do not meet the minimum safety criteria established by OSHA for working on energized electrical circuits. OSHA 29 CFR 1910.333 limits work on live energized electrical equipment as follows:

*“Live parts to which an employee may be exposed shall be deenergized before the employee works on or near them, unless the employer can demonstrate that deenergizing introduces additional or increased hazards or is not feasible due to equipment design or operational limitations.”*

Performing the above listed tasks on energized electrical systems do not meet the OSHA criteria.

The procedures provided in this SOP for replacing lighting system ballasts, installing receptacles, or inserting molded case circuit breakers into a panelboard or switchboard are based on first deenergizing the circuit. If the area occupants do not allow the circuit(s) to be deenergized, then the procedures specify to stop work and notify your supervisor that the work will need to be rescheduled.

**2.0 Applicability.**

This procedure applies to personnel that are designated as a qualified person with respect to working on or near electrical equipment rated at 50 volts or above.

**3.0 References.**

- 29 CFR 1910, *Occupational Safety and Health, General Industry Standards*

- Unified Facilities Criteria (UFC) 3-560-01, *Operation and Maintenance: Electrical Safety*
- NFPA 70E, *Electrical Safety in the Workplace*

#### 4.0 Definitions.

**De-energized.** Free from any electrical connection to a source of potential difference and from electrical charge; not having a potential different from that of the earth.

**Electrical Hazard.** A dangerous condition such that contact or equipment failure can result in electric shock, arc flash burn, thermal burn, or blast.

**Electrical Safety.** Recognizing hazards associated with the use of electrical energy and taking precautions so that hazards do not cause injury or death.

**Exposed (as applied to energized electrical conductors or circuit parts).** Capable of being inadvertently touched or approached nearer than a safe distance by a person. It is applied to electrical conductors or circuit parts that are not suitably guarded, isolated, or insulated.

**Low-Voltage.** Any voltage below 1,000 V.

**Medium Voltage.** Voltages above 1,000 and ranging to 72,500 V.

**Qualified Person.** One who has demonstrated skills and knowledge related to the construction and operation of electrical equipment and installations and has received safety training to identify and avoid the hazards involved.

**Unqualified Person.** A person who is not a qualified person.

**Working On (energized electrical conductors or circuit parts).** Intentionally coming in contact with energized electrical conductors or circuit parts with the hands, feet, or other body parts, with tools, probes, or with test equipment, regardless of the personal protective equipment (PPE) a person is wearing. There are two categories of “working on”: Diagnostic (testing) is taking readings or measurements of electrical equipment with approved test equipment that does not require making any physical change to the equipment; repair is any physical alteration of electrical equipment (such as making or tightening connections, removing or replacing components, etc.).

#### 5.0 Training and Qualification Requirements.

Personnel using this procedure must be trained and qualified in the following:

**Emergency response training.** Contact release. First aid, emergency response, and resuscitation.

**Qualified Person Employee training.** A qualified person must be trained and knowledgeable in the construction and operation of equipment or a specific work



method and be trained to identify and avoid the electrical hazards that might be present with respect to that equipment or work method.

Document all training.

## 6.0 Required Approach Distances.

Table 1 lists the minimum approach distances from exposed alternating current energized parts within which a qualified worker may not approach without the use of personal protective equipment appropriate for the potential electrical hazards, or place any conductive object without an approved insulating handle, unless certain other work techniques are used (such as isolation, insulation, shielding, or guarding).

**Table 1 Qualified Worker Minimum Approach Distances – AC Systems**

Nominal System Voltage Range Phase to Phase (1)	Arc Flash Boundary	Limited Approach Boundary		Restricted Approach Boundary (3) (4)
	From Phase to Phase Voltage (5), (6)	Exposed Movable Conductor	Exposed Fixed Circuit Part	Includes Standard Inadvertent Movement Adder
50 V to 150 V	(2)	10 ft 0 in (3.0 m)	3 ft 6 in (1.0 m)	Avoid contact
>151 V to 750 V	(2)	10 ft 0 in (3.0 m)	3 ft 6 in (1.0 m)	1 ft 0 in (0.3 m)
>750 V to 15 kV	(2)	10 ft 0 in (3.0 m)	5 ft 0 in (1.5 m)	2 ft 2 in (0.7 m)
>15 kV to 36 kV	(2)	10 ft 0 in (3.0 m)	6 ft 0 in (1.8 m)	2 ft 9 in (0.8 m)
>36 kV to 46 kV	(2)	10 ft 0 in (3.0 m)	8 ft 0 in (2.5 m)	2 ft 9 in (0.8 m)
>46 kV to 72.5 kV	(2)	10 ft 0 in (3.0 m)	8 ft 0 in (2.5 m)	3 ft 6 in (1.0 m)
>72.5 kV to 121 kV	(2)	10 ft 8 in (3.3 m)	8 ft 0 in (2.5 m)	3 ft 6 in (1.0 m)
>121 kV to 145 kV	(2)	11 ft 0 in (3.4 m)	10 ft 0 in (3.0 m)	3 ft 10 in (1.2 m)

Notes for Table 1:

1. For single phase systems  $V_{\text{above 250 volts}}$ ,  $\sqrt{2}$  select the range that is equal to the system's maximum phase to ground voltage times 1.732.
2. The arc flash boundary is determined by an arc flash analysis.
3. The restricted approach boundary is defined as the distance between energized parts and grounded objects without insulation, isolation, or guards.

4. *The restricted approach distance applied to hot sticks is the distance between a worker's hand and the working end of the stick.*
5. *Only qualified workers wearing appropriate PPE are permitted to be within the arc flash boundary.*
6. ~~2~~ Refer to NFPA 70E for AC voltages above 145 kV./2/

#### 7.0 **Personal Protective Equipment.**

Comply with UFC 3-560-01 for PPE requirements.

#### 8.0 **Lighting Ballast Replacement**

Replace a ballast on a lighting circuit as follows:

1. Deenergize the associated lighting circuit before starting work.
2. If the area occupants do not allow lighting to be deenergized while replacing one or more lighting ballasts, stop work. Inform the area occupants that work will be rescheduled by your supervisor. Inform your supervisor that lighting ballasts were not replaced. The supervisor will work with the area occupants to establish a future date when the lighting system can be deenergized for a short period for ballast replacement.
3. After the lighting system has been deenergized, replace the lighting ballasts.
4. Comply with fall protection requirements while working.
5. After the ballasts have been replaced, restore power to the lighting circuit. Confirm lighting fixtures appear to be operating normally.

#### 9.0 **Receptacle Installation.**

Install a low-voltage receptacle as follows:

1. Deenergize the associated electrical circuit before starting work.
2. If the area occupants do not allow the electrical circuit to be deenergized, stop work. Inform the area occupants that work will be rescheduled by your supervisor. Inform your supervisor that the scheduled work was not completed. The supervisor will work with the area occupants to establish a future date when the electrical system can be deenergized for a short period for receptacle installation.
3. After the electrical system has been deenergized, install the receptacle(s) as specified.
4. After the receptacles have been installed, restore power. Confirm the circuit(s) appears to be operating normally.

10.0 **Circuit Breaker Installation.**

Install a molded-case circuit breaker into a panelboard or switchboard as follows:

1. Deenergize the associated panelboard or switchboard before starting work.
2. If the area occupants do not allow the electrical circuit to be deenergized, stop work. Inform the area occupants that work will be rescheduled by your supervisor. Inform your supervisor that the scheduled work was not completed. The supervisor will work with the area occupants to establish a future date when the electrical system can be deenergized for a short period for circuit breaker installation.
3. After the electrical system has been deenergized, install the circuit breakers as specified.
4. After the circuit breakers have been installed, restore power. Confirm the circuit appears to be operating normally.

CANCELLED

## APPENDIX J LOCKOUT/TAGOUT GUIDANCE

This appendix is optional and provides typical lockout/tagout guidance that is applicable to electrical systems. Refer to Chapter 6 for requirements

Occupational Safety and Health Organization programs address energy control (lockout and tagout) for a variety of potential hazards, including non-electrical hazards. NFPA 70E addresses energy control specifically targeted towards electrical systems and is recommended as a reference for lockout/tagout programs for electrical equipment. The following sections provide additional information associated with lockout/tagout for electrical systems.

### J-1 SAFE CLEARANCE (SWITCHING ORDER) AND LOCKOUT/TAGOUT PROCEDURES

The basic safety rule governing safe clearance and lockout/tagout procedures is that all conductors and equipment are considered energized until:

- All sources of electrical energy (verified by checking applicable up-to-date drawings, diagrams, and identification tags) have been disconnected or otherwise prevented from energizing the equipment or circuits being worked on.
- A qualified person has operated the equipment operating controls or otherwise verified that the equipment cannot be restarted.
- And, a qualified person used test equipment to test the circuit elements and electrical parts of equipment to which employees will be exposed and verified that the circuit elements and equipment parts are deenergized. The test also determines if any energized condition exists as a result of inadvertently induced voltage or unrelated voltage backfeed even though specific parts of the circuit have been deenergized and presumed to be safe.

Even with safe clearance and lockout/tagout procedures applied, all lines (circuits) and apparatus must be tested for no voltage and grounded with approved grounding methods. This will reduce the voltage across the worker to the lowest practical value possible, in case the line or equipment being worked on is accidentally energized. Table J-1 summarizes the sequence of events associated with lockout and tagout. If the lines (circuits) or equipment cannot be grounded, due to its design or other restrictions, it must be isolated. As part of safe working practices, the lockout/tagout process requires a circuit be deenergized, tested dead, isolated, tested dead, locked out, tagged, and grounded

**Table J-1 Lockout/Tagout Sequence**

<b>Steps to Place a Circuit in an Electrically Safe Work Condition</b>	
1	Notify all affected workers of hazards, their control, and any possible stored energy.
2	Prior to shutdown, check voltage to insure test meters are working properly.
3	Shut down the system by isolation of energy sources. System is made inoperative.
4	Secure all energy source shutdown methods by lockout/tagout/tryout of controls. Tryout refers to verification of successful lockout/tagout.
5	Release any stored energy and verify such release.
6	Verify by testing that the system is deenergized (no voltage). Test each phase conductor or circuit part both phase-to-phase and phase-to-ground. Before and after each test, determine that the voltage detector is operating satisfactorily. The test also determines if any energized condition exists as a result of inadvertently induced voltage or unrelated voltage backfeed.
7	Test meter on known source to ensure testing meters are working properly. Do not use a meter's "self-check" feature to verify the test meter is working properly in lieu of using a known source.
8	Provide temporary grounding.
<b>Steps to Reenergize a Circuit</b>	
1	Inspect the work area for an operationally intact system and remove nonessential items.
2	Notify all affected workers that system will be reenergized and warn them to stand clear.
3	Remove temporary grounding.
4	Remove lockout/tagout devices.
5	Visually determine that all affected workers are clear of the circuit.
6	Check voltage and phasing before re-energizing system.
7	Proceed with restoring service.

**J-1.1 Development of Procedures.**

Establish safe clearance and lockout/tagout procedures at each base or facility. Each service has documents controlling this process; refer to Section 6 for a list of documents.

**J-1.2 Lockout.**

If a device is listed on the Safe Clearance and is capable of being locked out, then apply a lock. Release any stored energy and verify such release. Use of only tagout and not lockout must be justified on the Safe Clearance. This might occur when the device is

not physically configured to accept and cannot be adapted for a lockout device. In these cases, the Safe Clearance must include provisions for other means to provide a level of safety equivalent to that obtained by a lockout.

### **J-1.3 Tagouts.**

Apply Danger (red) tags to prohibit changing the position of devices by unauthorized persons. All energy-isolating devices must be provided with a Danger tag, even those locked out. Use a Danger tagout for each Safe Clearance. Use Caution (yellow) tags in connection with a Safe Clearance to provide precautions necessary before operation of a switch or other device. Out-of-Order tags are not used as part of a Safe Clearance. If used, green tags indicate placement of a ground on a circuit or equipment. Tags and tag ties must be nonreleasable, with a minimum strength of no less than 50 lb (23 kg).

### **J-1.4 Preparation of the Safe Clearance Form (Switching Order).**

The details and the person preparing the Safe Clearance must include:

- Details of blocking, switching, tags, and locks. A second worker who is at least classified as an electrical journeyman must check this information. This check must be done before beginning any switching. Enter details in their proper sequence, reading down the form. Include any switch operations (such as opening or shutting) necessary to transfer load or put other equipment into operation.
- Supplemental direction, if necessary, to be provided to the crew involved in the work to ensure their understanding of boundaries of coverage of the Safe Clearance.

### **J-1.5 Issue (Approval) of the Safe Clearance Form (Switching Order).**

Only designated persons must be authorized to issue (approve) Safe Clearances for work by qualified personnel. These persons must be designated in writing in accordance with local procedures. The designated person in issuing (approving) a Safe Clearance must ensure that the following objectives have been met:

- Inclusion of the correct switching and equipment operations sequence.
- Provisions are included to discharge and ground capacitors and other sources of stored electrical energy that might endanger personnel.
- Provisions are included to discharge or block the release of stored non-electric energy (such as springs) in any device that could cause electric circuits to re-energize.
- Selection of a qualified worker who is authorized to receive the approved Safe Clearance and then perform the required switching and operations.

The qualified worker must have previously been approved in writing as one authorized to receive a Safe Clearance.

- Arrangements have been made for any necessary interruption of service, such as notifying users and notifying the utility company supplying power to the facility. Notifications to the utility company must be given to the person designated by the utility company to receive such information. In the event this individual cannot be reached, the nearest system operating or load dispatching office of the company must be informed.

### **J-1.6 Safe Clearance Form Description.**

Detailed information follows section by section, for completing the Safe Clearance form.

#### **J-1.6.1 Record Number.**

A consecutive number must be assigned from records maintained in the appropriate (locally designated) office.

#### **J-1.6.2 Other Clearance Numbers.**

When feasible, only one safe clearance should be issued. If more than one safe clearance will be issued, or more than one crew assigned to the work, one authorized individual-in-charge must be responsible for all the crews and supervise the receipt of all safe clearances and the removal of lockouts and tagouts. Additionally, if more than one safe clearance is to be issued on the same line or equipment, show the serial numbers of the other clearances in the upper right-hand box.

#### **J-1.6.3 Issued By, Time, and Date.**

Provide the name and signature of the person issuing the Safe Clearance and time and date of issuance. This person is often the electrical supervisor.

#### **J-1.6.4 Issued To.**

Fill in the name of the person receiving the Safe Clearance. Safe Clearances must be issued only to workers authorized to receive them. A list of all such workers must be kept in the office that contains Safe Clearance records. The worker receiving a Safe Clearance is responsible for checking all lockouts and tagouts, especially being assured that all points of possible feed, including stored-energy devices, are open, locked out, and provided with correct tagouts.

#### **J-1.6.5 Line/Equipment Involved.**

Give a brief description of the lines or equipment on which work is to be performed. This information is prepared prior to issuance of the Safe Clearance.

**J-1.6.6 Details of Blocking and Tagging.**

Step-by-step instructions and supplemental information are provided relative to hanging tags and installing lockouts. This information is prepared prior to issuance of the Safe Clearance.

**J-1.6.7 Time Applied.**

Progressing downward in proper sequence of the form, fill in the actual time each step of the details is performed.

**J-1.6.8 Released By, Time Released, and Date Released.**

Provide the name and signature of the person releasing the Safe Clearance. This is usually the authorized individual-in-charge for the job. The person releasing a Safe Clearance is responsible for making sure that all workers and temporary grounds are clear and that the line or equipment is ready to return to service.

*Note: Switching operations, and removal of lockouts and tagouts are not yet approved or accomplished at this point.*

**J-1.6.9 Accepted By.**

Provide the name and signature of the person accepting the release of the Safe Clearance. This is often the same person that issued the Safe Clearance. If more than one Safe Clearance is issued for the same equipment or location, this person is also responsible for ensuring all Safe Clearances are released before any change is made in lockouts or tagouts. Once accepted, removal of lockouts and tagouts may be authorized, and switching operations may be performed to restore the line or equipment to service.

**J-1.6.10 Time Removed.**

Beginning with the last detail of switching, lockout, and tagout on the Safe Clearance, perform the reverse operation, progressing upward on the form, and enter the time each operation is performed. For instance, if a detail of switching, lockout, and tagout reads "Switch 'A' open and hang danger tag" the opposite operation is "remove danger tag and Switch 'A' shut." Do not operate the equipment or perform any switching operation after removing your danger tag if it is still tagged with another danger tag.

*Note: If lockouts and tagouts have been installed for more than one Safe Clearance on the same equipment or line, perform no switching operations until releases have been accepted for all Safe Clearances.*

**J-1.6.11 Notification.**

Return the completed Safe Clearance form to the office that retains Safe Clearance records.



## **J-1.7 Lockout and Tagout Precautions.**

### **J-1.7.1 Single Blade Stick-Operated Disconnect Switches.**

A single blade, stick-operated disconnect switch cannot be mechanically blocked open and ordinarily is not capable of being locked out. In this case, a danger tag hung on each phase would normally be considered an acceptable provision for electrical safety. Suitable tag holders, made of insulating material and designed for installation with a hot stick, must be used on single blade stick-operated disconnect switches, fused cutouts, open jumpers, and similar visible line breaks.

### **J-1.7.2 Gang-Operated Switches.**

Gang-operated switches are normally designed to be locked open and a single danger tag must be tied on the locked switch. Tag must be secured with minimum 50-pound pull-rated tie.

### **J-1.7.3 Overhead Lines.**

On overhead lines, a visible line break must be provided at all points of possible feed. An opened circuit breaker is not normally acceptable in lieu of a visible line break on overhead systems, and must be used only when it is not feasible to remove the line side leads from the circuit breaker bushings and it is not possible to provide a visible line break near the circuit breaker. If a circuit breaker is used for electrical isolation, the circuit breaker must be mechanically blocked or locked open, and a danger tag tied on the circuit breaker. Additionally, the authorized individual-in-charge must ensure workers are particularly careful in determining that the line is actually deenergized. Also, temporary grounds must be installed on overhead systems as close as possible to the worker. Tag must be secured with minimum 50-pound pull-rated tie.

### **J-1.7.4 Underground Lines.**

On underground systems, it is often not feasible to provide a visible line break. For these systems, use of a circuit breaker or subway disconnect switch locked or blocked mechanically in the open position and provided with a danger tag is acceptable. The authorized individual-in-charge must ensure workers are particularly careful in determining that the line is actually deenergized. Also, temporary grounds must be installed on underground system as close as possible to the worker.

### **J-1.7.5 Fused Cutouts.**

Fuse cutouts must be blocked or locked in the open position, the fuse block removed, and the clamp provided with a Danger tag.

### **J-1.7.6 Normally Open Switches.**

A Caution tag must be hung on a normally open switch if it has been closed to tie two lines together prior to taking a line out of service. For example, a normally open switch might be closed to provide an alternate source for a line that is downstream of the

intended work location. The position of the switch with the Caution tag must not be changed without prior approval of the authorized individual-in-charge. When all work is completed, this Caution tag will be removed as part of returning the system to its normal operating lineup. If the position of the switch with the Caution tag is to remain in the changed position (the normally open point in the system has moved to another location), the Safe Clearance must be updated with the new position and the date and time the change was made. Update system documentation to reflect the modified system configuration. Tag must be secured with minimum 50-pound pull-rated tie.

## **J-2 ENERGY CONTROL (LOCKOUT/TAGOUT).**

### **J-2.1 Low-Voltage Levels.**

Maintain the minimum approach distances given in Table 3-1 and wear appropriate personal protective equipment until the lines and equipment are positively proven to be in an electrically safe working condition. Safe Clearance procedures apply to low-voltage levels. Lines and equipment must be positively proven to be in an electrically safe work condition before work is begun. A locally approved voltage detector may be used for this test in conjunction with a direct contact voltmeter. Test each phase conductor or circuit part both phase-to-phase and phase-to-ground. Before and after each test, determine that the voltage detector is operating satisfactorily. Determine by test if any energized condition exists as a result of inadvertently induced voltage or unrelated voltage backfeed. A meter's "self-check" feature cannot be used to verify the test meter is working properly in lieu of using a known source. All energized conductors or equipment within reach of workers must be covered with insulating material or approved rubber protective equipment. Temporary grounding must be installed on lines and equipment to be worked on, unless the authorized individual-in-charge determines that temporary grounding is not practical. The authorized individual-in-charge must explain to the work crew the reasons for not installing temporary grounding. If it is not practical or possible to install temporary grounding then other methods of protection must be provided, such as, circuit breakers racked out to the disconnected position, removal of fuses from disconnect switches, disconnect conductors from terminals to isolate the circuit or equipment being worked on, or other methods. When pulling in new conductors near energized conductors, the new conductors must be provided with temporary grounds, and treated as if energized until the work is complete. Always treat bare wire communication conductors and neutrals on power poles as energized lines and use appropriate personal protective equipment.

### **J-2.2 High-Voltage Levels.**

Maintain the minimum approach distances given in Table 3-1 and wear appropriate personal protective equipment until the lines and equipment are proven to be in an electrically safe work condition. Use a locally approved voltage detector for this purpose. Test each phase conductor or circuit part both phase-to-phase and phase-to-ground. Before and after each test, determine that the voltage detector is operating satisfactorily. Determine by test if any energized condition exists as a result of inadvertently induced voltage or unrelated voltage backfeed. A meter's "self-check" feature cannot be used to verify the test meter is working properly in lieu of using a

known source. If an energized conductor is not available for the check, the detector may be checked on a spark plug of a running gasoline-powered engine. Commercially available spark testing devices can also be used. Include the following:

- Confirm that reactors and connected equipment are in an electrically safe work condition.
- Discharge surge arresters and stored energy devices in accordance with manufacturer's recommendations or local instructions.

After the lines or equipment have been proven to be in an electrically safe work condition, install a cluster mount ground on the pole the worker is working. When installing temporary grounds, make the earth connection first and then connect to the conductor or equipment. Use a hot stick when making the connection to the conductor due to the hazard of static discharge. When removing temporary grounds disconnect the earth connection last. Refer to Section 7 for additional grounding information.

CANCELLED

## APPENDIX K GLOSSARY

### ***Abbreviations and Acronyms:***

**ac**—Alternating Current

**AED**—Automatic External Defibrillator

**AFCEC**—Air Force Civil Engineer Center

**AFI**—Air Force Instruction

**AHJ**—Authority Having Jurisdiction

**ANSI**—American National Standards Institute

**AR**—Arc Rated

**ASTM**—American Society for Testing and Materials

**AWG**—American Wire Gauge

**BIL**—Basic Impulse Insulation Level

**cal/cm<sup>2</sup>**—Calories per centimeter squared

**CFR**—Code of Federal Regulations

**cm**—Centimeter

**CPR**—Cardiopulmonary Resuscitation

**CT**—Current Transformer

**dB**—Decibel

**dc**—Direct Current

**DoD**—Department of Defense

**EM**—Electromagnetic

**EMS**—Emergency Medical Service

**ER**—Engineering Regulation

**FRP**—Fiberglass-Reinforced Plastic

**ft**—Feet or foot

**HID**—High Intensity Discharge

**HQ**—Headquarters

**HVAC**—Heating, Ventilating, and Cooling

**Hz**—Hertz

**I**—Amperes

**IEEE**—Institute of Electrical and Electronics Engineers

**in**—inch

**ISEA** – International Safety Equipment Association

**J**—Joules

**J/cm<sup>2</sup>**—Joules per centimeter squared

**JHA**—Job Hazard Analysis

**JSA**—Job Safety Analysis

**kg**—Kilogram

**kW**—Kilowatts

**kWh**—Kilowatt Hours

**kV**—Kilovolts

**kVA**—Kilovolt-Amperes

**L**—Liter

**lb**—Pound

**LEL**—Lower Explosive Level

**m**—Meter

**MDF**—Main Distribution Frame

**MI**—Mineral Insulated

**MIL HDBK**—Military Handbook

**mm**—Millimeter

**MOV**—Metal Oxide Varistor

**MTS**—Maintenance Testing Specifications

**NAVFAC**—Naval Facilities

**NEC**—National Electrical Code

**NEMA**—National Electrical Manufacturers Association

**NESC**—National Electrical Safety Code

**NETA**—International Electrical Testing Association

**NFPA**—National Fire Protection Association

**O&M**—Operations and Maintenance

**ORM**—Operational Risk Analysis

**OSHA**—Occupational Safety and Health Administration

**PCB**—Polychlorinated Biphenyl

**PPE**—Personal Protective Equipment

**PT**—Potential Transformer

**R**—Resistance

**RE**—Remote

**RMS**—Root-Mean-Square

**SDS**—Safety Data Sheet

**SF<sub>6</sub>**—Sulfur Hexafluoride

**SOP**—Standard Operating Procedure

**SWD**—Switching Duty

**TM**—Technical Manual

**UFC**—Unified Facilities Criteria

**UPS**—Uninterruptible Power Supply

**US**—United States

**USACE**—U.S. Army Corps of Engineers

**V**—Volt

**VAC**—Volts Alternating Current

**VDC**—Volts Direct Current

**VRLA**—Valve-Regulated Lead Acid

**W**—Watts

**X**—Reactance

**X/R**—Ratio of Reactance to Resistance

**Terms:**

Note: The terms listed here are provided for clarification of the design criteria provided in this UFC. Refer to IEEE 100, *The Authoritative Dictionary of IEEE Standards Terms*, for additional electrical-related definitions.

**Accessible, Readily** (as applied to equipment)— Capable of being reached quickly for operation, renewal, or inspections without requiring those to whom ready access is requisite to actions such as to use tools, to climb over or remove obstacles, or to resort to portable ladders, and so forth.

**Ampacity**—The current, in amperes, that a conductor can carry continuously under the conditions of use without exceeding its temperature rating.

**Approved**—Acceptable to the authority having jurisdiction.

**Arc Duration**—The time span of an arc from initiation to extinction, usually specified as a number of cycles of current, typically 60 Hz or 50 Hz.

**Arc Energy**—The total energy discharged to a surrounding area by an electric arc.

**Arc Rating**—The value attributed to materials that describes their performance to exposure to an electrical arc discharge. The arc rating is expressed in cal/cm<sup>2</sup> and is derived from the determined value of the arc thermal performance value or energy of breakopen threshold. Arc rated clothing or equipment indicates that it has been tested for exposure to an electric arc. Flame resistant clothing without an arc rating has not been tested for exposure to an electric arc. All arc rated clothing is also flame resistant.

**Arc Thermal Protective Value**—For protective clothing is the minimum incident thermal energy that causes the onset of a second degree burn based on the energy transmitted through the clothing.

**Authority Having Jurisdiction (AHJ)**— An organization, office, or individual responsible for enforcing the requirements of a code or standard, or for approving equipment, materials, an installation, or a procedure.

**Authorized Person**—A person approved or assigned by a supervisor to perform a specific duty or duties or to be at a specific location or locations at the job site.

**Available Short-Circuit Current**—The maximum current that the power system can deliver through a given circuit point to any negligible impedance short circuit applied at the given point, or at any other point that will cause the highest current to flow through the given point.

**Barehand Work**—A technique of performing work on live parts, after the employee has been raised to the potential of the live part.

**Barricade**—A physical obstruction such as tape, cones, or structures intended to provide a warning about and to limit access to a hazardous area.

**Barrier**—A physical obstruction that is intended to prevent contact with equipment or energized electrical conductors, or to prevent unauthorized access to a work area.

**Blocking**—Placing a switch in the open or closed position and mechanically ensuring the position of the switch cannot be accidentally changed.

**Bolted Fault**—The highest magnitude short circuit current for a particular fault location. The impedance at the fault location is usually very low or zero for a bolted fault.

**Bonding**—A reliable connection to assure electrical conductivity. In terms of grounding, the permanent joining of metallic parts to form an electrically conductive path to assure electrical continuity with the capacity to conduct safely any current likely to be imposed.

**Bonding Conductor**—A conductor used specifically for the purpose of bonding.

**Boundary, Arc Flash**—The distance from an arc source (energized exposed equipment) at which the potential incident heat energy from an arcing fault on the surface of the skin is  $1.2 \text{ cal/cm}^2$  ( $5 \text{ J/cm}^2$ ). Within this boundary, workers are required to wear protective clothing, such as arc rated shirts and pants and other PPE. This boundary was previously referred to as the Flash Protection Boundary by NFPA 70E.

**Boundary, Limited Approach**—An approach limit at a distance from an exposed energized electrical conductor or circuit part within which a shock hazard exists.

**Boundary, Restricted Approach**—An approach limit at a distance from an exposed energized electrical conductor or circuit part within which there is an increased likelihood of electric shock, due to electrical arc-over combined with inadvertent movement, for personnel working in close proximity to the energized electrical conductor or circuit part.

**Cardiopulmonary Resuscitation (CPR)**—An emergency medical procedure which includes opening and maintaining an airway, providing ventilation through rescue breathing, and providing artificial circulation through the use of external cardiac compression.



**Circuit Breakers Incorporating Ground Fault Protection**—Circuit breakers that perform all normal circuit breaker functions and also trip when a current to ground exceeds some predetermined value.

**Circumaural**—ear protection type that covers the outer/external part of the ear.

**Clearing Time**—The total elapsed time between the beginning of an overcurrent and the final interruption of the circuit at rated voltage. For a fuse, the clearing time is considered the sum of the melting time and the arcing time. For a breaker, the clearing time is the elapsed time between the actuation of a release device and the instant of arc extinction on all poles of the primary arcing contacts.

**Conductor**—A material (usually a wire, cable, or bus bar) for carrying an electric current. *Note: This term is used only with reference to current carrying parts which are sometimes alive (energized).*

**Cycle**—One cycle equals  $1/60^{\text{th}}$  of a second for 60 Hz current, or  $1/50^{\text{th}}$  of a second for 50 Hz current.

**Dead Front**—Without live parts exposed to a person on the operating side of the equipment.

**Deenergized**—Free from any electrical connection to a source of potential difference and from electrical charge; not having a potential different from that of the earth.

**Earth Ground**—An electrical connection to earth obtained by a grounding electrode system.

**Electrical Hazard**—A dangerous condition such that contact or equipment failure can result in electric shock, arc flash burn, thermal burn, or blast.

**Electrically Safe Work Condition**—A state in which an conductor or circuit part has been disconnected from energized parts, locked/tagged in accordance with established standards, tested to ensure the absence of voltage, and grounded if determined necessary.

**Emergency Lighting System**—A system capable of providing minimum required illumination specified in NFPA 101, *Life Safety Code*, Section 5.9. It includes the lighting units, related backup power source(s), and required connections.

**Energized**—Electrically connected to, or is, a source of voltage.

**Energized Work**—Work on or near (e.g., part of tools being used or worker's body less than restricted approach boundary) energized or potentially energized lines (i.e. grounding, live-tool work, hotstick work, gloving, and bare hand work).

**Equipment**—A general term, including fittings, devices, appliances, luminaires, apparatus, machinery, and the like, used as a part of, or in connection with, an electrical installation.

**Equipment – Climbing**—Includes body belts, safety and climber straps, climbers and ladders.

**Equipment – Electrical Inspecting and Testing**—Electrical and mechanical devices such as voltmeters, ammeters, ohmmeters, phase meters, and similar devices.

**Equipment – Mobile and Portable Large Equipment**—Relatively large equipment items easily transported for maintenance, which must include line trucks, aerial lift trucks, motor-generator sets, pole hole diggers, and similar apparatus.

**Equipment – Protective**— Includes rubber gloves, matting, blankets, insulator hoods, and sleeves, in addition to barricades and warning devices.

**Equipment Grounding Conductor**—The conductor used to connect the non-current carrying parts of conduits, raceways, and equipment enclosures to the grounded conductor (neutral) and the grounding electrode at the service equipment (main panel) or secondary of a separately derived system, such as an isolation transformer.

**Exposed** (as applied to energized electrical conductors or circuit parts)—Circuit is in such as position that, in case of failure of supports or insulation, contact with another circuit may result. Capable of being inadvertently touched or approached nearer than a safe distance by a person. It is applied to parts that are not suitably guard, isolated, or insulated.

**Gloving**—A method of performing maintenance on energized electrical conductors rated above 600 volts and equipment whereby a worker or workers, wearing specially-made and tested insulating gloves, with or without sleeves, and using cover-up equipment while supported by the structure or insulated aerial lift equipment, work(s) directly on the energized electrical conductor or equipment.

**Ground**—A conducting connection, either intentional or accidental, by which an electric circuit or equipment is connected to the earth, or to some conducting body of relatively large extent that serves in place of the earth.

**Grounded (Grounding)**—Connected (connecting) to ground or to a conductive body that extends the ground connection.

**Grounded Neutral**—A point of an electrical system that is intentionally connected to ground.

**Grounded, Solidly**— Connected to ground without inserting any resistor or impedance device.

**Ground-Fault Circuit Interrupter**—A device intended for the protection of personnel that functions to deenergize a circuit or portion thereof within an established period of time when a current to ground exceeds some predetermined value that is less than that required to operate the overcurrent protective device of the supply input.

**Heat Flux**—The thermal intensity of an arc that is incident by the amount of energy transmitted per unit area and per unit of time, measured in calories per square centimeters per second (cal/cm<sup>2</sup>/sec).

**High Voltage**—For the purposes of this UFC, high voltage is defined as above 1,000 volts. IEEE 100 defines a high voltage system with an rms voltage above 72,500 volts.

**I<sup>2</sup>t**—Heating caused by current as a function of time.

**Incident Energy**— The amount of thermal energy impressed on a surface, a certain distance from the source, generated during an electrical arc event. Incident energy is typically expressed in calories per square centimeter (cal/cm<sup>2</sup>).

**Job Hazard Analysis (JHA)**—see Job Safety Analysis.

**Job Safety Analysis (JSA)**—A method for studying a job in order to identify hazards or potential hazards associated with each step or task involved. Additionally, it is used to develop controls or solutions to eliminate or mitigate those hazards identified. Also, referred to as a Job Hazard Analysis (JHA).

**Listed**—Equipment, materials, or services included in a list published by an organization that is acceptable to the authority having jurisdiction and concerned with evaluation of products or services, that maintains periodic inspection of production of listed equipment or materials or periodic evaluation of services, and whose listing states that either the equipment, material, or service meets appropriate designated standards or has been tested and found suitable for a specified purpose.

**Live (Energized or exposed)**—“Hot” electrically connected to a source of potential difference or electrically charged to have a potential significantly different from the earth in the vicinity. The terms “live” or “hot” are sometimes used in place of the term “current carrying” where the intent is clear to avoid repetition of the longer term.

**Live Front**—With live parts exposed to a person on the operating side of the equipment.

**Live-Line Tool**—A type of insulating tool used in various operations of energized work. This includes hot sticks.

**Live Parts**—Energized conductive components.

**Low Voltage System**—An electrical system having a maximum root-mean-square (rms) voltage of less than 1,000 V.

**Mishap**—An unplanned or unsought event or series of events that results in death, injury, or occupational illness or damage to or loss of equipment or property.

**Medium Voltage System**—An electrical system having a maximum rms ac voltage of 1,000 to 72,500 volts. For the purposes of this UFC, any voltage above 1,000 volts is referred to as “high voltage.”

**Qualified Person**—One who has demonstrated skills and knowledge related to the construction and operation of electrical equipment and installations and has received safety training to identify and avoid the hazards involved.

**Risk Assessment**—An overall process that identifies hazards, estimates the potential severity of injury or damage to health, estimates the likelihood of occurrence of injury or damage to health, and determines if protective measures are required.

**Supervisor**—Refers to the supervisor of “employees or workers” as used in this instruction. Generally includes the supervisor responsible for exterior electrical systems, the zone supervisor or foreman, and the infrastructure support element supervisor. Titles are necessary to assign specific responsibilities to a specific individual.

**Shock Hazard**—A dangerous condition associated with the possible release of energy caused by contact or approach to energized electrical conductors or circuit parts.

**Switch, Isolating**—A switch intended for isolating an electric circuit from the source of power. It has no interrupting rating, and it is intended to be operated only after the circuit has been opened by some other means.

**Tagging**—Placing a safety tag directly on a circuit opening device or equipment for additional safety to ensure it is not used or its position altered.

**Tags**—Temporary signs (usually attached to a piece of equipment or part of a structure) to warn of existing or immediate danger.

**Unqualified Person**— Any person who is not a qualified person.

**Voltage**—The greatest root-mean-square (rms) (effective) difference of potential between any two conductors of the circuit concerned.

**Working On (Energized Electrical Conductors or Circuit Parts)**—Intentionally coming in contact with energized electrical conductors or circuit parts with the hands, feet, or other body parts, with tools, probes, or with test equipment, regardless of the personal protective equipment (PPE) a person is wearing. There are two categories of “working on”: Diagnostic (testing) is taking readings or measurements of electrical equipment with approved test equipment that does not require making any physical change to the equipment; repair is any physical alteration of electrical equipment (such as making or tightening connections, removing or replacing components, etc.).