

UNIFIED FACILITIES CRITERIA (UFC)

VISUAL AIR NAVIGATION FACILITIES



UNIFIED FACILITIES CRITERIA (UFC)
VISUAL AIR NAVIGATION FACILITIES

Any copyrighted material included in this UFC is identified at its point of use. Use of the copyrighted material apart from this UFC must have the permission of the copyright holder.

U.S. ARMY CORPS OF ENGINEERS

NAVAL FACILITIES ENGINEERING COMMAND

AIR FORCE CIVIL ENGINEER SUPPORT AGENCY (Preparing Activity)

Record of Changes (changes are indicated by \1\ ... /1/)

Change No.	Date	Location
<u>1</u>	<u>7 March 2018</u>	<u>Paragraphs 1-6.4, 1-6.7, 12-1.4.17, and 12-1.8.3 modified; Chapters 13 and 14 deleted.</u>

This UFC supersedes UFC 3-535-01, dated 11 April 2017.

This UFC was not formatted using the UFC Template as specified by UFC 1-300-01.

FOREWORD

The Unified Facilities Criteria (UFC) system is prescribed by MIL-STD 3007 and provides planning, design, construction, sustainment, restoration, and modernization criteria, and applies to the Military Departments, the Defense Agencies, and the DoD Field Activities in accordance with [USD \(AT&L\) Memorandum](#) dated 29 May 2002. UFC will be used for all DoD projects and work for other customers where appropriate. All construction outside of the United States is also governed by Status of Forces Agreements (SOFA), Host Nation Funded Construction Agreements (HNFA), and in some instances, Bilateral Infrastructure Agreements (BIA.) Therefore, the acquisition team must ensure compliance with the most stringent of the UFC, the SOFA, the HNFA, and the BIA, as applicable.

UFC are living documents and will be periodically reviewed, updated, and made available to users as part of the Services' responsibility for providing technical criteria for military construction. Headquarters, U.S. Army Corps of Engineers (HQUSACE), Naval Facilities Engineering Command (NAVFAC), and Air Force Civil Engineer Center (AFCEC) are responsible for administration of the UFC system. Defense agencies should contact the preparing service for document interpretation and improvements. Technical content of UFC is the responsibility of the cognizant DoD working group. Recommended changes with supporting rationale should be sent to the respective service proponent office by the following electronic form: [Criteria Change Request](#). The form is also accessible from the Internet sites listed below.

UFC are effective upon issuance and are distributed only in electronic media from the following source:

- Whole Building Design Guide web site <http://dod.wbdg.org/>.

Refer to UFC 1-200-01, *DoD Building Code (General Building Requirements)*, for implementation of new issuances on projects.

AUTHORIZED BY:



GEORGE O. LEA, P.E.
Chief, Military Engineering Branch
U.S. Army Corps of Engineers



JOSEPH E. GOTT, P.E.
Chief Engineer
Naval Facilities Engineering Command



EDWIN H. OSHIBA, SES, DAF
Director
Air Force Civil Engineer Center

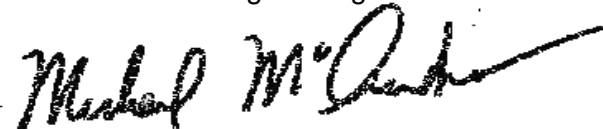

MICHAEL McANDREW
Deputy Assistant Secretary of Defense
(Facilities Investment and Management)
Office of the Assistant Secretary of Defense
(Energy, Installations, and Environment)

UNIFIED FACILITIES CRITERIA (UFC)
REVISION SUMMARY SHEET

Subject: UFC 3-535-01, *Visual Air Navigation Systems*

Supersedes: UFC 3-535-01, 11 April 2017.

Description of Changes: This revision brings requirements for new airfields in compliance with new FAA criteria for signage, updates taxiway lighting to include LED type fixtures (Engineering Brief 67D), provides grounding layouts for runway and taxiway lighting circuits, and updates terminal clearance heights (TCH) to comply with new and additional aircraft as requested by Air Force Flight Standards Agency. It also clarifies guidance in the superseded version for which multiple questions were fielded.

Reasons for Changes:

- Combine Army and Air Force criteria into one document.
- Incorporate new FAA guidance and changes.
- Provide information on testing and inspection of systems prior to service and information on the characteristics of an airfield lighting system
- Chapters 13 and 14 were removed and converted to TSEWG TP-20, *Air Visual Air Navigation Facilities: Qualifying Equipment*, and TSEWG TP-21, *Visual Air Navigation Facilities: Air Facility Equipment Inspection and Testing*, respectively (see Appendix A, "References").

Impact: Cost impact is negligible. However, the following benefit should be realized:

- Designers will have a better understanding of the design requirements.

Unification Issues

- Para 1-2 states the document scope. It indicates that "Navy requirements are currently contained in Naval Air Systems Command (NAVAIR) 51-50AAA-2. When using the NAVAIR document, be certain that the complementary markings are installed and that no conflict occurs with the placement of light fixtures." The Navy should clarify what "...no conflict occurs..." means, as it is unclear whether it references joint bases or only naval facilities.
- Para 1-5 and 1-6: Application of this document is used for Army and Air Force. Navy uses Naval Air Systems Command (NAVAIR) 51-50AAA-2, except for excerpts contained within this document which apply specifically to Navy that are not covered in NAVAIR 51-50AAA-2.

- Para 1-7: The Army and the Air Force generally follow FAA standards that are primarily published as ACs, handbooks, and specifications. However, when FAA documents are in conflict with the Air Force or Army requirements, this UFC takes precedence. For the Navy, NAVAIR 51-50AAA-2 takes precedence.
- Para 1-8.2.1: NATO STANAGs apply at Army and Air Force facilities in NATO theater countries except the United States and Canada, or wherever NATO funding is provided for the work, regardless of location. Navy application of NATO Standardization Agreements is guided by NAVAIR 51-50AAA-2.
- Para 1-10: The Army and Air Force have established tables within this document, which provide visual air navigation aids appropriate for operational requirements and associated electronic aids. See Table 2-1A, "Air Force Airfield Visual Facilities Requirements," Table 2-1B, "US Army Airfield Visual Facilities Requirements" or Table 2-3 "Theater of Operations (TO) Airfield Heliport/Helipad Visual Requirements." For the Navy, NAVAIR 51-50AAA-2 identifies visual air navigation aids appropriate for operational requirements.
- Para 1-11 provides the Air Force process for obtaining waivers to requirements of visual air navigation aids. Para 1-12 provides the Army process for obtaining waivers to requirements of visual air navigation aids. Navy waiver process is covered in NAVAIR 51-50AAA-2. These waiver processes are geared to the individual missions of these three services.
- Table 2-1A provides visual facilities requirements for Air Force airfields. Table 2-1B provides visual facilities requirements for Army airfields. Navy visual facilities requirements are provided in NAVAIR 51-50AAA-2. These visual facilities requirements are geared to the individual missions of these three services with the exception that Joint Army/Air Force bases may have additional requirements. This issue has been resolved by Army-Air Force coordination on Table 2-1A.
- Table 3-6 Visual Threshold Crossing Height Groups is modified and contains Army and Air Force coordinated information. Navy aircraft are not included.
- Figure 4-4A and Figure 4-4B provide Threshold Light Configurations for Air Force and Army, respectively. They differ, based on mission.
- Figures 4-5A through Figure 4-5D provide Threshold Light Circuiting for Air Force and Army, respectively. Interleaving is not recommended for Air Force airfields.
- Para 12-3 Siting PAPI: For aircraft in height group 4 (Table 3-6) for Army airfields only, the PAPI is sited at the RPI plus an additional 300 feet (90 meters), +50 feet –0 feet (+15 meters –0 meters), from threshold.
- Para 12-3.1.2.2 Threshold Crossing Height (TCH). See Table 3-6. For the Air Force, the TCH is based on the most predominant aircraft using the runway

(the major command will make this determination). For the Army, the TCH is based on the most demanding aircraft height group expected to use the runway (the aviation community will coordinate with US Army Aeronautical Service Agency (USAASA) for this determination).

CANCELLED

CANCELLED

CONTENTS

CHAPTER 1 INTRODUCTION TO STANDARDS AND CRITERIA.....	1
1-1	PURPOSE 1
1-2	SCOPE 1
1-3	SUMMARY OF CHANGES 1
1-4	BACKGROUND 2
1-5	APPLICATION 2
1-6	NAVY REQUIREMENTS 3
1-7	FAA STANDARDS 4
1-8	INTERNATIONAL MILITARY STANDARDS 5
1-9	BASE RIGHTS AGREEMENTS 5
1-10	VISUAL AND ELECTRONIC AIDS 5
1-11	AIR FORCE WAIVERS OF REQUIREMENT 6
1-11.1	Approval Authority 6
1-11.2	Existing Air Force Facilities 8
1-12	US ARMY WAIVERS OF REQUIREMENT 8
1-12.1	Waiver Procedures 8
1-12.2	Contents of Waiver Requests 9
1-12.3	Existing US Army Facilities 11
1-13	METRICATION OF DIMENSIONS 11
1-14	PHOTOMETRIC REQUIREMENTS..... 11
1-15	EXISTING FACILITIES..... 11
1-16	DOCUMENT ORGANIZATION. 11
1-17	UFC 3-535-02, <i>Design Drawings for Visual Air Navigation Facilities (TBD)</i> 11
CHAPTER 2 APPLICATION CRITERIA.....	13
2-1	PURPOSE OF CHAPTER 13
2-2	RELATION TO ELECTRONIC FACILITIES..... 13
2-3	APPLICATION OF REQUIREMENTS..... 13
2-4	REQUIREMENTS 13
2-5	LIGHT EMITTING DIODE (LED) LIGHT FIXTURES..... 14
2-5.1	Prohibited Placements 14
2-5.2	Signage..... 15
2-5.3	LED Performance Requirements 15
2-6	REFERENCE DOCUMENTS..... 15
CHAPTER 3 STANDARDS FOR LIGHTED APPROACH AIDS	21
3-1	APPROACH LIGHT SYSTEM WITH SEQUENCED FLASHING LIGHTS, (ALSF-1)..... 21
3-1.1	Purpose 21
3-1.2	Associated Systems..... 21
3-1.3	Configuration 21
3-1.4	Photometrics 24

3-1.5	Power Requirements	30
3-1.6	Control Requirements	31
3-1.7	Monitoring Requirements.....	31
3-1.8	Equipment.....	31
3-1.9	Compliance with International Military Standards	32
3-2	ALSF-2	32
3-2.1	Purpose	32
3-2.2	Configuration	32
3-2.3	Photometrics	33
3-2.4	Aiming Criteria	34
3-2.5	Power Requirements	34
3-2.6	Control Requirements	35
3-2.7	Monitoring Requirements.....	35
3-2.8	Equipment.....	35
3-2.9	Compliance with International Military Standards	35
3-3	SHORT APPROACH LIGHTING SYSTEM (SALS)	35
3-3.1	Purpose	35
3-3.2	Configuration	35
3-3.3	Photometrics	37
3-3.4	Power, Control and Monitoring	37
3-3.5	Equipment Used	37
3-3.6	Compliance with International Standards.....	37
3-4	SIMPLIFIED SHORT APPROACH LIGHTING SYSTEM WITH RUNWAY ALIGNMENT INDICATOR LIGHTS (SSALR).....	37
3-4.1	Purpose	37
3-4.2	Configuration	37
3-4.3	Other Requirements.....	38
3-4.4	Compliance with International Standards.....	38
3-5	MEDIUM INTENSITY APPROACH LIGHT SYSTEM WITH RUNWAY ALIGNMENT INDICATOR LIGHTS (MALSR)	39
3-5.1	Purpose	39
3-5.2	Associated Systems.....	39
3-5.3	Configuration	39
3-5.4	Photometrics.....	40
3-5.5	Aiming Criteria	41
3-5.6	Approach Light Planes.....	41
3-5.7	Tolerance.....	43
3-5.8	Power Requirements	43
3-5.9	Control Requirements	43
3-5.10	Monitoring Requirements.....	44
3-5.11	Equipment.....	44
3-5.12	Compliance with International Standards.....	44
3-6	RUNWAY END IDENTIFIER LIGHTS (REIL).....	44
3-6.1	Purpose	45
3-6.2	Associated Systems.....	45

3-6.3	Description.....	45
3-6.4	Configuration/Location/Aiming.....	45
3-6.5	Photometric Requirements.....	45
3-6.6	Power Requirements.....	45
3-6.7	Control Requirements.....	45
3-6.8	Monitoring Requirements.....	46
3-6.9	Compliance with International Standards.....	46
3-7	PRECISION APPROACH PATH INDICATOR (PAPI) SYSTEM.....	46
3-7.1	Purpose.....	46
3-7.2	Configuration.....	47
3-7.3	Photometric Requirements.....	48
3-7.4	Considerations.....	50
3-7.5	Power Requirements.....	52
3-7.6	Control Requirements.....	52
3-7.7	Foundations.....	52
3-7.8	Equipment.....	53
3-7.9	Flight Inspections.....	53
3-7.10	PAPI Siting.....	53
3-7.11	Compliance with International Standards.....	53
CHAPTER 4	STANDARDS FOR RUNWAY LIGHTING SYSTEMS.....	55
4-1	MIXING OF LIGHT SOURCE TECHNOLOGIES.....	55
4-1.1	Runway Perimeter Lighting.....	55
4-1.2	Runway Surface Lighting.....	55
4-1.3	Runway Visual Aid Requirements.....	55
4-1.4	Runway Circuiting Requirements.....	55
4-1.5	Photometric Testing.....	56
4-2	HIGH INTENSITY RUNWAY LIGHTS (HIRL) – RUNWAY EDGE LIGHTS.....	57
4-2.1	Purpose.....	57
4-2.2	Configuration.....	57
4-2.3	Photometric Requirements.....	60
4-2.4	Runway/Runway Intersections.....	60
4-2.5	Equipment.....	61
4-2.6	Power Requirements.....	61
4-2.7	Control Requirements.....	61
4-2.8	Compliance with International Military Standards.....	61
4-3	MEDIUM INTENSITY RUNWAY LIGHTS (MIRL).....	62
4-3.1	Purpose.....	62
4-3.2	Configuration.....	62
4-3.3	Photometric Requirements.....	62
4-3.4	Runway/Runway Intersections.....	62
4-3.5	Equipment.....	62
4-3.6	Power Requirements.....	63
4-3.7	Control Requirements.....	63

4-3.8	Compliance with International Military Standards	63
4-4	THRESHOLD LIGHTS	63
4-4.1	Purpose	63
4-4.2	High Intensity Threshold Light Configuration	63
4-4.3	Medium Intensity Threshold Lights	65
4-4.4	Photometric Requirements	66
4-4.5	Equipment.....	71
4-4.6	Power Requirements	71
4-4.7	Control Requirements	72
4-4.8	Aiming Threshold/ Approach.....	72
4-4.9	Monitoring Requirements.....	72
4-4.10	Compliance with International Military Standards	72
4-5	LIGHTING WITH DISPLACED THRESHOLDS	72
4-5.1	General	72
4-5.2	Configuration for Permanent Displacement	73
4-5.3	Configuration for Temporary Displacement	73
4-5.4	Equipment.....	78
4-5.5	Power, Control and Monitoring	79
4-5.6	Compliance with International Standards.....	79
4-5.7	Additional Information	79
4-6	RUNWAY END LIGHTS	79
4-6.1	Purpose	79
4-6.2	Configuration	79
4-6.3	Photometric Requirements	79
4-6.4	Equipment.....	80
4-6.5	Compliance with International Military Standards	80
4-6.6	Additional Information	81
4-7	RUNWAY CENTERLINE LIGHTS (RCL)	81
4-7.1	Purpose	81
4-7.2	Configuration.	81
4-7.3	Photometric Requirements	81
4-7.4	Adjustment and Tolerances	83
4-7.5	Equipment.....	83
4-7.6	Power Requirements	84
4-7.7	Control Requirements	84
4-7.8	Monitoring Requirements.....	84
4-7.9	Compliance with International Military Standards	84
4-8	TOUCHDOWN ZONE LIGHTS (TDZL)	84
4-8.1	Purpose	84
4-8.2	Configuration	85
4-8.3	Photometric Requirements	85
4-8.4	Adjustment and Tolerances	86
4-8.5	Equipment.....	86
4-8.6	Power, Control and Monitoring	86
4-8.7	Compliance with International Standards.....	86

4-8.8	Additional Information	87
CHAPTER 5	STANDARDS FOR TAXIWAY LIGHTING	89
5-1	TAXIWAY EDGE LIGHTING	89
5-1.1	Purpose	89
5-1.2	Configuration	89
5-1.3	Tolerances	93
5-1.4	Photometric Requirements	93
5-1.5	Equipment.....	93
5-1.6	Power Requirements	94
5-1.7	Control Requirements	94
5-1.8	Monitoring Requirements.....	94
5-1.9	Compliance with International Standards.....	94
5-2	TAXIWAY CENTERLINE LIGHTS	94
5-2.1	Purpose	94
5-2.2	Configuration	95
5-2.3	Tolerances	97
5-2.4	Equipment.....	97
5-2.5	Photometric Requirements	99
5-2.6	Power Requirements	99
5-2.7	Control Requirements	99
5-2.8	Monitoring Requirements.....	99
5-2.9	Compliance with International Standards.....	100
5-3	RUNWAY LEAD-OFF LIGHTS	100
5-3.1	Purpose	100
5-3.2	Configuration	100
5-3.3	Adjustments and Tolerances	103
5-3.4	Photometric Requirements and Horizontal Aiming	103
5-3.5	Equipment.....	103
5-3.6	Power Requirements	103
5-3.7	Control Requirements	103
5-3.8	Monitoring Requirements.....	103
5-3.9	Compliance with International Military Standards	103
5-4	TAXIWAY CLEARANCE BARS.....	103
5-4.1	Purpose	103
5-4.2	Configuration	104
5-4.3	Location of a Clearance Bar Installed at a Low Visibility Hold Point	104
5-4.4	Location of a Clearance Bar Installed at a Taxiway Intersection.....	105
5-4.5	Light Beam Orientation for Clearance Bars	105
5-4.6	Equipment.....	105
5-4.7	Photometric Requirements	105
5-4.8	Fixtures	105
5-4.9	Monitoring.....	106
5-4.10	Compliance with International Military Standards	106

5-5	RUNWAY GUARD LIGHTS (RGL)	106
5-5.1	Purpose	106
5-5.2	Configuration	106
5-5.3	Location of In-pavement Runway Guard Lights	106
5-5.4	Location of Elevated RGLs	109
5-5.5	Equipment.....	109
5-5.6	Power, Control and Monitoring	109
5-5.7	Compliance with International Standards.....	110
5-6	RUNWAY STOP BAR	110
5-6.1	Purpose	110
5-6.2	Configuration	110
5-6.3	Location of In-pavement Stop Bar Lights	110
5-6.4	Location of Elevated Stop Bar Lights	112
5-6.5	Equipment.....	113
5-6.6	Power and Control	114
5-6.7	Monitoring Requirements for Controlled Stop Bars.....	114
5-6.8	Compliance with International Standards.....	115
CHAPTER 6 STANDARDS FOR OBSTRUCTION LIGHTING		117
6-1	PURPOSE	117
6-2	OBJECTS TO BE LIGHTED	117
6-3	LIGHTING CONFIGURATION	117
6-4	LIGHTING VERSUS DAY MARKING	121
6-5	WAIVERS	121
6-6	EQUIPMENT	122
6-6.1	LED-Based Obstruction Lights.....	122
6-7	POWER REQUIREMENTS	122
6-7.1	Intensity Requirements	122
6-8	CONTROL REQUIREMENTS	122
6-8.1	Obstruction Lights.....	122
6-8.2	Dual Lighting.....	122
6-9	MONITORING REQUIREMENTS	122
6-10	COMPLIANCE WITH INTERNATIONAL STANDARDS	123
6-10.1	NATO.....	123
6-10.2	ASIC	123
CHAPTER 7 STANDARDS FOR LIGHTING HELIPADS		125
7-1	GENERAL DESCRIPTION	125
7-2	HELIPAD PERIMETER LIGHTS	125
7-2.1	Purpose	125
7-2.2	Standard Perimeter Light Configuration.....	125
7-2.3	Hospital Pad Perimeter Light Configuration	125
7-3	HELIPAD VFR LANDING DIRECTION AND APPROACH LIGHTS	125
7-3.1	Configuration of Landing Direction Lights	127
7-3.2	Purpose of Approach Direction Lights.....	128

7-3.3	Helipad IMC Approach Lights Category I	130
7-4	REFUELING AREA LIGHTS	130
7-5	HELIPAD FLOODLIGHTS	130
7-5.1	Purpose	130
7-5.2	Configuration	130
7-5.3	Helipad Refueling Floodlights	132
7-6	HELIPAD APPROACH SLOPE INDICATOR.....	132
7-6.1	Purpose	132
7-6.2	Justification	133
7-6.3	Configuration	133
7-7	HELIPAD/HELIPORT BEACON	133
7-7.1	Purpose	133
7-7.2	Configuration	133
7-7.3	Construction.....	133
7-7.4	Luminous Features	134
7-8	HELIPAD WIND DIRECTION INDICATORS.....	134
7-8.1	Purpose	134
7-8.2	Configuration	134
7-8.3	Construction.....	134
7-8.4	Illumination.....	134
7-9	PHOTOMETRIC REQUIREMENTS.....	135
7-9.1	Perimeter and Landing Direction Lights	135
7-9.2	Approach Direction Lights	135
7-9.3	Helipad Floodlights	135
7-9.4	Helipad Beacons.....	135
7-9.5	CHAPI Systems	136
7-10	POWER REQUIREMENTS	136
7-11	CONTROL REQUIREMENTS	138
7-11.1	Perimeter Lights.....	138
7-11.2	Landing Direction Lights	138
7-11.3	Approach Direction Lights.....	139
7-11.4	Helipad Floodlights	139
7-11.5	Helipad Beacons.....	139
7-11.6	CHAPI.....	139
7-12	MONITORING REQUIREMENTS.....	139
7-13	COMPLIANCE WITH INTERNATIONAL STANDARDS	139
7-13.1	ASIC	139
7-13.2	NATO.....	139
7-14	EQUIPMENT	139
CHAPTER 8	STANDARDS FOR LIGHTING HELIPOINTS	141
8-1	GENERAL DESCRIPTION.....	141
8-1.1	Helicopter Runway	141
8-1.2	Design Criteria	141
8-2	HELIPORT LIGHTS.....	143

8-2.1	Runway Edge Lights (White)	143
8-2.2	Taxiway Edge Lights (Blue)	143
8-2.3	Runway Threshold Lights	145
8-2.4	Taxiway Lights and Signs	145
8-2.5	Approach Lights	145
8-2.6	Heliport/Helipad Identification Beacon	145
8-3	ROTARY WING LANDING LANES	146
8-3.1	Rotary Wing Landing Lanes (formerly Stagefields).....	146
8-3.3	Edge Lights.....	146
8-3.4	Other Requirements.....	146
8-3.5	Threshold/End Lights.....	146
8-4	REFUELING AREA LIGHTS.....	149
8-5	HOVERLANE LIGHTING SYSTEMS.....	149
8-6	LIGHTING EQUIPMENT	149
8-6.1	Elevated Runway and Landing Lane Edge Lights	149
8-6.2	In-pavement Runway Lights	149
8-6.3	Threshold Lights	149
8-6.4	Runway Blue Lights	149
8-6.5	Refueling Area Lights.....	149
8-6.6	Runway and Taxiway Signs.....	149
8-6.7	Auxiliary Lighting.....	150
8-7	POWER REQUIREMENTS	150
8-7.1	Circuit Criteria	150
8-7.2	Cable Connectors, Plug and Receptacles	150
8-7.3	Cables.....	150
8-7.4	Isolation Transformers	150
8-8	CONTROL REQUIREMENTS	150
8-9	MONITORING REQUIREMENTS.....	152
8-10	COMPLIANCE WITH INTERNATIONAL STANDARDS.....	152
8-10.1	ASIC	152
8-10.2	NATO.....	153
8-11	EQUIPMENT	153
CHAPTER 9 STANDARDS FOR AIRFIELD SIGNS AND MARKERS.....		155
9-1	GENERAL	155
9-1.1	Purpose	155
9-1.2	Intent of Standard	155
9-1.3	Components of a Sign System	155
9-1.4	Sign Styles.....	156
9-1.5	Failure of Lighted Signs	156
9-2	MANDATORY SIGNS	157
9-2.1	Purpose	157
9-2.2	Installation.....	158
9-2.3	Characteristics	159
9-2.4	Power and Control	160

9-3	TAXIWAY GUIDANCE AND INFORMATION SIGNS	160
9-3.1	Purpose	160
9-3.2	Installation.....	162
9-3.3	Characteristics	164
9-3.4	Power and Control	165
9-4	LOCATION SIGNS	165
9-4.1	Purpose	165
9-4.2	Installation.....	166
9-4.3	Characteristics	167
9-4.4	Power and Control	168
9-5	SIGNING CONVENTIONS FOR AIRFIELD SIGNS	168
9-6	RUNWAY DISTANCE REMAINING (RDR) SIGNS.....	172
9-6.1	Purpose	172
9-6.2	Installation.....	173
9-6.3	Characteristics	175
9-6.4	Power and Control	175
9-7	ARRESTING GEAR MARKER.....	176
9-7.1	Purpose	176
9-7.2	Installation.....	176
9-7.3	Characteristics	177
9-7.4	Power and Control	178
9-8	OTHER SIGNS	178
9-8.1	Purpose	178
9-8.2	Installation.....	178
9-8.3	Characteristics	179
9-9	COMPLIANCE WITH INTERNATIONAL STANDARDS	179
9-9.1	ASIC	179
9-9.2	NATO.....	179
9-9.3	Additional Information	179
CHAPTER 10	STANDARDS FOR MISCELLANEOUS VISUAL AIDS	181
10-1	AIRPORT BEACONS.....	181
10-1.1	Purpose	181
10-1.2	Beacon Types.....	181
10-1.3	Location Requirements	182
10-1.4	Photometric Requirements	182
10-1.5	Aiming.....	183
10-1.6	Equipment.....	183
10-1.7	Power Requirements	183
10-1.8	Control Requirements	183
10-1.9	Monitoring Requirements.....	183
10-1.10	Compliance with International Military Standards	184
10-2	WIND DIRECTION INDICATORS (CONES)	184
10-2.1	Purpose	184
10-2.2	Siting Requirements	184

10-2.3	Wind Cone Configuration	184
10-2.4	Lighting Requirements	184
10-2.5	Power Requirements	185
10-2.6	Control Requirements	185
10-2.7	Monitoring Requirements	185
10-2.8	Equipment.....	185
10-2.9	Compliance with International Standards.....	185
10-2.10	Additional Information	185
10-3	RUNWAY AND TAXIWAY RETRO-REFLECTIVE MARKERS	185
10-3.1	Purpose	185
10-3.2	Characteristics	185
10-3.3	Equipment.....	186
10-4	FLOOD, SECURITY, OR AUXILIARY LIGHTING	186
10-4.1	Special Lighting Arrangements	186
10-4.2	Floodlights	186
10-4.3	Lighting Intensities	187
10-4.4	Additional Guidance.....	188
CHAPTER 11 PORTABLE EMERGENCY LIGHTING		189
11-1	GENERAL REQUIREMENTS	189
11-2	RUNWAY LIGHTING.....	189
11-2.1	Runway Edge Lighting	189
11-2.2	Runway End and Threshold Lighting	189
11-3	TAXIWAY EDGE LIGHTING	189
11-3.1	Straight Sections.....	189
11-3.2	Curved Sections	190
11-4	HELIPAD LIGHTING	190
11-5	FIXTURES	190
11-6	CONTROLS.....	190
11-7	COMPLIANCE WITH INTERNATIONAL MILITARY STANDARDS	190
11-7.1	ASIC	190
11-7.2	NATO.....	190
CHAPTER 12 DESIGN AND INSTALLATION		191
12-1	REQUIREMENTS	191
12-1.1	Light Fixture Mounting	191
12-1.2	Concrete Foundations.....	191
12-1.3	Cable and Duct Installation	191
12-1.4	Manhole/Handhole Design.....	193
12-1.5	Safety (Equipment) Grounding System.....	195
12-1.6	Counterpoise Lightning Protection System	196
12-1.7	Frangibility and Accident-Avoidance Construction	197
12-1.8	Airfield Lighting Vault	197
12-1.9	Emergency Power	201
12-1.10	Independent Power Sources.....	202

12-1.11	Airfield Lighting Control.....	202
12-1.12	Light Colors.....	207
12-1.13	Light Intensity.....	208
12-1.14	Special Considerations for Series Circuits.....	208
12-2	ADDITIONAL GUIDANCE.....	209
12-2.1	General.....	209
12-2.2	FAA Advisory Circulars (ACs).....	209
12-3	SITING PAPI.....	210
12-3.1	Considerations.....	210
12-3.2	Other Dimensions and Tolerances for PAPI.....	215
12-4	PULLING CABLE INTO DUCT.....	216
12-5	ICE DAMAGE PREVENTION.....	217
CHAPTER 13 CHARACTERISTICS OF AIRFIELD GROUND LIGHTING.....		219
13-1	GENERAL.....	219
13-2	POWER.....	222
13-3	CONTROL AND MONITORING SYSTEMS.....	222
13-4	CONSTANT CURRENT SERIES CIRCUITS.....	224
13-4.1	Circuit Failure.....	224
13-4.2	Advantages of Series Lighting Circuits.....	224
13-4.3	Major Disadvantages of Series Lighting Circuits.....	224
13-4.4	Typical Usage.....	225
13-5	CONSTANT CURRENT REGULATORS.....	225
13-6	REGULATOR SIZING.....	226
13-7	CABLE.....	230
13-8	TRANSFORMERS.....	234
13-9	LAMPS.....	234
13-10	PARALLEL CIRCUITS.....	236
13-10.1	Advantages of Parallel Lighting Circuits.....	236
13-10.2	Disadvantages of Parallel Lighting Circuits.....	236
13-10.3	Common Uses.....	237
13-11	CURRENT AND VOLTAGE ON SERIES CIRCUITS.....	237
13-12	CONSIDERATIONS FOR CIRCUIT DESIGN.....	239
13-13	CIRCUIT CONFIGURATION.....	240
13-13.1	Single Circuit per Lighting System.....	240
13-13.2	Multiple Circuits per Lighting System - Split Circuits.....	240
13-13.3	Multiple Circuits per Lighting System - Interleaved Circuits.....	240
13-14	PARALLEL CIRCUITS.....	240
13-15	PHOTOMETRIC CHARACTERISTICS OF LIGHT FIXTURES.....	241
13-15.1	Airfield Lighting.....	241
13-15.2	Wattage.....	241
13-15.3	Isocandela Curves.....	242
13-15.4	Main Beam Ellipse.....	243
13-15.5	Photometric Testing of New Airfield Lighting Systems.....	243
13-15.6	Photometric Testing of Existing Lighting Systems.....	244/1/

APPENDIX A REFERENCES..... 245
APPENDIX B GLOSSARY 252

FIGURES

Figure 3-1 ALSF-1 Configuration 23
 Figure 3-2 Approach Lighting Photometrics 25
 Figure 3-3 Ideal Light Plane Elevation Limits 28
 Figure 3-4 Block Diagram-Approach Lighting, ALSF-1..... 30
 Figure 3-5 ALSF-2 Configuration 33
 Figure 3-6 Block Diagram-Approach Lighting, ALSF-2..... 34
 Figure 3-7 SALS Configuration 36
 Figure 3-8 SSALR Configuration 38
 Figure 3-9 MALSR Configuration 40
 Figure 3-10 Light Plane Elevation Limits 42
 Figure 3-11 PAPI Configuration 48
 Figure 3-12 PAPI Photometric Requirements 49
 Figure 3-13 PAPI Aiming Criteria 50
 Figure 4-1 Optional Interleaved Runway Lighting Circuits (not recommended for
 Air Force Airfields) 56
 Figure 4-2 Runway Edge Light Configuration..... 58
 Figure 4-3 Elevated Fixture Height..... 59
 Figure 4-4A Threshold Light Configuration for Air Force 64
 Figure 4-4B Threshold Light Configuration for Army 65
 Figure 4-5A Threshold Light Circuiting for Air Force (interleaved) 67
 Figure 4-5B Air Force (non-interleaved) 68
 Figure 4-5C Threshold Light Circuiting for Army (interleaved) 69
 Figure 4-5D Army (non-interleaved) 70
 Figure 4-6 Threshold Light Photometric Requirements 71
 Figure 4-7 Displaced Threshold Light Configuration (Permanent) Where Runway
 Surface is Used as a Taxiway with Taxiway End Lights 74
 Figure 4-8 Displaced Threshold Light Configuration (Permanent) Where Runway
 Surface is Used for Takeoff and Landing Rollout 75
 Figure 4-9 Displaced Threshold Lighting Configuration (Temporary) 76
 Figure 4-10 Displaced Threshold Lighting Configuration With Co-Located
 Threshold/End of Runway Lights (Temporary) 77
 Figure 4-11 Runway End Light Photometrics 80
 Figure 4-12 Runway Centerline Light Configuration..... 82
 Figure 4-13 Runway Centerline Light Photometric Configuration..... 83
 Figure 4-14 Touchdown Zone Light Photometric Requirements 86
 Figure 5-1 Taxiway Edge Lighting Configuration (Straight) 90
 Figure 5-2 Taxiway Edge Lighting Configuration (Curves) 91
 Figure 5-3 Taxiway Edge Lighting Configuration Entrance/Exit 92
 Figure 5-4 Taxiway Circuit Layout 96

Figure 5-5 Taxiway Centerline Lighting Configuration (See FAA AC 120-57A).....	98
Figure 5-6 Taxiway Long Radius High Speed Exit Lights, Radius > 1,200 FT (360 M) (See FAA AC 120-57A).....	101
Figure 5-7 Taxiway Short Radius High Speed Exit Lights, Radius ≤ 1,200 FT (360 M) (See FAA AC 120-57A).....	102
Figure 5-8 Runway Guard Light Configuration	107
Figure 5-9 Light Beam Aiming Point for In-Pavement RGLs and Stop Bars.....	108
Figure 5-10 Runway Stop Bar Configuration.....	111
Figure 5-11 Typical Light Beam Orientation for In-Pavement RGLs and Stop Bars...	113
Figure 5-12 FAA L-862S, Elevated Stop Bar Light.....	114
Figure 6-1 Obstruction Light Configuration, Height up to 350 Feet (105 Meters)	118
Figure 6-2 Obstruction Light Configuration Height 150 to 350 Feet (45 to 105 Meters)	119
Figure 6-3 Obstruction Light Configuration Height 350 to 700 Feet (105 to 210 Meters)	120
Figure 6-4 Obstruction Lights on Buildings.....	121
Figure 7-1 Helipad Perimeter Lights, Standard Configuration	126
Figure 7-2 Helipad Perimeter Lights, Hospital Configuration.....	127
Figure 7-3 VFR Helipad Landing Direction Lights	128
Figure 7-4 Helipad VFR Approach Direction Lights.....	129
Figure 7-5 Approach Lights Category I.....	131
Figure 7-6 Helipad Floodlight Typical Configuration.....	132
Figure 7-7 Block Diagram Without Tower.....	137
Figure 7-8 Block Diagram with Tower	138
Figure 8-1 Layout Heliport Lighting	141
Figure 8-2 Rotary Wing Landing Lane.....	142
Figure 8-3 Heliport Threshold and Edge Light Details.....	143
Figure 8-4 Runway/Runway L Intersection.....	144
Figure 8-5 Runway/Runway T Intersection	144
Figure 8-6 Hoverlane Lighting Syste	148
Figure 8-7 Block Diagram Typical System	151
Figure 9-1 Typical Mandatory Signs.....	158
Figure 9-2 Typical Taxiway Guidance and Information Signs	161
Figure 9-3 Example of Taxiway-Taxiway Intersection Sign Location	163
Figure 9-4 Typical Location Signs	166
Figure 9-5 Examples of Signing Conventions	170
Figure 9-6 Signing Examples	171
Figure 9-7 TACAN Sign Location	172
Figure 9-8 Typical RDR Signs and AGM.....	173
Figure 9-9 RDR Sign Layout Configuration	174
Figure 9-10 Arresting Gear Marker (AGM) Configuration.....	177
Figure 10-1 Apron Area Flood Lighting Uniformity Criteria.....	187
Figure 12-1 Counterpoise and Ground Rod Installation	196
Figure 12-2 Series Cutout Circuit Diagram.....	199
Figure 12-3 Installation Plan, Power Equipment	204

Figure 12-4 Power and Control System Block Diagram	205
Figure 12-5 Computerized Control System using PLC Block Diagram.....	206
Figure 12-6 Computerized Control System using PC Block Diagram.....	207
Figure 12-7 Siting PAPI without an ILS Glide Slope (1 of 2)	212
Figure 12-7 Siting PAPI without an ILS Glide Slope (2 of 2)	213
Figure 12-8 PAPI Positioning Guidance	214
Figure 13-1 Typical AGL Layout.....	221
Figure 13-2 Typical AGL Series Lighting Circuit.....	222
Figure 13-3A Calculation of Steady Burning Load at the Lowest Brightness Level	227
Figure 13-3B Sample Calculation of CCR with High Signage Load	229
Figure 13-4 Sample Calculation of CCR Test Data	231
Figure 13-4 Sample Calculation of CCR Test Data (Cont.)	232
Figure 13-5 Current and Voltage Illustration.....	238
Figure 13-6 Runway Edge Light Photometric Requirements.....	241
Figure 13-7 Photometric Isocandela Curves	242

TABLES

Table 2-1A Air Force Airfield Visual Facilities Requirements	16
Table 2-1B US Army Airfield Visual Facilities Requirements.....	18
Table 2-2 Helipad/Heliport Visual Facilities Requirements.....	19
Table 2-3 Theater of Operations (TO) Airfield/Heliport/Helipad Visual Requirements...	20
Table 3-1 Required Intensities for Elevated SFLs	24
Table 3-2 Required Intensities for In-pavement SFLs	25
Table 3-3 Brightness Control Matching Criteria.....	26
Table 3-4 Elevation Setting Angles for ALSF-1	27
Table 3-5 Elevation Setting Angles for MALSR	41
Table 3-6 Visual Threshold Crossing Height Groups	51
Table 5-1 Taxiway Centerline Light Intensity and Beam Widths	99
Table 9-1 Perpendicular Distances for Taxiway Signage from Centerline of Crossing Taxiway	162
Table 12-1 Considerations for Cable and Duct Installation	192
Table 12-2 Intensity Requirement Levels for Incandescent Light Circuits	208
Table 12-3 Aiming of FAA Type L-880 PAPI Relative to Glide Path	216
Table 12-4 Maximum Allowable Non-Armored Cable Pulling Tension, Using Dynamometer	217
Table 13-1 AGL Series Circuit Load Calculation Data Sheet	233

CHAPTER 1 INTRODUCTION TO STANDARDS AND CRITERIA

1-1 PURPOSE.

This document provides the guidance and detailed information on standard configurations and equipment. Use this document when designing, planning, constructing, and installing new systems.

1-2 SCOPE.

This document applies to Army and Air National Guard and Army and Air Force Reserve bases with responsibility for maintaining their airfield facilities. Existing systems and components are not required to be upgraded to these standards unless as part of a major rehabilitation. It is also important to note that the absence of a formerly FAA-approved NAVAID or piece of equipment from the current AC 150/5345-53, Appendix 3 Addendum is not an indication that this equipment is no longer approved for use. It means that particular NAVAID or piece of equipment is no longer manufactured. Much of this equipment is still supported for repairs by a sub-party of the former manufacturer and this NAVAID/piece of equipment may be more reliable and powerful than the one currently listed in the AC. Contact AFCEC/COSM if told that a NAVAID or piece of equipment is no longer approved for use. Beacons are one example of this situation.

This document contains the configuration standards, application and installation criteria, and a listing of applicable specifications for all visual air navigation facilities, except marking, at Air Force and US Army facilities.

Navy requirements are currently contained in Naval Air Systems Command (NAVAIR) 51-50AAA-2. When using the NAVAIR document, be certain that the complementary markings are installed and that no conflict occurs with the placement of light fixtures.

1-3 SUMMARY OF CHANGES.

This document aligns Air Force/Army airfield lighting requirements to be as close as possible to those of the FAA, with the exception of requirements that are unique to Air Force/Army facilities. FAA Advisory Circulars (AC) that are equivalent to Air Force/Army requirements are referenced. Specific requirements for the Air Force/Army are stated with appropriate data and figures provided.

- a. Requirements for lightning protection system (counterpoise) and equipment safety grounding systems are modified.
- b. Figures and details are added to further clarify requirements. Runway stop bar requirements are also added.
- c. References to other documents are updated due to cancellations or revisions.

d. The “Special Air Force Requirements” of Chapter 12 are now required for all installations.

e. Constant current regulators (CCR) are now required to be ferro-resonant type. Silicon controlled rectifier (SCR) types are no longer approved for new installations.

f. 50 kW and 70 kW constant current regulators and 2400 VAC input regulators are no longer approved for new installations.

g. Mixing of incandescent and light-emitting diode (LED) lighting technologies on a single taxiway is not permitted. In addition, mixing of fixtures by LED manufacturers on a single taxiway is not permitted. If two taxiways are on a single circuit, fixtures for each taxiway must be uniform by type and manufacturer, not on the entire circuit, provided CCR is not overloaded.

1-4 BACKGROUND.

The term “visual air navigation facilities” refers to all lights, signs, symbols, and other visual aid devices located on and in the vicinity of an airfield. These facilities provide a visual reference and guidance to pilots when operating aircraft on the ground and in the air. These facilities also supplement the guidance provided by electronic aids such as Tactical Air Navigation (TACAN), Precision Approach Radar (PAR), and Instrument Landing System (ILS), for operating aircraft. Criteria for Air Force airfield markings are contained in Air Force Instruction (AFI) 32-1042, *Standards for Marking Airfields*.

1-4.1 Visual air navigation facilities must be standardized for operational safety. Standardization means that the configuration and color of the lights at each airfield is identical and has the same meaning. Standardization enables pilots to readily interpret the guidance information.

1-4.2 Per Public Law 85-726, the FAA regulates and promotes civil aviation to foster its development and to provide for the safe and efficient use of the airspace by both civil and military aircraft. The FAA develops, modifies, tests, and evaluates systems, procedures, facilities, and devices. It also defines the performance characteristics needed for safe and efficient navigation and traffic control of all civil and military aviation.

1-5 APPLICATION.

Use this document for all major rehabilitation (i.e., when over half of the lighting system requires replacement), or for the establishment of new visual air navigation facilities at Air Force and US Army installations.

Do not install visual air navigation facilities or equipment other than those covered in this publication except when an appropriate waiver has been obtained (refer to paragraph 1-11 for Air Force waivers, or paragraph 1-12 for US Army waivers).

Exceptions are where international military standards apply, where Base Rights Agreements apply, where existing facilities configured to prior standards and criteria continues to give satisfactory service.

1-6 NAVY REQUIREMENTS.

Department of the Navy (Navy) requirements are contained in NAVAIR 51-50AAA-2. Use NAVAIR 51-50AAA-2 on all Navy airfield construction projects. NAVAIR 51-50AAA-2 takes precedence over this UFC and over FAA and International Civil Aviation Organization (ICAO) documents. This paragraph takes precedence over information presented elsewhere in this UFC regarding Navy requirements.

1-6.1 Navy airfield requirements are listed in in Table 1, "Approach Visual Aids Requirements," in NAVAIR 51-50AAA-2.

1-6.2 LED-lighted obstruction lights are not permitted on Navy projects due to the use of Night Vision Goggles (NVG) by rotary wing aircraft operations. FAA Safety Alert for Operators (SAFO) 09007 contains additional information.

1-6.3 LED-lighted airfield lighting fixtures are permitted on Navy projects with the acknowledgement from the CO or Airfield Manager that LEDs may not be compatible with Enhanced Flight Vision System (EFVS) technology. EFVS is not known to be used on current Navy aircraft.

1-6.4 Additional Navy requirements that differ from Tri-service guidance include:

a. Install counterpoise systems using the equipotential method: above airfield lighting circuits and connected to all airfield lighting equipment, including light bases, guidance signs, and other metallic structures. Reference National Fire Protection Association (NFPA) 780, Chapter 11, "Protection for Airfield Lighting Circuits." ~~11~~The required use of the equipotential method of counterpoise takes precedence over NAVAIR 51-50AAA-2 counterpoise requirements.~~11~~

b. Install counterpoise ground rods at a 2,000 foot maximum spacing and at all changes in direction, terminations, crossings, and connection to existing counterpoise.

c. Ground rods are not required in cans or on cans with counterpoise systems.

d. Do not use counterpoise wire in conduit with circuit conductors.

e. An equipment ground is not required in constant current circuit conduits.

f. Encase constant current circuit ducts in concrete only when installing under new roadways.

g. For airfield constant current and low-voltage circuits, use aircraft-rated hand holes. Manholes are required for medium-voltage power systems, per UFC 3-550-01.

- h. Use 2-inch (53 mm) PVC ducts for airfield constant current circuits, with a maximum of two airfield cables per duct, and a maximum of two constant current circuits. This permits the interleaving of two circuits within one conduit.
- i. A drain system in light bases using a duct system or hand holes is not required.
- j. Insert PVC conduit through grommets 1 inch (25 mm) (minimum) to 1.5 inches (38 mm) (maximum) into the light base.
- k. Only in-pavement fixtures use L-868 cans; elevated lights and signs use L-867 cans.
- l. Except for runway in-pavement lights, use anti-seize compound on all threaded connections made on-site to cans, light supports, and sign legs. For runway in-pavement lights use ceramic fluoropolymer coated steel bolts without anti-seize.
- m. Photometric testing of newly installed airfield light fixtures, as specified in Unified Facilities Guide Specification (UFGS) 26 56 20 is not required.
- n. Consider at taxiway or runway intersections or crossings, provide two spare 2-inch (53 mm) PVC duct bank crossings with hand holes for future use and maintenance use.

1-6.5 Airfield Lighting Control Systems (AFLCS) for Navy projects are normally provided using project funding by Space and Naval Warfare Systems Center–Atlantic (SPAWARSYSCEN-Atlantic), Code 5.2.1.1.0, email: VIDS@navy.mil. Coordinate with SPAWAR during the 1391 development and during the at early stages of the project design.

1-6.6 Precision approach path indicators (PAPI) systems for Navy projects normally require coordination with the Space and Naval Warfare Systems Center–Atlantic (SPAWARSYSCEN-Atlantic), Code 525E0, Naval Flight Information Group (NAVFIG), email: NAVFIG@NAVY.MIL. Coordinate with SPAWAR during the early stages of the project design.

1-6.7 Copies of NAVAIR 51-50AAA-2 can be obtained from the Naval Air Technical Data and Engineering Service Center, located at the following website: <https://mynatec.navair.navy.mil/natechome.htm>.

1-7 FAA STANDARDS.

The Army and Air Force generally follow FAA standards that are primarily published as ACs, handbooks, and specifications. However, when FAA documents are in conflict with the Air Force or Army requirements, this UFC takes precedence.

1-8 INTERNATIONAL MILITARY STANDARDS.

1-8.1 This UFC satisfies the requirements of international military standards to the greatest extent possible.

1-8.1.1 NATO STANAGs are promulgated by the NATO Standardization Office (NSO).

1-8.1.2 ASIC Air Standards (AIR STD) are promulgated by representatives of the military air forces of Australia, Canada, New Zealand, United Kingdom, and the United States. AIR STDs governing airfield lighting and marking, obstructions, helipads, and heliports have been cancelled.

1-8.2 Applicable international military standards take precedence over standards in this UFC as follows:

1-8.2.1 NATO.

NATO STANAGs apply at Army and Air Force facilities in NATO theater countries except the United States and Canada, or wherever NATO funding is provided for the work, regardless of location.

1-8.2.2 ASIC.

At Army and Air Force facilities in New Zealand and Australia, contact:

AF/A8XX - USAF International Standardization Office
ASIC (Air & Space Interoperability Council)
Andrews AFB MD
+1.240.612.4237 DSN 312.612.4237

1-9 BASE RIGHTS AGREEMENTS.

When the Army or Air Force builds an airfield in a foreign country, the United States obtains a Base Rights Agreement. Provisions of the Base Rights Agreement must be observed and may require that construction complies with standards of the host nation. Under such an agreement, and whether or not international standards conform with standards of the host nation, the host nation must approve all plans. It may also be desirable to use equipment produced in the host nation.

1-10 VISUAL AND ELECTRONIC AIDS.

Provide visual air navigation aids appropriate for operational requirements and associated electronic aids. See Table 2-1A, "Air Force Airfield Visual Facilities Requirements," Table 2-1B, "US Army Airfield Visual Facilities Requirements" or Table 2-3 "Theater of Operations (TO) Airfield Heliport/Helipad Visual Requirements." Except for Visual Flight Rules (VFR) operation, electronic aids are needed to provide

initial positioning and direction information to approaching aircraft. Visual landing aids ensure a timely and safe transition from the instrument phase to the visual phase of an approach. Failure to provide the necessary visual aids on an instrument runway will degrade the utility of the electronic systems. Furthermore, enhancing a runway with unnecessary visual aids wastes resources and offers minimal operational advantages. Do not upgrade visual aids for a higher level of operations unless the runway, taxiway, or helipad is approved for that level, and appropriate electronic aids are programmed for installation. Waivers are required for all deviations. Also reference paragraph 2-3.

1-10.1 Electrical support equipment, including the emergency power system, for visual and air navigational aids are not airfield obstructions. If a visual or air navigation aid is classified a “permissible deviation,” then the power equipment supporting that visual or air navigation aid is also classified a “permissible deviation,” provided:

- The support equipment is installed behind the equipment it supports, from the perspective of a landing aircraft; and
- The horizontal footprint of the equipment, from the perspective of a landing aircraft, is minimized.

1-11 AIR FORCE WAIVERS OF REQUIREMENTS.

The major command Vice Commander may waive requirements of this UFC if compliance is not practical or feasible. In exercising this waiver authority, the Commander or Vice Commander must not adversely impact the effectiveness or safety of operations for any aircraft which may use the airfield. Under normal circumstances, funding or budgetary constraints are not adequate justification for granting a waiver.

1-11.1 Approval Authority.

Authority to approve waivers resides with the major command Commander or Vice Commander and may be delegated to the Director of Operations (DO), depending upon the waiver content, but may not be re-delegated.

1-11.1.1 Installation Representative.

The installation’s representative will:

- a. Coordinate all waiver requests with the operations/airfield management and wing safety offices through the base level operations and safety divisions. In accordance with AFI 13-213 and Air Force Policy Directive (AFPD) 13-2, the operations/airfield management offices must coordinate as necessary with local wings and air traffic control agencies (e.g., FAA) providing terminal instrument procedures (TERPS) services for the affected locations.

b. Submit installation commander-approved waiver requests to AFIMSC/IZB for technical review; AFCEC Operations Directorate (AFCEC/CO) will provide subject matter expert (SME) support to AFIMSC.

c. Notify the FAA of waiver requests involving facilities at joint-use airfields subject to provisions of Title 14 Code of Federal Regulations (CFR) Part 77. Contact the regional FAA Airports Division having jurisdiction over the airfield for the requirements and coordination process. For contact information, consult http://www.faa.gov/about/office_org/headquarters_offices/arc/ro_center/ and http://www.faa.gov/airports/news_information/contact_info/regional/. Also consult local U.S. Government telephone listings for contact numbers.

d. Maintain a complete record of all waivers requested and the disposition of each (approved or disapproved). Document all approved waivers and make these waiver packages a part of the permanent facility records, available for examination during inspections. Include a list of required waivers and those approved for a specific project in the project design analysis of future projects.

e. Forward copies of the completed documentation for each approved waiver with detailed justification to: SMEs:

AFCEC/COSM	139 Barnes Drive, Suite 1 Tyndall AFB FL 32403-5319 afcec.cos.workflow@tyndall.af.mil
AFIMSC/IZB	3515 S. General McMullen Drive San Antonio TX 78226 afimsc.izb.workflow@us.af.mil
AF/A3X	1480 Air Force Pentagon Washington DC 20330-1480 afa3xa.workflow@pentagon.af.mil
HQ AFSEC/SEFF	9700 G Avenue, South East Kirtland AFB NM 87117-5367 afsec.seff@kirtland.af.mil
HQ AFFSA/A3XA	6500 South MacArthur Blvd Bldg 4, Rm 240 Oklahoma City OK 73169 hqaffsa.xam@us.af.mil
ANG NGB/A7AD	3500 Fetchett Ave Joint Base Andrews MD 20762 (for Air National Guard installations only).

1-11.1.2 MAJCOM.

The MAJCOM will:

- a. Ensure that all required coordination has been accomplished.
- b. Ensure that the type of waiver requested is clearly identified as either “Temporary” or “Permanent.” Permanent waivers are required when no further mitigating actions are intended, necessary, or available. Temporary waivers are issued for a specified period during which additional actions to mitigate the situation must be initiated to fully comply with criteria or to allow the acquisition of a permanent waiver. Follow-up inspections will be necessary to ensure that mitigating actions proposed for each temporary waiver are on schedule or progressing. Re-accomplish temporary waivers at the end of the initial period or annually, whichever is earlier.

1-11.2 Existing Air Force Facilities.

A waiver to requirements within this UFC is not required where existing facilities meet prior standards and continue to give satisfactory service.

1-12 US ARMY WAIVERS OF REQUIREMENT.

1-12.1 Waiver Procedures.

1-12.1.1 The installation’s design agent, aviation representative (safety officer, operations officer, and/or Air Traffic and Airspace (AT&A) officer) and installation master planner will:

- a. Jointly prepare/initiate waiver requests.
- b. Submit requests through the installation to the major command (ACOM).
- c. Maintain a complete record of all waivers requested and the disposition of each waiver (approved or disapproved). Include a list of required waivers and waivers approved for a specific project in the project design analysis prepared by the design agent aviation representative or installation master planner.

1-12.1.2 The ACOM will:

- a. Ensure that all required coordination has been accomplished.
- b. Ensure that the type of waiver requested is clearly identified as either “Temporary” or “Permanent.” Permanent waivers are required when no further mitigating actions are intended or necessary. Temporary waivers are issued for a specified period during which additional actions to mitigate the situation must be initiated to fully comply with criteria or to obtain a permanent waiver. Follow-up

inspections will be necessary to ensure that mitigating actions proposed for each temporary waiver granted have been accomplished.

c. Review waiver requests and forward to US Army Aeronautical Service Agency (USAASA) for action. To expedite the waiver process, ACOMs are urged to simultaneously forward copies of requests to:

Director, US Army Aeronautical Services Agency (USAASA)	ATTN: MOAS-AI 9325 Gunston Road, Suite N319 Fort Belvoir VA 22060-5582
Commander, US Army Safety Center (USASC)	ATTN: CSSC-SPC Bldg. 4905, 5 th Ave. Fort Rucker AL 36362-5363
Director, US Army Aviation Center (USAAVNC)	ATTN: ATZQ-ATC-AT Fort Rucker AL 36362-5265
Director, USACE Transportation Systems Center (TSMCX)	ATTN: CENWO-ED-TX 1616 Capitol Ave. Omaha NE 68102-2403

1-12.1.3 USAASA is responsible for coordinating the following reviews for each waiver request:

- Air traffic control and safety and risk assessments by USASC.
- Technical engineering review by TSMCX.

Based upon these reviews, USAASA makes a final determination. USAASA is responsible for all waiver actions related to Army operational airfield/airspace criteria.

1-12.2 Contents of Waiver Requests.

Reference the standard/criterion to be waived, citing paragraph and page numbers.

1-12.2.1 Justification for Waivers.

Demonstrate that safety and cost factors have been considered in justification for noncompliance, and that they adequately support the Army's mission. Reference special studies which support the decision. Adequate justification for waivers of a requirement are when:

- Specific site conditions (physical and functional constraints) make compliance with existing criteria impractical and/or unsafe:
 - Recurring adverse weather conditions require hangar space to be provided for all aircraft.
 - Lack of land/space makes it necessary to expand hangar space closer to and within the runway clearances.
 - Maintaining fixed-wing Class A clearance when support of Class B fixed-wing aircraft operations exceeds 10 percent of airfield operations.
- Deviation(s) from criteria fall within a reasonable margin of safety and do not impair construction of a facility long-range; for example, installing security fencing around and within established clearance areas.
- Construction that does not conform to criteria is the only alternative to meet mission requirements. Evidence of analysis and efforts taken to adhere to criteria and standards must be documented and referenced.

1-12.2.2 Operational Factors.

Include information on the following existing and/or proposed operational factors used in the assessment:

- Mission urgency.
- All aircraft by type and operational characteristics.
- Density of aircraft operations at each air operational facility.
- Facility capability Visual Flight Rules (VFR) or Instrument Flight Rules (IFR)).
- Use of self-powered parking versus manual parking.
- Safety of operations (risk management).
- Existing navigational aids (NAVAID).

1-12.2.3 Alternatives Considered.

Record all alternatives considered, their consequences, required mitigation, and evidence of coordination.

1-12.3 Existing US Army Facilities.

A waiver to requirements within this UFC is not required where existing facilities meet prior standards and continue to give satisfactory service.

1-13 METRICATION OF DIMENSIONS.

Use ICAO standard English or metric equivalents rounded off (e.g., 30 meters equals 100 feet), although they do not represent exact conversions. No change in standard dimensions, tolerances, or performance specifications is needed if they are applied consistently.

NOTE: Executive Order 12770 requires use of metric units in procurement of supplies and services.

1-14 PHOTOMETRIC REQUIREMENTS.

Photometric requirements in this UFC are based on standards established by the ICAO and FAA. They have been modified as necessary to accommodate Air Force requirements.

1-15 EXISTING FACILITIES.

Do not use this document as the sole basis for advancing standards for existing facilities and equipment, except where necessary for a minimum acceptable level of safety, quality, and performance. If there is a change in mission that results in a reclassification of the facility, an upgrade to current standards is required. When existing facilities are modified, construction must conform to the criteria in this UFC unless waived per paragraphs 1-11 and 1-12. If new generation equipment must be integrated with older equipment, make certain any differences in individual performance do not degrade performance of the overall system.

1-16 DOCUMENT ORGANIZATION.

Chapters 1 through 11 provide siting criteria for the design of specific installations. They also provide application criteria to ensure that planned installations are appropriate for their intended purpose.

Chapters 12 and 13 contain information concerning design, installation and performance characteristics for each system, including an explanation of the purpose, configuration, construction, photometrics, and related equipment guidelines approved for US Army and Air Force use.

1-17 UFC 3-535-02, *DESIGN DRAWINGS FOR VISUAL AIR NAVIGATION FACILITIES*. DRAFT FINAL NOV 2017

UFC 3-535-02 supplements this UFC and provides drawing details for design and construction of individual components of visual navigation facilities.

CANCELLED

CHAPTER 2 APPLICATION CRITERIA

2-1 PURPOSE OF CHAPTER.

This chapter provides application criteria to ensure that the installation of visual air navigation facilities is appropriate for the purposes intended and that they are adequate to support desired levels of operation.

2-2 RELATION TO ELECTRONIC FACILITIES.

Except for VFR operations, electronic facilities are required to provide initial positioning and direction information to an approaching aircraft. Visual air navigation aids are necessary to ensure a timely and safe transition from the instrument phase of an approach to its visual phase. The planned operational level for an instrument runway can be achieved only through a combination of appropriate electronic and visual guidance systems. Failure to include the required visual aids in the planning of an instrument runway will degrade the utility of the electronic systems. Conversely, enhancing a runway with inappropriate visual aids will waste resources while providing little operational advantage.

2-3 APPLICATION OF REQUIREMENTS.

Use the criteria in this chapter for planning, budgeting, and installing visual air navigation facilities. Do not upgrade or increase visual aids to support a higher operational requirement unless the runway, taxiway, or helipad has been officially approved for the new level of operation and all appropriate electronic aids have been installed or are programmed for installation. Waivers are required for all deviations in accordance with paragraph 1-11 (Air Force) or 1-12 (US Army), as applicable.

2-4 REQUIREMENTS.

Table 2-1A contains requirements for Air Force airfields; requirements for US Army airfields are contained in Table 2-1B. Helipad/heliport requirements are listed in Table 2-2. Theater of Operations (TO) Airport Heliport/Helipad Visual Requirements are listed in Table 2-3. Each table contains application criteria for operational categories and the related visual aid requirements. A table of criteria for Navy airfields/heliports is contained in NAVAIR 51-50AAA-2.

2-4.1 Not Required (NR) designates a visual aid which is not required for a particular operation and is therefore not specifically provided to support it.

2-4.2 Not Applicable (NA) designates a visual aid whose operational performance is not adequate to support a particular operation or where a particular operation that could be supported is not required.

2-4.3 Optional (OPT) designates a visual aid which is not required, but may be installed to support operations, or a visual aid which is required only under certain

conditions, meteorological or otherwise. Design of any installed visual aid must comply with provisions of this UFC or the FAA Advisory Circular referenced, in that priority order.

2-5 LIGHT EMITTING DIODE (LED) LIGHT FIXTURES.

Increased use of airport LED light fixtures on the air operations area (AOA) has created problems when these fixtures are interspersed with their incandescent counterparts. LED light fixtures are essentially monochromatic (aviation white excepted); as such, their perceived color and/or brightness differs from equivalent incandescent fixtures. These differences may distort the visual presentation to a pilot. Therefore, LED light fixtures must not be interspersed with incandescent lights of the same type.

Example: An airport adds an extension to a runway. On the existing runway, the runway centerline light fixtures are incandescent. The airport decides to install LED runway centerline fixtures on the new section of runway and retains the incandescent fixtures on the existing section. This interspersion of dissimilar technology is not approved for installation.

In addition, defective incandescent fixtures must not be replaced with their LED counterparts. When replacing a defective light fixture, make certain that the replacement uses the same light source technology to maintain a uniform appearance.

2-5.1 Prohibited Placements.

Do not install LED-technology systems with previously installed incandescent equivalents at these locations:

- Runway guard lights (RGL). Each pair of elevated RGLs must be the same technology. For in-pavement lights, do not mix LED with incandescent fixtures in the same bar.
- Touchdown zones.
- Runway edges (including threshold, end, and stopway).
- Taxiway curved segments (centerline and edge).
- Taxiway straight segments (centerline and edge).
- Approaches.
- Stop bars.
- Runway centerlines.

- Lead-ons and lead-offs.
- Precision approach path indicators (PAPI).

2-5.2 Signage.

Do not collocate LED signs with incandescent signs.

Examples:

- Runway holding position signs on both sides of a taxiway.
- Holding position signs on both sides of a runway.
- Separate signs in a sign array.

2-5.3 LED Performance Requirements.

Refer to FAA Engineering Brief (EB) 67 (http://www.faa.gov/airports/engineering/engineering_briefs/) for additional detailed information.

2-6 REFERENCE DOCUMENTS.

Use the most current revision or publication date for documents referenced in this UFC.

This UFC is supplemented by technical papers for various topics supporting the selection, testing and maintenance of airfield navigation aids. See Appendix A for references citations.

Table 2-1A Air Force Airfield Visual Facilities Requirements

Facility	Operational Category				
	Night VMC	Non-Precision	Precision		
			I	II	III
APPROACH AIDS					
High Intensity Approach Light System (ALSF-1)	NR	NR	R ⁽¹⁾	NA	NA
High Intensity Approach Light System (ALSF-2)	NR	NR	NR	R	R
Short Approach Lighting (SALS) ⁽¹⁶⁾	NR	OPT	NA	NA	NA
Simplified Short Approach Lighting (SSALR) ⁽¹⁷⁾	NR	OPT	OPT	NA	NA
Medium Intensity Approach Light System (MALSR)	NR	NR	OPT ⁽¹⁾	NA	NA
Runway End Identifier Lights (REIL)	OPT	OPT	OPT	NA	NA
Precision Approach Path Indicator (PAPI)	R ⁽²⁾	R ⁽²⁾	OPT	NA	NA
RUNWAY AIDS					
High Intensity Runway Edge Lights (HIRL)	R	R	R	R	R
Medium Intensity Runway Edge Lights (MIRL) ^(12, 15)	OPT	OPT	OPT ⁽¹⁾	NA	NA
Threshold Lights	R	R	R	R	R
Runway End Lights	R	R	R	R	R
Runway Distance Remaining (RDR) Signs ⁽³⁾	R	R	R	R	R
Runway Centerline Lights (RCL)	NA	NA	NR	OPT	R
Touchdown Zone Lights (TDZL) ⁽¹³⁾	NA	NA	NR	OPT	R
TAXIWAY AIDS					
Taxiway Edge Lights	R	R	R	R	R
Taxiway Centerline Lights	NA	NA	OPT	OPT	OPT ⁽⁸⁾
Taxiway Clearance Bar (Hold Point)	NA	NA	OPT	R	R ⁽¹⁴⁾
Runway Guard Lights – Elevated, FAA Type L-804 ⁽⁹⁾	NR	NR	OPT	R	R
Runway Guard Lights – In-pavement, FAA Type L-852G	NR	NR	OPT	R	R
Runway Entrance-Exit Lights	NR	NR	NR	NR	R
Guidance Signs (information and location) ⁽¹¹⁾	R	R	R	R	R
Mandatory Signs ⁽³⁾	R	R	R	R	R
MISCELLANEOUS AIDS					
Airfield Beacons	R	R	R	R	R
Wind Cones ⁽⁴⁾	R	R	R	NA	NA
Obstruction Lights	R	R	R	R	R
Emergency Power ⁽⁵⁾	R	R	R	R	R
Apron Area Flood Lighting ⁽⁷⁾	OPT	OPT	OPT	OPT	OPT
Apron Edge Lights ^(6, 10)	R	R	R	R	R
Legend:					
	Note: Backup power must be provided for visual landing aids listed as “R” (required).				
R	Required.				
OPT	Optional, as recommended by the wing commander and approved by the MAJCOM.				
NR	Not required.				
NA	Not applicable. Not appropriate for this application.				
(1)	MAJCOM approval is required to substitute MALSR for an ALSF-1.				
(2)	Required only on primary runways.				

- (3) All new taxiway location and direction signs, RDRs, and mandatory signs are required to be internally lighted. See paragraph 9-1.4.
- (4) Wind direction indicators are required to meet ICAO Annex 14 (paragraph 5.1, "Indicators and Signaling Devices"). Lighted cone is required.
- (5) Emergency power required for all equipment designated "R."
- (6) Apron edge lighting is not required if apron flood lighting is provided.
- (7) Flood lighting is not required for night operations (refueling, loading, maintenance, etc.), but 0.2 fc may be required by the installation for perimeter security.
- (8) For surface movement and guidance of CAT III systems, refer to FAA AC 120-57.
- (9) Runway guard lights require monitoring IAW FAA AC 150/5345-46, paragraph 3.7.3.4.
- (10) Use of retroreflective markers is allowed where additional marking is required, but are not a substitute for apron edge lights.
- (11) FAA requires guidance signs for the purpose of clear guidance and direction and presents signage for average airfield configuration, but simple airfields (single runway and few entering taxiways) or airfields which utilize a "follow me" vehicle, may not require complicated signage. Required with the use of REILS.
- (12) Required with the use of REILS.
- (13) Required for medium intensity.
- (14) Required for RVR <600 only.
- (15) For RVR \geq 2400 only.
- (16) Waiver is required.
- (17) Waiver is not required when used as a subsystem of ALSF-1.

Table 2-1B US Army Airfield Visual Facilities Requirements

Facility	Operational Category		
	Night VMC	Non-Precision	Precision Approach (IMC)
			I
APPROACH AIDS			
High Intensity Approach Light System (ALSF-1)	NA	NA	OPT
High Intensity Approach Light System (ALSF-2)	NA	NA	NA
Short Approach Lighting (SALS)	NA	OPT	NA
Simplified Short Approach Lighting (SSALR)	NA	OPT	OPT
Medium Intensity Approach Light System (MALSR)	NA	NA	R
Runway End Identifier Lights (REIL)	OPT	OPT	OPT
Precision Approach Path Indicator (PAPI) ⁽⁵⁾	OPT	OPT	OPT
RUNWAY AIDS			
High Intensity Runway Edge Lights (HIRL)	NA	NA	R
Medium Intensity Runway Edge Lights (MIRL)	R ⁽¹⁾	R ⁽¹⁾	NA
High Intensity Threshold Lights	NA	NA	R
Medium Intensity Threshold Lights	R	R	NA
Runway End Lights	R	R	R
Runway Distance Remaining Signs (RDR)	R	R	R
Runway Centerline Lights (RCL)	NA	NA	NA
Touchdown Zone Lights (TDZL)	NA	NA	NA
TAXIWAY AIDS			
Taxiway Edge Lights	R	R	R
Taxiway Centerline Lights	NA	NA	NA
Taxiway Hold Lights/Stop Bar	NR	NR	NA
Runway Entrance-Exit Lights	OPT	OPT	OPT
Runway Guard Lights	OPT	OPT	OPT
Guidance Signs (Informative) ⁽³⁾	R	R	R
Guidance Signs (Mandatory) ⁽³⁾	R	R	R
MISCELLANEOUS AIDS			
Airfield Rotating Beacons	R	R	R
Wind Cones ⁽²⁾	R	R	R
Obstruction Lights	R	R	R
Emergency Power ⁽⁴⁾	R	R	R
Apron Area Flood Lighting ⁽⁵⁾	R	R	R
Apron Edge Lights ⁽⁶⁾	R	R	R
Legend:			
R Required.			
OPT Option as determined by the airfield commander and approved by USAASA.			
NR Not required.			
NA Not applicable.			
(1) Use with medium intensity threshold lights.			
(2) A lighted Style 1 wind cone; aviation community to determine size.			
(3) All taxiway location and direction signs, RDRs, and mandatory signs are required to be internally lighted. See paragraph 9-1.4.			
(4) Emergency power required for all "R" equipment.			
(5) See paragraph 3-7.1.1 for additional guidance.			
(6) Apron edge lighting is not required if apron flood lighting is provided.			

Table 2-2 Helipad/Heliport Visual Facilities Requirements

FACILITY	HELIPAD/HELIPORT				Helicopter Runway IMC Precision Instrument Category I
	VMC Day Non- Instrument	VMC Night Non- Instrument	IMC Non- Precision Instrument	IMC Precision Instrument Category I	
Perimeter Lights	NA	R	R	R	NA
Approach Direction Lights	NA	OPT	OPT	OPT	NA
Landing Direction Lights	NA	OPT	OPT	OPT	NA
Approach Lights Category I	NA	NA	NA	R	R
Floodlights	NA	OPT	OPT	OPT	OPT
Visual Glide Slope Indicator System ⁽⁵⁾	NA	OPT	OPT	OPT	OPT
Medium Intensity Runway Edge Lights	NA	NA	NA	NA	R
Threshold Lights	NA	NA	NA	NA	R
Runway End Lights	NA	NA	NA	NA	R
Taxiway Edge Lights	NA	OPT	OPT	OPT	R
Illuminated Heliport - Guidance Signs ⁽²⁾	R(1)	R	R	R	R
Obstruction Lighting	R	R	R	R	R
Hoverlane Lighting	NA	OPT	R	R	R
Rotating Beacon	R	R	R	R	R
Apron Flood Lighting	NA	OPT	OPT	OPT	OPT
Apron Edge Lighting	NA	OPT	OPT	OPT	R
Wind Direction Indicator	R ⁽¹⁾	R	R	R	R
Emergency Power ^(3, 4)	NA	R	R	R	R
Legend:					
R Required					
OPT Optional					
NA Not applicable					
(1) Not lighted for DAY VMC (VFR).					
(2) See FAA AC 150/5340-18 for guidance. All guidance signs are internally lighted.					
(3) Emergency power required for all "R" equipment.					
(4) See paragraph 7-9.5.1, "Justification."					
(5) See paragraph 7-6.					
NOTE: Refer to Chapter 7 and Chapter 8 for criteria.					

Table 2-3 Theater of Operations (TO) Airfield/Heliport/Helipad Visual Requirements (For Army Only)

FACILITY	Night VMC	Non-Precision Approach Runway	Precision Approach Runway
			Category I
APPROACH AIDS			
Precision Approach Path Indicator (PAPI)	OPT	OPT	OPT
Medium Approach Lighting System w/ Runway Alignment Indicator Lights (RAIL) (MALSR)	OPT	OPT	OPT
RUNWAY AIDS			
Medium Intensity Runway Edge Lights (MIRL)	R(1)	R(1)	R(1)
Threshold Lights	R(1)	R(1)	R(1)
Runway End Lights	R(1)	R(1)	R(1)
Runway Distance Remaining (RDR) Signs	R(2)	R(2)	R(2)
TAXIWAY AIDS			
Taxiway Edge Lights	OPT(3)	OPT(3)	OPT(3)
MISCELLANEOUS AIDS			
Wind Cones	OPT	OPT	OPT
Obstruction Lights	R	R	R
Legend:			
R	Required		
OPT	Optional - highly recommended when situation and operational environment permits.		
(1)	The lighting system must be connected to an emergency power source such as a diesel-generator or independent utility. For US Army-only aviation operations the emergency power source need only be readily available for connection.		
(2)	Runway distance remaining signs are not required to be lighted, but must conform to UFC 3-535-01 RDR lighted standards. Runway distance remaining signs are optional for rotary-wing aircraft-only operations.		
(3)	FAA Type L-853 Retro-reflective Markers may be used when power is not available.		
NOTES:			
1. A TO in Joint Publication 3-0, Joint Operations, is defined as an operational area defined by the geographic combatant commander for the conduct or support of specific military operations.			
2. Technical Paper 22 (TSEWG TP22) provides criteria and other essential information for this lighting.			

CHAPTER 3 STANDARDS FOR LIGHTED APPROACH AIDS

3-1 APPROACH LIGHT SYSTEM WITH SEQUENCED FLASHING LIGHTS (ALSF-1).

3-1.1 Purpose.

The ALSF-1 is a high intensity approach lighting system with sequenced flashing lights required for operations under Category I conditions. This system provides visual guidance to pilots aligning approaching aircraft with the runway and attempting final corrections before landing at night or during low visibility.

3-1.2 Associated Systems.

In addition to electronic aids such as ILS, PAR, or microwave landing system (MLS), the ALSF-1 should include features described in paragraphs 3-1.2.1 through 3-1.2.3:

3-1.2.1 A paved runway at least 150 feet (50 meters) wide and 6,000 feet (2,000 meters) long. Shorter runways may be approved for special operating conditions. The runway must be equipped with:

- Precision approach markings.
- High-intensity edge lights.
- High-intensity threshold lights.
- End lights.
- Runway distance remaining signs.
- Runway visual range (RVR) system.

3-1.2.2 An approach having a paved or stabilized end zone area extending 1,000 feet (300 meters) into the approach area and wider than the runway. The first 300 feet (100 meters) of paved or stabilized area requires the same slope as the first 1,000 feet (300 meters) of the runway. Slope of the remainder of paved or stabilized area may not exceed ± 1.5 percent. These criteria and further details are provided in UFC 3-260-01.

3-1.2.3 Air traffic control support during normal operating hours.

3-1.3 Configuration.

The ALSF-1 consists of a pre-threshold light bar, a terminating bar, a 1,000 foot (300 meter) cross bar, centerline lights (barrettes), sequenced flashing lights, and threshold lights. Figure 3-1 shows a typical layout. The system centerline coincides with

the extended runway centerline. The overall system length is 3,000 feet (900 meters), extending from the runway threshold into the approach zone. For the Air Force only, if terrain or other local conditions prevent a full-length installation, the system may be shortened to not less than 2,400 feet (720 meters). The generally accepted convention for locating lights along the longitudinal axis of approach light systems for the standard is that the longitudinal axis is divided in 100-foot (30 meters) stations with station 0+00 located at the threshold and higher station numbers located farther into the approach. Thus, a light at station 1+10 would be located 110 feet (33 meters) into the approach, measured from the threshold. Subsequent stations would be at 2+10, 3+10, etc. If a site condition requires a wider separation, the separation may be divided between barrettes. For example, a deviation resulting in a 34-foot increase in separation may result in 1+10, 2+20, 3+34, 4+34, etc. with a maximum deviation of 50 feet (15.2 meters) for the entire 3,000 foot approach.

Configurations of individual system elements are illustrated in Figure 3-1.

3-1.3.1 Pre-threshold Bar.

The pre-threshold bar consists of two barrettes in aviation red lights placed symmetrically about the system centerline at station 1+00. Each barrette consists of five lights on 3.5-foot (1-meter) centers, with the innermost light centers located not less than 75 feet (22.5 meters) nor more than 80 feet (24 meters) from the system centerline.

3-1.3.2 Terminating Bar.

The terminating bar consists of two barrettes in aviation red lights located symmetrically about and perpendicular to the system centerline at station 2+00. Each barrette consists of three lights on 5 foot (1.5 meter) centers, with the outermost light centers located 25 feet (7.5 meters) from the system centerline.

3-1.3.3 1,000-Foot (300-meter) Light Bar.

This light bar consists of two barrettes in aviation white lights located symmetrically about and perpendicular to the system centerline at station 10+00 and in line with the centerline barrette at that station. Each barrette consists of 8 lights on 5-foot (1.5-meter) centers with the outermost light center located 50 feet (15 meters) from the system centerline.

3-1.3.4 Centerline Lights.

The centerline lights consist of a series of barrettes with aviation white lights located at 100-foot (30-meter) intervals along the system centerline, from station 1+00 to station 30+00. Each barrette consists of five lights spaced at 40.5 inches (1.03 meters) on centers, centered on and perpendicular to the system centerline. Centerline lights on

elevated supports may be spaced at 40.5 inches (1.03 meters) to fit standard FAA support hardware.

Figure 3-1 ALSF-1 Configuration

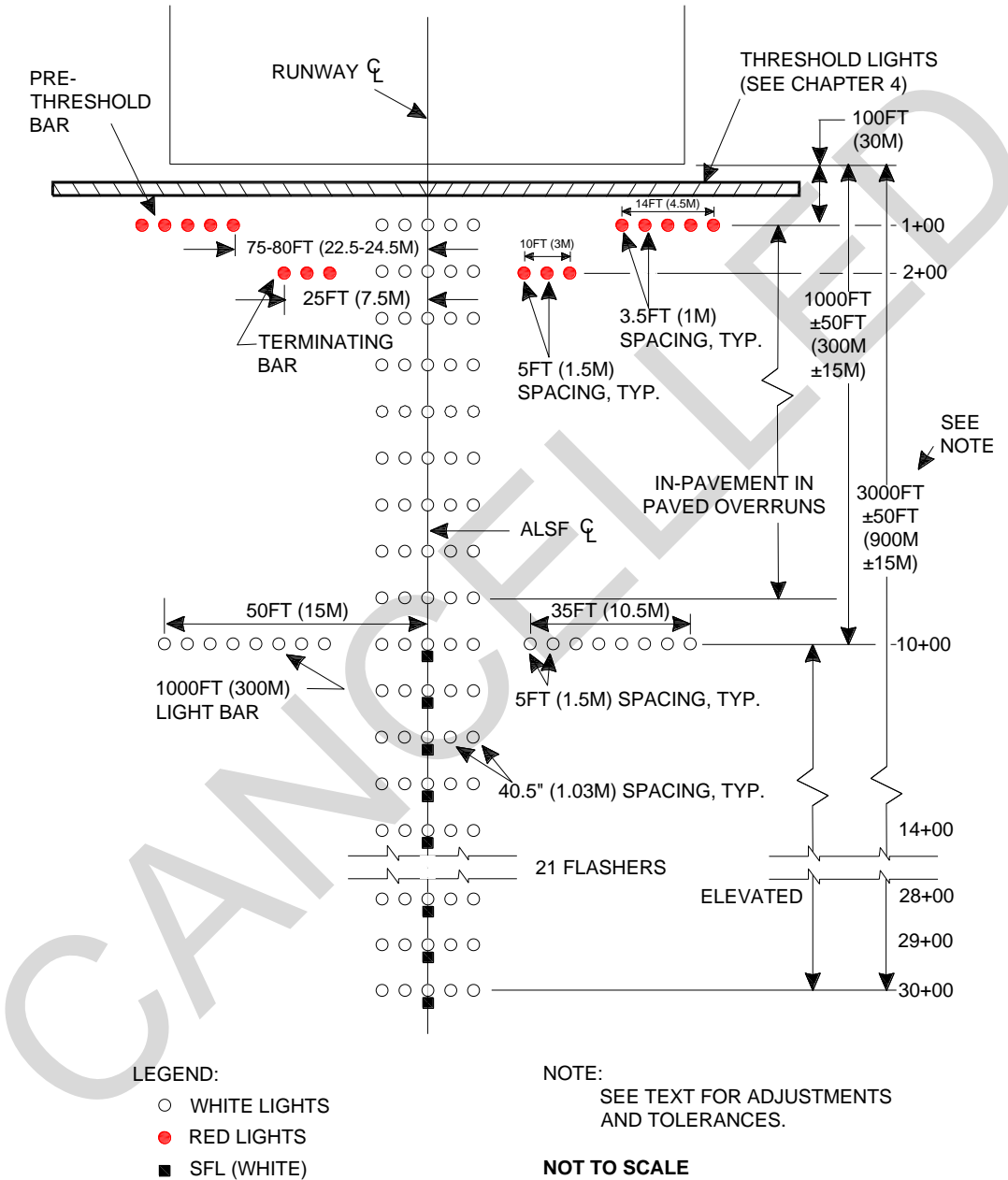

3-1.3.5 **Sequenced Flashing Lights (SFL).**

The sequenced flashing lights are a series of twenty-one (21) flashing lights located on the system centerline, beginning at station 10+00, 1,000 feet (300 meters) from the threshold and ending at station 30+00. The bluish-white light flashes at a rate of twice per second, in sequence from the outermost light station toward the threshold, appearing as a ball of white light traveling toward the runway. Sequenced flashing lights may be uniformly mounted a maximum of 4 feet (1.2 meters) below the steady burning lights, or when in-pavement lights are used, they may be displaced a maximum of 5 feet (1.5 meters) into the approach along the system centerline to avoid visual or physical interference between light units. (Note: SFLs are sometimes referred to in the field as “rabbits.”)

3-1.3.6 **Threshold Lights.**

While threshold lights are not actually a section of the approach light system, they must be present and installed according to paragraph 4-4.

3-1.4 **Photometrics.**

Optimum aiming of lights depends on the design and light output of the fixtures used in the system. Light fixtures may be designed to support several applications and may have fixed patterns and aiming angles which differ from the standard. Light aiming and patterns other than those prescribed in this UFC may be used, provided the resultant light pattern produces equivalent light intensities in the areas required by this UFC.

3-1.4.1 **Intensity.**

Luminous characteristics for the lights used in the ALSF-1 system are described below. The beam widths are measured symmetrically about the mechanical axis of the light unit, unless otherwise noted. Elevated and in-pavement SFLs must provide light intensities as specified in Tables 3-1 and 3-2. Steady burning lights used in the system must meet the intensity requirements presented in Figure 3-2.

Table 3-1 Required Intensities for Elevated SFLs

Intensity Setting	Maximum Effective Intensity (Candelas)	Minimum Effective Intensity (Candelas)
High	20,000	8,000
Medium	2,000	800
Low	450	150

Measure effective intensity over a rectangular pattern not less than 10 degrees by 30 degrees. Corners may be rounded on a 5 degree radius to determine compliance.

Table 3-2 Required Intensities for In-Pavement SFLs

Intensity Setting	Maximum Effective Intensity (Candelas)	Minimum Effective Intensity (Candelas)
High	20,000	5,000
Medium	2,000	500
Low	600	150

Measure effective intensity over a rectangular pattern not less than 10 degrees by 30 degrees. The geometric center of this 10 degree by 30 degree pattern must be 7 degrees ± 1/3 degree above horizontal. Corners may be rounded on a 5 degree radius to determine compliance.

Figure 3-2 Approach Lighting Photometrics

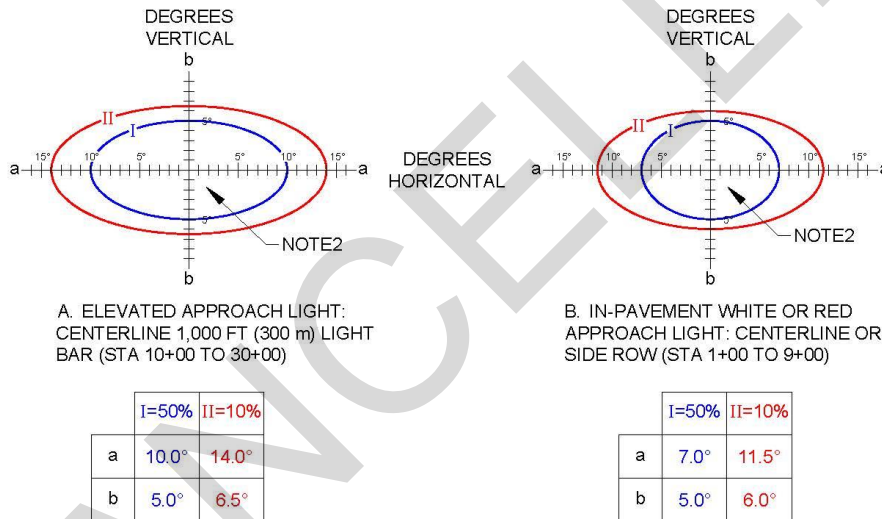

NOTES:

1. ALL CONTOURS ARE ELLIPSES CALCULATED BY EQUATION: $(X/a)^2 + (Y/b)^2 = 1$
2. THE MINIMUM AVERAGE INTENSITY OF THE MAIN BEAM (INSIDE CONTOUR I) IS 20,000 CD WHITE OR 5,000 CD RED.
3. MAXIMUM INTENSITY SHOULD NOT EXCEED 1.5 TIMES ACTUAL AVERAGE INTENSITY.
4. CONTOURS I AND II INDICATE THE MINIMUM PERCENT VALUES OF THE MAIN BEAM INTENSITY.
5. FOR IN-PAVEMENT FIXTURES, THE PORTION OF LIGHT CUT OFF BY THE MOUNTING SURFACE MAY BE DISREGARDED.

3-1.4.2 Intensity Control.

Provide brightness control with five intensity steps for steady burning lights and three intensity steps for flashing lights. Match the intensity of the sequenced flashing lights to the intensity of the steady burning lights in accordance with Table 3-3.

Table 3-3 Brightness Control Matching Criteria

Intensity Step	Steady Light Intensity Percentage	Flashing Light Intensity Percentage	Intensity Step
1	0.16	2.00	1
2	0.8	2.00	1
3	4.00	10.00	2
4	20.00	100.00	3
5	100.00	100.00	3

3-1.4.3 Aiming.

Aim the beams of all approach lights into the approach zone and away from the threshold, with the beam axis parallel to the extended runway centerline. Vertically aim elevated, unidirectional, steady burning lights in accordance with Table 3-4. Aiming angles are based on a three-degree glide slope. If other glide slope angles are used, adjust the vertical aiming for the same degree of difference. Some existing SFL may have fixed angles for the beam. Refer to paragraph 4-4.8 when threshold lights are used as part of an approach system.

Table 3-4 Elevation Setting Angles for ALSF-1

STEADY-BURNING TYPE FAA-E-982 LIGHTS					
Station	Setting Angle Above Horizontal* (Degrees)		Station	Setting Angle Above Horizontal* (Degrees)	
	Preferred	Permitted		Preferred	Permitted
30+00	8.0	8.0	14+00	7.0	7.0
29+00	7.9	8.0	13+00	6.9	7.0
28+00	7.9	8.0	12+00	6.9	7.0
27+00	7.8	8.0	11+00	6.8	7.0
26+00	7.7	7.5	10+00	6.7	6.5
25+00	7.7	7.5	9+00	6.7	6.5
24+00	7.6	7.5	8+00	6.6	6.5
23+00	7.6	7.5	7+00	6.5	6.5
22+00	7.5	7.5	6+00	6.5	6.5
21+00	7.4	7.5	5+00	6.4	6.5
20+00	7.4	7.5	4+00	6.3	6.5
19+00	7.3	7.5	3+00	6.3	6.5
18+00	7.2	7.0	2+00	6.2	6.0
17+00	7.2	7.0	1+00	6.2	6.0
16+00	7.1	7.0	0+00	6.1	6.0
15+00	7.0	7.0			

*See airfield commander for glide slope. For glide slopes other than 3 degrees, increase or decrease the setting angle by the amount of approach slope variance. For example, given a 2½ degree glide slope, the setting angle would be decreased by ½ degree.
Tolerances are ± 0.2 degrees.
Elevated SFL are all aimed 6 degrees above horizontal.

3-1.4.4 Obstruction Clearances.

3-1.4.4.1 A light plane (or planes) in which the lights of the system are located is used for determining obstruction clearances of the approach lights.

3-1.4.4.2 Side boundaries of the light plane are 200 feet (60 meters) on each side of the extended runway centerline (except SFL).

3-1.4.4.3 End boundaries are at the runway threshold and at 200 feet (60 meters) before the start of the approach light system.

3-1.4.4.4 All lines in the plane perpendicular to the centerline are level.

3-1.4.4.5 The ideal light plane (Figure 3-3) is a single horizontal plane through the runway threshold. If the 1,000 feet (300 meters) of the runway at the threshold end is

sloped, the first 300 feet (100 meters) of the paved or stabilized area of the approach zone and the light plane for this area must continue with the same slope.

Figure 3-3 Ideal Light Plane Elevation Limits

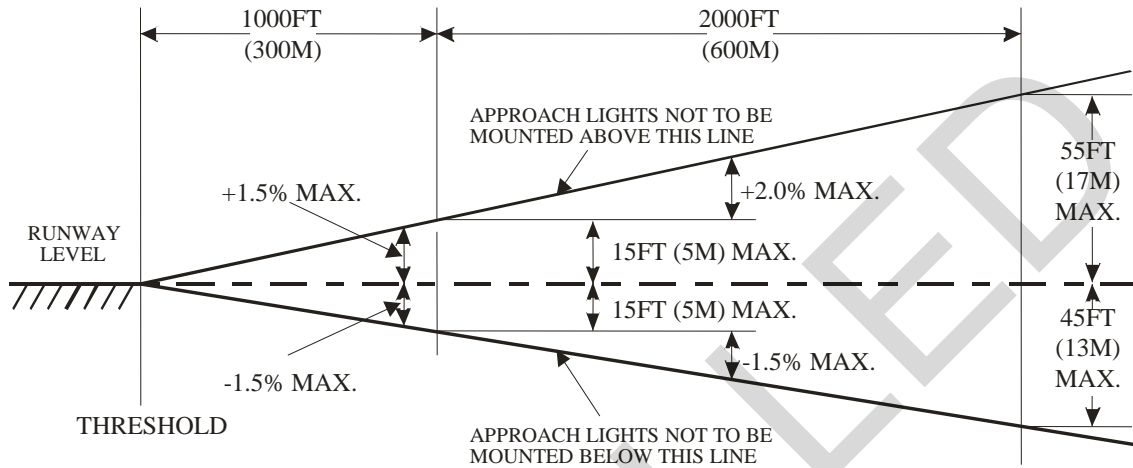

NOTE: THE BOUNDARIES OF THE LIGHT PLANES ARE THE RUNWAY THRESHOLD, 200FT (60M) AHEAD OF THE END LIGHT STATION, AND 200FT (60M) EACH SIDE OF CENTERLINE.

3-1.4.4.6 The final 700 feet (210 meters) of the paved or stabilized area may have a slope of not more than 1.5 percent up or down. From the 1,000-foot (300-meter) light bar to the beginning of the approach light system, the preferred light plane is horizontal and includes the 1,000-foot (300-meter) light bar lights.

3-1.4.4.7 If the clearance of obstructions or terrain prohibits using a horizontal light plane, this plane may be sloped. The slope of this plane must not exceed 2 percent up or 1.5 percent down. The preferred light plane in the area beyond the 1,000-foot (300-meter) light bar is a single plane, but changes in the slope of the plane are permitted. All light planes start and end at a light station and contain not less than three light stations.

3-1.4.5 Light Plane Obstructions.

3-1.4.5.1 No objects may penetrate the light plane except for ILS components and components of airfield lighting systems that are fixed by function. These components must not interfere with the pilot's view of the approach lights when on a normal approach and must be obstruction lighted. For clearance purposes, all roads, vehicle parking areas, and railroads are considered vertical solid objects.

3-1.4.5.2 To avoid roads, buildings, railroads, or other obstacles, it may be necessary to move a light station away from its nominal location. Where this is so, see paragraph 3-1.3.

3-1.4.5.3 Obtaining needed clearance above a road is preferred over controlling traffic. Obstructions beyond the approach light system must comply with UFC 3-260-01.

3-1.4.6 Configuration Adjustments.

Siting considerations may require adjustment of the approach light system configuration. Adjustments described in paragraphs 3-1.4.6.1 and 3-1.4.6.2 are permitted without a waiver.

3-1.4.6.1 System Centerline.

The system centerline may be offset laterally not more than 2 feet (0.6 meters) to maintain alignment with runway centerline lights or to avoid installation problems.

3-1.4.6.2 Light Station Adjustments.

To avoid roads, buildings, railroads, or other obstacles, it may be necessary to move a light station longitudinally away from its nominal location. In such instances, change the light bar spacing to distribute the difference uniformly so the spacing between adjacent light stations is kept at 100 feet \pm 10 feet (30 meters \pm 3 meters) and the system length is maintained.

3-1.4.7 Construction Tolerances.

Tolerances for positioning ALSF-1 and ALSF-2 lights are as follows:

- Light stations must be installed longitudinally within \pm 6 inches (150 millimeters) of the designated location.
- The lateral tolerance for installation of a light bar is \pm 3 inches (\pm 75 millimeters).
- The tolerance for distance between individual lights is \pm 1 inch (\pm 25 millimeters).
- Mounting height tolerances are:

<u>Support Height</u>	<u>Mounting Tolerance</u>
0-6 ft (0-1.8 m)	1 in. (25 mm)
6-40 ft (1.8-12 m)	2 in. (50 mm)
40+ ft (12+ m)	3 in. (75 mm)

- Deviation from a line perpendicular to the ALS centerline is \pm 1 inch (\pm 25 millimeters) maximum.
- Vertical angular alignment of a light must be within 1 degree.
- Horizontal angular alignment of a light must be within 5 degrees.

3-1.5 Power Requirements.

Provide a standby power system with automatic transfer within 15 seconds of a failure of the commercial system in accordance with UFC 3-540-01 Engine-Driven Generator Systems for Backup Power Applications. Do not locate the power and control substation or the standby power equipment within the approach light area, shown in Figure 3-4.

Figure 3-4 Block Diagram-Approach Lighting, ALSF-1

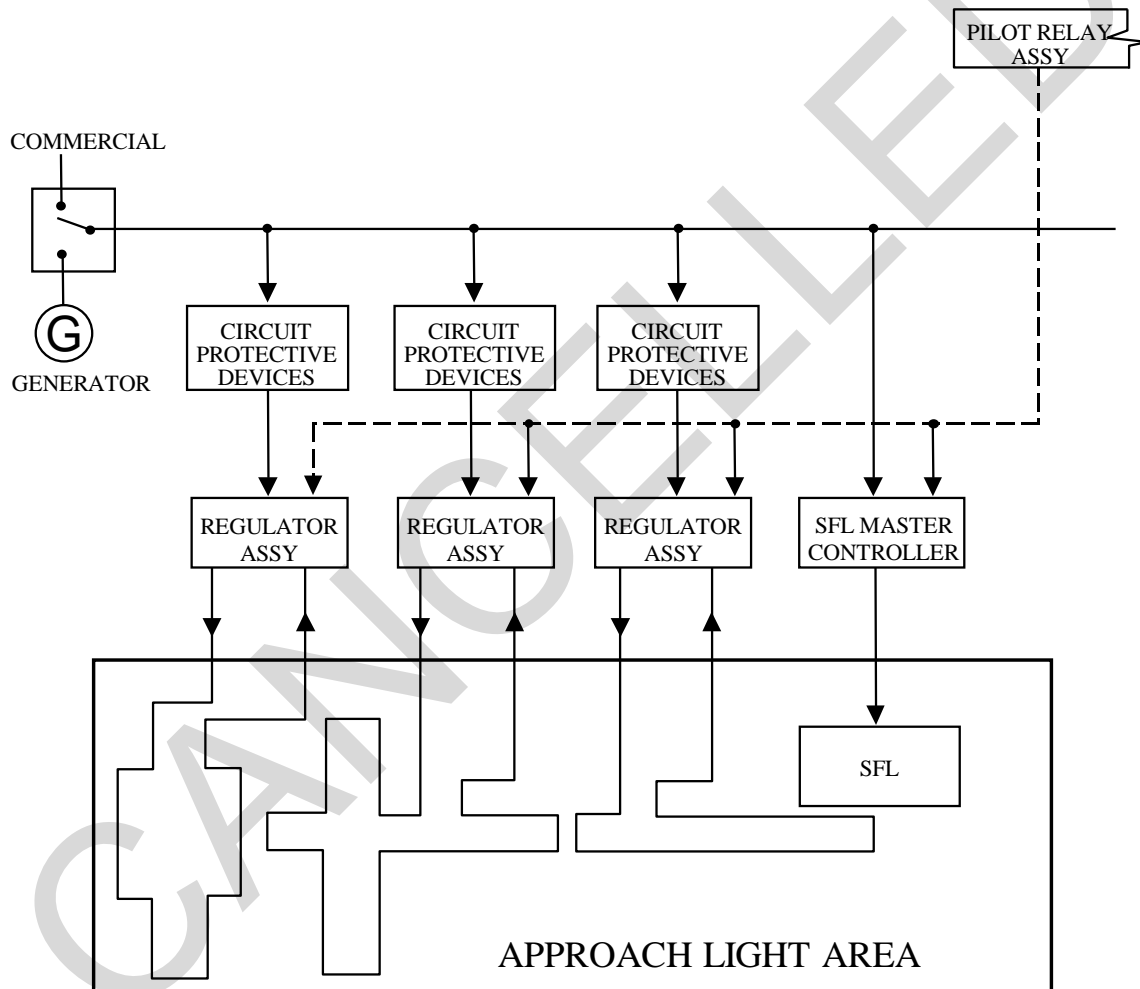

3-1.6 Control Requirements.

Provide remote on-and-off and five-step intensity control for the steady burning lights. Provide remote on-and-off for SFL with automatic three-step intensity matched with steady burning lights (reference paragraph 3-1.4.1). Provide new systems or systems receiving major upgrades with the capability of being electrically switched from the ALSF-1 configuration to the simplified short approach lighting system with runway alignment indicator lights (SSALR) configuration described in paragraph 3-4. No waiver is required for this configuration capability. Provide a selector switch in the control tower to switch from ALSF-1 to SSALR. SFLs must not be operated without steady burning lights.

3-1.7 Monitoring Requirements.

Monitoring is required if the runway will be used when the RVR is below 2,400 feet (720 meters). Provide monitoring when required, which, at a minimum, gives a positive indication at the control facility that power is provided to the system. Refer to FAA AC 150/5345-10 for additional information about monitoring.

3-1.8 Equipment.

3-1.8.1 Fixtures.

Use in-pavement fixtures in paved overruns and in displaced thresholds or where they are subject to damage by jet blast. They must be mounted on corrosion-proof steel light bases set in a concrete foundation. No part of the unit must extend more than 1 inch (25 millimeters) above surrounding pavement. All other fixtures must be elevated and capable of being aimed as required by this UFC.

3-1.8.2 Fixture Support.

Support elevated fixtures on frangible, low-impact resistant, or semi-frangible supports depending on the required mounting height:

<u>Mounting Height</u>	<u>Support Type</u>
0-6ft (0-1.8 meters)	Frangible
6-40 ft (1.8-12 meters)	Low impact resistant
40+ ft (12+ meters)	Semi-frangible

See FAA AC 150/5345-45 for more information about the available classifications (types and styles) of support structures. See also FAA AC 150/5220-23 for additional information about the selection and installation of frangible fittings.

3-1.9 Compliance with International Military Standards.

3-1.9.1 ASIC.

ASIC AIR STD 90/27 has been cancelled.

3-1.9.2 NATO.

This standard meets requirements for a Type II approach lighting system as described in NATO STANAG 3316 (Edition 10), 13 May 2004, except for the vertical aiming of the lights.

3-2 ALSF-2.

3-2.1 Purpose.

The ALSF-2 is a high intensity approach light system for operations under Category II or Category III conditions.

3-2.2 Configuration.

The ALSF-2 (reference Figure 3-5) is configured as an ALSF-1 system modified as described in paragraphs 3-2.2.1 through 3-2.2.4.

3-2.2.1 Pre-threshold Bar.

The red lights at the pre-threshold bar are removed.

3-2.2.2 Terminating Bar.

The red lights are re-designated to nine stations of side row lights.

3-2.2.3 500 Foot (150 Meter) Light Bar.

A 500 foot (150 meter) light bar is added. It consists of two barrettes of aviation white lights, located symmetrically about and perpendicular to the runway centerline, in line with the centerline barrette at that station. Each barrette consists of four aviation white lights on 5 foot (1.5 meter) centers, centered in the space between the centerline lights and the side row lights.

3-2.2.4 Side Row Lights.

Side row lights are added to the inner nine lights' stations at stations 1+00 through 9+00. They consist of barrettes containing three aviation red lights, located symmetrically about and perpendicular to the extended runway centerline at each of the light stations 1+00 through 9+00. The lights in each barrette are on 5 foot (1.5 meter) centers, with the innermost light spaced 36 feet (11 meters) from the extended runway centerline.

3-2.3 Photometrics.

The requirements in paragraphs 3-1.4 and 3-1.4.1 for ALSF-1 apply.

Figure 3-5 ALSF-2 Configuration

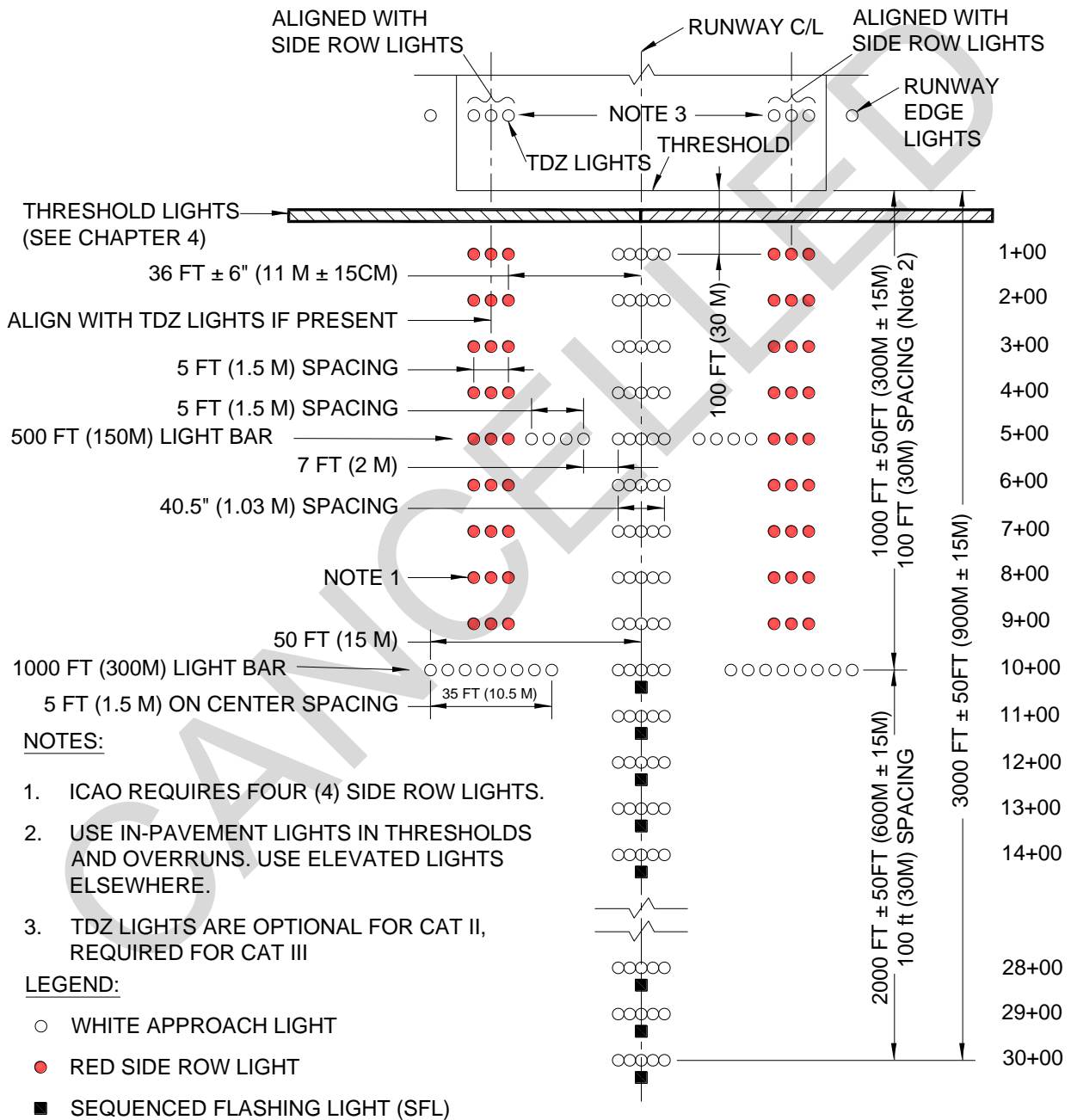

3-2.4 Aiming Criteria.

The aiming criteria as specified in paragraphs 3-1.4.2 through 3-1.4.5 for ALSF-1 apply, except that the red side row lights must be aligned with any existing touchdown zone lights.

3-2.5 Power Requirements.

Provide a standby power system with automatic transfer time within 1 second of a failure of the commercial system in accordance with UFC 3-540-01 Engine-Driven Generator Systems for Backup Power Applications. See system block diagram in Figure 3-6 and Chapter 12 for additional design guidance.

Figure 3-6 Block Diagram-Approach Lighting, ALSF-2

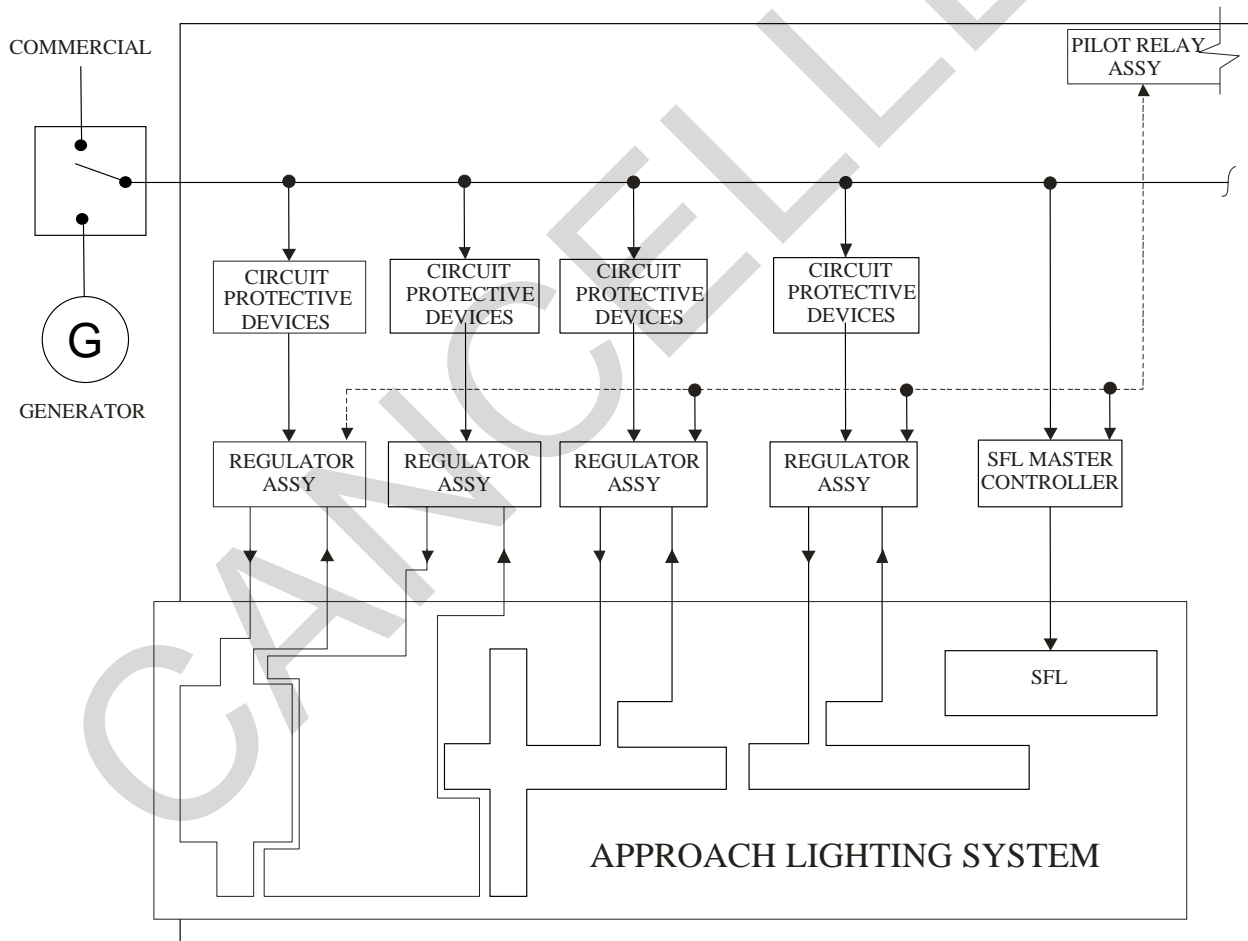

3-2.6 Control Requirements.

The control requirements in paragraph 3-1.6 for ALSF-1 systems apply. Provide a selector switch in the control tower to switch from ALSF-2 to SSALR.

3-2.7 Monitoring Requirements.

Provide monitoring that, at a minimum, gives a positive indication at a control facility that power is being provided to the system. Refer to FAA AC 150/5345-10 for additional information about monitoring.

3-2.8 Equipment.

See paragraph 13-9.1; fixtures and supports for ALSF-1 apply.

3-2.9 Compliance with International Military Standards.

3-2.9.1 ASIC.

ASIC AIR STD 90/27 has been cancelled.

3-2.9.2 NATO.

This standard meets the requirements for a Type II system as described in NATO STANAG 3316 (Edition 10), 13 May 2004, except for the vertical aiming of the lights.

3-3 SHORT APPROACH LIGHTING SYSTEM (SALS).

3-3.1 Purpose.

The SALS is a high intensity approach lighting system used at locations where installation space is limited and non-precision approaches are conducted. This configuration requires a waiver. See paragraphs 1-11 or 1-12 for Air Force and Army waiver processes, respectively.

3-3.2 Configuration.

The SALS, as shown in Figure 3-7, is configured as an ALSF-1, except the system is 1,500 feet (450 meters) long and does not have sequenced flashing lights.

Figure 3-7 SALS Configuration

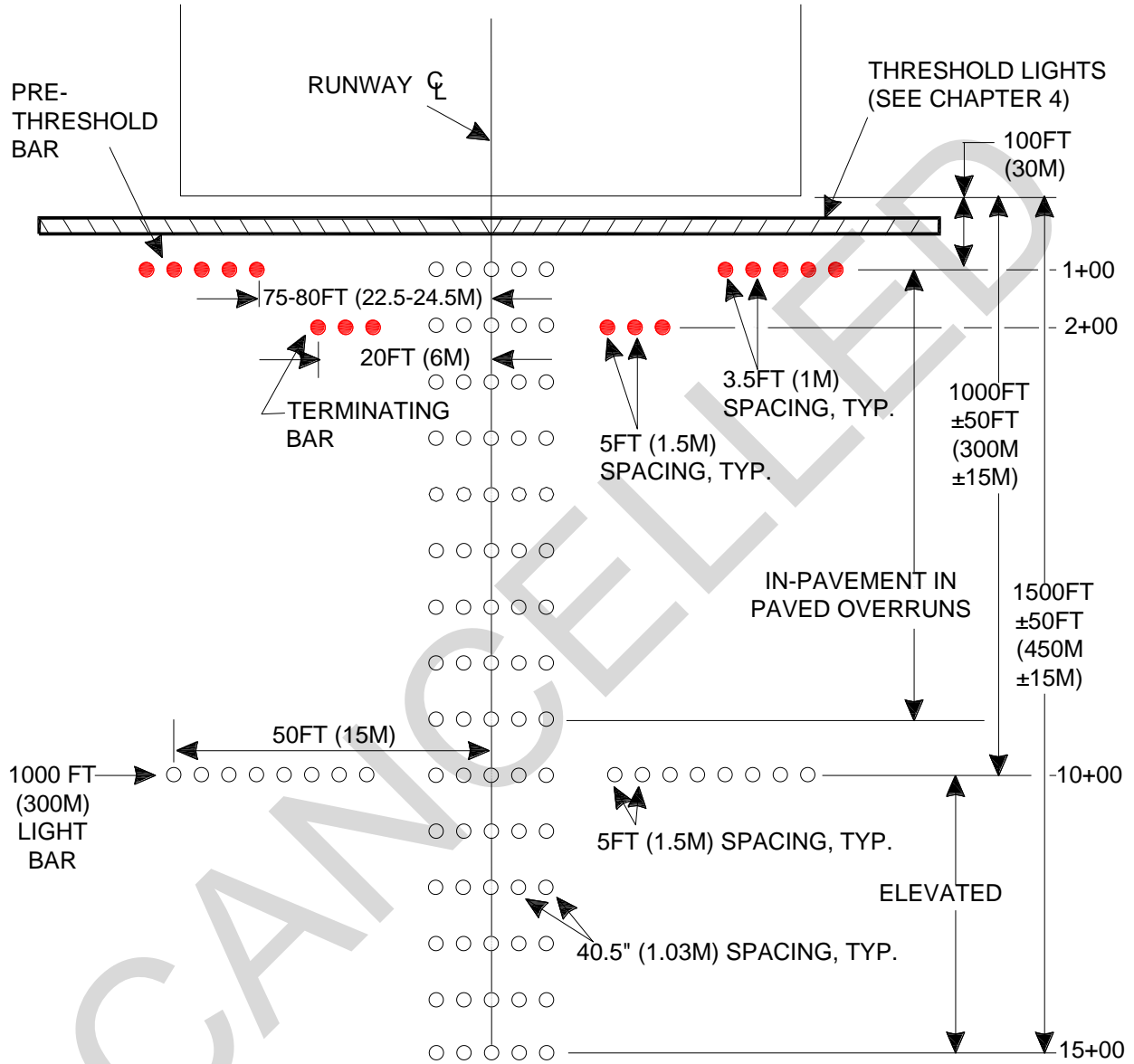

LEGEND:

- WHITE LIGHTS
- RED LIGHTS

NOTE: Requires a waiver for Air Force use.

3-3.3 Photometrics.

The requirements in paragraph 3-1.4 for ALSF-1 apply.

3-3.4 Power, Control and Monitoring.

The requirements in paragraphs 3-1.5, 3-1.6 and 3-1.7 for the ALSF-1 system apply. See Figure 3-4 for the system block diagram.

3-3.5 Equipment Used.

See paragraph 13-9.1 for applicable components.

3-3.6 Compliance with International Standards.

There are no equivalent systems in the previous ASIC AIR STDs or current NATO STANAGs.

3-4 SIMPLIFIED SHORT APPROACH LIGHTING SYSTEM WITH RUNWAY ALIGNMENT INDICATOR LIGHTS (SSALR).

3-4.1 Purpose.

The SSALR is a simplified version of the ALSF-1 or ALSF-2. This system configuration is achieved by electrically switching off elements of an ALSF-1 or ALSF-2 for energy conservation purposes, when weather conditions permit.

3-4.2 Configuration.

The SSALR, shown in Figure 3-8, is configured as an ALSF-1, except that the outer 16 light stations of the steady burning lights are inoperative, as are the odd numbered light stations on the inner 1,400 feet (420 meters), the outer three lights at each end of the 1,000-foot (300 meter) light bar, and the red lights in the terminating and pre-threshold bars. Also, the sequenced flashing lights are inoperative at stations 10+00 through 15+00 and at the odd numbered stations thereafter.

Figure 3-8 SSALR Configuration

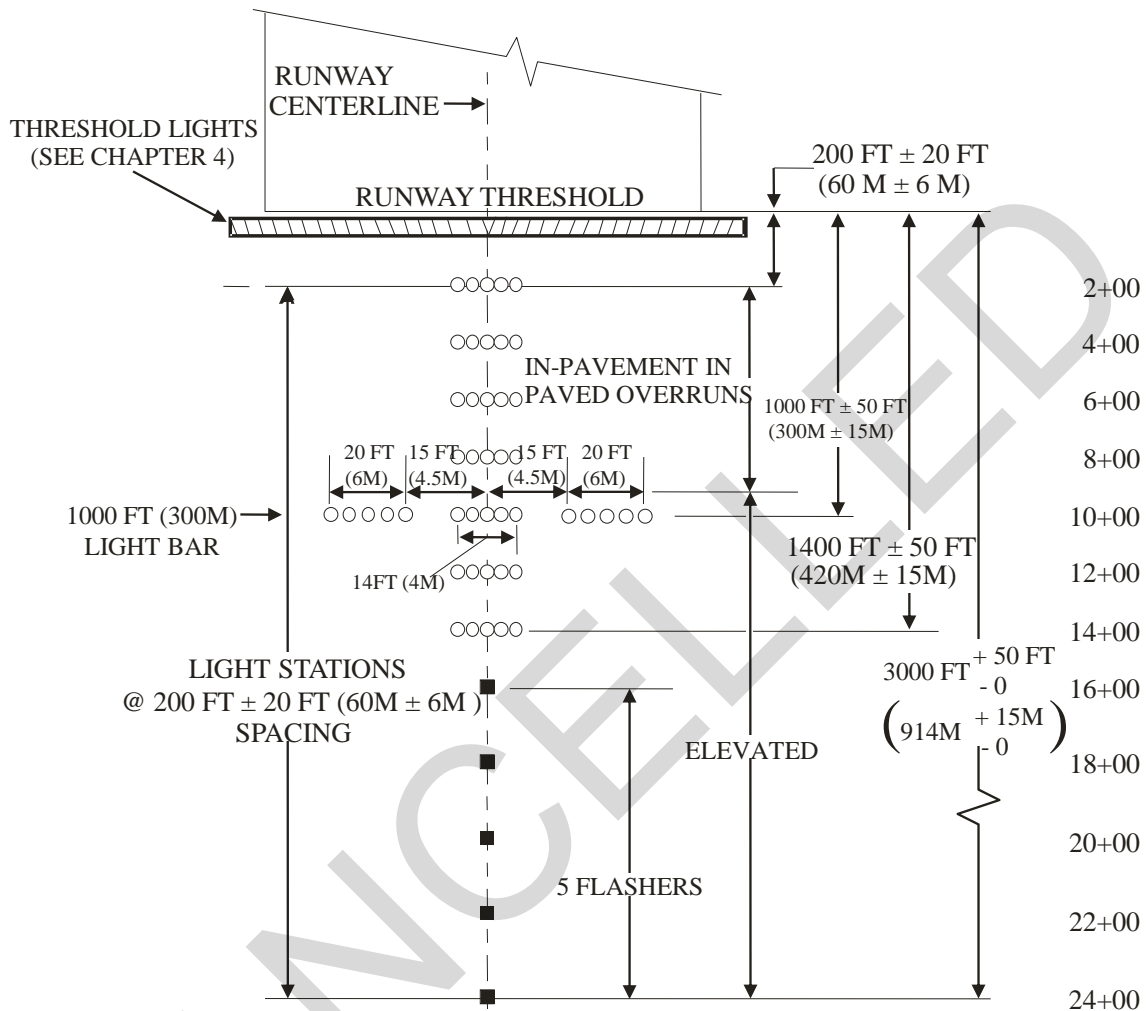

LEGEND:

- STEADY-BURNING LIGHT (7 APPROACH BARRETTES)
- SFL (5 SEQUENCED FLASHERS)

3-4.3 Other Requirements.

All other requirements in paragraph 3-1 for ALSF-1 apply.

3-4.4 Compliance with International Standards.

There are no equivalent systems in the previous ASIC AIR STDs or NATO STANAGs.

3-5 MEDIUM INTENSITY APPROACH LIGHT SYSTEM WITH RUNWAY ALIGNMENT INDICATOR LIGHTS (MALSR).

3-5.1 Purpose.

The MALSR is an economy medium intensity approach light system (MALSR) with SFLs used as the FAA standard system for Category I runways. This system provides visual approach area identification, centerline alignment, and roll reference for aircraft making approaches for landings during day or night operations. Although the MALSR system is FAA-approved for Category I approaches, a waiver is required for the system to be installed at an Air Force base. See paragraph 1-11.

3-5.2 Associated Systems.

In addition to electronic aids such as ILS, which provide electronic guidance down to a minimum of not less than 200 feet (60 meters) minimum decision height Category I condition, the MALSR includes the following:

- Non-precision or precision approach instrument runway markings.
- Runway threshold lights or displaced threshold lights.
- PAPI.

3-5.3 Configuration.

The MALSR is a system of light bars, barrettes, and SFLs in the approach zone immediately ahead of the runway threshold. The MALSR is configured the same as a SSALR, except the SSALR is a subsystem of an ALSF-1, while the MALSR is a complete system. The MALSR consists of 12 light stations made up of seven approach barrettes and five SFLs located at even numbered-stations. The 1,000-foot (300-meter) bar consists of five lights either side of the approach barrette.

Figure 3-9 MALSR Configuration

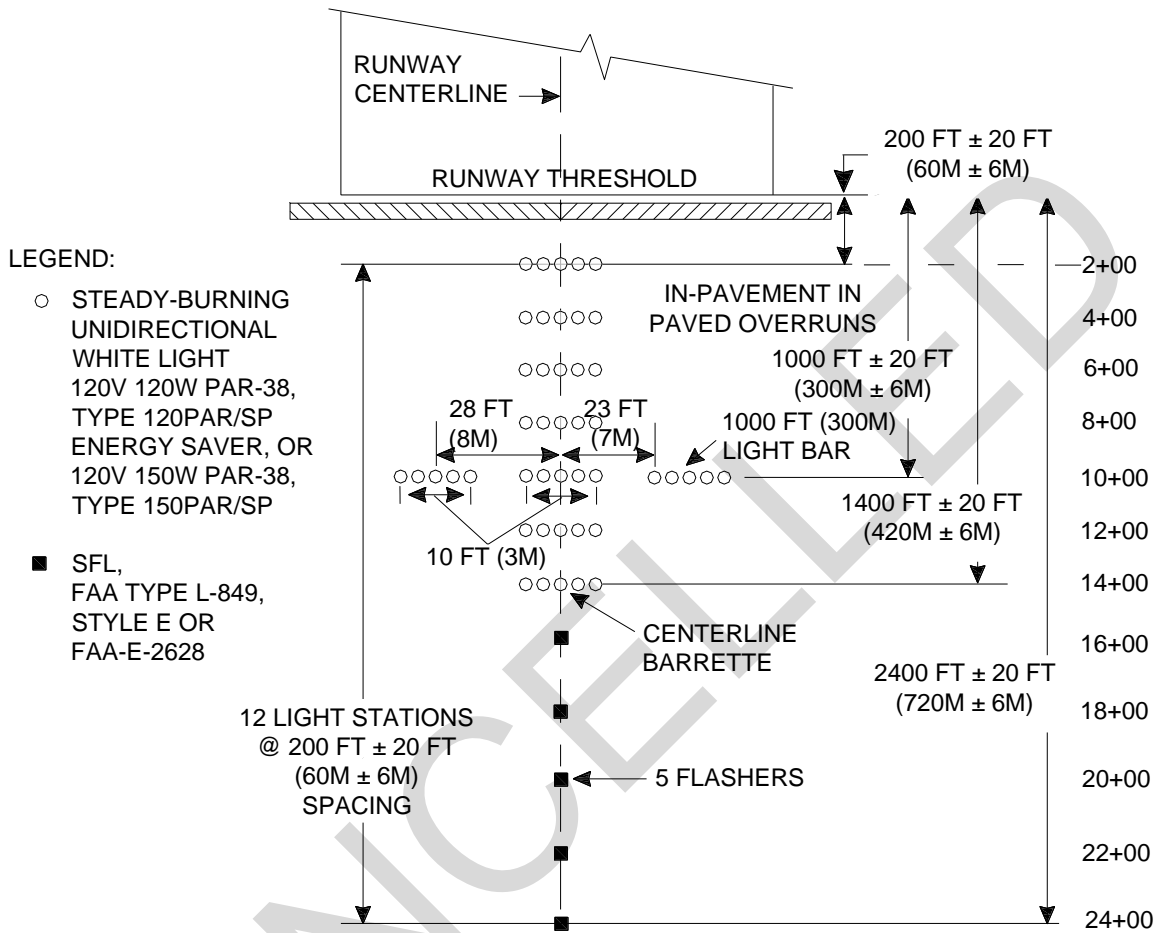

3-5.4 Photometrics.

See FAA-E-2980 for information about MALSR photometric requirements. The color of the steady-burning lights must be aviation white for the centerline and 1,000 foot (300 meter) light bar lights. The color of the SFL may be aviation white or bluish-white (xenon flash tube). The intensity steps based on rated intensity must be 100 percent for high setting, 20 percent for medium setting, and 4 percent for low setting for the steady burning centerline and 100 foot (30 meter) light bar lights; and 100 percent for high setting, 10 percent for medium setting, and 2 percent for low setting for the SFL. The SFL must flash in sequence from the outer end toward the runway threshold at a steady rate between 60 and 120 times per minute. The interval between flashes of adjacent lights must nominally be 1/30 seconds.

3-5.5 Aiming Criteria.

See FAA-E-2980 for information about MALSR light aiming settings. Aim the beams of all approach lights into the approach zone and away from the threshold with the axis of the beams parallel in azimuth to the extended runway centerline. Aim the elevated lights vertically in accordance with Table 3-5. The in-pavement lights have fixed elevation angles for the beams, and only require that the light base flange be level.

Table 3-5 Elevation Setting Angles for MALSR

ELEVATED UNIDIRECTIONAL LIGHTS Steady-Burning Lights					
Station	Setting Angle above Horizontal (Degrees)		Station	Setting Angle above Horizontal (Degrees)	
	Preferred	Permitted		Preferred	Permitted
14+00	3.7	3.5	6+00	3.4	3.5
12+00	3.6	3.5	4+00	3.3	3.5
10+00	3.5	3.5	2+00	3.2	3.0
8+00	3.4	3.5			
All elevated SFL are aimed 6 degrees above horizontal.					

3-5.6 Approach Light Planes.

See FAA-E-2980 and FAA JO 6850.2B for information about MALSR approach light planes. Restrictions described in paragraphs 3-5.6.1 and 3-5.6.2 apply for a MALSR installation.

3-5.6.1 The approach light plane (Figure 3-10) is an area 400 feet (120 meters) wide centered on the extended runway centerline which begins at the runway threshold and extends 200 feet (60 meters) beyond the outermost light in which the approach light centers are located. All lines in the planes perpendicular to the runway centerline are horizontal. Ideally, all the lights will be installed in a single horizontal plane at the same elevation as the runway threshold without any penetrations by fixed solid objects. Where deviations are necessary for terrain or objects which cannot be removed, the sections starting from the first approach light station from the threshold must have a slope not exceeding +2.0 percent upward or -1.0 percent downward for the steady-burning barrette lights. For the SFL section, the slope of the light planes must not exceed +2.0 percent or -2.5 percent. Any sloping or horizontal plane must contain not less than three light stations.

Figure 3-10 Light Plane Elevation Limits

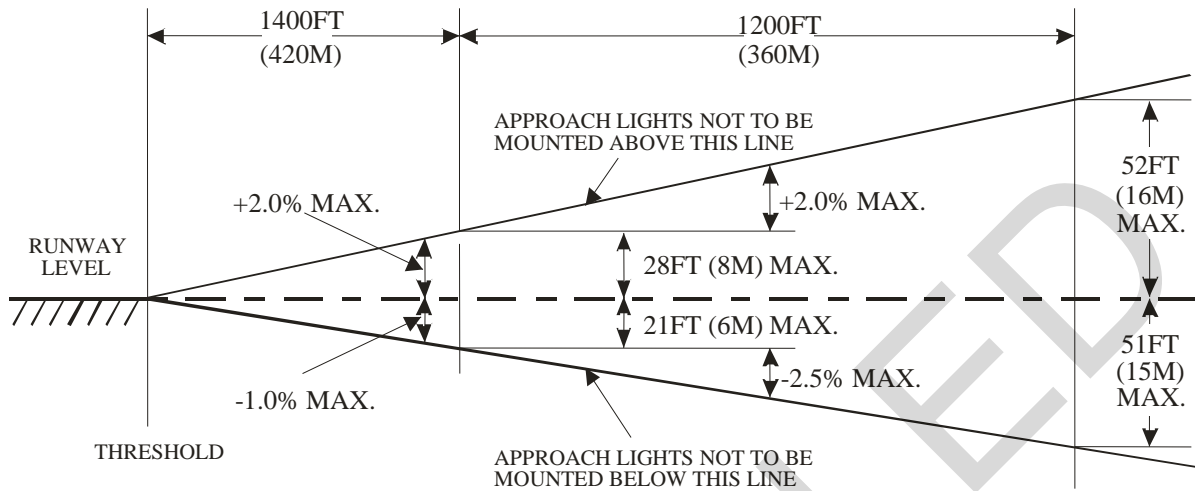

NOTE: THE BOUNDARIES OF THE LIGHT PLANES ARE THE RUNWAY THRESHOLD, 200FT (60M) AHEAD OF THE END LIGHT STATION, AND 200FT (60M) EACH SIDE OF CENTERLINE.

3-5.6.2 No object may penetrate the light plane except for ILS components and components of airfield lighting systems which are fixed by their function. These components must not interfere with the pilot's view of the approach lights when on a normal approach and must be obstruction lighted. For clearance purposes, all roads, vehicle parking areas and railroads are considered as vertical solid objects. The required clearance above railroads is 23 feet (6.9 meters) and above interstate highways is 17 feet (5.1 meters). The clearance required above other public roads and parking lots is 15 feet (4.5 meters). The clearance above private and military roads is 10 feet (3 meters). Airfield service roads, where traffic is controlled, are not considered as obstructions. Control of the service road traffic must be accomplished by appropriate signs or directly by the control tower; parking or stopping is prohibited between the signs. The airfield commander must approve the means of control and the wording of signs. It is preferred to get the needed clearance above a road, rather than controlling the traffic so the clearance is not necessary. Obstructions beyond the approach light system must be in accordance with UFC 3-260-01/TM 5-803-7.

3-5.6.2.1 Every effort must be made to remove or relocate objects which penetrate the light plane. For objects which cannot be moved, the height must be the minimum possible and located as far from the runway threshold as possible.

3-5.6.2.2 The major command has waiver authority to adjust the slope of the light plane beyond the allowances in this UFC to avoid interference from obstacles that cannot be removed or lowered.

3-5.7 Tolerance.

The tolerances for positioning steady burning MALSR lights are as follows:

- Lateral tolerance of a light bar is 6 inches (150 mm).
- Distance between individual light centers in a barrette is 2 inches (50 mm).
- Height for light centers up to 6 feet (1.8 meters) is 2 inches (50 mm).
- Height for light centers over 40 feet (12 meters) is 6 inches (150 mm).
- Tolerance for vertical aiming of light units is 1.0 degree.
- Tolerance for horizontal aiming of light unit is 5 degrees.

Longitudinal deviation for light bars or single SFL from a designated station is 20 feet (6 meters), except light stations may be displaced 100 feet (30 meters) to avoid omitting a light station where obstructions cannot be removed or cleared by acceptable clearance planes. Where a light station must be located more than 20 feet (6 meters) from the usual station, position the nearby light stations to provide more uniform spacing between lights.

3-5.8 Power Requirements.

Electrical power for the MALSR approach lights must be supplied as described in paragraphs 3-5.8.1 and 3-5.8.2.

3-5.8.1 For the centerline and 1,000 foot (300 meter) light bar steady-burning lights, a special power unit must furnish power to these lights from a multiple circuit rated at 120 volts or 120/240 volts 3-wire. This power unit must energize the lights at any of the three intensity settings selected.

3-5.8.2 For the SFL, the power to operate these lights is furnished by the master control unit at 120 volts. These lights have individual power supply units which may be combined with or separated from the flasher head. Allow an additional 5 KVA of transformer capacity for the SFL.

NOTE: Emergency power is not essential for the MALSR system, but if emergency power is available, it requires automatic emergency power transfer – an automatic transfer switch with isolation bypass.

3-5.9 Control Requirements.

The MALSR must be remotely controlled from the airfield lighting control panel in the control tower. Alternate control from the airfield lighting vault is desirable. A separate

control must provide for switching ON and OFF and for selecting the intensity setting of the centerline lights, the 1,000 foot (300 meter) light bar lights, and the SFL.

3-5.10 Monitoring Requirements.

Automatic monitoring is not required, but must be operational if installed.

3-5.11 Equipment.

See paragraphs 13-9.5 through 13-9.5.3 for typical MALSR components.

3-5.11.1 Light Supports.

The type of supports used for MALSR lights depends on the height of the light or barrette above the surface, as described in paragraphs 3-5.11.2.1 through 3-5.11.2.3.

3-5.11.1.1 Use in-pavement lights only in displaced threshold areas or paved overruns. They must be mounted on corrosion-proof steel light bases set in a concrete foundation. The lights may not project more than 1 inch (25 millimeters) above the paved surface.

Elevated light heights 6 feet (1.8 meters) or less use frangible supports. The support consists of a frangible coupling and sections of 2-inch (53-millimeter-) diameter conduit elbows set in concrete foundation.

3-5.11.1.2 Lights between 6 feet (1.8 meters) and 40 feet (12 meters) in height use low-impact-resistant supports. The individual SFL or five-light barrettes must be installed on low-impact-resistant supports of the correct height. These supports may be non-metallic or of the triangular antenna type; see FAA AC 150/5345-45 or FAA-E-2702.

3-5.11.1.3 For lights more than 40 feet (12 meters) in height, use semi-frangible supports; see descriptions in FAA AC 150/5345-45. The top 20 feet (6 meters) of supports for individual SFL or five-light barrettes must be low-impact resistant and installed on a rigid support of the correct height.

3-5.12 Compliance with International Standards.

There are no equivalents for the MALSR systems in previous ASIC AIR STDs or current NATO STANAGs; however, MALSR systems satisfy requirements for a Category I approach approved by the FAA.

3-6 RUNWAY END IDENTIFIER LIGHTS (REIL).

3-6.1 Purpose.

REILs provide the pilot with rapid and positive identification of the runway threshold during approach for landing. REILs aid pilots attempting landings under VFR conditions and during non-precision instrument approaches under IFR conditions.

3-6.2 Associated Systems.

Several visual aids must be used together with REILs: high intensity runway edge lights, runway threshold lights or displaced threshold lights, and runway markings. The PAPI system may also be an associated visual aid.

3-6.3 Description.

A REIL system consists of two synchronized flashing lights placed symmetrically about the runway centerline in the vicinity of the runway threshold, and are only allowed for use with a PAPI system.

3-6.4 Configuration/Location/Aiming.

See FAA AC 150/5340-30 for REIL installation details.

3-6.5 Photometric Requirements.

3-6.5.1 Unidirectional Fixtures.

See FAA AC 150/5345-51 for equipment-specific details and photometric data.

3-6.5.2 Omnidirectional Fixtures.

Omnidirectional fixtures must flash once per second, producing a white light through 360 degrees horizontally and vertically from +2 degrees to +10 degrees above the horizontal. Light units must be capable of being shielded when required by local conditions. Mount all REIL fixtures on frangible supports. See FAA AC 150/5345-51 for equipment-specific details and photometric data.

3-6.6 Power Requirements.

The system may be powered separately or by use of a power adapter unit connected to the runway light circuit. There is no requirement for standby power.

3-6.7 Control Requirements.

REIL systems may be controlled separately or matched to the associated runway edge light circuit through current sensing relays or other devices. When coupled to the runway edge lights, joint operation with edge lights is as follows:

<u>Edge Light Intensity</u>	<u>REIL Intensity</u>
Off	Off
Step 1 or 2	Low
Step 3	Medium
Step 4 or 5	High

3-6.8 Monitoring Requirements.

There are no monitoring requirements for the REIL system.

3-6.9 Compliance with International Standards.

3-6.9.1 NATO.

The unidirectional flashing lights meet the requirements of NATO STANAG 3316 (Edition 10), 13 May 2004, except for the displacement distance from the runway edge and the aiming angle.

3-6.9.2 ASIC.

ASIC AIR STD 90/27 has been cancelled.

3-7 PRECISION APPROACH PATH INDICATOR (PAPI) SYSTEM.

3-7.1 Purpose.

The PAPI is an unattended system that provides visual glide path guidance for landing an aircraft. See paragraph 12-3 for PAPI siting.

3-7.1.1 Justification.

For the US Army, a PAPI will be provided where one or more of the following conditions exists:

- The runway is used by turbojet or other aircraft with similar approach guidance requirements.
- The pilot of any type of aircraft may have difficulty judging the approach due to inadequate visual guidance that may be experienced during an approach over water or featureless terrain by day, or in the absence of sufficient extraneous lights in the approach area by night.
- If judging the approach is difficult due to misleading information, such as produced by deceptive surrounding terrain or runway slopes. Objects in the approach area may present a serious hazard if an aircraft descends below the

normal approach path, especially if there are no navigation aids to give warning of these objects.

- Physical conditions at either end of the runway present a serious hazard in the event of an aircraft undershooting or overrunning the runway.
- Terrain or prevalent meteorological conditions are such that the aircraft may be subjected to unusual turbulence during approach.

3-7.2 Configuration.

For airfields serving fixed wing aircraft, the PAPI system consists of a light bar with four light units (FAA L-880, per FAA AC 150/5345-28) placed on the left side of the runway in the vicinity of the touchdown point. (See Figure 3-11.)

3-7.2.1 Each light unit must be mounted on frangible fittings. Each unit must contain a minimum of two lamps (three lamps are preferred) and an optical system that produces a horizontally split, two-color (white over red) light beam.

3-7.2.2 Beginning at the out-board-most units, each unit in a light bar is aimed into the approach at a successively higher angle above the horizontal. When on a proper approach path, the pilot sees the two inboard lights in both light bars as red and the two outboard lights as white. As the approaching aircraft settles below the proper path, the pilot sees an increasing number of red lights in each light bar. As the aircraft rises above the path, the pilot sees an increasing number of white lights. (See Figure 3-11.)

3-7.2.3 See FAA AC 150/5340-30 for PAPI installation requirements.

Figure 3-11 PAPI Configuration

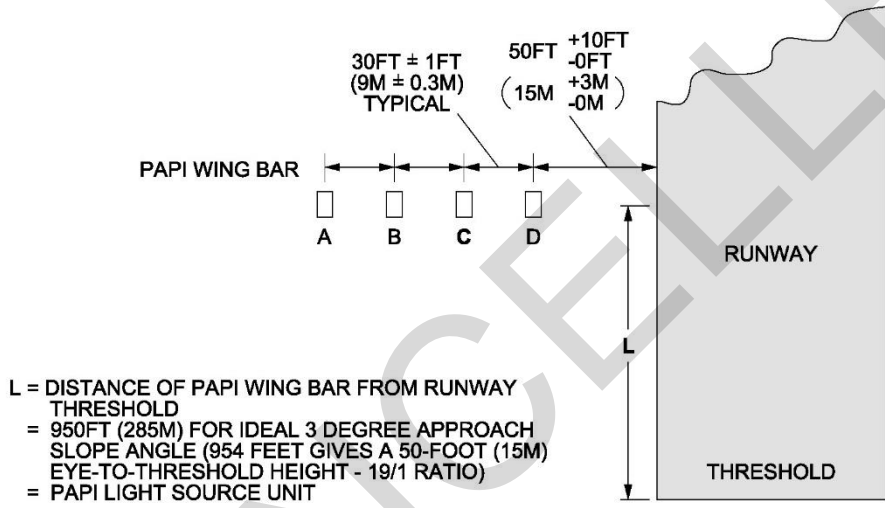
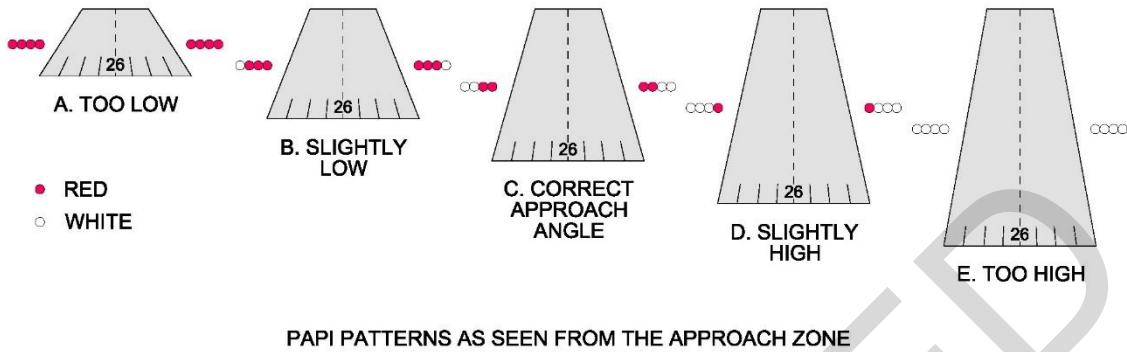

3-7.3 Photometric Requirements.

See Figure 3-12 and FAA AC 150/5345-28 for detailed PAPI photometric requirements.

Figure 3-12 PAPI Photometric Requirements

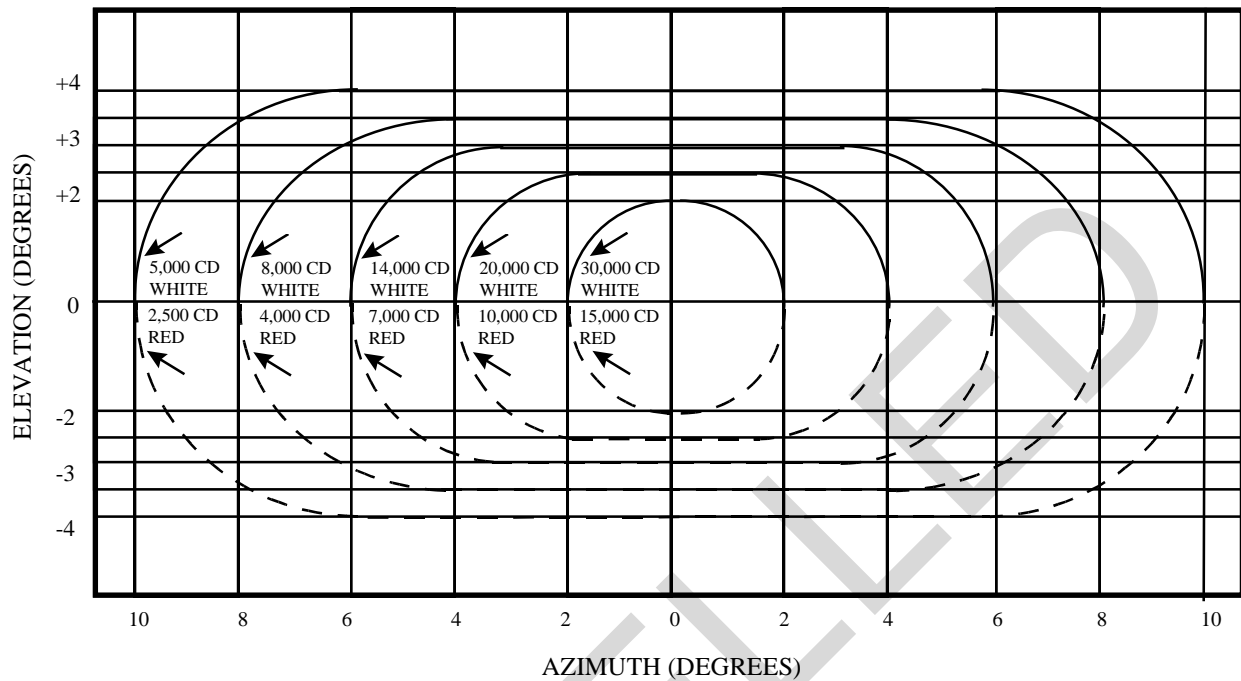

3-7.3.1 Aim PAPI units in accordance with FAA AC 150/5340-30, parallel with the approach within 0.5 degrees. Aim successive light units in a light bar vertically, beginning with the out-board-most unit, and incrementally at increasingly higher angles. The glide path angle is the mean of the highest and lowest angle setting. (See Figure 3-13.) Set the angular difference between successive light units as follows:

<u>Approach Angle</u>	<u>Angular Difference</u>
2 to 4 degrees	20 minutes
over 4 to 7 degrees	30 minutes
over 7 degrees	1 degree

3-7.3.2 The location and alignment of the PAPI may be varied to meet local conditions if the effective glide path is not less than 2.5 degrees or more than 4.0 degrees above the horizontal. Unless otherwise directed or where conditions dictate otherwise, use 3.0 degrees for the design glide path angle. For design purposes, the visual glide path begins at the PAPI runway reference point (RRP), which is a point on the runway centerline at the PAPI light bar (through lens center of light units) coinciding with the elevation of the lens center of the light units, and which projects into the approach at the glide path angle. (See Figure 3-13.) On a precision instrument runway, aim the PAPI at the same angle as the electronic glide path.

a. For the Army only, this procedure must be modified for runways that serve aircraft in height group 4 (Table 3-6); for these runways, the distance of the PAPI from the threshold must equal the distance to the electronic glide slope source plus an additional 300 feet (90 meters).

b. For the Air Force only, PAPI locating procedures will ensure a minimum safe wheel height above the threshold for all height groups using the runway.

Figure 3-13 PAPI Aiming Criteria

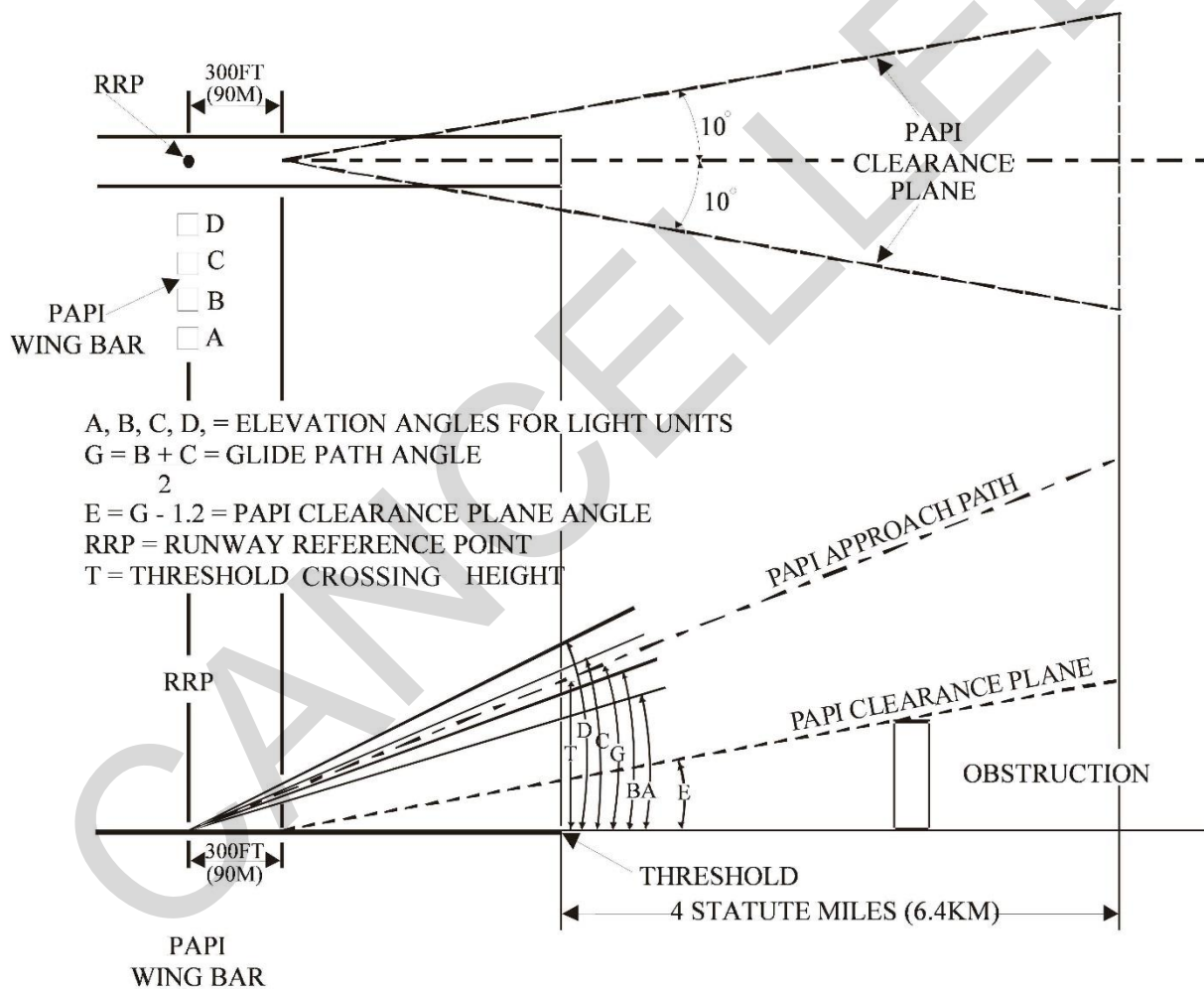

3-7.4 Considerations.

At a minimum, the following factors must be considered when siting a PAPI: existing or planned ILS glide slope; the established glide path (aiming angle, typically 3 degrees);

the threshold crossing height (TCH) for the selected aircraft height group; and the runway gradient (longitudinal slope) from the threshold to the PAPI location.

3-7.4.1 When used on a runway with ILS, the PAPI must be located the same distance from the runway threshold as the virtual source of the ILS glide slope, in accordance with FAA AC 150/5340-30. For Army airfield only, this is modified for aircraft in the height group #4 (Table 3-6), in which case the PAPI is sited at the runway point of intercept (RPI), plus an additional 300 feet (90 meters), +50 feet, -0 feet (+15 meters – 0 meters) from threshold. (See paragraph 12-3 to site PAPI.)

Table 3-6 Visual Threshold Crossing Height Groups

Height Group	Approximate Cockpit-to-Wheel Height	Visual Threshold Crossing Height
#1. General Aviation, Small Commuters, Corporate Turbojets, T-37, T-38, C-21, T-1, C-12, C-20 Fighter Jets	10 ft (3 m) or less	40 ft (+5, -20) (12 m (+1.5, -6))
#2. F-28, CV-340/440/580, B-737, DC-9, DC-8,	15 ft (4.5 m)	45 ft (+5, -20) (13.5 m (+1.5, -6))
#3. B-727/707/720/757	20 ft (6 m)	50 ft (+5, -15) (15 m (+1.5, -4.5))
#4. B747/767, L-1011, DC-10, A300, KC-46	over 25 ft (7.6 m)	75 ft (+5, -15) (22.5 m (+1.5, -4.5))
Refer to FAA AC 150/5340-30 for Group 4, ILS Glide Slope-PAPI coordination and other additional information.		

3-7.4.2 Without an ILS, determine the position and aiming for the PAPI that will yield the required TCH and clearance over obstacles in the approach area, per procedures in FAA AC 150/5340-30.

3-7.4.3 No light unit can be closer than 50 feet (15 meters) to any other runway, taxiway, or apron. Avoid locations where the system could be obscured by other installations. Do not place other lights so close to the PAPI as to cause pilot confusion. Where these conditions cannot readily be satisfied with the system located on the left side of the runway, the system, with waiver approval (paragraph 1-11 or paragraph 1-12), may be sited on the right side of the runway.

3-7.4.4 Establish a PAPI obstruction clearance plane per procedures in FAA AC-150/5340-30.

3-7.5 Power Requirements.

Provide the electrical power for the PAPI system from a separate 120/240 volt circuit or a 6.6A series circuit. The 120/240 volt circuit is for parallel operation with control by photocell and selector switch at the unit. Energize the 6.6A series circuit by a constant-current regulator. A 4 kW constant current regulator, five intensity steps, is used to energize the PAPI on a series circuit. When the PAPI is required to be on a series circuit, the lights must be connected to the series circuit by series isolation transformers of suitable capacity for each lamp housing assembly. For emergency power requirements, see Chapter 2. Monitoring of the PAPI is not required, except for daily visual checks of operations and periodic checks for proper aiming. See FAA AC 150/5340-30 for additional information about PAPI power requirements.

3-7.6 Control Requirements.

Control the PAPI on/off manually from the air traffic control tower and from the airfield lighting vault. Brightness control will be manual; however, the PAPI may also be controlled by photocell or pilot radio control at airfields without air traffic controllers, or where the air traffic control tower is not manned full time. At these locations, provide an electrical interlock between the PAPI and the runway edge lights. This interlock may be an electrical contractor or radio interface unit to ensure that, during the hours of darkness the PAPI is on only when the runway edge lights are on. During daylight hours, the PAPI will be capable of operating independently of the runway edge lights. PAPI on/off and intensity controls must be included on the airfield lighting control panel.

3-7.6.1 Provide radio control when required by using an FAA L-854 radio controller (see FAA AC 150/5345-49), which allows the PAPI to be turned on by a pilot on approach or by a ground control station.

3-7.6.2 The photocell must operate per requirements in FAA AC 150/5345-28. The photoelectric control requires a time delay of at least 30 seconds to prevent false switching caused by stray light or temporary shadows. Install the photocell at an unobstructed location and aim it towards the northern horizon.

3-7.7 Foundations.

Foundations for mounting light boxes and a power control unit (PCU) will be made of concrete and designed for the region, to prevent frost heave or other displacement. Extend the foundation at least 12 inches (300 millimeters) below the frost line. To minimize damage from mowers, extend the foundation at least 12 inches (300 millimeters) beyond the light boxes and do not install the foundation more than 1 inch (25 millimeters) above grade. All light boxes will be frangible-mounted to the foundation.

3-7.8 Equipment.

See FAA AC 150/5345-28 for additional information.

3-7.9 Flight Inspections.

Refer to AFJMAN 11-225(I) for flight inspection requirements (commissioning flight) prior to use.

3-7.10 PAPI Siting.

Refer to paragraph 12-3.

3-7.11 Compliance with International Standards.

3-7.11.1 NATO.

These PAPI criteria satisfy requirements of NATO STANAG 3316 (Edition 10), 13 May 2004, with the exception that the Air Force system is located on only one runway side.

3-7.11.2 ASIC.

ASIC AIR STD 90/27 has been cancelled.

CANCELLED

This Page Intentionally Left Blank

CANCELLED

CHAPTER 4 STANDARDS FOR RUNWAY LIGHTING SYSTEMS

4-1 MIXING OF LIGHT SOURCE TECHNOLOGIES.

LED light fixtures must not be interspersed with incandescent lights of the same type.

Example: An airport adds an extension to a runway. On the existing runway, the runway centerline light fixtures are incandescent. The airport decides to install LED runway centerline fixtures on the new section of runway and retains the incandescent fixtures on the existing section. This interspersing of dissimilar technology is not approved for installation. See FAA Engineering Brief 67D for mixed light source uses.

When replacing a defective light fixture, ensure the replacement is of the same light source technology, to maintain a uniform appearance. For Air Force and Army airfields, LED light fixtures are prohibited in the areas listed in Paragraph 2-5.1.

The prohibition of LED lighting includes both HIRL and MIRL edge lighting systems.

4-1.1 Runway Perimeter Lighting.

Runway edge lights, threshold lights, and runway end lights are used to outline the lateral and longitudinal limits of the usable surface of the runway. They are required for VFR night operation and for all categories of instrument operations.

For new construction, medium intensity is standard for Army airfields; high intensity is standard for Air Force airfields.

4-1.2 Runway Surface Lighting.

When Category III instrument operations are necessary, the runway perimeter lighting is augmented with touchdown zone and centerline lighting in-pavement light fixtures. For Category II instrument operations, touchdown zone and centerline lighting are optional.

4-1.3 Runway Visual Aid Requirements.

Table 2-1A and Table 2-1B show the visual landing aids required under various conditions.

4-1.4 Runway Circuiting Requirements.

Each runway lighting system (edge, center line and touchdown zone) must be served with two separate regulators. Light fixtures may be connected in an interleaved manner as shown in Figure 4-1, but interleaving is not recommended for Air Force.

4-1.5 Photometric Testing.

Photometric testing is recommended to be performed on all newly installed runway edge, centerline, touchdown cone, threshold and end lights on site. The purpose of these tests is to verify the installed fixtures meet or exceed the minimum photometric requirements.

Figure 4-1 Optional Interleaved Runway Lighting Circuits (not recommended for Air Force airfields)

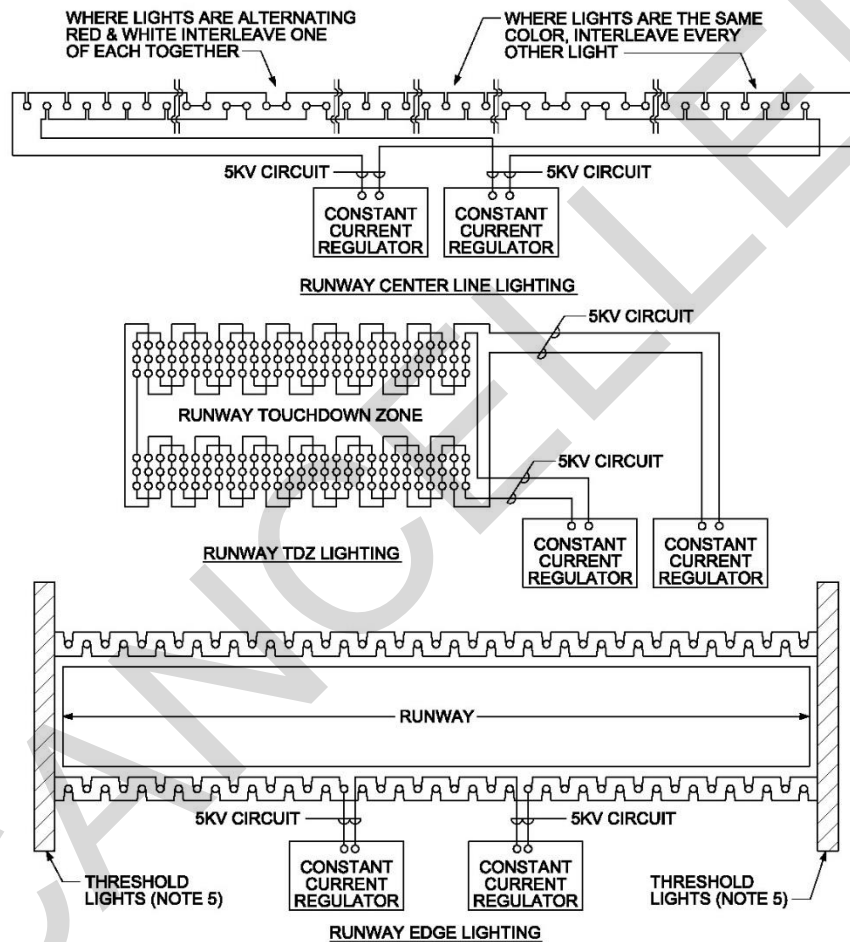

NOTES:

1. EXAMPLES ABOVE ARE ILLUSTRATIONS OF INTERLEAVED RUNWAY LIGHTING CIRCUITS.
2. INBOARD IN-PAVEMENT THRESHOLD LIGHTS SHOULD ALTERNATE BETWEEN APPROACH LIGHT CIRCUIT AND RUNWAY EDGE LIGHT CIRCUIT(S).
3. THE ONLY TYPE OF GUIDANCE SIGNS THAT SHOULD BE CONNECTED TO THE RUNWAY EDGE LIGHT CIRCUIT ARE MANDATORY HOLD SIGNS AND ARRESTING GEAR MARKERS. RUNWAY EXIT SIGNS SHOULD BE CONNECTED TO RESPECTIVE TAXIWAY EDGE LIGHT CIRCUITS. IF RUNWAY DISTANCE REMAINING SIGNS ARE CONNECTED TO RUNWAY EDGE LIGHTS THEY SHOULD ALL BE ON ONE OF THE INTERLEAVED CIRCUITS. IT IS PREFERRED THAT RUNWAY DISTANCE REMAINING SIGNS ARE ON A SEPARATE CIRCUIT.
4. EACH RUNWAY EDGE, TDZ AND CENTER LINE CIRCUIT SHOULD BE INSTALLED IN A DEDICATED 2" (53MM) CONDUIT.
5. FOR INTERLEAVING OF THRESHOLD LIGHTS REFER TO FIGURE 4-5A AND 4-5B (AIR FORCE) OR FIGURES 4-5C AND 4-5D (ARMY).

4-2 HIGH INTENSITY RUNWAY LIGHTS (HIRL) – RUNWAY EDGE LIGHTS.

4-2.1 Purpose.

A runway edge lighting system is a configuration of lights that defines the lateral and longitudinal limits of the usable landing area of the runway. Two straight lines of lights installed parallel to and at equal distances from the runway centerline define the lateral limits. Longitudinal limits of the usable landing area are defined at each end of the area by straight lines of lights called threshold/runway end lights, which are installed perpendicular to the lines of runway edge lights. HIRLs provide visual guidance during takeoff and landing operations at night and under low visibility conditions. High intensity runway edge lights are required for Air Force Night VMC, Non-Precision, and Category I, II, and III instrument operations. High intensity runway edge lights are required for Army for Category I operations.

4-2.2 Configuration.

See FAA AC 150/5340-30 for additional runway edge light configuration and installation information. Locate runway edge lights along the full length of the runway in two parallel rows equidistant from the centerline. Place along the edge of the area declared for use as the runway or outside the edge of the area not more than 10 feet (3 meters). (See Figure 4-2.) It is recommended that lights be placed at a distance of 7 to 8 feet (2.1 to 2.4 meters) unless otherwise justified.

4-2.2.1 Light Spacing (HIRL).

Longitudinally, space the lights along the runway light lines at equal distances not exceeding 200 feet (60 meters). Determine the distance between lights by dividing the length of the runway light line between the threshold light lines into equal spaces approaching but not exceeding 200 feet (60 meters).

4-2.2.2 Elevated Lights.

Use elevated lights in all instances except as noted in paragraph 4-2.2.3. If it is known that some fixtures will be changed to in-pavement fixtures in the near future, size the fixtures, light bases, and transformer housings to accept in-pavement fixtures.

Figure 4-2 Runway Edge Light Configuration

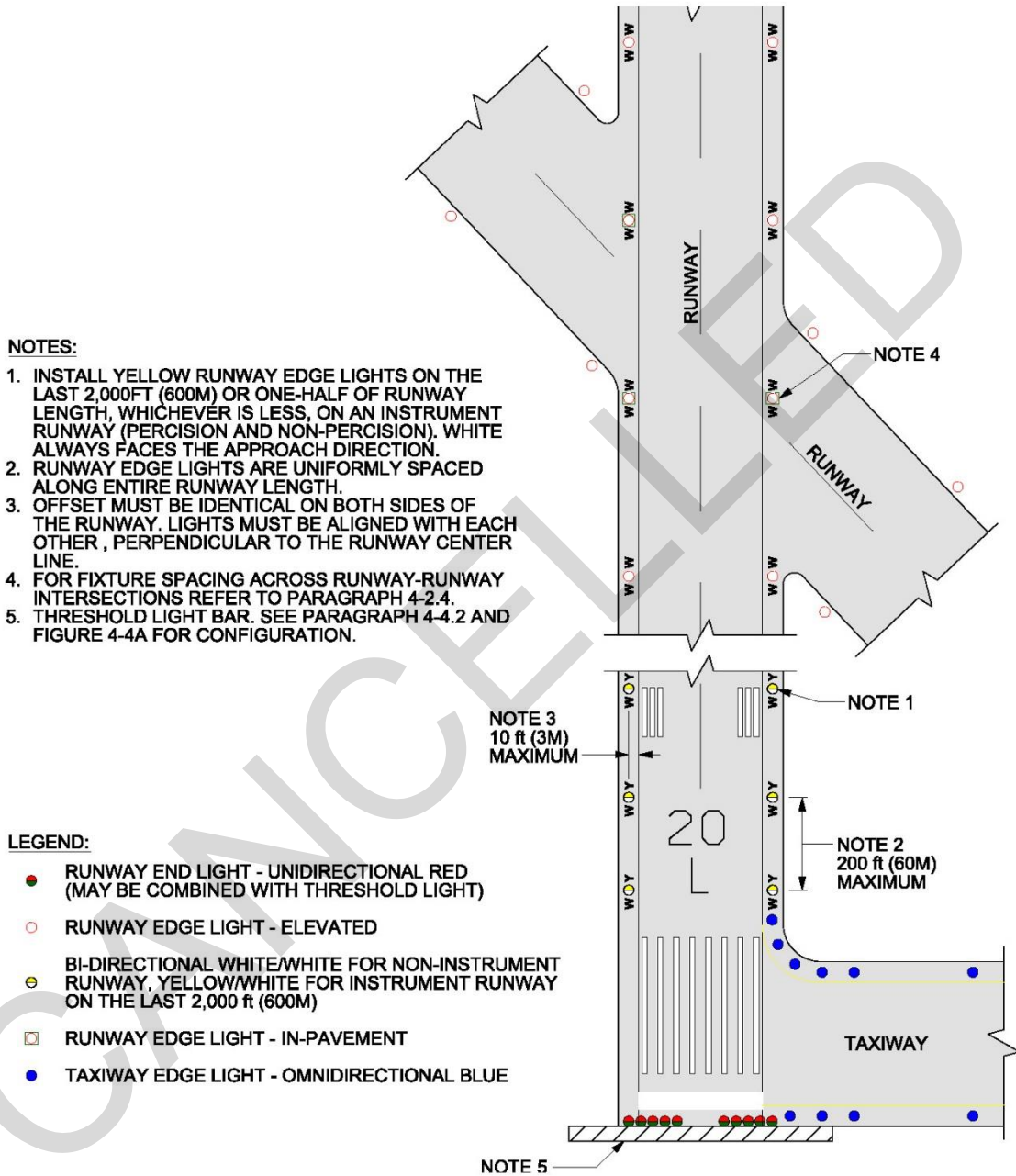

Note: This configuration for runway aligned taxiways will not be approved for new construction.

Figure 4-3 Elevated Fixture Height

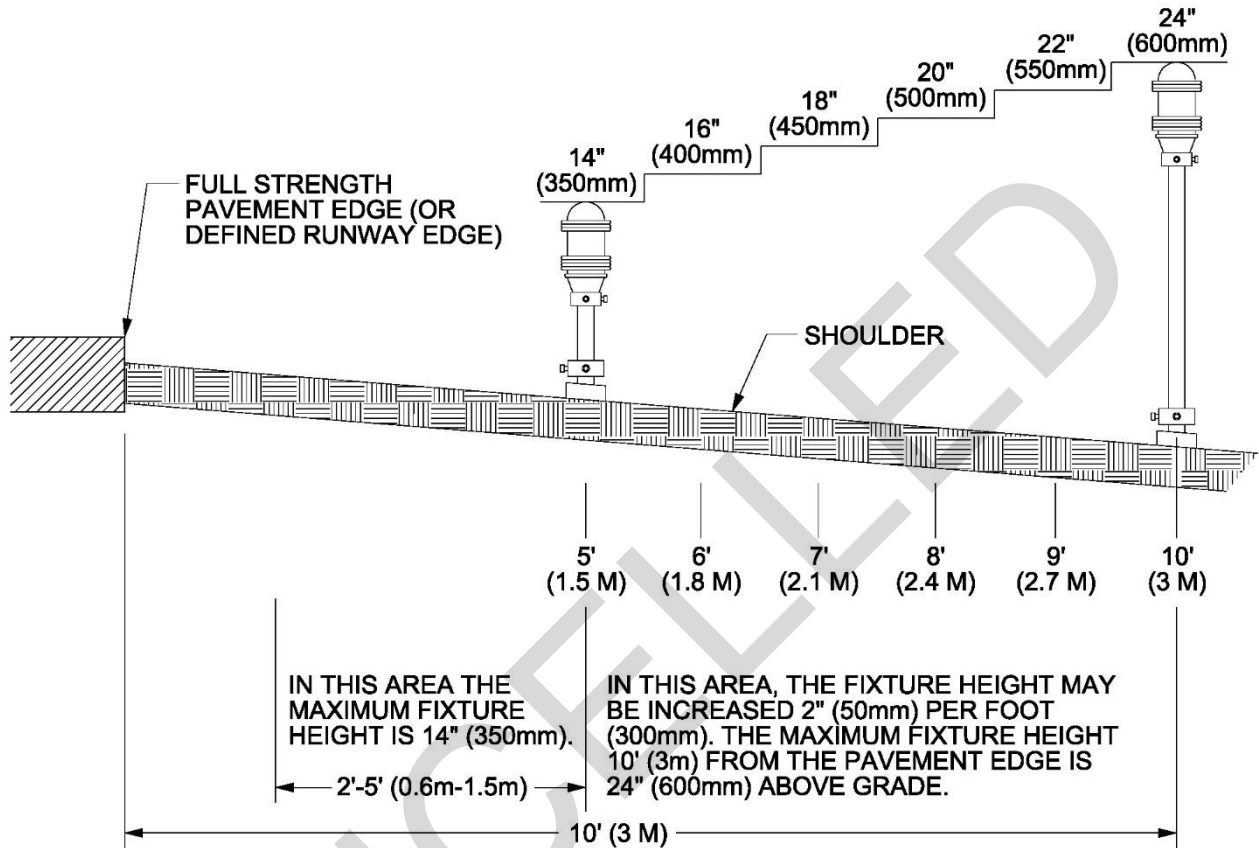

NOTES:

1. WHEN LIGHTS ARE ELEVATED ABOVE 14" (350mm) (STANDARD), A MINIMUM CLEARANCE OF 6" (150MM) MUST BE MAINTAINED BETWEEN THE FIXTURE AND ANY OVERHANGING PART OF AN AIRCRAFT.
2. FOR OTHER HEIGHT VARIANCES, SEE FAA AC150-5340-30.

4-2.2.3 In-Pavement Fixtures.

Use in-pavement units in areas where elevated lights are subject to damage from jet blast, operation of an arresting system, or interference with aircraft operation. (See paragraph 13-12.1.)

4-2.3 Photometric Requirements.

See FAA AC 150/5345-46 for detailed photometric requirements of runway edge light fixtures. See FAA AC 150/5340-26 for additional information about the toe-in of runway edge light fixtures. Follow the manufacturer’s instructions for proper fixture toe-in alignment. Use bidirectional high intensity runway edge lights. The lights must be white, except that the last 2,000 feet (600 meters) on an instrument runway must be yellow (caution zone indication to the pilot). The runway edge lights may be capable of providing small amounts of omnidirectional light to provide circling guidance to the runway. Ensure the omnidirectional component is capable of being shielded during times of emergency. The main beams must be toed-in 3.5 degrees and elevated 4 degrees above the horizontal. Edge lights are operated at five intensity steps:

<u>Intensity Step</u>	<u>Minimum Light Intensity Percentage</u>
1 (2.8 A)	0.15 %
2 (3.4 A)	1.0 %
3 (4.1 A)	3.9 %
4 (5.2 A)	16.9 %
5 (6.6 A)	100.00 %

4-2.4 Runway/Runway Intersections.

For runways that are approved for CAT III operations, maintain uniform spacing across intersections by installing in-pavement edge lights on the intersecting runway.

For other operations on runways with HIRL, the installation of an in-pavement edge light is based on the following:

- The availability of other visual cues at the intersection, such as guidance signs or runway centerline lighting.
- The geometric complexity of the intersection, such as crossing runways. When the gap exceeds 400 feet (120 meters install an in-pavement light fixture to maintain uniform spacing.
- Whether the addition or not the addition of an in-pavement edge light could cause confusion with ground operations.

4-2.4.1 In-Pavement Fixtures in Sweep Area of Arresting Gear Marker Tape

The runway edge lights in the immediate area of the arresting gear markers are vulnerable to being swept by the tape when an aircraft engages the arresting gear. The lights in the sweep area must be in-pavement fixtures. The length of the sweep area (B) along the row of edge lights on each side of the runway is calculated by: $B = A \times C / ((R / 2) + A - D)$, where

A = the displacement of the arresting gear sheave from the runway edge.

C = the cable runout, normally 1,333 feet (400 meters).

R = the runway width.

D = the distance from the runway centerline to the point of engagement on the pendant wire. The maximum expected distance is 40 feet (12 meters).

The sweep area is in the direction of engagement of the arresting gear and can be in either runway direction, if the arresting gear can be engaged in either direction.

4-2.5 Equipment.

Elevated fixtures must be mounted on a frangible fitting at a maximum height of 14 inches (350 millimeters) at 2 to 5 feet (0.6 to 1.5 meters) from the defined pavement edge. At locations with frequent snow accumulations of 12 inches (300 millimeters) or more, the mounting height may be increased to not more than 24 inches (600 millimeters) in height at 10 feet (3 meters) from the defined pavement edge. No part of in-pavement fixtures must extend more than 1 inch (25 millimeters) above the surrounding surface. See Figure 4-3 for heights.

4-2.6 Power Requirements.

Provide a main and a standby power system with automatic transfer. Where used in support of Category II or III instrument operations, the transfer must occur within 1 second of a failure of the system. For other operations, transfer must occur within 15 seconds of the power failure.

4-2.7 Control Requirements.

When used in support of instrument operations below 2,400 feet (720 meters) RVR, provide system monitoring which, at a minimum, gives positive indication at the control facility that power is being delivered to the system. For interleaved edge lights, do not place adjacent edge lights on the same side of the runway on the same circuit. Lights on direct opposite sides of the runway must be on the same circuit.

4-2.8 Compliance with International Military Standards.

4-2.8.1 NATO.

These standards meet NATO STANAG 3316 (Edition 10) – Airfield Lighting, 13 May 2004.

4-2.8.2 ASIC.

Previous ASIC AIR STD 90/27 cancelled.

4-3 MEDIUM INTENSITY RUNWAY LIGHTS (MIRL).

4-3.1 Purpose.

MIRL edge lights are used on VFR runways, or on non-precision Instrument Flight Rule runways, for either circling or straight-in approaches. MIRL edge lights are not installed on runways intended for precision approaches.

4-3.2 Configuration.

The configuration must be per paragraph 4-2.2 for high intensity runway edge lighting.

4-3.3 Photometric Requirements.

See FAA AC 150/5345-46 for detailed photometric requirements of runway edge light fixtures. See FAA AC 150/5340-26 for additional information about the toe-in of runway edge light fixtures. Follow the manufacturer's instructions for proper fixture toe-in alignment.

Optimum aiming of lights depends on the design and output of the fixtures used in the system. Light fixtures may be designed to cover several applications and may have fixed patterns and aiming angles that differ from this document. Light aiming and patterns other than those given in this document may be used if the resultant light pattern produces equivalent light intensities in the required areas. Medium intensity runway edge lights must be omnidirectional and white. Where in-pavement lights are required, they may be bidirectional. The edge lights must be operated at three intensities as follows:

<u>Intensity Step</u>	<u>Percent of Full Intensity</u>
1	10%
2	30%
3	100%

4-3.4 Runway/Runway Intersections

For runways using MIRL, where the configuration across the intersection does not allow the matching of edge lights on the opposite side of the runway to be maintained, the distance must not exceed 400 feet (120 meters). If the distance between the runway edge lights is greater than 400 feet (120 meters), install an FAA Type L-852D taxiway centerline light fixture. Modify the light fixture to produce white light (remove the filters) and maintain the designed spacing.

4-3.5 Equipment.

Elevated fixtures must be mounted on a frangible fitting at a maximum height of 14 inches (350 millimeters) at 2 to 5 feet (0.6 to 1.5 meters) from the defined pavement edge. At locations with frequent snow accumulations of 12 inches (300 millimeters) or

more, the mounting height may be increased to not more than 24 inches (600 millimeters) in height at 10 feet (3 meters) from the defined pavement edge. See FAA AC 150/5340-30 and Figure 4-3 for additional information about light fixture height versus distance from the defined pavement edge.

4-3.6 Power Requirements.

Standby power is not required for medium intensity runway lights, except where they are installed on the primary runway. When installed on the primary runway, provide a main and a standby power system with automatic transfer within 15 seconds of failure of the system in use.

4-3.7 Control Requirements.

Provide remote on, off, and brightness control.

4-3.8 Compliance with International Military Standards.

4-3.8.1 ASIC.

Previous ASIC AIR STD 90/27 cancelled.

4-3.8.2 NATO.

This system does not meet NATO STANAG 3316 (Edition 10) – Airfield Lighting, 13 May 2004, for lighting of subsidiary runways.

4-4 THRESHOLD LIGHTS.

4-4.1 Purpose.

Threshold lights provide positive identification of the beginning of the operational runway surface for approaching aircraft at night or under instrument weather conditions.

4-4.2 High Intensity Threshold Light Configuration.

Install threshold lights in a line perpendicular to the extended runway centerline outside the usable landing area a distance of not more than 10 feet (3 meters). The line of lights is symmetrical about the runway centerline and extends 40 feet (12 meters) outboard of the lines of runway edge lights. (See Figure 4-4A for the Air Force configuration, and Figure 4-4B for the Army configuration). Determine the position of the lights as follows:

4-4.2.1 Place a light where the line of threshold lights intersects the line of runway edge lights. Then place lights at 5 feet (1.5 meters) for a distance of 40 feet (12 meters) outboard of the runway edge light lines.

4-4.2.2 Place lights at uniform intervals between the lines of runway edge lights and along the line of the threshold lights. Space as near to 5 feet (1.5 meters) as possible and do not exceed 5 feet 2 inches (1.55 meters). The line of threshold lights may be gated to lessen the problem of tail hook bounce by eliminating those lights in the center 70-foot (21-meter) portion of the threshold. For new installations, it is recommended that where fixtures are not installed, bases be installed with blank covers that are flush with the runway surface and are suitable for future in-pavement fixtures. This is intended to accommodate future mission requirements where tail hook equipped aircraft are no longer using the runway.

Figure 4-4A Threshold Light Configuration for Air Force

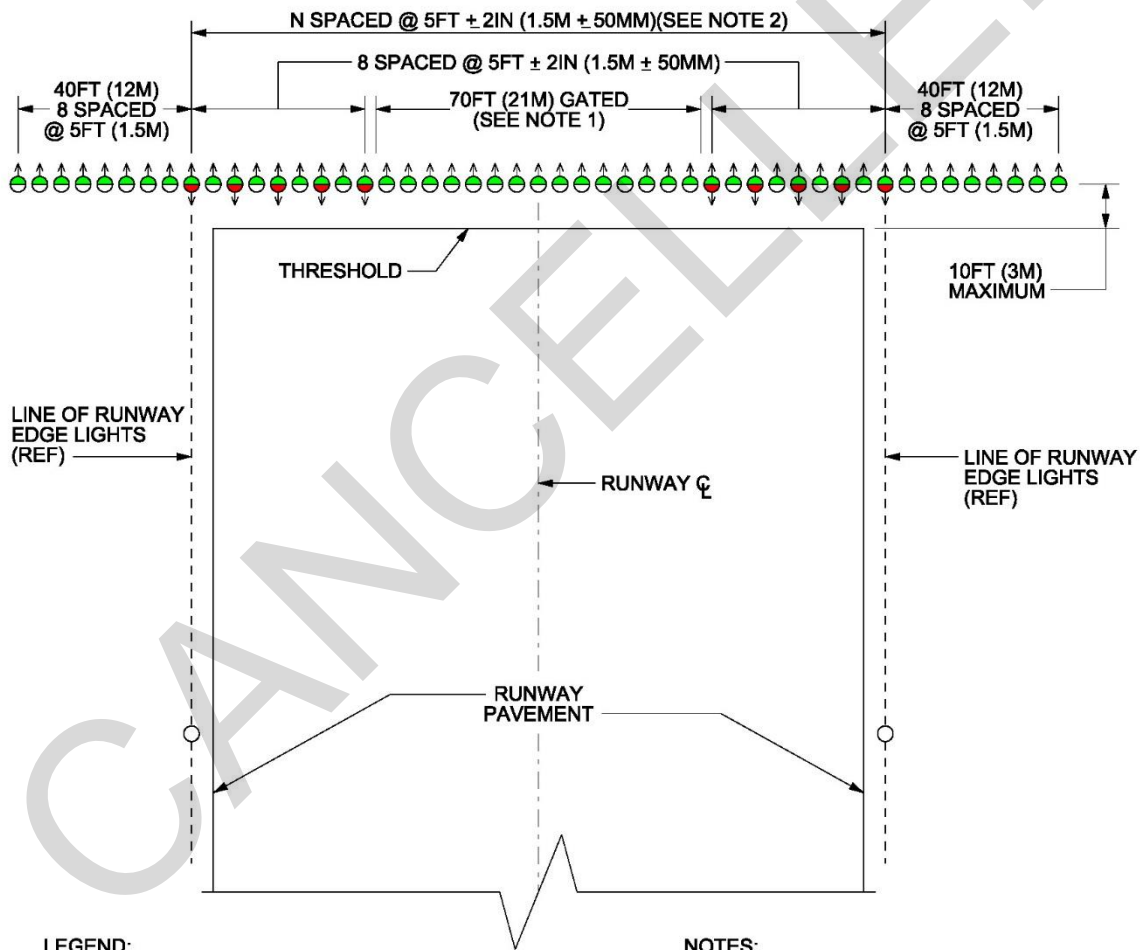

LEGEND:

- ⬆️ UNI-DIRECTIONAL GREEN THRESHOLD LIGHT
- ⬆️⬆️ GREEN THRESHOLD / RED RUNWAY END LIGHT, BI-DIRECTIONAL, 5 PER SIDE (MAXIMUM)
- RUNWAY EDGE LIGHT (REF)

NOTES:

1. LIGHTS IN THE GATE AREA MAY BE OMITTED IF REQUIRED TO AVOID HOOK BOUNCE PROBLEMS.
2. ADJUST THE NUMBER OF LIGHTS BASED ON THE WIDTH OF RUNWAY.

Note: Adjust the number of lights based on the width of runway.

Figure 4-4B Threshold Light Configuration for Army

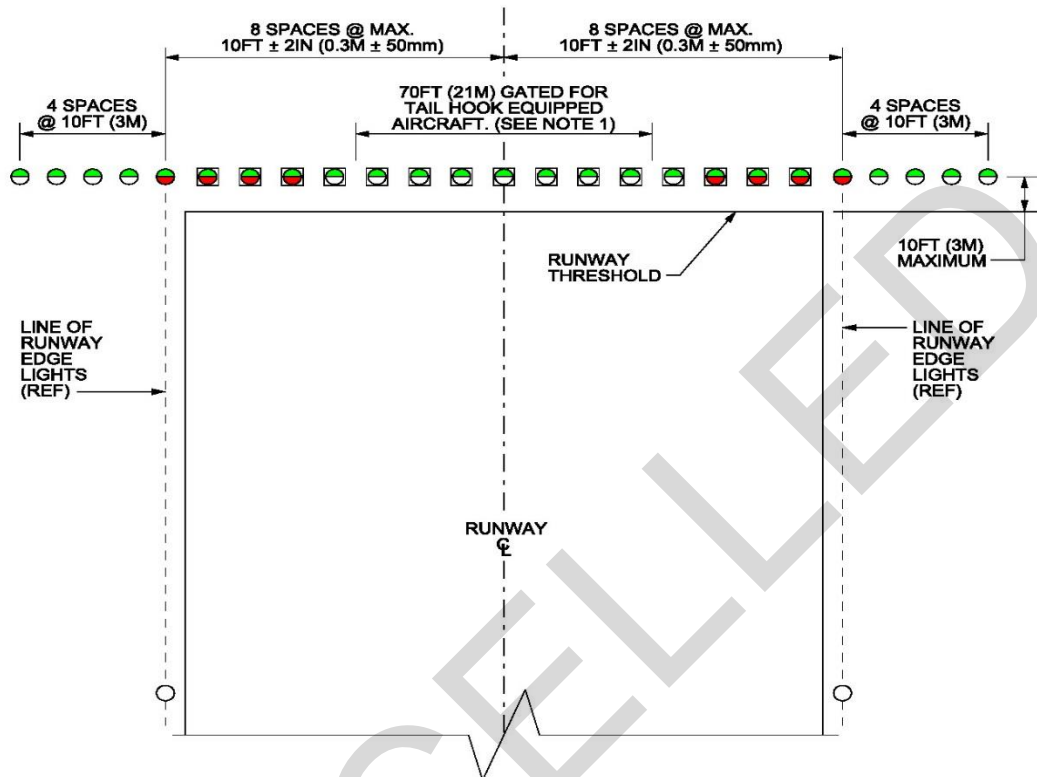

NOTES:

1. LIGHTS IN THE GATE AREA MAY BE OMITTED IF REQUIRED TO AVOID HOOK BOUNCE PROBLEMS.
2. IF ADDITIONAL END LIGHTS ARE DESIRED REPLACE UNI-DIRECTIONAL THRESHOLD LIGHTS WITH BI-DIRECTIONAL TYPE.

LEGEND:

- RUNWAY EDGE LIGHT (REFERENCE)
- ⊠ THRESHOLD LIGHT IN -PAVEMENT, UNI-DIRECTIONAL GREEN, L-852D, OPTIONAL FOR MEDIUM INTENSITY RUNWAY LIGHTING (NOTE 2)
- ⊠ THRESHOLD/END LIGHT, IN-PAVEMENT, BI-DIRECTIONAL GREEN/RED, L852D, OPTIONAL FOR MEDIUM INTENSITY RUNWAY LIGHTING
- ⊠ THRESHOLD LIGHT, ELEVATED, UNI-DIRECTIONAL GREEN, L-861SE, MINIMUM 5 EACH SIDE (NOTE 2)
- ⊠ THRESHOLD/END LIGHT, ELEVATED, BI-DIRECTIONAL GREEN/RED, L-861SE, MINIMUM 5 EACH SIDE

4-4.3 Medium Intensity Threshold Lights.

Install threshold lights in a line perpendicular to the extended runway centerline outside the usable landing area a distance of not more than 10 feet (3 meters). The line of lights is symmetrical about the runway centerline and extends 40 feet (12 meters) outboard of the lines of runway edge lights. (See Figure 4-5C and Figure 4-5D.) Determine the position of the lights as follows:

- Place a light where the line of threshold lights intersects the line of runway edge lights. Next, place lights at 10 feet (3 meters) for a distance of 40 feet (12 meters) outboard of the runway edge light lines.

- If inboard lights are used, place lights at uniform intervals between the lines of runway edge lights and along the line of the threshold lights. The interval must be a maximum of 10 feet (3 meters).

4-4.4 Photometric Requirements.

See Figure 4-6 for detailed photometric information for high intensity runway threshold lights. See FAA AC 150/5345-46 for detailed photometric information for medium intensity runway threshold lights.

4-4.4.1 High Intensity Threshold Lights.

The runway threshold lights must be unidirectional green aimed into the runway approach with intensities per Figure 4-6 when used with high intensity runway edge lights or approach lights. The light beams are aimed parallel with the runway centerline and angled upward at an angle of 4.5 degrees. High intensity threshold lights must operate at five intensity levels, together with the associated runway edge lights. High intensity runway edge lights will be used with high intensity threshold lights.

4-4.4.2 Medium Intensity Threshold Lights.

The lights must be bidirectional red/green, with green aimed towards the approach. Outboard threshold elevated lights must be FAA L-861SE, and inboard threshold in-pavement lights must be FAA L-852D. See FAA AC 150/5345-46 for additional requirements.

Figure 4-5A Threshold Light Circuiting for Air Force (interleaved)

Note: Interleaving is allowed, but not recommended.

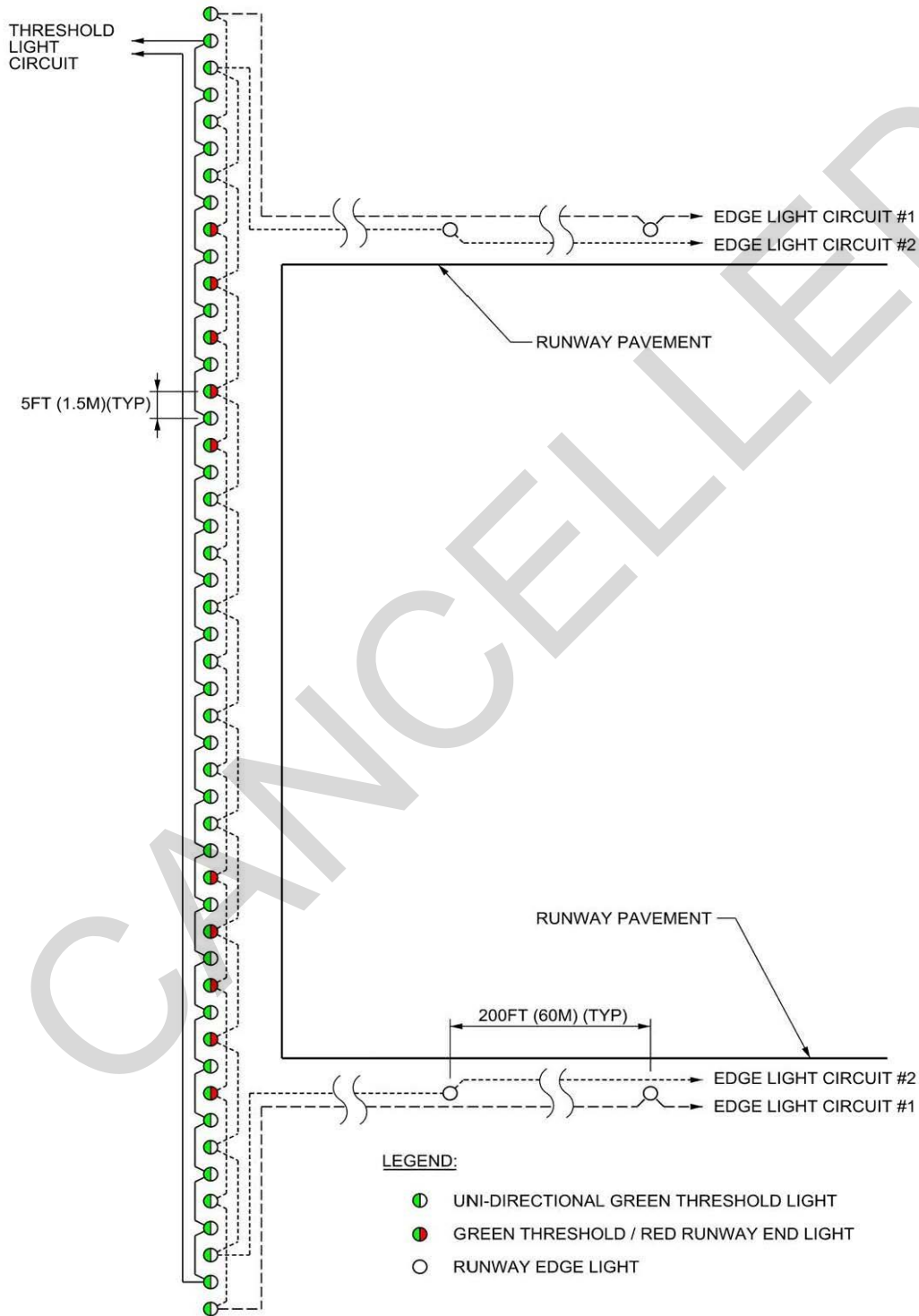

Figure 4-5B Air Force (non-interleaved)

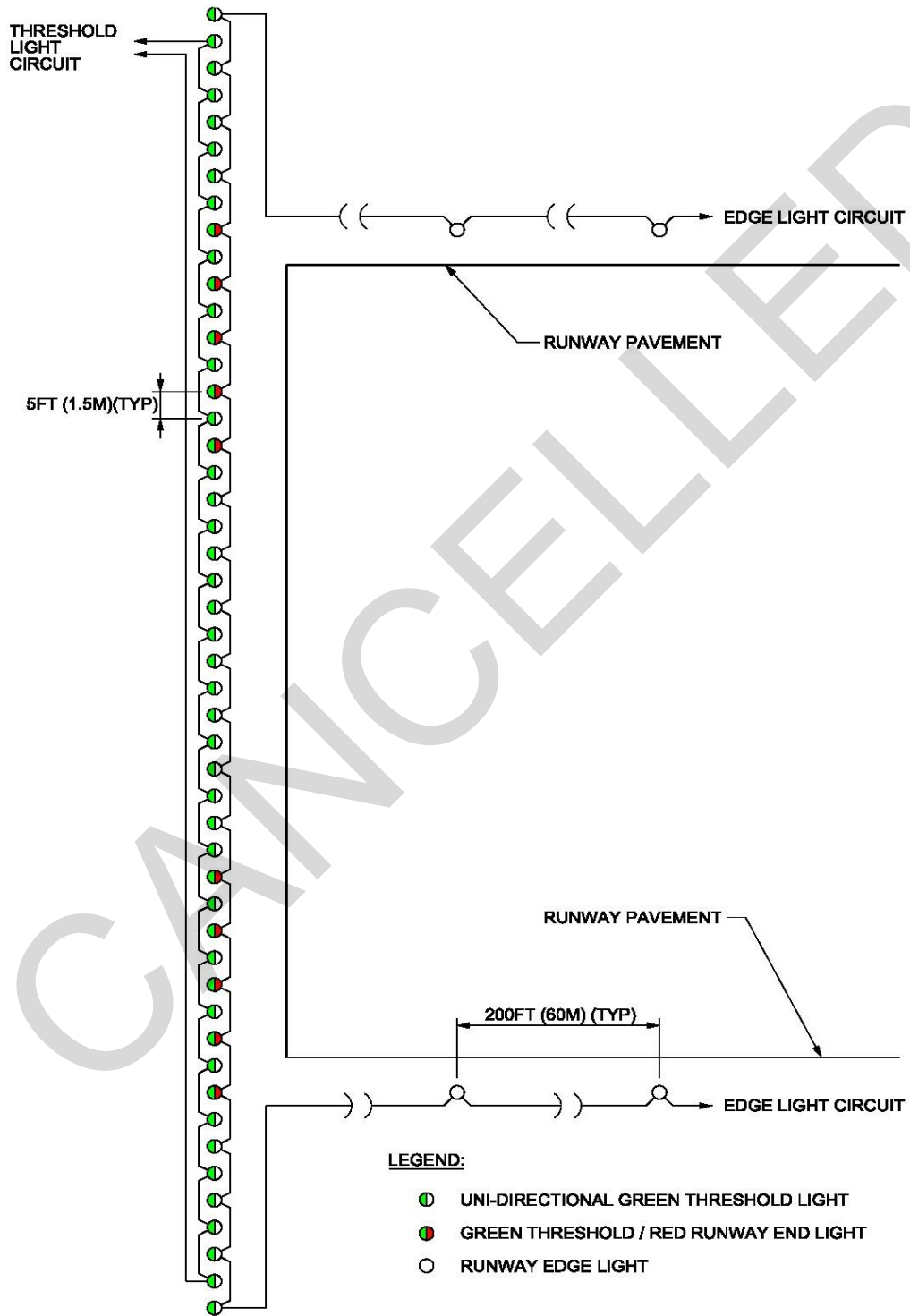
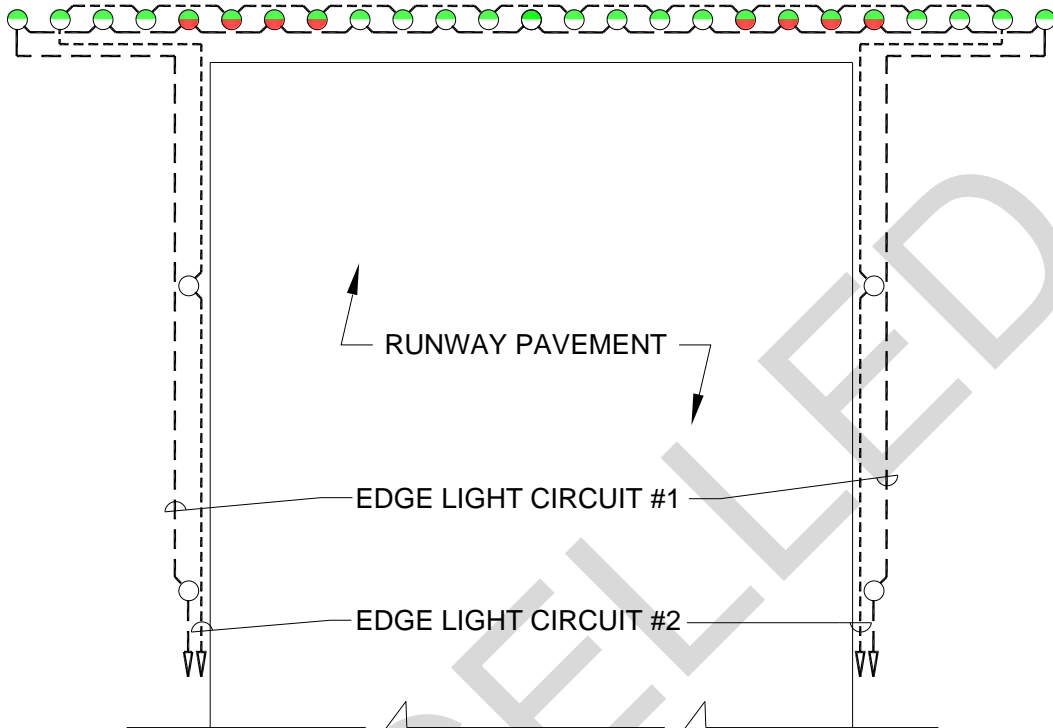

Figure 4-5C Threshold Light Circuiting for Army (interleaved)



LEGEND:

- GREEN THRESHOLD / RED RUNWAY END LIGHT
- GREEN THRESHOLD LIGHT
- RUNWAY EDGE LIGHT

Figure 4-5D Army (non-interleaved)

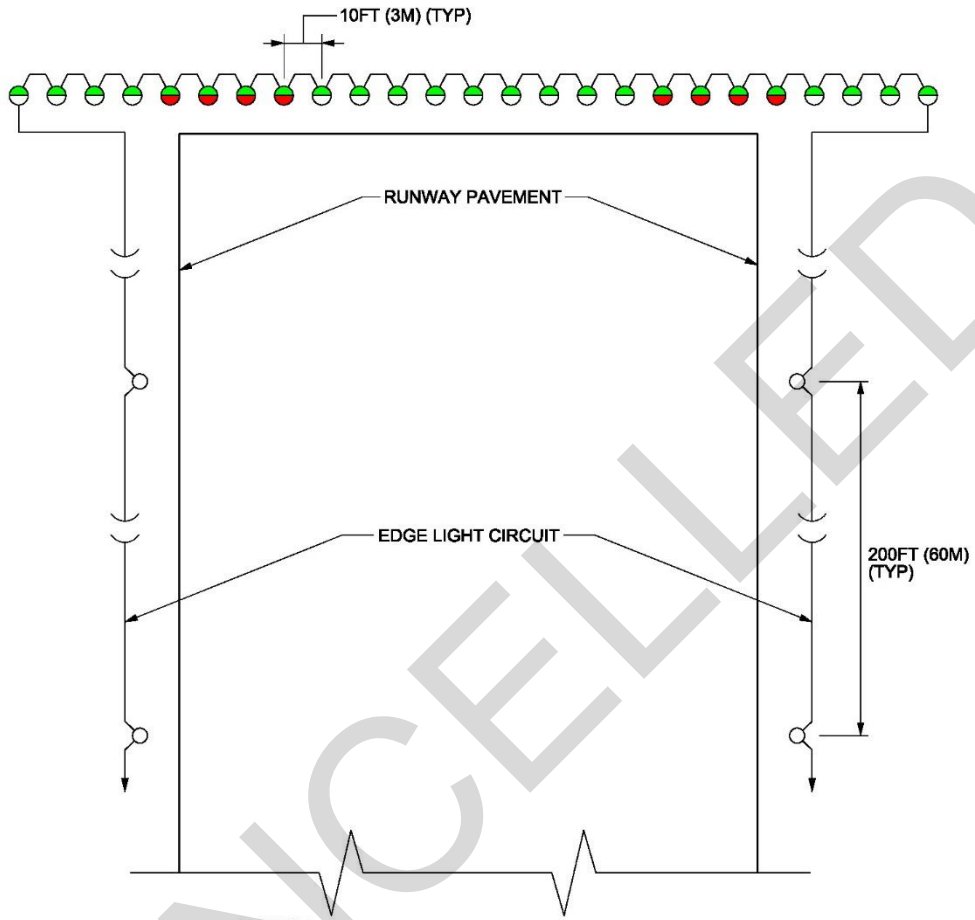

LEGEND:

- GREEN THRESHOLD / RED RUNWAY END LIGHT
- GREEN THRESHOLD LIGHT
- RUNWAY EDGE LIGHT

Figure 4-6 Threshold Light Photometric Requirements

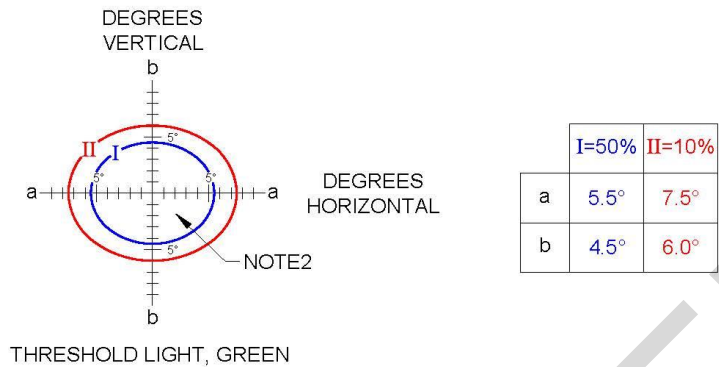

NOTES:

1. ALL CONTOURS ARE ELLIPSES CALCULATED BY EQUATION: $(X/a)^2 + (Y/b)^2 = 1$
2. THE MINIMUM AVERAGE CANDELA IN GREEN LIGHT OF THE MAIN BEAM (INSIDE CONTOUR I) IS 10,000 CD FOR HIGH INTENSITY SYSTEMS AND 100 CD FOR MEDIUM INTENSITY SYSTEMS.
3. MAXIMUM INTENSITY MUST NOT EXCEED 3 TIMES AVERAGE CANDELA SPECIFIED AND THE AVERAGE INTENSITY MUST NOT EXCEED 1.5 TIMES MINIMUM AVERAGE INTENSITY SPECIFIED.
4. PORTIONS OF THE LIGHT BEAM CUT OFF BY THE MOUNTING SURFACE MAY BE DISREGARDED.
5. CONTOURS I AND II INDICATE THE MINIMUM PERCENT VALUES OF THE MAIN BEAM INTENSITY.

4-4.5 Equipment.

Inboard threshold lights use in-pavement fixtures with no part of the fixture protruding more than 1 inch (25 millimeters) above the surrounding surface. Outboard threshold lights use elevated fixtures, frangible mounted. Where the opposite direction runway end is collocated with the threshold, runway end lights may be incorporated into threshold light fixtures. The number of bidirectional fixtures must be the minimum required to satisfy the requirement for end light fixtures. Where traffic patterns or arresting gear equipment interfere with the use of elevated fixtures, in-pavement fixtures must be used. (See paragraph 13-12.3.)

4-4.6 Power Requirements.

4-4.6.1 For Air Force airfields, connect the threshold lights with the interleaved runway edge light circuits as in Figure 4-5A. If the runway edge lights are not interleaved, connect the threshold lights as in Figure 4-5B.

4-4.6.2 For Army airfields, connect the threshold lights with the interleaved runway edge light circuits as in Figure 4-5C. If the runway edge lights are not interleaved, connect the threshold lights as in Figure 4-5D.

4-4.7 Control Requirements.

4-4.7.1 Where there is no approach light system, provide remote on and off and intensity levels to correspond to the runway edge light controls. The intensity levels must be the same as the runway edge lights.

4-4.7.2 When installing approach lights, the threshold lights may be circuited so approximately half of them are controlled by the approach light system. Interleave the threshold lights selected for operation with the approach lights, with the threshold lights to be operated with the runway lights so they present a uniform pattern symmetrical about the runway centerline when operated without runway lights. This may require that the two innermost lights be operated off the same circuit. Bidirectional fixtures are not allowed for operation with approach lights when runway end lights are installed. Interleaving of runway edge lights are allowed, but are not encouraged. When runway edge lights are interleaved with two circuits, connect the runway threshold lights so that a uniform symmetrical pattern will remain if either of the runway edge light circuits fails.

4-4.8 Aiming Threshold/ Approach.

When used as part of an approach light system, bidirectional threshold lights, both in-pavement and elevated, have fixed aiming angles (with 3.5 to 4.0 degree toe-in on the red side only) for the beams and cannot be adjusted.

4-4.9 Monitoring Requirements.

Threshold lights have the same monitoring requirements as the edge lights.

4-4.10 Compliance with International Military Standards.

4-4.10.1 NATO.

The standard meets NATO STANAG 3316 (Edition 10) – Airfield Lighting, 13 May 2004, for high intensity threshold lights.

4-4.10.2 ASIC.

Previous ASIC AIR STD 90/27 cancelled.

4-5 LIGHTING WITH DISPLACED THRESHOLDS.

4-5.1 General.

The runway threshold, which is the beginning of the landing area, may not be located at the beginning of the full strength runway pavement. It may be displaced because of obstructions or other operational problems. The area of full strength pavement in front of the threshold may be required for takeoff or for rollout on landings from the opposite direction. Where this occurs, changes to the standards for runway lighting are required.

4-5.2 Configuration for Permanent Displacement.

See Figure 4-7 and Figure 4-8 for typical layouts of displaced thresholds.

4-5.2.1 Install threshold lights, as specified in paragraph 4-4, with dimensions referenced to the theoretical beginning of the usable landing area.

4-5.2.2 Install runway end lights, as specified in paragraph 4-6 with measurements referenced from the end of the usable takeoff and rollout area.

4-5.2.3 When the displaced runway area is used for specific operations (takeoff, rollout, taxiing) appropriate edge lights for the function are installed to delineate the outline.

4-5.2.4 The runway centerline lights facing the approach direction in the displaced area must be blanked out if the length of the displacement is less than 700 feet (210 meters). If the displacement is 700 feet (210 meters) or greater, circuit the centerline lights in the area separately. Provide the capability to turn runway centerline lights off during landing operations. If a high intensity approach light system is installed, this switching capability is not required.

4-5.2.5 Install approach lights and visual approach slope indicators, such as PAPI, as specified in this standard using the theoretical beginning of the usable landing area (threshold) as the reference. Ensure coordination has been performed for relocation of any instrument approach aids.

4-5.2.6 Where the abandoned runway surface is not used for aircraft movement, the threshold lighting is relocated to the new threshold location. Lights in or along the abandoned surface are not required.

4-5.3 Configuration for Temporary Displacement.

See Figure 4-9 for a typical layout of temporary displaced threshold with construction or obstructions on the approach end. See Figure 4-10 for layout when threshold/end of runway lights are co-located.

Where the threshold is temporarily displaced and the duration of the displacement is insufficient to warrant the relocation of all facilities (normally 6 months or less), the following applies:

**Figure 4-7 Displaced Threshold Light Configuration (Permanent)
 Where Runway Surface is Used as a Taxiway with Taxiway End Lights**

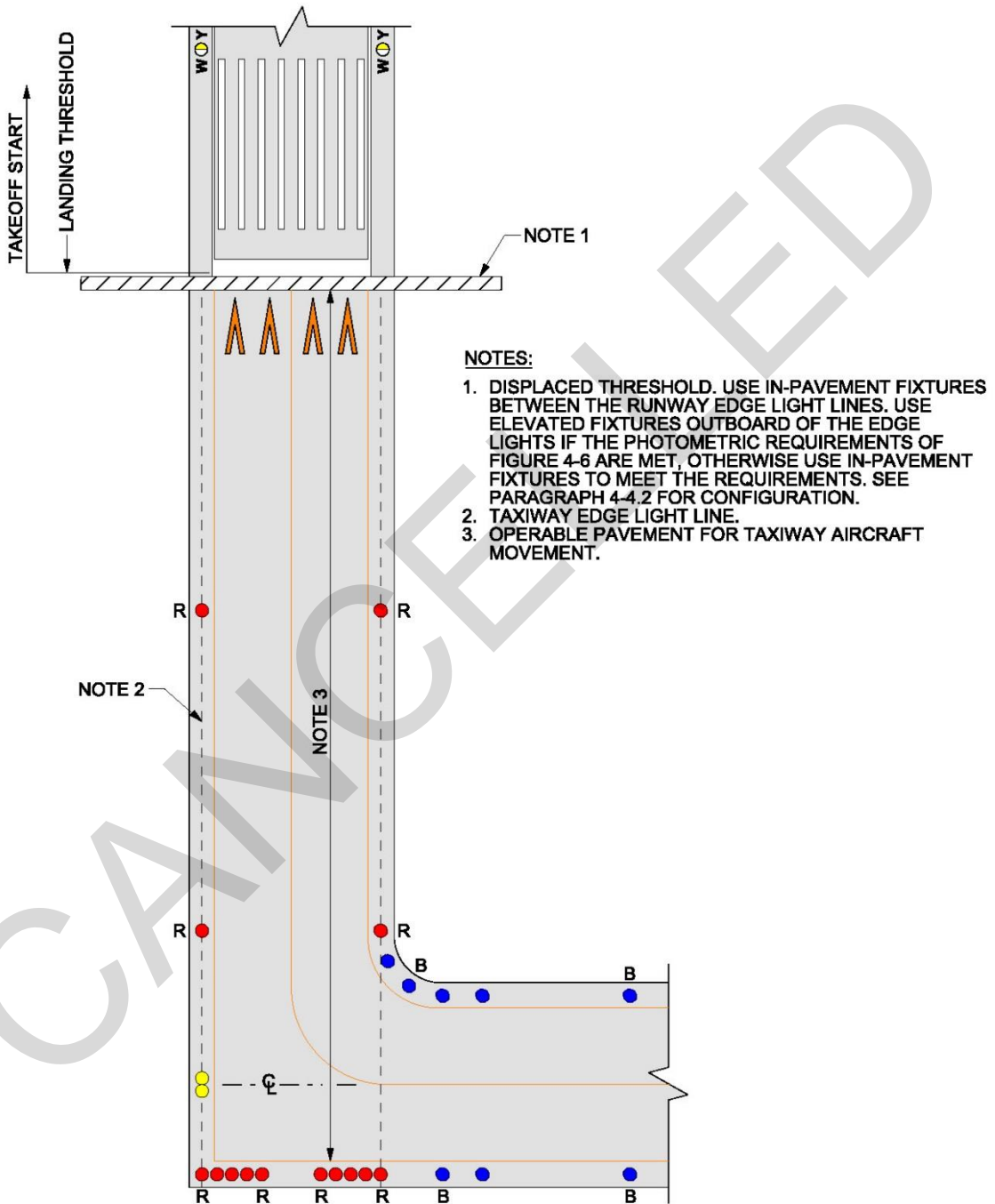

**Figure 4-8 Displaced Threshold Light Configuration (Permanent)
 Where Runway Surface is Used for Takeoff and Landing Rollout**

Note: Not supported for new construction.

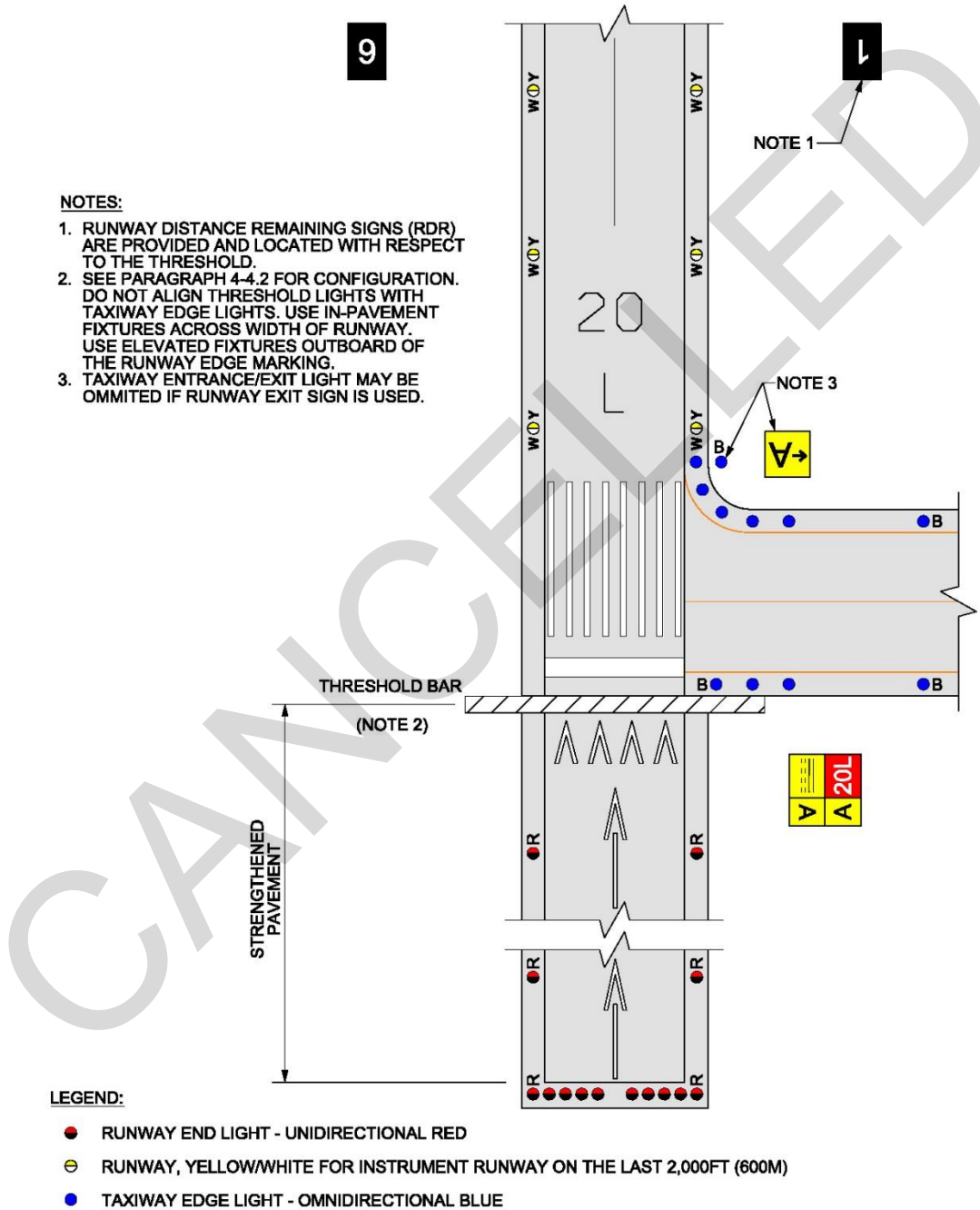

Figure 4-9 Displaced Threshold Lighting Configuration (Temporary)

Precautionary Note: Means must be provided to secure the plank and fixtures to prevent any movement arising from jet blast. Where spikes (asphalt) or concrete anchors (PCC) are used to secure the plank to the pavement, the holes left in the pavement after removal must be repaired.

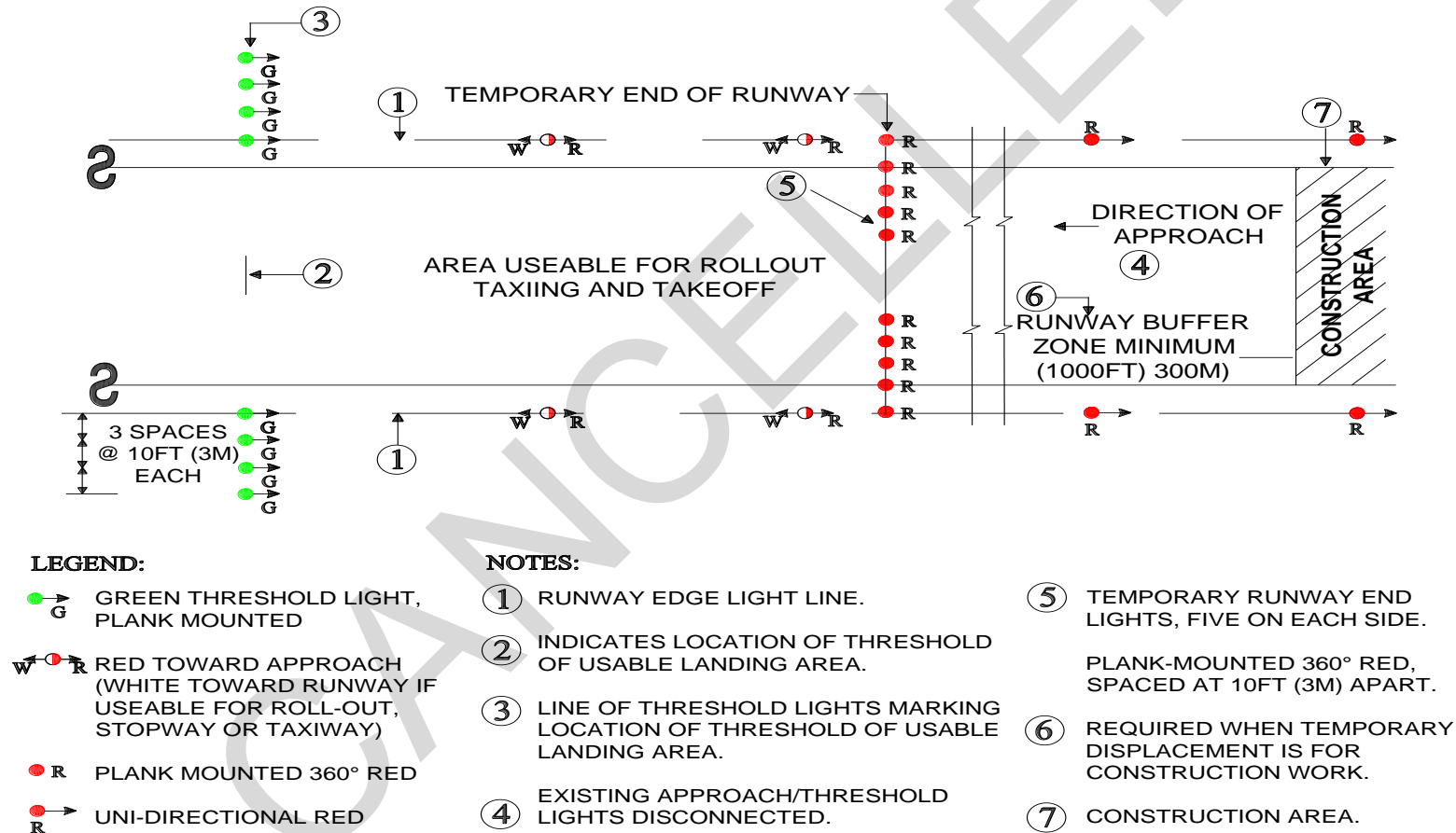
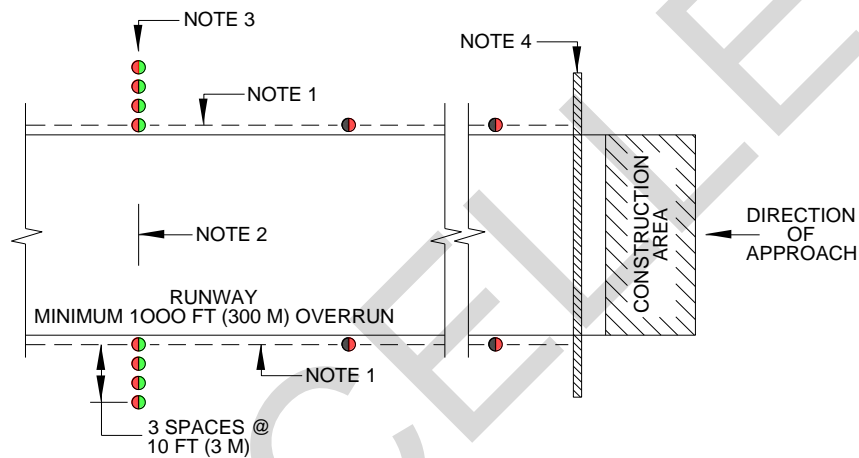

Figure 4-10 Displaced Threshold Lighting Configuration With Co-Located Threshold/End of Runway Lights (Temporary)

LEGEND:

- THRESHOLD/RUNWAY END LIGHT - BI-DIRECTIONAL RED/GREEN
- EXISTING RUNWAY EDGE LIGHTS. CHANGE TO RED TOWARD
- APPROACH AND BLANK TOWARD TEMPORARY THRESHOLD (MAY BE WHITE TOWARD TEMPORARY THRESHOLD IF USED FOR ROLL-OUT).



NOTES:

1. RUNWAY EDGE LIGHT LINE.
2. LOCATION OF THRESHOLD OF USEABLE LANDING AREA.
3. LINE OF THRESHOLD LIGHTS MARKING LOCATION OF THRESHOLD OF USEABLE LANDING AREA. (L-862 FOR HIRL, L-861 FOR MIRL) LIGHTS MAY BE STAKE OR PLANK MOUNTED.
4. EXISTING APPROACH THRESHOLD LIGHTS DISCONNECTED. RUNWAY END LIGHTS (UNI-DIRECTIONAL RED TOWARD RUNWAY) SHALL REMAIN ACTIVE IF AREA BETWEEN TEMPORARY AND EXISTING THRESHOLDS IS USED ROLL-OUT.

4-5.3.1 Coordinate with TERPS specialist or FAA equivalent, airfield manager, CE Community planner, safety, and standardization and evaluation office to determine placement of the threshold.

Include temporary displaced threshold layout and configuration in the construction phasing plan and submit temporary displaced threshold requirement/configuration as a

part of the temporary waiver request to the installation commander for a construction project within the airfield environment.

4-5.3.2 Disable the permanent runway threshold lights, runway end lights, approach lighting system, visual glide slope indicating systems such as PAPI or VASI, and any touchdown zone lights serving that end of the runway and runway edge lights along the section of runway not used for aircraft traffic.

4-5.3.3. Install temporary runway threshold lights, per Figure 4-9 or Figure 4-10, with dimensions referenced to the theoretical beginning of the usable landing area. Additional lights maybe added for a 300 foot (90 meter) wide runway. Reference UFC 3-260-01, Table 3-2, Runways.

4-5.3.4 Install temporary runway end lights, as specified in paragraph 4-6, with dimensions referenced from the end of the usable takeoff and rollout area.

NOTE: When temporary displacement is due to construction work, place the runway end lights to allow an additional 1,000 feet (300 meters) for emergency roll-out or to protect the Approach-Departure Clearance Surface from the tallest equipment that will be erected in the approach-departure zone. See UFC 3-260-01 for geometric requirements of the Approach-Departure Clearance Surface.

4-5.3.5 All fixtures are elevated and may be stake mounted or mounted on planks fastened to the runway surface.

4-5.3.6 Cables and transformers may be laid on the surface but must be protected from damage.

4-5.3.7 Modify runway edge lights in the temporary displaced area to show red light toward the approach direction (see Figure 4-9 and Figure 4-10). (When the displaced area is intended to be used for rollout or taxiing operations, the color of the edge lights must be modified with red toward approach and white toward the runway.) See paragraph 4-2.3 for photometric requirements on instrument runways.

4-5.3.8 Runway centerline lights in the displaced area will be blanked toward the approach direction and red toward the runway opposite the approach.

4-5.3.9 Runway Distance Remaining Signs (RDR) number panels facing toward the opposite end approach must be blanked or temporarily replaced with the new number panels reflecting the shorter distance to go. Renumbering is done so that at least 1,000 feet (300 meters) remain between the last number (#1) and the displaced runway end.

4-5.4 Equipment.

See paragraph 13-12.3.

4-5.5 Power, Control and Monitoring.

See paragraphs 4-4.6 and 4-4.7.

4-5.6 Compliance with International Standards.

4-5.6.1 NATO.

Same as paragraph 4-4.10.

4-5.6.2 ASIC.

Same as paragraph 4-4.10.

4-5.7 Additional Information.

See FAA AC 150/5345-46 for more information.

4-6 RUNWAY END LIGHTS.

4-6.1 Purpose.

Runway end lights define the end of the operational runway surface for aircraft for landing, rollout or takeoff. They are required on all lighted operational runways.

4-6.2 Configuration.

Runway end lights consist of 10 red lights in two groups of 5 lights for Air Force and 8 red lights in two groups of 4 lights for Army. Place the groups symmetrically and on a line perpendicular to, the runway centerline within 10 feet (3 meters) of the end of the usable runway surface. The lights in each group must have a uniform spacing of 5 feet \pm 2 inch (1.5 meters \pm 50 mm) for Air Force and 10 feet \pm 2 inch (3 meters \pm 50 mm) for Army. The outboard-most light in each group must be in line with the line of the runway edge lights on that side of the runway. Runway end lights are usually co-located with the opposite end threshold lights. Where they are co-located, runway end lights may be incorporated into the opposite end threshold fixtures provided the photometric requirements are met. (See Figure 4-4A for the Air Force configuration, and Figure 4-4B for the Army configuration). When runway width exceeds 150 feet (45 meters) additional runway end lights may be added.

4-6.3 Photometric Requirements.

Optimum aiming of lights depends on the design and output of the fixtures used in the system. Light fixtures may be designed to cover several applications and may have fixed patterns and aiming angles that differ from this document. Light aiming and patterns other than those in the standard may be used if the resultant light pattern produces equivalent light intensities in the areas required by this standard. Use

unidirectional red runway end lights facing toward the runway. Aim the lights parallel with the runway centerline and upward at 3 degrees above the horizontal. They must operate at five intensities as specified in paragraph 4-2.3 for HIRL. Note: This configuration for runway aligned taxiways will not be approved for new construction.

Runway end lights used with MIRL must have reduced intensities compatible with the edge lights and operate at three intensity steps. (See Figure 4-11.)

For detailed photometric requirements for runway end lights, see FAA AC 150/5345-46.

Figure 4-11 Runway End Light Photometrics

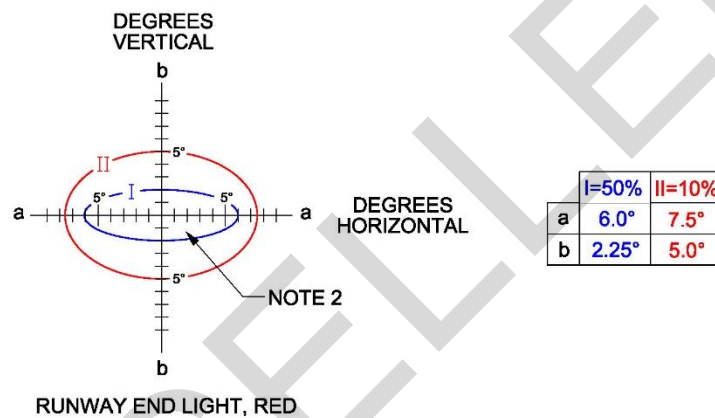

NOTES:

1. ALL CONTOURS ARE ELLIPSES CALCULATED BY EQUATION: $(X/a)^2 + (Y/b)^2 = 1$.
2. THE MINIMUM AVERAGE INTENSITY OF THE MAIN BEAM (INSIDE CONTOUR I) IS 2,500 CD AVIATION RED, MAXIMUM INTENSITY SHOULD NOT EXCEED 1.5 TIMES ACTUAL AVERAGE INTENSITY.
3. CONTOURS I AND II INDICATE THE MINIMUM PERCENT VALUES OF THE MAIN BEAM INTENSITY.

4-6.4 Equipment.

Unless the lights are to be located in an area not paved, use in-pavement fixtures with no part protruding more than 1 inch (25 millimeters) above the surrounding surface. Where the runway end is co-located with the opposite direction threshold, the threshold and runway end lights may not be incorporated into the same fixture unless the photometrics meet the requirements for both the red and green colors. (See paragraph 13-12.4.)

4-6.5 Compliance with International Military Standards.

4-6.5.1 NATO.

These standards meet NATO STANAG 3316 (Edition 10) – Airfield Lighting, 13 May 2004.

4-6.5.2 ASIC.

Previous ASIC AIR STD 90/27 cancelled.

4-6.6 Additional Information.

See FAA AC 150/5345-46 for more information.

4-7 RUNWAY CENTERLINE LIGHTS (RCL).

4-7.1 Purpose.

The runway centerline lights provide lateral guidance during landing, rollout and takeoff roll under low visibility conditions. They are optional for Category II and are required for Category III instrument operations.

4-7.2 Configuration.

The runway centerline lighting system is a straight line of lights which runs parallel with and within 2 feet (0.6 meters) of the runway centerline. Configure the system as shown in Figure 4-12. The lighting system extends from 75 feet (22.5 meters) of the upwind end of the runway. It is desirable to offset centerline light fixtures on runways equipped with aircraft arresting systems to avoid hook-skip problems and damage to the centerline light fixtures. Up to five fixtures may be omitted in the vicinity of the arresting gear pendant cables to avoid hook bounce and minimize light damage. Remove existing centerline light fixtures within this area and replace with blank cover plates.

4-7.3 Photometric Requirements.

See FAA AC 150/5345-46 for photometric requirements for runway centerline light fixtures. The lights must meet the intensity requirements shown in Figure 4-13. They must be aimed parallel with the runway centerline $\pm 1/2$ degree and upward at 4.5 degrees. They must operate at 5 intensity steps as specified in paragraph 4-2.3 for runway edge lights.

4-7.3.1 Color Coding.

The last 3,000-foot (900 meters) portion of the runway centerline lighting system is color coded to warn pilots of the impending runway end. Alternating red and white lights are installed, starting with red, as seen from 3,000 feet (900 meters) to 1,000 feet (300 meters) from the runway end, and red lights are installed in the last 1,000 foot (300 meters) portion.

Figure 4-12 Runway Centerline Light Configuration

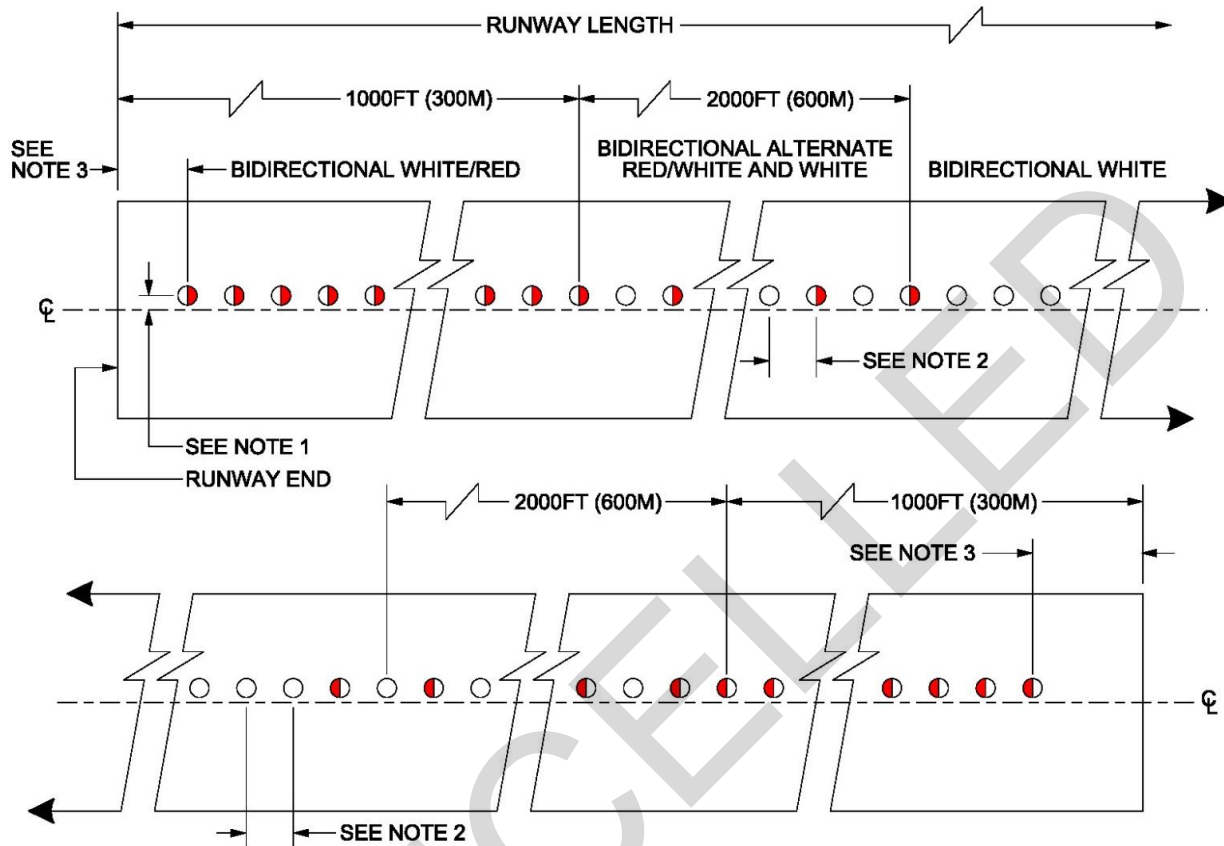

NOTES:

1. THE RCL LINE MAY BE OFFSET NOT MORE THAN 2FT (0.6M) RIGHT OR LEFT OF THE RUNWAY CENTERLINE. THE LATERAL TOLERANCE FROM THE LINE OF LIGHTS ± 1 IN (25MM).
2. THE RCL MUST BE EQUALLY SPACED AT 50FT (15M) FOR FAA TYPE L-850A LIGHTS. THE LONGITUDINAL TOLERANCES IS ± 2 FT (0.6M).
3. THE FIRST LIGHT FROM EITHER END OF THE RUNWAY MUST BE FOR FAA TYPE L-850A LIGHTS NOT LESS THAN 50FT (15M) AND NOT MORE THAN 87.5FT (26.25M).

LEGEND:

- BIDIRECTIONAL RCL - WHITE BOTH DIRECTIONS
- ◐ BIDIRECTIONAL RCL - RED IN DIRECTION OF SHADED SIDE, WHITE IN DIRECTION OF WHITE SIDE.

Figure 4-13 Runway Centerline Light Photometric Configuration

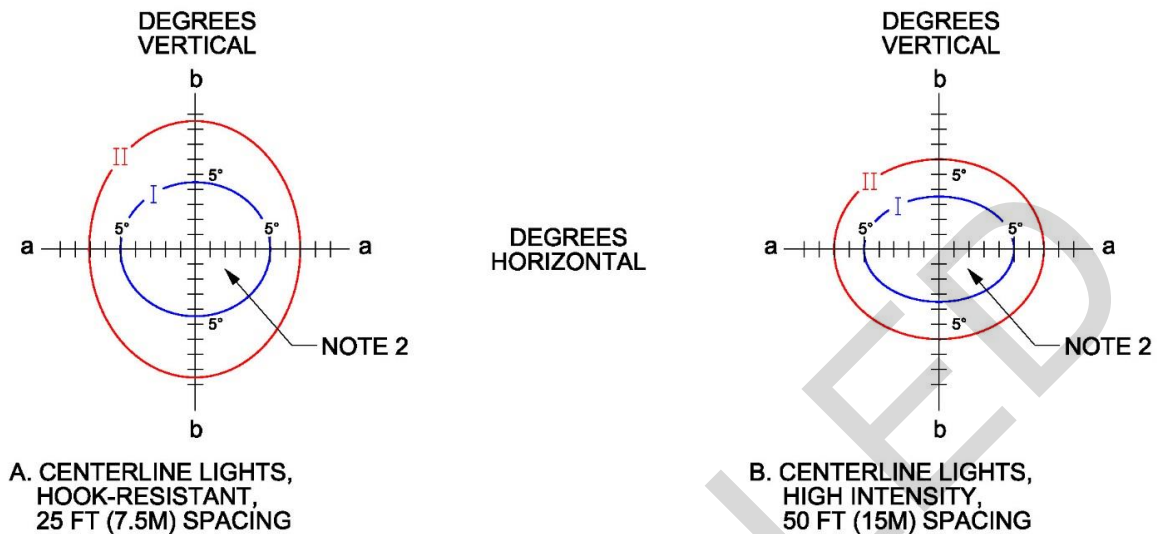

	I=50%	II=10%
a	5.0°	7.0°
b	4.5°	8.5°

	I=50%	II=10%
a	5.0°	7.0°
b	3.5°	6.0°

NOTES:

1. ALL CONTOURS ARE ELLIPSES CALCULATED BY EQUATION: $(X/a)^2 + (Y/b)^2 = 1$.
2. THE MINIMUM AVERAGE INTENSITY OF THE MAIN BEAM (INSIDE CONTOUR I) IS 250 CD WHITE OR 150CD RED FOR 25 FT (7.5M) SPACING; 5,000 CD WHITE AND 750 CD RED FOR 50 FT (15M) SPACING. MAXIMUM INTENSITY SHOULD NOT EXCEED 1.5 TIMES ACTUAL AVERAGE INTENSITY.
3. CONTOURS I AND II INDICATE THE MINIMUM PERCENT VALUES OF THE MAIN BEAM INTENSITY.

4-7.4 Adjustment and Tolerances.

The line of runway centerline lights may be uniformly offset laterally to the same side of the physical runway centerline a maximum of 2.5 feet (0.75 meters) (tolerance ± 1 inch (25 millimeters) measured from the physical runway centerline to the fixture centerline. For any new runway, the light base installation must be no closer than 2 feet (0.6 meters) (measured to the edge of the fixture base) to any pavement joints. The mounting surface of the fixture must be level within 1 degree in any direction and the horizontal must be within 1 degree of that specified.

4-7.5 Equipment.

Use in-pavement fixtures with no part protruding more than 0.5 inch (13 mm) above the surrounding surface.

4-7.6 Power Requirements.

For Categories II and III operations, provide a main and standby power system with automatic transfer within one second of a failure of the system. For Category I operation, a 15 second transfer is adequate.

4-7.7 Control Requirements.

Provide remote on-off and intensity control.

4-7.8 Monitoring Requirements.

When supporting of operations below 2,400 feet (720 meters) RVR, provide system monitoring which, at a minimum, gives positive indication at the control facility that power is being delivered to the lights.

4-7.9 Compliance with International Military Standards.

4-7.9.1 ASIC.

Previous ASIC AIR STD 90/27 cancelled.

4-7.9.2 NATO.

These standards meet the NATO STANAG 3316 (Edition 10) – Airfield Lighting, 13 May 2004.

4-7.9.3 Additional Information.

See FAA AC 150/5340-30 for more information.

4-8 TOUCHDOWN ZONE LIGHTS (TDZL).

4-8.1 Purpose.

Touchdown zone lights provide continuity when crossing the threshold into the touchdown area and provide visual cues during the flare out and touchdown phases of the landing. They are required for Category II or III operations.

4-8.2 Configuration.

Touchdown zone lights consist of 2 rows of transverse light bars located symmetrically about the runway centerline per FAA AC 150/5340-30, Figure 34. Each light bar consists of 3 unidirectional lights facing the landing threshold. The rows of light bars extend to 3,000 feet (900 meters), or one-half the runway length for runways less than 6,000 feet (1,800 meters), from the threshold with the first light bars located 100 feet (30 meters) from the threshold. See FAA AC 150/5340-30 for additional information about TDZ lights and installation adjustments (light optical assembly toe-in). (See Figure 4-14.)

4-8.3 Photometric Requirements.

Optimum aiming of the lights depends on the design and layout of the fixtures used in the system. The light fixtures may be designed to cover several applications and may have fixed patterns and aiming angles which differ from this document. The light aiming and patterns other than those cited in this standard may be used if the resultant light pattern produces equivalent light intensities in the areas regulated by the standard. TDZ lights must emit unidirectional aviation white light as shown FAA AC 150/5340-30. They must be toed in 4 degrees toward the centerline and aimed upward 5.5 degrees. This is achieved by either installing light fixtures that have had their optical assembly toed 4 degrees, in accordance with FAA AC 150/5340-30, or by angling the light base 4 degrees and installing the light fixture. The lights must operate at five intensity steps per paragraph 4-2.3 for HIRL.

Figure 4-14 Touchdown Zone Light Photometric Requirements

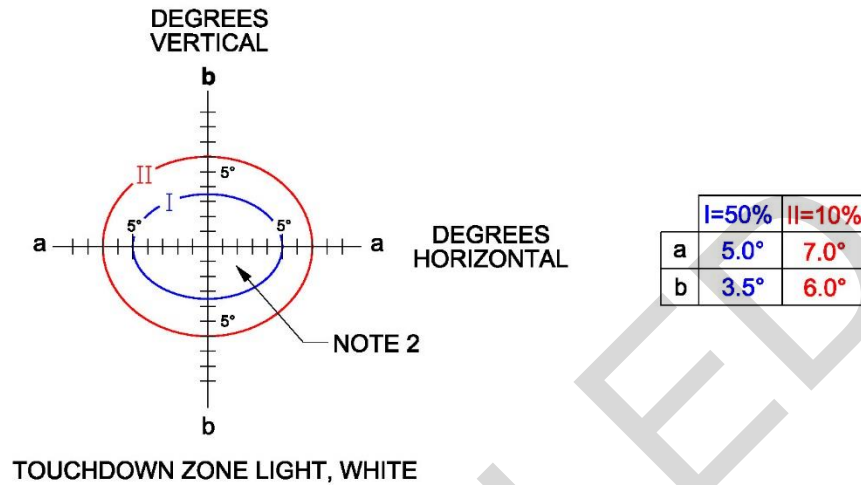

NOTES:

1. ALL CONTOURS ARE ELLIPSES CALCULATED BY EQUATION: $(X/a)^2 + (Y/b)^2 = 1$.
2. THE MINIMUM AVERAGE INTENSITY OF THE MAIN BEAM (INSIDE CONTOUR I) IS 5,000 CD WHITE, MAXIMUM INTENSITY SHOULD NOT EXCEED 1.5 TIMES ACTUAL AVERAGE INTENSITY.
3. CONTOURS I AND II INDICATE THE MINIMUM PERCENT VALUES OF THE MAIN BEAM INTENSITY.
4. THE INTENSITY REQUIREMENTS FOR ANGLES BELOW THE SURFACE OF THE PAVEMENT MAY BE DISREGARDED.

4-8.4 Adjustment and Tolerances.

Refer to Figure 4-2 for installation tolerances. All light bars must be located at the same distance from the runway centerline. The mounting surface of the fixture must be level within 1 degree in any direction and the horizontal aiming must be within 1 degree.

4-8.5 Equipment.

Use in-pavement fixtures with no part protruding more than 0.5 inches (13 mm) above the surrounding surface.

4-8.6 Power, Control and Monitoring.

The requirements in paragraphs 4-7.6 through 4-7.8 for runway centerline lights apply.

4-8.7 Compliance with International Standards.

4-8.7.1 ASIC.

Previous ASIC AIR STD 90/27 cancelled.

4-8.7.2 NATO.

These standards meet the requirement of STANAG 3316 (Edition 10) – Airfield Lighting, 13 May 2004.

4-8.8 Additional Information.

See FAA AC 150/5340-30 for more information.

CANCELLED

This Page Intentionally Left Blank

CANCELLED

CHAPTER 5 STANDARDS FOR TAXIWAY LIGHTING

5-1 TAXIWAY EDGE LIGHTING.

5-1.1 Purpose.

Taxiway edge lights define the lateral limits and direction of a taxiing route. Taxiway edge lighting must be installed for night VMC operations and for day and night instrument operations.

5-1.2 Configuration.

Locate the center line of taxiway edge lights on each side of the taxiway no more than 10 feet (3 meters) from the edge of the full-strength paving, and no closer than the edge of the full-strength paving. The line of lights on both sides of a taxiway must be the same distance from their respective taxiway sides. Runway aligned taxiways are not approved for new construction. For existing installations, it is strongly recommended that runway aligned lights ahead of the runway threshold be changed to red. To determine the spacing of lights along the taxiway length, such as intersections with runways and other taxiways or changes in alignment or width, a discontinuity on one side of a taxiway applies to the other side as well; Figure 5-1 illustrates most situations. Place an edge light at each discontinuity. For intersecting pavements, place them at the point of tangency (PT) of each fillet. Place a companion light on the side opposite the discontinuity as well.

5-1.2.1 Straight Sections.

Place edge lights along all straight taxiway edges at uniform intervals between the lights, as in paragraph 5-1.2. Where the length of the section is greater than 400 feet (120 meters), the spacing must not exceed 200 feet (60 meters) (see Figure 5-1, examples A and C). Where the light spacing exceeds 100 feet (30 meters), place one additional light 40 feet (12 meters) from each end of the section (See Figure 5-1, examples A and C). If the section under consideration is opposite an intersecting taxiway or apron area, the uniform spacing must not exceed 1/2 the width of the intersecting taxiway. Where the length of the section is equal to or less than 400 feet (120 meters) the spacing must not exceed 100 feet (30 meters) (see Figure 5-1, examples B and D). Where the section is opposite an ending taxiway, the uniform spacing must not exceed 1/2 the width of the ending taxiway (see Figure 5-1, example D). Place companion lights along the opposite edge where there is no intersecting pavement. Place all companion lights on lines perpendicular to the taxiway centerline (see Figure 5-1, examples A and B).

Figure 5-1 Taxiway Edge Lighting Configuration (Straight)

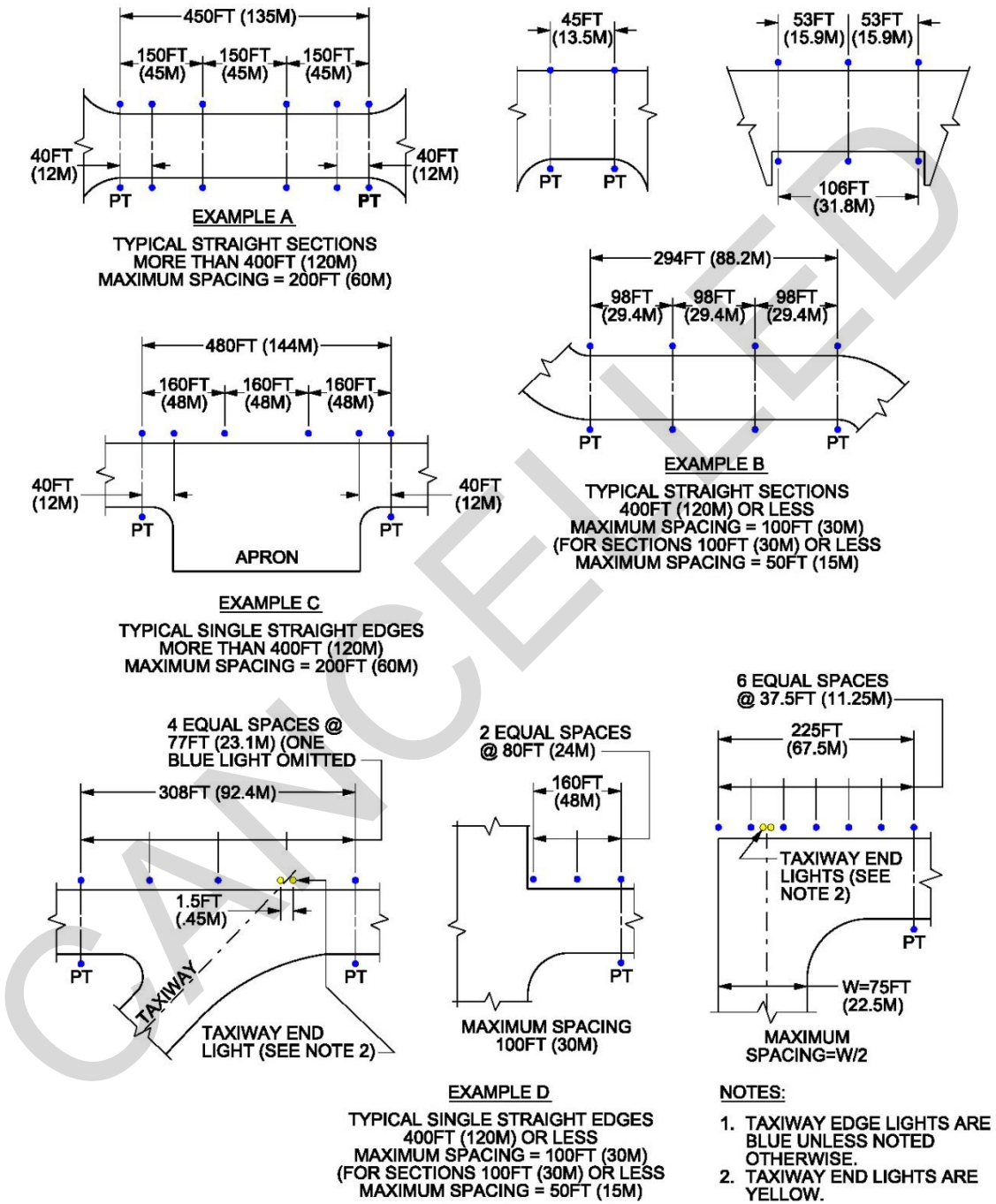

NOTE: See paragraph 5-1.2.3 for taxiway end lights.

5-1.2.2 Curved Sections.

Place edge lights along all curved taxiway sections. Uniformly space the lights on the outer line at a distance, not to exceed the value obtained from the formula given in Figure 5-2. Place the lights on the inner line on radials from the outer line of lights, except where the resultant spacing would be less than 20 feet (6 meters). In this case, select spacing not less than 20 feet (6 meters) for the inner line of lights and place the outer line of lights on radials from the inner line.

Place uniformly spaced edge lights at all fillets as shown in Figure 5-3. The spacing must not exceed one half the width of the straight taxiway section.

Figure 5-2 Taxiway Edge Lighting Configuration (Curves)

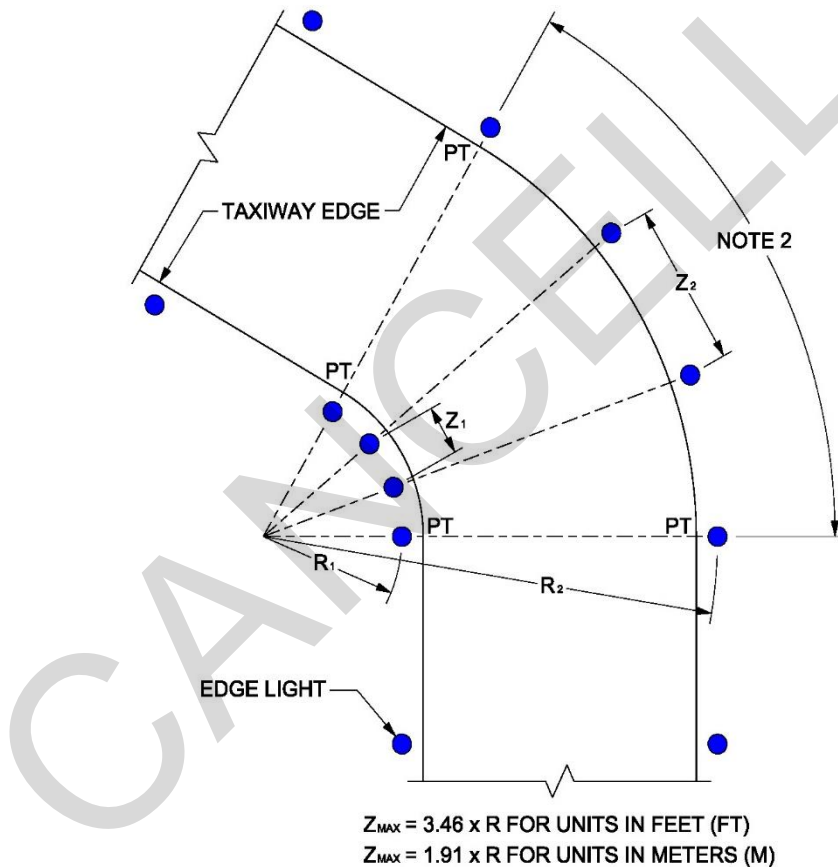

NOTES:

1. SPACE LIGHTS UNIFORMLY ON BOTH SIDES OF THE TAXIWAY BETWEEN POINTS OF TANGENCY (PT). DETERMINE SPACING BY DIVIDING TOTAL ARC INTO INCREMENTS (Z).
2. ON ALL CURVES IN EXCESS OF 30° OF ARC, USE A MINIMUM OF THREE EDGE LIGHTS, INCLUDING THOSE AT THE PTs FOR A CURVE OF 30° OR LESS PROVIDE LIGHTS ONLY AT THE PTs.
3. ALIGN LIGHTS ON THE INSIDE RADIUS (R₁) WITH THOSE ON THE OUTSIDE RADIUS (R₂). IF Z₁ < 20FT (6M) DECREASE THE NUMBER OF LIGHTS ON R₁ UNTIL Z₁ ≥ 20FT (6M) AND SPACE EVENLY ALONG RADIUS R₁.

Figure 5-3 Taxiway Edge Lighting Configuration Entrance/Exit

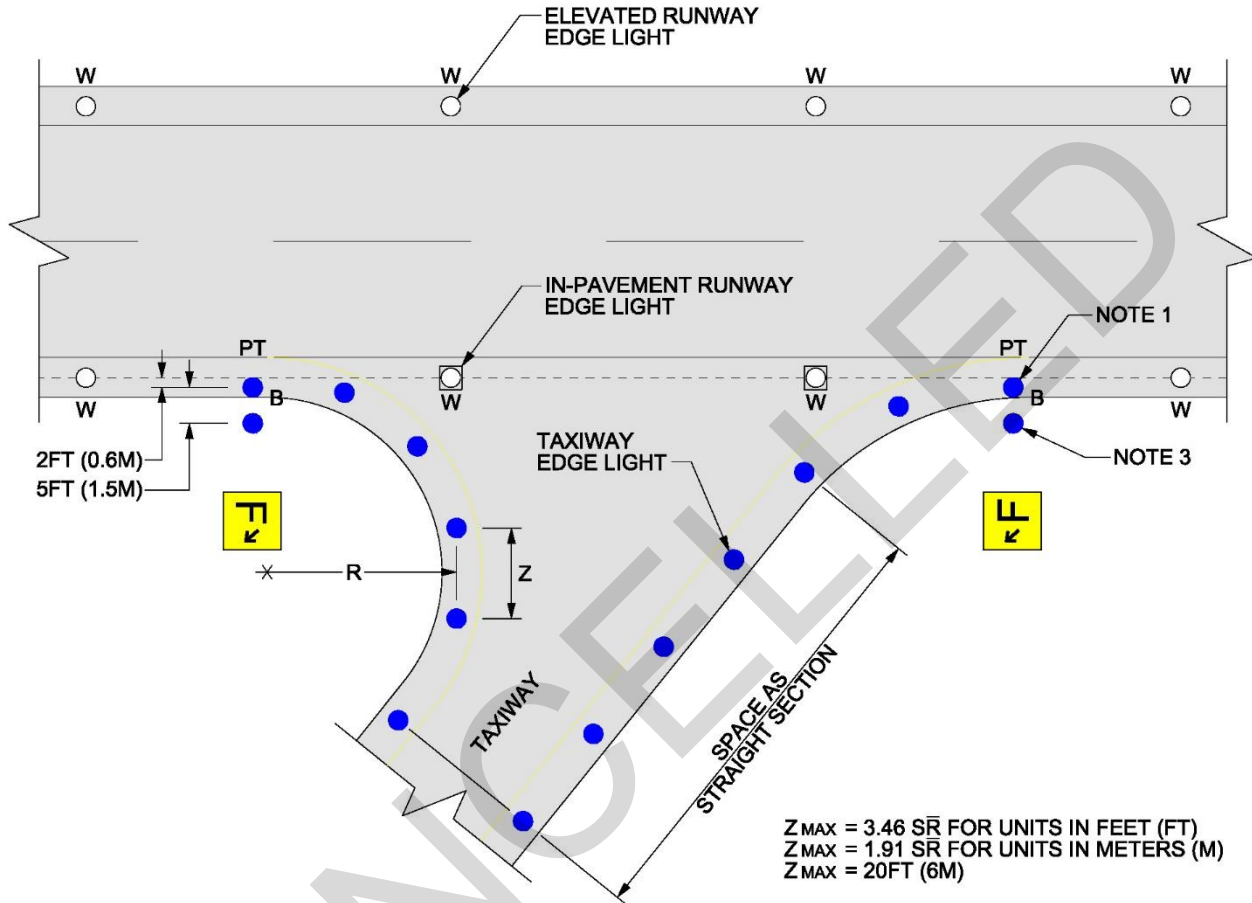

NOTES:

1. TAXIWAY LIGHTS MUST NOT BE IN LINE WITH RUNWAY LIGHTS.
2. PT = POINT OF TANGENCY.
3. TAXIWAY ENTRANCE/EXIT LIGHT MAY BE OMITTED IF RUNWAY EXIT SIGN IS USED.

5-1.2.3 Taxiway End Lights.

Where a taxiway ends at a crossing taxiway, place two yellow lights spaced 1.5 feet (0.45 meters) apart and in the line of the edge lights of the crossing taxiway. Center them on the point where the extended centerline of the ending taxiway intersects. If a yellow light falls within 5 feet (1.5 meters) of a blue edge light, the blue light may be eliminated (see Figure 5-1, examples C and D). Not supported for new construction.

5-1.2.4 Entrance/Exit Lights.

On intersections of taxiways with runways or aprons, place entrance/exit lights at the point of tangency of the taxiway fillet with the runway or apron. Do not place them at an intersection of taxiways. An entrance/exit light consists of 2 taxiway edge lights spaced 5 feet (1.5 meters) apart. One is located 5 feet (1.5 meters) out, on a line extending through the first light and perpendicular to the side of the runway or apron. The entrance/exit light may be omitted if a taxiway exit direction sign is used on the runway. See Figure 5-3.

5-1.2.5 Apron Taxiways.

For a taxiway that is adjacent to, or on the edge of, an apron, the taxiway edge lights are usually placed only on the side of the taxiway furthest from the apron. ("Taxiing" routes through an apron will not have these lights.)

5-1.2.6 Apron Perimeter Lights Without a Taxiway

Aircraft parking aprons are arranged in many ways, with perimeters defined by open spaces or hangars or other facilities. Generally, the edge lighting of the perimeter that is defined by an open space can have taxiway edge lights that are placed according to the spacing examples for straight and curved taxiway edge lighting.

5-1.3 Tolerances.

Adjust the longitudinal location of any light a maximum of 5 feet (1.5 meters) to avoid installation problems. Move the companion light the same amount, if practical, to maintain the relationship between them. Install taxiway edge lights within 6 inches (150 mm) laterally or longitudinally of the design location.

5-1.4 Photometric Requirements.

Optimum aiming of lights depends on the design and output of the fixtures used in the system. See FAA AC 150/5345-46 for additional detailed photometric information about taxiway edge lights.

5-1.5 Equipment.

Use frangible mounted elevated fixtures in all areas, including Category II and Category III operations, as described. Mount elevated fixtures a maximum of 14 inches (350 millimeters) above grade. Where there are frequent snow accumulations of 12 inches (300 millimeters) or more, the mounting height may be increased as shown in Figure 4-3.

5-1.5.1 Provide the fixture base that supports the elevated fixture and houses the isolation transformer to accept an in-pavement fixture. This facilitates future runway and taxiway configuration changes or modifications where an elevated fixture may not be suitable.

5-1.5.2 To reduce the “sea of blue lights” effect at an airfield that has many taxi routes, hoods may be used on elevated fixtures. Do not use hoods on taxiway entrance/exit light fixtures.

5-1.5.3 Where elevated lights may be damaged by jet blast or operation of an arresting gear, or where they interfere with aircraft operation such as B-52 outrigger gears, use in-pavement fixtures.

5-1.6 Power Requirements.

Provide a main power system and circuits which permit independent control of the taxiways. Provide standby power only for those taxiways supporting precision instrument approaches. Transfer time from the failed power system must not exceed 15 seconds.

5-1.7 Control Requirements.

Taxiway lighting circuits must be segmented and controlled to provide the degree of flexibility required for airfield operations. (See Figure 5-4.) Provide remote on/off control for all taxiway segments, and provide a three step intensity control.

5-1.8 Monitoring Requirements.

There is no requirement for monitoring taxiway circuits.

5-1.9 Compliance with International Standards.

5-1.9.1 ASIC.

Previous ASIC AIR STD 90/27 cancelled.

5-1.9.2 NATO.

These standards meet the requirements of STANAG 3316 (Edition 10) – Airfield Lighting, 13 May 2004, except for the light spacing on curves.

5-2 TAXIWAY CENTERLINE LIGHTS.

5-2.1 Purpose.

Taxiway centerline lights are a system of aviation green in-pavement lights installed along the taxiway centerlines to provide alignment and course guidance information in

specific instances of visibility, established by FAA AC 120-57A, *Surface Movement Guidance and Control System*. They may be installed where it is impractical to install taxiway edge lights. On taxiways which support Category II and Category III operations, the particular use of taxiway centerline lights depends upon the runway visual range (RVR) and allowable landing conditions.

Taxiway centerline light requirements are determined within FAA AC 120-57A, paragraph 8, "Visual Aid Requirements." When required, they are installed in accordance with FAA AC 150-5340-30, *Design and Installation Details for Airport Visual Aids*, Chapter 4, "Taxiway Lighting Systems."

5-2.2 Configuration.

Install taxiway centerline lights in smooth lines along the taxiway centerline. To avoid construction joints or markings, the line of lights may be offset uniformly a maximum of 2 feet (0.6 meters) from the centerline. Actual configuration and spacing must conform with FAA AC 150-5340-30.

5-2.2.1 Place a light at each holding position, at each PT of a curved section, at each taxiway end, at each intersection with a runway edge or apron, and at the PTs of all fillets. Where taxiways cross, place a light at the intersection of the centerlines.

Figure 5-4 Taxiway Circuit Layout

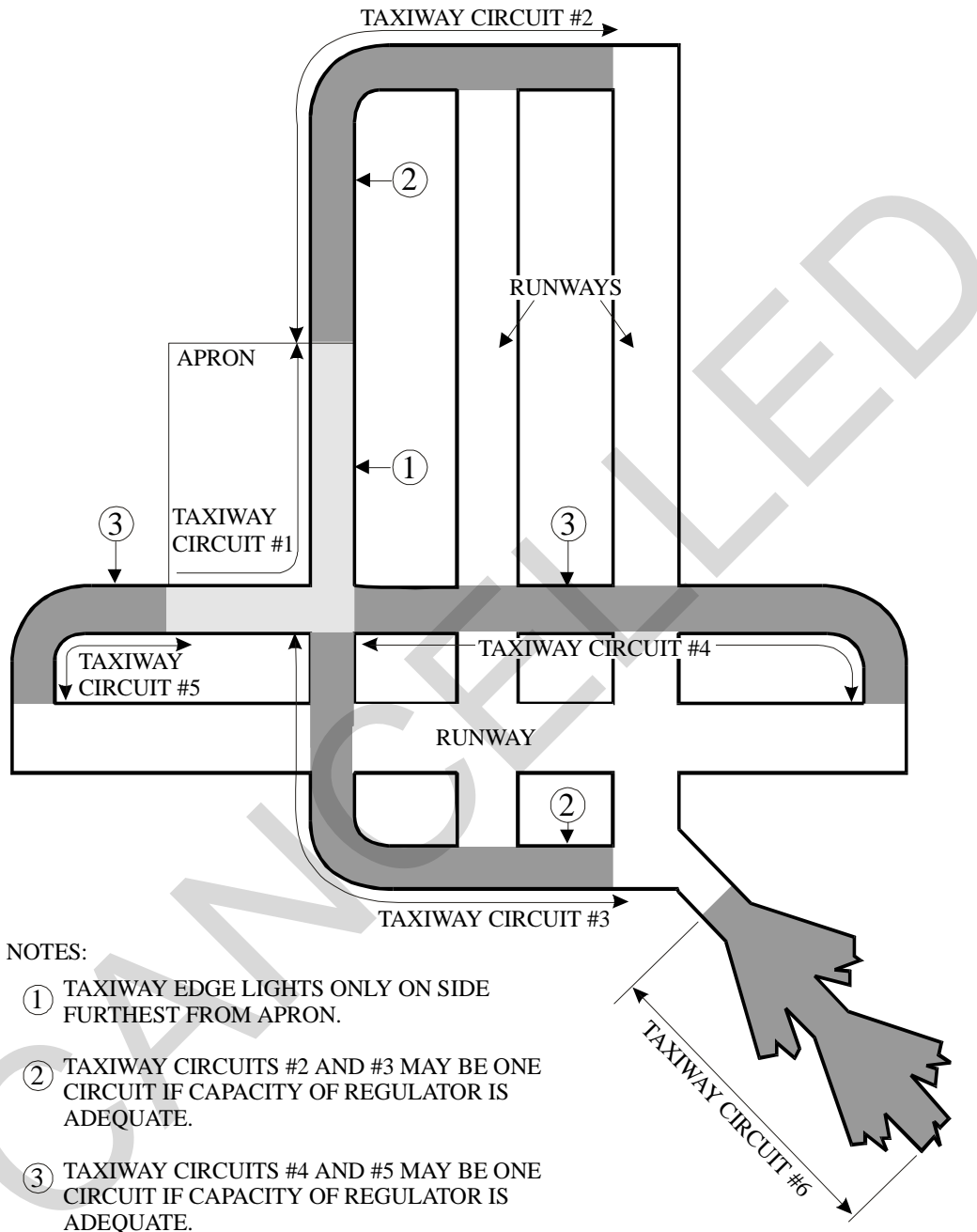

NOTES:

- ① TAXIWAY EDGE LIGHTS ONLY ON SIDE FURTHEST FROM APRON.
- ② TAXIWAY CIRCUITS #2 AND #3 MAY BE ONE CIRCUIT IF CAPACITY OF REGULATOR IS ADEQUATE.
- ③ TAXIWAY CIRCUITS #4 AND #5 MAY BE ONE CIRCUIT IF CAPACITY OF REGULATOR IS ADEQUATE.

LEGEND:

- LIGHTED TAXIING ROUTE
- LIGHTED TAXIING ROUTE ALONG EDGE OF APRON

5-2.2.2 Place uniformly spaced lights between the points defined above, along all straight and curved sections of the taxiway. The uniform spacing will approach, but not exceed, the criteria given in Figure 5-5. The location of individual lights may be adjusted along the line of lights a maximum of 2 feet (0.6 meters) to avoid construction problems. Note: See AC 120-57A, Chapter 8, for taxiway lighting requirements in the movement area.

5-2.2.3 At taxiway intersections, place lights along an arc drawn tangent to the centerlines of the taxiways (or lines of lights) in the direction of all aircraft turns. To reduce confusion where aircraft turns are not anticipated, the arc of lights may be omitted. The minimum clearance to the inner edge of either taxiway must be equal to one half the width of the narrower taxiway. Select the largest radius that will provide the clearance for the arc of lights. Do not install taxiway centerline lights on runway surfaces, except as specified for runway exit lights.

5-2.3 Tolerances.

Taxiway centerline lights must not be more than 3 inches (75 millimeters) off of the designated line of lights and not more than 6 inches (150 millimeters) from the designated locations along the line of lights.

5-2.4 Equipment.

Use in-pavement fixtures which do not protrude more than 0.50 inch (13 millimeters) above the pavement. They must be bidirectional aviation green except as follows:

- At crossing taxiways, the light at the intersection must be omnidirectional aviation yellow.
- On taxiways where the aircraft movement is in one direction only, the lights may be unidirectional and facing the oncoming aircraft.
- Where hold lights are installed, the centerline light must be aviation yellow facing the holding aircraft.

Figure 5-5 Taxiway Centerline Lighting Configuration (See FAA AC 120-57A)

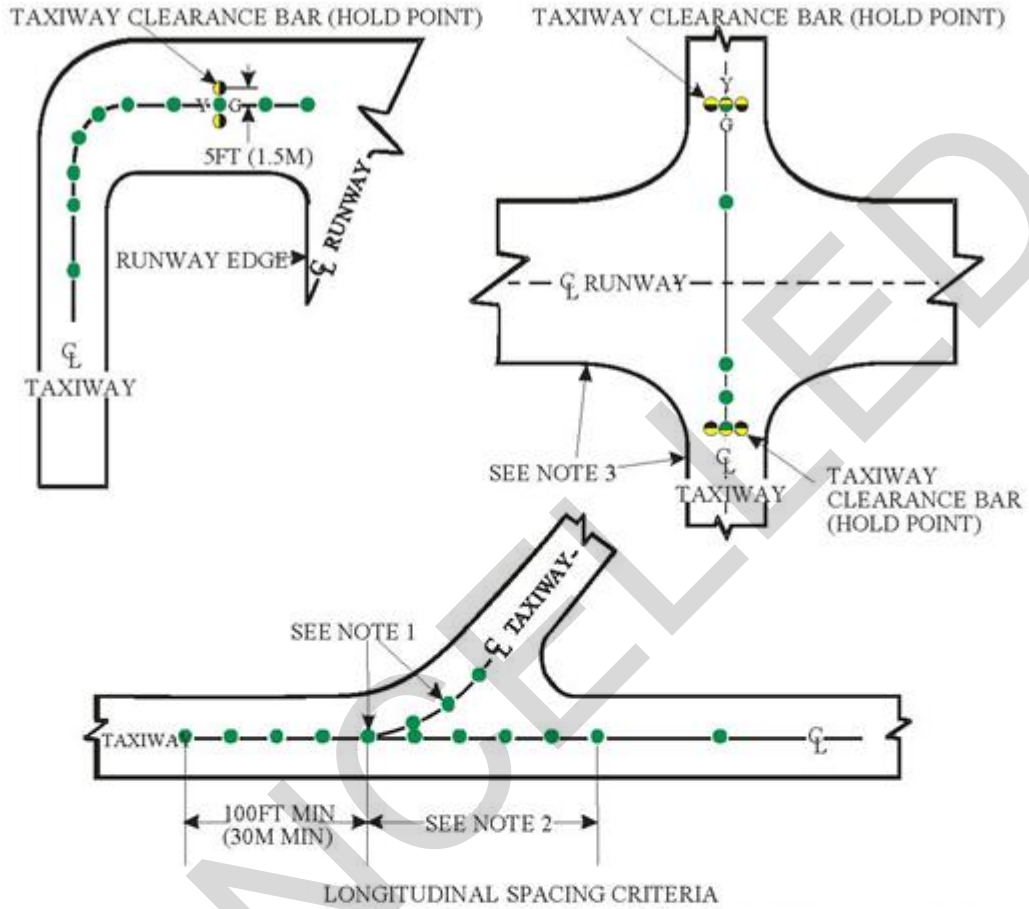

LONGITUDINAL SPACING CRITERIA

	CAT II/III IFR	ALL OTHER
NOMINAL AT INTERSECTIONS (SEE NOTE 2)	50FT (15M)	100FT (30M)
CURVES RADIUS LESS THAN 400FT (120M)	50FT (15M)	50FT (15M)
(SEE NOTE 1) RADIUS 400FT (122M) TO 1200FT (360M)	12.5FT (3.75M)	25FT (7.5M)
RADIUS GREATER THAN 1200FT (360M)	25FT (7.5M)	50FT (15M)
	50FT (15M)	100FT (30M)

- NOTES:
1. LOCATE LIGHTS AT PT1 AND PT2, AND SPACE INTERMEDIATE LIGHTS EQUALLY ALONG SELECTED CURVE IN COMPLIANCE WITH SPACING CRITERIA.
 2. SPACE LIGHTS EQUALLY BETWEEN PT1 AND CLEARANCE BAR (HOLD POINT) LIGHTS.
 3. RUNWAY AND TAXIWAY EDGE LIGHTS NOT SHOWN.

- LEGEND:
- $\frac{Y}{G}$ BIDIRECTIONAL, GREEN AND YELLOW
 - \bullet BIDIRECTIONAL, GREEN
 - \bullet UNIDIRECTIONAL, YELLOW

5-2.5 Photometric Requirements.

See FAA AC 150/5345-46 for taxiway centerline light fixture photometric requirements. Taxiway centerline lights must be bidirectional and emit aviation green light at three intensity steps: 100 percent, 30 percent, or 10 percent of full brightness. The minimum intensities and beam widths are shown in Table 5-1.

Table 5-1 Taxiway Centerline Light Intensity and Beam Widths

Application	Average Intensity of Main Beam	----- BEAM WIDTH -----			
		50% Of Main Beam Average		10% Of Main Beam Average	
		Hor.	Vert.	Hor.	Vert.
Category II					
Straight (L-852A)	20 cd	±10	1 to 4	±16	0.5 to 10
Curved (L-852B)	20 cd	±30	1 to 4	±30	0.5 to 10
Category III					
Straight (L-852C)	200 cd	±3.5	1 to 8	±4.5	0 to 13
Curved (L-852D)	100 cd	±30	1 to 10	±30	0 to 15

5-2.5.1 Horizontal Aiming.

Aim lights on straight sections parallel with the taxiway centerline. Aim lights on curved sections along the tangent at the light location. See FAA AC 150/5340-30 for additional detailed information about light fixture aiming.

5-2.6 Power Requirements.

Provide a main power system and circuits which permit independent control of the taxiways. Provide standby power only for those taxiways essential for precision instrument approaches. Transfer time from the failed system to standby system must not exceed 15 seconds for CAT I runways and 1 second for CAT II and CAT III runways.

5-2.7 Control Requirements.

For new installations, provide remote ON, OFF and stepped intensity control. Provide 3 step intensity control for taxiway edge lights. Provide 5 step (preferred) or 3 step intensity control for taxiway centerline lights. The system may be segmented to provide flexibility in choosing taxiway routing.

5-2.8 Monitoring Requirements.

There is no monitoring requirement for taxiways.

5-2.9 Compliance with International Standards.

5-2.9.1 ASIC.

Previous ASIC AIR STD 90/27 cancelled.

5-2.9.2 NATO.

These standards meet the requirements of STANAG 3316 (Edition 10) – Airfield Lighting, 13 May 2004, except for the light spacing on curves.

5-3 RUNWAY LEAD-OFF LIGHTS.

5-3.1 Purpose.

Runway lead-off lights are taxiway centerline lights that provide visual guidance to aircraft exiting the runway. They are color-coded green/yellow to warn pilots and vehicle drivers that they are within the runway environment or instrument landing system/microwave landing system (ILS/MLS) critical area. See FAA AC 150/5340-30 for detailed information about lead-off light installation.

5-3.2 Configuration.

5-3.2.1 Long Radius Exits.

Long radius exit lights are installed on exits with radii exceeding 1,200 feet (360 meters). They consist of a line of unidirectional taxiway centerline lights. The line begins at a point which is a maximum of 3 feet (1 meter) off the runway centerline and 200 feet (60 meters) before the beginning of the taxiway centerline curve. The line of lights runs parallel to the runway to the beginning of the taxiway centerline curve. It then follows the taxiway centerline curve to a point which is a minimum of 200 feet (60 meters) beyond the beginning of the straight portion of the taxiway. The lights are uniformly spaced at a distance of not more than 50 feet (15 meters). (See Figure 5-6.)

**Figure 5-6 Taxiway Long Radius High Speed Exit Lights,
 Radius > 1,200 FT (360 M) (See FAA AC 120-57A)**

LEGEND:

- UNI-DIRECTIONAL TAXIWAY CENTER LINE LIGHT (SEE PARAGRAPH 5-3.2.3 FOR COLOR CODING)
- TAXIWAY EDGE LIGHT (BLUE)
- BI-DIRECTIONAL ELEVATED RUNWAY EDGE LIGHT
- ◻ BI-DIRECTIONAL IN-PAVEMENT RUNWAY EDGE LIGHT
- ⊙ BI-DIRECTIONAL RUNWAY CENTER LINE LIGHT

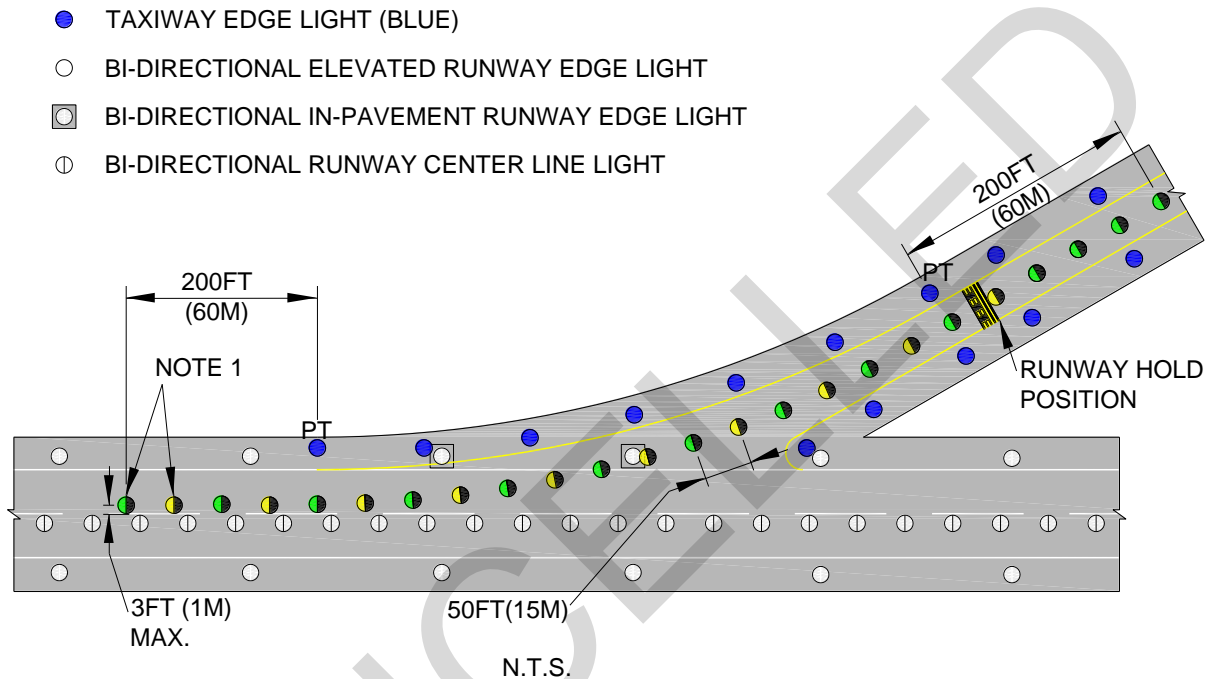

NOTES:

1. THE FIRST LIGHT ON THE RUNWAY IS GREEN. IF THERE IS AN ODD NUMBER OF COLOR-CODED LIGHTS, THE FIRST TWO LIGHTS SHOULD BE GREEN.
2. IF THERE IS AN ILS/MLS CRITICAL AREA PRESENT BEYOND THE RUNWAY HOLDING POSITION, THE COLOR-CODED LIGHTS CONTINUE TO THE ILS/MLS CRITICAL AREA HOLDING POSITION WITH THE LAST YELLOW LIGHT SIMILARLY LOCATED BEYOND THE CRITICAL AREA HOLDING POSITION.

5.3.2.2 Short Radius Exits.

Short radius exit lights consist of a line of taxiway centerline lights. The line of lights begins at a point that is not more than 3 feet (0.9 meter) off the runway centerline on the near side and is the PT of the exit curve. Ensure the radius of the curve is the largest that will provide a minimum clearance to the pavement edge equal to one half the width of the taxiway. The line of lights runs along the arc to the PT with the taxiway centerline. It then follows the taxiway centerline for a minimum of 200 feet (60 meters). The spacing between the lights is not greater than 25 feet (7.5 meters). (See Figure 5-7.)

**Figure 5-7 Taxiway Short Radius High Speed Exit Lights
 Radius \leq 1,200 FT (360 M) (See FAA AC 120-57A)**

LEGEND:

- UNI-DIRECTIONAL TAXIWAY
- CENTER LINE LIGHT (SEE PARAGRAPH 5-3.2.3 FOR COLOR CODING)
- TAXIWAY EDGE LIGHT (BLUE)
- BI-DIRECTIONAL ELEVATED RUNWAY EDGE LIGHT
- BI-DIRECTIONAL IN-PAVEMENT RUNWAY EDGE LIGHT
- ⊕ BI-DIRECTIONAL RUNWAY CENTER LINE LIGHT

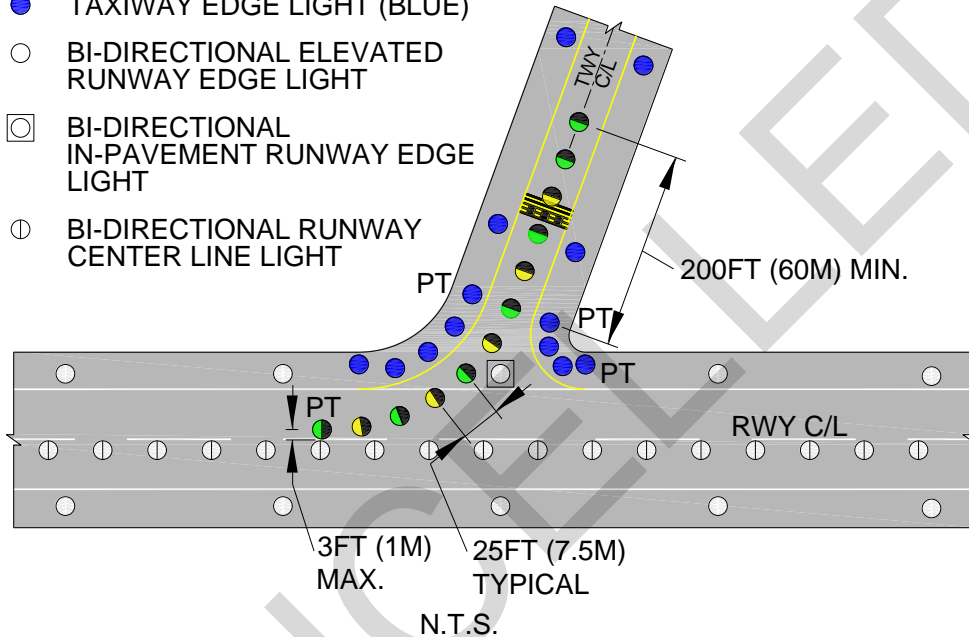

NOTES:

1. THE FIRST LIGHT ON THE RUNWAY IS GREEN. IF THERE IS AN ODD NUMBER OF COLOR-CODED LIGHTS, THE FIRST TWO LIGHTS SHOULD BE GREEN.
2. IF THERE IS AN ILS/MLS CRITICAL AREA PRESENT BEYOND THE RUNWAY HOLDING POSITION, THE COLOR-CODED LIGHTS CONTINUE TO THE ILS/MLS CRITICAL AREA HOLDING POSITION WITH THE LAST YELLOW LIGHT SIMILARLY LOCATED BEYOND THE CRITICAL AREA HOLDING POSITION.
3. TAXIWAY CENTERLINE LIGHTS MAY BE BI-DIRECTIONAL (GREEN-GREEN OR YELLOW-YELLOW) IF USED FOR BI-DIRECTIONAL TRAFFIC.

5-3.2.3 Color Coding.

Color-code taxiway exit lights within the runway safety area FAA aviation green or yellow. The first light on the runway must be green. Fixtures between the runway centerline and the runway hold position must alternate green and yellow. The first fixture past the runway hold position must be yellow. If there are an odd number of color-coded lights, the first two lights must be green. Taxiway centerline lights beyond the first fixture

past the runway hold position on the runway must be green. Where fixtures are used for bidirectional traffic, fixtures must be color coded in both directions.

5-3.3 Adjustments and Tolerances.

The requirements in paragraph 5-2.3 for taxiway centerline lights apply.

5-3.4 Photometric Requirements and Horizontal Aiming.

The requirements in paragraph 5-2.5 for taxiway centerline lights apply.

5-3.5 Equipment.

Use unidirectional, in-pavement fixtures with no part extending more than 0.5 inch (13 mm) above the surrounding pavement. (See paragraph 13-13.2.)

5-3.6 Power Requirements.

Provide a main power supply and circuits that permit independent control except on a taxiway with centerline lighting. In this case, they may be connected to and controlled with the taxiway centerline lights.

5-3.7 Control Requirements.

Provide remote on/off and intensity control. Runway exit lights shall be controlled with associated taxiway centerline lights.

5-3.8 Monitoring Requirements.

There are no monitoring requirements.

5-3.9 Compliance with International Military Standards.

5-3.9.1 ASIC.

Previous ASIC AIR STD 90/27 cancelled.

5-3.9.2 NATO.

These standards meet NATO STANAG 3316 (Edition 10) – Airfield Lighting, 13 May 2004.

5-4 TAXIWAY CLEARANCE BARS.

5-4.1 Purpose.

For Category III airfield operation (below 600 RVR), clearance bars serve two purposes:

5-4.1.1 In low visibility, clearance bars warn pilots and vehicle drivers that they are approaching a hold point (other than a runway holding position). They are installed at designated hold points on the taxiway for operations below 600 feet (180 meters) RVR.

5-4.1.2 At night and in inclement weather, clearance bars warn pilots and vehicle drivers that they are approaching an intersecting taxiway. They are generally installed at taxiway intersections where the taxiway centerline lights do not follow the taxiway curve and taxiway edge lights are not installed.

5-4.2 Configuration.

See FAA AC 150/5340-30 for information about taxiway clearance bar configuration.

A clearance bar consists of a row of three in-pavement yellow lights to indicate a low visibility hold point (see Figure 5-5). The fixtures are normally unidirectional but may be bidirectional depending upon whether the hold point is intended to be used in one or two directions. In addition, with the below exceptions, clearance bars are installed (without regard to visibility) at a taxiway intersection with non-standard fillets or where the taxiway centerline lights do not follow curves at intersections. Clearance bars installed for this purpose consist of unidirectional fixtures.

5-4.2.1 Clearance bars may be omitted if taxiway edge lights are installed at the intersection.

5-4.2.2 If the angle between the centerlines of any two adjacent segments of the pavement is 90 degrees \pm 10 degrees, clearance bars at a "T" or "+" shaped taxiway/taxiway intersection may be substituted by or supplemented with an omnidirectional yellow taxiway intersection light (L-852E or F, as appropriate) installed near the intersection of the centerline markings.

5-4.2.3 The clearance bar located on an exit taxiway may be omitted if it would be located before, or within 200 feet (60 meters) beyond, a runway holding position (as viewed while exiting the runway).

5-4.3 Location of a Clearance Bar Installed at a Low Visibility Hold Point.

A low visibility hold point consists of a taxiway/taxiway holding position marking, a geographic position marking, and a clearance bar. However, hold points are not necessarily located at taxiway/taxiway intersections. In-pavement clearance bar lights are centered on an imaginary line that is parallel to, and 2 feet (600 millimeters) from, the holding side of the taxiway/taxiway holding position marking. The lights may vary from this imaginary line up to \pm 2 inches (\pm 50 millimeters) (perpendicular to the holding position marking). If a conflict occurs with rigid pavement joints or other undesirable spots, the taxiway/taxiway holding position marking, geographic position marking, and the clearance bar may all be moved longitudinally any amount necessary to resolve the conflict. However, if the hold point is located at a taxiway/taxiway intersection, move the

aforementioned items away from the intersecting taxiway by the minimum necessary to resolve the conflict. If a conflict occurs between the center fixture in the clearance bar and a centerline light, the center fixture may take the place of an existing centerline light.

5-4.4 Location of a Clearance Bar Installed at a Taxiway Intersection.

A clearance bar installed at a taxiway intersection is located in accordance with the criteria of paragraph 5-4.3 if that location is established as a hold point and taxiway/taxiway holding position markings are present. Otherwise, locate the clearance bar in the same manner as if the holding position marking were present. This allows room for the possible future installation of the marking.

5-4.4.1 Lateral Spacing.

The center light of the clearance bar is installed in line with existing or planned taxiway centerline lights. The two remaining lights are installed outboard of the center fixture on 5 foot (1.5 meter) intervals, center-to-center. The outboard fixtures may be moved laterally a maximum of ± 1 foot (± 300 millimeters) to avoid an undesirable spot (e.g., conduit).

5-4.5 Light Beam Orientation for Clearance Bars.

The axis of the light beam for each fixture is parallel to the centerline of the designated taxiway path with a tolerance of ± 1 degree.

5-4.6 Equipment.

Use in-pavement fixtures with no part extending more than 0.50 inches (13 millimeters) above the surrounding pavement. Hold lights must emit unidirectional aviation yellow light toward the holding aircraft. When installed with taxiway centerline lights, the center light must be bidirectional aviation yellow/green with the yellow light toward the holding aircraft.

5-4.7 Photometric Requirements.

See FAA AC 150/5345-46 for taxiway clearance bar light fixture photometric requirements. All other photometric requirements in paragraph 5-2.5 for straight section taxiway centerline lights apply.

5-4.8 Fixtures.

Power and Control Requirements. The requirements for taxiway centerline lights apply. Power and control the fixtures with the associated taxiway lighting system.

5-4.9 Monitoring.

There is no requirement for monitoring.

5-4.10 Compliance with International Military Standards.

Previous ASIC AIR STDs and current NATO STANAGs contain no comparable systems.

5-5 RUNWAY GUARD LIGHTS (RGL).

5-5.1 Purpose.

RGLs provide a distinctive warning to anyone approaching the runway holding position that they are about to enter an active runway.

5-5.2 Configuration.

See FAA AC 50/5340-30 for detailed information about both elevated and in-pavement runway guard light installation and configuration.

Elevated and in-pavement RGLs serve the same purpose and are not generally both installed at the same runway holding position. However, if snow could obscure in-pavement RGLs or there is an acute angle between the holding position and the direction of approach to the holding position, it may be advantageous to supplement in-pavement RGLs with elevated RGLs. Each elevated RGL fixture consists of two alternately illuminated unidirectional yellow lights. In-pavement RGLs consist of a row or alternately illuminated unidirectional yellow lights.

5-5.3 Location of In-pavement Runway Guard Lights.

In-pavement RGLs are centered on an imaginary line that is parallel to, and 2 feet (600 millimeters) from, the holding side of the runway holding position marking (see Figure 5-8). The lights may vary from this imaginary line up to ± 2 inches (± 50 millimeters) in a direction perpendicular to the holding position marking. If a conflict with rigid pavement joints occurs, the RGLs may be moved away from the runway the minimum distance required to resolve the conflict.

5-5.3.1 Lateral Spacing – Preferred Method.

The lights are spaced across the entire taxiway, including fillets and holding bays, at intervals of 9 feet 10 inches (3 meters), ± 2 inches (± 50 millimeters), on-center. The lights are spaced in relation to a reference fixture that is installed in-line (longitudinally) with existing or planned taxiway centerline lights. However, it is not intended that the reference fixture replace a taxiway centerline light. If a conflict between the reference fixture and a centerline light occurs, the reference fixture may take the place of an existing centerline light and a new centerline light should be installed in accordance with

the criteria in FAA AC 150/5340-30, paragraph 4.3c. If the holding position marking is intersected by multiple taxiway centerline markings, set the reference fixture at the centerline. A fixture whose outboard edge falls at a point less than 2 feet (0.6 meters) from the defined edge of the taxiway (outboard edge of the taxiway marking) may be omitted. Individual fixtures may be moved laterally maximum of ± 1 foot (± 0.3 meters) to avoid undesirable spots (e.g., conduit). **NOTE:** Generally, undesirable spots must be avoided by a total of 2 feet (0.6 meters). If this cannot be met by applying the aforementioned ± 1 foot (± 0.3 meters) tolerance, then use the following alternate method.

Figure 5-8 Runway Guard Light Configuration

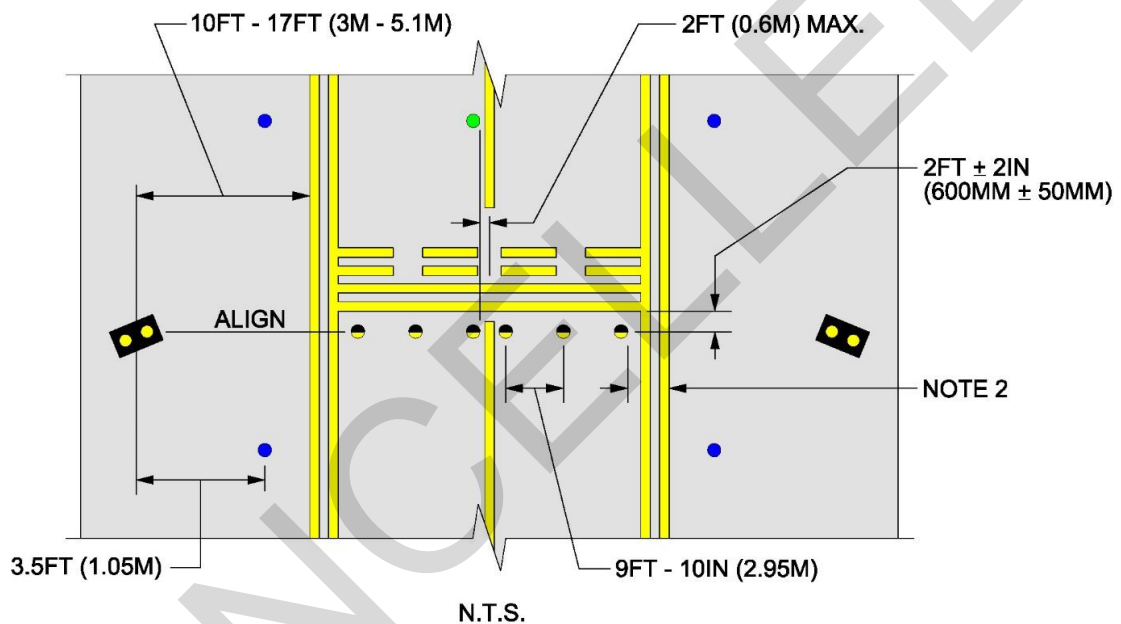

LEGEND:

- L-852G GUARD LIGHT FIXTURE - IN-PAVEMENT
- L-852 CENTERLINE FIXTURE - IN-PAVEMENT
- L-861 TAXIWAY EDGE LIGHT - ELEVATED
- L-804 RUNWAY GUARD LIGHT

NOTES:

1. THE ELEVATED RUNWAY GUARD LIGHT MAY BE MOVED UP TO 10FT (3M) MAX. AWAY FROM THE RUNWAY TO AVOID UNDESIRABLE SPOTS OR CONFLICT WITH TAXIWAY EDGE LIGHTS.
2. FIXTURE MAY BE OMITTED IF OUTSIDE EDGE IS LESS THAN 2FT (0.6M) FROM PAVEMENT EDGE.

5-5.3.2 Lateral Spacing – Alternate Method.

Use the following alternate method of spacing the lights if it is not possible to meet the preferred method specified in paragraph 4.4b(1), Lateral Spacing – Preferred Method, of FAA AC 150/5340-30. The lights are spaced across the entire taxiway, including fillets and holding bays. If allowing the reference fixture to be moved any amount laterally makes it possible to meet paragraph 4.4b(1) requirements, then use that

method. Otherwise, space the lights as uniformly as possible with a minimum spacing of 8 feet (2.4 meters) and a maximum of 13 feet (3.9 meters).

5-5.3.3 Light Beam Orientation for In-pavement RGLs.

Install L-868 bases for in-pavement RGLs such that a line through one pair of bolt holes on opposite sides of the base is parallel to the runway holding position marking. Each fixture is installed so that the light beam faces away from the runway and is perpendicular to the runway holding position marking within a tolerance of ± 1 degree. For some pavement configurations, it may be necessary to orient the lights at some angle to the marking. To accomplish this, install a 12 bolt-hole base using the above procedure. This allows the light fixtures to be adjusted 30 degrees left or right, as required. See Figure 5-9 for typical examples.

Figure 5-9 Light Beam Aiming Point for In-Pavement RGLs and Stop Bars

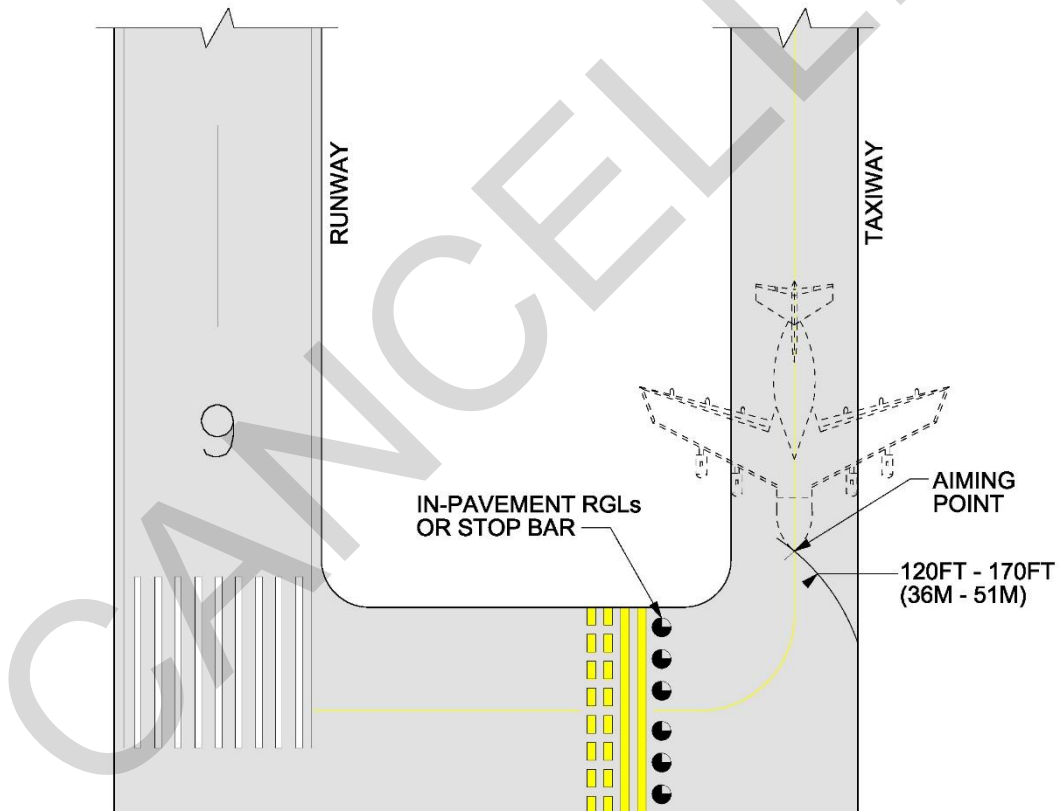

5-5.4 Location of Elevated RGLs.

Elevated RGLs are collocated with the runway holding position marking and are normally installed on each side of the taxiway (see Figure 5-8). Generally, elevated RGLs should be located as close as practical to the taxiway edge to maximize their conspicuity. The distance from the defined taxiway edge to the near side of an installed light fixture should be 10 to 17 feet (3 to 5.1 meters). To avoid undesirable spots, the RGL may be moved up to 10 feet (3 meters) farther from the runway, but may not be moved toward the runway. If a stop bar is installed at the runway holding position, the elevated RGL should be located at least 3 feet, 6 inches (1.05 meter) outboard of the elevated stop bar light. The RGL should not be located where it will interfere with the readability of the runway holding position sign.

5-5.4.1 Light Beam Orientation for Elevated RGLs.

RGLs should be oriented to maximize the visibility of the light by pilots of aircraft approaching the runway holding position. In general, the orientation should be specified by the design engineer to aim the center of the light beam toward the aircraft cockpit, when the aircraft is between 150 feet (45 meters) and 200 feet (60 meters) from the holding position, along the predominant taxi path to the holding position. The vertical aiming angle should be set between 5 degrees and 10 degrees above the horizontal. The designer should specify aiming of the lights such that the steady burning intensity at all viewing positions between 150 feet (45 meters) and 200 feet (60 meters) from the holding position is at least 300 cd when operated at the highest intensity step. (Refer to FAA AC 150/5345-46 for specifications for the light intensity and beam spread of the L-804 RGL fixture.) If these criteria cannot be met for all taxi paths to the holding position, consider the following: use of multiple fixtures aimed to adequately cover the different taxi paths, use of in-pavement fixtures to increase the viewing coverage, or aiming the single fixtures on each side of the holding position to optimize the illumination of the predominant taxi path.

5-5.5 Equipment.

Install the elevated RGLs on light bases, or on conduit set in concrete foundations, using frangible supports. The transformers, or power supply unit may be placed in the same light fixture base. The light emitted must be aviation yellow, and alternately flash 50 to 60 times per minute. The illumination period of each flash must not be less than 1/2 or more than 2/3 of the total cycle.

5-5.6 Power, Control and Monitoring.

Provide the electrical power for the guard lights with a dedicated 3-step regulator for each runway where they are installed. The regulator must be configured to operate only at steps two and three. There is no monitoring requirement.

5-5.7 Compliance with International Standards.

Previous ASIC AIR STDs and current NATO STANAGs contain no comparable systems.

5-6 RUNWAY STOP BAR.

5-6.1 Purpose.

Stop bars provide a distinctive "stop" signal to anyone approaching a runway.

5-6.1.1 Low Visibility.

In low visibility conditions, controlled stop bars are used to permit access to the active runway. Uncontrolled stop bars protect the active runway at taxiway/runway intersections that are not part of the low visibility taxi route. Stop bars are required for operations below 600 feet (180 meters) RVR on illuminated taxiways that provide access to the active runway.

5-6.1.2 Runway Incursion.

Stop bars may also be used as a means of preventing runway incursions regardless of visibility conditions. For example, stop bars could be illuminated in certain airfield configurations that would prevent aircraft access from particular taxiways to active, as well as closed runways.

5-6.2 Configuration.

A stop bar consists of a row of unidirectional in-pavement red lights and an elevated red light on each side of the taxiway.

5-6.3 Location of In-Pavement Stop Bar Lights.

In-pavement stop bar lights are centered on an imaginary line which is parallel to, and 2 feet (0.6 meters) from, the center of the fixture and the holding side of the runway holding position marking, as shown in Figure 5-10. The lights may vary from this imaginary line up to ± 2 in (± 50 mm) in a direction perpendicular to the holding position marking. Holding position marking locations are described in FAA AC 150/5340-1. If a conflict with rigid pavement joints occurs, move both the runway holding position marking and the stop bar lights away from the runway the minimum distance required to resolve the conflict.

Figure 5-10 Runway Stop Bar Configuration

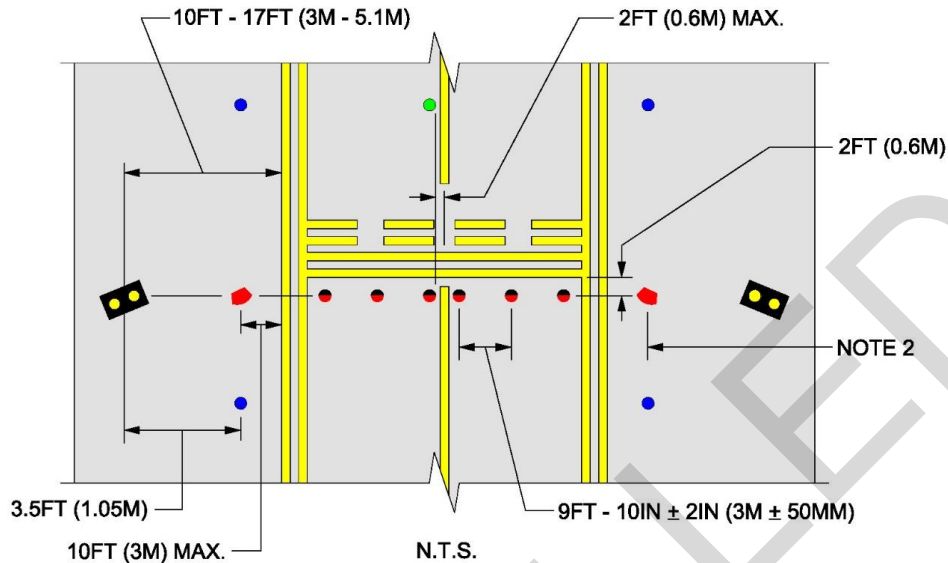

LEGEND:

- L-852S STOP BAR FIXTURE - IN-PAVEMENT
- L-852 CENTERLINE FIXTURE - IN-PAVEMENT
- L-862S STOP BAR FIXTURE - ELEVATED
- L-861 TAXIWAY EDGE LIGHT - ELEVATED
- L-804 RUNWAY GUARD LIGHT

NOTES:

1. THE ELEVATION RUNWAY GUARD LIGHT AND ELEVATED STOP BAR LIGHT MAY BE MOVED UP TO 10FT (3M) MAX. AWAY FROM THE RUNWAY TO AVOID UNDESIRABLE SPOTS OR CONFLICT WITH TAXIWAY EDGE LIGHTS.
2. WHERE SNOW REMOVAL OPERATIONS OCCUR, IT IS ADVANTAGEOUS TO INSTALL ELEVATED STOP BAR LIGHTS NOT CLOSER TO THE TAXIWAY EDGE THAN THE LINE OF TAXIWAY EDGE LIGHTS.
3. FIXTURE MAY BE OMITTED IF OUTSIDE EDGE IS LESS THAN 2FT (0.6M) FROM PAVEMENT EDGE.

5-6.3.1 Lateral Spacing – Preferred Method.

The lights are spaced across the entire taxiway, including fillets, holding bays, etc., at intervals of 9 feet 10 inches ±2 inches (3 meters ±50 millimeters), center-to-center, as shown in Figure 5-10. The lights are spaced in relation to a reference fixture which is installed inline (longitudinally) with existing or planned taxiway centerline lights. However, it is not intended that the reference fixture replace a taxiway centerline light. If a conflict between the reference fixture and a centerline light occurs, the reference fixture takes the place of an existing centerline light and a new centerline light must be installed per the criteria in paragraph 5-2.2. If the holding position marking is intersected by multiple taxiway centerline markings, the reference fixture must be set at the centerline that is used most. If a fixture's outboard edge falls at a point less than 2 feet (0.6 meters) from the defined edge of the taxiway marking, the outboard edge of the taxiway marking may be omitted. Individual fixtures may be moved laterally ± a maximum of 1 foot (0.3 meters) to avoid undesirable spots (e.g., conduit). If undesirable

spots cannot be avoided in this way, fixtures may be moved no more than 2 feet (0.6 meters) using the following alternate method.

5-6.3.2 Lateral Spacing – Alternate Method.

This alternate method of spacing the lights should be followed if it is not possible to meet the preferred method per paragraph 5-6.3.1. The lights are spaced across the entire taxiway, including fillets, holding bays, etc. If it is possible to meet paragraph 5-6.3.1 by allowing the reference fixture to be moved any amount laterally, then that method should be used. Otherwise, the lights should be spaced as uniformly as possible with a minimum spacing of 8 feet (2.4 meters) and a maximum spacing of 13 feet (4 meters).

5-6.3.3 Light Beam Orientation for Elevated Stop Bar Lights.

Elevated stop bar lights should be oriented to enhance conspicuity of the light by pilots of aircraft approaching the runway holding position. In general, the orientation must be specified by the design engineer to aim the axis of the light beam toward the aircraft cockpit when the aircraft is between 120 feet (36 meters) and 170 feet (51 meters) from the holding position, along the predominant taxi path to the holding position. The vertical aiming angle must be set between 5 degrees and 10 degrees above the horizontal. The designer must specify aiming of the lights such that the axis of the light beams intersects the primary taxiway centerline between 120 feet (36 meters) and 170 feet (51 meters) from the holding position (see Figure 5-9).

5-6.4 Location of Elevated Stop Bar Lights.

Elevated stop bar lights are installed in line with the in-pavement stop bar lights on each side of the taxiway. They are located not more than 10 feet (3 meters) from the defined edge of the taxiway. For airports that perform any snow removal operations, if taxiway edge lights are present, the elevated stop bar light should not be installed closer to the taxiway edge than the line of taxiway edge lights. This is to help prevent the elevated stop bar light from being struck by snow removal equipment. To avoid conflicts with taxiway edge lights or undesirable spots, the elevated stop bar lights may be moved up to 10 feet (3 meters) farther from the runway, but may not be moved toward the runway. See Figure 5-10.

5-6.4.1 Light Beam Orientation for In-Pavement Stop Bar Lights.

L-868 bases for in-pavement stop bar lights must be installed such that a line through one pair of bolt holes on opposite sides of the base is parallel to the runway holding position marking. Each fixture is installed so that the axis of the light beam faces away from the runway and is perpendicular to the marking with a tolerance of ± 1 degree. In some instances, it may be necessary to aim the lights at some angle to the marking. To accomplish this, install a 12 bolt-hole base using the above procedure. This allows the

light fixtures to be adjusted 30 degrees left or right, as required. See Figure 5-11 for typical examples.

Figure 5-11 Typical Light Beam Orientation for In-Pavement RGLs and Stop Bars

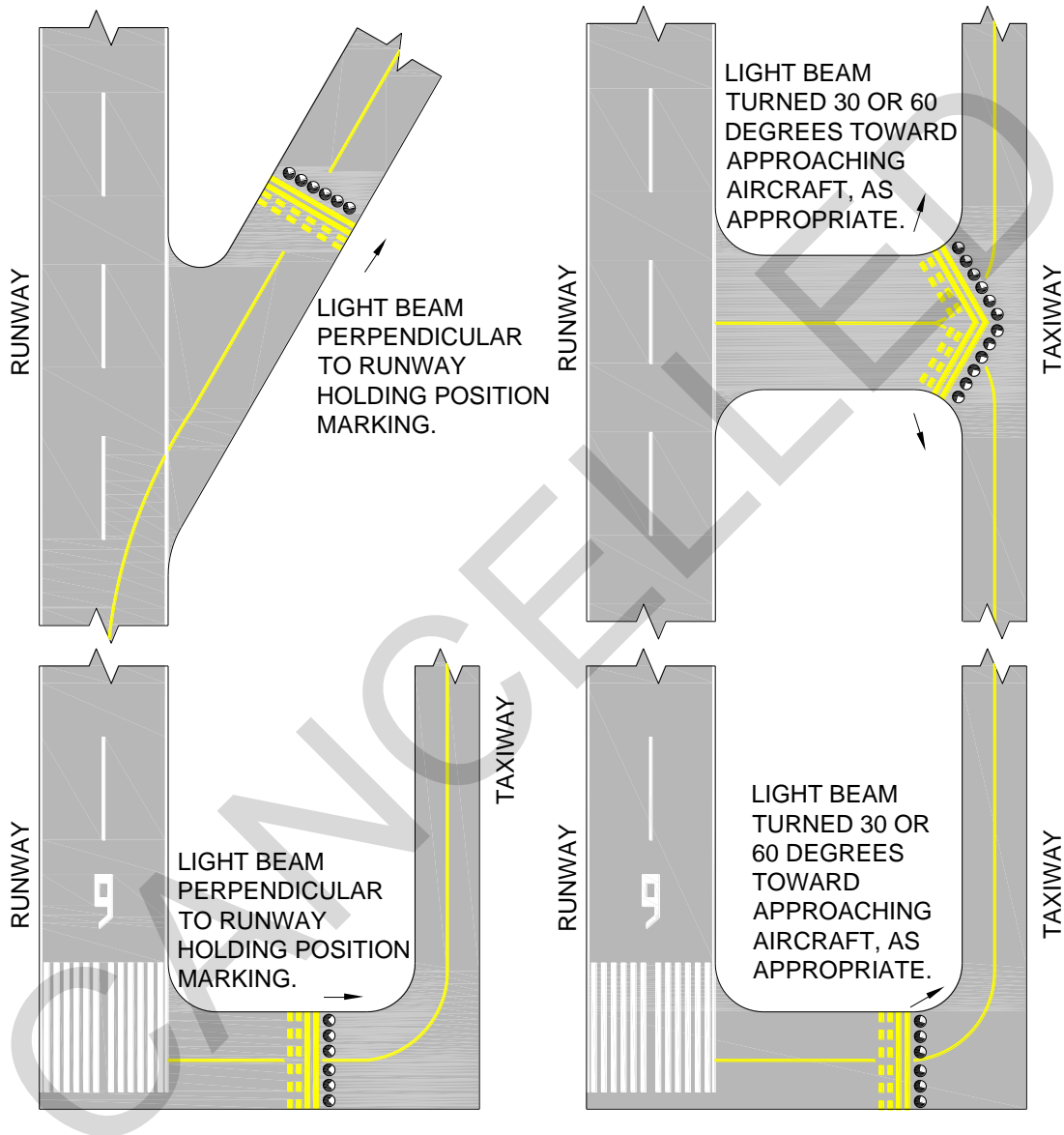

5-6.5 Equipment.

Install the elevated stop bar fixture on an FAA L-867 light base, using frangible supports. Install the in-pavement stop bar fixture on and FAA L-868 base. The current transformer may be placed in the same light fixture base. The light emitted must be traffic signal red. See Figure 5-12 for a typical elevated fixture.

Figure 5-12 FAA L-862S, Elevated Stop Bar Light

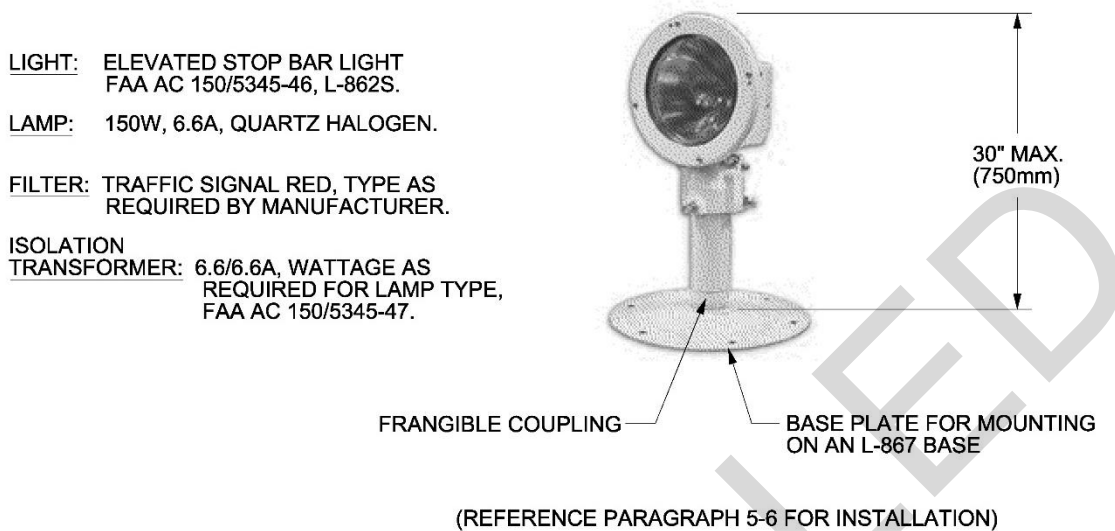

5.6.6 Power and Control.

You must power elevated and in-pavement stop bar light circuits from an appropriately sized L-828, Class 1, Style 1 (3-step) CCR. Brightness control is achieved by varying the output current of the CCR. You must install elevated stop bar fixtures on the same circuit as the associated in-pavement stop bar fixtures. There are two types of stop bars: controlled and uncontrolled. Controlled stop bars are controlled individually via FAA L-821 stop bar control panel(s) or via buttons on a touch screen display panel in the Air Traffic Control Tower (ATCT). Uncontrolled stop bars are generally "on" for the duration of operations below 1,200 feet (360 meters) RVR. If the need arises for an uncontrolled stop bar to be turned off, all stop bars for a given low visibility runway may be temporarily turned off via a master stop bar button for each low visibility runway.

5-6.7 Monitoring Requirements for Controlled Stop Bars.

Controlled stop bars and associated lead-on lights must be electronically monitored. Within 5 seconds of pressing the stop bar button, the actual status of the lights must be displayed on the stop bar control panel in the ATCT. This response time reflects the state-of-the-art for local control devices. Ideally, the lights would be switched and their status returned to the ATCT within 2 seconds of pressing the stop bar button. A standard L-827 monitor or L-829 CCR with integral monitor may be used if it is accurately calibrated to indicate a fault indication with approximately 2 stop bar or lead-on lights not functioning. In locations where the circuit resistance to ground varies widely from day to day, it may not be possible to use the L-827 monitor for this level of precision. Because this monitoring system is not capable of determining adjacency, a visual inspection would have to be made to determine whether or not the failed lights

are adjacent. There is individual lamp monitoring technology currently available; the system manufacturer must be consulted for the application of this technology.

5-6.8 Compliance with International Standards.

Previous ASIC AIR STDs and current NATO STANAGs contain no comparable systems.

CANCELLED

This Page Intentionally Left Blank

CANCELLED

CHAPTER 6 STANDARDS FOR OBSTRUCTION LIGHTING

6-1 PURPOSE.

Obstruction lighting defines the vertical and horizontal limits of natural or manmade objects which are considered a hazard to air navigation. Typical examples of various obstruction lighting arrangements are shown in Figure 6-1, Figure 6-2, Figure 6-3 and Figure 6-4.

6-2 OBJECTS TO BE LIGHTED.

Objects that penetrate the planes and surfaces defined in UFC 3-260-01 are hazards to air navigation and must have obstruction lights installed. Other objects, which are hazards due to their nature or location even though they do not penetrate the planes and surfaces, as defined above, must also be lighted. This includes obstructions that affect TERPS criteria. Construction or objects which may impact navigable airspace under the provisions of FAR Part 77 are also subject to the administrative procedures in FAA AC 70/7460-1 for determining obstruction marking and lighting requirements. Also, obstruction lighting is required on the facilities and other obstructions along the periphery of the Building Restriction Line defined in UFC 3-260-01.

6-3 LIGHTING CONFIGURATION.

The number and arrangement of obstruction lights must ensure unobstructed visibility of one or more lights from an aircraft at any normal angle of approach. Arrange obstruction lights per FAA AC 70/7460-1.

Figure 6-1 Obstruction Light Configuration, Height up to 350 Feet (105 Meters)

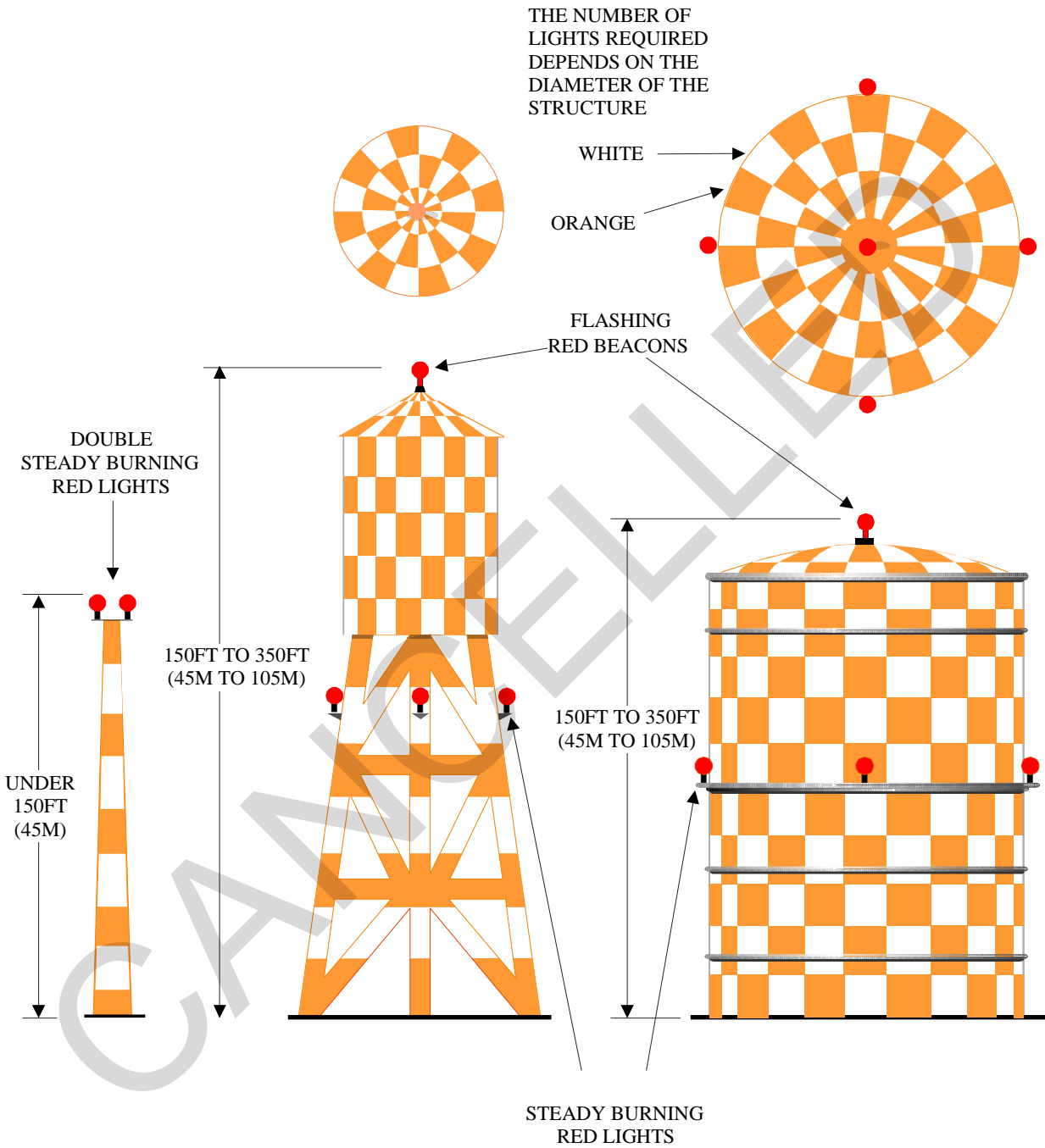

Figure 6-2 Obstruction Light Configuration Height 150 to 350 Feet (45 to 105 Meters)

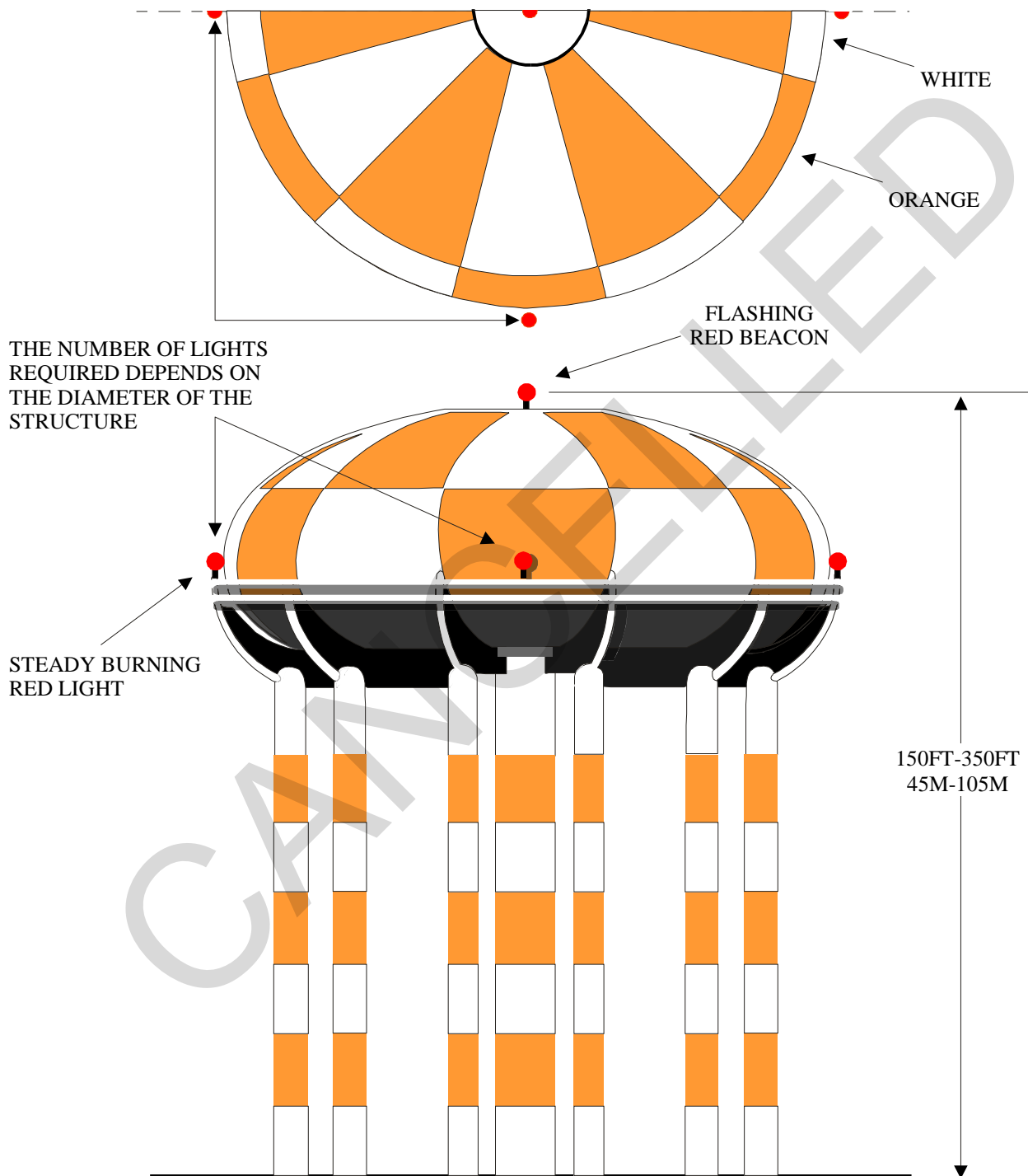

Figure 6-3 Obstruction Light Configuration Height 350 to 700 Feet (105 to 210 Meters)

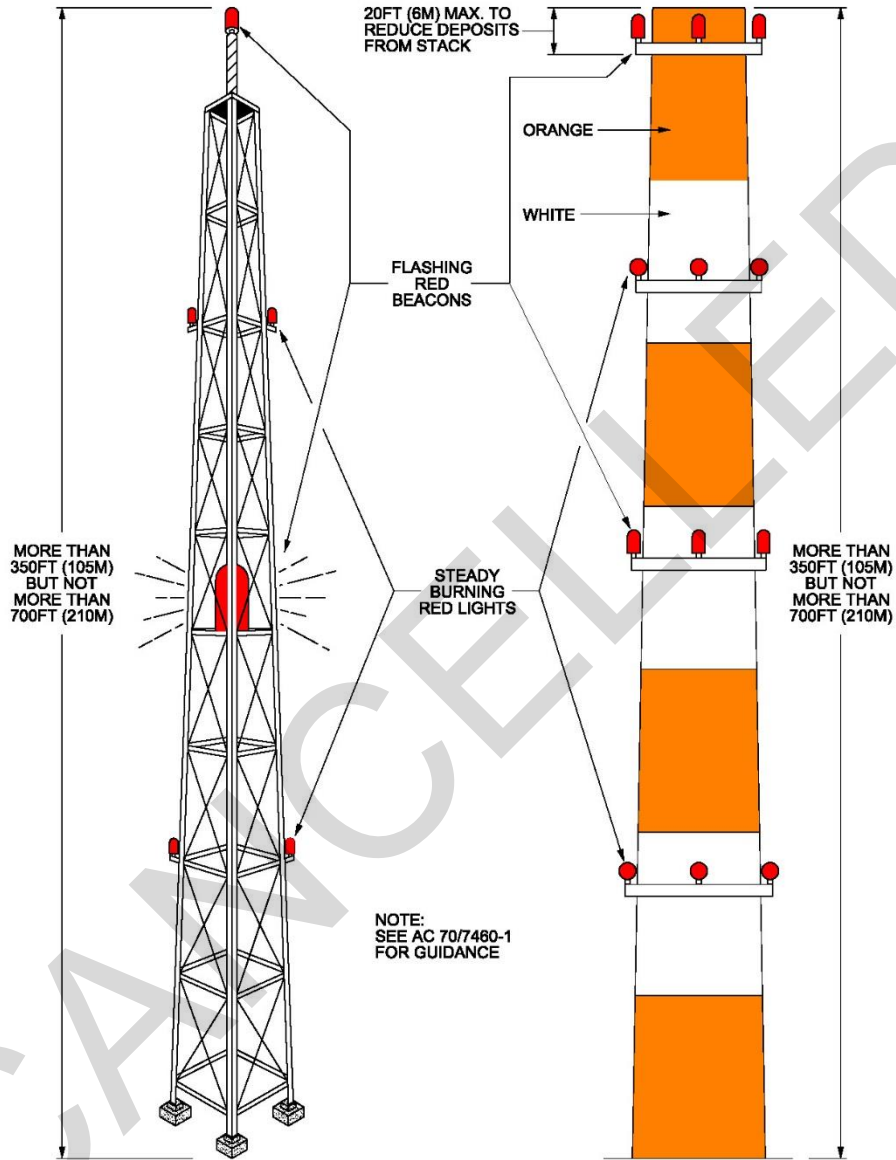
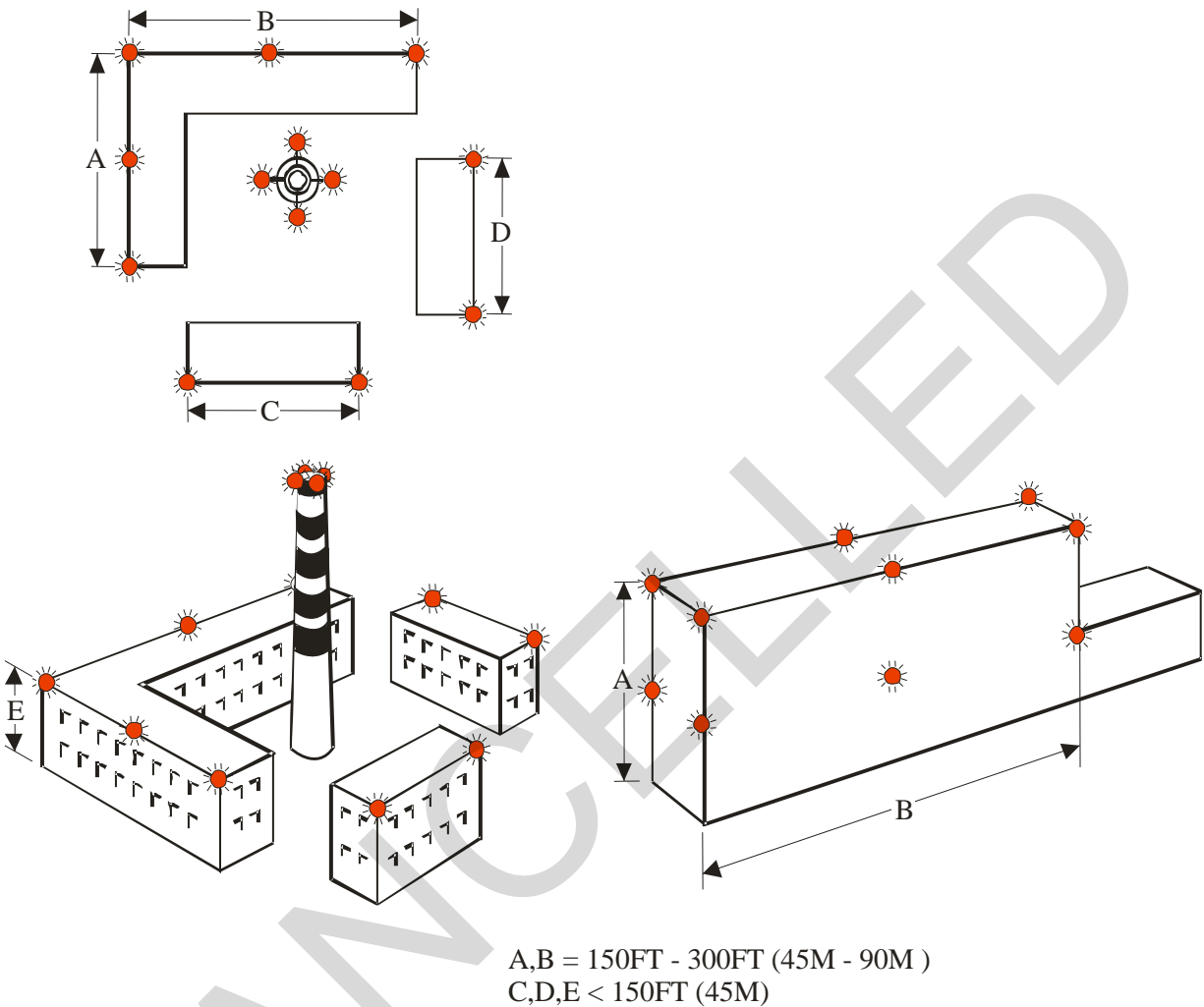

Figure 6-4 Obstruction Lights on Buildings



6-4 LIGHTING VERSUS DAY MARKING.

Flashing white obstruction lighting may be used instead of obstruction marking on structures less than 200 feet (60 meters) tall **with major command approval**. Do not install these lights in clear zones or on objects in the immediate vicinity of runways where approaching pilots may mistake them for other flashing white lights.

6-5 WAIVERS.

The decision to waive obstruction lighting requirements must be coordinated with appropriate civil aviation authorities to ensure there is no negative impact to civil aviation. (See paragraph 1-11 for Air Force waivers and paragraph 1-12 for US Army waivers.)

6-6 EQUIPMENT.

The equipment shown meets the requirements of the FAA.

6-6.1 LED-Based Obstruction Lights.

LED based obstruction lights are prohibited for use on Air Force and Army facilities.

6-7 POWER REQUIREMENTS.

Depending on the equipment installed, the power is usually 120/240 volts AC. Emergency power is not a requirement but is desirable if readily available.

6-7.1 Intensity Requirements.

See FAA AC 150/5345-43 for required obstruction light photometric characteristics.

6-8 CONTROL REQUIREMENTS.

6-8.1 Obstruction Lights

Obstruction lights intended for day marking must remain on at all times and have automatically selected reduced intensity levels for night operations. Other obstruction lights must be on when the northern sky illumination falls on a vertical surface to a level of not less than 35 footcandles (350 lux), or during daytime, when visibility is restricted. The lights may be turned off when the northern sky illuminance rises to a level of 58 footcandles (580 lux) or more. If practicable, obstruction lights should be controlled from the airfield lighting control panel. Otherwise use automatic controls and provide an auxiliary manual control (that can be locked) at ground level on the exterior of the object to be lighted.

6-8.2 Dual Lighting.

See FAA AC 70/7460-1 for information and requirements about dual lighting systems that use red lights for night operation and white medium or high intensity lights for day operation.

6-9 MONITORING REQUIREMENTS.

Obstruction lights should be visually observed for proper operation at least once each 24 hours. If the lighting cannot be readily observed, provide a remote monitoring system to indicate the malfunction of all the top lights and any flashing or rotating beacons regardless of their position.

6-10 COMPLIANCE WITH INTERNATIONAL STANDARDS.

6-10.1 NATO.

These standards meet the requirements of STANAG 3346 (Edition 7) – Marking and Lighting of Airfield Obstructions, 26 November 2012, except for the use of high intensity white lights.

6-10.2 ASIC.

Previous ASIC AIR STD 90/19 cancelled.

CANCELLED

This Page Intentionally Left Blank

CANCELLED

CHAPTER 7 STANDARDS FOR LIGHTING HELIPADS

7-1 GENERAL DESCRIPTION.

Helipad lighting defines the helicopter landing pad during operations at night and during periods of poor visibility. It is used for single helicopter landing pads. For heliport and helicopter landing lanes lighting system criteria, refer to Chapter 8.

7-2 HELIPAD PERIMETER LIGHTS.

7-2.1 Purpose.

Perimeter lights provide visual cues to pilots for identifying the safe operational limits of the helipad during takeoff, landing or hover operations.

7-2.2 Standard Perimeter Light Configuration.

Place aviation yellow, omnidirectional lights at each corner of the helipad, with three more lights spaced equally along each side between the corner lights. Lights on opposite sides of the helipad must be opposite each other. They must be equidistant and parallel to the extended centerlines of the helipad. They are usually located on the perimeter of the helipad, but may be placed not more than 7.5 feet (2.25 meters) away from the edge of the pad. In-pavement (FAA L-852E) fixtures must be used where taxiing of wheeled helicopters, skid mounted helicopters or other vehicular traffic is required. Elevated light fixtures (FAA L-861) should preferably be 14 inches (350 millimeters) maximum. Elevated light fixtures may be used where only approach and departure procedures are conducted. (See Figure 7-1.)

7-2.3 Hospital Pad Perimeter Light Configuration.

The lighting of a hospital helipad is the same as the standard helipad perimeter lights in paragraph 7-2.2, except there are additional wing lights located on the geometric centerlines of the helipad at a distance of 25 feet (7.5 meters), as shown in Figure 7-2, outboard of the existing perimeter light fittings.

7-3 HELIPAD VFR LANDING DIRECTION AND APPROACH LIGHTS.

These lights are installed to indicate a specific landing direction, in the procedure for touchdown or hover at the helipad.

Figure 7-1 Helipad Perimeter Lights, Standard Configuration

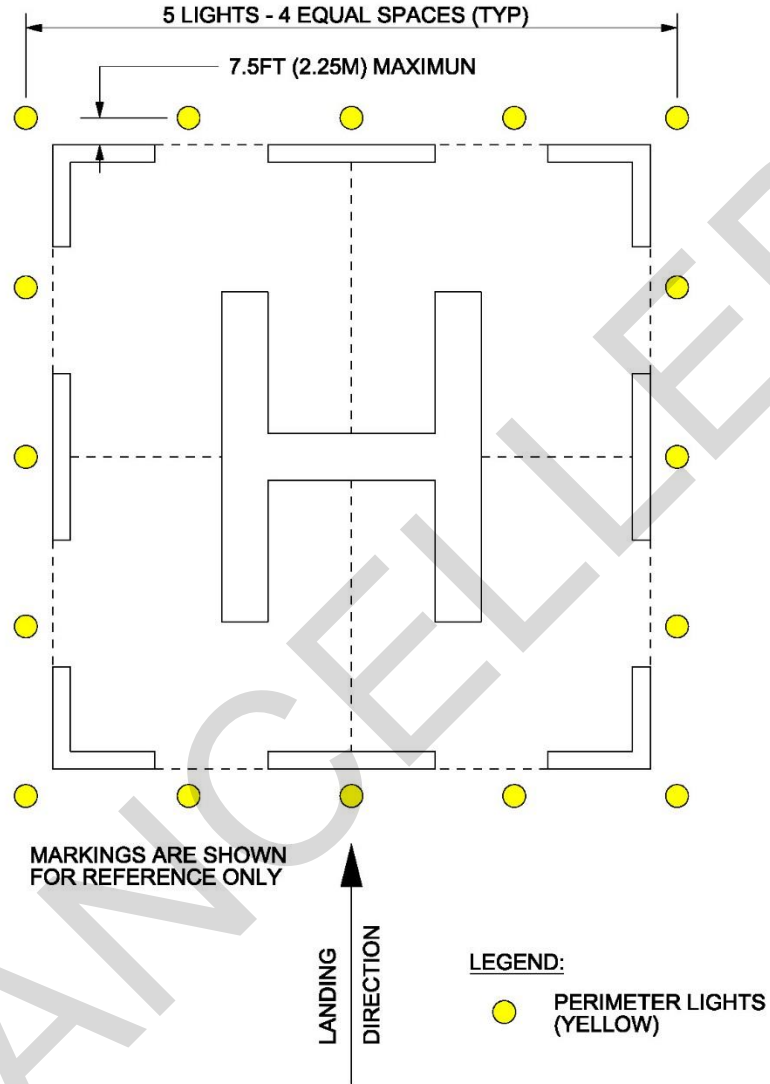
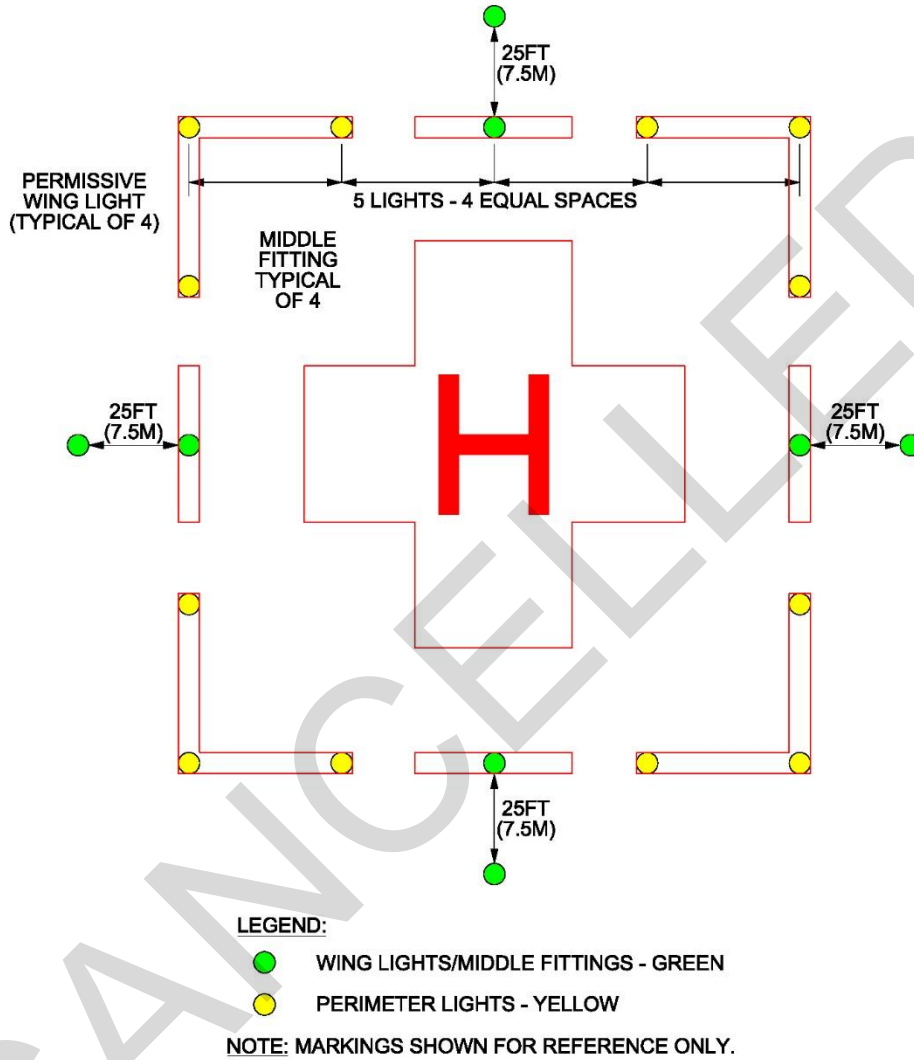

Figure 7-2 Helipad Perimeter Lights, Hospital Configuration



7-3.1 Configuration of Landing Direction Lights.

Provide aviation yellow omnidirectional lights (FAA L-861) in a straight line along one or more of the centerlines of the helipad, extended, and perpendicular to the perimeter lights. They must consist of six lights spaced 15 feet (4.5 meters) apart and starting 25 feet (7.5 meters) from the middle perimeter light. Locate the lights in a horizontal plane. (If a deviation is necessary, a tolerance of plus 2 percent or minus 1 percent in the longitudinal slope is permitted.) Use elevated fixtures on frangible supports, except use in-pavement fixtures when taxiing is a requirement. (See Figure 7-3.)

Figure 7-3 VFR Helipad Landing Direction Lights

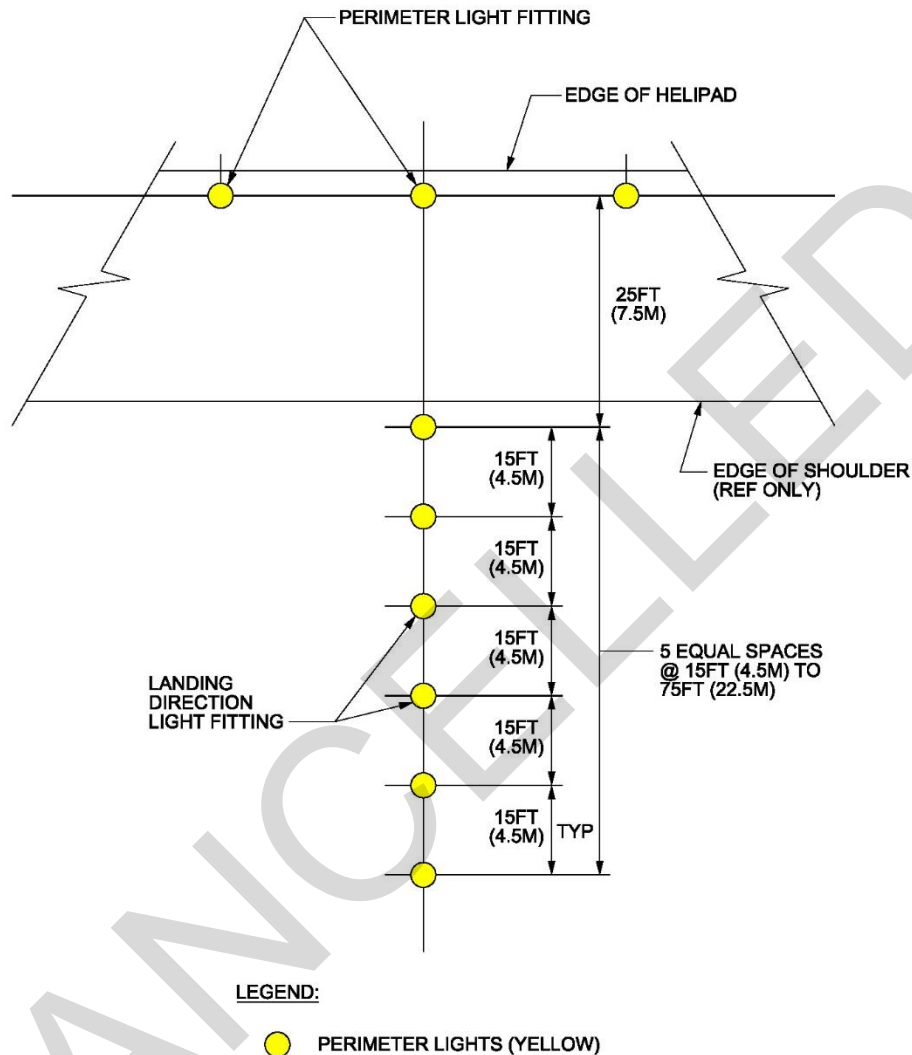

7-3.2 Purpose of Approach Direction Lights.

These lights are installed to provide approach guidance in order to restrict the path of approach to the helipad or when additional guidance is needed by the pilots.

7-3.2.1 Configuration of Approach Direction Lights.

Provide aviation white, unidirectional lights in two parallel rows extending out from the landing direction lights. Each row must consist of five lights spaced 50 feet (15 meters) apart, starting 125 feet (37.5 meters) from the perimeter lights and offset 5 feet (1.5 meters) either side of the extended centerline of the landing direction lights. The slope of the approach direction lights must be the same as that used for the landing direction lights. (See Figure 7-4.)

Figure 7-4 Helipad VFR Approach Direction Lights

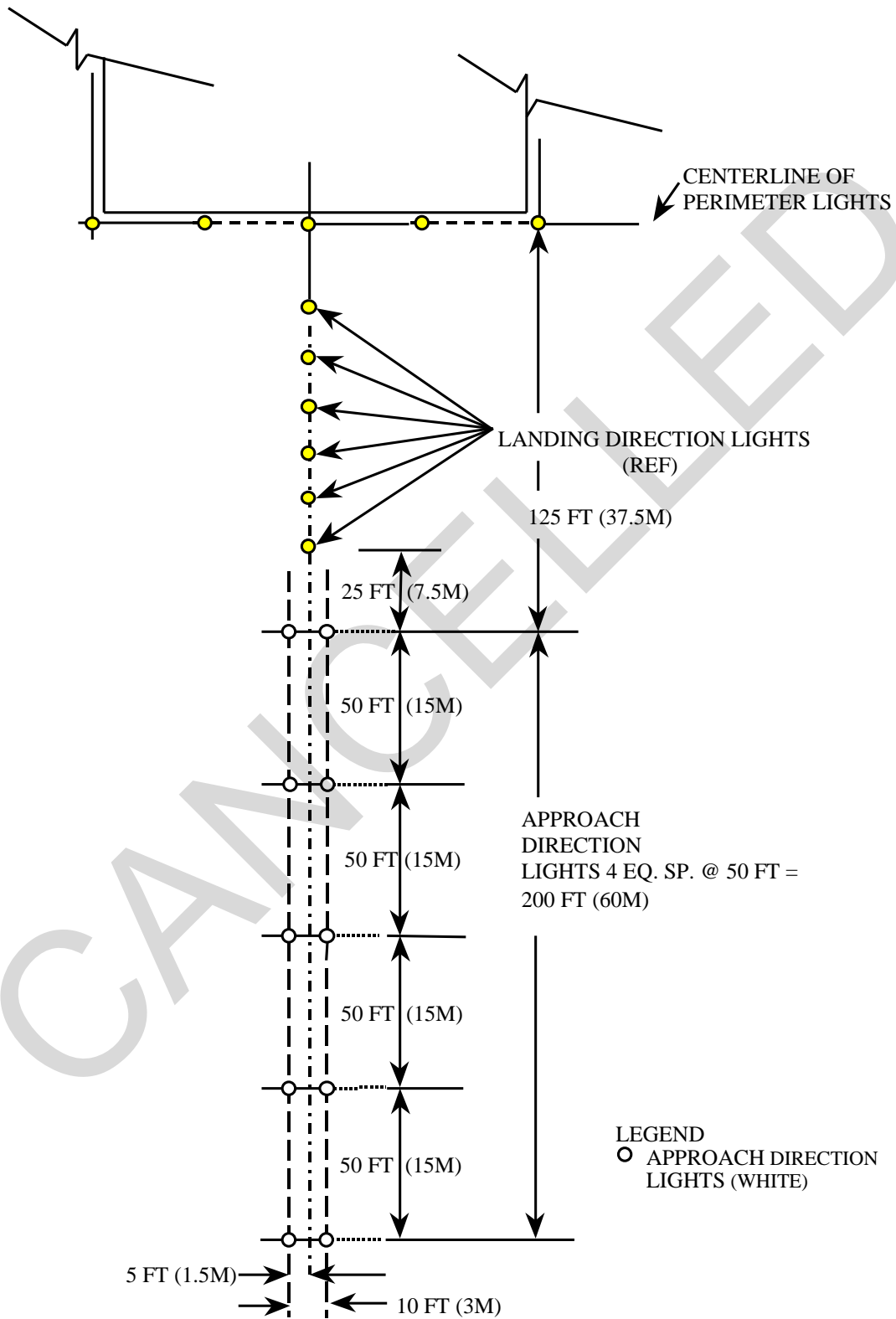

7-3.3 Helipad IMC Approach Lights Category I.

7-3.3.1 Purpose.

These lights provide additional approach guidance for instrument meteorological conditions, with a decision height of 200 feet (60 meters) and an RVR of 2,400 feet (720 meters).

7-3.3.2 Configuration of IMC Approach Lights.

The approach lighting system will be symmetrical about, and extend for the entire length of, the centerline of the helipad direction lights. This additional light system starts at the position of the approach direction lights, shown in Figure 7-3, at 125 feet (37.5 meters) from the helipad and extending out to 1,025 feet (307.5 meters), shown in Figure 7-5.

7-4 REFUELING AREA LIGHTS.

Refueling areas are class 1, division 1, group D hazardous locations as defined in NFPA 70 National Electrical Code. See paragraphs 8-4 and 8-6.5 for more information.

7-5 HELIPAD FLOODLIGHTS.

7-5.1 Purpose.

Helipad floodlights illuminate the helipad surface at night to provide visual cues to the pilot for determining his height above the surface during the touchdown phase of his approach. To prevent interference with or damage to an aircraft, the helipad floodlights must be as close to grade as practical and have frangible couplings. The floodlights must provide a uniform illumination of the helipad surface. When installed, the fixtures must not permit any direct light to be visible above the horizontal. The fixtures emit a narrow fan-shaped illuminating beam for which the axis of the beam must be adjustable in elevation between 1 degree up and 5 degrees from horizontal. Another purpose is for ground operations on a helipad where access to a lighted apron is not available for loading or unloading of equipment or personnel. A typical application would be a helipad located near a hospital or headquarters building.

7-5.2 Configuration.

Locate these lights a minimum of 16 feet (4.8 meters) beyond the edges of the helipad on two opposite sides, parallel to the normal approach to the helipad. Mount the floodlights not over 16 inches (400 millimeters) above the grade of the helipad with a small obstruction light at each floodlight visible from any direction. The number of floodlights installed depends on the size of the helipad and the light output of the fixtures used. (See Figure 7-6.)

Figure 7-5 Approach Lights Category I

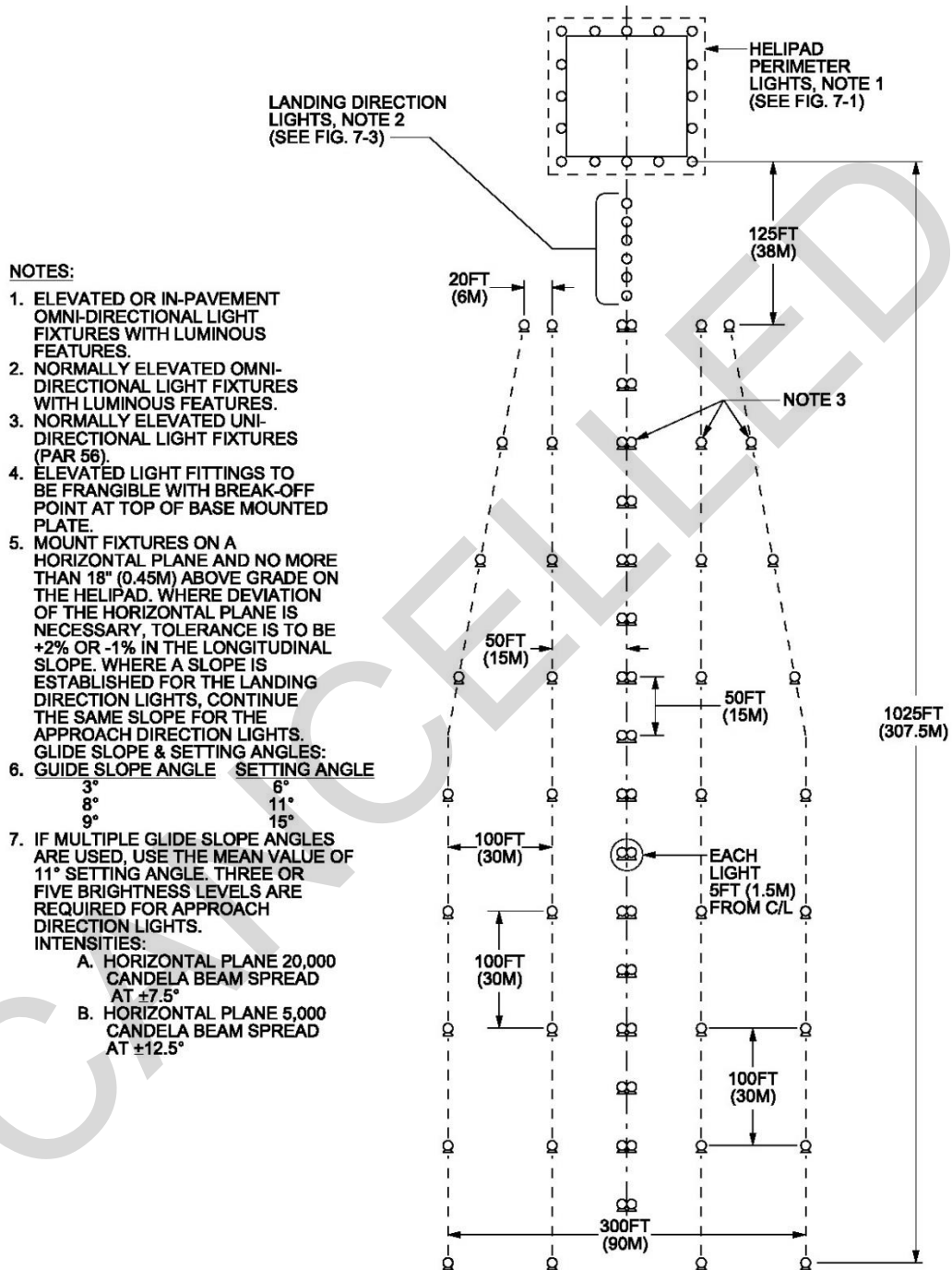
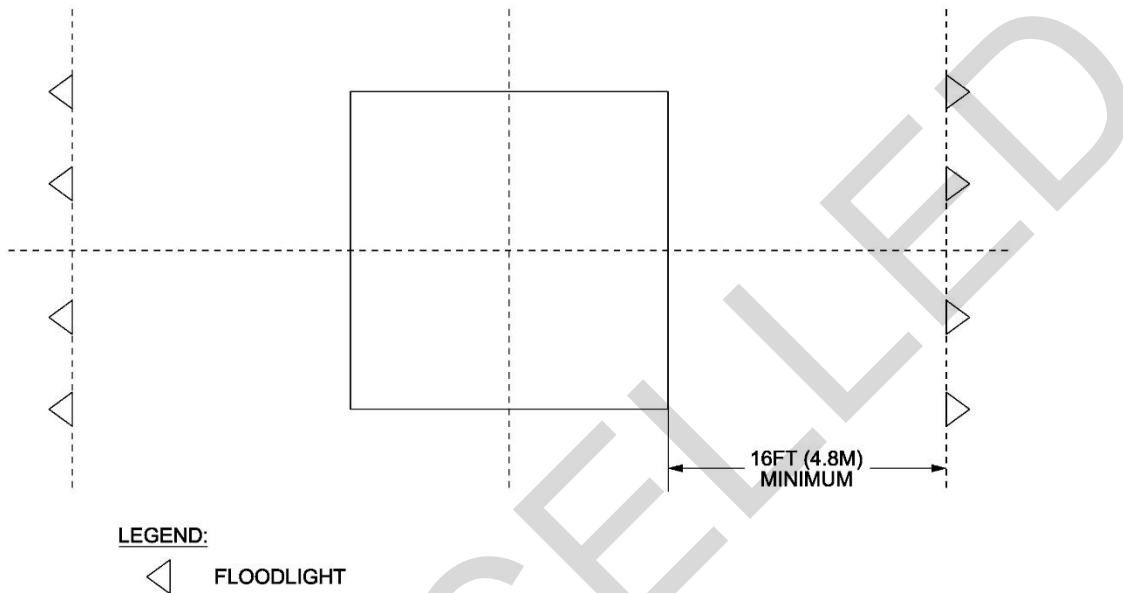

Figure 7-6 Helipad Floodlight Typical Configuration



7-5.3 Helipad Refueling Floodlights.

Helipad refueling floodlights are class 1, division 1, group D hazardous locations, as defined in NFPA 70 National Electrical Code. See paragraphs 8-4 and 8-6.5 for more information.

7-6 HELIPAD APPROACH SLOPE INDICATOR.

7-6.1 Purpose.

A visual glide slope indicator should be provided for a helipad when obstacle clearance, noise abatement or traffic control procedures require a particular approach slope angle be flown, when the environment of a helipad provides few visual cues, or when the characteristics of a particular helicopter requires a stabilized approach path. The preferred system is CHAPI. An FAA L-881 2-light housing assembly PAPI system is optional.

7-6.2 Justification.

A Visual Glide Slope Indicator System should be provided to serve the approach whether or not there are other visual approach aids or by non-visual aids where one or more of the following conditions exist, especially at night:

7-6.2.1 Obstacle clearance, noise abatement or traffic control procedures require a particular slope to be flown.

7-6.2.2 The environment of the heliport provides few visual surface cues.

7-6.2.3 The characteristics of the helicopter required a stabilized approach.

7-6.3 Configuration.

The CHAPI system consists of two transition light units projecting red/green/white lights. They are located forward of the helipad on the extended centerline at a distance determined in order to project an on glide path angle (usually 6 degrees) at the helipad hover point prior to touchdown. For precision approaches, the glide slope of the CHAPI must be consistent with the approach lighting system, instrument landing system (ILS), or other electronic NAVAID. The units are positioned at approximately 20 feet (6 meters) apart lateral (horizontal). The CHAPI system must be constructed and mounted as low as possible and be sufficiently lightweight and frangible so as not to constitute a hazard to helicopter operations.

7-7 HELIPAD BEACON.

7-7.1 Purpose.

A helipad beacon provides long-range guidance and helipad identification.

7-7.2 Configuration.

The beacon must contain a sequence of three lights. For Army or Air Force medical facilities – double-peaked white, a single green, and a single red. For all other facilities – double-peaked white, a single green, and a single yellow. For Navy medical facilities – double-peaked white, green, yellow as per NAVAIR 51-50AAA-2. The flash must be 10 to 15 sequences of flashes per minute. The time between each color should be one-third of the total sequence time. The beacon should not be installed within 1 mile (1.6 km) of any existing airport beacon or other helipad area.

7-7.3 Construction.

The beacon should be visible for a distance of 1 mile (1.6 kilometers) in 1 mile (1.6 kilometer) VMC visibility daylight, and 3 miles (4.8 kilometers) in 3 mile (4.8 kilometer) VMC at night, both from an altitude of 3,000 feet (900 meters) above ground level. The beacon should be mounted a minimum of 50 feet (15 meters) above

the helipad surface. Where a control tower or control area is utilized the beacon should be no closer than 400 feet (120 meters), nor further than 3,500 feet (1,050 meters), from that area, and not located between the control tower and the helipad. The beacon will be installed so that the base is not less than 15 feet (5 meters) above the floor of the control tower or operations room.

7-7.4 Luminous Features.

The main beam of the light should be aimed a minimum of 5 degrees above the horizontal and should not produce light below the horizontal in excess of 1,000 candelas. Light shields may be used to reduce the intensity below the horizontal.

7-8 HELIPAD WIND DIRECTION INDICATORS.

7-8.1 Purpose.

Helipad wind direction indicators enhance operational capabilities, increase safety and reduce pilot workload during approach, hover and takeoff operations.

7-8.2 Configuration.

A helipad should be equipped with at least one wind direction indicator located in a position to indicate the wind conditions over the final approach and take-off area. The wind indicator must be free from the effects of air flow disturbances caused by nearby objects or rotor wash. It must be visible from a helicopter in flight, in a hover, or on the movement area. Where a helipad may be subject to a disturbed air flow, additional indicators located close to the area should be provided to indicate surface winds.

7-8.3 Construction.

A wind direction indicator must be constructed to give a clear indication of the wind direction and a general indication of the wind speed. An indicator should be a truncated cone made of light weight fabric. The approximate minimum dimensions are 8 feet (2.4 meters) long, 18 inches (450 millimeters) diameter (large end), and 12 inches (300 millimeters) diameter (small end). The color selected must make it clearly visible and understandable from a height of at least 650 feet (195 meters) above the helipad. When practical the preferred colors should be white or orange. Where it is necessary to provide adequate conspicuity against varied backgrounds, combined colors are permitted such as orange and white, red and white, or black and white.

7-8.4 Illumination.

A wind direction indicator intended for use at night must be illuminated, and have a red obstruction light mounted on the mast.

7-9 PHOTOMETRIC REQUIREMENTS.

7-9.1 Perimeter and Landing Direction Lights.

These lights must emit omnidirectional aviation yellow light with intensities as follows:

2 to 10 degrees vertical	37 cd min.	67 cd average
10 to 15 degrees vertical	20 cd min.	

7-9.1.1 A 25 percent reduction in light output is permitted at structural ribs on in-pavement lights.

7-9.2 Approach Direction Lights.

These lights must emit directional aviation white light with intensities as follows:

2 to 10 degrees vertical	5 cd min.	125 cd average
10 to 15 degrees vertical	40 cd min.	

7-9.2.1 A 25 percent reduction in light output is permitted at structural ribs of in-pavement lights.

7-9.3 Helipad Floodlights.

These fixtures must direct the entire output of the fixture below the horizontal. The minimum average luminance in the horizontal helipad surface must be 2 footcandles (20 lux) with a uniformity ratio (average to minimum) that should be not more than 4 to 1.

7-9.4 Helipad Beacons.

These lights are rotating or flashing lights. They must appear to an observer at any azimuth as a series of flashing lights coded white-green-yellow or white-green-red as applicable. The flash duration must be 75 to 300 milliseconds. The effective intensities of white light for vertical angles above the horizontal must be:

1 to 2 degrees	12,500 cd
2 to 8 degrees	25,000 cd
8 to 10 degrees	12,500 cd

The minimum intensities of the green must be 15 percent of those given for the white light, and the minimum effective intensities of the yellow flashes must be 40 percent of that given for the white light.

7-9.5 CHAPI Systems.

The CHAPI light units are similar to a PAPI system (see paragraph 3-7.1), with the addition of a 2.0 degree wide green sector command path. The vertical color sectors for the CHAPI system are:

above course	7.5 degrees or more	W	W
slightly high	6.5 to 7.5 degrees	W	G
on course	6.0 degrees	G	G
slightly low	4.5 to 5.5 degrees	G	R
below course	4.5 degrees or less	R	R

7-9.5.1 Justification.

For the US Army, a CHAPI will be provided where one or more of the following conditions exist:

- The pilot of any type of aircraft may have difficulty judging the approach due to inadequate visual guidance that may be experienced during an approach over water or featureless terrain by day, or in the absence of sufficient extraneous lights in the approach area by night.
- If judging the approach is difficult due to misleading information produced by deceptive surrounding terrain or runway slopes. The presence of objects in the approach area may present a serious hazard if an aircraft descends below the normal approach path, especially if there are no navigation aids to give warning of these objects.
- Physical conditions at either end of the runway present a serious hazard in the event of an aircraft undershooting or overrunning the runway.
- Terrain or prevalent meteorological conditions are such that the aircraft may be subjected to unusual turbulence during approach.

7-10 POWER REQUIREMENTS.

Provide a main and an alternate power system with the capability to automatically transfer within 15 seconds from the system in use if a system fails. Typical lighting control diagrams for helipad lighting systems are shown in Figure 7-7 for systems without a control tower, and in Figure 7-8 with systems with a control tower.

Figure 7-7 Block Diagram Without Tower

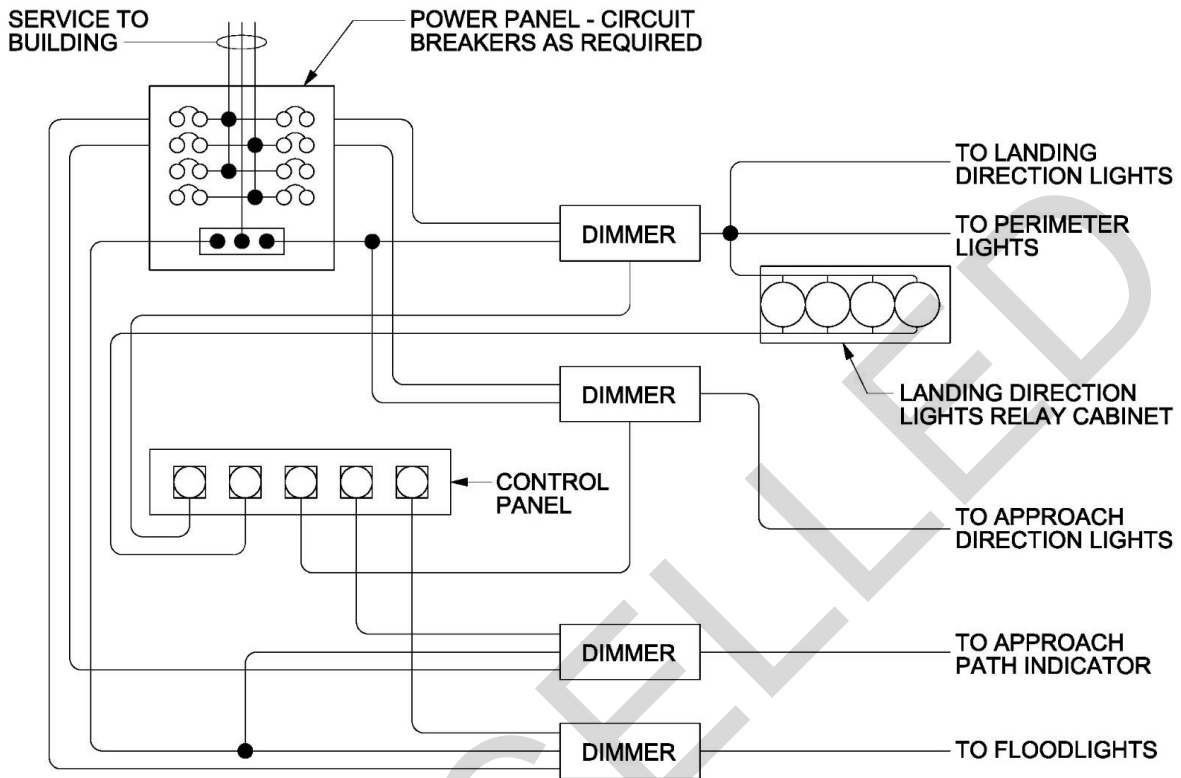

NOTE:
DELETE UNNEEDED COMPONENTS WHEN NOT
USED IN THE HELIPAD LIGHTING SYSTEM.

Figure 7-8 Block Diagram with Tower

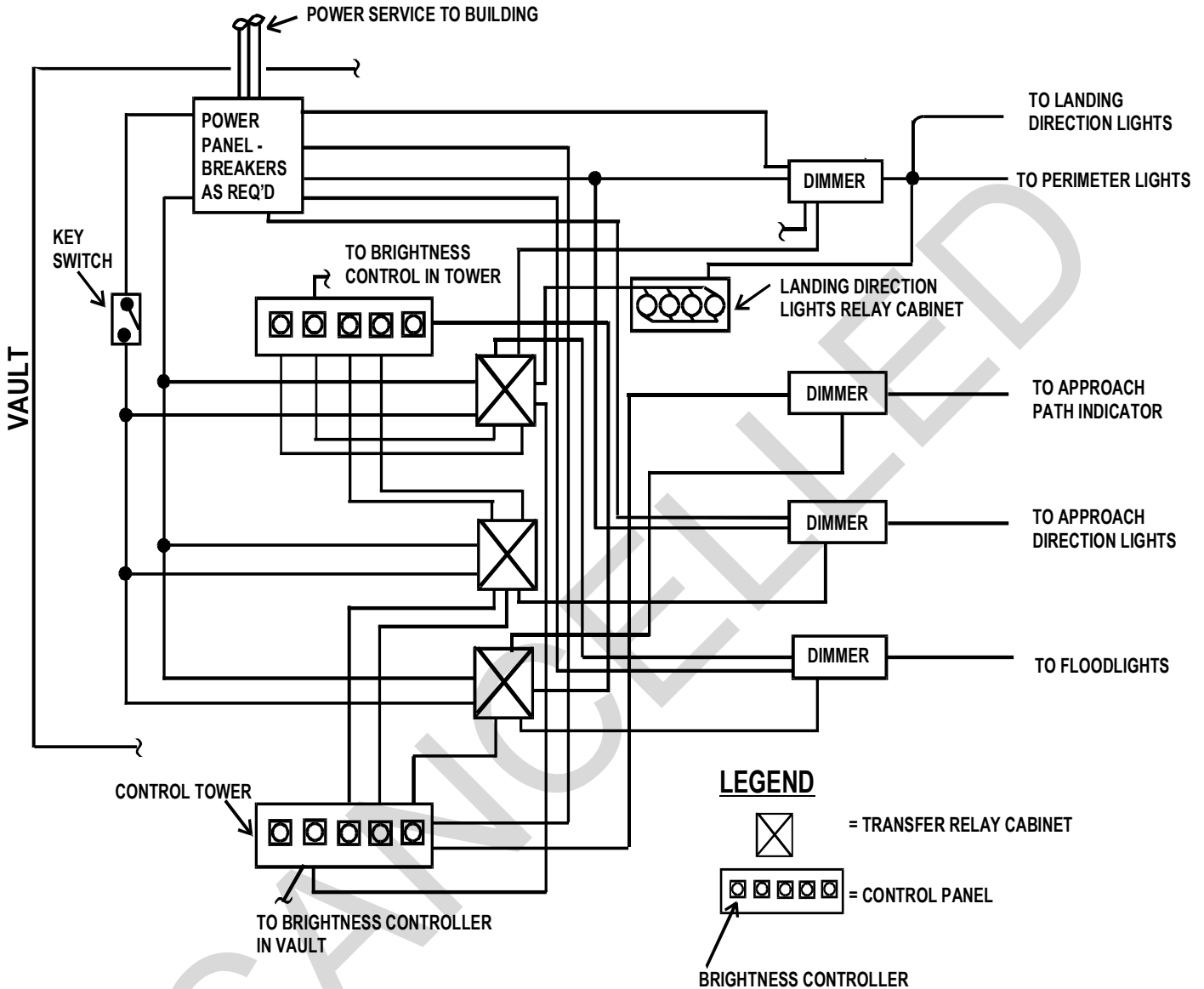

7-11 CONTROL REQUIREMENTS.

7-11.1 Perimeter Lights.

Provide on and off control and a three-step intensity control.

7-11.2 Landing Direction Lights.

Provide on and off control and a three-step intensity control. Interconnect the controls with the perimeter light controls to prevent operation without the perimeter lights being activated; however, they must have the capability of being independently turned off.

7-11.3 Approach Direction Lights.

Provide on and off control and a three-step intensity control. Interconnect the controls to the landing direction light circuit in order to prevent their operation unless the landing direction lights are activated; however, they must also be capable of being turned off independently. The intensity controls may be connected to the same regulator as the landing direction lights.

7-11.4 Helipad Floodlights.

Helipad floodlights require on and off control and intensity control from blackout to full intensity.

7-11.5 Helipad Beacons.

Provide on and off control only.

7-11.6 CHAPI.

Provide on and off control and a minimum of three-step intensity control, similar to the PAPI system.

7-12 MONITORING REQUIREMENTS.

There are no requirements for monitoring helipad lighting systems.

7-13 COMPLIANCE WITH INTERNATIONAL STANDARDS.

7-13.1 ASIC.

Previous ASIC AIR STD 90/34 cancelled.

7-13.2 NATO.

These standards meet the requirements of STANAG 3619 (Edition 5) – Helipad Marking and Lighting, 6 June 2013.

7-14 EQUIPMENT.

See paragraph 13-14 for appropriate Helipad lighting equipment.

This Page Intentionally Left Blank

CANCELLED

CHAPTER 8 STANDARDS FOR LIGHTING HELIPORTS

8-1 GENERAL DESCRIPTION.

8-1.1 Helicopter Runway

A helicopter runway is a prepared surface used for the approach and departure of rotary wing aircraft. It is not intended for use of fixed wing aircraft.

8-1.2 Design Criteria.

The design criteria set forth herein are intended to guide in designing and installing a permanent heliport lighting system utilizing elevated and in-pavement lights. Figure 8-1 illustrates a typical heliport having two 75 foot (22.5 meter) wide by 1,600 foot (480 meter) long intersecting runways with 40 foot (12 meter) wide connecting taxiways and 25 foot (7.5 meter) wide adjacent surface treated shoulders. Changes in the layout or design may be necessary to fit the requirements of a particular heliport runway installation, including a basic one runway configuration.

Figure 8-1 Layout Heliport Lighting

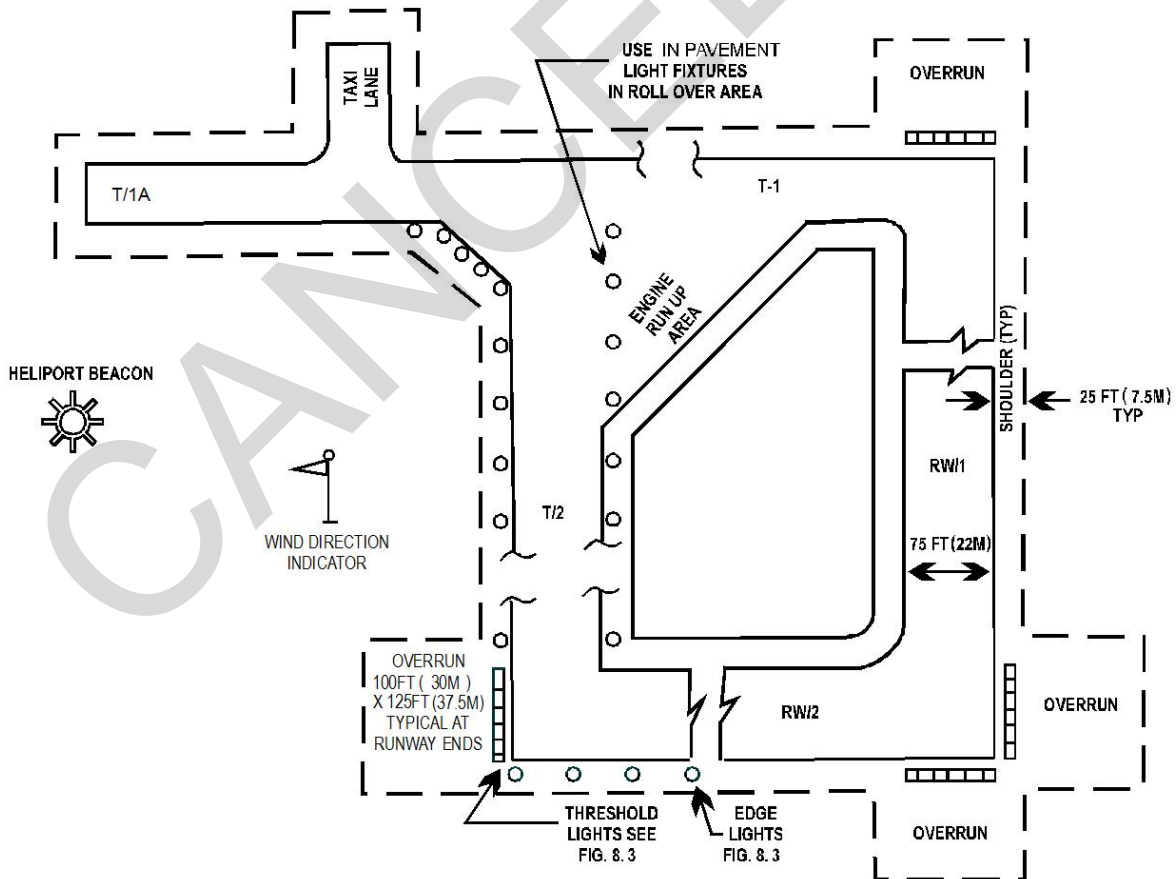
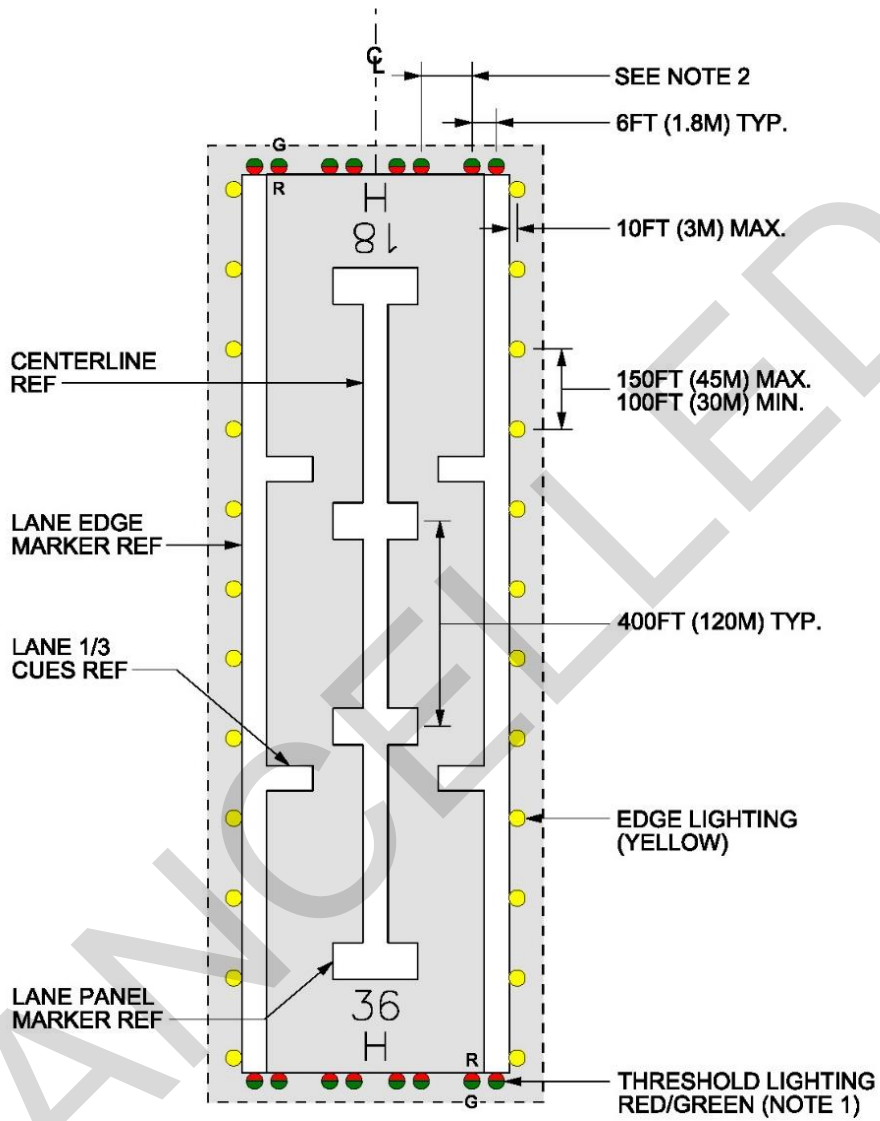

Figure 8-2 Rotary Wing Landing Lane



NOTES:

1. THRESHOLD LIGHTING MAY BE PLACED ON OR OFF THE PAVEMENT.
2. THE DISTANCE BETWEEN THE LIGHT GROUPS WILL VARY DEPENDING ON LANDING WIDTH. FOR EXAMPLE, 75FT (22.5M) = 17FT (5.1M) SPACING.

8-2 HELIPORT LIGHTS.

8-2.1 Runway Edge Lights (White).

The line of edge lights, aviation white, must be located on each side of a heliport runway, and not less than 5 feet (1.5 meters), nor more than 10 feet (3 meters) from the paved edge of the runway. The lights will be of the elevated type and will be uniformly spaced at 100 feet (30 meters).

8-2.2 Taxiway Edge Lights (Blue).

When a runway is also used as a taxiway, such as two runways at 90 degree intersections, where one of the runways leads to a taxiway opposite of the approach end, aviation blue taxiway lights will be installed in addition to the white lights. The line of blue lights will be spaced at 100 feet (30 meter) maximum intervals, between the white lights (Figure 8-3). Connect these blue lights to the appropriate intersecting taxiway circuit. The blue edge lights must not be ON when the white edge lights are ON (runway is active). Where only one runway is constructed, blue lights will not be installed. All lights, both white and blue, located in runway or taxiway intersections where subjected to rollover traffic will be the in-pavement type.

Figure 8-3 Heliport Threshold and Edge Light Details

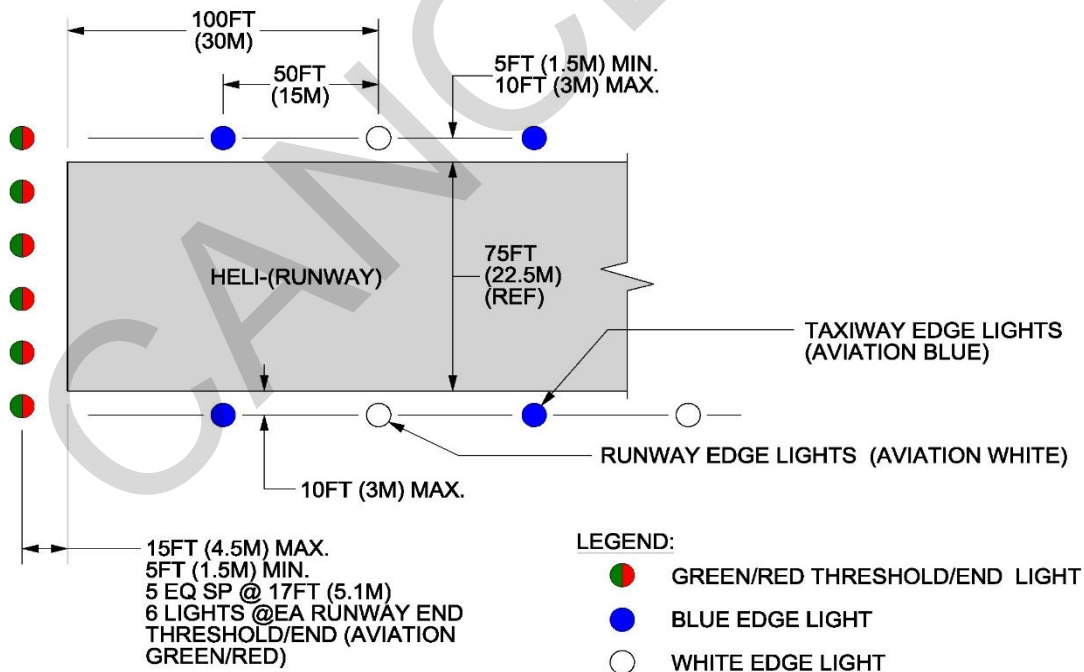

Figure 8-4 Runway/Runway L Intersection

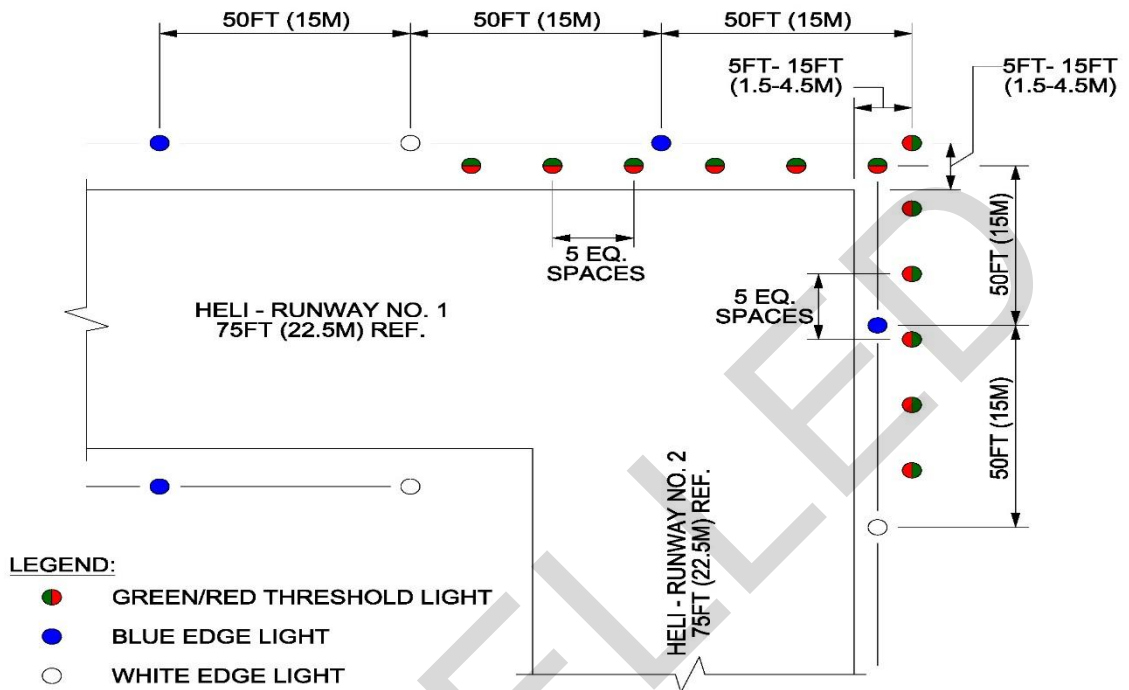
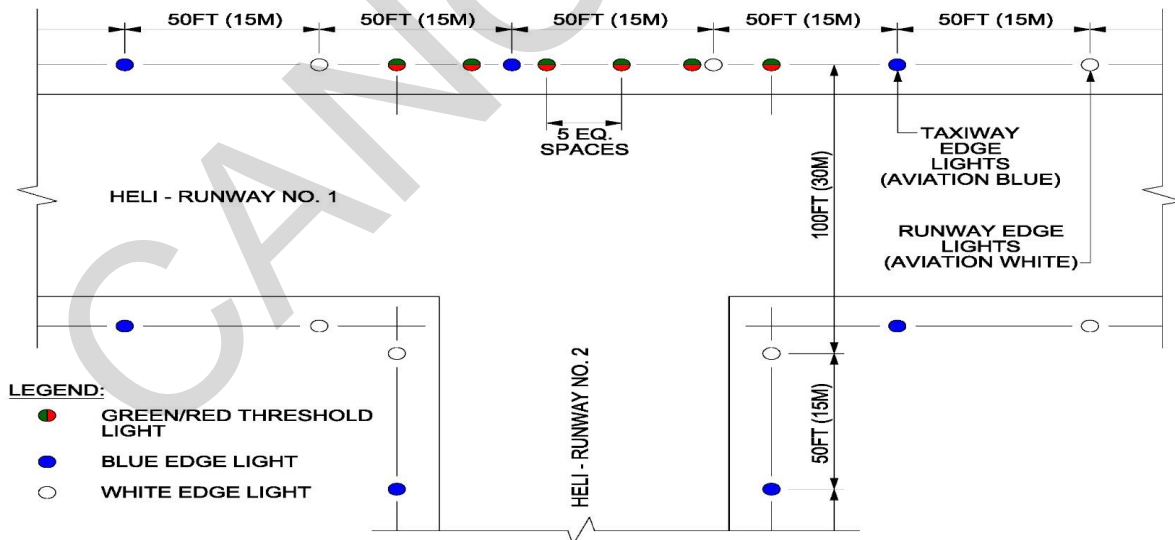

Figure 8-5 Runway/Runway T Intersection



8-2.3 Runway Threshold Lights.

The line of in-pavement threshold lights must be bidirectional, 180 degrees aviation green and 180 degrees aviation red, located not less than 5 feet (1.5 meters) or more than 15 feet (4.5 meters) from the runway ends, with the lights spaced approximately 17 feet (5.1 meters) on centers. The outermost light of each group will be located in line with the corresponding row of runway edge lights. Each group of threshold lights will contain a minimum of six lights. When the line of runway edge lights are located at the maximum distance of 10 feet (3 meters) from the pavement edge of the runway, an additional in-pavement light will be installed in each group for a total of 7 lights in each group. The threshold lights should be controlled with the runway edge light circuit.

8-2.4 Taxiway Lights and Signs.

Taxiway lighting (per Chapter 5) and associated taxiway guidance signs will be in accordance with the criteria stated in Chapter 9.

8-2.5 Approach Lights.

Approach light systems, when considered necessary, should be installed in accordance with the criteria cited in Chapter 7 for VFR or IFR conditions as appropriate.

8-2.6 Heliport/Helipad Identification Beacon.

8-2.6.1 Purpose.

A heliport beacon provides long-range guidance and helipad identification.

8-2.6.2 Configuration.

The beacon must contain a colored sequence of lights, double peak white flash, and a single peak green and yellow. The flash must be 10 to 15 sequences of flashes per minute. The time between each color should be one-third of the total sequence time. The beacon should not be installed within 1 mile (1.6 kilometers) of any existing airport beacon or other helipad area.

8-2.6.3 Construction.

The beacon should be visible for a distance of 1 mile (1.6 kilometers) in 1 mile (1.6 kilometer) VMC visibility daylight, and 3 miles (4.8 kilometers) in 3 miles (4.8 kilometer) VMC at night, both from an altitude of 3,000 feet (900 meters) above ground level. The beacon should be mounted a minimum of 50 feet (15 meters) above the helipad surface. Where a control tower or control area is utilized the beacon should be no closer than 400 feet (120 meters) nor further than 3,500 feet (1,050 meters) from that area, and not located between the control tower and the helipad. The beacon will be installed so that the base is not less than 15 feet (4.5 meters) above the floor of the control tower or operations room.

8-2.6.4 Luminous Features.

The main beam of the light should be aimed a minimum of 5 degrees above the horizontal and should not produce light below the horizontal in excess of 1,000 candelas. Light shields may be used to reduce the intensity below the horizontal.

8-3 ROTARY WING LANDING LANES.

8-3.1 Rotary Wing Landing Lanes (formerly Stagefields).

Figure 8-2 and the associated design criteria contained herein are intended to guide in designing and installing a permanent Army rotary wing landing lane, which is normally 1,600 feet (480 meters) long and 75 feet (22.5 meters) wide, utilizing elevated or in-pavement light fixtures.

8-3.2 Rotary wing landing lanes permit efficient simultaneous operations by a number of helicopters (in most cases, up to four at one time) while additional helicopters are in a designated traffic pattern.

8-3.3 Edge Lights.

The edge lights on landing lanes must be aviation white in color, located on a line 3 feet (0.9 meter) maximum from the edge of the full strength pavement that is designated for lane use, as illustrated in Figure 8-2.

8-3.4 Other Requirements.

The longitudinal spacing must be uniform and not greater than 150 feet (45 meters) and not less than 100 feet (30 meters) on each side of the landing lane. The height of the light fixture will not exceed 14 inches (350 millimeters) above grade except, when snow accumulations of 12 inches (300 millimeters) will be frequent, the edge light height may be increased to 24 inches (600 millimeters) above grade. The light fixtures will be mounted on frangible posts of not more than 2 inches (50 millimeters) in diameter. Each landing lane edge light system will be equipped with a 5-step constant current regulator which permits control from blackout to full intensity. For additional information see Chapter 13, or refer to FAA AC 150/5340-30.

8-3.5 Threshold/End Lights.

Combination threshold and lane end light fixtures must be located on a line perpendicular to the extended centerline of the landing lanes. The line of lights must not be less than 2 feet (0.6 meters) nor more than 10 feet (3 meters) outboard from the designated threshold of the landing lane. The lights must consist of four groups of two lights, symmetrically located perpendicular to the extended centerline of the landing lanes (see Figure 8-2).

8-4 REFUELING AREA LIGHTS.

A hazardous location exists within 50 feet (15 meters) of an aircraft fuel inlet or fuel system vent and within 63 feet (18.9 meters) of an aircraft direct fuel outlet/fuel-dispensing nozzle. Refueling areas are Class 1, Division 1, Group D hazardous locations as defined in National Fire Protection Association NFPA 70 National Electrical Code. The light fixture assemblies and associated wiring must be suitable for installation in the hazardous location. Refer to FAA AC 150/5345-39 for the use of retro-reflective markers.

8-5 HOVERLANE LIGHTING SYSTEMS.

8-5.1 A hoverlane is a designated aerial traffic lane (air taxi) for the directed movement of helicopters between a helipad or hover point and the servicing and parking area of a heliport or airfield.

8-5.2 Hoverlane lighting systems will consist of a single row of alternating aviation green and yellow taxiway light fixtures located along the centerline of the hoverlane (see Figure 8-4). Elevated fixtures (FAA L-861T light fixture modified with lens color as indicated) will be installed and will be spaced nominally 50 feet (15 meters) on center for long straight sections, and mounted on metal light base fittings. For curves, fixtures will be spaced nominally 25 feet (7.5 meters) on centers.

8-5.2.1 When hoverlanes terminate adjacent to hanger access aprons or boundaries of other areas not intended for own-power operation, the desirable limit of helicopter travel along hoverlanes toward such areas will be indicated by three lighting fixtures emitting aviation red light. Two red hoverlane limit lights will each be installed on opposite sides of, and approximately 15 feet (4.5 meters) from, the hoverlane centerline. The third light, forming a line of three such lights perpendicular to the alternating aviation green and yellow hoverlane lights, will be located in line with the alternating aviation green and yellow hoverlane lights.

8-5.2.2 Red hoverlane limit lights will provide unidirectional guidance by use of a combat-type hood attached to a taxiway light fitting. The row of alternating aviation green and yellow hoverlane lights described above will terminate approximately 25 feet (7.5 meters) from the red limit lights, outward from the apron or boundary.

8-5.2.3 Hoverlane limit light mountings and types will be as for the alternating aviation green and yellow hoverlane lights described above. Hoverlane turnoffs to individual parking pads will be indicated by aviation green and yellow hoverlane lights beginning approximately 25 feet (7.5 meters) from and perpendicular to the hoverlane, installed on nominal 25 foot (7.5 meter) centers. The line of hoverlane turnoff lights will terminate approximately 25 feet (7.5 meters) from the edge of the parking pad nearest the hoverlane.

8-5.2.4 The limit of helicopter travel from the hoverlane toward the pad, along the turnoff, will be indicated by two parking pad limit lights, which will be located

approximately 20 feet (6 meters) beyond the pad, 15 feet (4.5 meters) apart, and perpendicular to the turnoff light line.

8-5.2.5 Parking pad limit lights will emit aviation red light, and will provide unidirectional guidance with a combat-type hood, attached to a taxiway light fitting with red lens. All hoverlane limit and parking pad limit lights will be provided with brightness control and circuited separately, as a group, from other lights. Hoverlane lighting will not be installed in the rigid pavement area of mass parking aprons.

Figure 8-6 Hoverlane Lighting System

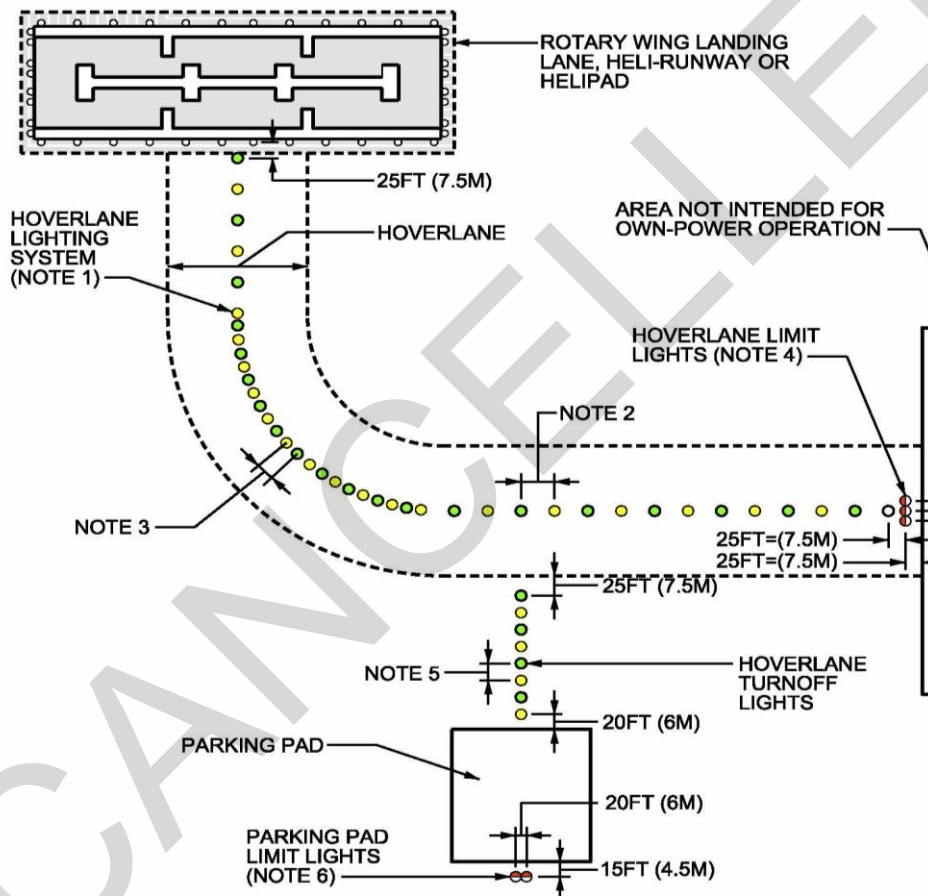

NOTE:

1. HOVERLANE LIGHTING SYSTEMS CONSIST OF ELEVATED ALTERNATING AVIATION GREEN YELLOW TAXIWAY LIGHT FIXTURES LOCATED ALONG THE CENTERLINE OF THE HOVERLANE (REFERENCE PARAGRAPH 8-5.2.)
2. FIXTURES SPACED NOMINALLY 50FT (15M) ON CENTER FOR LONG STRAIGHT SECTIONS.
3. FOR CURVES, FIXTURES ARE SPACED NOMINALLY 25FT (7.5M) ON CENTERS.
4. UNI-DIRECTIONAL RED LIMIT LIGHTS INDICATE HOVERLANE TERMINATION ADJACENT TO HANGER ACCESS APRONS OR BOUNDARIES OF OTHER AREAS NOT INTENDED FOR OWN-POWER OPERATION.
5. HOVERLANE TURNOFF LIGHTS ARE ALTERNATING AVIATION GREEN AND YELLOW FIXTURES SPACED NOMINALLY 25FT (7.5M) ON CENTER.
6. UNI-DIRECTIONAL RED LIMIT LIGHTS INDICATE THE END OF TRAVEL FROM HOVERLANE TO PARKING PAD.

8-6 LIGHTING EQUIPMENT.

8-6.1 Elevated Runway and Landing Lane Edge Lights.

Elevated runway edge lights will be omnidirectional, medium intensity, FAA type L-861. The lamp for this light will be approximately 30 watts, 6.6 amperes, as recommended by the manufacturer (Figure 13-11).

8-6.2 In-Pavement Runway Lights.

In-pavement runway lights will be medium intensity, FAA type L-852 E (FAA Type L-852D with colored lenses removed). Where rollover is anticipated on a runway or taxiway, use in-pavement light fixtures of the appropriate color.

8-6.3 Threshold Lights.

8-6.3.1 In-pavement threshold lights will be FAA type L-850D. A 180 degree aviation green, 180 degree aviation red filter, will be supplied with the light fixture.

8-6.3.2 Elevated threshold lights must be FAA Type L-861SE. A 180 degree aviation red filter will be supplied with the light fixture.

8-6.4 Runway Blue Lights.

Elevated and in-pavement lights will be aviation blue, FAA type L-861T or L-852T.

8-6.5 Refueling Area Lights.

Fixture assembly must meet the requirements Underwriters Laboratories (UL) test and approval requirements as stated in UL 844 for class 1, division 1, group D hazardous locations as defined in NFPA 70. The fixture assembly will include a light fixture, frangible coupling, power disconnect switch that will kill power if the frangible mount is broken, and a junction box. As an alternative, use the light fixture assemblies and associated wiring that are intrinsically safe and meet Underwriters Laboratories (UL) test and approval requirements as stated in UL 913 for class 1, division 1, group D hazardous locations as defined in NFPA 70.

8-6.6 Runway and Taxiway Signs.

When operational requirements consider it necessary to install informational mandatory guidance signs, see Chapter 5 for guidance. Runway and taxiway signs are designated in two groups: mandatory signs are white letters on a red background, and information signs are black letters on a yellow background.

8-6.7 Auxiliary Lighting.

For auxiliary lighting such as floodlights, protective lighting and intensities, see paragraph 10-4.

8-7 POWER REQUIREMENTS.

Runway lighting systems will be supplied through interleaved or non-interleaved series circuits served by constant current regulators. The regulators are available in various load capacities and output current values, and have brightness controls so that the light output can be adjusted to suit the visibility conditions.

8-7.1 Circuit Criteria.

The number and type of regulators required will be determined by the circuit length. Address power losses from cable lengths to and from the lighting vault to the lights and the isolation transformer loss when designing the lighting system.

8-7.2 Cable Connectors, Plugs and Receptacles.

See Chapter 13.

8-7.3 Cables.

Cables used for series circuit. Will be No.8 or No. 6 1/C stranded copper, 5,000 volt, cross-linked polyethylene (XLP). See paragraph 13-8.7 and FAA AC 150/5345-7. Use No. 6 cable on all 20 ampere circuits.

8-7.4 Isolation Transformers.

See paragraph 13-8.9.

8-8 CONTROL REQUIREMENTS.

The heliport lighting control system is an integral part of the control system for all heliport lighting facilities. The function of this portion of the control system is to energize and de-energize the selected runway lighting systems, and to control the brightness of the lights. All lights will be controlled from the control tower and from the lighting equipment vault. The circuits will be provided and connected as indicated in Figure 8-5, with the runway/taxiway combination control panels and associated equipment connected to permit separate control of each heliport lighting system, independent of each other, and permit simultaneous control of the taxiway circuits in combination. Coordinate the need to interlock the lighting on intersecting runways so that both runway lighting systems cannot be energized simultaneously. Taxiway circuit T-1A will be connected with separate individual control to permit flexibility in the operation of the runway and taxiway lights either singly, in combination, or simultaneously, as required for the heliport operations by the control tower operator. The layout will also allow for

future changes, and expansion in the methods of operation with a minimum of expense and interruption of service.

Figure 8-7 Block Diagram Typical System

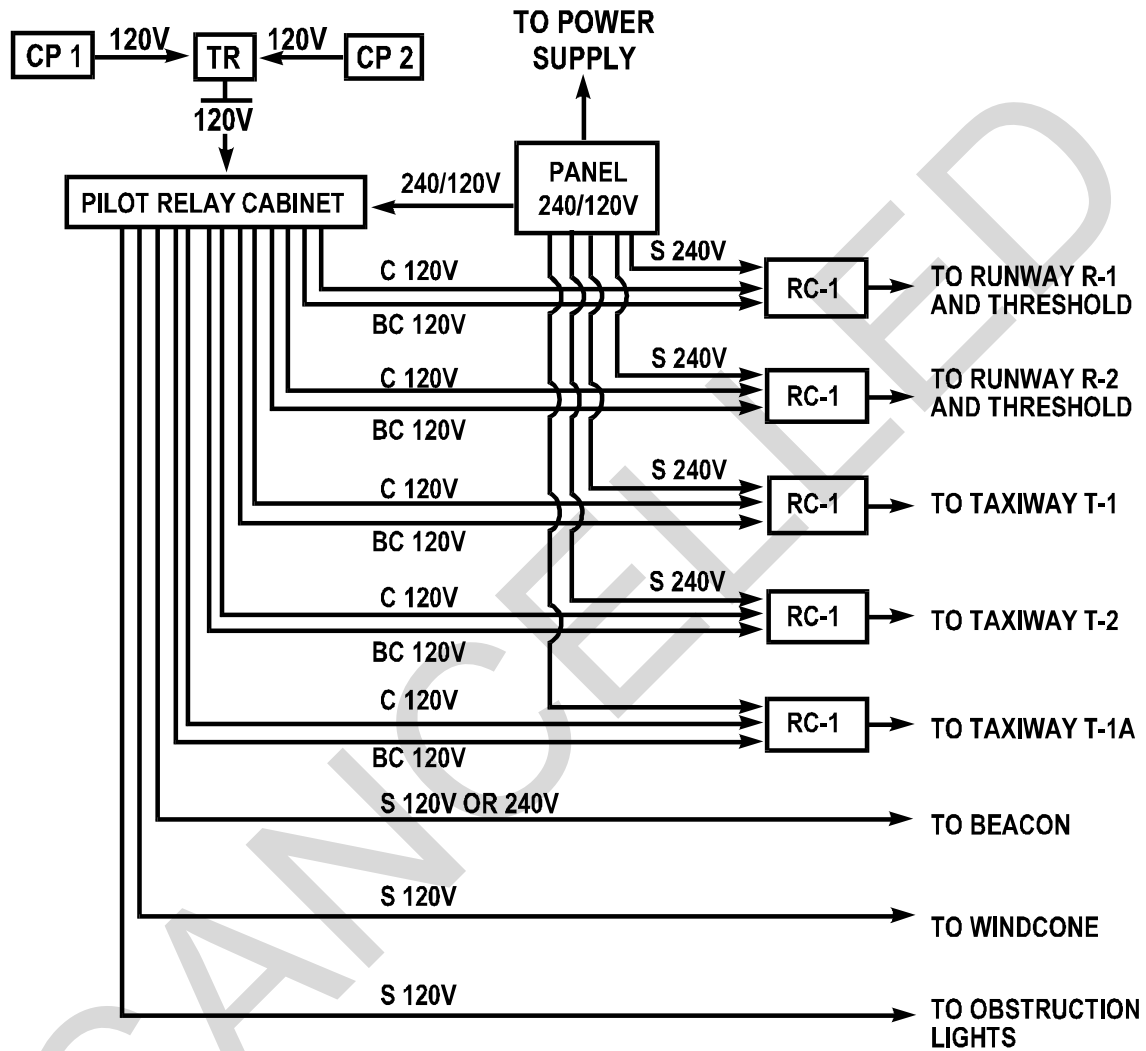

LEGEND

- CP-1 - Control Point Primary (Control Tower)
- CP-2 - Control Point Alternate (Vault)
- RC-1 - Regulator
- TR - Transfer Relay
- BC - Brightness Control
- C - Control
- S - Supply

NOTE: Electric power source, main service switch, emergency generator and transfer switch and main distribution panel not shown. Installation of these items will be designed to meet local conditions.

8-8.1 Provide edge lights and threshold lights with 3 intensities as follows:

<u>Intensity Step</u>	<u>Percent of Full Intensity</u>
1	10%
2	20%
3	100%

If required by the operations community, for compatibility with night vision goggles, the edge lights and threshold lights may be provided with 5 intensities as follows:

<u>Intensity Step</u>	<u>Percent of Full Intensity</u>
1	0.16%
2	0.8%
3	4.0%
4	20%
5	100%

8-8.2 The initial sequence of operations of the heliport lighting circuits anticipated is such that when helicopters are utilizing the night landing facilities of the heliport: the blue taxiway lights (circuits T-1 and T-2) will be turned on, but only the white edge lights and green/red threshold lights (circuits R-1 or R-2) of the runway in use will be turned on. Use Figure 8-1 as a reference.

Example: White edge lights, R-1, ON
 Threshold lights, R-1, ON
 Blue edge lights, R-2, ON
 Blue edge lights, T-2, ON
 Blue edge lights, T-1A, ON
 All other taxiway/runway lights, OFF

The above example will allow a helicopter to land on R-1, taxi on R-2, taxi on T-2, and proceed to a designated area via T-1A.

8-9 MONITORING REQUIREMENTS.

There are no requirements for monitoring the lighting systems on heliports or rotary landing lanes.

8-10 COMPLIANCE WITH INTERNATIONAL STANDARDS.

8-10.1 ASIC.

There are no AIR STDs for heliports or landing lanes.

8-10.2 NATO.

There are no standards for heliports or landing lanes; however, STANAG 3619 (Edition 5) – Helipad Marking and Lighting, 6 June 2013, makes reference to the US Army criteria for IFR approach lighting.

8-11 EQUIPMENT.

See Chapter 13 for lighting equipment.

CANCELLED

This Page Intentionally Left Blank

CANCELLED

CHAPTER 9 STANDARDS FOR AIRFIELD SIGNS AND MARKERS

9-1 GENERAL.

9-1.1 Purpose.

Signs and markers provide important guidance and control for the safe and efficient surface movement of aircraft on an airfield. Proper signing provides information on location, direction, destination, mandatory holding positions, important boundaries, and other information. Additionally, runway distance markers provide to the pilot the remaining distance on a runway for landing and take-off operations.

9-1.2 Intent of Standard.

The intent of this standard is to provide signing consistent with current FAA and ICAO requirements and standards, including: FAA AC 150/5340-18, FAA AC 150/5345-44 and ICAO Annex 14, Chapter 5, Visual Aids for Navigation. The signing criteria in this chapter and in the references above should be applied at all airfields to the extent that they do not conflict with any special local requirements. All signs must be internally lighted and meet the luminance values indicated.

9-1.3 Components of a Sign System.

The following types and styles of signs, discussed more below, are basic components of a sign system for an airfield:

9-1.3.1 Mandatory Instruction Signs.

Type L-858R. White legend on a red background (see FAA AC 150/4345-44, Appendix C, Figure 12, for examples of typical lighted signs). Note: the black outline is considered as background and does not add to the spacing to the next character or border (FAA AC 150/4345-44, Appendix I, Figure 18).

9-1.3.2 Direction, Destination, and Boundary signs.

Type L-858Y. Black legend on a yellow background (see FAA AC 150/4345-44, Appendix C, Figures 11 and 12, for examples of typical signs).

9-1.3.3 Taxiway Location Signs.

Type L-858L. Yellow legend and border on a black background indicating the surface on which the aircraft is operating. The yellow border is inset from the inner edge of the sign to provide a continuous black margin (see FAA AC 150/4345-44, Appendix C, Figures 11 and 12, for an example of a typical sign). While primarily indicating taxiway location, these also may be used to indicate runway location at potentially confusing areas.

9-1.3.3 Sign Arrays.

Signs are often established as a sign array with several messages. For example, a location sign may be grouped with a mandatory holding position sign or with one or several direction sign messages as a sign array. However, not all types of signs may be grouped together; for example, guidance and information signs may not be co-located with mandatory signs.

9-1.3.4 Runway Distance Remaining Signs.

Type L-858B. White legend on a black background, with a single number indicating in multiples of 1,000 feet (300 meters) the remaining runway distance for pilots during takeoff and landing operations. Metric measure is not used for this sign. (See FAA AC 150/4345-44, Appendix F, Figure 14.)

9-1.3.5 Arresting Gear Markers.

Yellow circle on black background, identifying the location of arresting system cables on the runway. (Similar to FAA Type L-858B)

9-1.3.6 Other Signs.

Other signs serving special situations may be used, provided they do not conflict with the sign standards, or have the potential for confusing ground traffic with respect to standard signing. Vehicle control signs conforming to the Manual of Uniform Traffic Control Devices (MUTCD) (Air Force use UFC 3-120-01), such as the standard octagonal stop sign, may be used at locations that would apply only to vehicles.

9-1.4 Sign Styles.

Lighted signs can be powered from a 3-step 6.6 ampere series circuit (FAA Style 2), a 5-step 6.6 or 20 ampere series circuit (FAA Style 3) or a dedicated 5.5 ampere series circuit (FAA Style 5). Unlighted signs are FAA Style 4.

For new installations, mandatory signs, runway exit signs, RDR and AGM must be FAA Style 5 and connected to a dedicated 5.5 ampere, 1-step regulator. The intent is to have a more reliable sign system for these signs by eliminating the electronics required to maintain uniform brightness over the range of a 3 or 5 step regulator. Taxiway guidance and information signs and location signs may be either FAA Style 2 or FAA Style 3 depending on the series circuit intensity steps the signs are connected to. See FAA AC 150/5345-44 for more information about sign power and electrical requirements.

9-1.5 Failure of Lighted Signs.

The failure of any light source within a sign must not result in a potential miscommunication of the intended message to a pilot. If the failure of an internal

lamp(s) in a sign causes a panel or any section of a panel to be dark, or have an average luminance less than the minimum required in FAA A/C 150-5345-44, paragraph 3.2.5.6, sign operation must be automatically discontinued.

9-2 MANDATORY SIGNS.

9-2.1 Purpose.

Mandatory signs provide an instruction that must be followed. They denote an entrance to a runway or critical area, or other situation such as a no-entry location. At controlled airfields (with active tower), aircraft and vehicles are required to hold at the holding position unless cleared by air traffic control. At uncontrolled airfields, the intent is that traffic may only proceed beyond the sign after appropriate precautions are taken by the pilot. Examples of mandatory sign messages are in FAA AC 150/5340-18 and 150/5345-44.

Note: All mandatory instruction sign white legends are now outlined in black (see Figure 9-1). See FAA AC 150/5345-44 for additional information about the black outline. Signs with white legends may be used until stock is exhausted.

CANCELLED

Figure 9-1 Typical Mandatory Signs

Note: These signs represent the bulk of existing signs and comply with previous edition of FAA AC 150/5345-44. These signs do not require replacement until the end of their economic lives or with a major renovation to the airfield. See current edition of FAA AC for new sign message elements.

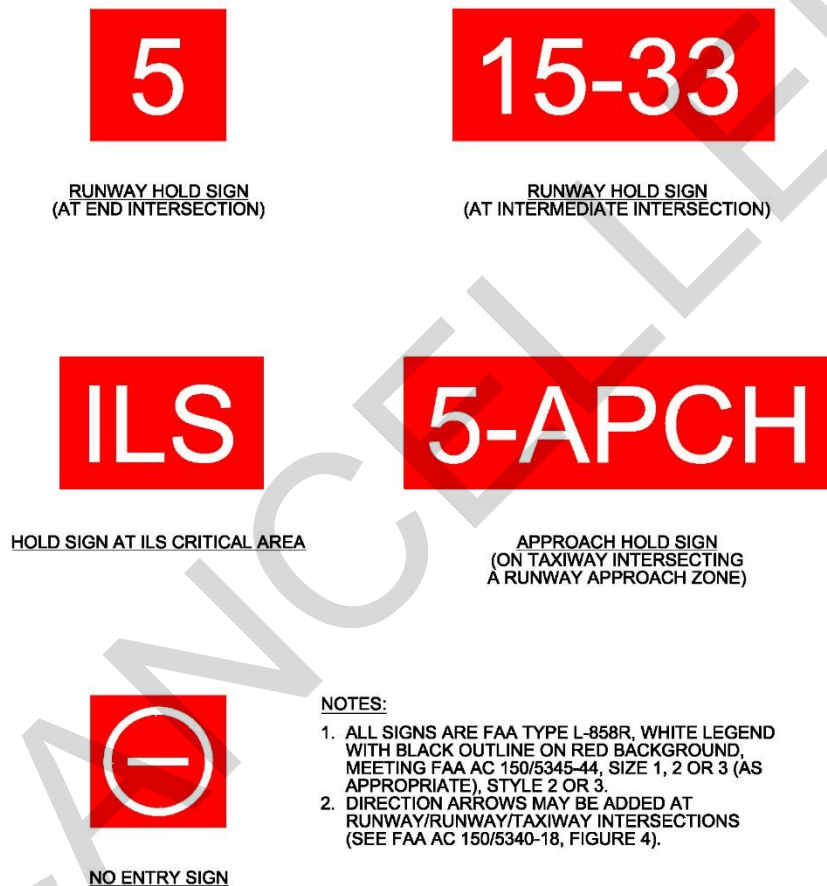

9-2.2 Installation.

Mandatory signs are installed on the left-hand side at taxiway/runway intersections, runway/runway intersections, ILS critical areas, runway approach zones, no entry areas.

9-2.2.1 At some locations, signs should be installed on both sides of runways and taxiways. This includes: runways more than 150 feet (45 meters) in width; runways of any width which are used for “land and hold short” operations; or taxiways that are 150 feet (45 meters) or greater in width.

9-2.2.2 Holding position signs should be collocated with holding position markings and located at a distance from the intersecting runway to meet the clearance requirements of the intersecting runway or ILS critical area. Coordinate this distance with Airfield Management and Flight Safety Offices. On taxiways in approach areas, the sign is installed where an aircraft would cross the runway safety area or penetrate the required airspace for approaches and departures.

9-2.2.3 Mandatory signs may be FAA Size 1, 2 or 3. Size 3 signs are recommended for Category I facilities and higher. From the defined edge of runway or taxiway, locate a Size 3 sign 35-60 feet (10.5-18 meters), a Size 2 sign 20-35 feet (6-10.5 meters), and a Size 1 sign 10-20 feet (3-6 meters). The distance indicated is the perpendicular distance from defined pavement edge to near side of sign. Signs are oriented perpendicular to the runway or taxiway centerline, but may be canted up to 15 degrees to increase visibility if the sign is not a double-face sign. At locations where large wingspan aircraft operations are common, place signs far enough from taxiway edges to allow required wingtip clearance. Signs must provide 12 inches (300 millimeters) of clearance between the top of any sign in an array and any part of the most critical aircraft using, or expected to use, the airfield when the aircraft's wheels are at the defined pavement edge.

9-2.2.4 Mandatory signs may be grouped in an array with a location sign, or may have a location sign or a Safety Area/Obstacle Free Zone (OFZ) or ILS Critical Area boundary sign on the back face. Direction or destination signs may not be grouped with a mandatory sign. In an array, the location sign is always positioned outboard of the mandatory sign. See FAA AC 150/5340-18 for further guidance on grouping several sign messages in an array. The Air Force will use "INST" instead of "ILS" for the instrument holding position/critical area boundary when more than just the ILS is available, such as PAR, MLS, or GPS.

9-2.3 Characteristics.

See Chapter 13 and FAA AC 150/5345-44 for additional sign characteristics information.

9-2.3.1 Message.

See FAA AC 150/5345-44 for technical information concerning sign legend sizes, fonts, spacing, border requirements, power requirements, sign sizes, and mounting methods.

9-2.3.2 Dimensions.

See FAA AC 150/5345-44 Tables 1 and 2 for sign and legend height dimensions. As an example, an FAA Size 3 sign has a legend height of 18 inches (457 millimeters), legend panel height of 30 inches (762 millimeters), overall sign mounting height of 3 to 3.5 feet (0.9-1.05 meters), maximum overall sign length of 170 inches (4.318 meters), and minimum sign length of 42 inches (1.07 meters).

9-2.3.3 Electrical.

For new installations, it is preferred that mandatory signs be FAA Style 5 and connected to the 5.5 amp, 1-step RDR circuit. The intent is to have a more reliable sign system by eliminating the electronics required to maintain uniform brightness over the range of a 3 or 5-step regulator. The mandatory sign 5.5 amp circuit can also be used for RDR signs and AGM signs.

9-2.3.4 Photometrics.

See FAA AC 150/5345-44 for detailed information about sign luminance and methods of measurement.

9-2.3.4.1 Photometric Testing.

It is recommended that photometric testing be performed on all newly installed mandatory signs on site. The purpose of these tests is to verify the installed fixtures meet or exceed the minimum photometric requirements.

9-2.4 Power and Control.

For new installations, mandatory signs will be powered from a dedicated 1-step (5.5 ampere) circuit. Control of the circuit will be interlocked with the corresponding runway edge lighting circuit so as to turn on and off with its runway edge lighting.

9-3 TAXIWAY GUIDANCE AND INFORMATION SIGNS.

9-3.1 Purpose.

See FAA AC 150/5340-18 for detailed information about taxiway guidance and information sign function, location, and rules for location. Taxiway guidance signs include direction signs, destination signs, other informational signs, and boundary signs. Direction signs indicate the direction of taxiways leading out of an intersection, and are installed at runway exits, taxiway intersections, and other locations. Destination signs indicate the general direction to a remote location. For example, outbound destination signs are used to identify the direction to takeoff runways, while inbound destination signs are used to indicate direction to major areas such as aprons, fueling points, and other locations. Both direction and destination sign messages include an arrow. Boundary signs indicate important boundaries such as ILS critical areas and runway approach areas. Other signs are used to provide specific information such as noise abatement procedures, check points, and others. Examples of guidance sign messages are shown in Figure 9-2.

Figure 9-2 Typical Taxiway Guidance and Information Signs

Note: These signs represent the bulk of existing signs and comply with previous edition of FAA AC 150/5345-44. These signs do not require replacement until the end of their economic lives or with a major renovation to the airfield. See current edition of FAA AC for new sign message elements.

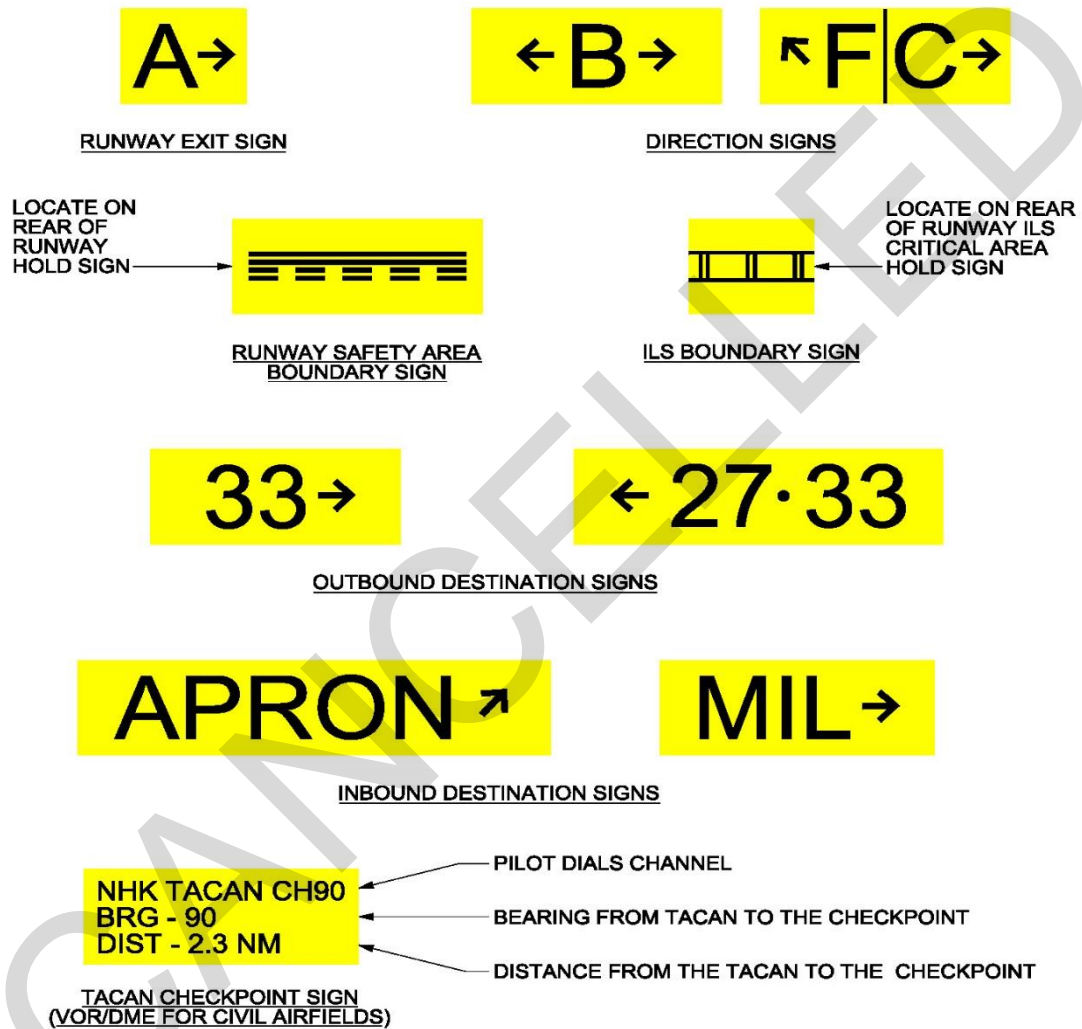

NOTE:

1. ALL SIGNS, EXCEPT TACAN CHECKPOINT SIGNS, ARE FAA TYPE L-858Y, WITH BLACK LEGEND ON YELLOW BACKGROUND, MEETING FAA AC 150/5345, SIZE 3, STYLE 2 OR 3.

9-3.2 Installation.

Signs are installed on the left side of the taxiway unless aircraft operations require otherwise.

9-3.2.1 Runway exits signs are located prior to the runway/taxiway intersection on the side and in the direction from which the aircraft is expected to exit. If a taxiway crosses a runway and an aircraft can be expected to exit on either side, then exit signs are located on both sides of the runway. For taxiways that are intended only to be used as exits from the runway in one direction, such as taxiways located near the end of the runway or intersecting the runway at an acute angle, the signs should be installed only for the runway direction in which they are intended to be used. When two acute-angle taxiways (e.g., high speed exits) are intended to be used in opposite directions and intersect the runway at a common point, the exit signs are located prior to the common point intersection rather than in the area between the two exits (see FAA AC 150/5340-18, Figure 18). “Bracketing” a runway exit sign (where a sign is placed before and after the exit) is not permitted. A runway exit sign should never have more than one arrow for each taxiway designation shown on the sign.

9-3.2.2 A direction sign is installed prior to an intersection. If there is no surface painted hold position marking at a taxiway intersection then the location of the direction sign can be used by the control tower to direct an aircraft to hold for crossing traffic. Typically they are installed at the point of tangency of the taxiway intersection, but not closer than the minimum distance from the intersecting taxiway centerline indicated in Table 9-1 (see Figure 9-3). The distance used for a given airfield should be applied uniformly and should be based on the predominant operating aircraft.

**Table 9-1 Perpendicular Distances for Taxiway Signage
from Centerline of Crossing Taxiway**

AIRCRAFT DESIGN GROUP (ADG) (FAA AC 150/5300-13)	I	II	III	IV	V	VI
WING SPAN	<49ft (<15m)	49ft- <79ft (15m- <24m)	79ft- <118ft (24m- <36m)	118ft- <171ft (36m- <52m)	171ft- <214ft (52m- <65m)	214ft- <262ft (65m- <85m)
AIRCRAFT TYPE	T-1, T-37, T-38, C-21	C-12, C-20, F28 (1000/2000)	T-43, C-9, F28 (3000/4000) CV- 340/440/580, B-727, B-737, DC-9	C-17, C-130, C-141, B-1B, KC-10, KC-135 B-707/720, B-757/767, L-1011, A-300, DC-8, DC-10	B-2, B-52, B-747, VC-25	C-5
PERPENDICULAR DISTANCE FROM CENTERLINE OF CROSSING TAXIWAY (1)	44.5ft (13.5m)	65.5ft (20m)	93ft (28.5m)	129.5ft (39m)	160ft (48.5m)	193ft (59m)

(1) DISTANCE IS DERIVED USING THE FORMULA: 0.7 X MAX. WINGSPAN IN ADG + 10ft (3m).
REFERENCE FAA AC 150/5300-13.

Figure 9-3 Example of Taxiway-Taxiway Intersection Sign Location

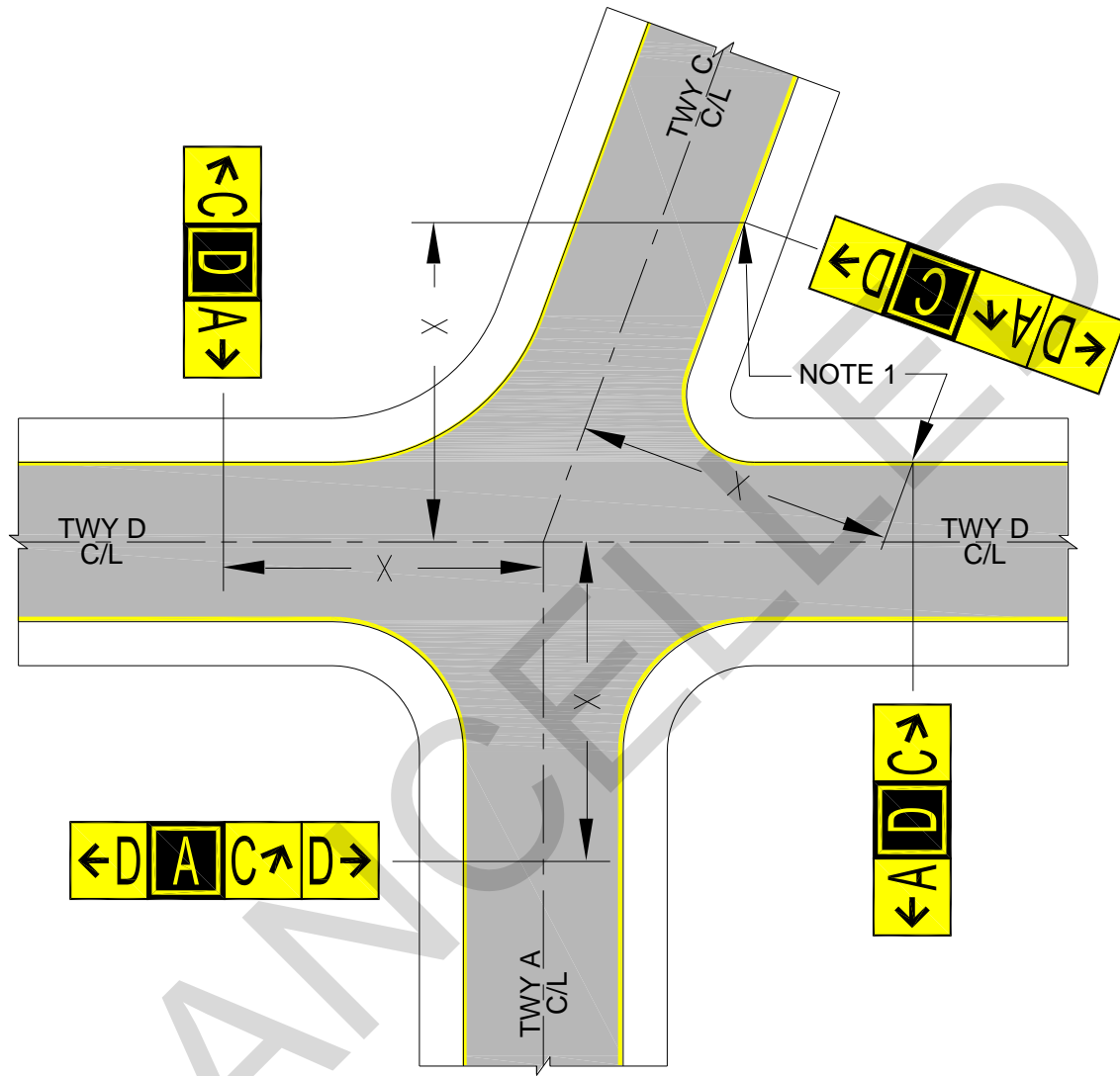

X = THE PERPENDICULAR DISTANCE FROM CENTERLINE OF THE CROSSING TAXIWAY (SEE TABLE 9-1).

NOTES:

1. SIGNS SHOULD BE LOCATED PERPENDICULAR TO THE POINT AT WHICH THE DISTANCE "X" INTERSECTS THE EDGE OF PAVEMENT THAT IS FARTHEST FROM THE INTERSECTION OF THE TAXIWAY CENTERLINES. THIS ASSURES THAT THE ENTIRETY OF AN AIRCRAFT AT THAT LOCATION IS BEHIND THE CLEAR DISTANCE "X".

9-3.2.3 Destination signs are not always needed where direction signs are used, but are helpful where direction signs alone do not adequately guide a pilot to the desired destination. They may be particularly helpful at uncontrolled airfields. Destination signs should be located where they will not cause confusion with direction signs, and are subject to the same minimum distances from intersecting taxiways. See FAA AC 150/5340-18 for additional guidance.

9-3.2.4 An ILS Critical Area boundary sign is installed at the boundary limit to indicate where it is clear of the ILS Critical Area.

9-3.2.5 TACAN checkpoint signs are provided when an airfield has a TACAN system and provides information for the pilot who verifies the operation of the navigational aid in the aircraft before takeoff. The sign includes information on the type of navigational aid, identification code, radio channel, magnetic bearing, and the distance in nautical miles to the transmitting antenna from the checkpoint marking. The sign is positioned so it will be visible to the pilot of the aircraft properly positioned on the checkpoint marking. See Figure 9-7. (Reference Air Force ETL 04-2, paragraph 9.6, "Ground Receiver Checkpoint Markings.")

9-3.2.6 When runway end elevations differ by 25 feet (7.5 meters) from the published field elevations, an "Altimeter Check Point Sign" is required. Coordinate with TERPS to verify runway and field elevations. This sign should be combined and/or collocated with the TACAN checkpoint sign when available, as the same height and lettering requirements apply. Lettering may be abbreviated as follows: "ALT CHK PT - ELEV: XXXX," where "XXXX" is the elevation in feet above mean sea level.

9-3.2.7 Other informational signs have messages and are located as determined by operations.

9-3.2.8 Guidance and information signs may be FAA Size 1, 2 or 3. Size 3 signs are recommended for Category I facilities and higher. Locate a Size 3 sign 35-60 feet (10.5-18 meters), a Size 2 sign 20-35 feet (6-10.5 meters), and a Size 1 sign 10-20 feet (3-6 meters) from the defined edge of runway or taxiway. The distance indicated is to the perpendicular distance from defined pavement edge to near side of the sign. Signs are oriented perpendicular to the runway or taxiway centerline, but may be canted up to 15 degrees to increase visibility if the sign is not a double-face sign.

9-3.2.9 Direction signs other than runway exit signs may be grouped in an array with a location sign. Destination signs may not be grouped with other signs, but may be on the back of another sign in which case it would be on the right-hand side for traffic. See guidance in paragraph 9-5 for conventions on sign arrays. See FAA AC 150/5340-18 for further guidance on grouping several sign messages in an array.

9-3.3 Characteristics.

See Chapter 13 and FAA AC 150/5345-44 for additional sign characteristic information.

9-3.3.1 Dimensions.

See paragraph 9-2.3.2. For TACAN checkpoint signs, the character height must not be less than 6 inches (152 millimeters) or more than 9 inches (229 millimeters), and the stroke width not less than 1 inch (25 millimeters). The height of a TACAN checkpoint sign must not be more than 32 inches (0.8 meters) with the maximum sign elevation above the taxiway edge not more than 40 inches (1 meter). The TACAN checkpoint sign should not be located less than 50 feet (15 meters) from the taxiway edge.

9-3.3.2 Electrical.

See paragraph 9-1.4.

9-3.3.3 Photometrics.

See FAA AC 150/5345-44 for detailed information about sign luminance and measurement methods.

9-3.3.3.1 Photometric Testing.

Photometric testing must be performed on all newly installed runway exit signs on site. The purpose of these tests is to verify the installed fixtures meet or exceed the minimum photometric requirements.

9-3.4 Power and Control.

For new installations, runway exit signs will be powered from a dedicated 1-step (5.5 ampere) circuit. Control of the circuit will be interlocked with the corresponding runway edge lighting circuit so as to turn on and off with its runway edge lighting. Other lighted guidance signs as well as information signs are typically connected to taxiway edge lighting circuits. This configuration permits the signs to be turned on and off with the respective runway or taxiway lighting.

9-4 LOCATION SIGNS.

9-4.1 Purpose.

Location signs identify the taxiway or runway on which the aircraft is located. Examples of location sign messages are shown in Figure 9-4.

Figure 9-4 Typical Location Signs

Note: These signs represent the bulk of existing signs and comply with previous edition of FAA AC 150/5345-44. These signs do not require replacement until the end of their economic lives or with a major renovation to the airfield. See current edition of FAA AC for new sign message elements.

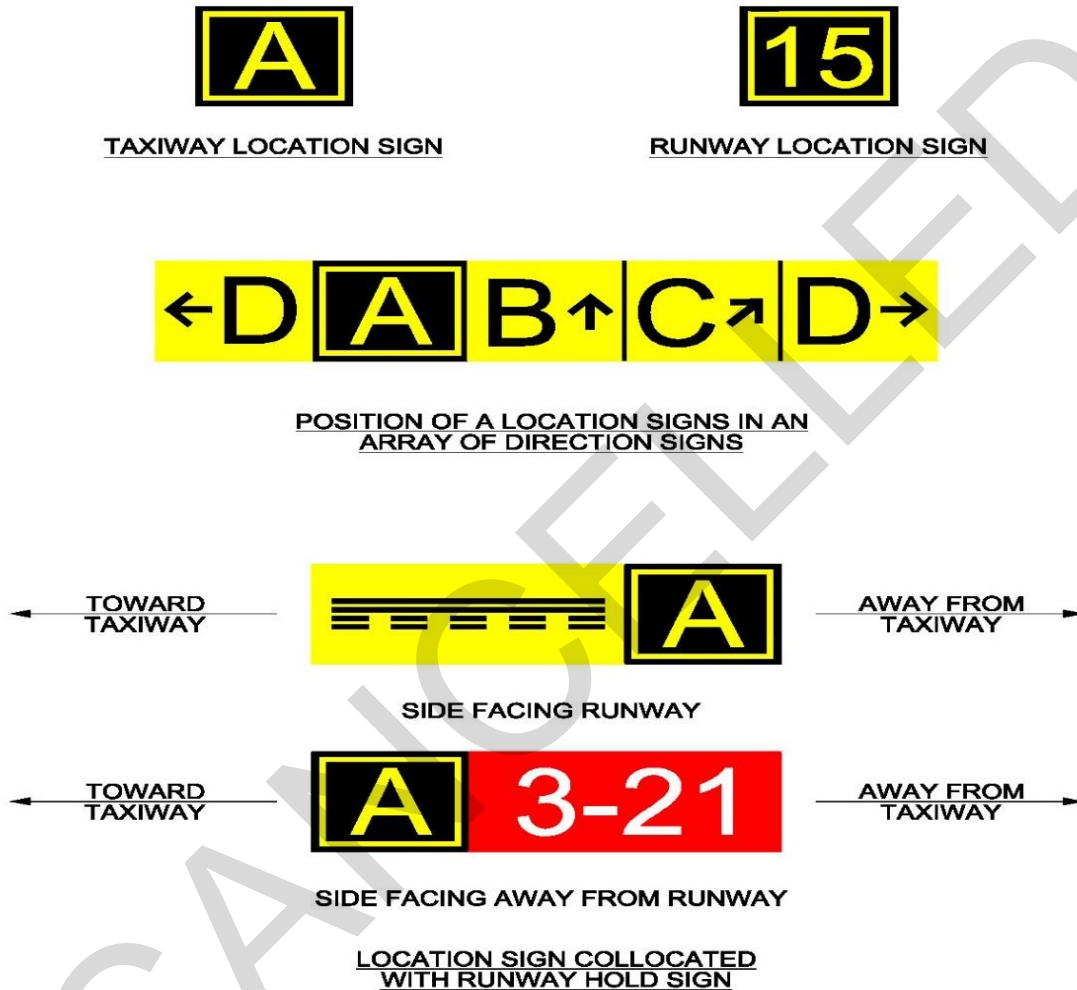

NOTE:

1. LOCATION SIGNS ARE FAA TYPE L-858L, WITH YELLOW LEGEND AND BORDER ON BLACK BACKGROUND, MEETING FFA AC 150/5340-44, SIZE 3, STYLE 2 OR 3.

9-4.2 Installation.

Location signs are typically installed on the left side of a taxiway, but also may be on the right side if this helps visibility. Often taxiway location signs are part of a sign array, hence may be together with a mandatory hold sign or a guidance direction sign (although not with a runway exit sign). Runway location signs may be installed on

runways where two runways are in proximity, which could create confusion, and are located to clearly indicate the runways for pilots. Runway location signs are not part of a sign array, and contain the runway designation only for the one runway end.

9-4.2.1 Location signs are subject to the same siting criteria as the direction and information signs in paragraph 9-3. Taxiway location signs may be part of a direction sign array, or may be stand-alone between taxiways where it would be helpful to reinforce pilot information as to location.

9-4.2.2 Location signs may be FAA Size 1, 2 or 3. Size 3 signs are recommended for Category I facilities and higher. Locate signs as indicated in paragraph 9-3.2.8.

9-4.2.3 A location sign may be grouped in a sign array. With mandatory signs, the location sign should always be positioned outboard. With a direction sign array, the location sign is placed so that all turns to the left would be located to the left of the location sign, and all turns to the right or straight ahead would be located to the right of the location sign. An exception is when only two taxiways intersect and the direction sign indicates the crossing taxiway with arrows both ways, in which case the location sign is positioned to the left.

9-4.2.4 Location signs are not always needed in conjunction with a direction sign. The need is determined from evaluating the complexity of the intersection layout, distance from the last location sign, complexity of prior intersections, traffic flow, and typical conditions under which the intersection is used. Do not include a location sign as an array with a destination sign or other information sign. See guidance in paragraph 9-5 for conventions on sign arrays. See FAA AC 150/5340-18 for further guidance on grouping several sign messages in an array.

9-4.3 Characteristics.

See Chapter 13 and FAA AC 150/5345-44 for additional characteristic information.

9-4.3.1 Message.

See paragraph 9-2.3.1.

9-4.3.2 Dimensions.

See paragraph 9-2.3.2.

9-4.3.3 Electrical.

See paragraph 9-1.4.

9-4.3.4 Photometrics.

See paragraph 9-3.3.3.

9-4.4 Power and Control.

Runway location signs are connected to the runway edge lighting series circuit. Taxiway location signs are typically connected to taxiway edge lighting circuits similar to taxiway guidance and information signs in paragraph 9-3.

9-5 SIGNING CONVENTIONS FOR AIRFIELD SIGNS.

9-5.1 There is no standard configuration for signing that applies to all airfields. In laying out signing for an airfield, first conduct a thorough study of the runway and taxiway layout drawings with local traffic controllers and the operational group using the airfield. Signs are not necessarily needed at all potential locations on an airfield, and judgment must be made based on standards, other guidance, and operational need to provide clear, non-conflicting direction to pilots. It is recommended that the appropriate local engineering function maintain and update a master sign plan for the entire airfield.

9-5.2 The following are general signing conventions to be followed for all airfields:

- a. Signs should always be placed on the left side of a taxiway as seen by the pilot of approaching aircraft. Exceptions are:
 - b. Where signs are placed on both sides of a surface (for example, at wide throat entrances to intersections).
 - c. Where a sign may be placed on the back of a left-handed sign for traffic in the other direction (such as a location or boundary sign on the back of a mandatory hold sign).
 - d. Where a destination sign might be placed at the top of a "T" at a "T" intersection.
 - e. Where necessary for clearance requirements.
 - f. Where it is impractical to install on the left because of terrain or conflicts with other objects.

9-5.2.1 If signs are installed on both sides of a taxiway at the same location, the sign faces should be identical. An exception is for holding position signs, where a location sign in the array should always be outboard of the mandatory sign.

9-5.2.2 All direction signs have arrows. Arrows on signs should be oriented to approximate the direction of the turn. Each designation on an array of direction signs should be accompanied only by one arrow. An exception is when an intersection has only two taxiways where it is permissible to have the designation of the cross taxiway with arrows both ways.

9-5.2.3 Location signs are typically included as part of a direction sign array. The location sign is placed so that the designations for all turns to the left are on the left of the location sign, and all turns to the right or straight ahead (if used) are on the right of the location sign. A location sign installed together with a mandatory sign is always located outboard of the mandatory sign.

9-5.2.4 A direction sign with an arrow indicating a taxiway continues straight ahead (25 degrees or less change in alignment) is usually not needed, unless the designation of the taxiway changes at the intersection.

9-5.2.5 Information signs should not be collocated with mandatory, location, direction, or destination signs.

9-5.2.6 Each designation and its associated arrow in a direction sign array should be delineated from the other designations in the array by a black vertical border. Where appropriate, a location sign may provide this delineation.

9-5.2.7 Destination signs are never grouped with other signs in a sign array. Destination signs may be installed on the back side of a direction sign on the far side of an intersection when the destination referred to is straight ahead. At intersections or junctions of runways, taxiways, or runways and taxiways, where there are alternate routes to a particular destination from a given direction of travel, indicate only one route on the destination sign.

9-5.2.8 Mark outbound routes from their beginning to their termination point with destination signs showing the appropriate runway(s) designation. Outbound routes usually begin at the entrance of a taxiway from an apron area; its termination point is the takeoff end of the appropriate runway. Outbound destination signs may show more than one runway destination number if the direction of travel on a taxiing route is the same to all the runway destinations shown on the sign. In such cases, separate any pair of runway designation numbers by a circular dot.

9-5.2.9 Mark inbound routes from their beginning with destination signs showing the appropriate symbols. Inbound routes usually begin at the entrance to a taxiway from a runway. Mark inbound traffic routes at the beginning with appropriate destination areas on the airfield as required. Typical examples are "APRON," "FUEL," "MIL," and "CARGO" with an arrow indicating the route. This is a general guide and may be varied to meet local conditions, ground traffic, and variations in airport layout.

9-5.3 It is recommended that all mandatory taxiway guidance and information signs, and location signs be of the same size for a runway and associated taxiway complex. FAA Size 3 signs are recommended for facilities that have Category I operational capability, and for other higher volume airfields. An exception can be made at a particular location where a sign must be positioned closer to a runway or taxiway allowed for a Size 3 sign. In this case a smaller sign may be installed within its allowable distance from the surface.

9-5.4 Examples of sign layouts are shown in Figure 9-5 and Figure 9-6. An example for positioning a TACAN checkpoint sign is shown in Figure 9-7.

Figure 9-5 Examples of Signing Conventions

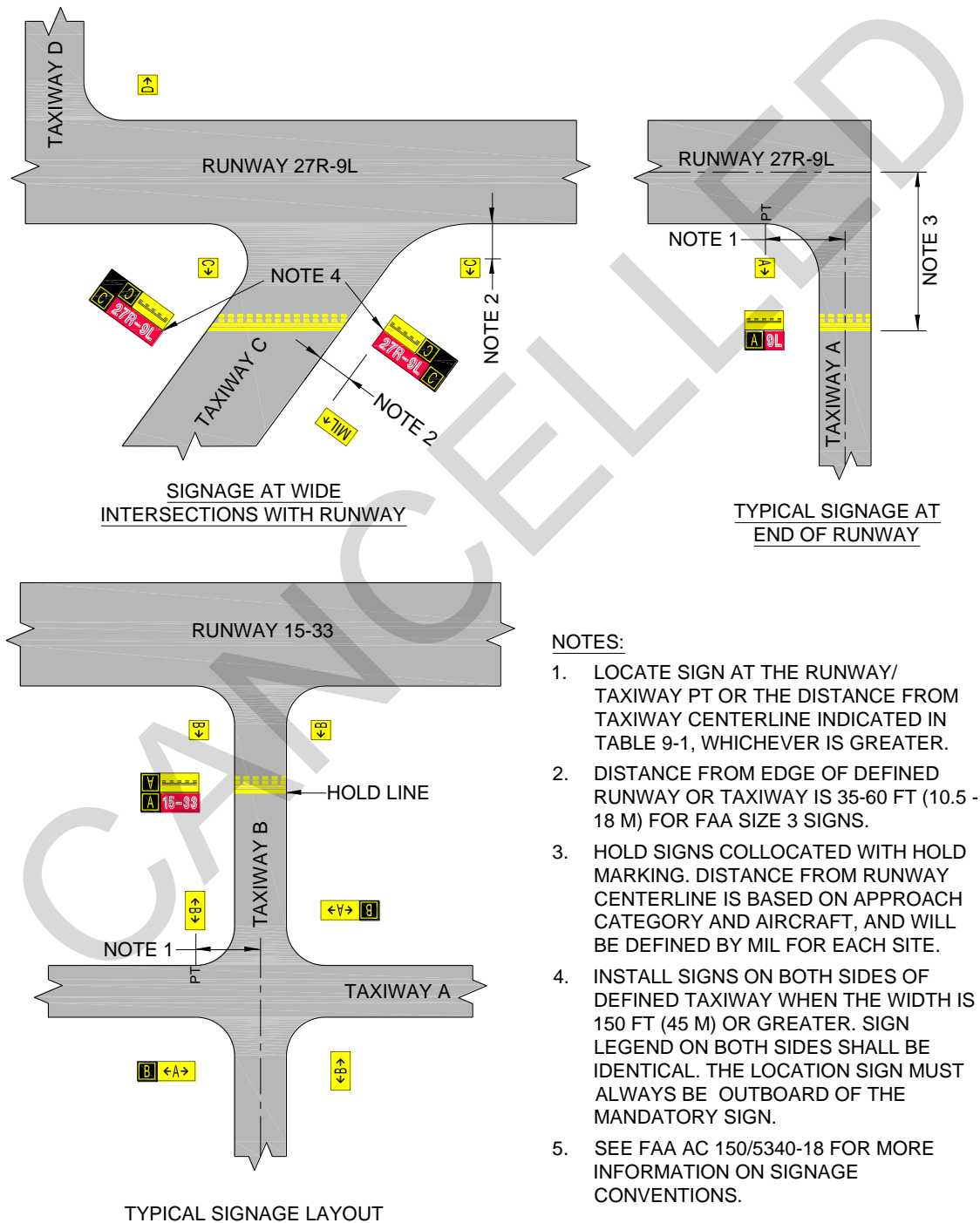
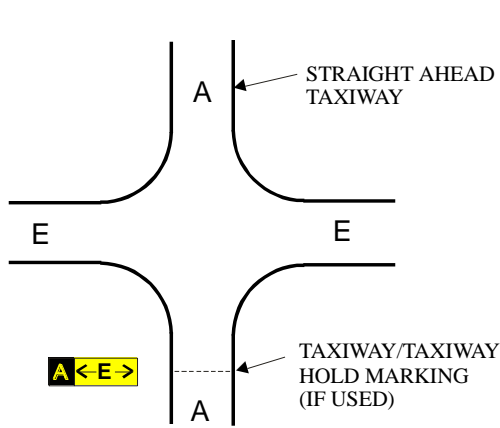
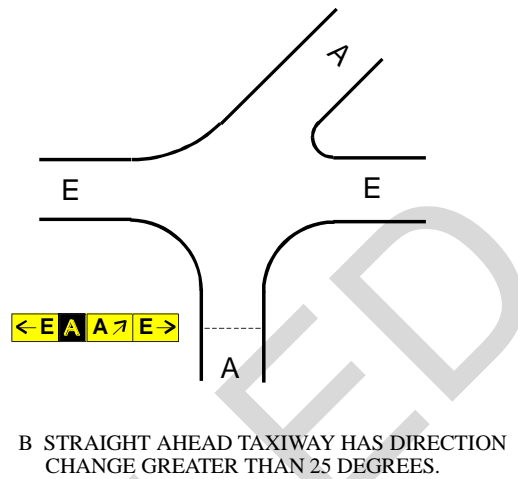

Figure 9-6 Signing Examples



A. STANDARD 4-WAY INTERSECTION.



B. STRAIGHT AHEAD TAXIWAY HAS DIRECTION CHANGE GREATER THAN 25 DEGREES.

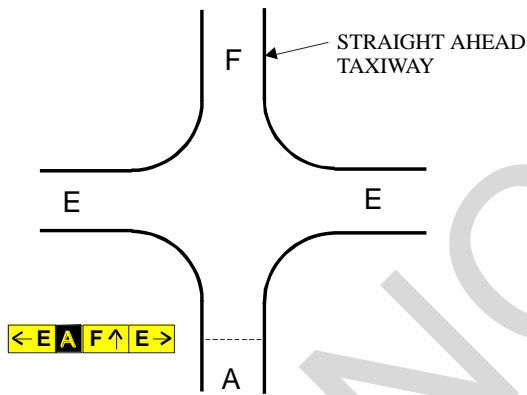

C. DESIGNATION OF STRAIGHT AHEAD TAXIWAY IS DIFFERENT.

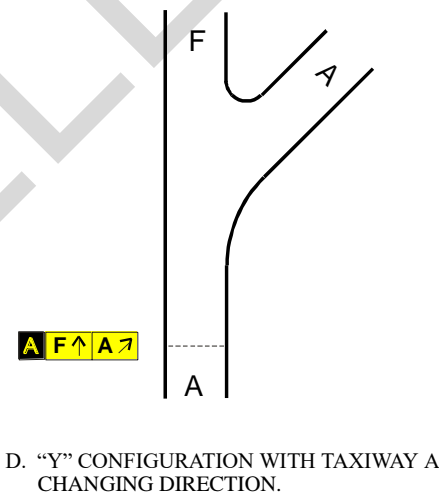

D. "Y" CONFIGURATION WITH TAXIWAY A CHANGING DIRECTION.

NOTE: ORIENTATION OF SIGNS ARE FROM LEFT TO RIGHT IN A CLOCKWISE MANNER. LEFT TURN SIGNS ARE ON THE LEFT OF THE LOCATION SIGN AND RIGHT TURN SIGNS ARE ON THE RIGHT OF THE LOCATION SIGN.

ALTERNATE ARRAY OF SIGNS SHOWN TO ILLUSTRATE SIGN ORIENTATION WHEN LOCATION SIGN IS NOT INSTALLED

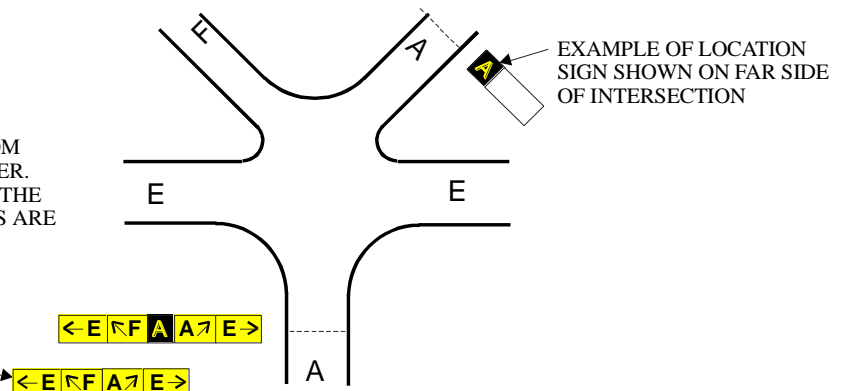

E. SIGNING AT INTERSECTION.

Figure 9-7 TACAN Sign Location

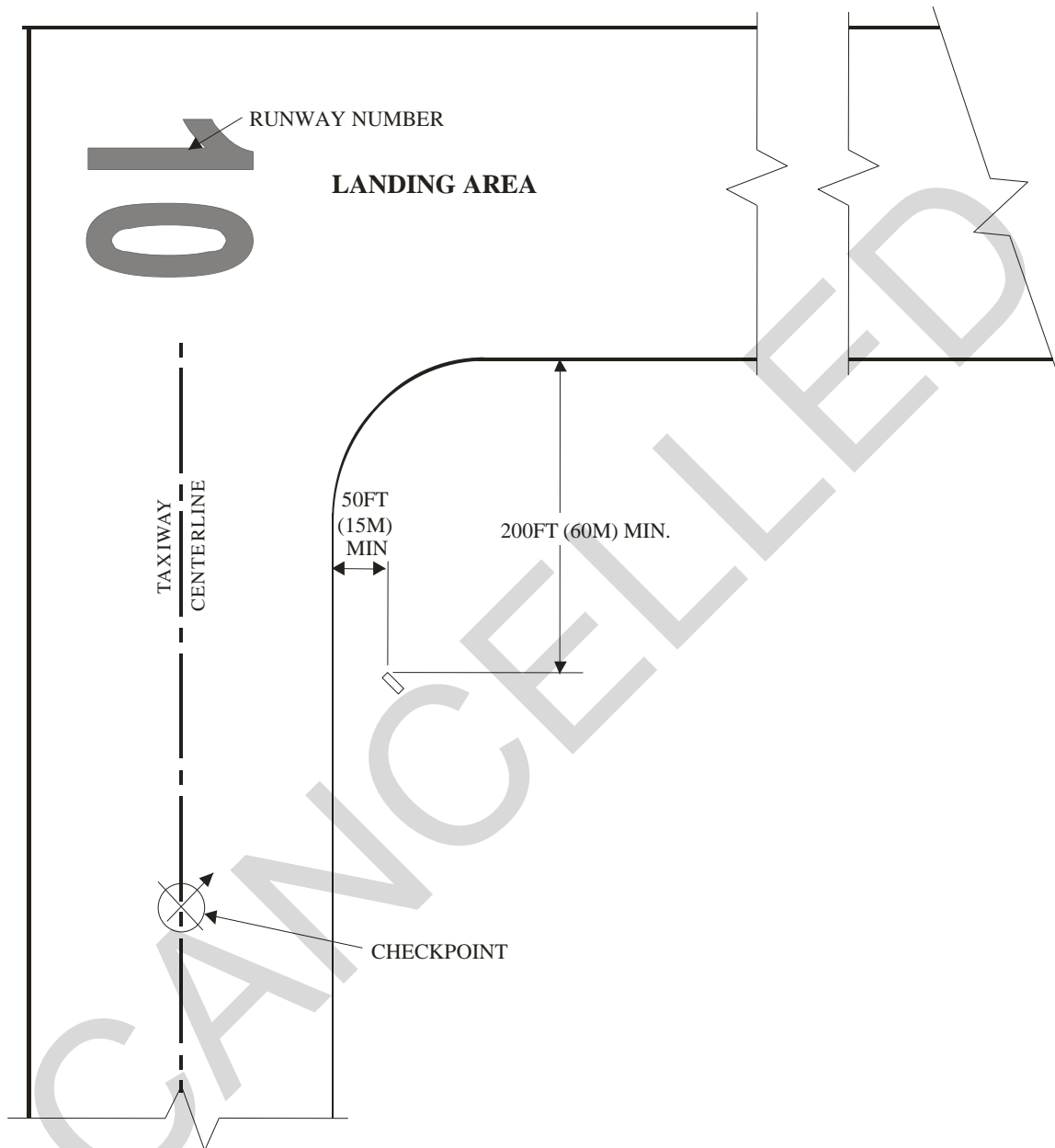

9-6 RUNWAY DISTANCE REMAINING (RDR) SIGNS.

9-6.1 Purpose.

Runway Distance Remaining (RDR) Signs are used to provide distance remaining information to pilots during takeoff and landing operations. The RDR are located along both sides of the runway, and the white numeral on the black background indicates the

runway distance remaining in increments of 1,000 feet (metric units are not used). A typical runway distance marker is shown in Figure 9-8.

Figure 9-8 Typical RDR Signs and AGM

Note: These signs represent the bulk of existing signs and comply with previous edition of FAA AC 150/5345-44. These signs do not require replacement until the end of their economic lives or with a major renovation to the airfield. See current edition of FAA AC for new sign message elements.

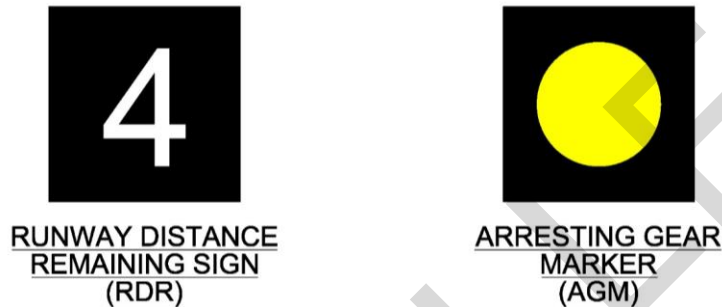

NOTES:

1. RDM ARE FAA TYPE L-858B, WITH WHITE LEGEND ON BLACK BACKGROUND, MEETING FAA AC 150/5345-44, SIZE 4.
2. AGM HAVE CHARACTERISTICS OF RDM BUT WITH A YELLOW CIRCLE 39" (1M) IN DIA. ON BLACK BACKGROUND, MEETING FAA AC 150/5345-44, SIZE 4.

9-6.2 Installation.

An RDR sign system (previously referred to as a Runway Distance Marker [RDM]) is required for all runways per Table 2-1A and Table 2-1B.

9-6.2.1 The row of markers along each side of the runway is parallel to the runway centerline, and equal distance from the runway edge. FAA Size 4 RDR signs are positioned 50-75 feet (15-22.5 meters) from the runway edge. Use only FAA Size 4 RDRs.

9-6.2.2 RDR signs are spaced at 1,000 foot (300 meter) intervals along the runway, excluding the threshold and runway end. Displaced threshold areas that are used for takeoffs and/or rollout are treated as part of the runway for purposes of locating the markers. Numerals are shown on both faces of the markers so the distance remaining can be seen in either direction of operations.

9-6.2.3 For runway lengths that are not an exact multiple of 1,000 feet (300 meters), one-half the excess distance is added to the distance of each marker for each runway end. For example, for a runway length of 6,500 feet (1,950 meters), the excess distance is 500 feet (150 meters) and the location of the last marker on each

runway end is 1,000 feet (300 meters) plus one-half of 500 feet (150 meters), or 1,250 feet (375 meters). A longitudinal tolerance of ± 50 feet (± 15 meters) is allowed if a marker cannot be installed at its standard location. A marker should be omitted if it cannot be installed within this tolerance. This standard procedure for siting RDR signs is illustrated by Figure 9-9. Alternative methods can be found in FAA AC 150/5340-18, as allowed by the appropriate command.

Figure 9-9 RDR Sign Layout Configuration

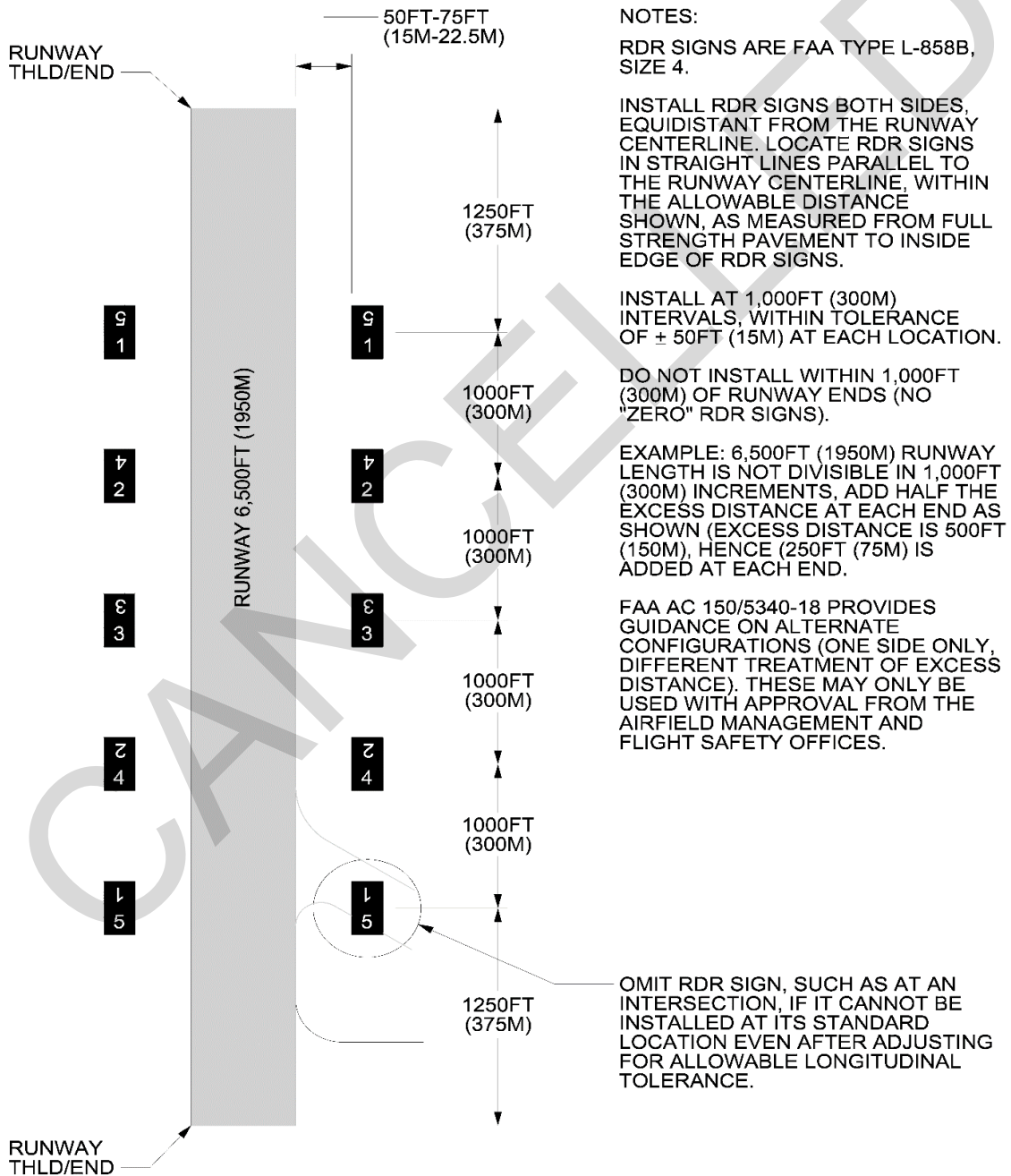

9-6.2.4 Runway Distance Remaining (RDR) Signs for military airfields are FAA Size 4, and are located 50-75 feet (15-22.5 meters) from runway edge. The distance indicated is to the inside edge of the sign. Signs are oriented perpendicular to and located equidistant from the runway centerline.

9-6.3 Characteristics.

See Chapter 13, FAA AC 150/5340-18, Chapter 2, and FAA AC 150/5345-44, Appendix 1, for additional characteristic information.

9-6.3.1 Message.

Signs are double face, internally lighted, with retro-reflective message faces that meet the color and reflectivity requirements of ASTM D 4956, Type I Sheeting. The spacing, stroke, and shape of legend characters, numerals, and symbols must be in accordance with FAA AC 150/5345-44, Appendices A-I.

9-6.3.2 Dimensions.

See FAA AC 150/5340-18 for marker and legend height dimensions. The marker should provide at least 12 inches (300 millimeters) clearance between the top of the sign and any part of the most critical aircraft expected to use the runway when the aircraft wheels are at the pavement edge.

9-6.3.3 Electrical.

For new installations, it is required that RDR signs be FAA Style 5 and connected to the 5.5 amp, 1-step RDR circuit. The intent is to have a more reliable sign system by eliminating the electronics required to maintain uniform brightness over the range of a 3 or 5-step regulator.

9-6.3.4 Photometrics.

The average minimum sign luminance for all intensity steps must be white legend, 300 CD/M² (88 foot-lamberts).

9-6.3.4.1 Photometric Testing.

It is recommended that photometric testing be performed on all newly installed RDR signs on site. The purpose of these tests is to verify the installed fixtures meet or exceed the minimum photometric requirements.

9-6.4 Power and Control.

For new installations, RDR signs will be powered from a dedicated 1-step (5.5 ampere) circuit. Control of the circuit will be interlocked with the corresponding runway edge lighting circuit so as to turn on and off with its runway edge lighting.

9-7 ARRESTING GEAR MARKERS.

9-7.1 Purpose.

Arresting Gear Markers (AGM) identify arresting gear pendant cables or barriers on the operational runway surface. The AGMs are located adjacent to the location of arresting system cables on the runway. An AGM is shown in Figure 9-8.

9-7.2 Installation.

Arresting pendant cables must be identified by AGM on both sides of the runway. The AGM are located in line with the cable \pm 10 feet (3 meters) and equidistant from the runway edge. AGM are similar to Size 4 RDR signs, and are positioned 50-75 feet (15-22.5 meters) from the runway edge. Where RDR signs are installed, locate the AGMs in line with the RDR signs, except where the AGM is within 20 feet (6 meters) of an RDR sign. In this case relocate the RDR sign to be in line with the AGM and 5 feet (1.5 meters) outboard of the AGM. The distance indicated is to the inside edge of the marker. If the arresting gear is in the overrun, signs are not allowed but obstruction lights are required. See Chapter 6. This is a common requirement for the BAK-15. Markers are oriented perpendicular to the runway centerline. Typical installation of AGM is shown in Figure 9-10.

Figure 9-10 Arresting Gear Marker (AGM) Configuration

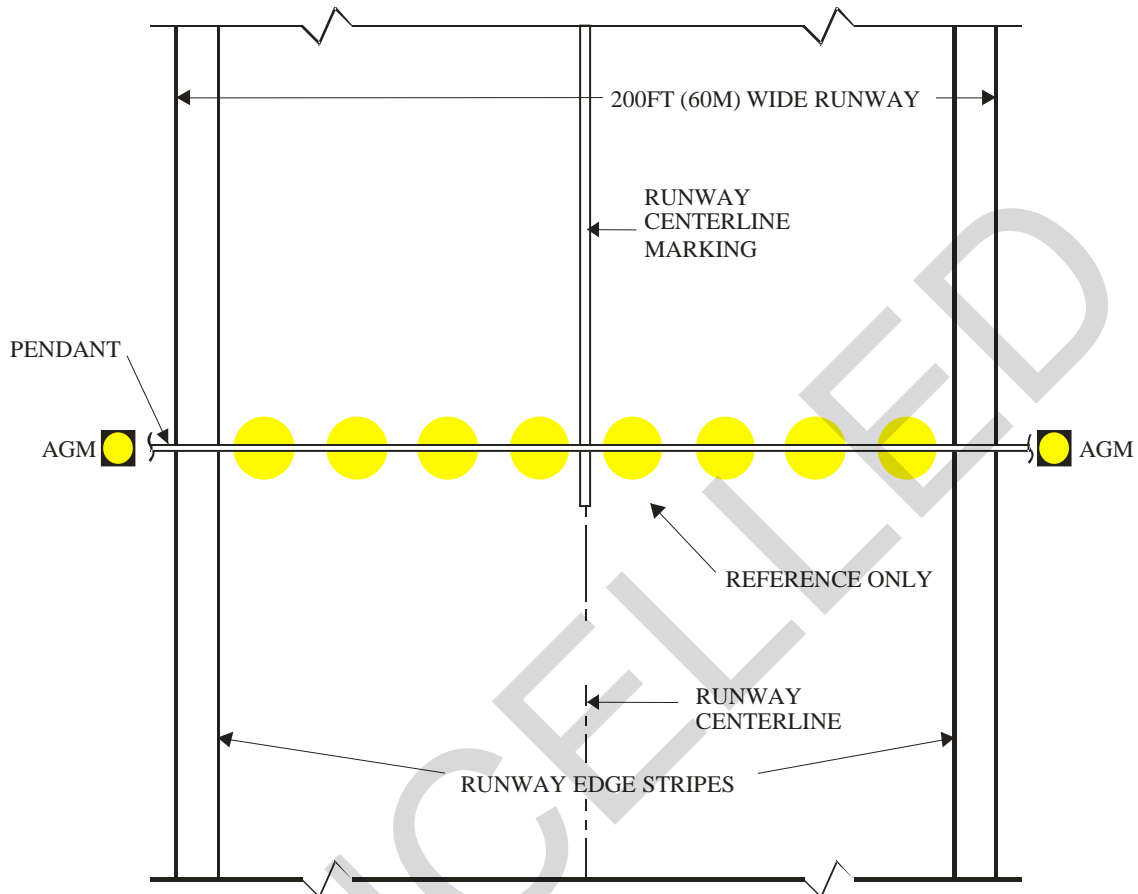

NOTES:

1. Install AGM in line with RDR Signs.
2. If an RDR sign is within 20ft (6m) of an AGM, then move the RDR sign even with the AGM and install it 5ft (1.5m) outboard of the AGM.

9-7.3 Characteristics.

See Chapter 13 for additional characteristic information.

9-7.3.1 Message.

Messaging is similar to RDR sign (paragraph 9-6.3.1) except that the white numeral of the RDR sign is replaced with a yellow translucent circle approximately 39 inches (1 meter) in diameter facing both runway directions.

9-7.3.2 Dimensions.

See paragraph 9-6.3.1 for legend dimensions. FAA Size 4 sign has a marker panel height of 48 inches (1,219 millimeters) and overall mounting height of 54-60 inches (1,350–1,500 millimeters). As with RDR, the marker provides at least 12 inches

(300 millimeter) clearance between the top of the sign and any part of the most critical aircraft expected to use the runway when the aircraft wheels are at the pavement edge.

9-7.3.3 Electrical.

For new installations, it is required that AGMs be FAA Style 5 and connected to the 5.5 amp, 1-step RDR circuit. The intent is to have a more reliable sign system by eliminating the electronics required to maintain uniform brightness over the range of a 3 or 5-step regulator.

9-7.3.4 Photometrics.

The average minimum sign luminance for all intensity steps must be yellow legend, 44 foot-lamberts (150 CD/M²).

9-7.3.4.1 Photometric Testing.

It is recommended that photometric testing be performed on all newly installed AGMs on site. The purpose of these tests is to verify the installed fixtures meet or exceed the minimum photometric requirements.

9-7.4 Power and Control.

See paragraph 9-6.4. Power the AGM to operate in unison with the runway edge lights. If the runway is used by Remotely Piloted Aircraft (RPA) or Unmanned Aerial Vehicles (UAVs), the Wing Commander may take written responsibility for powering them separately, for the safety of the RPAs or UAVs or a permanent waiver may be processed.

9-8 OTHER SIGNS.

9-8.1 Purpose.

Other signs not listed above may be installed on the airfield to serve special needs. This may include signs that apply only to vehicle traffic and special purpose signs that are not included in current standards but that may meet specific needs.

9-8.2 Installation.

Signs other than those listed in previous paragraphs must not conflict with current sign standards, and must not present confusing situations for ground traffic with respect to the sign's function and the standard signing on the airfield.

9-8.2.1 Signs intended for vehicles only, such as on vehicle service roads or lanes, typically follow the MUTCD. For example, standard highway stop signs may be installed on vehicle roadways at the intersection of each roadway with a runway or taxiway. A yield sign may be used in place of a stop sign at intersections with taxiways.

See FAA AC 150/5340-18 for additional information and requirements for vehicle roadway signs. Such signs should not be placed closer than a runway holding position for the same runway. Appropriate safe offset distances from Table 9-1 must also be used where roadways cross taxiways.

9-8.2.2 Special purpose signs other than those listed above should be approved by the appropriate military authority based on a specific need at an airfield. Also, special circumstances may dictate that a standard sign is unsuitable for a particular location sign. Placement of non-standard signs should be as needed, but should not violate the requirements for standard signing listed above in terms of proximity to runways and taxiways. To the extent allowable and as appropriate for the application, non-standard signs should follow the guidelines contained in FAA AC 150/5340-18 and FAA AC 150/5345-44.

9-8.2.3 In some cases standard signs may be painted on a pavement surface to enhance messaging. Painted signs on pavements should conform to AFI 32-1042.

9-8.3 Characteristics.

Vehicle signs should follow the requirements of the MUTCD. These are normally unlit signs, although in some cases external lighting may be useful. Other special purpose signs will be as required by the need, but must not conflict with or cause confusion with standard airfield signing.

9-9 COMPLIANCE WITH INTERNATIONAL STANDARDS.

9-9.1 ASIC.

Previous ASIC AIR STD 90/27 cancelled.

9-9.2 NATO.

This standard meets the requirements of STANAG 3316 (Edition 10) – Airfield Lighting, 13 May 2004, for taxiway signs, except for minimum size of signs and the location of some signs at intersections.

9-9.3 Additional Information.

See FAA AC 150/5340-18, FAA AC 150/5345-44, and ICAO Annex 14 for more information.

This Page Intentionally Left Blank

CANCELLED

CHAPTER 10 STANDARDS FOR MISCELLANEOUS VISUAL AIDS

10-1 AIRPORT BEACONS.

10-1.1 Purpose.

Airport beacons are high-intensity flashing lights which provide a visual signal to pilots to assist in locating and identifying the airfield or a hazardous obstruction at night, or in restricted visibility conditions. These beacons may be rotating or fixed, but must provide the signal through 360 degrees of azimuth. These requirements are to be used for new installations of airport beacons. Existing installations may continue to be used and maintained until the first airfield lighting upgrade project. The absence of a formerly FAA-approved or Mil-Spec NAVAID, or other piece of equipment from the current AC 150/5345-53, Appendix 3 Addendum is not an indication that this equipment is no longer approved for use. Absence from the AC means that particular NAVAID or piece of equipment is no longer manufactured. Beacons fitting this situation, such as the Model DCB-224M military beacon, is still supported for repairs by a sub-party of the former manufacturer and is typically more reliable and powerful than currently marketed beacons. Contact AFCEC/COSM for support information, if repairs to older beacons are required.

10-1.2 Beacon Types.

10-1.2.1 Airfield Rotating Beacon.

Each lighted airfield, except where one rotating beacon serves more than one airfield in close proximity, must use a high-intensity military type beacon (FAA Type L-802M). This beacon must have a double-peaked white beam to denote a military airfield and a single-peaked green beam to indicate that the airfield has lighted facilities for operations at night or in restricted visibility. The two beams must be directed 180 degrees apart. The signal from the beacon must be visible through 360 degrees of azimuth by rotating at six revolutions per minute (RPM). The airfield rotating beacon must be operated during twilight and night hours and during daytime when Instrument Flight Rules (IFR) are in effect. Alternating white and green flashes identify a lighted civil airport, and white flashes identify an unlighted civil airport.

10-1.2.2 Identification or Code Beacon.

For Air Force only, the identification beacon is used only at airfields where the airfield rotating beacon is located more than 6,000 feet (1,800 meters) from the nearest runway or where the airfield rotating beacon serves more than one airfield. The identification beacon is a non-rotating flashing omnidirectional light visible through 360 degrees. This beacon flashes a green coded signal at approximately 40 flashes per minute. The signal is an assigned code of characters to identify the particular airfield. The identification beacon must be operated whenever the associated airfield rotating beacon is operated.

10-1.3 Location Requirements.

See FAA AC 150/5340-30 for information about the location of beacon towers that are less than 200 feet (60 meters) above ground level (AGL). See the same AC for information about the construction of tubular or structural steel towers. For tower construction specific information see FAA AC 150/5370-10, Item L103, Airport Beacon Towers.

10-1.3.1 Visible through 360 degrees of azimuth if possible.

10-1.3.2 Not less than 1,000 feet (300 meters) from the centerline or centerline extended of the nearest runway.

10-1.3.3 Not in the line of sight from the control tower to the approach zone of any runway or to within 75 feet (22.5 meters) vertically over any runway.

10-1.3.4 Located 750 feet (225 meters) or more from the control tower. This is intended to prevent light reflection during foggy conditions which reduce visibility and interfere with light gun signals from the control tower cab.

10-1.3.5 Not more than 6,000 feet (1,800 meters) from the nearest point of usable landing area, except if surrounding terrain will restrict visibility of the beacon through an appreciable angle in some directions or the beacon will serve more than one airfield. If terrain restricts viewing the beacon or the beacon will serve more than one airfield, the distance of the beacon from the nearest runway may be increased to not more than two miles.

10-1.3.6 The base of the beacon must be not less than 20 feet (6 meters) higher than the elevation of the floor of the control tower cab. If the airfield rotating beacon is located more than 6,000 feet (1,800 meters) from the nearest point of usable landing area, an identification beacon must be installed and not more than 6,000 feet (1,800 meters) from the nearest point of usable landing area.

10-1.4 Photometric Requirements.

See FAA AC 150/5345-12 for detailed photometric beacon requirements.

10-1.4.1 Colors.

The color of the emitted light must be standard aviation colors per FAA AC 150/5345-12.

10-1.4.2 Airfield Rotating Beacon.

See FAA AC 150/5345-12 for airfield rotating beacon intensity values and methods of measurement.

10-1.4.3 Identification Beacon.

With the beacon operating steadily (not flashing) at rated voltage, the intensity of the green light must be not less than 1,500 candelas for a distribution through 360 degrees horizontally and 2 degrees vertically. The areas of the beam where the support rods are located may be less than these required intensities.

10-1.5 Aiming.

The vertical aiming of the beacons should be properly focused and aimed when manufactured, and leveling should be all that is required for aiming during installation. The axes of the beams vertically should be approximately five degrees above the horizontal for the rotating beacon. For the identification beacon, the center of the beam must be approximately 3 degrees above horizontal.

10-1.6 Equipment.

The airfield rotating beacon and the identification beacon equipment must be as shown in paragraph 13-12. The identification beacon must be provided with a keyer to flash the assigned identification code. The identification beacon is for Air Force only.

10-1.7 Power Requirements.

See FAA AC 150/5340-30 for additional information about the airport beacon power requirements. See also FAA AC 150/5370-10, Item L-103, Airport Beacon Towers, for construction, wiring, and contract requirements. The electrical power requirement for the beacons is 120 volts. The source of power may be from the airfield lighting vault or from a local source that is continuously available. If the distance from the power source is long and the line voltage drop is large, transmission of power at a higher voltage and step-down to 120 volts at the site may be desirable. Base the KVA rating of the step-up and step-down transformers on the total KVA load of the equipment. Emergency power is not required for the airport beacons, but should be used if it is available.

10-1.8 Control Requirements.

See FAA AC 150/5345-12 for airport/airbase beacon control requirements and description. The controls for the airport beacons are only those required to energize and switch off the beacon and its drive motor or keyer. Preferably, these beacons should be controlled remotely from the lighting control panel in the control tower or the airfield lighting vault. Control may be furnished by an automatic photoelectric switch or a clock-driven timer.

10-1.9 Monitoring Requirements.

There is no requirement for monitoring.

10-1.10 Compliance with International Military Standards.

There are no International Military Standards for airport beacons.

10-2 WIND DIRECTION INDICATORS (CONES).

10-2.1 Purpose.

Wind cones are installed near landing surfaces to provide a clear indication of the direction of the surface wind and a general indication of wind speed. Wind cones are lighted for night operation.

10-2.2 Siting Requirements.

Locate wind cones not less than 400 feet (120 meters) from the runway centerline and in a location free from the effects of air disturbances caused by nearby objects. If a wind cone is more than 27 feet (8.1 meters) above ground elevation a waiver to UFC 3-260-01 is required.

10-2.3 Wind Cone Configuration.

10-2.3.1 The wind cones must be in the form of a truncated cone made of fabric. They must have a length of not less than 8 feet (2.4 meters) and a diameter at the larger end of not less than 18 inches (450 millimeters). They must be constructed so it gives a clear indication of the direction of the surface wind and a general indication of the wind speed. Wind cones must extend fully in a fifteen knot wind.

10-2.3.2 The color(s) must be selected with consideration given to the background and to make the indicator clearly visible and understandable from a height of at least 1,000 feet (300 meters). Where practicable, use a single color, preferably white or orange. When a combination of two colors is required to provide conspicuity, the preferred colors are orange and white, red and white, or black and white. The colors must be arranged in 5 alternate bands, the first and last band being the darker.

10-2.3.3 There are two types of wind cone mounting structures: FAA Type L-806 (frangible) and FAA Type L-807 (rigid). Type L-806 is used for supplemental wind cones located near the ends of runways. Type L-807 is used for the primary wind cone. Refer to FAA AC 150/5340-30, for additional information about wind cone installation.

10-2.4 Lighting Requirements.

Illuminate the wind cone with floodlights which are arranged to provide a minimum illumination level of 2 footcandles (20 lux) at any point on the horizontal plane described by a complete rotation of the upper surface of a fully extended cone. The lights must be

shielded to prevent light emission above the horizontal. Equip the wind cone support with an obstruction light.

10-2.5 Power Requirements.

Provide a main power source only. If powered from the associated runway edge lights, they will have the provision so the cone floodlight brightness does not vary more than 20 percent with the available light, meeting the requirements of paragraph 10-2.4, at the lowest setting of the runway edge lights. Refer to paragraph 13-6.2 for additional information about runway edge light circuit power.

10-2.6 Control Requirements.

On and off control is the only requirement and may be accomplished via the runway edge light circuit if used.

10-2.7 Monitoring Requirements.

There are no requirements for monitoring wind cones.

10-2.8 Equipment.

The wind indicators must be as shown in paragraph 13-12.3.

10-2.9 Compliance with International Standards.

There are no ASIC AIR STDs or NATO STANAGs for wind indicators.

10-2.10 Additional Information.

See FAA AC 150/5345-27 and FAA AC 150/5340-30 for additional information.

10-3 RUNWAY AND TAXIWAY RETRO-REFLECTIVE MARKERS.

10-3.1 Purpose.

Reflectors and retro-reflective markers may be used to supplement existing runway and taxiway lighting, or for temporary installations. However, a waiver must be granted by the major command for their use.

10-3.2 Characteristics.

The retro-reflective materials used are designed to reflect light approaching at an oblique angle, back toward the light source.

10-3.3 Equipment.

For additional guidance on the types and styles of the markers refer to FAA AC 150/5345-39 and FAA AC 150/5340-30.

10-4 FLOOD, SECURITY, OR AUXILIARY LIGHTING.

10-4.1 Special Lighting Arrangements.

Special arrangements of lights, such as apron or parking area floodlights and protective and security lighting, may be required at an installation. These lights will not be connected to the airfield lighting circuits. Hangar access aprons (hangar entrances) may be lighted by floodlights installed around the apron or mounted on the hangar. Floodlights provided for these areas are considered as part of the hangar construction.

10-4.2 Floodlights.

10-4.2.1 Purpose.

Hangar areas are typically lighted to 1 footcandle. The functions of the apron floodlights are:

- Assist the pilot in taxiing the aircraft into and out of the final parking position.
- Provide lighting suitable for passengers to embark and disembark; for personnel to load and unload cargo and refuel; and to perform other apron service functions.
- Maintain airfield security.

10-4.2.2 Fixed Floodlights Glare Control.

Direct lamp light from the floodlights will be avoided in the direction of a control tower cab and landing and departing aircraft. Aiming of the floodlights should be, as far as practicable, in the directions away from a control tower cab and landing and departing aircraft. Direct light above the horizontal plane through a floodlight must be avoided. To minimize direct and indirect glare, the mounting height of the floodlights should be at least two times the maximum aircraft eye height of pilots of aircraft regularly using the airfield. Also, the location and height of the masts should be such that inconvenience to ground personnel due to glare is kept to a minimum. To meet these requirements, the floodlight light distribution may have to be restricted by use of glare shields. The maximum obtrusive light from all flood lights for the apron project must be no more than 1 lux (0.093 fc). If control tower personnel experience objectionable glare after flood lights are installed, re-aim lights until glare is eliminated.

10-4.2.3 Fixed Floodlights Design Considerations.

Floodlight masts must meet relevant obstacle clearance requirements. Locate and aim the floodlights to minimize shadows. Horizontal illuminance should have a uniformity ratio (average to minimum) of no more than 4:1 in any 100-foot (30 meter)- wide strip of pavement running parallel to the line of light poles. See Figure 10-1.

Figure 10-1 Apron Area Flood Lighting Uniformity Criteria

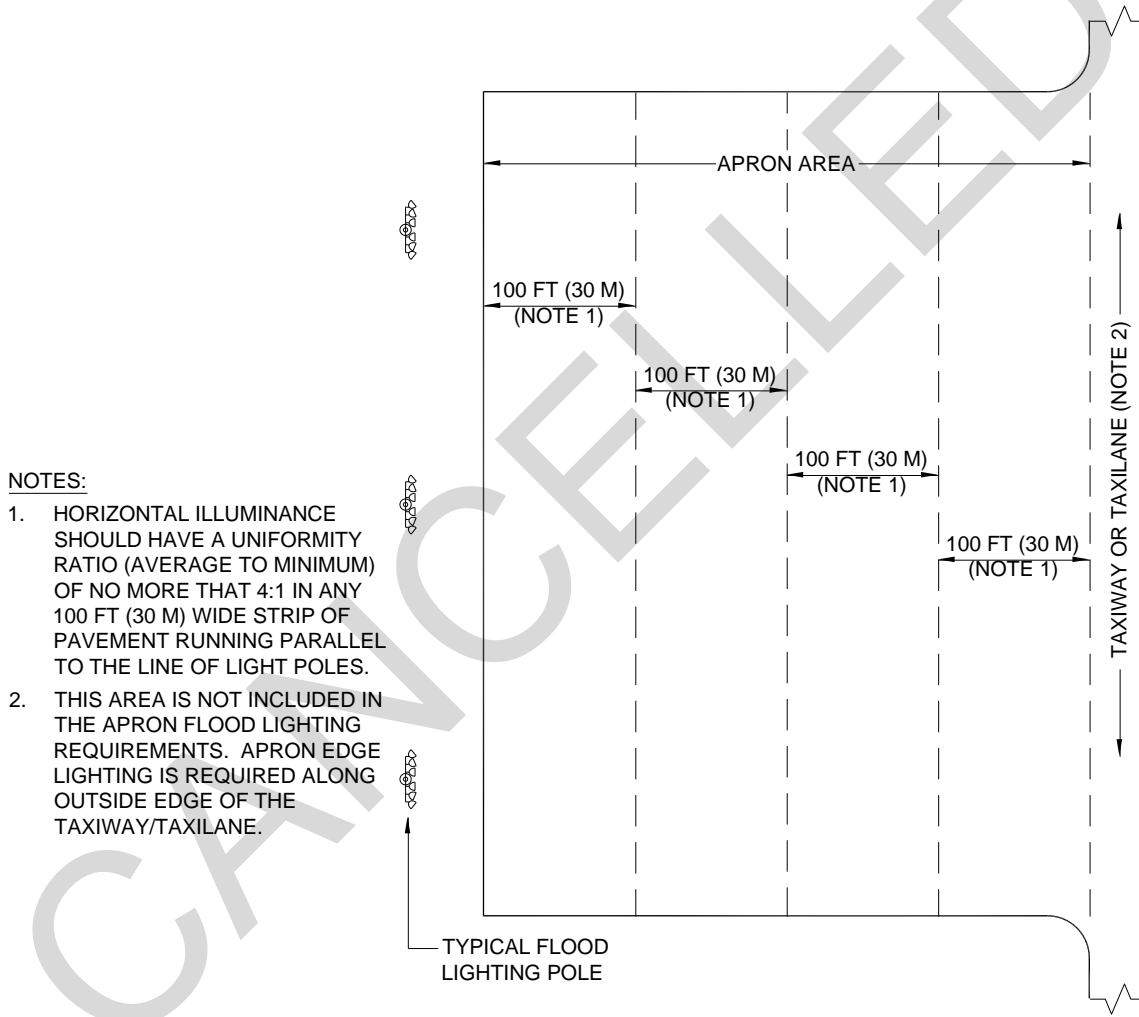

10-4.3 Lighting Intensities.

The various areas of the airfield, heliport, or helipad requiring normal and/or protective floodlighting will be lighted to meet the following minimum intensities in horizontal footcandles, in the horizontal plane at the pavement surface.

10-4.3.1 Apron Area Floodlighting

Security Area (1)	0.50
Parking Area	0.50
Loading Area (including hydrant fuel area)	2.00
Other Apron Areas	1.00
Maintenance	2.00

NOTES:

(1) Flood lighting for Army Security is required by AFR 190-51 if the installations security authority determines that the apron area is a risk level 3 asset.

(2) Taxiways and taxi lanes on or through aprons do not require flood lighting where apron edge lights are provided.

(3) It is assumed that supplemental lighting for maintenance is provided by portable light plant(s).

10-4.3.2 Protective and Security Lighting.

Boundary	0.20
Entrances	
Active, pedestrian and/or conveyance	5.00
Inactive, normally locked, infrequently used	1.00
Building surroundings	1.00

10-4.4 Additional Guidance.

Additional information on auxiliary lighting can be found in joint services technical manuals:

- Army/Navy/Air Force TM 5-684/NAVFAC MO 200/AFJMAN 32-1082.
- UFC 3-260-01 and UFC 3-550-03.

CHAPTER 11 PORTABLE EMERGENCY LIGHTING

11-1 GENERAL REQUIREMENTS.

In times of emergency, when standard airfield lighting is not available and aircraft operations must be performed at night, it may be necessary to use portable lighting devices to support operations. The lighting design standards in this section may be suitable for use in VFR night operations but do not qualify the airfield for instrument operations of any kind, except in the case of this UFC's Table 2-3 and Electrical Technical Paper (TP) 22. The standards in this section do not apply to requirements for portable lighting in a Theater of Operations (TO), forward tactical airfields or landing zones; see Table 2-3, Electrical TP 22, and AFI 13-217 for guidance. (Note: Landing zones are addressed in ETL 09-6; access is restricted: "For Official Use Only.") Care should be taken when installing portable lights to ensure that they are secured in a manner that will prevent movement as a result of jet blast or other forces. When application of the criteria in this section would result in a light location in an active paved area, the light must be omitted or relocated. Information on the Army's Airfield Lighting System (ALS), a TO portable ALS, is available from the Army's materiel developer, Program Manager – Air Traffic Control (PM-ATC), at Redstone Arsenal, AL: Tel (256) 955-9008 or (256) 842-4954.

11-2 RUNWAY LIGHTING.

11-2.1 Runway Edge Lighting.

Portable edge light configurations generally follow the standard configuration except that the spacing may be a maximum of 300 feet (90 meters) and the offset may be a maximum of 10 feet (3 meters) from the runway edge. The runway edge lights must be white.

11-2.2 Runway End and Threshold Lighting.

The number of lights required for runway end and threshold lights is reduced to 10. At each end of the runway they must be placed in two groups of 5 with the outermost lights in each group in line with the line of the runway lights spaced at 10 feet (3 meters) intervals toward the center. The line of threshold and runway end lights may be offset no more than 5 feet (1.5 meters) from the end of the runway. The lights must be red toward the runway and green toward the approach.

11-3 TAXIWAY EDGE LIGHTING.

The techniques for designing an emergency taxiway edge lighting system are generally the same as for a standard system except that the spacing is increased as follows:

11-3.1 Straight Sections.

The spacing must not exceed 220 feet (66 meters).

11-3.2 Curved Sections.

The spacing must not exceed 100 feet (30 meters).

11-4 HELIPAD LIGHTING.

Emergency helipad lighting must follow the standard configurations for perimeter, landing direction, and approach direction lighting except the adherence to light plane criteria is not required.

11-5 FIXTURES.

Fixtures may be omnidirectional, bidirectional or unidirectional. Where unidirectional fixtures are employed, they must be aimed in the direction of the planned operation. If the operational direction changes they must be installed for the new direction. Unidirectional fixtures generally have better light output for the energy being consumed than the other types. Omnidirectional fixtures meeting MIL-L-19661 Type I may be used with filters as appropriate for the application. Unidirectional and bidirectional fixtures meeting FAA AC 150/5345-50 may also be used. Other portable fixtures that are suitable for outdoor use, meet the duty cycle requirements and meet or exceed the light output of the specified fixtures may be considered.

11-6 CONTROLS.

The specified lights have individual on/off controls and are not capable of control from a central point. They may have been provided with a flashing mode which must not be used during periods when aircraft operations are being conducted.

11-7 COMPLIANCE WITH INTERNATIONAL MILITARY STANDARDS.

11-7.1 ASIC.

Previous ASIC AIR STD 90/20 cancelled.

11-7.2 NATO.

These standards comply with NATO STANAG 3534 (Edition 7) – Airfield Lighting, Marking and Tone Down Systems for Non-Permanent / Deployed Operations, 6 June 2013.

CHAPTER 12 DESIGN AND INSTALLATION

12-1 REQUIREMENTS.

When design options exist and operational requirements do not allow a clear choice between them, base the decision on the results of a life cycle cost analysis rather than the lowest first cost. All interior and exterior elements of the airfield lighting systems must meet the requirements of this document. Refer to UFC 3-535-02 for detailed installation information.

12-1.1 Light Fixture Mounting.

Wherever practical, mount the light fixtures on bases installed in a concrete envelope. The mounting bases support the light fixture and normally house the isolation transformer. For temporary construction the light fixtures may be stake mounted, and the transformers may be surface mounted. Beyond the shoulders, the top surface of foundations, covers, and frames must not exceed 2 inches (50 millimeters).

12-1.2 Concrete Foundations.

All foundations for lights, signs, towers, and other equipment must be flush with the grade and the surrounding area stabilized and compacted to prevent erosion and excessive rutting in the event an aircraft strays from the pavement.

12-1.3 Cable and Duct Installation.

12-1.3.1 Wherever practical, install cables in approved underground duct. Cable must be suitable for underground installation, and installed in direct buried duct. (Consider direct burial for locations with a high water table.) For multiple duct installation, spacers are required to maintain proper duct separation. Use concrete encased duct under paved areas. Maintain relative positions of multiple ducts from manhole/hand hole to manhole/hand hole.

12-1.3.2 The ducts under paved areas must have a minimum of 3 inches (75 millimeters) concrete encasement all around. For directional boring, maintain the relative positions of multiple conduit from manhole to manhole (ducts should not cross each other).

When installation under existing pavement is required, the designer must select the best conduit for the application considering strength and corrosion resistance. For temporary construction, the cables may be direct-buried. Make connections between the lighting cable, isolation transformers, and light fixtures with FAA L-823 connectors. Recommendations for the designer to consider regarding cable and duct installation are contained in Table 12-1.

Table 12-1 Considerations for Cable and Duct Installation

1. Install cables in the same location and running in the same general direction in the same trench or duct bank. Whenever possible, route cables in straight duct segments between manholes and hand holes, or between light bases.

When practical, route cables and duct rectilinear (parallel and at right angle) to runways, taxiways, and other surfaces.

2. Separate low voltage ($\leq 600\text{V}$) from higher voltage cables ($> 600\text{V} - 5,000\text{V}$). Separate all power cables from control, telephone, and coaxial type cables.
 - place 600V and 5,000V power cables in separate duct, or separate a minimum 4" (100mm) if direct buried in trench.
 - Power cables of more than 5,000V must be separated from all other cables by minimum 12" (300mm).
 - place all power cables in a separate duct bank from all control, telephone, coaxial type cables, or separate a minimum 6" (150mm) if either is direct buried.
3. If cables are placed at more than one level, install so that the minimum vertical separation is the same as the minimum horizontal separation. Do not directly overlap cables, so damage may be avoided during the compaction process.
4. Do not direct-bury cables under paved areas, roadways, railroad tracks or ditches. In these locations, install cable in concrete encased duct schedule 80 PVC, or PVC-coated rigid galvanized steel where encasement is impractical.
5. Where rock is encountered during excavation, install cable in duct. Remove rock to depth of at least 3" (8 cm) below required depth of duct, and use adequate bedding material to provide uniform support along entire length. Bedrock requires other action. Refer this to the designer.
6. Construct trenches for single-duct lines that are not encased with concrete so that they are not less than 6" (150mm) or more than 12" (300mm) wide. Construct the trench for 2 or more ducts proportionately wider.
7. For duct banks, use interlocking duct spacers at not more than 5' (1.5m) to ensure uniform spacing between ducts and to hold duct in place when concrete encasing. Stagger joints in adjacent duct at least 2' (0.6m).
8. Provide burial below frost line to prevent damage from frost heave if local experience has indicated problems.
9. Concrete encased duct may be used, as appropriate, for areas inhabited by digging rodents or animals to provide additional physical protection.
10. Slope duct lines where practical for drainage towards manholes/hand holes, or duct ends.
11. Provide grounding bushings where rigid conduits enter or leave a manhole.
12. Provide, whenever possible, a spare duct in each duct bank.
13. Where conduit is bound in pavement or other structural feature, provide conduit expansion joints when crossing pavement expansion joints. Consider conduit expansion joints also where local experience has indicated expansion problems.
14. When crossing pavements, large bodies of water and other environmentally sensitive locations, follow guidelines for trenchless directional boring contained in UFC 3-550-01.

[See also typical installation details, UFC 3-535-02]

12-1.4 Manhole/Handhole Design.

12-1.4.1 Each manhole/hand hole must have its own design detail to show orientation (with north arrow). This detail must include the access lid location. It is preferred that manholes/hand holes be cast with only one joint at the top.

12-1.4.2 The assembled manholes/hand holes including their access lids must meet wheel load ratings according to UFC 3-260-01. In areas not addressed by UFC 3-260-01, design manholes and hand holes to take HL-93 wheel loading per AASHTO LRFD Bridge Design Specifications, Section 3, "Loads and Load Factors." When calculating load ratings for manholes/hand holes, consider heavy tractors and fire trucks that will pass over them.

A project design analysis or basis of design must indicate the manufacture's information showing that the manhole/hand hole covers and frames will support the design loads. Structural calculations showing that the complete structure can support the required aircraft loading where located in the runway, taxiway, or shoulder areas described in UFC 3-260-01 must also be included.

12-1.4.3 The single wheel load rating for the manhole/hand hole and access lid assembly must be cast in the concrete top of each manhole/hand hole. The year of installation must be cast as "Installed Year - xxxx" in the each concrete top or the metal hatch. The words "Airfield Lighting" must be cast in the top of the each manhole/hand hole metal hatch used for airfield lighting circuits.

12-1.4.4 Design and orient manhole access lids so as to not interfere with cable runs through the manhole.

12-1.4.5 Design and orient manhole access lids and ladder rungs so as to not interfere with sump holes.

12-1.4.6 Manhole/hand hole access lids must be spring-assisted in opening when the access lid weighs over 30 pounds. Minimum opening must be 24" (0.6 meters) to allow portable ladder use. Safety arms used in keeping the lids locked open must not fall down into the hand hole/manhole. Safety arm(s) must not make contact with the cable(s) in the hand hole/manhole. Frames for access lids must have a ground lug attached on the inside of the manhole/hand hole. Access lids must be easily closed and have a minimum of two bolts to keep the lid closed.

12-1.4.7 Tie manhole tops to the side walls with rebar cast into the concrete tops and side walls. Install rebar so that it is not exposed.

12-1.4.8 Coat manholes/hand hole exteriors with a water sealant on the bottom and all sides. Sealant must not be placed on the manhole/hand hole tops, but can be on the sides of the top.

12-1.4.9 Show manhole/hand hole conduit penetration details on the construction contract documents. Female conduit connections cast into the manhole/hand hole are required. Show the outside seal and the inside seal at the concrete/conduit interface in conduit detail(s). The outside seal should not allow water to pass between the outside surface of the conduit and the manhole/hand hole wall. Provide unused conduits with plugs that are removable from within the manhole/hand hole. Seal conduits filled with cable(s) around the cable with duct seal, unless directed otherwise by the base electrical engineer. Cast rebar in place in the manhole/hand hole wall and stubbed out so that it can be used to attach the manhole/hand hole to the concrete-encased conduit system/duct bank it is mating to. Stubbed-out rebar lengths and diameters must be shown in design details.

12-1.4.10 Provide for future duct bank entrances to manhole with cast-in-place removeable window for installing duct bank.

12-1.4.11 Show a fold-down diagram on the construction contract documents for each new manhole. Fold-down diagrams must show conduits on each face, size, and material of conduit, circuits (cables) included in each conduit calling out the name of the circuit, and cable type/size. Use tables together with the fold-down diagrams to help convey the information.

12-1.4.12 It is preferred that cables take the shortest route through the manhole/hand hole. Do not loop cable inside the manhole/hand hole unless specifically directed by the base electrical engineer. If directed to loop the cables in hand holes/manholes, designate such on the construction contract documents.

12-1.4.13 Place non-metallic cable racks on all manhole walls whether currently used or not. Cable racks must be able to support 300 pounds (136 kilograms) without breaking.

12-1.4.14 Tie cables to racks using cable ties.

12-1.4.15 Identify cables with a tag using cable ties.

12-1.4.16 Cable ties and tags must be made of heavy-duty, corrosion resistant material or as directed by the base electrical engineer.

12-1.4.17 Each manhole/hand hole must have either a low point (sloped floor) or a sump hole. A sump hole will require a drain lid over the sump hole. Place the sump hole or low spot for easy access in lowering a portable sump pump into the manhole/hand hole from outside the manhole/hand hole. Do not allow sump holes to penetrate the floor unless each one is tied to a drain line. Tie drain lines to the base storm drainage system, and drain to daylight, or drain to an approved French drain. Build into the manhole rungs for access to the manhole. When attaching rungs to the manhole wall, use fasteners that will hold at least 300 pounds.//

12-1.4.18 Each manhole/hand hole must have a ¾ inch x 10 foot (20 millimeters x 3 meter) copper clad ground rod driven through a precast hole in the floor after the manhole/hand hole has been placed into its final position. Seat the precast manhole/hand hole water-tight with a non-corrosive sealant after installation of the ground rod. The ground rod must “stub up” a minimum 6 inches (150 millimeters) above the manhole/hand hole floor, with a ground lug attached for ground connections. Ground connections must be provided to all metal equipment in the manhole/hand hole using a AWG #4 (25 square mm) bare stranded copper cable. This includes the metal frame for the manhole/hand hole lid, cable racks, and system ground wires that feed through the conduits. The counterpoise must not be tied to this ground.

12-1.4.19 The soil grade around the manholes/hand holes must start one half inch below the top of the manhole/hand hole and slope one quarter inch per foot away from the manhole/hand hole for 15 feet (4.5 meters).

12-1.4.20 Place manholes/hand holes on undisturbed soil.

12-1.5 Safety (Equipment) Grounding System.

12-1.5.1 The safety ground is a separate system and must never be confused with the counterpoise. A safety ground must be installed at each light fixture. In-pavement (L-868) fixture bases, where the counterpoise is connected to the base can, are exempt. The purpose of the safety ground is to protect personnel from possible contact with an energized light base or mounting stake that may result from a shorted power cable or isolation transformer.

12-1.5.2 The safety ground must be a AWG #6 (16 square mm) solid bare copper conductor with one hole lug bolted to the exterior ground lug at the fixture base. The other end is connected to a ¾ inch by 10 foot (20 mm by 3 meter) ground rod installed beside the fixture. Ensure resistance-to-ground of the rod is 25 ohms or less in accordance with manufacturer’s requirements.

12-1.5.3 Do not exothermically weld connections to a galvanized light base. See FAA AC 150/5340-30, Chapter 12, for additional detailed ground connection information.

12-1.5.4 See the NEC Handbook for additional information about grounding electrode installation and testing. Additionally, in-pavement fixtures and base plates for elevated fixtures must be fitted with a braided ground strap connected to the interior ground lug of the base can. All exterior grounding connections must be bolted exothermic-weld-type. Ground connections interior to the can must be bolted-type connections.

12-1.6 Counterpoise Lightning Protection System.

The purpose of the counterpoise or lightning protection system is to provide low resistance preferred paths for the energy of lightning discharges to safely dissipate without causing damage to equipment or injury to personnel. The counterpoise is a separate system and must not be confused with equipment safety grounds that provide personnel protection from electrical shock hazards. Provide a continuous counterpoise of minimum AWG #6 (16 square mm) bare, stranded copper wire to protect the entire length of all primary circuits supplying airfield lighting, with a minimum 10 feet (3.0 meter) ground rod installed at least every 2,000 feet (600 meters). Do not connect counterpoise system to the light bases except at in-pavement fixtures. Refer to Figure 12-1 for an example of a typical installation. For additional guidance see 2017 NFPA 780, Figure 11.4.2.6.2.

Figure 12-1 Counterpoise and Ground Rod Installation

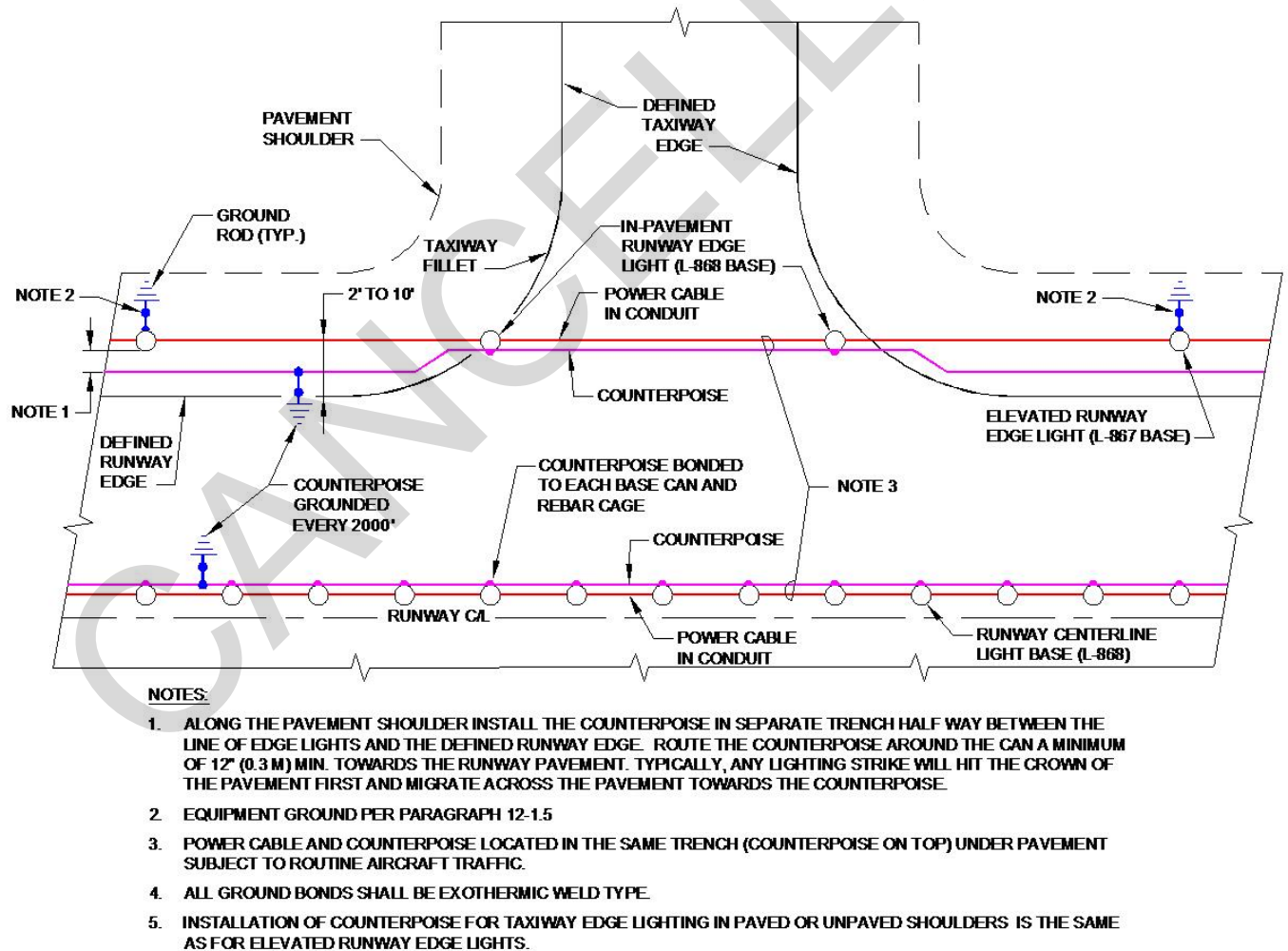

12-1.6.1 Counterpoise Criteria.

Along runway/taxiway or apron shoulders, install the counterpoise halfway between the pavement and at approximately half the depth of the duct (or cable, if direct buried) if at all possible. If this is not practical, install counterpoise 4-6 inches (100-150 millimeters) above the duct or direct-buried cable. Route the counterpoise around each light base or unit, at a distance of no less than 12 inches (300 millimeters) from the unit; do not connect to the unit. For duct not along a shoulder or for duct bank, lay the counterpoise 4-6 inches (100-150 millimeters) above the uppermost layer of direct buried ducts, or on the top of the concrete envelope of an encased duct bank. Provide only the quantity of counterpoise wires for cables for the same duct bank based on the width and depth of the duct bank as shown in NFPA 780. Connect all counterpoise wires leading to a duct bank to the single counterpoise wire for the duct bank. Lay the counterpoise at least 12 inches (300 millimeters) away from manholes or hand holes. Do not connect the counterpoise to the lighting vault power grounding system. Use exothermic-type weld for all connections. The counterpoise resistance to ground must not exceed 25 ohms at any point using the drop of potential method.

12-1.7 Frangibility and Accident-Avoidance Construction.

In the areas around the runway, including the approach zone, all above-grade structures must be lightweight and of a frangible or low impact resistant construction using breakaway sections to minimize hazards to aircraft. Concrete foundation or mounting slabs must not extend above the finished grade of the surrounding surface.

12-1.7.1 ALSF Frangibility.

A slight trade-off in frangibility can result in significant savings in energy. Older ALSF systems use 300 watt lamps in the outer 2,000 feet (600 meters) to satisfy the photometric requirements, which can actually be met with newer 200 watt lamps. However, the 200-watt lamps are rated at 6.6 amps rather than 20 amps and their use would require a change in isolation transformers. This would not be difficult in major renovations or new installations except that eight additional wires must be installed in low impact resistant and semi-frangible light supports. The major command may accept the slight loss of frangibility to achieve the energy savings.

12-1.8 Airfield Lighting Vault.

Vaults house the regulator and control equipment, emergency generator and power transfer switch, and other electrical equipment needed for operation of the airfield lighting system. The vault may be a separate building or structure, or an enclosure within a larger structure, as appropriate. Vaults must be of concrete or masonry construction meeting all building codes for the type of structure. Vaults constructed in the past generally had a primary service of 4.16/2.4 kV, 3 phase, 60 hertz power. All existing vaults not meeting the above described criteria may be used, provided the existing structure is otherwise adequate to serve the overall purpose or can be modified

economically to provide the desired facility. For new construction or major modernization, the following is recommended:

12-1.8.1 Vault Voltage.

Use 480 volts as a primary voltage within the vault for new installations.

12-1.8.2 Vault Location.

Locate vaults a minimum horizontal distance of 350 feet (105 meters) from the control tower to prevent radio interference with control equipment. The maximum horizontal distance between an airfield lighting vault and the control tower where nominal 120 volt control system is used (with L-841 relay panel and multi-conductor control cable) is 7,350 feet (2,205 meters). As an alternative, 48 volts dc can be used for long distance control. An existing vault not meeting required locations may be used, provided the existing structure is otherwise adequate to serve the overall purpose or can be modified economically to provide the desired facility.

12-1.8.3 Main Lighting Vault.

Design the main airfield lighting vault to contain power distribution and control equipment for runway and taxiway lighting circuits and any other lighting circuits that can be fed from the lighting vault. Provide adequate space for the maintenance of the systems interior to the lighting vault. Auxiliary vaults may be required for other airfield systems depending on the airfield configuration and layout. Locate the vaults above grade in locations that are the most suitable as supply points. For Army airfields, size the vault for the required equipment and work space and space allowances indicated in UFC 3-260-01. Provide a two-hour fire rated wall to isolate the engine generator room from the regulator room.

12-1.8.4 Circuit Selector Switches.

For new construction, circuit selector switches are not allowed for Army facilities. For new construction, circuit selector switches are not recommended for Air Force Facilities.

12-1.8.5 Floor Mounted Equipment.

Securely bolt all floor-mounted equipment to the floor to prevent movement during seismic disturbances.

12-1.8.6 Space for Constant Current Regulators.

Constant current regulators require adequate space for maintenance access and high voltage safety. The following minimum spacing is recommended: 3 feet (0.9 meter) from back wall to regulator and between regulators; 4 feet (1.2 meters) in front of regulator for access.

12-1.8.7 Vault Wiring Safety.

Series cutouts provide safety by preventing inadvertent live wires during maintenance on field circuits. These are recommended at the output to field circuits for constant current regulators. Install series cutouts in NEMA 1 enclosures. A circuit diagram for a series cutout is shown in Figure 12-2.

Figure 12-2 Series Cutout Circuit Diagram

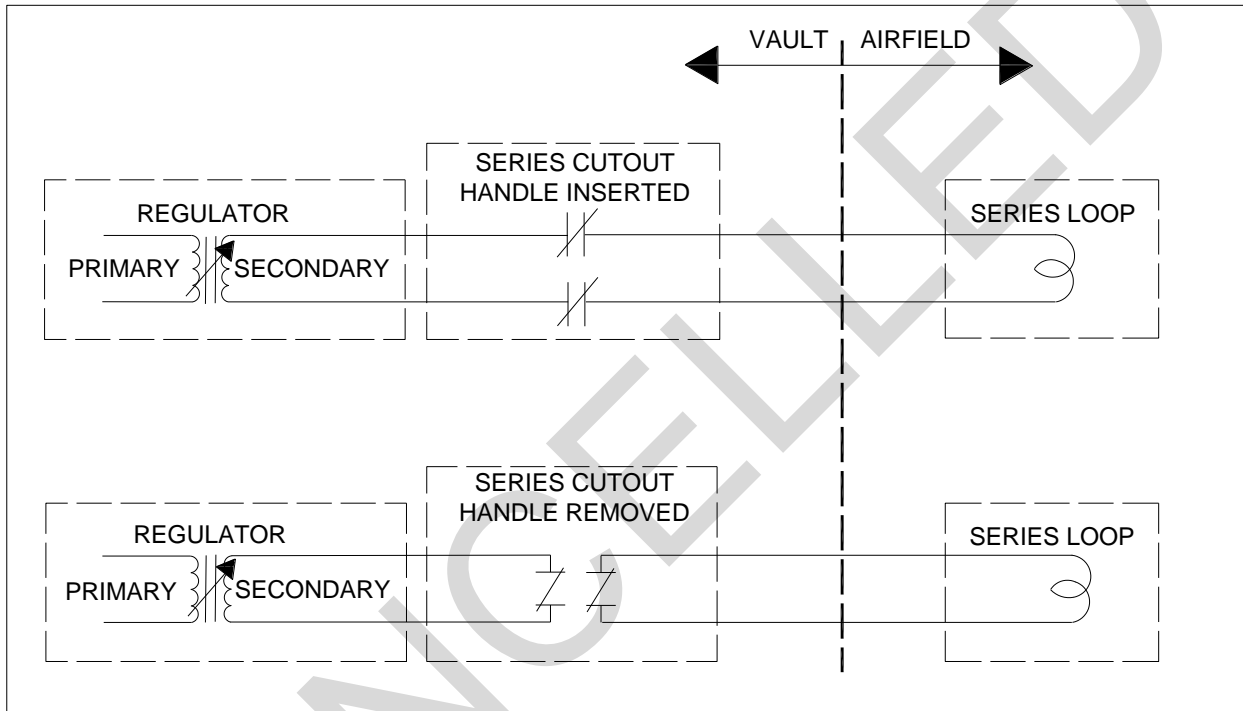

12-1.8.8 New Installations.

For new installations, install cables in conduit or enclosed wireways. The standard L-824 airfield lighting primary series circuit cable does not comply with NEC for installation in open trays. Run high voltage conductors (exceeding 600V) in rigid galvanized steel (RGS) conduit, intermediate metallic conduit, wireways or other wiring methods allowed by the National Electrical Code (NEC). Run low voltage feeders and control wires in rigid galvanized steel (RGS) conduit or intermediate metal conduit when run under the floor slab; in rigid galvanized steel (RGS) conduit, intermediate metallic (IMC) conduit, or electrical metallic tubing (EMT) when run on the walls or ceiling; and in cable trays supported from the ceiling or walls, IAW the NEC, when routing multiple cables or when a future expansion is a possibility within five years. Do not install conduit in concrete slabs on grade. Bring primary series cable from regulators and various other feeders out of the vault in PVC coated rigid steel galvanized conduit minimum 2 feet (0.6 meters) below grade.

12-1.8.8.1 To facilitate installation or replacement of constant current regulators and other heavy equipment, allow at least 8 feet (2.4 meters) of space between rows of equipment to allow access for lifting equipment or a truck to on-load or off-load/offload regulators. Provide a garage door to allow the truck or lifting equipment access to the building and consider installing a ceiling hoist system to install or remove regulators.

12-1.8.8.2 Provide an HVAC system with filtered outside air intake to maintain proper temperatures and humidity within the vault and to minimize dust levels. Insulate the vault envelope to reduce HVAC system run time and to minimize life cycle cost.

12-1.8.9 Installation Compliance.

Comply with the requirements of the NEC (NFPA 70) for the installation of power distribution equipment and control equipment in lighting vaults. See UFC 3-520-01 for lightning and surge protection design requirements. It is recommended to review the checklist for vault contained in Chapter 14.

12-1.8.10 Short Circuit Analysis.

Provide a short circuit analysis that complies with NEC Section 110-9, Section 110-10 and Section 110-12; and FAA Order 6950.27, as part of the design (to enhance reliability and safety). Include in the analysis critical points such as:

- Service entrance.
- Switchboards and panelboards.
- Transformer's primary and secondary.
- Transfer switches.
- Load centers.
- Fusible disconnects.

12-1.8.11 Surge Protective Device (SPD)/Lightning Protection.

To protect airfield lighting vault equipment from the effects of transient voltage surges, the main switchboard and panelboards serving regulators and field lighting control equipment must be provided with SPD equipment. Units must be either integral or external to the equipment being protected. Additionally, constant current regulators must have lightning arrestor protection.

12-1.8.11.1 SPD devices must be listed and labeled as defined in NFPA 70, Article 100, by an independent certified testing agency and marked for intended use. Design the SPD protection system for the airfield vault equipment in accordance with IEEE C62.41.1 and IEEE C62.41.2.

12-1.8.11.2 Surge protection device technology must be metal oxide varistor (MOV); silicone avalanche diode technology is not acceptable.

12-1.8.11.3 The short circuit current rating of a protection device must match or exceed that specified for the panel from which the surge protection device is fed.

12-1.8.11.4 For constant current regulators, arresters of the proper rating to protect the CCR from lightning-induced voltage and current surges must be installed at both the input and output terminals of the CCR. The CCR input lightning arresters must be rated for pulses per IEEE C62.41-1991, paragraph 4.2.17b, Table 6, Category B2, Medium. The CCR output lightning arresters must be rated for Location Category C3 in IEEE 62.41-1991, Table 4 (A 1.2/50 microsecond (μ s) 8/20 μ s combination wave at 20 kilovolts and 10 kiloamperes peak - the nominal ratio of peak open circuit voltage to peak short circuit current is 2 ohms). The ground side of the arresters must be connected to the cabinet grounding lug or other electrically equivalent ground location. If a bonding jumper wire is used, it must not be smaller than 6.

12-1.9 Emergency Power.

Provide an emergency generator or other independent power source at each vault which services systems requiring standby power for continuous operation if the principal power source fails. See FAA AC 150/5340-30 for additional design information and requirements for emergency power systems.

12-1.9.1 Engine Generator (E/G).

Where engine generators are installed, provide a separate room or shelter with independent ventilation. Make provision for engine exhaust to the exterior of the shelter. Mufflers may be installed inside or outside the building. If installed inside, they must be insulated. Engine cooling may be provided by externally-mounted radiators or by use of a radiator duct to an external exhaust louver. Make provisions for mounting and cooling resistive load banks for diesel engine testing if the station load is inadequate or cannot be made available for engine testing. Provide fuel storage capacity for 72 hours of uninterrupted operation of the standby power system. Also provide automatic starting and switching capable of supplying the rated load within 15 seconds of a power failure except where Category II instrument operations are conducted. During Category II instrument operations, a one-second power transfer is required. This is normally done by providing a remote start capability which permits operation of the lighting systems on the engine generator during Category II weather conditions. Standby power availability is then subject only to switching time. The actual procedure used must be locally coordinated. See FAA AC 150/5340-30, Chapter 9, for additional information. Provide an automatic battery charger for the starting batteries. Isolate the E/G foundation slab to reduce vibration and noise transmission to other parts of the vault. Comply with the requirements of the NEC, OSHA and local jurisdictions for emergency power.

12-1.10 Independent Power Sources.

An alternate independent power source qualifies as emergency standby power only if it is generated by a separate generating station and routed over separate power lines. In most cases in the past, careful investigation revealed that seemingly independent sources were so interconnected that failure of one could result in failure of the other. Exercise extreme care when determining the qualifications of alternate power sources before opting against an engine/generator for standby power.

12-1.11 Airfield Lighting Control.

The control system for airfield lighting consists of control panels, relaying equipment, accessories, and circuits which energize, de-energize, select lamp brightness, and otherwise control various airfield lighting circuits based on operational requirements. Control of any one airfield lighting system is normally provided at two points only: the air traffic control tower, and the lighting equipment vault. See Figure 12-3 for a typical lighting vault block diagram. A transfer relay assembly is provided at the vault to transfer control from the remote location to the vault when necessary:

12-1.11.1 Control Voltages.

Standard practice is to provide a 120 VAC control system using low burden pilot relays (pilot relay assemblies) to activate the power switches, contacts, and relays controlling the regulators and transformers supplying power to the airfield lighting circuits. The maximum horizontal distance from the control tower to the lighting vault is limited, for proper function of the pilot relay assemblies, to 7,350 feet (2,240 meters) when using 120 VAC control systems. There may be capacitance issues in long 120-volt ac control circuits. Where the distance between the tower and the vault exceeds the maximum, consider using a 48 VDC control system as described in FAA AC 150/5340-30, Figures 29, 30, and 70. Where both types of control system are installed, ensure the control power systems are isolated. See Figure 12-4 for a high level example of airfield lighting control.

12-1.11.2 Control Circuitry.

Design the control system to ensure the following:

- Lighting on intersecting runways cannot be energized simultaneously.
- All circuits supplying the lights for any one lighting system (for example, runway edge lighting) are energized simultaneously and operated at the same brightness step.
- Runway centerline lights cannot be energized unless the runway edge lights are energized.

- Touchdown zone lighting (TDZL) cannot be energized unless the runway centerline lights are energized.
- Certain systems associated with low-visibility operations (such as runway guard lights, hold-position lights, lead-in lights, land-and-hold-short lights), if installed, may also require linkage of control to runway lights. Recommend following guidance in applicable FAA documents, such as FAA AC 120-57 and FAA AC 150/5340-30.

CANCELLED

Figure 12-3 Installation Plan, Power Equipment

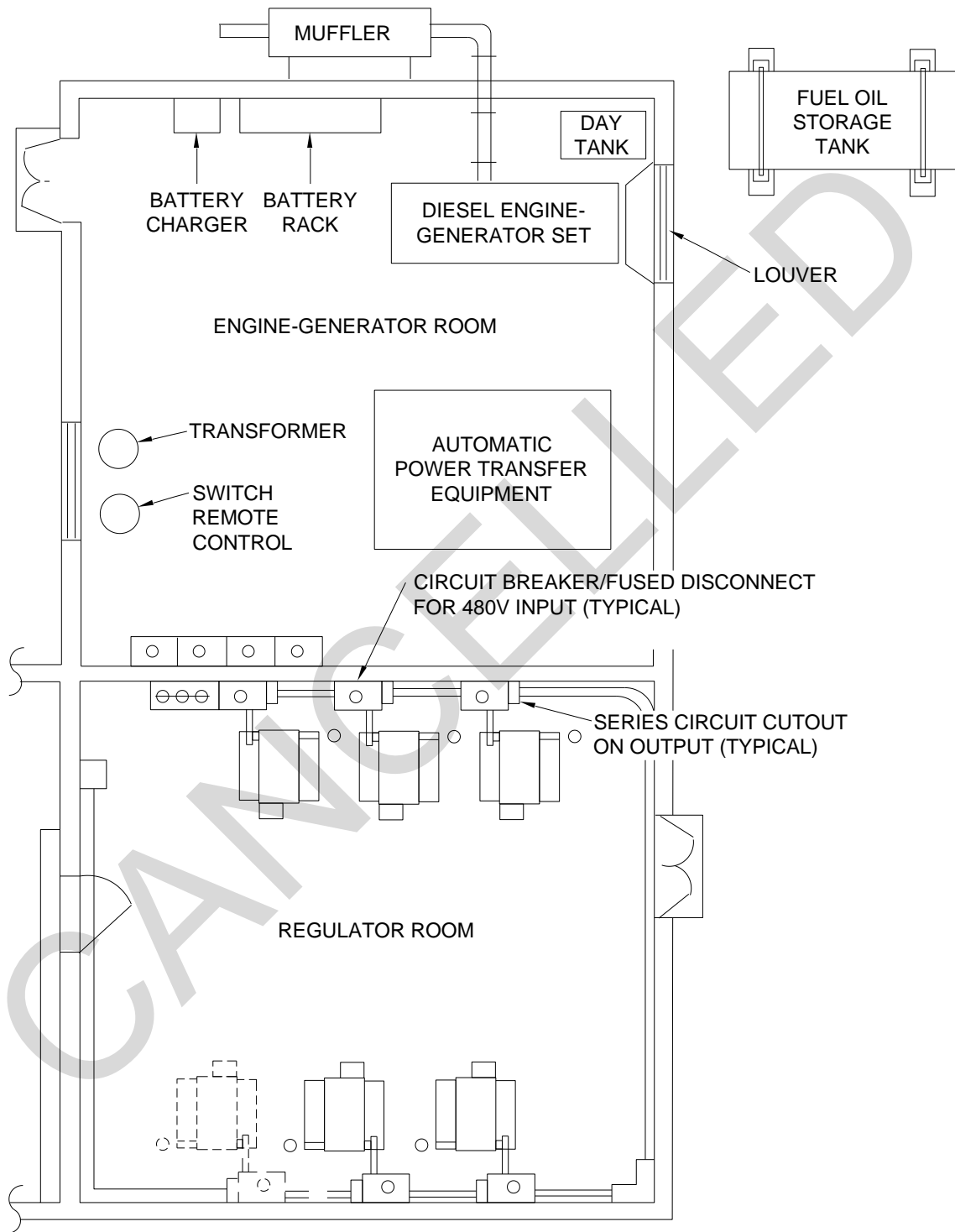
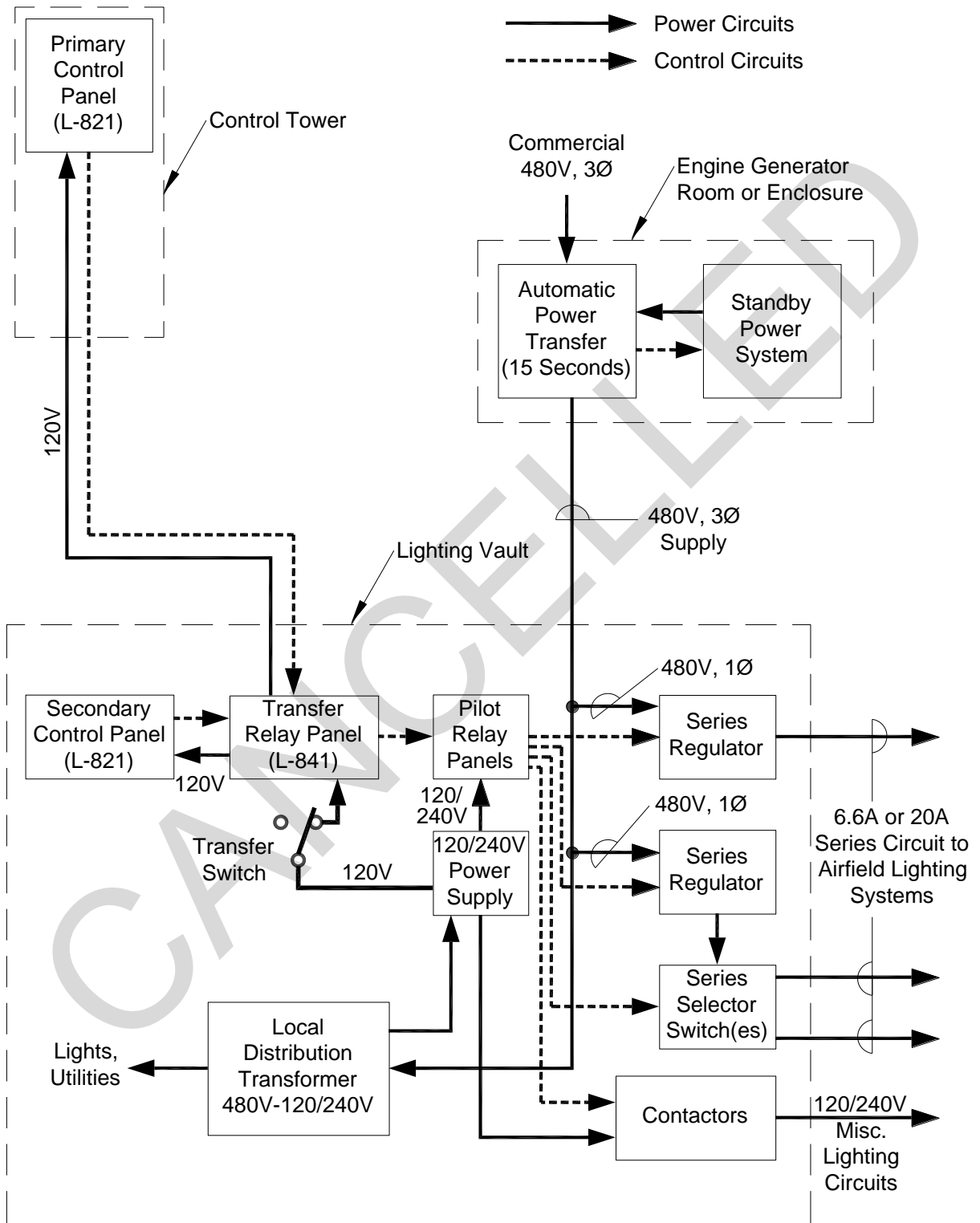

Figure 12-4 Power and Control System Block Diagram



12-1.11.3 Control System Modernization.

Major commands are encouraged to consider the use of control systems, where significant economies or operational improvements can be achieved. If an approved specification is not available, the use of such systems is subject to the requirements of paragraphs 1-11 or 1-12 of this document. Control systems using electromagnetic emissions also require the express approval of AFCEC/COSM. As examples, Figure 12-5 shows a block diagram for a control system using programmable logic controllers (PLC), and Figure 12-6 shows a block diagram for a PC-based control system. Further discussion of computerized control systems is also provided in Chapter 13.

Figure 12-5 Computerized Control System using PLC Block Diagram

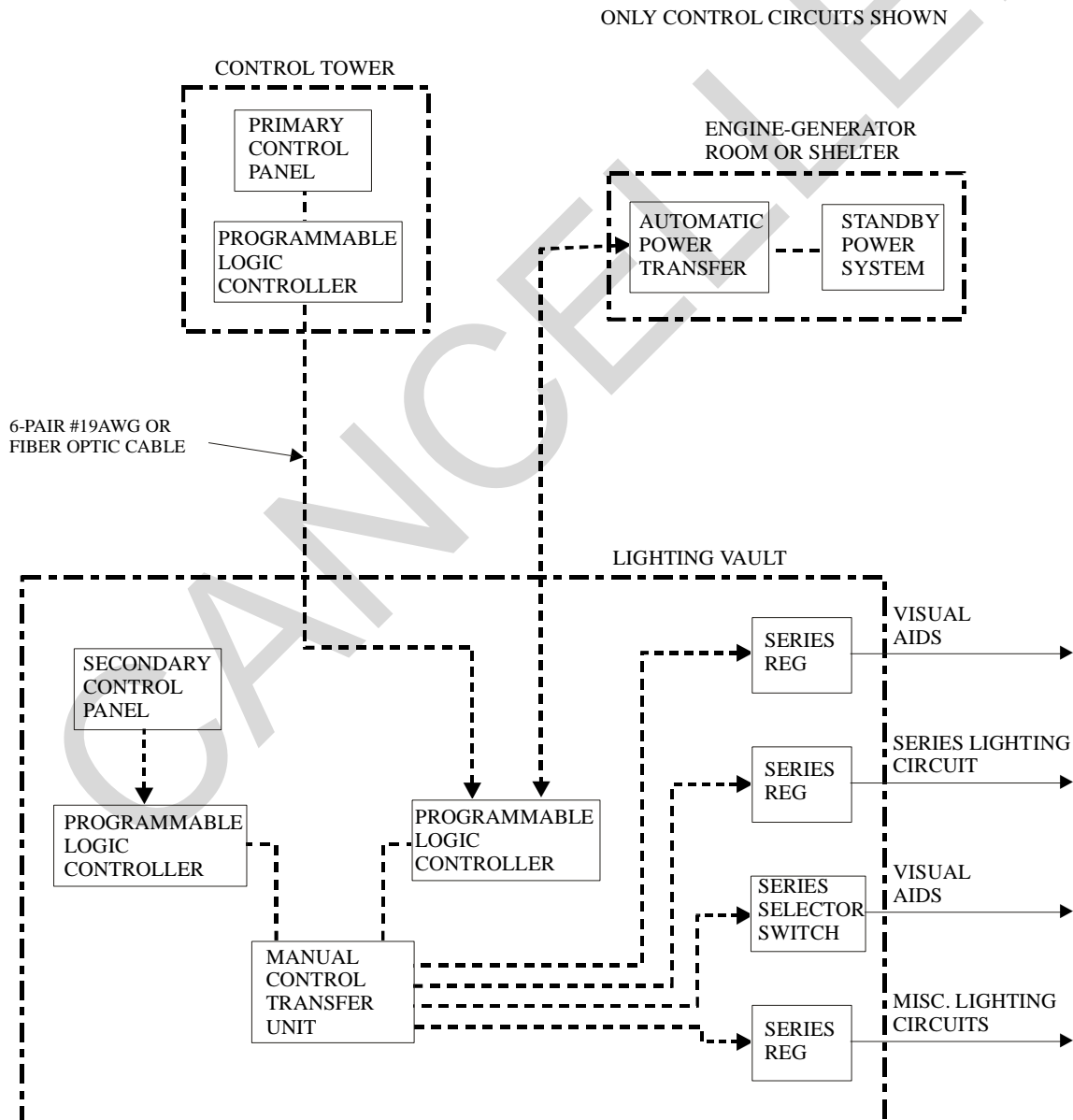
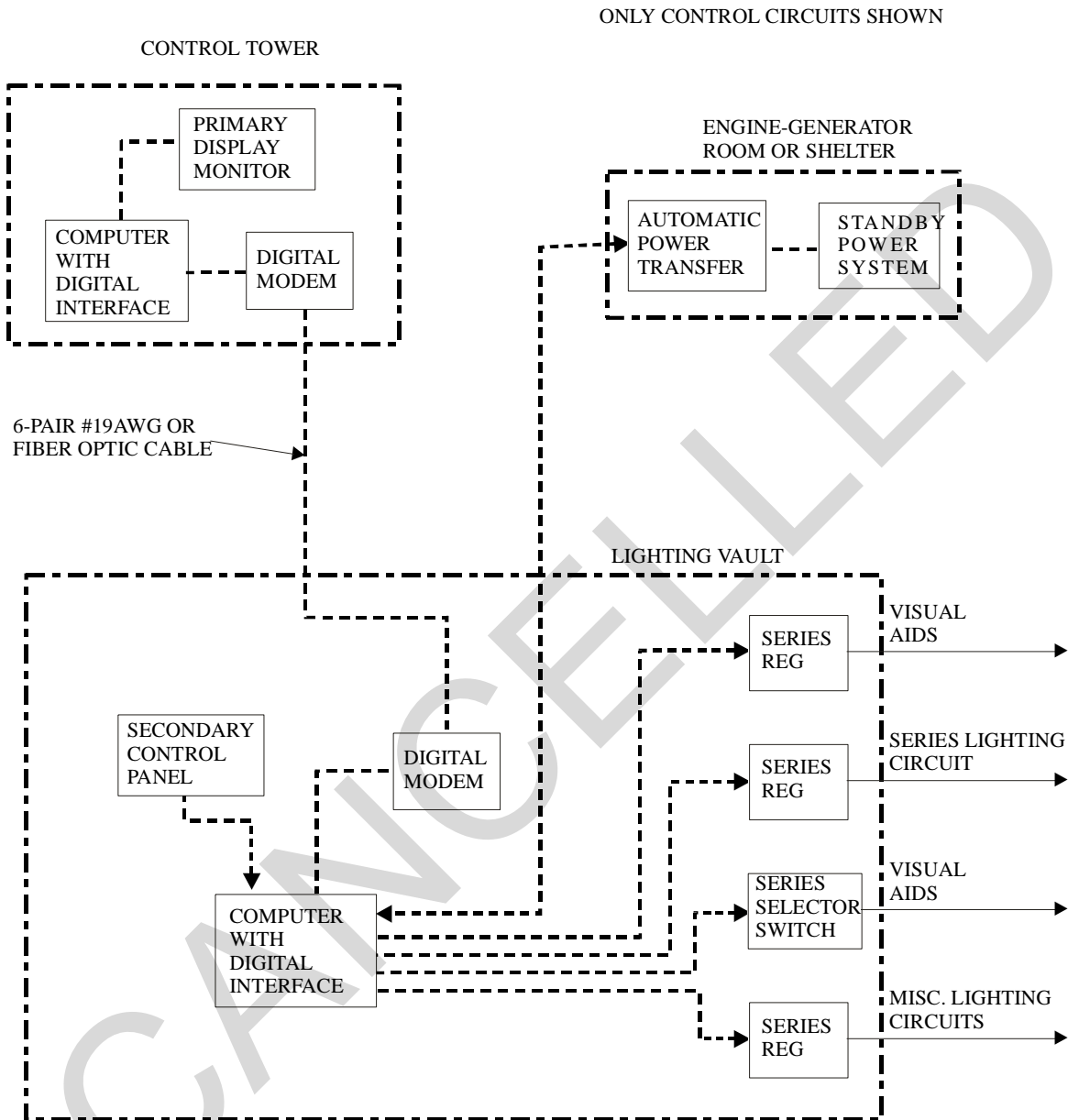

Figure 12-6 Computerized Control System using PC Block Diagram



See FAA AC 150/5345-56 for detailed ALCMS equipment requirements. See also FAA AC 150/5345-30, for ALCMS installation and operational requirements.

12-1.12 Light Colors.

For a complete description of incandescent aviation light colors, see SAE AS25050, the applicable FAA Advisory Circular, and a Chromaticity (CIE) color coordinate diagram.

For light emitting diode color requirements, see FAA Engineering Brief 67.

12-1.13 Light Intensity.

12-1.13.1 The brightness steps for the levels of incandescent lamp intensity are shown in Table 12-2.

Table 12-2 Intensity Requirement Levels for Incandescent Light Circuits

Brightness Step	Amperage Reading 20-Ampere Circuit	Amperage Reading 6.6-Ampere Circuit	Approximate Percent Rated Intensity
1	8.5	2.8	0.16
2	10.3	3.4	0.80
3	12.4	4.1	4.00
4	15.8	5.2	20.00
5	20.0	6.6	100.00

12-1.13.2 The brightness steps for three levels of incandescent lamp intensity are achieved by varying the current in the lighting circuit as follows:

<u>Brightness Level</u>	<u>Service Systems Lamp Current (amps)</u>	<u>Percent Brightness</u>
High	6.6	100
Medium	5.5	30
Low	4.8	10

For light emitting diode intensities, see FAA Engineering Brief 67.

12-1.14 Special Considerations for Series Circuits.

12-1.14.1 Selection of 6.6 or 20 Amperes Circuit.

12-1.14.1.1 See FAA AC 150/5340-30 for detailed information about airport series lighting system design. The FAA no longer allows 50 and 70 kW constant current regulators for new designs; these regulators can be used for replacements only. The FAA also suspended the use of 2400 V AC input regulators for all new designs; these regulators may only be used for replacements.

12-1.14.1.2 The determination of whether to use a 6.6 amperes or 20 amperes series circuit must be based on several factors relating to the characteristics of the circuit and the anticipated conditions under which the circuit will be operated. In general, if a circuit is not expected to operate at highest intensity more than 5 percent of the time, and if design calculations show that the voltage will not exceed 2.4 kV when operated at the midlevel (step 2 for 3-step circuits, step 3 for 5-step circuits), then a 6.6 ampere circuit is

recommended. If a circuit is expected to operate at highest intensity more than 5 percent of the time, and if design calculations show that the line voltage will be more than 2.4 kV at the mid-level, then consideration should be given to using a 20 amperes circuit, or alternatively using more than one 6.6 amperes circuit.

12-1.14.1.3 The primary circuit cables are insulated for 5,000 volts. If the load is over 33 kW and operated at 6.6 A, the required voltage would exceed 5,000 volts. Therefore, the circuit should be operated at 20 A to reduce the voltage below the insulation rating of the series lighting circuit high voltage cable.

12-1.14.1.4 Analysis should consider the economics over the expected life of the system, typically 20 years. A more detailed discussion of this can be found in Chapter 13. Recommend designing for multiple 6.6 ampere circuits instead of 20 ampere circuits.

12-1.14.2 REIL on Series Circuits.

REIL (runway end identifier lights) are typically connected to the runway edge lighting series circuit via a power adapter, or to a separate power source of 120/240 volts. If connected to a series circuit, it is necessary to consider the sizing of the regulator carefully to allow for the pulsing type of load. The impact on the constant current regulator may be up to 10 times the power requirement indicated by the manufacturer. More information on this can be found in Chapter 13.

12-2 ADDITIONAL GUIDANCE.

12-2.1 General.

The FAA has published guide specifications for installation of airfield lighting systems. FAA guide specifications come in two forms: advisory circulars in the 5340 series, and FAA-E specifications. A listing of applicable publications is provided below. Where those guides are in conflict with the Air Force requirements listed above, the Air Force requirements take precedence. The FAA has an Advisory Check List AC 00-X.X that provides a list of documents, and how to order them. Contact the FAA at 1-800-FAA-SURE, (fax: 301-386-5394).

12-2.2 FAA Advisory Circulars (ACs).

FAA Advisory Circulars and Engineering Briefs may be downloaded free of charge from the FAA website: <http://www.faa.gov/airports/engineering/>.

12-2.2.1 FAA AC 150/5340-30 covers runway/taxiway lighting, visual aids (PAPI, REIL, Airport Beacons, Wind Cones, MALSF).

12-2.2.2 FAA AC 150/5340-18 describes the recommended standards for design and installation of a taxiway guidance sign system.

12-3 SITING PAPI.

12-3.1 Considerations.

Siting a PAPI requires consideration of the following: if there is or will be an ILS glide slope, the established glide path (aiming angle, typically 3 degrees), the threshold crossing height (TCH) for the selected aircraft height group, the runway gradient (longitudinal slope) from the threshold to the PAPI location, and other factors.

12-3.1.1 With an ILS glide slope, the PAPI is located the same distance from the runway threshold so that the elevation of the lens center of the light units intercepts the runway at the same location as the virtual source of the ILS glide slope, within a tolerance of ± 30 feet (± 9 meters), and is aimed at the same angle as the ILS glide slope. The virtual source is the Runway Point of Intercept (RPI), where the glide path intercepts the ground elevation along the runway centerline. PAPI location considers the light beam, where the elevation of the lens center of the PAPI light units should intercept the ground elevation along the runway centerline (within tolerance). For aircraft in height group 4 (Table 3-6) for Army airfields only, the PAPI is sited at the RPI plus an additional 300 feet (90 meters), +50 feet –0 feet (+15 meters –0 meters), from threshold.

12-3.1.2 If there is no ILS or Precision Approach RADAR (PAR) glide slope, the PAPI is sited as shown in Figure 12-7. First determine the following:

12-3.1.2.1 Glide Path.

Typically this is 3 degrees, but it may vary at some locations.

12-3.1.2.2 Threshold Crossing Height (TCH).

See Table 3-6. For the Air Force, the TCH is based on the most predominant aircraft using the runway (the major command will make this determination). For the Army, the TCH is based on the most demanding aircraft height group expected to use the runway (the aviation community will coordinate with USAASA for this determination).

12-3.1.2.3 Runway Gradient.

This may be available from record drawings, or determined by field survey. Usually the grade is given as a percent representing the vertical elevation difference over a longitudinal distance (threshold through approximate PAPI location). For example, a 1 percent grade represents a 12 inch (300 millimeters) height difference over a 100 feet (30 meter) length. This is converted to an angle in degrees, α , using the relationship: $\tan \alpha = \text{percent grade (expressed as decimal)}$. With this relationship, a grade of 1 percent represents a runway slope of 0.573 degrees (from the horizontal).

12-3.1.3 Determine the Runway Reference Point (RRP) based on runway gradient, as shown in Figure 12-7, establishing the RRP where the elevation of the lens center of the light units coincides with the elevation of the runway centerline. The method provides a direct solution, based on two equations and two unknowns, when the grade of the runway is relatively uniform. The RRP is based on the PAPI light beam, where the elevation of the lens center of the PAPI light units intercept the ground elevation along the runway centerline (within tolerance). Case 4 in Figure 12-7 provides an iteration method for locating the RRP when the runway grade varies significantly through the first approximately 1,500 feet (450 meters).

12-3.1.4 Adjust the location of the PAPI for cross slope or other factors, as required. Several examples of how the location of the RRP or location of the PAPI might be adjusted are presented below. Stay within allowable tolerances and other dimensional requirements of paragraph 12-3.2. See Figure 12-8 for guidance on tolerances and adjustments if PAPI cannot be located at the RRP.

12-3.1.4.1 Where the terrain drops off rapidly near the approach threshold and severe turbulence is typically experienced, it would be beneficial to locate the RRP and PAPI farther from the threshold if sufficient runway length is available. In this case consider using the maximum TCH allowed by tolerance in determining the RRP.

12-3.1.4.2 On shorter runways, the RRP and PAPI may be located nearer the threshold to provide the maximum amount of runway for braking after landing. In this case consider using a lower TCH as allowed by tolerance in determining the RRP.

Figure 12-7 Siting PAPI without an ILS Glide Slope (1 of 2)

a. Case 1 - Runway with downward grade.

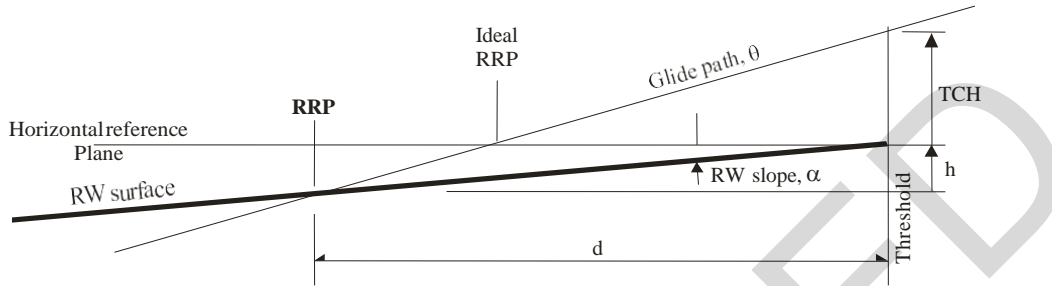

Two relationships can be defined which have two unknowns (d, h):

$$\tan \theta = \frac{TCH+h}{d}, \text{ and } \tan \alpha = \frac{h}{d}$$

Substituting and solving the above, d is determined directly by: $d = \frac{TCH}{(\tan \theta - \tan \alpha)}$

b. Case 2 - Runway with upward grade.

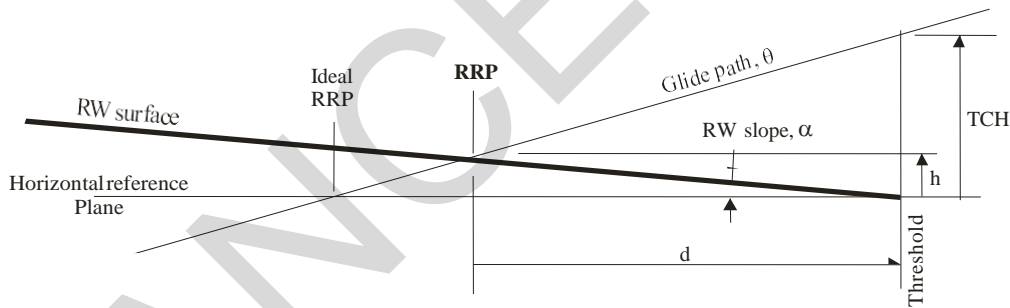

From the relationships, d is determined directly by: $d = \frac{TCH}{(\tan \theta + \tan \alpha)}$

EXAMPLES (Assume the following: TCH = 50 feet (15 meters), $\theta = 3$ degrees)

Case 1 (RW with 1% downward grade, $\alpha = 0.573$ degrees) $\Rightarrow d = 50 / [\tan 3 \text{ degrees} - \tan 0.573 \text{ degrees}] = 1,179 \text{ feet (360 meters)}$

Case 2 (RW with 1% upward grade, $\alpha = 0.573$ degrees) $\Rightarrow d = 50 / [\tan 3 \text{ degrees} + \tan 0.573 \text{ degrees}] = 801 \text{ feet (244 meters)}$

Case 3 (RW is level - 0% grade, α and $\tan \alpha$ are both 0) $\Rightarrow d = 50 / [\tan 3 \text{ degrees}] = 954 \text{ feet (290 meters)}$ [not illustrated]

While the slope should be constant through the first part of a runway, if the existing slope varies too much to directly apply Case 1, 2 or 3, then a trial method illustrated by Case 4 can be used. In all cases, the location of the glide path intercept with the actual runway surface (RRP) must be determined.

Case 4 - Runway grade varies too much to apply above methods \Rightarrow [See sheet 2 of 2]

Figure 12-7 Siting PAPI without an ILS Glide Slope (2 of 2)

c. Case 4 - Runway with varying grade.

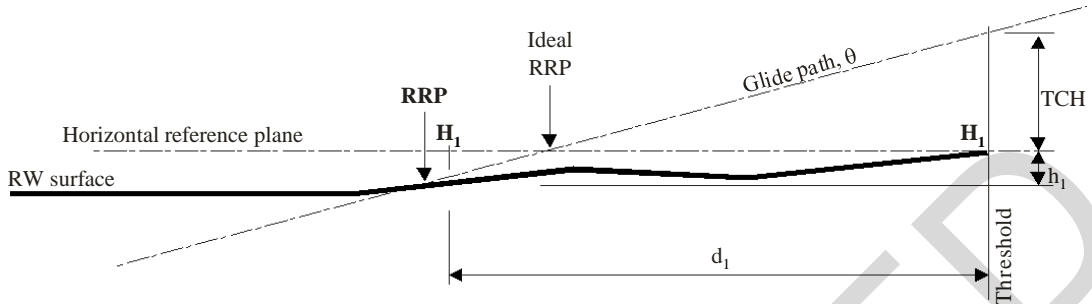

Use this method if longitudinal runway grade changes within 2200 feet (671 meters) from the runway threshold.

Consider that a 0.1% change in runway grade at about 500' (150M) from threshold translates to a 6" (15cm) change in elevation at 300M (1,000'), and about a 10' (3M) error in calculating the RRP, using the runway grade beginning at the threshold. The trial method requires elevation data along the runway centerline in proximity of the PAPI site.

- (1) Select a trial value for d_1 ("d"). [Case 1 or Case 2 can be used to select initial trial value].
- (2) At distance d_1 , determine elevation difference from threshold ($H_0 - H_1 = h_1$)
- (3) Test d_1 and h_1 in following equation:
$$TCH + \frac{h_1}{d_1} = ? \tan \theta$$

[NOTE: $\tan \theta = 0.0524$ for glide path angle of 3°.]

(4) If value in (3) is larger than $\tan \theta$, then increase d , determine new h , and test equation in (3). If value is smaller than $\tan \theta$, then decrease d , determine new h , and test equation in (3). Continue until within about ± 0.0001 of $\tan \theta$ [this yields a value for "d" within about $\pm 2'$ of where RRP should be located].

Example data from field survey				
Point	Station	D	H	h
Thld, 0	0+00	0	110.4'	-
1	9+50	950'	114.6'	4.2'
2	10+00	1,000'	115.0'	4.6'
3	10+50	1,050'	115.4'	5.0'

EXAMPLE Case 4 (Assume the following: $TCH = 50'$, $\theta = 3^\circ$).

At $d_1 = 950'$, $h_1 = 4.2'$, and $(TCH+h)/d = 0.0571$ (too large)

At $d_2 = 1,000'$, $h_2 = 4.6'$, and $(TCH+h)/d = 0.0546$ (closer)

At $d_3 = 1,050'$, $h_3 = 5.0'$, and $(TCH+h)/d = 0.0524$ (matches $\tan \theta$ - OK)

[NOTE: Suggested longitudinal tolerance for locating PAPI is + or - 10'.]

DEFINITIONS:

- RRP = RW reference point, where PAPI is located based on adjustment for runway grade.
- Ideal RRP = RW reference point if runway has 0% grade (no slope).
- RW = Runway
- TCH = Threshold crossing height
- d = Distance PAPI is located from runway threshold, based on adjustment for runway grade.
- θ = Glide path angle, degrees (from horizontal).
- α = Runway slope, degrees (use positive value in above equations).
- h = Elevation (height) difference between RW threshold and RRP, measured on RW centerline surface.
- H = Elevation at a point along runway centerline.

Figure 12-8 PAPI Positioning Guidance

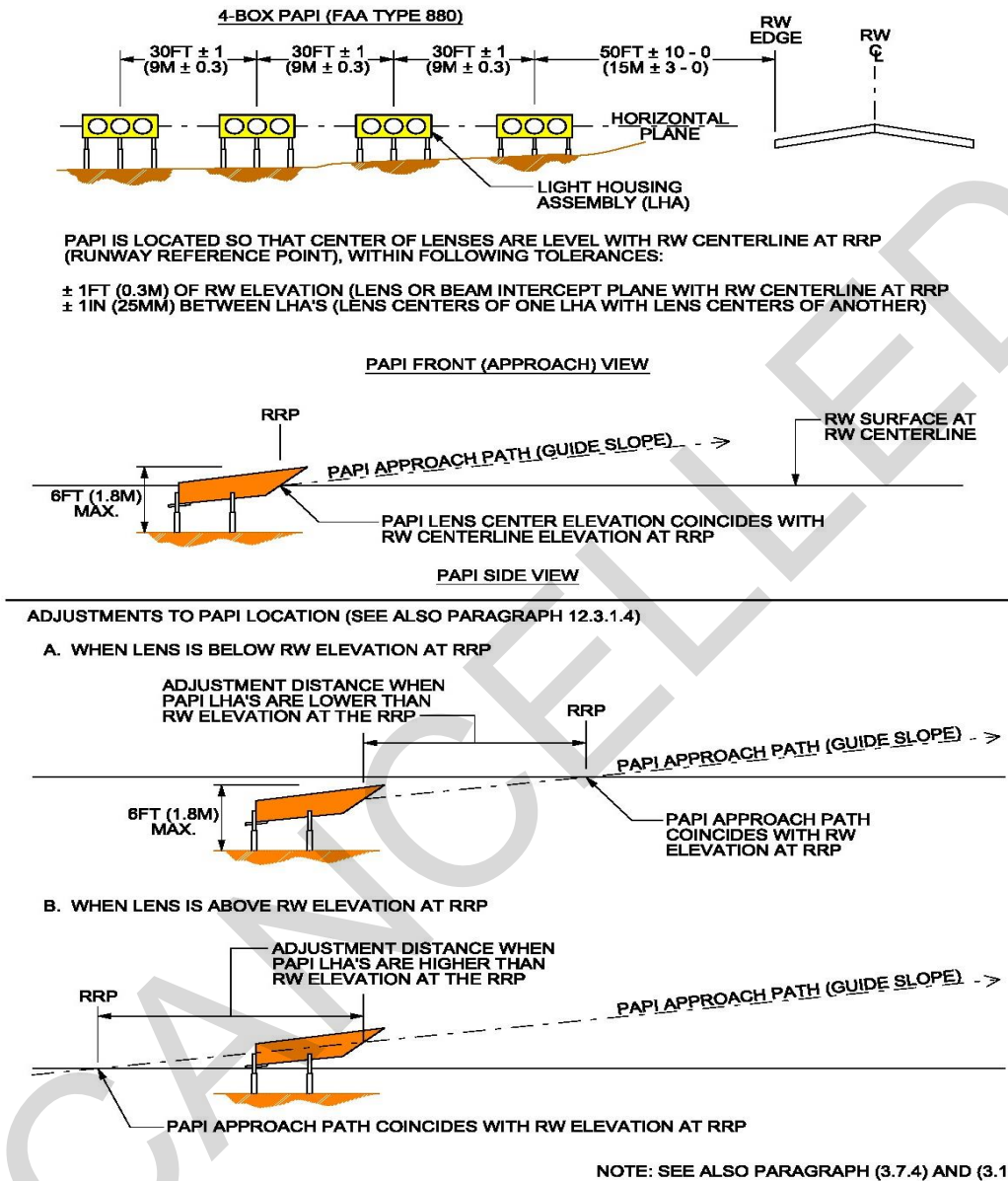

12-3.1.4.3 At locations where snow is likely to obscure the light beams, the light units may be installed so the top of the unit is a maximum 6 feet (1.8 meters) above ground level. This may require locating the light units farther from the runway edge to ensure adequate clearance for the most critical aircraft. If the light beams are higher than the allowable tolerance, with respect to the elevation of the runway centerline (raising the TCH for the visual glide path), the PAPI may be relocated closer to the threshold to maintain the RRP and TCH.

12-3.1.4.4 The cross slope at the preliminary RRP location may result in the light units sitting too high or too low with respect to the runway centerline elevation. In such cases, the PAPI may be relocated closer to or farther from the threshold to maintain the RRP and TCH and remain within tolerance.

12-3.2 Other Dimensions and Tolerances for PAPI.

12-3.2.1 Distance from Runway Edge.

Install the inboard PAPI light unit no closer than 50 feet, +10 feet –0 feet (15 meters, +3 meters –0 meters) from the runway edge, or from the edge of other runways or taxiways.

12-3.2.2 Separation Between Light Units.

Provide lateral separation of 30 feet (9 meters) between light units. This may be reduced to no less than 20 feet (6 meters) if warranted by conditions. The distance between light units must be equal and not vary by more than 1 foot (0.3 meters).

12-3.2.3 Azimuthal Aiming.

Aim each light unit towards the approach zone on a line parallel to the runway centerline, within a tolerance of ± 0.5 degree.

12-3.2.4 Mounting Height Tolerance.

The beam centers of the four light units must be within ± 1 inch (± 25 millimeters) of a horizontal plane. This plane must be within ± 1 foot (± 0.3 meters) of the elevation of the runway centerline at the intercept point of the visual glide path with the runway (RRP), except for adjustments under conditions in paragraph 12-3.1.4.

12-3.2.5 Tolerance Along Line Perpendicular to Runway.

The front face of each light unit in a light bar must be located on a line perpendicular to the runway centerline within a tolerance of ± 6 inches (± 150 millimeters).

12-3.2.6 Vertical Aiming of Light Beams.

For 4-box L-880 PAPI, the units are aimed as shown in Table 12-3.

Table 12-3 Aiming of FAA Type L-880 PAPI Relative to Glide Path

Light Unit	Aiming Angle (in minutes of arc)	
	Standard installation	Height Group 4 Aircraft on Runway with ILS
Unit nearest runway (#1)	30' above glide path	35' above glide path
Next adjacent unit (#2)	10' above glide path	15' above glide path
Next adjacent unit (#3)	10' below glide path	15' below glide path
Next adjacent (outside) unit (#4)	30' below glide path	35' below glide path

12-4 PULLING CABLE INTO DUCT.

12-4.1 Pull cable into ducts carefully to prevent harmful stretching of the conductor, injury to the insulation, or damage to the outer protective covering. Duct should be verified as open, continuous, and free of debris prior to installing cable. The following summarizes guidance for pulling cable from FAA Specification FAA C-1391. This document may be referenced for additional information.

12-4.2 Seal all cable ends with moisture-sealing tape before pulling, and maintain seals until connections are made. All cables to be installed in one duct should be pulled at the same time. Splices should not be pulled into a duct.

12-4.3 Apparatus for pulling cable at entrances to structures may include a pulling tube or framework and two sheaves. The diameter of the sheaves should be at least 10 times the diameter of the largest cable to be pulled. Cable may be pulled by power winch or by hand. Adequate cable pulling compound should be used of an approved type (do not use petroleum grease).

12-4.4 Structures such as manholes, hand holes, junction boxes, and light bases are typically spaced so as to avoid excessively long cable pulls. The spacing should not exceed 600 feet (180 meters), and spacing not more than 400 – 500 feet (120 – 150 meters) is preferred.

12-4.5 If possible, the maximum allowable cable length to be pulled should be obtained from the cable manufacturer. An estimate of the absolute maximum length of pull based on new, level, straight plastic duct and the use of adequate pulling compound is as follows:

$$L = T/CW$$

Where: L = Length of cable pulled (in feet)
 T = Total tension (in pounds)
 C = Coefficient of friction (0.3 for single cables, 0.4 for multiple cables)
 W = Weight of all cables being pulled (in pounds/foot)

12-4.6 A dynamometer should be used to monitor the cable tension during pulling. Alternatively, a contractor may adapt a rope harness properly sized to limit pull tension. Types and sizes for ropes used in this manner may be found in FAA C-1391 Table 1. Maximum pulling tension should be no greater than manufacturer's data on allowable cable pulling tension. Any combination of a group of cables to be pulled into a duct must not exceed the sum of individual allowable tension of each cable plus 15 percent. Typical examples of the allowable maximum tension for various types of cable are shown in Table 12-4.

Table 12-4 Maximum Allowable Non-Armored Cable Pulling Tension, Using Dynamometer

Cable	Tension Lb (Kg)
2 – 1/C AWG #8 solid (10 square mm)	275 (125)
3 – 1/C AWG #8 solid (10 square mm)	367 (167)
4 – 1/C AWG #8 solid (10 square mm)	550 (250)
2 – 1/C AWG #6 stranded (16 square mm)	420 (191)
3 – 1/C AWG #6 stranded (16 square mm)	630 (286)
4 – 1/C AWG #6 stranded (16 square mm)	840 (382)
1 – 2/C AWG #8 stranded (10 square mm)	305 (139)
1 – 3/C AWG #8 stranded (10 square mm)	395 (180)
1 – 4/C AWG #8 stranded (10 square mm)	585 (266)
1 – 2/C AWG #6 stranded (16 square mm)	455 (207)
1 – 3/C AWG #6 stranded (16 square mm)	685 (311)
1 – 4/C AWG #6 stranded (16 square mm)	880 (400)
1 – 6/C AWG #12 stranded (4 square mm)	315 (143)
1 – 12/C AWG #12 stranded (4 square mm)	630 (286)
1 – 12 pair AWG #19 solid (0.75 square mm)	230 (105)
1 – 25 pair AWG #19 solid (0.75 square mm)	541 (246)
1 – 50 pair AWG #19 solid (0.75 square mm)	1,061 (482)
1 – 100 pair AWG #19 solid (0.75 square mm)	2,000 (909)

12-4.7 The pressure on a cable or cables being pulled is affected by a radius or bend in a duct. For non-straight segments of duct the following, based on manufacturer information, is recommended as a guide in limiting the tension with duct radius (T is the maximum allowable pulling tension, and R is the radius of the duct):

$$T(\text{lbs}) / R(\text{ft}) \leq 300 \text{ (English Units) or } T(\text{kg}) / R(\text{m}) \leq 456 \text{ (Metric Units)}$$

12-5 ICE DAMAGE PREVENTION.

Water in light bases is very common. In cold regions placing several 2 by 8 inch (50 millimeter by 200 millimeter) closed cell foam disks in the light base will help prevent ice damage to the base, light fixture and isolation transformer.

This Page Intentionally Left Blank

CANCELLED

CHAPTER 13 CHARACTERISTICS OF AIRFIELD GROUND LIGHTING

13-1 GENERAL.

Airfield ground lighting (AGL) typically includes separate series-circuited lighting systems that provide visual guidance to the pilot for aircraft operations. The systems usually have brightness control for adapting to various visibility conditions. The types of lighting systems installed for a particular runway are an important part in determining the conditions under which aircraft operations are allowed (e.g., Visual Flight Rules (VFR), Category I, Category II, or Category III). The various lighting systems that may be installed for a runway are shown in Figure 13-1. Not included in this figure are the several approach lighting systems (ALS) which may also be installed. Details for lighted approach aids, runway lighting systems, and taxiway lighting are provided in Chapter 3, Chapter 4 and Chapter 5, respectively.

13-1.1 Airfield ground lighting is characterized by constant current series electrical circuits, which provide constant current for intensity control of lighting components. This system allows for selectively changing the brightness of the lighting components by increasing or decreasing the level of the constant current in the series loop. While some older systems use constant voltage for shorter length series circuits, most systems today are constant current type. The series circuit provides energy at constant current to each device (such as a light or sign) on the circuit, supplied from a CCR.

13-1.2 The major parts of a series circuit are: the CCR (power source), the primary circuit cable, isolation transformers, and lighting components (such as lights and signs). The isolation transformers are connected in series on the primary side, with connected loads on the secondary side of each isolation transformer (Figure 13-2). The system is characterized as follows:

- A constant current is delivered along the entire loop on the primary side of the isolation transformers, independent of the number of lighting loads. Power is provided by the CCR.
- The magnitude of the voltage along the series circuit primary depends on the number and size of connected lighting loads. The voltage along the primary cable will measure different at each point. (Calculating voltages for the constant current series circuit is illustrated later in this chapter.)
- The circuit is considered high voltage on the primary side, which typically may be several thousand volts (5kV cable is used), and low voltage on the secondary side or load side of the isolating transformers, which typically is less than 30V.

- The isolation transformer provides an effective short for the primary circuit in the event of a lamp filament failure, which opens the secondary circuit. This prevents failure of a connected light from causing an open condition on the series primary circuit.
- A constant current series circuit can also be used to power equipment with specific voltage requirements. In this case a power adapter is used. The power adapter also serves to isolate the device from the primary side similar to an isolation transformer. Examples of equipment which may be connected to series lighting circuits include: wind cones, PAPI, REIL, and others which typically may require 120/240V power. The lighting circuit must be ON for the equipment to receive power with this type of arrangement.

CANCELLED

Figure 13-1 Typical AGL Layout

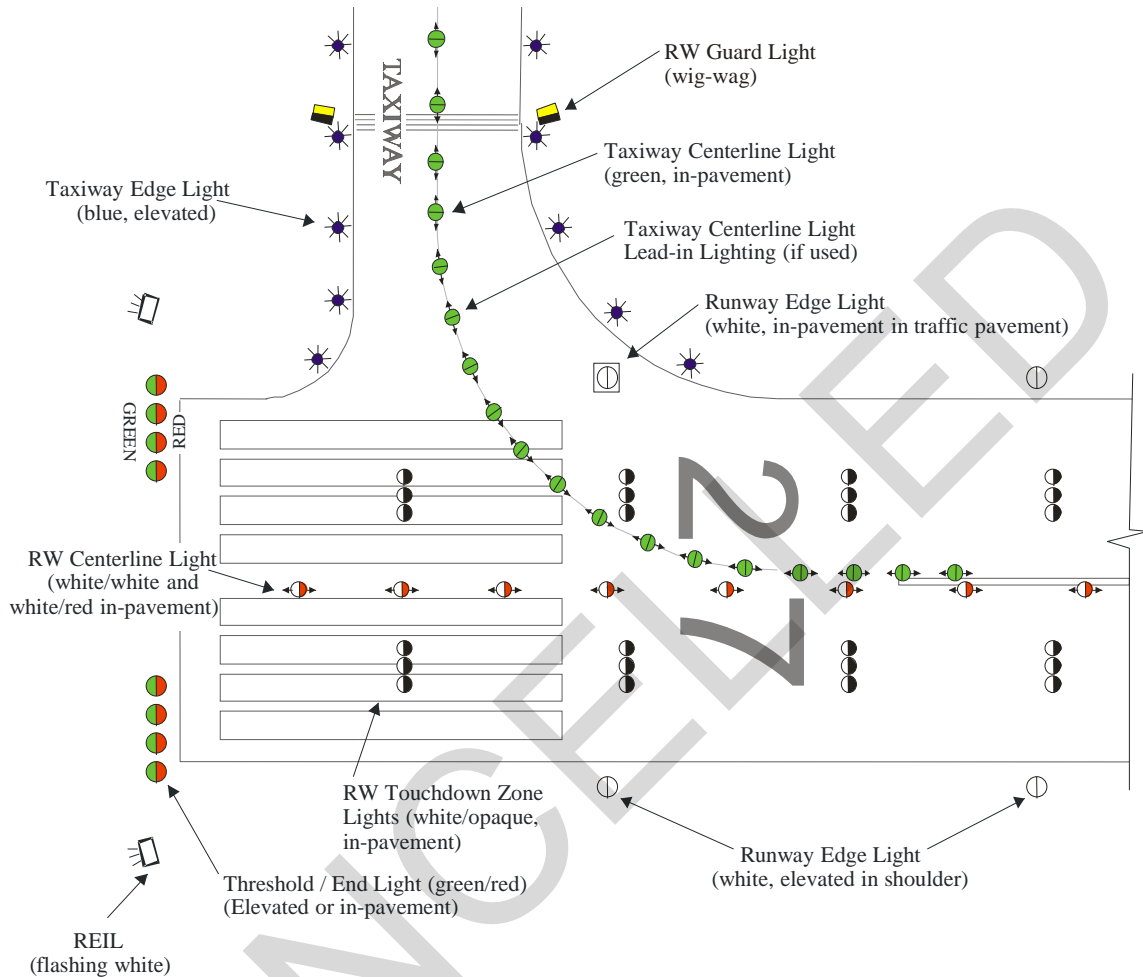

NOTES:

1. RW EDGE LIGHTING: For high intensity system (HIRL) bidirectional, white/white, with yellow on rollout for last 2,000' (610M) (L-862 elevated, with L-850C for in-pavement). Runway edge lights are spaced about 200' (61M) apart.
2. THRESHOLD/END (T/E) LIGHTS: Group of 4 or 5, spaced 10' (3M) apart symmetrical about centerline. Outer light in each group lines up with RW edge lights. Groups may be wing-out bars, where inner light in each group lines up with RW edge lights.

T/E lights show green to aircraft approaching for landing, and red to landing aircraft coming to end of the RW.
3. RW CENTERLINE LIGHTS: Bi-directional white/white, with alternating red/white and white/white from 3,000' to 2,000' (915M to 610M) from end of RW, and red/white for last 2,000' (610M) of RW.
4. RW TOUCHDOWN ZONE LIGHTS: Uni-directional, with white towards approaching aircraft.
5. TW EDGE LIGHTS: Omni-directional blue (L-861T).
6. TW CENTERLINE LIGHTING: Bi-directional green/green, but may be green/yellow or yellow/yellow for some conditions.
7. REIL: Runway End Identifier Lights, discharge type flashing white lights (about 90 times/min.), Aimed 15 deg outward and 10 deg above horizontal.
8. RW GUARD LIGHT: Uni-directional, flashing yellow. Elevated outside TW, or may be bar of in-pavement across pavement (L-804).

Figure 13-2 Typical AGL Series Lighting Circuit

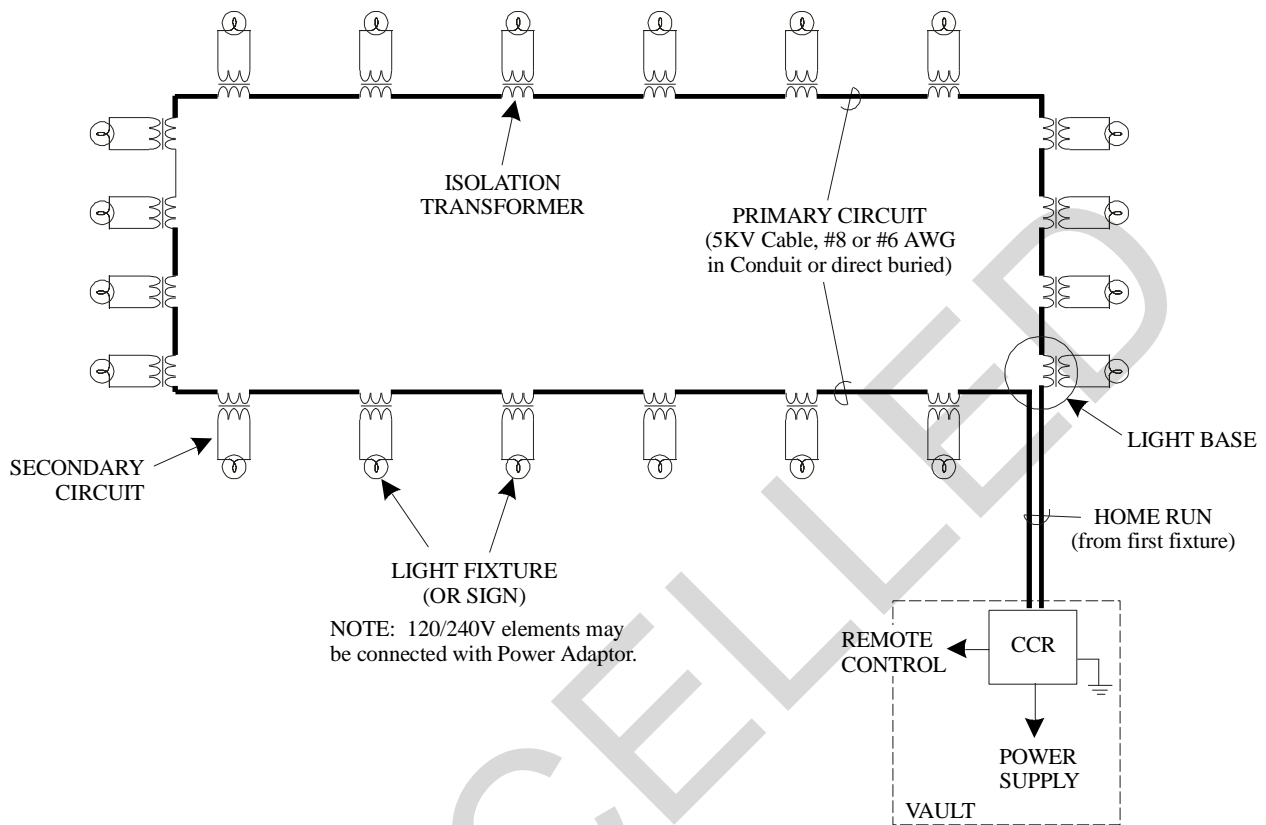

13-1.3 Parallel circuits are briefly discussed as these may be used to serve facilities such as wind cones, PAPI, REIL, and others. This may be directly from a power source, or via power adaptor from a series lighting circuit.

13-2 POWER.

Upstream power for the CCR feeding the AGL may be from a variety of sources. Equipment vaults for AGL may be fed from a variety of sources, and in many cases have emergency standby generator power with automatic transfer in case of outages. Older systems typically feed the CCR at 2400V, while newer installations feed vault CCRs at 480V; 2400V input CCR equipment is for replacement only. The upstream power distribution feeding the CCR is not covered in this section.

13-3 CONTROL AND MONITORING SYSTEMS.

Traditional control/monitoring systems, both military and commercial, are relay systems. L-821 relay panels are very reliable and are suitable for nearly all military airfields. Typically, cables required for these types of systems are multi-pair (50 or more pairs) cables to connect the airfield lighting vault on the airfield with the air traffic control tower. On many air bases, the distance between the two facilities is great, resulting in a costly cable installation with the cable vulnerable to possible damage or failure of one or more

pairs in the cable. In addition, these communications cables require separate duct systems to eliminate interference from the power cables. The traditional relay panel and multi-conductor control cable can also be simplified by using a multiplexer, which requires only one pair cable to communicate between the vault and tower (or other station). A multiplexer can also be built into a PLC system.

13-3.1 Some airfield control/monitoring systems have been installed using Programmable Logic Controllers (PLCs). The PLC industrial systems use high I/O modules that reduce the need for multi-pair cable installation. Cables with 2 to 6 pairs are typically needed, although fiber optic cable can also be used.

13-3.2 PC-based systems are currently being used, with computers (Windows 7 operating system is approved by AF Chief Information Officer) located in the tower, the vault, and/or other work stations. These systems have the capability of displaying the necessary information on a monitor. This is the most flexible system in use today, with off-the-shelf units readily available. Typically, standard operating software is used, and off-the-shelf graphics software is tailored for a specific site. The communications cable requirements are 2 to 6 pairs of cable or fiber optics. Fiber optic cable eliminates the need for separate ducts since there will be no interference between power cable and fiber optic cable. The control panel typically is a touch-screen type. At the time of this writing the essential system PCs are recommended to have the following characteristics: 19" (480 millimeter) rack mount form factor, fully enclosed metal housing, redundant hot-swappable solid state software and data storage devices, redundant hot-swappable cooling system, redundant hot-swappable power supplies. The systems incorporate uninterruptible power supplies (UPS) for primary power to all system components required for normal operation for a duration of fifteen minutes.

13-3.3 Compared to the traditional FAA Type L-821 control/monitoring systems, the PLC or PC-based systems are easily expanded and provide data for the air traffic controller and maintenance personnel. Refer to FAA AC 150/5345-56. Some industrial standards the PLCs meet are NEMA ICS1, NEMA ICS2, NEMA ICS 3, UL 508, ANSI/IEEE C 37.90.1-1989, CAN/CSA C22.2 No. 142, MIL-STD-461B, MIL-STD-810 and ISO 9000.

13-3.4 Often, the computerized system is based on one specific manufacturer's equipment. This limits the facility to one manufacturer for both service and parts. A good system design will avoid this by establishing competitive parameters in the procurement document.

13-3.5 Considerations for the design of a computerized control/monitoring system are in paragraph 13-18.6.

13-3.6 Factors for consideration when selecting a control system:

- Monitoring AGL equipment: the PLC based system must be customized for each type of CCR.

- For PC based systems, software has been developed and tested, and is easily configured to monitor AGL equipment. Software developed for PC systems is specific for the task and works with all types of CCRs and other related AGL equipment.
- With PLC systems there are established industrial standards and criteria for mean-time-between-failure (MTBF).

13-4 CONSTANT CURRENT SERIES CIRCUITS.

A constant current series circuit is an ungrounded system, where circuit elements are connected in a string with the same current flowing to each element. The circuit is one continuous loop starting and ending at the power source (the constant current regulator for the AGL circuit). The CCR maintains a constant current independent of the load on the circuit.

13-4.1 Circuit Failure.

With constant current, a short-circuit across the output of the CCR is a no-load condition, and an open-circuit is an overload. In a simple series circuit, a lamp failure would cause an open-circuit. For this reason a bypass device such as an isolating transformer is installed between the primary side and secondary side as part of each light fixture connection, or for connecting other loads such as guidance signs. In certain cases, such as for approach lights where 5 steady-burning lights are on a single secondary circuit isolated from the primary series circuit by one or more isolation transformers, a film disc cutout may be used. Film disc cutouts operate in such a way that when a lamp burns out, the film-disc cutout shorts the failed lamp, thereby allowing current to flow to the remaining connected fixtures.

13-4.2 Advantages of Series Lighting Circuits.

- All lamps operate at the same current, hence same intensity.
- Single-conductor cable of one size and insulation voltage rating can be used throughout the circuit.
- Intensity control of lights can be obtained over a wide range.
- A single ground fault along the circuit will not affect light operation.
- Ground faults are easily located.

13-4.3 Major Disadvantages of Series Lighting Circuits.

- Installation costs are high when considering the CCR and isolating transformers.

- Poor efficiency in use of electrical power.
- All components on the primary side must be insulated for full voltage.
- An open-circuit anywhere on the primary side makes the entire circuit inoperative and could damage cable insulation or the CCR.
- Locating faults such as open-circuit conditions can be time-consuming and may be difficult.

13-4.4 Typical Usage.

Series circuits are usually used for runway and taxiway lighting systems and most steady-burning lights of approach lighting systems because they provide more uniform intensity and better intensity control of the lights.

13-5 CONSTANT CURRENT REGULATORS.

The power input to the AGL circuits is controlled by the CCR to which the circuit is connected. While the CCR produces constant current to the circuits depending on the brightness step setting, the voltage input to the circuit varies with the actual load.

13-5.1 Basically, there are three types of constant current regulators used at airports:

- Resonant network circuit (ferro-resonant type using a resonant network control system to produce output current).
- Saturable reactor (ferro-resonant type, where the amount of reactor saturation via closed control loop determines output current).
- Silicon controlled rectifier (SCR) (uses SCR type thyristors to convert constant voltage source to constant current output, with solid state control circuiting).
These are not ferro-resonant and are not approved for new installations.

13-5.2 The first two types have been reliable over the years, but fluctuations in input voltage will cause corresponding changes in the output current. Most CCRs now manufactured are SCR type.

13-5.3 Tests have shown that, as circuit load increases toward the rated capacity of a CCR, harmonic distortion is reduced and the wave form approaches a sine wave. This suggests that loading closer to rated capacity results in better circuit performance. However, lamp failures and other factors may increase the output voltage, and this needs to be considered when matching circuit load to CCR size.

13-5.4 CCRs have “taps” for adjustment to accommodate loads. Some manufacturers have introduced taps which automatically adjust to the circuit load, while others use manual taps which are typically set when the CCR is installed, but can be changed later to accommodate changes in the load.

13-5.5 The allowable tolerances in CCR output current are shown in FAA AC 150/5345-10. The allowable tolerances are small, because small changes result in large changes in light output. For a 6.6 amp circuit, reducing the current by 3 percent (to 6.4 amps) will reduce the light output over 15 percent, and reducing the current by 6 percent (to 6.2 amps) will reduce the light output by over 30 percent. The impact is the opposite on lamp life, where a current lower than maximum will significantly increase lamp life, and a higher current will reduce lamp life. The percent of full brightness obtained at each of the nominal current levels for 3 and 5 step systems can be found in paragraph 12-1.11.

13-5.6 15KW through 30KW CCRs may be selected for either 20 or 6.6 amperes output current. Intensity steps are either 5-step or 3-step for all CCRs.

13-5.7 50 kW and 70 kW regulators operating with 20A output current are not approved for new installations and are allowed for replacement only. Regulators with 2400V input are not approved for new installations.

13-6 REGULATOR SIZING.

13-6.1 For steady burning loads such as edge, centerline and touchdown zone lights sizing the regulator is fairly straight forward. Steady burning lights and circuit conductors are resistive loads and therefore will vary as the current varies. Current transformers are impedance loads and have the same electrical characteristics as resistive loads. See Figure 13-3A for calculating the load as the current varies; i.e., at the lowest brightness step. Using Ohms Law ($P=IE$), the maximum load at the lowest brightness level for a five-step regulator is determined by the ratio of the currents; i.e., (2.8/6.6) or (8.5/20) or 42.4% of the regulator rating. For a three-step regulator it is 4.8/6.6, or 72.7% of the regulator rating. It can be seen that these load percentages are greater than the ones calculated in Figure 13-3A. Therefore, a regulator fully loaded only with lights (and associated transformers) will not overload at the lowest current level.

Figure 13-3A Calculation of Steady Burning Load at the Lowest Brightness Level

DATA:

P = Steady Burning Light Load

I = Regulator Current

R = Steady Burning Light Load Resistance

Subscript H is the value at the Highest Brightness Step

Subscript L is the value at the Lowest Brightness Step

Ohms Law: $P = I^2 \times R$

CALCULATIONS:

$$P_H = (I_H)^2 \times R \rightarrow R = P_H / (I_H)^2$$

$$P_L = (I_L)^2 \times R \rightarrow R = P_L / (I_L)^2$$

The resistance of the lamp filaments remains constant, therefore

$$P_L / (I_L)^2 = P_H / (I_H)^2 \rightarrow P_L = P_H \times (I_L)^2 / (I_H)^2 \rightarrow P_L = P_H \times (I_L / I_H)^2$$

The effective load of the steady burning fixtures at the lowest brightness step (P_L) is the load at the highest brightness step (P_H) times the squared ratio of the low (I_L) and high (I_H) currents.

For a 6.6A five step regulator the current ratio squared is $(2.8/6.6)^2$ or 0.18 or 18%.

For a 20A five step regulator the current ratio squared is $(8.5/20)^2$ or 0.18 or 18%.

For a three step regulator the current ratio squared is $(4.8/6.6)^2$ or 0.53 or 53%.

SUMMARY:

For five step regulators the load of steady burning lights at the lowest brightness step is 18% of the load at the highest brightness step.

For three step regulators the load of steady burning lights at the lowest brightness step is 53% of the load at the highest brightness step.

13-6.2 When loads such as REILs, PAPIs, windsocks and airfield signage are connected to a series circuit, consideration must be given to accommodate the effect of these loads on the regulator. Loads such as these have unique power requirements. PAPIs, signs and windsocks must maintain a constant level of light output and require a constant input voltage. When they are connected to a series circuit that has varying current levels the power from the current regulator must be converted to a constant voltage source within the equipment. Airfield signs are required to maintain a constant level of illuminance on the sign face and electronics are needed to operate them from a varying current source. The commonality with all these loads is that they present a constant load to the regulator regardless of current level on the circuit. When the circuit is a combination of steady burning lights and signs or other constant loads, the engineer must insure that the calculated load at the lowest brightness level does not exceed the percentage of the regulator rating as indicated above. Figure 13-3B shows an example where the regulator is over loaded at the lowest brightness step. Although most regulators will continue to operate when over loaded there are risks associated with that. Depending on the degree of overloading, negative effects may include the regulator's inability to stay within the FAA current tolerances. The result would be improper brightness levels. Operating an overloaded regulator can also lead to the premature failure of critical components because the regulator will raise the output voltage to maintain the required current level.

13-6.3 In its Advisory Circulars, the FAA does not address the load imposed on the CCRs by the constant current to constant voltage adapters necessary for REIL operation, or the REIL that are connected into series circuits. With the constant flashing of the lights and the resulting discharging of the capacitor, the REIL place a very short, but heavy, pulsing load on the regulator. Occasionally, this type of pulsing load results in pulsation of the illumination of the steady burning lights on the circuit. This "reflective" pulsation depends on the characteristics of the regulator powering the circuit and on the characteristics of the REIL connected into the circuit. The design engineer needs to ascertain from the regulator manufacturer which type of CCR will handle the overall series circuit load with the addition of the REIL pulse-type load without adverse effect. It has been shown that the problem will be minimized if the REIL are connected into series circuits that have primarily incandescent loads and the circuit load approaches the capacity of the regulator.

13-6.3.1 The actual regulator capacity needed to operate the REIL properly is much greater than the rated load indicated in the typical product literature. Usually the average power requirement is provided; however, the regulator has to accommodate the instantaneous, or pulsing, load to provide the flashing characteristics of the REIL. That REIL may be rated to require only 400 watts to operate, but may actually require up to 4 kilowatts of regulator capacity to meet the pulsing load requirements when also including the impact of the series circuit adapters between the series circuit and the REIL. The series circuit adapters convert 6.6 amps to 120 volts for REIL operation, and often have low efficiency that imposes higher than expected loads on the regulator. The

proper sizing of the regulator requires careful consideration of the types of loads on the circuit and the true impact of those loads on the regulator.

Figure 13-3B Sample Calculation of CCR with High Signage Load

DATA:

CCR: 30KW, 480V input, 5-step (2.8A – 6.6A)
 Cable: AWG #6, 5kV, L-824 Type C, 20,000 feet primary circuit

Circuit Loads: Steady Burn Lights	13,000 W
Transformer Losses (26% of Light Load)	3,380VA
Signage	13,000 VA
Cable losses (19 VA / 1,000')	383 VA

Circuit power factor is assumed to be 0.85.

CALCULATIONS:

1. Total connected load, VA = 13,000 + 3,380 + 13,000 + 383 = 29,763 VA
2. CCR Rated Load @ Lowest Brightness Step: (Reference paragraph 15-6.1)
 $30KW \times (2.8/6.6) = 12.72 \text{ KW or } 14.97 \text{ KVA}$
3. Calculated Load @ Lowest Brightness Step: (Reference Figure 15-3A)
 $(\text{Lights} + \text{Losses}) \times (2.8/6.6)^2 + \text{Signage} =$
 $((13,000 + 3,380 + 383) \times 0.18) + 13,000 = 16,017 \text{ VA}$

Because the signage load does not change for the various brightness steps the resulting demand on the regulator at the low step (16.02 KVA) is higher than the rated load for the regulator at the low step (14.97 KVA). While the load at the highest step (29.76 KVA) is less than the rating of the regulator, it will be overloaded at the lowest step; therefore, do not operate in this load configuration.

Loads such as signs, REILs, PAPIs and windsocks are constant regardless of the brightness level and must be carefully considered in circuit design and regulator sizing.

Where:

E = volts (V)	W = Wattage of light fixtures
I = Current, in amperes (A)	VA = Volt-Amps
P = Power Load	kW = kilowatts
	kVA = kilovolt-amps
	P.F. = Power Factor

Ohms Law: $P = IE, E=IR, P=I^2R$

13-6.3.2 As described in paragraph 13-6.1, the REIL can impose significant loads on the CCR powering the circuits to which they may be connected. It is preferable, if the budget permits, to have separate circuits with 240/120 volt service to power the REILs, thereby eliminating any adverse impacts on series lighting circuits.

13-6.3.3 Sample calculations and comparison with test data, as well as guidance for setting taps, are shown in Figure 13-4. A table format for calculating airfield lighting series circuit loads is shown in Table 13-1. Carefully consider the notes in Table 13-1 when determining load values.

13-6.3.4 Normally the airfield signage load on a circuit is less than the steady burning light load. When the sign load is significant on a circuit, care must be taken to prevent overloading the regulator at the lowest brightness step. Figure 13-3B shows an example calculation where the sign load is high enough to present a problem.

13-7 CABLE.

The primary series circuit utilizes FAA L-824 Type B or C cable. L-823 connectors are used for connections. For 6.6 ampere primary series AGL circuits, an AWG #8 conductor is normally used. An AWG #6 conductor is used with 20 ampere circuits. For the secondary side lighting loads, a two-conductor AWG #10, 600V insulation is normally used.

13-7.1 The cable is installed in conduit, although it may be direct buried (L-824 cable is rated for direct burial). It is important that insulation is intact and that proper connections are made. Deteriorated or damaged cable can result in current leakage and may present a high voltage hazard to maintenance personnel. While installation in conduit may cost more, this method usually provides longer circuit life, and makes troubleshooting and replacement of cable segments easier. Where cable is installed in the regulator vault it must be in conduit, wireway or conduit or wireway in a floor trench with a solid top. L-824 cable is not rated for installation in cable tray.

13-7.2 The types of faults associated with series circuit cable are open circuit conditions and shorts-to-ground. An open circuit condition will turn off all the lights. A single short-to-ground will not impact the lighting, but multiple shorts-to-ground can cause dimming of lights or outages for portions of the circuit or for the entire circuit.

Figure 13-4 Sample Calculation of CCR Test Data

(1 of 2)

SAMPLE CALCULATIONS, CCR TESTING

DATA: CCR: 30KW, 480V input, 5-step (2.8A - 6.6A), with Power Factor of 0.43

Cable: AWG #8, 5kV, L-824 Type C, 20,000 feet primary circuit

Circuit Load: 70 Edge lights @ 120W (100W transformer)
16 Threshold/end lights @ 200W (200W transformer)

10 signs @ 100VA (at step 5) }
5 signs @ 200VA (at step 5) } (at the input to the isolation transformer)
3 signs @ 300VA (at step 5) }

1 REIL system (2 units) @ 400W, connected by power adapter. [Note that in this example the REIL is only adjusted for PF. Some REIL may require further adjustment, based on manufacturer's information.]

Cable losses (resistance) @25°C: 0.68Ω/1,000'
Fixture losses (obtain from Mfg - This example assumes 18 percent for 120W, and 11 percent for 200W lights)

CALCULATIONS:

1. CCR rated output voltage, $V_{RMS} = 30KW/6.6A = \underline{4,545V}$

2. Total connected load, $KVA = \frac{[W_{lamps} + W_{REIL} + VA_{signs}]/PF + Fixture Loss + Cable loss}{1,000}$

Fixture losses = $(70 \times 120 \times 0.18) + (16 \times 200 \times 0.11) = \underline{1,864W}$

Cable losses = $I^2R = [6.6]^2 \times (0.68 \times 20) = \underline{592W}$

TOTAL KVA = $\frac{[(70 \times 120) + (16 \times 200) + (400) + (10 \times 100 + 5 \times 200 + 3 \times 300)]/0.43 + 1,864 + 592}{1,000}$

= 17.57 KVA

where:

KVA = kilovolt-amperes

V = volts

A = amperes

KW = kilowatts

CCR = Constant Current Regulator

R = Resistance in Ohms, Ω

V_{RMS} = Rated output voltage of CCR

W_{lamps} = Wattage of light fixtures

W_{REIL} = Wattage of REIL

PF = Power Factor

I = Current, in amperes

Figure 13-4 Sample Calculation of CCR Test Data (Cont.)

(2 of 2)

SAMPLE CALCULATIONS, CCR TESTING (Cont.)

NOTE: Traditional method for determining the load KW assumes that the CCR powers a unity power factor lamp circuit. With REILs, new type signs, and runway guard lights (wig-wags), a unity power factor is not representative, and power factor must be considered.

MEASURED RESULTS (Case 1):

- Output current at Step 5 = 6.52A
 - Output voltage at Step 5 = 2,880V
- Total KVA Load based on measurements = $6.52\text{A} \times 2.88\text{kV} = 18.8\text{KVA}$

CONCLUSIONS: The output current is within FAA tolerance. The total KVA measured is slightly higher than the calculated load. This may be due to slightly higher actual fixture losses than assumed values. Overall, the CCR is operating satisfactorily.

MEASURED RESULTS (Case 2):

- Output current at Step 5 = 6.52A
 - Output voltage at Step 5 = 1,880V
- Total KVA Load based on measurements = $6.52\text{A} \times 1.88\text{kV} = 12.3\text{KVA}$

CONCLUSIONS: The output current is within FAA tolerance. The total KVA measured is significantly less than the calculated load. The results suggest a partial shorting of the load.

MEASURED RESULTS (Case 3):

- Output current at Step 5 = 6.30A
 - Output voltage at Step 5 = 2,550V
- From test results, Total KVA Load = $6.30\text{A} \times 2.55\text{kV} = 16.1\text{KVA}$

CONCLUSIONS: The output current is below that allowed by FAA tolerance. The total KVA measured is below the normal value (2,880V) as found in first test. Results indicate faulty CCR. Perform a short circuit test on the CCR before it is used.

NOTE: Analysis compares KVA with KW. This is because the rated output of the CCR is specified in KW in compliance with FAA AC 150/5345-10. However, load measurements result in KVA. The requirement for total load in KVA to be below the CCR output in KW under operational conditions ensures that the CCR is not overloaded.

13-8 TRANSFORMERS.

The isolation transformer provides: electrical isolation between the high voltage series circuit and the low voltage secondary feeding the lighting load (such as a fixture or sign), constant current output for a constant current input at the correct ratio, and an effective short circuit in the event of an open condition in the light fixture, for example with lamp filament failure.

13-8.1 With the isolation transformer, only low voltage is brought to the light fixture (via the secondary circuit), and failure of the light does not cause an open condition on the primary circuit that would result in other lights and other connected loads to be shut off.

13-8.2 Isolation transformers for AGL are covered by FAA Specification L-830 (for 60 Hz) and FAA Specification L-831 (for 50 Hz), and are typically 6.6 amperes on the secondary side, with either 6.6 amperes or 20 amperes on the primary side for series lighting circuits at the highest intensity step. The wattage of the isolation transformer is approximately matched to the connected load on the secondary side.

Ensure the load powered by the transformer is within ± 10 percent of the transformer wattage rating to maintain isolation transformer efficiency. Light fixture manufacturers have their fixtures certified using a specified wattage for the isolation transformers. Use the light fixture manufacturer's recommended size for isolation transformers.

13-9 LAMPS.

The connected load typically includes light fixtures, lighted guidance signs, and in some cases other lighted visual aids such as REIL, PAPI, or lighted wind cones.

13-9.1 Runway and taxiway lights may have newer quartz-type lamps or incandescent-type lamps. Quartz-type lamps provide improved photometrics at lower wattage for higher intensity systems, hence lower energy consumption. Quartz lamp life can be significantly reduced if the lamp is installed with bare hands. Fingerprint (oil) deposit on the quartz lamp will cause premature failure.

13-9.2 Light fixtures basically provide a resistive type load on a series circuit. Some items, such as flashing REIL, or signs using electronics to provide light output within a certain range at all circuit intensity steps, introduce other reactive type loads into a circuit, which may distort the waveform and have an adverse effect on performance and control. Incandescent lamps have an initial cost lower than quartz lamps.

13-9.3 Current levels have been established such that, for 5-step system, the light output (brightness) is 100 percent, 20 percent, 4 percent, 0.8 percent, and 0.16 percent. A system with 3-step control provides light output at 100 percent, 30 percent and 10 percent at the respective brightness steps.

13-9.4 FAA-specified types of connected loads that may be used for AGL systems are:

Elevated Light Fixtures

L-860	RW edge, low intensity
L-860E	RW threshold/end, low intensity
L-861	RW edge, medium intensity
L-861SE	RW threshold/end, medium intensity.
L-861E	RW threshold/end, medium intensity (may be used instead of SE for RWs with either REIL, PAPI or medium approach lighting (MALS)).
L-862	RW edge, high intensity
L-862E	RW threshold/end, high intensity
L-861T	TW edge
L-804	Runway guard light.
L-862S	Runway stop bar light

In-pavement Light Fixtures

L-850A	RW centerline, high intensity
L-850B	RW touchdown zone, high intensity
L-850C	RW edge, high intensity
L-850D	RW threshold/end, high intensity
L-852A	TW centerline, for straight portion (narrow beam) (non-Category III). Also used for caution bar.
L-852B	TW centerline, for curved portion (wide beam) (non-Category III).
L-852C	TW centerline, for straight sections (narrow beam) (Category III)
L-852D	TW centerline, for curved portion (narrow beam) (Category III)
L-852E	TW intersection (non-Category III)
L-852F	TW intersection (Category III)
L-852G	Runway guard light
L-852S	Runway stop bar light
L-852T	Taxiway/Apron edge

Light Bases for Lights or as Junction Boxes.

L-867	Non-load bearing (used in shoulder areas or other non-traffic areas).		
L-868	Load bearing (used in RW and TW pavements and other aircraft load areas).		
Sizes	A - 10" (25 cm) dia. (L-868 only)	C - 15" (38 cm) dia. (L-868 only)	
	B - 12" (30 cm) dia. (L-867 & L-868)	D - 16" (40 cm) dia. (L-867 only)	
L-869	In-pavement junction box (used with cables in saw kerfs, 6" (15 cm) dia.)		

Airfield Signs

L-858Y	Direction, Destination and Boundary. Black legend on yellow background.
L-858R	Mandatory Instruction. White legend on red background.

- | | |
|--------|---|
| L-858L | TW and RW Location. Yellow legend and border on black background. |
| L-858B | Runway Distance Remaining. White legend on black background. |

Other Examples

- | | |
|-------|--------------------------------|
| L-849 | REIL |
| L-880 | PAPI system with 4 light units |
| L-881 | PAPI system with 2 light units |

Some of the above have variations specific for certain military applications.

13-10 PARALLEL CIRCUITS.

Parallel (or multiple) circuits have circuit elements connected across the conductors to which input voltage is applied. In theory, the same voltage is applied to each light, although voltage drop occurs along the conductor, which can be significant for longer circuits. The reduced voltage can reduce the intensity of lights at the far end of a circuit. If intensity control is required for this type lighting circuit, tapped transformers or inductive-voltage regulators are used, which increases the cost and reduces efficiency of the circuit.

13-10.1 Advantages of Parallel Lighting Circuits.

- Lower cost installation, particularly if voltage regulation and intensity control are not required.
- More efficient utilization of electrical power.
- Easy to add to or reduce an existing circuit.
- Circuits are more familiar to most people.
- Cable faults such as open-circuits are easier to locate.
- An open-circuit may not disable entire circuit.

13-10.2 Disadvantages of Parallel Lighting Circuits.

- Intensity of lights decreases with line voltage drop along the circuit. This could be misinterpreted if noticeable in a pattern of many lights.
- Two conductors are required along the complete circuit, and larger conductors may be needed to reduce voltage drop.
- Lamp filaments are usually longer which may require larger optics and larger light fixtures.

- Intensity control, particularly at the lower intensity, is more difficult to achieve without added equipment cost.
- A single ground fault on the high voltage feeder will disable the circuits.
- Ground faults are difficult to locate.

13-10.3 Common Uses.

Parallel circuits are used for most area illumination, individual or small numbers of visual aids, and power distribution. AGL systems typically using parallel circuits are apron floodlighting, other apron lights, sequence-flashing lights, special purpose visual aids such as beacons and wind direction indicators, some obstacle lights, and electrical distribution circuits.

13-11 CURRENT AND VOLTAGE ON SERIES CIRCUITS.

The output current for AGL constant current series circuits have become standardized at either 6.6 amperes or 20 amperes (at highest intensity). The loaded output voltage from the CCR is limited to 5,000 volts because the cable used for the primary lighting circuit is rated for 5kV.

13-11.1 The voltage will vary depending on the load. Figure 13-4 illustrates the constant current and varying voltage through several examples. As seen from Figure 13-4, the voltage measured across the outputs of the CCR (at highest intensity step) is simply the total watts divided by 6.6 A (assuming power factor of 1.0), or 3,030V for 200 each 100W lamps (such as light fixtures or signs). With 200W lamps, the voltage is calculated at 6,060V, which exceeds the 5kV cable rating of the primary circuit. However, if a 20A circuit is used, the voltage calculates to be only 2,000V at the CCR. Similarly, if 45W lamps are used in the above example, the voltage across the CCR output terminals is calculated at 1,364V.

13-11.2 The examples above show that the voltage on the primary circuit is additive and will vary with the load, but the current will remain the same. The secondary circuit is always 6.6A (highest intensity step), with a 6.6A/6.6A isolation transformer used with 6.6A primary circuits, and 20A/20A or 20A/6.6A isolation transformers used with 20A primary circuits.

13-11.3 Figure 13-5 shows that measuring the voltage across the secondary circuit for a 100W light fixture will yield 15.15V. Similarly, the voltage will be 30.3V with a 200W light, and only 6.8V with a 45W light. This illustrates the much lower voltage that is present on the secondary side of a lighting circuit. From the examples it can be seen that:

- The current is constant regardless of load (within limits), while the voltage is will vary with load.

- The low voltage on the secondary side is isolated from the high voltage primary side by the isolation transformer.

Figure 13-5 Current and Voltage Illustration

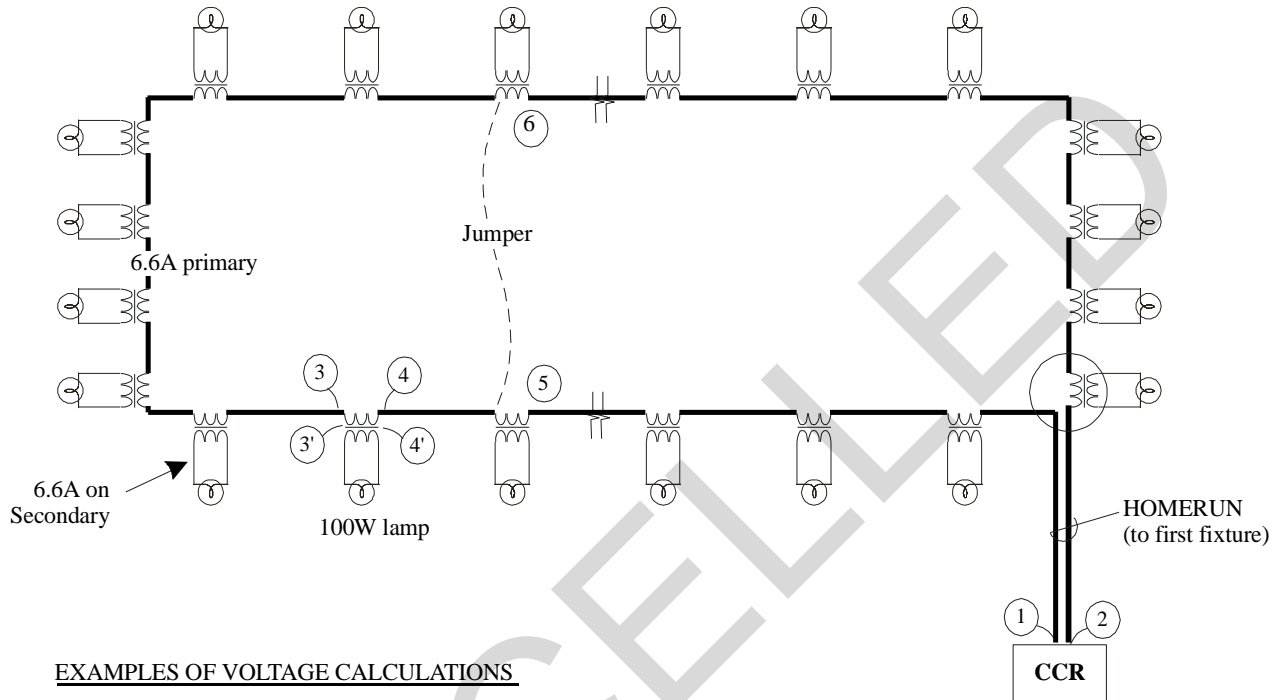

EXAMPLES OF VOLTAGE CALCULATIONS

ASSUMPTIONS 200 lights on 6.6A primary series circuit
 Each light 100W (fixture or sign, etc)
 Power factor of 1.0 for all components.

- Measured across homeruns at CCR, (1) & (2) $\text{voltage} = \frac{200ea \times 100W}{6.6A} = 3,030V$
 If only 100 lights, then voltage is 1,515V
- Measured across isolation transformer primary (3) & (4) or secondary (3') & (4')
 $\text{Voltage} = \frac{100W}{6.6A} = 15.15V$
 With 200W light, voltage on secondary = $\frac{200W}{6.6A} = 30.3V$
 With 200W lamps, voltage at CCR = $\frac{200ea \times 200W}{6.6A} = 6,060V$
- With 200W lamps and a 20A primary, voltage at CCR = $\frac{200ea \times 200W}{20A} = 2,000V$
- If jumper across at light fixtures (5) & (6), the voltage at CCR is based on load remaining on circuit.
- If 85 each 200W lights remain on 6.6A circuit: $\text{Voltage} = \frac{85ea \times 200W}{6.6A} = 2,576V$

Note that: (1) Current is constant regardless of load, while voltage varies and is additive, depending on load.
 (2) The low voltage secondary side is isolated from the high voltage primary side by the isolation transformer.

13-11.4 When more than one light is connected to a secondary circuit, they are connected in series. An isolation transformer is designed to provide a proper variable operating voltage on its secondary. This forces a constant load current to flow so that each light in the secondary will receive the same current regardless of the wattage of the lamp or the quantity of lamps (within the design limits of the transformer). This approach may be seen on light bars for approach lighting systems, on runway centerline lights configured as smaller segments with several lights on a single transformer, and other applications.

13-11.5 It is important to recognize that the isolation transformer, which is similar to a current transformer, operates differently than the standard voltage transformer. The current will remain constant even when the secondary side is shorted. The output terminals of the CCR are not grounded, hence the airfield lighting series circuit is an ungrounded system. The result is that one short-to-ground in the primary circuit will not shut down the system. When the secondary side is open (for example a burned out lamp), the instantaneous voltage present at the lamp socket can be very high, presenting a potential hazard for maintenance personnel. This can be the condition when changing lamps and a short occurs between the socket terminals and the body of the light fixture. Maintenance personnel are prohibited from working on energized circuits.

13-12 CONSIDERATIONS FOR CIRCUIT DESIGN.

Two major considerations in designing an airfield lighting series circuit are: maximum allowable voltage on the primary series cable (discussed in paragraph 15-12 in the selection of 6.6A or 20A circuit); and the insulation resistance of the entire primary circuit.

13-12.1 FAA has established a minimum insulation resistance of 50 megohms for new installations. Experience from many projects has shown that this value is achievable in most installation configurations. However, insulation resistance depends on the length of the primary series cable, the number of splices on the circuit, soil conditions, and primarily the number of isolation transformers of the circuit. Consider all these factors in configuring a lighting circuit.

13-12.2 From the standpoint of economy, life expectancy and reliability, it may be practical to use 50 megohms as the minimum insulation resistance. The selected value depends on the specific configuration of the particular system being designed. It is recommended the following criteria be applied in optimizing design of new airfield lighting circuits:

- Limit the voltage to 2.4 kV, at least for 90 percent of the operational time (assume this to be step 2 for 3-step CCR, step 3 for 5-step CCR).
- Limit the number of isolation transformers on any one primary circuit to not more than 130.
- Limit the number of splices on any one primary circuit (not including those connecting isolation transformers) to not more than 8.

13-13 CIRCUIT CONFIGURATION.

There are three circuit configurations that are normally used to power runway and taxiway systems:

13-13.1 Single Circuit per Lighting System.

This is the standard FAA configuration, with a single circuit for each of the different lighting systems (for example, one circuit for the runway edge lights, one for the touchdown zone lights, or one for the runway centerline lights). It is the most economical configuration. In some cases, however, this approach may create very high voltages on the primary series circuit, which can reduce the life and reliability of the system and increase the potential hazards for maintenance personnel. In addition, in the event of a fault in the circuit, the entire circuit is out of service. Also, the troubleshooting of line faults can be a lengthy, time consuming process because of the length of the circuit.

13-13.2 Multiple Circuits per Lighting System - Split Circuits.

Advantages include easier troubleshooting and reduction in circuit voltages. A disadvantage with this configuration is the higher cost compared with a single circuit, particularly if the available space in the vault or the duct system is limited. Consider the possible consequences of a partial system failure. For example, where two circuits power a runway edge lighting system, the failure of one circuit leaves the other circuit to light only half the runway, indicating a much shorter available runway to the pilot. It may be necessary to install an interlock between the regulators so that both circuits will shut down if either circuit fails.

13-13.3 Multiple Circuits per Lighting System - Interleaved Circuits.

This is the type of circuit configuration specified by ICAO. Although this is the most expensive configuration, requiring more cable, it has the advantage of preserving the full pattern of the airfield lighting system for the pilots in the event of one circuit failure, hence provides a measure of additional operational safety. Further, it has the advantages noted for the split circuit configuration. Because of operational disadvantages, this is not recommended for Air Force airfields.

13-14 PARALLEL CIRCUITS.

Parallel (or multiple) circuits have circuit elements connected across the conductors to which input voltage is applied. In theory, the same voltage is applied to each light, although voltage drop occurs along the conductor, which can be significant for longer circuits. The reduced voltage can reduce the intensity of lights at the far end of a circuit. If intensity control is required for this type lighting circuit, tapped transformers or inductive-voltage regulators are used, which increases the cost and reduces efficiency of the circuit.

13-15 PHOTOMETRIC CHARACTERISTICS OF LIGHT FIXTURES.

13-15.1 Airfield Lighting.

Airfield lighting provides visible light to pilots for guidance during landing and taxiing operations. The guidance provided is a function of configuration of the lights, light color, and strength and “shape” of the light output (photometric performance). The strength is the brightness or intensity of the light output, measured in candelas. The required shape of the light “beam” from a light fixture is typically represented by an ellipse (an “isocandela curve” of same values), although for some fixtures the requirements may be rectangular or simply numerical. Examples are shown in Figure 13-6 (high intensity white or “clear” runway edge light) and Figure 4-6 (high intensity green threshold light), which illustrate the photometric requirements at highest intensity step for the type of light.

Figure 13-6 Runway Edge Light Photometric Requirements

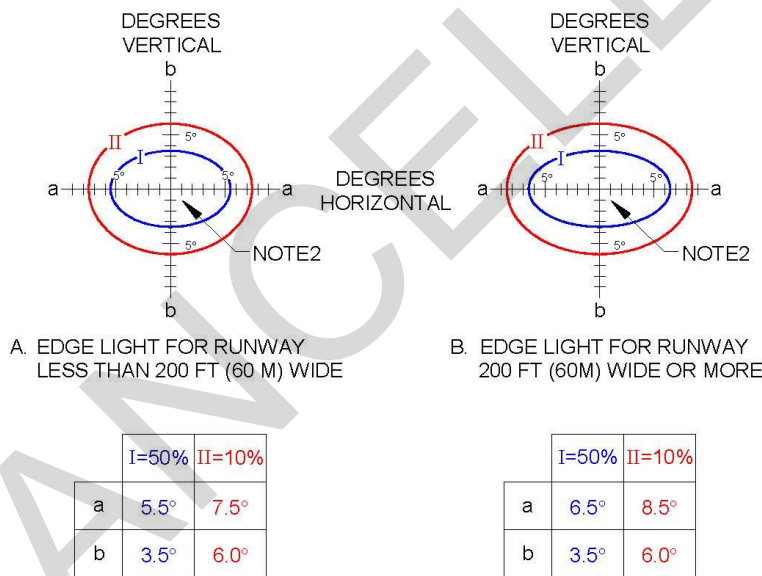

NOTES:

1. ALL CONTOURS ARE ELLIPSES CALCULATED BY EQUATION: $(X/a)^2 + (Y/b)^2 = 1$
2. THE MINIMUM AVERAGE INTENSITY OF THE MAIN BEAM (INSIDE CONTOUR) IS 10,000 CD WHITE OR 5,000 CD YELLOW. MAXIMUM INTENSITY SHOULD NOT EXCEED 1.5 TIMES ACTUAL AVERAGE INTENSITY.
3. CONTOURS I AND II INDICATE THE MINIMUM PERCENT VALUES OF THE MAIN BEAM INTENSITY.

13-15.2 Wattage.

The wattage of lamp(s) and other light fixture characteristics are determined by each manufacturer to meet the photometric requirements for a particular type of light, which are tested and certified for compliance with the requirements. A light fixture design is

based on achieving the required photometric output at full rated lamp wattages, in fixtures connected on a 6.6 amperes series lighting circuit. The lower current steps of series lighting circuits are based on achieving lower levels of light output.

13-15.3 Isocandela Curves

Figure 15-7 shows a typical photometric requirements or “isocandela curves” for a runway edge light. The ellipses are defined by degree of angle from the center along vertical and horizontal axes. The requirements for the inner ellipse, or “main beam,” are:

- Minimum average intensity (10,000 cd, aviation white in the example).
- Minimum intensity no less than 50 percent of the minimum average intensity (5,000 cd in this case).
- Maximum intensity should not exceed 1.5 times the actual average intensity.

For the outer ellipse, the minimum intensity should not be less than 10 percent of the minimum average intensity (1,000 cd in the example).

Figure 13-7 Photometric Isocandela Curves

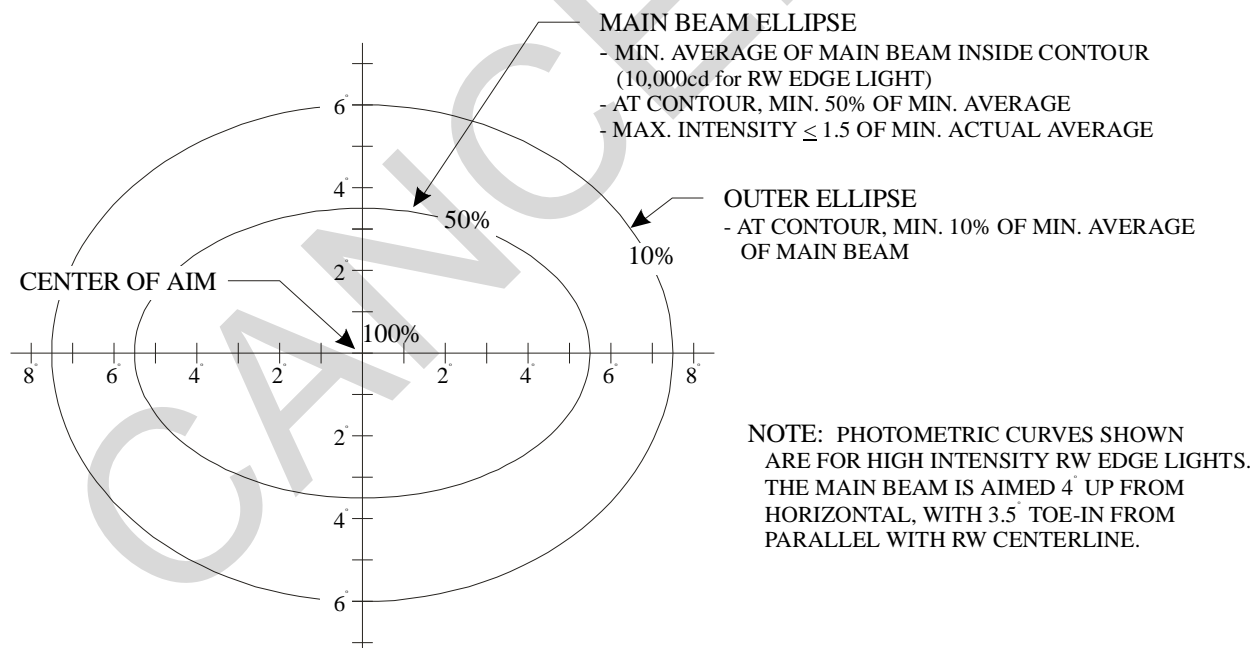

13-15.4 Main Beam Ellipse.

For the example shown by Figure 13-7 (high intensity runway edge light for runways less than 200 feet (60 meters) wide), the inner or main beam ellipse is defined by ± 5.5 degrees on the horizontal axis and ± 3.5 degrees and -3.5 degrees on the vertical axis, while the outer ellipse is defined by ± 7.5 degrees on the horizontal axis and ± 6 degrees on the vertical axis. Note that in Figure 13-6, the runway edge lights have a wider beam ellipse for runways 200 feet (60 meters) or more wide, providing broader light coverage. The runway edge lights are “toed-in” 3.5 degrees and aimed up 4 degrees above the horizontal. Threshold lights are parallel with the runway centerline and aimed up 4.5 degrees. Other lights may also have a toe-in or aimed vertically upward; however, this is identified separately and not indicated on the photometric curves.

13-15.5 Photometric Testing of New Airfield Lighting Systems.

Photometric testing of new airfield lighting installations is being performed more and more as a part of the acceptance testing of the overall system, and includes the evaluation of a variety of factors in the lighting system being tested. While field testing the photometrics of installed lights has not been practical in the past, current available technology enables the testing of an entire system in a relatively short period of time, testing each fixture, with good correlation to laboratory testing for meeting photometric requirements. In addition to verifying the photometric performance of installed light fixtures, proper testing can also help identify the following:

- Possible leakage on the secondary side of the isolation transformer.
- Improper alignment of fixtures.
- Loose sockets and brackets.
- If improper lamps have been installed.
- Possible damage to lenses from sandblasting or other source of abrasion.
- Improper current output from the constant current regulator.
- These types of deficiencies may cause significant reductions in the photometric output of a fixture, as well as the quality of the overall system performance. The cost of photometric testing is relatively inexpensive compared with the cost of a new airfield lighting system, while providing assurances for operational safety. The testing can usually be performed with minimal disruption to airfield operations, and is typically performed at night during periods of low or no aircraft traffic.

13-15.6 Photometric Testing of Existing Lighting Systems.

This can provide benefits similar to acceptance testing of new lighting systems. Typically, photometric performance deteriorates over time, and periodic testing will provide an up-to-date evaluation of performance. When photometric output is validated at below 50 percent to 70 percent of the minimum specified output, investigate for the possible cause and for possible corrective action. Two options are replacement of small sections or repair-by-replacement of the system in question. Test results enable the airfield to repair/replace fixtures on a "need" basis rather than scheduled basis, with possible cost savings plus the assurance that the lighting system is providing the proper light output./1/

CANCELLED

APPENDIX A REFERENCES

Executive Orders

Executive Order 12770, *Metric Usage in Federal Government Programs*, July 25, 1991

Unified Facilities Criteria

UFC 3-120-01, *Air Force Sign Standard*, 7 October 2014,
http://www.wbdg.org/FFC/DOD/UFC/ufc_3_120_01_2014.pdf

UFC 3-260-01, *Airfield and Heliport Planning and Design*, 17 November 2008,
http://www.wbdg.org/FFC/DOD/UFC/ufc_3_260_01_2008.pdf

UFC 3-520-01, *Interior Electrical Systems*, 6 October 2015,
http://www.wbdg.org/FFC/DOD/UFC/ufc_3_520_01_2015.pdf

UFC 3-535-02, *Design Drawings for Visual Air Navigation Facilities*
<https://www.wbdg.org/ffc/dod/unified-facilities-criteria-ufc/ufc-3-535-02>

UFC 3-550-01, *Exterior Electrical Power Distribution, with Change 1*
<https://www.wbdg.org/ffc/dod/unified-facilities-criteria-ufc/ufc-3-550-01>

UFC 3-560-01, *Electrical Safety, O&M*, 14 April 2015,
http://www.wbdg.org/FFC/DOD/UFC/ufc_3_560_01_2006_C5.pdf

DOD Supplemental Technical Criteria

TSEWG TP-20: Visual Air Navigation Facility Qualifying Equipment
<http://www.wbdg.org/ffc/dod/supplemental-technical-criteria/tsewg-tp-20>

TSEWG TP-21: Visual Air Navigation Facilities Equipment Inspection and Testing
<http://www.wbdg.org/ffc/dod/supplemental-technical-criteria/tsewg-tp-21>

TSEWG TP-22: Airfield/Heliport/Helipad Portable Lighting Requirements for Theater of Operations"
<http://www.wbdg.org/ffc/dod/supplemental-technical-criteria/tsewg-tp-22>

Air Force /Army/Navy

AFJMAN 32-1082 / TM 5-684 / NAVFAC MO-200, *Facilities Engineering Electrical Exterior Facilities*, 29 November 1996,
<http://www.wbdg.org/FFC/NAVFAC/OPER/ARCHIVES/mo200.pdf>

JP 3-0, Joint Operations, 17 January 2017,
http://www.dtic.mil/doctrine/new_pubs/jp3_0.pdf

Army/Navy/Air Force/ Federal Aviation Administration (FAA)

TM 95-225 / NAVAIR 16-1-520 / AFMAN 11-225 / 8200.1C, *United States Standard Flight Inspection Manual*, 1 October 2005,
<http://www.faa.gov/documentLibrary/media/Order/nd/8200.1C.pdf>

Air Force

AFI 13-204, Volume 3, *Airfield Operations Procedures and Programs*, with Change 2, 20 April 2017,
http://static.e-publishing.af.mil/production/1/af_a3/publication/afi13-204v3/afi13-204v3.pdf

AFI 13-217, *Drop Zone and Landing Zone Operations*, 10 May 2007,
http://www.static.e-publishing.af.mil/production/1/af_a3_5/Publication/AFI13-217.pdf

AFI 32-1042, *Standards for Marking Airfields*, 19 October 2016,
http://www.static.e-publishing.af.mil/production/1/af_a4/Publication/afi32-1042/afi32-1042.pdf

AFI 32-1044, *Visual Air Navigation Systems*, 24 December 2014,
http://www.static.e-publishing.af.mil/production/1/af_a4/Publication/afi32-1044/afi32-1044.pdf

AFI 32-1062, *Electrical systems, Power Plants and Generators*, 15 January 2015,
http://www.static.e-publishing.af.mil/Production/1/af_a4/Publication/AFI32-1062.pdf

Army

EM 385-1-1, *Safety and Health Requirements*, 30 November 2014,
http://www.publications.usace.army.mil/Portals/76/Publications/EngineerManuals/EM385-1-1/2008_English/EM_385-1-1.pdf

V1 Corps of Engineers Computer-Aided Design and Drafting (CADD) Details (CAD/BIM Center)
<https://cadbimcenter.erdcdren.mil/cadlib.aspx/1/>

Navy

NAVAIR 51-50AAA-2, *General Requirements for Shorebased Airfield Marking and Lighting*.
<http://www.navair.navy.mil/index.cfm?fuseaction=home.download&key=9A7208C5-1186-4C01-87E1-C615F4390594>

Other DoD

MIL-L-6273, *Light, Navigational, Beacon, Obstacle or Code, Type G1*

MIL-L-19661, *Light, Marker, Portable, Emergency, Battery Operated*

MIL-L-7158, *Light, Beacon, Rotating, 24-Inch*

MIL-L-7830, *Light Assembly, Marker, Aircraft Obstruction*

MIL-STD-461B, *Electromagnetic Emission and Susceptibility Requirements for the Control of Electromagnetic Interference*

MIL-STD-8106, *Department of Defense Test Method Standard for Environmental Engineering Consideration and Laboratory Tests*

NATO

STANAG 3316 (Edition 10), *Airfield Lighting*, 13 May 2004

STANAG 3346 (Edition 7), *Marking and Lighting of Airfield Obstructions*, 26 November 2012

STANAG 3534 (Edition 7), *Airfield Lighting, Marking and Tone Down Systems for Non-Permanent / Deployed Operations*, 6 June 2013

STANAG 3619 (Edition 5), *Helipad Marking and Lighting*, 6 June 2013

FAA

Advisory Circulars, available at web site: <http://www.faa.gov/>

AC 70/7460-1, *Obstruction Marking and Lighting*

AC 120-57A, *Surface Movement Guidance and Control System*

AC 150/5220-23, *Frangible Connections*

AC 150/5340-1, *Standards for Airport Markings*

AC 150/5340-18F, *Standards for Airport Sign Systems*

AC 150/5340-26C, *Maintenance of Airport Visual Aid Facilities*

AC 150/5340-30H, *Design and Installation Details for Airport Visual Aids* (**NOTE:** This AC incorporates and replaces several ACs which are now cancelled: AC 150/5340-4, *Installation Details for Runway Centerline Touchdown Zone Lighting Systems*; AC 150/5340-17, *Standby Power for Non-FAA Airport Lighting Systems*; AC 150/5340-21,

Airport Miscellaneous Lighting Visual Aids; AC 150/5340-23, Supplemental Wind Cones; AC 150/5340-24, Runway and Taxiway Edge Lighting System.)

AC 150/5345-3, Specification for L-821 Panels for Control of Airport Lighting

AC 150/5345-5, Circuit Selector Switch

AC 150/5345-7F, Specification for L-824 Underground Electrical Cable for Airport Lighting Circuits

AC 150/5345-10H, Specification for Constant Current Regulators and Regulator Monitors

AC 150/5345-12F, Specification for Airport and Heliport Beacons

AC 150/5345-13, Specification for L-841 Auxiliary Relay Cabinet Assembly for Pilot Control of Airport Lighting Circuits,

AC 150/5345-26D, Specification for L-823 Plug and Receptacle, Cable Connectors

AC 150/5345-27E, Specification for Wind Cone Assemblies

AC 150/5345-28G, Precision Approach Path Indicators (PAPI) Systems

AC 150/5345-39D, Specification for L-853, Runway and Taxiway Retroreflective Markers

AC 150/5345-42H, Specification for Airport Light Bases, Transformer Housings, Junction Boxes and Accessories

AC 150/5345-43H, Specification for Obstruction Lighting Equipment

AC 150/5345-44K, Specification for Taxiway and Runway Signs

AC 150/5345-45C, Low-Impact Resistant (LIR) Structures

AC 150/5345-46E, Specification for Runway and Taxiway Light Fixtures

AC 150/5345-47C, Specifications for Series to Series Isolation Transformers for Airport Lighting Systems

AC 150/5345-49C, Specification L-854, Radio Control Equipment

AC 150/5345-50B, Specification for Portable Runway and Taxiway Lights

AC 150/5345-51B, Specification for Discharge-Type Flashing Light Equipment

AC 150/5345-53D Airport Lighting Equipment Certification Program

AC 150/5345-56B, *Specification for L-890 Airport Lighting Control and Monitoring System (ALCMS)*

AC 150/5370-10G, *Standards for Specifying Construction of Airports*

Drawings:

C-6046, *Frangible Coupling Type I and Type IA, Details*

D-6076, *ALSF-2 Approach Lighting System 6'-0" to 128'-0" Low Impact Resistant (LIR) Structures*

D-6155, *ALSF-2, 6' to 128' and MALS, 40' to 128' LIR Structures*

Specifications:

C-1391B, *Installation and Splicing of Underground Cable*

E-910, *Structural Steel*

E-982H, *PAR 56 Lamp Holder*

E-1315, *Light Base and Transformer Housing*

E-2159, *Runway End Identifier Lighting System (REIL)*

E-2325, *Medium Intensity Approach Light System with Runway Alignment Indicator Lights (MALSR)*

E-2491, *Approach Light, Semi-flush, Steady Burning*

E-2628, *Sequenced Flashing Lighting System Elevated and Semi-flush with Dimming and Monitoring*

E-2689A, *Dual Mode High Intensity Approach Lighting System (ALSF-2/SSALR)*

E-2702, *Low Impact Resistant Structures*

E-2756B, *Four Box Precision Approach Path Indicator (PAPI) without Remote Monitoring Subsystem (RMS)*

Miscellaneous:

FAA Engineering Brief 67D, *Light Sources Other Than Incandescent and Xenon for Airport and Obstruction Lighting Fixtures*, 6 March 2012

14 CFR Part 77, *Safe, Efficient Use, and Preservation of the Objects Affecting Navigable Airspace*, <http://www.ecfr.gov/cgi-bin/text-idrgn=div5+node=14:2.0.1.2.9>

14 CFR Part 139, *Airport Certification*, http://www.faa.gov/airports/airport_safety/part139_cert/

Miscellaneous

ANSI A14.3-1984, *Fixed Safety Requirements for Ladders*

- ANSI/EIA-222, *Structural Standards for Steel Antenna Towers and Antenna Supporting Structures*
- ANSI/IEEE C 37.90.1-1989, *Standard Surge Withstand Capability (SWC) Tests for Protective Relays and Relay Systems*
- ASTM A-123, *Standard Specification for Zinc (Hot-Dip Galvanized) Coatings on Iron and Steel Products E1-1998*
- ASTM A-153, *Standard Specification for Zinc Coating (Hot-Dip) on Iron and Steel Hardware E1-1998*
- ASTM D 4956, *Standard Specification for Retroreflective Sheeting for Traffic Control*
- CAN/CSA C22.2 No. 142, *Process Control Equipment*
- ICAO Annex 14, Chapter 5, *Visual Aids for Navigation*
- IEEE 519-1992, *Recommended Practices and Requirements for Harmonic Control in Electrical Power Systems*
- IEEE C62.41.1, *Guide on the Surge Environment in Low-Voltage (1000 V and less) AC Power Circuits*
- IEEE C62.41.2, *Recommended Practice on Characterization of Surges in Low-Voltage (1000 V and less) AC Power Circuits*
- ISO 9000, *Quality Management and Quality Assurance Standards*
- NEMA ICS1, *Industrial Control and Systems General Requirements*
- NEMA ICS2, *Industrial Control and Systems Controllers, Contractors, and Overload Relays 600 Volts*
- NEMA ICS 3, *Medium Voltage Controllers Rated 2001 to 7200 Volts AC*
- SAE AS25050, *Colors, Aeronautical Lights and Lighting Equipment, General Requirements For*
- UL 508, *UL Standard for Safety Industrial Control Equipment Seventeenth Edition; Reprint with Revisions through and including 7/16/99*

APPENDIX B GLOSSARY

B-1 ACRONYMS

A	ampere
AASHTO	American Association of State Highway and Transportation Officials
AC	Advisory Circular
AC, ac	alternating current
AF/A3X	AF Director, Future Operations
AF/A8XX	Air Force International Standardization Office
AFCEC	Air Force Civil Engineer Center
AFCEC/CO	AFCEC Operations Directorate
AFCEC/COSM	AFCEC, Mechanical Division
ACMU	addressable control and monitoring unit
AFI	Air Force Instruction
AFIMSC/IZB	Air Force Installation Management Support Center, Engineering Support Division
AFJMAN	Air Force Joint Manual
AFPD	Air Force Policy Directive
AFR	Air Force Regulation
AGL	airfield ground lighting
AGM	arresting gear marker
AIR STD	Air Standard
ALCMS	airport lighting control and monitoring system
ALS	approach lighting system
ALSF	approach lighting system with sequence flashing lights
ALSF-1	approach lighting system with sequence flashing lights for Category I
ALSF-2	approach lighting system with sequence flashing lights for Category II or Category III
AMC	Air Mobility Command
ANG NGB	Air National Guard National Guard Bureau
ANSI	American National Standards Institute
ASIC	Air and Space Interoperability Council
ASTM	American Society for Testing and Materials

AT&A	air traffic and airspace
ATCT	air traffic control tower
AWG	American Wire Gauge
AWS	American Welding Society
BIA	Bilateral Infrastructure Agreement
CAN/CSA	Canada/Canadian Standards Association
CCR	constant current regulator
cd	candela
cd/m ²	candela per square meter
CFR	Code of Federal Regulations
CHAPI	chase helicopter approach path indicator
cm	centimeter
CV	vice commander
DAF	Department of the Air Force
DASD	Deputy Assistant Secretary of Defense
DCS	Deputy Chief of Staff
DoD	Department of Defense
DO	Director of Operations
E/G	engine generator
EALS	emergency airfield lighting system
EB	Engineering Brief (FAA)
EFVS	enhanced flight vision system
EIA	Electronic Industries Association
EM	Engineer Manual
EMT	electrical metal tubing
ETL	Engineering Technical Letter (Air Force)
FAA	Federal Aviation Administration
FAR	Federal Acquisition Regulation
fc	footcandle
fL	foot-lambert
ft	foot
GPS	global positioning system

HIRL	high intensity runway edge light
HNFA	Host Nation Funded (Construction) Agreement
HQ AFFSA/A3A	Air Force Flight Standards Agency, Flight Operations
HQ AFSEC/SEFF	Air Force Safety Center, Flight Safety
HQ USACE	Headquarters, U.S. Army Corps of Engineers
HVAC	heating, ventilation, and air conditioning
ICAO	International Civil Aviation Organization
IEEE	Institute of Electrical and Electronics Engineers
IFR	instrument flight rules
ILS	instrument landing system
IMC	instrument meteorological conditions
ISO	International Standards Organization
ksi	kips per square inch
kW	kilowatt
LED	light emitting diode
LIR	low impact resistant
m	meter
MACOM	major command (Army)
MAJCOM	major command (Air Force)
MALS	medium (intensity) approach light system
MALSR	medium intensity approach light system with runway alignment indicator
MIL-STD	Military Standard
MIRL	medium intensity runway edge light
MLS	microwave landing system
mm	millimeter
MO	Maintenance & Operation (NAVFAC manual)
MOV	metal oxide varistor
mPa	milli-pascal
MTBF	mean-time-between-failure
MUTCD	Manual of Uniform Traffic Control Devices (Air Force use AFPAM 32-1097, <i>Sign Standards Pamphlet</i>)

NA	not applicable
NATO	North Atlantic Treaty Organization
NAVAID	navigational aid
NAVAIR	Naval Air Systems (Command)
NAVFAC	Naval Facilities (Command)
NAVSEA	Naval Sea Systems (Command)
NEC	National Electrical Code (NFPA 70)
NEMA	National Electrical Manufacturers Association
NFPA	National Fire Protection Association
NR	not required
NSO	NATO Standardization Office
NVG	night vision goggle
OC	on center
OFZ	obstacle free zone
OPT	optional
P.E.	Professional Engineer
PAPI	precision approach path indicator
PAR	parabolic aluminized reflector
PAR	precision approach radar
PCU	power control unit
PLASI	pulsed light approach slope indicator
PLC	programmable logic controller
PVC	polyvinyl chloride
PT	point of tangency
RCL	runway centerline light
RDR	runway distance remaining sign
REIL	runway end identifier light
RGL	runway guard light
RMS	root mean squared
RPI	runway point of intercept
RPM	revolutions per minute
R	required

REA	Rural Electrification Administration
RRP	runway reference point
RVR	runway visual range
RW	runway
SAE	Society of Automotive Engineers
SAFO	Safety Alert for Operators (FAA)
SALS	short approach light system
SCR	silicon controlled rectifier
SES	Senior Executive Service
SFL	sequenced flashing lights
SME	subject matter expert
SOFA	Status of Forces Agreement
SPAWARSYSCEN	Space and Naval Warfare Systems Center
SPD	surge protection device
SSALR	simplified short approach light system with runway alignment indicator lights
STANAG	Standardization Agreement (NATO)
TACAN	tactical air navigation
TCH	threshold crossing height
TDZL	touchdown zone lights
TERPS	terminal instrument procedures
TM	Technical Manual (Army)
TO	Theater of Operations
TP	Technical Paper
TSEWG	Tri-Service Electrical Working Group
TSMCX	Director, USACE Transportation Systems Center
TW	taxiway
UAS	unmanned aerial system
UAV	unmanned aerial vehicle
UFC	Unified Facilities Criteria
UFGS	Unified Facilities Guide Specification
UL	Underwriters Laboratory

UPS	uninterruptible power supply
USAASA	US Army Aeronautical Service Agency
USAAVNC	US Army Aviation Center
USASC	US Army Safety Center
USD(AT&L)	Under Secretary of Defense for Acquisition, Technology and Logistics
US	United States
Vac	volts alternating current
VASI	visual approach slope indicator
VFR	visual flight rules
VGLEAP	Visual Guidance Lighting Equipment Approval Program
VMC	visual meteorological conditions
V	volt
W	watt

B-2 DEFINITION OF TERMS

Approach Light Plane: An imaginary plane that passes through the beam centers of the lights in the system. The plane is rectangular, centered on the ALS centerline, starting at the landing threshold and extending 200 feet (60 meters) beyond the last light at the approach end of system. The plane may have irregularities. The width varies according to the lighting system.

Decision Height: The height above the highest elevation in the touchdown zone, specified for a glide slope approach at which a missed approach procedure must be initiated if the required reference has not been established.

Displaced Threshold Area: An area of full strength pavement on the approach slope of the threshold intended for use during takeoff or during rollout after landing from the opposite direction.

Footcandle: One lumen per square foot (10.8 lux).

Frangible Support: A support for elevated fixtures or other devices composed of a supporting element with a fracture mechanism at its base. It is designed to present a minimum of mass and to break at the base when impacted.

Helipad: A prepared area designated and used for takeoff and landing of helicopters (includes touchdown and hoverpoint). May be located at facilities with fixed and rotary wing aircraft.

Heliport: A facility designed for the exclusive operating, basing, servicing and maintaining of rotary-wing aircraft (helicopters). The facility may contain a rotary-wing runway and/or helipads.

Instrument Runway: A runway served by non-visual aids giving directional guidance adequate for a straight in approach. It may be further classified as:

Non-Precision Approach Runway: A runway with two-dimensional operations conducted under IFR using lateral guidance but not vertical guidance.

Precision Approach Runway, Category I: A runway served by an instrument landing system (ILS), microwave landing system (MLS), or precision approach radar (PAR) and visual aids intended for operations down to 200 feet (60 meters) decision height, and down to a runway visual range (RVR) on the order of 2,400 feet (720 meters). These criteria also apply to visual lighting aids supporting Air Force precision approach radar approaches down to a decision height of 100 feet (30 meters) and an RVR on the order of 1,200 feet (360 meters).

Precision Approach Runway, Category II: A runway served by ILS or MLS and visual aids intended for operations down to 100 feet (30 meters) decision height and down to an RVR on the order of 1,200 feet (360 meters).

Precision Approach Runway, Category III: A runway served by ILS or MLS (no decision height being applicable) and:

Category IIIa: By visual aids intended for operations down to an RVR on the order of 700 feet (210 meters).

Category IIIb: By visual aids intended for operations down to an RVR on the order of 150 feet (45 meters).

Category IIIc: Intended for operations without reliance on external visual reference. (The RVR is 0).

Light Bar: A set of lights arranged in a row perpendicular to the light system centerline, also known as a barrette.

Lux: One lumen per square meter (1/10 (0.0929)) footcandle).

Message Element: the use of characters, symbols, or a combination of characters and symbols in its simplest form used to communicate a location, direction, or action where aircraft operate. (See paragraph 9-1.)

Overrun: An area on the approach side of the runway threshold which is stabilized or paved but is not intended for normal operational use. It serves as a safety area for aircraft which overrun the end of the runway or touch down short of the threshold.

Positive Slope: A slope of the approach light plane upward and outward from the landing threshold.

Rigid Support: A support for elevated lights or other devices which has been designed to support the lights under all foreseeable weather conditions without regard for impact resistance. Do not use these supports in new construction for systems in safety clearance zones or where there is present danger of impact by aircraft.

Runway Centerline: A line halfway between the edges of the surface designated for normal aircraft landing and takeoff operations.

Runway Edge: The sides of a runway designated as full strength and capable of supporting aircraft wheel loads; any area beyond that point is a non-operational area.

Runway End: The longitudinal limit of usable runway opposite the runway threshold. It often, but not always, coincides with the threshold of the opposite direction runway surface.

Runway Visual Range (RVR): The maximum distance in the direction of take-off or landing from which the runway (or the specified lights or markers delineating it) can be seen from a position above a specified point on the runway centerline and at a height corresponding to the average eye level of pilots at touchdown.

Semi-frangible Support: A two element support for light fixtures or other devices designed for use in applications where the mounting is over 40 feet (12 meters) above the ground and exceeds the design limits for low impact resistant supports mounted on a rigid support and a means to lower the lights for servicing.

Sign array: message elements that may be within multiple individual housings (See paragraph 9-1.)

Theater of Operations: (TO) An operational area defined by the geographic combatant commander for the conduct or support of specific military operations. (Joint Publication 3-0)