

UNIFIED FACILITIES CRITERIA (UFC)

DESIGN: PETROLEUM FUEL FACILITIES



APPROVED FOR PUBLIC RELEASE; DISTRIBUTION UNLIMITED

UNIFIED FACILITIES CRITERIA (UFC)

DESIGN: PETROLEUM FUEL FACILITIES

Any copyrighted material included in this UFC is identified at its point of use. Use of the copyrighted material apart from this UFC must have the permission of the copyright holder.

U.S. ARMY CORPS OF ENGINEERS

NAVAL FACILITIES ENGINEERING COMMAND (Preparing Activity)

AIR FORCE CIVIL ENGINEER SUPPORT AGENCY

Record of Changes (changes are indicated by \1\ ... /1/)

Change No.	Date	Location
1	1 Nov 2013	See Revision Summary page for description of changes; editorial changes throughout.

FOREWORD

The Unified Facilities Criteria (UFC) system is prescribed by MIL-STD 3007 and provides planning, design, construction, sustainment, restoration, and modernization criteria, and applies to the Military Departments, the Defense Agencies, and the DoD Field Activities in accordance with [USD \(AT&L\) Memorandum](#) dated 29 May 2002. UFC will be used for all DoD projects and work for other customers where appropriate. All construction outside of the United States is also governed by Status of Forces Agreements (SOFA), Host Nation Funded Construction Agreements (HNFA), and in some instances, Bilateral Infrastructure Agreements (BIA.) Therefore, the acquisition team must ensure compliance with the most stringent of the UFC, the SOFA, the HNFA, and the BIA, as applicable.

UFC are living documents and will be periodically reviewed, updated, and made available to users as part of the Services' responsibility for providing technical criteria for military construction. Headquarters, U.S. Army Corps of Engineers (HQUSACE), Naval Facilities Engineering Command (NAVFAC), and Air Force Civil Engineer Center (AFCEC) are responsible for administration of the UFC system. Defense agencies should contact the preparing service for document interpretation and improvements. Technical content of UFC is the responsibility of the cognizant DoD working group. Recommended changes with supporting rationale should be sent to the respective service proponent office by the following electronic form: [Criteria Change Request](#). The form is also accessible from the Internet sites listed below.

UFC are effective upon issuance and are distributed only in electronic media from the following source:

- Whole Building Design Guide web site <http://dod.wbdg.org/>.

Refer to UFC 1-200-01, *General Building Requirements*, for implementation of new issuances on projects.

AUTHORIZED BY:

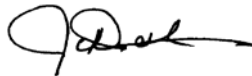

JAMES C. DALTON, P.E.
Chief, Engineering and Construction
U.S. Army Corps of Engineers



DENNIS FIRMAN
Director of the Air Force Center for Engineering
and the Environment
Department of the Air Force



JOSEPH E. GOTT, P.E.
Chief Engineer
Naval Facilities Engineering Command



MICHAEL McANDREW
Director, Facility Investment and
Management
Office of the Deputy Under Secretary of Defense
(Installations and Environment)

UNIFIED FACILITIES CRITERIA (UFC) REVISION SUMMARY SHEET

Document: UFC 3-460-01, Design: Petroleum Fuel Facilities, dated 16 August 2010, With Change 1

Superseding: UFC 3-460-01, Design: Petroleum Fuel Facilities, dated 16 August 2010.

Description of Changes: This update to UFC 3-460-01 incorporate changes to the design requirements for fuel facilities. These changes are based on lessons learned from the previous guidelines, new technologies, updated requirements by the services for fuel handling and quality, and new regulations and other reference documents. Incorporation of these changes will decrease the life-cycle costs by ensuring the integrity of the fueling systems during operations and decreasing maintenance requirements. These changes include, but not limited to updating the references, and the requirements for:

- Updating Command/Codes throughout document
- Add UFC 3-575-01 in paragraph 2-12.3, Grounding and Bonding
- Added stilling well requirements in Chapter 2 and 8.
- Added additional marking requirements in Chapter 2.
- Updated containment volume requirements for truck fill & offload facilities in Chapters 3 and 4.
- Updated meter requirements in Chapters 3, 4, 5, and 6.
- Removed tank spacing requirements in Chapters 3 and 4 and 7, and added the tank spacing requirements in Chapter 8.
- Clarified the wording for tank truck fillstand and offload equipment in Chapters 3, 4, 5, and 6.
- Clarified the wording for Canopies in Chapters 3, 4, 5, 6 and 7.
- Changed references to NAVFAC drawing no. 1404000 and 1404005 to DoD Standard Design AW 078-24-29.
- Updated Chapter 8 to be consistent with DoD Standard AW 78-24-27.
- Updated Chapter 8 to clarify requirements for shop fabricated tanks.
- Updated Chapter 9 to provide guidance on the installation of small diameter piping.
- Deleted paragraph 11-5.7 for remote spill containment for truck parking areas. This is already included in paragraph 11-5.6.
- Added that helium testing is allowed to locate a tank leak in Chapter 12.
- Deleted references to Document DESC-X-P-2. This document is for expeditionary use only.
- Revised Facility Plates: 005, 014, 015, 016, and 021.
- Updated APPENDIX B to provide corrected formulas.
- Updated APPENDIX C.

This update also includes hyperlinks between the Table of Contents to the document, and the document to the glossary and references.

Reasons for Changes:

- Requirements for the fueling systems and related facilities have changed due to the type of fuels currently used, and the quality requirements for these fuels. The quality requirements for these fuels are set by the Naval Air Systems Command, Naval Sea Systems Command, Air Force Petroleum Agency, and the Army Petroleum Center.
- Many of the changes are from lessons learned from design, construction, maintenance and operations of the fuel facilities.
- Many of the references have changed or out dated.

Impact: The changes to this UFC will impact the design and cost of fuel facilities. However, the following benefits should be realized.

- Ensure that the fuel quality issued to the DoD aircraft, trucks, ships, and vehicles is such that no damage is realized to all of the DoD assets
- By ensuring that all fuel facilities will be standardized throughout the tri-services.
- Decrease the amount of maintenance and repair required on the fuel facility system.

Non-Unified Items: There are a few items that are either Navy, Air Force or Army specific. The list below summarizes these items, along with the justification for it to be Service Specific:

- The Navy requires the use of a fusible link butterfly valve at the inlet to truck fillstand and on supply and return risers at aircraft direct fueling stations. The Navy's position for fusible link valves is primarily because JP-5, which is primarily used by the Navy, does not have the Static dissipater additive (SDA), so it is more likely to spark during transport thru pipelines and equipment than any other fuel. (Refer to paragraph 2-3.14.3). The fusible link will shut if there is a fire or other high-temperature event. Also, the Navy's aircraft direct fueling stations are designed to hot refuel aircraft, so the fusible link will also protect the aircraft if there is a high-temperature event between the tank and the fusible link.
- The Air Force allows the use of internally coated filter separators and piping from the filter/separators to the skin of the aircraft. Since it is Air Force policy to always filter the fuel at the skin of the aircraft, any paint and carbon particles in the fuel will be filtered before entering the aircraft. The Navy does not filter at the skin of the aircraft, therefore the filter-separator must be either aluminum or stainless steel, and the piping from the filter-separator to the aircraft is to be stainless steel. In addition, for

Navy systems, the return line is also to be stainless steel if there is any possibility for recirculating the fuel without going thru two filtrations.

- This UFC references Service-Specific documents, which the tri-service fuel community does not oversee. Also, each service has its own requirements for fuel quality and operations.

CANCELLED

ABSTRACT

This guidance is for individual project planning and for preparing engineering and construction documentation. Basic guidance is provided to professional facility planners, engineers, and architects for use in designing liquid fueling and dispensing facilities, liquefied petroleum gas facilities, and compressed natural gas facilities. Included are basic requirements for the design of fueling systems; the design of receiving, dispensing, and storage facilities; ballast treatment and sludge removal; corrosion and fire protection; and environmental requirements.

CANCELLED

This Page Intentionally Left Blank

CANCELLED

TABLE OF CONTENTS

CHAPTER 1 INTRODUCTION	1
1-1 SCOPE	1
1-2 USE OF UFC	1
1-3 PURPOSE OF CRITERIA	1
1-4 DEPARTMENT OF DEFENSE (DOD) FUELS FACILITY ENGINEERING PANEL	1
1-5 SERVICE HEADQUARTERS SUBJECT MATTER EXPERTS (SME).....	2
1-5.1 Service Provider Subject Matter Expert (SME)	2
1-6 WAIVERS AND EXEMPTIONS.....	2
1-7 RELATED CRITERIA	2
1-8 POLICY	3
1-9 REFERENCED STANDARDS.....	3
1-10 PROJECTS OUTSIDE OF CONTINENTAL UNITED STATES.....	3
1-10.1 NATO Standards	3
1-10.2 Non-NATO Projects	3
CHAPTER 2 GENERAL DESIGN INFORMATION.....	5
2-1 OPERATIONAL CAPABILITIES.....	5
2-2 FUEL SPECIFICATIONS	5
2-3 FUEL PROPERTIES AND ADDITIVES.....	6
2-3.1 Motor Gasoline (Mogas) [F-46] [ASTM D4814].....	6
2-3.2 Aviation Gasoline (Avgas) [F-18] [ASTM D910].....	6
2-3.3 Aviation Turbine Fuels	7
2-3.4 Kerosene [ASTM D3699].....	8
2-3.5 Diesel Fuels	8
2-3.6 Burner Fuel Oils.....	9
2-3.7 Alternative Fuel (E85) [ASTM D5798].....	10
2-3.8 Alternative Fuel Bio-Diesel (B20).....	11
2-3.9 Liquefied Petroleum Gas (LPG).....	12
2-3.10 Compressed Natural Gas (CNG)	12
2-3.11 OTTO Fuels	14
2-3.12 Lubricating Oils.....	14

2-3.13	Hydrazine - Water (H-70) [MIL-PRF-26536]	14
2-3.14	Fuel Additives	15
2-4	PRODUCT SEGREGATION	16
2-4.1	Product Grades.....	16
2-4.2	Exceptions	16
2-5	TRANSFER FLOW RATES	16
2-6	PHYSICAL SECURITY	18
2-6.1	Antiterrorism and Physical Security	18
2-6.2	Security Fencing	19
2-7	MAINTAINABILITY CAPABILITIES	19
2-8	VOICE COMMUNICATIONS	19
2-9	OTHER COMMUNICATIONS	19
2-9.1	Data Communications.....	19
2-9.2	Fire Alarm Communication	20
2-10	VAPOR RECOVERY	20
2-11	WORKER SAFETY	20
2-11.1	Safety Showers and Eyewash Fountains.....	20
2-12	ELECTRICAL DESIGN	20
2-12.1	Area Classifications	20
2-12.2	Illumination.....	22
2-12.3	Grounding and Bonding	23
2-13	CATHODIC PROTECTION	25
2-13.1	Tanks	25
2-13.2	Piping.....	25
2-13.3	Structures	26
2-14	ENVIRONMENTAL PROTECTION	26
2-14.1	General Policy	26
2-14.2	Regulations.....	26
2-14.3	Transfer of Fuel at Ports	27
2-14.4	Air Quality Control.....	28
2-14.5	Water Quality Control.....	29
2-14.6	Aboveground Storage Tanks	32

2-14.7	Underground Storage Tanks.....	33
2-15	FIRE PROTECTION	33
2-15.1	General Requirements.....	33
2-15.2	Protection of Aboveground Storage Tanks	33
2-15.3	Fire Protection of Pumping Facilities	34
2-15.4	Fire Protection of Underground Vertical Storage Tanks	34
2-15.5	Protection of Tank Truck and Tank Car Facilities	35
2-15.6	Protection of Aircraft Fueling Facilities.....	35
2-15.7	Protection of Fuel Testing Laboratory.....	35
2-15.8	Protection of Support Facilities	35
2-15.9	Protection of Fuel Piers.....	35
2-16	EMERGENCY SHUT-DOWN	35
2-17	ELECTROMAGNETIC RADIATION HAZARDS	36
2-18	IDENTIFICATION	36
2-19	ANTISTATIC DESIGN.....	37
2-19.1	Piping Inlet Connections	37
2-19.2	Enclosed Vapor Spaces.....	37
2-19.3	Filter/Separators	37
2-19.4	Aircraft Direct Fueling Stations	38
2-19.5	Truck Bottom Loading.....	38
2-20	OPERATION AND MAINTENANCE DOCUMENTATION.....	38
2-20.1	Equipment Operation and Maintenance Documentation	38
2-20.2	Operation and Maintenance Support Information (OMSI).....	38
2-21	PROTECTION AGAINST SEISMIC ACTIVITY	38
2-22	STRUCTURAL DESIGN.....	38
2-23	CONCRETE.....	39
2-24	AIRFIELD/AIRSPACE REQUIREMENTS.....	39
2-25	PERMITS.....	39
CHAPTER 3	BULK FUEL STORAGE FACILITIES.....	41
3-1	INTRODUCTION	41
3-2	GENERAL REQUIREMENTS	41
3-3	RECEIVING FACILITIES.....	41

3-3.1	Pipeline Receiving Facilities	41
3-3.2	Tank Truck and Tank Car Off-loading Facilities.....	43
3-3.3	Marine Off-loading Facilities	49
3-4	DISPENSING FACILITIES	49
3-4.1	Pipeline Pumping Facilities.....	49
3-4.2	Tank Truck and Tank Car Loading Facilities.....	51
3-4.3	Marine Loading Facilities	57
3-5	PIPING SYSTEMS	57
3-5.1	Product Segregation	57
3-6	EQUIPMENT DESCRIPTIONS.....	57
3-6.1	Bulk Air Eliminators.....	57
3-6.2	Meters.....	57
3-6.3	Pressure or Pressure/Vacuum Gauges	58
3-6.4	Strainers	59
3-6.5	Surge Suppressors	60
3-6.6	Pumps.....	60
3-6.7	Valves.....	61
3-6.8	Other Valves (Except Diaphragm Control Valves)	64
3-6.9	Diaphragm Control Valves.....	65
3-6.10	Thermometers	67
3-6.11	Fuel Hoses.....	67
3-7	CONTROLS.....	67
3-7.1	Design Requirements	67
3-7.2	Flow Controls.....	67
3-7.3	Pump Controls	68
3-8	CANOPIES	70
3-8.1	Canopies to Protect Fixed Assets from Extreme Weather Conditions	70
3-8.2	Canopies to Reduce Stormwater	70
3-9	PRODUCT RECOVERY SYSTEMS.....	71
3-10	FUEL ADDITIVES	71
CHAPTER 4 AIRCRAFT FUELING FACILITIES.....		73
4-1	INTRODUCTION	73

4-1.1	Function.....	73
4-1.2	Aviation Turbine Fuels.....	73
4-1.3	Special Precautions for Aviation Turbine Fuel Quality.....	73
4-2	GENERAL REQUIREMENTS	74
4-3	RECEIVING FACILITIES.....	74
4-3.1	Pipeline Receiving Facilities.....	74
4-3.2	Tank Truck and Tank Car Off-Loading Facilities.....	76
4-3.3	Marine Off-Loading Facilities.....	82
4-3.4	Special In-Bound Filtration.....	82
4-4	DISPENSING FACILITIES	82
4-4.1	Refueler Truck Fillstands.....	82
4-4.2	Aircraft Direct Fueling Systems.....	88
4-4.3	Marine Loading Facilities.....	93
4-5	PIPING SYSTEMS	93
4-5.1	Product Segregation.....	93
4-6	EQUIPMENT DESCRIPTIONS.....	93
4-6.1	Bulk Air Eliminators.....	93
4-6.2	Meters.....	93
4-6.3	Pressure or Pressure/Vacuum Gauges.....	94
4-6.4	Strainers.....	95
4-6.5	Surge Suppressors.....	96
4-6.6	Filter/Separators.....	96
4-6.7	Pumps.....	98
4-6.8	Valves.....	99
4-6.9	Other Valves (Except Diaphragm Control Valves).....	102
4-6.10	Diaphragm Control Valves.....	103
4-6.11	Fuel Hoses.....	105
4-7	CONTROLS.....	105
4-7.1	Design Requirements.....	105
4-7.2	Flow Controls.....	105
4-7.3	Pump Controls.....	105
4-8	CANOPIES.....	107

4-8.1	Canopies to Protect Fixed Assets from Extreme Weather Conditions ...	107
4-8.2	Canopies to Reduce Stormwater	108
4-9	FUEL ADDITIVES	108
4-9.1	Plus 100 Additive	108
4-10	DEFUELING AND RETURN-TO-BULK (RTB) SYSTEMS	108
4-10.1	General Criteria	108
4-10.2	JP-5 Systems.....	109
4-10.3	JP-8 Systems.....	109
4-11	PRODUCT RECOVERY SYSTEMS.....	110
4-11.1	Tank Trucks and Fuel Bowsers	110
4-11.2	Return to Bulk.....	110
CHAPTER 5	MARINE RECEIVING AND DISPENSING FACILITIES	113
5-1	FUNCTION	113
5-2	FUEL PIERS AND WHARVES.....	113
5-3	BERTHING PIERS	113
5-4	OFFSHORE MOORINGS.....	113
5-5	GENERAL REQUIREMENTS	113
5-6	GENERAL LAYOUT.....	114
5-7	PIPING SYSTEMS	115
5-7.1	Piping Arrangement	115
5-8	EQUIPMENT DESCRIPTIONS.....	115
5-8.1	Loading/Off-Loading Arms	115
5-8.2	Fuel Hoses.....	116
5-8.3	Submarine Fuel Hoses	116
5-8.4	Meters.....	116
5-8.5	Strainers	117
5-8.6	Surge Suppressors	118
5-8.7	Valves.....	118
5-8.8	Other Valves	120
5-8.9	Pressure or Pressure/Vacuum Gauges	121
5-8.10	Stripper Pumps.....	122
5-8.11	Excess Flow Sensors.....	122

5-8.12	Solid Cyclonic Separators.....	122
5-8.13	Grounding Systems	122
5-8.14	Special Considerations for AviationTurbine Fuels	122
5-9	PRODUCT RECOVERY SYSTEMS.....	122
5-10	WEATHER SHEDS	123
5-11	CANOPIES	123
5-12	SPECIAL CALCULATIONS	123
5-13	SAFETY SHOWERS AND EYEWASH FOUNTAINS.....	123
5-14	TRAFFIC BOLLARDS.....	123
5-15	SPECIAL DRAINAGE FOR FUELING PIERS	123
5-16	BALLAST TREATMENT AND SLUDGE REMOVAL.....	124
5-16.1	Ballast Receiving and Treatment Facilities	124
5-17	SLUDGE REMOVAL SYSTEMS.....	126
5-17.1	Design Requirements	126
5-17.2	Sludge Disposal.....	126
5-17.3	Piping Materials	127
CHAPTER 6	INTERTERMINAL AND INSTALLATION PIPELINES	129
6-1	INTRODUCTION	129
6-2	GENERAL REQUIREMENTS	129
6-3	DESIGN REQUIREMENTS	129
6-3.1	Fuel Segregation	129
6-3.2	Applicable Regulations	129
6-3.3	Sampling.....	130
6-3.4	Pigging.....	130
6-3.5	Surge Suppression	130
6-4	PIPING SYSTEMS	130
6-5	EQUIPMENT	130
6-5.1	Meters.....	130
6-5.2	Manual Valves	131
6-5.3	Other Valves (Except Diaphragm Control Valves)	134
6-5.4	Diaphragm Control Valves	134
6-5.5	Strainers	136

6-5.6	Surge Suppressors	137
6-5.7	Pigging Equipment.....	137
6-5.8	Pumps.....	137
6-5.9	Sampling Connections.....	137
6-5.10	Special Consideration for AviationTurbine Fuels	137
6-6	PRODUCT RECOVERY SYSTEMS.....	137
6-7	CANOPIES	138
6-7.1	Canopies to Protect Fixed Assets from Extreme Weather Conditions ...	138
6-7.2	Canopies to Reduce Stormwater	138
6-8	SPECIAL CALCULATIONS	138
CHAPTER 7 GROUND PRODUCTS FUELING FACILITIES.....		139
7-1	INTRODUCTION	139
7-1.1	Types of Facilities	139
7-2	GENERAL REQUIREMENTS	139
7-3	DESIGN REQUIREMENTS	139
7-3.1	Fuel Segregation	139
7-3.2	Facility Size.....	139
7-3.3	Facility Configurations.....	140
7-3.4	Shelters.....	140
7-3.5	Concrete Fueling Area – Filling Stations.....	140
7-3.6	Concrete Fueling Area – Tactical Refueler Truck Loading Facilities.....	140
7-3.7	Canopies.....	140
7-3.8	Regulations.....	141
7-3.9	Bottom Loading.....	141
7-3.10	Truck Offload and Loading Facilities.....	141
7-4	STORAGE TANKS.....	141
7-5	PIPING SYSTEMS	141
7-5.1	Piping System – Tactical Refueler Facilities	141
7-5.2	Aboveground Piping System – Filling Stations	142
7-6	EQUIPMENT DESCRIPTIONS.....	142
7-6.1	Filling Stations	142
7-6.2	Tactical Refueler Truck Loading Facilities	143

7-6.3	Valves	143
7-6.4	Diaphragm Control Valves	144
7-6.5	Other Valves	144
7-7	VAPOR RECOVERY	145
CHAPTER 8 ATMOSPHERIC STORAGE TANKS.....		147
8-1	INTRODUCTION	147
8-2	GENERAL REQUIREMENTS	147
8-3	GENERAL CRITERIA	147
8-3.1	Materials	147
8-3.2	Protection.....	147
8-3.3	Design Requirements	147
8-3.4	Storage Capacity	148
8-3.5	Tank Spacing.....	148
8-3.6	Distance from Buildings and Property Lines	149
8-3.7	Distance from Roadway, Railroads and Power Lines	150
8-3.8	Distance from Tank Truck and Tank Car Off-Loading and Loading Facilities.....	151
8-3.9	Interior Coatings	151
8-3.10	Exterior Coatings	152
8-3.11	Fill Piping	152
8-3.12	Vapor Emission Control Systems	152
8-3.13	Strapping Tables.....	152
8-3.14	Product Recovery Systems.....	153
8-3.15	Registration.....	154
8-4	HORIZONTAL ABOVEGROUND TANKS (SINGLE-WALL STEEL)....	154
8-4.1	General Design Considerations	154
8-4.2	Tank Design Requirements	154
8-5	HORIZONTAL ABOVEGROUND TANKS (DOUBLE-WALL STEEL)..	155
8-5.1	General Design Considerations	155
8-5.2	Tank Design Requirements	155
8-6	HORIZONTAL ABOVEGROUND TANKS (FIRE-RESISTANT)	156
8-6.1	General Design Considerations	156

8-6.2	Tank Design Requirements	157
8-7	HORIZONTAL ABOVEGROUND TANKS (PROTECTED TANKS).....	157
8-7.1	General Design Considerations	157
8-7.2	Tank Design Requirements	158
8-8	ABOVEGROUND VERTICAL STORAGE TANKS	159
8-8.1	General Design Considerations	159
8-8.2	Tank Roofs	160
8-8.3	Internal Floating Pans.....	160
8-8.4	Tank Bottoms.....	161
8-8.5	Foundations	161
8-9	UNDERGROUND HORIZONTAL STORAGE TANKS.....	163
8-9.1	General Design Considerations	163
8-9.2	Installation.....	163
8-10	UNDERGROUND VERTICAL STORAGE TANKS (CUT AND COVER)	163
8-10.1	General Design Considerations	163
8-11	APPURTENANCES.....	164
8-12	HEATERS.....	164
8-12.1	General Design Considerations	164
8-12.2	Heating Medium.....	164
8-12.3	Convection-Type.....	164
8-12.4	In-Line Type.....	165
8-12.5	Insulation and Tracing.....	165
8-13	UNDERGROUND STORAGE TANK SPILL CONTAINMENT SYSTEMS	165
8-13.1	General Design Considerations	165
8-14	ABOVEGROUND TANK SPILL CONTAINMENT SYSTEMS.....	166
8-14.1	General Design Considerations	166
8-14.2	Spill Containment System Capacity	167
8-14.3	Remote Containment/Impoundment Spill Collection Systems	167
8-14.4	Diked Enclosure – Earthen Dike Type	167
8-14.5	Diked Enclosure – Reinforced Concrete Dike Type	168
8-14.6	Diked Enclosure – Combination Dike Type.....	168

8-14.7	Stormwater Collection Systems	168
8-14.8	Dike Access	168
8-15	MISCELLANEOUS USE TANKS	169
8-15.1	Installation.....	169
8-15.2	Heating Oil Tanks	169
8-15.3	Generator Fuel Tanks.....	169
8-15.4	Fire Pump Fuel Tanks.....	169
8-15.5	Waste Oil Tanks	169
8-15.6	Containment	169
8-15.7	Underground Tanks	170
8-16	SHIPBOARD OFF-LOAD FUEL STORAGE TANKS.....	170
8-16.1	Function	170
8-16.2	General Design Considerations	170
8-16.3	Locations	170
8-17	JET ENGINE TEST CELL FUEL STORAGE TANKS.....	170
8-18	FUELS AUTOMATED SYSTEM	170
CHAPTER 9	PIPING SYSTEMS.....	179
9-1	INTRODUCTION	179
9-2	GENERAL REQUIREMENTS	179
9-2.1	Design Requirements	179
9-2.2	Piping Arrangement.....	181
9-2.3	Surge Analysis.....	182
9-3	ABOVEGROUND PIPING	184
9-3.1	Identification.....	185
9-3.2	Pipe Supports	185
9-3.3	Arrangement	185
9-3.4	Anchors.....	185
9-3.5	Thermal Relief Valves.....	186
9-4	UNDERGROUND PIPING	187
9-4.1	Depth of Cover.....	187
9-4.2	Parallel and Crossing Pipes.....	187
9-4.3	Casing Sleeves.....	188

9-4.4	Line Markers	188
9-4.5	Warning Tapes	188
9-4.6	Double-Wall Piping	188
9-4.7	Single-Wall Piping Leak Detection Systems	188
9-5	UNDERWATER PIPING	189
9-5.1	Special Arrangements.....	189
9-5.2	Connections.....	189
9-5.3	Unique Considerations.....	189
9-5.4	Corrosion Protection	190
9-5.5	Depth of Burial	190
9-5.6	Pipe Thickness and Weight	190
9-6	PIPING MATERIALS	190
9-6.1	Non-Aviation Systems.....	190
9-6.2	Aviation Systems	191
9-7	WELDING CRITERIA	191
9-8	PIPING CONNECTIONS	191
9-9	INTERIOR PIPE COATINGS.....	192
9-10	EXTERIOR PIPE COATINGS	192
9-11	SAMPLING FACILITIES	193
CHAPTER 10	ALTERNATE POL FACILITIES	195
10-1	INTRODUCTION	195
10-2	LIQUEFIED PETROLEUM GAS (LPG).....	195
10-2.1	Uses.....	195
10-2.2	General Design Considerations	195
10-2.3	Receiving Facilities	197
10-2.4	Storage Facilities	199
10-2.5	Distribution Facilities.....	200
10-2.6	Air Mixing Facilities	203
10-3	COMPRESSED NATURAL GAS (CNG).....	204
10-3.1	Uses.....	204
10-3.2	General Design Considerations	204
10-3.3	Warning	208

10-4	HYDRAZINE STORAGE AND SERVICING FACILITIES	208
10-4.1	Uses.....	208
10-4.2	General Design Considerations.....	208
10-4.3	Construction Concepts.....	209
10-5	OTTO FUELS	214
CHAPTER 11 SUPPORT FACILITIES		215
11-1	INTRODUCTION	215
11-2	OPERATIONS BUILDING.....	215
11-2.1	Design Standards	215
11-2.2	Fuel Office	215
11-2.3	Training/Conference Room.....	215
11-2.4	Fuel Maintenance Workshop	215
11-2.5	Storeroom	215
11-2.6	Laboratory.....	216
11-2.7	Miscellaneous Safety Equipment.....	217
11-2.8	Control Room.....	217
11-2.9	Miscellaneous Spaces	217
11-2.10	Communications	218
11-3	ROADS.....	218
11-4	UTILITIES.....	218
11-5	AIRCRAFT REFUELER AND FUEL DELIVERY VEHICLE PARKING	218
11-5.1	General.....	218
11-5.2	Clearances.....	218
11-5.3	Arrangement	220
11-5.4	Ingress/Egress.....	220
11-5.5	Paving.....	220
11-5.6	Containment Area.....	220
11-5.7	Fire Protection	220
11-5.8	Security.....	221
11-5.9	Lighting	221
11-5.10	Block Heater Connections	221
CHAPTER 12 MAJOR REHABILITATION.....		223

12-1	INTRODUCTION	223
12-2	GENERAL REQUIREMENTS	223
12-3	ABOVEGROUND FUEL STORAGE TANK REHABILITATION	223
12-3.1	Aboveground Vertical Tank Inspections.....	223
12-3.2	Increase Manhole Sizes.....	224
12-3.3	Replace Tank Floors.....	224
12-3.4	Replace Floating Roof Tanks With Fixed Roofs	225
12-3.5	Product Recovery Systems.....	226
12-3.6	Coatings.....	226
12-3.7	Isolation Valves.....	226
12-3.8	Alarms and High Level Shut-off Valves.....	226
12-4	UNDERGROUND OPERATING TANKS.....	227
12-4.1	Manholes	227
12-4.2	Interior Coatings	227
12-5	HYDRANT SYSTEMS	227
12-5.1	Pumps.....	227
12-5.2	Filter/Separators	227
12-5.3	Fuel Quality Monitors.....	228
12-5.4	Control Systems	228
12-5.5	Electrical Systems	228
12-5.6	Lateral Control Pits	229
12-5.7	Distribution Piping.....	229
12-5.8	Diaphragm Control Valves	229
12-5.9	Hydrant Outlets.....	229
12-6	DIKES, LINERS, AND BASINS	229
12-7	LEAK DETECTION	230
12-8	CATHODIC PROTECTION	230
12-9	ISOLATION VALVES	230
12-10	SOIL AND GROUNDWATER REMEDIATION.....	230
12-11	LIQUEFIED PETROLEUM GAS (LPG) FACILITIES	231
12-12	PIPELINE INSPECTION.....	231
12-12.1	Inspection	231

12-12.2	Smart Pigging	231
12-13	CHECKLIST	231
CHAPTER 13 FUELING FACILITY TEMPORARY DEACTIVATION.....		235
13-1	INTRODUCTION	235
13-2	GENERAL REQUIREMENTS	235
13-3	FUEL STORAGE AND DISTRIBUTION FACILITIES	235
13-3.1	Tanks	235
13-3.2	Pipelines	237
13-4	FACILITIES	238
13-4.1	General Considerations	238
13-4.2	Fencing	238
13-4.3	Paved Surfaces	238
CHAPTER 14 FUELING FACILITY CLOSURE.....		241
14-1	CLOSURE REQUIREMENTS	241
14-1.1	Aboveground Tanks	241
14-1.2	Underground Tanks	241
14-1.3	Pipelines	241
14-2	GENERAL REQUIREMENTS	242
14-3	INVENTORY	242
APPENDIX A REFERENCES		243
APPENDIX B MANUAL SURGE CALCULATIONS FOR SIMPLE PIPING SYSTEMS		259
APPENDIX C CHARTER OF DOD FUELS FACILITY ENGINEERING PANEL		263
APPENDIX D GLOSSARY.....		267
D-1	ABBREVIATIONS AND ACRONYMS.....	267
D-2	TERMS	271
APPENDIX E PLATES.....		285

TABLES

TABLE 2-1. PROPERTIES OF AVIATION FUELS	7
TABLE 2-2. PHYSICAL PROPERTIES OF DIESEL FUELS	9
TABLE 2-3. PHYSICAL PROPERTIES OF BURNER FUEL OILS	10
TABLE 2-4. DESIGN FLOW RATES.....	17
TABLE 4-1. AVIATION TURBINE FUEL RECEIPT FILTRATION TABLE (1) (3)	111
TABLE 8-1. APPURTENANCES.....	171
TABLE 9-1. ALLOWABLE PRESSURE TABLE – ANSI CLASS 150 FLANGED JOINTS	184

CANCELLED

CHAPTER 1 INTRODUCTION

1-1 SCOPE

This Unified Facilities Criteria, UFC 3-460-01, contains general criteria and standard procedures for the design and construction of military land-based facilities which receive, store, distribute, or dispense liquid fuels. It is also applicable to the handling of liquefied petroleum gases (LPG) and compressed natural gas (CNG). It provides guidance on the rehabilitation, deactivation, or closure of fueling facilities. Support facilities are also included. [Facility Plate 001](#) provides assistance in identifying UFC chapter numbers for specific fueling components.

1-2 USE OF UFC

The guidance contained in this UFC is intended for use by facility planners, engineers, and architects for individual project planning and for preparing engineering and construction documentation. In addition, it is intended for use by operations and maintenance personnel as a guidance document for facility design, modifications, and improvements.

1-3 PURPOSE OF CRITERIA

These criteria, except Chapters [12](#), [13](#), and [14](#) of this UFC, are intended for new construction only and do not apply retroactively to facilities existing at the time this UFC was issued. However, these criteria, including Chapters [12](#), [13](#), and [14](#), are applicable when modernizing or expanding existing facilities if the improvements can be justified in terms of obsolescence, expanded operational requirements, safety, environmental compliance, or excessive maintenance costs.

1-4 DEPARTMENT OF DEFENSE (DOD) FUELS FACILITY ENGINEERING PANEL

This UFC was updated by the [DoD](#) Fuels Facility Engineering Panel. \1\ The [DoD](#) FFEP (Panel) consists of recognized POL experts, primarily from the engineering community, to establish the criteria for the [DoD](#) community on ways to provide safe, operationally effective, and economic [DoD](#) fuel facilities systems to meet the mission requirements. The Panel will examine, develop, recommend, and provide design features for the standardization of facilities and equipment, and procedures used in fuel handling systems for storage, distribution, maintenance and dispensing of aircraft, marine, and ground fuels. The Panel will evaluate facility component parts on [DoD](#) installations and will serve as a pool of expertise to assist in resolving systemic fuel handling facility problems. Panel meetings will also serve as a forum to update members on new equipment, [DoD](#) or service-specific programs, and changes affecting the fuels maintenance, repair and construction community. /1/ Refer to [Appendix C](#), Charter for DoD Fuels Facility Engineering for more information.

1-5 SERVICE HEADQUARTERS SUBJECT MATTER EXPERTS (SME)

It is recognized that the policies, obligations, and responsibilities of the military branches may vary on some minor points. Therefore, consult the Subject Matter Expert at the appropriate [Service Headquarters](#) for interpretation. For the purposes of interpretation of this UFC, the Subject Matter Expert at the appropriate [Service Headquarters](#) is defined as follows:

\1\

- a) Army – Headquarters, U.S. Army Corps of Engineers, POL Facilities Proponent (CECW-EC)
- b) Air Force – The Air Force Fuels Facilities Subject Matter Expert (HQ AFCEC/COS) through the applicable Major Command (MAJCOM) Fuels Engineer
- c) Navy/Marine Corps: NAVFAC POL Facility Subject Matter Expert (NAVFAC EXWC, PW54).

/1/

1-5.1 Service Provider Subject Matter Expert (SME)

DLA Installation Support for Energy (DLA DS-FEI) is the Executive Agent as defined in [DOD 4140.25M](#).

\1\

1-6 WAIVERS AND EXEMPTIONS

For specific interpretations, waivers or exemption, contact the appropriate [Service Headquarters](#) Subject Matter Experts (SME) and refer to [MIL-STD-3007](#) for the waiver process. Substantial deviations from this UFC must first be presented to the appropriate Service Headquarters SMEs, and then reviewed / approved by the [DoD Fuels Facility Engineering Panel](#).

Recommended UFC language generated from recurring waivers and exemptions will be considered by the DoD Fuel Facilities Engineering Panel with supporting rationale [for inclusion on FFEP voting agendas](#). Recommended changes to this UFC are then reviewed/approved by the voting members of the [DoD Fuels Facility Engineering Panel](#), preferably in a normal recurring meeting.

/1/

1-7 RELATED CRITERIA

Other sources for criteria related to petroleum fuel facilities are identified in [Appendix A, References](#). Any reference noted is the latest edition unless otherwise stated.

UFC 1-200-01, *General Building Requirements*, provides applicability of model building codes and government-unique criteria for typical design disciplines and building systems, as well as for accessibility, antiterrorism, security, sustainability, and safety. Use this UFC in addition to UFC 1-200-01 and the UFCs and government criteria referenced therein.

1-8 POLICY

Design petroleum fuel facilities to meet the operational and management requirements of the command in which the facility is located, as well as to meet all applicable federal, state, and local regulations concerning environmental, health, safety, and fire protection issues.

1-9 REFERENCED STANDARDS

The execution agency issuing a contract for design and/or construction services will direct the use of standard designs, guide specifications, and/or definitive drawings. In other situations where these standards are not readily available, contact appropriate [Service Headquarters](#) for assistance in obtaining these documents.

1-10 PROJECTS OUTSIDE OF CONTINENTAL UNITED STATES

1-10.1 NATO Standards

For fueling projects outside of the continental United States (CONUS) and in a NATO (North Atlantic Treaty Organization) country, review and comply with all appropriate NATO documents, \1\ host-nation regulations, and this UFC. Where a direct conflict between the NATO documents, Host Nation regulations, or this UFC exists, the host-nation regulations must be met, followed by NATO documents, and then to this UFC.
/1/

1-10.2 Non-NATO Projects

For fueling projects located outside of the CONUS and not in a NATO country, use this UFC, applicable Service policy, and host-nation standards (if more stringent).

This Page Intentionally Left Blank

CANCELLED

CHAPTER 2 GENERAL DESIGN INFORMATION

2-1 OPERATIONAL CAPABILITIES

Design fuel facilities for continued operation using emergency or temporary expedients despite the loss of one or more components of the fuel receiving and/or dispensing system by enemy action or other factors. For tactical or mission-related fuel facilities, provide an alternative source of fuel supply to the fuel facility to ensure emergency operation under the most adverse conditions, including back-up power (emergency generators). Maintain consistency with prescribed criteria in appropriate directives, instructions, and standard designs (including NATO Standards).

2-2 FUEL SPECIFICATIONS

The following specifications apply to the various petroleum fuels that may be addressed:

- a) MIL-DTL-5624, Turbine Fuel, Aviation, Grades JP-4 and JP-5.
- b) MIL-DTL-38219, Turbine Fuel, Low Volatility, JP-7.
- c) MIL-DTL-83133, Turbine Fuel, Aviation, Kerosene Type, JP-8 (NATO F-34), and NATO F-35, and JP-8+100 (NATO F-37).
- d) MIL-DTL-25524, Turbine Fuel, Aviation, Thermally Stable.
- e) ASTM D1655, Standard Specification for Aviation Turbine Fuels.
- f) CID A-A-52557, Fuel Oil, Diesel; for Posts, Camps and Stations.
- g) CID A-A-59693, Diesel Fuel, Biodiesel Blend (B20).
- h) MIL-DTL-16884, Fuel, Naval Distillate.
- i) ASTM D3699, Standard Specification for Kerosene.
- j) ASTM D4814, Standard Specification for Automotive Spark-Ignition Engine Fuel.
- k) ASTM D910, Standard Specification for Aviation Gasoline (Avgas)
- l) ASTM D975, Standard Specification for Diesel Fuel Oils.
- m) MIL-DTL-87107, Propellant, High Density Synthetic Hydrocarbon Type, Grade JP-10.
- n) ASTM D5798, Standard Specification for Fuel Ethanol (Ed75-Ed85) for Automotive Spark-Ignition Engines.

- o) ASTM D6751, Standard Specification for Biodiesel Fuel Blend Stock (B100) for Middle Distillate Fuels.

\1\

- p) ASTM D7467, Standard Specification for Diesel Fuel Oil, Biodiesel Blend (B6 to B20)

/1/

2-3 FUEL PROPERTIES AND ADDITIVES

In addition to the fuel specifications, refer to Coordinating Research Council, Inc., [CRC Report No. 635](#), Handbook of Aviation Fuel Properties, for additional fuel properties.

The following paragraphs list typical physical properties of various grades of fuel and [additives](#) which would affect the design of a petroleum fuel facility. The NATO designation is shown in brackets.

2-3.1 Motor Gasoline (Mogas) [F-46] [[ASTM D4814](#)]

2-3.1.1 Special Precautions for Mogas

Because of its high [volatility](#), gasoline produces large amounts of vapor at ordinary temperatures. When confined in a tank or container at liquid temperatures above 20 degrees F (-7 degrees C), the vapor space is normally too rich to be explosive. At temperatures 20 degrees F (-7 degrees C) or less, vapor spaces above gasoline may be in the explosive range. One gallon (3.785 L) of liquid gasoline when vaporized will occupy about 25 cubic feet (700 L) of space, and if permitted to escape and become diluted with air, it is highly flammable. Provide a design that precludes disposing of Mogas into storm or sanitary sewers.

2-3.2 Aviation Gasoline (Avgas) [F-18] [[ASTM D910](#)]

2-3.2.1 Description of Aviation Gasoline

Aviation gasoline is a high-octane aviation fuel used for piston or Wankel engine powered aircraft. It is distinguished from motor gasoline, which is the everyday gasoline used in ground vehicles. In military service, avgas is seldom used in manned aircraft but is commonly used in Unmanned Aerial Vehicles (UAVs).

2-3.2.2 Avgas Grades

100LL, spoken as "100 low lead", is the most common grade used in military applications. It is dyed blue, and contains a maximum of 2 grams of lead per US gallon (0.56 grams/liter) and is the most commonly available and used aviation gasoline. Other grades that are theoretically available include Grade 80, Grade 91, Grade 100,

and Grade 82UL. The differences between all 80, 91, 100, and 100LL are lead content and color. Grade 82UL is unleaded.

2-3.2.3 Special Precautions for Avgas

Using the wrong grade of gasoline will cause engine problems. Virtually all grades of avgas available contain tetra-ethyl lead (TEL) as a lead based anti-knock compound. See Mogas for flammability issues.

2-3.3 Aviation Turbine Fuels

2-3.3.1 Physical Properties of Aviation Turbine Fuels

Table 2-1. Properties of Aviation Fuels

Grade Number	Property					
	Relative density	Specific Gravity	Reid Vapor Pressure at 100°F(38°C) psia (kPa)	Minimum Flash Point, °F (°C)	Average (kin.) Viscosity at 100°F (38°C), ft ² /s x 10 ⁻⁵ (cSt)	Freezing Point, °F (°C)
JP-4 [F-40]	57° to 45° API	0.751 to 0.802	2 to 3 (13.8 to 20.7)	-20 (-29)	0.9 x 10 ⁻⁵ (0.8)	-72 (-58)
JP-5 [F-44]	48° to 36° API	0.788 to 0.845	0.04 (0.3)	140 (60)	1.6 x 10 ⁻⁵ (1.5)	-61 (-52)
JP-8 [F-34, F-37]	51° to 37° API	0.775 to 0.840	0.05 (0.3)	100 (38)	1.9 x 10 ⁻⁵ (1.8)	-53 (-47)
JP-10	20° to 18.5° API	0.935 to 0.943	0.11 (0.8)	67 (19)	3.4 x 10 ⁻⁵ (3.2)	-110 (-79)
JPTS	53° to 46° API	0.767 to 0.797	0.11 (0.8)	110 (43)	1.3 x 10 ⁻⁵ (1.2)	-64 (-53)
Jet A	51° to 37° API	0.775 to 0.840	0.029 (0.2)	100 (38)	1.6 x 10 ⁻⁵ (1.5)	-40 (-40)
Jet A-1 [F-35]	51° to 37° API	0.775 to 0.840	0.05 (0.3)	100 (38)	1.6 x 10 ⁻⁵ (1.5)	-53 (-47)
Hydrazine	9° API	1.007	NA	126 (52)	NA	NA

2-3.3.2 Special Precautions for Aviation Turbine Fuels

Because of the serious consequences of a turbine engine failure and the nature of the fuel systems in turbine engines, provide designs which include means to prevent [Contamination](#) of aviation turbine fuels by dirt, water, or other types of fuels. Solid contaminants are generally those which are insoluble in fuel. Most common are iron rust, scale, sand, and dirt. Iron rust contaminates aviation turbine fuel. Special filtration is required for receiving aviation turbine fuel into bulk storage and operating storage to remove contaminants before the fuel is delivered to aircraft. To preserve fuel quality, limit materials in contact with the fuel to stainless steel, non-ferrous, or coated carbon steel for aircraft fueling systems. Do not use zinc, copper, and zinc- or copper-bearing

alloys in contact with aviation turbine fuels, including pipe, valves, equipment, and accessories. The maximum allowable aircraft servicing use limits of solids is 2.0 mg/L and the maximum allowable aircraft servicing use limits of [free water](#) is 5 ppm. \1\ The maximum allowable Air Force aircraft servicing use limits for solids is 0.5 mg/L and maximum allowable servicing use limits of free water is 10 ppm. /1/ Provide a design that precludes disposing of aviation turbine fuels into storm or sanitary sewers.

2-3.4 Kerosene [[ASTM D3699](#)]

2-3.4.1 Physical Properties of [Kerosene](#)

- a) Relative density
- b) API Gravity 51 degrees to 37 degrees API
- c) Specific Gravity 0.775 to 0.840
- d) Reid Vapor Pressure 0.5 psia (3.5 kPa) (maximum at 100 degrees F (38 degrees C))
- e) Flash Point (minimum) 100 degrees F (38 degrees C)
- f) Viscosity at 104 degrees F (40 degrees C) 1 to 2 x 10⁻⁵ ft²/s (0.9 to 1.9 cSt.)
- g) Freezing Point -22 degrees F (-30 degrees C) (maximum)

2-3.4.2 Special Precautions for Kerosene

Design separate systems for [kerosene](#) to avoid discoloration caused by [contamination](#). Provide a design that precludes disposing of [kerosene](#) into storm or sanitary sewers.

2-3.5 Diesel Fuels

2-3.5.1 Sulfur Content of Diesel Fuels

Diesel fuel that is available for [motive fuel](#) in the United States is Low Sulfur Diesel (LSD) which has a maximum sulfur content of 500 ppm and Ultra Low Sulfur Diesel (ULSD) which has a maximum sulfur content of 15 ppm, both meeting [ASTM D975](#).

2-3.5.2 Physical Properties of Diesel Fuels

Table 2-2. Physical Properties of Diesel Fuels

	Automotive DF-2 [F-54]	Diesel Fuel Marine [F-76]	Ultra Low Sulfur Diesel [ASTM D975]
(a) Relative density API Gravity , °API (Specific Gravity)	40 to 34 (0.825 to 0.855)	39 to 33 (0.830 to 0.860)	30 (0.876)
(b) Reid Vapor Pressure at 100 °F (38 °C), psia (kPa)	0 (0)	0 (0)	0 (0)
(c) Flash Point , °F (°C)	131 (55)	140 (60)	150 (66)
(d) Viscosity at 104°F (40°C) ft ² /s (cSt)	2.0 to 4.4 x 10 ⁻⁵ (1.9 to 4.1)	1.8 to 4.6 x 10 ⁻⁵ (1.7 to 4.3)	2.7 x 10 ⁻⁵ (2.5)
(e) Pour Point, °F (°C)	10 (-12)	20 (-7)	0 (-18)

Notes: JP-8 is currently used as arctic grade diesel fuel (DFA) in the Arctic and Antarctic for heating fuel. The gross heating value of JP-8 is 18,400 Btu/lb (42 800 kJ/kg).

DF-1, winter grade diesel fuel, has a [flash point](#) of 100 degrees F (38 degrees C) and a [viscosity](#) of 1.4 to 2.6 x 10⁻⁵ ft²/s (1.3 to 2.4 cSt) at 104 degrees F (40 degrees C).

2-3.5.3 Special Precautions for Low Sulfur Diesel Fuels

While not as critical as with aviation turbine fuels, diesel fuel systems are subject to damage by dirt and water in the fuel. Avoid [contamination](#) by dirt and water or dilution by lighter fuels. In cold climates, provide designs that will prevent “gelling.” Provide a design that precludes disposing of diesel fuels into storm or sanitary sewers.

2-3.5.4 Special Precautions for Ultra Low Sulfur Diesel

With the reduction in sulfur content comes a reduction in overall lubricity and conductivity of the fuel. A lower lubricity level can cause premature wear and damage to metal parts in typical compression ignition engines. Lubricity additives are added in accordance with [ASTM D975](#). Lower conductivity can cause a potential for an increased risk in fire or explosion caused by static electricity. Even though a conductivity additive is added it is recommended that flow rates are limited and bonding and grounding equipment be utilized to minimize static electricity during loading operations.

2-3.6 Burner Fuel Oils

2-3.6.1 Physical Properties of Burner Fuel Oils

Table 2-3. Physical Properties of Burner Fuel Oils

	Grade Number					
	1	2	4	5 Light	5 Heavy	6
Relative Density °API	48 to 36	40 to 28	30 to 15	22 to 14	23 to 8	22 to 7
Specific Gravity	0.786 to 0.843	0.825 to 0.877	0.876 to 0.966	0.922 to 0.972	0.913 to 1.017	0.922 to 1.022
Reid Vapor Pressure at 100°F (38°C), psia (kPa)	< 0.1 (< 0.7)	< 0.1 (< 0.7)	< 0.1 (< 0.7)	< 0.1 (< 0.7)	< 0.1 (< 0.7)	< 0.1 (< 0.7)
Minimum Flash Point , °F (°C)	100 (38)	100 (38)	130 (54)	130 (54)	130 (54)	150 (66)
Average viscosity at 100°F (38°C), ft ² /s x 10 ⁻⁵ (cSt)	1.5 to 2.4 (1.4 to 2.2)	2 to 3.3 (1.9 to 3.1)	11.3 to 70 (10.5 to 65)	70 to 215 (65 to 200)	323 to 969 (300 to 900)	208 to 807 (193 to 750)
Pour Point , °F (°C)	-10 (-23)	-5 (-21)	21 (-6)	20 to 30 (-7 to -1)	20 to 30 (-7 to -1)	30 to 70 (-1 to 21)
Gross Heat Value, Btu/lb (kJ/kg)	19,765 (45 973)	19,460 (45 264)	18,840 (43 820)	18,560 (43 171)	18,825 (43 787)	18,200 (42 333)

2-3.6.2 Special Precautions for Burner Fuel Oils

When the [ambient](#) temperature of the burner fuel oil is less than 20 degrees F (11 degrees C) above the [pour point](#) temperature, the burner fuel oil needs to be heated. At the burner fuel oil's [pour point](#) temperature, the fuel oil has reached a gel-like state and would be difficult to pump. In nearly all cases, No. 6 fuel oil requires heating to be pumped. In some cases, No. 4 and No. 5 burner fuel oils will require heating. Provide a design that precludes disposing of burner fuel oils into storm or sanitary sewers.

2-3.7 Alternative Fuel (E85) [[ASTM D5798](#)]

2-3.7.1 Physical Properties of E85

- a) Specific Gravity 0.760 to 0.780
- b) Reid Vapor Pressure 6-12 psia (42 to 83 kPa)
- c) Flash Point (minimum) -20 degrees F (-30 degrees C)
- d) Viscosity is 6.1x10⁻⁶ to 3.4x10⁻⁵ ft²/s (0.57 to 3.19 cSt)
- e) Pour Point -212 degrees F (-100 degrees C)

2-3.7.2 Special Precautions for E85

Due to the corrosiveness of E85, many common materials used with gasoline systems are not compatible with the handling and storage of alcohols (E85, or ethanol, is 85 percent ethyl alcohol). Zinc, brass, lead, aluminum, and lead based solder are several metals that become degraded by ethanol exposure. Other metals, including unplated steel, stainless steel, black iron and bronze seem to have acceptable resistance to ethanol corrosion. Certain nonmetallic materials that have been successfully used with ethanol include: Buna-N, Neoprene rubber, polyethylene, nylon, polypropylene, nitrile, Viton, and Teflon. Common nonmetallic materials degraded by ethanol are natural rubber, polyurethane, cork gasket material, leather, polyester-bonded fiberglass laminate, polyvinyl chloride (PVC), polyamides, and methyl-methacrylate plastics. Proper cleaning of existing tanks that are being converted for E85 storage is required, because E85's solvent properties loosen tank deposits. In ethanol dispensing a one-micron in-line filter is recommended for impurity/particle removal. The shelf life of E85 is approximately 60-90 days in some cases. At normal temperatures E85 is less explosive than gasoline, but E85 is more explosive at lower temperatures. Ethanol vapors have similar behavior to gasoline, but a lower vapor pressure. E85 is an electrical conductor, and is potentially carcinogenic. Provide a design that precludes disposing of E85 into storm or sanitary sewers. For Air Force projects see [ETL 03-04](#).

2-3.8 Alternative Fuel Bio-Diesel (B20)

2-3.8.1 Physical Properties of Bio-Diesel

Biodiesel fuel B20 is a blend of petroleum diesel fuel meeting [ASTM D975](#) and 100 percent (neat) biodiesel fuel meeting either [ASTM D6751](#) or EN 14214, where the biodiesel content of the blended fuel is no more than 20 percent biodiesel by volume (B20). Biodiesel has physical properties very similar to conventional diesel.

- a) [Specific Gravity](#) 0.870 to 0.890
- b) Reid Vapor Pressure 0.0 psia (0.0 kPa) (maximum at 100 degrees F (38 degrees C))
- c) [Flash Point](#) (minimum) 100 degrees F (38 degrees C) for D1, 126 degrees F (52 degrees C)
- d) [Viscosity](#) at 104 degrees F (40 degrees C) 1.2 to 4.4 x 10⁻⁵ ft²/s (1.3 to 4.1 cSt.)
- e) [Pour Point](#) 10 degrees F (-12 degrees C)

2-3.8.2 Special Precautions for Bio-Diesel

In dispensing Bio-Diesel, it is recommended that a 30-micron and a 10-micron in-line filter be used, in succession, as a primary and secondary means for impurity/particle

removal. Bio-Diesel (B100) has good solvent qualities and will remove deposits from fuel systems. As a result, it may require more filter changes initially. One of the most commonly used blends of Bio-Diesel is B20. B20 has not been approved for use in combat or tactical vehicles or equipment. The usage of bio-diesel in other engines/vehicles has been reviewed by vehicle manufacturers and copies can be obtained at <http://www.biodiesel.org/>. B20 should be used within six months of manufacturer, because of the fuels shelf life. Users should be aware that a B20 blend will have increased viscosity requirements. Provide a design that precludes disposing of bio-diesel fuels into storm or sanitary sewers. For Air Force projects see [ETL 03-04](#).

2-3.9 Liquefied Petroleum Gas (LPG)

2-3.9.1 Physical Properties of LPG

LPG is composed predominantly of propane and propylene with minor amounts of butane, isobutane, and butylene. It is odorless, colorless, and non-toxic. To reduce the danger of an explosion from undetected leaks, commercial LPG usually contains an odorizing agent which gives it a distinctive pungent odor. LPG is a vapor at atmospheric conditions. It is normally stored as a liquid at a storage pressure of 200 psia (1400 kPa). LPG has the following properties:

- a) Freezing Point, degrees F (degrees C) -305 (-187)
- b) Relative [Density \(Specific Gravity\)](#) 147 degrees API (0.588)
- c) [Vapor Pressure](#) at 100 degrees F (38 degrees C), 175.8 (1212) psi (kPa)
- d) Heat Content, Btu/lb (kJ/kg) 21,591 (50 221)

2-3.9.2 Special Precautions for LPG

- a) Store LPG under pressure in appropriate pressure-rated tanks.
- b) The potential for fire and explosion presents extreme hazards to life and property. Provide adequate relief venting and additional fire protection in accordance with [NFPA 58](#)
- c) Provide tank spacing in accordance with the requirements of [Chapter 10](#) of this UFC.

2-3.10 Compressed Natural Gas (CNG)

2-3.10.1 Physical Properties of CNG

[Appendix A](#) to [NFPA 52](#), Compressed Natural Gas (CNG) Vehicular Fuel Systems, defines certain CNG properties. Natural gas is a flammable gas. It is colorless, tasteless, and non-toxic. It is a light gas, weighing about two thirds as much as air. It

tends to rise and diffuse rapidly in air when it escapes from the system. Natural gas burns in air with a luminous flame. At [atmospheric pressure](#), the ignition temperature of natural gas mixtures has been reported to be as low as 900 degrees F (482 degrees C). The flammable limits of natural gas-air mixtures at [atmospheric pressure](#) are about 5 percent to 15 percent by volume of natural gas. While natural gas consists principally of methane, it also contains ethane, small amounts of propane, butane, and higher [Hydrocarbons](#) and may contain small amounts of nitrogen, carbon dioxide, hydrogen sulfide, and helium which will vary from zero to a few percent depending upon the source and seasonal effects. As distributed in the United States and Canada, natural gas also contains water vapor. This "pipeline quality" gas can contain 7 pounds or more of water per million cubic feet of gas (112 kg/106 m³). Some constituents of natural gas, especially carbon dioxide and hydrogen sulfide in the presence of liquid water, can be corrosive to carbon steel, and the corrosive effect is increased by pressure. The pressures used in CNG systems covered by [NFPA 52](#) are substantial and well above those used in transmission and distribution piping and in other natural gas consuming equipment. As excessive [corrosion](#) can lead to sudden explosive rupture of a container, this hazard must be controlled. Pressures in CNG fueling stations are typically less than 5,000 psi (35 000 kPa).

2-3.10.2 Special Precautions for CNG

- a) Provide venting for safety relief in areas where CNG is to be stored.
 - (1) CNG is a highly flammable substance. Therefore, in design of facilities, use the following precautions to prevent fires from becoming uncontrollable:
 - (2) Do not directly extinguish fires with water.
 - (3) Do not extinguish large fires.
 - (4) Allow large fires to burn while cooling adjacent equipment with water spray.
 - (5) Shut-off CNG source, if possible.
 - (6) Extinguish small fires with dry chemicals.
- b) CNG is non-toxic but can cause anoxia (asphyxiation) when it displaces the normal 21 percent oxygen in a confined area without adequate ventilation.
- c) Because of [corrosion](#) problems, water in Department of Transportation (DOT) certified tanks is limited to 0.5 pounds per million cubic feet (8 kg/10 6 m³).

2-3.11 OTTO Fuels

Information on OTTO fuels is contained in [NAVSEA S6340-AA-MMA-010](#), Technical Manual for OTTO Fuel II Safety, Storage, and Handling Instructions, published by direction of Commander, Naval Sea Systems Command. Distribution of this document is restricted and Naval Sea Systems Command handles requests for information.

2-3.12 Lubricating Oils

2-3.12.1 Steam Turbine Lubricating Oils [0-250] [[MIL-PRF-17331](#)]

- a) For use in main turbines and gears, auxiliary turbine installations, certain hydraulic equipment, general mechanical lubrication, and air compressors.
- b) Physical Properties:
 - (1) [Flash Point](#): 400 degrees F (204 degrees C) minimum.
 - (2) [Pour Point](#): 20 degrees F (-6 degrees C) maximum.
 - (3) [Viscosity](#) at 104 degrees F (40 degrees C), 80 to 104 x 10⁻⁵ ft²/s (74 to 97 x 10⁻⁶ m²/s).

2-3.12.2 Lubricating Oils [0-278], [[MIL-PRF-9000](#)]

For use in advanced design high-output shipboard main propulsion and auxiliary diesel engines using fuel conforming to [MIL-DTL-16884](#).

2-3.12.3 Special Precautions for Lubricating Oils

To pump the oil when the [ambient](#) temperature of the lubricating oil is less than 20 degrees F (11 degrees C) above the [pour point](#) temperature, heat the lubricating oil. At the [pour point](#) temperature, the oil becomes gel-like and is difficult to pump. Ensure the design does not allow the discharge of lubricating oil into storm or sanitary sewers.

2-3.13 Hydrazine - Water (H-70) [[MIL-PRF-26536](#)]

2-3.13.1 Physical Properties of H-70

This fuel is a mixture of 70 percent hydrazine and 30 percent water. It is a clear, oily, water-like liquid with a fishy, ammonia-like odor. It is stable under extremes of heat and cold; however, it will react with carbon dioxide and oxygen in the air. It may ignite spontaneously when in contact with metallic oxides such as [rust](#).

2-3.13.2 Special Precautions for H-70

Keep working and storage areas clean and free of materials that may react with hydrazine. Provide only stainless steel in areas where extended contact is possible. Areas where incidental contact is possible should be kept free of [rust](#). Ensure the design does not allow the discharge of H-70 into storm or sanitary sewers.

2-3.14 Fuel Additives

2-3.14.1 Fuel System Icing Inhibitor (FSII), High Flash, [[MIL-DTL-85470](#)] (diethylene glycol monomethyl ether (DIEGME))

- a) Used in aviation turbine fuels to prevent the formation of ice crystals from entrapped water in the fuel at freezing temperatures. In addition, it has good biocidal properties, preventing growth of microorganisms in the fuel.
- b) Avoid water entry/bottoms in storage tanks because the [additive](#) will dissolve in the water, reducing the concentration of additives left in the fuel.
- c) Refer to fuel specification for more information.
- d) Consult federal, state, and local regulations for appropriate disposal methods.

2-3.14.2 Corrosion Inhibitor/Lubricity Improver (CI), [[MIL-PRF-25017](#)]

A combination lubricity improver and corrosion inhibitor additive, procured under [MIL-PRF-25017](#), is injected in all military aviation turbine fuels at the refinery in order to improve the lubricating characteristics of the fuel.

2-3.14.3 Static Dissipater Additive

Static dissipater [additive](#) (SDA) enhances safety during handling and flight by reducing static discharge potential in the vapor space above the fuel. SDA increases the conductivity of the fuel, thus decreasing the electrostatic charge relaxation time (the rate of which a charge dissipates or travels through the fuel) which decreases the potential for ignition from static charges. The actual proportion is in accordance with the specific fuel military specification. For fuel system design purposes, assume a lower limit of 50 picosiemens per meter in the determination of relaxation requirements. SDA is added to all JP-8 (F-34; F-35; F-37). SDA is not added to JP-5 and F-76 or to Jet A/A-1 that is stored at military installations.

2-3.14.4 Thermal Stability Improver Additive (+100 Additive)

Thermal stability [additive](#) (TSIA) enhances safety during handling and flight by increasing fuel tolerance to elevated temperatures. JP-8+100 (NATO F-37) is the aviation turbine fuel that utilizes TSIA.

2-4 PRODUCT SEGREGATION

2-4.1 Product Grades

Except as otherwise approved by [Service Headquarters](#), provide separate receiving, storage, and distribution systems for each product. Except as otherwise approved by [Service Headquarters](#), prevent misfueling (transferring a type of fuel other than the type intended) by using different size piping, valves, adaptors, nozzles, etc. The products to be segregated include:

- a) Mogas.
- b) Diesel fuel, including ultra-low sulfur diesel and [distillate](#) type burner fuels (No. 1, No. 2, and [kerosene](#)).
- c) Aviation turbine fuel, separate systems for each grade.
- d) Residual type burner fuels (No. 4, No. 5, and No. 6).
- e) LPG.
- f) CNG.
- g) OTTO fuels.
- h) E85.
- i) Bio-diesel.

2-4.2 Exceptions

Designs for different products using the same piping may be approved for long receiving lines such as from a tanker or barge pier or a cross-country pipeline to a storage facility. Where such common use occurs, make provisions for receiving and segregating the interface between two products. Consider the use of pigs or break-out tanks to separate batches. Exceptions will not be approved for common systems to carry both clean and residual type fuels.

2-5 TRANSFER FLOW RATES

[Table 2-4](#) shows the recommended range of design flow rates. In some cases, greater rates may be needed to meet the operational requirements of a particular facility.

Table 2-4. Design Flow Rates

Service¹	Aviation Turbine Fuel	Diesel Fuel	Burner Fuel Oils	Mogas
Between storage tanks, gpm (m ³ /hr)	600 to 1,200 (136 to 272)	600 to 1,200 (136 to 272)	600 to 1,200 (136 to 272)	600 to 1,200 (136 to 272)
Tank car unloading to storage (per car), gpm (m ³ /hr)	300 to 600 (68 to 136)	300 to 600 (68 to 136)	300 to 600 (68 to 136)	300 (68)
Tank truck unloading to storage (per truck), gpm (m ³ /hr)	300 to 600 (68 to 136)	300 to 600 (68 to 136)	300 to 600 (68 to 136)	300 to 600 (68 to 136)
Gravity receipt tank to storage gpm (m ³ /hr)	600 (136)	600 (136)	600 (136)	600 (136)
Storage to tank truck/refueler loading (per truck), gpm (m ³ /hr)	300 or 600 (68 or 136)	300 or 600 (68 or 136)	300 or 600 (68 or 136)	300 or 600 (68 or 136)
Delivery from direct fueling stations to aircraft, gpm (m ³ /hr)	Varies ²	N/A	N/A	N/A
Delivery from direct fueling stations to helicopters, gpm (m ³ /hr)	Varies ²	N/A	N/A	N/A
Between super tanker and storage, gpm (m ³ /hr)	16,800 (3815)	16,800 (3815)	16,800 (3815)	16,800 (3815)
Between regular tanker and storage, gpm (m ³ /hr)	7,000 (1590)	7,000 (1590)	7,000 (1590)	7,000 (1590)
Between barge and storage, gpm (m ³ /hr)	2,800 (636)	2,800 (636)	2,800 (636)	2,800 (636)
To fleet oilers, gpm (m ³ /hr)	3,500 (795)	3,500 (795)	N/A	N/A
To AOE's, gpm (m ³ /hr)	7,000 (1590)	7,000 (1590)	N/A	N/A
To carriers, gpm (m ³ /hr)	2,450 (556)	2,450 (556)	N/A	N/A
To average cruisers, gpm (m ³ /hr)	700 (159)	1,400 (318)	N/A	N/A
To average destroyers, gpm (m ³ /hr)	700 (159)	1,400 (318)	N/A	N/A
Storage to tank car loading (per car), gpm (m ³ /hr)	300 or 600 (68 or 136)	300 or 600 (68 or 136)	300 or 600 (68 or 136)	300 or 600 (68 or 136)

At dockside, deliveries from tankers should be assumed to be at a pressure of 80 to 100 psig (600 to 700 kPa), and deliveries to tankers to be at 60 psig (400 kPa). Rates to other ships are maximums based on fueling at sea capacities. Lesser rates for fueling at piers can be used if more practical. Loading rates are based on 40 psig (300 kPa) maximum per hose at ship connections.

² Refer to [Chapter 4](#) of this UFC for guidance on fueling rates for aircraft. Contact appropriate [Service Headquarters](#) for actual fueling rates for aircraft for which design applies.

2-6 PHYSICAL SECURITY

Plan and design fuel facilities with the goal of protecting the fuels, storage, and transfer capability from enemy attack, terrorists, sabotage, fire, seismic activity, and other damaging influences. In high threat areas, more extensive protection may be required. Consult appropriate [Service Headquarters](#) for guidance. NATO projects have their own specific criteria which govern protection level requirements.

2-6.1 Antiterrorism and Physical Security

\1\

2-6.1.1 Physical Security Program

Per [DoD 5200.08-R](#), *Physical Security Program*, at a minimum, fuel support points, pipeline, pumping stations, and piers shall be designated and posted as Controlled Areas. Areas containing critical assets may be designated as a restricted area.

Controlled and restricted areas are defined areas in which there are special restrictive measures employed to prevent unauthorized entry. Restricted areas may be of different types depending on the nature and varying degree of importance of the protected asset. Restricted areas must be authorized by the installation commander, properly posted, and shall employ physical security measures.

2-6.1.2 DoD Security Engineering Facilities Planning Manual

[UFC 4-020-01](#), *DoD Security Engineering Facilities Planning Manual*, supports the planning of DoD facilities that include requirements for security and antiterrorism. Use in conjunction with [UFC 4-010-01](#), *DoD Minimum Antiterrorism Standards for Buildings*, to establish the security and antiterrorism design criteria that will be the basis for DoD facility designs.

2-6.1.3 DoD Minimum Antiterrorism Standards for Buildings

[UFC 4-010-01](#), *DoD Minimum Antiterrorism Standards for Buildings*, establishes the standards that provide minimum levels of protection against terrorist attacks for the occupants of all DoD inhabited buildings. Incorporate the minimum standards into the design of all new construction and major renovations of inhabited DoD buildings.

Coordinate with installation or activity Security and Antiterrorism Officer (ATO) to determine area designation (controlled or restricted), threat environment, Design Basis Threat (DBT), level of protection and access control requirements.

/1/

2-6.2 Security Fencing

Unless otherwise directed by [Service Headquarters](#), provide security fencing around all petroleum facilities to ensure safety and inhibit sabotage, theft, vandalism, or entry by unauthorized persons. Install a 7-foot (2.1 m) fabric height fence of chain-link type with three-strand barbed wire outriggers on top or its equivalent. Ensure fencing, gates, and associated clearance requirements are in accordance with [UFC 4-022-03](#) or [UFC 4-020-03FA](#). Contact the Installation Security Organization for additional requirements.

2-7 MAINTAINABILITY CAPABILITIES

Provide adequate maintenance space around all equipment including:

- a) Filter/separator and other filtration device maintenance access, particularly element removal. For vertical filtration devices provide stair and platform access to at least one side of each unit.
- b) Manual valves, especially replacement of slips in [double block and bleed](#) tapered lift plug valves.
- c) Adequate room and locations for the use of an intelligent pig launcher/receiver in all section of piping.
- d) Meter reading and maintenance.
- e) Control valves.
- f) Pumps, including removal.
- g) Instruments, especially those mounted on tank shells.

2-8 VOICE COMMUNICATIONS

Provide voice communications (direct line for Air Force projects only) between separated areas such as receiving, dispensing, pump stations, and fuel storage areas to coordinate operations involved in fuel transfer. Refer to [UFC 3-501-01](#) and [UFC 3-550-01](#) or [Corps TM 5-811-9](#).

2-9 OTHER COMMUNICATIONS

2-9.1 Data Communications

Data communications systems shall be designed and accredited by designated accrediting authority or authorizing official in accordance with the applicable Telecommunications Industry Association (TIA) and Electronic Industries Association (EIA) documents. Coordinate with local Base Communications squadron where applicable. For Army, Navy, and Air Force communication systems design criteria see USACE [ETL 1110-3-502](#), Air Force [ETL11-1](#) and DoD [UFC 3-580-01](#).

2-9.2 Fire Alarm Communication

Fire alarm communications systems shall be coordinated with the Base Fire Department. For fire alarm communication system requirements see the relevant [UFGS](#).

2-10 VAPOR RECOVERY

Provide vapor recovery where required by federal, state, and local regulations ([40 CFR Part 60 Subpart XX](#)) and other chapters of this UFC. Refer to paragraph titled "Air Quality Control" in this chapter of the UFC.

2-11 WORKER SAFETY

Design facilities to comply with the most stringent of the Occupational Safety and Health Administration (OSHA) or the host nation standards. Also, ensure that design complies with service-specific occupational safety and health criteria. For Navy, [OPNAVINST 5100.23](#) \1\ Series applies. For Air Force, [AFI 91-203](#) applies. /1/

2-11.1 Safety Showers and Eyewash Fountains

Safety showers and eyewash facilities are required in workshops, laboratories, pumphouses, fueling piers and other similar facilities. Fixed safety showers and eyewash facilities, or portable eyewash units, shall be installed at other locations where fuel is transferred to/from trucks, rail cars, and aircraft. Refer to Appendix D of [UFC 3-420-01, Plumbing Systems](#), for additional requirements associated with Emergency Shower and Eyewash Stations.

2-12 ELECTRICAL DESIGN

2-12.1 Area Classifications

Classify all fuel facilities, except as modified by this UFC, in accordance with [API RP 500](#), [NFPA 30](#), [NFPA 70](#), and [ANSI/IEEE C2](#). These practices may be modified where unusual conditions occur, where locations contain hazardous atmospheres classified other than Group D (as defined by [NFPA 70](#)), or where equipment malfunction may cause hazardous situations. Use sound judgment in applying these requirements. Specify a higher classification wherever necessary to maintain safety and continuity of service. Treat [combustible liquids](#) under pressure as [flammable liquids](#). All piping and equipment including that connected to an atmospheric storage tank shall be considered pressurized. Ensure design is in accordance with the requirements designated in [NFPA 70](#) for the specific division and class. Ensure equipment temperature class or operating temperature is in accordance with [NFPA 70](#). Ensure that project drawings include hazardous area plans indicating extent and classification of areas. Drawings should provide dimensions indicating extent of classified areas and should include sections/elevations when required to fully convey the extent of the areas.

2-12.1.1 Class I, Division 1

Class I, Division 1 locations include:

- a) Outdoor locations and those indoor locations having positive mechanical ventilation that is within 3 feet (0.9 m) of the fill openings or vents on individual containers to which [flammable liquids](#) are being transferred. Provide alarm devices on all ventilation systems.
- b) Outdoor locations within 5 feet (1.5 m) of open end of vents and openings on liquid fuel storage tanks extending in all directions.
- c) Entire pit, sump, open trench, or other depression, any part of which is within a Division 1 or 2 location and is without mechanical ventilation.
- d) Locations within and on exterior walls of open top spill containment structures including [oil/water separators](#) and spill containment boxes.
- e) Locations at fuel dispensers.
- f) Locations within 3 feet (0.9 m) of vent, extending in all directions, when loading a truck through the bottom connection.
- g) All pump/filter houses handling liquid fuels.
- h) Any area containing electrical equipment that is or may be exposed to atomized fuel and where the [ambient](#) temperature can at any time be above the [flash point](#) of the fuel.

2-12.1.2 Class I, Division 2

Class I, Division 2 locations include:

- a) Outdoor locations between 5 feet (1.5 m) and 10 feet (3 m) of the Division 1 zones at vents and openings, on liquid fuel storage tanks extending in all directions.
- b) Entire pit, sump, open trench, or other depression, any part of which is within a Division 1 or 2 location and is provided with mechanical ventilation.
- c) Outdoor locations within 3 feet (0.9 m) of the exterior surface of pumps, air relief valves, withdrawal fittings, meters, and similar devices that are located in pipelines handling liquid fuels under pressure. Class I, Division 2 locations extend upward 18 inches

(450 mm) above grade level and within 10 feet (3 m) horizontally from any surface of the device.

- d) Locations within and extending upward to the top of the [dikes](#) that surround aboveground tanks containing liquid fuels and within 10 feet (3 m), extending in all directions of the tank shell, ends, or roof.
- e) Locations extending upward 18 inches (450 mm) above grade level within 15 feet (4.6 m) horizontally from any surface of open top spill containment structures including [oil/water separators](#) and spill containment boxes, whether installed indoors or outdoors.
- f) Locations 25 feet (7.6 m) horizontally in all directions on pier side from portion of hull containing cargo and from water level to 25 feet (7.6 m) above cargo tank at highest point.
- g) Area between 3 feet (0.9 m) and 10 feet (3 m) extending in all directions from vent when loading a truck. Also upward 18 inches (450 mm) above grade and within 10 feet (3 m) horizontally from the truck load connection.

2-12.1.3 Non-Classified Locations

Non-classified locations include:

- a) Outdoor locations having closed piping systems handling flammable or [combustible liquids](#) that have no pumps, air relief valves, withdrawal fittings, valves, screwed fittings, flanges, meters, or similar devices which create joints in piping.
- b) Office buildings, boiler rooms, control rooms, and similar locations that are outside the limits of hazardous locations, as defined above, and are not used for transferring flammable or [combustible liquids](#) or containers for such liquids.
- c) Areas in which flammable and [combustible liquids](#) are stored in accordance with [NFPA 30](#), outside the limits of a classified location, and the liquids are not transferred.

2-12.2 Illumination

Illuminate all working areas for night operations to the minimum intensity recommended in Table 4 of [API RP 540](#). Lighting design should also provide for road access on tall light posts to allow for lamp replacement. For facilities within the jurisdiction of the U.S. Coast Guard under [33 CFR Part 154](#), illuminate to the minimum intensity required by

that regulation. Provide security lighting in accordance with \1\ [UFC 3-530-01](#) /1/. If local or state regulations exist, follow the most stringent requirements.

2-12.3 Grounding and Bonding

The following references apply to [grounding](#) and [bonding](#) systems:

- a) [ANSI/IEEE 142](#)
- b) [NFPA 70](#)
- c) [NFPA 77](#)
- d) [NFPA 780](#)
- e) [API RP 540](#)
- f) [API RP 2003](#)
- g) [ANSI/IEEE 1100](#)
- h) [NFPA 407](#)
- \1\
- i) [UFC 3-575-01](#)
- /1/

2-12.3.1 Grounding Requirements

[Ground](#) the following items in accordance with Article 250 of [NFPA 70](#):

- a) Motor, generator, and transformer frames.
- b) Non-current-carrying metallic parts of electrical equipment and installations, such as enclosures for panelboards, switchgear, and motor control centers.
- c) Metallic messengers of self-supporting cables.
- d) Exposed conductive materials enclosing [electrical conductors](#), such as metallic conduit, metallic tubing, metallic armoring, sheaths and shields, cable troughs, trays and racks, wireways, and busways.
- e) Filter/separators and other filtration equipment.

2-12.3.2 Current and Lightning Protection

Provide lightning protection in accordance with [Corps TM 5-811-3](#), [AFM 88-9](#), [NFPA 780](#), [MIL-HDBK-1004/6](#), and local installation requirements. For fault current protection and lightning protection, [ground](#) the following items through ground rods or beds or [bond](#) to a grounded network. Provide [ground](#) for these items as required by the above references.

- a) Fences.
- b) Lightning arrestors and lightning shield conductors.
- c) Operating mechanisms of overhead airbreak switches.
- d) Canopies.
- e) Aboveground storage tanks.

2-12.3.3 Static Electricity Prevention

To prevent the buildup [static electricity](#), [ground](#) the following items directly through ground rods or beds or [bond](#) to a grounded network. Do not exceed 10,000 ohms of resistance to [ground](#), unless otherwise stated. Do not bond dissimilar metals together.

- a) Aboveground tanks, vessels, stacks, heat exchangers, and similar equipment not directly supported or bolted to a [grounded](#) supporting network.
- b) Pipe and pipe support columns in accordance with the more stringent of [NFPA 77](#) or below.
 - (1) Provide (minimum) 1 ground rod on pipe runs 100 feet (30 m) long or less unless the pipe is connected to a grounded source within the 100 feet (30 m).
 - (2) Provide (minimum) 2 ground rods on runs of pipe that exceed 100 feet (30 m), but are less than 300 feet (90 m) in length.
 - (3) Provide (minimum) 1 ground rod at intervals not exceeding 300 feet (90 m) on runs of pipe that are greater than 300 feet (90 m) in length.
 - (4) Parallel pipes may be bonded and common ground rods used, spaced in accordance with (1) through (3) above.
- c) Aircraft direct fueling stations.
- d) Hydrant pits.

- e) Internal floating pans [bonded](#) to the storage tank shell.
- f) Aboveground portions of electrically isolated piping at truck, rail, and marine loading and unloading stations.

2-12.3.4 Installation

Isolate grounding systems for instrumentation, instrument control boards, and electronic equipment from all other [ground](#) systems. Additional [grounding](#) is not required for overhead electrical equipment bolted directly to grounded metallic structures. Where feasible, separate the conductor connecting a lightning rod to the grounding [electrode](#) from other grounding conductors. Route with a minimum of sharp bends and in the most direct manner to the grounding [electrode](#). Do not use this [electrode](#) in lieu of grounding [electrodes](#) which may be required for other systems. This provision does not prohibit the required bonding together for grounding [electrodes](#) of different systems.

2-13 CATHODIC PROTECTION

Obtain the services of a National Association of Corrosion Engineers (NACE)-certified Corrosion Specialist or Cathodic Protection Specialist or a registered professional Corrosion Engineer to perform all [cathodic protection](#) design and testing. For Army and Air Force designs, comply with the current Engineering Technical Letters in addition to the following requirements. For Navy designs, comply with NAVFAC Interim Technical Guidance [FY94-01](#).

2-13.1 Tanks

For all underground steel tanks and tank bottoms of aboveground vertical tanks, provide [cathodic protection](#) in accordance with [UFC 3-570-02N](#), [API RP 651](#), [40 CFR Part 280](#), [UL 1746](#), and [UFC 3-460-03](#). For additional information on [cathodic protection](#), refer to [NAVFAC MO-230](#) and [AFI 32-1054](#). Current tank design configuration electrically isolates the tank bottom from surrounding earth. Therefore, install [cathodic protection](#) between the liner and the tank bottom.

2-13.2 Piping

For all carbon steel and stainless steel underground and underwater piping, provide [cathodic protection](#) in accordance with [UFC 3-570-02N](#) and [40 CFR Part 280](#) for piping associated with underground storage tanks. For additional information on [cathodic protection](#), refer to [NAVFAC MO-230](#), [NACE SP0169](#) Control of External Corrosion on Underground or Submerged Metallic Piping Systems, and [49 CFR Part 195](#). Buried stainless steel corrodes and, therefore, must be cathodically protected.

2-13.2.1 Surge Arrestors

Provide [surge arrestors](#) across all aboveground insulated flanges connected to belowground cathodically protected piping. Require [surge arrestors](#) to be designed for

use with insulated flanges and for use in Class I, Division 1 areas. Provide covers over flanges to preclude dirt from degrading surge arrestors; refer to DoD Standard Design [AW 78-24-28](#).

2-13.3 Structures

Obtain the services of a (NACE)-certified Corrosion Specialist or Cathodic Protection Specialist or a registered professional Corrosion Engineer to evaluate the need for [cathodic protection](#) on steel portions of fueling support facilities. Comply with [UFC 3-570-02N](#).

2-14 ENVIRONMENTAL PROTECTION

2-14.1 General Policy

It is the firm policy of the Department of Defense to design and construct fueling facilities in a manner that will prevent damage to the environment by accidental discharge of fuels, their vapors or residues. Designs must comply with foreign government, national, state, and local environmental protection regulations that are in effect at a particular facility.

2-14.2 Regulations

2-14.2.1 Within U.S.A.

Within the jurisdiction of the United States, adhere to the following environmental protection regulations:

- a) National Environmental Policy Act (NEPA), [42 USC 4321](#).
- b) U.S. Coast Guard Regulations, [33 CFR Part 154](#).
- c) Environmental Protection Agency Regulations, [40 CFR Part 60](#).
- d) Environmental Protection Agency Regulations, [40 CFR Part 112](#).
- e) Environmental Protection Agency Regulations, [40 CFR Part 122](#).
- f) Environmental Protection Agency Regulations, [40 CFR Part 280](#).
- g) Environmental Protection Agency Regulations, [40 CFR Part 281](#).
- h) Department of Transportation Regulations, [49 CFR Part 195](#)
- i) Obtain additional data on anti-pollution regulations for specific locations from Service Headquarters Environmental Support Office.

2-14.2.2 Outside U.S.A.

At facilities in other countries, consult appropriate service environmental directives, DODD Overseas Environmental Baseline Guidance Doctrine and for Navy, [OPNAVINST 5090.1](#). It may be appropriate to address the [DoD](#) Overseas Environmental Baseline Guidance Document and appropriate Final Governing Standards for the region/country. If tank is to be installed in a locale or state with more stringent criteria, use the more stringent criteria. If tank is to be installed in a NATO country other than the CONUS, follow the most stringent of local regulations or NATO Airfield Standard Design - Jet Fuel Storage and Dispensing Systems.

2-14.3 Transfer of Fuel at Ports

2-14.3.1 Bulk Transfer

Compliance with [33 CFR Part 154](#) is required for each fixed facility capable of transferring fuel in bulk to or from a vessel with a capacity of 10,500 gallons (39,700 L) or more. These facilities are required to have an operations manual approved by the Captain of the Port. In the operations manual, include the requirement for the following systems:

- a) Hose assemblies
- b) Loading arms
- c) Closure devices
- d) Monitoring devices
- e) Small discharge containment
- f) Discharge removal
- g) Discharge containment equipment
- h) Emergency shutdown
- i) Communications
- j) Lighting

2-14.3.2 Vapor Collection

For facilities that collect vapor from vessel cargo tanks, ensure that the requirements of [40 CFR Part 60](#) for the following items are met:

- a) Vapor line connections
- b) Vessel liquid overflow protection
- c) Vessel vapor overpressure and vacuum protection
- d) Fire, explosion, and detonation protection
- e) Detonation arrestors, flame arrestors, and flame screens
- f) Inerting, enriching, and diluting systems
- g) Vapor compressors and blowers
- h) Vapor recovery and vapor destruction units

2-14.4 Air Quality Control

2-14.4.1 Design Requirements

Regulatory requirements pertaining to air quality control will vary according to locality and to type and size of the petroleum vapor source. Petroleum storage and dispensing facilities are common sources of air pollution. Their emissions are typically restricted through requirements in state and local regulations. Federal regulations ([40 CFR Part 60 Subparts Kb and XX](#)) may also apply depending on the product handled and size of the tank or facility being constructed.

2-14.4.2 Aboveground Storage Tanks

Federal regulation [40 CFR Part 60 Subpart Kb](#) requires that tanks used for the storage of fuel with a design capacity greater than 19,000 gallons (72,000 L) having a [true vapor pressure](#) greater than 0.75 psia (5. kPa) at operating temperature must be equipped with either: 1) a fixed roof in combination with an internal floating pan; 2) an external floating roof equipped with a dual seal closure device between the wall of the tank and the roof edge; or 3) a closed vent system designed to collect all volatile organic compound (VOC) vapors and gases discharged from the tank and a control device designed to reduce VOC emissions by 95 percent or greater. It is the design intent that most vertical aboveground tanks will have internal floating pans and that vapor recovery will be used only if required by federal, state, or local regulations for the type of fuel and type of tank proposed, except as specifically required by another chapter of this UFC. Refer to [Chapter 8](#) of this UFC for specific requirements for floating pans.

2-14.4.3 Truck and Rail Loading Facilities

Tank truck and tank car loading facilities constructed or modified after December 17, 1980 which load an annual average of more than 20,000 gallons (76,000 L) per day of fuel having a [true vapor pressure](#) (TVP) of 0.75 psia (5 kPa) or greater must discharge the vapors resulting from such operations into a closed system. Ensure this system

leads to a vapor recovery or disposal system which is capable of removing 95 percent of the petroleum vapor before final discharge into the atmosphere. Equip bulk gasoline terminals (handling fuels with TVP > 4.003 psia or 27.60 kPa) with a vapor collection system designed to collect total organic compound (TOC) vapors displaced from tank trucks during loading. Emissions from the vapor control system due to loading must not exceed 35 mg of TOC per liter of gasoline loaded. For facilities with an existing vapor processing system, the TOC emissions must not exceed 80 mg of TOC per liter of gasoline loaded ([40 CFR Part 60 Subpart XX](#)).

2-14.4.4 Permit Requirements

Air quality permits are typically required for the construction of petroleum storage and dispensing facilities. It is essential for designers to review regulatory requirements to ensure incorporation of proper environmental controls. State and local regulations are primary sources for air quality requirements, but for particularly large facilities, it is also beneficial to confer with the EPA regional office. The permit review and air quality controls will further depend on whether the construction site is located in an attainment or non-attainment area for ozone. Different permit programs apply in these areas, but they can both yield strict control requirements depending on the air quality of the area. An emissions offset analysis may be necessary before any construction permit can be granted. This analysis will require and demonstrate a reduction in VOC emissions from other sources in the locality where the new source construction is to take place. The offset can be obtained by providing new or better controls or otherwise decreasing emissions from an existing source.

2-14.5 Water Quality Control

2-14.5.1 Design Requirements

Protection of the natural waters against pollution from discharge of petroleum is achieved by complying with federal, state, and local regulations.

2-14.5.2 Stormwater Discharge

A National Pollutant Discharge Elimination System (NPDES) Permit, [40 CFR Part 122](#), may be required for the discharge of stormwater. A review of federal, state, and local stormwater regulations is required prior to design and construction. Discharge of stormwater includes:

- a) Controlled drainage from storage tank areas with impermeable [diked](#) enclosures or drainage systems leading to impoundments.
- b) Drainage from treatment systems.
- c) Drainage from facility transfer operations, pumping, and tank car and tank truck loading/off-loading areas.

- d) Drainage from equipment/vehicle maintenance areas.

2-14.5.3 Spill Prevention Control and Countermeasures (SPCC) Plan

The minimum requirements for spill prevention in the United States are contained in [40 CFR Part 112](#). It requires the preparation of a SPCC Plan for facilities that may discharge fuel into navigable waters of the United States. Specific design features are necessary to meet the SPCC objectives at all facilities. The SPCC plan must demonstrate that the fuel facility will be designed and constructed in a manner that will prevent spillage, and should such a spillage occur, prevent the spill from leaving the property and entering a waterway. Review [API Bulletin D16](#) to assist with conformance to regulations. Refer to [33 CFR Part 154](#) for small discharge containment.

2-14.5.4 Meeting SPCC Plan Objectives

[40 CFR Part 112](#) allows SPCC Plan objectives to be met by either spill containment or spill treatment. For facilities covered by this UFC only spill containment systems are acceptable. Spill treatment systems shall not be allowed to meet SPCC requirements unless required by regulations. Provide treatment systems ([oil/water separators](#)) to treat the discharge from spill containment systems only when required by federal, state, or local regulations, or by [Service Headquarters](#). Typical facilities requiring a spill containment system are fuel storage tanks, tank truck loading/off-loading/parking areas, and tank car loading/off-loading areas.

2-14.5.5 Spill Containment Systems

The SPCC Plan objectives expressed in [40 CFR Part 112](#) shall be met with impermeable spill containment system designed to prevent a spill from leaving the property unless a spill treatment system is required by federal, state, or local regulations, or by Service Headquarters. See the individual chapters of this UFC for requirements.

2-14.5.6 Spill Treatment Systems ([Oil/Water Separators](#))

Treatment systems (oil/water separators) may not be used to meet the requirements of [40 CFR Part 112](#) unless required by federal, state, or local regulations, or as determined by the appropriate [Service Headquarters](#). Do not provide [oil/water separator](#) to treat the discharge from spill containment systems (e.g. secondary containment [dikes](#), tank truck parking areas, loading/off-loading facilities), unless specifically required by regulations. Select either a conventional rectangular API type gravity [oil/water separator](#) or one with inclined parallel plates. Where possible, design the separator as a rectangular vessel with a fully open top with lid for ease of inspection and cleaning.

- a) Design and construct the separator in accordance with the following:
 - (1) [UFC 1-200-01](#) and [UFC 3-301-01](#).
 - (2) [UFGS 44 42 53](#).
 - (3) Army Corps of Engineers [ETL 1110-3-466](#).
 - (4) [ACI 350.4R-04](#), Design Considerations for Environmental Engineering Concrete Structures.

- b) Consider the following items in sizing the oil/water separator:
 - (1) Anticipated inlet flow rate of a 5-year, 1-hour duration storm event.
 - (2) Type of fuel.
 - (3) [Specific gravity](#) and [viscosity](#) of fuel.
 - (4) Specific [ambient](#) and product temperature ranges.
 - (5) Product storage capacity required.
 - (6) Possible contaminants present.
 - (7) Operating parameters are intermittent or continuous.

- c) Require parallel plates to be constructed from non-oleophilic materials such as [fiberglass](#). Arrange the plates in either a downflow or crossflow mode so that the oil collects in the high point of the corrugations and rises to the top without clogging from settleable solids.

- d) Consider installing a retention basin upstream of the [oil/water separator](#). This would allow solids to settle prior to reaching the [oil/water separator](#) and allow the option of either releasing the stormwater to the [oil/water separator](#) or to an appropriate stormwater collection system.

2-14.5.7 Leak Detection

As required by federal, state, and local regulations install leak detection on aboveground tank bottoms, underground storage tanks, and underground piping.

2-14.5.8 Wastewater Disposal

Provide a holding tank for wastewater. Wastewater is any water which has been in contact with significant quantities of fuel such as water collected from tank sumps, equipment drains, and equipment sumps. Ensure that tank construction conforms to federal, state, and local environmental requirements. Provide a means to remove wastewater for off-site disposal.

2-14.5.9 Dewatering

Where dewatering for construction purposes is necessary and [contamination](#) is suspected, test the groundwater prior to construction to determine the extent of [contamination](#). If the groundwater is, or has the potential to be, contaminated with petroleum products, review federal, state, and local regulations for acceptable treatment methods. Permits may be required for treatment and/or disposal of the water. Contact facility Environmental Department for guidance.

2-14.6 Aboveground Storage Tanks

2-14.6.1 Design Requirements

Aboveground storage tanks may be single wall, double wall, horizontal, vertical, protected, or fire resistant as discussed in [Chapter 8](#). There is not a single federal regulation that specifically addresses aboveground storage tanks similar to [40 CFR Part 280](#) that solely governs underground storage tanks. The majority of the federal environmental design requirements come from either [40 CFR Part 112](#) or [29 CFR Part 1910.106](#). These regulations include environmental related requirements for:

- a) Diking and drainage.
- b) Flooding.
- c) Corrosion Protection.
- d) Inspections, Tests, and Records.
- e) Brittle Fracture Analysis.

The designer must consult the latest version of these regulations and comply with all federal, state, and local regulations.

2-14.6.2 Other Requirements

If a tank is to be installed in a locale or state with more stringent criteria, use the more stringent criteria. If tank is to be installed in a NATO country other than the CONUS, follow the most stringent of local regulations or NATO Airfield Standard Design - Jet Fuel Storage and Dispensing Systems.

2-14.7 Underground Storage Tanks

2-14.7.1 Design Requirements

All underground and cut and cover storage tanks are to be double wall type. Single wall underground storage tanks are not allowed. For underground storage tanks larger than 110 gallons (416 L), the following are required by [40 CFR Part 280](#):

- a) Corrosion protection for tanks and associated underground piping.
- b) High level alarm.
- c) Spill and overfill protection.
- d) Release detection.

2-14.7.2 Other Requirements

If a tank is to be installed in a locale or state with more stringent criteria, use the more stringent criteria. If tank is to be installed in a NATO country other than the CONUS, follow the most stringent of local regulations or NATO Airfield Standard Design - Jet Fuel Storage and Dispensing Systems.

2-15 FIRE PROTECTION

2-15.1 General Requirements

Design all petroleum fuel storage, handling, transportation, and distribution facilities with full consideration of the hazardous nature of the fuels to be handled and their vapors. Ensure compliance with [UFC 3-600-01](#).

2-15.2 Protection of Aboveground Storage Tanks

2-15.2.1 Tank Exterior Fire Protection Water Systems

Provide fire protection water mains, hydrants, valves, pumps, and application devices to permit control of brush and grass fires and cooling of storage tanks in the event of a fire exposure. Provide a minimum of two hydrants. Locate hydrants and valves outside of [diked](#) areas and accessible to fire department pumper vehicles. Locate hydrants so that protected exposures can be reached through hose runs not exceeding 300 feet (90 m). Comply with all requirements of [UFC 3-600-01](#) for water supply.

2-15.2.2 Tank Interior Fire Protection Systems

Tanks containing Class I flammable fuels or mission-critical Class II combustible fuels, such as JP-8, shall be equipped with a full contact, aluminum honeycomb floating pan. Other Class II fuels require a floating pan if the tank does not comply with the spacing and diking requirements of this UFC. Tanks storing mission-critical Class III fuels, such

as JP-5 and diesel fuel marine (F-76), if located in hot (desert-like) climate, also require a floating pan to eliminate the fuel/air interface. A single slotted stilling well, that penetrates the floating pan, has a maximum diameter of 10 inches (250 mm) and is used for the automatic tank gauge system, is allowed to be provided without a vapor sleeve (bellow). The slotted well used for manual measurements shall be equipped with an approved floating plug. The 8 inch (200 mm) slotted stilling well for the automatic tank gauge system level sensing device and the 6-inch (150 mm) minimum nominal size slotted stilling well for the automatic tank gauge system water probe are allowed to be provided without floating plugs. /1/

2-15.3 Fire Protection of Pumping Facilities

Fuel pump houses where over 50% of the fuel hydrant pumping capacity is in one fire area and that area is enclosed shall be protected with an automatic fire suppression system, such as a fire sprinkler system, foam water fire suppression system, etc. Fuel pump houses where over 50% of the transfer pumping is in one (enclosed) fire area shall be protected with an automatic fire suppression system, foam water fire suppression system, etc. Readily available mobile pumping equipment with 50% of the total pumping capacities can be used to eliminate need for a fire suppression system. Where mobile pumping option is selected, provide connection points in the fuel system for temporary mobile pumps in the event that a pump facility is lost. Pump pads and pump shelters do not need fire suppression systems.

2-15.3.1 Pumphouses, Pump Shelters, and Pump Pads

A pump pad has no roof or canopy. A pump shelter has a roof, at least one wall completely open with adequate fire department access, and a total open wall area of 50 percent or more. A pumphouse has a roof, and a total open wall area of less than 50 percent.

2-15.3.2 Fire Department Access

Provide adequate fire department access for all pumping facilities. Provide fire department access to all open sides of a pumphouse or pump shelter. Provide fire department access to at least two sides of a pump pad.

2-15.4 Fire Protection of Underground Vertical Storage Tanks

2-15.4.1 Fire Protection Water Systems

Provide fire protection water mains, hydrants, valves, pumps, and application devices to permit control of brush and grass fires and for cooling of the aboveground piping and equipment associated with underground vertical storage tanks in the event of a fire exposure. Provide a minimum of two hydrants. Locate hydrants so that protected exposures can be reached through hose runs not exceeding 300 feet (90 m). Comply with all requirements of [UFC 3-600-01](#) for water supply except that the minimum fire

flow rate and minimum duration per hydrant shall be calculated using the smallest diameter of aboveground POL tank.

2-15.5 Protection of Tank Truck and Tank Car Facilities

For facilities (such as loading stands) used for the transfer of flammable or [combustible liquids](#) to or from tank truck, [refuelers](#), tank cars, drums, or other portable containers, provide portable dry chemical extinguishers of appropriate size, number, and location for the exposure.

2-15.6 Protection of Aircraft Fueling Facilities

Provide fire fighting equipment in accordance with service requirements. Refer to USAF [AFTO 00-25-172](#), [NAVAIR 00-80R-14](#), [NAVAIR 00-80T-109](#), [AR 420-90](#) and [NFPA 407](#).

2-15.7 Protection of Fuel Testing Laboratory

Laboratories shall comply with the general facility requirements of [UFC 3-600-01](#) and [NFPA 45](#) Laboratories using Chemicals.

2-15.8 Protection of Support Facilities

Comply with [UFC 3-600-01](#) for fire protection of support facilities.

2-15.9 Protection of Fuel Piers

Provide protection for piers with fixed piping systems used for the transfer of flammable or [combustible liquids](#) in accordance with the following:

- a) [UFC 3-600-01](#)
- b) [UFC 4-152-01](#), [UFC 4-150-02](#), and [UFC 4-150-06](#)
- c) [NFPA 30](#)
- d) [NFPA 30A](#)
- e) [NFPA 307](#) (If liquids are handled in bulk quantities across general purpose piers and wharves.)

2-15.9.1 Fire Protection Water Systems

Use fire water systems with hydrants located so that vessels alongside can be reached through hose lines not longer than 300 feet (90 m). Consult [UFC 3-600-01](#) to determine total water demands for piers based on an extra hazard occupancy classification.

2-16 EMERGENCY SHUT-DOWN

Emergency fuel shutoff (EFSO) pushbuttons are required wherever there is a potential for an accidental release. EFSO pushbutton stations are required near tanks (outside of berm area), tank car and tank truck loading and off-loading, [refueler](#) truck fillstands, aircraft direct fueling stations, pumps, fuel piers, etc. All pumps shall shut down and all motor operated valves shall close when an EFSO pushbutton is pressed. An alarm shall be annunciated at the master alarm panel. Operation of all pumps and valves shall be discontinued until all EFSO pushbuttons are cleared and the alarm acknowledged. Off-base pipeline receipt and tanker receipt may be exceptions; contact [Service Headquarters](#) for direction.

2-17 ELECTROMAGNETIC RADIATION HAZARDS

Potential ignition hazards to petroleum storage, dispensing, or handling facilities may be created by emissions from electromagnetic devices such as radio and radar. Beam/signal strength has been known to cause ignition of flammable vapor-air mixtures from inductive electrical heating of solid materials or from electrical arcs or sparks from chance resonant connections. For additional information, refer to [MIL-STD-461](#) and [NFPA 407](#). Incorporate the following specific precautions and restrictions in the design of petroleum fuel facilities:

- a) Locate the radio transmitting antennas as far as practically possible from fuel storage or transfer areas.
- b) Do not locate the fuel storage or transfer facilities closer than 300 feet (90 m) from aircraft warning radar antennas.
- c) Do not locate fuel storage or transfer facilities closer than 500 feet (150 m) from airport ground approach and control equipment.
- d) Do not locate fuel storage or transfer facilities closer than 300 feet (90 m) from areas where airborne surveillance radar may be operated.
- e) Do not locate fuel storage and transfer facilities closer than 100 feet (30 m) from airport surface detection radar equipment.

2-18 IDENTIFICATION

Identify all pipelines and tanks as to product service by color coding, banding, product names, NATO designation, and directions of flow in accordance with [MIL-STD-161](#).

- a) Mark valves, pumps, meters, and other items of equipment with easily discernible painted numbers or numbered corrosion-resistant metal or plastic tags attached with a suitable fastener. Ensure numbers correspond to those on the schematic flow diagrams and other drawings for the installation.

\1\

- b) Mark tanks with easily discernible painted numbers and letters indicating the following in addition to the requirements stated in [MIL-STD-161](#): Tank number, Facility number, “No Smoking” on class 1 tanks, and “Confined Space” on Roof Manhole/Ladder Hatch
- c) Mark tanks in accordance with [NFPA 704](#).

/1/

2-19 ANTISTATIC DESIGN

Consider static build-up in the design. Refer to CRC Report [No. 346](#) and [No. 355](#), [API RP 2003](#); and [NAVFAC MO-230](#). Because of the many variables involved, such as properties of fuels and geometry of equipment layouts, no specific limits are established for design factors such as flow velocities.

2-19.1 Piping Inlet Connections

Design connections to tanks for reduced velocity and to prevent splashing by use of diffusers. Fuel products are not permitted to free fall under any circumstances. Position inlet as close to the tank floor as possible to limit free fall.

2-19.2 Enclosed Vapor Spaces

Spaces above flammable or combustible [Hydrocarbons](#) in tanks or other liquid containers must not have any pointed projection or probes which could be focal points for [static electricity](#) discharges.

2-19.3 Filter/Separators

The heaviest electrostatic charges are usually developed in filtering elements of this equipment. The design should attempt to reduce such charges before fuel is transferred into storage tanks, vehicle tanks, or any equipment containing vapor spaces.

- a) By means of residence time in piping or in a relaxation tank, provide a minimum of 30 seconds relaxation time between this equipment and discharging into a tank or vehicle. The only aviation turbine fuel currently in the inventory that requires this minimum relaxation time are JP-5, JPTS and other aviation turbine fuels that do not contain SDA.
- b) Relaxation time is not required for projects handling only fuels containing a static dissipator additive that provides a conductivity level greater than 50 conductivity units (50 picosiemens per meter)

at the fuel temperature of the operations. Examples of this are JP-4 and JP-8.

- c) Provide a means for slow filling, to prevent static discharge when first filling empty filter-separator vessels.

2-19.4 Aircraft Direct Fueling Stations

JP-5 requires a 30-second residence time in the piping or in a [relaxation tank](#) after flowing through filtration and before being discharged into the aircraft to allow separate charges generated by the filtering elements to recombine and neutralize themselves. Where possible, design the piping layout to provide the required 30-second relaxation time without use of a [relaxation tank](#).

2-19.5 Truck Bottom Loading

Provide facilities only capable of [bottom loading](#) of trucks. Army facilities that routinely handle trucks that are not capable of [bottom loading](#) must obtain approval for the addition of [top loading](#) capability from the Army Service Headquarters. Refer to [NFPA 77](#) and [API RP 2003](#) for additional information and requirements.

2-20 OPERATION AND MAINTENANCE DOCUMENTATION

2-20.1 Equipment Operation and Maintenance Documentation

In all construction and procurement contracts, require operation and maintenance data for pieces of equipment which require maintenance and/or which require setting, adjusting, starting, stopping, calibrating, and similar operational activities.

2-20.2 Operation and Maintenance Support Information (OMSI)

An OMSI for all new facilities is required. The determination to include a requirement for a complete OMSI for new facilities or a major rehabilitation will be made by the appropriate [Service Headquarters](#).

2-21 PROTECTION AGAINST SEISMIC ACTIVITY

Design fuel facility buildings and structures for seismic requirements in accordance with [UFC 1-200-01](#). Design aboveground vertical storage tanks in accordance with [API Std 650](#), Appendix E. Analyze flexible aboveground pipelines using techniques to account for harmonic response.

2-22 STRUCTURAL DESIGN

Design all buildings and structures in accordance with [UFC 1-200-01](#).

2-23 CONCRETE

Concrete where used in this UFC refers to cast-in-place, Portland Cement Concrete (PCC), reinforced as required, finished, and cured. The use of coated or uncoated bituminous asphalt concrete (asphalt), "shotcrete", or autoclaved cellular concrete (ACC) in its place is prohibited.

2-24 AIRFIELD/AIRSPACE REQUIREMENTS

Incorporate requirements for airfield and airspace clearances into all construction documents for work near an airfield. Verify compliance with \1\ [UFC 3-260-01](#). /1/

2-25 PERMITS

The planner, programmer, and designer should give consideration to required permits (dredging, air emissions, water discharges, etc.). Considerations are cost of permit, cost impact of project to meet permit requirements, schedule impact of permit, who is to obtain permit, and at what time in the project schedule should application be made.

CANCELLED

This Page Intentionally Left Blank

CANCELLED

CHAPTER 3 BULK FUEL STORAGE FACILITIES

3-1 INTRODUCTION

This chapter provides guidance for the design of bulk fuel storage facilities, including [bulk storage tanks](#) and those components normally located within a typical bulk storage compound. These components include pipeline receiving facilities, tank truck and tank car receiving facilities, pipeline dispensing (pumping) facilities, tank truck and tank car loading facilities, and all related piping and equipment. Fuel storage tanks are discussed in [Chapter 8](#) and piping systems in [Chapter 9](#) of this UFC. Support facilities, which are discussed in [Chapter 11](#) of this UFC, are often collocated within bulk facilities. Systems used to receive and dispense aviation turbine fuels are discussed in [Chapter 4](#) of this UFC. Systems used to receive and dispense fuel from barges and ships are discussed in [Chapter 5](#) of this UFC. [Installation pipelines](#) connecting bulk facilities with marine receiving and dispensing facilities, aircraft fueling facilities, and ground vehicle fueling facilities, as well as [interterminal pipelines](#) are discussed in [Chapter 6](#) of this UFC. Refer to [Facility Plate 001](#) for the entire chapter identification plan pertaining to this UFC.

Note: If aviation fuel can be pumped directly from a tank into an aircraft, [aircraft direct fueling system](#) or a [refueler](#), treat the tank as an [operating storage tank](#) regardless of size and location and must meet the applicable requirements for aviation turbine fuel operating tanks. The exception is [bulk storage tanks](#) that are configured to fill refuelers on an emergency basis only.

3-2 GENERAL REQUIREMENTS

[Chapter 2](#), General Design Information, contains important information on fueling facilities. Do not begin the design of any fueling system without first becoming completely familiar with [Chapter 2](#) of this UFC.

3-3 RECEIVING FACILITIES

Fuel is normally received at bulk fuel storage facilities by pipeline, tank truck, tank car, barge, or ship. In many cases, the fuel is pumped by pipeline from the marine receiving facility to the bulk storage facility. Marine receiving facilities are addressed in [Chapter 5](#) of this UFC. [Service Headquarters](#), with concurrence from the \1\ DLA-Energy /1/, will determine the appropriate type of delivery method based on mission requirements and an economic analysis. A secondary method of delivery is normally required for aviation activities.

3-3.1 Pipeline Receiving Facilities

3-3.1.1 General Criteria

Petroleum fuels may be supplied to bulk fuel storage tanks by [interterminal pipelines](#) which may be dedicated to serving the particular facility or may be commercial pipelines

handling a number of types or grades of fuel for more than one user. In some cases, the pipeline will be an installation pipeline. If different fuel types are used, separate each type within the receiving facility. Exercise extreme care to avoid designing a system that could create damaging [surges](#) in the pipeline created by quick closing valves.

3-3.1.2 Equipment Required

- a) Provide pressure-regulating diaphragm control valves to reduce pipeline pressures to the design pressure of the facility's piping and equipment. Provide a manual isolation valve at both the upstream and downstream side of each diaphragm control valve. Prior to designing any features into the system which might affect the flow from a pipeline, contact the operator of the pipeline to ascertain the current operating conditions, evaluate the use of diaphragm control valves, conduct a [surge](#) analysis of the pipeline, and determine whether the use of diaphragm control valves is appropriate.
- b) Provide a meter at the receiving end of the line to measure quantities of fuel received. Turbine-type meters are commonly used for pipeline receipt. However, positive displacement meters are acceptable if available at the required flow rate. Consider also the use of alternative meter technologies such as ultrasonic meters. Compensate for fuel temperature at the point of custody transfer. Provide a basket strainer on the upstream side of the meter and connections for proving the meter with a portable prover. A meter prover connection consists of a manual isolation valve in the main pipeline with a tee on both the upstream and downstream sides of the valve. The branch of each of the tees has a manual isolation valve and a hose connection. The master meter can be attached to the hose connections.
- c) Provide a means for sampling each pipeline product at a breakout manifold.
- d) Provide provisions for a contractor to bolt pig launchers and receivers to the system for [pigging](#). Arrange pig receiving connections to avoid introducing pipeline [sludge](#) and sediment into the tanks. Pig launching and receiving provisions are required for interterminal (cross-country) and installation (as described in [Chapter 6](#) of this UFC) underground pipelines.
- e) Provide an interface tank to receive mixed fuels at the beginning and end of a shipment unless the commercial pipeline company can provide this service satisfactorily.

- f) Provide a breakout tank only if pipeline flow cannot be stopped due to pipeline operational requirements. Provide valves to divert the flow of fuel from the pipeline to the breakout tank in the event fuel transfer is blocked by a manual or automatic valve within the fuel facility system such that the fuel facility system would be overpressurized from transient [surge](#) or high pressure from deadheading a pipeline supply pump. Provide appropriate breakout tank overflow alarms and alarm breakout operation so fuel facility operators can take necessary steps to stop pipeline flow. Provide means of transferring fuel out of breakout tank back to fuel systems after a breakout event. Conduct a thorough review with the pipeline operator and perform a transient [surge](#) analysis to determine if [surge](#) pressure reduction methods are required to avoid damage to the pipeline.
- g) Provide means of inbound filtration for all products. The selection of filtration depends on anticipated impurities, the source of fuel, and the shipping methods. Consider the use of [micronic filters](#), [cyclonic filters](#), and [haypack coalescers](#) as possible filtration devices. Avoid the use of water slug shutoff diaphragm control valves or other rapid-closing valves on pipeline receipt facilities. For inbound filtration of aviation turbine fuels, refer to “Special In-Bound Filtration” paragraph of [Chapter 4](#) of this UFC.
- h) Provide manual isolation valves to isolate equipment for service.
- i) Provide basket strainers upstream of pumps, meters and receipt filtration.
- j) Provide [thermal relief valves](#) around isolation and check valves to relieve excessive pressures caused by thermal expansion of liquid trapped between shutoff points. See Facility Plates [023](#), [024](#), [025](#) and [026](#).
- k) Provide a concrete housekeeping pad and, unless otherwise directed by Service Headquarters, a canopy to protect fixed facilities assets and equipment from the elements. See the “Canopies” paragraph of this chapter.

3-3.2 Tank Truck and Tank Car Off-loading Facilities

3-3.2.1 General Criteria

Bulk fuel storage facilities may be supplied with fuel by tank truck or tank car or both. At facilities with pipeline or water transport as their principal supply source, provide tank truck or tank car deliveries as a secondary supply source. Tank truck deliveries are the most common method. However, special transportation considerations or changing

circumstances may make the use of rail facilities desirable. Therefore, at an activity with railroad service, arrange a tank truck receiving facility so that the system can be easily and economically extended to the existing rail spur. See [Facility Plate 002](#).

- a) The preferred off-loading method is into a drop tank off-loading system. See Facility Plate 003.
- b) Provide a packaged off-loading system when a drop tank type off-loading is not practical for off-loading tank trucks or tank cars due to environmental concerns, site limitations, or cost considerations, and/or directed by [Service Headquarters](#). See [Facility Plate 004](#).
- c) Provide a direct off-loading system when only an occasional tank truck requires off-loading and when directed by Service Headquarters. See [Facility Plate 005](#).
- d) Do not locate tank truck or tank car receiving facilities closer than 50 feet (15 m) from buildings, roads, overhead power lines, pad-mounted transformers, and property lines, or 25 feet (7.6 m) from the fuel farm fence. See Chapter 8 of this UFC for clearance requirements from tanks.
- e) Provide an adequate number (minimum two) of positions to off-load the daily fuel requirements of the facility in an eight-hour period without causing detention or demurrage of delivery conveyances.
- f) Provide separate off-loading connections for each type of fuel to be handled. To facilitate the use of tank trucks with multiple independent compartments, provide a hose manifold with a minimum of two connections per tank truck. A manifold with hose connections equal to the number of truck compartments is recommended for quick turnaround. If less than five connections are provided, provide a [blind flange](#) on the end of the manifold to accommodate additional connections.
- g) Provide a containment area at each truck off-loading position consisting of an impermeable retention and controlled drainage system leading to a concrete remote spill containment system. Pave the containment area consisting of the islands, the spaces between islands and on each side of the outer islands, with concrete pitched a minimum of one percent toward catch basins or trench drains. Design the containment area in accordance with [UFC 1-200-01](#), federal, state, and local regulations. Do not use asphalt within a spill containment area. The maximum slope of any paving within a truck movement or parking area shall not exceed 2 percent excepting rollover curbs. If a rollover curb is provided, the sum of the vertical entrance and exit grades shall not

exceed 8 percent and the rollover curb shall be aligned perpendicular with direction of truck movement. \1\ The designer shall assure that adequate ground clearance is achieved for all vehicles utilizing the containment areas. /1/

- h) At tank car off-loading areas, pave the containment area with concrete (or otherwise provide containment) for an area extending from 5 feet (1.5 m) outside of each outer rail and extending longitudinally 15 feet (4.6 m) each way from the center of each loading position. Slope the paved area to a spill containment system as described previously.
- i) Provide a concrete remote spill containment system for each containment area. Design the remote spill containment system in accordance with [UFC 1-200-01](#), federal, state, and local regulations. Provide the remote spill containment system with capacity greater than \1\ the volume of the largest tank truck or tank car compartment to be off-loaded. A curbed truck position may be provided in addition to a remote system. Twenty-five percent or more of the total required containment volume must be directed to, and stored at, the remote system before any of the shared containment volume will pond at the truck stand area.. Provide a lockable eccentric plug valve with indicator post located outside the containment area at a location /1/ that will be safely accessible during a fire. The valve shall be lockable and normally closed to allow for containment during fueling operations and which can be opened to drain the area when necessary. Tank trucks can be as large as 10,000 gallons (38,000 L) in capacity and tanks cars as large as 40,000 gallons (150,000 L). If a canopy is installed, reduce the sizing for rainfall, accounting for wind-blown rain. Consider combining the remote spill containment system with other spill containment systems on site, except with tank containment systems. However, take the level of [contamination](#) in each containment area into consideration.
- j) Construct the drain piping between the containment area and the concrete remote spill containment system, and between the remote spill containment system and lockable \1\ plug /1/ valve of petroleum-resistant, fire-resistant, impermeable materials. Do not use clay, concrete, fiberglass, or plastic piping materials.
- k) For off-loading tank trucks, arrange the flow of traffic to permit continuous forward movement of tank trucks at all times. Commercial tank trucks off-load on the passenger side.

- l) To determine the number of connections needed for off-loading tank cars, consult with [Service Headquarters](#) and consider minimizing tank car movements, tank car shipping schedules, conveyance turn-around times, local rail switching capabilities, and quantity of fuel needed for one day's fuel supply.
- m) Provide an electrical design that meets the minimum requirements of [NFPA 70](#), [NFPA 77](#), and [NFPA 780](#). Treat [combustible liquids](#) under pressure as a [flammable liquid](#).
- n) Provide a canopy for protection from the elements of fixed facility assets and equipment per the "Canopies" paragraph of this chapter.
- o) Provide a canopy to preclude rain from the containment area when the requirements listed in the "Canopies" paragraph of this chapter are met.
- p) Provide for egress and entrance of emergency response vehicles. The egress and entrance routes need to be large enough to allow both, trucks and emergency vehicles, leaving and entering the facility.
- q) Provide a means of inbound filtration for all products. The selection of filtration depends on anticipated impurities, the source of fuel, and the shipping methods. Consider the use of [micronic filters](#), [cyclonic filters](#), and [haypack coalescers](#) as possible filtration devices. For inbound filtration of aviation turbine fuels, refer to [Chapter 4](#) of this UFC.

3-3.2.2 Tank Truck and Tank Car Drop Tank Off-Loading System

The introduction of air into a fuel receiving system poses extreme hazards which can result in fire and/or explosion. Hazards are compounded when an air/fuel mixture is passed through receipt [filter/separators](#) where [static electricity](#) is generated and ignition can occur. Design off-loading facilities so air is not introduced into the system. For facilities with the capability to off-load several tank trucks at once or where newer tank trucks with multiple hoses are connected to multiple isolated compartments, consider providing an underground, gravity-type, receiving tank with submersible transfer pumps and level controls. For smaller systems of one or two tank trucks, consider a low profile, aboveground, receiving tank with a centrifugal transfer pump. For either case, provide level sensors to control the flow. Provide a temperature compensated meter on the receipt line to the tank at points of transfer and custody. For materials of construction for off-loading drop tanks, refer to [Chapter 8](#). See [Facility Plate 003](#).

3-3.2.3 Tank Truck and Tank Car Packaged Off-Loading System

For tank truck or tank car off-loading, an off-loading drop tank may not be practical due to environmental concerns, site limitations, or cost considerations. In these instances, provide a 600 gpm (38 L/s) packaged off-loading system. Provide one packaged system, including vertical inline centrifugal pump, diaphragm control valves to control flow, meter, and multiple hose connections (one for each tank truck compartment), for each tank truck or tank car receiving station. Provide an air eliminator tank to remove air from the system, reducing the risk of an air/fuel mixture passing through receipt [filter/separators](#) and preventing the metering of air. Level sensors in the air eliminator tank control the pump discharge diaphragm control valves, modulating the flow rate based on the level in the air eliminator tank. Refer to \1\ [AW 078-24-28](#) /1/ and [Facility Plate 004](#).

3-3.2.4 Tank Truck and Tank Car Direct Off-Loading System

Use when only an occasional tank truck requires off-loading and when directed by [Service Headquarters](#). Refer to [Facility Plate 005](#).

3-3.2.5 Equipment Required

- a) When tank trucks or tank cars are off-loaded with a drop tank off-loading system, do not provide an off-loading pump. Provide at least two pumps in the drop tank to transfer fuel to the storage tank.
- b) When tank trucks or tank cars are off-loaded with packaged off-loading systems, provide one system for each tank truck or tank car that is to be off-loaded simultaneously, at an average capacity of 600 gpm (38 L/s) each. The number of systems shall be determined by Service Headquarters but shall be a minimum of two. The capacity of the systems may be reduced to 300 gpm (19 L/s) each only when directed by Service Headquarters.
- c) When tank trucks or tank cars are off-loaded with direct off-loading systems, provide [centrifugal pumps](#) configured to provide automatic air elimination as shown on [Facility Plate 005](#). Provide at least two pumps to allow continued operation if one is out of service. The capacity of the pumps may be increased to 600 gpm (38 L/s) each only when directed by Service Headquarters. The centerline height of suction line from manifold to pump should not exceed 23.25 inches (591 mm) above truck unloading, parked position. Locate the pump as close as possible to the off-load point to prevent suction problems.
- d) Provide 4-inch (100 mm) diameter by 10-foot (3 m) long lightweight reinforced vacuum rated off-loading hoses and covered hose

storage racks for each hose connection at each off-loading position. Eliminate covered hose storage rack if off-load rack is to be covered by a canopy. Ensure that all swivels are non-lubricated aluminum or stainless steel in-line repairable type. Consult with Activity to verify the need for hoses, since at some locations, the fuel hauling contractor provides the hoses.

- e) Equip each tank truck off-loading position with an electronic, intrinsically safe, automatic, self-monitoring ground verification unit with a lockable bypass. If grounding is not verified and there is an off-loading pump dedicated to that position, ensure the unit prevents the pump from starting. If the pump is not dedicated, ensure an alarm sounds if the off-loading valve is opened prior to grounding verification. Include a separate grounding reel to accommodate vehicles without grounding equipment.
- f) Provide emergency fuel shutoff (EFSO) pushbutton stations. For truck off-loading with multiple positions, an EFSO pushbutton station is required for each position and along routes of personnel ingress and egress between 100 and 200 feet (30 m and 60 m) from the off-loading position. Design in such a manner that activation of the emergency stop will shutoff all fueling in the off-loading area and/or the associated pumphouse or pump pad.
- g) Provide fuel sampling connections at each position for each product line for collecting test samples.
- h) Provide pressure gauges on both sides of each strainer or a differential type gauge across each strainer. Where a strainer is upstream of a pump, the pump suction gauge may function as the strainer downstream gauge.
- i) Provide a compound (pressure/vacuum) gauge on the inlet side of pumps and a pressure gauge on the outlet side of pumps.
- j) If the system is for JP-5 or other fuel that does not have a static dissipater [additive](#) which provides a conductivity level greater than 50 conductivity units (50 picosiemens per meter), and a 30-second retention time is not provided between [filter/separator](#) and receiving tank, provide a [relaxation tank](#) downstream of [filter/separator](#) to ensure a combined 30-second retention time (time in the relaxation tank and time in the piping).
- k) Provide basket strainers upstream of pumps, meters, and receipt filtration.

- l) Provide a combination flow control and non-surge check diaphragm control valve on all off-load pumps except positive displacement types. If a bulk air eliminator with automatic air release head is included, provide a means of closing the diaphragm control valve with a solenoid pilot.
- m) Provide a positive displacement or turbine meter and meter proving connections. Provide meter with temperature compensation capability wherever custody transfer occurs. Provide a basket strainer on the upstream side of the meter.
- n) On each off-loading connection or on the off-loading riser, install a visual fuel flow indicator (maximum pressure 275 psi (1900 kPa) at 100 degrees F (38 degrees C), with Viton Seals with a maximum temperature rating of 350 degrees F (177 degrees C)). This will allow visual quality assurance and provide the operator with a backup system to shut off the pumps when off-loading is complete to prevent air build-up in the receipt lines.
- o) Provide manual isolation valves to isolate equipment for service.
- p) Provide [thermal relief valves](#) around isolation and check valves to relieve excessive pressures caused by thermal expansion of liquid trapped between shutoff points. See Facility Plates [023](#), [024](#), [025](#) and [026](#).

3-3.3 Marine Off-loading Facilities

See [Chapter 5](#) of this UFC.

3-4 DISPENSING FACILITIES

Fuel is normally dispensed from a bulk facility via an installation pipeline, interterminal pipeline, tank truck, or tank car.

3-4.1 Pipeline Pumping Facilities

3-4.1.1 General Criteria

As discussed in [Chapter 6](#) of this UFC, pipelines are either [interterminal pipelines](#) or [installation pipelines](#). [Installation pipelines](#) are commonly used to transfer fuel to an aircraft fueling facility or a marine dispensing facility. [Interterminal pipelines](#) are cross-country between installations. However, since pipeline pumping facilities are typically at a bulk fuel storage facility, they are covered in this chapter.

3-4.1.2 Equipment Required

- a) [Centrifugal pumps](#) complying with [API Std 610](#) with adequate head and capacity. Always provide one additional pump as back-up.
- b) Turbine or positive displacement meter with proving connections. Consideration can also be given to alternative meter technologies such as ultrasonic meters. Compensate for fuel temperature at custody transfer point.
- c) Provide fuel sampling connections for collecting test sample.
- d) Pig launching and receiving capability for interterminal and [installation pipelines](#).
- e) Strainer on the upstream side of meters and pumps.
- f) Manual double block and bleed isolation valves where total isolation is required.
- g) Pressure gauges on both sides of the strainer or a differential pressure type gauge across the strainer.
- h) Compound (pressure/vacuum) gauges on the inlet side of pumps and pressure gauges on the outlet side of pumps.
- i) Provide a combination flow control and non-surge check diaphragm control valve on all pumps except positive displacement types. If a bulk air eliminator with automatic air release head is included, provide a means of closing the diaphragm control valve with a solenoid pilot.
- j) Provide manual isolation valves to isolate equipment for service.
- k) Provide [thermal relief valves](#) around isolation and check valves to relieve excessive pressures caused by thermal expansion of liquid trapped between shutoff points. See Facility Plates [023](#), [024](#), [025](#) and [026](#).
- l) Provide a concrete housekeeping pad and, unless otherwise directed by Service Headquarters, a canopy to protect fixed facilities assets and equipment from the elements. See the “Canopies” paragraph of this chapter.

3-4.2 Tank Truck and Tank Car Loading Facilities

3-4.2.1 General Criteria

This chapter applies to facilities required for loading over-the-road tank truck transports or rail tank cars used for the bulk transfer of fuel. A typical application is the transfer by tank truck from a storage terminal to secondary storage, such as a [filling station](#) or a heating plant. In many cases, the receiving and loading facilities are combined. In these cases, both receiving and loading facility requirements must be addressed. This chapter does not include facilities for loading aviation [refuelers](#) for direct issue to aircraft. This process requires special design considerations as discussed in [Chapter 4](#) of this UFC. See Facility Plates [002](#), [003](#) and [005](#).

- a) Determine the volume of fuel and number of tank trucks or tank cars to be handled by an operational analysis with assistance from [Service Headquarters](#).
- b) Do not locate tank truck or tank car loading facilities closer than a minimum of 50 feet (15 m) from buildings, roads, overhead power lines, pad-mounted transformers, and property lines, or 25 feet (7.6 m) from the fuel farm fence. Do not locate a tank truck loading facility closer than 100 feet (30 m) from a railroad track (or spur) or rail siding for loading/offloading. See [Chapter 8](#) of this UFC for clearance requirements from tanks. /1/
- c) [Bottom loading](#) is the only acceptable method of loading tank trucks. [Bottom loading](#) results in increased safety, manpower savings, quality control of product, and area cleanliness. At non-U.S. locations where only contracted [top loading](#) tank trucks are available, install a [top loading](#) rack with permission of [Service Headquarters](#). In this event, provide future [bottom loading](#) capabilities.
- d) Provide a containment area at each truck loading position consisting of an impermeable retention and controlled drainage system leading to a concrete remote spill containment system. Pave the containment area consisting of the islands, the spaces between islands and on each side of the outer islands, with concrete pitched a minimum of one percent toward catch basins or trench drains. Design the containment area in accordance with [UFC 1-200-01](#), federal, state, and local regulations. Do not use asphalt within a spill containment area. The maximum slope of any paving within a truck movement or parking area shall not exceed 2 percent excepting rollover curbs. If a rollover curb is provided, the sum of the vertical entrance and exit grades shall not exceed 8 percent and the rollover curb shall be aligned

perpendicular with direction of truck movement. The designer shall assure that adequate ground clearance is achieved for all vehicles utilizing the containment areas. /1/

- e) At tank car loading areas, pave the containment area with concrete (or otherwise provide containment) for an area extending from 5 feet (1.5 m) outside of each outer rail and extending longitudinally 15 feet (4.6 m) each way from the center of each loading position. Slope the paved area to a spill containment system as described previously in Item (d).
- f) Provide a concrete remote spill containment system for each containment area. Design the remote spill containment system in accordance with [UFC 1-200-01](#), federal, state, and local regulations. Provide the remote spill containment system with capacity greater than \1\ the volume of the largest tank truck or tank car compartment to be off-loaded. A curbed truck position may be provided in addition to a remote system. Twenty-five percent or more of the total required containment volume must be directed to, and stored at, the remote system before any of the shared containment volume will pond at the truck stand area. Provide a lockable eccentric plug valve with indicator post located outside the containment area at a location /1/ that will be safely accessible during a fire. The valve shall be lockable and normally closed to allow for containment during fueling operations and which can be opened to drain the area when necessary. Tank trucks can be as large as 10,000 gallons (38,000 L) in capacity and tanks cars as large as 40,000 gallons (150,000 L). If a canopy is installed, reduce the sizing for rainfall, accounting for wind-blown rain. Consider combining the remote spill containment system with other spill containment systems on site, except with tank containment systems. However, take the level of [contamination](#) in each containment area into consideration.
- g) Construct the drain piping between the containment area and the concrete remote spill containment system, and between the remote spill containment system and lockable \1\ eccentric plug /1/ valve of petroleum-resistant, fire-resistant, impermeable materials. Do not use clay, concrete, fiberglass, or plastic piping materials.
- h) Provide a canopy for protection from the elements of fixed facility assets and equipment per the “Canopies” paragraph of this chapter.

- i) Provide a canopy to preclude rain from the containment area when the requirements listed in the “Canopies” paragraph of this chapter are met.
- j) Provide separate piping, pumps, loading connections, and controls for each different type and grade of fuel.
- k) Arrange loading rack with a row of islands with sufficient clearance between to allow easy access to all parts of the tank trucks when parked. Arrange islands and approaches in a manner that allows forward motion for all tank trucks at all times with ample room for turning. Space and arrange [bottom loading](#) islands to accommodate one tank truck only on the side adjacent to the tank truck’s liquid connections, usually the passenger side of the tank truck.
- l) Provide for entrance and egress of emergency vehicles.
- m) If [top loading](#) is required for tank cars (normally only when commercial contract leaves no other choice) and approved by [Service Headquarters](#), provide a typical tank car loading rack with an elevated steel platform, consisting of a walkway, 4 feet (1.2 m) wide, 10.5 feet (3.2 m) above the top of the rails, and the full length of six tank cars. Ensure that the centerline of the structure is 10.5 feet (3.2 m) above the centerline of the tracks. Equip the platform with a counterweighted or spring-loaded tilting bridge to connect to the tank car dome at each loading station. Design so that when released from the horizontal position, the bridge will automatically move and lock in an upright position away from any part of the tank car under all weather conditions. Ensure conformance with [UFC 1-200-01](#) requirements. Platform is not required on Air Force projects.

3-4.2.2 Tank Truck Fillstand Equipment Required

- a) Provide a positive displacement or turbine meter for each tank truck fill connection. Protect each meter with an upstream basket strainer. Include temperature compensation if rack is to be point of custody transfer.
- b) Provide fuel sampling connections for collecting test samples.
- c) Provide pressure gauges on both sides of the strainer or a differential pressure type across the strainer.

- d) Provide fusible link butterfly isolation valves as the first piece of equipment (in the direction of the flow) on the loading position. (Valve is not required on Air Force projects.)
- e) Make provisions to start and stop the pumps with start and stop pump controls at each position. Include pump status indicator light on control box.
- f) Provide a solenoid operated truck loading diaphragm control valve with opening/closing speed control, pressure regulating, check and solenoid shut-off features. Interlock the solenoid with the electronic high-level shutoff, \1\ and ground verification /1/ control system.
- g) Provide each fill position with an electronic high-level shutoff, \1\ electronic ground verification, and electronic or hydraulic /1/ deadman control system. The system shall be intrinsically safe and self-checking. Interlock the system with either the solenoid operated truck loading diaphragm control valve or the pump such that the valve cannot remain open or the pump cannot operate if the tank truck compartment is full, the tank truck is not [grounded](#), or the deadman is released. Ensure the system is compatible with both electronic and fiber optic sensors with manual-keyed bypass. (May require a parallel effort beyond the project scope to ensure that all trucks using the facility have compatible connections. If facility has trucks that do not have fixed probes, use cane probes instead.) (This unit is optional on Army projects with only tactical refuelers. Contact the [Service Headquarters](#) for guidance.)
- h) Provide emergency fuel shutoff (EFSO) pushbutton stations. For fillstands with multiple positions, an EFSO pushbutton station is required for each position and along routes of personnel ingress and egress between 100 and 200 feet (30 m and 60 m) from the fillstand. Design in such a manner that activation of the emergency stop will shutoff all fueling at that pump house or pump pad.
- i) Equip liquid connections to tank trucks for [bottom loading](#) with drybreak couplers in accordance with [API RP 1004](#).
- j) Refer to [Chapter 2](#) of this UFC for guidelines on vapor collection and recovery or disposal systems.
- k) Provide heaters and insulated, heated pipelines, as required, where viscous fuels are to be loaded to maintain the temperature of the fuel at its minimum pumping temperature.

- l) Provide stainless steel loading arms (pantograph, without hoses) equipped with non-lubricated swivels may be used instead of hoses, if approved by [Service Headquarters](#). Ensure all swivels are non-lubricated, stainless steel in-line repairable type.
- m) Provide meter proving connections as described in the paragraph titled "Pipeline Receiving Facilities", unless local procedure provides an alternative.
- n) Provide [relaxation tank](#) or piping configuration with sufficient capacity to retain the maximum flow of the loading station for 30 seconds from the time the fuel leaves the last piece of filtration equipment to the fuel reaching the loading [nozzle](#). Applies only to JP-5 or other fuels which do not have a static dissipation [additive](#) that provides a conductivity level greater than 50 picosiemens.
- o) Provide basket strainer upstream of meters and pumps.
- p) Provide manual isolation valves to isolate equipment for service.
- q) Provide [thermal relief valves](#) around isolation and check valves to relieve excessive pressures caused by thermal expansion of liquid trapped between shutoff points. See Facility Plates [023](#), [024](#), [025](#) and [026](#).
- r) Grounding/bonding reel (provided as an integral part of the high level shutoff system).
- s) Provide hydraulic shock surge suppressors (if required).

3-4.2.3 Tank Car Loading Station Equipment Required

- a) Provide a positive displacement or turbine meter for each tank car fill connection. Protect each meter with an upstream basket strainer. Include temperature compensation if rack is to be point of custody transfer.
- b) Provide meter proving connections as described in the paragraph titled "Pipeline Receiving Facilities", unless local procedure provides an alternative.
- c) Provide fuel sampling connections for collecting test samples.
- d) Provide pressure gauges on both sides of the strainer or a differential pressure type across the strainer.

- e) Provide fusible link butterfly isolation valves as the first piece of equipment (in the direction of the flow) on the loading position. (Valve is not required on Air Force projects.)
- f) Provide loading connections, controls, valves, etc., on one or both sides of the loading platform as specified by [Service Headquarters](#). Load tank cars from the bottom using counterbalanced, articulated tank car loading assemblies.
- g) Provide an electronic, intrinsically safe, portable liquid high level sensor with adjustable height at each loading rack. To prevent an overflow, interlock the sensor with the electronic high-level shutoff \1\ and ground verification /1/ control system.
- h) Provide an electronic high-level shutoff, \1\ electronic ground verification, and electronic or hydraulic /1/ deadman control systems. The system shall be intrinsically safe and self-checking. Interlock the system with either the solenoid operated tank car loading diaphragm control valve or the pump such that the valve cannot remain open or the pump cannot operate if: the tank car is full, the tank car is not [grounded](#), or the deadman is released. Provide the capability to connect the ground verification rack to the rail tank car frame.
- i) Provide emergency fuel shutoff (EFSO) pushbutton stations. For fillstands with multiple positions, an EFSO pushbutton station is required for each position and along routes of personnel ingress and egress between 100 and 200 feet (30 m and 60 m) from the fillstand. Design in such a manner that activation of the emergency stop will shutoff all fueling at that pump house or pump pad.
- j) Provide solenoid operated tank car loading diaphragm control valve with opening/closing speed control, pressure regulating, check, and solenoid shut-off features. Interlock the solenoid with the electronic high-level shutoff, \1\ and ground verification /1/ control system.
- k) Provide a basket strainer upstream of meters and pumps.
- l) Provide manual isolation valves to isolate equipment for service.
- m) Provide [thermal relief valves](#) around isolation and check valves to relieve excessive pressures caused by thermal expansion of liquid trapped between shutoff points. See Facility Plates [023](#), [024](#), [025](#) and [026](#).

- n) Provide [relaxation tank](#) or piping configuration with sufficient capacity to retain the maximum flow of the loading station for 30 seconds from the time the fuel leaves the last piece of filtration equipment to the fuel reaching the loading [nozzle](#). Applies only to JP-5 or other fuels which do not have a static dissipation [additive](#) that provides a conductivity level greater than 50 picosiemens.
- o) Provide hydraulic shock surge suppressors (if required).

3-4.3 Marine Loading Facilities

See [Chapter 5](#) of this UFC.

3-5 PIPING SYSTEMS

Refer to [Chapter 9](#) of this UFC for more information regarding piping systems.

3-5.1 Product Segregation

Except as otherwise approved by [Service Headquarters](#) provide separate receiving, storage, and distribution systems for each product. Except as otherwise approved by [Service Headquarters](#), prevent misfueling (transferring a type of fuel other than the type intended) by using different size piping, valves, adaptors, nozzles, etc.

3-6 EQUIPMENT DESCRIPTIONS

The appropriate guide specification and/or standard design provides specific information for equipment selection. Make provisions to drain equipment for maintenance. Provide hardpiped drains when the equipment holds more than 5 gallons (19 L) of fuel or when a pipe which drains to the [product recovery tank](#) is within 12 ft (3.7 m) of the equipment.

3-6.1 Bulk Air Eliminators

Use flange-connected, steel bodied bulk air eliminator of the desired pressure and flow rating for the applicable service requirement. Include an automatic air release head and interlock the equipment with a float or solenoid-operated hydraulically operated diaphragm control valve. Provide discharge piping to the product recovery tank or other safe means of containment.

3-6.2 Meters

Provide meters with swivel mounted counter heads at truck fillstands to accommodate varying truck and operator positions.

3-6.2.1 Meters - Positive Displacement

Use flange-connected, cast steel bodied positive displacement meters of the appropriate pressure and flow rating to meet applicable service requirements. Ensure

meter has case drain and register. Provide meters with temperature compensation and adjustable [calibration](#) /1/ where there is custody transfer. Ensure meter accessories are compatible with either the mechanical or electronic support equipment selected. Provide an accuracy of plus or minus 0.5 percent when used for custody transfer. Consult the appropriate [Service Headquarters](#) for requirements for the meter to communicate to a remote location or equipment. Consider the use of a card-operated or key-operated data acquisition system. Refer to “Card and Key Locks” under “Controls” paragraph of this chapter.

3-6.2.2 Meters – Turbine

Use flange-connected steel bodied turbine meters of the appropriate pressure and flow rating to meet applicable service requirements. Provide a flow straightener before turbine meters or provide a straight length of pipe at a minimum of ten pipe diameters upstream and five pipe diameters downstream of all turbine meters, or as required by manufacturer. Ensure meter has case drain and register. Provide meters with temperature compensation and adjustable [calibration](#) /1/ where there is custody transfer. Provide an accuracy of plus or minus 0.5 percent when used for custody transfer. Ensure all supporting equipment for meter is compatible with the turbine meter selected. Consult the appropriate [Service Headquarters](#) for requirements for the meter to communicate to a remote location or equipment. Consider the use of a card-operated or key-operated data acquisition system. Refer to “Card and Key Locks” under “Controls” paragraph of this chapter.

3-6.2.3 Meters – Orifice

Use this type of meter only where custody transfer or accounting/inventory control is not required. Provide with flange connections. Provide a flow straightener before orifice meters or provide a straight length of pipe at a minimum of ten pipe diameters upstream and five pipe diameters downstream of all orifice meters, or as required by manufacturer.

3-6.3 Pressure or Pressure/Vacuum Gauges

Use liquid-filled gauges of range and dial size, as necessary, but not less than 0 to 160 psig (0 to 1100 kPa) pressure range and 4-inch (100 mm) diameter dial. Gauges shall be all stainless steel construction, with black graduations on a white face. For extreme temperature environments, consult [Service Headquarters](#) for direction on the possible use of air-filled gauges. For locations where the temperature is less than -40 degrees F (-40 degrees C), use appropriate gauge liquid that will not freeze to prevent damaging the gauge.

- a) Consider the location, year-round weather conditions, and service requirements for the type of liquid filling to be used.
- b) Gauge liquids and service ranges.

Liquid	Range
Glycerin	0 °F to 400 °F (-18 °C to 204 °C)
Silicone	-40 °F to 600 °F (-40 °C to 316 °C)

- c) Provide a lever handle gauge cock and pressure snubber in each pressure gauge connection.
- d) Provide indicating and recording pressure gauges on suction and discharge lines for interterminal pipeline pumping stations and on the incoming line at the delivery terminal of each such pipeline, if required by [Service Headquarters](#).
- e) Pressure gauges shall be installed so that they are testable without removing them from the piping.

3-6.4 Strainers

Require a strainer to protect [centrifugal pumps](#), unless it precludes meeting the net positive suction head of the pump. Whether or not strainers are installed on the suction side of [centrifugal pumps](#), require a spool piece so that temporary strainers can be installed during startup of the system. Strainers are required on the suction side of all pumps, meters, and receipt filtration. Also:

- a) Use flanged basket strainers constructed of steel and fitted with removable baskets of fine Monel metal or stainless steel mesh with large mesh reinforcements. Provide quick opening, single screw type with drain connection in bottom.
- b) Provide a fine screen mesh as follows:

	Mesh	Size of Opening
Pump suctions (Centrifugal)	7	0.108 inch (2.74 mm)
Pump suctions (Positive Displacement)	40	0.016 inch (0.40 mm)
Receipt Filtration	40	0.016 inch (0.40 mm)
Meter inlets (unless downstream of a filter/separator)	40	0.16 ch (0.40 mm)

- c) In all cases, ensure the effective screen area is not less than three times the cross sectional area of the pipe.
- d) Provide pressure gauges on both sides of the strainer or a differential type gauge across the strainer.

3-6.5 Surge Suppressors

Every effort should be made to control hydraulic [surge](#) or shock to acceptable limits by the design of the piping system rather than by the use of [surge suppressors](#). Where this is not possible or becomes extremely impractical, [surge suppressor\(s\)](#) may be incorporated. Use the diaphragm or bladder type equipped with a top-mounted liquid-filled pressure gauge, wafer-style check valve at the bottom, drain above the check valve, and isolation valve. Provide a needle valve around the check valve to permit controlled bleed back of the surge suppresser without rebounding. Locate [surge suppressors](#) as close as possible to the point of shutoff that is expected to cause the shock. [Surge suppressors](#) can reduce shock pressure but will not eliminate it entirely. The preferred solution to hydraulic shock is conservative piping design, use of loops, and slow-closing valves. [Surge suppressors](#) are strictly a last resort solution and require the approval of [Service Headquarters](#) prior to designing into a system.

3-6.6 Pumps

3-6.6.1 Design Requirements

Design pumps to deliver the full range of operating conditions anticipated at any facility with flow rates as presented in [Chapter 2](#) of this UFC. Ensure pumps develop sufficient head to overcome the friction and static head losses in the system at the rated flow. Consider the [specific gravity](#), temperature, [viscosity](#), [vapor pressure](#), corrosive, and solvent properties of the fuel. If a range is given for the [specific gravity](#), etc., in the "Fuel Properties and Additives" paragraph of [Chapter 2](#), use the larger value for the purpose of calculations. For any single grade of fuel, connect pumps in parallel. Select according to the type most suitable for the particular application. Do not use positive displacement or reciprocating pumps for product issue or pipeline transfer. Provide enough pumps to allow the system to operate at full capacity with the largest pump out-of-service.

3-6.6.2 Centrifugal Pumps

Use [API Std 610 centrifugal pumps](#) to pump from aboveground tanks with continuously flooded suctions.

3-6.6.3 Vertical Turbine Pumps

Use [API Std 610](#) vertical turbine pumps to pump from underground tanks. Do not use horizontal transfer pumps in a pit alongside the underground tank as an alternative.

3-6.6.4 Rotary Pumps

Use sliding vane positive displacement pumps or self-priming [centrifugal pumps](#) for applications such as stripping pipelines or similar service where the pump may frequently lose its prime. For these pumps, provide a pressure relief valve located on

the discharge side of the pumps. A variable speed motor can be used on positive displacement pumps to gradually bring the pump to normal operating speed.

Note: On positive displacement pumps the pressure relief valves shall be considered safety relief valves, not operating valves (valves that modulate on a normal basis to maintain a set pressure). Use of the relief valve to modulate the pump discharge pressure voids the pump warranty.

3-6.6.5 Drivers

Drive permanently installed pumps by an electric motor which is properly classified in accordance with [NFPA 70](#). Size drivers to be non-overloading at any point on the curve. Provide anti-reversing ratchets on all vertical turbine pump motors.

3-6.6.6 Materials of Construction

Use carbon steel or nodular iron casings and components. Refer to [Chapter 4](#) of this UFC for aviation turbine fuels requirements.

3-6.6.7 Installation

Mount permanently installed pumps on substantial foundations of reinforced concrete designed in accordance with Hydraulic Institute Standards.

3-6.7 Valves

3-6.7.1 Materials of Construction – General Service

Require valves to have carbon steel bodies and bonnets except for aviation turbine fuels (see below). Valves in general service may be internal nickel plated, or internal epoxy coated. Do not allow valves with aluminum, cast iron, or bronze materials. Use only API fire-safe valves.

3-6.7.2 Materials of Construction – Aviation Turbine Fuel Service

Valve materials in contact with aviation turbine fuel shall either be stainless steel, chrome plated carbon steel, or electroless nickel plated carbon steel. Do not allow zinc, zinc-coated, copper, or copper bearing materials in contact with the fuel. Do not allow internally epoxy-coated valves.

Require manual valves in aviation turbine fuel systems to have stainless steel bodies and bonnets. Carbon steel bodied valves are permitted provided they are internally plated with nickel plating. Do not allow aluminum, cast iron, or bronze bodied valves. Use only API fire-safe valves.

3-6.7.3 Isolation Valve Types

- a) [Double Block and Bleed Isolation Valves:](#)

- (1) Use these for separation of product services, on tank shell connections, when piping goes above or below ground, between pier and tank storage, and other locations critical to pressure-testing of piping.
 - (2) Plug Valves ([Double Block and Bleed](#)): Use double-seated, tapered lift, lockable, plug type valves with a body bleed between the seats ([double block and bleed](#)). Valves shall be designed so that if the synthetic seating material is burned out in a fire, a metal-to-metal seat will remain to effect closure and comply with [API Std 607](#). Lubricated plug valves are not allowed. Include integral body cavity thermal relief valve.
 - (3) Ball Valves ([Double Block and Bleed](#)): Use double-seated, trunion mounted, lockable, ball type valves with a body bleed between the seats ([double block and bleed](#)). These will be very rarely used but are acceptable as an alternative to [double block and bleed](#) plug valves in applications where the valve is operated very infrequently. An example is isolation valve pits where they are only closed to perform pressure testing of piping. Valves shall be designed so that if the synthetic seating material is burned out in a fire, a metal-to-metal seat will remain to affect closure and comply with [API Std 607](#). Include integral body cavity [thermal relief valve](#).
 - (4) Gate Valves ([Double Block and Bleed](#)): Use double-seated, lockable, gate type valves with a body bleed between the seats ([double block and bleed](#)). These will be very rarely used but are acceptable as an alternative to [double block and bleed](#) plug valves and [double block and bleed](#) ball valves only when other [double block and bleed valves](#) will not physically fit. Valves shall be designed so that if the synthetic seating material is burned out in a fire, a metal-to-metal seat will remain to affect closure and comply with [API Std 607](#). Single seated gate valves are not allowed. Include integral body cavity [thermal relief valve](#).
- b) Quick Opening/Frequent Opening Isolation Valves:
- (1) Use these for less critical applications where [double block and bleed](#) shutoff is not required.
 - (2) Ball Valves: Ball type, lockable, valves designed so that if the synthetic seating material is burned out in a fire, a metal-to-metal seat will remain to affect closure and comply with

[API Std 607](#). Use Teflon or Viton synthetic seals or seating material. Use full port ball valves where line [pigging](#) is required or if within ten pipe diameters upstream and/or five pipe diameters downstream of a flow or pressure control valve, or a flow-sensing device such as a venturi. Valves should comply with [API Std 608](#).

- (3) Butterfly Valves: High-performance wafer trunion butterfly type valves designed so that if the synthetic seating material is burned out in a fire, a metal-to-metal seat will remain to affect closure and comply with [API Std 607](#). Use Teflon or Viton synthetic seals or seating material. Use valves of high-performance type with eccentric disc shaft and clamping action for bubble-tight shutoff. Provide only at inlet to truck fillstand and on supply and return risers at aircraft direct fueling stations with fusible link set to release at 165 degrees F (74 degrees C). These valves are not required nor permitted on Air Force projects.

- c) Use full port valves with exact same diameter of the pipe when line [pigging](#) is required.

3-6.7.4 Isolation Valve Operators

Manually operate valves not specified for remote, automatic, or emergency operation. Use geared operators for ball and [double block and bleed](#) plug valves larger than 6 inches (150 mm). [Double block and bleed](#) gate, ball, and [double block and bleed valves](#) specified for remote, automatic, or emergency service may have electric motor operators, if approved by [Service Headquarters](#). Provide locking tabs on isolation valves to allow padlock to be used to lock out the valves during maintenance. Provide chain operators on valves which are located 72 inches (1800 mm) or higher above grade.

3-6.7.5 Isolation Valve Locations

Provide isolation valves in piping systems to control flow and to permit isolation of equipment for maintenance or repair. Provide additional valves at locations necessary to conduct a valid [hydrostatic test](#). Require manually operated valves, except where motor operators are specifically authorized by applicable standard drawings or technical specifications. Use [double block and bleed](#) type isolation valves for separation of product services, on tank shell connections (ASTs over 12,000 gallons (45 800 L) only), when piping goes above or below ground, between pier and tank storage, and other locations critical to periodic pressure-testing of piping. Quick opening/frequent opening type isolation valves may be used for less critical applications where [double block and bleed](#) shutoff is not required. As a minimum requirement, provide isolation valves at the following locations:

- a) Where piping goes underground or comes aboveground and requires periodic pressure testing.
- b) At all subsurface and aboveground piping connections to storage tanks.
- c) On each branch line at the point of connection to the main product pipeline or header.
- d) On the product pipeline or header just before the line leaves a pumping station.
- e) On the suction side and discharge side of each pumping unit, except the suction side of vertical [centrifugal pumps](#) installed in underground tanks.
- f) On the upstream and downstream side of each [line blind](#) at connections to cross country pipelines.
- g) On the inlet and outlet connection of each line strainer, [filter/separator](#), meter, diaphragm control valve, and other equipment that requires periodic servicing. One inlet valve and one outlet valve may be used to isolate more than one piece of adjacent equipment which are connected in series.
- h) On each main distribution pipeline immediately downstream of the branch connection to each existing or future operating storage facility served by the pipeline.
- i) On the aboveground piping at each tank car or tank truck off-loading connection, and at each inlet to the gravity drop tank.
- j) On the aboveground piping at each tank car and tank truck loading connection.
- k) At critical roadway, runway and taxiway crossings, consider isolation valves on both sides of runway/taxiway to facilitate [hydrostatic testing](#) and isolation.

3-6.7.6 Isolation Valve Pits

Provide [fiberglass](#) or concrete pits with a rolling or hinged cover designed in accordance with the Air Force Standard Design [AW 78-24-28](#) for all isolation valves installed in non-traffic areas on underground fuel systems. Design valve pits and valve operators so that the valves can be operated by personnel, without confined space entry.

3-6.8 Other Valves (Except Diaphragm Control Valves)

3-6.8.1 Check Valves

Use check valves to prevent backflow through pumps, branch lines, meters, or other locations where runback or reverse flow must be avoided. Check valves may be of the swing disk, globe, dual plate hinged disk, spring-loaded poppet, ball, or diaphragm-actuated types. Use checks of soft-seated non-slamming type with renewable seats and disks. Ensure check valves conform to [API Spec 6D](#). Use non-surge check diaphragm control valves with flow control feature on the discharge of all pumps. When using non-surge check diaphragm control valves on pump discharge, consider the use of a spring type wafer check before the diaphragm valve to prevent sudden flow reversals during shutdown from passing back thru the pump before the diaphragm control valve diaphragm chamber is filled and reacts by closing the valve.

3-6.8.2 Thermal Relief

Provide [thermal relief valves](#) around isolation and check valves to relieve excessive pressures caused by thermal expansion of liquid trapped between shutoff points. See Facility Plates [023](#), [024](#), [025](#) and [026](#).

3-6.9 Diaphragm Control Valves

Hydraulically operated, single-seated, globe type, diaphragm actuated control valves are used extensively in fueling systems as control valves. These valves consist of a main valve and a pilot control system. The main valve consists of a body, diaphragm, and cover and is operated by varying the amount of pressure above the diaphragm. Since the chamber above the diaphragm exposes a greater area of the diaphragm to chamber pressure than the area of the disc exposed to line pressure, an equal pressure in the chamber and pipeline results in a greater force being applied to the top of the disc. This forces the disc against the seat, thus closing the valve. By selecting the proper pilot control system, these valves can be used in numerous ways to control flow, pressure, and level within fueling systems.

3-6.9.1 Open/Close Operation

This is the most basic function of hydraulically operated diaphragm control valves. The operation is accomplished by applying pressure above the diaphragm to close the valve and relieve that pressure to allow line pressure to open the valve. The pilot trim used to perform this operation is a three-way valve which can be controlled by a solenoid, hand, pressure, pressure differential, or a float.

3-6.9.2 Throttling Operation

This is the other main method of controlling the hydraulically operated diaphragm control valve. In this case, the valve modulates to any degree of opening, in response to changes in the throttling control. The throttling control reacts to a pressure or a pressure differential across the main valve or a pressure differential across an [orifice plate](#) to regulate the position of the disc in the main valve. For proper operation these

valves should be installed with straight pipe on both sides of the valve. Ten pipe diameters on the upstream side and five diameters on the downstream side is sufficient; provide full port manual isolation valves if they are placed within these limits.

3-6.9.3 Check Valve Function

This is a unique function of a control valve. In this case, the main valve outlet pressure is connected to the diaphragm cover. Therefore, if the downstream outlet pressure exceeds the inlet pressure, which normally holds the valve open, the valve will close and prevent backflow. Note: In order for the valve to close it must backflow, sometimes for a substantial amount of time. Consider putting a regular check valve in series with this valve in cases where this is a concern.

3-6.9.4 Remote Operations

Hydraulically operated diaphragm control valves can be operated remotely. This is accomplished by installing tubing from the point of pressure sensing to the valve or by using remote-controlled solenoids within the trim.

3-6.9.5 Materials of Construction

Use stainless steel pilot control valves and stainless steel tubing. Use bodies, bonnets, and covers made stainless steel, internally plated (chrome) steel, or internally plated (nickel) nodular iron. Provide Viton or Buna-N diaphragm and disc ring. Enclose all electrical apparatus according to classification of the area in which they are installed. Provide a means to wire seal all adjustable pilots. Do not use aluminum valves.

3-6.9.6 Applications

For fueling systems, use hydraulically operated diaphragm control valves in the following applications (also refer to specific chapters for applications):

- a) [Water slug shutoff.](#)
- b) Rate of flow control.
- c) Pressure reduction.
- d) Pressure relief.
- e) Liquid level control.
- f) Non-surge check control.
- g) [Deadman control](#)
- h) Electrical block control.

3-6.9.7 Combinations

A combination of these controls is also possible. A typical use of these controls is on a [filter/separator](#) for [water slug shutoff](#) and rate of flow control.

3-6.10 Thermometers

Provide thermometers in Burner Fuel No. 5 and No. 6 distribution piping systems at each loading and receiving point and on the inlet and outlet of each heater.

3-6.11 Fuel Hoses

Use sizes as required for design flow rates. For hose flanges and [nipples](#), use carbon steel or brass, except at aviation turbine fuel issue points use brass, stainless steel, or aluminum where metal parts contact the fuel.

3-6.11.1 Loading Fuel Hoses

Provide pressurized loading hoses and connections complying with [EI Std 1529](#).

3-6.11.2 Off-Loading Fuel Hoses

Provide lightweight, flexible, non-pressurized off-loading hoses constructed of nitrile rubber, rigid polyvinyl chloride (PVC) helix, synthetic braiding, smooth bore, and corrugated outer diameter. Provide non-pressurized hoses with a 65 psi (450 kPa) rating at 72 degrees F (22 degrees C) and 27 in Hg (90 kPa) vacuum rating.

3-7 CONTROLS

3-7.1 Design Requirements

Automatic controls at any facility may include temperature, pressure, fuel level and pump controls, automatic flow controls, alarm and limit switches, motor operated isolation valves, solenoid pilot actuated diaphragm control, and remote system condition indicators. Other forms of automatic controls are remote meter indication, electronic access control, data logging, and application of computer techniques. Base the selection of advanced automation and telemetry systems on a study of the particular application with consideration of possible economic justification, operational, and security requirements.

3-7.2 Flow Controls

Where it is possible to achieve flow rates which exceed equipment ratings, provide an adjustable flow control valve on the outlet connection of each meter or [filter/separator](#). Use a diaphragm control valve controlled by the pressure differential across an orifice or a venturi in the main line. Where necessary, provide remote-operated valves on storage tank inlet and outlet lines, suction and discharge of transfer pumps, and transfer lines at fuel piers and other locations.

3-7.3 Pump Controls

Operation of pump suction and discharge valves may be a part of the automatic sequence for the starting of a [centrifugal pump](#) and for shutting it down, remotely, locally, or by a protective shutdown device. Remote-operated valves on the discharge side of the pump can be either motor-operated or the solenoid pilot-type, hydraulically operated diaphragm control valves. Remote control valves on the suction side of the pump can be motor-operated valves only. Equip these valves with green and red (open and closed) indicating lights at their pushbutton control locations. Consider the use of PLCs on more complicated systems.

3-7.3.1 All Pumps

Provide the following controls:

- a) A keyed hand/auto button at each pump and a keyed hand-off-auto switch at the motor starter for each remotely operated pump. Both devices will use the same key.
- b) Indicator lights at the control station to give positive indications both when a pump is operating and when it is not energized. Use the "push-to-test" type.
- c) A signal light or alarm to indicate pump failure when a pump is controlled automatically.
- d) Reduced voltage starting if required by electric utility supplier or in all cases for pump motors greater than 50 horsepower (37 kW) and all vertical pumps.
- e) Emergency fuel shut-off (EFSO) pushbutton stations, between 100 and 200 feet (30 m and 60 m) from the pump in the expected ingress and egress direction, with maintained contacts. Provide additional EFSO pushbutton stations at the point of fuel delivery or receipt (fillstands, piers, tanks, etc.) using the same spacing and location requirements.

3-7.3.2 Multi-Function Pumps

Multi-function pumps are typically used at small facilities and are designed and arranged to be able to perform different functions such as fuel loading, off-loading, or transfer depending on how valves are aligned. Provide each function with the control system requirements for each function described elsewhere in this chapter. For each multi-task pump provide a manual selector switch to choose which set of control and set points the pump is to "look at" when performing a particular function.

3-7.3.3 Transfer Pumps

Transfer pumps are used to supply fuel to a tank truck loading facility, tank car loading facility, or transfer fuel from one place on the installation to another (e.g., bulk storage tank facility to operating storage tank). If these pumps exceed 150 horsepower (112 kW), comply with the paragraph titled "Pipeline Pumps" in this Chapter. In addition to requirements in the paragraph titled "Pipeline Pumps" in this Chapter, provide transfer pumps with push button start/stop stations. Where these pumps are used for truck and/or car loading, provide push button controls adjacent to the pumps and at each loading station. Use programmable logic controllers (PLC) where multiple pumps supply header loading multiple trucks or cars to obtain desired flow rate to each loading station.

3-7.3.4 Pipeline Pumps

For pumps over 150 horsepower (112 kW), provide protective shutdown devices with alarm at central supervisory control station in the event of the following:

- a) High pump case temperature due to blocked discharge.
- b) Excessive pump vibration.
- c) Mechanical seal or packing gland failure.
- d) High discharge pressure or loss of discharge pressure.
- e) Excessive motor vibration.
- f) High motor winding temperature.
- g) Electrical interlocks which will prevent starting a pump if certain key valve settings are not correct and which will cause a pump shutdown if a key valve setting is changed.
- h) Loss of pump suction pressure.
- i) High bearing temperature and/or loss of cooling water flow.

3-7.3.5 Temperature Controls

Provide temperature controls at all fuel oil heaters to control the outlet oil temperature within safe limits. Provide a sensing element in the fuel outlet line which activates a thermostatic valve in the heating medium supply connection to the heater. Use a self-actuating control valve that requires no external power for closure. Use a manually adjustable set point for each temperature variable over the desired temperature range. Provide a bypass around the control valve with a V-port globe or ball valve for manual operation.

3-7.3.6 Card and Key Locks

Consider the possible economic and operational advantages of using an electronic card or key system which permits 24-hour unmanned operation of the facility. These types of systems are comprised of a card/key reader which is located near the service pump. The reader is activated by a card or key and accumulates issues and customer data which is downloaded to a central computer on a periodic basis. Activities with capitalized fuel, that is petroleum product owned by Defense Logistics Agency (\1\ DLA-Energy) /1/, are eligible for projects to install automated card/key lock systems. Activities with capitalized fuel report inventories of these products to \1\ DLA-Energy/1/ through a system called Business Systems Modernization - Energy (BSM-E). Automated systems to control capitalized inventories must be able to interface with the BSM-E. These types of automated systems are managed under the automated fuel service station (AFSS) program by \1\ DLA-Energy/1/. It should be noted that AFSS equipment is used to control issues of product and is not an automated tank gauging system. Further information on AFSS systems and funding programs may be obtained by contacting \1\ DLA-Energy /1/ -FE.

3-8 CANOPIES

\1\

3-8.1 Canopies to Protect Fixed Assets from Extreme Weather Conditions

/1/

Unless otherwise directed by [Service Headquarters](#), provide a canopy to protect fixed facility assets, \1\ operators, and equipment from the extreme weather conditions (I.E. re-occurring / sustained extreme icing/snow or desert like conditions). /1/ Fixed facilities and equipment include but are not limited to: pump pads, filtration pads, meter pads, isolation valve pads, tank truck and tank-car off-loading and loading equipment pads, control panels, electrical panels, and motor control centers (MCCs). Ensure structural design is in accordance with [UFC 1-200-01](#) and [UFC 3-301-01](#).

3-8.2 Canopies to Reduce Stormwater

Do not provide a canopy to preclude rain from reaching the containment area unless it is required by federal, state, or local regulations; or it is economically justified by reducing the size of the concrete remote spill containment or spill treatment system; or if directed by [Service Headquarters](#). At a canopy over a tank truck or tank car loading and off-loading containment area, ensure that the underside of the canopy is high enough to provide operator head room when walking on top of the truck or car. Ensure structural design is in accordance with [UFC 1-200-01](#) and [UFC 3-301-01](#).

3-9 PRODUCT RECOVERY SYSTEMS

Provide a product recovery system to collect and store usable aviation turbine fuel that would otherwise become waste from operational or maintenance activities. Consider a product recovery system for other products. See [Chapter 8](#) of this UFC for product recovery systems.

3-10 FUEL ADDITIVES

If directed by \1\ DLA-Energy /1/, provide bulk storage facilities which store aviation turbine fuels with the equipment to inject fuel additives. This will require proportional injectors, storage of additives, and capability of recirculating tanks through piping with injectors. If the additives have a corrosive characteristic, construct the system, including storage tanks, tank appurtenances, pumps, if required, piping and associated fittings, valves, and injector assemblies of stainless steel components.

CANCELLED

This Page Intentionally Left Blank

CANCELLED

CHAPTER 4 AIRCRAFT FUELING FACILITIES

4-1 INTRODUCTION

This chapter provides guidance for the design of aircraft fueling facilities, including [operating storage tanks](#) and those components normally located within a typical compound. These components include pipeline receiving facilities, tank truck and tank car receiving facilities, [refueler](#) truck fillstands, type III, IV, and V [aircraft direct fueling systems](#), and associated piping and equipment. Fuel storage tanks are discussed in [Chapter 8](#) and piping systems in [Chapter 9](#) of this UFC. Systems used to receive fuels from barges and ships are discussed in [Chapter 5](#). Pipelines that transport fuel from off base and pipelines between bulk tanks and [operating storage tanks](#) are discussed in [Chapter 6](#) of this UFC.

Note: If aviation fuel can be pumped directly from a tank into an aircraft, [aircraft direct fueling system](#) or a [refueler](#), treat the tank as an [operating storage tank](#) regardless of size and location and meet the applicable requirements for aviation turbine fuel operating tanks. The exception is [bulk storage tanks](#) that are configured to fill refuelers on an emergency basis only.

4-1.1 Function

Aircraft fueling facilities, as discussed in this chapter, are designed for ground fueling of fixed and rotary wing aircraft. Two methods are used for refueling aircraft: [refueler](#) trucks and [aircraft direct fueling systems](#) (e.g., [hydrant system](#)). The preferred method of fueling used at most Navy, Marine Corps, and Army small aircraft bases is by [refueler](#) trucks. For Air Force transport, tanker, cargo, bomber, and other large aircraft, the preferred method of fueling is by [hydrant system](#) where the aircraft are fueled on the apron in their parked positions. Where operational/mission requirements dictate a quick return to the air, small-frame aircraft, both fixed and rotary wing, are refueled with the engines running via [aircraft direct fueling systems](#) under a "gas and go" or hot pit refueling concept. Install [aircraft direct fueling systems](#) only when specifically authorized by [Service Headquarters](#).

4-1.2 Aviation Turbine Fuels

The fuels covered in this chapter are JP-4, JP-5, JP-8, JPTS, Jet A, and Jet A-1. Because of the critical nature of the end use of the fuel, protection of fuel quality, dependability of the system, and safety are very important. Refer to [Chapter 2](#) of this UFC for information on fuel properties.

4-1.3 Special Precautions for Aviation Turbine Fuel Quality

Take extra care to prevent the [contamination](#) of aviation turbine fuels by dirt, water, and other fuels. For additional information, refer to [Chapter 2](#) of this UFC. Aircraft fueling system must be designed with capability to generate sufficient turbulent flow to flush

sediment and condensed water from all portions of piping systems. Refer to [Chapter 9](#) of this UFC for fuel velocity criteria.

4-2 GENERAL REQUIREMENTS

Chapter 2, General Design Information, contains information on fueling facilities. Do not begin the design on any fueling system without first becoming completely familiar with Chapters 2 and 9 of this UFC and with the airfield clearance requirements found in \1\ [UFC 3-260-01](#) /1/ .

4-3 RECEIVING FACILITIES

Fuel deliveries to a military aviation activity are normally made by tank truck, railroad tank car, barge, or pipeline. A secondary method of delivery is normally required. [Service Headquarters](#), with concurrence from the \1\ DLA-Energy/1/, will determine the appropriate type of delivery method based on mission requirements and an economic analysis.

4-3.1 Pipeline Receiving Facilities

4-3.1.1 General Criteria

Petroleum fuels may be supplied to aviation turbine fuel storage tanks by [interterminal pipelines](#) or [installation pipelines](#). [Interterminal pipelines](#) may be dedicated to serving the particular facility or may be commercial pipelines handling a number of types or grades of fuel for more than one user. [Installation pipelines](#) will normally be a pipe from the bulk facility to the aircraft fueling facility. Provide for separate receiving and distribution piping for each grade of aviation turbine fuel unless otherwise approved by [Service Headquarters](#). Exercise extreme care to avoid designing a system that could create damaging [surges](#) in the pipeline created by quick closing valves.

4-3.1.2 Equipment Required

- a) Provide pressure-regulating diaphragm control valves to reduce pipeline pressures to the design pressure of the facility's piping and equipment. Provide a manual isolation valve at both the upstream and downstream side of each diaphragm control valve. Prior to designing any features into the system which might affect the flow from a pipeline, contact the operator of the pipeline to ascertain the current operating conditions, evaluate the use of diaphragm control valves, conduct a [surge](#) analysis of the pipeline, and determine whether the use of diaphragm control valves is appropriate.
- b) Provide a meter at the receiving end of the line to measure quantities of fuel received. Turbine-type meters are commonly used for pipeline receipt. However, positive displacement meters

are acceptable if available at the required flow rate. Consider the use of alternative meter technologies such as ultrasonic meters. Compensate for fuel temperature at the point of custody transfer. Provide a basket strainer on the upstream side of the meter and connections for proving the meter with a portable prover. A meter prover connection consists of a manual isolation valve in the main pipeline with a tee on both the upstream and downstream sides of the valve. The branch of each of the tees has a manual isolation valve and a hose connection. The master meter can be attached to the hose connections.

- c) Provide a means for sampling each pipeline product at a breakout manifold.
- d) Provide provisions for a contractor to bolt pig launchers and receivers to the system for [pigging](#). Arrange pig receiving connections to avoid introducing pipeline [sludge](#) and sediment into the tanks. Pig launching and receiving connections are required for interterminal (cross-country) and installation (as described in [Chapter 6](#) of this UFC) underground pipelines.
- e) Provide an interface tank to receive mixed fuels at the beginning and ending of a shipment unless the commercial pipeline company can provide this service satisfactorily.
- f) Provide a breakout tank only if pipeline flow cannot be stopped due to pipeline operational requirements. Provide valves to divert the flow of fuel from the pipeline to the breakout tank in the event fuel transfer is blocked by a manual or automatic valve within the fuel facility system such that the fuel facility system would be overpressurized from transient [surge](#) or high pressure from deadheading a pipeline supply pump. Provide appropriate breakout tank overflow alarms and alarm breakout operation so fuel facility operators can take necessary steps to stop pipeline flow. Provide means of transferring fuel out of breakout tank back to fuel systems after a breakout event. Conduct a thorough review with the pipeline operator and perform a transient [surge](#) analysis to determine if [surge](#) pressure reduction methods are required to avoid damage to the pipeline.
- g) Provide means of inbound filtration for all products. The selection of filtration depends on anticipated impurities, the source of fuel, and the shipping methods. Avoid the use of water slug shutoff diaphragm control valves or other rapid-closing valves on pipeline receipt facilities. See the "Special In-Bound Filtration" paragraph and [Table 4-1](#) of this Chapter of the UFC for details.

- h) Provide manual isolation valves to isolate equipment for service.
- i) Provide basket strainers upstream of meters and filtration.
- j) Provide [thermal relief valves](#) around isolation and check valves to relieve excessive pressures caused by thermal expansion of liquid trapped between shutoff points. See Facility Plates [023](#), [024](#), [025](#) and [026](#).
- k) Provide a concrete housekeeping pad and, unless otherwise directed by Service Headquarters, a canopy to protect fixed facilities assets and equipment from the elements. See the “Canopies” paragraph of this chapter.

4-3.2 Tank Truck and Tank Car Off-Loading Facilities

4-3.2.1 General Criteria

Fuel system operating tanks may be supplied with fuel by tank truck or tank car or both. At facilities with pipeline or water transport as their principal supply source, provide tank truck or tank car deliveries as a secondary supply source. Tank truck deliveries are the most common method. However, special transportation considerations or changing circumstances may make the use of rail facilities desirable. Therefore, at an activity with railroad service, arrange a tank truck receiving facility so that the system can be easily and economically extended to the existing rail spur. See [Facility Plate 002](#).

- a) The preferred off-loading method is into a drop tank off-loading system. See [Facility Plate 003](#).
- b) Provide a packaged off-loading system when a drop tank type off-loading system is not practical for off-loading tank trucks or tank cars due to environmental concerns, site limitations, or cost considerations, and/or when directed by [Service Headquarters](#). See [Facility Plate 004](#).
- c) Provide a direct off-loading system when only an occasional tank truck requires off-loading and when directed by [Service Headquarters](#). See [Facility Plate 005](#).
- d) Do not locate tank truck or tank car receiving facilities closer than 50 feet (15 m) from buildings, roads, overhead power lines, pad-mounted transformers, and property lines, or 25 feet (7.6 m) from the fuel farm fence. See [Chapter 8](#) of this UFC for clearance from tanks. Comply with [NFPA 30](#) and assume that the property line is the fuel farm fence. Use the criteria for Class I liquids regardless of product and do not take a reduction for fixed fire protection.

- e) Provide an adequate number (minimum two) of positions to off-load the daily fuel requirements of the facility in an 8-hour period without causing detention or demurrage of delivery conveyances.
- f) Provide separate off-loading connections for each type of fuel to be handled. To facilitate the use of tank trucks with multiple independent compartments, provide a hose manifold with a minimum of two connections per tank truck. A manifold with hose connections equal to the number of truck compartments is recommended for quick turnaround. If less than five connections are provided, provide a [blind flange](#) on the end of the manifold to accommodate additional connections.
- g) Provide a containment area at each truck off-loading position consisting of an impermeable retention and controlled drainage system leading to a concrete remote spill containment system. Pave the containment area consisting of the islands, the spaces between islands and on each side of the outer islands, with concrete pitched a minimum of one percent toward catch basins or trench drains. Design the containment area in accordance with [UFC 1-200-01](#), federal, state and local regulations. Do not use asphalt within a spill containment area. The maximum slope of any paving within a truck movement or parking area shall not exceed 2 percent excepting rollover curbs. If a rollover curb is provided, the sum of the vertical entrance and exit grades shall not exceed 8 percent \1\ and the rollover curb shall be aligned perpendicular with direction of truck movement. The designer shall assure that adequate ground clearance is achieved for all vehicles utilizing the containment areas. /1/
- h) At tank car off-loading areas, pave the containment area with concrete (or otherwise provide containment) for an area extending from 5 feet (1.5 m) outside of each outer rail and extending longitudinally 15 feet (4.6 m) each way from the center of each loading position. Slope the paved area to a spill containment system as described previously in item (g).
- i) Provide a concrete remote spill containment system for each containment area. Design the remote spill containment system in accordance with [UFC 1-200-01](#), federal, state, and local regulations. Provide the remote spill containment system with capacity greater than \1\ the volume of the largest tank truck or tank car compartment to be off-loaded. A curbed truck position may be provided in addition to a remote system. Twenty-five percent or more of the total required containment volume must be directed to, and stored at, the remote system before any of the

shared containment volume will pond at the truck stand area. Provide a lockable eccentric plug valve with indicator post located outside the containment area at a location /1/ that will be safely accessible during a fire. The valve shall be lockable and normally closed to allow for containment during fueling operations and which can be opened to drain area when necessary. Tank trucks can be as large as 10,000 gallons (38,000 L) in capacity and tank cars as large as 40,000 gallons (151,000 L). If a canopy is installed, reduce the sizing for rainfall, accounting only for wind-blown rain. Consider combining the remote spill containment system with other spill containment systems on-site, except with tank containment systems. However, take the level of [contamination](#) in each containment area into consideration.

- j) Construct the drain piping between the containment area and the remote spill containment system, and between the remote spill containment system and lockable \1\ plug /1/ valve of petroleum-resistant, fire-resistant, impermeable materials. Do not use clay, concrete, fiberglass, or plastic piping materials.
- k) For off-loading tank trucks, arrange the flow of traffic to permit continuous forward movement of trucks at all times. Commercial tank trucks off-load on the passenger side.
- l) To determine the number of connections needed for off-loading tank cars, consult with [Service Headquarters](#) and consider minimizing tank car movements, tank car shipping schedules, conveyance turn-around times, local rail switching capabilities, and quantity of fuel needed for one day's fuel supply.
- m) Provide an electrical design that meets the minimum requirements of [NFPA 70](#), [NFPA 77](#), and [NFPA 780](#). Treat [combustible liquids](#) under pressure as a [flammable liquid](#).
- n) Provide a canopy for protection from the elements of fixed facility assets and equipment per the "Canopies" paragraph of this chapter.
- o) Provide a canopy to preclude rain from the containment area when the requirements listed in the "Canopies" paragraph of this chapter are met.
- p) Provide for egress and entrance of emergency response vehicles. The egress and entrance routes need to be large enough to allow both, trucks and emergency vehicles to leave and enter the facility simultaneously.

- q) Provide means of inbound filtration for all products. The selection of filtration depends on anticipated impurities, the source of fuel, and the shipping methods. See “Special In-Bound Filtration” paragraph and [Table 4-1](#) in this chapter of this UFC.

4-3.2.2 Tank Truck and Tank Car Drop Tank Off-Loading System

The introduction of air into a fuel receiving system poses extreme hazards which can result in fire and/or explosion. Hazards are compounded when an air/fuel mixture is passed through receipt filter/separators where static electricity is generated and ignition can occur. Design off-loading facilities so air is not introduced into the system. For facilities with the capability to off-load several tank trucks at once or where newer tank trucks with multiple hoses are connected to multiple isolated compartments, consider providing an underground, gravity-type, receiving tank with deepwell turbine transfer pumps and level controls. For smaller systems of one or two tank trucks, consider providing a low profile, aboveground, receiving tank with a centrifugal transfer pump. For either case, provide level sensors to control the transfer rate. Provide a meter on the receipt line to the tank at points of custody transfer and when directed. For materials of construction for off-loading drop tanks, refer to Chapter 8. See [Facility Plate 003](#).

4-3.2.3 Tank Truck and Tank Car Packaged Off-Loading System

For tank truck or tank car off-loading an off-loading drop tank may not be practical due to environmental concerns, site limitations, or cost considerations. In these instances, provide a 600 gpm (38 L/s) packaged off-loading system. Provide one packaged system, including vertical inline centrifugal pump, diaphragm control valves to control flow, meter, and multiple hose connections (one for each tank truck compartment), for each tank truck or tank car receiving station. Provide an air eliminator tank to remove air from the system, reducing the risk of an air/fuel mixture passing through receipt [filter/separators](#) and preventing the metering of air. Level sensors in the air eliminator tank control the pump discharge diaphragm control valves, modulating the flow rate based on the level in the air eliminator tank. Refer to \1\ DoD Standard Design [AW 78-24-28 /1/](#) and [Facility Plate 004](#).

4-3.2.4 Tank Truck and Tank Car Direct Off-Loading System

Use when only an occasional tank truck requires off-loading and when directed by [Service Headquarters](#). Refer to [Facility Plate 005](#).

4-3.2.5 Equipment Required

- a) When tank trucks or tank cars are off-loaded with a drop tank off-loading system, do not provide an off-loading pump. Provide at least two pumps in the drop tank to transfer fuel to the storage tank.

- b) When tank trucks or tank cars are off-loaded with packaged off-loading systems, provide one system for each tank truck or tank car that is to be off-loaded simultaneously, at an average capacity of 600 gpm (38 L/s) each. The number of systems shall be determined by Service Headquarters but shall be a minimum of two. The capacity of the systems may be reduced to 300 gpm (19 L/s) each only when directed by Service Headquarters.
- c) When tank trucks or tank cars are off-loaded with direct off-loading systems, provide centrifugal pumps configured to provide automatic air elimination as shown on [Facility Plate 005](#). Provide at least two pumps to allow continued operation if one is out of service. The capacity of the pumps may be increased to 600 gpm (38 L/s) each only when directed by Service Headquarters. The centerline height of suction line from manifold to pump should not exceed 23.25 inches (591 mm) above truck unloading, parked position. Locate the pump as close as possible to the off-load point to prevent suction problems.
- d) When tank trucks or tank cars are off-loaded with a drop tank off-loading system, do not provide an off-loading pump. Provide at least two pumps in the drop tank to transfer fuel from the drop tank to the storage tank.
- e) Provide 4-inch (100 mm) diameter by 10-foot (3 m) long lightweight reinforced vacuum rated off-loading hoses and covered hose storage racks for each hose connection at each off-loading position. Ensure that all swivels are non-lubricated aluminum or stainless steel in-line repairable type.
- f) Equip each tank truck off-loading position with an electronic, intrinsically safe, automatic, self-monitoring ground verification unit with a lockable bypass. If grounding is not verified and there is an off-loading pump dedicated to that position, ensure the unit prevents the pump from starting. If the pump is not dedicated, ensure an alarm sounds if the off-loading valve is opened prior to grounding verification. Include a separate grounding reel to accommodate vehicles without grounding equipment.
- g) Provide emergency fuel shutoff (EFSO) pushbutton stations. For truck off-loading stations with multiple positions, an EFSO pushbutton station is required for each position and along routes of personnel ingress and egress between 100 and 200 feet (30 m and 60 m) from the off-loading position. Design in such a manner that activation of the emergency stop will shutoff all fueling in the off-loading area and/or its associated pumphouse or pump pad.

- h) Provide fuel sampling connections at each position for each product line for collecting test samples.
- i) Provide pressure gauges on both sides of each strainer or a differential type gauge across each strainer. Where a strainer is upstream of a pump, the pump suction gauge may function as the strainer downstream gauge.
- j) Provide a compound (pressure/vacuum) gauge on the inlet side of the pumps and a pressure gauge on the outlet side of pumps.
- k) If system is for JP-5 or other fuel that does not have a static dissipation [additive](#) which provides a conductivity level greater than 50 picosiemens, and a 30-second retention time is not provided between [filter/separator](#) and receiving tank, provide a [relaxation tank](#) or design the piping layout to provide the required 30-second relaxation time downstream of [filter/separator](#).
- l) Provide basket strainers upstream of pumps, meters and receipt filtration.
- m) Provide a combination flow control and non-surge check diaphragm control valve on all off-loading pumps except positive displacement types. If a bulk air eliminator with automatic air release head is included, provide a means of closing the diaphragm control valve with a solenoid pilot.
- n) Provide a positive displacement or turbine meter and meter proving connections. Provide meter with temperature compensation capability wherever custody transfer occurs. Provide a basket strainer on the upstream side of the meter.
- o) On each off-loading connection or on the off-loading riser, install a visual fuel flow indicator (maximum pressure 275 psi (1900 kPa) at 100 degrees F (38 degrees C), with Viton Seals with a maximum temperature rating of 350 degrees F (177 degrees C)). This will allow visual quality assurance and provide the operator with a backup system to shut off the pumps when off-loading is complete to prevent air build-up in the receipt lines.
- p) Provide [filter/separators](#) and other filtration devices as described in [Table 4-1](#) to filter fuel before it enters the storage tank.
- q) Provide manual isolation valves to isolate equipment for service.
- r) Provide [thermal relief valves](#) around isolation and check valves to relieve excessive pressures caused by thermal expansion of liquid

trapped between shutoff points. See Facility Plates [023](#), [024](#), [025](#) and [026](#).

- s) For JP-8 systems, provide a capability to defuel JP-8 refueler trucks back into operating storage as described in the paragraph titled “Defueling and Return-to-Bulk Systems” in this chapter.
- t) Where tank trucks or tank cars are off-loaded into drop tanks provide a meter on the receipt line to the tank only when directed by [Service Headquarters](#).

4-3.3 Marine Off-Loading Facilities

See [Chapter 5](#) of this UFC

4-3.4 Special In-Bound Filtration

Where fuel is transferred to the base fuel system operating tanks from tankers, barges, or directly from the supplier (off base) by a multi-product pipeline, pass the fuel through strainers, then [pre-filtration](#), then [fine filtration](#). In other cases, pass the fuel through strainers and [fine filtration](#) only. See [Table 4-1](#) of this chapter for details.

4-4 DISPENSING FACILITIES

4-4.1 Refueler Truck Fillstands

Mission and turn-around times will establish the number of fill positions, with two being the minimum. [Service Headquarters](#) can assist in determining the number. See Facility Plates [006](#) and [007](#) for general design guidance and also DoD Standard Design [AW 78-24-29](#), Type IV/V. Provide a separate loading system for each grade or type of fuel to be handled.

4-4.1.1 General Criteria

- a) Locate the [refueler](#) loading facility as close as practical or permissible to the location of the aircraft to be fueled but not less than 50 feet (15 m) from buildings, roads, overhead power lines, pad-mounted transformers, and property lines \1\ and 25 feet (7.6m) from the fuel farm fence. See Chapter 8 of this UFC for clearance requirements from tanks. /1/
- b) For [aircraft direct fueling systems](#), the fuel supply piping to the [refueler](#) truck loading facility may be a spur or extension from that system and constructed of the same material as that system. In this case, the [filter/separators](#) are not required since they are provided as part of the [aircraft direct fueling system](#). Where

filtration is downstream of the pump house and the spur connects prior to the filtration equipment, a filtered lateral is required.

- c) Arrange fuel loading equipment on one or more concrete islands configured for refueling on one side only. Make the direction of traffic appropriate for the location of the loading connections on the [refueler](#), located on the driver's side. When more than one island is required because of the volume or number of fuel grades to be handled, arrange them in a parallel fashion with approximately 15 feet (4.6 m) between adjacent sides. Arrange the islands and approaches to allow forward motion for all trucks at all times with ample room for turning. Allow for egress and entrance of emergency response vehicles.
- d) Provide a containment area at each truck loading position, consisting of an impermeable retention and controlled drainage system leading to a concrete remote spill containment. Pave the containment area consisting of the islands, the spaces between islands and on each side of the outer islands, with concrete pitched a minimum of one percent toward catch basins or trench drains. Design the containment areas in accordance with [UFC 1-200-01](#), federal, state, and local regulations. Do not use asphalt within a spill containment area. The maximum slope of any paving within a truck movement or parking area shall not exceed 2 percent excepting rollover curbs. If a rollover curb is provided, the sum of the vertical entrance and exit grades shall not exceed 8 percent, and the rollover curb shall be aligned perpendicular with direction of truck movement. The designer shall assure that adequate ground clearance is achieved for all vehicles utilizing the containment areas.
- e) At tank car loading areas, pave the containment area with concrete (or otherwise provide containment) for an area extending from 5 feet (1.5 m) outside of each outer rail and extending longitudinally 15 feet (4.6 m) each way from the center of each loading position. Slope the paved area to a spill containment system as described previously in item (d).
- f) Provide a concrete remote spill containment system for each containment area. Design the remote spill containment system in accordance with [UFC 1-200-01](#), federal, state, and local regulations. Provide the remote spill containment system with capacity greater than the volume of the largest [refueler](#) to be off-loaded. A curbed truck position may be provided in addition to a remote system. Twenty-five percent or more of the total required containment volume must be directed to, and stored at, the remote

system before any of the shared containment volume will pond at the truck stand area. Provide a lockable eccentric plug valve with indicator post located outside the containment area at a location /1/ that will be safely accessible during a fire. The valve on the drain system shall be lockable and normally closed to allow for containment during fueling operations and which can be opened to drain the area when necessary. Tank trucks can be as large as 10,000 gallons (38,000 L) in capacity. If a canopy is installed, reduce the sizing for rainfall, accounting only for wind-blown rain. Consider combining the remote spill containment systems with other spill containment systems on-site, except with tank containment systems. However, take the level of [contamination](#) in each containment area into consideration.

- g) Construct the drain piping between the containment area and the concrete remote spill containment system, and between the remote spill containment system and lockable \1\ eccentric plug /1/ valve of petroleum-resistant, fire-resistant, impermeable materials. Do not use clay, concrete, fiberglass, or plastic piping materials.
- h) Load aircraft [refueler](#) trucks by [bottom loading](#) only. Design the system to deliver a nominal flowrate of 600 gpm (38 L/s) with a [pressure refueling nozzle](#) pressure of 35 psig (240 kPa). System design shall take into consideration pressure and flow settings to prevent damage to bottom loader. Contact [Service Headquarters](#) for further direction.
- i) Provide a canopy for protection from the elements of fixed facility assets and equipment per the “Canopies” paragraph of this chapter.
- j) Provide a canopy to preclude rain from the containment area when the requirements listed in the “Canopies” paragraph of this chapter are met.
- k) Design all electrical systems and apparatus for use in Class I, Division 1, Group D, [hazardous areas](#) in accordance with [NFPA 70](#), regardless of the type of fuel dispensed.
- l) Provide for egress and entrance of emergency response vehicles. The egress and entrance routes need to be large enough to allow both, trucks and emergency vehicles, leaving and entering the facility.
- m) For JP-8 systems, provide a capability to defuel JP-8 refueler trucks back into operating storage as described in the paragraph titled “Defueling and Return-to-Bulk Systems” in this chapter.

4-4.1.2 Equipment Required

Provide separate piping, pumps, loading connections, and controls for each different type or grade of fuel. Provide an individual isolation valve for each fill connection. Include the following equipment in each [refueler](#) truck fillstand:

- a) Self-closing emergency valve with 165 degrees F (74 degrees C) fusible link (These valves are not required nor permitted on Air Force projects).
- b) Provide manual isolation valves to isolate equipment for service.
- c) Provide [thermal relief valves](#) around isolation and check valves to relieve excessive pressures caused by thermal expansion of liquid trapped between shutoff points. See Facility Plates [023](#), [024](#), [025](#) and [026](#).
- d) Provide [filter/separator](#), unless fillstand is supplied from an [aircraft direct fueling system](#) via a non-ferrous branch connection downstream of the issue [filter/separator](#).
- e) Positive displacement or turbine meter with rated capacity equal to the maximum flow of the loading station and the following accessories:
 - (1) If custody transfer point: a combination ticket printer and large numeral zero reset counter with self-closing [weatherproof](#) cover. Ticket printer not required on Army or Air Force projects.
 - (2) Pulse transmitter of the photoelectric, high resolution type required for projects which employ electronic data acquisition systems.
 - (3) Temperature compensation if at a custody transfer point.
- f) Provide [relaxation tank](#) or piping configuration with sufficient capacity to retain the maximum flow of the loading station for 30 seconds from the time the fuel leaves the last piece of filtration equipment to the fuel reaching the loading [pressure refueling nozzle](#). Applies only to JP-5 or other fuels which do not have a static dissipation [additive](#) that provides a conductivity level greater than 50 picosiemens per meter.
- g) Mechanical loading arm. The preferred device is a non-lubricated, swiveled, stainless steel, counterbalanced mechanical loading arm. As an option, with the approval of [Service Headquarters](#), use

a loading hose approximately 10 feet (3 m) long, 3 or 4-inch (75 or 100 mm) nominal diameter, and meeting requirements of [EI Std 1529](#). A spiral protective device (slinky) may be installed around the hose. House the hose in a covered hose tray to protect from ultraviolet damage. Install with a non-lubricated stainless steel in-line repairable swivel.

- h) [SAE AS5877 pressure refueling nozzle](#) of size and type compatible with truck-loading connections (coded for product use, if more than one type of fuel is issued at the fillstand). Connect the pressure fueling nozzle to the loading arm or hose with a dry-break quick disconnect.
- i) Sample outlet with a 1/4-inch (8 mm) diameter sample point with probe, ball valve, and quick disconnect at each position for each product line.
- j) Make provisions to start and stop the pumps with start and stop pump controls at each position. Include pump status indicator light on control box.
- k) A hydraulically operated diaphragm control valve with the following functions (care must be taken to select equipment which is compatible with electronic or mechanical meter stacks):
 - (1) Adjustable rate of flow control if fillstand is on a branch line from an [aircraft direct fueling system](#) or other multiple pump arrangement which could result in issue exceeding 600 gpm (38 L/s).
 - (2) Pressure regulating to maintain desired upstream or downstream pressures.
 - (3) Adjustable time delay for opening and closing speed control.
 - (4) Control valve to close in the event of diaphragm failure.
 - (5) Thermal relief to relieve excessive pressures caused by thermal expansion of liquid trapped between shutoff points.
 - (6) Position indicator.
 - (7) Solenoid Shutoff. Interlock the solenoid with the electronic high-level shutoff \1\ and ground verification control systems.
/1/

- l) Provide each fill position with an electronic high-level shutoff, \1\ electronic ground verification, and hydraulic or electronic /1/ deadman control system. The system shall be intrinsically safe and self-checking. Interlock the system with either the solenoid operated truck loading diaphragm control valve or the pump such that the valve cannot remain open or the pump cannot operate if the tank truck compartment is full, the tank truck is not [grounded](#), or the deadman is released. Ensure the system is compatible with both electronic and fiber optic sensors with manual-keyed bypass. (May require a parallel effort beyond the project scope to ensure that all trucks using the facility have compatible connections. If facility has trucks that do not have fixed probes, use cane probes instead.) (This unit is optional on Army projects with only tactical refuelers. Contact the [Service Headquarters](#) for guidance.)
- m) Provide emergency fuel shutoff (EFSO) pushbutton stations. For fillstands with multiple positions, an EFSO pushbutton station is required for each position and along routes of personnel ingress and egress between 100 and 200 feet (30 m and 60 m) from the fillstand. Design in such a manner that activation of the emergency stop will shutoff all fueling at that pump house or pump pad.
- n) Low-intensity area lighting, in accordance with [API RP 540](#), to permit full visibility of all equipment and controls during night operations.
- o) Refer to [Chapter 2](#) of this UFC for information on vapor collection and recovery or disposal systems.
- p) On/off station for pumps, if pumps are dedicated to fillstand. Provide a light to indicate on/off status.
- q) Grounding reel and grounding plate as detailed in Standard Design [AW 78-24-29](#), Type III with multiple connections.
- r) Provide basket strainer upstream of pumps, meters, and where a [filter/separator](#) is not provided at the load rack.
- s) Pressure gauge.
- t) Maintenance drains.
- u) Vents.
- v) Provide hydraulic shock surge suppressors (if required).

- w) For JP-8 systems, to allow defueling of refueler trucks, provide a Return-To-Bulk (RTB) station by providing a [MIL-STD MS 24484 aircraft refueling adapter](#) a point upstream of receipt filtration. Acceptable locations include the return line at a truck fillstand, the return line at a hydrant hose truck check-out station, the return line at a pantograph flush station, the [product recovery tank](#), or at a truck off-load station. Provide one SPR connection per group of fillstands or truck off-load stations. If into a [product recovery tank](#), do not bypass the level control valve.
- x) Meter proving connections, unless local procedure provides an alternative.

4-4.2 Aircraft Direct Fueling Systems

[Aircraft direct fueling systems](#) are fuel systems that deliver fuel directly into an aircraft and require additional fueling hardware, such as a hydrant hose truck, pantograph, or hydrant hose cart. These may be Type III [hydrant systems](#) (DoD Standard Design [AW 78-24-28](#)) for portable pantographs or hydrant servicing trucks/carts; or may be hard piped with fixed pantographs, which is usually the case for Type V in-shelter fueling (DoD Standard Design [AW 78-24-29](#)) and Type IV hot fueling stations (DoD Standard Design [AW 78-24-29](#)). While individual components may vary slightly between the various aircraft fueling systems, the basic philosophy of a system configured in a loop with no dead ends, is followed by all the services. The loop is made up of the supply/return piping with a flushing/back-pressure control valve that maintains a constant pressure on the supply side piping and relieves excess fuel not taken on by the aircraft(s) into the return portion of the piping and back to the tank. The lead pump is turned on either automatically by a drop in the system pressure or manually by an on/off switch at each direct fueling station. A venturi in the supply piping senses flow rate in the loop and works in conjunction with a venturi in the return loop. Depending on the flow demand, the return venturi turns on/off additional pumps as required. If return flow is below a preset limit (indicating that fuel is being dispensed), a low flow is sensed and additional pump(s) are turned on, one at a time, until a steady flow condition is reached. Conversely, if the return flow is above a preset limit (indicating less fuel is being dispensed), the return venturi senses high flow conditions and turns the pump(s) off, one at a time, until the system is brought to rest. The continued circulation of the fuel not only provides a self-cleaning action but when properly adjusted, the system is able to more closely match the varying fuel filling rates of aircraft. This provides smooth operation and helps eliminate destructive [surge](#) pressure spikes. In order to ensure the highest quality of fuel, contact with bare carbon steel is limited to an absolute minimum prior to filtration and is not permitted downstream of the issue [filter/separators](#), unless specifically authorized by [Service Headquarters](#).

4-4.2.1 General Requirements

Install [aircraft direct fueling systems](#) only when specifically authorized. [Service Headquarters](#) or MAJCOMs assist in determining the number and type of stations required by the activity and with locating hydrant pits in aircraft parking ramps. Construct new facilities only for issuing aviation turbine fuels through [pressurized refueling nozzles](#) and closed circuit fueling [nozzles](#). Locate fueling stations at the edge of the aircraft parking apron or taxiways or at apron parking spots for large frame aircraft. Size and configure these systems based on the types of aircraft to be refueled, aircraft fuel capacity, and the number and types of aircraft to be simultaneously refueled. A parking plan shall be approved before proceeding with the hydrant pit layout design. Some aircraft, such as fighters and some helicopters, may be refueled with engines running. See Facility Plates [008](#), [009](#) and [010](#). For additional guidance on Air Force projects, refer to [AFH 32-1084](#).

4-4.2.2 Fixed-Wing Small-Frame Aircraft

Locate aircraft direct fueling stations for small-frame aircraft (carrier aircraft, patrol aircraft, fighter aircraft, and small transports) along the edge of designated access ramps, aprons, or fueling lanes with easy access by aircraft and as close to their normal taxi routes as practical while still meeting centerline clearance requirements. Provide facilities for fueling aircraft with engines or support equipment running. These systems are installed where the mission dictates a continuing need for rapid turnaround without shutting engines down and are located to permit quick return to the runway. Configure taxi patterns to and from fueling stations to keep jet blast away from people. Refer to DoD Standard Design [AW 78-24-29](#) \1\ /1/. Use the following design criteria:

- a) Outside of the limits prescribed for clear areas by [UFC 3-260-01](#) and [UFC 3-260-02](#), locate the equipment aboveground on a concrete slab adjacent to the edge of an access ramp, apron, or fueling lane. Ensure that the width of the slab and location of the equipment, including the pantograph when retracted, with respect to the ramp, apron, or fueling lane, does not interfere with any part of the aircraft on its approach to or departure from the fueling station. Equip Army and Navy hot fueling stations with an emergency dry [breakaway coupling](#).
- b) Limit the height of the equipment, including lighting, on the slab to no more than 30 inches (762 mm) above nominal grade. Contact Airfield Manager for additional clearances.
- c) Provide a nominal maximum flow rate for each direct fueling station of 600 gpm (38 L/s). However, design the system to deliver 400 gpm (25 L/s) with a [nozzle](#) pressure of 35 psig (240 kPa). Ensure adequate pump design for 600 gpm flowrate. (In general, systems designed to deliver 400 gpm at 35 psig have been shown to be

fully capable of delivering 600 gpm with a [nozzle](#) pressure reading of 10 to 20 psig.) Actual fueling rates for small-frame aircraft range from 250 to 550 gpm (16 to 35 L/s). Since the actual flow rate will vary as the [nozzle](#) back pressure varies, it is necessary to limit the maximum [nozzle](#) pressure to 55 psig (380 kPa) at the skin of the aircraft to protect the aircraft. The issue venturi in a pantograph is a critical component of the [aircraft direct fueling system](#) and must be able to correctly simulate [nozzle](#) pressure and compensate for all pressure losses up to and including the fueling [nozzle](#). Use maximum rates and the number of required simultaneous refuelings for system sizing.

- d) Provide at least two fueling stations, with the system sized for a minimum flow rate of 1,200 gpm (76 L/s). Where more than two fueling stations are required, increase the total system rate by 600 gpm (38 L/s) for every three additional fueling stations. [Service headquarters](#) and Major Command approval are required for systems exceeding 2400 gpm. However, systems are not recommended to exceed 3,000 gpm (including spare pump).
- e) DOD has two variations of the standard design for fixed-wing, small frame aircraft direct fueling stations – Type IV (DoD Standard Design [AW 78-24-29](#)) and Type V (DoD Standard Design [AW 78-24-29](#)). Both variations use pantographs for fueling the aircraft. The Type V is the same as the Type IV except that the refueling points are located in hardened aircraft shelters. The Type V variation is also known as in-shelter refueling.
- f) Both hose-end and hoseless pantographs can be used with either Type IV or Type V [aircraft direct fueling systems](#). Contact the service headquarters for which type of pantograph to use. Use [SAE AS5877 pressure refueling nozzles](#) on pantographs. Equip pantographs on Navy/Marine Corps projects with 55 psi hose end pressure regulators located just before the refueling nozzle. Refer to DoD Standard Design [AW 78-24-29](#), Type IV/V.

4-4.2.3 Large-Frame Aircraft

Locate aircraft direct fueling stations for large aircraft (transports, cargo planes, tankers, long-range patrol planes, and bombers) adjacent to their normal parking positions. Use the following design criteria:

- a) Individually determine the number of fueling stations required for each activity. This depends on the number of large aircraft based at the activity or the number of aircraft that will need refueling as transients. To accommodate the fueling of a number of aircraft

within a given time span without moving them, more fueling stations are normally required than would actually be used at one time.

- b) Provide a flow rate criteria for each fueling station of 600 gpm (38 L/s) or 1,200 gpm (76 L/s) at 45 psig (310 kPa) [nozzle](#) pressure. The selection of 600 gpm (38 L/s) or 1,200 gpm (76 L/s) is based on aircraft. Contact MAJCOM for guidance. Size combined system requirements in multiples of 600 gpm (38 L/s), starting at a minimum flow rate of 1,200 gpm (76 L/s) up to a maximum flow rate of 2,400 gpm (152 L/s).
- c) Design the piping, hydraulics, materials, and pumps in accordance with other paragraphs in this chapter.
- d) Large aircraft such as transports and cargo planes can be fueled from flush-mounted hydrant pits (preferred method for Air Force projects). Flush-mounted hydrant pits are required to conform to DoD Standard Design [AW 78-24-28](#) for Type III [hydrant systems](#). Pantographs can be used where normal aircraft parking positions can be located adjacent to edge of the ramp (fixed long-reach pantographs have a maximum reach of 135 feet (41 m)).
- e) Use self-propelled hydrant hose trucks, Type III hydrant hose carts, or detachable pantograph assemblies to provide the connection from the flush-mounted hydrant pits to the aircraft and the necessary controls. Provide a hydrant control valve that is hydraulically or pneumatically actuated and operated, depending on the type of mobile refueling equipment used. In order to ensure that the control valve is always in control and modulating and thus able to protect the aircraft, provide a differential pressure pilot with a set point of 15 psi (100 kPa). Provide Navy fueling stations with hose end controllers to limit pressure at the aircraft skin.
- f) Equip pantographs in accordance with DoD Standard Designs. When incorporating the detachable pantograph into the design, follow USAFE/NATO specifications in which the swivels contain in-line repairable roller bearings. In addition, include the pantograph(s) as part of the construction project. Normally, the number of pantographs required equals the number of simultaneous refuelings to be performed.
- g) The Air Force large-frame [aircraft direct fueling system](#) is referred to as a Type III pressurized fueling system. The Type III fueling system, or the constant pressure system, is the standard hydrant fueling system for large-frame aircraft. It is comprised of two

[operating storage tanks](#), a pump house, a hydrant loop, and hydrants at each parking position. The system is controlled by two redundant PLCs and is constantly pressurized when in operation. Fuel is pumped from the tanks, through filter separators and a supply venturi into the hydrant loop. It flows through the appropriate hydrant valve, through a hydrant servicing vehicle or mobile pantograph, into the aircraft if refueling is underway. A backpressure control valve keeps system pressure at a pre-set level and a return venturi measures flow back to the storage tank. Working in conjunction with the return venturi, pumps are turned on and off depending on refueling requirements. This system is sized in 600 gpm (38 L/s) increments up to 2,400 gpm (152 L/s). Issue pumps are sized to provide a minimum of 100 psi (690 kPa) at the outlet of the most distant hydrant adapter. Each hydrant pit control valve is equipped with a pressure control and [surge](#) shutdown pilot. These pilot controls are set at 45 psig (310 kPa) and 50 psig (345 kPa), respectively. The hydrant control valves allow nominal flow rates up to 900 gpm (57 L/s) using a 4-inch valve and nominal flow rates up to 1200 gpm (76 L/s) using a 6-inch valve. Contact [Service Headquarters](#) for specific guidance and sizing of the hydrant control valve. Refer to DoD Standard Design [AW 78-24-28](#) for Type III [hydrant systems](#).

4-4.2.4 Helicopters

Refer to DoD Standard Design [AW 78-24-29](#), Type IV, and use the following design criteria for designing direct fueling systems for helicopters:

- a) Design piping, pumps, controls, accessories, and auxiliary systems in accordance with other applicable paragraphs of this chapter. For each direct fueling station, provide a nominal maximum flow of 300 gpm (19 L/s). Design system to be capable of delivering 275 gpm (17 L/s) at 35 psig (240 kPa) [nozzle](#) pressure. Make the minimum size system 600 gpm (38 L/s) with at least two fueling stations. For diversity usage, increase by 300 gpm (19 L/s) for every three additional fueling stations. At outlying fields and with [Service Headquarters](#)' approval, a single fueling station may be used.
- b) Provide aboveground direct fueling stations equipped identical to fixed-wing small-frame aircraft fueling stations. Design the horizontal position and vertical projection of fueling equipment to avoid interference with the helicopters' blades when in the drooped attitude.

- c) Coordinate the type of [pressure refueling nozzle](#), [SAE AS5877](#) or closed-circuit, with the end user.

4-4.2.5 Surface-Effect Hovercraft

Turbine-powered, surface-effect hovercraft can be fueled on the parking apron with [aircraft direct fueling systems](#). Use a 200 gpm (13 L/s) maximum fueling rate at 30 psig (207 kPa) [nozzle](#) pressure. The fueling hardware components are similar to those required for aircraft direct fueling with JP-5. Orient fueling stations so that the blast generated from the turbine engine does not damage the direct fueling station components. Refer to DoD Standard Design [AW 78-24-29](#), Type IV.

4-4.3 Marine Loading Facilities

See [Chapter 5](#) of this UFC.

4-5 PIPING SYSTEMS

Refer to [Chapter 9](#) of this UFC for information and guidelines regarding piping systems.

4-5.1 Product Segregation

Except as otherwise approved by [Service Headquarters](#), prevent contamination of aviation turbine fuel by providing separate receiving, storage, and distribution systems for each product. Except as otherwise approved by [Service Headquarters](#) prevent misfueling (transferring a type of fuel other than that intended) by using different size piping, valves, adaptors, nozzles, etc.

4-6 EQUIPMENT DESCRIPTIONS

The appropriate guide specifications and/or standard design will provide specific information for equipment selection. Make provisions to drain equipment for maintenance. Provide hard piped drains when the equipment holds more than 5 gallons (19 L) of fuel or when a pipe which drains to the [product recovery tank](#) is within 12 feet (3.7 m) of the equipment.

4-6.1 Bulk Air Eliminators

Use flange-connected, steel bodied bulk air eliminator of the desired pressure and flow rating for the applicable service requirement. Include an automatic air release head and interlock the equipment with a float or solenoid-operated hydraulically operated diaphragm control valve. Provide discharge piping to the [product recovery tank](#) or other safe means of containment.

4-6.2 Meters

Provide meters with swivel mounted counter heads at truck fillstands to accommodate varying truck and operator positions.

4-6.2.1 Meters – Positive Displacement

Use flange-connected, cast steel bodied (except aluminum or stainless steel if after the issue [filter/separator](#)) positive displacement meters of the desired pressure and flow rating for the applicable service requirements. Ensure meter has case drain and register. Provide \1\ meter with temperature compensation and adjustable [calibration](#) /1/ where there is custody transfer. Ensure meter accessories are compatible with either the mechanical or electronic support equipment selected. Provide an accuracy of plus or minus 0.5 percent when used for custody transfer. Consult the appropriate [Service Headquarters](#) for requirements for the meter to communicate to a remote location or equipment. Consider the use of a card-operated or key-operated data acquisition system. Cards or keys, as appropriate, are coded to identify the receiver of the fuel and to allow access to the fuel. The quantities taken are transmitted to a data-receiving device by electronic pulse transmitters mounted on each meter, and each transaction is automatically recorded.

4-6.2.2 Meters – Turbine

Use flange-connected, stainless steel-bodied turbine meters of the desired pressure and flow rating for the applicable service requirement. Provide a flow straightener before turbine meters or provide a straight length of pipe at a minimum of ten pipe diameters upstream and five pipe diameters downstream of all turbine meters, or as required by manufacturer. Ensure meter has case drain and register. Provide \1\ meter with temperature compensation and adjustable [calibration](#) /1/ where there is custody transfer. Ensure all supporting equipment for meter is compatible with the turbine meter selected. Provide an accuracy of plus or minus 0.5 percent when used for custody transfer. Consult the appropriate [Service Headquarters](#) for requirements for the meter to communicate to a remote location or equipment. Consider the use of a card-operated or key-operated data acquisition system. Cards or keys, as appropriate, are coded to identify the receiver of the fuel and to allow access to the fuel. The quantities taken are transmitted to a data-receiving device by electronic pulse transmitters mounted on each meter, and each transaction is automatically recorded.

4-6.3 Pressure or Pressure/Vacuum Gauges

Use liquid-filled gauges of range and dial size, as necessary, but not less than 0 to 160 pounds per square inch (0 to 1100 kPa) pressure range and 4-inch (100 mm) diameter dial. Gauges are to be of all stainless steel construction, with black graduations on a white face. For locations where the temperature exceeds 100 degrees F (38 degrees C), consult [Service Headquarters](#) for direction on the possible use of gas-filled gauges. For locations where the temperature is less than -40 degrees F (-40 degrees C), use appropriate gauge liquid that will not freeze to prevent damaging the gauge.

- a) Consider the location, year-round weather conditions, and service requirements for the type of liquid filling to be used.
- b) Gauge liquids and service ranges:

Liquid	Range
Glycerin	0 °F to 400 °F (-18 °C to 204 °C)
Silicone	-40 °F to 600 °F (-40 °C to 316 °C)

- c) Provide a lever handle gauge cock and pressure snubber in each pressure gauge connection.
- d) Provide indicating and recording pressure gauges on suction and discharge lines for interterminal pipeline pumping stations and on the incoming line at the delivery terminal of each such pipeline, if required by [Service Headquarters](#).
- e) Pressure gauges shall be installed so that they are testable without removing them from the piping.

4-6.4 Strainers

Require a strainer to protect [centrifugal pumps](#), unless it precludes meeting the net positive suction head of the pump. Whether or not strainers are installed on the suction side of [centrifugal pumps](#), require a spool piece so that temporary strainers can be installed during startup of the system. Strainers are required on the suction side of all positive displacement pumps, meters and receipt filtration. Strainers are not required upstream of issue [filter/separators](#) or diaphragm control valves. Also:

- a) Use flanged basket strainers constructed of steel and fitted with removable baskets of fine Monel metal or stainless steel mesh with large mesh reinforcements. Provide quick opening, single screw type with drain connection in bottom.
- b) Provide a fine screen mesh as follows:

	Mesh	Size of Opening
Pump suction (Centrifugal)	7	0.108 inch (2.74 mm)
Pump suction (Positive Displacement)	40	0.016 inch (0.40 mm)
Receipt Filtration	40	0.016 inch (0.40 mm)
Meter inlets (unless downstream of a filter/separator)	40	0.016 inch (0.40 mm)

- c) In all cases, ensure the effective screen area is not less than three times the cross sectional area of the pipe.
- d) Provide pressure gauges on both sides of the strainer or a differential type gauge across the strainer.

4-6.5 Surge Suppressors

Every effort should be made to control hydraulic [surge](#) or shock to acceptable limits by the design of the piping system rather than by the use of [surge suppressors](#). Where this is not possible or becomes extremely impractical, [surge suppressors](#) may be incorporated. Use the diaphragm or bladder type equipped with a top-mounted liquid-filled pressure gauge, wafer-style check valve at the bottom, drain above the check valve, and isolation valve. Provide a needle valve around the check valve to permit controlled bleed back of the surge suppresser without rebounding. Locate [surge suppressors](#) as close as possible to the point of shutoff that is expected to cause the shock. [Surge suppressors](#) can reduce shock pressure but will not eliminate it entirely. The preferred solution to hydraulic shock is conservative piping design, use of loops, and slow-closing valves. [Surge suppressors](#) are strictly a last resort solution and require the approval of [Service Headquarters](#) prior to designing into a system.

4-6.6 Filter/Separators

The common aviation turbine fuel contaminants are water, solids, surfactants, micro-organisms, and miscellaneous contaminants. Solid contaminants are generally those which are insoluble in fuel, most common are iron [rust](#), scale, sand, and dirt. However, metal particles, dust, lint from filter material and rags, gasket pieces, and even [sludge](#) produced by bacterial action are included. The maximum amount and size of solids that an aircraft can tolerate vary by aircraft type and fuel system. Close [Tolerance](#) mechanisms in turbine engines can be damaged by particles as small as 1/20th the diameter of a human hair. [Filter/separators](#) continually remove dirt and [free water](#) from aviation turbine fuels. Ensure that the design requires two separate filtrations prior to the fuel reaching the refueler truck fillstand, hydrant pit, or aircraft direct fueling station.

4-6.6.1 Design Requirements

All aviation turbine fuels pumped into an operating tank must pass through a [filter/separator](#). Provide a [filter/separator](#) on the discharge line from the [operating storage tank](#). [Filter/separators](#) are required for all aviation turbine fuel systems in facilities where the fuel is dispensed directly to aircraft or is loaded on [refuelers](#) that eventually dispense the fuel to aircraft. As a minimum for such facilities, provide [filter/separators](#) as follows:

- a) Design and construct [filter/separators](#) in accordance with [EI Specification 1581](#) (Edition 5).
- b) Elements for [filter/separators](#) shall be of the same size as other elements at the activity.
- c) Provide horizontal [filter/separators](#). Provide vertical [filter/separators](#) only where space constraints prohibit horizontal units. Provide access to at least one side of every vertical unit via

a separate (not attached to the [filter/separator](#)), stand alone, fixed platform.

- d) Design and construct [filter/separators](#) in accordance with the American Society of Mechanical Engineers (ASME) [Boiler and Pressure Vessel Code](#). Construct metal parts which will be in contact with the fuel, including the shell, head, and internal attachments of 3003 or 5083 aluminum alloy. (The Air Force also allows interior epoxy-coated carbon steel.) Include the following accessories:
- (1) Piston-type differential pressure gauge with 1 psi (5 kPa) graduations across the elements. Pressure gauge shall be testable without removal from the piping.
 - (2) Sight glass on the water sump.
 - (3) Hydraulically operated diaphragm control valve in the main discharge piping with rate of flow and water slug features. Include a manual check mechanism external to the [filter/separator](#) to check the float. (The water slug feature must not be included on pipeline, barge, or tanker receipt lines. In those cases, use a differential pressure alarm and a differential pressure-actuated bypass valve.)
 - (4) Only at barge-receiving locations or where large quantities of water are expected, automatic water drain valve connected to the bottom of the water sump.
 - (5) Manual water drain valve from the bottom of the water sump.
 - (6) [Safety relief valve](#) in accordance with the American Society of Mechanical Engineers (ASME) [Boiler and Pressure Vessel Code](#).
 - (7) Thermal relief.
 - (8) Automatic air release with check valve.
 - (9) Basket strainers upstream of all receipt [filter/separators](#).
 - (10) Connect automatic water drains, manual drains, [thermal relief valves](#), and air releases to a permanently installed product recovery tank as described in [Chapter 8](#) of this UFC.
 - (11) Fuel sample points upstream and downstream.

- e) Do not provide sight gauges (sight flow indicators) on drain piping and pressure relief valves. Do not allow sight flow indicators to be installed on any filtration device.
- f) Do not allow reverse flow thru filter/separators or any other filtration devices.
- g) Provide a means to slow-fill the vessel. This is necessary to avoid static buildup during the filling of the filter/separator. DoD Standard Design [AW 78-24-28](#) gives details for this design feature.

4-6.6.2 Arrangement

Arrange the system piping so that fuel from the discharge side of the fueling system transfer pumps can be recirculated back through the inlet [filter/separators](#) into the [operating storage tank](#). Inlet [filter/separators](#) may serve more than one [operating storage tank](#). In [aircraft direct fueling systems](#) on the downstream side of [operating storage tanks](#), arrange the piping so that the fuel can be circulated from the [operating storage tanks](#), through the [filter/separators](#), to each aircraft fixed fueling station and back through the inlet [filter/separators](#) to the [operating storage tanks](#). Provide dispensing [filter/separators](#) of the same number and capacity as the transfer pumps; that is, for three 600 gpm (38 L/s) pumps, provide three 600 gpm (38 L/s) [filter/separators](#).

4-6.7 Pumps

4-6.7.1 Design Requirements

Design pumps to deliver the full range of operating conditions anticipated at any facility with flow rates as presented in this chapter. Ensure pumps develop sufficient head to overcome the friction and static head losses in the system at the rated flow. Consider the [specific gravity](#), temperature, [viscosity](#), [vapor pressure](#), corrosive, and solvent properties of the fuel. Provide at least two pumps for each aviation turbine fueling system. For any single grade of fuel, connect pumps in parallel. Select according to the type most suitable for the particular application. Do not use positive displacement or reciprocating pumps for product issue or pipeline transfer. Provide separate pumps for each type of aviation turbine fuel. Provide at least two transfer pumps, each capable of delivering the required system capacity.

4-6.7.2 Centrifugal Pumps

Use [API Std 610 centrifugal pumps](#) to pump from aboveground tanks with continuously flooded suctions.

4-6.7.3 Vertical Turbine Pumps

Use [API Std 610](#) vertical turbine pumps to pump from underground tanks. Do not use horizontal transfer pumps in a pit alongside the underground tank. Provide a foot valve on all vertical turbine pumps on Navy and USAFE Projects.

4-6.7.4 Rotary Pumps

Use sliding vane positive displacement pumps or self-priming [centrifugal pumps](#) for applications such as stripping pipelines or similar service where the pump may frequently lose its prime. For these pumps, provide a pressure relief valve located on the discharge side of the pumps. A variable speed motor can be used on positive displacement pumps to gradually bring the pump to normal operating speed.

Note: On positive displacement pumps the pressure relief valve shall be considered [safety relief valves](#), not operating valves (valves that modulate on a normal basis to maintain a set pressure). Use of the relief valve to modulate the pump discharge pressure voids the pump warranty.

4-6.7.5 Drivers

Drive permanently installed pumps by an electric motor which is properly classified in accordance with [NFPA 70](#). Size drivers shall be non-overloading at any point on the curve. Provide anti-reversing ratchets on all vertical turbine pump motors.

4-6.7.6 Materials of Construction

For aviation turbine fuels, require cast steel or nodular iron casings and stainless steel impellers and trim. Consider nonferrous materials in severe corrosive environments, consult [Service Headquarters](#).

4-6.7.7 Installation

Mount permanently installed pumps on substantial foundations of reinforced concrete, designed in accordance with Hydraulic Institute Standards.

4-6.8 Valves

4-6.8.1 Materials of Construction – Aviation Turbine Fuel Service

Valve materials in contact with aviation turbine fuel shall either be stainless steel, chrome plated carbon steel, or electroless nickel plated carbon steel. Do not allow zinc, zinc-coated, copper, or copper bearing materials in contact with the fuel. Do not allow internally epoxy-coated valves.

Require manual valves in aviation turbine fuel systems to have stainless steel bodies and bonnets. Carbon steel bodied valves are permitted provided they are internally

plated with nickel plating. Do not allow aluminum, cast iron, or bronze bodied valves. Use only API fire-safe valves.

4-6.8.2 Isolation Valve Types

a) [Double Block and Bleed Isolation Valves](#):

- (1) Use these for separation of product services, on tank shell connections, when piping goes above or below ground, between pier and tank storage, and other locations critical to pressure-testing of piping.
- (2) Plug Valves ([Double Block and Bleed](#)): Use double-seated, tapered lift, lockable, plug type valves with a body bleed between the seats ([double block and bleed](#)). Valves shall be designed so that if the synthetic seating material is burned out in a fire, a metal-to-metal seat will remain to affect closure and comply with [API Std 607](#). Lubricated plug valves are not allowed. Include integral body cavity [thermal relief valve](#).
- (3) Ball Valves ([Double Block and Bleed](#)): Use double-seated, trunion mounted, lockable, ball type valves with a body bleed between the seats ([double block and bleed](#)). These will be very rarely used but are acceptable as an alternative to [double block and bleed](#) plug valves in applications where the valve is operated very infrequently. An example is isolation valve pits where they are only closed to perform pressure testing of piping. Valves shall be designed so that if the synthetic seating material is burned out in a fire, a metal-to-metal seat will remain to affect closure and comply with [API Std 607](#). Include integral body cavity [thermal relief valve](#).
- (4) Gate Valves ([Double Block and Bleed](#)): Use double-seated, lockable, gate type valves with a body bleed between the seats ([double block and bleed](#)). These will be very rarely used but are acceptable as an alternative to [double block and bleed](#) plug valves and [double block and bleed](#) ball valves only when other [double block and bleed valves](#) will not physically fit. Valves shall be designed so that if the synthetic seating material is burned out in a fire, a metal-to-metal seat will remain to affect closure and comply with [API Std 607](#). Single seated gate valves are not allowed. Include integral body cavity [thermal relief valve](#).

b) Quick Opening/Frequent Opening Isolation Valves:

- (1) Use these for less critical applications where [double block and bleed](#) shutoff is not required.
 - (2) Ball Valves: Ball type, lockable, valves designed so that if the synthetic seating material is burned out in a fire, a metal-to-metal seat will remain to affect closure and comply with [API Std 607](#). Use Teflon or Viton synthetic seals or seating material. Use full port ball valves where line [pigging](#) is required or if within ten pipe diameters upstream and/or five pipe diameters downstream of a flow or pressure control valve, or a flow-sensing device such as a venturi. Valves should comply with [API Std 608](#).
 - (3) Butterfly Valves: High-performance wafer trunion butterfly type valves designed so that if the synthetic seating material is burned out in a fire, a metal-to-metal seat will remain to affect closure and comply with [API Std 607](#). Use Teflon or Viton synthetic seals or seating material. Use valves of high-performance type with eccentric disc shaft and clamping action for bubble-tight shutoff. Provide only at inlet to truck fillstand and on supply and return risers at aircraft direct fueling stations with fusible link set to release at 165 degrees F (74 degrees C). These valves are not required nor permitted on Air Force projects.
- c) Use full port valves with exact same diameter of the pipe when line [pigging](#) is required.

4-6.8.3 Isolation Valve Operators

Provide manually operated valves not specified for remote, automatic, or emergency operation. Use geared operators for ball and [double block and bleed valves](#) larger than 6 inches (150 mm). [Double block and bleed](#) gate, ball and [double block and bleed valves](#) specified for remote, automatic, or emergency service may have electric motor operators, if approved by [Service Headquarters](#). Provide locking tabs on isolation valves to allow padlock to be used for lock-out during maintenance. Provide chain operators on valves which are located 72 inches (1800 mm) or higher above grade.

4-6.8.4 Isolation Valve Locations

Provide isolation valves in product piping systems to control flow and to permit isolation of equipment for maintenance or repair. Provide additional valves at required locations necessary to conduct a valid [hydrostatic test](#). Require manually operated valves, except where motor operators are specifically authorized by applicable standard drawings or technical specifications. Use [double block and bleed](#) type isolation valves for separation of product services, on tank shell connections (ASTs over 12,000 gallons (45,800 L) only), when piping goes above or below ground, between pier and tank

storage, and other locations critical to periodic pressure-testing of piping. Quick opening/frequent opening type isolation valves may be used for less critical applications where [double block and bleed](#) shutoff is not required. As a minimum requirement, provide isolation valves at the following locations:

- a) Provide [double block and bleed valves](#) where piping goes below/aboveground and requires periodic pressure testing.
- b) At all subsurface and aboveground piping connections to storage tanks.
- c) On each branch line at the point of connection to the main product pipeline or header.
- d) On the product pipeline or header just before the line leaves a pumping station.
- e) On the suction side and discharge side of each pumping unit, except the suction side of vertical [centrifugal pumps](#) installed in underground tanks.
- f) At all aircraft fuel dispensing points.
- g) On the inlet and outlet connection of each line strainer, [filter/separator](#), meter, diaphragm control valve, and other equipment that requires periodic servicing. One inlet valve and one outlet valve may be used to isolate more than one piece of adjacent equipment which are connected in series.
- h) On the aboveground piping at each tank car or tank truck off-loading connection. This requirement does not apply to gravity off-loading lines unless isolation valves are specifically called for on applicable drawings.
- i) On the aboveground piping at each [refueler](#) loading connection.
- j) At critical points where pipes cross runways, roads, and taxiways.

4-6.8.5 Isolation Valve Pits

Provide [fiberglass](#) or concrete pits with a rolling or hinged cover designed in accordance with the DoD Standard Design [AW 78-24-28](#) for all isolation valves installed in non-traffic areas on underground fuel systems. Design valve pits and valve operators so that the valves can be operated by personnel, without confined space entry.

4-6.9 Other Valves (Except Diaphragm Control Valves)

4-6.9.1 Check Valves

Use check valves to prevent backflow through pumps, branch lines, meters, or other locations where runback or reverse flow must be avoided. Check valves may be of the swing disk, globe, dual plate hinged disk, spring-loaded poppet, ball, or diaphragm-actuated types. Use checks of soft-seated non-slamming type with renewable seats and disks. Ensure check valves conform to [API Spec 6D](#). Use non-surge check diaphragm control valves with flow control feature on the discharge of all pumps. When using non-surge check diaphragm control valves on pump discharge, consider the use of a spring type wafer check before the diaphragm valve to prevent sudden flow reversals during shutdown from passing back thru the pump before the diaphragm control valve diaphragm chamber is filled and reacts by closing the valve.

4-6.9.2 Thermal Relief

Provide [thermal relief valves](#) around isolation and check valves to relieve excessive pressures caused by thermal expansion of liquid trapped between shutoff points. See Facility Plates [023](#), [024](#), [025](#) and [026](#).

4-6.10 Diaphragm Control Valves

Hydraulically operated, single-seated, globe type, diaphragm actuated valves are used extensively in fueling systems as control valves. These valves consist of a main valve and a pilot control system. The valve is operated by varying the amount of pressure above the diaphragm. Since the chamber above the diaphragm exposes a greater area of the diaphragm to chamber pressure than the area of the disc exposed to line pressure, an equal pressure in the chamber and pipeline results in a greater force being applied to the top of the disc. This forces the disc against the seat, thus closing the valve. By selecting the proper pilot control system, these valves can be used in numerous ways to control flow, pressure, and level within fueling systems.

4-6.10.1 Open/Close Operation

This is the most basic function of hydraulically operated diaphragm control valves. The operation is accomplished by applying pressure above the diaphragm to close the valve and relieve that pressure to allow line pressure to open the valve. The pilot trim used to perform this operation is a three-way valve which can be controlled by a solenoid, hand, pressure, pressure differential, or a float.

4-6.10.2 Throttling Operation

This is the other main method of controlling the hydraulically operated diaphragm control valve. In this case, the valve modulates to any degree of opening, in response to changes in the throttling control. The throttling control reacts to a pressure, or a pressure differential across the main valve, or pressure differential across an [orifice plate](#) to regulate the position of the disc in the main valve. For proper operation these valves should be installed with straight pipe on both sides of the valve. Ten pipe

diameters on the upstream side and five diameters on the downstream side is sufficient; provide full port manual isolation valves if they are placed within these limits.

4-6.10.3 Check Valve Function

This is a unique function of a control valve. In this case, the main valve outlet pressure is connected to the diaphragm cover. Therefore, if the downstream outlet pressure exceeds the inlet pressure, which normally holds the valve open, the valve will close and prevent backflow. Note: In order for the valve to close, it must backflow, sometimes for a substantial amount of time. Consider putting a regular check valve in series with this valve in cases where this is a concern.

4-6.10.4 Remote Operations

Hydraulically operated diaphragm control valves can be operated remotely. This is accomplished by installing tubing from the point of pressure sensing to the valve or by using remote-controlled solenoids within the trim.

4-6.10.5 Materials of Construction

Use stainless steel pilots and stainless steel tubing. Use bodies, bonnets, and covers made of stainless steel, internally plated (chrome) steel, or internally plated (nickel) nodular iron. Provide Viton or Buna-N diaphragm and disc ring. Enclose all electrical apparatus according to classification of the area in which they are installed. Provide a means to wire seal all adjustable pilots. Do not use aluminum valves.

4-6.10.6 Applications

For fueling systems, use hydraulically operated diaphragm control valves in the following applications (also refer to specific chapters for applications):

- a) [Water slug shutoff](#).
- b) Rate of flow control.
- c) Pressure reduction.
- d) Pressure relief.
- e) Liquid level control.
- f) Non-surge check control.
- g) [Deadman control](#).
- h) Electrical block control.

4-6.10.7 Combinations

A combination of these controls is also possible. A typical use of these controls is on a [filter/separator](#) for [water slug shutoff](#) and rate of flow control.

4-6.11 Fuel Hoses

Use sizes as required for design flow rates. For hose flanges and [nipples](#), use carbon steel or brass, except at aviation turbine fuel issue points use \1\ /1/ stainless steel, or aluminum where metal parts contact the fuel.

4-6.11.1 Loading Fuel Hoses

Provide pressurized loading hoses and connections complying with [EI Std 1529](#).

4-6.11.2 Off-Loading Fuel Hoses

Provide lightweight, flexible, non-pressurized off-loading hoses constructed of nitrile rubber, rigid polyvinyl chloride (PVC) helix, synthetic braiding, smooth bore, and corrugated outer diameter. Provide non-pressurized hoses with a 65 psi (450 kPa) rating at 72 degrees F (22 degrees C) and 27 in Hg (90 kPa) vacuum rating.

4-7 CONTROLS

4-7.1 Design Requirements

Automatic controls at any facility may include temperature, pressure, fuel level and pump controls, automatic flow controls, alarm and limit switches, motor operated isolation valves, solenoid pilot actuated diaphragm control valves, and remote system condition indicators. Other forms of automatic controls are remote meter indication, electronic access control, data logging, and application of computer techniques. Base the selection of advanced automation and telemetry systems on a study of the particular application with consideration of possible economic justification, operational, and security requirements.

4-7.2 Flow Controls

Where it is possible to achieve flow rates which exceed equipment ratings, provide an adjustable flow control diaphragm control valve on the outlet connection of each meter or [filter/separator](#). Use a diaphragm control valve controlled by the pressure differential across an [orifice plate](#) in the valve or a venturi in the main line. Where necessary, provide remote-operated valves on storage tank inlet and outlet lines, suction and discharge of transfer pumps, and transfer lines at fuel piers and other locations.

4-7.3 Pump Controls

Operation of pump suction and discharge valves may be a part of the automatic sequence for the starting of a [centrifugal pump](#) and for shutting it down, remotely,

locally, or by a protective shutdown device. Remote-operated valves on the discharge side of the pump can be either motor-operated or the solenoid pilot-type, hydraulically operated diaphragm control valves. Remote control valves on the suction side of the pump can be motor-operated valves only. Equip these valves with green and red (open and closed) indicating lights at their pushbutton control locations. Consider the use of PLCs on more complicated systems.

4-7.3.1 All Pumps

Provide the following controls:

- a) A keyed hand/auto button at each pump and a keyed hand-off-auto switch at the motor starter for each remotely operated pump. Both devices will use the same key.
- b) Indicator lights at the control station to give positive indications both when a pump is operating and when it is not energized. Use the "push-to-test" type.
- c) A signal light or alarm to indicate pump failure when a pump is controlled automatically.
- d) Reduced voltage starting if required by electric utility supplier or, in all cases, for pump motors greater than 50 hp (37 kW) and all vertical pumps.
- e) Emergency fuel shut-off (EFSO) pushbutton stations, between 100 and 200 feet (30 m to 60 m) from the pump in the expected ingress and egress direction, with maintained contacts. Provide additional EFSO pushbutton stations at the point of fuel delivery or receipt (tanks, piers, fillstands, etc.) using the same spacing and locations requirements.

4-7.3.2 Multi-Function Pumps

Multi-function pumps are typically used at small facilities and are designed and arranged to be able to perform different functions such as fuel loading, off-loading, or transfer depending on how valves are aligned. Provide each function with the control system requirements for each function described elsewhere in this chapter. For each multi-task pump provide a manual selector switch to choose which set of control and set points the pump is to "look at" when performing a particular function.

4-7.3.3 Transfer Pumps

Parallel transfer pumps supplying an issuing facility with varying demand flow rates must be sequenced automatically by flow-sensing sequence equipment. Lead pumps can be started by a pushbutton at an issuing facility, or automatically by a pressure

switch actuated by a decrease in system pressure as might be caused by opening a valve at the issuing facility. This method requires the system to be pressurized at all times and is normally incorporated in the Type III [hydrant system](#) design. Incorporate the following control features:

- a) Automatically controlled pumps with emergency stop buttons with lock-key reset at issuing stations and at the central supervisory control station.
- b) Automatic shut-off of transfer pumps on loss of suction or no flow for more than 3 minutes. Upon automatic shut-off, a corresponding alarm at the central supervisory control station is activated.

4-7.3.4 Pipeline Pumps

For pumps over 150 horsepower (112 kW), provide protective shutdown devices with alarm at central supervisory control station in the event of the following:

- a) High pump case temperature due to blocked discharge.
- b) Excessive pump vibration.
- c) Mechanical seal or packing gland failure.
- d) High discharge pressure or loss of discharge pressure.
- e) Excessive motor vibration.
- f) High motor winding temperature.
- g) Electrical interlocks which will prevent starting a pump if certain key valve settings are not correct and which will cause a pump shutdown if a key valve setting is changed.
- h) Loss of pump suction pressure.
- i) High-bearing temperature and/or loss of cooling water flow.

4-8 CANOPIES

\1\

4-8.1 Canopies to Protect Fixed Assets from Extreme Weather Conditions

/1/

Unless otherwise directed by [Service Headquarters](#), provide a canopy to protect fixed facility assets, \1\ operators, and equipment from the extreme weather conditions (I.E. re-occurring/sustained extreme icing/snow or desert like conditions /1/. Fixed facilities and equipment include but are not limited to: pump pads, filtration pads, meter pads, isolation valve pads, tank truck and tank-car off-loading and loading equipment pads, control panels, electrical panels, and motor control centers (MCCs). Ensure structural design is in accordance with [UFC 1-200-01](#) and [UFC 3-301-01](#).

4-8.2 Canopies to Reduce Stormwater

Do not provide a canopy to preclude rain from reaching the containment area unless it is required by federal, state, or local regulations; or it is economically justified by reducing the size of the concrete remote spill containment or spill treatment system; or if directed by [Service Headquarters](#). At a canopy over a tank truck or tank car loading and off-loading containment area, ensure that the underside of the canopy is high enough to provide operator head room when walking on top of the truck or car. Ensure structural design is in accordance with [UFC 1-200-01](#) and [UFC 3-301-01](#).

4-9 FUEL ADDITIVES

Provide storage facilities which store aviation turbine fuels with the equipment to inject fuel [additives](#) if directed by [Service Headquarters](#). This will require proportional injectors with manual bypass, storage of [additives](#), and recirculation of tanks through piping with injectors. If the [additives](#) have a corrosive characteristic, construct the system, including storage tanks, tank appurtenances, pumps if required, piping and associated fittings, valves, and injector assemblies of stainless steel components. Consult [Service Headquarters](#) for guidance as to which [additives](#) must be included.

4-9.1 Plus 100 Additive

[Additives](#) used to raise the thermal stability of jet fuel by a minimum of 100 degrees F (38 degrees C) also act as surfactants that will disable the water removal properties of the [filter/separators](#) that do not meet the requirements of [EI Specification 1581](#) (Edition 5). Because fuel containing a thermal stability [additive](#) is issued only at designated air bases, the major command fuels engineer (for USAF air bases), Army Petroleum Office (for US Army airfields), or Naval Air Systems Command (AIR-4.4.5) (for USN/USMC stations) will provide direction as to those bases where its use is permitted and guidance concerning the location of additive injection equipment and additive storage facilities.

4-10 DEFUELING AND RETURN-TO-BULK (RTB) SYSTEMS

4-10.1 General Criteria

Acceptable locations for defueling and RTB Systems include the return line at a truck fillstand, the return line at a hydrant hose truck check-out station, the return line at a pantograph flush station, the product recovery tank, or at a truck off-load station.

4-10.2 JP-5 Systems

4-10.2.1 Hydrant Systems

Because the degradation of flash point below the minimum JP-5 requirement can occur when other than JP-5 is defueled from aircraft directly into operating tanks, ensure that JP-5 direct fueling systems are not capable of defueling an aircraft back into hydrant systems and operating storage. Defuel aircraft into mobile tanker vehicles or into fixed dedicated defuel tanks.

4-10.2.2 Other

Do not provide a capability to defuel JP-5 refueler trucks back into storage unless directed by Service Headquarters.

JP-5 systems do not use fuel bowsers (mobile defuel tanks).

4-10.3 JP-8 Systems

4-10.3.1 Hydrant Systems – Hydrant Loop

Provide JP-8 hydrant systems with capability to defuel aircraft back into the hydrant systems and operating storage through the hydrant pit diaphragm control valves.

4-10.3.2 Hydrant Systems – Other

To allow defueling of refueler trucks provide a Return-To-Bulk (RTB) station on the return line of a hydrant hose truck check-out station or a pantograph check-out station, or a pantograph flushing station. Provide one adapter per group.

4-10.3.3 Tank Truck and Tank Car Off-Loading

To allow defueling of refueler trucks, provide a Return-To-Bulk (RTB) station by providing a [MIL-STD MS 24484 aircraft refueling adapter](#) at a tank truck or tank car off-loading station. Provide one adapter per group of tank truck or tank car off-load stations. If defueling into a product recovery tank, do not bypass the level control valve.

4-10.3.4 Refueler Truck Fillstands

To allow defueling of refueler trucks, provide a Return-To-Bulk (RTB) station by providing a [MIL-STD MS 24484 aircraft refueling adapter](#) at a point upstream of receipt filtration when the fillstand has a return line. Provide one adapter per group of refueler truck fillstands. If defueling into a product recovery tank, do not bypass the level control valve.

4-10.3.5 Fuel Bowsers (Mobile Defuel Tanks)

Provide a capability to empty JP-8 fuel bowsers mobile defuel tanks by providing a gravity drain connection on underground [product recovery tanks](#), or by providing a pump at aboveground [product recovery tanks](#). Do not bypass the [product recovery tank](#) level control valve.

4-11 PRODUCT RECOVERY SYSTEMS

Provide a system with pumps, piping, valves, and tanks to collect and store usable aviation turbine fuel which would otherwise become waste from operational or maintenance activities. See [Chapter 8](#) of this UFC.

4-11.1 Tank Trucks and Fuel Bowsers

Provide a capability to receive fuel from JP-8 tank trucks and JP-8 fuel bowsers into the [product recovery tank](#), either at the [product recovery tank](#) location, the truck fillstands, or through a connection at the fuel receipt facility.

4-11.2 Return to Bulk

Provide a capability to return aviation turbine fuel from JP-5 and JP-8 [product recovery tank](#) back into operating storage by pumping the fuel into the receipt piping upstream of receipt filtration.

Table 4-1. Aviation Turbine Fuel Receipt Filtration Table (1) (3)

ITEM	DESCRIPTION	PIPELINE				MARINE				TRUCK/RAIL			
		SPP(IB) (1)	SPP(IOT) (1)	MPP(IB) (1)	MPP(IOT) (1)	B(IB) (1)	B(IOT) (1)	T(IB) (1)	T(IOT) (1)	OTRTT(IB)	OTRTT(IOT)	RC(IB)	RC(IOT)
a.	Provide strainers upstream of filter/separators .	✓	✓	✓	2	✓	✓	1	1	✓	✓	✓	✓
b.	Provide pre-filtration consisting of pre-filter or coalescer vessels , or both. For a receipt rate of 1200 gpm or less, provide at least two equal sized vessels of each type in parallel, each sized to handle at least 100% of the normal off-loading flow rate. When the flowrate is over 1200 gpm, provide two sets of each type of vessel installed in parallel, each set sized for 100% of the normal off-loading flow rate.			✓	2	✓	✓	1	1				
c.	Consider pre-filtration consisting of pre-filter or coalescer vessels , or both.	✓	✓		2					✓	✓	✓	✓
d.	When receiving from a non-government controlled source: Provide fine filtration . For a receipt rate of 1200 gpm or less, provide two equal sized filter/separators in parallel, each sized to handle at least 100% of the normal off-loading flow rate. When the flowrate is over 1200 gpm, provide two sets of filter/separators installed in parallel, each set sized for 100% of the normal off-loading flow rate.	✓		✓	2	✓	✓	1	1				
e.	When receiving from a non-government controlled source: Provide fine filtration consisting of a sufficient number of equally sized receipt filter/separators to handle 100% of the maximum expected flow, plus provide an equally sized spare filter/separator .		✓		2					✓	✓	✓	✓

- (1) Tankers always, and barges and pipelines may, receive at greater than 2,800 gpm. In these cases, fuel is typically received without filtration into a breakout tank, usually for economic reasons. Contact Service Headquarters to determine what filtration is needed.
- (2) MPP(IOT) included for information only. **NEVER** receive fuel from a Multi-Product Pipeline into an Operating Tank.
- (3) This table will not typically apply to receipt into regional bulk storage centers such as Defense Fuel Support Points (DFSPs). These typically do not have filtration on receipt. Contact [Service Headquarters](#) for guidance.

SPP(IB) - Single Product Pipeline (Into Bulk)
SPP(IOT) - Single Product Pipeline (Into Operating Tank)
MPP(IB) - Multi-Product Pipeline (Into Bulk)
MPP(IOT) - Multi-Product Pipeline (Into Operating Tank)
B(IB) - Barge (Into Bulk)
B(IOT) - Barge (Into Operating Tank)
T(IB) - Tanker (Into Bulk)
T(IOT) - Tanker (Into Operating Tank)
OTRTT(IB) - Over the Road Tank Truck (Into Bulk)
OTRTT(IOT) - Over the Road Tank Truck (IOT)
RC(IB) - Rail Car (Into Bulk)
RC(IOT) - Rail Car (Into Operating Tank)

Table 4-1 – (Continued) (3)

ITEM	DESCRIPTION	PIPELINE				MARINE				TRUCK/RAIL			
		SPP(IB) (1)	SPP(IOT) (1)	MPP(IB) (1)	MPP(IOT) (1)	B(IB) (1)	B(IOT) (1)	T(IB) (1)	T(IOT) (1)	OTRTT(IB)	OTRTT(IOT)	RC(IB)	RC(IOT)
f.	When receiving from a government controlled source: Provide fine filtration consisting of a sufficient number of equally sized receipt filter/separators to handle 100% of the maximum expected flow.		✓		2			1	1	✓	✓	✓	✓
g.	Provide each vessel with a feature to automatically switch the fuel stream to the other vessel when the differential pressure across the vessel reaches a preset limit. Require a warning signal to the operator that the switching operation has occurred. In cases of emergency, include the capability to bypass the inlet filter/separator bank.	✓	✓	✓	2	✓	✓	1	1				
h.	Disable filter/separator control valve water slug feature. Provide water conductance probe tied to an alarm in place of water slug float. Provide differential pressure alarm and differential pressure-actuated bypass valve.	✓	✓	✓	2	✓	✓	1	1				
i.	Provide filter/separator sump with automatic water drain valve connected to the bottom of the water sump. (4)				2	✓	✓	1	1				
j.	Consider providing filter/separator sump with automatic water drain valve connected to the bottom of the water sump when large quantities of water are expected. (4)	✓	✓	✓	2			1	1				

- (1) Tankers always, and barges and pipelines may, receive at greater than 2,800 gpm. In these cases, fuel is typically received into a breakout tank, usually for economic reasons. Contact Service Headquarters to determine what filtration is needed.
- (2) MPP(IOT) included for information only. NEVER receive fuel from a Multi-Product Pipeline into an Operating Tank.
- (3) This table will not typically apply to receipt into regional bulk storage centers such as Defense Fuel Support Points (DFSPs). These typically have not filtration on receipt. Contact [Service Headquarters](#) for guidance.
- (4) Consider also in any situation where large quantities of water are expected.

SPP(IB) - Single Product Pipeline (Into Bulk)
SPP(IOT) - Single Product Pipeline (Into Operating Tank)
MPP(IB) - Multi-Product Pipeline (Into Bulk)
MPP(IOT) - Multi-Product Pipeline (Into Operating Tank)
B(IB) - Barge (Into Bulk)
B(IOT) - Barge (Into Operating Tank)
OTRTT(IB) - Over the Road Tank Truck (Into Bulk)
OTRTT(IOT) - Over the Road Tank Truck (IOT)
RC(IB) - Rail Car (Into Bulk)
RC(IOT) - Rail Car (Into Operating Tank)
T(IB) - Tanker (Into Bulk)
T(IOT) - Tanker (Into Operating Tank)

CHAPTER 5 MARINE RECEIVING AND DISPENSING FACILITIES

5-1 FUNCTION

Design marine fuel receiving and dispensing facilities for the purpose of receiving fuel and/or loading fuel aboard ships, barges and boats for consumption or as cargo. In many cases, the marine receiving and dispensing facilities will be combined. Special requirements for aviation turbine Fuels are in [Chapter 4](#) of this UFC.

5-2 FUEL PIERS AND WHARVES

Ensure that the structural design of fuel piers and wharves is in accordance with [UFC 4-152-01](#). When required and approved by the appropriate [Service Headquarters](#), design fuel piers for dispensing and receiving fuel. Ensure that the size of the facility is compatible with the fuel requirements of the activity and the number of simultaneous loadings and off-loadings to be accommodated. For dispensing of fuel, consider the number, type, and size of vessels to be fueled or loaded to provide the required number and locations of fuel outlets. In most cases, use dedicated fuel piers and wharves for fuel receipt. Include in the design an energy absorbing [fender](#) system. Refer to NAVFAC Definitive Drawings [1403995](#) through [1403999](#).

5-3 BERTHING PIERS

In some cases, permanent fuel piping and equipment may be installed on berthing piers which were not primarily designed for handling fuel. Design such piers in accordance with [UFC 4-152-01](#). These facilities are normally used only for dispensing fuel to surface combatants for consumption. Operational requirements usually dictate a clear berthing pier surface area. This imposes restrictions on the use of loading arms and above deck piping. For these areas, trench-contained piping may be considered. Prior to designing facilities on berthing piers for receiving and/or dispensing of bulk fuel for transport, review plans with appropriate port operations agency.

5-4 OFFSHORE MOORINGS

When operations of an activity do not warrant construction of fuel piers, provide offshore moorings for vessels to discharge or receive fuel through underwater pipelines connecting to the shore facility. Clearly mark the moorings so that the vessel, when moored, will be in the proper position to pick up and connect to the underwater connection. Coordinate offshore mooring systems with Naval Facilities Engineering \1\ and Expeditionary Warfare Center, CIOFP4, Ocean Facilities Division (NAVFAC EXWC, CIOFP4) /1/.

5-5 GENERAL REQUIREMENTS

[Chapter 2](#), General Design Information, of this UFC contains important information on fueling facilities. Do not start the design of any fueling system without first becoming completely familiar with [Chapter 2](#) of this UFC. In particular, refer to [Chapter 2](#) for

guidance on spill prevention, air quality control, and other environmental, safety and fire protection issues.

5-6 GENERAL LAYOUT

Provide pier loading and off-loading connections, with blind flange and with ball valve for throttling and isolation, at the pier edge for each product to be transported. The intent is for a loading arm manifold with a separate manual isolation plug valve for each product connection. This will allow simultaneous loading and off-loading of different products, each through a dedicated arm. Provide a [double block and bleed](#) plug valve at the point which the line is being stripped. Use the following criteria:

- a) Provide each branch line to the pier edge with a manual isolation valve located at the main line. Provide [thermal relief valves](#) around isolation and check valves to relieve excessive pressures caused by thermal expansion of liquid trapped between shutoff points. See [Facility Plate 025](#).
- b) Do not provide a gauge outboard of the hose connection shutoff valve because hose movement will indicate the presence or absence of pressure in the hose.
- c) If required, provide one or more loading arms at each station.
- d) Provide a liquid-filled pressure gauge for each loading arm, located to be easily read from the operator position. This gauge is provided because the drybreak check valve at the end of the loading arm and the rigid piping will not intuitively indicate the presence or absence of pressure at the loading arm.
- e) Provide for venting and draining of the branch lines and loading arm manifolds. Provide for manual venting of the branch lines, connect the vents to the oil waste line, similar to a sanitary vent system to avoid spillage. When pier drain lines cannot be sloped back to the pierhead stripping pumps, a design including separate oil waste drain lines, holding tank and dedicated stripping pump is a viable alternative.
- f) Provide segregated handling of multiple products through the loading arms, while allowing easy selection of the products to be transported. [Double block and bleed valves](#) can be used for this application.
- g) Provide a separate pipe and connection for [ballast water](#) or offspec fuel if the size of the facility and level of activity warrants it.

- h) Provide each hose handling and loading arm area with fixed spill containment as defined in [33 CFR Part 154](#).
- i) Provide hydraulic shock surge suppressors (if required).

5-7 PIPING SYSTEMS

Refer to [Chapter 9](#) of this UFC for information regarding piping systems.

5-7.1 Piping Arrangement

In addition to complying with [Chapter 9](#), use the following criteria:

- a) Where simultaneous deliveries of the same fuel may be made by more than one vessel, size fuel headers and related equipment for the total flow rates of all vessels discharging into the headers. Ensure that flow rates are in accordance with [Chapter 2](#) of this UFC.
- b) Place pier piping above the pier deck within a containment area for fueling piers and within a trench on berthing piers. Slope piping toward shore to permit stripping. Use gratings as required to allow access across the piping.
- c) Provide flexibility in the piping between the pier and the shore to allow for small movement of the pier relative to the shore. Use a suitable pipe bend or offset configuration, preferably in a horizontal plane, that will allow three-dimensional movement. If vertical bends are used, install vents and drains.
- d) Provide flexibility in the piping along the pier to allow for pipe growth due to thermal expansion. Horizontal expansion loops are preferred. In cases where space is tight provide vertical expansion loops or bellows expansion joints where necessary. Where practical provide vertical expansion loops with vents and drains.
- e) Include in the pier facilities, pipe manifolds for each fuel type arranged parallel to the face of the pier.
- f) Pipe hangers are not allowed.

5-8 EQUIPMENT DESCRIPTIONS

5-8.1 Loading/Off-Loading Arms

Provide articulated marine loading arms for receiving and shipping fuel cargoes so that the connected vessel can move 15 feet (4.6 m) forward, 15 feet (4.6 m) aft, and 10 feet (3 m) off the face of the pier and vertically as caused by loading or off-loading of the

vessel and tidal changes, without damage to the arm. Provide a hydraulic power assist system for operating loading arms larger than 8-inch (200 mm) nominal size. Equip the end of the loader to be connected to the ship's manifold with an insulating section, a standard ANSI forged steel flange, and a steel quick coupling device, manually or hydraulically operated. Refer to NAVFAC Drawing No. [1403997](#). Consider [breakaway couplings](#) for locations with strong current.

5-8.2 Fuel Hoses

Loading/off-loading arms are the preferred method to be used. Provide a facility for storing and protecting the hose as near as practical to the pier if hose is provided in lieu of loading/off-loading arm.

5-8.3 Submarine Fuel Hoses

Provide submarine fuel hose where offshore moorings are used. Use heavy duty, smooth bore, oil and gasoline, marine cargo, discharge hose rated for a working pressure of not less than 225 psig (1550 kPa) and built-in [nipples](#) with Class 300 flanges with stainless steel bolts and Monel nuts. Hoses should be U. S. Coast Guard certified.

5-8.4 Meters

Provide a turbine or positive displacement meter for each dispensing outlet that might be used simultaneously. With the approval of the appropriate [Service Headquarters](#), use portable meters where fueling operations are intermittent. Also consider the use of alternative technologies such as ultrasonic meters. Require temperature compensation feature at each meter used for custody transfer.

5-8.4.1 Meters – Positive Displacement

Require flange-connected, cast steel bodied positive displacement meters of the desired pressure and flow rating for the applicable service requirements. Ensure meter has case drain and register. Provide \1\ meter with temperature compensation and adjustable [calibration](#) /1/ when there is custody transfer. Ensure meter accessories are compatible with either the mechanical or electronic support equipment selected. Provide an accuracy of plus or minus 0.5 percent when used for custody transfer. Consult the appropriate [Service Headquarters](#) for requirements for the meter to communicate to a remote location or equipment. Consider the use of a card-operated or key-operated data acquisition system. Cards or keys, as appropriate, are coded to identify the receiver of the fuel and to allow access to the fuel. The quantities taken are transmitted to a data-receiving device by electronic pulse transmitters mounted on each meter, and each transaction is automatically recorded.

5-8.4.2 Meters – Turbine

Use flange-connected, steel bodied turbine meters of the desired pressure and flow rating for the applicable service requirement. Provide a flow straightener before turbine meters or provide a straight length of pipe at a minimum of ten pipe diameters upstream and five pipe diameters downstream of all turbine meters, or as required by manufacturer. Ensure meter has case drain and register. Provide \1\ meter with temperature compensation and adjustable [calibration](#) /1/ when there is custody transfer. Ensure all supporting equipment for meter is compatible with the turbine meter selected. Provide an accuracy of plus or minus 0.5 percent when used for custody transfer. Consult the appropriate [Service Headquarters](#) for requirements for the meter to communicate to a remote location or equipment. Consider the use of a card-operated or key-operated data acquisition system. Cards or keys, as appropriate, are coded to identify the receiver of the fuel and to allow access to the fuel. The quantities taken are transmitted to a data-receiving device by electronic pulse transmitters mounted on each meter, and each transaction is automatically recorded.

5-8.5 Strainers

Require a basket strainer to protect [centrifugal pumps](#), unless it precludes meeting the net positive suction head of the pump. Whether or not strainers are installed on the suction side of [centrifugal pumps](#), install a spool piece so that temporary strainers can be installed during startup of the system. Strainers are required on the suction side of all pumps, meters, and receipt filtration. Strainers are not required upstream of issue [filter/separators](#) or diaphragm control valves. Also:

- a) Use flanged basket strainers constructed of steel and fitted with removable baskets of fine Monel metal or stainless steel mesh with large mesh reinforcements.
- b) Unless otherwise specified, provide a fine screen mesh as follows:

	Mesh	Size of Opening
Pump suction (Centrifugal)	7	0.108 inch (2.74 mm)
Pump suction (Positive Displacement)	40	0.016 inch (0.40 mm)
Receipt Filtration	40	0.016 inch (0.40 mm)
Meter inlets (unless downstream of a filter/separator)	40	0.016 inch (0.40 mm)

- c) In all cases, ensure the effective screen area is not less than three times the cross sectional area of the pipe.
- d) Strainers upstream of pump shall be quick opening, single screw type.

- e) Provide pressure gauges on both sides of the strainer and a differential type gauge across the strainer.

5-8.6 Surge Suppressors

Every effort should be made to control hydraulic [surge](#) or shock to acceptable limits by the design of the piping system rather than by the use of [surge suppressors](#). Where this is not possible or becomes extremely impractical, [surge suppressor\(s\)](#) may be incorporated. Use the diaphragm or bladder type equipped with a top-mounted liquid-filled pressure gauge, wafer-style check valve at the bottom, drain above the check valve, and isolation valve. Provide a needle valve around the check valve to permit controlled bleed back of the surge suppressor without rebounding. Locate [surge suppressors](#) as close as possible to the point of shutoff that is expected to cause the shock. [Surge suppressors](#) can reduce shock pressure but will not eliminate it entirely. The preferred solution to hydraulic shock is conservative piping design, use of loops, and slow-closing valves. [Surge suppressors](#) are strictly a last resort solution and require the approval of [Service Headquarters](#) prior to designing into a system.

5-8.7 Valves

5-8.7.1 Materials of Construction

Require valves to have carbon steel bodies and bonnets. Do not allow valves with aluminum, cast iron, or bronze materials. Use only API fire-safe valves.

5-8.7.2 Isolation Valve Types

- a) [Double Block and Bleed Isolation Valves](#):
 - (1) Use these for separation of product services, on tank shell connections, when piping goes above or below ground, between pier and tank storage, and other locations critical to pressure-testing of piping.
 - (2) Plug Valves ([Double Block and Bleed](#)): Use double-seated, tapered lift, lockable, plug type valves with a body bleed between the seats ([double block and bleed](#)) in critical applications such as separation of product services, when piping goes above or below ground, between pier and tank storage, and other locations critical to pressure-testing of piping. Valves shall be designed so that if the synthetic seating material is burned out in a fire, a metal-to-metal seat will remain to affect closure and comply with [API Std 607](#). Lubricated plug valves are not allowed. Include integral body cavity [thermal relief valve](#).

- (3) Ball Valves ([Double Block and Bleed](#)): Use double-seated, trunion mounted, lockable, ball type valves with a body bleed between the seats ([double block and bleed](#)). These will be very rarely used but are acceptable as an alternative to [double block and bleed](#) plug valves in applications where the valve is operated very infrequently. An example is isolation valves in the middle of piers that are only closed to perform pressure testing of piping. Valves shall be designed so that if the synthetic seating material is burned out in a fire, a metal-to-metal seat will remain to affect closure and comply with [API Std 607](#). Include integral body cavity [thermal relief valve](#).
- (4) Gate Valves ([Double Block and Bleed](#)). Use double-seated, lockable, gate type valves with a body bleed between the seats ([double block and bleed](#)). These will be very rarely used but are acceptable as an alternative to [double block and bleed](#) plug valves and [double block and bleed](#) ball valves only when other [double block and bleed valves](#) will not physically fit. Valves shall be designed so that if the synthetic seating material is burned out in a fire, a metal-to-metal seat will remain to affect closure and comply with [API Std 607](#). Single seated gate valves are not allowed. Include integral body cavity [thermal relief valve](#).
- b) Quick Opening/Frequent Opening Isolation Valves
- (1) Use these for less critical applications where [double block and bleed](#) shutoff is not required.
- (2) Ball Valves: Ball type valves may be used as valves for quick or frequent opening applications when a [double block and bleed valve](#) is not required. Ball valves shall be designed so that if the synthetic seating material is burned out in a fire, a metal-to-metal seat will remain to affect closure and comply with [API Std 607](#). Use Teflon or Viton synthetic seals or seating material. Use full port ball valves with exact same diameter of the pipe within ten pipe diameters upstream and/or five pipe diameters downstream of a flow or pressure control valve, or a flow-sensing device such as a venturi. Valves should comply with [API Std 608](#).
- c) Butterfly Valves: Butterfly valves are not allowed.
- d) Use full port valves with exact same diameter of the pipe when line [pigging](#) is required.

5-8.7.3 Isolation Valve Operators

Provide manually operated valves not specified for remote, automatic, or emergency operation. Use geared operators for ball and [double block and bleed](#) plug valves larger than 6 inches (150 mm). [Double block and bleed](#) gate, ball and [double block and bleed valves](#) specified for remote, automatic, or emergency service may have electric motor operators, if approved by [Service Headquarters](#). Provide locking tabs on isolation valves to allow padlock to be used for lock-out during maintenance. Provide chain operators on valves which are located 72 inches (1800 mm) or higher above grade.

5-8.7.4 Isolation Valve Locations

- a) Provide an isolation valve on each line at the shore end. For piping used only for receiving fuel, also provide a check valve at the shore end. Use [double block and bleed](#) type, which may be motor-operated with remote control. To minimize [surge](#) potential, use a slow-closing speed, if possible.
- b) Provide [double block and bleed](#) isolation valves on the aboveground piping at each barge or tanker off-loading and loading connection.
- c) Provide [double block and bleed](#) isolation valves near the shoreline of a submerged pipeline to offshore moorings.
- d) Provide [double block and bleed](#) isolation valves on the inlet and outlet connection of each line strainer, [filter/separator](#), meter, diaphragm control valve, and other equipment that requires periodic servicing. One inlet valve and one outlet valve may be used to isolate more than one piece of adjacent equipment which are connected in series.
- e) Provide [thermal relief valves](#) around all isolation and check valves to relieve excessive pressures caused by thermal expansion of liquid trapped between shutoff points. See Facility Plates [023](#), [024](#), [025](#) and [026](#).

5-8.7.5 Isolation Valve Pits

Provide [fiberglass](#) or concrete pits with a rolling or hinged cover designed in accordance with the DoD Standard Design [AW 78-24-28](#) for all isolation valves installed in non-traffic areas on underground fuel systems. Design valve pits and valve operators so that the valves can be operated by personnel, without confined space entry.

5-8.8 Other Valves

5-8.8.1 Check Valves

Use check valves to prevent backflow through pumps, branch lines, meters, or other locations where runback or reverse flow must be avoided. Check valves may be of the swing disk, globe, dual plate hinged disk, spring-loaded poppet, ball, or diaphragm-actuated types. Use checks of soft-seated non-slamming type with renewable seats and disks. Ensure check valves conform to [API Spec 6D](#). Use non-surge check diaphragm control valves with flow control feature on the discharge of all pumps. When using non-surge check diaphragm control valves on pump discharge, consider the use of a spring type wafer check before the diaphragm control valve to prevent sudden flow reversals during shutdown from passing back thru the pump before the diaphragm control valve diaphragm chamber is filled and reacts by closing the valve.

5-8.8.2 Thermal Relief

Provide thermal relief valves around isolation and check valves to relieve excessive pressures caused by thermal expansion of liquid trapped between shutoff points. See Facility Plates 023, 024, 025 and 026.

5-8.9 Pressure or Pressure/Vacuum Gauges

Use glycerin-filled or silicone-filled pressure gauges of range and dial size, as necessary, but not less than 0 to 160 psig (0 to 1100 kPa) pressure range and 4-inch (100 mm) diameter dial. Also:

- a) Use pressure gauges upstream and downstream of strainers and filters/separators. A differential pressure gauge may be used in lieu of gauges on each side.
- b) Install compound (pressure/vacuum) gauges on the suction side of each pump at fuel storage tanks.
- c) Provide a lever handle gauge cock and pressure snubber in each pressure gauge connection.
- d) Provide a pressure gauge on each side of the pipeline shutoff valve at the shore end of each pier-mounted pipeline. Provide the indicating pointer with a high-pressure-reading tell-tale indicator suitable for reporting the highest pressure experienced since last reset. Provide for non-contact resetting of the tell-tale by means of a small magnet.
- e) Provide a pressure gauge on each branch line at each fueling station on each pier-mounted pipeline. Ensure that the pressure gauge is legible from the fuel hose connection array and from the pantograph loading arm location (if provided).

- f) Provide a pressure gauge on each marine loading arm assembly (if provided). Ensure that the gauge is visible by the operator.
- g) Pressure gauges shall be installed so that they are testable without removing them from the piping.

5-8.10 Stripper Pumps

Provide positive displacement [stripper pumps](#) for emptying loading arms, hoses, and manifolds. Provide a [stripper pump](#) to reclaim each [clean product](#) from each main product line, or connect the product lines to the oil waste drain line. Conduct an economic analysis of the two alternatives to determine the appropriate choice. Larger, longer, or more frequently drained lines will favor the [stripper pump](#) choice. Use a [stripper pump](#) on multi-product lines, but do not exceed acceptable limits of cross [contamination](#). Provide a dedicated [stripper pump](#) to each separate product line, such as aviation turbine fuels.

5-8.11 Excess Flow Sensors

In piping used for both loading and off-loading, provide a sensor that will alarm both the control room and at the pier to detect excess flow that might occur in the event of a line break.

5-8.12 Solid Cyclonic Separators

In facilities which receive product by tankers or barge, consider the use of solid separators in the receiving lines as part of [pre-filtration](#) to remove gross impurities from the incoming product. In systems equipped with [filter/separators](#) in the receiving lines, locate strainers or cyclonic separators upstream of the [filter/separator](#). Ensure that there is no slug valve feature on the [filter/separator](#). Consider the use of automatic water drains. Do not allow reverse flow thru cyclonic separators.

5-8.13 Grounding Systems

Provide grounding systems for barges in accordance with [UFC 3-460-03](#), Figure 9.2.

5-8.14 Special Considerations for Aviation Turbine Fuels

For inbound filtration of aviation turbine fuels, refer to [Chapter 4](#) of this UFC.

5-9 PRODUCT RECOVERY SYSTEMS

Provide a product recovery system to collect and store usable aviation turbine fuel that would otherwise become waste from operational or maintenance activities. Consider a product recovery system for other products. See [Chapter 8](#) of this UFC for product recovery systems.

5-10 WEATHER SHEDS

Provide adequate shelter for personnel, as well as for spill containment [booms](#), absorbent material, and other weather-sensitive equipment.

5-11 CANOPIES

Provide a canopy, as directed by [Service Headquarters](#), for all aboveground equipment including pumps, meters, strainers, filters, control panels, electrical panels, and motor control centers (MCCs). Ensure structural design is in accordance with [UFC 1-200-01](#) and [UFC 3-301-01](#).

5-12 SPECIAL CALCULATIONS

Calculate pipeline filling/venting times and draining/stripping times. The larger and the longer the pipeline, the greater the volume of fuel required to fill the line and, therefore, the greater the volume of air required to be vented. Undersized vent lines will delay filling the lines and delay changeover of products in multiproduct lines. Size the vent lines to allow filling of the line at not more than four times the design transit time of the line. Connect vent line to the drain line to avoid spills to the environment. Check vent line air velocity, which must not exceed the allowable air velocity to avoid electrostatic buildup, in accordance with [API RP 2003](#). Vent rate must be not less than the lowest allowable pumping rate from ship or shore. Vent rate must be less than the design transit velocity to minimize hydraulic shock.

5-13 SAFETY SHOWERS AND EYEWASH FOUNTAINS

Provide manual shutoff valves on the potable water branch to the safety shower and eyewash fountain. Provide a means to seal shutoff valve in the open position. This will ensure operation in an emergency, yet allow for servicing a single shower without shutting off potable water to the whole pier. Design for freeze protection in climates subject to freezing. Install safety showers and eyewash fountains in accordance with [ISEA Z358.1](#).

5-14 TRAFFIC BOLLARDS

Provide traffic [bollards](#) to protect fueling piping and equipment on piers and wharves. Utilize concrete-filled steel pipe of minimum 4-inch (100 mm) diameter and 4-foot (1.2 m) height, embedded in concrete or welded to a steel plate mounted on the structure.

5-15 SPECIAL DRAINAGE FOR FUELING PIERS

- a) Provide an intercept system to collect oil spills. Place pipes on piers in a curb containment area with a drain system independent of the deck drainage. Provide containment also for loading arms and risers. Provide locking valves in normally closed positions on

all containment areas along with [sump](#) pumps or other means of removing the spilled fuel to a collection point or tank.

- b) In cases where the stormwater collected in the intercept system is contaminated, the water/fuel mixture should be treated as an oil spill as described previously.

5-16 BALLAST TREATMENT AND SLUDGE REMOVAL

5-16.1 Ballast Receiving and Treatment Facilities

5-16.1.1 Design Requirements

It is the policy of the United States that there should be no discharge of oil or hazardous substances into or upon the navigable waters of the United States, adjoining shorelines, or into or upon the waters of the contiguous zone. Petroleum fuel facilities, which transfer fuel by barge or tanker or which fuel large ships, require [ballast water](#) collection and treatment facilities to receive and treat oily ballast from cargo or fuel tanks. Also:

- a) Blend the fuel oil which has been reclaimed from the [ballast water](#) during the collection and treatment process with [boiler fuel oil](#) for use in shoreside boilers. Perform a quality assurance check on the reclaimed fuel oil to ensure that it meets the minimum requirements for shoreside boiler fuel. Dispose of [sludge](#) accumulated during the collection and treatment of ballast water in accordance with applicable hazardous waste management disposal procedures.
- b) Select and design the appropriate treatment system based on an evaluation of the types of oil/water mixtures that may be encountered at the particular facility. If possible, base the evaluation on samples of typical [ballast water](#) receipts and tank washings including the following:
 - (1) Whether they are simple mixtures, simple gravity suspensions, or chemically stable [emulsions](#).
 - (2) The [specific gravity](#) and [viscosity](#) of the oil in the mixture.
 - (3) Whether other substances, such as chemicals or bacteria, in the mixtures must be removed.
 - (4) The general condition of the ship's tanks expected to be discharged (e.g., new, clean, coated, well maintained, or dirty and normally full of [sludge](#), scale, and [rust](#)).

- (5) Whether [ballast water](#) is clean sea water or polluted harbor water.
 - (6) Whether the treatment system proposed (“ship’s waste off-load barge” or fixed shore-based facilities) meets the standards of [effluent](#) water quality established by local environmental regulations.
- c) If it is determined that both simple mixtures and [emulsions](#) are present, consider the possibility of using two segregated separate systems, one for gravity separation and the other for breaking [emulsions](#). Avoid mixing the two types of suspensions when possible. For bilge water and other contaminated oily wastes which require additional treatment, refer to [UFC 4-832-01N](#), Industrial and Oily Wastewater Control or for Army and Air Force projects [MIL-HDBK-1005/17](#), Nondomestic Wastewater Control and Treatment Design.
 - d) For typical schematic arrangement of [ballast water](#) treatment and disposal systems, refer to [UFGS 44 42 53](#).

5-16.1.2 Receiving and Settling Tanks

The minimal ballast water receiving facility usually requires two storage tanks, usually of equal capacity, to be used alternately as receiving and settling tanks. If these tanks are sized to allow 4 to 5 days undisturbed settlement, separation of simple suspensions of light oils in water can be achieved. Use welded steel vertical aboveground storage tanks designed and constructed in accordance with Chapter 8 of this UFC. In addition to complying with Chapter 8 of this UFC for construction appurtenances, provide the following fittings and appurtenances:

- a) An automatic float gauge suitable for use with transmitting device for remote readout.
- b) One cable-operated swing-line assembly on the oil outlet pipe.
- c) One shell fill [nozzle](#).
- d) Valved sample connections in the shell, having nonfreezing-type valves in cold climates, every 2 feet (0.6 m) vertically, easily accessible from the ladder or stairway.
- e) When chemical feed is provided, a chemical feed inlet valve, to be nonfreezing type in cold climates.
- f) When air blowing is provided, a perforated pipe air sparger for mixing. Make the perforations in the sides of the pipe to avoid

plugging by settling solids. Use nonfreezing-type air inlet valve(s) in cold climates.

- g) Sight glass or look box on oil outlet line.
- h) Sight glass or look box on water outlet line.
- i) Oil [sump](#) tank with high-level alarm.
- j) Water and oil pumps as required to move fluids from receiving tanks or from oil [sump](#) tanks. For transfer of oily water, use low-speed-type pumps to minimize emulsification.
- k) If heaters are required to reduce oil [viscosity](#) and promote separation, use either tank wall heaters or internal pipes. Keep internal pipes at least 2 feet (0.6 m) above the tank floor.
- l) Insulation for tanks that will be regularly heated.
- m) Provide automatic temperature controls and thermometers for all heated tanks.

5-16.1.3 Oil/Water Separators

Separate water/fuel mixtures from storage or settling tanks with an API [oil/water separator](#). Recycle the fuel portion and pass the water portion to another treatment process. Do not discharge water drawn from tanks to surface water without additional treatment and permits. [Chapter 2](#) of this UFC contains design information for an API [oil/water separator](#).

5-17 SLUDGE REMOVAL SYSTEMS

5-17.1 Design Requirements

Install [sludge](#) removal systems where the accumulation of [sludge](#) in substantial quantities is likely to occur on a regular basis. Sources of such [sludge](#) are a [ballast water](#) treatment system, a [contaminated fuel](#) recovery system, or frequent cleaning of shore or ships' tanks. If routine cleaning of [clean product](#) storage tanks occurs on an irregular basis, [sludge](#) removal systems are not required.

5-17.2 Sludge Disposal

- a) Where possible, provide pumps, tanks, and piping to return [sludge](#) containing recoverable oil to the contaminated oil recovery system. If this is not possible, consider transferring the [sludge](#) to a refinery or waste oil treatment facility. For additional details, refer to [UFC 3-240-02N](#) or for Army projects, [UFC 3-240-09FA](#).

- b) Provide a tank or tanks with transfer pump(s) for pumpable [sludges](#) that are unreclaimable. Include piping for receiving [sludge](#) and for mixing other low [viscosity](#) waste oils for thinning as required. Ensure that tanks are [dike](#)-enclosed and have cone bottoms.
- c) Provide tank heating where climate conditions prove necessary.
- d) Coordinate [sludge](#) disposal method and design with facility environmental office.
- e) Enclose the [sludge](#) disposal facility with a security fence to prevent unauthorized entry. Do not use this facility for disposal of sand, gravel, [rust](#) scale, or other solid nonpumpable matter found on tank bottoms. For further discussion of disposal methods, refer to NAVFAC [MO-230](#).

5-17.3 Piping Materials

Refer to [Chapter 9](#) of this UFC for information regarding piping materials.

This Page Intentionally Left Blank

CANCELLED

CHAPTER 6 INTERTERMINAL AND INSTALLATION PIPELINES

6-1 INTRODUCTION

This chapter provides guidance for the design of pipelines. Military pipelines are typically either [interterminal pipelines](#) which are cross country and connect government installations, or [installation pipelines](#) which connect POL facilities within an installation. The primary differences are that [interterminal pipelines](#) cross public and private properties, streets, highways, railroads, and utility rights-of-way, whereas [installation pipelines](#) do not. [Interterminal pipelines](#) may be dedicated lines connecting two or more facilities or privately owned common carrier lines serving several commercial or military shippers. In some cases, the shipping facility may consist of a relatively short spur which delivers the fuel to the suction side of a pumping station which is part of the main line of a larger pipeline system. Pipeline receiving and dispensing facilities are normally part of a bulk fuel storage facility, which is discussed in [Chapter 3](#) of this UFC. Special requirements for aviation turbine Fuels are in [Chapter 4](#) of this UFC.

6-2 GENERAL REQUIREMENTS

[Chapter 2](#), General Design Information, contains important information on fueling facilities. Do not start the design of any fueling system without first becoming completely familiar with [Chapter 2](#) of this UFC.

6-3 DESIGN REQUIREMENTS

6-3.1 Fuel Segregation

[Clean products](#), such as diesel fuel and [distillate](#)-type burner fuels, may be shipped in the same system without segregation. Batches are usually pumped product to product, but they may be separated by fresh or suitably treated water. Separate piping systems are required for residual fuels. For [DoD](#) projects, provide a dedicated pipeline for aviation turbine fuels.

6-3.2 Applicable Regulations

Interterminal and installation pipelines shall be designed as described below. Where federal, state, or local regulations are more restrictive than the requirements indicated, the more restrictive requirements shall apply.

6-3.2.1 Installation Pipelines

All [installation pipelines](#) shall be designed in accordance with [ANSI/ASME B31.3](#).

6-3.2.2 Interterminal Pipelines

The U.S. Department of Transportation regulates the design, construction and operation of [interterminal pipelines](#) for liquid petroleum. [Intrastate interterminal pipelines](#) shall be

designed in accordance with [ANSI/ASME B31.4](#). [Interstate interterminal pipelines](#), shall be designed in accordance with the requirements of [49 CFR Part 195](#).

6-3.3 Sampling

Provide a means for taking samples of the products shipped.

6-3.4 Pigging

Pipelines shall be smart piggable including long radius elbows and barred fittings unless otherwise directed by [Service Headquarters](#).

6-3.5 Surge Suppression

Provide surge suppressors for hydraulic shock when required.

6-4 PIPING SYSTEMS

Refer to [Chapter 9](#) of this UFC for information regarding piping systems.

6-5 EQUIPMENT

Equip all pipelines with meters and basket strainers, and provide the capability to install a proving meter.

6-5.1 Meters

6-5.1.1 Meters – Positive Displacement

Use flange-connected, cast steel bodied positive displacement meters of the desired pressure and flow rating to meet applicable service requirements. Ensure that meter has case drain and register. Provide \1\ meter with temperature compensation and adjustable [calibration](#) /1/ where there is custody transfer. Ensure meter accessories are compatible with either the mechanical or electronic support equipment selected. Consult the appropriate [Service Headquarters](#) for requirements for the meter to communicate to a remote location or equipment.

6-5.1.2 Meters – Turbine

Use flange-connected steel bodied turbine meters of the desired pressure and flow rating to meet applicable service requirements. Provide a flow straightener before turbine meters or provide a straight length of pipe at a minimum of ten pipe diameters upstream and five pipe diameters downstream of all turbine meters, or as required by manufacturer. Ensure meter has case drain and register. Provide \1\ meter with temperature compensation and adjustable [calibration](#) /1/ where there is custody transfer. Ensure all supporting equipment for meter is compatible with the turbine meter selected. Consult the appropriate [Service Headquarters](#) for requirements for the meter to communicate to a remote location or equipment. Consider the use of a card-

operated or key-operated data acquisition system. Cards or keys, as appropriate, are coded to identify the receiver of the fuel and to allow access to the fuel. The quantities taken are transmitted to a data-receiving device by electronic pulse transmitters mounted on each meter, and each transaction is automatically recorded.

6-5.2 Manual Valves

6-5.2.1 Materials of Construction

Require valves to have carbon steel bodies and bonnets. Do not allow valves with aluminum, cast iron, or bronze materials. Use only API fire-safe valves.

6-5.2.2 Isolation Valve Types

a) [Double Block and Bleed Isolation Valves](#):

- (1) Use these for separation of product services, on tank shell connections, when piping goes above or below ground, between pier and tank storage, and other locations critical to pressure-testing of piping.
- (2) Plug Valves ([Double Block and Bleed](#)): Use lockable, double-seated, tapered lift, plug type valves with an automatic body bleed between the seats ([double block and bleed](#)) in critical applications such as separation of product services, on each line at the shore end, when piping goes above or below ground, between pier and tank storage, and other locations critical to pressure-testing of piping. Valves shall be designed so that if the synthetic seating material is burned out in a fire, a metal-to-metal seat will remain to affect closure and comply with [API Std 607](#). Lubricated plug valves are not allowed. Include integral body cavity [thermal relief valve](#).
- (3) Ball Valves ([Double Block and Bleed](#)): Use double-seated, trunion mounted, lockable, ball type valves with a body bleed between the seats ([double block and bleed](#)). These will be very rarely used but are acceptable as an alternative to [double block and bleed](#) plug valves in applications where the valve is operated very infrequently. An example is isolation valves in the middle of piers that are only closed to perform pressure testing of piping. Valves shall be designed so that if the synthetic seating material is burned out in a fire, a metal-to-metal seat will remain to affect closure and comply with [API Std 607](#). Include integral body cavity [thermal relief valve](#).

- (4) Gate Valves: Use double-seated, lockable, gate type valves with a body bleed between the seats ([double block and bleed](#)). These will be very rarely used but are acceptable as an alternative to [double block and bleed](#) plug valves and [double block and bleed](#) ball valves only when other [double block and bleed valves](#) will not physically fit. Valves shall be designed so that if the synthetic seating material is burned out in a fire, a metal-to-metal seat will remain to affect closure and comply with [API Std 607](#). Single seated gate valves are not allowed. Include integral body cavity [thermal relief valve](#).
- b) Quick Opening/Frequent Opening Isolation Valves
 - (1) Use these for less critical applications where [double block and bleed](#) shutoff is not required.
 - (2) Ball Valves: Ball type valves may be used as valves for quick or frequent opening applications when a [double block and bleed valve](#) is not required. Ball valves shall be designed so that if the synthetic seating material is burned out in a fire, a metal-to-metal seat will remain to affect closure and comply with [API Std 607](#). Use Teflon or Viton synthetic seals or seating material. Use full port ball valves with exact same diameter of the pipe within ten pipe diameters upstream and/or five pipe diameters downstream of a flow or pressure control valve, or a flow-sensing device such as a venturi. Valves should comply with [API Std 608](#).
- c) Butterfly Valves: Butterfly valves are not allowed.
- d) Use full port valves with exact same diameter of the pipe when line [pigging](#) is required.

6-5.2.3 Isolation Valve Operators

Provide manually operated valves not specified for remote, automatic, or emergency operation. Use geared operators for ball and [double block and bleed valves](#) larger than 6 inches (150 mm). [Double block and bleed](#) gate, ball, and [double block and bleed valves](#) specified for remote, automatic, or emergency service may have electric motor operators with suitable torque limiting controls if approved by [Service Headquarters](#). For remote valves, consider using solar battery packs to reduce cost of routing power for the motor operators. Provide locking tabs on isolation valves to allow padlocks to be used to lock out valves during maintenance. Provide chain operators on valves which are located 72 inches (1800 mm) or higher above grade.

6-5.2.4 Isolation Valve Locations

Provide valves in product piping systems to control flow and to permit isolation of equipment for maintenance or repair. Provide additional valves at required locations necessary to conduct a valid [hydrostatic test](#). Provide manually operated valves, except where motor operators are specifically authorized by applicable standard drawings or technical specifications. Use [double block and bleed type isolation valves](#) for separation of product services, on tank shell connections (ASTs over 12,000 gallons (45,800 L) only), when piping goes above or below ground, between pier and tank storage, and other locations critical to periodic pressure-testing of piping. Quick opening/frequent opening type isolation valves may be used for less critical applications where [double block and bleed](#) shutoff is not required. Before adding isolation valves, evaluate piping system and make modifications to prevent pressure buildup caused by thermal expansion. Review paragraph on “Relief Valves” in [Chapter 9](#) of this UFC. As a minimum requirement, provide isolation valves at the following locations:

- a) Provide a [double block and bleed isolation valve](#) on each branch line at the point of connection to the main product pipeline or header.
- b) Provide a [double block and bleed isolation valve](#) on the product pipeline or header just before the line leaves a pumping station.
- c) Provide a [double block and bleed isolation valve](#) at the inlet and outlet connection of each line strainer, [filter/separator](#), meter, diaphragm control valve, [thermal relief valve](#), and other equipment that requires periodic servicing. One inlet and one outlet [double block and bleed isolation valve](#) may be used to isolate more than one piece of adjacent equipment which are connected in series.
- d) Provide a [double block and bleed isolation valve](#) on the upstream and downstream side of each [line blind](#) at connections to cross country pipelines.
- e) Provide a [double block and bleed isolation valve](#) on each main distribution pipeline immediately downstream of the branch connection to each existing or future operating storage facility served by the pipeline.
- f) Provide a [double block and bleed isolation valve](#) at intermediate points of approximately 10 miles (16 km) in cross country distribution pipelines to facilitate isolation of a section of the line for maintenance and repair.
- g) Provide a [double block and bleed isolation valve](#) on each side of water crossing exceeding 100 feet (30 m) in width, and near the shoreline of a submerged sea pipeline.

- h) Provide a [double block and bleed isolation valve](#) at critical points where pipes cross under runways, taxiways, and roadways.
- i) For low-point drains and high-point vents.

6-5.2.5 Isolation Valve Pits

Provide [fiberglass](#) or concrete pits with a rolling or hinged cover designed in accordance with the DoD Standard Design [AW 78-24-28](#) for all isolation valves installed in non-traffic areas on underground fuel systems. Design valve pits and valve operators so that the valves can be operated by personnel, without confined space entry.

6-5.3 Other Valves (Except Diaphragm Control Valves)

6-5.3.1 Check Valves

Use check valves to prevent backflow through pumps, branch lines, meters, or other locations where runback or reverse flow must be avoided. Check valves may be of the swing disk, globe, dual plate hinged disk, spring-loaded poppet, ball, or diaphragm-actuated types. Use checks of soft-seated non-slamming type with renewable seats and disks. Ensure check valves conform to [API Spec 6D](#). Use diaphragm non-surge check valves with flow control feature on the discharge of all pumps. When using non-surge check diaphragm control valves on pump discharge, consider the use of a spring type wafer check before the diaphragm valve to prevent sudden flow reversals during shutdown from passing back thru the pump before the diaphragm control valve diaphragm chamber is filled and reacts by closing the valve.

6-5.3.2 Thermal Relief

Provide [thermal relief valves](#) around shutoff and check valves to relieve excessive pressures caused by thermal expansion of liquid trapped between shutoff points. See Facility Plates [023](#), [024](#), [025](#) and [026](#).

6-5.4 Diaphragm Control Valves

Hydraulically operated, single-seated, globe type, diaphragm actuated control valves are used extensively in fueling systems as control valves. These valves consist of a main valve and a pilot control system. The valve is operated by varying the amount of pressure above the diaphragm. Since the chamber above the diaphragm exposes a greater area of the diaphragm to chamber pressure than the area of the disc exposed to line pressure, an equal pressure in the chamber and pipeline results in a greater force being applied to the top of the disc. This forces the disc against the seat, thus closing the valve. By selecting the proper pilot control system, these valves can be used in numerous ways to control flow, pressure, and level within fueling systems.

Use extreme care when including these valves on pipelines as they can significantly contribute to [surge](#) potential, if closing time is too short. When properly adjusted, they can reduce [surges](#).

6-5.4.1 Open/Close Operation

This is the most basic operation of hydraulically operated diaphragm control valves. The operation is accomplished by applying pressure above the diaphragm to close the valve and relieve that pressure to allow line pressure to open the valve. The pilot trim used to perform this operation is a three-way valve which can be controlled by a solenoid, hand, pressure, pressure differential, or a float.

6-5.4.2 Throttling Operation

This is the other main method of controlling the hydraulically operated diaphragm control valve. In this case, the valve modulates to any degree of opening, in response to changes in the throttling control. The throttling control reacts to a pressure, or a pressure differential across the main valve, or pressure differential across an [orifice plate](#) to regulate the position of the disc in the main valve; provide full port manual isolation valves if they are placed within these limits.

6-5.4.3 Check Valve Function

This is a unique function of a control valve. In this case, the main valve outlet pressure is connected to the diaphragm cover. Therefore, if the downstream outlet pressure exceeds the inlet pressure, which normally holds the valve open, the valve will close and prevent backflow.

6-5.4.4 Remote Operations

Hydraulically operated diaphragm control valves can be operated remotely. This is accomplished by installing tubing from the point of pressure sensing to the valve or by using remote-controlled solenoids within the trim.

6-5.4.5 Materials of Construction

Use stainless steel pilots and stainless steel tubing. Use bodies, bonnets, and covers made of stainless steel, internally plated (chrome) steel, or internally plated (nickel) nodular iron. Provide Viton or Buna-N diaphragm and disc ring. Enclose all electrical apparatus according to classification of the area in which they are installed. Provide a means to wire seal all adjustable pilots. Do not use aluminum valves.

6-5.4.6 Applications

For pipeline systems, use hydraulically operated diaphragm control valves in the following applications:

- a) Rate of flow control.
- b) Pressure reduction.
- c) Pressure relief.
- d) Excess flow shutdown.

6-5.4.7 Combinations

A combination of these controls is also possible.

6-5.5 Strainers

Require a strainer to protect [centrifugal pumps](#), unless it precludes meeting the net positive suction head of the pump. Whether or not strainers are installed on the suction side of [centrifugal pumps](#), install a spool piece so that temporary strainers can be installed during startup of the system. Strainers are required on the suction side of all pumps, meters, and receipt filtration. Strainers are not required upstream of issue [filter/separators](#) or diaphragm control valves. Also:

- a) Use flanged strainers constructed of steel and fitted with removable baskets of fine Monel metal or stainless steel mesh with large mesh reinforcements.
- b) Unless otherwise specified, provide a fine screen mesh as follows:

	Mesh	Size of Opening
Pump suctions (Centrifugal)	7	0.108 inch (2.74 mm)
Pump suctions (Positive Displacement)	40	0.016 inch (0.40 mm)
Receipt Filtration	40	0.016 inch (0.40 mm)
Meter inlets (unless downstream of a filter/separator)	40	0.016 inch (0.40 mm)

- c) In all cases, ensure the effective screen area is not less than three times the cross sectional area of the pipe.
- d) Strainers upstream of pump shall be quick opening, single screw type with drain connection at bottom.
- e) Provide pressure gauges on both sides of the strainer and a differential type gauge across the strainer.

6-5.6 Surge Suppressors

Every effort should be made to control hydraulic [surge](#) or shock to acceptable limits by the design of the piping system rather than by the use of [surge suppressors](#). Where this is not possible or becomes extremely impractical, [surge suppressor\(s\)](#) may be incorporated. Use the diaphragm or bladder type equipped with a top-mounted liquid-filled pressure gauge, wafer-style check valve at the bottom, drain above the check valve, and isolation valve. Provide a needle valve around the check valve to permit controlled bleed back of the surge suppresser without rebounding. Locate [surge suppressors](#) as close as possible to the point of shutoff that is expected to cause the shock. [Surge suppressors](#) can reduce shock pressure but will not eliminate it entirely. The preferred solution to hydraulic shock is conservative piping design, use of loops, and slow-closing valves. [Surge suppressors](#) are strictly a last resort solution and require the approval of [Service Headquarters](#) prior to designing into a system.

6-5.7 Pigging Equipment

Equip all pipelines with outlets to allow the connection of pig launchers and receivers. Design the outlets so that they can accommodate internal nondestructive inspection trains. Provide sufficient curvature of bends in the pipeline to permit free passage for such equipment. Provide tees with, factory installed internal guide bars, at all branch connections.

6-5.8 Pumps

Primary pumping facilities are discussed in [Chapter 3](#) of this UFC. If multiple pump stations are required to keep pipeline pressure within safe limits, provide them at appropriate locations. [Chapter 3](#) also provides guidance for those pumping facilities.

6-5.9 Sampling Connections

Provide connections for sampling fuels on each section of a fuel transfer piping system. Install sampling and testing connections at receiving points, tank outlets, inlet and outlet sides of [filter/separators](#), fuel dispensing points, and between isolation valves so that remaining fuel in each portion of a fuel transfer pipeline can be sampled. Where possible, install sampling connections in vertical runs. Provide a 1/4-inch (8 mm) diameter sample point with a probe, ball valve, and quick disconnect with dust cap.

6-5.10 Special Consideration for Aviation Turbine Fuels

For inbound filtration of aviation turbine fuels, refer to [Chapter 4](#) of this UFC.

6-6 PRODUCT RECOVERY SYSTEMS

Provide a product recovery system to collect and store usable aviation turbine fuel that would otherwise become waste from operational or maintenance activities. Consider a

product recovery system for other products. See [Chapter 8](#) of this UFC for product recovery systems.

6-7 CANOPIES

\1\

6-7.1 Canopies to Protect Fixed Assets from Extreme Weather Conditions

Unless otherwise directed by [Service Headquarters](#), provide a canopy to protect fixed facility assets, operators, and equipment from the extreme weather conditions (I.E. re-occurring/sustained extreme icing/snow or desert like conditions. Fixed facilities and equipment include but are not limited to: pump pads, filtration pads, meter pads, isolation valve pads, tank truck and tank-car off-loading and loading equipment pads, control panels, electrical panels, and motor control centers (MCCs). Ensure structural design is in accordance with [UFC 1-200-01](#) and [UFC 3-301-01](#).

/1/

6-7.2 Canopies to Reduce Stormwater

Do not provide a canopy to preclude rain from reaching the containment area unless it is required by federal, state, or local regulations; or it is economically justified by reducing the size of the concrete remote spill containment or spill treatment system; or if directed by [Service Headquarters](#). At a canopy over a tank truck or tank car loading and off-loading containment area, ensure that the underside of the canopy is high enough to provide operator head room when walking on top of the truck or car. Ensure structural design is in accordance with [UFC 1-200-01](#) and [UFC 3-301-01](#).

6-8 SPECIAL CALCULATIONS

Calculate pipeline filling/venting times and draining/stripping times. The larger and the longer the pipeline, the greater the volume of fuel required to fill the line and, therefore, the greater the volume of air required to be vented. Undersized vent lines will delay filling the lines and delay changeover of products in multiproduct lines. Size vent lines to allow filling of the line at not more than four times the design transit time of the line. Where applicable, connect vent lines to system drain lines to avoid spills to the environment. Check vent line air velocity, which must not exceed the allowable air velocity to avoid electrostatic buildup, in accordance with [API RP 2003](#). Vent rate must be not less than the lowest allowable pumping rate from ship or shore. Vent rate must be less than the design transit velocity to minimize hydraulic shock.

CHAPTER 7 GROUND PRODUCTS FUELING FACILITIES

7-1 INTRODUCTION

This chapter provides guidance for the design of ground products (gasoline, diesel) fueling facilities and covers government vehicle [motive fuel filling stations](#) and tactical refueler truck loading facilities. Private vehicle [filling stations](#), such as exchange service stations, are not included.

7-1.1 Types of Facilities

The following three types of filling stations may be required (see Facility Plates [011](#), [012](#) and [013](#)):

- a) A [filling station](#) for dispensing [motive fuel](#) gasoline and diesel into government (commercial type) sedans, vans, and small trucks. See [Facility Plate 011](#).
- b) A [filling station](#) for dispensing [motive fuel](#) gasoline and diesel into tactical vehicles. See [Facility Plate 011](#).
- c) A truck loading facility for loading gasoline and diesel into tactical [refueler](#) vehicles. See Facility Plates [012](#) and [013](#).

7-2 GENERAL REQUIREMENTS

[Chapter 2](#), General Design Information, contains important information on fueling facilities. Do not start design of any fueling system without first becoming completely familiar with [Chapter 2](#) of this UFC.

7-3 DESIGN REQUIREMENTS

7-3.1 Fuel Segregation

Provide separate receiving, storage and distribution systems for each grade or type of fuel. Except as otherwise approved by Service Headquarters, prevent misfueling (transferring a type of fuel other than the type intended) by using different size piping, valves, adaptors, nozzles, etc.

In the CONUS, use color coding in accordance with [API RP 1637](#). In non-CONUS facilities, use host nation standard if it is different than [API RP 1637](#). Use [API RP 1637](#) if no other standard is in effect. For Air Force projects to refer to [AFTO 37-1-1](#).

7-3.2 Facility Size

In each [filling station](#), provide one commercial-type dispensing unit which displays volume only for each 100 vehicles assigned to the activity. The total amount of storage capacity in each station should be approximately twice the capacity of all vehicle fuel

tanks, by grade or type of fuel, assigned to the activity. Minimum storage capacity for any grade or type of fuel is 5,000 gallons (19,000 L) unless approved by [Service Headquarters](#). For tactical refueler truck loading facilities, see [Chapter 3](#) of this UFC.

7-3.3 Facility Configurations

In general, for control and safety, separate the three types of [filling stations](#). For a relatively small installation or one on which there is a limited amount of activity expected at one time, it may not be practical to provide totally separate facilities. In those cases, separate the functions as much as possible to minimize mixing traffic of commercial-type vehicles from tactical vehicles and, more importantly, from mixing tactical [refuelers](#) which are being loaded with relatively large quantities of fuel from other vehicles which are being fueled for their own engine ([motive fuel](#)). \1\ Filling stations must be configured to comply with all [NFPA 30A](#) siting and storage requirements./1/

7-3.4 Shelters

For staffed facilities, provide a shelter for personnel, records, and tools.

7-3.5 Concrete Fueling Area – Filling Stations

Create a fueling area constructed of concrete by surrounding fueling islands with a concrete slab graded at a minimum of 1 percent away from the islands.

7-3.6 Concrete Fueling Area – Tactical Refueler Truck Loading Facilities

Provide concrete spill containment areas and concrete remote spill containment systems as described for truck loading facilities in [Chapter 3](#) of this UFC.

7-3.7 Canopies

7-3.7.1 Canopies to Protect Fixed Assets

Provide a canopy for protection from the elements of fixed facility assets and equipment \1\ as directed by [Service Headquarters](#), for all pumps, meters, strainers, filters, /1/ control panels, electrical panels, and motor control centers (MCCs). Ensure structural design is in accordance with [UFC 1-200-01](#) and [UFC 3-301-01](#).

7-3.7.2 Canopies to Reduce Stormwater at Tactical Refueler Truck Loading Facilities

Do not provide a canopy to preclude rain from reaching the containment area unless it is required by federal, state, or local regulations; or it is economically justified by reducing the size of the concrete remote spill containment or spill treatment system; or if directed by [Service Headquarters](#). Ensure that the underside of the canopy is high enough to provide operator head room when walking on top of the truck. Ensure structural design is in accordance with [UFC 1-200-01](#) and [UFC 3-301-01](#).

7-3.7.3 Canopies to Reduce Stormwater of Filling Stations

Do not provide a canopy to preclude rain from reaching the concrete fueling area unless it is required by federal, state, or local regulations; or a concrete remote spill containment or treatment system is required by federal, state, or local regulations and it is economically justified by reducing the size of the remote spill containment or spill treatment system; or if directed by [Service Headquarters](#). Ensure structural design is in accordance with [UFC 1-200-01](#) and [UFC 3-301-01](#).

7-3.8 Regulations

Design must comply with [NFPA 30](#), [NFPA 30A](#), and [API RP 1615](#).

7-3.9 Bottom Loading

The [bottom loading](#) of [refuelers](#) is required if the [refuelers](#) are equipped for it. However, there are Army [refuelers](#) which are not equipped for [bottom loading](#) and which will be in inventory for several years. Therefore, consult [Service Headquarters](#) before providing [top loading](#) at tactical refueler fillstands.

\1\

7-3.10 Truck Offload and Loading Facilities

Design of service station truck offload and loading facilities must comply with [NFPA 30](#), [NFPA 30A](#) and [40 CFR Part 112](#). Also, do not locate truck offload or tactical refueler loading facilities closer than 25 feet (7.6 m) from above ground tanks, buildings, roads, overhead power lines, pad-mounted transformers, and property lines. With the exception of overhead power lines, these minimum separation distances may be permitted to be reduced to 15 feet (4.6 m) for Class II or III liquids.

/1/

7-4 STORAGE TANKS

[Chapter 8](#), Atmospheric Storage Tanks, contains information on aboveground and underground storage tanks. For ground products fueling facilities underground, horizontal tanks are preferred. Follow federal, state, and local regulations when determining use of AST or UST.

7-5 PIPING SYSTEMS

7-5.1 Piping System – Tactical Refueler Facilities

For systems serving tactical refueler fillstands see the requirements for tank truck loading facilities in [Chapter 3](#) of this UFC.

7-5.2 Aboveground Piping System – Filling Stations

Follow state or local regulations when they exceed these requirements. When they do not exceed them, provide as described in [Chapter 9](#) of this UFC with the following exceptions:

- a) Piping 4 inches (100 mm) and larger shall be butt welded or socket welded. Use flange connections for joining pipe to equipment.
- b) Piping smaller than 4 inches (100 mm) may be butt welded, or socket welded. Use flange connections, or socket weld connections with unions for joining pipe to equipment. Threaded end connections may be used only where butt welded or socket welded connections cannot physically be provided.
- c) Branch outlet fittings do not have to be designed to be [radiographed](#).

7-6 EQUIPMENT DESCRIPTIONS

7-6.1 Filling Stations

7-6.1.1 Fuel Dispensers

Use a commercially available dispenser with a self-contained electric motor and pumping unit or a remote pumping type where the pump and motor are located in the storage tank. If an in-tank type of pump is used, ensure that it is equipped with a reduced start volume as a leak check. Provide a meter for each dispenser. Dispenser flow rates are typically a maximum of 10 gpm (0.6 L/s); follow state and local regulations for actual maximum. Designer shall check with state and local regulations for limitations on dispenser flowrates. Dispensing system will include management control system, printers, computers, and microprocessors. Equip fuel dispensers with an inline filtration system capable of sediment removal to 10 mg/L or less. Add emergency break-away hose connections at each fuel dispenser in accordance with [NFPA 30A](#). Where liquid is supplied to the dispenser under pressure, provide an emergency shutoff valve, incorporating a fusible link, in the supply line at the base of each dispenser as required by [NFPA 30A](#). Equip dispensing islands with [impervious](#) spill containment pans under the dispensers.

7-6.1.2 Card and Key Locks

Consider the possible economic and operational advantages of using an electronic card or key system which permits 24-hour unmanned operation of the facility. These types of systems are comprised of a card/key reader which is located near the service pump. The reader is activated by a card or key and accumulates issues and customer data which is downloaded to a central computer on a periodic basis. Activities with capitalized fuel, that is petroleum product owned by \1\ DLA-Energy /1/, are eligible for

projects to install automated card/key lock systems. Activities with capitalized fuel report inventories of these products to \1\ DLA-Energy /1/ through a system called BSM-E. Automated systems to control capitalized inventories must be able to interface with the BSM-E. These types of automated systems are managed under the AFSS program by \1\ DLA-Energy /1/. It should be noted that AFSS equipment is used to control issues of product and is not an automated tank gauging system. Further information on AFSS systems and funding programs may be obtained by contacting DES-Energy.

7-6.2 Tactical Refueler Truck Loading Facilities

Equip similar to truck loading facilities covered in [Chapter 3](#) of this UFC except provide a grounding reel in lieu of the high-level shutoff/ground detecting system. Verify the type of [nozzle](#) required by the user.

7-6.3 Valves

For systems serving tactical refueler fillstands see the requirements for tank truck loading facilities in [Chapter 3](#) of this UFC. The below requirements apply to [filling station](#) only.

7-6.3.1 Materials of Construction

Require valves to have carbon steel bodies and bonnets. Do not allow valves with aluminum, cast iron, or bronze materials. Use only API fire-safe valves.

7-6.3.2 Isolation Valve Types

- a) Ball Valves: These are the only approved quick opening/frequent opening isolation valves. Ball type, lockable, valves designed so that if the synthetic seating material is burned out in a fire, a metal-to-metal seat will remain to affect closure and comply with [API Std 607](#). Use Teflon or Viton synthetic seals or seating material. Valves should comply with [API Std 608](#).
- b) [Double Block and Bleed Isolation Valves](#): Do not provide unless directed by [Service Headquarters](#).
- c) Lubricated Plug Valves: Lubricated plug valves are not allowed.
- d) Gate Valves: Gate valves are not allowed.
- e) Butterfly Valves: Butterfly valves are not allowed.

7-6.3.3 Isolation Valve Operators

Manually operate valves not specified for remote, automatic, or emergency operation. Use geared operators for ball valves larger than 6 inches (150 mm). Provide locking tabs on isolation valves to allow padlock to be used to lock out the valves during

maintenance. Provide chain operators on valves which are located 72 inches (1800 mm) or higher above grade.

7-6.3.4 Isolation Valve Locations

Provide isolation valves in piping systems to control flow and to permit isolation of equipment for maintenance or repair, or as necessary to conduct a valid [hydrostatic test](#). As a minimum requirement, provide isolation valves at the following locations:

- a) Where piping goes underground or comes aboveground and requires periodic pressure testing.
- b) At all subsurface and aboveground piping connections to storage tanks.
- c) On the suction side and discharge side of each pumping unit, except the suction side of vertical [centrifugal pumps](#) installed in underground tanks.
- d) On the inlet and outlet connection of each line strainer, meter, diaphragm control valve, and other equipment that requires periodic servicing. One inlet valve and one outlet valve may be used to isolate more than one piece of adjacent equipment which are connected in series.

7-6.4 Diaphragm Control Valves

These valves are not required in [filling stations](#).

7-6.5 Other Valves

7-6.5.1 Check Valves

Use check valves to prevent backflow through pumps, branch lines, meters, or other locations where runback or reverse flow must be avoided. Check valves may be of the swing disk, globe, dual plate hinged disk, spring-loaded poppet, ball, or diaphragm-actuated types. Use checks of soft-seated non-slamming type with renewable seats and disks. Ensure check valves conform to [API Spec 6D](#).

7-6.5.2 Thermal Relief

Provide [thermal relief valves](#) around isolation and check valves to relieve excessive pressures caused by thermal expansion of liquid trapped between shutoff points. See Facility Plates [023](#), [024](#), [025](#) and [026](#).

7-7 VAPOR RECOVERY

Provide vapor recovery in accordance with guide specifications unless there are more stringent federal, state, and local codes or regulations. Some requirements are in [40 CFR Part 60 Subpart XX](#). If gasoline is being handled, provide, as a minimum, Stage I vapor recovery and the piping for Stage II. If Stage II is not required by local or state regulations at time of installation, cap the vapor return pipe at the dispenser.

CANCELLED

This Page Intentionally Left Blank

CANCELLED

CHAPTER 8 ATMOSPHERIC STORAGE TANKS

8-1 INTRODUCTION

This chapter provides guidance for the design of [bulk storage tanks](#), [operating storage tanks](#), ground vehicle fueling tanks, miscellaneous use tanks, product recovery system tanks, [contaminated fuel](#) storage tanks, and jet engine test cell fuel storage tanks. Design guidance on issues related to storage tanks such as protection, location, coatings, product recovery, and spill containment systems are also covered in this chapter. [Ballast water](#) storage tanks are covered in [Chapter 5](#) and pressurized tanks for storage of LPG are covered in [Chapter 10](#) of this UFC. This chapter generally applies to new tanks. Refer to [Chapter 12](#) for repair or refurbishment of existing tanks.

8-2 GENERAL REQUIREMENTS

[Chapter 2](#), General Design Information, contains important information on fueling facilities. Do not start design of any fueling system without first becoming completely familiar with [Chapter 2](#) of this UFC.

8-3 GENERAL CRITERIA

Design liquid fuel storage tanks to comply with the operational requirements of the particular command having jurisdiction of the facility. Ensure that the design is appropriate for the mission of the facility. Consider the operational requirements of the users of the fuel.

8-3.1 Materials

All aboveground storage tanks shall be constructed of steel or concrete encased steel.

8-3.2 Protection

Provide protection to preserve product quality and ensure minimal losses by evaporation, dilution, leakage, substitution, theft, [contamination](#), attack, sabotage, fire, and damage to the environment. Use aboveground steel tanks unless the mission of the facility or other practical considerations dictate that underground tanks be used. [Cut and cover](#) (buried vertical) tanks are not normally used in the CONUS. [Cut and cover](#) tanks may be required if the dispensing system is located in clear zones or explosive cordon areas. Conduct economic, operational, and mechanical analyses of remotely locating the pump house/system from the [hydrant system](#) versus constructing [cut and cover](#) tanks. \1\ For tanks located in areas subject to flooding, design in accordance with [NFPA 30](#). /1/

8-3.3 Design Requirements

Fuel storage facilities provide an operating and reserve supply of fuel. The types and sizes of storage tanks depend on safety, economics, terrorist activity, locality, and

intended service. Provide separate storage for each type and grade of fuel. For aviation activities, provide a minimum of two tanks for each type of fuel.

8-3.4 Storage Capacity

The capacity or size of each fuel storage tank is based upon the logistical and mission requirements for the facility and any other facility to be supported from it. For a stated volume of each fuel, fewer tanks of larger size will result in maximum economy. The appropriate [Service Headquarters](#) with \1\ DLA-Energy /1/ approval will determine the number and size of tanks required. Rule of thumb guidance for operating storage and bulk storage capacity is available in Navy [UFC 2-000-05N/P-80](#). Provide a minimum of two tanks at aviation activities for each type of aviation turbine fuel to receive and isolate new receipts until tested and checked for quality and quantity while the facility continues to function with stocks on hand. In general, capacities of individual tanks should not exceed 50 percent of the total storage volume required for each type and grade of fuel. Do not provide tanks with capacities greater than 100,000 [barrels](#) (16,000,000 L) except when larger tanks are specifically authorized by [Service Headquarters](#).

8-3.5 Tank Spacing

8-3.5.1 Vertical Tanks

Provide a minimum distance between the shells of vertical tanks, both aboveground and underground, of not less than one diameter of the larger tank.

8-3.5.2 Horizontal Underground Tanks

Provide a minimum clearance between shells of adjacent horizontal underground tanks of 3 feet (0.9 m).

8-3.5.3 Horizontal Aboveground Tanks (Single-Wall and Double-Wall Steel) (Non-Fire Resistant and Non-Protected)

Provide a minimum clearance between aboveground horizontal tanks with capacities \1\ 50,000 gallons (189,300 L) /1/ or under as follows:

- a) Arrange tanks in pairs with a minimum of 5 feet (1.5 m) between tanks in each pair and 10 feet (3 m) between adjacent tanks of two pairs in the same row.
- b) Space adjacent groups of more than two pairs in a single row with at least 20 feet (6 m) between the nearest tanks of the groups.
- c) Provide a minimum end-to-end spacing between tanks in longitudinal rows of 20 feet (6 m).

- d) Provide a UL nameplate on tanks stating that the tanks are approved for that material and service.
- e) In addition to requirements listed in this paragraph, tanks located in facilities governed by [NFPA 30A](#), such as marine/motor fuel dispensing facilities, shall comply with [NFPA 30A](#).

8-3.5.4 Horizontal Aboveground Tanks ([Fire Resistant](#))

Provide minimum clearance and spacing between fire resistant, secondarily contained aboveground horizontal tanks in compliance with [NFPA 30](#) and [NFPA 30A](#) as applicable.

8-3.5.5 Horizontal Aboveground Tanks ([Protected](#))

Provide minimum clearance and spacing between protected, secondarily contained aboveground horizontal tanks in compliance with [NFPA 30](#) and [NFPA 30A](#) as applicable.

8-3.6 Distance from Buildings and Property Lines

Locate tanks a sufficient distance from buildings and property lines to prevent the ignition of vapors from the tank and to protect buildings and their occupants or contents from damage by a tank fire. Assume that the maximum internal pressure in a fire exposure will not exceed 2.5 psig (17 kPa). As a minimum, comply with requirements of the following paragraphs.

8-3.6.1 Underground Tanks

Locate underground tanks with respect to buildings or similar structures so that the soil pressure created by the building foundations will not be transmitted to the tank. Pumping facilities which are often located directly above underground tanks are accepted. Locate horizontal cylindrical tanks less than or equal to 12 feet (3.7 m) in diameter not less than 10 feet (3 m) from the nearest point of an adjacent building or property line. Locate vertical underground tanks at least 25 feet (7.6 m) from the nearest point of an adjacent building and 50 feet (15 m) from the nearest property line.

8-3.6.2 Aboveground Tanks

Locate aboveground tanks with consideration of fire safety. The first consideration is to prevent the ignition of vapors from the tank, and the second consideration is to protect the building and its occupants or contents from damage by a tank fire. As a protective measure, provide all aboveground tanks with some form of emergency relief venting for fire exposure in accordance with [NFPA 30](#). In the following, it is assumed that all tanks are constructed or equipped so that the maximum internal pressure in a fire exposure will not exceed 2.5 psi (17 kPa). \1\ Required /1/ minimum distances for aboveground tanks from buildings and property lines are as follows:

- a) Tanks, all sizes and types, not protected or fire-resistant, containing petroleum fuels with a [flash point](#) less than 100 degrees F (38 degrees C), 100 feet (30 m) or one tank diameter, whichever is greater, \1\ with the exception that tanks /1/ located in facilities governed by [NFPA 30A](#), such as marine/motor fuel dispensing facilities, shall comply with [NFPA 30A](#) \1\ criteria /1/.
- b) Tanks, not protected or fire-resistant, containing petroleum fuels with a flash point of 100 degrees F (38 degrees C) or greater in accordance with the following:

Tank Capacity gallons (L)	Minimum Distance from Nearest Property Line Feet (m)	Minimum Distance from Nearest Building Feet (m)
275 or less (1040 or less)	10 (3.0)	5 (1.5)
276 to 750 (1041 to 2800)	20 (6.0)	10 (3.0)
751 to 12,000 (2801 to 45 400)	30 (10)	15 (4.5)
12,001 to 30,000 (45 401 to 113 500)	40 (12)	20 (6.0)
30,001 to 50,000 (113 501 to 189 000)	60 (18)	60 (18)
50,001 to more (189 001 or more)	100 (30)	100 (30)

- c) For aboveground, fire-resistant tanks in facilities governed by [NFPA 30A](#), use [NFPA 30A](#) guidelines.
- d) For aboveground, protected tanks, use [NFPA 30](#) guidelines. Protected tanks located in facilities governed by [NFPA 30A](#), such as marine/motor fuel dispensing facilities, shall comply with [NFPA 30A](#) \1\ criteria /1/.

8-3.7 Distance from Roadway, Railroads and Power Lines

\1\ For tanks located in facilities governed by [NFPA 30A](#), use [NFPA 30A](#) guidelines and [Chapter 7](#) of this UFC. For all other storage tanks, the minimum distances /1/ from adjacent roadways, railways, railroads, and overhead electric power lines are as follows:

8-3.7.1 Underground Tanks

\1\ Spacing and clearances for underground tanks shall be /1/:

- a) A minimum of 25 feet (7.6 m) from regularly traveled roads and highways, not including tank farm utility and fire access roads.
- b) 25 feet (7.6 m) from railroad spur tracks not used for through traffic.
- c) No less than 100 feet (30 m) from main railroad tracks carrying through traffic.

- d) 50 feet (15 m) from overhead electric power transmission and distribution wires.

8-3.7.2 Aboveground Tanks

- a) The greater of 100 feet (30 m) or one tank diameter from regularly traveled roads and highways, not including tank farm utility and fire access roads.
- b) 50 feet (15 m) from railroad spur tracks not used for through traffic.
- c) 200 feet (60 m) from main railroad tracks carrying through traffic.
- d) 50 feet (15 m) from overhead electric power transmission and distribution wires.

\1\ /1/

8-3.8 Distance from Tank Truck and Tank Car Off-Loading and Loading Facilities

\1\ For tanks located in facilities governed by [NFPA 30A](#), use [NFPA 30A](#) guidelines and [Chapter 7](#) of this UFC. For fire resistant or protected horizontal aboveground tanks and underground tanks, provide a minimum separation of 25 feet (7.6 m) from tank truck and tank car off-loading and loading facilities. For all other tanks, provide a minimum separation of 50 feet (15 m) from tank truck and tank car off-loading and loading facilities. /1/

8-3.9 Interior Coatings

To extend the life of steel storage tanks, coat new tanks according to the following guidelines:

- a) Vertical tanks
 - (1) All aviation, diesel fuel marine (F-76), [additive](#), and [lube oil](#) tank. Interiors shall be 100 percent coated, including floor, shell, and underside of the roof.
 - (2) Other products. Coat the floor, the underside of the fixed roof, and the bottom 40 inches (1000 mm) of the tank shell. Additional coating of up to 100 percent requires economic justification and [Service Headquarters](#) approval. \1\ Tanks containing E85 are not to be coated internally unless otherwise approved by [Service Headquarters](#). /1/
- b) Horizontal tanks

- (1) For all products, tank interiors shall be 100 percent coated.
\\ Tanks containing E85 are not to be coated internally unless otherwise approved by Service Headquarters. /1/
- c) For all products coat the interior and exterior of carbon steel piping located inside the tank, and steel appurtenances inside all tanks.
\\ Carbon steel piping, and steel appurtenances located inside of tanks containing E85 are not to be coated internally unless otherwise approved by [Service Headquarters](#). /1/

8-3.10 Exterior Coatings

- a) Protect the exterior surface of all aboveground steel tanks by coating in accordance with appropriate guide specifications.
- b) Protect the exterior surfaces of all underground horizontal steel tanks with a factory-applied coating specified in the appropriate guide specifications.
- c) For protected tanks, with exterior steel containment, consider exterior [fiberglass](#) cladding for extremely corrosive atmospheres or seaside locations.

8-3.11 Fill Piping

Size the pipe so that the velocity does not exceed 12 feet (3.7 m) per second at maximum flow rate. Provide a means for reducing the velocity of flow to 3 feet (0.9 m) per second until the filling inlet [nozzle](#) is completely submerged and/or the floating pan has lifted off its legs.

8-3.12 Vapor Emission Control Systems

Provide a vapor emission control system for tanks that store products having a [true vapor pressure](#) of 0.75 psia (5 kPa) or more located in air pollution control areas in which the discharge of petroleum vapors is controlled or prohibited. Ensure that the system has sufficient capacity to control the vapor discharged from the tank vents at maximum filling rate in conformance with local air quality regulations. If gasoline is being handled, provide, as a minimum, Stage I vapor recovery and the piping for Stage II. If not required by local or state regulations at time of construction, connect the Stage II piping to the tank and cap it at the dispenser.

8-3.13 Strapping Tables

\\ Provide two [API MPMS Chapter 2](#) strapping tables for all tanks greater than 5,000 gallons (19,000 L). Provide one of the tables in U.S. Customary units reading in 1/16-inch increments, gallons and barrels and one in metric units reading in 2mm increments, liters and cubic meters. Provide electronic media data files. Determine [strapping](#) table

volumes for tanks of 5,000 gallons (19,000 L) and larger using physical measurements, not calculated values. The tables are to be calibrated for critical measurement and certified by a Professional Engineer. For tanks less than 5,000 gallons (19,000 L), provide strapping table certified by the tank manufacturer that reads 1/16-inch (2mm) increments in gallons (liters). /1/

8-3.14 Product Recovery Systems

8-3.14.1 General Design Considerations

Provide pumps, piping, valves, and tanks to collect and store usable aviation turbine fuel which would otherwise become waste from operational or maintenance activities. Consider a product recovery system for other products. Include a tank to collect fuel/water mixtures from tank and equipment [sumps](#), equipment drains, product saver tanks, high point vents, low point drains, and any other equipment from which fuel/water mixtures can be collected. Separate the fuel and water portions. Filter the fuel portion and return to [operating storage tanks](#). Do not discharge the water portion to surface water without additional treatment and permits or treat the water portion as wastewater. Refer to [Chapter 2](#) of this UFC for information on handling of wastewater. Refer to DoD Standard Design [AW 78-24-28](#). These systems are standard with the hydrant and [aircraft direct fueling systems](#).

8-3.14.2 Product Recovery Tanks

For hydrant and aircraft direct fueling systems provide the tank indicated in DoD Standard Design [AW 78-24-28](#). For other systems, provide a tank with, at a minimum, the following appurtenances:

- a) Level gauge.
- b) Overfill protection level control valve.
- c) High and low level switches with alarms and controls.
- d) A motor driven fuel transfer pump that returns recovered fuel back to the system through a hard piped connection.
- e) A motor driven sump pump for emptying the tank.
- f) Manual gauging hatch.
- g) Vent.
- h) ATG system for aboveground [product recovery tanks](#) having a capacity more than or equal to 4,000 gallons (15,000 L).

- i) Do not allow sight flow indicators to be installed on [product recovery tanks](#).

8-3.14.3 Vertical Storage Tanks

In addition to the [product recovery tank\(s\)](#) for the facility, all vertical storage tanks storing aviation turbine fuel should include a product saver tank with electric pump, unless the tank is equipped with a filter/separator to remove water from the sump. A product saver tank is a small aboveground tank piped and valved to allow drawing water from the bottom of the storage tank and returning the product after the water has been separated and disposed of in accordance with environmental regulations.

8-3.15 Registration

Register all tanks with the appropriate state and local agencies as required. All tanks shall have a nameplate installed in accordance with [API Std 650](#).

8-4 HORIZONTAL ABOVEGROUND TANKS (SINGLE-WALL STEEL)

8-4.1 General Design Considerations

If small factory-built aboveground storage tanks are required, use horizontal tanks. Limit tank diameter to 12 feet (3.7 m) or less and capacity to \1\ 50,000 gallon (191,000 L) or less /1/. Require tank to be of welded steel construction in accordance with [UL 142](#). Plastic and/or fiberglass aboveground storage tanks are not allowed. Requirements for all horizontal aboveground storage tanks shall comply with [NFPA 30 Chapter 22 Aboveground Storage Tanks](#). Tanks located in facilities governed by [NFPA 30A](#), such as marine/motor fuel dispensing facilities, shall comply with [NFPA 30A](#).

\1\

8-4.2 Tank Design Requirements

- a) Install the tank so that the bottom slopes downward toward one end at a slope of 1 percent. Locate transfer pumps or suction piping at the high end of the tank; locate water drawoff at low end of the tank.
- b) Provide water drawoff lines in each tank. For aviation fueling systems, arrange piping so that the fuel in the tanks may be recirculated through the filter/separators.
- c) Provide steel tanks with steel saddles or skids in accordance with UL 142. The bottom of tank is to be no more than 12 inches (300 mm) above grade to avoid the need for fireproofing. Mount steel supports on a reinforced concrete foundation.

- d) Tanks shall be inspected in accordance with [STI SP001](#) by a STI certified inspector prior to commissioning.

/1/

8-5 HORIZONTAL ABOVEGROUND TANKS (DOUBLE-WALL STEEL)

8-5.1 General Design Considerations

Limit tank diameter to 12 feet (3.7 m) or less and capacity to \1\ 50,000 gallon (191,000 L) or less /1/. Require tank to be of welded steel construction in accordance with [UL 142](#). No fiberglass aboveground storage tanks are allowed. The main advantage of double-wall steel storage tanks over single-wall steel storage tanks is that separate spill containment may not be required. \1\ Secondary containment-type tanks can be used to provide spill control per [NFPA 30](#), if the capacity of the tank is no more than 12,000 gallons (45,400 L). The tank size may be increased to 20,000 gallons (75,700 L) if Class II or III liquids are used. All of the criteria in the NFPA regulations for the appropriate application must be met before a secondary containment-type tank is used without separate spill containment. Requirements for double-wall steel horizontal aboveground storage tanks shall comply with [NFPA 30](#), the chapter entitled, "Aboveground Storage Tanks". Tanks located in facilities governed by [NFPA 30A](#), such as marine/motor fuel dispensing facilities, shall comply with [NFPA 30A](#) /1/

\1\

8-5.2 Tank Design Requirements

- a) For [flammable liquid](#) installations, require additional curbing containment based on tank filling rates if there is a chance of a fuel spill entering a critical area.
- b) Install the tank so that the bottom slopes downward toward one end at a slope of 1 percent. Locate transfer pumps or suction piping at the high end of the tank; locate [water drawoff](#) at low end of the tank.
- c) Provide [water drawoff](#) lines in each tank. For aviation fueling systems, arrange piping so that the fuel in the tanks may be recirculated through the [filter/separators](#).
- d) Provide protective [bollards](#) for tanks not surrounded by a [dike](#). Bollards shall not be less than 4 feet (1.2 m) high and 4-inches (100 mm) in diameter, of steel construction, filled with concrete, and spaced not less than 4 feet (1.2 m) on center.
- e) Provide steel tanks with steel saddles or skids in accordance with [UL 142](#). The bottom of tank is to be no more than 12 inches (300

mm) above grade to avoid the need for fireproofing. Mount steel supports on a reinforced concrete foundation. Mount rectangular (flat bottomed) tanks of 4,000 gallons (15,100 L) or greater 12 inches (300 mm) above grade to allow inspection and maintenance of the tank bottom.

- f) Require the tank to be pressure-tested after installation.
- g) Tanks shall be inspected in accordance with [STI SP001](#) by a STI certified inspector prior to commissioning.
- h) A primary tank constructed of stainless steel is permitted when required.
- i) Require support channels with anchor holes for earthquake/hurricane/flood restraint tie down.
- j) Require steel to be a minimum thickness of 3/16-inch (5 mm) for interior carbon steel tank.

/1/

8-6 HORIZONTAL ABOVEGROUND TANKS ([FIRE-RESISTANT](#))

8-6.1 General Design Considerations

When small (250 to 20,000 gallon (900 to 75,000 L) capacity) aboveground storage tanks are required and there are clearance or fire exposure problems and the additional cost can be justified, consider the use of fire-resistant storage tanks. The main advantage of fire-resistant tanks over the single wall steel tanks is that separate spill containment may not be required and the vault system provides an added measure of fire protection. \1\ Secondary containment-type tanks can be used to provide spill control per [NFPA 30](#), if the capacity of the tank is no more than 12,000 gallons (45,400 L). The tank size may be increased to 20,000 gallons (75,700 L) if Class II or III liquids are used. All of the criteria in the NFPA regulations for the appropriate application must be met before a secondary containment-type tank is used without separate spill containment. Require tanks to be factory-constructed with a [UL 142](#) welded steel primary tank. /1/ Tanks may be used in applications where, in addition to the above considerations, construction of a separate spill containment system for secondary containment purposes would have a negative impact on operations and/or aesthetics. Tanks located close to buildings or with integral fuel dispensers must be UL-listed secondary containment tanks, utilizing steel inner and outer tanks that can provide interstitial containment which is both pressure testable and verifiable. Such tanks usually have a fill of regular or insulating concrete. Ensure the two-hour fire rating meets or exceeds all requirements of [NFPA 30A](#) for "fire resistance" tanks, meets the requirements of [UFC 3-600-01](#) and provides a minimum two-hour fire rating in accordance with [UFC 3-600-01](#) and [UL 2080](#).

\1\

8-6.2 Tank Design Requirements

- a) For [flammable liquid](#) installations, require additional curbing containment based on tank filling rates if there is a chance of a fuel spill entering a critical area.
- b) Install the tank so that the bottom slopes downward toward one end at a slope of 1 percent. Locate transfer pumps or suction piping at the high end of the tank; locate [water drawoff](#) at low end of the tank.
- c) Provide [water drawoff](#) lines in each tank. For aviation fueling systems, arrange piping so that the fuel in the tanks may be recirculated through the [filter/separators](#).
- d) A primary tank constructed of stainless steel is permitted when required.
- e) Require support channels with anchor holes for earthquake/hurricane/flood restraint tie down.
- f) Require steel to be a minimum thickness of 3/16-inch (5 mm) for the interior carbon steel tank.
- g) Mount rectangular (flat bottomed) tanks of 4,000 gallons (15,100 L) or greater 12 inches (300 mm) above grade to allow inspection and maintenance of the tank bottom.
- h) Provide protective [bollards](#) in traffic areas. Bollards shall be not less than 4 feet (1.2 m) high and 4-inches (100 mm) in diameter, of steel construction, filled with concrete and spaced not less than 4 feet (1.2 m) on center.
- i) Require the tank to be pressure-tested after installation.
- j) Tanks shall be inspected in accordance with [STI SP001](#) by a STI certified inspector prior to commissioning.

/1/

8-7 HORIZONTAL ABOVEGROUND TANKS ([PROTECTED TANKS](#))

8-7.1 General Design Considerations

When small (250 to 20,000 gallon (900 to 75,000 L) capacity) aboveground storage tanks are required and there are clearance or fire exposure problems and the additional cost can be justified, consider the use of protected storage tanks. The main advantages

of protected tanks over the single wall steel tanks are that a separate [dike](#) (containment) may not be required and the vault system provides an added measure of fire protection. \1\ Secondary containment-type tanks can be used to provide spill control per [NFPA 30](#), if the capacity of the tank is no more than 12,000 gallons (45,400 L). The tank size may be increased to 20,000 gallons (75,700 L) if Class II or III liquids are used. All of the criteria in the NFPA regulations for the appropriate application must be met before a secondary containment-type tank is used without separate spill containment. Additional benefits include added protection from ballistic and vehicular impact and reduced evaporation of volatile fuels in warm climates. Require tanks to be factory-constructed with a [UL 142](#) welded steel primary tank. /1/ Tanks may be used in applications where, in addition to the above considerations, construction of a separate [dike](#) for secondary containment purposes would have a negative impact on operations and/or aesthetics. Tanks located close to buildings or with integral fuel dispensers must be UL-listed secondary containment tanks, utilizing steel inner and outer tanks that can provide interstitial containment which is both pressure testable and verifiable. Such tanks usually have a fill of regular or insulating concrete. Ensure the two-hour fire rating meets or exceeds all requirements of [NFPA 30A](#) for “fire resistance” tanks, meets the requirements of [UFC 3-600-01](#) and provides a minimum two-hour fire rating in accordance with [UFC 3-600-01](#) and [UL 2085](#).

\1\

8-7.2 Tank Design Requirements

- a) For [flammable liquid](#) installations, require additional curbing containment based on tank filling rates if there is a chance of a fuel spill entering a critical area.
- b) Install the tank so that the bottom slopes downward toward one end at a slope of 1 percent. Locate transfer pumps or suction piping at the high end of the tank; locate water draw-off at low end of the tank.
- c) Provide [water drawoff](#) lines in each tank. For aviation fueling systems, arrange piping so that the fuel in the tanks may be recirculated through the [filter/separators](#). Locate the [water drawoff](#) piping at the low end of the tank.
- d) For applications not requiring secondary containment, such as residential heating oil tanks where aesthetics may be the prime concern, consider protected, exposed aggregate, tanks with a [UL 2085](#) secondary containment protected rating without the outer steel jacket.
- e) A primary tank constructed of stainless steel is permitted when required.

- f) Require support channels with anchor holes for earthquake/hurricane/flood restraint tie down.
- g) Require steel to be a minimum thickness of 3/16-inch (5 mm) for the interior carbon steel tank.
- h) Mount rectangular (flat bottomed) tanks of 4,000 gallons (15,100 L) or greater 12 inches (300 mm) above grade to allow inspection and maintenance of the tank bottom.
- i) Provide protective [bollards](#) in traffic areas. Bollards shall be not less than 4 feet (1.2 m) high and 4-inches (100 mm) in diameter, of steel construction, filled with concrete, and spaced not less than 4 feet (1.2 m) on center.
- j) Require the tank to be pressure-tested after installation.
- k) Tanks shall be inspected in accordance with [STI SP001](#) by a STI certified inspector prior to commissioning.

/1/

8-8 ABOVEGROUND VERTICAL STORAGE TANKS

8-8.1 General Design Considerations

Provide cylindrical single-wall steel aboveground vertical storage tanks meeting one of the following criteria (as approved by [Service Headquarters](#)):

- a) Factory-fabricated tanks complying with [UL 142](#) criteria. The diameter of the tanks is limited by transportation restrictions. Although these tanks are fabricated in sizes up to 50,000 gallon (191,000 L), they become quite tall due to the diameter limitation. Give special consideration to height/diameter ratio to ensure tank stability.
- b) Field-erected tanks not requiring an internal pan \1\ comply with DoD Standard Design [AW 78-24-27](#). The standard design includes tanks ranging in capacity from 5,000 barrels (800,000 L) through 100,000 barrels (16,000,000 L). Requires following design considerations for tanks without floating pan and site-adapted by the design team. For tanks larger than 100,000 barrels (16,000,000 L), use the multicolumn [API Std 650](#) design /1/.
- c) Field-erected tanks complying with DoD Standard Design [AW 78-24-27](#). The standard design includes tanks ranging in capacity from \1\ 5,000 [barrels](#) (800,000 L) through 100,000 [barrels](#)

(16,000,000 L) with internal pan and requires site-adapting by the design team. For tanks larger than 100,000 [barrels](#) (16,000,000 L), /1/ use the multicolumn [API Std 650](#) design.

- d) Require tanks to be inspected by a STI Registered Inspector with Level 1 and 2 Certification or an [API Std 653](#) Certified Inspector, where applicable, prior to the tanks being put into service.

8-8.2 Tank Roofs

For tanks with internal floating pans, design the roofs in conformance with DoD Standard Design [AW 78-24-27](#).

8-8.3 Internal Floating Pans

- a) Tanks containing Class I flammable fuels or mission-critical Class II combustible fuels, such as JP-8, shall be equipped with a full contact, aluminum honeycomb floating pan. Other Class II fuels require a floating pan if the tank does not comply with the spacing and diking requirements of this UFC. Tanks storing mission-critical Class III fuels, such as JP-5 and diesel fuel marine (F-76), if located in hot (desert-like) climate, also require a floating pan to eliminate the fuel/air interface. \1\ The slotted well used for manual measurements shall be equipped with an approved floating plug. The 8 inch (200 mm) slotted stilling well for the automatic tank gauge system level sensing device and the 6-inch (150 mm) minimum nominal size slotted stilling well for the automatic tank gauge system water probe are allowed to be provided without floating plugs. /1/
- b) For cone roof tanks with floating pans, provide roof vent/inspection hatches in the fixed roof and overflow port/vents near the top of the shell near a device(s) in the floating pan which is (are) sized by the manufacturer to evacuate air and gases from underneath the pan when the pan is on its supports during filling operations.
- c) Provide grounding [bonds](#) between the floating pan and shell as follows:
 - (1) \1\ Two /1/ lengths of bare, 3/16-inch (5 mm) diameter, stranded, extra-flexible, stainless steel wire rope, each extending from the top of the floating pan to the underside of the fixed roof.
 - (2) Attach two of the wires near the tank periphery, 180 degrees apart. Attach \1\ an additional third wire from the floating pan to the floating pan /1/ manhole cover.

- (3) Securely connect the wires to the pan and extend vertically to the tank roof. Ensure wires are accessible for inspection.
 - (4) Ensure wires are long enough to accommodate the full travel of the pan. Locate wires to miss all interior tank appurtenances and structure.
- d) Provide anti-rotation cables in accordance with DoD Standard Design [AW 78-24-27](#).
 - e) For cone roof tanks with floating pans, provide gauge and sampling hatches in accordance with DoD Standard Design [AW 78-24-27](#).
 - f) Provide a 36-inch (900 mm) diameter covered manhole in the floating pan.

8-8.4 Tank Bottoms

Slope the tank bottoms downward in accordance with DoD Standard Design [AW 78-24-27](#). A slope of 5 percent is required for positive drainage and self-cleaning action for tanks storing aviation turbine fuels. After tank construction is complete perform a hydrostatic test \1\ /1/ prior to tank coating. Conduct all tests as recommended by [API Std 650](#).

8-8.5 Foundations

Design tank foundations on the basis of a soils exploration program including preliminary exploration as a minimum and detailed exploration and testing, if existing soil data is not available and/or inadequate. Refer to [UFC 3-220-10N](#). Analyze the results of the exploration program to determine the most practical and economical design to provide a stable foundation for the tank. See DoD Standard Design [AW 78-24-27](#). As a minimum, use the following criteria for all tank designs:

- a) \1\ Prevent external corrosion of tank bottoms by locating the tank bottom perimeters well above the general tank field grade, provide adequate tank field drainage away from the tank, and construct the foundation pad as specified in [AW 78-24-27](#). /1/
- b) Ensure a minimum electrical resistance of 50,000 ohm-cm. Foundation material should be neutral or alkaline with a pH greater than 7, a chloride concentration less than 300 ppm, and a sulfate concentration less than 150 ppm as specified by DoD Standard Design [AW 78-24-27](#). The sand may be washed and the pH may be raised to meet the requirements. Include cathodic protection to prevent external corrosion of the tank bottoms. Do not use oil in the sand under the tank. Do not use dredge material or beach sand.

- c) Provide good drainage under the tank.
- d) Provide a reinforced concrete ringwall foundation and secondary containment. Locate the top of the foundation a minimum of 12 inches (300 mm) above the dike basin.
- e) Cover the area beneath the tanks with a fuel-impermeable liner complying with DoD Standard Design [AW 78-24-27](#) and meeting local and state requirements. Install all liners according to the manufacturer's requirements.
- f) Over the liner, provide a minimum of 12 inches (300 mm) of compacted clean sand or similar material as described above. Securely attach and seal the liner to the inside of the concrete foundation ring wall beneath the tank shell.
- g) Provide a leak detection system for the tank bottom by installing a pipe or pipes through the concrete foundation ring wall as a telltale for tank bottom leaks in accordance with DoD Standard Design [AW 78-24-27](#). These pipes will also permit water beneath the tank to escape by gravity.
- h) Perform subsurface investigation in sufficient detail to determine if any compressible, weak, organic, or otherwise objectionable soils exist within a distance of two tank diameters below ground surface.
- i) Estimate the magnitudes and rates of settlement (uniform, differential, and seismic induced) as part of the design. Provide adequate flexibility in piping, appurtenances, and other systems to accommodate anticipated settlements. Accomplish flexibility by using pipe offsets or ball joints. Do not use corrugated or bellows type expansion compensators. Do not exceed differential settlement values given in [UFC 3-220-10N](#).
- j) Where objectionable materials exist or magnitudes of anticipated settlement are sufficient to cause damage or unacceptable distortion, consider subsurface improvement. Potential improvement techniques may include removal of objectionable materials and replacement with clean compacted granular fill, preloading or surcharging in conjunction with drainage wicks, deep dynamic compaction, vibrocompaction, stone columns, compaction grouting, or similar techniques.
- k) Where justified by subsurface conditions and economics, consider using deep foundations such as driven piling or drilled shafts. Design foundation in accordance with [UFC 3-220-01N](#).

8-9 UNDERGROUND HORIZONTAL STORAGE TANKS

8-9.1 General Design Considerations

Where underground storage tanks of 50,000 gallon (191,000 L) or less capacity are required, use factory-built horizontal cylindrical double-wall tanks (welded steel or [fiberglass](#) reinforced plastic (FRP)). Ensure that contract requires the design and installation in accordance with [40 CFR Part 280](#) and [NFPA 30](#) or any more stringent state or local criteria. Require separation of exterior tank walls from the interior walls with standoffs, thus creating an open space, or interstitial, for monitoring of leaks. This is called a Type II tank. Do not exceed 12 feet (3.7 m) in diameter for tanks. Limit tank length to eight times the diameter. Ensure that factory-fabricated tanks comply with [UL 58](#) and [STI P3](#) criteria.

8-9.2 Installation

- a) Install tanks in accordance with [NFPA 30](#) and also in strict accordance with the manufacturer's installation instructions.
- b) Install the tank so that the bottom slopes downward toward one end at a slope of 1 percent. Locate transfer pumps and suction piping at the low end of the tank.
- c) Provide straps and anchors designed to prevent flotation of tanks located in areas with high groundwater levels or subject to flooding. Provide electrical isolation strips between hold-down straps and metal tanks. Anchors may be a concrete anchor slab under the tank or concrete deadmen.
- d) Place tanks on a uniform bed of homogeneous granular material at least 12 inches (300 mm) thick. If a concrete anchor slab is used, place a minimum of 6 inches (150 mm) of bedding for steel tanks and 12 inches (300 mm) of bedding for [fiberglass](#) tanks between the tank and the concrete anchor slab. Do not use blocks, chocks, or rocks.
- e) Ensure that tank is installed by state-certified contractor if state has a certification program.
- f) Ensure that tank is installed by a contractor that is certified by the tank manufacturer.

8-10 UNDERGROUND VERTICAL STORAGE TANKS ([CUT AND COVER](#))

8-10.1 General Design Considerations

Underground vertical storage tanks are steel-lined reinforced concrete with leak monitoring capability. These tanks may be completely buried, surface-constructed and then covered with embankment, or any variation in between. OCONUS Pacific they are only required in high threat areas or when tanks are required to be constructed within the explosive cordon area or clear zone. Tanks being constructed OCONUS NATO refer to [STANAG 3784](#) for design guidance. They are not used within CONUS except when tanks are required to be constructed within the explosive cordon. Design underground vertical steel storage tanks in accordance with DoD Standard Design [AW 78-24-27](#), except as modified herein. These standards include tank sizes of 10,000 through 100,000 [barrels](#) (1,600,000 L through 16,000,000 L) capacity. In general, do not exceed 100,000 [barrels](#) (16,000,000 L) capacity. Alternative designs using prefabricated/pre-stressed tank sections must be approved by the appropriate [Service Headquarters](#). Provide leak detection for underground storage tanks in accordance with federal, state, and local regulations.

8-11 APPURTENANCES

[Table 8-1](#) describes appurtenances for atmospheric storage tanks and identifies the type of tank to which they should be mounted. Full seal weld all tank attachments to prevent moisture/water from corroding the tank shell and attachments.

8-12 HEATERS

8-12.1 General Design Considerations

Provide tank heaters and controls for tanks intended for storage of high viscosity products, such as lube oils, or burner fuels No. 4, No. 5, and No. 6, in climates where the ambient tank temperature would be less than 20 degrees F (11 degrees C) above the fuel's pour point temperature. Heat heavy burner fuel oils and lube oils to a temperature of 20 degrees F (11 degrees C) above the fuel's pour point prior to pumping. Use one of the types of heaters listed below.

8-12.2 Heating Medium

Use the appropriate heating medium for the particular application based on temperature, pressure, and availability. Saturated steam is the preferred heating medium, but consider using hot oil, hot water, and electric heating where steam is not available from existing sources.

8-12.3 Convection-Type

Use convection-type heaters installed inside a storage tank and capable of passing through a 36-inch (900 mm) diameter manhole with a capacity to raise the temperature of a full tank of burner fuel oil approximately 60 degrees F (33 degrees C) in 24 hours. The appropriate [Service Headquarters](#) and/or \1\ DLA-Energy /1/ will determine if the capacity of the heater could be reduced if it is not necessary to heat a full tank of fuel within 24 hours.

8-12.4 In-Line Type

In-line heaters consist of two general types: tank suction and straight tube. All in-line heaters are of the shell and tube construction. A tank suction or suction in-line heater is installed inside the tank on the tank issue line. The fuel oil enters the exchanger at the end within the tank and exits at the opposite end outside of the tank. The steam or other heating medium enters and exits the exchanger at the end outside of the tank. A straight tube or pipe in-line heater is installed directly into the pipeline. The fuel oil enters the exchanger at one end and exits from the other. The entry and exit points for the steam side can vary. The following criteria applies to in-line heaters:

- a) Capable of heating fuel oil passing through them from the [ambient](#) tank temperature to a minimum of 20 degrees F (11 degrees C) above the fuel oil's [pour point](#) temperature at required flow rate.
- b) If installed in tanks, allow removal of heater tube bundles without emptying the tank.
- c) If multipass in-line heaters are used, do not allow the oil temperature rise to exceed 30 degrees F (17 degrees C) per pass.
- d) Use carbon steel shells designed for a minimum 175 psig (1210 kPa) cold working pressure on both steam and oil sides.
- e) Do not exceed 0.2 psig (1.4 kPa) for the [pressure drop](#) on the oil side of pump suction line nor exceed 10 psig (70 kPa) of [pressure drop](#) for heaters installed on pump discharge.

8-12.5 Insulation and Tracing

In cases where fuels are heated, examine the possible economic incentives for insulating heated storage vessels and piping. In many cases, piping carrying heated products must be heat traced to prevent possible solidification of the fuel during a shutdown period. Insulate traced lines. Consider possible incentives for installing a condensate collection and return system. If a condensate return system is installed, include a monitor to detect oil in the condensate.

8-13 UNDERGROUND STORAGE TANK SPILL CONTAINMENT SYSTEMS

8-13.1 General Design Considerations

Provide drainage structures to impound escaping fuel where rupture of an underground tank in a hillside location would endanger other activities and structures at elevations lower than the tank.

8-14 ABOVEGROUND TANK SPILL CONTAINMENT SYSTEMS

8-14.1 General Design Considerations

Provide a spill containment system for all aboveground tanks to prevent spilled petroleum from leaving the property. Individual tanks larger than 10,000 [barrels](#) (1,600,000 L) in capacity should be enclosed in an individual [diked](#) enclosure. Groups of tanks, with no tank larger than 10,000 [barrels](#) (1,600,000 L) and not exceeding 15,000 [barrels](#) (2,400,000 L) in aggregate capacity, may be enclosed in a single [diked](#) enclosure. Subdivide each [diked](#) area containing two or more tanks by intermediate curbs to prevent spills from endangering adjacent tanks within the [diked](#) area. When subdividing is required, use intermediate curbs not less than 18 inches (450 mm) in height. Designer can take advantage of the exception granted for protected tanks by [NFPA 30](#) or [NFPA 30A](#) if the provisions of that document are met and local, state, and federal regulations permit. Refer to DoD Standard Design [AW 78-24-27](#). Use the following criteria for tank spill containment systems:

- a) The preferred method of containment is by [diked](#) enclosure (impounding spilled fuel around the tank by means of \1\ /1/ [dikes](#)) to prevent the accidental discharge of petroleum.
- b) As an alternative to [diked](#) enclosures, use a remote impoundment spill collection system consisting of a series of drains leading from storage tank areas to a remote containment or impoundment designed to prevent the accidental discharge of petroleum. This is not the preferred method and requires approval of [Service Headquarters](#). Generally, this system is used for tanks on a hillside.
- c) Slope the area within the containment at no less than 1 percent to carry drainage away from the tank to a [sump](#) located at the low point of the enclosure.
- d) Construct the drain line from the [sump](#) of petroleum-resistant, fire-resistant, [impervious](#) material. Do not use clay, concrete, fiberglass or plastic piping materials.
- e) Control drainage from the [sump](#) to the outside of the enclosure by \1\ an eccentric plug /1/ valve with indicator post located outside of the enclosure in an area that will be safely accessible during a fire.
- f) Do not allow fuel to run off or escape from the containment area under any circumstances. Provide means for disposing or for treating contaminated water from the containment to meet the most stringent of applicable federal, state, or local requirements.

8-14.2 Spill Containment System Capacity

8-14.2.1 Diked Enclosures

Design [diked](#) enclosures in accordance with the most stringent of [NFPA 30](#), [40 CFR Part 112](#), and other federal, state and local regulations. Additionally, ensure that the capacity of the [diked](#) enclosure is, at a minimum, greater than the largest tank volume located within the [diked](#) enclosure, plus sufficient freeboard equal to the greater of a 24-hour, 25-year storm or one foot (0.3 m) over the entire area of drainage \1\ or the flow of the water from firefighting activities /1/. In appropriate environmental climates, consider snow and ice accumulation as well. Limit [dike](#) heights to 6 feet (1.8 m) or less.

8-14.2.2 Remote Impoundments

If approved by [Service Headquarters](#), design remote impoundments in accordance with the most stringent of [NFPA 30](#), [40 CFR Part 112](#), and other federal, state and local regulations. Additionally, ensure the capacity of the remote impoundment is, at a minimum, greater than the largest tank volume located within the area of drainage \1\ or the flow of water from firefighting activities on neighboring storage tanks sharing the same spill collection system /1/, plus sufficient freeboard equal to the greater of a 24-hour, 25-year storm or one foot (0.3 m) over the entire area of drainage. When sizing the remote impoundment consider the total drainage area from all tanks that are included within the spill collection system. \1\ /1/ In appropriate environmental climates, consider snow and ice accumulation as well.

8-14.3 Remote Containment/Impoundment Spill Collection Systems

Construct the remote impoundment as generally described for [diked](#) enclosures and in accordance with [UFC 1-200-01](#) and [UFC 3-600-01](#).

8-14.4 Diked Enclosure – Earthen Dike Type

Construct earthen [dikes](#) of earthen materials with fuel impermeable liner cover. Where space is a premium, construct [dikes](#) of vertical concrete walls. For earthen [dikes](#), make the minimum distance from the toe of the [dike](#) to the tank foundation 5 feet (1.5 m) and provide a flat surface on the top of the [dike](#) at least 3 feet (0.9 m) wide. Do not make earthen [dike](#) slopes steeper than \1\ 2.5 horizontal to 1 vertical. If space is restricted, dike slopes may be increased to 2 horizontal to 1 vertical if the sloped dikes are concrete surfaced /1/. Cover the sides and top of the earthen [dike](#) and the floor around the tank with one of the following materials (see [Facility Plate 019](#)):

- a) A fuel impermeable liner. If liner is exposed, the exposed areas must be resistant to the effects of direct sunlight and to wind uplift. Provide sandbags in accordance with the appropriate UFGS, \1\ or other means approved by the liner manufacturer, /1/ to assure the liner is resistant to wind uplift. Follow the liner manufacturer's recommendations for protecting the liner by the use of geotextile

cover or other recommended means. Provide a concrete maintenance pad for personnel access to the tank and for work areas around tank manholes and valves.

- b) Do not use Bentonite or a Bentonite composite material in the construction of [dikes](#) or basins.
- c) Do not use asphalt.

8-14.5 Diked Enclosure – Reinforced Concrete Dike Type

Design reinforced concrete (prefabricated or cast-in-place) [dikes](#) and their foundations to resist and contain the full hydrostatic load when filled to capacity. Consider the use of reinforced concrete blocks with or without exterior earth mounding. Use vertical reinforced concrete [dikes](#) where space is a premium. Seal all concrete surfaces with a flexible, UV-resistant, fuel-resistant coating if required by local or State regulations. Use a fuel impermeable liner as described above for the [dike](#) floor.

8-14.6 Diked Enclosure – Combination Dike Type

A vertical concrete wall backed by an external earthen berm may be used. Design the combined earthen and concrete unit and its foundation to resist and contain the full hydrostatic load when filled to capacity. Use a fuel impermeable liner as described above for the [dike](#) floor.

8-14.7 Stormwater Collection Systems

Design a stormwater collection system to contain, transport, treat, and discharge any stormwater that collects in the tank enclosure. Refer to [Chapter 2](#) of this UFC. Review state and local regulations for design requirements and permitting of stormwater treatment systems.

8-14.8 Dike Access

Provide concrete, steel, or aluminum steps with pipe handrails for passage across a dike. Steps and handrails must comply with [29 CFR Part 1910.36](#). Include a removable section of the handrail to provide access to the flat top of earthen dikes. If steel steps are used, they should be hot-dipped galvanized after fabrication. Provide enough access locations for safe emergency egress and for normal operation. This will normally include steps over the dikes separating adjacent tanks, as well as on one wall without an adjacent tank. Locate steps at the most accessible points, preferably on the same side as the access stairs to a tank roof. For tanks $\geq 10,000$ barrels (1,600,000 L) and larger, consider providing earth-filled ramps to permit vehicle access into the dike when approved by Service Headquarters. If there is sufficient need to provide vehicle access into diked areas, provide a concrete paved road and/or earth-filled ramp for vehicle travel-ways. A removable steel bulkhead section may be a cost-effective method to provide access for dikes with vertical reinforced concrete walls.

Where the vehicle access road crosses the dike, provide a security gate and prominent sign indicating that access is limited to a 1-ton pick-up truck that is compliant with NFPA 70 Class I, Group D, Division 2 criteria.

8-15 MISCELLANEOUS USE TANKS

This paragraph provides design guidance for miscellaneous use tanks. These tanks are typically less than 550 gallons (2,100 L) in capacity. Check state and local regulations before beginning design. If a miscellaneous use tank has a capacity greater than 12,000 gallons (45,800 L), follow the requirements of [Table 8-1](#). Otherwise, use the standards described below.

8-15.1 Installation

Install the tank in conformance with the requirements of [NFPA 30](#). The exception used for the deletion of [dike](#) containment is acceptable if all of the criteria associated with that exception are met. Provide containment for all tanks, regardless of size, except small residential heating oil tanks, by complying with the paragraph titled “Aboveground Tank Spill Containment Systems” in this chapter of this UFC or by using properly installed aboveground concrete-encased tanks in accordance with the paragraph titled “Horizontal Aboveground Tanks (Protected Tanks)” in this chapter of this UFC.

8-15.2 Heating Oil Tanks

Comply with [NFPA 31](#).

\1\

8-15.3 Generator Fuel Tanks

/1/

Comply with [NFPA 31](#), [NFPA 37](#), and [NFPA 110](#).

8-15.4 Fire Pump Fuel Tanks

Comply with [NFPA 20](#), [NFPA 30](#), and [NFPA 31](#).

8-15.5 Waste Oil Tanks

Check local and state environmental regulations for any additional requirements for storage of waste oil.

8-15.6 Containment

As discussed previously in this chapter, provide containment, under and around all aboveground tanks except home heating oil tanks.

8-15.7 Underground Tanks

Ensure all underground tanks are double-walled and have overfill protection, as described previously in this chapter.

8-16 SHIPBOARD OFF-LOAD FUEL STORAGE TANKS

8-16.1 Function

In addition to regular storage, consider a storage tank for fuel removed from ships that may be [off-specification](#) or otherwise not satisfactory for its intended use. This fuel may be [downgraded](#) to heating oil or diesel fuel marine.

8-16.2 General Design Considerations

Determine the volume requirements of the [contaminated fuel](#) storage tank by an activity survey. Provide bottom-loading facilities for tank truck loading and off-loading of [contaminated fuel](#).

8-16.3 Locations

Locate the [contaminated fuel](#) storage tank(s) in or near the facility tank farm. Clearly mark the tank(s) as to the type or grade of fuel.

8-17 JET ENGINE TEST CELL FUEL STORAGE TANKS

Design jet engine test cell fuel storage and issue systems to the same standards as [operating storage tank](#) fuel systems (e.g., high level alarms, gauging, shut-offs, etc.). Normally, tanks are refilled using station aircraft refueling trucks through aircraft single-point refueling adaptors.

8-18 FUELS AUTOMATED SYSTEM

The Defense Logistics Agency's Business System Modernization (BSM Enterprise Resource Programs (ERP) - Fuels section) is an Automated Information System (AIS) designed to support the \1\ DLA-Energy /1/ and the Military Services in performing their responsibilities in fuel management and distribution. FAS is a multi-functional AIS which provides for point of sale data collection, inventory control, finance and accounting, procurement, and facilities management. BSM-ERP is composed of an integrated set of commercial off the shelf (COTS) software applications, based around an oracle relational database management system (RDBMS), which is hosted on commercially available computer hardware. The system will provide interfaces to existing logistics/financial AIS's or to be used only when directed by \1\ DLA-Energy /1/.

Table 8-1. Appurtenances

Item	Appurtenance	V-A	H-A	H-U	F-A	P-A	V-U
Manhole							
a	A 30-inch (750 mm) diameter manhole, a minimum of one manhole for tanks between 1,000 gallons (4,000 L) and 5,000 gallons (19,000 L) capacity, and a minimum of two manholes (both are to be at least 36 inches (900 mm), for tanks larger than 5,000 gallons (19,000 L) capacity.		✓	✓	✓	✓	✓
b	A dedicated manhole, other than required above, as the primary point for piping penetrations into a tank (may be as small as 22 inches (559 mm)).			✓			
c	A \1\ shell /1/ manhole located above the internal floating pan's high position to aid in venting the tank during cleaning and to provide access to the floating pan's elastomeric wiper seals as required by DoD Standard AW 78-24-27 .	✓					
d	Containment sumps and extension manhole.			✓			
e	Roof manholes in accordance with API Std 650 . \1\ /1/ Locate the roof manholes near the perimeter of the roof at opposite ends of a diameter and approximately 90 degrees from the shell manholes.	✓					
f	Shell manholes in accordance with API Std 650 . Two 36-inch (900 mm) shell manholes 180 degrees from each other. Align shell manholes parallel with prevailing wind direction. \1\ Support shell manhole covers by davits /1/.	✓					
g	A bolted cover in the roof for installation and removal of the internal floating pan as required by the tank supplier based on the pan manufacturer.	✓					
\1\ Inspection Hatches /1/							
h	\1\ A minimum of four 24-inch (600 mm) square inspection hatches on fixed roof tanks with floating pans. Inspection hatches are not required for tanks without floating pans. /1/	✓					
Ladder/Stairs							
i	Internal ladders (in accordance with OSHA criteria) for tanks of 5,000 gallons (19,000 L) or larger. \1* with floating pans /1/	✓	✓	✓	✓	✓	✓
j	An external ladder and platform with safety railing for gauging and sampling in accordance with 29 CFR Part 1910.23 (if height justifies it).		✓		✓	✓	
k	Ladders, railings, toeboards, a spiral stairway, top platform, and handrail in accordance with API Std 650 and OSHA requirements. Provide stairways to access high level shut-off and alarms. Provide \1\ metal bar grating stair tread and platforms. Provide stair tread with non-slip nosings /1/.	✓					

Item	Appurtenance	V-A	H-A	H-U	F-A	P-A	V-U
Level Alarms							
1	1. Tanks Greater \geq 30,000 gallons (112 500L): An individual automatic level alarm system, independent of the gauging device or system for each tank. Include high, high-high, low and low-low level alarms. On aboveground tanks: provide a means to manually test each alarm sensor to ensure system operability without a full tank; locate level alarm equipment for ready access from ground level, stairway platforms, or roof access. On aboveground vertical tanks set level alarms as defined in AW 78-24-27 . For underground tanks, high and high-high will be 90 and 95 percent, respectively (although this may have to be adjusted downwards for horizontal tanks). On tanks without floating pans, set the low level alarm no less than 5 percent before loss of suction to avoid pump cavitation, and the low-low level alarm as defined in AW 78-24-27 . In determining the low level, consider the time it would take for the pump or system to shut down. Provide both audible and visible alarms in a manned area responsive to the alarm. Review facility size and operating method to determine the most desirable location for audible and visible alarms, this will usually be in the tank farm or near the operations building. Interface the alarm output to stop issue pump on low level alarm and receipt pump/valve on high-high level alarm. Install alarms on winter sun side of the tank. Comply with most stringent of federal, state, or local regulations. For vertical aboveground tanks, see Facility Plates 014 and 015 .	✓ *	✓ *	✓ *	✓	✓	✓

Item	Appurtenance	V-A	H-A	H-U	F-A	P-A	V-U
I (cont)	<p>2. Tanks < 30,000 gallons (112,500 L):</p> <p>An automatic level alarm system for each tank to include high, high-high, low and low-low level alarms. On aboveground tanks: provide a single multi-set point Automatic Tank Gauge (ATG) level probe with continual/dynamic testing for both gauging and alarm; locate ATG level alarm equipment for ready access from roof or platform access. Additional redundancy level sensors or switches that interface with the ATG may be added. On aboveground vertical tanks, in general conformance with API RP 2350, set high-level at 95 percent and high-high at 98 percent; on tanks with floating pans locate the low level at 5 percent and locate the low-low level alarm at 2 percent above the low level of the floating pan. For underground tanks, high and high-high will be 90 and 95 percent, respectively (although this may have to be adjusted downwards for horizontal tanks). On all tanks without floating pans, set the low level alarm 5 percent before loss of suction, and the low-low level alarm 2 percent before loss of suction to avoid pump cavitation. In determining the low level, consider the time it would take for the pump or system to shut down. Provide both audible and visible alarms in a manned area responsive to the alarm. Review facility size and operating method to determine the most desirable location for audible and visible alarms, this will usually be in the tank farm and in or near the operations building. Interface the alarm output to stop issue pump on \1\ low-low /1/ level alarm and receipt pump/valve on high-high level alarm. Comply with most stringent of federal, state, or local regulations. For vertical aboveground tanks, see Facility Plates 014 and 015.</p>	<p>✓ *</p>	<p>✓ *</p>	<p>✓ *</p>	<p>✓</p>	<p>✓</p>	<p>✓</p>

Item	Appurtenance	V-A	H-A	H-U	F-A	P-A	V-U
I (cont)	<p>3. Product Recovery Tanks (PRT):</p> <p>An automatic level alarm system for each tank to include high and high-high level alarms. On aboveground tanks: provide a single multi-set point Automatic Tank Gauge (ATG) level probe with continual/dynamic testing for both gauging and alarm; locate ATG level alarm equipment for ready access from ground level or stairway platforms. Additional redundancy level sensors or switches that interface with the ATG may be added. On aboveground tanks, in general conformance with API RP 2350, set high-level at 95 percent and high-high at 98 percent. For underground tanks, high and high-high will be 90 and 95 percent, respectively (although this may have to be adjusted downwards for horizontal tanks). Provide both audible and visible alarms in a manned area responsive to the alarm. Review facility size and operating method to determine the most desirable location for audible and visible alarms, this will usually be in the tank farm and in or near the operations building. Interface the alarm output to receipt pump/valve on high-high level alarm. Comply with most stringent of federal, state, or local regulations. For vertical aboveground tanks, see Facility Plates 014 and 015..</p> <p>/1/</p>	✓ *	✓ *	✓ *	✓	✓	✓
<p>*NOTE: State and local regulations may be more restrictive. Because underground and aboveground horizontal tanks will fill extremely fast in the last 5 percent, values of high level alarm positions should be chosen based on filling rate, tank size, and time needed to respond to the alarm condition. Adjust values as well for extremely large vertical tanks with small receipt rates and extremely small vertical tanks with high receipt rates.</p>							

Item	Appurtenance	V-A	H-A	H-U	F-A	P-A	V-U
Vents							
m	Open atmospheric vents with weather hoods and bird screens for tanks to be used for products with true vapor pressure of 0.75 psia (5 kPa) or less. For higher vapor pressure , or if a vapor recovery system is used, provide pressure/vacuum vents in lieu of open vents. Consider using pressure/vacuum vents if product quality is at risk by blowing sand, dust, or snow. Comply with NFPA 30 , host nation requirements, Chapter 2 of this UFC, API Std 650 , API Std 2000 , 29 CFR Part 1910.106 , and DoD Standard Design AW 78-24-27 , where applicable. Do not use flame arrestors.	✓	✓	✓	✓	✓	✓
n	Emergency relief venting with capacity in accordance with NFPA 30 and UL 142 , as applicable. For vertical aboveground tanks, a \1\ floating roof or weak /1/ roof-to-shell seam, as specified in API Std 650 , may be used to fulfill emergency relief requirements.	✓	✓		✓	✓	✓
Gauge/Gauge Hatch/Stilling Wells							
o	A liquid level gauge calibrated in 1/16-inch (2 mm) graduations mounted at 60 inches (1500 mm) above the walking surface.	✓	✓	✓	✓	✓	✓
p	\1\ Automatic Tank Gauging (ATG) for all tanks with fuel managed through the Defense Logistics Agency's Business Modernization {BSM Enterprise Resource Programs (ERP) - Fuels section}, that complies with API MPMS Chapter 3 . Key features include: measures fluid level to ±0.05 inch (1 mm); measures standard volume ±0.1 percent; measures average product temperature ±1 F (0.5 C); measures product density ±1 percent; detects water in the tank sump to a level equal to or slightly above the water draw-off pipe; converts volume to API standard conditions; local tank readout; For tanks that are 30K gallons or less certain ATG systems (Veeder-Root and Ronan) can provide backup alarms for high, high-high, low, and low-low level conditions; meet American Standard Code for Information Interchange (ASCII) interface. /1/	✓	✓	✓	✓	✓	✓
q	A 4-inch (100 mm) gauge hatch with drop tube to within 3 inches (75 mm) of the bottom of the tank.* A second 4-inch (100 mm) opening without a drop tube or gauge hatch.		✓	✓			✓
* = Lowest point in the tank not the sump .							
r	\1\ One 10-inch (250 mm) roof flanged nozzle with an 8-inch (200 mm) aluminum, fully slotted, stilling	✓					✓

Item	Appurtenance	V-A	H-A	H-U	F-A	P-A	V-U
	well for ATG near the edge of the roof near the top of the stairway platform. /1/						
s	\1\ One 8-inch (200 mm) roof flanged nozzle with a 6-inch (150 mm) aluminum, fully slotted, stilling well for temperature and water bottom sensor, as close to or in the tank sump as possible. See DoD Standard Design AW 78-24-27 . /1/	✓					✓
t	\1\ One 10-inch (250 mm) roof nozzle and an /1/ aluminum, slotted stilling well extended to within 3 inches (75 mm) of the bottom of the tank* for gauging and sampling. A datum plate to establish a gauging zero point.	✓					✓
Piping Connection							
u	Inlet fill connection. See Facility Plates 016 , 017 , and 018 , as applicable. For H-A tanks, Facility Plate 017 applies to single wall tanks only.	✓	✓	✓			
v	Main suction and low suction. See DoD Standard Design AW 78-24-27 .	✓					
w	Inlet fill pipe with horizontal exit perpendicular to a tank radial. Discharge is approximately 4 inches (100 mm) above tank floor and enlarged to reduce fuel velocity. An inverted trap is placed in the line to serve as a liquid lock to prevent entry of fire or an explosion from outside the fill pipe.						✓
Overfill Protection							
x	Overfill protection with a hydraulically operated diaphragm control valve. Tanks connected to commercial pipelines or marine offload systems with restrictions on shut-off may require diversion to additional tankage. On vertical tanks, valve typically closes midway between high and high-high levels, but ensure valve closes no later than on high-high level. For underground tanks, (per NFPA 30) and in aboveground horizontal tanks, automatically shut off the flow into the tank when the tank is no more than 95 percent full. Comply with most stringent of federal, state, or local regulations. \1\ Include /1/ a solenoid on the control valve to close the valve as a backup. Use API RP 2350 to establish the proper overfill level setting. On gravity drop fills, replace valve with an integral high level shut-off valve in the drop tube. Prior to designing automatic valve closure features, conduct a surge analysis on pressure filled systems. See Plates 017 and 018 . * If pressure-filled.	✓	✓	✓ *	✓	✓	✓
y	A lockable, welded steel overfill protection box (15 gallon (60L) minimum) and a manual drain valve to				✓	✓	

Item	Appurtenance	V-A	H-A	H-U	F-A	P-A	V-U
	return spills to the inner tank (omit the drain feature on aviation turbine fuel tanks).						
Water Drawoff							
z	A 2-inch (50 mm) double block and bleed , plug valve \1\1/ at the low end of the tank, unless tank contains aviation turbine fuels with icing inhibitors. In those cases, the water drawoff valve may be a ball valve.		✓				
aa	Water drawoff connections. See DoD Standard Design AW 78-24-27 .	✓					
bb	A 1-inch (25 mm) connection from the low end of the tank to approximately 3.5 feet (1.1 m) above the ground and equipped with a positive displacement-type, hand-operated pump for water drawoff . For Air Force projects, use electrical pumps only.			✓			
cc	A water removal suction tube at low end of tank with connection for water removal by truck. Consider installing a fixed, hand-operated pump as an alternative.				✓	✓	
dd	A central sump pump.						✓
Ball Joints							
ee	Ball joints on pipes to relieve strain caused by tank settling or seismic activity. Ensure that contract specifications do not allow piping connections to be made until after the tank has been completely tested and allowed to settle. As an alternative, settlement calculations can be made and piping flexibility can be designed to account for settling. In this case, pipe can be connected prior to testing. * May be required on tanks 25,000 gallons (94,600 L) and larger.	✓	✓ *				
Cable Supports							
ff	On the fixed roof of all tanks, provide two scaffold cable supports in accordance with API Std 650 . Locate the supports near the center of the tank so that supported cables will have maximum range and flexibility of operation with minimum interference with other tank fittings.	✓					
Striker Plates							
gg	Striker plates under all openings used for manual gauging in steel tanks and all openings in fiberglass tanks.	✓	✓	✓	✓	✓	✓
Monitoring Port							
hh	A 2-inch (50 mm) monitoring port including a tube which provides a means to detect product leakage from the primary tank into the secondary tank.				✓	✓	

V-A = Vertical Aboveground Storage Tank
H-U = Horizontal Underground Storage Tank
P-A = Protected Aboveground Storage Tank

H-A = Horizontal Aboveground Storage Tank
F-A = Fire-Resistant Aboveground Storage Tank
V-U = Vertical Underground Storage Tank

CANCELLED

CHAPTER 9 PIPING SYSTEMS

9-1 INTRODUCTION

This chapter provides guidance for the design of new piping portions of fueling systems, as discussed in other chapters of this UFC. The criteria provided is intended to be general in scope except where specific criteria is necessary for given situations.

9-2 GENERAL REQUIREMENTS

[Chapter 2](#), General Design Information, contains important information on fueling facilities. Do not start design of any fueling system without first becoming completely familiar with [Chapter 2](#) of this UFC.

9-2.1 Design Requirements

Ensure that piping design, materials, fabrication, assembly, erection, inspection, and pressure tests for fuel piping systems are in accordance with [ANSI/ASME B31.3](#). See [Chapter 6](#) of this UFC for design requirements for [interterminal](#) and [installation pipelines](#). Follow appropriate guide specifications for piping design and materials selection. Use the following design criteria for piping systems:

- a) Unless otherwise specified by [Service Headquarters](#), provide underground piping systems in and around areas subject to aircraft ground movements. If approved by [Service Headquarters](#), install piping in concrete trenches. When trenches are employed, comply with [NFPA 415](#). The use of common trenches for more than one utility is prohibited. Fueling equipment may be aboveground where it does not interfere with aircraft or service vehicle movements. Design all clearances in accordance with \1\ [UFC 3-260-01](#) /1/ and DoD Standard Design [AW 78-24-28](#).
- b) In other cases, aboveground piping is preferred where it is not aesthetically objectionable or not exposed to accidental damage, vandalism, blast damage, or sabotage. \1\ Small diameter (≤ 4 inches (100mm)) pipe associated with the aboveground storage of fuel/oil shall be single wall aboveground piping. Exemptions may be granted by the [Service Headquarters](#) in cases where routing aboveground could result in catastrophic damage to the pipe. If an exemption is granted, double-wall piping must be installed in accordance with the paragraph titled "Double-Wall Piping" in this chapter of this UFC. /1/
- c) The preferred method of routing aboveground piping out of a [diked](#) area is over the top of the [dike](#). However, avoid creating an inverted "U" on the suction side of a pump to avoid an air trap.

Provide high point vents and low point drains as required, refer to [Facility Plate 019](#).

- d) Hydrostatically test new piping systems in accordance with [ANSI/ASME B31.3](#). During testing, disconnect system components such as storage tanks or equipment which were not designed for the piping test pressure or protect them against damage by over-pressure. Hydrostatically test systems to 1.5 times the maximum allowable design pressure of the ANSI/ASME B16.5 piping system flanges at 100 degrees F (38 degrees C), see Table 9-1. Test hydrant and direct aircraft fueling systems and installation fuel pipelines with fuel that will be used in the pipeline or, at a minimum, a fuel with the same minimum specification flashpoint as the fuel that will be used when the piping is in service. The temperature of the fuel, and the ambient temperature, shall be at least 20 degrees F (11 degrees C) below its flashpoint during the test.
- e) Testing with water requires [Service Headquarters](#) approval. When water is authorized for hydrostatic testing of fuel piping, ensure that all water is removed from the piping by either [pigging](#) the piping, air drying the line, or by vacuum extraction.
- f) Lay out piping between piers and storage tanks, cross-country pipelines, and between bulk storage and operating tanks to accommodate [pigging](#) operations. Use long radius elbows, full port valves, barred tees, and provisions for the connection of temporary launchers and receivers. Give special consideration to smart [pigging](#) for single wall pipelines.
- g) When laying out piping for single wall aircraft [hydrant systems](#), consider smart pigging/[pigging](#) in the design. For systems with required piping slopes and high and low level drains, provide long radius turns, and provide spool pieces for temporary pig launchers and receivers. Ensure valves are accessible for removal and replacement with spool pieces. Where it is more economical or practical to lay hydrant piping flat (slope less than 0.2 percent), provide the capability to rapidly clean the lines with a pig or to launch a smart pig. This includes providing long radius turns, full port valves, barred tees, and pig launchers and receivers.
- h) Provide thermal relief devices on all installed [double block and bleed valves](#) and other valves within the piping system. Provide drain out with non-freeze valves at all low points of pipelines.

- i) Refer to \1\ /1/ UFC 3-130 series for construction of aboveground and underground piping in arctic and subarctic conditions.

9-2.1.1 Hydraulic Design

In general, provide a hydraulic design with a velocity of 7 to 12 feet per second (2.1 to 3.7 m/s) on pump discharge and 3 to 5 feet per second (0.9 to 1.5 m/s) on pump suction at full flow. If project-specific conditions make it advisable to exceed these values, consult the appropriate [Service Headquarters](#). Consult with appropriate [Service Headquarters](#) for outlet pressure requirements. Design suction piping to ensure that the net positive suction head required by the pumps is available under all conditions of operation. Consider the following factors in selecting pipe sizes:

- a) Operating requirements of the facility to be served.
- b) Capital cost of the pipe.
- c) Capital cost of pumping stations and attendant facilities.
- d) Operating cost of the system.
- e) Harmful effects of excessive velocity of flow including hydraulic shock and static generation.
- f) Fatigue failure caused by cyclic loading.

9-2.2 Piping Arrangement

Wherever possible, arrange piping in parallel groups to facilitate multiple use of supports, to minimize the amount of trenching for underground piping, and to minimize the number of steps or stiles needed across pipe runs. For underground applications, consider constructability when determining amount of spacing between pipes. Use the following criteria:

- a) Provide looped piping systems whenever practical. Loops add to the flexibility and reliability of the system, contribute to product cleanliness by making circulation possible, and can be used to reduce the magnitude of hydraulic shock. Sectionalize loops by [double block and bleed valves](#) to provide verifiable isolation and to facilitate pressure testing.
- b) Between mains, install cross connections for flexibility of operation and as an auxiliary means of continuous operation in emergency situations. In addition, permit the use of [line blinds](#) where space limitations preclude the use of removable pipe sections or fittings. Provide a separate piping system for each grade of fuel to be handled. Do not provide cross connections between grades.

- c) For short runs, provide a line slope of at least 0.2 percent. For long runs, make line slope sufficient to establish positive drainage by gravity, but without excessive bury depth. Make gradients uniform between high and low points. Traps are undesirable because they provide a place for water and sediment to accumulate. Install drains at low points to allow removal of any water from condensation. These low point drains also provide the capability to remove fuel for line maintenance. If slope is not possible, design the system to accommodate [pigging](#) by providing flange connections for pig launchers/receivers, long curvature fittings, barred tees, and full port valves. Install high point vents to remove trapped air. Low point drains are not required on [interterminal pipelines](#).
- d) As a general rule of thumb, provide spacing between piping that will allow a minimum clearance of 3 inches (75 mm) between adjacent flanges. In certain situations, such as in a piping trench or other restrictive location, it may be necessary to reduce the spacing. A minimum of 12 inches (300 mm) or one pipe diameter, whichever is greater, should still be maintained between pipe walls.

9-2.3 Surge Analysis

Conduct a complete [surge](#) analysis of system operation using a computer simulation program for all systems with quick closing valves and for aircraft hydrant and [direct fueling systems](#) with more than two outlets. Give full consideration to the causes and effects of hydraulic shock. This is especially important in closed fueling systems such as aircraft fueling systems where the receiving tanks or dispensing equipment may be damaged by shock pressure. Reduce the possibility of shock by limiting flow velocity and avoiding the use of quick opening/closing valves except where required for system operation such as hydrant pit valves. Do not reduce flow velocities below minimum velocity indicated in the paragraph titled "Hydraulic Design" in this chapter of the UFC. Every reasonable effort must be made to control hydraulic [surge](#) or shock within acceptable limits by the design of the piping system rather than by the use of [surge suppressors](#). [Surge suppressors](#) are strictly a last resort solution and require the approval of [Service Headquarters](#) prior to designing into a system. For all [aircraft direct fueling/hydrant system](#) designs, the loop backpressure control valve is critical in preventing excessive hydraulic shock. Use the following design criteria and [Table 9-1](#) for piping design pressures:

- a) For all complex piping systems (main header, several laterals, mobile equipment), employ computer modeling techniques to determine if surge suppression is required. Conduct a run at steady state flow conditions to establish system flow rates for the scenario being modeled. After that, conduct a transient [surge](#)

analysis imposing worst-case operating conditions on the system. For [hydrant systems](#) incorporating the use of a back pressure control valve, simulate this valve as an active modulating valve. If acceptable peak pressures are exceeded, discuss the results with the [Service Headquarters](#) fuels engineer to review parameters used and consider alternatives. If this consultation produces no workable solution, perform a second [surge](#) analysis to model the use of [surge suppressors](#) in the system. This analysis must indicate that damaging peak pressures are not exceeded. Do not use manual [surge](#) calculations, except as found under (c) below, because they do not account for dampening effects of the system and yield overly conservative results.

- b) Most systems designed in accordance with this manual will have ANSI Class 150 flanges and the maximum allowable operating pressures seen in [Table 9-1](#). Design the system such that the total pressure including [surge](#), pump shutoff pressure, thermal fuel expansion effects, and static pressure in any part of the system never exceeds the maximum allowable operating pressure. Other equipment items such as tank trucks, aircraft fuel tanks, or shipboard fuel tanks which may be damaged by shock pressures may require lower maximum [surge](#) pressure. Assume a near instantaneous shut-off by the aircraft in the design of aircraft [hydrant systems](#).
- c) Do not use manual calculations instead of computer modeling when system surge pressures are crucial and the piping system is complex. However, for simple piping systems that operate under 80 psi (550 kPa) the manual calculations contained in [Appendix B](#) can be used to ascertain if surge will be a problem.

Table 9-1. Allowable Pressure Table – ANSI Class 150 Flanged Joints

	ASTM A 105	ASTM A 182 Gr. F304	ASTM A 182 Gr. F304L
Maximum Allowable Design Pressure	285 psig (1970 kPa)	275 psig (1900 kPa)	230 psig (1590 kPa)
Maximum Hydrostatic Test Pressure	450 psig (3100 kPa)	425 psig (2930 kPa)	350 psig (2400 kPa)
Minimum Hydrostatic Test Pressure	425 psig (2930 kPa)	400 psig (2760 kPa)	325 psig (2240 kPa)
Maximum Allowable Operating Pressure	285 psig (1970 kPa)	275 psig (1900 kPa)	230 psig (1590 kPa)
Maximum Allowable Surge Pressure	380 psig (2620 kPa)	366 psig (2525 kPa)	306 psig (2100 kPa)

1. All pressure values are taken from [ANSI/ASME B16.5](#), [ANSI/ASME B16.47](#) and [ANSI/ASME B31.3](#) at 100 degrees F (38 degrees C).
2. Values are presented for information only. Confirm actual values with [ANSI/ASME B16.5](#), latest edition, based on actual temperatures, bolting and gasket materials, etc.
3. For other materials, see [ANSI/ASME B16.5](#) and [ANSI/ASME B31.3](#).
4. For lower hydrostatic test pressures, the maximum allowable operating pressure will be lower than indicated. See [ANSI/ASME B31.3](#).

9-3 ABOVEGROUND PIPING

Support aboveground piping so that the bottom of the pipe is a minimum of 18 inches (450 mm) above the ground surface or higher if required to service valves and equipment. In areas subject to flooding, greater clearance may be desirable. At intersections with roadways, allow enough clearance for the passage of tank trucks, cranes, and similar heavy vehicles. In areas subject to seismic activity, provide the piping configuration and support in accordance with the seismic design criteria in [UFC 3-310-04](#). Refer to UFC 3-130 series for considerations in extremely cold climate. Wherever possible, arrange piping in parallel groups to facilitate multiple uses of supports, to minimize the amount of trenching for underground piping, and to minimize the number of pipe stiles needed. Consider constructability and maintenance in spacing of piping. As a general rule of thumb, provide spacing between piping that will allow a minimum clearance of 3 inches (75 mm) between adjacent flanges. In certain situations, such as in a piping trench or other restrictive location, it may be necessary to reduce the spacing. A minimum of 12 inches (300 mm) or one pipe diameter, whichever is greater, should still be maintained between pipe walls.

9-3.1 Identification

Identify piping in accordance with [Chapter 2](#) of this UFC. In addition, mark fuel lines at head of fueling pier near valves, and mark valve “open” and “close” positions.

9-3.2 Pipe Supports

Rest piping on supports, both insulated and uninsulated, on a steel shoe welded to the bottom of the pipe. Leave the shoe free to move on the support. Construct the portion of pipe supports in contact with the ground with concrete. [Facility Plate 020](#) shows the design of typical “slide/guide” pipe supports. Ensure that support material is the same as the pipe material. Other support configurations are acceptable provided the support does not contain rollers, does not allow movement of the pipe on a metal surface, and does not include hangars. Design pipe supports to meet the applicable requirements of [ANSI/ASME B31.3](#) or [ANSI/ASME B31.4](#).

9-3.3 Arrangement

Arrange pipes to provide for expansion and contraction caused by changes in [ambient](#) temperature. Where possible, accommodate expansion and contraction by changes in direction in piping runs, offsets, loops, or bends. Where expansion loops or off-sets are not possible, use flexible ball joint offsets. Provide sliding pipe supports or other method of maintaining alignment on each side of the expansion joint. Do not use expansion devices which employ packings, slip joints, friction fits, or other non-fire resistant arrangements. Use ball-type offset joints to accommodate possible settlement of heavy structures such as storage tanks, if piping design cannot provide enough flexibility. Design expansion bends, loops, and offsets within stress limitations in accordance with [ANSI/ASME B31.3](#) and [ANSI/ASME B31.4](#). Thermal expansion of pipes should also be calculated based on the pipe being empty to include considerations for when the pipe is being installed or drained.

9-3.4 Anchors

Anchor aboveground piping at key points so expansion will occur in the desired direction. Anchors and guides may also be required to control movement in long runs of straight pipe or near a connection to fixed equipment such as a pump or filter. See [Facility Plate 021](#). Space anchors to provide maximum amount of straight runs of piping from expansion points to the anchors. In general, place anchors at all points of the system where only minimum piping movement can be tolerated, such as at branch connections and equipment connections. Key locations are pump houses or other buildings, manifolds, at changes of direction if not used as an expansion joint, at points where the pipe size is drastically reduced related to adjacent piping, and at all terminal points. Limit the use of anchors to the situations described above. Where an anchor is welded directly to a pipe, ensure that the anchor material is compatible with the pipe material.

9-3.5 Thermal Relief Valves

The coefficient of expansion of liquid petroleum in the range of 35 degrees to 60 degrees API (0.8498 to 0.7389) at 60 degrees F (16 degrees C) is 0.0005 gallon per gallon per degree F (0.0009 L per L per degree C). The total volume generated in most cases is very small, but the pressure increase resulting from this expansion can equate to as much as 75 psi for every degree rise in the fuel temperature if not relieved. For this reason, provide any section of pipe that has the potential to be isolated by a shut-off valve or other means with a [thermal relief valve](#) to relieve the isolated piping section. Provide a thermal relief of the internal cavity of valves where pressure is trapped when the valve is in the closed position ([double block and bleed](#) plug valves for example).

\1\

9-3.5.1 Material of Thermal Relief Valves

The [thermal relief valve](#) should match the material of the piping in which it is installed. Provide valves used for relief of thermal expansion of not less than 3/4-inch (20 mm) nominal pipe size. It should be provided with isolation ball valves, with removable handles, on the inlet and outlet. The set pressure of the relief valve will vary, but consider a set pressure of about 10 percent above the dead-head pressure of the pump. This should keep the valve from opening during normal fueling operations. Ensure the set point is within the design limitations of the piping. Do not provide thermal relief piping with sight flow indicators.

9-3.5.2 Discharge of Thermal Relief Valves

[Thermal relief valves](#) should never discharge to grade or to a stormwater drainage system. Ideally, the relief valve should discharge to a header which is piped directly to an atmospheric source such as a storage tank or [product recovery tank](#). Often, the practical alternative, is to configure the relief valves into a cascading system, where each relief valve bypass the shut-off valve that is isolating the piping section and discharges back into the main product piping. The excess volume may pass through two or more relief valves before finally making its way back to an atmospheric source. Caution must be taken to ensure that the relief valves have the capacity to handle the additive relief flows this type of system creates and that the total relief pressure does not exceed that system maximum allowable operating pressure. In a cascading system, consider using balanced type relief valves. Balanced type relief valves limit pressure buildup that is created in a cascading system, because the balanced type relief valves relieve at a point independent of downstream pressure.

In some cases a small [atmospheric tank](#) may need to be placed to properly relieve a piping system. This may be the case if a system component has a lower maximum allowable pressure than the rest of the system or in a remote location where a cascading system will not work. Equip the tank with self-checking high level alarms and containment. See Facility Plates [023](#), [024](#), [025](#) and [026](#).

/1/

9-4 UNDERGROUND PIPING

Provide underground piping which passes under public roadways or railroad tracks in accordance with Department of Transportation regulations [49 CFR Part 195](#) and [API RP 1102](#). Refer to [Chapter 2](#) of this UFC for [corrosion](#) protection and for environmental protection. Before installing underground pipelines, review all federal, state, and local regulations for double wall pipe, leak detection, and [corrosion](#) protection requirements.

9-4.1 Depth of Cover

Use the following criteria for depth of cover over buried fuel pipelines:

- a) Locate top of lines at a minimum of 3 feet (0.9 m), except that less cover is permissible for occasional stretches where overriding conditions exist, such as the need to pass over a large culvert or beneath drainage ditches. At such locations, build sufficient slack into the line to allow for vertical and lateral movement due to frost heave. Refer to UFC 3-130 series for additional guidance. Protective measures, such as the installation of reinforced concrete slabs above the pipe, may also be required where depth is less than required under Paragraph (b) below.
- b) Subject to Paragraph (a), provide minimum depths in accordance with [49 CFR Part 195](#) and federal, state and local regulations. Under roadways and shoulders of roadways, provide a minimum depth of 4 feet (1.2m).

9-4.2 Parallel and Crossing Pipes

Provide a minimum clearance of 12 inches (300 mm) between the outer wall of any buried POL pipe and the extremity of any underground structure \1\ /1/ including other underground pipe. Where pipelines cross and a minimum clearance of 12 inches (300 mm) cannot be achieved, provide an insulating mat between the pipes and centered vertically and on the point of intersection. Insulating mat shall be constructed of neoprene or butyl rubber and shall be 36 inch (900 mm) by 36 inch (900 mm) and 1/8 inch (3 mm) thick. Provide a test station with two test leads from each pipe. See [UFC 3-570-02N](#), Electrical Engineering Cathodic Protection for more information. Where non-government and government owned pipe cross or are in proximity of less than 150 feet, contact owner of non-government pipe for coordination to prevent/mitigate cathodic protection interference. In areas where multiple utilities are routed in the same area (e.g., a utility corridor), make sure electrical and communication ducts/conduits are kept a minimum of 36 inches (900 mm) from all other underground utilities especially fuel, steam, and high-temperature water pipes. Refer to [ANSI /IEEE C2](#), [ANSI/ASME B31.4](#), and [49 CFR Part 195](#) for additional requirements. For pipes in concrete trenches, provide a minimum clearance of 6 inches (150 mm) between flanges and the trench wall

and between adjacent flanges. If there are no flanges, provide a minimum clearance of 12 inches (300 mm) or one pipe diameter (based on largest pipe), whichever is greater, between the pipe and the trench wall and between adjacent pipes within the concrete trench.

9-4.3 Casing Sleeves

Use steel casing sleeves only for those crossings where sleeves are required by authorities having jurisdiction, where it is necessary to bore under the roadway or railroad tracks to avoid interference with traffic, or where boring is the most economical construction method. When planning construction of open trench crossings, consider the economics of installing spare casing sleeves to eliminate excavating for future fuel lines. Ensure that the design isolates fuel-carrying pipes from contact with the casing pipes. Require a seal of the annular space at each end of the casing. Include a vent on the higher end of each casing. Locate crossings at a minimum depth of 36 inches (900 mm) beneath the bottom of drainage ditches. If this depth cannot be obtained, install above, but not in contact with, the casing or pipe, a 6-inch (150 mm) thick reinforced concrete slab of adequate length and width to protect the casing or pipe from damage by equipment such as ditch graders and mowers. Refer to [API RP 1102](#) for additional information.

9-4.4 Line Markers

Except where prohibited by national security considerations, install line markers over each buried line and allow for maintenance provisions in accordance with [49 CFR Part 195](#).

9-4.5 Warning Tapes

Provide buried warning tape for all underground pipelines as required by the appropriate guide specification.

9-4.6 Double-Wall Piping

Provide double-wall piping for Ground Vehicle Fueling Facilities \1\ and any other small diameter (≤ 4 inches (100 mm)) underground pipe installations /1/. For other applications \1\ pipes > 4 inches (100 mm) in diameter) /1/, do not use double-wall piping unless required by state or local regulations, and approved by [Service Headquarters](#). [Service Headquarters](#) approval to use \1\ large diameter (> 4 inches (100 mm)) /1/ double-walled pipe must be obtained at the programming level and at the 35 percent design level.

9-4.7 Single-Wall Piping Leak Detection Systems

For all single-wall buried pipe not used in [aircraft direct fueling systems](#), consider providing a leak detection system approved by [Service Headquarters](#).

9-4.7.1 Leak Detection for Aircraft Direct Fueling Systems

For [aircraft direct fueling systems](#), provide an automatic leak detection system approved by Service Headquarters, to test all buried portions of the piping system. Automatic leak detection systems measure changes in either the volume or pressure of the fuel in a fixed piping system, while accounting for variations in ambient temperature. The pressure type shall work by measuring the time rate of change of line pressure at two different pressures. The volume type shall work by measuring the amount of fuel required to maintain a constant pressure in a line, also at two different pressures. The system shall have sufficient sensitivity to detect leaks of at least 0.004 percent of line volume with a Probability of Detection = 95 percent and a Probability of False Alarm = 5 percent. All leak detection system shall be third party certified.

9-5 UNDERWATER PIPING

To receive fuel from offshore moorings, provide one or more underwater pipelines from the shore facility to the mooring. Limit the design of these systems to engineers with this type of experience. Coordinate offshore piping systems with \1\ Naval Facilities Engineering and Expeditionary Warfare Center, CIOFP4, Ocean Facilities Division /1/.

9-5.1 Special Arrangements

At the mooring end of each pipeline, provide lengths of submarine fuel hose equal to 2.5 times the depth at high water. At the pipe end of the hose, provide a flanged removable section of hose 10 feet (3 m) long. At the free end of the hose, provide a steel valve with a marker buoy attached to a cable or chain which has sufficient strength and suitable fittings for the vessel to lift the hose and valve aboard.

9-5.2 Connections

Lay out multiple fuel lines and connections so that they correspond to the layout of the ship's discharge manifold.

9-5.3 Unique Considerations

In piping design, consider fuel characteristics as they may be affected by the sea water temperature, particularly in cold water. For diesel fuel, aviation turbine fuel, or other light fuels, small individual lines are preferable as follows:

- a) Minimum nominal pipe size of 6 inches (150 mm).
- b) For transfers of fuels exceeding 3,000 gpm (189 L/s), use 12-inch (300 mm) to 16-inch (400 mm) diameter pipe.
- c) Instead of pipes larger than 16 inches (400 mm) in diameter, consider using two smaller diameter pipes.

- d) At an accessible upland location, as close to the water entry as practical, provide a [double block and bleed valve](#) and a manually operated check valve or bypass to allow reversal of flow when required.
- e) Provide a dependable means of communication between the vessel in the offshore berth and the shore facility.

9-5.4 Corrosion Protection

Wrap, coat, and cathodically protect underwater pipelines in accordance with [Chapter 2](#) of this UFC.

9-5.5 Depth of Burial

Provide sufficient burial depth of underwater pipelines to prevent damage by dredging of the waterway, by ships' anchors, trawls, or by scouring action of the current. Specifically, ensure depth conforms to the requirements of 49 CFR Part 195. Where lines cross ship channels or anchorages, ensure the top of the pipe is at least 12 feet (3.7 m) below the theoretical, present or planned future bottom elevation, whichever is deeper. Recommended backfill in such areas is 2 feet (0.6 m) of gravel directly over the pipe, followed by stones weighing 50 to 60 pounds (23 kg to 27 kg) up to the bottom elevation.

9-5.6 Pipe Thickness and Weight

Provide sufficient pipe wall thickness to keep stresses due to maximum operating pressure and other design loads within design limits. Include full consideration to extra stresses which may occur in laying the pipe. It is common practice to use heavier wall pipe for water crossings of more than 200 feet (60 m) from bank to bank at normal water level. This affords greater stiffness and resistance to buckling during handling of the assembled crossing pipe and requires less weighting material to obtain the necessary negative buoyancy to keep the line in place while empty or containing a light product. Reinforced sprayed-on concrete is an acceptable weighting material. Hydrostatically test assembled crossing pipe before placing, unless crossing pipe is too long for prior assembly in one segment. In this case, separately test each segment as described.

9-6 PIPING MATERIALS

9-6.1 Non-Aviation Systems

Use carbon steel piping material for [interterminal pipelines](#) (regardless of product) and for all portions of non-aviation turbine fuel systems. FRP may be used for underground pipe (not in concrete trenches) in ground vehicle fueling facilities. FRP is not to be used in aviation turbine fuel system applications. The appropriate service guide specification includes the necessary requirements. See [Facility Plate 022](#).

9-6.2 Aviation Systems

New systems shall use stainless steel issue piping. Interior coated carbon steel may be used only with the approval of the [Service Headquarters](#) for piping downstream of the last issue [filter/separator](#). Return piping shall be interior coated carbon steel. Give special consideration to the pressure rating of both the pipe and fittings to ensure adequacy to accommodate [surge](#) pressure. See [Facility Plate 022](#) for piping material options.

9-7 WELDING CRITERIA

Ensure that the contract requires welding and welding inspections in accordance with appropriate guide specifications and/or standard design. Proper welding, done in accordance with the guide specifications, will prevent loose and adhered slag on the inside of the pipeline. Use 100 percent [radiographed](#) weld joints meeting the standards for severe cyclic service contained in [ANSI/ASME B31.3](#) for piping downstream of the pump in [hydrant systems](#). For all other underground steel pipes, use 100 percent [radiographed](#) weld joints meeting the requirements of [ANSI/ASME B31.3](#).

9-8 PIPING CONNECTIONS

- a) For steel piping systems, use weld neck forged flanges with raised faces having a modified spiral serrated gasket surface finish.
- b) Do not use cast iron flanges.
- c) Do not use grooved pipe type couplings or similar fittings in permanent fixed piping systems.
- d) Do not direct bury flanges, valves, mechanical couplings, threaded fittings, or any mechanical equipment. If they must be used in an underground system, enclose them in an accessible pit.
- e) Use welded connections for joining steel pipe. Use flange connections for joining pipe to equipment. Use threaded connections only where unavoidable such as on differential pressure gages, pressure snubbers, and fuel sample points.
- f) Use carbon steel bolts, studs, and nuts with carbon steel flanges. Use stainless steel bolts, studs, and nuts with stainless steel flanges. Stainless steel bolts may be used on carbon steel flanges in corrosive environments. Select stainless steel bolts, studs, and nuts based on seizing and elongation. Coordinate both strength with force needed to compress selected gasket. In locations where severe corrosion (typically salt air) is susceptible use flange and bolt seals, filled with grease preservative, as required to prevent and control corrosion.

- g) In steel piping systems, use socket weld joints on 2-inch (50 mm) diameter nominal size and smaller pipe.
- h) Make branch connections with butt welded tees except where the branch is at least two pipe sizes smaller than the run, in which case the branch connection can be made with a forged or seamless branch outlet fitting, which is designed in such a way that the connection can be [radiographed](#).
- i) Do not use wrinkle bends or mitered bends for changes in direction.
- j) Except for unions and control tubing couplings, do not use threaded joints in stainless steel systems. Socket-weld stainless steel drain, vent, and pressure relief valve lines 2-inch (50 mm) in diameter or less. If aboveground, flanges may be used.
- k) Join glass FRP piping by bell and spigot joints sealed with adhesive, except use FRP flanges for connections to flanged equipment such as pumps or valves. Ensure that no loading can be transferred from steel piping to FRP piping.
- l) Connect all dissimilar metals with isolation flanges.

9-9 INTERIOR PIPE COATINGS

To protect aviation fuel quality and extend the life of the piping, minimize bare carbon steel piping (except [interterminal pipeline](#)) which comes in contact with aviation turbine fuels especially downstream of initial filtration equipment. Maximize the use of internally coated pipe. This is not intended to allow the use of lined carbon steel piping as a substitute for areas requiring non-ferrous piping. Comply with other paragraphs of this chapter for material selection. Interior pipe coating is not required on non-aviation piping except for carbon steel piping within the lower 36 inches (900 mm) of aboveground vertical storage tanks, and ballast lines on piers.

9-10 EXTERIOR PIPE COATINGS

- a) Protect the exterior surfaces of all underground steel piping systems with a continuously extruded polyethylene coating system or fusion bonded epoxy. Coat welded joints with a system compatible with the pipe coating.
- b) Protect the exterior surfaces of all aboveground carbon steel piping systems by coating in accordance with applicable service requirement. Exterior surface of pipe shall be prepared by abrasive blasting and cleaned prior to coating application.

- c) Coat underwater piping with the same materials used for underground piping. In addition, coat underwater piping with a reinforced sprayed-on concrete, or similar type material, for pipe stabilization and to provide negative buoyancy when the pipeline is empty.

9-11 SAMPLING FACILITIES

Provide connections for sampling fuels on each section of a fuel transfer piping system. Install sampling and testing connections at receiving points, tank outlets, inlet and outlet sides of [filter/separators](#), all fuel dispensing points, and between isolation valves so that the remaining fuel in each portion of a fuel transfer pipeline can be sampled. Where possible, install sampling connections in vertical runs. Provide a 1/4-inch (8 mm) diameter sample point with a probe, ball valve, and quick disconnect with dust cap.

CANCELLED

This Page Intentionally Left Blank

CANCELLED

CHAPTER 10 ALTERNATE POL FACILITIES

10-1 INTRODUCTION

This chapter provides guidance for design of alternate POL facilities. The alternate fuels discussed are: LPG, CNG, hydrazine, and OTTO fuel. This chapter contains information on products which are unique. Therefore, some special considerations are discussed, in addition to information provided in [Chapter 2](#), General Design Information, which contains important information on fueling facilities. Do not start the design of any fueling system without first becoming completely familiar with [Chapter 2](#) of this UFC.

10-2 LIQUEFIED PETROLEUM GAS (LPG)

10-2.1 Uses

The uses for which LPG fuel is procured and the methods of transportation of the fuel are as follows:

- a) LPG fuel is used for general heating, metal cutting and brazing, and in laboratories. LPG is procured in cylinders or for bulk storage by tank car or tank truck. Cylinders usually contain 100 pounds (45 kg) of gas, in a liquid state.
- b) Fuel supply for firefighting trainers and crash and rescue training facilities.
- c) Where economically justified, LPG facilities supplement utility-supplied gas systems for meeting peak loads and as a standby where interruption to a supply is possible.
 - (1) Standby LPG facilities serving large capacity equipment, such as boilers of 200,000 British thermal units (Btu's) per hour (58 000 W) and above, may consist of a separate gas system to an alternate set of burners on the equipment.
 - (2) For a gas system serving multiple small appliances, provide the standby equipment with means for air mixing to dilute the LPG with the proper amount of air to match combustion characteristics of either natural or manufactured gas serving the system in place of the utility-supplied gas, or in conjunction with it to reduce utility peak loads.

10-2.2 General Design Considerations

LPG is odorless, colorless, non-toxic, heavier than air, and explosive. To permit easier leak detection, an artificial odor may be introduced when shipped from a refinery. Under standard atmospheric conditions, LPG is in a vapor phase, but it is liquefied

under moderate pressure for shipping and storage. The maximum [vapor pressure](#) for LPG design is 215 psig (1480 kPa) at 100 degrees F (38 degrees C). All LPG purchased by the military should emit a distinct odor at a concentration required by [NFPA 58](#). See Facility Plates [027](#), [028](#), [029](#) and [030](#).

10-2.2.1 Fire Hazards

In the vapor phase, LPG is a hazard comparable to flammable natural or manufactured gas. The explosive range is 2.16 to 9.6 percent by volume of air-gas mixture.

- a) Provide ventilation in accordance with [NFPA 58](#).
- b) In the liquid phase, LPG is a highly volatile, [flammable liquid](#). Because of rapid vaporization, an LPG fire is basically a gas fire. Therefore, in the event of a fire, provide means to automatically shut off the LPG supply feeding the fire.
- c) Provide emergency shut-off consisting of the combination of three modes: manual shut-off, remote shut-off, and thermal shut-off. Remote shut-off normally consists of a nitrogen system with plastic tubing at the controlled point so that the pressure holds open the valve. The plastic tubing acts as a fusible link. Provide a cable release shut-off with remote shut-off for combination shut-off. Refer to [UFC 4-179-01](#) and [API Std 2510](#).
- d) Provide leak detection in accordance with [NFPA 59](#).
- e) For LPG equipment located inside buildings where there is a potential for loss of LPG, provide an alarm/detection system with local and remote alarms (audible and visual), high and low ventilation, doors with panic hardware, a leak detector readout with the readout outside, and a leak detector kit located outside.

10-2.2.2 Refrigerating Effects

At normal [atmospheric pressure](#), the [boiling point](#) of propane is -45 degrees F (-43 degrees C). Propane in a liquid state and open to the atmosphere will evaporate (not boil).

- a) Provide means to address operational concerns as described in the following paragraph. When LPG is expanded through a regulator from its [vapor pressure](#) to normal service pressures, the cooling effect may freeze the regulator if water is present in the LPG. Freeze-up can also occur on equipment which accumulates water such as strainers and control valves. The freezing effect can also result in exterior ice formations which disrupts the valve operator.

Freeze-ups can be avoided by cleaning and nitrogen-purging the system.

- b) Although it is dehydrated at the refinery, provide a means to keep LPG dry.
- c) In flashing to vapor from the liquid phase, the refrigerating effect can be severe if an abrupt [pressure drop](#) occurs. Therefore, design a system which provides means to avoid this problem.

10-2.2.3 Design Standards

Use the following references for general design and safety standards for all LPG facilities. (Follow particular sections of standards applicable to types of facilities. Where conflicts occur, use the more stringent requirements.) Appropriate standards are as follows:

- a) [NFPA 54](#), [NFPA 58](#), and [NFPA 59](#).
- b) [API Std 2510](#).
- c) Gas Processors Association [Standard 2140](#).
- d) Commercial Item Description [A-A-59666](#), Sections ICC 4BW, ICC 4E, and ICC 4BA.
- e) [UFC 4-179-01](#).
- f) Factory Mutual Engineering Corp. (FM), Loss Prevention Data, Liquid Petroleum Gas, [Section 7-55](#).

10-2.3 Receiving Facilities

10-2.3.1 General Design Considerations

LPG may be received by truck, rail, or water for either cylinder (bottled gas) or bulk systems.

10-2.3.2 Transfer Methods

Design the facility to accommodate one of the following transfer methods:

- a) No pumping or pressurizing facilities are required for small bulk systems utilizing truck delivery. Use pumping equipment provided on trucks instead of stationary pumps.
- b) Provide LPG vapor piping, pumps, and compressors for off-loading tank cars or waterborne LPG tanks to operate, as follows:

- (1) Provide compressor and piping to take suction from the vapor space of the storage tanks to be filled through an equalizing line and pressurize the tank to be off-loaded. This forces the LPG out through the liquid off-loading line into the storage tank.
 - (2) Arrange the piping so that after all liquid has been evacuated, the compressor suction can be reversed to pump the LPG gas from the delivery tank to the storage tank through a subsurface dip tube.
 - (3) Provide connections and valving to allow bleeding of the liquid propane from the connection after shutting off the valve at both the hose end and at the off-loading piping. This is done after off-loading the liquid from either a transport truck or a tank car. Provide a bleed attachment built into the off-loading equipment for this purpose.
 - (4) See Facility Plates [027](#), [028](#), [029](#) and [030](#) for typical installation. Provide liquid pumps as standbys for compressors.
- c) Provide the transfer point from trucks or tank cars with a substantial concrete bulkhead. Anchor the piping in the bulkhead. Do not use pipe sleeves. Provide with the bulkhead hose or swivel-type piping connections. The bulkhead provides a breakaway point if the truck or tank car moves away without first disconnecting the hoses. Also provide emergency shut-off and excess flow valves. Refer to [NFPA 58](#) and [UFC 4-179-01](#) for additional information.

10-2.3.3 Flow Rates

Use the following flow rates:

- a) Provide flow rates commensurate with the storage capacity and the size of pumps, compressors, and loading devices.
- b) Provide flow rates that allow operators adequate time to shut down facilities before tanks or trucks are filled beyond maximum allowable. Limit flow rates from tanks by setting excess flow valves.
- c) Provide off-loading lines with manually operated throttle valves so operators can adjust flow rates to points below shut-off settings of excess flow valves.

10-2.4 Storage Facilities

10-2.4.1 Types of Storage

Types of storage facilities include cylinders or [bulk storage tanks](#).

- a) Provide cylinders or containers conforming to ASME and/or DOT criteria as described in guide specifications. Used tanks are not allowed. The number of cylinders at a facility depends on the maximum required flow rate and the vaporization rate per cylinder at the minimum operating temperatures.
- b) Provide [bulk storage tanks](#) as follows:
 - (1) For storage tanks up to 30,000 gallons (114,000 L) capacity, use horizontal steel tanks.
 - (2) For storage tanks above 30,000 gallons (114,000 L) capacity, use spherical or spheroidal steel tanks.
 - (3) Do not use underground tanks for LPG.

10-2.4.2 Number and Size of Bulk Tanks

Storage capacity depends on requirements, frequency of deliveries, and dependability of supply. Consider a multi-tank system for more dependability.

10-2.4.3 Design Requirements

Design requirements are as follows:

- a) Tanks and tank appurtenances require conformance with [NFPA 58](#) and [API Std 2510](#). Design LPG tanks for a minimum working pressure of 250 psig (1700 kPa).
- b) Tank spacing requires conformance with [UFC 4-179-01](#) and FM criteria. See Facility Plates [029](#) and [030](#).
- c) Provide sufficient flexibility in piping connections to tanks to allow for differential settlement of tank and equipment.
- d) Provide [cathodic protection](#) in accordance with [Chapter 2](#) of this UFC.
- e) If using compressor transfer systems, fit tanks with dip pipes a minimum of 3/4 inches (20 mm) diameter, and gas inlet lines from compressors, so that gas pumped into storage tanks from empty

delivery vessels is bubbled through liquid LPG to prevent overpressuring tanks.

- f) Provide float-actuated high-level alarms set at maximum permissible filling level of 80 percent on all tanks of 3,000 gallon (11,000 L) capacity and above.
- g) If using installed transfer systems, provide pressure switches on tanks set to open at pressures 5 psig (35 kPa) below set pressures of safety valves to stop compressor pumps transferring LPG to tanks.
- h) Ensure that tanks are ASME coded and have the ASME national registration number.
- i) Size storage tanks for 120 percent of required storage volume.
- j) Electrically [ground](#) all storage tanks.

10-2.4.4 Inspection, Testing, and Certifications

Inspect, test, and certify all new unfired pressure vessels prior to placing into operation. Do not operate the unfired pressure vessel (UPV) without a valid certificate. Perform the following tests on the UPV:

- a) A general UPV site inspection
- b) An external UPV inspection
- c) An internal UPV inspection
- d) A [hydrostatic test](#) (strength and tightness tests)
- e) An operational test

The inspector must be registered by the National Board of Boiler and Pressure Vessel Inspectors (NBBI) and must possess a Certificate of Competency and a NBBI National Board Inspection Code (NBIC) Commission. Upon completion and passing of the inspections and tests, the tank will be certified. Post a current, valid certificate on or near the UPV under a protective coating.

10-2.5 Distribution Facilities

See Facility Plates [027](#), [028](#), [029](#) and [030](#).

10-2.5.1 General Design Considerations

The following distribution system requirements apply to the transfer of both the gas and liquid phases of LPG:

- a) Lay all distribution piping underground when practicable.
- b) Provide the required flow rates.
- c) Install electrical equipment in accordance [NFPA 70](#) and [API RP 500](#). Use only equipment approved for each classified area. Ensure electrical design conforms to [API RP 540](#).
- d) [Ground](#) and [bond](#) all piping, tanks, and equipment in accordance with [API RP 2003](#), [API Std 2510](#), [API RP 540](#), and [NFPA 70](#).
- e) Refer to [Chapter 2](#) of this UFC for [corrosion](#) protection requirements of underground pipe.

10-2.5.2 Piping Materials

Provide pipe, valves, and fittings in accordance with applicable sections of [API Std 2510](#). Use Schedule 80 welded carbon steel. Threaded connections are only allowed for valves and equipment. Provide design characteristics and features for gas and liquid pipelines in accordance with [Chapter 9](#) of this UFC. The minimum design pressure for liquid LPG piping is 350 psig (2400 kPa) as required by [NFPA 58](#). Use Class 300 ANSI flanges as a minimum.

10-2.5.3 Accessories

- a) Provide totalizing-type meters, pressure gauges, thermometers, strainers, and [surge suppressors](#).
- b) Ensure that meters are turbine-type with pressure and temperature compensation and have electronic/digital readout capability.
- c) Install meters, if required, in accordance with requirements of [API MPMS Chapter 5](#).
- d) Provide pressure gauges of suitable range on all tanks, on suction and discharge of pumps and compressors, on inlet and outlet of vaporizers and on downstream of throttle valves.
- e) Provide thermometers on all tanks, in all transfer lines for both liquid and gas, and on inlet and outlet of vaporizers.
- f) Provide strainers in compressor suctions, upstream of meters and control valves.

- g) Provide [surge suppressors](#) on liquid lines, if required.
- h) Provide knock-out drums or scrubbers of suitable capacities in suction lines of compressors to remove entrained liquid. Provide drums with high level, shut-down devices, automatic liquid drainers, glass gauges, and drains.
- i) Ensure all valves are UL listed or FM approved for LPG service. At a minimum, use Class 300 valves.
- j) Provide equipment to inject alcohol into the LPG off-loading line. Provide equipment capable of injecting alcohol at a rate of 1:800 alcohol to LPG by volume.

10-2.5.4 Pumps and Compressors

Design and install pumps and compressors in accordance with [API Std 2510](#) and [NFPA 58](#).

10-2.5.5 Vaporizers

Provide vaporizing equipment for distribution facilities as follows:

- a) Provide vaporizers at locations where liquid temperatures are too low to produce sufficient [vapor pressure](#) to meet the maximum required flow rate.
- b) Use vaporizers that are indirect fired-type utilizing steam or hot water as a heating medium or direct fire waterbath-type.
- c) Size vaporizers to provide at least 125 percent of expected peak load.
- d) Design and install vaporizers in accordance with [NFPA 58](#).
- e) Use waterbath vaporizers approved by Factory Mutual.
- f) Space waterbath vaporizers in accordance with FM [Section 7-55](#), except provide a minimum of 75 feet (23 m) between truck off-load stations and tank storage. Where space is limited, provide a blast wall at the truck off-load stations.
- g) When using waterbath vaporizers, provide fire-safe fusible link shut-off valves in LPG supply piping at the vaporizers. Provide remote shut-off capability and 24-hour remote monitoring.
- h) When using waterbath vaporizers, provide an automatic excess flow/emergency shut-off valves in LPG supply lines to vaporizers.

Use a hydraulically operated diaphragm control valve and locate at tank storage.

10-2.5.6 Controls

Provide the following controls.

- a) Use pumps and/or compressors that can be started and stopped by manual pushbutton.
- b) Provide automatic limit switches as follows:
 - (1) Pressure switches on storage tanks set 5 psig (35 kPa) below relief valve settings.
 - (2) Liquid level switches on storage tanks set at maximum filling levels.
 - (3) Liquid level switches on knock-out drums set to shut off compressor at high liquid levels.
 - (4) High pressure switches in compressor discharges to shut off compressor at safe pressure levels.
- c) Provide manually operated throttle valves in liquid off-loading lines to adjust flow rates below excess flow valve settings on delivery tanks.
- d) Provide a sight flow indicator in liquid lines near throttle valves.
- e) Provide automatic temperature, pressure, and limit controls on vaporizers in accordance with [NFPA 58](#).

10-2.6 Air Mixing Facilities

10-2.6.1 Pressure Controls

Provide pressure control valves in both air and gas lines to air mixing equipment. Provide a low pressure alarm in both lines to shut-off air and gas in the event of low pressure.

10-2.6.2 Volumetric Controls

Provide volumetric controls at all distribution facilities as follows:

- a) Provide displacement-type or flow-type meters in both air and gas lines to maintain a proportional flow of air and gas.

- b) Use a venturi-type proportioner where the variation in demand flow rate does not exceed the limited range of the venturi proportioner. Where the demand flow rate varies excessively, use a venturi-type proportioner in conjunction with a downstream storage tank, if economically justified. The storage tank will permit a varying rate of flow to the system while being filled continually or intermittently at a constant rate of flow through the proportioner.

10-2.6.3 Specific Gravity Indication

Provide a [specific gravity](#) indicator and recorder with high and low-limit switches to sound an alarm if the variation of [specific gravity](#) of an air-gas mixture exceeds acceptable limits of the system. For air mixing systems using LPG with a propane content of 90 percent and above, the [specific gravity](#) of the air-gas mixture is a sufficiently accurate index of its Btu or joule (J) content, so calorimetric controls and indication are not required.

10-2.6.4 Calorimetric Controls

Where economically justified, provide an automatic calorimeter to indicate and record the Btu or J content of the air-gas mixture. Provide high- and low-limit switches to calorimeter to sound an alarm if the variation of Btu content exceeds acceptable limits of the system.

10-3 COMPRESSED NATURAL GAS (CNG)

Design CNG storage and dispensing facilities to comply with [NFPA 52](#) and appropriate sections of [NFPA 55](#).

10-3.1 Uses

CNG is primarily used as an alternative fuel in light duty vehicles although it and its cryogenic counterpart liquid natural gas are gaining acceptance in heavy duty applications. Energy policy has mandated with certain reservations that by fiscal year 2000 and thereafter, 75 percent of the light-duty vehicles purchased by the government will use alternative fuels. Therefore, there will be a significant increase in alternative fuel consumption.

10-3.2 General Design Considerations

10-3.2.1 System Sizing

To size the system, determine the total daily fuel consumption of base liquid natural gas vehicles. Based on daily miles driven, determine the number to be refueled each day. The number of vehicles refueled during [surges](#) limits the capacity of most fast fill (3 to 6 minutes) operations. Scheduling vehicles to refuel through the day will effectively increase system capacity. Use a computer program to size the system because manual

calculations usually result in larger systems than needed. Refer to the Gas Technology Institute [GTI-02/0136](#) in the References section of this UFC for ordering information of one possible program. Use the latest version.

10-3.2.2 Future Requirements

Anticipate future requirements when sizing the system but normally limit the project to 100 to 150 standard cubic feet per minute (scfm) (47 to 71 L/s). If additional capability will be needed in the future, plan a second system later or consider other options such as slow fill systems for overnight fueling. This will provide redundancy and reduce initial cost. Usually, [surge](#) requirements drive machine size and can be controlled by management actions. Additionally, boosters operating from system pressure or special control systems may increase [surge](#) handling capacity (e.g., 25 to 30 percent of the gas in a cascade system is available for fast fill operations. A booster or special control system can increase it to 60 percent.) The combination of these actions could delay installing a second system many years at most installations.

10-3.2.3 Pressures

Most vehicle conversions use 3,000 psig (21 000 kPa) storage systems while original equipment manufacturers use 3,600 psig (25 000 kPa) systems. The compressors should operate up to 5,000 psig (35 000 kPa) to refuel at either pressure.

10-3.2.4 Connections

Design the systems to be skid-mounted with compressor system, cascade storage, and controls. Limit field tie-ins to connecting electricity and high and low pressure gas.

10-3.2.5 Compressors

Use crosshead guide type compressors for CNG service. Although more expensive, the design life of these units is significantly longer. Another option is a conventional style compressor designed specifically for CNG service. Do not use modified air compressors. Choose the type compressor after comparing maintenance and reliability data. Test all compressors at the factory with natural gas before shipping.

10-3.2.6 Compressor Drives

Use either electric or engine-driven compressor drives. Gas engine drives are less expensive to operate, but maintenance costs are higher. Use a life cycle cost analysis to determine which compressor drive is best. Although an engine-driven compressor is more expensive than an electric motor, electrical upgrade costs may be reduced. It also may be able to operate during power outages.

10-3.2.7 Compressor Inlet Pressure

Suction pressure is a key factor in selecting a compressor. Use high pressure gas mains to reduce both initial and operating costs. Avoid pressures less than 20 psig (140 kPa). If high and low pressure lines are near each other and the pressure differential is at least 150 psig (1030 kPa), 250 psig (1720 kPa) is preferred, and the low pressure line has a continuous load, a system can be installed and powered by the differential pressure. Such systems are extremely effective and have low initial and operating costs. Where a high pressure differential exists, another option is a turbine to drive the compressor.

10-3.2.8 Storage

Install a cascade system using ASME vessels; either tubes or spheres. Avoid banks of DOT cylinders since they must be inspected every 5 years.

10-3.2.9 Controls

Use either pneumatic or electronic controls depending on local practices. Electronic controls are preferred in most areas because they provide more accurate compensation for temperature effects. Pneumatic controls are simpler, but do not fill tanks to their limits. Normally, this is not a problem, since base vehicles do not normally operate to their maximum range in one day. Since vehicle tank pressures are rated at 70 degrees F (21 degrees C), tanks will fill to a higher pressure when outside temperatures are warmer and to a lower pressure when temperatures are cooler.

10-3.2.10 Dispensers

Although more expensive, provide conventional rather than post style dispensers. To reduce installation costs, use dispensers with the electronics internally mounted and calibrated at the factory. A dispenser makes CNG refueling similar to conventional refueling. Depending on funds, a post style dispenser is an option.

10-3.2.11 Nozzles

Use the industry standard [nozzle](#). It comes in three pressure ranges: 2,400 psig (16 500 kPa), 3,000 psig (21 000 kPa), and 3,600 psig (25 000 kPa). These [nozzles](#) are designed so that a fill system cannot connect to a vehicle tank with a lower pressure rating, yet it can connect to vehicle tanks with higher ratings.

10-3.2.12 Environmental Considerations

- a) The compressor unit's receiver is usually blown-down automatically, releasing about 0.06 gallons (0.2 L) of oil to the base and subsequently the ground. Discharges from other components, such as intercoolers, add to the [contamination](#). Therefore, drip gutters with drains are required at each corner of

the base. Develop a means of collection and retention of these wastes. Deactivating the automatic dump features and manually draining is an alternative to a collection system.

- b) Provide gas recovery system as part of the compressor package to recover gas into an ASME recapture tank when off-loading the compressor.
- c) At the dispenser, provide a vent 8 feet (2.4 m) to 10 feet (3 m) above ground level to discharge vent gas from dispenser hoses. Oversize the conduit from the dispenser to the cascade for a vent line to a future gas recovery system.
- d) Locate units with care because of noise. Use landscaping to conceal units and attenuate the sound.
- e) Natural gas engine drives, if used, may require an air emissions permit.

10-3.2.13 Weather

As a minimum, protect compressor units from the weather with a canopy. In colder climates, use a heated shelter/enclosure with sound attenuation. Some vendors have enclosures as normal options. Costs vary widely depending on the degree of protection. Enclosures may require ventilation and Class I, Division 1 classified electrical components. They should also be accessible by inspectors and servicing personnel. In lieu of a heated facility/enclosure, crankcase heaters and/or circulating block heaters may be suitable in moderately cold climates.

10-3.2.14 Coatings

The CNG equipment comes factory-painted. Specify special coatings where climatic conditions warrant. Select a color from the base color scheme. Light beige is a practical choice. White is a poor choice since the heat of operation discolors it. Storage containers may have to be painted white with blue letters to meet codes.

10-3.2.15 Water Content

Water content in natural gas varies with region. Gas in the Southeast United States is usually dry, while gas from West Virginia is very wet. Provide dryers to dry the gas to a pressure (storage pressure) dew point (PDP) at least 10 degrees F (6 degrees C) below the winter design dry bulb temperature.

10-3.2.16 Design Standards

Design CNG systems to [NFPA 52](#). Use [NFPA 54](#) for the gas supply to the compressor. Use the [ASME Boiler and Pressure Vessel Code](#) (BPVC) for cascade storage.

Electrical work must conform to [NFPA 70](#). When collocating CNG and gasoline stations, also use [NFPA 30A](#).

10-3.3 Warning

During peak demand periods, some suppliers mix propane air mixtures with natural gas. When the amount added exceeds 10 percent by volume, the CNG produced from this gas will normally not perform properly in CNG vehicles because propane becomes a permanent liquid in storage tanks. Oxygen sensors can be installed to shut down the station during such periods. Installations with this situation should use dual fuel vehicles.

10-4 HYDRAZINE STORAGE AND SERVICING FACILITIES

10-4.1 Uses

A blend of 70 percent hydrazine and 30 percent water, known as H-70 fuel, is used to operate the F-16 emergency power unit (EPU). The F-16 H-70 tank carries 56 pounds (25 kg) of fuel and requires servicing after the fuel has been used. The H-70 tanks are removed from the aircraft when the fuel is depleted below a level specified by the using activity. The tanks are delivered to the servicing facility where any remaining fuel is drained into a closed 55-gallon (210 L) stainless steel drum. The aircraft H-70 tank is filled using a closed system charging unit and is either returned to the aircraft or placed in a handling/storage container for future use. The bulk H-70 storage tank is a 55-gallon (210 L) stainless steel drum containing approximately 51 gallons (190 L) of H-70. Nitrogen gas is used as an inert pressure head in the bulk drum to transfer H-70 to the charging unit. The charging unit is 75 inches (1900 mm) long by 36 inches (900 mm) wide by 92 inches (2340 mm) high and weighs approximately 475 pounds (216 kg). An F-16 tactical wing is expected to use approximately 100 gallons (380 L) of H-70 per 20,000 flight hours with an additional minimum of 150 gallons (570 L) held in reserve to handle deployment/safety stock requirements.

10-4.2 General Design Considerations

- a) H-70 carries the compatibility group designation of Group C.
- b) Separate H-70 fuel storage and liquid/gaseous oxygen storage in accordance with [AFMAN 91-201](#). Locate the facility a minimum of 50 feet (15 m) from aboveground explosive storage in accordance with [AFMAN 91-201](#).
- c) Locate the facility a minimum of 100 feet (30 m) from public highways; civilian or government living areas; public facilities such as schools, churches, clubs, sewage treatment plants; or rivers, lakes, or streams because of bio-environmental considerations.

- d) Segregate the servicing and storage facility from large population concentrations within the confines of a military installation and subject to the criteria stated above.
- e) Store 55-gallon (210 L) drums of hydrazine in facilities no less than 80 feet (24 m) apart. The spacing is also subject to the other criteria stated in this chapter. This criterion is limited to ten 55-gallon (210 L) drums and 20 EPU tanks (provided the tanks are stored inside an approved shipping container).
- f) Refer to Air Force [AFTO-42B1-1](#).

10-4.3 Construction Concepts

Provide the H-70 facility with space for tank servicing, storage, and personnel hygiene.

10-4.3.1 Access

- a) Provide security fencing with a vehicle entrance gate surrounding the facility to restrict access.
- b) Provide a doorway leading into storage areas to allow for forklift access.

10-4.3.2 Architectural

- a) The total area recommended for the facility is 783 square feet (73 m²) with H-70 and N₂ bulk storage occupying 210 square feet (20 m²), a servicing and storage area of 449 square feet (42 m²), and a personnel area of 124 square feet (12 m²).
- b) Provide ceiling height of 12 feet (3.7 m) in storage and servicing areas and 8 feet (2.4 m) in personnel areas.
- c) Provide hollow, metal, exterior and interior doors with panic hardware and automatic closure. Provide double doors, 6 feet (1.8 m) wide to allow for equipment movement. Ensure single doors are standard size.
- d) Provide a rack in the servicing and storage area for vertical drum storage (bung side up) to allow for drainage of flush water. Construct storage rack of hydrazine compatible materials such as stainless steel, plastic, or high-density polyethylene (HDPE).
- e) Design floors to permit drainage and prevent collection of liquids on any floor surface.

10-4.3.3 Fire Protection Systems

A wet pipe sprinkler system is recommended. Consider above-ceiling detectors, as well as room detectors. Provide fire extinguishers of a type approved for use in combating [hydrocarbon](#) fuel fires in regulated areas. Use AFFF or water. Do not use halogens or CO₂ extinguishers. Refer to Air Forces [AFTO 00-25-172](#).

10-4.3.4 Spill Containment

- a) Provide spill containment in the H-70 storage area with a capacity equal to the larger of 110 percent of the largest drum present or 10 percent of the total volume present.
- b) Spill containment for facilities which store only one or two drums of H-70 can be individual containers for each drum.
- c) Provide a [diked](#) containment area for facilities which store multiple drums of H-70.
 - (1) Provide ramps for vehicle access.
 - (2) Provide a coating or liner for concrete containment areas. Do not allow exposed iron or rebar in the containment area.

10-4.3.5 Floor Drains

- a) Provide a concrete floor in the regulated areas, sloped to floor drains which lead to a collection tank.
- b) Provide a floor trench drain 18 inches (450 mm) wide by 6 inches (150 mm) deep by 9 feet (2.7 m) long, covered with an open stainless steel grate in the H-70 fuel tank servicing area. The trench is required to contain any possible H-70 spillage and periodic draining of the H-70 servicing stand. Construct the trench parallel to the wall separating the storage area from the servicing area. Locate the servicing stand so the drain spigot from the scrubber is in-line with the trench drain. A polypropylene or polyethylene elbow connection directly from the drain spigot to the trench drain is required.
- c) Ensure deluge shower and eyewash units in the servicing area drain into the containment tank.
- d) Ensure industrial sink in the protective equipment room drains into the containment tank.
- e) Equip drains leading to the containment tank with traps to prevent vapors from contaminating the area.

- f) Provide access to the sanitary sewer for both clean change room and shower facilities.
- g) Construct floor drains which are subject to carrying H-70 residue of polypropylene or polyethylene.

10-4.3.6 Collection Tank and Piping

- a) Provide a collection tank and piping of materials compatible with hydrazine, water, and neutralizer.
- b) Size the collection tank to contain 100 times the maximum quantity of H-70 that could spill with a minimum capacity of 1,000 gallons (4,000 L).
- c) Provide piping of 304 stainless steel, HDPE, or to a limited extent, galvanized steel.
- d) Provide gaskets of suitable materials such as Viton.
- e) Test the system annually with water.

10-4.3.7 Grounding

In the storage area, provide a ground strap or grounding point system to [ground](#) each drum of H-70. Locate the grounding strap around the interior walls of the storage room, 54 inches (1370 mm) above the floor. The grounding system must have a resistance of 25 ohms or less. The facility must also have an approved lightning protection system.

10-4.3.8 Hygiene Support Criteria

- a) Provide lavatory washing facilities in a non-regulated area close to the exit from the regulated area and contiguous to the clean change room.
- b) Provide shower facilities for each 10 or less workers.
- c) Provide a clean change room. Provide a separate area for the removal of contaminated clothing to prevent the spread of potential [contamination](#) from the regulated area.
- d) Provide toilet facilities if the H-70 facility is isolated from other buildings where toilet facilities are available.
- e) Post signs which state that consumption of food, beverages, cosmetics, tobacco products, and chewing materials are prohibited.

10-4.3.9 Lighting

Provide lighting intensities of 50 foot-candles (540 lux) in the servicing area and 30 foot-candles (320 lux) in the remainder of the facility. Provide exterior lighting at all entrances and security lighting as required.

10-4.3.10 Safety

- a) Provide vapor sniffers for use in the H-70 fuel drum storage area and servicing area to alert personnel to excessive levels of H-70 fuel vapors. Provide sniffers capable of detecting 10 ppb of H-70.
- b) A facility respirator air system is recommended. Breathing air shall meet at least the minimum Grade D breathing air requirements of [29 CFR Part 1910.134](#) and Compressed Gas Association (CGA) [Pamphlet G-7.1](#).
- c) Provide an [explosion-proof](#) observation window (4 feet (1.2 m) by 4 feet (1.2 m)) between the H-70 fuel drum storage area and the tank servicing area.
- d) All lighting fixtures, electrical outlets, and electrical components located within the storage and servicing area should be [explosion-proof](#).
- e) Provide eyewash fountains and deluge shower units within sight of and on the same level as locations where direct exposure to H-70 might occur. Pipe eyewash and showers to the H-70 collection tank.
- f) Post signs at entrances to all areas. Signs should warn personnel that “H-70 is a cancer suspect agent,” “Authorized Personnel Only,” and “No Smoking.”
- g) All tools and equipment must be constructed of hydrazine compatible, rust-free, corrosion-resistant materials.

10-4.3.11 Utilities

- a) For electricity, provide 120-VAC, 60-Hz, single phase, three-wire, 20 amperes, duplex convenience outlets in each area of the facility (minimum six outlets). Two-way switching is preferred to control lighting in the H-70 fuel drum storage area from the H-70 fuel tank servicing area. Provide [explosion-proof](#), Class I, Division 2, Group C electrical fixtures.

- b) Provide 15 gpm (1.0 L/s) hose bibb water outlets with backflow prevention. Size hose bibb for standard lawn hose connections. Locate the hose bibb to provide water to service stand on the inside of the exterior wall, on the center of the servicing trench, about 2.5 feet (0.8 m) above the finished floor (below the 4-inch (100 mm) pipe sleeve). Water with a reduced pressure-type backflow preventor will also be required for the fire suppression system and potable water systems.

10-4.3.12 Ventilation

- a) Segregate mechanical ventilation for regulated versus non-regulated areas. Exhaust regulated areas through a common manifold. Evaluate the need for an air pollution control system on a case-by-case basis and consider federal, state, or local emissions criteria applicable to the construction location.
- b) Design ventilation systems for regulated areas to maintain a negative pressure of 0.05 to 0.1 inches of water (12 to 25 Pa) with respect to adjacent non-regulated areas.
- c) Design ventilation for servicing and storage areas to provide a minimum of 20 air changes per hour.
- d) Design the ventilation system for automatic shutdown in the event of a fire within the facility.
- e) Use flexible exhaust vent of the “elephant trunk” type to exhaust vapors that are released when full hydrazine drums are opened. Design for air flow at the vent [nozzle](#) to be approximately 150 cfm (71 L/s). Refer to American Conference of Governmental Industrial Hygienists (ACGIH), [Industrial Ventilation: A Manual of Recommended Practice for Design](#).
- f) Place exhaust ports at approximately 18 inches (450 mm) above the floor. To avoid exhausting H-70 vapors into areas where personnel are present, such as walkways or escape paths, consider placing exhaust ports above the roof line.
- g) Place a switch on the outside of the building, near an entrance that will allow personnel to turn on all exhaust fans prior to entering the facility. This will purge the facility of any H-70 vapors that may have collected in the facility while not in use.
- h) Maintain temperature in regulated areas below 120 degrees F (49 degrees C). Provide environmental controls consistent with ventilation for personnel comfort.

10-4.3.13 Waste Product Disposal

- a) Add water to H-70 spills in a 100 to 1 ratio to reduce the H-70 concentration to less than 1 percent. Size collection tank accordingly.
- b) Use neutralizers, such as 65 percent granular calcium hypochlorite (HTH), 14 percent bleach, and 5 percent bleach to stabilize the H-70/water mixture.
- c) Provide storage for HTH away from hydrazine and other potentially reactive materials. HTH is extremely corrosive.
- d) Consult with local base bio-environmental engineer as to procedures for emptying the collection tank.

10-5 OTTO FUELS

Information on OTTO fuels is contained in [NAVSEA S6340-AA-MMA-010](#). Distribution of this document is restricted. Requests for information are handled by Naval Sea Systems Command. Refer to [Chapter 2](#) of this UFC for additional information.

CHAPTER 11 SUPPORT FACILITIES

11-1 INTRODUCTION

This chapter provides design criteria for facilities which may be required to support fueling activities. Specifically, operations buildings, [contaminated fuel](#) recovery systems, roads, utilities, and aircraft [refueler](#) parking areas are detailed in this chapter.

11-2 OPERATIONS BUILDING

Review the fueling activity to establish a need for each component of this building. Factors which will affect these reviews are number of people required for fueling activity, level of activity, types of fuels handled, on-site quality control, availability of replacement parts, availability of maintenance support, and level of training required.

11-2.1 Design Standards

The support facilities shall be designed in accordance with [UFC 1-200-01](#), General Requirements. See [UFC 3-600-01](#) for fire protection requirements.

11-2.2 Fuel Office

Provide a fuel office with sufficient space to perform the necessary planning, administrative, and management functions associated with the accomplishment of the fuel division's mission. Refer to [AFH 32-1084](#) for size on Air Force projects.

11-2.3 Training/Conference Room

Provide a multipurpose room with equipment for training, conferences, and briefings. Design this room to accommodate furniture and have built-in features such as markerboard, tack board, book shelves, screen, clock, coat hooks, and storage cabinets.

11-2.4 Fuel Maintenance Workshop

Provide a fuel maintenance workshop with an adequately sized and convenient work bench with compressed air and electrical outlets available. Provide slip and fuel-resistant floor, emergency shower/eye wash, and adequate storage space adjacent to the workbench for frequently used tools, spare hardware items and accessories. If facility is large enough and mission warrants, consider overhead crane, laundry facility, and shower facility. Refer to [Chapter 2](#) of this UFC for electrical hazard classification and requirements and NFPA for ventilation requirements.

11-2.5 Storeroom

Provide an adequate storeroom for spare hoses, [nozzles](#), filtration elements, special tools, special clothing, test equipment, and fuel spill clean-up equipment. Determine

size and location of each facility to provide sufficient space for orderly storage and location for ready access to needed material by fuels division personnel.

11-2.6 Laboratory

Laboratories shall comply with the general facility requirements of [UFC 3-600-01](#) and [NFPA 45](#) Laboratories using Chemicals. The fuel laboratory size and associated equipment depend on the scope of the quality surveillance and testing program performed. Design the laboratory in accordance with applicable NFPA and CFR codes. Review NFPA 45 for applicability. Minimum laboratory requirements are as follows:

- a) Lighting and fixtures in accordance with [NFPA 70](#).
- b) Sink with running hot and cold water. Include hot water heater capable of providing water at 130 degrees F (54 degrees C) for cleaning laboratory glassware.
- c) Work bench(s) or counter(s) of sufficient size to accommodate and maintain all required test equipment in a ready-to-use position. Compose countertops of a non-permeable material suitable for working with petroleum fuels. Ensure that laboratory flooring material is impermeable and suitable for a fuels laboratory.
- d) Storage cabinets for test equipment support items; for example, bottles, drying rack, and spare millipore pads. Construct cabinets of a non-permeable material suitable for exposure to petroleum fuels.
- e) Fume hood, comply with [29 CFR Part 1910.1450](#), Appendix A. Electrical equipment located inside the fume hood shall be rated for classified areas.
- f) Emergency eyewash/shower. Construct adjacent walls of waterproof/water-resistant materials.
- g) Outward opening doors with panic bars. Multiple doors may need to be provided in accordance with [NFPA 45](#).
- h) Portable firefighting equipment.
- i) Telephone.
- j) Fire alarm box.
- k) A waste tank or means to dispose of fuel samples.
- l) Lighted exit signs.

- m) Capabilities to maintain laboratory at 73 degrees F (23 degrees C) plus or minus 5 degrees F (3 degrees C). (Required to protect laboratory equipment.)
- n) [Bonding](#) and [grounding](#) of all metal working surfaces and electrical equipment. Also, provide a common static grounding strap or approved grounding points readily accessible to all fixed working surfaces and alongside entrance doors.
- o) Recessed floor to prevent spilled fuel from flowing into adjacent areas.
- p) Windows constructed of fireproof materials. Draperies and curtains are prohibited. If interior windows are provided, use translucent reinforced safety glass.
- q) An HVAC system designed so that air from the laboratory does not recirculate to other portions of the building.
- r) Interior separations from other portions of the building with a partition rated for fire separation as required by [NFPA 45](#).
- s) Type "N" unprotected non-combustible construction.
- t) Provide a location and connections for an automatic laboratory glassware washer.
- u) Electrical installations in the laboratory work areas are non-classified.

11-2.7 Miscellaneous Safety Equipment

Provide firefighting, fire alarm, and emergency eyewash/shower equipment. Provide emergency eyewash/shower with tempered water in cold weather climates. Also see applicable service-specific guidelines.

11-2.8 Control Room

Where computerized control equipment is anticipated, provide a control room of adequate size and with a maximum view of outside activities. Allow extra space along the ceiling/wall interface for future installation of security monitors. Consider electrical receptacles and data outlets for future use.

11-2.9 Miscellaneous Spaces

Provide toilets, shower facilities, lockers, dressing rooms, mechanical room, electrical room, janitor closet, break room, etc. based on the size of the facility and the planned activities. Provide exhaust for locker rooms through the back or top of the lockers.

11-2.10 Communications

Make provisions for telephone, data transmission, and other planned communications equipment.

11-3 ROADS

Design roads within a fueling facility to accommodate maintenance activities, operations personnel, and fuel delivery and/or issues. In addition, evaluate the roads leading to the facility for their adequacy of width, access, geometrics, and weight restrictions. For vehicle access roads in [diked](#) areas around tanks, see [Chapter 8](#) of this UFC. Refer to [UFC 3-250-18FA](#) and [UFC 3-250-01FA](#) for design guidance.

11-4 UTILITIES

In most cases, a fueling facility requires water (domestic and fire protection), sanitary sewer, storm sewer, and electricity.

11-5 AIRCRAFT REFUELER AND FUEL DELIVERY VEHICLE PARKING

11-5.1 General

Ensure aircraft [refueler](#) and ground fuel delivery vehicle parking areas meet the following criteria at a minimum. For additional design guidance, refer to [NAVAIR 00-80T-109](#) and Air Force [AFTO 00-25-172](#).

11-5.2 Clearances

- a) Provide a minimum of 25 feet (7.6 m) between the centerlines of adjacent aircraft [refueler](#) trucks and ground fuel delivery vehicles when in the parked position or 10 feet (3 m) minimum of clear space between parked trucks, whichever is greater.
- b) Provide a minimum of 50 feet (15 m) between aircraft [refueler](#)/ground fuel delivery vehicle parking area and the following:
 - (1) Uninhabited building for new projects.
 - (2) Pump house or [filter/separator](#) building.
 - (3) Taxiing aircraft.
 - (4) Fence, if space is a limitation (100 feet (30 m), if space is available).
 - (5) Roads outside of a security fence.

- (6) Overhead power and communication lines.
 - (7) Pad-mounted transformers.
 - (8) Parked aircraft.
 - (9) Any building other than a maintenance building.
- c) Provide a minimum of 100 feet (30 m) between aircraft [refueler](#)/ground fuel delivery vehicle parking area and the following:
- (1) Inhabited buildings.
 - (2) Aboveground Storage Tanks
 - (3) Truck or tank car off-loading station.
 - (4) Truck fillstation.
 - (5) Property lines.
 - (6) Highways.
 - (7) New POL Operations Building.
 - (8) Airport surface detection radar equipment.
- d) Provide a minimum of 300 feet (90 m) between an aircraft [refueler](#)/ground fuel delivery vehicle parking areas and the following:
- (1) Aircraft warning radar antennas.
 - (2) Areas where airborne surveillance radar may be operated.
- e) Provide a minimum of 500 feet (150 m) between an aircraft [refueler](#)/ground fuel delivery vehicle parking areas and airport ground approach and control equipment.
- f) Provide a distance as great as practically possible between an aircraft [refueler](#)/ground fuel delivery vehicle parking areas and radio transmitting antennas.
- g) Contact the installation safety office to obtain distance criteria from an aircraft [refueler](#)/ground fuel delivery vehicle parking areas to aircraft carrying explosive materials.

11-5.3 Arrangement

The preferred arrangement is parallel positions, but “front-to-back” and variations of the two are acceptable. Provide “front-to-back” clearance between vehicles such that the aircraft [refueler](#)/ground fuel delivery vehicle in the “back” position would not have to back-up to pull out of the parking position. This distance will vary according to the turning radius of each aircraft [refueler](#)/ground fuel delivery vehicle. Arrangement should satisfy functional requirements of users and provide for safe operation and efficient use of available space. Provide for parking of all refueling vehicles expected to use this facility and include identification of positions.

11-5.4 Ingress/Egress

Provide for “drive-ahead” motion of vehicles at all stages to avoid backing up vehicles under normal circumstances. Provide for smooth and efficient movement from the truck fillstand area to the parking positions and from the parking positions to the aircraft apron. Where necessary, provide adequate markings to ensure safe and efficient vehicle movements. At a minimum, provide two means of ingress/egress.

11-5.5 Paving

Use concrete pavement, capable of withstanding design vehicle wheel loads. Seal joints with fuel-resistant materials. For circulation pavements, provide bituminous flexible pavements unless an economic analysis shows rigid concrete is more cost-effective. Use concrete pavement in aircraft [refueler](#)/ground fuel delivery vehicle parking areas.

11-5.6 Containment Area

Provide a containment area consisting of an impermeable retention and controlled drainage system leading to a concrete remote spill containment system. Pave the area with concrete pitched a minimum of 1 percent toward catch basins or trench drains. Design the containment area in accordance with [UFC 1-200-01](#), federal, state, and local regulations. Do not use asphalt within a spill containment area. The maximum slope of any paving within a truck movement or parking area shall not exceed 2 percent excepting rollover curbs. If a rollover curb is provided, the sum of the vertical entrance and exit grades shall not exceed 8 percent and the rollover curb shall be aligned perpendicular with direction of truck movement. The designer shall assure that adequate ground clearance is achieved for all vehicles utilizing the containment areas.

/1/

11-5.7 Fire Protection

Refer to [Chapter 2](#) of this UFC for fire protection requirements.

11-5.8 Security

Provide fencing and lighting for security as required in [Chapter 2](#) of this UFC.

11-5.9 Lighting

Provide 1-footcandle (10 lux) lighting to ensure that a fuel leak from the [refueler](#) is seen.

11-5.10 Block Heater Connections

At facilities where aircraft [refuelers](#)/ground fuel delivery vehicles have block heaters, provide connections for those heaters.

CANCELLED

This Page Intentionally Left Blank

CANCELLED

CHAPTER 12 MAJOR REHABILITATION

12-1 INTRODUCTION

Decisions concerning major rehabilitation will be based on economics, mission, safety, or environmental factors. It is not the intent of this chapter to mandate rehabilitation, but only to provide guidance if the decision is made. The most common reasons for rehabilitation are to meet environmental needs or to extend the usable life of the facility. If a tank or major component is taken out of service for rehabilitation, review other chapters of this UFC. However, consider each change based on its merits and its compliance with this UFC. It is not the intent of this UFC to initiate changing and upgrading of existing facilities. Before initiating a facility improvement or major rehabilitation fuel project, it is recommended that a Physical Condition Survey be conducted to survey the condition of the facility with the goal of identifying major deficiencies and prioritizing the work required. Contact the appropriate Command Fuels Engineer, Naval Facilities Engineering Component Commands and the \1\ Naval Facilities Engineering and Expeditionary Warfare Center /1/, or Army Corps of Engineers regional design office. For Naval Air Stations and Marine Corps Air Stations, include a representative from NAVAIR on the survey team. In most cases, coordinate major rehabilitation proposals with the base master plan.

12-2 GENERAL REQUIREMENTS

[Chapter 2](#), General Design Information, contains important information on fueling facilities. Do not begin the design or modification of any fueling system without first becoming completely familiar with [Chapter 2](#) of this UFC.

12-3 ABOVEGROUND FUEL STORAGE TANK REHABILITATION

Existing aboveground storage tanks can be modified to meet fuel quality standards, safety requirements, and environmental regulations. To maintain the structural integrity of aboveground storage tanks and to ensure a complete and usable facility, ensure all designs are accomplished by an engineering firm regularly engaged in tank modification or have all plans and specifications reviewed by an [API Std 653](#) certified inspector. Complete all tank modifications, repairs, alterations, or inspections in accordance with [API Std 653](#) and [API Std 650](#). Require a new [strapping](#) table after any major tank rehabilitation.

12-3.1 Aboveground Vertical Tank Inspections

Prior to modifying the tank, conduct a thorough inspection consistent with the requirements of [API Std 653](#). This inspection will reveal any repairs that need to be made in order to comply with current regulations. \1\ If the tank is suspected of leaking, a helium test may be conducted. /1/

12-3.2 Increase Manhole Sizes

Many older aboveground vertical tanks have inadequately sized shell manholes. The ventilation and equipment requirements for maintenance have created a need for 36-inch (900 mm) diameter manholes. If they do not exist, consider rehabilitation. Provide in accordance with [Chapter 8](#) of this UFC.

12-3.3 Replace Tank Floors

Replace existing tank floors only when an API Std 653 inspection (including a magnetic flux leakage test) indicates that the useful life of the bottom has expired, or that the bottom requires more than minor repairs or upgrades, or if significant fuel quality problems due to ponding water exist. Contact Service Headquarters for guidance. Whenever a tank bottom is replaced it shall comply with current design standards including either a double bottom or single bottom with liner. In no case shall a tank with a single bottom remain in service when the bottom warrants replacement, unless other provisions such as a programmed MILCON or SRM project has been approved to replace the tank and/or bottom. Conduct an analysis of the existing tank and local conditions to determine the most desirable approach. The type of new bottom to be installed depends upon a number of factors, including: condition of the existing bottom, tank foundation, shell condition, and amount of tank capacity which can be "lost." Install double bottoms or replacement bottoms in accordance with [API Std 653](#). Install sloped bottoms (3 to 5 percent) either above the existing bottom if the user can accept the resulting loss in tank capacity or remove the existing bottom and install a new sloped bottom in its place. A slope of 5 percent is preferred, but not required. If conditions and cost make the recommended slope impractical, provide a minimum slope of 2 percent. In either case, install an impermeable liner in accordance with DoD Standard Design [AW 78-24-27](#), as well as leak detection between the two floors. The technology exists and it may be cost effective to raise the tank off its foundation to accomplish under tank modifications or repairs (e.g., adding containment liner/tell-tale system, [cathodic protection](#), ringwall, etc.).

12-3.3.1 Double Bottom With Washed Sand Layer and Liner

Clean and repair the existing tank bottom, install a liner on top of the existing tank bottom, add a 4- to 6-inch (100 to 150 mm) silica sand layer on top of the liner, and install the new steel tank bottom on top of the sand layer. Refer to [Chapter 8](#) of this UFC for suitable sand criteria. Leak detection consists of tell-tale slotted PVC pipes within the sand layer at regularly spaced intervals and extending out through the outer shell of the tank. Provide [cathodic protection](#) by sacrificial [anodes](#) or impressed current close to the liner to allow maximum clearance from the new tank bottom. Install adequate numbers of a [cathodic protection](#) reference cells between the two bottoms.

12-3.3.2 Double Bottom With Concrete Layer and New Steel Bottom

Clean and repair the existing tank bottom, install a liner on top of the existing tank bottom, pour 4 to 6 inches (100 to 150 mm) of fiber reinforced (low slump mix - typically

3,000 psig (21 000 kPa)) concrete over the liner and existing bottom, shape the concrete to provide adequate slope, and install the new steel tank bottom on top of the concrete. Slope the concrete towards a [sump](#) and form with a series of grooves along the top surface to collect any product which may leak through the new bottom. Slope the channels to a collection point with a pipe extending to an observation well. Provide concrete with an alkalinity of 13 or higher.

12-3.3.3 Double Steel Bottom

Clean and repair the existing tank bottom, place a structural support system on top of the existing tank bottom, and install the new tank bottom. Design the structural support system to prevent excessive deflections resulting from loads on the primary (new) tank bottom. Allow for an interstitial space between the two tank bottoms to detect and collect any product from a leak. Purge the interstitial space between the two bottoms with nitrogen to remove the oxygen, thus creating a non-corrosive, non-combustible environment. The elimination of condensation and oxygen within the space minimizes corrosion formation for the upper (new) bottom. Provide leak detection with sensors which can detect pressure changes within the space. A pressure increase results from a leak in the upper tank bottom as product enters the space. A decrease in pressure indicates a leak or steel failure has occurred in the lower tank bottom.

12-3.3.4 Single Bottom With Liner

Remove the existing tank bottom and prepare the sub-base for bearing capacity. Place sand layer on the sub-base to support the primary tank bottom, install a liner with a slope to a center liner [sump](#), place a minimum 12-inch layer of sand on top of the liner, and install a new tank bottom on top of the sand layer. The liner [sump](#) is the collection point for any leaks from the bottom and consists of a drain pipe leading to an observation well. An alternative method is to use tell-tale slotted PVC or stainless steel pipes in accordance with DoD Standard Design [AW 78-24-27](#). Provide [cathodic protection](#) by sacrificial [anodes](#) or impressed current close to the liner to allow maximum clearance from the new tank bottom. Install adequate numbers of a [cathodic protection](#) reference cells between the two bottoms. Place [cathodic protection](#) in the sand layer approximately 6 inches (150 mm) below the new tank bottom and above the liner.

12-3.4 Replace Floating Roof Tanks With Fixed Roofs

If a floating roof requires significant repair work, is corroded beyond economic repair, or for any reason is considered unserviceable (by an [API Std 653](#) inspection), consider replacing it with a fixed cone roof and internally sealed honeycomb cell floating pan, as required in the "Protection of Aboveground Storage Tanks" paragraph of Chapter 2.. When a fixed cone roof is added to an existing tank the roof manufacturer and the designer must determine that the tank has sufficient strength to support the new roof. If the shell is structurally insufficient, a geodesic dome may be considered. Install structural supported roofs in accordance with [API Std 650](#), [API Std 653](#), and DoD Standard Design AW [78-24-27](#). In general, all open top, [floating roof tanks](#) containing

aviation fuel should be programmed to receive a cover, as should all tanks in northern climates where snow and ice is a problem.

12-3.5 Product Recovery Systems

Provide storage tanks with pumps, piping, valves, and tanks to collect, recover, and return usable aviation turbine fuel which would otherwise become waste. Include a tank(s) to collect fuel/water mixtures from tank and equipment sumps, equipment drains, high point vents, low point drains, and any other equipment from which fuel/water mixtures can be collected. Separate the fuel and water portions. Filter the fuel portion and return to [bulk storage tanks](#). Do not discharge the water portion to surface water without additional treatment and permits or treat the water portion as wastewater. Refer to [Chapter 2](#) of this UFC for information on handling of wastewater. Design in accordance with DoD Standard Design [AW 78-24-27](#).

12-3.6 Coatings

In tank coating projects, minimize the generation of hazardous waste associated with coating removal. Some alternatives to traditional sand blasting include shot “blasting”, chemical stripping, high pressure water, carbon dioxide, or chemical stabilizer [additive](#) process. Designs for maintenance painting, both interior and exterior, should be based on a coating condition survey, as discussed in the notes to UFGS [09 97 13.15](#), [09 97 13.17](#), and [09 97 13.27](#). An evaluation of shell coating should be based not only on condition but on the need for coating the shell and an evaluation of apparent [corrosion](#) pressures on the shell. [Corrosion](#) pressure on shell coatings is generally fairly low; therefore, there is not the same need for coating thickness and integrity that is required for floors and ceilings. Refer to [Chapter 8](#) of this UFC for additional information on interior and exterior coatings for storage tanks. Re-coat the portion of the tank that is already coated. When tanks are taken out of service for inspection or repairs, inspect the underside of the roof for [rust](#). If conditions merit, coat the underside of the roof in conformance with [Chapter 8](#) of this UFC.

12-3.7 Isolation Valves

Require tank isolation valves to prevent the accidental release of fuel into the environment. On aboveground tanks larger than 12,000 gallons (45,800 L), provide [double block and bleed](#) tank shell valves located between the tank shell and the high level shut-off valve.

12-3.8 Alarms and High Level Shut-off Valves

Equip storage tanks with a means to prevent accidental overflow. Design in accordance with DoD Standard Design [AW 78-24-27](#). Refer to [Chapter 8](#) of this UFC for applicable requirements for alarm and valve installation.

12-4 UNDERGROUND OPERATING TANKS

If major rehabilitation is required, upgrade existing underground operating tanks to conform with [40 CFR Part 280](#) and [40 CFR Part 281](#) and applicable state and local underground storage tank regulations. As a minimum, provide leak detection, [cathodic protection](#), and overflow protection. Careful study of [cut and cover](#) tanks is necessary since construction features may make it impossible to comply.

12-4.1 Manholes

Provide a 36-inch (900 mm) diameter manhole for tanks. Extension necks and internal ladders are required for cleaning and inspection. Provide a minimum of one manhole for tanks between 1,000 gallons (4,000 L) and 5,000 gallons (19,000 L). Provide a minimum of two manholes for tanks larger than 5,000 gallons (19,000 L). Provide manhole containment [sumps](#) for all manholes.

12-4.2 Interior Coatings

Coat underground operating tanks in accordance with [Chapter 8](#) of this UFC.

12-5 HYDRANT SYSTEMS

Decisions concerning major rehabilitation of existing direct aircraft refueling systems will be made by [Service Headquarters](#). This paragraph addresses existing direct aircraft refueling systems (Type I and Type II) which can be rehabilitated or modified to meet fuel quality standards, safety requirements, mission requirements, and environmental regulations. All designs should be accomplished by an engineering firm regularly engaged in the design of direct aircraft fueling systems. The provisions of [Chapter 4](#) of this UFC are applicable.

12-5.1 Pumps

Repair or replace existing pumps to meet increased fuel demands. Rebuild pumps including complete bearing replacement, additional bowls or increased impeller size, replacement of mechanical seals, shaft lengthening or shortening to match replacement tanks, etc. In some cases, additional capacity can only be achieved by total pump replacement or rearrangement of piping. Consider pump replacement where, due to equipment age or condition, it is more economical to replace than to rebuild. Pump and motor replacement may also result in higher efficiency units with lower power demands and increased spare part availability.

12-5.2 Filter/Separators

Existing [filter/separators](#) must be capable of meeting requirements of [EI Specification 1581](#) (Edition 5). Existing [filter/separator](#) vessels built to earlier editions of API 1581 may be able to be reutilized with [EI Specification 1581](#) (Edition 5) coalescer and separator elements. Where possible, the replacement elements shall be of the same

size as other elements at the activity /1/. Contact the [Service Headquarters](#) for guidance. Replace existing vessels if they cannot be converted to use [EI Specification 1581](#) (Edition 5) elements or if the vessel with [EI Specification 1581](#) (Edition 5) elements fails to meet quality standards. Issue [filter/separators](#) should be given priority for upgrade on a stand-alone project. Upgrade of all [filter/separators](#) is mandatory on any major rehabilitation project.

12-5.3 Fuel Quality Monitors

Existing fuel quality monitors will be removed. Fuel quality monitor elements degrade when they come in contact with fuel additives (FSII) in aviation turbine fuel causing fuel quality issues.

12-5.4 Control Systems

Pump houses and [hydrant systems](#) typical of the Panero (circa 1952) and Pritchard (circa 1958) designs utilize hard-wired, high-voltage mechanical relays. Control systems installed from the pump house to the lateral control pits, emergency stops, and pit activation switches are typically high voltage. Age, elements, and exposure to fuels may deteriorate control system wiring and render it no longer reliable or safe to operate. Consider control system replacement whenever a significant portion of the pump house is repaired or when fire, safety, or electrical codes indicate a hazard exists. Generally, hard-wired relay logic systems are expensive to build and maintain and do not offer the flexibility of PLC based systems. Control systems should be of low voltage design incorporating industry standard PLCs. If control facilities are isolated from the pump house (not subject to atomized fuel) and the facility has positive ventilation, then non-[explosion-proof](#) fixtures may be incorporated into the design. Existing control wiring has probably deteriorated and numerous conduits are no longer intrinsically safe. Replace control wiring and wherever possible run control wiring in overhead conduit. If necessary, replace kill switch and emergency stop circuits as part of the pump house rehabilitation. Cable wiring systems are easier to install and troubleshoot and should be considered whenever the wiring to [hydrant system](#) is replaced.

12-5.5 Electrical Systems

Replace secondary electrical systems, including lighting and motor conductors and motor control centers, as part of pump house repairs. Ensure circuits within the pump house, exposed to the possibility of atomized fuel, comply with the provisions of [NFPA 30](#) and are classified Class I, Division 1. If the motor control center is isolated from the pump house (not subject to atomized fuel) and the facility has positive ventilation, then the area may be derated and non-[explosion-proof](#) lighting fixtures may be incorporated into the design. Existing secondary wiring has probably deteriorated and numerous conduits are no longer intrinsically safe. Replace motor wiring and wherever possible run control wiring in overhead conduit.

12-5.6 Lateral Control Pits

Lateral control pits are typically concrete structures with heavy metal-hinged lids containing valves, pumps, filters, and piping associated with the supply of fuel from a pump house to a hydrant outlet. Repair or replace pits to prevent the accidental release of aviation turbine fuel to the environment and water infiltration. Slope pit floors to a [sump](#) and provide manually operated [sump](#) pumps to aid in water removal. Use either rolling or light-weight hinged aluminum pit lids with a water-tight design. Comply with DoD Standard Design [AW 78-24-28](#).

12-5.7 Distribution Piping

Minimize the use of unlined carbon steel pipe, especially with jet aircraft. A number of alternatives exist which reduce the exposure of aviation turbine fuel to unlined carbon steel pipe. One option is to internally coat existing systems without pipe removal. In-situ coatings can prevent fuel degradation; however, final filtration must still be provided at the aircraft by either a mobile or fixed [filter/separator](#). Another option is to sleeve the piping with a non-ferrous material (stainless steel). Consider this option if reduced flow rates are acceptable.

12-5.8 Diaphragm Control Valves

Consider reusing existing diaphragm control valves wherever possible. Diaphragm control valves can typically be refurbished by either the original manufacturer or by a factory authorized repair facility for less than the replacement cost. Ensure refurbishers modify or replace pilot assemblies, tubing, and solenoids to meet specifications as outlined in DoD Standard Design [AW 78-24-28](#). As a minimum, replace non-ferrous pilot tube assemblies with a stainless steel unit. Provide stainless steel control tubing and replace all internal valve components. If the valve body is carbon steel, request [Service Headquarters](#) to determine if the valve body should be sand-blasted and cleaned or replaced. Coat or plate carbon steel bodies to meet DoD Standard Design [AW 78-24-28](#).

12-5.9 Hydrant Outlets

Remove and replace existing hydrant outlets and connections (e.g., Buckeye) with API adapters. Conversion to API adapters ensures compatibility with all refueling equipment. If adequate pressure control (regulating and [surge](#)) in accordance with DoD Standard Design [AW 78-24-28](#) does not exist at the hydrant pit or at the lateral control pit, then install a control valve at either location.

12-6 DIKES, LINERS, AND BASINS

If [dikes](#), liners, and basins do not comply with the requirements of this UFC, [40 CFR Part 112](#), state, or local spill containment regulations and the potential for accidental fuel discharges exists, repair or replace the existing structures. The provisions of [Chapter 8](#)

of this UFC are applicable. In general, if the [dike](#) does not retain rainwater, improvements are necessary.

12-7 LEAK DETECTION

When rehabilitating fuel facilities, install leak detection, if necessary, as detailed in [Chapter 2](#) of this UFC.

12-8 CATHODIC PROTECTION

When rehabilitating any fuel facility, install or upgrade [cathodic protection](#). Ensure cathodic protection systems are designed by a NACE certified Corrosion Specialist or Cathodic Protection Specialist or a registered professional Corrosion Engineer. Install cathodic protection on all steel structures including, but not limited to, aboveground storage tanks, underground storage tanks, and underground piping systems. The provisions of Chapters [2](#) and [8](#) of this UFC are applicable.

12-9 ISOLATION VALVES

Provide valves in product piping systems to control flow and to permit isolation of equipment for maintenance or repair. Provide additional valves at required locations necessary to conduct a valid [hydrostatic test](#). Provide manually operated valves, except where motor operators are specifically authorized by applicable standard drawings or technical specifications. Use [double block and bleed](#) type isolation valves for separation of product services, on tank shell connections (ASTs over 12,000 gallons (45,800 L) only), when piping goes above or below ground, between pier and tank storage, and other locations critical to periodic pressure-testing of piping. Quick opening/frequent opening type isolation valves may be used for less critical applications where [double block and bleed](#) shutoff is not required. Before adding isolation valves, evaluate piping system and make modifications to prevent pressure buildup caused by thermal expansion. Review paragraph on "Relief Valves" in [Chapter 9](#) of this UFC. Except for those serving tactical refueler fillstands, this paragraph does not apply to systems covered by [Chapter 7](#) of this UFC unless otherwise directed by [Service Headquarters](#).

12-10 SOIL AND GROUNDWATER REMEDIATION

Monitor, store, and dispose of petroleum-contaminated soil disturbed during rehabilitation in accordance with state and local environmental regulations. Collect, test (if appropriate), and treat petroleum-contaminated groundwater removed during dewatering by one of the following methods:

- a) Off-site disposal at an industrial waste facility.
- b) On-site treatment with a portable groundwater treatment system.
- c) Treatment through an [oil/water separator](#).

- d) Treatment through the sanitary sewer.

Prior to selecting a treatment method, review state and local environmental regulations and consult the facility for acceptable alternatives and permits required for on-site treatment and disposal.

12-11 LIQUEFIED PETROLEUM GAS (LPG) FACILITIES

When rehabilitating an LPG facility, back weld (seal weld) all existing threaded piping.

12-12 PIPELINE INSPECTION

12-12.1 Inspection

Conduct pipeline inspections in accordance with [API 570](#) and NACE [SP0169](#).

12-12.2 Smart Pigging

To determine if or how a pipeline requires rehabilitation, information on the pipeline's structural integrity is essential. One method to survey the condition of the pipeline is to use smart pigs.

12-12.2.1 General

A "smart" or "intelligent" pig is one of a variety of instrumented tools using one or more physical or electro-mechanical principles for recording and measuring information for positioning and relative severity of anomalies in a pipeline. Smart pigs can detect cracks, metal loss, and curvature/bends. Other types available can map and profile pipe, detect leaks, perform photographic inspection, and sample product. Use of smart pigs may require modifying the pipeline to increase the radius of sharp elbows and eliminate obstructions caused by valves that are not full port type.

12-12.2.2 Types

The three basic types of smart pigs are ultrasonic, magnetic flux leakage (MFL), and eddy current. Ultrasonic, MFL, and eddy current pigs can be used in liquid pipelines. An alternative form of ultrasonic inspection is an electromagnetic acoustic transducer (EMAT). An EMAT can be used in either a liquid or gas pipeline. MFL can also be used in gas pipelines. Prior to choosing a smart pig, consider expected results, cost of various options, and expected pipeline condition.

12-13 CHECKLIST

The following is a checklist of items to be considered in a major rehabilitation.

- a) Aboveground storage tank rehabilitation

- (1) [API Std 653](#) inspection.

- (2) 36 inch (900 mm) diameter manholes for maintenance.
- (3) Add double bottom.
- (4) Repair and slope tank floor.
- (5) Repair or replace floating roof.
- (6) Product recovery system.
- (7) Internal and external coating systems.
- (8) Tank isolation valves.
- (9) Fill and overfill protection.
- (10) Corrosion protection to tank bottom.
- (11) Leak detection.
- (12) Automatic tank gauging system.
- (13) Thermal expansion relief.

b) Underground storage tank rehabilitation

- (1) 36 inch (900 mm) diameter manhole(s).
- (2) Leak detection.
- (3) Corrosion protection.
- (4) Overfill protection.
- (5) Interior coating.

c) Aviation/[Hydrant system](#) rehabilitation

- (1) Repair or replace pumps to [API Std 610](#).
- (2) Upgrade filter/separators to comply with [EI Specification 1581](#) (Edition 5).
- (3) Remove automatic water drains from filter separators.
- (4) Repair or replace control systems.
- (5) Repair or replace electrical systems.

- (6) Repair or replace lateral control valve pits and lids, including an [impervious](#) liner.
 - (7) Internal coating to carbon steel distribution pipe.
 - (8) Refurbish diaphragm control valves.
 - (9) Hydrant outlets to API adapters.
 - (10) Replace lubricated valves and swivels with non-lubricated.
- d) Truck fill/off-load stands
- (1) Grounding, deadman, and high level shut-off systems.
 - (2) Pantographs - convert from 3-inch to 4-inch (75 mm to 100 mm).
 - (3) Low profile filters.
 - (4) Fusible link butterfly valves (These valves are not required nor permitted on Air Force projects).
 - (5) Piping of pressure reliefs to contained tank.
 - (6) Updated meters and meter diaphragm control valves.
 - (7) Adequacy of piping and system [grounding](#).
 - (8) Adequacy of spill collection and containment.
 - (9) Upgrade military specification filter separators to comply [with EI Specification 1581](#) (Edition 5). (Issue filters have priority over receipt filters.)
 - (10) Remove automatic water drains on [filter/separators](#) and ensure that any liquid drained from separators is properly handled.
- e) Add isolation valves and blind flanges throughout system.
- f) Use smart [pigging](#) to determine the condition of the distribution piping.
- g) Monitor, remove, and dispose of petroleum-contaminated soil and groundwater.
- h) Spill Containment and collection.

- (1) Concrete containment areas for [dikes](#), equipment pads, fillstands, etc.
- (2) [Impervious](#) lining system for [dikes](#), containment areas, and catch basins.
- (3) When required to meet federal, state, and local regulations, refer to Chapter 2 of this UFC for information on design and sizing of oil/water separators for treatment of stormwater discharges from containment areas (e.g., [dike](#) areas, fillstands, equipment pads, etc.).

CANCELLED

CHAPTER 13 FUELING FACILITY TEMPORARY DEACTIVATION

13-1 INTRODUCTION

Follow the more stringent of local, state, or applicable guidelines of this chapter during the initial deactivation of a fueling facility. Follow the applicable subsection when temporarily deactivating a fueling facility for three months or more. For continuing maintenance issues and reactivation of a deactivated facility, refer to inactive document [UFC 4-911-01N](#), which is required for these circumstances. Additional guidelines for the deactivation of storage tanks and pipes are provided in [API Std 2610](#) and [NFPA 30](#), Appendix C. Federal regulations addressing out-of-service underground storage tank systems are in [40 CFR Part 280](#).

13-2 GENERAL REQUIREMENTS

[Chapter 2](#), General Design Information, contains important information on fueling facilities. Do not begin the design of any deactivation plan without first becoming completely familiar with [Chapter 2](#) of this UFC.

13-3 FUEL STORAGE AND DISTRIBUTION FACILITIES

13-3.1 Tanks

The following items apply to deactivation of all tanks in general.

- a) Empty and clean tanks in accordance with [API Std 2015](#) and [UFGS 33 65 00](#), *Cleaning Petroleum Storage Tanks*.
- b) Provide water ballast with a copper sulphite solution (1 part copper sulphite to 3 million parts water) to discourage organic growth. Verify compatibility with environmental regulations prior to employing this solution.
- c) Follow the procedures of [MO-230](#) and [29 CFR Part 1910](#) when entering tanks or performing maintenance on tanks.
- d) For tanks equipped with [cathodic protection](#) systems, inspect for proper operation and repair if necessary. For tanks not equipped with [cathodic protection](#) systems, investigate the economic trade-offs of installing those systems at deactivation versus the associated caretaker maintenance costs and various environmental protection concerns.
- e) Mark each tank clearly with its status. Place a warning sign on the tank to indicate its current and former contents.

- f) If required by state or local regulatory agencies, submit required documentation for “out-of-service” storage tanks.

13-3.1.1 Aboveground Tanks

- a) Empty and evaluate for hazardous atmosphere as defined by [29 CFR Part 1910.146](#).
- b) Wash and dry tank interior until visibly clean in accordance with [API Std 2015](#).
- c) Physically disconnect all fuel connections.
- d) Treat the interiors of tanks that have been used to store fuel oil with a corrosion-preventive compound. For all other steel tanks, coat the unpainted interior surfaces with a preservative lubricating oil.
- e) Close vents on lubricating oil tanks. Vents on other tanks should remain open.
- f) Partially fill tanks subjected to high winds to prevent overturning. Use water except where there is the possibility of it freezing and rupturing the tanks. In those environments, use [kerosene](#). Add caustic soda to the water to obtain a pH of 10 or a corrosion inhibitor. Determine the amount of liquid ballast required based on the expected winds, size of the tank, and [specific gravity](#) of the liquid used.
- g) Comply with [API Std 2015](#).
- h) Comply with state and local environmental requirements.

13-3.1.2 Underground Tanks

- a) Empty, evaluate for hazardous atmosphere as defined by [29 CFR Part 1910.146](#), and clean underground metal and concrete tanks.
- b) Partially fill tanks insufficiently anchored against flotation with water to prevent buoyancy. Provide adequate safeguards where there is danger of the water freezing.
- c) Provide a minimum of 12 inches (300 mm) of water in rubber-lined concrete tanks.
- d) Leave vent lines on underground tanks open and make sure the vents are adequately screened.

- e) Tightly cap or plug all other tank openings after removal of equipment.
- f) Provide release detection where fuel is left in the tank.
- g) Comply with [40 CFR Part 280](#) and any applicable state and local environmental regulations.

13-3.1.3 Tank Level Controls

- a) Remove controls such as float control valves, float-operated gauges, low level cutoffs, water detector locks, and probes from tanks.
- b) Clean, treat with corrosion-preventive compound, and store controls in a dry place.

13-3.2 Pipelines

- a) Drain and vacuum extract all fuel from the pipeline.
- b) If possible, pig the pipeline to remove any residual fuels.
- c) Blind all flange connections and vents.
- d) Charge the line with nitrogen gas.
- e) Continue to provide [cathodic protection](#) and maintain the nitrogen charge.
- f) Externally coat unpainted and unwrapped lines exposed to the weather with a corrosion-preventive compound.

13-3.2.1 Pipeline Equipment

- a) Remove, clean, coat inside and outside with a light oil, and reinstall strainers.
- b) Remove, clean, treat with corrosion-preventive compound, and store meters in a dry place.
- c) Keep gaskets tight to prevent dirt and water from entering.
- d) Remove, clean, grease, and store hydraulically operated diaphragm control valves in a dry place.

- e) Paint exterior or treat with a corrosion-preventive compound and leave all other valves, such as plug valves and check valves in place.
- f) Lubricate plug valves and leave in an open position.
- g) Remove, tag, date, and store hoses in dry storage.

13-3.2.2 Fueling Pits

- a) Inspect, tag, and secure fueling pits.
- b) Make provisions for pumping pits dry.

13-4 FACILITIES

13-4.1 General Considerations

- a) Make arrangements to retain the minimum amount of maintenance equipment.
- b) Check and label all keys to all doors, gates, hatches, and other moving items.
- c) Clean and repair as necessary all storm sewers, drainage ditches, and other drainage structures to prevent flooding and storm damage to roads, runways, tracks, and structures.

13-4.2 Fencing

- a) Tighten connections at gates, posts, braces, guys, and anchorages to ensure stability and correct alignment.
- b) Clean and lubricate all hinges, latches, locking devices, and all other alignment hardware.
- c) Confine painting to those parts of fences and gates that show signs of [corrosion](#).

13-4.3 Paved Surfaces

- a) Unpaved shoulders
 - (1) Provide unpaved shoulders with only the repairs necessary to ensure positive drainage of surface water from the adjoining pavement.

- (2) Fill holes and ruts and blade ridges to eliminate standing water.
- (3) Backfill depressions when the undermining of pavement is threatened.
- (4) When possible, retain existing ground cover.

b) Concrete pavements

- (1) Repair concrete pavements only as required to perform service activities and to prevent severe disintegration.
- (2) Patch bituminous surfaces of depressed or broken slabs to prevent ponding of water and the resultant saturation of the subgrade.
- (3) Seal joints and cracks in concrete pavement with bituminous material.

c) Bituminous pavements

- (1) Limit surface repairs of bituminous pavements to the repair of holes, raveled areas, edge failures, and open cracks.
- (2) Repair unused surfaces only as necessary to maintain drainage and to prevent the ponding of surface water.

This Page Intentionally Left Blank

CANCELLED

CHAPTER 14 FUELING FACILITY CLOSURE

14-1 CLOSURE REQUIREMENTS

Follow the more stringent of local, state, or applicable guidelines in this chapter when permanently closing a fuel facility or a portion of a fuel facility. Additional guidance on closure and disposal of storage tanks is available in Appendix C of [NFPA 30](#) and [API Std 2610](#).

14-1.1 Aboveground Tanks

- a) Physically disconnect all fuel connections.
- b) Remove fuel.
- c) Clean tank in accordance with [API Std 2015](#).
- d) Dismantle the tank and dispose of as scrap steel.
- e) Comply with [API Publ 2202](#).
- f) Comply with state and local environmental requirements.

14-1.2 Underground Tanks

- a) Perform a soil and groundwater analysis to determine if a fuel release occurred.
- b) Review and comply with [40 CFR Part 280](#) and any applicable state and local environmental regulations.
- c) If allowed by federal, state and local regulations, perform closure in place, as outlined in [API RP 1604](#). However, this alternative may be more expensive than removal for small volume tanks. Abandoning in place also impedes soil clean-up and future land use.
- d) If removal is required, excavate and dispose of the tank in accordance with [API RP 1604](#).
- e) Comply with applicable guide specifications and [EM 1110-1-4006](#).

14-1.3 Pipelines

- a) Physically disconnect the pipeline from any active fuel systems.
- b) Remove all fuel and pig to remove any residual fuel.

- c) Purge the pipeline to remove all vapors. Do not use water as flushing media because it will typically generate large quantities of hazardous waste with high disposal costs.
- d) Excavate the line only if required by federal, state, or local regulations or if deemed necessary by [Service Headquarters](#) for land reuse.
- e) Report any contaminated soil or groundwater discovered during excavation to the appropriate state and local environmental authorities.
- f) If excavation is not performed, fill the pipeline with cellular concrete or other acceptable inert solid material allowed by regulations requiring the filling. Consider the lowest cost from the acceptable materials list. As an option, the pipeline can be capped, where it meets environmental regulations and with approval from [Service Headquarters](#).

14-2 GENERAL REQUIREMENTS

[Chapter 2](#), General Design Information, contains important information on fueling facilities. Do not begin the design or modification of any closure plan without first becoming completely familiar with [Chapter 2](#) of this UFC.

14-3 INVENTORY

Prepare an inventory of valuable fueling hardware which could be easily salvaged and reused at another base. Equipment such as pantographs, control valves, pumps, and filtration equipment are always in demand. Submit list to your command fuels engineer.

APPENDIX A REFERENCES

NOTE: THE FOLLOWING REFERENCED DOCUMENTS FORM A PART OF THIS UFC TO THE EXTENT SPECIFIED HEREIN. USERS OF THIS DOCUMENT SHOULD REFER TO THE LATEST REVISIONS OF CITED DOCUMENTS UNLESS OTHERWISE DIRECTED.

FEDERAL/MILITARY SPECIFICATIONS, STANDARDS, BULLETINS, HANDBOOKS, USAFE/NATO STANDARD DESIGNS, AND NAVFAC GUIDE SPECIFICATIONS:

Unless otherwise indicated, copies are available from the Standardization Document Order Desk, Building 4D, 700 Robbins Avenue, Philadelphia, PA 19111-5094. For account and order information, the phone number is (215) 697-6257 or DSN 442-2179/2667. Many of the documents below are also available on the following websites:

- The Whole Building Design Guide website provided by the National Institute of Building Sciences at <http://www.wbdg.org/ccb>.
- The Department of Defense Single Stock Point for Military Specifications, Standards and Related Publications at <http://dodssp.daps.dla.mil/>

MILITARY SPECIFICATIONS

MIL-DTL-5624	Turbine Fuel, Aviation, Grades JP-4 and JP-5
MIL-DTL-16884	Fuel, Naval Distillate
MIL-DTL-25524	Turbine Fuel, Aviation, Thermally Stable (JPTS)
MIL-DTL-38219	Turbine Fuel, Low Volatility , JP-7
MIL-DTL-83133	Turbine Fuel, Aviation, Kerosene Type, JP-8 (NATO F-34), NATO F-35, and JP-8+100 (NATO F-37).
MIL-DTL-85470	Inhibitor, Icing, Fuel System, High Flash
MIL-DTL-87107	Propellant, High Density Synthetic Hydrocarbon Type, Grade JP-10
MIL-PRF-17331	Lubricating Oil, Steam Turbine and Gear, Moderate Service
MIL-PRF-25017	Inhibitor, Corrosion/Lubricity Improver, Fuel Soluble
MIL-PRF-26536	Propellant, Hydrazine
MIL-PRF-9000	Lubricating Oil, Shipboard Internal Combustion Engine, High Output Diesel

DoD STANDARD DESIGNS

AW 78-24-27	Standard Fueling Systems; Aboveground Vertical Steel Tanks with Floating Pans and Fixed Roofs
AW 78-24-28	Pressurized Hydrant Fueling System, Type III
AW 78-24-29	\1\ Pressurized Hydrant Direct Fueling System /1/

HANDBOOKS

MIL-HDBK-1004/6	Lightning Protection
MIL-HDBK-1005/17	Nondomestic Wastewater Control and Pretreatment Design Criteria

\1\ /1/

UNIFIED FACILITIES GUIDE SPECIFICATIONS

UFGS 09 97 13.15	Epoxy/Fluoropolyurethane Interior Coating of Welded Steel Petroleum Fuel Tanks
UFGS 09 97 13.17	Three Coat Epoxy Interior Coating of Welded Steel Petroleum Fuel Tanks
UFGS 09 97 13.27	Exterior Coating of Steel Structures

\1\ /1/

UFGS 33 65 00	Cleaning Petroleum Storage Tanks
UFGS 44 42 53	Parallel Plate [or Vertical Tube], Gravity Oil-Water Separator

UNIFIED FACILITIES CRITERIA

UFC 1-200-01	General Building Requirements
UFC 2-000-05N/P-80	Facility Planning Criteria for Navy/Marine Corps Shore Installations
UFC 3-130-01	General Provisions - Arctic and Subarctic Construction
UFC 3-130-02	Site Selection and Development - Arctic and Subarctic

	Construction
<u>UFC 3-130-03</u>	Runway and Road Design - Arctic and Subarctic Construction
<u>UFC 3-130-04</u>	Foundations for Structures - Arctic and Subarctic Construction
<u>UFC 3-130-05</u>	Utilities - Arctic and Subarctic Construction
<u>UFC 3-130-06</u>	Calculation Methods for Determination of Depths of Freeze and Thaw in Soil - Arctic and Subarctic Construction
<u>UFC 3-130-07</u>	Buildings - Arctic and Subarctic Construction
<u>UFC 3-220-01N</u>	Geotechnical Engineering Procedures for Foundation Design of Buildings and Structures
<u>UFC 3-220-10N</u>	Soil Mechanics
<u>UFC 3-240-02N</u>	Wastewater Treatment Systems Augmenting Handbook
<u>UFC 3-240-09FA</u>	Domestic Wastewater Treatment
<u>UFC 3-250-01FA</u>	Pavement Design for Roads, Streets, Walks, and Open Storage Areas
<u>UFC 3-250-18FA</u>	General Provisions and Geometric Design for Roads, Streets, Walks, and Open Storage Areas
<u>UFC 3-260-01</u>	Airfield and Heliport Planning and Design
<u>UFC 3-260-02</u>	Pavement Design for Airfields
<u>UFC 3-301-01</u>	Structural Engineering
<u>UFC 3-310-04</u>	Seismic Design for Buildings
<u>UFC 3-420-01</u>	Plumbing Systems
<u>UFC 3-460-03</u>	O&M: Maintenance of Petroleum Systems
<u>UFC 3-501-01</u>	Electrical Engineering

\1\ UFC 3-530-01	Design: Interior, Exterior Lighting and Controls /1/
UFC 3-550-01	Exterior Electrical Power Distribution
UFC 3-570-02N	Electrical Engineering Cathodic Protection
\1\ UFC 3-575-01	Lightning and Static Electricity Protection Systems /1/
UFC 3-580-01	Telecommunications Building Cabling Systems Planning and Design
UFC 3-600-01	Fire Protection Engineering for Facilities
UFC 4-010-01	DoD Minimum Antiterrorism Standards for Buildings
UFC 4-020-01	DoD Security Engineering Facilities Planning Manual
UFC 4-020-03FA	Security Engineering: Final Design
\1\ UFC 4-022-03	Security Fences and Gates /1/
UFC 4-150-02	Dockside Utilities for Ship Service
UFC 4-150-06	Military Harbors and Coastal Facilities
UFC 4-152-01	Design: Piers and Wharves
UFC 4-179-01	Design: Navy Firefighting School Facilities
UFC 4-832-01N	Design: Industrial and Oily Wastewater Control
UFC 4-911-01N	O&M: Inactive Care and Closure of Shore Facilities
STANDARDS	
MIL-STD-161	Identification Methods for Bulk Petroleum Products Systems Including Hydrocarbon Missile Fuels
MIL-STD-461	Requirements for the Control of Electromagnetic Interference Characteristics of Subsystems and Equipment
MIL-STD MS 24484	Adapter, Pressure Fuel Servicing, Nominal 2.5-inch Diameter
\1\ MIL-STD-3007	Department of Defense Standard Practice for Unified

Facilities Criteria and Unified Facilities Guide
Specifications /1/

AIR FORCE

AIR FORCE HANDBOOKS

[AFH 32-1084](#) Facility Requirements

AIR FORCE INSTRUCTIONS (AFI)

[AFI 32-1054](#) Corrosion Control

\1\ AFI 91-203 Air Force Consolidated Occupational Safety
Instruction /1/

AIR FORCE MANUALS (AFM)

[AFM 88-9](#) Electrical Design – Lightning and Static Electricity
Protection

[AFMAN 91-201](#) Explosives Safety Standards

\1\ /1/

TECHNICAL MANUALS

\1\ [AF ETL 11-1](#) Civil Engineer Industrial Control System Information
Assurance Compliance/1/

AFTO 00-25-172 Ground Servicing of Aircraft and Static
Grounding/Bonding

AFTO 37-1-1 General Operation and Inspection of Installed Fuel
Storage and Dispensing Systems

AFTO 42B1-1 Quality Control of Fuels and Lubricants

DEPARTMENT OF DEFENSE

\1\

DOD 4140.25M DoD Management of Bulk Petroleum Products,
Natural Gas, and Coal

[DOD 5200.08-R](#) Physical Security Program

/1/

NATO STANDARDS

STANAG 3784 Technical Guidance For The Design And Construction
Of Aviation And Ground Fuel Installations On NATO
Airfields

U.S. ARMY CORPS OF ENGINEERS

Unless otherwise indicated, copies are available from the U.S. Army Corps of Engineers, Washington, D.C. 20314-1000. Many of the documents below are also available on the following website: the Whole Building Design Guide website provided by the National Institute of Building Sciences at <http://www.wbdg.org/ccb>.

ENGINEER MANUAL

[EM 1110-1-4006](#) Removal of Underground Storage Tanks

ENGINEER TECHNICAL LETTERS

[ETL 1110-3-466](#) Selection and Design of Oil/Water Separators at Army
Facilities

ETL 1110-3-502 Telephone and Network Distribution System Design
Implementation Guide

ETL 03-04 Alternative Fuels E85 and B20

REGULATION

AR 420-90 Fire and Emergency Services

TECHNICAL MANUALS

[TM 5-811-3](#) Electrical Design - Lightning and Static Electricity
Protection

TM 5-811-9 Voice/Data Telephone Systems

NAVY DESIGN MANUALS, P-PUBLICATIONS, AND MAINTENANCE AND
OPERATION MANUALS:

Available from National Technical Information Service (NTIS), 5285 Port Royal Road, Springfield, VA 22161, Attention: Defense Publications. Many of the documents below are also available on the following website: the Whole Building Design Guide website

provided by the National Institute of Building Sciences at <http://www.wbdg.org/ccb>.

NAVAIR

NAVAIR 00-80R-14	NATOPS U.S. Navy Aircraft Fire Fighting and Rescue Manual
NAVAIR 00-80T-109	Aircraft Refueling NATOPS Manual

NAVFAC

DEFINITIVE DRAWINGS

\1\

Nos. 1403995 thru 1403999	Non-Polluting Fuel Piers
------------------------------	--------------------------

/1/

INSTRUCTIONS

OPNAVINST 5090.1	Environmental Readiness Program Manual
OPNAVINST 5100.23	Navy Safety and Occupational Health (SOH) Manual

INTERIM TECHNICAL GUIDANCE

FY94-01	Cathodic Protection Systems
-------------------------	-----------------------------

P-PUBLICATIONS

P-80/UFC 2-000-05N	Facility Planning Criteria for Navy/Marine Corps Shore Installations
------------------------------------	--

MAINTENANCE AND OPERATION MANUALS

MO-230	Petroleum Fuel Facilities
------------------------	---------------------------

NAVSEA

NAVSEA S6340-AA-MMA-010	Technical Manual for OTTO Fuel II Safety, Storage, and Handling Instructions
-------------------------	--

GENERAL SERVICES ADMINISTRATION

COMMERCIAL ITEM DESCRIPTION

CID A-A-52557	Fuel Oil, Diesel; for Posts, Camps and Stations
CID A-A-59693	Diesel Fuel, Biodiesel Blend (B20)
CID A-A-59666	Cylinder, Compressed Gas

(Unless otherwise indicated, copies are available from:

- GSA, 1800 F Street NW, Washington, D.C. 20405, Phone Number: (816) 823-1219) (www.gsa.gov)
- The Department of Defense Single Stock Point for Military Specifications, Standards and Related Publications at <http://dodssp.daps.dla.mil/>

OTHER GOVERNMENT DOCUMENTS AND PUBLICATIONS:

CODE OF FEDERAL REGULATIONS (CFR)

29 CFR Part 1910	Occupational Safety and Health Standards
33 CFR Part 154	Facilities Transferring Oil or Hazardous Material in Bulk
40 CFR Part 60	Standards of Performance for New Stationary Sources
40 CFR Part 112	Oil Pollution Prevention
40 CFR Part 122	EPA Administered Permit Programs: The National Pollutant Discharge Elimination System (NPDES)
40 CFR Part 280	Technical Standards and Corrective Action Requirements for Owners and Operators of Underground Storage Tanks (UST)
40 CFR Part 281	Approval of State Underground Storage Tank Programs
49 CFR Part 195	Transportation of Hazardous Liquids by Pipeline

(Unless otherwise indicated, copies are available from the Superintendent of Documents, U.S. Government Printing Office (GPO), Washington, D.C. 20402.)

UNITED STATES CODE

[42 USC 4321](#)

National Environmental Policy Act (NEPA)

NON-GOVERNMENT PUBLICATIONS:

AMERICAN CONFERENCE OF GOVERNMENTAL INDUSTRIAL HYGIENISTS
(ACGIH)

-- Industrial Ventilation: A Manual of Recommended
Practice for Design

(Unless otherwise indicated, copies are available from American Conference of
Governmental Industrial Hygienists (ACGIH), 1330 Kemper Meadow Drive, Cincinnati,
OH 45240. Phone Number: (513) 742-2020.) (www.acgih.org)

AMERICAN CONCRETE INSTITUTE

ACI 350.4R-04 Design Considerations for Environmental Engineering
Concrete Structures.

(Unless otherwise indicated, copies are available from American Concrete Institute,
P.O. Box 9094, Farmington Hills, MI 48333-9094. Phone Number: (248) 848-3800.)
(<http://www.aci-int.org/general/home.asp>)

AMERICAN NATIONAL STANDARDS INSTITUTE (ANSI)/AMERICAN SOCIETY OF
MECHANICAL ENGINEERS (ASME)/INSTITUTE OF ELECTRICAL AND
ELECTRONICS ENGINEERS (IEEE)

ASME BPVC	Boiler and Pressure Vessel Code
ANSI/ASME B16.5	Pipe Flanges and Flanged Fittings
ANSI/ASME B16.47	Large Diameter Steel Flanges: NPS 26 through NPS 60
ANSI/ASME B31.3	Process Piping
ANSI/ASME B31.4	Pipeline Transportation Systems for Liquid Hydrocarbons and other liquids
ANSI/IEEE 142	Recommended Practice for Grounding of Industrial and Commercial Power Systems
ANSI/IEEE 1100	Recommended Practice for Powering and Grounding Electronic Equipment

ANSI/IEEE C2

National Electrical Safety Code

(Unless otherwise indicated, copies are available from the American National Standards Institute (ANSI), 25 West 3rd Street, New York, NY 10036, Phone Number: (202) 293-8020 (www.ansi.org); American Society of Mechanical Engineers (ASME), 22 Law Drive, Fairfield, NJ 07007-2900, Phone Number: (973) 882-1170 (www.asme.org); and Electrical and Electronics Engineers (IEEE), Inc., IEEE Standards, 445 Hoes Street, Piscataway, NJ 08855-1331, Phone Number: (800) 701-4333 (www.ieee.org).)

AMERICAN PETROLEUM INSTITUTE (API)

API 570	Piping Inspection Code: In-Service Inspection, Rating, Repair and Alteration of Piping Systems
Bulletin D16	Suggested Procedure for Development of Spill Prevention Control and Countermeasure Plans
MPMS Chapter 2	Tank Calibration
MPMS Chapter 3	Tank Gauging
MPMS Chapter 5	Metering
Pub 2202	Dismantling and Disposing of Steel from Tanks which have Contained Leaded Gasoline
RP 500	Recommended Practice for Classification of Locations for Electrical Installations at Petroleum Facilities – Classified as Class I, Division I and Division 2
RP 540	Electrical Installations in Petroleum Processing Plants
RP 651	Cathodic Protection of Aboveground Petroleum Storage Tanks
RP 1004	Bottom Loading and Vapor Recovery for MC-306 Tank Motor Vehicles
RP 1102	Steel Pipelines Crossing Railroads and Highways
RP 1604	Closure of Underground Petroleum Storage Tanks

RP 1615	Installation of Underground Petroleum Storage Systems
RP 1637	Using the API Color-Symbol System to Mark Equipment and Vehicles for Product Identification at Gasoline Dispensing Facilities and Distribution Terminals
RP 2003	Protection Against Ignitions Arising Out of Static, Lightning, and Stray Currents
RP 2350	Overfill Protection for Storage Tanks in Petroleum Facilities
Spec 6D	Specification for Pipeline
Std 607	Testing of Valves – Fire Type-Testing Requirements
Std 608	Metal Ball Valves – Flanged, Threaded and Butt-Welding Ends
Std 610	Centrifugal Pumps for Petroleum, Petrochemical and Natural Gas Industries
Std 650	Welded Tanks for Oil Storage
Std 653	Tank Inspection, Repair, Alteration, and Reconstruction
Std 2000	Venting Atmospheric and Low-Pressure Storage Tanks
Std 2015	Requirements for Safe Entry and Cleaning of Petroleum Storage Tanks
Std 2510	Design and Construction of Liquefied Petroleum Gas (LPG) Installations
Std 2610	Design, Construction, Operation, Maintenance, and Inspection of Terminal and Tank Facilities

(Unless otherwise indicated, copies are available from American Petroleum Institute (API), 1220 L Street NW, Washington, DC 20005-4070 (www.api.org).

AMERICAN SOCIETY FOR TESTING AND MATERIALS (ASTM)

ASTM D910	Standard Specification for Aviation Gasoline (Avgas)
ASTM D975	Standard Specification for Diesel Fuel Oils
ASTM D1655	Standard Specification for Aviation Turbine Fuels (DoD Adopted)
ASTM D3699	Standard Specification for Kerosene
ASTM D4814	Standard Specification for Automotive Spark-Ignition Engine Fuel
ASTM D5798	Standard Specification for Fuel Ethanol (Ed75-Ed85) for Automotive Spark-Ignition Engines
ASTM D6751	Standard Specification for Biodiesel Fuel Blend Stock (B100) for Middle Distillate Fuels
\1\ ASTM D7467	Standard Specification for Diesel Fuel Oil, Biodiesel Blend (B6 to B20) /1/
\1\ /1/	

(Unless otherwise indicated, copies are available from the American Society for Testing and Materials (ASTM), 100 Barr Harbor Drive, West Conshohocken, PA 19428-2959, Phone Number: (610) 832-9585 (www.astm.org).)

COMPRESSED GAS ASSOCIATION (CGA)

Pamphlet G-7.1. Commodity Specification for Air

(Unless otherwise indicated, copies are available from the Compressed Gas Association, 4221 Walney Road, 5th Floor, Chantilly VA 20151-2923, Phone Number: (703) 788-2700 (www.cganet.com).)

COORDINATING RESEARCH COUNCIL, INC. (CRC)

Report No. 346	Electrostatic Discharges in Aircraft Fuel Systems – Phase I
Report No. 355	Electrostatic Discharges in Aircraft Fuel Systems – Phase II
Report No. 635	Handbook of Aviation Fuel Properties

(Unless otherwise indicated, copies are available from the Coordinating Research Council, Inc., 3650 Mansell Road, Suite 140, Alpharetta, GA 30022, Phone Number: (678) 795-0506 (www.crao.com/.)

ENERGY INSTITUTE (EI)

EI Std 1529	Aviation Fueling Hose and Hose Assemblies (formerly API Std 1529)
EI Specification 1581	Specifications and Qualification Procedures for Aviation Jet Fuel Filter/Separators (formerly API/IP Specification 1581)

(Unless otherwise indicated, copies are available from the Energy Institute (EI), 61 New Cavendish Street, London W1G 7AR, UK, Phone Number: +44 (0) 20-7467-7100 (<http://www.energyinst.org/>.)

FACTORY MUTUAL ENGINEERING CORP. (FM)

Section 7-55	Loss Prevention Data, Liquid Petroleum Gas
--------------	--

(Unless otherwise indicated, copies are available from FM Global, 1301 Atwood Avenue, Johnston, RI 02919, Phone Number: (877)364-6726 (www.fmglobaldatasheets.com.)

GAS PROCESSORS ASSOCIATION

Standard 2140	Liquefied Petroleum Gas Specifications and Test Methods
---------------	---

(Unless otherwise indicated, copies are available from Gas Processors Association, 6526 East 60th Street, Tulsa, OK 74145 , Phone Number: (918)493-3872, (www.gpaglobal.org.)

GAS TECHNOLOGY INSTITUTE (GTI)

GTI-02/0136	CASCADE™ Gaseous Fueling System Sizing Software
-------------	---

(Unless otherwise indicated copies are available from the Gas Technology Institute, 1700 South Mount Prospect Road, Des Plaines, IL 60018, Phone Number: (847) 768-0500 (www.gastechnology.org.)

HYDRAULIC INSTITUTE

-- Individual Standards for Centrifugal, Vertical, Rotary,
and Reciprocating Pumps, as well as General
Guidelines for Pumps

(Unless otherwise indicated, copies are available from the Hydraulic Institute, 9 Sylvan
Way, Parsippany, NJ 07054-3802, Phone Number: (973) 267-9700 (www.pumps.org.)

INTERNATIONAL SAFETY EQUIPMENT ASSOCIATION (ISEA)

ISEA Z358.1 Emergency Eyewash and Shower Equipment
(formerly ANSI Z358.1)

(Unless otherwise indicated, copies are available from the International Safety
Equipment Association (ISEA), 1901 North Moore Street, Arlington, VA 22209-1762,
Phone Number: (703) 525-1695 (www.safetysafetyequipment.org.)

NATIONAL ASSOCIATION OF CORROSION ENGINEERS (NACE) INTERNATIONAL

SP0169 Control of External Corrosion on Underground or
Submerged Metallic Piping Systems

(Unless otherwise indicated, copies are available from the National Association of
Corrosion Engineers (NACE) International, 1440 South Creek Drive, Houston, TX
77218-8340, Phone Number: (281) 228-6200 (www.nace.org/.)

NATIONAL FIRE PROTECTION ASSOCIATION (NFPA)

\1\ /1/

[NFPA 20](#) Standard for the Installation of Stationary Pumps for
Fire Protection

[NFPA 30](#) Flammable and Combustible Liquids Code

[NFPA 30A](#) Code for Motor Fuel Dispensing Facilities and Repair
Garages

[NFPA 31](#) Standard for the Installation of Oil-Burning Equipment

[NFPA 37](#) Standard for the Installation and Use of Stationary
Combustion Engines and Gas Turbines

[NFPA 45](#) Standard on Fire Protection for Laboratories Using
Chemicals

NFPA 52	Vehicular Gaseous Fuel Systems Code
NFPA 54	National Fuel Gas Code
NFPA 55	Compressed Gases and Cryogenic Fluids Code
NFPA 58	Liquefied Petroleum Gas Code
NFPA 59	Utility LP-Gas Plant Code
NFPA 70	National Electrical Code
NFPA 77	Recommended Practice on Static Electricity
NFPA 110	Standard for Emergency and Standby Power Systems
NFPA 307	Standard for the Construction and Fire Protection of Marine Terminals, Piers, and Wharves
NFPA 407	Standard for Aircraft Fuel Servicing
NFPA 415	Standard on Airport Terminal Buildings, Fueling Ramp Drainage, and Loading Walkways
\1\ NFPA 704	Standard System for the Identification of the Hazards of Materials for Emergency Response /1/
NFPA 780	Standard for the Installation of Lightning Protection Systems

(Unless otherwise indicated, copies are available from the National Fire Protection Association (NFPA), 1 Batterymarch Park, Quincy, MA 02169-7471, (www.nfpa.org.)

UNDERWRITERS LABORATORIES, INC. (UL)

UL 58	Steel Underground Tanks for Flammable and Combustible Liquids
UL 142	Steel Aboveground Tanks for Flammable and Combustible Liquids
UL 1746	External Corrosion Protection Systems for Steel Underground Storage Tanks
UL 2080	Fire Resistant Tanks for Flammable and Combustible

Liquids

UL 2085

Protected Aboveground Tanks for Flammable and Combustible Liquids

(Unless otherwise indicated, copies are available from the Underwriters Laboratories, Inc. (UL), 333 Pfingsten Road, Northbrook, IL 60062-2096, Phone Number: (847) 272-8800 (www.ul.com).)

SOCIETY OF AUTOMOTIVE ENGINEERS

AS5877

Detailed Specification for Aircraft Pressure Refueling Nozzle

(Unless otherwise indicated, copies are available from SAE Customer Service, 400 Commonwealth Drive, Warrendale, PA 15096-0001, Phone Number: (877) 606-7323 (www.sae.org).

STEEL TANK INSTITUTE

STI P3

Specification and Manual for External Corrosion Protection of Underground Steel Storage Tanks

\1\ STI SP001

Aboveground Tank System Inspector Training /1/

(Unless otherwise indicated, copies are available from the Steel Tank Institute, 944 Donata Court, Lake Zurich, IL 60047, Phone Number: (847) 438-8265 (www.steeltank.com/).

\1\

APPENDIX B MANUAL SURGE CALCULATIONS FOR SIMPLE PIPING SYSTEMS

- (1) Determine the critical time of the system. This is defined as the time it takes for the first increment of the pressure wave to travel upstream, reflect, and return to the valve. Use the following equation:

EQUATION: $T_c = 2L/a$ (1)

where:

T_c = critical closure time of system(s)
 L = length of pipe (ft or m)
 a = surge pressure wave velocity (fps or m/s)

Values for “a” for liquid petroleum in schedule 40 steel pipe are as follows. These values are based on [hydrocarbons](#) with a [specific gravity](#) of 0.8 at a temperature of 68 degrees F (20 degrees C):

Nominal Pipe Size inches (mm)	Surge Pressure Wave Velocity, “a” ft/s (m/s)
2 (50)	3,771 (1149.4)
3 (75)	3,763 (1147.0)
4 (100)	3,736 (1138.7)
6 (150)	3,692 (1125.3)
8 (200)	3,663 (1116.5)
10 (250)	3,639 (1109.2)
12 (300)	3,599 (1097.0)

- (2) If valve closure time (T) is less than T_c , it is equivalent to instantaneous closure and will result in maximum [surge](#) pressure. The equation used to calculate [surge](#) pressure rise for this situation is:

EQUATION:

METRIC UNITS: $P_1 - P = (V_1 - V_0)(\rho)(a)$ (2)
 (Metric)

ENGLISH UNITS: $P_1 - P = [(V_1 - V_0)(\rho)(a)] / [(C)(g_c)]$ (2) (English)

Where:

P_1 = maximum pressure (psig or Pa)

P = pump shutoff pressure (psig or Pa) (equal to system static pressure)

V_1 = initial velocity (fps or m/s)

V_0 = final velocity (fps or m/s)

ρ = density of the fluid (lbm/ft³ or kg/m³)

a = surge pressure wave velocity (fps or m/s)

C = unit conversion factor (144 in²/ft²)

g_c = gravitational unit conversion constant (32.17 ft · lb_{mass} / (lb_{force} · sec²))

Metric units require no conversion. 1 Pa = 1 N / m² = 1 kg / (m · sec²)

- (3) For example, a fuel storage facility has a truck loading rack located 2,000 feet (610 m) away. The load rack is fed by a 600 gpm (38 L/s) pump located at the storage facility. The load rack is equipped with a deadman apparatus which is tied to a hydraulically operated diaphragm control valve at the rack. The valve has a closure time of 1.0 seconds. The pipe is 6-inch (150 mm) diameter carbon steel, Schedule 40, with Class 150 flanges. The pump shutoff pressure is 60 psig (410 kPa). Find the critical time of the system if the loading rack control valve closes.

$$T_c = 2L/a = 2 \times 2,000 / 3,692 = 1.08 \text{ seconds}$$

From the table of values for “a”, the [surge](#) pressure wave velocity (a) is 3,692 fps (1125.3 m/s). The maximum pressure in any pipeline occurs when the total discharge is stopped in a period of time equal to or less than the critical time. Since the valve will theoretically close prior to this, Equation (2) should be used to determine the pressure rise. In this case, the final velocity (V_0) will be assumed to be zero because the critical time is greater than the valve closure time.

$$P_1 - P = [(V_1)(\rho)(a)] / [(144)(g_c)]$$

$$= [(6.81 \times 51.5 \times 3,692)] / [(144 \times 32.2)] = 279 \text{ psig (1925 kPa)}$$

$$P_1 = P + 273 = 60 + 279 = 339 \text{ psi (2337 kPa)}$$

Initial velocity (V_1) was found by dividing the given flow rate of 600 gpm (38 L/s) by the cross sectional area of the 6-inch (150 mm) diameter, Schedule 40 pipe. Considerations will have to be made for this system to deal with the maximum predicted pressure.

- (4) When the valve closure time is longer than the critical time, the [surge](#) will be less than predicted by Equation (2). The equation used to calculate [surge](#) pressure rise for this situation is:

EQUATION:

$$P_1 - P = [2(L)(\rho)(V_1 - V_c)] / [1.3 (T)] \quad (3 \text{ Metric})$$

$$P_1 - P = [2(L)(\rho)(V_1 - V_c)] / [1.3 (C)(g_c)(T)] \quad (3 \text{ English})$$

where:

P_1 = maximum pressure (psig or Pa)

P = pump shutoff pressure (psig or Pa) (equal to system static pressure)

L = length of pipe (ft or m)

V_1 = initial velocity (fps or m/s)

V_c = velocity at T_c (fps or m/s)

ρ = density of the fluid ($\text{lb}_{\text{mass}}/\text{ft}^3$ or kg/m^3)

T = valve closure time (sec)

C = unit conversion ($144 \text{ in}^2/\text{ft}^2$)

g_c = gravitational unit conversion constant ($32.17 \text{ ft} \cdot \text{lb}_{\text{mass}} / (\text{lb}_{\text{force}} \cdot \text{sec}^2)$)

Metric units require no conversion. $1 \text{ Pa} = 1 \text{ N} / \text{m}^2 = 1 \text{ kg} / (\text{m} \cdot \text{sec}^2)$

Determination of V_c is too complex for simple calculation. Therefore, for the conditions where $T > T_c$, use a computer modeling program.

/1/

This Page Intentionally Left Blank

CANCELLED

\1\

APPENDIX C CHARTER OF DOD FUELS FACILITY ENGINEERING PANEL

A. INTRODUCTION

1. To benefit from Department of Defense ([DoD](#)) wide petroleum, oils, and lubricants (POL) expertise and apply it to fuel facilities issues facing the [DoD](#), the Fuels Facility Engineering Panel (FFEP) is hereby established. The [DoD](#) FFEP (Panel) consists of recognized POL experts, primarily from the engineering community, to establish the criteria for the [DoD](#) community on ways to provide safe, operationally effective, and economic [DoD](#) fuel facilities systems to meet the mission requirements. The Panel will examine, develop, recommend and provide design features for the standardization of facilities and equipment, and procedures used in fuel handling systems for storage, distribution, maintenance and dispensing of aircraft, marine, and ground fuels. The Panel will evaluate facility component parts on [DoD](#) installations and will serve as a pool of expertise to assist in resolving systemic fuel handling facility problems. Panel meetings will also serve as a forum to update members on new equipment, [DoD](#) or service-specific programs, and changes affecting the fuels maintenance, repair and construction community.

B. COMPOSITION

1. Voting members:
 - a) Air Force Fuels Facility Subject Matter Expert (HQ [AFCEC](#)/COS)
 - b) NAVFAC POL Facility Subject Matter Expert (NAVFAC EXWC)
 - c) HQ Army Corps of Engineers Technical POC, POL Facility Criteria (CECW-EC)
 - d) Defense Logistics Agency Installation Support for Energy – Facilities Engineer (DLA-DS-FEI)
2. Coordinating members:
 - a) Defense Logistics Agency
 - b) Defense Fuel Region Facility Managers
 - c) AF MAJCOM Fuels Engineers
 - d) AF Petroleum Agency Fuels Facilities Team
 - e) NAVSUP Fuels Facility Engineers
 - f) NAVAIR Fuels Engineers
 - g) NAVFACENGCOM, Fuels Facility Engineers
 - h) Army Petroleum Center Fuel Facility Team Members
 - i) Army Corps of Engineers, Omaha District, POL Facility Technical Center of Expertise
 - j) Space and Naval Warfare Systems Center Atlantic (SPAWAR Atlantic)
3. The Chairperson will be rotated biennially among the voting members.

C. TASKS

1. Tasks of the DoD FFEP include but are not limited to:
 - a) Develop and maintain standardized designs for receipt, storage, and dispensing fuel facilities and fuel systems.
 - b) Periodically review and update [UFC 3-460-01](#) and [UFC 3-460-03](#), including referenced [DoD](#) fuel handling facility criteria, and fuel system maintenance and repair criteria.
 - c) Perform technical review and provide approval of new or proposed design standards or concepts.
 - d) Review fuel system operational challenges, including system components and materials, and recommend corrections.
 - e) Cross-feed information such as problems and solutions, new missions and equipment, needed modifications to equipment, and new [DoD](#) or Service-wide programs and periodically communicate this information in a newsletter.
 - f) Provide a means of communication among the Air Force, Army, Navy, and DLA Energy to reduce duplication and institutionalize [DoD](#)-wide Standardization for fuel facilities.
 - g) Evaluate changes to fuel facilities that enhance training and efficient use of operation and maintenance personnel.
 - h) Provide information to fueling operations personnel to assure proper operation of equipment.
 - i) Assess the impact of mission demand, environmental, health and fire safety, energy, economic, and other drivers on fuel facilities design, and develop criteria that will address these impacts.
2. Substantial deviations, or departures from [UFC 3-460-01](#) and fuel facilities standard designs and specifications, must be approved by the DoD FFEP in accordance with the procedures outlined in Chapter 1.

D. MEETINGS

1. The Panel will meet at the call of the Chairperson but not less than once per year. Voting members may request a meeting at any time. A quorum consists of not less than three Voting members, and no more than one Proxy.
2. Decisions of the DoD FFEP will attempt to achieve consensus among the Voting members of the DoD FFEP. Any member of the Panel (Voting or Coordinating) may request a vote for any decision by the Voting members. A majority is required for passage of decision.
3. When a Voting member cannot attend a FFEP meeting, the Voting member shall appoint a proxy for meeting attendance and voting. The FFEP must be advised of the proxy prior to the meeting.

E. CHARTER REVIEW

1. The Panel will review the Charter at least once per year, and update as required.

/1/

CANCELLED

This Page Intentionally Left Blank

CANCELLED

APPENDIX D GLOSSARY

D-1 ABBREVIATIONS AND ACRONYMS

ACGIH. American Conference of Governmental Industrial Hygienists.

AEI. Architectural and Engineering Instruction.

\1\ AFCEC. Air Force Civil Engineering Center. /1/

AFFF. Aqueous film-forming foam.

\1\ AFPA. Air Force Petroleum Agency /1/

AFSS. Automated fuel service station.

AIS. Automated Information System.

ANSI. American National Standards Institute.

APC. Army Petroleum Center.

API. American Petroleum Institute.

ASCII. American Standard Code for Information Interchange.

ASME. American Society of Mechanical Engineers.

AST. Aboveground Storage Tank.

ASTM. American Society for Testing and Materials.

ATG. Automatic tank gauging.

BOCA. Building Officials and Code Administrators International, Inc.

BSM-E. Business System Modernization – Energy.

BS&W. Common abbreviation for bottom sediment and water as found in the bottom of fuel tanks, also; a type of sampling procedure.

Btu. British thermal unit.

CFR. Code of Federal Regulations.

CI. Corrosion inhibitor.

CNG. Compressed Natural Gas.

CO₂. Chemical notation for carbon dioxide; fire extinguishing agent.

CONUS. Continental United States.

COTS. Commercial-off-the-shelf.

DBB. Double block and bleed.

1\ /1/

DFM. Diesel fuel marine.

DIEGME. Diethylene glycol monomethyl ether.

DLA. Defense Logistics Agency.

DoD. Department of Defense.

DOT. Department of Transportation.

EFSO. Emergency fuel shut-off.

EMAT. Electromagnetic acoustic transducer.

EPDM. Ethylene-propylene terpolymer.

EPU. Emergency power unit.

F-A. Fire Resistant Aboveground Storage Tank.

FDV. Fuel Delivery Vehicle.

FRP. Fiberglass reinforced plastic.

FSII. Fuel system icing inhibitor.

H-A. Horizontal Aboveground Storage Tank.

HDPE. High-density polyethylene.

HTH. Calcium hypochlorite.

H-U. Horizontal Underground Storage Tank.

ICBO. International Conference of Building Officials.

ICC. International Code Council.

JPTS. Jet Propellant Thermally Stable.

LPG. Abbreviation for liquefied petroleum gas; propane, butane.

MAJCOM. Major Command. A major subdivision of the Air Force, directly subordinate to Headquarters US Air Force.

MFL. Magnetic flux leakage.

MIL. A unit of length equal to one thousandth of an inch, especially used to measure the thickness of paints and coatings.

Mogas. Common contraction of motor gasoline, referring to fuel for land vehicles.

NACE. National Association of Corrosion Engineers.

NATO. North Atlantic Treaty Organization.

NAVAIR. Naval Air Systems Command.

NBBI. National Board of Boiler and Pressure Vessel Inspectors.

NBIC. National Board Inspection Code.

\1\ NAVFAC EXWC. Naval Facilities Engineering and Expeditionary Warfare Center. /1/

\1\ NAVFAC EXWC, CIOFP4. Naval Facilities Engineering and Expeditionary Warfare Center, Ocean Facilities Division. /1/

NFPA. Abbreviation for the National Fire Protection Association.

\1\ NAVSUP-Energy. Naval Supply Systems Command-Energy. /1/

NPDES. National Pollutant Discharge Elimination System.

OCONUS. Outside of the Continental United States.

OMSI. Operation and maintenance support information.

OSHA. Occupational Safety and Health Act of 1970.

P-A. Protected Aboveground Storage Tank.

PACAF. Pacific Air Force.

PDP. Pressure dew point.

pH. A number assigned to indicate whether a substance is acidic or alkaline (pH 7 is considered neutral, less than 7 is acidic and more than 7 is alkaline).

PLC. Programmable logic controller.

POL. A commonly used abbreviation which broadly refers to all petroleum, oils, and lubricants.

PSI or PSIG. Abbreviation for pounds per square inch, the unit of pressure measurement; gage pressure above atmospheric.

PSIA. Pounds per square inch absolute; pressure above an absolute vacuum.

PVC. Polyvinyl chloride.

RDBMS. Relational Database Management System.

SAE. Abbreviation for Society of Automotive Engineers, used in conjunction with specification for [viscosity](#) of lubricating oils.

SPCC. Spill prevention control and countermeasure.

SPR. Single Point Receptacle.

SSPC. Steel Structures Painting Council.

STANAG. Standardization Agreement (NATO term)

TAU. Twin agent unit.

TYCOM. Type Command (Navy/Marine Corps equivalent of MAJCOM).

UFGS. Unified Facilities Guide Specifications.

ULSD. Ultra Low Sulfur Diesel.

UPV. Unfired pressure vessel.

UST. Underground Storage Tank.

USAFE. United States Air Forces in Europe.

V-A. Vertical Aboveground Storage Tank.

VOC. Volatile organic compound.

V-U. Vertical Underground Storage Tank.

D-2 TERMS

Additive. Chemical added in minor proportions to fuels or lubricants to create, enhance or inhibit selected properties; example, fuel system icing inhibitor (FSII).

Aircraft Direct Fueling System. Method used to refuel aircraft by issuing fuel directly to the aircraft from the tank farm without first transferring the fuel to a [refueler](#) truck. Also known as a [hydrant system](#).

Aircraft Refueling Adapter. A device, mounted on an aircraft, that combines with a [pressure refueling nozzle](#) mounted on a refueling vehicle or station to form a quick disconnect connection for the purpose of refueling or defueling aircraft. It can also be used for refueling and defueling [refuelers](#).

Ambient. Encompassing on all sides, as temperature.

Anode. The positively charged electrode of an electrolytic cell.

API Gravity. Petroleum industry scale for measuring the density of oils.

Aromatic Hydrocarbons. Characterized by the presence of the hexagonal benzene ring; also having an aroma.

Atmospheric Pressure. The pressure exerted by the earth's atmosphere, when measured at sea level under standard conditions is equal to 14.7 pounds per square inch (101 kPa).

Atmospheric Tank. Storage tank which operates at or near atmospheric pressure (14.7 psi (101 kPa) at sea level).

Auto-ignition Temperature. The temperature at which a substance will ignite without the further addition of energy from an outside source.

Ballast Water. Water carried in ship's fuel tanks or cargo tanks to improve the vessel's stability when empty of petroleum.

Barrel. Measure of volume as used in the petroleum industry, equivalent of 42 U.S. gallons (0.16 m³).

Blind Flange. Piping flange with no passage through the center.

Boiler Fuel Oil. Fuel oil that is burned in furnaces to create steam or hot water, also called fuel oil.

Boiling Point. The temperature at which the [vapor pressure](#) of a liquid is equal to the pressure of the vapor above the liquid, usually atmospheric pressure. The temperature increases as the atmospheric pressure increases.

Bollard. A heavy solid post used to protect equipment from an impact. Also used on docks and ships for mooring.

Bond. Electrical connection between two objects which equalizes their potential.

Boom. Flexible floating barrier consisting of linked segments designed to contain free oil on the surface of a body of water.

Booster Pump. Pump installed along the run of a long pipeline for the purpose of increasing pressure.

Bottom Loading. Method of filling tank trucks or tank cars through a tight connection at the bottom.

Breakaway Coupling. Coupling designed to part easily with a moderate pull with a dry-break from both directions.

Breathing. The movement of vapors into or out of a container because of natural cyclical heating and cooling.

Bulk Storage Tank. Storage tank for fuel normally received by pipeline, tank truck, or tank car. For aviation turbine fuel, configure tank to supply fuel to [operating storage tanks](#), either directly tank-to-tank, or indirectly by issuing fuel to tank trucks, tank cars, barges, ships, or pipelines.

Bunkers. Common expression referring to heavy residual boiler fuel.

Calibration. Adjustment of the scale of a graduated device to meet an established standard, especially applicable to the adjustment of meter registers to indicate true volume as determined by a standard measure.

Catalyst. A substance that provokes or accelerates chemical reactions without itself being altered.

Cathodic Protection. A method for preventing the corrosion of metals by electrolysis.

Centistokes. A centistoke (cSt) is equal to 1 millimeter squared per second.

Centrifugal Pump. A rotating device which moves liquids and develops liquid pressure by imparting centrifugal force.

Centrifugal Separator. A rotating device which separates liquids of different density by centrifugal force, a form of centrifuge.

Clarifier. Commonly used name for a micron filter.

Clean Product. Refined light petroleum products such as gasoline or [distillates](#), as differentiated from residuals or black oils.

Clear and Bright. Description of uncontaminated fuel indicating a complete absence of haze, free water or particulate matter.

Cloud Point. The temperature at which a fuel develops a cloudy or hazy appearance due to the precipitation of or moisture. The condition developed is called temperature haze.

Coalescer. A porous substance through which a liquid is passed to remove unwanted water from fuel by causing very small drops of water to form larger drops (coalesce) which will separate from fuel by gravity.

Coalescer Vessel. A pre-filtration vessel designed to remove gross amounts of water and, to a lesser degree, particulate water. Types include [haypack coalescers](#).

Combustible Liquid. Any liquid having a [flash point](#) at or above 100 °F (38 °C).

Combustible Vapor Indicator. Device which measures the quantity of combustible vapor in the atmosphere; explosion meter.

Contaminated Fuel. Petroleum fuel containing suspended or emulsified water, cleaning chemicals; or other foreign matter such as iron scale, dust, or other solid particles; or containing an unacceptable percentage of noncompatible fuel or other liquids; or containing more than one, or all of these classes of contaminants.

Contamination. The accidental addition to a petroleum fuel of some foreign material (contaminant) such as dirt, [rust](#), water, or accidental mixing with another grade of petroleum.

Copper-copper Sulphate Electrode. Reference electrode used to measure structure-to-soil potentials for corrosion control; a half cell.

Corrosion. The process of dissolving, especially of metals due to exposure to electrolytes.

Crude Oil. Petroleum in its natural state prior to refining.

Cut and Cover. Refers to underground vertical storage tanks.

Cyclonic Filter. A filter used to remove gross amount of particulate matter using the principle of centrifugal force to separate solid particles from a liquid.

Deadman Control. A control device, such as a switch or valve, designed to interrupt flow if the operator leaves his station.

Defueler. Tank vehicle used to remove fuel from aircraft.

Density. The mass per unit volume of a substance.

Dike. An embankment or wall, usually of earth or concrete, surrounding a storage tank to impound the contents in case of a spill.

Dissolved Water. Water which is in solution with fuel as opposed to in suspension.

Distillate. Common term for any of a number of fuels obtained directly from distillation of crude petroleum, usually includes [kerosene](#), JP-5, light diesel, and light burner fuels.

Double Block and Bleed Valve. A valve with two seats with a cavity in between them which can be drained while the valve is closed to prove the valve is not leaking.

Downgrade. To use a fuel for a lesser purpose than originally specified, often because of contamination.

Effluent. Stream flowing; discharge.

Electrode. [Electrical conductor](#) through which an electric current enters or leaves an electrolyte.

Electrolysis. Chemical change, especially decomposition, produced in an electrolyte by an electric current.

Electrolyte. A substance capable of forming solutions with other substances which produce ions and thereby permit the flow of electric currents.

Electrical Conductor. A substance which permits the flow of electric currents without permanent physical or chemical change; copper, aluminum.

Element. Term used to describe the 'disposable' part of a filter vessel such as a filter/separator, micron filter, or haypack coalescer. Also referred to as a cartridge.

Emulsion. A suspension of small globules of one liquid in a second liquid with which the first will not mix.

Epoxy Coating. A coating of thermosetting resins having strong adhesion to the parent structure, toughness, and high corrosion and chemical resistance, also used as an adhesive.

Explosive Limits - (Upper and Lower). Limits of percentage composition of mixtures of combustible vapors and air which are capable of producing an explosion or combustion when ignited; also flammable limit.

Explosion-proof. Classification of electrical enclosures for use in [hazardous areas](#) designed to prevent the passage of internal arcs, sparks or flames.

Fender. Part of a pier structure designed to absorb the impact of a moving vessel.

Fiberglass. Composite material consisting of glass fibers in a matrix of resin such as epoxy.

Filling Station. A facility designed to fill vehicles with gasoline or diesel as [motive fuel](#).

Filter. A porous substance through which a liquid is passed to remove unwanted particles of solid matter. Types include [cyclonic filters](#) and [micronic filters](#).

Filter/Coalescer Elements. A type of coalescer that removes water and particulate matter from fuel. Used as the first element in filter/separators. Also referred to as coalescer elements or [coalescers](#).

Filter/separator. A filtration vessel consisting of two separate element types (also called stages). The first stage consists of [filter/coalescer elements](#) to remove fine particulate matter and to remove entrained water by coalescing it; the second stage consists of separator elements to prevent fine droplets of water (caused by the coalescing process) from reaching the vessel outlet. It removes dirt and free water down to the very low levels required for aircraft operations. Filter/separators are the only approved vessels for use in [fine filtration](#); they are occasionally used for [pre-filtration](#) as well.

Fine Filtration. A term used to refer to filtration vessels used to remove dirt and [free water](#) down to the very low levels required for aircraft operations. Fine filtration vessels are always [filter/separators](#).

Fire Resistant Tank. Aboveground storage tank that is listed in accordance with [UL 2080](#), that consists of a primary tank that is protected or insulated from a 2-hour fire exposure.

Flammable Liquid. Any liquid having a [flash point](#) below 100 degrees F (38 degrees C) and a [vapor pressure](#) not exceeding 40 psia (275 kPa) at 100 degrees F (38 degrees C).

Flash Point. The lowest temperature at which a combustible or flammable liquid

produces enough vapor to support combustion.

Floating Roof Tank. Petroleum storage tank with a roof that floats on the liquid surface and rises and falls with the liquid level.

Flocculation. A treatment process in which waste waters are clarified by the addition of chemical coagulants to produce finely divided precipitates which will agglomerate into larger particles.

Free Water. Undissolved water content in fuel.

Freeze Point. The temperature at which [wax](#) crystals form in distillate fuels and aviation turbine fuels.

Fuel Oil. See [Boiler Fuel Oil](#).

Fuel Quality Monitor. A special type of filter designed to interrupt the flow of fuel when dirt or water content becomes too great.

Galvanizing. [Rust](#) \1\ inhibiting /1/ zinc coating applied to iron and steel.

Ground. An electrical connection to earth.

Haypack Coalescer. A type of coalescer that uses hay, straw, or excelsior as a medium to remove large slugs of water.

Hazardous Area. Electrical classification for areas where flammable or combustible liquids or vapors may be present.

Hot Refueling. Refueling of aircraft when one or more engines are running.

Housekeeping Pad. Concrete pad usually installed on concrete slabs or floors to elevate and anchor equipment. Housekeeping pads aid in maintenance and keep equipment clear of debris.

Hydrant System. Distribution and dispensing system for aviation turbine fuels consisting of a series of fixed flush type outlets or hydrants connected by piping. It issues fuel directly to the aircraft from the tank farm without first transferring the fuel to a [refueler](#) truck. Also known as an [aircraft direct fueling system](#).

Hydrocarbon. A compound made up exclusively of hydrogen and carbon in various ratios and molecular arrangements.

Hydrostatic Head. Pressure caused by a column of liquid.

Hydrostatic Test. A test for leaks in a piping system using liquid under pressure as the test medium.

Hydrostatic Test Pressure. The pressure in the system while it is undergoing a hydrostatic leak test as defined by ANSI/ASME B31.3. For the purpose of this document, set at 1.5 times the maximum allowable design pressure.

Ignition Temperature. The minimum temperature required to initiate or cause self-sustained combustion independent of any heating or heated element.

Intrastate Interterminal Pipelines. Interterminal pipelines that do not cross state lines.

Interstate Interterminal Pipelines. Interterminal pipelines that cross state lines.

Impervious. Not easily penetrated. The property of a material that does not allow, or allows only with great difficulty, the movement or passage of a fluid. Also referred to as impermeable.

Impressed Current System. A cathodic protection system using an outside source of electric power.

Inert Material. Any solid, liquid, or gaseous substance not combustible or fire-producing when exposed to the atmosphere under ordinary climatic conditions; it includes common metals, packing materials, ceramic materials, construction materials such as concrete, mineral aggregates, and masonry.

Installation Pipelines. Pipelines which connect POL facilities within an installation such as a barge pier to a bulk facility and a bulk facility to an operating (ready-issue) tank. These pipelines do not cross property lines and, therefore, do not leave the government facility and control.

Interterminal Pipelines. Pipelines which connect two government installations such as a Defense Energy Supply Center depot to a military installation. These pipelines cross property lines and cross public and/or private properties, streets, highways, railroads, and utility rights-of-way.

JP Fuel. Military designation applied to aviation turbine fuels (e.g., JP-4, JP-5, and JP-8).

Kerosene. A general term covering the class of refined petroleum which boils between 370 degrees F and 515 degrees F (188 degrees C and 268 degrees C). Mostly used in oil lamps and cooking stoves.

Kerosene Type Aviation Turbine Fuel. JP fuel derived from [kerosene](#) without the addition of [naphtha](#); characterized by a flash point of 100 degrees F (38 degrees C) or more.

Kinematic Viscosity. The ratio of [viscosity](#) of a liquid to its [specific gravity](#) at the temperature at which the [viscosity](#) is measured.

Lead Hazard. Poisonous contamination of the atmosphere, [sludge](#), or other surroundings, particularly in petroleum storage tanks, -caused by tetraethyl lead or its residues.

Line Blind. A solid flat plate used to obtain absolute shut-off of flow. Also, referred to as spectacle plates or flanges, blinding plate, figure eights and paddle blinds.

Liter (L). Equivalent to 0.001 m³.

Lube Oil. Common contraction for lubrication oil; used to reduce friction and cool machinery.

Maximum Allowable Design Pressure. The maximum allowable pressure of a fuel system or component will see. For the purposes of this document, set at the pressure rating of a flanged joint per [ANSI/ASME B16.5](#).

Maximum Allowable Operating Pressure. The maximum pressure at which a system is to operate. For the purposes of this document set at 2/3 of the hydrostatic test pressure, not to exceed the maximum allowable design pressure..

Maximum Allowable Surge Pressure. The maximum pressure allowed during a surge event. For the purposes of this document, set the pressure at 133% of the qualified Maximum Allowable Operating Pressure.

Micron. A unit of length equal to one millionth of a meter, especially used as a measure of the size of very fine particles found as contaminants in fuel.

Micronic Filter. A type of [pre-filter](#) vessel equipped with paper filter elements, designed to remove particulate matter from a fuel stream. Will not remove water.

Military Specifications. Guides for determining the quality requirements for materials and equipment used by the military services (MIL).

Motive Fuel. Any fuel that is used to power vehicles, aircraft, or vessels.

Naphthas. Refined petroleum which boils at 800 degrees F (427 degrees C) to 4400 degrees F (2427 degrees C), used as a component of gasoline and solvents.

Nipple. Short length of pipe, usually used to make side branch connections.

Nondestructive Testing. A method of inspecting materials without cutting, drilling or otherwise destroying the material; usually used to examine steel plates, pipes, and welds.

Nozzle. A spout or connection, usually with a control valve through which fuel is discharged into a receiving container.

Octane Number. A numerical measure of the antiknock properties of automotive gasoline as measured against standard reference fuels, under controlled laboratory conditions. Iso-octane is a reference fuel whose octane number is given a value of 100.

Off-Specification. Usually referring to fuel which is contaminated or otherwise deficient in quality. Commonly used contraction for off-specification is “off-spec”.

Oil/water Separator. A device used to separate mixtures of oil and water, usually by the difference in [specific gravity](#) and usually to protect the environment from contamination by the oil.

Oily-water Mixture. Mixture in which water comprises more than half the total volume. Most such untreated mixtures contain less than 15 percent oil, some of which may be in emulsified form.

Operating Storage Tanks. Storage tank for aviation turbine fuel configured to issue fuel directly to an aircraft, [hydrant system](#), or [refueler](#). A tank configured to issue aviation turbine fuel to a [refueler](#) only in an emergency is considered a [bulk storage tank](#).

Orifice Plate. A plate with a hole in the center held between two flanges in a pipeline, used to create a drop in pressure which is proportional to flow and can be used to measure the flow or to modulate control devices.

Pantograph. A series of pipes, joined by flexible joints, used to connect fueling equipment to aircraft.

Parallel Pumps. Two or more pumps having common suction and discharge connections.

Particulate Matter. Solid particles such as dirt, grit, and [rust](#), which contaminate fuel.

Pigging. The use of internal pipe tools, called pigs, to clean the inside of the pipe, determine the geometry of the pipe, and determine the location and magnitude of any internal or external corrosion occurring on the pipe.

Pig Launcher. An arrangement of valves and closure devices to launch pigs at the beginning of their run through a pipeline.

Pig Receiver. An arrangement of valves and closure devices to trap pigs at the end of their run through a pipeline.

Pile Cluster. A group of pilings driven close together and usually wrapped with wire rope to act as [fender](#) or mooring for small vessels.

Pour Point. The lowest temperature at which an oil will pour or flow without disturbance.

Pontoon Roof. A type of floating roof for a storage tank having liquid-tight compartments for positive buoyancy.

Pre-filter. A term used to refer to any filtration vessel used immediately upstream of a [fine filtration filter/separator](#) in a fuel storage/delivery system. They are used to remove gross amounts of particulates and/or free water from a fuel stream in order to prolong the life of the elements used in the [fine filtration filter/separator](#). Typically [cyclonic](#) or [micronic filters](#) are used as pre-filters although [haypack coalescers](#) or even [filter/separators](#) may also be used in this role.

Pre-Filtration. [Pre-filters](#) or [coalescers vessels](#) placed ahead of additional, more sophisticated, [fine filtration](#) vessels for the gross removal of solids and/or [free water](#).

Pressure Drop. The loss in pressure of a liquid flowing through a piping system caused by friction of pipe and fittings, velocity, and change in elevation.

Pressure Refueling Nozzle. A device, mounted on a refueling vehicle or station, that combines with an [aircraft refueling adapter](#) mounted on an aircraft to form a quick disconnect connection for the purpose of refueling or defueling aircraft. It can also be used for refueling and defueling [refuelers](#).

Product Recovery Tank. Tank used to collect and store aviation turbine fuel that would otherwise become waste fuel. It is part of a closed system that, either manually or automatically, pumps the fuel back into the system through a hard piped connection. Tanks that do not have this hard piped connection are not product recovery tanks.

Protected Tank. Aboveground storage tank that is listed in accordance with [UL 2085](#), that consists of a primary tank that is protected or insulated from a 2-hour fire exposure and protected from physical damage.

Radiograph. An image produced on radiosensitive film by invisible radiation such as X-ray, specifically the image produced by radiographic inspection of welds and plates.

Ready-Issue Tank. See [operating storage tank](#).

Recoverable Fuel. That portion of the fuel which may be separated and collected from a given lot of contaminated fuel, by proper processing in the treating facility in question.

Recovered Oil. Used to denote untreated petroleum fuel removed from oil-water separators or picked up after being spilled on land or water. Also used to mean oil which has been separated from and collected from a given lot of contaminated fuel by processing in a treating facility.

Refueler. Except for tactical refuelers, tank truck vehicles used to resupply aircraft with fuel. Tactical refuelers may transport ground products (gasoline, diesel) or aviation turbine fuel.

Reid Vapor Pressure. [Vapor pressure](#) measured under controlled conditions with the liquid temperatures at 100 °F (38 °C).

Residual Fuel Oil. Topped crude petroleum from refinery operations. Commercial grades of Burner Fuel No. 5, No. 6, and bunker fuels are residual fuel oils.

Relaxation Tank. Small tank in a fuel dispensing piping system downstream of filter/separators designed to remove [static electricity](#) from the liquid stream before discharge into a receiving tank.

Rotary Pump. A positive displacement pump which operates in rotary fashion such as a vane, gear, bucket, lobe, or screw pump; not centrifugal, turbine, or propeller pumps.

Rust. Ferric oxide, a reddish-brown scaly or powdery deposit found on the surface of steel and iron as a result of oxidation of the iron.

Safety Relief Valves. Valves that are installed on pressurized vessels to relieve pressure in excess of the maximum allowable working pressure of the vessel. Safety valves are provided to protect people, equipment, and property.

Scraper. A type of cleaning pig used in pipelines.

Secondary Containment-Type Tank. A tank that has an inner and outer wall with an interstitial space (annulus) between the walls and that has a means for monitoring the interstitial space for a leak.

Service Headquarters. Defined as follows: Army – Headquarters, U.S. Army Corps of Engineers Technical POC, POL Facility Criteria (CECW-CE); Air Force - The Air Force Fuels Engineer (\1\ [AFCEC](#)/COS /1/) through the applicable Major Command (MAJCOM) Fuels Engineer; Navy/Marine Corps: NAVFAC POL Facility Subject Matter Expert (\1\ NAVFAC EXWC, Code 54 /1/)

\1\ Service Provider. Defined as follows: Defense Logistics Agency (DLA) – DLA Facilities Engineer, DLA Installation Support for Energy (DLA DS-FEI) /1/

Single Point Receptacle. Point at which fueling hose is attached to skin of aircraft during aircraft refueling operations.

Skimmer. A device used to collect thin layers of oil floating on a body of water.

Slop Oil. Oil or fuel which has become contaminated with other oils or substances, often requiring separation or treatment before it is fit for use.

Sludge. Heavy viscous oily mass found in the bottom of storage tanks and treatment vessels, often contains [rust](#), scale, dirt, lead additives, [wax](#), gum, or asphalt.

Specific Gravity. The ratio of the weight in air of a given volume of a substance to the weight in air of an equal volume of distilled water (62.4 lb/ft³) (1000 kg/m³), both taken at the same temperature, usually 39.2 °F (3.98 °C /1).

Static Electricity. Accumulation of electric charge on an insulated body; also the electrical discharge resulting from such accumulation.

Strapping. The process of determining the volume of a storage tank or cargo hold by measuring its linear dimensions.

Stripper Pump. A pump used to strip or remove the last bit of liquid from a tank or pipe.

Sump. A low area or depression which receives drainage.

Surge. Sudden increase in fluid pressure caused by sudden stopping of a moving stream as by a quick closing valve; hydraulic shock; also the sudden, brief increase in voltage or current in an electrical circuit.

Surge Arrestor. A protective device for limiting surge voltages by discharging or bypassing surge current, and it also prevents continued flow of follow current while remaining capable of repeating these functions. Designed primarily for connection between a conductor of an electrical system and ground to limit the magnitude of transient (surge) overvoltages on equipment. Also known as arrestor or arrester, surge arrester, lightning arrestor or arrester.

Surge Suppressor. Device designed to control or reduce surges; hydraulic shock absorber.

Thermal Relief Valves. Valves that are installed around isolation valves to relieve excessive pressure caused by thermal expansion of the fuel in the pipe.

Tolerance. An allowable variation from a specified standard of measurement, commonly applied to the accuracy of meters.

Top Loading. Method of filling tank cars and trucks through an opening in the top.

True Vapor Pressure. [Vapor pressure](#) measured at actual liquid temperature.

Vapor Lock. Malfunction of an engine fuel system or of a pumping system caused by vaporization of the fuel, usually associated with gasoline.

Vapor Pressure. Internal pressure of vapor in a liquid usually in pounds per square inch; an indication of [volatility](#).

Viscosity. Measure of the internal resistance of a fluid to flow or movement, most commonly measured in centistokes.

Volatility. Measure of the tendency of a liquid to vaporize; vapor pressure.

Waste Oil. Oil from which the water and other contaminants cannot be removed by the available treating facilities, and hence is unfit for further use. This term is also loosely used for contaminated oil which may contain recoverable fuel collected at facilities having no treatment facility for fuel reclamation.

Water Bottom. [Free water](#) which has settled to the bottom of a storage tank.

Water Drawoff. A valve or similar device used to remove water from the bottom of a tank.

Water Slug Shutoff. A valve in the discharge piping from a filter/separator which closes automatically when the water in the unit rises above a set level.

Wax. Viscous or solid high molecular weight [hydrocarbon](#) substance; paraffin.

Weatherproof. Type of enclosure for electrical apparatus for outdoor service in nonhazardous areas.

Wharf. A landing place where vessels tie up to load or unload; pier.

This Page Intentionally Left Blank

CANCELLED

APPENDIX E PLATES

- Plate 001 – UFC Chapter Identification Plan
- Plate 002 – Tank Truck and Tank Car Receiving and Dispensing Facilities
- Plate 003 – Tank Truck and Tank Car Off-Loading Drop Tank System
- Plate 004 – Tank Truck and Tank Car Packaged Off-Loading System
- Plate 005 – Tank Truck and Tank Car Loading System and Direct Off-Loading System
- Plate 006 – Refueler Truck Facilities Layout Plan
- Plate 007 – Refueler Truck Loading Systems
- Plate 008 – Aircraft Direct Fueling Systems Large Frame Aircraft On-Apron Fueling Positions
- Plate 009 – Aircraft Direct Fueling Systems Small Frame Aircraft Fueling Lane and Apron Edge
- Plate 010 – Aircraft Direct Fueling Systems Small Frame Aircraft In-Shelter Fueling Positions
- Plate 011 – GOV Vehicle Motive Fuel Filling Station Plan
- Plate 012 – Tactical Refueler Ground Product Truck Loading Facility Plan
- Plate 013 – Tactical Refueler Ground Product Truck Loading Systems
- Plate 014 – Level Alarm Setpoints Vertical Aboveground Tank with Floating Pan
- Plate 015 – Level Alarm Setpoints Vertical Aboveground Tank without Floating Pan
- Plate 016 – Aboveground Vertical Storage Tanks Inlet Fill Connection
- Plate 017 – Horizontal Underground Storage Tanks Inlet Fill Connection
- Plate 018 – Horizontal Aboveground Storage Tanks Inlet Fill Connection
- Plate 019 – Earthen Dikes
- Plate 020 – Piping Systems Sliding Pipe Support
- Plate 021 – Piping Systems Anchor Pipe Support
- Plate 022 – Aviation System Piping Materials System Standards

Plate 023 – Thermal Relief Piping Systems Integral Valve and Conventional

Plate 024 – Thermal Relief Piping Systems Equipment Pump House or Pads

Plate 025 – Thermal Relief Piping Systems Tank Truck and Refueler Racks

Plate 026 – Thermal Relief Piping Systems Storage Tanks

Plate 027 – Liquefied Petroleum Gas Facilities Small Volume Facility for Trucks and
Cylinders

Plate 028 – Liquefied Petroleum Gas Facilities Large Volume Facility for Tank Cars and
Water Vessels

Plate 029 – Liquefied Petroleum Gas Facilities Tank Spacing Requirements

Plate 030 – Liquefied Petroleum Gas Facilities Tank Spacing Requirements

CANCELLED

Plate 001 – UFC Chapter Identification Plan

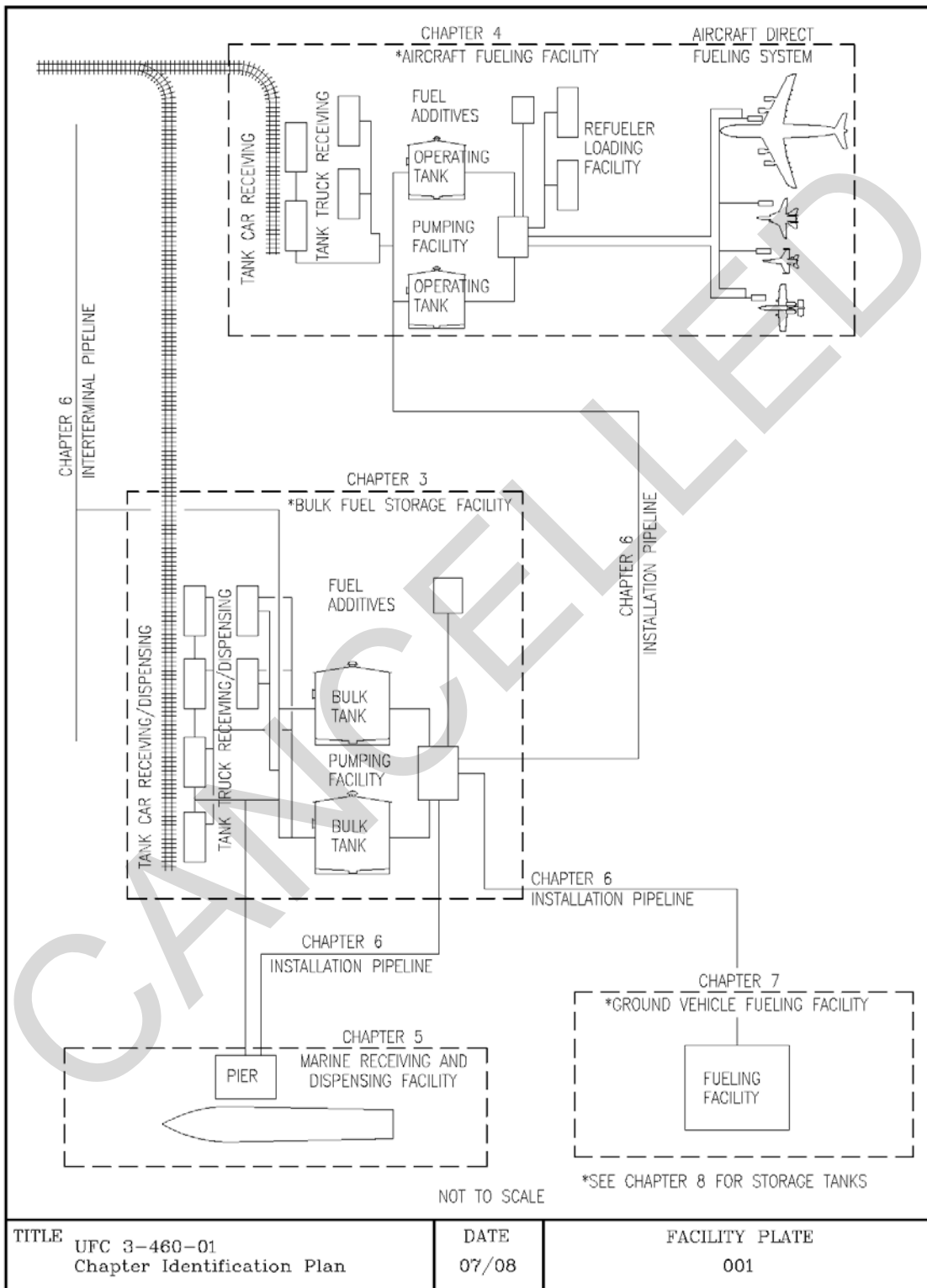

Plate 002 – Tank Truck and Tank Car Receiving and Dispensing Facilities

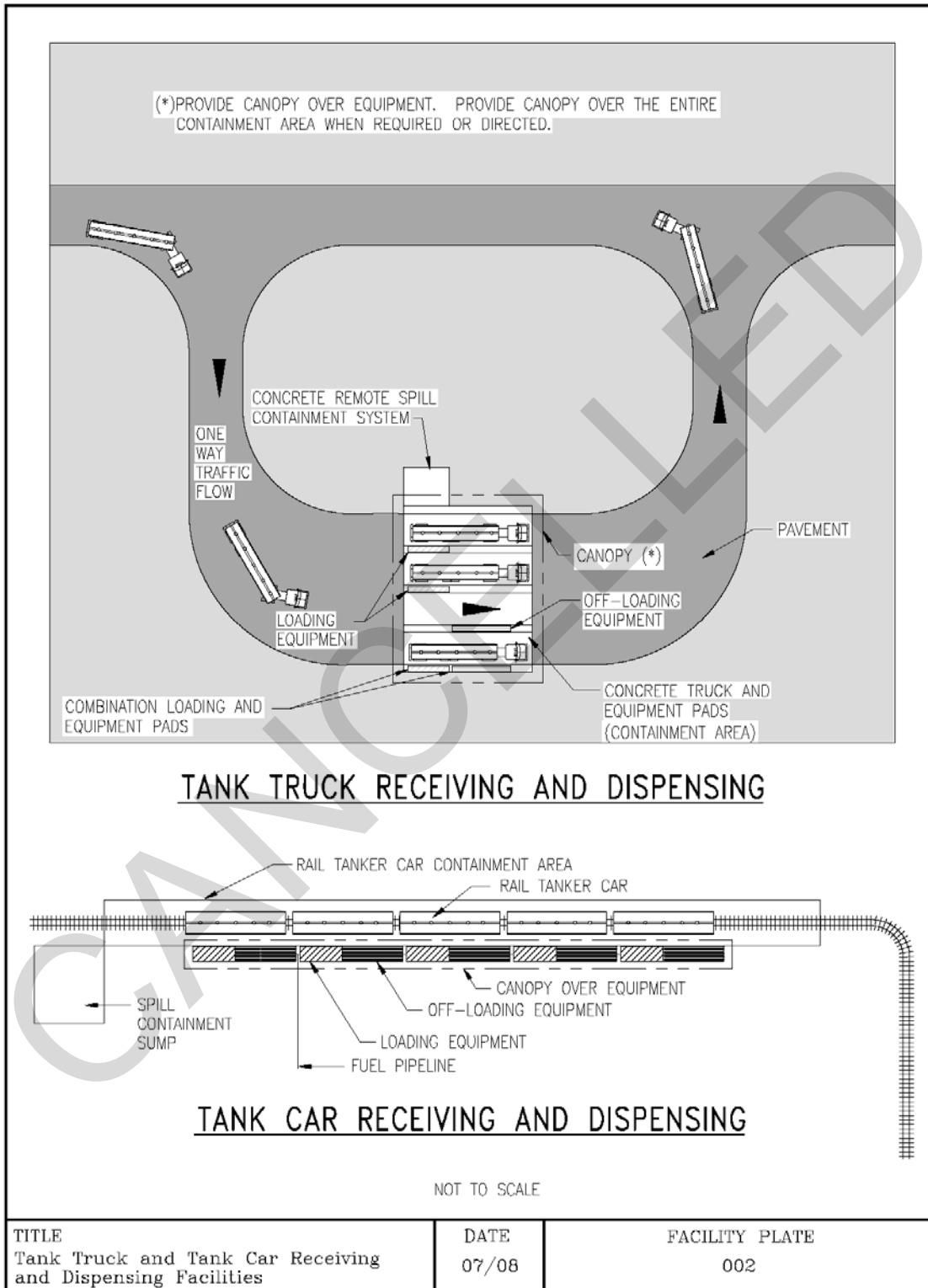

Plate 003 – Tank Truck and Tank Car Off-Loading Drop Tank System

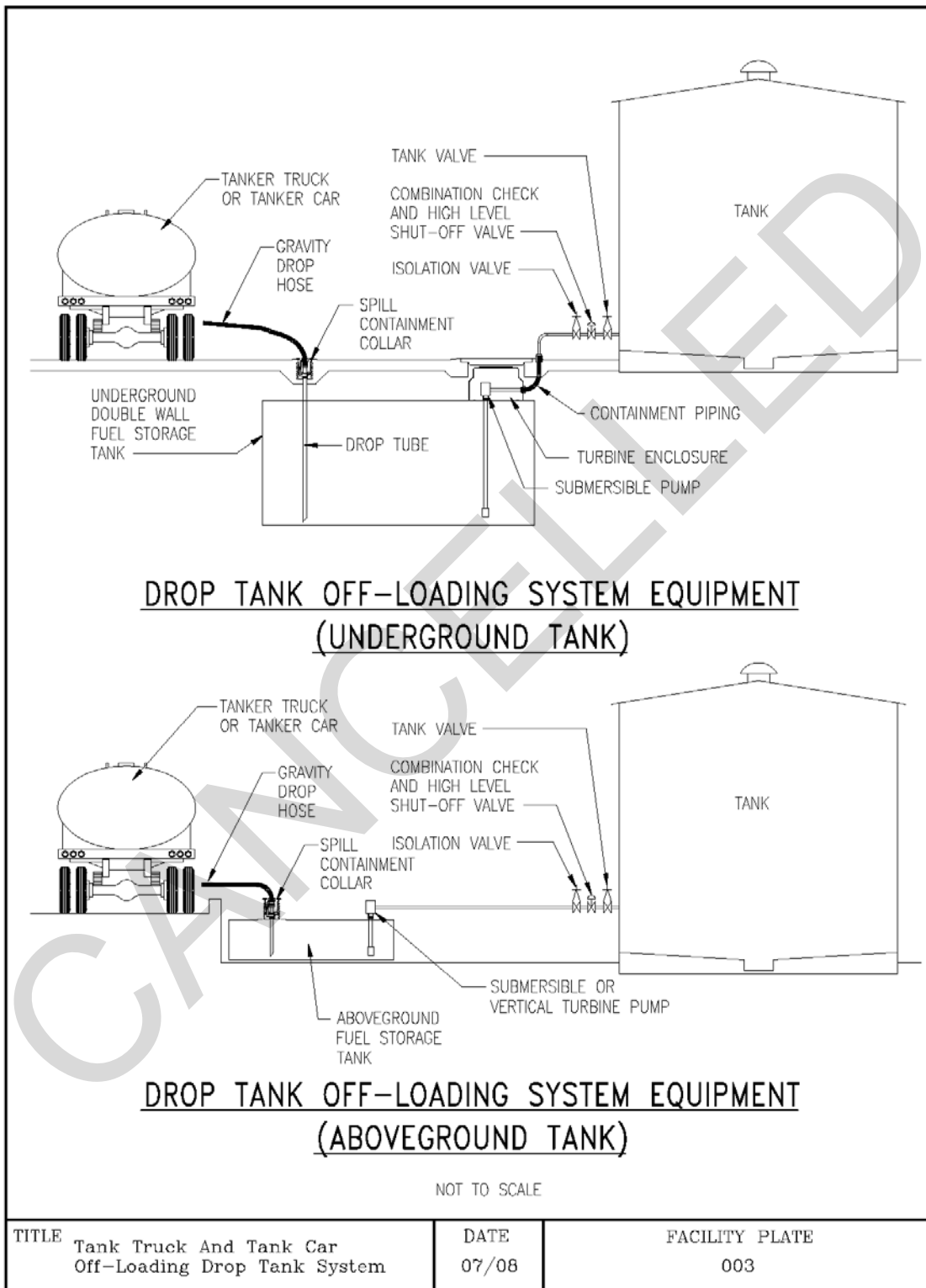
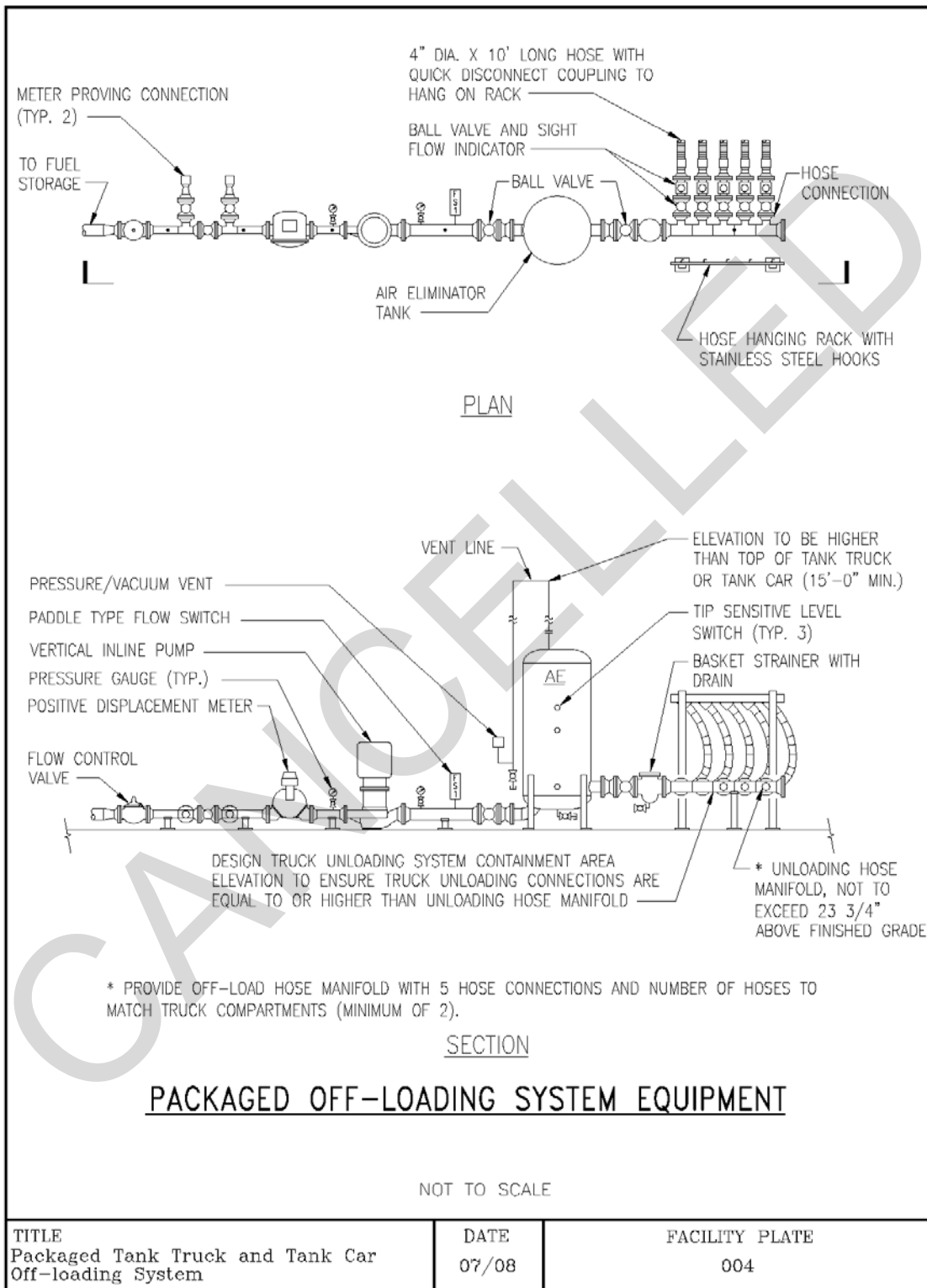
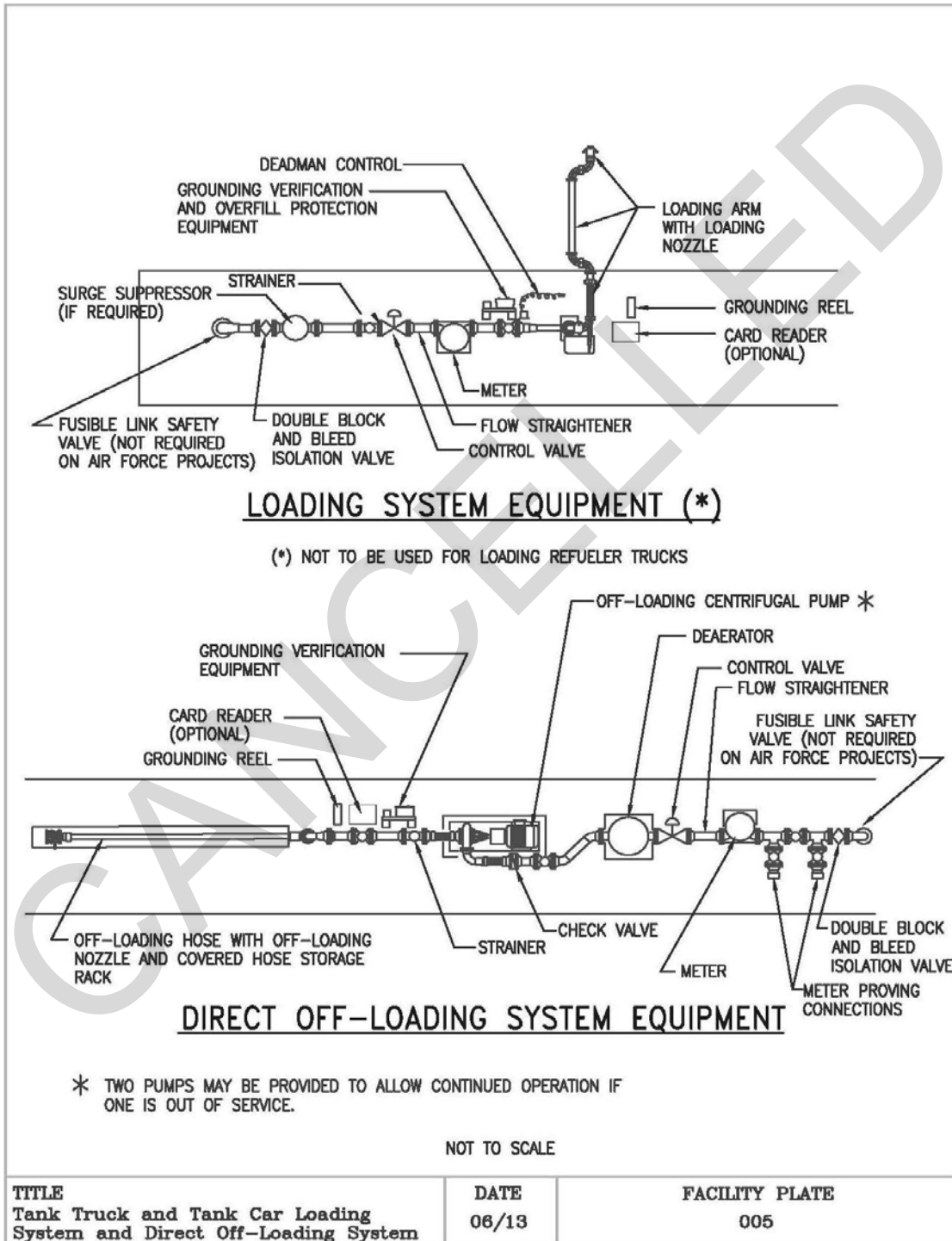

Plate 004 – Tank Truck and Tank Car Packaged Off-Loading System



\1\

Plate 005 – Tank Truck and Tank Car Loading System and Direct Off-Loading System



/1/

Plate 006 – Refueler Truck Facilities Layout Plan

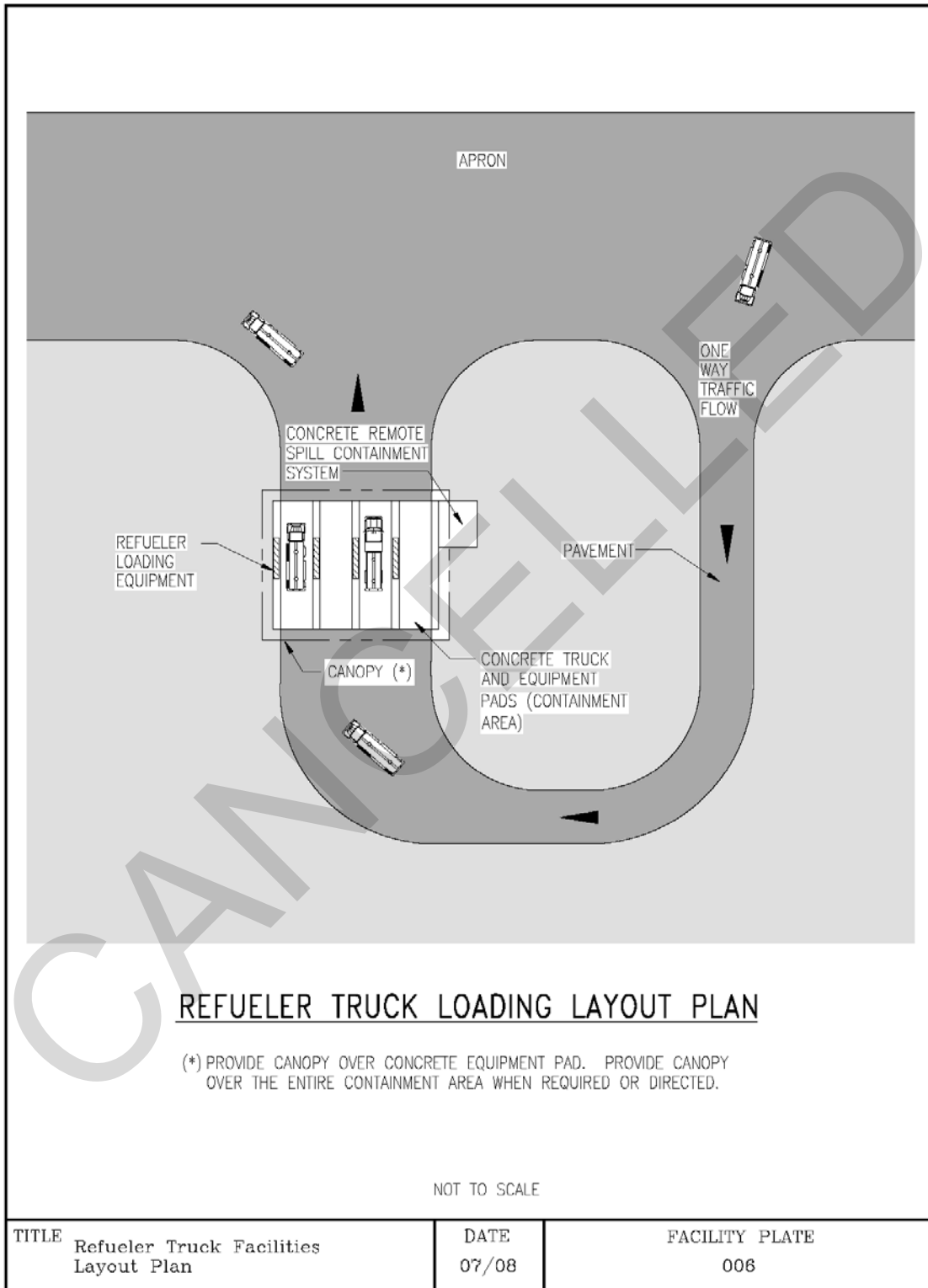
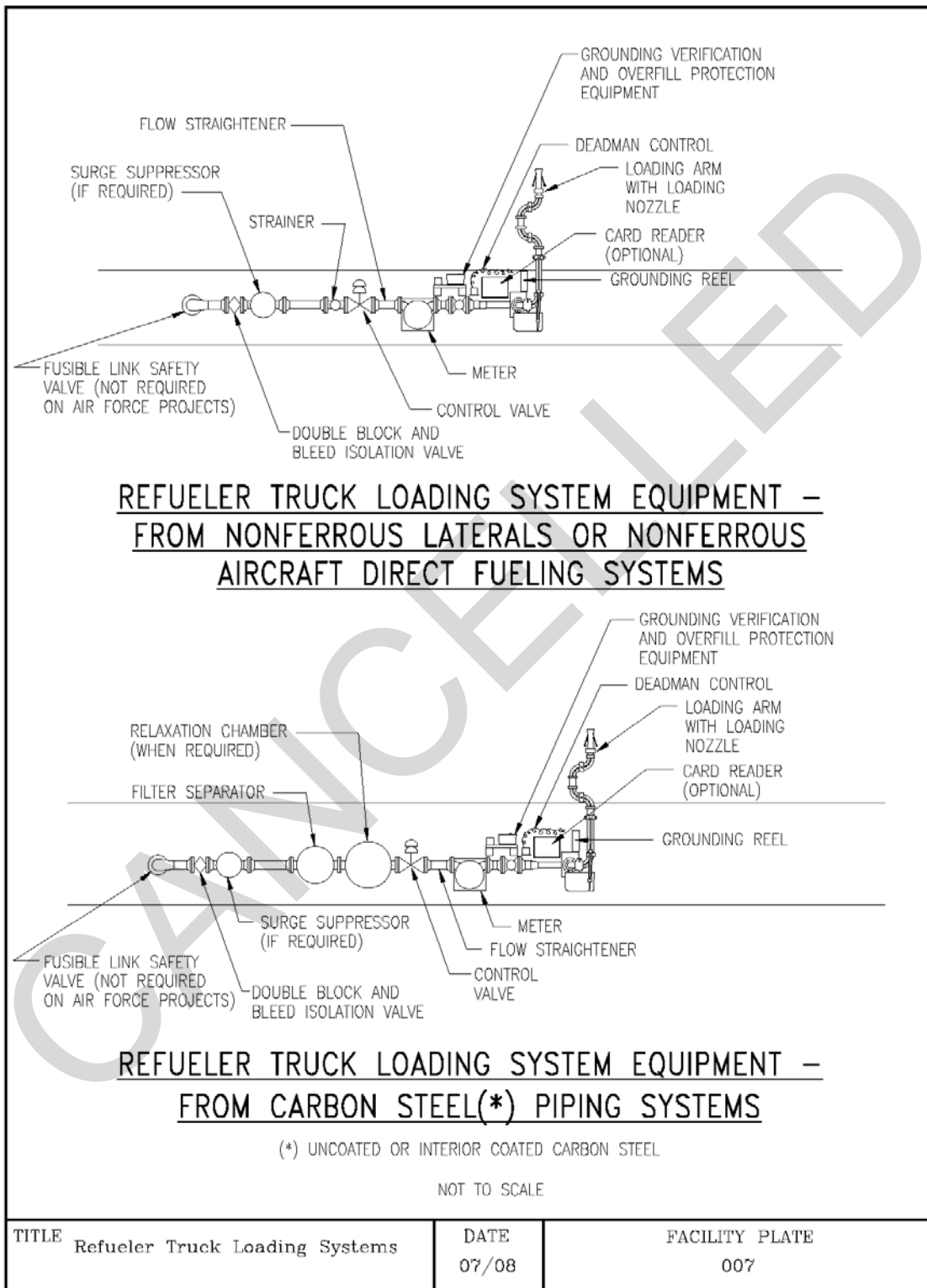

Plate 007 – Refueler Truck Loading Systems



**Plate 008 – Aircraft Direct Fueling Systems Large Frame Aircraft On-Apron
Fueling Positions**

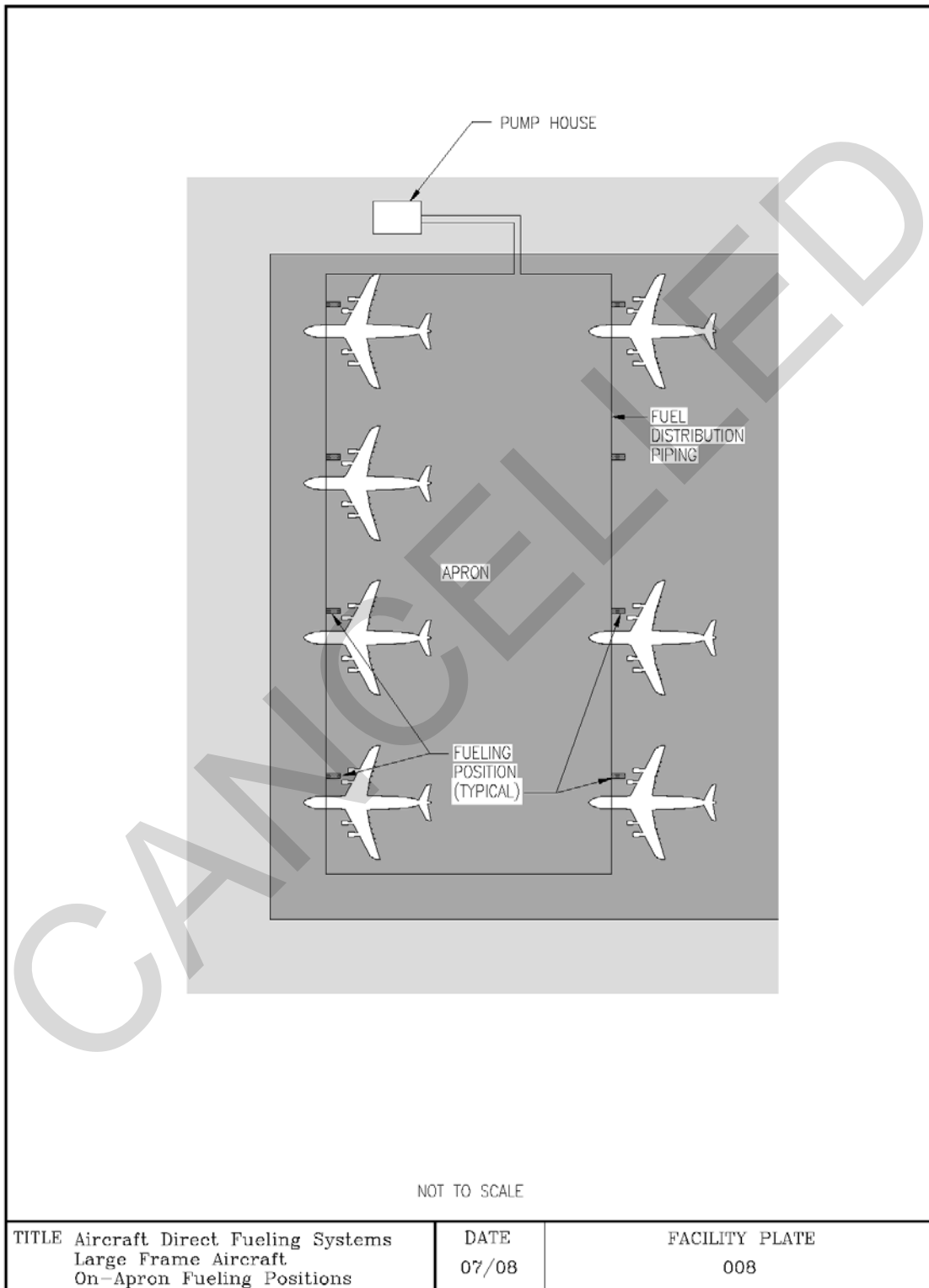
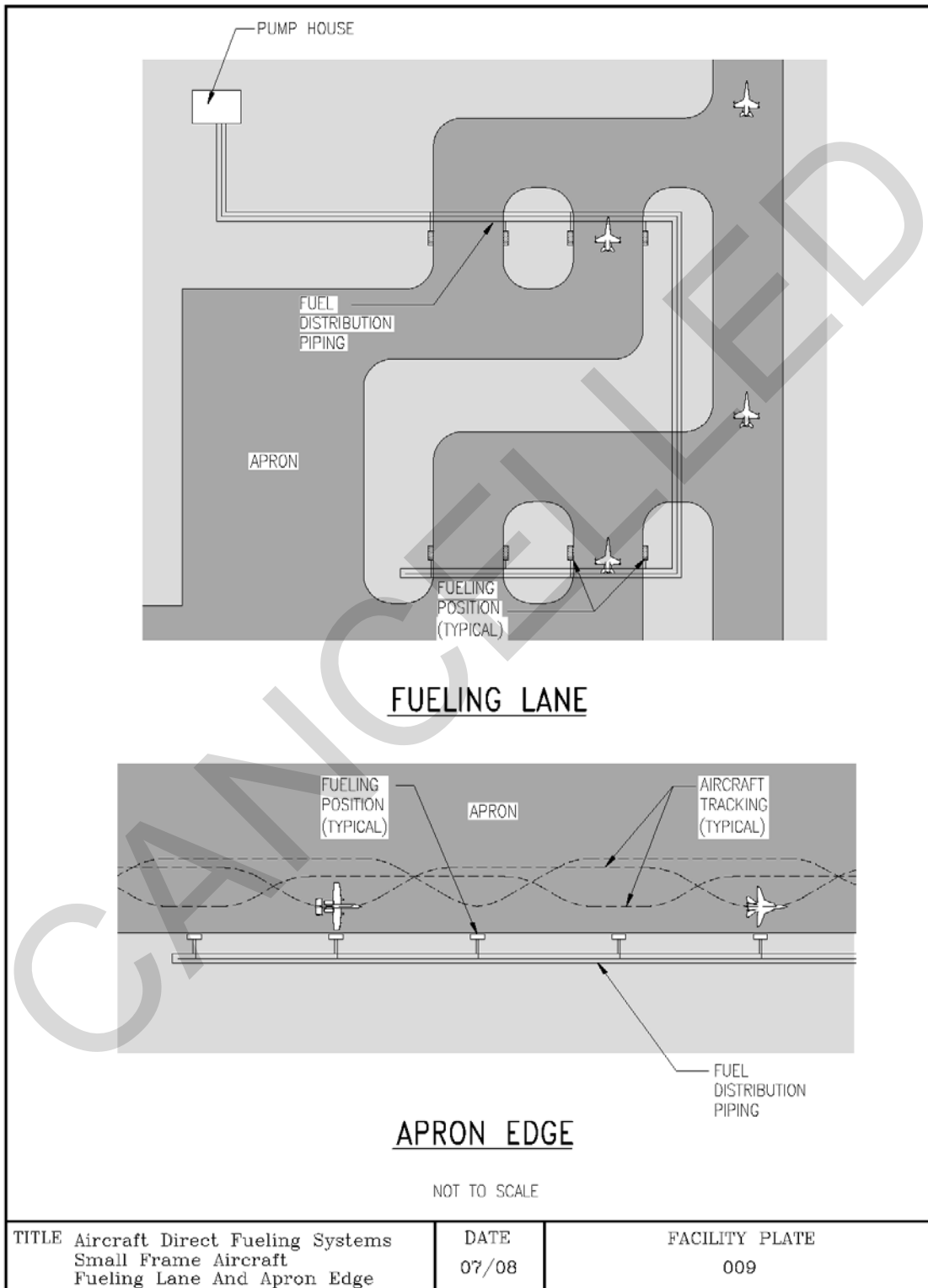

Plate 009 – Aircraft Direct Fueling Systems Small Frame Aircraft Fueling Lane and Apron Edge



**Plate 010 – Aircraft Direct Fueling Systems Small Frame Aircraft In-Shelter
Fueling Positions**

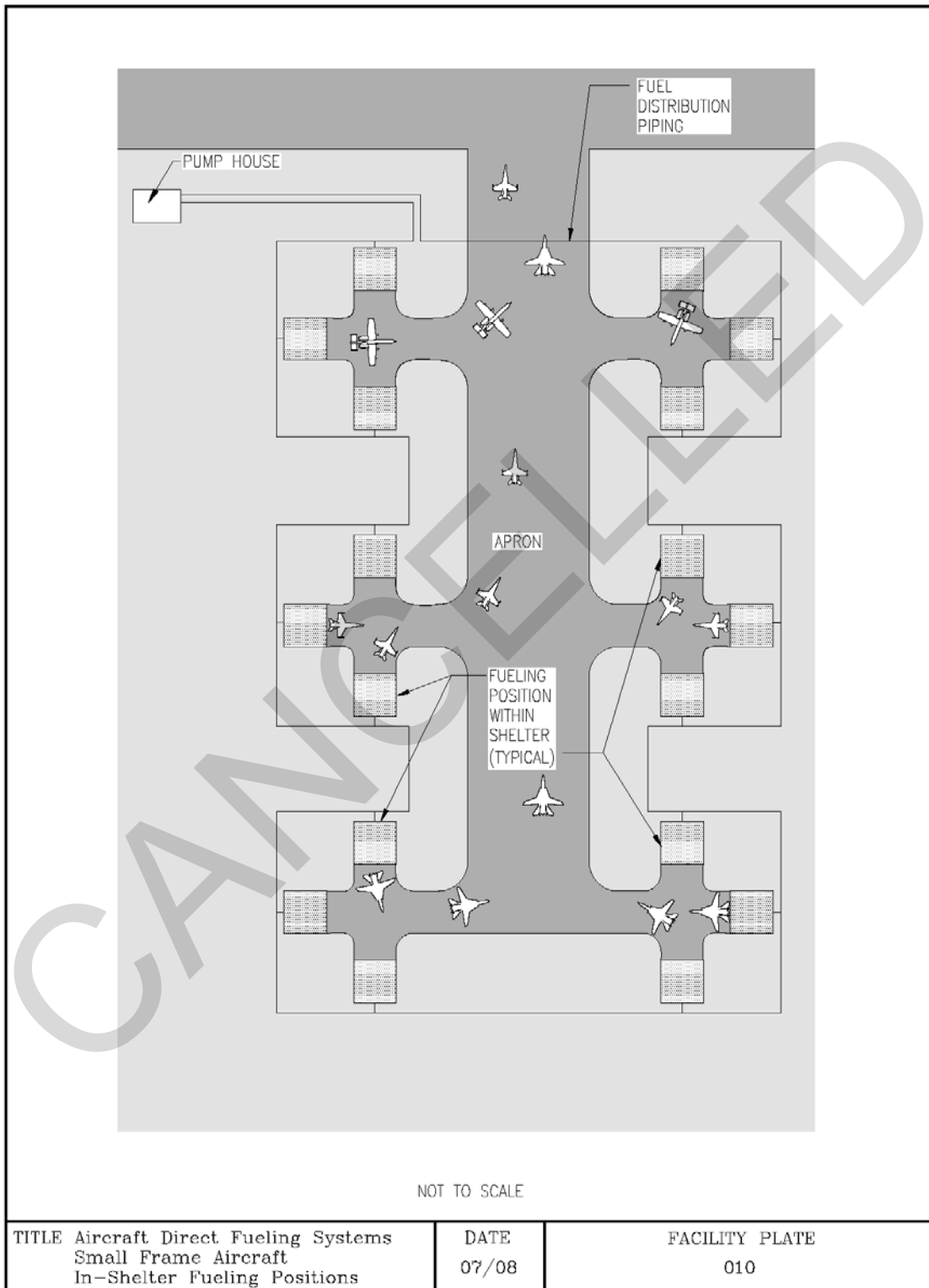
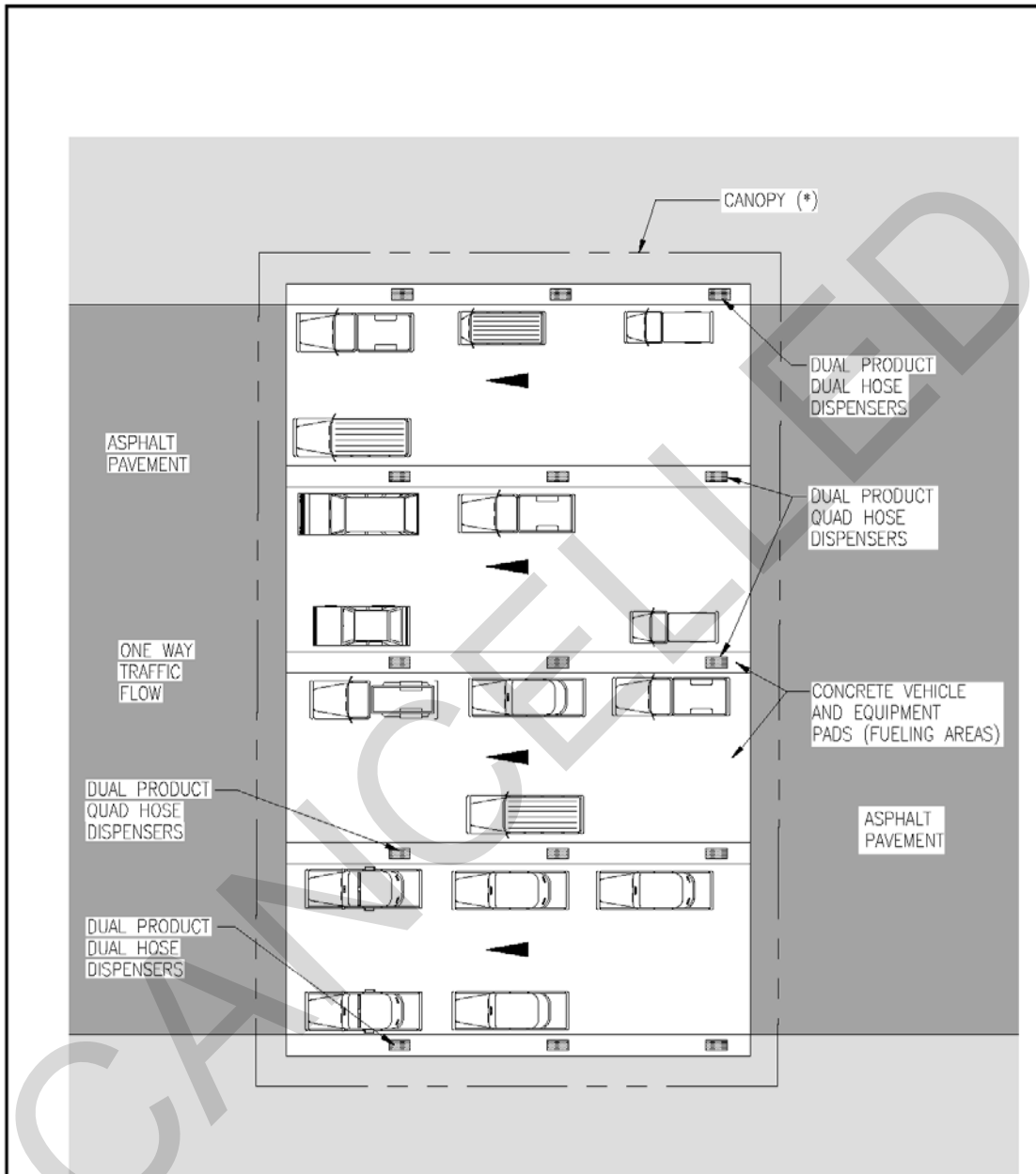

Plate 011 – GOV Vehicle Motive Fuel Filling Station Plan



GOV VEHICLE MOTIVE FUEL FILLING STATION PLAN

(*) PROVIDE CANOPY OVER CONCRETE EQUIPMENT PADS. PROVIDE CANOPY OVER THE ENTIRE FUELING AREA WHEN REQUIRED OR DIRECTED.

NOT TO SCALE

TITLE GOV Vehicle Motive Fuel Filling Station Plan	DATE 07/08	FACILITY PLATE 011
---	---------------	-----------------------

Plate 012 – Tactical Refueler Ground Product Truck Loading Facility Plan

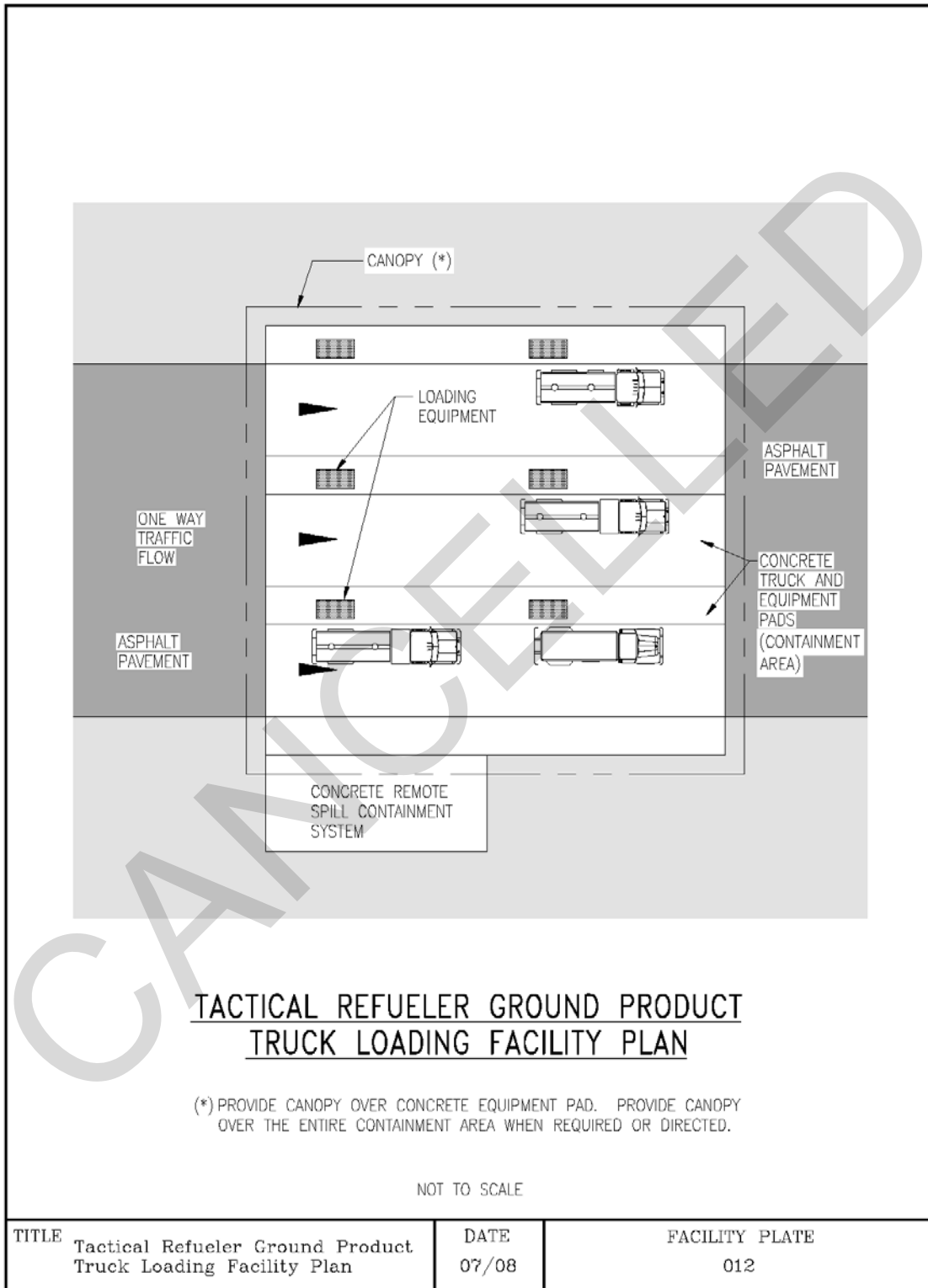
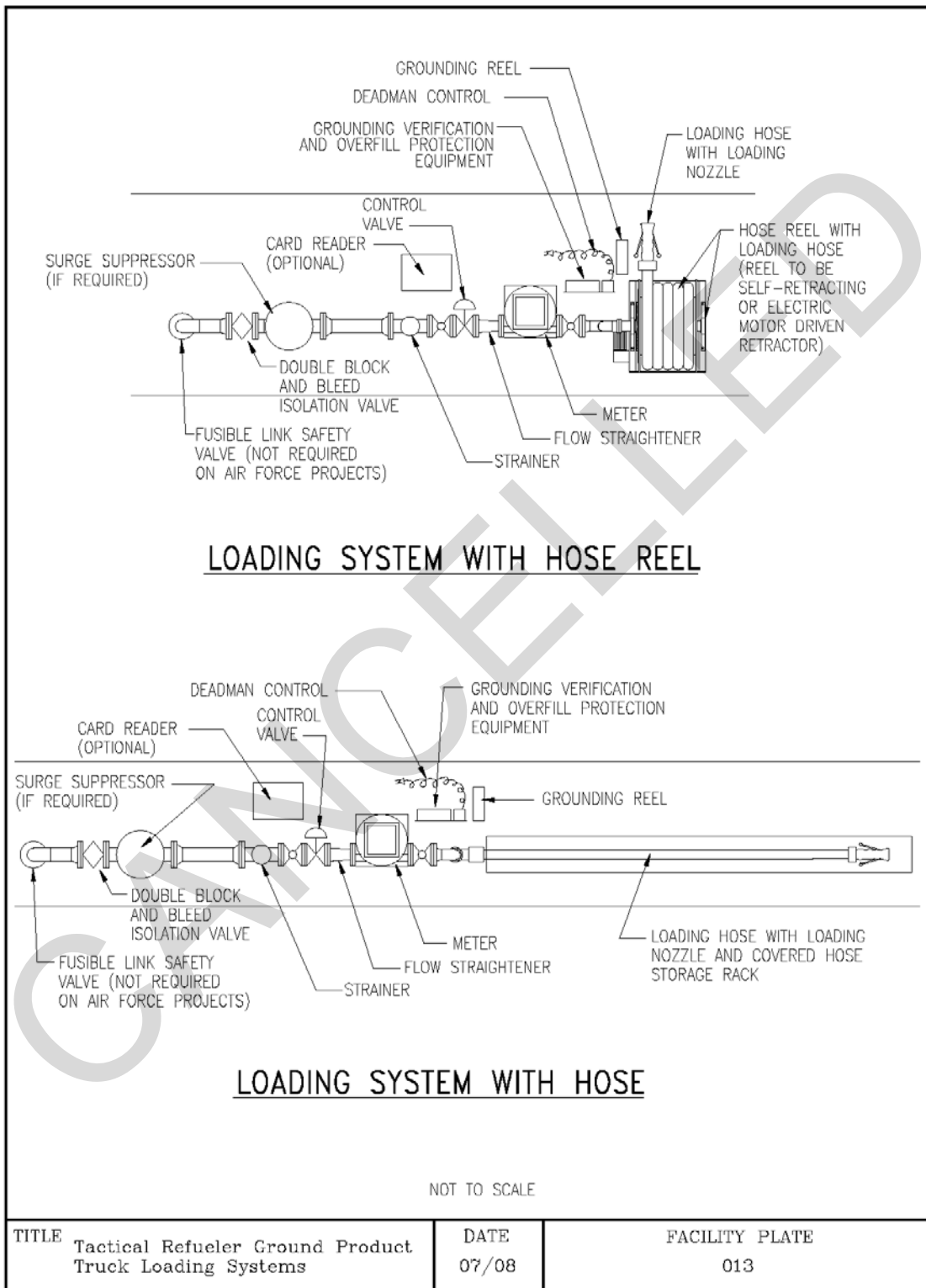
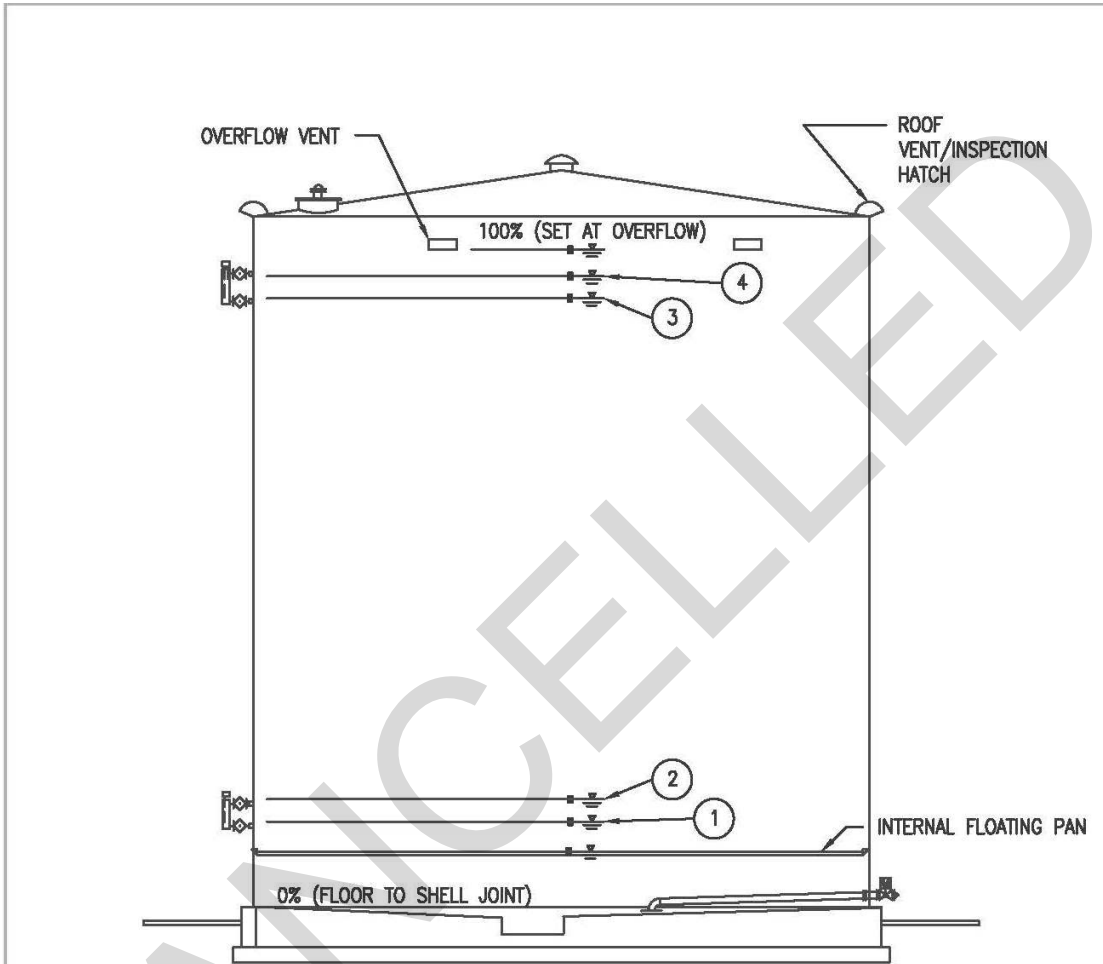

Plate 013 – Tactical Refueler Ground Product Truck Loading Systems



\1\

Plate 014 – Level Alarm Setpoints Vertical Aboveground Tank with Floating Pan



SET LEVEL ALARMS AS DEFINED IN TABLE 8-1

- ① LOW-LOW LEVEL ALARM
- ② LOW LEVEL ALARM
- ③ HIGH LEVEL ALARM
- ④ HIGH-HIGH LEVEL ALARM

NOTES:

1. CALCULATE MINUTES FROM MAXIMUM NOMINAL ISSUE RATES FOR LOW AND LOW-LOW LEVELS AND MAXIMUM NOMINAL RECEIPT RATES FOR HIGH AND HIGH-HIGH LEVELS.
2. ADJUST TIMES FOR EXTREMELY LARGE TANKS WITH LOW RECEIPT RATES THAT FILL SLOWLY, OR SMALL TANKS WITH UNUSUALLY HIGH RECEIPT RATES THAT FILL RAPIDLY.
3. FLOATING PAN LOW LEG LEVEL VARIES PER TANK, CONTACT SERVICE HEADQUARTERS.

TITLE LEVEL ALARM SETPOINTS VERTICAL ABOVEGROUND TANK W/ FLOATING PAN	DATE 06/13	FACILITY PLATE 014
--	----------------------	------------------------------

Plate 015 – Level Alarm Setpoints Vertical Aboveground Tank without Floating Pan

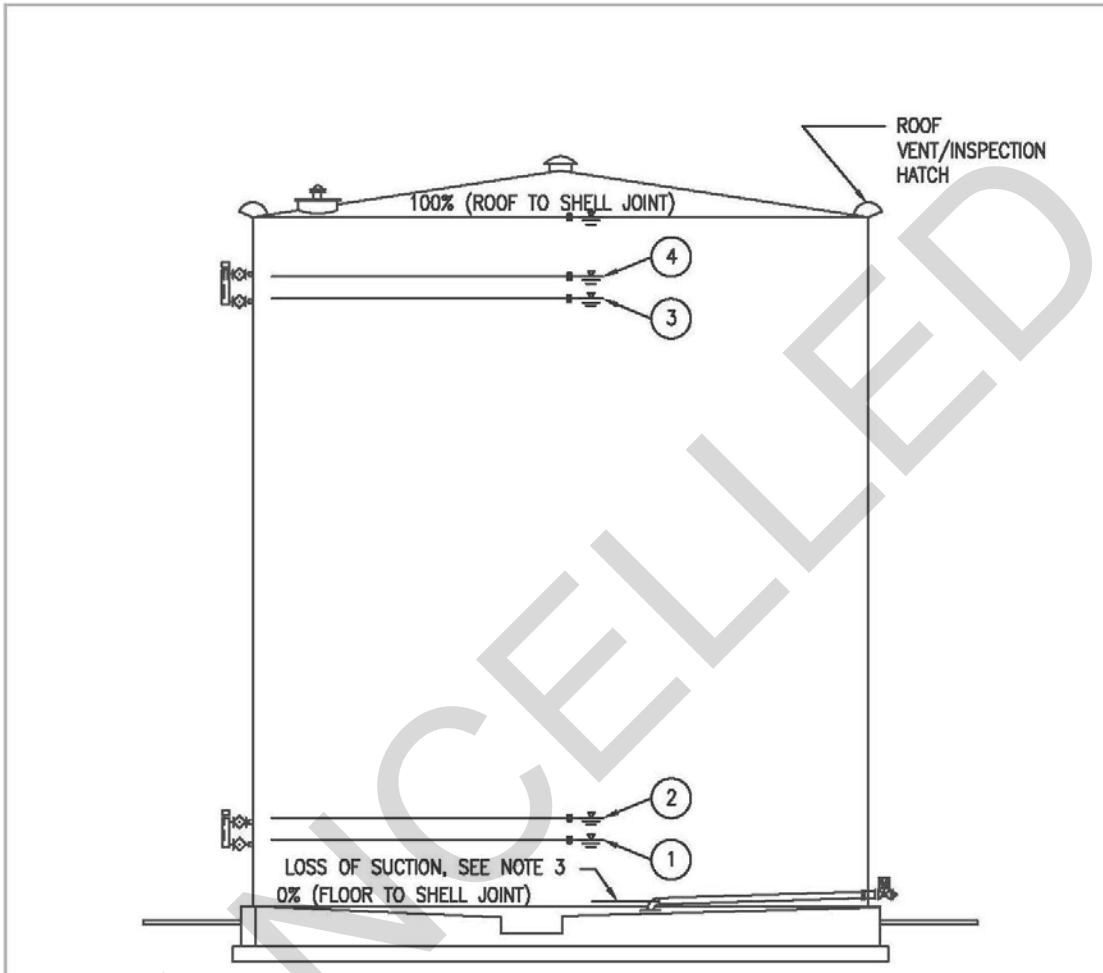

VERTICAL ABOVEGROUND TANK W/O FLOATING PAN

SET LEVEL ALARMS AS DEFINED IN TABLE 8-1

- ① LOW-LOW LEVEL ALARM
- ② LOW LEVEL ALARM
- ③ HIGH LEVEL ALARM
- ④ HIGH-HIGH LEVEL ALARM

NOTES:

1. CALCULATE MINUTES FROM MAXIMUM NOMINAL ISSUE RATES FOR LOW LEVELS AND MAXIMUM NOMINAL RECEIPT RATES FOR HIGH AND HIGH-HIGH LEVELS.
2. ADJUST TIMES FOR EXTREMELY LARGE TANKS WITH LOW RECEIPT RATES THAT FILL SLOWLY, OR SMALL TANKS WITH UNUSUALLY HIGH RECEIPT RATES THAT FILL RAPIDLY.
3. LOSS OF SUCTION, ELEVATION IS TYPICALLY SET 6 INCHES ABOVE INLET. CONTACT SERVICE HEADQUARTERS FOR GUIDANCE.

TITLE LEVEL ALARM SETPOINTS VERTICAL ABOVEGROUND TANK W/O FLOATING PAN	DATE 06/13	FACILITY PLATE 015
---	----------------------	------------------------------

Plate 016 – Aboveground Vertical Storage Tanks Inlet Fill Connection

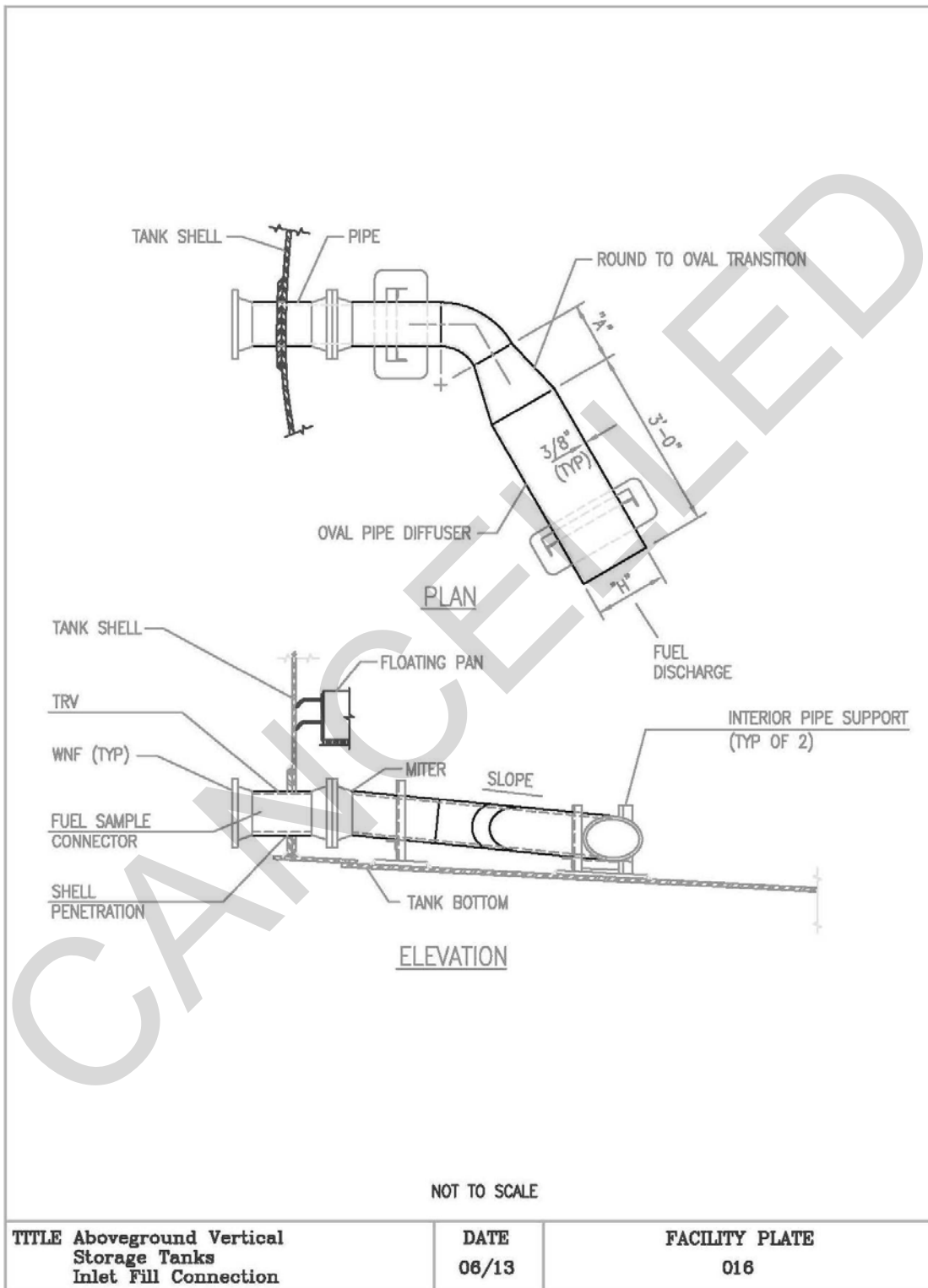

Plate 017 – Horizontal Underground Storage Tanks Inlet Fill Connection

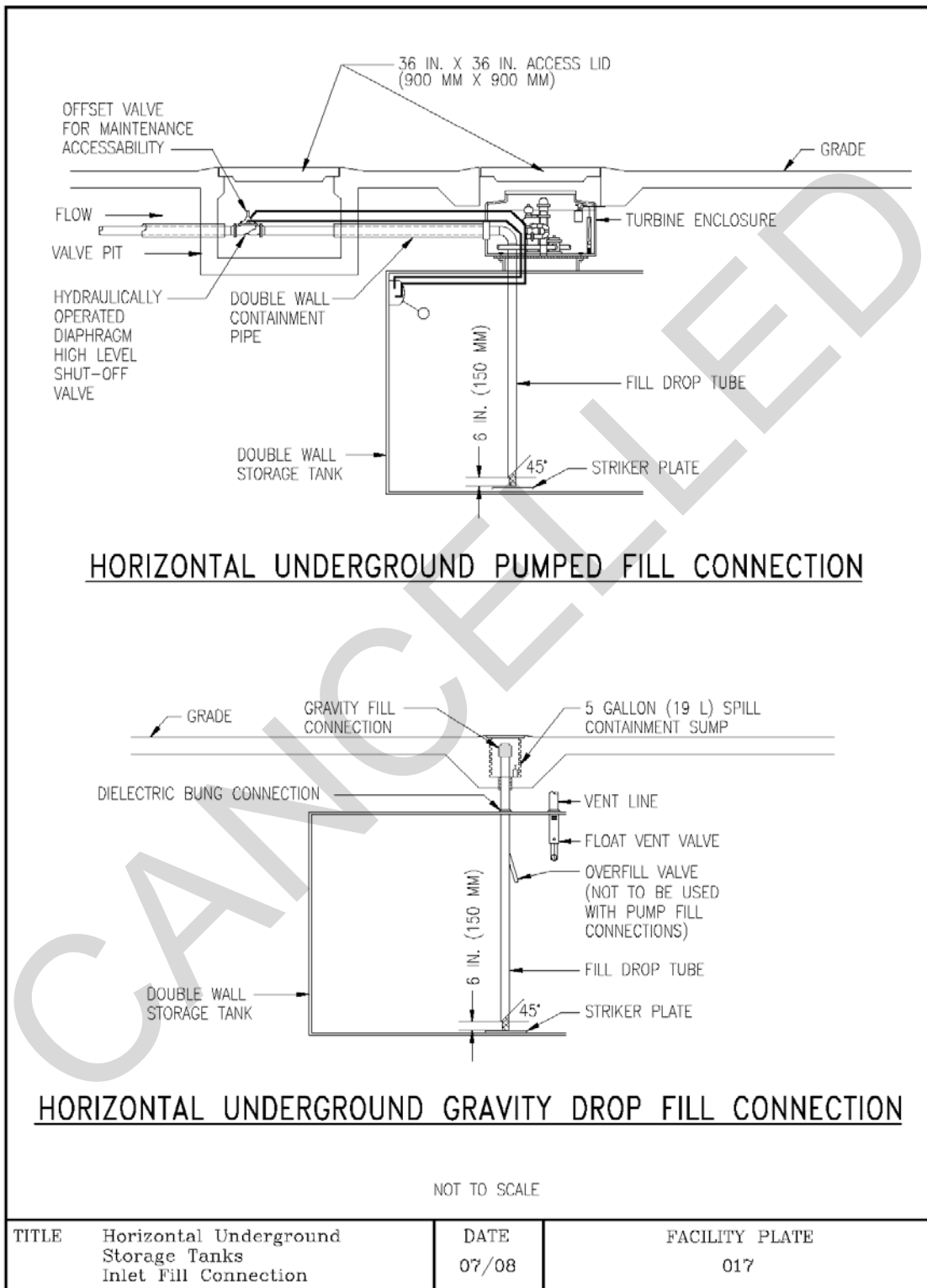
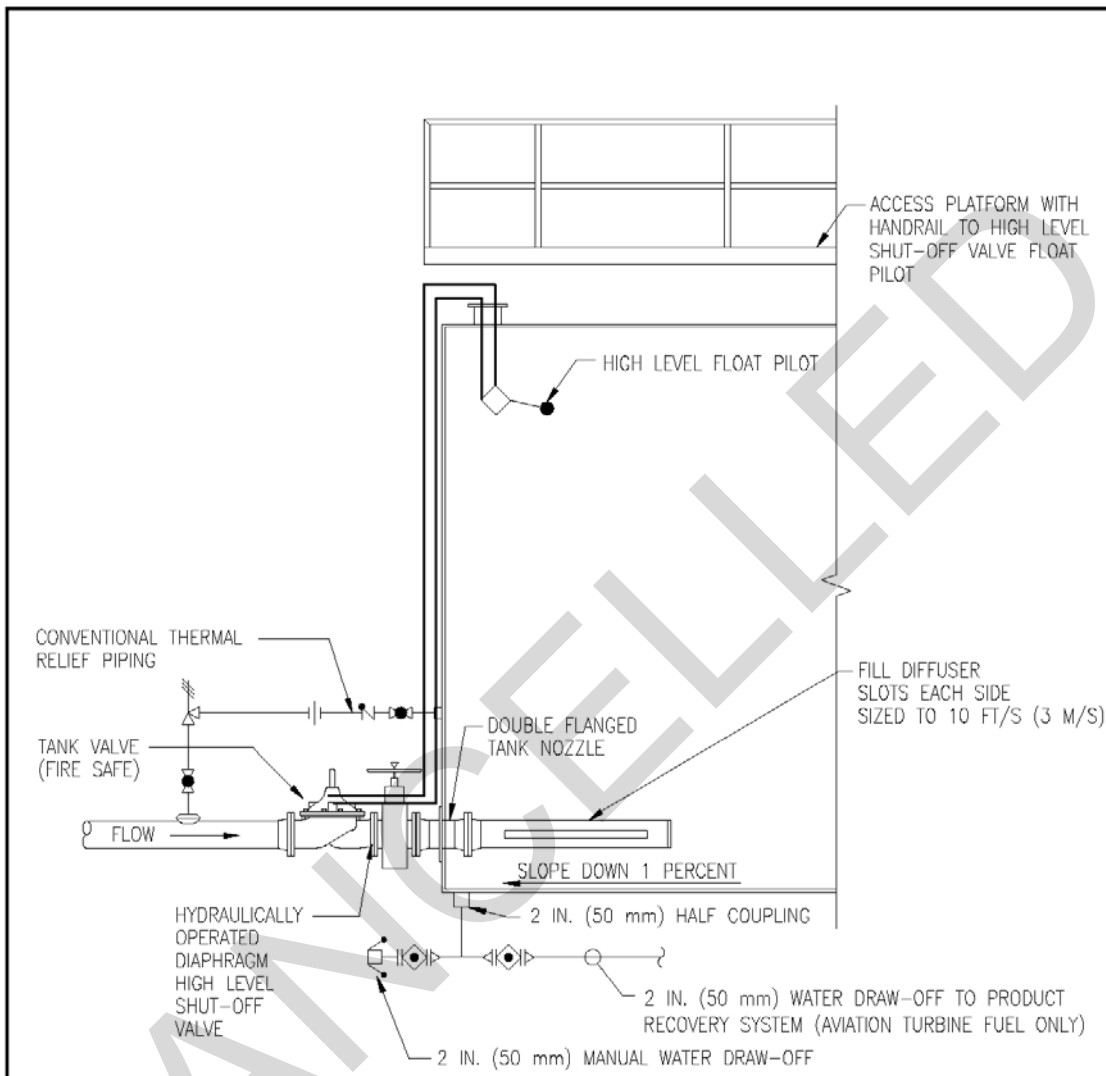

Plate 018 – Horizontal Aboveground Storage Tanks Inlet Fill Connection



HORIZONTAL ABOVEGROUND PUMPED FILL CONNECTION

NOTES:

1. FACILITY PLATE APPLIES ONLY TO HORIZONTAL, SINGLE WALL ABOVEGROUND, TANKS AS DEFINED BY NFPA 30 AND NFPA 30A.
2. WATER DRAW-OFF LINE SIZE IS A MINIMUM.
3. LIMIT FILL RATE TO 3 FT/S (900 mm/S) UNTIL THE FILL DIFFUSER IS COMPLETELY SUBMERGED.

NOT TO SCALE

TITLE	Horizontal Aboveground Storage Tanks Inlet Fill Connection	DATE	07/08	FACILITY PLATE	018
-------	--	------	-------	----------------	-----

Plate 019 – Earthen Dikes

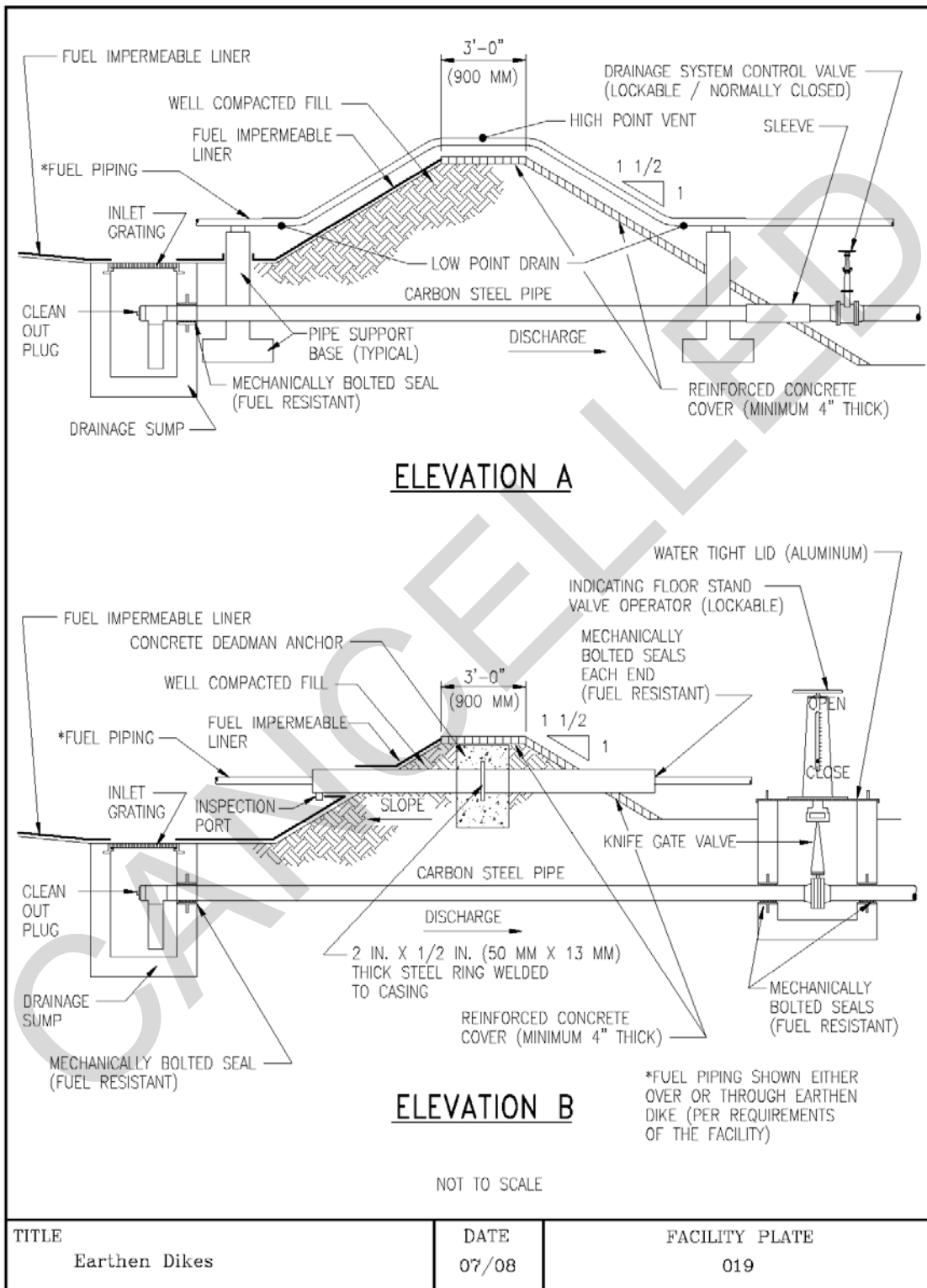
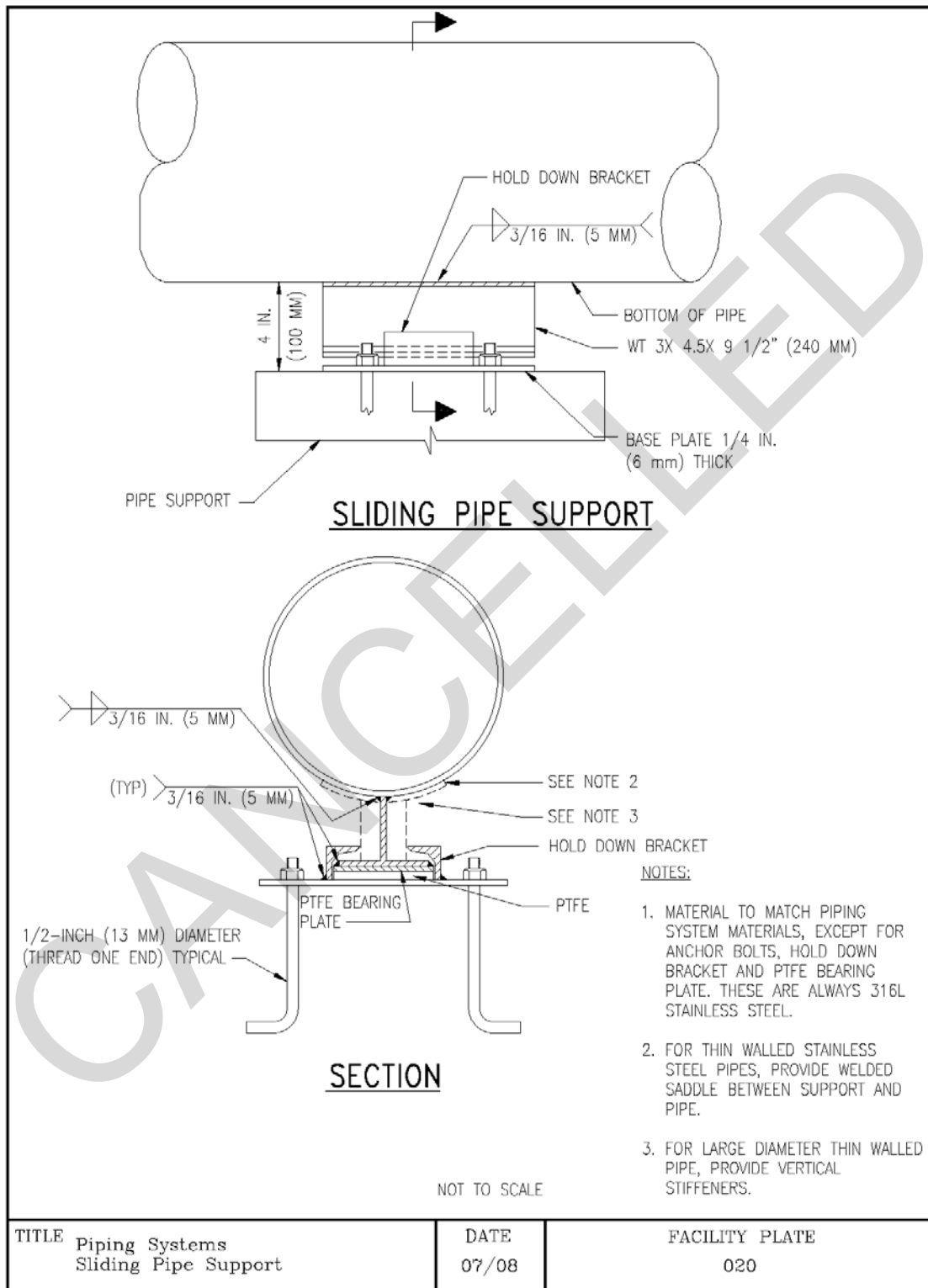
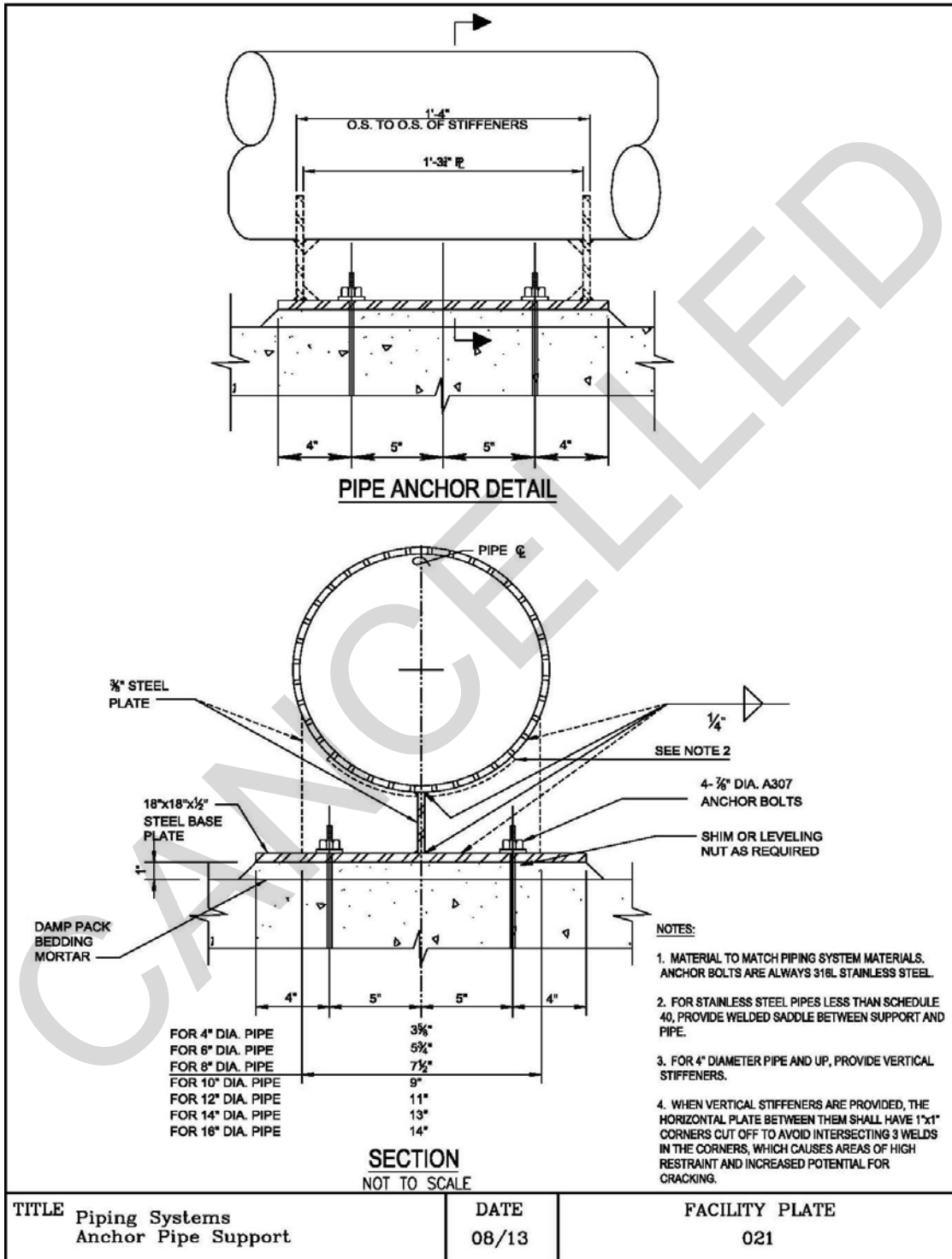

Plate 020 – Piping Systems Sliding Pipe Support



11

Plate 021 – Piping Systems Anchor Pipe Support



11

Plate 022 – Aviation System Piping Materials System Standards

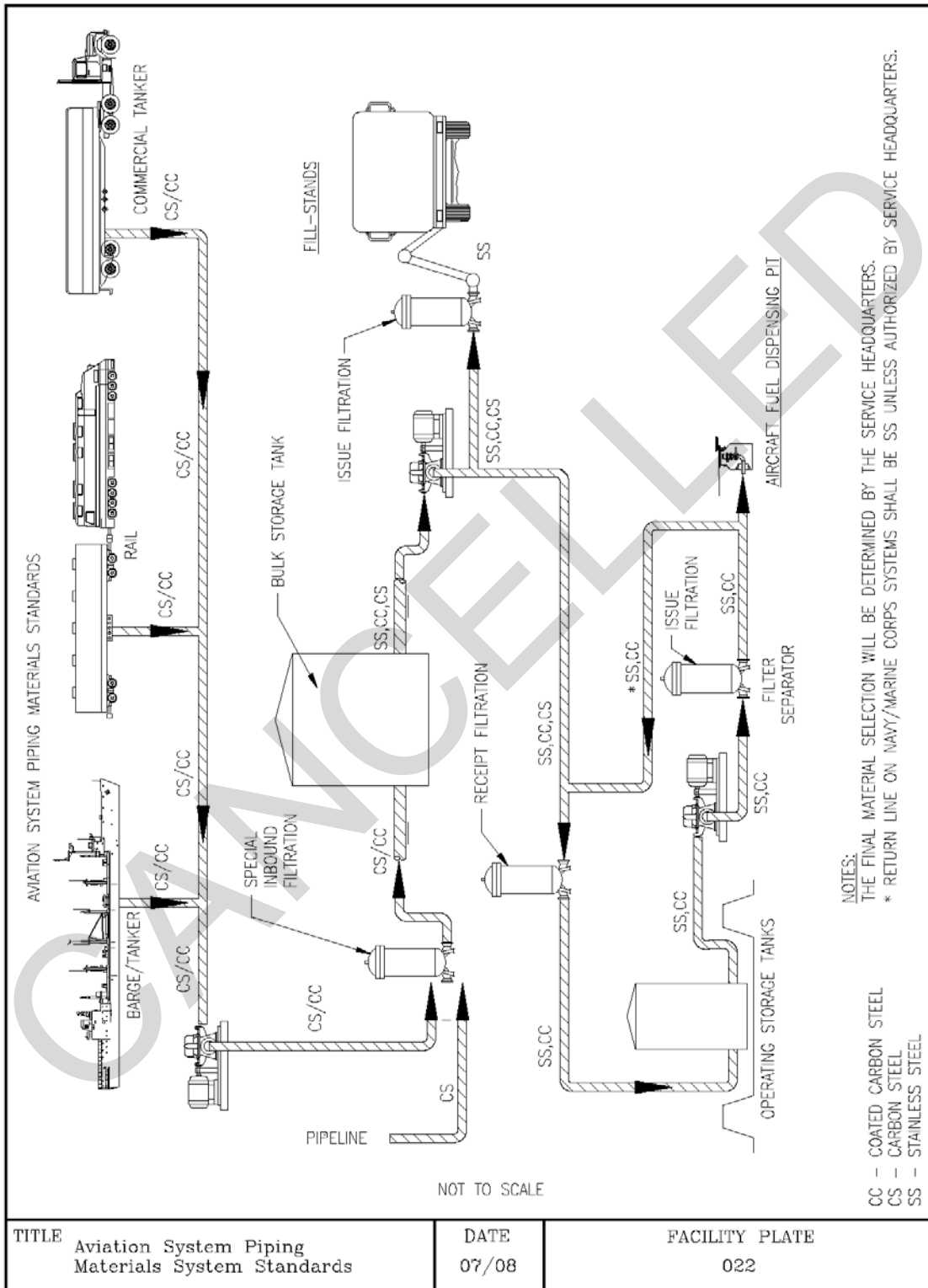

Plate 023 – Thermal Relief Piping Systems Integral Valve and Conventional

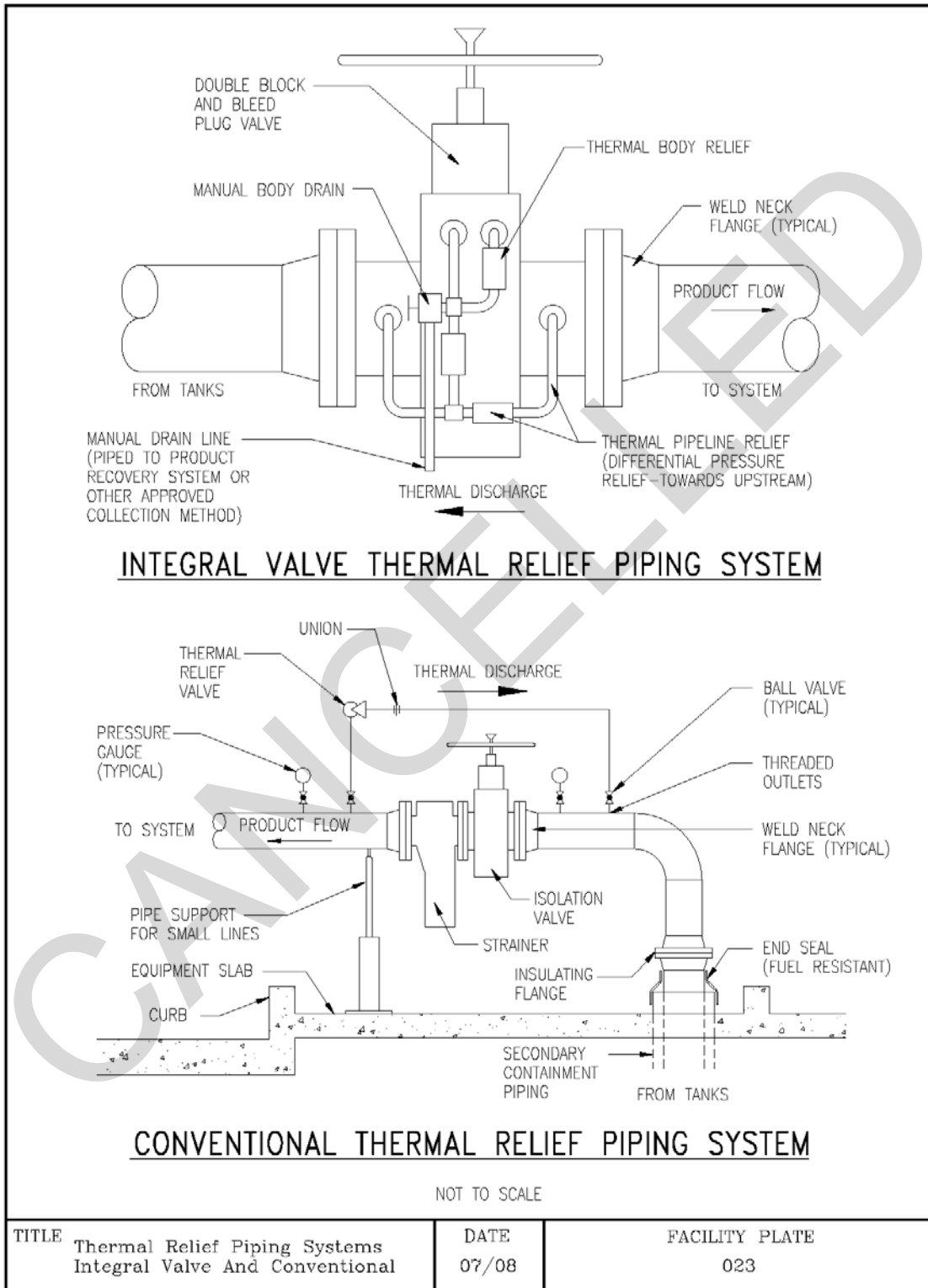

Plate 024 – Thermal Relief Piping Systems Equipment Pump House or Pads

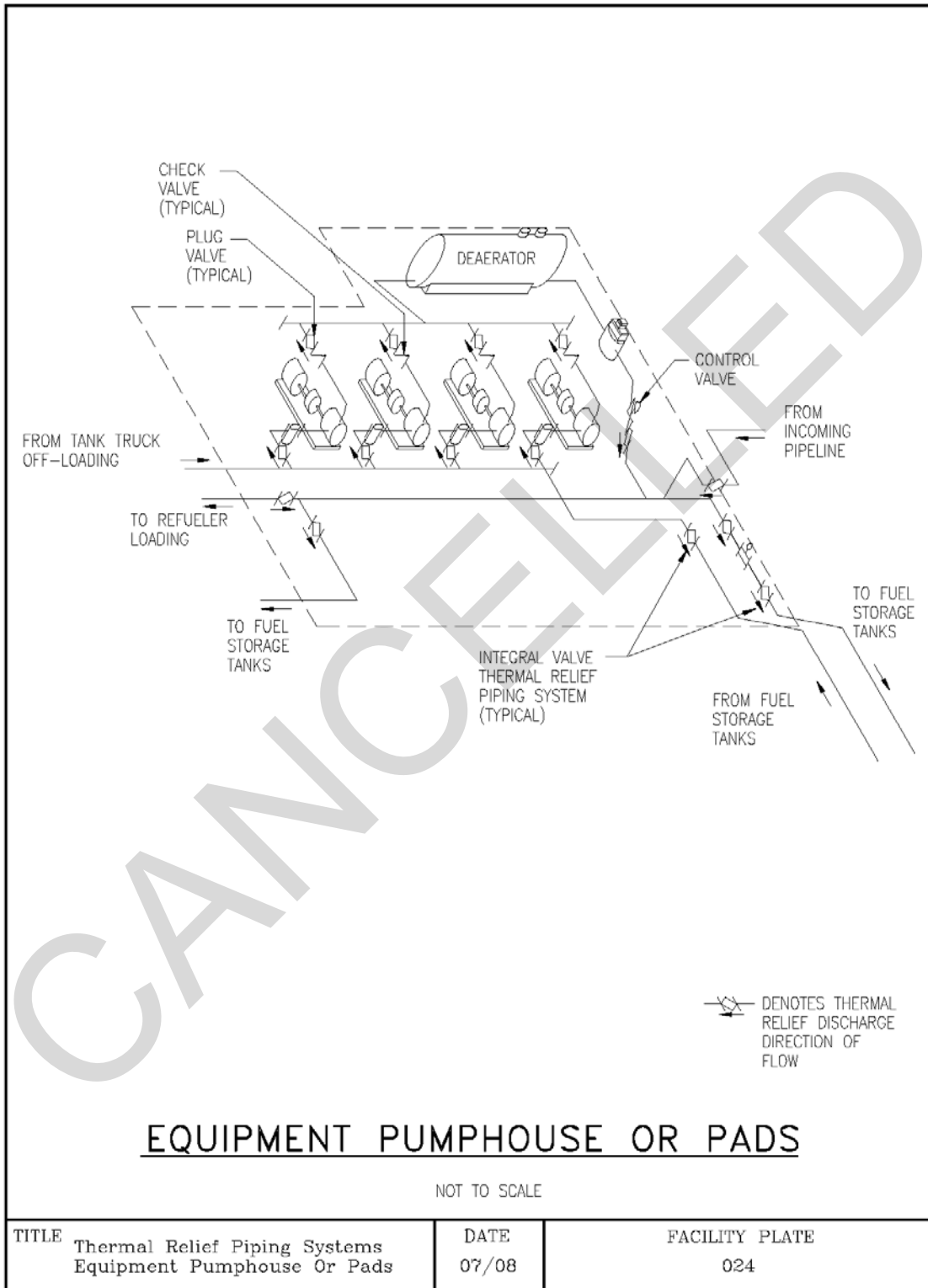

Plate 025 – Thermal Relief Piping Systems Tank Truck and Refueler Racks

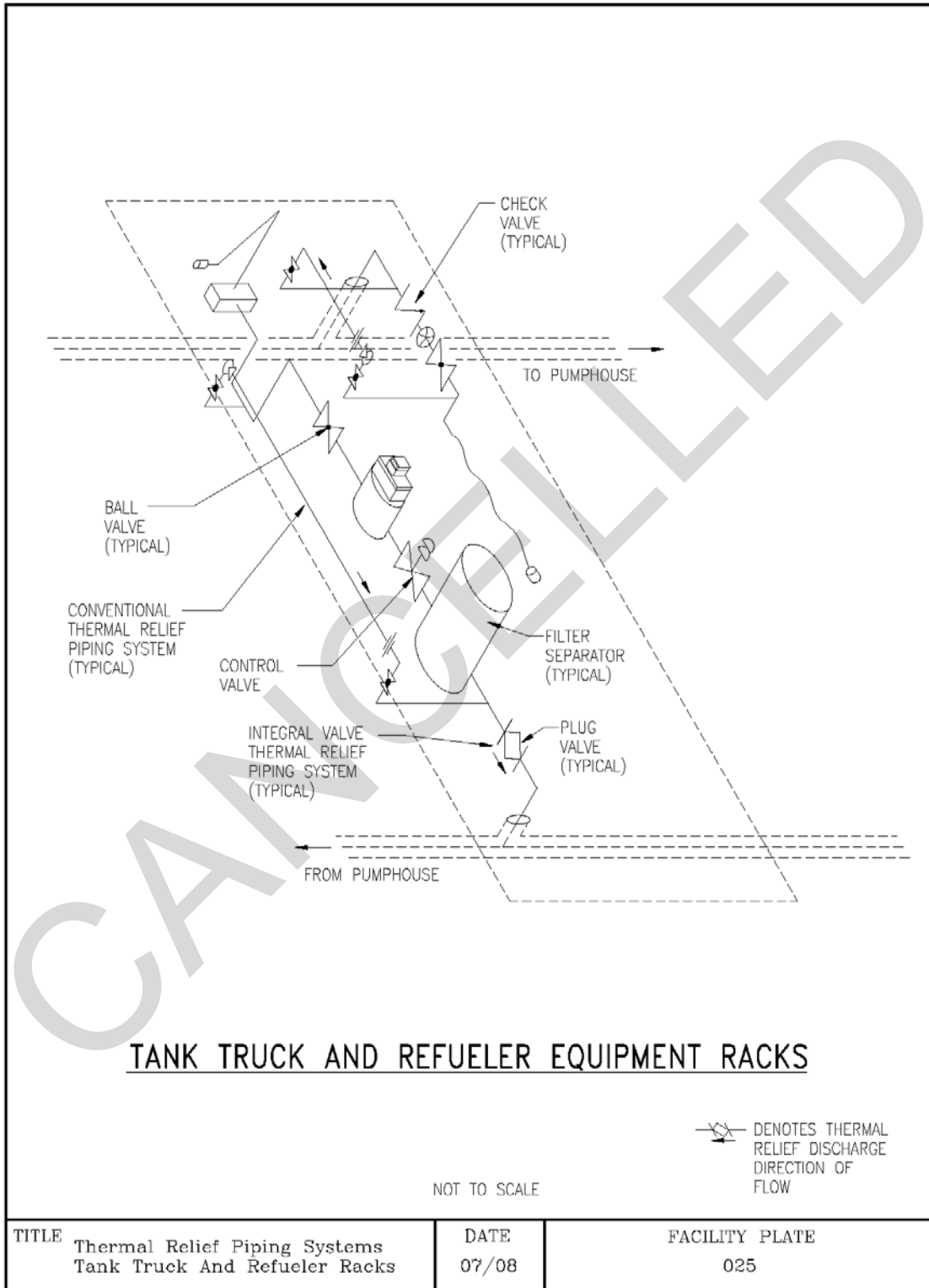

Plate 026 – Thermal Relief Piping Systems Storage Tanks

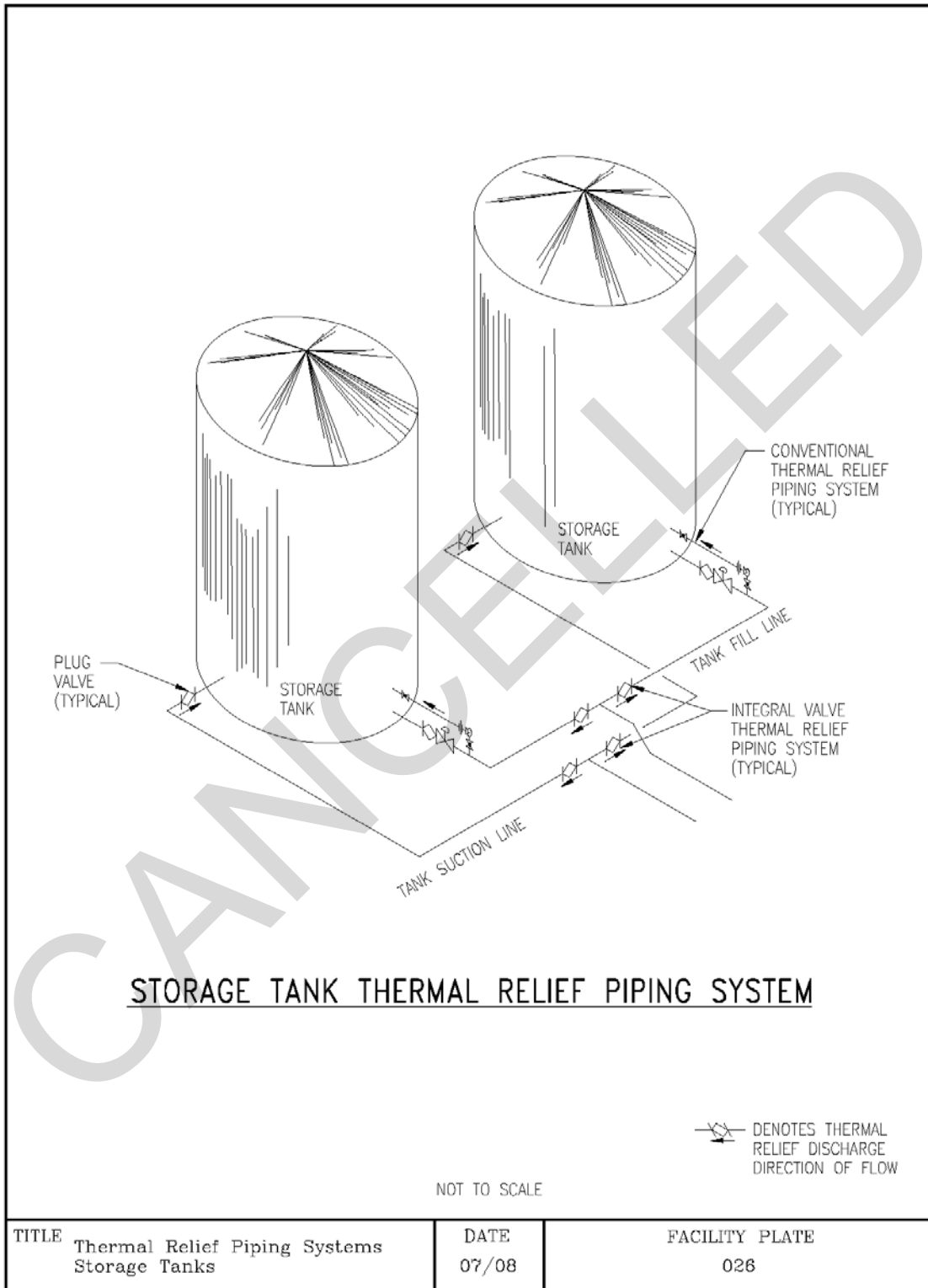

Plate 027 – Liquefied Petroleum Gas Facilities Small Volume Facility for Trucks and Cylinders

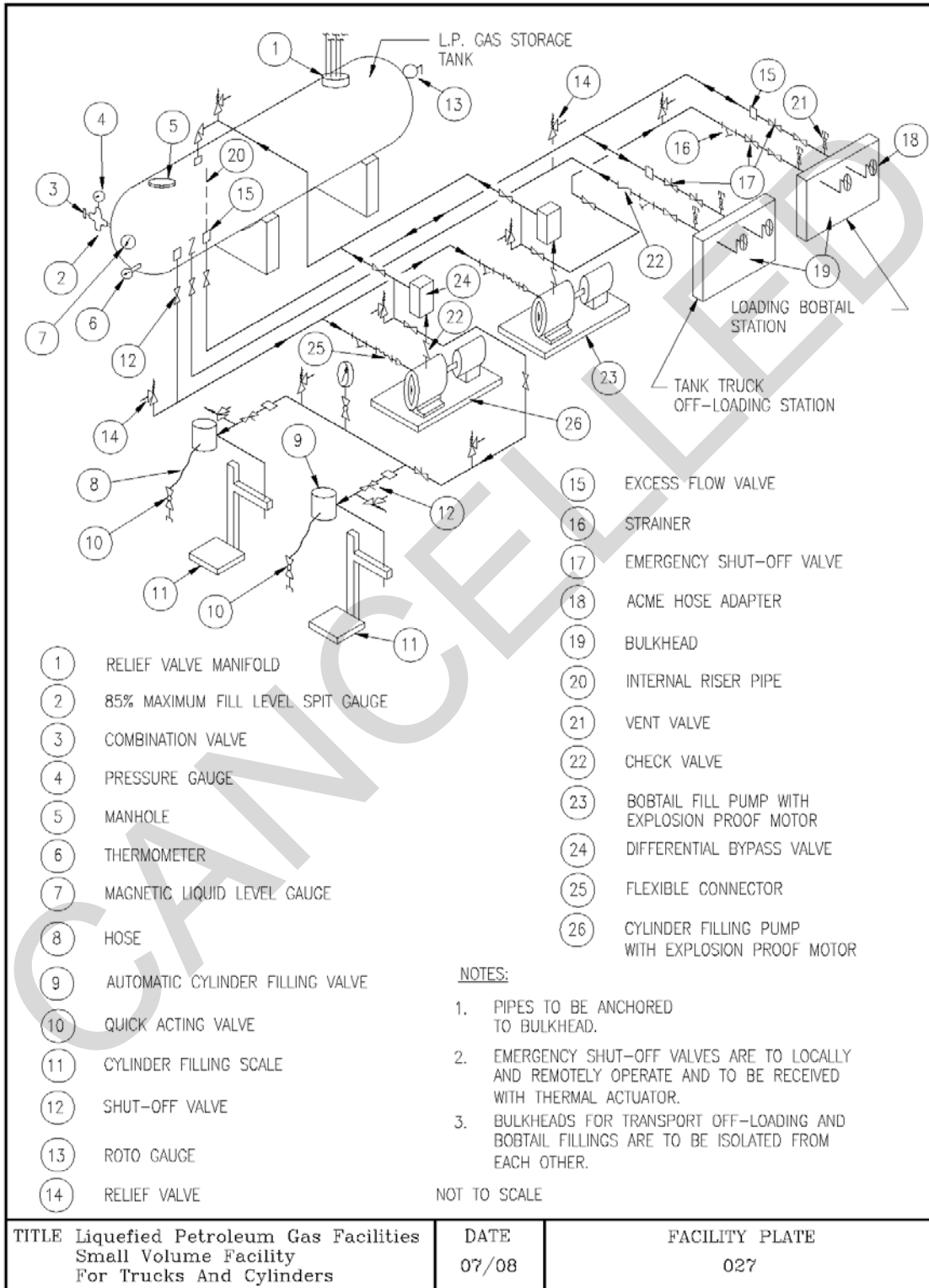

Plate 028 – Liquefied Petroleum Gas Facilities Large Volume Facility for Tank Cars and Water Vessels

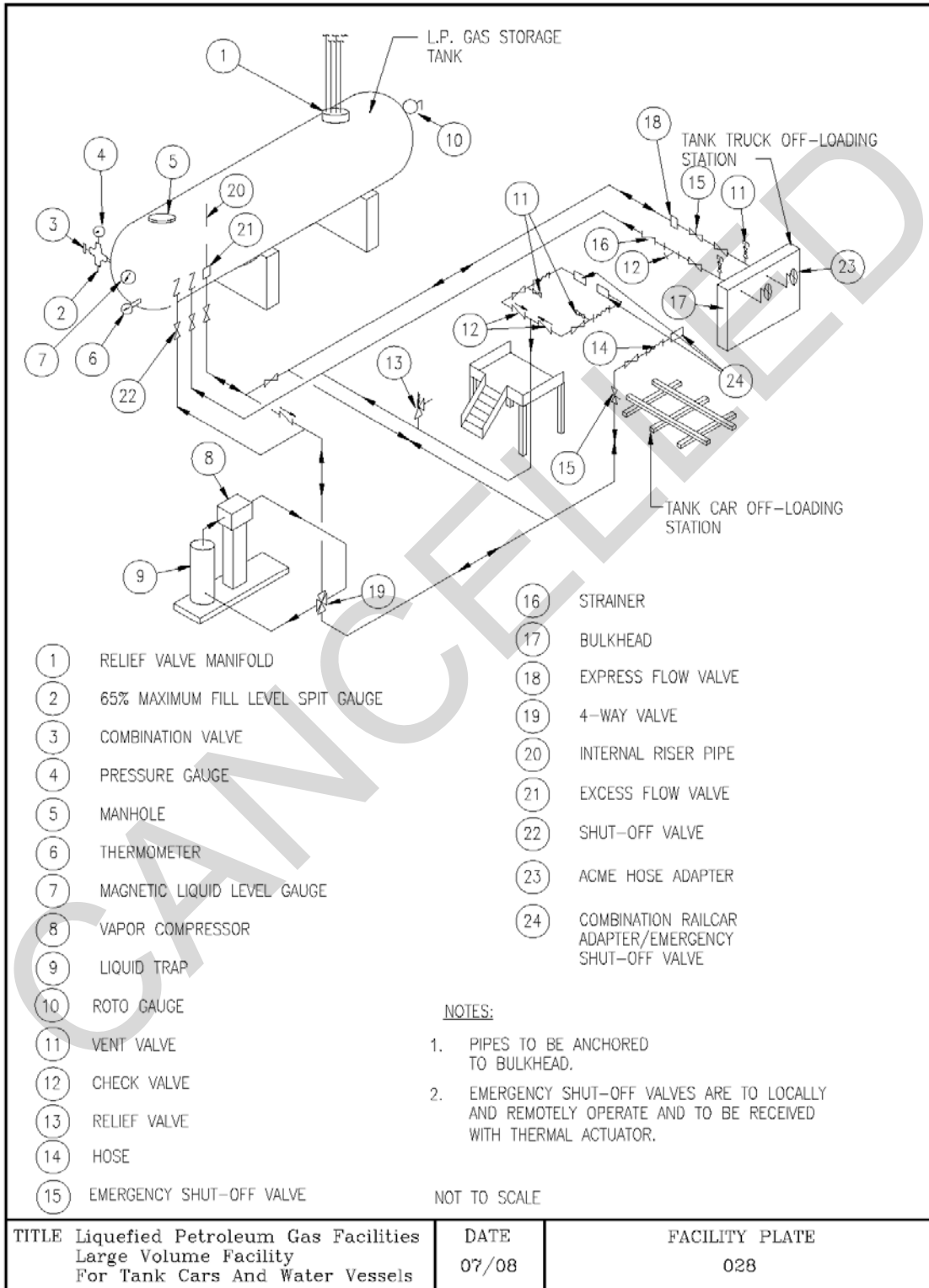

Plate 029 – Liquefied Petroleum Gas Facilities Tank Spacing Requirements

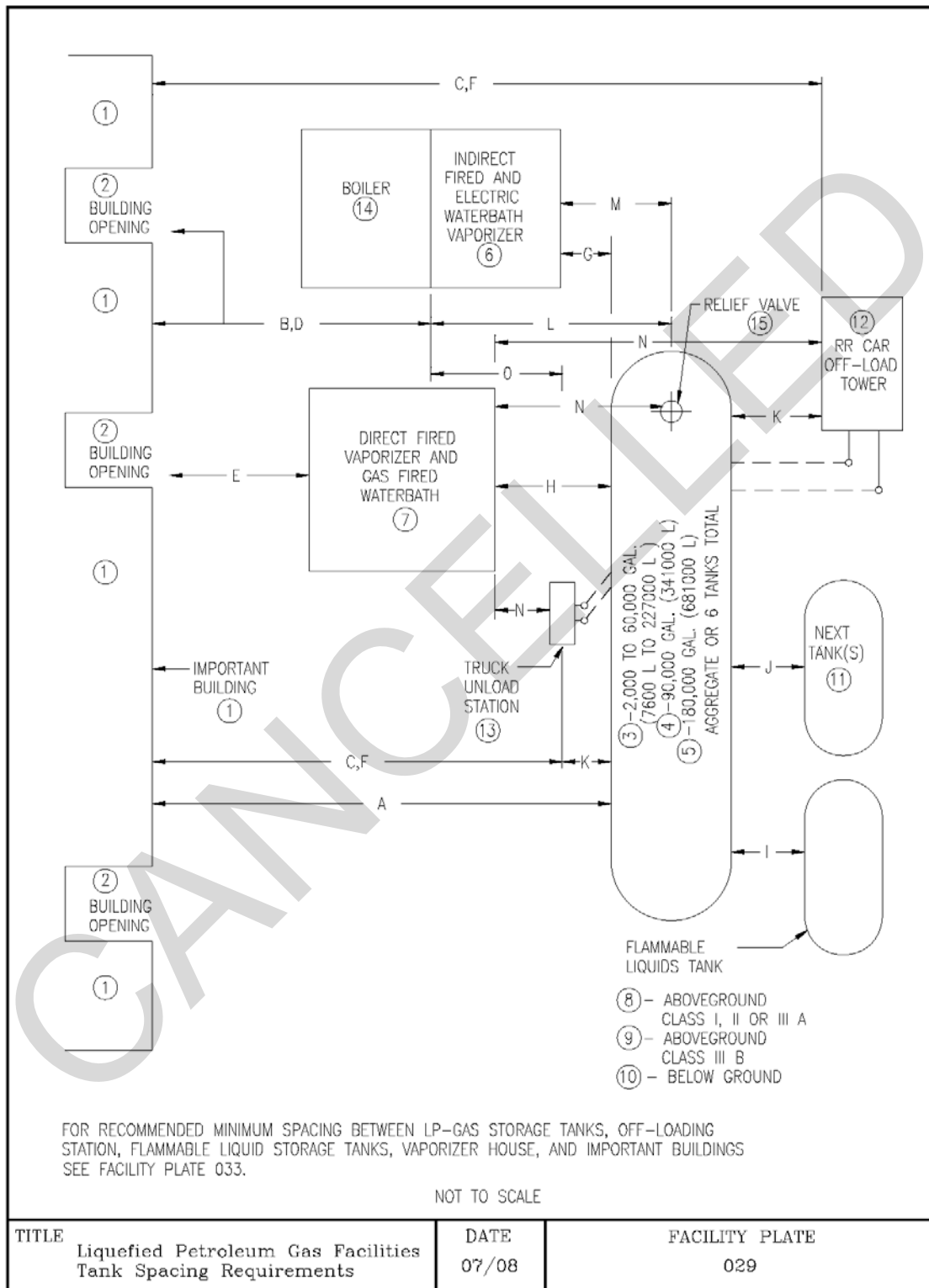

Plate 030 – Liquefied Petroleum Gas Facilities Tank Spacing Requirements

MINIMUM RECOMMENDED DISTANCE			
DIMENSION	POINT TO POINT	DISTANCE, FT.	DISTANCE, M
A	1 TO 3 ^A	75	23
	4 ^A	150	46
	5 ^B	200	60
	5 ^C	350	105
B	6	20	6
C	12	200	60
	13	50	15
D	2 TO 6	20	6
E	7	50	15
F	12	200	60
	13	75	23
G	3,4,5 TO 6	5	1.5
H	7	15	4.5
I	8	100	30
	9	50	15
	10	20	6
J	11 ^D	75	23
K	12	75	23
	13	50	15
L	14	75	23
M	6 TO 15	50	15
N	7 TO 12,13,15 ^E	75	23
O	13 TO 14	75	23

NOTES:

- A. FOR SINGLE TANKS ONLY. TREAT MULTIPLE TANKS AS NO. 5.
- B. FOR BUILDINGS WITH HYDRANT PROTECTION.
- C. FOR BUILDINGS WITHOUT HYDRANT PROTECTION.
- D. 5 FT. (1.5M) FOR TANKS WITHIN A GROUP.
- E. FOR TANKS SMALLER THAN 2,000 GAL. (7600 L), 25 FT. (7.6M).

NOT TO SCALE

TITLE Liquefied Petroleum Gas Facilities Tank Spacing Requirements	DATE 07/08	FACILITY PLATE 030
--	---------------	-----------------------