

UNIFIED FACILITIES CRITERIA (UFC)

ACTIVE SOLAR PREHEAT SYSTEMS



APPROVED FOR PUBLIC RELEASE; DISTRIBUTION UNLIMITED

UNIFIED FACILITIES CRITERIA (UFC)

ACTIVE SOLAR PREHEAT SYSTEMS

Any copyrighted material included in this UFC is identified at its point of use. Use of the copyrighted material apart from this UFC must have the permission of the copyright holder.

U.S. ARMY CORPS OF ENGINEERS (Preparing Activity)

NAVAL FACILITIES ENGINEERING COMMAND

AIR FORCE CIVIL ENGINEER SUPPORT AGENCY

Record of Changes (changes are indicated by \1\ ... /1/)

Change No.	Date	Location

FOREWORD

The Unified Facilities Criteria (UFC) system is prescribed by MIL-STD 3007 and provides planning, design, construction, sustainment, restoration, and modernization criteria, and applies to the Military Departments, the Defense Agencies, and the DoD Field Activities in accordance with [USD\(AT&L\) Memorandum](#) dated 29 May 2002. UFC will be used for all DoD projects and work for other customers where appropriate. All construction outside of the United States is also governed by Status of forces Agreements (SOFA), Host Nation Funded Construction Agreements (HNFA), and in some instances, Bilateral Infrastructure Agreements (BIA.) Therefore, the acquisition team must ensure compliance with the more stringent of the UFC, the SOFA, the HNFA, and the BIA, as applicable.

UFC are living documents and will be periodically reviewed, updated, and made available to users as part of the Services' responsibility for providing technical criteria for military construction. Headquarters, U.S. Army Corps of Engineers (HQUSACE), Naval Facilities Engineering Command (NAVFAC), and Air Force Civil Engineer Support Agency (AFCEA) are responsible for administration of the UFC system. Defense agencies should contact the preparing service for document interpretation and improvements. Technical content of UFC is the responsibility of the cognizant DoD working group. Recommended changes with supporting rationale should be sent to the respective service proponent office by the following electronic form: [Criteria Change Request \(CCR\)](#). The form is also accessible from the Internet sites listed below. _____

UFC are effective upon issuance and are distributed only in electronic media from the following source:

- Whole Building Design Guide web site <http://dod.wbdg.org/>.

Hard copies of UFC printed from electronic media should be checked against the current electronic version prior to use to ensure that they are current.

AUTHORIZED BY:

DONALD L. BASEMAN
Chief, Engineering and Construction
U.S. Army Corps of Engineers

DR. JAMES W. WRIGHT, P.E.
Chief Engineer
Naval Facilities Engineering Command

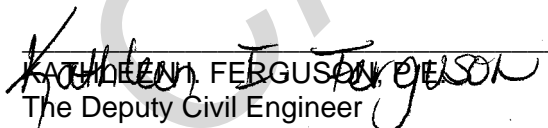
KATHLEEN FERGUSON
The Deputy Civil Engineer
DCS/Installations & Logistics
Department of the Air Force

DR. GEN. W. MOY, P.E.
Director, Installations Requirements and
Management
Office of the Deputy Under Secretary of Defense
(Installations and Environment)

CONTENTS

	<u>Page</u>
INTRODUCTION	
Paragraph 1-1	PURPOSE AND SCOPE 1-1
1-2	APPLICABILITY. 1-1
1-3	REFERENCES 1-1
1-4	ADDITIONAL RESOURCES 1-1
REQUIREMENTS	
2-1	INTRODUCTION..... 2-1
2-2	ECONOMIC EVALUATION 2-1
Paragraph 2-2.1	Screening Tool. 2-1
2-2.2	Detailed Analysis and Study 2-1
2-3	FEASIBILITY DISCUSSION..... 2-2
2-3.1	System Selection..... 2-2
2-3.2	Summary. 2-2
2.4	FUNDING 2-2
SYSTEM SELECTION, PLANNING, AND COORDINATION	
3-1	INTRODUCTION..... 3-1
3-2	STANDARD SYSTEM TYPES. 3-1
Paragraph 3-2.1	Closed-Loop System 3-1
3-2.2	Direct Circulation System 3-3
3-3	SYSTEM SELECTION. 3-4
3-4	SYSTEM LAYOUT 3-4
3-4.1	Collector Sub-System..... 3-4
3-4.2	Storage Sub-System..... 3-10
3-4.3	Transport Sub-System..... 3-11
3-4.4	Control Sub-System..... 3-11
3-5	COORDINATION..... 3-12
3-5.1	Architect..... 3-12
3-5.2	Structural Engineer 3-13
SYSTEM DESIGN	
4-1	INTRODUCTION..... 4-1
4-2	COLLECTOR SUB-SYSTEM 4-1
Paragraph 4-2.1	Collector Specification 4-1
4-2.2	Collector Sub-System Piping and Layout 4-3
4-3	STORAGE SUB-SYSTEM..... 4-13
4-3.1	Storage Tank Construction 4-13
4-3.2	Storage Tank Sizing 4-14
4-3.3	Storage Sub-System Flow Rate 4-14
4-4	TRANSPORT SUB-SYSTEM 4-15
4-4.1	Transport Sub-System Design..... 4-15
4-4.2	Transport Sub-System Checklist 4-21

4-5	CONTROL SUB-SYSTEM.....	4-22
4-5.1	Differential Temperature Control Unit (DTC)	4-22
4-5.2	Temperature Sensors and Locations	4-23
4-5.3	Monitoring Equipment.....	4-24
4-6	SAFETY FEATURES.....	4-25
4-6.1	Fall Protection.....	4-25
4-6.2	Equipment Lockout and Disconnect	4-25
4-7	CASE STUDY	4-25
APPENDIX A REFERENCES		A-1
APPENDIX B HOT WATER LOAD ESTIMATIONS		B-1
APPENDIX C WATER QUALITY ANALYSIS.....		C-1
APPENDIX D EXAMPLE DESIGN CHECKLIST.....		D-1
APPENDIX E EXAMPLE DRAWINGS CHECKLIST		E-1
APPENDIX F SOLAR ENERGY SYSTEM FUNDAMENTALS		F-1
APPENDIX G SOLAR ENERGY CASE STUDY AT FORT HUACHUCA, AZ		G-1

FIGURES

<u>Figure</u>	<u>Title</u>	
Figure 3-1.	Closed-Loop Antifreeze System.....	3-2
Figure 3-2.	Direct Circulation System	3-3
Figure 3-3.	System Selection Flowchart	3-5
Figure 3-4.	Flat-Plate Collector.....	3-6
Figure 3-5.	Minimum Collector Row Spacing	3-8
Figure 3-6.	Possible Array Configurations and Area	3-10
Figure 4-1.	Collector Manifold Types.....	4-2
Figure 4-2.	Collector Array Terminology	4-4
Figure 4-3.	Reverse-Return Versus Direct- Return Piping Strategies	4-6
Figure 4-4.	Steps in Developing a Reverse Return Piping Layout.....	4-7
Figure 4-5.	Examples of Reverse-Return Piping	4-8
Figure 4-6.	Manifold Sizing Example	4-11
Figure 4-7.	Manifold Sizing Example (Metric).....	4-12
Figure 4-8.	Thermal Expansion Versus Temperature Differential for Copper Pipe ...	4-14

Figure 4-9. Calculation of Total Expansion Tank Volume	4-19
Figure 4-10. Typical Pump and System Operation Curves	4-22
Figure D-1. Manifold Sizing Worksheet	D-6
Figure F-1. Typical Solar Thermal Energy System	F-1
Figure F-2. Typical Collector Efficiency Curve	F-6
Figure F-3. Typical Solar Collector Efficiency Plots	F-7
Figure F-4. Solar Fraction Versus Collector Area	F-13
Figure G-1. Photo of Collector Arrays	G-2
Figure G-2. Solar Hot Water System Piping Diagram	G-3
Figure G-3. Typical Array Layout	G-4
Figure G-4. "Quad Rod" Double Wall Heat Exchanger	G-4
Figure G-5. Connection to the Existing Domestic System	G-5
Figure G-6. Equipment Housing	G-5
Figure G-7. Wiring Diagram	G-6
Figure G-8. Differential Temperature Controller	G-6
Figure G-9. Solar Insolation Measured for May 1997	G-9
Figure G-10. Solar Insolation Measured for June 1997	G-10
Figure G-11. Solar Insolation Measured for July 1997	G-10
Figure G-12. Hot Water Demand for May 1997	G-11
Figure G-13. Hot Water Demand for June 1997	G-11
Figure G-14. Hot Water Demand for July 1997	G-12
Figure G-15. Temperature Differences Across Heat Exchanger (May 1997)	G-12
Figure G-16. Temperature Differences Across Heat Exchanger (June 1997)	G-13
Figure G-17. Temperature Differences Across Heat Exchanger (July 1997)	G-13
Figure G-18. Temperature Responses (8 May 1997)	G-14
Figure G-19. Temperature Responses (17 June 1997)	G-14
Figure G-20. Temperature Responses (15 July 1997)	G-15
Figure G-21. Supply and Return Temperature Differences (May 1997)	G-15
Figure G-22. Supply and Return Temperature Differences (June 1997)	G-16
Figure G-23. Supply and Return Temperature Differences (July 1997)	G-16
Figure G-24. Solar Array BTU's Delivered and Hot Water Demand	G-17
Figure G-25. Solar Array Joule's Delivered and Hot Water Demand	G-17
Figure G-26. Solar Array BTU's Delivered, Gas Usage and Hot Water Usage	G-18
Figure G-27. Solar Array Joule's Delivered, Gas Usage and Hot Water Usage	G-18

TABLES

<u>Table</u>	<u>Title</u>	
4-1	Pressure Drop Corrections	4-10
B-1	Estimated Average Hot Water Loads for Various Facilities	B-1
C-1	Data for Calculating pH of Saturation (pH _s) Calcium Carbonate	C-2
C-2	Prediction of Water Tendencies by the Ryznar Index	C-2

CHAPTER 1

INTRODUCTION

1-1 **PURPOSE AND SCOPE.** This manual provides guidance for the standard design of active solar energy systems to preheat domestic and service water. The systems treated by this manual are liquid based. Guidelines apply to the larger commercial-scale applications that require an effort on the part of the designer, as opposed to residential-sized "packaged" systems, which in the past have been available from a number of manufacturers. The concepts developed in this document are targeted for new construction, although most are also appropriate for retrofit applications.

1-2 **APPLICABILITY.** This UFC applies to all service elements and contractors developing active solar preheat systems.

1-3 **REFERENCES.** APPENDIX A contains a list of references used in this document.

1-4 **ADDITIONAL RESOURCES.** For additional resources on solar water heating applications, refer to the Whole Building Design Guide (WBDG) Internet site <http://www.wbdg.org/>.

CHAPTER 2

REQUIREMENTS

2-1 INTRODUCTION. In view of a history of fluctuating energy costs and uncertain availability of fossil fuels, the economic feasibility study of any energy-related project becomes the foundation of the design process. For the case of renewable energy, Title 10 of the U.S. Code (10 USC) requires that an economic feasibility analysis be performed for all new military construction to determine whether the use of renewable forms of energy will result in a net monetary savings to the government. The methodologies and parameters required for federal energy project feasibility studies are mandated by federal law (10 CFR 436). Furthermore, installation of a renewable energy system is required if it is deemed economically feasible. This chapter provides the tools necessary to perform a feasibility study in accordance with these required procedures.

2-2 ECONOMIC EVALUATION

2-2.1 Screening Tool. To evaluate the feasibility of designing and installing an active solar preheat system, the first step will be to use the Solar Payback screening tool developed by the Construction Engineering Research Laboratory (CERL). The tool is a Microsoft Excel spreadsheet that contains screening criteria developed by the National Renewable Energy Laboratory (NREL). The program is a quick, straightforward tool that requires minimal input (general site location as well as starting point energy costs and system costs) to calculate numerous payback periods for the two most common solar hot water technologies (flat-plate and evacuated tube collectors) when used to displace either electricity or natural gas energy costs. The tool is available for download from <http://www.cecer.army.mil/swp/swp.html>.

2-2.2 Detailed Analysis and Study. If the results of the Solar Payback screening tool indicate that an active solar hot water system should be considered further, then the next step will be to perform a detailed life-cycle cost analysis (LCCA) to determine the most effective design alternative to develop. LCCA calculations and reports will be performed in accordance with a service's economic analysis manual, such as TM 5-802-1. Computer calculations will be performed using a service's economic analysis program, such as the Life Cycle Cost In Design (LCCID) computer program. Information defined in this UFC document will be used in the development of the LCCA calculations. For additional guidance in the development of the LCCA calculations, refer to the American Society of Heating, Refrigerating, and Air-Conditioning Engineers (ASHRAE) publication "Active Solar Heating Systems Design Manual". The manual was developed by ASHRAE, the Solar Energy Industries Association (SEIA), the American Consulting Engineers Council (ACEC), and the Department of Energy (DOE) contractors and is intended to give solar designers an effective means to use the collective knowledge of government and industry to better select options for improving the quality and energy efficiency of solar systems.

2-3 FEASIBILITY DISCUSSION

2-3.1 **System Selection.** If one or more systems show a positive LCC savings, the system with the highest LCC savings must be designed. In the case of two systems LCC savings having approximately equal values, the system with the highest savings-to-investment ratio (SIR) should be chosen for detailed design. If no system shows a positive LCC savings, an active solar energy system is not to be considered for the project.

2-3.2 **Summary.** Examination of many feasibility studies shows that the service water preheating application is typically the most cost-effective alternative. Space heating by use of solar energy is best accomplished by passive solar building design. Solar cooling of any form is seldom cost-effective, largely due to prohibitive equipment and M&R costs.

2-4 **FUNDING.** One of the biggest obstacles to using solar hot water technologies is often the inability to obtain the funding for the initial capital costs, even though a life-cycle cost analysis might show that the investment would pay for itself several times over. Funding for energy projects in general, and renewable energy projects in particular, has been consistently reduced over the last several years. There are still opportunities for funding these projects through the Department of Energy's (DOE) Federal Energy Management Program (FEMP), the US Army Engineering Center, Huntsville's Energy Savings Performance Contracting (ESPC) program, or the Department of Defense's (DOD) Model Utility Agreement. With the last two funding mechanisms, a third party contractor or the local utility company provides the funding for installing the solar hot water systems, and is paid back the investment through the energy savings, over the term of the contract agreement.

CHAPTER 3

SYSTEM SELECTION, PLANNING, AND COORDINATION

3-1 **INTRODUCTION.** This chapter provides criteria for selection of a specific type and configuration of solar energy system, and discusses special issues that must be considered. Once the system type is selected, coordination with the architect and structural engineer is critical for determining estimates of roof area, roof and collector support, and equipment space requirements. It should be noted that this manual applies to the design of systems for the northern hemisphere. Appropriate corrections should be made for the design of these systems in the southern hemisphere.

3-2 **STANDARD SYSTEM TYPES.** To meet the Services' goal of standardizing solar energy installations, the following system types have been selected for use on all active solar installations.

3-2.1 **Closed-Loop System.** The closed-loop solar energy system has proven to be very reliable when designed and maintained properly, largely due to its ability to successfully withstand freezing temperatures. Freeze protection is provided by circulating a solution of propylene glycol and water through a closed collector loop. Figure 3-1 is a schematic of the closed-loop system.

3-2.1.1 System Operation

3.2.1.1.1 **Solar Loop.** The differential temperature controller activates the solar loop pump in the collector loop when the temperature difference between the collector and storage is large enough for energy to be collected. The propylene glycol solution circulates in a pressurized closed-loop through the solar collector to an external heat exchanger. An expansion tank is provided to account for thermal expansion of the fluid in the collector loop, stagnation, and over-pressure protection. Refer to APPENDIX F for a discussion of stagnation conditions in solar systems.

3.2.1.1.2 **Storage Loop.** The control system activates the storage loop pump simultaneously with the collector loop pump. Water in the storage loop is heated by the solution in the heat exchanger and passed to the solar storage tank. When there is a hot water demand, cold water is drawn into the solar storage (preheat) tank and solar heated water is sent to an auxiliary water heater where it is heated further (if necessary) and sent to the load.

3-2.1.2 **Design Precautions.** While the closed-loop solar energy system can provide reliable service in any climate, certain design precautions must be taken.

Figure 3-1. Closed-Loop Antifreeze System

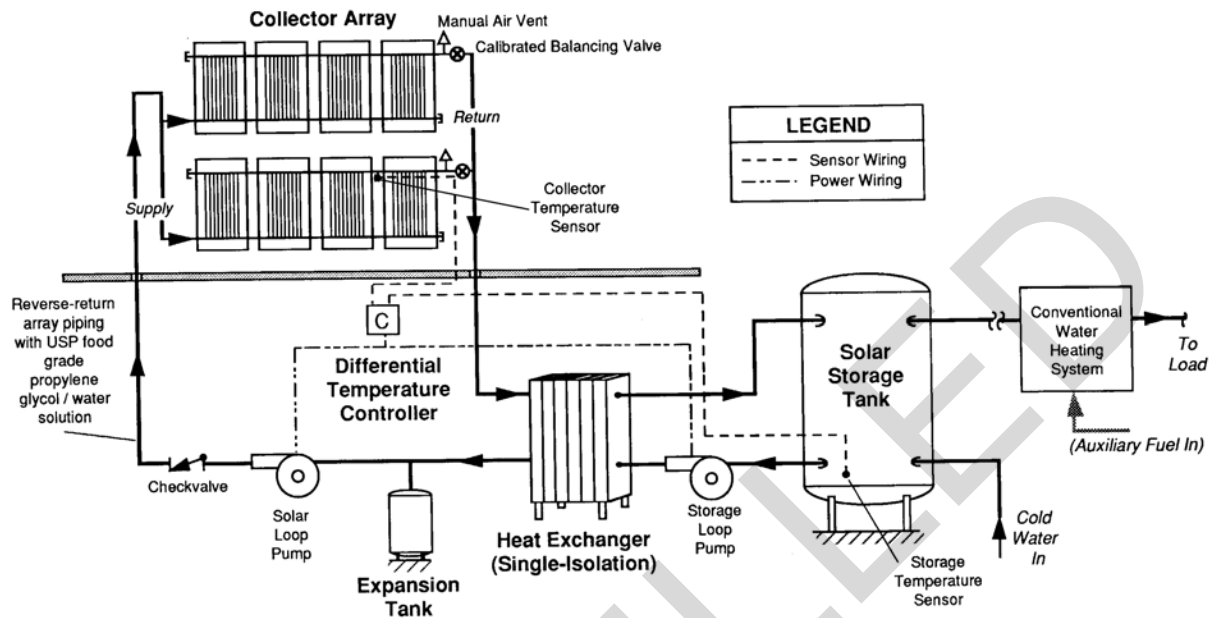

3.2.1.2.1 Collector Loop Check Valve. The check valve shown in the collector loop is required to prevent "reverse thermosiphoning". This phenomenon can occur on cold nights when the collector loop is not active. Warm solution from the lower part of the loop (usually located indoors) becomes buoyant and rises toward the top of the loop where it becomes colder. This cold, denser solution then drops to the bottom of the loop, often passing through the heat exchanger and removing energy from the storage loop. Extreme cases have resulted in frozen heat exchangers. Care should be taken to locate the check valves so that the fluid in the collector loop can be drained if necessary.

3.2.1.2.2 Piping and Component Protection. Fluid problems and associated corrosion and maintenance issues are a common cause of closed-loop system failure. However, results from the testing of degraded, uninhibited propylene glycol indicate that with proper design, a closed-loop system may run without fluid maintenance for up to 20 years. Designers should ensure that non-ferrous piping and components are used whenever possible, that no air is allowed to be drawn into or contained within the system, and that the expansion tank and pressure relief valves are correctly sized to prevent loss of solution and opening of the collector loop in the event of high pressure stagnation.

3.2.1.2.3 Collector Loop Air Vent. The manual air vent shown at the top of the collector loop allows air that has been released from solution to be purged. Propylene glycol has a strong affinity for air, and dissolved oxygen in solution can greatly impair system performance by contributing to corrosion.

3.2.1.2.4 Mixing Valves. Mixing valves are typically used to provide a high

temperature limit to the load or to supply the load with a specific hot water temperature. It is important to ensure that the cold-water leg between the mixing valve and the cold water supply to the solar storage tank is not used for connection to any other fixture. Experience has shown that backflow through the storage tank can occur which sends solar heated water to a cold water user. Although a check valve can be used in the cold water supply to prohibit back flow, it is best to avoid this situation whenever possible.

3-2.2 Direct Circulation System. The direct circulation system is the most basic active solar energy system recommended for adoption by the Services. It should be limited to use in locations where there are no freezing days, and where the water supply is of sufficiently high quality (i.e., not highly scaling). The entire system operates at existing water supply pressure and circulates potable water through the collectors directly to storage. Figure 3-2 is a schematic of a direct circulation system.

Figure 3-2. Direct Circulation System

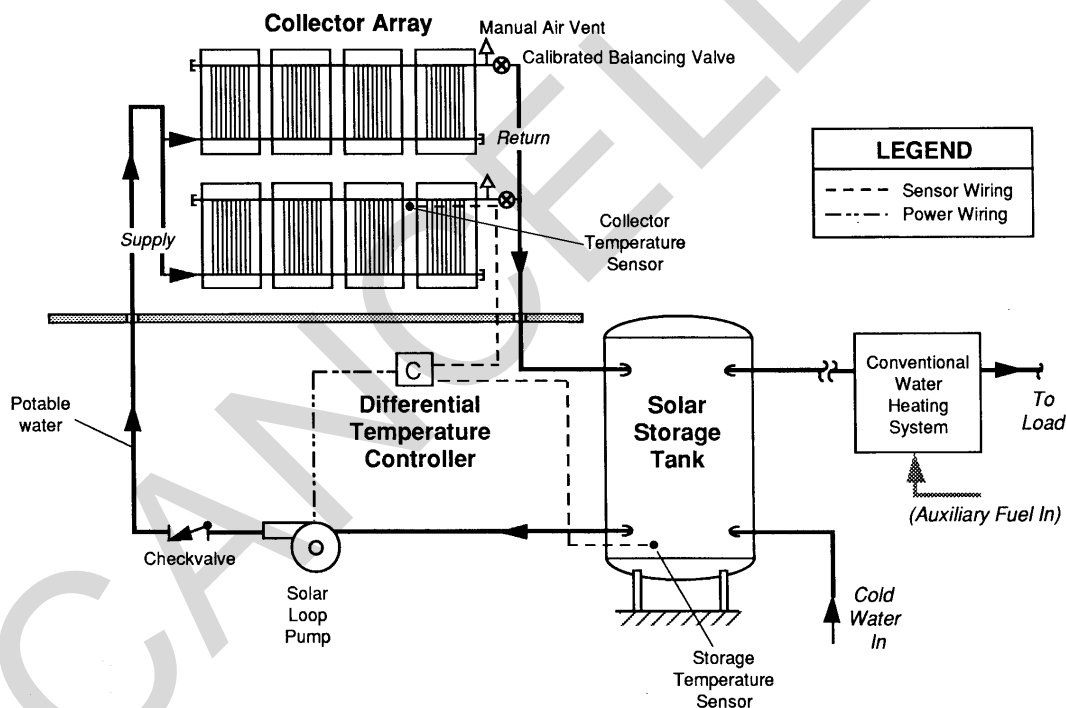

3-2.2.1 System Operation

3.2.2.1.1 Collector Loop. The collector loop pump is activated when the collector temperature is large enough for energy to be collected and transferred to the solar storage tank.

3.2.2.1.2 Storage Loop. The solar storage tank is used as a preheater for a conventional water-heating unit, which is placed in series between the solar storage tank and the load. When a demand for hot water occurs, cold water is drawn into the

solar storage tank where it then passes through the collector array (if activated) or on to the conventional water heater.

3-2.2.2 Water Supply. Due to their inability to withstand freezing temperatures, there is a relatively small market for direct circulation systems within the military. However, because of their simplicity and straightforward operation, they have proven superior when used at the proper location. An overwhelming consideration for the success of these systems is the quality of the local water supply. Water is circulated directly through the collectors, so that corrosion and scale buildup can be a major cause of failure in these systems. In many regions where the water supply is of poor quality, it is necessary to treat the incoming water supply so that it is within the prescribed quality limits.

3-3 SYSTEM SELECTION. The standard systems described represent proven designs that are both simple and reliable. System selection is largely based on the site location, with the number of freezing days being the critical factor. Also important are the estimated load size and the water quality at the site. Use APPENDIX B to estimate average hot water loads for various facilities. Use APPENDIX C to evaluate the water quality for various locations and water sources. Figure 3-3 is a flowchart to facilitate the system selection process. This figure allows only service water preheating applications to be chosen.

3-4 SYSTEM LAYOUT. The system layout phase identifies the solar energy system requirements that will impose certain constraints on the building design. The architect and structural engineer must be notified of these requirements early in the design stage of the project. These requirements include proper orientation of the building, identification of available roof area and structural criteria, and proper design and location of the equipment room. Once these requirements are met and the necessary building parameters are fixed, the solar system design can be completed.

3-4.1 Collector Sub-System

3-4.1.1 Representative Solar Collectors. Many flat-plate solar collector (refer to Figure 3-4) sizes are available. Typical collectors range in size from about 16 to 47 ft² (1.5 to 4.4 m²) of net aperture area, with corresponding gross dimensions of 3 by 6 ft (914 by 1829 mm), to 4 by 13 ft (1219 by 3962 mm). Two standard sizes are considered to be about 30 and 40 ft² (2.8 and 3.7 m²), with gross dimensions of 4 by 8 ft (1219 by 2348 mm) and 4 by 10 ft (1219 by 3048 mm), respectively. Single-glazed collectors filled with liquid weigh approximately 4 to 5 lbs/ ft² (192 to 239 Pa). Recommended flow rates vary over a wide range, but most fall between 0.01 to 0.05 gals/min-ft² (0.007 to 0.034 L/sec-m²).

Figure 3-3. System Selection Flowchart

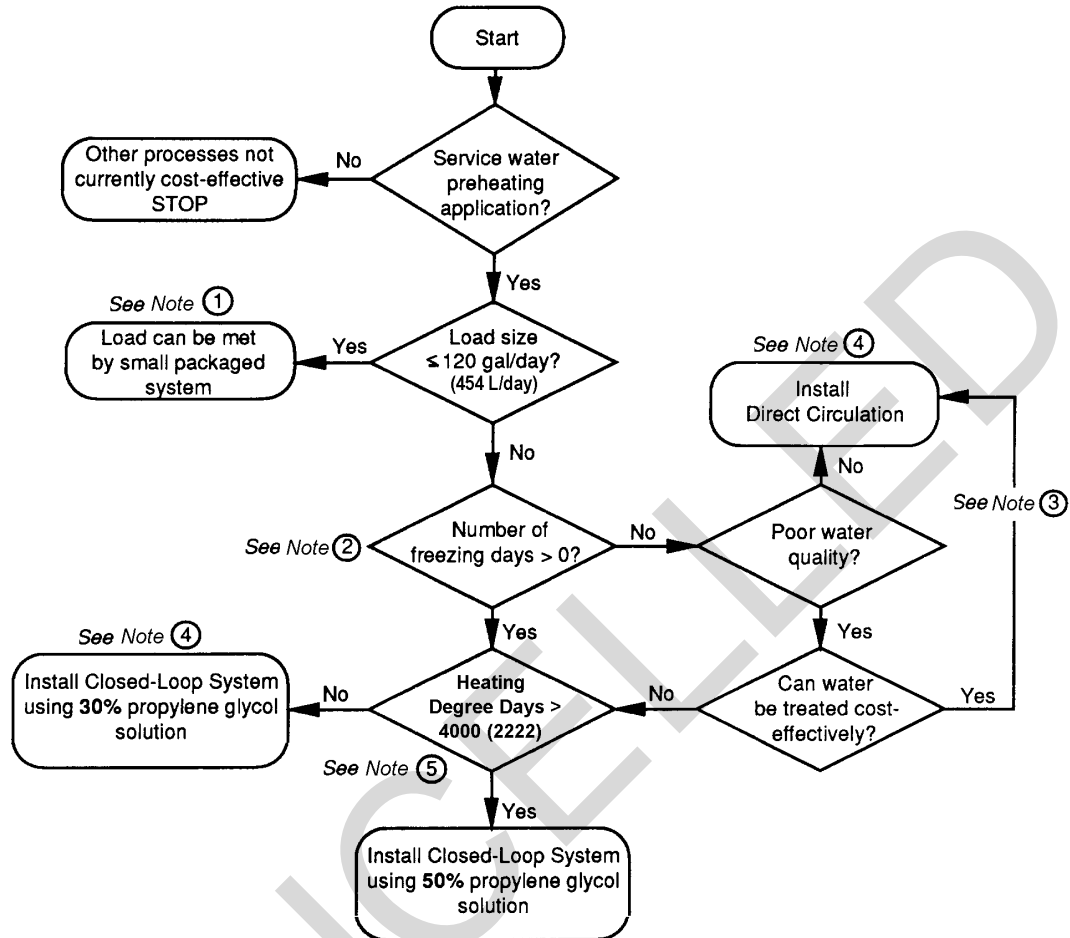

Figure 3-3 Notes: Notes keyed into the flowchart are listed below by corresponding number.

1. For small loads on the order of a residential-sized service water heating system, the design effort and expense can be avoided by purchasing a pre-designed "packaged" system from a reliable manufacturer. These systems are sold in a variety of configurations, including drainback and closed-loop.

2. The number of freezing days at the site should be determined, based on recorded historical data. To meet the "no freezing day" criterion, there should be no evidence of freezing temperatures for a period approximately equal to the expected lifetime of the system. Existing data shows that no location in the continental U.S. can meet this criterion. Historical weather data can be obtained from the Air Force Engineering Weather Data web site (<http://www.afccc.af.mil/>) or from local National Weather Bureau stations or from the Environmental Data Service, a branch of the U.S. Department of Commerce.

3. Water quality should be determined using APPENDIX C.

4. Systems larger than 3,000 ft² (279 m²) will require very large piping (4-inch (100 mm) diameter or larger) and roof area, and are not recommended. If this situation occurs, the designer should consider installing two separate systems. Although this approach is somewhat more costly, it improves the ease of construction and allows solar energy to be collected in the event of one system being down due to maintenance or repair. The decision to use separate system depends on specific project parameters and is left to the designer

5. Both the Fahrenheit (F) and Celsius (C) based versions of heating degree days are presented (the Celsius based number is in parentheses). Heating degree days are based on the mean annual number of degree days using a base of 65 degrees F (18 degrees C). Only 30 to 50 percent volume propylene glycol/water solutions can be used in closed-loop systems. Locations requiring a closed-loop system that have less than 4,000 (2222) heating degree-days per year may use the 30 percent solution; those having more heating degree days should use a 50 percent solution. This heating day criteria is provided as a suggested guideline only. It is up to the designer to take into account each location's particular climate and freezing-day characteristics when determining whether a 30 or 50 percent solution should be used.

Figure 3-4. Flat-Plate Collector

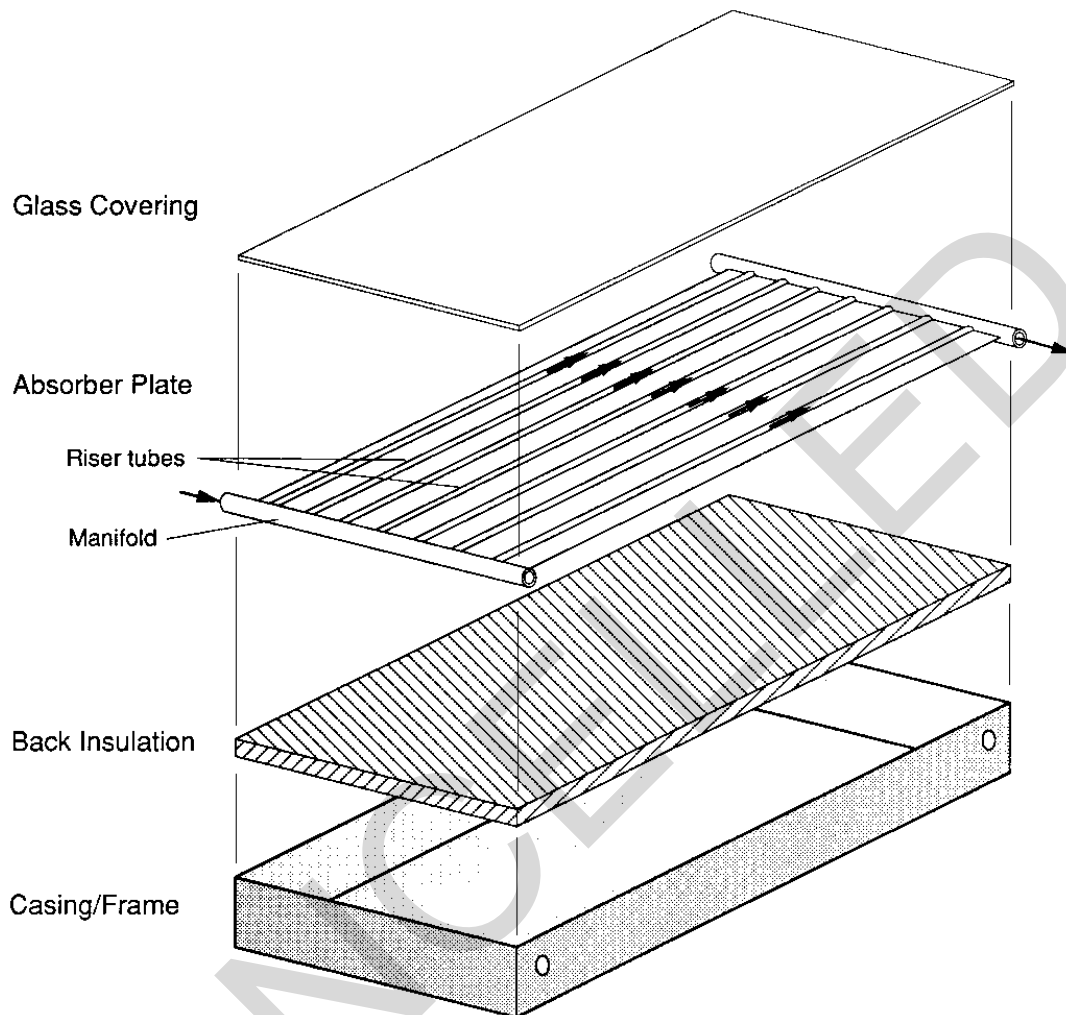

3-4.1.2 **Array Size.** The first step in the system layout is to estimate collector array size (the actual array size cannot be determined until a specific collector is chosen for the detailed design).

3-4.1.3 **Array Tilt Angle.** The collector array tilt angle is defined to be the angle between the collector and the horizontal, with 0 degrees being horizontal and 90 degrees being vertical. The proper tilt angle is a function of the time of year when the load occurs. For annual loads, such as service and process water heating, the widely accepted practice is to tilt the collectors to the value of the local latitude. If the load tends to have a seasonal variation, the tilt can be varied to favor the season. Examples include seasonal hot water requirements, space heating, and space cooling. If the collectors are tilted to the latitude angle plus 10 degrees, the energy output will be more evenly distributed over the entire year, although winter losses will tend to increase, due to lower outdoor temperatures. Tilting the array to the latitude minus 10 degrees favors summer energy output. It is not generally recommended to tilt the array any more than

plus or minus 10 degrees from the site latitude. It should be noted that as the tilt angle increases, the minimum spacing between rows due to shading increases and larger roof area is required.

3-4.1.4 Array Azimuth Angle. The array azimuth angle is defined to be the angle between the projection of the normal to the surface on a horizontal plane and the local meridian (north-south line). Zero degrees is defined as due south, a due west facing array is defined as plus 90 degrees, and a due east facing array is defined as minus 90 degrees (in the northern hemisphere). The optimal orientation requires the azimuth angle to be 0 degrees (due south) whenever possible, although deviations of plus or minus 20 degrees off of due south have a minimal effect on flat-plate system performance.

3-4.1.5 Collector Grouping. Internal-manifold collectors should be grouped into banks ranging from four to seven collectors each, with each bank containing the same number of collectors. Proper sizing of the collector banks is essential to maintaining uniform flow throughout the collector array. The maximum number of collectors that can be banked together is a function of the maximum flow rate allowed in the plumbing, internal manifold and riser diameters, thermal expansion characteristics of the collector piping and absorber plate assembly, and the recommended flow rate of the particular collector chosen (usually given in gallons per minute (liters per second) per collector or gallons per minute per square feet (liters per second per square meter) of collector area). Thermal expansion problems are minimized by keeping the bank size less than eight collectors.

3-4.1.6 Minimum Array Row Spacing. The minimum row spacing must be calculated for multi-row arrays. A general routine for north-south spacing of collector banks can be devised, based on a "no shading" criterion for a particular time of year. The guidance presented assumes no shading of the array on the "worst" solar day of the year (21 December, when the sun is lowest in the sky in the northern hemisphere) for the designated time period of 10 a.m. to 2 p.m. solar time. Most large-scale military solar systems are installed on low-slope flat roofs, and there are two possible cases to consider. The first is for a flat roof with enough space to locate the collector array at one elevation. The second case is for a flat roof with too little space for the collector array. This requires the collector banks to be "stepped", that is, each succeeding row of collectors must be elevated. This arrangement is necessary if the collector roof area required is larger than that available or if roof area costs are more expensive than elevated rack costs. The equations developed for minimum collector row spacing are presented graphically in Figure 3-5.

Figure 3-5. Minimum Collector Row Spacing

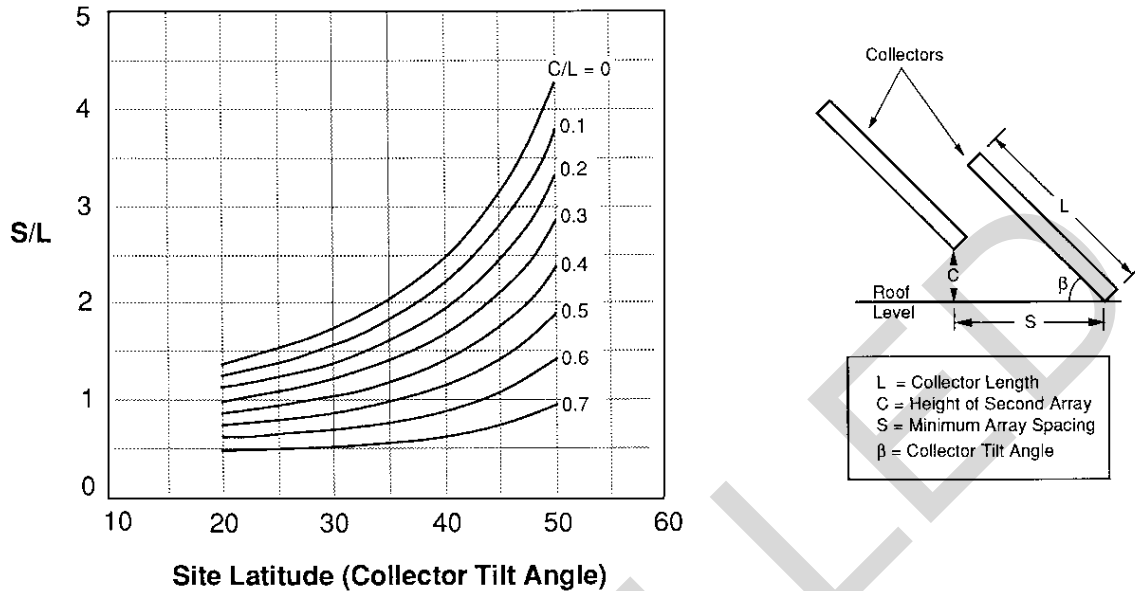

3.4.1.6.1 **Azimuth Orientations.** The curves shown in Figure 3-5 are for collector azimuth orientations of plus or minus 20 degrees. For the due south orientation (0 degrees), the deviation from these results is less than 10 percent. Use of Figure 3-5 for due south orientations is thus slightly conservative. The effect of elevating the rear collector row (larger C/L values) shows a marked decrease in the minimum spacing (S/L). The flat roof, no elevation collector case is represented by the curves where $C/L = 0$.

3.4.1.6.2 **Roof Pitch.** Collectors can also be mounted on pitched roofs. Often, when a solar energy system is to be added to a building, the roof is pitched and constructed such that the collectors could be mounted on the roof surface. This practice does not necessarily impose unreasonable constraints in the roof design, since there is some flexibility in the choice of collector tilt angle. If the roof cannot be pitched to allow flush mounting of the collectors, or if the tilt angle must be fixed, then the collectors can be raised at one end to give them the proper tilt. Figure 3-5 can be used to determine the spacing by including the appropriate roof pitch with the height C .

3.4.1.6.3 **Array Layouts and Estimated Roof Area Options.** Collector array layouts and estimated roof area requirements for the system can be determined by using the estimated array size. For example, assume that 818 ft² (76 m²) of collector area is required for a project located at 40 degrees N latitude. The number of collectors to install can be determined by dividing the calculated array area by the net aperture area of the collector. If a 4 by 8 foot (1219 by 2438 mm) collector with 31 ft² (2.9 m²) of net aperture area is to be used, the calculation results in 26.4 collectors. Since 26 collectors cannot be divided evenly into banks of four, five, six, or seven, the designer must deviate from the calculated value by rounding to the next highest possibility result (i.e., 28 collectors). These units can be grouped into four banks of seven collectors or

seven banks of four collectors each. The length required for the collector banks is the width of the collectors plus connective piping. It is conservative to estimate 6 inches (152 mm) of connective piping between collectors, 3 ft (914 mm) between banks in the lateral dimension, and 4 ft (1219 mm) around the banks for personnel clearance. The bank widths are then estimated to be 31 ft (9449 mm) for the seven-collector bank and 17.5 ft (5334 mm) for the four-collector bank. The distance required between collector rows can be found from Figure 3-5. For example, an 8 ft (2438 mm) collector at 40 degrees N latitude requires row spacing of about 2.5 times 8 ft (2438 mm), or 20 ft (6096 mm). The array layout should be determined by keeping in mind that the piping length should be minimized while geometric symmetry is maintained. This guidance results in a tendency for the banks to contain as many collectors as possible, and for the array layout to be rectangular in area with an even number of banks installed in multiple rows. Therefore, the case of four banks with seven collectors each is the most preferred. A number of roof area dimensions should be proposed so the architect has some flexibility in determining the building orientation and dimensions. Figure 3-6 shows three possible collector array layouts for the 28-collector array. Similar consideration can be given to the use of a 4 by 10 ft (1219 by 3048 mm) collector. The result would be 21 collectors (possibly rounded to 24 or 20), 25 ft (7620 mm) row spacing (if needed), and banks of seven, six, or five collectors respectively.

3-4.1.7 Array Support Structure. The support structure must transmit the various loads incident upon the array to the building roof structure without overstressing it. The design must meet all code requirements and should be coordinated with, or reviewed by, a qualified structural engineer. At the system layout stage, the structural engineer or architect should have an idea about the building and roof type before the support structure is planned. Although steel has often been used for array structures, all systems designed under this guidance will be made from aluminum, to avoid the cost of applying and maintaining a protective finish. Although it is difficult to generalize, experience has yielded some useful estimates about the weight and cost of large collector support structures. As a rough guideline for rack-type structures, the weight of the structure should be less than 5 lbs/ft² (239 Pa) of collector area. The cost of the support structure typically represents less than 15 to 20 percent of the total solar system cost. Any support structures falling outside of these guidelines could be considered inefficient from a cost versus performance view. It is expected that the support structure may be heavier and more costly in areas where design loads are higher or where stepped collector rows are required. Further, stepped arrays require elevated walkways for maintenance a personnel, which results in higher material and design costs.

Figure 3-6. Possible Array Configurations and Area

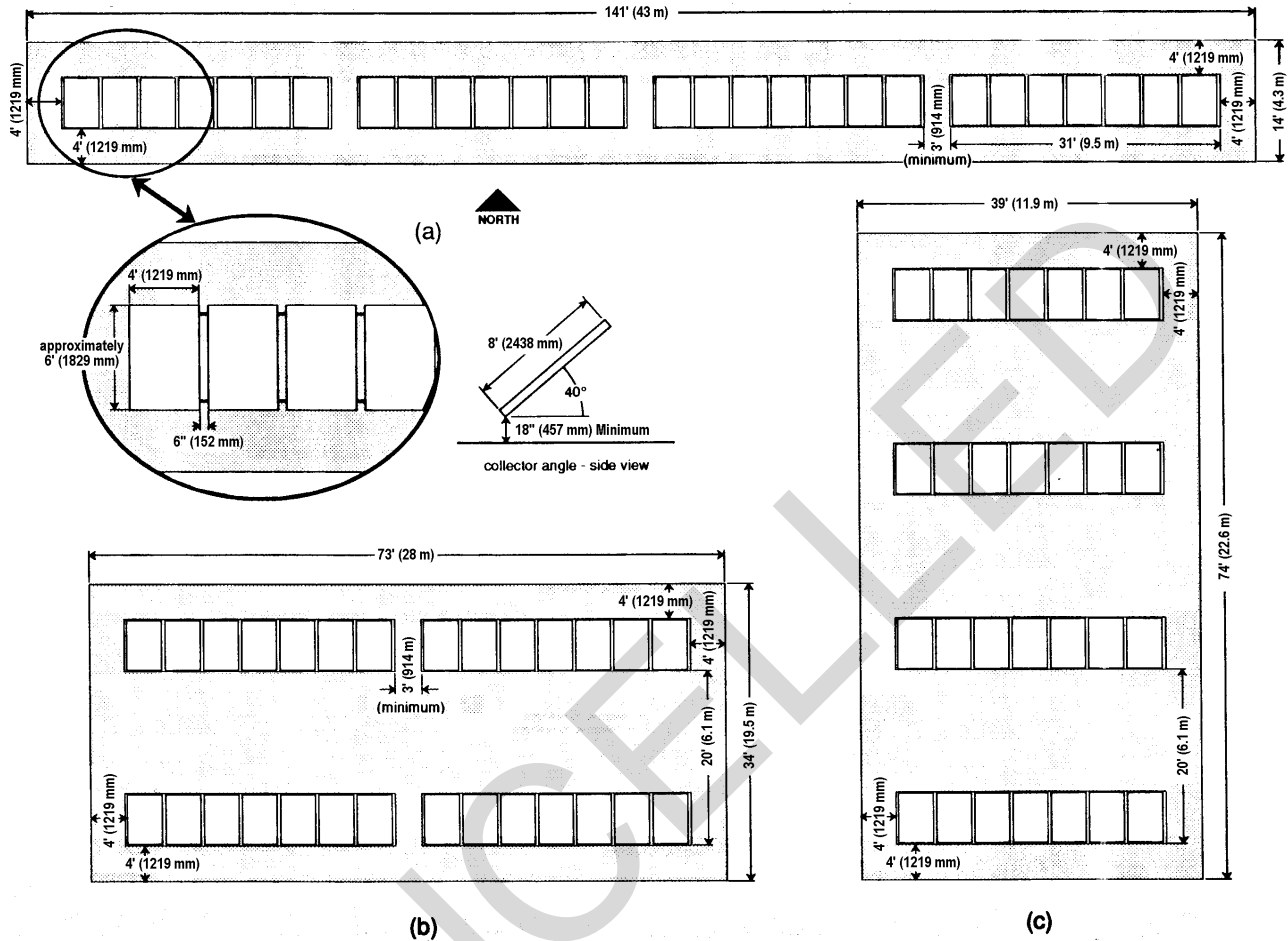

3-4.2 Storage Sub-System

3-4.2.1 Storage Tank Size. At the system layout stage, the storage tank volume and dimensions have a major impact on the design and location of the equipment room. Selection or specification of the storage tank requires first determining the appropriate volume of the tank. The widely accepted practice for service water heating applications is to provide a storage tank volume of 1.5 to 2 gals per square foot (61.1 to 81.5 L per square meter) of collector area. Storage systems larger than this do not significantly increase the performance of the solar system, and the additional costs associated with larger storage are not justified. Storage systems smaller than this size can decrease system performance. The lower performance is due to relatively high storage temperatures, resulting in lower solar collector efficiencies. Within these guidelines, the exact size of the storage tank is not critical to system performance and should be based upon available standard sizes. To provide proper stratification and to meet space requirements, vertical storage tanks are preferred. As tank size increases, space considerations and floor area become increasingly critical. When it becomes apparent that a single vertical tank is not possible, a horizontal tank or a series of vertical tanks will be necessary.

3-4.2.2 Storage Tank Location

3.4.2.2.1 **Indoor Versus Outdoor.** As with conventional energy systems, a solar system requires an equipment room to contain the heat exchanger, pumps, control system, and associated plumbing. If possible, the equipment room should be designed to house the solar storage tank. For retrofit situations where existing space does not permit the required tank volume, an outdoor location may be chosen. However, many factors discourage the location of storage tanks outside the building, such as a higher annual standby energy loss (in most climates) and adverse environmental effects on the tank (including ultraviolet and moisture-based degradation). Solar storage tanks are not to be located underground. Underground tanks have had numerous problems, including leakage due to tank and ground shifting and thermal stresses; corrosion due to the lack of cathodic protection; tanks surfacing due to buoyant forces while empty; and difficulty in retrieving and repairing sensors and instruments.

3.4.2.2.2 **Tank Support and Floor Loads.** Reinforced concrete pads and footings are often required to ensure that the weight of the tank does not endanger the structural integrity of the building. The design load calculation should take into account the estimated weight of the empty tank, the water to be stored in the tank, the insulation, and the tank support structure. The design load for the footing is also dependent on the type of tank support used.

3-4.2.3 **Legionnaire's Disease.** If a direct circulating system is supplying water for domestic use, ensure that water in the storage tank is heated to a minimum of 140 degrees F (60 degrees C) in order to avoid any potential source of Legionnaire's disease. For additional information on Legionnaire's disease refer to <http://www.efdlant.navfac.navy.mil/criteria>.

3-4.3 **Transport Sub-System.** To ensure that the transport sub-system is properly accounted for in the building design, space must be provided in the equipment room for the heat exchanger, expansion tank, pumps, and system plumbing, in addition to the storage tank and control system. Pipe chases are also required between the equipment room and the space on the roof where the system will be located.

3-4.4 Control Sub-System

3-4.4.1 **Control Strategy.** For the control strategy, the designer must specify operating modes and freeze/over-temperature protection methods. It should be noted that the control strategy presented for the standard closed-loop system is intended to be simple, reliable, and built with off-the-shelf components.

3.4.4.1.1 **Pump Activation.** Using the differential temperature controller, the collector and storage loop pumps should be energized whenever the difference between the absorber plate and storage tank temperatures is greater than some high setpoint differential temperature T_H , typically 15 to 25 degrees F (8 to 14 degrees C). The pumps should stay on until that temperature difference is less than some low setpoint differential temperature T_L , usually between 5 to 8 degrees F (3 to 4 degrees

C).

3.4.4.1.2 **Freeze Protection.** The propylene glycol mixture used in the closed-loop system provides freeze protection. Direct circulation is used only in non-freezing climates. Because the direct circulation system is more or less a special type of closed-loop system, its control strategy is the same.

3.4.4.1.3 **Over-Temperature Protection.** Over-temperature protection of the collector loop in the event of stagnation is provided through expansion tank sizing (refer to Chapter 4). The pressure-temperature relief valve located on the storage tank supplies over-temperature protection of the storage loop. If a direct circulating system is supplying water for domestic use, it is required that users be protected against the possibility of live steam being issued from taps or showerheads. This protection is provided through the proper use of relief and mixing valves.

3.4.4.1.4 **Auxiliary Pump Switches.** The use of auxiliary high- and low-temperature switches that will trip the pumps as a backup to the differential controller are not recommended. These switches are as prone to failure as the controller, and have been the cause of many solar system failures.

3-4.4.2 **Location of Controls.** Whenever possible, electronic displays and visual pressure and temperature gauges should be panel-mounted together in the mechanical room. Temperature sensors, which are located on the collector manifolds and on the storage tank, should be easily accessible for calibration and servicing. A common problem is sources of electromagnetic interference with the sensor wiring. This problem can be avoided by making the sensor wiring path as short as possible and by using conduit separate from AC power wiring. It may be desirable to include extra conductors for future expansion or maintenance needs.

3-5 **COORDINATION.** The system designer is responsible for ensuring that all essential information is provided to the architect and structural engineer, so that the building plan can accommodate the solar system requirements.

3-5.1 **Architect**

3-5.1.1 **Roof Requirements.** The most important requirement for the architect, with regard to the solar energy system, is to provide adequate unshaded roof area and proper orientation for the system. Other architectural requirements for roof design include providing roof penetrations near the array for collector supply and return lines; designing the array support structure; allowing adequate access to the array for maintenance; including access to the roof for personnel (and equipment); including walkways around the array; and locating the collector array above or near an area that can be used for pipe chases.

3-5.1.2 **Equipment Room**

3.5.1.2.1 **Location.** The equipment room for the solar energy system hardware will

be configured to allow easy access by operation and maintenance (O&M) personnel. The designer will minimize piping distances, both to the array and to the load.

3.5.1.2.2 **Design.** Whenever possible, the solar system equipment room will house solar storage tank, heat exchanger, expansion tank, pumps, control system, and related plumbing. The backup heating system will also be located in the equipment room. The room will be sized to allow O&M personnel to move about freely and replace equipment as necessary. A floor drain will be provided near the storage tank relief valve. Control panels will be installed in easily accessible areas and will be clearly visible.

3-5.2 **Structural Engineer**

3-5.2.1 **Array Support System.** The structural engineer (or project designer, if qualified) is responsible for the design of the array support structure once the architect has decided on a roof type. This step includes deciding if a flush roof-mounted or elevated rack-type support will be used and the type of materials and finish to be considered for the structure.

3-5.2.2 **Roof Loading.** The roof loads due to the array are point loads, and depend on the collector array layout and the type of array support structure used. By knowing the array layout (the width, length, and approximate spacing of the array) and the proposed roof design and array support structure, the structural engineer and architect can determine the best proposed roof support mechanism.

CHAPTER 4

SYSTEM DESIGN

4-1 **INTRODUCTION.** This chapter presents the information required to complete the solar energy system design.

4-2 COLLECTOR SUB-SYSTEM

4-2.1 Collector Specification

4-2.1.1 Collector Construction

4.2.1.1.1 **Absorber Construction and Components.** The solar collector absorber surface normally has two separate components: the absorber plate and fluid passageways. Many types of absorber designs have been used, such as parallel or serpentine tubes bonded to the absorber plate and double plates rolled together and bonded with hydrostatically expanded fluid passages. The method for bonding the tubes, the circuit flow path, and the absorber surface properties are each critically important to collector performance. The flow path geometry, cross-sectional area, and flow rate determine the fluid pressure drop across the collector. This pressure drop affects the flow distribution throughout the array. Methods used to bond the flow tubes to the absorber plate include mechanical bonds (soldered, brazed, or welded), adhesives, and mechanical encirclement. Flow tubes that have separated from the absorber plates are a leading cause of poor performance for flat-plate collectors. It is imperative that the bond be able to withstand the expected stagnation temperature of the collector and the daily temperature variations to which the collectors are exposed. Serpentine flow tubes and roll-bonded absorber plates can trap the heat transfer fluid in the collector, which can freeze and burst the tubes or absorber plate. Some roll-bonded absorbers have also been found to separate with time and cause flow problems or short-circuiting within the fluid passageway.

4.2.1.1.2 **Absorber Surface.** The absorber plate surface is also an important factor in the performance of the collector. There are two basic surface finishes, selective and non-selective. Selective surfaces are typically finished with black chrome or black nickel deposited film. Non-selective surfaces are usually finished with flat black paint and can have as large a value of emissivity as they do absorptivity. Selective surfaces have the advantage of absorbing the same amount of energy as the painted surface, but they emit much less radiation back to the cover. Non-selective painted surfaces have had numerous problems with fading, peeling, and outgassing. In contrast, deposited metallic surface coatings have an excellent history for retaining their properties with time. The most common absorber plate materials are copper, although aluminum absorbers can still be found. Copper has shown the best success due to the lack of thermal expansion problems with the attached copper flow tubes.

4.2.1.1.3 **Collector Manifold.** The collector manifold is the piping that branches

from the array supply to each of the individual collectors. There are two main types of collector manifolds: external and internal. External-manifold collectors have small diameter inlets and outlets that are meant to carry the flow for only one collector. The manifold piping to each inlet and from each outlet remains external to the collector. Today, external-manifold collectors are being replaced by those with internal manifolds. Internal-manifold collectors have larger manifolds designed to carry the flow for many collectors connected together, with the manifolds built into the collector unit. Figure 4-1 shows an example of both types of manifold collectors. The internal-manifold collector has many advantages, particularly when used in large systems. Benefits include reduced costs for piping materials, pipe supports, insulation, and labor; more effective flow balancing, which improves thermal performance; and the reduced heat losses to ambient air. Use internally manifolded collectors for all new design projects (externally manifolded collectors will not be used).

Figure 4-1. Collector Manifold Types

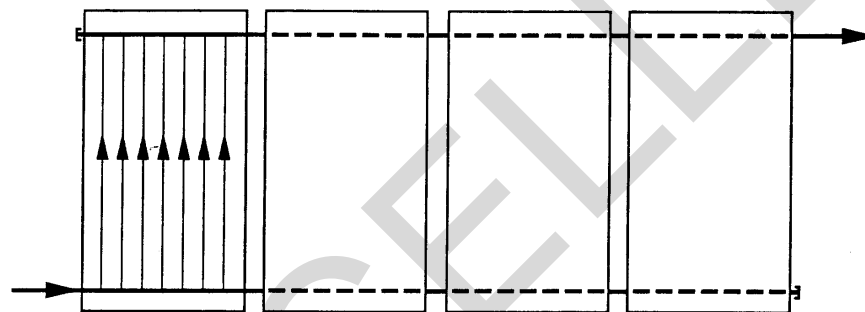

(a) Internally Manifolded Collectors (Required)

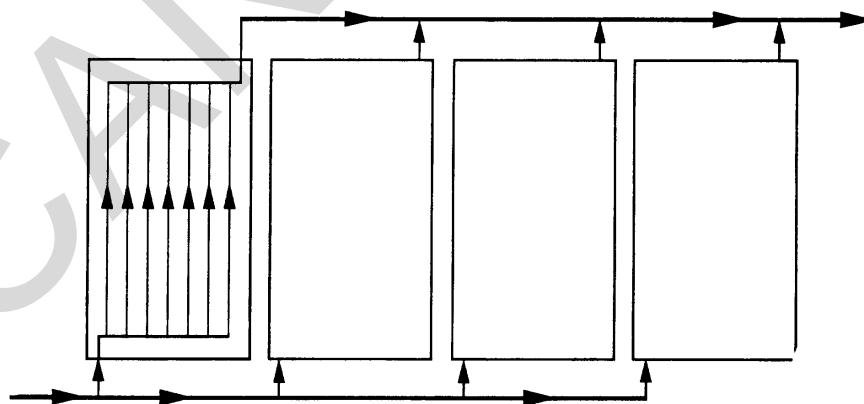

(b) Externally Manifolded Collectors

4.2.1.1.4 Collector Glazings. Collector covers, or glazings, are required to let radiant energy from the sun through to the absorber and to prevent convection from the hot absorber plate to the ambient air. Some properties to consider when choosing glazings are structural integrity and strength, durability, performance and safety.

Tempered, low-iron glass is by far the most common glazing used because of its excellent optical properties and durability. Clear plastics, such as acrylics and polycarbonates, have a history of problems with clarity over time due to ultraviolet degradation and are not recommended. Double-glazing reduces the thermal losses from the collector, but also decreases optical efficiency and increases weight and cost. This fact can be seen on a collector efficiency plot as a decrease in the F_R value and a decrease in the slope $F_R U_L$. (Refer to APPENDIX F for additional discussion.) For certain higher temperature applications, the increase in efficiency at larger values of $(T_i - T_a)/I$ may warrant the extra expense of double glazing, but for service water heating applications, single-glaze collectors will suffice.

4.2.1.1.5 Insulation. An insulating material is required behind the absorber plate and on the sides of the collector to reduce conduction losses. Insulation types currently in use include fibrous glass, mineral insulation, and insulating foams. The primary considerations of the insulating materials are their thermal conductivity, ability to withstand stagnation temperatures and moisture, dimensional stability, flammability, and outgassing characteristics. Fibrous glass, closed cell polyisocyanurate foam, and polyurethane foams are currently used in most solar systems. Polyurethane foam is especially well suited because of its ability to retain its shape and to resist moisture that may be present from condensation. Often, a layer of fibrous glass will be sandwiched between polyisocyanurate insulation and the absorber plate, since this material is better suited to withstand the high stagnation temperatures, which can exceed 350 degrees F (177 degrees C) in that part of the collector.

4-2.1.2 Collector Selection. Required information on the chosen collector includes the net aperture area (A_c); overall dimensions of length or height (L) and width (W); the manufacturer's recommended collector flow rates (CFR) and the pressure drop across the collector at that flow rate; the internal manifold tube diameter; and the collector weight when filled. The designer should note whether the manufacturer recommends a maximum number of collectors per bank less than seven. Of special importance are the values for A_c and CFR. While collector areas range from approximately 16 to 47 ft² (1.5 to 4.4 m²), it is recommended that collectors with net areas of 28 ft² (2.6 m²) or more be specified whenever possible. For large commercially-sized arrays, smaller collectors result in higher installation costs due to increased materials and labor required to achieve a given array area. The pressure drop is often reported in units of "ft of water". The following range of values could apply to typical flat-plate collectors: A_c = 28 to 40 ft² (2.6 to 3.7 m²), Length = 8 to 10 ft (2438 to 3048 mm), Width = 4 to 5 ft (1219 to 1524 mm), CFR = 0.01 to 0.05 gals/min-ft² (0.007 to 0.034 L/sec-m²), pressure drop = 0.1 to 0.5 psi (690 to 3447 Pa), internal manifold diameter = 1 to 1.5 inches (25 to 38 mm), and collector filled weight = 100 to 160 lbs (45 to 73 kg). When the designer has this information, the final array layout can be completed.

4-2.2 Collector Sub-System Piping and Layout

4-2.2.1 Layout and Terminology. Figure 4-2 provides an example of a collector array layout with the appropriate terminology.

Figure 4-2. Collector Array Terminology

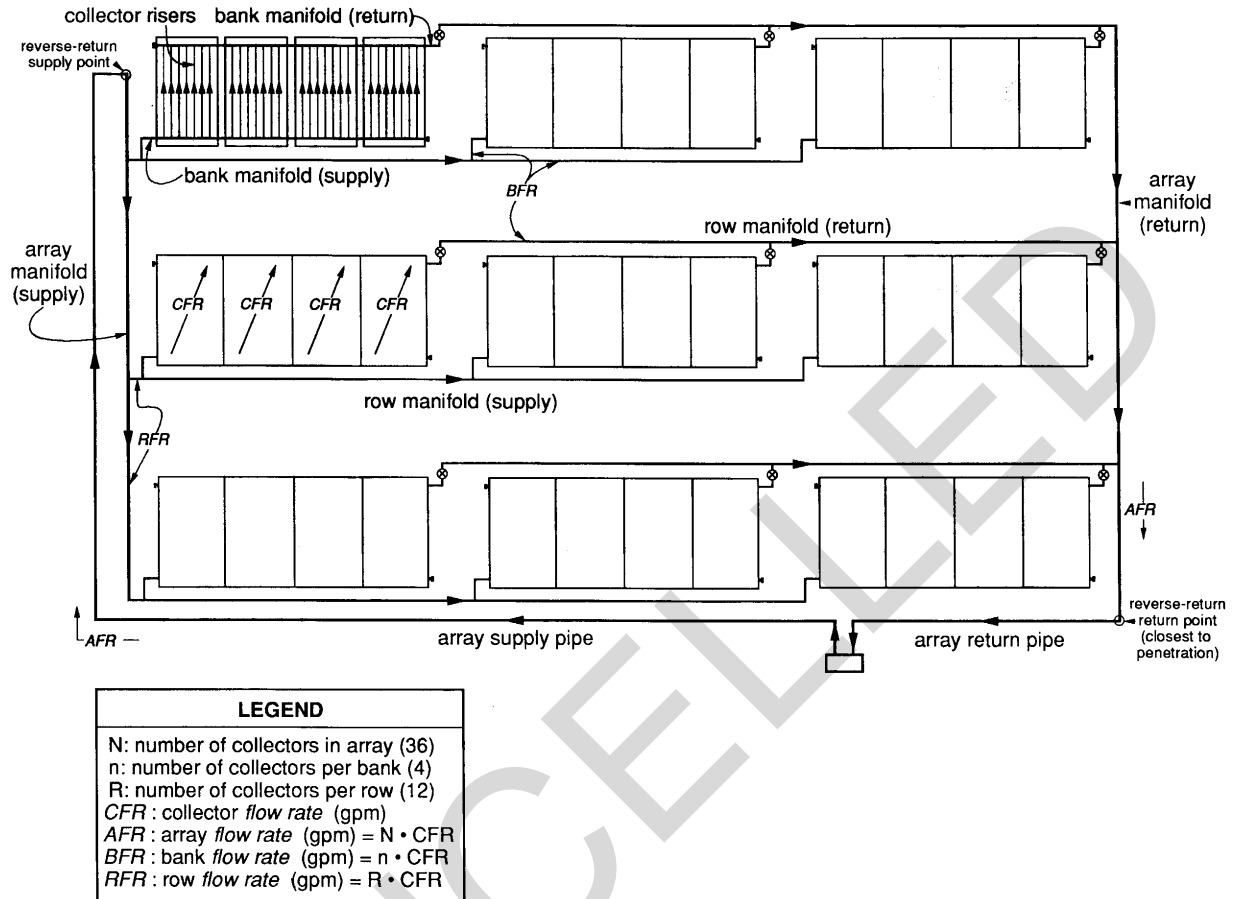

4.2.2.1.1 **Collector Array.** The collector is one internal-manifold, flat-plate collector unit. The collector array is the entire set of collectors necessary to satisfy the collector area specified by the thermal analysis. These collectors are often connected together into smaller sub-arrays, or banks. These banks can be arranged in different ways (rows and columns) to provide the required area, allowing the roof shape to vary depending on the building plan. "Supply" piping provides unheated fluid to the array and "return" piping carries heated fluid away from the array.

4.2.2.1.2 **Manifolds.** The piping used to carry the heat transfer fluid through the array can act as either manifold (also called header) piping or riser piping. Simply stated, the pipes that act as risers branch off of a main supply pipe, or manifold. Manifold piping typically serves two functions, as an array manifold (supply or return) or as a bank manifold (supply or return). As the name implies, the array supply manifold is the supply for the entire array, whereas a bank supply manifold is the pipe run consisting of all of the collector internal manifolds, after the bank is connected together. The bank manifold acts as a riser off of the array manifold. For the case of a small system that has only one bank, the array supply manifold is the same as the bank manifold. When more than one bank exists, the array supply manifold branches to

separate row and/or bank manifolds. The diameter of the array supply manifold will be larger than the bank manifold, and the bank manifold diameter will be larger than the collector riser diameter. This design is required to maintain balanced flow through the array. The actual pipe sizes and layouts to be used depend on many factors, as will be discussed in the following sections.

4-2.2.2 Flow Balancing. Flow can be balanced by active flow control or by "passive" piping strategies. For active flow balancing, automatic or manual valves are installed on manifolds and risers to regulate the fluid flow. In passive flow balancing, the array plumbing is designed so that uniform flow will occur as naturally as possible in the array. The most successful passive flow balancing method requires the designer to consider the fluid path length and the pressure drop along this path. The solar systems described rely mainly on the passive flow balancing method discussed below. In addition, manually calibrated balancing valves are included on the outlet of each bank to adjust for any flow imbalances after construction. Automatic flow control strategies have been a cause of system failure and are not recommended.

4-2.2.3 Reverse-Return-Piping Layout - The Diagonal Attachment Rule. The pipe run configuration is important balancing flow, especially with regard to fluid path length. The reverse-return piping layout provides almost equal path lengths for any possible flow path that the fluid may take. This design is in contrast to the "direct-return" system, which results in non-uniform flow through the collector bank due to unequal path lengths. These two strategies are illustrated for collector banks in Figure 4-3, with vectors on the collector risers to indicate relative fluid velocities. Note that even for the reverse-return system, the flow is not shown to be perfectly balanced since pipe resistance is a function of flow rate. The reverse-return strategy of providing approximately equal length flow paths can be applied to any bank layout or complete collector array layout by insuring that the supply and return pipes attach to the array at any two opposite diagonal corners of the array (See Figure 4-3). Use reverse-return piping strategies for all new design projects (direct return piping strategies will not be used).

4.2.2.3.1 Reverse-Return Piping Schematics. Figure 4-4 illustrates the steps in the development of a reverse-return piping schematic, and Figure 4-5 shows some examples of proper reverse-return piping schematics. Small circles show the attachment points on opposite sides of the bank in Figure 4-3 and opposite sides of the array in Figure 4-4 and Figure 4-5. The corner closest to the pipe roof penetrations will be used as the return point, since this results in the shortest pipe length for the heated fluid. A slight variation of the diagonal attachment rule is needed if the pipe roof penetrations are near the centerline of a multiple row, multiple column array with an even number of columns. For this case, some pipe length can be saved by feeding the array on the outside and returning the heated fluid from the center of the array. This case is shown in Figure 4-5(c).

Figure 4-3. Reverse-Return Versus Direct-Return Piping Strategies

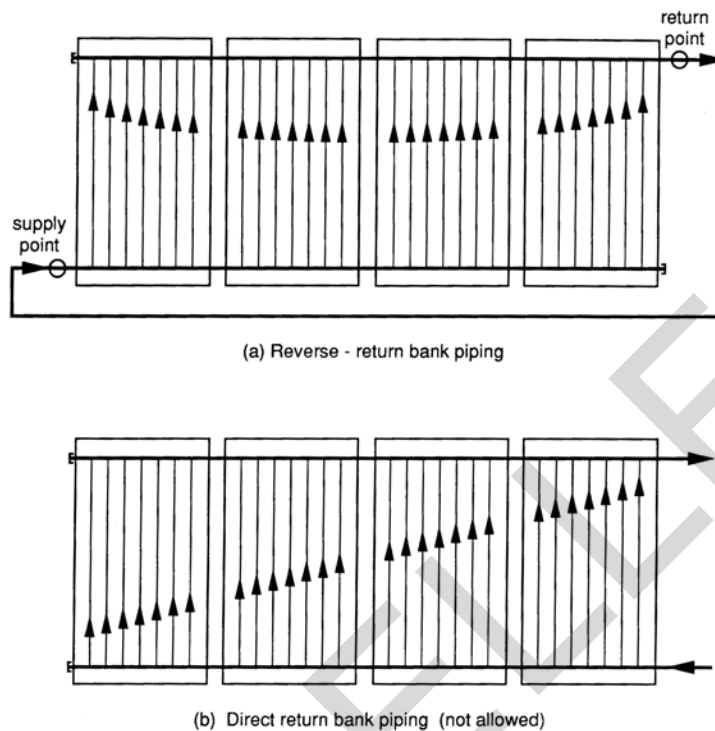

4.2.2.3.2 Stepped Collector Rows. Note that true reverse-return is not possible for stepped collector rows. The reason is that extra pipe length is required to reach the roof level supply and return manifolds up to and back from the elevated bank inlets and outlets. However, the same diagonal attachment strategy should be used and the extra pipe length for each elevation should be accounted for in the pressure drop/pump sizing calculation.

4-2.2.4 Array Layout and Piping Schematic. The final array layout should be determined using the methodology discussed under paragraph 3-4. If the dimensions of the collector to be specified differ from those used to perform the estimated roof area calculations, the array layout will need to be performed based on the collector specification and the unshaded roof area available. The designer has the option to decide which collector grouping is best within the guidelines requiring that the actual collector area be plus or minus 10 percent of the calculated area from the thermal analysis. For the example given under paragraph 3-4, the deviation is a 6 percent area increase from the 26 to 28-collector case. The next smallest collector areas would have required 25 or 24 collectors, representing 5 and 9 percent decreases, respectively. The 24-collector case may be preferred over the 25-collector option since more variations are possible for the array layout. With this array layout and using the reverse-return piping strategy discussed earlier, piping schematics similar to those shown in Figure 4-4 and Figure 4-5 can be determined. The array layout and piping schematic should be noted in the construction drawings to alert the contractor to pipe the array exactly as

that shown to ensure flow balance.

Figure 4-4. Steps in Developing a Reverse Return Piping Layout

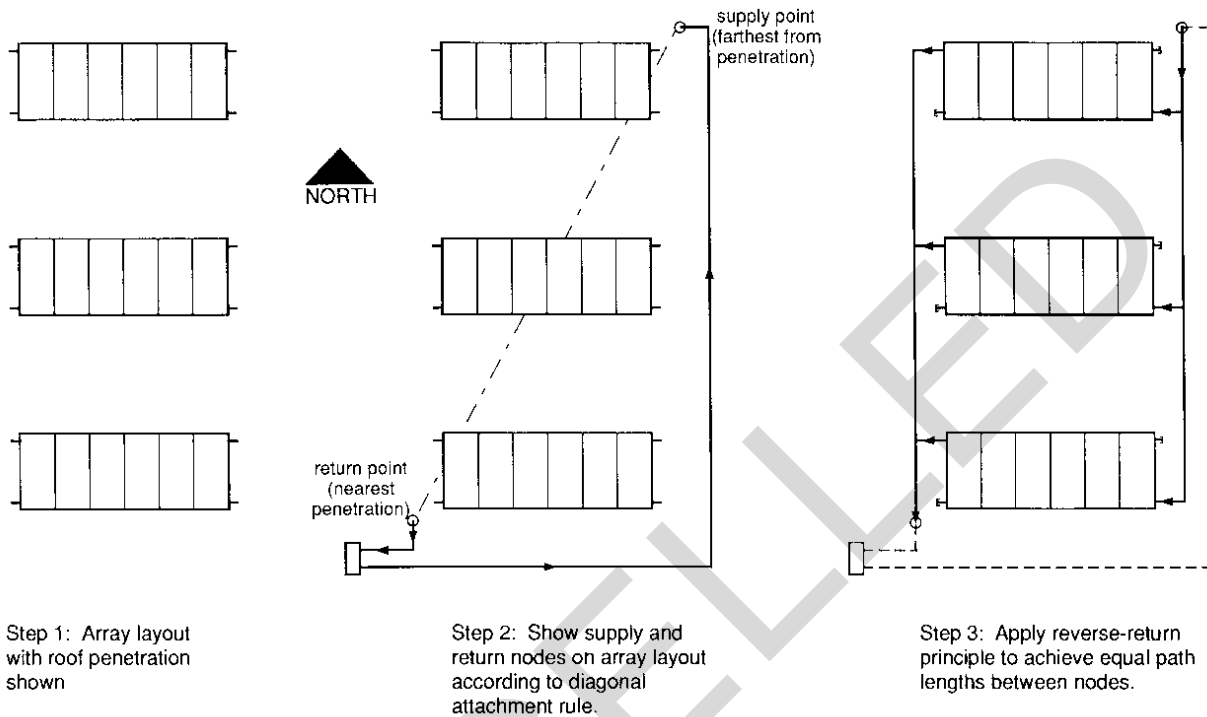

4-2.2.5 Pressure Drop

4.2.2.5.1 The 30 Percent Rule. Flow balance through the collector array depends on the relative pressure drop associated with the different piping branches of the array. The change in pressure along any flow path is a measure of the resistance to flow. Of interest to the solar system designer are the pressure losses across the collector risers, along a manifold, and along linear uninterrupted pipe. As the ratio of a manifold's pressure drop to its riser pressure drop becomes smaller, the flow becomes more uniform. To ensure uniform flow through the collector bank, this ratio should be around 10 percent, and under no circumstances should it exceed 30 percent (for a pressure drop ratio of 30 percent, the flow in any riser does not deviate from the average riser flow rate by more than plus or minus 5 percent). It is thus an advantage to choose a collector with a relatively large pressure drop and to ensure that the pipe diameters throughout the system are sized correctly to maintain adequate riser to manifold pressure drop while allowing enough cross-sectional area for the calculated flow rate and keeping the flow velocity below the 5 ft/s (1.5 m/s) limit for copper pipe.

Figure 4-5. Examples of Reverse-Return Piping

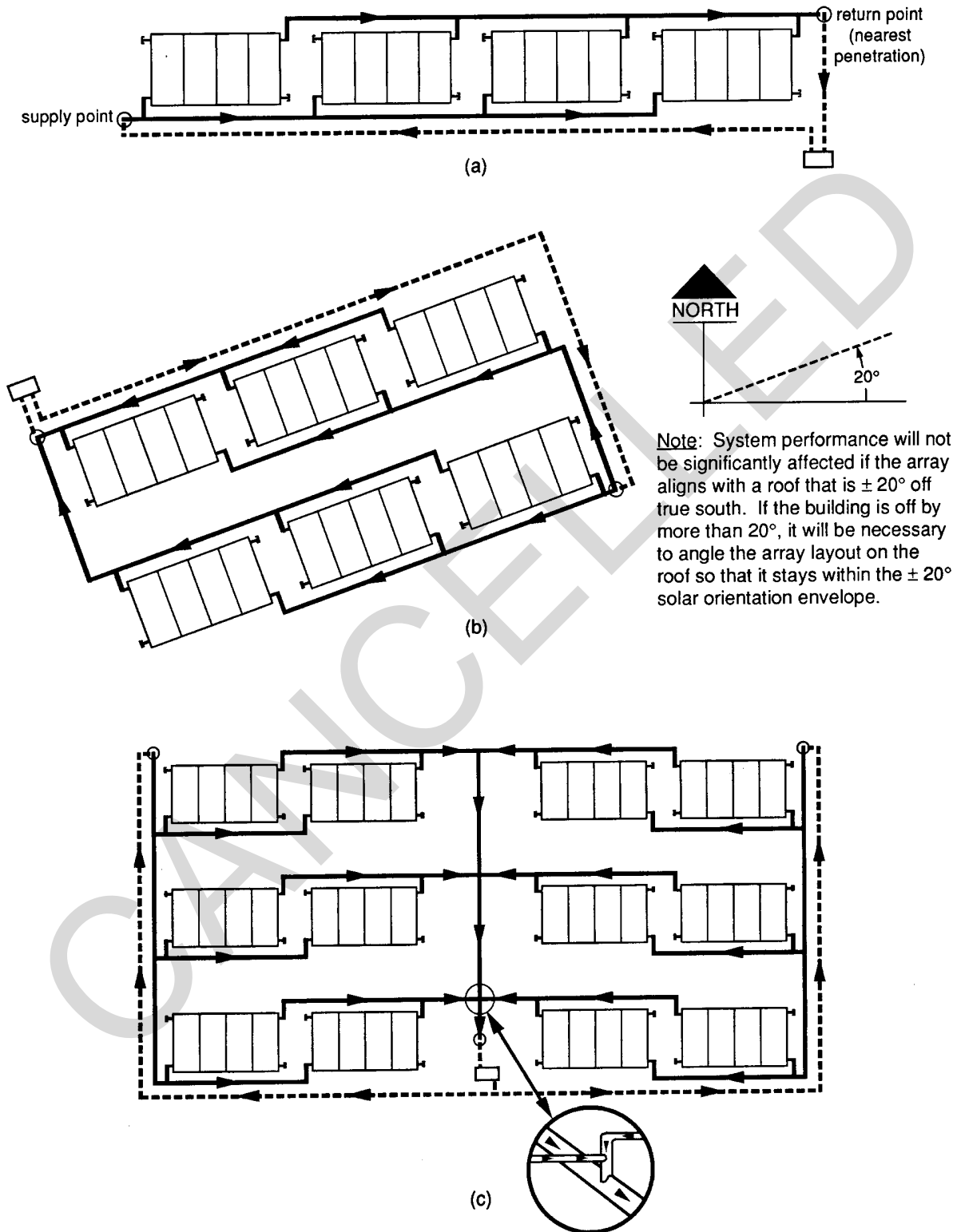

4.2.2.5.2 Pressure Drop Across Banks and Rows. The pressure drop across a bank of collectors must be determined in order to calculate the pipe sizes necessary to achieve balanced flow in the array. Once the array layout is determined and assuming that the pressure drop across each collector unit at the recommended flow rate is known, the pressure drop associated with each branch extending from a manifold can be determined. When internal-manifold collectors are banked together in groups of seven or less, it can be assumed that the pressure drop across the entire bank is equal to the pressure drop across a single collector. This information will be used in sizing the pipe, as described below.

4.2.2.6 Pipe Sizing. Sizing of the piping in the solar array is critical to system performance. Flow throughout the array should be in balance at the proper flow rates, while maintaining a maximum velocity limit of about 5 ft/s (1.5 m/s). These two criteria impose constraints on the minimum pipe diameter possible, while material and labor costs pose a constraint on excessively large piping. Another consideration is pumping power. Specifying pipe diameters that are larger than the minimum can sometimes lower the system life-cycle cost. By doing so, pumping power requirements are reduced and the savings over the system lifetime can exceed the initial material and labor costs of the larger pipe. This situation however is not important for the sizes and types of solar systems discussed in this guidance.

4.2.2.6.1 Volumetric Flow Rates. The manufacturer's recommended collector flow rate, CFR, and the piping schematic should be used to determine the design flow rates throughout the collector sub-system. The total array flow rate, AFR, is determined by multiplying the CFR by the actual number of collectors, N. Bank flow rates (BFR) and row or other branch flow rates are determined by multiplying the CFR by the number of collectors per bank (n) or per row. These flow rates were previously illustrated in Figure 4-2.

4.2.2.6.2 Pressure Drop Models and the Fluid Velocity Constraints. The fluid velocities in the various pipe branches should be kept below 5 ft/s (1.5 m/s) to prevent erosion of the copper piping. Below this value, fluid velocity is of no great concern. The fluid velocity for a given flow rate is dependent on the fluid properties, internal pipe diameter, the pipe material, and its internal surface characteristics. Empirical expressions have been developed to model the flow rate, pressure loss, and velocity behavior of different liquids flowing through various types of pipe. These expressions are widely available in graphical form for water (usually at 60 degrees F (15 degrees C) and for turbulent flow) and standard practice dictates their use. For this reason, they are not presented in this guidance. Although more precise methods can be considered, the designer can easily correct the pressure drop for water to account for propylene glycol solutions by the use of Table 4-1. The pressure drop correction is more important than the velocity correction since there is an increasing effect on the pressure drop. Use of the velocity result for water is conservative and as such requires no correction. This velocity correction calculation assumes similar turbulent flow characteristics for water and propylene glycol solutions (an incorrect assumption in many cases). Due to the viscosity differences of water and propylene glycol solutions, flow of the solution is often laminar. This fact can be neglected and the turbulent water

model can still be used with a correction for propylene glycol, since such use will be conservative. In addition, although these flows are often laminar, they are usually near the laminar/turbulent transition point where pipe bends and flow restrictions can easily trip laminar flow to turbulent. The design operating temperature of the collector loop should be between 60 and 90 degrees F (15 and 32 degrees C), with the 60 degree F (15 degrees C) value preferred because it is the lowest temperature (thus highest viscosity and pressure drop) that steady-state operation could be expected. If a higher temperature is to be used, the designer should apply the standard temperature corrections for water before correcting for the use of propylene glycol.

Table 4-1. Pressure Drop Corrections

Heat Transfer Fluid (Percent Propylene-Glycol)	Pressure Drop Correction	Velocity Correction (Estimated)
50 (closed loop)	x 1.4	x 0.8
30 (closed-loop)	x 1.2	x 0.9
0 (direct circulation)	(x 1.0)	(x 1.0)

4.2.2.6.3 Flow Balancing. Flow balancing of the main array supply manifold and its associated risers can be accomplished using the "30 percent rule" cited earlier. To begin, the pressure drop in the risers must be known - this usually means that the flow balancing calculations start with the collector banks since the pressure drop across a collector bank can be considered to be the same as the pressure drop across a single collector. The flow rates required in all branches must also be known. A first guess of the manifold internal diameter should be made. Each section of manifold between the risers will have a different flow rate, and the pressure drop associated with each flow rate and pipe length must be determined. The sum of each of these pressure losses will be the pressure drop along the entire manifold. This pressure loss is compared to the pressure drop across the riser (in this case, the row or bank manifold), and if it is less than 0.3 (around 0.1 is preferred) of the bank manifold pressure drop, the proposed diameter is acceptable from a flow balancing point of view. This assumption neglects the additional pressure loss associated with the bank manifold and its connections, and is thus conservative. If the proposed diameter is too small (or too large), another guess should be made. Figure 4-6 and Figure 4-7 provides an example of sizing a manifold to provide balanced flow while satisfying both the 30 percent rule and the 5 ft/s (1.5 m/s) velocity restriction.

Figure 4-7. Manifold Sizing Example (Metric)

Example: Manifold with 4 Risers

- Riser pressure drop: $\Delta P_R = 4826$ Pa
- Manifold flow rate = 1.3 L/s
- 50% propylene-glycol solution

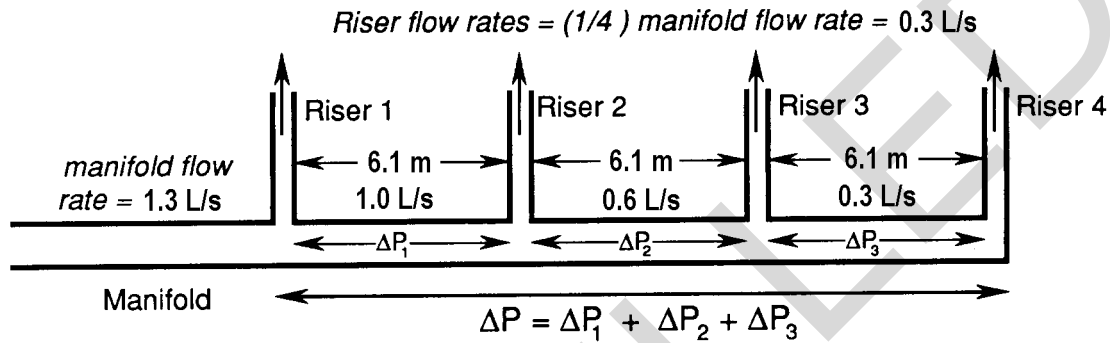

Note: Bank pressure drop = single collector unit pressure drop

From pressure drop tables: $\Delta P_1 = f$ (Flow rate in section 1, Manifold diameter)
 $\Delta P_2 = f$ (Flow rate in section 2, Manifold diameter)
 $\Delta P_3 = f$ (Flow rate in section 3, Manifold diameter)

Manifold Position	Flow Rate	Guess A: 32 mm		Guess B: 40 mm		Guess C: 50 mm	
		ΔP	Velocity < 1.5 m/s ?	ΔP	Velocity < 1.5 m/s ?	ΔP	Velocity < 1.5 m/s ?
after riser 1	1.0	2758	yes	1241	yes	345	yes
after riser 2	0.6	1379	yes	690	yes	207	yes
after riser 3	0.3	414	yes	207	yes	69	yes

Total manifold pressure drop (corrected for 50%):

$$\Delta P_A = 4551 \times 1.4 = 6371 \text{ Pa}$$

$$\Delta P_B = 2138 \times 1.4 = 2993 \text{ Pa}$$

$$\Delta P_C = 621 \times 1.4 = 869 \text{ Pa}$$

Ratio (must be less than 0.3):

$$\frac{\Delta P_A}{\Delta P_R} = 1.3$$

$$\frac{\Delta P_B}{\Delta P_R} = 0.61$$

$$\frac{\Delta P_C}{\Delta P_R} = 0.19$$

Result: 50 mm manifold or greater

4-2.2.7 Collector Sub-System Plumbing Details. The collector banks must be able to be valved off for maintenance, repair, or replacement. It is recommended that ball valves be used in this capacity instead of gate or globe valves. Manually operated, calibrated balancing valves are also to be located at the outlet to each collector bank to adjust for any flow imbalances present after construction. Drain valves should be located at all low points in the collector sub-system to allow the collectors to be drained if necessary. Pressure relief valves should be located on each collector bank that could be valved off accidentally and allowed to stagnate. Finally, manual air vents should be located at the high points of the collector loop to allow air to escape during the filling process. Ensure that adequate room is provided for expansion of the internal manifold and absorber plate assembly within the collector casing. The differential expansion between the system flow paths and the system and the support structure must be considered in the design.

4-2.2.8 Thermal Expansion. Thermal expansion control becomes important when long lengths of pipe are present or when pipes must be secured at a given location. Other locations for which pipe movement can be critical are in pipe chases and near pumps, where expanding pipe could cause shifts in pump alignment. The preferred method of accounting for thermal expansion is to construct a U-shaped bend in the pipe run that can absorb the anticipated movement at a given location. When necessary, these loops should be located horizontally and supported properly so that the fluid contained within can be drained. Figure 4-8 shows the change in length of copper pipe with temperature change. When long pipe runs are required, the designer will ensure that the resulting expansion or contraction will not harm system components or cause undue stress on the system or the building. If the plumbing geometry cannot withstand the length changes or if the plumbing must be anchored at certain locations, pipe supports and guides must be designed to allow freedom of movement in the direction of motion.

4-3 STORAGE SUB-SYSTEM

4-3.1 Storage Tank Construction. Solar storage tanks must be insulated to a value of R-30 or better, to minimize loss of collected solar energy. The storage tank should be equipped with a minimum of four pipe connections, two located near the top of the tank and two located near the bottom. To take advantage of storage tank stratification, pipes supplying the collector array and the cold-water inlet should be connected to the bottom penetrations, and the pipes returning to the tank from the collector array and hot water supplied to the load should be connected to the penetrations near the top. Instrumentation openings will be required as well as openings for relief valves, drains, and the like. Since copper is to be used for all system plumbing, the designer should ensure that a dielectric coupling is included in the design of any necessary penetrations of the storage tank.

Figure 4-8. Thermal Expansion Versus Temperature Differential for Copper Pipe

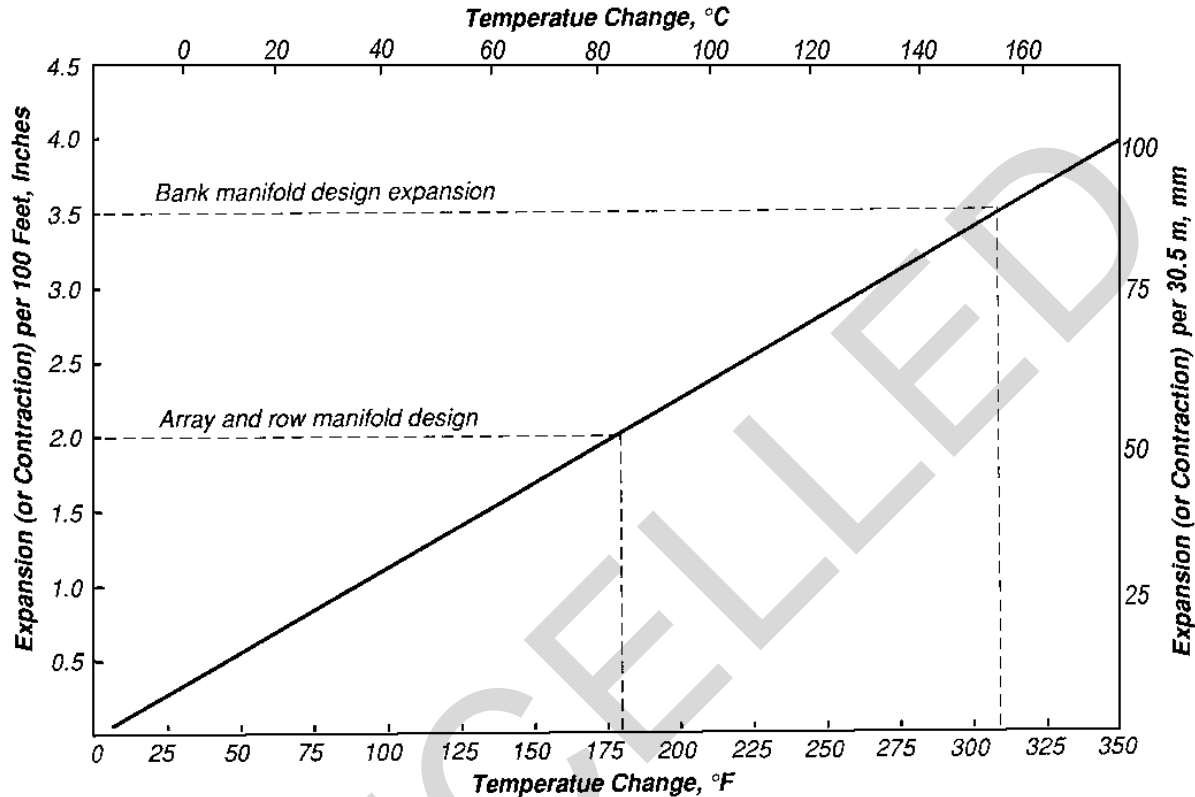

4-3.2 **Storage Tank Sizing.** The solar storage tank should be specified based on the sizing criteria that the volume be between 1.5 to 2 gals per square foot (61.1 to 81.5 L per square meter) of total array collector area. This allows considerable flexibility for finding an off-the-shelf, standard-sized tank that will meet all specifications. Tank dimensions for the given storage volume and expected floor loads should be noted.

4-3.3 **Storage Sub-System Flow Rate.** The flow rate in the storage loop depends on the collector loop flow rate. To ensure that the storage loop can accept the energy available, the thermal capacity on the storage side of the heat exchanger (the product of the mass flow rate and constant pressure specific heat) must be greater than or equal to the thermal capacity on the collector side of the heat exchanger. An expression relating the volumetric flow rates in the two loops can be determined by noting that the constant pressure specific heat for propylene glycol is as low as 85 percent of that for water and that the density of water is as low as 95 percent of that for propylene glycol. Substituting these relationships into the thermal capacities yields the result that the storage sub-system volumetric flow rate should be at least 0.9 times that of the total array volumetric flow rate. To be conservative, the flow rate relationship across the heat exchanger should be determined using Equation 4-1.

$$\text{Storage Sub-System Flow Rate} = 1.25 \times \text{AFR} \quad (\text{eq. 4-1})$$

4-4 TRANSPORT SUB-SYSTEM

4-4.1 **Transport Sub-System Design.** Although the collector array layout may differ for each building, the design of the transport sub-system should be similar for all solar energy systems.

4-4.1.1 **Heat Transfer Fluid.** As discussed in Chapter 3, a solution of 30 percent or 50 percent food-grade, uninhibited propylene glycol and distilled water is required as the heat transfer fluid for closed-loop solar energy systems. Ethylene glycol is highly toxic and should never be used.

4-4.1.2 Heat Exchanger

4.4.1.2.1 **Heat Exchanger Analysis.** Two methods of heat exchanger analysis are used in design: the log mean temperature difference (LMTD) method and the effectiveness-number of transfer units (e-NTU) method. The LMTD method is used most often for conventional HVAC systems and requires knowledge of three of the four inlet and outlet temperatures. This method cannot be applied directly to solar systems because the inlet temperatures to the heat exchangers from both the collectors and storage are not constant. Since the goal of the solar system heat exchanger is to transfer as much energy as possible, regardless of inlet and outlet temperatures, the e-NTU method should be used. However, a complete e-NTU analysis can be avoided by considering the impact of the heat exchanger on the overall system performance. The annual system solar fraction is decreased by less than 10 percent as heat exchanger effectiveness is decreased from 1.0 to 0.3. By setting a minimum acceptable effectiveness of 0.5, the e-NTU method can be used to generate the temperatures required by the LMTD method. These temperatures and the corresponding flow rates can then be used to size the heat exchanger according to the LMTD method, with the resulting heat exchanger satisfying the minimum effectiveness of 0.5.

4.4.1.2.2 **Sizing.** For proprietary reasons, manufacturer's representatives, through the use of computer codes, typically size heat exchangers. These codes are usually based on the LMTD method and require the designer to provide three temperatures and the flow rates of both streams. To ensure that an effectiveness greater than 0.5 is achieved, the following temperatures and flow rates should be used for sizing the heat exchanger:

Temperatures:

Solar loop inlet	= 140 degrees F (60 degrees C)
Solar loop exit	= 120 degrees F (49 degrees C) or less
Storage side inlet	= 100 degrees F (38 degrees C)

Flow rates:

Solar loop	= AFR (see Figure 4-2 legend)
Storage loop	= 1.25 x AFR

The 120 degrees F (49 degrees C) solar loop exit temperature corresponds to an

effectiveness of 0.5. Raising the required solar loop exit temperature to 125 degrees F (52 degrees C) decreases the effectiveness to about 0.4. The cost difference at these levels of effectiveness is not significant for either plate or shell-and-tube heat exchangers. As the heat exchanger effectiveness is further increased (or as the required solar loop exit temperature is decreased), heat exchanger costs are affected more. The designer should use judgment to determine if the cost of increasing effectiveness is justified. For plate-and-frame heat exchangers, gains in effectiveness can often be achieved with low additional cost.

4.4.1.2.3 Specification. The heat exchanger area should be available from the manufacturer, along with the pressure drop across each side at various flow rates. A single-isolation heat exchanger can be used, since non-toxic USP propylene glycol is required as the heat transfer fluid. All materials used in the heat exchanger must be compatible with the fluids used. The plate or plate-and-frame types of heat exchangers are becoming increasingly popular, due to their compact size and excellent performance, availability in a wide range of materials, and ease of cleaning and servicing. If a shell-and-tube heat exchanger is used, it should be installed such that the shell side is exposed to the heat transfer fluid, with the tube side containing potable water. This design is required because potable water tends to foul the tube bundle, so it must be possible to remove and clean the bundle. Further discussion of heat exchangers can be found in APPENDIX F.

4-4.1.3 Piping

4.4.1.3.1 Sizing. The collector loop piping to the manifold should be sized small enough to reduce material costs but large enough to reduce excess pressure drop (and associated pump and energy costs) and to maintain the fluid velocity below 5 ft/s (1.5 m/s). The upper limit is the size of the array supply and return manifold, while the lower side is that defined by the 5 ft/s (1.5 m/s) velocity limit. Although an optimization procedure could be performed to determine the pipe size providing the lowest life-cycle cost (LCC), experience shows that the supply piping can be sized at least one size smaller than the supply manifold as long as the fluid velocity restriction is not exceeded. The pipe size on the storage side of the heat exchanger can also be calculated based on the storage loop flow rate, pump costs, and the 5 ft/s (1.5 m/s) fluid velocity limit.

4.4.1.3.2 Materials. Piping materials are limited to copper. To ensure materials compatibility, only tin-antimony (Sn-Sb) solders are allowed (Sb5, Sn94, Sn95, and Sn96).

4.4.1.3.3 Insulation. Insulation should withstand temperatures up to 400 degrees F (204 degrees C) within 1.5 ft (457 mm) of the collector absorber surface, and 250 degrees F (121 degrees C) at all other locations. Insulation exposed to the outside environment should be weatherproof and protected against ultraviolet degradation. Pre-formed, closed-cell polyisocyanurate insulation has an excellent history of withstanding the temperatures and environmental conditions required, and its use is recommended when possible. The amount of insulation to be used is dependent on the operating temperature of the pipe; however, a minimum of R-4 should be specified

on all piping.

4-4.1.4 Expansion Tank

4.4.1.4.1 **Operation.** An expansion tank is required in the collector circulation loop. In a closed-loop system, the expansion tank must serve two purposes: to protect the system from overpressure due to thermal expansion of the fluid at high temperatures and to maintain the required minimum pressure when the fluid in the loop is cold. Expansion tanks are closed and initially charged with a gas (usually air) at some given minimum pressure. As the temperature increases in the loop and thermal expansion takes place, increasing amounts of displaced fluid enter the expansion tank and compress the air within it. There are three common types of closed expansion tanks: non-bladder, bladder, and diaphragm. In the non-bladder expansion tank, the expanding fluid is in direct contact with the air charge. Bladder tanks are fitted with a flexible balloon-like surface that separates the air from the expanding fluid. Usually, bladder tanks require an initial fluid volume and air pressure, and do not permit the fluid to come in contact with the metal tank surface. Diaphragm tanks are initially charged with air also, but allow some fluid-metal contact as they fill. These mechanisms prevent the air charge from being absorbed into the expanding fluid, with a resulting decrease of corrosion problems and periodic venting maintenance. Because bladder tanks are widely available and they prevent any metal-fluid contact, their use is required for solar preheat systems. The expansion tank should be located in the equipment room on the suction side of the pump.

4.4.1.4.2 **Determination of Acceptance Volume.** Determination of the collector loop expansion tank acceptance volume is similar to that for a conventional hydronic or boiler system tank sizing, with one important variation. Typical expansion tank sizing routines account only for the variation of fluid volume with temperature change in the liquid phase. While this is the condition existing within the solar collector loop during normal operation, a more critical condition exists in the event of system stagnation that requires a much larger volume than the conventional sizing routines. A detailed account of stagnation and over-temperature protection of the system is discussed in APPENDIX F. Solar energy systems are quite capable of boiling during stagnation, and the expansion tank must be sized to account for the displacement of all of the fluid contained in the collector array that is subject to vaporization. Since the stagnation condition requires far greater volume than that needed for the conventional liquid-phase expansion case and these two situations will never occur at the same time, the conventional temperature-based expansion term is not needed. Experience shows that during stagnation conditions, only the volume of fluid located in the collector array and associated piping above the lowest point of the collectors is subject to vaporization. Thermal stratification prevents fluid below this point from vaporizing to any significant degree. The required acceptance volume of the collector loop expansion tank is thus determined by adding the total volume of all collectors plus the volume of any piping at or above the elevation of the collector inlets. When properly applied, this procedure provides fail-safe pressure protection of the system, and prevents the loss of the propylene glycol solution from the pressure relief valves. The result is a large decrease in the number of failures and resulting maintenance calls.

4.4.1.4.3 Determination of Design Pressures. The air-side of closed expansion tanks are normally required by the manufacturer to be precharged to some pressure above atmospheric. This initial or precharged pressure (P_i) must be determined, along with the collector loop fill pressure (P_f) and the maximum relief pressure allowed in the system (P_r). As discussed previously, the maximum pressure in the collector loop should be 125 psi (862 kPa). The system fill pressure should result in a +10 to +15 psi (+69 to +103 kPa) pressure at the highest point of the system. The expansion tank precharge pressure should be equal to the fill pressure at the expansion tank inlet, minus 5 to 10 psi (35 to 69 kPa). This initial condition allows fluid to be contained within the expansion tank at the time of filling and will provide positive pressure in the event of the system operating at temperatures below that occurring when the system is filled.

4.4.1.4.4 Sizing and Specification. Once the acceptance volume and the design pressures have been determined, the total (fluid plus air) expansion tank volume V_T can be calculated by using Equation 4-2.

$$V_T = \frac{V_{coll}}{\left(\frac{P_i}{P_f} - \frac{P_i}{P_r} \right)} \quad (\text{eq. 4-2})$$

where V_{coll} is the total volume of the collectors and piping above the collectors. This equation is plotted graphically in Figure 4-9. Manufacturers provide expansion tank sizes by either the total volume of both the air and fluid, or by separate specification of the acceptance volume and design pressures. When the manufacturer supplies both the acceptance and total tank volumes, the designer should specify the tank that satisfies both conditions. The volume data given by the manufacturer in these cases may not coincide exactly with those calculated by the methods shown above. The values should be close, however, since variations should only be due to slightly different types of fluid/air separation mechanisms. The manufacturer should supply literature on their particular requirements for initial charge (if any) and temperature and pressure limits. Careful attention should be given to the bladder materials. EPDM rubber is the recommended material for use with propylene glycol. As in other parts of the system, the propylene glycol based heat transfer fluid should not be allowed to come in contact with ferrous materials, especially galvanized steel.

Figure 4-9. Calculation of Total Expansion Tank Volume

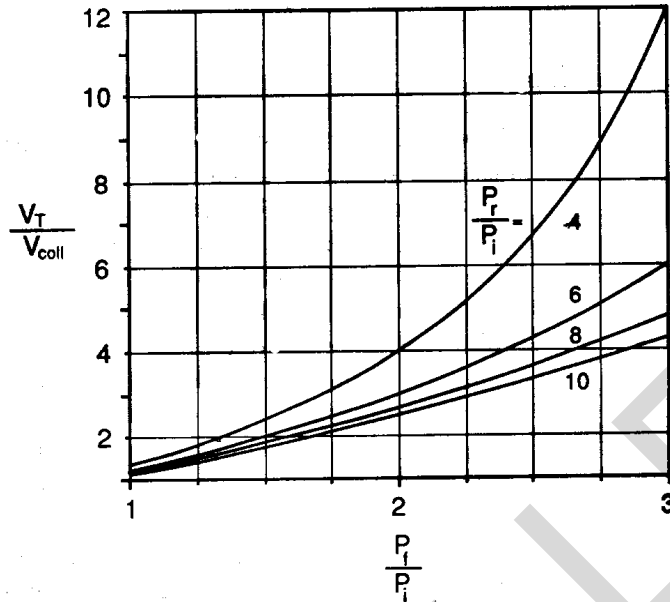

4-4.1.5 Fittings

4.4.1.5.1 Isolation Valves. Gate and ball valves are installed to allow components or sections of the system to be isolated without draining the entire system. Gate valves are less expensive than ball valves and will be used in locations where only on/off operation is required. Ball valves are recommended at locations where partial flow may be required, such as on the outlet side of the collector banks. These valves are manually operated and may have a key or special tool to prevent unauthorized tampering. Care should be taken when locating isolation valves to ensure that system pressure relief cannot be valved off accidentally. Globe-type valves are not recommended because they can reduce flow (even when fully open), cause excessive pressure drop, and reduce system efficiency.

4.4.1.5.2 Thumb Valves. Thumb valves also function as on/off valves for smaller sized tubing (typically 1/4 inch (6 mm) or less). They are used to manually open pressure gauges or flow indicators to local flow and are not meant for constant use.

4.4.1.5.3 Drain Valves. Drain valves are required at all system low points. Specifically, these locations include the low points of the collector banks, the bottom of the storage tank, and two at the bottom of the collector loop between the expansion tank and the pump. These latter two drain valves are used for filling and draining and should be separated by a gate valve. When the system is to be filled, the gate is closed and a pump is connected to one of the drains. As the propylene glycol solution is pumped into the system, the other open drain allows air to escape. When filling is complete, both drains are closed and the gate between them is opened.

4.4.1.5.4 Check Valves. A spring-type check valve should be located in the system between the pump and the collector array, on the supply side. This check valve

prevents reverse thermosiphoning, which can occur when the system is off and warm fluid in the collector loop rises from the heat exchanger to the collector array and is cooled.

4.4.1.5.5 Pressure Relief Valves. A pressure relief valve is required in any line containing a heat source that can be isolated (such as a collector row) and is also typically provided between the heat exchanger and the suction side of the collector loop pump. The latter pressure relief valve is provided in case of stagnation in the fully open collector loop. This relief valve should open before those at the top of the loop due to the elevation head experienced at the bottom of the loop. Pressure relief for solar systems should be set at 125 psi (862 kPa) (maximum system design pressure). The discharge from pressure relief valves will be either routed to an appropriate floor drain or captured as required by either local or state regulatory requirements. The discharge should be piped to avoid personnel injury from the hot fluid. Some means for determining if fluid has discharged may be provided.

4.4.1.5.6 Temperature-Pressure Relief Valves. Temperature/pressure relief valves are similar in operation to pressure relief valves, except they also contain a temperature sensor to detect and relieve any temperature exceeding the design temperature. They should be installed on the solar storage tank and set for 125 psi (862 kPa) or 210 degrees F (99 degrees C).

4.4.1.5.7 Manual Air Vents. Manual air vents are recommended to purge trapped air within the system. They should be located at the high point(s) of the system where air will accumulate. Air can be present in the system from the initial charge or can be drawn in at leaks in the system piping or components. Automatic air vents with air separators have a tendency to fail when moisture condenses and freezes near the relief port, and should thus be avoided.

4.4.1.5.8 Strainers. Standard plumbing practice recommends that a strainer be located before the pump to test for system flush.

4-4.1.6 Pumps

4.4.1.6.1 Operation. Circulation pumps are required in both the collector and storage loops. Both pumps are activated simultaneously by the control sub-system when it has been determined that net energy collection can occur.

4.4.1.6.2 Flow Path Pressure Drop. The pump size is based on the required flow rate and the resistance to flow in the loop (at that flow rate). The total pressure loss to be overcome by the pump is the sum of the individual component and piping pressure losses around the loop. To calculate the pressure drop around the loop, the piping layout must be determined, certain major components specified, and approximate pipe lengths, fittings and diameters known. The pressure drop in the plumbing is calculated by first determining a flow path length, which is equal to the length of all linear piping plus the "equivalent lengths" of all valves and fittings. These equivalent lengths can be found in most plumbing handbooks; or accounted for by multiplying the linear pipe

length by an appropriate factor (usually between 1.2 and 2, depending on the complexity of the plumbing circuit). Manufacturers should supply the pressure drops associated with the heat exchanger, solar collectors (or collector array), and other components at the respective loop flow rates. The pressure drops listed for these components will most likely assume water as the working fluid. The designer should be slightly conservative to account for the difference between pure water and the propylene glycol solution in these components. The correct values for the system piping should be available, since Table 4-1 provides corrections for pressure losses with propylene glycol solutions.

4.4.1.6.3 Pump Sizing and Specification. Pump performance is usually plotted as pressure rise versus flow rate. The pressure drop in the loop at a given flow rate is represented by a point on this plot (or a line if the pressure drops for a variety of flow rates are known). Figure 4-10 shows an example of these curves. If this operating point is inside, or to the left of a given pump curve, that pump can be used. In Figure 4-10, pump "B" can be used. It should be noted that the pump could only operate at points along its curve. For this reason, the designer should try to find a pump curve lying as near the recommended system operating point as possible (unless this point lies on the pump curve, the pump will be slightly oversized). After the selected pump is installed and the system is started, the flow at the pump outlet must be throttled slightly to increase the pressure drop (or resistance) of the loop (refer to the system performance curve "D"). This procedure is normally done using a ball valve at the pump outlet (cavitation is possible if the throttling is done on the suction side). Many pump manufacturers supply pumps with built-in throttling valves (refer to Figure 4-10).

4-4.2 Transport Sub-System Checklist

4-4.2.1 Schematic. Based on the topics discussed thus far, the complete closed-loop system schematic can be completed. Except for the collector array and piping layout, the system schematic is not specific to any given building. For this reason, the system schematic need not be to scale and thermal expansion loops need not be shown. Information should be provided on the drawings wherever possible to ensure that construction is completed according to design. A design checklist is provided in APPENDIX D and a drawings checklist is provided in APPENDIX E, for additional guidance.

4-4.2.2 Construction Details. This section provides information on various system details that commonly cause problems. These details are not necessarily solar-specific issues, but are important to ensure a quality solar energy system.

Figure 4-10. Typical Pump and System Operation Curves

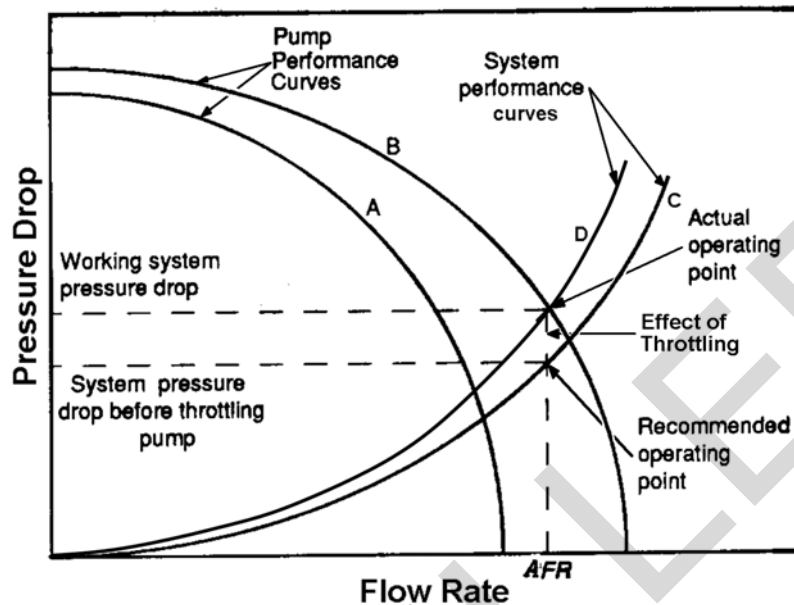

4.4.2.2.1 **Component Connections.** Major system components, such as the collector banks, storage tank, heat exchanger, and circulation pumps, should be able to be valved off and removed for cleaning, repair, or replacement. Installing valves on both sides of the component usually provides this feature.

4.4.2.2.2 **Roof Penetrations.** Roof penetrations for the array supply and return piping and sensor wiring conduit should be designed carefully to prevent leaking and to account for movement due to thermal expansion. Standard penetration schemes (such as those used for plumbing system vents) can fail because of the increased temperature extremes to which solar system piping is subjected.

4-5 **CONTROL SUB-SYSTEM.** There are four areas concerning the control sub-system that needs to be addressed during the final design stage. These include specification of a control unit, location of control sensors, the location of local monitoring equipment, and measurement of thermal energy delivered by the system.

4-5.1 **Differential Temperature Control Unit (DTC).** The proper specification of the differential temperature control unit is important to ensure reliable system performance. Because the cost of a simple solar system controller is small relative to the total system cost, a high quality, commercially available unit is recommended. The controller should include solid-state design with an integral transformer. The designer should also ensure that the switching relay or other solid state output device is capable of handling the starting current imposed by the system pump(s). The control unit should allow the on and off set-points to be variable, and should allow the instantaneous temperatures of the collector and storage tank to be displayed by the system operator or maintenance personnel. Faulty sensors are a common cause of system failure, so it is desirable to choose a control unit that will diagnose and flag open

or short circuits. Since a non-functioning solar system can go undetected by maintenance personnel due to the presence of the backup heating system, some means for determining if the system is not operating or has not functioned for a given amount of time is helpful. The most commonly used method provides a visual indication at the control panel when the pump(s) are energized, although this indication is only instantaneous and does not provide any history. Some controllers indicate the elapsed time that the controller has signaled the pumps to switch on, but this is not necessarily an indication of whether the pumps have in fact been operational. The elapsed time indicator required on the pump showing cumulative running time of the system provides a check of system operation, if maintenance personnel choose to inspect and record it.

4-5.2 Temperature Sensors and Locations. There are two temperature sensors that the DTC relies upon to determine when to activate the collector loop pump and storage loop pump. It is important that these sensors be reliable and accurate, as they can have a significant impact on system performance. Platinum resistance temperature detectors (RTD's) are most commonly used and are recommended, although 10 K-ohm thermistors are also sometimes used for this application.

4-5.2.1 Collector Temperature Sensor. One sensor is required on the collector array to determine when sufficient energy is available for collection. This sensor is typically located in the fluid stream or is fastened directly to the absorber plate. When specifying a location in the fluid stream, the sensor should be located on a nearby collector bank and in the top internal manifold piping between two collectors. This location allows the sensor to be heated by the heat transfer fluid by natural convection. To minimize the length of sensor wiring, mount the sensor between two collectors on the bank closest to the roof penetration whenever possible. Most sensor manufacturers provide threaded wells to allow insertion of sensors into pipe flows. These wells should not consist of ferrous materials due to material compatibility with the propylene glycol heat transfer fluid. The sensor assembly should also be covered with a weatherproof junction box to shield connections from moisture while allowing room for the insulation around the manifold. The collector temperature sensor may be attached to the absorber plate of a collector only if the collector manufacturer provides this service at the factory. Sensors located in wells are easy to replace but may leak, whereas those located on the absorber plate are usually quite difficult to repair.

4-5.2.2 Storage Tank Sensor. The storage tank temperature sensor is intended to measure the temperature of the coolest part of the storage tank. This is the fluid that will be delivered to the heat exchanger. Ideally, this sensor should be located within a well protruding into the storage tank near the outlet to the heat exchanger. If desired, auxiliary sensors may be added in the top half of the tank to check for stratification and in the bottom of the tank to provide backup.

4-5.2.3 Sensor Wiring. Wiring from the controller to the collector and storage sensors should be located within metal conduit. It is recommended that spare conductors be provided in the conduit for future maintenance or expansion needs. Color-coding should be consistent from the controller to the sensor, and junctions or

pull boxes should not be located in concealed areas.

4-5.3 Monitoring Equipment. Monitoring devices are provided at various points in the system to enable inspection and maintenance personnel to visually check system operation.

4-5.3.1 Pressure Indicators. Pressure gauges should be installed on the supply and discharge sides of both pumps, on all inlets and outlets of the heat exchanger, and on the storage tank. Duplex gauges can be used or single pressure gauges can be connected to supply and discharge pipe with small plug valves installed in the gage lines. This arrangement allows the pressure to be monitored on either side of the pump by closing the opposite valve. A decrease in the pressure rise across the pump indicates a potential problem with the pump, whereas an increase may mean flow restrictions are developing in the loop. Monitoring the pressure drop across the heat exchanger can also alert system operators to heat exchanger fouling. Pressure gauges should be rated for 125 psi (862 kPa) and 210 degrees F (99 degrees C) operation.

4-5.3.2 Temperature Indicators. Thermometers should be provided at the heat exchanger inlets and outlets (hot and cold sides) and at the top and bottom of the solar storage tank. These can be used to monitor both heat exchanger performance and the fluid temperature being supplied by the collector array. Although some differential temperature control units are capable of monitoring all of these temperatures remotely, it is recommended that local fluid-in-glass or bi-metal thermometers be retained in the system as a backup.

4-5.3.3 Flow Indicators. Show and specify a flow indicator in the collector loop, and in the storage loop, after the pump(s) to verify that flow exists. Venturi-type flow meters are recommended when quantified flow measurement is deemed necessary, whereas rotary or impeller-type flow indicators suffice to visually confirm flow in the collector loop. Since the flow indicator is wetted by the propylene glycol solution, components within it should be brass, bronze, or other compatible non-ferrous material. Flow devices should be installed at least five pipe diameters downstream of any other fittings.

4-5.3.4 Elapsed Time Monitor. An elapsed time monitor is required to record the operating time of each circulation pump. This time recorder is used to alert maintenance personnel to problems with pump operation.

4-5.3.5 Btu Meter. An optional Btu meter may be specified for cases when the solar energy system performance is monitored. Btu meters are not required for control of the system. Therefore, if it is not essential to monitor performance, the cost of a Btu meter is not justified. When used, this device is installed in the storage loop to measure the total thermal energy that is delivered to the storage tank. It consists of a flow meter, temperature sensors for the heat exchanger inlet and outlet, and electronics to calculate the amount of energy (in Btu) delivered from the measured temperature change and flow. These units are available commercially and should be installed according to the manufacturer's recommendation.

4-6 SAFETY FEATURES

4-6.1 **Fall Protection.** Design equipment so that fall hazards are minimized during maintenance, repair, and inspection or cleaning. Consider future degradation of installed fall prevention components in maintenance and inspection activities. Design should minimize work at heights. Include in a design prevention systems such as guardrails, catwalks, and platforms. Provide anchorage points compatible with the job tasks and work environment. Design horizontal cable, vertical rail, cage or I-beam trolley systems in areas where employees require continuous mobility and where platforms, handrails, or guardrails are not feasible. Ensure proper test methods are used to ensure systems are capable of fall prevention functions. References applicable to fall protection include OSHA 29 CFR 1910 (Subpart F), ANSI Z359.1, and NFPA 101.

4-6.2 **Equipment Lockout and Disconnect.** Specify or design energy isolation devices capable of being lockedout. Layout machinery and equipment to ensure safe access to lockout devices and provide each machine/equipment with independent disconnects. Specify lockout devices that will hold the energy isolating devices in a "safe" or "off" position. Ensure equipment and utilities have lockout capability and that any replacement, major repair, renovation, or modification of equipment will still accept lockout devices. Design emergency and non-emergency shutoff controls for easy access and usability. Integrate actuation controls with warning lights and alarms to prevent personnel exposure to hazards. References applicable to equipment lockout and disconnect include OSHA 29 CFR 1910.147, ANSI Z244.1, and NFPA 70.

4-7 **CASE STUDY.** For additional reference material, refer to APPENDIX G to view a case study of a solar hot water heating installation at Fort Huachuca, Arizona.

APPENDIX A
REFERENCES

GOVERNMENT PUBLICATIONS:

1. Department of the Army

Army Technical Manuals (TM)

TM 5-802-1, Economic Studies for Military Construction Design Applications

TM 5-804-2, Domestic and Service Water Active Solar Energy Preheat Systems (superceded by this UFC 3-440-01)

2. United States Federal Government

Code of Federal Regulations (CFR)

10 CFR 436A, Federal Energy Management and Planning Programs

10 CFR 1910.147, The Control of Hazardous energy (lockout/tagout)

10 CFR 1910 (Subpart F) Powered Platforms, Manlifts, and Vehicle-Mounted Work Platforms

NON-GOVERNMENT PUBLICATIONS:

1. American National Standards Institute (ANSI)

ANSI Z244.1, Safety Requirement for Lock Out/Tag Out of Energy Sources

ANSI Z359.1, Safety Requirements for Personal Fall Arrest Systems, Subsystems and Components

2. American Society of Heating, Refrigerating, and Air-Conditioning Engineers, Inc. (ASHRAE)

ASHRAE 93, Methods of Testing to Determine the Thermal Performance of Solar Collectors

Active Solar Heating Systems Design Manual

NON-GOVERNMENT PUBLICATIONS (continued):

3. National Fire Protection Agency
(NFPA)

NFPA 70, National Electric Code

NFPA 101, Life Safety Code

CANCELLED

APPENDIX B
HOT WATER LOAD ESTIMATIONS

B-1. The feasibility analysis requires that the designer estimate the thermal energy loads for a facility on a daily or monthly basis. Although the economic feasibility of the solar project is not usually dependent on the estimated hot water load, this value is important when determining the size of the system to be designed.

B-2. Since solar energy systems are not designed to supply the full hot water demand of a building, average values should be used for the hot water estimate. This is in contrast to sizing conventional water heating equipment, which typically is sized according to an expected maximum or design load. Table B-1 lists a variety of service hot water applications and the average amounts of water required on a per person basis. The value given for industrial buildings is that required for personal use by the workers. It does not include possible process water heating applications that may exist. Other applications not listed in Table B-1 should be evaluated by considering existing buildings with similar applications.

Table B-1. Estimated Average Hot Water Loads for Various Facilities

Type of Building	Gallons per day (Liters per day)	Unit
Office buildings and similar facilities	1.0 (3.8)	per person
Barracks w/ dining facilities	20.3 (76.8)	per person
Barracks w/o dining facilities	13.1 (49.6)	per person
Hospitals	18.4 (69.7)	per bed
Hotels	14.0 (53)	per unit
Industrial buildings	2.5 (9.5)	per worker
Quarters and apartments	40.0 (151.4)	per apartment

APPENDIX C WATER QUALITY ANALYSIS

C-1. The following analysis must be performed to determine if the quality of the potable water is sufficient to allow the use of a direct circulation solar energy system.

a. Obtain a standard water chemistry report for the water to be used in the system. In most cases, this report can be obtained from local water treatment centers or most any local laboratory (a similar report is often required for determining appropriate boiler feedwater treatment). Results of this report must include, as a minimum:

- (1) Total dissolved solids (TDS) [mg/l]
- (2) Calcium hardness [mg/l]
- (3) M alkalinity [mg/l]
- (4) pH

b. Calculate the pH of saturation (pH_s) of calcium carbonate (CaCO_3) for the water using Equation C-1:

$$\text{pH}_s = 9.3 + A + B - (C+D) \quad (\text{eq. C-1})$$

where, from Table C-1:

A = value for range of TDS.

B = value for application temperature range.
(normal system operating temperature).

C = factor for calcium hardness.

D = factor for M alkalinity.

c. From the results of the water chemistry report and Equation C-1, calculate the Ryznar Index (RI) using Equation C-2:

$$\text{RI} = 2(\text{pH}_s) - \text{pH} \quad (\text{eq. C-2})$$

C-2. Using Table C-2 and the calculated RI from above, determine the tendency of the water in question for scaling and/or corrosion. For direct use of the water in a solar system, the RI must be between 5 and 7. For water with a calculated RI outside of this range, the designer may either choose another system type or require water treatment resulting in an RI within the acceptable range.

Table C-1. Data for Calculating pH of Saturation (pH_s) Calcium Carbonate

Total Solids (mg/l)	A	Temperature Range F (C)	B	Calcium Hardness (mg/l of CaCO ₃)	C	M alkalinity (mg/l of CaCO ₃)	D
50 - 300	0.1	32 - 34 (0 - 1)	2.6	10 - 11	0.6	10 - 11	1.6
400 - 1000	0.2	36 - 42 (2 - 6)	2.5	12 - 13	0.7	12 - 13	1.0
		44 - 48 (7 - 9)	2.4	14 - 17	0.8	14 - 17	1.2
		50 - 56 (10 - 13)	2.3	18 - 22	0.9	18 - 22	1.3
		58 - 62 (14 - 17)	2.2	23 - 27	1.0	23 - 27	1.4
		64 - 70 (18 - 21)	2.1	28 - 34	1.1	28 - 35	1.5
		72 - 80 (22 - 27)	2.0	35 - 43	1.2	36 - 44	1.6
		82 - 88 (28 - 31)	1.9	44 - 55	1.3	45 - 55	1.7
		90 - 98 (32 - 37)	1.8	56 - 69	1.4	56 - 69	1.8
		100 - 110 (38 - 43)	1.7	70 - 87	1.5	70 - 88	1.9
		112 - 122 (44 - 50)	1.6	88 - 110	1.6	89 - 110	2.0
		124 - 132 (51 - 56)	1.5	111 - 138	1.7	111 - 139	2.1
		134 - 146 (57 - 63)	1.4	139 - 174	1.8	140 - 176	2.2
		148 - 160 (64 - 71)	1.3	175 - 220	1.9	177 - 220	2.3
		162 - 178 (72 - 81)	1.2	230 - 270	2.0	230 - 270	2.4
				350 - 430	2.2	360 - 440	2.6
				440 - 550	2.3	450 - 550	2.7
				560 - 690	2.4	560 - 690	2.8
				700 - 870	2.5	700 - 880	2.9
				800 - 1000	2.6	890 - 1000	3.0

Table C-2. Prediction of Water Tendencies by the Ryznar Index

Ryznar Index	Tendency of Water
4.0 - 5.0	Heavy scale
5.0 - 6.0	Light scale
6.0 - 7.0	Little scale or corrosion
7.0 - 7.5	Significant corrosion
7.5 - 9.0	Heavy corrosion
9.0 and higher	Intolerable corrosion

APPENDIX D

EXAMPLE DESIGN CHECKLIST

D-1. **FEASIBILITY STUDY.** This design checklist provides the solar system designer, project manager, and quality assurance personnel with a guide to evaluate the feasibility of solar system designs.

a. **General Information**

- (1) Site location.
- (2) Estimated daily load.
- (3) Back-up fuel type.
- (4) Fuel Costs for Project Location (i.e., electricity, natural gas, etc.).

b. **Feasibility Study Results**

- (1) Is the life cycle cost savings positive for any of the systems? If "yes", proceed with the design. If "no", stop here.
- (2) Which service water heating system has the highest LCC savings?
- (3) Discounted payback.
- (4) Calculated array area for above system. If array area is larger than 3000 square feet, two or more separate systems should be considered.
- (5) Geographic latitude of project location.

D-2. **SYSTEM SELECTION, PLANNING, AND COORDINATION**

a. **System Selection: Closed-loop or direct circulation**

- (1) Is load size greater than 120 gals (454 L) per day?
- (2) Does the project location experience freezing temperatures?
- (3) Are there more than 4000 heating degree days at the project location?
- (4) Will system be closed-loop or direct circulation?
 - (a) If closed-loop, will system use 30 percent or 50 percent propylene-glycol?
 - (b) If direct circulation, what is the Ryznar Index (RI) of the water to be used in the system?

(c) Is the RI between 5.0 and 7.0?

(d) If "no" to (c) above, will necessary water treatment be provided?

b. Coordination

(1) Architectural.

(a) Unobstructed roof area and access to roof must be available for the solar system.

(b) Building should be located with adequate solar access and free from shading by other buildings or landscaping.

(c) Mechanical equipment room, pipe chases, roof access will be required.

(2) Structural.

(a) Roof design will need to support solar system loads.

(b) Aluminum array support structure will be required.

c. System Planning - Array Layout and Estimated Roof Area Requirement

(1) Minimum number of collectors. Assuming a nominal 4 by 10 ft (1219 by 3048 mm) collector (40 ft^2 (3.7 m^2)), determine the minimum number of collectors required by dividing the calculated array size by 40 (3.7) and round to nearest whole number.

(2) Maximum number of collectors. Assuming a nominal 4 by 8 ft (1219 by 2438 mm) collector (32 ft^2 (3.0 m^2)), determine the maximum number of collectors required by dividing the calculated array size by 32 (3) and round to nearest whole number.

(3) Bank size (B). Based on the range of values from above, determine the size of the collector banks. All banks must have the same number of collectors (between 4 and 7), and must be capable of being arranged symmetrically on the roof to allow for reverse-return piping. The area of the collector unit (A_c , minimum of 28 ft^2 (2.6 m^2)) and the collector dimensions (height and width) should now be determined.

(4) Minimum row spacing (optional). The collector unit height and site latitude can be used to establish the minimum spacing necessary between multiple collector rows to prevent shading. Figure 3-5 can be used for this purpose. If the collector banks are to be laid out in a single row, this step may be avoided.

(5) Array layouts and estimated roof area options. Having been informed of the need for a solar system, the architect should have information available regarding

possible building orientations and roof area availability. Within the possible orientation constraints, the designer should develop an acceptable preliminary array layout (or a variety of layouts) which satisfy the following criteria:

- (a) Array is facing within 20 degrees of true south.
 - (b) All banks contain same number of collectors.
 - (c) Minimum row spacing criteria satisfied or collector rows are to be elevated.
 - (d) Layout(s) satisfy geometrical symmetry.
 - (e) No interference from other rooftop apparatus (chillers, vents, etc.).
- (6) Final array layout determined and accepted by architect or project manager.
- (7) Total collector area (Area). Determine the final system size (total collector area) by multiplying the number of collectors in the final array layout by the collector unit area. This value will be used in the detailed design of the system.

d. **System Planning - Equipment Room Size.** The equipment room should be designed to include the equipment for both the solar system and the backup water heating system, if possible. The following information should be taken into consideration:

- (1) Storage tank size can be as large as 2 gals per square feet (81.5 L per square meter) of collector area. This will be the largest piece of equipment in the room. The storage tank can be located outside only if an inside location is not practical.
- (2) Heat exchanger size will be small in comparison with other equipment, but will require a small amount of floor area. Indicate access area allowance for heat exchanger tube pull-out or plate-stack disassembly.
- (3) Expansion tank volume will be roughly between 1.5 and 2 gals (5.7 and 7.6 L) per collector unit.
- (4) Pumps, connecting piping, control panel. Indicate access area allowance for the propylene glycol drum(s) (55 gal) for the fill and drainage of the collector loop.
- (5) Access to all equipment by maintenance personnel.

D-3. SYSTEM DESIGN

a. **Collector Subsystem.** The designer must choose a particular collector unit around which to design the system. The components of the solar system are sized

according to the parameters of the particular collector unit chosen. The following collector specifications and parameters are needed to complete the design. The specifications are minimum requirements for any collector under consideration and are listed for the designer's information; the parameters are variables that may vary between manufacturers and models. The collector parameters used for the system design should be included on the drawings.

- (1) Flat-plate collector requirements.
 - (a) Maximum temperature (350 degrees F (177 degrees C) or greater).
 - (b) Maximum pressure (125 psi (862 kPa) or greater).
 - (c) Collector performance, y-intercept (0.68 or greater), slope (between 0 and -1.0 Btu per hour per square foot per degree F.).
 - (d) Copper absorber plate and flow passages.
 - (e) Black chrome, low emittance absorber surface.
 - (f) Internal manifold.
 - (g) Single sheet, low iron, tempered glass cover.
 - (h) Back and side insulation of fibrous glass, polyisocyanurate or polyurethane.
- (2) Flat-plate collector design parameters.
 - (a) Collector unit area (A_c).
 - (b) Collector unit dimensions.
 - (c) Design collector flow rate (CFR).
 - (d) Pressure drop at design flow rate.
 - (e) Collector internal manifold diameter (d).
 - (f) Collector volume.
- (3) Array layout.
 - (a) Array orientation (due south when possible; within 20 degrees of true south allowed).
 - (b) Array tilt angle (collectors should be tilted from the horizontal to within 10 degrees of the site latitude).

- (c) Total number of collectors (N).
- (d) Number of collector banks.
- (e) Number of collectors per bank ($4 < B < 7$).

(4) Array piping. It is critical to system performance that the piping layout satisfies the reverse-return criteria of equal lengths for any possible flow path. This list presents the steps necessary for proper sizing of the array piping based on the geometric layout. It is necessary for the designer to know the design flow rates in all branches of the array - calculation of branches should begin from the bank manifold diameter (collector internal manifold diameter) and work outward to the array supply and return manifold diameters.

- (a) System flow rate ($AFR = CFR \times N$).
- (b) Bank flow rate ($BFR = CFR \times B$).
- (c) Row flow rates (if applicable).
- (d) Pipe sizing criteria to be satisfied.

NOTE: The ratio of manifold pressure drop to riser pressure drop for any branch must be less than 0.3 (around 0.1 is preferred); and the fluid velocities must be below 5 ft/s (1.5 m/s) (Refer to Figure D-1).

- (e) Collector internal (bank) manifold diameter.
- (f) Row manifold diameter(s) (if applicable).
- (g) Array supply and return manifold diameter (@AFR).

b. Storage Sub-System

- (1) Storage tank volume.
 - (a) Minimum storage tank volume = 1.5 gal per square foot (61.1 L per square meter) of total collector area.
 - (b) Maximum storage tank volume = 2.0 gal per square foot (81.5 L per square meter) of total collector area.
 - (c) Standard sized storage tank volume within above constraints.
- (2) Storage subsystem flow rate.
 - (a) Storage subsystem flow rate = $1.25 \times (AFR)$.

Figure D-1. Manifold Sizing Worksheet

Manifold Sizing Worksheet

- Riser pressure drop: $\Delta P_R = \underline{\hspace{2cm}}$ psi (Pa)
- Manifold flow rate = $\underline{\hspace{2cm}}$ gpm (L/s)
- Fluid: $\underline{\hspace{2cm}}$

Riser flow rates = (1/ $\underline{\hspace{1cm}}$) manifold flow rate = $\underline{\hspace{2cm}}$

$\Delta P = \Delta P_1 + \Delta P_2 + \Delta P_3$

Note: Bank pressure drop = single collector unit pressure drop

From pressure drop tables: $\Delta P_1 = f$ (Flow rate in section 1, Manifold diameter)
 $\Delta P_2 = f$ (Flow rate in section 2, Manifold diameter)
 $\Delta P_3 = f$ (Flow rate in section 3, Manifold diameter)

Guess A: $\underline{\hspace{1cm}}$ Guess B: $\underline{\hspace{1cm}}$ Guess C: $\underline{\hspace{1cm}}$

Manifold Position	Flow Rate	Guess A:		Guess B:		Guess C:	
		ΔP	Velocity <5 fps (1.5 m/s)?	ΔP	Velocity <5 fps (1.5 m/s)?	ΔP	Velocity <5 fps (1.5 m/s)?
after riser 1	$\underline{\hspace{1cm}}$	$\underline{\hspace{1cm}}$	$\underline{\hspace{1cm}}$	$\underline{\hspace{1cm}}$	$\underline{\hspace{1cm}}$	$\underline{\hspace{1cm}}$	$\underline{\hspace{1cm}}$
after riser 2	$\underline{\hspace{1cm}}$	$\underline{\hspace{1cm}}$	$\underline{\hspace{1cm}}$	$\underline{\hspace{1cm}}$	$\underline{\hspace{1cm}}$	$\underline{\hspace{1cm}}$	$\underline{\hspace{1cm}}$
after riser 3	$\underline{\hspace{1cm}}$	$\underline{\hspace{1cm}}$	$\underline{\hspace{1cm}}$	$\underline{\hspace{1cm}}$	$\underline{\hspace{1cm}}$	$\underline{\hspace{1cm}}$	$\underline{\hspace{1cm}}$
⋮	⋮	⋮	⋮	⋮	⋮	⋮	⋮

Total manifold pressure drop: $\Delta P_A = \underline{\hspace{2cm}}$ $\Delta P_B = \underline{\hspace{2cm}}$ $\Delta P_C = \underline{\hspace{2cm}}$

Ratio (must be less than 0.3): $\frac{\Delta P_A}{\Delta P_R} = \underline{\hspace{2cm}}$ $\frac{\Delta P_B}{\Delta P_R} = \underline{\hspace{2cm}}$ $\frac{\Delta P_C}{\Delta P_R} = \underline{\hspace{2cm}}$

c. Transport Subsystem

(1) Heat transfer fluid. Propylene-glycol concentration (30 percent, 50 percent, or 0 percent).

(2) Heat exchanger (closed-loop system only). Single-isolation plate-type or shell-in-tube heat exchanger? (plate heat exchangers are preferred).

(3) Pipe sizes and design pressure drop.

(a) Pipe size to and from collector array. Upper limit is size of array supply/return manifold; the lower limit is imposed by the 5 ft/s (1.5 m/s) velocity restriction. To reduce life-cycle costs (pump power versus pipe cost), it is often possible to size the piping to the array manifolds to be one size less than the manifold. The designer must insure that fluid velocities with this reduced size are acceptable.

(b) Collector loop design pressure drop. The pressure drop around the collector loop at the design flow rate (AFR) must be calculated and will be used to determine pump capacity. The designer should note if the collector loop fluid is propylene glycol and appropriate pressure drop allowances (x 1.2 for 30 percent or x 1.4 for 50 percent) will be made.

(c) Storage loop design pressure drop. The pressure drop around the storage loop at the design flow rate (AFRx1.25) must be calculated and will be used to determine pump capacity.

(4) Expansion tank (closed-loop system only).

(a) Expansion tank acceptance volume. Calculate the total fluid volume in collectors plus the volume of all piping located at the same level as or above the bottom of the collectors.

(b) System fill pressure at the expansion tank. Determine the proper system fill pressure by evaluating the system elevation head. This fill pressure should allow for 10 to 15 psi (69 to 103 kPa) at the top of the collector loop.

(c) Expansion tank precharge pressure. The precharge pressure should equal the fill pressure at the expansion tank location minus 5 to 10 psi (35 to 69 kPa) to provide an initial fluid volume in the tank.

(5) Circulation pump(s).

(a) Collector pump minimum capacity. The circulation pump provides the system flow rate determined above and should be sized according to standard plumbing practice.

(b) Storage pump minimum capacity. The circulation pump provides the storage flow rate determined above and should be sized according to standard

plumbing practice.

d. Control Subsystem

(1) Monitoring equipment.

(a) Visual or quantified flow measurement. Provide for visual flow measurement only unless quantified measurements are required for data collection purposes.

(b) Provide BTU-meter. BTU meters should only be shown when quantified measurements are required for data collection purposes.

CANCELLED

APPENDIX E

EXAMPLE DRAWINGS CHECKLIST

E-1. **PURPOSE.** The drawings checklist provides the solar system designer, project manager, and quality assurance personnel with a list of those items that are called out by the guide specification to appear on the drawings, or are strongly suggested based on previous experience with solar system design problems. The designer is encouraged to annotate the drawings in any way seen fit to ensure that design changes are properly accounted for, to provide a record of system settings and performance criteria, and to ensure that important details not be overlooked during construction. An example of the latter would be noting that the reverse-return piping be constructed as shown for flow balancing purposes. Under this arrangement, some of the piping may look unnecessary. In the past, such piping has been altered or eliminated by the contractor, resulting in a system that could not be balanced. After a few years, the designer's drawings are often the only existing record of the intended system design and performance expectations. The following items should be included as part of the system drawings.

E-2. SUGGESTED DRAWINGS

a. **System Schematic (No Scale).** The system schematic should closely resemble the schematic in Figure 3-1 or Figure 3-2. The main job-specific item to develop is the collector array layout. The collector array layout will be in accordance with the guidance defined in Chapter 4 and as a minimum define the proper layout, number of collectors, bank sizes, rows (if applicable), and required fittings. The job specific system schematic will include the following:

- (1) Note the collector parameters around which the system was designed:
 - (a) Collector net aperture area.
 - (b) Collector fluid volume.
 - (c) Collector gross dimensions (length, width, and thickness).
 - (d) Collector design flow rate (CFR, recommended by manufacturer).
 - (e) Pressure drop at design flow rate.
 - (f) Internal manifold diameter.
- (2) Note the following system parameters:
 - (a) System calculated net aperture area.
 - (b) System (collector loop) flow rate required ($AFR = CFR \times \text{Number of collectors}$).

- (c) Storage loop flow rate = $1.25 \times \text{AFR}$.
 - (d) Propylene glycol concentration required in collector loop.
 - (e) Minimum pressure drop throughout piping loop, corrected for propylene glycol solution, if necessary.
- (3) Note the following information about the heat transfer fluid:
- (a) Only food-grade propylene glycol/distilled water solutions will be allowed as the heat transfer fluid.
 - (b) Percent concentration required (30 percent or 50 percent).
 - (c) Tamper-resistant seals are required at all fill ports or drains.
- (4) Note the heat exchanger minimum performance requirements:
- (a) Solar loop (hot) inlet = 140 degrees F (60 degrees C).
 - (b) Storage loop (cold) inlet = 100 degrees F (38 degrees C).
 - (c) Solar loop (hot) outlet = 120 degrees F (49 degrees C), or less.
 - (d) Solar loop (hot) flow rate = AFR.
 - (e) Storage loop (cold) flow rate = $1.25 \times \text{AFR}$.
 - (f) Solar (hot) fluid: 30 percent or 50 percent propylene glycol/water solution.
 - (g) Storage (cold) fluid: water.
- (5) Note required pipe diameters.
- (6) Locate expansion tanks near pump inlets.
- (7) Require expansion tank bladders to be compatible with propylene glycol/water solutions.
- (8) Require a check valve in the collector loop in order to prevent reverse thermosiphoning.
- (9) Require isolation valves around collector banks and all major components.
- (10) Require pressure relief shown on all banks.
- (11) Require calibrated balancing valves at all bank outlets.

(12) Require drain valves at low points of each collector bank or row.

(13) Require thumb valves (if required) to manually open and close pressure gauges and flow indicators not meant for constant use.

(14) Require two drain valves, with gate in between, at all low points in the system to allow for filling.

(15) Require 125 psi/210 degrees F (862 kPa/99 degrees C), pressure/temperature relief valve on the storage tank.

(16) Require manual air vents at all high points of the system plumbing.

(17) Locate collector temperature sensor on a nearby collector bank and in the top internal manifold piping between two collectors; or on the collector absorber plate, only if installed by manufacturer.

(18) Locate a storage sensor in the thermal well at the bottom of the storage tank.

(19) Require sensor wiring be installed in a conduit.

(20) Require pressure gauges, rated for 125 psi (862 kPa), on both sides of pump(s), on all ports of the heat exchanger, and on the storage tank.

(21) Require thermometers on all ports of the heat exchanger and at the top and bottom of the storage tank.

(22) Require flow indicators or meters in each loop to allow either visual or quantified flow measurements to be observed.

(23) Require a elapsed time meter be installed on circulation pump(s).

(24) Require Btu meter be located across the heat exchanger on the storage side (if needed).

b. Roof Plan (To Scale)

(1) Collector groupings in banks and rows as designed.

(2) Minimum row spacing shown and noted.

(3) Orientation with respect to due south shown and noted.

(4) Rooftop mounted equipment, vents, and system penetrations shown and noted.

(5) Reverse-return piping shown and noted.

- (6) Expansion loops (if required) shown and noted.
- (7) Manual air vents, pressure relief, valves and drains shown.
- (8) Pipe diameters noted for array supply, supply and return manifolds, and all branch manifolds.
- (9) Walkway, catwalk, or other array access shown and noted.

c. System Elevation

- (1) Pipe pitches for positive draining shown and noted.
- (2) Piping elevations from equipment room to system and throughout array shown and system elevation head noted.
- (3) Required collector tilt angle shown and noted.
- (4) Mechanical chase shown between equipment room and roof.
- (5) Array support structure shown.
- (6) Walkway, catwalk, or other array access shown and noted.

d. Equipment Room Layout

- (1) Storage tank, pump(s), piping, control panel, heat exchanger, expansion tank, and drain shown.
- (2) Backup water heating unit shown.
- (3) Access is available to all equipment by maintenance personnel for repair, replacement, or monitoring.

e. Schedules and Instructions

- (1) Schedule of operation. The operating characteristics (including the on/off temperature differential) of the system should be indicated.
- (2) Installation instructions. Instructions should be provided regarding important installation details. These details include the use of Sb5, Sn94, Sn95, or Sn96 solder for copper piping and on-site insulating instructions for equipment and piping.
- (3) Design information schedule. Include the system design parameters into a drawing schedule(s).
- (4) System filling and start-up instructions. Instructions on mixing the propylene glycol solution and filling the system will be provided. System fill pressure

will be stated.

- (5) Equipment schedule (standard).

f. Details

- (1) Storage tank.

- (a) Minimum of two tank penetrations each shown at both top and bottom of tank shown and noted.

- (b) Minimum insulation value of R-30 (factory or on-site application) shown and noted.

- (c) Storage sensor located in thermal well at bottom of storage tank shown and noted.

- (d) Show and note that incoming water supply and outlet to solar system are connected to bottom of storage tank; inlet from solar system and outlet to backup heating unit are connected to top of tank.

- (e) Dielectric couplings will be used on all piping connections.

- (f) Note that tank is to be lined with epoxy, glass or cement.

- (g) If outdoors, weather protection and added insulation should be shown and noted.

- (h) Storage tank weight when filled should be noted.

- (i) Proper foundation for storage tank should be shown and noted.

- (2) Heat exchanger (optional).

- (a) For shell-in-tube heat exchangers, indicate the access areas allotted for tube bundle removal (to allow cleaning). Indicate that materials in the heat exchanger must be compatible with propylene glycol.

- (3) Array support structure (typical).

- (a) Collector mounting to support detail at proper tilt (within 10 degrees of site latitude) shown.

- (b) Support mounting to roof detail shown.

- (c) Aluminum structure with stainless steel hardware noted.

- (d) Design loads noted.

(4) Collector temperature sensor mounting details. Detail showing mounting of the collector array temperature sensor should be provided. The sensor should show either mounting in the upper manifold piping between two collectors or should show mounting by the manufacturer directly to the absorber plate.

(5) Building piping penetrations. Design of piping penetration is weather tight and will withstand temperature expansion variations from 350 degrees F (177 degrees C) to the design low temperature of the project location.

(6) Pipe support. Pipe support design allows for temperature expansion variations from 350 degrees F (177 degrees C) to the design low temperature of the project location.

CANCELLED

APPENDIX F SOLAR ENERGY SYSTEM FUNDAMENTALS

F-1. **INTRODUCTION.** A solar thermal energy collection system (or "solar system" for short) is thus defined as a set of equipment that intercepts incident solar radiation and stores it as useful thermal energy to offset or eliminate the need for fossil fuel consumption. Four basic functions are performed by a typical solar system. For this manual, each function is defined within specific sub-systems of a typical solar energy system as illustrated in Figure F-1 and discussed below.

Figure F-1. Typical Solar Thermal Energy System

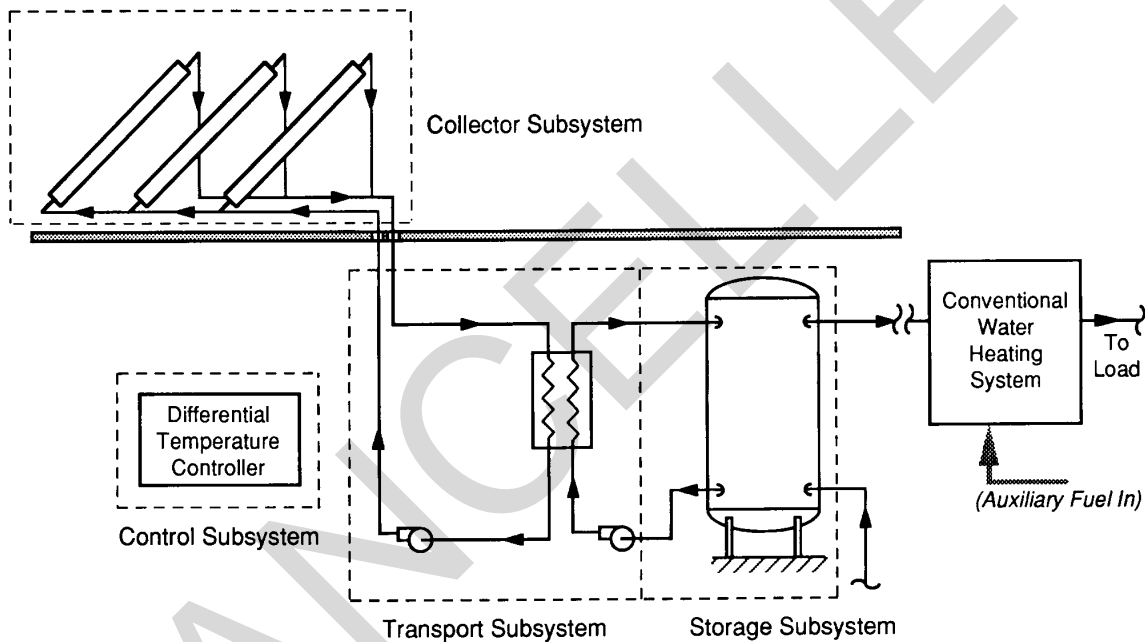

a. **Collector Sub-System.** The collector sub-system intercepts incident solar radiation and transfers it as thermal energy to a working fluid. It is defined as the solar collectors, the hardware necessary to support the solar collectors, and all interconnecting piping and fittings required exterior to the building housing the system.

b. **Storage Sub-System.** The storage sub-system retains collected thermal energy for later use by the process load. It is defined as a storage tank and its fittings, as well as necessary supports.

c. **Transport Sub-System.** The transport sub-system delivers energy from the collectors to storage. This sub-system is defined to include the heat transfer (or working) fluid, pump(s), the remaining system piping and fittings, an expansion tank, and a heat exchanger (if required).

d. **Control Sub-System.** The control sub-system must first determine when enough energy is available for collection. It must then activate the entire system to collect this energy until it is no longer available as a net energy gain. The control sub-system thus consists of electronic temperature sensors, a main controlling unit that analyzes the data available from the temperature sensors, and the particular control strategy used by the controller.

F-2. SOLAR ENERGY APPLICATIONS

a. **Types of Loads.** Due to the intermittent and varying amounts of solar radiation available, solar systems used to heat service water are usually not intended to meet the full thermal energy demands of the process being served. For any given thermal load, an integrated system should be designed which consists of both a solar energy collection system and a backup system that can meet the full load requirements. The solar system size and configuration will be a function of the annual or monthly energy loads. It is up to the designer to specify a system that will be expected to provide a given fraction of this load. This is in contrast to the design of a conventional heating, ventilation, and air-conditioning (HVAC) system, which is typically sized to meet an anticipated maximum or design load with no provision to be augmented by another source. For this reason, solar systems are often sized to meet the average expected load. Important characteristics of a load include the amount of energy required, the time of the demand (load schedule), and the temperature range required. Each of these factors is discussed below solar service water applications.

b. **Service Water Heating.** Heating domestic hot water and low-temperature process water (both referred to as service water heating) will normally be the most thermally efficient means of using solar energy. The reason is that the demand for thermal energy for these applications is approximately constant during the entire year, with the result that auxiliary fuel savings can be realized over the year. In the preheat configuration, solar heated water is useful at any temperature above that of the incoming water. An additional benefit is that, when preheating process hot water, thermal energy may be delivered at a relatively low temperature, which increases the efficiency of the solar collection process.

F-3. **BASIC MATERIAL CONSIDERATIONS IN SOLAR ENERGY SYSTEMS.** The designer should be alert to fundamental materials problems that can occur with solar energy systems, and careful attention must be given to the materials and fluids used. Large temperature fluctuations, severe ambient weather conditions, and the variety of possible fluids and metals that can come in contact with each other are often a cause of system failure. Some of the basic issues that must be addressed are discussed briefly below.

a. **Metallic Corrosion and Erosion.** Common causes of corrosion include the presence of dissimilar metals (galvanic corrosion), the presence of dissolved oxygen, or fluids with a chemical composition that adversely affects the wetted metal surface. Corrosion may be minimized in solar systems by avoiding dissimilar metals, decreasing the amount of available dissolved oxygen, and treating particularly corrosive fluids with

inhibitors (However, when using a non-toxic fluid, inhibitors should be avoided since they require considerable maintenance and often become mildly toxic upon degradation). Metallic erosion can occur in the system piping if excessive fluid velocities occur. For the copper piping required for solar systems designed under this guidance, a velocity limit of 5 feet per second is to be used. Maximum allowable fluid velocities are dependent upon the type of metal used. Correct pipe sizing and analysis of fluid flow paths should be used to avoid this problem.

b. **Scaling.** Scaling commonly refers to mineral deposits, such as calcium and magnesium compounds, that collect and adhere to pipe interiors and equipment. Scaling is promoted in systems by increased temperatures, high mineral concentrations and high (alkaline) pH levels. The result of scaling is flow restriction, high fluid velocities, and a decreased heat transfer rate. Scaling problems are most often associated with poor-quality water supplies and can be avoided by proper analysis and treatment of fluids to be used in the system.

c. **Thermal Expansion.** Differences between thermal rates of expansion for dissimilar materials often cause problems throughout a solar system. This manual addresses the thermal expansion issue for locations in the system where the most problems occur.

F-4. COLLECTOR SUB-SYSTEM

a. **Definition.** The collector sub-system includes the collectors and support structure, and all piping and fittings required to reach a common heat transfer fluid inlet and outlet. For roof-mounted structures, this sub-system includes all components above the roofline.

b. Solar Collectors

(1) **Operation.** A solar collector is a device that absorbs direct (and in some cases, diffuse) radiant energy from the sun and delivers that energy to a heat transfer fluid. While there are many different types of collectors, all have certain functional components in common. The absorber surface is designed to convert radiant energy from the sun to thermal energy. The fluid pathways allow the thermal energy from the absorber surface to be transferred efficiently to the heat transfer fluid. Some form of insulation is typically used to decrease thermal energy loss and allow as much of the energy to reach the working fluid as possible. Finally, the entire collector package must be designed to withstand ambient conditions ranging from sub-zero temperatures and high winds to stagnation temperatures as high as 350 degrees F (177 degrees C).

(2) **Collector Types.** The three major categories that have been used most often are flat-plate glazed collectors, unglazed collectors, and evacuated tube collectors. A general description of each collector type and its application is given below.

(a) **Flat-Plate.** Flat-plate solar collectors are the most common type used and are best suited for low temperature heating applications, such as service

water and space heating. These collectors usually consist of four basic components: casing, back insulation, absorber plate assembly, and a transparent cover. Figure 3-4 shows the typical components of a flat plate collector. The absorber panel is a flat surface that is coated with a material that readily absorbs solar radiation in the thermal spectrum. Some coatings, known as "selective surfaces", have the further advantage of radiating very little of the absorbed energy back to the environment. Channels located along the surface or within the absorber plate allow the working fluid to circulate. Energy absorbed by the panel is carried to the load or to storage by the fluid. The absorber panel is encased in a box frame equipped with insulation on the back and sides and one or two transparent covers (glazing) on the front side. The glazing allows solar radiation into the collector while reducing convective energy losses from the hot absorber plate to the environment. Similarly, back insulation is used to reduce conductive energy loss from the absorber plate through the back of the collector.

(b) Unglazed. Unglazed collectors are the least complex collector type and consist of an absorber plate through which water circulates. This plate has no glazing or back insulation. These collectors are often made of extruded plastic because they are designed to operate at relatively low temperatures. Since they are not thermally protected, these collectors should be operated only in warm environments where lower thermal losses will occur. Swimming pool heating is the most common use of unglazed collectors.

(c) Evacuated Tube. Evacuated tube collectors are best suited for higher temperature applications, such as those required by space cooling equipment or for higher temperature industrial process water heating. Convective losses to the environment are decreased in this type of collector by encapsulating the absorber and fluid path within a glass tube that is kept at a vacuum. Tracking mechanisms and/or parabolic solar concentrating devices (simple or compound) are often used, resulting in somewhat higher equipment costs.

(3) Collector Efficiency and Performance.

(a) Definitions. Collector efficiency is defined as the fraction of solar energy incident upon the face of the collector that is removed by the fluid circulating through the collector. Several parameters are defined as follows:

T_i = heat transfer fluid inlet temperature.

T_a = ambient air temperature.

I = solar irradiance on the collector

A_c = solar collector surface area.

F_R = collector heat removal factor, a dimensionless parameter describing the ratio of actual energy gained by the collector to that which would be gained, in the limit, as the absorber plate temperature approaches the fluid inlet temperature. This value is similar to a conventional heat exchanger's effectiveness.

- U_L = overall heat loss coefficient. This factor describes the cumulative heat transfer between the collector and the ambient surroundings.
- t = transmittance of the glazing.
- a = absorption coefficient for the absorber plate. Note that this value varies with wavelength. A selective surface is one that absorbs short wavelength solar radiation very well while emitting longer wavelength thermal radiation poorly.

(b) Efficiency Parameters. The efficiency of a given solar collector will vary greatly with ambient temperature, storage tank temperature, and the amount of solar insolation available. For this reason, each type of collector will perform best under different select conditions. Two parameters are required to describe the efficiency of a collector. The first is commonly referred to as F_{Rta} . This factor includes the product of the glazing transmittance and the absorption coefficient and is related to the optical efficiency of the collector. It takes into account reflection losses both through the cover glazing and those due to imperfect absorption by the absorber plate coating. For liquid collectors, the fluid flow rate and collector insulation have very little effect on this factor. The second factor is related to the thermal losses from the collector to the surrounding environment. The product of the collector heat removal factor and the overall heat loss coefficient, $F_R U_L$, is used to account for the thermal resistance characteristics of the collector. Usually, the fluid circulating through the collector is hotter than the ambient temperature around the collector. This condition means that solar radiation absorbed by the collector can follow two paths. One path is from the absorber plate to the circulation fluid. The second path is from the absorber plate to the surrounding environment. The absorbed solar radiation will be divided according to the temperature differences of each path and the relative thermal resistances. For a given process, these temperature differences normally cannot be controlled. Therefore, the thermal resistances of each path must be considered. The resistance from the absorber plate to the circulation fluid should be as small as possible (i.e., a good thermal bond should be made between the fluid circulation tube and the absorber plate). It then follows that the resistance between the absorber plate and the surrounding environment should be as large as possible.

(c) Collector Energy Balance. The collector parameters described above allow an energy balance to be expressed as:

Energy Collected = Solar Energy Absorbed - Thermal Energy Losses to the Environment

The energy balance can be written in a simple equation form using the efficiency parameters described above:

$$\text{Energy Collected} = (F_{Rta})(I)(A_c) - (F_R U_L)(A_c)(T_i - T_a) \quad (\text{eq. F-1})$$

Equation E-1 shows that heat losses to the environment are subtracted from the net solar radiation transmitted into, and absorbed by, the collector. Assuming that the efficiency parameters are fixed for a given collector model, the main factors that affect the amount of energy collected are I , T_i , and T_a . The geographical location and the season dictate the

weather variables I and T_a . The type of process load and system configuration determines the relative circulation fluid temperature, T_i .

(d) Collector Efficiency Plot. Equation F-1 can be rewritten as a dimensionless "efficiency" equation by dividing both sides by the product of I and A_c :

$$\text{Collector Efficiency} = F_R \tau \alpha - F_R U_L (T_i - T_a) / I \quad (\text{eq. F-2})$$

Note that this efficiency equation is dependent on only one variable that is a combination of I , T_i , and T_a . This allows it to be graphed in a straightforward manner. Figure F-2 is an example of a typical collector efficiency plot. Optical losses are shown as a constant decrease in collector performance, while thermal losses increase as $(T_i - T_a)/I$ increases. The values of $F_R \tau \alpha$ and $F_R U_L$ can be determined from this type of plot. $F_R \tau \alpha$ corresponds to the intercept value where the collector efficiency curve crosses the vertical graph axis. $F_R \tau \alpha$ is a dimensionless variable with a value between 0 and 1. $F_R U_L$ is calculated by dividing $F_R \tau \alpha$ by the intercept value on the horizontal axis (it is the negative slope of the plotted line). $F_R U_L$ has units of Btu per square foot per hour per degree F.

Figure F-2. Typical Collector Efficiency Curve

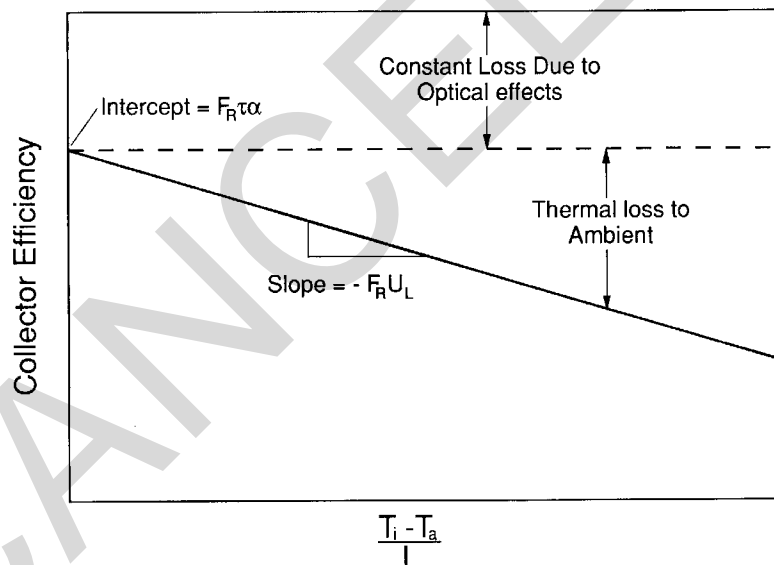

(e) Performance of Various Collector Types. Figure F-3 shows why collector efficiency is not always a good indicator of overall collector performance. On any given day, a solar collector can operate over a wide range of efficiencies as the solar radiation, ambient temperature, and heat transfer fluid temperature change. When insolation levels are low early in the day, the efficiency of the collector approaches zero. As solar radiation levels increase, the collection efficiency increases until it reaches some maximum level. It will then decrease as the solar insolation and ambient temperature decrease at the end of the day. Because of the variable position of the sun, collectors must be oriented so that they are exposed to an acceptable amount of solar radiation throughout the year. Proper collector orientation and tilt

values depend on the specific application and system type. Each collector type operates most efficiently in a certain region of the plot, which corresponds to different operating conditions or applications. For example, the unglazed collector works very well under conditions of high solar radiation levels and small temperature differences between the collector fluid and the outdoor temperature (this condition corresponds to the left-hand side of plot). Glazed collectors are better insulated from the outdoor environment and are therefore less sensitive to the solar radiation level and outdoor temperature (shaded region of plot). Evacuated tube collectors are the best insulated of the three types, and will outperform the others at higher operating temperatures (right-hand side of plot). In general, the left-hand side of the plot corresponds to low temperature applications such as swimming pool heating and the shaded region to service water heating and building space heating. The right-hand side is most applicable to high-temperature processes such as space cooling. An ideal collector is illustrated at the top of the plot, with $F_R \tau \alpha$ equal to one and $F_R U_L$ equal to zero.

Figure F-3. Typical Solar Collector Efficiency Plots

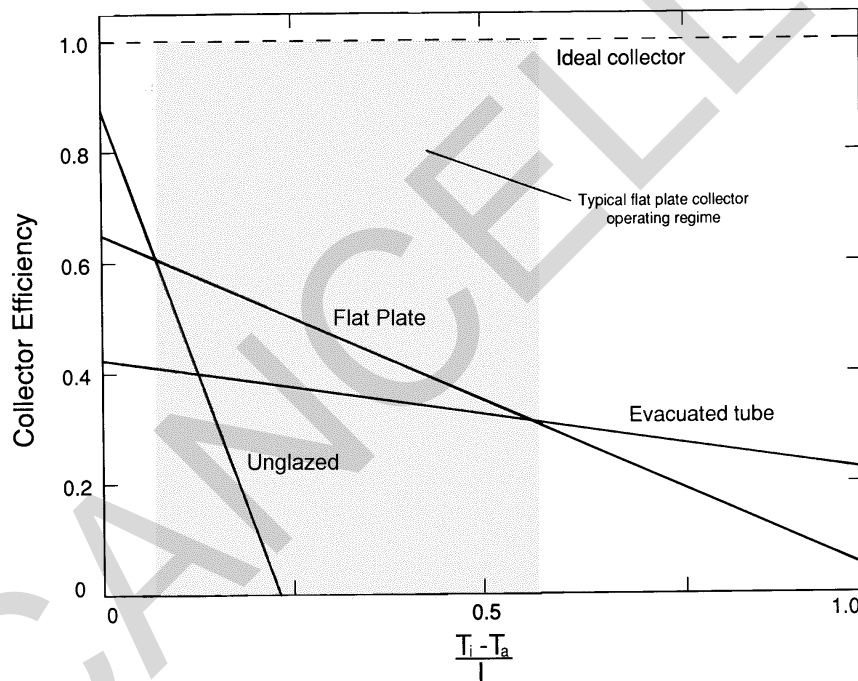

(f) Performance Ratings. The established test for defining the efficiency parameters of solar collectors is ASHRAE Standard 93. This test is performed by independent laboratories and should be available from collector manufacturers.

c. **Collector Array.** Individual collectors are normally connected together into groups called "banks". These banks are then piped together to form the complete collector array. Proper sizing of these banks is required to maintain uniform flow throughout the collector array. For efficient system performance, the flow must be balanced throughout the entire array.

d. Array Support Structure

(1) Purpose. A support system is required for the following reasons.

- (a) Secure the collectors in the correct orientation for maximum solar gain.
- (b) Withstand the various structural and thermal loads imposed upon the array.
- (c) Resist the impact of environmental deterioration.
- (d) Be as lightweight and inexpensive as possible.

(2) Types. There are two basic types of support structures: roof-mounted and ground-mounted. Roof-mounted structures are the most common and are preferred over ground-mounted structures, to avoid vandalism and aesthetic problems. Ground mounting may be necessary where there is insufficient solar access at the roof level and in retrofit situations where the roof cannot support the array or proper access to the roof for piping and sensor wiring is not available. Flat roofs require rack-type structures that are heavier and more costly than the type of structure normally used to mount collectors on sloped roofs. However, rack-mounted collectors on flat roofs are usually easier to service.

(3) Structural Considerations. One of the most important issues addressed by structural codes is the design load. Many loads are imposed on a collector array, including dead and live loads; those imposed by the environment, such as wind, snow and seismic loads; and thermal loads caused by the effects of temperature extremes and changes. Wind loads (along with snow loads at some locations) have, by far, the most significant effect on the structure. Dead loads are defined as those attached permanently to the array structure. Live loads are those applied to the array structure temporarily, other than wind, seismic and dead loads (a maintenance worker, for example). The combination of these loads at any instant must be accommodated by the structural design. Local building codes usually prescribe the design load combination to be used. The design and construction of support structures is usually governed by local building and structural codes that are often adapted from nationally recognized U.S. codes. These codes establish the design criteria to insure structural safety and integrity over the expected life of the system.

(4) Material Considerations. The materials chosen for the array structure must also be able to withstand environmental degradation. Oxidation, caused by humidity and precipitation, affects all metallic surfaces to varying degrees. Aluminum is required for the array support structure because the oxide layer that forms on the surface when it is exposed to moisture protects it from further degradation. Often, aluminum is anodized to provide a controlled layer of oxidation. The use of steel would require a coating system to be applied and maintained, which adds to the system life-cycle cost. The effect of temperature changes must also be taken into account for lengthy structures, especially the difference in thermal expansion between the various

types of metals used in solar systems. System piping, which is usually copper, expands at a different rate than the aluminum structure.

e. Collector Sub-Systems (Lessons Learned)

(1) Collectors. The single glazed, flat-plate, selective surface collector has proven to be the most reliable and best suited for service water heating needs. Although reflector systems are sometimes advocated to increase the insolation on a collector, they can seldom be justified because they must be cleaned, adjusted, and maintained, and can add a large capital expense. Similarly, strategies involving seasonal collector tilt adjustment are to be avoided. Problems also have arisen with evacuated tube collectors due to thermal expansion and improper fluid flow. The interior construction quality of flat plate collectors remains an issue. Problems such as poor absorber plate/fluid path bonding and improper allowance for absorber plate expansion have been observed. Some collectors have not performed as advertised due to atypical flow rates used during testing and degradation of collector components. Outgassing from insulation and binder materials also remains an issue.

(2) Arrays. The most common problem with collector arrays is that they do not achieve balanced flow. Shading of the collectors by other collectors and nearby objects must be avoided. Some systems have experienced leaks because thermal expansion was not considered, or improper design methods were used in allowing for thermal expansion.

(3) Array Support. Most support structure problems have been associated with material maintenance and aesthetics rather than structural integrity.

F-5. STORAGE SUB-SYSTEM

a. **Definition and Operation.** The intermittent nature of solar energy establishes a need for a sub-system capable of storing energy for 1 to 2 days. The most common method of doing this for an active solar system is through the use of a water-filled tank that obtains thermal energy from the collector loop either directly or through a heat exchanger. The water from the storage tank then functions as a source of preheated water to an auxiliary heater or boiler that adds the necessary energy to raise it to the required temperature. In some cases, the storage medium may be heated above the required temperature, and a mixing valve can be used to reduce the storage fluid to the desired temperature before it reaches the load. The systems discussed in this manual assume a storage requirement of approximately 1 day.

b. **Storage Media.** The most effective and trouble-free storage medium is water. For this reason, systems discussed in this manual will assume water-based storage.

F-6. TRANSPORT SUB-SYSTEM

a. **Purpose.** The fluid transport sub-system is required to maintain efficient transport of thermal energy from the collectors to the storage tank. Fundamental

design decisions regarding freeze protection, corrosion resistance, control strategies, and fluid toxicity issues will be made with respect to this part of the solar energy system. The transport subsystem consists of all fluid piping on the interior of the building, a heat transfer fluid, heat exchanger, expansion tank, pumps, and various types of valves and fittings.

b. Freeze Protection

(1) Purpose. Freeze protection is required in any climate that can experience temperatures less than 32 degrees F (0 degrees C). However, collectors may be subjected to sub-freezing temperatures (due to radiant heat transfer to the sky on a clear night) even when ambient temperatures are as high as 38 degrees F (3 degrees C).

(2) Strategies. Common freeze protection strategies include the use of an antifreeze fluid in the collector loop, or to drain all exposed piping when freezing conditions exist

c. **Stagnation and Overheat Protection.** Stagnation is a condition that may occur when the system is deactivated while fluid is contained in the collectors during periods of solar insolation. For example, on a sunny day stagnation temperatures in a flat-plate collector can exceed 350 degrees F (177 degrees C), leading to vaporization of the transport fluid within the collector and excessive pressure build up in the system piping. In the case of a closed-loop system, it is important to ensure that all components in the collector loop can withstand these temperatures and pressures. A pressure relief valve and an expansion tank should also be used to protect the system components and control pressures.

d. Heat Transfer Fluids

(1) Definition. The heat transfer fluid is contained in the collector loop. Selection of the proper fluid is critical, since certain fluid properties can cause serious corrosion problems or degrade performance. Only water and propylene-glycol/water solutions are considered.

(2) Types of Fluids

(a) Water. As a heat transfer fluid, good quality water offers many advantages. It is safe, non-toxic, chemically stable, inexpensive, and a good heat transfer medium. Two drawbacks include a relatively high freezing point and a low boiling point. Excessive scaling may occur if poor quality water is used.

(b) Glycols. Propylene or ethylene glycol is often mixed with water to form an antifreeze solution. Propylene glycol has the distinct advantage of being non-toxic, whereas ethylene glycol is toxic and extreme caution must be used to ensure that it is isolated from any potable water. For this reason, uninhibited USP/food-grade propylene glycol and water solution will be specified for any solar preheat system that requires an antifreeze solution.

e. Heat Exchangers

(1) Purpose. Heat exchangers are used to transfer thermal energy between fluids while keeping them separate to prevent mixing or to maintain a pressure difference between fluid loops.

(2) Types. Heat exchangers are available in a wide variety of sizes and configurations. The primary concern is the chemical composition of the fluids used in the heat exchanger. The fluid determines whether a single- or double-isolation heat exchanger will be necessary. Double-isolation heat exchangers are required whenever there is possible contamination of the potable water supply by a toxic collector loop fluid. Also important is the heat exchanger location with regard to the storage tank. Immersion-type heat exchangers are located within the storage tank and operate by forced convection on the tube side and natural convection on the tank side. Single-isolation external heat exchangers are separate from the tank and require two pumps to circulate the fluid on both the hot and the cold side. For solar systems, increased performance due to forced convection heat transfer in external heat exchangers usually offsets the additional cost of operating a second pump. For this reason, external, forced convection heat exchangers are usually used for systems designed under this guidance.

(3) Configurations. Of the many configurations of heat exchangers possible, two have found widespread use with liquid-based solar systems. The most common heat exchanger used in past solar projects is the shell-and-tube configuration, in which an outer casing or shell encloses a tube bundle. These units are usually thermally efficient, compact, reliable and easy to maintain and clean. Shell-and-tube exchangers typically provide only single isolation. The other commonly used heat exchanger is the plate or plate-and-frame type. This type of exchanger is becoming increasingly popular with designers and contractors. It can afford single- or double-wall protection, provide high performance, use superior materials, have low volume and surface area, and be easily enlarged or reduced if the system size is changed. Most heat exchangers are available with copper fluid passages, and many plate-type exchangers have stainless steel passages.

(4) Heat Exchanger Performance. A common measure of heat exchanger performance is its effectiveness. Effectiveness is defined as the ratio of the actual rate of heat transfer to the maximum possible. Two common problems, fouling and freezing, can decrease heat exchanger effectiveness. Fouling is the term used for scale and corrosion that collects in the passageways. Fouling decreases the amount of energy transferred and is often taken into account in heat exchanger analysis. The amount and rate of fouling to be expected depend on the fluids and materials used. Heat exchangers can freeze in systems containing antifreeze due to reverse thermosiphoning or improper control.

(5) Effect on System Performance. The use of heat exchangers can only serve to degrade the performance of the solar energy system. However, since they are required for most systems, their impact on performance should be understood.

Although system performance suffers by only about 10 percent for heat exchangers with effectiveness values as low as 0.3, the popularity of compact plate-type heat exchangers and their low add-on costs allow the designer to achieve high effectiveness levels with only a slight increase in equipment cost.

f. **Pumps.** Heat transfer fluids are circulated by pumps. Two circulation pumps are required in the system shown in Figure F-1. For the majority of liquid-based solar energy systems, centrifugal pumps with fractional horsepower requirements are used for heat transfer fluid circulation.

g. **Transport Sub-System (Lessons Learned)**

(1) **Heat Transfer Fluids.** To eliminate past problems with fluid maintenance, freeze protection, and corrosion control, a USP/food-grade uninhibited propylene glycol/distilled water mixture is required for systems that need freeze protection and pure water is recommended for systems that do not

(2) **Piping and Transport Sub-System Materials.** Materials problems with piping include corrosion, erosion, and scaling. Corrosion can be avoided by using flow passages of copper, bronze, brass or other non-ferrous alloys. Pipe erosion and excessive hydraulic noise can be avoided by ensuring that fluid velocities in closed piping systems are kept below 5 ft/s (1.5 m/s).

F-7. **CONTROL SUB-SYSTEM**

a. **Purpose and Experiences.** The control sub-system consists of an electronic control unit, temperature sensors, and interfaces to pumps. A Btu meter may also be installed for system diagnostics and monitoring purposes. Experience with past systems has shown that a major cause of system failure has been control systems that were too complicated and unreliable. Control strategies for solar energy systems should be as simple and reliable as possible.

b. **Control Strategy.** Most solar systems use a control strategy known as differential temperature control. Temperature sensors are located on the collectors and at the coolest part (the bottom) of the storage tank. Circulating pumps in the collector and storage loop are simultaneously activated whenever the temperature of the solar collector is a specified level greater than that of the storage tank (typically 15 to 25 degrees F (-9 to -4 degrees C). The pumps are then shut off when the temperature difference falls below another limit (typically 5 to 8 degrees F (-15 to -13 degrees C)). This built in hysteresis helps prevent short cycling of the pumps during start-up as the colder water from the storage tank comes in contact with the hot collector plate.

c. **Diagnostics.** The control system can contribute to the system's longevity and ease of maintenance by providing remote readings of system parameters such as component temperatures, pump status, and maximum/minimum temperatures. If installed, a Btu meter can measure the flow rate and temperature of fluid delivered to storage in order to calculate the total energy contributed by a system. It is possible for a solar system to be inoperative and yet show no symptoms due to the existence of an

auxiliary heat source. The use of built-in diagnostic devices helps prevent this condition from occurring.

F-8. SOLAR ENERGY SYSTEM PERFORMANCE. To design a cost-effective solar energy system, it is important to understand the difference between collector efficiency and annual system performance. The solar fraction (SF) is the ratio of the energy supplied by the solar system to the total energy required by the process. Figure F-4 is a typical plot of solar fraction versus collector area. Note that, for small collector areas, a relatively small increase in collector area leads to a steep increase in solar fraction. As the collector area is increased, however, each additional square foot of collector area yields a smaller increase in solar fraction, until the curve asymptotically approaches a solar fraction of 100%. Another important parameter is the solar load ratio (SLR), which is defined as the ratio of the annual (or monthly) radiation incident on the collector array to the annual (or monthly) energy requirements of the building system. The selection of the optimum collector area for a given building system is ultimately an economic decision, as the cost of additional collector area and system capacity must be weighed against the diminishing return in solar fraction gained.

Figure F-4. Solar Fraction Versus Collector Area

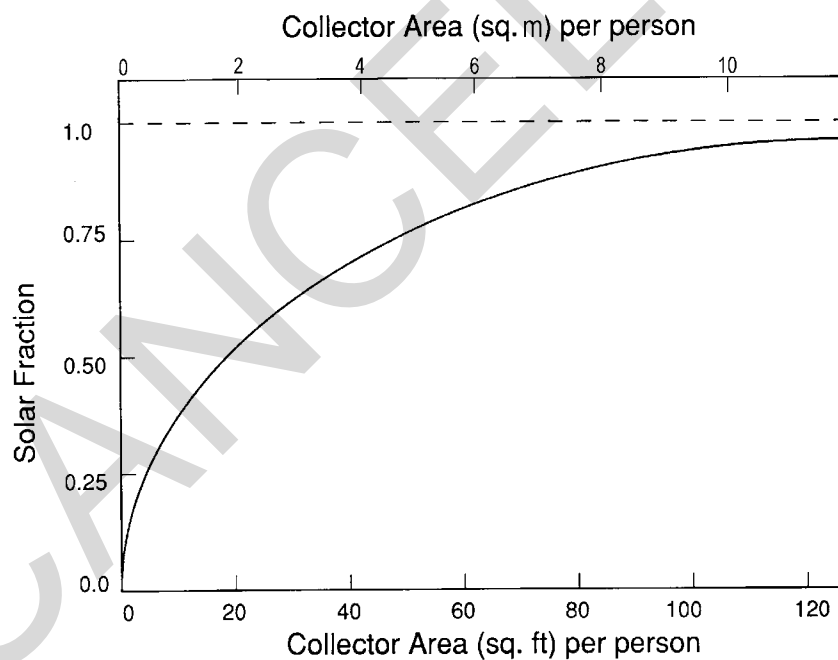

F-9. SUMMARY

a. **Service Water Heating.** Experience, experimental simulations, and economic analyses have shown that the most efficient use of solar energy in military facilities is for loads that use low temperatures on a year-around basis, such as that needed by service water heating. This application yields the best use of energy per square foot of installed collector area and represents the greatest potential for cost-effective solar energy use within the Services.

b. **Standard Solar Energy System.** Although fundamental principles for many types of systems have been discussed, the type of system best suited for water heating will use flat-plate, liquid-based collectors, water storage, and a propylene glycol/water solution as the heat transfer fluid. Control systems should use simple differential temperature control with built-in diagnostics. This type of system will be the most reliable and effective in meeting the Services' needs and design/construction practices.

CANCELLED

APPENDIX G
SOLAR ENERGY CASE STUDY AT FORT HUACHUCA, AZ
(MARCH 1998)

G-1. **PURPOSE.** The purpose of this study is to present findings on the installation and the subsequent operation of the solar hot water heating system in the Koch barracks (Building 80306) at Ft. Huachuca in Sierra Vista AZ. Systems Engineering and Management Corporation (Systems Corp), under Contract Number DACA88-94-D-0016 for the U. S. Army Construction Engineering Research Laboratories, completed the installation.

G-2. **SCOPE OF WORK (SOW).** The scope of work (SOW) required that a 1,000 ft² (93 m²), or larger, flat plate solar energy system be developed for installation on Building 80306. The system was to connect to the existing recirculating domestic hot water (DHW) heating system. Systems Corp determined through load calculations that a 1,000 ft² (93 m²) system was too large for Building 80306. The final system design included 384 nominal ft² (36 m²) of collector area.

G-3. **CONSTRUCTION ISSUES.** During the development of this project, multiple issues arose which were obstacles to design completion. The primary issues were building selection, system selection, and storage tank size.

a. **Building Selection.** Approximately eight different buildings were evaluated for the installation of the previously described system. Different factors were used during the evaluation, including domestic hot water (DHW) load and building orientation. Building 80306 was selected because of a relatively large DHW load and because of its orientation.

b. **System Selection.** The SOW required that the solar energy system be designed in accordance with TM 5-804-2 (now UFC 3-440-01). Systems Corp designed a system that corresponded to the requirements of the technical manual as closely as possible. Two problems were encountered. The first was connecting the solar energy system to the existing DHW system. The existing system is a recirculating system that is not addressed in the manual. The second problem encountered was the location of the solar system storage tank. According to the technical manual, the storage tank should be sized to hold 1.5 to 2 gals of water per square foot (61.1 to 81.5 L of water per square meter) of collector area. For the original system at 1,000 ft² (93 m²), this equates to a minimum tank size of 1,500 gals (5678 L). For the revised system at 384 ft² (36 m²), at least 576 gals (2180 L) of storage is required. With the existing equipment in place, the mechanical room is too small for that amount of storage. Therefore, the storage tank for this design had to be located outdoors.

c. **Storage Tank Size.** Several options for outdoor storage tanks were evaluated for this project. The first option was the use of a single "standard" domestic water storage tank insulated for outdoor installation. The price for a nominal 2,000 gal (7571 L) cement-lined storage tank, evaluated for the 1,000 ft² (93 m²) system, was

\$7,100. The second option investigated was the use of a 12 to 24 inch (305 to 610 mm) pipe coated and capped for use as a domestic water storage tank. The price for this storage system was estimated to be \$3,900 for 705 gals (2669 L) of storage. The primary problem with both of these options was the delivery time of the equipment. The fastest shipment available was approximately six weeks. The storage option used in this project was nine 80 gal (303 L) storage tanks priced at \$4,279.90. The tanks are electric water heater tanks with the heating elements removed. The advantage to this type of storage is that the tanks are available immediately. Disadvantages to the use of a large number of smaller tanks include maintenance, system balancing, and increased heat loss due to increased surface area. The use of a large number of small tanks is also less cost effective with the price per gallon of storage being \$5.94 versus \$3.55 per gallon for the single tank and \$5.53 per gallon for the 24-inch (610 mm) pipe system. Piping is also more extensive and therefore more costly for multiple tanks.

G-4. SYSTEM DESCRIPTION

a. **Overall Design.** After many design iterations, a system was configured with the assistance of Sandia National Laboratories for installation in the rock area next to Building 80306. The system consists of twelve 4 by 8 ft (1219 by 2438 mm) collector panels arranged in two rows of four and eight panels. An overall view of the system can be seen in Figure G-1.

Figure G-1. Photo of Collector Arrays



b. **Array Design.** The system is divided into three arrays: east, west, and south. Each array contains four collector panels, one “quad rod” double-walled heat exchanger, two circulation pumps, and three 80 gal (303 L) storage tanks. A detailed piping diagram of the entire solar hot water system can be seen in Figure G-2. A schematic for the west zone, which is typical for the three, can be seen in Figure G-3. A detailed schematic of the “quad rod” double-walled heat exchanger can be seen in Figure G-4. As previously stated, each zone contains two circulation pumps that are

listed on Figure G-2 as P-1 and P-2. For each array, pump P-1 circulates a water-glycol solution through the panels and heat exchanger. Pump P-2 circulates domestic water from the building through the heat exchanger and storage tanks. Figure G-5 illustrates the connection of the solar supply and return lines to the existing recirculating domestic water system. The storage tanks, heat exchangers, and pumps are located in the housing behind the second row of collectors. The backside of the housing is removable to allow access to the equipment as illustrated in Figure G-6.

Figure G-2. Solar Hot Water System Piping Diagram

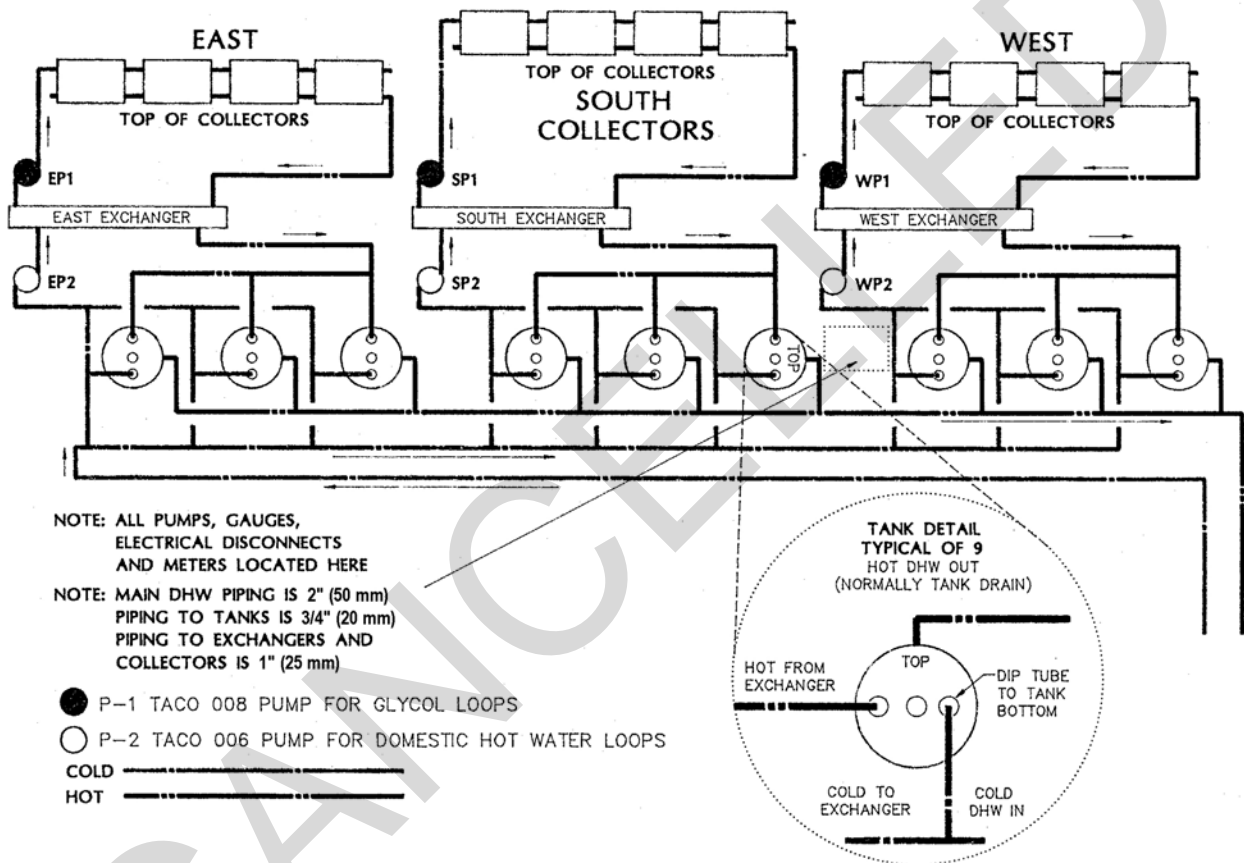

c. **System Controls.** The system is controlled through the use of a differential temperature controller. The system pumps are switched on when the temperature of the collectors is greater than the temperature in the storage tanks. The system uses two 10K ohm thermistors for the differential temperature control. One is located at the outlet pipe of the glycol loop on the western most collector, while the other is located on the incoming cold water line to the system. The wiring diagram for the system is illustrated in Figure G-7. The photo of the system controller can be seen in Figure G-8.

Figure G-3. Typical Array Layout

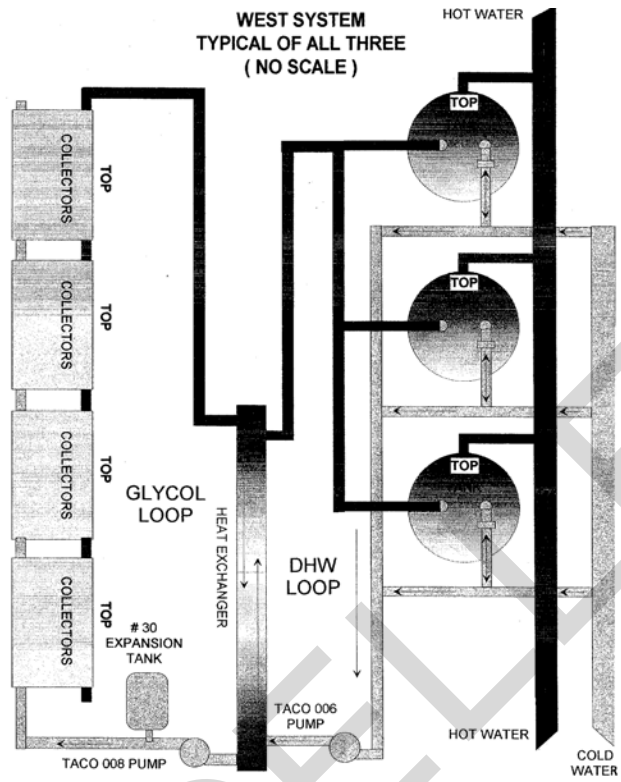

Figure G-4. "Quad Rod" Double Wall Heat Exchanger

21st CENTURY ENERGY
"QUAD ROD" DOUBLE WALL
HEAT EXCHANGER

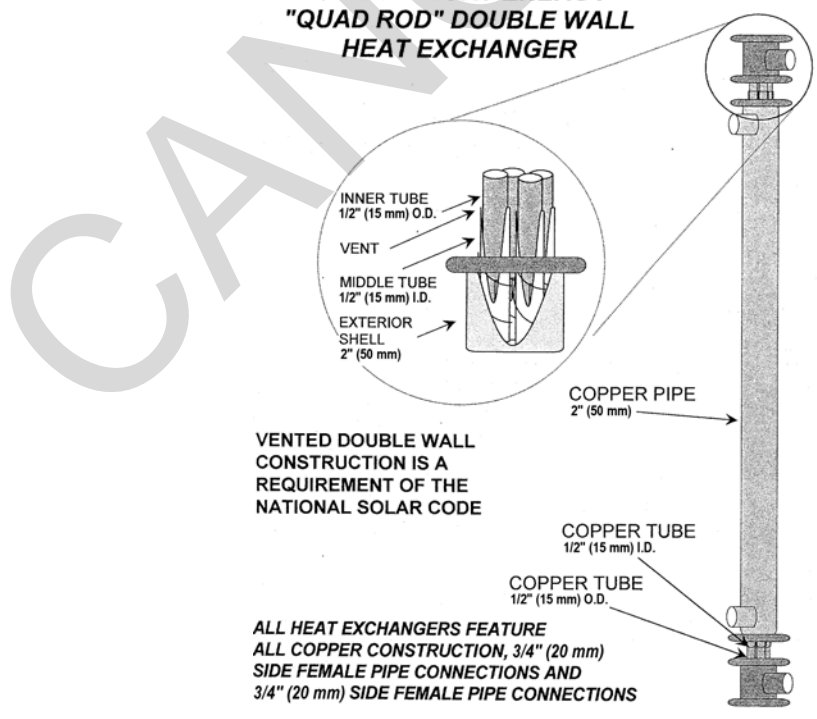
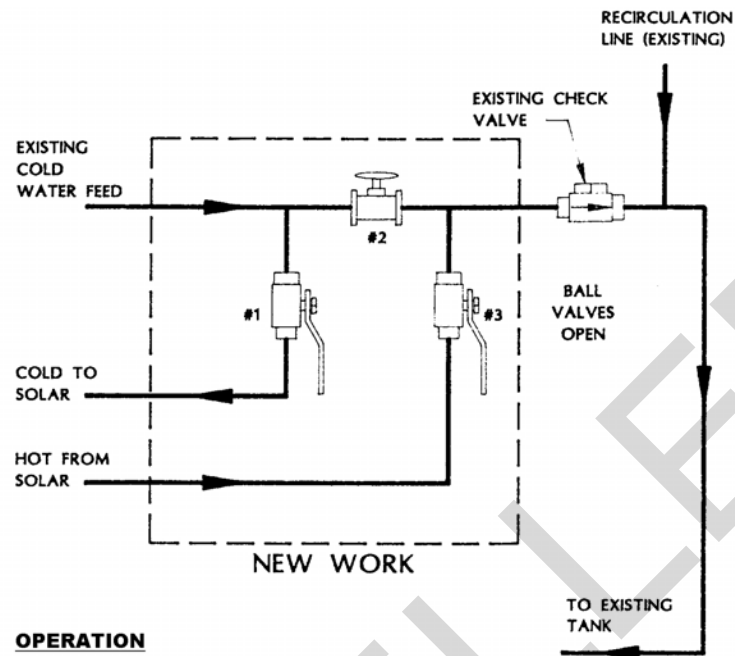

Figure G-5. Connection to the Existing Domestic System



OPERATION

SOLAR IN THE LOOP
VALVES # 1 & 3 OPEN, VALVE # 2 CLOSED

SOLAR BYPASSED
VALVES # 1 & 3 CLOSED, VALVE # 2 OPEN

Figure G-6. Equipment Housing



Figure G-7. Wiring Diagram

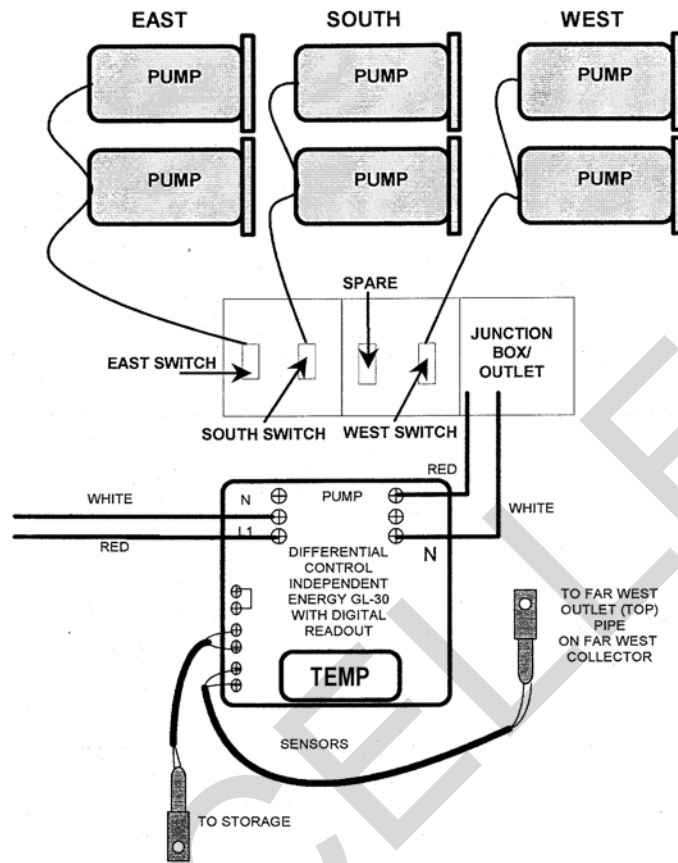

Figure G-8. Differential Temperature Controller



G-5. COSTS

a. **Development Costs.** The development costs for this system were determined based upon the engineering and drafting hours required in the design and construction of the system. The Systems Corp development costs for the project were as follows:

Total Development Costs \$25,479.00

b. **Material Costs.** Material costs for the project were as follows:

Collectors	\$8,773.00
Tanks	\$4,279.90
Heat Exchangers	\$ 938.47
Controls	\$ 219.45
Piping, Valves, & Insulation	\$6,443.72
Pumps, Gauges & Expansion Tanks	\$1,110.36
Miscellaneous & Structural Materials	<u>\$2,677.94</u>
Total	\$24,442.84

c. **Labor Costs.** Labor costs for the project included the services of six men for a total of 542 hours. The total labor cost was \$11,334.16 (\$7,687.88 of actual labor cost and \$3,648.28 for travel).

d. **Total Costs.** The total cost for the 384 ft² (36 m²) solar hot water system was as follows:

Development Costs	\$25,479.00
Material Costs	\$24,442.84
Labor Costs	<u>\$11,334.16</u>
Total	\$61,256.00

G-6. **CONSTRUCTION COMPLETION.** Construction on the solar hot water system was completed on 08 April 1996.

G-7. **DATA MONITORING.** The hot water system was monitored for a period of 3 months (May, June, and July) in 1997. Because of the similarity of the 3 arrays, only the east array of the solar hot water system was monitored for performance. Data was collected by a data logger and downloaded via a modem.

a. **Solar Insolation.** A pyranometer sensor was used to measure the solar insolation. Recorded measurements from the sensor for the months of May, June, and July can be seen in Figures G-9, G-10, and G-11.

b. **Hot Water Demand.** An ultrasonic flowmeter was used to measure the total hot water flow going from the solar hot water system to Building 80306. Recorded measurements from the flowmeter for the months of May, June, and July can be seen in Figures G-12, G-13, and G-14.

c. Temperature Differences Across the DHW Heat Exchanger.

Temperatures were measured by exposed junction type-T thermocouples taped to the outside of the copper tubing and insulated to minimize the influence of the outside air temperature. Recorded temperature differences across the DHW heat exchanger for the months of May, June, and July can be seen in Figures G-15, G-16, and G-17.

d. Temperature Responses. Temperature responses recorded on May 8, June 17, and July 15 can be seen in Figures G-18, G-19, and G-20 respectively. Note how the fluid temperature coming from the array in May reached about 65 degrees C (149 degrees F) but in June and July it reaches 120 degrees C (248 degrees F). The controller for the whole system is programmed to shut down the re-circulating pumps when the water in the DHW storage tanks reaches 54 degrees C (130 degrees F). The demand for hot water was low enough in these months that the system controller shut the re-circulation pumps off, which in turn caused the fluid temperatures in the array to increase.

e. BTU's Measurements. An energy monitor was installed on the DHW system inside Building 80306. The monitor was connected to a paddle wheel flowmeter and two platinum resistance thermometer (PRT) temperature probes. The temperature probes were used to measure the temperature of the solar hot water system's supply and return water. Recorded temperature differences between the supply and return for the months of May, June, and July can be seen in Figures G-21, G-22, and G-23.

(1) Figure G-24 and Figure G-25 presents the energy provided by the solar hot water system to Building 80306 as well as the total water usage for each month. The leftmost column for each month shows the calculated energy (BTUs or Joule) delivered at 10-second intervals. The middle column for each month shows the calculated energy delivered using the average 10-second reading over a 10-minute period. The rightmost column shows the total water usage for Building 80306 during each month. As seen from the figure, the two calculated energy columns are almost identical. This indicates that hot water usage for Building 80306 was not in short spurts or has sudden changes. Also note from the figure the dramatic decrease of energy and hot water being delivered from May to June. The drop off in delivered energy and hot water can be accounted for by the fluctuating occupancy of the facility. During June and July, Building 80306 was not fully occupied.

(2) The energy monitor used to record the measurements shown in Figure G-24 and Figure G-25 was replaced with a new, more accurate monitor in September 1997. Data from this new monitor has been continuously collected since it was installed in September and is shown in Figure G-26 and Figure G-27. As seen in the figure, the solar hot water system supplied a peak of 25.5 MBTU's (26,800 MJ) in March of 1998 (this also corresponds with the highest monthly water usage). Figure G-26 and Figure G-27 also show gas usage for Building 80306 since September 1997. The gas readings include the amount of gas used for both the DHW gas heater and the clothes dryers. Heat is supplied to Building 80306 from a central plant. Note how for March the water usage almost doubled from February. The energy delivered by the solar hot water system also almost doubled but the amount of gas used only increased by 15%. This

clearly shows that the solar system is capable of supplying the hot water demands for fully occupied barracks.

f. **Monitoring Totals.** To date, the solar hot water system has operated as expected. During the three-month monitoring period the system delivered 3.78 MBTU's (4,000 MJ) and 92,313 gals (349,443 L) of hot water at an average temperature of 130 degrees F (54 degree C) to Building 80306.

G-8. **Economic Evaluation to Date.** The hot water system delivered a maximum of 25.5 MBTU's (26,800 MJ) of hot water for a one-month period (refer to March 1998 from Figure G-25). Assuming the efficiency of the DHW gas heaters is 50% (for the kind of hot water heater used this is a good estimate), the total displaced gas would be 1.5 times 25.5 MBTU's (26,800 MJ), or 38.3 MBTU (40,400 MJ) for a savings of \$341.19 in displaced gas. If this were accomplished every month, the system payback time would be 8.7 years. Note however that the estimate assumes there are no maintenance costs during this period. Any maintenance will increase the payback time. Also note that the solar hot water system was designed to supply hot water for a fully occupied building year-round. As seen in Figures G-24, G-25, G-26, and G-27, Building 80306 was not fully occupied during the months of June and July and therefore the potential peak MBTU (kW-h) for those months was not realized. As a result of the varying occupancy of the facility, the hot water usage varied which in turn extended the originally calculated payback period.

Figure G-9. Solar Insolation Measured for May 1997

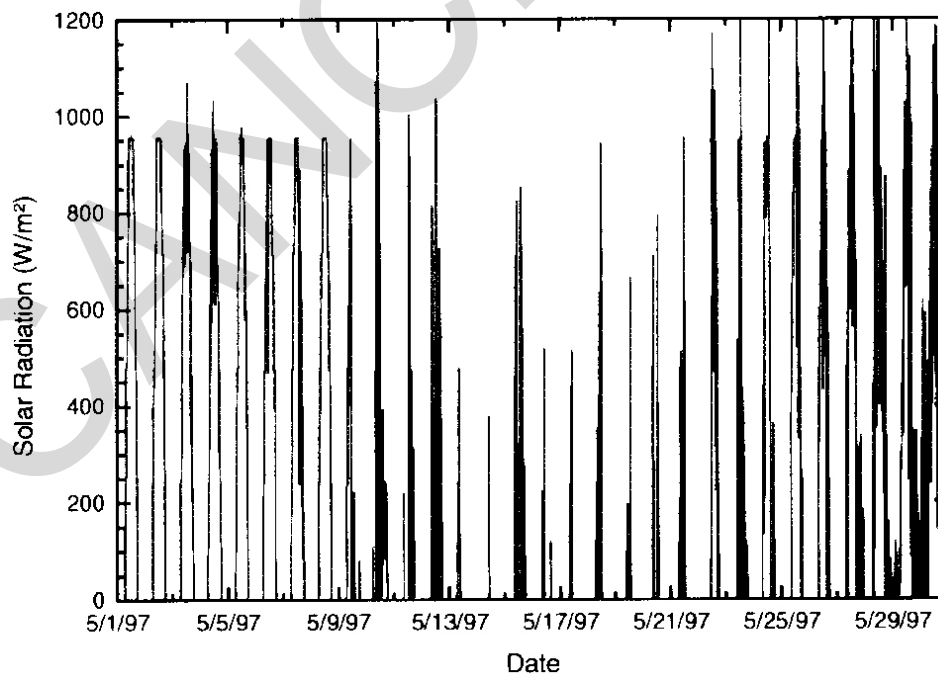

Figure G-10. Solar Insolation Measured for June 1997

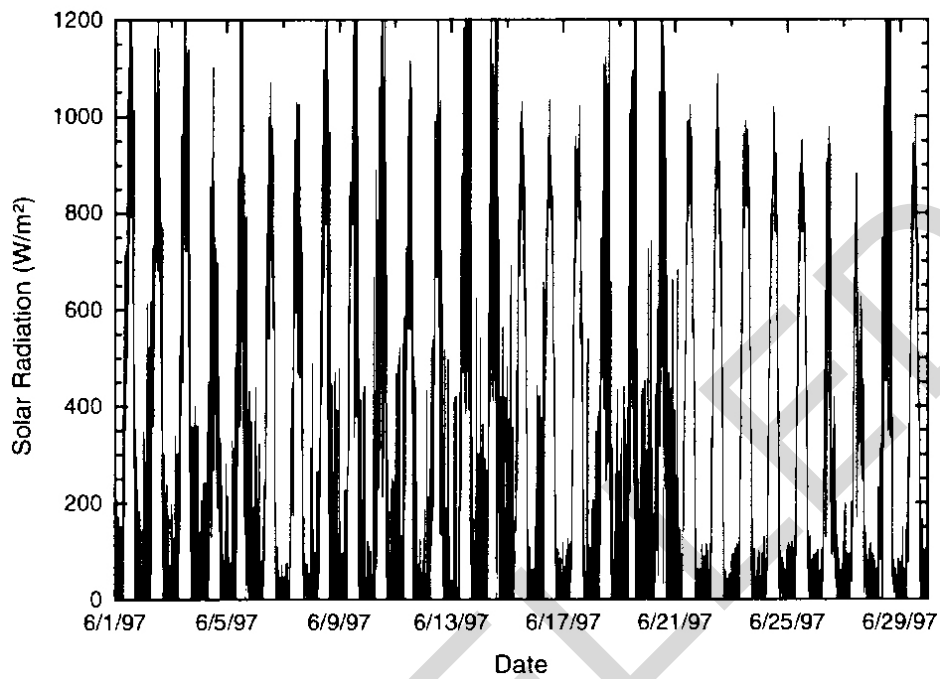

Figure G-11. Solar Insolation Measured for July 1997

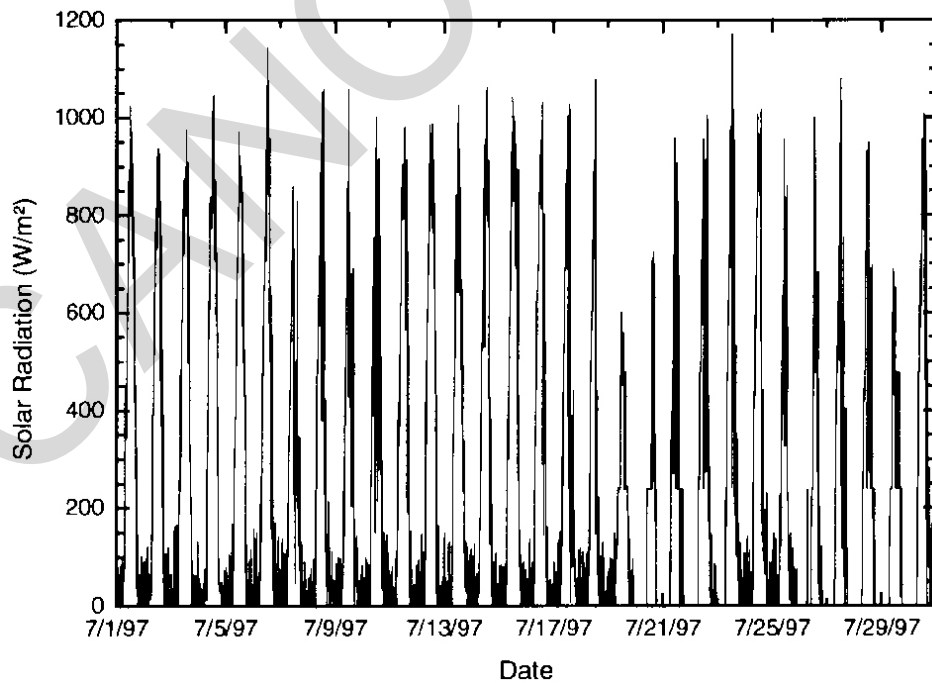

Figure G-12. Hot Water Demand for May 1997

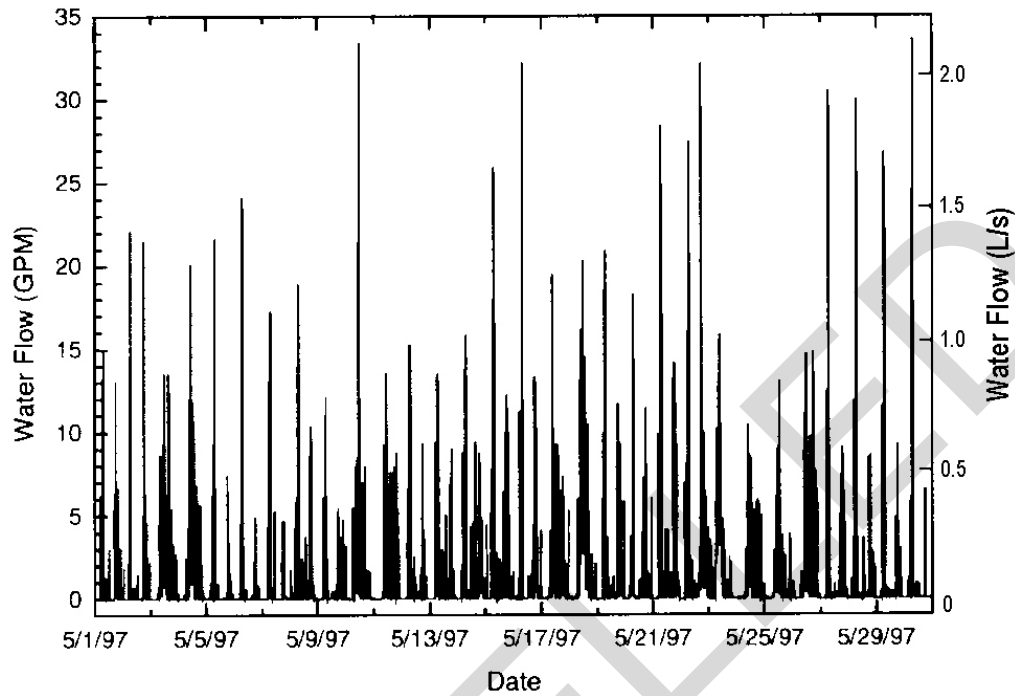

Figure G-13. Hot Water Demand for June 1997

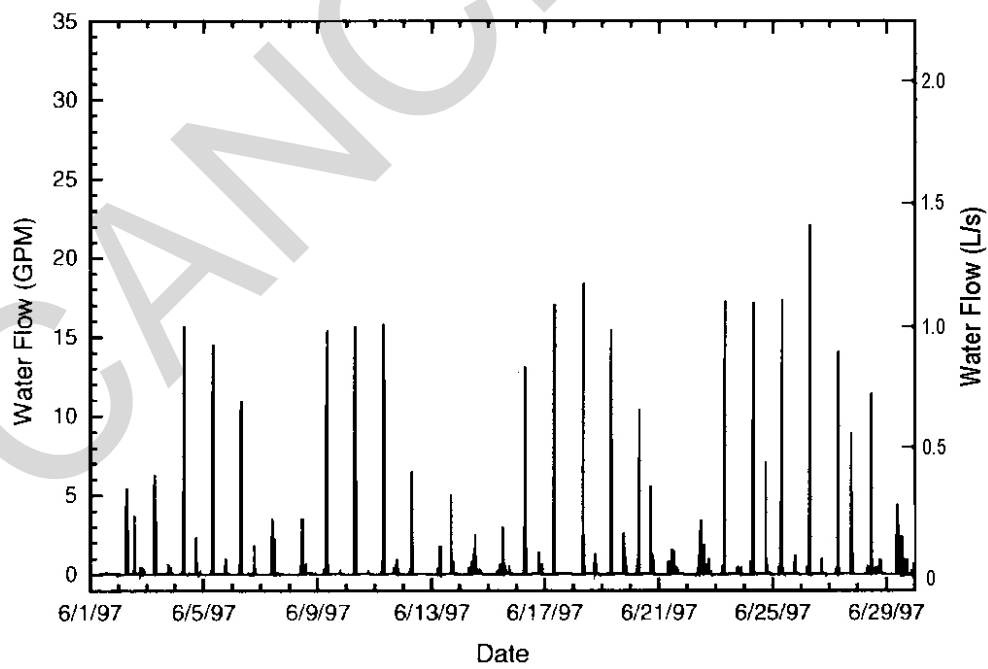

Figure G-14. Hot Water Demand for July 1997

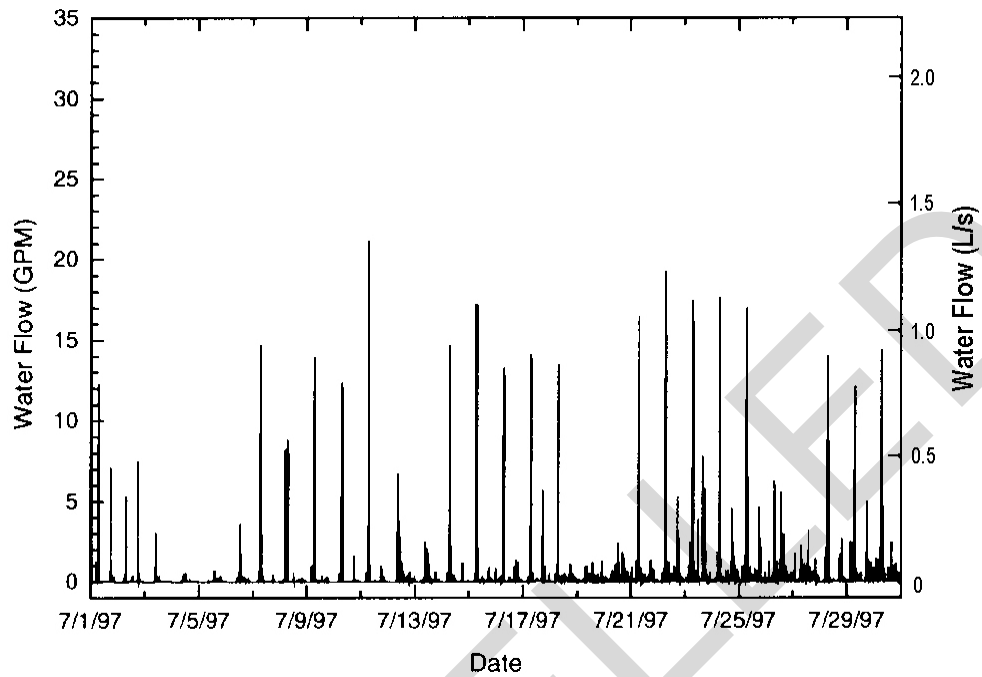

Figure G-15. Temperature Differences Across Heat Exchanger (May 1997)

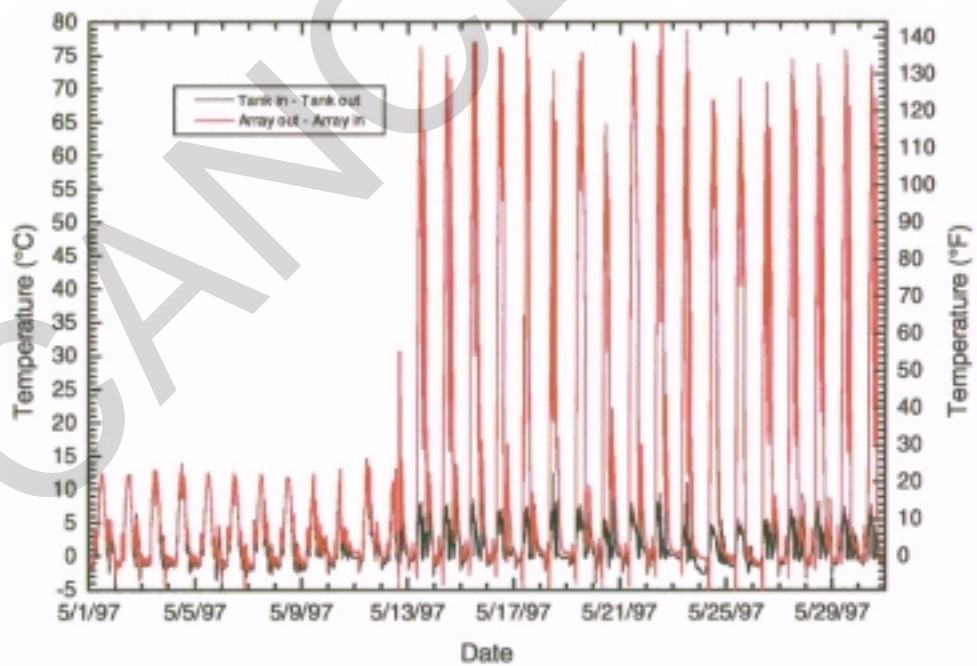

Figure G-16. Temperature Differences Across Heat Exchanger (June 1997)

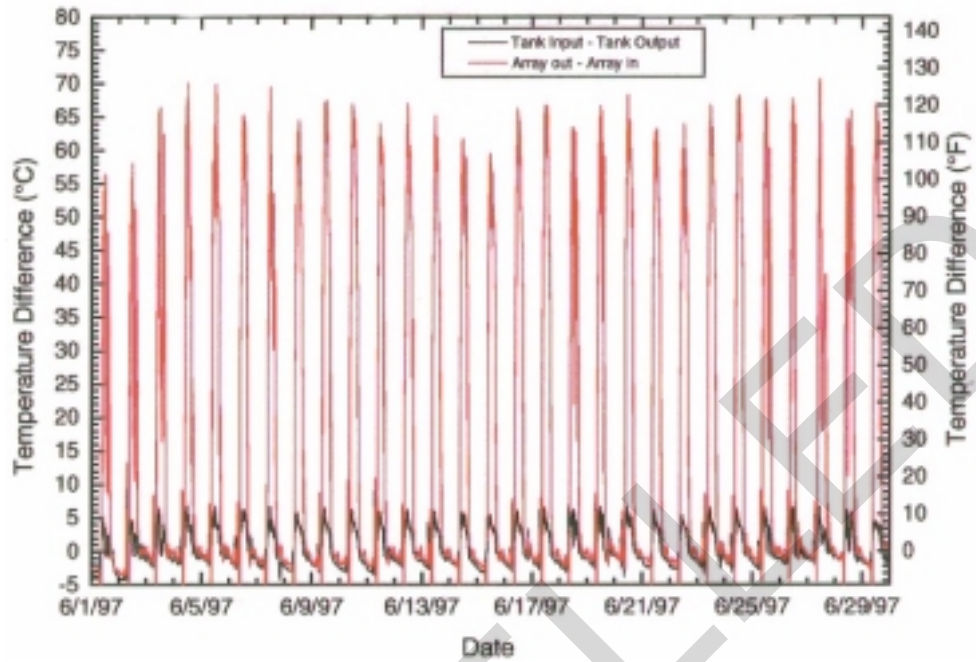

Figure G-17. Temperature Differences Across Heat Exchanger (July 1997)

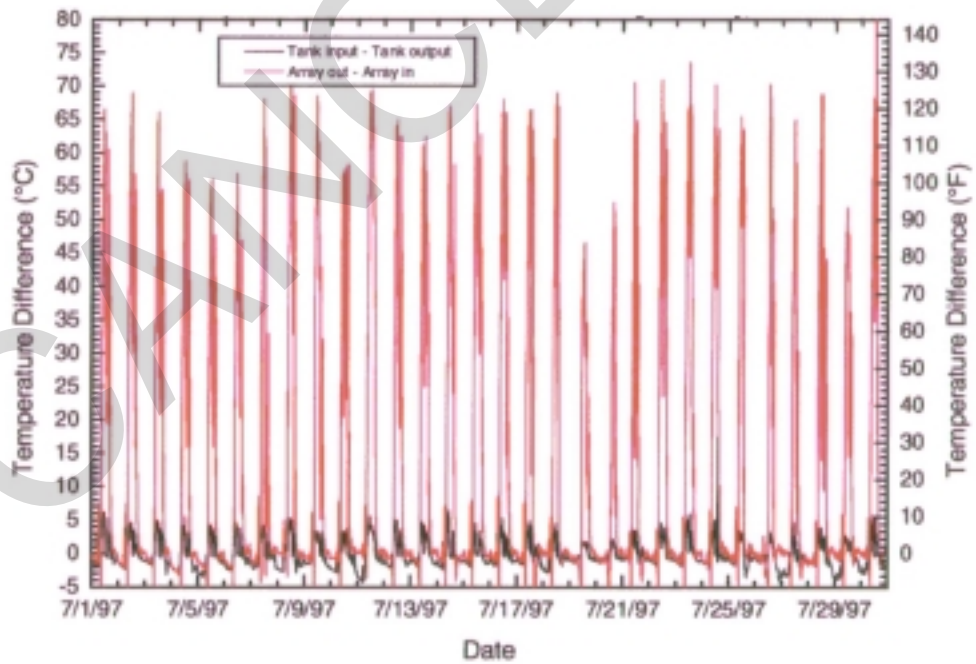

Figure G-18. Temperature Responses (8 May 1997)

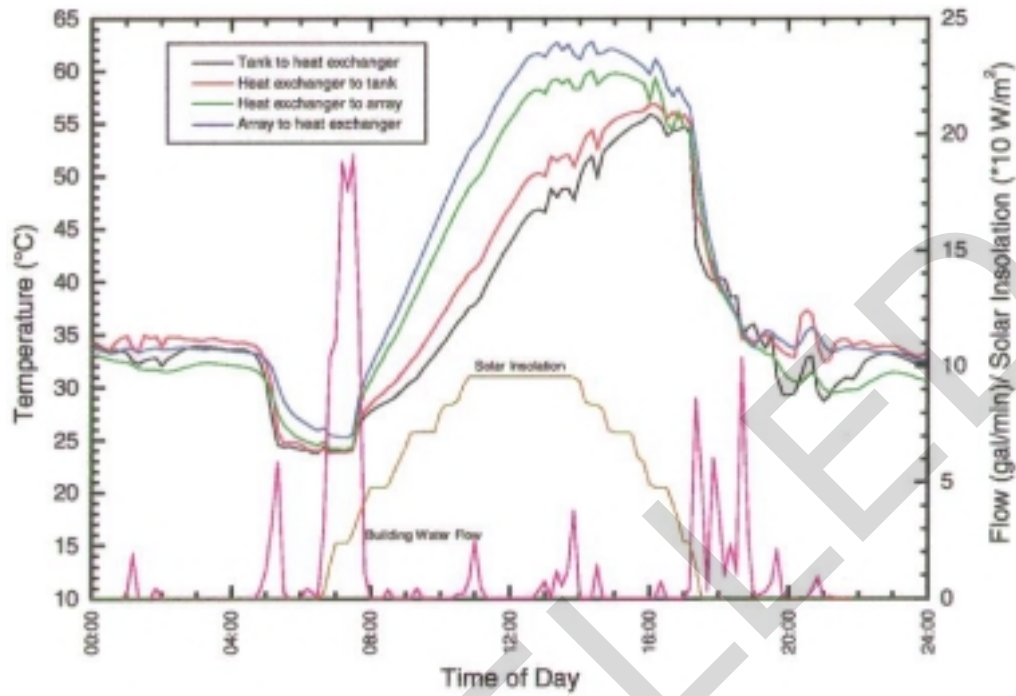

Figure G-19. Temperature Responses (17 June 1997)

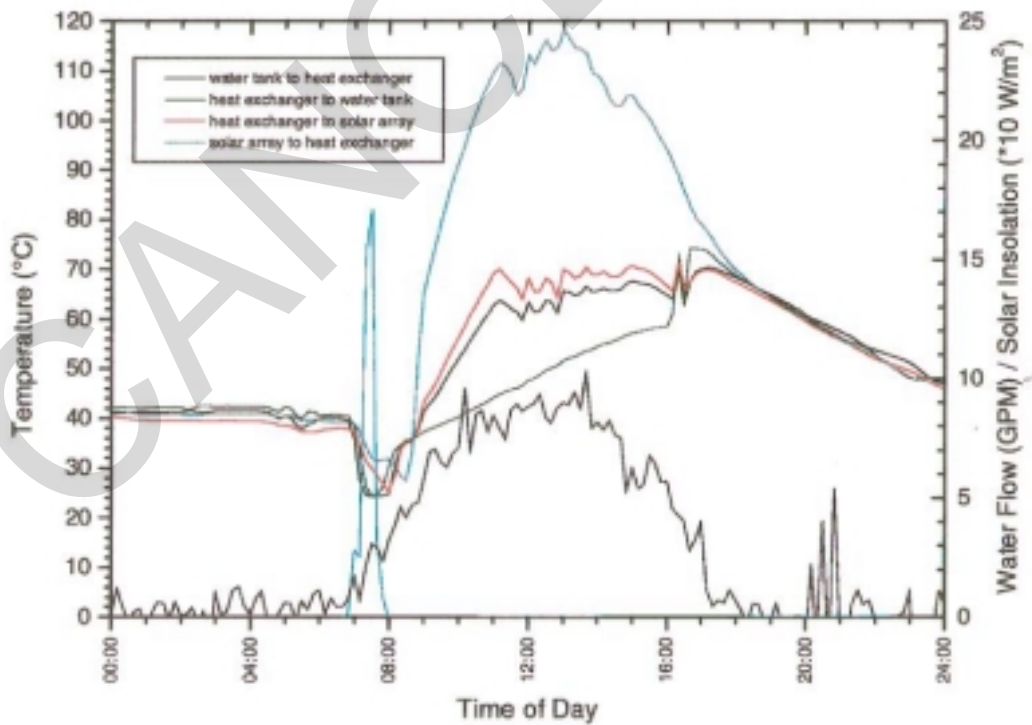

Figure G-20. Temperature Responses (15 July 1997)

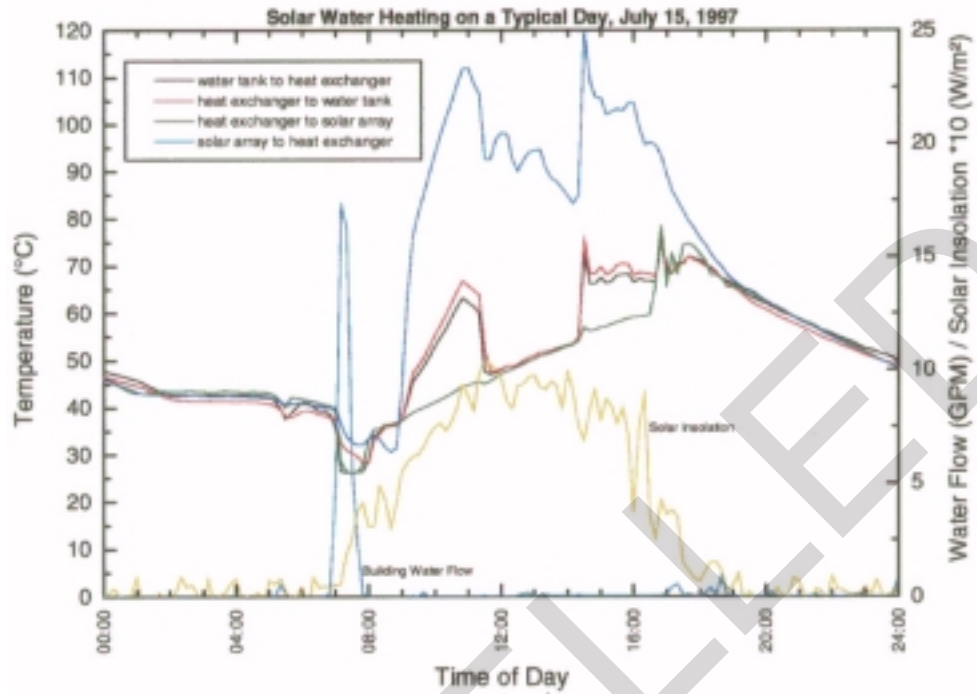

Figure G-21. Supply and Return Temperature Differences (May 1997)

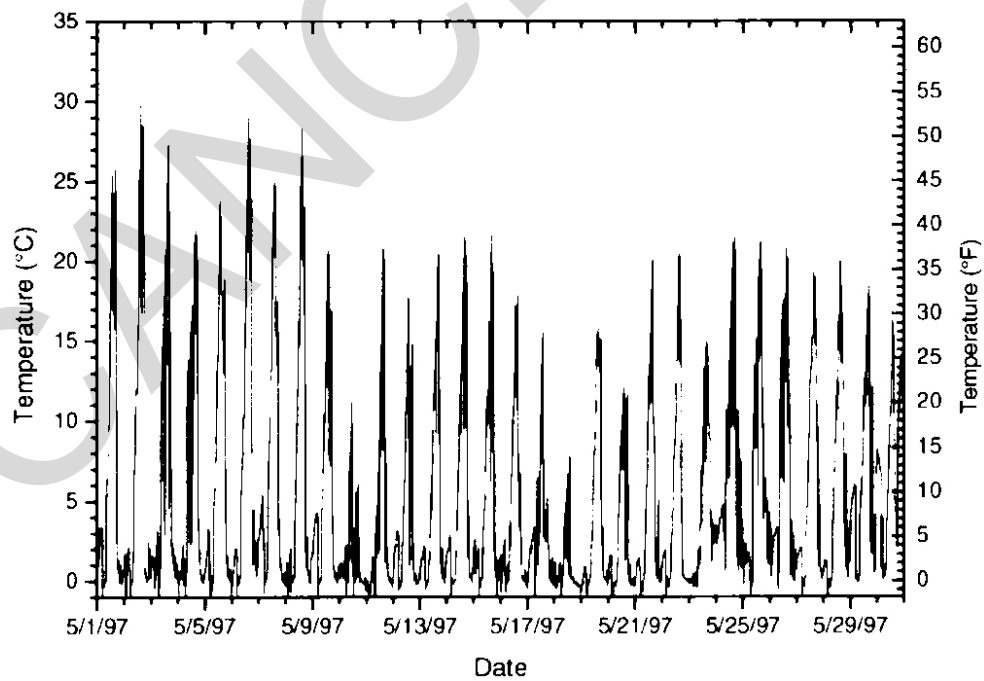

Figure G-22. Supply and Return Temperature Differences (June 1997)

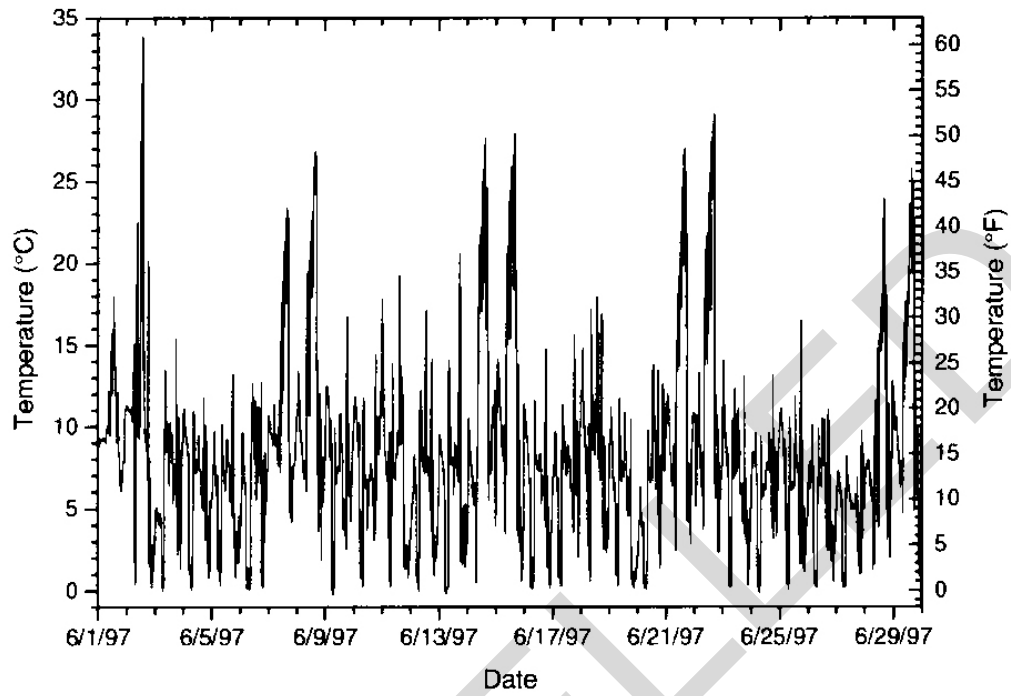

Figure G-23. Supply and Return Temperature Differences (July 1997)

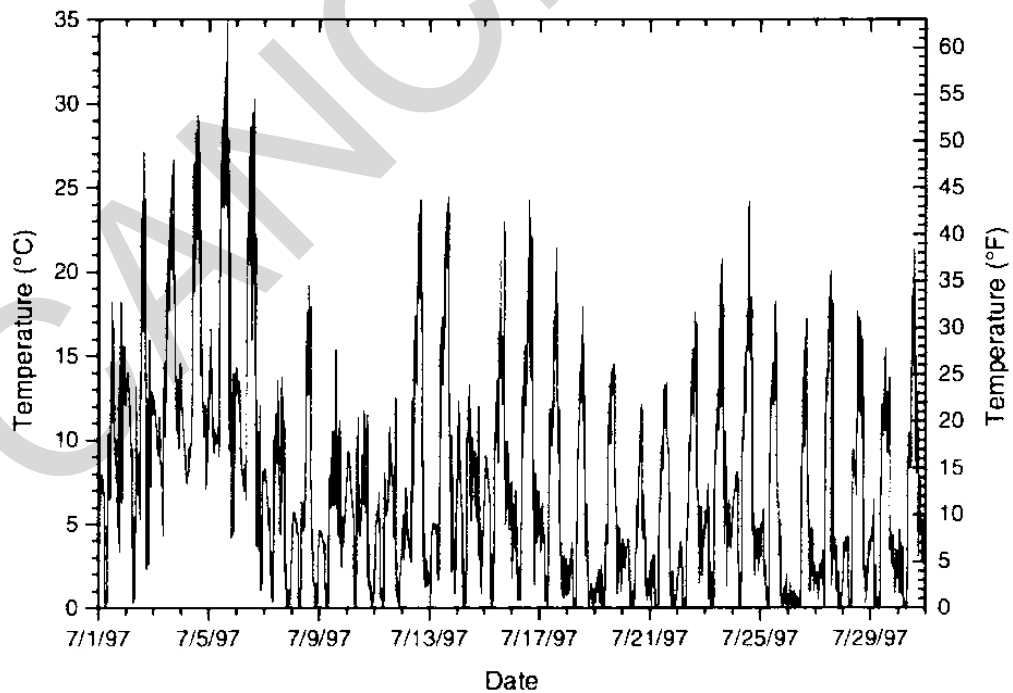

Figure G-24. Solar Array BTU's Delivered and Hot Water Demand

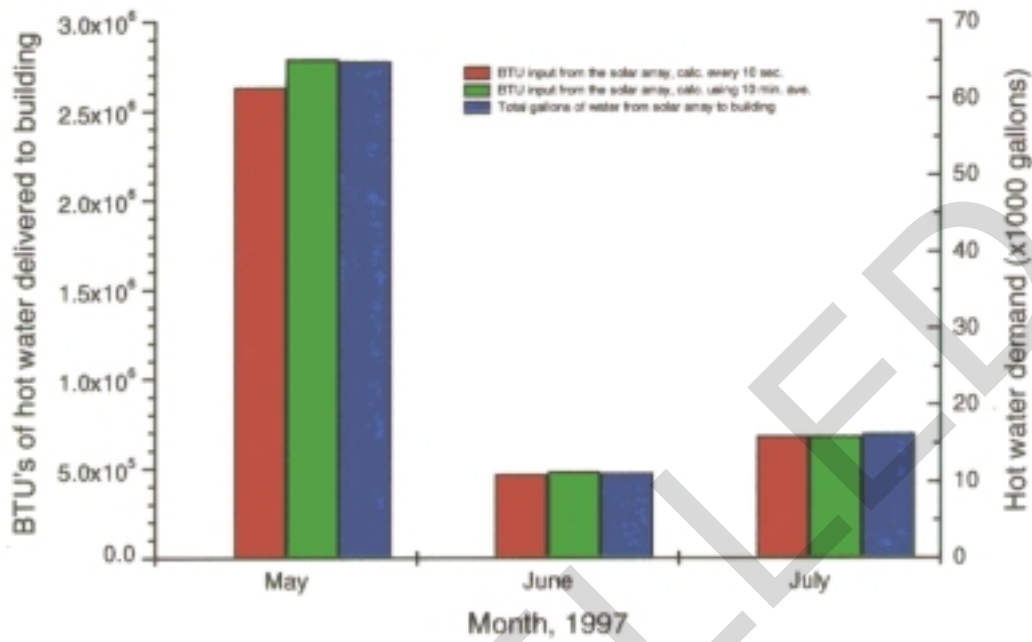

Figure G-25. Solar Array Joule's Delivered and Hot Water Demand

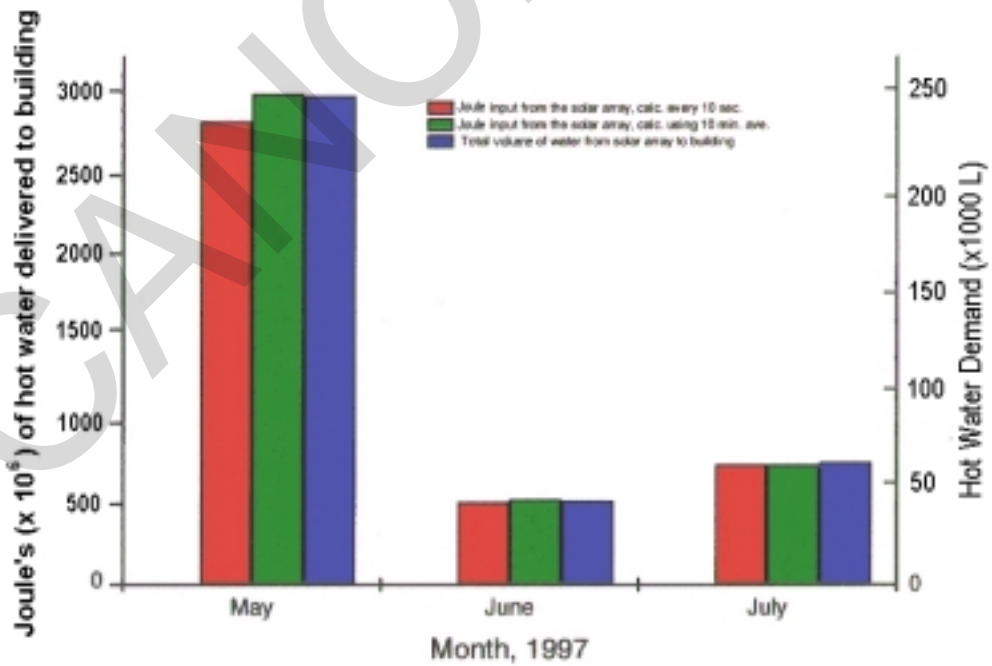

Figure G-26. Solar Array BTU's Delivered, Gas Usage and Hot Water Usage

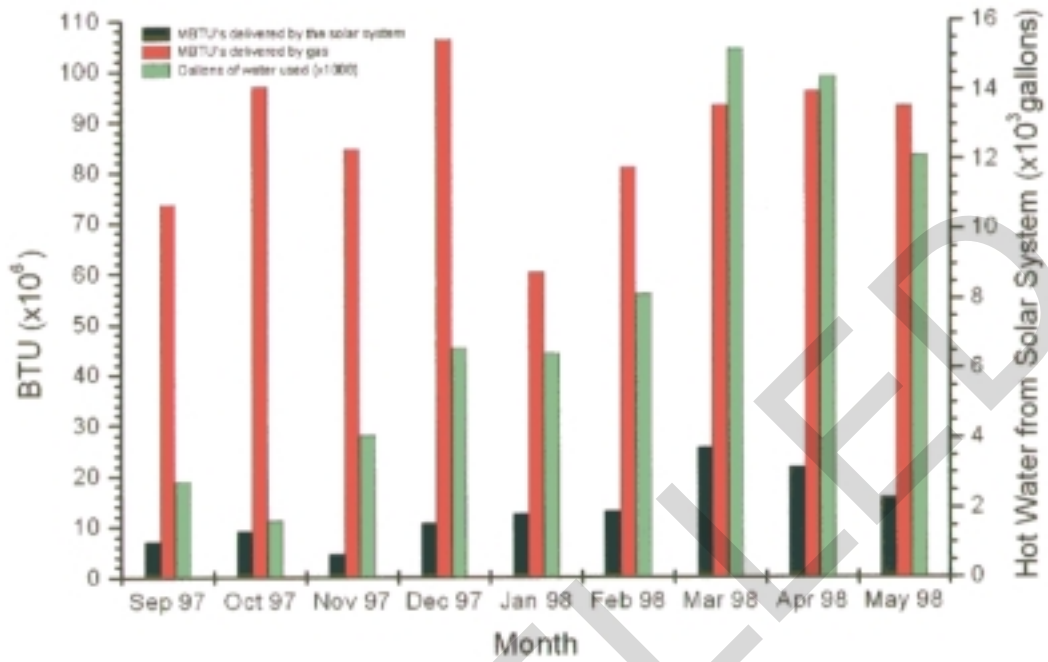

Figure G-27. Solar Array Joule's Delivered, Gas Usage and Hot Water Usage

