

UNIFIED FACILITIES CRITERIA (UFC)

HEATING, VENTILATING, AND AIR CONDITIONING (HVAC) CONTROL SYSTEMS



APPROVED FOR PUBLIC RELEASE; DISTRIBUTION UNLIMITED

UNIFIED FACILITIES CRITERIA (UFC)

HEATING, VENTILATING, AND AIR CONDITIONING (HVAC) CONTROL SYSTEMS

Any copyrighted material included in this UFC is identified at its point of use. Use of the copyrighted material apart from this UFC must have the permission of the copyright holder.

U.S. ARMY CORPS OF ENGINEERS (Preparing Activity)

NAVAL FACILITIES ENGINEERING COMMAND

AIR FORCE CIVIL ENGINEER SUPPORT AGENCY

Record of Changes (changes are indicated by \1\ ... /1/)

Change No.	Date	Location

This UFC supersedes TI 810-11, dated 30 November 1998. The format of this UFC does not conform to UFC 1-300-01; however, the format will be adjusted to conform at the next revision. The body of this UFC is a document of a different number.

FOREWORD

\1\

The Unified Facilities Criteria (UFC) system is prescribed by MIL-STD 3007 and provides planning, design, construction, sustainment, restoration, and modernization criteria, and applies to the Military Departments, the Defense Agencies, and the DoD Field Activities in accordance with [USD\(AT&L\) Memorandum](#) dated 29 May 2002. UFC will be used for all DoD projects and work for other customers where appropriate. All construction outside of the United States is also governed by Status of forces Agreements (SOFA), Host Nation Funded Construction Agreements (HNFA), and in some instances, Bilateral Infrastructure Agreements (BIA.) Therefore, the acquisition team must ensure compliance with the more stringent of the UFC, the SOFA, the HNFA, and the BIA, as applicable.

UFC are living documents and will be periodically reviewed, updated, and made available to users as part of the Services' responsibility for providing technical criteria for military construction. Headquarters, U.S. Army Corps of Engineers (HQUSACE), Naval Facilities Engineering Command (NAVFAC), and Air Force Civil Engineer Support Agency (AFCEA) are responsible for administration of the UFC system. Defense agencies should contact the preparing service for document interpretation and improvements. Technical content of UFC is the responsibility of the cognizant DoD working group. Recommended changes with supporting rationale should be sent to the respective service proponent office by the following electronic form: [Criteria Change Request \(CCR\)](#). The form is also accessible from the Internet sites listed below.

UFC are effective upon issuance and are distributed only in electronic media from the following source:

- Whole Building Design Guide web site <http://dod.wbdg.org/>.

Hard copies of UFC printed from electronic media should be checked against the current electronic version prior to use to ensure that they are current.

AUTHORIZED BY:

DONALD L. BASHAM, P.E.
Chief, Engineering and Construction
U.S. Army Corps of Engineers

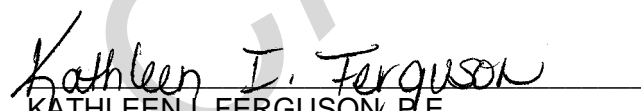
KATHLEEN I. FERGUSON, P.E.
The Deputy Civil Engineer
DCS/Installations & Logistics
Department of the Air Force

DR. JAMES W. WRIGHT, P.E.
Chief Engineer
Naval Facilities Engineering Command

Dr. GET W. MOY, P.E.
Director, Installations Requirements and
Management
Office of the Deputy Under Secretary of Defense
(Installations and Environment)

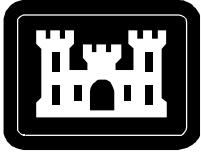

**US Army Corps
of Engineers®**

TI 810-11
30 November 1998

Technical Instructions

Heating, Ventilating, and Air Conditioning (HVAC) Control Systems

Headquarters
U.S. Army Corps of Engineers
Engineering and Construction Division
Directorate of Military Programs
Washington, DC 20314-1000

TECHNICAL INSTRUCTIONS

HEATING, VENTILATING, AND AIR CONDITIONING (HVAC) CONTROL SYSTEMS

Any copyrighted material included in this document is identified at its point of use. Use of the copyrighted material apart from this document must have the permission of the copyright holder.

Approved for public release; distribution is unlimited.

Record of Changes (changes indicated \1\... /1/)

No.	Date	Location
-----	------	----------

This Technical Instruction covers material previously contained in TM 5-815-3, dated July 1991.

FOREWORD

These technical instructions (TI) provide design and construction criteria and apply to all U.S. Army Corps of Engineers (USACE) commands having military construction responsibilities. TI will be used for all Army projects and for projects executed for other military services or work for other customers where appropriate.

TI are living documents and will be periodically reviewed, updated, and made available to users as part of the HQUSACE responsibility for technical criteria and policy for new military construction. CEMP-ET is responsible for administration of the TI system; technical content of TI is the responsibility of the HQUSACE element of the discipline involved. Recommended changes to TI, with rationale for the changes, should be sent to HQUSACE, ATTN: CEMP-ET, 20 Massachusetts Ave., NW, Washington, DC 20314-1000.

TI are effective upon issuance. TI are distributed only in electronic media through the TECHINFO Internet site <http://www.hnd.usace.army.mil/techinfo/index.htm> and the Construction Criteria Base (CCB) system maintained by the National Institute of Building Sciences at Internet site <http://www.nibs.org/ccb/>. Hard copies of these instructions produced by the user from the electronic media should be checked against the current electronic version prior to use to assure that the latest instructions are used.

FOR THE COMMANDER:



DWIGHT A. BERANEK, P.E.
Chief, Engineering and Construction Division
for Military Programs

HEATING, VENTILATING AND AIR CONDITIONING (HVAC) CONTROL SYSTEMS**Table of Contents**

	Page
CHAPTER 1. GENERAL	
Paragraph 1. Purpose	1-1
2. Scope	1-1
3. References	1-1
4. Policy	1-1
5. Control system designer guidance	1-1
6. Design concept	1-2
7. DDC versus SLDC	1-2
8. Control system standards	1-5
9. Project implementation	1-7
10. Design package requirements for HVAC control systems	1-8
11. EMCS interface with standard local control panels	1-10
12. Fan starter control circuit override by external control systems	1-13
13. Coordination with HVAC system balancing	1-13
14. Symbols	1-13
15. Explanation of terms	1-13
CHAPTER 2. HVAC CONTROL SYSTEM EQUIPMENT, EQUIPMENT USES AND HVAC CONTROL LOOPS	
Paragraph 1. General	2-1
2. Control system operating modes and process variables	2-1
3. Control system equipment	2-2
4. Control loops	2-14

Table of Contents (cont'd)

5.	Open control loops	2-14
6.	Closed control loops	2-14
7.	Application of open-loop control and closed-loop control to HVAC systems.	2-15
8.	Typical control modes	2-15
9.	Standard HVAC system control loops	2-20
10.	Sizing and selection of control system devices	2-20
11.	Sizing of the air compressor motor	2-20
12.	Determination of control valve flow coefficient (K_v / C_v)	2-22
13.	Calculation of liquid control valve flow coefficient (K_v / C_v)	2-22
14.	Calculation of steam control valve flow coefficient (K_v / C_v)	2-25
15.	Determining valve actuator close-off pressure ratings	2-29
16.	Surge protection provisions for transmitter and control wiring	2-30
CHAPTER 3. STANDARD CONTROL LOOPS		
Paragraph	1. General	3-1
	2. Cooling coil temperature control loop	3-1
	3. Outside air preheat coil temperature control loop	3-1
	4. Heating coil temperature control loop	3-2
	5. Mixed air temperature and economizer control loops	3-5
	6. Minimum outside air control loop for VAV HVAC systems	3-7
	7. Supply duct static pressure control loop	3-9
	8. Return fan volume control loop	3-9
	9. Humidifier control loop	3-11
	10. The typical schematic	3-11
	11. The typical ladder diagram	3-11

Table of Contents (cont'd)

12.	The typical equipment schedule	3-12
13.	The typical data terminal strip (DTS) layout	3-13
CHAPTER 4. STANDARD HVAC CONTROL SYSTEMS		
Paragraph	1. General	4-1
	2. Identification of control system devices	4-1
	3. Project specific drawings	4-1
	4. Space temperature controlled perimeter radiation control system	4-2
	5. Unit heater temperature control system	4-2
	6. Gas-fired infrared heater control system	4-2
	7. Small packaged unitary system control system	4-3
	8. Dual-temperature fan coil unit control system	4-3
	9. Control systems that require control panels	4-4
	10. Standard single-loop controller HVAC control panel	4-4
	11. Central plant steam hydronic heating control system	4-6
	12. Single building hydronic heating with hot water boiler control system	4-8
	13. Central plant high-temperature hot water hydronic heating control system	4-10
	14. Central plant steam dual-temperature hydronic control system	4-13
	15. Central plant high-temperature hot water dual-temperature hydronic control system	4-15
	16. Single building dual-temperature hydronic control system	4-17
	17. Heating and ventilating control system	4-20
	18. Multizone HVAC control system with return fan	4-23
	19. Dual-duct HVAC control system with return fan	4-28
	20. Bypass multizone HVAC control system with return fan	4-32
	21. Variable air volume (VAV) HVAC control system without return fan	4-37

Table of Contents (cont'd)

22.	Variable air volume (VAV) HVAC control system with return fan	4-42
23.	Single zone HVAC control system	4-47
24.	Dual-temperature coil single zone HVAC control system	4-51
25.	Single zone HVAC control system with humidity control	4-56
26.	Single zone HVAC control system with direct-expansion (DX) cooling coil .	4-60
 CHAPTER 5. CONTROL SYSTEM DESIGN VARIATIONS		
Paragraph	1. General	5-1
	2. Control system variations for 100-percent outside air (continuous operation)	5-1
	3. Control system variations for exhaust fans	5-2
	4. Control system variations for smoke dampers	5-2
	5. Control system variations for variable speed drives	5-3
	6. Control system variations for steam preheat coil with face and bypass damper	5-4
	7. Control system variation for hot water or glycol preheat coil	5-4
	8. Control system variation for combining hydronic system and air system controls in the same control panel	5-4
	9. Unoccupied mode space temperature setback control for terminal units . . .	5-4
	10. Control system variations for 2-way shutoff valves for fan coil units	5-4
	11. Control system variation for building purge / flush cycle.	5-5
	12. Control system variations for EMCS initiated building purge and recirculation modes	5-5
	13. Control system variations for smoke control and freeze protection	5-6
	14. Control system variations for non-economizer HVAC systems	5-6
	15. Control system variations for dual steam valves	5-7
	16. Control system variations for hydronic systems with boilers requiring constant flow	5-7

Table of Contents (cont'd)

CHAPTER 6. RETROFIT OF EXISTING HVAC CONTROL SYSTEMS

Paragraph	1. Introduction	6-1
	2. Valve sizing and its effect on hydronic systems	6-1
	3. Damper sizing and its effect on air handling systems	6-1
	4. Replacement of 3-way and 2-way valves	6-1
	5. Retrofit projects where only final elements may be left in place	6-1
	6. Retrofits involving economizer control loops	6-1
	7. Retrofit projects involving HVAC systems not covered in this manual	6-2
	8. General considerations for retrofit projects	6-2
GLOSSARY	Glossary 1

LIST OF FIGURES

Figure	Title
2-1.	Two butterfly valves on a common pipe tee.
2-2.	Conversion of an electronic signal to a pneumatic signal.
2-3.	Simultaneous heating and cooling with pneumatic actuators without positive positioners.
2-4.	Control system with positive positioners to avoid simultaneous heating and cooling.
2-5.	Modulating control circuits impedance limitation.
2-6.	Manual reset feature.
2-7.	Control loop.
2-8.	Open control loop.
2-9.	Closed control loop.
2-10.	Two loops controlling one device (humidity control with high limit).
2-11.	Two-position control.
2-12.	Simple control loop applied to outside air heating.
2-13.	Proportional control mode.
2-14.	Proportional plus integral control mode.
2-15.	Comparison of P mode, PI mode and PID mode for a step change in setpoint and the contributions of each mode to controller output signal.
2-16.	Typical normally-open pneumatic valve.
2-17.	Close-off pressure for two-way valves.
2-18.	Close-off pressure for three-way valves.
3-1.	Cooling coil temperature control loop.
3-2.	Outside air preheat coil temperature control loop.
3-3.	Heating coil temperature control loop (scheduled from outside air temperature).
3-4.	Outside air temperature controller input / output schedule.
3-5.	Heating coil temperature control loop with heating coil controlled at a constant temperature.

Table of Contents (cont'd)

3-6.	Mixed air temperature and economizer control loops.
3-7.	Design condition for economizer mode operation.
3-8.	Selecting the economizer switchover point.
3-9.	Effect on energy conservation of selection of the economizer switchover point.
3-10.	Minimum outside air and mixed air temperature / economizer control loops for VAV systems.
3-11.	Supply duct static pressure control loop.
3-12.	Return fan volume control loop.
3-13.	Humidifier control loop.
3-14.	Typical single-loop controller schematic.
3-15.	Typical DDC schematic.
3-16.	Typical ladder diagram.
3-17.	Typical equipment schedule.
3-18.	Typical DDC data terminal strip layout.
4-1.	Space temperature controlled perimeter radiation control system.
4-2.	Unit heater temperature control system.
4-3.	Gas-fired infrared heater temperature control system.
4-4.	Small packaged unitary system control system.
4-5.	Dual-temperature fan coil unit temperature control system.
4-6a.	Standard wall-mounted HVAC control panel arrangement.
4-6b.	Section "A-A" through standard HVAC control panel.
4-6c.	Standard HVAC control panel interior door.
4-6d.	Standard HVAC control panel back panel layout.
4-6e.	Standard HVAC control panel terminal block assignments.
4-6f.	Controller wiring.
4-6g.	Supply fan and return fan starter wiring.
4-6h.	Exhaust fan and pump starter wiring.
4-6i.	HVAC control panel power wiring.
4-7a.	Control system schematic for central plant steam hydronic system.
4-7b.	Control system ladder diagram for central plant steam hydronic system.
4-7c.	Control system equipment for central plant steam hydronic system.
4-7d.	Control panel interior door layout for central plant steam hydronic system.
4-7e.	Control panel back panel layout for central plant steam hydronic system.
4-7f.	Control panel terminal block layout for central plant steam hydronic system.
4-7g.	DDC control system schematic for central plant steam hydronic system.
4-7h.	DDC control system ladder diagram for central plant steam hydronic system.
4-7i.	DDC control system equipment for central plant steam hydronic system.
4-7j.	DDC control system I/O table and data terminal strip layout for central plant steam hydronic system.
4-8a.	Control system schematic for single building hydronic heating system with hot water boiler.
4-8b.	Control system ladder diagram for single building hydronic heating system with hot water boiler.
4-8c.	Control system equipment for single building hydronic heating system with hot water boiler.
4-8d.	Control panel interior door layout for single building hydronic heating system with hot water boiler.
4-8e.	Control panel back panel layout for single building hydronic heating system with hot water boiler.

Table of Contents (cont'd)

4-8f.	Control panel terminal block layout for single building hydronic heating system with hot water boiler.
4-8g.	DDC control system schematic for single building hydronic heating system with hot water boiler.
4-8h.	DDC control system ladder diagram for single building hydronic heating system with hot water boiler.
4-8i.	DDC control system equipment for single building hydronic heating system with hot water boiler.
4-8j.	DDC control system I/O table and data terminal strip layout for single building hydronic heating system with hot water boiler.
4-9a.	Control system schematic for central plant high-temperature hot water hydronic heating system.
4-9b.	Control system ladder diagram for central plant high-temperature hot water hydronic heating system.
4-9c.	Control system equipment for central plant high-temperature hot water hydronic heating system.
4-9d.	Control panel interior door layout for central plant high-temperature hot water hydronic heating system.
4-9e.	Control panel back panel layout for central plant high-temperature hot water hydronic heating system.
4-9f.	Control panel terminal block layout for central plant high-temperature hot water hydronic heating system.
4-9g.	DDC control system schematic for central plant high-temperature hot water hydronic heating system.
4-9h.	DDC control system ladder diagram for central plant high-temperature hot water hydronic heating system.
4-9i.	DDC control system equipment for central plant high-temperature hot water hydronic heating system.
4-9j.	DDC control system I/O table and data terminal strip layout for central plant high-temperature hot water hydronic heating system.
4-10a.	Control system schematic for central plant steam dual-temperature hydronic system.
4-10b.	Control system ladder diagram for central plant steam dual-temperature hydronic system.
4-10c.	Control system equipment for central plant steam dual-temperature hydronic system.
4-10d.	Control panel interior door layout for central plant steam dual-temperature hydronic system.
4-10e.	Control panel back panel layout for central plant steam dual-temperature hydronic system.
4-10f.	Control panel terminal block layout for central plant steam dual-temperature hydronic system.
4-10g.	DDC control system schematic for central plant steam dual-temperature hydronic system.
4-10h.	DDC control system ladder diagram for central plant steam dual-temperature hydronic system.
4-10i.	DDC control system equipment for central plant steam dual-temperature hydronic system.
4-10j.	DDC control system I/O table and data terminal strip layout for central plant steam dual-temperature hydronic system.
4-11a.	Control system schematic for central plant high-temperature hot water dual-temperature hydronic system.

Table of Contents (cont'd)

4-11b.	Control system ladder diagram for central plant high-temperature hot water dual-temperature hydronic system.
4-11c.	Control system equipment for central plant high-temperature hot water dual-temperature hydronic system.
4-11d.	Control panel interior door layout for central plant high-temperature hot water dual-temperature hydronic system.
4-11e.	Control panel back panel layout for central plant high-temperature hot water dual-temperature hydronic system.
4-11f.	Control panel terminal block layout for central plant high-temperature hot water dual-temperature hydronic system.
4-11g.	DDC control system schematic for central plant high-temperature hot water dual-temperature hydronic system.
4-11h.	DDC control system ladder diagram for central plant high-temperature hot water dual-temperature hydronic system.
4-11i.	DDC control system equipment for central plant high-temperature hot water dual-temperature hydronic system.
4-11j.	DDC control system I/O table and data terminal strip layout for central plant high-temperature hot water dual-temperature hydronic system.
4-12a.	Control system schematic for single building dual-temperature hydronic system.
4-12b.	Control system ladder diagram for single building dual-temperature hydronic system.
4-12c.	Control system equipment for single building dual-temperature hydronic system.
4-12d.	Control panel interior door layout for single building dual-temperature hydronic system.
4-12e.	Control panel back panel layout for single building dual-temperature hydronic system.
4-12f.	Control panel terminal block layout for single building dual-temperature hydronic system.
4-12g.	DDC control system schematic for single building dual-temperature hydronic system.
4-12h.	DDC control system ladder diagram for single building dual-temperature hydronic system.
4-12i.	DDC control system equipment for single building dual-temperature hydronic system.
4-12j.	DDC control system I/O table and data terminal strip layout for single building dual-temperature hydronic system.
4-13a.	Control system schematic for heating and ventilating system.
4-13b.	Control system ladder diagram for heating and ventilating system.
4-13c.	Control system equipment for heating and ventilating system.
4-13d.	Control panel interior door layout for heating and ventilating system.
4-13e.	Control panel back panel layout for heating and ventilating system.
4-13f.	Control panel terminal block layout for heating and ventilating system.
4-13g.	DDC control system schematic for heating and ventilating system.
4-13h.	DDC control system ladder diagram for heating and ventilating system.
4-13i.	DDC control system equipment for heating and ventilating system.
4-13j.	DDC control system I/O table and data terminal strip layout for heating and ventilating system.
4-14a.	Control system schematic for multizone HVAC system.
4-14b.	Control system ladder diagram for multizone HVAC system.
4-14c.	Control system equipment for multizone HVAC system.
4-14d.	Control panel interior door layout for multizone HVAC system.
4-14e.	Control panel back panel layout for multizone HVAC system.
4-14f.	Control panel terminal block layout for multizone HVAC system.
4-14g.	DDC control system schematic for multizone HVAC system.
4-14h.	DDC control system ladder diagram for multizone HVAC system.
4-14i.	DDC control system equipment for multizone HVAC system.

Table of Contents (cont'd)

4-14j.	DDC control system I/O table and data terminal strip layout for multizone HVAC system.
4-15a.	Control system schematic for dual-duct HVAC system.
4-15b.	Control system ladder diagram for dual-duct HVAC system.
4-15c.	Control system equipment for dual-duct HVAC system.
4-15d.	Control panel interior door layout for dual-duct HVAC system.
4-15e.	Control panel back panel layout for dual-duct HVAC system.
4-15f.	Control panel terminal block layout for dual-duct HVAC system.
4-15g.	DDC control system schematic for dual-duct HVAC system.
4-15h.	DDC control system ladder diagram for dual-duct HVAC system.
4-15i.	DDC control system equipment for dual-duct HVAC system.
4-15j.	DDC control system I/O table and data terminal strip layout for dual-duct HVAC system.
4-16a.	Control system schematic for bypass multizone HVAC system.
4-16b.	Control system ladder diagram for bypass multizone HVAC system.
4-16c.	Control system equipment for bypass multizone HVAC system.
4-16d.	Control panel interior door layout for bypass multizone HVAC system.
4-16e.	Control panel back panel layout for bypass multizone HVAC system.
4-16f.	Control panel terminal block layout for bypass multizone HVAC system.
4-16g.	DDC control system schematic for bypass multizone HVAC system.
4-16h.	DDC control system ladder diagram for bypass multizone HVAC system.
4-16i.	DDC control system equipment for bypass multizone HVAC system.
4-16j.	DDC control system I/O table and data terminal strip layout for bypass multizone HVAC system.
4-17a.	Control system schematic for VAV HVAC system without return fan.
4-17b.	Control system ladder diagram for VAV HVAC system without return fan.
4-17c.	Control system equipment for VAV HVAC system without return fan.
4-17d.	Control panel interior door layout for VAV HVAC system without return fan.
4-17e.	Control panel back panel layout for VAV HVAC system without return fan.
4-17f.	Control panel terminal block layout for VAV HVAC system without return fan.
4-17g.	DDC control system schematic for VAV HVAC system without return fan.
4-17h.	DDC control system ladder diagram for VAV HVAC system without return fan.
4-17i.	DDC control system equipment for VAV HVAC system without return fan.
4-17j.	DDC control system I/O table and data terminal strip layout for VAV HVAC system without return fan.
4-18a.	Control system schematic for VAV HVAC system with return fan.
4-18b.	Control system ladder diagram for VAV HVAC system with return fan.
4-18c.	Control system equipment for VAV HVAC system with return fan.
4-18d.	Control panel interior door layout for VAV HVAC system with return fan.
4-18e.	Control panel back panel layout for VAV HVAC system with return fan.
4-18f.	Control panel terminal block layout for VAV HVAC system with return fan.
4-18g.	DDC control system schematic for VAV HVAC system with return fan.
4-18h.	DDC control system ladder diagram for VAV HVAC system with return fan.
4-18i.	DDC control system equipment for VAV HVAC system with return fan.
4-18j.	DDC control system I/O table and data terminal strip layout for VAV HVAC system with return fan.
4-19a.	Control system schematic for single zone HVAC system.
4-19b.	Control system ladder diagram for single zone HVAC system.
4-19c.	Control system equipment for single zone HVAC system.
4-19d.	Control panel interior door layout for single zone HVAC system.
4-19e.	Control panel back panel layout for single zone HVAC system.
4-19f.	Control panel terminal block layout for single zone HVAC system.

Table of Contents (cont'd)

4-19g.	DDC control system schematic for single zone HVAC system.
4-19h.	DDC control system ladder diagram for single zone HVAC system.
4-19i.	DDC control system equipment for single zone HVAC system.
4-19j.	DDC control system I/O table and data terminal strip layout for single zone HVAC system.
4-20a.	Control system schematic for single zone HVAC system with dual-temperature coil.
4-20b.	Control system ladder diagram for single zone HVAC system with dual-temperature coil.
4-20c.	Control system equipment for single zone HVAC system with dual-temperature coil.
4-20d.	Control panel interior door layout for single zone HVAC system with dual-temperature coil.
4-20e.	Control panel back panel layout for single zone HVAC system with dual-temperature coil.
4-20f.	Control panel terminal block layout for single zone HVAC system with dual-temperature coil.
4-20g.	DDC control system schematic for single zone HVAC system with dual-temperature coil.
4-20h.	DDC control system ladder diagram for single zone HVAC system with dual-temperature coil.
4-20i.	DDC control system equipment for single zone HVAC system with dual-temperature coil.
4-20j.	DDC control system I/O table and data terminal strip layout for single zone HVAC system with dual-temperature coil.
4-21a.	Control system schematic for single zone HVAC system with humidity control.
4-21b.	Control system ladder diagram for single zone HVAC system with humidity control.
4-21c.	Control system equipment for single zone HVAC system with humidity control.
4-21d.	Control panel interior door layout for single zone HVAC system with humidity control.
4-21e.	Control panel back panel layout for single zone HVAC system with humidity control.
4-21f.	Control panel terminal block layout for single zone HVAC system with humidity control.
4-21g.	DDC control system schematic for single zone HVAC system with humidity control.
4-21h.	DDC control system ladder diagram for single zone HVAC system with humidity control.
4-21i.	DDC control system equipment for single zone HVAC system with humidity control.
4-21j.	DDC control system I/O table and data terminal strip layout for single zone HVAC system with humidity control.
4-22a.	Control system schematic for single zone HVAC system with DX coil.
4-22b.	Control system ladder diagram for single zone HVAC system with DX coil.
4-22c.	Control system equipment for single zone HVAC system with DX coil.
4-22d.	Control panel interior door layout for single zone HVAC system with DX coil.
4-22e.	Control panel back panel layout for single zone HVAC system with DX coil.
4-22f.	Control panel terminal block layout for single zone HVAC system with DX coil.
4-22g.	DDC control system schematic for single zone HVAC system with DX coil.
4-22h.	DDC control system ladder diagram for single zone HVAC system with DX coil.
4-22i.	DDC control system equipment for single zone HVAC system with DX coil.
4-22j.	DDC control system I/O table and data terminal strip layout for single zone HVAC system with DX coil.
5-1.	Schematic variations for 100-percent outside air systems.
5-2.	Ladder diagram variations for 100-percent outside air systems.
5-3.	Schematic variations for exhaust fans.
5-4.	Ladder diagram variations for exhaust fans.
5-5.	Schematic variations for smoke dampers.
5-6.	Ladder diagram variations for smoke dampers.
5-7a.	Schematic variations for variable speed drives.
5-7b.	Ladder diagram variations for variable speed drives.
5-7c.	Equipment variations for variable speed drives.

Table of Contents (cont'd)

5-7d.	Control panel interior door layout variations for variable speed drives.
5-7e.	Control panel back panel layout variations for variable speed drives.
5-7f.	Control panel terminal block layout variations for variable speed drives.
5-7g.	DDC schematic variations for variable speed drives.
5-7h.	DDC ladder diagram variations for variable speed drives.
5-7i.	DDC schedule variations for variable speed drives.
5-7j.	DDC I/O table and data terminal strip layout variations for variable speed drives.
5-8.	Control system variations for steam preheat coil with face and bypass dampers.
5-9.	Control system variations for unoccupied mode setback (perimeter radiation).
5-10.	Control system variations for unoccupied mode setback (unit heater).
5-11.	Control system variations for 2-way shutoff valve on fan coil units.
5-12a.	Control system schematic for multizone HVAC system with building flush mode of operation
5-12b.	Control system ladder diagram for multizone HVAC system with building flush mode of operation.
5-12c.	Control system equipment for multizone HVAC system with building flush mode of operation.
5-12d.	Control panel interior door layout for multizone HVAC system with building flush mode of operation.
5-12e.	Control panel back panel layout for multizone HVAC system with building flush mode of operation.
5-12f.	Control panel terminal block layout for multizone HVAC system with building flush mode of operation.
5-13.	Control system variations for EMCS building purge and recirculation modes for pneumatic actuators.
5-14.	Control system variations for EMCS building purge and recirculation modes for electric or electronic actuators.
5-15a.	Control system schematic for single-zone HVAC system without economizer control mode.
5-15b.	Control system ladder diagram for single-zone HVAC system without economizer control mode.
5-15c.	Control system equipment for single-zone HVAC system without economizer control mode.
5-15d.	Control panel interior door layout for single-zone HVAC system without economizer control mode.
5-15e.	Control panel back panel layout for single-zone HVAC system without economizer control mode.
5-15f.	Control panel terminal block layout for single-zone HVAC system without economizer control mode.
5-15g.	DDC control system schematic for single-zone HVAC system without economizer control mode.
5-15h.	DDC control system ladder diagram for single-zone HVAC system without economizer control mode.
5-15i.	DDC control system equipment for single-zone HVAC system without economizer control mode.
5-15j.	DDC control system I/O table and data terminal strip layout for single-zone HVAC system without economizer control mode.
5-16.	Schematic variations for dual steam valves.
5-17.	Equipment schedule variations for dual steam valves.

Table of Contents (cont'd)

5-18a.	Control system schematic for single building hydronic heating system with constant volume hot water boiler loop.
5-18b.	Control system ladder diagram for single building hydronic heating system with constant volume hot water boiler loop.
5-18c.	Control system equipment for single building hydronic heating system with constant volume hot water boiler loop.
5-18d.	Control panel interior door layout for single building hydronic heating system with constant volume hot water boiler loop.
5-18e.	Control panel back panel layout for single building hydronic heating system with constant volume hot water boiler loop.
5-18f.	Control panel terminal block layout for single building hydronic heating system with constant volume hot water boiler loop.
5-18g.	DDC control system schematic for single building hydronic heating system with constant volume hot water boiler loop.
5-18h.	DDC control system ladder diagram for single building hydronic heating system with constant volume hot water boiler loop.
5-18i.	DDC control system equipment for single building hydronic heating system with constant volume hot water boiler loop.
5-18j.	DDC control system I/O table and data terminal strip layout for single building hydronic heating system with constant volume hot water boiler loop.
5-19a.	Control system schematic for single building dual-temperature hydronic system with constant volume boiler loop.
5-19b.	Control system ladder diagram for single building dual-temperature hydronic system with constant volume boiler loop.
5-19c.	Control system equipment for single building dual-temperature hydronic system with constant volume boiler loop.
5-19d.	Control panel interior door layout for single building dual-temperature hydronic system with constant volume boiler loop.
5-19e.	Control panel back panel layout for single building dual-temperature hydronic system with constant volume boiler loop.
5-19f.	Control panel terminal block layout for single building dual-temperature hydronic system with constant volume boiler loop.
5-19g.	DDC control system schematic for single building dual-temperature hydronic system with constant volume boiler loop.
5-19h.	DDC control system ladder diagram for single building dual-temperature hydronic system with constant volume boiler loop.
5-19i.	DDC control system equipment for single building dual-temperature hydronic system with constant volume boiler loop.
5-19j.	DDC control system I/O table and data terminal strip layout for single building dual-temperature hydronic system with constant volume boiler loop.

LIST OF TABLES

Table	Title
1-1.	Commissioning procedure.
2-1.	Controller features.
2-2.	Air consumption of control devices.
2-3.	Available control valves with Cv in the range of 16 to 25.

CHAPTER 1

GENERAL

1. **PURPOSE.** This document provides criteria and guidance for the design of heating, ventilating and air conditioning (HVAC) control systems, and designates the standard control loops to be used.
2. **SCOPE.** These instructions describe frequently encountered control system loops, provide examples of how these loops are used, and provide guidance and criteria for the design of standard HVAC control systems and standard control panels. This document does not provide guidance on selecting HVAC systems and does not prohibit selection of system types not included herein.
3. **REFERENCES.** The following documents form a part of this technical instruction to the extent referenced:
 - a. Government Publications TM-5-785 Engineering Weather Data.
 - b. Government Publications TM-815-2 Energy Monitoring and Control Systems.
4. **POLICY.**
 - a. **Adherence to the standards.** The design of the HVAC control systems will not deviate from the standards established in these instructions, except where the design agency has an approved waiver request.
 - b. **Control system designer responsibilities.** The HVAC control system designer will be responsible for designing each control system required for the project HVAC systems, and will incorporate the control loops, control system sequences of operation, and HVAC control panel layouts (except when designing a Direct Digital Control (DDC) HVAC control system), using the symbols, abbreviations, and acronyms designated in these instructions. This design responsibility requires producing a design package that includes a specification, a set of drawings, and commissioning procedures for each HVAC control system. The designer will not depend on any HVAC control system vendor for the design of the HVAC control systems.
 - c. **Control system vendor compliance.** The HVAC control system vendor will be required by the contract documents to make the system product specific. The specification will require the HVAC control system vendor to produce shop drawings, schedules, instructions, test plans, test procedures, commissioning procedures, and other documents showing the application of products to implement the control system design. The specification will require that the HVAC control system vendor test the control system and document the test to show that the control system functions as designed, and to commission the control system.
5. **CONTROL SYSTEM DESIGNER GUIDANCE.**
 - a. **Control system loops and control logic.** These instructions include descriptions of loops for controlling temperature, humidification, airflow, and duct system static pressure. In addition, these instructions contain control logic for the following:
 - (1) Scheduling and initiating system operation.
 - (2) Changes in control modes of operation.
 - (3) Normal interlocks.

- (4) Life Safety system interlocks.
- (5) Special interlocks (such as for freeze protection).

b. Control system variations. These instructions show some of the possible HVAC system equipment and control system variations, and provide guidance and examples to show how the designer can modify control loops and systems for applications not specifically shown. The HVAC equipment and system variations for which control system guidance is provided include:

- (1) Outside air preheat coils using hot water or glycol.
- (2) Outside air preheat coils using steam.
- (3) One-hundred percent outside air in lieu of outside air/ return air economizer.
- (4) Deleting economizer control.
- (5) Return fans.
- (6) Exhaust fans.
- (7) Humidity controls.
- (8) Smoke dampers in HVAC supply air and return air ducts.
- (9) Override of control of valves and dampers for freeze protection or smoke control systems.
- (10) Startup and shutdown of HVAC fan systems by external systems such as smoke control.
- (11) Variable speed fan drives.
- (12) Combining systems in a common control panel.
- (13) Unoccupied mode space temperature setback control of HVAC equipment.
- (14) Building purge and recirculation modes.
- (15) Variations in the use of control valves.

c. Project applicability. The HVAC control systems shown in these instructions are applicable to new construction building projects, building addition projects, building renovation projects, and (as further described in chapter 6) building retrofit projects.

d. Types of HVAC equipment covered. These instructions provide control system guidance for HVAC systems for heating, cooling, humidity control, ventilation and air delivery, terminal units, and small packaged unitary systems. Terminal units include Variable Air Volume (VAV) boxes, duct coils, fan coil units, unit heaters, gas-fired infrared heaters, and radiators.

e. Exceptions. These instructions do not cover control systems for HVAC equipment such as boilers and chillers, which usually have controls integral to the equipment.

6. DESIGN CONCEPT. The guidance contained in these instructions adheres to a particular concept for designing HVAC control systems. This concept includes the use of standard control systems that incorporate standard control loops. These instructions then show these control loops implemented in two different ways. One is with standard control system devices which are housed in a standard HVAC system control panel. This design concept also includes the use of single-loop digital controllers (SLDC) for the control of air handling systems and hydronic systems. The use of these controllers for such systems has been tested in the laboratory and in the field. The other method of implementation of the standard control loops in these instructions is Direct Digital Control (DDC) systems. Where DDC implementation differs from implementation with single-loop controllers, the DDC description will follow the descriptions of control via single-loop controllers. DDC control systems are widely available and have been in use for HVAC control for many years. However, these systems utilize proprietary hardware and software and, in general, are not compatible from one vendor's system to another.

7. DDC VERSUS SLDC.

a. Background. "Single-loop" digital controls are currently the Army standard, but there are situations where direct digital control is a better choice. DDC is a more sophisticated technology and its use may be warranted in complex applications such as laboratory or medical facilities. A complex application may loosely be defined as one where numerous points must be remotely monitored and controlled. In this type of application the DDC system will likely include a dedicated operator work station (front-end or supervisory computer) which is staffed by an operator up to 24 hours per day. Waiver requests for the use of DDC systems may be approved by the District Commander or at the Division on a project by project basis, as with other Corps criteria. The design agent or district shall ensure that the customer understands the problems as well as the benefits of a DDC system and supports its use on the project. The district/division shall also ensure that proprietary DDC procurement is only included in a contract package when fully justified with strong, clear and accurate documentation.

b. Comparisons. Prior to making a decision on whether to use DDC as opposed to the SLDC technology, the designer is advised to consider the impact and ramifications of the decision. Comparisons include:

MULTI-LOOP DDC

Commercial DDC systems are software-based with terminal connections, setpoints, calibration parameters, and calculations all handled by proprietary programs. Software operation, diagnostics and modification requirements vary by manufacturer.

With present DDC systems, software/hardware maintenance and repair or system expansion is vendor-dependent, resulting in sole source requirements that can potentially increase costs. This dependence on a single vendor for each DDC system is further complicated if the vendor drops support for older equipment or withdraws from the market. Historically, changes in the DDC market have been frequent.

Open competition and the low bid procurement environment could result in numerous proprietary DDC system manufacturers on an installation. Since each system would have different hardware, software, and maintenance requirements, in-house forces would have

SINGLE-LOOP
DIGITAL CONTROLS

The single-loop controller is industrial-grade and firmware-based, with relatively simple, straightforward configuration requirements and does not require programming capability. Army installations currently have personnel with the skills required to support the single-loop controller approach with minimal training.

The single-loop controller market is well established in the process controls industry. Single-loop controllers and other components of an SLDC-based system are interchangeable between manufacturers and are not dependent on any single vendor. SLDC systems' configurations are nonproprietary for maintenance, repair, and expansion. This nonproprietary arrangement can significantly reduce spare parts requirements.

SLDC-based systems should present fewer special training or maintenance problems as all replacement parts could be provided by a single manufacturer.

to maintain expertise in each manufacturer's equipment. Contract maintenance might be the only feasible way to maintain such systems, which could require the management and quality assurance of numerous contracts by the installation. The installation might also be subject to the high costs often associated with sole source maintenance contracts.

Since each DDC vendor has a different communication protocol and the development and acceptance of an industry standard communications protocol is not complete, the systems of different vendors cannot be easily interconnected and the application of any global control strategies would be difficult.

DDC, used in a networked architecture, can provide a significant degree of functionality in that a multitude of operating parameters can be accessed, viewed, and modified from a remote location. This functionality is a built-in, well established, and time tested feature of most vendor's individual DDC systems.

Competitively procured commercial DDC systems may have a lower first cost in larger buildings where one panel serves several air handling units. However, if the panel fails, several HVAC systems may be out of service until the appropriate maintenance personnel can locate and diagnose the problem and make the necessary repairs. Reprogramming of the panel, if necessary, would require the services of an individual trained in that system's software.

Software-based DDC systems can provide some energy saving features that local SLDC-based panels cannot provide. The actual incremental savings of these features is very site-specific.

Interfacing an SLDC-based control system to a higher level computer could be achieved via a 4-20 mA signal which eliminates problems with proprietary manufacturer protocols.

SLDC-based control systems have been interfaced to a higher level computer in a networked architecture, but the functionality is more constrained than that of DDC and the methodology and technology for accomplishing this is less well established and more expensive than that of DDC.

In the event of a failure, only one unit or one control loop of an SLDC-based system would be affected until a nonproprietary controller or other component could be replaced. Since the single-loop controller is firmware-based and not software-based, no programming is required.

Many local energy saving features as well as traditional cost effective global features, such as demand limiting, can be provided by SLDC-based panels in conjunction with the standard EMCS, a modified EMCS or a central FM system.

c. DDC system procurement

(1) Procurement. Procurement methods which have been used include:

(a) Write a five year requirements contract for DDC system components where the requirements contract is executed as a competitive procurement. Subsequent work done by controls contractors is then accomplished using government furnished DDC components. The contractor is responsible for providing all non-proprietary system components (valves, actuators, sensors, wiring, etc.), installing the government furnished proprietary components, and commissioning the entire control system. The disadvantage to this approach is that you may encounter compatibility problems after the 5 year contract expires as there is no guarantee that the same vendor will win the next contract.

(b) Write contract for SLDC, but indicate in the contract that in lieu of SLDC the contractor can provide DDC, but the DDC system must be compatible with the base-wide (UMCS or EMCS) system. This approach requires two designs and two specifications (one for the SLDC system and one for the DDC system). They will closely resemble each other, thus they are not both being developed from scratch. The separate designs must include all drawings and complete contract specifications. The selection of which system to use is up to the contractor. Using this approach, experience indicates that 70 to 80% of the time, or more, the contractor will provide the DDC system.

(c) Contract documents depict a non-proprietary DDC system, allowing for open competition. This approach is best used in single-building DDC applications where the control system is strictly "local" with no immediate or future need to interface with a supervisory system, and the facility has a dedicated maintenance staff, such as a hospital. This use of this approach is not recommended for multiple contracts or on a continuing basis because there is a high potential for eventually having a number of systems provided by different manufacturers. This leads to separate systems which have unique maintenance and training requirements, operating software, and generally will not communicate with each other without the addition of gateway interpreters.

(d) Sole source procurement of a single vendor's DDC system. The use of this approach is strongly discouraged due to the potential for protests which would delay contract award. A strong sole source acquisition justification and approval would be required on each project. If protested, it is questionable if the sole source acquisition justification could be substantiated since nonproprietary alternatives are available which surpass the minimum needs of the Army. The resolution of protests currently being argued may provide some insight for the use of this approach in the future; however, until that time, it is recommended that this approach be avoided.

8. CONTROL SYSTEM STANDARDS.

a. Standard instrumentation signals. The HVAC control system transmitter signals and the single-loop controller signals will be standard instrumentation signals of 4 to 20 milliamperes, which can be readily interfaced with any Corps standard EMCS, UMCS, or FM system and virtually any other central or head end system. When required, the controller output signal will be converted to 21 to 103 kPa (3 to 15 psig).

b. Actuators. Actuation of valves and dampers for HVAC systems such as air handling units and convertors will normally be by pneumatic actuators. These instructions also provide guidance on substituting electric or electronic actuators for pneumatic actuators.

c. Terminal unit control systems. Terminal unit control systems will use only electric or electronic control devices. The foregoing requirement for standard instrumentation signals does not apply to terminal unit control systems.

d. Standard controller. A single version of an electronic, self-tuning controller (generally known as a single-loop digital controller (SLDC)) will be used as the standard controller for HVAC systems in all applications except for terminal unit control-system applications (and when designing DDC systems). This type of controller has a history of reliable use, and is available from multiple sources as a standard product with the features described for its use in this manual. Using a standard controller will make control systems easier to maintain. The standard controller will accept one analog signal as a process variable input (PV) and one analog signal as a remote setpoint adjustment (CPA) input, and will produce one analog output signal (OUT). The controller will fit in a standard-size panel cutout. A controller of one manufacturer may be replaced by a controller of another manufacturer because several manufacturers produce the same version of the controller.

e. BACnet™ communication protocol.

(1) In some cases it may be desirable and beneficial to connect different vendors DDC field panels together to perform supervisory monitoring, management and control functions. The Building Automation and Control Networking (BACnet™) protocol provides a means to interconnect different manufacturers control equipment.

(2) BACnet™ is a communication protocol specification. The development of this specification was prompted by the desire of the building owners and operators for cost-effective inter-operability, i.e., the ability to integrate equipment from different vendors into a coherent automation and control system. Work on the BACnet™ specification began in June 1987 and was completed/approved by ASHRAE standards committee in June 1995 and approved by the American National Standards Institute in December 1995. Although the specification is complete, work is not yet complete on a specification for and a methodology for conformance testing of products claimed by vendors to be BACnet™ compatible.

(3) BACnet™ is intended as a standard communications protocol for HVAC&R. It is not directly intended for other building services such as lighting, fire and security although it does not preclude integrating these functions into a common system.

(4) BACnet™ is a mechanism that conveys information including, but not limited to:

- (a) Hardware binary I/O values
- (b) Hardware analog I/O values
- (c) Software binary and analog I/O values
- (d) Schedule Information
- (e) Alarm and event information
- (f) Files
- (g) Control logic

(5) To use the BACnet™ standard the specifier should;

- (a) Understand the structure of the protocol
 - Conformance Classes
 - Devices, Objects, Services
 - Architecture

- (b) Define your inter-operability needs at each level of the system: supervisory computer, operator interfaces, field panels, sensors/actuators.
- (c) Choose which devices will be capable of sending and receiving messages.
- (d) Define the functionality of the communicating devices (based on specifics/ definitions in the standard -- conformance class and functional groups).
- (e) Define networking options. Be aware of the need for inter-networking devices (LANs, routers, repeaters, segments, gateways, and bridges).
- (f) Obtain integration and commissioning services (from a vendor)

Rule 1: It isn't as simple as saying, "All devices shall conform to BACnet™ standard."

(6) The standard recommends use of a **Protocol Implementation Conformance Statement (PICS)** - although recent developments indicate that the PICS may be replaced by a related, but not yet official, requirement referred to as a BACnet™ Interoperability Building Block (BIBB). The PICS is a vendor developed document/submittal that defines the BACnet™ specifications supported by the product. The PICS includes:

- (a) Basic Product Information
- (b) **Conformance Class.** A product/device that meets one conformance class meets the requirements of all other classes with a lower number.
- (c) Devices (or Functional Groups) supported (a collection of **Object** types and the **Services** they perform).
- (d) **Object** types that are supported (18 possible).
- (e) **Services** provided (standard and proprietary) (35 standard ones).
- (f) Data Link Layer

Rule 2: Products claimed to be "BACnet™ compatible" require further clarification.

(7) The information provided above is intended as a primer to BACnet. Further information on BACnet and how to specify BACnet compliant systems is available from ASHRAE as well as the major control system vendors.

9. PROJECT IMPLEMENTATION.

a. Impact of other design disciplines on control system design. Design of HVAC control systems is largely driven by decisions on the overall building HVAC mechanical and electrical design. Therefore, design of the HVAC control system must be incorporated into the overall design process to insure adequate consideration of the space requirements for the HVAC control system's mechanical and electrical support services. Early involvement of the HVAC control system designer in the project can help prevent unfortunate HVAC system design choices that could result in marginally controllable HVAC systems. The control system designer's involvement should start with the development of the design

concept and continue throughout the design process. The control parameter criteria (temperature, humidity, pressurization, occupancy schedules, etc.) must be defined for all systems. These criteria are the starting point for the HVAC control system design. The controller setpoints are shown on the HVAC control system contract drawings and are based on the HVAC system design criteria. The setpoints are guidance for maintenance of the control system.

b. Reuse of existing control devices. Renovation and addition projects require extra engineering work in the form of a detailed field survey of existing HVAC control systems to determine if existing control devices can be reused for the project, and, if so, the extent to which they require modification. Devices that use standard 4-20 milliampere or 21-103 kPa (3-15 psig) signals are among those which possibly may be reused. Existing control system components which do not meet the current specification requirements might be of questionable quality and/or reliability. The contract drawings must show control devices that will be reused, replaced, modified, or removed.

c. Locations of control devices. The designer will show the locations of wall-mounted instruments, HVAC control panels and outside air sensors, transmitters, and sunshields on HVAC floor plan drawings. The designer must show the location of sensing elements and primary measuring devices on the HVAC system drawings. The control system designer must coordinate with the mechanical designer to show the sensing location of the duct static pressure sensor on the HVAC ductwork drawing for a VAV system. This requirement is intended to insure that design consideration is given to these details so that the sensing will be proper and accurate, and to provide for clearance and access for maintenance of the control system. The locations of thermometers and pressure gauges should be selected for normal visual access by personnel required to read them.

d. Control device clearance and access. Control system elements must not intrude upon the space required for mechanical and electrical system maintenance access. The control system design must be coordinated with the HVAC system design to provide ductwork access to install and service sensing elements and transmitters including access doors for permanently mounted devices such as air flow measurement stations and in-line fan inlet guide vanes.

e. Location of permanent instrumentation. The location of the permanent instrumentation thermometers, spare wells, and valved outlets for gauges in piping systems must be coordinated with the HVAC system design and must be shown on the HVAC system contract drawings. Sufficient access space must be provided in the ductwork downstream of each air flow measurement sensor and array, to allow for a traverse with a portable instrument for calibration purposes.

f. Coordination with electrical system design. The designer will coordinate the control system design with the electrical system design to show power circuits for HVAC control panels, air compressor, and drier.

10. DESIGN PACKAGE REQUIREMENTS FOR HVAC CONTROL SYSTEMS.

a. Drawings.

(1) The designer will include standard HVAC control panel drawings to describe control panel construction and mounting arrangements as shown in chapter 4. These drawings are:

- (a) Standard wall-mounted HVAC control panel arrangement.
- (b) Standard HVAC control panel interior door.
- (c) Standard HVAC control panel back panel layout.

- (d) Controller wiring.
- (e) Supply fan and return fan starter wiring.
- (f) Exhaust fan and pump starter wiring.
- (g) HVAC control panel power wiring.
- (h) Damper schedule
- (l) Control system schematic
- (j) Ladder diagram
- (k) Equipment schedule
- (l) Terminal block layout

(2) Some simple control systems do not require a control panel and would not require panel drawings. DDC systems do not require a panel design, as these are available "off-the-shelf" from the system vendor.

(3) The schematic will show control loop devices and other permanent indicating instrumentation (such as pressure and draft gauges, thermometers, flow meters, and spare thermometer wells). The indicating instrumentation is intended to permit a visual check on the operation of the HVAC control system.

(4) Control systems for HVAC often require connections to boiler control systems, chiller control systems, variable speed drives, fire alarm and smoke detection systems, and EMCS. The schematic and the ladder diagram will show the interface points between field installed HVAC control systems, factory installed HVAC control systems, and other control systems.

(5) The ladder diagram will show the relationship of the devices within the HVAC control panel and their relationship to HVAC equipment magnetic starters and other control panels.

(6) The equipment schedule will show the information that the vendor needs to:

- (a) Provide instrumentation of the calibrated ranges.
- (b) Select control valves and associated actuators.
- (c) Adjust the control system devices for sequencing operations.
- (d) Configure the controller parameters, such as setpoints and schedules.
- (e) Set the control system time clocks.

(7) The interior door layout will show the controllers, switches, pilot lights, pneumatic gauges, current-to-pneumatic signal devices, and other door mounted devices.

(8) The back panel layout will show the location of all other panel mounted devices, and will assign a back panel area for terminal blocks.

(9) The terminal block layout will show the location of specific terminal locations according to their function, and the locations of spare terminals and unassigned spaces.

(10) The drawings will be those shown in chapter 4 of these instructions for the standard HVAC control systems, with site-specific modifications and any additional control system loops required. The number of contract drawings necessary to show each control system varies with the system size and complexity. Most control systems in these instructions can be shown with the schematic, ladder diagram, and equipment schedule on one drawing, and control panel details on two drawings.

b. The HVAC control system specification.

(1) Because the HVAC control system designer has the responsibility to completely design the control system, the specification requires more technical detail than would be required if the designer needed to specify only the end performance result of control.

(2) The designer must specify extensive vendor submittal requirements. The submittals required are shop drawings, commissioning procedures, operating and maintenance instructions, training course documentation, a calibration/ commissioning/ adjusting report, testing documentation, and a list of service organizations.

(3) The control devices to be used must be specified in detail.

(4) Because the control system is electronic and can interface with various EMCS, the requirements for electrical surge protection devices installed in the system wiring must be specified, both to protect the HVAC control system and to prevent surges on HVAC control system wiring from adversely affecting the EMCS.

(5) Each control system must have a sequence of operation and a commissioning procedure.

c. Sequence of operation. Each control system will have a sequence of operation. The sequences will be included in the project specification or they may be shown on the contract drawings. Where the project HVAC systems are similar, the control loops and logic having identical control functions will be described identically in the sequences. The text of the sequences will vary only to the extent necessary to describe the operation of dissimilar control loops and logic.

d. Commissioning procedure. On projects that include HVAC system or building commissioning, the contract specifications and requirements for control system commissioning and other commissioning requirements shall be coordinated to support each other and ensure effective and accurate system and subsystem operation in accordance with the design with minimum duplication or conflict. The project specification for each control system will include a commissioning procedure. The commissioning procedure is a four-step process that details how the vendor will inspect, calibrate, adjust, and commission each HVAC control system. The types and quality of calibration instrumentation to be used in the procedure and the extent of documentation of the procedure will be specified. Where project HVAC systems are similar, the requirement for applying the procedure to control loops and logic will be described identically in each procedure. The text of the procedures will vary only to the extent necessary to describe the application of the commissioning procedure to dissimilar loops and logic. The four steps of the commissioning procedure are as shown in table 1-1.

TABLE 1-1 - COMMISSIONING PROCEDURE

<u>Step</u>	<u>Activity</u>	<u>HVAC-System Condition</u>	<u>Purpose</u>
1	System inspection	Shut down	Observe system for position of valves and dampers, and readiness of HVAC control panel.
2	Calibration accuracy check	Shut down	Collect one data point for each sensing element, transmitter, and controller combination under steady-state conditions.

3	Actuator range adjustments	Shut down	Set full-stroke travel of actuators matched to controller output range.
4	System commissioning	Operating	Collect second data point for calibration accuracy check, tune controllers, observe control of HVAC system in each mode of operation, and observe the operation of safety devices.

11. EMCS INTERFACE WITH STANDARD LOCAL CONTROL PANELS. There are three feasible methods of interfacing the standard SLDC control panel with an EMCS or UMCS. A demonstration project at Fort Riley Kansas and associated research compared the analog/binary interface method to a digital communications and binary interface method. A third method uses frequency modulation (FM) switches. In deciding whether or not and how to interface the control panel with EMCS, the designer should consider the advantages and disadvantages associated with the available interface methods.

a. EMCS interface using analog and binary signals. The standard HVAC control panel designs include terminal blocks designated for interfacing with an EMCS using 4-20 milliampere (analog) input/output (I/O) signals and binary I/O signals. The analog I/O signals are used to interface the EMCS with the controller process variable retransmission and control point adjustment. The binary (contact closure) I/O signals are used to interface the EMCS with control panel shutdown and status devices and to override the control panel.

(1) Analog outputs to EMCS. Process variable retransmission (PVR) is a 4-20 milliampere analog output signal from each controller that is identical to the 4-20 milliampere PV input to the controller. The control system design will show HVAC control panel terminal blocks showing connections for interfacing controller process variable retransmission with EMCS.

(2) Analog inputs from EMCS. Control point adjustment (CPA) is a 4-20 milliampere analog input signal available to the controller that provides for adjustment of controller setpoints. The control system design will show HVAC control panel terminal blocks and wiring that allow connection of the CPA signal, from an EMCS device, to the controller 4-20 milliampere remote-setpoint input terminals.

(3) Binary outputs to EMCS. Freezestats and smoke detectors operate relays, located inside the control panel, as part of the HVAC control system shutdown circuits. Contacts of these relays are wired to terminal blocks in the HVAC system control panel for EMCS use. The economizer controller operates a relay located inside the control panel. A contact on this relay will be wired to terminal blocks in the HVAC system control panel for EMCS use. Differential pressure switches across the air handling system filters will have a contact in the device reserved for EMCS use.

(4) Binary inputs from EMCS. The control system ladder diagrams and HVAC control panel details will show provisions for override of HVAC control panels by:

- (a) Replacing HVAC control panel time clocks with EMCS start-stop contacts.
- (b) Installing EMCS override of the HVAC system's economizer controller signal.

(5) The advantages of this method of interface are:

(a) The EMCS can be used to perform basic monitoring and supervisory control functions.

(b) The 4-20 mA I/O between the control panel controllers and the EMCS remains non-proprietary and, in principle, any vendors EMCS can be interfaced with the controllers.

(6) The disadvantages of this method of interface are:

(a) In the absence of an industry standard communications protocol, the EMCS interface device (located in the field) and the EMCS central station are likely to be proprietary.

(b) In the absence of a control panel mounted time clock, the stand-alone capability of the panel is compromised. For example, with EMCS performing the time clock function, failure of the EMCS may result in loss of the time clock function.

(c) The electrical connection between the EMCS and the controller CPA port and/or PVR terminals may present ground loop problems thus requiring the use of loop drivers to provide for electrical isolation.

(d) The cost of the interface can be prohibitive. Preliminary results, based on one installed system, indicates a cost of about \$12k per panel. Subsequent technological developments may lead to a lower cost.

b. EMCS interface using digital communication signals. Controllers are available with optional digital communications ports, such as Electronics Industries Association (EIA)-485. Using the communications port and vendor developed protocol, the control panel controllers can exchange data with an EMCS. Contact closure (binary) I/O signals are used to interface the EMCS with control panel shutdown and status devices and to override the control panel.

(1) Process variable retransmission (PVR) is not required. The functional equivalent is performed using digital communications. Delete the wiring between the control panel PVR terminal block connections and the controller PVR terminals.

(2) Control point adjustment (CPA) is not required. The functional equivalent is performed using digital communications. Delete the wiring between the control panel CPA terminal block connections and the controller CPA input terminals.

(3) Binary outputs to EMCS. Freezestats and smoke detectors operate relays, located inside the control panel, as part of the HVAC control system shutdown circuits. Contacts of these relays are wired to terminal blocks in the HVAC system control panel for EMCS use. The economizer controller operates a relay located inside the control panel. A contact on this relay will be wired to terminal blocks in the HVAC system control panel for EMCS use. Differential pressure switches across the air handling system filters will have a contact in the device reserved for EMCS use.

(4) Binary inputs from EMCS. The control system ladder diagrams and HVAC control panel details will show provisions for override of HVAC control panels by:

(a) Replacing HVAC control panel time clocks with EMCS start-stop contacts.

(b) Installing EMCS override of the HVAC system's economizer controller signal.

(5) The advantages of this method of interface are:

(a) With this interface, the EMCS can be used to perform monitoring and supervisory control functions.

(b) This method provides greater functionality than does the analog/binary interface method. All controller configuration parameters can be viewed and adjusted from the EMCS central station.

(c) This method of interface, in a demonstration project, was shown to be slightly less expensive than the analog/binary interface method primarily due to the need for less wiring.

(6) The disadvantages of this method of interface are:

(a) In the absence of an industry standard communications protocol, the EMCS interface device (located in the field) and the EMCS central station are likely to be proprietary.

(b) In the absence of an industry standard communications protocol, the control panel controllers are most likely to be proprietary. In addition, a later version of the same vendors controller may not be communications compatible, on a replacement basis, with the original panel controller(s).

(c) This method does not eliminate the need for a binary (contact closure) interface between the control panel and EMCS to accommodate control panel status devices (freezestats and smoke detectors) and override (time clock, economizer, remote safety shutdown, and remote safety override).

(d) In the absence of a control panel mounted time clock, the stand-alone capability of the panel is compromised. For example, with EMCS performing the time clock function, failure of the EMCS may result in loss of the time clock function.

(e) The cost of the interface can be prohibitive. Preliminary results, based on one installed system, indicates a cost of about \$10k per panel. Subsequent technological developments may lead to a lower cost.

c. EMCS interface using frequency modulation (FM) switches. Locally mounted FM switches are controlled by one-way transmission from a centrally located FM transmitter. Individual switches may be used to override HVAC control panel operating modes. If this option is chosen, the designer should modify the control system ladder diagrams and HVAC control panel details to show provision for:

(1) Replacing HVAC control panel time clocks with FM switch start-stop contacts.

(2) Installing FM switch override of the HVAC system's economizer controller signal.

(3) The advantages of using this method of interface are:

(a) The cost is relatively inexpensive.

(4) The disadvantages of using this method of interface are:

(a) Functionality is limited to binary outputs (contact closures).

12. **FAN STARTER CONTROL CIRCUIT OVERRIDE BY EXTERNAL CONTROL SYSTEMS.** The ladder diagrams for fan starter control circuits will show provisions for shutting down the fans and for overriding low temperature safety thermostats and smoke detectors to start the fans from external systems. These provisions are intended to allow interface with smoke control systems.

13. **COORDINATION WITH HVAC SYSTEM BALANCING.** The project specification will require that balancing is completed, that minimum damper positions are set, and that a balancing report is issued before control systems are tuned. Other control system commissioning activities may be performed independently of HVAC system balancing.

14. **SYMBOLS.** The standard symbols used in these instructions are shown in the glossary.

15. **EXPLANATION OF TERMS.** Terms, abbreviations and acronyms used in these instructions are found in the glossary.

CANCELLED

CHAPTER 2

HVAC CONTROL SYSTEM EQUIPMENT, EQUIPMENT USES AND HVAC CONTROL LOOPS

1. GENERAL. The design of HVAC control systems is implemented by defining the operating modes of the HVAC equipment, defining the control loops required, and selecting the control system equipment to be used in the loop. The process of selecting the control system equipment includes calculations by the designer to specify the flow capacity of control devices, the physical size of control devices and the electric service required. This chapter describes the operating modes, process variables, control modes, control system devices and their features, control system equipment applications, and inter-connection of control devices. This chapter provides criteria and guidance for selecting and sizing control devices.

2. CONTROL SYSTEM OPERATING MODES AND PROCESS VARIABLES.

a. Control system operating modes. Control systems start and stop the HVAC system equipment according to a time schedule, and at specific outside air temperatures and specific indoor temperatures. In addition, the control systems operate the HVAC systems in the following modes of operation:

(1) Occupied mode is initiated automatically to allow HVAC systems to start in sufficient time to bring the space to the proper temperatures at the start of occupancy.

(2) Ventilation delay mode is initiated automatically to prevent the use of outside air when the unit is started prior to occupancy, to cool down or warm up the area served.

(3) Unoccupied mode is initiated automatically to prevent unnecessary operation of HVAC-system equipment during periods of non-occupancy except for special purposes such as operation to maintain minimum space temperatures for freeze protection.

(4) Heating or cooling modes are initiated manually to provide either heating or cooling media to HVAC equipment.

b. Control system process variables. While the HVAC systems are in operation, the process variables commonly sensed and controlled by HVAC control systems are:

- (1) Temperature.
- (2) Relative humidity.
- (3) Static pressure of air.
- (4) Differential pressure of air.
- (5) Air flow rate.

c. Constraints on process variables by operating modes. The constraints placed on the control of HVAC process variables by the operating modes are:

- (1) Cooling and humidification are shut off during the unoccupied mode.
- (2) Outside air is not supplied to the space during the unoccupied and ventilation delay modes.

d. Modulating control. The amount of heat delivered to a space (or removed from a space) from certain types of HVAC equipment is regulated by varying the heat exchanger capacity from zero to one-hundred percent in response to the variation of a continuous, gradual input signal. This is called modulating control. Heat exchanger control valves, mixing dampers, fan inlet vanes, variable speed drives, and humidifier valves are examples of HVAC equipment that are controlled by modulating control.

e. Two-position control. The amount of heat delivered to a space from certain types of HVAC equipment is controlled by turning the equipment on and by shutting the equipment off. This type of control is also called on-off control. Examples of 2-position control are the starting and stopping of the fans of unit heaters and fan coil units by room thermostats to maintain space temperature, and the opening and closing of shutoff dampers when fans are started and stopped.

3. CONTROL SYSTEM EQUIPMENT.

a. Control valves.

(1) Control valves are used to regulate the flow of fluids in piping systems by compressing and releasing a valve spring to move a valve closure disk or plug toward or away from the closure seat of a flow port. The valves are used both in modulating and in 2-position control applications.

(2) Examples of the use of modulating control valves are:

- (a) Heating and cooling coil control valves.
- (b) Converter steam control valves.
- (c) Humidifier control valves.
- (d) Perimeter radiation system zone valves.

(3) Examples of the use of 2-position control valves are:

- (a) Dual-temperature water system changeover valves.
- (b) Shutoff valves used in fan coil unit coils.

(4) Control valves are classified according to their flow regulating body patterns. A 2-way valve restricts fluid flow in one direction, because it has one inlet and one outlet; a 3-way valve restricts flow in two directions. The designer will use 2-way control valves for controlling the following types of HVAC equipment:

- (a) Convertors.
- (b) Radiators.
- (c) Coils served by variable volume pumping systems.
- (d) Steam coils.

(5) A 3-way mixing valve has two inlets and one outlet, and a 3-way bypass (diverting) valve has one inlet and two outlets. For the systems shown in this manual, the 3-way mixing valve is used in both flow mixing and flow diverting type applications, except that a 3-way bypass valve is used as a dual-temperature changeover control valve.

(6) In the flow mixing application, the 3-way valve is used to mix heated primary flow, from a boiler or a converter, with system return flow to produce system secondary supply, for the purpose of controlling temperature. When used on the return line from a coil, one of the 3-way valve's inlets is from the coil, and the other inlet is from the bypass around the coil. The designer may choose to use 3-way mixing valves in lieu of the 2-way valves shown in this manual for controlling the following types of HVAC equipment to prevent deadheading of pumps:

- (a) Coils served by constant volume pumping systems.
- (b) As means of pump pressure relief in variable volume pumping systems.
- (c) As perimeter radiation zone valves.
- (d) As diverting valves around boilers or cooling towers.

(7) The designer may choose to use either four 2-way valves or one 3-way mixing valve, and one 3-way bypass valve for 2-position flow control applications as dual-temperature system changeover valves.

(8) Control valves are classified according to the action of the valve spring in moving the disk or plug relative to the seat when the control signal or the power is removed. A 2-way valve that opens its flow port under this condition is called a normally open (NO) valve, and one that closes its flow port under this condition is called a normally closed (NC) valve. A 3-way mixing valve has both NC and NO inlet flow ports connected to a common (C) outlet flow port. A 3-way bypass valve has both NC and NO outlet flow ports connected to a C inlet flow port.

(9) The flow regulating characteristic of a valve is generally determined by the shape of a disk or plug that passes through the flow port. The flow regulating characteristics used for control systems covered by this manual are:

(a) Linear flow, in which the percent of valve travel equals the percent of maximum flow rate through the valve.

(b) Equal-percentage flow in which equal increments in the percentage of valve travel produce an equal-percentage change in flow rate from the previous flow rate, when a constant pressure drop is maintained.

(10) The applications of 3-way mixing valves covered by this manual require the use of valves with linear flow characteristics. The applications of 2-way valves covered by this manual require the use of valves with equal-percentage flow characteristics. This requirement results from the application of the valves as modulating fluid control devices. The equal-percentage flow characteristic matches the non-linear heat exchange characteristics of the HVAC equipment coils with a change in fluid flow that tends to linearize the heat exchange output of the coil with a linear signal to the control valve. The linear-flow characteristic is more suitable for mixing applications and for humidification.

(11) The purchase price of a control valve increases with its size. The installation cost of a control valve also increases with its size, because of:

(a) The change from screwed ends to flanged ends

(b) Because larger valves and their weight require more installation and handling labor.

(12) At a pipe size of 4 inches or larger, a type of rotary control valve (known as a butterfly valve) becomes economically suitable for HVAC control applications because of the combination of the price of the valve and the installation costs. The butterfly valve has a disk that rotates on a shaft and closes against a seat. The seat is concentric with the connected pipe. The butterfly valve can have flow control characteristics similar to equal percentage when used with an appropriate actuator and positioner. In three-way applications of valves for 4-inch pipe size and larger, the designer will show two valves on a common pipe tee, with separate actuators that will operate the two valves simultaneously. One of the valves will be NC, and one will be NO. The C connection can be either an inlet or an outlet. This allows the combination of two valves and a pipe tee to function as a 3-way mixing valve or a 3-way bypass valve. Figure 2-1 shows butterfly valves used in 3-way mixing and 3-way bypass arrangements on a common pipe tee.

Figure 2-1. Two butterfly valves on a common pipe tee.

b. Control dampers.

(1) Dampers are used to regulate the flow of air in ductwork in both modulating and 2-position control applications.

(2) Examples of the use of modulating dampers are:

- (a) Air plenum temperature control by mixing outside air and return air.
- (b) Space temperature control by mixing warm air and cool air.
- (c) Space temperature control by varying the flow of cool air.

(3) Examples of the use of 2-position dampers are:

- (a) Closing outside air dampers or building exhaust dampers when fans are stopped.
- (b) Isolating sections of ductwork for smoke control purposes.

(4) Dampers are classified by the action of their blades, which connect to a common shaft that is rotated to open or to close the damper. Opposed blade dampers provide better flow characteristic in throttling applications. A throttling application is one where the damper is installed in series with the path of flow and the damper is used to add pressure drop to reduce air flow. Parallel blade dampers are used to provide better flow characteristics in mixing applications. A mixing application is one where more than one flow path exists in parallel. Usually, two or more dampers are installed in parallel to each other and the dampers divert flow rather than increase total system pressure drop.

(5) The control action of dampers (NC or NO) depends on the direction of their blade rotation caused by the spring return stroke of an actuator connected to the damper's drive shaft, when the control signal or power is removed.

(6) When a control system application requires that a damper be open prior to the start of a fan, an adjustable switch is connected to the damper; this device is called an end switch or limit switch. The end switch operates a set of contacts in the fan starter control circuit when the damper is fully open, to allow the fan to start; the end switch opens the circuit to prevent the fan from continuing to operate if the damper begins to close.

c. Actuators.

(1) Actuators are used to operate valves and dampers. Pneumatic actuators are powered by air pressure, and are controlled directly by a pneumatic control signal and indirectly by an electric or electronic signal. An electro-pneumatic device converts an electric or electronic signal to a pneumatic signal to stroke the actuator. Electric and electronic actuators are electrically powered and are controlled directly from an electric or electronic signal to stroke the actuator. While all pneumatic actuators have a spring-return feature, some electric/ electronic actuators are not equipped with a spring to move the valve or damper to a fail-safe position upon loss of power or control signal.

(2) Modulating control of actuators requires either the use of a 4 to 20 milliampere control signal directly to an electronic actuator or the conversion of the signal to a pneumatic control signal of 21 to 103 kPa (3 to 15 psig). The pneumatic signal can be directly or inversely proportional to the electronic signal. The signal conversion values are shown in figure 2-2.

Figure 2-2. Conversion of an electronic signal to a pneumatic signal.

(3) Two-position control of electric actuators requires the closing and opening of a contact to operate an electric actuator. Two-position control of pneumatic actuators requires an electric/pneumatic device to pass 140 kPa (20 psig) main air to the actuator, or to exhaust air from the actuator.

(4) Sequencing occurs when actuators are modulated from a common signal by using a portion of the 4 to 20 milliampere signal or the converted 21 to 103 kPa (3 to 15 psig) signal. The actuator stroke is adjusted to move its connected valve or damper from fully closed to fully open over the assigned portion of the common control signal. Deadbands between the movement of valves and dampers are achieved by

assigning a portion of the common control signal as a deadband. Each actuator is adjusted so that its full stroke occurs on either side of the deadband limits outside of the deadband. Examples of the use of sequencing with a deadband are:

- (a) Sequencing of heating and cooling with a deadband between heating and cooling.
- (b) Sequencing of heating and outside ventilation air beyond the required minimum quantity with a deadband between heating and increased ventilation.

(5) Actuators are modulated in parallel by assigning the identical portion of the control signal to each actuator for its full stroke. Modulation in parallel occurs in air stream mixing applications such as:

- (a) Modulation of outside air, return air and relief air dampers for free cooling.
- (b) Modulation of multizone hot deck and cold deck dampers in parallel.

d. Current-to-pneumatic transducers. The modulating device for converting a current control signal to a pneumatic control signal is a current-to-pneumatic transducer (IP). A 140 kPa (20 psig) main air supply to the IP is the source that develops a 21 - 103 kPa (3 - 15 psig) output signal in a scaled relationship to a 4 - 20 milliamper input signal.

e. Solenoid operated pneumatic valves. The 2-position device for converting an electric contact closure signal to a pneumatic signal is the solenoid operated pneumatic valve (EP). The EP is a 3-way valve that connects the normally closed and common ports when the solenoid coil is energized and connects the normally open and common ports when the solenoid coil is de-energized. The EP is used to switch 140 kPa (20 psig) main air to the actuators and to exhaust air from the actuators.

f. Positive Positioners.

(1) All modulating control applications of pneumatic actuators require that the actuator be equipped with a positive positioner (PP). A main air supply is the source of its operating power. The device throttles main air as required to stroke the actuator to the position dictated by the pneumatic control signal. However, the positive positioner can exert pressure higher than that of the pneumatic control signal and thus can maintain the required position against the opposing force of the HVAC system pressure. Piping system pressures tend to compress the air in the diaphragm chamber of the valve actuator. The compression causes a shift in the actual operating ranges of the valves. The positive positioner has an adjustable pneumatic signal start point for the stroke of the actuator and an adjustable pressure span for the full stroke of the actuator. The stroke is proportional to the pneumatic control signal.

(2) Non-modulating (two-position) control applications where pneumatic actuators are used do not require positive positioners.

(3) Simultaneous heating and cooling can occur when pneumatic actuators are used, even though the spring operating ranges are selected without an overlap. The results of this phenomenon are shown in figure 2-3. Because of this phenomenon, sequencing applications for HVAC systems must have positive positioners on pneumatic valves and damper actuators, to maintain deadbands between actuator operating ranges. A control system with positive positioners is illustrated in figure 2-4. When sequencing actuators from a common control signal, the simultaneous use of heating and cooling can accidentally occur if:

- (a) Heating and cooling valve operating ranges overlap.
- (b) Heating valve and ventilation damper operating ranges overlap.
- (c) Heating valve and cooling air damper operating ranges overlap.

Figure 2-3. Simultaneous heating and cooling with pneumatic actuators without positive positioners.

Figure 2-4. Control system with positive positioners to avoid simultaneous heating and cooling.

g. The choice between pneumatic and electric actuators. All terminal unit control systems will have electric or electronic actuators. For all other control system applications, the designer will make an estimate of the total cost of actuators required for all control systems in the project. The designer will take into account the cost of multiple actuators on large dampers and the cost of larger actuators required for higher torques to operate large valves. The total installed cost estimate of pneumatic actuators will include:

- (1) The actuators.
- (2) The IPs.
- (3) Tubing.
- (4) Local indicators.
- (5) The cost of the compressed air system.

The total installed cost estimate of electric actuators will include consideration of:

- (1) The actuators.
- (2) Wiring.
- (3) Loop driving circuits as explained in this manual.
- (4) Power transformers (24 VAC)

h. Existing compressed air source. If sufficient air is available from an existing temperature control compressed air system, it may be used as the air source for additional control systems.

i. Life cycle cost. After the installed cost estimates are prepared, a life cycle cost estimate will determine the choice between pneumatic and electric actuators. Some manufacturers' catalogs provide guidelines to assist in estimating the cost benefits of using electric versus pneumatic actuators.

j. Sequencing actuators. The actuators that control valves and dampers are sequenced when HVAC applications require that the process variables be sensed at a common location and controlled from a common modulating signal. The objective of sequencing is to avoid energy waste by preventing the following opposing processes from acting simultaneously:

- (1) Heating and cooling.
- (2) Humidification and dehumidification.

k. Design requirement in regard to actuator sequencing ranges. The designer will show the actuator sequencing ranges in the equipment schedule when standard control signals apply.

(1) Pneumatic actuators are sequenced by connecting the signal input connections of the actuators' positive positioners to the same pneumatic control signal and adjusting the positioners' starting points and spans to achieve the required sequence. For example, two valves can be operated in sequence if their positive-positioner spans are set at 28 kPa (4 psig) and their starting points are set at 21 kPa (3 psig) and 62 kPa (9 psig) respectively. This results in ranges of valve full-stroke operation of 21 to 48 kPa (3 to 7 psig) and 62 to 90 kPa (9 to 13 psig), with a 14 kPa (2 psig) deadband between the ranges of operation.

(2) Some electric actuators have starting points and span adjustments similar to those of the pneumatic actuator's positive positioner. This is sometimes an optional feature, and must be specified if required for sequencing. In this case, the starting points and spans are adjusted in milliampere values. When electric actuators are sequenced, the modulating control circuit will be designed within a 600 ohm limitation.

l. Multiple actuators connected to the same control damper. When the operating torque requirement for an HVAC system damper exceeds the output torque of a single actuator, additional actuators are connected together to operate in parallel to control the damper. The designer is not required to show multiple actuators connected to the same damper on the schematic. The vendor has the information necessary in the contract specification to apply multiple actuators when required.

m. Design of modulating control circuits within a 600 ohm circuit impedance limitation.

(1) The output of an HVAC system controller is connected in series to actuators external to the HVAC control panel, and also to other devices in the HVAC control panel in a direct current series circuit. The number of devices varies with the complexity of the control sequence, and the impedance of each connected device is additive as a resistance in the circuit. The amount of output circuit impedance that a controller will tolerate is product specific. The limitation of 600 ohms in the output circuit design is needed to permit the controllers of several manufacturers to function in the same circuit. The limitation permits standardization in the design and permits substitution of one manufacturer's controller for that of another during maintenance of the system.

(2) If a modulating control circuit is designed to use electric or electronic actuators, the impedance can exceed the 600 ohm limitation if:

(a) Multiple actuators are required for the same damper.

(b) More than one damper is modulated from the same control signal, such as in the case of modulating outside air, return air, and relief air dampers.

(c) Multiple control system devices located within the HVAC control panel are necessary to achieve the sequence of control.

(3) Individual control system devices typically add 250 ohms impedance to a series circuit. This 250 ohm impedance value comes from a dropping resistor in the device that is used to convert the 4 - 20 milliampere current signal at 24 volts dc to a 1 - 5 volt signal used by the device's internal circuitry.

(4) Figure 2-5 shows methods for designing circuits within the 600 ohm limitation. The figure shows the following examples:

(a) The limitation exceeded by connecting 750 ohms in series.

(b) Limiting the control circuit connection to a single actuator.

(c) The circuit designed within the limitation by the use of an additional control circuit device.

Figure 2-5. Modulating control circuits impedance limitation.

(5) In the first example, shown in the upper part of the figure 2-5, control devices 1, 2 and 3 can be actuators or devices in the HVAC control panel. In the second example, the controller is connected to actuator 1, and actuator 2 is operated by an auxiliary actuator driver (AAD) circuit on actuator 1; actuator 2 can operate another actuator by its AAD. (Note that the functionality provided by the AAD is usually a built-in feature of the actuator and the AAD is not necessarily a separate device.) In the third example, the same control devices are connected to a loop driver (LD). Control device 1 and the loop driver are connected to the controller. The modulating circuit from the controller is limited to 500 ohms, consisting of 250 ohms for control device 1 and 250 ohms for the input to LD. Control devices 2 and 3 add a total of 500 ohms to the output circuit of LD. The output signal of LD varies in a 1:1 ratio with its input signal.

(6) Some of the control devices necessary to implement the control sequence have an input impedance of 250 ohms, and their output circuits can accept from 800 ohms to 1000 ohms of impedance. The amount of allowable impedance in their output circuits is product specific. Any control device whose modulating control output circuit has greater impedance loading capability than the impedance of its modulating control input circuit can function as a loop driver, in addition to performing a specific control sequence function. This output driving capability is found in most modulating control devices.

(7) When the control system requires more than one damper with electric or electronic actuators to be modulated by a control circuit, the designer will show the signal (on the schematic) connected to one of the damper actuators. The AAD circuit of that actuator will be shown as connected to drive a separate actuator on another damper, which, in turn, can drive another actuator on still another damper.

(8) When a modulating control circuit must drive multiple panel mounted control devices, the designer will show on the schematic:

(a) Not more than 2 devices (such as IPs) connected to that circuit, unless one of the devices is a control device that accepts a modulating input signal and produces a modulating output signal.

(b) Not more than two panel mounted control devices connected to the modulating output of a panel mounted control device.

(9) The schematic is not intended to show the physical connections to the devices, but rather to show the relationship of the necessary control devices in the control loop.

n. Transmitters. Variables such as temperature, pressure, and relative humidity are sensed by means of elements that are connected to the control loops via transmitters. The output signal of the transmitter is the standard 4 to 20 milliampere dc signal, which is factory calibrated for zero point and span relative to the input resistance value of the sensing element. The transmitters are 2-wire, loop-powered (i.e., powered by the control panel power supply) devices that connect in a series circuit with the controller input. The impedance limitation of the circuit in which the transmitter can function is product specific. A typical value is 700 ohms at 24 volts dc.

o. Single loop digital controller.

(1) As shown for the standard control systems, single loop controllers are used for essentially all systems other than simple unitary systems and terminal units that are controlled directly from room or zone thermostats. In all applications where it is used, the controller will be mounted in a HVAC control panel. The controller mounting dimensions will conform to a standard panel cutout requirement. The controller will be used for the following applications:

(a) As a controller for maintaining temperature, relative humidity, static pressure, and/or airflow setpoints.

(b) As an economizer mode switchover controller that determines whether outside air is suitable for cooling.

(c) As an outside air temperature controller for scheduling hydronic heating supply temperature and for starting and stopping pumps.

(2) The controller will be a microprocessor-based device with manually configurable control features resident in solid state electronic memory components. Manual access to the features of the controller will be through a keypad and an alphanumeric indicator on the face of the controller. The controller will have standard features that will allow it to serve all functions prescribed in its application.

Standard features will allow the replacement of any controller by a spare not necessarily of the same manufacturer.

- (3) The single-loop digital controller will have the following inputs and outputs:
- (a) A process variable analog input (PV).
 - (b) A remote setpoint analog input for control point adjustment (CPA).
 - (c) An analog output (OUT).
 - (d) A process variable actuated contact closure output (PV contact).
 - (e) A contact output that responds to the difference between PV and CPA analog inputs (DEV contact).
 - (f) An analog output which is identical to the process variable input (PV Retransmission).
- (4) Some controller features are configurable by manual input, and others are selectable by setting switches or jumper wires. The configuration methods vary with the specific manufacturer and model. The controller will have the selection of features for its inputs and outputs as shown in table 2-1.

TABLE 2-1 CONTROLLER FEATURES

<u>Input</u>	<u>Output</u>	<u>Feature</u>
PV		Scalable to the range of the input transmitter.
CPA		Adjustable bias of setpoint relative to the PV input range.
CPA		Adjustable ratio of setpoint relative to the PV input range.
CPA		Scalable to the range of the CPA input signal.
CPA		High and low limits of setpoint adjustment.
	OUT	Selection of direct acting or reverse acting.
	OUT	Adjustable high and low limits.
	OUT	Adjustable bias (Manual reset).
	OUT	Selection of manual or automatic control.
	OUT	Selection of proportional (P), proportional plus integral (PI), and proportional plus integral plus derivative control modes (PID).
	OUT	Anti-reset windup.
	OUT	Selection of manual tuning or operator initiated self tuning.
	OUT	Manual reset feature for use when the controller is configured from porportional mode only and is manually tuned.
	PV Contact	Adjustable contact setpoint.

PV Contact	Adjustable hysteresis or deadband.
DEV Contact	Adjustable contact setpoint.
DEV Contact	Adjustable hysteresis or deadband.

(5) The output control modes that can be used in combination are:

(a) Proportional mode, which varies the output proportionally to the error between the PV input value and the controller setpoint.

(b) Integral mode, which modifies the output signal as a time related function of the error between the PV input value and the controller setpoint.

(c) Derivative mode, which modifies the output signal as function of the rate of change of the error between the PV input value and the controller setpoint.

(6) Each of these control modes has an assignable constant, which is adjusted in the process of tuning the controller.

(7) The integral mode will have a feature that automatically stops the integration of the error signal when the controller output signal reaches its minimum or maximum value. This feature is known as anti-reset windup. If the process being controlled does not respond to the controller output for a period of time (such as an overnight shutdown), continuing the integration of the error signal during that period would result in the controller failing to respond to control the process immediately on startup. Without the anti-reset windup feature, the controller would reverse the integration process on startup, but the reversal would require a time period equal to the time period of the integration during shutdown.

(8) The controller will have the following selectable modulating control functions:

(a) Self tuning of control mode constants.

(b) Manual tuning of control mode constants.

(9) Self tuning allows the controller to select the optimal combination of proportional, integral, and derivative control mode constants. The controller continues to use these selected constants until the self-tuning control function is again selected. The Guide Specification requires that the self-tuning process be operator initiated. Applications where self tuning is used are as follows:

(a) Mixed air temperature control.

(b) Heating coil temperature control for multizone hot deck and dual-duct hot duct applications.

(c) Modulating valve and modulating damper preheat coil control.

(d) Cooling coil discharge temperature control for multizone cold-deck, dual-duct cold-duct, and VAV system discharge temperature.

(e) Relative humidity control.

(f) Supply duct static pressure control.

- (g) Return fan volume control.
- (h) Hydronic heating supply temperature control.
- (i) Hydronic-heating space-temperature control.

(10) If integral and derivative control modes are not appropriate for an application, the controller is manually tuned for proportional mode control, and the integral and derivative mode constants are set to zero. Applications where manual tuning is used are as follows:

- (a) Relative humidity high limit control.
- (b) Outdoor air scheduling of hydronic heating supply temperatures or hot deck/ heating coil discharge air temperatures.
- (c) Space temperature control of single-zone HVAC units and heating and ventilating units.

(11) When the single-loop digital controller is manually tuned to operate as a temperature controller in the proportional mode, the proportional band setting is determined by the use of equation 2-1.

$$PB = \frac{(TR \times 100)}{T_s} \quad (\text{eq. 2-1})$$

Where:

- PB = Proportional band constant (percent).
- TR = Throttling range or the portion of the transmitter span required for full-scale controller output change (deg. C (deg. F)).
- T_s = The temperature span of the transmitter (degrees C (degrees F)).

(12) If the controller output is to change from 4 to 20 milliamperes over the range of minus 18 to plus 16 degrees C (0 to 60 degrees F) and the transmitter range is in the range of minus 35 to plus 55 degrees C (minus 30 to plus 130 degrees F) (a span of 90 degrees C (160 degrees F)), the use of equation 2-1 would result in: PB = 37.5 percent.

(13) When a single-loop controller is configured for proportional control mode only, the output of the controller must be set to match the value required for the application when the PV input value coincides with the controller setpoint. This is accomplished by configuring the manual reset setting as a percent of controller output. The effect of this configuration parameter is to shift the controller output throttling range with respect to the controller setpoint. As an example, refer to figure 2-6 which shows the setpoint relative to the controller throttling range for manual reset settings of 25, 50 and 75 percent for a direct-acting controller.

Figure 2-6. Manual reset feature.

(14) When used as an economizer switching controller, the functions of the controller inputs and outputs will be as follows:

- (a) A return air temperature transmitter connected to the PV input.
- (b) An outside air temperature transmitter connected to the CPA input.

(c) An output contact configured as PV and acting as a switch.

(d) An output contact configured as DEV and acting as a switch.

(e) There are exceptions to the above listed connections (such as when an economizer is used in a multizone system).

(15) As the outside air temperature changes, the potential for using outside air for cooling is affected. When the outside air temperature is lower by a specified number of degrees than the return air temperature, outside air can be used for cooling; when the reverse is true, outside air must be at minimum quantity. The PV contact setpoint prevents the use of outside air beyond minimum quantity until the return air temperature rises to its setpoint. When the return air temperature rises to the PV contact setpoint, the HVAC system is no longer experiencing a heating load. The DEV contact setpoint allows the use of outside air until the outside air temperature approaches the return air temperature. The DEV contact then puts the dampers under control of a minimum-position switch. A minimum-position switch is a device whose control output is manually modulated to an actuator that then remains fixed until reset manually. Both conditions must be met (PV and DEV contacts closed) for the use of outside air beyond minimum quantity.

p. Function Modules.

(1) There are control functions required with less frequency in HVAC control applications than those included in the prescribed version of the single-loop controller. Control devices to perform specific control functions not available in the single-loop digital controller are called function modules in this manual. Function modules will be located in the HVAC control panel, except as noted. Function modules accept contact, analog, or gradual manual adjustment input signals to provide:

(a) Signal selection,

(b) Signal inverting,

(c) Contact transfer output from analog signal input,

(d) Contact transfer output from the comparison of two analog input signals, and

(e) Generation of constant analog output signals.

(2) A minimum-position switch is a manually adjustable modulating output device used to hold an outside air damper open to admit minimum ventilation air. This same device is used as a temperature setpoint selector. In this application, it allows manual adjustment of the CPA input signal to a single-loop digital controller. In the case of certain single-zone HVAC systems, this device is wall-mounted and accessible to the occupant for adjustment of the space temperature controller setpoint.

(3) A signal inverter is a modulating input and modulating output device used to reverse the direction of its input. The signal reversal is required when spring return position of a valve or damper actuator has been chosen to operate with a direct acting signal, and when an actuator with which it must be sequenced has been chosen to operate with a reverse acting signal. For example, a chilled water coil is used for dehumidification and cooling. The chilled water valve is chosen as NC because it is to be sequenced with a NO heating coil valve, and is to close when the control signal is removed during fan shutdown and during the unoccupied mode. The direct acting temperature control signal is correct for this combination. The humidifier control valve is also chosen as NC because it also is to close when the control signal is removed on fan shutdown and during the unoccupied mode. The humidity control signal must be reverse acting when it operates the humidifier valve, and must be direct acting when it operates the cooling coil valve. A signal inverter is used to reverse the signal direction of the humidity controller signal to the cooling coil valve.

(4) A signal selector is a device with multiple modulating inputs and a modulating output. This device is used to select the highest or the lowest of its input signals as its output.

(5) A sequencer is a device with a modulating input and one or more contact outputs which operate in sequence and is used in applications that require the operation of stages in refrigeration control from a modulating control signal. A deadband surrounding each of the sequencer setpoints prevents all stages of refrigeration from starting simultaneously when the HVAC system starts. The contact opens instantaneously on power failure (or on signal failure) to the sequencer.

(6) A loop-driver module is used where required to allow modulating control circuits to be designed within a 600 ohm impedance limitation. A loop-driver module can be any modulating input or modulating output device used for this purpose alone or while performing an additional control loop function. Signal selectors and signal invertors strategically located in control loops often perform such dual service.

q. Relays, including time-delay relays. All relays, including time-delay relays, will be 2-pole, double-throw devices; they are used for control system interlocking functions and will be located in the system's HVAC control panel.

r. Time clocks.

(1) A time clock will be used to control the timing of the modes of operation of an HVAC control system when the control system is not interfaced with EMCS. When a time clock is used, it will be located in a HVAC control panel. The modes of operation are occupied, unoccupied and ventilation delay.

(2) The time clock will be a device that accepts a time schedule by manual input through a keypad and an alphanumeric display. The time clock features will be:

- (a) Four independent time-controlled contacts.
- (b) A program of 4 "on" events and 4 "off" events for each contact.
- (c) 365 day schedule.
- (d) Twelve selectable holidays.
- (e) Standard-time and daylight-time adjustments.
- (f) Timed override of programs.
- (g) Battery backup of memory.

(3) When used to time the modes of operation of air handling systems, one contact of the clock will be used for occupied and unoccupied timing; the second contact will be used for ventilation delay mode timing. For other applications, the contacts may be used as convenient to the design.

4. CONTROL LOOPS. A control loop performs three distinct functions: sensing of a variable as the input to a controller; decision making or control based on the value of the input; and output or actuation as a result of control. Figure 2-7 illustrates a simple control loop. The input signal is a continuous analog of the process, and the controller either continuously sees the input or continually scans it. The controller changes its output as required by changes in its input.

Figure 2-7. Control loop.

5. OPEN CONTROL LOOPS. When a control loop senses a variable, makes a control decision, and sends an output signal to a control device without receiving input information related to the results of its control action, the control loop is said to be an open loop. There are some open-loop control applications used in HVAC control, such as:

- (1) Operation of pumps above or below a certain outside temperature.
- (2) Automatic stopping of HVAC systems based on outside air temperature.
- (3) Scheduling of hydronic heating supply temperatures based on outside temperature.
- (4) Timing and time-delay operations.

Figure 2-8 illustrates an open control loop.

Figure 2-8. Open control loop.

6. CLOSED CONTROL LOOPS. When the controller changes its output decision based on updated input information, the control loop is said to be a closed loop. Most of the control loops used in HVAC control are closed loops. Control of coil air discharge temperatures is an example. The transmitter, connected to a temperature sensing element in the air stream passing through the coil, signals the temperature controller; the controller makes a decision as to whether to open or close the valve that allows water to flow through the coil; and an actuator operates the valve. The feedback in this example is the continuous input to the controller of a changing temperature signal from the coil air discharge temperature sensor and transmitter. The transmitter continuously updates the controller on temperature information from the sensor, and the controller modifies its output to control the valve. See figure 2-9 for an example of a closed control loop.

Figure 2-9. Closed control loop.

7. APPLICATION OF OPEN-LOOP CONTROL AND CLOSED-LOOP CONTROL TO HVAC SYSTEMS.

a. Open loops and closed loops in combination. Open loops and closed loops are used in combinations in some HVAC control-system applications. A perimeter hydronic heating system may have open-loop components to start and stop the pump and to schedule the supply water temperature based on outside air temperature. At the same time, it may have a closed loop for the control of the supply water temperature.

b. Closed loops in combination. There are some HVAC control applications that use two simultaneously acting, closed control loops to actuate the same device. An example, as shown in figure 2-10, is control of a duct humidifier. A space relative humidity transmitter is the primary input to a relative humidity controller for the humidifier valve in a closed loop (loop 1). A duct-mounted humidity transmitter downstream of the humidifier signals a high limit relative humidity controller, which provides a high limit closed-loop control function (loop 2), by overriding the primary controller loop 1 to shut off humidification by closing the valve if the relative humidity of the air stream rises to the loop-2 relative humidity high-limit setting.

Figure 2-10. Two loops controlling one device (humidity control with high limit).

8. TYPICAL CONTROL MODES.

- a. Two-position control.

(1) Some HVAC equipment can be turned on and off as a method of temperature control. This type of HVAC equipment is not applied where temperature control between close limits is required.

(2) When a thermostat or other control device cycles equipment to maintain its setpoint the control mode is called two-position control. A thermostat used for two-position control opens and closes contacts for control rather than providing a modulating output signal. The contacts either open or close when the temperature is at the thermostat setpoint. The state of the contact reverses when the temperature changes in the proper direction. Such thermostat contacts usually either open on a temperature rise (in a heating application), or close on a temperature rise (in a cooling application). The temperature at which this happens depends on the switch temperature differential (hysteresis).

(3) An example of two-position control is unit heater control, in which a space thermostat turns on a unit heater when the space temperature drops to 18 degrees C (65 degrees F) and turns it off when the space temperature rises to 19 degrees C (67 degrees F). The thermostat is said to have a differential of 1 degree C (2 degrees F) and a setpoint of 18 degrees C (65 degrees F). This type of control can result in a slight undershoot below the lower end of the differential, and a slight overshoot above the higher end of the differential.

(4) The thermostat may turn off the unit at 19 degrees C (67 degrees F), but the heating load may decrease due to increasing outside air temperatures. In this event, water circulating through the unit coil, which will then be acting as a radiator with the fan off, may raise the temperature in the space slightly above 19 degrees C (67 degrees F) as an apparent overshoot. Even though the unit turns on when the space temperature drops to 18 degrees C (65 degrees F), the space temperature may fall slightly below 18 degrees C (65 degrees F) after the unit starts. This depends on the heating load at the time and on the heating capacity of the unit. If the heating load decreases, the temperature may subsequently rise to 18.5 degrees C (66 degrees F) and stay at that temperature for a considerable time, while the fan continues to run. A similar situation can happen after the unit heater shuts off at 19 degrees C (67 degrees F) and the space temperature drops to 18.5 degrees C (66 degrees F). Consequently, the space temperature may be 18.5 degrees C (66 degrees F) with the unit heater fan either running or stopped. A graphic representation of two-position control is shown in figure 2-11.

Figure 2-11. Two-position control.

b. Modulating Control. A simple control loop is shown in figure 2-12 as it would be applied to heat outside air for ventilation using a pneumatic valve actuator rather than an electric or electronic valve actuator. The controller operates an IP in response to the signal of the temperature sensing element in the air duct, downstream of the coil, via a transmitter. The IP pneumatic output signal modulates the positioner on the pneumatic valve actuator. The positive-positioner output throttles main air to the actuator, which moves the valve stem. This example is used to explain two modes of modulating control that are applicable to the control of valves, dampers, inlet vanes, and other devices. The modes applicable to most HVAC control applications are:

- (1) Proportional mode (P).
- (2) Proportional plus integral mode (PI).

Figure 2-12. Simple control loop applied to outside air heating.

c. Proportional mode (P). The most common control mode in HVAC control is proportional mode.

- (1) Proportional mode is used for the following applications:

(a) As a method of scaling an outside air temperature signal to schedule water temperatures for heating.

(b) As a method of space temperature control for single-zone air handling units.

(c) As a method of controlling terminal units that can be modulated.

(2) Figure 2-13 shows the kind of control that would be expected if the controller in figure 2-12 were configured for the proportional control mode. The controller modulates its output signal in proportion to variations of the input signal. For example, the controller, operating through the IP, sends a 21 kPa (3 psig) air signal to the normally open preheat coil valve when the discharge temperature is 6 degrees C (43 degrees F), and it sends a 103 kPa (15 psig) signal when the discharge temperature is 8 degrees C (47 degrees F). The 21 kPa (3 psig) signal completely opens the valve to heating, and the 103 kPa (15 psig) signal completely closes the valve to heating. The controller/IP combination has a proportional sensitivity of 37.2 kPa per degree C (3 psig per degree F), and throttles the valve over a range of 2 degrees C (4 degrees F). The setpoint of the controller is 7 degrees C (45 degrees F), but the temperature at which it is controlling is somewhere between 6 degrees C (43 degrees F) and 8 degrees C (47 degrees F). It takes a 2 degree C (4 degree F) change in controller output signal for the valve to go from full heating to no heating.

Figure 2-13. Proportional control mode.

(3) On a fall in outside air temperature, the heating load increases. The resultant drop in temperature at the sensor causes the transmitter to signal the controller to lower its output to the IP transducer. The IP transducer lowers the control air pressure to the normally open valve, allowing more heating medium to pass through the coil, thereby returning the discharge temperature almost to the temperature maintained before the fall in outside temperature. Increasing the controller's sensitivity would shrink the full heating/no heating temperature range; decreasing its sensitivity would increase that range.

(4) The phenomenon that prevents the proportional control mode from achieving its control point exactly at setpoint is called "offset due to load". This occurs when an equilibrium is reached between HVAC system output and the load imposed on the HVAC system. When this equilibrium occurs, the discharge temperature does not change. This means that the proportional mode controller does not change its output and cause a change in the HVAC system output. Conversely, without the change in HVAC system output to drive the temperature toward the controller setpoint, the controller output does not change. Therefore, at these equilibrium points, the controls do not bring the system back to setpoint.

(5) Figure 2-13 shows the relationship between coil discharge temperature and controller/IP output in response to changes in outside air temperature. Except between points A and B the controller/IP output is proportional to the discharge air temperature. Between points A and B, the coil discharge air temperature is the same as the outside air temperature. At points A and B, with a coil discharge temperature of 8 degrees C (47 degrees F), the output is 103 kPa (15 psig) and the valve is closed. At the fifth hour when the discharge temperature is at the 7 degrees C (45 degrees F) setpoint the controller/IP output is 62 kPa (9 psig) and the valve is half open. If the valve is closed at 8 degrees C (47 degrees F) outside air temperature and is half open with a 11 degrees C (20 degrees F) pick-up at -4 degrees C (25 degrees F) outside air temperature, then by extrapolation the valve is fully open at outside air temperatures of -16 degrees C (3 degrees F) and below. As soon as the air temperature leaving the coil, the incoming outside air temperature, and the heating action of the coil reach an equilibrium, the valve remains at a given position until the equilibrium is disturbed by changes in the outside air temperature.

(6) For a given load on the system, there is some optimal proportional sensitivity adjustment at which the controller will be in stable control and close to the setpoint. In some HVAC control applications, proportional control may function quite well with a high sensitivity adjustment. A high sensitivity adjustment

results in a narrow range of temperature drift from setpoint while the controller changes its output from full output to minimum output. Too high a sensitivity adjustment causes the control point to continuously overshoot and undershoot the setpoint. In other control applications, stable control may not be achievable with a high sensitivity adjustment. A low sensitivity adjustment results in a wide range of temperature drift from setpoint while the controller changes its output from full output to minimum output, but control is usually more stable. After the controller sensitivity has been adjusted, changing conditions of load due to seasonal and other factors tend to make the adjustment less than optimal. This phenomenon is a function of HVAC system capacity and HVAC system response to load changes. The sensitivity of a proportional controller to process variable changes is called proportional gain.

(7) As long as the proportional controller is controlling in a stable fashion, at varying load conditions, at some control point near the setpoint and the proportional gain setting is optimum, the controller has achieved the most precise control of which it is capable.

d. Proportional plus integral mode (PI).

(1) Many control applications require a controller that can eliminate offset due to load and can control very close to setpoint. To achieve closer control than is available from the proportional control mode, some automatic adjustment has to be made to the controller output to change the actuator position without changing the setpoint or the proportional gain setting. The method used to adjust the controller output for changes in load is called "integral mode". Integral mode adds a gain component algebraically to the controller output. This component is time proportional to the difference between the setpoint and the stable control point produced by the controller's proportional gain. This difference is caused by the offset due to load and is called steady-state error, which is the error between control point and setpoint when a balance between the load on the system versus the system capacity output and controller output is established. Steady-state error differs from the transitory error between setpoint and control point due to an upset in the process, such as a changing load or a step change in setpoint.

(2) The integral mode adds a component of output to the output of the controller that is produced by the controller's proportional gain. The size of the component is determined by the integral gain multiplied by the error. As the error decreases, the size of the component integrated to the output signal also decreases, and becomes zero when the controller is controlling at the setpoint. This added component of output causes the valve actuator stroke position to change. The change in valve capacity resulting from the change in the actuator stroke position upsets equilibrium or prevents equilibrium from occurring until the control point reaches setpoint. This action causes two things to happen. The resulting temperature change due to the change in valve actuator stroke position causes the proportional gain to change its component of output signal at a magnitude proportional to the change in the temperature being sensed. While this is happening, the error changes because the control point is closer to setpoint, and this in turn causes the integral gain to make a change in the magnitude of its component of the output signal due to the changing value of the magnitude of the error between control point and setpoint. There will be no further change in the proportional-mode or integral-mode output components when the steady-state error is zero. Because of the combined action of both of these control modes, the controller can reduce the offset to zero, or nearly zero, and can establish a steady-state equilibrium of HVAC system control at a value very near setpoint. This type of control is called Proportional-Integral (PI) control.

(3) See figure 2-14 for an illustration of proportional plus integral modes. The upper graph of the figure is identical to the upper graph of figure 2-13. The lower and middle graphs provide a comparison of the proportional mode controller output and resulting coil air discharge temperatures (light lines) versus those of a PI-mode controller (dark lines). In the beginning of the middle graph the integral mode component is positive and is added to the proportional mode component. This additional pressure closes the normally-open valve when the outside air temperature reaches setpoint 7 degrees C (45 degrees F), instead of at point A, at which the coil discharge air temperature is 7 degrees C (45 degrees F) plus half the controller throttling range or 8 degrees C ($7 + 2/2$) (47 degrees F ($45 + 4/2$)). The 8 degrees C (47 degrees

F) temperature would have occurred with proportional control, at point A. Similarly, when the outside air temperature falls to 8 degrees C (47 degrees F), the integral mode component prevents the valve from opening until the outside air temperature falls below 7 degrees C (45 degrees F). The proportional only mode controller would have begun to open the valve at 8 degrees C (47 degrees F) outside air temperature at point B. From the time the valve begins to open at the outside air temperature of 7 degrees C (45 degrees F) until the fifth hour when the outside air temperature is -4 degrees C (25 degrees F) the integral mode component of the controller output signal becomes smaller until at the fifth hour the integral mode component becomes zero. This additional pressure on the normally-open valve allows the coil air discharge temperature to remain at the 7 degrees C (45 degrees F) setpoint instead of controlling between 8 and 7 degrees C (47 and 45 degrees F) when the outside air temperature is between 7 and -4 degrees C (45 and 25 degrees F) as would have occurred with proportional only control. Similarly, when the outside air temperature falls below -4 degrees C (25 degrees F), the integral mode component is subtracted from the proportional mode component of the controller output signal to open the valve enough to keep the discharge air temperature at 7 degrees C (45 degrees F) rather than at 6 degrees C (43 degrees F) as would have occurred with proportional mode control.

Figure 2-14. Proportional plus integral control mode.

e. Effects of rapid load changes. The rate of change of load imposed on the HVAC system by the process affects how well the controller will perform its task of controlling at setpoint. The temperature of the outside air changes relatively slowly, and the temperature conditions inside also require some time to change. Inside conditions change as a function of air temperature changes made by the HVAC system, which warm up or cool down masses of material within the building. Inside conditions also change as functions of lighting load and occupancy. Because of these relatively slow rates of change, most of the HVAC processes that require gradual controller output changes can be controlled quite well with proportional plus integral (PI) control modes. Except for lighting loads on the HVAC system, these variable changes are relatively slow compared to the rates of change of variables that affect some non-HVAC processes. Lighting loads are sometimes imposed on the HVAC system quickly. This is an example of a step change in the process variable. The combined actions of proportional and integral modes are not always adequate to control rapidly changing variables.

f. Proportional-integral-derivative (PID) mode.

(1) Some processes require a controller that can respond to rapidly changing process variables. One answer to control of rapidly changing processes has been the addition of another control mode called derivative mode. When this control mode is added to proportional-integral control, the combination is known as proportional-integral-derivative (PID) control mode. The PID control mode adds a component algebraically to the output signal; this component is proportional to the rate of change of the error between the control point and setpoint. This automatic adjustment also affects the proportional and integral output components in a manner analogous to the way in which the integral component affects the proportional component. As the valve actuator stroke position changes, the temperature changes as a result of changing flow through the valve, and the rate of error signal change between the control point and setpoint varies as the control point comes closer to setpoint.

(2) There are a few HVAC control applications that are difficult for either P-mode or PI-mode control because of the fast rates of change of the process variables. One such application is the control of tankless heating converters, such as might be found in some domestic hot water heating applications. The I-mode component of PI-mode takes care of the varying range of offsets due to loads that occur in domestic hot water heating applications. For example, high-rise residential buildings have morning and evening peak periods of demand for hot water use. These peak demand periods drive the domestic hot water temperature to the low end of the offset range. Periods of relative nonoccupancy, such as late morning and early afternoon, drive the temperature to the high end of the offset range due to the minimal demand for domestic hot water use. Periods of relative inactivity during occupancy, such as late evening

and very early morning, require practically no domestic hot water. It is this period that defines the top end of the offset temperature range. The P-mode control alone does not control the water temperature very close to the controller setpoint in this kind of application. The addition of the I mode to the P mode makes the offset range much narrower than would occur with P mode alone. However, PI modes alone cannot handle the unpredictable diversity of demand as the peak periods start and end. What happens during the period of light demand for hot water use is that the turn-on of a shower or the startup of a dishwasher produces an upset in equilibrium that has a greater effect than the same event would have during a period of heavy demand. Periods of heavy demand tend to filter out some of the effect of a single turn-on.

(3) In the control loop applications where manual tuning is prescribed, the proportional mode constant is set as the result of a calculation. These applications cannot use the integral or derivative control modes. Self tuning is prescribed for these applications because finding the optimum settings manually is difficult and time consuming. When controllers self-tune, these settings are automatically optimized, and an optimized derivative-mode setting is selected due to the controller's self-tune feature. The effects of adding the I and D modes to the P mode is illustrated in figure 2-15, which shows the results that would be expected with a step change in setpoint. Step changes in setpoints rarely occur in HVAC control system applications. The illustration of the step change in setpoint is used to graphically explain the actions of P, I, and D modes.

Figure 2-15. Comparison of P mode, PI mode and PID mode for a step change in setpoint, and the contributions of each mode to controller output signal.

9. STANDARD HVAC SYSTEM CONTROL LOOPS.

a. Standard HVAC system control loops will be used for the design of HVAC control systems. The standard HVAC system control loops use the single-loop digital controller and additional components. These components are collectively called the control loop logic. The logic varies with the loop requirements, and its purposes are to interface the loops with the operational mode signals, to modify signals, and to interface with EMCS. The control loop logic is implemented by the use of combinations of relays and function modules.

b. Relay coils are activated by occupied-unoccupied, ventilation-delay, safety shutdown, EMCS-override, and other signals external to the HVAC control system. The contacts of the relays interrupt analog signals of controllers and function modules, provide inputs to on/off control loops (such as starter circuits), and operate HVAC control panel pilot lights.

c. All the relays, contacts, and function modules are defined for each loop. The relative physical locations of the relays and function modules will be assigned in the HVAC control panels.

d. Each of the standard HVAC control loops is described in this Technical Manual as the designer will show them on the contract drawings. Each control loop on the drawings will show the elements of the control loop, such as sensor/transmitters, controller, function modules, relay contacts, current to pneumatic signal converter (IP), and final actuator. The control loops will show all the field-mounted and panel-mounted devices for a standard loop. Each control loop will show function modules and relay contacts that are defined for the interfacing of analog control loops with on/off control loops.

10. SIZING AND SELECTION OF CONTROL SYSTEM DEVICES.

a. The designer will estimate the required motor horsepower of the HVAC control system air compressor, to provide the proper requirements for incorporation into the electrical power design.

b. Control system devices such as dampers and valves are sized on the basis of capacity requirements and allowable pressure drops and velocity ranges. The selection of the type of valve or damper is based on factors such as allowable leakage rates and available or practical size ranges.

c. The designer will analyze piping circuit pressure drops and their effects on the system's pressure drop due to the control valves, based on criteria presented in this manual. The designer will calculate the required liquid-flow coefficients (K_v (C_v)) for each valve and will show the K_v (C_v) for each valve. The designer will make sure that pumps are selected to include the pressure drop through the total circuit, and will then show the pressure against which the valve must close.

d. The designer will size control dampers based on the criteria presented in this manual and will show the size of each damper.

e. Oversizing of control devices would result in systems in which it would be difficult or impossible to obtain satisfactory control loop operation, regardless of the quality of the controller and components used. The designer must not assume that self-tuning controllers will compensate for oversizing of control devices. The I and D modes compensate for HVAC system load variations and HVAC system equilibrium upsets, but do not compensate for incorrect valve and damper sizing.

11. SIZING OF THE AIR COMPRESSOR MOTOR.

a. Calculation. The designer will estimate the required air compressor motor size, using equation 2-2, in order to coordinate with the power circuit serving the air compressor.

$$T_r = \frac{Q_c}{Q_d} \times 100 \quad (\text{eq. 2-2})$$

Where:

T_r = Air compressor running time (percent).

Q_c = Control system air consumption in standard milliliters per second (cubic inches per minute (scim)).

Q_d = Air compressor delivery in standard milliliters per second (cubic inches per minute (scim)).

b. Running-time criteria. The designer will use the following running-time criteria for sizing air compressor motors:

(1) New air compressors. The running-time design criterion for new air compressors is that the running time will not exceed 33-1/3 percent. This requires that, initially, the delivery capacity of the air compressor must be at least three times the estimated air consumption for the whole control system that it serves. The designer will count the number of each type of air-consuming device shown on the schematics and apply their characteristic consumption values to arrive at the consumption total. The designer will base the calculation on the air consumption for each device as shown in table 2-2.

(2) Existing air compressors. Control systems can be added to an existing air compressor until the running time reaches 50 percent. Exceeding 50 percent run-time risks excessive oil carryover into the air supply.

Table 2-2. Air consumption of control devices.

<u>Device</u>	<u>Air Consumption (ml/s (scim))</u>
---------------	--------------------------------------

IP	8 (30)
Damper or valve positive positioner	6 (20)
EP	0 (0)

c. Application of air consumption values to sizing of air compressor motors. An example of the application of the values in table 2-2 is as follows:

5 IPs @ 8 ml/s (30 scim) each = 40 ml/s (150 scim)

15 valve and damper positioners @ 6 ml/s (20 scim) each = 90 ml/s (300 scim)

Total = 40 + 90 ml/s (150 + 300 scim) = 130 ml/s (450 scim)

Therefore, 130 ml/s (450 scim) x 3 (for 1/3 running time) = 390 ml/s (1,350 scim)

A manufacturer's catalog indicates that a typical ¼ hp compressor delivers about 390 ml/s (1,420 scim) and that a ½ hp compressor delivers about 712 ml/s (2,600 scim). The ¼ hp compressor would run 35 percent of the time, while a ½ hp compressor would run only 26 percent of the time. On the basis of this calculation, a power circuit capable of serving a ½ hp motor would provide adequate margin to compensate for variances in the air consumption of control devices selected by the control system vendor.

12. DETERMINATION OF CONTROL VALVE FLOW COEFFICIENT (K_v / C_v).

a. The control valve flow coefficient ($K_v (C_v)$) is a number representing the quantity of water, at a given temperature, that will flow through a valve with a given pressure drop. The designer will calculate and select the flow coefficient ($K_v (C_v)$) of all modulating control valves required for the design, and show the pressure against which the valve must close. The selection of the valve's $K_v (C_v)$ provides the guidelines for the vendor's selection of the valve's port size. The close-off pressure information gives the required criterion for sizing the actuators for the valve selected by the vendor.

b. It should be noted that there is not yet an agreed upon international definition of control valve flow coefficients expressed in SI units (K_v). K_v data seems to be commonly expressed in units of either 1) $m^3/hr @ \Delta p = 100 \text{ kPa}$ (1 bar), or 2) $L/s @ \Delta p = 1 \text{ kPa}$. Because of this, one needs to note the units associated with published K_v data and explicitly cite units associated with K_v when producing specifications or drawings. In this document K_v will be associated with the units of $m^3/hr @ \Delta p = 100 \text{ kPa}$. (For conversion purposes: $K_v (L/s @ 1 \text{ kPa}) = 36 \times K_v (m^3/hr @ 100 \text{ kPa})$.) A control valve flow coefficient expressed in inch-pound (I-P) units is denoted as C_v and is generally expressed with units of gallons per minute (gpm), at 60 degrees F, at a pressure drop of 1 psid.

c. A valve that is operated in a 2-position open and closed manner will be a line-size valve with the largest available $K_v (C_v)$, in order to reduce the pressure drop across the valve and the pumping horsepower required. This applies to dual-temperature system changeover valves and dual-temperature fan coil unit 3-way valves.

d. The designer will select the $K_v (C_v)$ of the valve based on the maximum flow and the pressure drop for the valve. The selected control valve will be checked against manufacturer's catalogs to insure that such a valve $K_v (C_v)$ is available in a product of the control valve manufacturers.

e. To insure good control characteristics, the pressure drop through the control valve at full flow must be greater than the pressure drop through the coil and piping circuit (without the control valve) between the point where the piping circuit connects to the supply and return mains. The pressure drop through the control valve will then be at least 50 percent of the total pressure drop through the circuit. The valve K_v (C_v) must be specified accordingly. For liquid service, the vendor may supply a control valve with a plus 25 percent deviation from that specified. The designer must check to insure that the pressure drop through the valve will be acceptable at both the specified K_v (C_v) and at a K_v (C_v) 25 percent greater than specified. As the K_v (C_v) increases the pressure drop through the valve decreases. For steam service, the vendor must supply a control valve with a K_v (C_v) not less than the value specified and not larger than the manufacturer's next larger value.

13. CALCULATION OF LIQUID CONTROL VALVE FLOW COEFFICIENT (K_v / C_v).

a. A physical phenomenon known as cavitation is a cause of valve failure. Cavitation is caused when the velocity through the valve creates an absolute pressure lower than the vaporization pressure of the liquid. To avoid cavitation, use equation 2-3 to determine the maximum allowable pressure drop through open valves.

$$\Delta P_m = k_m (P_e - P_v) \quad (\text{eq. 2-3})$$

Where:

ΔP_m = maximum allowable pressure drop through the valve, kPa (psid)

k_m = valve pressure recovery coefficient (use 0.45)

P_e = absolute pressure entering the valve, kPa (psia) (by design calculations).

P_v = absolute vapor pressure of the liquid, kPa (psia) (from steam tables).

For example: If 111 degree C (200 degree F) water with an equivalent vapor pressure of 79.5 kPa (11.53 psia) is to flow through a valve with an inlet pressure of 138 kPa (239 kPa (abs.)) (20 psig (34.7 psia)), the maximum allowable pressure drop through the valve will be, as a result of using equation 2-3, 71.9 kPa (10.43 psid).

b. The pressure drop through the control valve must be at least 50 percent of the total pressure drop, at full flow, through the circuit. Continuing with the above example, assume a coil with a flow of 11.35 m³/hr (50 gpm) and a 27.6 kPa (4 psig) drop through the coil, piping and fittings between the mains. The maximum allowable pressure drop to avoid cavitation was calculated to be 71.9 kPa (10.43 psid). An initial valve pressure drop selection of 41.4 kPa (6 psid) will prevent cavitation and provide sufficient valve pressure drop for good control. The K_v (C_v) can be calculated from equation 2-4:

$$K_v = \frac{Q}{\sqrt{\frac{\Delta P}{G}}} \quad (\text{eq. 2-4 SI})$$

Where:

K_v = flow coefficient, m³/hr @ Δp = 100 kPa (1 bar)

Q = flow, m^3/hr

Δp = pressure drop through valve, in bars (100 kPa = 1 bar)

G = specific gravity of the liquid.

$$C_v = \frac{Q}{\sqrt{\frac{\Delta p}{G}}} \quad (\text{eq. 2-4 IP})$$

Where:

C_v = flow coefficient, gpm @ $\Delta p = 1$ psi

Q = flow, gpm

Δp = pressure drop through valve, psi

G = specific gravity of the liquid.

The specific gravity of water is 1. As the result of using equation 2-4, $K_v = 17.64$ ($C_v = 20.41$). If the designer specifies a K_v of 17 (C_v of 20), the vendor can provide a valve with a K_v in the range of 17 to 21.25 (C_v in the range of 20 to 25). If the vendor provides a valve with a K_v of 21.25 (C_v of 25), the pressure drop would be 28.5 kPa (4 psid) as calculated by using equation 2-4. This valve selection would make the pressure drop through the valve 50 percent of the drop through the total piping circuit. Knowing that a plus 25 percent deviation in valve K_v (C_v) selection is allowable, the designer could select a K_v (C_v) which would result in a larger pressure drop through the control valve. With a K_v of 14 (C_v of 16), the valve pressure drop will be 65.7 kPa (9.76 psid) as calculated by the use of equation 2-4. This is less than the maximum allowable valve pressure drop of 71.9 kPa (10.43 psid), and the total circuit pressure drop would be 27.6 kPa (4 psid) (coil and piping) plus 65.7 kPa (9.76 psid) (valve) = 93.3 kPa (13.76 psid). A K_v of 14 (C_v of 16) would result in the pressure through the valve being 71 percent of the drop through the piping circuit. If the designer specifies a K_v of 14 (C_v of 16), the vendor can provide a valve with a K_v in the range of 14 to 17.5 (C_v in the range of 16 to 20). Cavitation will not be a problem in this example if the water temperature used is 111 degrees C (200 degrees F), or less. In most HVAC control valve applications, water temperatures are less than 111 degrees C (200 degrees F). When the hot water temperature is scheduled from outside air, 111 degree C (200 degree F) water will occur only on design heating days. Also, cavitation should not be a problem in hydronic systems when expansion tank pressures are adjusted so that cavitation is not present at the pump inlet. Selection by the designer of a control valve K_v of 17 (C_v of 20) rather than a K_v of 14 (C_v of 16) would be technically acceptable according to the criteria of this EI, but would not be a good engineering practice. If the larger K_v (C_v) is used as the basis of design, the contractor may provide a valve with a K_v of 21.25 (C_v of 25). A K_v of 21.25 (C_v of 25) may result in the valve pressure drop being less than 50 percent of the drop through the circuit. The basis of design valve K_v (C_v) is selected because of the drop expected through the basis of design coil and the piping system configuration shown by the designer. The coil provided by the contractor, field piping conditions and aging of the piping system are factors which could result in the installed valve being less than 50 percent of the drop through the coil when the contractor provides a valve with the largest K_v (C_v) permissible.

c. Review of manufacturers' catalogs shows the ready availability of valves with K_v in the range of 14 to 22 (C_v in the range of 16 to 25), as listed in table 2-3.

Table 2-3. Available control valves with K_v (C_v) in the range of 14 to 22 (16 to 25)

Valve Type	Valve Size	K_v (m^3/hr @ $\Delta p = 100$ kPa) / C_v (gpm @ $\Delta p = 1$ psi)
Normally-open water valve	25 mm (1-inch)	15.5 / 18
Normally-open water valve	32 mm (1-1/4 inch)	19.2 / 22.2
Normally-open water valve	32 mm (1-1/4 inch)	14.7 / 17
Normally-open water valve	32 mm (1-1/4 inch)	13.8 / 16
Normally-open water valve	40 mm (1-1/2 inch)	21.6 / 25
Normally-open water valve	40 mm (1-1/2 inch)	17.3 / 20
Three-way valve	25 mm (1-inch)	15.5 / 18
Three-way valve	25 mm (1-inch)	15.6 / 18.1
Three-way valve	32 mm (1-1/4 inch)	13.8 / 16
Three-way valve	32 mm (1-1/4 inch)	14.7 / 17
Three-way valve	40 mm (1-1/2 inch)	21.6 / 25
Three-way valve	40 mm (1-1/2 inch)	18.2 / 21

At this point, the designer will check the line size of the piping circuit and check the piping size of the reducing fittings. A good choice for the designer would be to show the K_v at 14 (C_v at 16) and the maximum close-off pressure at 140 kPa (20 psig) in this example because there are more control valves available in the range of 14 to 17.5 (16 to 20) (a plus 25 percent deviation) than there are in the range of 17.5 to 21.25 (20 to 25) (a plus 25 percent deviation).

c. The K_v (C_v) calculations for selecting a butterfly valve are identical to those for any valve except that the valve K_v (C_v) is selected using the calculated K_v (C_v) at a maximum of 70 degrees open when the valve is to be used in a modulating control application. (The butterfly valve does not have a good modulating control characteristic curve between 70 degrees and 90 degrees open.)

d. When selecting control valves for liquid service other than water, the designer will take into account the specific gravity of the liquid. If the liquid has a specific gravity of 1.05, for the same flow rate, the liquid flow will produce a 5 percent greater pressure drop through the valve.

14. CALCULATION OF STEAM CONTROL VALVE FLOW COEFFICIENT (K_v / C_v).

a. Calculating and selecting the required K_v (C_v) of a steam valve requires the designer to consider:

- (1) The saturated or superheated condition of the steam.
- (2) The inlet pressure at the valve.
- (3) The minimum required steam pressure entering the steam-condensing apparatus at peak heating load.

b. The designer will use equations that correct the liquid K_v (C_v) for the compressibility of the steam. The designer will take into account in his calculations that the limiting factor of steam flow through a control valve is the flow that occurs at critical pressure drop, and will use an appropriate factor for calculating the critical pressure drop. The designer will calculate the critical pressure drop across the valve by using equation 2-5.

$$\Delta p_{cr} = k_m \times p_e \quad (\text{eq. 2-5})$$

Where:

Δp_{cr} = critical pressure drop, kPa (psid)

k_m = valve pressure recovery coefficient, (use 0.45)

p_e = Absolute pressure of the steam entering the valve, kPa (psia)

c. For steam control valve application using saturated steam at a pressure drop across the valve less than the critical pressure drop, the K_v (C_v) will be calculated using equation 2-6.

$$K_v = \frac{Q_s}{0.161 \sqrt{(p_e + p_o) \Delta p}} \quad (\text{eq. 2-6 SI})$$

Where:

K_v = flow coefficient, m^3/hr @ $\Delta p = 100$ kPa (1 bar)

Q_s = steam flow, kg/hr

0.161 = compressibility and conversion factor.

p_e = absolute steam pressure entering the valve, kPa

p_o = absolute pressure entering steam coil, kPa

Δp = pressure drop through valve, kPa

$$C_v = \frac{Q_s}{2.11 \sqrt{(p_e + p_o) \Delta p}} \quad (\text{eq. 2-6 IP})$$

Where:

C_v = flow coefficient, gpm @ $\Delta p = 1$ psi

Q_s = steam flow, lb/hr

2.11 = compressibility and conversion factor.

p_e = absolute steam pressure entering the valve, psia

p_o = absolute pressure entering steam coil, psia

Δp = pressure drop through valve, psid

d. When the drop across the valve will be at or greater than the critical pressure drop and the steam is saturated, the K_v (C_v) will be calculated using equation 2-7.

$$K_v = \frac{Q_s}{0.133 p_e} \quad (\text{eq 2-7 SI})$$

Where:

K_v = flow coefficient, m^3/hr @ $\Delta p = 100 \text{ kPa}$ (1 bar)

Q_s = steam flow, kg/hr

0.133 = compressibility and conversion factor.

p_e = absolute pressure of entering steam, kPa

$$C_v = \frac{Q_s}{1.74 p_e} \quad (\text{eq 2-7 IP})$$

Where:

C_v = flow coefficient, gpm @ $\Delta p = 1 \text{ psid}$

Q_s = steam flow, lb/hr

1.74 = compressibility and conversion factor.

p_e = absolute pressure of entering steam, psia

e. For superheated steam applications where the drop across the valve is less than the critical pressure, the K_v (C_v) will be calculated using equation 2-8.

$$K_v = \frac{Q_s (1 + 0.00131 (T_{sh}))}{0.161 \sqrt{(p_e + p_o) \Delta p}} \quad (\text{eq. 2-8 SI})$$

Where:

K_v = flow coefficient, m³/hr @ $\Delta p = 100$ kPa (1 bar)

Q_s = steam flow, kg/hr

$(1 + 0.00131 (T_{sh}))$ = superheat factor.

T_{sh} = superheat temperature, degrees C

0.161 = compressibility and conversion factor.

p_e = absolute pressure of the steam entering the valve, kPa

p_o = absolute pressure of the steam entering the coil, kPa

Δp = pressure drop through the valve, kPa

$$C_v = \frac{Q_s (1 + 0.0007 (T_{sh}))}{2.11 \sqrt{(p_e + p_o) \Delta p}} \quad (\text{eq. 2-8 IP})$$

Where:

C_v = flow coefficient, gpm @ $\Delta p = 1$ psid

Q_s = steam flow, lb/hr

$(1 + 0.0007 (T_{sh}))$ = superheat factor.

T_{sh} = superheat temperature, degrees F

2.11 = compressibility and conversion factor.

p_e = absolute pressure of the steam entering the valve, psia

p_o = absolute pressure of the steam entering the coil, psia

Δp = pressure drop through the valve, psid

T_{sh} is the superheat temperature of the steam reduced to the lower pressure from the higher pressure.

f. For superheated steam applications with the pressure drop across the valve at or greater than the valve's critical pressure, the K_v (C_v) will be calculated using equation 2-9.

$$K_v = \frac{Q_s (1 + 0.00131 (T_{sh}))}{0.133 p_e} \quad (\text{eq. 2-9 SI})$$

Where:

K_v = flow coefficient, m³/hr @ $\Delta p = 100$ kPa (1 bar)

Q_s = steam flow, kg/hr

$(1 + 0.00131 (T_{sh}))$ = superheat factor

T_{sh} = superheat temperature, degrees C

0.133 = compressibility and conversion factor.

p_e = absolute pressure of the steam entering the valve, kPa

$$C_v = \frac{Q_s (1 + 0.0007 (T_{sh}))}{1.74 p_e} \quad (\text{eq. 2-9 IP})$$

Where:

C_v = flow coefficient, gpm @ $\Delta p = 1$ psid

Q_s = steam flow, lb/hr

$(1 + 0.0007 (T_{sh}))$ = superheat factor

T_{sh} = superheat temperature, degrees F

1.74 = compressibility and conversion factor.

p_e = absolute pressure of the steam entering the valve, psia

g. An example of the calculation required for the K_v (C_v) of a valve designed to handle saturated steam when the pressure drop will be less than critical is as follows: An air coil requires 113.4 kg/hr (250 lb/hr) of steam entering the coil at 13.8 kPa (2 psig). The steam is generated by a local boiler with the boiler's operating pressure switches set at 34.5 kPa (5 psig) "on" and 55.2 kPa (8 psig) "off". Assuming 34.5 kPa (5 psig) at peak load at the valve inlet and 13.8 kPa (2 psig) at the valve outlet, the $K_v = 9.8$ ($C_v = 11.34$) as a result of using equation 2-6. In this example, critical pressure drop is not a limiting factor, because the coil pressure at critical pressure drop would be $(101.4 + 34.5) \times .45 = 61.2$ kPa $((14.7 + 5) \times 0.45 = 8.87$ psia), which is not possible unless the system is designed to operate at a high vacuum. A check of

manufacturers' literature shows K_v of 8.6, 10.4, 11.2 (C_v of 10, 12, and 13) in a 25 mm (1 inch) valve. A valve K_v of 10.4 (C_v of 12) would be a good design choice for this application.

h. When the calculation for steam valve selection results in a K_v greater than 47.5 (C_v greater than 55), the designer will select two valves, sized to split the flow unevenly between the valves; a good ratio is one-third of the flow for the smaller valve and two-thirds of the flow for the larger valve, which, however, is not always achievable from the normally available stock of valves. As an example of the calculation required, a steam converter requires 2,722 kg/hr (6,000 lb/hr) of steam at 7 kPa (1 psig) entering the converter shell at peak load with the steam pressure reduced from 862 kPa (125 psig) to 172 kPa (25 psig) near the converter. The critical pressure drop is 123 kPa (17.87 psid) as a result of using equation 2-5, and the pressure drop across the valve is $172 - 7 = 165$ kPa ($25 - 1 = 24$ psid), which is greater than the critical pressure drop. The constant-enthalpy process of reducing the steam pressure from 862 kPa (125 psig) to 172 kPa (25 psig) results in 26.7 degrees C (48 degrees F) of superheat. The required K_v (C_v) is 77.5 (89.1) as a result of using equation 2-9. This K_v (C_v) is 3 percent larger than it would have been if the steam were saturated at 172 kPa (25 psig) and the K_v (C_v) were calculated from equation 2.7. In this example, the designer should show two valves in parallel and attempt to find available valves with K_v s of approximately 52 and 26 (C_v s of approximately 60 and 30). A check of manufacturers' catalogs for this example results in the designer showing valves with K_v s of 60.5 and 19.9 (C_v s of 70 and 23) and a close-off pressure of 172 kPa (25 psig). The selection results from the following available control valve combinations, any of which will meet the design intent:

(1) one 65 mm (2-1/2 inch) valve, $K_v = 64$ ($C_v = 74$), and one 40 mm (1-1/2 inch) valve, $K_v = 15.6$ ($C_v = 18$), or total $K_v = 79.6$ ($C_v = 92$)

(2) one 65 mm (2-1/2 inch) valve, $K_v = 60.5$ ($C_v = 70$), and one 40 mm (1-1/2 inch) valve, $K_v = 19.9$ ($C_v = 23$), or total $K_v = 80.4$ ($C_v = 93$)

(3) one 80 mm (3-inch) valve, $K_v = 61.1$ ($C_v = 70.7$), and one 40 mm (1-1/2 inch) valve, $K_v = 20$ ($C_v = 23.1$), or total $K_v = 81.1$ ($C_v = 93.8$)

15. DETERMINING VALVE ACTUATOR CLOSE-OFF PRESSURE RATINGS.

a. The close-off rating indicates the pressure against which a valve must be able to close. Figure 2-16 is a normally open pneumatic valve. F_1 is the force of the air pressure acting to close the valve. F_2 is the opposing spring pressure and F_3 is the force exerted by the fluid (water pump head or steam pressure). The value of F_3 is actually the difference in pressure on the two sides of the valve plug. The valve and actuator must be able to close the valve against fluid force F_3 . The expected value of F_3 is part of the hydraulic design of the piping system and depends upon the location of the valve within the system. To provide for a safety factor, the pressure the valve must close against is normally specified at several times the value actually expected at the valve's location. A three-way valve must operate against a similar fluid pressure in moving from one position to another.

Figure 2-16. Typical normally-open pneumatic valve.

b. In piping circuits with two-way valves, the flow is not constant. As the valve closes, the flow decreases. As the flow decreases, the friction losses decrease and the pump delivers more pressure. As a valve shuts off (worst condition) the valve must take the full pump pressure at zero flow (dead head). To provide a measure of safety and to allow for differences between design and installed conditions, close-off pressure ratings for two-way valves should be specified to be 100% to 125% of the rated pump pressure at the design flow rate.

Figure 2-17. Close-off pressure for two-way valves.

c. In piping circuits with three-way valves, the flow is constant. Therefore, friction losses are constant and the pump pressure is constant. The three-way valve must close against the pressure difference between the supply and return headers. Three-way valves should be sized for $\beta = 0.7$ and the close-off pressure rating should be specified to be twice the valve pressure drop.

Figure 2-18. Close-off pressure for three-way valves.

16. SURGE PROTECTION PROVISIONS FOR TRANSMITTER AND CONTROL WIRING. Because HVAC control system transmitter signals and single-loop controller signals are interfaced with EMCS, the appropriate surge protection will be provided in the HVAC control system design as described in TM 5-815-2.

CANCELLED

CHAPTER 3

STANDARD CONTROL LOOPS

1. GENERAL.

The standard control loops described in this chapter consist of control system equipment and devices, arranged to perform specific control system functions. In the ensuing discussions of the different types of control loops, all loop devices (including transmitters) are shown, and their associated indicators (such as thermometers) are included where required. The sensing elements are included with the transmitters and are not shown separately. Signals from the transmitters represent the changing conditions at the sensing elements. Also, the required panel-mounted and field-mounted pneumatic indicators are shown. Modulating control signals from controllers are converted from 4-20 milliamperes to 21-103 kPa (3-15 psig) by a current-to-pneumatic transducer (IP) connected to a positive positioner (PP) of a valve or damper actuator as applicable.

2. COOLING COIL TEMPERATURE CONTROL LOOP.

a. The cooling coil temperature control loop is a constant temperature control loop and is shown in figure 3-1. Temperature sensing element and transmitter TT sends a temperature signal to controller TC (or to the DDC panel), which modulates an IP. The pneumatic signal from the IP is connected to positive-positioner PP, which operates cooling coil valve VLV. The conditions that must be operative for the control valve to be controlled are: the supply fan is on and the control system is in the occupied mode.

b. A relay contact between TC and IP is open when either constraint is operative.

Figure 3-1. Cooling coil temperature control loop.

3. OUTSIDE AIR PREHEAT COIL TEMPERATURE CONTROL LOOP.

a. When the mixed air temperature of the outside air and the return air is too low, a preheat coil will be used to heat the outside air. This modulating control loop will be used only with hot water or hot glycol heating units. A variation of the preheat coil control loop for use with steam preheat coils is shown in chapter 5. The purpose of raising the mixed air temperature is to prevent freezing of chilled water coils and hot water coils downstream of the mixed air plenum. The coil is sized to raise the temperature of the maximum design quantity of outside air just high enough to bring the mixed air temperature within the range of 7 to 10 degrees C (45 to 50 degrees F). The loop controls the temperature of the air leaving the preheat coil before the air mixes with return air. The setpoint of the controller of this loop is the HVAC system designer's calculation of the coil discharge air temperature required to maintain a minimum temperature in the mixed air plenum when the outside air is at the coldest temperature. This setpoint assures an adequate minimum temperature entering the cooling coil of an HVAC system. The outside air preheat coil temperature control loop is shown in figure 3-2.

Figure 3-2. Outside air preheat coil temperature control loop.

b. A temperature sensing element and transmitter TT, in the discharge air stream from the preheat coil, sends a temperature signal to preheat coil temperature controller TC. Controller TC operates transducer IP to maintain the setpoint of the controller by modulating a valve VLV. Since the TC setpoint is normally in the range of 4.5 to 13 degrees C (40 to 55 degrees F), the valve is controlled during the heating season when the outside-air temperature is below the TC setpoint. When the outside air temperature is at or above the TC setpoint, VLV is closed.

c. In this control loop, TC is direct acting (DIR), and VLV is normally open (NO) and fails open under the pressure of the valve actuator's return spring upon loss of electric signal, pneumatic signal, or positive-positioner air supply. The purpose of this is to avoid freezing of the preheat coil and other coils in the HVAC system should such an event occur in cold weather.

d. The preheat coil control loop functions continuously, without regard to the operating condition of the HVAC system. This has the advantage of maintaining a minimum temperature in the ductwork when the HVAC system supply fan is off.

e. For DDC applications, the DDC panel takes the place of controller TC.

4. HEATING COIL TEMPERATURE CONTROL LOOP.

a. Heating coils in HVAC systems are usually controlled by either of the following methods:

(1) Coil discharge air temperature setpoint is fixed.

(2) Coil discharge air temperature setpoint is based on the outside air temperature. This is usually referred to as "set point reset" of the coil discharge air temperature according to a "reset schedule". Although set point reset can help to conserve energy through reduced piping system heat loss, its primary advantage is improved control system performance and occupant comfort (in multizone and dual duct systems) through improved temperature regulation as the downstream air dampers tend to modulate freely as system capacity better matches the load.

b. Figure 3-3 shows an example of set point reset of a heating coil (HC) temperature controller. The output of the reverse acting OA controller (TC) is the input to the control point adjustment (CPA) of the direct acting HC discharge air temperature controller (TC). As the outside air temperature increases, the output of the OA TC decreases, which causes the setpoint of the HC TC to decrease linearly. Alternatively, as the outside temperature decreases, the output of the OA TC increases, which causes the setpoint of HC TC to increase linearly.

Figure 3-3. Heating coil temperature control loop (scheduled from outside air temperature).

c. Figure 3-4 and Table 3-1 define an example setpoint reset schedule. The schedule requires that the discharge air set point not rise above 49°C (120°F) or below 32°C (90°F) and that there is a linear

relationship between these two extremes.

Table 3-1. Setpoint reset schedule

<u>Outside air temperature</u>	<u>HC discharge air temperature setpoint</u>
-18°C (0°F)	49°C (120°F)
16°C (60°F)	32°C (90°F)

Figure 3-4. Outside air temperature controller input / output schedule.

d. To achieve the schedule defined in Figure 3-4 and Table 3-1, the controller parameters shown in Table 3-2 must be selected.

Table 3-2. Controller configuration parameters

<u>Outside air temperature controller</u> (TC REV)	<u>Discharge air temperature controller</u> (TC DIR)
Scaled low range of the PV input	Scaled low range of the PV input
Scaled high range of the PV input	Scaled high range of the PV input
Setpoint	Scaled low range of the CPA input
Proportional band	Scaled high range of the CPA input
Manual reset	Minimum setpoint (optional)
Minimum output	Maximum setpoint (optional)
Maximum output	

e. The PV input configuration parameters of both controllers must be selected so that the controllers scale their inputs to the ranges of their respective temperature transmitters. The outside air controller PV input low range and high range is -35°C (-30°F) and 55°C (130°F), at 4 and 20 mA, respectively. Similarly, the discharge air controller PV input low range and high range is 5°C (40°F) and 60°C (140°F), respectively. With these configuration parameters defined, the controllers scale, in a linear fashion, their PV input signals between 4 and 20 mA to the range of their corresponding temperature transmitters.

f. The discharge air temperature controller CPA input signal must be scaled independently of its PV input to recognize that a 4 mA signal at its CPA input from the outside air controller corresponds to a 32°C (90°F) discharge air setpoint. Likewise the discharge air controller must recognize that a 20 mA

signal at its CPA input corresponds to a 49°C (120°F) setpoint. With these configuration parameters defined, the controller scales, in a linear fashion, CPA input signals between 4 and 20 mA. These CPA input low and high range configuration parameter selections are extracted directly from the reset schedule shown in Figure 3-4 and Table 3-1.

g. The discharge air temperature controller minimum and maximum setpoints can also be defined as 32°C (90°F) and 49°C (120°F), but are optional since the full range of the CPA input has already been defined by the low and high range scale configuration parameters.

h. The outside air reset controller (TC REV) proportional band instructs the controller to change its output in proportion to its input. In our example, the outside air controller proportional band must be selected so that as the outside air temperature changes from -18°C (0°F) to 16°C (60°F) (also called the "throttling range", TR), the controller output changes full-scale from 20 to 4 mA. This signal is applied to the CPA input of the discharge air temperature controller, changing its setpoint from 49°C (120°F) to 32°C (90°F). The proportional band calculation was previously defined in equation 2-1 and in this example is:

$$PB = \frac{(TR \times 100)}{T_s} \quad (\text{eq. 2-1, repeated})$$

$$PB = \frac{(16 - (-16))^\circ\text{C} \times 100}{55 - (-35)^\circ\text{C}} = 37.5\% PB = \frac{(60 - 0)^\circ\text{F} \times 100}{130 - (-30)^\circ\text{F}} = 37.5\%$$

i. The outside air reset controller (TC REV) setpoint is (arbitrarily) selected to be at the midpoint (50%) of the controller throttling range (TR). In our example, the throttling range is -18°C (0°F) to 16°C (60°F) as dictated by the reset schedule. Therefore the setpoint is -1°C (30°F).

j. The outside air reset controller (TC REV) manual reset value is selected to be 50% because the setpoint was selected to be at the midpoint (50%) of the throttling range. By definition of proportional control, to achieve the desired result, the outside air controller setpoint and manual reset values must be set to corresponding values, where in this case 50% was selected.

k. The outside air reset controller minimum and maximum output ranges must be selected to be 4 and 20 mA, respectively. Note that with some controllers this may be defined as 0 and 100% output, respectively. The minimum and maximum output range parameters ensure that the outside air controller output will change full range to correspondingly adjust the discharge air temperature controller setpoint over its full 32°C (90°F) to 49°C (120°F) range as defined in the reset schedule.

l. Table 3-3 shows the final controller configuration parameter settings. These parameters and the reset schedule are to be shown on the control system Equipment Schedule drawing.

Table 3-3. Controller configuration parameters

Outside air temperature controller (TC REV)	Discharge air temperature controller (TC DIR)
Scaled low range of the PV input = -35°C (-30°F)	Scaled low range of the PV input = 5°C (40°F)
Scaled high range of the PV input = 55°C (130°F)	Scaled high range of the PV input = 60°C (140°F)
Setpoint = -1°C (30°F)	Scaled low range of the CPA input = 32°C (90°F)
Proportional band = 37.5 %	Scaled high range of the CPA input = 49°C (120°F)
Manual reset = 50 %	Minimum setpoint (optional) = 32°C (90°F)
Minimum output = 4 mA	Maximum setpoint (optional) = 49°C (120°F)
Maximum output = 20 mA	

m. The heating coil temperature control loop, with its fixed controller setpoints, is similar to the preheat coil temperature control loop in that it also controls the coil valve at all times. Figure 3-5 shows the heating coil controlled in a fixed temperature application. Temperature sensing element and transmitter TT sends a signal to heating-coil temperature controller TC. The operations of the control devices affected by the output signal of TC are identical, as previously described in paragraph 3-3.b. For DDC applications, the DDC panel takes the place of heating coil temperature controller TC.

Figure 3-5. Heating coil temperature control loop with heating coil controlled at a constant temperature.

n. The heating coil temperature control loop functions continuously, without regard to the operating condition of the HVAC system. This has the advantage of maintaining a minimum temperature in the ductwork when the HVAC-system supply fan is off.

5. MIXED AIR TEMPERATURE AND ECONOMIZER CONTROL LOOPS.

a. The use of up to 100 percent outdoor air to provide “free” cooling when the outdoor air conditions are favorable is called an economizer cycle. Whenever the enthalpy of the outdoor air is less than the enthalpy of the return air, conditions are favorable for an economizer cycle to provide cooling. While ideally the decision to allow the introduction of outside air beyond the minimum ventilation requirements for cooling would be based on a comparison of the enthalpies of the outside and return air, enthalpy sensors do not have the reliability of temperature sensors and they require more maintenance. Because

of this, the economizer cycle discussed herein is based on a comparison of the temperature of the outside and return air. Furthermore the decision to enable an economizer cycle to operate is partially based on the temperature of the return air to determine whether the space requires heating or cooling. This decision process relies on a deadband between heating and cooling. Federal regulations (10 CFR 435) require the use of economizer cycles and deadbands between heating and cooling in most situations for all federally owned buildings.

b. The mixed air temperature and economizer control loops are shown in figure 3-6. The actuators on the dampers operate like the actuator on a control valve. The outside air damper and relief air damper are normally closed and operate in parallel with each other. The return air damper is normally open and works opposite to the outside air and relief air dampers. The mixed air temperature control loop is linked to the economizer control logic.

Figure 3-6. Mixed air temperature and economizer control loops.

c. Outside air will not be used when the control system is in the unoccupied mode or in the ventilation-delay mode. A normally open (NO) relay contact in the circuit to IP keeps the outside air damper closed under these conditions, and also when the supply fan is off. An open relay contact in the circuit between TC and high signal selector TY keeps the dampers open to the manual setting of minimum position switch MPS, when the system is in the minimum outside air mode, and the outside air damper is allowed to open by the absence of other constraints. When both of these relay contacts are closed, the control system is then operating in both the occupied and economizer modes. Controller TC maintains the mixed air temperature by controlling the IP to modulate the dampers beyond minimum position. The signal from MPS or the signal from TC operates through high signal selector TY to operate the IP, which sends a pneumatic signal to positive-positioner PP to control the damper actuators. The output of IP to the damper actuator positioners can be read on PIs at the panel and at the damper location. Mixed air temperature sensing element and transmitter TT sends a signal to TC, which changes its output to operate the dampers between minimum outside air position and full outside air.

d. The temperature sensing elements and transmitters TT in both the outside air intake and the return air duct send temperature signals to economizer controller EC.

e. The economizer controller EC requires a setpoint for each of two contacts that determine whether the coil of the relay that puts the system in the economizer mode is energized or de-energized. The setpoints and switching differentials for each of the contacts are adjustable in EC. One of the contacts, configured as a PV contact, responds to the temperature sensing element and transmitter TT in the return air duct and prevents the economizer mode from operating when the HVAC system is heating the space that it serves. The return air temperature setpoint of the contact will be selected at a temperature that is below the expected cooling season return air temperature but higher than the expected heating season space temperature. Two-deck multizone and dual-duct multizone systems present a special situation and will be discussed separately. The other contact, configured as a deviation (DEV) contact, responds to the difference in the signals of outside air temperature and return air temperature. The setpoint of the DEV contact requires a calculation by the designer. The designer will indicate the return air temperatures at which the PV contacts open and close and the temperature differences between the outside air temperature and the return air temperature at which the DEV contacts open and close.

f. In two-deck multizone and dual-duct multizone systems, given that there is no deadband between heating and cooling, there may not be sufficient change in the return air temperature between heating and cooling seasons to provide an indication as to what mode the system is in (heating or cooling). (Note that the use of two-deck or dual-duct multizones does not comply with federal regulations (10 CFR 435) which require a deadband between heating and cooling; a bypass multizone is a better choice and allows for the use of a deadband.) After evaluating several alternative methods for economizer mode initiation, the method described herein was judged to be the simplest and most reliable, and is therefore the recommended method.

We will look at two situations: 1) the unit is either served by a dual-temp hydronic system, or HW and CHW availability is seasonally scheduled (i.e.- only HW is available during the heating season and vice versa), and 2) HW and CHW are both available year-round.

Case 1: Dual-temp hydronics or scheduled HW & CHW - Make the "cooling mode" decision based on OA temperature rather than RA temperature. (i.e. - If OA is above X degrees, then assume the space needs cooling.) In this case, the outside air temperature would be the PV input to EC and the return air temperature would be the CPA input to EC. The outdoor air temperature above which the space will require cooling could be determined using computer models; however, the value would change as internal loads changed. In practice, it would seem that an engineering judgement should be made initially and adjusted later if required.

Case 2: Simultaneous availability of HW and CHW - In this case it is recommended that an economizer cycle not be used. An example system which does not utilize an economizer cycle is depicted in Chapter 5.

g. Because of the difficulty of maintaining enthalpy based economizer switchover hardware, the economizer controller operation is based on dry bulb temperature measurements rather than enthalpy measurements. The comparison of outside air and return air temperatures for determining the economizer switchover point is a method of control that uses local weather data for selecting an optimum dry-bulb temperature difference. An explanation of this method begins with figure 3-7.

Figure 3-7. Design condition for economizer mode operation.

h. The skeleton psychrometric chart shows a return air design condition of 24 degrees C (75 degrees F) dry-bulb temperature and 50 percent relative humidity (point A). A constant enthalpy line (B-C) drawn through this condition divides the chart into 4 regions of outside air temperatures and outside air relative humidities, which are:

(1) Region A, in which temperature and enthalpy conditions are less than return air design conditions.

(2) Region B, in which temperature conditions are lower but enthalpy conditions are higher than return air design conditions.

(3) Region C, in which both temperature and enthalpy conditions are higher than the return air design conditions.

(4) Region D, in which temperature conditions are higher but enthalpy conditions are lower than return air design conditions.

i. Cooling energy can be saved by using outside air for cooling when outside air conditions are in region A. Less energy will be used in cooling outside air than in cooling return air when outside air conditions are in region D. When outside air conditions are in region B, the outside air dry-bulb temperature is less than the return air dry-bulb temperature; however, excess cooling energy would be used if more than the required minimum of outside air is used, because the enthalpy of the outside air is higher than the design return air condition. When outside air conditions are in region C, there is no energy saving available from the use of outside air.

j. Figure 3-8 illustrates the method for selection of a setpoint for the DEV contact for economizer mode switchover in a relatively humid southeastern United States city, based on the published weather data in TM 5-875. The designer will consult the local weather data for the nearest location of the project. The method presumes that the location is such that an economizer mode is acceptable in the HVAC design because it would not place an energy burden on the system due to a requirement for humidification of more than the minimum quantity of outside air. Using a psychrometric chart, the designer will use the following procedure to determine the setting of the DEV contact:

(1) Plot a constant-enthalpy line (B-C) through the return air design temperature and relative-humidity condition (A). If the outside air conditions are below this line, the total heat content of the outside air is less than that of the return air and it can be used for cooling.

(2) Plot an average-weather line (E-F) by using the midpoint of the 2.8 degree C (5 degree F) bin and the mean coincident wet-bulb temperature for that temperature bin from TM 5-785.

(3) Read the difference in dry-bulb temperature between the design return air temperature and the outside air temperature where the average-weather line crosses the constant-enthalpy line (D-G).

(4) Use this difference in dry-bulb temperatures as the setting for the DEV contact. The temperature differential setpoint of the DEV contact is shown as 4.5 degrees C (8 degrees F). However, the temperature differential determined by this method will vary with: the design return-air conditions; and the average weather line for the locality. Less-humid climates will tend to shift the average weather line downward toward the design return air condition, which would result in a smaller differential. The effect on energy conservation of using this method is shown in figure 3-9.

Figure 3-8. Selecting the economizer switchover point.

Figure 3-9. Effect on energy conservation of selection of the economizer switchover point.

k. Figure 3-9 shows that the dry-bulb temperature line at the intersection of the average weather line and the constant enthalpy line bisects region B. The area shown as region B-1 represents outside air conditions when the economizer mode will not save cooling energy even though outside air beyond the minimum quantity will be used if the control system modulates the dampers open. The area shown as region A-1 represents outside air conditions when the economizer mode will save cooling energy. The net effect on energy use depends on how many operating hours per year of the HVAC system are coincident with the occurrence of the outside air conditions of region B-1.

I. For DDC applications, the high-signal selector TY, the minimum position switch MPS, the mixed air temperature controller TC, and the economizer controller EC will not be required, as these functions are performed in software in the DDC panel. The logic remains the same as for control via single-loop controllers. Thus, the design will include temperature transmitters in the mixed air, in the return air, and in the outside air which will provide input to the DDC panel which operates the outside air damper, the return air damper, and the relief air damper according to the logic described above.

6. MINIMUM OUTSIDE AIR CONTROL LOOP FOR VAV HVAC SYSTEMS.

a. ASHRAE standard 62-1989, "Ventilation for Acceptable Indoor Air Quality", defines recommended quantities of ventilation air for various building types. Guidelines provided by standard 62-1989 were set forth with the intent of helping to improve indoor air quality. It is important to maintain the minimum amount of outside air quantity introduced into a building due to the potential health damaging effects that inadequate fresh outside air (OA) quantities may have on building occupants. In addition, introducing OA quantities in excess of the minimum can waste energy.

b. Variable air volume systems are particularly problematic due to the fact that the air flow quantity changes with changes in system load. Included here is the recommended technique for control of minimum outside air quantity in VAV systems. Use of other schemes to control fresh air quantity is discouraged, including schemes that use CO₂ sensors. This technology in HVAC applications has not matured. The accuracy, reliability, and cost effectiveness of CO₂ sensing devices is in question and is presently being investigated.

c. In the past, the minimum outside air quantity for VAV systems was established during system balancing by setting the minimum position of the outside air (OA) damper at maximum fan turndown. This is accomplished with all the zone terminal units positioned to provide minimum airflow while maintaining the duct static pressure control setpoint. This approach helps to ensure that an adequate quantity of outside air is supplied to the building during normal operation of the system, but because the damper position is fixed, during periods of increased load, the minimum outside air quantity is exceeded as the fan speed and therefore system air volume is increased. This is energy intensive.

d. Since the issue of indoor air quality began to receive more attention, the industry consensus is that a better approach for ensuring adequate ventilation is to maintain the outside air quantity based on direct measurement and control of the volumetric outside air flow. This is accomplished using a separate duct section through which the OA air volume is measured using an air flow measurement array (AFMA) and is illustrated in figure 3-10. The AFMA flow transmitter output is sent to a PI controller (FC) which modulates a minimum OA damper located downstream of the AFMA to control the OA flow quantity at the controller setpoint. In DDC applications, the DDC panel takes the place of the flow controller FC. Note that two separate duct sections are used to help ensure accurate control of the minimum outside air quantity. The second outside air duct is utilized during economizer operation and is controlled the same as previously discussed.

Figure 3-10. Minimum outside air and mixed air temperature/ economizer control loops for VAV systems.

e. Early in the system design process, the designer must give consideration to the space requirements necessary to successfully implement minimum outside air flow control. The OA ductwork must be long enough to permit accurate measurement by the AFMA. The minimum functional length of the ductwork section between the upstream weather louver and the AFMA is two times the equivalent duct diameter. Transition angles leading to the AFMA should not exceed 15 degrees. The minimum functional length of the ductwork section between the AFMA and the downstream control damper is one half the equivalent duct diameter. Do not locate control dampers upstream. These distances assume that an AFMA with multiple sensors and an air straightener is used. It is recommended that an access door be located immediately upstream of the air flow station.

f. The minimum OA duct section should be sized for the condition where the main OA damper is closed and the return air damper is open with the fan speed at minimum load turn down. Under this condition the flow through the minimum OA duct is at maximum. The recommended duct sizing range is between 1.5 and 2 m/s (300 and 400 fpm) at the location of the AFMA. Louver openings should be sized in accordance with ASHRAE recommendations such that they limit louver face velocity to 2 m/s (400 fpm) or less. Pressure drop across the air flow measurement array plus air flow straightener can be estimated to be 1 Pa (0.003" wc) at 2 m/s (400 fpm).

g. Pitot tube type AFMAs are not recommended for use in outside air measurement applications, as their minimum measurable air flow velocity is approximately 3.5 m/s (700 fpm). Pitot tube AFMAS are also more inclined to be adversely affected by airborne contaminants.

h. Electronic AFMAs, by design, are resistant to airborne contaminants, but the station is to include a honeycombed airflow straightening device located immediately upstream of the AFMA. The airflow straightener helps to remove turbulent and rotational air flow. The honeycombs are specified to be 3 mm (1/8 inch) diameter, presenting the potential for clogging by bugs and other particulate matter. Because of this, filter media are to be used, located no less than 1 m (39) inches upstream of the AFMA.

i. Exhaust fans impact building ventilation because they can remove significant volumes of air from a building. This exhaust must be considered in determining the quantity of air to be returned to the air handling unit. To help ensure a small positive building pressure, slightly more air must be supplied than is returned. If a return duct is used, size it to account for exhaust fan and exfiltration losses.

j. When a return fan is used, determine the differential volume flow rate (bias) between the supply and return ducts by taking into account the exhaust from the supplied spaces. The bias setting will be slightly larger than the total building exhaust. Making the bias slightly larger than the maximum exhaust will help to ensure positive building pressure and adequate ventilation. Refer to section 8 - RETURN FAN VOLUME CONTROL LOOP for additional guidance on selection of the return fan bias setting.

7. SUPPLY DUCT STATIC PRESSURE CONTROL LOOP. The supply duct static pressure control loop is shown in figure 3-11. A differential pressure sensing element and transmitter (DPT) sends a signal to static pressure controller PC, which operates IP to control DA, which in turn operates fan inlet vane IV provided that the fan is on. DPT must have a relatively low range, such as 0 to 500 Pa (0.0 to 2.0 inches of water column). The supply fan may have been selected for a much larger static pressure, but the static pressure at the location of the DPT's sensor is typically 250 to 375 Pa (1.0 to 1.5 inches of water column). The recommended sensing location of DPT is approximately 75 to 100 percent of the distance from the first to the last air terminal unit along the duct calculated to have the greatest pressure drop. This sensing location insures that the static pressure will be controlled at the value required to enable all

VAV boxes to function. The "Fan-On" relay contact disconnects PC from IP, causing DA to hold IV in the closed position (unloaded) on fan shutdown; the purpose in unloading the fan is to allow it to start unloaded. DPI is a low differential pressure gauge used as an indicator for DPT. Details of the action of the rest of the control system devices connected to the IP's output are similar to comparable parts of other loops previously described. For DDC applications, the DDC panel takes the place of the static pressure controller PC.

Figure 3-11. Supply duct static pressure control loop.

8. RETURN FAN VOLUME CONTROL LOOP. The return fan volume control loop is shown in figure 3-12. Flow sensing elements and linearized transmitters FTs in the supply air and the return air get signals from duct-mounted air flow measurement stations and sensing arrays, AFMA. Both FTs send signals to controller FC. These signals are the information necessary to maintain a fixed flow difference (in L/s (cfm)) between the supply air and return air ducts. The controller measures and controls the return air flow through the PV input based on the supply air flow measured at the CPA input. More than likely, the ranges of the air flow velocities in each duct will be different because of differences in design velocity and in the cross-sectional areas of the ducts. The FTs in the supply air duct and return air duct may or may not have the same span and range. This means that a given flow rate in the supply duct may have a different signal level than the exact same flow rate in the return duct. In order for FC to control the return air flow at a specific rate (L/s (cfm)), the CPA signal from the supply fan FT must have the same value that will appear at PV when the setpoint is achieved. To achieve this, the CPA signal from the supply duct must be converted by FC's ratio and bias feature to perform two functions. A ratio factor must be applied to the signal from the supply air flow transmitter/air flow measurement station (FT/AFMA) combination so that it will match the signal range of the return air FT/AFMA combination. Also, the ratio is used to account for differences in the cross-sectional area of the ducts at the locations of the measuring stations. The signal must then be biased to maintain the design fixed air flow difference. For example, if the fixed difference is required to be 1415 L/s (3,000 cfm) for minimum outside air requirements when the supply air flow is 9440 L/s (20,000 cfm), CPA tells FC to control PV at 8025 L/s (17,000 cfm); when the supply air flow is 5900 L/s (12,500 cfm), CPA tells FC to control PV at 4485 L/s (9,500 cfm). The 1415 L/s (3000-cfm) difference is the bias to be set in the controller in L/s (cfm) units. The CPA signals at two such supply air flow points must match the PV signals at two corresponding return air flow points. When this is achieved at two points, the required results will be achieved for any supply fan flow and the appropriate return fan flows within the turndown capabilities of the return fan. The ratio can be calculated according to equation 3-2. Equation 3-2 assumes that the low end of the transmitter span is 0 m/s (0 fpm) at 4 milliamperes for each transmitter.

$$R = \frac{A_s/A_r}{V_s/V_r} \quad (\text{eq. 3-2})$$

Where:

R = Ratio (dimensionless)

As = Area of supply air duct at the measuring station (sq m (sq ft)).

Ar = Area of return air duct at the measuring station (sq m (sq ft)).

Vs = Span of the flow transmitter in the supply duct (m/s (fpm)).

Vr = Span of the flow transmitter in the return duct (m/s (fpm)).

The bias is set in the controller in L/s (cfm) units. Selecting the bias value requires consideration of the exfiltration flow ($Flow_{exf}$) required to pressurize the space and the space exhaust flow ($Flow_{exh}$) (such as that from toilet areas) as follows:

$$\text{Bias} = Flow_{exf} + Flow_{exh}$$

Where:

$Flow_{exf}$ = Space exfiltration flow, L/s (cfm)

$Flow_{exh}$ = Space exhaust flow, L/s (cfm)

Determination of the exhaust flow is straightforward. It is the total flow due to exhaust fans located in the space served by the air handling unit. Determining the exfiltration flow can be slightly more involved and is related to building pressurization. Detailed guidance in determining this value is presented in PROSPECT course 340 "HVAC Control Systems Design", although a reasonable approximation can be obtained by assuming that the $Flow_{exf}$ is 10 to 15 percent of the design airflow quantity. Use 10 percent for a tight building and 15 percent for a loosely constructed building.

The bias quantity should be coordinated with the minimum outside air flow quantity as follows:

MIN OA = $Flow_{ventilation}$ if $Flow_{ventilation} > \text{Bias}$

Or:

MIN OA = Bias if $Flow_{ventilation} < \text{Bias}$

Where:

$Flow_{ventilation}$ = Fresh air ventilation quantity (per ASHRAE Standard 62), l/s (cfm)

Bias = $Flow_{exf} + Flow_{exh}$, l/s (cfm)

$Flow_{exf}$ = Building or space exfiltration flow, l/s (cfm)

$Flow_{exh}$ = Building or space exhaust flow (ie. Toilets, etc), l/s (cfm)

For DDC applications, the DDC panel takes the place of flow controller FC. The ratio and bias logic remains the same as for control via single-loop controllers, but is performed in software.

Figure 3-12. Return fan volume control loop.

9. HUMIDIFIER CONTROL LOOP. The humidifier control loop is shown in figure 3-13. Humidifier control valve VLV is normally closed. It is inhibited from opening by the contact of a relay that is open unless the fan is on, the system is in the occupied mode, and the ventilation delay period has expired. When these conditions of operation are met, space relative-humidity sensing element and transmitter RHT signals relative-humidity controller RHC to operate IP to control humidifier valve VLV. A high-limit relative-humidity controller RHC receives a signal from a duct relative-humidity sensing element and transmitter RHT downstream of the humidifier. Both controllers are reverse-acting. Low-signal selector RHY allows the space relative-humidity controller to operate the valve if the high-limit relative-humidity setpoint is not exceeded. The high-limit relative-humidity controller must be a proportional only controller. For DDC applications, the DDC panel takes the place of the two relative humidity controllers RHC and the

low-signal selector RHY. Low signal selection is performed in software.

Figure 3-13. Humidifier control loop.

10. THE TYPICAL SCHEMATIC.

a. The integration of standard control loops into a standard system starts with a schematic. A typical schematic for single-loop controller applications is shown in figure 3-14 and for DDC applications is shown in figure 3-15.

Figure 3-14. Typical single-loop controller schematic.

Figure 3-15. Typical DDC schematic.

b. Figure 3-14 shows the control loops arranged around an airflow diagram. When showing the schematic, the designer will:

- (1) Label all HVAC equipment.
- (2) Label each control device with a unique identifier.
- (3) Label the action (NC or NO) of all valves, dampers, and other appropriate devices.
- (4) Label the action of all controllers as direct-acting DIR or reverse-acting REV.
- (5) Label the input of all controllers (PV or CPA).
- (6) For each device that operates contacts, show a line number on which each contact will appear on a ladder diagram.
- (7) For each relay contact, show the line number of a ladder diagram on which the relay operating coil will appear.
- (8) Show the location of all instruments not located in the flow stream or in the HVAC control panel.
- (9) Show a graphic representation of sequencing operations with open and closed positions versus controller output and space temperature.

11. THE TYPICAL LADDER DIAGRAM.

a. When all the information necessary for a description of the system is not shown on the schematic, a ladder diagram will be required for single-loop controller applications. As the logic is performed in software, no ladder diagram is required for DDC applications.. A typical ladder diagram is shown in figure 3-16.

Figure 3-16. Typical ladder diagram.

b. In the ladder diagram, the designer will:

- (1) Show a section of the diagram for the HVAC control panel logic.
- (2) Show a section of the diagram for each starter control circuit and interlock circuit for HVAC equipment.
- (3) Label control devices and relays with their unique identifiers.
- (4) Label magnetic starter coils.
- (5) If multiple control devices of the same type (such as low temperature protection thermostats or smoke detectors) are required, assign a unique identifier for each and show its contact.
- (6) Show separate relays to control ac and dc circuits.
- (7) Number the ladder diagram lines according to their control power source.
- (8) Show a switch, located in the HVAC control panel, to override the clock (or EMCS) and to be used to place the control system in continuous occupied mode (auto/auto override).
- (9) Show a switch, located in the HVAC control panel, that can be used to shut down HVAC equipment and interlocked equipment (off/enable).

c. The HVAC control panel section of the ladder diagram will be in accordance with the following format:

- (1) Line numbers will start with 0 for the clock circuit and continue as required.
- (2) Control system switches and contacts will be shown on the left of the diagram.
- (3) Relay coils will be shown in the center of the diagram, centered below the clock circuit.
- (4) Pilot lights will be shown on the right of the diagram.
- (5) Contacts available to EMCS will be shown outside the ladder and to the right of the diagram.

d. Each section of the HVAC equipment starter control circuits and interlock circuits will be in accordance with the following format:

- (1) The line numbers of the first section will begin with 100, the second section with 200, and subsequent sections with appropriate higher numbers in increments of one hundred.
- (2) Magnetic starter circuits will show one phase powering a control circuit transformer, switches, fuse, and overload relays.
- (3) The panel ladder diagram will have a jumper shown for connection to EMCS of an economizer enable and disable function. The panel ladder diagram will show terminal points for remote system shutdown and remote safety override control of HVAC system fans.
- (4) Starter ladder diagrams will have an off-enable switch to allow HVAC system motors to be stopped from the HVAC control panel.

12. THE TYPICAL EQUIPMENT SCHEDULE.

a. An equipment schedule is required to show the control system parameters not shown on the schematic and the ladder diagram. Not all HVAC control devices shown on the schematic and the ladder diagram are included in the equipment schedule because it is not necessary to show parameters for them. Control devices that are excluded from the schematic are relays, IPs, loop drivers, and signal selectors. A typical equipment schedule is shown in figure 3-17.

Figure 3-17. Typical equipment schedule.

- b. In the equipment schedule, the designer will:
- (1) Arrange all control devices by loop function.
 - (2) Show the unique identifier as the device number.
 - (3) Name the device function.
 - (4) Show setpoints, ranges, time schedules, and other parameters.
 - (5) Show the selected Cv and required close-off pressure for each valve.

13. THE TYPICAL DDC DATA TERMINAL STRIP (DTS) LAYOUT.

For DDC applications, a data terminal strip layout is required to show all connections for inputs and outputs (also referred to as "points") to the system. Each DDC panel should have a corresponding DTS. The layout should show the terminals numbered, show the device number (from the schematic) which is connected to the terminals, have a description of the device and indicate whether each point is an analog input, an analog output, a digital input, or a digital output. It is a good idea to include 25 percent of the terminals as "spares". A typical data terminal strip layout is shown in figure 3-18.

Figure 3-18. Typical DDC data terminal strip layout.

CHAPTER 4

STANDARD HVAC CONTROL SYSTEMS

1. GENERAL.

a. The complete HVAC control system design will include a series of drawings for each HVAC control system, based on the standard control systems presented in this chapter.

b. Variations to these control systems are shown in chapter 5.

c. Air delivery systems can be designed with or without return fans. For example, selected systems are shown with return fans. These HVAC systems are the multizone system, the bypass multizone system, the dual-duct system, and the VAV system.

d. Where required, the control of a return fan can be incorporated into any air delivery HVAC system shown in this manual by appropriately modifying the HVAC control system drawings.

e. The decision to use only a supply fan for HVAC systems versus the use of both a supply and a return fan is based on the following: lower first cost, lower maintenance cost, lower energy costs, and less complex control systems. The advantages of the supply / return fan system include positive control of the outside air, return air, and relief air quantities under varying modes of operation. Return fans are sized smaller than the supply fan by the amount of air necessary for minimum outside air, space pressurization air, and exhaust makeup air.

f. In the case of the VAV system, the control loop necessary to allow the return air flow to vary as the supply air flow changes is known as the return fan volume control loop. This loop is costly, complex, and, in some applications, difficult to control with stability. A return fan should be used in a VAV system only when absolutely necessary. The need for a return fan can be reduced by keeping return duct losses to a minimum using a plenum or making the return duct as short and as large as possible.

g. The transmitter ranges shown are standard. These ranges match corresponding EMCS ranges where appropriate, and will not be changed.

h. The setpoints, timeclock schedules, etc. used throughout this chapter are used for example purposes only. The actual values to be used in contract documents must be determined by the designer as appropriate for each project and location.

2. IDENTIFICATION OF CONTROL SYSTEM DEVICES. Control system devices will be numbered in accordance with the convention described for the unique identifiers shown in Section II of the Glossary.

3. PROJECT SPECIFIC DRAWINGS. To make the standard HVAC control system drawings project specific:

a. Add or delete loops as required.

b. Use a common time clock and common control panel where appropriate for HVAC systems (as described in chapter 5) unless the HVAC system is extended to EMCS.

c. If the project has EMCS, the time clock may be deleted and replaced with EMCS contacts.

- d. Incorporate system variations as required.
- e. Replace "XX" in the drawing titles and unique identifiers with numbers specific to the project HVAC control system.
- f. For single-loop controller applications, modify HVAC control panel interior door layouts, back panel layouts, and terminal block layouts as required. For DDC applications, modify data terminal strip layouts as required.
- g. Parameters shown in the equipment list must be modified to make the standard HVAC control system drawings project specific.
- h. Damper and valve position diagrams.

4. SPACE TEMPERATURE CONTROLLED PERIMETER RADIATION CONTROL SYSTEM.

a. Description of perimeter radiation system. This system consists of fin-tube radiation, a portion of the hydronic heating system. Figure 4-1 shows the schematic and ladder diagrams and the equipment schedule for this type of system.

Figure 4-1. Space temperature controlled perimeter radiation control system.

- b. General sequence of operation. A room thermostat controls a perimeter radiation valve to maintain a set temperature. The following options are available:
 - (1) Two-position thermostat with two-position valve.
 - (2) Microprocessor-based thermostat which cycles a two-position valve during the occupied mode to maintain the programmed occupied mode setpoint, and during the unoccupied mode to maintain the programmed unoccupied mode setpoint.
 - (3) A modulating thermostat with a modulating valve.
- c. Detailed sequence of operation.
 - (1) In two-position control, the contacts of room thermostat T-XX01 close on a rise in temperature to its setpoint, energizing normally-open valve VLV-XX01, which closes. On a fall in temperature below its setpoint, the contacts of thermostat T-XX01 open, de-energizing valve VLV-XX01, which opens.
 - (2) In modulating control, thermostat T-XX01 modulates valve VLV-XX01 to maintain its setpoint.

5. UNIT HEATER TEMPERATURE CONTROL SYSTEM.

a. Description of unit heater system. This system consists of a unit with a heating coil and a fan to circulate air through a coil to provide heat to the space served. The heating coil is uncontrolled (no

valve), but the fan is controlled. Unit heaters are used to provide heat in mechanical spaces and stairwells. Figure 4-2 includes the ladder diagram and equipment schedule for this type of system.

Figure 4-2 Unit heater temperature control system.

b. General sequence of operation. A unit thermostat cycles the unit heater fan to maintain its setpoint temperature. A microprocessor-based thermostat could also be used to provide for a night-setback setpoint, as shown in chapter 5.

c. Detailed sequence of operation. Space thermostat TSL-XX01 has a manual "OFF-AUTO" switch. When the switch is indexed to "OFF", the unit-heater motor is de-energized. When the switch is indexed to "AUTO", the fan starts when the space temperature falls below the thermostat setpoint, and stops when the temperature rises to its setpoint.

6. GAS-FIRED INFRARED HEATER CONTROL SYSTEM.

a. Description of infrared heater system. This system consists of gas infrared heaters. Figure 4-3 shows the ladder diagram and equipment schedule for this system.

Figure 4-3. Gas-fired infrared heater temperature control system.

b. General sequence of operation. A thermostat cycles the infrared heater (or heaters) to maintain the programmed setpoint.

c. Detailed sequence of operation. A microprocessor-based room thermostat TuP-XX01 has an "AUTO-OFF" switch. When the thermostat switch is indexed to the "OFF" position, the infrared heater remains off. When the switch is indexed to the "AUTO" position, the infrared heater cycles during the occupied mode to maintain the programmed occupied temperature setpoint and during the unoccupied mode to maintain the programmed unoccupied temperature setpoint.

7. SMALL PACKAGED UNITARY SYSTEM CONTROL SYSTEM.

a. Description of all-air small packaged unitary system. This system consists of a small self-contained air handling unit provided with both heating and cooling equipment. Figure 4-4 shows the ladder diagram and equipment schedule for this system.

Figure 4-4. Small packaged unitary system control system.

b. General sequence of operation. When indexed to "HEAT", a microprocessor-based room thermostat cycles the unit fan and heating equipment, to maintain the programmed temperature. When indexed to "COOL", the thermostat cycles the fan and cooling equipment, to maintain the programmed temperature.

c. Detailed sequence of operation. Microprocessor-based room thermostat TuP-XX01 is equipped with "HEAT-OFF-COOL" and "AUTO-ON" switches. It can be programmed to maintain separate occupied and unoccupied heating mode and occupied cooling mode temperatures. When the system switches are indexed to "HEAT" and "AUTO", the thermostat cycles the heating unit and the fan to maintain the programmed temperature; the cooling unit remains de-energized. When the thermostat is indexed to "COOL" and "AUTO", the thermostat cycles the cooling unit and the fan to maintain the programmed temperature; the heating unit remains de-energized. At the conclusion of the cooling occupied mode, the system is de-energized and remains de-energized throughout the unoccupied mode. When indexed to "ON" the unit fan runs continuously. When the "HEAT-OFF-COOL" switch is indexed to "OFF", neither heating nor cooling can be energized.

8. DUAL-TEMPERATURE FAN COIL UNIT CONTROL SYSTEM.

a. Description of dual-temperature fan coil system. The system consists of a fan and a dual-temperature coil that is supplied with cold water during the cooling season and hot water during the heating season. Figure 4-5 shows the schematic and ladder diagrams and equipment schedule for this type of system.

Figure 4-5. Dual-temperature fan coil unit temperature control system.

b. General sequence of operation. A wall-mounted two-stage thermostat cycles the fan in winter to maintain its lower setpoint and in summer to maintain its higher setpoint. Fan speed is manually indexed by the room occupants.

c. Detailed sequence of operation.

(1) Wall-mounted two-stage thermostat TS-XX01 has two setpoints. The lower setpoint is a heating mode setpoint, which, on a fall in temperature, cycles the fan to maintain the setpoint. The higher setpoint is a cooling mode setpoint, which, on a rise in temperature, cycles the fan to maintain the setpoint.

(2) Strap-on aquastat TS-XX02, located on the return line downstream of the fan coil 3-way valve, senses whether hot water or cold water is being supplied to the dual-temperature coil, and its snap-acting contacts determine which thermostat contact and setpoint will cycle the fan.

(3) Whenever the fan is energized, a three-way electric valve VLV-XX01 is also energized, to open the hydronic medium to the coil. Whenever the fan is de-energized, VLV-XX01 is also de-energized and closes the hydronic medium to the coil and opens it to coil bypass.

9. CONTROL SYSTEMS THAT REQUIRE SINGLE-LOOP CONTROLLER PANELS.

a. An HVAC control panel is required for each system that requires the control capabilities of the single-loop controller. The designer will show all the details of the standard HVAC control panel on the contract drawings. These details will describe the construction, mounting, and general arrangement of the standard HVAC control panel.

b. In addition, the contract drawings for each control system will show the specific interior door arrangement, showing front and rear views, the back panel layout, and the terminal block layout for the control system, on the contract drawings.

10. STANDARD SINGLE-LOOP CONTROLLER HVAC CONTROL PANEL.

a. Figures 4-6a through 4-6i will provide the guidance for the HVAC control panel arrangement for typical HVAC control systems.

Figure 4-6a. Standard wall-mounted HVAC control panel arrangement.

Figure 4-6b. Section "A-A" through the standard HVAC control panel.

Figure 4-6c. Standard HVAC control panel interior door.

Figure 4-6d. Standard HVAC control panel back panel layout.

Figure 4-6e. Standard HVAC control panel terminal block assignments.

Figure 4-6f. Controller wiring.

Figure 4-6g. Supply fan and return fan starter wiring.

Figure 4-6h. Exhaust fan and pump starter wiring.

Figure 4-6i. HVAC control panel power wiring.

b. The standard wall-mounted HVAC control panel (see figure 4-6a) is a standard enclosure of a specific size. This panel contains the single-loop controllers, IPs, power supply, indicators, gauges, function modules, relays, clocks, and terminal blocks, for connection to external devices and circuits and for connection to EMCS.

c. Figure 4-6b, section "A-A" through the panel, shows the general arrangement of the inside of the panel. The interior door, located behind the exterior key-locked door, is the mounting surface for controllers, receiver gauges, main air gauge, switches, and lights. The interior door has a continuous piano-type hinge to support the door and its devices. The back panel accommodates vertical and horizontal wiring ducts, and standard-size mounting rails. The mounting rails for the terminal blocks are elevated from the back panel to accommodate the wiring from the wiring ducts.

d. Figure 4-6c shows the general layout of the interior door for HVAC control panels. The front view shows that the panel's interior door will accommodate up to six controllers with receiver gauges in two rows of three controllers each. The main air gauge is on the right, and five pneumatic output indicators for IPs are located to the left of the main air gauge. The rear view shows rail-mounted IPs, connections to gauges, and a valve to access the main air for maintenance. In the event that additional space is required for function modules, such as loop drivers, they may be shown on this rail. The general arrangement shown will not be changed for the sake of symmetry. It is intended that this panel will accommodate one control system for an air-delivery HVAC system and may also accommodate hydronic or other HVAC control systems. The switch and pilot light matrix will have the devices arranged in the

array shown.

e. Figure 4-6d shows the general arrangement of the back panel, which will have two vertical wiring ducts and four horizontal wiring ducts, with covers as shown. The mounting rail shown at the top of the panel will accommodate up to 15 relay bases, which will accept the wiring for plug-in relays. The relays will be placed from right to left in the numerical order of their unique identifiers. Below the relay mounting rail will be a horizontal wiring duct, and below this duct there will be three mounting rails and wiring ducts that will accommodate the terminal blocks to accept the control system wiring. There will be a mounting rail for function modules, time clock, and power supply located below the terminal block mounting rails and wiring ducts; loop drivers may also be mounted on this rail. A duplex receptacle, intended for maintenance use, will be mounted on the right side of the cabinet. The power conditioner and system fuses will be mounted on the left side of the cabinet. The system's dc power supply will be located to the left of the clock. The ac wiring will enter the wiring duct on the lower left of the panel and will be distributed vertically. The dc wiring will enter the wiring duct on the right and will also be distributed vertically.

f. The relative location assignments for three rows of numbered terminal block locations are shown in figure 4-6e. Only the terminal blocks needed for the specific control system loops will be included in the panel. Locations 1 through 70 in row 1 are dedicated to controller loop wiring in groups of 10.

g. Figure 4-6f shows the standard wiring for a typical controller and for a controller used as an economizer controller. The left side of the figure shows that terminal 1 is always a shield terminal, and that terminals 2 and 3 are always for the transmitter connection. These terminals are designated as PV. Terminal 2 is connected to a dc-power terminal block and is jumpered to terminal 4 to supply power to the CPA; terminals 4 and 5 make the CPA available to EMCS. The signal returns of PV and CPA are connected to a dc-power terminal. Terminals 6 and 7 are wired to PVR and allow the 4-20 ma PVR signal to be connected to EMCS. Terminals 8 and 9 are wired to OUT. Removal of the jumper connecting terminals 8 and 9 will allow the controller to interface with an electric actuator rather than an IP. The controller, TC, powers its output loop. Terminal 10 is an additional shield terminal. The right side of the figure shows that when the controller is used as an economizer controller, terminals 2 and 3 are connected to the return air temperature transmitter, and terminals 6 and 7 are connected to the outside air temperature transmitter. Terminals 8 and 9 contain the jumper for EMCS interface to the economizer logic.

h. Figure 4-6g shows the standard wiring for the HVAC system's supply fan and return fan starters. The "ENABLE-OFF" switch is connected to the supply fan only. If there are no smoke dampers, a jumper will be installed between terminals 185 and 186. 100-percent outside air systems with high-pressure fans will have end switches on the outside air damper to insure that the damper is open before the fan starts. 100-percent outside air units with electric actuators will have end switches on the outside air damper because of the inherently slower speed of the electric actuators in opening the damper. Under normal conditions, local control switches for the supply fan, return fan, and exhaust fan starters will be in the "AUTO" position. When the "ENABLE-OFF" switch is indexed to the "OFF" position, the return and exhaust fans will stop when the supply fan stops, through interlocked relay contacts in the "AUTO" position of the local starter control switch.

i. Figure 4-6h shows the wiring of exhaust fans when interlocked to other fans and also shows the wiring of pumps. The left side of the figure shows the exhaust fan wiring. This wiring is similar to the return fan wiring, except that a jumper is shown installed between terminals 205 and 206 because exhaust fans do not normally require the circuitry to prove that the exhaust dampers are open before the fan starts. If high-pressure fans are used for exhaust fans, the exhaust dampers should have end

switches and should be wired as a return fan, as shown in figure 4-6g. The right side of the figure shows the pump starter wiring. A safety shutdown circuit is not required. A jumper is shown installed between terminals 205 and 206. Each pump will have an "ENABLE-OFF" switch.

j. Figure 4-6i shows the HVAC control panel power wiring for ac and dc sources.

11. CENTRAL PLANT STEAM HYDRONIC HEATING CONTROL SYSTEM.

a. Description of hydronic heating system. This hydronic heating system consists of a steam to hot water converter that provides hot water to a primary pumping system. The primary pumping system supplies hot water to secondary pumping systems that provide hot water to separate zones of space temperature control. Figures 4-7a through 4-7f show the system design for this type of heating system using a SLDC control panel. Figures 4-7g through 4-7j show the system design for this type of heating system using DDC controls.

Figure 4-7a. Control system schematic for central plant steam hydronic system.

Figure 4-7b. Control system ladder diagram for central plant steam hydronic system.

Figure 4-7c. Control system equipment for central plant steam hydronic system.

Figure 4-7d. Control panel interior door layout for central plant steam hydronic system.

Figure 4-7e. Control panel back panel layout for central plant steam hydronic system.

Figure 4-7f. Control panel terminal block layout for central plant steam hydronic system.

Figure 4-7g. DDC control system schematic for central plant steam hydronic system.

Figure 4-7h. DDC control system ladder diagram for central plant steam hydronic system.

Figure 4-7i. DDC control system equipment for central plant steam hydronic system.

Figure 4-7j. DDC control system I/O table and data terminal strip layout for central plant steam hydronic system.

b. General sequence of operation.

(1) The primary pumping system and the steam/hot water converter operate continuously whenever the outside air temperature is low enough for the building to require heating. When this occurs, an outside air temperature controller starts the primary pump, enables the converter control

system, and enables the secondary pumps to operate. The outside air temperature controller raises the primary hot water supply temperature as the outside air temperature falls.

(2) The primary hot water supply temperature controller maintains its setpoint by modulating the converter steam valve to maintain the scheduled primary hot water supply temperature.

(3) During the occupied mode, the secondary hot water pumps run whenever the primary hot water pump runs. Each zone temperature controller modulates its zone control valve to blend primary hot water supply with secondary hot water return in order to maintain the zone's space temperature setpoint, which is adjustable by the zone occupant.

(4) During the unoccupied mode, the secondary hot water pumps are cycled by the zone night thermostat to maintain the low limit setpoint and to prevent freezing. During this mode, the space temperature controller setpoint is determined by an adjustment within the system's HVAC control panel.

c. Detailed sequence of operation.

(1) Outside air temperature transmitter TT-XX-01 signals outdoor air temperature to temperature controller TC-XX-01. On a fall in outside air temperature to 16 degrees C (60 degrees F), the process variable (PV) contacts of TC-XX-01 close to energize relays R-XX-04 and R-XX-05, and pilot light PL-XX-02. The contacts of relay R-XX-04 energize the primary hot water pump, and the contacts of relay R-XX-05 enable the secondary pumps. The auxiliary contacts of the primary pump starter energize relay R-XX-06, whose contacts then allow the primary water temperature control system to operate.

(2) On a rise in outside air temperature to 17 degrees C (62 degrees F), the PV contacts of controller TC-XX-01 open to de-energize relay R-XX-04 to stop the primary pump, and to de-energize relay R-XX-05 to stop each secondary pump. The auxiliary contacts of the primary pump starter open, de-energizing relay R-XX-06, whose contacts then remove valve VLV-XX-01 from control, causing it to close.

(3) Controller TC-XX-01 raises the setpoint of primary hot water supply temperature controller TC-XX-02 as the outside air temperature falls, and lowers the setpoint as the outside air temperature rises.

(4) Temperature transmitter TT-XX-02 signals the primary hot water supply temperature to temperature controller TC-XX-02, which then maintains its setpoint by varying its signal to current-to-pneumatic transducer IP-XX-01. The pneumatic signal from IP-XX-01 modulates converter steam valve VLV-XX-01 to maintain the primary supply water temperature setpoint of controller TC-XX-02.

(5) Temperature transmitter TT-XX-03 signals the zone space temperature to controller TC-XX-03, which then maintains its setpoint by varying its current output signal to transducer IP-XX-02. The pneumatic signal from IP-XX-02 modulates secondary zone control valve VLV-XX-02. Zone control valve VLV-XX-02 mixes primary supply water with secondary return water to maintain the zone space temperature setpoint. The temperature control loops for the other secondary zones function identically.

(6) Throughout the occupied mode, the contacts of time clock CLK-XX-01 are closed to energize relays R-XX-01, R-XX-02, and R-XX-03, and to turn on pilot light PL-XX-01. The contacts of relay R-XX-01 connect temperature setpoint device TSP-XX-01 to allow manual adjustment of the setpoint of temperature controller TC-XX-03. Relay R-XX-02 provides the same function for TSP-XX-03 in

adjustment of controller TC-XX-04. Relay R-XX-03 closes contacts in the starter control circuits of the secondary pumps. The secondary system pumps will start whenever the contacts of relay R-XX-03 (occupied) and R-XX-05 (heating) are closed in their respective pump starter circuits.

(7) During the unoccupied mode, the contacts of time clock CLK-XX-01 are open and de-energize relays R-XX-01, R-XX-02, and R-XX-03; pilot light PL-XX-01 turns off. The transfer of contacts of relay R-XX-01 transfers the temperature setpoint adjustment of TC-XX-03 from TSP-XX-01 to TSP-XX-02; likewise, relay R-XX-02 transfers the temperature setpoint adjustment of TC-XX-04 from TSP-XX-03 to TSP-XX-04. The contacts of relay R-XX-03 open the secondary pump starter circuits, to place the secondary pumps under the respective night thermostats TSL-XX-01 and TSL-XX-02. When the zone space temperature falls to 13 degrees C (55 degrees F), the zone's secondary pump is energized and remains energized until the temperature rises to 14 degrees C (57 degrees F).

d. Sequence of operation for DDC applications.

(1) The DDC system shall accept a signal from a sunshielded outside air temperature sensing element and transmitter located as shown. The DDC system shall start and stop the pumps at the outside air temperature shown. The DDC system shall reset the hydronic heating supply temperature setpoint in a linear schedule based on the outside air temperature as shown. The DDC system shall accept a signal from a temperature sensing element and transmitter located in the hydronic heating supply line and the DDC system output shall modulate the converter steam control valve to maintain the reset schedule setpoint in the hydronic heating supply line.

(2) When the system time schedule places the system in the occupied mode, a space temperature sensing element and transmitter located as shown shall signal the DDC system, which shall maintain the space temperature setpoint by modulating the secondary hydronic system zone valve.

(3) When the system is in the unoccupied mode, the space temperature setpoint shall be as shown.

12. SINGLE BUILDING HYDRONIC HEATING WITH HOT WATER BOILER CONTROL SYSTEM.

a. Description of the hydronic heating system. This hydronic heating system consists of a hot water boiler that provides hot water to a primary pumping system. The primary pumping system supplies hot water to secondary pumping systems that provide hot water to separate zones of space temperature control. This control system varies the hot water flow through the boiler. Therefore, it can be used only with boilers whose operation is not affected by flow variation. A variation of this system which utilizes constant flow through the boiler is depicted in Chapter 5. Figures 4-8a through 4-8f show the system design for this type of heating system using a SLDC control panel. Figures 4-8g through 4-8j show the system design for this type of heating system using DDC controls.

Figure 4-8a. Control system schematic for single building hydronic heating system with hot water boiler.

Figure 4-8b. Control system ladder diagram for single building hydronic heating system with hot water boiler.

Figure 4-8c. Control system equipment for single building hydronic heating system with hot water boiler.

Figure 4-8d. Control panel interior door layout for single building hydronic heating system with hot water boiler.

Figure 4-8e. Control panel back panel layout for single building hydronic heating system with hot water boiler.

Figure 4-8f. Control panel terminal block layout for single building hydronic heating system with hot water boiler.

Figure 4-8g. DDC control system schematic for single building hydronic heating system with hot water boiler.

Figure 4-8h. DDC control system ladder diagram for single building hydronic heating system with hot water boiler.

Figure 4-8i. DDC control system equipment for single building hydronic heating system with hot water boiler.

Figure 4-8j. DDC control system I/O table and data terminal strip layout for single building hydronic heating system with hot water boiler.

b. General Sequence of Operation.

(1) The primary pumping system and the boiler operate continuously whenever the outside air temperature is low enough for the building to require heating. When this occurs, an outside air temperature controller starts the primary pump, enables the boiler to function under its own control system to maintain a constant boiler water temperature, and enables the secondary pump to operate. The outside air temperature controller raises the primary hot water supply temperature as the outside air temperature falls.

(2) The primary hot water supply temperature controller maintains its setpoint by modulating a valve to mix hot water from the boiler with return water from the primary pumping system to maintain the scheduled primary hot water supply temperature.

(3) During the occupied mode, the secondary hot water pumps run whenever the primary hot water pumps run. Each zone temperature controller modulates its zone control valve to blend primary hot water supply with secondary hot water return in order to maintain the zone's space temperature setpoint, which is adjustable by the zone occupant.

(4) During the unoccupied mode, the secondary hot water pumps are cycled by the zone's night thermostat to maintain the low limit setpoint and to prevent freezing. During this mode, the controller setpoint is determined by an adjustment within the system's HVAC control panel.

c. Detailed sequence of operation.

(1) Outside air temperature transmitter TT-XX-01 signals outdoor air temperature to temperature controller TC-XX-01. On a fall in outside air temperature to 16 degrees C (60 degrees F), the process variable (PV) contacts of TC-XX-01 close to energize relays R-XX-04, R-XX-05, and R-XX-06 and pilot light PL-XX-02. The contacts of relay R-XX-04 energize the primary hot water pump, the contacts of relay R-XX-05 enable the secondary pumps, and the contacts of relay R-XX-06 enable the boiler control circuit.

(2) On a rise in outside air temperature to 17 degrees C (62 degrees F), the PV contacts of controller TC-XX-01 open to de-energize relays R-XX-04 to stop the primary pump, to de-energize relay R-XX-05 to stop both secondary pumps, and to de-energize relay R-XX-06 to disable the boiler control circuit and to turn off pilot light PL-XX-02.

(3) Controller TC-XX-01 raises the setpoint of primary hot water supply temperature controller TC-XX-02 as the outside air temperature falls, and lowers the setpoint as the outside air temperature rises.

(4) Temperature transmitter TT-XX-02 signals the primary hot water supply temperature to temperature controller TC-XX-02, which then maintains its setpoint by varying its signal to current-to-pneumatic transducer IP-XX-01. The pneumatic signal from IP-XX-01 modulates primary hot water valve VLV-XX-01 to mix boiler water and primary return water to maintain the primary supply water temperature setpoint of controller TC-XX-02.

(5) Temperature transmitter TT-XX-03 signals the zone space temperature to controller TC-XX-03, which then maintains its setpoint by varying its current output signal to transducer IP-XX-02. The pneumatic signal from IP-XX-02 modulates secondary zone control valve VLV-XX-02. Zone control valve VLV-XX-02 mixes primary supply water with secondary return water to maintain the zone space temperature setpoint. The temperature control loop for the other secondary zone functions identically.

(6) Throughout the occupied mode, the contacts of time clock CLK-XX-01 are closed to energize relays R-XX-01, R-XX-02, and R-XX-03, and to turn on pilot light PL-XX-01. The contacts of relay R-XX-01 connect temperature setpoint device TSP-XX-01 to allow manual adjustment of the setpoint of temperature controller TC-XX-03. Relay R-XX-02 provides the same function for TSP-XX-03 in adjustment of controller TC-XX-04. Relay R-XX-03 closes contacts in the starter control circuits of the secondary pumps. The secondary system pumps will start whenever the contacts of relay R-XX-03 (occupied) and R-XX-05 (heating) are closed in their respective pump starter circuits.

(7) During the unoccupied mode, the contacts of time clock CLK-XX-01 are open, de-energizing relays R-XX-01, R-XX-02, and R-XX-03, and pilot light PL-XX-01 turns off. The transfer of the contacts of relay R-XX-01 transfer temperature setpoint adjustment of TC-XX-03 from TSP-XX-01 to TSP-XX-02; likewise, relay R-XX-02 transfers temperature setpoint adjustment of TC-XX-04 from TSP-XX-03 to TSP-XX-04. The contacts of relay R-XX-03 open the secondary pump starter circuits to place the secondary pumps under the respective night thermostats TSL-XX-01 and TSL-XX-02. When the zone space temperature falls to 13 degrees C (55 degrees F), the zone's secondary pump is energized and remains energized until the temperature rises to 14 degrees C (57 degrees F).

d. Sequence of operation for DDC applications.

(1) The DDC system shall accept a signal from a sunshielded outside air temperature sensing

element and transmitter located as shown. The DDC system shall start and stop the distribution pumps, boiler pump, and boiler at the outside air temperatures shown. The DDC system shall reset the hydronic heating supply temperature setpoint in a linear schedule based on the outside air temperature as shown. The DDC system shall accept a signal from a temperature sensing element and transmitter located in the hydronic heating supply line and the DDC system output shall modulate the hydronic heating system control valve to maintain the reset schedule setpoint in the hydronic heating supply line.

(2) When the system time schedule places the system in the occupied mode, a space temperature sensing element and transmitter located as shown shall signal the DDC system, which shall maintain the space temperature setpoint shown by modulating the secondary hydronic system zone valve.

(3) When the system is in the unoccupied mode, the space temperature setpoint shall be as shown.

13. CENTRAL PLANT HIGH TEMPERATURE HOT WATER HYDRONIC HEATING CONTROL SYSTEM.

a. Description of the hydronic heating system. This hydronic heating system consists of a high-temperature hot water converter that provides hot water to a primary pumping system. The primary pumping system supplies hot water to secondary pumping systems that provide hot water to separate zones of space temperature control. Figures 4-9a through 4-9f show the system design for this type of heating system using a SLDC control panel. Figures 4-9g through 4-9j show the system design for this type of heating system using DDC controls.

Figure 4-9a. Control system schematic for central plant high-temperature hot water hydronic heating system.

Figure 4-9b. Control system ladder diagram for central plant high-temperature hot water hydronic heating system.

Figure 4-9c. Control system equipment for central plant high-temperature hot water hydronic heating system.

Figure 4-9d. Control panel interior door layout for central plant high-temperature hot water hydronic heating system.

Figure 4-9e. Control panel back panel layout for central plant high-temperature hot water hydronic heating system.

Figure 4-9f. Control panel terminal block layout for central plant high-temperature hot water hydronic heating system.

Figure 4-9g. DDC control system schematic for central plant high-temperature hot water hydronic heating system.

Figure 4-9h. DDC control system ladder diagram for central plant high-temperature hot water hydronic heating system.

Figure 4-9i. DDC control system equipment for central plant high-temperature hot water hydronic heating system.

Figure 4-9j. DDC control system I/O table and data terminal strip layout for central plant high-temperature hot water hydronic heating system.

b. General Sequence of Operation.

(1) The primary pumping system and the high-temperature hot water converter operate continuously whenever the outside air temperature is low enough for the building to require heating. When this occurs, an outside air temperature controller starts the primary pump, enables the high-temperature hot water converter's control system, and enables the secondary pumps to operate. The outside air temperature controller raises the primary hot water supply temperature as the outside air temperature falls.

(2) The primary hot water supply temperature controller maintains its setpoint by modulating the high-temperature hot water converter valve to maintain the scheduled primary hot water supply temperature.

(3) During the occupied mode, the secondary hot water pumps run whenever the primary hot water pump runs. Each zone temperature controller modulates its zone control valve to blend water from the primary hot water supply with secondary hot water return in order to maintain the zone space temperature setpoint, which is adjustable by the zone occupant.

(4) During the unoccupied mode, the secondary hot water pumps are cycled by the zone night thermostat to maintain the low limit setpoint and to prevent freezing. During this mode, the controller setpoint is determined by an adjustment within the system's HVAC control panel.

c. Detailed Sequence of Operation.

(1) Outside air temperature transmitter TT-XX-01 signals outdoor air temperature to temperature controller TC-XX-01. On a fall in outside air temperature to 16 degrees C (60 degrees F), the process variable (PV) contacts of TC-XX-01 close to energize relays R-XX-04 and R-XX-05, and to turn on pilot light PL-XX-02. The contacts of relay R-XX-04 energize the primary hot water pump, and the contacts of relay R-XX-05 enable the secondary pumps. The auxiliary contacts of the primary pump starter energize relay R-XX-06. The contacts of relay R-XX-06 allow the primary water temperature control system to operate.

(2) On a rise in outside air temperature to 17 degrees C (62 degrees F), the PV contacts of controller TC-XX-01 open to de-energize relay R-XX-04 to stop the primary pump, and relay R-XX-05 to

stop both secondary pumps. The auxiliary contacts of the primary pump starter open, de-energizing relay R-XX-06. The contacts of relay R-XX-06 remove valve VLV-XX-01 from control, and it closes.

(3) Controller TC-XX-01 raises the setpoint of primary hot water supply temperature controller TC-XX-02 as the outside air temperature falls, and lowers the setpoint as outside air temperature rises.

(4) Temperature transmitter TT-XX-02 signals the primary hot water supply temperature to temperature controller TC-XX-02. Controller TC-XX-02 maintains its setpoint by varying its signal to current-to-pneumatic transducer IP-XX-01. The pneumatic signal from IP-XX-01 modulates high-temperature hot water converter valve VLV-XX-01 to maintain the primary supply water temperature setpoint of controller TC-XX-02.

(5) Temperature transmitter TT-XX-03 signals the zone space temperature to controller TC-XX-03. Controller TC-XX-03 maintains its setpoint by varying its current output signal to transducer IP-XX-02. The pneumatic signal from IP-XX-02 modulates secondary zone control valve VLV-XX-02, which mixes primary supply water with secondary return water to maintain the zone space temperature setpoint. The temperature control loop for the other secondary zone functions identically.

(6) Throughout the occupied mode, the contacts of time clock CLK-XX-01 are closed to energize relays R-XX-01, R-XX-02, and R-XX-03, and to turn on pilot light PL-XX-01. The contacts of relay R-XX-01 connect temperature setpoint device TSP-XX-01 to allow manual adjustment of the setpoint of temperature controller TC-XX-03. Relay R-XX-02 provides the same function for TSP-XX-03 in adjustment of controller TC-XX-04. Relay R-XX-03 closes contacts in the starter control circuits of the secondary pumps. The secondary system pumps will start whenever the contacts of relay R-XX-03 (occupied) and R-XX-05 (heating) are closed in their respective pump starter circuits.

(7) During the unoccupied mode, the contacts of time clock CLK-XX-01 are open and de-energize relays R-XX-01, R-XX-02, and R-XX-03, and pilot light PL-XX-01 turns off. The transfer of the contacts of relay R-XX-01 transfers the temperature setpoint adjustment of TC-XX-03 from TSP-XX-01 to TSP-XX-02. The transfer of the contacts of relay R-XX-02 transfers TC-XX-04 temperature setpoint adjustment from TSP-XX-03 to TSP-XX-04. The contacts of relay R-XX-03 open the secondary pump starter circuits to place the secondary pumps under the respective night thermostats TSL-XX-01 and TSL-XX-02. When the zone space temperature falls to 13 degrees C (55 degrees F), the zone secondary pump is energized and remains energized until the temperature rises to 14 degrees C (57 degrees F).

d. Sequence of operation for DDC applications.

(1) The DDC system shall accept a signal from a sunshielded outside air temperature sensing element and transmitter located as shown. The DDC system shall start and stop the pumps at the outside air temperatures shown. The DDC system shall reset the hydronic heating supply temperature setpoint in a linear schedule based on the outside air temperature as shown. The DDC system shall accept a signal from a temperature sensing element and transmitter located in the hydronic heating supply line and the DDC system output shall modulate the converter high-temperature hot water control valve to maintain the reset schedule setpoint in the hydronic heating supply line.

(2) When the system time schedule places the system in the occupied mode, a space temperature sensing element and transmitter located as shown shall signal the DDC system, which shall

maintain the space temperature setpoint as shown by modulating the secondary hydronic system zone valve.

(3) When the system is in the unoccupied mode, the space temperature setpoint shall be as shown.

14. CENTRAL PLANT STEAM DUAL-TEMPERATURE HYDRONIC CONTROL SYSTEM.

a. Description of the hydronic system. This hydronic heating and cooling system consists of hot water from a steam converter, chilled water from a central plant, and related pumping systems. Figures 4-10a through 4-10f show the system design for this type of heating system using a SLDC control panel. Figures 4-10g through 4-10j show the system design for this type of heating system using DDC controls.

Figure 4-10a. Control system schematic for central plant steam dual-temperature hydronic system.

Figure 4-10b. Control system ladder diagram for central plant steam dual-temperature hydronic system.

Figure 4-10c. Control system equipment for central plant steam dual-temperature hydronic system.

Figure 4-10d. Control panel interior door layout for central plant steam dual-temperature hydronic system.

Figure 4-10e. Control panel back panel layout for central plant steam dual-temperature hydronic system.

Figure 4-10f. Control panel terminal block layout for central plant steam dual-temperature hydronic system.

Figure 4-10g. DDC control system schematic for central plant steam dual-temperature hydronic system.

Figure 4-10h. DDC control system ladder diagram for central plant steam dual-temperature hydronic system.

Figure 4-10i. DDC control system equipment for central plant steam dual-temperature hydronic system.

Figure 4-10j. DDC control system I/O table and data terminal strip layout for central plant steam dual-temperature hydronic system.

b. General sequence of operation.

(1) Heating and cooling modes are manually selected.

(2) When the system is in the heating mode, the pumping system and the converter operate continuously whenever the outside air temperature is low enough for the building to require heating. When this occurs, an outside air temperature controller starts the system pump, and the converter control is activated. The outside air temperature controller raises the hot water supply temperature as the outside air temperature falls.

(3) The hot water supply temperature controller maintains its setpoint by modulating the converter valve to maintain the scheduled temperature.

(4) When the system is indexed to cooling, the converter valve closes. The pump continues to run for cooldown and when the return water temperature falls to 29 degrees C (85 degrees F), the changeover valves transfer the water flow from the converter to the central plant chilled water system.

(5) As long as the heating/cooling switch is indexed to cooling, the pump will be energized during the occupied mode and de-energized during the unoccupied mode.

c. Detailed sequence of operation.

(1) Manual switch HS-XX-02 provides for indexing the system to the heating or the cooling mode.

(2) When heating/cooling switch HS-XX-02 is indexed from heating to cooling, relay R-XX-02 is de-energized, and relay R-XX-05 is energized. Contacts of relay R-XX-05 open, removing control from the converter valve, which then closes. Through the normally closed contacts of relay R-XX-02 and the normally open contacts of relay R-XX-06, pump relay R-XX-07 is energized and the pump runs to distribute the hot water in order to reduce its temperature. When the return water temperature falls to the setpoint of TSL-XX-01, the solenoid actuated pneumatic valve EP-XX-01 and relay R-XX-06 are energized, and cooling pilot light PL-XX-03 is turned on. Through EP-XX-01, changeover valves VLV-XX-02 and VLV-XX-03 stop the flow to and from the converter, and open the system to the central plant chilled water system. The normally closed contacts of relay R-XX-06 (line 13) open to stop the pump, but the normally open contacts of that relay (line 12) close. If occupied relay R-XX-01 is energized, the pump continues to run.

(3) Throughout the cooling mode, pump relay R-XX-07, through the normally closed contacts of relay R-XX-02 and the normally open contacts of relay R-XX-06, is energized during the occupied mode and de-energized during the unoccupied mode by the contacts of relay R-XX-01.

(4) When heating/cooling switch HS-XX-02 is indexed from cooling to heating, relays R-XX-05 and R-XX-06 and solenoid actuated pneumatic valve EP-XX-01 are de-energized, cooling pilot light PL-XX-03 is turned off, and relay R-XX-02 is energized. When EP-XX-01 is de-energized, valves VLV-XX-02 and VLV-XX-03 open the system to the converter and close it to the central plant chilled water system.

(5) On a fall in outside air temperature to the setpoint of the PV contacts of controller TC-XX-01, relay R-XX-04 is energized and heating pilot light PL-XX-02 is turned on. The contacts of relay R-XX-04 (line 11), which are closed throughout the heating mode, energize relay R-XX-07. The contacts of relay R-XX-07 energize the system pump. Pump starter auxiliary contacts, through the normally closed contacts of relay R-XX-05 (line 4) energize relay R-XX-03, and the contacts of relay R-XX-03 connect the output of temperature controller TC-XX-02 to current-to-pneumatic transducer IP-XX-01. The transducer output modulates hot water converter valve VLV-XX-01. On a rise in outdoor air temperature to 17 degrees C (62 degrees F), the PV contacts of controller TC-XX-01 open, and relay R-XX-04 is de-energized, de-energizing relay R-XX-07 and stopping the pump. Pump starter auxiliary contacts remove the converter valve from control, and the converter valve closes.

(6) Outside air controller TC-XX-01 raises the setpoint of hot water supply temperature controller TC-XX-02 as the outside air temperature falls and lowers the setpoint as the outside air temperature rises.

(7) Temperature controller TC-XX-02, with its temperature transmitter in the hot water supply piping, through current-to-pneumatic transducer IP-XX-01, modulates high-temperature hot water converter valve VLV-XX-01 to maintain the supply water temperature setpoint of controller TC-XX-02.

d. Sequence of operation for DDC applications.

(1) Switch HS-XX-01 provides for manual switching of the dual-temperature hydronic system between the heating and cooling modes.

(2) When the heating mode is selected, the system changeover valves shall close to the central plant chilled water flow and shall open to flow through the converter, and the distribution pump shall be under control of the DDC system. The DDC system shall accept a signal from a sunshielded outside air temperature sensing element and transmitter located as shown. The DDC system shall start and stop pump at the outside air temperatures shown. The DDC system shall reset the hydronic heating supply temperature setpoint in a linear schedule based on the outside air temperature. The DDC system shall accept a signal from a temperature sensing element and transmitter located in the hydronic heating supply line and the DDC system output shall modulate the converter's steam control valve to maintain the reset schedule setpoint in the hydronic heating supply line.

(3) When the cooling mode is selected, the converter steam valve shall be closed. The DDC system shall accept a signal from a temperature sensing element and transmitter located in the system return. The DDC system shall continue to operate pump to circulate water through the system. When the system return water temperature drops below the setpoint shown, the DDC system shall allow the changeover valves to close to flow through the converter and to open to the central plant chilled water flow, and place the control of pump under control of the system time schedule. During the occupied mode, pump shall operate continuously. In the unoccupied mode, pump shall stop.

15. CENTRAL PLANT HIGH-TEMPERATURE HOT WATER DUAL-TEMPERATURE HYDRONIC CONTROL SYSTEM.

a. Description of the hydronic system. This hydronic heating and cooling system consists of hot water from a high-temperature hot water converter, chilled water from a central plant, and related pumping systems. Figures 4-11a through 4-11f show the system design for this type of heating system using a SLDC control panel. Figures 4-11g through 4-11j show the system design for this type of heating system using DDC controls.

Figure 4-11a. Control system schematic for central plant high-temperature hot water dual-temperature hydronic system.

Figure 4-11b. Control system ladder diagram for central plant high-temperature hot water dual-temperature hydronic system.

Figure 4-11c. Control system equipment for central plant high-temperature hot water dual-temperature hydronic system.

Figure 4-11d. Control panel interior door layout for central plant high-temperature hot water dual-temperature hydronic system.

Figure 4-11e. Control panel back panel layout for central plant high-temperature hot water dual-temperature hydronic system.

Figure 4-11f. Control panel terminal block layout for central plant high-temperature hot water dual-temperature hydronic system.

Figure 4-11g. DDC control system schematic for central plant high-temperature hot water dual-temperature hydronic system.

Figure 4-11h. DDC control system ladder diagram for central plant high-temperature hot water dual-temperature hydronic system.

Figure 4-11i. DDC control system equipment for central plant high-temperature hot water dual-temperature hydronic system.

Figure 4-11j. DDC control system I/O table and data terminal strip layout for central plant high-temperature hot water dual-temperature hydronic system.

b. General sequence of operation.

(1) Heating and cooling modes are manually selected.

(2) When the system is in the heating mode, as selected by a panel-mounted HEATING/COOLING switch, the pumping system and the high-temperature hot water converter operate continuously whenever the outside air temperature is low enough for the building to require heating. This temperature is to be selected by the designer. When this condition is met, an outside air temperature controller starts the system pump, and the converter is under control. As the outside air temperature rises and falls, the outside air temperature controller resets the hot water supply temperature setpoint in accordance with a schedule established by the designer.

(3) The hot water supply temperature controller maintains the scheduled hot water supply temperature setpoint by modulating the high temperature hot water converter valve.

(4) When the system heating/cooling switch is indexed to cooling, the converter valve closes. The pump continues to run for cooldown of the system water. When the return water temperature falls to 29 degrees C (85 degrees F), the changeover valves divert the water flow from the converter to the central plant chilled water system.

(5) As long as the switch HS-XX-02 is indexed to cooling, the pump will be energized during the occupied mode and de-energized during the unoccupied mode.

c. Detailed sequence of operation.

(1) Manual HEATING/COOLING switch HS-XX-02 allows for indexing of the system between the heating and the cooling modes.

(2) When switch HS-XX-02 is indexed from heating to cooling, relays R-XX-02 and R-XX-03 are de-energized which causes the converter valve to close and the system pump to momentarily shut down. Simultaneously, relay R-XX-04 is energized, causing its normally open contact on Line 10 to close. Assuming that the temperature of the return water is above the setpoint of TSL-XX-01, the system pump is operated through the normally closed contact of relay R-XX-05 on Line 11. The pump continues to run until the temperature of the return water cools down below the setpoint of TSL-XX-01. When this occurs, pilot light PL-XX-03 (COOLING) is lit and relay R-XX-05 is energized which allows the pump to stop and energizes solenoid actuated pneumatic valve EP-XX-01 on Line 12. When EP-XX-01 is energized, two-position changeover valves VLV-XX-02 and VLV-XX-03 close to the hot water converter and open to the central plant chiller. Hereafter, the system pump operates through the contacts of relay R-XX-01 only when the system is in the occupied mode.

(3) When hand switch HS-XX-02 is indexed from cooling to heating, EP-XX-01 and relays R-XX-04 and R-XX-05 are de-energized and cooling pilot light PL-XX-03 is turned off. When EP-XX-01 is deenergized, changeover valves VLV-XX-02 and VLV-XX-03 open to the conveter and close to the central plant chilled water system.

(4) On a fall in outdoor air temperature to the setpoint of the PV contacts of outside air temperature reset controller TC-XX-01, relay R-XX-03 is energized and heating pilot light PL-XX-02 is lit. The pump is started through the normally open contacts of relay R-XX-03 (Line 9). When the pump starter is energized, its auxiliary contacts (M01 on Line 3) close. This energizes relay R-XX-02 whose normally open contacts close to allow the output of temperature controller TC-XX-02 to be received by current-to-pneumatic transducer IP-XX-01. On a rise in outdoor air temperature to 18 degrees C (65 degrees F) the PV contacts of temperature controller TC-XX-01 open and relay R-XX-03 is de-energized, stopping the pump. The pump starter's auxiliary contacts open, which de-energizes relay R-XX-02 and causes the converter valve to close.

(5) Outside air temperature reset controller TC-XX-01 raises the setpoint of hot water supply temperature controller TC-XX-02 as the outside air temperature falls and lowers the setpoint as the outside air temperature rises.

(6) Temperature transmitter TT-XX-02 sends a hot water supply temperature signal to temperature controller TC-XX-02. Temperature controller TC-XX-02 maintains its setpoint by varying its output to current-to-pneumatic transducer IP-XX-01. The pneumatic signal from IP-XX-01 modulates high temperature hot water converter valve VLV-XX-01 to maintain the hot water supply temperature setpoint of temperature controller TC-XX-02.

d. Sequence of operation for DDC applications.

(1) Switch HS-XX-01 provides for manual switching of the dual-temperature hydronic system between the heating and cooling modes.

(2) When the heating mode is selected, the system changeover valves shall close to the central plant chilled water flow and shall open to flow through the converter, and the distribution pump shall be under control of the DDC system. The DDC system shall accept a signal from a sunshielded outside air temperature sensing element and transmitter located as shown. The DDC system shall start and stop pump at the outside air temperatures shown. The DDC system shall reset the hydronic heating supply temperature setpoint in a linear schedule based on the outside air temperature as shown. The DDC

system shall accept a signal from a temperature sensing element and transmitter located in the hydronic heating supply line and the DDC system output shall modulate the converter's high-temperature hot water control valve to maintain the reset schedule setpoint in the hydronic heating supply line.

(3) When the cooling mode is selected, the converter high-temperature hot water control valve shall be closed. The DDC system shall accept a signal from a temperature sensing element and transmitter located in the system return as shown. The DDC system shall continue to operate pump to circulate water through the system. When the system return water temperature drops below the setpoint shown, the DDC system shall allow the changeover valves to close to flow through the converter and to open to the central plant chilled water flow, and place the control of pump under control of the system time schedule. During the occupied mode, pump shall operate continuously. In the unoccupied mode, pump shall stop.

16. SINGLE BUILDING DUAL-TEMPERATURE HYDRONIC CONTROL SYSTEM.

a. Description of the hydronic system. This hydronic heating and cooling system consists of a boiler, chiller, pump and distribution piping. This system varies the hot water flow through the boiler. Therefore, it can be used only with boilers that are not sensitive to flow variation. A variation of this system which utilizes constant flow through the boiler is depicted in Chapter 5. Figures 4-12a through 4-12f show the control system design for this type of hydronic system using a SLDC control panel. Figures 4-12g through 4-12j show the control system design for this type of hydronic system using DDC controls.

Figure 4-12a. Control system schematic for single building dual-temperature hydronic system.

Figure 4-12b. Control system ladder diagram for single building dual-temperature hydronic system.

Figure 4-12c. Control system equipment for single building dual-temperature hydronic system.

Figure 4-12d. Control panel interior door layout for single building dual-temperature hydronic system.

Figure 4-12e. Control panel back panel layout for single building dual-temperature hydronic system.

Figure 4-12f. Control panel terminal block layout for single building dual-temperature hydronic system.

Figure 4-12g. DDC control system schematic for single building dual-temperature hydronic system.

Figure 4-12h. DDC control system ladder diagram for single building dual-temperature hydronic system.

Figure 4-12i. DDC control system equipment for single building dual-temperature hydronic system.

Figure 4-12j. DDC control system I/O table and data terminal strip layout for single building dual-temperature hydronic system.

b. General sequence of operation.

(1) Heating and cooling modes are manually selected at the control panel. The position of the dual-temperature changeover valves is manually selected at the control panel.

(2) When the system is indexed to heating, the boiler and pump operate continuously whenever the outside air temperature is low enough for the building to require heating. When this occurs, the system boiler is started and the system pump is energized. The boiler functions under its own control system to maintain a constant boiler water temperature.

(3) The control system modulates a three-way valve to mix supply and return hot water to maintain the scheduled hot water supply temperature setpoint. As the outside air temperature falls the supply water temperature is raised.

(4) When the system is indexed from the heating mode to the cooling mode, the boiler is shut down. The pump continues to run to dissipate the heat from the piping system and the boiler until the return water temperature drops below the setpoint of the return water thermostat. When this occurs, the distribution pump stops and the changeover valves are then permitted to close to the boiler and open to the chiller.

(5) When the system is indexed to cooling and changeover has occurred, the chiller and pump are energized during the occupied mode. At the conclusion of the occupied period, the chiller is de-energized but the pump continues to circulate water for a period of time while the chiller completes its shutdown cycle, and then the pump stops.

(6) When the system is indexed from cooling mode to heating mode, the chiller enters its shutdown cycle and the pump continues to circulate water through the chiller for a period of time while the chiller completes its shutdown cycle.

c. Detailed sequence of operation.

(1) Switch HS-XX-02 allows for manual indexing of the dual-temperature hydronic system between the heating and cooling modes. Switch HS-XX-03 allows for manual operation of the dual-temperature changeover valves.

(2) When switch HS-XX-02 is indexed from the heating mode to the cooling mode, relays R-XX-02 and R-XX-03 are de-energized, heating pilot light PL-XX-02 is turned off, and time-delay relay TDR-XX-01 is energized. One set of normally open contacts of relay R-XX-03 (Line 200) open to de-energize the boiler and a second set of normally open contacts open to interrupt the input signal to IP-XX-01. A set of normally open contacts of relay R-XX-02 on Line 13 open and normally open contacts of time-delay relay TDR-XX-01 on Line 14 close, transferring control of pump relay R-XX-06 from the heating mode to the cooling mode. If the return water temperature is above the setpoint of TSL-XX-01, relay R-XX-04 (Line 9) remains de-energized. As a result, its normally closed contact on Line 8 remains closed and the pump continues circulating water through the system to dissipate heat. When the temperature of the return water falls below the setpoint of TSL-XX-01, relay R-XX-04 is energized. The normally closed contacts of relay R-XX-04 on line 8 are now open, de-energizing time-delay relay TDR-XX-01. Once the time-delay period expires, the normally open contacts of TDR-XX-01 on line 14 open, de-energizing relay R-XX-06, causing the pump to stop. When relay R-XX-04 is energized as a result of the return water temperature falling below the setpoint of TSL-XX-01, a set of normally open contacts on line 12 are closed, which allows EP-XX-01 to become energized, when switch HS-XX-03 is in the "cooling" position, causing the changeover valves to open to the chiller.

(3) When the system enters the occupied mode, as determined by timeclock CLK-XX-01 on Line 0, relay R-XX-01 on Line 1 is energized and pilot light PL-XX-01 (OCCUPIED) is lit. When relay R-XX-01 is energized, the normally open contact on Line 7 is closed, which energizes time-delay relay

TDR-XX-01. The normally open contacts of TDR-XX-01 on line 14 close, which energizes relay R-XX-06, causing the system pump to start. Relay R-XX-01 also has a set of normally open contacts on line 10 which are closed during the occupied mode. This causes the chiller to be enabled, if flow through the chilled water loop is proven by flow switch FS-XX-02, and pilot light PL-XX-03 (COOLING) is lit.

(4) When the occupied period ends, relay R-XX-01 is de-energized. The contact on line 10 opens to de-energize R-XX-05 and PL-XX-03. This causes the chiller to shut down. The normally open contact of relay R-XX-01 on line 7 also opens, de-energizing time-delay relay TDR-XX-01. The normally open contact of TDR-XX-01 on line 14 remains closed until the expiration of the time delay, allowing the pump to continue running while the chiller completes its shut-down process. After the time-delay period expires, this contact opens, de-energizing relay R-XX-06 and thereby shutting off the pump.

(5) When switch HS-XX-02 is indexed from the cooling mode to the heating mode, relays R-XX-04, R-XX-05, and TDR-XX-01 are de-energized. As a result, the chiller is shut down and PL-XX-03 is turned off. The pump continues to run until the expiration of the time delay period of TDR-XX-01.

(6) With the system indexed to the heating mode, if the outside air temperature is below the PV alarm setpoint of temperature controller TC-XX-01, the controller's PV contact on Line 3 will be closed. This energizes relay R-XX-02 to start the system pump. Once flow is proven through the heating loop by flow switch FS-XX-01, relay R-XX-03 is energized and pilot light PL-XX-02 (HEATING) is lit. R-XX-03 starts the boiler (Line 200) and also closes a contact between TC-XX-02 and IP-XX-01, placing valve VLV-XX-01 under the control of temperature controller TC-XX-02.

(7) Temperature transmitter TT-XX-02 sends a hot water supply temperature signal to temperature controller TC-XX-02. Controller TC-XX-02 maintains its setpoint by varying its output signal to current-to-pneumatic transducer IP-XX-01. The pneumatic output from IP-XX-01 modulates three-way valve VLV-XX-01 to mix boiler water and return water to maintain the temperature setpoint of controller TC-XX-02. Outside air temperature transmitter TT-XX-01 sends an outside air temperature signal to temperature controller TC-XX-01. As the outside air temperature falls, TC-XX-01 raises the setpoint of controller TC-XX-02.

d. Sequence of operation for DDC applications.

(1) Switch HS-XX-01 provides for manual indexing of the dual-temperature hydronic system between the heating and cooling modes.

(2) When the heating mode is selected, the chiller shall be stopped. The distribution pump shall continue to operate until the expiration of a time delay as recommended by the chiller manufacturer. At the expiration of the time delay, the system changeover valves shall close to flow through the chiller and shall open to flow through the boiler, and the distribution pump shall be under control of the DDC system. The DDC system shall accept a signal from a sunshieldeed outside air temperature sensing element and transmitter located as shown. The DDC system shall start and stop the distribution pump and the boiler at the outside air temperatures shown. The DDC system shall reset the hydronic heating supply temperature setpoint in a linear schedule based on the outside air temperature as shown. The DDC system shall accept a signal from a temperature sensing element and transmitter located in the hydronic supply line and the DDC system output shall modulate the hydronic heating system control valve to maintain the reset schedule setpoint in the hydronic heating supply line.

(3) When the cooling mode is selected, the boiler shall be stopped. The DDC system shall accept a signal from a temperature sensing element and transmitter located in the system supply as

shown. The DDC system shall continue to operate the distribution pump to circulate water through the system with the boiler shut off. When the system supply water temperature drops below the setpoint shown, the DDC system shall allow the changeover valves to close to flow through the boiler and to open to flow through the chiller, and shall place the chiller and the distribution pump under control of the system time schedule. During the occupied mode, the distribution pump shall operate continuously and the chiller shall be permitted to operate. When the system is in the unoccupied mode, the chiller shall shut down. The distribution pump shall continue to operate until the expiration of the time delay.

17. HEATING AND VENTILATING CONTROL SYSTEM.

a. Description of the heating and ventilating system. This air handling system consists of a supply fan, outside air, return air and relief air dampers, a filter, and a heating coil. Figures 4-13a through 4-13f show the control system design for this type of air handling system using a SLDC control panel. Figures 4-13g through 4-13j show the control system design for this type of air handling system using DDC controls.

Figure 4-13a. Control system schematic for heating and ventilating system.

Figure 4-13b. Control system ladder diagram for heating and ventilating system.

Figure 4-13c. Control system equipment for heating and ventilating system.

Figure 4-13d. Control panel interior door layout for heating and ventilating system.

Figure 4-13e. Control panel back panel layout for heating and ventilating system.

Figure 4-13f. Control panel terminal block layout for heating and ventilating system.

Figure 4-13g. DDC control system schematic for heating and ventilating system.

Figure 4-13h. DDC control system ladder diagram for heating and ventilating system.

Figure 4-13i. DDC control system equipment for heating and ventilating system.

Figure 4-13j. DDC control system I/O table and data terminal strip layout for heating and ventilating system.

b. General sequence of operation.

(1) Supply fan off. When the fan is off, the outside air and relief air dampers are closed and the return air damper is open. The heating coil valve is under the control of the space temperature controller.

(2) Supply fan operating. When the supply fan is on, the control dampers and the heating coil valve are operated as required by the system's mode of operation. The control dampers are either positioned for full recirculation of air, positioned to introduce minimum outside air, or modulated in sequence with the heating coil to maintain space temperature. The heating coil is modulated by the space temperature controller.

(3) Control of the supply fan. Unless the fan is stopped as the result of a safety shutdown, it is on or off as required by the control system's mode of operation.

(4) Safety shutdown of the fans. The control system shuts down the fans if there is a low temperature condition or smoke is detected.

(5) Low temperature detection. On a fall in temperature to its setpoint, a low temperature protection thermostat stops the supply fan. To restart the fan, the thermostat and the control panel must be manually reset.

(6) Smoke detection. Duct smoke detectors in the supply and return air stop the supply fan whenever either detects the presence of smoke. To restart the fan, the smoke detectors and control panel must be manually reset.

(7) Filter condition. Filter condition is monitored by a pressure gauge and a differential pressure switch. On a rise in pressure drop across the filter to the switch setpoint, the switch turns on a pilot light.

(8) Unoccupied mode of operation. Throughout the unoccupied mode, the outside air and relief air dampers remain closed and the return air damper remains open. The supply fan is cycled by the system's night thermostat to maintain its low limit space temperature setpoint.

(9) Ventilation delay mode of operation. During the ventilation delay mode, the dampers remain as they were throughout the unoccupied mode and the supply fan runs continuously. Until the ventilation delay mode ends, the HVAC system circulates return air to bring the building to comfort conditions, using a minimum of energy.

(10) Occupied mode of operation. The supply fan runs continuously. The heating coil valve and control dampers are modulated, with a deadband between them, by the space temperature controller.

c. Detailed sequence of operation.

(1) Time clock CLK-XX-01 has two independent sets of contacts, which between them determine the mode under which the system operates. Five minutes before the scheduled beginning of the occupied mode, the ventilation delay contacts close, energizing relay R-XX-03 and turning on pilot light PL-XX-02. The normally closed contacts of relay R-XX-03 open, to prevent relay R-XX-02 from being energized. The normally open contacts of relay R-XX-02 prevent signals from reaching current-to-pneumatic transducer IP-XX-01. The dampers remain in their normal positions, with outside air and relief air dampers closed and return air damper open.

(2) When the occupied contacts of time clock CLK-XX-01 close, relay R-XX-01 is energized and pilot light PL-XX-01 is turned on. Contacts of relay R-XX-01 energize the supply fan. The auxiliary contacts of the supply fan starter energize relay R-XX-04.

(3) When the ventilation delay contacts of time clock CLK-XX-01 open to end the ventilation delay mode, relay R-XX-03 is de-energized and pilot light PL-XX-02 is turned off. With the now closed but normally open contacts of energized relays R-XX-01 and R-XX-04, the normally closed contacts of relay R-XX-03 energize relay R-XX-02. The normally open contacts of relay R-XX-02 connect the output signal of high signal selector TY-XX-01 to current-to-pneumatic transducer IP-XX-01. The pneumatic output of transducer IP-XX-01 places the dampers at the minimum position set on minimum position

switch MPS-XX-01 or under control of space temperature controller TC-XX-01, whichever signal is higher.

(4) Temperature controller TC-XX-01, with its temperature transmitter in the space served, through current-to-pneumatic transducer IP-XX-02, modulates heating coil valve VLV-XX-01, and during the occupied mode after the expiration of the ventilation delay mode, modulates the control dampers in sequence with the heating coil valve to maintain the temperature controller setpoint.

(5) On a fall in temperature to its setpoint, low temperature protection thermostat TSL-XX-01 opens a set of closed contacts in the supply fan circuit, de-energizing the supply fan. Through its open contacts, thermostat TSL-XX-01 energizes relay R-XX-05 and lights pilot light PL-XX-04. The contacts of relay R-XX-05 energize relay R-XX-07. The normally closed contacts of relay R-XX-07 de-energize the supply fan, the normally open contacts lock in relay R-XX-07. To restart the fan after a low temperature shutdown, both the low temperature protection thermostat TSL-XX-01 and the control panel must be reset. The control panel is reset by depressing manual switch HS-XX-02.

(6) Whenever smoke detector SMK-XX-01 or smoke detector SMK-XX-02 detects the presence of smoke, its normally closed contacts in the supply fan start circuit open, de-energizing the fan. The normally open contacts close, energizing relay R-XX-06 and lighting pilot light PL-XX-05. Normally open contacts of relay R-XX-06 close, energizing relay R-XX-07. Normally closed contacts of relay R-XX-07 in the supply fan start circuit open, and the normally open contacts close to lock in relay R-XX-07. To restart the fan after a smoke shutdown, smoke detectors SMK-XX-01 and/or SMK-XX-02 and the control panel must be reset. The control panel is reset by depressing manual switch HS-XX-02.

(7) Differential pressure gauge DPI-XX-01 across the filter provides local indication of filter loading. On a rise in pressure drop across the filter to its setpoint, differential pressure switch DPS-XX-01 turns on pilot light PL-XX-03.

(8) At the conclusion of the occupied mode, the occupied contacts of time clock CLK-XX-01 open, and relay R-XX-01 is de-energized. The contacts of relay R-XX-01 open, de-energizing the supply fan and placing it under the control of the night thermostat TSL-XX-02.

d. Sequence of operation for DDC applications.

(1) Ventilation delay mode timing shall start prior to the occupied mode timing. During ventilation delay mode, the DDC system shall prevent the outside air damper from opening. At the time shown, the DDC system shall place the system in the occupied mode. At the expiration of the ventilation delay mode timing period, the DDC system shall place the outside air, return air, and relief air dampers under space temperature control. At the time shown, the DDC system shall place the control system in the unoccupied mode of operation and the dampers shall return to their normal positions.

(2) During occupied and ventilation delay modes the supply fan shall operate continuously. During unoccupied mode the supply fan shall cycle according to the night setback schedule. The fan shall start and stop at the setpoints as shown.

(3) A differential pressure switch across the filter shall initiate a filter alarm when the pressure drop across the filter exceeds the setpoint as shown.

(4) A freezestat, located as shown, shall stop the supply fan, cause the outside air, return air, and relief air dampers to return to their normal position, and shall initiate a low temperature alarm if the

temperature drops below the freezestat's setpoint. Return to the normal mode of operation shall require manual reset at the freezestat. The DDC panel shall monitor the freezestat through auxiliary contacts and shall indicate an alarm condition when the freezestat trips.

(5) A space temperature sensing element and transmitter operating through the DDC system shall first gradually shut off the heating coil valve. After the heating coil valve is fully closed, the DDC system shall then gradually operate the outside air damper to admit outside air beyond the minimum quantity to maintain the setpoint as shown.

(6) Smoke Detectors in the supply air and return air ductwork shall stop the supply fan and initiate a smoke alarm if smoke is detected at either location. Restarting the supply fan shall require manual reset at the smoke detector.

18. MULTIZONE HVAC CONTROL SYSTEM WITH RETURN FAN.

a. Description of the HVAC system. This is an air handling system with supply and return fans, economizer dampers, a cold deck with a cooling coil, a hot deck with a heating coil, individual zone mixing dampers, and individual zone heating controls. Figures 4-14a through 4-14f show the control system design for this type of air handling system using a SLDC control panel. Figures 4-14g through 4-14j show the control system design for this type of air handling system using DDC controls. Note that because a two-deck multizone system has no deadband between heating and cooling, the decision to use an economizer cycle with this type system needs to be evaluated in accordance with the guidance presented in chapter three.

Figure 4-14a. Control system schematic for multizone HVAC system.

Figure 4-14b. Control system ladder diagram for multizone HVAC system.

Figure 4-14c. Control system equipment for multizone HVAC system.

Figure 4-14d. Control panel interior door layout for multizone HVAC system.

Figure 4-14e. Control panel back panel layout for multizone HVAC system.

Figure 4-14f. Control panel terminal block layout for multizone HVAC system.

Figure 4-14g. DDC control system schematic for multizone HVAC system.

Figure 4-14h. DDC control system ladder diagram for multizone HVAC system.

Figure 4-14i. DDC control system equipment for multizone HVAC system.

Figure 4-14j. DDC control system I/O table and data terminal strip layout for multizone HVAC system.

b. General sequence of operation.

(1) Supply and return fans off. When the fans are off, the cooling coil valve and the outside air and relief air dampers are closed. The return air damper is open. The heating coil valve is modulated

under the control of the hot deck temperature controller. Zone dampers are under the control of their zone thermostats.

(2) Supply and return fans operating. When the fans are on, the control dampers are either positioned for full recirculation of air, positioned to introduce minimum outside air, or modulated to maintain mixed air temperature. The cooling coil valve is either closed or modulated to maintain the cold deck discharge temperature. The heating coil valve is modulated to maintain the hot deck discharge temperature. Zone dampers are under the control of their zone thermostats.

(3) Control of supply fan and return fan. Unless the fans are stopped as the result of a safety shutdown, they are on or off as required by the control system's mode of operation.

(4) Safety shutdown of the fans. The control system shuts down the fans if there is a low temperature condition or if smoke is detected.

(5) Low temperature detection. On a fall in temperature to its setpoint, a low temperature protection thermostat stops the supply and return fans. To restart the fans, the thermostat and the control panel must be manually reset.

(6) Smoke detection. Duct smoke detectors stop the supply and return fans whenever either detects the presence of smoke. To restart the fans, the smoke detectors and control panel must be manually reset.

(7) Filter condition. Filter condition is monitored by a pressure gauge and a differential pressure switch. On a rise in pressure drop across the filter to the switch setpoint, the switch turns on a pilot light.

(8) Economizer control. When the control system mode of operation no longer requires the outside air, return air, and relief air dampers to be in their full recirculation operating positions, the dampers are positioned to admit outside air for ventilation. The dampers then remain at minimum position until the economizer controller closes both its PV and DEV contacts. The economizer controller closes its PV contacts when the outside air temperature indicates that the building requires cooling rather than heating. The economizer controller closes its DEV contacts when the outside air temperature is sufficiently below the return air temperature to be effective for cooling. When both these contacts close, the dampers are modulated by the mixed air temperature controller.

(9) Mixed air temperature control. A mixed air temperature controller with its temperature transmitter in the mixed air modulates the outside air and relief air dampers between minimum position and fully open to maintain a mixed air temperature of 13 degrees C (55 degrees F). As the outside air and relief air dampers open, the return air damper closes.

(10) Cold deck temperature control. A cold deck temperature controller with its temperature transmitter in the cold deck discharge modulates the cooling coil valve to maintain its setpoint temperature during the ventilation delay and occupied modes.

(11) Hot deck temperature control. A hot deck temperature controller with its temperature transmitter in the heating coil discharge modulates the heating coil valve to maintain its temperature setpoint. Outside air temperature controller TC-XX-04 with its temperature transmitter in the outside air lowers the setpoint of the hot deck controller as outside air temperature rises. On a fall in outside air temperature, the reverse occurs.

(12) Zone space temperature control. On a rising space temperature, each zone space thermostat modulates the zone mixing damper toward closed to the hot deck and open to the cold deck.

(13) Unoccupied mode of operation. Throughout the unoccupied mode, the outside air and relief air dampers and the cooling coil valve remain closed, and the return air damper remains open. The supply and return fans are cycled by the system's night thermostat to maintain its low limit space temperature setpoint.

(14) Ventilation delay mode of operation. During the ventilation delay mode, the dampers remain as they were throughout the unoccupied mode, and the supply and return fans run continuously. Until the ventilation delay mode ends, the HVAC system circulates return air to bring the building to comfort conditions, using a minimum of energy.

(15) Occupied mode of operation. The supply and return fans run continuously, and the outside air and relief air dampers are at minimum position or are under mixed air temperature control as previously described.

c. Detailed sequence of operation.

(1) Timeclock CLK-XX-01 has two independent sets of contacts, which between them determine the mode under which the system operates. Five minutes before the scheduled beginning of the occupied mode, the ventilation delay contacts close, energizing relay R-XX-04 and lighting pilot light PL-XX-02. The normally closed contacts of relay R-XX-04 open, preventing relay R-XX-03 from being energized. The normally open contacts of relay R-XX-03 prevent any signal reaching current-to-pneumatic transducer IP-XX-01. Thus, the dampers remain in their normal positions, with outside air and relief air dampers closed and return air damper open.

(2) When the timeclock's occupied contacts close, relay R-XX-01 is energized. The contacts of relay R-XX-02 energize the supply fan. The auxiliary contacts of the supply fan starter energize relay R-XX-05 and, with the contacts of relay R-XX-01, energize relay R-XX-06. The contacts of relay R-XX-06 place the cold deck temperature controller in control of cooling coil valve VLV-XX-01. The outside air and relief air dampers remain closed and the return air damper remains open.

(3) When the ventilation delay contacts of timeclock CLK-XX-01 open to end the ventilation delay mode of operation, relay R-XX-04 is de-energized. The normally closed contacts of relay R-XX-04, in series with the now closed but normally open contacts of relays R-XX-01 and R-XX-05, energize relay R-XX-03. The normally open contacts of relay R-XX-03 connect the output signal of high signal selector TY-XX-01 to current-to-pneumatic transducer IP-XX-01. The pneumatic output of transducer IP-XX-01 places the dampers at the minimum position set on minimum position switch MPS-XX-01, unless relay R-XX-07 is energized. Economizer EC-XX-01 controls the action of relay R-XX-07. The economizer receives signals from outside air temperature transmitter TT-XX-02 and from return air transmitter TT-XX-03. The difference between the return air temperature and the outside air temperature controls the DEV contacts, and the outside air temperature controls the PV contacts. When both these contacts are closed, relay R-XX-07 is energized and pilot light PL-XX-03 is turned on. When relay R-XX-07 is energized, its contacts connect the output of mixed air controller TC-XX-01 to high signal selector TY-XX-01 to modulate the outside air and relief air dampers between minimum position and fully open while modulating the return air damper in the opposite direction to maintain the mixed air temperature controller setpoint.

(4) On a fall in temperature to its setpoint, low temperature protection thermostat TSL-XX-01 opens a set of closed contacts in the supply fan starter circuit, de-energizing the supply fan. The auxiliary contacts of the supply fan starter de-energize relay R-XX-05, and the contacts of relay R-XX-05 in the return fan starter circuit de-energize the return fan. A set of open contacts in low temperature protection thermostat TSL-XX-01 close, energizing relay R-XX-08 and lighting pilot light PL-XX-05. The contacts of relay R-XX-08 energize relays R-XX-10 and R-XX-11. One set of the contacts of relay R-XX-10 locks in relays R-XX-10 and R-XX-11, and another set de-energizes the supply fan. Relay R-XX-11 de-energizes the return fan. To restart the fans after a low temperature shutdown, both the low temperature thermostat TSL-XX-01, and the control panel must be manually reset. The control panel is reset by momentarily depressing manual switch HS-XX-02.

(5) When smoke detector SMK-XX-01 or smoke detector SMK-XX-02 detects the presence of smoke, its normally closed contacts in the supply fan starter circuit open, de-energizing the supply fan. The auxiliary contacts of the supply fan starter de-energize relay R-XX-05, and the contacts of relay R-XX-05 in the return fan starter circuit de-energize the return fan. Its normally open contacts close, energizing relay R-XX-09. The normally open contacts of R-XX-09 close, energizing relays R-XX-10 and R-XX-11. One set of contacts of relay R-XX-10 (line 17) locks in relays R-XX-10 and R-XX-11. The other set of contacts of relay R-XX-10 (line 101) de-energizes the supply fan, and the contacts of relay R-XX-11 de-energize the return fan. To restart the fans after a smoke alarm shutdown, smoke detectors SMK-XX-01 and/or SMK-XX-02 and the control panel must be manually reset. The control panel is reset by momentarily depressing manual switch HS-XX-02.

(6) Differential pressure gauge DPI-XX-01 across the filter provides local indication of filter loading. On a rise in pressure drop across the filter to its setpoint, differential pressure switch DPS-XX-01 turns on pilot light PL-XX-04.

(7) Temperature controller TC-XX-02, with its temperature transmitter TT-XX-04 in the cooling coil discharge, through the contacts of relay R-XX-06 and current-to-pneumatic transducer IP-XX-02, modulates cooling coil valve VLV-XX-01 to maintain its temperature setpoint. Relay R-XX-06 is energized during the ventilation delay and occupied modes. During the unoccupied mode, R-XX-06 is de-energized, cooling coil valve control is interrupted, and the valve closes.

(8) Hot deck temperature controller TC-XX-03, with its temperature transmitter TT-XX-05 in the heating coil discharge, modulates hot deck heating coil valve VLV-XX-02 to maintain its temperature setpoint. Controller TC-XX-04 with temperature transmitter TT-XX-02 in the outside air raises the setpoint of controller TC-XX-03 on a fall in outside air temperature and lowers it on a rise in outside air temperature.

(9) On a rising zone space temperature, thermostat T-XX-XX modulates damper actuator DA-XX-XX to gradually close the zone damper to the hot deck and open it to the cold deck. The reverse occurs on a falling zone space temperature.

(10) When the occupied contacts of time clock CLK-XX-01 open to end the occupied mode and index the system to the unoccupied mode, relays R-XX-01 and R-XX-02 are de-energized and pilot light PL-XX-01 is turned off. The contacts of relay R-XX-02 open, de-energizing the supply fan and placing the system's night thermostat TSL-XX-02 in control of the supply fan, and, through interlock, in control of the return fan. On a fall in space temperature to 13 degrees C (55 degrees F), the contacts of TSL-XX-02 close, energizing both fans; on a rise in temperature to 16 degrees C (60 degrees F), the contacts open, de-energizing the fans.

d. Sequence of operation for DDC applications.

(1) Ventilation delay mode timing shall start prior to the occupied mode timing. During ventilation delay mode the dampers shall remain in their normal positions as shown, except when under economizer control. At the time shown, the DDC system shall place the system in the occupied mode. At the expiration of the ventilation delay mode timing period, the DDC system shall place the outside air, return air, and relief air dampers under mixed air temperature and economizer control. At the time shown, the DDC system shall place the control system in the unoccupied mode of operation and the dampers shall return to their normal positions as shown.

(2) During occupied and ventilation delay modes the supply fan and return fan shall operate continuously. During unoccupied mode the supply fan and the return fan shall cycle according to the night setback schedule. The fans shall start and stop at the setpoints as shown.

(3) A differential pressure switch across the filter shall initiate a filter alarm when the pressure drop across the filter exceeds the setpoint as shown.

(4) A freeze-stat, located as shown, shall stop the supply and return fans, cause the outside air, return air, and relief air dampers to return to their normal position, and shall initiate a low temperature alarm if the temperature drops below the freeze-stat's setpoint. Return to the normal mode of operation shall require manual reset at the freeze-stat. The DDC panel shall monitor the freeze-stat through auxiliary contacts and shall indicate an alarm condition when the freeze-stat trips.

(5) Smoke Detectors in the supply air and return air ductwork shall stop the supply fan and the return fan and initiate a smoke alarm if smoke is detected at either location. Restarting the fans shall require manual reset at the smoke detector.

(6) The DDC system shall modulate the heating coil control valve from the signal of a temperature sensing element and transmitter located in the discharge air of the coil to maintain the hot deck temperature setpoint. A temperature sensing element and transmitter in the outside air intake shall reset the hot deck temperature setpoint with respect to the outside air temperature signal in a linear schedule as shown.

(7) During occupied and ventilation delay modes, the cooling coil control valve shall be modulated by the DDC system from the signal of a temperature sensing element and transmitter located in the coil discharge air to maintain the cold deck temperature setpoint as shown. During the unoccupied mode, the cooling coil control valve shall remain closed.

(8) The DDC system shall accept the signal of an outside air temperature sensing element and transmitter and the signal of a return air temperature sensing element and transmitter. The DDC system shall perform switch over between outside air economizer control mode and minimum outside air mode. Until the outside air temperature rises above the setpoint, the DDC system shall hold the system in the minimum outside air mode. When the outside air temperature rises above the setpoint, the DDC system shall place the AHU in the economizer mode or in the minimum outside air mode as determined by a comparison of the outside air and return air temperatures in accordance with the differential temperature setpoints as shown. When the outside air temperature is low with respect to the return air temperature, the AHU shall be in the economizer mode. When the DDC system places the control system in the minimum outside air mode, the outside air damper shall be open to the minimum outdoor air setting.

When the DDC system places the system in the economizer mode, it shall modulate the dampers from the signal of a temperature sensing element and transmitter in the mixed air stream to maintain the setpoint as shown.

(9) A space temperature sensor for each zone shall signal the DDC system to gradually operate the zone mixing damper to heat and cool its respective zone by mixing cold deck air and hot deck air to maintain the setpoint. On a rise in space temperature, the hot deck damper shall gradually close, and the cold deck damper shall gradually open.

19. DUAL-DUCT HVAC CONTROL SYSTEM WITH RETURN FAN.

a. Description of the HVAC system. This is an air handling system with supply and return fans, economizer dampers, a cold duct with a cooling coil, and a hot duct with a heating coil. In addition, each dual-duct zone has a thermostat and a dual-duct box with damper and damper actuator. Figures 4-15a through 4-15f show the control system design for this type of air handling system using a SLDC control panel. Figures 4-15g through 4-15j show the control system design for this type of air handling system using DDC controls. Note that because a dual-duct multizone system has no deadband between heating and cooling, the decision to use an economizer cycle with this type system needs to be evaluated in accordance with the guidance presented in chapter three.

Figure 4-15a. Control system schematic for dual-duct HVAC system.

Figure 4-15b. Control system ladder diagram for dual-duct HVAC system.

Figure 4-15c. Control system equipment for dual-duct HVAC system.

Figure 4-15d. Control panel interior door layout for dual-duct HVAC system.

Figure 4-15e. Control panel back panel layout for dual-duct HVAC system.

Figure 4-15f. Control panel terminal block layout for dual-duct HVAC system.

Figure 4-15g. DDC control system schematic for dual-duct HVAC system.

Figure 4-15h. DDC control system ladder diagram for dual-duct HVAC system.

Figure 4-15i. DDC control system equipment for dual-duct HVAC system.

Figure 4-15j. DDC control system I/O table and data terminal strip layout for dual-duct HVAC system.

b. General sequence of operation.

(1) Supply and return fans off. When the fans are off, the cooling coil valve and the outside air and relief air dampers are closed. The return air damper is open. The heating coil valve is modulated under the control of the hot duct temperature controller. Dual-duct boxes are under the control of their zone thermostats.

(2) Supply and return fans operating. When the fans are on, the control dampers and the cooling coil and heating coil valves are operated as required by the system's mode of operation. The control dampers are either positioned for full recirculation of air, positioned to introduce minimum outside air, or modulated to maintain mixed air temperature. The cooling coil valve is either closed, or modulated to maintain the cold duct discharge temperature setpoint. The heating coil valve is modulated to maintain the hot duct discharge temperature. Dual-duct boxes are under the control of their thermostats.

(3) Control of supply and return fans. Unless the fans are stopped as the result of a safety shutdown, they are on or off as required by the control system's mode of operation.

(4) Safety shutdown of the fans. The control system shuts down the fans if there is a low temperature condition, or if smoke is detected.

(5) Low temperature detection. On a fall in temperature to its setpoint, a low temperature protection thermostat stops the supply and return fans. To restart the fans, the thermostat and the control panel must be manually reset.

(6) Smoke detection. Duct smoke detectors stop the supply and return fans whenever either detects the presence of smoke. To restart the fans, the smoke detectors and control panel must be manually reset.

(7) Filter condition. Filter condition is monitored by a pressure gauge and a differential pressure switch. When the pressure drop across the filter reaches the switch setpoint, the switch turns on a pilot light.

(8) Economizer control. When the control system's mode of operation no longer requires the outside air, return air, and relief air dampers to be in their full recirculating positions, the dampers are positioned to admit outside air for ventilation. The dampers then remain at minimum position until the economizer controller closes both its PV and DEV contacts. The economizer controller closes its PV contacts when the outside air temperature indicates that the building requires cooling rather than heating. The economizer controller closes its DEV contacts when the outside air temperature is sufficiently below the return air temperature to be effective for cooling. When both these contacts close, the dampers are modulated by mixed air temperature control.

(9) Mixed air temperature control. A mixed air temperature controller with its temperature transmitter in the mixed air modulates the outside air damper and relief air dampers between minimum position and fully open to maintain a mixed air temperature of 13 degrees C (55 degrees F). As the outside air and relief air dampers open, the return air damper closes.

(10) Cold duct temperature control. A cold duct temperature controller with its temperature transmitter in the cold duct discharge modulates the cooling coil valve to maintain its setpoint temperature, during the ventilation delay and occupied modes.

(11) Hot duct temperature control. A hot duct temperature controller with its temperature transmitter in the heating coil discharge modulates the heating coil valve to maintain its temperature setpoint. Another controller with a temperature transmitter in the outside air lowers the setpoint of the hot duct controller as outside air temperature rises. On a fall in outside air temperature the reverse occurs.

(12) Zone space temperature control. On a rise in temperature, each zone thermostat modulates the zone dual-duct box damper actuator to maintain its setpoint.

(13) Unoccupied mode of operation. Throughout the unoccupied mode, the outside air and relief air dampers and the cooling coil valve remain closed, and the return air damper remains open. The supply and return fans are cycled by the system's night thermostat to maintain its low limit space temperature setpoint.

(14) Ventilation delay mode of operation. During the ventilation delay mode, the dampers remain as they were throughout the unoccupied mode, and the supply and return fans run continuously. Until the ventilation delay mode ends, the HVAC system circulates return air to bring the building to comfort conditions, using a minimum of energy.

(15) Occupied mode of operation. The supply and return fans run continuously, and the outside air and relief air dampers are at minimum position or are under mixed air temperature control as previously described.

c. Detailed sequence of operation.

(1) Time clock CLK-XX-01 has two independent sets of contacts, which between them determine the mode of system operation. Five minutes before the scheduled beginning of the occupied mode, the ventilation delay contacts close, energizing relay R-XX-04 and lighting pilot light PL-XX-02. The normally closed contacts of relay R-XX-04 open, preventing relay R-XX-03 from being energized. The normally open contacts of relay R-XX-03 prevent any signal from reaching current-to-pneumatic transducer IP-XX-01. Thus, the dampers remain in their normal positions, with outdoor air and relief air dampers closed and return air damper open.

(2) When the timeclock's occupied contacts close, relays R-XX-01 and R-XX-02 are energized and pilot light PL-XX-01 is turned on. The contacts of relay R-XX-02 energize the supply fan. The auxiliary contacts of the supply fan starter energize relay R-XX-05, energizing the return fan, and, with the contacts of relay R-XX-01, energize relay R-XX-06. The contacts of relay R-XX-06 put the cold duct temperature controller in control of cooling coil valve VLV-XX-01. The outside air and relief air dampers remain closed and the return air damper remains open.

(3) When the ventilation delay contacts of time clock CLK-XX-01 open to end the ventilation delay mode of operation, relay R-XX-04 is de-energized and pilot light PL-XX-02 is turned off. The normally closed contacts of relay R-XX-04, in series with the now closed but normally open contacts of relays R-XX-01 and R-XX-05, energize relay R-XX-03. The normally open contacts of relay R-XX-03 connect the output signal of high signal selector TY-XX-01 to current-to-pneumatic transducer IP-XX-01. The pneumatic output of transducer IP-XX-01 places the dampers at the minimum position set on minimum position switch MPS-XX-01, unless relay R-XX-07 is energized. Economizer EC-XX-01 controls the action of relay R-XX-07. The economizer receives signals from outside air temperature transmitter TT-XX-02 and from return air transmitter TT-XX-03. The difference between the return air temperature and the outside air temperature controls the DEV contacts, and the outside air temperature controls the PV contacts. When both these contacts are closed, relay R-XX-07 is energized and pilot light PL-XX-03 is turned on. When relay R-XX-07 is energized, its contacts connect the output of mixed air controller TC-XX-01 to high signal selector TY-XX-01 to modulate the outside air and return air dampers between minimum position and fully open, while modulating the return air damper in the opposite direction to maintain the mixed air temperature controller setpoint.

(4) On a fall in temperature to its setpoint, low temperature protection thermostat TSL-XX-01 opens a set of closed contacts in the supply fan circuit, de-energizing the supply fan. The auxiliary contacts of the supply fan starter de-energize relay R-XX-05, and the contacts of relay R-XX-05 in the return fan starter circuit de-energize the return fan. A set of open contacts in low temperature protection thermostat TSL-XX-01 close, energizing relay R-XX-08 and lighting pilot light PL-XX-05. The contacts of relay R-XX-08 energize relays R-XX-10 and R-XX-11. One set of the contacts of relay R-XX-10 locks in relays R-XX-10 and R-XX-11, and another set de-energizes the supply fan. The contacts of relay R-XX-11 de-energize the return fan. To restart the fans after a low temperature shutdown, both the low temperature thermostat TSL-XX-01 and the control panel must be manually reset. The control panel is reset by momentarily depressing manual switch HS-XX-02.

(5) When smoke detector SMK-XX-01 or smoke detector SMK-XX-02 detects the presence of smoke, its normally closed contacts in the supply fan starter circuit open, de-energizing the supply fan. The auxiliary contacts of the supply fan starter de-energize relay R-XX-05, and the contacts of relay R-XX-05 in the return fan starter circuit de-energize the return fan. Its normally open contacts close, energizing relay R-XX-09. The normally open contacts of R-XX-09 close, energizing relays R-XX-10 and R-XX-11. One set of contacts of relay R-XX-10 locks in relays R-XX-10 and R-XX-11. The other set of the contacts of relay R-XX-10 de-energizes the supply fan, and the contacts of relay R-XX-11 de-energize the return fan. To restart the fans after a smoke alarm shutdown, smoke detectors SMK-XX-01 and/or SMK-XX-02 and the control panel must be manually reset. The control panel is reset by momentarily depressing manual switch HS-XX-02.

(6) Differential pressure gauge DPI-XX-01 across the filter gives local indication of filter loading. On a rise in pressure drop across the filter to its setpoint, differential pressure switch DPS-XX-01 turns on filter pilot light PL-XX-04.

(7) Temperature transmitter TT-XX-04 signals the cold duct discharge temperature to temperature controller TC-XX-02. During the ventilation delay and occupied modes, relay R-XX-06 is energized and its contacts close, allowing the TC-XX-02 signal to be received by current-to-pneumatic transducer IP-XX-02. The pneumatic output of IP-XX-02 modulates cooling coil valve VLV-XX-01 to maintain the setpoint of controller TC-XX-02. During the unoccupied mode, the contacts of relay R-XX-06 are open, cooling coil valve control is interrupted, and the valve closes.

(8) Hot duct temperature controller TC-XX-03, with its temperature transmitter TT-XX-05 in the heating coil discharge, modulates hot duct heating coil valve VLV-XX-02 to maintain its temperature setpoint. Controller TC-XX-04, with its temperature transmitter TT-XX-02 in the outside air, raises the setpoint of controller TC-XX-03 on a fall in outside air temperature, and lowers it on a rise in outside air temperature.

(9) On a rising space temperature, thermostat T-XX-XX modulates dual-duct box actuator DA-XX-XX to gradually close the box to the hot duct and gradually open it to the cold duct.

(10) When the occupied contacts of time clock CLK-XX-01 open to end the occupied mode and index the system to the unoccupied mode, relays R-XX-01 and R-XX-02 are de-energized and pilot light PL-XX-01 is turned off. The contacts of relay R-XX-02 open, de-energizing the supply fan and placing the system's night thermostat TSL-XX-02 in control of the supply fan, and, through interlock as previously described, in control of the return fan. On a fall in space temperature to 13 degrees C (55 degrees F), the contacts of TSL-XX-02 close, energizing both fans; on a rise in temperature to 16 degrees C (60 degrees F), the contacts open, de-energizing the fans.

d. Sequence of operation for DDC applications.

(1) Ventilation delay mode timing shall start prior to the occupied mode timing. During ventilation delay mode the dampers shall remain in their normal positions as shown, except when under economizer control. At the time shown, the DDC system shall place the system in the occupied mode. At the expiration of the ventilation delay mode timing period, the DDC system shall place the outside air, return air, and relief air dampers under mixed air temperature and economizer control. At the time shown, the DDC system shall place the control system in the unoccupied mode of operation and the dampers shall return to their normal positions as shown.

(2) During occupied and ventilation delay modes the supply fan and return fan shall operate continuously. During unoccupied mode the supply fan and the return fan shall cycle according to the night setback schedule. The fans shall start and stop at the setpoints as shown.

(3) A differential pressure switch across the filter shall initiate a filter alarm when the pressure drop across the filter exceeds the setpoint as shown.

(4) A freeze-stat, located as shown, shall stop the supply and return fans, cause the outside air, return air, and relief air dampers to return to their normal position, and shall initiate a low temperature alarm if the temperature drops below the freeze-stat's setpoint. Return to the normal mode of operation shall require manual reset at the freeze-stat. The DDC panel shall monitor the freeze-stat through auxiliary contacts and shall indicate an alarm condition when the freeze-stat trips.

(5) Smoke Detectors in the supply air and return air ductwork shall stop the supply fan and the return fan and initiate a smoke alarm if smoke is detected at either location. Restarting the fans shall require manual reset at the smoke detector.

(6) The DDC system shall modulate the heating coil control valve from the signal of a temperature sensing element and transmitter located in the discharge air of the coil to maintain the hot duct temperature setpoint. A temperature sensing element and transmitter in the outside air intake shall reset the hot duct temperature setpoint with respect to the outside air temperature signal in a linear schedule as shown.

(7) During occupied and ventilation delay modes, the cooling coil control valve shall be modulated by the DDC system from the signal of a temperature sensing element and transmitter located in the coil discharge air to maintain the cold duct temperature setpoint as shown. During the unoccupied mode, the cooling coil control valve shall remain closed.

(8) The DDC system shall accept the signal of an outside air temperature sensing element and transmitter and the signal of a return air temperature sensing element and transmitter. The DDC system shall perform switch over between outside air economizer control mode and minimum outside air mode. Until the outside air temperature rises above the setpoint, the DDC system shall hold the system in the minimum outside air mode. When the outside air temperature rises above the setpoint, the DDC system shall place the AHU in the economizer mode or in the minimum outside air mode as determined by a comparison of the outside air and return air temperatures in accordance with the differential temperature setpoints as shown. When the outside air temperature is low with respect to the return air temperature, the AHU shall be in the economizer mode. When the DDC system places the control system in the minimum outside air mode, the outside air damper shall be open to the minimum outdoor air setting.

When the DDC system places the system in the economizer mode, it shall modulate the dampers from the signal of a temperature sensing element and transmitter in the mixed air stream to maintain the setpoint as shown.

(9) A space temperature sensor for each zone shall signal the DDC system to gradually operate the control dampers of the dual-duct box to heat and cool its respective zone by mixing cold duct air and hot duct air to maintain the setpoint. On a rise in space temperature, the hot duct damper shall gradually close, and the cold duct damper shall gradually open.

20. BYPASS MULTIZONE HVAC CONTROL SYSTEM WITH RETURN FAN.

a. Description of the HVAC system. This is an air handling system with supply and return fans, economizer dampers, a cold deck with a cooling coil, a bypass deck, individual zone mixing dampers, and individual zone heating controls. Figures 4-16a through 4-16f show the control system design for this type of air handling system using a SLDC control panel. Figures 4-16g through 4-16j show the control system design for this type of air handling system using DDC controls. Since this system provides for a deadband between heating and cooling, the use of an economizer cycle does not have the problems associated with the previous two systems. A more detailed discussion is presented in chapter three.

Figure 4-16a. Control system schematic for bypass multizone HVAC system.

Figure 4-16b. Control system ladder diagram for bypass multizone HVAC system.

Figure 4-16c. Control system equipment for bypass multizone HVAC system.

Figure 4-16d. Control panel interior door layout for bypass multizone HVAC system.

Figure 4-16e. Control panel back panel layout for bypass multizone HVAC system.

Figure 4-16f. Control panel terminal block layout for bypass multizone HVAC system.

Figure 4-16g. DDC control system schematic for bypass multizone HVAC system.

Figure 4-16h. DDC control system ladder diagram for bypass multizone HVAC system.

Figure 4-16i. DDC control system equipment for bypass multizone HVAC system.

Figure 4-16j. DDC control system I/O table and data terminal strip layout for bypass multizone HVAC system.

b. General sequence of operation.

(1) Supply air and return air fans off. When the fans are off, the cooling coil valve, the outside air and relief air dampers are closed. The return air damper is open. Zone heating coil valves and dampers are under the control of their zone thermostats.

(2) Supply air and return air fans operating. When the fans are on, the control dampers and the cooling coil valve are operated as required by the system's mode of operation. Zone heating coil valves and dampers are under the control of their zone thermostats. The control dampers are either positioned for full recirculation of air, positioned to introduce minimum outside air, or modulated to maintain mixed air temperature. The cooling coil valve is either closed, or modulated to maintain cold deck temperature.

(3) Control of supply air and return air fans. Unless the fans are stopped as the result of a safety shutdown, they are on or off as required by the control system's mode of operation.

(4) Safety shutdown of the fans. The control system shuts down the fans if there is a low temperature condition, or if smoke is detected.

(5) Low temperature detection. On a fall in temperature to its setpoint, a low temperature protection thermostat stops the supply air and return air fans. To restart the fans, the thermostat and the control panel must be manually reset.

(6) Smoke detection. Duct smoke detectors stop the supply air and return air fans whenever either detects the presence of smoke. To restart the fans, the smoke detectors and control panel must be manually reset.

(7) Filter condition. Filter condition is monitored by a pressure gauge and a differential pressure switch. On a rise in pressure drop across the filter to the switch setpoint, the switch turns on a pilot light.

(8) Economizer control. When the control system modes of operation no longer require the outside air, return air, and relief air dampers to be in their full recirculation positions, the dampers are positioned to admit outside air for ventilation. The dampers then remain at minimum position until the economizer controller closes both its PV and DEV contacts. The economizer controller closes its PV contacts when the return air temperature indicates that the building requires cooling rather than heating. The economizer controller closes its DEV contacts when the outside air temperature is sufficiently below the return air temperature to be effective for cooling. When both these contacts close, the dampers are modulated by mixed air temperature control.

(9) Mixed air temperature control. A mixed air temperature controller with its temperature transmitter in the mixed air modulates the outside air and relief air dampers between minimum position and fully open, to maintain a mixed air temperature of 13 degrees C (55 degrees F). As the outside air and relief air dampers open, the return air damper closes.

(10) Cold deck temperature control. A cold deck temperature controller with its temperature transmitter in the cold deck discharge modulates the cooling coil valve to maintain its setpoint temperature. During the unoccupied mode, the cooling coil valve is not controlled and remains closed.

(11) Space temperature control. On a rise in temperature, each zone thermostat first modulates its zone reheat coil valve toward closed. On a further rise in temperature after a space temperature deadband, each zone thermostat modulates its cold deck damper toward open and simultaneously modulates its bypass damper toward closed.

(12) Unoccupied mode of operation. Throughout the unoccupied mode, the outside air and relief air dampers and the cooling coil valve remain closed, and the return air damper remains open. The supply and return fans are cycled by the system's night thermostat to maintain its low limit space temperature setpoint.

(13) Ventilation delay mode of operation. During the ventilation delay mode, the dampers remain as they were throughout the unoccupied mode, and the supply air and return air fans run continuously. Until the ventilation delay mode ends, return air is circulated, to bring the building to comfort conditions using a minimum of energy.

(14) Occupied mode of operation. The supply air and return air fans run continuously, and the outside air and relief air dampers are at minimum position or are under mixed air temperature control as previously described.

c. Detailed sequence of operation.

(1) Time clock CLK-XX-01 has two independent sets of contacts, which between them determine the mode under which the system operates. Five minutes before the scheduled beginning of the occupied mode, the ventilation delay contacts close, energizing relay R-XX-04 and lighting pilot light PL-XX-02. The normally closed contacts of relay R-XX-04 open, preventing relay R-XX-03 from being energized. The normally open contacts of relay R-XX-03 prevent any signal reaching current-to-pneumatic transducer IP-XX-01. Thus, the dampers remain in their normal positions with outside air and relief air dampers closed and return air damper open.

(2) When the timeclock's occupied contacts close, relays R-XX-01 and R-XX-02 are energized and pilot light PL-XX-01 is turned on. The contacts of relay R-XX-02 energize the supply fan. The auxiliary contacts of the supply fan energize relay R-XX-05 and, with contacts of relay R-XX-01, energize relay R-XX-06. The contacts of relay R-XX-06 places the cold deck temperature controller in control of cooling coil valve VLV-XX-01. The outside air and relief air dampers remain closed and the return air damper remains open.

(3) When the ventilation delay contacts of time clock CLK-XX-01 open to end the ventilation delay mode of operation, relay R-XX-04 is de-energized and pilot light PL-XX-02 is turned off. The normally closed contacts of relay R-XX-04, in series with the now closed but normally open contacts of relays R-XX-01 and R-XX-05, energize relay R-XX-03. The normally open contacts of relay R-XX-03 connect the output signal of high signal selector TY-XX-01 to current-to-pneumatic transducer IP-XX-01. The pneumatic output of transducer IP-XX-01 places the dampers at the minimum position set on minimum position switch MPS-XX-01, unless relay R-XX-07 energized. Economizer EC-XX-01 controls the action of relay R-XX-07. The economizer receives signals from outside air temperature transmitter TT-XX-02 and from return air transmitter TT-XX-03. The difference between the return air temperature and the outside air temperature controls the DEV contacts, and the return air temperature controls the PV contacts. When both these contacts are closed, relay R-XX-07 is energized and pilot light PL-XX-03 is turned on. When relay R-XX-07 is energized, its contacts connect the output of mixed air controller TC-XX-01 to high signal selector TY-XX-01 to modulate the outside air and return air dampers between minimum position and fully open while modulating the return air damper in the opposite direction to maintain the temperature controller setpoint.

(4) On a fall in temperature to its setpoint, low temperature protection thermostat TSL-XX-01 opens a set of closed contacts in the supply fan circuit, de-energizing the supply fan. The auxiliary contacts of the supply fan starter de-energize relay R-XX-05, and the contacts of relay R-XX-05 in the return fan starter circuit de-energize the return fan. A set of open contacts in low temperature protection thermostat TSL-XX-01 close, energizing relay R-XX-08 and lighting pilot light PL-XX-05. The contacts of relay R-XX-08 energize relays R-XX-10 and R-XX-11. One set of the contacts of relay R-XX-10 locks in relays R-XX-10 and R-XX-11, and another set de-energizes the supply fan. The contacts of relay R-XX-11 de-energize the return fan. To restart the fans after a low temperature shutdown, both the low

temperature thermostat TSL-XX-01 and the control panel must be manually reset. The control panel is reset by momentarily depressing manual switch HS-XX-02.

(5) When smoke detector SMK-XX-01 or smoke detector SMK-XX-02 detects the presence of smoke, its normally closed contacts in the supply fan starter circuit open, de-energizing the supply fan. The auxiliary contacts of the supply fan starter de-energize relay R-XX-05, and the contacts of relay R-XX-05 in the return fan starter circuit de-energize the return fan. Its normally open contacts close, energizing relay R-XX-09. The normally open contacts of R-XX-09 close, energizing relays R-XX-10 and R-XX-11. One set of the contacts of relay R-XX-10 locks in relays R-XX-10 and R-XX-11; the other set de-energizes the supply fan. The contacts of relay R-XX-11 de-energize the return fan. To restart the fans after a smoke alarm shutdown, smoke detectors SMK-XX-01 and/or SMK-XX-02 and the control panel must be manually reset. The control panel is reset by momentarily depressing manual switch HS-XX-02.

(6) A differential pressure gauge DPI-XX-01 across the filter gives local indication of filter loading. On a rise in pressure drop across the filter to its setpoint, differential pressure switch DPS-XX-01 turns on pilot light PL-XX-04.

(7) Temperature transmitter TT-XX-04 signals the cold deck discharge temperature to temperature controller TC-XX-02. During the ventilation delay and occupied modes, relay R-XX-06 is energized and its contacts close, allowing the TC-XX-02 signal to be received by current-to-pneumatic transducer IP-XX-02. The pneumatic output of IP-XX-02 modulates cooling coil valve VLV-XX-01 to maintain the setpoint of controller TC-XX-02. During the unoccupied mode, R-XX-06 is de-energized, cooling coil valve control is interrupted, and the valve closes.

(8) On a rising space temperature, thermostat T-XX-XX first modulates reheat coil valve VLV-XX-XX closed, through the auxiliary actuator driver (AAD) of damper actuator DA-XX-XX, and on a further temperature rise modulates DA-XX-XX to close the zone damper to the bypass duct and open it to the cold duct.

(9) When the occupied contacts of time clock CLK-XX-01 open to end the occupied mode and index the system to the unoccupied mode, relays R-XX-01 and R-XX-02 are de-energized, and pilot light PL-XX-01 is turned off. The contacts of relay R-XX-02 open, de-energizing the supply fan and placing the system's night thermostat TSL-XX-02 in control of the supply fan and, through interlock, in control of the return fan. On a fall in space temperature to 13 degrees C (55 degrees F), the contacts of TSL-XX-02 close, energizing both fans; on a rise in temperature to 16 degrees C (60 degrees F), the contacts open, de-energizing the fans.

d. Sequence of operation for DDC applications.

(1) Ventilation delay mode timing shall start prior to the occupied mode timing. During ventilation delay mode the dampers shall remain in their normal positions as shown, except when under economizer control. At the time shown, the DDC system shall place the system in the occupied mode. At the expiration of the ventilation delay mode timing period, the DDC system shall place the outside air, return air, and relief air dampers under mixed air temperature and economizer control. At the time shown, the DDC system shall place the control system in the unoccupied mode of operation and the dampers shall return to their normal positions as shown.

(2) During occupied and ventilation delay modes the supply fan and return fan shall operate continuously. During unoccupied mode the supply fan and the return fan shall cycle according to the night setback schedule. The fans shall start and stop at the setpoints as shown.

(3) A differential pressure switch across the filter shall initiate a filter alarm when the pressure drop across the filter exceeds the setpoint as shown.

(4) A freeze-stat, located as shown, shall stop the supply and return fans, cause the outside air, return air, and relief air dampers to return to their normal position, and shall initiate a low temperature alarm if the temperature drops below the freeze-stat's setpoint. Return to the normal mode of operation shall require manual reset at the freeze-stat. The DDC panel shall monitor the freeze-stat through auxiliary contacts and shall indicate an alarm condition when the freeze-stat trips.

(5) Smoke Detectors in the supply air and return air ductwork shall stop the supply fan and the return fan and initiate a smoke alarm if smoke is detected at either location. Restarting the fans shall require manual reset at the smoke detector.

(6) During occupied and ventilation delay modes, the cooling coil control valve shall be modulated by the DDC system from the signal of a temperature sensing element and transmitter located in the coil discharge air to maintain the cold duct temperature setpoint as shown. During the unoccupied mode, the cooling coil control valve shall remain closed.

(7) The DDC system shall accept the signal of an outside air temperature sensing element and transmitter and the signal of a return air temperature sensing element and transmitter. The DDC system shall perform switch over between outside air economizer control mode and minimum outside air mode. Until the return air temperature rises above the setpoint, the DDC system shall hold the system in the minimum outside air mode. When the return air temperature rises above the setpoint, the DDC system shall place the AHU in the economizer mode or in the minimum outside air mode as determined by a comparison of the outside air and return air temperatures in accordance with the differential temperature setpoints as shown. When the outside air temperature is low with respect to the return air temperature, the AHU shall be in the economizer mode. When the DDC system places the control system in the minimum outside air mode, the outside air damper shall be open to the minimum outdoor air setting. When the DDC system places the system in the economizer mode, it shall modulate the dampers from the signal of a temperature sensing element and transmitter in the mixed air stream to maintain the setpoint as shown.

(8) A space temperature sensor for each zone shall signal the DDC system to gradually operate the zone mixing damper and heating coil to heat and cool its respective zone by mixing cold deck air and bypass deck air to maintain the setpoint. On a rise in space temperature, the heating coil valve shall gradually close, and after a deadband as shown, the bypass deck damper shall gradually close and the cold deck damper shall gradually open.

21. VARIABLE AIR VOLUME (VAV) HVAC CONTROL SYSTEM WITHOUT RETURN FAN.

a. Description of the HVAC system. This is an air handling system with an inlet vane equipped supply fan, economizer dampers, filters, and cooling coil. Variable air volume (VAV) boxes, some of which have heating coils, are located downstream in the ductwork near the areas served by the system. Figures 4-17a through 4-17f show the control system design for this type of air handling system using a SLDC control panel. Figures 4-17g through 4-17j show the control system design for this type of air handling system using DDC controls.

Figure 4-17a. Control system schematic for VAV HVAC system without return fan.

Figure 4-17b. Control system ladder diagram for VAV HVAC system without return fan.

Figure 4-17c. Control system equipment for VAV HVAC system without return fan.

Figure 4-17d. Control panel interior door layout for VAV HVAC system without return fan.

Figure 4-17e. Control panel back panel layout for VAV HVAC system without return fan.

Figure 4-17f. Control panel terminal block layout for VAV HVAC system without return fan.

Figure 4-17g. DDC control system schematic for VAV HVAC system without return fan.

Figure 4-17h. DDC control system ladder diagram for VAV HVAC system without return fan.

Figure 4-17i. DDC control system equipment for VAV HVAC system without return fan.

Figure 4-17j. DDC control system I/O table and data terminal strip layout for VAV HVAC system without return fan.

b. General sequence of operation.

(1) Supply fan off. When the fan is off, the cooling coil valve and the outside air, relief air, and supply fan inlet vane dampers are closed. The return air damper is open.

(2) Supply fan operating. When the supply fan is on, the cooling coil valve and the control dampers are operated as required by the system's mode of operation. The control dampers are either positioned for full recirculation of air, positioned to introduce minimum outside air, or modulated to maintain the mixed air temperature. The cooling coil valve is either closed, or modulated to maintain unit discharge temperature.

(3) Control of supply fan. Unless the fan is stopped as the result of a safety shutdown, it is on or off as required by the control system's mode of operation. When the fan is on, the inlet vanes are modulated to maintain the required supply air static pressure.

(4) Safety shutdown of the fan. The control system shuts down the fan if there is a low temperature condition, if smoke is detected, or if a high static pressure condition is detected.

(5) Low temperature detection. On a fall in temperature to its setpoint, a freezestat stops the supply fan. To restart the fan, the freezestat and the control panel must be manually reset.

(6) Smoke detection. Duct smoke detectors stop the supply fan whenever either detects the presence of smoke. To restart the fan, the smoke detectors and the control panel must be manually reset.

(7) High static pressure detection. On a rise in static pressure above the setpoint of a high limit static pressure switch downstream of the supply fan, the fan stops. To restart the fan, the control panel must be manually reset.

(8) Filter condition. Filter conditions are monitored by a pressure gauge and a differential pressure switch. When the pressure drop across the filter exceeds the switch setpoint, the switch turns on a pilot light.

(9) Minimum Outside Air Flow Control. A minimum outside air flow controller accepts a signal from a outside air flow station transmitter. When the fan is on, with the control system in the occupied mode, and with the ventilation delay mode off, the outside air flow controller modulates the minimum outside air damper to maintain the control setpoint.

(10) Economizer control. The economizer controller closes its PV contacts when the return air temperature indicates that the building requires cooling rather than heating. The economizer controller closes its DEV contacts when the outside air temperature is sufficiently below the return air temperature to be effective for cooling. When both these contacts close, the dampers are modulated by the mixed air temperature controller.

(11) Mixed air temperature control. A mixed air temperature controller, with its temperature transmitter in the mixed air, modulates the economizer outside air damper, relief air damper, and the return air damper to maintain a mixed air temperature of 13 degrees C (55 degrees F). As the economizer outside air and relief air dampers open, the return air damper closes.

(12) Cooling coil temperature control. During the ventilation delay and occupied modes, a cooling coil temperature controller, with its temperature transmitter in the unit discharge air, modulates the cooling coil valve to maintain its setpoint temperature. During the unoccupied mode, the cooling coil valve is not controlled and remains closed.

(13) Space temperature control. Each controlled space is equipped with a variable air volume (VAV) box, which is controlled by a microprocessor based VAV box controller. The controller receives temperature signals from a temperature sensing element in the space served and from a flow sensor upstream of the VAV box. On a fall in space temperature, the controller modulates the damper toward minimum position, to maintain the cooling mode setpoint. After the minimum position is reached, the controller is inactive while the space temperature falls through a temperature deadband. On a further fall in temperature below the temperature deadband, the heating coil valve modulates to maintain the heating setpoint.

(14) Unoccupied mode of operation. Throughout the unoccupied mode, the outside air and relief air dampers and the cooling coil valve remain closed, and the return air damper remains open. The supply fan is cycled by the system's night thermostat to maintain its low limit space temperature setpoint.

(15) Ventilation delay mode of operation. During the ventilation delay mode, the dampers remain as they were throughout the unoccupied mode, and the supply fan runs continuously. Until the ventilation delay mode ends, return air is recirculated, to bring the building to comfort conditions using a minimum of energy.

(16) Occupied mode of operation. The supply fan runs continuously, the minimum outside air damper is modulated to maintain minimum outside air flow, and the economizer outside air and relief air dampers are either closed or are under mixed air temperature control as previously described.

c. Detailed sequence of operation.

(1) Timeclock CLK-XX-01 has two independent sets of contacts, which between them determine the mode of system operation. Five minutes before the scheduled beginning of the occupied mode, the ventilation delay contacts close, energizing relay R-XX-04 and lighting pilot light PL-XX-02. The normally closed contacts of relay R-XX-04 open, preventing relay R-XX-03 from being energized. The normally open contacts of relay R-XX-03 prevent any signal from reaching current-to-pneumatic transducers IP-XX-01 and IP-XX-04. Thus, the dampers remain in their normal positions, with outside air and relief air dampers closed and return air damper open.

(2) When the timeclock's occupied contacts close, relays R-XX-01 and R-XX-02 are energized and pilot light PL-XX-01 is turned on. The contacts of relay R-XX-02 energize the supply fan. The auxiliary contacts of the supply fan starter energize relay R-XX-05 and relay R-XX-07, and, with the contacts of relay R-XX-01, energize relay R-XX-06. The contacts of relay R-XX-05 are involved in the energizing of relay R-XX-03 when the ventilation delay mode of operation is over. The contacts of relay R-XX-06 enable discharge temperature controller TC-XX-02 to control cooling coil valve VLV-XX-01. The contacts of relay R-XX-07 enable control of the inlet guide vanes on the supply fan. The outside air and relief air dampers remain closed and the return air damper remains open.

(3) When the ventilation delay contacts of timeclock CLK-XX-01 open to end the ventilation delay mode of operation, relay R-XX-04 is de-energized and pilot light PL-XX-01 is turned off. The normally closed contacts of relay R-XX-04, in series with the now closed but normally open contacts of relays R-XX-01 and R-XX-05, energize relay R-XX-03. One pair of normally open contacts of relay R-XX-03 connect the output of the minimum outside air flow controller FC-XX-01 to current-to-pneumatic transducer IP-XX-04, allowing modulation of the minimum outside air damper to maintain the flow at setpoint. The other pair of normally open contacts of relay R-XX-03 connect the output signal of the mixed air temperature controller TC-XX-01 to current-to-pneumatic transducer IP-XX-01, if the normally open contacts of relay R-XX-08 are also closed. Economizer EC-XX-01 controls the action of relay R-XX-08. The economizer receives signals from outside air temperature transmitter TT-XX-02 and from return air transmitter TT-XX-03. The difference between the return air temperature and the outside air temperature controls the DEV contacts, and the return air temperature controls the PV contacts. When both these contacts are closed, relay R-XX-08 is energized and pilot light PL-XX-03 is turned on. When relays R-XX-03 and R-XX-08 are both energized, the output of mixed air controller TC-XX-01 is received by current-to-pneumatic transducer IP-XX-01 and the economizer outside air, relief air, and return air dampers are modulated to maintain the mixed air temperature controller setpoint.

(4) On a fall in temperature to its setpoint, low temperature protection thermostat TSL-XX-01 opens a set of closed contacts in the supply fan circuit, de-energizing the supply fan. A set of normally open contacts in low temperature protection thermostat TSL-XX-01 close, energizing relay R-XX-09 and lighting pilot light PL-XX-05. The contacts of relay R-XX-09 energize relay R-XX-12. One set of the contacts of relay R-XX-12 locks in relay R-XX-12, and another set de-energizes the supply fan. To restart the fan after a low temperature shutdown, both low temperature thermostat TSL-XX01 and the control panel must be manually reset. The control panel is reset by momentarily depressing manual switch HS-XX-03.

(5) When either smoke detector SMK-XX-01 or smoke detector SMK-XX-02 detects the presence of smoke, its normally closed contacts in the supply fan starter circuit open, de-energizing the supply fan. Its normally open contacts close, energizing relay R-XX-10 and turning on pilot light PL-XX-06. The normally open contacts of R-XX-10 close, energizing relay R-XX-12. One set of contacts of relay R-XX-12 locks in relay R-XX-12. The other set of contacts of relay R-XX-12 de-energizes the

supply fan. To restart the fans after a smoke alarm shutdown, smoke detectors SMK-XX-01 and/or SMK-XX-02 and the control panel must be manually reset. The control panel is reset by momentarily depressing manual switch HS-XX-03.

(6) Differential pressure gauge DPI-XX-01 across the filter provides local indication of filter loading. On a rise in pressure drop across the filter to its setpoint, differential pressure switch DPS-XX-01 turns on filter pilot light PL-XX-04.

(7) Differential pressure gauge DPI-XX-03 across the outside air filter provides local indication of filter loading. On a rise in pressure drop across the filter to its setpoint, differential pressure switch DPS-XX-03 turns on filter pilot light PL-XX-08.

(8) Temperature controller TC-XX-02, with its temperature transmitter TT-XX-04 in the unit discharge, through the contacts of relay R-XX-06 and current-to-pneumatic transducer IP-XX-02 modulates cooling coil valve VLV-XX-01 to maintain its temperature setpoint. The contacts of relay R-XX-06 are closed during the ventilation delay and occupied modes, allowing control. The contacts are open during the unoccupied mode, the cooling coil valve control signal is interrupted, and the valve remains closed.

(9) A pressure sensing element and transmitter DPT-XX-01 located in the supply duct (the location is determined by field conditions) signals duct static pressure to controller PC-XX-01. Whenever the supply fan runs, the auxiliary contacts of the fan starter energize relay R-XX-07. The output of pressure controller PC-XX-01 is sent, through the contacts of relay R-XX-07, to current-to-pneumatic transducer IP-XX-03. The pneumatic output of the transducer modulates the supply fan inlet vane actuator DA-XX-04 to maintain the pressure controller setpoint. When the fan is de-energized, relay R-XX-07 is de-energized, its contacts open, and the inlet vane dampers remain closed.

(10) When the setpoint of high limit static pressure switch DPS-XX-02 in the supply fan discharge is exceeded, its contacts close, energizing relay R-XX-11 and lighting high-static pilot light PL-XX-07. One set of the contacts of relay R-XX-11 locks in relay R-XX-11, and another set of contacts energizes relay R-XX-12. One set of the contacts of relay R-XX-12 locks in relay R-XX-12, and the other set of contacts de-energizes the supply fan. To restart the fan, manual switch HS-XX-02 must be momentarily depressed and then manual switch HS-XX-03 must be depressed.

(11) Temperature sensing element TE-XX-XX and air flow sensing element FE-XX-XX signal the VAV box controller to modulate reheat coil valve VLV-XX-XX and VAV box damper actuator DA-XX-XX. On a rising space temperature, the VAV box controller first gradually closes VLV-XX-XX and then, after the space temperature passes through a dead band, gradually opens the VAV box beyond minimum air flow position to maximum air flow position to maintain setpoint.

(12) When the occupied contacts of timeclock TC-XX-01 open to end the occupied mode and index the system to the unoccupied mode, relays R-XX-01 and R-XX-02 are de-energized and pilot light PL-XX-01 is turned off. The contacts of relay R-XX-02 open, de-energizing the supply fan and placing the system's night thermostat TSL-XX-02 in control of the supply fan. On a fall in space temperature to 13 degrees C (55 degrees F), the contacts of TSL-XX-02 close, energizing the supply fan; on a rise in temperature to 16 degrees C (60 degrees F), the contacts open, de-energizing the fan.

d. Sequence of operation for DDC applications

(1) Ventilation delay mode timing shall start prior to the occupied mode timing. During ventilation delay mode, the dampers shall remain in their normal positions as shown, except when under economizer control. At the time shown, the DDC system shall place the system in the occupied mode. At the expiration of the ventilation delay mode timing period, the DDC system shall place the minimum outside air damper under minimum outside air flow control and shall place the economizer outside air, return air, and relief air dampers under mixed air temperature and economizer control. At the time shown, the DDC system shall place the control system in the unoccupied mode of operation and all dampers shall return to their normal positions as shown.

(2) During occupied and ventilation delay modes the supply fan shall operate continuously. During unoccupied mode the supply fan shall cycle according to the night setback schedule. The fan shall start and stop at the setpoints as shown.

(3) When the supply fan starts, the DDC system shall modulate the inlet vanes from the signal of a static pressure sensing element and transmitter to maintain the setpoint as shown. A high limit static pressure switch in the fan discharge shall stop the supply fan and initiate a high static alarm when the static pressure exceeds the setpoint. When the fan is off, the inlet vanes shall be closed.

(4) A differential pressure switch across each filter shall initiate a filter alarm when the pressure drop across the filter reaches the setpoint as shown.

(5) A freezestat, located as shown, shall stop the supply fan, cause the outside air, return air, and relief air dampers to return to their normal position, and shall initiate a low temperature alarm if the temperature drops below the freezestat's setpoint as shown. The DDC system shall monitor the freezestat through auxiliary contacts and shall indicate an alarm condition when the freezestat trips.

(6) Smoke detectors in the supply air and return air ductwork shall stop the supply fan and initiate a smoke alarm if smoke is detected at either location. Restarting the supply fan shall require manual reset at the smoke detector.

(7) During occupied and ventilation delay modes, the cooling coil control valve shall be modulated by the DDC system from the signal of a temperature sensing element and transmitter located in the coil discharge air to maintain the setpoint as shown. During unoccupied mode, cooling coil control valve shall remain closed.

(8) Minimum Outside Air Flow Control. When the fan is on, with the control system in the occupied mode, and with the ventilation delay mode off, the minimum outside air damper shall be modulated to maintain the minimum outside air flow at setpoint, as sensed by an air flow measurement station located in the minimum outside air duct.

(9) The DDC system shall accept the signal of an outside air temperature sensing element and transmitter and the signal of a return air temperature sensing element and transmitter. When the return air temperature is above the economizer setpoint, and the outside air temperature is sufficiently below the return air temperature to be effective for cooling, the DDC system shall place the AHU in the economizer mode by modulating the economizer outside air, relief air, and the return air dampers to maintain the mixed air temperature at setpoint. As the economizer outside air and relief air dampers open, the return air damper closes. When the system is not in economizer mode, the economizer outside air and relief air dampers shall remain closed and the return air damper shall remain open.

(10) The control damper of the VAV box shall modulate in response to the signal from a flow sensing element at the discharge or inlet of the VAV box to a microprocessor based VAV box velocity controller. The velocity controller shall control the box damper from the minimum flow position to the full flow position from the signal of a space temperature sensing element located as shown. When the space temperature decreases, the damper shall gradually close to the minimum flow position to maintain the cooling setpoint as shown. When the space temperature calls for heating after the minimum flow position is reached, control shall then pass through a temperature dead band as shown. When the space temperature has dropped through the dead band, the duct heater coil shall be gradually controlled to maintain the heating setpoint as shown.

22. VARIABLE AIR VOLUME (VAV) HVAC CONTROL SYSTEM WITH RETURN FAN.

a. Description of the HVAC system. This is an air handling system with inlet vane equipped supply and return fans, economizer dampers, filters, and cooling coil. Variable air volume (VAV) boxes, some of which have heating coils, are located downstream in the ductwork near the areas served by the system. Figures 4-18a through 4-18f show the control system design for this type of air handling system using a SLDC control panel. Figures 4-18g through 4-18j show the control system design for this type of air handling system using DDC controls. A variation of this system which uses variable speed drives instead of inlet guide vanes is shown in the following chapter. The return fan volume control loop is costly, complex, and, in some applications, difficult to control with stability. A return fan should be used in a VAV system only when absolutely necessary. The need for a return fan can be reduced by keeping return duct losses to a minimum using a plenum or making the return duct as short and as large as possible.

Figure 4-18a. Control system schematic for VAV HVAC system with return fan.

Figure 4-18b. Control system ladder diagram for VAV HVAC system with return fan.

Figure 4-18c. Control system equipment for VAV HVAC system with return fan.

Figure 4-18d. Control panel interior door layout for VAV HVAC system with return fan.

Figure 4-18e. Control panel back panel layout for VAV HVAC system with return fan.

Figure 4-18f. Control panel terminal block layout for VAV HVAC system with return fan.

Figure 4-18g. DDC control system schematic for VAV HVAC system with return fan.

Figure 4-18h. DDC control system ladder diagram for VAV HVAC system with return fan.

Figure 4-18i. DDC control system equipment for VAV HVAC system with return fan.

Figure 4-18j. DDC control system I/O table and data terminal strip layout for VAV HVAC system with return fan.

b. General sequence of operation.

(1) Supply and return fans off. When the fans are off, the cooling coil valve and the outside air, relief air, supply fan inlet vane, and return fan inlet vane dampers are closed. The return air damper is open.

(2) Supply and return fans operating. When the fans are on, the cooling coil valve and the control dampers are operated as required by the system's mode of operation. The control dampers are either positioned for full recirculation of air, positioned to introduce minimum outside air, or modulated to maintain mixed air temperature. The cooling coil valve is either closed, or modulated to maintain unit discharge temperature.

(3) Control of supply and return fans. Unless the fans are stopped as the result of a safety shutdown, they are on or off as required by the control system's mode of operation. When the fans are on, the inlet vanes are modulated to maintain the required supply air static pressure and return air flow.

(4) Safety shutdown of the fans. The control system shuts down the fans if there is a low temperature condition, if smoke is detected, or if a high static pressure condition is detected.

(5) Low temperature detection. On a fall in temperature to its setpoint, a freezestat stops the supply and return fans. To restart the fans, the freezestat and the control panel must be manually reset.

(6) Smoke detection. Duct smoke detectors stop the supply and return fans whenever either detects the presence of smoke. To restart the fans, the smoke detectors and the control panel must be manually reset.

(7) High static pressure detection. On a rise in static pressure above the setpoint of a high limit static pressure switch downstream of the supply fan, the fans stop. To restart the fans, the control panel must be manually reset.

(8) Filter condition. Filter conditions are monitored by a pressure gauge and a differential pressure switch. When the pressure drop across the filter exceeds the switch setpoint, the switch turns on a pilot light.

(9) Minimum Outside Air Flow Control. A minimum outside air flow controller accepts a signal from a outside air flow station transmitter. When the fans are on, with the control system in the occupied mode, and with the ventilation delay mode off, the outside air flow controller modulates the minimum outside air damper to maintain the control setpoint.

(10) Economizer control. The economizer controller closes its PV contacts when the return air temperature indicates that the building requires cooling rather than heating. The economizer controller closes its DEV contacts when the outside air temperature is sufficiently below the return air temperature to be effective for cooling. When both these contacts close, the dampers are modulated by the mixed air temperature controller.

(11) Mixed air temperature control. A mixed air temperature controller, with its temperature transmitter in the mixed air, modulates the economizer outside air damper, relief air damper, and the return air damper to maintain a mixed air temperature of 13 degrees C (55 degrees F). As the economizer outside air and relief air dampers open, the return air damper closes.

(12) Cooling coil temperature control. During the ventilation delay and occupied modes, a cooling coil temperature controller, with its temperature transmitter in the unit discharge air, modulates

the cooling coil valve to maintain its setpoint temperature. During the unoccupied mode, the cooling coil valve is not controlled and remains closed.

(13) Space temperature control. Each controlled space is equipped with a variable air volume (VAV) box, which is controlled by a microprocessor based VAV box controller. The controller receives temperature signals from a temperature sensing element in the space served and from a flow sensor upstream of the VAV box. On a fall in space temperature, the controller modulates the damper toward minimum position, to maintain the cooling mode setpoint. After the minimum position is reached, the controller is inactive while the space temperature falls through a temperature deadband. On a further fall in temperature below the temperature deadband, the heating coil valve modulates to maintain the heating setpoint.

(14) Unoccupied mode of operation. Throughout the unoccupied mode, the outside air and relief air dampers and the cooling coil valve remain closed, and the return air damper remains open. The supply and return fans are cycled in unison by the system's night thermostat to maintain its low limit space temperature setpoint.

(15) Ventilation delay mode of operation. During the ventilation delay mode, the dampers remain as they were throughout the unoccupied mode, and the supply and return fans run continuously. Until the ventilation delay mode ends, return air is recirculated, to bring the building to comfort conditions using a minimum of energy.

(16) Occupied mode of operation. The supply and return fans run continuously, the minimum outside air damper is modulated to maintain minimum outside air flow, and the economizer outside air and relief air dampers are either closed or are under mixed air temperature control as previously described.

c. Detailed sequence of operation.

(1) Timeclock CLK-XX-01 has two independent sets of contacts, which between them determine the mode of system operation. Five minutes before the scheduled beginning of the occupied mode, the ventilation delay contacts close, energizing relay R-XX-04 and lighting pilot light PL-XX-02. The normally closed contacts of relay R-XX-04 open, preventing relay R-XX-03 from being energized. The normally open contacts of relay R-XX-03 prevent any signal from reaching current-to-pneumatic transducers IP-XX-01 and IP-XX-05. Thus, the dampers remain in their normal positions, with outside air and relief air dampers closed and return air damper open.

(2) When the timeclock's occupied contacts close, relays R-XX-01 and R-XX-02 are energized and pilot light PL-XX-01 is turned on. The contacts of relay R-XX-02 energize the supply fan. The auxiliary contacts of the supply fan starter energize relay R-XX-05, and relay R-XX-07, and, with the contacts of relay R-XX-01, energize relay R-XX-06. One set of contacts of relay R-XX-05 energizes the return fan. The other set of contacts (line 4) is involved in the energizing of relay R-XX-03 when the ventilation delay mode of operation is over. The contacts of relay R-XX-06 enable discharge temperature controller TC-XX-02 to control cooling coil valve VLV-XX-01. The contacts of relay R-XX-07 enable control of the inlet guide vanes on the supply and return fans. The outside air and relief air dampers remain closed and the return air damper remains open.

(3) When the ventilation delay contacts of timeclock CLK-XX-01 open to end the ventilation delay mode of operation, relay R-XX-04 is de-energized and pilot light PL-XX-01 is turned off. The normally closed contacts of relay R-XX-04, in series with the now closed but normally open contacts of

relays R-XX-01 and R-XX-05, energize relay R-XX-03. One pair of normally open contacts of relay R-XX-03 connect the output of the minimum outside air flow controller FC-XX-02 to current-to-pneumatic transducer IP-XX-05, allowing modulation of the minimum outside air damper to maintain the flow at setpoint. The other pair of normally open contacts of relay R-XX-03 connect the output signal of the mixed air temperature controller TC-XX-01 to current-to-pneumatic transducer IP-XX-01, if the normally open contacts of relay R-XX-08 are also closed. Economizer EC-XX-01 controls the action of relay R-XX-08. The economizer receives signals from outside air temperature transmitter TT-XX-02 and from return air transmitter TT-XX-03. The difference between the return air temperature and the outside air temperature controls the DEV contacts, and the return air temperature controls the PV contacts. When both these contacts are closed, relay R-XX-08 is energized and pilot light PL-XX-03 is turned on. When relays R-XX-03 and R-XX-08 are both energized, the output of mixed air controller TC-XX-01 is received by current-to-pneumatic transducer IP-XX-01 and the economizer outside air, relief air, and return air dampers are modulated to maintain the mixed air temperature controller setpoint.

(4) On a fall in temperature to its setpoint, low temperature protection thermostat TSL-XX-01 opens a set of closed contacts in the supply fan circuit, de-energizing the supply fan. The auxiliary contacts of the supply fan starter de-energize relay R-XX-05, and the contacts of relay R-XX-05 in the return fan starter circuit de-energize the return fan. A set of normally open contacts in low temperature protection thermostat TSL-XX-01 close, energizing relay R-XX-09 and lighting pilot light PL-XX-05. The contacts of relay R-XX-09 energize relay R-XX-12 and relay R-XX-13. One set of the contacts of relay R-XX-12 locks in relays R-XX-12 and R-XX-13, and the normally closed contacts of R-XX-12 de-energize the supply fan. The normally closed contacts of R-XX-13 in the return fan starter circuit de-energize the return fan. To restart the fans after a low temperature shutdown, both low temperature thermostat TSL-XX-01 and the control panel must be manually reset. The control panel is reset by momentarily depressing manual switch HS-XX-03.

(5) When either smoke detector SMK-XX-01 or smoke detector SMK-XX-02 detects the presence of smoke, its normally closed contacts in the supply fan starter circuit open, de-energizing the supply fan. Its normally open contacts close, energizing relay R-XX-10 and turning on pilot light PL-XX-06. The normally open contacts of R-XX-10 close, energizing relays R-XX-12 and R-XX-13. One set of contacts of relay R-XX-12 locks in relays R-XX-12 and R-XX-13. The other set of contacts of R-XX-12 de-energizes the supply fan, and the contacts of relay R-XX-13 de-energize the return fan. To restart the fans after a smoke alarm shutdown, smoke detectors SMK-XX-01 and/or SMK-XX-02 and the control panel must be manually reset. The control panel is reset by momentarily depressing manual switch HS-XX-03.

(6) Differential pressure gauge DPI-XX-01 across the filter provides local indication of filter loading. On a rise in pressure drop across the filter to its setpoint, differential pressure switch DPS-XX-01 turns on filter pilot light PL-XX-04.

(7) Differential pressure gauge DPI-XX-03 across the outside air filter provides local indication of filter loading. On a rise in pressure drop across the filter to its setpoint, differential pressure switch DPS-XX-03 turns on filter pilot light PL-XX-08.

(8) Temperature controller TC-XX-02, with its temperature transmitter TT-XX-04 in the unit discharge, through the contacts of relay R-XX-06 and current-to-pneumatic transducer IP-XX-02 modulates cooling coil valve VLV-XX-01 to maintain its temperature setpoint. The contacts of relay R-XX-06 are closed during the ventilation delay and occupied modes, allowing control. The contacts are open during the unoccupied mode, the cooling coil valve control signal is interrupted, and the valve remains closed.

(9) A pressure sensing element and transmitter DPT-XX-01 located in the supply duct (the location is determined by field conditions) signals duct static pressure to controller PC-XX-01. Whenever the supply fan runs, the auxiliary contacts of the fan starter energize relay R-XX-07. The output of pressure controller PC-XX-01 is sent, through the contacts of relay R-XX-07, to current-to-pneumatic transducer IP-XX-03. The pneumatic output of the transducer modulates the supply fan inlet vane actuator DA-XX-04 to maintain the pressure controller setpoint. When the fan is de-energized, relay R-XX-07 is de-energized, its contacts open, and the inlet vane dampers remain closed.

(10) When the setpoint of high limit static pressure switch DPS-XX-02 in the supply fan discharge is exceeded, its contacts close, energizing relay R-XX-11 and lighting high-static pilot light PL-XX-07. One set of the contacts of relay R-XX-11 locks in relay R-XX-11, and another set of contacts energizes relays R-XX-12 and R-XX-13. One set of the contacts of relay R-XX-12 locks in relays R-XX-12 and R-XX-13, and the other set of contacts de-energizes the supply fan. The contacts of relay R-XX-13 de-energize the return fan. To restart the fans, manual switch HS-XX-02 must be momentarily depressed and then manual switch HS-XX-03 must be depressed.

(11) Air flow measuring station AFMA-XX-01 and flow transmitter FT-XX-01, located in the supply air duct, and air flow measuring station AFMA-XX-02 and flow transmitter FT-XX-02, located in the return air duct, send flow signals to flow controller FC-XX-01. The output of FC-XX-01, through the contacts of relay R-XX-07, is sent to current-to-pneumatic transducer IP-XX-04. The pneumatic output of IP-XX-04 modulates the return fan inlet vane dampers to maintain the constant differential air volume between the supply and return fans set on controller FC-XX-01. When the fans are de-energized, relay R-XX-07 is de-energized, its contacts open, breaking the control loop, and the return fan inlet vanes remain closed.

(12) Temperature sensing element TE-XX-XX and air flow sensing element FE-XX-XX signal the VAV box controller to modulate reheat coil valve VLV-XX-XX and VAV box damper actuator DA-XX-XX. On a rising space temperature, the VAV box controller first gradually closes VLV-XX-XX and then, after the space temperature passes through a dead band, gradually opens the VAV box beyond minimum air flow position to maximum air flow position to maintain setpoint.

(13) When the occupied contacts of timeclock TC-XX-01 open to end the occupied mode and index the system to the unoccupied mode, relays R-XX-01 and R-XX-02 are de-energized and pilot light PL-XX-01 is turned off. The contacts of relay R-XX-02 open, de-energizing the supply fan and placing the system's night thermostat TSL-XX-02 in control of the supply fan, and, through the supply fan auxiliary contacts and relay R-XX-05, in control of the return fan. On a fall in space temperature to 13 degrees C (55 degrees F), the contacts of TSL-XX-02 close, energizing both fans; on a rise in temperature to 16 degrees C (60 degrees F), the contacts open, de-energizing the fans.

d. Sequence of operation for DDC applications

(1) Ventilation delay mode timing shall start prior to the occupied mode timing. During ventilation delay mode, the dampers shall remain in their normal positions as shown, except when under economizer control. At the time shown, the DDC system shall place the system in the occupied mode. At the expiration of the ventilation delay mode timing period, the DDC system shall place the minimum outside air damper under minimum outside air flow control and shall place the economizer outside air, return air, and relief air dampers under mixed air temperature and economizer control. At the time shown, the DDC system shall place the control system in the unoccupied mode of operation and all dampers shall return to their normal positions as shown.

(2) During occupied and ventilation delay modes the supply fan and return fan shall operate continuously. During unoccupied mode the supply fan and the return fan shall cycle according to the night setback schedule. The fans shall start and stop at the setpoints as shown.

(3) When the supply fan starts, the DDC system shall modulate the inlet vanes from the signal of a static pressure sensing element and transmitter to maintain the setpoint as shown. A high limit static pressure switch in the fan discharge shall stop the supply fan and the return fan and initiate a high static alarm when the static pressure exceeds the setpoint. When the fans are off, the inlet vanes shall be closed.

(4) When the return fan starts, the DDC system shall modulate the return fan inlet vanes from the signals of an air flow measurement station and transmitter in the return air ductwork, in combination with an air flow measurement station and transmitter in the supply air ductwork, to maintain a constant difference between supply air and return air flow rates as shown.

(5) A differential pressure switch across each filter shall initiate a filter alarm when the pressure drop across the filter reaches the setpoint as shown.

(6) A freezestat, located as shown, shall stop the supply and return fans, cause the outside air, return air, and relief air dampers to return to their normal position, and shall initiate a low temperature alarm if the temperature drops below the freezestat's setpoint as shown. The DDC system shall monitor the freezestat through auxiliary contacts and shall indicate an alarm condition when the freezestat trips.

(7) Smoke detectors in the supply air and return air ductwork shall stop the supply fan and the return fan and initiate a smoke alarm if smoke is detected at either location. Restarting the supply fan and the return fan shall require manual reset at the smoke detector.

(8) During occupied and ventilation delay modes, the cooling coil control valve shall be modulated by the DDC system from the signal of a temperature sensing element and transmitter located in the coil discharge air to maintain the setpoint as shown. During unoccupied mode, cooling coil control valve shall remain closed.

(9) Minimum Outside Air Flow Control. When the fans are on, with the control system in the occupied mode, and with the ventilation delay mode off, the minimum outside air damper shall be modulated to maintain the minimum outside air flow at setpoint, as sensed by an air flow measurement station located in the minimum outside air duct.

(10) The DDC system shall accept the signal of an outside air temperature sensing element and transmitter and the signal of a return air temperature sensing element and transmitter. When the return air temperature is above the economizer setpoint, and the outside air temperature is sufficiently below the return air temperature to be effective for cooling, the DDC system shall place the AHU in the economizer mode by modulating the economizer outside air, relief air, and the return air dampers to maintain the mixed air temperature at setpoint. As the economizer outside air and relief air dampers open, the return air damper closes. When the system is not in economizer mode, the economizer outside air and relief air dampers shall remain closed and the return air damper shall remain open.

(11) The control damper of the VAV box shall modulate in response to the signal from a flow sensing element at the discharge or inlet of the VAV box to a microprocessor based VAV box velocity controller. The velocity controller shall control the box damper from the minimum flow position to the full flow position from the signal of a space temperature sensing element located as shown. When the space

temperature decreases, the damper shall gradually close to the minimum flow position to maintain the cooling setpoint as shown. When the space temperature calls for heating after the minimum flow position is reached, control shall then pass through a temperature dead band as shown. When the space temperature has dropped through the dead band, the duct heater coil shall be gradually controlled to maintain the heating setpoint as shown.

23. SINGLE ZONE HVAC CONTROL SYSTEM.

a. Description of the HVAC system. The air handling system consists of a supply fan, economizer dampers, filter, heating coil, and cooling coil. Figures 4-19a through 4-19f show the control system design for this type of air handling system using a SLDC control panel. Figures 4-19g through 4-19j show the control system design for this type of air handling system using DDC controls.

Figure 4-19a. Control system schematic for single zone HVAC system.

Figure 4-19b. Control system ladder diagram for single zone HVAC system.

Figure 4-19c. Control system equipment for single zone HVAC system.

Figure 4-19d. Control panel interior door layout for single zone HVAC system.

Figure 4-19e. Control panel back panel layout for single zone HVAC system.

Figure 4-19f. Control panel terminal block layout for single zone HVAC system.

Figure 4-19g. DDC control system schematic for single zone HVAC system.

Figure 4-19h. DDC control system ladder diagram for single zone HVAC system.

Figure 4-19i. DDC control system equipment for single zone HVAC system.

Figure 4-19j. DDC control system I/O table and data terminal strip layout for single zone HVAC system.

b. General sequence of operation.

(1) Supply fan off. When the fan is off, the cooling coil valve and the outside air and relief air dampers are closed, and the return air damper is open. The heating coil valve remains under space temperature control.

(2) Supply fan operating. When the fan is on, the control dampers and the cooling coil valve are operated as required by the system's operational modes. The control dampers are positioned for full recirculation of air, positioned to introduce minimum outside air, or modulated to maintain space temperature. The cooling coil valve is either closed, or modulated to maintain space temperature.

(3) Control of supply fan. Unless the fan is stopped as the result of a safety shutdown, it is on or off as required by the control system mode of operation.

- (4) Safety shutdown of the fan. The control system shuts down the fan if there is a low temperature condition, or if smoke is detected.
- (5) Low temperature detection. On a fall in temperature to its setpoint, a low temperature protection thermostat stops the supply fan. To restart the fan, the thermostat and the control panel must be manually reset.
- (6) Smoke detection. Duct smoke detectors stop the supply fan whenever either detects the presence of smoke. To restart the fan, the smoke detectors and control panel must be manually reset.
- (7) Filter condition. Filter condition is monitored by a pressure gauge and a differential pressure switch. When the rise in pressure drop across the filter reaches the switch setpoint, the switch turns on a pilot light.
- (8) Economizer control. When the system does not need full return air recirculation, the dampers are set at minimum position until the economizer controller closes both its PV and DEV contacts. The economizer controller closes its PV contacts when the return air temperature indicates that the building requires cooling rather than heating. The economizer controller closes its DEV contacts when the outside air temperature is sufficiently below the return air temperature to be effective for cooling. When both these contacts close, the dampers are modulated as part of the space temperature control.
- (9) Space temperature control. On a rise in space temperature, the heating coil valve is modulated toward closed. On a further rise in temperature, the outside air and relief air dampers are modulated from minimum position toward fully open while the return air damper is modulated toward fully closed. On a still further rise in space temperature, the cooling coil valve is modulated toward open. The reverse occurs on a fall in temperature.
- (10) Unoccupied mode of operation. Throughout the unoccupied mode, the outside air and relief air dampers and the cooling coil valve remain closed, and the return air damper remains open. The supply fan is cycled by the system's night thermostat to maintain its low limit space temperature setpoint.
- (11) Ventilation delay mode of operation. During the ventilation delay mode, the dampers remain as they were throughout the unoccupied mode, and the supply fan runs continuously. Until the ventilation delay mode ends, return air is circulated, to bring the space to comfort conditions using a minimum of energy. Heating coil and cooling coil valves are under space temperature control.
- (12) Occupied mode of operation. The supply fan runs continuously, and the outside air and relief air dampers are at a minimum position or are under space temperature control as previously described.

c. Detailed sequence of operation.

- (1) Timeclock CLK-XX-01 has two independent sets of contacts, which between them determine the mode of system operation. Five minutes before the scheduled beginning of the occupied mode, the ventilation delay contacts close, energizing relay R-XX-04 and lighting pilot light PL-XX-02. The normally closed contacts of relay R-XX-04 open, preventing relay R-XX-03 from being energized. The normally

open contacts of relay R-XX-03 prevent any signal from reaching current-to-pneumatic transducer IP-XX-01. Thus, the dampers remain in their normal positions, with outside air and relief air dampers closed and return air damper open.

(2) When the timeclock's occupied contacts close, relays R-XX-01 and R-XX-02 are energized, and pilot light PL-XX-01 is turned on. The contacts of relay R-XX-02 energize the supply fan. The auxiliary contacts of the supply fan starter energize relay R-XX-05 and, with the contacts of relay R-XX-01, energizes pneumatic valve EP-XX-01, which allows the space temperature controller to control cooling coil valve VLV-XX-02. Temperature setpoint device TSP-XX-01 provides the means for adjusting the setpoint of space temperature controller TC-XX-01.

(3) When the ventilation delay contacts of timeclock CLK-XX-01 open to end the ventilation delay mode of operation, relay R-XX-04 is de-energized and pilot light PL-XX-02 is turned off. The contacts of relay R-XX-04, in series with the now closed but normally open contacts of relays R-XX-01 and R-XX-05, energize relay R-XX-03. The contacts of relay R-XX-03 connect the output signal of high signal selector TY-XX-01 to current-to-pneumatic transducer IP-XX-01. The pneumatic output of transducer IP-XX-01 places the dampers at minimum position unless relay R-XX-06 is energized. Economizer controller EC-XX-01 controls the action of relay R-XX-06. The economizer receives signals from outside air temperature transmitter TT-XX-01 and from return air transmitter TT-XX-02. The difference between the return air temperature and the outside air temperature controls the DEV contacts, and the return air temperature controls the PV contacts. When both these contacts are closed, relay R-XX-06 is energized, and pilot light PL-XX-03 is turned on. The contacts of relay R-XX-06 close, allowing the space temperature controller TC-XX-01 signal to modulate the dampers beyond minimum position.

(4) Space temperature proportional only controller TC-XX-01, with its temperature transmitter TT-XX-03, on a rise in space temperature modulates the heating coil valve toward closed. On a further rise in temperature, it modulates the outside air and relief air dampers from minimum position toward fully open while modulating the return air damper toward closed. On a still further rise in temperature, the cooling coil valve is modulated toward fully open. The reverse occurs on a fall in temperature. Whenever the economizer controller de-energizes relay R-XX-06, the dampers revert to the minimum position set on minimum position switch MPS-XX-01. At the conclusion of the occupied mode, relay R-XX-01 is de-energized and, through its contacts, relay R-XX-03 is de-energized, closing the dampers; pneumatic valve EP-XX-01 is de-energized closing cooling coil valve VLV-XX-02. Heating coil valve VLV-XX-01 is always under the control of temperature controller TC-XX-01.

(5) On a fall in temperature to its setpoint, low temperature protection thermostat TSL-XX-01 opens its set of closed contacts in the supply fan circuit, de-energizing the supply fan. A set of open contacts in low temperature protection thermostat TSL-XX-01 closes, energizing relay R-XX-07 and lighting pilot light PL-XX-05. The contacts of relay R-XX-07 energize relay R-XX-09. One set of the contacts of relay R-XX-09 locks in relay R-XX-09, and the other set de-energizes the supply fan. To restart the fan after shutdown, both low temperature thermostat TSL-XX-01 and the control panel must be manually reset. The control panel is reset by momentarily depressing manual switch HS-XX-02.

(6) When smoke detector SMK-XX-01 or smoke detector SMK-XX-02 detects the presence of smoke, its normally closed contacts in the supply fan starting circuit open, de-energizing the supply fan. The normally open contacts of the smoke detector(s) close, energizing relay R-XX-08 and lighting smoke pilot light PL-XX-06. The contacts of relay R-XX-08 energize relay R-XX-09. One set of the contacts of

relay R-XX-09 closes to lock in R-XX-09, and the other set of contacts, in the supply fan starter circuit, opens. To restart the fan, the smoke detectors must be manually reset and the HVAC panel must also be reset by depressing momentary switch HS-XX-02.

(7) Differential pressure gauge DPI-XX-01 across the filter provides local indication of filter loading. On a rise in pressure drop across the filter to its setpoint, differential pressure switch DPS-XX-01 turns on pilot light PL-XX-04.

(8) When the occupied contacts of timeclock TC-XX-01 open to end the occupied mode and index the system to the unoccupied mode, relays R-XX-01 and R-XX-02 are de-energized and pilot light PL-XX-01 is turned off. The contacts of relay R-XX-02 open, de-energizing the supply fan and placing the system's night thermostat TSL-XX-02 in control of the supply fan. On a fall in space temperature to 13 degrees C (55 degrees F), the contacts of TSL-XX-02 close, energizing the fan; on a rise in temperature to 16 degrees C (60 degrees F), the contacts open, de-energizing the fan.

d. Sequence of operation for DDC applications.

(1) Ventilation delay mode timing shall start prior to the occupied mode timing. During ventilation delay mode the dampers shall remain in their normal positions as shown, except when under economizer control. At the time shown, the DDC system shall place the system in the occupied mode. At the expiration of the ventilation delay mode timing period, the DDC system shall place the outside air, return air, and relief air dampers under space temperature and economizer control. At the time shown, the DDC system shall place the control system in the unoccupied mode of operation and the dampers shall return to their normal positions as shown.

(2) During occupied and ventilation delay modes the supply fan shall operate continuously. During unoccupied mode the supply fan shall cycle according to the night setback schedule. The fan shall start and stop at the setpoints as shown.

(3) A differential pressure switch across the filter shall initiate a filter alarm when the pressure drop across the filter exceeds the setpoint as shown.

(4) A freezestat, located as shown, shall stop the supply fan, cause the outside air, return air, and relief air dampers to return to their normal position, and shall initiate a low temperature alarm if the temperature drops below the freezestat's setpoint. Return to the normal mode of operation shall require manual reset at the freezestat. The DDC panel shall monitor the freezestat through auxiliary contacts and shall indicate an alarm condition when the freezestat trips.

(5) Smoke Detectors in the supply air and return air ductwork shall stop the supply fan and initiate a smoke alarm if smoke is detected at either location. Restarting the supply fan shall require manual reset at the smoke detector.

(6) The DDC system shall accept the signal of an outside air temperature sensing element and transmitter and the signal of a return air temperature sensing element and transmitter. The DDC system shall perform switch over between outside air economizer control mode and minimum outside air mode. Until the outside air temperature rises above the setpoint, the DDC system shall hold the system in the minimum outside air mode. When the outside air temperature rises above the setpoint, the DDC system shall place the AHU in the economizer mode or in the minimum outside air mode as determined by a comparison of the outside air and return air temperatures in accordance with the differential temperature setpoints as shown. When the outside air temperature is low with respect to the return air temperature,

the AHU shall be in the economizer mode. When the DDC system places the control system in the minimum outside air mode, the outside air damper shall be open to the minimum outdoor air setting. When the DDC system places the system in the economizer mode, the dampers shall be modulated to admit additional outside air to maintain the space temperature setpoint as shown.

(7) Space temperature control shall be maintained as follows.

(a) During unoccupied mode, the dampers shall remain in their normal positions as shown and the cooling coil valve shall remain closed. The supply fan shall be cycled by the system's night thermostat and the heating coil valve shall be modulated to maintain the space temperature low limit setpoint.

(b) During occupied mode, the supply fan shall run continuously and the heating and cooling coil valves shall be under space temperature control. While the system is in ventilation delay mode, the dampers shall remain in their normal position unless the system is also calling for economizer operation. When the DDC system is in economizer mode, on a rise in space temperature, the DDC system shall first gradually close the heating coil valve. After passing through a deadband, the outside air damper shall be modulated to admit outside air beyond the minimum quantity and after the outside air damper is fully open the cooling coil valve shall be modulated to maintain the space temperature setpoint. When the system is in the minimum outside air mode, the dampers shall remain in the minimum outside air position and the heating and cooling coil valves shall be modulated in sequence to maintain the space temperature setpoint.

24. DUAL-TEMPERATURE COIL SINGLE ZONE HVAC CONTROL SYSTEM.

a. Description of the HVAC system. This air handling system consists of a supply fan, economizer dampers, filter, and dual-temperature coil. Figures 4-20a through 4-20f show the control system design for this type of air handling system using a SLDC control panel. Figures 4-20g through 4-20j show the control system design for this type of air handling system using DDC controls.

Figure 4-20a. Control system schematic for single zone HVAC system with dual-temperature coil.

Figure 4-20b. Control system ladder diagram for single zone HVAC system with dual-temperature coil.

Figure 4-20c. Control system equipment for single zone HVAC system with dual-temperature coil.

Figure 4-20d. Control panel interior door layout for single zone HVAC system with dual-temperature coil.

Figure 4-20e. Control panel back panel layout for single zone HVAC system with dual-temperature coil.

Figure 4-20f. Control panel terminal block layout for single zone HVAC system with dual-temperature coil.

Figure 4-20g. DDC control system schematic for single zone HVAC system with dual-temperature coil.

Figure 4-20h. DDC control system ladder diagram for single zone HVAC system with dual-temperature coil.

Figure 4-20i. DDC control system equipment for single zone HVAC system with dual-temperature coil.

Figure 4-20j. DDC control system I/O table and data terminal strip layout for single zone HVAC system with dual-temperature coil.

b. General sequence of operation.

(1) Supply fan off. When the fan is off, the outside air and relief air dampers are closed and the return air damper is open. The dual-temperature coil valve is under control.

(2) Supply fan operating. When the fan is on, the control dampers and the dual-temperature coil valve are operated as required by the system's operational modes. The control dampers are positioned for full recirculation of air, positioned to introduce minimum outside air, or modulated to maintain space temperature. The dual-temperature coil valve is under control.

(3) Control of supply fan. Unless the fan is stopped as the result of a safety shutdown, it is on or off as required by the control system mode of operation.

(4) Safety shutdown of the fan. The control system shuts down the fan if there is a low temperature condition or if smoke is detected.

(5) Low temperature detection. On a fall in temperature to its setpoint, a low temperature protection thermostat stops the supply fan. To restart the fan, the thermostat and the control panel must be manually reset.

(6) Smoke detection. Duct-smoke detectors stop the supply fan whenever either detects the presence of smoke. To restart the fan, the smoke detectors and control panel must be manually reset.

(7) Filter condition. Filter condition is monitored by a pressure gauge and a differential pressure switch. When the rise in pressure drop across the filter reaches the switch setpoint, the switch turns on a pilot light.

(8) Economizer control. When the control system's mode of operation no longer requires the outside air, return air, and relief air dampers to be in their full recirculation positions, the dampers are positioned to admit outside air for ventilation. When both these contacts close, the dampers are modulated as part of the space temperature control.

(9) Space temperature control. The space temperature controls have different sequences depending on whether hot water or chilled water is being delivered to the unit dual-temperature coil.

(a) Whenever hot water is being supplied to the unit's dual-temperature coil, on a rise in space temperature, the dual-temperature coil valve is modulated toward closed. On a further rise through the temperature deadband, the controls make no changes. Then, on a still further rise in space temperature above the deadband, the outside air and relief air dampers are modulated from the minimum position toward fully open, and the return air damper is simultaneously modulated toward closed.

(b) Whenever chilled water is being supplied to the unit's dual-temperature coil, on a rise in space temperature above the deadband, economizer control permitting, the outside air and relief air dampers are modulated from minimum position toward fully open, and simultaneously the return air damper is modulated toward fully closed and the dual-temperature coil valve is modulated toward open.

(10) Unoccupied mode of operation. During the unoccupied mode throughout the heating season, the supply fan is cycled by the night thermostat to maintain its low limit space temperature setpoint, the outside air and relief air dampers remain closed, and the return air damper remains open. During the unoccupied mode in the cooling season, the unit remains de-energized.

(11) Ventilation delay mode of operation. During the ventilation delay mode, the dampers remain as they were throughout the unoccupied mode, and the supply fan runs continuously. Until the ventilation delay mode ends, return air is circulated, to bring the building to comfort conditions using a minimum of energy.

c. Detailed sequence of operation.

(1) Timeclock CLK-XX-01 has two independent sets of contacts, which between them determine the mode under which the system operates. Five minutes before the scheduled beginning of the occupied mode, the ventilation delay contacts close, energizing relay R-XX-04 and lighting pilot light PL-XX-02. The normally closed contacts of relay R-XX-04 open, preventing relay R-XX-03 from being energized. The normally open contacts of relay R-XX-03 prevent any signal from reaching current-to-pneumatic transducer IP-XX-01. Thus, the dampers remain in their normal positions, with outside air and relief air dampers closed and return air damper open.

(2) When the timeclock's occupied contacts close, relays R-XX-01 and R-XX-02 are energized, and pilot light PL-XX-01 is turned on. The contacts of relay R-XX-02 energize the supply fan. The auxiliary contacts of the supply fan starter energize relay R-XX-05.

(3) When the ventilation delay contacts of time clock CLK-XX-01 open to end the ventilation delay mode, relay R-XX-04 is de-energized and pilot light PL-XX-02 is turned off. The contacts of relay R-XX-04, in series with the now closed but normally open contacts of relays R-XX-01 and R-XX-05, energize relay R-XX-03. The contacts of relay R-XX-03 close between high signal selector TY-XX-01 and current-to-pneumatic transducer IP-XX-01; this allows the economizer dampers to assume the position set on minimum position switch MPS-XX-01 unless relay R-XX-06 is energized.

(4) Economizer controller EC-XX-01 receives signals from outside air temperature transmitter TT-XX-01 and from return air temperature transmitter TT-XX-02. The difference between the return air temperature and the outside air temperature controls the DEV contacts, and the return air temperature controls the PV contacts. When both these contacts are closed, relay R-XX-06 is energized and pilot light PL-XX-03 is turned on. When relay R-XX-06 is energized, its contacts connect the output of space temperature controller TC-XX-02 to high signal selector TY-XX-01, to modulate the outside air and return air dampers between minimum position and fully open while modulating the return air damper in the opposite direction to maintain the temperature controller setpoint.

(5) Space temperature transmitter TT-XX-03 signals the space temperature to controllers TC-XX-01 and TC-XX-02. Controllers TC-XX-01 and TC-XX-02 are proportional only controllers. Temperature setpoint device TSP-XX-01 provides the means for adjusting the setpoints of space zone temperature controllers, TC-XX-01 and TC-XX-02. On a rise in temperature during the heating season when hot water is being supplied to the dual-temperature coil, space temperature controller TC-XX-02 modulates the dual-temperature coil valve VLV-XX-01 toward closed. On a further rise in space temperature through the temperature deadband, the controller is inactive. On a still further rise in space temperature, economizer controller permitting, controller TC-XX-02 modulates the outside air and relief air dampers from the minimum position set on minimum position switch MPS-XX-01 toward fully open, and simultaneously modulates the return air damper toward closed.

(6) On a fall in temperature to its setpoint, changeover aquastat TS-XX-01 in the dual-temperature water supply energizes electrically actuated pneumatic valve EP-XX-01, which interrupts the TC-XX-02 / IP-XX-02 signal to dual-temperature coil valve VLV-XX-01 and replaces it with the reverse acting TC-XX-01 / IP-XX-03 signal. In addition, TS-XX-01 energizes changeover relay R-XX-10. When relay R-XX-10 is energized, its contacts turn off heating pilot light PL-XX-07 and turn on cooling pilot light PL-XX-08. On a rise in space temperature during the cooling season, temperature controller TC-XX-02, economizer controller permitting, modulates the outside air and relief air dampers AD-XX-01 and AD-XX-03 from minimum position toward fully open and simultaneously modulates the return air damper AD-XX-02 toward fully closed. Controller TC-XX-01, through current-to-pneumatic transducer IP-XX-03, modulates dual-temperature coil valve VLV-XX-01 toward open.

(7) On a fall in temperature to its setpoint, low temperature protection thermostat TSL-XX-01 opens a set of closed contacts in the supply fan circuit, de-energizing the supply fan. A set of open contacts in low temperature protection thermostat TSL-XX-01 closes, energizing relay R-XX-07 and lighting pilot light PL-XX-05. The contacts of relay R-XX-07 energize R-XX-09. One set of the contacts of relay R-XX-09 locks in relay R-XX-09 and the other set de-energizes the supply fan. To restart the fans after a low temperature shutdown both the low temperature thermostat TSL-XX-01 and the control panel must be manually reset. The control panel is reset by momentarily depressing manual switch HS-XX-02.

(8) When smoke detector SMK-XX-01 or smoke detector SMK-XX-02 detects the presence of smoke, its normally closed contacts in the supply fan starting circuit open, de-energizing the supply fan. The normally open contacts of the smoke detector(s) close, energizing relay R-XX-08 and lighting smoke pilot light PL-XX-06. The contacts of relay R-XX-08 energize relay R-XX-09. One set of the contacts of relay R-XX-09 closes to lock in R-XX-09, and the other set of contacts, in the supply fan starter circuit, opens. To restart the fan, the smoke detectors must be manually reset and the HVAC panel must also be reset by momentarily depressing manual switch HS-XX-02.

(9) Differential pressure gauge DPI-XX-01 across the filter gives local indication of filter loading. On a rise in pressure drop across the filter to its setpoint, differential pressure switch DPS-XX-01 turns on pilot light PL-XX-04.

(10) When the occupied contacts of time clock CLK-XX-01 open to end the occupied mode and index the system to the unoccupied mode, relays R-XX-01 and R-XX-02 are de-energized and pilot light PL-XX-01 is turned off. The contacts of relay R-XX-02 open, de-energizing the supply fan and placing the system's night thermostat TSL-XX-02 in control of the supply fan. On a fall in space temperature to 13 degrees C (55 degrees F), the contacts of TSL-XX-02 close, energizing the fan; on a rise in temperature to 16 degrees C (60 degrees F), the contacts open, de-energizing the fan.

d. Sequence of operation for DDC applications.

(1) Ventilation delay mode timing shall start prior to the occupied mode timing. During ventilation delay mode the dampers shall remain in their normal positions as shown, except when under economizer control. At the time shown, the DDC system shall place the system in the occupied mode. At the expiration of the ventilation delay mode timing period, the DDC system shall place the outside air, return air, and relief air dampers under space temperature and economizer control. At the time shown, the DDC system shall place the control system in the unoccupied mode of operation and the dampers shall return to their normal positions as shown.

(2) During occupied and ventilation delay modes the supply fan shall operate continuously. During unoccupied mode the supply fan shall cycle according to the night setback schedule. The fan shall start and stop at the setpoints as shown.

(3) A differential pressure switch across the filter shall initiate a filter alarm when the pressure drop across the filter exceeds the setpoint as shown.

(4) A freeze-stat, located as shown, shall stop the supply fan, cause the outside air, return air, and relief air dampers to return to their normal position, and shall initiate a low temperature alarm if the temperature drops below the freeze-stat's setpoint. Return to the normal mode of operation shall require manual reset at the freeze-stat. The DDC panel shall monitor the freeze-stat through auxiliary contacts and shall indicate an alarm condition when the freeze-stat trips.

(5) Smoke Detectors in the supply air and return air ductwork shall stop the supply fan and initiate a smoke alarm if smoke is detected at either location. Restarting the supply fan shall require manual reset at the smoke detector.

(6) The DDC system shall accept the signal of an outside air temperature sensing element and transmitter and the signal of a return air temperature sensing element and transmitter. The DDC system shall perform switch over between outside air economizer control mode and minimum outside air mode. Until the outside air temperature rises above the setpoint, the DDC system shall hold the system in the minimum outside air mode. When the outside air temperature rises above the setpoint, the DDC system shall place the AHU in the economizer mode or in the minimum outside air mode as determined by a comparison of the outside air and return air temperatures in accordance with the differential temperature setpoints as shown. When the outside air temperature is low with respect to the return air temperature, the AHU shall be in the economizer mode. When the DDC system places the control system in the minimum outside air mode, the outside air damper shall be open to the minimum outdoor air setting. When the DDC system places the system in the economizer mode, the dampers shall be modulated to admit additional outside air to maintain the space temperature setpoint as shown.

(7) The DDC system shall select the heating and cooling modes based on input from a temperature sensor and transmitter located in the dual-temperature supply. When the dual-temperature supply temperature is above the setpoint, the DDC panel shall operate the dual-temperature coil valve as a heating coil valve in sequence with the outside air, return air, and relief air dampers. When the dual-temperature supply temperature is below the setpoint, the DDC panel shall operate the dual-temperature coil valve as a cooling coil valve in sequence with the outside air, return air, and relief air dampers.

(8) When the DDC system is operating the system in heating mode, space temperature shall be controlled as follows.

(a) When the DDC system is in the economizer mode, it shall maintain the setpoint from the signal of a space temperature sensor and transmitter. On a rise in space temperature, the DDC system shall first gradually close the coil valve. After passing through a deadband, the DDC system shall then gradually operate the outside air damper to admit outside air beyond the minimum quantity to maintain the setpoint as shown.

(b) When the DDC system is in the minimum outside air mode, the outside air damper shall be open to the minimum outside air setting. On a rise in space temperature, the DDC system shall gradually close the coil valve to maintain the setpoint as shown.

(9) When the DDC system is operating the system in cooling mode, space temperature shall be controlled as follows.

(a) When the DDC system is in the economizer mode, it shall maintain the setpoint from the signal of a space temperature sensor and transmitter. On a rise in space temperature, the DDC system shall first gradually open the outside air damper to admit outside air beyond the minimum quantity. When the outside air damper is fully open, on a further rise in space temperature, the DDC system shall gradually open the coil valve.

(b) When the DDC system is in the minimum outside air mode, the outside air damper shall be open to the minimum outside air setting. On a rise in space temperature, the DDC system shall gradually open the coil valve to maintain the setpoint.

25. SINGLE ZONE HVAC CONTROL SYSTEM WITH HUMIDITY CONTROL.

a. Description of the HVAC system. This air handling system consists of a supply fan, filter, preheat coil, cooling coil, reheat coil, and humidifier. The system also has a steam-to-water heat exchanger and pump to supply hot water to the preheat and reheat coils. Figures 4-21a through 4-21f show the control system design for this type of air handling system using a SLDC control panel. Figures 4-21g through 4-21j show the control system design for this type of air handling system using DDC controls.

Figure 4-21a. Control system schematic for single zone HVAC system with humidity control.

Figure 4-21b. Control system ladder diagram for single zone HVAC system with humidity control.

Figure 4-21c. Control system equipment for single zone HVAC system with humidity control.

Figure 4-21d. Control panel interior door layout for single zone HVAC system with humidity control.

Figure 4-21e. Control panel back panel layout for single zone HVAC system with humidity control.

Figure 4-21f. Control panel terminal block layout for single zone HVAC system with humidity control.

Figure 4-21g. DDC control system schematic for single zone HVAC system with humidity control.

Figure 4-21h. DDC control system ladder diagram for single zone HVAC system with humidity control.

Figure 4-21i. DDC control system equipment for single zone HVAC system with humidity control.

Figure 4-21j. DDC control system I/O table and data terminal strip layout for single zone HVAC system with humidity control.

b. General sequence of operation.

(1) Supply fan off. When the fan is off, the outside air damper and the cooling coil, humidifier and heat exchanger valves are all closed, and the pump is off. The reheat coil valve remains under space temperature control.

(2) Supply fan operating. When the fan is on, the pump is on, and the outside air damper, heat exchanger valve, preheat coil valve, cooling coil valve, reheat coil valve and humidifier valve are operated as required by the system's operational modes. The outside air damper is either open or closed. The preheat coil and reheat coil valves are under the control of their respective controllers. The cooling coil valve is either closed or modulated to maintain the space temperature and/or humidity.

(3) Control of supply fan. Unless the fan is stopped as the result of a safety shutdown, it is on or off as required by the control system's mode of operation.

(4) Safety shutdown of the fan. The control system shuts down the fan if there is a low temperature condition, or if smoke is detected.

(5) Low temperature detection. On a fall in temperature to its setpoint, a low temperature protection thermostat stops the supply fan. To restart the fan, the thermostat and the control panel must be manually reset.

(6) Smoke detection. Duct smoke detectors stop the supply fan whenever they detect the presence of smoke. To restart the fan, the smoke detectors and control panel must be manually reset.

(7) Filter condition. Filter condition is monitored by a pressure gauge and a differential pressure switch. When the rise in pressure drop across the filter reaches the switch setpoint, the switch turns on a pilot light.

(8) Preheat coil control. The preheat coil valve is modulated to maintain a constant preheat coil discharge temperature.

(9) Space temperature control. The reheat coil valve and cooling coil valve are modulated in sequence to maintain a constant space temperature.

(10) Space humidity control. The humidifier valve and cooling coil valve are modulated in sequence to maintain a constant relative humidity in the space. A high limit humidity control overrides the space control of the humidifier valve when necessary, to prevent the relative humidity in the supply duct from exceeding its high limit setpoint.

(11) Unoccupied mode of operation. Throughout the unoccupied mode, the outside air damper and cooling coil valve remain closed. The supply fan is cycled by the night thermostat to maintain its low limit space temperature setpoint.

(12) Ventilation delay mode of operation. Throughout the ventilation delay mode, the outside air damper remains closed. The reheat coil and cooling coil valves are under the control of the room temperature controller. Return air is circulated, to bring the building to comfort conditions, using a minimum of energy.

(13) Occupied mode of operation. The supply fan runs continuously with the outside air dampers open. The space temperature and humidity are controlled as previously described.

c. Detailed sequence of operation.

(1) Timeclock CLK-XX-01 has two independent sets of contacts, which between them determine the mode under which the system operates. Five minutes before the scheduled beginning of the

occupied mode, the ventilation delay contacts close, energizing relay R-XX-04 and lighting ventilation delay pilot light PL-XX-02. The closed contacts of relay R-XX-04 open, preventing relay R-XX-03 and electrically actuated pneumatic valve EP-XX-01 from being energized. The open contacts of relay R-XX-03 interrupt the signal to IP-XX-03 keeping the humidifier valve closed. When EP-XX-01 is de-energized, the damper remains closed.

(2) When the occupied contacts of timeclock CLK-XX-01 close, relays R-XX-01 and R-XX-02 are energized and pilot light PL-XX-01 is turned on. The contacts of relay R-XX-01 energize the supply fan. The auxiliary contacts of the supply fan starter energize relay R-XX-05, and since R-XX-01 is already energized it also energizes relay R-XX-06. The contacts of relay R-XX-05 energize the pump starter, and the contacts of relay R-XX-06 place the cooling coil valve under space temperature / humidity control.

(3) When the ventilation delay contacts of timeclock CLK-XX-01 open to end the ventilation delay mode of operation, relay R-XX-04 is de-energized. The normally closed contacts of relay R-XX-04 close, energizing relay R-XX-03 and pneumatic valve EP-XX-01. Pneumatic valve EP-XX-01 opens the outdoor air damper. The contacts of relay R-XX-03 place the humidifier valve under control as described elsewhere.

(4) On a rise in differential pressure to its setpoint, differential pressure switch DPS-XX-01 or DPS-XX-02 lights the filter pilot light PL-XX-03.

(5) On a fall in temperature to its setpoint, the closed contacts of low temperature protection thermostat TSL-XX-01 open, de-energizing the fan; its open contacts close, energizing relay R-XX-07 and lighting low temperature pilot light PL-XX-04. The contacts of relay R-XX-07 energize shutdown relay R-XX-09. One set of the contacts of relay R-XX-09 closes to lock relay R-XX-09 in, and the other set de-energizes the supply fan. To restart the fan, the thermostat and the control panel both must be reset. Momentary switch HS-XX-02 is used to reset the panel.

(6) When either smoke detector SMK-XX-01 or SMK-XX-02 detects the presence of smoke, its normally closed contacts in the supply fan starting circuit open, de-energizing the supply fan. The normally open contacts of the smoke detector(s) close, energizing relay R-XX-08 and lighting smoke pilot light PL-XX-05. The contacts of relay R-XX-08 energize relay R-XX-09. One set of the contacts of relay R-XX-09 close to lock in R-XX-09, and the other set of contacts, in the supply fan starter circuit, opens to de-energize the fan. To restart the fan, the smoke detectors must be manually reset and the HVAC panel must also be reset by depressing momentary switch HS-XX-02.

(7) Whenever the pump runs, the auxiliary contacts of the pump starter energize relay R-XX-10 and light heating pilot light PL-XX-06. The contacts of relay R-XX-10 place heat exchanger valve VLV-XX-05 under control.

(8) Temperature transmitter TT-XX-01 signals the preheat coil discharge temperature to temperature controller TC-XX-01. The output of TC-XX-01 is received by current-to-pneumatic transducer IP-XX-01. The pneumatic output of IP-XX-01 modulates the preheat coil valve VLV-XX-01 to maintain the setpoint of controller TC-XX-01.

(9) Space temperature transmitter TT-XX-02 signals the space temperature to temperature controller TC-XX-02. The output of TC-XX-02 is received by current-to-pneumatic transducer IP-XX-04 and high signal selector TY-XX-01. The pneumatic output of current-to-pneumatic transducer IP-XX-04 modulates the reheat coil valve VLV-XX-03. High signal selector TY-XX-01 passes the higher of the temperature signal and the humidity signal (next paragraph) during the ventilation delay and occupied

modes to current-to-pneumatic transducer IP-XX-02. The pneumatic signal of IP-XX-02 modulates the cooling coil valve VLV-XX-02 to maintain the space temperature or humidity setpoint.

(10) Space humidity transmitter RHT-XX-02 signals the space relative humidity to relative humidity controller RHC-XX-02. The output of relative humidity controller RHC-XX-02 is transmitted to low signal selector RHY-XX-01 and inverter INV-XX-01. Low signal selector RHY-XX-01 also receives a signal from unit discharge high limit humidity controller RHC-XX-01, (must be proportional only) which receives unit discharge relative humidity signals from unit discharge relative humidity transmitter RHT-XX-01. The output of RHY-XX-01, during the occupied mode only, is received by current-to-pneumatic transmitter IP-XX-03, and the pneumatic output of IP-XX-03 modulates humidifier steam valve VLV-XX-04. The signal from controller RHC-XX-02 to inverter INV-XX-01 is reversed and sent to high signal selector TY-XX-01. The signal from space temperature controller TC-XX-02, (previous paragraph) and the signal from space relative humidity controller RHC-XX-02, after inversion are compared, and the higher signal, during the ventilation delay and occupied modes, is sent to current-to-pneumatic transducer IP-XX-02. The pneumatic signal of IP-XX-02 modulates the cooling coil valve VLV-XX-02 to maintain the space temperature or humidity setpoint.

(11) Temperature transmitter TT-XX-03 in the heat exchanger discharge, signals the hot water supply temperature to temperature controller TC-XX-03. Whenever the pump runs, relay R-XX-10 is energized, and, through the contacts of R-XX-10, the output of TC-XX-03, through current-to-pneumatic transducer IP-XX-05, modulates heat exchanger valve VLV-XX-05 to maintain the TC-XX-03 temperature setpoint. When the pump is de-energized, the contacts of relay R-XX-10 open, and the valve closes.

(12) When the occupied contacts of CLK-XX-01 open to end the occupied mode and index the system to the unoccupied mode, relay R-XX-01 is de-energized and pilot light PL-XX-01 is turned off. The contacts of relay R-XX-01 open, de-energizing the supply fan and placing the system's night thermostat TSL-XX-02 in control of the supply fan. On a fall in space temperature to 13 degrees C (55 degrees F), the contacts of TSL-XX-02 close, energizing the fan; on a rise in temperature to 16 degrees C (60 degrees F), the contacts open, de-energizing the fan.

d. Sequence of operation for DDC applications.

(1) Ventilation delay mode timing shall start prior to the occupied mode timing. During ventilation delay mode the outside air damper shall remain closed. At the time shown, the DDC system shall place the system in the occupied mode. At the expiration of the ventilation delay mode timing period, the DDC system shall open the outside air damper. At the time shown, the DDC system shall place the control system in the unoccupied mode of operation and the outside air damper shall close.

(2) During occupied and ventilation delay modes the supply fan shall operate continuously. During unoccupied mode the supply fan shall cycle according to the night setback schedule. The fan shall start and stop at the setpoints as shown.

(3) A differential pressure switch across the filter shall initiate a filter alarm when the pressure drop across the filter exceeds the setpoint as shown.

(4) A freezestat, located as shown, shall stop the supply fan, cause the outside air damper to close, and shall initiate a low temperature alarm if the temperature drops below the freezestat's setpoint. Return to the normal mode of operation shall require manual reset at the freezestat. The DDC panel shall monitor the freezestat through auxiliary contacts and shall indicate an alarm condition when the freezestat trips.

(5) Smoke Detectors in the supply air and return air ductwork shall stop the supply fan and initiate a smoke alarm if smoke is detected at either location. Restarting the supply fan shall require manual reset at the smoke detector.

(6) The DDC system shall modulate the preheat coil control valve from the signal of a temperature sensing element and transmitter in the preheat coil discharge to maintain the setpoint as shown.

(7) During occupied and ventilation delay modes, the DDC system shall compare the signals of a space temperature sensor / transmitter and space relative humidity sensor / transmitter to operate the cooling coil valve. Based on the highest signal received, the DDC system shall modulate the valve to maintain space temperature or space humidity at setpoint. During the unoccupied mode, the cooling coil control valve shall remain closed.

(8) During the occupied mode, the DDC system shall accept the signals from a space relative humidity sensor and a duct relative humidity sensor to control the humidifier valve and the cooling coil valve. The DDC system shall gradually open the cooling coil valve in the event that the space relative humidity continues to rise after the humidifier valve is closed. The DDC system shall gradually operate the humidifier valve from the signal of a space relative humidity sensor / transmitter to maintain relative humidity setpoint. The DDC system shall receive a signal from a relative humidity sensor / transmitter in the ductwork downstream of the humidifier and shall limit the relative humidity at that point to a high limit relative humidity setpoint. During unoccupied and ventilation delay modes, the humidifier valve shall remain closed.

(9) The DDC system shall gradually close the reheat coil valve on a rise in space temperature to maintain the setpoint.

(10) The DDC system shall accept a signal from a temperature sensing element and transmitter in the heating supply line, and shall modulate the hydronic system control valve to maintain the setpoint.

26. SINGLE ZONE HVAC CONTROL SYSTEM WITH DIRECT-EXPANSION (DX) COOLING COIL.

a. Description of the HVAC system. This air handling system consists of a supply fan, economizer dampers, filter, heating coil, and a three stage direct expansion cooling coil. Figures 4-22a through 4-22f show the control system design for this type of air handling system using a SLDC control panel. Figures 4-22g through 4-22j show the control system design for this type of air handling system using DDC controls.

Figure 4-22a. Control system schematic for single zone HVAC system with DX coil.

Figure 4-22b. Control system ladder diagram for single zone HVAC system with DX coil.

Figure 4-22c. Control system equipment for single zone HVAC system with DX coil.

Figure 4-22d. Control panel interior door layout for single zone HVAC system with DX coil.

Figure 4-22e. Control panel back panel layout for single zone HVAC system with DX coil.

Figure 4-22f. Control panel terminal block layout for single zone HVAC system with DX coil.

Figure 4-22g. DDC control system schematic for single zone HVAC system with DX coil.

Figure 4-22h. DDC control system ladder diagram for single zone HVAC system with DX coil.

Figure 4-22i. DDC control system equipment for single zone HVAC system with DX coil.

Figure 4-22j. DDC control system I/O table and data terminal strip layout for single zone HVAC system with DX coil.

b. General sequence of operation.

(1) Supply fan off. When the fan is off, the outside air and relief air dampers are closed and the return air damper is open. The heating coil valve is under control.

(2) Supply fan operating. When the fan is on, the control dampers are either positioned for full recirculation of air, positioned to introduce minimum outside air, or modulated to maintain space temperature. The cooling is either de-energized or cycled in stages to maintain space temperature.

(3) Control of supply fan. Unless the fan is stopped as the result of a safety shutdown, it is on or off as required by the control system's mode of operation.

(4) Safety shutdown of the fan. The control system shuts down the fan if there is a low temperature condition, or if smoke is detected.

(5) Low temperature detection. On a fall in temperature to its setpoint, a low temperature protection thermostat stops the supply fan. To restart the fan, the thermostat and the control panel must be manually reset.

(6) Smoke detection. Duct smoke detectors stop the supply fan whenever they detect the presence of smoke. To restart the fan, the smoke detectors and control panel must be manually reset.

(7) Filter condition. Filter condition is monitored by a pressure gauge and a differential pressure switch. When the rise in pressure drop across the filter reaches the switch setpoint, the switch turns on a pilot light.

(8) Economizer control. When the control system's mode of operation no longer requires the outside air, return air, and relief air dampers to be in their full recirculating positions, the dampers are positioned to admit outside air for ventilation. The amount of ventilation air then remains at minimum until the economizer controller closes both its PV and DEV contacts. The economizer controller closes its PV contacts when the return air temperature indicates that the building requires cooling rather than heating. The economizer controller closes its DEV contacts when the outside air temperature is sufficiently below the return air temperature to be effective for cooling. When both these contacts close, the dampers are modulated as part of the space temperature control.

(9) Space temperature control. On a rise in space temperature, the heating coil valve is modulated toward closed. On a further space temperature rise, economizer control permitting, the outside air and relief air dampers are modulated between minimum position toward fully open, and simultaneously the return air damper is modulated toward fully closed to maintain space temperature. On a still further rise in temperature, the stages of cooling are cycled to maintain the space temperature.

(10) Unoccupied mode of operation. Throughout the unoccupied mode, the outside air and relief air dampers remain closed, and the return air damper remains open. The heating coil valve remains under space temperature control. The cooling stages are de-energized. The supply fan is cycled by the system's night thermostat to maintain its low limit space temperature setpoint.

(11) Ventilation delay mode of operation. During the ventilation delay mode, the dampers remain as they were throughout the unoccupied mode, and the supply fan runs continuously. The cooling system is enabled. Until the ventilation delay mode ends, return air is circulated, to bring the building to comfort conditions, using a minimum of energy.

(12) Occupied mode of operation. The supply fan runs continuously, and the outside air and relief air dampers are at minimum position or are under space temperature control as previously described.

c. Detailed sequence of operation.

(1) Timeclock CLK-XX-01 has two independent sets of contacts, which between them determine the mode under which the system operates. Five minutes before the scheduled beginning of the occupied mode, the ventilation delay contacts close, energizing relay R-XX-04 and lighting pilot light PL-XX-02. The normally closed contacts of relay R-XX-04 open, preventing relay R-XX-03 from being energized. The normally open contacts of relay R-XX-03 prevent any signal from reaching electric damper actuators DA-XX-01, DA-XX-02, and DA-XX-03. Thus, the dampers remain in their normal positions, with outside air and relief air dampers closed and return air damper open.

(2) When the timeclock's occupied contacts close, relays R-XX-01 and R-XX-02 are energized, and occupied pilot light PL-XX-01 is turned on. The contacts of relay R-XX-02 energize the supply fan. The auxiliary contacts of the supply fan starter energize relay R-XX-05 and, with the contacts of relay R-XX-01, energize relay R-XX-06, which places the space temperature controller TC-XX-01 in control of cooling sequencer SQCR-XX-01.

(3) When the ventilation delay contacts of timeclock CLK-XX-01 open to end the ventilation delay mode, relay R-XX-04 is de-energized and pilot light PL-XX-02 is turned off. The contacts of relay R-XX-04 energize relay R-XX-03. The contacts of relay R-XX-03 close between high signal selector TY-XX-01 and the electric damper actuators. This allows the economizer dampers to assume the position set on minimum position switch MPS-XX-01 unless relay R-XX-07 is energized.

(4) Economizer controller EC-XX-01 receives signals from outside air temperature transmitter TT-XX-01 and from return air temperature transmitter TT-XX-02. The difference between the return air temperature and the outside air temperature controls the DEV contacts, and the return air temperature controls the PV contacts. When both these contacts are closed, relay R-XX-07 is energized and pilot light PL-XX-03 is turned on. When relay R-XX-07 is energized, its contacts connect the output of space temperature controller TC-XX-01 to high signal selector TY-XX-01, to modulate the outside air and return air dampers between minimum position and fully open while modulating the return air damper in the opposite direction to maintain the temperature controller setpoint.

(5) Space temperature transmitter TT-XX-03 signals the space temperature to proportional only space temperature controller TC-XX-01. The TC-XX-01 output through loop drivers LD-XX-01, LD-XX-02, and LD-XX-03 controls the cooling sequencer, the economizer dampers, and the heating coil valve respectively. On a rise in space temperature, controller TC-XX-01 through loop driver LD-XX-03 modulates heating coil valve VLV-XX-01 closed. On a further temperature rise, if the economizer

controller permits, the controller, through loop driver LD-XX-02, modulates the outside air and relief air dampers from minimum position toward fully open and simultaneously modulates the return air damper toward fully closed. On a still further rise, the controller, through loop driver LD-XX-01 and sequencer SQCR-XX-01, successively energizes the stages of cooling. The reverse occurs on a fall in temperature.

(6) On a fall in temperature to its setpoint, low temperature protection thermostat TSL-XX-01 opens a set of closed contacts in the supply fan circuit, de-energizing the supply fan. A set of open contacts in low temperature protection thermostat TSL-XX-01 closes, energizing relay R-XX-08 and lighting low temperature pilot light PL-XX-05. The contacts of R-XX-08 energize relay R-XX-10. One set of the contacts of relay R-XX-10 locks in relay R-XX-10, and the other set de-energizes the supply fan. To restart the fans after a low temperature shutdown both the low temperature thermostat TSL-XX-01 and the control panel must be manually reset. The control panel is reset by momentarily depressing manual switch HS-XX-02.

(7) When smoke detector SMK-XX-01 or smoke detector SMK-XX-02 detects the presence of smoke, its normally closed contacts in the supply fan starting circuit open, de-energizing the supply fan. The normally open contacts of the smoke detector(s) close, energizing relay R-XX-09 and lighting smoke pilot light PL-XX-06. The contacts of relay R-XX-09 energize relay R-XX-10. One set of the contacts of relay R-XX-10 closes to lock in R-XX-10, and the other set of contacts, in the supply fan starter circuit, opens. To restart the fan, the smoke detectors must be manually reset and the HVAC panel must also be reset by depressing momentary switch HS-XX-02.

(8) Differential pressure gauge DPI-XX-01 across the filter provides local indication of filter loading. On a rise in pressure drop across the filter to its setpoint, differential pressure switch DPS-XX-01 turns on pilot light PL-XX-04.

(9) When the occupied contacts of time clock CLK-XX-01 open to end the occupied mode and index the system to the unoccupied mode, relays R-XX-01 and R-XX-02 are de-energized and pilot light PL-XX-01 is turned off. The contacts of relay R-XX-02 open, de-energizing the supply fan and placing the system's night thermostat TSL-XX-02 in control of the supply fan. On a fall in space temperature to 13 degrees C (55 degrees F), the contacts of TSL-XX-02 close, energizing the fan; on a rise in temperature to 16 degrees C (60 degrees F), the contacts open, de-energizing the fan.

d. Sequence of operation for DDC applications.

(1) Ventilation delay mode timing shall start prior to the occupied mode timing. During ventilation delay mode the dampers shall remain in their normal positions as shown, except when under economizer control. At the time shown, the DDC system shall place the system in the occupied mode. At the expiration of the ventilation delay mode timing period, the DDC system shall place the outside air, return air, and relief air dampers under space temperature and economizer control. At the time shown, the DDC system shall place the control system in the unoccupied mode of operation and the dampers shall return to their normal positions as shown.

(2) During occupied and ventilation delay modes the supply fan shall operate continuously. During unoccupied mode the supply fan shall cycle according to the night setback schedule. The fan shall start and stop at the setpoints as shown.

(3) A differential pressure switch across the filter shall initiate a filter alarm when the pressure drop across the filter exceeds the setpoint as shown.

(4) A freezestat, located as shown, shall stop the supply fan, cause the outside air, return air, and relief air dampers to return to their normal position, and shall initiate a low temperature alarm if the temperature drops below the freezestat's setpoint. Return to the normal mode of operation shall require manual reset at the freezestat. The DDC panel shall monitor the freezestat through auxiliary contacts and shall indicate an alarm condition when the freezestat trips.

(5) Smoke Detectors in the supply air and return air ductwork shall stop the supply fan and initiate a smoke alarm if smoke is detected at either location. Restarting the supply fan shall require manual reset at the smoke detector.

(6) The DDC system shall accept the signal of an outside air temperature sensing element and transmitter and the signal of a return air temperature sensing element and transmitter. The DDC system shall perform switch over between outside air economizer control mode and minimum outside air mode. Until the outside air temperature rises above the setpoint, the DDC system shall hold the system in the minimum outside air mode. When the outside air temperature rises above the setpoint, the DDC system shall place the AHU in the economizer mode or in the minimum outside air mode as determined by a comparison of the outside air and return air temperatures in accordance with the differential temperature setpoints as shown. When the outside air temperature is low with respect to the return air temperature, the AHU shall be in the economizer mode. When the DDC system places the control system in the minimum outside air mode, the outside air damper shall be open to the minimum outdoor air setting. When the DDC system places the system in the economizer mode, the dampers shall be modulated to admit additional outside air to maintain the space temperature setpoint as shown.

(7) Space temperature control shall be maintained as follows.

(a) During unoccupied mode, the dampers shall remain in their normal positions as shown and the DX condensing unit shall remain off. The supply fan shall be cycled by the system's night thermostat and the heating coil valve shall be modulated to maintain the space temperature low limit setpoint.

(b) During occupied mode, the supply fan shall run continuously and the heating coil and the DX cooling coil shall be under space temperature control. While the system is in ventilation delay mode, the dampers shall remain in their normal position unless the system is also calling for economizer operation. When the DDC system is in economizer mode, on a rise in space temperature, the DDC system shall first gradually close the heating coil valve. After passing through a deadband, the outside air damper shall be modulated to admit outside air beyond the minimum quantity and after the outside air damper is fully open, the DDC system shall operate the stages of cooling in sequence to maintain the space temperature setpoint. When the system is in the minimum outside air mode, the dampers shall remain in the minimum outside air position. On a rise in space temperature, the DDC system shall first gradually close the heating coil valve. After passing through a deadband, the DDC system shall operate the stages of cooling in sequence.

CHAPTER 5

CONTROL-SYSTEM DESIGN VARIATIONS

1. GENERAL. The control systems shown in Chapter 4 will be modified when required to account for HVAC-system equipment variations. The variations covered in this chapter are as follows:

- a. 100 percent outside air systems.
- b. Control of exhaust fans.
- c. Smoke dampers.
- d. Variable speed drives.
- e. Steam preheat coil with face and bypass dampers.
- f. Modulating hot water or hot glycol preheat coil.
- g. Combining hydronic system and air system control systems in the same control panel.
- h. Unoccupied mode space temperature setback control for terminal units.
- i. Two-way shut-off valves on fan coil units.
- j. Building purge/flush cycle.
- k. EMCS initiated building purge and recirculation modes.
- l. Smoke control and freeze protection.
- m. Control systems without economizer modes.
- n. Dual steam valves.
- o. Hydronic systems with boilers requiring constant flow.

2. CONTROL SYSTEM VARIATIONS FOR 100 PERCENT OUTSIDE AIR (CONTINUOUS OPERATION).

a. HVAC systems that introduce 100-percent outside air are used as makeup air systems when large quantities of air are exhausted from the space. Such systems are used in the heating and cooling of such spaces as hospital operating rooms and laboratories, which cannot recirculate air from the space through the system. Spaces that cannot use return air will usually have more air exhausted than is supplied, to insure that the space is at a negative pressure with respect to surrounding spaces. This may be accomplished by an exhaust fan interlocked with the supply fan.

b. A 100-percent outside air system does not require the economizer changeover and mixed air temperature control loops, but does require an outside air preheat coil and associated temperature control loop in most climates.

c. The 100-percent outside air system may need a humidifier and its associated control loop. This loop would function identically as discussed in paragraph 3-9 and shown in figure 3-13.

d. Figure 5-1 shows the variations that would occur for a 100-percent outside air unit. The outside air preheat coil may be a heat recovery coil, which may be part of a glycol run-around system that recovers heat in the air from one or more exhaust fans. The heating coil will not be part of the recovery system. The system shown in figure 5-1 has a temperature/ humidity control sequence as described in Chapter 4. If the system has a heat recovery coil, some additional controls may be required if they are not part of a total heat recovery package. The exhaust fan is shown with a pneumatic damper actuator. Device EP-XX02 is shown as field-mounted, but it may be located in a local fan starter or may be included in the HVAC control panel. The designer will make this choice.

Figure 5-1. Schematic variations for 100-percent outside air systems.

e. The ladder diagram variations for the 100-percent outside air system are shown in figure 5-2, which is similar to figure 4-21B, but modified to delete the relay and pilot lights associated with the ventilation delay mode and with the system stops during the unoccupied mode. A smoke detector is required in the supply fan discharge. Figure 5-2 shows an exhaust fan section of the ladder diagram on lines 300 through 303. Each interlocked exhaust fan requires a contact of R-XX02 for safety shutdown and a remote safety override, located at assigned terminal blocks in the HVAC control panel.

Figure 5-2. Ladder diagram variations for 100-percent outside air systems.

3. CONTROL SYSTEM VARIATIONS FOR EXHAUST FANS.

a. Schematic variations for an exhaust fan are shown in figure 5-3, for electric and pneumatic actuators. Solenoid 3-way air valve EP-XX02 and damper actuator DA-XX02 will be energized to open their respective dampers when their respective fans start. These devices will be powered from a source other than the starter transformer, such as the HVAC control panel.

Figure 5-3. Schematic variations for exhaust fans.

b. Ladder diagram variations for exhaust fans are shown in figure 5-4. These variations are somewhat different from the exhaust fan interlock shown in figure 5-2, which are intended for exhaust fans that are interlocked to HVAC systems handling return air. One exhaust fan example is shown with a pneumatic damper operator, for guidance in applying pneumatic actuators to shutoff dampers. No positive positioner is required for the actuator. In this example, the fan is off and the dampers are closed in the unoccupied and ventilation delay mode. Another example is shown with an electric damper actuator, for guidance in applying electric actuators to shutoff dampers. In this example, the dampers are open whenever the supply fan runs. The designer will add relays in parallel with R-XX01, R-XX03, and R-XX11, as required to accommodate contacts to control additional exhaust fans. The designer will show contact and coil references on the schematic and the ladder diagram for the additional relays.

Figure 5-4. Ladder diagram variations for exhaust fans.

c. The designer will check the exhaust fan selection for the rated shutoff static pressure to determine whether a damper end switch should be applied to the control of the exhaust fan starter circuit. If the shutoff static pressure is 1 inch of water column or higher, the designer will incorporate an end switch in the design as described later in this manual under variations for smoke dampers.

4. CONTROL SYSTEM VARIATIONS FOR SMOKE DAMPERS.

a. Smoke dampers can be used with any HVAC air delivery system, but generally the smoke dampers are required only when the HVAC unit exceeds a given air capacity. An example of the use of smoke dampers is shown in figure 5-5. Actuators DA-XX04 and DA-XX05 will be powered from some source other than the fan starter holding coil transformer, such as the HVAC control panel. The contacts of relay R-XX12 must be closed to allow the smoke dampers to open.

Figure 5-5. Schematic variations for smoke dampers.

b. Figure 5-6 shows the ladder diagram variations for smoke dampers. When relay coil R-XX12 on line 105 is energized, contacts in the power circuits to DA-XX04 and DA-XX05 are closed allowing the smoke dampers to open. When the smoke dampers open, end switches ES-XX01 and ES-XX02 close their contacts on line 20 to energize relay coil R-XX11. When relay coil R-XX11 is energized, contacts on lines 104 and 204 close, to allow starter holding coils MO1 and MO2 to energize and start the fans. Tripping either end switch will shut down both fans. Relay coil R-XX12 is the only device that will be powered from the starter holding coil transformers. Relay coil R-XX12 must be wired through the overload relay contacts and must be powered in the "HAND" and "AUTO" positions of the "HAND-OFF-AUTO" switch; it also must be powered in the event that the remote safety override circuit is closed. Both dampers must open before either fan can start,

Figure 5-6. Ladder diagram variations for smoke dampers.

c. The designer will modify HVAC control panel layouts to show the relays and terminal blocks associated with these variations.

5. CONTROL SYSTEM VARIATIONS FOR VARIABLE SPEED DRIVES.

a. Figure 5-7a shows variable speed drives in lieu of the supply and return fan inlet vanes. Relay contacts in the supply duct static pressure control loop and the return fan volume control loop, which open on supply fan shutdown, are not necessary because there are no inlet vanes.

Figure 5-7a. Schematic variations for variable speed drives.

b. The variable speed drive must accept a 4 to 20 milliamperes signal as an input.

c. Figure 5-7b shows the ladder diagram variations for variable speed drives. It shows connections to the variable speed drive control circuits in lines 100 and up and in lines 200 and up. There is no magnetic starter in this case, because all starter functions are provided by the variable speed drive controller.

Figure 5-7b. Ladder diagram variations for variable speed drives.

d. Figure 5-7c shows variable speed drives in lieu of actuators for the inlet vanes.

Figure 5-7c. Equipment variations for variable speed drives.

e. Figure 5-7d shows the variations in the control panel interior door layout for variable speed drives. There are no receiver gauges in the interior door, because IPs for the inlet vanes are not required.

Figure 5-7d. Control panel interior door layout variations for variable speed drives.

f. Figure 5-7e shows the variations in the back panel arrangements for variable speed drives, with the bulkhead fittings for control of the dampers and the cooling coil valve. There is no need for bulkhead fittings for control of inlet vanes.

Figure 5-7e. Control panel back panel layout variations for variable speed drives.

g. The terminal block layout will show terminals assigned to the variable speed drive units rather than for the magnetic starter circuits for fans.

Figure 5-7f. Control panel terminal block layout variations for variable speed drives.

h. Figures 5-7g through 5-7j depict the use of variable speed drives in lieu of inlet guide vanes for a DDC system.

Figure 5-7g. DDC schematic variations for variable speed drives.

Figure 5-7h. DDC ladder diagram variations for variable speed drives.

Figure 5-7i. DDC schedule variations for variable speed drives.

Figure 5-7j. DDC I/O table and data terminal strip layout variations for variable speed drives.

6. CONTROL SYSTEM VARIATIONS FOR STEAM PREHEAT COIL WITH FACE AND BYPASS DAMPER.

a. The schematic diagram and ladder diagram additions to incorporate control for this type of preheat coil are shown in figure 5-8. The steam coil valve, VLV, is controlled from a 2-position thermostat, TSL, in the incoming outside air duct. The thermostat opens the steam valve when the outside air temperature drops to its setpoint and remains open as long as the outside air temperature is at or below the setpoint. The loop consisting of devices TT, TC, IP, and DA controls the air temperature in the discharge of the coil by modulating the preheat coil face and bypass damper to maintain the preheat coil discharge air temperature.

Figure 5-8. Control system variations for steam preheat coil with face and bypass dampers.

b. Thermometer TI in the outside air intake is required if there is not already such a device at an outside air temperature transmitter associated with an economizer controller.

c. The control devices and their parameters must be added to the equipment schedule.

7. CONTROL SYSTEM VARIATION FOR HOT WATER OR GLYCOL PREHEAT COIL. The loop to be added to control system schematics for modulating control of such preheat coils is as discussed in paragraph 3-3 and shown in figure 3-2. When required, this loop can be added to any HVAC system by showing the loop in the control system schematic, showing the loop devices and their parameters in the equipment schedule, and showing the controller and related devices in the control panel drawings.

8. CONTROL SYSTEM VARIATION FOR COMBINING HYDRONIC SYSTEM AND AIR SYSTEM CONTROLS IN THE SAME CONTROL PANEL. This variation is shown in Chapter 4 in the single-zone HVAC system with humidity control. Small buildings generally require a hydronic heating system or a dual-temperature water system and an air handling system. When appropriate, the designer will combine such systems into a common HVAC control panel.

9. UNOCCUPIED MODE SPACE TEMPERATURE SETBACK CONTROL FOR TERMINAL UNITS. In Chapter 4, the control systems for unit heaters and perimeter radiation are shown with room thermostats capable of one temperature setting. When the hydronic systems serving such units are controlled to maintain a reduced space temperature in the unoccupied mode, a microprocessor-based room thermostat will be substituted for the single-temperature thermostat shown in Chapter 4. Examples of the substitution are shown in figures 5-9 and 5-10.

Figure 5-9. Control system variations for unoccupied mode setback.

Figure 5-10. Control system variations for unoccupied mode setback.

10. CONTROL SYSTEM VARIATIONS FOR 2-WAY SHUTOFF VALVES FOR FAN COIL UNITS. For dual-temperature hydronic systems with variable flow pumping, the fan coil units will have 2-way shutoff valves in lieu of 3-way shutoff valves. The designer may show 3-way shutoff valves on selected fan coil units for pump relief of the variable flow pumping system. The schematic and ladder diagram variations are shown in figure 5-11.

Figure 5-11. Control system variations for 2-way shutoff valve on fan coil units.

11. CONTROL SYSTEM VARIATION FOR BUILDING PURGE / FLUSH CYCLE.

a. This variation provides the means to utilize a time-clock scheduled 100% outside air "building purge" cycle in situations such as laboratories, etc. where it is desirable to flush airborne contaminants on a regular basis. The "purge cycle" variation is applicable to all of the systems represented in figures 4-13x thru 4-22x. An example, as applied to the standard multizone system is shown in figures 5-12a through 5-12f. For a DDC control system, this variation can be incorporated by software changes, which should be reflected in the schedules and the sequence of operation.

b. The purge cycle utilizes a third set of contacts on the system timeclock for initiation. When this set of contacts close, a relay is energized to start the fan and a pilot light is turned on in the control panel. Once the fan is started, a solenoid valve (EP-XX-01) is energized, supplying main air to the mixed air dampers. This will move the outside air and relief air dampers to the fully open position, and the return air damper to the fully closed position; thereby supplying 100% outside air to the space. When the timeclock "purge" contacts open, ending the purge mode of operation, the system's mode of operation is determined by the remaining timeclock functions. Note that the purge mode of operation overrides the other modes, so far as the control of the mixed air dampers is concerned.

Figure 5-12a. Control system schematic for multizone HVAC system with building flush mode of operation.

Figure 5-12b. Control system ladder diagram for multizone HVAC system with building flush mode of operation.

Figure 5-12c. Control system equipment for multizone HVAC system with building flush mode of operation.

Figure 5-12d. Control panel interior door layout for multizone HVAC system with building flush mode of operation.

Figure 5-12e. Control panel back panel layout for multizone HVAC system with building flush mode of operation.

Figure 5-12f. Control panel terminal block layout for multizone HVAC system with building flush mode of operation.

12. CONTROL SYSTEM VARIATIONS FOR EMCS INITIATED BUILDING PURGE AND RECIRCULATION MODES.

a. When EMCS requires control of HVAC system outside air, return air, and relief air dampers, the devices used by EMCS to assume control of the dampers are external to the HVAC control panel. The devices required depend on whether the actuators are pneumatic or electric/ electronic.

b. Figure 5-13 shows the schematic variation for pneumatic actuators. The EMCS devices are: EPs labeled "EMCS", the purge/ auto and recirculating/auto contacts, and the associated control circuit. When EMCS is not in control, the EPs pass the pneumatic control signal from IP-XX01 to the PPs of the damper actuators. When the "PURGE/AUTO" contact is closed, main air passes through EP-1 to the PPs of the dampers, which causes the outside air damper to fully open. When the

"RECIRCULATING/AUTO" contact is closed, air is exhausted from the damper actuator PPs, causing the outside air damper to close. The return air and relief air dampers normally work in concert with the outside air damper. When both EMCS contacts are open, the EPs are de-energized and IP-XX01's pneumatic control signal is connected to the damper actuator's PPs.

Figure 5-13. Control system variations for EMCS building purge and recirculation modes for pneumatic actuators.

c. Figure 5-14 shows the EMCS devices required when the damper actuators are electric or electronic. The relays labelled "R-1 EMCS" and "R-2 EMCS" function in a manner similar to the EPs required for pneumatic actuators. The device labelled "EMCS MPS" is a minimum position switch set to hold the outside air damper open in the purge mode. The signal to the actuators is interrupted in the recirculating mode to close the outside air damper.

Figure 5-14. Control system variation for EMCS building purge and recirculation modes for electric or electronic actuators.

13. CONTROL SYSTEM VARIATIONS FOR SMOKE CONTROL AND FREEZE PROTECTION. In addition to the required HVAC control panels already shown, an HVAC system may have a smoke control and freeze protection panel, to house the equipment required to connect these systems to the HVAC control system. These systems can interrupt the control signals to starters, valves, and dampers for these special purposes. The smoke control and freeze protection panels, if required, will be custom designed specifically for each project. The standard HVAC control panels have interface provisions at terminal blocks for smoke control systems, freeze protection systems, or other external systems designed either to shut down the HVAC system or to bypass the shutdown circuits of the HVAC control system as required. The contract documents must show the interface requirements and locations of each non-HVAC control panel in the project. When direct digital controls are used to control an HVAC system, smoke control or freeze protection may be provided by a separate system as above, or these features can be integrated into one system.

14. CONTROL SYSTEM VARIATIONS FOR NON-ECONOMIZER HVAC SYSTEMS.

a. The economizer mode of operation is not appropriate for every HVAC application. When an HVAC system is designed for comfort applications without humidity control (i.e., no humidification or dehumidification), the control system will have a minimum-position switch to allow some adjustment of the mixed air flow. The steps involved in modifying a standard single-zone economizer mode control system (such as shown in Chapter 4) to convert it to a non-economizer control system are:

- (1) Delete all economizer loop devices (such as the economizer controller and its transmitter, relay contacts, and signal selector) from the control system schematic.
- (2) Delete the economizer's PV and DEV contacts and their associated relay and pilot light from the ladder diagram.
- (3) Delete the economizer controller and associated devices from the equipment schedule.

- (4) Delete the economizer controller from the interior door layout.
 - (5) Delete the signal selector and relays associated with the economizer controller from the back panel layout.
 - (6) Delete the economizer controller terminals from the terminal block layout.
- b. Control systems other than a single-zone control system can be modified to delete the economizer mode by deleting additional devices as follows:
- (1) Delete the mixed air temperature control loop and associated devices from the schematic.
 - (2) Delete the mixed air temperature controller and associated devices from the equipment schedule.
 - (3) Delete the mixed air temperature controller from the interior door layout.
 - (4) Delete the mixed air temperature controller terminal blocks from the terminal block layout.
- c. To show the results of the previously described procedures, the single-zone system shown in figures 4-19a through 4-19j has been modified to show a single-zone, non-economizer control system as figures 5-15a through 5-15j.

Figure 5-15a. Control system schematic for single-zone HVAC system without economizer control mode.

Figure 5-15b. Control system ladder diagram for single-zone HVAC system without economizer control mode.

Figure 5-15c. Control system equipment for single-zone HVAC system without economizer control mode.

Figure 5-15d. Control panel interior door layout for single-zone HVAC system without economizer control mode.

Figure 5-15e. Control panel back panel layout for single-zone HVAC system without economizer control mode.

Figure 5-15f. Control panel terminal block layout for single-zone HVAC system without economizer control mode.

Figure 5-15g. DDC control system schematic for single-zone HVAC system without economizer control mode.

Figure 5-15h. DDC control system ladder diagram for single-zone HVAC system without economizer control mode.

Figure 5-15i. DDC control system equipment for single-zone HVAC system without economizer control mode.

Figure 5-15j. DDC control system I/O table and data terminal strip layout for single-zone HVAC system without economizer control mode.

15. CONTROL SYSTEM VARIATIONS FOR DUAL STEAM VALVES. Generally when the size of a steam control valve exceeds 65 mm (2-1/2 inches) (pipe size) or when there is a seasonal requirement for low flow, two steam valves will be used to enhance control authority. Usually the valves are sized for 1/3 of the total flow and 2/3 of the total flow. The valve K_v s (C_v s) will be selected from available products with one valve having a smaller K_v (C_v). The valves are then sequenced without a control signal deadband. The control signal range available for operating the valves is to be split into two parts - one third of the signal range (21 to 48 kPa (3 to 7 psi)) is used to modulate the smaller valve and two thirds (48 to 103 kPa (7 to 15 psi)) of the signal range is used to modulate the larger valve. In the control sequence, the smaller control valve opens first. The control system drawings affected are the schematic and the equipment schedule. Figures 4-10a and 4-10c have been modified to show the required changes and are shown as figures 5-16 and 5-17.

Figure 5-16. Schematic variations for dual steam valves.

Figure 5-17. Equipment schedule variations for dual steam valves.

16. CONTROL SYSTEM VARIATIONS FOR HYDRONIC SYSTEMS WITH BOILERS REQUIRING CONSTANT FLOW. Figures 4-8a through 4-8j and 4-12a through 4-12j depict single building hydronic systems which vary the flow through the boiler. However, some boilers will not tolerate low-flow conditions. Figures 5-18a through 5-18j and 5-19a through 5-19j show variations of these systems which maintain a constant flow rate through the boiler. The variations consist of adding an additional piping loop around the boiler and an additional pump.

Figure 5-18a. Control system schematic for single building hydronic heating system with constant volume hot water boiler loop.

Figure 5-18b. Control system ladder diagram for single building hydronic heating system with constant volume hot water boiler loop.

Figure 5-18c. Control system equipment for single building hydronic heating system with constant volume hot water boiler loop.

Figure 5-18d. Control panel interior door layout for single building hydronic heating system with constant volume hot water boiler loop.

Figure 5-18e. Control panel back panel layout for single building hydronic heating system with constant volume hot water boiler loop.

Figure 5-18f. Control panel terminal block layout for single building hydronic heating system with constant volume hot water boiler loop.

Figure 5-18g. DDC control system schematic for single building hydronic heating system with constant volume hot water boiler loop.

Figure 5-18h. DDC control system ladder diagram for single building hydronic heating system with constant volume hot water boiler loop.

Figure 5-18i. DDC control system equipment for single building hydronic heating system with constant volume hot water boiler loop.

Figure 5-18j. DDC control system I/O table and data terminal strip layout for single building hydronic heating system with constant volume hot water boiler loop.

Figure 5-19a. Control system schematic for single building dual-temperature hydronic system with constant volume boiler loop.

Figure 5-19b. Control system ladder diagram for single building dual-temperature hydronic system with constant volume boiler loop.

Figure 5-19c. Control system equipment for single building dual-temperature hydronic system with constant volume boiler loop.

Figure 5-19d. Control panel interior door layout for single building dual-temperature hydronic system with constant volume boiler loop.

Figure 5-19e. Control panel back panel layout for single building dual-temperature hydronic system with constant volume boiler loop.

Figure 5-19f. Control panel terminal block layout for single building dual-temperature hydronic system with constant volume boiler loop.

Figure 5-19g. DDC control system schematic for single building dual-temperature hydronic system with constant volume boiler loop.

Figure 5-19h. DDC control system ladder diagram for single building dual-temperature hydronic system with constant volume boiler loop.

Figure 5-19i. DDC control system equipment for single building dual-temperature hydronic system with constant volume boiler loop.

Figure 5-19j. DDC control system I/O table and data terminal strip layout for single building dual-temperature hydronic system with constant volume boiler loop.

CHAPTER 6

RETROFIT OF EXISTING HVAC CONTROL SYSTEMS

1. INTRODUCTION. When determining whether to retain or replace existing control systems (in whole or in part) in the retrofit of existing HVAC systems, the designer must evaluate the applicability of the design guidance provided in this manual. The reason for this evaluation is that deviation from this guidance may be necessary in certain circumstances to prevent adverse impacts on the operation and performance of the retrofitted HVAC systems. Examples of control system situations that require such evaluation are as follows:

- a. Reuse of existing valves, where their sizes may affect the existing or new hydronic systems and their pump sizing.
- b. Reuse of existing dampers, where their sizes may affect the existing or new air handling systems and their fan sizing.
- c. Replacing three-way valves with two-way valves and vice versa and its effect on hydronic systems and their pump sizing.
- d. Partial retrofit, where only the final elements such as dampers, valves, and operators may be left in place.
- e. Retrofits involving economizer control loops.
- f. HVAC systems that may not match the systems shown in Chapter 4 or their variations in Chapter 5.

2. VALVE SIZING AND ITS EFFECT ON HYDRONIC SYSTEMS. Quite likely the guidance provided in this manual for the sizing of control valves differs from the design criteria on which the existing control valves (in a retrofit project) were selected. Consequently, the designer must compare the pressure drop across the existing control valve with the pressure drop for a control valve based on the sizing requirements of this manual. If the existing valve sizes do not meet the pressure drop requirement for sizing valves in accordance with this manual, it may be that the sizing of the existing valves was based on pressure drop through the valves lower than required by the manual. The designer must then determine if the existing pumping system can provide adequate flow throughout the system with new valves (sized in accordance with this manual) in place. If not, the existing pumping system will have to be upgraded or replaced if the valve sizing pressure drop guidance of this manual is applied.

3. DAMPER SIZING AND ITS EFFECT ON AIR HANDLING SYSTEMS. Evaluation of control dampers in a retrofit project is similar to control valve evaluation, because changing the size of an existing damper would change the damper's pressure drop and in turn affect fan air volume delivery. Also, the damper actuators might have to be retrofitted if the evaluation shows a change in the damper's pressure drop.

4. REPLACEMENT OF 3-WAY AND 2-WAY VALVES. Whenever there is a change in the type of control valve in a retrofit project (either from a 2-way valve to a 3-way valve or vice versa), the designer must make additional pressure and flow evaluations. If the change is from 3-way to 2-way, the pressure could increase significantly with a significant pumping system flow decrease as the valve closes. Conversely, the change from 2-way to 3-way could cause significant pressure decrease and flow

increase. In either case, there could be adverse effects on HVAC system performance. The designer must evaluate and account for the new pressure drops in deciding whether to change the type of valve.

5. RETROFIT PROJECTS WHERE ONLY FINAL ELEMENTS MAY BE LEFT IN PLACE. Some HVAC retrofit projects may involve new controls, but may not require replacement of existing primary elements such as dampers, valves, sensing elements, or other measurement devices. In such instances, the designer must insure that the control signals (both input and output) and actuators for the final elements are in accordance with the design guidance provided in this manual.

6. RETROFITS INVOLVING ECONOMIZER CONTROL LOOPS. If an HVAC system with an economizer mode of operation is to be retrofitted, or if an economizer mode is to be added to an existing HVAC system, the economizer components must be in accordance with the guidance described in the manual.

7. RETROFIT PROJECTS INVOLVING HVAC SYSTEMS NOT COVERED IN THIS MANUAL. When an individual HVAC control system not shown in this manual requires upgrading, it may not be feasible nor suitable to follow the guidance of this manual. It is most likely that maintaining consistency with the remainder of the control system is of more value. It is the responsibility of the designer to evaluate existing conditions to determine the suitability of following the guidance of this manual.

8. GENERAL CONSIDERATIONS FOR RETROFIT PROJECTS.

- a. Only electric or electronic terminal unit controls, if serviceable, may be reused.
- b. No existing pneumatic controls except pneumatic valve actuators and damper actuators, if serviceable, may be reused.
- c. If pneumatic actuators are to be reused and the designer finds that their use is justified on the basis of life-cycle cost, the existing air compressors and related accessories, if serviceable, may be reused.
- d. Electric or electronic HVAC control systems with standard signal levels (i.e., 4-20 ma) if serviceable, may be reused.
- e. If existing HVAC systems are retrofitted with control systems designed in accordance with this TI, extension of EMCS to such HVAC systems will interface with the control system as shown in this TI.

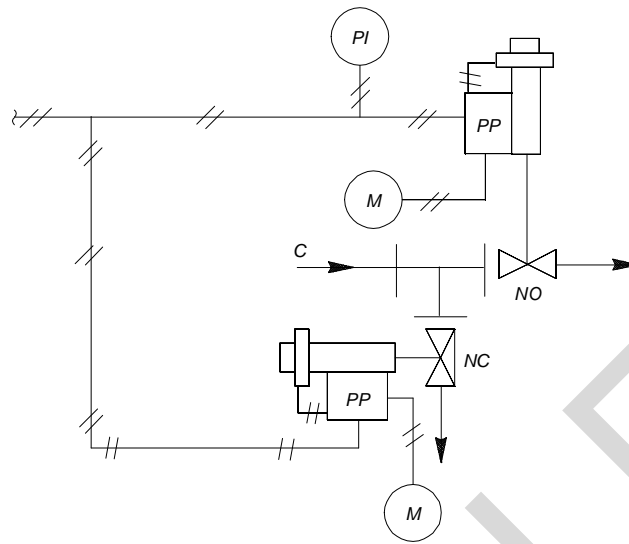

3-WAY BYPASS APPLICATION

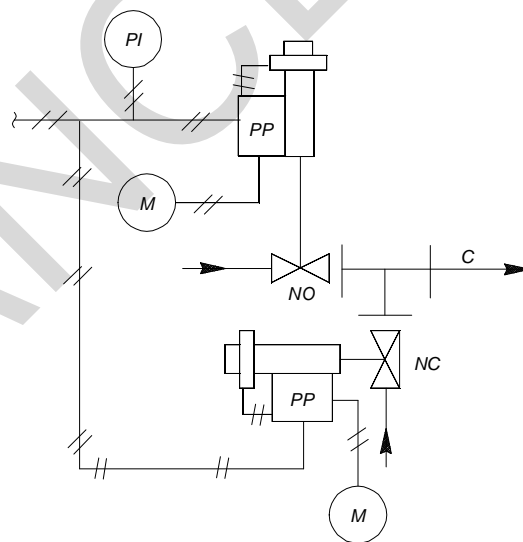

3-WAY MIXING APPLICATION

Figure 2-1. Two butterfly valves on a common pipe tee.

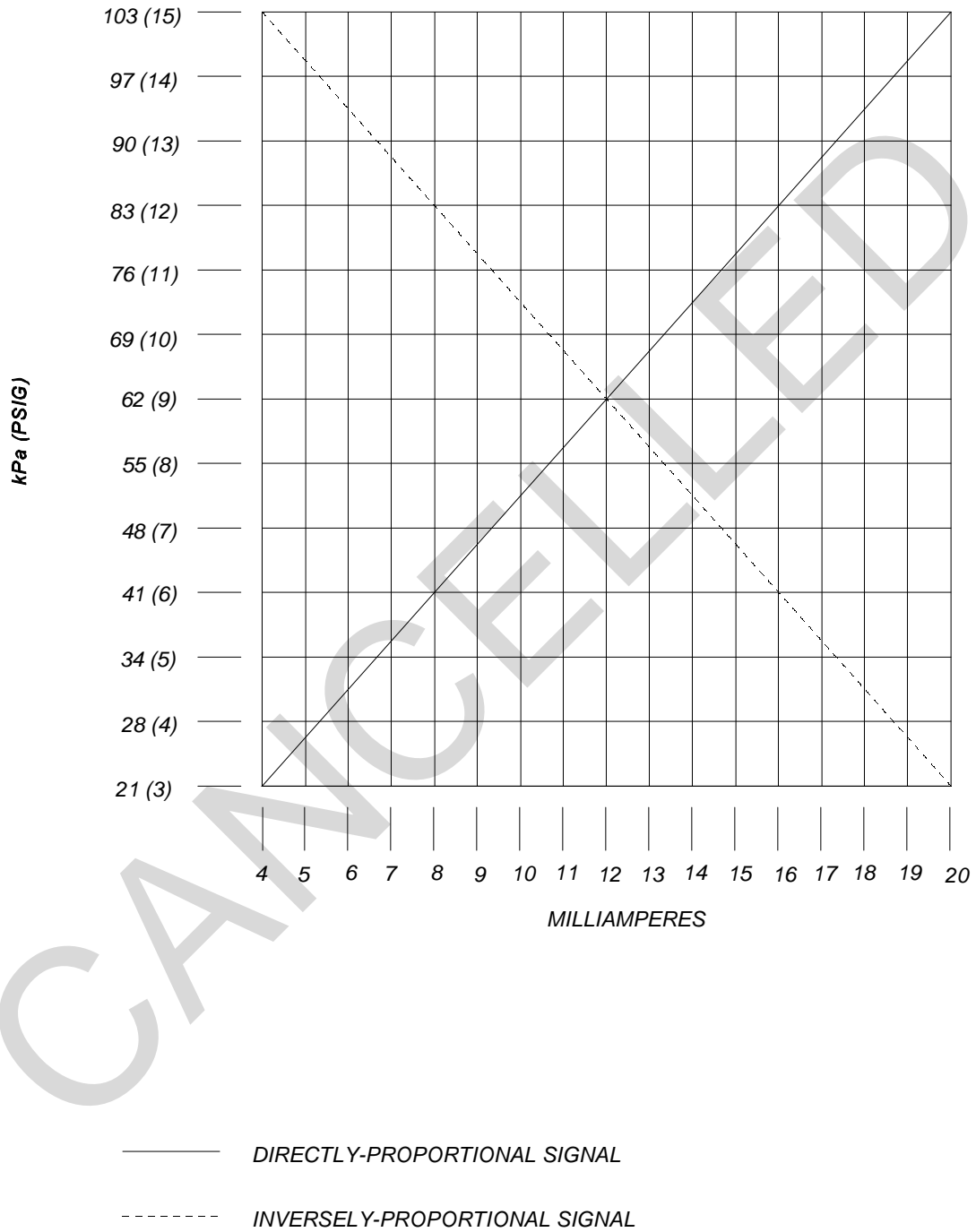

Figure 2-2. Conversion of an electronic signal to a pneumatic signal.

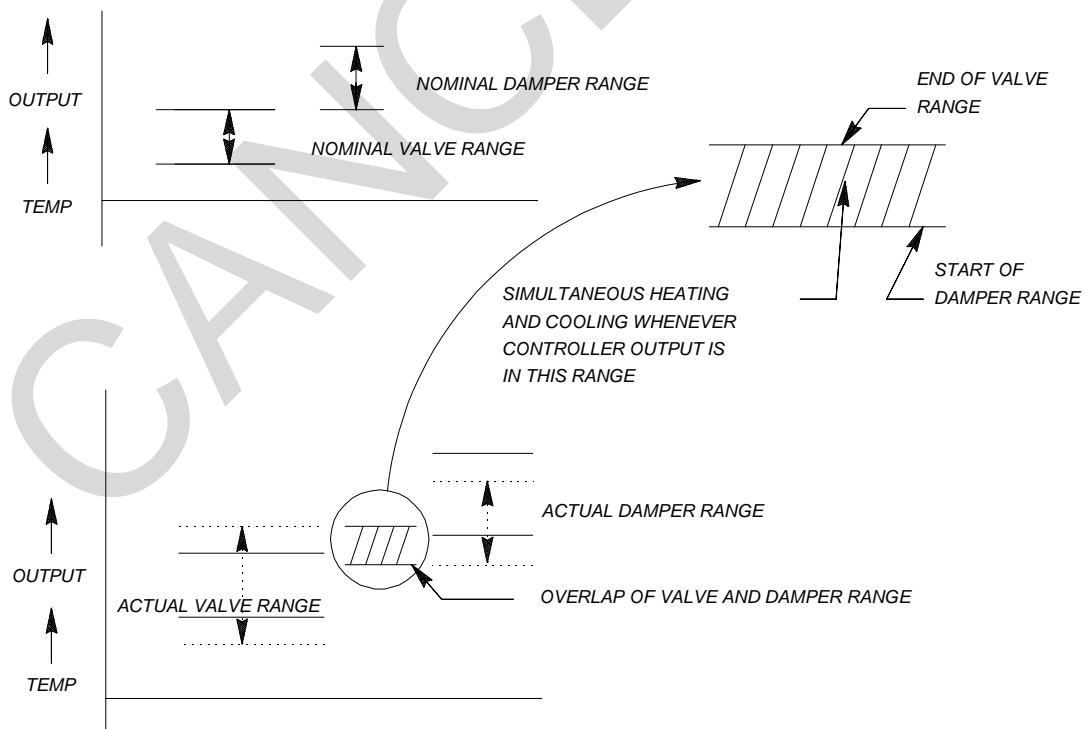
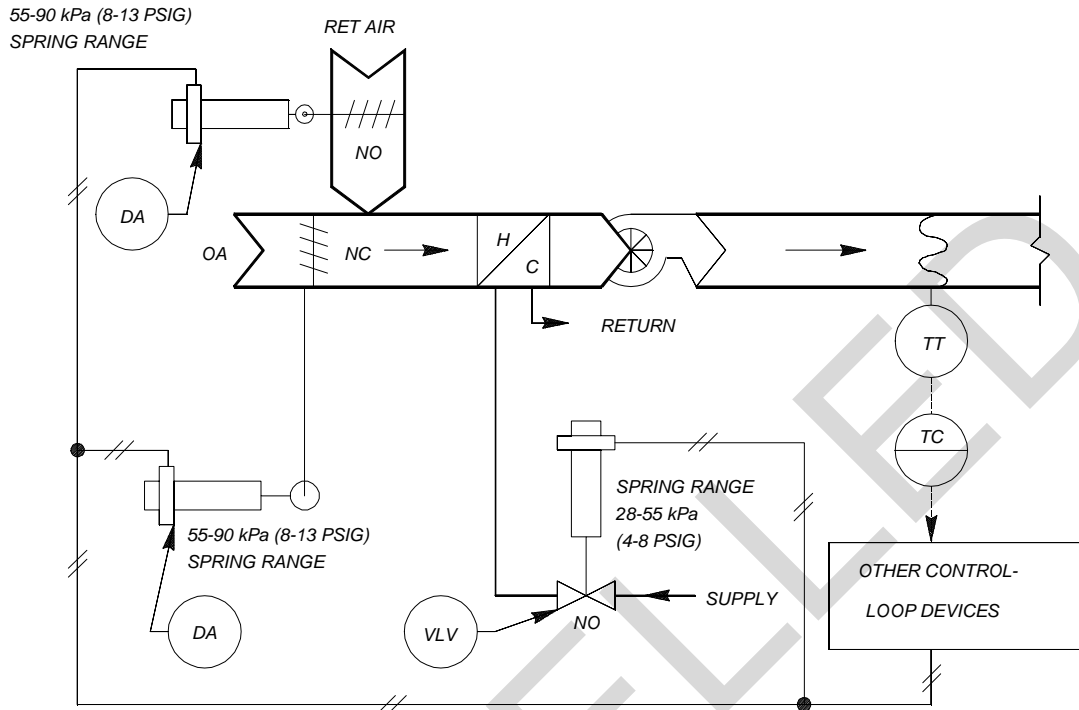

Figure 2-3. Simultaneous heating and cooling with pneumatic actuators without positive positioners.

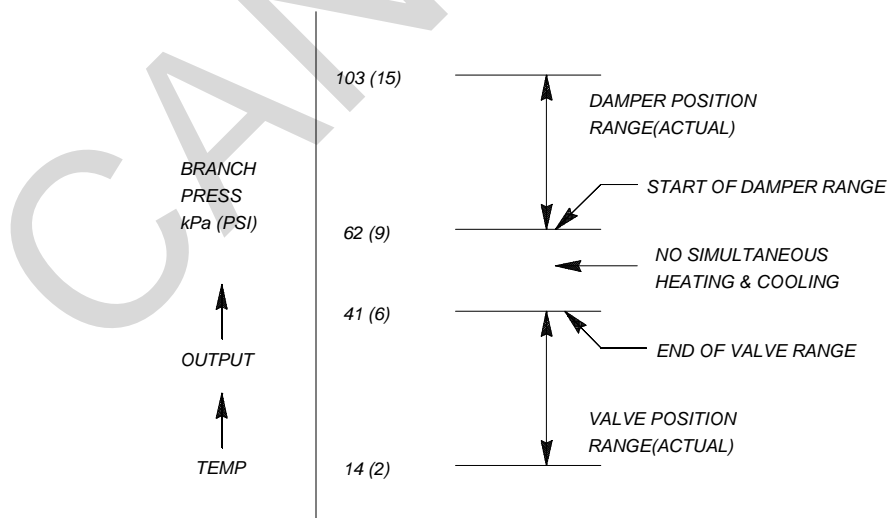
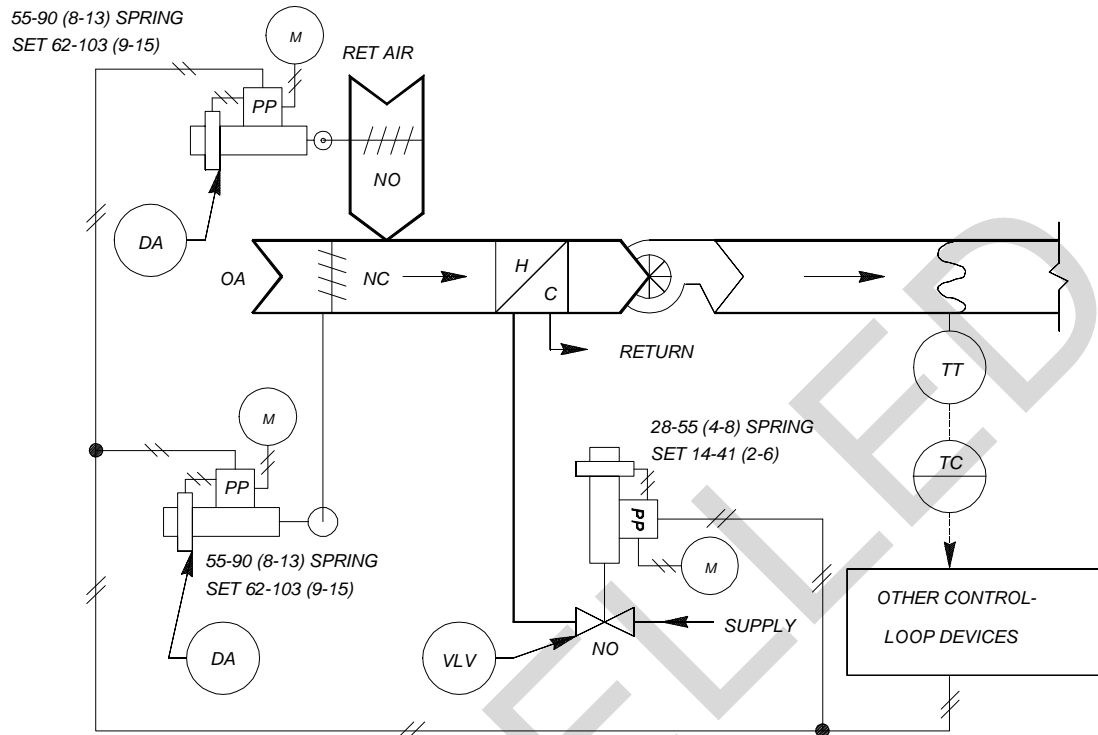

Figure 2-4. Control system with positive positioners to avoid simultaneous heating and cooling.

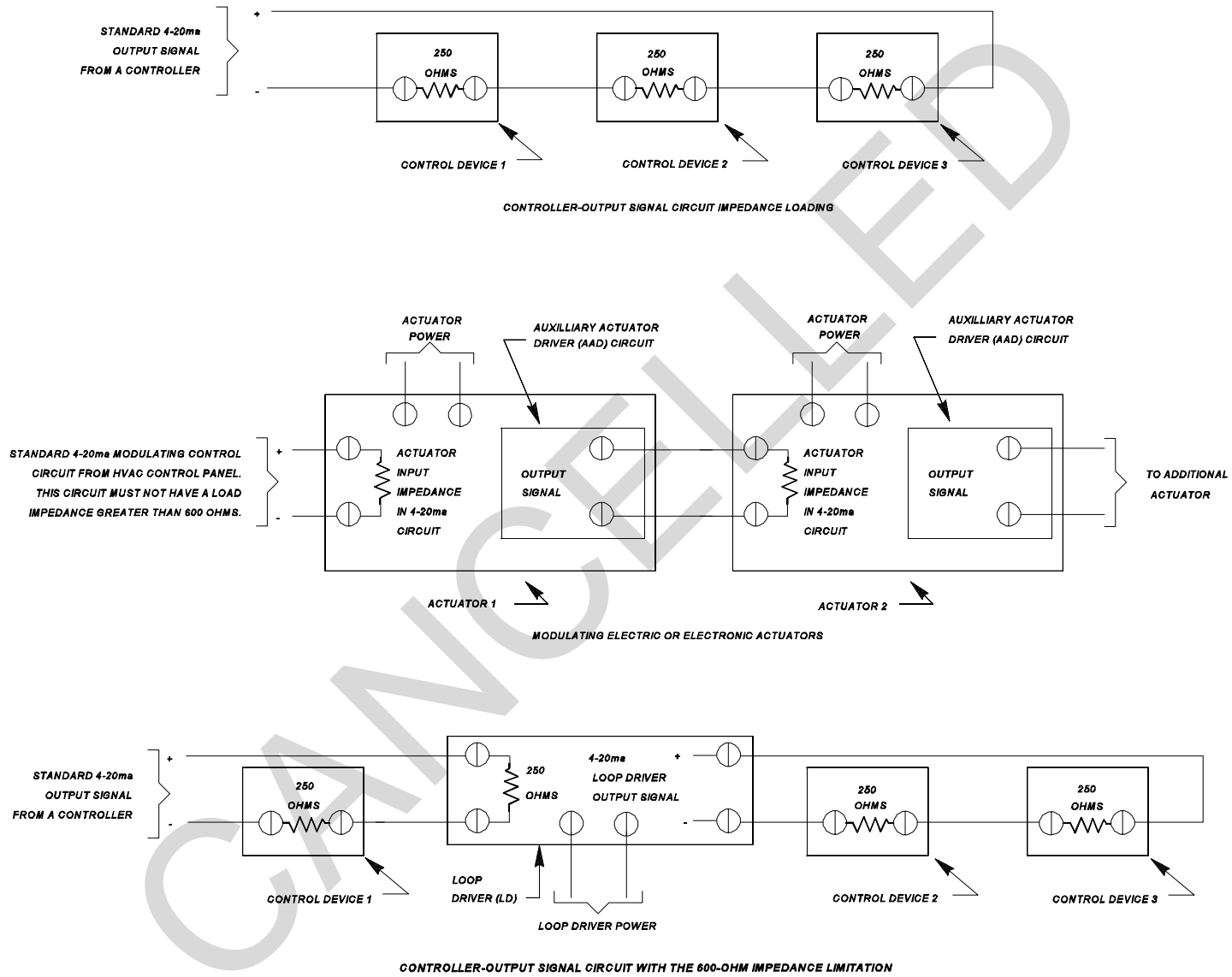

Figure 2-5. Modulating control circuits impedance limitation.

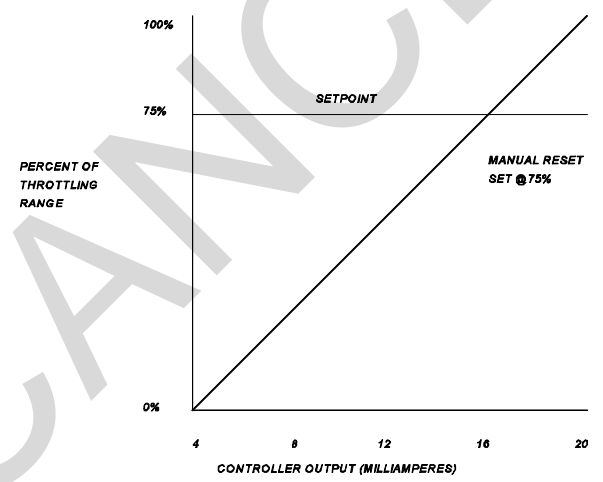
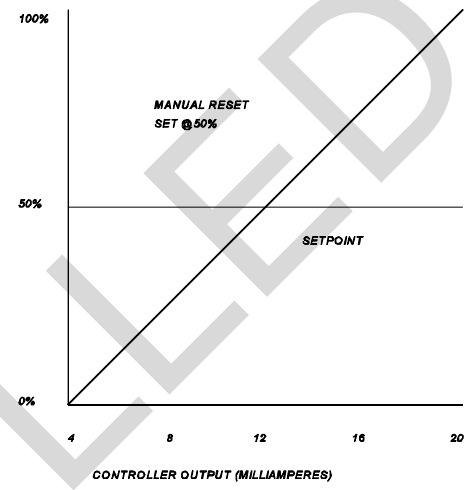
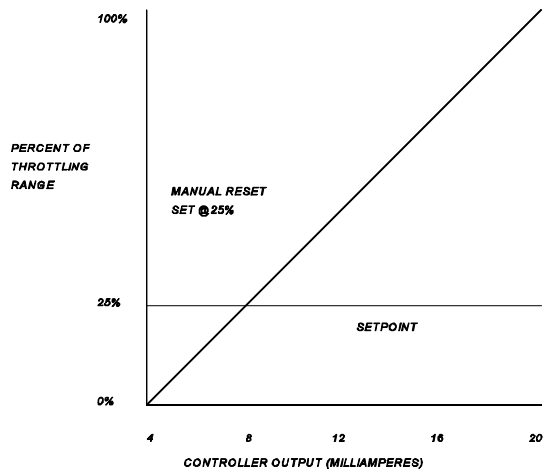

Figure 2-6. Manual reset feature.

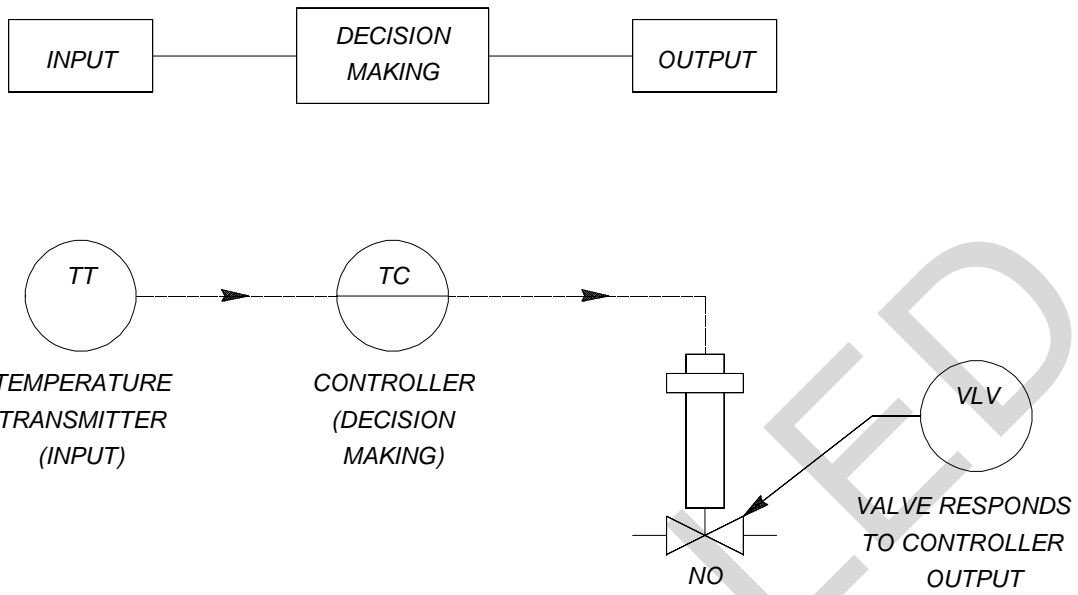

Figure 2-7. Control loop.

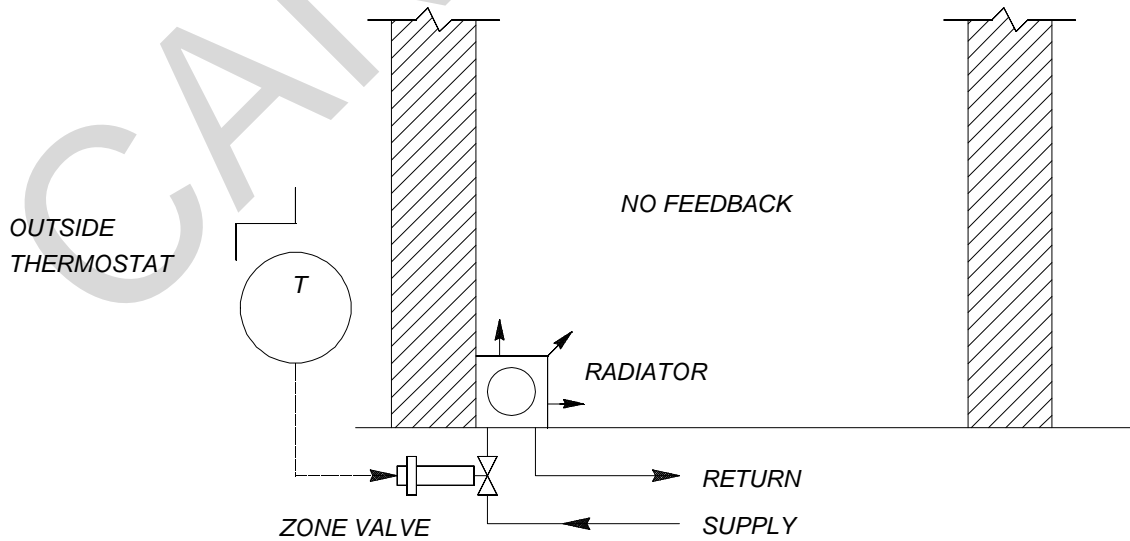

Figure 2-8. Open control loop.

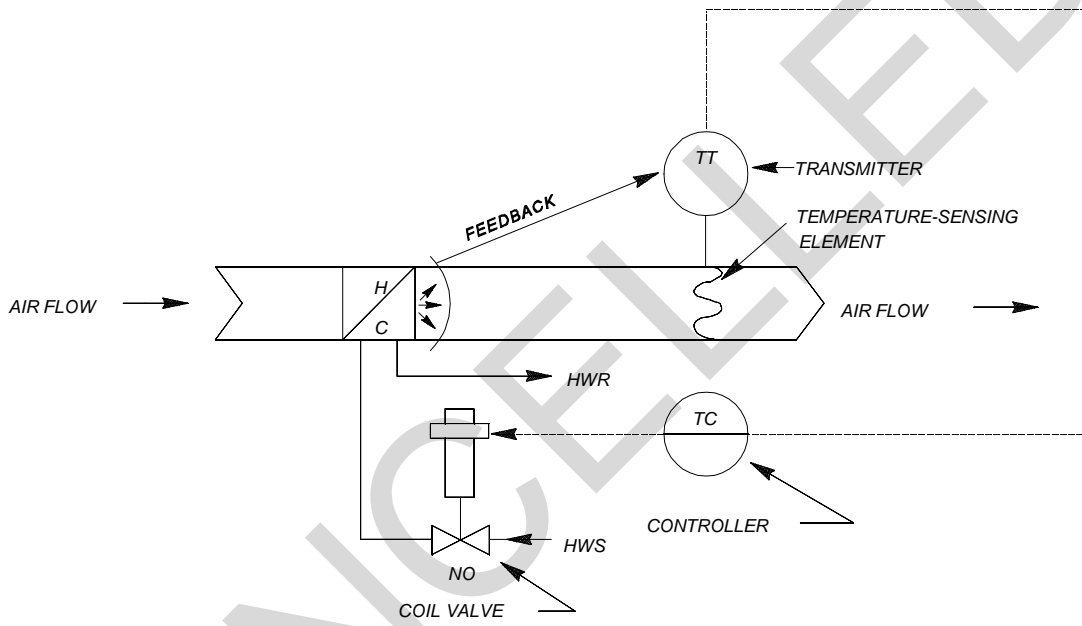

Figure 2-9. Closed control loop.

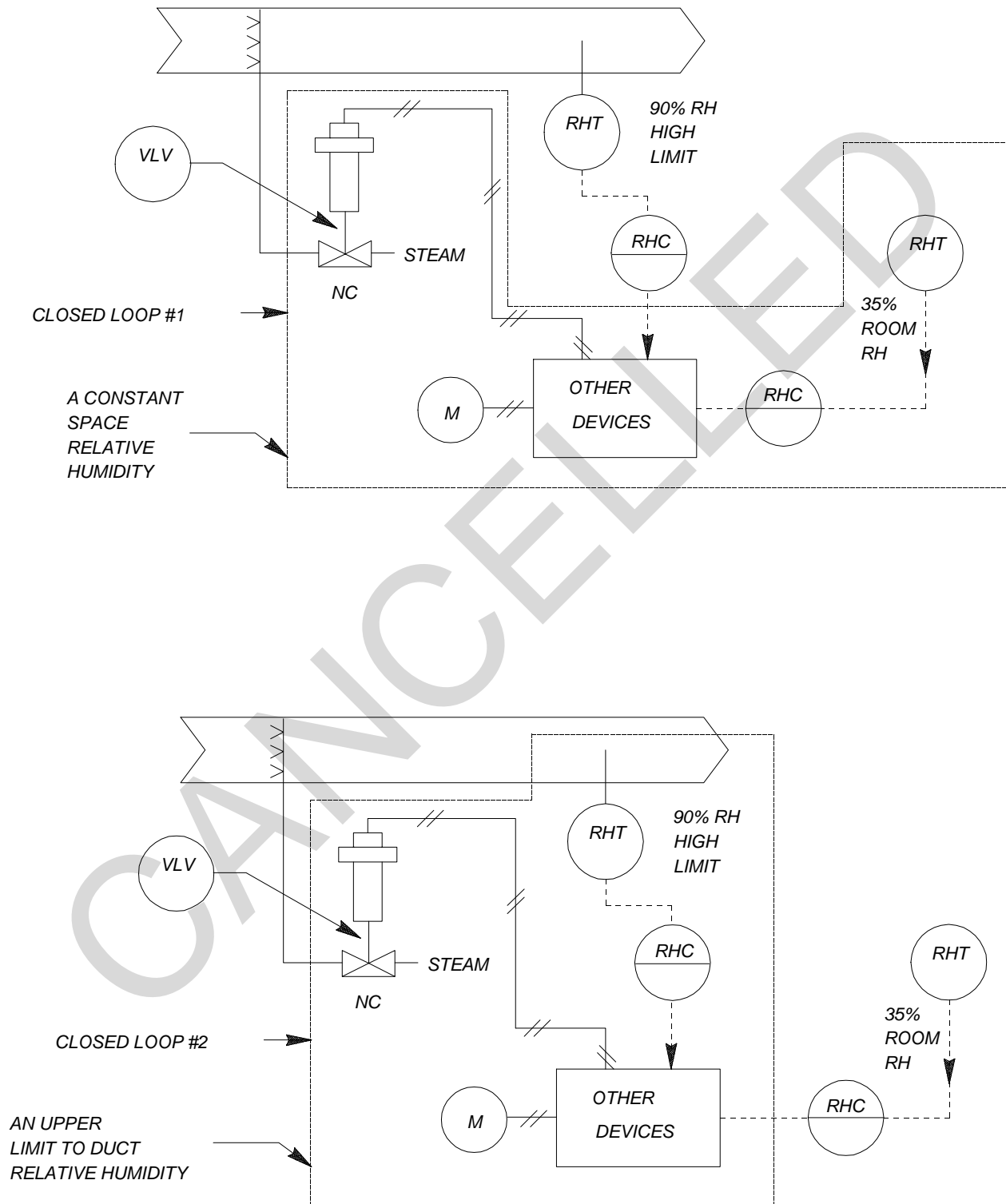

Figure 2-10. Two loops controlling one device (humidity control with high limit).

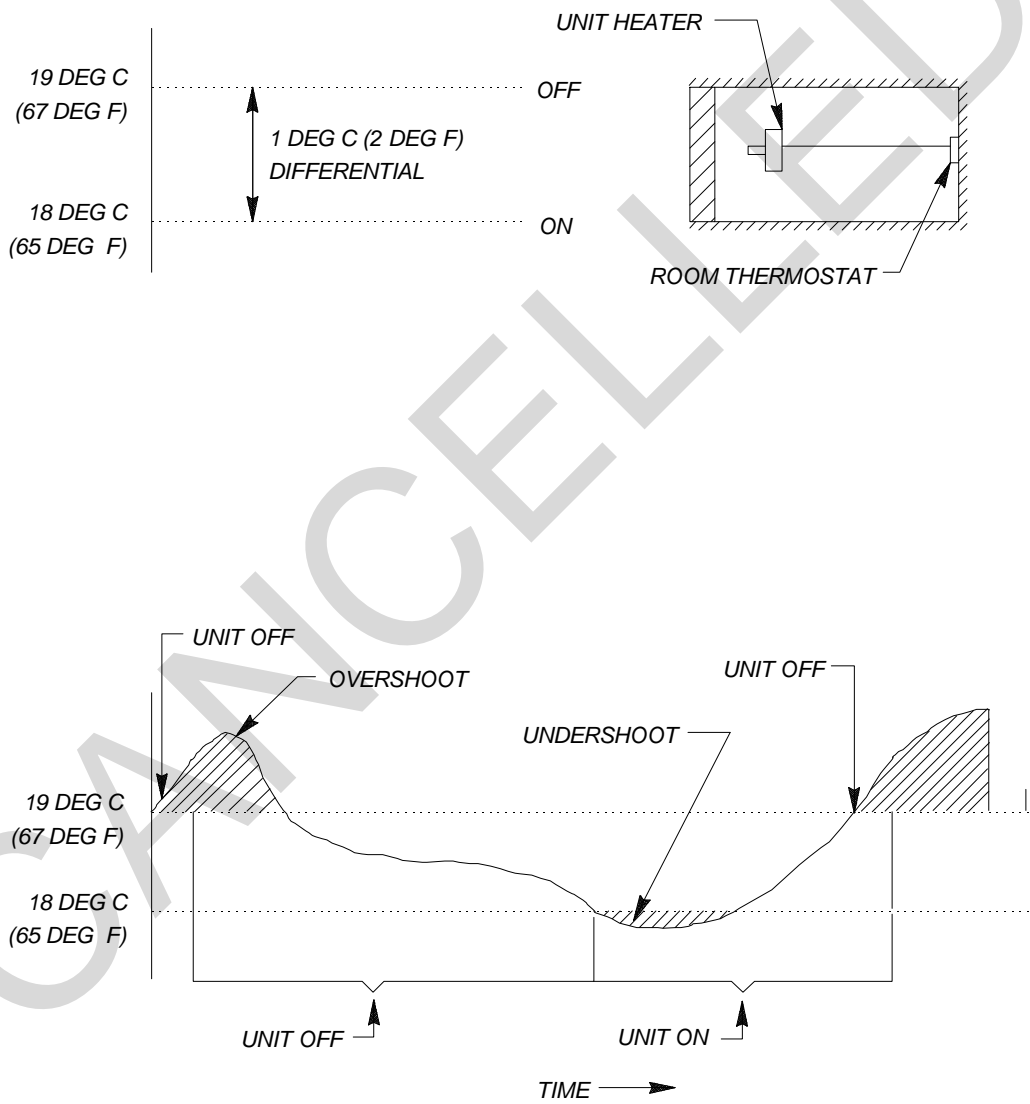

Figure 2-11. Two-position control.

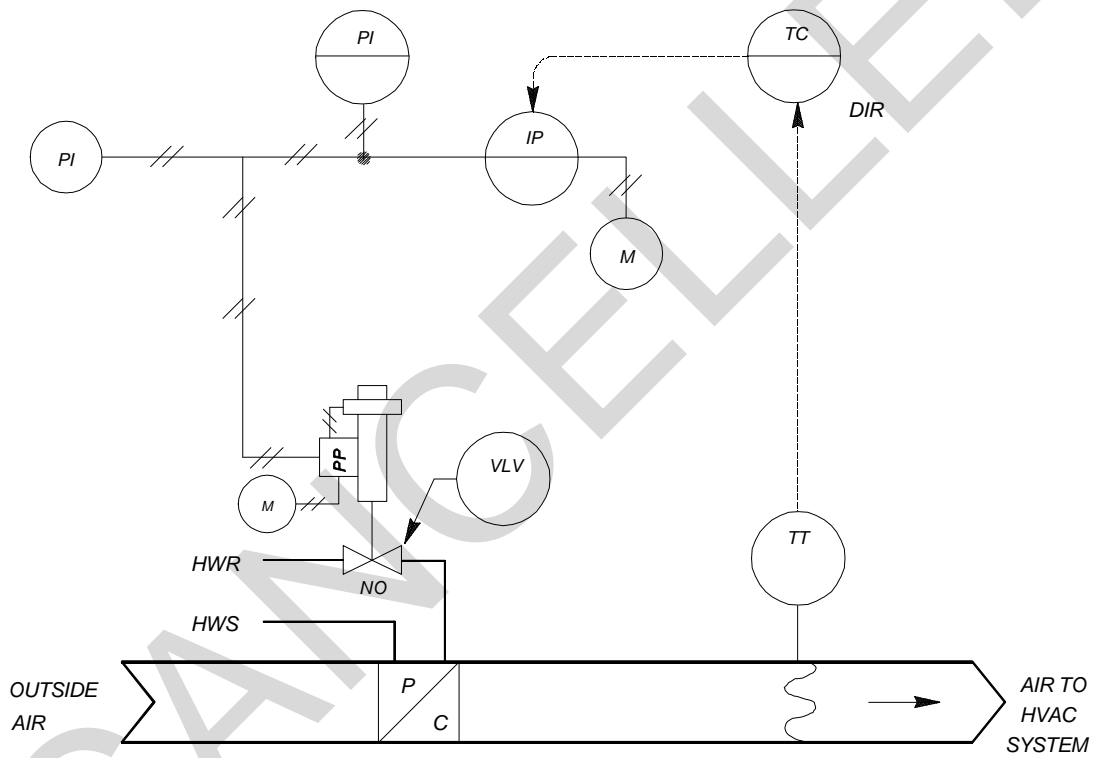

Figure 2-12. Simple control loop applied to outside air heating.

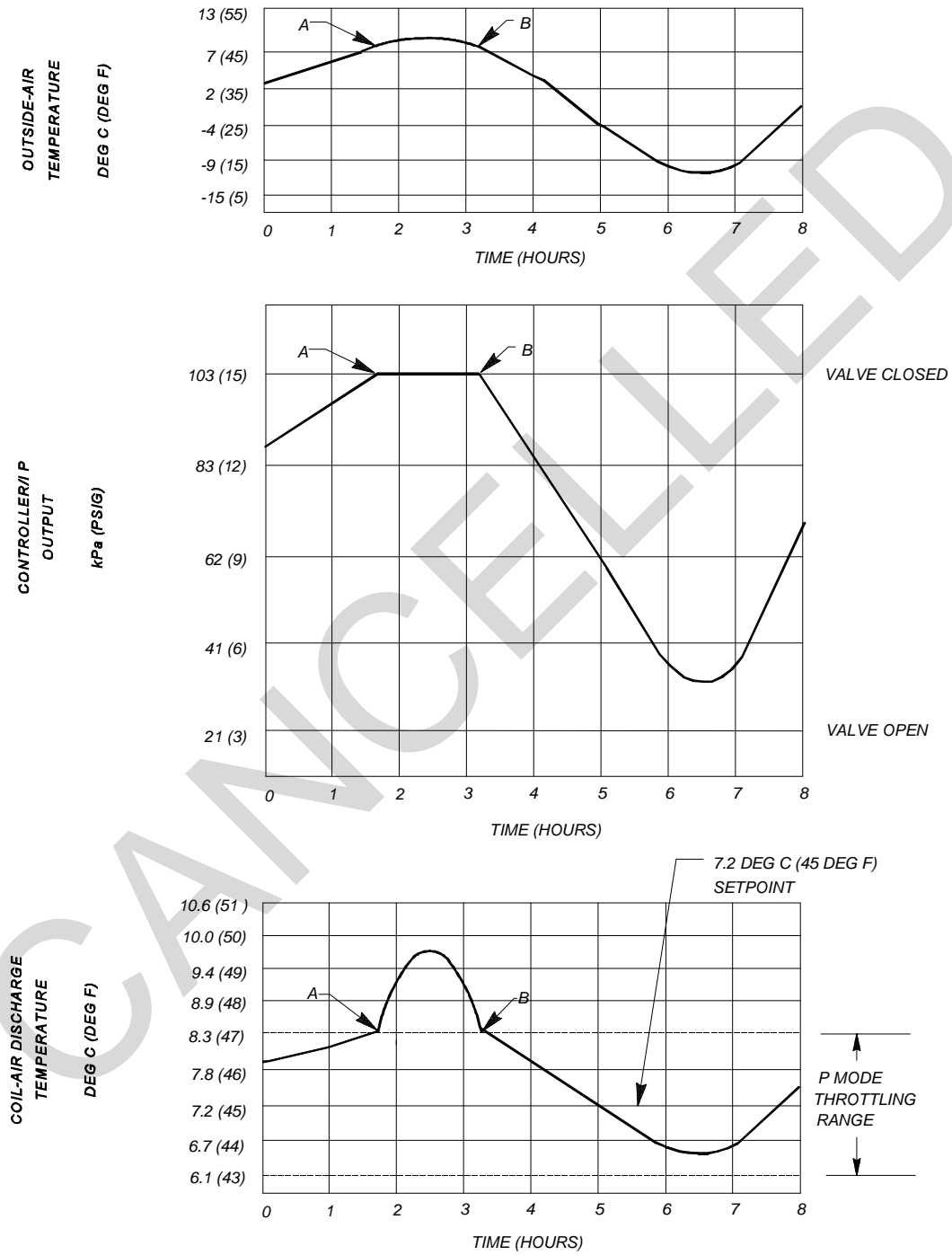

Figure 2-13. Proportional control mode.

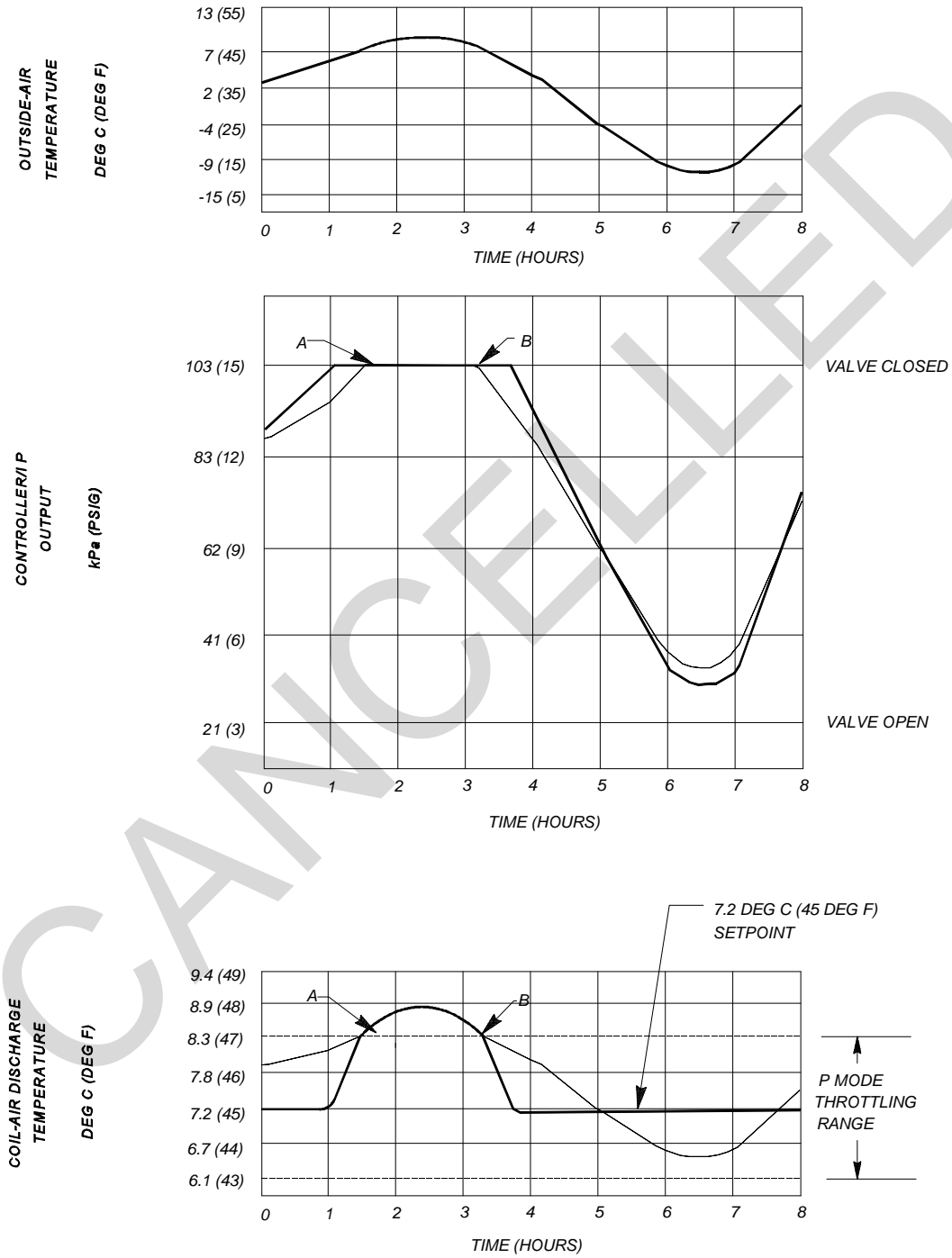

Figure 2-14. Proportional plus integral control mode.

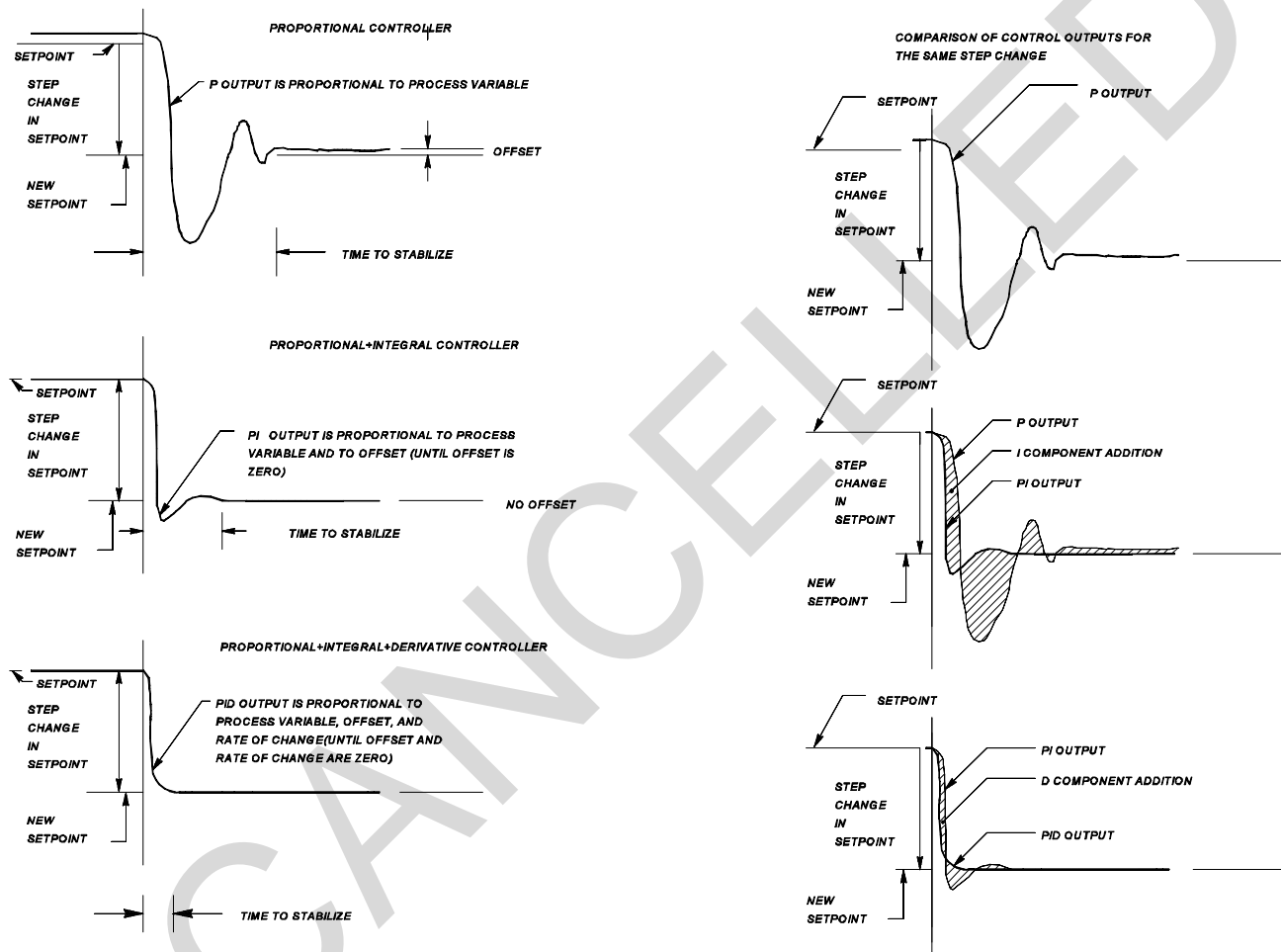

Figure 2-15. Comparison of P mode, PI mode, and PID mode for a step change in setpoint, and the contributions of each mode to controller output signal.

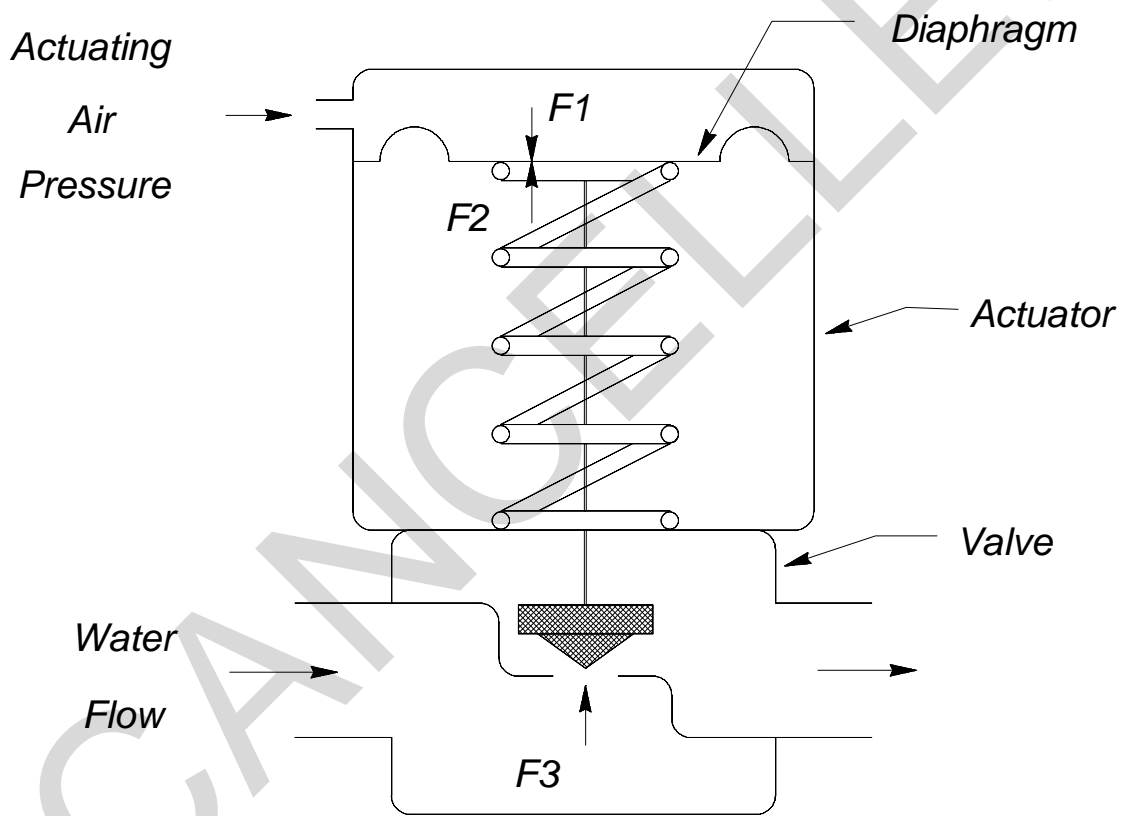

Figure 2-16. Typical normally-open pneumatic valve.

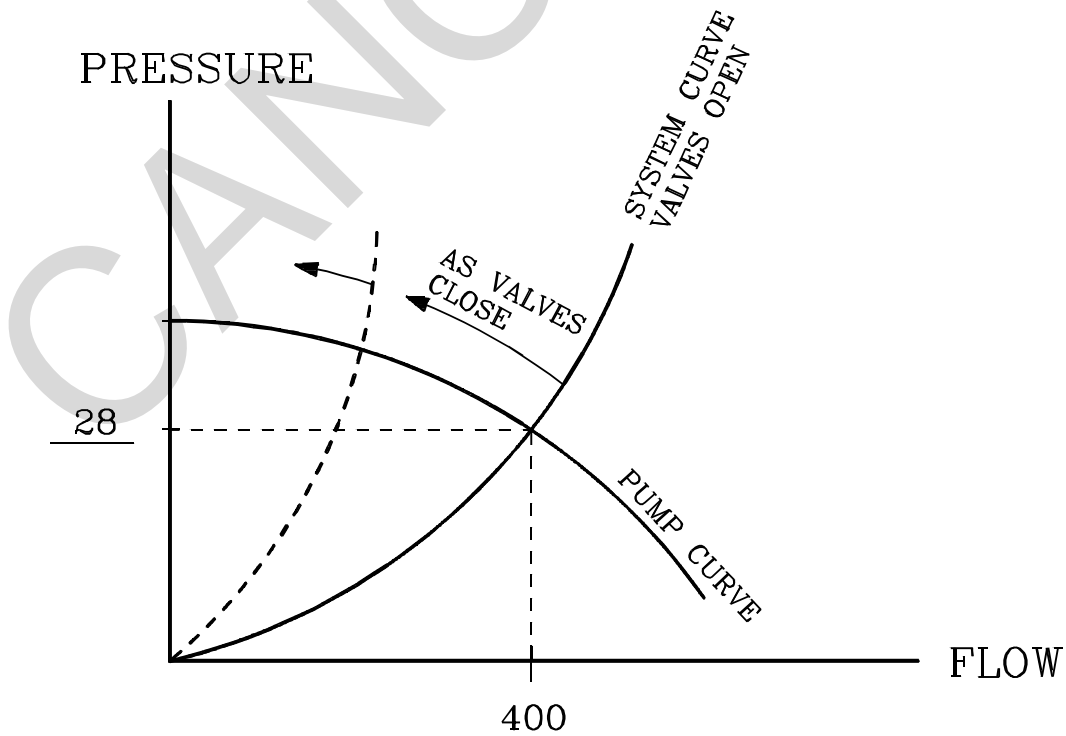
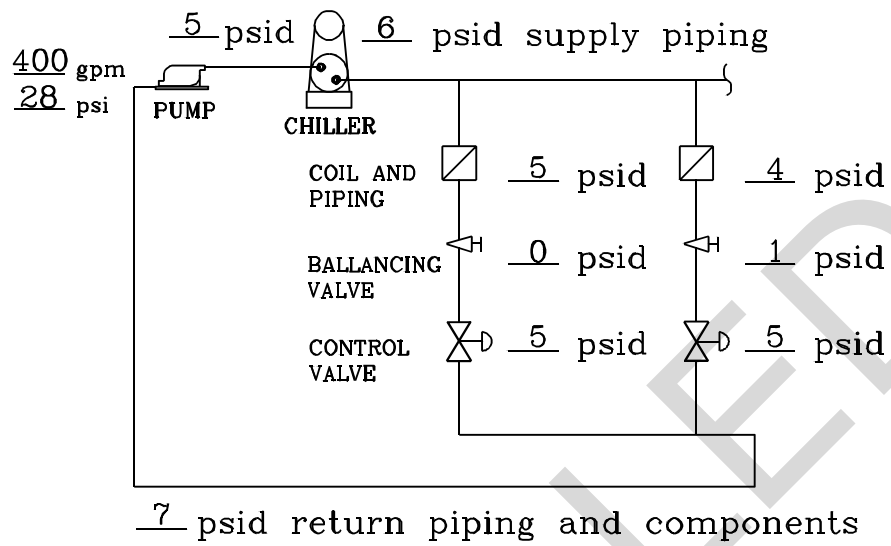

Figure 2-17. Close-off pressure for two-way valves.

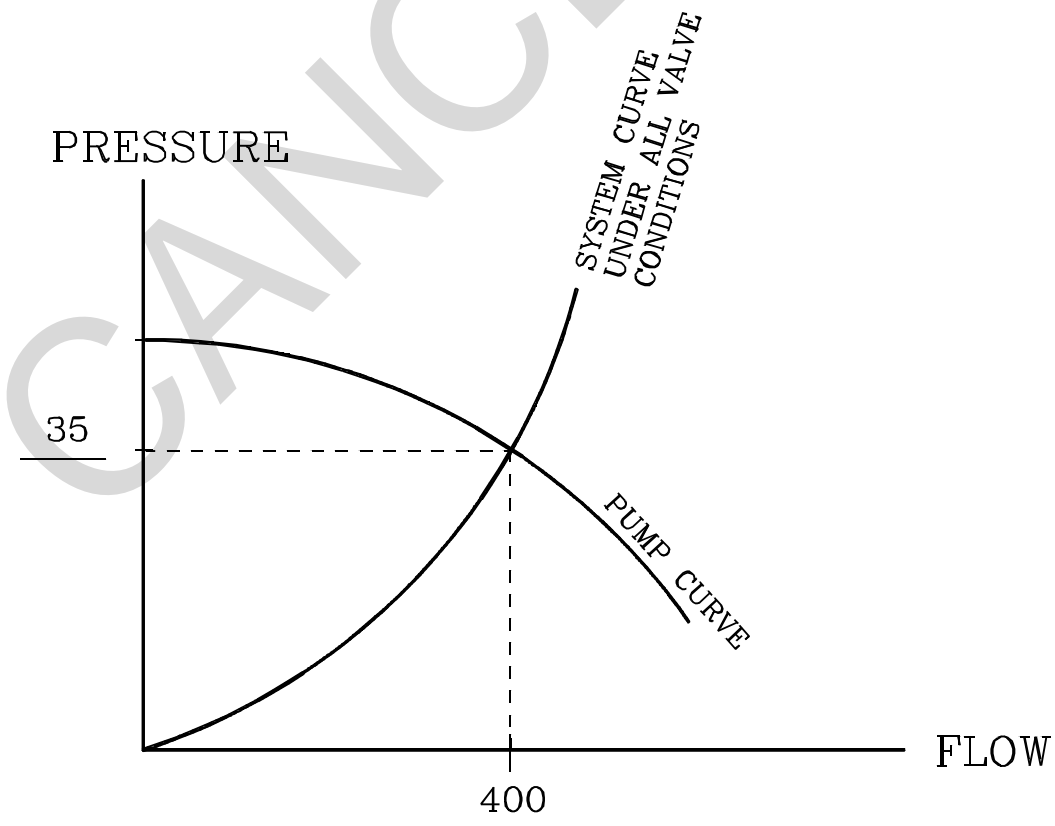
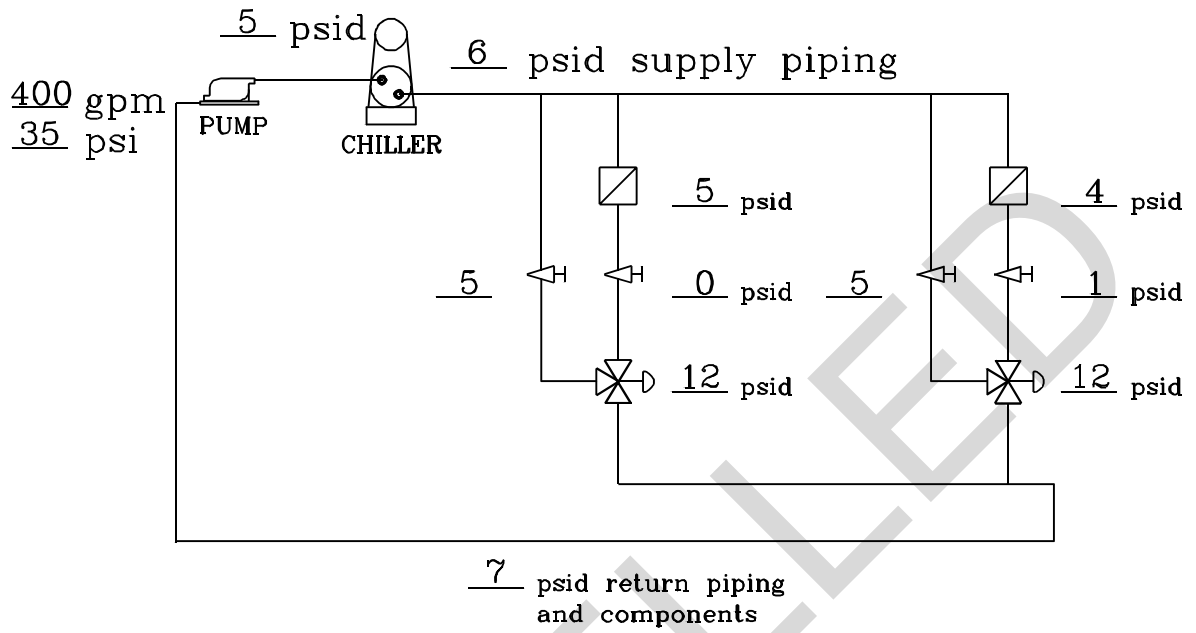

Figure 2-18. Close-off pressure for three-way valves.

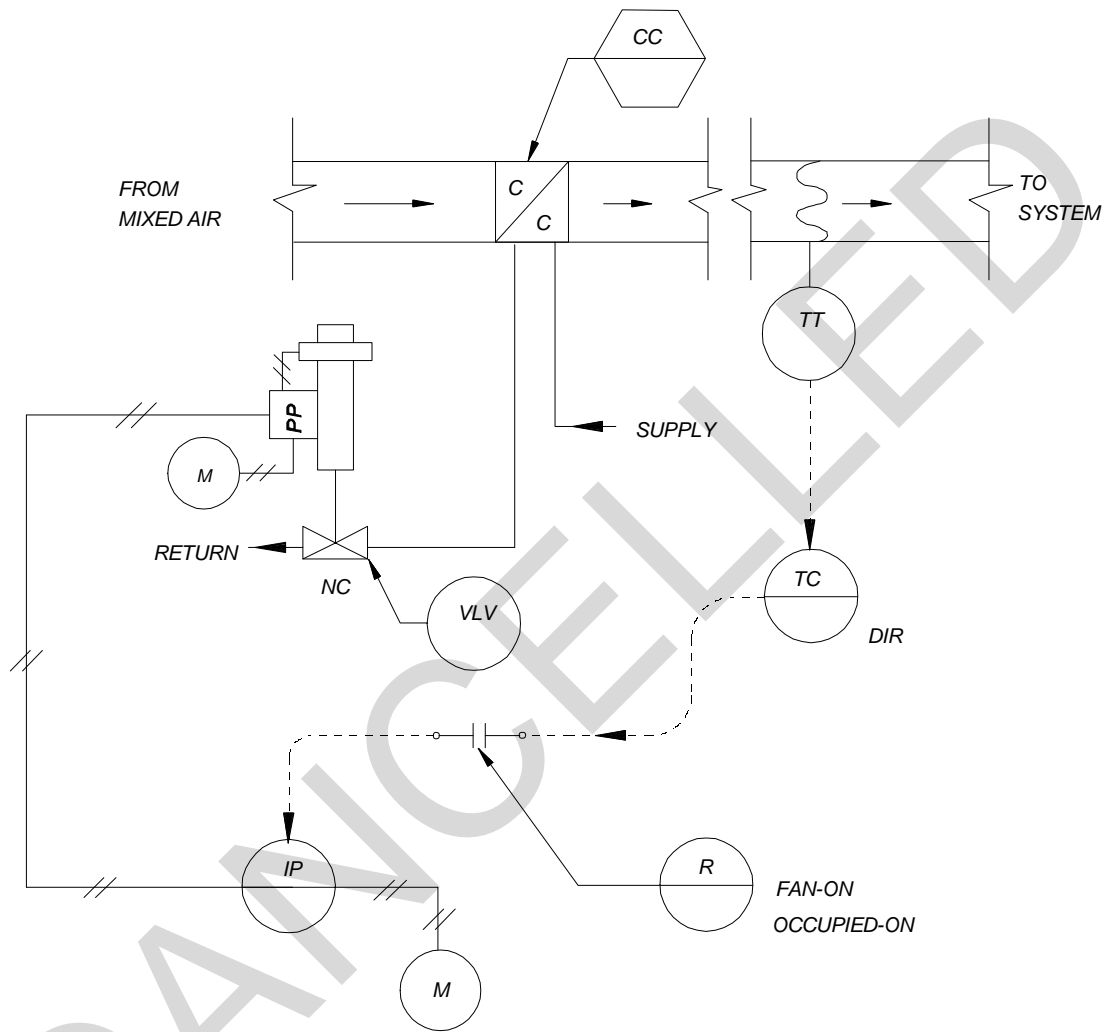

Figure 3-1. Cooling coil temperature control loop.

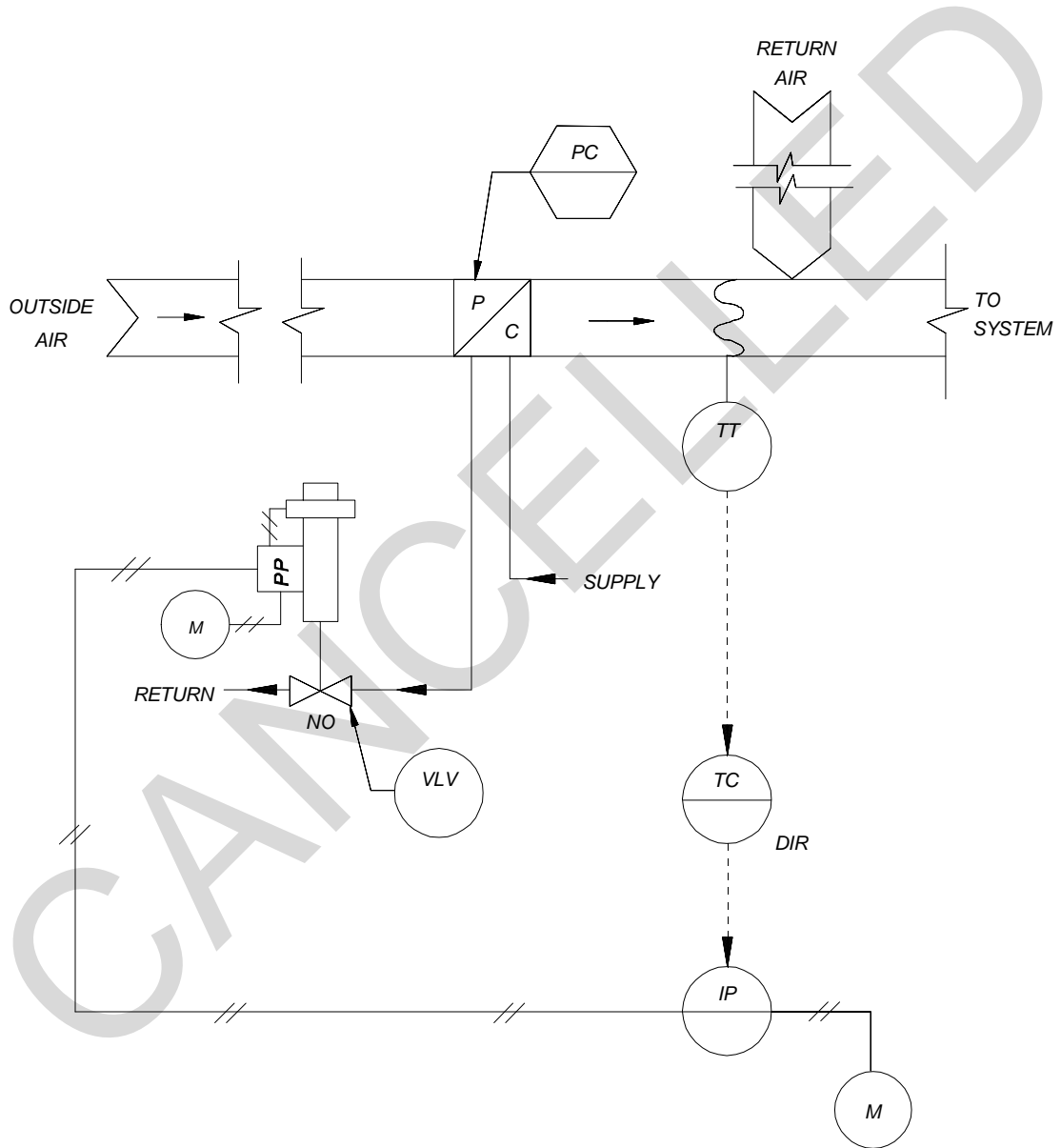

Figure 3-2. Outside air preheat coil temperature control loop.

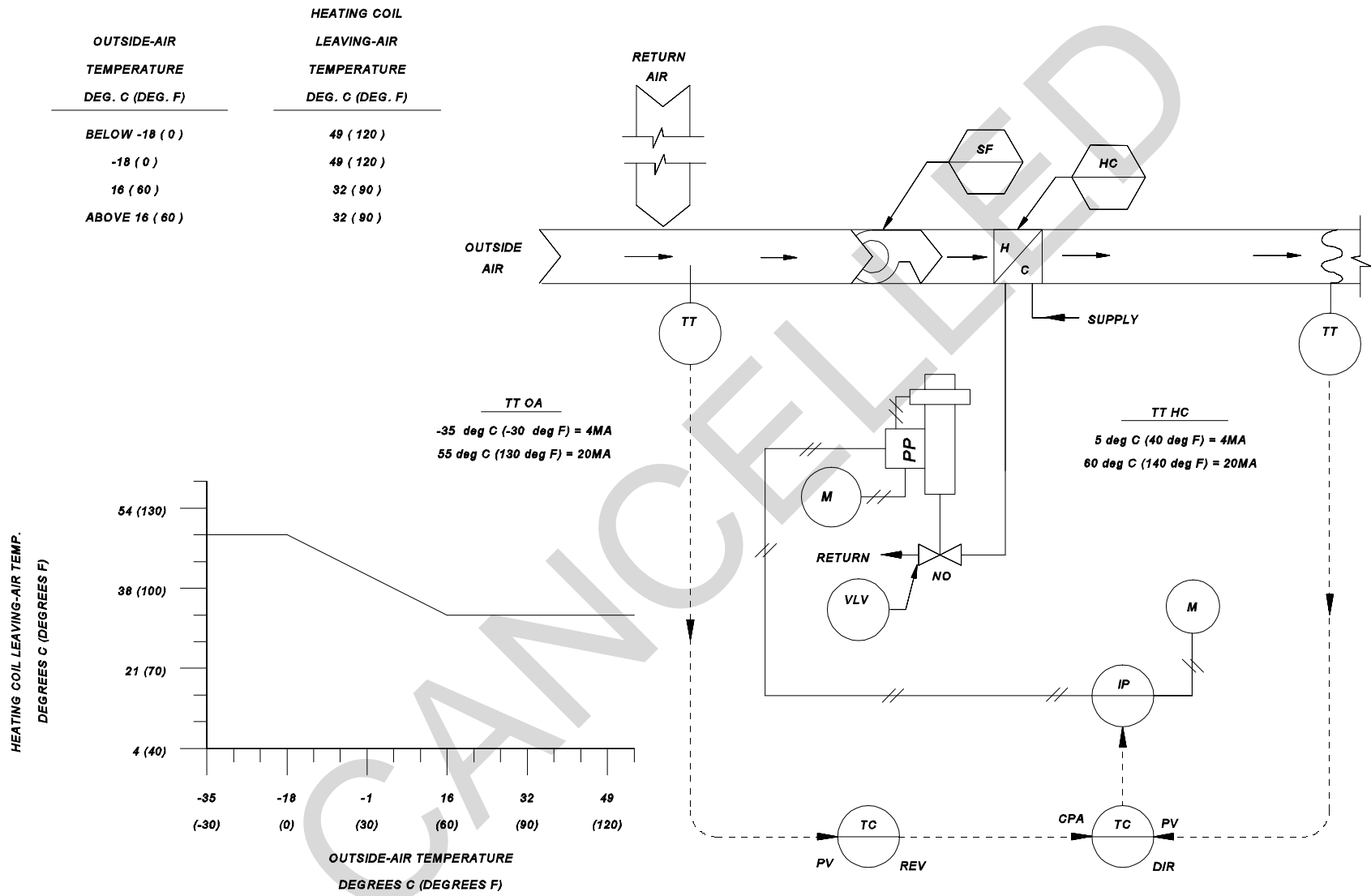

Figure 3-3. Heating coil temperature control loop (scheduled from outside air temperature).

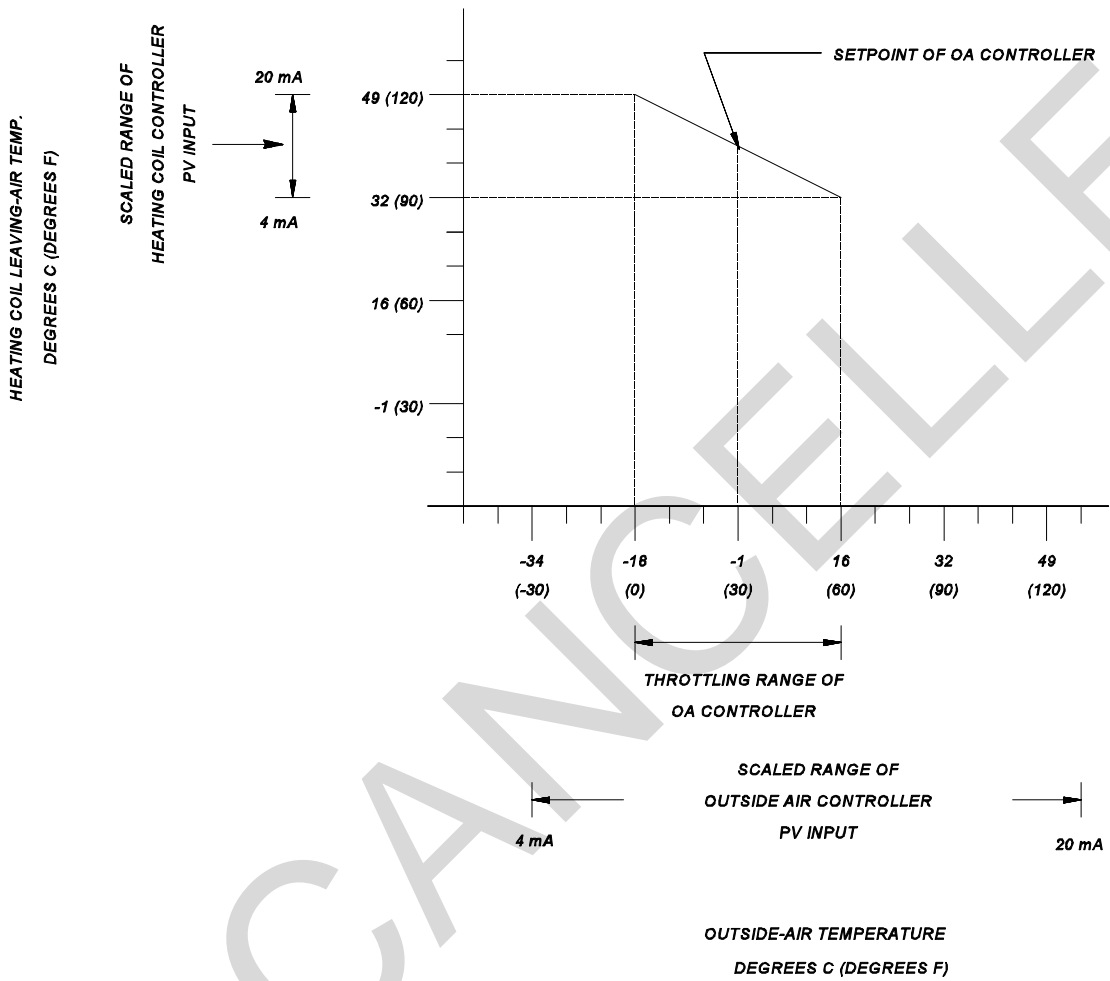

Figure 3-4. Outside air temperature controller input / output schedule.

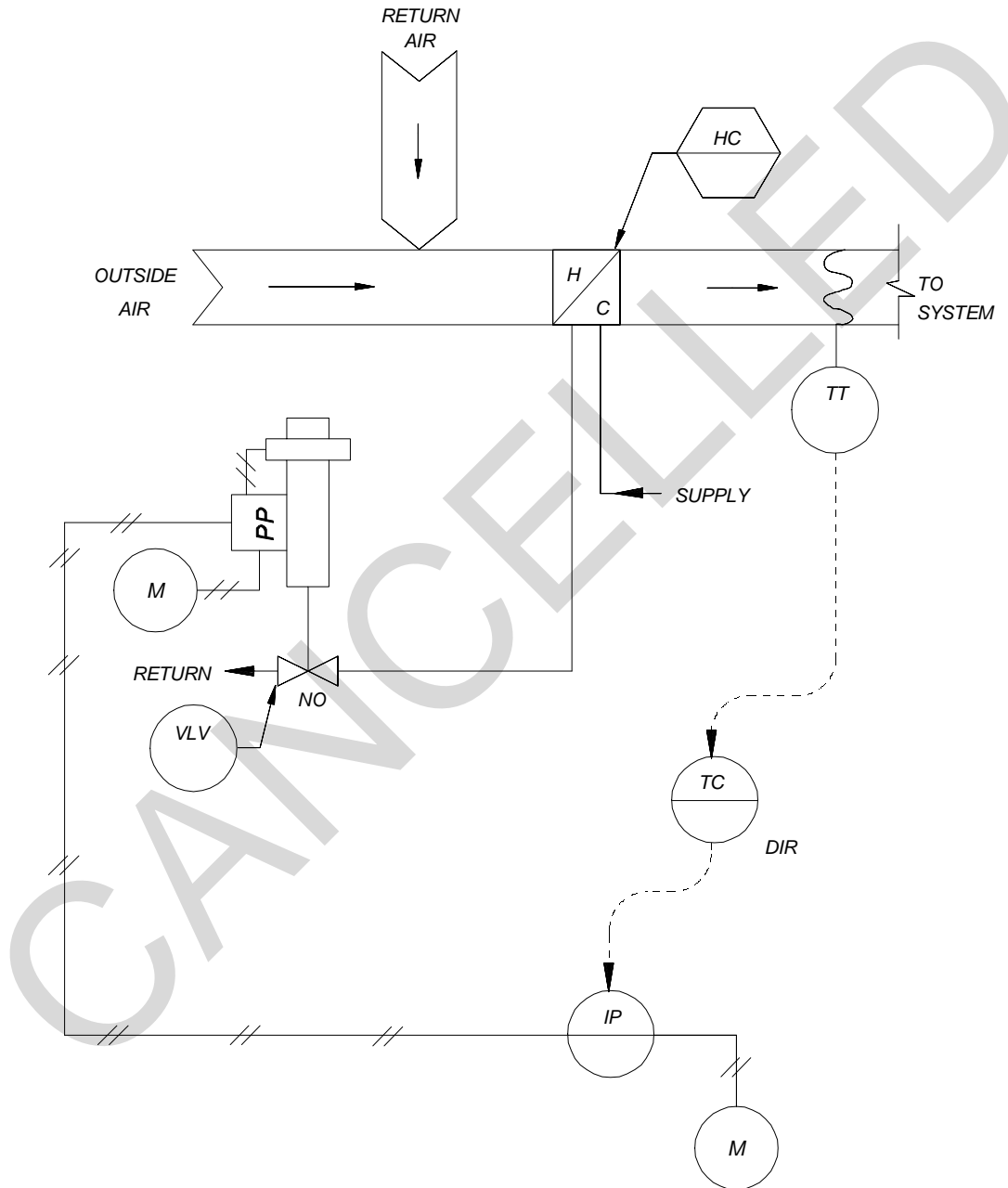

Figure 3-5. Heating coil temperature control loop with heating coil controlled at a constant temperature.

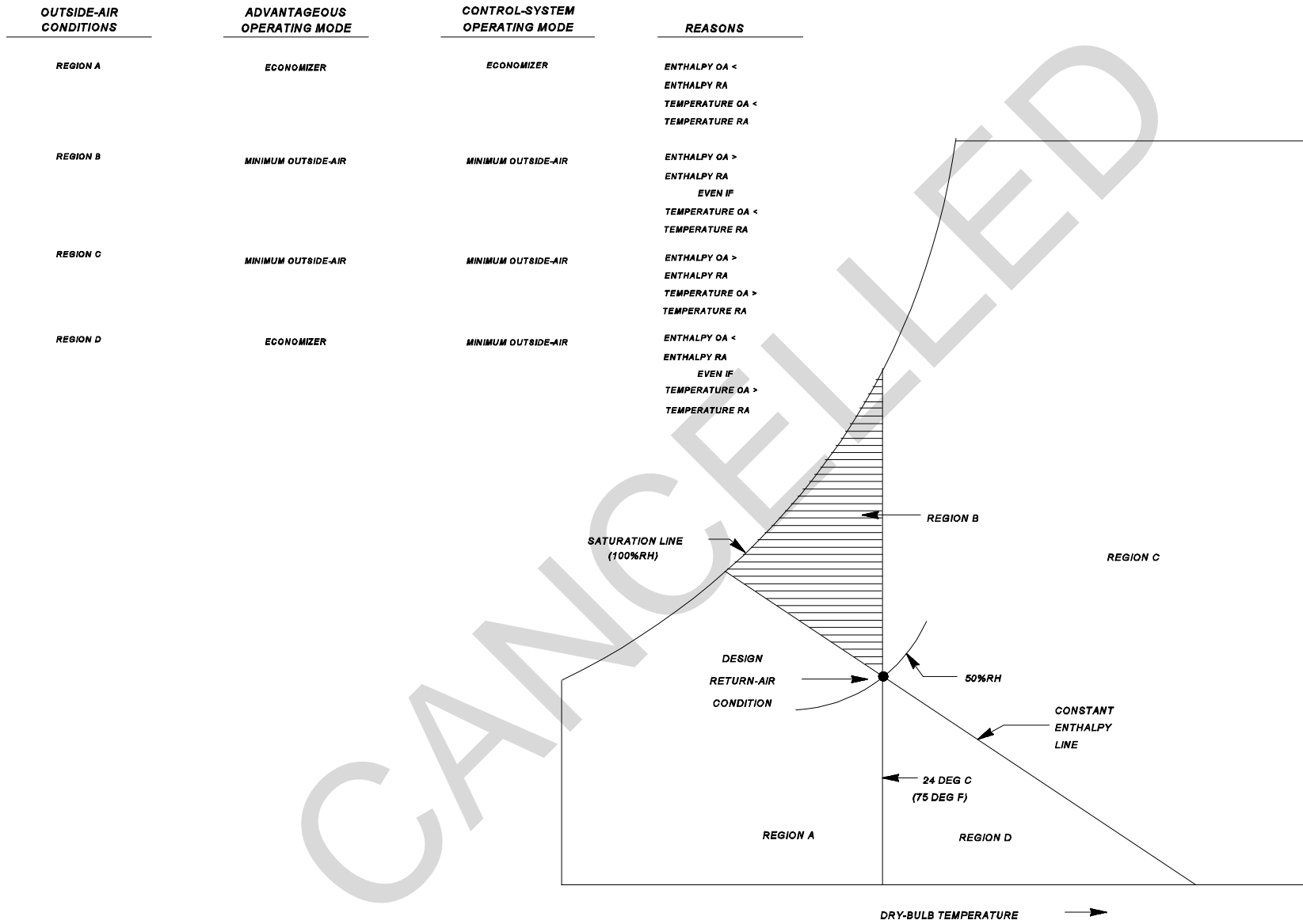

Figure 3-7. Design condition for economizer mode operation.

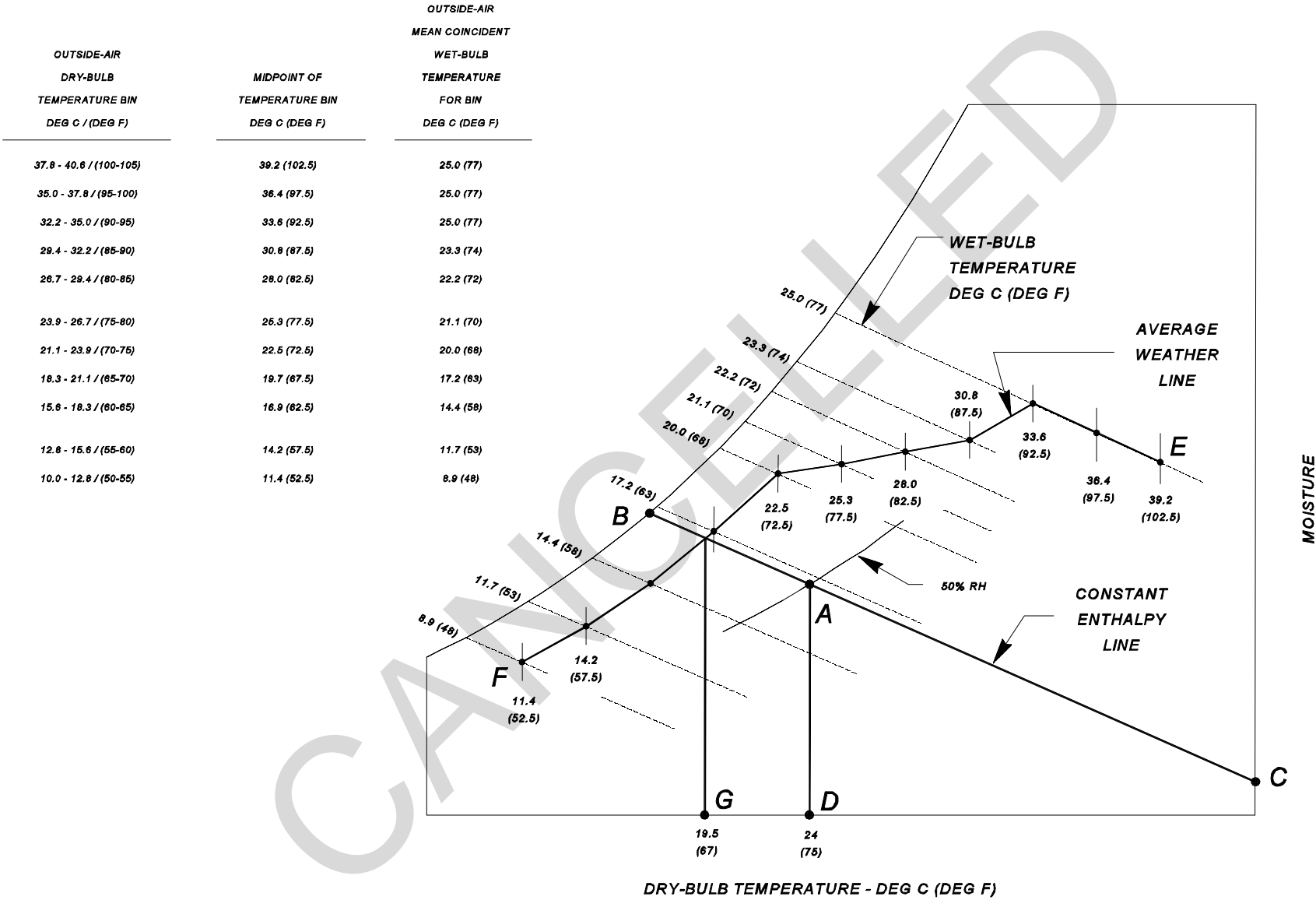

Figure 3-8. Selecting the economizer switchover point.

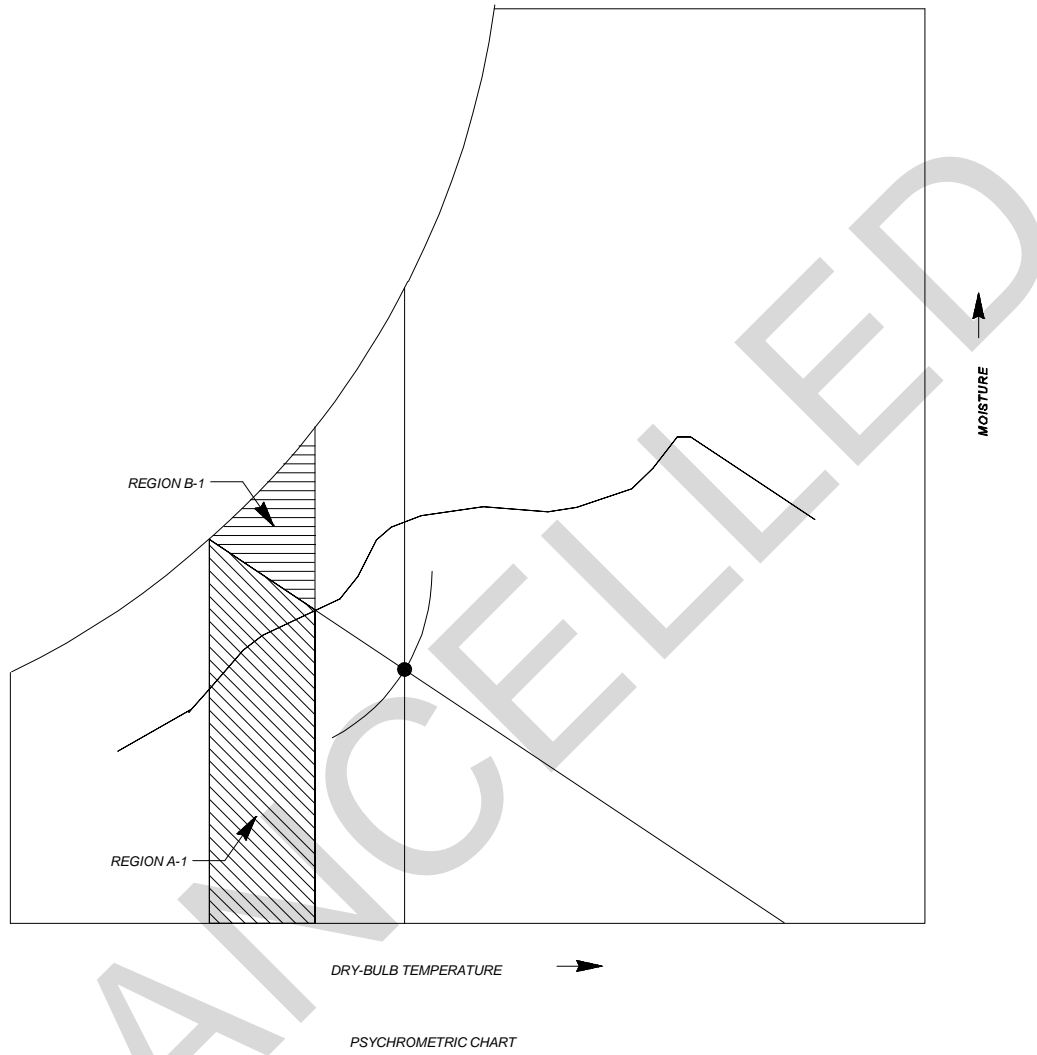

Figure 3-9. Effect on energy conservation of selection of the economizer switchover point.

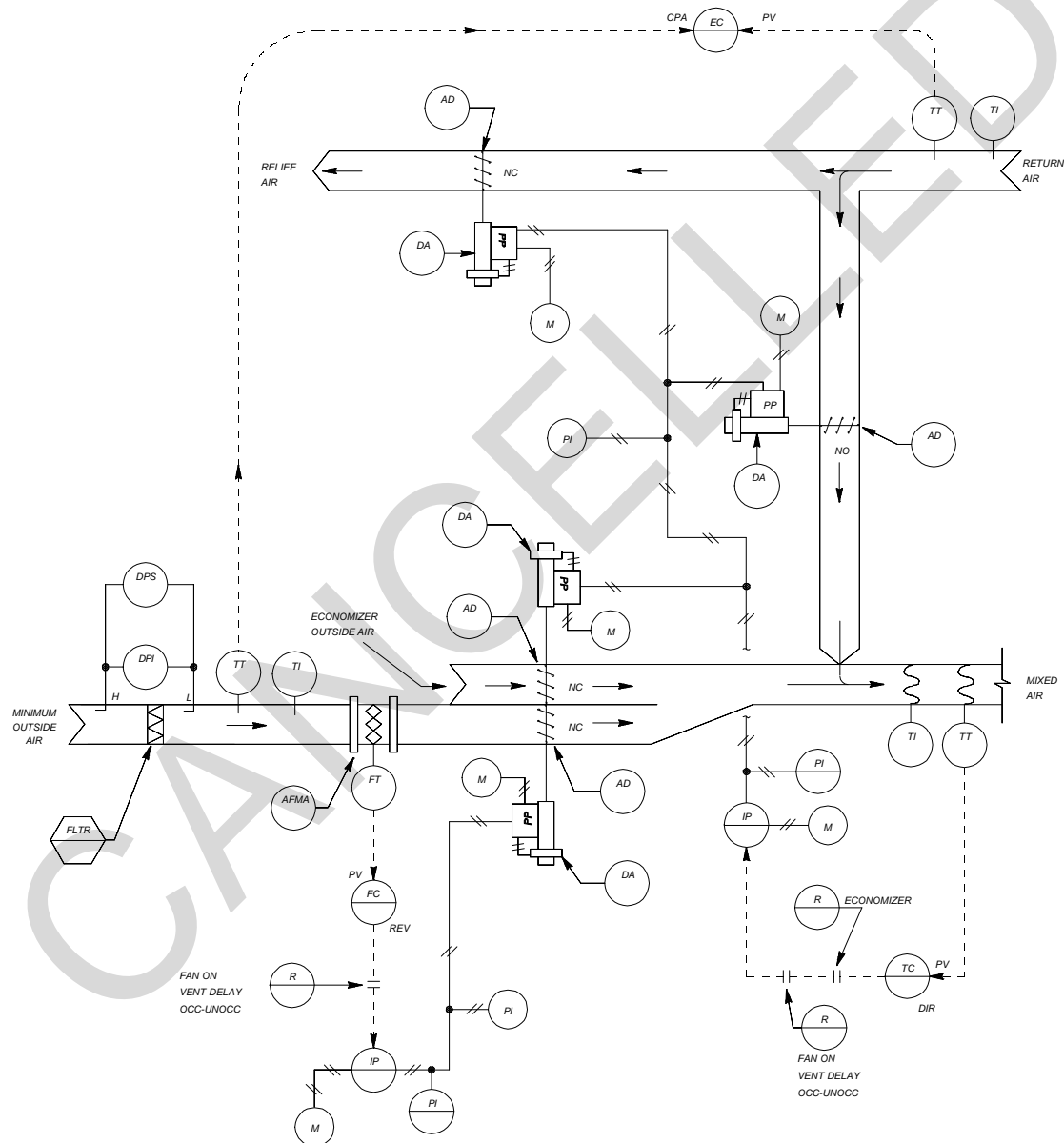

Figure 3-10. Minimum outside air and mixed air temperature / economizer control loops for VAV systems.

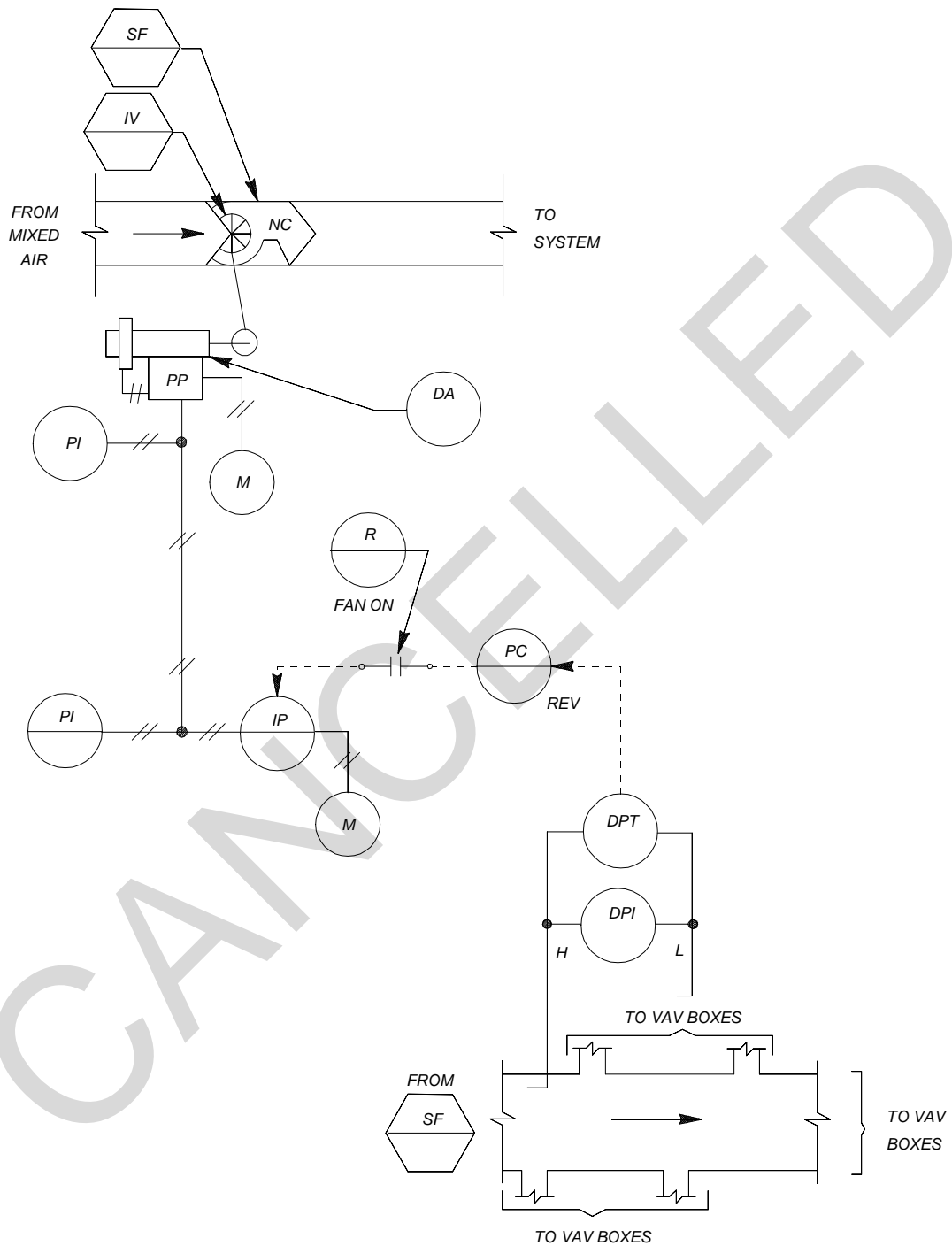

Figure 3-11. Supply duct static pressure control loop.

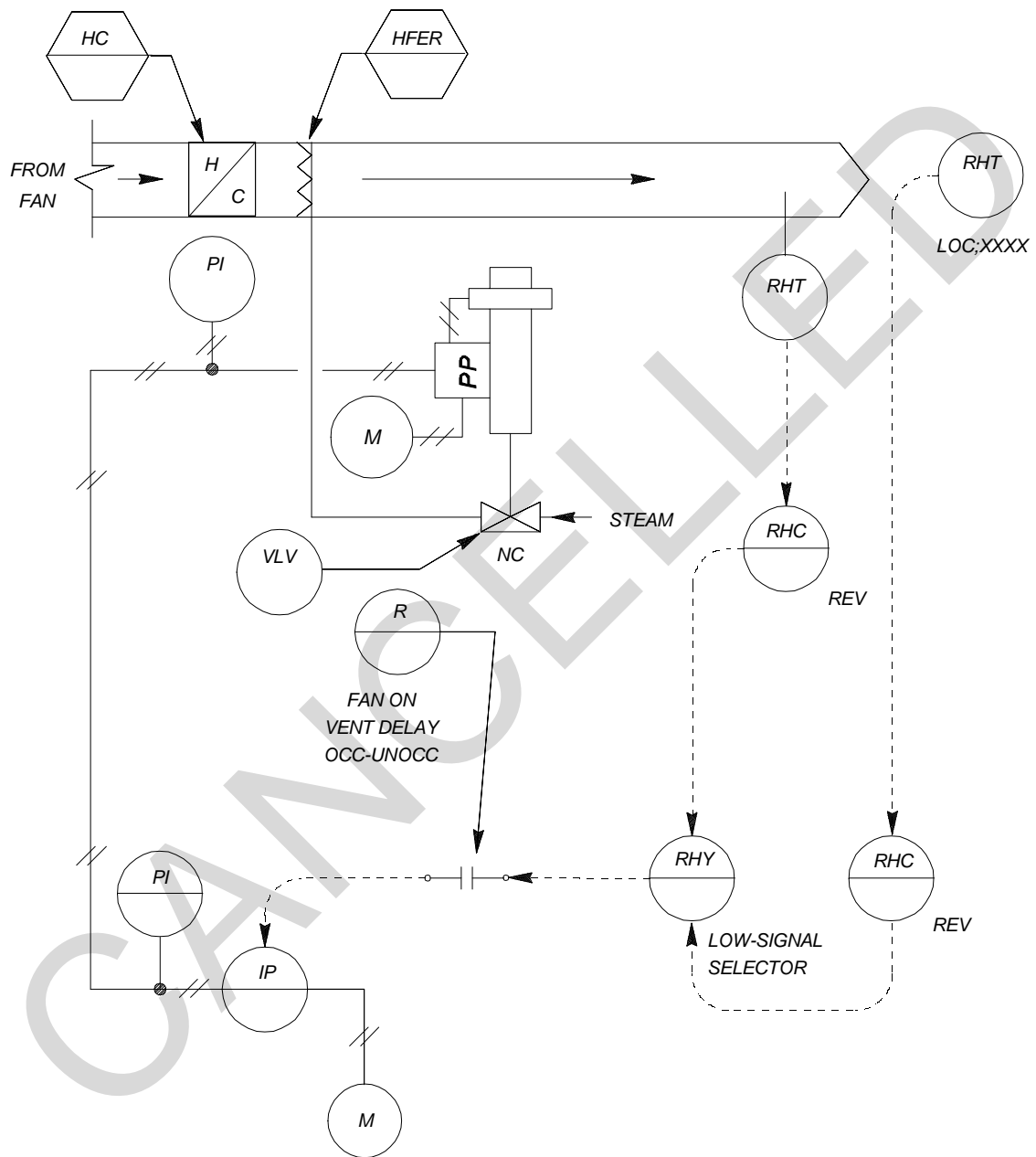

Figure 3-13. Humidifier control loop.

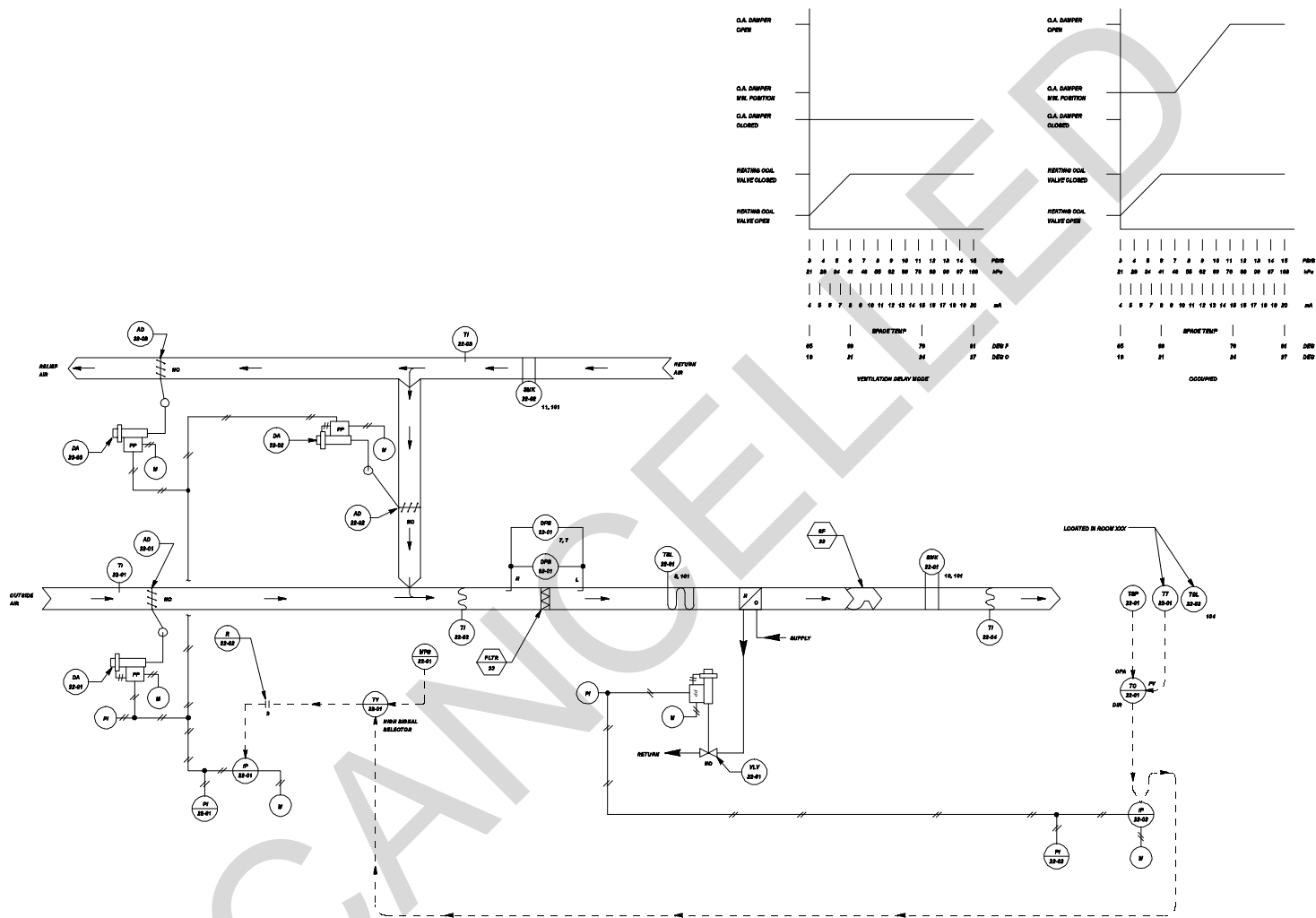

Figure 3-14. Typical single-loop controller schematic.

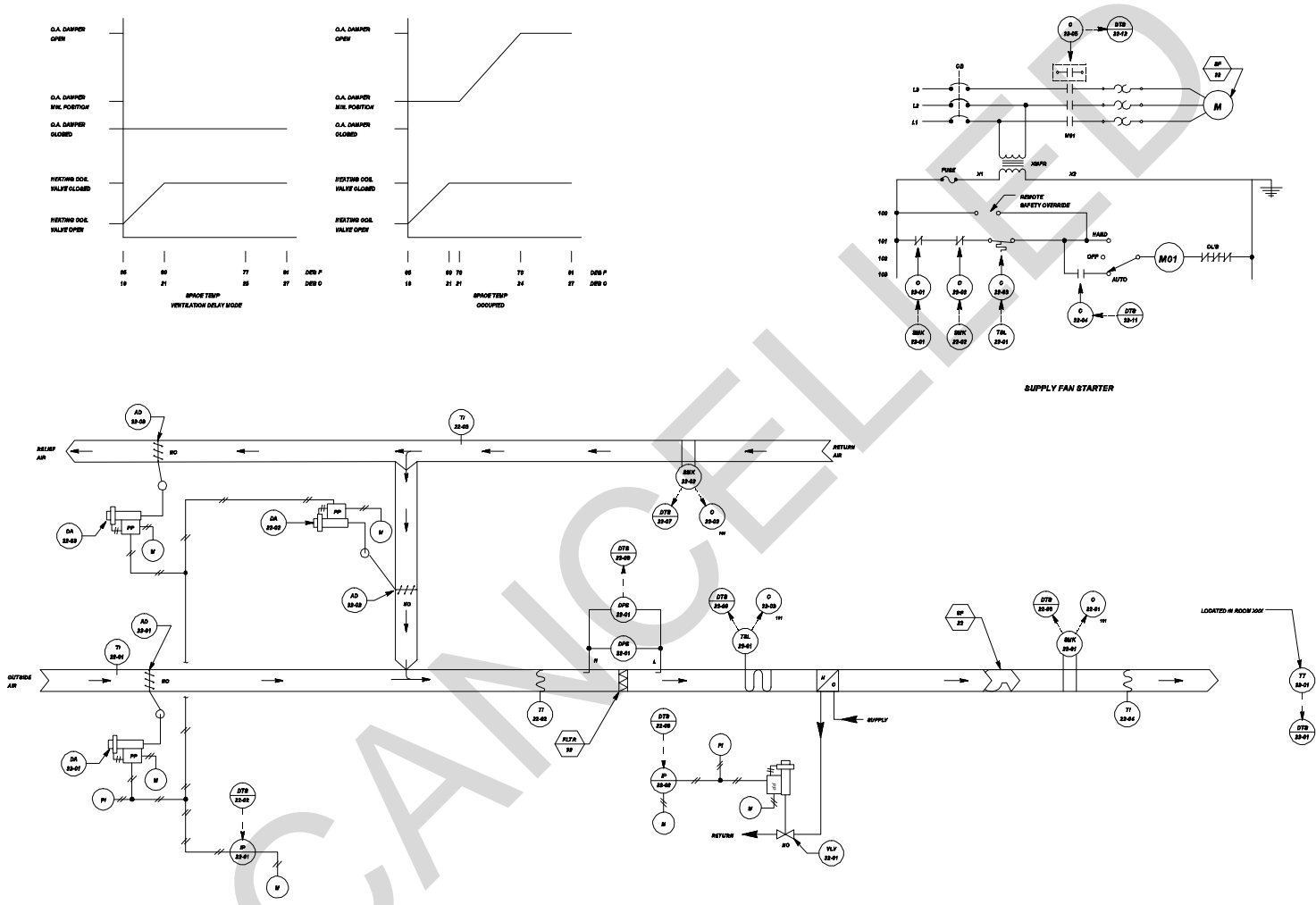

Figure 3-15. Typical DDC schematic.

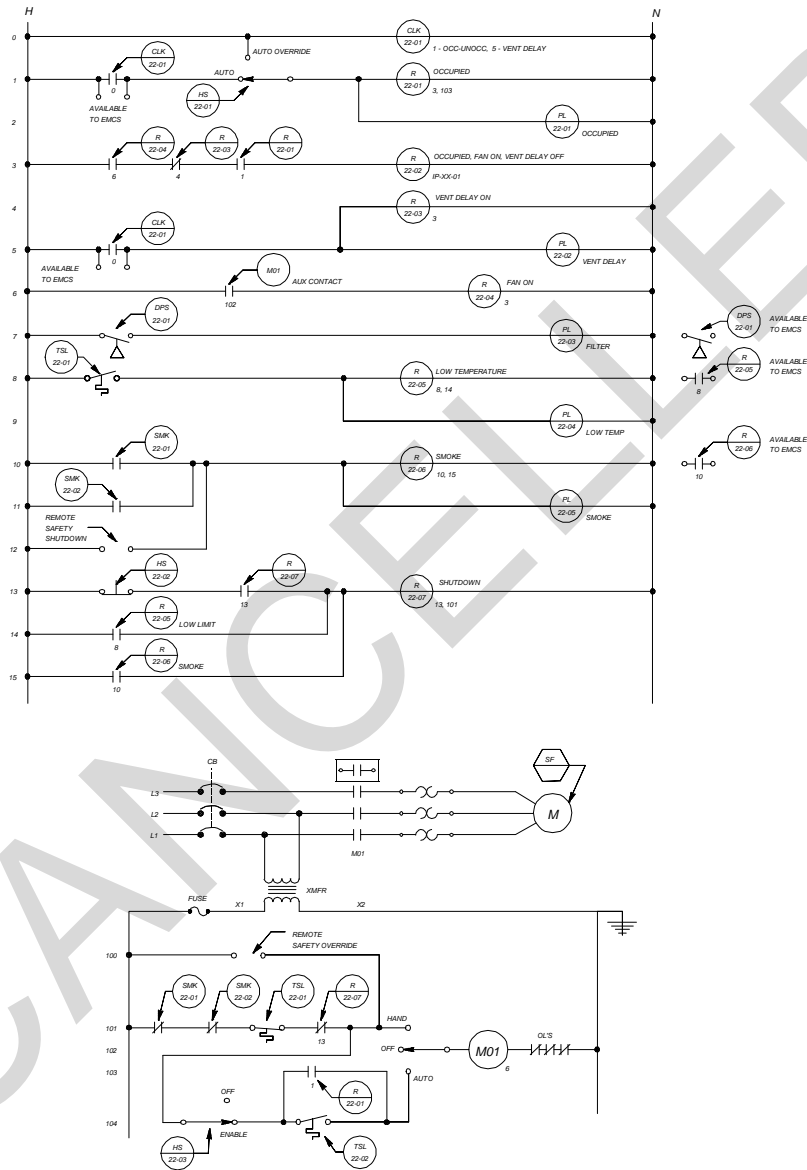
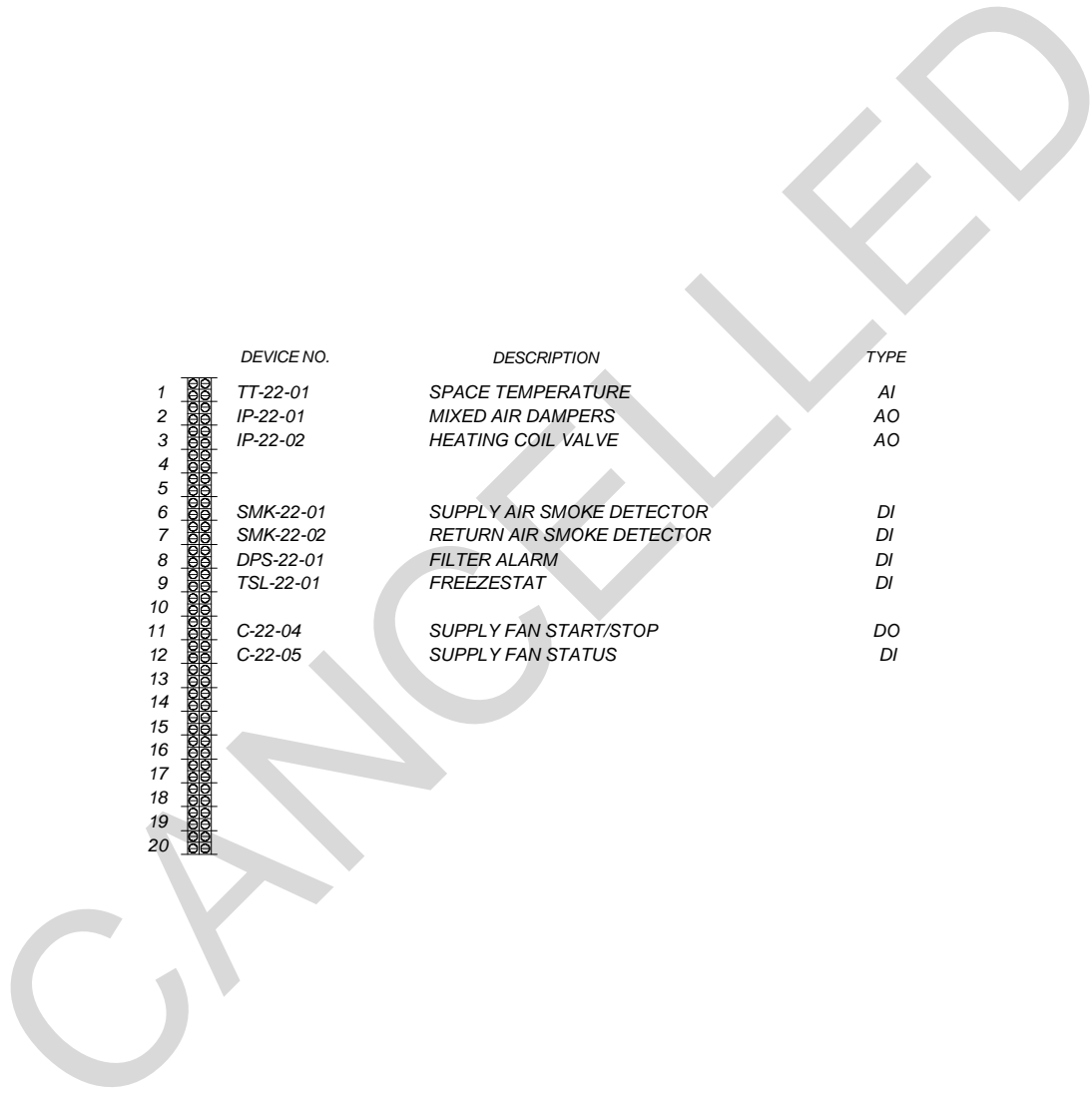

Figure 3-16. Typical ladder diagram.

LOOP CONTROL FUNCTION	DEVICE NUMBER	DEVICE FUNCTION	SETPOINT	RANGE	ADDITIONAL PARAMETERS
SPACE TEMPERATURE	DA-22-01 DA-22-02 DA-22-03	DAMPER ACTUATOR	—	40 - 70 kPa (7 - 11 PSI)	—
	MPS-22-01	MINIMUM POSITION SWITCH	—	—	SET MIN OA L ₆ (OPM) EQUAL TO ___ L ₆ (___ CFM)
	TT-22-01	SPACE TEMPERATURE TRANSMITTER	—	10 TO 30 DEG C (50 TO 85 DEG F)	—
↓	TSP-22-01	SPACE TEMPERATURE SETPOINT ADJUSTMENT	4 mA = 10 DEG C (50 DEG F) 20 mA = 20 DEG C (65 DEG F)	—	—
	TC-22-01	SPACE TEMPERATURE CONTROLLER	4 mA = 10 DEG C (50 DEG F) 20 mA = 20 DEG C (65 DEG F)	10 TO 30 DEG C (50 TO 85 DEG F)	SET LIMITS AVAILABLE TO OCCUPANT BY TSP-22-01 AT 10 TO 22 DEG C (50 TO 72 DEG F)
	VLY-22-01	HEATING COIL VALVE	—	21 - 41 kPa (3 - 6 PSI)	Kv = ___ (CV = ___) CLOSE AGAINST ___ kPa (___ PSI)
MIXED AIR	TSL-22-01	LOW TEMPERATURE PROTECTION THERMOSTAT	2 DEG C (35 DEG F)	—	—
↓	DPB-22-01	FILTER ALARM	PER FILTER MANUFACTURER'S RECOMMENDATION	PER FILTER MANUFACTURER'S RECOMMENDATION	—
SPACE LOW TEMPERATURE	TSL-22-02	NIGHT STAT - SPACE LOW TEMPERATURE PROTECTION	15 DEG C (55 DEG F)	DIFFERENTIAL = 3 DEG C (5 DEG F)	—
OCCUPIED MODE	CLK-22-01 CONTACT	365 DAY SCHEDULE	—	NORMAL SCHEDULE (M-F) CONTACT CLOSED: 0700 HRS CONTACT OPEN: 1700 HRS	CONTACT OPEN: 0AT, 6UN
VENTILATION DELAY MODE	CLK-22-01 CONTACT	365 DAY SCHEDULE	—	NORMAL SCHEDULE (M-F) CONTACT CLOSED: 0700 HRS CONTACT OPEN: 0800 HRS	↓

NOTE: OTHER CONTROL DEVICES SUCH AS V₆, RELAYS, AND SIGNAL SELECTORS ARE NOT SHOWN.

Figure 3-17. Typical equipment schedule.



	DEVICE NO.	DESCRIPTION	TYPE
1	TT-22-01	SPACE TEMPERATURE	AI
2	IP-22-01	MIXED AIR DAMPERS	AO
3	IP-22-02	HEATING COIL VALVE	AO
4			
5			
6	SMK-22-01	SUPPLY AIR SMOKE DETECTOR	DI
7	SMK-22-02	RETURN AIR SMOKE DETECTOR	DI
8	DPS-22-01	FILTER ALARM	DI
9	TSL-22-01	FREEZESTAT	DI
10			
11	C-22-04	SUPPLY FAN START/STOP	DO
12	C-22-05	SUPPLY FAN STATUS	DI
13			
14			
15			
16			
17			
18			
19			
20			

Figure 3-18. Typical DDC data terminal strip layout.

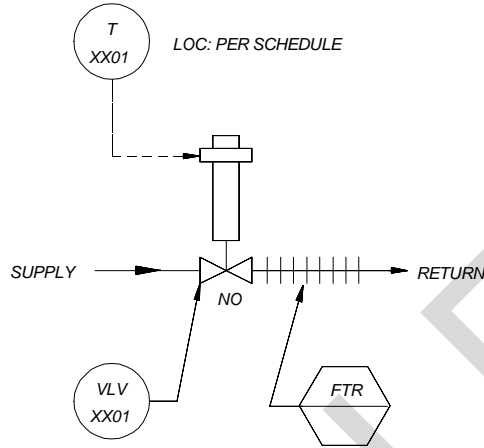

SCHEMATIC FOR MODULATING CONTROL OR 2- POSITION CONTROL

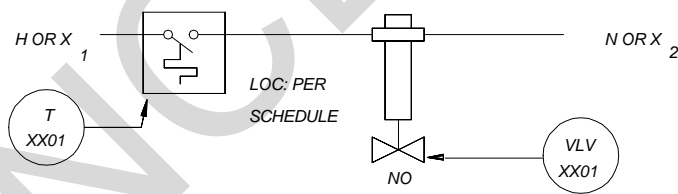

LADDER DIAGRAM FOR 2-POSITION CONTROL

SPACE	FTR	THERMOSTAT	VALVE	REMARKS
XXXX	XX	T-XX01 SET: 20 DEG C (68 DEG F)	VLV-XX01	$K_v=17$ ($C_v=0.2$) CLOSE AGAINST 70 kPa (10 PSIG)
.
YYYY	YY	T-XXXX SET: 20 DEG C (68 DEG F)	VLV-XXXX	$K_v=60$ ($C_v=0.7$) CLOSE AGAINST 70 kPa (10 PSIG)

EQUIPMENT SCHEDULE

Figure 4-1. Space temperature controlled perimeter radiation control system.

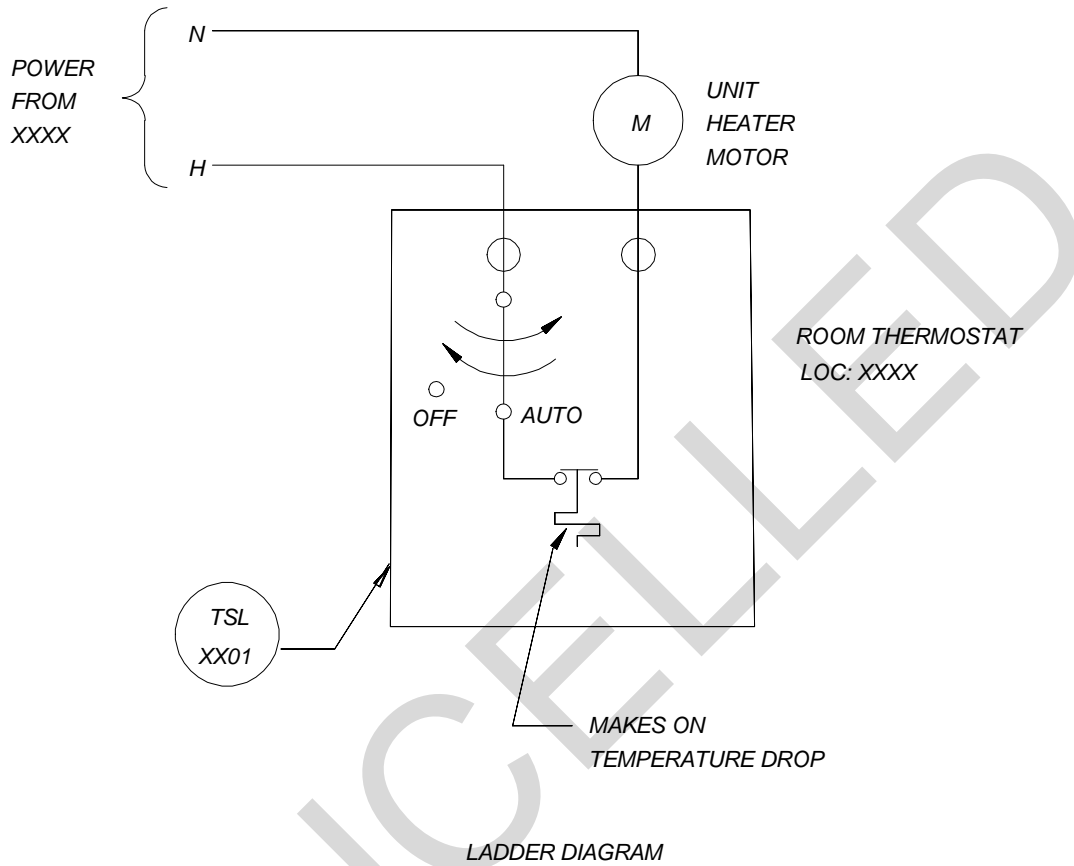

SPACE	UH	THERMOSTAT
XXXX	XX	TSL-XX01 SET: 13 C (55 F)
o	o	o
YYYY	YY	TSL-XXXX SET: 13 C (55 F)

EQUIPMENT SCHEDULE

Figure 4-2. Unit heater temperature control system.

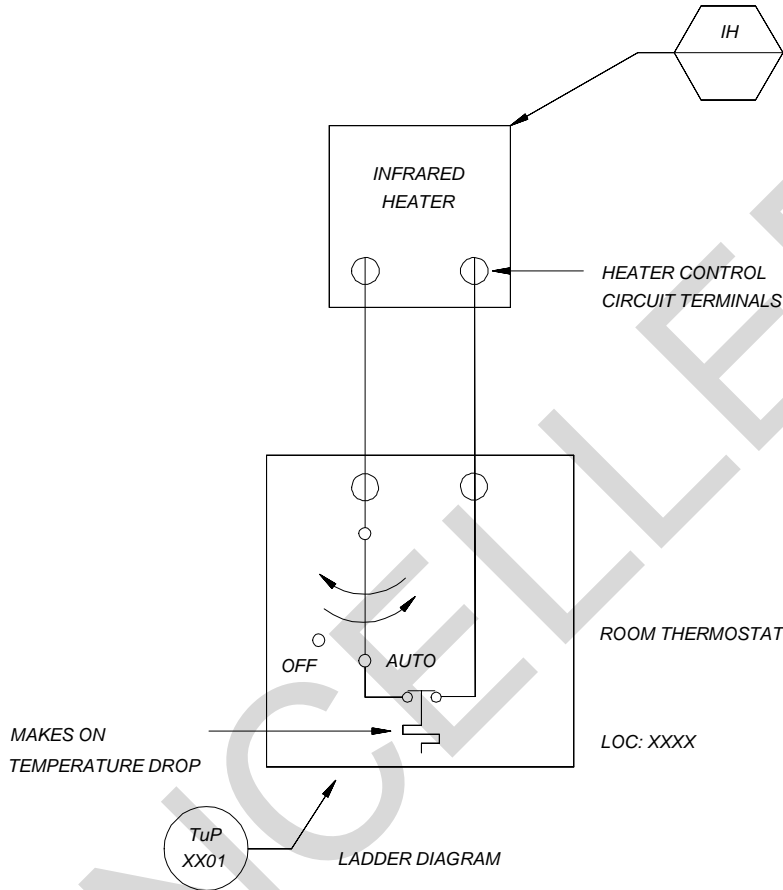

SPACE	IH	THERMOSTAT	OCCUPIED MODE
XXXX	XX	TuP-XX01 SET: 20 C (68 F) - DAY 13 C (55 F) - NIGHT	M - F M - F: 0830 TO 1730 HRS SUN: 0830 TO 1200 HRS
o	o	o	
YYYY	YY	TuP-XXXX SET: 20 C (68 F) - DAY 13 C (55 F) - NIGHT	M - F M - F: 0830 TO 1730 HRS SUN: 0830 TO 1200 HRS

EQUIPMENT SCHEDULE

Figure 4-3. Gas-fired infrared heater temperature control system.

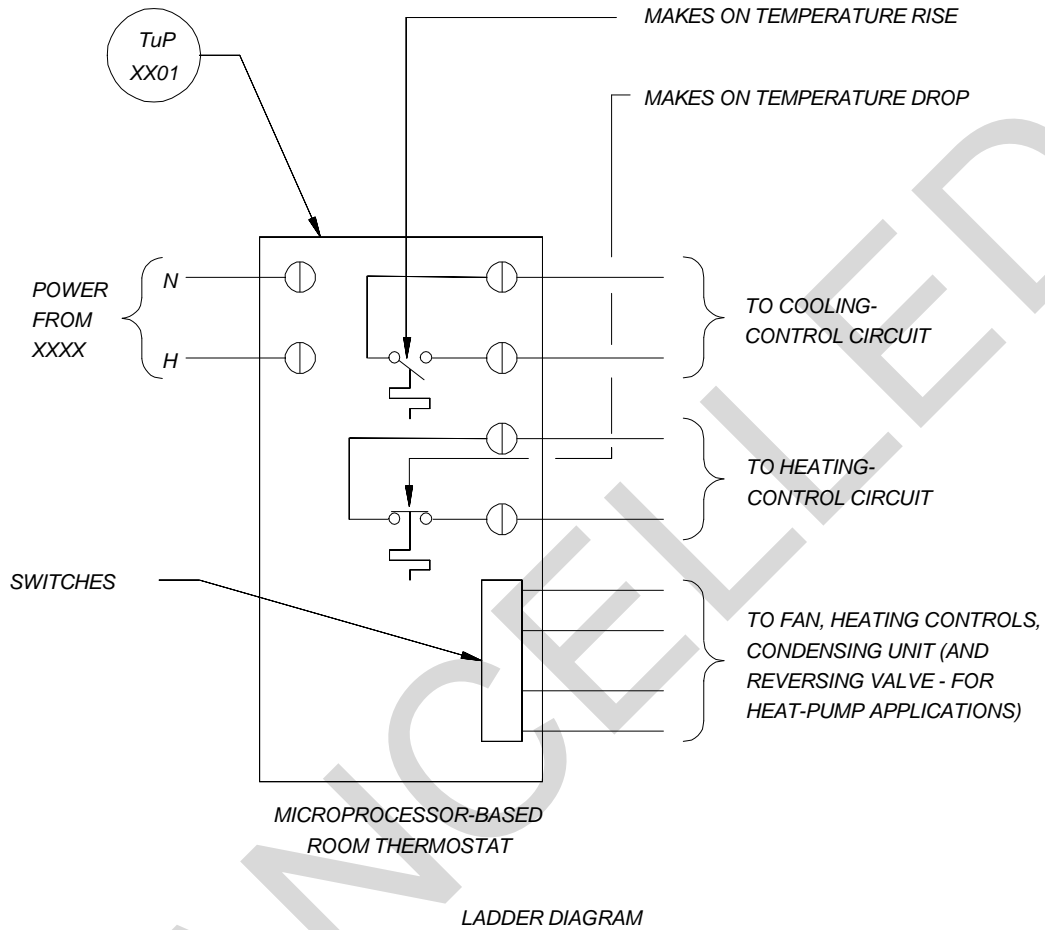

SPACE	AC	THERMOSTAT	OCCUPIED MODE
XXXX	XY	<p style="text-align: center;">TUP-XX01</p> <p>SET: 20 DEG C (68 DEG F) - DAY HEATING 13 DEG C (55 DEG F) - NIGHT HEATING 26 DEG C (78 DEG F) - DAY COOLING OFF - NIGHT COOLING</p>	<p style="text-align: center;">M,T,W,TH,F 0830 HRS TO 1730 HRS</p>

EQUIPMENT SCHEDULE

Figure 4-4. Small packaged unitary system control system.

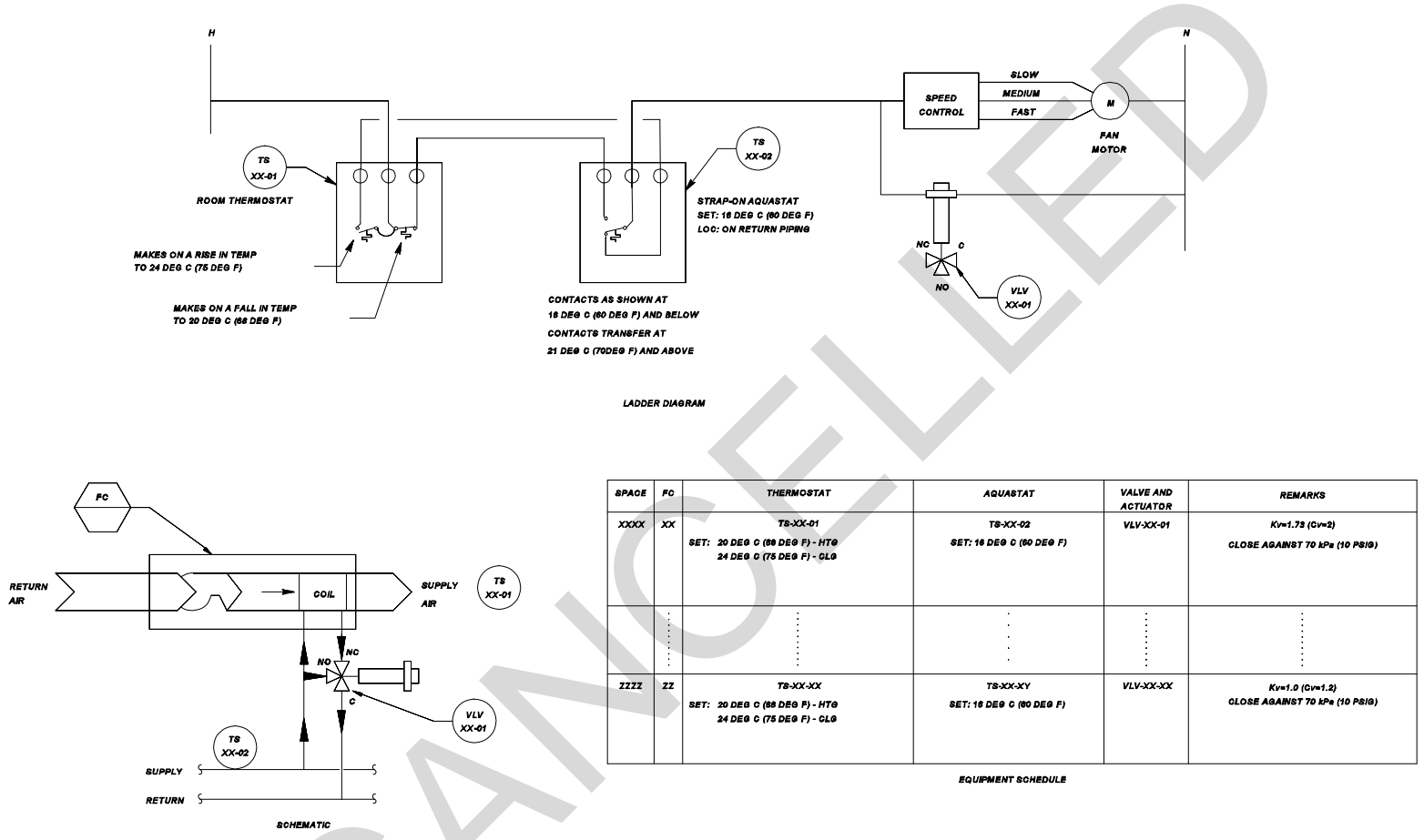

Figure 4-5. Dual-temperature fan coil unit temperature control system.

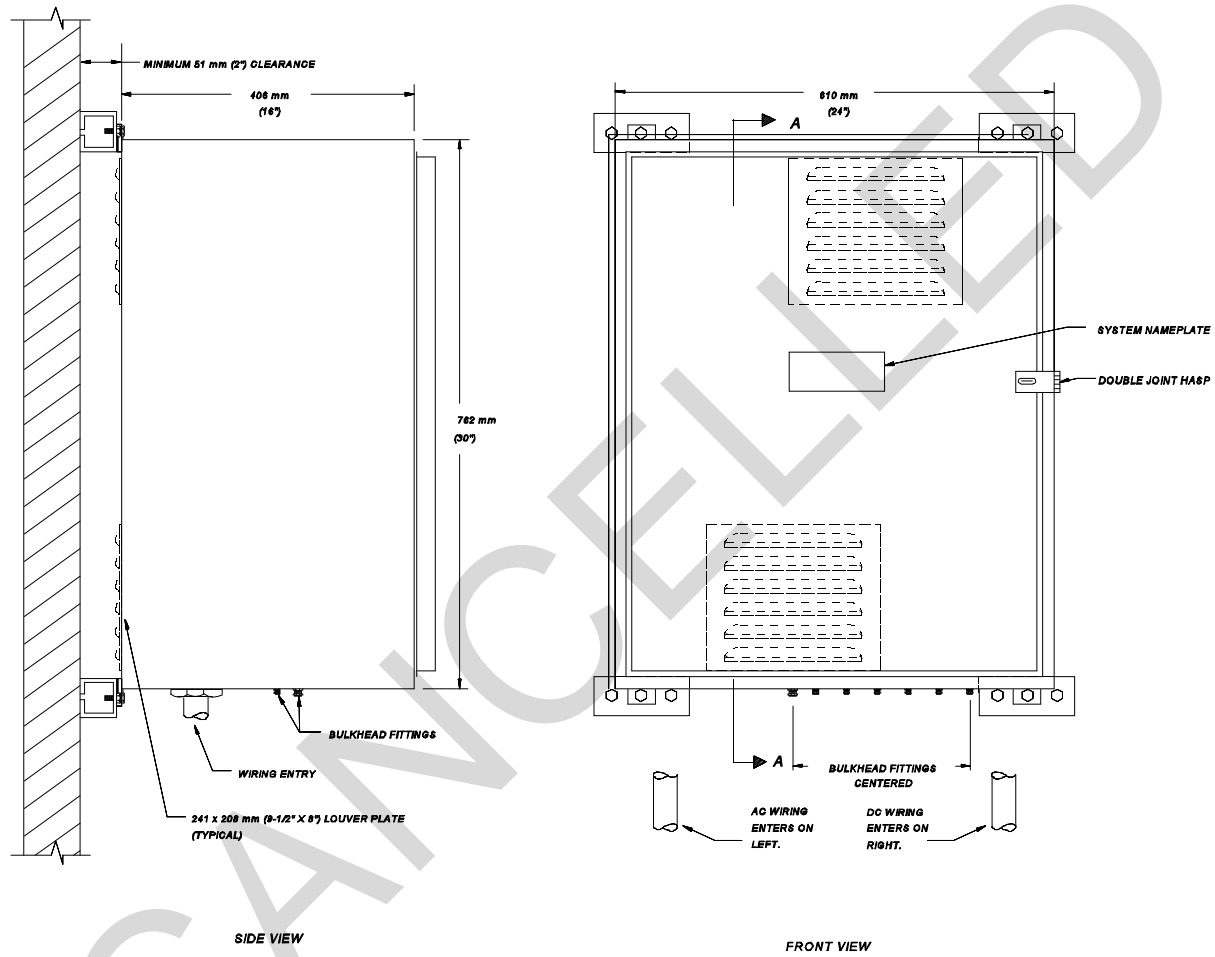

Figure 4-6a. Standard wall-mounted HVAC control panel arrangement.

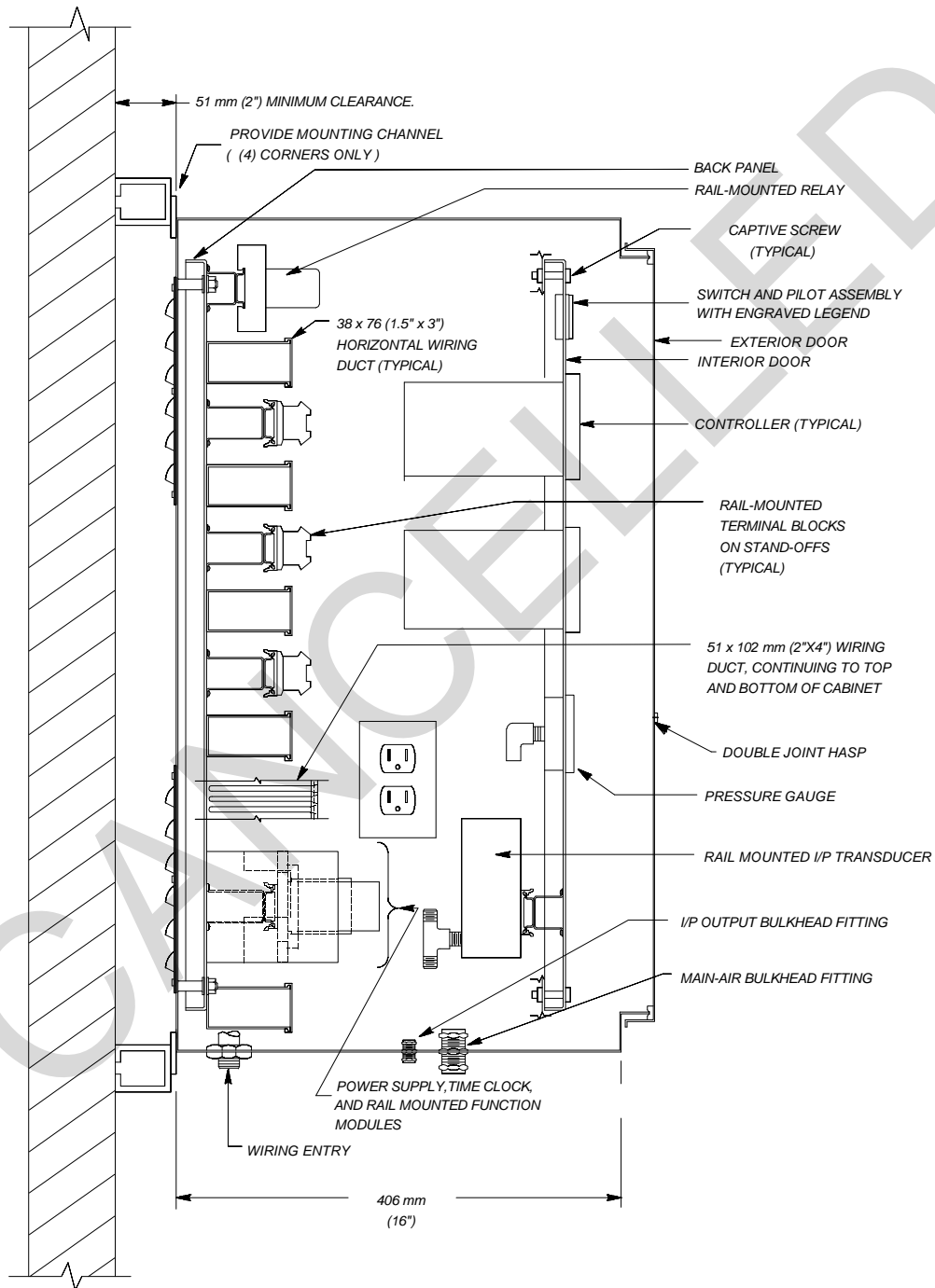
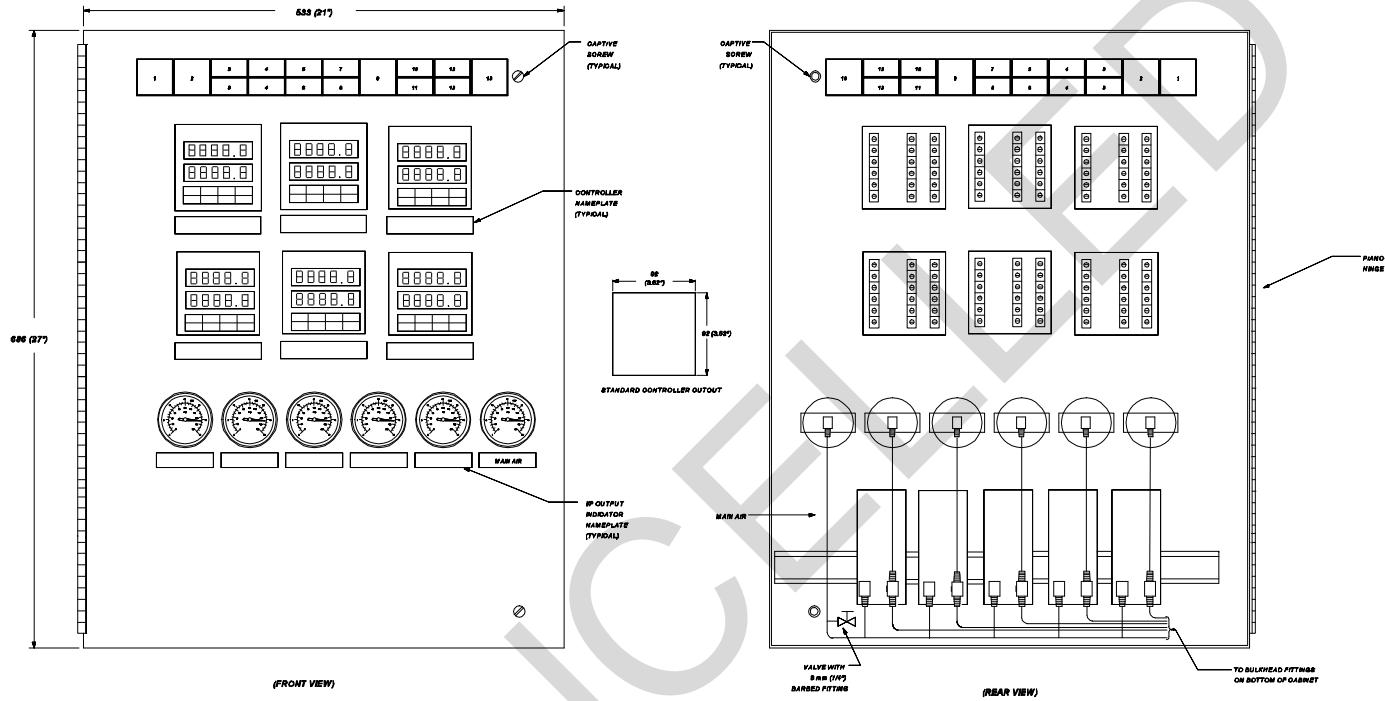

Figure 4-6b. Section "A-A" through standard HVAC control panel.



SWITCH AND PILOT LIGHT LEGEND

POSITION LEGEND	DEVICE TYPE	POSITION LEGEND	DEVICE TYPE	POSITION LEGEND	DEVICE TYPE
1 - REEST	NON-ILLUMINATED MOMENTARY PUSHBUTTON SWITCH	8 - LOWTEMP	PILOT LIGHT	9 - OOD	PILOT LIGHT
2 - STATO ARREST	NON-ILLUMINATED MOMENTARY PUSHBUTTON SWITCH	9 - SMOKE	PILOT LIGHT	10 - VENT DELAY	PILOT LIGHT
3 - AUTONUTO OVERRIDE	ILLUMINATED MAINTAINED-CONTACT INTERLOCKED SWITCHES	7 - NEW STATO	PILOT LIGHT	11 - EDDM	PILOT LIGHT
4 - ENABLEDOP	ILLUMINATED MAINTAINED-CONTACT INTERLOCKED SWITCHES	8 - FATER	PILOT LIGHT	12 - HEATCOOL	ILLUMINATED MAINTAINED-CONTACT INTERLOCKED SWITCHES
				13 -	AVAILABLE

Figure 4-6c. Standard HVAC control panel interior door.

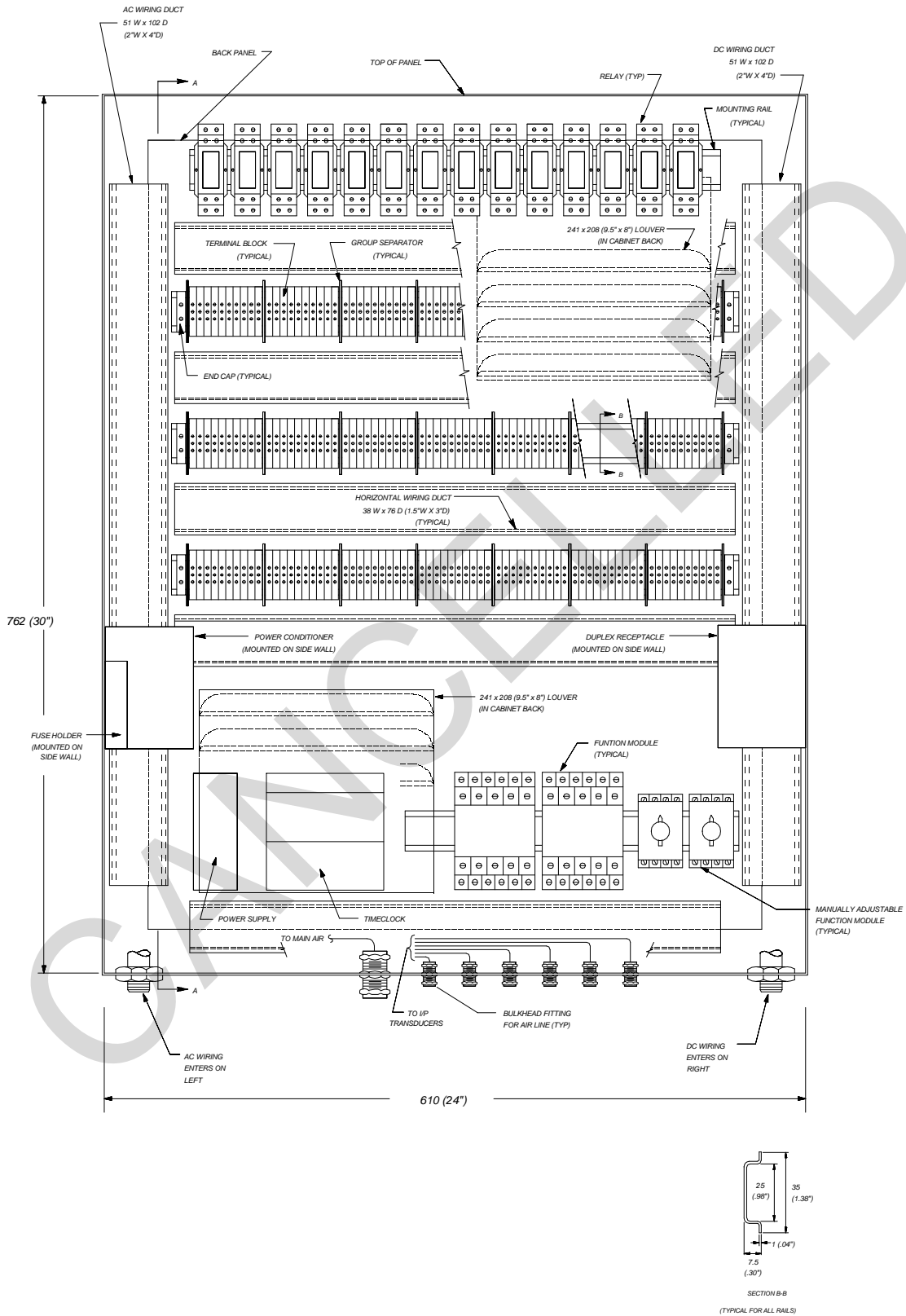

Figure 4-6d. Standard HVAC control panel back panel layout.

1-10 CONTROLLER	11-20 CONTROLLER	21-30 CONTROLLER	31-40 CONTROLLER	41-50 CONTROLLER	51-60 CONTROLLER	61-70 SPACE
71-80 SPACE	81-90 EMCS START/STOP INTERLOCKS	91-100 LOW-TEMP TSTAT SMOKE DET & EMCS	101-110 FILTER DPS & EMCS	111-120 DUCT STATIC- PRESSURE SWITCH	121-130 EMCS ECONOMIZER OVERRIDE	131-140 NIGHT LOW-LIMIT T-STAT & HYDRONIC SYSTEM INTERLOCK
141-170 120V AC POWER-DISTRIBUTION TERMINAL BLOCKS		171-180 24V DC POWER- DISTRIBU- TION TERMINAL BLOCKS		181-190 STARTER WIRING & END SWITCHES	191-200 STARTER WIRING & END SWITCHES	201-210 SPARE

Figure 4-6e. Standard HVAC control panel terminal block assignments.

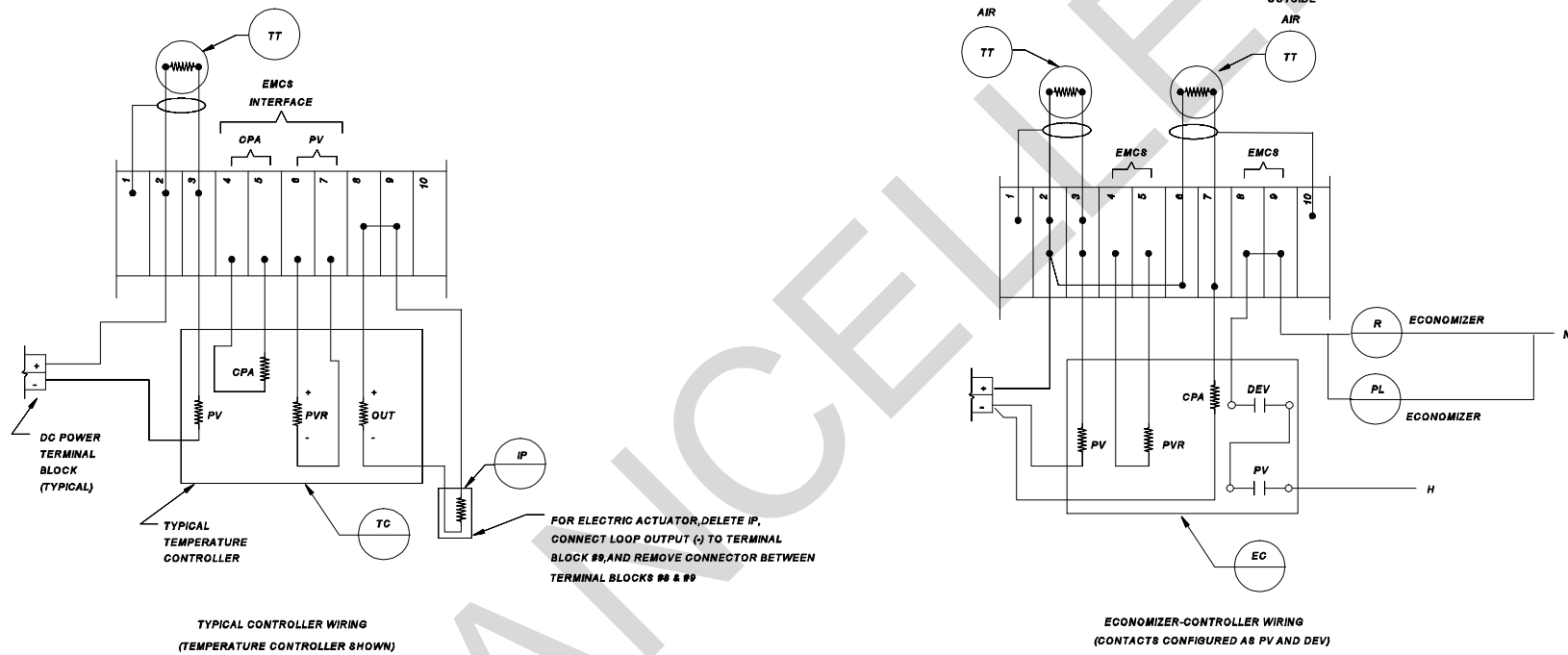

Figure 4-6f. Controller wiring.

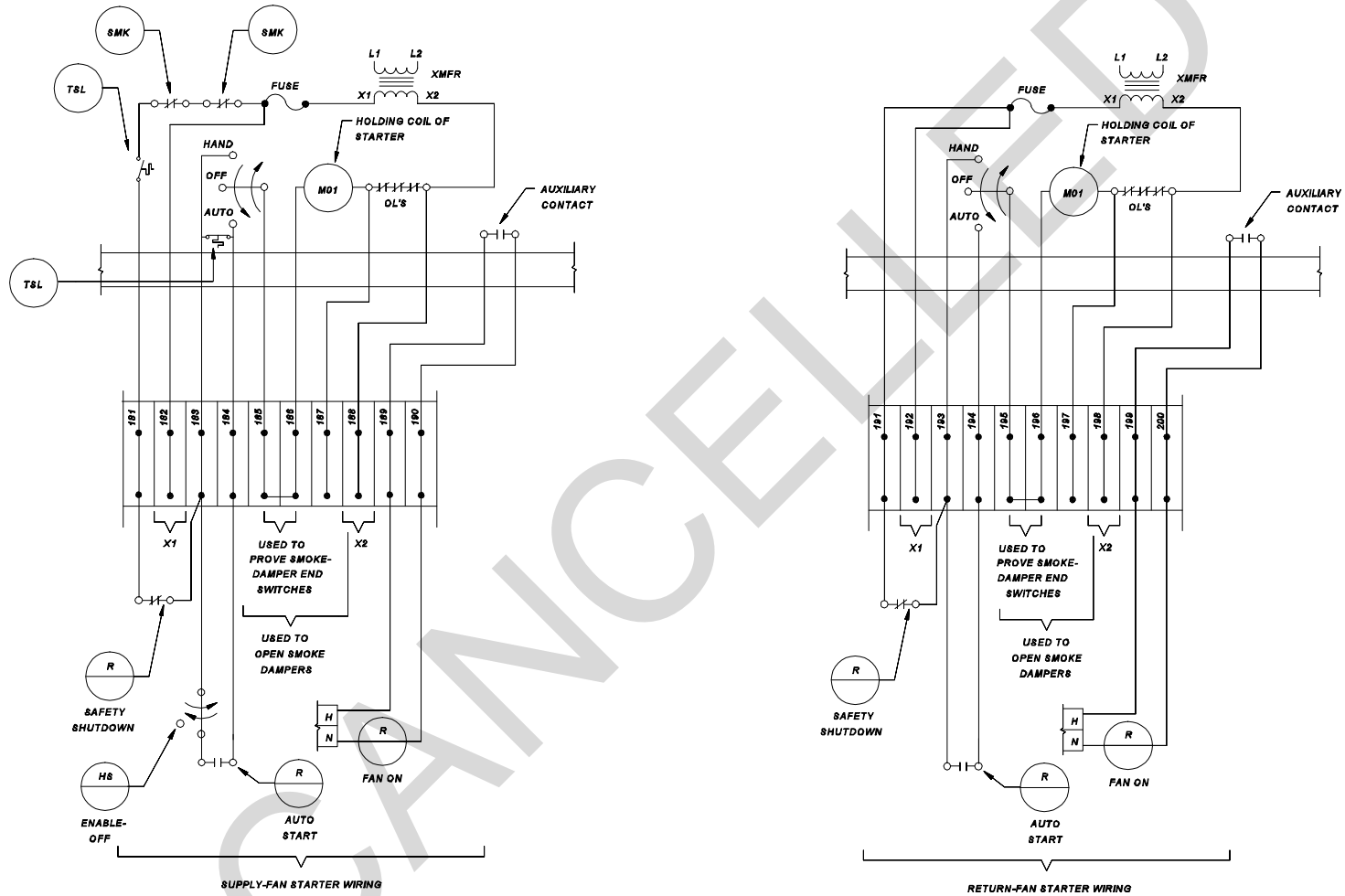

Figure 4-6g. Supply fan and return fan starter wiring.

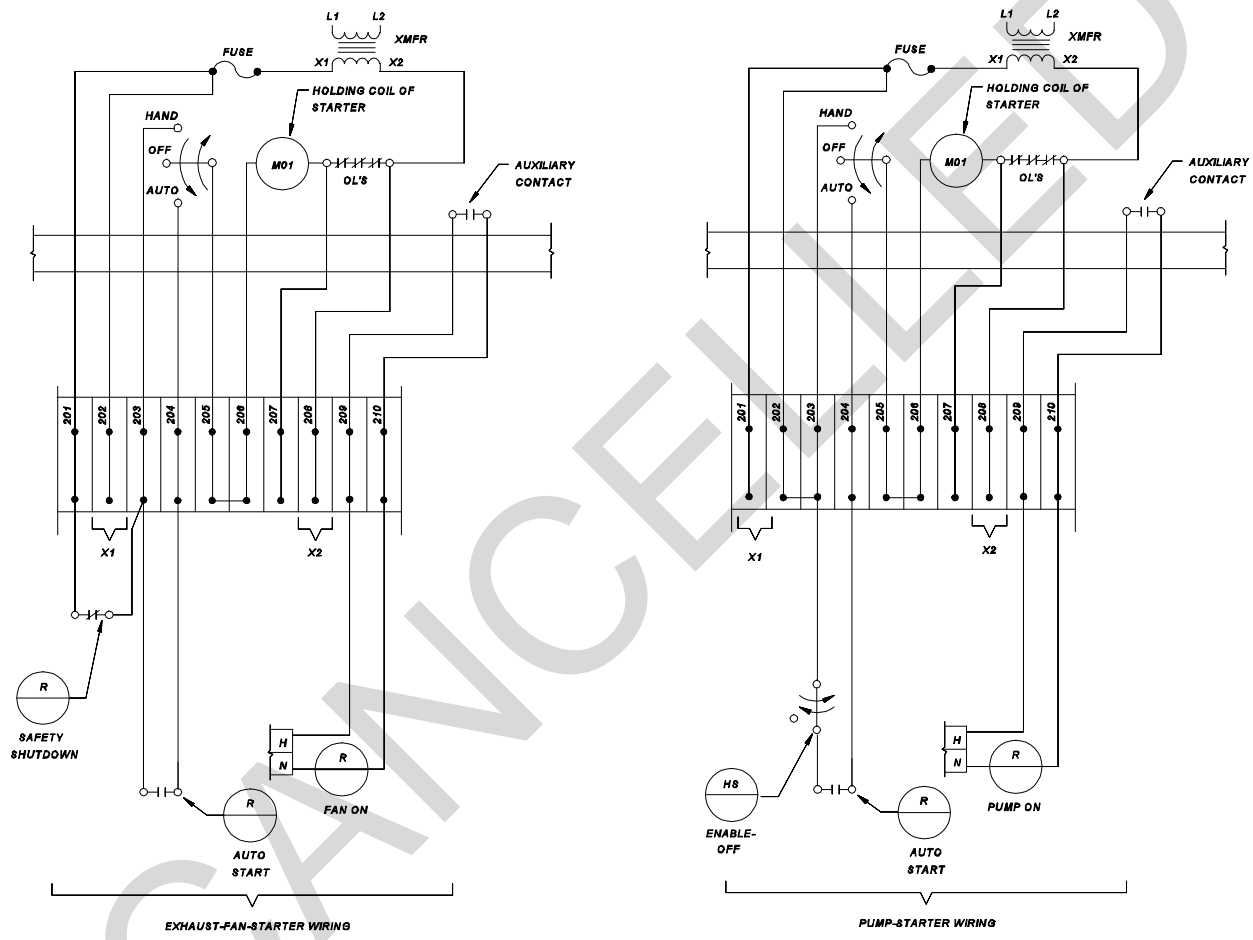

Figure 4-6h. Exhaust fan and pump starter wiring.

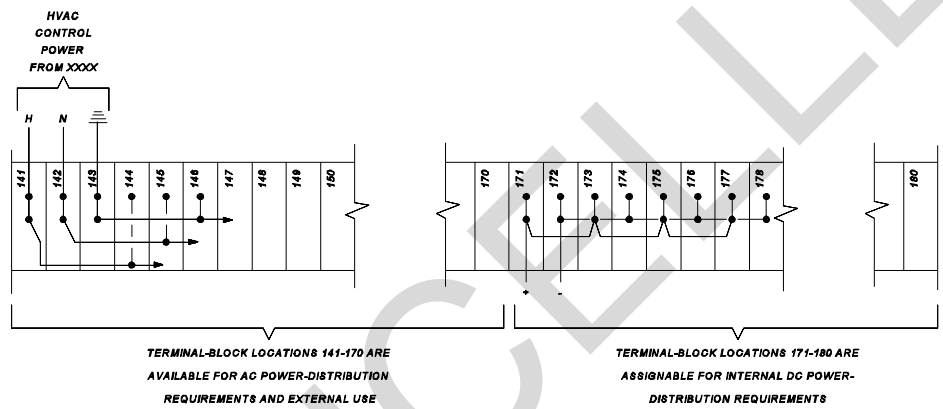

Figure 4-6i. HVAC control panel power wiring.

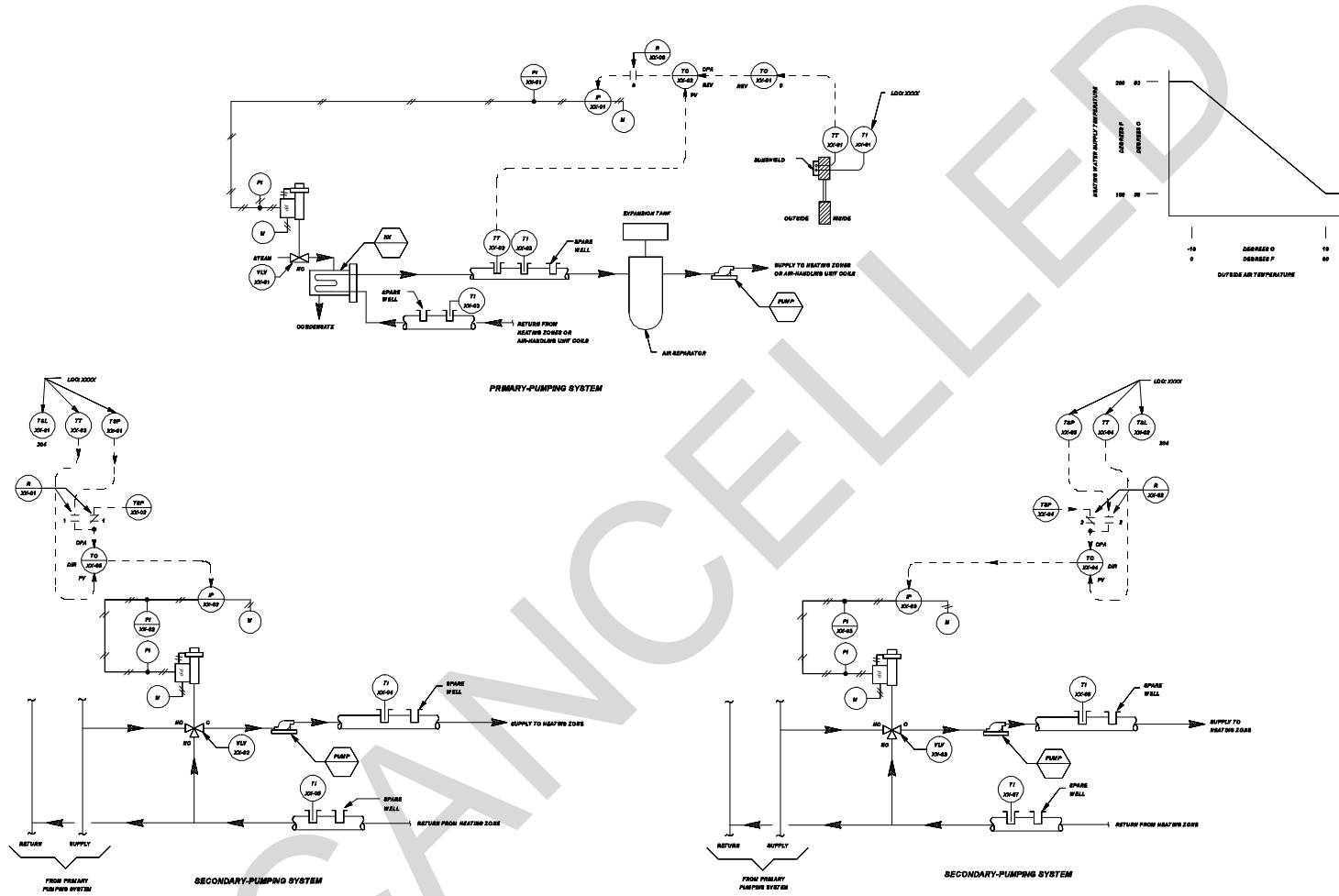

Figure 4-7a. Control system schematic for central plant steam hydronic system.

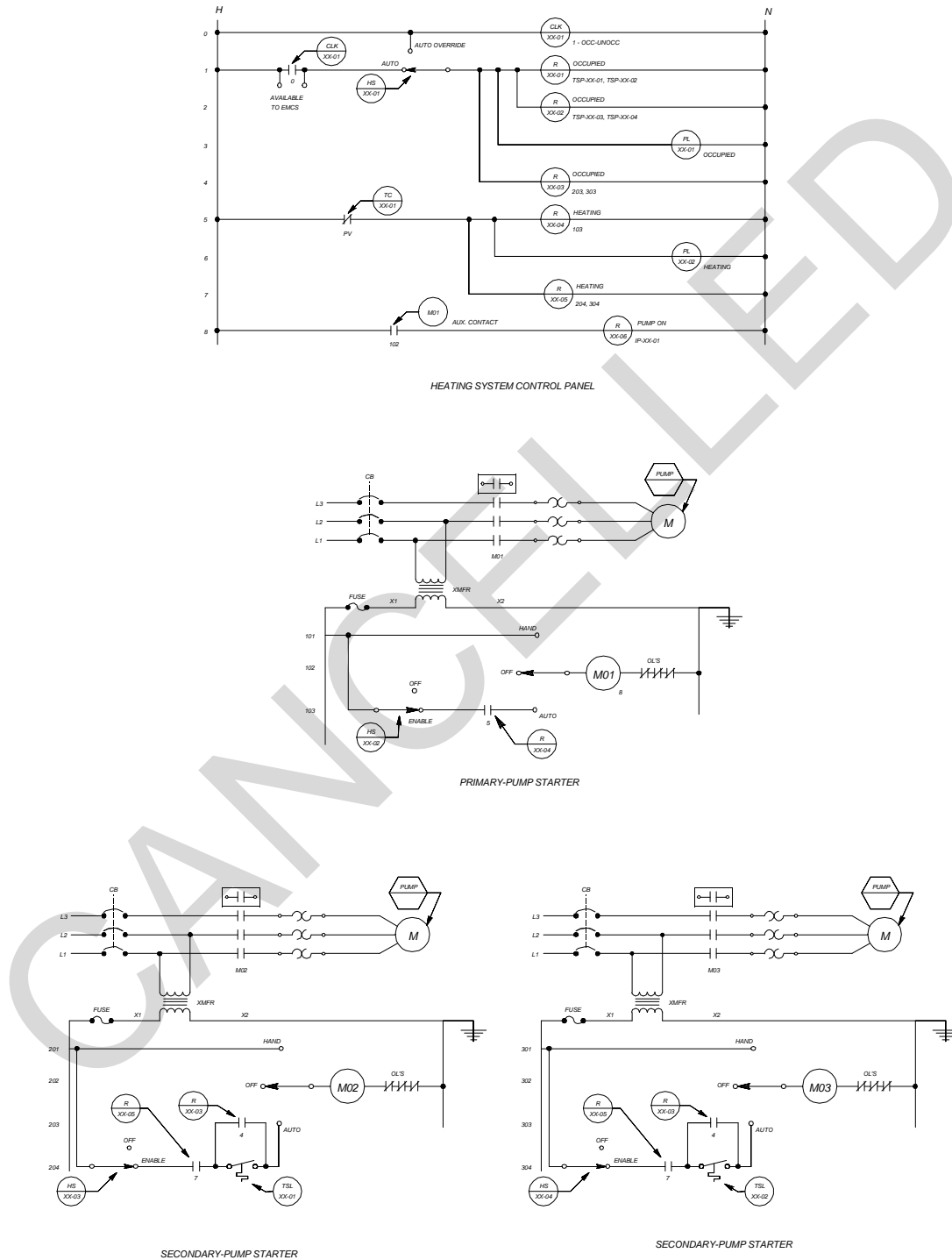
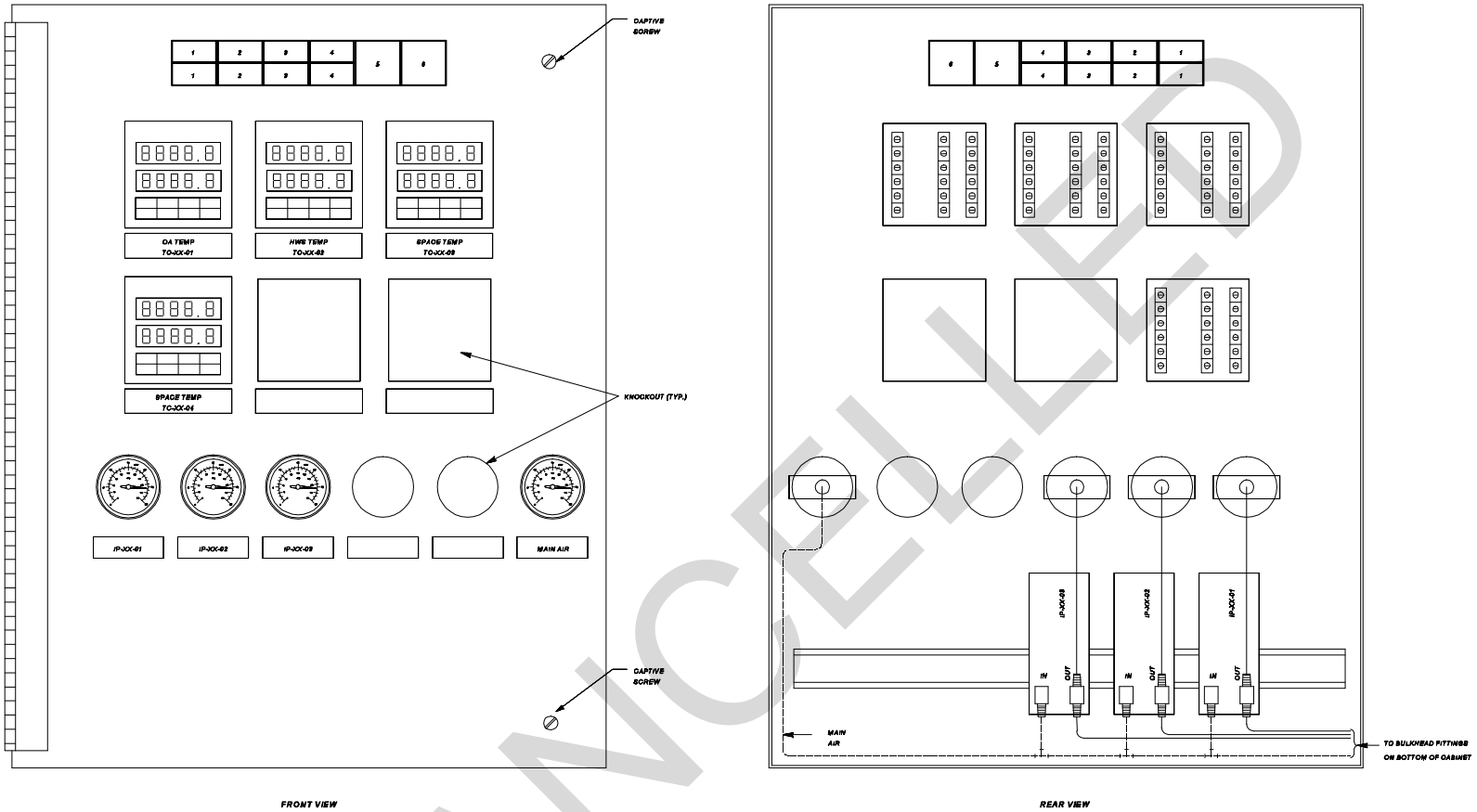

Figure 4-7b. Control system ladder diagram for central plant steam hydronic system.

LOOP CONTROL FUNCTION	DEVICE NUMBER	DEVICE FUNCTION	SETPPOINT	RANGE	ADDITIONAL PARAMETERS
CONVERTER TEMPERATURE	VLV-JX-01	CONVERTER VALVE	—	21 - 103 kPa (2-15 PSIG)	Kv = 17.3 (Cv = 30) CLOSE AGAINST 70 kPa (10 PSIG)
	TC-JX-01	OUTSIDE-AIR TEMPERATURE CONTROLLER	-1 DEG C (30 DEG F) PROPORTIONAL BAND 37.5% MANUAL RESET 50%	-35 TO +55 DEG C (-30 TO +130 DEG F)	PV CONTACT STARTS PUMP AT 16 DEG C (60 DEG F) STOPS PUMP AT 17 DEG C (62 DEG F)
	TC-JX-02	SYSTEM-SUPPLY TEMPERATURE CONTROLLER	OA TEMP = -18 DEG C (0 DEG F), HW'S TEMP = 83 DEG C (200 DEG F) OA TEMP = 16 DEG C (60 DEG F), HW'S TEMP = 38 DEG C (100 DEG F)	PV = 38 TO 121 DEG C (100 TO 250 DEG F) CPA = 38 TO 83 DEG C (100 TO 200 DEG F)	CPA LO-LIMIT = 38 DEG C (100 DEG F) CPA HI-LIMIT = 83 DEG C (200 DEG F)
	TT-JX-01	OUTSIDE-AIR TEMPERATURE TRANSMITTER	—	-35 TO +55 DEG C (-30 TO +130 DEG F)	—
	TT-JX-02	SYSTEM-SUPPLY TEMPERATURE TRANSMITTER	—	38 TO 121 DEG C (100 TO 250 DEG F)	—
SPACE TEMPERATURE	TT-JX-03	SPACE-TEMPERATURE TRANSMITTER	—	10 TO 30 DEG C (50 TO 85 DEG F)	—
	VLV-JX-02	ZONE VALVE	—	21 - 103 kPa (2-15 PSIG)	Kv = 6 (Cv = 7) CLOSE AGAINST 70 kPa (10 PSIG)
	TC-JX-03	SPACE TEMPERATURE CONTROLLER	21 DEG C (70 DEG F)	10 TO 30 DEG C (50 TO 85 DEG F)	SET LIMITS AVAILABLE TO OCCUPANT BY T8P-JX-01 AT 18 TO 22 DEG C (65 TO 72 DEG F)
	T8P-JX-01	MANUAL SETPOINT ADJUSTMENT	4 MA = 10 DEG C (50 DEG F) 20 MA = 29 DEG C (85 DEG F)	—	AVAILABLE TO OCCUPANT
	T8P-JX-02	MANUAL SETPOINT ADJUSTMENT	14 DEG C (57 DEG F)	—	—
SPACE LOW-LIMIT TEMPERATURE	T8L-JX-01	SPACE LOW-LIMIT THERMOSTAT	13 DEG C (55 DEG F)	—	STARTS PUMP AT 13 DEG C (55 DEG F) STOPS PUMP AT 14 DEG C (57 DEG F)
SPACE TEMPERATURE	TT-JX-04	SPACE TEMPERATURE TRANSMITTER	—	10 TO 30 DEG C (50 TO 85 DEG F)	—
	VLV-JX-03	ZONE VALVE	—	21 - 103 kPa (2-15 PSIG)	Kv = 6 (Cv = 7) CLOSE AGAINST 70 kPa (10 PSIG)
	TC-JX-04	SPACE TEMPERATURE CONTROLLER	21 DEG C (70 DEG F)	10 TO 30 DEG C (50 TO 85 DEG F)	SET LIMITS AVAILABLE TO OCCUPANT BY T8P-JX-03 AT 18 TO 22 DEG C (65 TO 72 DEG F)
	T8P-JX-03	MANUAL SETPOINT ADJUSTMENT	4 MA = 10 DEG C (50 DEG F) 20 MA = 29 DEG C (85 DEG F)	—	AVAILABLE TO OCCUPANT
	T8P-JX-04	MANUAL SETPOINT ADJUSTMENT	14 DEG C (57 DEG F)	—	—
SPACE LOW-LIMIT TEMPERATURE	T8L-JX-02	SPACE LOW-LIMIT THERMOSTAT	13 DEG C (55 DEG F)	—	STARTS PUMP AT 13 DEG C (55 DEG F) STOPS PUMP AT 14 DEG C (57 DEG F)
OCCUPIED MODE	CLK-JX-01 CONTACT	865-DAY SCHEDULE	—	NORMAL SCHEDULE: M - F CONTACT CLOSED: 0700 HRS CONTACT OPEN: 1700 HRS	CONTACT OPEN: SAT, SUN

NOTE : OTHER CONTROL DEVICES SUCH AS IPS AND RELAYS ARE NOT SHOWN

Figure 4-7c. Control system equipment for central plant steam hydronic system.



FRONT VIEW

REAR VIEW

SWITCH AND PILOT LIGHT LEGEND

POSITION LEGEND

- 1 - AUTOMATO OVERRIDE
- 2 - ENABLE/OFF
- 3 - ENABLE/OFF

DEVICE TYPE

- ILLUMINATED MAINTAINED CONTACT INTERLOCKED SWITCHES
- ILLUMINATED MAINTAINED CONTACT INTERLOCKED SWITCHES
- ILLUMINATED MAINTAINED CONTACT INTERLOCKED SWITCHES

IDENTIFIER

- H8-XX-01
- H8-XX-02
- H8-XX-03

POSITION LEGEND

- 4 - ENABLE/OFF
- 5 - OCCUPIED
- 6 - HEATING

DEVICE TYPE

- ILLUMINATED MAINTAINED CONTACT INTERLOCKED SWITCHES
- PILOT LIGHT
- PILOT LIGHT

IDENTIFIER

- H8-XX-04
- PL-XX-01
- PL-XX-02

Figure 4-7d. Control panel interior door layout for central plant steam hydronic system.

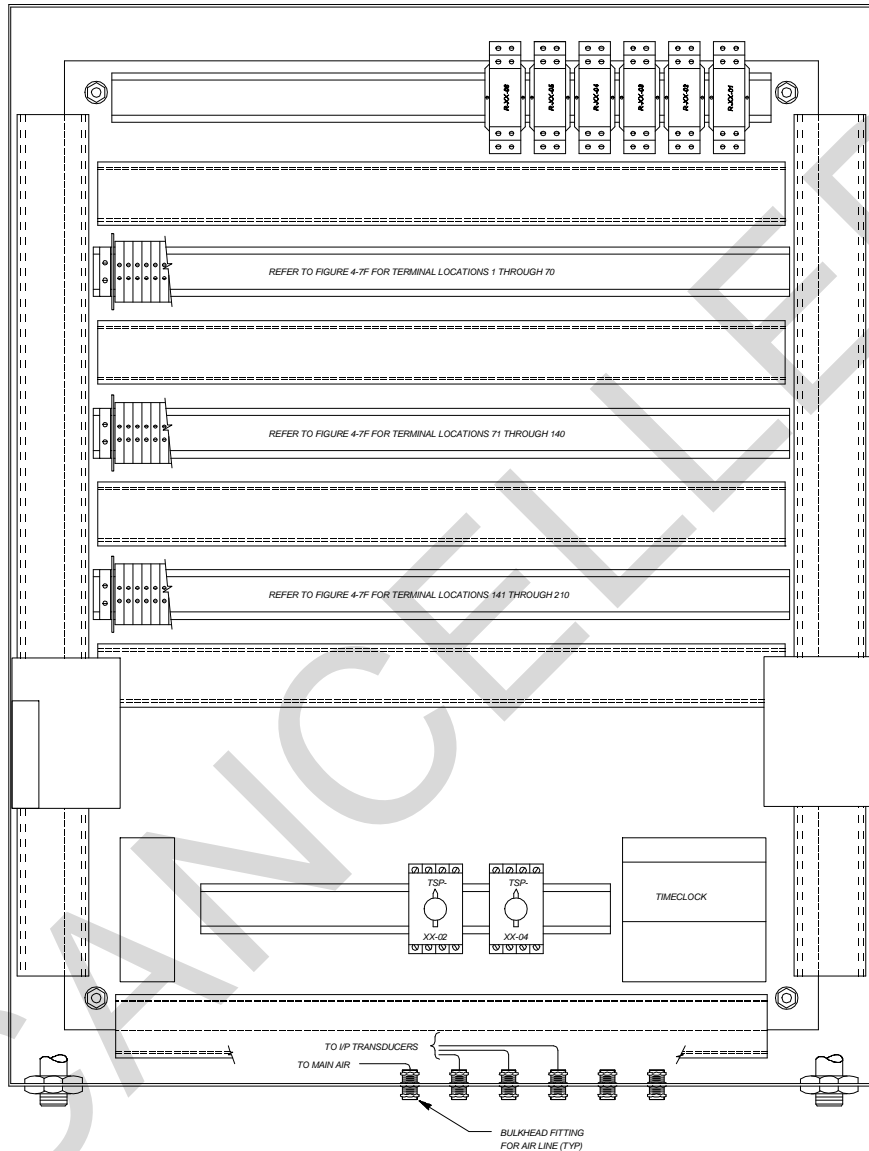

Figure 4-7e. Control panel back panel layout for central plant steam hydronic system.

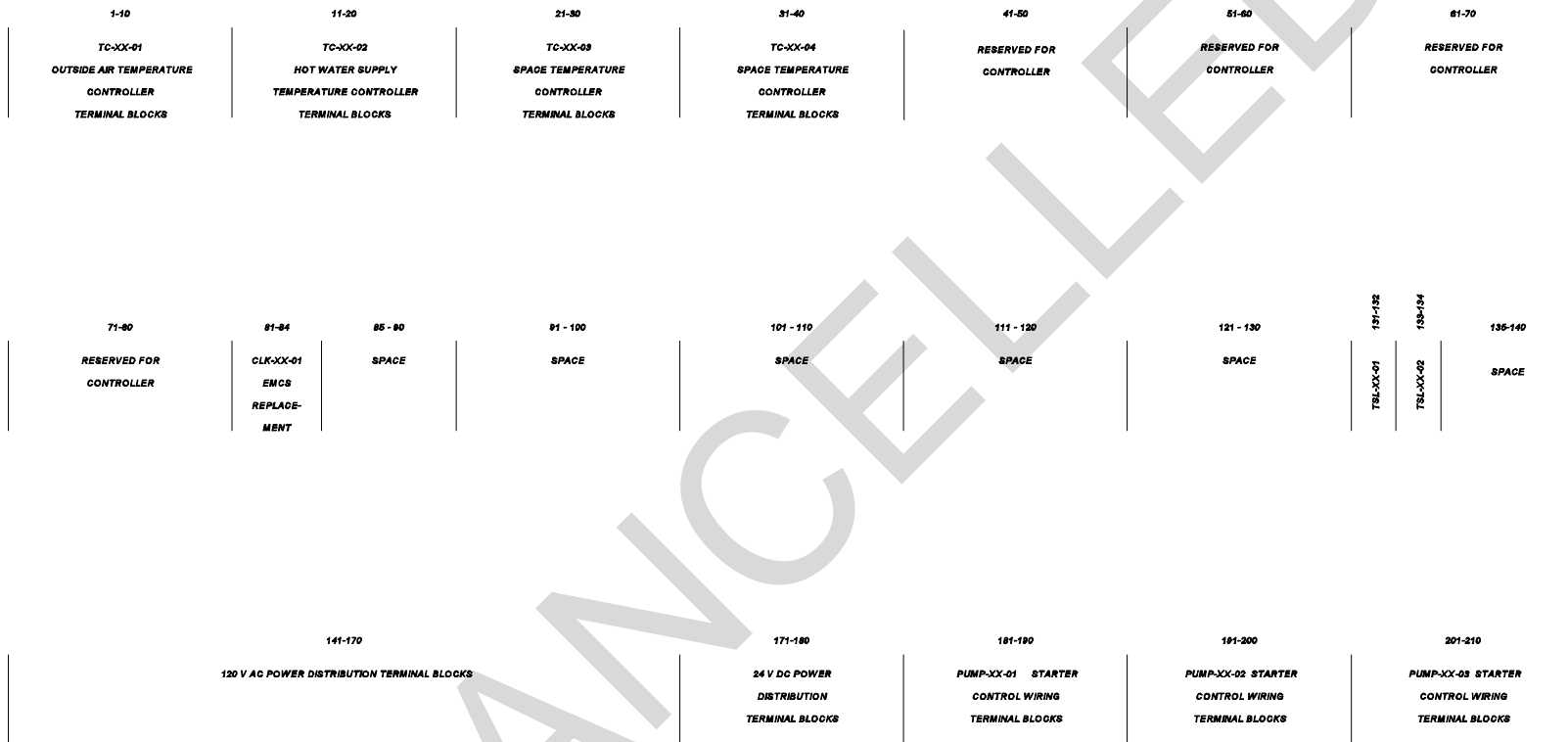

Figure 4-7f. Control panel terminal block layout for central plant steam hydronic system.

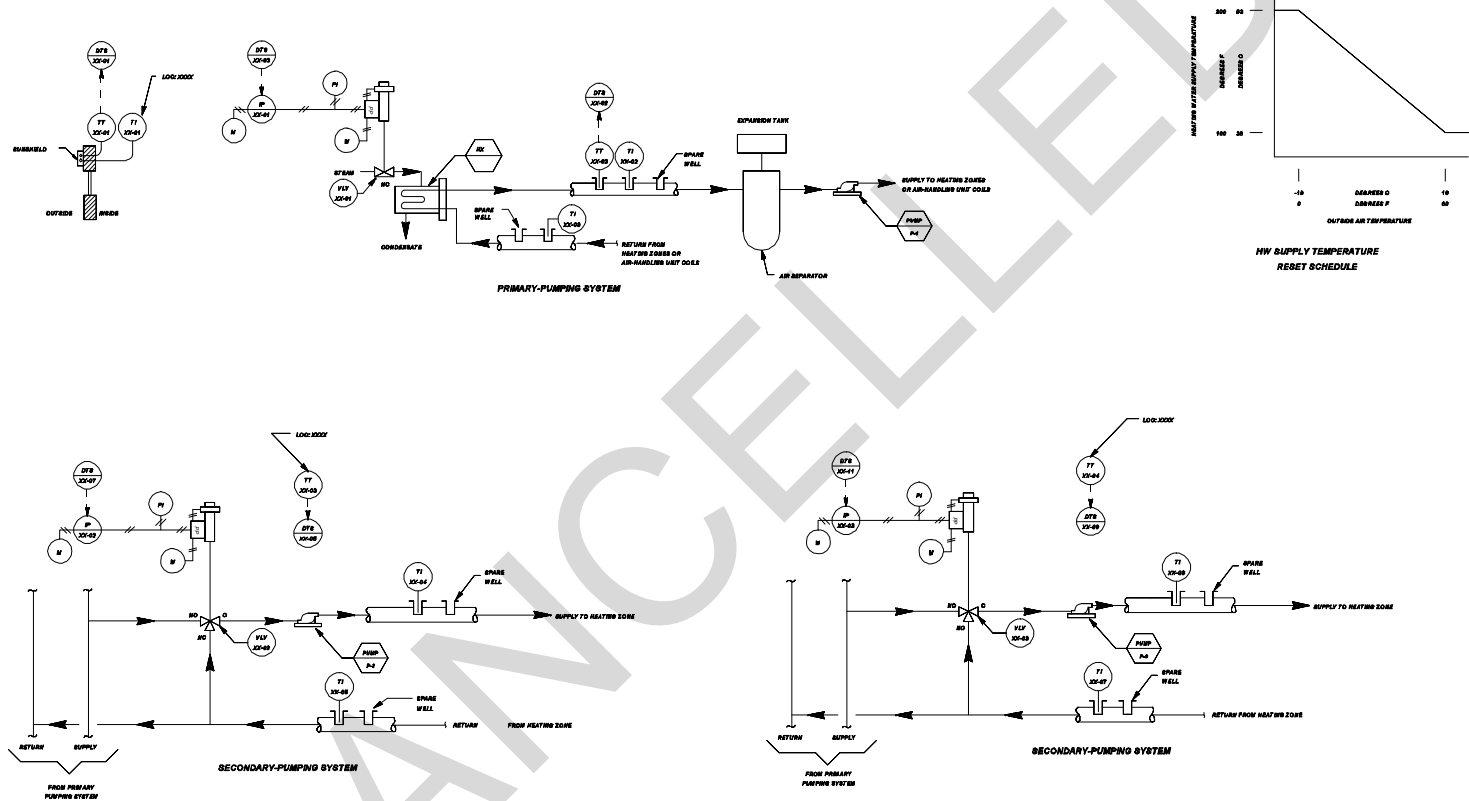

Figure 4-7g. DDC control system schematic for central plant steam hydronic system.

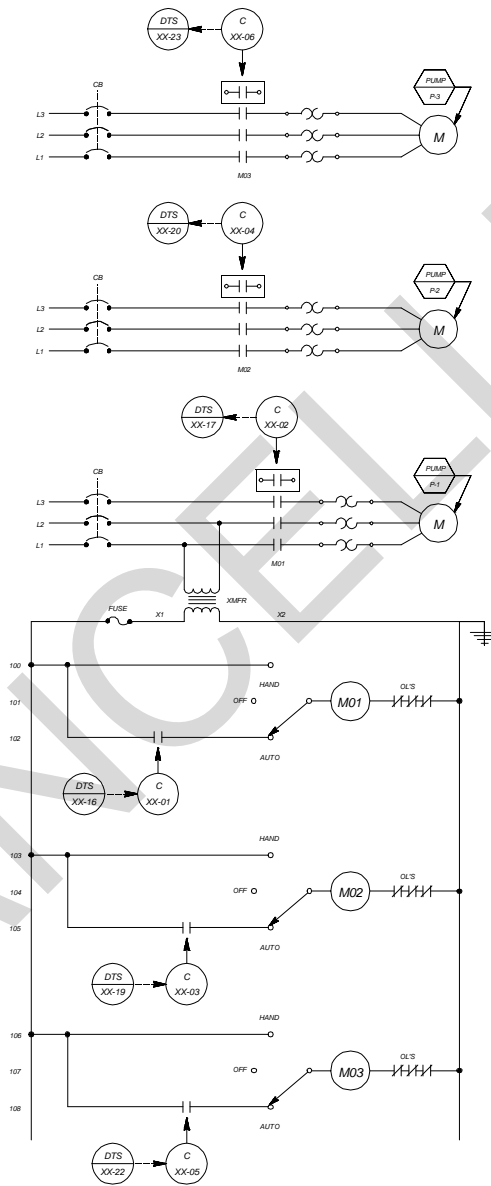

Figure 4-7h. DDC control system ladder diagram for central plant steam hydronic system.

SENSOR SCHEDULE

IDENTIFIER	FUNCTION	RANGE
TT-XX-01	OUTSIDE AIR TEMPERATURE TRANSMITTER	-35 TO +55 DEG C (-30 TO +130 DEG F)
TT-XX-02	PRIMARY SYSTEM SUPPLY TEMPERATURE TRANSMITTER	38 TO 121 DEG C (100 TO 250 DEG F)
TT-XX-03	SPACE TEMPERATURE TRANSMITTER	10 TO 30 DEG C (50 TO 85 DEG F)
TT-XX-04	SPACE TEMPERATURE TRANSMITTER	10 TO 30 DEG C (50 TO 85 DEG F)

CONTROL VALVE SCHEDULE

IDENTIFIER	FUNCTION	TYPE	RANGE	Kv (Cv)	CLOSE-OFF RATING	REMARKS
VLV-XX-01	CONVERTER STEAM VALVE	2-WAY, MODULATING	21 - 103 kPa (3-15 PSIG)	XX	XX kPa (XX PSIG)	
VLV-XX-02	ZONE VALVE	3-WAY, MODULATING	21 - 103 kPa (3-15 PSIG)	XX	XX kPa (XX PSIG)	
VLV-XX-03	ZONE VALVE	3-WAY, MODULATING	21 - 103 kPa (3-15 PSIG)	XX	XX kPa (XX PSIG)	

OPERATING PARAMETERS

FUNCTION	SETPOINT	REMARKS
OUTSIDE AIR TEMPERATURE		START PRIMARY PUMP AT OA TEMP = XX DEG C (XX DEG F) STOP PRIMARY PUMP AT OA TEMP = XX DEG C (XX DEG F)
PRIMARY SYSTEM SUPPLY TEMPERATURE	XX DEG C (XX DEG F)	OA TEMP = -18 DEG C (0 DEG F); PRIMARY SYSTEM SUPPLY SETPOINT = 93 DEG C (200 DEG F) OA TEMP = 16 DEG C (60 DEG F); PRIMARY SYSTEM SUPPLY SETPOINT = 38 DEG C (100 DEG F)
SPACE TEMP. (OCCUPIED)	XX DEG C (XX DEG F)	
SPACE TEMP. (UNOCCUPIED)	XX DEG C (XX DEG F)	
OCCUPIED MODE		MONDAY - FRIDAY : 0705 HRS - 1700 HRS

Figure 4-7i. DDC control system equipment for central plant steam hydronic system.

	HARDWARE										SOFTWARE									
	OUTPUT					INPUT					ALARMS					APPLICATION PROGRAMS				
	DIGITAL		ANALOG			DIGITAL		ANALOG			DIGITAL		ANALOG							
	CONTROL RELAY		POSITION ADJUSTMENT	CONTROL POINT ADJUST.	AUXILIARY CONTACT	TEMPERATURE	CONTROL POINT ADJUST.	PSIA, PSIA, PSID	FLOW	CONTACT CLOSURE	HIGH LIMIT	LOW LIMIT	RAIN TIME	SCHEDULED START/STOP	OPTIMUM START/STOP	DUTY CYCLING	DEMAND LIMITING	HW ON RESET	FAILURE MODE #	
OUTSIDE AIR						1												X		
PRIMARY SYSTEM HW SUPPLY						1					X	X								
ZONE						1					X	X								
ZONE						1					X	X								
CONVERTER VALVE			1																	
ZONE VALVE			1																	
ZONE VALVE			1																	
PRIMARY PUMP	1				1					X			X	X	X	X				
ZONE PUMP	1				1					X			X	X	X	X				
ZONE PUMP	1				1					X			X	X	X	X				

** C - LAST COMMAND
H - HIGH VALUE
L - LOW VALUE
O - ON (OPEN)
F - OFF (CLOSED)

DDC DATA TERMINAL STRIP LAYOUT

DEVICE NO.	DESCRIPTION	TYPE	
1	TT-XX-01	OUTSIDE AIR TEMPERATURE	AI
2	TT-XX-02	PRIMARY SYSTEM SUPPLY TEMP.	AI
3	IP-XX-01	CONVERTER VALVE	AO
4			
5	TT-XX-03	SPACE TEMPERATURE	AI
6			
7	IP-XX-02	ZONE VALVE	AO
8			
9	TT-XX-04	SPACE TEMPERATURE	AI
10			
11	IP-XX-03	ZONE VALVE	AO
12			
13			
14			
15			
16	C-XX-01	PRIMARY PUMP START/STOP	DO
17	C-XX-02	PRIMARY PUMP STATUS	DI
18			
19	C-XX-03	ZONE PUMP START/STOP	DO
20	C-XX-04	ZONE PUMP STATUS	DI
21			
22	C-XX-05	ZONE PUMP START/STOP	DO
23	C-XX-06	ZONE PUMP STATUS	DI
24			
25			
26			
27			
28			
29			
30			

Figure 4-7j. DDC control system I/O table and data terminal strip layout for central plant steam hydronic system.

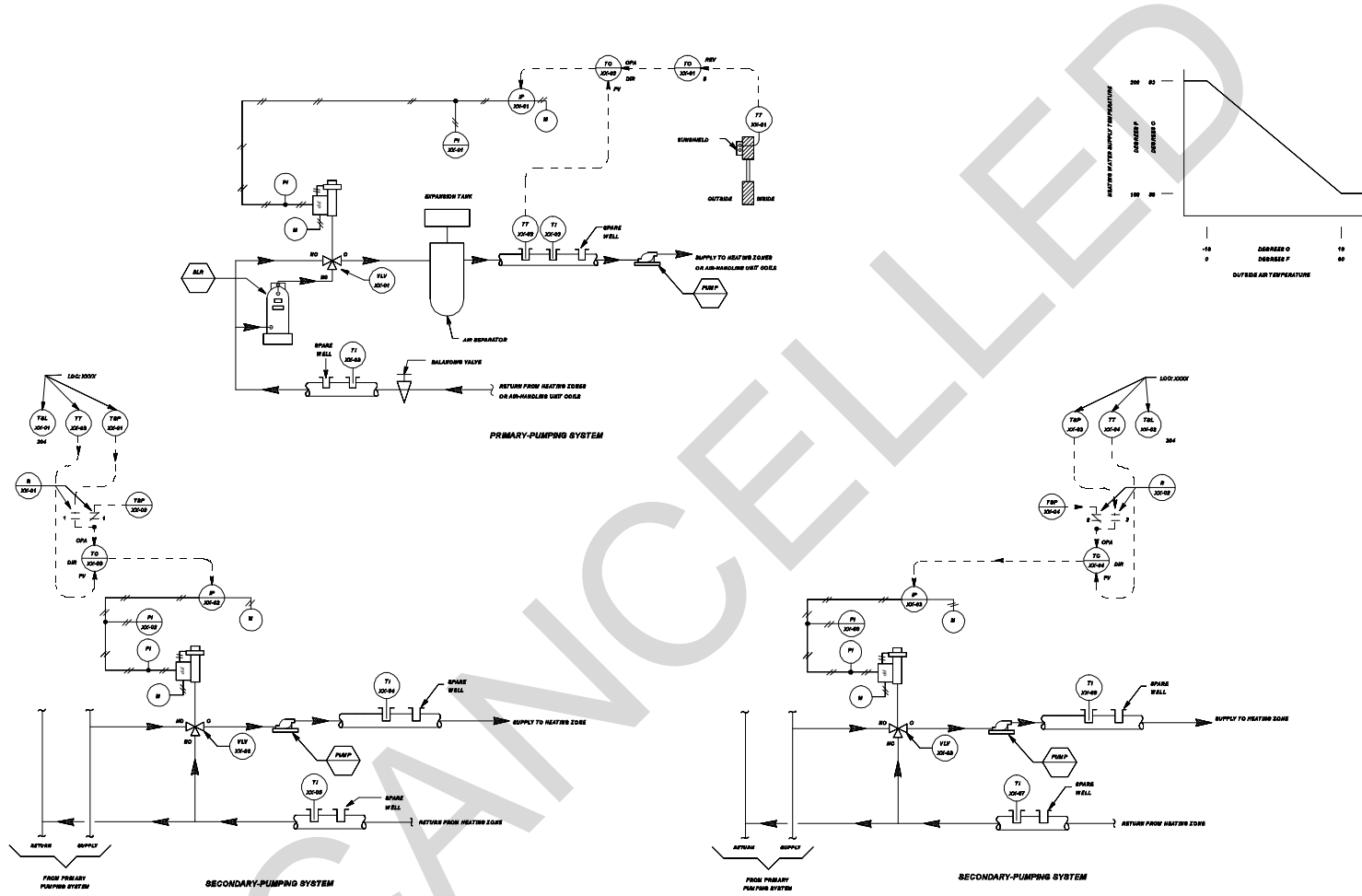

Figure 4-8a. Control system schematic for single building hydronic heating system with hot water boiler.

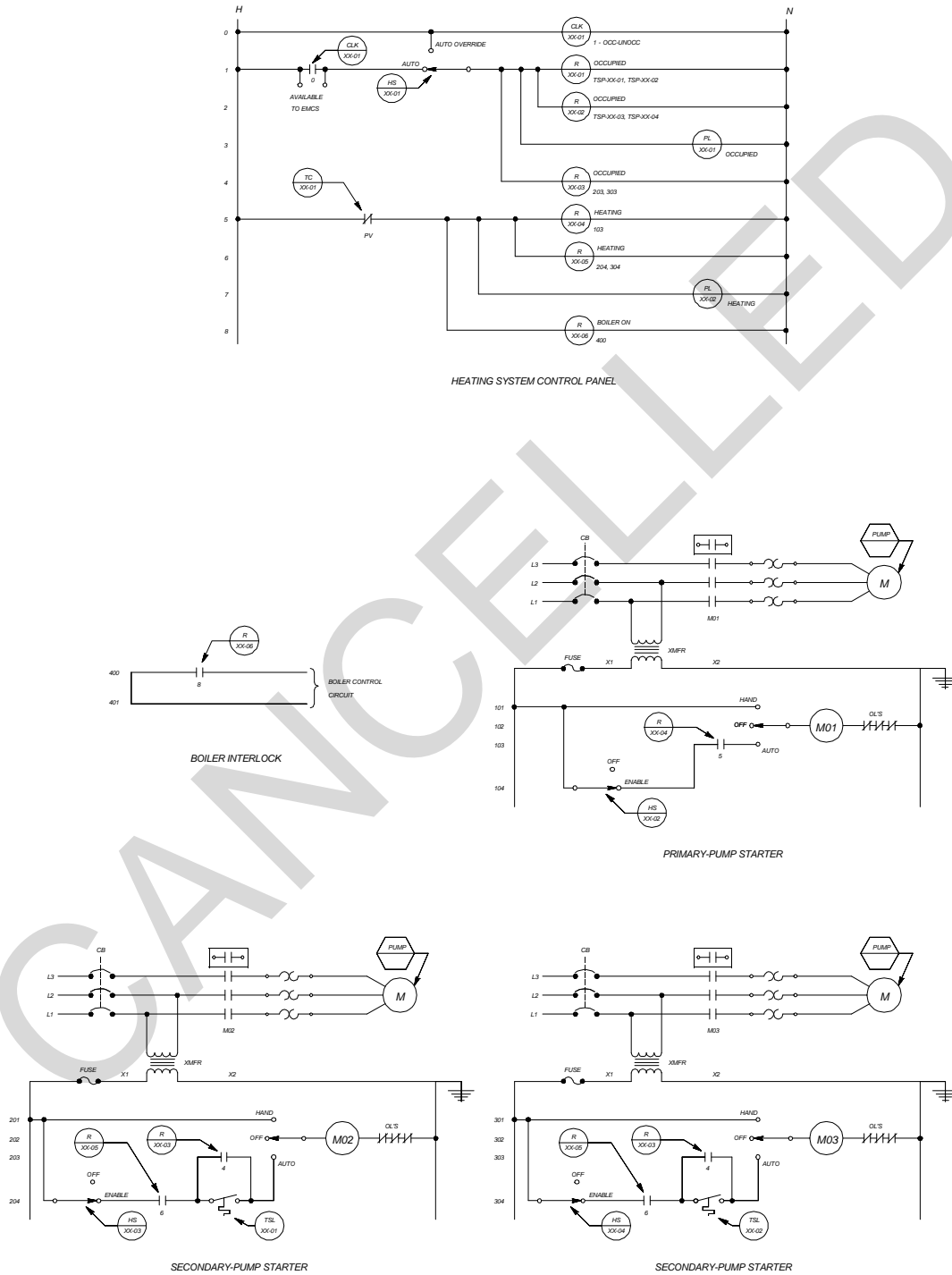
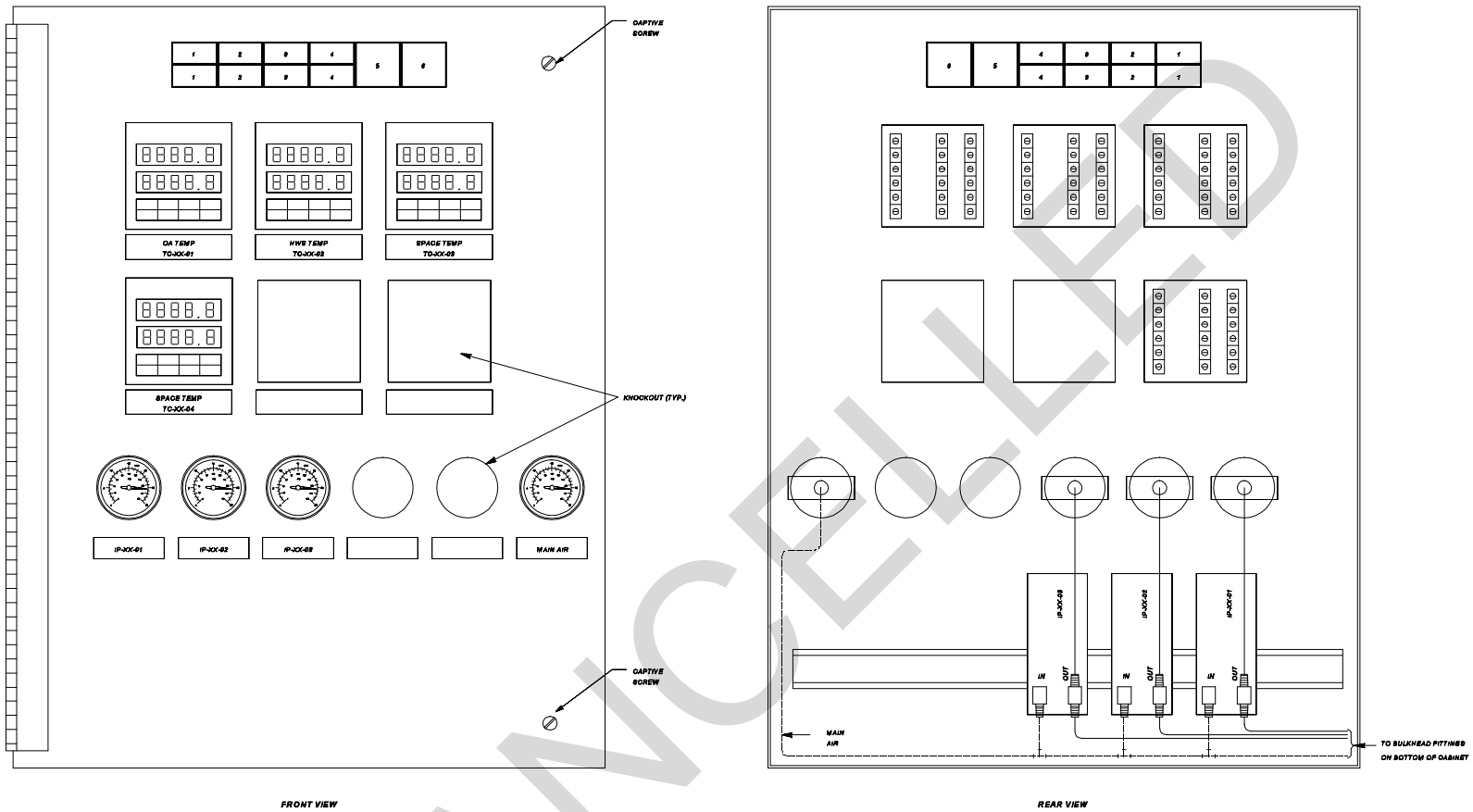

Figure 4-8b. Control system ladder diagram for single building hydronic heating system with hot water boiler.

LOOP CONTROL FUNCTION	DEVICE NUMBER	DEVICE FUNCTION	SETPOINT	RANGE	ADDITIONAL PARAMETERS
HW SUPPLY TEMPERATURE	VLV-JX-01	SYSTEM VALVE	—	21 - 103 kPa (8-18 PSIG)	Kv = 17.5 (Cv = 80) CLOSE AGAINST 70 kPa (10 PSIG)
	TC-JX-01	OUTSIDE-AIR TEMPERATURE CONTROLLER	-1 DEG C (30 DEG F) PROPORTIONAL BAND 37.5% MANUAL RESET 60%	-35 TO +55 DEG C (-30 TO +130 DEG F)	PV CONTACT STARTS PUMP AT 16 DEG C (60 DEG F) STOPS PUMP AT 17 DEG C (62 DEG F)
	TC-JX-02	SYSTEM-SUPPLY TEMPERATURE CONTROLLER	OA TEMP = -18 DEG C (0 DEG F), HW8 TEMP = 83 DEG C (200 DEG F) OA TEMP = 16 DEG C (60 DEG F), HW8 TEMP = 38 DEG C (100 DEG F)	PV = 38 TO 121 DEG C (100 TO 250 DEG F) CPA = 38 TO 83 DEG C (100 TO 200 DEG F)	CPA LO-LIMIT = 38 DEG C (100 DEG F) CPA HI-LIMIT = 83 DEG C (200 DEG F)
	TT-JX-01	OUTSIDE-AIR TEMPERATURE TRANSMITTER	—	-35 TO +55 DEG C (-30 TO +130 DEG F)	—
	TT-JX-02	SYSTEM-SUPPLY TEMPERATURE TRANSMITTER	—	38 TO 121 DEG C (100 TO 250 DEG F)	—
SPACE TEMPERATURE	TT-JX-03	SPACE-TEMPERATURE TRANSMITTER	—	10 TO 30 DEG C (50 TO 85 DEG F)	—
	VLV-JX-02	ZONE VALVE	—	21 - 103 kPa (8-18 PSIG)	Kv = 8 (Cv = 7) CLOSE AGAINST 70 kPa (10 PSIG)
	TC-JX-03	SPACE TEMPERATURE CONTROLLER	21 DEG C (70 DEG F)	10 TO 30 DEG C (50 TO 85 DEG F)	SET LIMITS AVAILABLE TO OCCUPANT BY TSP-JX-01 AT 18 TO 22 DEG C (65 TO 72 DEG F)
	TSP-JX-01	MANUAL SETPOINT ADJUSTMENT	4 MA = 10 DEG C (50 DEG F) 20 MA = 28 DEG C (85 DEG F)	—	AVAILABLE TO OCCUPANT
	TSP-JX-02	MANUAL SETPOINT ADJUSTMENT	14 DEG C (57 DEG F)	—	—
SPACE LOW-LIMIT TEMPERATURE	TSL-JX-01	SPACE LOW-LIMIT THERMOSTAT	13 DEG C (55 DEG F)	—	STARTS PUMP AT 13 DEG C (55 DEG F) STOPS PUMP AT 14 DEG C (57 DEG F)
SPACE TEMPERATURE	TT-JX-04	SPACE TEMPERATURE TRANSMITTER	—	10 TO 30 DEG C (50 TO 85 DEG F)	—
	VLV-JX-03	ZONE VALVE	—	21 - 103 kPa (8-18 PSIG)	Kv = 6 (Cv = 7) CLOSE AGAINST 70 kPa (10 PSIG)
	TC-JX-04	SPACE TEMPERATURE CONTROLLER	21 DEG C (70 DEG F)	10 TO 30 DEG C (50 TO 85 DEG F)	SET LIMITS AVAILABLE TO OCCUPANT BY TSP-JX-03 AT 18 TO 22 DEG C (65 TO 72 DEG F)
	TSP-JX-03	MANUAL SETPOINT ADJUSTMENT	4 MA = 10 DEG C (50 DEG F) 20 MA = 28 DEG C (85 DEG F)	—	AVAILABLE TO OCCUPANT
	TSP-JX-04	MANUAL SETPOINT ADJUSTMENT	14 DEG C (57 DEG F)	—	—
SPACE LOW-LIMIT TEMPERATURE	TSL-JX-02	SPACE LOW-LIMIT THERMOSTAT	13 DEG C (55 DEG F)	—	STARTS PUMP AT 13 DEG C (55 DEG F) STOPS PUMP AT 14 DEG C (57 DEG F)
OCCUPIED MODE	CLK-JX-01 CONTACT	885-DAY SCHEDULE	—	NORMAL SCHEDULE: M - F CONTACT CLOSED: 6700 HRS CONTACT OPEN: 1700 HRS	CONTACT OPEN: SAT, SUN

NOTE : OTHER CONTROL DEVICES SUCH AS IPS AND RELAYS ARE NOT SHOWN

Figure 4-8c. Control system equipment for single building hydronic heating system with hot water boiler.



FRONT VIEW

REAR VIEW

SWITCH AND PILOT LIGHT LEGEND

POSITION LEGEND

1 - AUTOMATO OVERRIDE
2 - ENABLE/OFF
3 - ENABLE/OFF

DEVICE TYPE	IDENTIFIER
ILLUMINATED MAINTAINED CONTACT INTERLOCKED SWITCHES	HS-XX-01
ILLUMINATED MAINTAINED CONTACT INTERLOCKED SWITCHES	HS-XX-02
ILLUMINATED MAINTAINED CONTACT INTERLOCKED SWITCHES	HS-XX-03

POSITION LEGEND

4 - ENABLE/OFF
5 - OCCUPIED
6 - HEATING

DEVICE TYPE	IDENTIFIER
ILLUMINATED MAINTAINED CONTACT INTERLOCKED SWITCHES	HS-XX-04
PILOT LIGHT	PL-XX-01
PILOT LIGHT	PL-XX-02

Figure 4-8d. Control panel interior door layout for single building hydronic heating system with hot water boiler.

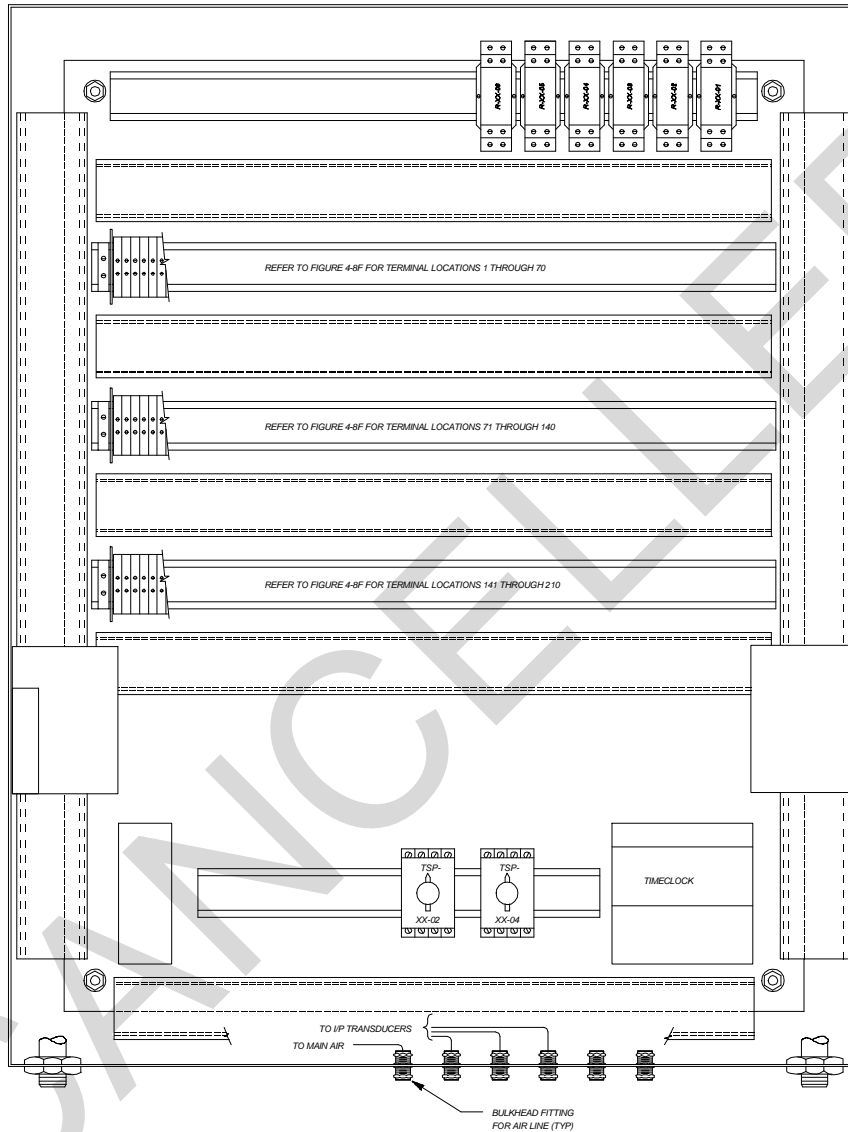

Figure 4-8e. Control panel back panel layout for single building hydronic heating system with hot water boiler.

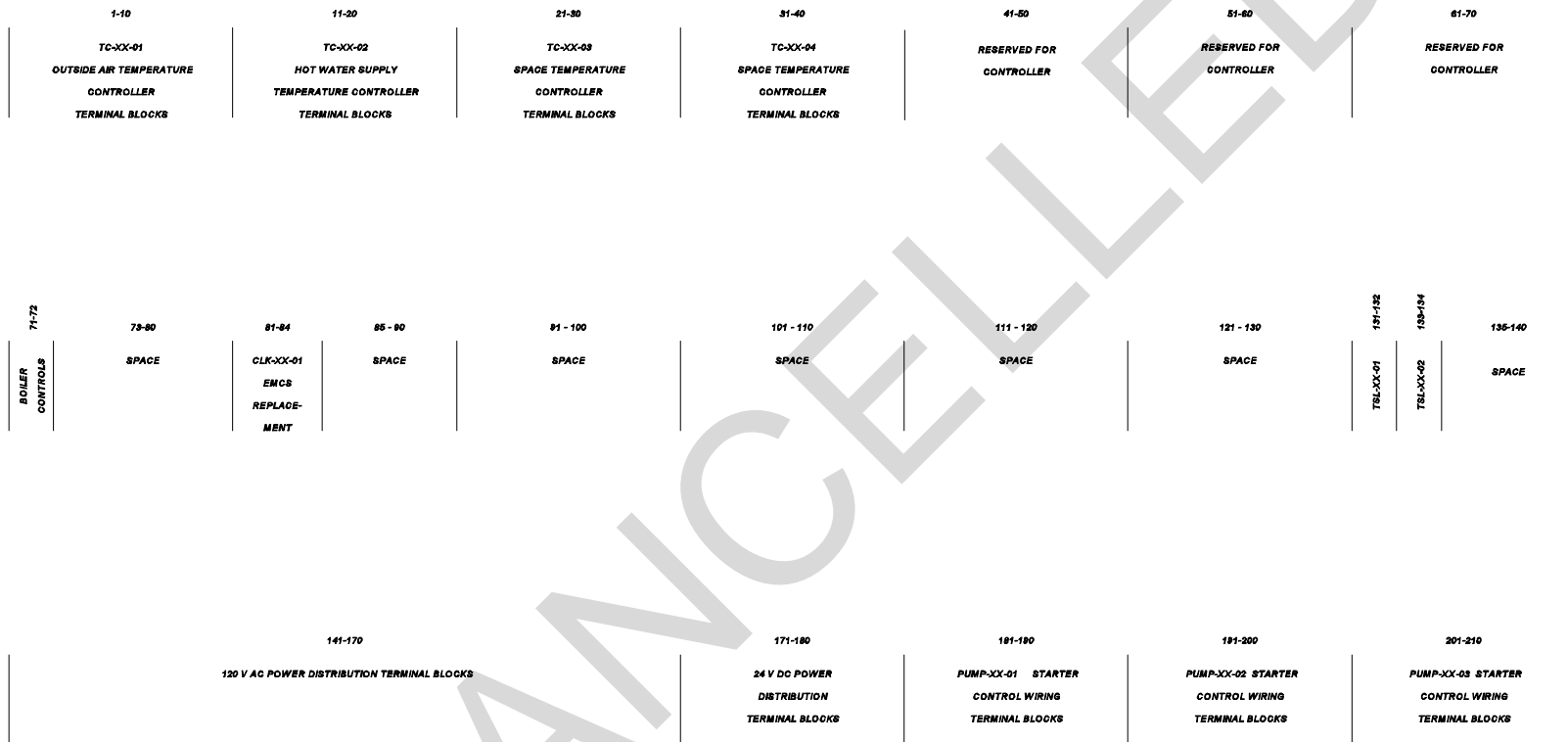

Figure 4-8f. Control panel terminal block layout for single building hydronic heating system with hot water boiler.

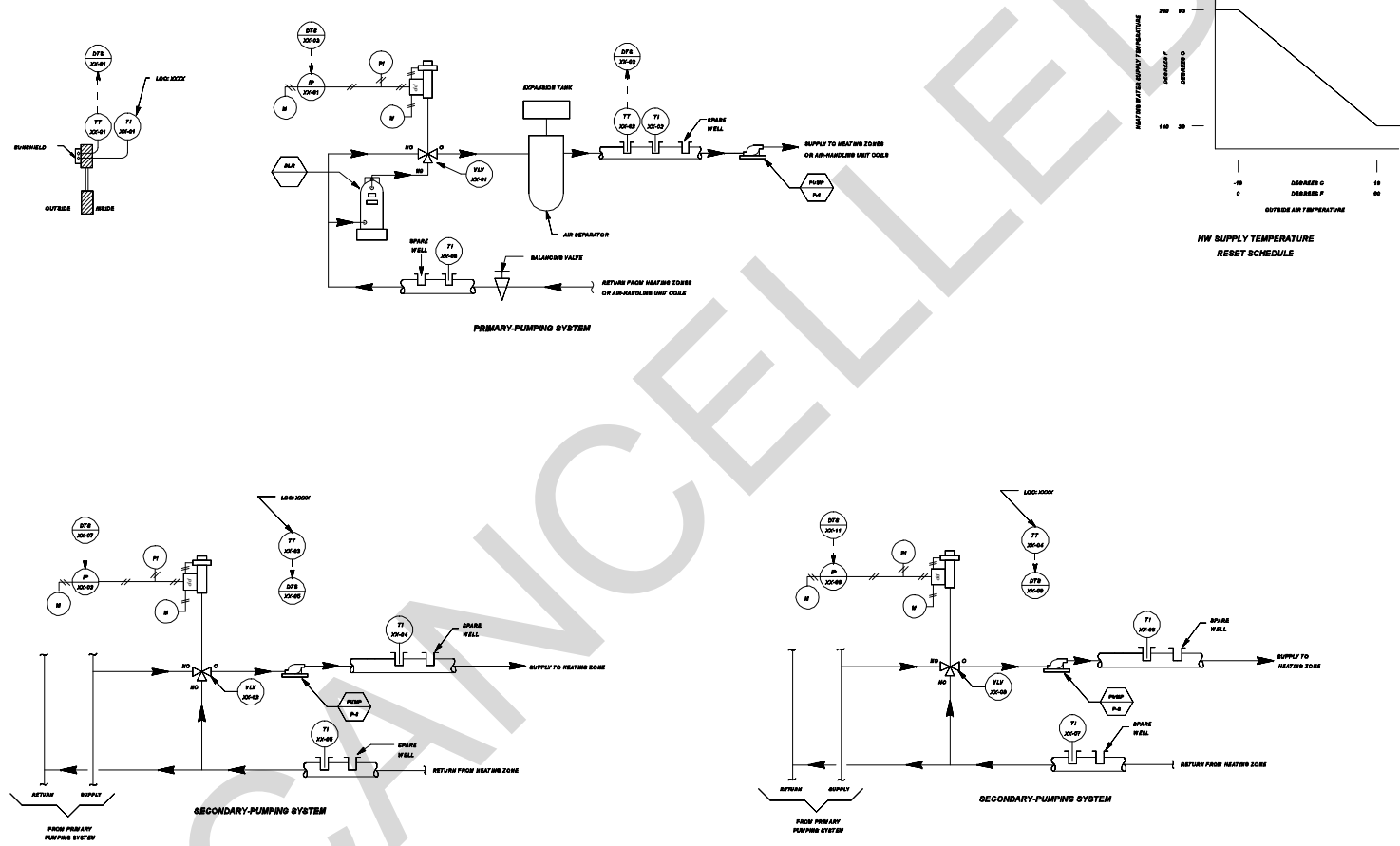

Figure 4-8g. DDC control system schematic for single building hydronic heating system with hot water boiler.

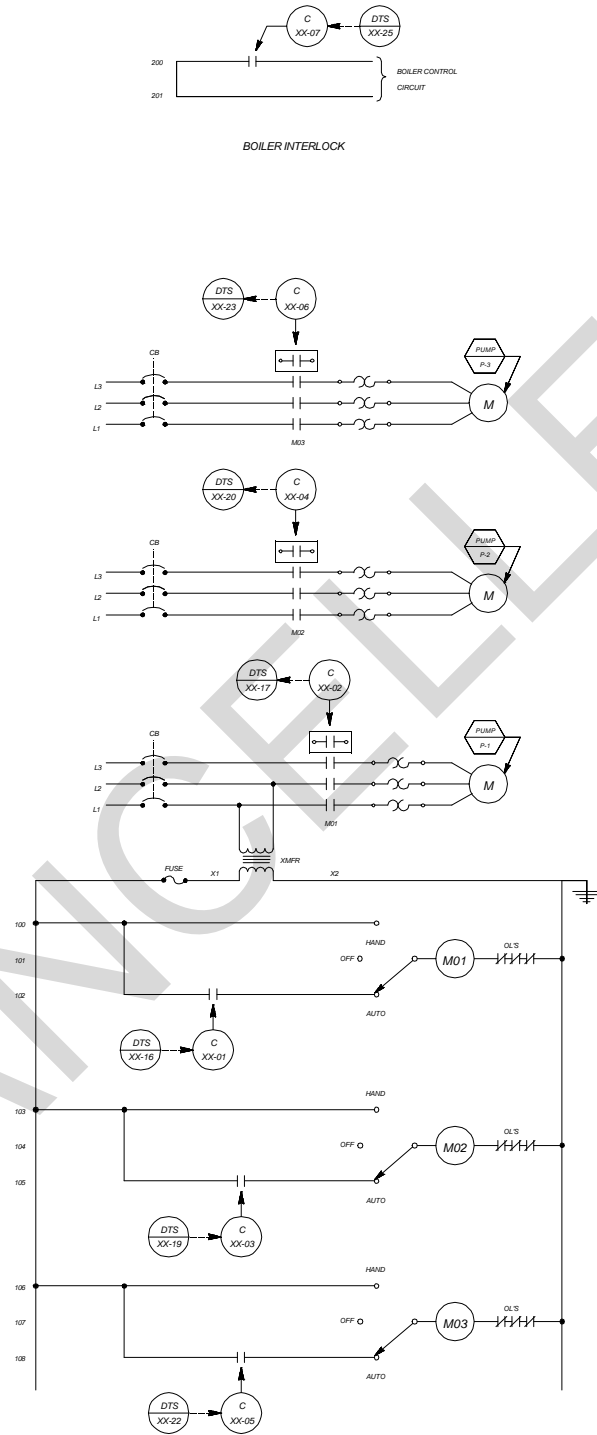

Figure 4-8h. DDC control system ladder diagram for single building hydronic heating system with hot water boiler.

SENSOR SCHEDULE

IDENTIFIER	FUNCTION	RANGE
TT-XX-01	OUTSIDE AIR TEMPERATURE TRANSMITTER	-35 TO +55 DEG C (-30 TO +130 DEG F)
TT-XX-02	PRIMARY SYSTEM SUPPLY TEMPERATURE TRANSMITTER	38 TO 121 DEG C (100 TO 250 DEG F)
TT-XX-03	SPACE TEMPERATURE TRANSMITTER	10 TO 30 DEG C (50 TO 85 DEG F)
TT-XX-04	SPACE TEMPERATURE TRANSMITTER	10 TO 30 DEG C (50 TO 85 DEG F)

CONTROL VALVE SCHEDULE

IDENTIFIER	FUNCTION	TYPE	RANGE	Kv (Cv)	CLOSE-OFF RATING	REMARKS
VLV-XX-01	PRIMARY SYSTEM VALVE	3-WAY, MODULATING	21 - 103 kPa (3-15 PSIG)	XX	XX kPa (XX PSIG)	
VLV-XX-02	ZONE VALVE	3-WAY, MODULATING	21 - 103 kPa (3-15 PSIG)	XX	XX kPa (XX PSIG)	
VLV-XX-03	ZONE VALVE	3-WAY, MODULATING	21 - 103 kPa (3-15 PSIG)	XX	XX kPa (XX PSIG)	

OPERATING PARAMETERS

FUNCTION	SETPOINT	REMARKS
OUTSIDE AIR TEMPERATURE		START PRIMARY PUMP AT OA TEMP = XX DEG C (XX DEG F) STOP PRIMARY PUMP AT OA TEMP = XX DEG C (XX DEG F)
PRIMARY SYSTEM SUPPLY TEMPERATURE	XX DEG C (XX DEG F)	OA TEMP = -18 DEG C (0 DEG F); PRIMARY SYSTEM SUPPLY SETPOINT = 93 DEG C (200 DEG F) OA TEMP = 16 DEG C (60 DEG F); PRIMARY SYSTEM SUPPLY SETPOINT = 38 DEG C (100 DEG F)
SPACE TEMP. (OCCUPIED)	XX DEG C (XX DEG F)	
SPACE TEMP. (UNOCCUPIED)	XX DEG C (XX DEG F)	
OCCUPIED MODE		MONDAY - FRIDAY : 0705 HRS - 1700 HRS

Figure 4-8i. DDC control system equipment for single building hydronic heating system with hot water boiler.

	HARDWARE										SOFTWARE													
	OUTPUT					INPUT					ALARMS					APPLICATION PROGRAMS								
	DIGITAL		ANALOG			DIGITAL		ANALOG			DIGITAL		ANALOG											
	CONTROL RELAY		POSITION ADJUSTMENT	CONTROL POINT ADJUST.		ALLEGORY CONTACT		TEMPERATURE	CONTROL POINT ADJUST.	PRSS, PRSA, PRSD	FLOW		CONTACT CLOSURE		HIGH LIMIT	LOW LIMIT	RUN TIME	SCHEDULED START/STOP	OPTIMUM START/STOP	DUTY CYCLING	DEMAND LIMITING	HW ON RESET		FAILURE MODE
OUTSIDE AIR							1								X	X						X		
PRIMARY SYSTEM HW SUPPLY							1								X	X						X		
ZONE							1								X	X								
ZONE							1								X	X								
PRIMARY SYSTEM VALVE				1																		X		
ZONE VALVE				1																				
ZONE VALVE				1																				
PRIMARY PUMP	1					1						X			X		X	X	X	X				
ZONE PUMP	1					1						X			X		X	X	X	X				
ZONE PUMP	1					1						X			X		X	X	X	X				
BOILER INTERLOCK	1											X			X		X	X						

** C - LAST COMMAND
H - HIGH VALUE
L - LOW VALUE

O - ON (OPEN)
F - OFF (CLOSED)

DDC DATA TERMINAL STRIP LAYOUT

DEVICE NO.	DESCRIPTION	TYPE	
1	TT-XX-01	OUTSIDE AIR TEMPERATURE	AI
2	TT-XX-02	PRIMARY SYSTEM SUPPLY TEMP.	AI
3	IP-XX-01	PRIMARY SYSTEM VALVE	AO
4			
5	TT-XX-03	SPACE TEMPERATURE	AI
6			
7	IP-XX-02	ZONE VALVE	AO
8			
9	TT-XX-04	SPACE TEMPERATURE	AI
10			
11	IP-XX-03	ZONE VALVE	AO
12			
13			
14			
15			
16	C-XX-01	PRIMARY PUMP START/STOP	DO
17	C-XX-02	PRIMARY PUMP STATUS	DI
18			
19	C-XX-03	ZONE PUMP START/STOP	DO
20	C-XX-04	ZONE PUMP STATUS	DI
21			
22	C-XX-05	ZONE PUMP START/STOP	DO
23	C-XX-06	ZONE PUMP STATUS	DI
24			
25	C-XX-07	BOILER INTERLOCK	DO
26			
27			
28			
29			
30			

Figure 4-8j. DDC control system I/O table and data terminal strip layout for single building hydronic heating system with hot water boiler.

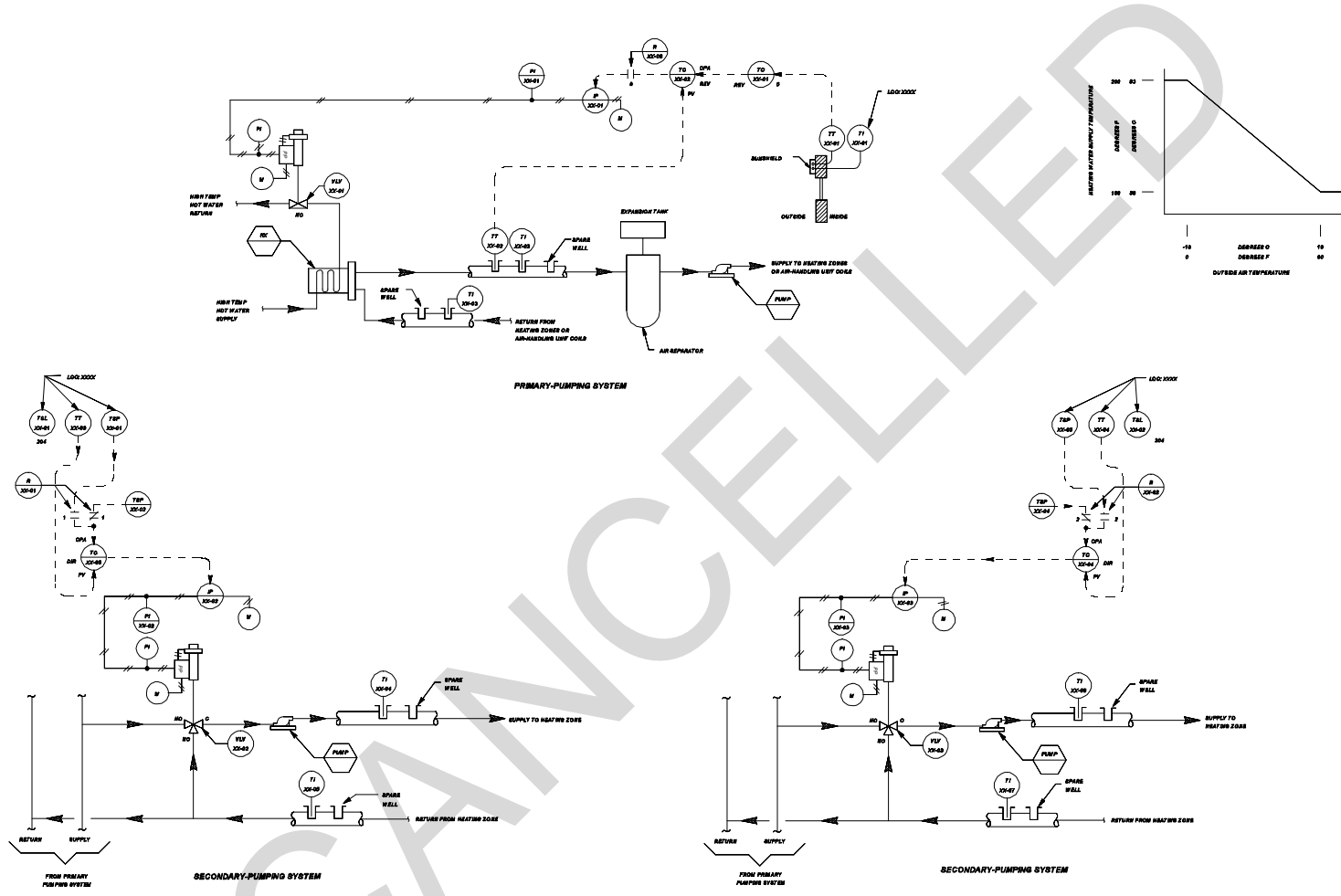
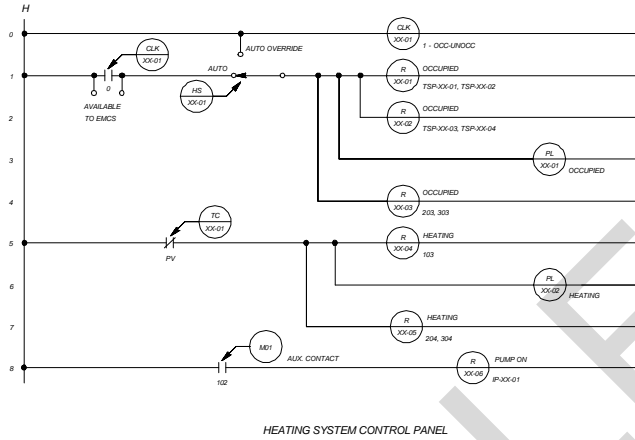
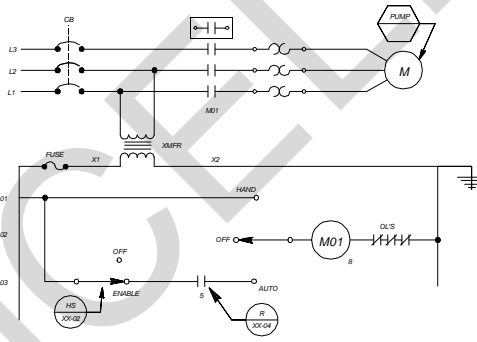

Figure 4-9a. Control system schematic for central plant high-temperature hot water hydronic heating system.



HEATING SYSTEM CONTROL PANEL



PRIMARY-PUMP STARTER

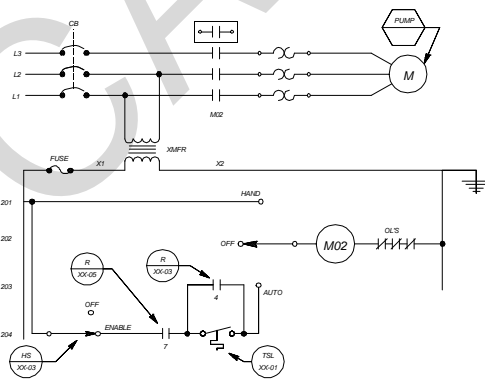

SECONDARY-PUMP STARTER

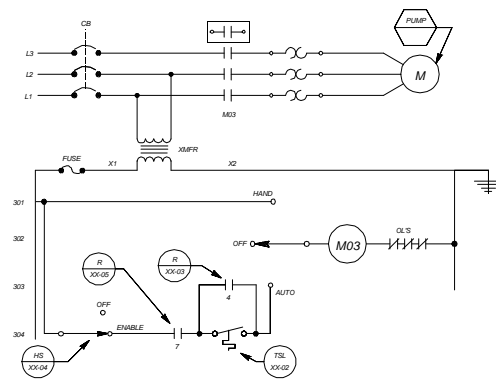

SECONDARY-PUMP STARTER

Figure 4-9b. Control system ladder diagram for central plant high-temperature hot water hydronic heating system.

LOOP CONTROL FUNCTION	DEVICE NUMBER	DEVICE FUNCTION	SETPPOINT	RANGE	ADDITIONAL PARAMETERS
CONVERTER TEMPERATURE	VLV-XX-01	CONVERTER VALVE	—	21 - 103 kPa (3-15 PSIG)	Kv = 17.3 (Cv = 30) CLOSE AGAINST 70 kPa (10 PSIG)
	TC-XX-01	OUTSIDE-AIR TEMPERATURE CONTROLLER	-1 DEG C (30 DEG F) PROPORTIONAL BAND 37.5% MANUAL RESET 60%	-35 TO +55 DEG C (-30 TO +130 DEG F)	PV CONTACT STARTS PUMP AT 16 DEG C (60 DEG F) STOPS PUMP AT 17 DEG C (62 DEG F)
	TC-XX-02	SYSTEM-SUPPLY TEMPERATURE CONTROLLER	OA TEMP = -18 DEG C (0 DEG F), HWB TEMP = 63 DEG C (200 DEG F) OA TEMP = 16 DEG C (60 DEG F), HWB TEMP = 38 DEG C (100 DEG F)	PV = 38 TO 121 DEG C (100 TO 250 DEG F) CPA = 38 TO 63 DEG C (100 TO 200 DEG F)	CPA LO-LIMIT = 38 DEG C (100 DEG F) CPA HS-LIMIT = 63 DEG C (200 DEG F)
	TT-XX-01	OUTSIDE-AIR TEMPERATURE TRANSMITTER	—	-35 TO +55 DEG C (-30 TO +130 DEG F)	—
	TT-XX-02	SYSTEM-SUPPLY TEMPERATURE TRANSMITTER	—	38 TO 121 DEG C (100 TO 250 DEG F)	—
SPACE TEMPERATURE	TT-XX-03	SPACE-TEMPERATURE TRANSMITTER	—	10 TO 30 DEG C (50 TO 85 DEG F)	—
	VLV-XX-02	ZONE VALVE	—	21 - 103 kPa (3-15 PSIG)	Kv = 6 (Cv = 7) CLOSE AGAINST 70 kPa (10 PSIG)
	TC-XX-03	SPACE TEMPERATURE CONTROLLER	21 DEG C (70 DEG F)	10 TO 30 DEG C (50 TO 85 DEG F)	SET LIMITS AVAILABLE TO OCCUPANT BY TSP-XX-01 AT 19 TO 22 DEG C (66 TO 72 DEG F)
	TSP-XX-01	MANUAL SETPOINT ADJUSTMENT	4 MA = 10 DEG C (50 DEG F) 20 MA = 26 DEG C (85 DEG F)	—	AVAILABLE TO OCCUPANT
	TSP-XX-02	MANUAL SETPOINT ADJUSTMENT	14 DEG C (57 DEG F)	—	—
SPACE LOW-LIMIT TEMPERATURE	TSL-XX-01	SPACE LOW-LIMIT THERMOSTAT	13 DEG C (55 DEG F)	—	STARTS PUMP AT 13 DEG C (55 DEG F) STOPS PUMP AT 14 DEG C (57 DEG F)
SPACE TEMPERATURE	TT-XX-04	SPACE TEMPERATURE TRANSMITTER	—	10 TO 30 DEG C (50 TO 85 DEG F)	—
	VLV-XX-03	ZONE VALVE	—	21 - 103 kPa (3-15 PSIG)	Kv = 6 (Cv = 7) CLOSE AGAINST 70 kPa (10 PSIG)
	TC-XX-04	SPACE TEMPERATURE CONTROLLER	21 DEG C (70 DEG F)	10 TO 30 DEG C (50 TO 85 DEG F)	SET LIMITS AVAILABLE TO OCCUPANT BY TSP-XX-02 AT 19 TO 22 DEG C (66 TO 72 DEG F)
	TSP-XX-03	MANUAL SETPOINT ADJUSTMENT	4 MA = 10 DEG C (50 DEG F) 20 MA = 26 DEG C (85 DEG F)	—	AVAILABLE TO OCCUPANT
	TSP-XX-04	MANUAL SETPOINT ADJUSTMENT	14 DEG C (57 DEG F)	—	—
SPACE LOW-LIMIT TEMPERATURE	TSL-XX-02	SPACE LOW-LIMIT THERMOSTAT	13 DEG C (55 DEG F)	—	STARTS PUMP AT 13 DEG C (55 DEG F) STOPS PUMP AT 14 DEG C (57 DEG F)
OCCUPIED MODE	CLK-XX-01 CONTACT	865-DAY SCHEDULE	—	NORMAL SCHEDULE, M - F CONTACT CLOSED: 0700 HRS CONTACT OPEN: 1700 HRS	CONTACT OPEN: SAT, SUN

NOTE : OTHER CONTROL DEVICES SUCH AS IPS AND RELAYS ARE NOT SHOWN

Figure 4-9c. Control system equipment for central plant high-temperature hot water hydronic heating system.

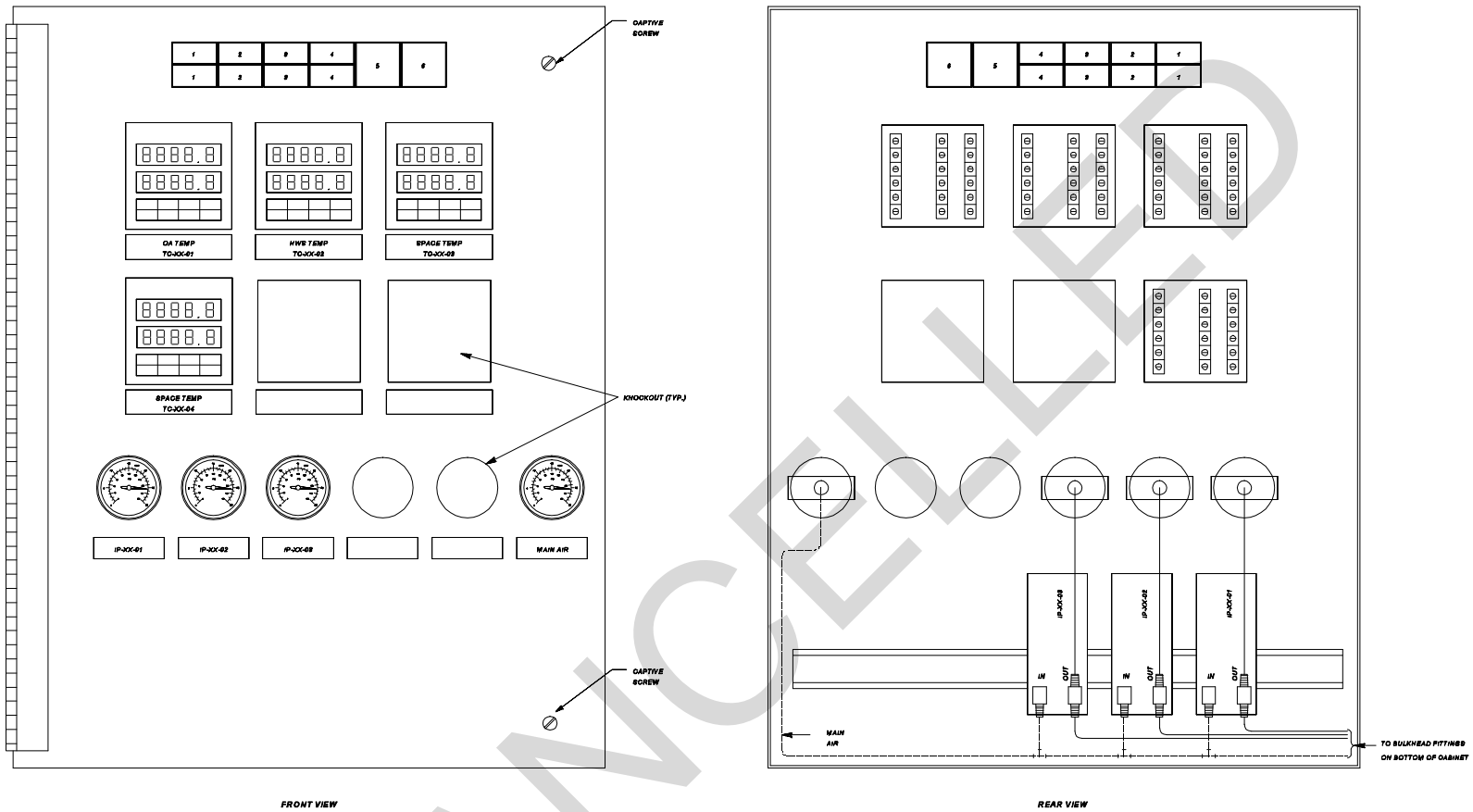

FRONT VIEW

REAR VIEW

SWITCH AND PILOT LIGHT LEGEND

POSITION LEGEND

1 - AUTOMATO OVERRIDE
2 - ENABLE/OFF
3 - ENABLE/OFF

DEVICE TYPE

ILLUMINATED MAINTAINED CONTACT INTERLOCKED SWITCHES	IDENTIFIER
ILLUMINATED MAINTAINED CONTACT INTERLOCKED SWITCHES	HS-XX-01
ILLUMINATED MAINTAINED CONTACT INTERLOCKED SWITCHES	HS-XX-02
ILLUMINATED MAINTAINED CONTACT INTERLOCKED SWITCHES	HS-XX-03

POSITION LEGEND

4 - ENABLE/OFF	DEVICE TYPE	IDENTIFIER
5 - OCCUPIED	ILLUMINATED MAINTAINED CONTACT INTERLOCKED SWITCHES	HS-XX-04
6 - HEATING	PILOT LIGHT	PL-XX-01
	PILOT LIGHT	PL-XX-02

Figure 4-9d. Control panel interior door layout for central plant high-temperature hot water hydronic heating system.

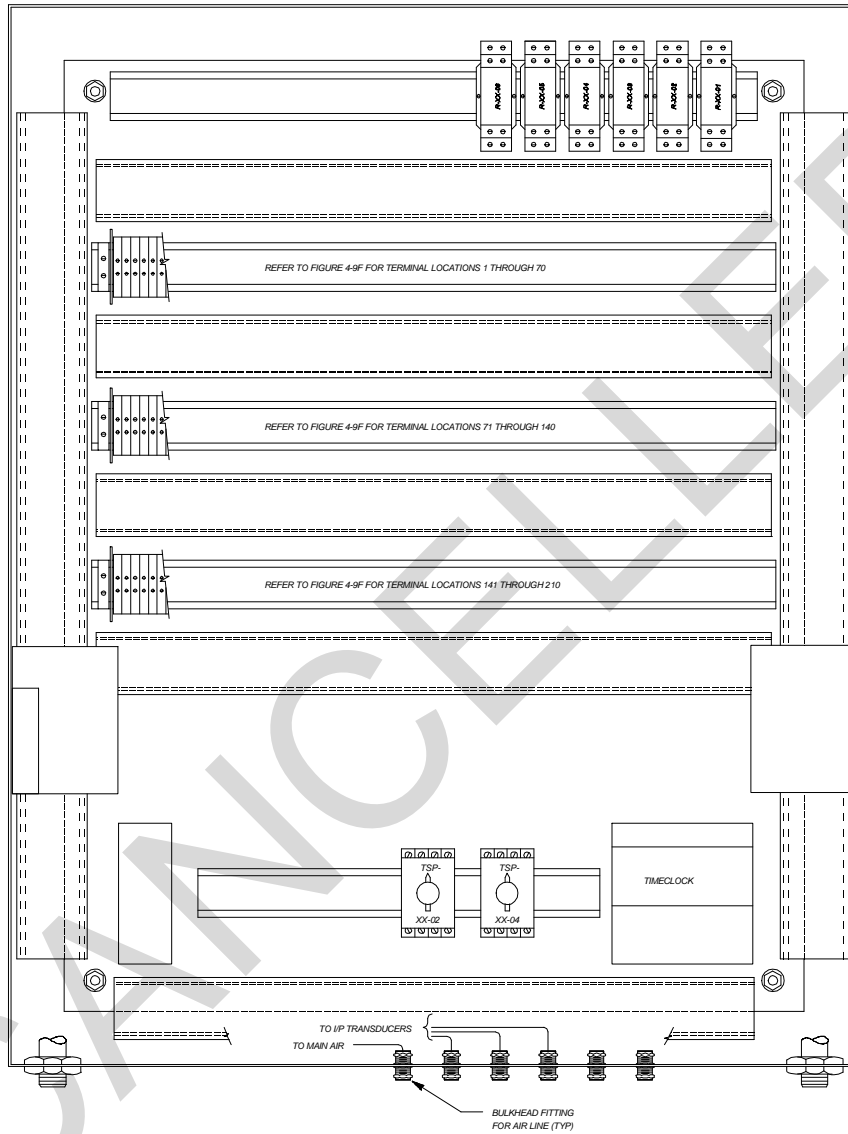

Figure 4-9e. Control panel back panel layout for central plant high-temperature hot water hydronic heating system.

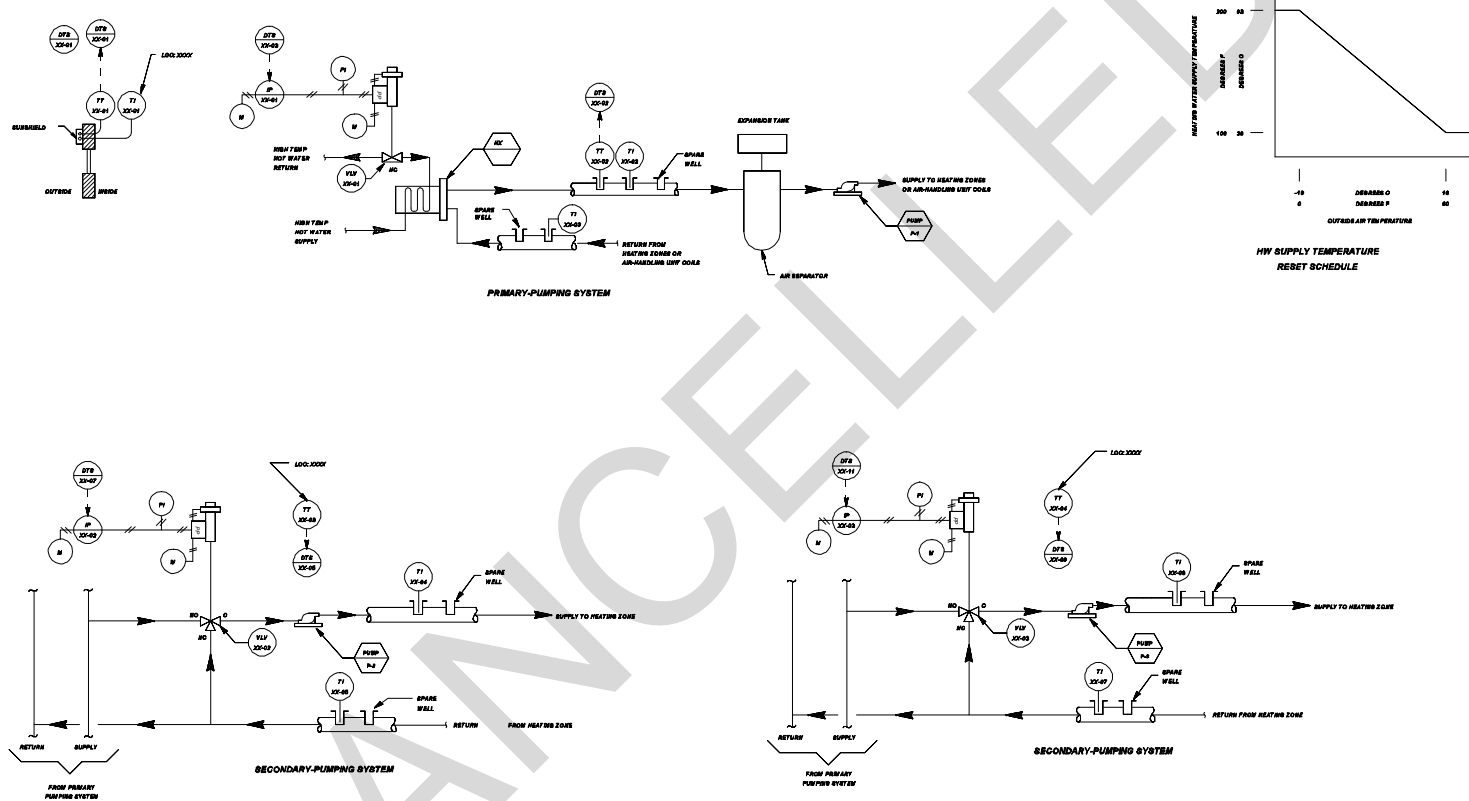

Figure 4-9g. DDC control system schematic for central plant high-temperature hot water hydronic heating system.

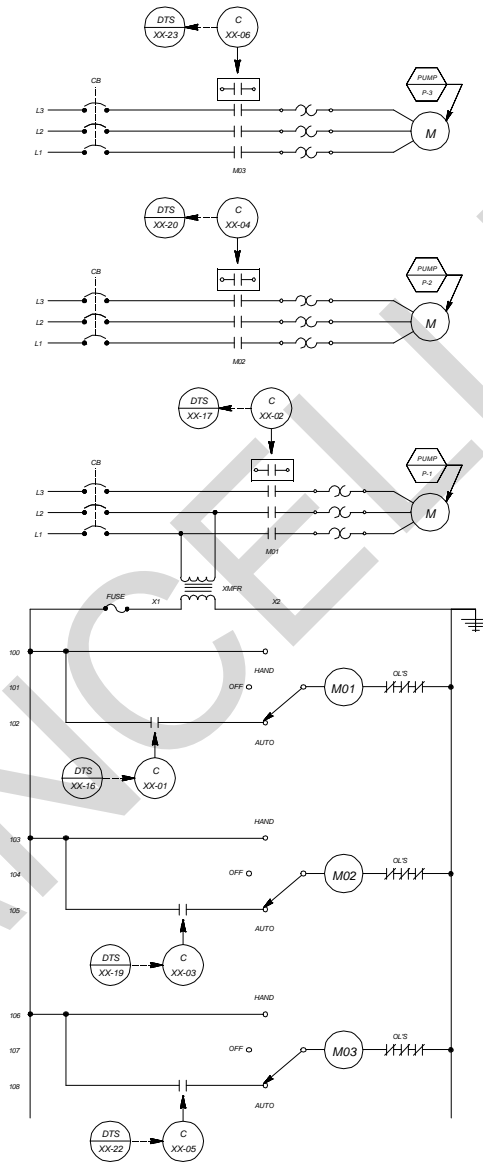

Figure 4-9h. DDC control system ladder diagram for central plant high-temperature hot water hydronic heating system.

SENSOR SCHEDULE

IDENTIFIER	FUNCTION	RANGE
TT-XX-01	OUTSIDE AIR TEMPERATURE TRANSMITTER	-35 TO +55 DEG C (-30 TO +130 DEG F)
TT-XX-02	PRIMARY SYSTEM SUPPLY TEMPERATURE TRANSMITTER	38 TO 121 DEG C (100 TO 250 DEG F)
TT-XX-03	SPACE TEMPERATURE TRANSMITTER	10 TO 30 DEG C (50 TO 85 DEG F)
TT-XX-04	SPACE TEMPERATURE TRANSMITTER	10 TO 30 DEG C (50 TO 85 DEG F)

CONTROL VALVE SCHEDULE

IDENTIFIER	FUNCTION	TYPE	RANGE	Kv (Cv)	CLOSE-OFF RATING	REMARKS
VLV-XX-01	CONVERTER VALVE	2-WAY, MODULATING	21 - 103 kPa (3-15 PSIG)	XX	XX kPa (XX PSIG)	
VLV-XX-02	ZONE VALVE	3-WAY, MODULATING	21 - 103 kPa (3-15 PSIG)	XX	XX kPa (XX PSIG)	
VLV-XX-03	ZONE VALVE	3-WAY, MODULATING	21 - 103 kPa (3-15 PSIG)	XX	XX kPa (XX PSIG)	

OPERATING PARAMETERS

FUNCTION	SETPPOINT	REMARKS
OUTSIDE AIR TEMPERATURE		START PRIMARY PUMP AT OA TEMP = XX DEG C (XX DEG F) STOP PRIMARY PUMP AT OA TEMP = XX DEG C (XX DEG F)
PRIMARY SYSTEM SUPPLY TEMPERATURE	XX DEG C (XX DEG F)	OA TEMP = -18 DEG C (0 DEG F); PRIMARY SYSTEM SUPPLY SETPOINT = 93 DEG C (200 DEG F) OA TEMP = 16 DEG C (60 DEG F); PRIMARY SYSTEM SUPPLY SETPOINT = 38 DEG C (100 DEG F)
SPACE TEMP. (OCCUPIED)	XX DEG C (XX DEG F)	
SPACE TEMP. (UNOCCUPIED)	XX DEG C (XX DEG F)	
OCCUPIED MODE		MONDAY - FRIDAY : 0705 HRS - 1700 HRS

Figure 4-9i. DDC control system equipment for central plant high-temperature hot water hydronic heating system.

	HARDWARE														SOFTWARE													
	OUTPUT							INPUT							ALARMS					APPLICATION PROGRAMS								
	DIGITAL			ANALOG				DIGITAL			ANALOG				DIGITAL		ANALOG											
	CONTROL RELAY			POSITION ADJUSTMENT	CONTROL POINT ADJUST.			AUXILIARY CONTACT			TEMPERATURE	CONTROL POINT ADJUST.	PRESS, PRESS, FLOW			CONTACT CLOSURE			HIGH LIMIT	LOW LIMIT	RUN TIME	SCHEDULED START/STOP	OPTIMUM START/STOP	DUTY CYCLING	DEMAND LIMITING	HW ON RESET	FAULTS MODE **	
OUTSIDE AIR																												
PRIMARY SYSTEM HW SUPPLY																												
ZONE																												
ZONE																												
CONVERTER VALVE				1																								
ZONE VALVE				1																								
ZONE VALVE				1																								
PRIMARY PUMP	1						1								X				X		X	X	X	X				
ZONE PUMP	1						1								X				X		X	X	X	X				
ZONE PUMP	1						1								X				X		X	X	X	X				

** C - LAST COMMAND
H - HIGH VALUE
L - LOW VALUE

O - ON (OPEN)
F - OFF (CLOSED)

DDC DATA TERMINAL STRIP LAYOUT

DEVICE NO.	DESCRIPTION	TYPE	
1	TT-XX-01	OUTSIDE AIR TEMPERATURE	AI
2	TT-XX-02	PRIMARY SYSTEM SUPPLY TEMP.	AI
3	IP-XX-01	CONVERTER VALVE	AO
4			
5	TT-XX-03	SPACE TEMPERATURE	AI
6			
7	IP-XX-02	ZONE VALVE	AO
8			
9	TT-XX-04	SPACE TEMPERATURE	AI
10			
11	IP-XX-03	ZONE VALVE	AO
12			
13			
14			
15			
16	C-XX-01	PRIMARY PUMP START/STOP	DO
17	C-XX-02	PRIMARY PUMP STATUS	DI
18			
19	C-XX-03	ZONE PUMP START/STOP	DO
20	C-XX-04	ZONE PUMP STATUS	DI
21			
22	C-XX-05	ZONE PUMP START/STOP	DO
23	C-XX-06	ZONE PUMP STATUS	DI
24			
25			
26			
27			
28			
29			
30			

Figure 4-9j. DDC control system I/O table and data terminal strip layout for central plant high-temperature hot water hydronic heating system.

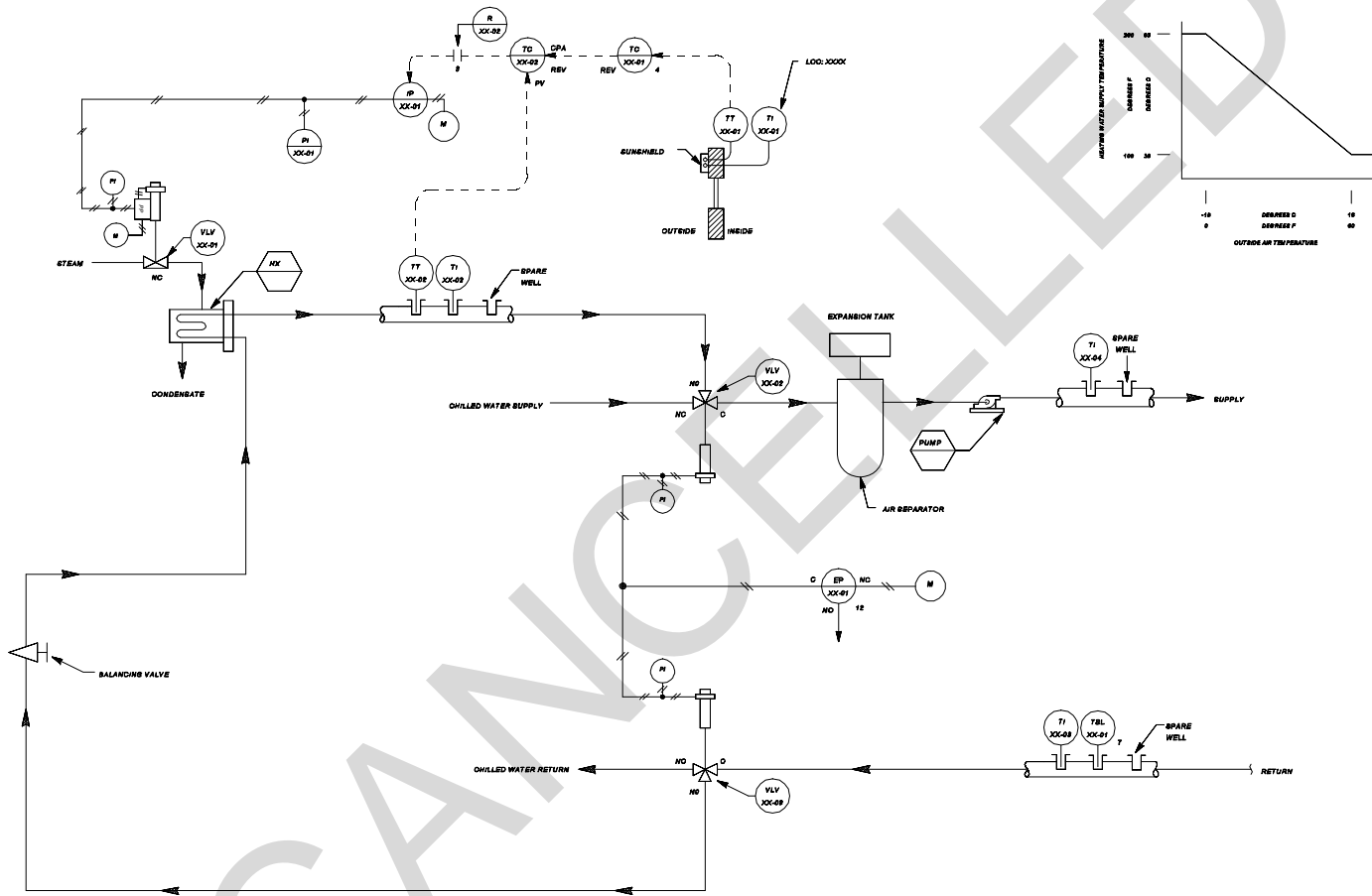

Figure 4-10a. Control system schematic for central plant steam dual-temperature hydronic system.

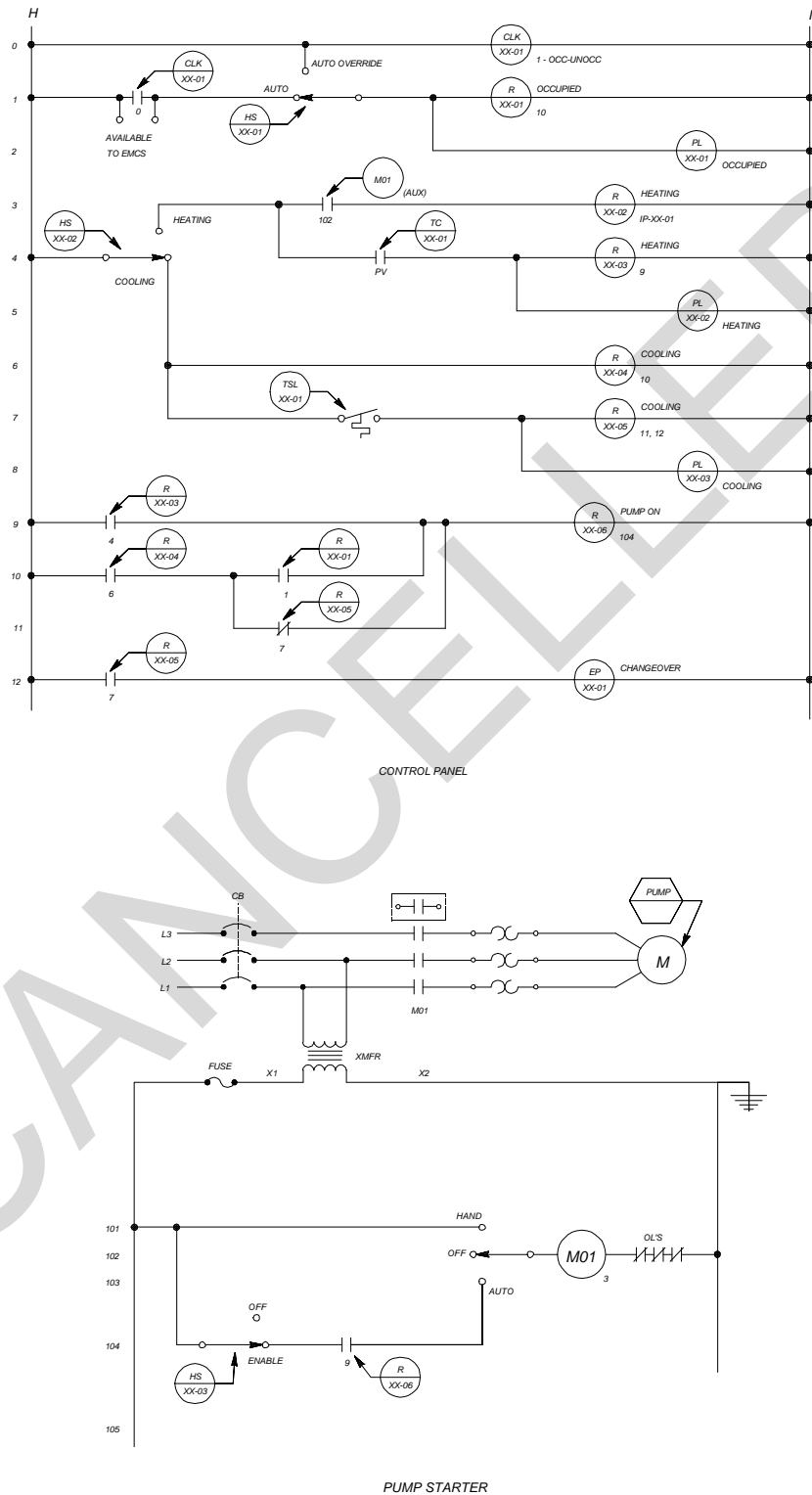
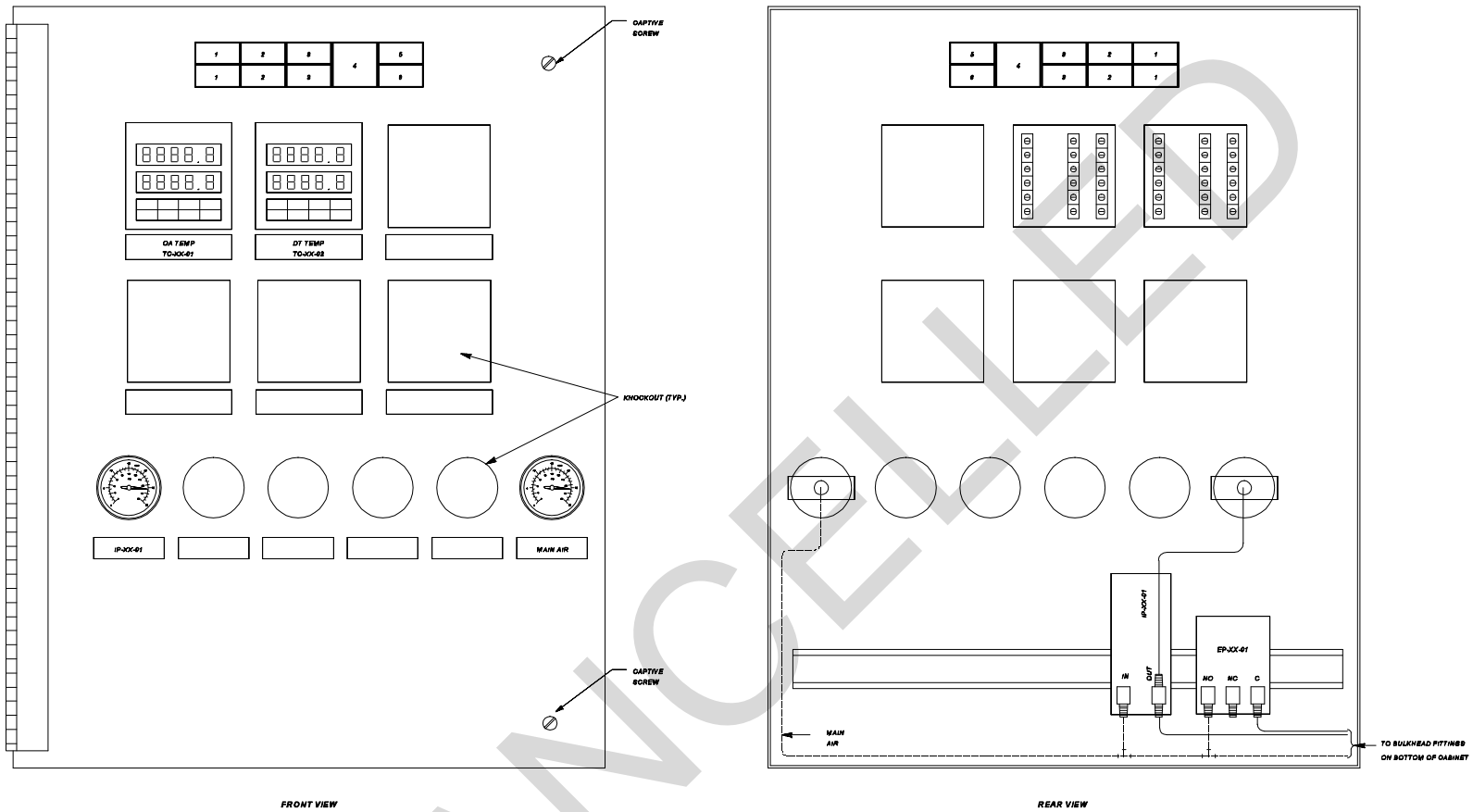

Figure 4-10b. Control system ladder diagram for central plant steam dual-temperature hydronic system.

LOOP CONTROL FUNCTION	DEVICE NUMBER	DEVICE FUNCTION	SETPOINT	RANGE	ADDITIONAL PARAMETERS
DUAL-TEMP SUPPLY TEMPERATURE	VLV-XX-01	CONVERTER STEAM VALVE	—	21 - 103 kPa (3-15 PSIG)	Kv = 17.3 (Cv = 20) CLOSE AGAINST 70 kPa (10 PSIG)
	TC-XX-01	OUTSIDE-AIR TEMPERATURE CONTROLLER	-1 DEG C (30 DEG F) PROPORTIONAL BAND 37.5% MANUAL RESET 50%	-35 TO +55 DEG C (-30 TO +130 DEG F)	PV CONTACT STARTS PUMP AT 16 DEG C (60 DEG F) STOPS PUMP AT 17 DEG C (63 DEG F)
	TC-XX-02	SYSTEM-SUPPLY TEMPERATURE CONTROLLER	OA TEMP = -16 DEG C (0 DEG F), HW&S TEMP = 35 DEG C (90 DEG F) OA TEMP = 16 DEG C (60 DEG F), HW&S TEMP = 36 DEG C (100 DEG F)	PV = 38 TO 121 DEG C (100 TO 250 DEG F) CPA = 38 TO 43 DEG C (100 TO 100 DEG F)	CPA LO-LIMIT = 38 DEG C (100 DEG F) CPA HI-LIMIT = 43 DEG C (100 DEG F)
	TT-XX-01	OUTSIDE-AIR TEMPERATURE TRANSMITTER	—	-35 TO +55 DEG C (-30 TO +130 DEG F)	—
	TT-XX-02	SYSTEM-SUPPLY TEMPERATURE TRANSMITTER	—	38 TO 121 DEG C (100 TO 250 DEG F)	—
	DUAL-TEMP CHANGEOVER	T8L-XX-01	SYSTEM RETURN CHANGEOVER THERMOSTAT	—	-1 TO 118 DEG C (30 TO 240 DEG F)
	VLV-XX-02	SUPPLY CHANGEOVER VALVE	—	2-POSITION	Kv = 8 (Cv = 7) CLOSE AGAINST 70 kPa (10 PSIG)
	VLV-XX-03	RETURN CHANGEOVER VALVE	—	2-POSITION	Kv = 8 (Cv = 7) CLOSE AGAINST 70 kPa (10 PSIG)
OCCUPIED MODE	GLK-XX-01 CONTACT	365-DAY SCHEDULE	—	NORMAL SCHEDULE: M - F CONTACT CLOSED: 0700 HRS CONTACT OPEN: 1700 HRS	CONTACT OPEN: SAT, SUN

NOTE : OTHER CONTROL DEVICES SUCH AS IPS AND RELAYS ARE NOT SHOWN

Figure 4-10c. Control system equipment for central plant steam dual-temperature hydronic system.



FRONT VIEW

REAR VIEW

SWITCH AND PILOT LIGHT LEGEND

POSITION LEGEND

1 - AUTOMATO OVERRIDE
2 - HEATING/COOLING
3 - ENABLE/OFF

DEVICE TYPE	IDENTIFIER
ILLUMINATED MAINTAINED CONTACT INTERLOCKED SWITCHES	HS-XX-01
ILLUMINATED MAINTAINED CONTACT INTERLOCKED SWITCHES	HS-XX-02
ILLUMINATED MAINTAINED CONTACT INTERLOCKED SWITCHES	HS-XX-03

POSITION LEGEND

4 - OCCUPIED
5 - HEATING
6 - COOLING

DEVICE TYPE	IDENTIFIER
PILOT LIGHT	PL-XX-01
PILOT LIGHT	PL-XX-02
PILOT LIGHT	PL-XX-03

Figure 4-10d. Control panel interior door layout for central plant steam dual-temperature hydronic system.

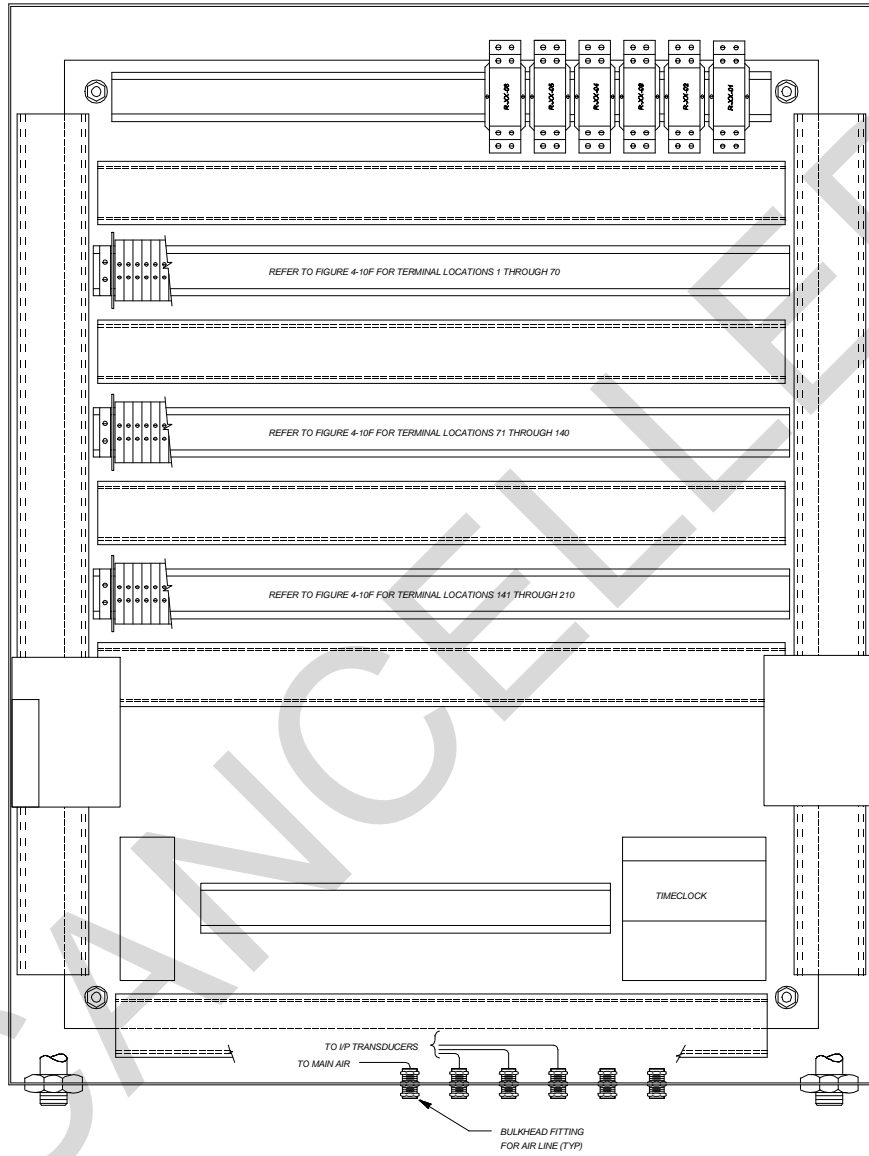

Figure 4-10e. Control panel back panel layout for central plant steam dual-temperature hydronic system.

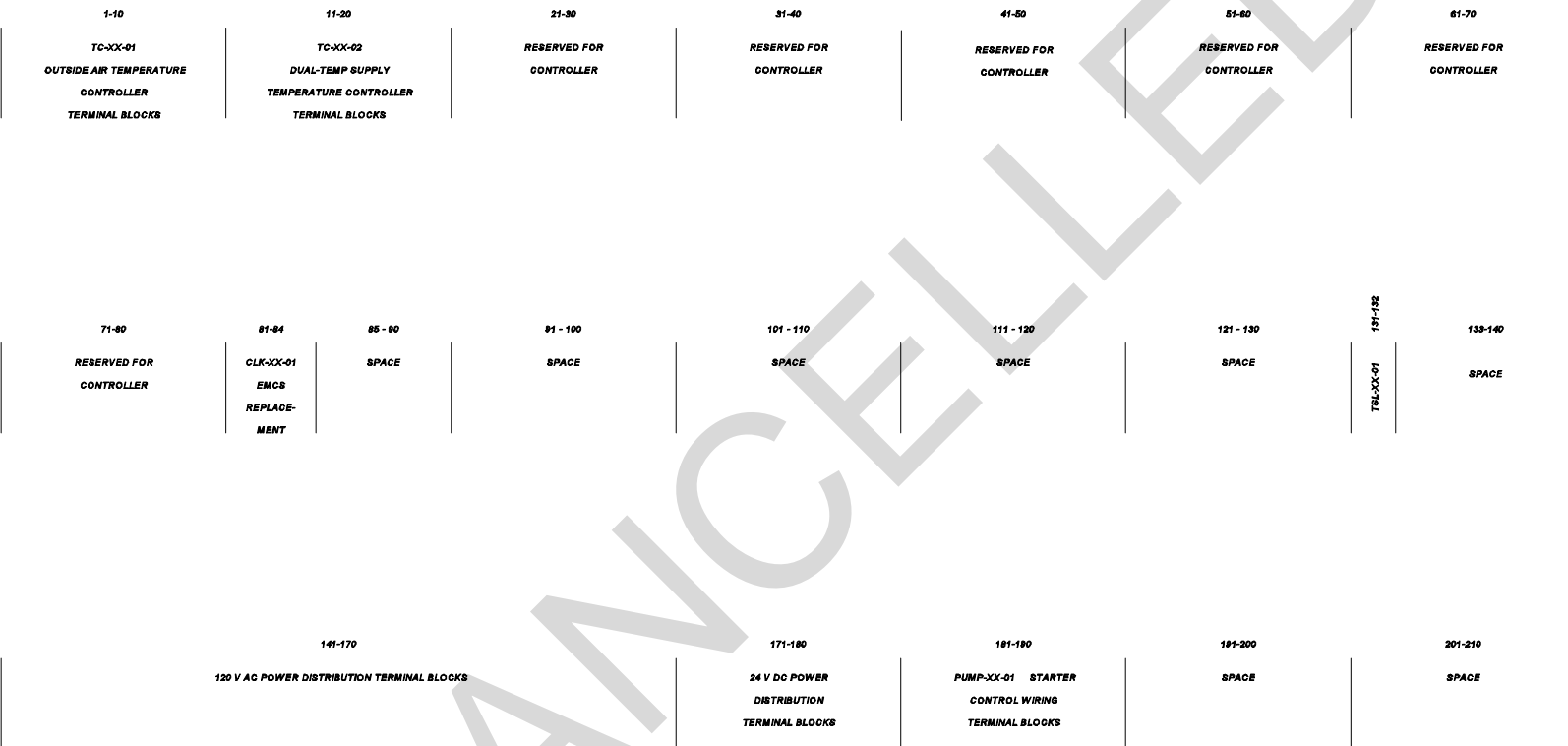
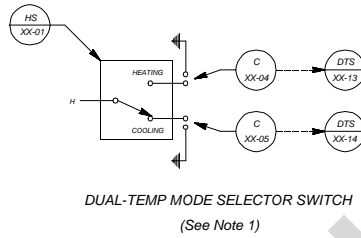
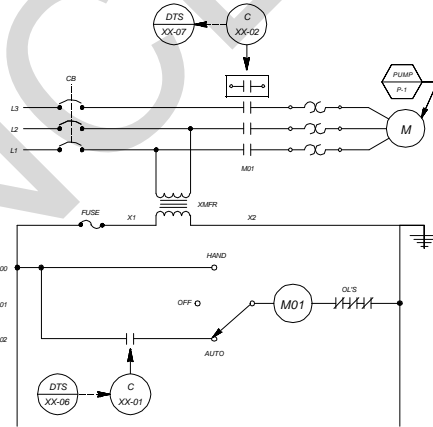

Figure 4-10f. Control panel terminal block layout for central plant steam dual-temperature hydronic system.



DUAL-TEMP MODE SELECTOR SWITCH
(See Note 1)

Notes:
1. HS-XX-01 shall be located adjacent to the DDC panel.



PUMP STARTER LADDER DIAGRAM

Figure 4-10h. DDC control system ladder diagram for central plant steam dual-temperature hydronic system.

SENSOR SCHEDULE

IDENTIFIER	FUNCTION	RANGE
TT-XX-01	OUTSIDE AIR TEMPERATURE TRANSMITTER	-35 TO +55 DEG C (-30 TO +130 DEG F)
TT-XX-02	HEATING WATER SUPPLY TEMPERATURE TRANSMITTER	38 TO 121 DEG C (100 TO 250 DEG F)
TT-XX-03	DUAL-TEMP RETURN WATER TEMPERATURE TRANSMITTER	-1 TO 116 DEG C (30 TO 240 DEG F)

CONTROL VALVE SCHEDULE

IDENTIFIER	FUNCTION	TYPE	RANGE	Kv (Cv)	CLOSE-OFF RATING	REMARKS
VLV-XX-01	CONVERTER VALVE	2-WAY, MODULATING	21 - 103 kPa (3-15 PSIG)	XX	XX kPa (XX PSIG)	
VLV-XX-02	DUAL-TEMP SUPPLY CHANGEOVER VALVE	3-WAY, 2-POSITION		XX	XX kPa (XX PSIG)	
VLV-XX-03	DUAL-TEMP RETURN CHANGEOVER VALVE	3-WAY, 2-POSITION		XX	XX kPa (XX PSIG)	

OPERATING PARAMETERS

FUNCTION	SETPOINT	REMARKS
OUTSIDE AIR TEMPERATURE		START PRIMARY PUMP AT OA TEMP = XX DEG C (XX DEG F) STOP PRIMARY PUMP AT OA TEMP = XX DEG C (XX DEG F)
HEATING WATER SUPPLY TEMPERATURE	XX DEG C (XX DEG F)	OA TEMP = -19 DEG C (0 DEG F); PRIMARY SYSTEM SUPPLY SETPOINT = 93 DEG C (200 DEG F) OA TEMP = 16 DEG C (60 DEG F); PRIMARY SYSTEM SUPPLY SETPOINT = 38 DEG C (100 DEG F)
DUAL-TEMP CHANGEOVER	XX DEG C (XX DEG F)	DIFFERENTIAL = XX DEG C (XX DEG F)
OCCUPIED MODE		MONDAY - FRIDAY: 0705 HRS - 1700 HRS

Figure 4-10i. DDC control system equipment for central plant steam dual-temperature hydronic system.

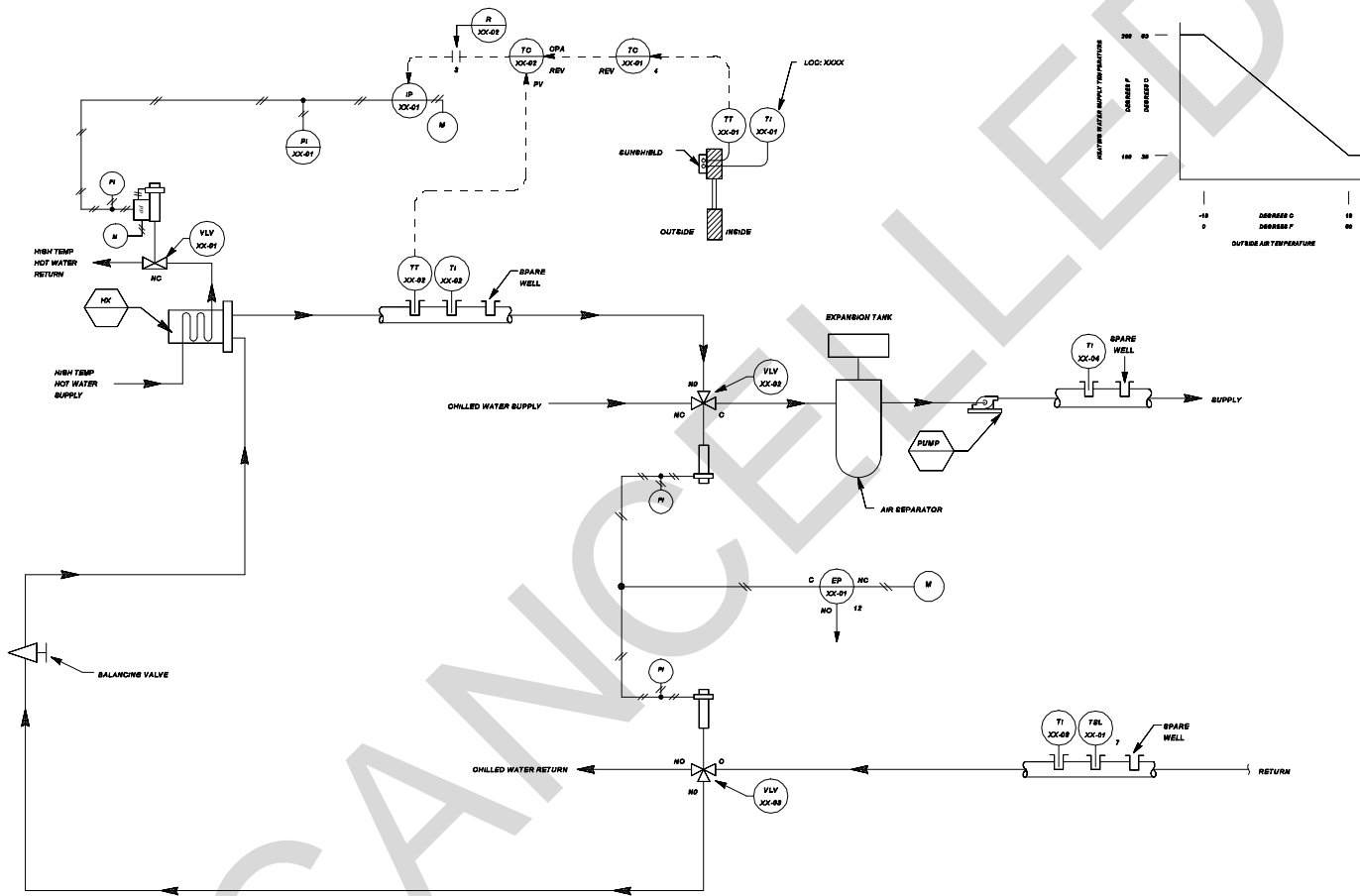

Figure 4-11a. Control system schematic for central plant high-temperature hot water dual-temperature hydronic system.

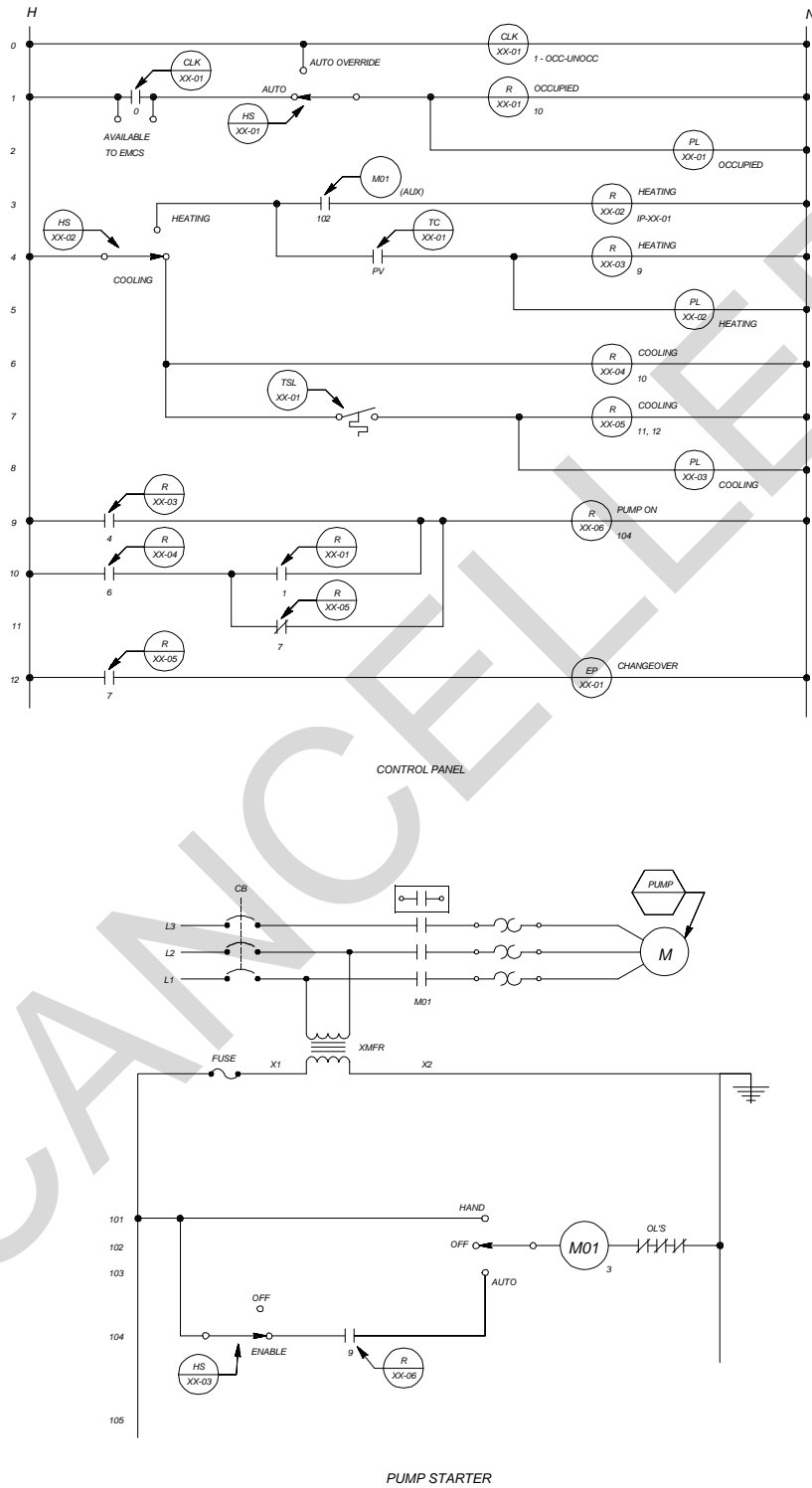
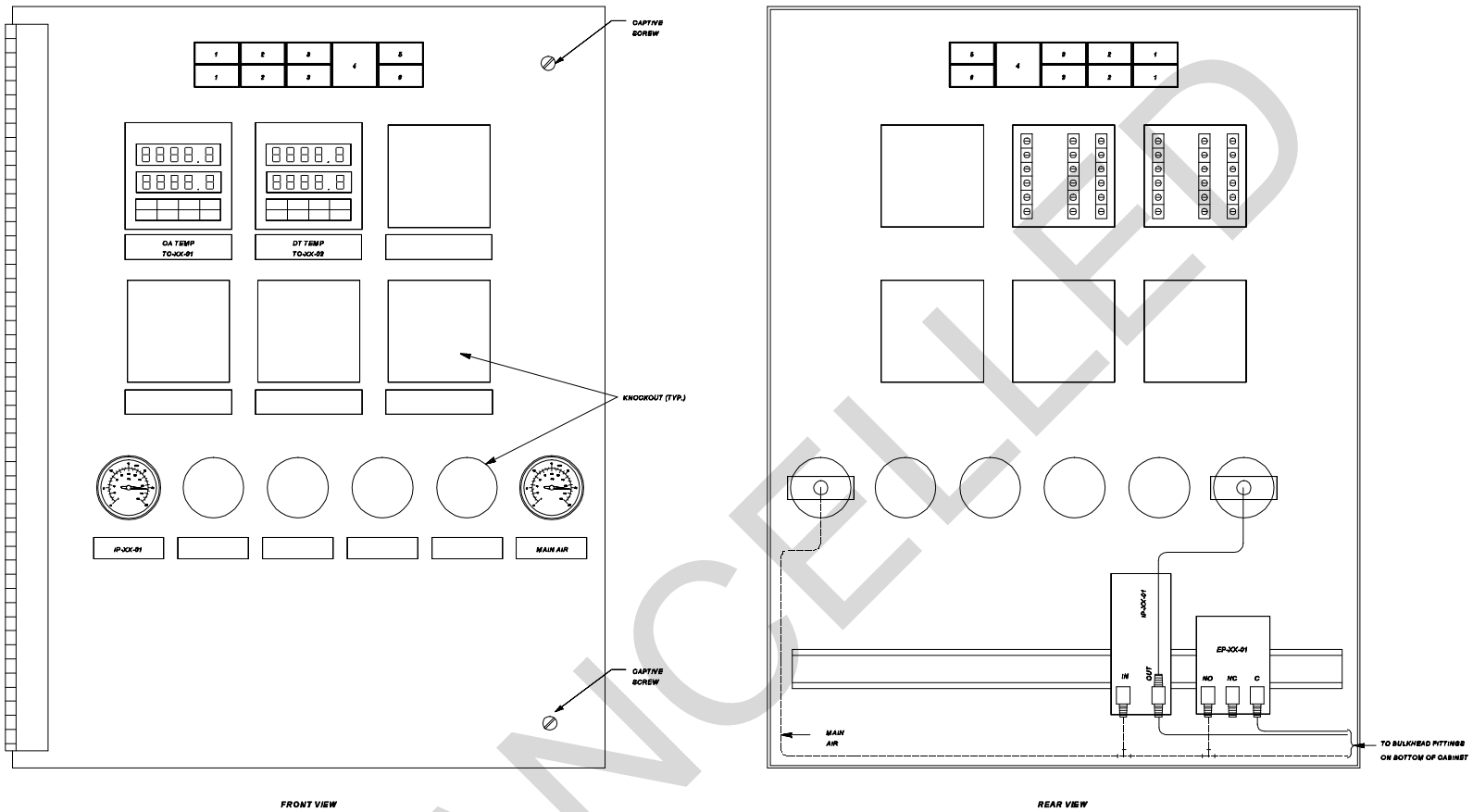

Figure 4-11b. Control system ladder diagram for central plant high-temperature hot water dual-temperature hydronic system.

LOOP CONTROL FUNCTION	DEVICE NUMBER	DEVICE FUNCTION	SETPOINT	RANGE	ADDITIONAL PARAMETERS
DUAL-TEMP SUPPLY TEMPERATURE	VLV-XX-01	CONVERTER CONTROL VALVE	---	21 - 103 kPa (3-15 PSIG)	Kv = 17.8 (Cv = 20) CLOSE AGAINST 70 kPa (10 PSIG)
	TC-XX-01	OUTSIDE-AIR TEMPERATURE CONTROLLER	-1 DEG C (30 DEG F) PROPORTIONAL BAND 37.5% MANUAL RESET 5PS	-35 TO +55 DEG C (-30 TO +130 DEG F)	PV CONTACT STARTS PUMP AT 16 DEG C (60 DEG F) STOPS PUMP AT 17 DEG C (62 DEG F)
	TC-XX-02	SYSTEM-SUPPLY TEMPERATURE CONTROLLER	OA TEMP = -18 DEG C (F DEG F), HW6 TEMP = 83 DEG C (200 DEG F) OA TEMP = 16 DEG C (60 DEG F), HW6 TEMP = 38 DEG C (100 DEG F)	PV = 38 TO 121 DEG C (100 TO 250 DEG F) GPA = 38 TO 83 DEG C (100 TO 200 DEG F)	GPA LO-LIMIT = 38 DEG C (100 DEG F) GPA HI-LIMIT = 83 DEG C (200 DEG F)
	TT-XX-01	OUTSIDE-AIR TEMPERATURE TRANSMITTER	---	-36 TO +66 DEG C (-30 TO +150 DEG F)	---
	TT-XX-02	SYSTEM-SUPPLY TEMPERATURE TRANSMITTER	---	38 TO 121 DEG C (100 TO 250 DEG F)	---
DUAL-TEMP CHANGEOVER	T8L-XX-01	SYSTEM RETURN CHANGEOVER THERMOSTAT	---	-1 TO 118 DEG C (30 TO 240 DEG F)	CONTACT CLOSE AT 28 DEG C (85 DEG F) CONTACT OPEN AT 32 DEG C (90 DEG F)
	VLV-XX-02	SUPPLY CHANGEOVER VALVE	---	3-POSITION	Kv = 6 (Cv = 7) CLOSE AGAINST 70 kPa (10 PSIG)
	VLV-XX-03	RETURN CHANGEOVER VALVE	---	3-POSITION	Kv = 6 (Cv = 7) CLOSE AGAINST 70 kPa (10 PSIG)
OCCUPIED MODE	CLK-XX-01 CONTACT	365-DAY SCHEDULE	---	NORMAL SCHEDULE: 8 - 5 CONTACT CLOSED: 0700 HRS CONTACT OPEN: 1700 HRS	CONTACT OPEN: SAT, SUN

NOTE : OTHER CONTROL DEVICES SUCH AS IPS AND RELAYS ARE NOT SHOWN

Figure 4-11c. Control system equipment for central plant high-temperature hot water dual-temperature hydronic system.



FRONT VIEW

REAR VIEW

SWITCH AND PILOT LIGHT LEGEND

POSITION LEGEND
1 - AUTOMATO OVERRIDE
2 - HEATING/COOLING
3 - ENABLE/OFF

DEVICE TYPE	IDENTIFIER
ILLUMINATED MAINTAINED CONTACT INTERLOCKED SWITCHES	HS-XX-01
ILLUMINATED MAINTAINED CONTACT INTERLOCKED SWITCHES	HS-XX-02
ILLUMINATED MAINTAINED CONTACT INTERLOCKED SWITCHES	HS-XX-03

POSITION LEGEND
4 - OCCUPIED
5 - HEATING
6 - COOLING

DEVICE TYPE	IDENTIFIER
PILOT LIGHT	PL-XX-01
PILOT LIGHT	PL-XX-02
PILOT LIGHT	PL-XX-03

Figure 4-11d. Control panel interior door layout for central plant high-temperature hot water dual-temperature hydronic system.

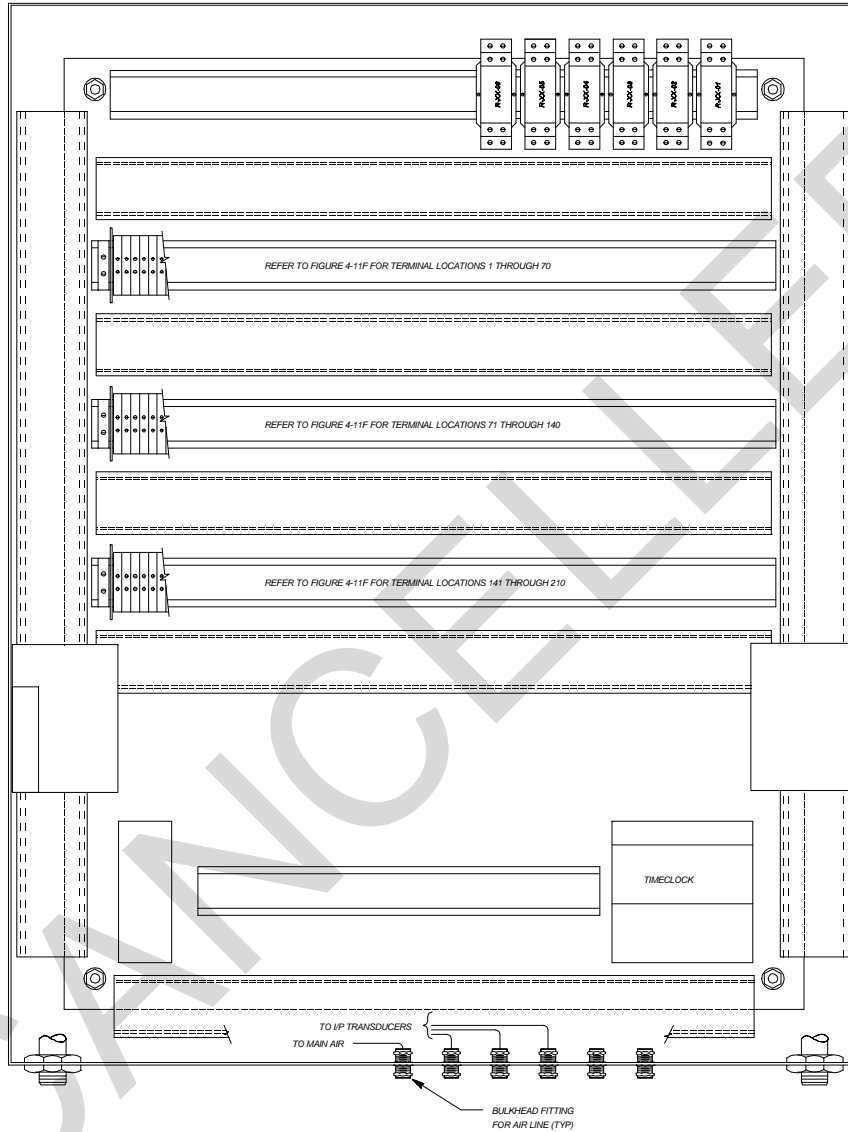

Figure 4-11e. Control panel back panel layout for central plant high-temperature hot water dual-temperature hydronic system.

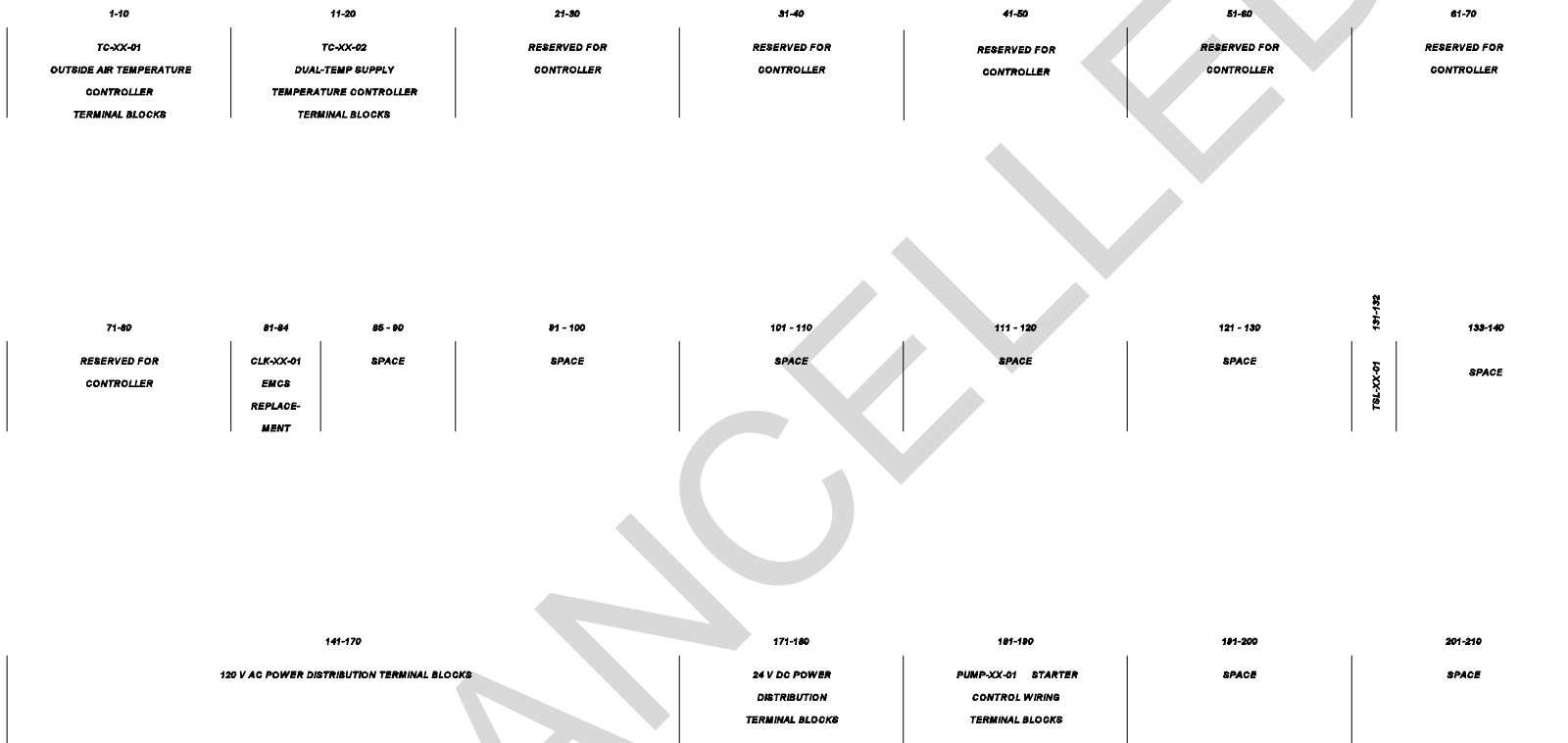

Figure 4-11f. Control panel terminal block layout for central plant high-temperature hot water dual-temperature hydronic system.

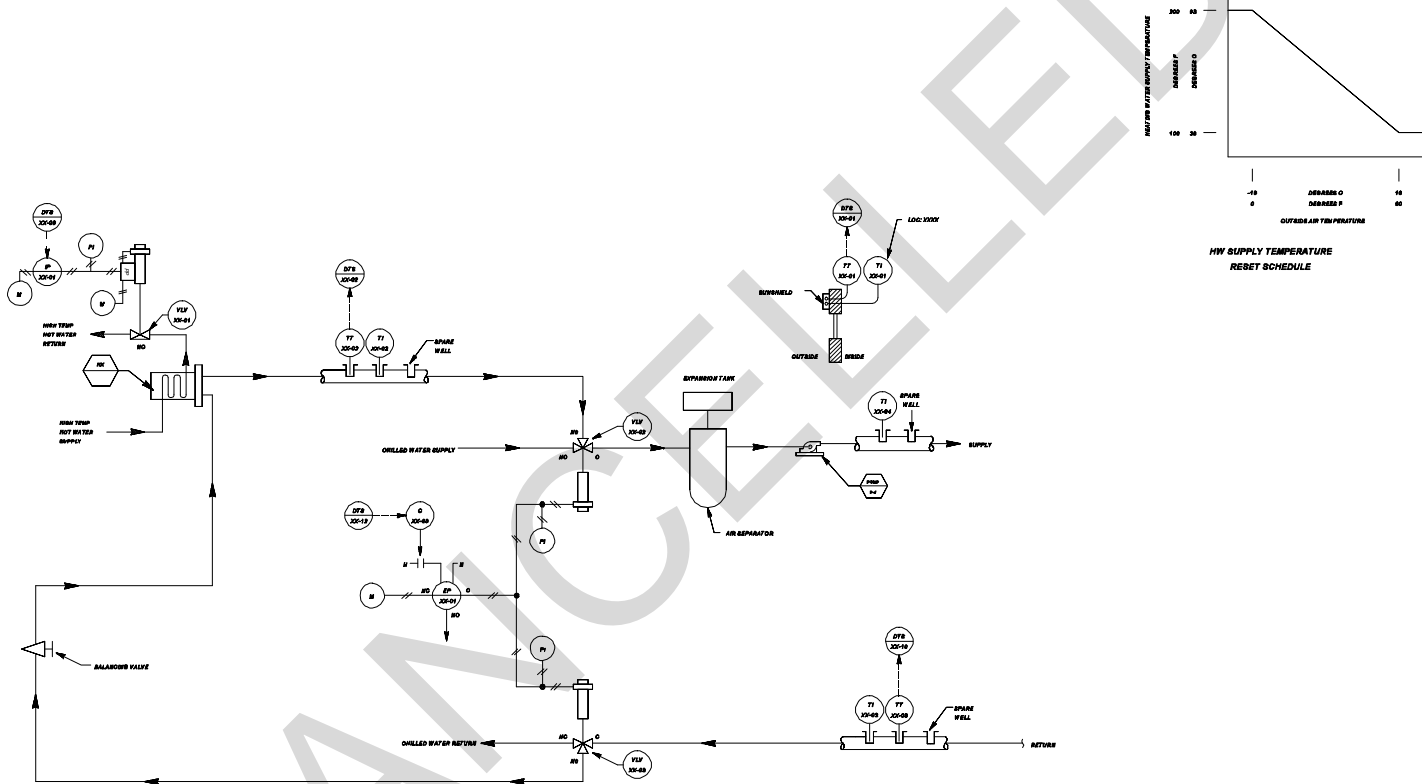
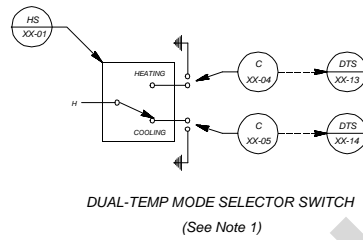
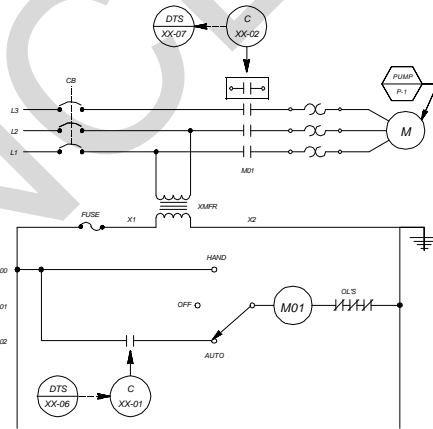

Figure 4-11g. DDC control system schematic for central plant high-temperature hot water dual-temperature hydronic system.



DUAL-TEMP MODE SELECTOR SWITCH
(See Note 1)

- Notes:
1. HS-XX-01 shall be located adjacent to the DDC panel.



PUMP STARTER LADDER DIAGRAM

Figure 4-11h. DDC control system ladder diagram for central plant high-temperature hot water dual-temperature hydronic system.

SENSOR SCHEDULE

IDENTIFIER	FUNCTION	RANGE
TT-XX-01	OUTSIDE AIR TEMPERATURE TRANSMITTER	-35 TO +55 DEG C (-30 TO +130 DEG F)
TT-XX-02	HEATING WATER SUPPLY TEMPERATURE TRANSMITTER	38 TO 121 DEG C (100 TO 250 DEG F)
TT-XX-03	DUAL-TEMP RETURN WATER TEMPERATURE TRANSMITTER	-1 TO 116 DEG C (30 TO 240 DEG F)

CONTROL VALVE SCHEDULE

IDENTIFIER	FUNCTION	TYPE	RANGE	Kv (Cv)	CLOSE-OFF RATING	REMARKS
VLV-XX-01	CONVERTER VALVE	2-WAY, MODULATING	21 - 103 kPa (3-15 PSIG)	XX	XX kPa (XX PSIG)	
VLV-XX-02	DUAL-TEMP SUPPLY CHANGEOVER VALVE	3-WAY, 2-POSITION		XX	XX kPa (XX PSIG)	
VLV-XX-03	DUAL-TEMP RETURN CHANGEOVER VALVE	3-WAY, 2-POSITION		XX	XX kPa (XX PSIG)	

OPERATING PARAMETERS

FUNCTION	SETPOINT	REMARKS
OUTSIDE AIR TEMPERATURE		START PRIMARY PUMP AT OA TEMP = XX DEG C (XX DEG F) STOP PRIMARY PUMP AT OA TEMP = XX DEG C (XX DEG F)
HEATING WATER SUPPLY TEMPERATURE	XX DEG C (XX DEG F)	OA TEMP = -18 DEG C (0 DEG F); PRIMARY SYSTEM SUPPLY SETPOINT = 93 DEG C (200 DEG F) OA TEMP = 16 DEG C (60 DEG F); PRIMARY SYSTEM SUPPLY SETPOINT = 38 DEG C (100 DEG F)
DUAL-TEMP CHANGEOVER	XX DEG C (XX DEG F)	DIFFERENTIAL = XX DEG C (XX DEG F)
OCCUPIED MODE		MONDAY - FRIDAY : 0705 HRS - 1700 HRS

Figure 4-11i. DDC control system equipment for central plant high-temperature hot water dual-temperature hydronic system.

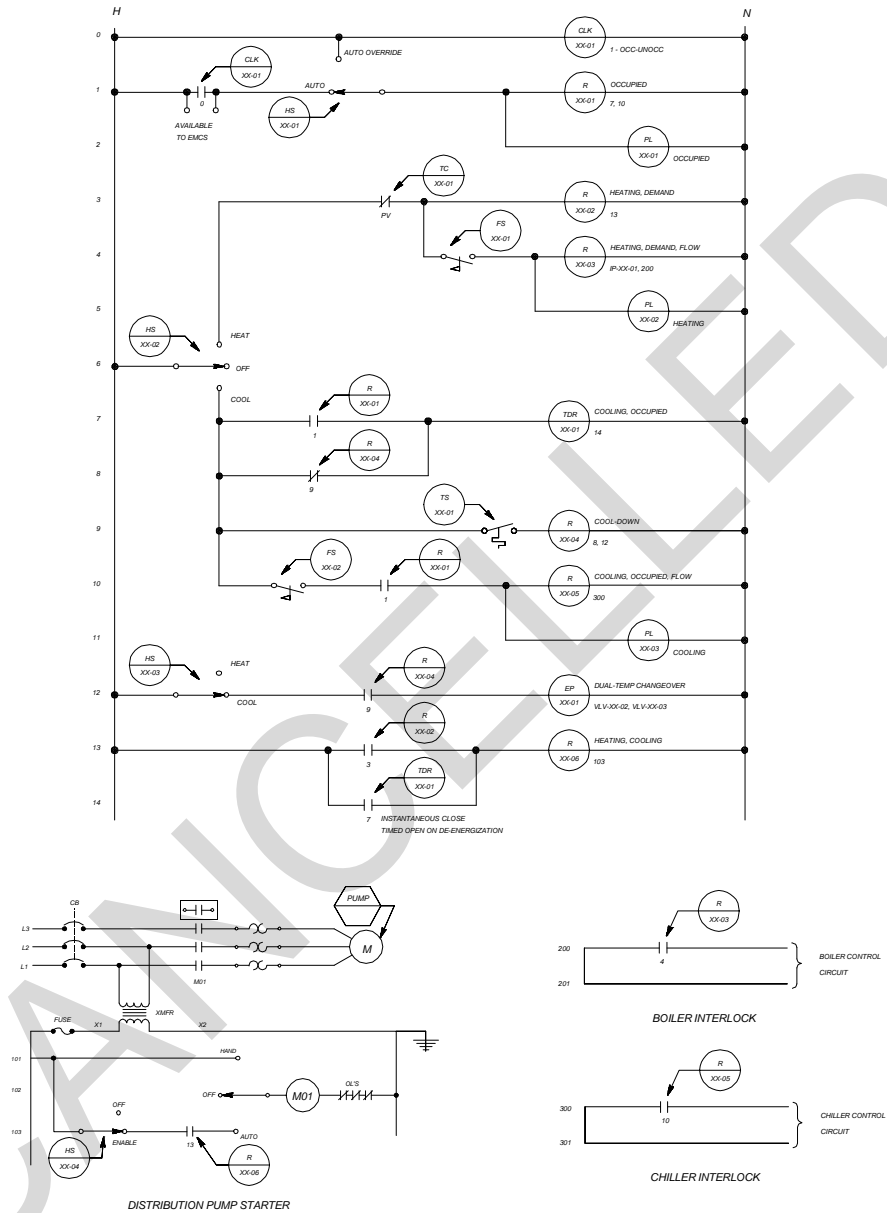
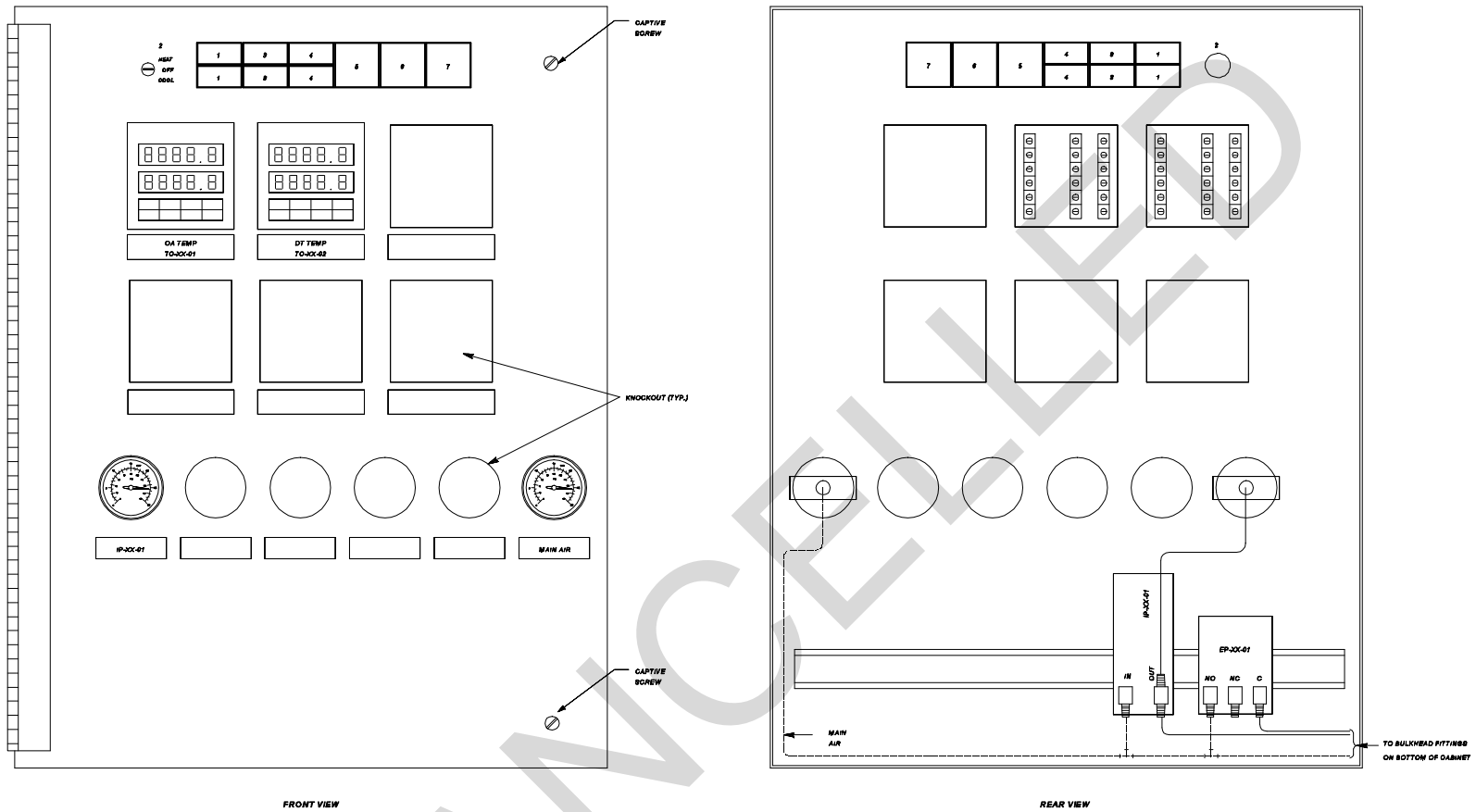

Figure 4-12b. Control system ladder diagram for single building dual-temperature hydronic system.

LOOP CONTROL FUNCTION	DEVICE NUMBER	DEVICE FUNCTION	SETPPOINT	RANGE	ADDITIONAL PARAMETERS
DUAL-TEMP SUPPLY TEMPERATURE	VLV-XX-01	CONVERTER CONTROL VALVE	---	21 - 103 kPa (2-15 PSIG)	Kv = 17.3 (Cv = 20) CLOSE AGAINST 70 kPa (10 PSIG)
	TC-XX-01	OUTSIDE-AIR TEMPERATURE CONTROLLER	-1 DEG C (30 DEG F) PROPORTIONAL BAND 37.5% MANUAL RESET 50%	-35 TO +55 DEG C (-30 TO +130 DEG F)	PV CONTACT STARTS PUMP AT 16 DEG C (60 DEG F) STOPS PUMP AT 17 DEG C (63 DEG F)
	TC-XX-02	SYSTEM-SUPPLY TEMPERATURE CONTROLLER	DA TEMP = -18 DEG C (0 DEG F), HWS TEMP = 83 DEG C (200 DEG F) OA TEMP = 16 DEG C (60 DEG F), HWS TEMP = 38 DEG C (100 DEG F)	PV = 38 TO 121 DEG C (100 TO 250 DEG F) CPA = 38 TO 83 DEG C (100 TO 200 DEG F)	CPA LO-LIMIT = 38 DEG C (100 DEG F) CPA HI-LIMIT = 83 DEG C (200 DEG F)
	TT-XX-01	OUTSIDE-AIR TEMPERATURE TRANSMITTER	---	-35 TO +55 DEG C (-30 TO +130 DEG F)	---
	TT-XX-02	SYSTEM-SUPPLY TEMPERATURE TRANSMITTER	---	38 TO 121 DEG C (100 TO 250 DEG F)	---
DUAL-TEMP CHANGEOVER	TS-XX-01	SYSTEM RETURN CHANGEOVER THERMOSTAT	---	-1 TO 118 DEG C (30 TO 240 DEG F)	CONTACT CLOSED AT 24 DEG C (75 DEG F) CONTACT OPEN AT 27 DEG C (80 DEG F)
	VLV-XX-02	SUPPLY CHANGEOVER VALVE	---	3-POSITION	Kv = 6 (Cv = 7) CLOSE AGAINST 70 kPa (10 PSIG)
	VLV-XX-03	RETURN CHANGEOVER VALVE	---	3-POSITION	Kv = 6 (Cv = 7) CLOSE AGAINST 70 kPa (10 PSIG)
	TDR-XX-01	TIME-DELAY RELAY	---	---	TIME DELAY = COORDINATE WITH CHILLER MANUFACTURER
OCCUPIED MODE	CLK-XX-01 CONTACT	365-DAY SCHEDULE	---	NORMAL SCHEDULE: M - F CONTACT CLOSED: 0700 HRS CONTACT OPEN: 1700 HRS	CONTACT OPEN: SAT, SUN

NOTE : OTHER CONTROL DEVICES SUCH AS IPS AND RELAYS ARE NOT SHOWN

Figure 4-12c. Control system equipment for single building dual-temperature hydronic system.



FRONT VIEW

REAR VIEW

SWITCH AND PILOT LIGHT LEGEND

POSITION LEGEND

- 1 - AUTO/AUTO OVERRIDE
- 2 - HEAT/OFF/CDDL
- 3 - HEAT/COOL
- 4 - ENABLE/OFF

DEVICE TYPE

- ILLUMINATED MAINTAINED CONTACT INTERLOCKED SWITCHES
- THREE-POSITION ROTARY SWITCH
- ILLUMINATED MAINTAINED CONTACT INTERLOCKED SWITCHES
- ILLUMINATED MAINTAINED CONTACT INTERLOCKED SWITCHES

IDENTIFIER

- HS-XX-01
- HS-XX-02
- HS-XX-03
- HS-XX-04

POSITION LEGEND

- 5 - OCCUPIED
- 6 - HEATING
- 7 - COOLING

DEVICE TYPE

- PILOT LIGHT
- PILOT LIGHT
- PILOT LIGHT

IDENTIFIER

- PL-XX-01
- PL-XX-02
- PL-XX-03

Figure 4-12d. Control panel interior door layout for single building dual-temperature hydronic system.

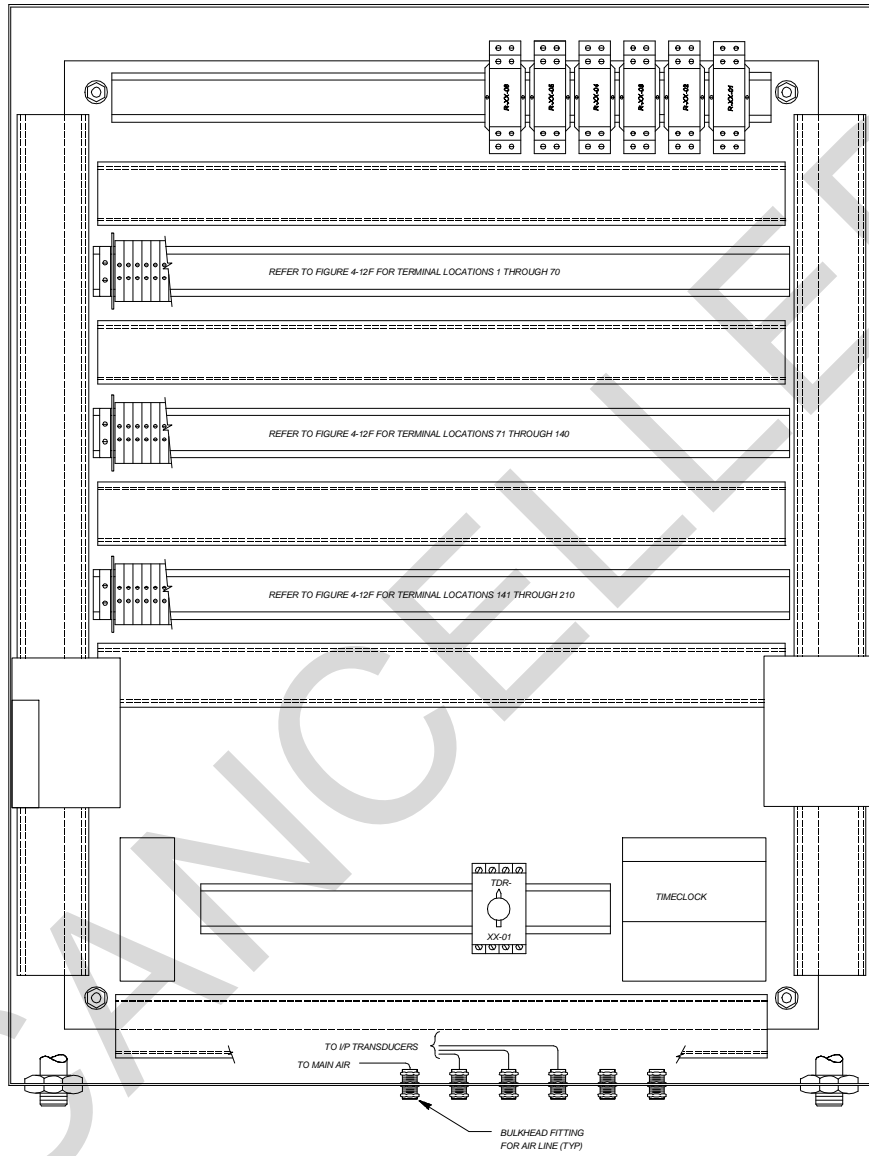
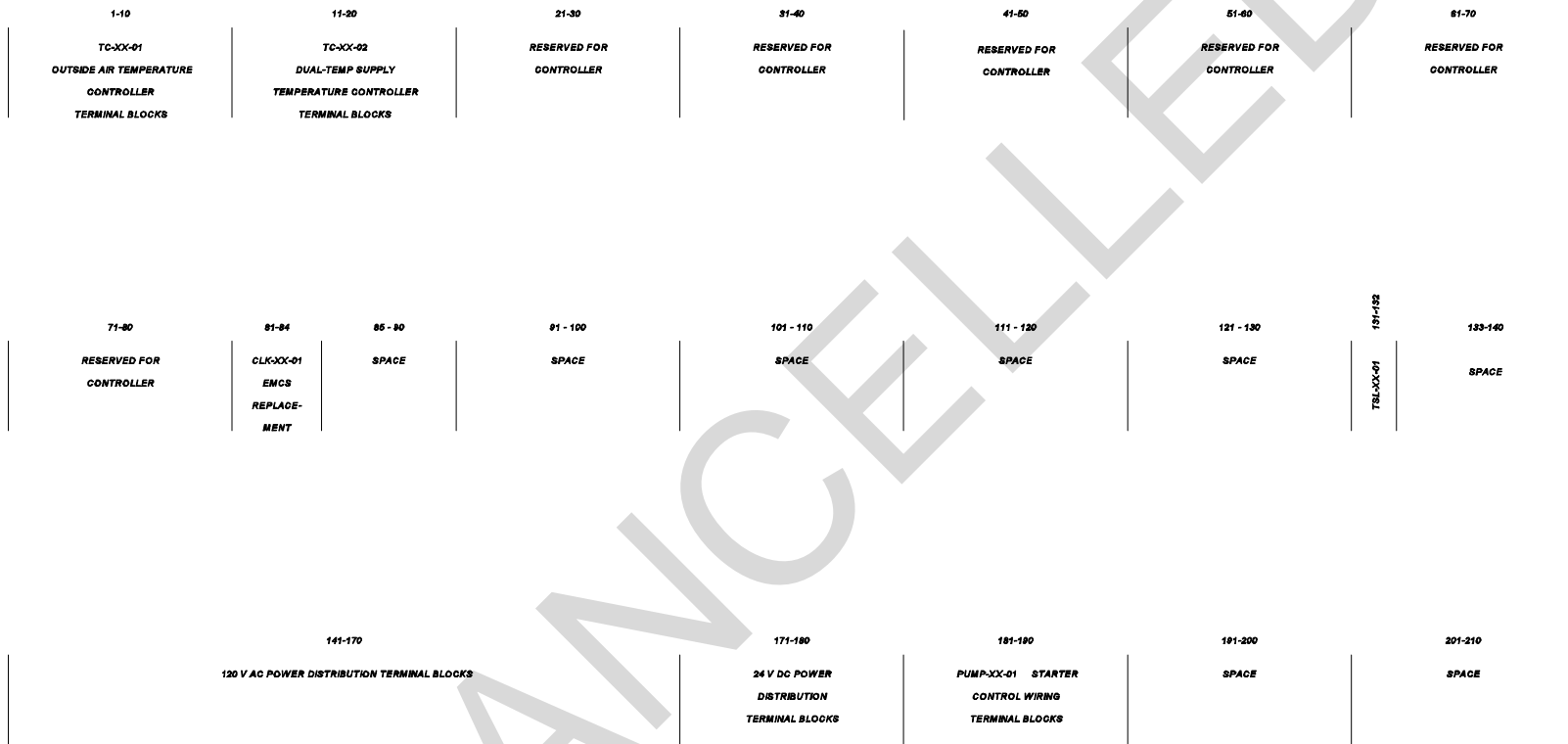
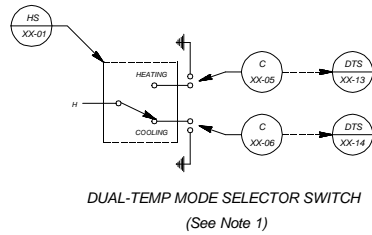

Figure 4-12e. Control panel back panel layout for single building dual-temperature hydronic system.



CANCELLED

Figure 4-12f. Control panel terminal block layout for single building dual-temperature hydronic system.



Notes:
1. HS-XX-01 shall be located adjacent to the DDC panel.

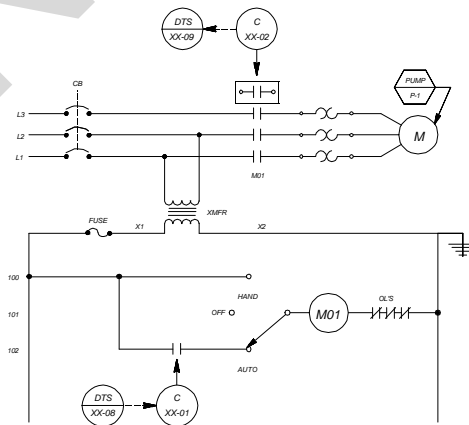
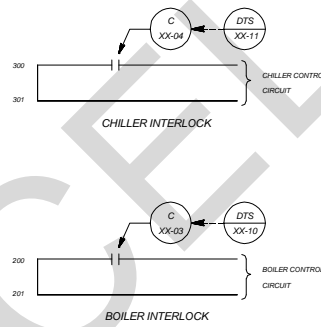

Figure 4-12h. DDC control system ladder diagram for single building dual-temperature hydronic system.

SENSOR SCHEDULE

IDENTIFIER	FUNCTION	RANGE
TT-XX-01	OUTSIDE AIR TEMPERATURE TRANSMITTER	-35 TO +55 DEG C (-30 TO +130 DEG F)
TT-XX-02	HEATING WATER SUPPLY TEMPERATURE TRANSMITTER	38 TO 121 DEG C (100 TO 250 DEG F)
TT-XX-03	DUAL-TEMP RETURN WATER TEMPERATURE TRANSMITTER	-1 TO 116 DEG C (30 TO 240 DEG F)

CONTROL VALVE SCHEDULE

IDENTIFIER	FUNCTION	TYPE	RANGE	Kv (Cv)	CLOSE-OFF RATING	REMARKS
VLV-XX-01	HW SUPPLY VALVE	3-WAY, MODULATING	21 - 103 kPa (3-15 PSIG)	XX	XX kPa (XX PSIG)	
VLV-XX-02	DUAL-TEMP SUPPLY CHANGEOVER VALVE	3-WAY, 2-POSITION		XX	XX kPa (XX PSIG)	
VLV-XX-03	DUAL-TEMP RETURN CHANGEOVER VALVE	3-WAY, 2-POSITION		XX	XX kPa (XX PSIG)	

OPERATING PARAMETERS

FUNCTION	SETPOINT	REMARKS
OUTSIDE AIR TEMPERATURE		START PUMP AT OA TEMP = XX DEG C (XX DEG F) STOP PUMP AT OA TEMP = XX DEG C (XX DEG F)
HEATING WATER SUPPLY TEMPERATURE	XX DEG C (XX DEG F)	OA TEMP = -19 DEG C (0 DEG F); HEATING WATER SUPPLY SETPOINT = 93 DEG C (200 DEG F) OA TEMP = 16 DEG C (60 DEG F); HEATING WATER SUPPLY SETPOINT = 38 DEG C (100 DEG F)
DUAL-TEMP CHANGEOVER	XX DEG C (XX DEG F)	DIFFERENTIAL = XX DEG C (XX DEG F)
OCCUPIED MODE		MONDAY - FRIDAY: 0705 HRS - 1700 HRS

Figure 4-12i. DDC control system equipment for single building dual-temperature hydronic system.

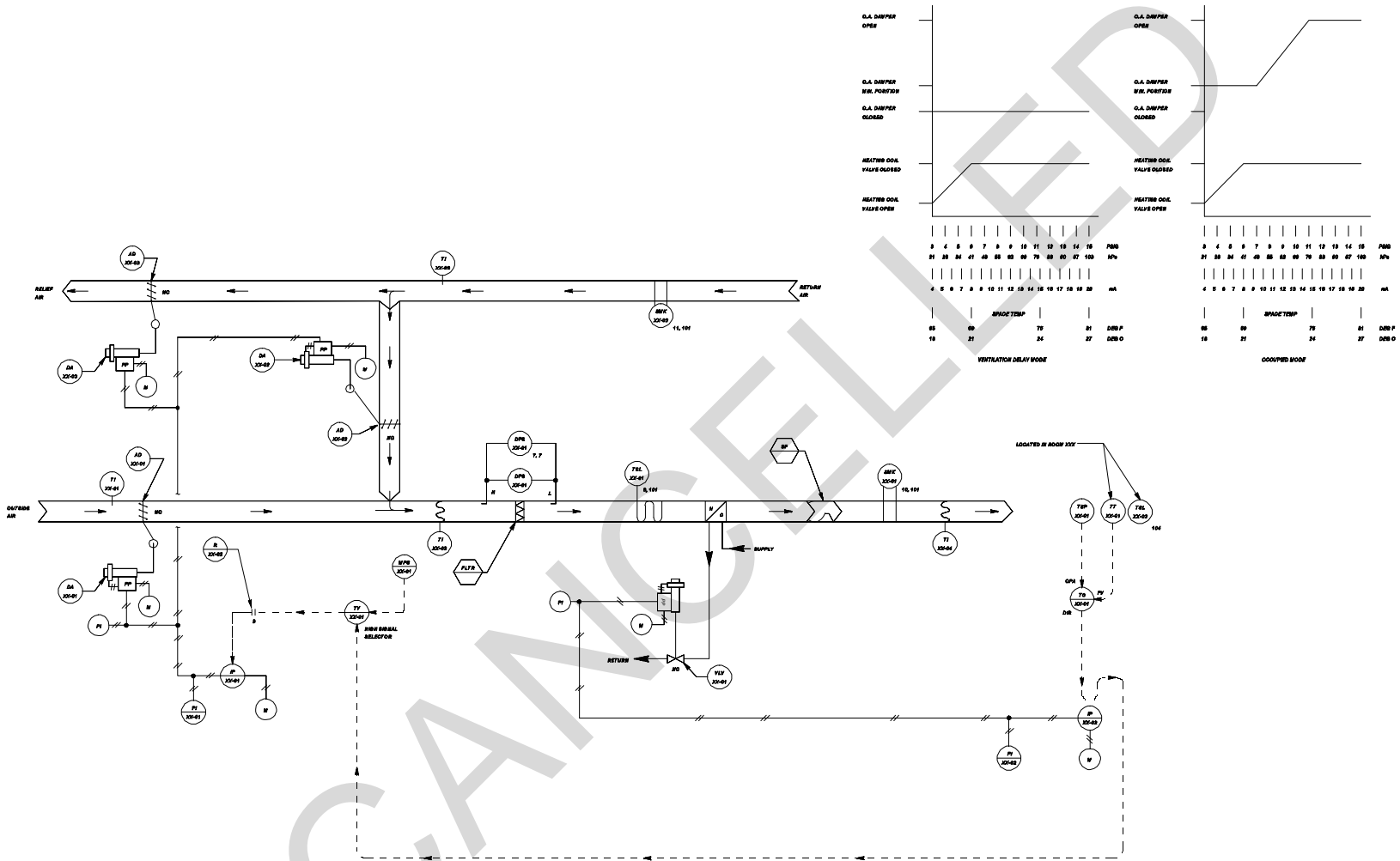

Figure 4-13a. Control system schematic for heating and ventilating system.

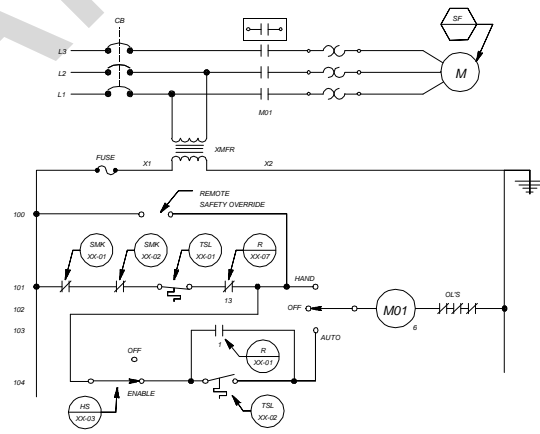
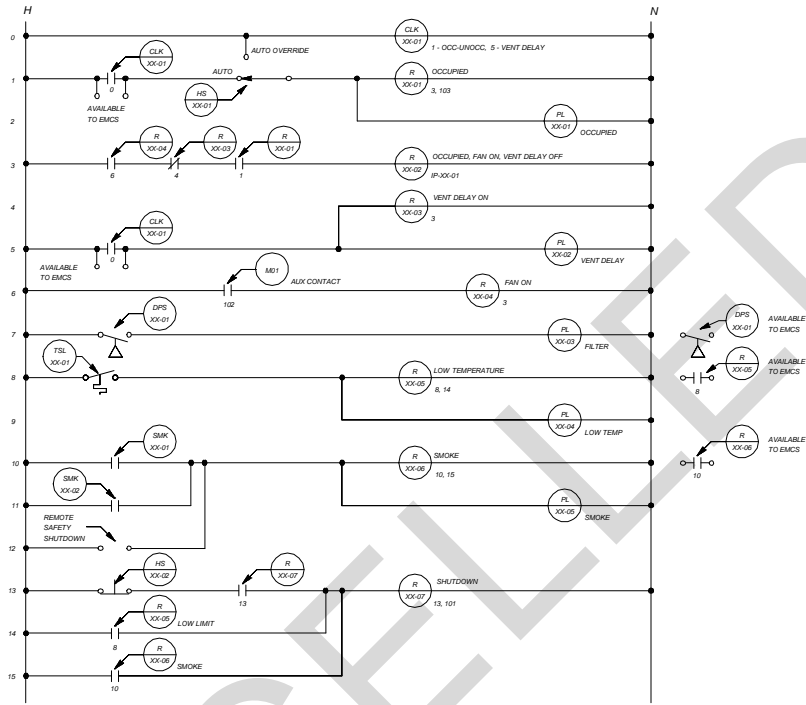
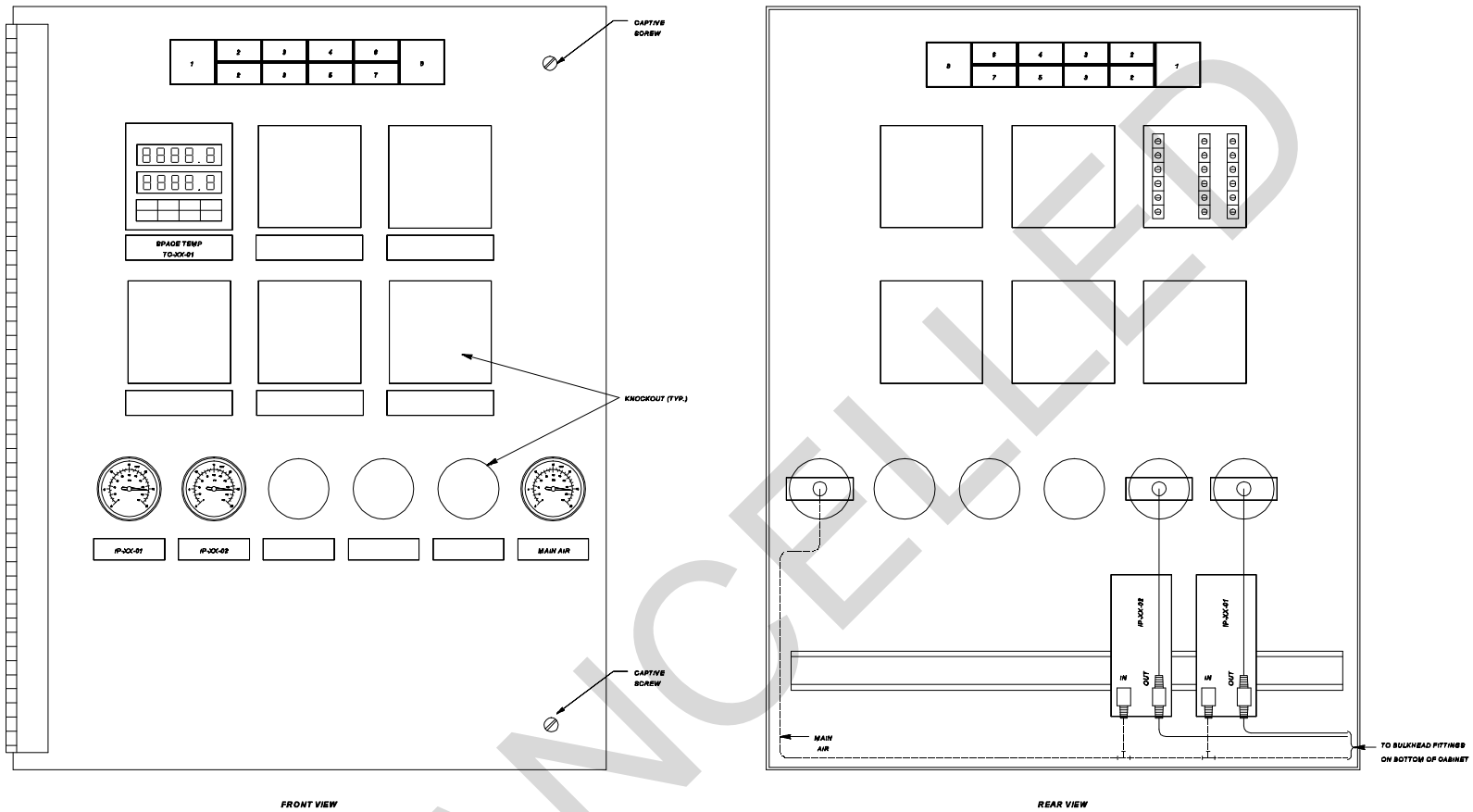

Figure 4-13b. Control system ladder diagram for heating and ventilating system.

LOOP CONTROL FUNCTION	DEVICE NUMBER	DEVICE FUNCTION	SETPONT	RANGE	ADDITIONAL PARAMETERS
SPACE TEMPERATURE	DA-XX-01 DA-XX-02 DA-XX-03	DAMPER ACTUATOR	---	48 - 76 kPa (7 - 11 PSIG)	---
	MPS-XX-01	MINIMUM POSITION SWITCH	---	---	SET MIN OA LA (CFM) EQUAL TO ___ L/S (___ CFM)
	TT-XX-01	SPACE TEMPERATURE TRANSMITTER	---	10 TO 30 DEG C (50 TO 85 DEG F)	---
	TSP-XX-01	SPACE TEMPERATURE SETPOINT ADJUSTMENT	4 mA = 10 DEG C (50 DEG F) 20 mA = 30 DEG C (85 DEG F)	---	---
	TC-XX-01	SPACE TEMPERATURE CONTROLLER	4 mA = 10 DEG C (50 DEG F) 20 mA = 30 DEG C (85 DEG F)	10 TO 30 DEG C (50 TO 85 DEG F)	SET LIMITS AVAILABLE TO OCCUPANT BY TSP-XX-01 AT 19 TO 22 DEG C (64 TO 72 DEG F)
	VLV-XX-01	HEATING OIL VALVE	---	21 - 41 kPa (3 - 6 PSIG)	Kv = ___ (CV = ___) CLOSE AGAINST ___ kPa (___ PSIG)
MIXED AIR	TSL-XX-01	LOW TEMPERATURE PROTECTION THERMOSTAT	2 DEG C (35 DEG F)	---	---
SPACE LOW TEMPERATURE	DPS-XX-01	FILTER ALARM	PER FILTER MANUFACTURER'S RECOMMENDATION	PER FILTER MANUFACTURER'S RECOMMENDATION	---
	TSL-XX-02	NIGHT STAT - SPACE LOW TEMPERATURE PROTECTION	19 DEG C (65 DEG F)	DIFFERENTIAL = 3 DEG C (5 DEG F)	---
OCCUPIED MODE	CLK-XX-01 CONTACT	365 DAY SCHEDULE	---	NORMAL SCHEDULE (M-F) CONTACT CLOSED: 0700 HRS CONTACT OPEN: 1700 HRS	CONTACT OPEN: SAT, SUN
VENTILATION DELAY MODE	CLK-XX-01 CONTACT	365 DAY SCHEDULE	---	NORMAL SCHEDULE (M-F) CONTACT CLOSED: 0700 HRS CONTACT OPEN: 0800 HRS	↓

NOTE: OTHER CONTROL DEVICES SUCH AS I/Ps, RELAYS, AND SIGNAL SELECTERS ARE NOT SHOWN.

Figure 4-13c. Control system equipment for heating and ventilating system.



FRONT VIEW

REAR VIEW

SWITCH AND PILOT LIGHT LEGEND

POSITION LEGEND

- 1 - RESET
- 2 - AUTO/AUTO OVERRIDE
- 3 - ENABLE/OFF
- 4 - LOW TEMP

DEVICE TYPE

- NON-ILLUMINATED MOMENTARY CONTACT PUSH BUTTON SWITCH
- ILLUMINATED MAINTAINED CONTACT INTERLOCKED SWITCHES
- ILLUMINATED MAINTAINED CONTACT INTERLOCKED SWITCHES
- PILOT LIGHT

IDENTIFIER

- HS-XX-02
- HS-XX-01
- HS-XX-03
- PL-XX-04

POSITION LEGEND

- 5 - SMOKE
- 6 - OCCUPIED
- 7 - VENT DELAY
- 8 - FILTER

DEVICE TYPE

- PILOT LIGHT
- PILOT LIGHT
- PILOT LIGHT
- PILOT LIGHT

IDENTIFIER

- PL-XX-05
- PL-XX-01
- PL-XX-02
- PL-XX-03

Figure 4-13d. Control panel interior door layout for heating and ventilating system.

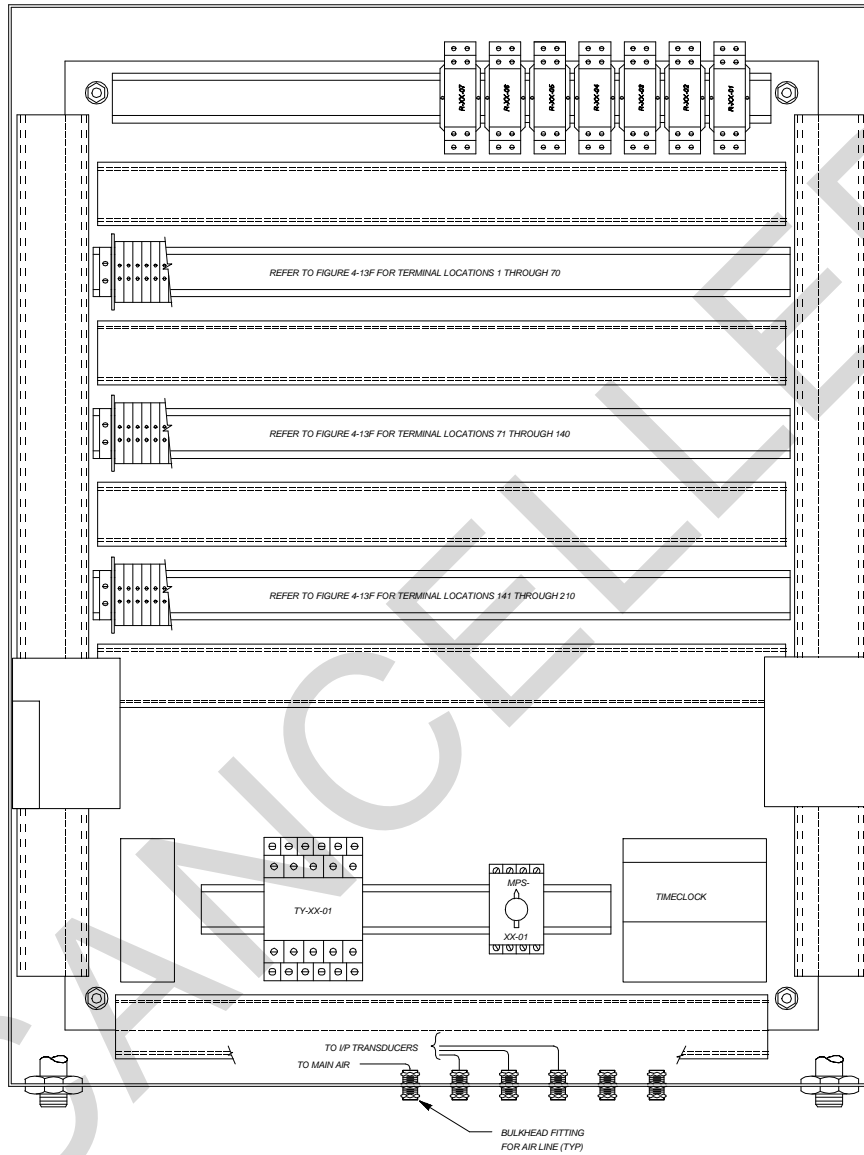

Figure 4-13e. Control panel back panel layout for heating and ventilating system.

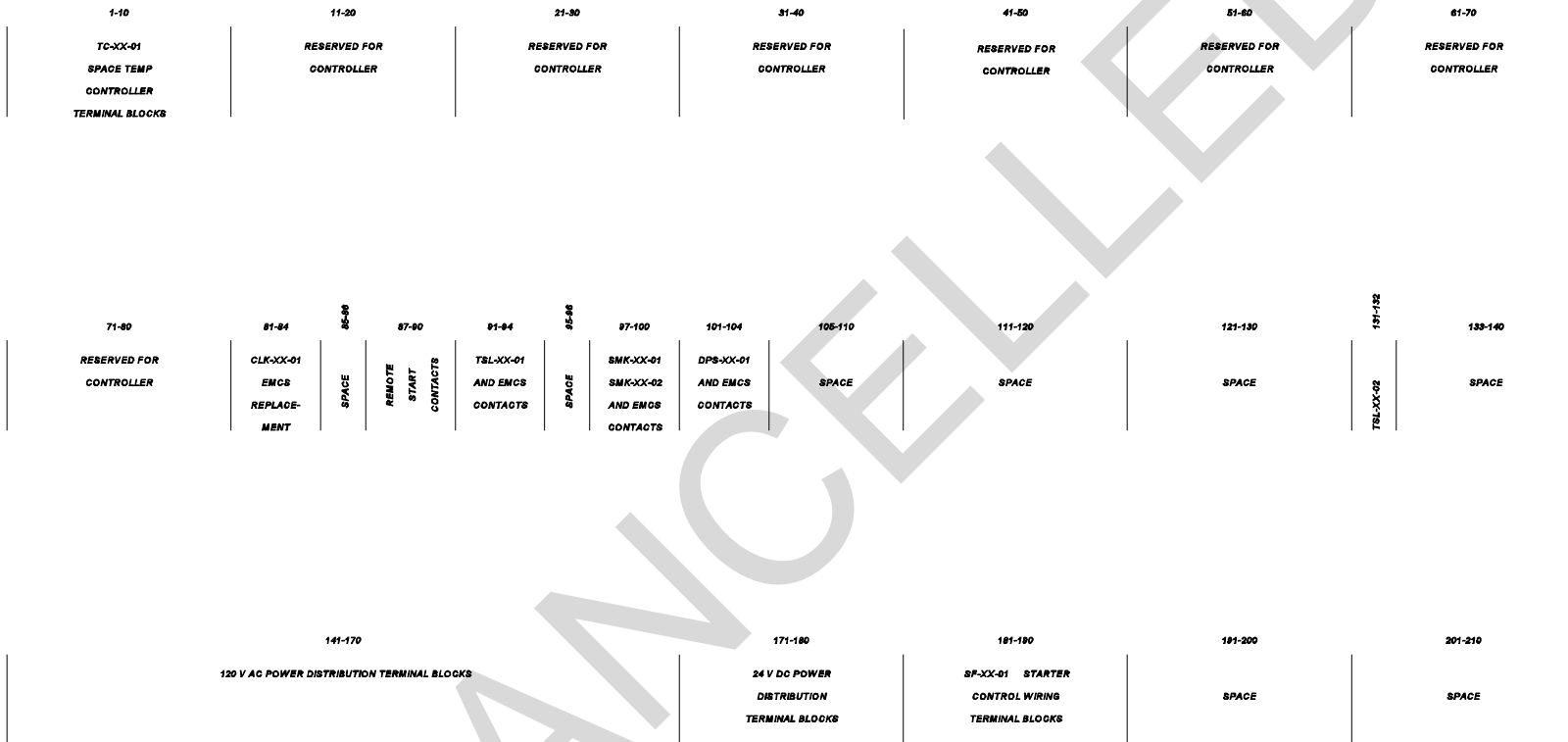

Figure 4-13f. Control panel terminal block layout for heating and ventilating system.

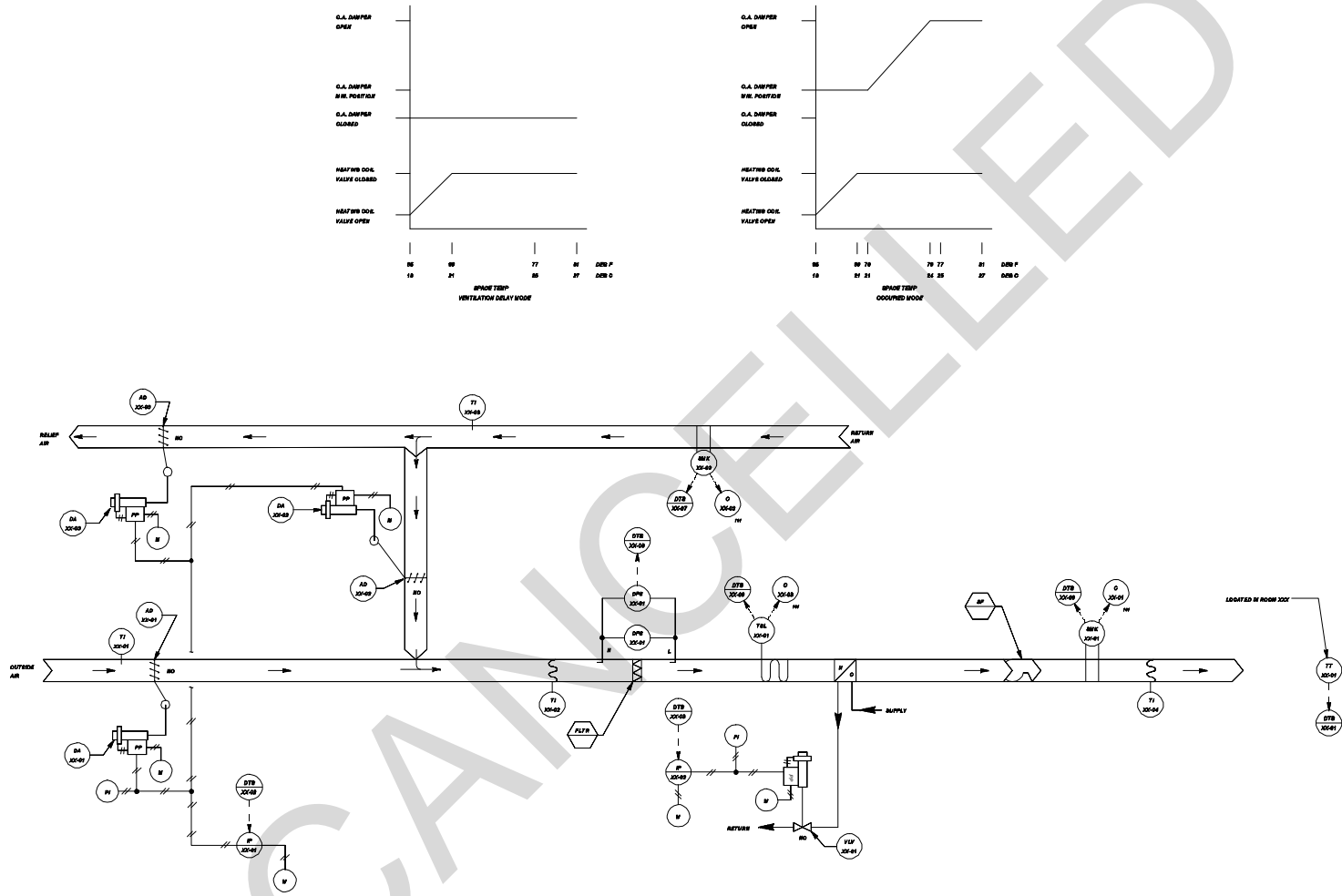

Figure 4-13g. DDC control system schematic for heating and ventilating system.

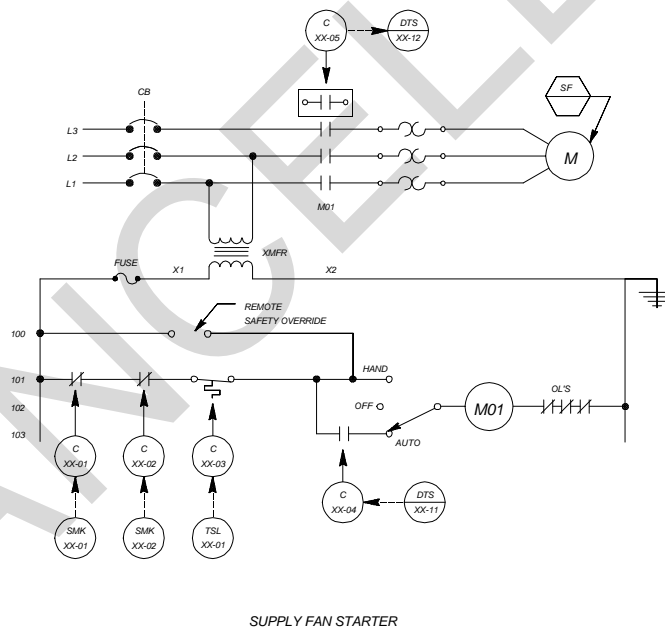

Figure 4-13h. DDC control system ladder diagram for heating and ventilating system.

SENSOR SCHEDULE

IDENTIFIER	FUNCTION	RANGE
TT-XX-01	SPACE TEMPERATURE TRANSMITTER	10 TO 30 DEG C (50 TO 85 DEG F)

CONTROL VALVE SCHEDULE

IDENTIFIER	FUNCTION	TYPE	RANGE	Kv (Cv)	CLOSE-OFF RATING	REMARKS
VLV-XX-01	HEATING COIL VALVE	2-WAY, MODULATING	21 - 103 kPa (3-15 PSIG)	XX	XX kPa (XX PSIG)	

CONTROL DAMPER SCHEDULE

IDENTIFIER	FUNCTION	TYPE	SIZE	RANGE	REMARKS
AD-XX-01	OUTSIDE AIR	MODULATING	W x H (mm) (WW" X HH")	21 - 103 kPa (3-15 PSIG)	PARALLEL BLADE
AD-XX-02	RETURN AIR	MODULATING	W x H (mm) (WW" X HH")		PARALLEL BLADE
AD-XX-03	RELIEF AIR	MODULATING	W x H (mm) (WW" X HH")	↓	PARALLEL BLADE

OPERATING PARAMETERS

FUNCTION	SETPOINT	REMARKS
MINIMUM OUTSIDE AIR	XXXX L/s (XXXX CFM)	
SPACE TEMPERATURE	XX DEG C (XX DEG F) XX DEG C (XX DEG F)	(HEATING) (COOLING)
SPACE TEMP. (NIGHT SETBACK)	XX DEG C (XX DEG F)	(HEATING ONLY)
FREEZE/STAT	XX DEG C (XX DEG F)	
FILTER ALARM	XX kPa (XX INL WATER)	
OCCUPIED MODE		MONDAY - FRIDAY : 0705 HRS - 1700 HRS
VENT DELAY MODE		MONDAY - FRIDAY : 0700 HRS - 0800 HRS

Figure 4-13i. DDC control system cooling equipment for heating and ventilating system.

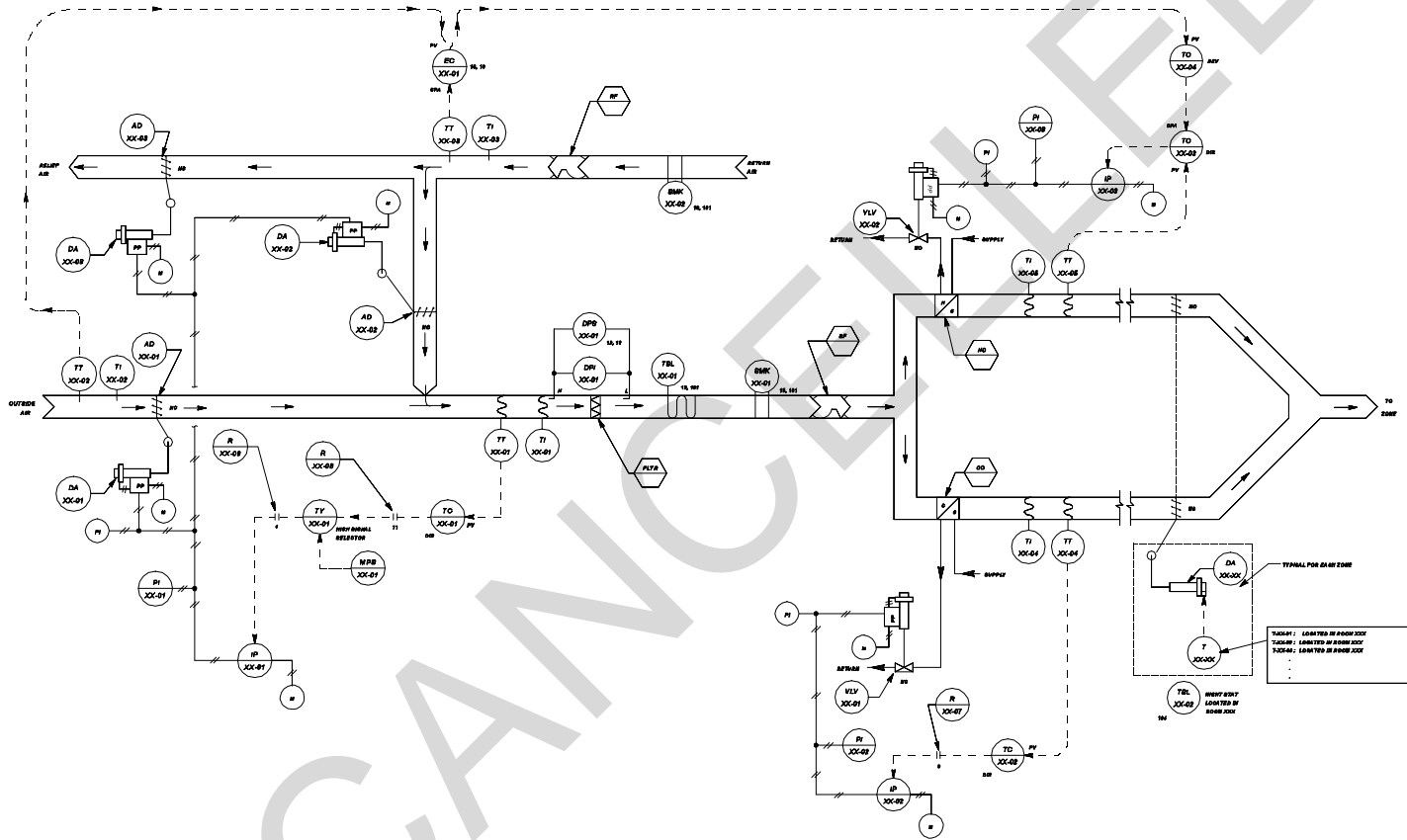

Figure 4-14a. Control system schematic for multizone HVAC system.

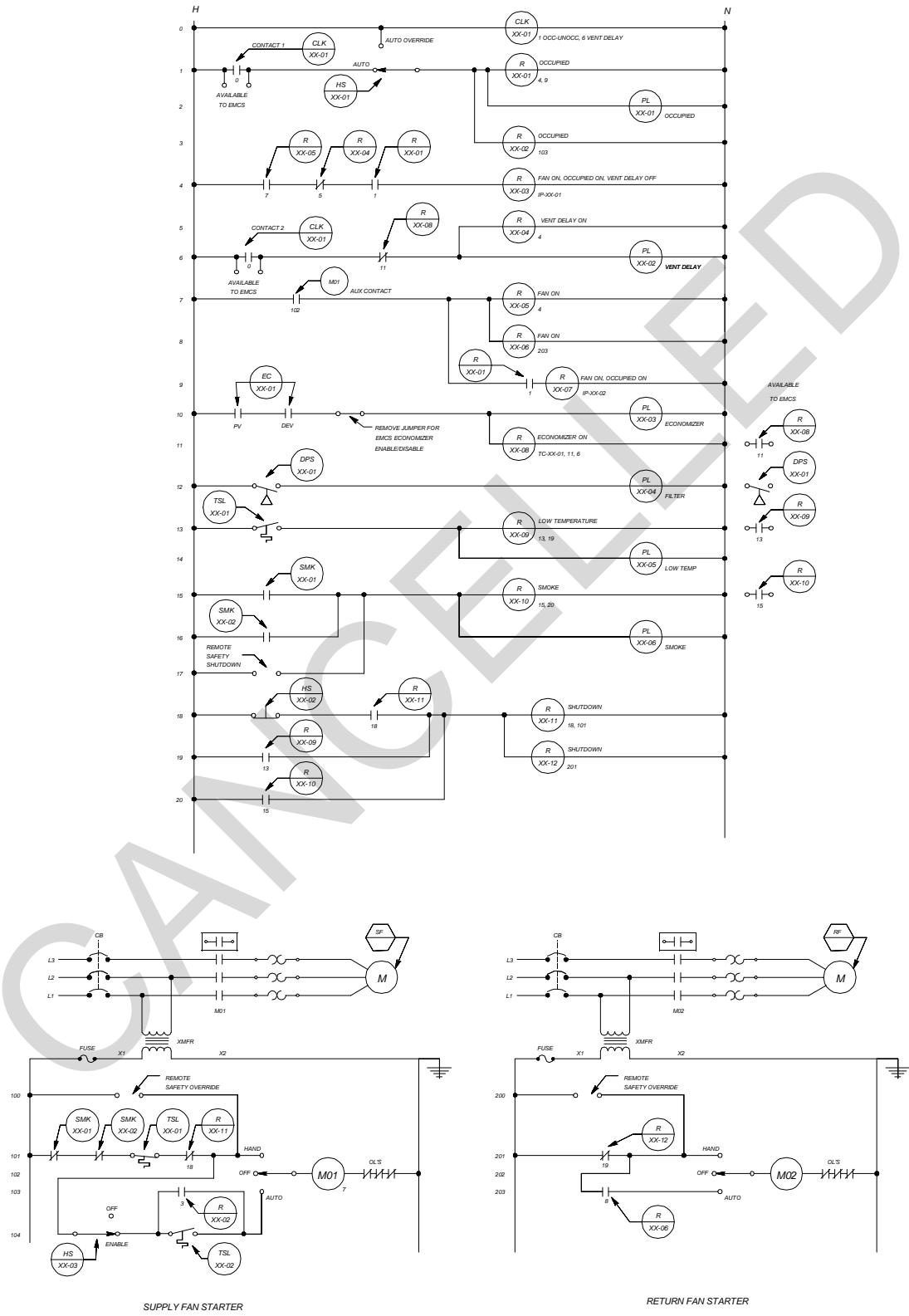
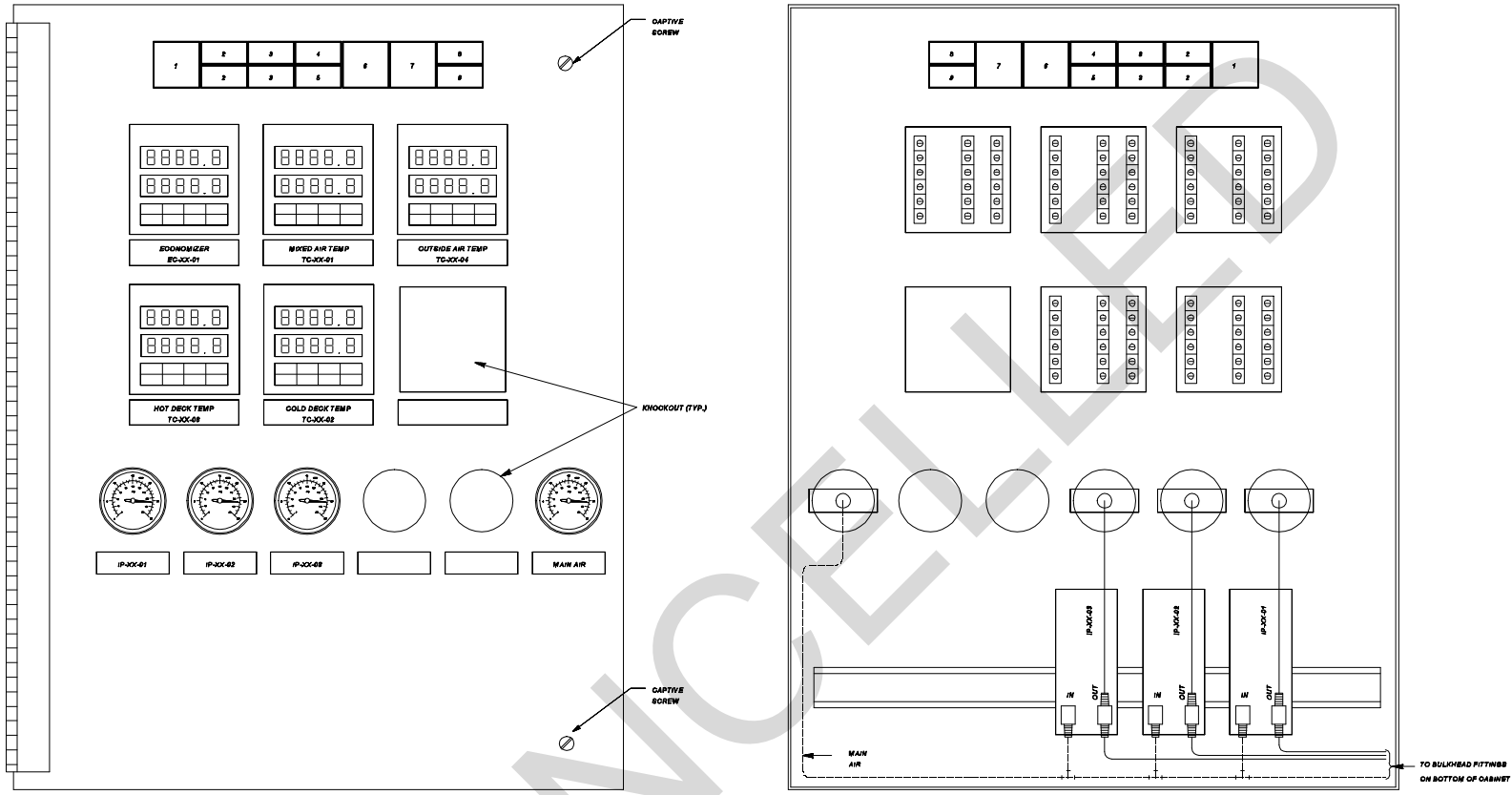

Figure 4-14b. Control system ladder diagram for multizone HVAC system.

LOOP CONTROL FUNCTION	DEVICE NUMBER	DEVICE FUNCTION	SETPPOINT	RANGE	ADDITIONAL PARAMETERS
MIXED AIR TEMPERATURE	DA-XX-01 DA-XX-02 DA-XX-03	DAMPER ACTUATOR	---	21-100 kPa (3 - 15 PSIG)	---
	MPS-XX-01	MINIMUM POSITION SWITCH	---	---	SET MIN OA LA (CFM) EQUAL TO ___ L/s (___ CFM)
	TC-XX-01	MIXED AIR TEMPERATURE CONTROLLER	13 DEG C (55 DEG F)	4 TO 80 DEG C (40 TO 140 DEG F)	---
	TT-XX-01	MIXED AIR TEMPERATURE TRANSMITTER	---	4 TO 80 DEG C (40 TO 140 DEG F)	---
	TT-XX-02	OUTSIDE AIR TEMPERATURE TRANSMITTER	---	-34 TO 54 DEG C (-30 TO +100 DEG F)	---
	TT-XX-03	RETURN AIR TEMPERATURE TRANSMITTER	---	-34 TO 54 DEG C (-30 TO +100 DEG F)	---
	EC-XX-01	ECONOMIZER CONTROLLER	PIV CONTACT CLOSE AT ___ DEG C (___ DEG F) OPEN AT ___ DEG C (___ DEG F)	-34 TO 54 DEG C (-30 TO +100 DEG F)	DEV CONTACT CLOSE @ DELTA T= ___ DEG C (___ DEG F) OPEN @ DELTA T= ___ DEG C (___ DEG F)
	TSL-XX-01	FREEZE STAT	2 DEG C (35 DEG F)	3 DEG C DIFFERENTIAL (5 DEG F DIFFERENTIAL)	---
	DPS-XX-01	FILTER ALARM	PER FILTER MANUFACTURER'S RECOMMENDATION	PER FILTER MANUFACTURER'S RECOMMENDATION	---
SPACE LOW TEMPERATURE	TSL-XX-02	NIGHT STAT - SPACE LOW TEMPERATURE PROTECTION	13 DEG C (55 DEG F)	3 DEG C DIFFERENTIAL (5 DEG F DIFFERENTIAL)	---
COLD DECK AIR TEMPERATURE	VLV-XX-01	COOLING COIL VALVE	---	21-100 kPa (3 - 15 PSIG)	Kv= ___ (Cv= ___) CLOSE AGAINST ___ kPa (___ PSIG)
	TC-XX-03	COLD DECK TEMPERATURE CONTROLLER	14 DEG C (57 DEG F)	4 TO 80 DEG C (40 TO 140 DEG F)	---
	TT-XX-04	COLD DECK TEMPERATURE TRANSMITTER	---	4 TO 80 DEG C (40 TO 140 DEG F)	---
HOT DECK AIR TEMPERATURE	VLV-XX-02	HEATING COIL VALVE	---	21-100 kPa (3 - 15 PSIG)	Kv= ___ (Cv= ___) CLOSE AGAINST ___ kPa (___ PSIG)
	TC-XX-03	HOT DECK TEMPERATURE CONTROLLER	OA TEMP = -18 DEG C (0 DEG F), HOT DECK = 48 DEG C (120 DEG F) OA TEMP = 18 DEG C (60 DEG F), HOT DECK = 32 DEG C (90 DEG F)	PIV = 4 TO 80 DEG C (40 TO 140 DEG F) CPA = 32 TO 48 DEG C (90 TO 120 DEG F)	CPA LO-LIMIT = 32 DEG C (90 DEG F) CPA HI-LIMIT = 48 DEG C (120 DEG F)
	TC-XX-04	OUTSIDE AIR TEMPERATURE CONTROLLER	SET POINT = -1 DEG C (30 DEG F) PROPORTIONAL BAND = 37.5 % MANUAL RESET = 50 %	-34 TO 54 DEG C (-30 TO +100 DEG F)	---
	TT-XX-05	HOT DECK TEMPERATURE TRANSMITTER	---	4 TO 80 DEG C (40 TO 140 DEG F)	---
OCCUPIED MODE	CLK-XX-01 CONTACT	365 DAY SCHEDULE	---	---	CONTACT OPEN: SAT, SUN
VENTILATION DELAY MODE	CLK-XX-01 CONTACT	365 DAY SCHEDULE	---	---	CONTACT CLOSED: 0700 HRS CONTACT OPEN: 0800 HRS

NOTE: OTHER CONTROL DEVICES SUCH AS I/Ps, RELAYS, AND SIGNAL SELECTORS ARE NOT SHOWN.

Figure 4-14c. Control system equipment for multizone HVAC system.



FRONT VIEW

REAR VIEW

SWITCH AND PILOT LIGHT LEGEND

POSITION LEGEND	DEVICE TYPE	IDENTIFIER	POSITION LEGEND	DEVICE TYPE	IDENTIFIER
1 - RESET	NON-ILLUMINATED MOMENTARY CONTACT PUSH BUTTON SWITCH	H8-XX-08	6 - FILTER	PILOT LIGHT	PL-XX-04
2 - AUTOMATO OVERRIDE	ILLUMINATED MAINTAINED CONTACT INTERLOCKED SWITCHES	H8-XX-01	7 - OCC	PILOT LIGHT	PL-XX-01
3 - ENABLE/OFF	ILLUMINATED MAINTAINED CONTACT INTERLOCKED SWITCHES	H8-XX-03	8 - VENT DELAY	PILOT LIGHT	PL-XX-02
4 - LOW TEMP	PILOT LIGHT	PL-XX-05	9 - ECONOMIZER	PILOT LIGHT	PL-XX-03
5 - SMOKE	PILOT LIGHT	PL-XX-06			

Figure 4-14d. Control panel interior door layout for multizone HVAC system.

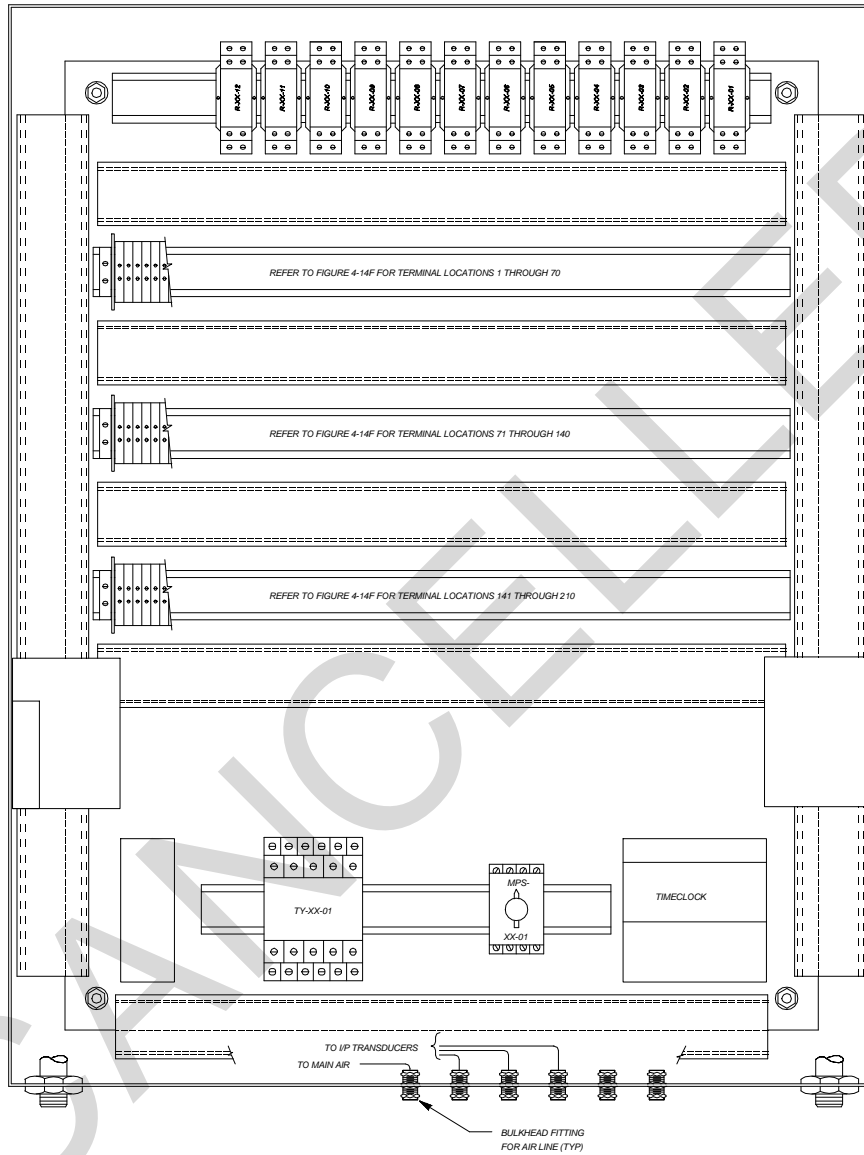

Figure 4-14e. Control panel back panel layout for multizone HVAC system.

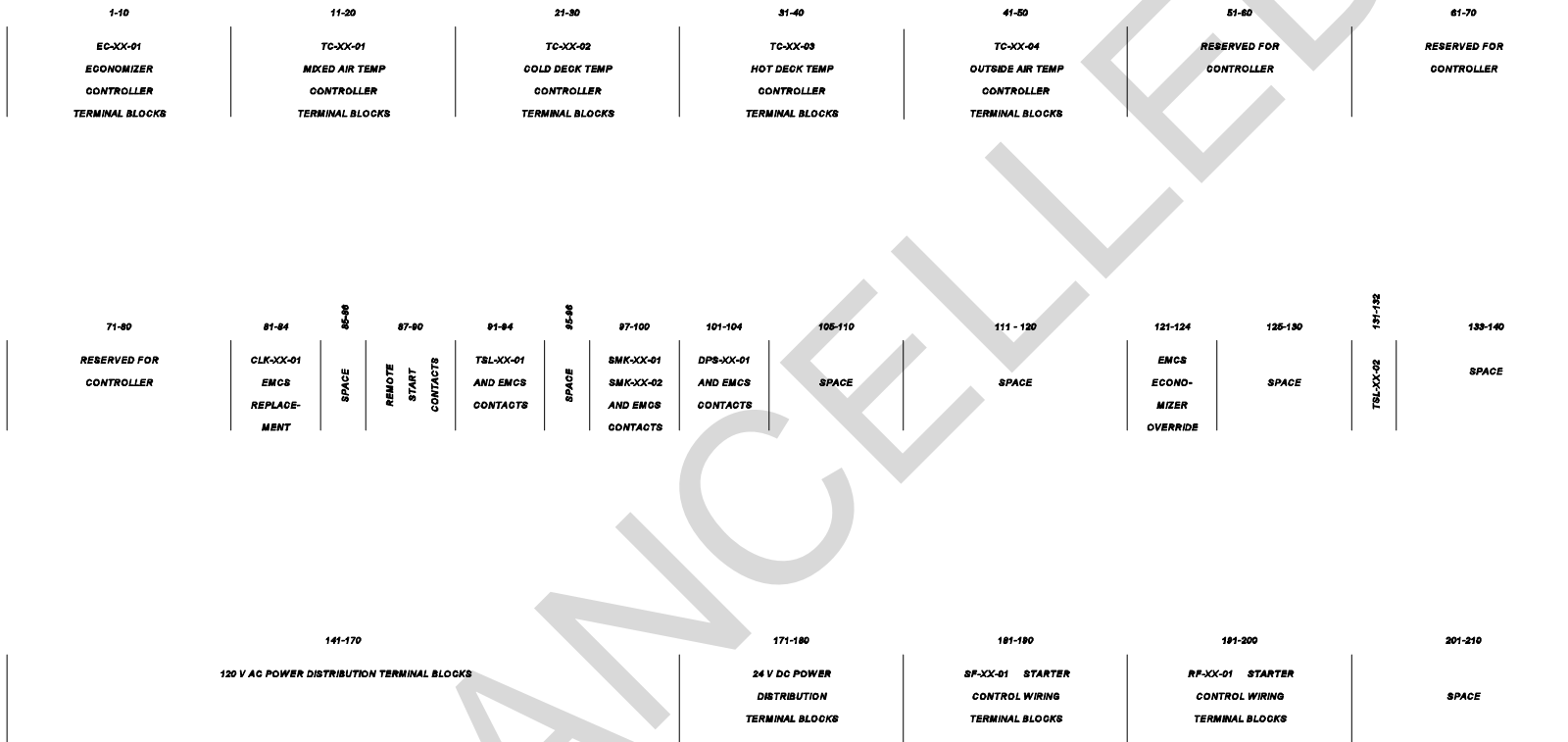

Figure 4-14f. Control panel terminal block layout for multizone HVAC system.

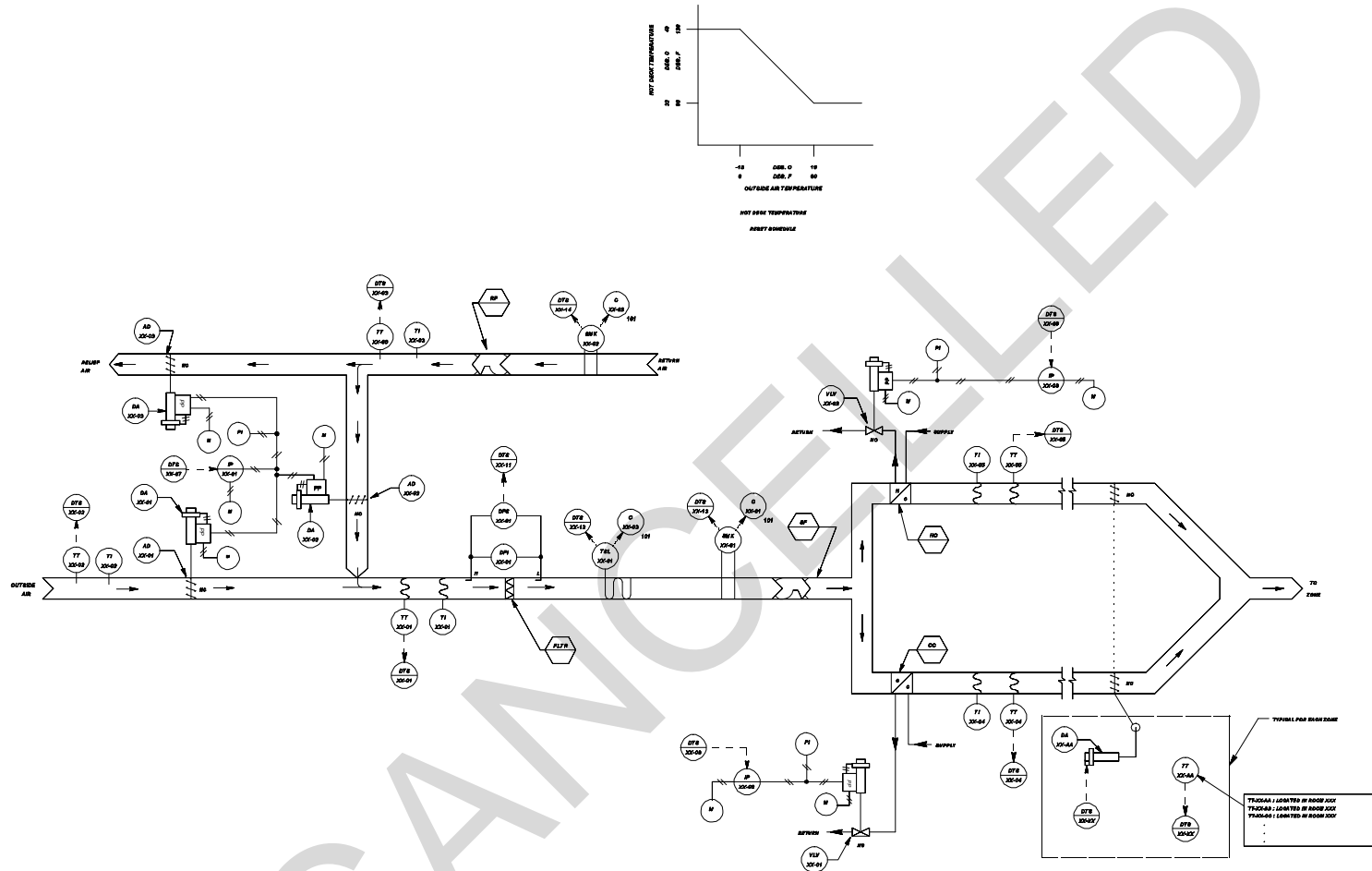

Figure 4-14g. DDC control system schematic for multizone HVAC system.

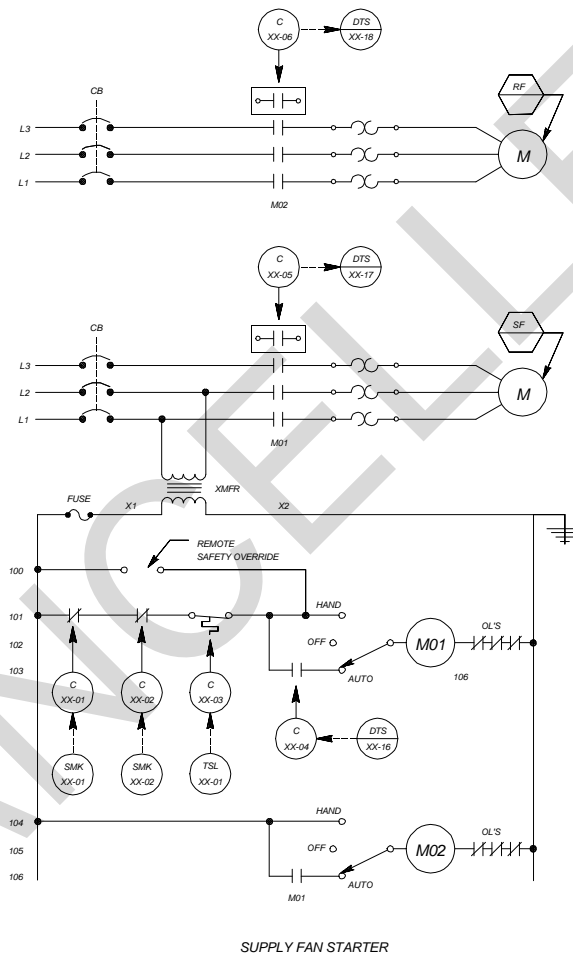

Figure 4-14h. DDC control system ladder diagram for multizone HVAC system.

SENSOR SCHEDULE

IDENTIFIER	FUNCTION	RANGE
TT-XX-01	MIXED AIR TEMPERATURE TRANSMITTER	4 TO 60 DEG C (40 TO 140 DEG F)
TT-XX-02	OUTSIDE AIR TEMPERATURE TRANSMITTER	-34 TO 54 DEG C (-30 TO +130 DEG F)
TT-XX-03	RETURN AIR TEMPERATURE TRANSMITTER	4 TO 60 DEG C (40 TO 140 DEG F)
TT-XX-04	COLD DECK TEMPERATURE TRANSMITTER	4 TO 60 DEG C (40 TO 140 DEG F)
TT-XX-05	HOT DECK TEMPERATURE TRANSMITTER	4 TO 60 DEG C (40 TO 140 DEG F)
TT-XX-AA	SPACE TEMPERATURE TRANSMITTER	10 TO 30 DEG C (50 TO 85 DEG F)

CONTROL VALVE SCHEDULE

IDENTIFIER	FUNCTION	TYPE	RANGE	Cv (Kv)	CLOSE-OFF RATING	REMARKS
VLV-XX-01	COOLING COIL VALVE	2-WAY, MODULATING	21 - 103 kPa (3-15 PSIG)	XX	XX kPa (XX PSIG)	
VLV-XX-02	HEATING COIL VALVE	2-WAY, MODULATING	21 - 103 kPa (3-15 PSIG)	XX	XX kPa (XX PSIG)	

CONTROL DAMPER SCHEDULE

IDENTIFIER	FUNCTION	TYPE	SIZE	RANGE	REMARKS
AD-XX-01	OUTSIDE AIR	MODULATING	W x H (mm) (WW" x HH")	21 - 103 kPa (3-15 PSIG)	DUCT SIZE, PARALLEL BLADE
AD-XX-02	RETURN AIR	MODULATING	W x H (mm) (WW" x HH")		DUCT SIZE, PARALLEL BLADE
AD-XX-03	RELIEF AIR	MODULATING	W x H (mm) (WW" x HH")	↓	DUCT SIZE, PARALLEL BLADE
DA-XX-XX	ZONE DAMPER	MODULATING	—	—	

OPERATING PARAMETERS

FUNCTION	SETPPOINT	REMARKS
MINIMUM OUTSIDE AIR	XXXX L/s (XXXX CFM)	
MIXED AIR TEMPERATURE	XX DEG C (XX DEG F)	
COLD DECK TEMPERATURE	XX DEG C (XX DEG F)	
HOT DECK TEMPERATURE		RESET SCHEDULE: 0A TEMP = XX DEG C (XX DEG F); HOT DECK SETPOINT = XX DEG C (XX DEG F) 0A TEMP = XX DEG C (XX DEG F); HOT DECK SETPOINT = XX DEG C (XX DEG F)
SPACE TEMP. (NIGHT SETBACK)	XX DEG C (XX DEG F)	(HEATING ONLY)
ECONOMIZER MODE		ECONOMIZER MODE = ON, WHEN CONDITION 1 AND CONDITION 2 ARE BOTH SATISFIED. CONDITION 1: RETURN AIR TEMP. > XX DEG C (XX DEG F) CONDITION 2: RETURN AIR TEMP. MINUS OUTSIDE AIR TEMP. > XX DEG C (XX DEG F)
OCCUPIED MODE		MONDAY - FRIDAY : 0705 HRS - 1700 HRS
VENT DELAY MODE		MONDAY - FRIDAY : 0700 HRS - 0800 HRS
FREEZESTAT	XX DEG C (XX DEG F)	
FILTER ALARM	XX kPa (XX IN. WATER)	

Figure 4-14i. DDC control system equipment for multizone HVAC system.

	HARDWARE														SOFTWARE														
	OUTPUT							INPUT							ALARMS					APPLICATION PROGRAMS									
	DIGITAL			ANALOG				DIGITAL			ANALOG				DIGITAL		ANALOG												
	CONTROL RELAY			POSITION ADJUSTMENT				AUXILIARY CONTACT			TEMPERATURE	% RELATIVE HUMIDITY	PSIA, PSIA, PSLD	FLOW	CONTACT CLOSURE		HIGH LIMIT	LOW LIMIT	RUN TIME	SCHEDULED START/STOP	OPTIMUM START/STOP	DUTY CYCLING	DEMAND LIMITING	DAY/NIGHT SETBACK	ECONOMIZER	VENTILATION/REGULATION	HOT/COLD DECK RESET	FAILURE MODE	
SUPPLY FAN	1							1							X			X		X	X	X	X	X					
RETURN FAN	1							1							X		X			X	X	X	X						
MIXED AIR											1						X	X											
OUTSIDE AIR											1						X	X											
RETURN AIR											1						X	X											
COLD DECK											1						X	X											
HOT DECK											1						X	X									X		
MIXED AIR DAMPERS																									X	X			
COOLING COIL VALVE																													
HEATING COIL VALVE																													
FILTER											1					X													
FREEZESTAT											1					X													
SMOKE DETECTOR											2					X													
SPACE TEMP												X					X	X						X					
ZONE DAMPER																													

-- C - LAST COMMAND
H - HIGH VALUE
L - LOW VALUE

O - ON (OPEN)
F - OFF (CLOSED)

DATA TERMINAL STRIP LAYOUT

DEVICE NO.	DESCRIPTION	TYPE
1	TT-XX-01 MIXED AIR TEMPERATURE	AI
2	TT-XX-02 OUTSIDE AIR TEMPERATURE	AI
3	TT-XX-03 RETURN AIR TEMPERATURE	AI
4	TT-XX-04 COLD DECK TEMPERATURE	AI
5	TT-XX-05 HOT DECK TEMPERATURE	AI
6		
7	IP-XX-01 MIXED AIR DAMPERS	AO
8	IP-XX-02 COOLING COIL VALVE	AO
9	IP-XX-03 HEATING COIL VALVE	AO
10		
11	DPS-XX-01 FILTER ALARM	DI
12	TSL-XX-01 FREEZESTAT	DI
13	SMK-XX-01 SUPPLY AIR SMOKE DETECTOR	DI
14	SMK-XX-02 RETURN AIR SMOKE DETECTOR	DI
15		
16	C-XX-04 SUPPLY FAN START/STOP	DO
17	C-XX-05 SUPPLY FAN STATUS	DI
18	C-XX-06 RETURN FAN STATUS	DI
19		
20	TT-XX-AA SPACE TEMP - ZONE AA	AI
21	DA-XX-AA ZONE DAMPER - ZONE AA	AO
22	TT-XX-BB SPACE TEMP - ZONE BB	AI
23	DA-XX-BB ZONE DAMPER - ZONE BB	AO
24	TT-XX-CC SPACE TEMP - ZONE CC	AI
25	DA-XX-CC ZONE DAMPER - ZONE CC	AO
26		
27		
28		
29		
30		

Figure 4-14j. DDC control system I/O table and data terminal strip layout for multizone HVAC system.

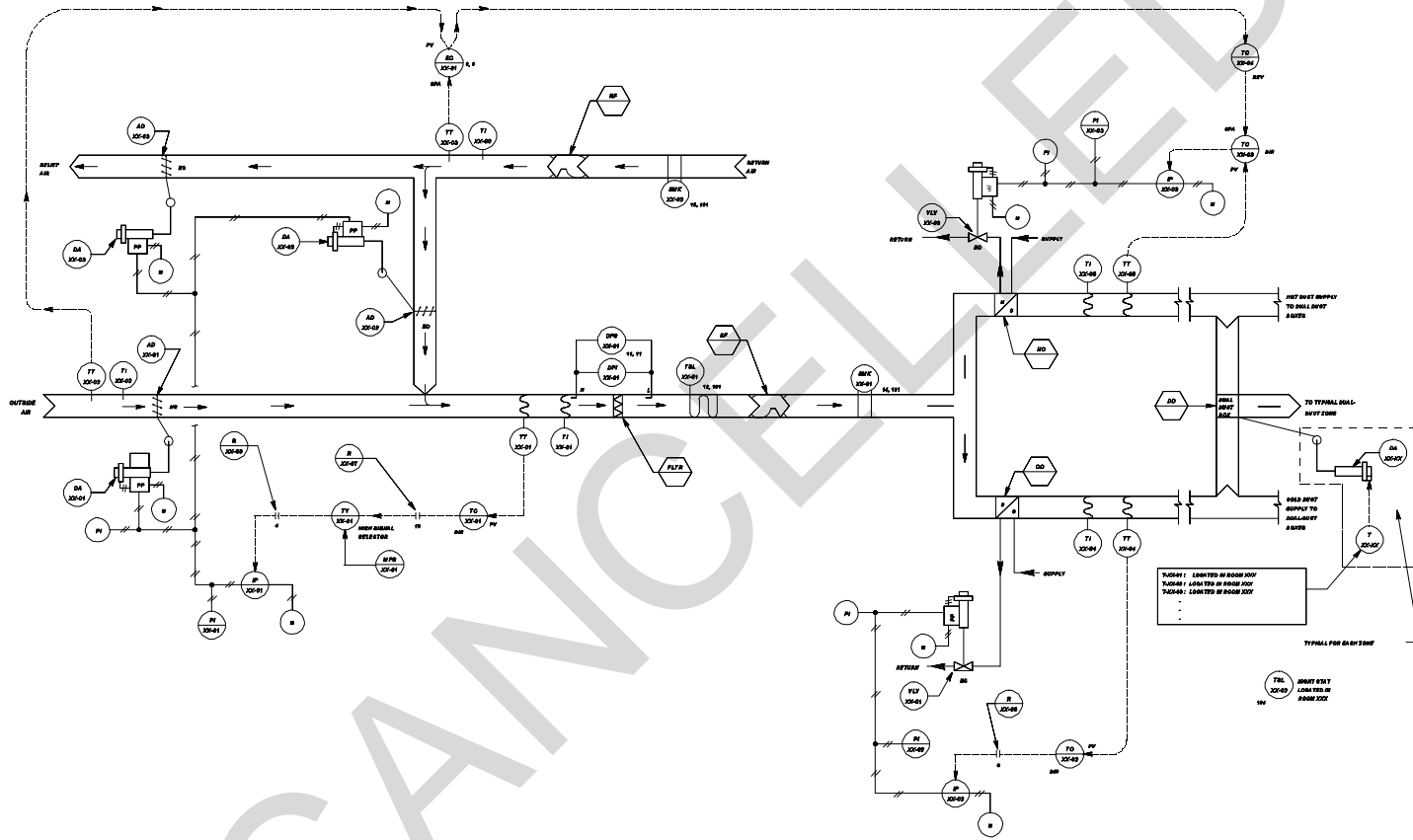

Figure 4-15a. Control system schematic for dual-duct HVAC system.

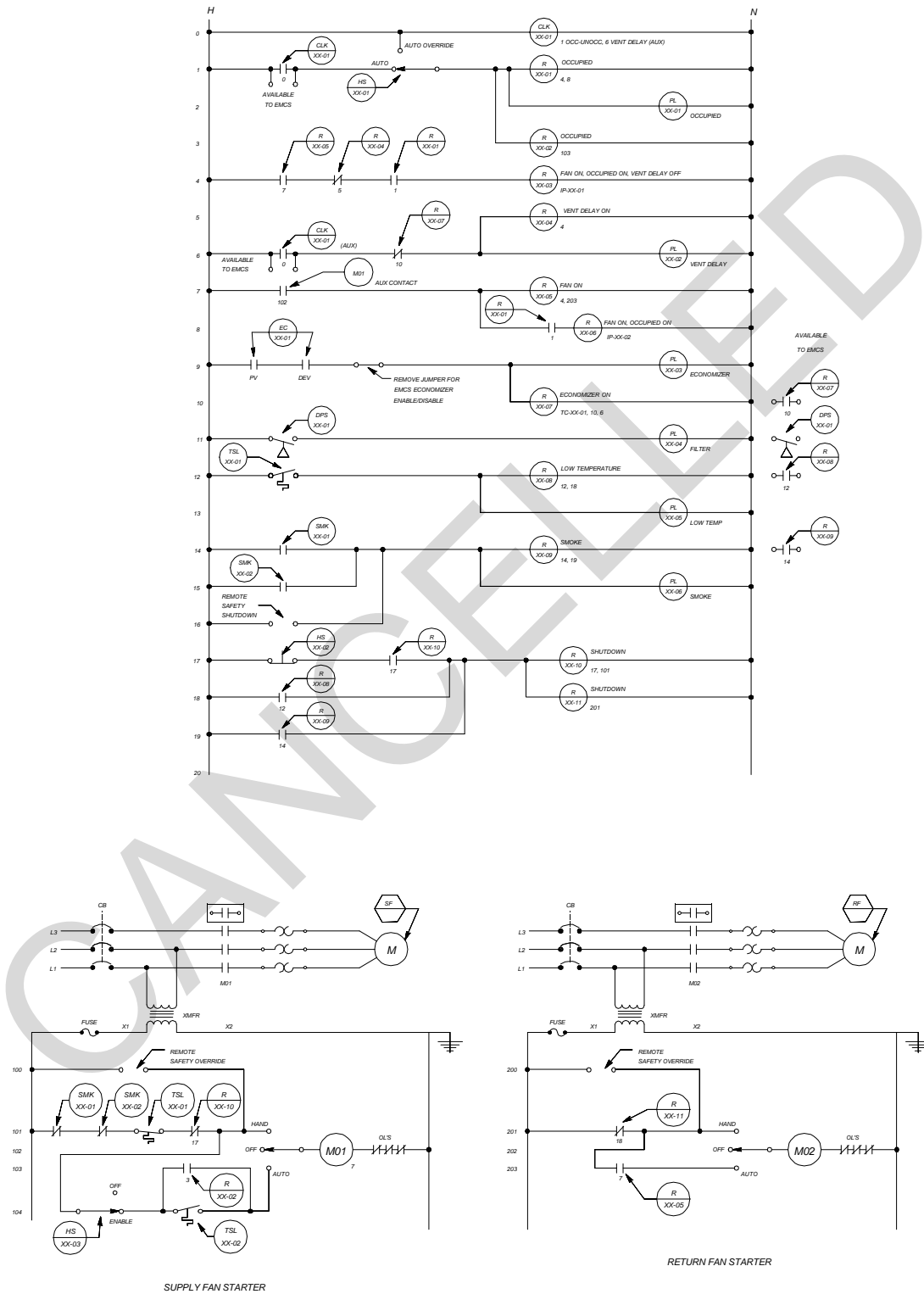
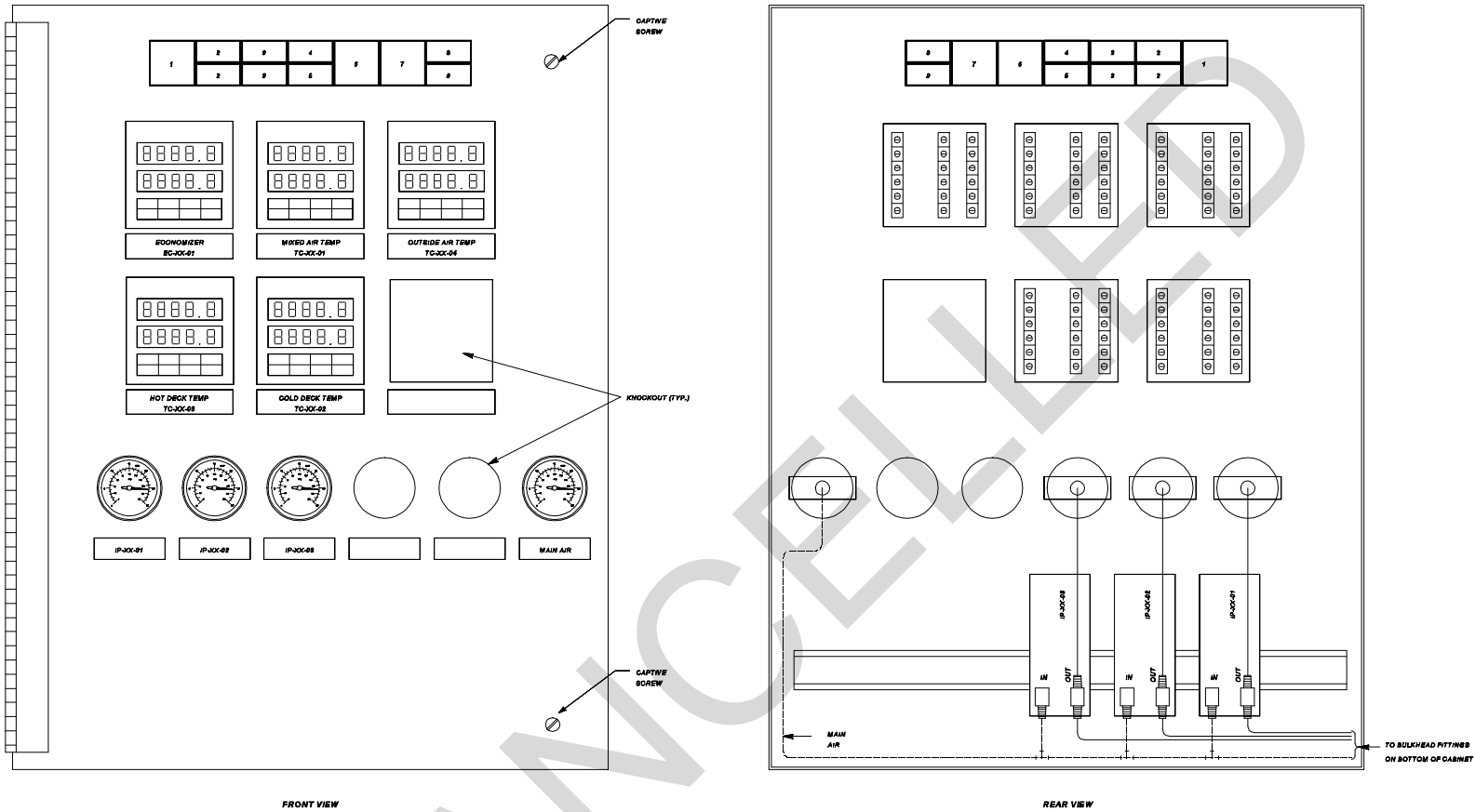

Figure 4-15b. Control system ladder diagram for dual-duct HVAC system.

LOOP CONTROL FUNCTION	DEVICE NUMBER	DEVICE FUNCTION	SETPOINT	RANGE	ADDITIONAL PARAMETERS
MIXED AIR TEMPERATURE	DA-XX-01 DA-XX-02 DA-XX-03	DAMPER ACTUATOR	---	21-103 kPa (3 - 15 PSIG)	---
	MPB-XX-01	MINIMUM POSITION SWITCH	---	---	SET MIN OA L _{1/2} (CFM) EQUAL TO ___ L _{1/2} (___ CFM)
	TC-XX-01	MIXED AIR TEMPERATURE CONTROLLER	13 DEG C (55 DEG F)	4 TO 85 DEG C (40 TO 140 DEG F)	---
	TT-XX-01	MIXED AIR TEMPERATURE TRANSMITTER	---	4 TO 85 DEG C (40 TO 140 DEG F)	---
	TT-XX-02	OUTSIDE AIR TEMPERATURE TRANSMITTER	---	-34 TO 84 DEG C (-30 TO +130 DEG F)	---
	TT-XX-03	RETURN AIR TEMPERATURE TRANSMITTER	---	-34 TO 84 DEG C (-30 TO +130 DEG F)	---
	EC-XX-01	ECONOMIZER CONTROLLER	PV CONTACT CLOSE AT ___ DEG C (___ DEG F) OPEN AT ___ DEG C (___ DEG F)	-34 TO 84 DEG C (-30 TO +130 DEG F)	DEV CONTACT CLOSE @ DELTA T= ___ DEG C (___ DEG F) OPEN @ DELTA T= ___ DEG C (___ DEG F)
	TSL-XX-01	FREEZE/TAT	2 DEG C (35 DEG F)	3 DEG C DIFFERENTIAL (5 DEG F DIFFERENTIAL)	---
	DPB-XX-01	FILTER ALARM	PER FILTER MANUFACTURER'S RECOMMENDATION	PER FILTER MANUFACTURER'S RECOMMENDATION	---
SPACE LOW TEMPERATURE	TSL-XX-02	NIGHT STAT - SPACE LOW TEMPERATURE PROTECTION	13 DEG C (55 DEG F)	3 DEG C DIFFERENTIAL (5 DEG F DIFFERENTIAL)	---
COLD DUCT AIR TEMPERATURE	VLV-XX-01	COOLING COIL VALVE	---	21-103 kPa (3 - 15 PSIG)	K _v = ___ (Cv = ___) CLOSE AGAINST ___ kPa (___ PSIG)
	TC-XX-02	COLD DUCT TEMPERATURE CONTROLLER	14 DEG C (57 DEG F)	4 TO 85 DEG C (40 TO 140 DEG F)	---
	TT-XX-04	COLD DUCT TEMPERATURE TRANSMITTER	---	4 TO 85 DEG C (40 TO 140 DEG F)	---
HOT DUCT AIR TEMPERATURE	VLV-XX-02	HEATING COIL VALVE	---	21-103 kPa (3 - 15 PSIG)	K _v = ___ (Cv = ___) CLOSE AGAINST ___ kPa (___ PSIG)
	TC-XX-03	HOT DUCT TEMPERATURE CONTROLLER	OA TEMP = -18 DEG C (0 DEG F), HOT DUCT = 49 DEG C (120 DEG F) OA TEMP = 16 DEG C (60 DEG F), HOT DUCT = 52 DEG C (90 DEG F)	PV = 4 TO 85 DEG C (40 TO 140 DEG F) CPA = 32 TO 49 DEG C (90 TO 120 DEG F)	CPA LO-LIMIT = 23 DEG C (90 DEG F) CPA HI-LIMIT = 49 DEG C (120 DEG F)
	TC-XX-04	OUTSIDE AIR TEMPERATURE CONTROLLER	SET POINT = -1 DEG C (30 DEG F) PROPORTIONAL BAND = 37.5 % MANUAL RESET = 50 %	-34 TO 84 DEG C (-30 TO +130 DEG F)	---
	TT-XX-05	HOT DUCT TEMPERATURE TRANSMITTER	---	4 TO 85 DEG C (40 TO 140 DEG F)	---
OCCUPIED MODE	CLK-XX-01 CONTACT	965 DAY SCHEDULE	---	NORMAL SCHEDULE (96F) CONTACT CLOSED: 0700 HRS CONTACT OPEN: 1700 HRS	CONTACT OPEN: SAT, SUN
VENTILATION DELAY MODE	CLK-XX-01 CONTACT	965 DAY SCHEDULE	---	NORMAL SCHEDULE (96F) CONTACT CLOSED: 0700 HRS CONTACT OPEN: 0800 HRS	↓

NOTE: OTHER CONTROL DEVICES SUCH AS I/Ps, RELAYS, AND SIGNAL SELECTORS ARE NOT SHOWN.

Figure 4-15c. Control system equipment for dual-duct HVAC system.



FRONT VIEW

REAR VIEW

SWITCH AND PILOT LIGHT LEGEND

POSITION LEGEND	DEVICE TYPE	IDENTIFIER	POSITION LEGEND	DEVICE TYPE	IDENTIFIER
1 - RESET	NON-ILLUMINATED MOMENTARY CONTACT PUSH BUTTON SWITCH	HB-XX-02	6 - FILTER	PILOT LIGHT	PL-XX-04
2 - AUTOMATO OVERRIDE	ILLUMINATED MAINTAINED CONTACT INTERLOCKED SWITCHES	HB-XX-01	7 - OCC	PILOT LIGHT	PL-XX-01
3 - ENABLE/OFF	ILLUMINATED MAINTAINED CONTACT INTERLOCKED SWITCHES	HB-XX-03	8 - VENT DELAY	PILOT LIGHT	PL-XX-02
4 - LOW TEMP	PILOT LIGHT	PL-XX-05	9 - ECONOMIZER	PILOT LIGHT	PL-XX-03
5 - SMOKE	PILOT LIGHT	PL-XX-06			

Figure 4-15d. Control panel interior door layout for dual-duct HVAC system.

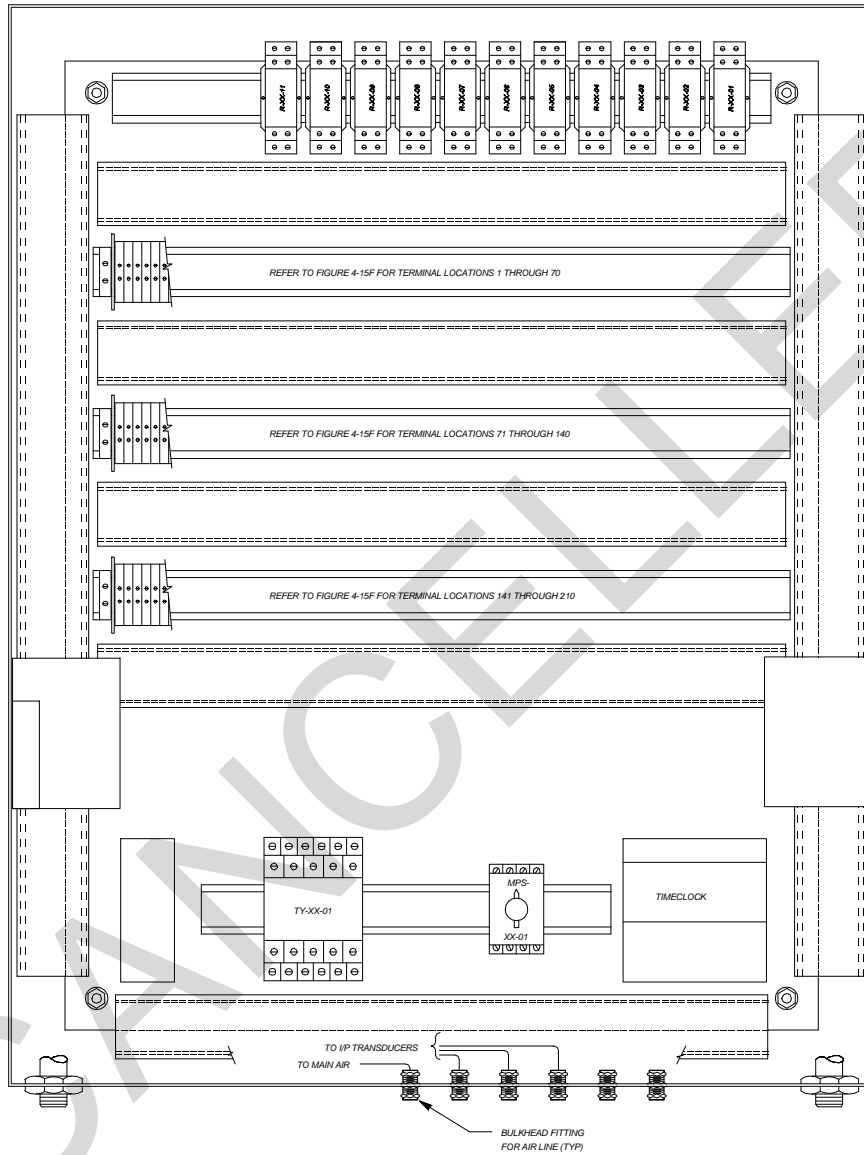

Figure 4-15e. Control panel back panel layout for dual-duct HVAC system.

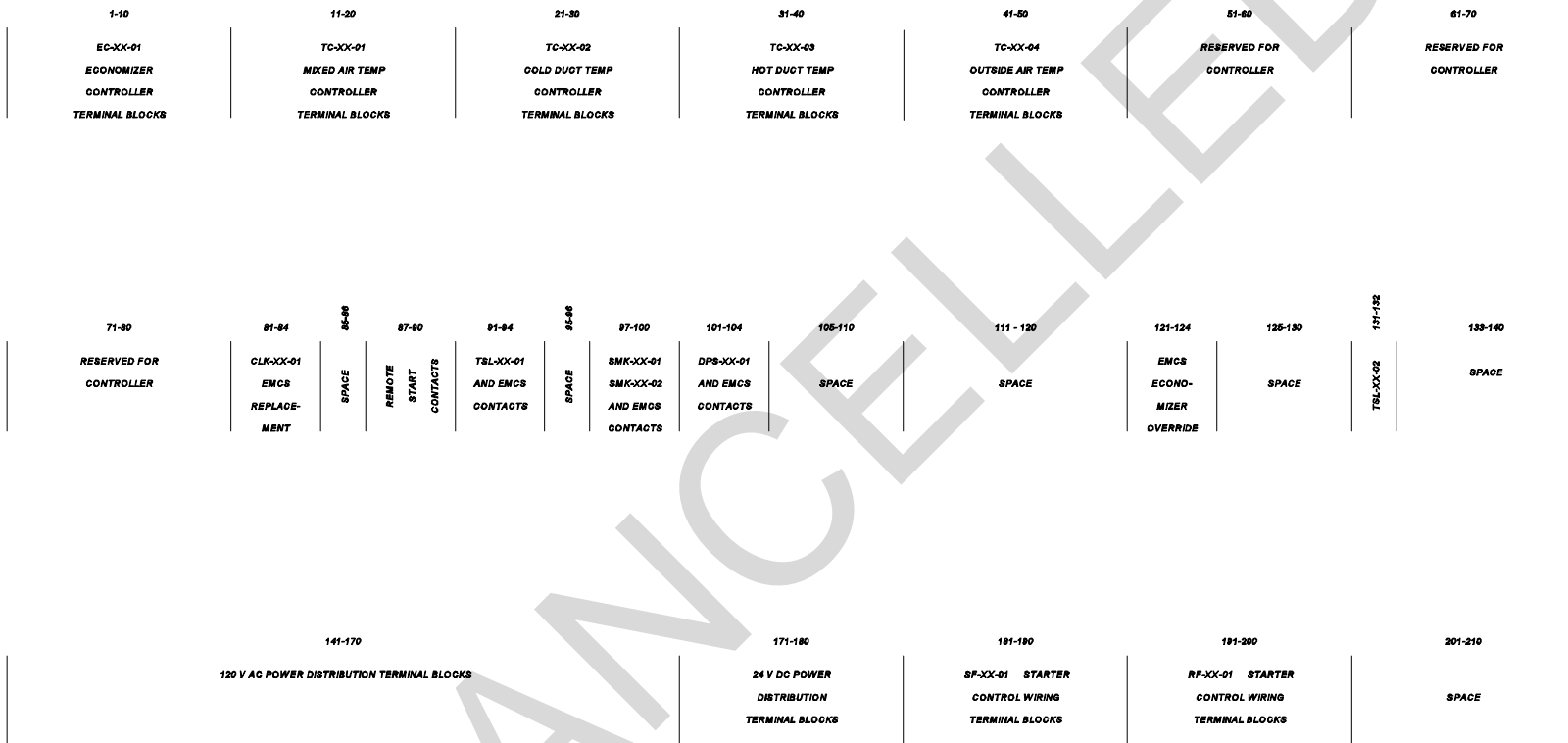

Figure 4-15f. Control panel terminal block layout for dual-duct HVAC system.

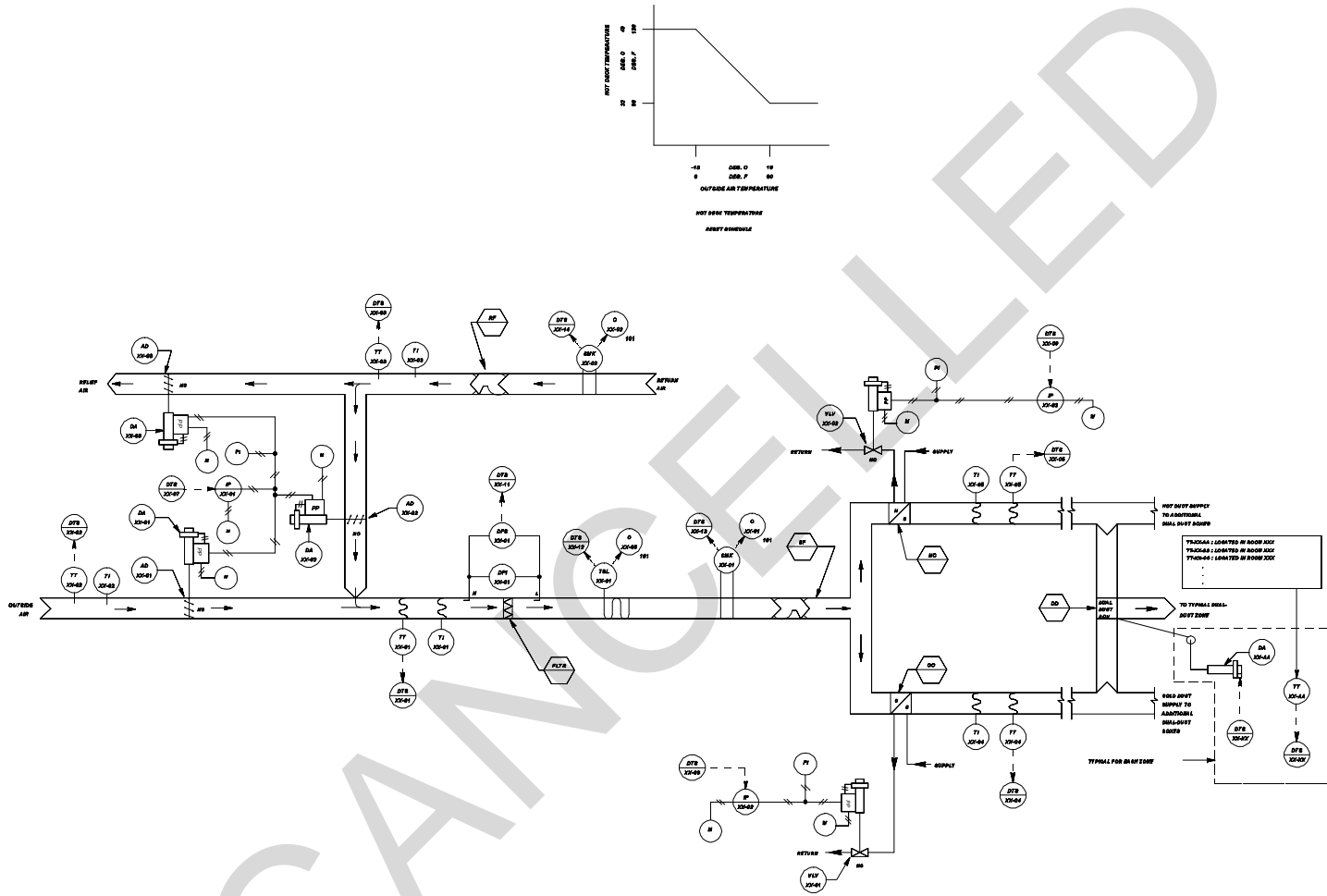

Figure 4-15g. DDC control system schematic for dual-duct HVAC system.

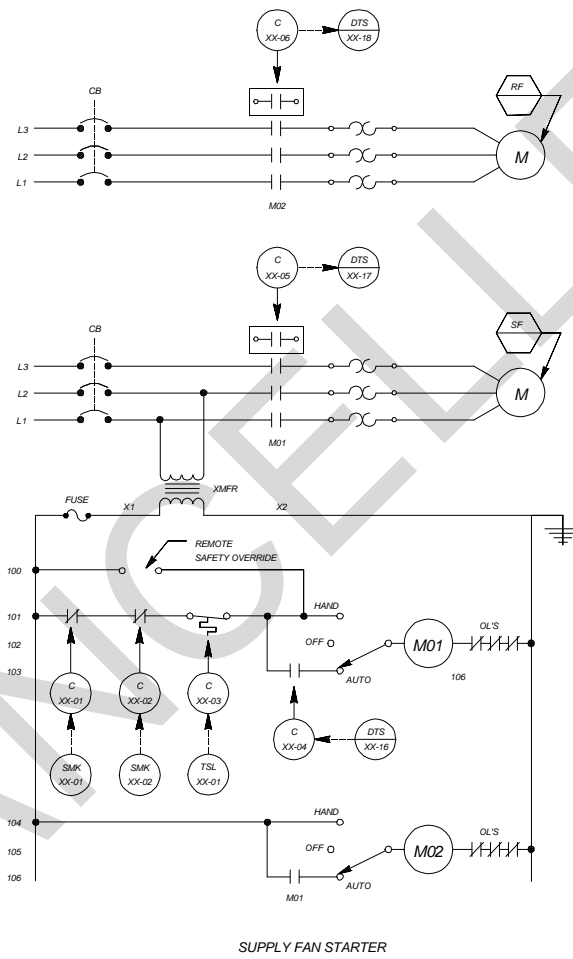

Figure 4-15h. DDC control system ladder diagram for dual-duct HVAC system.

SENSOR SCHEDULE

IDENTIFIER	FUNCTION	RANGE
TT-XX-01	MIXED AIR TEMPERATURE TRANSMITTER	4 TO 60 DEG C (40 TO 140 DEG F)
TT-XX-02	OUTSIDE AIR TEMPERATURE TRANSMITTER	-34 TO 54 DEG C (-30 TO +130 DEG F)
TT-XX-03	RETURN AIR TEMPERATURE TRANSMITTER	4 TO 60 DEG C (40 TO 140 DEG F)
TT-XX-04	COLD DECK TEMPERATURE TRANSMITTER	4 TO 60 DEG C (40 TO 140 DEG F)
TT-XX-05	HOT DECK TEMPERATURE TRANSMITTER	4 TO 60 DEG C (40 TO 140 DEG F)
TT-XX-AA	SPACE TEMPERATURE TRANSMITTER	10 TO 30 DEG C (50 TO 85 DEG F)

CONTROL VALVE SCHEDULE

IDENTIFIER	FUNCTION	TYPE	RANGE	Cv (Kv)	CLOSE-OFF RATING	REMARKS
VLV-XX-01	COOLING COIL VALVE	2-WAY, MODULATING	21 - 103 kPa (3-15 PSIG)	XX	XX kPa (XX PSIG)	
VLV-XX-02	HEATING COIL VALVE	2-WAY, MODULATING	21 - 103 kPa (3-15 PSIG)	XX	XX kPa (XX PSIG)	

CONTROL DAMPER SCHEDULE

IDENTIFIER	FUNCTION	TYPE	SIZE	RANGE	REMARKS
AD-XX-01	OUTSIDE AIR	MODULATING	W x H (mm) (WW" x HH")	21 - 103 kPa (3-15 PSIG)	DUCT SIZE, PARALLEL BLADE
AD-XX-02	RETURN AIR	MODULATING	W x H (mm) (WW" x HH")		DUCT SIZE, PARALLEL BLADE
AD-XX-03	RELIEF AIR	MODULATING	W x H (mm) (WW" x HH")	↓	DUCT SIZE, PARALLEL BLADE
DA-XX-XX	ZONE TERMINAL BOX DAMPER	MODULATING	—	—	

OPERATING PARAMETERS

FUNCTION	SETPPOINT	REMARKS
MINIMUM OUTSIDE AIR	XXXX L/s (XXXX CFM)	
MIXED AIR TEMPERATURE	XX DEG C (XX DEG F)	
COLD DECK TEMPERATURE	XX DEG C (XX DEG F)	
HOT DECK TEMPERATURE		RESET SCHEDULE: 0A TEMP = XX DEG C (XX DEG F); HOT DECK SETPOINT = XX DEG C (XX DEG F) 0A TEMP = XX DEG C (XX DEG F); HOT DECK SETPOINT = XX DEG C (XX DEG F)
SPACE TEMP. (NIGHT SETBACK)	XX DEG C (XX DEG F)	(HEATING ONLY)
ECONOMIZER MODE		ECONOMIZER MODE = ON, WHEN CONDITION 1 AND CONDITION 2 ARE BOTH SATISFIED. CONDITION 1: RETURN AIR TEMP. > XX DEG C (XX DEG F) CONDITION 2: RETURN AIR TEMP. MINUS OUTSIDE AIR TEMP. > XX DEG C (XX DEG F)
OCCUPIED MODE		MONDAY - FRIDAY : 0705 HRS - 1700 HRS
VENT DELAY MODE		MONDAY - FRIDAY : 0700 HRS - 0800 HRS
FREEZE STAT	XX DEG C (XX DEG F)	
FILTER ALARM	XX kPa (XX IN. WATER)	

Figure 4-15i. DDC control system equipment for dual-duct HVAC system.

	HARDWARE																SOFTWARE																	
	OUTPUT								INPUT								ALARMS					APPLICATION PROGRAMS												
	DIGITAL				ANALOG				DIGITAL				ANALOG				DIGITAL		ANALOG															
	CONTROL RELAY				POSITION ADJUSTMENT				AUXILIARY CONTACT					TEMPERATURE	% RELATIVE HUMIDITY	PSIA, PSIA, PSD	FLOW	CONTACT CLOSURE			HIGH LIMIT	LOW LIMIT	RUN TIME	SCHEDULED START/STOP	OPTIMUM START/STOP	DUTY CYCLING	DEMAND LIMITING	DAY/NIGHT SETBACK	ECONOMIZER	VENTILATION/REGULATION	NOTFOLD DECK/RESET			FAILURE MODE
SUPPLY FAN	1							1									X				X		X	X	X	X								
RETURN FAN	1							1									X				X		X	X	X	X								
MIXED AIR													1							X	X													
OUTSIDE AIR													1							X	X													
RETURN AIR													1							X	X													
COLD DECK													1							X	X													
HOT DECK													1							X	X											X		
MIXED AIR DAMPERS									1																						X	X		
COOLING COIL VALVE									1																									
HEATING COIL VALVE									1																									
FILTER									1									X																
FREEZESTAT									1									X																
SMOKE DETECTOR									2									X																
SPACE TEMP													X							X	X						X							
ZONE DAMPER					X																													

-- C - LAST COMMAND
H - HIGH VALUE
L - LOW VALUE
O - ON (OPEN)
F - OFF (CLOSED)

DATA TERMINAL STRIP LAYOUT

DEVICE NO.	DESCRIPTION	TYPE
1	TT-XX-01 MIXED AIR TEMPERATURE	AI
2	TT-XX-02 OUTSIDE AIR TEMPERATURE	AI
3	TT-XX-03 RETURN AIR TEMPERATURE	AI
4	TT-XX-04 COLD DECK TEMPERATURE	AI
5	TT-XX-05 HOT DECK TEMPERATURE	AI
6		
7	IP-XX-01 MIXED AIR DAMPERS	AO
8	IP-XX-02 COOLING COIL VALVE	AO
9	IP-XX-03 HEATING COIL VALVE	AO
10		
11	DPS-XX-01 FILTER ALARM	DI
12	TSL-XX-01 FREEZESTAT	DI
13	SMK-XX-01 SUPPLY AIR SMOKE DETECTOR	DI
14	SMK-XX-02 RETURN AIR SMOKE DETECTOR	DI
15		
16	C-XX-04 SUPPLY FAN START/STOP	DO
17	C-XX-05 SUPPLY FAN STATUS	DI
18	C-XX-06 RETURN FAN STATUS	DI
19		
20	TT-XX-AA SPACE TEMP - ZONE AA	AI
21	DA-XX-AA ZONE DAMPER - ZONE AA	AO
22	TT-XX-BB SPACE TEMP - ZONE BB	AI
23	DA-XX-BB ZONE DAMPER - ZONE BB	AO
24	TT-XX-CC SPACE TEMP - ZONE CC	AI
25	DA-XX-CC ZONE DAMPER - ZONE CC	AO
26		
27		
28		
29		
30		

Figure 4-15j. DDC control system I/O table and data terminal strip layout for dual-duct HVAC system.

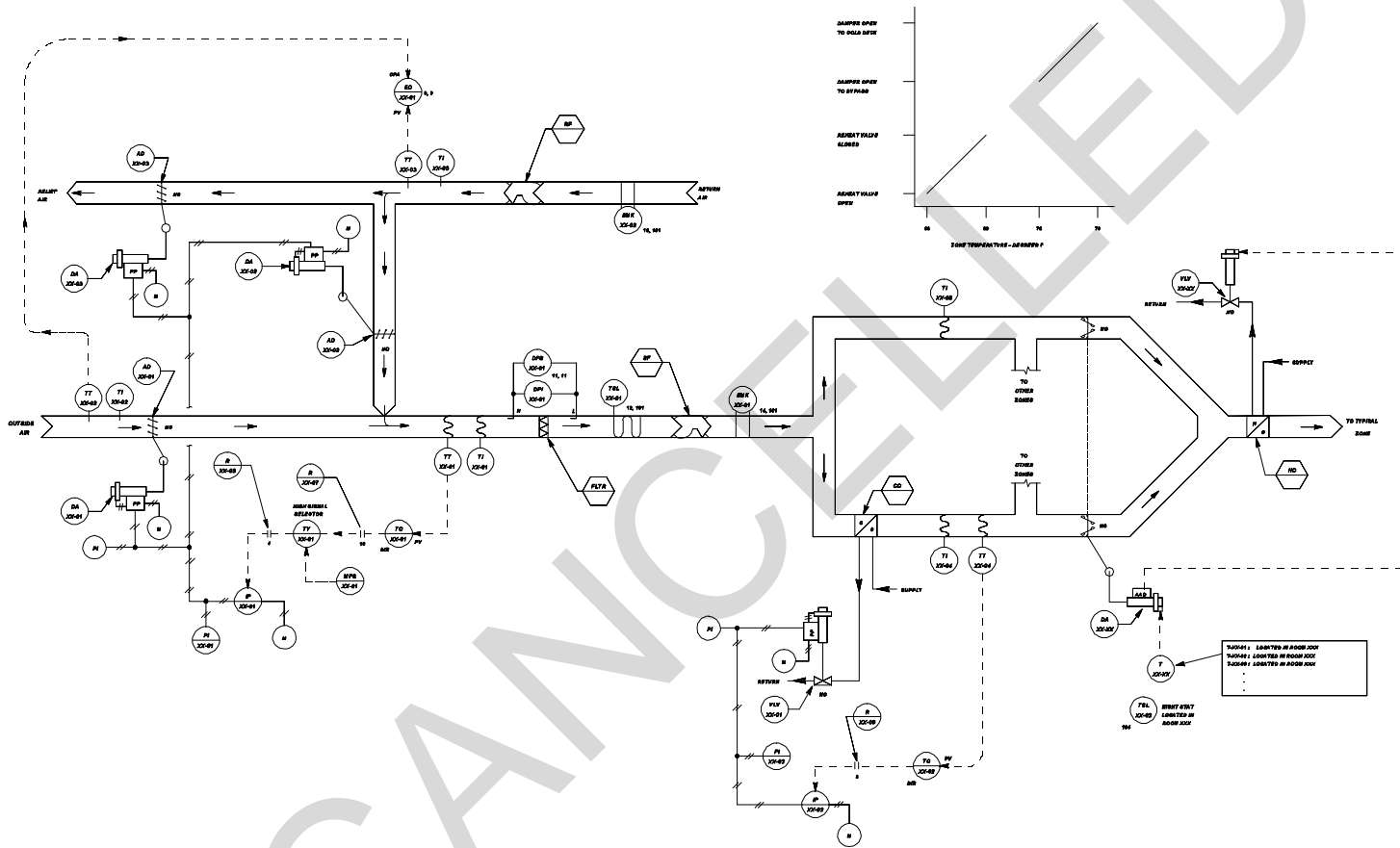
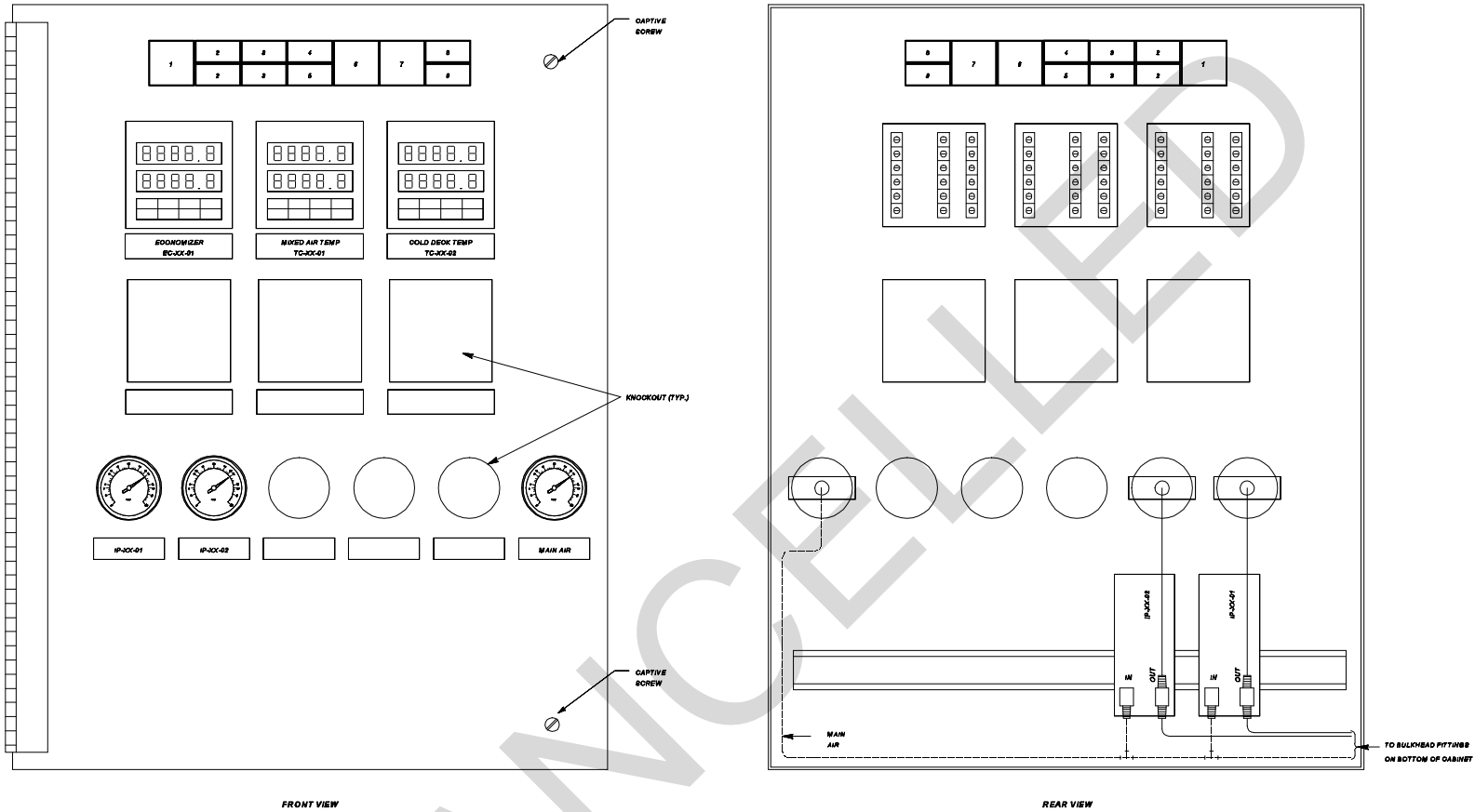

Figure 4-16a. Control system schematic for bypass multizone HVAC system.

LOOP CONTROL FUNCTION	DEVICE NUMBER	DEVICE FUNCTION	SETPOINT	RANGE	ADDITIONAL PARAMETERS
MIXED AIR TEMPERATURE	DA-XX-01 DA-XX-02 DA-XX-03	DAMPER ACTUATOR	---	21-103 kPa (3 - 15 PSIG)	---
	MPB-XX-01	MINIMUM POSITION SWITCH	---	---	SET MIN OA L/s (CFM) EQUAL TO ___ L/s (___ CFM)
	TC-XX-01	MIXED AIR TEMPERATURE CONTROLLER	18 DEG C (65 DEG F)	4 TO 60 DEG C (40 TO 140 DEG F)	---
	TT-XX-01	MIXED AIR TEMPERATURE TRANSMITTER	---	4 TO 60 DEG C (40 TO 140 DEG F)	---
	TT-XX-02	OUTSIDE AIR TEMPERATURE TRANSMITTER	---	-34 TO 64 DEG C (-30 TO +150 DEG F)	---
	TT-XX-03	RETURN AIR TEMPERATURE TRANSMITTER	---	-34 TO 64 DEG C (-30 TO +150 DEG F)	---
	EC-XX-01	ECONOMIZER CONTROLLER	PIV CONTACT CLOSE AT ___ DEG C (___ DEG F) OPEN AT ___ DEG C (___ DEG F)	-34 TO 64 DEG C (-30 TO +150 DEG F)	DEV CONTACT CLOSE @ DELTA T= ___ DEG C (___ DEG F) OPEN @ DELTA T= ___ DEG C (___ DEG F)
	TSL-XX-01	FREEZE STAT	2 DEG C (35 DEG F)	3 DEG C DIFFERENTIAL (5 DEG F DIFFERENTIAL)	---
	DPS-XX-01	FILTER ALARM	PER FILTER MANUFACTURER'S RECOMMENDATION	PER FILTER MANUFACTURER'S RECOMMENDATION	---
	SPACE LOW TEMPERATURE	TSL-XX-02	NIGHT STAT - SPACE LOW TEMPERATURE PROTECTION	18 DEG C (65 DEG F)	3 DEG C DIFFERENTIAL (5 DEG F DIFFERENTIAL)
COLD DECK AIR TEMPERATURE	VLV-XX-01	COOLING COIL VALVE	---	21-103 kPa (3 - 15 PSIG)	Kv = ___ (Cv = ___) CLOSE AGAINST ___ kPa (___ PSIG)
	TC-XX-02	COLD DECK TEMPERATURE CONTROLLER	14 DEG C (57 DEG F)	4 TO 60 DEG C (40 TO 140 DEG F)	---
	TT-XX-04	COLD DECK TEMPERATURE TRANSMITTER	---	4 TO 60 DEG C (40 TO 140 DEG F)	---
OCCUPIED MODE	CLK-XX-01 CONTACT	365 DAY SCHEDULE	---	NORMAL SCHEDULE (86-F) CONTACT CLOSED: 0700 HRS CONTACT OPEN: 1700 HRS	CONTACT OPEN: SAT, SUN
VENTILATION DELAY MODE	CLK-XX-01 CONTACT	365 DAY SCHEDULE	---	NORMAL SCHEDULE (86-F) CONTACT CLOSED: 0700 HRS CONTACT OPEN: 0800 HRS	↓ Kv = ___ (Cv = ___) CLOSE AGAINST ___ kPa (___ PSIG)
SPACE AA	VLV-XX-AA	ZONE HEATING COIL VALVE	---	0 TO 40 % OF THERMOSTAT OUTPUT	---
	DA-XX-AA	ZONE DAMPER ACTUATOR	---	60 TO 100 % OF THERMOSTAT OUTPUT	---
	T-XX-AA	ZONE THERMOSTAT	20 DEG C (68 DEG F) - HEATING 23 DEG C (74 DEG F) - COOLING	---	---
SPACE BB					

NOTE: OTHER CONTROL DEVICES SUCH AS I/Ps, RELAYS, AND SIGNAL SELECTORS ARE NOT SHOWN.

Figure 4-16c. Control system equipment for bypass multizone HVAC system.



FRONT VIEW

REAR VIEW

POSITION LEGEND

1 - RESET
2 - AUTO/AUTO OVERRIDE
3 - ENABLE/OFF
4 - LOW TEMP
6 - SMOKE

DEVICE TYPE

NON-ILLUMINATED MOMENTARY CONTACT PUSH BUTTON SWITCH
ILLUMINATED MAINTAINED CONTACT INTERLOCKED SWITCHES
ILLUMINATED MAINTAINED CONTACT INTERLOCKED SWITCHES
PILOT LIGHT
PILOT LIGHT

IDENTIFIER

HS-XX-02
HS-XX-01
HS-XX-03
PL-XX-05
PL-XX-06

SWITCH AND PILOT LIGHT LEGEND

POSITION LEGEND

6 - FILTER
7 - OCC
8 - VENT DELAY
9 - ECONOMIZER

DEVICE TYPE

PILOT LIGHT
PILOT LIGHT
PILOT LIGHT
PILOT LIGHT

IDENTIFIER

PL-XX-04
PL-XX-01
PL-XX-02
PL-XX-03

Figure 4-16d. Control panel interior door layout for bypass multizone HVAC system.

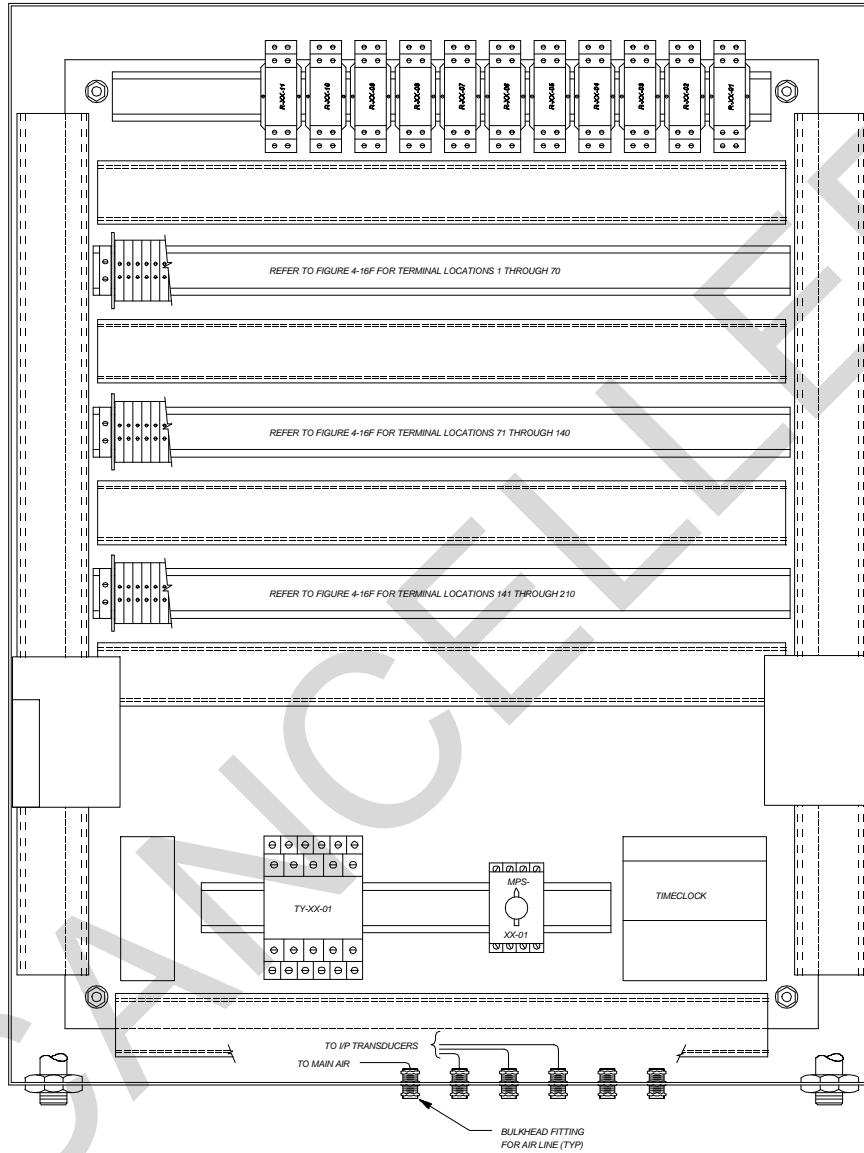

Figure 4-16e. Control panel back panel layout for bypass multizone HVAC system.

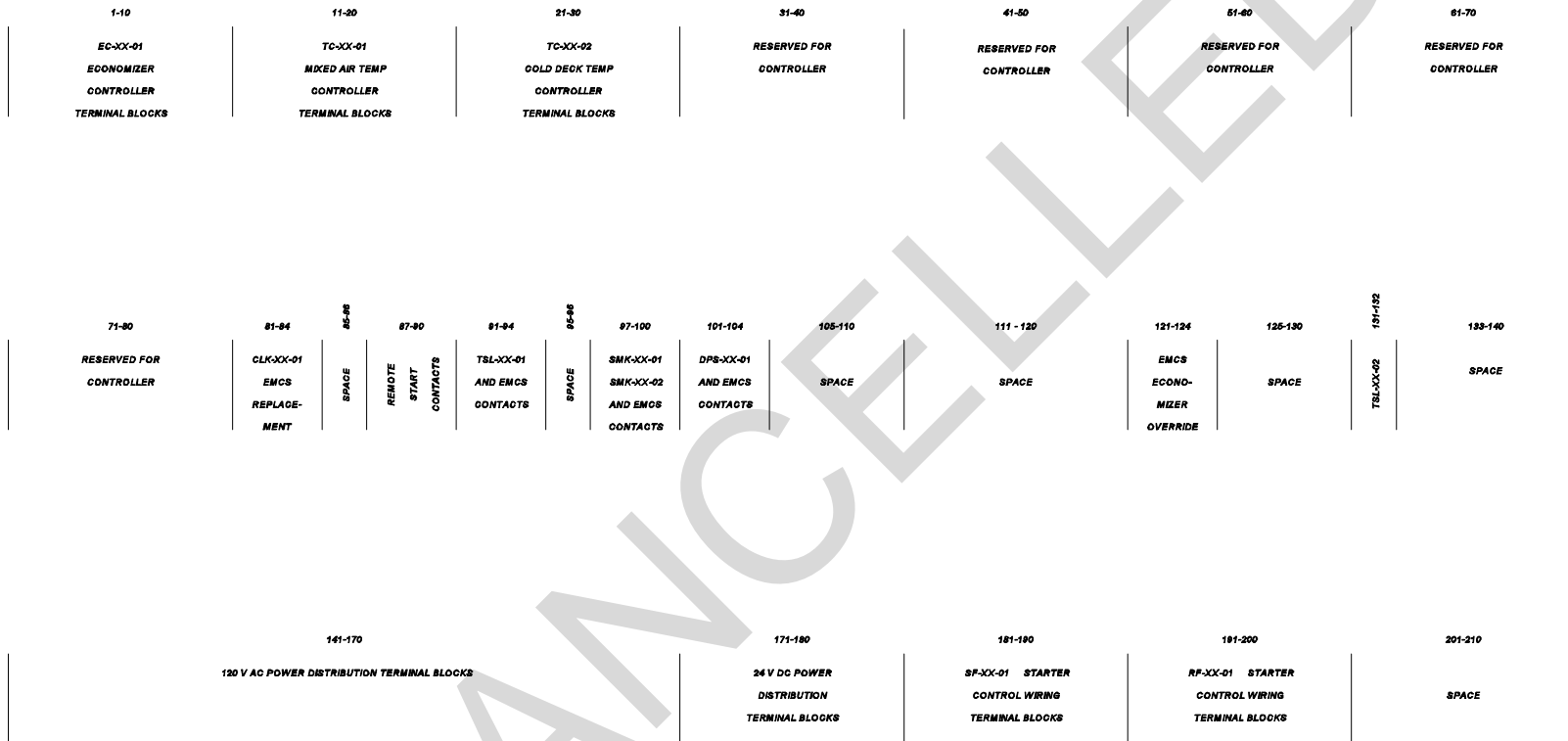

Figure 4-16f. Control panel terminal block layout for bypass multizone HVAC system.

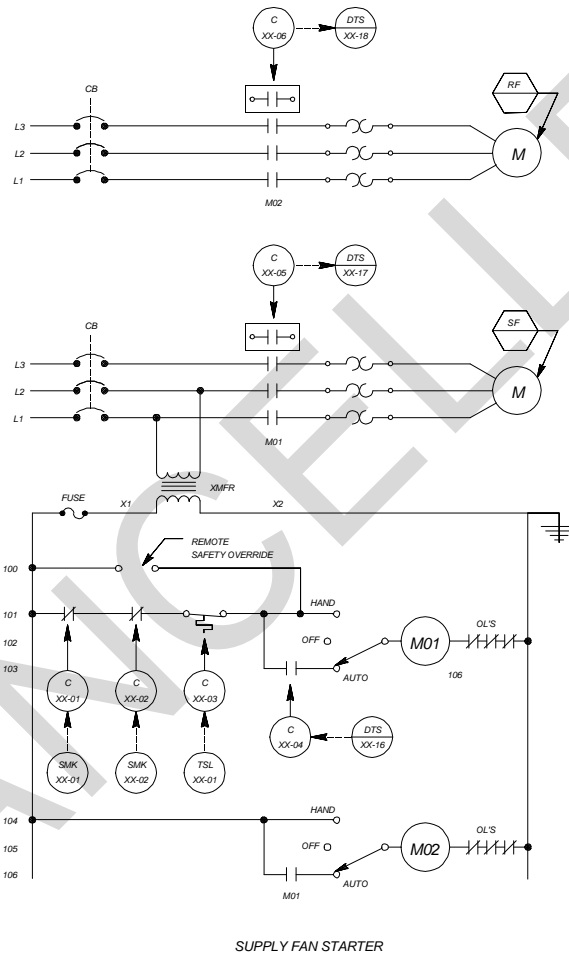

Figure 4-16h. DDC control system ladder diagram for bypass multizone HVAC system.

SENSOR SCHEDULE

IDENTIFIER	FUNCTION	RANGE
TT-XX-01	MIXED AIR TEMPERATURE TRANSMITTER	4 TO 60 DEG C (40 TO 140 DEG F)
TT-XX-02	OUTSIDE AIR TEMPERATURE TRANSMITTER	-34 TO 54 DEG C (-30 TO +130 DEG F)
TT-XX-03	RETURN AIR TEMPERATURE TRANSMITTER	4 TO 60 DEG C (40 TO 140 DEG F)
TT-XX-04	COLD DECK TEMPERATURE TRANSMITTER	4 TO 60 DEG C (40 TO 140 DEG F)
TT-XX-AA	SPACE TEMPERATURE TRANSMITTER	10 TO 30 DEG C (50 TO 85 DEG F)

CONTROL VALVE SCHEDULE

IDENTIFIER	FUNCTION	TYPE	RANGE	Cv (Kv)	CLOSE-OFF RATING	REMARKS
VLV-XX-01	COOLING COIL VALVE	2-WAY, MODULATING	21 - 103 kPa (3-15 PSIG)	XX	XX kPa (XX PSIG)	
VLV-XX-02	ZONE HEATING COIL VALVE	2-WAY, MODULATING	—	XX	XX kPa (XX PSIG)	

CONTROL DAMPER SCHEDULE

IDENTIFIER	FUNCTION	TYPE	SIZE	RANGE	REMARKS
AD-XX-01	OUTSIDE AIR	MODULATING	W x H (mm) (WW" x HH")	21 - 103 kPa (3-15 PSIG)	DUCT SIZE, PARALLEL BLADE
AD-XX-02	RETURN AIR	MODULATING	W x H (mm) (WW" x HH")	—	DUCT SIZE, PARALLEL BLADE
AD-XX-03	RELIEF AIR	MODULATING	W x H (mm) (WW" x HH")	—	DUCT SIZE, PARALLEL BLADE
DA-XX-XX	ZONE DAMPER	MODULATING	—	—	

OPERATING PARAMETERS

FUNCTION	SETPOINT	REMARKS
MINIMUM OUTSIDE AIR	XXXX L/s (XXXX CFM)	
MIXED AIR TEMPERATURE	XX DEG C (XX DEG F)	
COLD DECK TEMPERATURE	XX DEG C (XX DEG F)	
SPACE TEMPERATURE	XX DEG C (XX DEG F) - HTG XX DEG C (XX DEG F) - CLG	
SPACE TEMP. (NIGHT SETBACK)	XX DEG C (XX DEG F)	(HEATING ONLY)
ECONOMIZER MODE		ECONOMIZER MODE = ON, WHEN CONDITION 1 AND CONDITION 2 ARE BOTH SATISFIED. CONDITION 1: RETURN AIR TEMP. > XX DEG C (XX DEG F) CONDITION 2: RETURN AIR TEMP. MINUS OUTSIDE AIR TEMP. > XX DEG C (XX DEG F)
OCCUPIED MODE		MONDAY - FRIDAY : 0705 HRS - 1700 HRS
VENT DELAY MODE		MONDAY - FRIDAY : 0700 HRS - 0900 HRS
FREEZESTAT	XX DEG C (XX DEG F)	
FILTER ALARM	XX kPa (XX IN. WATER)	

Figure 4-16i. DDC control system equipment for bypass multizone HVAC system.

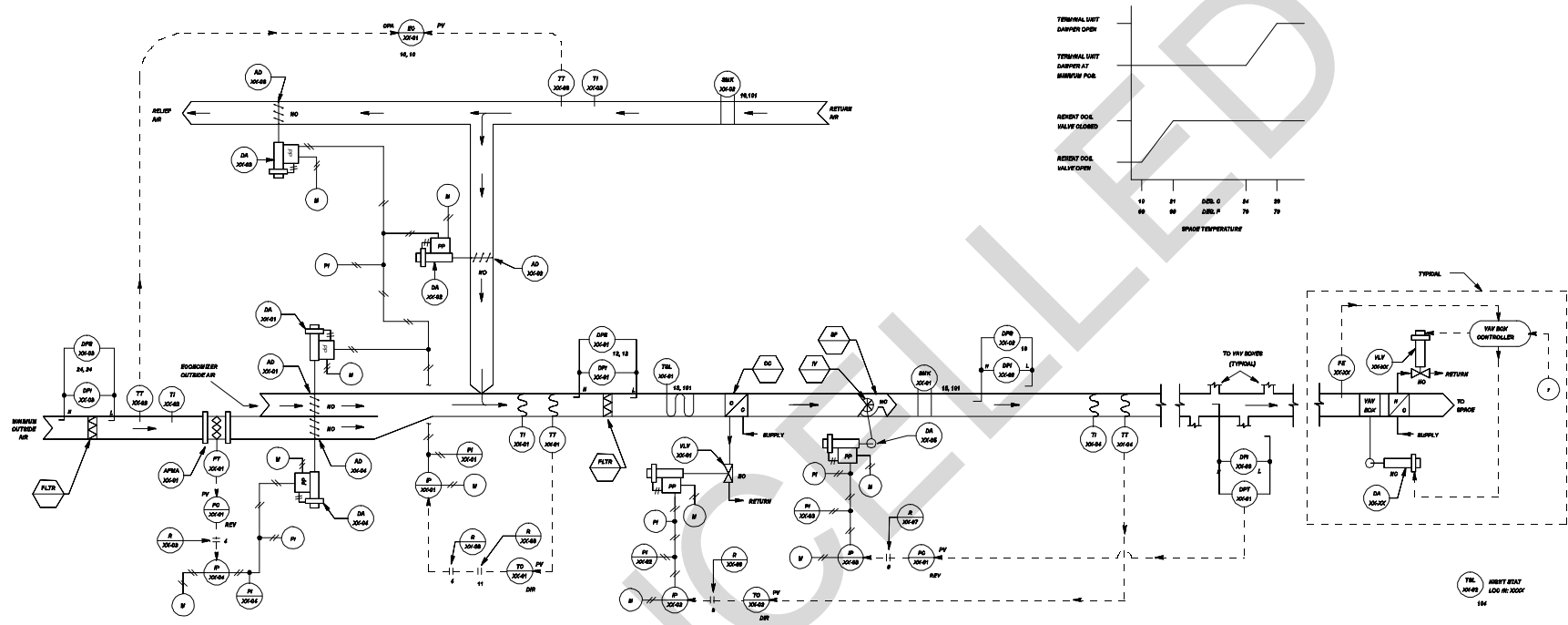

Figure 4-17a. Control system schematic for VAV HVAC system without return fan.

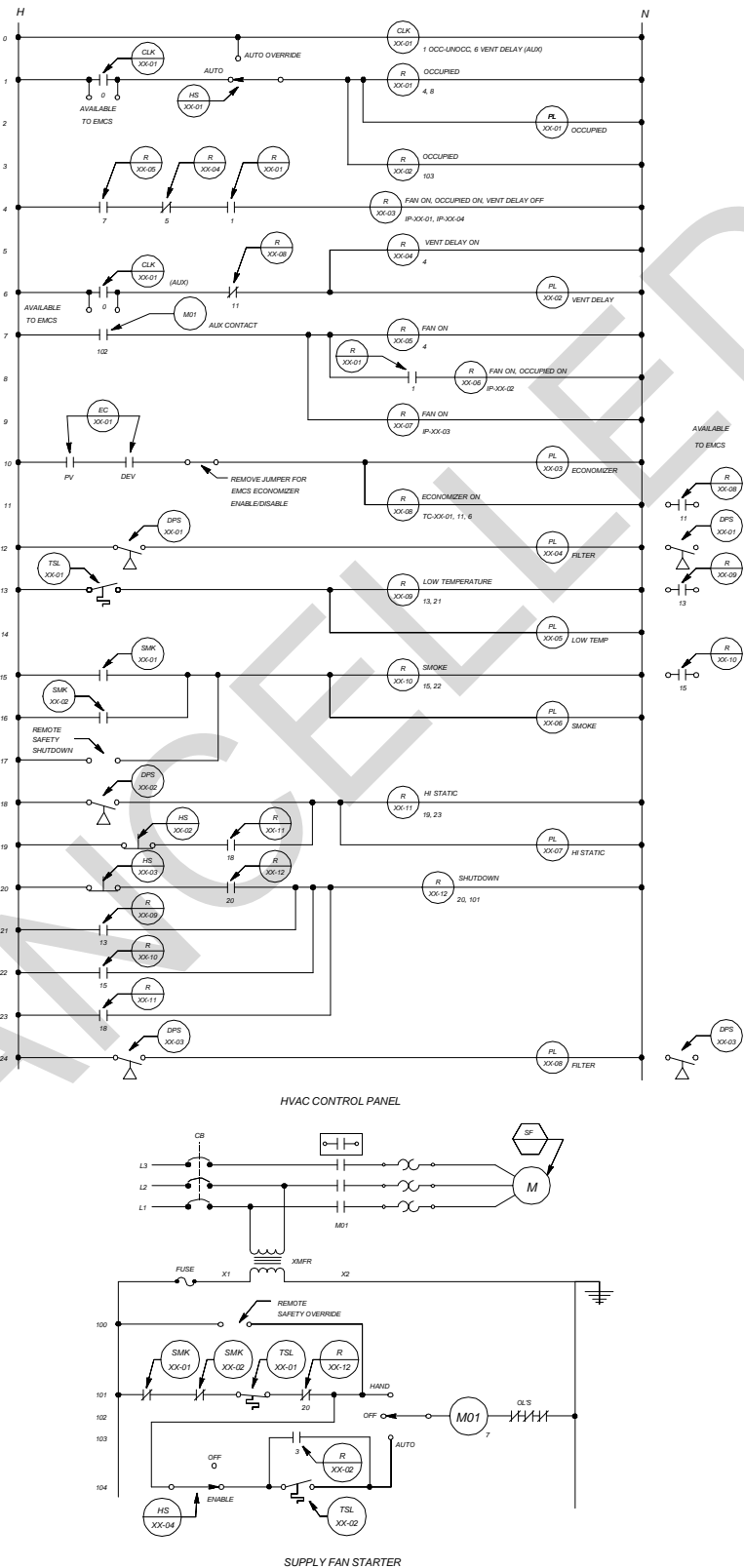

Figure 4-17b. Control system ladder diagram for VAV HVAC system without return fan.

LOOP CONTROL FUNCTION	DEVICE NUMBER	DEVICE FUNCTION	SETPOINT	RANGE	ADDITIONAL PARAMETERS
MIXED AIR TEMPERATURE	DA-XX-01 DA-XX-02 DA-XX-03	DAMPER ACTUATOR	—	21-103 kPa (3-15 PSIG)	—
	TC-XX-01	MIXED AIR TEMPERATURE CONTROLLER	13 DEG C (55 DEG F)	4 TO 60 DEG C (40 TO 140 DEG F)	—
	TT-XX-01	MIXED AIR TEMPERATURE TRANSMITTER	—	4 TO 60 DEG C (40 TO 140 DEG F)	—
	TT-XX-02	OUTSIDE AIR TEMPERATURE TRANSMITTER	—	-34 TO 54 DEG C (-30 TO 130 DEG F)	—
	TT-XX-03	RETURN AIR TEMPERATURE TRANSMITTER	—	-34 TO 54 DEG C (-30 TO 130 DEG F)	—
	EC-XX-01	ECONOMIZER CONTROLLER	PV CONTACT CLOSE AT ___ DEG C (___ DEG F) OPEN AT ___ DEG C (___ DEG F)	-34 TO 54 DEG C (-30 TO 130 DEG F)	DEV CONTACT CLOSE @ DELTA T= ___ DEG C (___ DEG F) OPEN @ DELTA T= ___ DEG C (___ DEG F)
	TSL-XX-01	LOW TEMPERATURE PROTECTION THERMOSTAT	2 DEG C (35 DEG F)	—	—
	DPS-XX-01	FILTER ALARM	PER FILTER MANUFACTURER'S RECOMMENDATION	PER FILTER MANUFACTURER'S RECOMMENDATION	—
MIN. OUTSIDE AIR FLOW	DA-XX-04	DAMPER ACTUATOR	—	21 - 103 kPa (3-15 PSIG)	—
	FC-XX-01	MIN. OUTSIDE AIR DUCT FLOW CONTROLLER	Min OA = ___ L/s (___ cfm)	0 - ___ L/s (0 - ___ CFM)	(SEE NOTE 1)
	FT-XX-01	MIN. OUTSIDE AIR DUCT FLOW TRANSMITTER	—	0 - ___ m/s (0 - ___ FPM)	UPPER RANGE AS REQUIRED (SEE SPECIFICATIONS)
	DPS-XX-03	PRE-FILTER ALARM	PER FILTER MANUFACTURER'S RECOMMENDATION	PER FILTER MANUFACTURER'S RECOMMENDATION	—
SPACE LOW TEMPERATURE	TSL-XX-02	NIGHT STAT - SPACE LOW TEMPERATURE PROTECTION	13 DEG C (55 DEG F)	DIFFERENTIAL = 3 DEG C (5 DEG F)	—
DISCHARGE AIR TEMPERATURE	VLV-XX-01	COOLING COIL VALVE	—	21-103 kPa (3-15 PSIG)	Kv = ___ (Cv = ___) CLOSE AGAINST ___ kPa (___ PSIG)
	TC-XX-02	FAN DISCHARGE TEMPERATURE CONTROLLER	13 DEG C (55 DEG F)	4 TO 60 DEG C (40 TO 140 DEG F)	—
	TT-XX-04	FAN DISCHARGE TEMPERATURE TRANSMITTER	—	4 TO 60 DEG C (40 TO 140 DEG F)	—
SUPPLY DUCT STATIC PRESSURE	DA-XX-05	SUPPLY FAN INLET VANE ACTUATOR	—	21 - 103 kPa (3-15 PSIG)	—
	PC-XX-01	SUPPLY DUCT STATIC PRESSURE CONTROLLER	300 kPa (1.2 INCHES WATER)	0 - 500 kPa (0.0 - 2.0 INCHES WATER)	—
	DPT-XX-01	SUPPLY DUCT STATIC PRESSURE TRANSMITTER	—	0 - 500 kPa (0.0 - 2.0 INCHES WATER)	—
	DPS-XX-02	SUPPLY DUCT - HIGH STATIC PRESSURE SAFETY	—	1000 - 1500 kPa (4.0 - 6.0 INCHES WATER)	—
OCCUPIED MODE	CLK-XX-01 CONTACT	365 DAY SCHEDULE	—	NORMAL SCHEDULE (M-F) CONTACT CLOSED: 0705 HRS CONTACT OPEN: 1700 HRS	CONTACT OPEN: SAT, SUN
VENTILATION DELAY MODE	CLK-XX-01 CONTACT	365 DAY SCHEDULE	—	NORMAL SCHEDULE (M-F) CONTACT CLOSED: 0700 HRS CONTACT OPEN: 0800 HRS	↓
TERMINAL UNITS	VLV-XX-AA	HEATING COIL VALVE SPACE AA	—	—	Kv = ___ (Cv = ___) CLOSE AGAINST ___ kPa (___ PSIG)
	•	•	•	•	•
	VLV-XX-ZZ	HEATING COIL VALVE SPACE ZZ	—	—	Kv = ___ (Cv = ___) CLOSE AGAINST ___ kPa (___ PSIG)

NOTES:

1. Upper range (L/s) of flow controller (FC-XX-XX) = Upper range (m/s) of associated flow transmitter (FT-XX-XX) TIMES the duct area (sq m).
(Upper range (CFM) of flow controller (FC-XX-XX) = Upper range (fpm) of associated flow transmitter (FT-XX-XX) TIMES the duct area (sq ft).

2. OTHER CONTROL DEVICES SUCH AS I/Ps, RELAYS, SIGNAL SELECTERS AND TERMINAL UNIT CONTROLLERS AREN SHOWN.

Figure 4-17c. Control system equipment for VAV HVAC system without return fan.

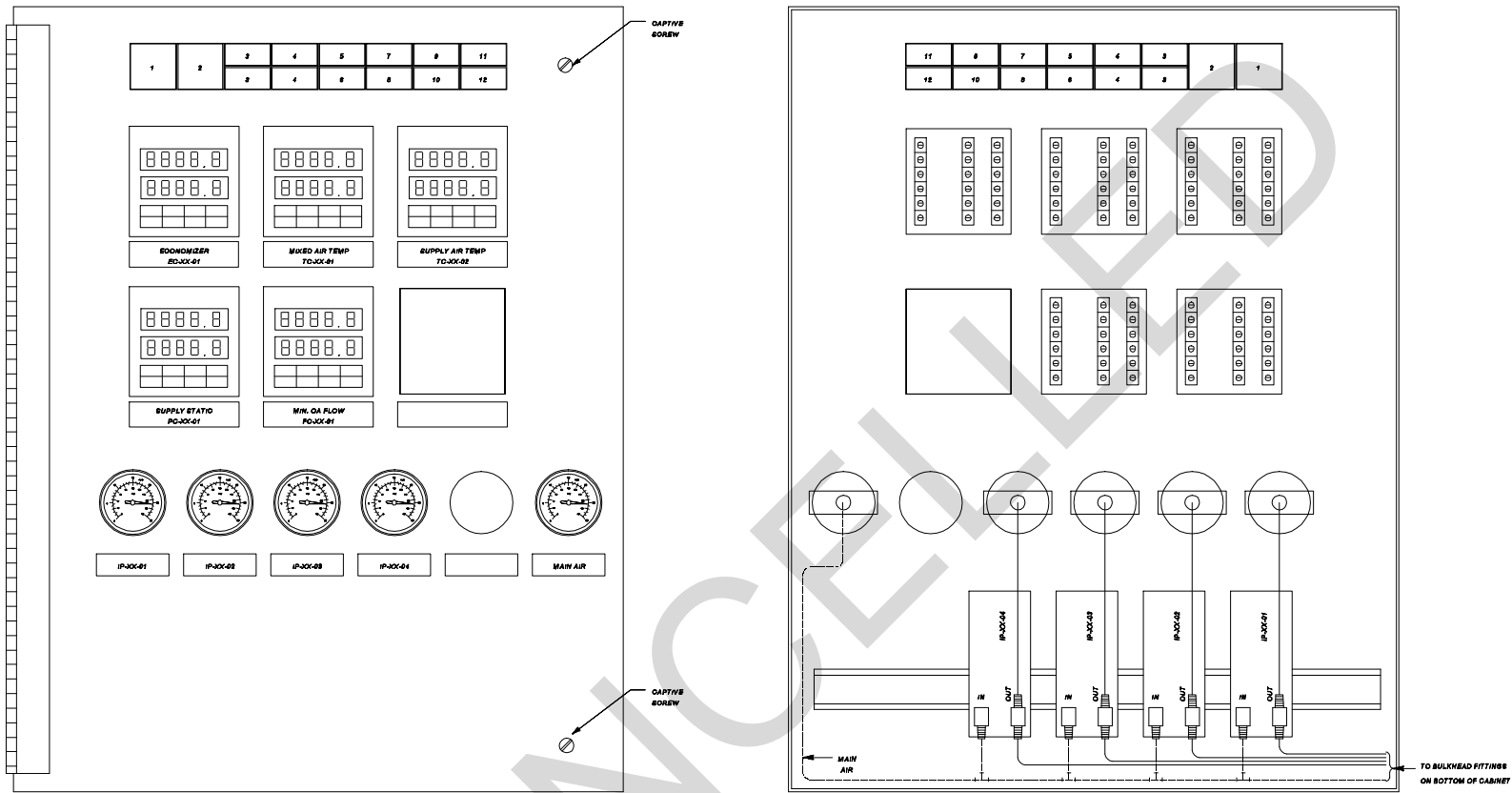

FRONT VIEW

REAR VIEW

SWITCH AND PILOT LIGHT LEGEND

POSITION LEGEND

- 1 - RESET
- 2 - STATIC RESET
- 3 - AUTOMATO OVERRIDE
- 4 - ENABLE/OFF
- 5 - LOW TEMP
- 6 - SMOKE

DEVICE TYPE

- NON-ILLUMINATED MOMENTARY CONTACT PUSH BUTTON SWITCH
- NON-ILLUMINATED MOMENTARY CONTACT PUSH BUTTON SWITCH
- ILLUMINATED MAINTAINED CONTACT INTERLOCKED SWITCHES
- ILLUMINATED MAINTAINED CONTACT INTERLOCKED SWITCHES
- PILOT LIGHT
- PILOT LIGHT

IDENTIFIER

- HS-XX-03
- HS-XX-02
- HS-XX-01
- HS-XX-04
- PL-XX-05
- PL-XX-06

POSITION LEGEND

- 7 - HIGH STATIC
- 8 - FILTER
- 9 - OCC
- 10 - VENT DELAY
- 11 - ECON
- 12 - FILTER

DEVICE TYPE

- PILOT LIGHT
- PILOT LIGHT
- PILOT LIGHT
- PILOT LIGHT
- PILOT LIGHT
- PILOT LIGHT

IDENTIFIER

- PL-XX-07
- PL-XX-04
- PL-XX-01
- PL-XX-02
- PL-XX-03
- PL-XX-08

Figure 4-17d. Control panel interior door layout for VAV HVAC system without return fan.

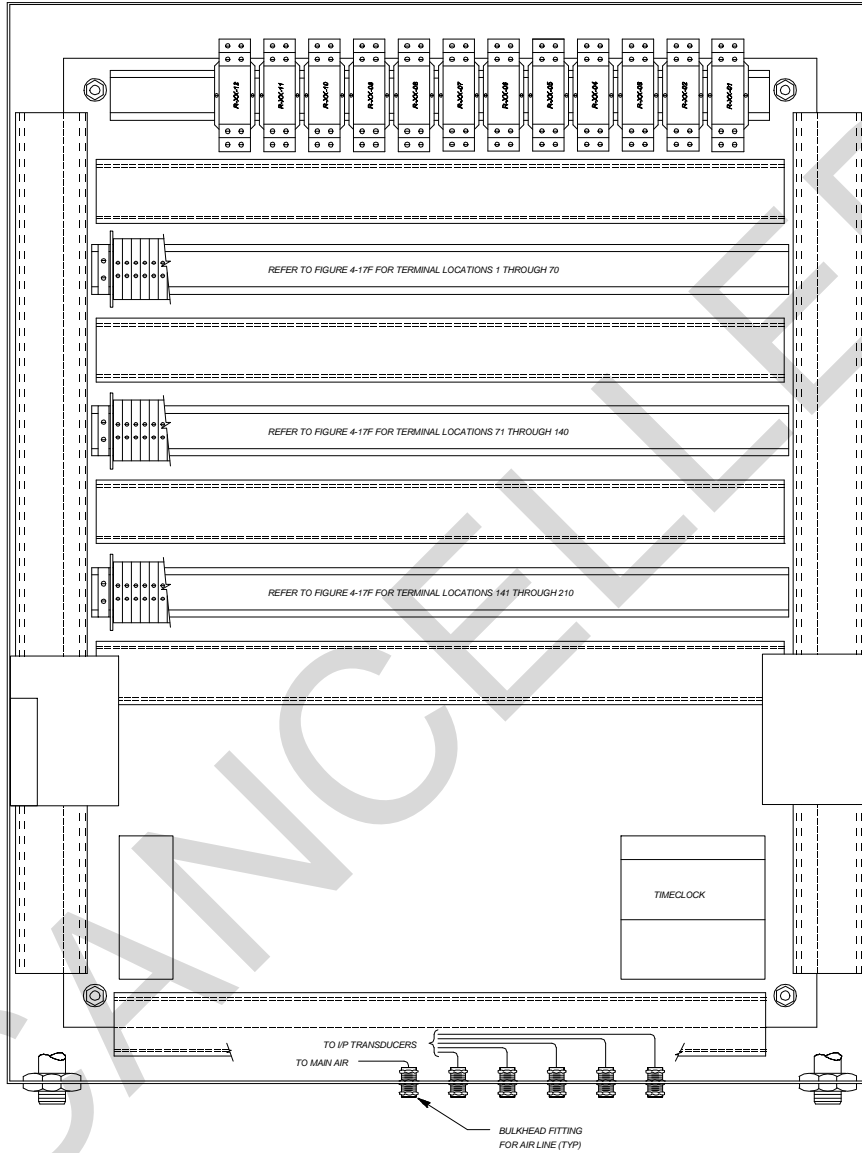

Figure 4-17e. Control panel back panel layout for VAV HVAC system without return fan.

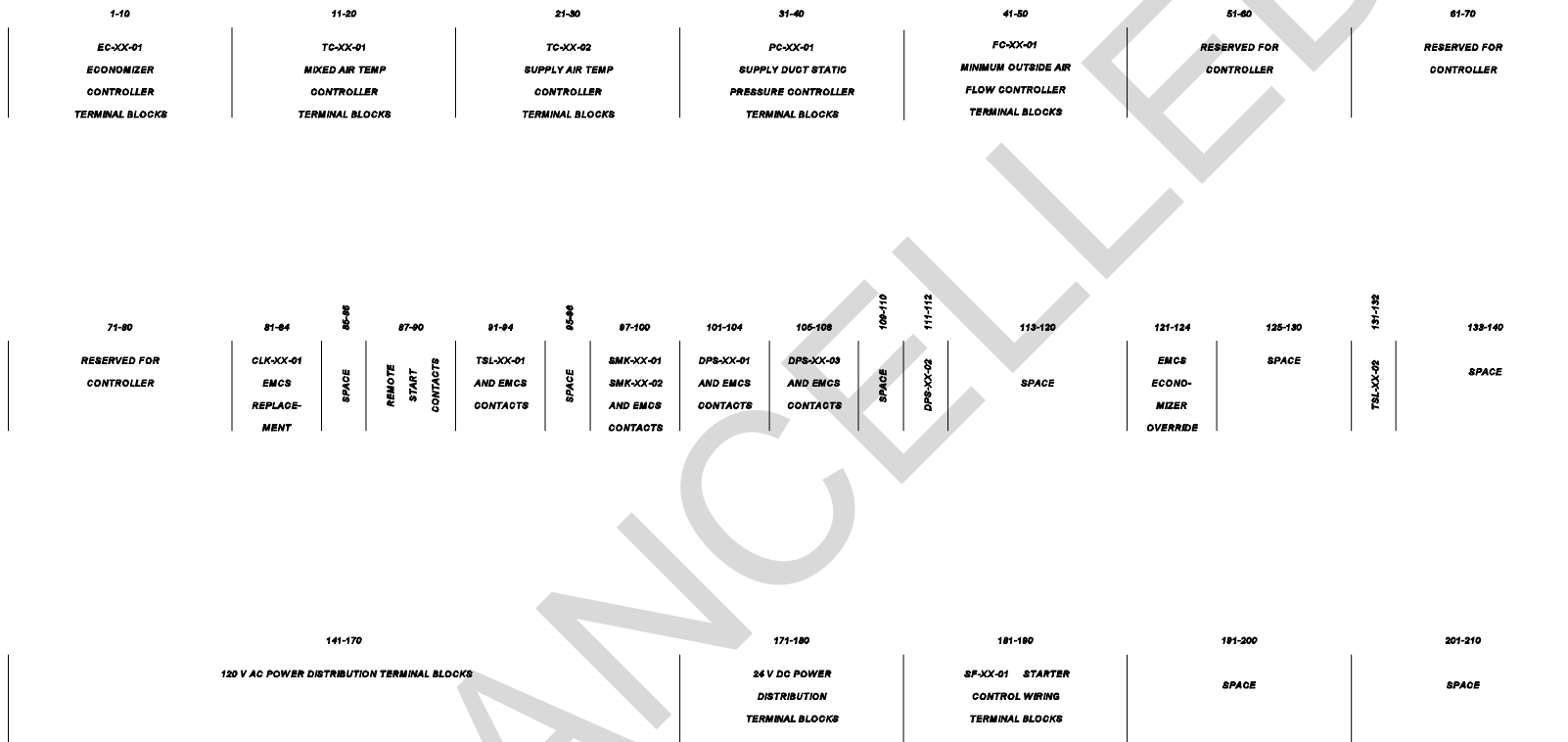

Figure 4-17f. Control panel terminal block layout for VAV HVAC system without return fan.

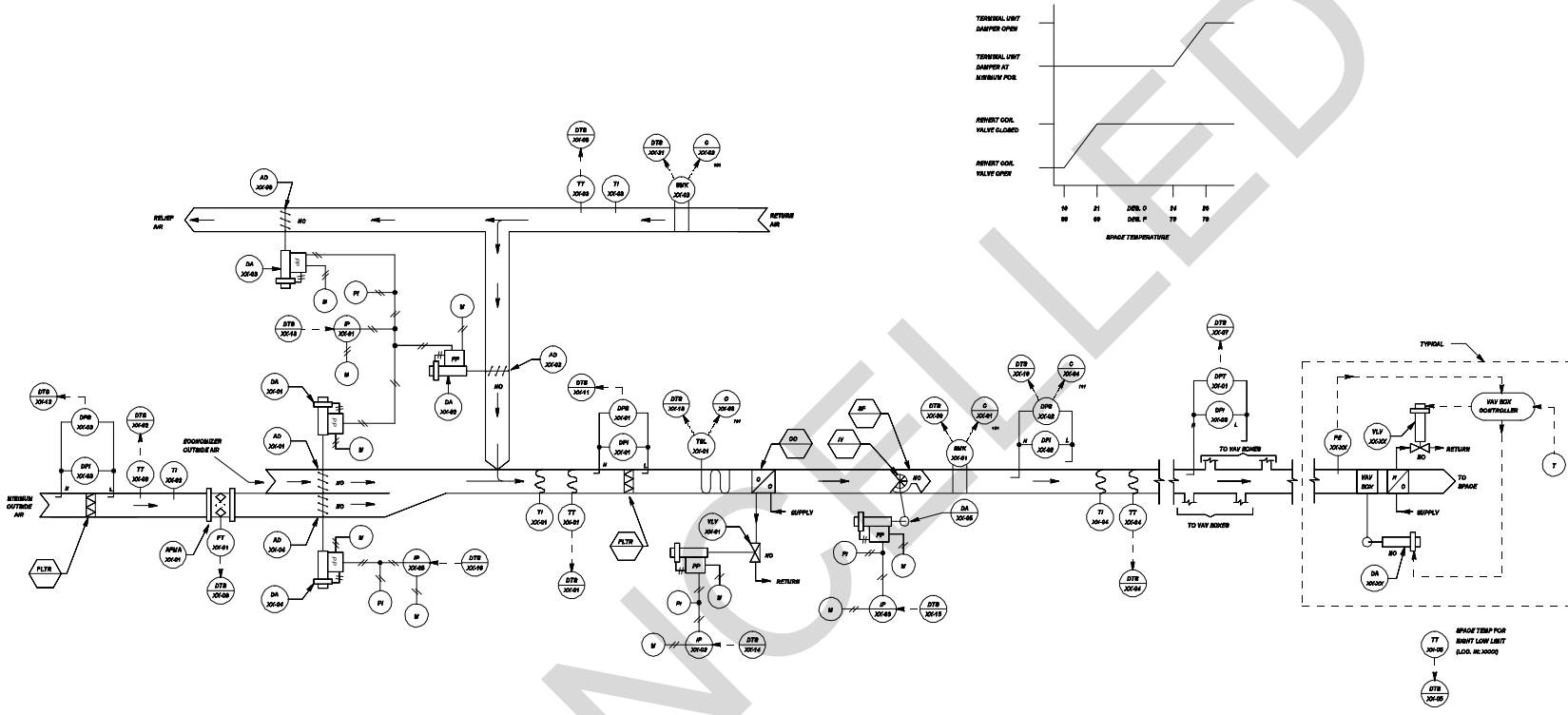

Figure 4-17g. DDC control system schematic for VAV HVAC system without return fan.

SENSOR SCHEDULE

IDENTIFIER	FUNCTION	RANGE
TT-XX-01	MIXED AIR TEMPERATURE TRANSMITTER	4 TO 60 DEG C (40 TO 140 DEG F)
TT-XX-02	OUTSIDE AIR TEMPERATURE TRANSMITTER	-34 TO 54 DEG C (-30 TO +130 DEG F)
TT-XX-03	RETURN AIR TEMPERATURE TRANSMITTER	4 TO 60 DEG C (40 TO 140 DEG F)
TT-XX-04	SUPPLY AIR TEMPERATURE TRANSMITTER	4 TO 60 DEG C (40 TO 140 DEG F)
TT-XX-05	SPACE AIR TEMPERATURE TRANSMITTER	10 TO 30 DEG C (50 TO 85 DEG F)
FT-XX-01	MINIMUM OUTSIDE AIR FLOW TRANSMITTER	0 - ... m/s (... FPM)
DPT-XX-01	SUPPLY AIR STATIC PRESSURE TRANSMITTER	0 - 500 kPa (0.0 - 2.0 IN. WATER)

CONTROL VALVE SCHEDULE

IDENTIFIER	FUNCTION	TYPE	RANGE	K _v (Cv)	CLOSE-OFF RATING	REMARKS
VLV-XX-01	COOLING COIL VALVE	2-WAY, MODULATING	21 - 103 kPa (3-15 PSIG)	XX	... kPa (... PSIG)	
VLV-XX-AA	TERMINAL UNIT HEATING COIL	2-WAY, MODULATING	---	XX	... kPa (... PSIG)	
•	•	•	•	•	•	
VLV-XX-ZZ	TERMINAL UNIT HEATING COIL	2-WAY, MODULATING	---	XX	... kPa (... PSIG)	

CONTROL DAMPER SCHEDULE

IDENTIFIER	FUNCTION	TYPE	SIZE	RANGE	REMARKS
AD-XX-01	ECONOMIZER OUTSIDE AIR	MODULATING	W X H	21 - 103 kPa (3-15 PSIG)	PARALLEL BLADE
AD-XX-02	RETURN AIR	MODULATING	W X H		PARALLEL BLADE
AD-XX-03	RELIEF AIR	MODULATING	W X H		PARALLEL BLADE
AD-XX-04	MINIMUM OUTSIDE AIR	MODULATING	W X H		PARALLEL BLADE
DA-XX-05	SUPPLY FAN FLOW	INLET VANE	---		

OPERATING PARAMETERS

FUNCTION	SETPOINT	REMARKS
MINIMUM OUTSIDE AIR	... L/s (... CFM)	
MIXED AIR TEMPERATURE	... DEG C (... DEG F)	
SUPPLY AIR TEMPERATURE	... DEG C (... DEG F)	
SPACE TEMP. (NIGHT SETBACK)	... DEG C (... DEG F)	(HEATING ONLY)
SUPPLY AIR STATIC PRESSURE	... kPa (... IN. WATER)	
ECONOMIZER MODE		ECONOMIZER MODE = ON, WHEN CONDITION 1 AND CONDITION 2 ARE BOTH SATISFIED. CONDITION 1: RETURN AIR TEMP. > XXDEGC (... DEG F) CONDITION 2: RETURN AIR TEMP. MINUS OUTSIDE AIR TEMP. > ... DEG C (... DEG F)
OCCUPIED MODE		MONDAY - FRIDAY : 0705 HRS - 1700 HRS
VENT DELAY MODE		MONDAY - FRIDAY : 0700 HRS - 0800 HRS
FREEZESTAT	... DEG C (... DEG F)	
MIN OA FILTER ALARM	... kPa (... IN. WATER)	
MAIN FILTER ALARM	... kPa (... IN. WATER)	
HIGH STATIC ALARM	... kPa (... IN. WATER)	

Figure 4-17i. DDC control system equipment for VAV HVAC system without return fan.

	HARDWARE														SOFTWARE												
	OUTPUT							INPUT							ALARMS					APPLICATION PROGRAMS							
	DIGITAL			ANALOG				DIGITAL			ANALOG				DIGITAL		ANALOG										
	CONTROL RELAY			POSITION ADJUSTMENT			AUXILIARY CONTACT			TEMPERATURE	% RELATIVE HUMIDITY	PH, PHS, PHD	FLOW	CONTACT CLOSURE		HIGH LIMIT	LOW LIMIT	RUN TIME	SCHEDULED START/STOP	OPTIMUM START/STOP	DUTY CYCLING	DEMAND LIMITING	DAY/NIGHT SETBACK	ECONOMIZER	VENTILATION/RECIRCULATION	FAILURE MODE **	
SUPPLY FAN	1						1							X				X	X	X	X	X					
SUPPLY FAN INLET VANES				1																							
SUPPLY AIR										1	1					X	X										
RETURN AIR										1						X	X										
MIXED AIR										1						X	X										
MINIMUM OUTSIDE AIR				1						1	1					X	X										
MIXED AIR DAMPERS				1																			X	X			
COOLING COIL VALVE				1																							
FILTER								2							X												
FREEZESTAT								1							X												
SMOKE DETECTOR								2							X												
SUPPLY AIR HIGH STATIC								1							X												
SPACE TEMP (NIGHT LOW LIMIT)											X					X	X						X				

** C - LAST COMMAND
H - HIGH VALUE
L - LOW VALUE

O - ON (OPEN)
F - OFF (CLOSED)

DDC DATA TERMINAL STRIP LAYOUT

DEVICE NO.	DESCRIPTION	TYPE
1	TT-XX-01 MIXED AIR TEMPERATURE	AI
2	TT-XX-02 OUTSIDE AIR TEMPERATURE	AI
3	TT-XX-03 RETURN AIR TEMPERATURE	AI
4	TT-XX-04 SUPPLY AIR TEMPERATURE	AI
5	TT-XX-05 SPACE TEMP (NITE LOW LIMIT)	AI
6		
7	DPT-XX-01 SUPPLY AIR STATIC PRESSURE	AI
8	FT-XX-01 MINIMUM OUTSIDE AIR FLOW	AI
9		
10		
11	DPS-XX-01 FILTER ALARM	DI
12	DPS-XX-03 PRE-FILTER ALARM	DI
13	IP-XX-01 MIXED AIR DAMPERS	AO
14	IP-XX-02 COOLING COIL VALVE	AO
15	IP-XX-03 SUPPLY FAN INLET VANES	AO
16	IP-XX-04 MINIMUM OUTSIDE AIR DAMPER	AO
17		
18	TSL-XX-01 FREEZESTAT	DI
19	DPS-XX-02 SUPPLY AIR HIGH STATIC	DI
20	SMK-XX-01 SUPPLY AIR SMOKE DETECTOR	DI
21	SMK-XX-02 RETURN AIR SMOKE DETECTOR	DI
22		
23	C-XX-05 SUPPLY FAN START/STOP	DO
24	C-XX-06 SUPPLY FAN STATUS	DI
25		
26		
27		
28		
29		
30		

Figure 4-17j. DDC control system I/O table and data terminal strip layout for VAV HVAC system without return fan.

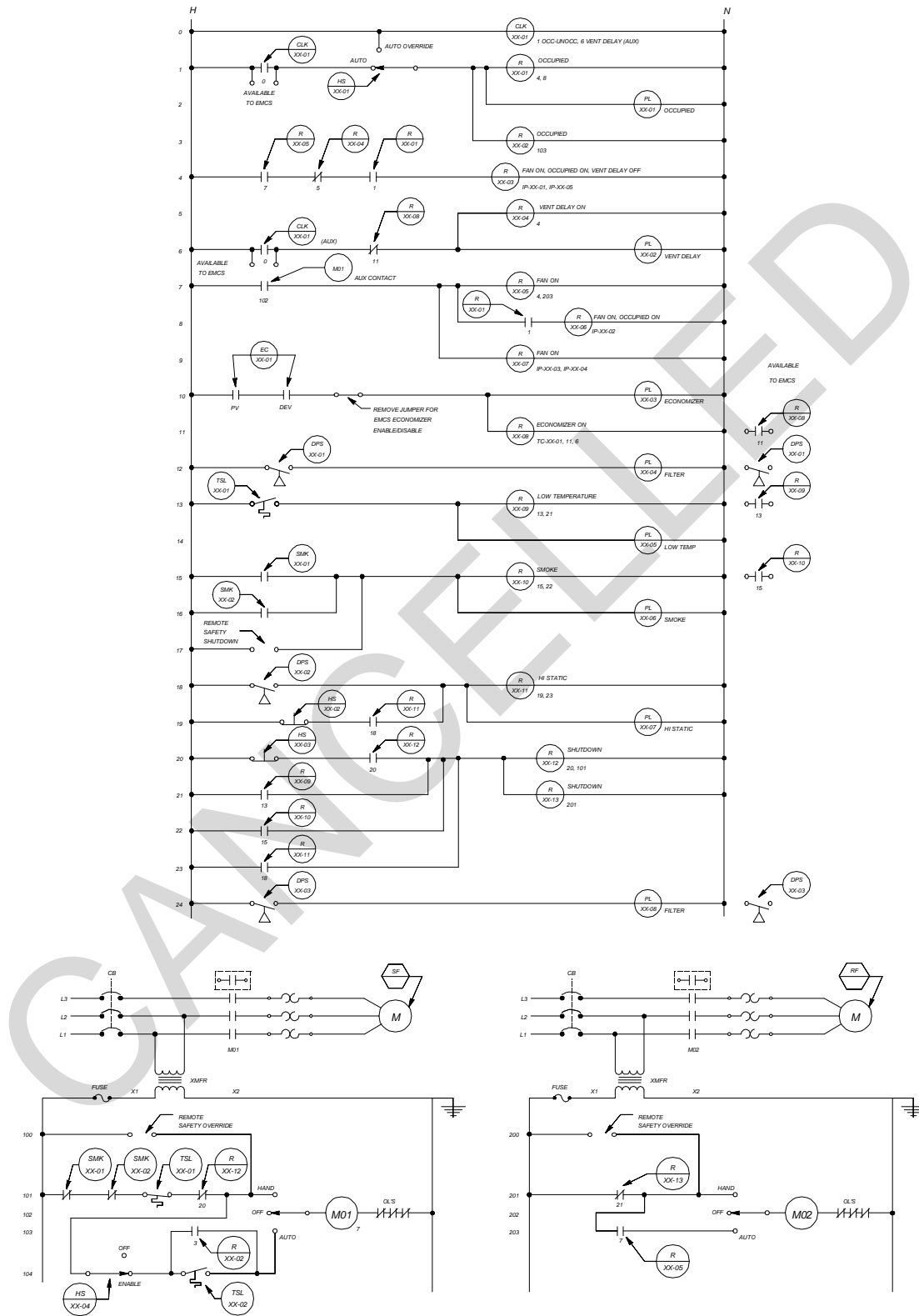

Figure 4-18b. Control system ladder diagram for VAV HVAC system with return fan.

LOOP CONTROL FUNCTION	DEVICE NUMBER	DEVICE FUNCTION	SETPOINT	RANGE	ADDITIONAL PARAMETERS
MIXED AIR TEMPERATURE	DA-XX-01 DA-XX-02 DA-XX-03	DAMPER ACTUATOR	—	21-103 kPa (3-15 PSIG)	—
	TC-XX-01	MIXED AIR TEMPERATURE CONTROLLER	13 DEG C (55 DEG F)	4 TO 60 DEG C (40 TO 140 DEG F)	—
	TT-XX-01	MIXED AIR TEMPERATURE TRANSMITTER	—	4 TO 60 DEG C (40 TO 140 DEG F)	—
	TT-XX-02	OUTSIDE AIR TEMPERATURE TRANSMITTER	—	-34 TO 54 DEG C (-30 TO 130 DEG F)	—
	TT-XX-03	RETURN AIR TEMPERATURE TRANSMITTER	—	-34 TO 54 DEG C (-30 TO 130 DEG F)	—
	EC-XX-01	ECONOMIZER CONTROLLER	PV CONTACT CLOSE AT ___ DEG C (___ DEG F) OPEN AT ___ DEG C (___ DEG F)	-34 TO 54 DEG C (-30 TO 130 DEG F)	DEV CONTACT CLOSE @ DELTA T= ___ DEG C (___ DEG F) OPEN @ DELTA T= ___ DEG C (___ DEG F)
	TSL-XX-01	LOW TEMPERATURE PROTECTION THERMOSTAT	2 DEG C (35 DEG F)	—	—
	DPS-XX-01	FILTER ALARM	PER FILTER MANUFACTURER'S RECOMMENDATION	PER FILTER MANUFACTURER'S RECOMMENDATION	—
MIN. OUTSIDE AIR FLOW	DA-XX-04	DAMPER ACTUATOR	—	21 - 103 kPa (3-15 PSIG)	—
	FC-XX-02	MIN. OUTSIDE AIR DUCT FLOW CONTROLLER	Min OA = ___ L/s (___ cfm)	0 - ___ L/s (0 - ___ CFM)	(SEE NOTE 1)
	FT-XX-03	MIN. OUTSIDE AIR DUCT FLOW TRANSMITTER	—	0 - ___ m/s (0 - ___ FPM)	UPPER RANGE AS REQUIRED (SEE SPECIFICATIONS)
	DPS-XX-03	PRE-FILTER ALARM	PER FILTER MANUFACTURER'S RECOMMENDATION	PER FILTER MANUFACTURER'S RECOMMENDATION	—
SPACE LOW TEMPERATURE	TSL-XX-02	NIGHT STAT - SPACE LOW TEMPERATURE PROTECTION	13 DEG C (55 DEG F)	DIFFERENTIAL = 3 DEG C (5 DEG F)	—
DISCHARGE AIR TEMPERATURE	VLV-XX-01	COOLING COIL VALVE	—	21-103 kPa (3-15 PSIG)	Kv = ___ (Cv = ___) CLOSE AGAINST ___ kPa (___ PSIG)
	TC-XX-02	FAN DISCHARGE TEMPERATURE CONTROLLER	13 DEG C (55 DEG F)	4 TO 60 DEG C (40 TO 140 DEG F)	—
	TT-XX-04	FAN DISCHARGE TEMPERATURE TRANSMITTER	—	4 TO 60 DEG C (40 TO 140 DEG F)	—
SUPPLY DUCT STATIC PRESSURE	DA-XX-05	SUPPLY FAN INLET VANE ACTUATOR	—	21 - 103 kPa (3-15 PSIG)	—
	PC-XX-01	SUPPLY DUCT STATIC PRESSURE CONTROLLER	300 kPa (1.2 INCHES WATER)	0 - 500 kPa (0.0 - 2.0 INCHES WATER)	—
	DPT-XX-01	SUPPLY DUCT STATIC PRESSURE TRANSMITTER	—	0 - 500 kPa (0.0 - 2.0 INCHES WATER)	—
	DPS-XX-02	SUPPLY DUCT - HIGH STATIC PRESSURE SAFETY	—	1000 - 1500 kPa (4.0 - 6.0 INCHES WATER)	—
RETURN FAN VOLUME	DA-XX-06	RETURN FAN INLET VANE ACTUATOR	—	21 - 103 kPa (3-15 PSIG)	—
	FC-XX-01	RETURN FAN VOLUME CONTROLLER	SUPPLY FAN L/s (CFM) MINUS ___ L/S (___ CFM)	0 - 9500 L/s (0 - 20,000 CFM)	—
	FT-XX-01	SUPPLY DUCT FLOW TRANSMITTER (FPM)	—	0 - 9500 L/s (0 - 20,000 CFM)	—
	FT-XX-02	RETURN DUCT FLOW TRANSMITTER (FPM)	—	0 - 9500 L/s (0 - 20,000 CFM)	—
OCCUPIED MODE	CLK-XX-01	365 DAY SCHEDULE CONTACT	—	—	CONTACT OPEN: SAT, SUN
VENTILATION DELAY MODE	CLK-XX-01	365 DAY SCHEDULE CONTACT	—	—	NORMAL SCHEDULE (M-F) CONTACT CLOSED: 0705 HRS CONTACT OPEN: 1700 HRS
TERMINAL UNITS	VLV-XX-AA	HEATING COIL VALVE SPACE AA	—	—	Kv = ___ (Cv = ___) CLOSE AGAINST ___ kPa (___ PSIG)
	•	•	•	•	•
	VLV-XX-ZZ	HEATING COIL VALVE SPACE ZZ	—	—	Kv = ___ (Cv = ___) CLOSE AGAINST ___ kPa (___ PSIG)

NOTES:

1. Upper range (L/s) of flow controller (FC-XX-XX) = Upper range (m/s) of associated flow transmitter (FT-XX-XX) TIMES the duct area (sq m) TIMES 1000 (L/cu. m).
(Upper range (CFM) of flow controller (FC-XX-XX) = Upper range (fpm) of associated flow transmitter (FT-XX-XX) TIMES the duct area (sq ft).

2. OTHER CONTROL DEVICES SUCH AS I/Ps, RELAYS, SIGNAL SELECTERS AND TERMINAL UNIT CONTROLLERS ARE NOT SHOWN.

Figure 4-18c. Control system equipment for VAV HVAC system with return fan.

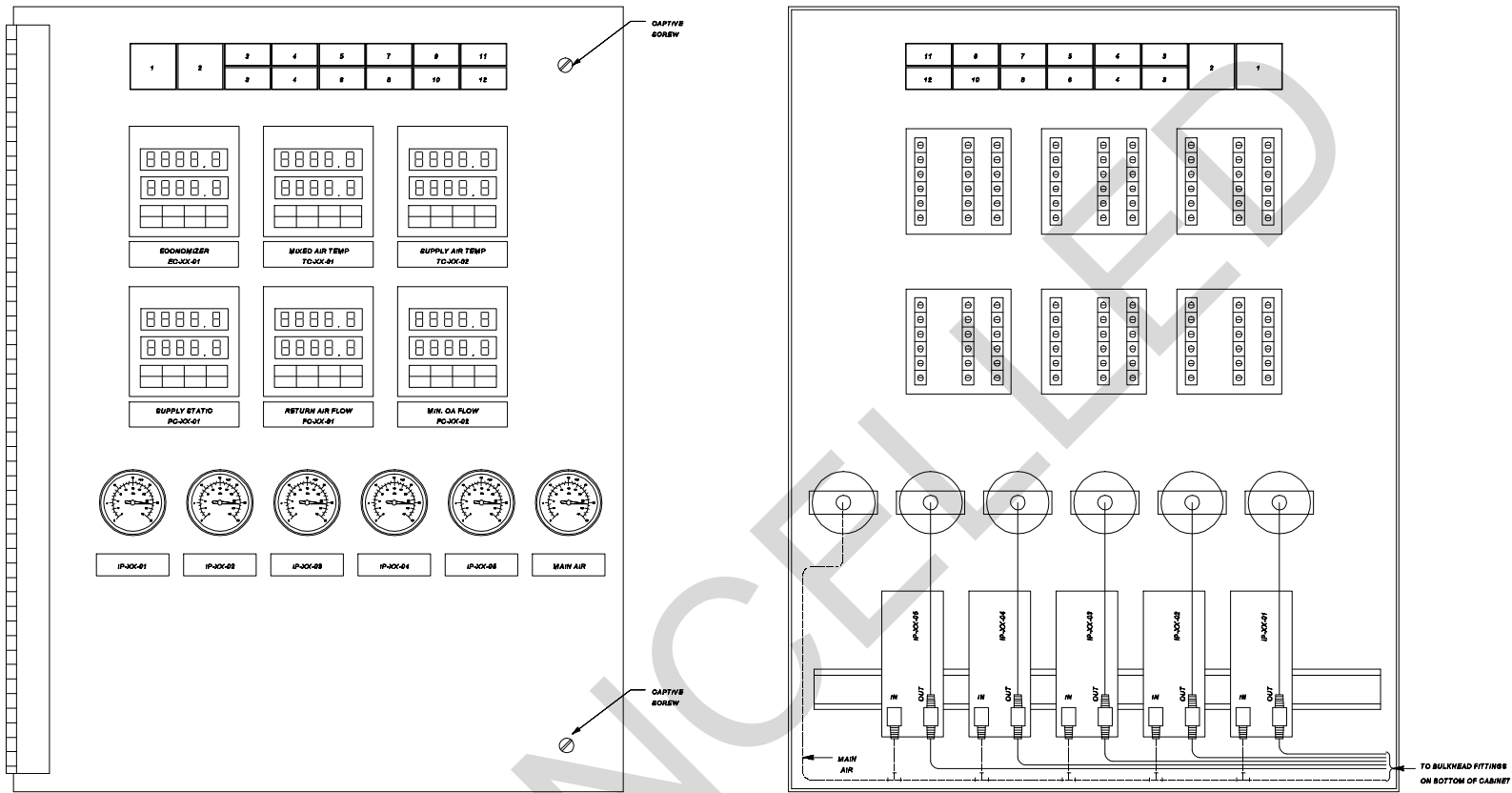

FRONT VIEW

REAR VIEW

SWITCH AND PILOT LIGHT LEGEND

POSITION LEGEND

- 1 - RESET
- 2 - STATIC RESET
- 3 - AUTOMATO OVERRIDE
- 4 - ENABLE/OFF
- 5 - LOW TEMP
- 6 - SMOKE

DEVICE TYPE

- NON-ILLUMINATED MOMENTARY CONTACT PUSH BUTTON SWITCH
- NON-ILLUMINATED MOMENTARY CONTACT PUSH BUTTON SWITCH
- ILLUMINATED MAINTAINED CONTACT INTERLOCKED SWITCHES
- ILLUMINATED MAINTAINED CONTACT INTERLOCKED SWITCHES
- PILOT LIGHT
- PILOT LIGHT

IDENTIFIER

- HS-XX-03
- HS-XX-02
- HS-XX-01
- HS-XX-04
- PL-XX-05
- PL-XX-06

POSITION LEGEND

- 7 - HIGH STATIC
- 8 - FILTER
- 9 - OCC
- 10 - VENT DELAY
- 11 - ECON
- 12 - FILTER

DEVICE TYPE

- PILOT LIGHT
- PILOT LIGHT
- PILOT LIGHT
- PILOT LIGHT
- PILOT LIGHT
- PILOT LIGHT

IDENTIFIER

- PL-XX-07
- PL-XX-04
- PL-XX-01
- PL-XX-02
- PL-XX-03
- PL-XX-08

Figure 4-18d. Control panel interior door layout for VAV HVAC system with return fan.

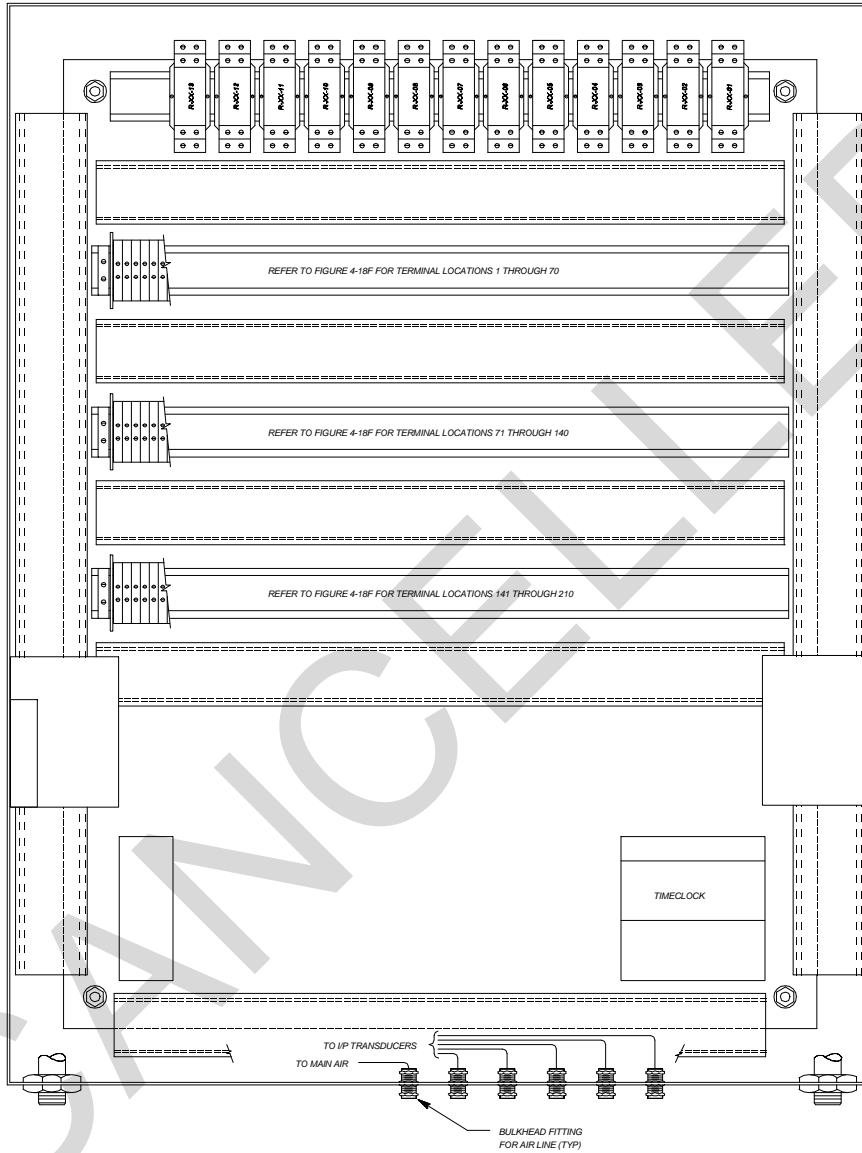

Figure 4-18e. Control panel back panel layout for VAV HVAC system with return fan.

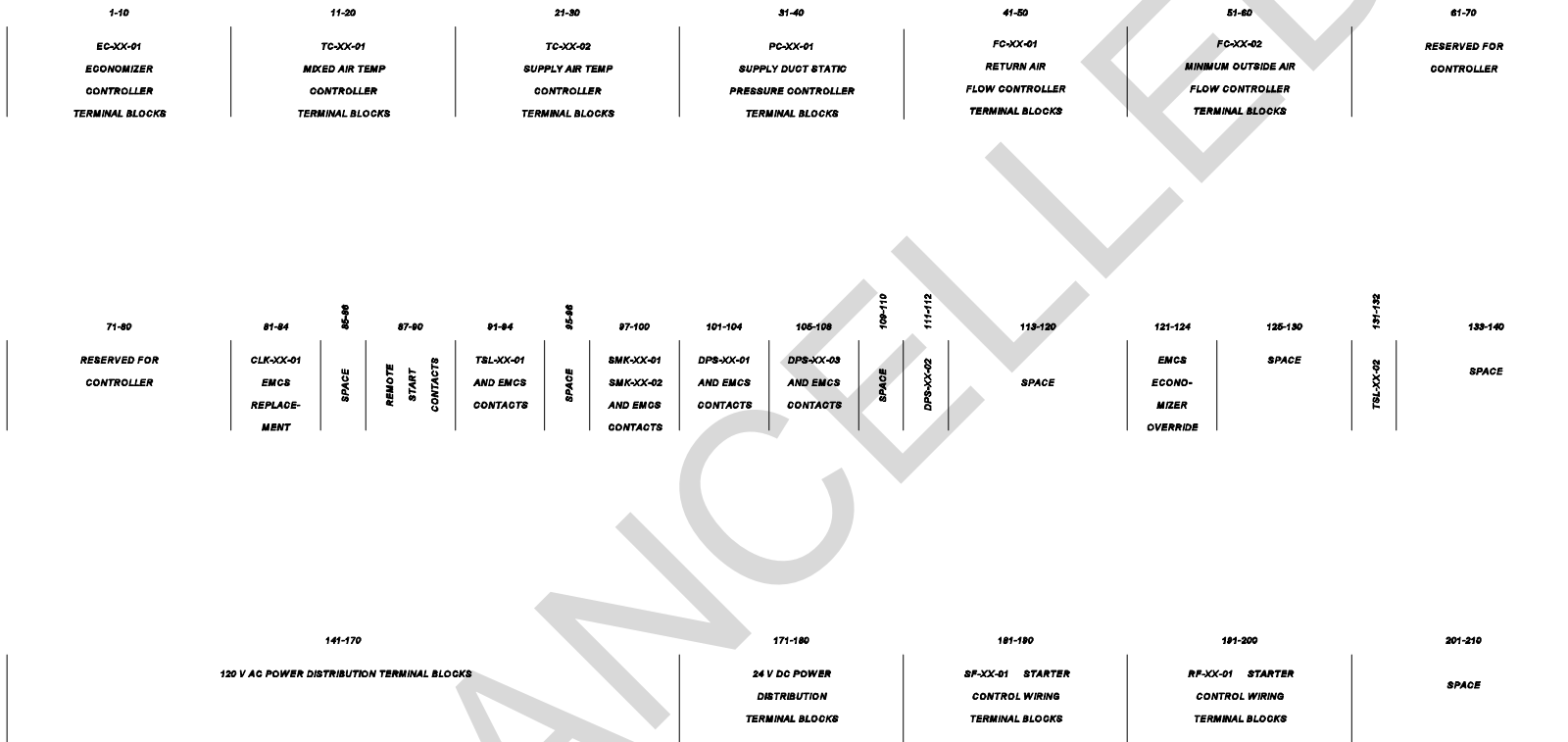

Figure 4-18f. Control panel terminal block layout for VAV HVAC system with return fan.

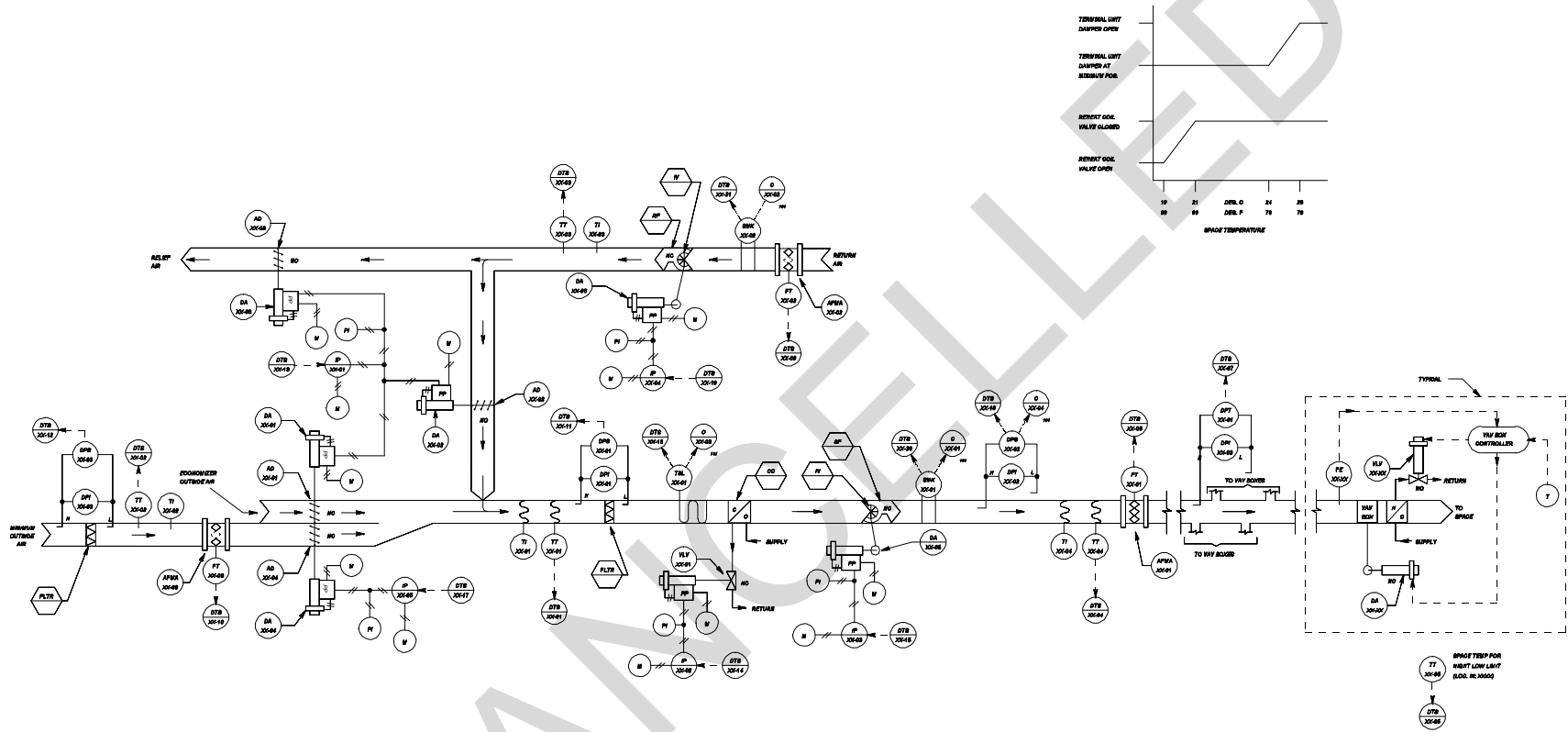

Figure 4-18g. DDC control system schematic for VAV HVAC system with return fan.

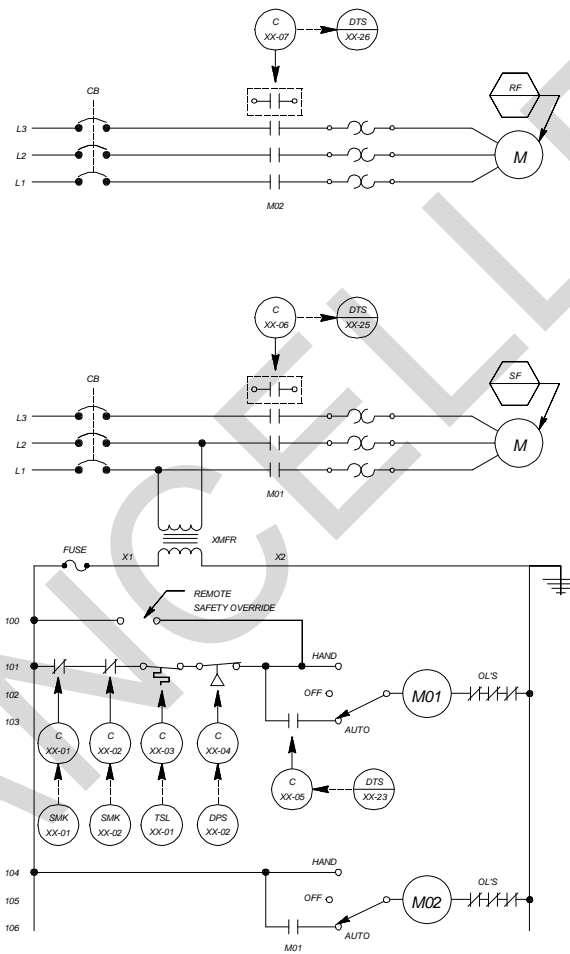

Figure 4-18h. DDC control system ladder diagram for VAV HVAC system with return fan.

SENSOR SCHEDULE

IDENTIFIER	FUNCTION	RANGE
TT-XX-01	MIXED AIR TEMPERATURE TRANSMITTER	4 TO 60 DEG C (40 TO 140 DEG F)
TT-XX-02	OUTSIDE AIR TEMPERATURE TRANSMITTER	-34 TO 54 DEG C (-30 TO +130 DEG F)
TT-XX-03	RETURN AIR TEMPERATURE TRANSMITTER	4 TO 60 DEG C (40 TO 140 DEG F)
TT-XX-04	SUPPLY AIR TEMPERATURE TRANSMITTER	4 TO 60 DEG C (40 TO 140 DEG F)
TT-XX-05	SPACE AIR TEMPERATURE TRANSMITTER	10 TO 30 DEG C (50 TO 85 DEG F)
FT-XX-01	SUPPLY AIR FLOW TRANSMITTER	0 - ... m/s (... FPM)
FT-XX-02	RETURN AIR FLOW TRANSMITTER	0 - ... m/s (... FPM)
FT-XX-03	MINIMUM OUTSIDE AIR FLOW TRANSMITTER	0 - ... m/s (... FPM)
DPT-XX-01	SUPPLY AIR STATIC PRESSURE TRANSMITTER	0 - 500 kPa (0.0 - 2.0 IN. WATER)

CONTROL VALVE SCHEDULE

IDENTIFIER	FUNCTION	TYPE	RANGE	Kv (Cv)	CLOSE-OFF RATING	REMARKS
VLV-XX-01	COOLING COIL VALVE	2-WAY, MODULATING	21 - 103 kPa (3-15 PSIG)	XX	... kPa (... PSIG)	
VLV-XX-AA	TERMINAL UNIT HEATING COIL	2-WAY, MODULATING	---	XX	... kPa (... PSIG)	
•	•	•	•	•	•	
VLV-XX-ZZ	TERMINAL UNIT HEATING COIL	2-WAY, MODULATING	---	XX	... kPa (... PSIG)	

CONTROL DAMPER SCHEDULE

IDENTIFIER	FUNCTION	TYPE	SIZE	RANGE	REMARKS
AD-XX-01	ECONOMIZER OUTSIDE AIR	MODULATING	W X H	21 - 103 kPa (3-15 PSIG)	PARALLEL BLADE
AD-XX-02	RETURN AIR	MODULATING	W X H		PARALLEL BLADE
AD-XX-03	RELIEF AIR	MODULATING	W X H		PARALLEL BLADE
AD-XX-04	MINIMUM OUTSIDE AIR	MODULATING	W X H		PARALLEL BLADE
DA-XX-05	SUPPLY FAN FLOW	INLET VANE	---		
DA-XX-06	RETURN FAN FLOW	INLET VANE	---		

OPERATING PARAMETERS

FUNCTION	SETPOINT	REMARKS
MINIMUM OUTSIDE AIR	... L/s (... CFM)	
MIXED AIR TEMPERATURE	... DEG C (... DEG F)	
SUPPLY AIR TEMPERATURE	... DEG C (... DEG F)	
SPACE TEMP. (NIGHT SETBACK)	... DEG C (... DEG F)	(HEATING ONLY)
SUPPLY AIR STATIC PRESSURE	... kPa (... IN. WATER)	
RETURN AIR FLOW		SUPPLY AIR FLOW MINUS ... L/s (... CFM)
ECONOMIZER MODE		ECONOMIZER MODE = ON, WHEN CONDITION 1 AND CONDITION 2 ARE BOTH SATISFIED. CONDITION 1: RETURN AIR TEMP. > XX/BB/CC (... DEG F) CONDITION 2: RETURN AIR TEMP. MINUS OUTSIDE AIR TEMP. > ... DEG C (... DEG F)
OCCUPIED MODE		MONDAY - FRIDAY : 0705 HRS - 1700 HRS
VENT DELAY MODE		MONDAY - FRIDAY : 0700 HRS - 0800 HRS
FREEZESTAT	... DEG C (... DEG F)	
MIN OA FILTER ALARM	... kPa (... IN. WATER)	
MAIN FILTER ALARM	... kPa (... IN. WATER)	
HIGH STATIC ALARM	... kPa (... IN. WATER)	

Figure 4-18i. DDC control system equipment for VAV HVAC system with return fan.

	HARDWARE														SOFTWARE												
	OUTPUT							INPUT							ALARMS					APPLICATION PROGRAMS							
	DIGITAL			ANALOG				DIGITAL			ANALOG				DIGITAL		ANALOG										
	CONTROL RELAY			POSITION ADJUSTMENT			AUXILIARY CONTACT			TEMPERATURE	% RELATIVE HUMIDITY	PH, PMA, PWD	FLOW	CONTACT CLOSURE		HIGH LIMIT	LOW LIMIT	RUN TIME	SCHEDULED START/STOP	OPTIMUM START/STOP	DUTY CYCLING	DEMAND LIMITING	DWINDRIFT SETBACK	ECONOMIZER	VENTILATION/RECIRCULATION	FAILURE MODE **	
SUPPLY FAN	1						1							X				X	X	X	X	X					
SUPPLY FAN INLET VANES				1															X	X	X	X					
RETURN FAN	1						1							X				X	X	X	X						
RETURN FAN INLET VANES				1															X	X	X	X					
SUPPLY AIR										1	1					X	X										
RETURN AIR										1						X	X										
MIXED AIR										1						X	X										
MINIMUM OUTSIDE AIR				1						1	1					X	X										
MIXED AIR DAMPERS				1																			X	X			
COOLING COIL VALVE				1																							
FILTER								2						X													
FREEZESTAT								1						X													
SMOKE DETECTOR								2						X													
SUPPLY AIR HIGH STATIC								1						X													
SPACE TEMP (NIGHT LOW LIMIT)										X						X	X						X				

** C - LAST COMMAND
H - HIGH VALUE
L - LOW VALUE

O - ON (OPEN)
F - OFF (CLOSED)

DDC DATA TERMINAL STRIP LAYOUT

DEVICE NO.	DESCRIPTION	TYPE
1	TT-XX-01 MIXED AIR TEMPERATURE	AI
2	TT-XX-02 OUTSIDE AIR TEMPERATURE	AI
3	TT-XX-03 RETURN AIR TEMPERATURE	AI
4	TT-XX-04 SUPPLY AIR TEMPERATURE	AI
5	TT-XX-05 SPACE TEMP (NITE LOW LIMIT)	AI
6		
7	DPT-XX-01 SUPPLY AIR STATIC PRESSURE	AI
8	FT-XX-01 SUPPLY AIR FLOW	AI
9	FT-XX-02 RETURN AIR FLOW	AI
10	FT-XX-03 MINIMUM OUTSIDE AIR FLOW	AI
11	DPS-XX-01 FILTER ALARM	DI
12	DPS-XX-03 PRE-FILTER ALARM	DI
13	IP-XX-01 MIXED AIR DAMPERS	AO
14	IP-XX-02 COOLING COIL VALVE	AO
15	IP-XX-03 SUPPLY FAN INLET VANES	AO
16	IP-XX-04 RETURN FAN INLET VANES	AO
17	IP-XX-05 MINIMUM OUTSIDE AIR DAMPER	AO
18	TSL-XX-01 FREEZESTAT	DI
19	DPS-XX-02 SUPPLY AIR HIGH STATIC	DI
20	SMK-XX-01 SUPPLY AIR SMOKE DETECTOR	DI
21	SMK-XX-02 RETURN AIR SMOKE DETECTOR	DI
22		
23	C-XX-05 SUPPLY FAN START/STOP	DO
24		
25	C-XX-06 SUPPLY FAN STATUS	DI
26	C-XX-07 RETURN FAN STATUS	DI
27		
28		
29		
30		

Figure 4-18j. DDC control system I/O table and data terminal strip layout for VAV HVAC system with return fan.

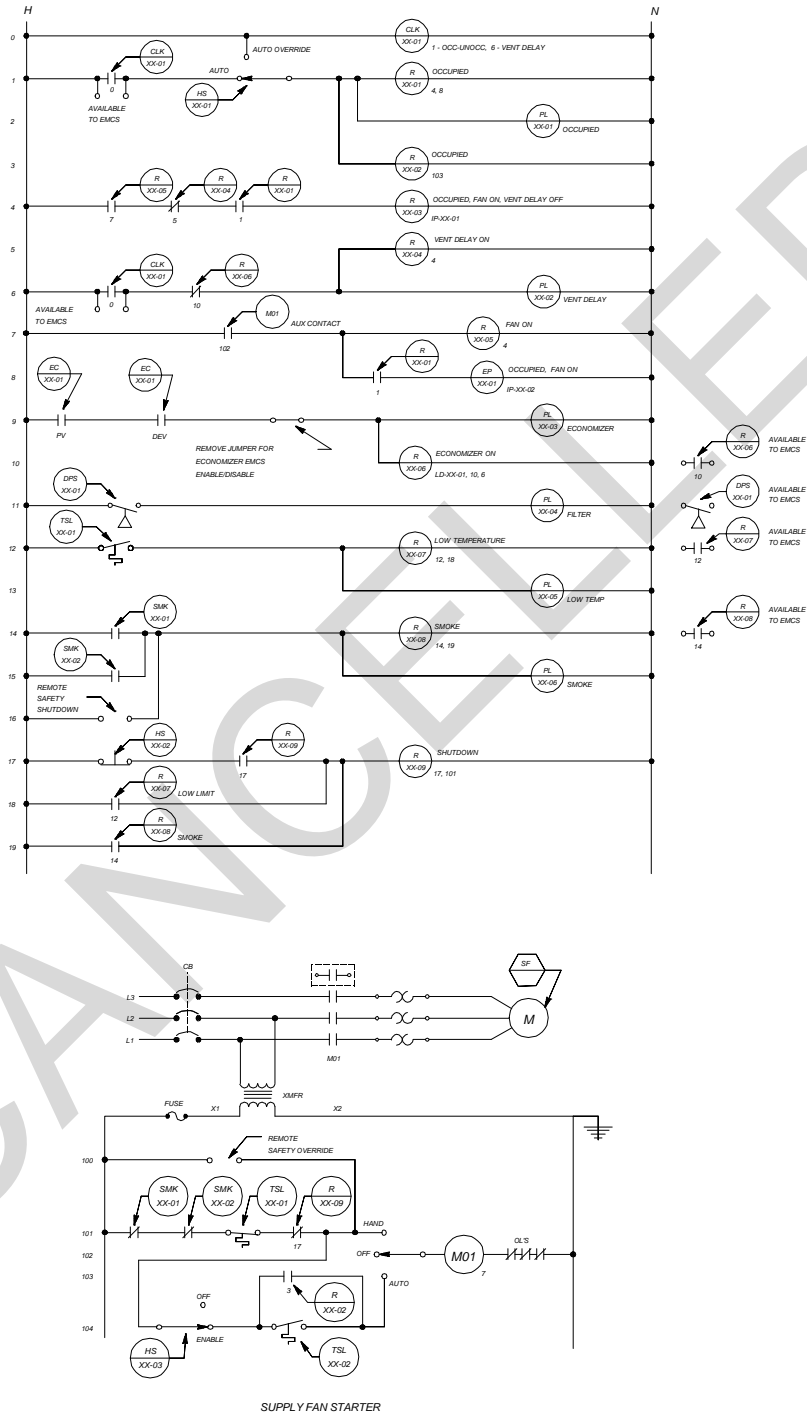
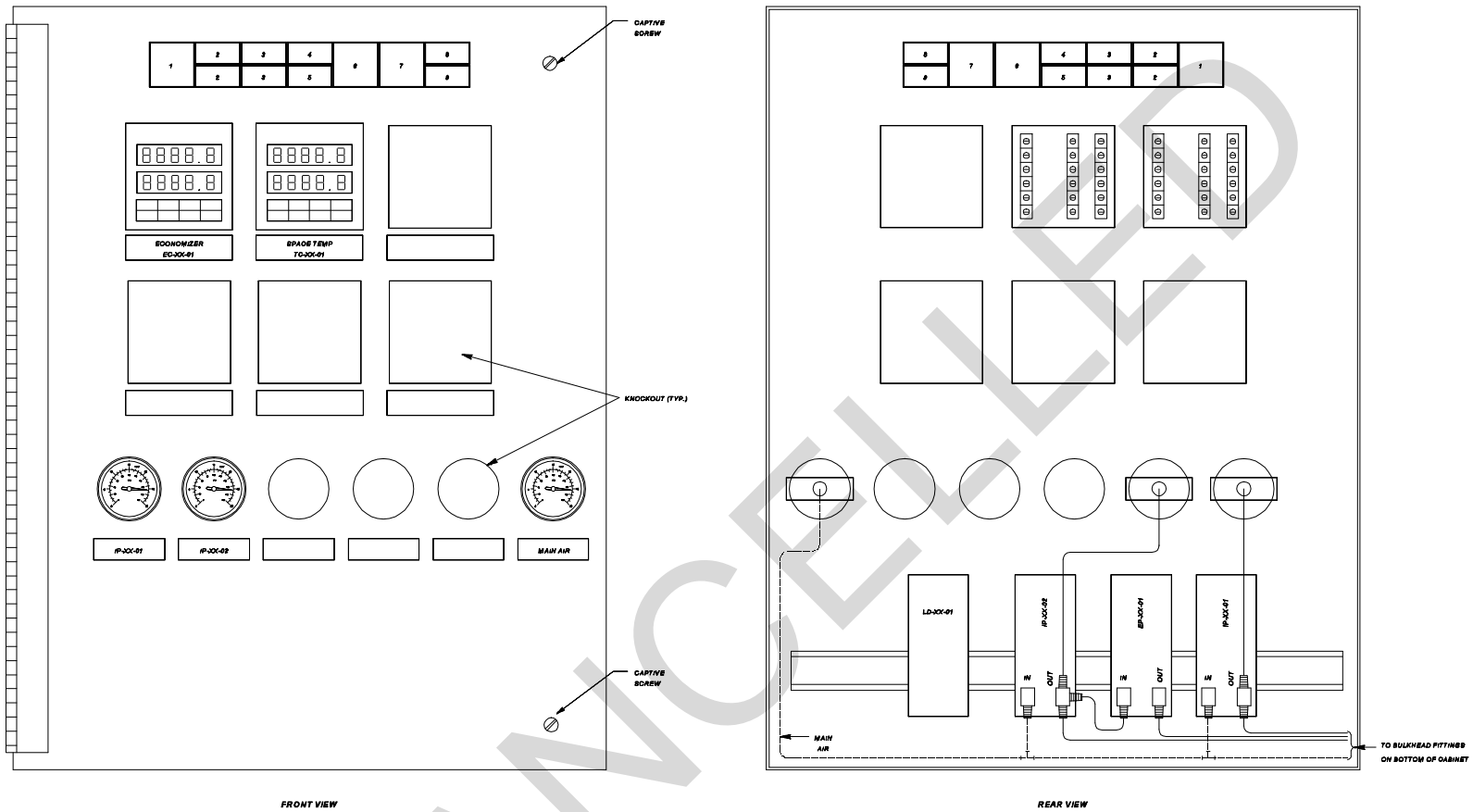

Figure 4-19b. Control system ladder diagram for single zone HVAC system.

LOOP CONTROL FUNCTION	DEVICE NUMBER	DEVICE FUNCTION	SETPOINT	RANGE	ADDITIONAL PARAMETERS
SPACE TEMPERATURE	DA-XX-01 DA-XX-02 DA-XX-03	DAMPER ACTUATOR	---	48 - 76 kPa (7 - 11 PSIG)	---
	MPB-XX-01	MINIMUM POSITION SWITCH	---	---	SET MIN OA LA (CFM) EQUAL TO ___ L/S (___ CFM)
	TT-XX-01	OUTSIDE AIR TEMPERATURE TRANSMITTER	---	-84 TO 54 DEG C (-30 TO +130 DEG F)	---
	TT-XX-02	RETURN AIR TEMPERATURE TRANSMITTER	---	-84 TO 54 DEG C (-30 TO +130 DEG F)	---
	EO-XX-01	ECONOMIZER CONTROLLER	PV CONTACT CLOSE AT ___ DEG C (___ DEG F) OPEN AT ___ DEG C (___ DEG F)	-84 TO 54 DEG C (-30 TO +130 DEG F)	DEV CONTACT CLOSE @ DELTA T= ___ DEG C (___ DEG F) OPEN @ DELTA T= ___ DEG C (___ DEG F)
	VLV-XX-01	HEATING COIL VALVE	---	21 - 41 kPa (3 - 6 PSIG)	Kv = ___ (Cv = ___) CLOSE AGAINST ___ kPa (___ PSIG)
	VLV-XX-02	COOLING COIL VALVE	---	82 - 103 kPa (12 - 15 PSIG)	Kv = ___ (Cv = ___) CLOSE AGAINST ___ kPa (___ PSIG)
	TC-XX-01	SPACE TEMPERATURE CONTROLLER	4 mA = 10 DEG C (50 DEG F) 20 mA = 30 DEG C (86 DEG F)	10 TO 80 DEG C (50 TO 85 DEG F)	SET LIMITS AVAILABLE TO OCCUPANT BY TSP-XX-01 AT 19 TO 22 DEG C (66 TO 72 DEG F)
	TT-XX-03	SPACE TEMPERATURE TRANSMITTER	---	10 TO 80 DEG C (50 TO 85 DEG F)	---
	TSP-XX-01	SPACE TEMPERATURE SETPOINT ADJUSTMENT	4 mA = 10 DEG C (50 DEG F) 20 mA = 30 DEG C (86 DEG F)	---	---
MIXED AIR	TSL-XX-01	LOW TEMPERATURE PROTECTION THERMOSTAT	2 DEG C (36 DEG F)	---	---
	DPS-XX-01	FILTER ALARM	PER FILTER MANUFACTURER'S RECOMMENDATION	PER FILTER MANUFACTURER'S RECOMMENDATION	---
SPACE LOW TEMPERATURE	TSL-XX-02	NIGHT STAT - SPACE LOW TEMPERATURE PROTECTION	13 DEG C (55 DEG F)	DIFFERENTIAL = 3 DEG C (5 DEG F)	---
OCCUPIED MODE	CLK-XX-01 CONTACT	365 DAY SCHEDULE	---	NORMAL SCHEDULE (M-F) CONTACT CLOSED: 0705 HRS CONTACT OPEN: 1700 HRS	CONTACT OPEN: SAT, SUN
VENTILATION DELAY MODE	CLK-XX-01 CONTACT	365 DAY SCHEDULE	---	NORMAL SCHEDULE (M-F) CONTACT CLOSED: 0700 HRS CONTACT OPEN: 0800 HRS	↓

NOTE: OTHER CONTROL DEVICES SUCH AS IP#, RELAYS, AND SIGNAL SELECTORS ARE NOT SHOWN.

Figure 4-19c. Control system equipment for single zone HVAC system.



FRONT VIEW

REAR VIEW

SWITCH AND PILOT LIGHT LEGEND

POSITION LEGEND

- 1 - RESET
- 2 - AUTO/AUTO OVERRIDE
- 3 - ENABLE/OFF
- 4 - LOW TEMP
- 5 - SMOKE

DEVICE TYPE

- NON-ILLUMINATED MOMENTARY CONTACT PUSH BUTTON SWITCH
- ILLUMINATED MAINTAINED CONTACT INTERLOCKED SWITCHES
- ILLUMINATED MAINTAINED CONTACT INTERLOCKED SWITCHES
- PILOT LIGHT
- PILOT LIGHT

IDENTIFIER

- HS-XX-02
- HS-XX-01
- HS-XX-03
- PL-XX-04
- PL-XX-05

POSITION LEGEND

- 6 - FILTER
- 7 - OCC
- 8 - VENT DELAY
- 9 - ECON

DEVICE TYPE

- PILOT LIGHT
- PILOT LIGHT
- PILOT LIGHT
- PILOT LIGHT

IDENTIFIER

- PL-XX-04
- PL-XX-01
- PL-XX-02
- PL-XX-03

Figure 4-19d. Control panel interior door layout for single zone HVAC system.

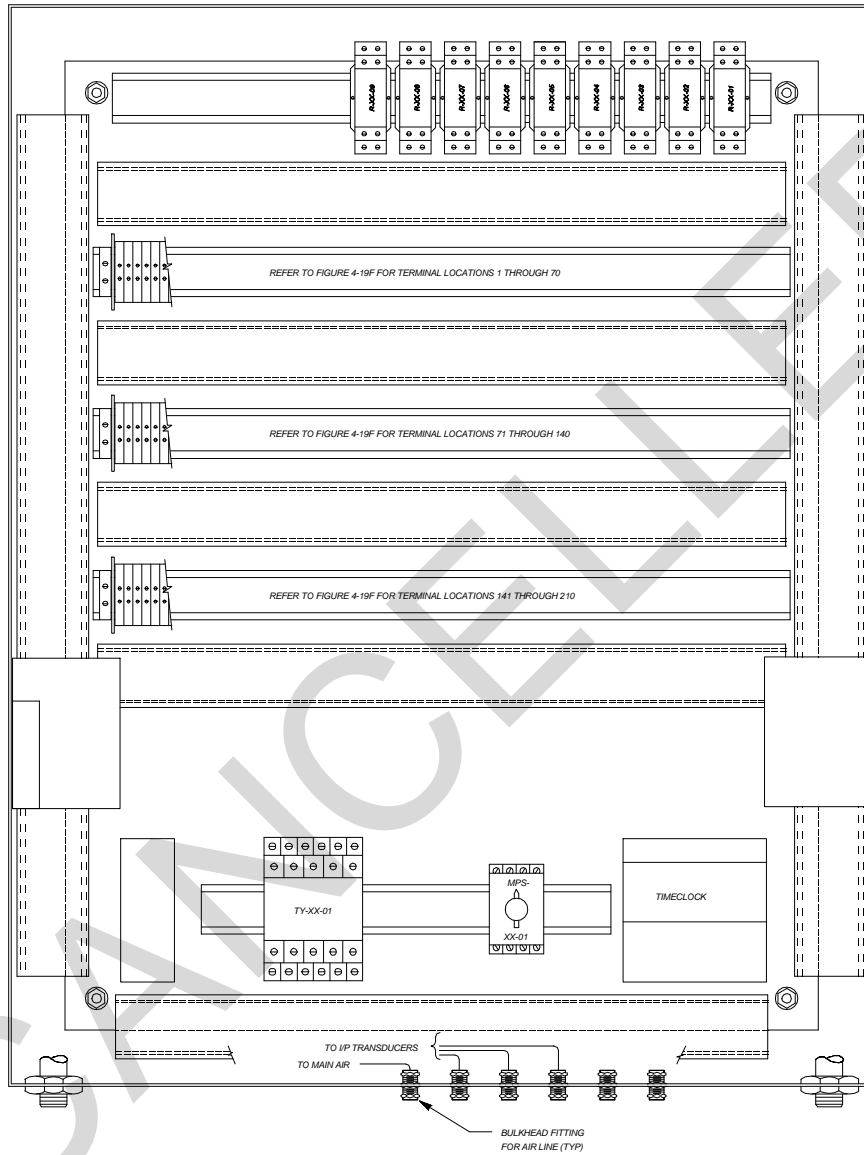

Figure 4-19e. Control panel back panel layout for single zone HVAC system.

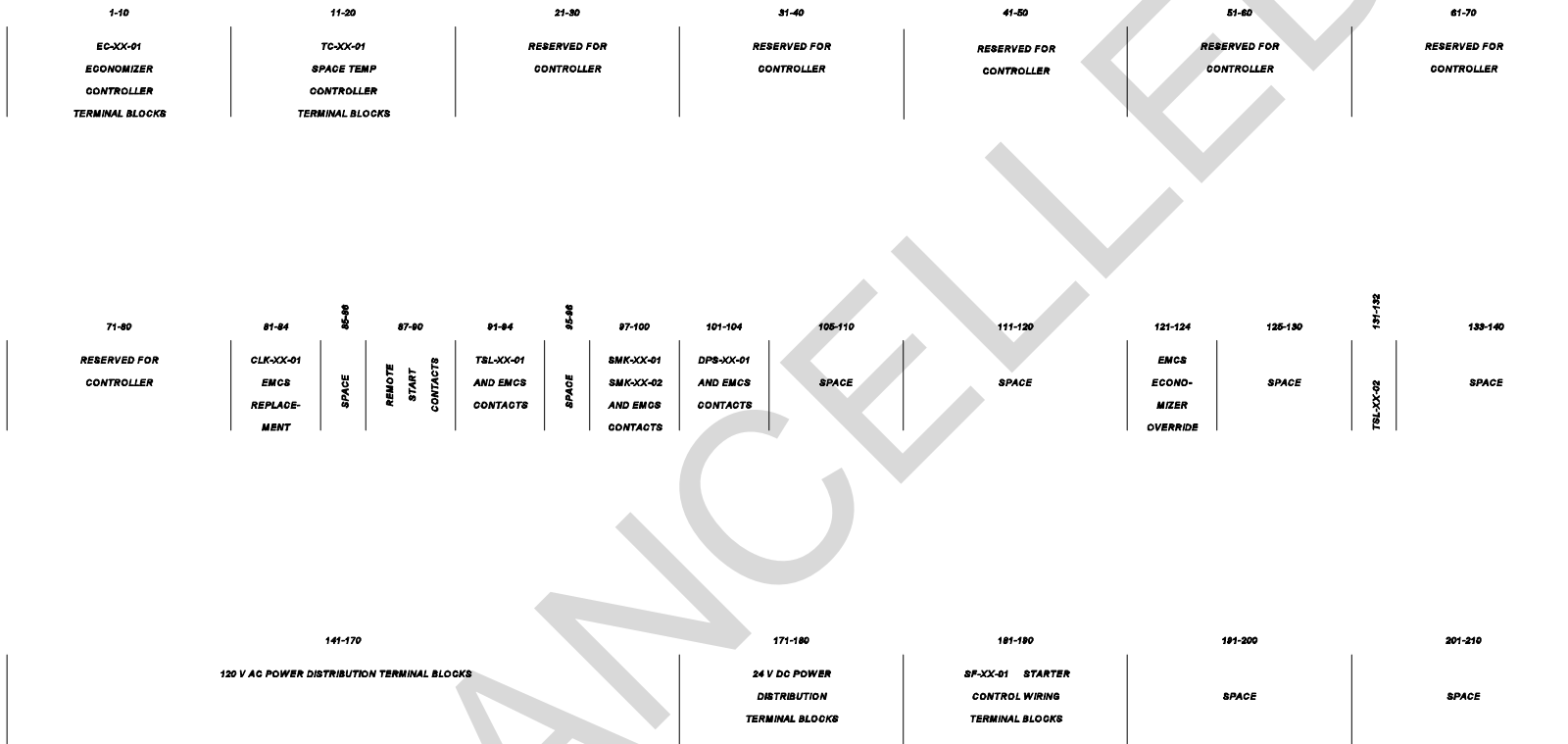

Figure 4-19f. Control panel terminal block layout for single zone HVAC system.

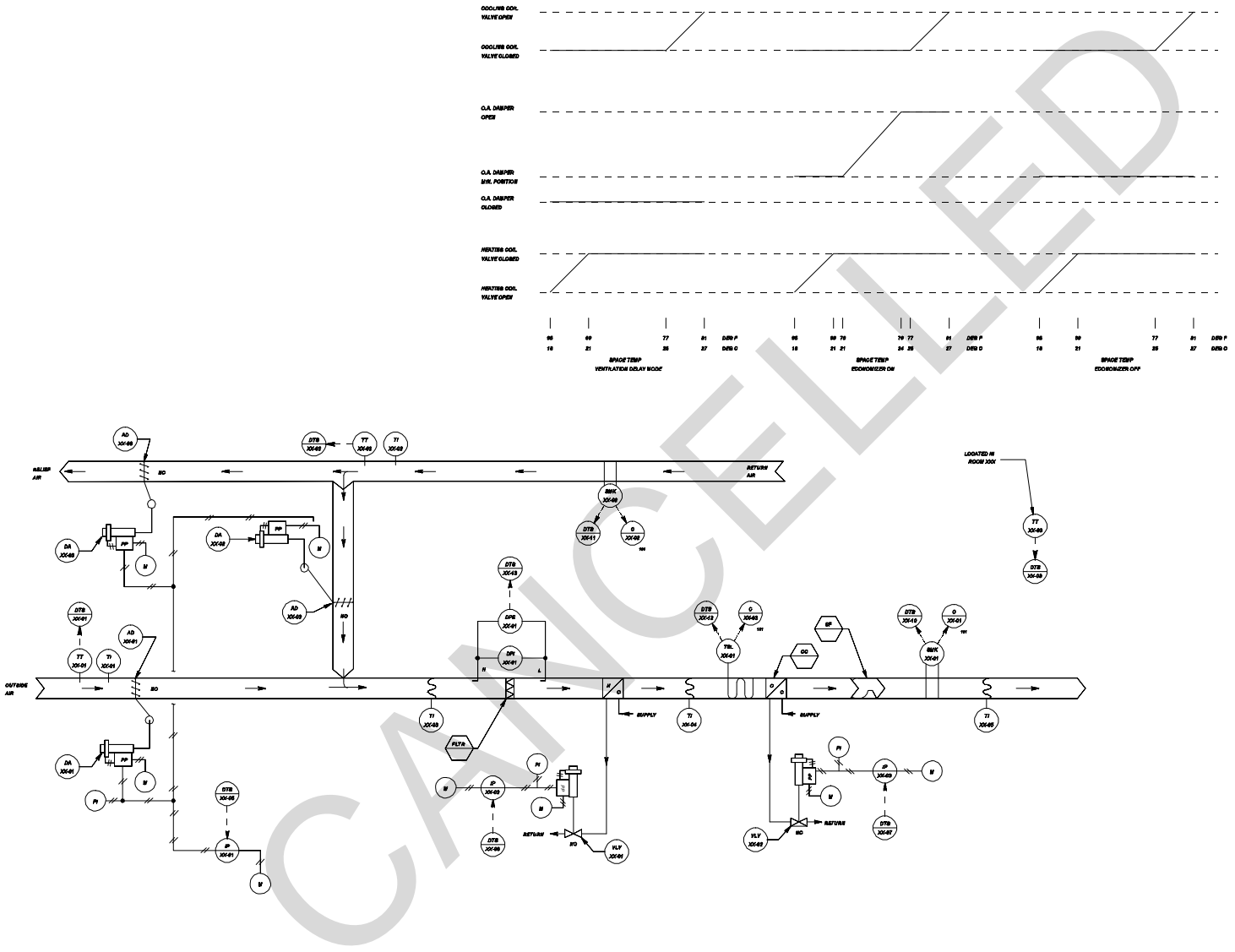

Figure 4-19g. DDC control system schematic for single zone HVAC system.

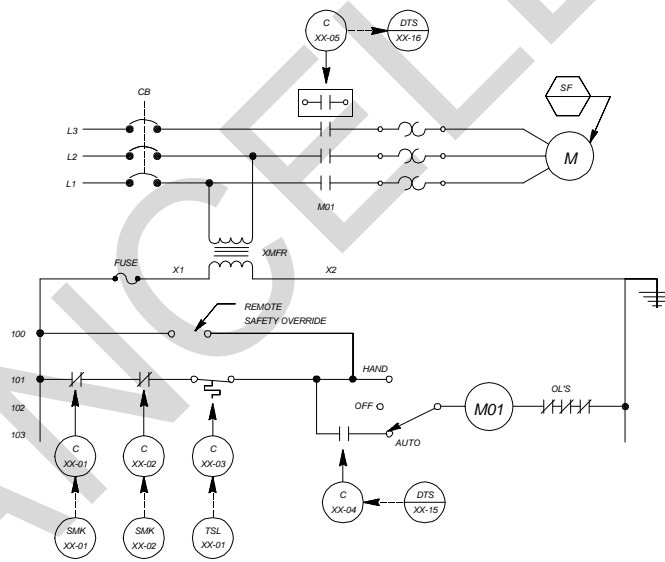

Figure 4-19h. DDC control system ladder diagram for single zone HVAC system.

SENSOR SCHEDULE

IDENTIFIER	FUNCTION	RANGE
TT-XX-01	OUTSIDE AIR TEMPERATURE TRANSMITTER	-34 TO 54 DEG C (-30 TO +130 DEG F)
TT-XX-02	RETURN AIR TEMPERATURE TRANSMITTER	-34 TO 54 DEG C (-30 TO +130 DEG F)
TT-XX-03	SPACE TEMPERATURE TRANSMITTER	10 TO 30 DEG C (50 TO 85 DEG F)

CONTROL VALVE SCHEDULE

IDENTIFIER	FUNCTION	TYPE	RANGE	Kv (Cv)	CLOSE-OFF RATING	REMARKS
VLV-XX-01	HEATING COIL VALVE	2-WAY, MODULATING	21 - 103 kPa (3-15 PSIG)	XX	XX kPa (XX PSIG)	
VLV-XX-02	COOLING COIL VALVE	2-WAY, MODULATING	21 - 103 kPa (3-15 PSIG)	XX	XX kPa (XX PSIG)	

CONTROL DAMPER SCHEDULE

IDENTIFIER	FUNCTION	TYPE	SIZE	RANGE	REMARKS
AD-XX-01	OUTSIDE AIR	MODULATING	W x H (mm) (WW" X HH")	21 - 103 kPa (3-15 PSIG)	PARALLEL BLADE
AD-XX-02	RETURN AIR	MODULATING	W x H (mm) (WW" X HH")		PARALLEL BLADE
AD-XX-03	RELIEF AIR	MODULATING	W x H (mm) (WW" X HH")		PARALLEL BLADE

OPERATING PARAMETERS

FUNCTION	SETPOINT	REMARKS
MINIMUM OUTSIDE AIR	XXXX L/s (XXXX CFM)	
SPACE TEMPERATURE	XX DEG C (XX DEG F) XX DEG C (XX DEG F)	(HEATING) (COOLING)
SPACE TEMP. (NIGHT SETBACK)	XX DEG C (XX DEG F)	(HEATING ONLY)
ECONOMIZER MODE		ECONOMIZER MODE = ON, WHEN CONDITION 1 AND CONDITION 2 ARE BOTH SATISFIED. CONDITION 1: RETURN AIR TEMP. > XX DEG C (XX DEG F) CONDITION 2: RETURN AIR TEMP. MINUS OUTSIDE AIR TEMP. > XX DEG C (XX DEG F)
OCCUPIED MODE		MONDAY - FRIDAY : 0705 HRS - 1700 HRS
VENT DELAY MODE		MONDAY - FRIDAY : 0700 HRS - 0800 HRS
FREEZESTAT	XX DEG C (XX DEG F)	
FILTER ALARM	XX kPa (XX IN. WATER)	

Figure 4-19i. DDC control system equipment for single zone HVAC system.

	HARDWARE																SOFTWARE															
	OUTPUT								INPUT								ALARMS					APPLICATION PROGRAMS										
	DIGITAL				ANALOG				DIGITAL				ANALOG				DIGITAL		ANALOG													
	CONTROL RELAY				POSITION ADJUSTMENT				AUXILIARY CONTACT					TEMPERATURE	% RELATIVE HUMIDITY	PSIA, PSIA, PSH	FLOW	CONTACT CLOSURE			HIGH LIMIT	LOW LIMIT	RUN TIME	SCHEDULED START/STOP	OPTIMUM START/STOP	DUTY CYCLING	DEMAND LIMITING	DAY/NIGHT SETBACK	ECONOMIZER	VENTILATION/REGULATION	FAILURE MODE	
SUPPLY FAN	1							1									X					X	X	X	X							
OUTSIDE AIR													1								X	X										
RETURN AIR													1								X	X										
SPACE													1								X	X				X	X					
MIXED AIR DAMPERS					f																							X	X			
HEATING COIL VALVE					f																											
COOLING COIL VALVE					f																											
SMOKE DETECTOR								2									X															
FREEZESTAT								f									X															
FILTER								f									X															

** C - LAST COMMAND
H - HIGH VALUE
L - LOW VALUE
O - ON (OPEN)
F - OFF (CLOSED)

DDC DATA TERMINAL STRIP LAYOUT

DEVICE NO.	DESCRIPTION	TYPE
1	TT-XX-01 OUTSIDE AIR TEMPERATURE	AI
2	TT-XX-02 RETURN AIR TEMPERATURE	AI
3	TT-XX-03 SPACE TEMPERATURE	AI
4		
5	IP-XX-01 MIXED AIR DAMPERS	AO
6	IP-XX-02 HEATING COIL VALVE	AO
7	IP-XX-03 COOLING COIL VALVE	AO
8		
9		
10	SMK-XX-01 SUPPLY AIR SMOKE DETECTOR	DI
11	SMK-XX-02 RETURN AIR SMOKE DETECTOR	DI
12	TSL-XX-01 FREEZESTAT	DI
13	DPS-XX-01 FILTER ALARM	DI
14		
15	C-XX-04 SUPPLY FAN START/STOP	DO
16	C-XX-05 SUPPLY FAN STATUS	DI
17		
18		
19		
20		

Figure 4-19j. DDC control system I/O table and data terminal strip layout for single zone HVAC system.

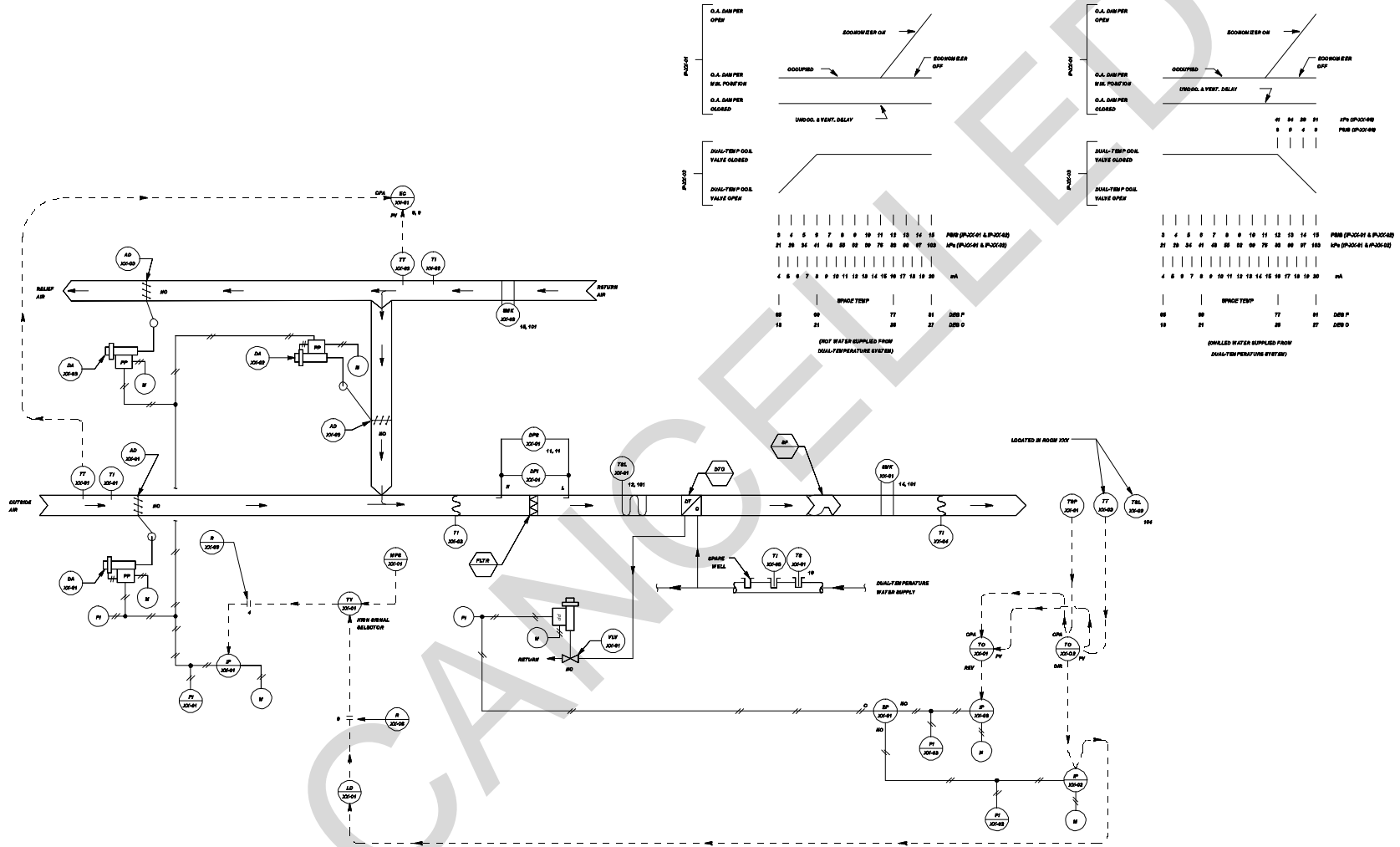

Figure 4-20a. Control system schematic for single zone HVAC system with dual-temperature coil.

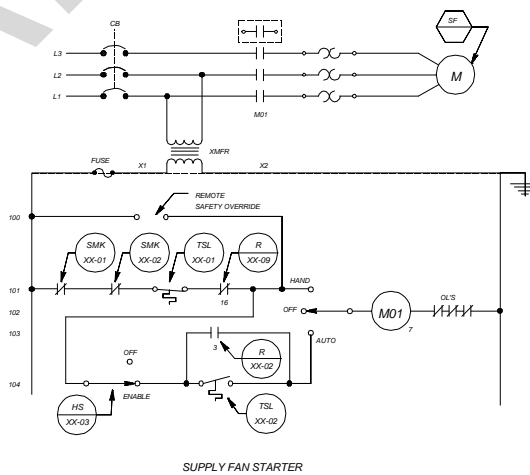
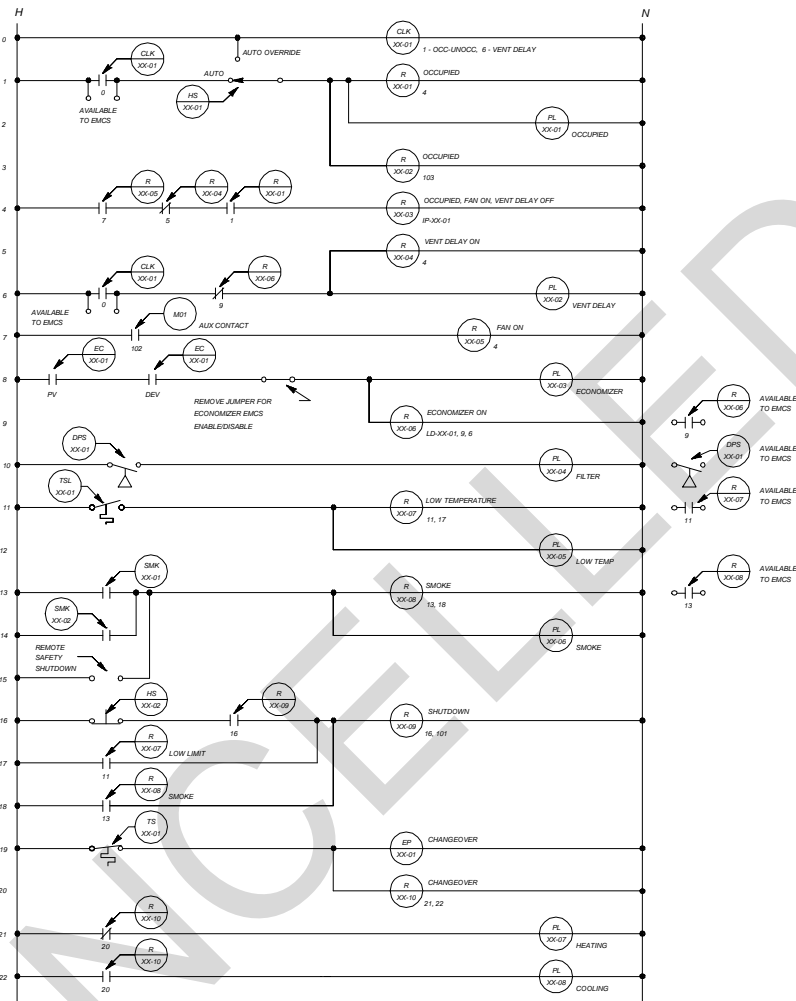
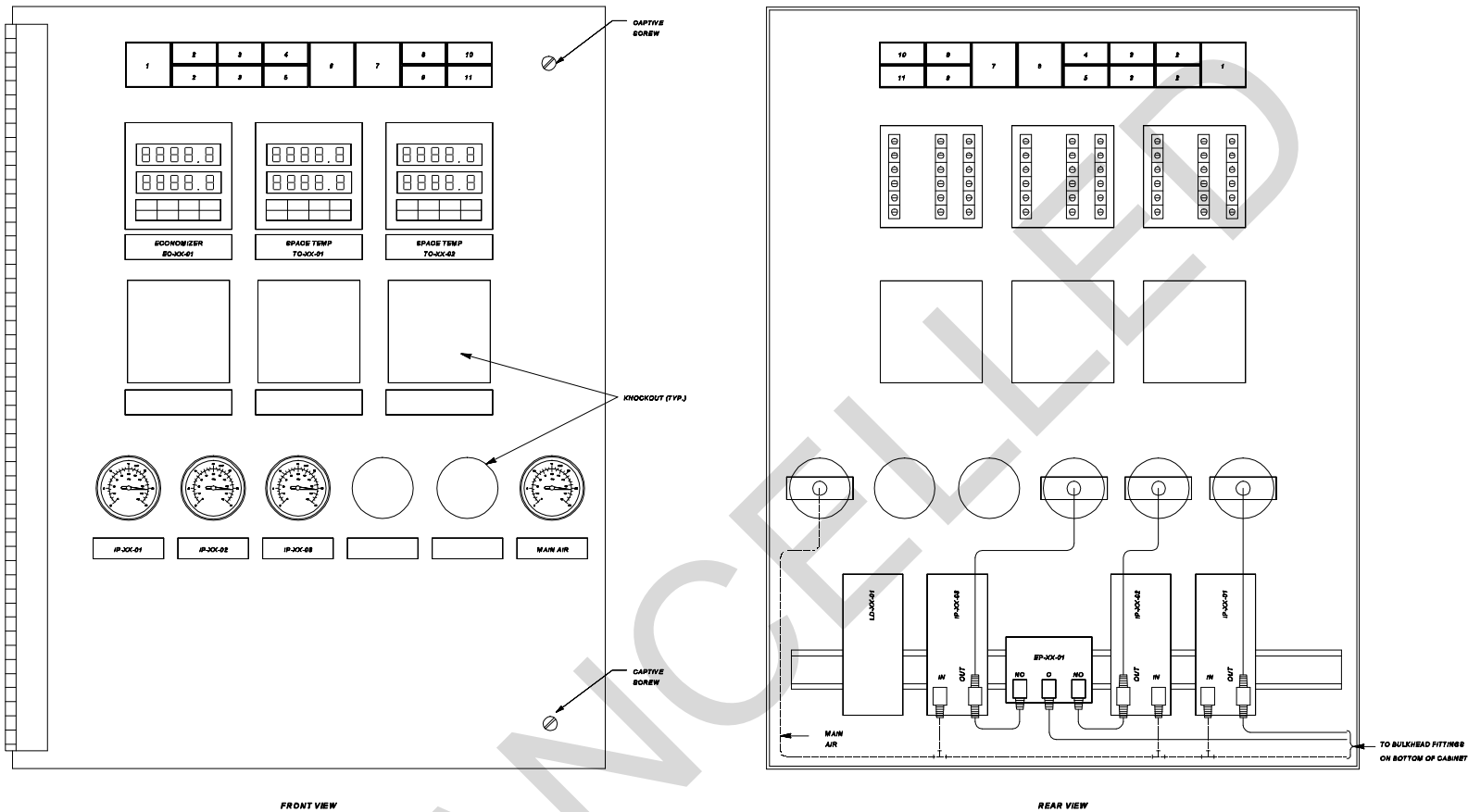

Figure 4-20b. Control system ladder diagram for single zone HVAC system with dual-temperature coil.

LOOP CONTROL FUNCTION	DEVICE NUMBER	DEVICE FUNCTION	SETPOINT	RANGE	ADDITIONAL PARAMETERS
SPACE TEMPERATURE	DA-XX-01 DA-XX-02 DA-XX-03	DAMPER ACTUATOR	---	76 - 108 kPa (11 - 16 PSID)	---
	MPB-XX-01	MINIMUM POSITION SWITCH	---	---	SET MIN OA L/A (CFM) EQUAL TO ___ L/B (___ CFM)
	TT-XX-01	OUTSIDE AIR TEMPERATURE TRANSMITTER	---	-34 TO 84 DEG C (-30 TO +130 DEG F)	---
	TT-XX-02	RETURN AIR TEMPERATURE TRANSMITTER	---	-34 TO 84 DEG C (-30 TO +130 DEG F)	---
	EC-XX-01	ECONOMIZER CONTROLLER	FV CONTACT CLOSE AT ___ DEG C (___ DEG F) OPEN AT ___ DEG C (___ DEG F)	-34 TO 84 DEG C (-30 TO +130 DEG F)	DEV CONTACT CLOSE @ DELTA T= ___ DEG C (___ DEG F) OPEN @ DELTA T= ___ DEG C (___ DEG F)
	VLV-XX-01	DUAL-TEMP COIL VALVE	---	21 - 41 kPa (3 - 6 PSID)	Kv= ___ (Cv= ___) CLOSE AGAINST ___ kPa (___ PSID)
	TC-XX-01	SPACE TEMPERATURE COOLING CONTROLLER	4 mA = 10 DEG C (50 DEG F) 20 mA = 30 DEG C (85 DEG F)	10 TO 30 DEG C (50 TO 85 DEG F)	SET LIMITS AVAILABLE TO OCCUPANT BY TSP-XX-01 AT 24 TO 27 DEG C (76 TO 81 DEG F)
	TC-XX-02	SPACE TEMPERATURE HEATING CONTROLLER	4 mA = 10 DEG C (50 DEG F) 20 mA = 30 DEG C (85 DEG F)	10 TO 30 DEG C (50 TO 85 DEG F)	SET LIMITS AVAILABLE TO OCCUPANT BY TSP-XX-01 AT 18 TO 22 DEG C (66 TO 71 DEG F)
	TT-XX-03	SPACE TEMPERATURE TRANSMITTER	---	10 TO 30 DEG C (50 TO 85 DEG F)	---
	TSP-XX-01	SPACE TEMPERATURE SETPOINT ADJUSTMENT	4 mA = 10 DEG C (50 DEG F) 20 mA = 30 DEG C (85 DEG F)	---	---
MIXED AIR TEMPERATURE	TSL-XX-01	LOW TEMPERATURE PROTECTION THERMOSTAT	2 DEG C (35 DEG F)	---	---
	DPS-XX-01	FILTER ALARM	PER FILTER MANUFACTURER'S RECOMMENDATION	PER FILTER MANUFACTURER'S RECOMMENDATION	---
SPACE LOW TEMPERATURE	TSL-XX-02	NIGHT STAT - SPACE LOW TEMPERATURE PROTECTION	13 DEG C (55 DEG F)	DIFFERENTIAL = 3 DEG C (5 DEG F)	---
OCCUPIED MODE	CLK-XX-01 CONTACT	365 DAY SCHEDULE	---	NORMAL SCHEDULE (M-F) CONTACT CLOSED: 0705 HRS CONTACT OPEN: 1700 HRS	CONTACT OPEN SAT, SUN
VENTILATION DELAY MODE	CLK-XX-01 CONTACT	365 DAY SCHEDULE	---	NORMAL SCHEDULE (M-F) CONTACT CLOSED: 0700 HRS CONTACT OPEN: 0800 HRS	↓
HEATING/COOLING CHANGEOVER	TB-XX-01	AQUASTAT	OPEN AT 18 DEG C (60 DEG F) CLOSE AT 10 DEG C (50 DEG F)	DIFFERENTIAL = 8 DEG C (10 DEG F)	---

NOTE: OTHER CONTROL DEVICES SUCH AS VPS, RELAYS, AND SIGNAL SELECTORS ARE NOT SHOWN.

Figure 4-20c. Control system equipment for single zone HVAC system with dual-temperature coil.



FRONT VIEW

REAR VIEW

SWITCH AND PILOT LIGHT LEGEND

POSITION LEGEND
1 - RESET
2 - AUTOMATO OVERRIDE
3 - ENABLE/OFF
4 - LOW TEMP
5 - SMOKE

DEVICE TYPE
NON-ILLUMINATED MOMENTARY CONTACT PUSH BUTTON SWITCH
ILLUMINATED MAINTAINED CONTACT INTERLOCKED SWITCHES
ILLUMINATED MAINTAINED CONTACT INTERLOCKED SWITCHES
PILOT LIGHT
PILOT LIGHT

IDENTIFIER
HS-XX-02
HS-XX-01
HS-XX-03
PL-XX-05
PL-XX-08

POSITION LEGEND
6 - FILTER
7 - DGG
8 - VENT DELAY
9 - ECON
10 - HEATING
11 - COOLING

DEVICE TYPE
PILOT LIGHT
PILOT LIGHT
PILOT LIGHT
PILOT LIGHT
PILOT LIGHT

IDENTIFIER
PL-XX-04
PL-XX-01
PL-XX-02
PL-XX-03
PL-XX-07
PL-XX-08

Figure 4-20d. Control panel interior door layout for single zone HVAC system with dual-temperature coil.

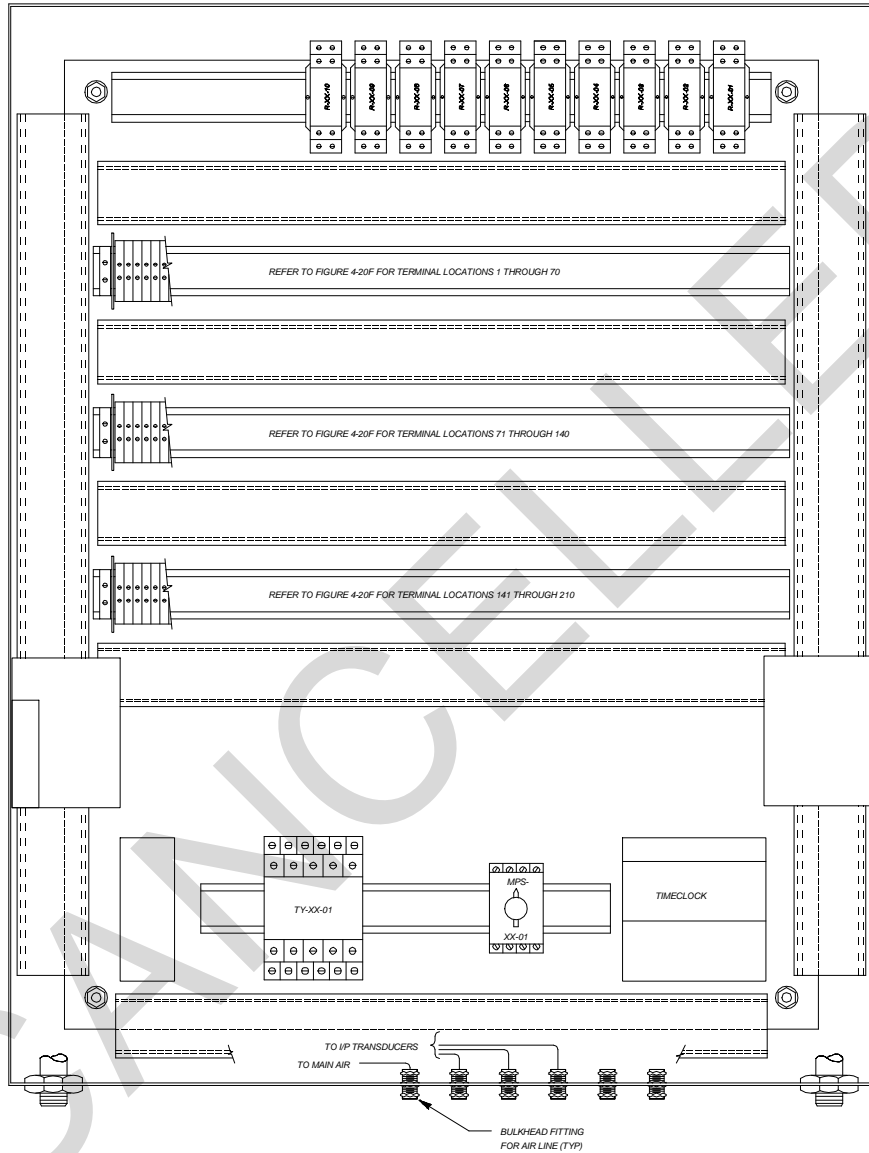

Figure 4-20e. Control panel back panel layout for single zone HVAC system with dual-temperature coil.

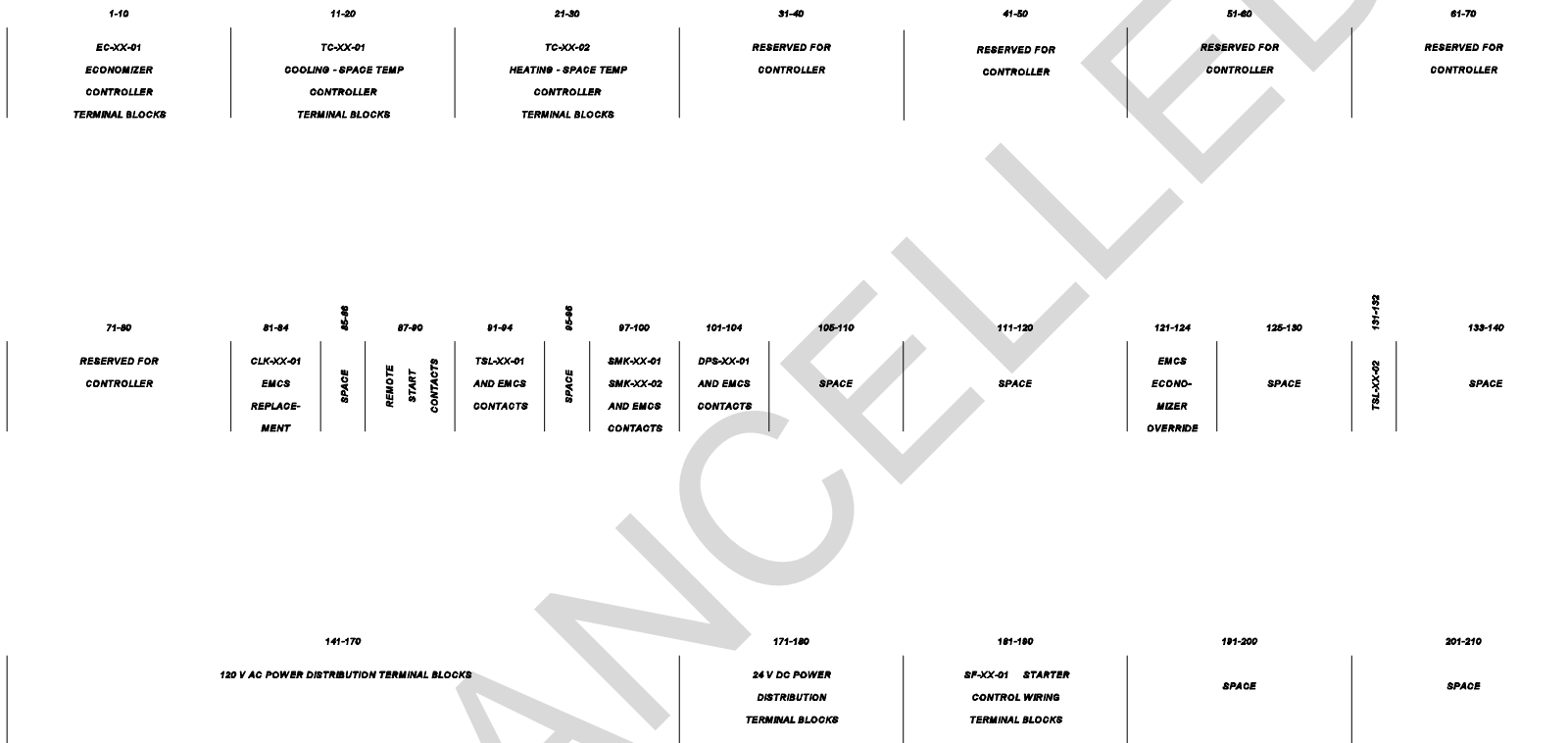

Figure 4-20f. Control panel terminal block layout for single zone HVAC system with dual-temperature coil.

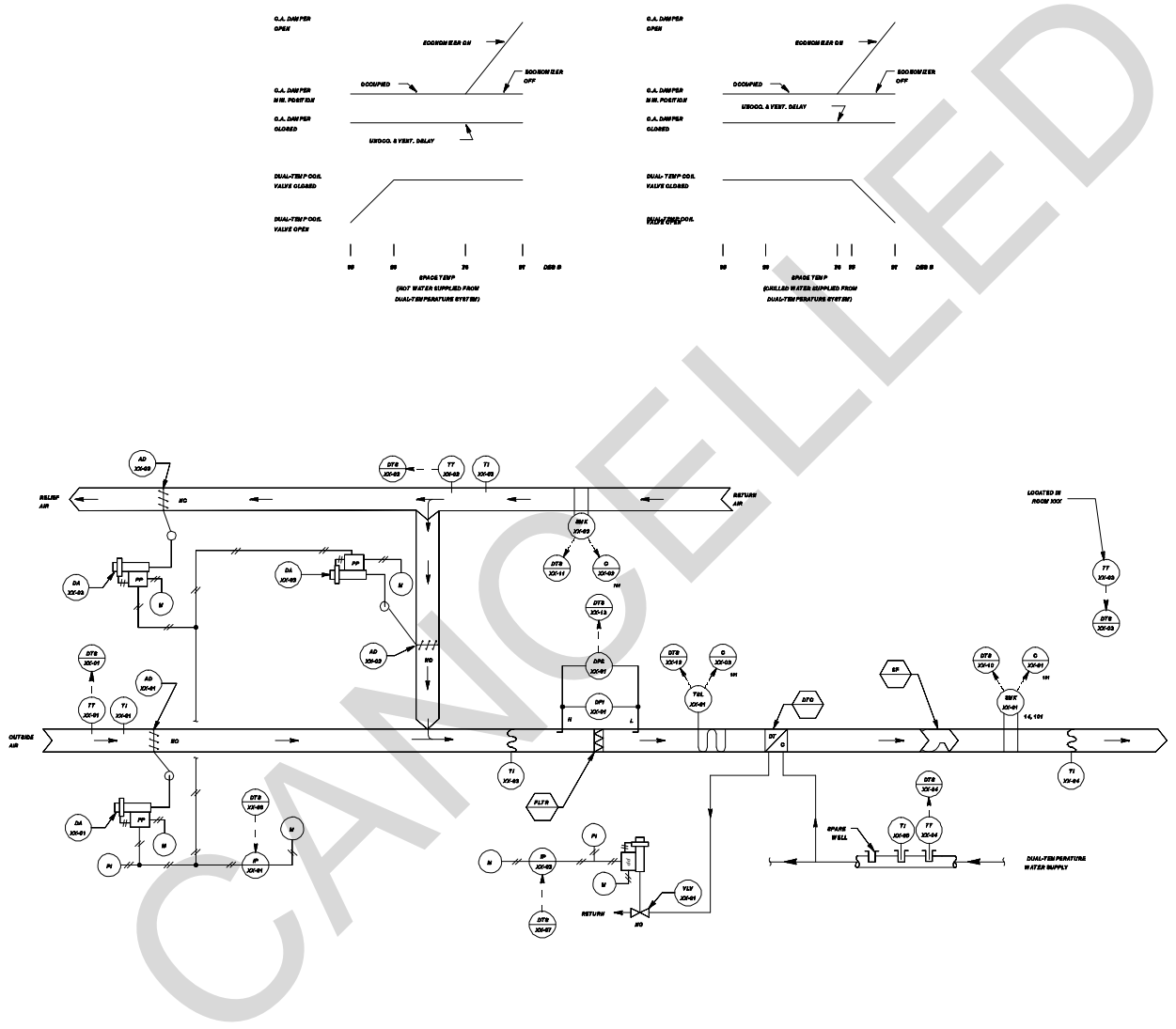

Figure 4-20g. DDC control system schematic for single zone HVAC system with dual-temperature coil.

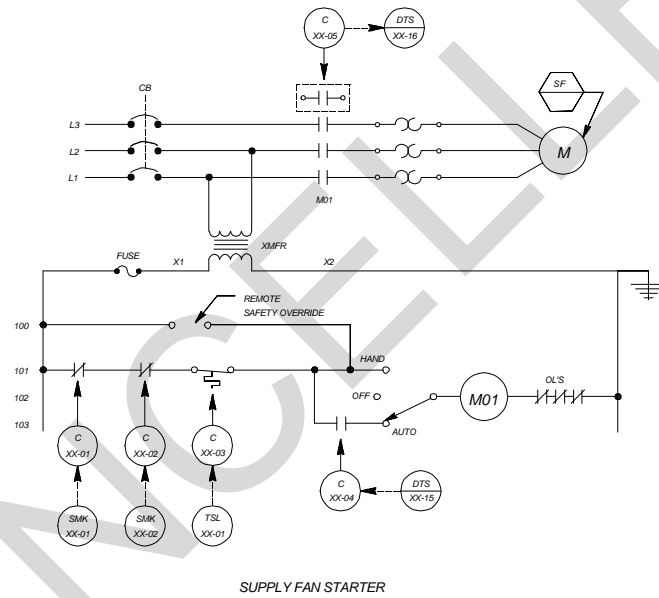

Figure 4-20h. DDC control system ladder diagram for single zone HVAC system with dual-temperature coil.

SENSOR SCHEDULE

IDENTIFIER	FUNCTION	RANGE
TT-XX-01	OUTSIDE AIR TEMPERATURE TRANSMITTER	-34 TO 54 DEG C (-30 TO +130 DEG F)
TT-XX-02	RETURN AIR TEMPERATURE TRANSMITTER	-34 TO 54 DEG C (-30 TO +130 DEG F)
TT-XX-03	SPACE TEMPERATURE TRANSMITTER	10 TO 30 DEG C (50 TO 85 DEG F)
TT-XX-04	DUAL-TEMP WATER TEMPERATURE TRANSMITTER	1 TO 116 DEG C (30 TO 240 DEG F)

CONTROL VALVE SCHEDULE

IDENTIFIER	FUNCTION	TYPE	RANGE	Kv (Cv)	CLOSE-OFF RATING	REMARKS
VLV-XX-01	DUAL-TEMP COIL VALVE	2-WAY, MODULATING	21 - 103 kPa (3-15 PSIG)	XX	XX kPa (XX PSIG)	

CONTROL DAMPER SCHEDULE

IDENTIFIER	FUNCTION	TYPE	SIZE	RANGE	REMARKS
AD-XX-01	OUTSIDE AIR	MODULATING	W x H (mm) (WW" X HH")	21 - 103 kPa (3-15 PSIG)	PARALLEL BLADE
AD-XX-02	RETURN AIR	MODULATING	W x H (mm) (WW" X HH")		PARALLEL BLADE
AD-XX-03	RELIEF AIR	MODULATING	W x H (mm) (WW" X HH")		PARALLEL BLADE

OPERATING PARAMETERS

FUNCTION	SETPOINT	REMARKS
MINIMUM OUTSIDE AIR	XXXX L/s (XXXX CFM)	
SPACE TEMPERATURE	XX DEG C (XX DEG F) XX DEG C (XX DEG F)	(HEATING) (COOLING)
SPACE TEMP. (NIGHT SETBACK)	XX DEG C (XX DEG F)	(HEATING ONLY)
ECONOMIZER MODE		ECONOMIZER MODE = ON, WHEN CONDITION 1 AND CONDITION 2 ARE BOTH SATISFIED. CONDITION 1: RETURN AIR TEMP. > XX DEG C (XX DEG F) CONDITION 2: RETURN AIR TEMP. MINUS OUTSIDE AIR TEMP. > XX DEG C (XX DEG F)
OCCUPIED MODE		MONDAY - FRIDAY : 0705 HRS - 1700 HRS
VENT DELAY MODE		MONDAY - FRIDAY : 0700 HRS - 0800 HRS
FREEZESTAT	XX DEG C (XX DEG F)	
FILTER ALARM	XX kPa (XX IN. WATER)	
DUAL-TEMP CHANGEOVER	XX DEG C (XX DEG F)	XX DEG C DIFFERENTIAL (XX DEG F DIFFERENTIAL)

Figure 4-20i. DDC control system equipment for single zone HVAC system with dual-temperature coil.

	HARDWARE																SOFTWARE																		
	OUTPUT								INPUT								ALARMS					APPLICATION PROGRAMS													
	DIGITAL				ANALOG				DIGITAL				ANALOG				DIGITAL		ANALOG																
	CONTROL RELAY				POSITION ADJUSTMENT				AUXILIARY CONTACT					TEMPERATURE	% RELATIVE HUMIDITY	PSIA, PPA, PWD	FLOW	CONTACT CLOSURE				HIGH LIMIT	LOW LIMIT	RUN TIME	SCHEDULED START/STOP	OPTIMUM START/STOP	DUTY CYCLING	DEMAND LIMITING	DAMPHIT SETBACK	ECONOMIZER	VENTILATION/RECIRCULATION	FAILURE MODE **			
SUPPLY FAN	1																	X					X	X	X	X	X								
OUTSIDE AIR													1									X	X												
RETURN AIR													1									X	X												
SPACE													1									X	X				X	X							
DUAL-TEMP WATER													1									X	X												
MIXED AIR DAMPERS									1																										
DUAL-TEMP COIL VALVE									1																										
SMOKE DETECTOR																																			
FREEZESTAT																																			
FILTER																																			

** C - LAST COMMAND
H - HIGH VALUE
L - LOW VALUE
O - ON (OPEN)
F - OFF (CLOSED)

DDC DATA TERMINAL STRIP LAYOUT

DEVICE NO.	DESCRIPTION	TYPE
1	TT-XX-01 OUTSIDE AIR TEMPERATURE	AI
2	TT-XX-02 RETURN AIR TEMPERATURE	AI
3	TT-XX-03 SPACE TEMPERATURE	AI
4	TT-XX-04 DUAL-TEMP WATER TEMP.	AI
5		
6	IP-XX-01 MIXED AIR DAMPERS	AO
7	IP-XX-02 DUAL-TEMP COIL VALVE	AO
8		
9		
10	SMK-XX-01 SUPPLY AIR SMOKE DETECTOR	DI
11	SMK-XX-02 RETURN AIR SMOKE DETECTOR	DI
12	TSL-XX-01 FREEZESTAT	DI
13	DPS-XX-01 FILTER ALARM	DI
14		
15	C-XX-04 SUPPLY FAN START/STOP	DO
16	C-XX-05 SUPPLY FAN STATUS	DI
17		
18		
19		
20		

Figure 4-20j. DDC control system I/O table and data terminal strip layout for single zone HVAC system with dual-temperature coil.

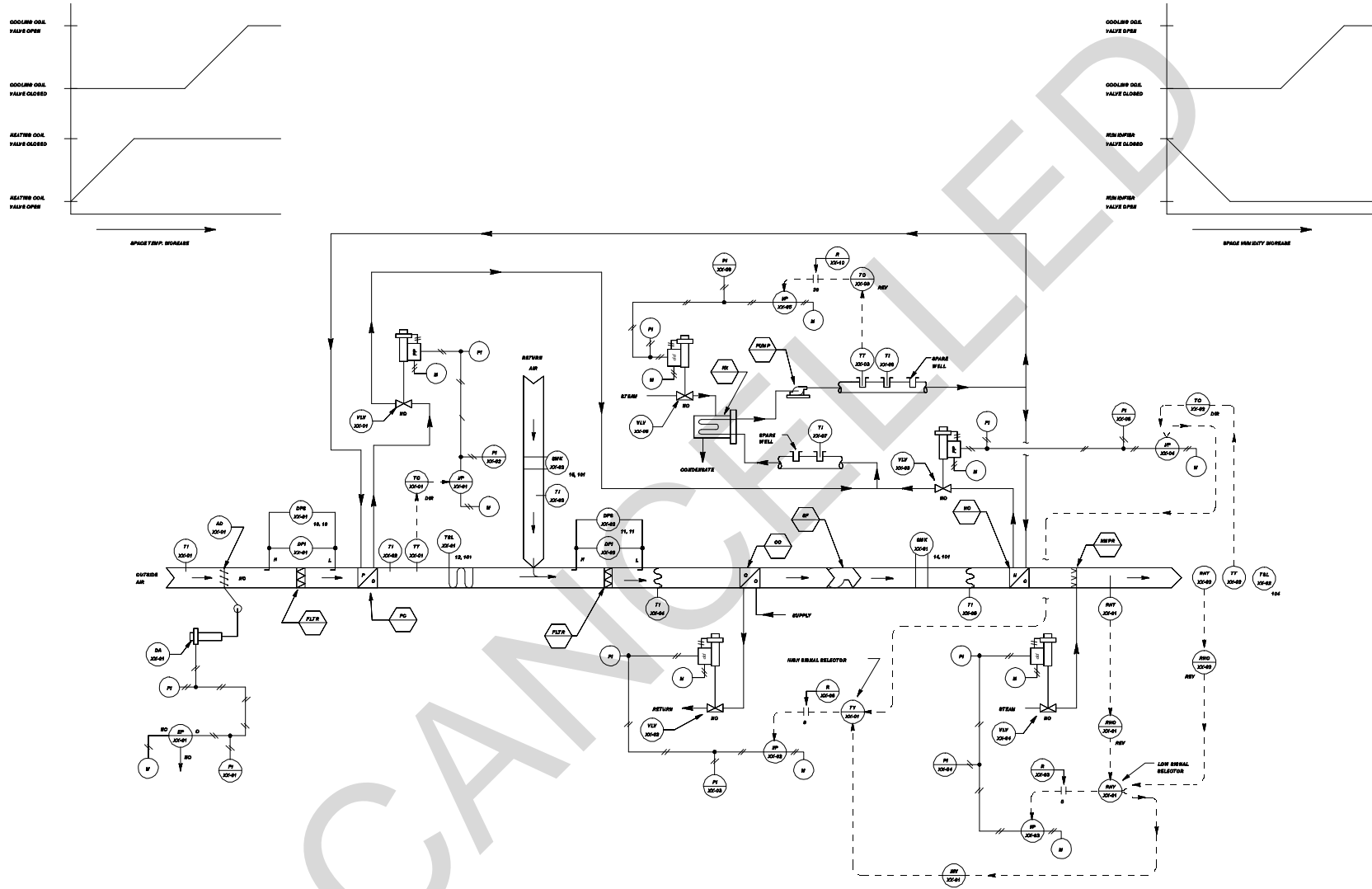

Figure 4-21a. Control system schematic for single zone HVAC system with humidity control.

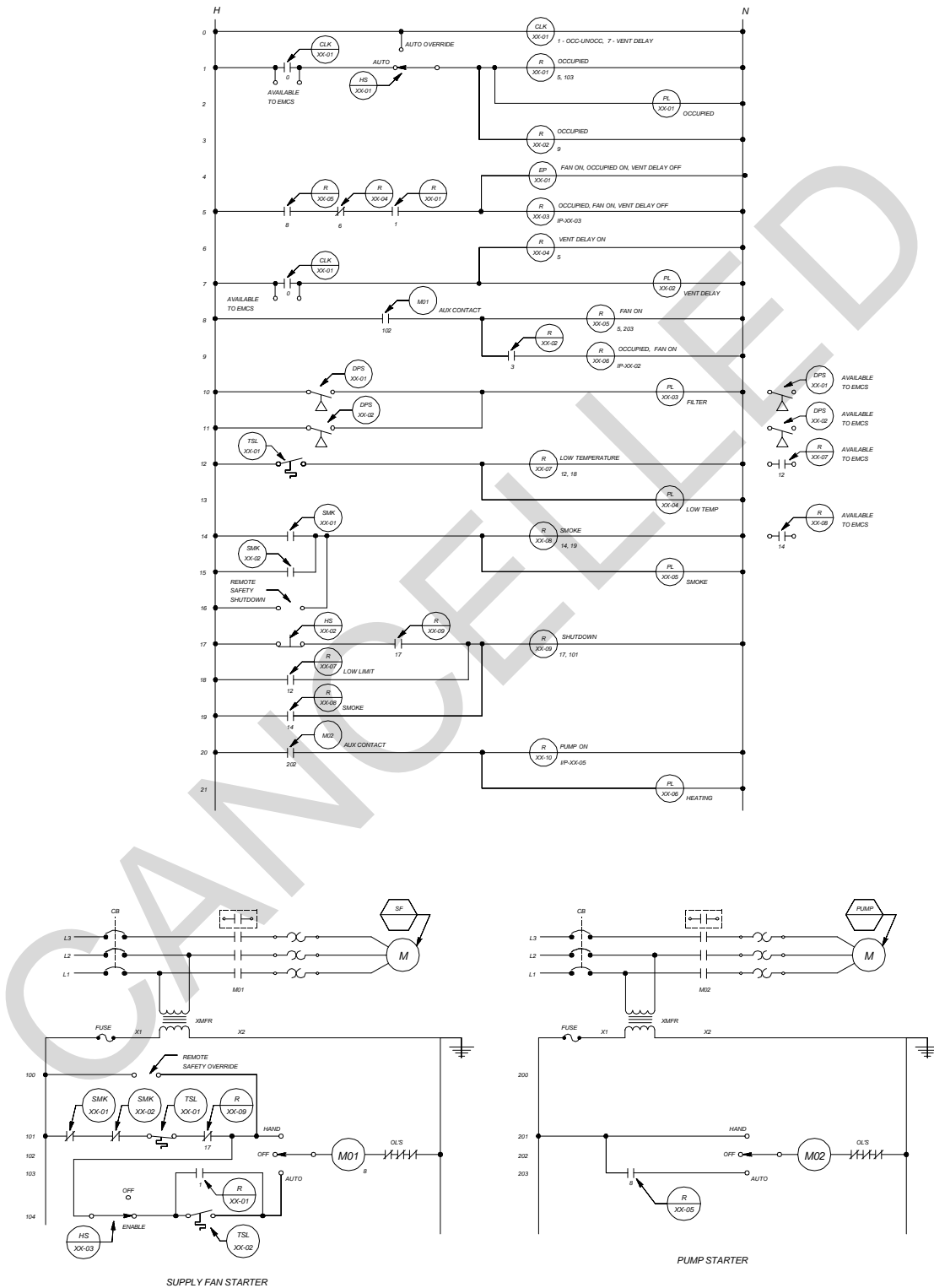
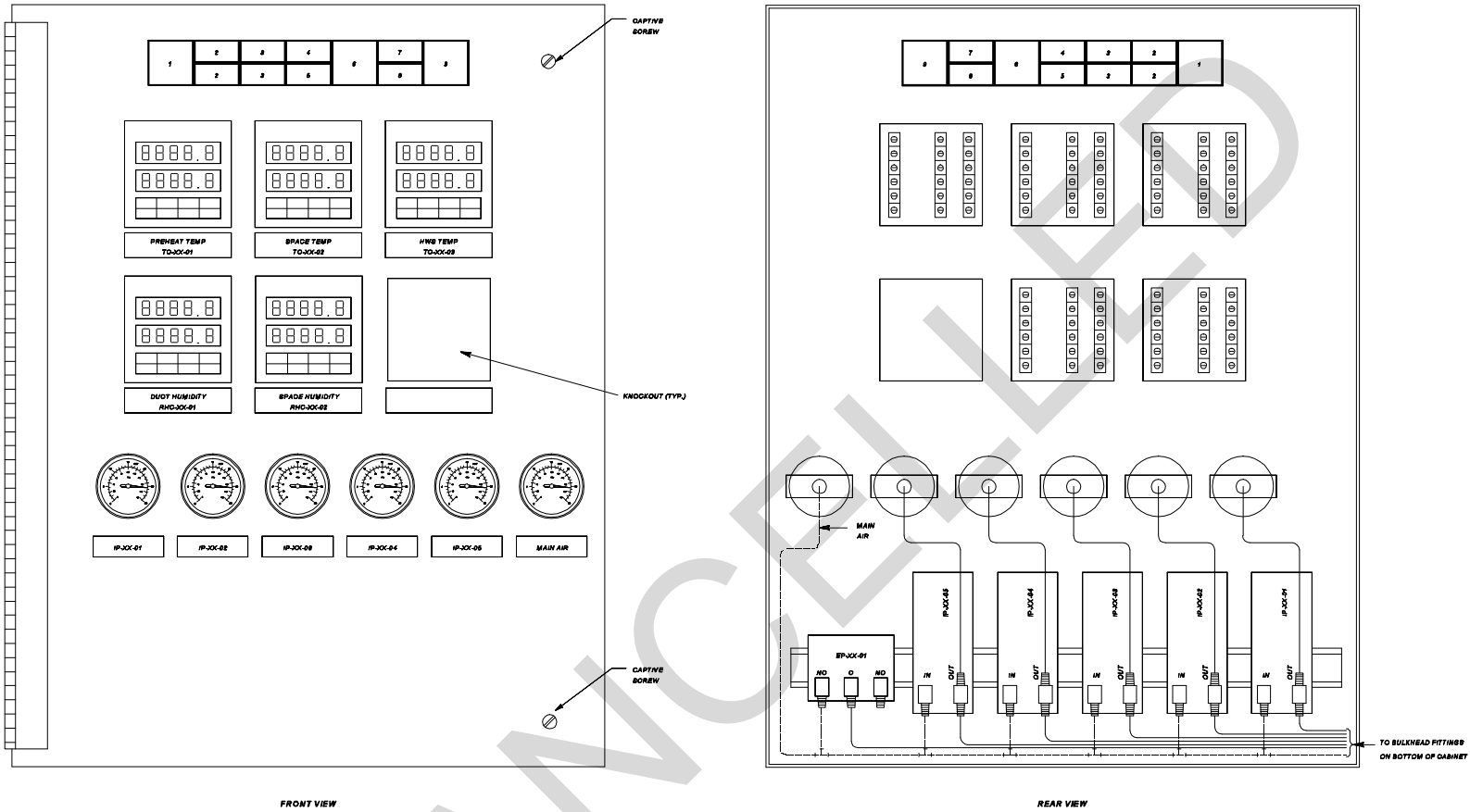

Figure 4-21b. Control system ladder diagram for single zone HVAC system with humidity control.

LOOP CONTROL FUNCTION	DEVICE NUMBER	DEVICE FUNCTION	SETPOINT	RANGE	ADDITIONAL PARAMETERS
OUTSIDE AIR	DA-XX-01	DAMPER ACTUATOR	---	SPRNG RANGE	(TWO-POSITION)
PRE-HEAT COOL TEMPERATURE	VLV-XX-01	PRE-HEAT COOL VALVE	---	21 - 108 kPa (3 - 15 PSIG)	Kv = __ (Cv = __) CLOSE AGAINST __ kPa (__ PSIG)
	TT-XX-01	PRE-HEAT TEMPERATURE TRANSMITTER	---	4 TO 80 DEG C (40 TO 140 DEG F)	---
	TC-XX-01	PRE-HEAT TEMPERATURE CONTROLLER	---	4 TO 80 DEG C (40 TO 140 DEG F)	---
	DPB-XX-01	PRE-FILTER ALARM	PER FILTER MANUFACTURER'S RECOMMENDATION	PER FILTER MANUFACTURER'S RECOMMENDATION	---
MIXED AIR	TBL-XX-01	LOW TEMPERATURE PROTECTION THERMOSTAT	3 DEG C (35 DEG F)	---	---
	DPB-XX-02	FILTER ALARM	PER FILTER MANUFACTURER'S RECOMMENDATION	PER FILTER MANUFACTURER'S RECOMMENDATION	---
SPACE LOW TEMPERATURE	TBL-XX-02	NIGHT STAT - SPACE LOW TEMPERATURE PROTECTION	13 DEG C (55 DEG F)	DIFFERENTIAL = 3 DEG C (5 DEG F)	---
SPACE TEMPERATURE	TT-XX-02	SPACE TEMPERATURE TRANSMITTER	---	10 TO 30 DEG C (50 TO 85 DEG F)	---
	TC-XX-02	SPACE TEMPERATURE CONTROLLER	24 DEG C (75 DEG F)	10 TO 30 DEG C (50 TO 85 DEG F)	---
	VLV-XX-02	COOLING COIL VALVE	---	88 - 108 kPa (10 - 15 PSIG)	Kv = __ (Cv = __) CLOSE AGAINST __ kPa (__ PSIG)
	VLV-XX-03	REHEAT COIL VALVE	---	21 - 85 kPa (3 - 8 PSIG)	Kv = __ (Cv = __) CLOSE AGAINST __ kPa (__ PSIG)
RELATIVE HUMIDITY	RHT-XX-01 RHT-XX-02	RELATIVE HUMIDITY TRANSMITTER	---	0 TO 100 % RH	---
	RHC-XX-01	SUPPLY DUCT REL. HUM. LIMIT CONTROLLER	SETPOINT = 90 % RH PROPORTIONAL BAND = 10 % MANUAL RESET = 50 %	0 TO 100 % RH	---
	RHC-XX-02	SPACE RELATIVE HUMIDITY CONTROLLER	50 % RH	0 TO 100 % RH	---
	VLV-XX-04	HUMIDIFIER VALVE	---	88 - 108 kPa (10 - 15 PSIG)	Kv = __ (Cv = __) CLOSE AGAINST __ kPa (__ PSIG)
HYDRONIC HEATING	TT-XX-03	HW SUPPLY TEMPERATURE TRANSMITTER	---	38 TO 121 DEG C (100 TO 250 DEG F)	---
	TC-XX-03	HW SUPPLY TEMPERATURE CONTROLLER	63 DEG C (200 DEG F)	38 TO 121 DEG C (100 TO 250 DEG F)	---
	VLV-XX-05	CONVERTER VALVE	---	21 - 108 kPa (3 - 15 PSIG)	Kv = __ (Cv = __) CLOSE AGAINST __ kPa (__ PSIG)
OCCUPIED MODE	CLK-XX-01 CONTACT	888 DAY SCHEDULE	---	NORMAL SCHEDULE (M-F) CONTACT CLOSED: 0705 HRS CONTACT OPEN: 1700 HRS	CONTACT OPEN: SAT, SUN
VENTILATION DELAY MODE	CLK-XX-01 CONTACT	885 DAY SCHEDULE	---	NORMAL SCHEDULE (M-F) CONTACT CLOSED: 0700 HRS CONTACT OPEN: 0800 HRS	---

NOTE: OTHER CONTROL DEVICES SUCH AS UPs, RELAYS, AND SIGNAL SELECTORS ARE NOT SHOWN.

Figure 4-21c. Control system equipment for single zone HVAC system with humidity control.



FRONT VIEW

REAR VIEW

SWITCH AND PILOT LIGHT LEGEND

POSITION LEGEND

- 1 - RESET
- 2 - AUTOMATO OVERRIDE
- 3 - ENABLE/OFF
- 4 - LOW TEMP
- 5 - SMOKE

DEVICE TYPE

- NON-ILLUMINATED MOMENTARY CONTACT PUSH BUTTON SWITCH
- ILLUMINATED MAINTAINED CONTACT INTERLOCKED SWITCHES
- ILLUMINATED MAINTAINED CONTACT INTERLOCKED SWITCHES
- PILOT LIGHT
- PILOT LIGHT

IDENTIFIER

- HS-XX-02
- HS-XX-01
- HS-XX-03
- PL-XX-04
- PL-XX-05

POSITION LEGEND

- 6 - FILTER
- 7 - DOG
- 8 - VENT DELAY
- 9 - HEATING

DEVICE TYPE

- PILOT LIGHT
- PILOT LIGHT
- PILOT LIGHT
- PILOT LIGHT

IDENTIFIER

- PL-XX-03
- PL-XX-01
- PL-XX-02
- PL-XX-06

Figure 4-21d. Control panel interior door layout for single zone HVAC system with humidity control.

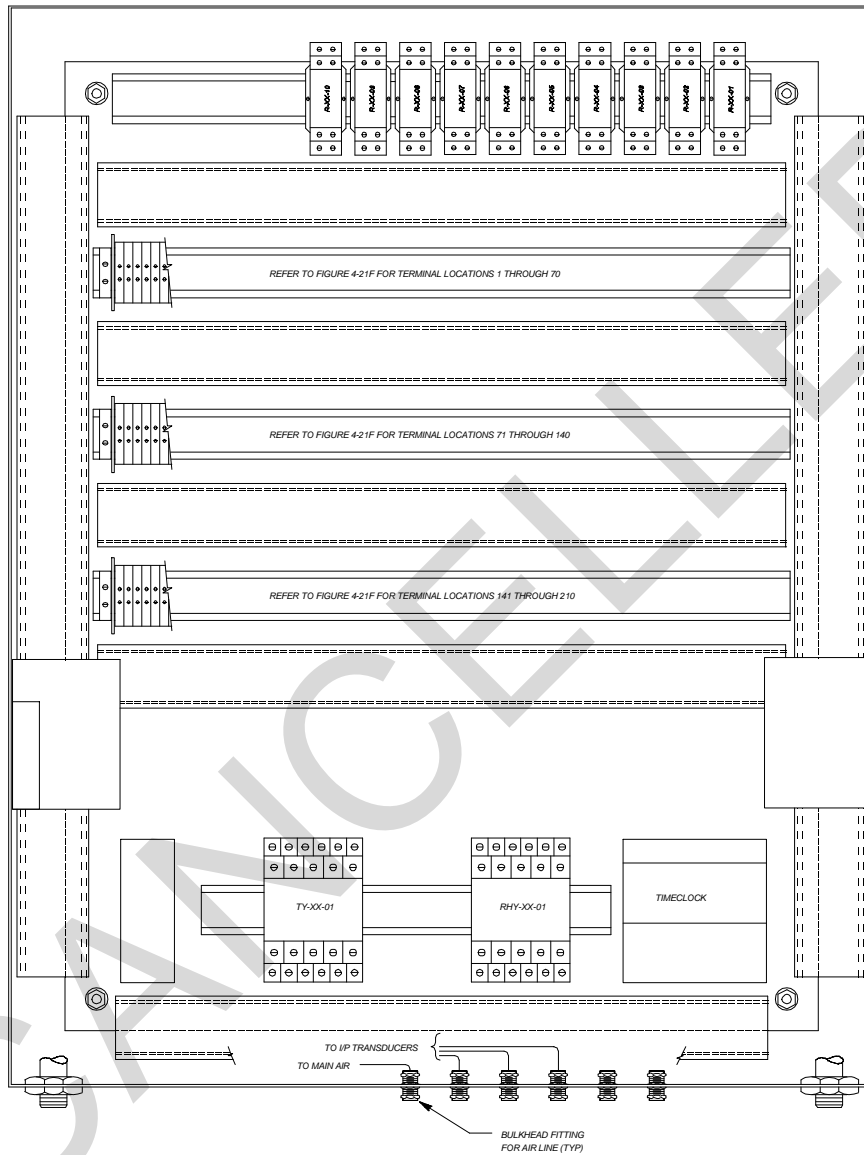

Figure 4-21e. Control panel back panel layout for single zone HVAC system with humidity control.

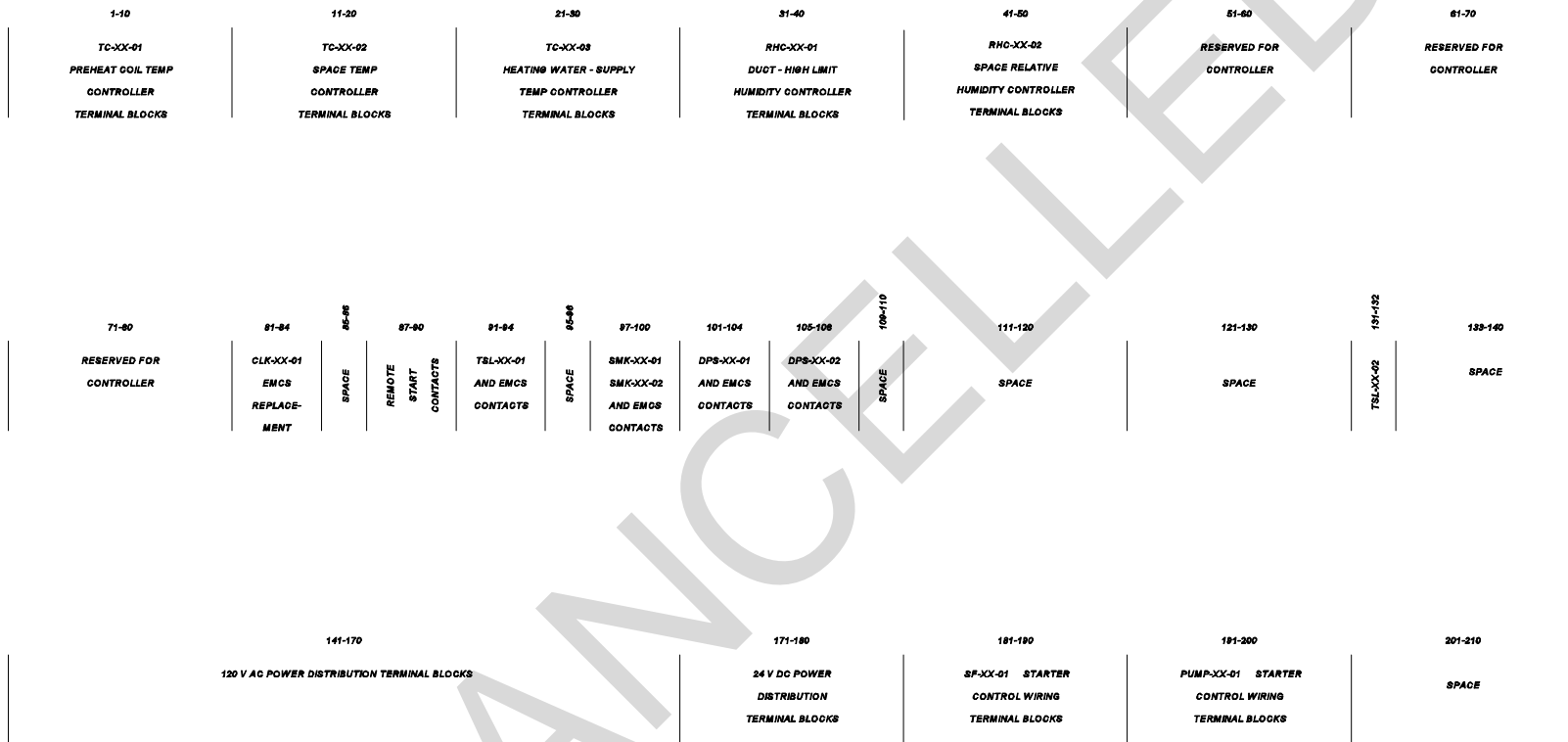

Figure 4-21f. Control panel terminal block layout for single zone HVAC system with humidity control.

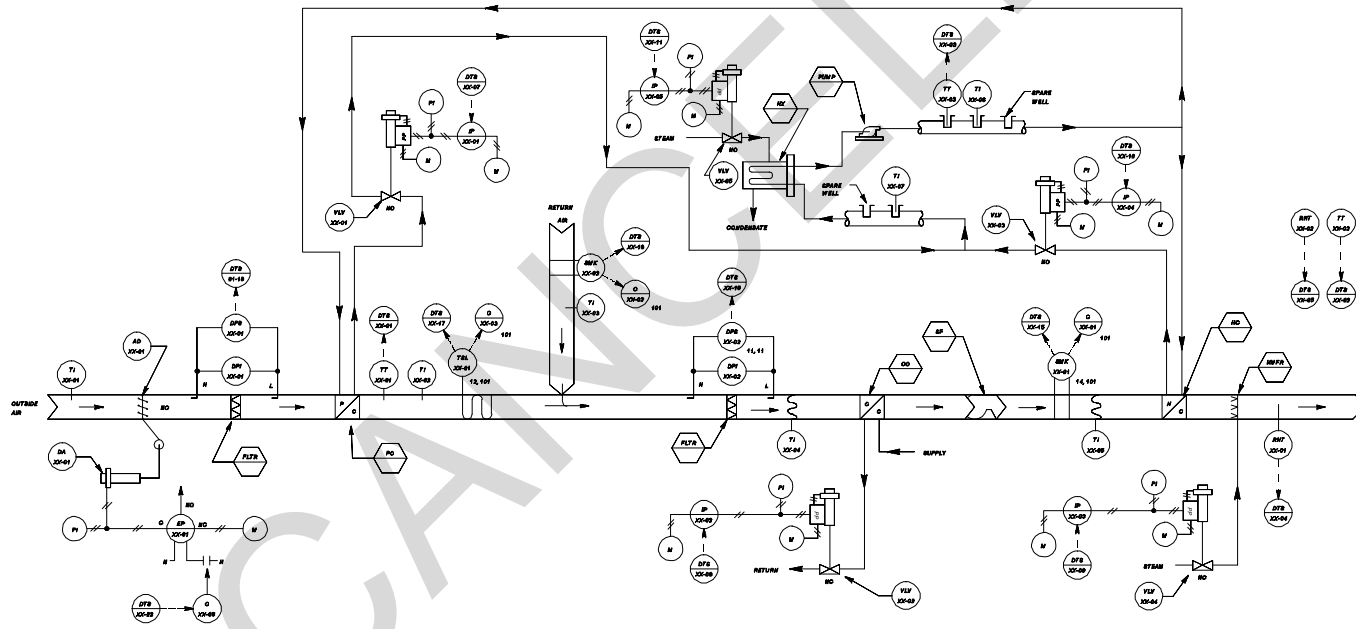

Figure 4-21g. DDC control system schematic for single zone HVAC system with humidity control.

SENSOR SCHEDULE

IDENTIFIER	FUNCTION	RANGE
TT-XX-01	OUTSIDE AIR TEMPERATURE TRANSMITTER	-34 TO 54 DEG C (-30 TO +130 DEG F)
TT-XX-02	SPACE TEMPERATURE TRANSMITTER	10 TO 30 DEG C (50 TO 85 DEG F)
TT-XX-03	HEATING SUPPLY WATER TEMPERATURE TRANSMITTER	38 TO 121 DEG C (100 TO 250 DEG F)
RHT-XX-01	SUPPLY AIR RELATIVE HUMIDITY TRANSMITTER	0 TO 100% R.H.
RHT-XX-02	SPACE RELATIVE HUMIDITY TRANSMITTER	0 TO 100% R.H.

CONTROL VALVE SCHEDULE

IDENTIFIER	FUNCTION	TYPE	RANGE	Kv (Cv)	CLOSE-OFF RATING	REMARKS
VLV-XX-01	PREHEAT COIL VALVE	2-WAY, MODULATING	21 - 103 kPa (3-15 PSIG)	XX	XX kPa (XX PSIG)	
VLV-XX-02	COOLING COIL VALVE	2-WAY, MODULATING	21 - 103 kPa (3-15 PSIG)	XX	XX kPa (XX PSIG)	
VLV-XX-03	HEATING COIL VALVE	2-WAY, MODULATING	21 - 103 kPa (3-15 PSIG)	XX	XX kPa (XX PSIG)	
VLV-XX-04	HUMIDIFIER VALVE	2-WAY, MODULATING	21 - 103 kPa (3-15 PSIG)	XX	XX kPa (XX PSIG)	
VLV-XX-05	CONVERTER VALVE	2-WAY, MODULATING	21 - 103 kPa (3-15 PSIG)	XX	XX kPa (XX PSIG)	

CONTROL DAMPER SCHEDULE

IDENTIFIER	FUNCTION	TYPE	SIZE	RANGE	REMARKS
AD-XX-01	OUTSIDE AIR	TWO-POSITION	W x H (mm) (WW" X HH")		PARALLEL BLADE

OPERATING PARAMETERS

FUNCTION	SETPOINT	REMARKS
PREHEAT COIL DISCHARGE	XX DEG C (XX DEG F)	
SPACE TEMPERATURE	XX DEG C (XX DEG F) XX DEG C (XX DEG F)	(HEATING) (COOLING)
SPACE TEMP. (NIGHT SETBACK)	XX DEG C (XX DEG F)	(HEATING ONLY)
FREEZE/STAT	XX DEG C (XX DEG F)	
SUPPLY AIR HUMIDITY HIGH LIMIT	XX% R.H.	
SPACE HUMIDITY	XX% R.H.	
HYDRONIC HEATING SUPPLY	XX DEG C (XX DEG F)	
OCCUPIED MODE		MONDAY - FRIDAY : 0705 HRS - 1700 HRS
VENT DELAY MODE		MONDAY - FRIDAY : 0700 HRS - 0800 HRS
FILTER ALARM	XX kPa (XX IN. WATER)	

Figure 4-21i. DDC control system equipment for single zone HVAC system with humidity control.

	HARDWARE														SOFTWARE												
	OUTPUT							INPUT							ALARMS					APPLICATION PROGRAMS							
	DIGITAL			ANALOG				DIGITAL			ANALOG				DIGITAL		ANALOG										
	CONTROL RELAY			POSITION ADJUSTMENT			AUXILIARY CONTACT			TEMPERATURE	% RELATIVE HUMIDITY	PSIA, PPA, PWD	FLOW	CONTACT CLOSURE		HIGH LIMIT	LOW LIMIT	RUN TIME	SCHEDULED START/STOP	OPTIMUM START/STOP	DUTY CYCLING	DEMAND LIMITING	DWINDRIFT SETBACK	ECONOMIZER	VENTILATION/RECIRCULATION	FAILURE MODE **	
SUPPLY FAN	1						1							X				X	X	X	X	X					
OUTSIDE AIR DAMPER	1																										
PREHEAT COIL DISCHARGE										1						X	X								X		
SPACE										1	1					X	X						X				
SUPPLY AIR										1						X	X										
HEATING WATER SUPPLY										1						X	X										
PREHEAT COIL				1																							
COOLING COIL				1																							
HUMIDIFIER				1																							
HEATING COIL				1																							
CONVERTER				1																							
SMOKE DETECTOR							2							X													
FREEZESTAT							1							X													
FILTER							1							X													

** C - LAST COMMAND
H - HIGH VALUE
L - LOW VALUE
O - ON (OPEN)
F - OFF (CLOSED)

DDC DATA TERMINAL STRIP LAYOUT

DEVICE NO.	DESCRIPTION	TYPE
1	TT-XX-01 PREHEAT DISCHARGE AIR	AI
2	TT-XX-02 SPACE TEMPERATURE	AI
3	TT-XX-03 HEATING SUPPLY WATER	AI
4	RHT-XX-01 SUPPLY AIR RELATIVE HUMIDITY	AI
5	RHT-XX-02 SPACE RELATIVE HUMIDITY	AI
6		
7	IP-XX-01 PREHEAT COIL VALVE	AO
8	IP-XX-02 COOLING COIL VALVE	AO
9	IP-XX-03 HUMIDIFIER VALVE	AO
10	IP-XX-04 HEATING COIL VALVE	AO
11	IP-XX-05 CONVERTER VALVE	AO
12		
13		
14		
15	SMK-XX-01 SUPPLY AIR SMOKE DETECTOR	DI
16	SMK-XX-02 RETURN AIR SMOKE DETECTOR	DI
17	TSL-XX-01 FREEZESTAT	DI
18	DPS-XX-01 PRE-FILTER	DI
19	DPS-XX-02 FILTER	DI
20	C-XX-04 SUPPLY-FAN START/STOP	DO
21	C-XX-05 SUPPLY FAN STATUS	DI
22	EP-XX-01 OUTSIDE-AIR DAMPER	DO
23		
24		
25		

Figure 4-21j. DDC control system I/O table and data terminal strip layout for single zone HVAC system with humidity control.

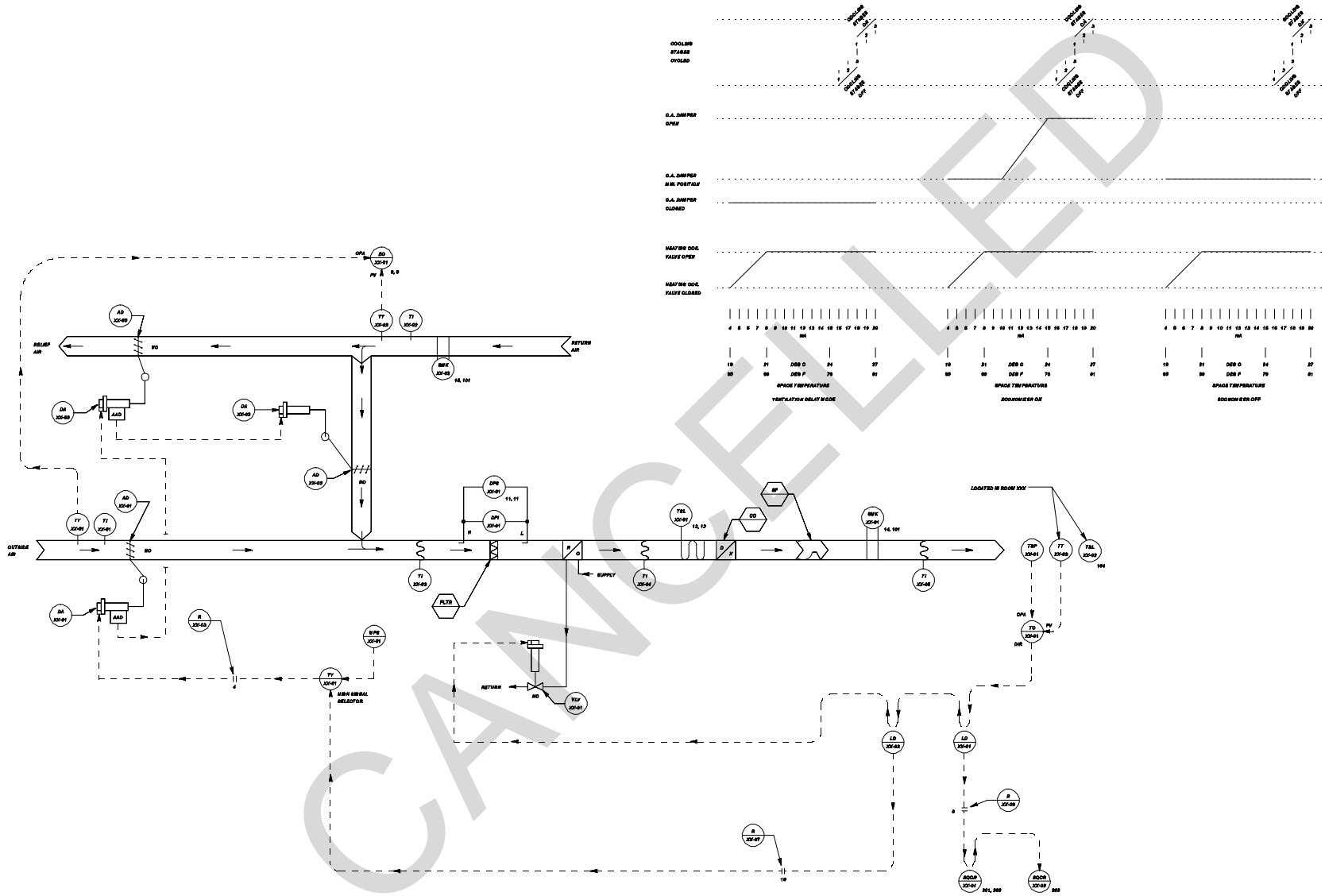
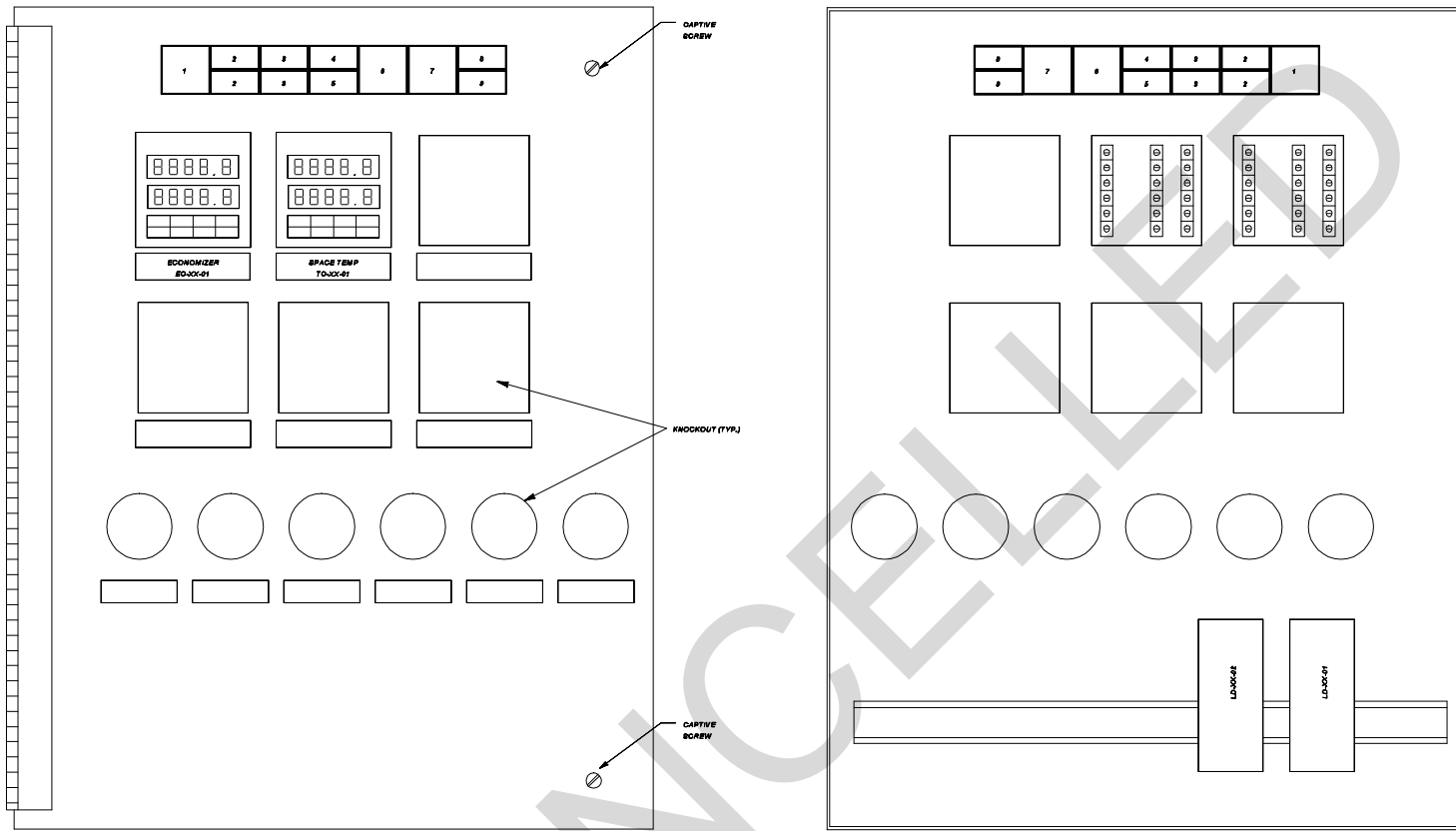

Figure 4-22a. Control system schematic for single zone HVAC system with DX coil.

LOOP CONTROL FUNCTION	DEVICE NUMBER	DEVICE FUNCTION	SETPPOINT	RANGE	ADDITIONAL PARAMETERS
SPACE TEMPERATURE	DA-JX-01 DA-JX-02 DA-JX-03	DAMPER ACTUATOR	---	10 - 16 mA	---
	MPS-JX-01	MINIMUM POSITION SWITCH	---	---	SET MIN OA LA (CFM) EQUAL TO ___ L/S (___ CFM)
	TT-JX-01	OUTSIDE AIR TEMPERATURE TRANSMITTER	---	-34 TO +54 DEG C -30 TO +130 DEG F	---
	TT-JX-02	RETURN AIR TEMPERATURE TRANSMITTER	---	-34 TO +54 DEG C -30 TO +130 DEG F	---
	EO-JX-01	ECONOMIZER CONTROLLER	PV CONTACT CLOSE AT ___ DEG C (___ DEG F) OPEN AT ___ DEG C (___ DEG F)	-34 TO +54 DEG C -30 TO +130 DEG F	DEV CONTACT CLOSE @ DELTA T= ___ DEG C (___ DEG F) OPEN @ DELTA T= ___ DEG C (___ DEG F)
	TT-JX-03	SPACE TEMPERATURE TRANSMITTER	---	10 TO 30 DEG C 60 TO 85 DEG F	---
	TSP-JX-01	SPACE TEMPERATURE SETPOINT ADJUSTMENT	4 mA = 10 DEG C (50 DEG F) 20 mA = 30 DEG C (85 DEG F)	---	---
	TC-JX-01	SPACE TEMPERATURE CONTROLLER	4 mA = 10 DEG C (50 DEG F) 20 mA = 30 DEG C (85 DEG F)	10 TO 30 DEG C 60 TO 85 DEG F	SET LIMITS AVAILABLE TO OCCUPANT BY TSP-JX-01 AT 19 TO 22 DEG C (65 TO 72 DEG F)
	VLV-JX-01	HEATING COIL VALVE	---	4 - 8 mA	KV = ___ (GV = ___) CLOSE AGAINST ___ kPa (___ PSIG)
	SQR-JX-01	CONDENSING UNIT SEQUENCER	---	STAGE 1: ON = 18 mA STAGE 2: ON = 18 mA	STAGE 1: OFF = 16 mA STAGE 2: OFF = 17 mA
	SQR-JX-02	CONDENSING UNIT SEQUENCER	---	STAGE 3: ON = 20 mA	STAGE 3: OFF = 18 mA
MIXED AIR	TSL-JX-01	LOW TEMPERATURE PROTECTION THERMOSTAT	2 DEG C 35 DEG F	---	---
	DFB-JX-01	FILTER ALARM	PER FILTER MANUFACTURER'S RECOMMENDATION	PER FILTER MANUFACTURER'S RECOMMENDATION	---
SPACE LOW TEMPERATURE	TSL-JX-02	NIGHT STAT - SPACE LOW TEMPERATURE PROTECTION	19 DEG C 65 DEG F	3 DEG C DIFFERENTIAL 5 DEG F DIFFERENTIAL	---
OCCUPIED MODE	CLK-JX-01 CONTACT	365 DAY SCHEDULE	---	NORMAL SCHEDULE (M-F) CONTACT CLOSED: 0705 HRS CONTACT OPEN: 1700 HRS	CONTACT OPEN: SAT, SUN
VENTILATION DELAY MODE	CLK-JX-01 CONTACT	365 DAY SCHEDULE	---	NORMAL SCHEDULE (M-F) CONTACT CLOSED: 0700 HRS CONTACT OPEN: 0800 HRS	↓

NOTE: OTHER CONTROL DEVICES SUCH AS VPA, RELAYS, AND SIGNAL SELECTERS ARE NOT SHOWN.

Figure 4-22c. Control system equipment for single zone HVAC system with DX coil.



FRONT VIEW

REAR VIEW

SWITCH AND PILOT LIGHT LEGEND

POSITION LEGEND

- 1 - RESET
- 2 - AUTO/AUTO OVERRIDE
- 3 - ENABLE/OFF
- 4 - LOW TEMP
- 5 - SMOKE

DEVICE TYPE

- NON-ILLUMINATED MOMENTARY CONTACT PUSH BUTTON SWITCH
- ILLUMINATED MAINTAINED CONTACT INTERLOCKED SWITCHES
- ILLUMINATED MAINTAINED CONTACT INTERLOCKED SWITCHES
- PILOT LIGHT
- PILOT LIGHT

IDENTIFIER

- H8-XX-02
- H8-XX-01
- H8-XX-03
- PL-XX-06
- PL-XX-06

POSITION LEGEND

- 6 - FILTER
- 7 - OCC
- 8 - VENT DELAY
- 9 - ECON

DEVICE TYPE

- PILOT LIGHT
- PILOT LIGHT
- PILOT LIGHT
- PILOT LIGHT

IDENTIFIER

- PL-XX-04
- PL-XX-01
- PL-XX-02
- PL-XX-03

Figure 4-22d. Control panel interior door layout for single zone HVAC system with DX coil.

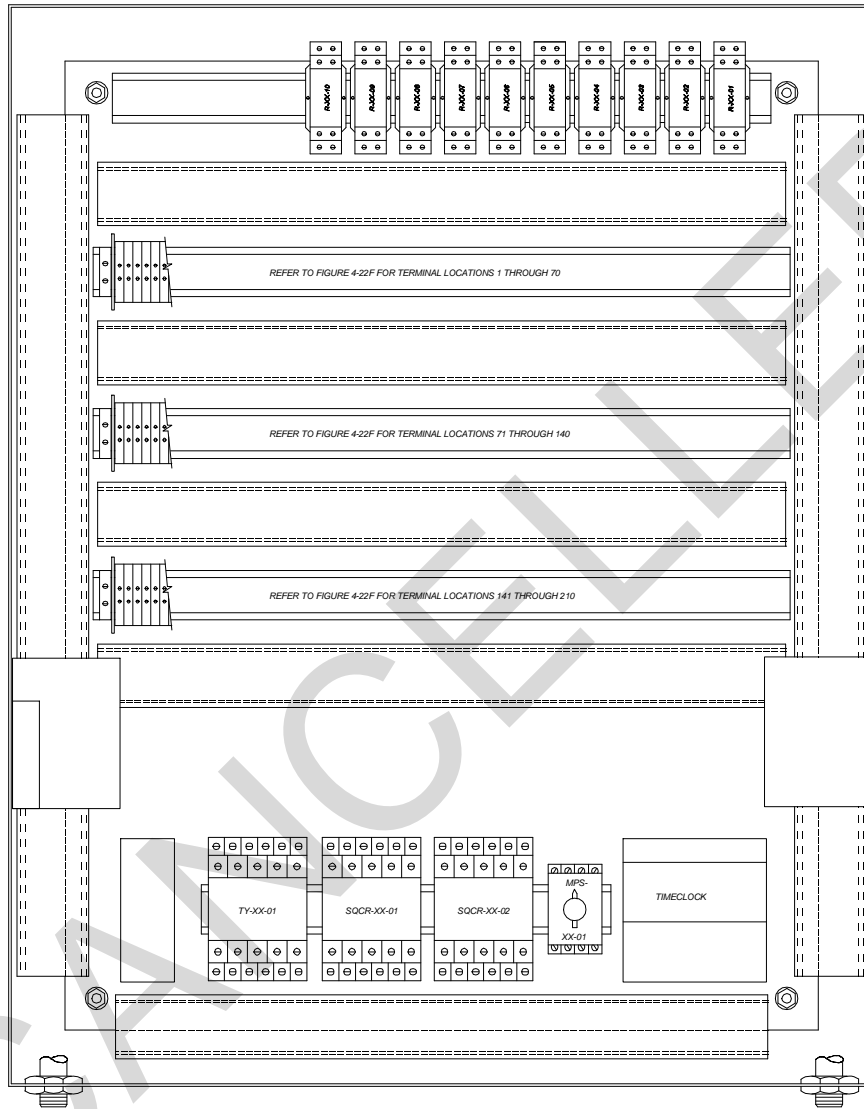

Figure 4-22e. Control panel back panel layout for single zone HVAC system with DX coil.

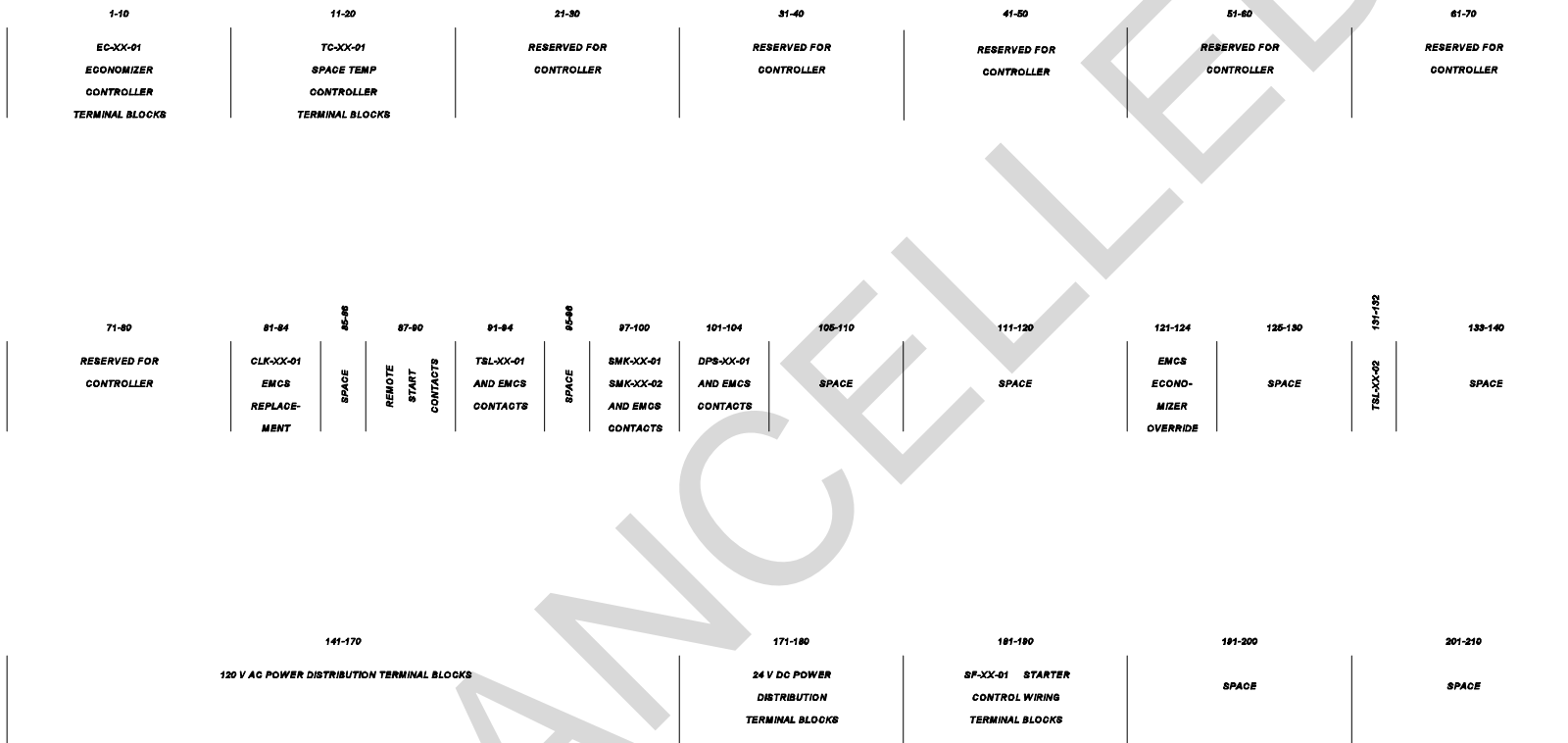

Figure 4-22f. Control panel terminal block layout for single zone HVAC system with DX coil.

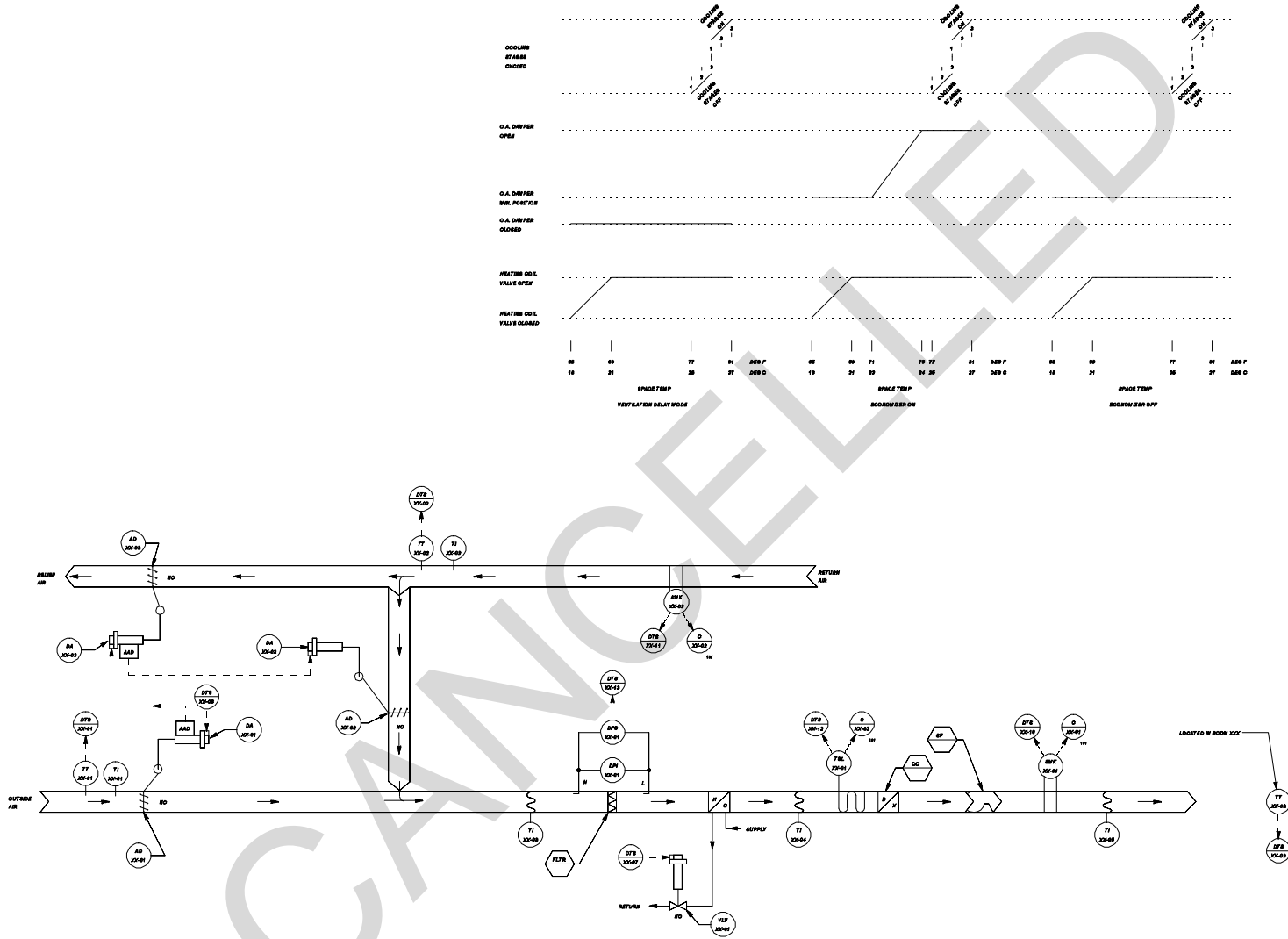

Figure 4-22g. DDC control system schematic for single zone HVAC system with DX coil.

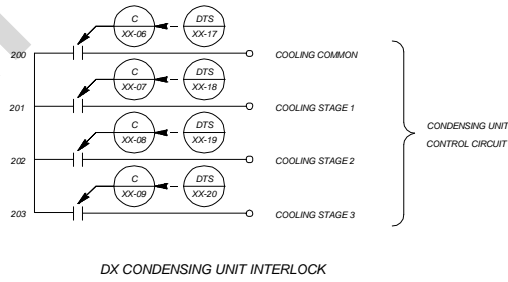
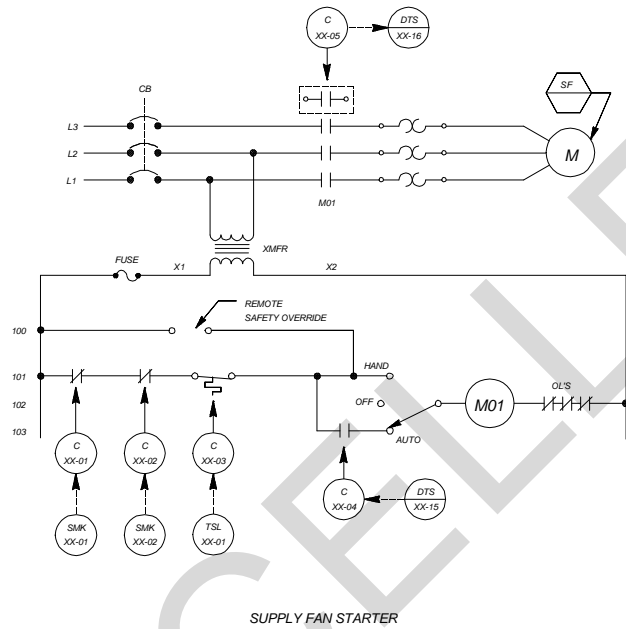

Figure 4-22h. DDC control system ladder diagram for single zone HVAC system with DX coil.

SENSOR SCHEDULE

IDENTIFIER	FUNCTION	RANGE
TT-XX-01	OUTSIDE AIR TEMPERATURE TRANSMITTER	-34 TO 54 DEG C (-30 TO +130 DEG F)
TT-XX-02	RETURN AIR TEMPERATURE TRANSMITTER	-34 TO 54 DEG C (-30 TO +130 DEG F)
TT-XX-03	SPACE TEMPERATURE TRANSMITTER	10 TO 30 DEG C (50 TO 85 DEG F)

CONTROL VALVE SCHEDULE

IDENTIFIER	FUNCTION	TYPE	RANGE	Kv (Cv)	CLOSE-OFF RATING	REMARKS
VLV-XX-01	HEATING COIL VALVE	2-WAY, MODULATING	4 - 20 mA	XX	XX kPa (XX PSIG)	

CONTROL DAMPER SCHEDULE

IDENTIFIER	FUNCTION	TYPE	SIZE	RANGE	REMARKS
AD-XX-01	OUTSIDE AIR	MODULATING	W x H (mm) (WW" x HH")	4 - 20 mA	PARALLEL BLADE
AD-XX-02	RETURN AIR	MODULATING	W x H (mm) (WW" x HH")		PARALLEL BLADE
AD-XX-03	RELIEF AIR	MODULATING	W x H (mm) (WW" x HH")		PARALLEL BLADE

OPERATING PARAMETERS

FUNCTION	SETPPOINT	REMARKS
MINIMUM OUTSIDE AIR	XXXX L/s (XXXX CFM)	
SPACE TEMPERATURE	XX DEG C (XX DEG F) XX DEG C (XX DEG F)	(HEATING) NIGHT SETBACK (HEATING ONLY)
CONDENSING UNIT STAGING		STAGE 1: ON @ XX DEG C (XX DEG F), OFF @ XX DEG C (XX DEG F) STAGE 2: ON @ XX DEG C (XX DEG F), OFF @ XX DEG C (XX DEG F) STAGE 3: ON @ XX DEG C (XX DEG F), OFF @ XX DEG C (XX DEG F)
ECONOMIZER MODE		ECONOMIZER MODE = ON, WHEN CONDITION 1 AND CONDITION 2 ARE BOTH SATISFIED: CONDITION 1: RETURN AIR TEMP. > XX DEG C (XX DEG F) CONDITION 2: RETURN AIR TEMP. MINUS OUTSIDE AIR TEMP. > XX DEG C (XX DEG F)
OCCUPIED MODE		MONDAY - FRIDAY : 0705 HRS - 1700 HRS
VENT DELAY MODE		MONDAY - FRIDAY : 0700 HRS - 0800 HRS
FREEZE STAT	XX DEG C (XX DEG F)	
FILTER ALARM	XX kPa (XX IN. WATER)	

Figure 4-22i. DDC control system equipment for single zone HVAC system with DX coil.

	HARDWARE														SOFTWARE																				
	OUTPUT							INPUT							ALARMS							APPLICATION PROGRAMS													
	DIGITAL			ANALOG				DIGITAL			ANALOG				DIGITAL			ANALOG																	
	CONTROL RELAY			POSITION ADJUSTMENT				AUXILIARY CONTACT				TEMPERATURE	% RELATIVE HUMIDITY	PH, PNA, PHD	FLOW	CONTACT CLOSURE				HIGH LIMIT	LOW LIMIT	RUN TIME	SCHEDULED START/STOP	OPTIMUM START/STOP	DUTY CYCLING	DEMAND LIMITING	DIVERSION SETBACK	ECONOMIZER	VENTILATION/REGULATION				FAULT/REMODE **		
SUPPLY FAN	1							1								X					X	X	X	X	X										
OUTSIDE AIR											1									X	X														
RETURN AIR											1								X	X							X	X							
SPACE											1								X	X															
MIXED AIR DAMPERS				1																							X	X							
HEATING COIL VALVE				1																															
CONDENSING UNIT	4																		X					X	X										
SMOKE DETECTOR										2						X																			
FREEZESTAT										1						X																			
FILTER										1						X																			

** C - LAST COMMAND
H - HIGH VALUE
L - LOW VALUE
O - ON (OPEN)
F - OFF (CLOSED)

DDC DATA TERMINAL STRIP LAYOUT

DEVICE NO.	DESCRIPTION	TYPE
1	TT-XX-01 OUTSIDE AIR TEMPERATURE	AI
2	TT-XX-02 RETURN AIR TEMPERATURE	AI
3	TT-XX-03 SPACE TEMPERATURE	AI
4		
5		
6	DA-XX-01 MIXED AIR DAMPERS	AO
7	VLV-XX-01 HEATING COIL VALVE	AO
8		
9		
10	SMK-XX-01 SUPPLY AIR SMOKE DETECTOR	DI
11	SMK-XX-02 RETURN AIR SMOKE DETECTOR	DI
12	TSL-XX-01 FREEZESTAT	DI
13	DPS-XX-01 FILTER ALARM	DI
14		
15	C-XX-04 SUPPLY FAN START/STOP	DO
16	C-XX-05 SUPPLY FAN STATUS	DI
17	C-XX-06 CONDENSING UNIT - COMMON	DO
18	C-XX-07 CONDENSING UNIT - STAGE 1	DO
19	C-XX-08 CONDENSING UNIT - STAGE 2	DO
20	C-XX-09 CONDENSING UNIT - STAGE 3	DO

Figure 4-22j. DDC control system I/O table and data terminal strip layout for single zone HVAC system with DX coil.

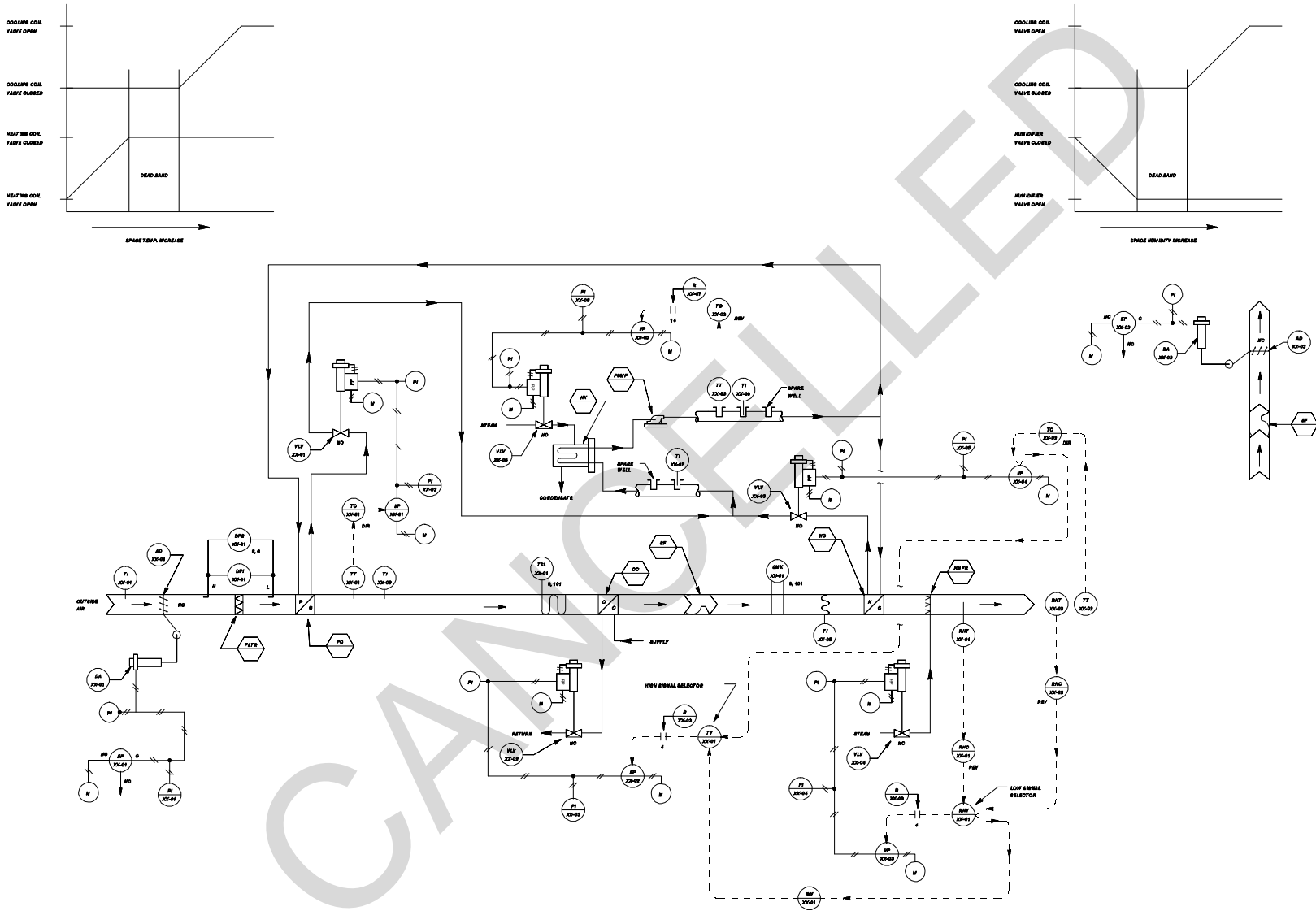

Figure 5-1. Schematic variations for 100-percent outside air systems.

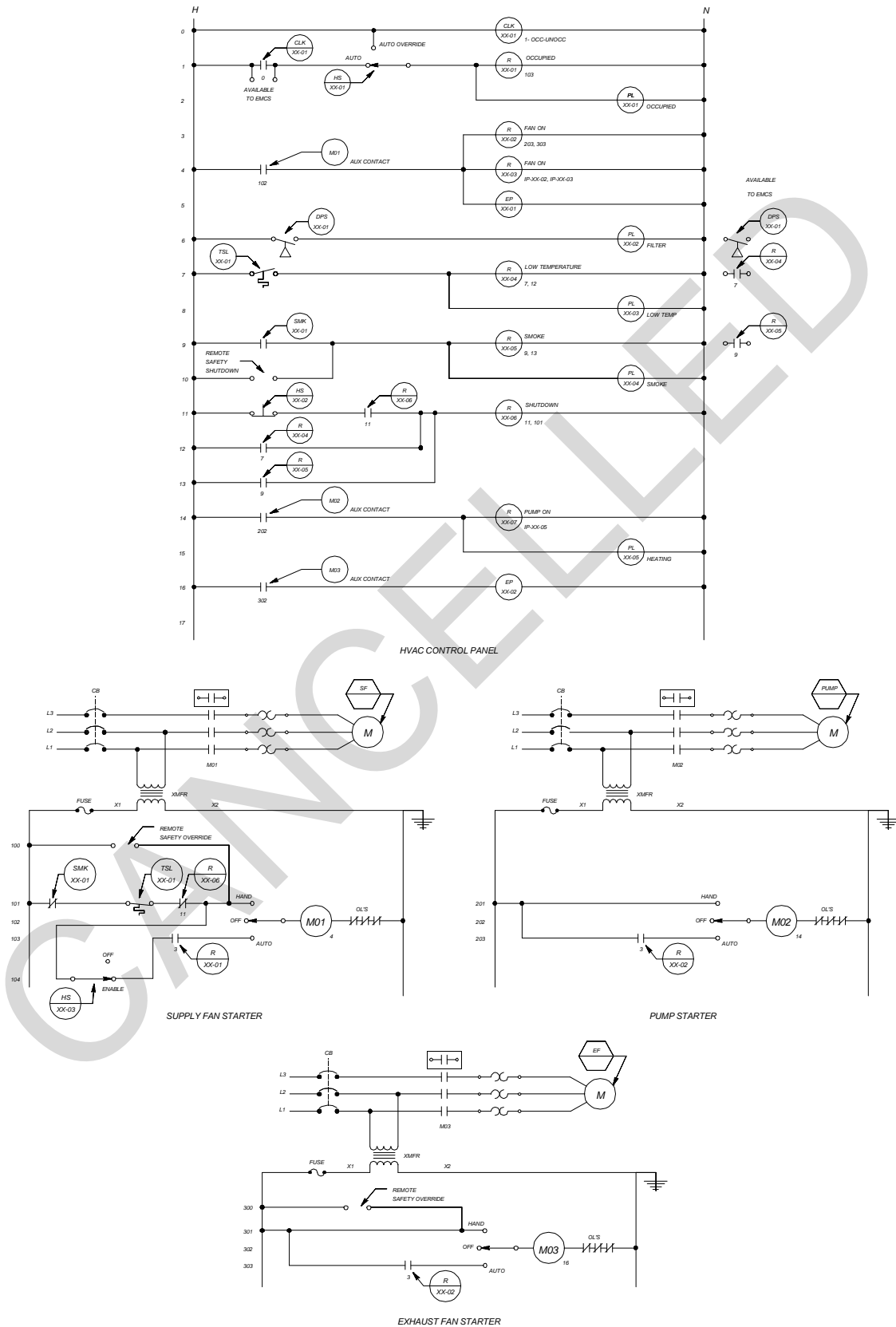

Figure 5-2. Ladder diagram variations for 100-percent outside air systems.

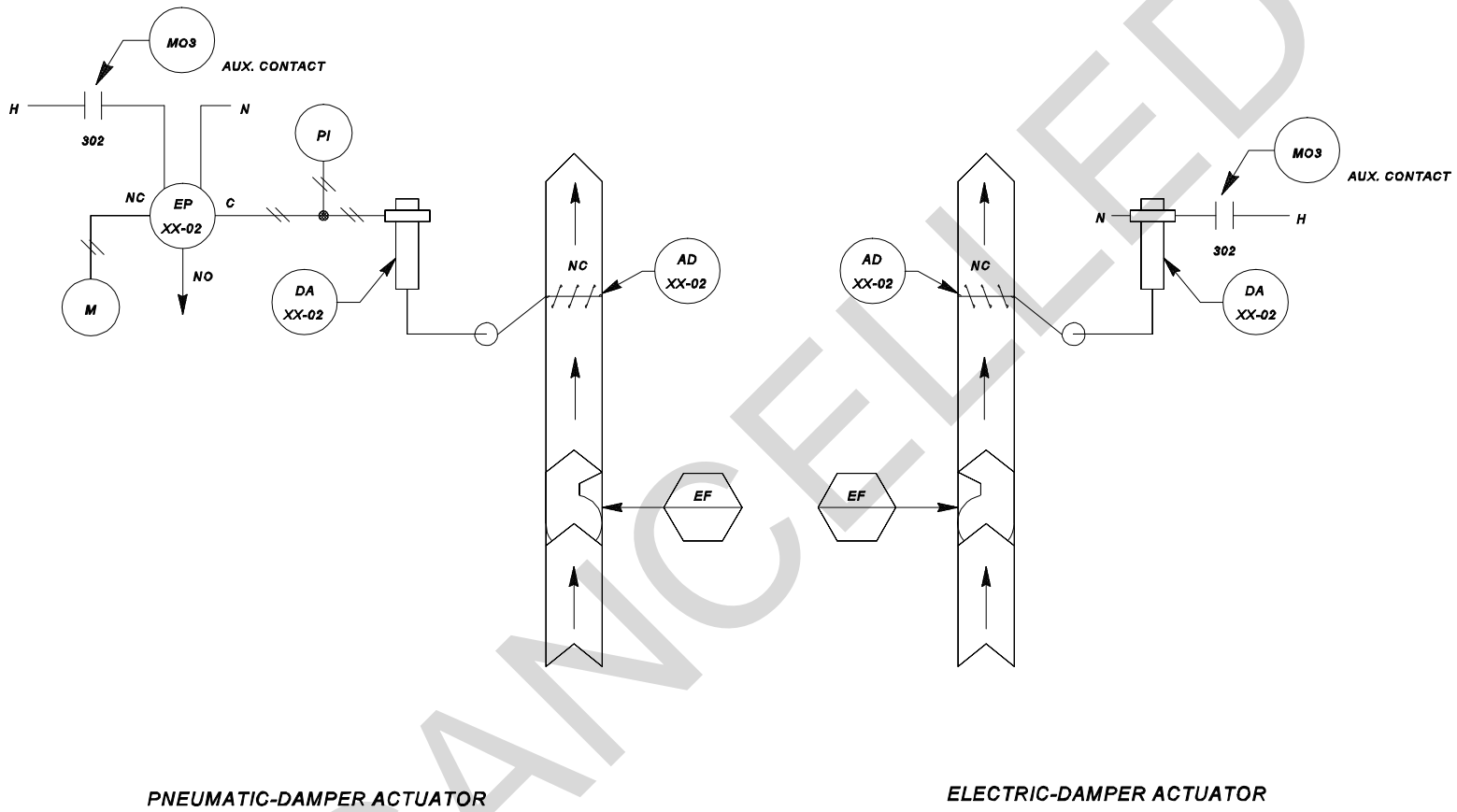
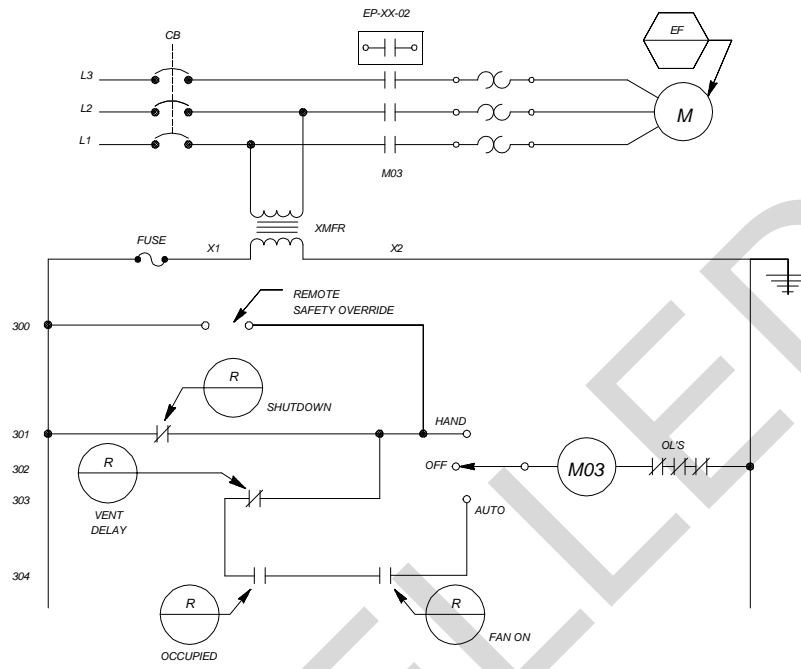
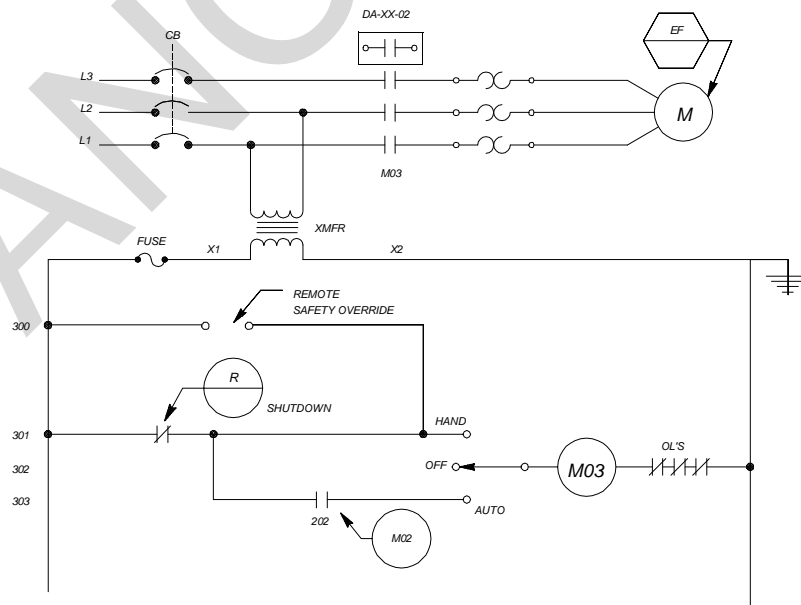

Figure 5-3. Schematic variations for exhaust fans



SYSTEMS WITH PNEUMATIC DAMPER ACTUATOR AND WITH OCCUPIED/UNOCCUPIED & VENTILATION DELAY MODES OF OPERATION



SYSTEMS WITH ELECTRIC DAMPER ACTUATOR AND WITH NO OCCUPIED/UNOCCUPIED & VENTILATION DELAY MODES OF OPERATION

Figure 5-4. Ladder diagram variations for exhaust fans.

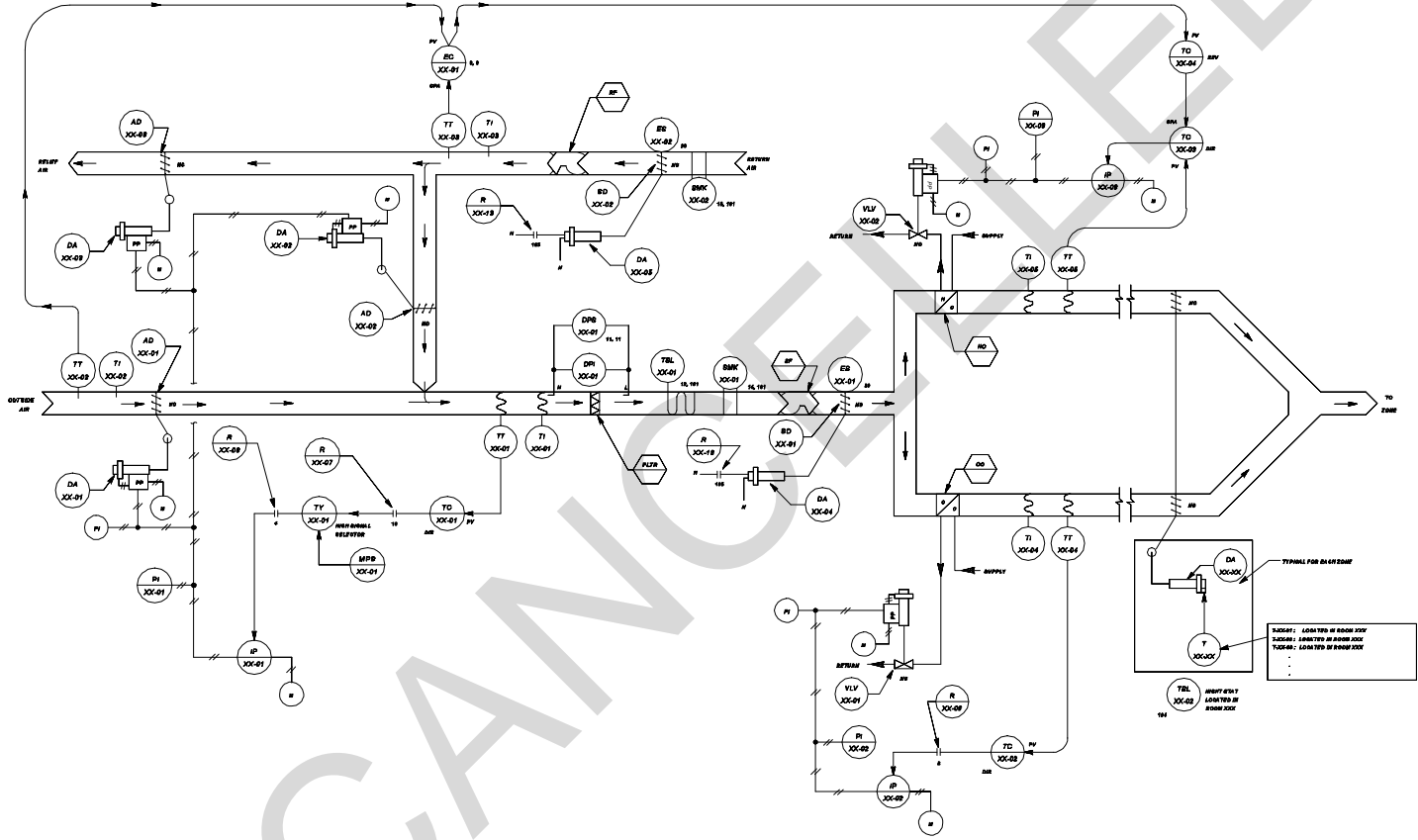

Figure 5-5. Schematic variations for smoke dampers.

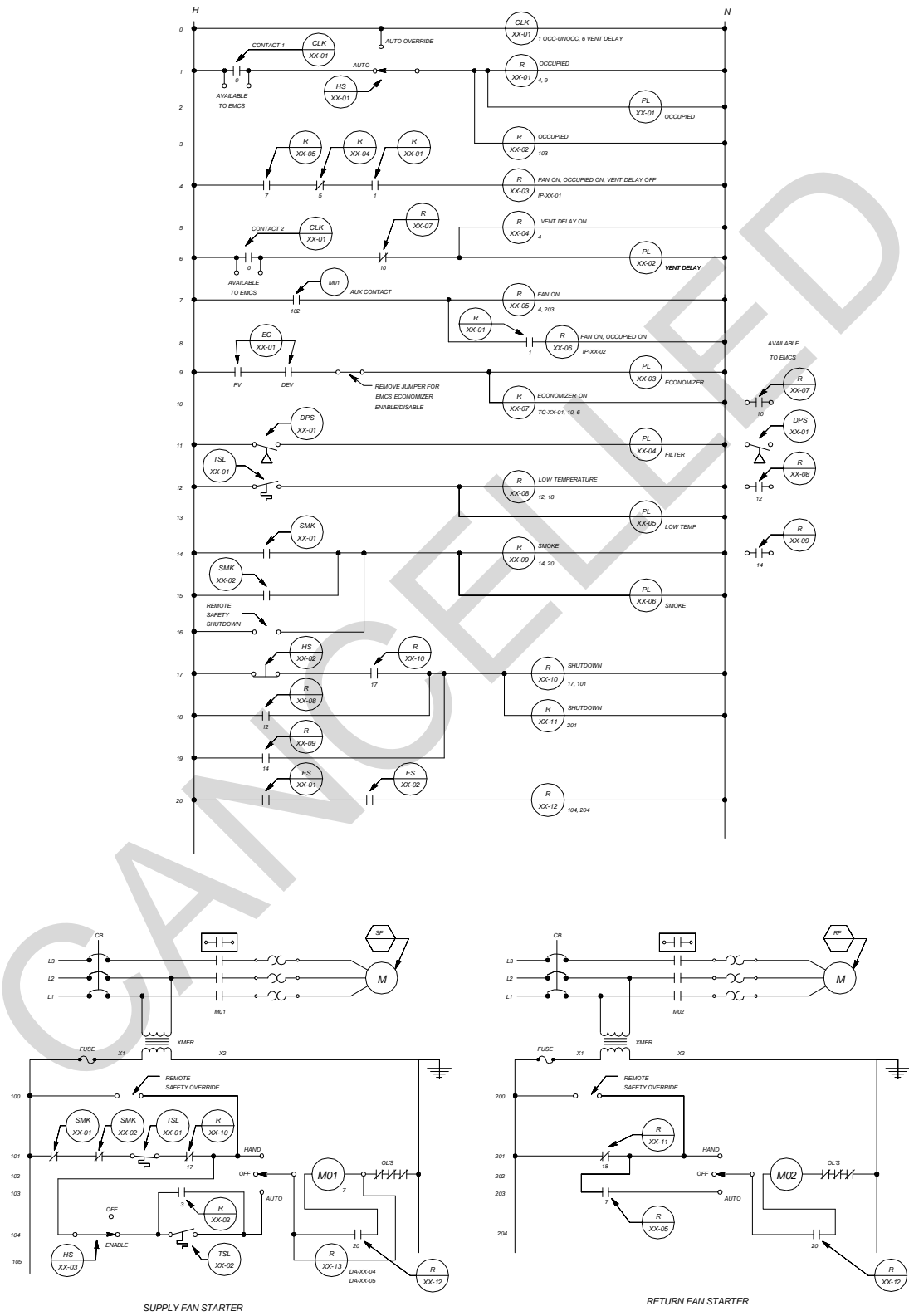

Figure 5-6. Ladder diagram variations for smoke dampers.

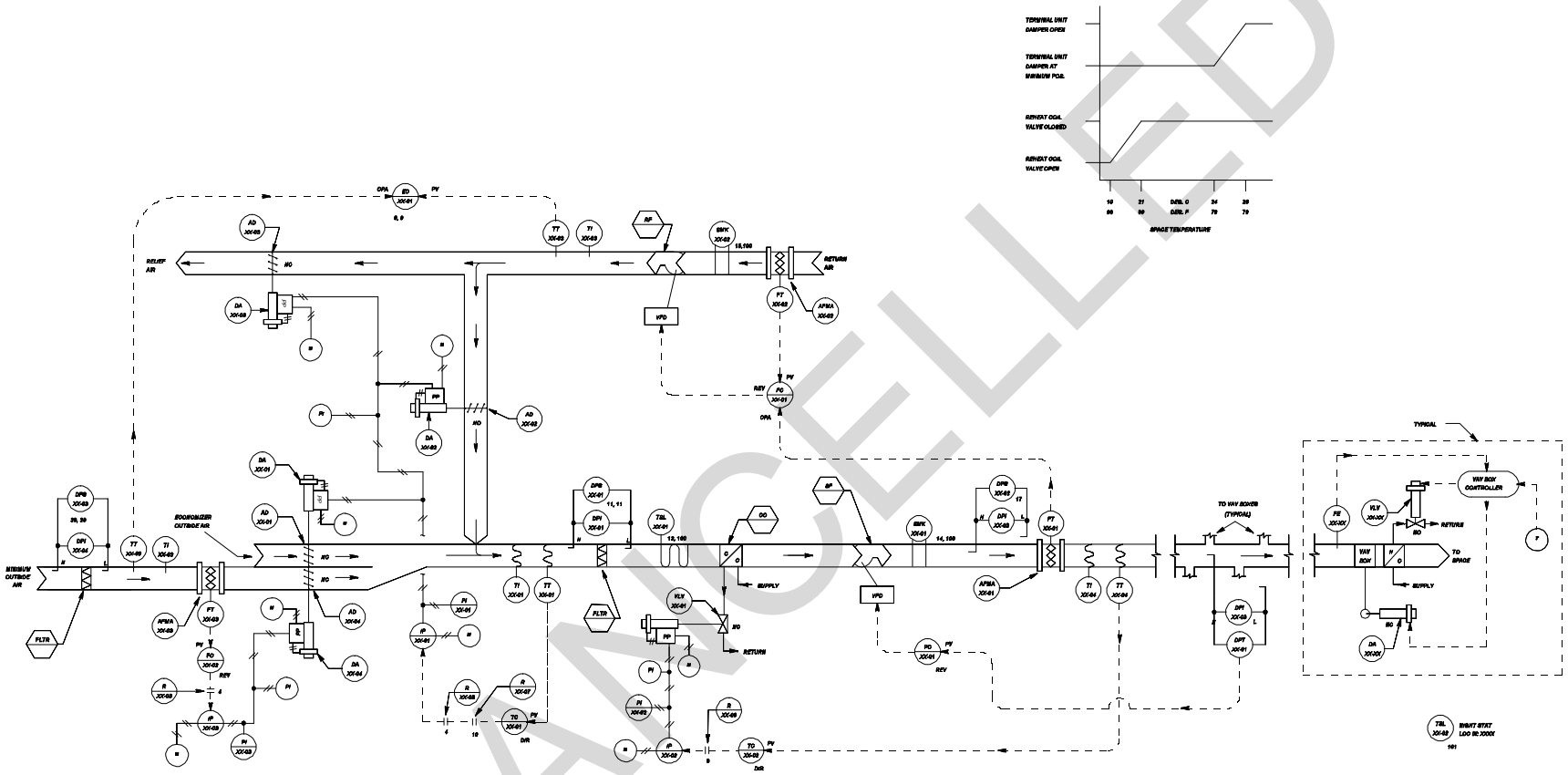

Figure 5-7a. Schematic variations for variable speed drives.

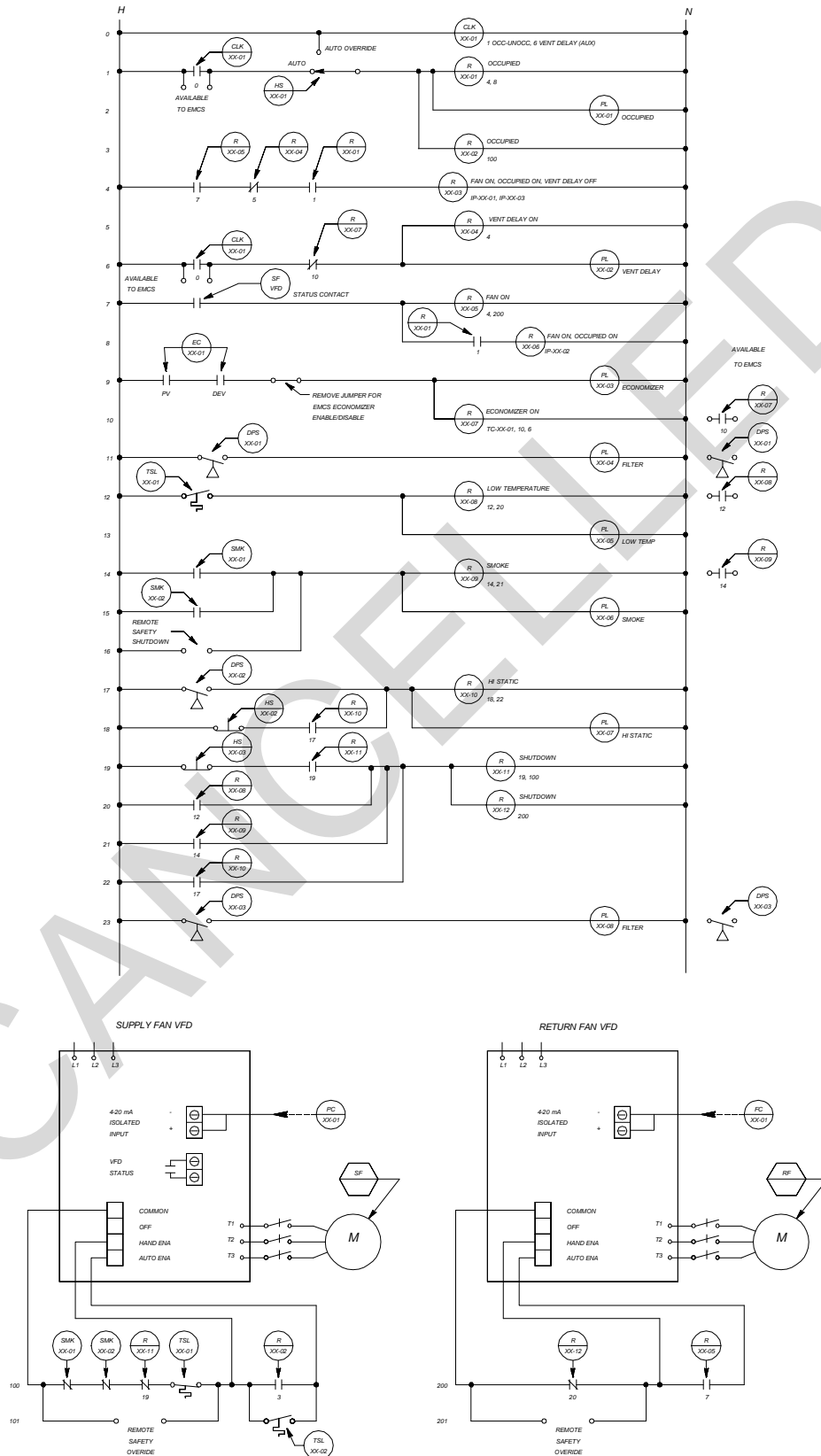

Figure 5-7b. Ladder diagram variations for variable speed drives.

LOOP CONTROL FUNCTION	DEVICE NUMBER	DEVICE FUNCTION	SETPOINT	RANGE	ADDITIONAL PARAMETERS
MIXED AIR TEMPERATURE	DA-XX-01 DA-XX-02 DA-XX-03	DAMPER ACTUATOR	—	21-103 kPa (3-15 PSIG)	—
	TC-XX-01	MIXED AIR TEMPERATURE CONTROLLER	13 DEG C (55 DEG F)	4 TO 60 DEG C (40 TO 140 DEG F)	—
	TT-XX-01	MIXED AIR TEMPERATURE TRANSMITTER	—	4 TO 60 DEG C (40 TO 140 DEG F)	—
	TT-XX-02	OUTSIDE AIR TEMPERATURE TRANSMITTER	—	-34 TO 54 DEG C (-30 TO 130 DEG F)	—
	TT-XX-03	RETURN AIR TEMPERATURE TRANSMITTER	—	-34 TO 54 DEG C (-30 TO 130 DEG F)	—
	EC-XX-01	ECONOMIZER CONTROLLER	PV CONTACT CLOSE AT ___ DEG C (___ DEG F) OPEN AT ___ DEG C (___ DEG F)	-34 TO 54 DEG C (-30 TO 130 DEG F)	DEV CONTACT CLOSE @ DELTA T= ___ DEG C (___ DEG F) OPEN @ DELTA T= ___ DEG C (___ DEG F)
	TSL-XX-01	LOW TEMPERATURE PROTECTION THERMOSTAT	2 DEG C (35 DEG F)	—	—
MIN. OUTSIDE AIR FLOW	DPS-XX-01	FILTER ALARM	PER FILTER MANUFACTURER'S RECOMMENDATION	PER FILTER MANUFACTURER'S RECOMMENDATION	—
	DA-XX-04	DAMPER ACTUATOR	—	21 - 103 kPa (3-15 PSIG)	—
	FC-XX-02	MIN. OUTSIDE AIR DUCT FLOW CONTROLLER	Min OA = ___ L/s (___ cfm)	0 - ___ L/s (0 - ___ CFM)	(SEE NOTE 1)
	FT-XX-03	MIN. OUTSIDE AIR DUCT FLOW TRANSMITTER	—	0 - ___ m/s (0 - ___ FPM)	UPPER RANGE AS REQUIRED (SEE SPECIFICATIONS)
	DPS-XX-03	PRE-FILTER ALARM	PER FILTER MANUFACTURER'S RECOMMENDATION	PER FILTER MANUFACTURER'S RECOMMENDATION	—
SPACE LOW TEMPERATURE	TSL-XX-02	NIGHT STAT - SPACE LOW TEMPERATURE PROTECTION	13 DEG C (55 DEG F)	DIFFERENTIAL = 3 DEG C (5 DEG F)	—
DISCHARGE AIR TEMPERATURE	VLV-XX-01	COOLING COIL VALVE	—	21-103 kPa (3-15 PSIG)	Kv = ___ (Cv = ___) CLOSE AGAINST ___ kPa (___ PSIG)
	TC-XX-02	FAN DISCHARGE TEMPERATURE CONTROLLER	13 DEG C (55 DEG F)	4 TO 60 DEG C (40 TO 140 DEG F)	—
	TT-XX-04	FAN DISCHARGE TEMPERATURE TRANSMITTER	—	4 TO 60 DEG C (40 TO 140 DEG F)	—
	PC-XX-01	SUPPLY DUCT STATIC PRESSURE CONTROLLER	300 kPa (1.2 INCHES WATER)	0 - 500 kPa (0.0 - 2.0 INCHES WATER)	—
SUPPLY DUCT STATIC PRESSURE	DPT-XX-01	SUPPLY DUCT STATIC PRESSURE TRANSMITTER	—	0 - 500 kPa (0.0 - 2.0 INCHES WATER)	—
	DPS-XX-02	SUPPLY DUCT - HIGH STATIC PRESSURE SAFETY	—	1000 - 1500 kPa (4.0 - 6.0 INCHES WATER)	—
RETURN FAN VOLUME	FC-XX-01	RETURN FAN VOLUME CONTROLLER	SUPPLY FAN L/s (CFM) MINUS ___ L/s (___ CFM)	0 - 9500 L/s (0 - 20,000 CFM)	—
	FT-XX-01	SUPPLY DUCT FLOW TRANSMITTER (FPM)	—	0 - 9500 L/s (0 - 20,000 CFM)	—
	FT-XX-02	RETURN DUCT FLOW TRANSMITTER (FPM)	—	0 - 9500 L/s (0 - 20,000 CFM)	—
OCCUPIED MODE	CLK-XX-01 CONTACT	365 DAY SCHEDULE	—	NORMAL SCHEDULE (M-F) CONTACT CLOSED: 0705 HRS CONTACT OPEN: 1700 HRS	CONTACT OPEN: SAT, SUN
VENTILATION DELAY MODE	CLK-XX-01 CONTACT	365 DAY SCHEDULE	—	NORMAL SCHEDULE (M-F) CONTACT CLOSED: 0700 HRS CONTACT OPEN: 0800 HRS	↓
TERMINAL UNITS	VLV-XX-AA	HEATING COIL VALVE SPACE AA	—	—	Kv = ___ (Cv = ___) CLOSE AGAINST ___ kPa (___ PSIG)
	VLV-XX-ZZ	HEATING COIL VALVE SPACE ZZ	—	—	Kv = ___ (Cv = ___) CLOSE AGAINST ___ kPa (___ PSIG)

NOTES:

1. Upper range (L/s) of flow controller (FC-XX-XX) = Upper range (m/s) of associated flow transmitter (FT-XX-XX) TIMES the duct area (sq m) TIMES 1000 (L/cu. m).
Upper range (CFM) of flow controller (FC-XX-XX) = Upper range (fpm) of associated flow transmitter (FT-XX-XX) TIMES the duct area (sq ft).

2. OTHER CONTROL DEVICES SUCH AS VPs, RELAYS, SIGNAL SELECTERS AND TERMINAL UNIT CONTROLLERS ARE NOT SHOWN.

Figure 5-7c. Equipment variations for variable speed drives.

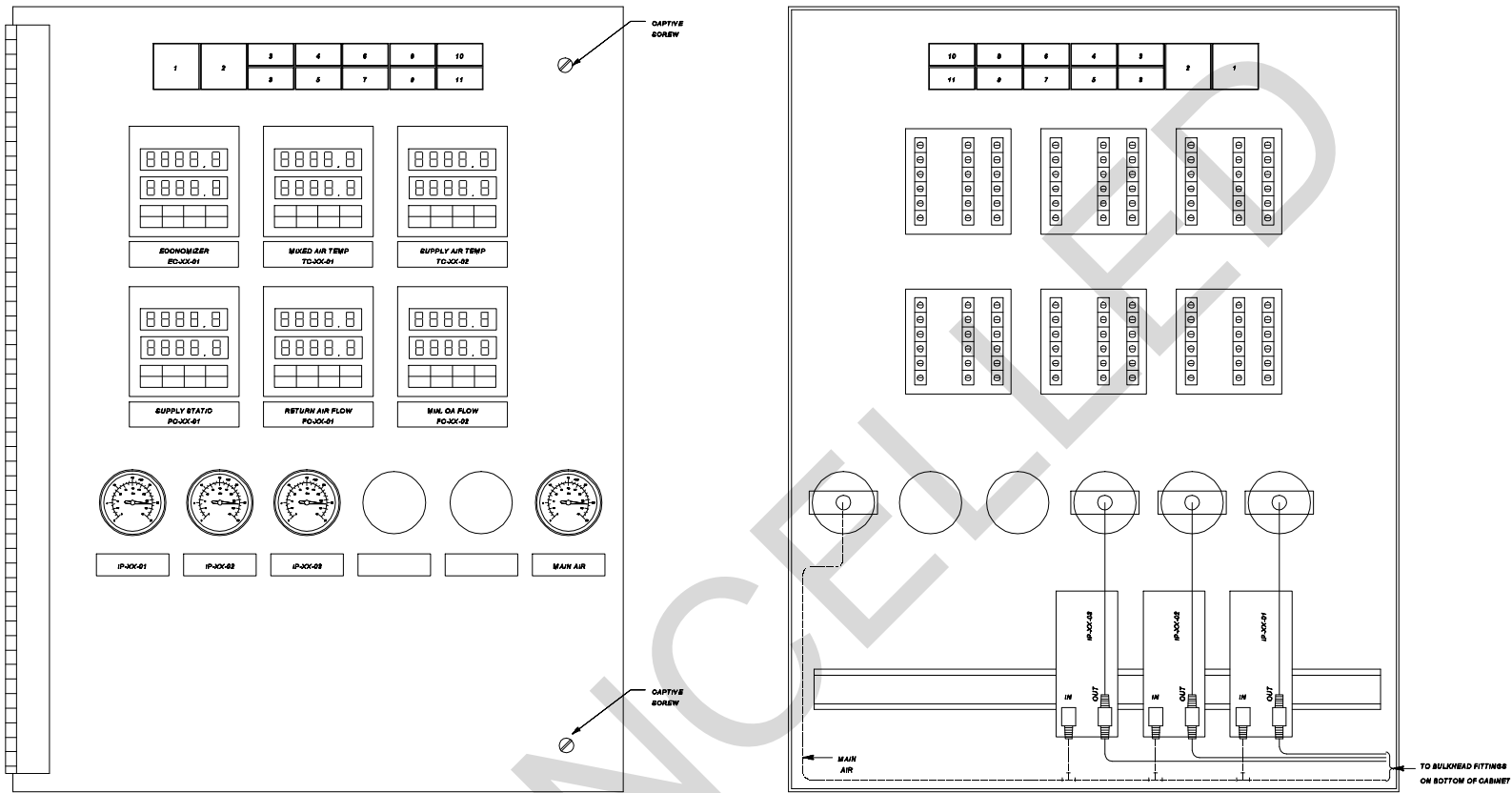

FRONT VIEW

REAR VIEW

SWITCH AND PILOT LIGHT LEGEND

POSITION LEGEND

- 1 - RESET
- 2 - STATIC RESET
- 3 - AUTO/AUTO OVERRIDE
- 4 - LOW TEMP
- 5 - SMOKE

DEVICE TYPE

- NON-ILLUMINATED MOMENTARY CONTACT PUSH BUTTON SWITCH
- NON-ILLUMINATED MOMENTARY CONTACT PUSH BUTTON SWITCH
- ILLUMINATED MAINTAINED CONTACT INTERLOCKED SWITCHES
- PILOT LIGHT
- PILOT LIGHT

IDENTIFIER

- HS-XX-03
- HS-XX-02
- HS-XX-01
- PL-XX-05
- PL-XX-06

POSITION LEGEND

- 6 - HIGH STATIC
- 7 - FILTER
- 8 - OCC
- 9 - VENT DELAY
- 10 - ECON
- 11 - FILTER

DEVICE TYPE

- PILOT LIGHT
- PILOT LIGHT
- PILOT LIGHT
- PILOT LIGHT
- PILOT LIGHT

IDENTIFIER

- PL-XX-07
- PL-XX-04
- PL-XX-01
- PL-XX-02
- PL-XX-03
- PL-XX-08

Figure 5-7d. Control panel interior door layout variations for variable speed drives.

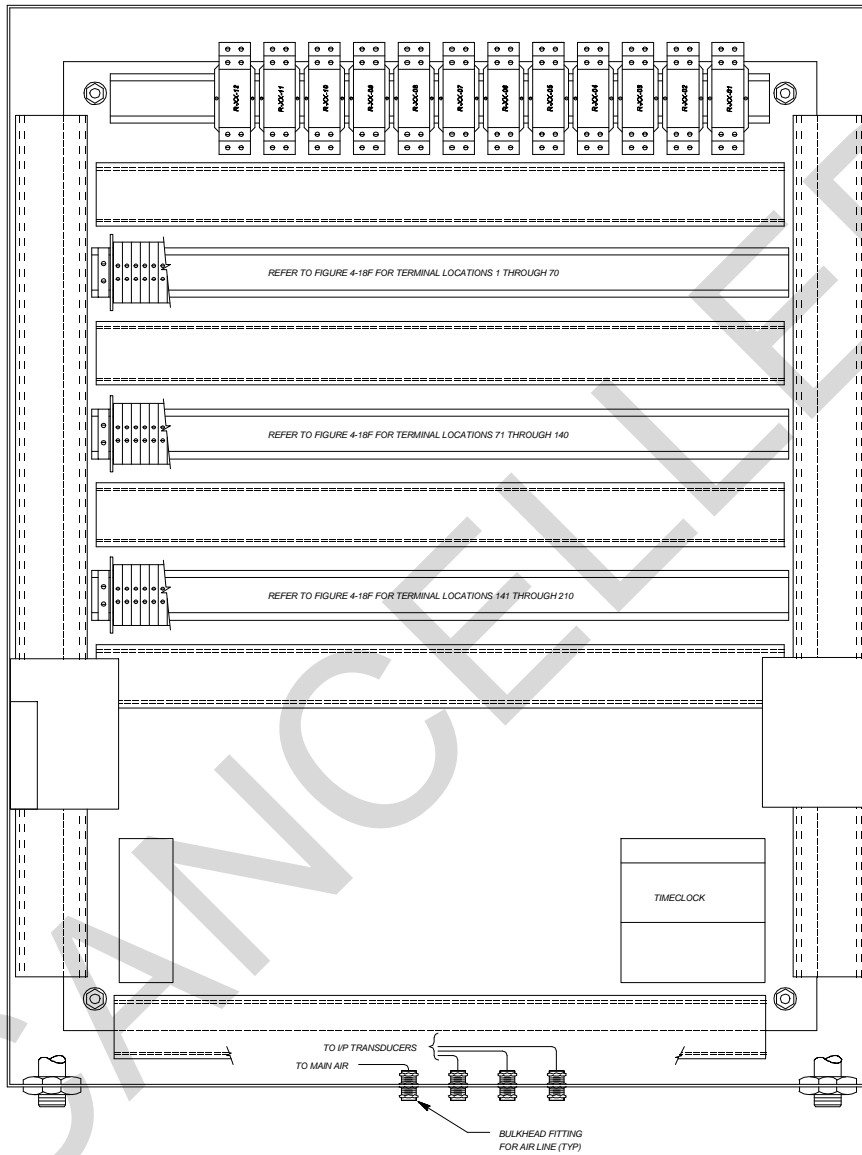

Figure 5-7e. Control panel back panel layout variations for variable speed drives.

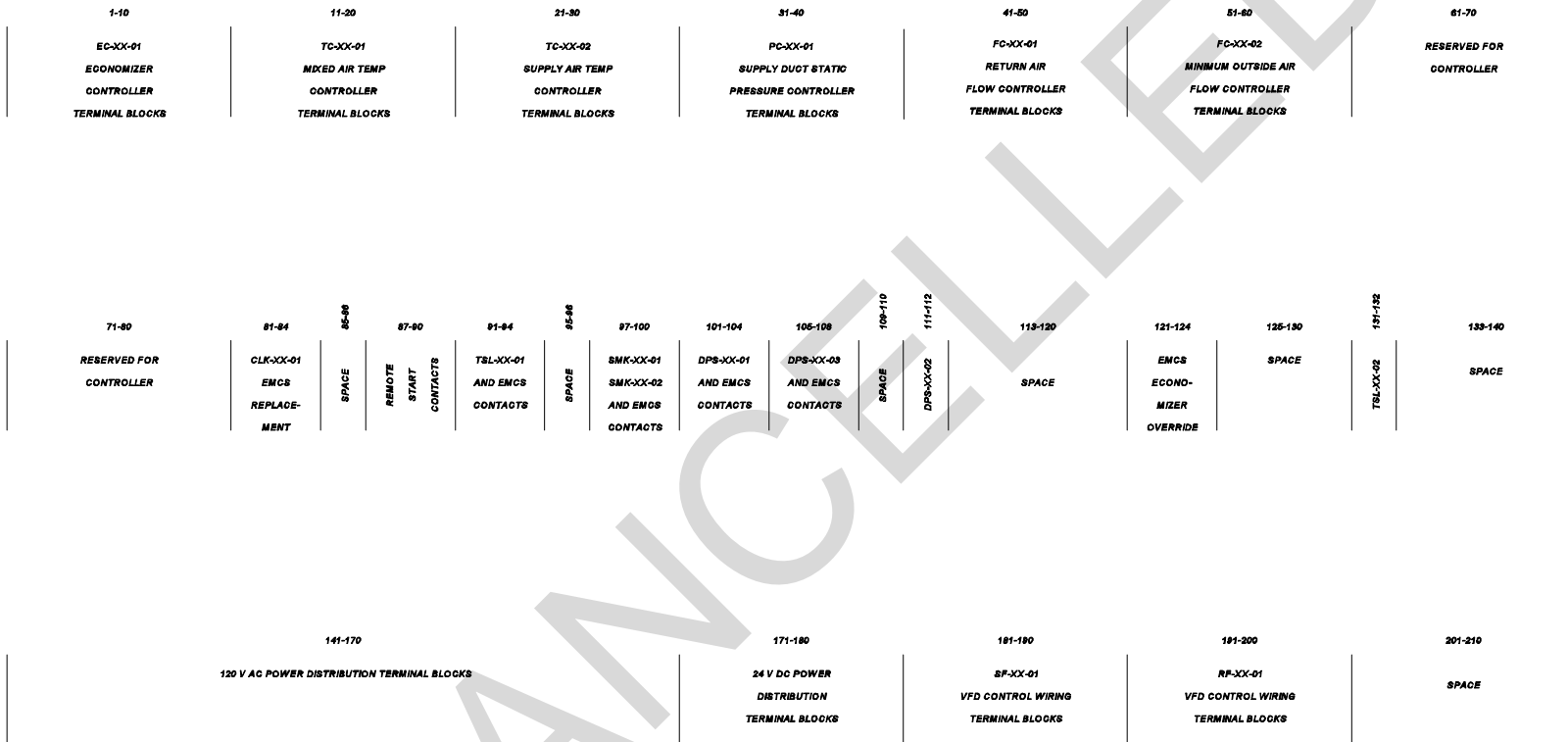

Figure 5-7f. Control panel terminal block layout variations for variable speed drives.

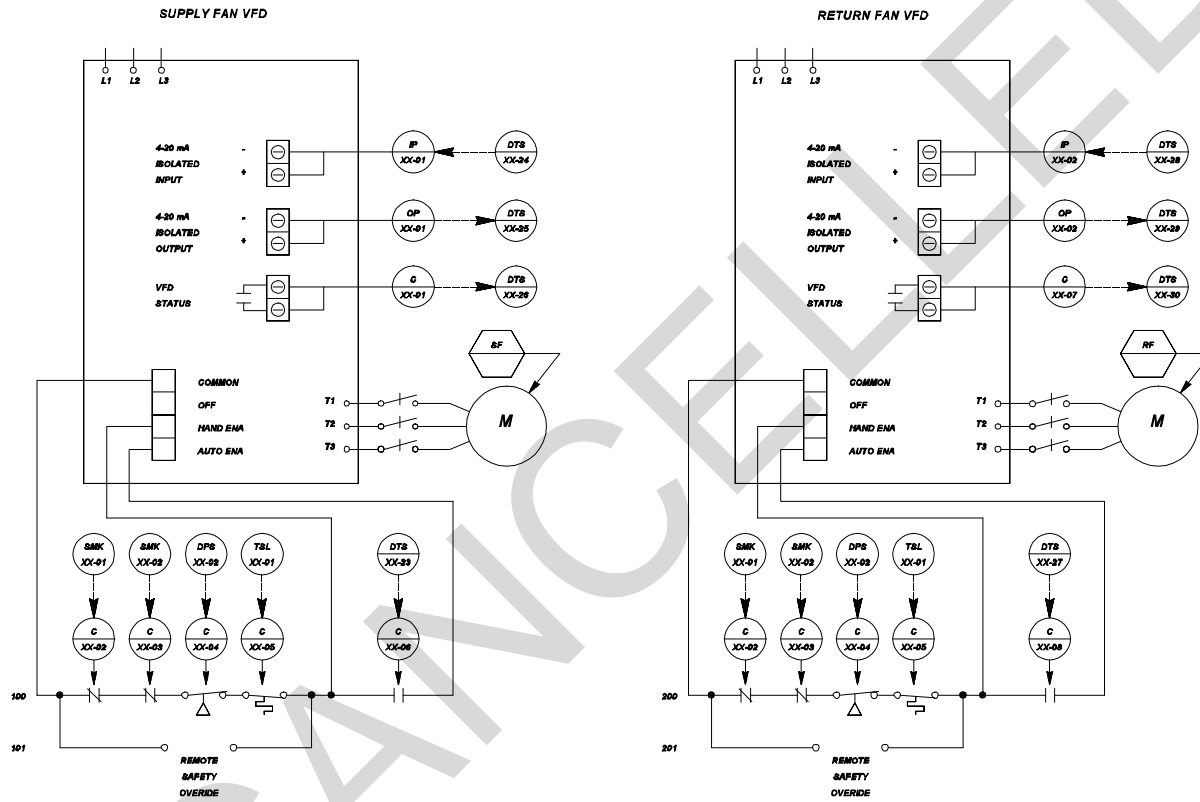

Figure 5-7h. DDC ladder diagram variations for variable speed drives.

SENSOR SCHEDULE

IDENTIFIER	FUNCTION	RANGE
TT-XX-01	MIXED AIR TEMPERATURE TRANSMITTER	4 TO 60 DEG C (40 TO 140 DEG F)
TT-XX-02	OUTSIDE AIR TEMPERATURE TRANSMITTER	-34 TO 54 DEG C (-30 TO +130 DEG F)
TT-XX-03	RETURN AIR TEMPERATURE TRANSMITTER	4 TO 60 DEG C (40 TO 140 DEG F)
TT-XX-04	SUPPLY AIR TEMPERATURE TRANSMITTER	4 TO 60 DEG C (40 TO 140 DEG F)
TT-XX-05	SPACE AIR TEMPERATURE TRANSMITTER	10 TO 30 DEG C (50 TO 85 DEG F)
FT-XX-01	SUPPLY AIR FLOW TRANSMITTER	0 - ... m/s (... FPM)
FT-XX-02	RETURN AIR FLOW TRANSMITTER	0 - ... m/s (... FPM)
FT-XX-03	MINIMUM OUTSIDE AIR FLOW TRANSMITTER	0 - ... m/s (... FPM)
DPT-XX-01	SUPPLY AIR STATIC PRESSURE TRANSMITTER	0 - 500 kPa (0.0 - 2.0 IN. WATER)

CONTROL VALVE SCHEDULE

IDENTIFIER	FUNCTION	TYPE	RANGE	Kv (Cv)	CLOSE-OFF RATING	REMARKS
VLV-XX-01	COOLING COIL VALVE	2-WAY, MODULATING	21 - 103 kPa (3-15 PSIG)	XX	... kPa (... PSIG)	
VLV-XX-AA	TERMINAL UNIT HEATING COIL	2-WAY, MODULATING	---	XX	... kPa (... PSIG)	
•	•	•	•	•	•	
VLV-XX-ZZ	TERMINAL UNIT HEATING COIL	2-WAY, MODULATING	---	XX	... kPa (... PSIG)	

CONTROL DAMPER SCHEDULE

IDENTIFIER	FUNCTION	TYPE	SIZE	RANGE	REMARKS
AD-XX-01	ECONOMIZER OUTSIDE AIR	MODULATING	W X H	21 - 103 kPa (3-15 PSIG)	PARALLEL BLADE
AD-XX-02	RETURN AIR	MODULATING	W X H		PARALLEL BLADE
AD-XX-03	RELIEF AIR	MODULATING	W X H		PARALLEL BLADE
AD-XX-04	MINIMUM OUTSIDE AIR	MODULATING	W X H		PARALLEL BLADE

OPERATING PARAMETERS

FUNCTION	SETPOINT	REMARKS
MINIMUM OUTSIDE AIR	... L/s (... CFM)	
MIXED AIR TEMPERATURE	... DEG C (... DEG F)	
SUPPLY AIR TEMPERATURE	... DEG C (... DEG F)	
SPACE TEMP. (NIGHT SETBACK)	... DEG C (... DEG F)	(HEATING ONLY)
SUPPLY AIR STATIC PRESSURE	... kPa (... IN. WATER)	
RETURN AIR FLOW		SUPPLY AIR FLOW MINUS ... L/s (... CFM)
ECONOMIZER MODE		ECONOMIZER MODE = ON, WHEN CONDITION 1 AND CONDITION 2 ARE BOTH SATISFIED. CONDITION 1: RETURN AIR TEMP. > XX/BB/CC (... DEG F) CONDITION 2: RETURN AIR TEMP. MINUS OUTSIDE AIR TEMP. > ... DEG C (... DEG F)
OCCUPIED MODE		MONDAY - FRIDAY : 0705 HRS - 1700 HRS
VENT DELAY MODE		MONDAY - FRIDAY : 0700 HRS - 0800 HRS
FREEZESTAT	... DEG C (... DEG F)	
MIN OA FILTER ALARM	... kPa (... IN. WATER)	
MAIN FILTER ALARM	... kPa (... IN. WATER)	
HIGH STATIC ALARM	... kPa (... IN. WATER)	

Figure 5-7i. DDC schedule variations for variable speed drives.

	HARDWARE														SOFTWARE																
	OUTPUT							INPUT							ALARMS					APPLICATION PROGRAMS											
	DIGITAL			ANALOG				DIGITAL			ANALOG				DIGITAL		ANALOG														
	CONTROL RELAY			POSITION ADJUSTMENT	SPEED			AUXILIARY CONTACT				TEMPERATURE	% RELATIVE HUMIDITY	PSIA, PSIA, PSID	FLOW	SPEED	CONTACT CLOSURE			HIGH LIMIT	LOW LIMIT	RUN TIME	SCHEDULED START/STOP	OPTIMUM START/STOP	DUTY CYCLING	DEMAND LIMITING	DAY/NIGHT SETBACK	ECONOMIZER	VENTILATION/REGULATION	PULL-UP MODE	
SUPPLY FAN	1			1			1									1	X				X		X	X	X	X					
RETURN FAN	1			1			1									1	X				X		X	X	X						
SUPPLY AIR											1	1	1							X	X										
RETURN AIR											1	1								X	X										
MIXED AIR											1									X	X										
MINIMUM OUTSIDE AIR				1							1		1							X	X										
MIXED AIR DAMPERS				1																						X	X				
COOLING COIL VALVE				1																											
FILTER							2														X										
FREEZESTAT							1														X										
SMOKE DETECTOR							2														X										
SUPPLY AIR HIGH STATIC							1														X										
SPACE TEMP (NITE LOW LIMIT)											X									X	X					X					

-- C - LAST COMMAND
H - HIGH VALUE
L - LOW VALUE

O - ON (OPEN)
F - OFF (CLOSED)

DDC DATA TERMINAL STRIP LAYOUT

DEVICE NO.	DESCRIPTION	TYPE
1	TT-XX-01 MIXED AIR TEMPERATURE	AI
2	TT-XX-02 OUTSIDE AIR TEMPERATURE	AI
3	TT-XX-03 RETURN AIR TEMPERATURE	AI
4	TT-XX-04 SUPPLY AIR TEMPERATURE	AI
5	TT-XX-05 SPACE TEMP (NITE LOW LIMIT)	AI
6		
7	DPT-XX-01 SUPPLY AIR STATIC PRESSURE	AI
8	FT-XX-01 SUPPLY AIR FLOW	AI
9	FT-XX-02 RETURN AIR FLOW	AI
10	FT-XX-03 MINIMUM OUTSIDE AIR FLOW	AI
11	DPS-XX-01 FILTER ALARM	DI
12	DPS-XX-03 PRE-FILTER ALARM	DI
13	IP-XX-01 MIXED AIR DAMPERS	AO
14	IP-XX-02 COOLING COIL VALVE	AO
15		
16		
17	IP-XX-03 MINIMUM OUTSIDE AIR DAMPER	AO
18	TSL-XX-01 FREEZESTAT	DI
19	DPS-XX-02 SUPPLY AIR HIGH STATIC	DI
20	SMK-XX-01 SUPPLY AIR SMOKE DETECTOR	DI
21	SMK-XX-02 RETURN AIR SMOKE DETECTOR	DI
22		
23	C-XX-06 SUPPLY FAN START/STOP	DO
24	IP-XX-01 SUPPLY FAN SPEED	AO
25	OP-XX-01 SUPPLY FAN SPEED	AI
26	C-XX-01 SUPPLY FAN STATUS	DI
27	C-XX-08 RETURN FAN START/STOP	DO
28	IP-XX-02 RETURN FAN SPEED	AO
29	OP-XX-02 RETURN FAN SPEED	AI
30	C-XX-07 RETURN FAN STATUS	DI

Figure 5-7j. DDC I/O table and data terminal strip layout variations for variable speed drives.

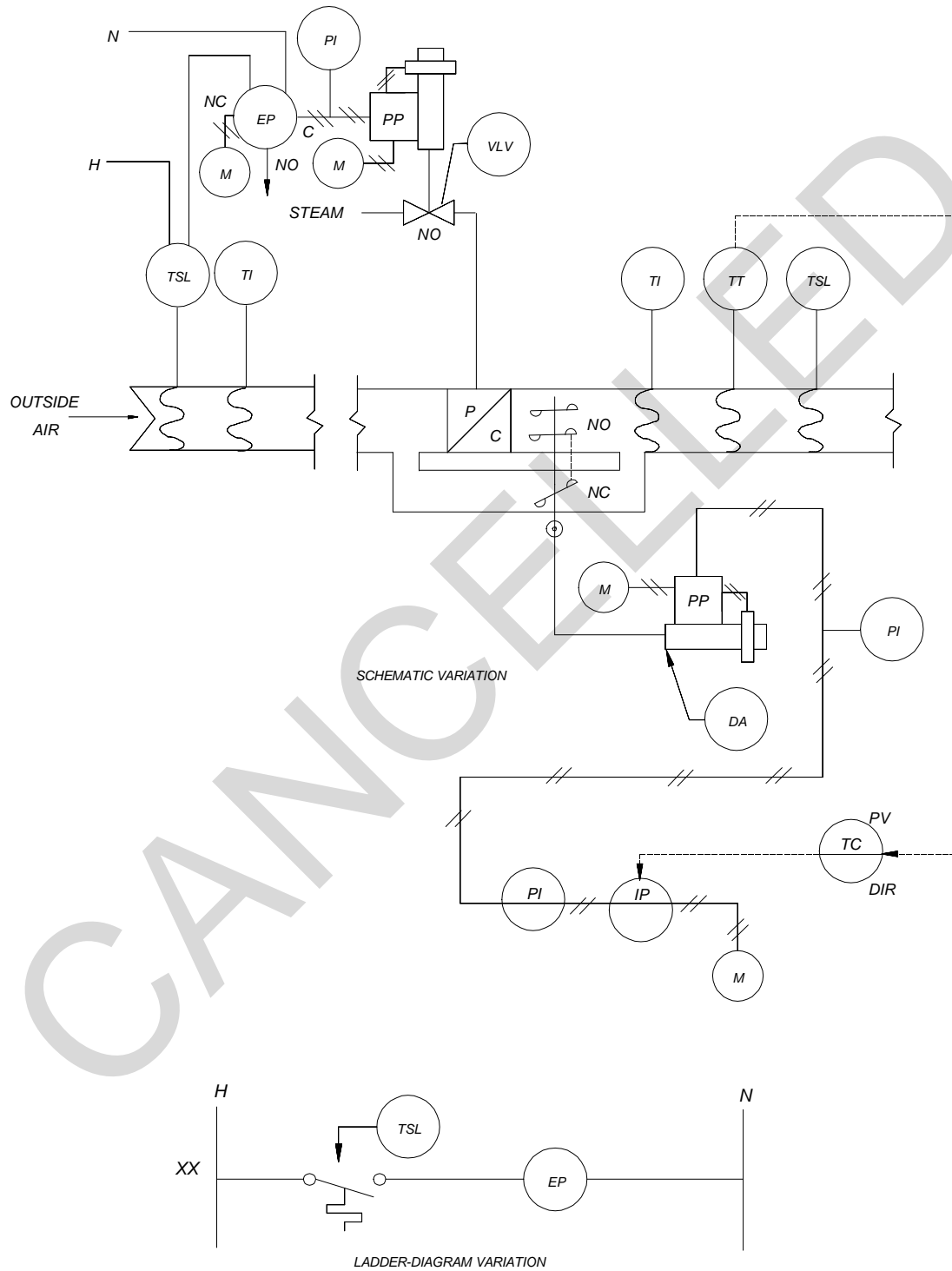
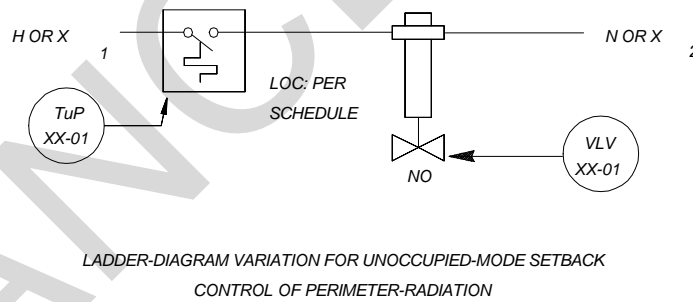
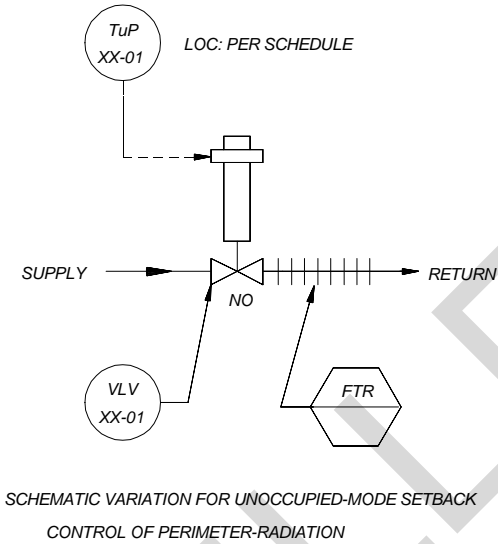

Figure 5-8. Control system variations for steam preheat coil with face and bypass dampers.



SPACE	FTR	THERMOSTAT	VALVE	REMARKS
XXXX	XX	TuP-XX-01 SET: DAY = 20 DEG C (68 DEG F) NIGHT = 13 DEG C (55 DEG F)	VLV-XX-01	Kv=.17 (Cv=0.2) CLOSE AGAINST 70 kPa (10 PSIG)
.
YYYY	YY	TuP-XX-XX SET: DAY = 20 DEG C (68 DEG F) NIGHT = 13 DEG C (55 DEG F)	VLV-XX-XX	Kv=.60 (Cv=0.7) CLOSE AGAINST 70 kPa (10 PSIG)

EQUIPMENT SCHEDULE

Figure 5-9. Control system variations for unoccupied mode setback.

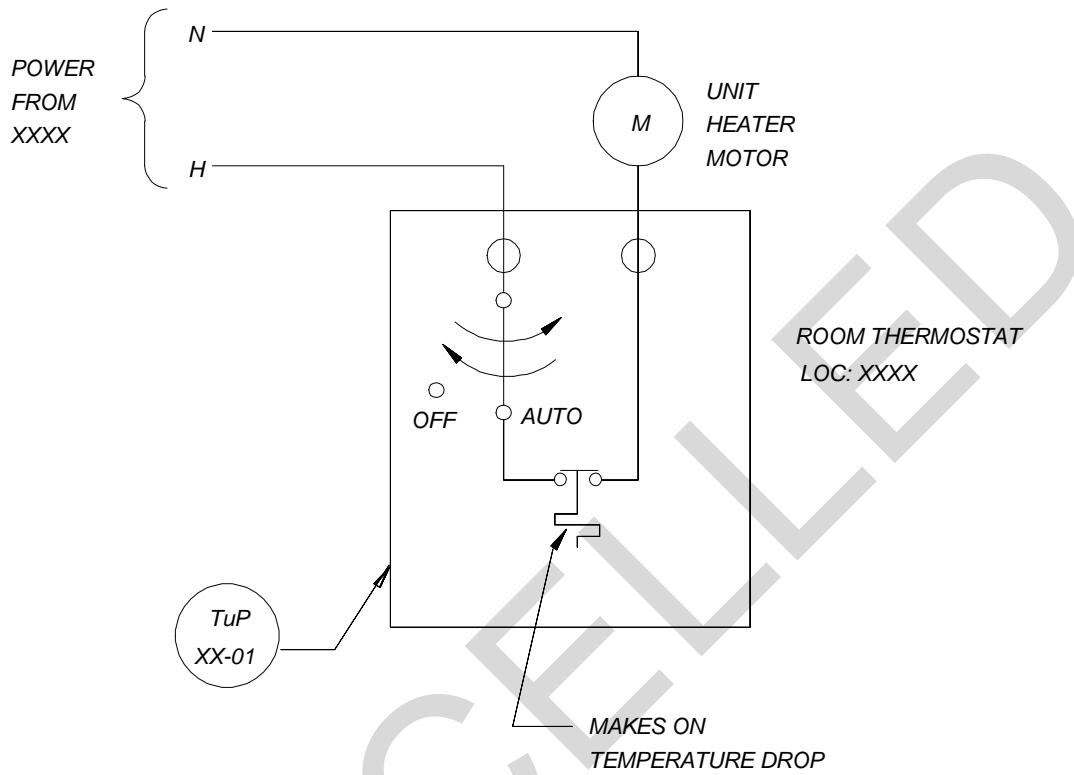

LADDER-DIAGRAM VARIATION FOR UNOCCUPIED-MODE SETBACK CONTROL OF UNIT HEATER

SPACE	UH	THERMOSTAT
XXXX	XX	TuP-XX-01 SET: DAY = 20 DEG C (68 DEG F) NIGHT = 13 DEG C (55 DEG F)
o	o	o
YYYY	YY	TuP-XX-XX SET: DAY = 20 DEG C (68 DEG F) NIGHT = 13 DEG C (55 DEG F)

EQUIPMENT-SCHEDULE VARIATION FOR UNOCCUPIED-MODE SETBACK CONTROL OF UNIT HEATER

Figure 5-10. Control system variations for unoccupied mode setback.

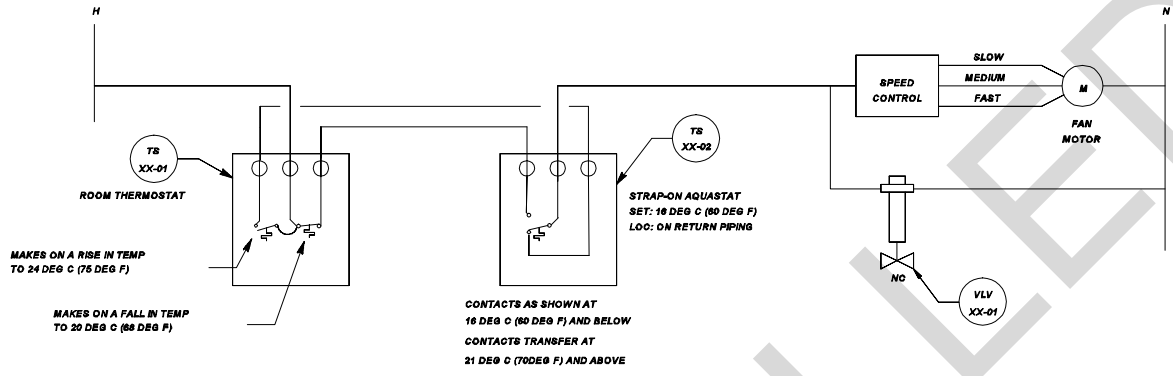

LADDER DIAGRAM

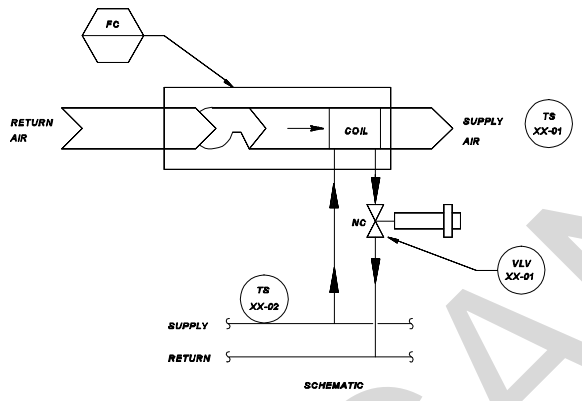

SPACE	FC	THERMOSTAT	AQUASTAT	VALVE AND ACTUATOR	REMARKS
XXXX	XX	TS-XX-01 SET: 20 DEG C (68 DEG F) - HTS 24 DEG C (75 DEG F) - CLS	TS-XX-02 SET: 16 DEG C (60 DEG F)	VLV-XX-01	Kv=1.73 (Cv=2) CLOSE AGAINST 70 kPa (10 PSIG)
ZZZ	ZZ	TS-XX-XX SET: 20 DEG C (68 DEG F) - HTS 24 DEG C (75 DEG F) - CLS	TS-XX-XY SET: 16 DEG C (60 DEG F)	VLV-XX-XX	Kv=1.0 (Cv=1.2) CLOSE AGAINST 70 kPa (10 PSIG)

EQUIPMENT SCHEDULE

Figure 5-11. Control system variations for 2-way shutoff valve on fan coil units.

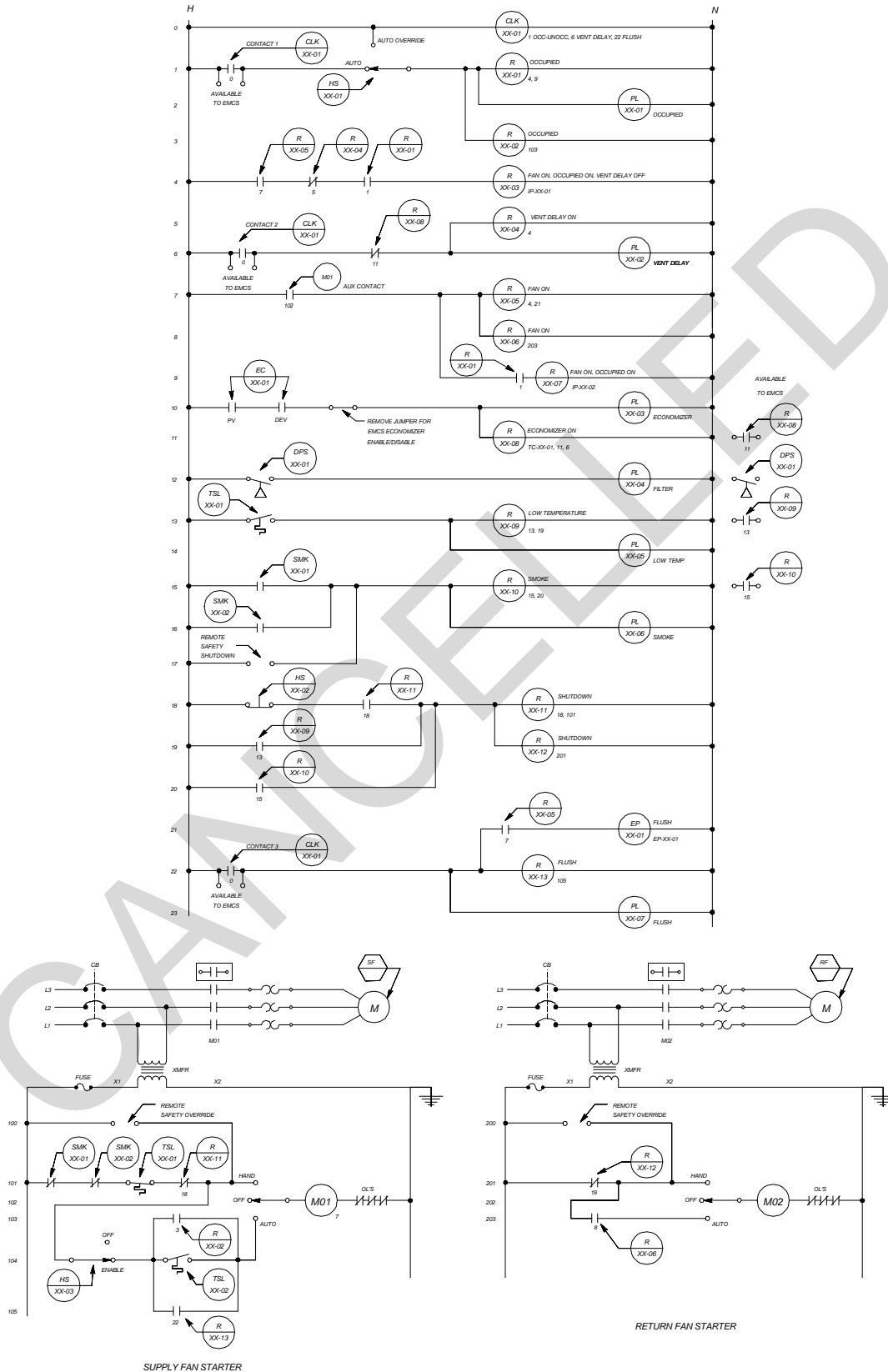
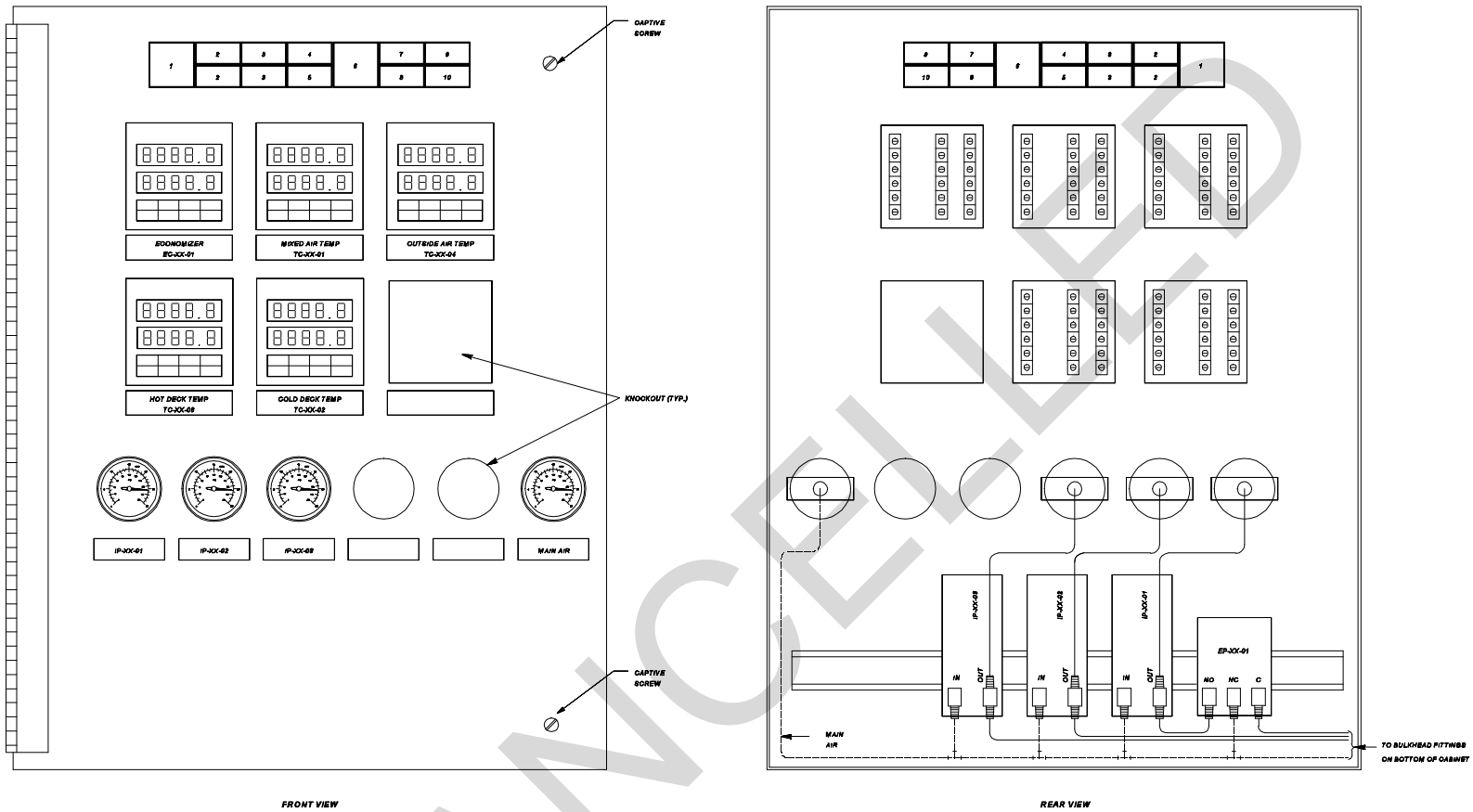

Figure 5-12b. Control system ladder diagram for multizone HVAC system with building flush mode of operation.

LOOP CONTROL FUNCTION	DEVICE NUMBER	DEVICE FUNCTION	SETPOINT	RANGE	ADDITIONAL PARAMETERS
MIXED AIR TEMPERATURE	DA-XX-01 DA-XX-02 DA-XX-03	DAMPER ACTUATOR	---	21-103 kPa (3 - 15 PSIG)	---
	MPB-XX-01	MINIMUM POSITION SWITCH	---	---	SET MIN OA L/A (CFM) EQUAL TO ___ L/A (___ CFM)
	TC-XX-01	MIXED AIR TEMPERATURE CONTROLLER	13 DEG C (55 DEG F)	4 TO 60 DEG C (40 TO 140 DEG F)	---
	TT-XX-01	MIXED AIR TEMPERATURE TRANSMITTER	---	4 TO 60 DEG C (40 TO 140 DEG F)	---
	TT-XX-03	OUTSIDE AIR TEMPERATURE TRANSMITTER	---	-34 TO 54 DEG C (-30 TO +130 DEG F)	---
	TT-XX-03	RETURN AIR TEMPERATURE TRANSMITTER	---	-34 TO 54 DEG C (-30 TO +130 DEG F)	---
	EC-XX-01	ECONOMIZER CONTROLLER	PV CONTACT CLOSE AT ___ DEG C (___ DEG F) OPEN AT ___ DEG C (___ DEG F)	-34 TO 54 DEG C (-30 TO +130 DEG F)	DEV CONTACT CLOSE @ DELTA T= ___ DEG C (___ DEG F) OPEN @ DELTA T= ___ DEG C (___ DEG F)
	TSL-XX-01	FREEZE STAT	3 DEG C (35 DEG F)	3 DEG C DIFFERENTIAL (5 DEG F DIFFERENTIAL)	---
	DPB-XX-01	FILTER ALARM	PER FILTER MANUFACTURER'S RECOMMENDATION	PER FILTER MANUFACTURER'S RECOMMENDATION	---
SPACE LOW TEMPERATURE	TSL-XX-02	NIGHT STAT - SPACE LOW TEMPERATURE PROTECTION	13 DEG C (55 DEG F)	3 DEG C DIFFERENTIAL (5 DEG F DIFFERENTIAL)	---
COLD DECK AIR TEMPERATURE	VLV-XX-01	COOLING COIL VALVE	---	21-103 kPa (3 - 15 PSIG)	Kv = ___ (Dv = ___) CLOSE AGAINST ___ kPa (___ PSIG)
	TC-XX-03	COLD DECK TEMPERATURE CONTROLLER	14 DEG C (57 DEG F)	4 TO 60 DEG C (40 TO 140 DEG F)	---
	TT-XX-04	COLD DECK TEMPERATURE TRANSMITTER	---	4 TO 60 DEG C (40 TO 140 DEG F)	---
HOT DECK AIR TEMPERATURE	VLV-XX-02	HEATING COIL VALVE	---	21-103 kPa (3 - 15 PSIG)	Kv = ___ (Dv = ___) CLOSE AGAINST ___ kPa (___ PSIG)
	TC-XX-03	HOT DECK TEMPERATURE CONTROLLER	OA TEMP = -18 DEG C (0 DEG F), HOT DECK = 48 DEG C (120 DEG F) OA TEMP = 16 DEG C (60 DEG F), HOT DECK = 32 DEG C (90 DEG F)	PV = 4 TO 60 DEG C (40 TO 140 DEG F) CPA = 32 TO 48 DEG C (90 TO 120 DEG F)	CPA LO-LIMIT = 23 DEG C (90 DEG F) CPA HI-LIMIT = 48 DEG C (120 DEG F)
	TC-XX-04	OUTSIDE AIR TEMPERATURE CONTROLLER	SET POINT = -1 DEG C (30 DEG F) PROPORTIONAL BAND = 37.5 % MANUAL RESET = 50 %	-34 TO 54 DEG C (-30 TO +130 DEG F)	---
	TT-XX-05	HOT DECK TEMPERATURE TRANSMITTER	---	4 TO 60 DEG C (40 TO 140 DEG F)	---
OCCUPIED MODE	CLK-XX-01 CONTACT 1	365 DAY SCHEDULE	---	NORMAL SCHEDULE (M-F) CONTACT CLOSED: 0700 HRS CONTACT OPEN: 1700 HRS	CONTACT OPEN: SAT, SUN
VENTILATION DELAY MODE	CLK-XX-01 CONTACT 2	365 DAY SCHEDULE	---	NORMAL SCHEDULE (M-F) CONTACT CLOSED: 0700 HRS CONTACT OPEN: 0800 HRS	---
FLUSH MODE	CLK-XX-01 CONTACT 3	365 DAY SCHEDULE	---	NORMAL SCHEDULE (M-F) CONTACT CLOSED: 0800 HRS CONTACT OPEN: 0700 HRS	---

NOTE: OTHER CONTROL DEVICES SUCH AS I/Ps, RELAYS, AND SIGNAL SELECTORS ARE NOT SHOWN.

Figure 5-12c. Control system equipment for multizone HVAC system with building flush mode of operation.



FRONT VIEW

REAR VIEW

SWITCH AND PILOT LIGHT LEGEND

POSITION LEGEND

1 - RESET
2 - AUTOMATO OVERRIDE
3 - ENABLE/OFF
4 - LOW TEMP
5 - SMOKE

DEVICE TYPE

NON-ILLUMINATED MOMENTARY CONTACT PUSH BUTTON SWITCH
ILLUMINATED MAINTAINED CONTACT INTERLOCKED SWITCHES
ILLUMINATED MAINTAINED CONTACT INTERLOCKED SWITCHES
PILOT LIGHT
PILOT LIGHT

IDENTIFIER

H8-XX-02
H8-XX-01
H8-XX-03
PL-XX-05
PL-XX-06

POSITION LEGEND

6 - FILTER
7 - OCC
8 - VENT DELAY
9 - ECONOMIZER
10 - FLUSH

DEVICE TYPE

PILOT LIGHT
PILOT LIGHT
PILOT LIGHT
PILOT LIGHT

IDENTIFIER

PL-XX-04
PL-XX-01
PL-XX-02
PL-XX-03
PL-XX-07

Figure 5-12d. Control panel interior door layout for multizone HVAC system with building flush mode of operation.

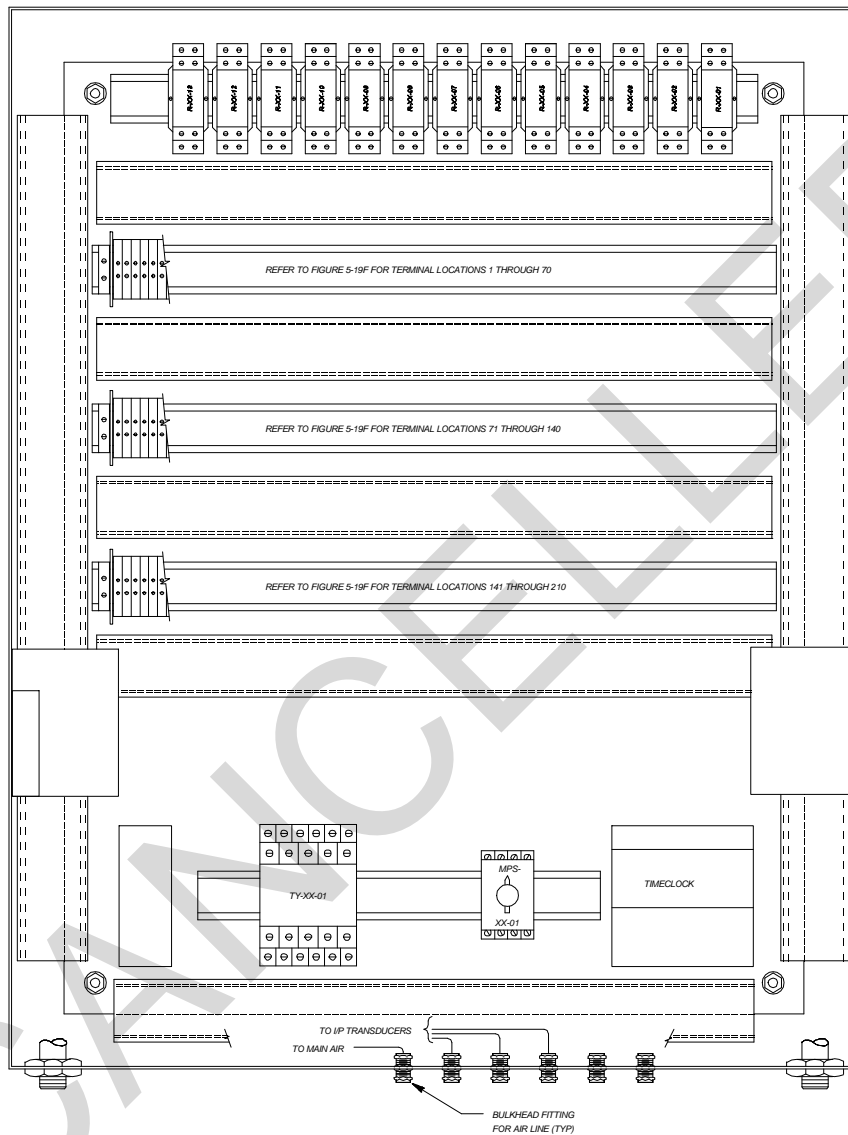

Figure 5-12e. Control panel back panel layout for multizone HVAC system with building flush mode of operation.

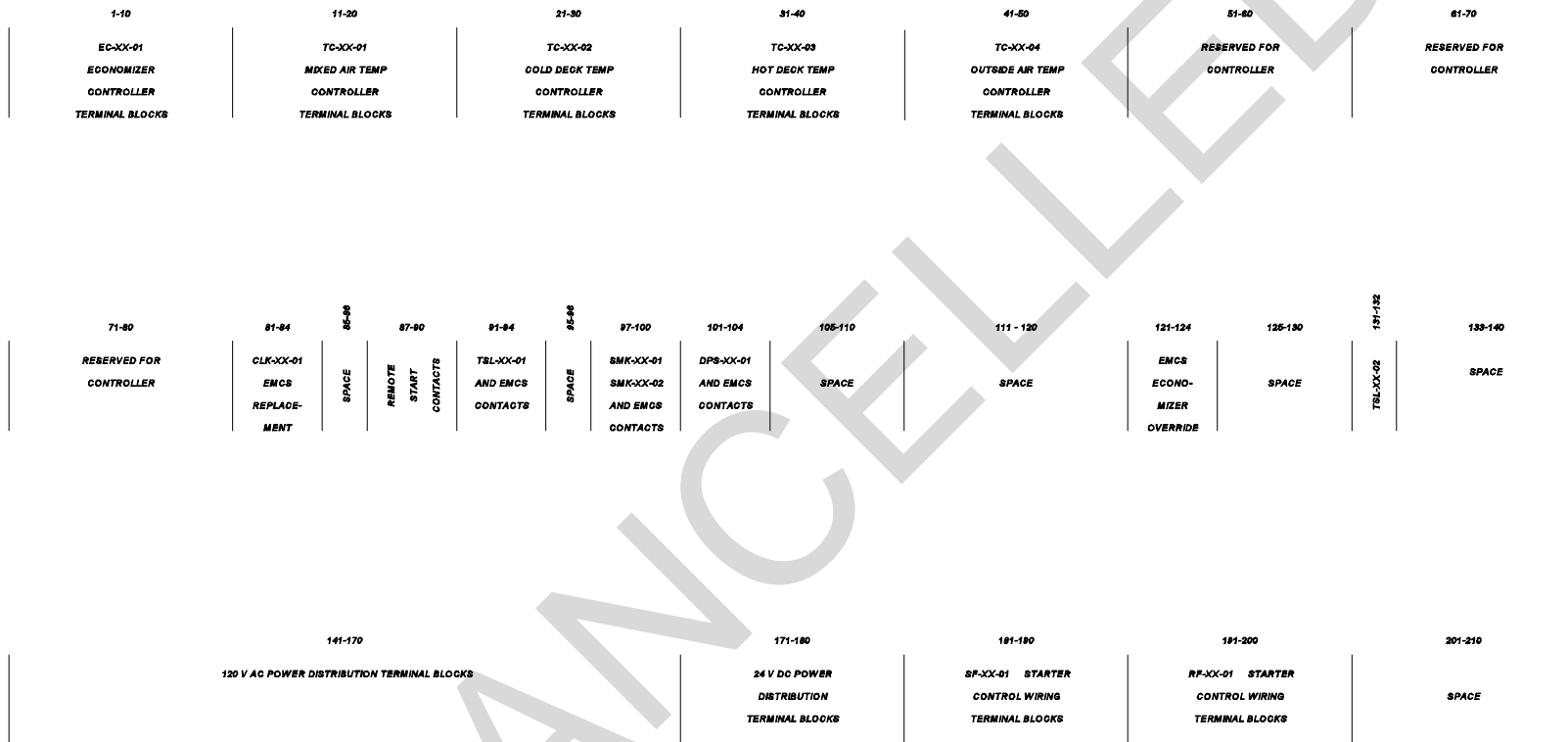

Figure 5-12f. Control panel terminal block layout for multizone HVAC system with building flush mode of operation.

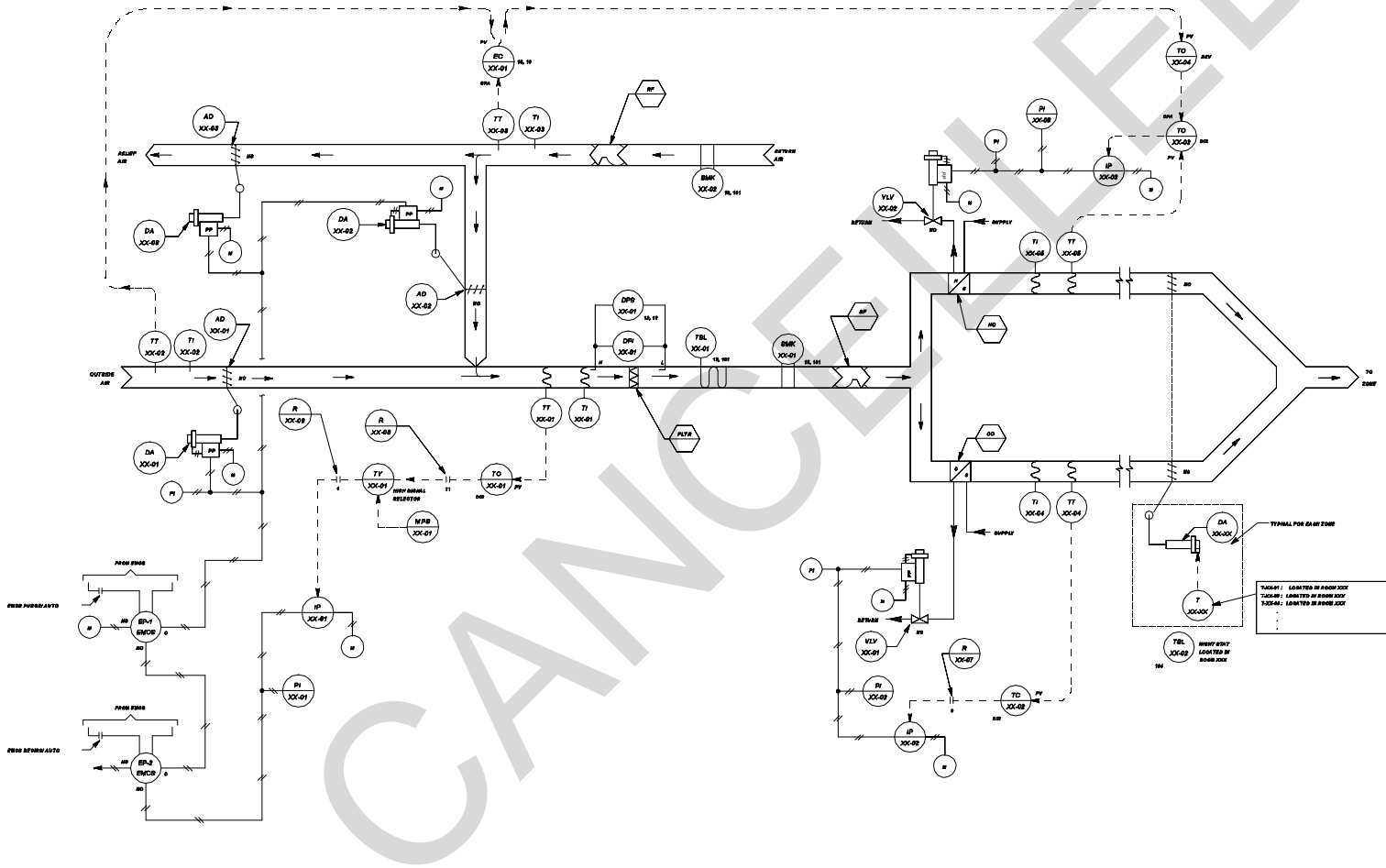

Figure 5-13. Control system variations for EMCS building purge and recirculation modes for pneumatic actuators.

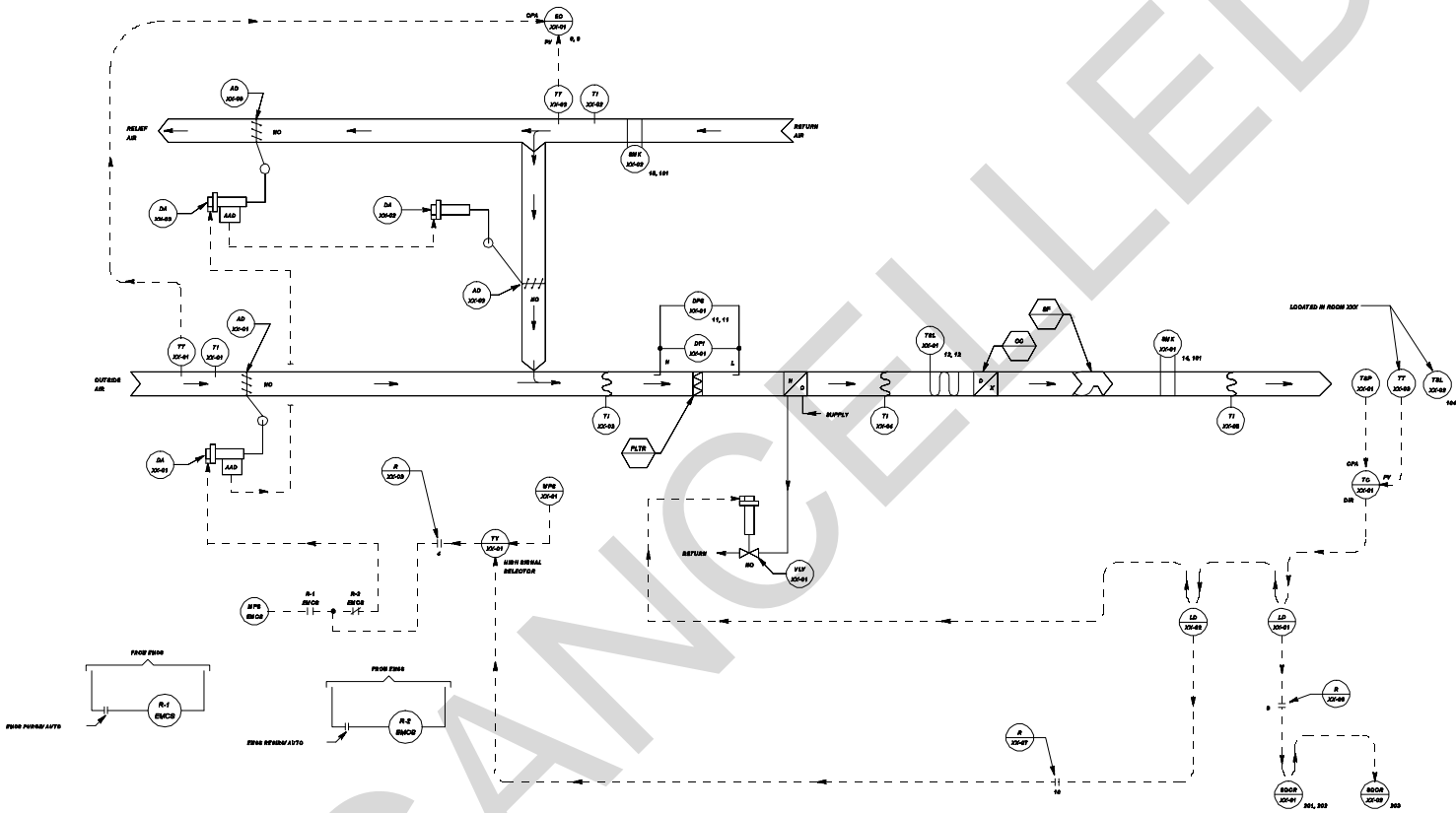

Figure 5-14. Control system variations for EMCS building purge and recirculation modes for electric or electronic actuators.

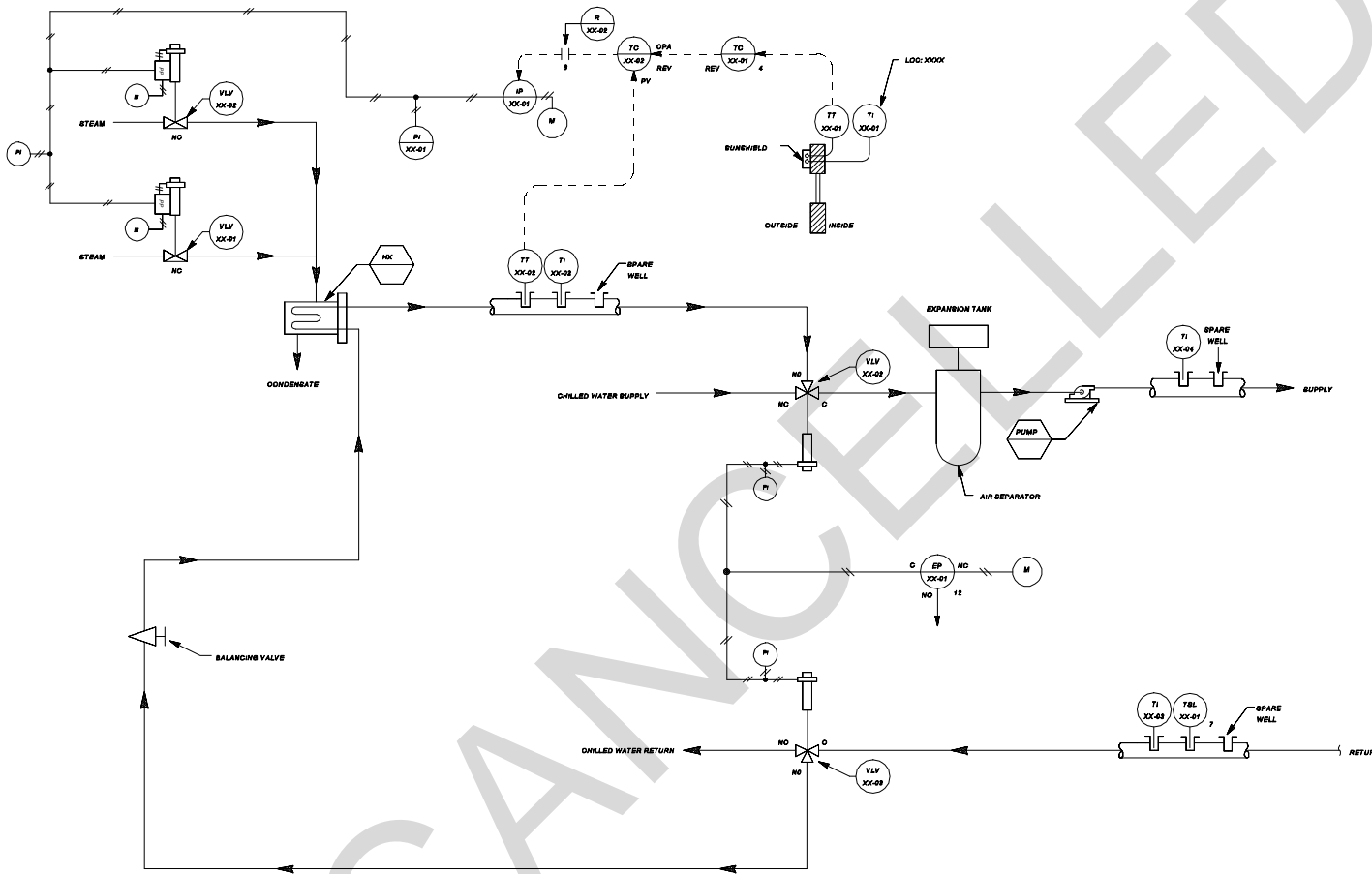

Figure 5-16. Schematic variations for dual steam valves.

LOOP CONTROL FUNCTION	DEVICE NUMBER	DEVICE FUNCTION	SETPOINT	RANGE	ADDITIONAL PARAMETERS
DUAL-TEMP SUPPLY TEMPERATURE	VLV-XX-01	CONVERTER STEAM VALVE	_____	21 - 48 kPa (3-7 PSIG)	Kv = 8.6 (Cv = 10) CLOSE AGAINST 70 kPa (10 PSIG)
	VLV-XX-02	CONVERTER STEAM VALVE	_____	48 - 103 kPa (7-15 PSIG)	Kv = 26 (Cv = 30) CLOSE AGAINST 70 kPa (10 PSIG)
	TC-XX-01	OUTSIDE-AIR TEMPERATURE CONTROLLER	-1 DEG C (30 DEG F) PROPORTIONAL BAND 37.5 % MANUAL RESET 60%	-35 TO +55 DEG C (-30 TO +130 DEG F)	PV CONTACT STARTS PUMP AT 10 DEG C (50 DEG F) STOPS PUMP AT 17 DEG C (62 DEG F)
	TC-XX-02	SYSTEM-SUPPLY TEMPERATURE CONTROLLER	OA TEMP = -18 DEG C (0 DEG F), HW8 TEMP = 83 DEG C (200 DEG F) OA TEMP = 16 DEG C (60 DEG F), HW8 TEMP = 38 DEG C (100 DEG F)	PV = 38 TO 121 DEG C (100 TO 250 DEG F) CPA = 38 TO 83 DEG C (100 TO 200 DEG F)	CPA LO-LIMIT = 38 DEG C (100 DEG F) CPA LO-LIMIT = 83 DEG C (200 DEG F)
	TT-XX-01	OUTSIDE-AIR TEMPERATURE TRANSMITTER	_____	-35 TO +65 DEG C (-30 TO +130 DEG F)	_____
	TT-XX-02	SYSTEM-SUPPLY TEMPERATURE TRANSMITTER	_____	38 TO 121 DEG C (100 TO 250 DEG F)	_____
DUAL-TEMP CHANGEOVER	TSL-XX-01	SYSTEM RETURN CHANGEOVER THERMOSTAT	_____	-1 TO 118 DEG C (30 TO 240 DEG F)	CONTACT CLOSE AT 28 DEG C (85 DEG F) CONTACT OPEN AT 32 DEG C (90 DEG F)
	VLV-XX-02	SUPPLY CHANGEOVER VALVE	_____	3-POSITION	Kv = 6 (Cv = 7) CLOSE AGAINST 70 kPa (10 PSIG)
	VLV-XX-03	RETURN CHANGEOVER VALVE	_____	3-POSITION	Kv = 6 (Cv = 7) CLOSE AGAINST 70 kPa (10 PSIG)
OCCUPIED MODE	CLK-XX-01 CONTACT	365-DAY SCHEDULE	_____	NORMAL SCHEDULE: M - F CONTACT CLOSED: 0700 HRS CONTACT OPEN: 1700 HRS	CONTACT OPEN: 8AT, 6UN

NOTE : OTHER CONTROL DEVICES SUCH AS IPS AND RELAYS ARE NOT SHOWN

Figure 5-17. Equipment schedule variations for dual steam valves.

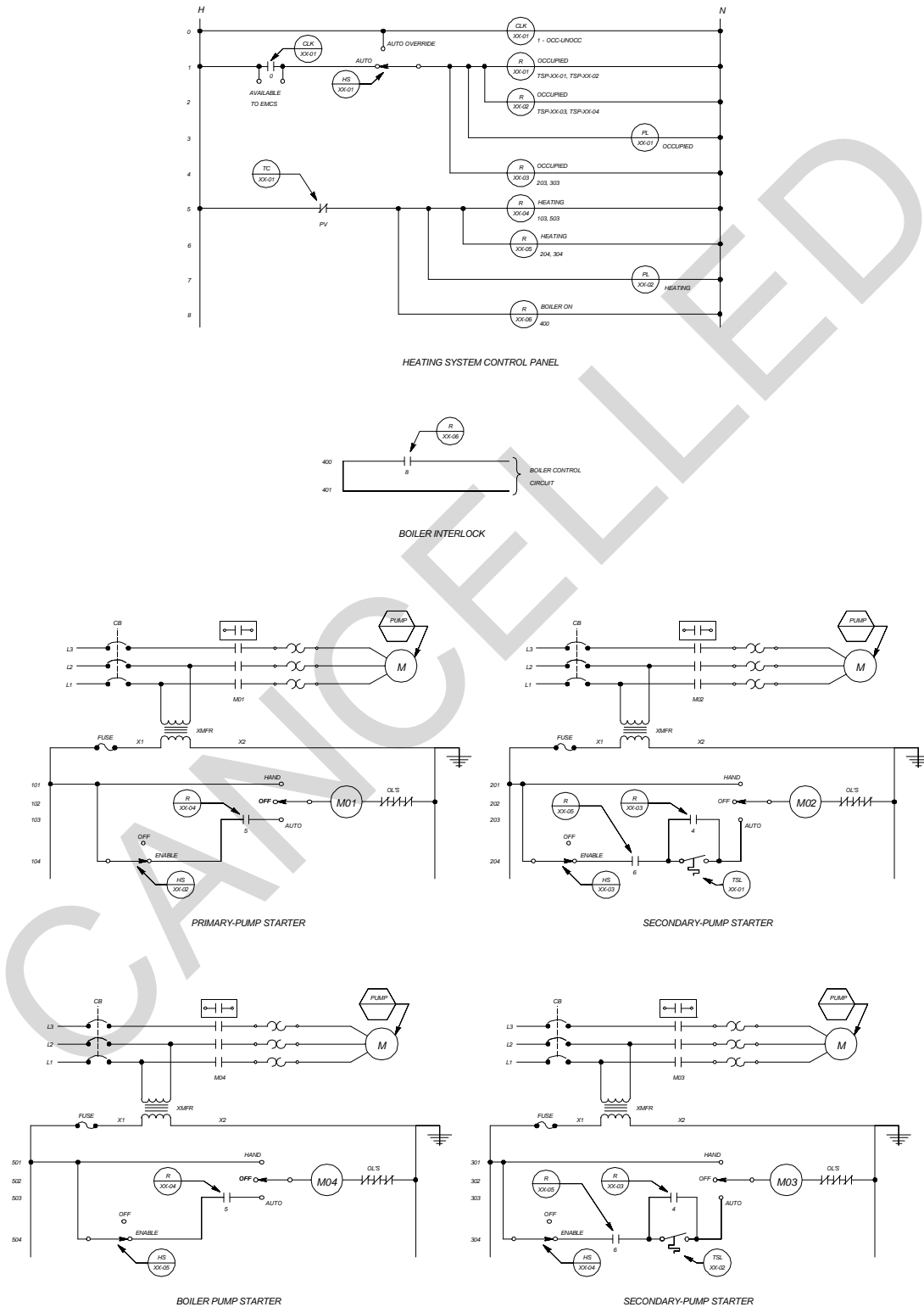
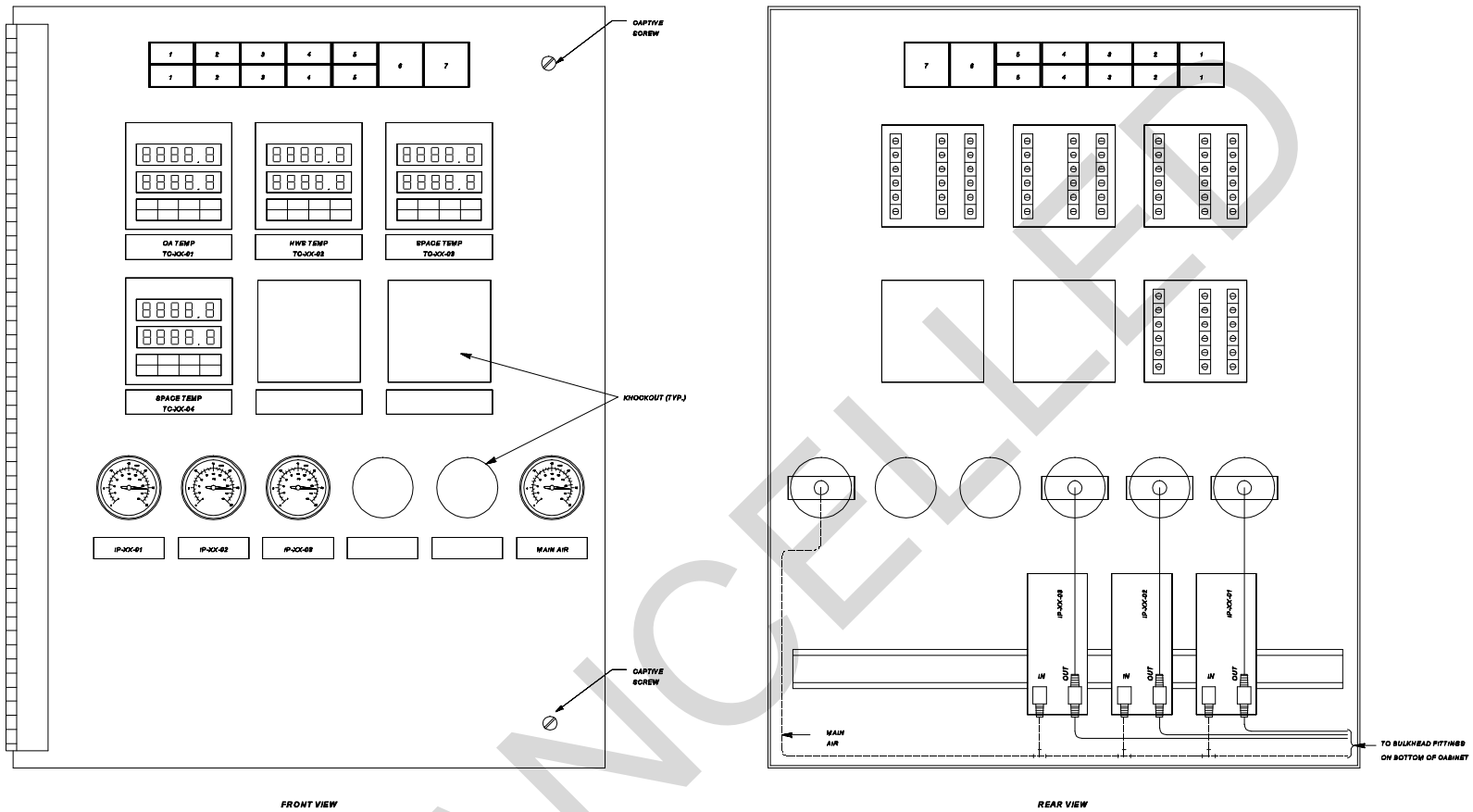

Figure 5-18b. Control system ladder diagram for single building hydronic heating system with constant volume hot water boiler loop.

LOOP CONTROL FUNCTION	DEVICE NUMBER	DEVICE FUNCTION	SETPOINT	RANGE	ADDITIONAL PARAMETERS
HW SUPPLY TEMPERATURE	VLV-XX-01	SYSTEM VALVE	—	21 - 103 kPa (8-15 PSIG)	Kv = 17.8 (Cv = 20) CLOSE AGAINST 70 kPa (10 PSIG)
	TC-XX-01	OUTSIDE-AIR TEMPERATURE CONTROLLER	-1 DEG C (30 DEG F) PROPORTIONAL BAND 37.5 % MANUAL RESET 60%	-35 TO +55 DEG C (-30 TO +130 DEG F)	PV CONTACT STARTS PUMP AT 18 DEG C (60 DEG F) STOPS PUMP AT 17 DEG C (63 DEG F)
	TC-XX-02	SYSTEM-SUPPLY TEMPERATURE CONTROLLER	OA TEMP = -18 DEG C (0 DEG F), HW'S TEMP = 83 DEG C (200 DEG F) OA TEMP = 16 DEG C (60 DEG F), HW'S TEMP = 38 DEG C (100 DEG F)	PV = 38 TO 121 DEG C (100 TO 250 DEG F) CPA = 38 TO 83 DEG C (100 TO 200 DEG F)	CPA LO-LIMIT = 38 DEG C (100 DEG F) CPA HI-LIMIT = 83 DEG C (200 DEG F)
	TT-XX-01	OUTSIDE-AIR TEMPERATURE TRANSMITTER	—	-35 TO +55 DEG C (-30 TO +130 DEG F)	—
	TT-XX-02	SYSTEM-SUPPLY TEMPERATURE TRANSMITTER	—	38 TO 121 DEG C (100 TO 250 DEG F)	—
SPACE TEMPERATURE	TT-XX-03	SPACE-TEMPERATURE TRANSMITTER	—	10 TO 30 DEG C (50 TO 85 DEG F)	—
	VLV-XX-02	ZONE VALVE	—	21 - 103 kPa (8-15 PSIG)	Kv = 8 (Cv = 7) CLOSE AGAINST 70 kPa (10 PSIG)
	TC-XX-03	SPACE TEMPERATURE CONTROLLER	21 DEG C (70 DEG F)	10 TO 30 DEG C (50 TO 85 DEG F)	SET LIMITS AVAILABLE TO OCCUPANT BY TSP-XX-01 AT 18 TO 22 DEG C (68 TO 72 DEG F)
	TSP-XX-01	MANUAL SETPOINT ADJUSTMENT	4 MA = 10 DEG C (50 DEG F) 20 MA = 28 DEG C (85 DEG F)	—	AVAILABLE TO OCCUPANT
	TSP-XX-02	MANUAL SETPOINT ADJUSTMENT	14 DEG C (57 DEG F)	—	—
SPACE LOW-LIMIT TEMPERATURE	TSL-XX-01	SPACE LOW-LIMIT THERMOSTAT	13 DEG C (55 DEG F)	—	STARTS PUMP AT 13 DEG C (55 DEG F) STOPS PUMP AT 14 DEG C (57 DEG F)
SPACE TEMPERATURE	TT-XX-04	SPACE TEMPERATURE TRANSMITTER	—	10 TO 30 DEG C (50 TO 85 DEG F)	—
	VLV-XX-03	ZONE VALVE	—	21 - 103 kPa (8-15 PSIG)	Kv = 8 (Cv = 7) CLOSE AGAINST 70 kPa (10 PSIG)
	TC-XX-04	SPACE TEMPERATURE CONTROLLER	21 DEG C (70 DEG F)	10 TO 30 DEG C (50 TO 85 DEG F)	SET LIMITS AVAILABLE TO OCCUPANT BY TSP-XX-03 AT 18 TO 22 DEG C (68 TO 72 DEG F)
	TSP-XX-03	MANUAL SETPOINT ADJUSTMENT	4 MA = 10 DEG C (50 DEG F) 20 MA = 28 DEG C (85 DEG F)	—	AVAILABLE TO OCCUPANT
	TSP-XX-04	MANUAL SETPOINT ADJUSTMENT	14 DEG C (57 DEG F)	—	—
SPACE LOW-LIMIT TEMPERATURE	TSL-XX-02	SPACE LOW-LIMIT THERMOSTAT	13 DEG C (55 DEG F)	—	STARTS PUMP AT 13 DEG C (55 DEG F) STOPS PUMP AT 14 DEG C (57 DEG F)
OCCUPIED MODE	CLK-XX-01 CONTACT	865-DAY SCHEDULE	—	NORMAL SCHEDULE (M - F) CONTACT CLOSED: 0700 HRS CONTACT OPEN: 1700 HRS	CONTACT OPEN: SAT, SUN

NOTE : OTHER CONTROL DEVICES SUCH AS IPS AND RELAYS ARE NOT SHOWN

Figure 5-18c. Control system equipment for single building hydronic heating system with constant volume hot water boiler loop.



FRONT VIEW

REAR VIEW

SWITCH AND PILOT LIGHT LEGEND

POSITION LEGEND
1 - AUTOMATO OVERRIDE
2 - ENABLE/OFF
3 - ENABLE/OFF

DEVICE TYPE	IDENTIFIER
ILLUMINATED MAINTAINED CONTACT INTERLOCKED SWITCHES	HS-XX-01
ILLUMINATED MAINTAINED CONTACT INTERLOCKED SWITCHES	HS-XX-02
ILLUMINATED MAINTAINED CONTACT INTERLOCKED SWITCHES	HS-XX-03

POSITION LEGEND
4 - ENABLE/OFF
5 - ENABLE/OFF
6 - OCCUPIED
7 - HEATING

DEVICE TYPE	IDENTIFIER
ILLUMINATED MAINTAINED CONTACT INTERLOCKED SWITCHES	HS-XX-04
ILLUMINATED MAINTAINED CONTACT INTERLOCKED SWITCHES	HS-XX-05
PILOT LIGHT	PL-XX-01
PILOT LIGHT	PL-XX-02

Figure 5-18d. Control panel interior door layout for single building hydronic heating system with constant volume hot water boiler loop.

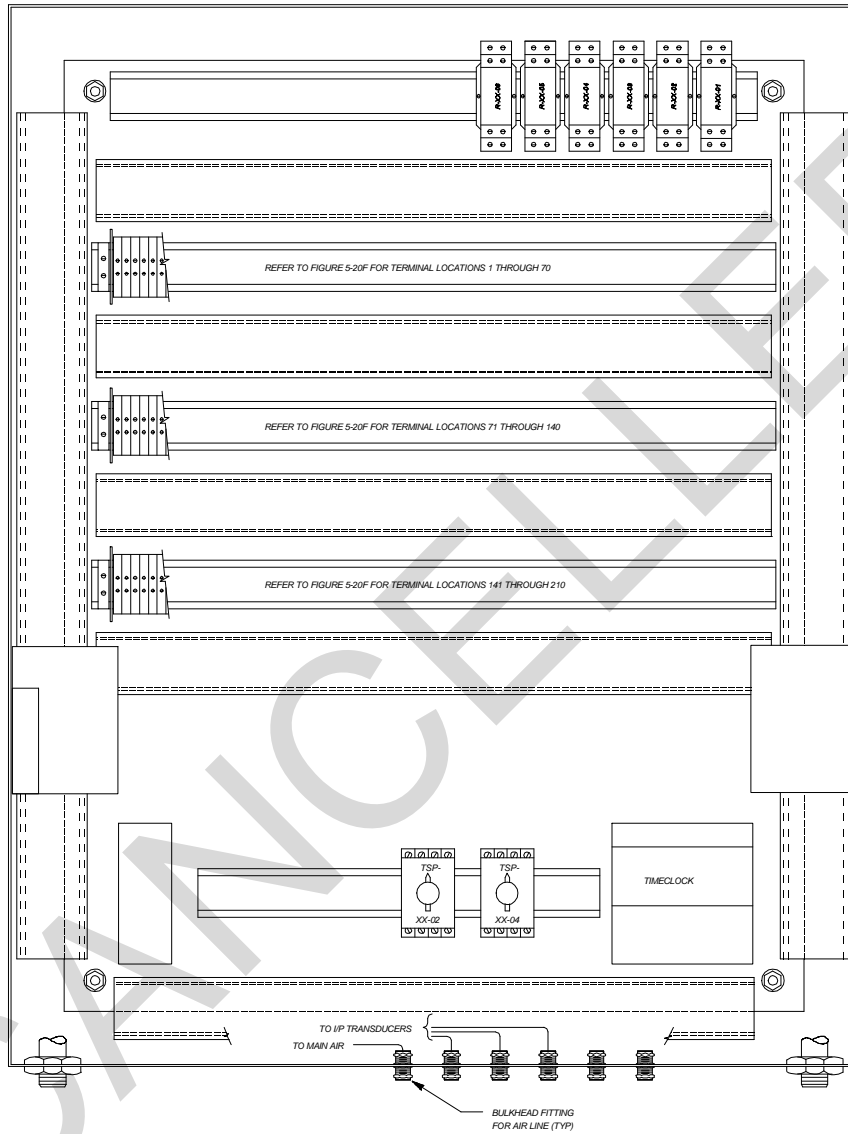

Figure 5-18e. Control panel back panel layout for single building hydronic heating system with constant volume hot water boiler loop.

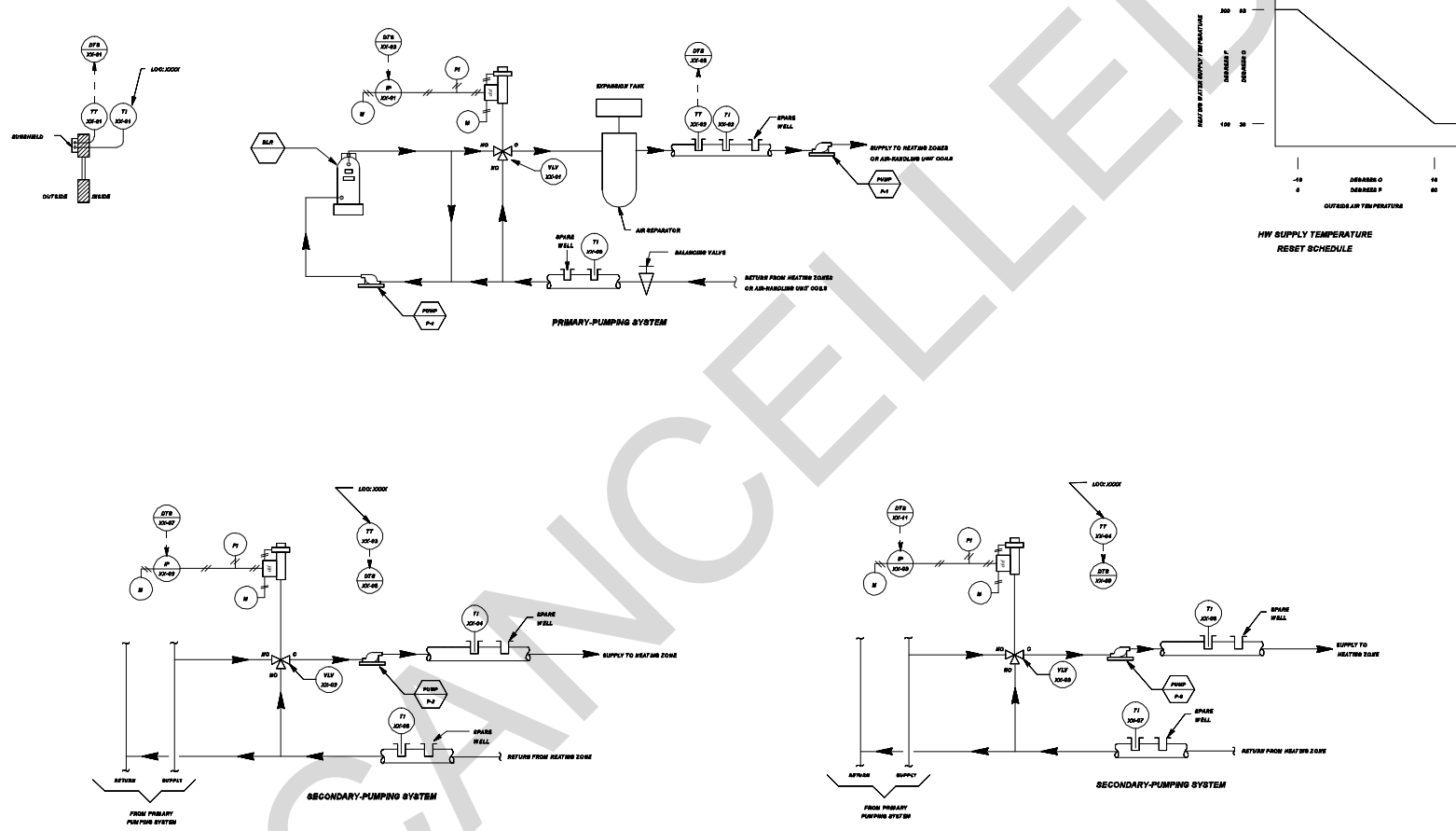

Figure 5-18g. DDC control system schematic for single building hydronic heating system with constant volume hot water boiler loop.

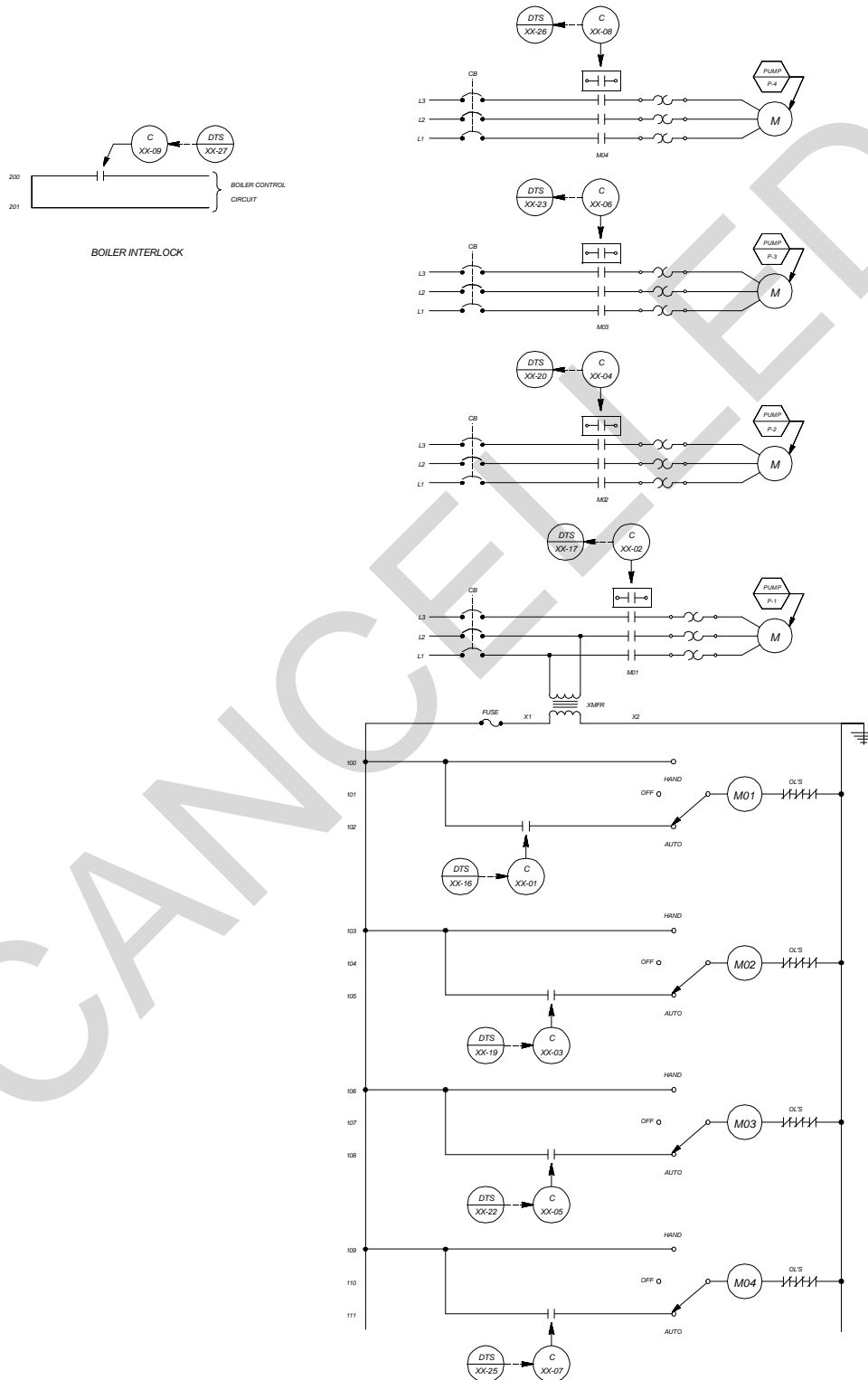

Figure 5-18h. DDC control system ladder diagram for single building hydronic heating system with constant volume hot water boiler loop.

SENSOR SCHEDULE

IDENTIFIER	FUNCTION	RANGE
TT-XX-01	OUTSIDE AIR TEMPERATURE TRANSMITTER	-35 TO +55 DEG C (-30 TO +130 DEG F)
TT-XX-02	PRIMARY SYSTEM SUPPLY TEMPERATURE TRANSMITTER	38 TO 121 DEG C (100 TO 250 DEG F)
TT-XX-03	SPACE TEMPERATURE TRANSMITTER	10 TO 30 DEG C (50 TO 85 DEG F)
TT-XX-04	SPACE TEMPERATURE TRANSMITTER	10 TO 30 DEG C (50 TO 85 DEG F)

CONTROL VALVE SCHEDULE

IDENTIFIER	FUNCTION	TYPE	RANGE	Kv (Cv)	CLOSE-OFF RATING	REMARKS
VLV-XX-01	PRIMARY SYSTEM VALVE	3-WAY, MODULATING	21 - 103 kPa (3-15 PSIG)	XX	XX kPa (XX PSIG)	
VLV-XX-02	ZONE VALVE	3-WAY, MODULATING	21 - 103 kPa (3-15 PSIG)	XX	XX kPa (XX PSIG)	
VLV-XX-03	ZONE VALVE	3-WAY, MODULATING	21 - 103 kPa (3-15 PSIG)	XX	XX kPa (XX PSIG)	

OPERATING PARAMETERS

FUNCTION	SETPPOINT	REMARKS
OUTSIDE AIR TEMPERATURE		START PRIMARY PUMP AT OA TEMP = XX DEG C (XX DEG F) STOP PRIMARY PUMP AT OA TEMP = XX DEG C (XX DEG F)
PRIMARY SYSTEM SUPPLY TEMPERATURE	XX DEG C (XX DEG F)	OA TEMP = -18 DEG C (0 DEG F); PRIMARY SYSTEM SUPPLY SETPOINT = 93 DEG C (200 DEG F) OA TEMP = 16 DEG C (60 DEG F); PRIMARY SYSTEM SUPPLY SETPOINT = 38 DEG C (100 DEG F)
SPACE TEMP. (OCCUPIED)	XX DEG C (XX DEG F)	
SPACE TEMP. (UNOCCUPIED)	XX DEG C (XX DEG F)	
OCCUPIED MODE		MONDAY - FRIDAY : 0705 HRS - 1700 HRS

Figure 5-18i. DDC control system equipment for single building hydronic heating system with constant volume hot water boiler loop.

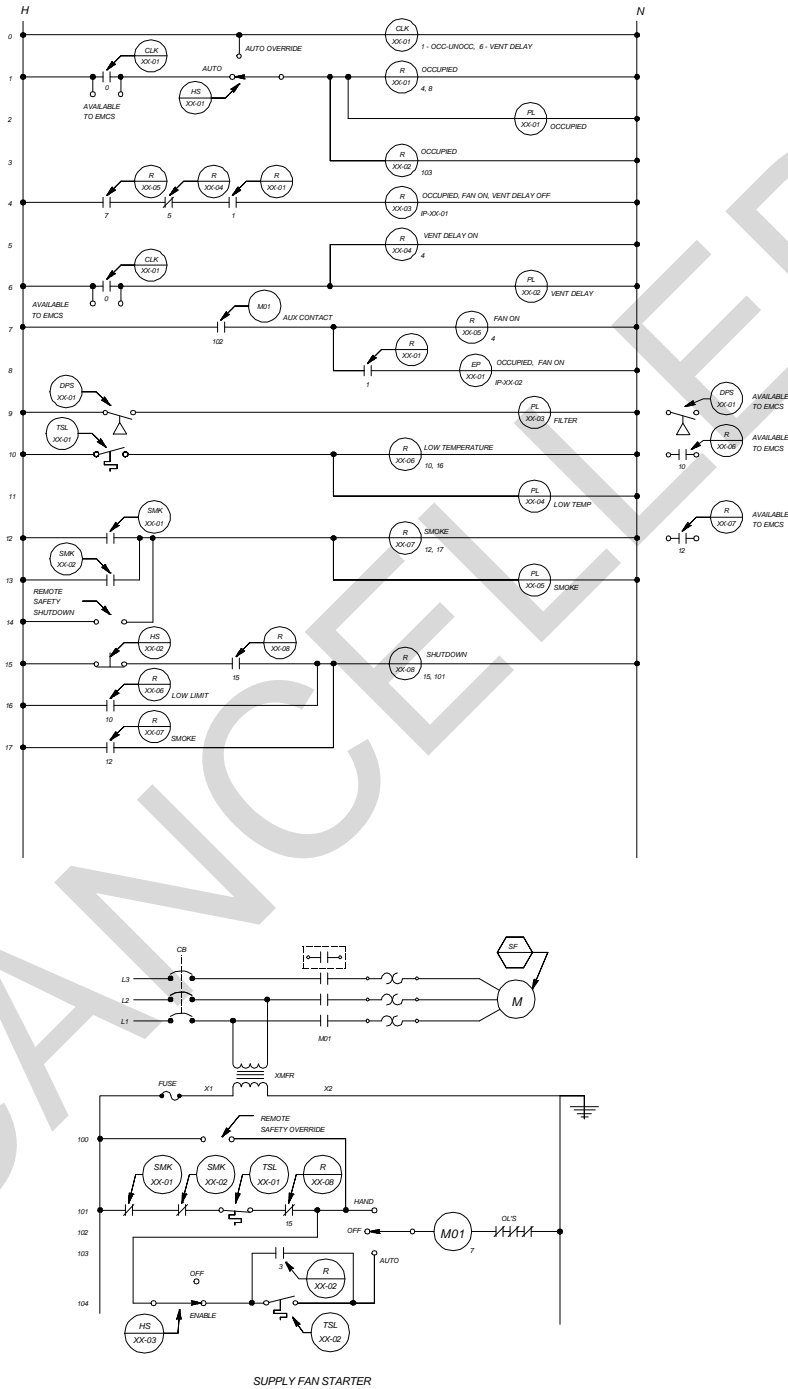

Figure 5-15b. Control system ladder diagram for single-zone HVAC system without economizer control mode.

LOOP CONTROL FUNCTION	DEVICE NUMBER	DEVICE FUNCTION	SETPOINT	RANGE	ADDITIONAL PARAMETERS
SPACE TEMPERATURE	DA-XX-01 DA-XX-02 DA-XX-03	DAMPER ACTUATOR	---	48 - 78 kPa (7 - 11 PSIG)	---
	MPS-XX-01	MINIMUM POSITION SWITCH	---	---	SET MIN OA L/s (CFM) EQUAL TO ___ L/s (___ CFM)
	TT-XX-01	SPACE TEMPERATURE TRANSMITTER	---	10 TO 30 DEG C (50 TO 85 DEG F)	---
	TSP-XX-01	SPACE TEMPERATURE SETPOINT ADJUSTMENT	4 mA = 10 DEG C (50 DEG F) 20 mA = 30 DEG C (85 DEG F)	---	---
	TC-XX-01	SPACE TEMPERATURE CONTROLLER	4 mA = 10 DEG C (50 DEG F) 20 mA = 30 DEG C (85 DEG F)	10 TO 30 DEG C (50 TO 85 DEG F)	SET LIMITS AVAILABLE TO OCCUPANT BY TSP-XX-01 AT 18 TO 22 DEG C (64 TO 72 DEG F)
	VLV-XX-01	HEATING COIL VALVE	---	21 - 41 kPa (3 - 6 PSIG)	Kv = ___ (Cv = ___) CLOSE AGAINST ___ kPa (___ PSIG)
	VLV-XX-02	COOLING COIL VALVE	---	65 - 100 kPa (12 - 15 PSIG)	Kv = ___ (Cv = ___) CLOSE AGAINST ___ kPa (___ PSIG)
MIXED AIR	TSL-XX-01	LOW TEMPERATURE PROTECTION THERMOSTAT	3 DEG C (35 DEG F)	---	---
	DPS-XX-01	FILTER ALARM	PER FILTER MANUFACTURER'S RECOMMENDATION	PER FILTER MANUFACTURER'S RECOMMENDATION	---
SPACE LOW TEMPERATURE	TSL-XX-02	NIGHT STAT - SPACE LOW TEMPERATURE PROTECTION	18 DEG C (65 DEG F)	DIFFERENTIAL = 3 DEG C (5 DEG F)	---
OCCUPIED MODE	CLK-XX-01 CONTACT	365 DAY SCHEDULE	---	NORMAL SCHEDULE (M-F) CONTACT CLOSED: 0700 HRS CONTACT OPEN: 1700 HRS	CONTACT OPEN: SAT, SUN
VENTILATION DELAY MODE	CLK-XX-01 CONTACT	365 DAY SCHEDULE	---	NORMAL SCHEDULE (M-F) CONTACT CLOSED: 0700 HRS CONTACT OPEN: 0900 HRS	↓

NOTE: OTHER CONTROL DEVICES SUCH AS VPs, RELAYS, AND SIGNAL SELECTORS ARE NOT SHOWN.

Figure 5-15c. Control system equipment for single-zone HVAC system without economizer control mode.

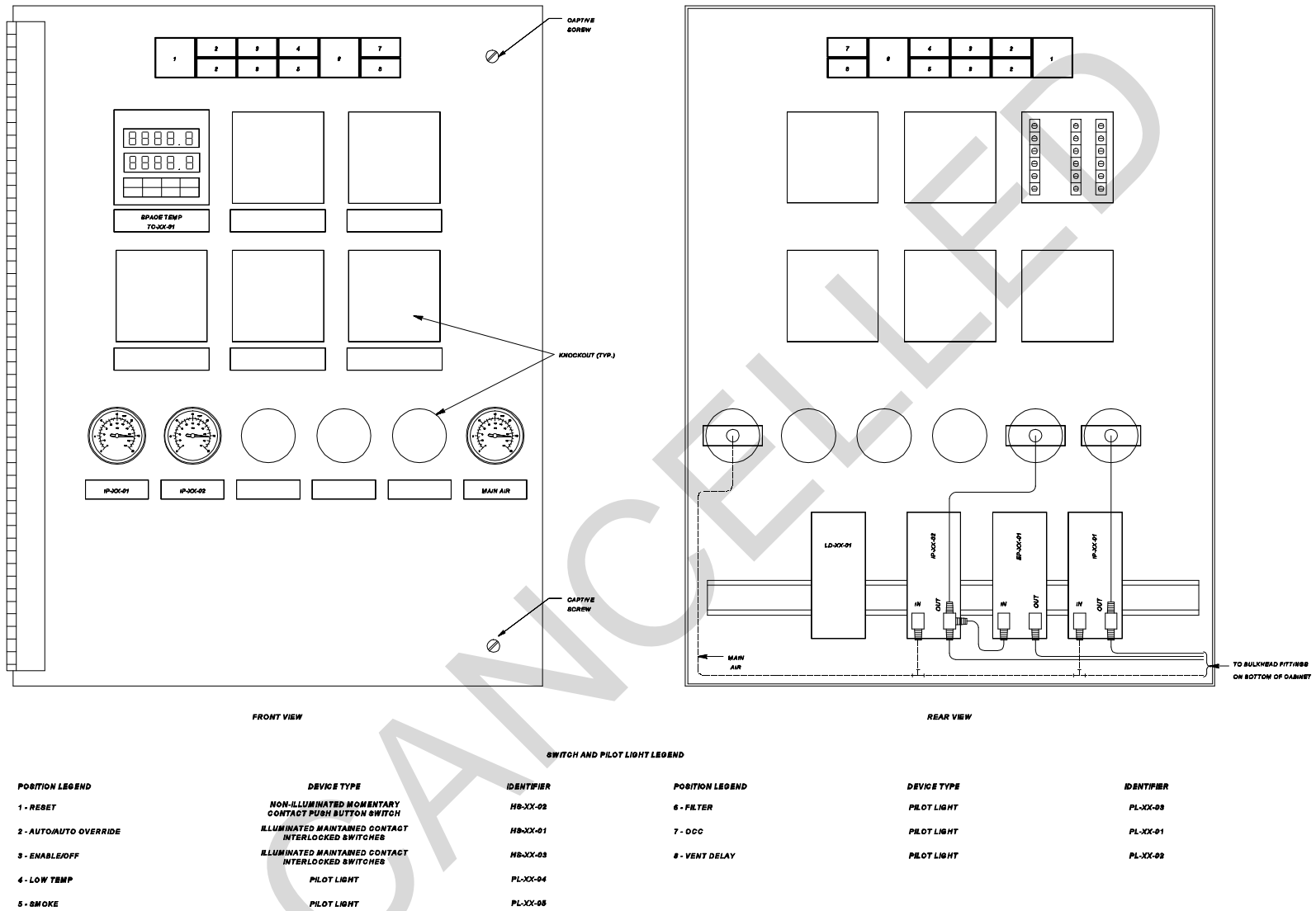

Figure 5-15d. Control panel interior door layout for single-zone HVAC system without economizer control mode.

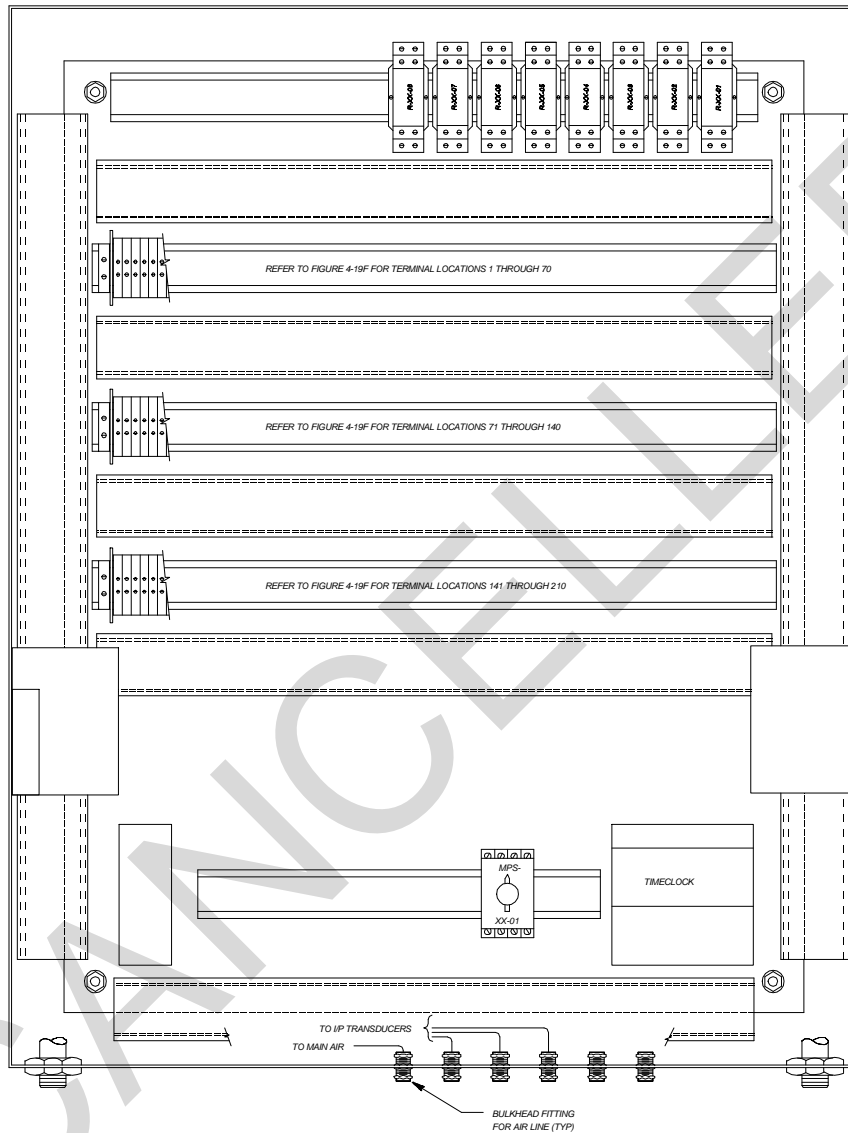

Figure 5-15e. Control panel back panel layout for single-zone HVAC system without economizer control mode.

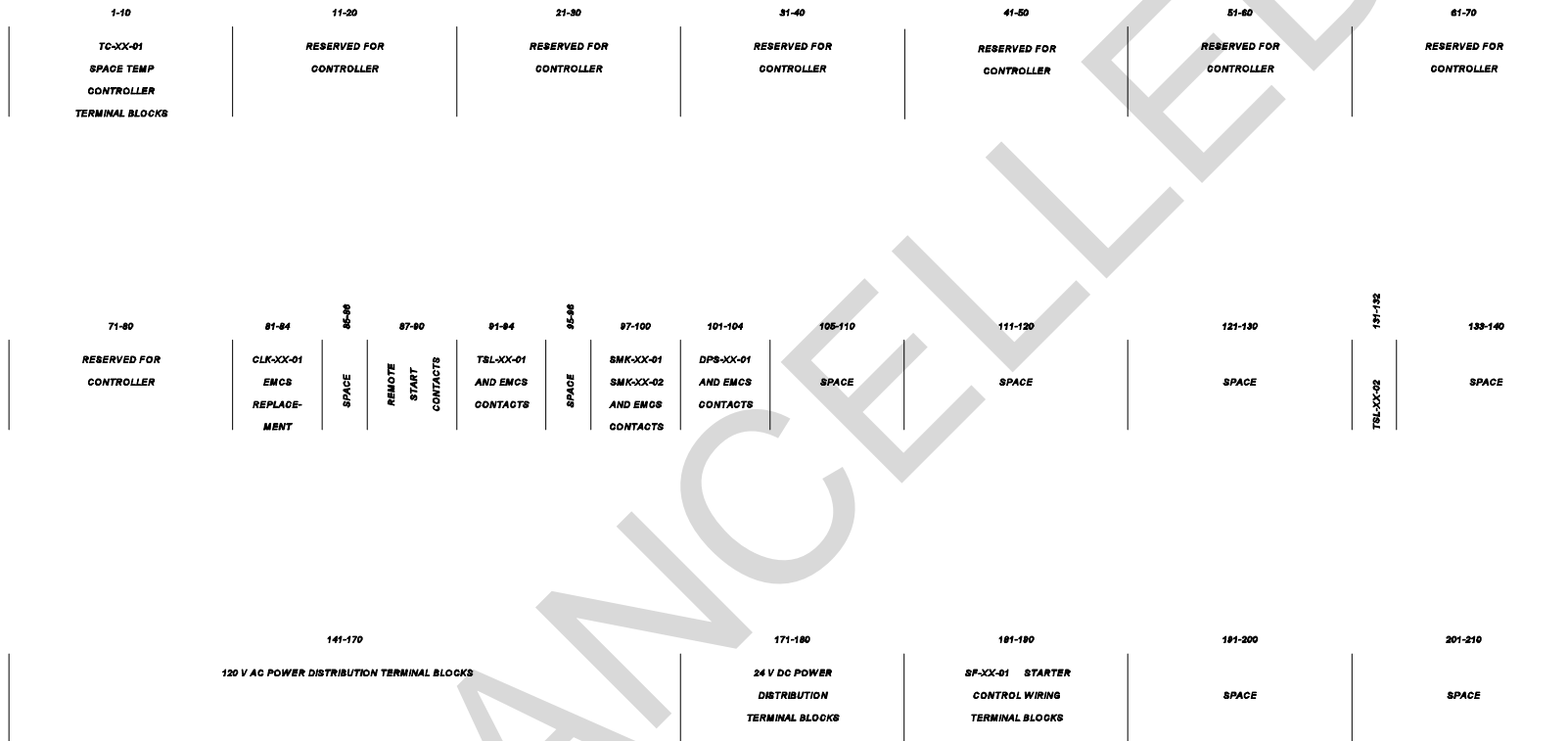

Figure 5-15f. Control panel terminal block layout for single-zone HVAC system without economizer control mode.

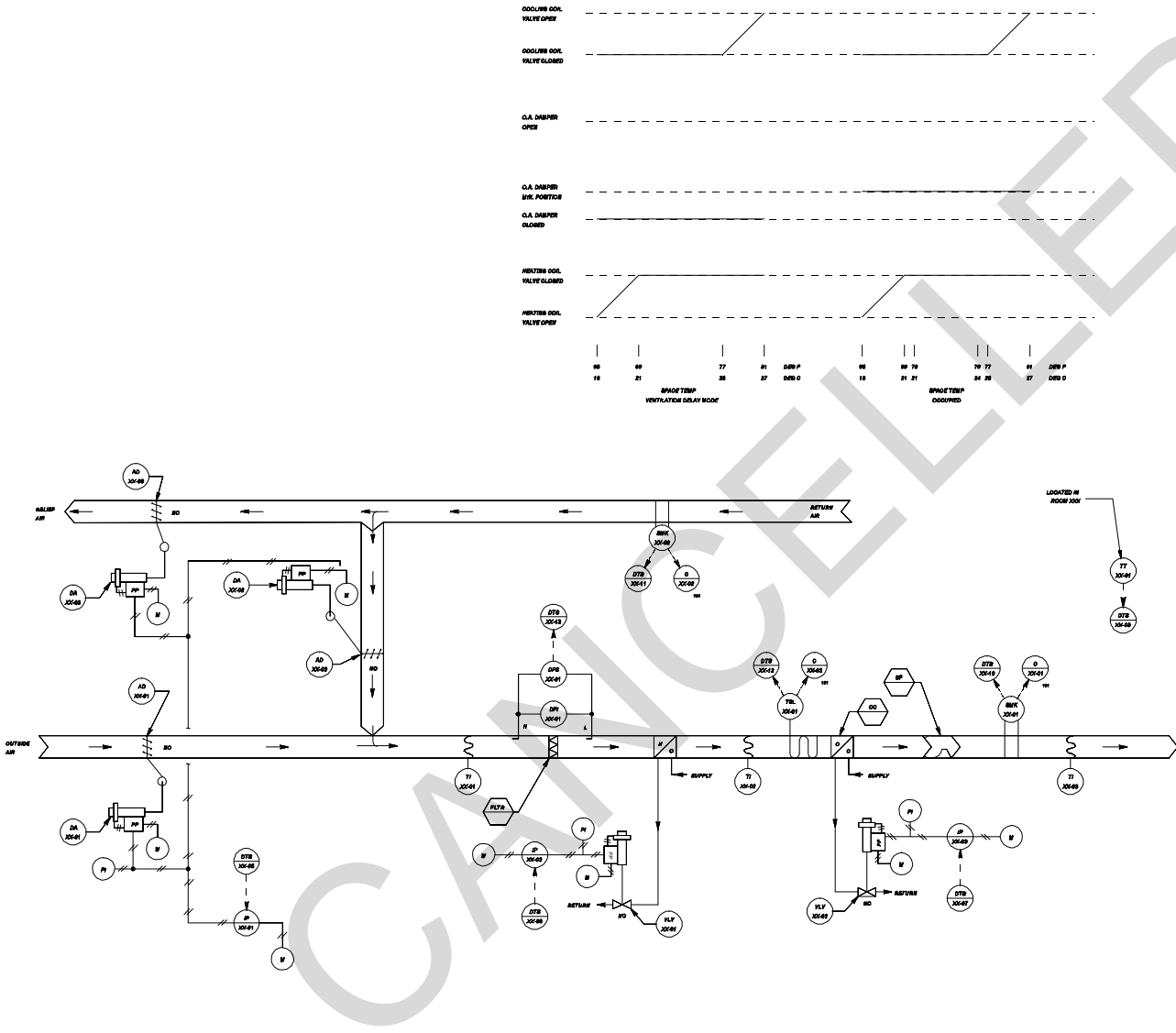

Figure 5-15g. DDC control system schematic for single-zone HVAC system without economizer control mode.

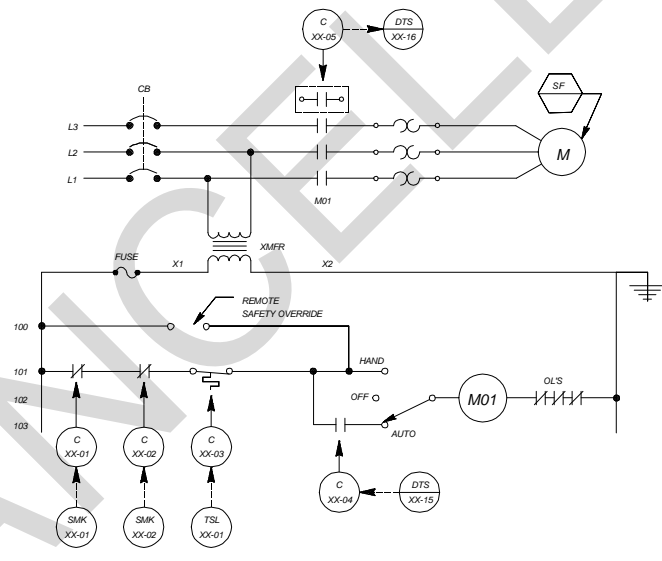

Figure 5-15h. DDC control system ladder diagram for single-zone HVAC system without economizer control mode.

SENSOR SCHEDULE

IDENTIFIER	FUNCTION	RANGE
TT-XX-01	SPACE TEMPERATURE TRANSMITTER	10 TO 30 DEG C (50 TO 85 DEG F)

CONTROL VALVE SCHEDULE

IDENTIFIER	FUNCTION	TYPE	RANGE	Kv (Cv)	CLOSE-OFF RATING	REMARKS
VLV-XX-01	HEATING COIL VALVE	2-WAY, MODULATING	21 - 103 kPa (3-15 PSIG)	XX	XX kPa (XX PSIG)	
VLV-XX-02	COOLING COIL VALVE	2-WAY, MODULATING	21 - 103 kPa (3-15 PSIG)	XX	XX kPa (XX PSIG)	

CONTROL DAMPER SCHEDULE

IDENTIFIER	FUNCTION	TYPE	SIZE	RANGE	REMARKS
AD-XX-01	OUTSIDE AIR	MODULATING	W x H (mm) (WW" X HH")	21 - 103 kPa (3-15 PSIG)	PARALLEL BLADE
AD-XX-02	RETURN AIR	MODULATING	W x H (mm) (WW" X HH")		PARALLEL BLADE
AD-XX-03	RELIEF AIR	MODULATING	W x H (mm) (WW" X HH")	↓	PARALLEL BLADE

OPERATING PARAMETERS

FUNCTION	SETPOINT	REMARKS
MINIMUM OUTSIDE AIR	XXXX L/s (XXXX CFM)	
SPACE TEMPERATURE	XX DEG C (XX DEG F) XX DEG C (XX DEG F)	(HEATING) (COOLING)
SPACE TEMP. (NIGHT SETBACK)	XX DEG C (XX DEG F)	(HEATING ONLY)
OCCUPIED MODE		MONDAY - FRIDAY : 0705 HRS - 1700 HRS
VENT DELAY MODE		MONDAY - FRIDAY : 0700 HRS - 0800 HRS
FREEZE STAT	XX DEG C (XX DEG F)	
FILTER ALARM	XX kPa (XX IN. WATER)	

Figure 5-15i. DDC control system equipment for single-zone HVAC system without economizer control mode.

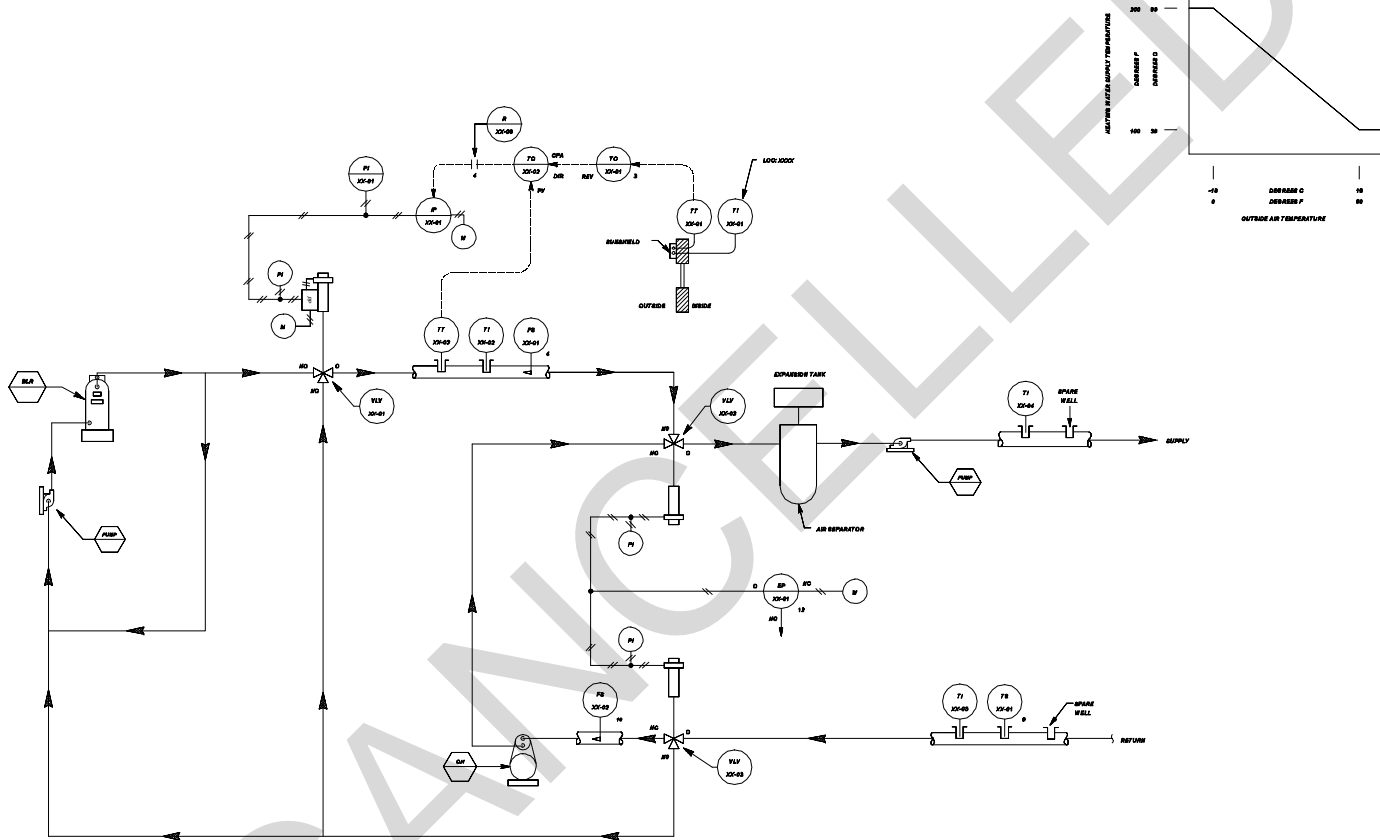

Figure 5-19a. Control system schematic for single building dual-temperature hydronic system with constant volume boiler loop.

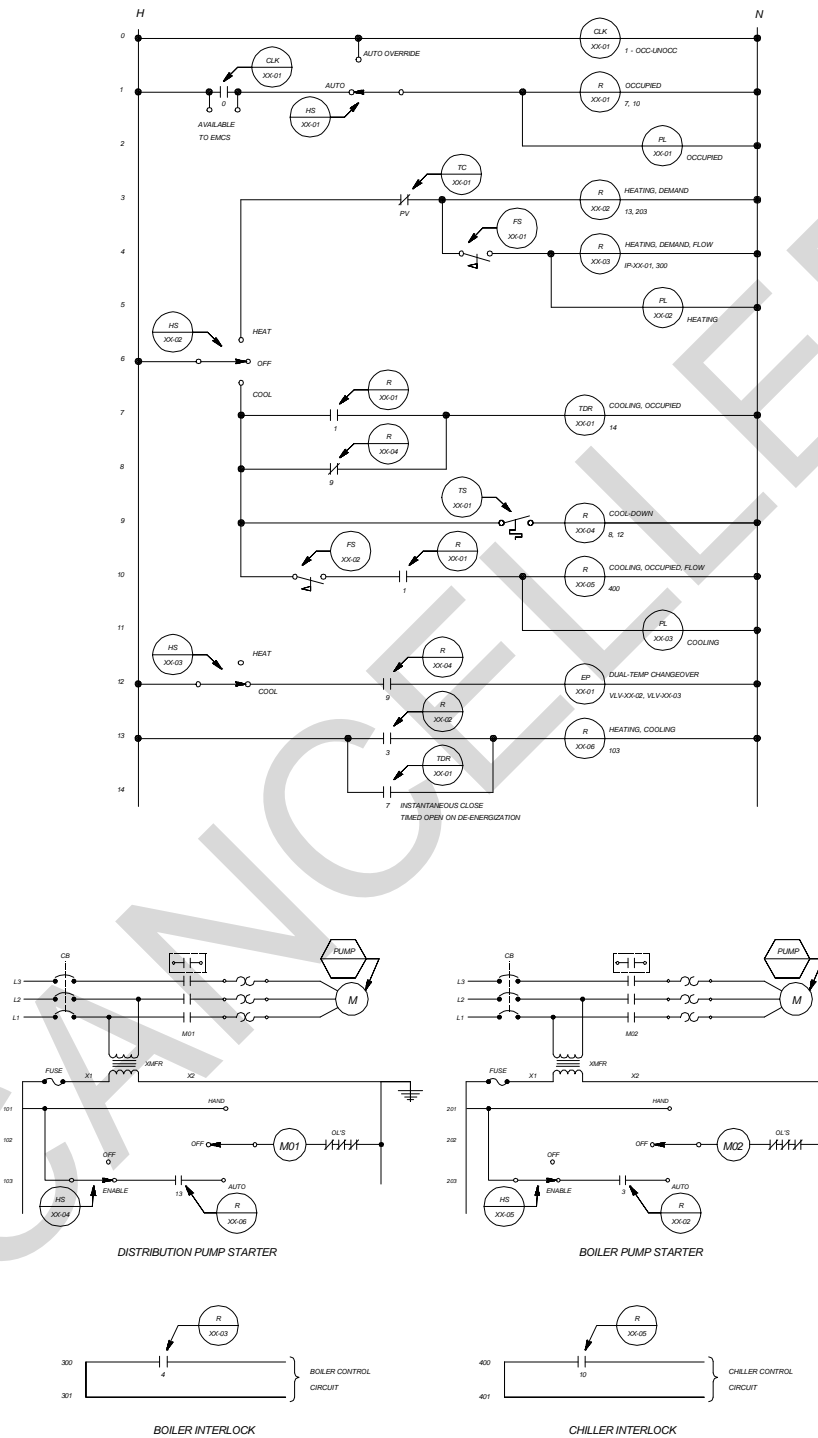
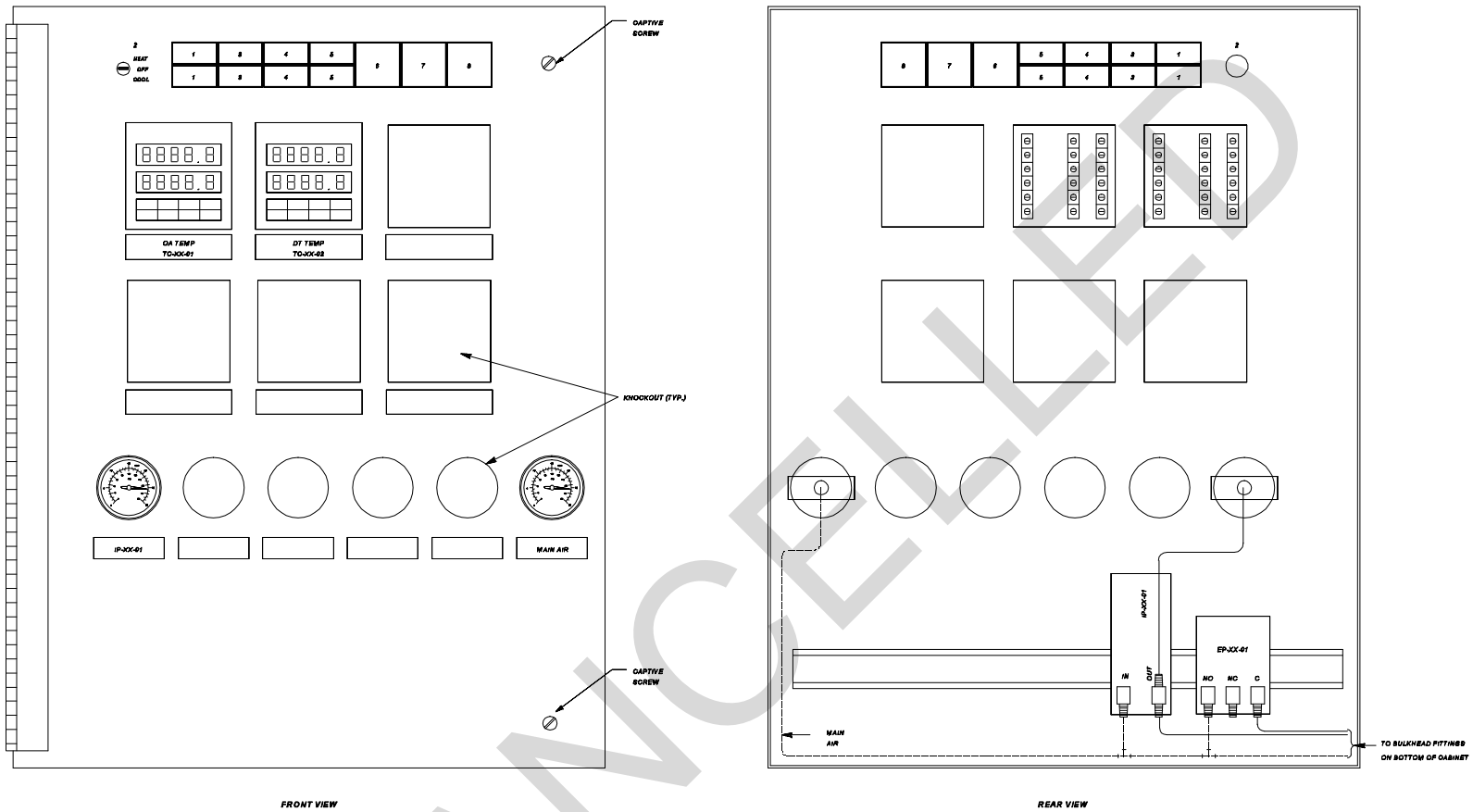

Figure 5-19b. Control system ladder diagram for single building dual-temperature hydronic system with constant volume boiler loop.

LOOP CONTROL FUNCTION	DEVICE NUMBER	DEVICE FUNCTION	SETPOINT	RANGE	ADDITIONAL PARAMETERS
DUAL-TEMP SUPPLY TEMPERATURE	VLV-XX-01	CONVERTER CONTROL VALVE	—	21 - 103 kPa (3-15 PSIG)	Kv = 17.3 (Cv = 30) CLOSE AGAINST 70 kPa (10 PSIG)
	TC-XX-01	OUTSIDE-AIR TEMPERATURE CONTROLLER	-1 DEG C (30 DEG F) PROPORTIONAL BAND 37.5 % MANUAL RESET 80%	-35 TO +55 DEG C (-30 TO +130 DEG F)	PV CONTACT STARTS PUMP AT 16 DEG C (60 DEG F) STOPS PUMP AT 17 DEG C (63 DEG F)
	TC-XX-02	SYSTEM-SUPPLY TEMPERATURE CONTROLLER	OA TEMP = -18 DEG C (0 DEG F), HWB TEMP = 83 DEG C (200 DEG F) CA TEMP = 16 DEG C (60 DEG F), HWB TEMP = 84 DEG C (190 DEG F)	PV = 38 TO 121 DEG C (100 TO 250 DEG F) CPA = 83 TO 83 DEG C (190 TO 200 DEG F)	CPA LO-LIMIT = 38 DEG C (100 DEG F) CPA HI-LIMIT = 83 DEG C (200 DEG F)
	TT-XX-01	OUTSIDE-AIR TEMPERATURE TRANSMITTER	—	-35 TO +55 DEG C (-30 TO +130 DEG F)	—
	TT-XX-02	SYSTEM-SUPPLY TEMPERATURE TRANSMITTER	—	38 TO 121 DEG C (100 TO 250 DEG F)	—
DUAL-TEMP CHANGEOVER	TS-XX-01	SYSTEM RETURN CHANGEOVER THERMOSTAT	—	-1 TO 116 DEG C (30 TO 240 DEG F)	CONTACT CLOSED AT 24 DEG C (75 DEG F) CONTACT OPEN AT 27 DEG C (80 DEG F)
	VLV-XX-02	SUPPLY CHANGEOVER VALVE	—	2-POSITION	Kv = 6 (Cv = 7) CLOSE AGAINST 70 kPa (10 PSIG)
	VLV-XX-03	RETURN CHANGEOVER VALVE	—	2-POSITION	Kv = 6 (Cv = 7) CLOSE AGAINST 70 kPa (10 PSIG)
	TDR-XX-01	TIME-DELAY RELAY	—	—	TIME DELAY = COORDINATE WITH CHILLER MANUFACTURER
OCCUPIED MODE	CLK-XX-01 CONTACT	365-DAY SCHEDULE	—	NORMAL SCHEDULE (M - F) CONTACT CLOSED: 0700 HRS CONTACT OPEN: 1700 HRS	OPEN: SAT, SUN

NOTE : OTHER CONTROL DEVICES SUCH AS IPS AND RELAYS ARE NOT SHOWN

Figure 5-19c. Control system equipment for single building dual-temperature hydronic system with constant volume boiler loop.



FRONT VIEW

REAR VIEW

SWITCH AND PILOT LIGHT LEGEND

POSITION LEGEND

- 1 - AUTO/AUTO OVERRIDE
- 2 - HEAT/OFF/COOL
- 3 - HEAT/COOL
- 4 - ENABLE/OFF

DEVICE TYPE

- ILLUMINATED MAINTAINED CONTACT INTERLOCKED SWITCHES
- THREE-POSITION ROTARY SWITCH
- ILLUMINATED MAINTAINED CONTACT INTERLOCKED SWITCHES
- ILLUMINATED MAINTAINED CONTACT INTERLOCKED SWITCHES

IDENTIFIER

- HS-XX-01
- HS-XX-02
- HS-XX-03
- HS-XX-04

POSITION LEGEND

- 5 - ENABLE/OFF
- 6 - OCCUPIED
- 7 - HEATING
- 8 - COOLING

DEVICE TYPE

- ILLUMINATED MAINTAINED CONTACT INTERLOCKED SWITCHES
- PILOT LIGHT
- PILOT LIGHT
- PILOT LIGHT

IDENTIFIER

- HS-XX-05
- PL-XX-01
- PL-XX-02
- PL-XX-03

Figure 5-19d. Control panel interior door layout for single building dual-temperature hydronic system with constant volume boiler loop.

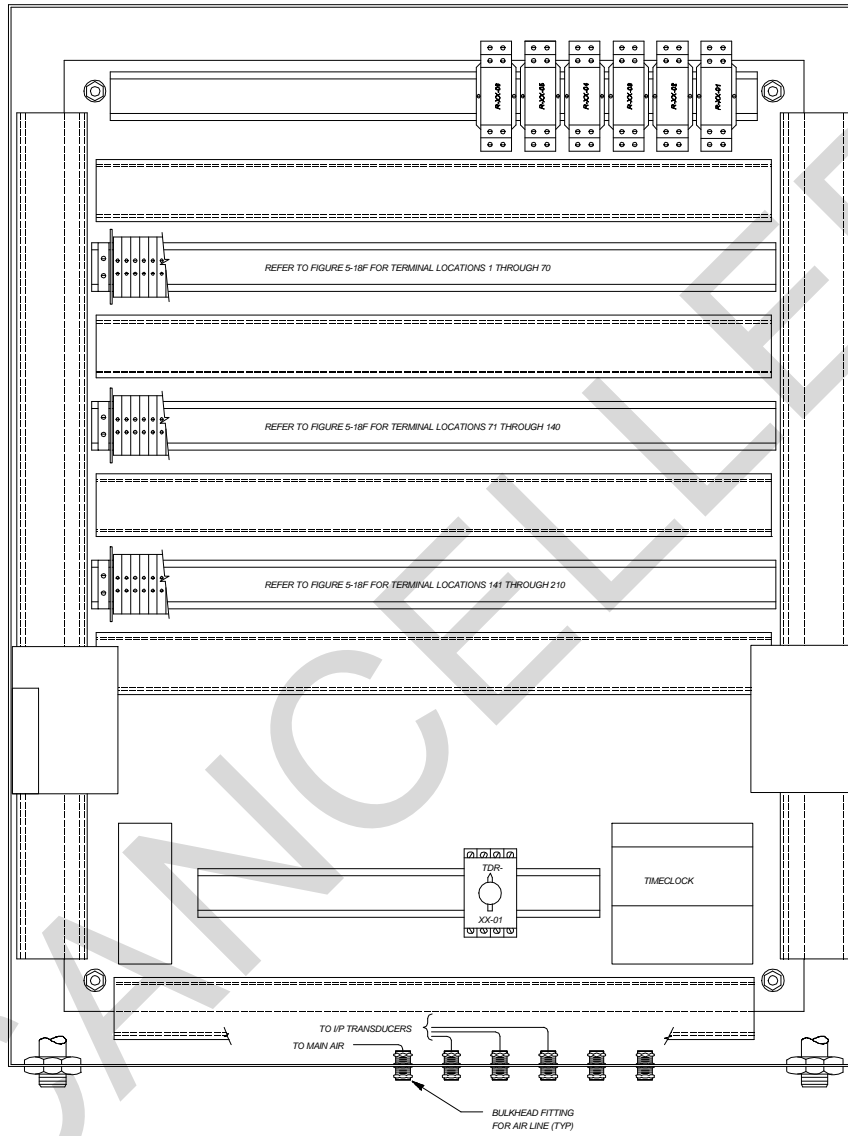

Figure 5-19e. Control panel back panel layout for single building dual-temperature hydronic system with constant volume boiler loop.

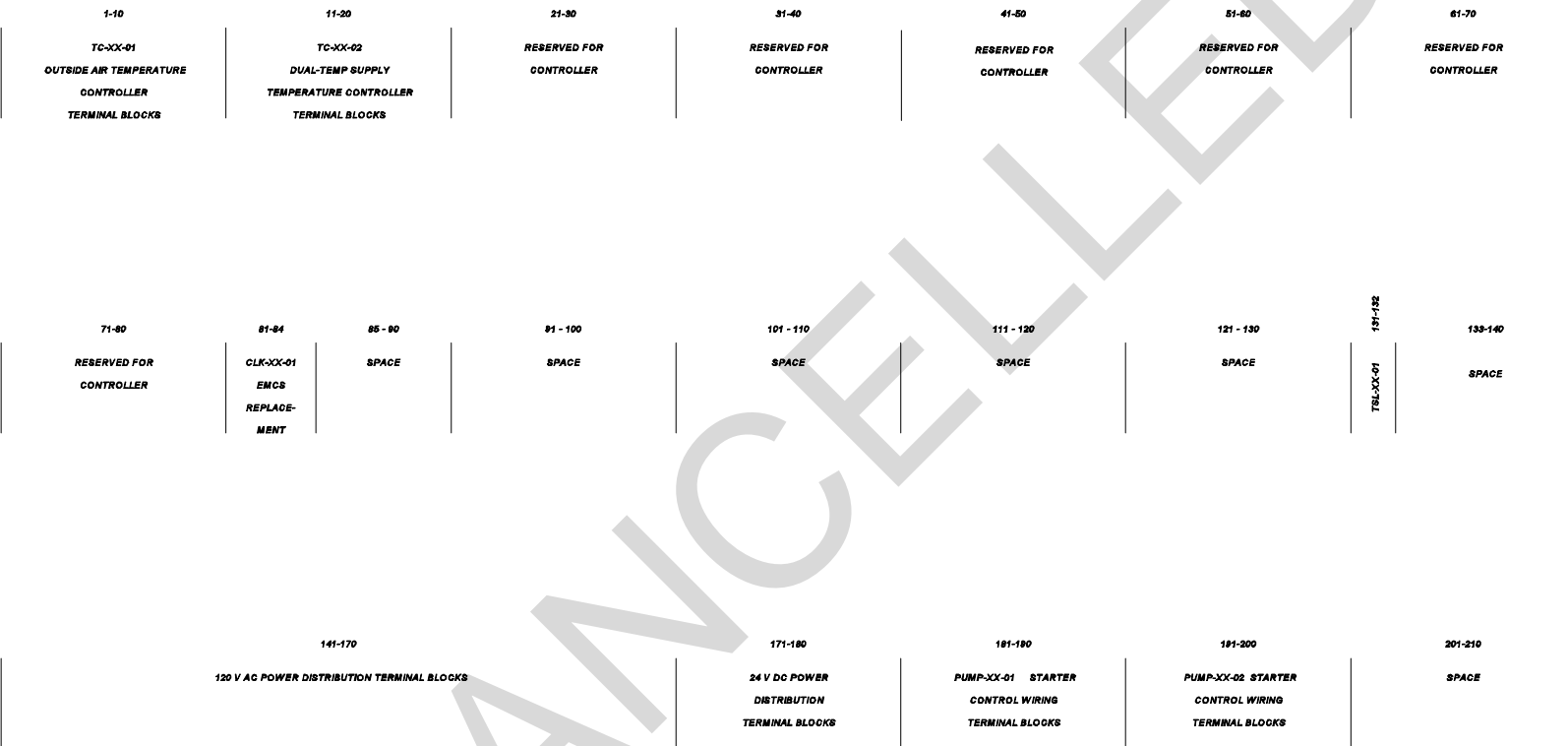

Figure 5-19f. Control panel terminal block layout for single building dual-temperature hydronic system with constant volume boiler loop.

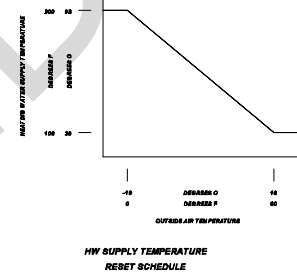
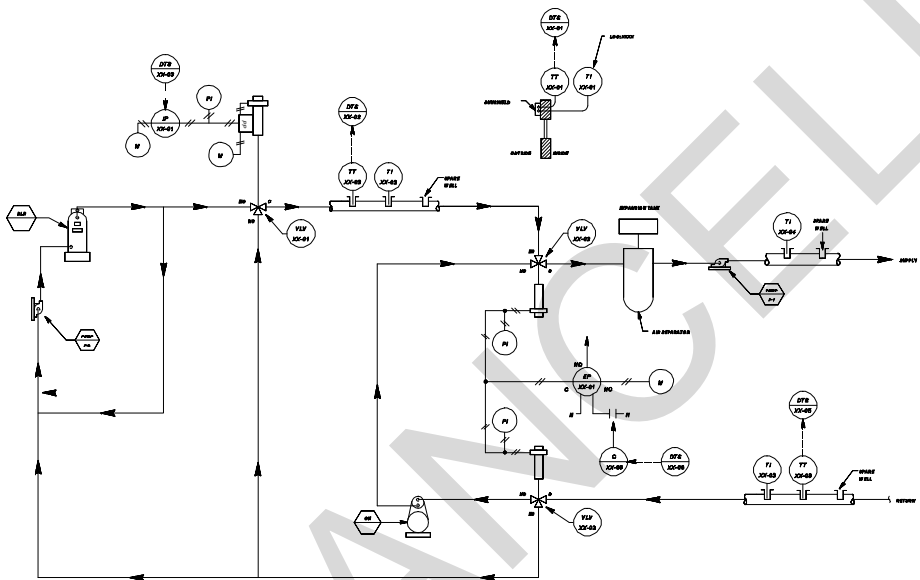
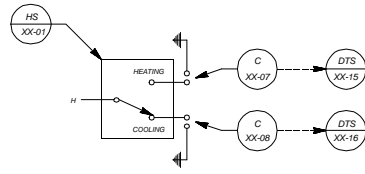

Figure 5-19g. DDC control system schematic for single building dual-temperature hydronic system with constant volume boiler loop.



DUAL-TEMP MODE SELECTOR SWITCH
(See Note 1)

Notes:
1. HS-XX-01 shall be located adjacent to the DDC panel.

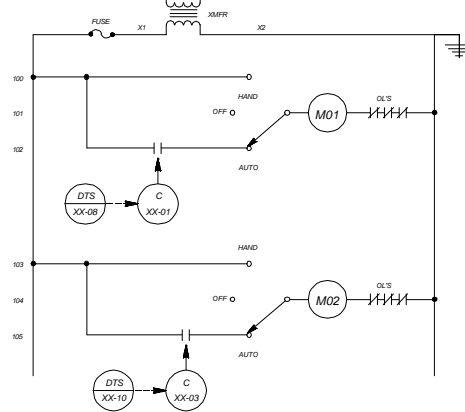
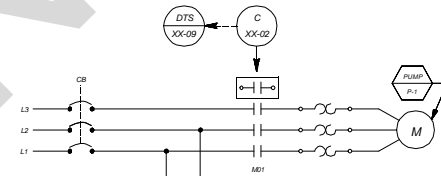
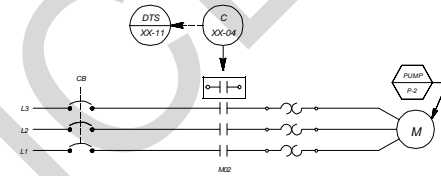
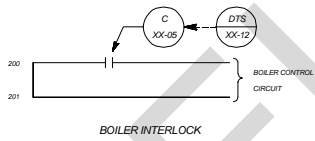
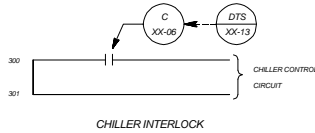

Figure 5-19h. DDC control system ladder diagram for single building dual-temperature hydronic system with constant volume boiler loop.

SENSOR SCHEDULE

IDENTIFIER	FUNCTION	RANGE
TT-XX-01	OUTSIDE AIR TEMPERATURE TRANSMITTER	-35 TO +55 DEG C (-30 TO +130 DEG F)
TT-XX-02	HEATING WATER SUPPLY TEMPERATURE TRANSMITTER	38 TO 121 DEG C (100 TO 250 DEG F)
TT-XX-03	DUAL-TEMP RETURN WATER TEMPERATURE TRANSMITTER	-1 TO 116 DEG C (30 TO 240 DEG F)

CONTROL VALVE SCHEDULE

IDENTIFIER	FUNCTION	TYPE	RANGE	Kv (Cv)	CLOSE-OFF RATING	REMARKS
VLV-XX-01	HW SUPPLY VALVE	3-WAY, MODULATING	21 - 103 kPa (3-15 PSIG)	XX	XX kPa (XX PSIG)	
VLV-XX-02	DUAL-TEMP SUPPLY CHANGEOVER VALVE	3-WAY, 2-POSITION		XX	XX kPa (XX PSIG)	
VLV-XX-03	DUAL-TEMP RETURN CHANGEOVER VALVE	3-WAY, 2-POSITION		XX	XX kPa (XX PSIG)	

OPERATING PARAMETERS

FUNCTION	SETPPOINT	REMARKS
OUTSIDE AIR TEMPERATURE		START PUMPS AT OA TEMP = XX DEG C (XX DEG F) STOP PUMPS AT OA TEMP = XX DEG C (XX DEG F)
HEATING WATER SUPPLY TEMPERATURE	XX DEG C (XX DEG F)	OA TEMP = -18 DEG C (0 DEG F); HEATING WATER SUPPLY SETPOINT = 93 DEG C (200 DEG F) OA TEMP = 16 DEG C (60 DEG F); HEATING WATER SUPPLY SETPOINT = 38 DEG C (100 DEG F)
DUAL-TEMP CHANGEOVER	XX DEG C (XX DEG F)	DIFFERENTIAL = XX DEG C (XX DEG F)
OCCUPIED MODE		MONDAY - FRIDAY : 0705 HRS - 1700 HRS

Figure 5-19i. DDC control system equipment for single building dual-temperature hydronic system with constant volume boiler loop.

GLOSSARYSection 1
Terms, Abbreviations and Acronyms

=:	Equal to
<:	Less Than
>:	Greater Than
A:	Ampere
AAD:	Auxiliary Actuator Driver
AC:	Alternating Current
Accuracy:	The degree of conformity of an indicated value to a recognized accepted standard value.
Actuator:	A device that, either electrically or pneumatically operated, changes the position of a valve or damper.
AD:	Control Damper
AFMA:	Air-Flow Measurement Station
AHU:	Air-Handling Unit
AI:	Analog Input
Analog:	A signal type representing a system variable (such as temperature, humidity, or pressure) that can be measured continuously over a scale.
AO:	Analog Output
AUTO:	Automatic
Automatic Temperature Control:	A local loop network of pneumatic or electric/electronic devices that are interconnected to control temperature.
AUX:	Auxiliary
Auxiliary Actuator Driver:	An actuator circuit that can be used to control a separate actuator.

Bias:	A single-loop digital controller function which maintains a fixed difference in engineering units between controller setpoint and the remote setpoint signal to the controller in engineering units.
BLR:	Boiler
C:	Common
Cavitation:	A phenomenon that results in valve damage from too great a pressure drop through a valve.
CB:	Circuit Breaker
CC:	Cooling Coil
CDHR:	Condenser, Hydronic Return
CDHS:	Condenser, Hydronic Supply
CFM:	Cubic Feet Per Minute
CH:	Chiller
CLK:	Time Clock
Closed Loop System:	Control system configuration that allows system feedback.
COND:	Condenser
Controlled Device:	The instrument that receives the controller's output signal and regulates the controlled process.
Controlled Variable:	The temperature, humidity, or pressure value to whose variations the controller responds. Controlled variable is also called process variable.
Controller:	The instrument that measures the controlled variable and responds by producing an output signal that holds the controlled variable within preset limits.
Controller Feedback:	The change in the controller's output in response to a measured change in the controlled variable that is transmitted back to the controller's input.
Control Point:	The actual value at which a controller is holding a process variable.

Controller Configuration:	Information manually entered through a controller keyboard which selects built-in controller options and sets controller parameters.
Control Point Adjustment (CPA):	Adjustment of a controller's setpoint. The control point value may vary from the setpoint due to load offset. Control point adjustment can be accomplished by a signal generated from a local adjustment device, by a signal generated from a remote location, or by means of software.
Controls:	Devices that govern the performance of a system.
COOL:	Cooling
CPA:	Control Point Adjustment (Remote Setpoint Adjustment)
C.T.:	Cooling Tower
CUH:	Cabinet Unit Heater
C_v :	The liquid flow coefficient of a valve that has the units of gpm per psid and is used to select the valve for a required flow in the open position at a calculated pressure drop.
D:	Derivative Control Mode
DA:	Damper Actuator
DC:	Direct Current
DD:	Dual Duct
DDC:	Direct Digital Control
Deadband:	A range of thermostat output signal, between the shutoff of heating and start of cooling, in which no heating or cooling energy is used.
DEG:	Degree
Derivative (D) Mode:	Control mode in which the output is proportional to the rate of change of the input.

Deviation Contact (DEV):	A single-loop digital controller output contact that can be configured to respond to a given difference between the setpoint of the controller and the process variable input signal.
DI:	Digital Input
DIA:	Diagram
Differential:	The difference in values of the controlled variable that will cause a two-position controller to change its output.
Differential Pressure:	The difference between the static pressures measured at two points in an HVAC system.
Direct Acting:	An output signal that changes in the same direction as the controlled or measured variable. An increase in the controlled or measured variable results in an increase in the output signal.
DMPR:	Damper
DO:	Digital Output
DPI:	Differential-Pressure Gauge
DPDT:	Double-Pole, Double-Throw
DPS:	Differential-Pressure Switch
DPST:	Double-Pole, Single-Throw
DPT:	Differential-Pressure Transmitter
DX:	Direct-Expansion Coil
EA:	Each
EC:	Economizer Controller
ECON:	Economizer
Economizer Mode:	The control system mode of operation in which outside air is used for free-cooling of building spaces.
EF:	Exhaust Fan

EMCS:	Energy Monitoring and Control Systems used in military facilities for supervisory control of HVAC control systems and energy related monitoring and control functions.
EP:	The acronym for a two-position electric-solenoid-operated 3-way air valve. (Electric to pneumatic.).
Equipment Schedule:	A listing of control devices by loop function, unique identifier, setpoints, ranges, and other parameters.
ES:	End Switch
EXH:	Exhaust
F:	Fahrenheit, Friday
FC:	Flow Controller
FCU:	Fan-Coil Unit
FE:	Flow-Sensing Element
FLTR:	Filter
FPM:	Feet Per Minute
FPS:	Feet Per Second
Free-Cooling:	Cooling without mechanical refrigeration.
FT:	Flow Transmitter
FTR:	Finned-Tube Radiator
Function Module:	A device for performing a control-loop function between the transmitter and the controller or between the controller output and the controlled devices.
Gain:	The amount of change in controller output per unit change of controller input.
GC:	Glycol Coil
GPM:	Gallons Per Minute
H:	High
HC:	Heating Coil
HD:	Head

Heat:	Heating
HFER:	Humidifier
HL:	High Limit
HOA:	Hand-Off-Automatic
HP:	Horsepower
HPS:	High-Pressure Steam
HR:	Heat Recovery
HRC:	Heat-Recovery Coil
HRS:	Hours
HS:	Manual Switch
HTHW:	High-Temperature Hot Water
HVAC:	Heating, Ventilating, and Air Conditioning
HWS:	Hot Water Supply
HX:	Heat Exchanger (Converter)
Hydronic:	A term used to describe HVAC systems using liquid heating and cooling media.
HZ:	Cycles Per Second (Hertz)
I:	Integral Control Mode
IH:	Infrared Heater
Input Signal:	The variable signal, received by an instrument, which provides that instrument with a means of changing its output signal.
INV:	Signal-Invertor Module
IO:	Input/Output
IP:	The acronym for a current to pneumatic signal transducer. (I for current and P for pneumatic.)
Integral (I) Mode:	Control mode in which the output is proportional to the time integral of the input; i.e., the rate of change of output is proportional to the input.

IV:	Inlet Vane
K _v :	The liquid flow coefficient of a valve that has the units of m ³ /hr per 100 kPa pressure drop and is used to select the valve for a required flow in the open position at a calculated pressure drop.
kPa:	Kilo-Pascal
L1, L2, N:	Control-Power Lines and Neutral
L:	Low
Ladder Diagram:	A diagram that shows the electrical control-logic portion of a control system.
LD:	Loop Driver
LDR:	Ladder
Linearity:	A relation such that any change of input signal is accompanied by a similar output change that is directly proportional to the input.
Local-Loop Control:	The local pneumatic or electric/electronic controls for any system or subsystem.
LOC:	Location
Loop Driver:	A device used in control loops to assure that the single-loop digital controller will not be required to drive a loop with a greater impedance than 600 ohms.
LPS:	Low-Pressure Steam
L/s:	Liters per second
LTHW:	Low-Temperature Hot Water
M:	Main Air, Motor, Monday
MA:	Milliamp
MAN.:	Manual

Manual Reset:	<p>The act of manually restoring control-circuit electrical continuity after the circuit has been opened by a safety device.</p> <p>A feature of the single-loop digital controller that allows manual adjustment of the analog output signal when proportional mode control is used without integral mode control or derivative mode control.</p>
Measured Variable:	<p>The uncontrolled variable (such as temperature, relative humidity, or pressure) sensed by the measuring element.</p>
Microprocessor Controller:	<p>A microprocessor-based controller (non-analog in processing its internal signals) that performs a dedicated function and does not require software programming.</p>
MIN:	<p>Minimum</p>
Minimum-Position Switch:	<p>A manual switch used to set the position of mixing plenum control dampers to assure that the minimum quantity of outside air is introduced by an HVAC system.</p>
MO1, MO2:	<p>Magnetic-Starter Holding coil</p>
Modulating Control:	<p>Control achieved by gradually changing a controller analog output signal to an actuator in response to a change in a sensed variable.</p>
MPS:	<p>Minimum-Position Switch</p>
M/S:	<p>Meters per second</p>
MZ:	<p>Multizone</p>
Normally Closed:	<p>A controlled device that closes when its power supply or input signal is removed.</p>
Normally Open:	<p>A controlled device that opens when its power supply or input signal is removed.</p>
Normal Mode:	<p>The usual or expected operating condition.</p>
OA:	<p>Outside Air</p>
OCC:	<p>Occupied</p>
Offset:	<p>The difference between the setpoint of a controller and the actual control point of the controlled variable, caused by changes in load.</p>

OL:	Overload
Open-Loop System:	Control-system configuration that does not have system feedback.
OUT:	Output
Output Signal:	A signal produced in response to an input.
P:	Proportional Control Mode
Pa:	Pascal
Parameter:	Information and values to be used in configuring a microprocessor controller for its purpose in the control-system application.
PB:	Proportional Band
PC:	Outside-Air Preheat Coil, Pressure Controller
PE:	Pneumatic-Electric Switch
PH:	Phase
PI:	Pressure Indicator (Gauge) or Proportional-Plus-Integral Control Mode
PID:	Proportional-Plus-Integral-Plus Derivative Control Mode
PL:	Pilot Light
Positive Positioner:	A mechanical device that measures actuator position and control signal value and sends main air to the actuator to maintain the correct position for the signal.
PP:	Positive Positioner
Process Control:	The science of regulating variables by measuring, processing, and manipulating process variables coupled to the regulated variables.
Process Variable:	See Controlled Variable.
Process Variable Contact (PV):	A single-loop digital controller output contact that can be configured to respond to a given value of the process variable input signal.
PROP:	Proportional

Proportional Band:	A controller parameter setting which determines the change in the number of engineering units of a process variable input signal that will produce a full-scale change of the controller analog output signal.
Proportional (P) Mode:	Control mode in which there is a continuous linear relationship between the input and the output.
Proportional-Integral (PI) Mode:	Control mode in which the output is proportional to a linear combination of the input plus a value proportional to the time integral of the error between setpoint and control point.
Proportional-Integral-Derivative (PID) Mode:	Control mode in which the output is a value proportional to the input, plus a value proportional to the time integral of the error between setpoint and control point plus a value proportional to the time rate of change of the error.
PSI:	Pounds Per Square Inch
PSIA:	Pounds Per Square Inch, Absolute
PSID:	Pounds Per Square Inch, Differential
PSIG:	Pounds Per Square Inch, Gauge
PV:	Process Variable
R:	Relay
RA:	Return Air
Range:	The upper and lower limits of the value of a variable.
Ratio:	A single-loop digital controller feature which multiplies the remote setpoint input signal to the controller by a constant and uses the resulting value as the controller setpoint.
Relay:	An electric device that changes the position of its contacts when its coil is energized.
Remote Setpoint:	See Control Point Adjustment.
Resistance Temperature Detector (RTD):	A device whose resistance changes linearly as a function of temperature.
REV:	Reverse-Acting

Reverse Acting:	An output signal that changes in the opposite direction from the controlled or measured variable. An increase in the controlled or measured variable results in a decreased output signal.
RF:	Return Fan
RH:	Relative Humidity
RHC:	Relative-Humidity Controller, Reheat Coil
RHT:	Relative-Humidity Transmitter
RHY:	Humidity Loop Device
SA:	Supply Air
SAT:	Saturday
Schematic:	A diagram that shows the relationship of control devices to control loops and shows the relationship of control loops to systems.
SCIM:	Standard Cubic Inches Per Minute
Self-Tuning:	A single-loop digital controller feature that, when selected, commands the controller to calculate the optimal proportional, integral and derivative mode constants for the process being controlled and to use the calculated constants for control.
Sensitivity:	The unit change in controller output per unit change in the controlled variable. Usually expressed in psi or milliamps per degree, cfm, etc.
Sensing Element:	A device used to detect or measure physical phenomena.
Sequence of Operation:	A narrative that describes the actions of control devices such as valves and dampers as the process variable changes in a given direction, such as on a temperature, humidity, or pressure increase.
Setpoint:	The desired value of the controlled variable at which the controller is set.
SF:	Supply Fan
SHLD:	Sunshield

Signal Inverter:	A device that linearly converts a 4 to 20 milliampere input signal to an output signal of 20 to 4 milliamperes.
Signal Selector:	A device that selects the highest or the lowest of its input signals as its output signal.
SLDC	Single Loop Digital Controller - A controller that accepts analog input signals, processes the signals digitally according to the controller configuration, and, as a result, produces analog output and two-position output signals.
SMK:	Smoke Detector
Smoke Detector:	A generic term for devices that are used to operate safety circuits on the detection of smoke or products of combustion.
SP:	Static Pressure
S.P.:	Setpoint
Span:	The number of engineering units between the extremes of a calibration range.
SPRG:	Spring Range
Spring Range:	The range over which the input signal to a controlled device must change to move the device from one extreme to the other.
SPT:	Static-Pressure Transmitter
SQCR:	Sequencer
STM:	Steam
SUN:	Sunday
Sunshield:	A device installed outdoors on the surface of a building to house outside-air temperature-sensing elements and to shield them from direct exposure to sun's radiation.
Supply Pressure:	Gauge pressure of the compressed air supplied to a pneumatic control system, usually 140 kPa (20 psig).
Supply Voltage:	Voltage of the electric energy supply to an electric/electronic control system.

Surge Protection:	Methods of protecting signal wiring and power wiring circuits from damage by electrical voltage and current overrange due to such factors as lightning strikes.
System Feedback:	System's response to the controller's action in changing the value of a controlled variable, as transmitted back to the controller.
SZ:	Single Zone
T:	Modulating Thermostat, Tuesday
TC:	Temperature Controller
TDR:	Time Delay Relay
TE:	Temperature-Sensing Element
TEMP:	Temperature
Terminal Unit:	A unit through which heating or cooling is distributed to the conditioned space. Terminal units include radiators, unit heaters, gas-fired infrared heaters, variable-air-volume boxes, duct heating coils, and fan-coil units.
TH:	Thursday
Thermostat:	A device that senses temperature and changes its output as a result of temperature changes.
Throttling Range:	The portion of the instrument range of a controlled variable required to move the controlled device from one extreme to the other.
TI:	Thermometer
Time Clock:	A device that changes the positions of its output contacts according to a timing schedule.
Transmitter:	A transducer that senses the value of a variable and converts this value into a standardized transmission signal.
TS:	Non-Modulating Space Thermostat or Aquastat
TSL:	Low-Temperature-Protection Thermostat or Nightstat, Non-modulating

TSP:	Temperature-Setpoint Device
Tuning:	The process of finding the control-mode constants the use of which results in the stable control of a process at or near the controller setpoint.
TuP:	Microprocessor Room Thermostat
TT:	Temperature Sensor and Transmitter
Two-Position Control:	Control achieved by switching a controller output signal on and off in response to a change in a sensed variable.
TY:	Temperature Loop Device
UH:	Unit Heater
Unique Identifier:	An alphanumeric identifier that consists of: 1) an abbreviation for the type of device; and 2) a number made up of an HVAC-system number and a serial number for the device.
UNOCC:	Unoccupied
VAV:	Variable Air Volume
VFDU:	Variable-Frequency Drive Unit
VLV:	Valve
W:	Wednesday
WTR:	Water
X1, X2:	transformer Power, Hot and Ground
X:	Times (Multiplication)
XMFR:	Transformer

Section II
Standard Symbols

This section contains the symbols which will be used for HVAC control system drawings produced in accordance with this Engineering Instruction.

Each symbol will be referenced to a unique identifier, which will use the following format:

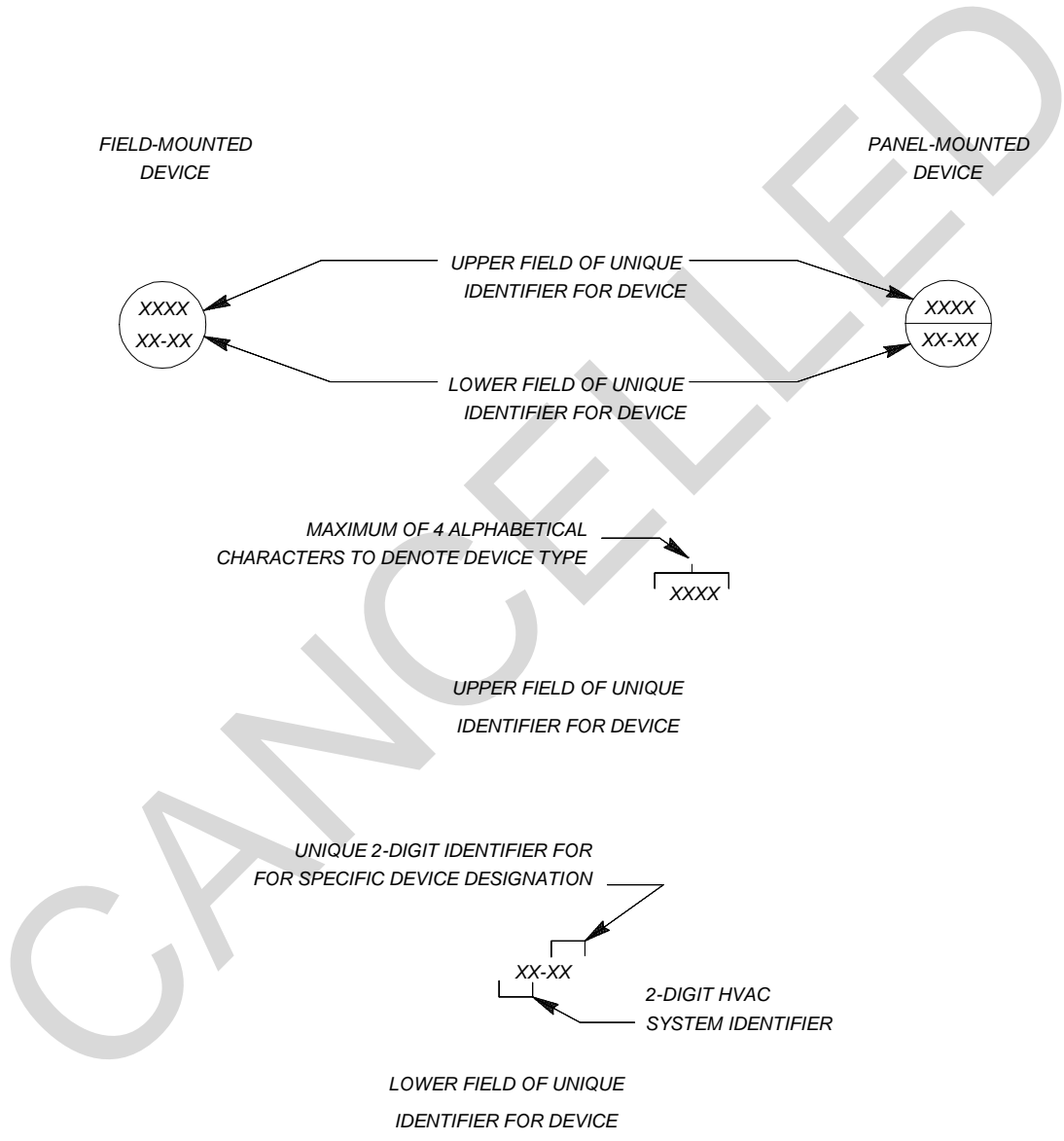

Instrumentation and control device symbols for HVAC control system drawings are as follows:

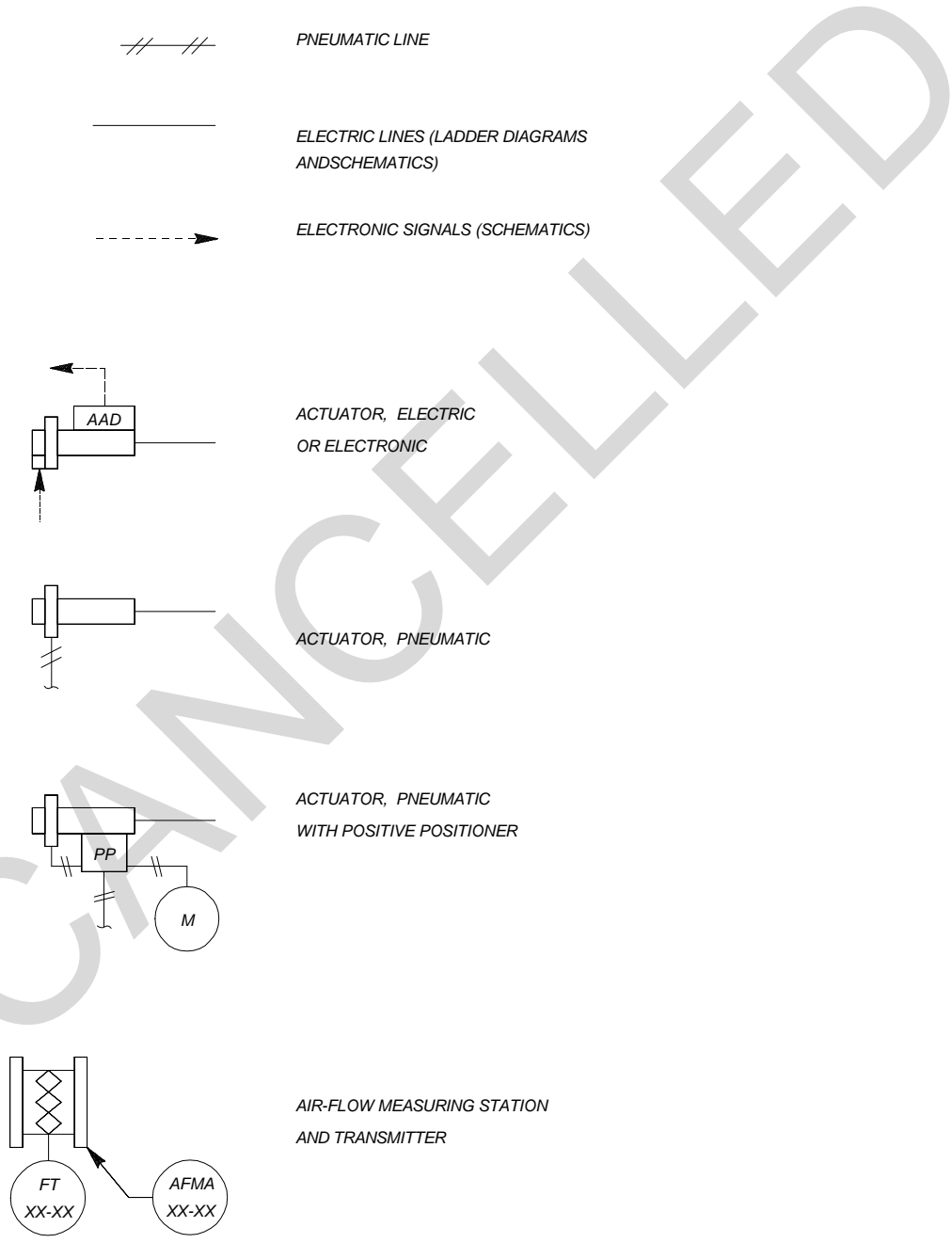

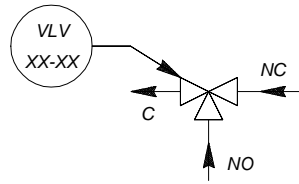

VALVE, 3-WAY MIXING

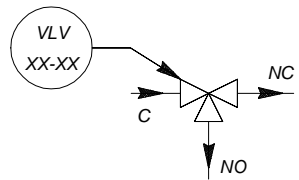

VALVE, 3-WAY DIVERTING

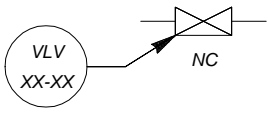

2-WAY VALVE, NORMALLY CLOSED

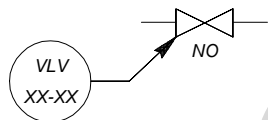

2-WAY VALVE, NORMALLY OPEN

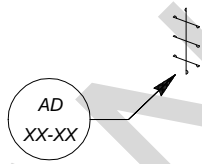

DAMPER, PARALLEL-BLADE WITH SEALS

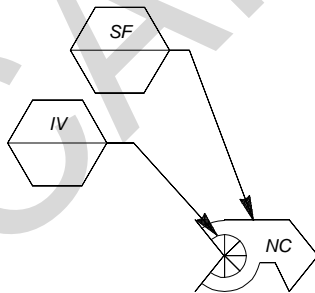

FAN, WITH INLET GUIDE VANES

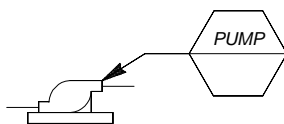

PUMP

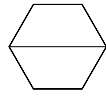

HVAC EQUIPMENT IDENTIFIER

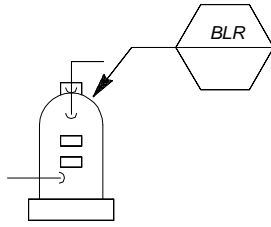

BOILER

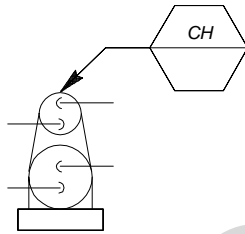

CHILLER

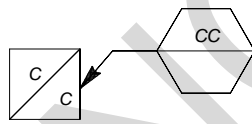

COIL, COOLING

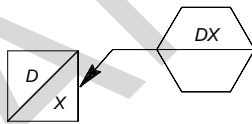

COIL, COOLING, DIRECT-EXPANSION

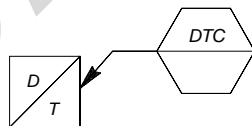

COIL, DUAL TEMPERATURE

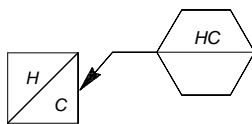

COIL, HEATING

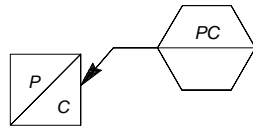

COIL, OUTSIDE-AIR PREHEAT

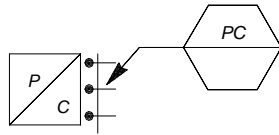

COIL, OUTSIDE-AIR PREHEAT
FACE & BYPASS DAMPER

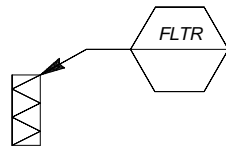

FILTER



EXHAUST FAN



RETURN FAN



SUPPLY FAN



THERMOWELL









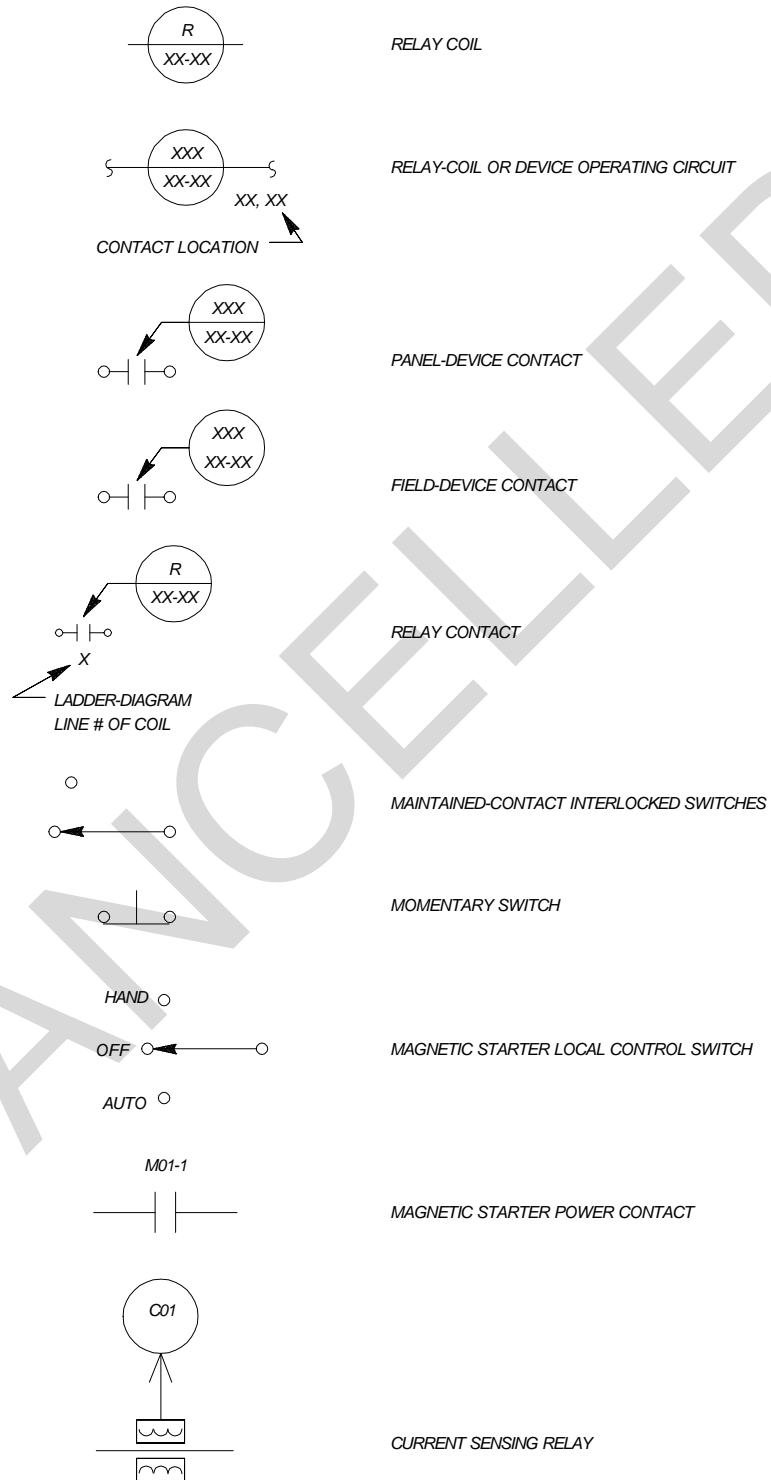





MAIN AIR



FIELD-MOUNTED PRESSURE GAUGE



	<p>MAGNETIC STARTER CIRCUIT BREAKER</p>
	<p>MAGNETIC STARTER CONTROL-CIRCUIT FUSE</p>
	<p>MOTOR</p>
	<p>MAGNETIC STARTER HOLDING COIL</p>
	<p>MAGNETIC STARTER CONTROL CIRCUIT TRANSFORMER</p>
	<p>MAGNETIC STARTER OVERLOADS</p>
	<p>HUMIDITY SWITCH CONTACT (MAKES ON HUMIDITY INCREASE)</p>
	<p>HUMIDITY SWITCH CONTACT (BREAKS ON HUMIDITY INCREASE)</p>
	<p>PRESSURE SWITCH CONTACT (MAKES ON PRESSURE INCREASE)</p>
	<p>PRESSURE SWITCH CONTACT (BREAKS ON PRESSURE INCREASE)</p>
	<p>TEMPERATURE SWITCH CONTACT (MAKES ON TEMPERATURE RISE) (BREAKS ON TEMPERATURE FALL)</p>
	<p>TEMPERATURE SWITCH CONTACT (BREAKS ON TEMPERATURE RISE) (MAKES ON TEMPERATURE FALL)</p>

	TIME CLOCK
	DIFFERENTIAL PRESSURE SWITCH
	DIFFERENTIAL PRESSURE TRANSMITTER
	ECONOMIZER CONTROLLER
	ELECTRIC-SOLENOID-ACTUATED PNEUMATIC VALVE
	FLOW CONTROLLER
	FLOW TRANSMITTER, DUCT-MOUNTED
	FLOW SWITCH
	
	CURRENT-TO-PNEUMATIC TRANSDUCER
	LOOP DRIVER
	MINIMUM-POSITION SWITCH
	PRESSURE CONTROLLER



PANEL-MOUNTED PRESSURE GAUGE



PRESSURE TRANSMITTER



RELATIVE HUMIDITY CONTROLLER



HI-LIMIT HUMIDISTAT, NON-MODULATING



RELATIVE HUMIDITY TRANSMITTER, DUCT-MOUNTED



RELATIVE HUMIDITY TRANSMITTER, SPACE-MOUNTED



SIGNAL SELECTOR, HUMIDITY CONTROL LOOP



SMOKE DETECTOR, DUCT-MOUNTED



MODULATING SPACE THERMOSTAT

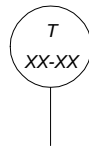

MODULATING DUCT THERMOSTAT, NON-AVERAGING



MODULATING DUCT THERMOSTAT, AVERAGING



TEMPERATURE CONTROLLER



THERMOMETER, AVERAGING

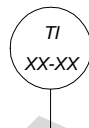

THERMOMETER, NON-AVERAGING









NON-MODULATING SPACE THERMOSTAT,
(MAKES/BREAKS CONTACTS ON TEMPERATURE RISE)

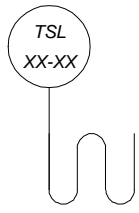

NON-MODULATING SPACE THERMOSTAT,
(MAKES CONTACT ON TEMPERATURE RISE)

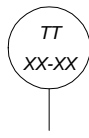

NIGHT THERMOSTAT, NON-MODULATING
SPACE THERMOSTAT, (BREAKS CONTACT
ON TEMPERATURE RISE)

	<i>THERMOSTAT, LOW-TEMPERATURE PROTECTION</i>
	<i>MANUAL TEMPERATURE SETPOINT DEVICE</i>
	<i>SPACE TEMPERATURE TRANSMITTER</i>
	<i>TEMPERATURE TRANSMITTER, AVERAGING</i>
	<i>TEMPERATURE TRANSMITTER, DUCT-MOUNTED</i>
	<i>MICROPROCESSOR-BASED SPACE THERMOSTAT</i>
	<i>SIGNAL SELECTOR, TEMPERATURE CONTROL LOOP</i>

TI 810-11, Heating, Ventilating, and Air Conditioning (HVAC)

Control Systems CADD Files Index

This directory contains "typical contract drawing" templates which can be used when creating design drawings for HVAC control systems. The templates are not intended to be incorporated into a contract package "as-is." They are "seed" or "starter" files and will require editing to make them "project specific." It is the designer's responsibility to ensure that a complete and biddable set of contract drawings is produced. Development of contract drawings and specifications is to be done in accordance with the guidance contained in TI 810-11.

Each file contains standard HVAC control system designs for systems based on the use of the Single-Loop Digital Controller (SLDC) control panel and also the use of Direct Digital Controls (DDC). You must open and download each file to a directory and then use a zip/unzip (Winzip, etc.) utility to access each file. All files were created in Autocad.

File names correspond to the figure numbers used for the standard systems depicted in chapter 4 of TI 810-11 as follows:

[4_07.dwg](#) - Standard control system for central plant steam hydronic system.

[4_08.dwg](#) - Standard control system for single building hydronic heating system with hot water boiler.

[4_09.dwg](#) - Standard control system for central plant high-temperature hot water hydronic heating system.

[4_10.dwg](#) - Standard control system for central plant steam dual-temperature hydronic system.

[4_11.dwg](#) - Standard control system for central plant high-temperature hot water dual-temperature hydronic system.

[4_12.dwg](#) - Standard control system for single building dual-temperature hydronic system.

[4_13.dwg](#) - Standard control system for heating and ventilating system.

[4_14.dwg](#) - Standard control system for multizone HVAC system.

[4_15.dwg](#) - Standard control system for dual-duct HVAC system.

[4_16.dwg](#) - Standard control system for bypass multizone HVAC system.

[4_17.dwg](#) - Standard control system for VAV HVAC system without return fan.

[4_18.dwg](#) - Standard control system for VAV HVAC system with return fan.

[4_19.dwg](#) - Standard control system for single zone HVAC system.

[4_20.dwg](#) - Standard control system for single zone HVAC system with dual-temperature coil.

[4_21.dwg](#) - Standard control system for single zone HVAC system with humidity control.

[4_22.dwg](#) - Standard control system for single zone HVAC system with DX coil.

[Legend.dwg](#) - standard symbols

Questions, comments, suggestions, or reports of errors found concerning these drawings are welcomed and encouraged.

Please direct any of the above to:

U.S. Army Engineer District, Savannah

Attn: HVAC Controls , EN-DM/E

P.O. Box 889

Savannah, GA 31402-0889

(912) 652-5386

richard.s.gobin@sas02.usace.army.mil