

UNIFIED FACILITIES CRITERIA (UFC)

INDUSTRIAL WATER TREATMENT OPERATION AND MAINTENANCE



APPROVED FOR PUBLIC RELEASE; DISTRIBUTION UNLIMITED

UNIFIED FACILITIES CRITERIA (UFC)

**INDUSTRIAL WATER TREATMENT
OPERATION AND MAINTENANCE**

Any copyrighted material included in this UFC is identified at its point of use. Use of the copyrighted material apart from this UFC must have the permission of the copyright holder.

U.S. ARMY CORPS OF ENGINEERS

NAVAL FACILITIES ENGINEERING COMMAND (Preparing Activity)

AIR FORCE CIVIL ENGINEER SUPPORT AGENCY

Record of Changes (changes are indicated by \1\ ... /1/)

Change No.	Date	Location
<u>1</u>	<u>Dec 2005</u>	<u>FOREWORD</u>



FOREWORD

vii

The Unified Facilities Criteria (UFC) system is prescribed by MIL-STD 3007 and provides planning, design, construction, sustainment, restoration, and modernization criteria, and applies to the Military Departments, the Defense Agencies, and the DoD Field Activities in accordance with [USD\(AT&L\) Memorandum](#) dated 29 May 2002. UFC will be used for all DoD projects and work for other customers where appropriate. All construction outside of the United States is also governed by Status of forces Agreements (SOFA), Host Nation Funded Construction Agreements (HNFA), and in some instances, Bilateral Infrastructure Agreements (BIA.) Therefore, the acquisition team must ensure compliance with the more stringent of the UFC, the SOFA, the HNFA, and the BIA, as applicable.

UFC are living documents and will be periodically reviewed, updated, and made available to users as part of the Services' responsibility for providing technical criteria for military construction. Headquarters, U.S. Army Corps of Engineers (HQUSACE), Naval Facilities Engineering Command (NAVFAC), and Air Force Civil Engineer Support Agency (AFCEA) are responsible for administration of the UFC system. Defense agencies should contact the preparing service for document interpretation and improvements. Technical content of UFC is the responsibility of the cognizant DoD working group. Recommended changes with supporting rationale should be sent to the respective service proponent office by the following electronic form: [Criteria Change Request \(CCR\)](#). The form is also accessible from the Internet sites listed below.

UFC are effective upon issuance and are distributed only in electronic media from the following source:

- Whole Building Design Guide web site <http://dod.wbdg.org/>.

Hard copies of UFC printed from electronic media should be checked against the current electronic version prior to use to ensure that they are current. /1/

AUTHORIZED BY:

DONALD L. BASHAM, P.E.
Chief, Engineering and Construction
U.S. Army Corps of Engineers

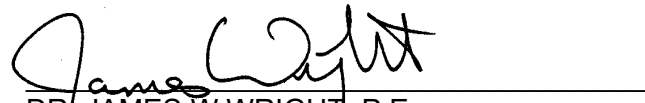
DR. JAMES W. WRIGHT, P.E.
Chief Engineer
Naval Facilities Engineering Command

KATHLEEN I. FERGUSON, P.E.
The Deputy Civil Engineer
DCS/Installations & Logistics
Department of the Air Force

Dr. GET W. MOY, P.E.
Director, Installations Requirements and
Management
Office of the Deputy Under Secretary of Defense
(Installations and Environment)

CONTENTS

	<u>Page</u>
CHAPTER 1 INTRODUCTION TO INDUSTRIAL WATER TREATMENT	
Paragraph 1-1	PURPOSE AND SCOPE 1
1-1.1	Fire Protection and Other Uses 1
1-1.2	Problems Encountered in Industrial Water Systems 1
1-1.2.1	Deposits 2
1-1.2.2	Scale 2
1-1.2.3	Biological 2
1-1.2.4	Suspended Solids (SS) 2
1-1.2.5	Corrosion 2
1-1.3	Objectives of Industrial Water Treatment 2
1-1.4	Water Conservation 3
1-1.5	Responsibility for Treatment 3
1-1.5.1	Office Responsible 3
1-1.5.2	Organizational Assignments 3
1-1.6	Unauthorized Non-Chemical Devices 3
1-1.7	Health and Safety 3
1-1.7.1	Protection of Potable Water 4
1-1.7.1.1	Cross-connection 4
1-1.7.1.2	Backflow Prevention Devices 4
1-1.7.1.3	Air Gaps 4
1-1.8	Restrictions on Direct Steam Use 4
1-1.9	Record-Keeping Requirements 4
1-1.9.1	Control Charts 4
1-1.9.2	Operations Logs 5
1-1.9.2.1	Large Boilers 5
1-1.9.2.2	Cooling Towers 5
1-1.9.2.3	Other Systems 5
1-1.9.3	Historical Records 5
1-1.10	Support Available 6
1-1.10.1	Boiler and Cooling Water Quality Assurance (QA) Program 6
1-1.10.2	Other Support 6
1-2	INDUSTRIAL WASTEWATER 6
1-2.1	Disposal Procedures 6
1-2.1.1	Water Discharge Pretreatment 6
1-2.1.2	Water Discharge Restrictions 7
1-2.1.2.1	Discharge Location 7
1-2.1.2.2	Discharge Rate 7
1-2.1.2.3	Discharge Time 7
1-2.1.2.4	Discharge Responsibilities 7
1-2.1.2.5	Review of Chemicals 7
1-2.2	Environmental Regulations 7
1-2.2.1	The Toxic Substances Control Act 7
1-2.2.2	The Clean Water Act 7
1-2.2.3	The Safe Drinking Water Act 8
1-2.2.4	The Federal Insecticide, Fungicide, and Rodenticide Act 8
1-2.2.5	The Resource Conservation and Recovery Act 8
1-2.2.6	The Occupational Safety and Health Act 8

1-2.2.7	The Comprehensive Environmental Response, Compensation and Liability Act.....	8
1-2.2.8	The Code of Federal Regulations Act.....	8
1-2.3	Container Management Policy.....	8
1-3	REFERENCES.....	8

CHAPTER 2 MAKEUP WATER

Paragraph	2-1	MAKEUP WATER FOR INDUSTRIAL WATER SYSTEMS.....	9
	2-1.1	Sources of Makeup Water.....	9
	2-1.1.1	Groundwater.....	9
	2-1.1.2	Surface Water.....	9
	2-1.1.3	Reuse Water.....	9
	2-1.1.4	Source Selection Factors to Consider.....	9
	2-1.2	Reasons and Criteria for Treating Makeup Water.....	10
	2-1.2.1	Reasons for Treating Makeup Water.....	10
	2-1.2.2	Criteria for Treating Makeup Water.....	10
	2-1.2.2.1	Makeup Water for Cooling Tower Systems.....	10
	2-1.2.2.2	Makeup Water for Steam Boilers.....	10
	2-1.2.2.3	Makeup Water for High-Temperature Hot Water Systems.....	10
	2-1.2.2.4	Other Systems.....	10
	2-1.2.3	Measurement of Makeup Water Rates.....	10
	2-2	MAKEUP WATER TREATMENT METHODS.....	10
	2-2.1	External Treatment.....	11
	2-2.2	Aeration.....	15
	2-2.3	Filters and Filtration.....	15
	2-2.3.1	Sand Filters.....	16
	2-2.3.1.1	Sand Filter Description.....	16
	2-2.3.1.2	Method of Action.....	16
	2-2.3.1.3	Filter Cycle.....	16
	2-2.3.1.4	Sand Filtration Rates.....	16
	2-2.3.2	Cartridge and Bag Filters.....	16
	2-2.3.3	Centrifuge Separators.....	16
	2-2.4	Lime-Soda Softening.....	16
	2-2.4.1	Method of Action.....	16
	2-2.4.2	Cold and Hot Processes.....	17
	2-2.5	Ion Exchange Process.....	17
	2-2.5.1	Sodium Ion Exchange.....	18
	2-2.5.1.1	Service Cycle.....	18
	2-2.5.1.2	Regeneration Cycle.....	19
	2-2.5.1.3	Testing and Record Keeping.....	21
	2-2.5.1.4	Operating Problems.....	21
	2-2.5.2	Hydrogen Ion Exchange.....	22
	2-2.5.2.1	Exchange Process.....	22
	2-2.5.2.2	Regeneration Method.....	22
	2-2.5.2.3	Equipment Requirements.....	23
	2-2.5.2.4	Regeneration Cycle.....	23
	2-2.5.2.5	Troubleshooting.....	23
	2-2.5.2.6	Effluent Water Properties.....	23
	2-2.5.2.7	Carbon Dioxide Production.....	23
	2-2.5.3	Demineralization.....	23
	2-2.5.3.1	Anion Exchange Process.....	24

2-2.5.3.2	Anion Ion Exchange Regeneration Method	24
2-2.5.3.3	Process Result.....	25
2-2.5.3.4	Exchange Method.....	25
2-2.5.3.5	High Silica Waters	25
2-2.5.3.6	Deionization Process Use.....	25
2-2.5.4	Dealkalization	25
2-2.5.4.1	Anion Dealkalization	25
2-2.5.4.2	Split-Stream Dealkalization.....	26
2-2.5.5	Decarbonation	28
2-2.5.5.1	Methods of Decarbonation.....	28
2-2.5.5.2	Analysis of Carbon Dioxide Content.....	28
2-2.6	Evaporators	29
2-2.7	Reverse Osmosis (RO).....	29
2-2.7.1	RO Pretreatment.....	30
2-2.7.1.1	SS Removal.....	30
2-2.7.1.2	Iron Oxide Removal	30
2-2.7.1.3	Scale Prevention.....	30
2-2.7.1.4	Biological Fouling.....	31
2-2.7.2	Membrane Configuration	31
2-2.7.2.1	Tubular Configuration	31
2-2.7.2.2	Spiral Configuration	31
2-2.7.2.3	Hollow Configuration.....	31
2-2.7.3	Sea Water	31
2-2.8	Ultrafiltration.....	31
2-2.9	Electrodialysis.....	32
2-2.10	Nanofiltration.....	32

CHAPTER 3 STEAM BOILER SYSTEMS

Paragraph	3-1	STEAM BOILER SYSTEM DEFINED.....	33
	3-1.1	Types of Steam Boilers.....	33
	3-1.1.1	Pressure Classification	33
	3-1.1.2	Fire Tube Boilers	33
	3-1.1.3	Water Tube Boilers	34
	3-1.1.4	Boiler Capacity Rating	34
	3-1.2	Components of a Steam Boiler System.....	34
	3-1.2.1	Pre-Boiler.....	35
	3-1.2.2	After-Boiler.....	36
	3-1.2.3	Boiler Components	36
	3-1.2.4	Steam Drum.....	36
	3-1.2.5	Steam Header.....	36
	3-1.3	Measuring Equipment.....	36
	3-1.4	Common Boiler Problems.....	37
	3-1.4.1	Corrosion Problems	37
	3-1.4.2	Deposition Problems.....	37
	3-1.4.3	Carryover Problems.....	40
	3-1.5	Calculations	40
	3-1.5.1	Cycles of Concentration (COC)	40
	3-1.5.2	Blowdown	41
	3-1.5.3	Water Balance for Feedwater, Evaporation, and Blowdown	41
	3-1.5.4	Calculation of Feedwater and Blowdown Water	41
	3-1.5.5	Relationship Between Feedwater, Blowdown,	

	Steam Generation, and COC.....	42
3-1.5.6	Calculating Blowdown Rates	42
3-1.5.7	Determining Feedwater and Blowdown Rates.....	42
3-1.6	Determining Makeup Water and Condensate Return Rates	43
3-1.6.1	Makeup Water Rate.....	44
3-1.6.2	Condensate Return Rate	44
3-1.6.3	Difference Between Amount of Steam Produced and Amount of Condensate	45
3-1.6.4	Basis for Evaluating Boiler System Efficiency	45
3-2	BOILER WATER TREATMENT AND CONTROL	45
3-2.1	Boiler Deposit Formation	46
3-2.1.1	Scale.....	46
3-2.1.2	Sludge Deposits.....	46
3-2.1.3	Dissolved Solid Materials.....	46
3-2.2	Common Scale Found in Boilers	47
3-2.2.1	Calcium Carbonate	47
3-2.2.2	Calcium Sulfate.....	47
3-2.2.3	Calcium Phosphate.....	47
3-2.2.4	Magnesium Phosphate	47
3-2.2.5	Magnesium Silicate.....	47
3-2.2.6	Iron Oxide and Iron Hydroxide.....	48
3-2.3	External Boiler Water Treatment	48
3-2.3.1	External Water Treatment for High-Pressure Boilers	48
3-2.3.2	External Treatment for Low-Pressure Boilers	48
3-2.4	Internal Treatment of Boiler Water.....	48
3-2.4.1	Preventing Scale Formation	48
3-2.4.1.1	Low-Pressure Boilers.....	49
3-2.4.1.2	High-Pressure Boilers.....	49
3-2.4.2	Determining Chemical Treatment Feed Rates	50
3-2.4.3	Preventing Sludge Deposits	51
3-2.5	Corrosion in the Boiler	51
3-2.5.1	General Corrosion	51
3-2.5.1.1	Proper pH for Boilers up to 6205 Kilopascals	52
3-2.5.1.2	Proper pH for Boilers Over 6205 Kilopascals	52
3-2.5.2	Pitting Corrosion	52
3-2.5.3	Other Types of Corrosion	52
3-2.6	Removing Oxygen from Feedwater	52
3-2.6.1	Mechanical Oxygen Removal	53
3-2.6.1.1	Deaerator Operation	53
3-2.6.2	Chemical Removal of Free Oxygen.....	55
3-2.6.2.1	Oxygen Scavengers for Boilers up to 6205 Kilopascals	55
3-2.6.2.2	Oxygen Scavengers for Boilers Over 6205 Kilopascals	55
3-2.7	Condensate Corrosion and Control	57
3-2.7.1	Causes of Condensate Corrosion.....	57
3-2.7.1.1	Air	57
3-2.7.1.2	Carbon Dioxide	57
3-2.7.2	Estimating Carbon Dioxide in Steam	58
3-2.7.3	Control of Carbon Dioxide by Neutralizing Amines.....	59
3-2.7.3.1	Control Limits.....	59
3-2.7.3.2	Vapor-Liquid Distribution Ratios	59
3-2.7.3.3	Morpholine	61
3-2.7.3.4	DEAE	61

3-2.7.3.5	Cyclohexylamine.....	61
3-2.7.3.6	Amine Blends.....	61
3-2.7.4	Control of Carbon Dioxide and Oxygen by Filming Amines.....	61
3-2.7.5	Control of Carbon Dioxide and Oxygen by Specialty Volatile Amines	62
3-2.7.6	Amine Limitations and Indoor Air and Steam Quality Issues	62
3-2.7.6.1	Steam Used for Sterilization	62
3-2.7.6.2	Food Preparation	63
3-2.7.6.3	Humidification	63
3-2.8	Water Carryover in Steam	63
3-2.8.1	Mist Carryover	63
3-2.8.2	Foaming Carryover	64
3-2.8.3	Priming Carryover	64
3-2.8.4	Silica Carryover	64
3-2.8.5	Determining Water Carryover in Steam.....	65
3-2.8.5.1	Conductivity Measurement Implications	65
3-2.8.5.2	Deposit Analysis	65
3-3	DEVELOPING A STEAM BOILER SYSTEM WATER TREATMENT PROGRAM.....	65
3-3.1	Organizing a Treatment Program	66
3-3.2	Operator Training.....	66
3-3.2.1	Pretreatment Training	66
3-3.2.2	Treatment Training	66
3-3.2.2.1	Boiler Water Treatment.....	66
3-3.2.2.2	Cooling Systems Treatment	67
3-3.2.2.3	Blowdown	67
3-3.2.3	Program Content	68
3-3.3	Equipment and Procedures	68
3-3.4	Feedwater Quality Limits	68
3-3.5	Boiler Water Chemistry Limits	72
3-3.6	Shore-to-Ship Steam Quality	75
3-3.7	Treatment Guidelines for Low-Pressure Steam.....	76
3-3.8	Treatment Guidelines for Medium- and High-Pressure Steam..	77
3-3.9	Condensate Corrosion and Control	78
3-3.10	Treatment Guidelines for Very-High-Pressure Steam	78
3-3.11	Boiler Operator Duties	79
3-4	CHEMICAL REQUIREMENTS FOR BOILER START-UP	79
3-4.1	Common Problems During Start-up of New Boilers.....	79
3-4.2	Start-up of New Boilers and Condensate Systems or Repaired Boilers	79
3-4.2.1	Start-up of Boiler from Wet Layup	81
3-4.2.2	Start-up of Boiler from Dry Layup	81
3-5	CHEMICAL REQUIREMENTS FOR BOILER LAYUP.....	82
3-5.1	Operational Considerations	82
3-5.2	Common Problems that Occur During Layup	82
3-5.3	Dry Layup of Boilers	82
3-5.3.1	Open Dry Layup Method.....	82
3-5.3.2	Quicklime or Silica Gel Layup Method	83
3-5.4	Wet Layup of Boilers.....	83
3-5.4.1	Wet Layup Without Draining (Operational Boilers).....	83
3-5.4.2	Wet Layup of Drained Boilers	84
3-5.5	Layup of Condensate Systems.....	85

3-6	COMMONLY ASKED QUESTIONS AND ANSWERS ON BOILER WATER TREATMENT	86
-----	---	----

CHAPTER 4 COOLING WATER SYSTEMS

Paragraph	4-1	TYPES OF COOLING WATER SYSTEMS	88
	4-1.1	Once-Through Cooling Water Systems	88
	4-1.2	Open Recirculating Cooling Water Systems.....	88
	4-1.3	Types of Cooling Towers	91
	4-1.3.1	Natural-Draft Towers	91
	4-1.3.2	Forced-Draft Towers.....	92
	4-1.3.3	Induced-Draft Towers	92
	4-1.3.4	Typical Cooling Towers at Government Installations.....	94
	4-1.4	Components of a Cooling Tower	95
	4-1.4.1	Basin and Cold Well	95
	4-1.4.2	Louvers	95
	4-1.4.3	Fill	96
	4-1.4.4	Drift Eliminators	96
	4-1.4.5	Water Distribution and Fan Deck.....	96
	4-1.4.6	Cell	96
	4-1.5	Common Cooling Water System Problems	97
	4-1.5.1	Enhanced and Super-Enhanced Chiller Condenser Tubing.....	97
	4-1.5.2	White Rust	98
	4-1.5.3	Cooling Tower Film Fill	99
	4-1.5.4	Legionella Bacteria	99
	4-2	COOLING TOWER WATER CALCULATIONS.....	100
	4-2.1	Principles of Cooling Tower System Operations	100
	4-2.1.1	Relationship Between Evaporation, Blowdown, and Makeup....	100
	4-2.1.2	Cycles of Concentration (COC)	100
	4-2.1.2.1	Calculating COC by Volume	101
	4-2.1.2.2	Determining COC by Water Analyses.....	101
	4-2.1.2.3	Controlling COC.....	102
	4-2.1.2.4	Relationship Between COC and Makeup	102
	4-2.1.3	Relationship Between Blowdown, Evaporation, and COC.....	103
	4-3	OBJECTIVES OF COOLING WATER TREATMENT.....	105
	4-3.1	Deposit Formation and Control	105
	4-3.2	Scale.....	105
	4-3.2.1	Determining Scaling Potential.....	105
	4-3.2.2	Calcium Carbonate Scale	106
	4-3.2.3	Calcium Phosphate Scale.....	106
	4-3.2.4	Calcium Sulfate Scale.....	106
	4-3.2.5	Silica Scale	107
	4-3.3	Determining COC to Control Operations	107
	4-3.4	Calcium Carbonate Scaling Indices.....	108
	4-3.4.1	Langelier and Ryznar Indices	108
	4-3.4.2	Practical (Puckorius) Scaling Index (PSI).....	109
	4-3.5	Scale Control Methods	109
	4-3.5.1	Calcium Carbonate Scale Control Using Solubilizing Chemicals	110
	4-3.5.1.1	Acids	110
	4-3.5.1.2	Phosphonates.....	110
	4-3.5.2	Calcium Carbonate Scale Control Using Solubilizing	

	Polymers.....	110
4-3.5.3	Calcium Carbonate Scale Control Using Sludge-Forming Polymers.....	110
4-3.5.4	Calcium Phosphate Scale Control Using Solubilizing Inhibitors.....	110
4-3.5.5	Calcium Sulfate Scale Control Using Solubilizing Polymers.....	111
4-3.5.6	Magnesium Silicate Scale Control.....	111
4-3.5.7	Silica Scale Control.....	111
4-3.6	Cooling Water Fouling.....	111
4-3.7	Fouling Control.....	111
4-4	MICROBIOLOGICAL DEPOSITS AND CONTROL	112
4-4.1	Algae.....	113
4-4.2	Bacteria.....	113
4-4.2.1	Planktonic Bacteria.....	113
4-4.2.2	Sessile Bacteria.....	113
4-4.3	Fungi.....	115
4-4.4	Microbiological Control.....	115
4-4.4.1	Oxidizing Biocides.....	115
4-4.4.1.1	Chlorine and Chlorine Release Agents.....	115
4-4.4.1.2	Bromine Release Agents.....	116
4-4.4.1.3	Ozone.....	117
4-4.4.1.4	Chlorine Dioxide.....	117
4-4.4.1.5	Hydrogen Peroxide.....	117
4-4.4.2	Non-Oxidizing Biocides.....	119
4-4.5	Algae Control.....	121
4-4.6	Bacterial Control.....	121
4-4.6.1	Bacterial Control with Oxidizing Biocides.....	121
4-4.6.2	Bacterial Control with Non-Oxidizing Biocides.....	121
4-4.7	Legionnaires' Disease.....	122
4-4.8	Macrobiological Control.....	122
4-5	CORROSION IN COOLING SYSTEMS	122
4-5.1	Galvanic Corrosion.....	123
4-5.2	General Corrosion.....	124
4-5.3	Concentration Cell Corrosion.....	125
4-5.3.1	Crevice Corrosion.....	125
4-5.3.2	Under-Deposit Corrosion.....	125
4-5.3.2.1	Microbiologically Influenced Corrosion (MIC).....	125
4-5.4	Corrosion Rate.....	125
4-5.5	Corrosion Control Methods.....	126
4-5.5.1	Effective Corrosion Control.....	128
4-5.5.1.1	Anodic Inhibitors.....	128
4-5.5.1.2	Cathodic Inhibitors.....	128
4-5.5.1.3	General Inhibitors.....	129
4-5.5.1.4	Corrosion Inhibitors for Specific Metals.....	129
4-5.5.1.5	Galvanic or Crevice Corrosion.....	129
4-5.5.1.6	Deposit Corrosion.....	129
4-5.5.1.7	Microbiologically Influenced Corrosion (MIC).....	129
4-6	DEVELOPING AN EFFECTIVE COOLING WATER TREATMENT PROGRAM	130
4-6.1	Equipment.....	130
4-6.2	Operational Features and Parameters.....	130
4-6.3	Water Quality.....	131

4-6.4	Cooling Water Treatment Programs	131
4-6.4.1	Categories	131
4-6.4.2	Cycles of Concentration.....	131
4-6.5	Treatment Program for Small Cooling Towers.....	131
4-6.5.1	Treatment	132
4-6.5.2	Testing	132
4-6.6	Treatment Program for Medium and Large Cooling Towers.....	132
4-6.6.1	Treatment	133
4-6.6.2	Testing	133
4-6.7	Cooling Tower Operator Duties	133
4-6.7.1	Cooling Tower Distribution Deck	134
4-6.7.2	Cooling Tower Fill, Air Intake Slats, and Basin.....	134
4-6.7.2.1	Scale Deposits on Cooling Tower Fill.....	134
4-6.7.2.2	Scale Deposits on Air Intake Slats.....	134
4-6.7.2.3	Slime Deposits.....	134
4-6.7.2.4	Suspended Solids.....	134
4-6.7.3	Corrosion Test Coupons.....	134
4-6.7.4	Inside Surface of Heat Exchanger Tubes	134
4-6.7.5	Chiller Performance	135
4-6.7.6	Cooling Tower Surfaces	135
4-7	COOLING WATER SYSTEM START-UP AND LAYUP REQUIREMENTS.....	135
4-7.1	Stand-by Conditions	135
4-7.2	Common Problems During Layup or Due to Improper Initial Start-up.....	135
4-7.3	Start-up of New Cooling Water Tower Systems	136
4-7.3.1	Initial Cleaning	136
4-7.3.2	Cleaning and Passivation Procedures.....	136
4-7.3.2.1	Hydrostatic Testing	136
4-7.3.2.2	Pre-operational Cleaning Procedure	136
4-7.3.2.3	Chemical Cleaning and Passivation Formulation	137
4-7.3.2.4	Passivation of the System	137
4-7.3.2.5	Operational Readiness	137
4-7.4	Layup of Cooling Tower Systems	138
4-7.4.1	Wet Layup of Cooling Water Systems and Equipment.....	138
4-7.4.2	Dry Layup of Cooling Water Systems and Equipment.....	138

CHAPTER 5 CLOSED INDUSTRIAL WATER SYSTEMS

Paragraph	5-1	DEFINITION.....	139
	5-1.1	Hot Water Heating Systems	139
	5-1.1.1	Hot Water Boilers.....	139
	5-1.1.2	Description of Hot Water Systems.....	140
	5-1.2	Closed Chilled Water Systems, Brine Systems, and Glycol Systems	141
	5-1.2.1	Closed Chilled Water Systems	141
	5-1.2.2	Closed Brine Systems	142
	5-1.2.3	Closed Glycol Systems.....	142
	5-1.3	Combined Hot and Chilled Water Systems	142
	5-1.4	Diesel Engine Jacket Cooling Systems	142
	5-1.4.1	Air-Cooled Diesel Cooling Systems.....	142
	5-1.4.2	Water-Cooled Diesel Engine Cooling Systems	143

5-1.4.3	Vapor-Phase Diesel Engine Cooling Systems.....	143
5-2	WATER TREATMENT FOR CLOSED SYSTEMS	143
5-2.1	Makeup Water Requirements	143
5-2.2	Corrosion Control Programs	144
5-2.2.1	Sulfite-Caustic (or other Oxygen Scavenger-Caustic) Treatment Program.....	145
5-2.2.2	Nitrite-Azole Treatment Program	146
5-2.2.3	Molybdate-Azole Treatment Program	146
5-2.2.4	Molybdate-Nitrite-Azole Treatment Program	147
5-2.2.5	Polysilicate-Azole Treatment Program	147
5-2.3	Treatment and Control of Microbiological Growth	148
5-2.4	Identifying Water Leaks	148
5-2.5	Procedures for Layup of Hot and Chilled Water Systems	149

CHAPTER 6 WATER SAMPLING AND TESTING OF WATER SYSTEMS

Paragraph	6-1	WATER SAMPLING AND TESTING.....	150
	6-1.1	In-Plant Testing.....	150
	6-1.2	Independent QA Analysis	151
	6-2	COOLING TOWER WATER SAMPLING AND TESTING.....	151
	6-2.1	Cooling Water Testing Requirements	151
	6-2.2	Frequency of Cooling Water Sampling and Testing	152
	6-2.3	Cooling Water Sampling	152
	6-3	ROUTINE BOILER WATER SAMPLING AND TESTING	153
	6-3.1	Boiler Water Sampling Cooler	154
	6-3.2	Boiler Water Sampling Procedures.....	154
	6-3.3	Sampling Locations	155
	6-3.4	Frequency of Sampling and Testing	156
	6-3.5	Boiler Feedwater Sample	158
	6-3.6	Condensate Water Sample.....	158
	6-3.7	Boiler Blowdown Water Sample	158
	6-3.8	Boiler Water QA Analysis	158
	6-4	WATER SAMPLING AND TESTING FOR CLOSED HOT AND CHILLED CIRCULATING WATER SYSTEMS.....	159
	6-4.1	Sampling and Testing of Makeup Water.....	160
	6-4.2	Ion Exchangers and Dealkalizer Water	160
	6-4.2.1	Influent Water Testing.....	160
	6-4.2.2	Effluent Water Testing	160
	6-4.2.3	Sampling Location	160
	6-4.2.4	Brine Testing.....	160
	6-5	WATER TESTING.....	160
	6-5.1	Water Sample Testing Methods	161
	6-5.2	Corrosion Testing	161
	6-5.2.1	Corrosion Test Coupons.....	161
	6-5.2.2	Corrosion Pipe Inserts	161
	6-5.2.3	Commercial Resources for Testing	161
	6-5.2.4	Corrosion Test Results	161
	6-5.2.5	Testing Instruments	161
	6-5.2.6	Heat Transfer Corrosion Test Equipment.....	162
	6-6	INTERPRETATION OF RESULTS FROM WATER TESTS.....	162
	6-6.1	Alkalinity Test Relationships.....	162
	6-6.1.1	Sources of Alkalinity	162

6-6.1.2	Relationship of P, M, and OH Alkalinities	163
6-6.2	pH (Hydrogen Ion Concentration).....	165
6-6.2.1	Meaning of pH	165
6-6.2.2	Relationship to Causticity	165
6-6.3	Conductivity and TDS	166
6-7	IN-PLANT LABORATORY WATER TESTING REQUIREMENTS	167
6-7.1	Recommended Laboratory Equipment	167
6-7.2	Chemical Reagents	167

CHAPTER 7 WATER TREATMENT CHEMICAL FEED AND CONTROL

Paragraph	7-1	CHEMICAL FEED AND CONTROL SYSTEMS.....	168
	7-1.1	Controller Types	168
	7-1.1.1	Cooling Tower Water Controllers.....	168
	7-1.1.2	Boiler Water Controllers.....	169
	7-1.2	Chemical Pumps.....	170
	7-1.2.1	Feed Pumps	170
	7-1.2.2	Pumps of Various Types.....	170
	7-1.3	Water Meters, Automatic Valves, and Timers	170
	7-1.3.1	Water Meters	170
	7-1.3.2	Automatic Valves	170
	7-1.3.3	Timers.....	171
	7-1.4	Other Feed Devices.....	171
	7-1.4.1	Bypass Feeders.....	171
	7-1.4.2	Slowly Dissolving Dry Chemical Packages.....	171
	7-1.4.3	Eductor Chemical Addition Systems.....	171
	7-1.4.4	Chemical Drip Pots	171
	7-2	CHEMICAL FEED METHODS.....	171
	7-2.1	Manual Water Treatment Chemical Feed.....	171
	7-2.1.1	Chemical Pot Feeders	171
	7-2.1.2	Dry Chemical Feeders	172
	7-2.2	Automatic Chemical Feed with Manual Preparation.....	172
	7-2.3	Automatic Neat Chemical Feed	173
	7-3	CHEMICAL CONTROL VERIFICATION.....	174
	7-3.1	Continuous Testing.....	174
	7-3.2	Manual Testing	174
	7-3.3	Little or No Testing.....	174
	7-3.4	Calibrated Mass Balance.....	175
	7-3.5	Automated Sensor Control	175
	7-4	SAFETY AND GENERAL INFORMATION.....	175
	7-4.1	Safety.....	175
	7-4.1.1	Handling Acid.....	175
	7-4.1.2	Handling Caustic Soda (Sodium Hydroxide)	176
	7-4.1.3	Handling Other Chemicals.....	176
	7-4.1.4	Chemical Spill Kits	176
	7-4.1.5	First Aid Information.....	176
	7-4.1.6	Eyewash Fountain	176
	7-4.1.7	Safety Shower	176
	7-4.1.8	Safety Inspection	176
	7-4.2	Container Management	176
	7-4.3	Chemical Storage	177

CHAPTER 8 NON-CHEMICAL, NON-TRADITIONAL WATER TREATMENT DEVICES

Paragraph	8-1	POLICY	178
	8-1.1	Function	178
	8-1.2	Acceptance	178
	8-1.3	Performance Standards	178
	8-2	TYPES OF NON-CHEMICAL WATER TREATMENT DEVICES	178
	8-2.1	Electrical Impressed Current Devices	179
	8-2.2	Grounded Wire Devices	179
	8-2.3	Sacrificial Anodes	179
	8-2.4	Filters	179
	8-2.5	Magnetic Filters	179
	8-2.6	Ultraviolet Light Generators	179
	8-2.7	Magnetic and Electromagnetic Devices	180
	8-2.8	Electrostatic Devices	180
	8-2.9	Non-Traditional Water Treatment Chemical Devices	180
	8-2.9.1	Ozone	180
	8-2.9.2	Copper and Silver Ionizing Devices	180

CHAPTER 9 CHEMICAL CLEANING OF WATER SYSTEMS

Paragraph	9-1	GENERAL GUIDANCE	182
	9-1.1	Pre-Operational Cleaning	182
	9-1.2	Remedial Cleaning	183
	9-1.2.1	Safety and Environmental Issues	183
	9-1.2.2	Contracting Cleaning Services	183
	9-1.3	Reasons for Cleaning	183
	9-1.4	Types of Deposits	183
	9-1.4.1	Waterside Deposits Located in Heat Exchangers	183
	9-1.4.2	Boiler Deposits	184
	9-2	REMEDIAL CLEANING PROCEDURES	184
	9-2.1	Cleaning Methods	184
	9-2.1.1	Mechanical Methods	184
	9-2.1.2	Cleaning Agents	184
	9-2.1.3	General Guidance and Procedures for Preparing Cleaning Solutions	184
	9-2.2	Hydrochloric (Muriatic) Acid	184
	9-2.2.1	Example Procedure for 10% Solution	185
	9-2.2.2	Carbonate Deposits	185
	9-2.2.3	Phosphate Deposits	186
	9-2.2.4	Metallic Oxides	186
	9-2.2.5	Silica and Sulfate Scale	186
	9-2.2.6	Hydrochloric Acid Limitations	186
	9-2.3	Sulfamic Acid	186
	9-2.4	Cleaning Preparation	187
	9-2.5	Methods for Removing Scale	188
	9-2.5.1	Recirculating Cleaning Process for Boilers	188
	9-2.5.2	Circulating Method Without Heat	189
	9-2.5.3	Fill and Soak Method	190
	9-2.6	Checking Acid Solution Strength	190

CHAPTER 10 DEVELOPING A WATER TREATMENT PROGRAM

Paragraph	10-1	GENERAL INFORMATION	192
	10-2	OPTIONS FOR SETTING UP A WATER TREATMENT PROGRAM....	192
	10-2.1	Generic Chemical Water Treatment Programs.....	193
	10-2.2	Outsourcing Chemicals and Services	193
	10-2.3	Contracts Based on Cost Per Unit of Water	193
	10-3	DEVELOPING A SCOPE OF WORK (SOW) FOR INDUSTRIAL WATER TREATMENT	194
	10-3.1	Qualifications	194
	10-3.2	Submittal Requirements and Format	194
	10-3.3	Water Quality	194
	10-3.4	Description of Systems and Operations	194
	10-3.5	Performance Specification	194
	10-3.6	Service Requirements	195
	10-3.7	Control, Feed, Monitoring and Sampling Equipment Requirements	195
	10-3.8	Chemicals and Test Equipment.....	195
	10-3.9	Quotation for Cost and Usage	195
	10-4	REPORTS AND AUDITS	195
GLOSSARY		196
APPENDIX A		REFERENCES.....	206
APPENDIX B		PRACTICAL (PUCKORIUS) SCALING INDEX (PSI).....	208
APPENDIX C		CORROSION TESTING WITH COUPON-TYPE TEST SPECIMENS	218
APPENDIX D		CORROSION TESTING WITH TEST NIPPLE ASSEMBLY.....	221
APPENDIX E		TESTING INDUSTRIAL WATER SYSTEM SAMPLES	224
APPENDIX F		NONPROPRIETARY INDUSTRIAL WATER TREATMENT CHEMICALS	226

FIGURES

<u>Figure</u>	<u>Title</u>	
2-1	Effects of Treatment on Raw Water	13
2-2	Typical Ion Exchange Unit.....	17
2-3	Duplex Softener	18
2-4	Demineralization Process.....	24
2-5	Anion Dealkalization Process	26
2-6	Split-Stream Dealkalizer	27
2-7	RO Schematic	29
2-8	RO Unit	30
3-1	Fire Tube Boiler	33

3-2	Water Tube Boiler	34
3-3	Components of a Simple Steam Boiler System.....	35
3-4	Boiler Tube Oxygen Pitting.....	37
3-5	Scaled Boiler Tube	38
3-6	Impact of Scale on Heat Transfer.....	39
3-7	Metal Fatigue on Boiler Tube	39
3-8	Failed Boiler Tube	40
3-9	Simplified Boiler System Water Balance	43
3-10	Localized Scale Formation Process	46
3-11	Mechanical Deaerator Schematic (Spray Type).....	54
3-12	Mechanical Deaerator Schematic (Tray Type).....	55
3-13	Effect of pH on Mild Steel and Copper Corrosion.....	58
3-14	Water Boiler Mist Formation	64
3-15	Inspection Gauge for Wet Boiler Layup.....	84
4-1	Once-Through Cooling Water System Diagram	88
4-2	Evaporative Fluid Cooler and Evaporative Condenser Diagram	89
4-3	Open Recirculating Cooling Tower Water System Diagram.....	90
4-4	Cooling Tower Water System.....	91
4-5	Hyperbolic Natural-Draft Cooling Towers.....	92
4-6	Cross-Flow Cooling Tower	93
4-7	Cross-Flow Cooling Tower	93
4-8	Counter-Flow Cooling Tower.....	94
4-9	Counter-Flow Cooling Tower.....	94
4-10	Induced-Draft Cross-Flow Cooling Tower Components	95
4-11	High-Efficiency Cooling Tower Film Fill.....	96
4-12	Super-Enhanced Copper Tubes.....	98
4-13	Close-Up of Corrosion Pitting on Super-Enhanced Copper Tube.....	98
4-14	Heavily Fouled Cooling Tower Film Fill	99
4-15	Effect of COC on Makeup Requirement.....	103
4-16	Halogen Species vs. pH in Water.....	116
4-17	Forms of Corrosion.....	123
4-18	Galvanic Series of Common Metals and Alloys Found in Cooling Water Systems	124
4-19	Effect of pH on Corrosion Rate of Unprotected Mild Steel in Water.....	127
5-1	Hot Water Boiler.....	140
5-2	Typical Closed Chilled Water System Schematic.....	141
5-3	Chillers	142
6-1	Typical Water Sampling Points for an Open Recirculating Cooling Water System	153
6-2	Boiler or Condensate Water Sample Cooling Coil.....	154
6-3	Typical Locations for Water Sampling in a Steam Boiler Water System.....	156
6-4	Acidity, Alkalinity, and pH Ranges.....	163
7-1	Chemical Pot Feeder.....	172
7-2	Manual Chemical Feed System.....	173
7-3	Automatic Chemical Feed System	173
7-4	Automatic Neat Chemical Feed.....	174
C-1	Bypass Piping for Corrosion Testing Cooling Water and Condensate Systems	219
D-1	Condensate Corrosion Tester	223

TABLES

<u>Table</u>	<u>Title</u>	
2-1	Makeup Water Treatment Methods for Removing Impurities	12
2-2	External Treatment Equipment Selection Guide for Steam Boiler Makeup Water	14
2-3	Salt Required for Regeneration of a Commonly Used Cation Resin.....	20
2-4	Carbon Dioxide Content in Water vs. pH.....	28
3-1	Summary of Phosphate Treatment Programs.....	52
3-2	Deaerator Water Outlet Temperature for Boiler Systems at Various Sea Level Pressures	53
3-3	Levels of Sulfite to be Carried in Boiler Water.....	56
3-4	Physical and Chemical Properties of Neutralizing Amines.....	60
3-5	Neutralizing Amine Selection Chart.....	60
3-6	Amine Limits	62
3-7	Silica Levels Allowed in Boiler Water	65
3-8	Suggested Feedwater Limits for Industrial Water Tube Boiler 0-2.068 MPa (0-300 psig).....	69
3-9	Suggested Feedwater Limits for Industrial Water Tube Boiler 2.075-4.137 MPa (301-600 psig).....	70
3-10	Suggested Feedwater Limits for Industrial Fire Tube Boiler 0-2.068 MPa (0-300 psig).....	70
3-11	ASME Feedwater Limits for Industrial Water Tube Boilers	71
3-12	ASME Suggested Feedwater Limits for Marine Propulsion Water Tube Boiler	72
3-13	ASME Suggested Boiler Water Limits for Industrial Water Tube Boiler	73
3-14	ASME Boiler Water Limits for Industrial Water Tube Boilers.....	74
3-15	ASME Boiler Water Limits for Industrial Fire Tube Boilers 0-2.068 MPa (0-300 psig).....	75
3-16	ASME Suggested Boiler Water Limits for Marine Propulsion Water Tube Boiler	75
3-17	NAVSEASYSKOM Shore-to-Ship Steam Purity Requirements	76
3-18	Treatment Guidelines for Low-Pressure Steam	77
3-19	Treatment Guidelines for Medium- and High-Pressure Steam.....	78
3-20	Treatment Guidelines for Very-High-Pressure Steam	79
3-21	Troubleshooting Boiler System Water	81
4-1	Summary of Scale Control Methods.....	112
4-2	Summary of Foulant Control Methods.....	112
4-3	Bacterial Types and Problems Created.....	114
4-4	Chlorine Release Agents.....	116
4-5	Bromine Release Agents.....	117
4-6	Guidelines for Oxidizing Microbiocide Effectiveness.....	118
4-7	Guidelines for Non-Oxidizing Microbiocide Selection.....	120
4-8	Guidelines for Bacterial Control in Cooling Towers	121
4-9	Assessing Corrosion Rates in Cooling Water Systems: 90-Day Corrosion Coupon Test	126
4-10	Criteria for Corrosion Inhibitor Selection	128
4-11	Guidelines for Passivation Film Formation and Subsequent Maintenance .	130
4-12	Small Cooling Tower Treatment Program	132
4-13	Treatment Program for Medium and Large Cooling Towers	133
4-14	Required Chemical Technology	137

4-15	Supplemental Chemical Technology	138
5-1	Makeup Water Requirements for Closed Systems.....	144
5-2	Selection Guidelines for Closed System Treatment.....	145
5-3	Microbiological Control Guidelines for Closed Water Systems	145
6-1	Recommended Water Sample Frequency and Testing Requirements for Cooling Tower Systems	151
6-2	Water Sampling Frequency and Testing Requirements for Boiler Water Systems	157
6-3	Water Sampling and Testing Requirements for Other Water Systems	159
6-4	Alkalinity Relationships Based on P and M Tests	164
6-5	Relationship Between Causticity and pH	166
7-1	Cooling System Controller Functions	169
7-2	Steam Boiler System Controller Functions.....	169
B-1	Factor "A" for TDS	209
B-2	Factor "B" for Temperature.....	210
B-3	Factor "C" for Calcium Hardness (as ppm CaCO ₃) – Zero to 200 ppm.....	211
B-4	Factor "C" for Calcium Hardness (as ppm CaCO ₃) – 200 to 990 ppm	212
B-5	Factor "D" for Alkalinity (as ppm CaCO ₃) – Zero to 200 ppm	213
B-6	Factor "D" for Alkalinity (as ppm CaCO ₃) – 200 to 890 ppm	214
B-7	pH _{eq} Determined from Total Alkalinity	214
B-8	Scaling Indices vs. Condition	216
C-1	Flow Rate	220

CANCELED

CHAPTER 1

INTRODUCTION TO INDUSTRIAL WATER TREATMENT

1-1 **PURPOSE AND SCOPE.** This UFC provides an overview of industrial water treatment operations and management. As used in this UFC, the term “industrial water” refers to the water used in military power generation, heating, air conditioning, refrigeration, cooling, processing, and all other equipment and systems that require water for operation. Industrial water is not the same as potable water. Industrial water is never consumed or used under situations that require a high degree of sanitation. Industrial water requires water preparation or chemical treatment, or both, to avoid the problems described in paragraph 1-1.2. Water preparation and chemical treatment requirements are described in Chapters 2 through 5 according to the type of system in question. The Navy has special uses for shore-to-ship steam. The Naval Sea Systems Command (NAVSEASYS COM) shore-to-ship steam purity standards are described in Chapter 3. Examples of industrial water systems and their uses are:

- Steam Boiler Systems. (See Chapter 3.) Steam uses include space and hot water heating, sterilization, humidification, indirect food processing, and power generation.
- Cooling Water Systems. (See Chapter 4.) Cooling water is used in cooling towers, evaporative coolers, evaporative condensers, and once-through systems. Applications are broad, ranging from simple refrigeration to temperature regulation of nuclear reactors.
- Closed Water Systems. (See Chapter 5.) These include closed hot water, closed chilled water, and diesel jacket systems.

1-1.1 **Fire Protection and Other Uses.** Fire protection water systems are not technically industrial water systems. These include building fire suppression sprinkler systems and firemain systems at waterfronts. The need to chemically treat the water within such systems is recognized; however, there are currently no industrial standards in place. The firemain systems at waterfronts often use salt water or brackish water. This type of water can also be used for once-through condenser cooling.

1-1.2 **Problems Encountered in Industrial Water Systems.** Problems found in industrial water systems are attributable to reduced or restricted water flow or other changes in operational parameters, and often caused by corrosion, deposits, and biological growth. These problems result in reduced system efficiency (higher operating costs), increased equipment replacement costs, and reduced safety. At times they can be serious enough to cause complete system shutdown. The problems in industrial water systems fall into three main categories:

- Steam boiler water problems (corrosion, deposits, and carryover).
- Cooling water problems (corrosion, deposits, and biological).
- Closed loop problems (corrosion, deposits, and biological).

1-1.2.1 **Deposits.** The term “deposits” refers to a broad categorization of residues. Deposits are composed of mineral scale, biological matter, and suspended or insoluble materials (e.g., sludge, dirt, or corrosion byproducts). Deposits can be created by the attachment of deposit-forming materials to pipe or equipment surfaces, or by settling and accumulation.

1-1.2.2 **Scale.** The term “scale” describes specific types of deposits caused when mineral salts, dissolved in water, are precipitated either because their solubility limits have been exceeded or as a result of reaction to water treatment chemicals. Scale adheres to pipe and equipment surfaces and its formation results in loss of heat transfer and restricted flow of water or steam. Many different types of scale reflect the quality and characteristics of the makeup water and the type of chemical treatment being applied.

1-1.2.3 **Biological.** The term “biological” describes both macrobiological organisms (mollusks, clams, fish) and microbiological organisms (algae, fungi, bacteria). Algae are microscopic plants that may grow in various industrial water systems but most commonly appear on the distribution decks of cooling towers. Fungi are living organisms that may cause damage to the wooden parts of cooling towers by causing decay. Slimes are accumulations of these biological contaminants that foul and corrode the cooling water equipment. Macrobiological organisms can cause fouling problems in once-through cooling water systems if untreated (“raw”) water is used.

1-1.2.4 **Suspended Solids (SS).** The term “suspended solids” refers to any materials present in the water stream that are not actually dissolved in the water. SS can result from the presence of dirt, silt, and sand in the makeup water or can be introduced into the water from air in a cooling tower system. Biological matter, both dead and living, can be a form of SS if carried in the water stream. Corrosion products, such as iron oxide, are forms of SS that often originate in the system piping.

1-1.2.5 **Corrosion.** The term “corrosion” refers to metal deterioration resulting from a refined metal’s tendency to return to its original state (i.e., the ore from which the refined metal was produced). The process of corrosion involves a series of electrochemical reactions. Metals that contact water in any type of water system can corrode if there is no attempt to protect them.

1-1.3 **Objectives of Industrial Water Treatment.** Industrial water is treated to achieve the following objectives with respect to the equipment in which it is used: maintaining its efficiency, prolonging its usable “life,” and reducing the frequency of repair or replacement (or both). These objectives can be achieved by treating the water to prevent scale and to control corrosion, fouling, and microbiological growth. To meet

these objectives, an adequate and continuous supply of both properly conditioned makeup water and conditioned or chemically treated system water (i.e., water within the water-using system) is produced. The source for industrial water is often the installation's potable water distribution system; however, there is a growing trend to use recycled municipal wastewater for makeup to cooling tower systems. When this source of makeup water is used, additional steps can be taken to provide a backup water supply.

1-1.4 **Water Conservation.** Make every effort to conserve water used in boilers, cooling towers, and other water-using equipment. This includes identifying and fixing leaks throughout the systems, reducing uncontrolled water losses (drift) from cooling towers, and operating the systems at the highest permissible cycles of concentration (COC) by using proper procedures for blowdown and chemical treatment. Water conservation (i.e., using less water) also reduces the amount of treatment chemicals required for the water treatment program. This, in turn, eases operation of wastewater treatment facilities, reduces the requirements for chemical handling, reduces the volume of chemical wastes generated, and reduces the cost of water treatment.

1-1.5 **Responsibility for Treatment**

1-1.5.1 **Office Responsible.** The office responsible for industrial water treatment exists at the base or facility level. This office is responsible for developing short-term and long-term strategies for acquiring the resources needed to execute an effective water treatment program that incorporates the principles, procedures, and programs provided in this manual.

1-1.5.2 **Organizational Assignments.** The development and implementation of efficient and economical procedures for industrial water treatment and water testing processes requires the assignment of specific and appropriate organizational responsibilities. If the person assigned to perform the treatment and testing of industrial water is assigned additional duties, assignment of additional personnel may be required to ensure that adequate and continuous attention is given to industrial water treatment and testing. A system for the regular reporting of trends in test results and for the regular assessment of system performance can be established to keep the assigned personnel appropriately informed.

1-1.6 **Unauthorized Non-Chemical Devices.** The military does not currently recognize using non-chemical treatment devices for comprehensive water treatment or trials. These situations are described in detail in Chapter 8.

1-1.7 **Health and Safety.** Many of the chemicals used to treat industrial water may be harmful to the health of the system operator and other installation personnel unless they are properly handled and controlled. Handle water treatment chemicals and test reagents with care, following the guidance of Occupational Safety and Health Administration (OSHA) directives, manufacturers' recommendations, and material safety data sheets (MSDS). To minimize chemical handling, you can use automated control and feed equipment. Chapter 7 describes chemical application processes.

1-1.7.1 **Protection of Potable Water.** Protecting potable water supplies, as it applies to an industrial water system, involves preventing contamination of the potable water system. Eliminating cross-connections in the water system and using backflow prevention devices or air gaps to provide an interconnection barrier between the water systems are ways to achieve this prevention.

1-1.7.1.1 **Cross-connections.** A cross-connection is a physical connection between a potable water supply system and a non-potable water system (such as an industrial water system) through which contaminated water can enter the potable water system. Cross-connections are eliminated to maintain the safety of potable water supplies. Backflow prevention devices are installed to prevent cross-connections where potable water is supplied to industrial water systems.

1-1.7.1.2 **Backflow Prevention Devices.** Class III backflow prevention devices (air gap or reduced pressure principle devices) are required when connecting a potable water supply system to an industrial water system that uses a source of non-potable water. They are also required when connecting a potable water supply system to an industrial water system to which chemicals have been added.

1-1.7.1.3 **Air Gaps.** If potable makeup water is supplied to a tank or other type of open system, provide an air gap between the water inlet and the maximum overflow level of the tank, device, or system.

1-1.8 **Restrictions on Direct Steam Use.** Neutralizing amine chemicals, which are added to the steam to protect the condensate lines from corrosion, make the steam and condensate unfit for consumption or for other uses normally reserved for potable water. Treated steam should not come into direct contact with food and should not be used for heating food trays or for humidification. For these applications, steam-to-steam heat exchangers can be used to provide amine-free steam (see paragraph 3-2.7.6).

1-1.9 **Record-Keeping Requirements.** Procedures for industrial water treatment and testing may vary from one installation to another based on differences in the characteristics and quality of the water, as well as on differences in the type and size of the systems. Water system specifications are developed to address local factors such as the installation's mission, geographic location, and climate. The data and information records and logs used to record the results of industrial water treatment and testing can be developed to reflect the minimum documentation requirements needed to verify adequate operation and control of the treatment program. Computer-generated logs require regularly scheduled backup. Chapter 6 provides recommended frequencies for sampling and testing various industrial water systems.

1-1.9.1 **Control Charts.** Control charts can be developed to identify the following information: the treatment chemicals used; the chemical levels required to be maintained in the system; other required testing procedures (e.g., conductivity, pH); and the information specific to the particular water system (especially for the larger boilers

and cooling towers). Water treatment service companies commonly supply these control charts.

1-1.9.2 **Operations Logs.** Operations logs can be maintained to establish trends for parameters and items identified in the program control charts. These logs are best maintained as computer-generated spreadsheets and graphs. Hardcopy records are also acceptable.

1-1.9.2.1 **Large Boilers.** Maintain water treatment logs on-site in all plants operating above 103 kilopascal [kpa] (15 pounds per square inch gauge [psig]) steam or 207 kpa (30 psig) hot water, with an output capacity above 1 megawatt (3.5 million British thermal units per hour [MMBTUH]), or 100 boiler horsepower. The logs should provide a record of the treatment and test results of boiler water, makeup water, and condensate water. One log can be maintained for each boiler and one for the plant makeup water data.

1-1.9.2.2 **Cooling Towers.** Maintain operating logs on-site for all operating cooling towers, and those logs should contain results (including dates) of all chemical tests performed, calculated cycles of concentration (COC), and the amount of chemicals added.

1-1.9.2.3 **Other Systems.** Maintain operating logs on-site for low-pressure steam boilers, high-temperature hot water boilers, medium-temperature hot water boilers, low-temperature water boilers, and closed chilled water systems. These logs should contain results (including dates) of all chemical tests, amount of chemicals added, and the volume of blowdown water, where applicable.

1-1.9.3 **Historical Records.** Information pertaining to the maintenance and history of industrial water treatment, other than that which can be entered on the log form or data accumulated for log form entries, can be maintained for each system in a computerized maintenance management system, a separate computer application, or as a hardcopy historical record book. Hardcopy records should be letter size (216 millimeters x 279 millimeters, 8.5 inches by 11 inches) or larger, and can be entered into a bound book rather than a loose-leaf binder. Records should contain information (including dates) about system start-up and shut-down, occurrences of corrosion and scale, major maintenance activities performed on the system, replacement of piping and equipment, accidents, outages, changes in method of operation and treatment used, and other pertinent data, including equipment inspection results logs.

1-1.10 Support Available

1-1.10.1 **Boiler and Cooling Water Quality Assurance (QA) Program.** Submit heating or cooling system water samples to a laboratory for analysis in accordance with an appropriate water QA and quality control (QC) program. The purpose of QA is to verify that applied treatment chemicals, control limits, and external treatment are appropriate. QA is used to assist operators and managers to achieve accurate in-plant chemical testing and control. The primary purpose for a QA/QC program is to ensure and verify that the in-plant test results represent accurately tested and reported concentrations of water treatment chemicals. If the QA/QC procedures are in error or are not followed, or if the test results are not accurate, the consequences are reduced safety, possible damage to the equipment, and wasted energy, chemicals, and water.

1-1.10.2 **Other Support.** Matters pertaining to military policy, requests for technical staff visits to troubleshoot industrial water systems, training of water treatment personnel, and general technical questions can be addressed to the appropriate military office.

U.S. Army Corps of Engineers
441 G. Street, NW
Washington, D.C. 20314-1000

HQ AFCEA/CESM
139 Barnes Drive, Suite 1
Tyndall AFB, FL 32403-5319

U.S. Navy
Utilities Systems Branch Code 231
Naval Facilities Engineering Service Center
1100 23rd Ave.
Port Hueneme, CA 93043-4370
Comm (805) 982-3540

Also see Naval Facilities Instruction (NAVFACINST) 11300.37a.

1-2 **INDUSTRIAL WASTEWATER.** "Industrial wastewater" is a term that refers to any water discharged from an industrial water system. This term applies primarily to cooling tower and steam boiler blowdown; the term also applies to discharged industrial process water (e.g., plating wastes).

1-2.1 **Disposal Procedures.** Coordinate the treatment and disposal of liquid and solid (sludge) wastes from industrial systems with the installation environmental engineer.

1-2.1.1 **Water Discharge Pretreatment.** Pretreatment of water discharge refers to a treatment procedure that is applied to water before it is discharged to the storm water system, the sanitary sewer system, or the base industrial wastewater treatment

system. The installation environmental engineer is usually the individual responsible for determining when pretreatment is required and which methods will be used.

1-2.1.2 **Water Discharge Restrictions.** The discharge of industrial water treatment system wastes may be regulated. All requirements can be established by working with the installation environmental engineer. The primary restriction is water quality. In addition to water quality restrictions, the discharge may be controlled in the following ways:

1-2.1.2.1 **Discharge Location.** The location of the discharge can be determined by the configuration of both the water treatment system and the available sewers. Normal practice at the installation may include discharge into either the sanitary or industrial wastewater treatment system.

1-2.1.2.2 **Discharge Rate.** The maximum rate of discharge to the designated sewer system may be a discharge requirement. Two factors are of importance in setting a maximum rate: the hydraulic capacity of the sewer and the strength (chemical concentration) of the waste.

1-2.1.2.3 **Discharge Time.** Discharge from a water treatment system unit may be allowed only at specified times.

1-2.1.2.4 **Discharge Responsibilities.** The water treatment system operator is responsible for complying with the procedures and policies established at the installation, including directives on waste disposal that have been issued by the installation environmental engineer. The responsibilities of the installation environmental engineer include compliance of the installation's directives with government environmental regulations.

1-2.1.2.5 **Review of Chemicals.** The installation environmental engineer should review the procedures for use of a new water treatment chemical to determine whether or not it can be safely disposed of using the existing procedures, or if new disposal procedures must be developed.

1-2.2 **Environmental Regulations.** Numerous environmental regulations established by law may apply at the installation level. Current regulatory information is available from the installation environmental engineer.

1-2.2.1 **The Toxic Substances Control Act.** The Toxic Substances Control Act (TCSA) authorizes the United States Environmental Protection Agency (EPA) to control all new and existing chemical substances that have been determined to pose a potential unreasonable risk to the public health or environment.

1-2.2.2 **The Clean Water Act.** The Clean Water Act (CWA) incorporates the Federal Water Pollution Control Act and amendments. The CWA establishes limits for the discharge of pollutants to navigable waters, provides regulation of specific toxic

pollutants in wastewater discharges, and provides requirements for the control of oil and hazardous substance discharges.

1-2.2.3 **The Safe Drinking Water Act.** The Safe Drinking Water Act provides for protection of underground sources of drinking water and establishes primary and secondary drinking water standards. These standards are available from the installation environmental engineer.

1-2.2.4 **The Federal Insecticide, Fungicide and Rodenticide Act.** The Federal Insecticide, Fungicide and Rodenticide Act requires that all pesticides be registered with the EPA. This requirement includes microbiocides used for cooling system treatment.

1-2.2.5 **The Resource Conservation and Recovery Act.** The Resource Conservation and Recovery Act (RCRA) addresses the control of solid waste. Hazardous wastes are defined in the RCRA and are controlled by use of a complex manifest system that is designed to track waste from its generation to final disposal.

1-2.2.6 **The Occupational Safety and Health Act.** The Occupational Safety and Health Act establishes health and safety requirements for the workplace, including handling and labeling requirements, safety precautions, and exposure limits to workplace contaminants.

1-2.2.7 **The Comprehensive Environmental Response, Compensation and Liability Act.** The Comprehensive Environmental Response, Compensation and Liability Act (CERCLA), also commonly referred to as "Superfund," establishes the responsibilities and procedures for the response to, and control of, existing uncontrolled hazardous waste sites.

1-2.2.8 **The Code of Federal Regulations.** The Code of Federal Regulations (CFR) Title 21, Part 173.310, *Boiler Water Additives*, limits use of neutralizing amines and filming amines with the goal of maintaining indoor air quality standards.

1-2.3 **Container Management Policy.** The military may not accept responsibility for disposal of water treatment chemical containers. Companies that have been contracted to provide chemicals will use containers that are either reusable or returnable at the contractor's cost. The containers remain the property of the contractor. All container systems are required to have secondary containment of the contents.

1-3 **REFERENCES.** Appendix A contains a list of references used in this UFC.

CHAPTER 2

MAKEUP WATER

2.1 **MAKEUP WATER FOR INDUSTRIAL WATER SYSTEMS.** Industrial water systems at most United States Government installations use fresh water and, often, potable water. Makeup water, often referred to as “makeup,” is fresh water that is added to an industrial water system to replace water lost by blowdown, evaporation, wind drift, leaks, steam, humidification, or withdrawal from these systems.

2-1.1 **Sources of Makeup Water.** The usual source of makeup water is the installation's potable water supply. This source is water that has been conditioned and is usually of a very uniform quality from day to day. Other sources of makeup water could include groundwater obtained from shallow or deep wells, or surface water from streams or holding ponds. These sources are not treated to the extent that the potable water source is treated. Still another source is reuse water (i.e., water that is “used” and reclaimed and not rated as potable).

2-1.1.1 **Groundwater.** The term “groundwater” refers to subsurface water, such as that obtained from wells or artesian springs. This water contains a high amount of dissolved minerals and is often consistent in quality, although it may vary with the seasons of the year and the conditions of the aquifer from which the water is drawn. Treating groundwater can improve its quality.

2-1.1.2 **Surface Water.** The term “surface water” refers to water found in rivers or lakes. Surface water may vary in quality with the seasons of the year or local weather conditions, with higher turbidity and SS possible during rainy weather. Treating these waters prior to use can make the quality more uniform, depending on the type of treatment.

2-1.1.3 **Reuse Water.** Reuse water is any water that has been previously used. Reuse water helps conserve the precious limited supply of fresh water since less fresh water is needed for an intended use. Treated municipal wastewater is a type of reuse water and can be a source of makeup. In addition to the natural impurities of a fresh water source, municipal wastewater usually contains ammonia, phosphate, and other byproducts of the waste treatment process. These impurities are factors that affect the usability of reuse water. Other examples of reuse water include cooling tower and boiler blowdown, softener rinse water, plating water effluent, condensate, and reverse osmosis (RO) reject water. Examine each type and source of reuse water and establish its suitability prior to use.

2-1.1.4 **Source Selection Factors to Consider.** Industrial water systems will operate more effectively if the source for water is both reliable and (ideally) uniform in quality. A backup water source should be available for use in case of need.

2-1.2 Reasons and Criteria for Treating Makeup Water

2-1.2.1 **Reasons for Treating Makeup Water.** Makeup water is treated to remove or reduce the concentration of any unwanted impurity, including impurities that will cause corrosion, create a deposit or scale in the system, or otherwise interfere with the operation of the industrial water system or limit the use of the original water. The process of treating makeup water often results in water conservation, which minimizes the chemical treatments in terms of frequency and amount of use and the resulting cost.

2-1.2.2 Criteria for Treating Makeup Water

2-1.2.2.1 **Makeup Water for Cooling Tower Systems.** To allow the system to operate at a minimum of 3 COC, the makeup water needs to be of a minimum standard of quality. Pretreatment of makeup water for cooling towers is not required if the levels of impurities in the water are not excessive. Refer to Chapter 4 for factors limiting COC, including mineral limitations.

2-1.2.2.2 **Makeup Water for Steam Boilers.** The quality requirement for makeup water often necessitates using water softeners (zeolite or ion-exchange units) to remove water hardness before use. Dealkalizers can be used to remove alkalinity. High-quality steam applications require demineralization or RO, or both. Refer to Chapter 3 for treatment requirements.

2-1.2.2.3 **Makeup Water for High-Temperature Hot Water Systems.** The makeup water for high-temperature (177 °C [350 °F]), high-pressure hot water systems should be softened when its total hardness exceeds 10 parts per million (ppm) as calcium carbonate (CaCO₃). See Chapter 5 for specific requirements.

2-1.2.2.4 **Other Systems.** Soften the makeup water for chilled water systems and for dual-purpose (hot and chilled) systems if its total hardness exceeds 250 ppm (as calcium carbonate [CaCO₃]). For hot water boilers, treat makeup water with sodium sulfite and caustic soda, and soften makeup water used for diesel jacket systems if the total hardness of the raw makeup water exceeds 50 ppm (as CaCO₃). Refer to Chapter 5 for specific requirements.

2-1.2.3 **Measurement of Makeup Water Rates.** Knowing the use rates of makeup water is essential for calculating proper operating data on cooling towers and steam boilers. You may estimate makeup water use rates by recording the time it takes to fill a container of known volume with water obtained from a blowdown line or, preferably, measured with an appropriately sized makeup meter to provide more accurate values. Filling a container is not a recommended method for measuring hot water streams such as boiler blowdown.

2-2 **MAKEUP WATER TREATMENT METHODS.** Treatment of industrial makeup water is a process of external water treatment. External treatment involves the treatment, by various processes, of makeup water to remove or reduce hardness, alkalinity, dissolved gases, or other impurities before the water enters the water system

(e.g., steam boiler, cooling tower, closed hot water system or chilled water system). This process of external treatment is often referred to as “pre-treatment.” In contrast, internal treatment involves the treatment of water directly within the water system. Both external and internal treatment methods may be used in a given system.

2-2.1 **External Treatment.** External treatment equipment processes and water treatment chemicals reduce or remove impurities contained in the makeup water before the impurities in the water stream enter the internal system. The most effective way to protect the system, reduce boiler problems, and improve operating efficiency is to use a process of removing impurities before they enter a system, particularly a steam boiler. The required treatment methods and equipment are determined by the specific type and amount of impurities that must be reduced or removed from the makeup water. Table 2-1 lists the various external treatment methods that are available to remove the typical impurities found in makeup water. Figure 2-1 illustrates the effects of these treatment methods on raw water.

The treatment process may be applied to only a portion of the makeup water, in which case the treated water is then blended with raw (untreated) water to achieve a specific quality. Treatment involving this type of blending is known as “split-stream” treatment. Split-stream treatment may also involve the blending of two different treated waters to achieve a specific quality. Paragraphs 2-2.2 through 2-2.10 briefly describe external treatment methods. External water treatment is required only for steam boilers and high-temperature hot water systems, but its use may be justified for other industrial water systems as well. Although several types of treatment may be available, government installations most commonly use sodium zeolite softening (ion exchange) for treating makeup water. Table 2-2 provides a guide for selecting external treatment methods/equipment for steam boilers.

Table 2-1. Makeup Water Treatment Methods for Removing Impurities

Impurity	Removal/Reduction Method
Hardness (calcium & magnesium)	Sodium ion exchange Hydrogen ion exchange Lime-soda softening Evaporators RO Electrodialysis
Alkalinity (bicarbonate & carbonate)	Lime-soda softening Hydrogen ion exchange (followed by degasifying) Dealkalization (chloride ion exchange)
SS/turbidity	Filtration/clarification
Dissolved solids	Demineralization (deionization) Evaporators RO Electrodialysis
Dissolved iron	Aeration (converts to precipitated iron), then filtration Sodium ion exchange (iron will foul the resin)
Dissolved gases (carbon dioxide, hydrogen sulfide, methane)	Aeration Degasifying

Figure 2-1. Effects of Treatment on Raw Water

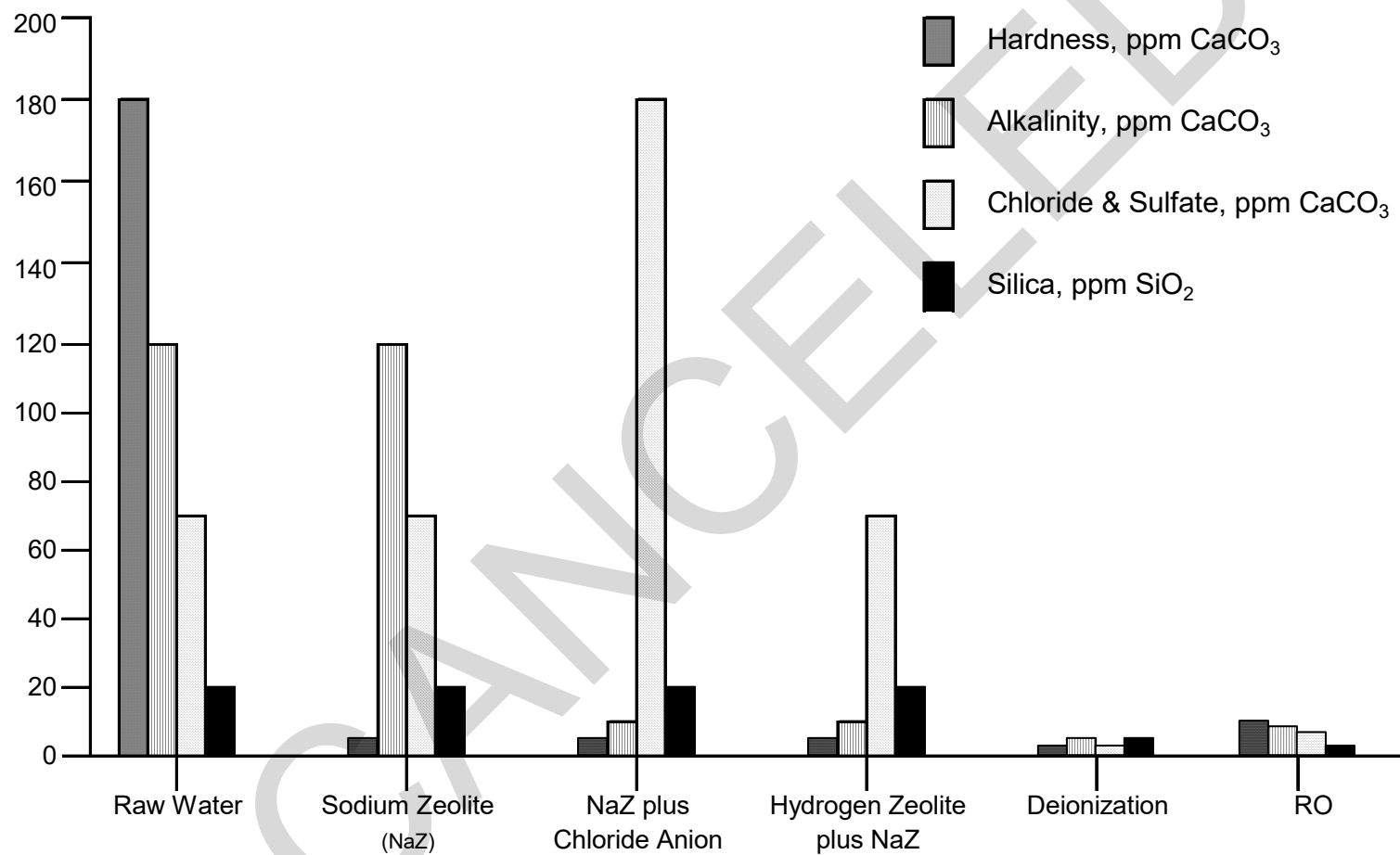

Table 2-2. External Treatment Equipment Selection Guide for Steam Boiler Makeup Water

Makeup Rate l/sec (gpm)	Steam Pressure KPa (psig)	Alkalinity (ppm CaCO ₃)	Turbidity	Recommended External Treatment Equipment
All	< 103 (< 15)	All	< 10	Normally internal treatment only
			> 10	Filtration plus internal treatment
< 6.3 (< 100)	103-138 (15-200)	< 75	< 10	Sodium zeolite
			> 10	Filtration plus sodium zeolite
		> 75	< 10	1. Sodium zeolite plus hydrogen zeolite 2. Sodium zeolite plus chloride/anion exchange 3. Hydrogen zeolite
			> 10	1. Filtration plus sodium zeolite plus hydrogen zeolite 2. Hydrogen zeolite
	138-448 (200-650)	< 35	< 10	Sodium zeolite
			> 10	Filtration plus sodium zeolite
		> 35	< 10	1. Sodium zeolite plus hydrogen zeolite 2. Demineralization
			> 10	1. Filtration plus sodium zeolite plus hydrogen zeolite 2. Filtration plus demineralization
> 6.3 (> 100)	103-138 (15-200)	< 75	< 10	Sodium zeolite
			> 10	1. Filtration plus sodium zeolite 2. Hot-lime soda
		> 75	< 10	Sodium zeolite plus hydrogen zeolite
			> 10	1. Filtration plus sodium zeolite plus hydrogen zeolite 2. Filtration plus demineralization
	138-448 (200-650)	All	< 10	1. Sodium zeolite plus hydrogen zeolite 2. Demineralization
			> 10	1. Filtration plus sodium zeolite plus hydrogen zeolite Filtration plus demineralization Hot-lime hot-sodium zeolite
All	> 448 (> 650) (normally super-heated)	All	< 10	Demineralization
			10-400	Filtration plus demineralization
			> 400	1. Filtration plus demineralization 2. RO 3. Electrodialysis

NOTES:

1. Table 2-2 provides only general guidelines. The final choice of treatment system must be based upon complete raw water analysis, feedwater requirements, and overall economics, including both external and internal treatment and blowdown. External treatment may be necessary to reach recommended levels of total dissolved solids (TDS) without exceeding other parameter limits for causticity, silica, or SS.
2. Separate deaeration is required for all boilers with pressure over 0.103 megapascal (15 pounds per square inch gauge), except where lime-soda softeners are designed to provide adequate deaeration as well as softening.
3. Degasification is required after hydrogen zeolite treatment.
4. The filtration process may require clarification and aeration.

2-2.2 **Aeration.** Well water can contain high levels of dissolved iron (1 to 5 ppm). Although this quantity of dissolved iron may seem small, it can produce excessive precipitates when the iron comes in contact with air. If these precipitates are deposited in system lines, they will restrict flow and heat transfer. Soluble iron can be removed by filtration after contact with air (aeration), a process that causes the soluble iron to be converted by oxidation to insoluble iron, which then precipitates. Aerators are designed to mix air and makeup water in equipment that contains slats or trays to provide thorough mixing (i.e., aeration of the water). They are usually of the coke tray or wood slat design. Coke tray aerators consist of a series of coke-filled trays through which the water percolates. A forced-draft fan supplies air for aeration during the percolation process, with the water free falling from one tray to the next. Wood slat aerators are similar to small atmospheric cooling towers with staggered slats to break the free fall of the water and thereby increase the surface contact with air. Wood slat aerators can also be equipped with a forced-draft fan to increase efficiency. In addition to oxidizing iron, aeration can also strip or remove dissolved gases such as carbon dioxide, hydrogen sulfide, and methane. Aerators also contribute to a reduction in dissolved manganese by causing it to be oxidized to an insoluble salt.

2-2.3 **Filters and Filtration.** A variety of filters can remove particles in a wide range of sizes, from course to very fine. These solids or particles may include soluble iron that has been precipitated, residual calcium carbonate particles, sand, dirt, debris, and some microbiological organisms.

2-2.3.1 Sand Filters

2-2.3.1.1 **Sand Filter Description.** A sand filter is a bed of sand (or anthracite coal) located below a set of distribution headers and resting on a support layer of coarse rock. The collection header, through which the clarified water is drawn, is situated below the sand filter. Water flows downward through the filter bed, either due to gravity or by applied pressure.

2-2.3.1.2 **Method of Action.** The sand or anthracite acts as a support bed for a layer of SS laid down on top of the bed as a result of the filtering process. This layer of deposited solids, formerly SS, does most of the actual removal of solids from the water and is known as the filter cake.

2-2.3.1.3 **Filter Cycle.** As the thickness of the filter cake builds up, the water flow decreases and the backpressure increases. When the flow rate becomes too low or the back-pressure too great, the water flow can be reversed, with the filter cake then being backwashed with the wash water to a waste collection point. The filter is then returned to service and the cycle is repeated.

2-2.3.1.4 **Sand Filtration Rates.** Sand filtration rates are typically 2 liters per second per square meter (3 gallons per minute per square foot). Backwash rates are 8.1 to 10.2 liters per second per square meter (12 to 15 gallons per minute per square foot) for sand filters and 5.4 to 8.1 liters per second per square meter (8 to 12 gallons per minute per square foot) for anthracite filters. A variety of filter types are available.

2-2.3.2 **Cartridge and Bag Filters.** Cartridge and bag filters are available in various mesh and pore sizes, which determine the size of the particles removed.

2-2.3.3 **Centrifuge Separators.** Centrifuge separators represent still another way to remove suspended materials by passing water through a centrifuge chamber where particles are removed due to density instead of size. Using separators is limited to removing very small particulates. An advantage of separators is that they do not require backflushing or change-outs of filter cartridges or bags.

2-2.4 **Lime-Soda Softening.** The lime-soda process is often used for treating large volumes of water (i.e., 37,850 liters per day [10,000 gallons per day] or higher) for potable and industrial uses. The process is used primarily to reduce the levels of hardness and alkalinity, but also to reduce the quantity of silica and SS. The process could be applicable to an entire base or facility; usually this process is not practical for individual small site locations. The process is labor intensive and can produce large amounts of sludge from the precipitated materials.

2-2.4.1 **Method of Action.** The process involves adding hydrated lime (calcium hydroxide) and soda ash (sodium carbonate) to the water in an open reaction tank. The calcium and magnesium concentration is reduced by the resulting precipitation of solids. Bicarbonate and carbonate alkalinity is also reduced, as may be some silica. The sludge

that is formed is allowed to settle for subsequent removal as a watery sludge. The treated water is filtered prior to use as makeup.

2-2.4.2 Cold and Hot Processes. Adding lime and soda ash at ambient temperature is referred to as the “cold lime-soda process.” When lime and soda ash are reacted with the water at temperatures greater than 100 °C (212 °F), the process is called the “hot lime-soda process”. The hot process removes a greater amount of the hardness, alkalinity, and silica from the water than the cold process.

2-2.5 Ion Exchange Process. Several types of ion exchange units are used at military installations. An ion exchange unit is an open or closed vessel containing an ion exchange material, also known as resin, which has been deposited on a gravel support bed. Most ion exchange units operate under pressure, but gravity flow units are also available. Flow rates vary with the type of equipment but are in the range of 4 to 5.4 liters per second per square meter (6 to 8 gallons per minute per square foot of ion exchange material surface). A backup ion exchange unit and a storage tank are typically included to permit an uninterrupted supply of treated water. The manufacturer's recommendations for proper equipment operation should be posted near the softening unit. A typical ion exchange hardness softener unit is illustrated in Figure 2-2. Figure 2-3 shows a typical duplex softener.

Figure 2-2. Typical Ion Exchange Unit

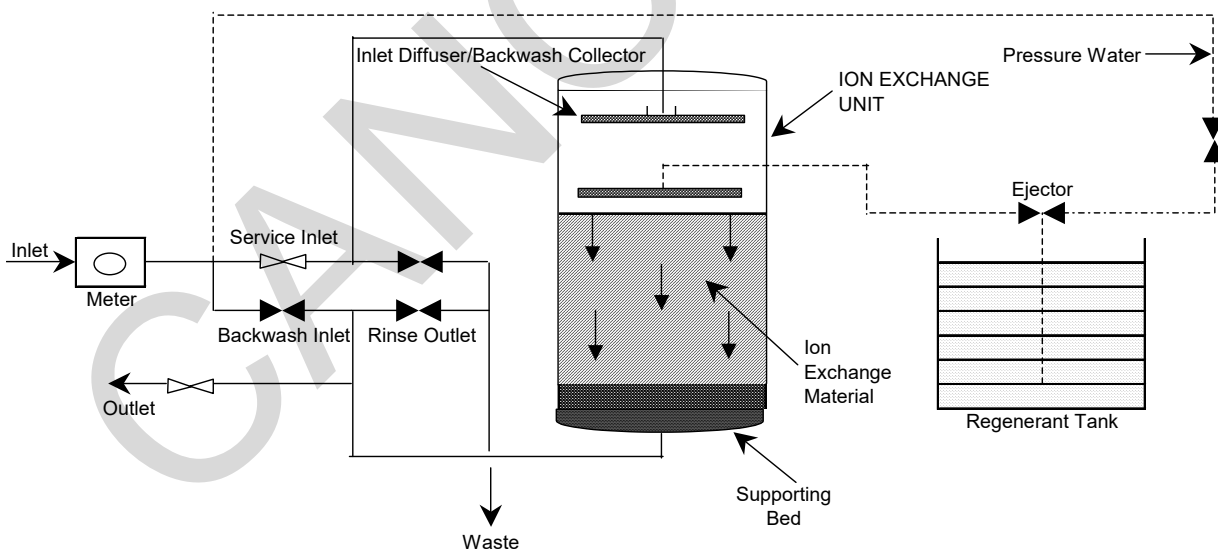
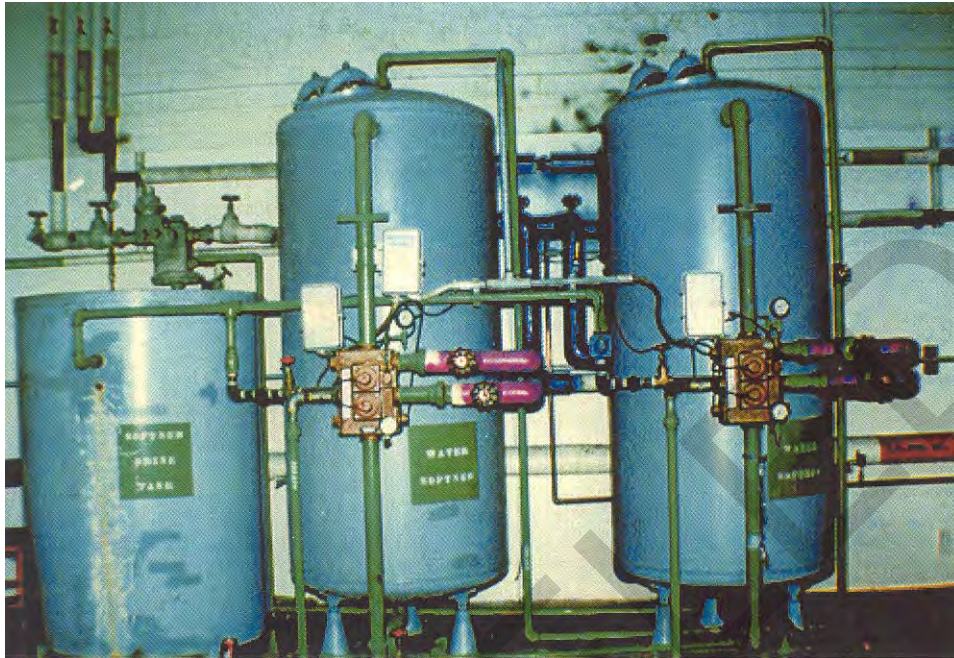

Figure 2-3. Duplex Softener



2-2.5.1 **Sodium Ion Exchange.** The sodium ion exchange process is used on most military installations. It is preferred to other softening processes because the equipment is compact, easy to operate, relatively inexpensive, and produces a makeup that is suitable for use in industrial water systems. This system exchanges (removes) hardness (cations) from incoming water with sodium ions contributed by the sodium chloride (salt) used in regenerating the cation ion exchange resin.

2-2.5.1.1 **Service Cycle.** The normal operating cycle during which hardness is removed from the makeup water flowing through the softener is determined by calculating the amount of water that can be softened by a given ion exchange material. The operator must consider several factors:

2-2.5.1.1.1 **Sodium Ion Exchange Process.** The sodium ion exchange process depends upon the exchange of sodium ions in either the zeolite material or synthetic ion exchange resins (whichever is used) for calcium and magnesium ions in the makeup water, as shown below:

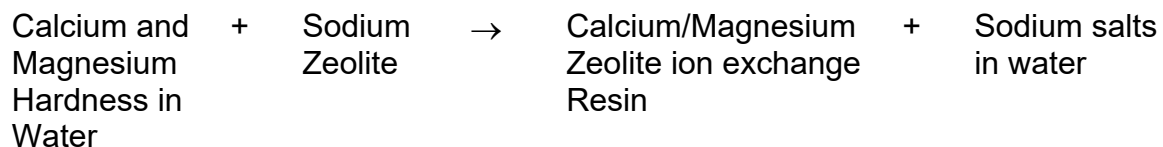

2-2.5.1.1.2 **Water Softener Capacity.** The softening capability or capacity of an ion exchange softener is usually given in units of grains (grams) of total hardness of calcium carbonate (CaCO_3). The operator needs to know how much water can be softened before regeneration is necessary. The volume of water that can be softened

between regeneration cycles is determined by the softener capacity and the hardness in the water. See the example calculations below.

English Units

The maximum capacity of the ion exchange softener is 2,000,000 grains. The water being treated has 257 ppm total hardness. If the softener regenerations cycle is set for maximum capacity, how many gallons of water can be softened before the softener must be regenerated?

$$\begin{aligned}
 \text{Removal} &= \frac{\text{Capacity, grains} \times 17.12}{\text{Total hardness, ppm, in raw water}} \\
 &= \frac{2,000,000 \text{ grains} \times 17.12 \text{ ppm/1 grain per gallon}}{257 \text{ ppm}} \\
 &= 133,230 \text{ gallons}
 \end{aligned}$$

Metric Units

$$\begin{aligned}
 &2,000,000 \text{ grains} \times (1 \text{ pound}/7,000 \text{ grains}) \times (453.6 \text{ grams}/1 \text{ pound}) \\
 &= 129,600 \text{ grams}
 \end{aligned}$$

$$\begin{aligned}
 \text{Removal} &= \frac{\text{Capacity, grams} \times 1000 \text{ mg/gram}}{\text{Total hardness, ppm (mg/liter), in raw water}} \\
 &= \frac{129,600 \text{ grams} \times 1000 \text{ mg/gram}}{257 \text{ ppm (mg/liter)}} \\
 &= 504,280 \text{ liters}
 \end{aligned}$$

Thus, for a softener with a rated capacity of 2,000,000 grains (129,600 grams), 133,230 gallons (504,280 liters) of water, with 257 ppm total hardness, can be softened between regeneration cycles.

2-2.5.1.2 Regeneration Cycle. Regeneration of the ion exchange resin refers to replacement of the calcium/magnesium hardness that has accumulated on the ion exchange resin as a result of the exchange with sodium ions. The regeneration cycle is a process involving a number of steps during which the softener is taken off-line and backwashed. The resin is regenerated by treatment with a strong solution of salt (sodium chloride) and then rinsed.

When the exhausted ion exchange resin material is washed with a strong sodium chloride salt solution (brine), the resin is regenerated by the hardness (calcium and magnesium ions) being exchanged for sodium ions.

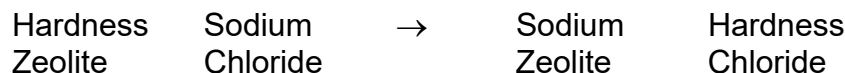

The completeness of the regeneration is dependent upon the strength of the salt solution (brine) used and the length of time the solution is in contact with the resin. After the resin is regenerated, it can be used again and again (after regeneration) to continue to remove hardness from water. The following procedure is typical for an ion exchange resin regeneration process.

2-2.5.1.2.1 Backwash. Before the exhausted resin bed is regenerated, it must be backwashed by flowing water from bottom to top. The flow rate must be adequate to remove any solids that have been caught on top of the bed. The resin bed volume will also be expanded by about 50% due to the backwash flow; the volume of expansion will be dependent upon the flow rate. The backwash flow rate should be controlled so that it will not sweep ion exchange resin out of the softener to the waste collection area. A backwash rate of 2.72 to 4.07 liters per second per square meter (4 to 6 gallons per minute per square foot) of bed surface for about 10 minutes is normal, but the manufacturer's recommendations should be followed.

2-2.5.1.2.2 Brining. Next comes the addition of salt, a process known as "brining." A 10% (by saturation) solution of sodium chloride salt brine is slowly added with a down-flow rate of 1.11 to 2.22 liters per second per cubic meter (0.5 to 1 gallon per minute per cubic foot) of bed volume for about 30 minutes. Rock salt is preferred to granulated salt as a brining salt because it is equally as effective, less expensive, and less prone to cake. Some installations may start with a solution of concentrated or saturated brine, which must be diluted before use in the brining step. The salt required and the capacity regenerated is shown for a typical resin in Table 2-3; however, the manufacturer's instructions should be followed, if available.

Table 2-3. Salt Required for Regeneration of a Commonly Used Cation Resin

Salt Use per liter of Ion Exchange Material kg/m ³ (lb/ft ³)	Capacity of Ion Exchange Material g Hardness/m ³ (gr/ft ³)
80 (5.0)	43,450 (19,000)
120 (7.5)	55,130 (24,000)
160 (10.0)	61,615 (27,000)
240 (15.0)*	73,290 (32,000)*

* Practical upper limit for exchange capacity. This upper limit and the actual dose per capacity relationship may vary with the resin; the manufacturer's instructions should be followed.

2-2.5.1.2.3 Slow Rinse. A slow rinse follows the brining step and is performed at the same rate as the brining step. The rinse is performed with downflow through the softener. One to 3 bed volumes of fresh water are used to remove most of the excess

sodium and hardness brine from the bed. The volume of fresh water is equal to 1000 to 3000 liters per cubic meter (7.5 to 22.5 gallons per cubic foot) of bed volume.

2-2.5.1.2.4 **Fast Rinse.** In the last step, a fast rinse is used, also with downflow, to remove any traces of the sodium and hardness brines. This is done at a rate of 200 to 270 liters per minute per cubic meter (1.5 to 2 gallons per minute per cubic foot) of bed volume until the discharge is free of hardness; 4690 to 13,400 liters per cubic meter (35 to 100 gallons per cubic foot) of bed volume is required. The unit is now ready for another service cycle.

2-2.5.1.3 **Testing and Record Keeping.** Influent water should be tested for hardness on a weekly basis. The softener effluent water should be tested for hardness on a daily basis, every shift (3 times a day), or as required for systems that require frequent (1 to 3 days) or less frequent regeneration. Accurate records should be kept of these tests, including recording the number of liters (gallons) of water that have been treated during each service cycle, and the amount of salt that was used during each regeneration cycle.

2-2.5.1.4 **Operating Problems.** Several common problems are sometimes encountered during softener operation:

2-2.5.1.4.1 **Resin Fouling.** A normal decrease in exchange capacity due to resin fouling is about 5% per year. Any decrease greater than this should be investigated and the reason determined.

2-2.5.1.4.2 **Fouling Due to Iron.** A common cause of loss of capacity is resin fouling by iron salts. Soluble iron will exchange for sodium during the service cycle, but sodium will only be incompletely exchanged for iron during the regeneration cycle. There is a simple test to determine iron fouling: a pinch of iron-fouled ion exchange material added to a 10% hydrochloric acid solution in a test tube will cause the hydrochloric acid to turn yellow, indicating the presence of iron.

Iron-fouled resin can be returned to design capacity by cleaning with dilute hydrochloric acid, sodium bisulfite, or special resin cleaners. Specific procedures are required.

NOTE: The softener manufacturer's recommendations should be consulted before using this acid cleaning procedure, including those prohibiting acid procedures with a galvanized or unlined steel tank. To use acid procedures, the tank must be constructed of reinforced plastic or rubber, or must be plastic-lined with no breaks in the lining.

2-2.5.1.4.3 **Improper Backwash.** Improper backwash is another common problem. A backwash rate that is too high can result in the ion exchange material being washed out of the unit. The bed depth can be measured by carefully probing to the underdrain support bed. Normal bed depth is usually 0.75 to 1 meter (30 to 36 inches). The bed volume in cubic meters (cubic feet) can be calculated by the following formula:

$$\text{Volume, m}^3 = (\text{Radius, m})^2 \times (\text{Depth, m}) \times 3.14$$

Check the bed depth at 10 points and use the average value. If there is much difference (15% or more) in the thickness of different points, channeling may be occurring. Channeling can be caused by too low a backwash rate.

If the calculated bed volume is less than the volume given by the manufacturer, material has been lost during the backwash step. The lost material should be replaced and the backwash rate carefully controlled to ensure material is not being washed out. If the cause of the unit's performance problem or deficiency cannot be determined, the manufacturer's service representative should be consulted.

2-2.5.1.4.4 Resin Replacement. The resin in the ion exchanger should be replaced when either the resin capacity or the softening efficiency has decreased by 25% and cannot be restored by cleaning and by following the specific procedures recommended by the manufacturer. Based on a normal decrease of 1 to 5% per year, the typical ion exchange resin should last from 5 to 25 years. With good operation, the average service life is 8 to 10 years.

2-2.5.2 Hydrogen Ion Exchange. The hydrogen ion exchange process is essentially the same as the sodium ion exchange process except that the regenerant chemical is an acid (sulfuric or hydrochloric) rather than a salt. The hydrogen ion exchange process will reduce both the amount of the total dissolved solids and the alkalinity of the treated water. During operation of the hydrogen cycle softener, it is necessary to check the outlet (softened) water at regular intervals. The hardness of the outlet water should always be less than 1 ppm. The ion exchange resin must be regenerated if the hardness exceeds 1 ppm. This check can be performed daily, once per shift, or as required depending on unit capacity.

2-2.5.2.1 Exchange Process. Resins exchange calcium, magnesium, sodium and all cations with hydrogen ions.

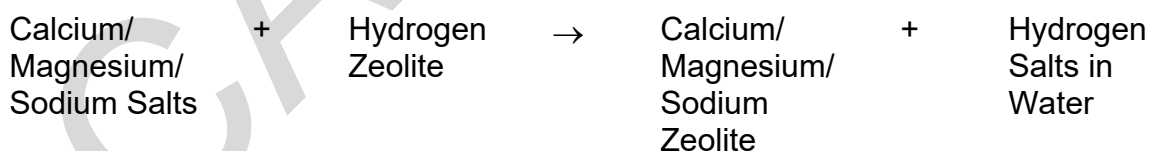

The hydrogen salts are acidic and will react with alkalinity to produce carbon dioxide and water. To provide for effective operation, the carbon dioxide must be removed after leaving the vessel by other means.

2-2.5.2.2 Regeneration Method. The spent ion exchange material is regenerated by contact with dilute acid, such as sulfuric acid or hydrochloric acid.

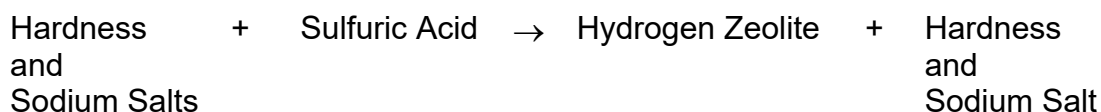

Adding sulfuric acid in several steps of increasing strength, such as 2, 4, 6 percent are required for sulfonated styrene resins if fouling of the exchange resin with calcium sulfate is to be avoided.

2-2.5.2.3 Equipment Requirements. The hydrogen ion exchanger is much the same as the sodium ion exchanger, except that all equipment must be made of, or lined with, acid-resistant material.

2-2.5.2.4 Regeneration Cycle. The regeneration cycle is much the same as that for the sodium ion exchanger, except that sulfuric acid is used instead of salt. To improve efficiency, regeneration of hydrogen ion exchangers is commonly done counter-currently. During operation of the hydrogen cycle softener, it is necessary to check the outlet (softened) water at regular intervals. The hardness of the outlet water should always be less than 1 ppm. The ion exchange resin must be regenerated if the hardness exceeds 1 ppm. This check can be performed daily, once per shift, or as required depending on unit capacity. Available information on safety and first aid should be reviewed before using sulfuric acid. Chemical handling and safety instructions should be posted near sulfuric acid equipment. Sulfuric acid is corrosive to skin, eyes, clothing, and other materials. Hydrochloric acid should be used with the same precautions. See paragraph 7-4 for chemical safety information.

2-2.5.2.5 Troubleshooting. Troubleshooting is much the same as for sodium ion exchange, although iron fouling does not occur in hydrogen ion exchangers since the acid removes iron from the resin.

2-2.5.2.6 Effluent Water Properties. The hydrogen ion exchange effluent water is acidic and cannot be used directly. The water can be mixed with the outlet of a sodium ion exchanger with the result that the acid in the hydrogen ion exchange water will be neutralized to some degree and, at the same time, the degree of alkalinity in the sodium ion exchange water will be lessened. The proportion of the effluent waters to be mixed is dependent upon the analysis of the water being treated, but typically the proportion is approximately one-to-one (half-and-half). The testing of blended water should be done prior to blending to assure that the blended water is satisfactory for use in the boiler or cooling water system. If neutral (pH 7) water is required, a chemical (such as sodium hydroxide) must be added.

2-2.5.2.7 Carbon Dioxide Production. Carbon dioxide is produced during the hydrogen ion exchange process and is also produced when the effluent water from hydrogen and sodium ion exchange is mixed. It is removed from the water in a decarbonator (degasifier or deaerator).

2-2.5.3 Demineralization. Sodium and hydrogen ion exchangers remove only the positively charged ions (cation exchange - i.e., calcium, magnesium, and sodium). Other ion exchange materials have been developed to remove negatively charged ions (anion exchange - i.e., sulfates, chlorides, and alkalinity). The process of demineralization uses both cation and anion exchange resins to remove all ions from the water, thus producing mineral-free water. A typical deionization (demineralizer)

process is illustrated in Figure 2-4. During operation of the demineralizer, it is necessary to check the outlet water at regular intervals. The TDS of the outlet water should always be less than 1 ppm. The ion exchange resin must be regenerated if the TDS exceeds 1 ppm. This check can be performed daily, once per shift, or as required depending on unit capacity.

Figure 2-4. Demineralization Process

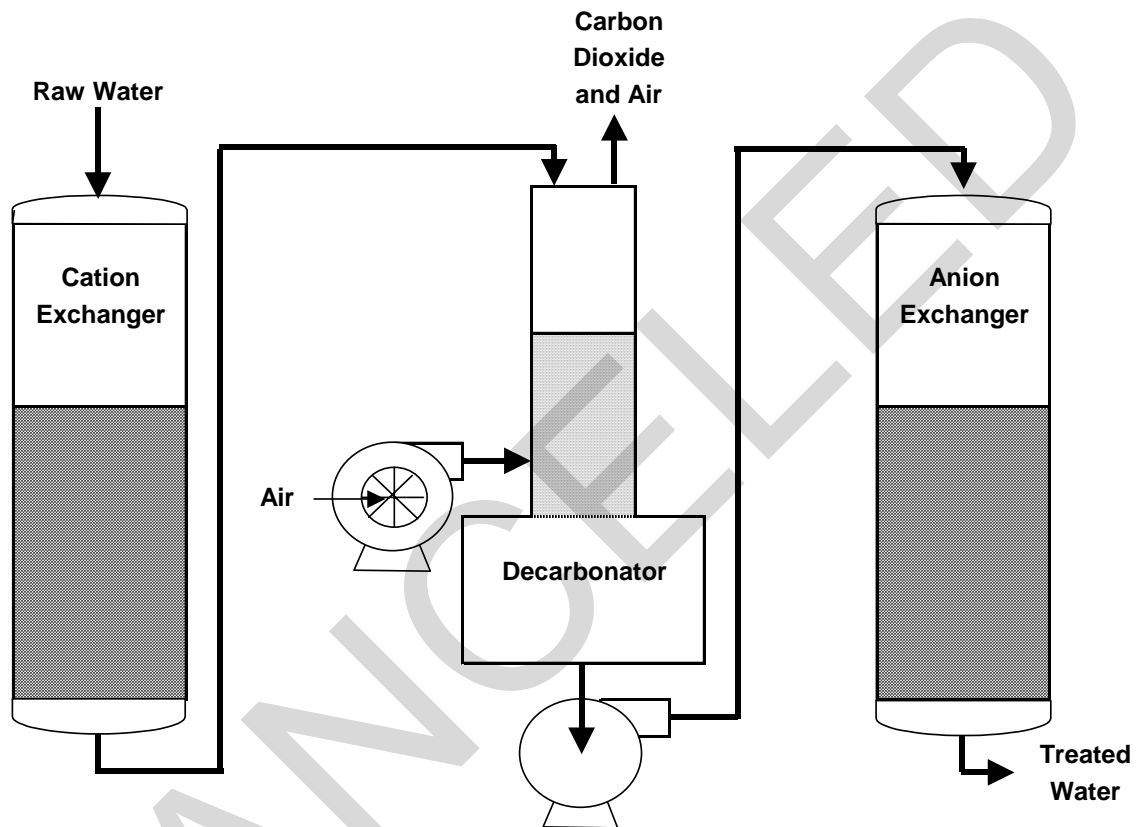

2-2.5.3.1 **Anion Exchange Process.** The hydrogen ion cation exchange process is described in paragraph 2-2.5.2. The anion exchange process involves reactions of hydroxyl-regenerated zeolite with the effluent from the hydrogen ion exchanger:



2-2.5.3.2 **Anion Ion Exchange Regeneration Method.** The spent anion ion exchange material containing chlorides, sulfates, and other anions is regenerated with sodium hydroxide (caustic).

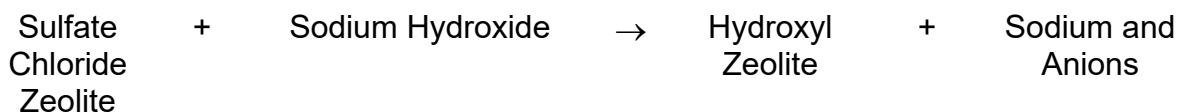

2-2.5.3.3 **Exchange Process Result.** When the anion exchange process is combined with the hydrogen exchange process, the resulting final water will contain no minerals. It has become deionized (also referred to as demineralized) by exchanging all minerals to hydrogen hydroxide, HOH, commonly referred to as water and written as H₂O.

2-2.5.3.4 **Exchange Method.** The two reactions can take place in separate vessels (a “two-bed” deionizer), or the two ion exchange materials can be combined in a single vessel (a “mixed-bed” deionizer).

2-2.5.3.5 **High Silica Waters.** Removal of silica and magnesium beyond what most demineralizers will provide is accomplished through pre-heating of caustic solution used for regeneration. Optimum temperature is 49 °C (120 °F) and should not exceed 60 °C (140 °F), as that temperature can damage the resin; however, few demineralizers are designed for this application.

2-2.5.3.6 **Deionization Process Use.** The deionization process is not used at government installations. It is required mainly for high-pressure boilers or high-purity water use. The deionization process may also be used by the Navy for shore plants providing steam or boiler feedwater to ships.

2-2.5.4 Dealkalization

2-2.5.4.1 **Anion Dealkalization.** It may be necessary to treat water having low hardness and high alkalinity to reduce the alkalinity (bicarbonate and carbonate). The anion exchange process called “anion dealkalization” will remove alkalinity and other anions (i.e., sulfates and nitrates). In most cases, the anion dealkalizer is used following a hardness softener (i.e., it is located downline from the softener) because hardness, if not previously removed, can precipitate in the anion resin bed and cause plugging. Bicarbonate and carbonate (anions) are exchanged for chloride (anion) as illustrated by the following reaction, where “Z” is the zeolite resin material:

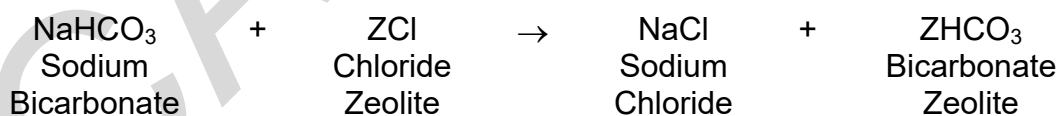

2-2.5.4.1.1 **System Regeneration.** The system is regenerated with sodium chloride (salt) as shown below. The regeneration will be more efficient and effective if the brine used contains about 10% of the salt as caustic.

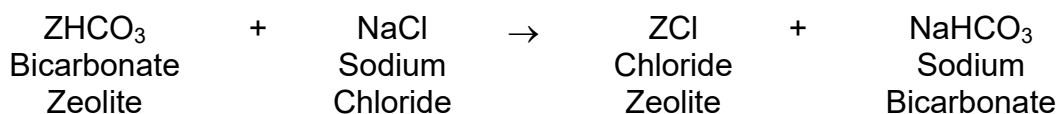

2-2.5.4.1.2 **Equipment and Operation.** The equipment and operation of such a system is much the same as for a sodium ion exchange material system described in paragraph 2-2.5.1. This process is illustrated in Figure 2-5.

Figure 2-5. Anion Dealkalization Process

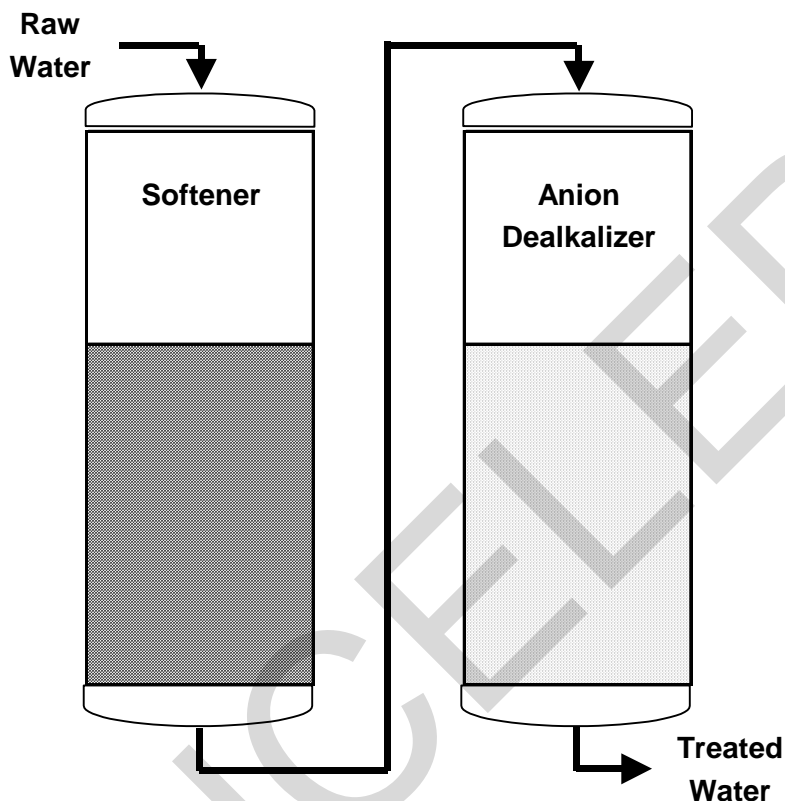

2-2.5.4.2 **Split-Stream Dealkalization.** In a split-stream dealkalization process, the water is split into two parallel streams with one stream passing through a strong acid cation exchanger (dealkalizer) and the other through a sodium zeolite softener. Blending of the two product streams produces a soft water that is low in alkalinity. The alkalinity reduction is described by the following equation, where “Z” is the zeolite resin material:



The carbonic acid dissociates into carbon dioxide (CO₂) and water (H₂O). The water is then passed into a decarbonator (degasifier or deaerator) to remove the CO₂.

2-2.5.4.2.1 **Free Mineral Acid Production.** The strong acid cation exchange resin replaces the sodium, calcium, and magnesium ions with hydrogen ions. Thus, due to the presence of chlorides, sulfates, nitrates, and other anions, free mineral acids (FMA) (i.e., hydrochloric, sulfuric) are produced. Adjustment of the pH level is necessary to balance alkalinity with acidity (FMA) and form neutral water.

2-2.5.4.2.2 **System Regeneration.** The strong acid cation system is regenerated with sulfuric acid as described in paragraph 2-2.5.2.

2-2.5.4.2.3 **Equipment Requirements.** The acid exchanger tank must be made of, or lined with, an acid-resistant material.

2-2.5.4.2.4 **Decarbonator Use.** Since blending the two split streams of finished water also produces CO_2 , a decarbonator (degasifier or deaerator) is normally used to reduce the CO_2 concentration to 5 to 10 ppm or less. A typical split-stream process is shown in Figure 2-6.

Figure 2-6. Split-Stream Dealkalizer

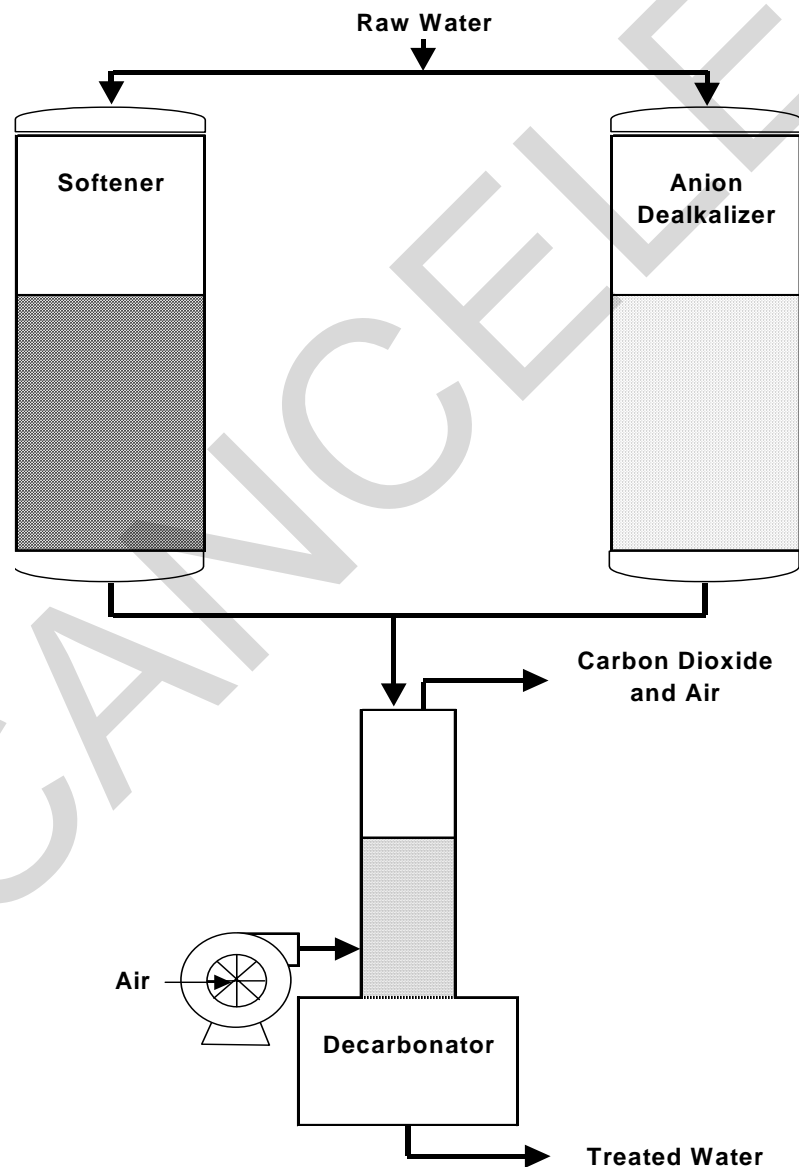

2-2.5.5 **Decarbonation.** Carbon dioxide is produced during hydrogen ion exchange and when the effluent waters from strong acid cation ion exchange and the sodium ion exchange are mixed. Carbon dioxide dissolved in water can cause corrosion in water lines, pump impellers, and vessels. As described in Chapter 3, the carbon dioxide concentration must be kept as low as possible in the boiler feed water and in the water entering steam condensate lines.

2-2.5.5.1 **Methods of Decarbonation.** Free carbon dioxide is commonly removed in a degasifier or aerator (see paragraph 2-2.2). In steam systems and in high-temperature water systems, removal of CO₂ is usually achieved in the deaerator rather than with a separate degasifier unit, although steam systems can have degasifiers.

2-2.5.5.2 **Analysis of Carbon Dioxide Content.** By analyzing the water for the hydrogen ion concentration (pH) and the total (M) alkalinity, the free carbon dioxide content can be calculated (see Table 2-4).

Table 2-4. Carbon Dioxide Content of Water vs. pH

pH	CO ₂	pH	CO ₂	pH	CO ₂
5.4	4.4 M	6.6	0.45 M	7.3	0.099 M
6.0	1.9 M	6.7	0.38 M	7.4	0.079 M
6.1	1.5 M	6.8	0.31 M	7.5	0.062 M
6.2	1.23 M	6.9	0.24 M	7.6	0.050 M
6.3	0.92 M	7.0	0.19 M	7.7	0.040 M
6.4	0.75 M	7.1	0.15 M	7.8	0.033 M
6.5	0.62 M	7.2	0.12 M	7.9	0.026 M

NOTES:

1. At pH levels of 8.0 or higher, the free CO₂ content is negligible.
2. "M" is total alkalinity (as calcium carbonate [CaCO₃]).

EXAMPLE 2-2:

- a) Total alkalinity (M) of an inlet water to a degasifier is 100 ppm and the pH is 6.8.

$$\text{CO}_2 \text{ content} = \text{Value} \times \text{M} = 0.31 \times 100 = 31 \text{ ppm}$$

- b) The outlet pH is 7.9, so the CO₂ content will be (let M = 80, since some alkalinity was removed as CO₂):

$$\text{CO}_2 \text{ content} = 0.026 \times 80 = 2.1 \text{ ppm}$$

c) The carbon dioxide removal is: $31 - 2.1 = 28.9$ ppm

2-2.6 **Evaporators.** In the evaporation process used in evaporators, water is heated to produce relatively pure water vapor that is then condensed to liquid water and used for boiler feed. Evaporators are of several different types. The simplest is a tank of water through which steam coils are passed to heat the water to the boiling point. To increase efficiency, the vapor from the first tank may pass through coils in a second tank of water to produce additional heating. Another type of evaporator operates under a partial vacuum, lowering the boiling point of water and enabling evaporation at lower temperatures. Following its production in the evaporator, water vapor is cooled and becomes liquid water that is essentially pure water, without any dissolved solids. Using evaporators may be economical where inexpensive steam is readily available as the source of heat. Evaporators also have an advantage over deionization units when the dissolved solids in the raw water are very high, such as on ocean-going vessels.

2-2.7 **Reverse Osmosis (RO).** This process is the opposite of osmosis. It produces very pure water by separating dissolved minerals from the water. Water pressure is used to push water through a membrane. The membrane allows only pure water to pass through. Water thus produced is known as RO product water. All dissolved solids, organics, and gases that do not pass through the membrane are removed in the waste stream of RO reject water. Sufficient care must be taken to protect the membrane from deposits, which reduce efficiency or plug the membrane. This RO process is illustrated in Figure 2-7. An RO unit is shown in Figure 2-8.

Figure 2-7. RO Schematic

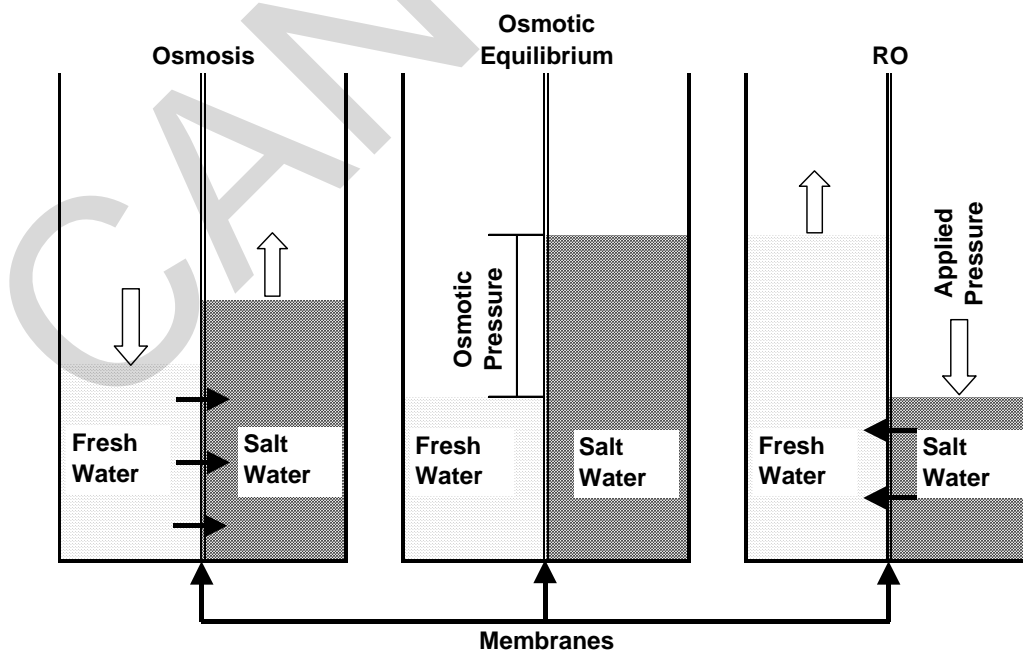
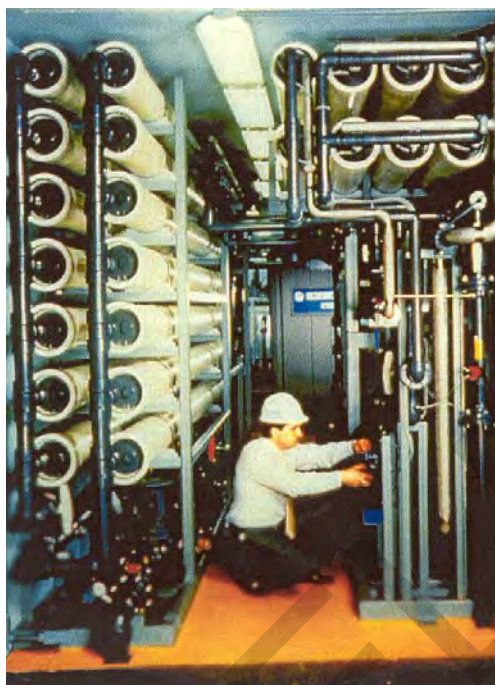

Figure 2-8. RO Unit



2-2.7.1 **RO Pretreatment.** Material that can potentially foul (or plug) the membrane will interfere with the RO process and must be removed before the water contacts the membrane. Foulants include suspended and colloidal solids, iron, metal oxides, scale, and biological materials. It is important to determine a Silt Density Index (SDI), a measurement of suspended materials in the water, prior to using the water in the RO unit. Only water determined to be within the manufacturer's acceptable SDI range should be used. Pretreatment may be required to achieve an acceptable SDI.

2-2.7.1.1 **SS Removal.** SS can be removed by filtration, usually using a sand filter followed by a cartridge filter. The addition of filter aids may be necessary to achieve acceptable filtration. In certain instances, coagulation and clarification may be required before the filtration step.

2-2.7.1.2 **Iron Oxide Removal.** Iron oxides are the result of the oxidation of dissolved ferrous salts or corrosion of the equipment. The first process can be controlled by aerating the water prior to its being filtered, the second by threshold treatment with sodium hexametaphosphate before any aeration. For proper operation, these iron oxides must be removed prior to the water contacting the membrane.

2-2.7.1.3 **Scale Prevention.** Scale-forming salts are concentrated as a result of the RO process just as they are during an evaporative process. To prevent scale, the water's pH is adjusted by adding either acid to produce a pH of between 5.0 and 6.5, or a scale inhibitor such as sodium hexametaphosphate or any of the phosphonates (PBTC [2-phosphonobutane-1,2,4-tricarboxylic acid], HEDP [1-hydroxyethylidene 1,1-diphosphonic acid], or AMP [amino-tri (methylene) phosphonic acid]). The solubility of scale-forming salts controls the rejection rate of the water that cannot be processed

through the RO unit (i.e., the amount of blowdown water produced). Specific guidelines should be obtained from the RO manufacturer.

2-2.7.1.4 **Biological Fouling.** Biological fouling is a condition that must be prevented. Potentially, the RO unit membrane may be damaged when chlorine or other oxidants are used. For proper operation, the water must be dechlorinated with a reducing agent or with activated carbon before it contacts the RO membrane.

2-2.7.2 **Membrane Configuration.** There are three basic membrane configurations: tubular, spiral-wound or scroll, and hollow fiber.

2-2.7.2.1 **Tubular Configuration.** The tubular configuration is simply a porous tube supporting a membrane. Feedwater is introduced into the tube. Product water permeates the membrane going to the outside of the tube. The reject water exits from the far end of the tube.

2-2.7.2.2 **Spiral Configuration.** The spiral configuration is a sheet membrane that is supported on each side by a porous material that provides flow distribution and rolled into a spiral or "jelly roll" configuration. The membrane is put in a pressure vessel so pressure can be maintained on its surface. This pressure forces the water through the membrane, separating it from the impurities. The membrane is laminated between porous sheets and sealed on three sides. The laminate is then attached on the fourth side to a porous tube and rolled around the tube into an element. Feed solution is forced into the element at one end, and the permeate works its way through the spiral to the axis tube where it emerges as purified product.

2-2.7.2.3 **Hollow Configuration.** The hollow fiber configuration consists of small (85-millimeter [3.3-inch] diameter) tubes whose outside wall is semi-permeable. A large number of these tubes are placed in a shell, similar to a heat exchanger. Water, under pressure, on the exterior of the tubes permeates the tubes and is collected from the tube interiors.

2-2.7.3 **Sea Water.** RO technology is particularly useful when feedwater is high in dissolved solids or when the source is brackish water or seawater. When used ahead of a deionizer, the chemical requirements for the deionizers are greatly reduced, resin life is extended, and a smaller quantity of chemical regenerants is required.

2-2.8 **Ultrafiltration.** The term "ultrafiltration" describes a pressurized membrane process in which particulate, colloidal, and high-molecular-weight dissolved materials are filtered from the water. Ultrafiltration is a process that is similar to RO in that a semi-permeable membrane is used to remove the filterable solids, except that the membrane is more porous, thus allowing some water-dissolved minerals to pass through with the product water. The feedwater flows through the inside of the fibers, permeates through the membrane, and is removed as product from the shell side. The filtered solids are continuously removed from the other end of the fiber in a reject stream that typically contains 5 to 10% of the feedwater dissolved solids.

2-2.9 **Electrodialysis.** The term “electrodialysis” describes a process that separates all materials and minerals that are ionized from water by attracting the ions dissolved in the water through membranes that are oppositely charged. When the water is high in dissolved minerals, as in brackish water that contains more than 2500 ppm TDS, its use may be more economical than the ion exchange methods. Under some circumstances, it may remove enough minerals to make seawater usable in industrial water systems. This process does not remove un-ionized or poorly ionized materials such as some organics and soluble silica. As with RO, membranes must be kept clean.

2-2.10 **Nanofiltration.** This is a process that, in terms of the size of materials removed, is intermediate between ultrafiltration and RO. The molecular weight cut-off properties of nanofiltration membranes are in the range of $< 1 \times 10^{-3}$ m (400 to 800 Daltons or 10 angstroms). Ionic rejections vary widely depending on the valence of the salts. Multivalent salts such as magnesium sulfate (MgSO_4) are rejected as much as 99%, while monovalent salts such as sodium chloride (NaCl) may have rejections as low as 20%.

CANCELLED

CHAPTER 3

STEAM BOILER SYSTEMS

3-1 **STEAM BOILER SYSTEM DEFINED.** A steam boiler is an enclosed vessel that holds water and is heated by an external source that converts the water to steam. All steam boilers contain tubes that separate the water from the heat source. Steam boilers are described in this Chapter; hot water boilers are addressed in Chapter 5.

3-1.1 **Types of Steam Boilers.** Boilers are classified by two criteria: 1) operating pressure (i.e., the amount of internal pressure generated by the steam that is produced); and 2) the operational design (i.e., whether the water [water tube boiler] or the heat source [fire tube boiler] passes through the inside of the tubes of the boiler vessel.

3-1.1.1 **Pressure Classification.** A boiler that operates at pressures below 103 kilopascals (15 pounds per square inch gauge) is defined as a low-pressure boiler. A boiler operating pressure greater than 103 kilopascals (15 pounds per square inch gauge) is defined as high pressure. High-pressure boilers can operate at pressures reaching thousands of kilopascals (thousands of pounds per square inch gauge).

3-1.1.2 **Fire Tube Boilers.** Fire tube boilers pass fire and hot combustion gas through the interior of the boiler tubes to heat the water that surrounds the tubes (see Figure 3-1). This type of boiler design is commonly used for factory-assembled (package) boilers, which are low pressure.

Figure 3-1. Fire Tube Boiler

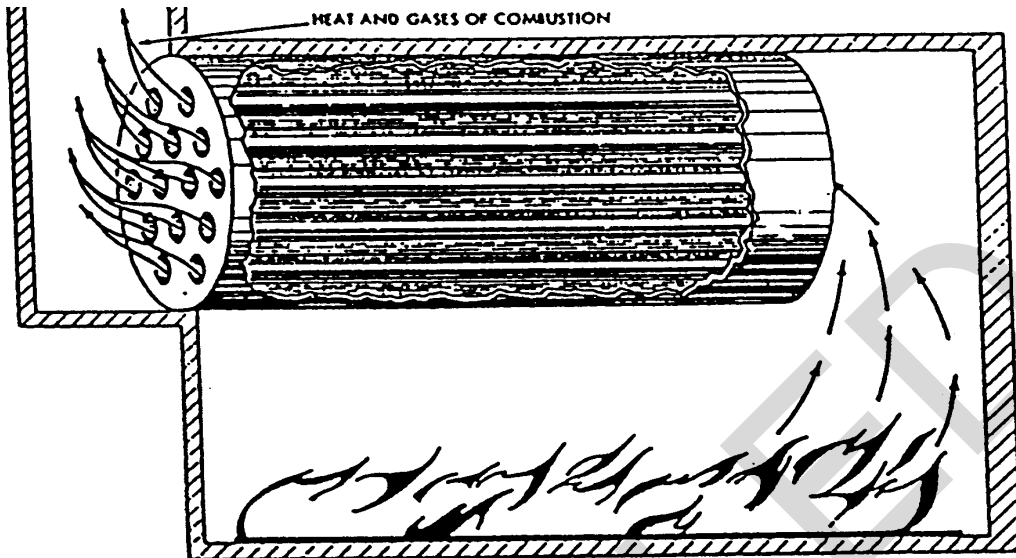

Fire tube boiler. The heat is inside the tubes.

3-1.1.3 **Water Tube Boilers.** Water tube boilers pass water through the boiler tubes, with the fire and hot combustion gases contacting the exterior of the tubes (see Figure 3-2). Water tube boilers are used in high-pressure and very-high-pressure applications. Most military installations have a central boiler plant containing water tube boilers in addition to fire tube boilers that are located in, and serve, individual buildings.

Figure 3-2. Water Tube Boiler

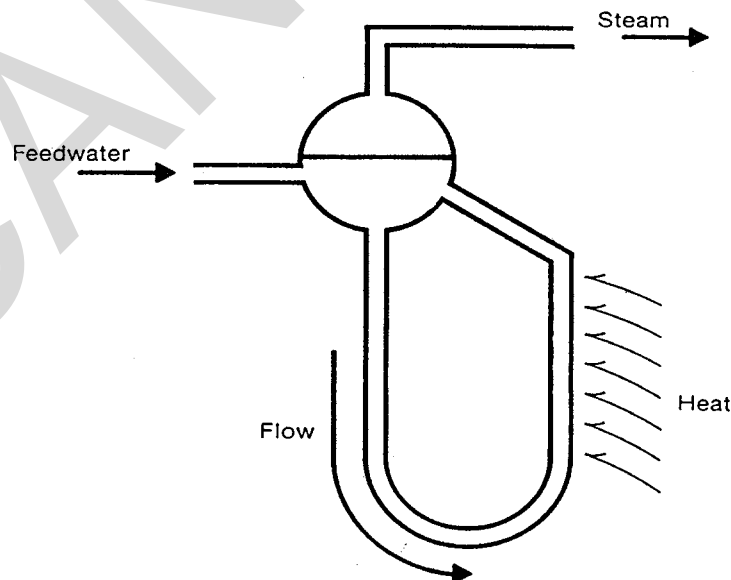

3-1.1.4 **Boiler Capacity Rating.** Boiler capacity rating is given as units of either boiler horsepower, kilograms of steam per second (pounds per hour), or kilowatts (British thermal units [BTU] per hour), specifically: 1) one boiler horsepower unit reflects the energy to convert 15.7 kilograms (34.5 pounds) of water to steam from (and at) 100 °C at sea level, which is equivalent to 9.812 kilowatts (33,479 BTU per hour); 2) kilogram of steam produced per second (pound of steam produced per hour) represents the number of kilograms of water used each second (pound per hour) to produce the steam; and 3) kilowatts (3,413 BTUs per hour) reflect the energy needed to evaporate the water (produce steam) each hour. The actual quantity of steam produced will vary depending on the boiler efficiency, boiler operating pressure, and altitude with respect to sea level.

3-1.2 **Components of a Steam Boiler System.** The functional components of steam boiler systems vary from one system to another based on a variety of design, engineering and service requirements. The typical components that may be included in a specific unit are illustrated in Figure 3-3 and are briefly described in paragraphs 3-1.2.1 through 3-1.2.5.

Figure 3-3. Components of a Simple Steam Boiler System

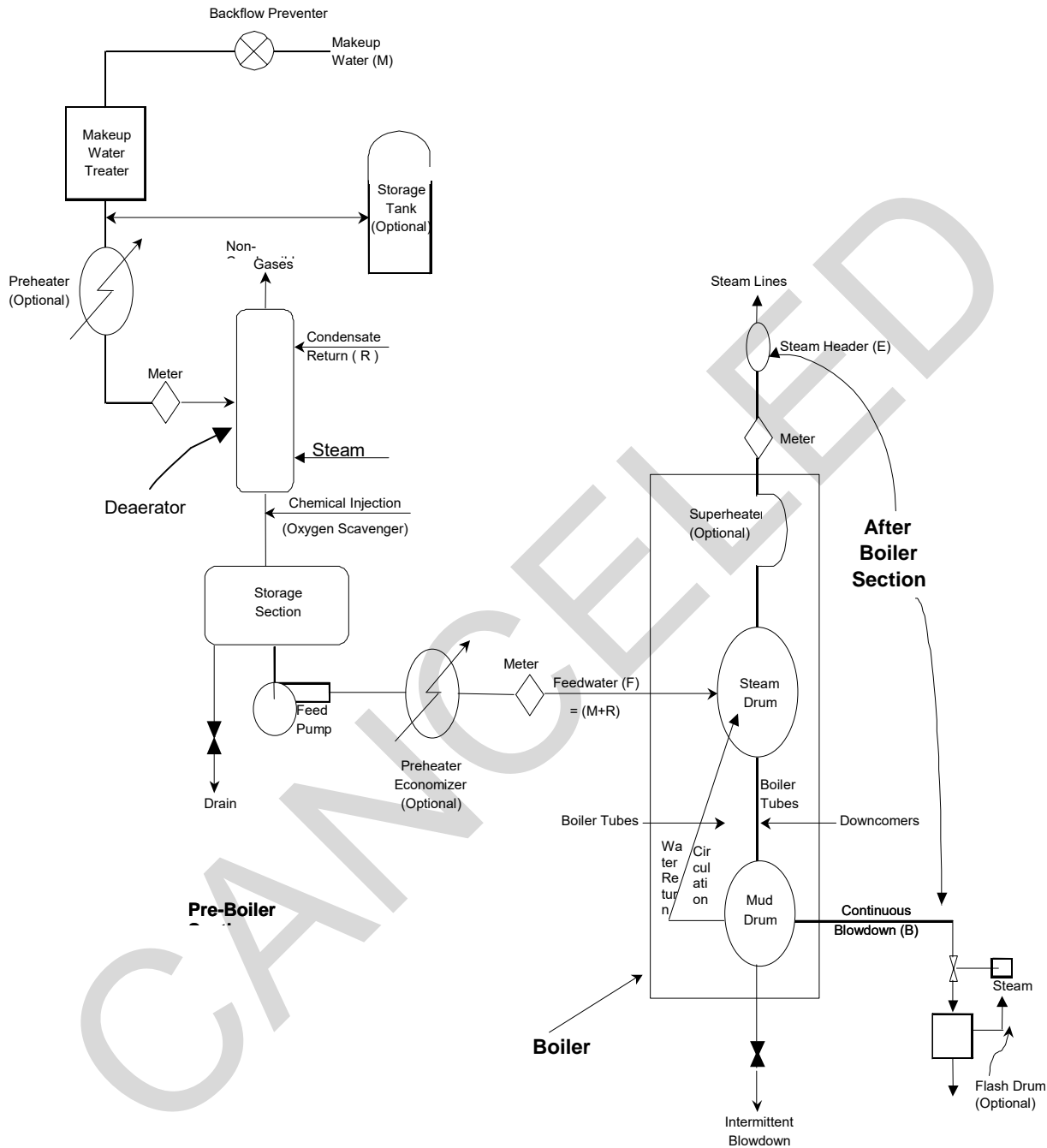

3-1.2.1 **Pre-Boiler.** The pre-boiler section of a steam boiler encompasses the boiler system's structural components that hold, move, and treat the water before the water enters the boiler. These pre-boiler system components include the integrated or supplementary water pre-treatment equipment used to process the boiler makeup water, the deaerator used to remove oxygen and other non-condensable gases, and the

feedwater heaters and pumps. The pre-boiler section may include a storage tank for the treated makeup water. The boiler feedwater is usually composed of the makeup water combined with the condensed steam (condensate) that is returned from the distribution system (called the condensate return). The feedwater, pre-heated or not, then enters the deaerator, which is used to remove (deaerate) oxygen and other volatile gases. (See paragraphs 3-2.6.1 and 3-2.6.1.1 for more information on deaerators.)

3-1.2.2 After-Boiler. The after-boiler, or post-boiler, section of the boiler system encompasses all structural components of the boiler system that hold, move, and process the steam and water downstream from the actual boiler. The after-boiler includes steam piping, heat exchangers, steam traps, condensate piping, turbines, process equipment, and superheaters.

3-1.2.3 Boiler Components. A fire tube boiler passes the hot combustion gases through the tubes, which are surrounded by the water to be converted to steam. A water tube boiler passes the hot combustion gases around the tubes, which contain the water to be converted to steam. In either type of boiler, the steam passes into a steam drum and then into the steam lines. The circulation of water in the water tube boiler may be accomplished by heating only, through a process of "natural circulation," which requires no external force or pumping. Alternatively, the water can be pumped through the heating circuit of the boiler by a process referred to as "forced circulation." Usually, a mud drum is provided at the lowest point in the water circulation section to allow the removal of any water-formed sludge. There will be at least two locations for the removal of boiler water blowdown: 1) for surface blowdown, sometimes referred to as a skimmer, located just below the operating water level of the steam drum; and 2) one or more bottom blowdown locations at the mud drum.

3-1.2.4 Steam Drum. The feedwater is added to the steam drum, where a mixture of steam and water is produced and where the steam is separated from the water. This separation process usually includes using mechanical devices to assist in removing any entrained boiler water from the steam. Chemicals used for internal boiler water treatment may be added (fed) to the water in the steam drum. A process of either continuous or intermittent surface blowdown is used to maintain the TDS of the boiler water and achieve the optimal operating conditions in the boiler. In some boiler systems, the blowdown water will be discharged to a flash tank, where a lower pressure steam is produced (possibly for use in the deaerator). Also, water from continuous blowdown may be used to preheat the makeup water by means of a heat exchanger. Steam from the drum may be discharged directly to the steam header or, in some boilers, heated further in a superheater to generate superheated steam.

3-1.2.5 Steam Header. The steam generated by the boiler is discharged from the steam drum to a header. The steam header feeds the steam to the steam distribution system. The steam is consumed by process equipment, lost through leaks, lost from valves, fittings, or steam traps, or condensed for return to the deaerator and subsequently reused for additional steam production.

3-1.3 **Measuring Equipment.** To develop an appropriate water treatment program for a steam boiler system, as well as to monitor the effectiveness of the on-going program, measure the quantities of steam, feedwater, blowdown, makeup, and condensate into and from the system. As a minimum, install a flow meter in the makeup water line. Installing flow meters on the feedwater line and in the steam header is also advisable, but due to cost considerations this practice is usually limited to large steam boilers. The rates and volumes for production of condensate and blowdown water can be calculated using the method described in paragraphs 3-1.5 and 3-1.6.

3-1.4 **Common Boiler Problems.** Common water-related problems inside the entire boiler system are corrosion, deposition, and carryover.

3-1.4.1 **Corrosion Problems.** Corrosion problems are the result of the action of oxygen and the effect of low or high pH on metal components, including the boiler tubes and drum, which are constructed of carbon steel. Corrosion can also occur from excessive alkalinity or excessive pH of the boiler water. This caustic attack is most likely to occur under scale or deposits, where very high local concentrations of hydroxide can build or in zones where insufficient cooling flows fails to sufficiently remove the heat input, leading to boiling, and thus steam blanketing occurs.” Corrosion can occur in the boiler, as well as in the pre-boiler and after-boiler sections, which can also be constructed of carbon steel. Corrosion can result in loss of metal volume or in a reduction of the integrity of the metal, situations that can lead to structural failure, particularly when metal loss is localized (see Figure 3-4). Corrosion is therefore also a safety concern. Corrosion in the steam lines, condensate lines located in the after-boiler section, and in the carbon steel piping can result in the production of system leaks leading to the loss of condensate, a situation which increases demands for energy, water, and chemicals.

Figure 3-4. Boiler Tube Oxygen Pitting

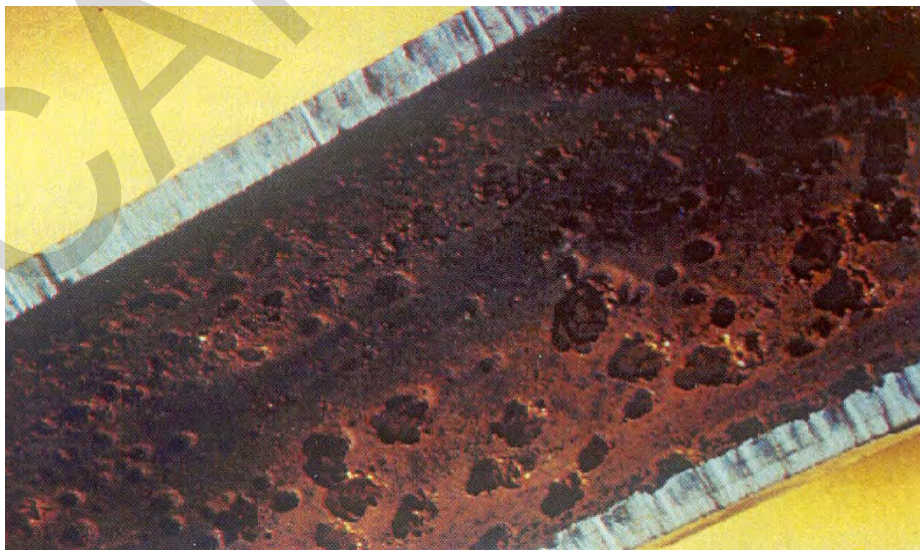

3-1.4.2 **Deposition Problems.** Deposition problems result from the precipitation of minerals dissolved in the feedwater, causing the formation of one or more types of scale on boiler system components. Deposition can occur by other mechanisms when corrosion products (rust) enter the boiler after being created in either the after-boiler or pre-boiler sections. These corrosion products can form iron-based scales. Using certain water treatment chemicals can also result in the formation of scale when the chemicals are not properly applied. All scales provide insulation to the transfer of heat between the water and the heated metal tubes (see Figure 3-5). Scale can occur in any section of the boiler system, resulting in a reduced capacity for heat transfer. Due to the resulting reduced heat transfer from the fireside of the tube to the water, the metal tubes operate at a higher temperature than if the scale were not providing insulation. Consequently, steam is produced inefficiently due to greater fuel demands, and fuel costs are increased. The greater the thickness of scale, the greater the insulating effect, and the higher the temperature of the tubes (see Figure 3-6). At sufficiently high metal temperatures, the tube can lose its tensile strength and rupture (see Figures 3-7 and 3-8).

FIGURE 3-5. Scaled Boiler Tube



Figure 3-6. Impact of Scale on Heat Transfer

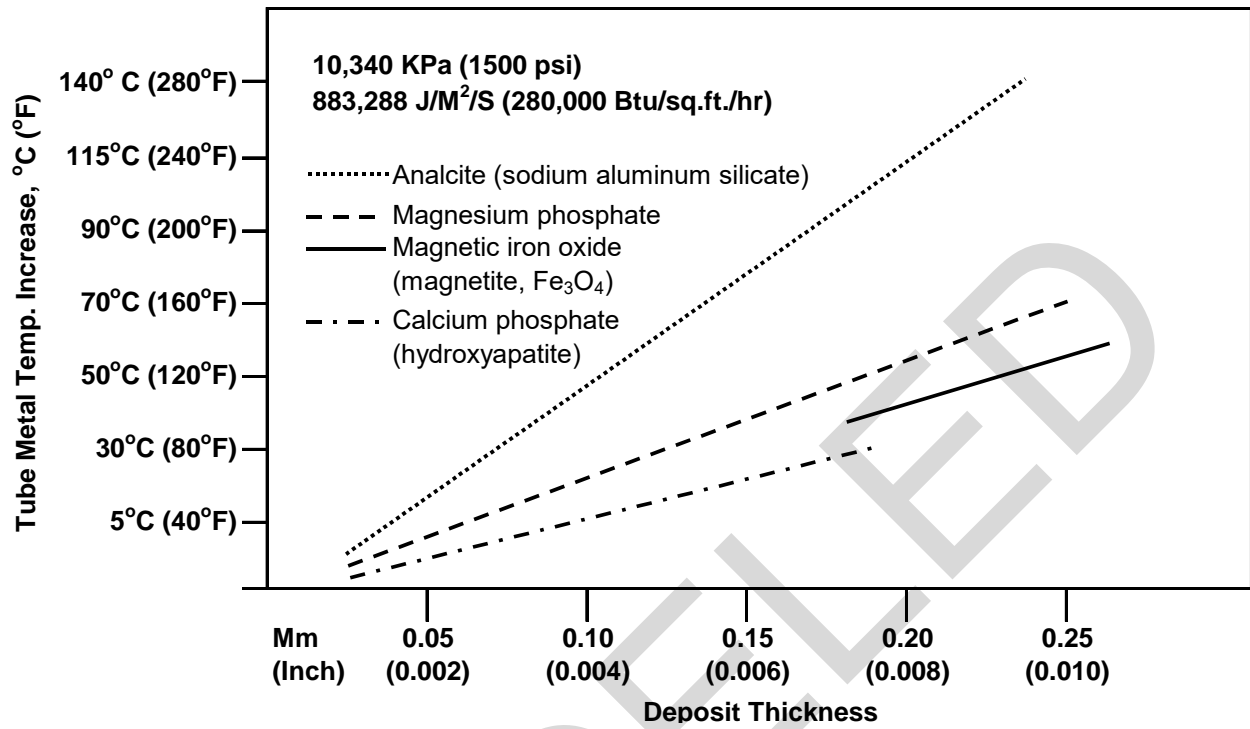

Figure 3-7. Metal Fatigue on Boiler Tube



Figure 3-8. Failed Boiler Tube



3-1.4.3 **Carryover Problems.** Carryover problems are caused by misting, foaming, priming, and silica carryover (see paragraph 3-2.8). Carryover is a process that results in impure steam quality. Dissolved solids contained in the carryover material can contribute to corrosion and deposition problems.

3-1.5 **Calculations.** To understand and produce efficient boiler operations, boiler calculations are performed and the results applied correctly. Boiler calculations are the means for providing information used to determine optimal blowdown rates and to assess condensate return. The greatest efficiency of boiler operations can be achieved by optimizing the COC by adjusting the amount of blowdown to give the proper volume of water. Efficient boiler operations recover and return as much condensate as possible. The material balance or mass balance of an operating boiler system can be calculated from the results of water tests and the known (measured) value of a single boiler operational parameter such as steam production, makeup water usage, feedwater usage, or blowdown. Steam table data can be used with mass balance information to calculate energy input and energy output for the boiler system. Chemical feed rates can be used with mass balance information to develop an estimation tool for the annual consumption of water treatment chemicals. Familiarity with these calculation procedures and their application to boiler system operations assessment is required of any base or facility engineer or section supervisor. This knowledge is also useful for boiler operators. Examples of boiler calculations are provided in paragraphs 3-1.5.3 through 3-1.6.3.

3-1.5.1 **Cycles of Concentration (COC).** COC in a steam boiler is a term that refers to the number of times the minerals in the feedwater have been concentrated in the boiler by its operation. As boiler water is evaporated and steam is produced, minerals that were dissolved in the boiler water remain behind, increasing the mineral

content of the remaining water. As steam is produced, additional mineral-laden feedwater enters the boiler, resulting in additional minerals being introduced into the boiler and increasing the amount present in the boiler. Mineral content in an operating boiler water system can be limited only by blowdown.

3-1.5.2 **Blowdown.** Blowdown consists of draining some of the boiler water with its accumulated solids, and replacing it with treated feedwater before harmful levels of solids are reached. Dissolved solids tend to concentrate near the water surface in the steam drum. Therefore, surface blowdown is most effective in reducing the concentration of dissolved solids. Bottom blowdown is used to remove precipitated sludge from the boiler mud drum. However, blowdown results in the loss of heated water and treatment chemicals. Economical operation requires careful control of blowdown to maintain safe solids levels, while minimizing both heat and chemical additive losses.

3-1.5.3 **Water Balance for Feedwater, Evaporation, and Blowdown.** The total volume of the water (feedwater) that is added to the boiler must equal the total volume of the water (steam plus boiler water blowdown) that is removed from the boiler. By convention, these water quantities are commonly expressed in kilograms per second (pounds per hour) in this equation for water balance:

$$\text{EQUATION} \quad | \quad F = E + B \quad (1)$$

where

F = feedwater, kg/s (lb/hr)
E = steam generated, kg/s (lb/hr)
B = blowdown, kg/s (lb/hr)

3-1.5.4 **Calculation of Feedwater and Blowdown Water.** The feedwater or blowdown water (or both) can be calculated in relation to the COC using these equations:

$$\text{EQUATION} \quad | \quad \begin{array}{l} \text{COC} = F \div B, \text{ or } F = B \times \text{COC} \\ \text{or} \\ B = F \div \text{COC} \end{array} \quad (2)$$

where

COC= cycles of concentration, no units
F= feedwater, kg/s (lb/hr)
B= blowdown, kg/s (lb/hr)

It is common to express blowdown as a percentage:

$$\text{EQUATION} \quad | \quad \% B = 100/\text{COC} \quad (3)$$

3-1.5.5 **Relationship Between Feedwater, Blowdown, Steam Generation, and COC.** Using the terms defined in paragraphs 3-1.5.3 and 3-1.5.4, the relationship between feedwater, blowdown, steam generation, and COC is represented as:

- a) $F = B \times \text{COC}$, from COC, Equation (2) above
- b) $F = E + B$, from COC, Equation (1) above
- c) $B \times \text{COC} = E + B$, replacing F in Equation (2) with Equation (1)
- d) $B \times \text{COC} - B = E$, rearranging Equation c) above
- e) $B \times (\text{COC}-1) = E$, rearranging Equation d) above
- f) $B = E \div (\text{COC}-1)$, rearranging Equation a) above

3-1.5.6 **Calculating Blowdown Rates.** The blowdown water volume is rarely measured by a meter. As shown below, it can be calculated if any two of the following parameters are known: 1) feedwater; 2) COC; or 3) steam generation (E). Steam volume is usually measured in units of meters on large boilers. The COC can be calculated by measuring the conductivity or TDS in both the boiler water and the feedwater. Note that the conductivity and quantity of TDS is the same for the boiler water and the blowdown water.

$$\text{EQUATION} \quad \left| \begin{array}{l} \text{COC} = B_{\text{TDS}} / F_{\text{TDS}} \\ \text{or} \\ B_{\mu\text{mhos}} / F_{\mu\text{mhos}} \end{array} \right. \quad (4)$$

where

- COC= cycles of concentration, no units
- B_{TDS} = blowdown TDS, ppm
- F_{TDS} = feedwater TDS, ppm
- $B_{\mu\text{mhos}}$ = blowdown conductivity, micromhos
- $F_{\mu\text{mhos}}$ = feedwater conductivity, micromhos

3-1.5.7 **Determining Feedwater and Blowdown Rates.** The blowdown calculations in paragraph 3-1.5.6 can be used to determine the feedwater rate in units of kilograms per hour (pounds per hour). Note that the term “feedwater” refers to water that is fed to the boiler and includes the makeup water plus the condensate return and steam from the deaerator.

EXAMPLE 3-1:

- a) A 1720-kilopascal (250-pound-per-square-inch-gauge) boiler operates at a conductivity level of 5000 μmhos . The boiler feedwater has a conductivity of 250 μmhos . The COC calculation is:

EQUATION $\left| \begin{array}{l} \text{COC} = B_{\mu\text{mhos}} / F_{\mu\text{mhos}} \\ \text{or} \\ 5000 \mu\text{mhos} / 250 \mu\text{mhos} = 20 \text{ COC} \end{array} \right. \quad (5)$

b) The percent blowdown is:

EQUATION $\left| \begin{array}{l} \%B = 100/\text{COC} \\ \text{or} \\ 100/20 = 5\% \end{array} \right. \quad (6)$

c) If the boiler is producing 5 kilograms per second of steam (40,000 pounds per hour), the blowdown must be:

EQUATION $\left| \begin{array}{l} B = E \div (\text{COC} - 1) \\ = 5.0 \div (20 - 1) = 0.26 \text{ kg/s (2105 lb/hr)} \end{array} \right. \quad (7)$

d) The feedwater is calculated to be:

EQUATION $\left| F = E + B = 5.0 + 0.26 = 5.26 \text{ kg/s (42,105 lb/hr)} \right. \quad (8)$

This is equivalent to 5.3 liters per second (5054 gallons per hour at 8.33 pounds per gallon). This example is illustrated in Figure 3-9.

Figure 3-9. Simplified Boiler System Water Balance

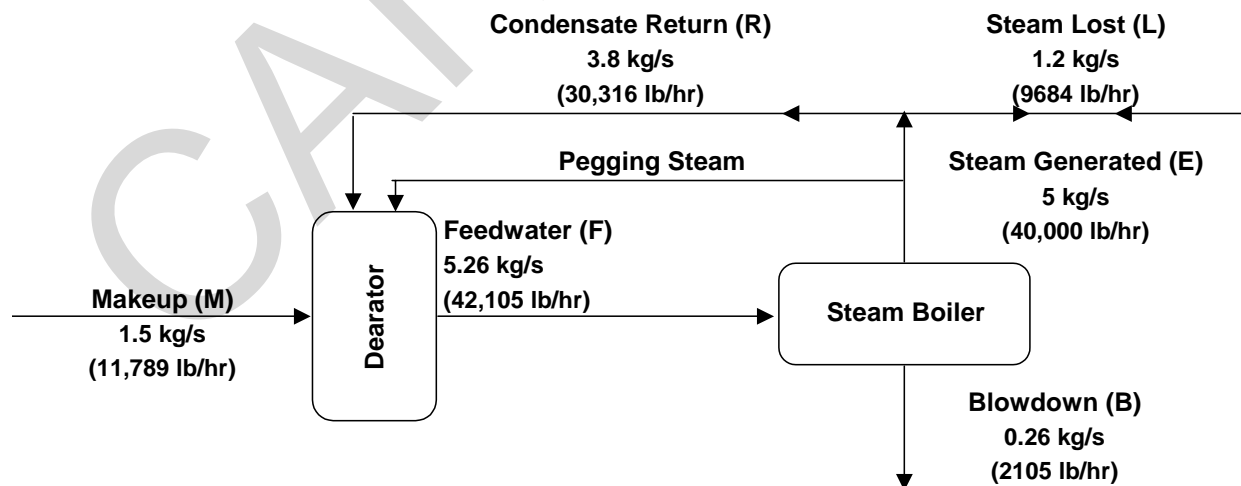

3-1.6 **Determining Makeup Water and Condensate Return Rates.** Makeup is the water from the external water treatment system added to the boiler system

upstream of the deaerator. The amount, expressed as either volume or percentage, of makeup water required in a boiler is affected by blowdown, steam leaks, consumption of steam in process equipment, and loss of condensate by boiler system leakage. In a “tight” boiler system, where steam is not lost in process equipment, about 5 to 10% makeup is expected. Water balance is affected by condensate return; however, boilers that lose considerable condensate due to losses of steam or condensate can approach a requirement for 100% makeup, which is a very inefficient and costly condition. The calculations below can be used for determining makeup water needs and condensate return rates.

3-1.6.1 **Makeup Water Rate.** Makeup is the difference between the volume of condensate return and the volume of feedwater.

$$\text{EQUATION} \quad | \quad M = F - R \quad (9)$$

where

M = makeup, kg/s (lb/hr)
F = feedwater, kg/s (lb/hr)
R = condensate return, kg/s (lb/hr)

3-1.6.2 **Condensate Return Rate.** Since the returned condensate usually does not contain any appreciable level of dissolved solids or conductivity, determination of percent makeup is calculated using the equation:

$$\text{EQUATION} \quad | \quad \%M = (1 - F_{\mu\text{mho}} / M_{\mu\text{mho}}) \times 100\% \quad (10)$$

where

%M = % makeup
 $F_{\mu\text{mho}}$ = feedwater conductivity, micromhos
 $M_{\mu\text{mho}}$ = makeup conductivity, micromhos

EXAMPLE 3-2:

- a) Makeup water conductivity is 900 μmhos for the boiler water in this example. The percent makeup is calculated:

$$\begin{array}{l} \text{EQUATION} \quad | \quad \%M = (1 - F_{\mu\text{mho}} / M_{\mu\text{mho}}) \times 100\% \\ \quad \quad \quad | \quad \text{or } (1 - 250 / 900) \times 100\% \\ \quad \quad \quad | \quad \%M = 72\% \end{array} \quad (11)$$

- b) This means that the makeup water is 28% of the feedwater. The condensate return percent is calculated:

$$\text{EQUATION} \quad | \quad \%R = 100 - \%M = 100 - 28 = 72\% \quad (12)$$

c) The quantity of makeup water is calculated:

$$\begin{aligned} M &= (\%M/100) \times F \\ &\text{or } (28/100) \times 5.3 \text{ kg/s (42,105 lb/hr)} \\ M &= 1.5 \text{ kg/s (11,789 lb/hr)} \end{aligned}$$

d) The quantity of condensate return is calculated:

$$\text{EQUATION} \quad R = F - M = 5.3 - 1.5 = 3.8 \text{ kg/s (30,316 lb/hr)} \quad (13)$$

3-1.6.3 Difference Between Amount of Steam Produced and Amount of Condensate. The difference between amount of steam produced and the amount of condensate returned represents the combined loss from the system of both steam and condensate. These losses may result from leakage of steam, consumption of steam by the process equipment, leakage of condensate, or deliberate discharge of contaminated condensate. The total water loss can be calculated:

$$\text{EQUATION} \quad L = E - R \quad (14)$$

where

L = total steam and condensate losses, kg/s (lb/hr)
E = steam generated, kg/s (lb/hr)
R = condensate return, kg/s (lb/hr)

EXAMPLE 3-3:

a) The steam losses from the boiler described in Examples 3-1 and 3-2 can be calculated:

$$\text{EQUATION} \quad L = E - R = 5.0 - 3.8 = 1.2 \text{ kg/s (9684 lb/hr)} \quad (15)$$

b) This relationship and the information from the previous examples are presented in Figure 3-9.

3-1.6.4 Basis for Evaluating Boiler System Efficiency. A good basis for evaluating boiler system efficiency can be developed by monitoring the system's water conductivity values, measuring the quantity of steam generated, and performing the required calculations after a regularly scheduled interval of time. An increase in steam loss may indicate a new leak, a size increase in existing leaks, a new consumption of steam, or condensate losses. Additionally, calculations of boiler system efficiency can provide a good basis for estimating savings in steam cost resulting from maintenance efforts to reduce steam and condensate losses.

3-2 **BOILER WATER TREATMENT AND CONTROL.** References to boiler water treatment in the late nineteenth century relate that the process of removing the scale from a boiler required much less effort and time if the boiler operator had forgotten to remove cooked potatoes from the boiler water. It was determined that the starch in potatoes causes a soft sludge, rather than a hard scale, to be formed, and this sludge was easier to remove than hard scale. Other natural organics, including lignin and tannins from wood, plant matter, plant extracts, and even manure and coffee grounds, produced similar results. It was determined that addition of phosphate by itself produces a manageable sludge, although starch, lignins, and tannins have been used to supplement the phosphate. Phosphate is still very commonly combined with other water treatment chemicals. Early use of alkaline materials included lime, soda ash, and caustic soda. Oxygen scavengers, such as sodium sulfite, were found to be effective for preventing oxygen corrosion. Many of these materials are still used today. The wide range of water treatment chemicals that is currently available allows for development of a comprehensive approach to industrial boiler water treatment, including using specialty chemicals such as chelants, polymers, and amines.

3-2.1 **Boiler Deposit Formation.** Dissolved solids in boiler feed water become more concentrated in the boiler water as steam is generated. Some of the dissolved solids can come out of solution (precipitate) and form scale in the boiler tubes. Some dissolved solids can form sludge (mud) in the boiler and form adherent deposits on boiler tubes. These deposits reduce heat transfer.

3-2.1.1 **Scale.** Scale can occur in isolated spots due to water evaporation, as illustrated in Figure 3-10. When a steam bubble forms on a heated surface, a thin film of water situated between the bubble and the tube wall becomes more concentrated with the dissolved materials. This thin layer can be as much as 17 °C (30 °F) hotter than the average boiler water temperature. These local conditions can cause precipitation of the dissolved solids and local formation of scale.

Figure 3-10. Localized Scale Formation Process

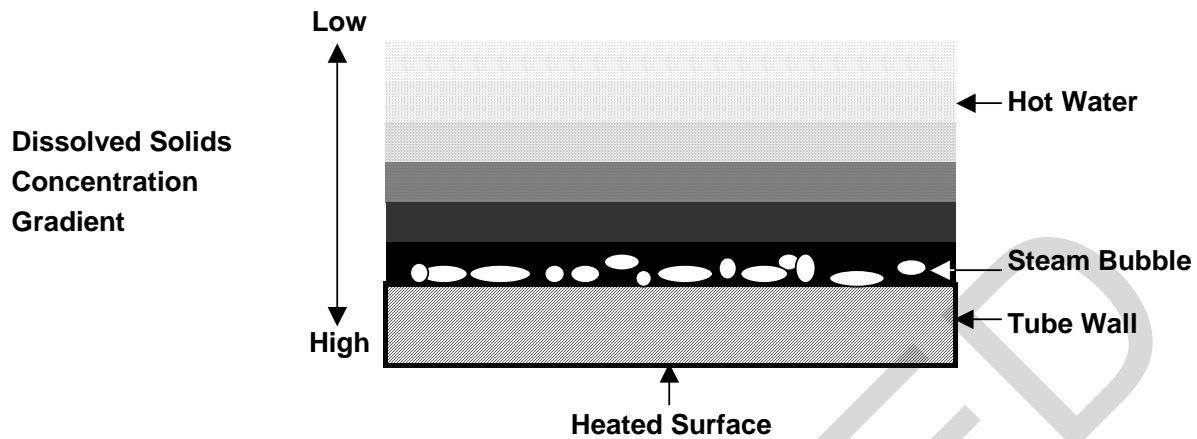

3-2.1.2 **Sludge Deposits.** Sludge deposits can form when the precipitated materials in the boiler water stick to the boiler tubes due to their hot surfaces as a result of the same phenomenon described in paragraph 3-2.1.1. Scale and sludge often form together.

3-2.1.3 **Dissolved Solid Materials.** Some dissolved solid materials become less soluble as the water temperature increases. This situation occurs with most of the salts that constitute calcium and magnesium hardness (CaCO_3 , CaSO_4 , MgCO_3 , $\text{Mg}[\text{OH}]_2$). As a result of this property, these materials tend to form scale in the hotter areas of the boiler because they remain soluble in the cooler areas of the boiler. By using an appropriate form of water treatment, these scaling agents can be removed from the boiler system water either before they enter the boiler (external treatment) or after (internal treatment), although it is often best to remove the dissolved magnesium and calcium minerals (hardness) before they enter the boiler (see paragraph 2-2). With the proper chemical treatment, they can be effectively controlled and treated internally in the boiler.

3-2.2 **Common Scale Found in Boilers.** The most common scale materials consist of calcium and magnesium salts and iron oxide. Calcium and magnesium salt deposits are white or off-white. Iron oxide scales are red or black deposits. The type of scale can be identified accurately by deposit analysis. It is common to have more than one type of scale in boiler deposits.

3-2.2.1 **Calcium Carbonate.** Calcium carbonate scale is white or off-white in color and is formed by the breakdown of calcium bicarbonate with heat. Calcium carbonate scale is formed in both untreated boilers and improperly treated boilers. A drop of a dilute acid solution on the deposit will cause bubbling on the calcium carbonate scale area as a result of the release of carbon dioxide. This procedure can be used to identify this type of scale. Calcium carbonate scale can result when there is calcium hardness in

the boiler feedwater due to improper softener operation and when there is an inadequate level of sludge or scale conditioner or dispersant.

3-2.2.2 **Calcium Sulfate.** Calcium sulfate (gypsum) is off-white or tan in color and is formed in boilers that are using water of high hardness and low alkalinity without proper treatment. Addition of a strong acid will dissolve the calcium sulfate scale with no gas bubble formation or release of carbon dioxide. Calcium sulfate is much less common than calcium carbonate, but it can form when there is calcium hardness in the boiler feedwater due to improper softener operation and when there is an inadequate level of sludge or scale conditioner or dispersant.

3-2.2.3 **Calcium Phosphate.** Calcium phosphate is formed when the dissolved calcium in the feedwater reacts with phosphate treatment chemicals added to the boiler water. With proper treatment controls, calcium phosphate forms a sludge that will be removed in the blowdown. However, calcium phosphate can deposit as scale if the pH of the boiler water is below 11.0 and if a sludge conditioner is not used. Addition of a strong acid will dissolve this scale fairly easily with no gas bubble formation.

3-2.2.4 **Magnesium Phosphate.** Magnesium phosphate scale is an off-white deposit formed by the reaction of magnesium salts from the feedwater with the phosphate used in the boiler water treatment. It will form only if both the hydroxide content and silica content of the boiler water are low. Addition of a strong acid will dissolve this scale fairly readily with no gas bubble formation.

3-2.2.5 **Magnesium Silicate.** Magnesium silicate scale, an off-white deposit, is formed from the magnesium and silica in the feedwater when the pH is above 11.0 and the silica level is more than half that of the phosphate level in the boiler water. Normally, it forms as a sludge that will be removed in the blowdown, but it may form scale deposits on tubes if a sludge conditioner is not present. Most acids will not remove this deposit. Caustic or special chemicals are needed to remove the magnesium sulfate scale.

3-2.2.6 **Iron Oxide and Iron Hydroxide.** Iron oxide scales and iron hydroxide scales are red/black deposits that are formed when the iron salts dissolved in the feedwater react with hydroxide found in the boiler water. Usually, the dissolved iron is introduced into the system from the condensate return due to corrosion. Iron oxide can be deposited as a scale on the boiler tubes if the proper type of sludge conditioner is not present. With proper water treatment, this deposit should form as sludge, rather than scale, and can be removed by blowdown. The presence of iron oxide on the internal boiler surfaces can be caused by oxygen corrosion of the boiler metal.

3-2.3 **External Boiler Water Treatment.** Specific technologies for external treatment or pre-treatment are described in Chapter 2. The strategy for external treatment is to remove unwanted impurities in the makeup water before they can enter the boiler. Proper external treatment can eliminate, or at least minimize, scale- and

corrosion-forming conditions and minimize the internal water treatment required to protect the boiler system components.

3-2.3.1 External Water Treatment for High-Pressure Boilers. The higher the pressure of the boiler, the greater the need for high-purity feedwater. A 5-kilogram-per-second (40,000-pound-per-hour) water tube boiler operating at 6205 kilopascals (900 pounds per square inch gauge) requires deionized feedwater. External treatment options include RO followed by demineralization. Guidelines for feedwater purity are described in paragraph 3-3.4.

3-2.3.2 External Treatment for Low-Pressure Boilers. Low-pressure boilers can operate with simple external treatment or sometimes no external treatment at all. A 0.44-kilogram-per-second (3450-pound-per-hour) (100 horsepower) fire tube boiler operating at less than 103 kilopascals (15 pounds per square inch gauge) may require using only a sodium zeolite softener for water treatment. A small heating boiler that is returning over 99% of the condensate may not require any external treatment, particularly if the makeup water is low in hardness and the condensate is not contaminated.

3-2.4 Internal Treatment of Boiler Water. Internal treatment of boiler water is a process of adding chemicals to the boiler to control deposition and corrosion. Internal water treatment, together with proper blowdown control, controls the water impurities that have not been removed or reduced through external treatment.

3-2.4.1 Preventing Scale Formation. Internal boiler water treatment for scale prevention can be performed using either a solubilizing chemical treatment program or a precipitating chemical treatment program. The solubilizing treatment program uses chemicals designed to keep scale-causing materials with hardness (mineral ions) in solution, whereas the precipitating treatment program uses chemicals designed to react with hardness-causing materials and precipitate them as a sludge that will not adhere to tube surfaces. Both the solubilizing approach and the precipitating approach require good blowdown control to keep hardness and sludge levels within chemical performance capabilities.

3-2.4.1.1 Low-Pressure Boilers. Low-pressure steam boiler systems (103 kilopascals [15 pounds per square inch gauge] and less) that use little or no makeup or blowdown are usually not chemically treated for scale control because, due to low makeup water demands, there is no continuous addition of scaling agents (present in the makeup water) to the boiler. If there are high makeup requirements (over 1% per month) or if the makeup water is over 300 ppm total hardness, a treatment program is required to protect the boiler system.

3-2.4.1.2 High-Pressure Boilers. High-pressure boilers (103 to 6205 kilopascals [15 to 900 pounds per square inch gauge]) must use either a precipitating-type water treatment chemical program or a solubilizing-type chemical treatment program.

3-2.4.1.2.1 Precipitating Water Treatment Programs. A precipitating program often uses phosphate, which will react with calcium to form a calcium phosphate sludge called “hydroxyapatite” ($3\text{Ca}_3[\text{PO}_4]_2 \bullet \text{Ca}[\text{OH}]_2$), and act as both as a sludge conditioner or dispersant. Magnesium reacts with hydroxide and silica to form a magnesium silicate sludge called “serpentine” ($2\text{MgSiO}_3 \bullet \text{Mg}[\text{OH}]_2 \bullet \text{H}_2\text{O}$). Sufficient hydroxyl alkalinity (causticity) is required to allow the formation of the proper types of sludge. Sludge that is properly formed and conditioned is fluid enough to be removed through bottom blowdown of the boiler. Sodium hydroxide may be required to maintain the appropriate hydroxyl alkalinity (causticity). Phosphate precipitating agents are prepared as either orthophosphate (“ortho” means single phosphate) or as one of several forms of polyphosphate (“poly” means multiple phosphate molecules bonded together). Sodium hexametaphosphate, sodium tripolyphosphate, and sodium pyrophosphate are examples of polyphosphates. In the boiler, polyphosphate breaks down to the orthophosphate form due to the higher temperature. Polyphosphates can be added either to the feedwater or directly to the steam drum. Orthophosphate should only be fed into the steam drum, not to the feedwater, since it can react with the hardness (mineral ions) to form scale in the feedwater lines.

3-2.4.1.2.2 Solubilizing Water Treatment Programs. A solubilizing program uses one or more of the following chemicals to keep scale-forming materials in solution: phosphonates (also known as organic phosphate), chelants, or polymers. Solubilizing agents, such as phosphonates (not to be confused with phosphate), chelants, and polymers are common chemicals used in boiler water treatment formulations. Chelants, such as ethylene diamine tetra-acetic acid (EDTA) or nitrilo-triacetic acid (NTA), bind (chelate) calcium, magnesium, and iron. Using phosphonates and chelants requires special injection systems and excellent feed control. Excess (free) phosphonate or chelant can attack metal surfaces, causing corrosion, although phosphonates are less aggressive than chelants. Water-treating polymers are long-chain, water-soluble compounds containing electrochemically active side branches that perform various functions such as solubilization, dispersion, agglomeration, and crystal distortion to prevent boiler deposits. Polymers do not attack metal surfaces and can be fed into the feedwater line or directly into the boiler steam drum with proper injection equipment.

3-2.4.1.2.3 Boiler-Specific Treatment Programs. High-pressure boilers over 6205 kilopascals (900 pounds per square inch gauge) use high-quality feedwater that is produced by extensive external treatment; thus, scale-forming materials are not normally present in the water and cannot form scale in the boiler. These boilers often use water treatment programs designed specifically for that particular boiler. These programs require excellent control of water chemistry and involve applying coordinated phosphate, congruent phosphate, equilibrium phosphate, and all volatile treatment. Boiler pressures of this level are usually found in operations used to drive turbines for the generation of electrical power.

3-2.4.2 Determining Chemical Treatment Feed Rates. Development of a chemical treatment program involves selecting the type of chemical to be used, selecting appropriate concentration levels for each chemical (when used in combination

with other chemicals), and selecting the required chemical treatment (addition) scheme to ensure proper water treatment. Selection factors are described in paragraph 3-3. Blowdown discharge rates can be used to calculate the rate of chemical addition and the amount of chemical required to replace that lost in the blowdown and to meet the treatment objectives. In practice, chemical feed equipment is set up to deliver the chemicals on a “proportional-feed-on-demand” basis. The operator must keep treatment levels within prescribed control ranges by adjusting pumps and timers while controlling COC within the system. Selection of the type and quantity of required chemical treatment is an issue that involves both technical concerns and ancillary issues pertaining to institutional concerns in the areas of procurement, contracts, and budgets. This situation is described in Chapter 10.

Example 3-4 illustrates phosphate demand. Similar approaches could be used for other treatment technologies. In the case of sulfite, the treatment requirement must first satisfy the demand due to oxygen in the feedwater. Additional sulfite is fed to attain a residual or excess amount in the boiler water to ensure adequate protection. The second part of Example 3-4 takes into account that the treatment chemical formulation is not composed of 100% active ingredients. Formulations are most often less than 50% active and can be as little as 10% active chemical, with the balance of the formulation usually being water.

EXAMPLE 3-4:

- a) The boiler in Examples 3-1, 3-2, and 3-3 will be operated with a phosphate level of 60 ppm (as PO_4) in the boiler water. The blowdown has been determined to be 0.26 kilogram per second (2105 pounds per hour). The required phosphate addition on a daily basis must equal the phosphate that is discharged with the blowdown water, plus that used up in precipitating calcium phosphate. The amount of phosphate required to replace that lost in blowdown is calculated by this method:

$$\begin{aligned}\text{Phosphate loss} &= (B)(\text{treatment ppm residual})/1,000,000 \\ &= 0.26 \text{ kg/s} \times (60 \text{ ppm})/1,000,000 \\ &= 0.000016 \text{ kg/s} (0.13 \text{ lb/hr}) \text{ or } 1.38 \text{ kg/day}\end{aligned}$$

- b) The treatment chemical selected is sodium hexametaphosphate (HMP) containing 90.5% phosphate as PO_4 . This means there is 0.905 kilogram (0.905 pound) of phosphate (PO_4) per kilogram (pound) of chemical:

$$\begin{aligned}\text{Chemical required} &= \text{phosphate loss} \div 0.905 \\ &= 1.38 \div 0.905 \\ &= 1.52 \text{ kg/day} (3.35 \text{ lb/day})\end{aligned}$$

NOTE: This calculation does not incorporate any phosphate reaction and precipitation with hardness (see paragraph 3-2.4.3), so the practical amount of HMP needed would be slightly higher.

3-2.4.3 Preventing Sludge Deposits. In either low-pressure or high-pressure boilers, the feedwater hardness (dissolved minerals) can precipitate in the boiler. To prevent the formation of adherent sludge deposits, natural or synthetic (or both) water-soluble organic chemicals are added to the boiler water. Organic chemicals help to create sludge by distorting the crystal structure of scale-forming compounds and preventing the formation of scale. Properly formed and conditioned sludge is fluid enough to be removed through bottom blowdown of the boiler mud drum. A typical natural organic compound, quebracho tannin, has been used traditionally with satisfactory results in military boilers, but its use is diminishing in favor of the new synthetic, water-soluble polymers. Tannin is effective for the control and minimization of sludge and contributes to corrosion control since it absorbs a small amount of dissolved oxygen and helps to form a protective film on mild steel surfaces. To be effective, tannin levels should be maintained at several hundred ppm (of active component) in the boiler water. Polymer materials are typically maintained between 5 to 20 ppm (of active component). The most recently developed synthetic water-soluble polymers have been shown to be more cost-effective than tannins. For example, polyacrylates or copolymers of methacrylate and sulfonated styrene are dispersants, sludge and scale inhibitors commonly used for minimizing the formation of deposits in boilers. Polymer treatments are commonly found in water treatment formulations available from vendors.

3-2.5 Corrosion in the Boiler. Corrosion within the boiler results from an improper pH level (below 10.3), a situation that contributes to general (overall) corrosion, and from oxygen not being removed from the feedwater, a situation that causes pitting of the mild steel tubes and drums.

3-2.5.1 General Corrosion. “General corrosion” is a term that refers to an overall uniform corrosion of metal surfaces. Adequate prevention of general corrosion is achieved by maintaining a proper pH, thus allowing the formation of a protective iron oxide coating known as magnetite. Magnetite is a self-limiting form of corrosion that forms in the outermost surface layers of, and that adheres to, the mild steel tube surfaces. Magnetite is composed of an iron oxide complex of $\text{Fe}_3\text{O}_4 + \text{FeO} + \text{Fe}_2\text{O}_3$.

3-2.5.1.1 Proper pH for Boilers up to 6205 Kilopascals. The proper pH range for boilers up to 6205 kilopascals (900 pounds per square inch gauge) is between 10.3 and 12.0. Adjustment of the boiler water to within this pH range is achieved through cycling up the natural alkalinity contained in the feedwater and, if necessary, adding a chemical alkalinity agent such as sodium hydroxide (caustic soda), sodium carbonate (soda ash), or an alkaline phosphate treatment.

3-2.5.1.2 Proper pH for Boilers Over 6205 Kilopascals. Proper pH adjustment for boilers over 6205 kilopascals (900 pounds per square inch gauge) is achieved by using water treatment chemicals, which are added because the demineralized feedwater is

essentially unbuffered. The chemical treatment programs include coordinated phosphate, congruent phosphate, equilibrium phosphate, and all volatile treatment. Phosphate programs of this type are not used as conventional precipitating agents for hardness-causing materials but instead are used as buffering agents for pH control (see Table 3-1).

Table 3-1. Summary of Phosphate Treatment Programs

Program	PO ₄	OH	Na:PO ₄ Ratio	pH
Conventional	30-60	20-350	N/A	11-12
Coordinated	5-25	trace	2.85:1 to 3:1	9-10.5
Congruent	2-5	zero	2.3 to 2.6:1	8.8-9.4
Equilibrium	<2.4	<1.0	N/A	9.3-9.6

3-2.5.2 Pitting Corrosion. Pitting corrosion is a term that refers to a deep, localized corrosion usually caused by oxygen molecules on the metal surfaces in the boiler water. This process results in the formation of corrosion pits that can extend into the interior metal layers of metal boiler components. Corrosion pitting can be severe enough to lead to perforations of tube surfaces (see Figure 3-4).

3-2.5.3 Other Types of Corrosion. Other types of corrosion can occur in high-pressure boilers over 6205 kilopascals (900 pounds per square inch gauge) for which the water treatment program includes coordinated, congruent, or equilibrium phosphate-type chemical treatment (not to be confused with standard phosphate precipitating programs). These other corrosion mechanisms include caustic attack, hydrogen embrittlement, and phosphate hideout.

3-2.6 Removing Oxygen from Feedwater. A very corrosive liquid results when oxygen is dissolved in water. Oxygenated water is particularly corrosive to mild steel, which is almost always used to construct the main components of the boiler system. The corrosivity rate of oxygenated water doubles with every 10 °C (18 °F) increase in temperature. Oxygen corrosion can be recognized by the presence of pits found typically in the top of, or at the waterline of, the steam drum. Oxygen can be removed from feedwater by mechanical or chemical methods, or both; a combination of these methods is used commonly.

3-2.6.1 Mechanical Oxygen Removal. Mechanical removal of oxygen from feedwater requires a deaerating heater in which both the makeup water and condensate return are in contact with live steam and mixed using trays, sprays, or both. This heating process literally strips most of the oxygen and other non-condensable gases out of the feedwater. The oxygen and other gases, along with a small amount of steam, are vented from the deaerator to the atmosphere.

3-2.6.1.1 **Deaerator Operation.** Two key parameters associated with deaerator operation are controlled to maintain maximum oxygen removal. First, the deaerator vent is checked to verify that a plume of steam is always flowing out of the vent. Second, both the pressure within the deaerator and the temperature of the outlet water are controlled. Deaerators should operate at a pressure of 20.68 kilopascals (3 pounds per square inch gauge) or more. At any given pressure, the deaerator water outlet temperature should be within 1 °C (2 °F) of the water temperatures shown in Table 3-2, adjusted for the altitude of the installation. If the deaerator is operating with low or no steam flow or at a low water temperature, the deaerator is not being operated efficiently and is not removing the maximum amount of oxygen. Schematic diagrams of mechanical deaerators are shown in Figures 3-11 and 3-12.

Table 3-2. Deaerator Water Outlet Temperature for Boiler Systems at Various Sea Level Pressures

Deaerator Pressure kPa (psig)	Deaerator Water Outlet Temperature °C (°F)	Deaerator Pressure kPa (psig)	Deaerator Water Outlet Temperature °C (°F)
0.00 (0)	100 (212.0)	75.84 (11)	116.4 (241.6)
6.89 (1)	101.8 (215.3)	82.74 (12)	118 (244.4)
13.79 (2)	103.6 (218.5)	89.63 (13)	119.1 (246.4)
20.68 (3)	105.3 (221.5)	96.53 (14)	120.2 (248.4)
27.58 (4)	106.9 (224.4)	103.42 (15)	121.3 (250.3)
34.47 (5)	108.4 (227.1)	110.32 (16)	122.3 (252.2)
41.37 (6)	109.9 (229.8)	117.21 (17)	123.4 (254.1)
48.26 (7)	111.2 (232.2)	124.11 (18)	124.1 (255.3)
55.16 (8)	112.7 (234.8)	131 (19)	125 (257.0)
62.05 (9)	113.9 (237.1)	137.90 (20)	126 (258.8)
68.95 (10)	115.2 (239.4)	--	--

NOTE: For every 152 meters (500 feet) in elevation from sea level, subtract 0.5 °C (1 °F) from the listed temperature. A mechanical deaerator that is operating efficiently can reduce the oxygen content of feedwater from the saturation level to a fraction of a ppm. However, even a trace amount of oxygen can cause corrosion pitting in the boiler. The complete removal of oxygen requires the addition of a chemical agent called an “oxygen scavenger.”

Figure 3-11. Mechanical Deaerator Schematic (Spray Type)

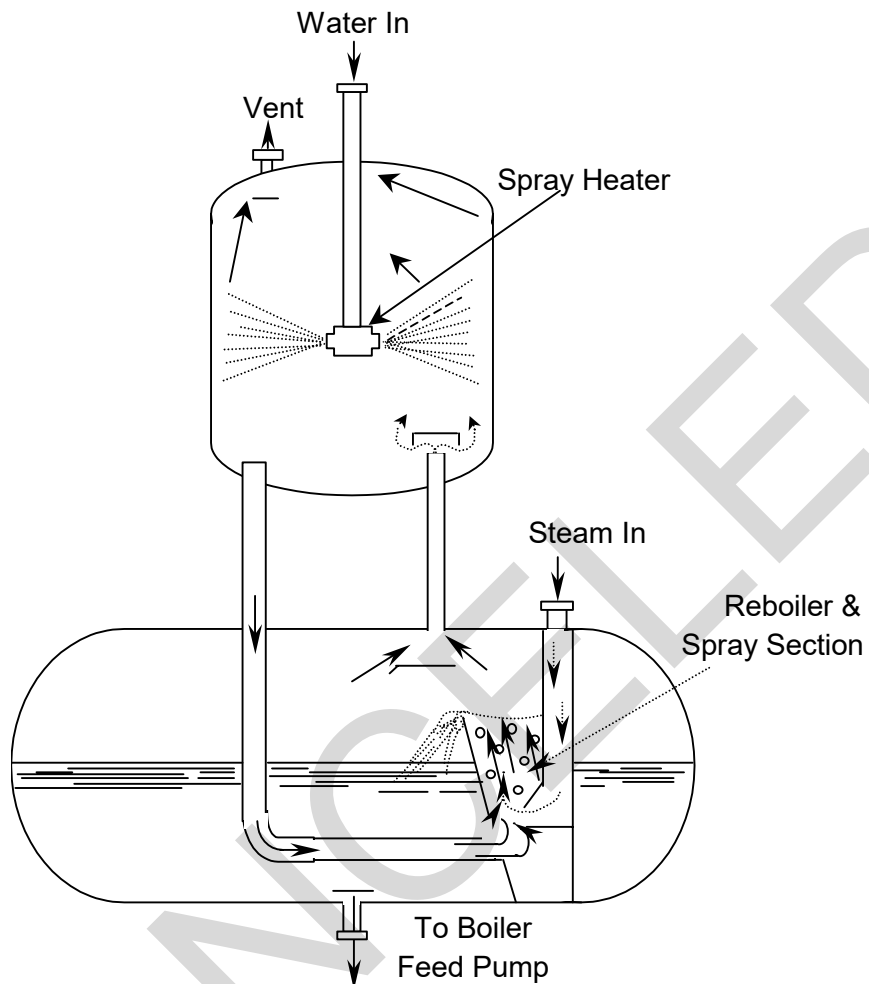
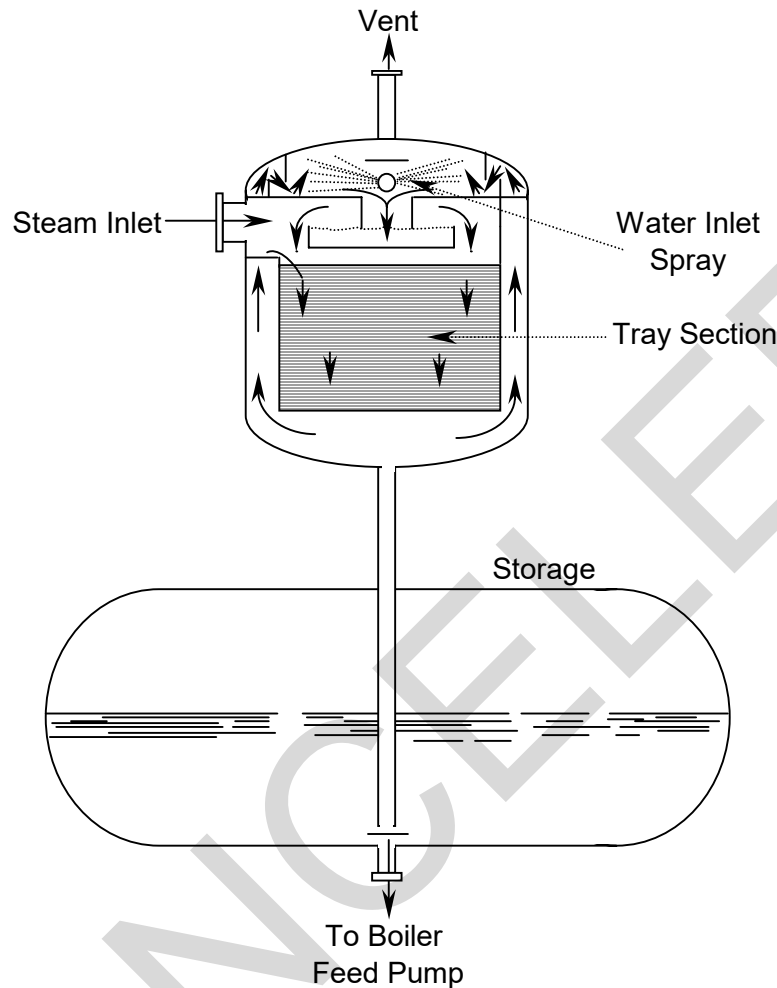

Figure 3-12. Mechanical Deaerator Schematic (Tray Type)



3-2.6.2 **Chemical Removal of Free Oxygen.** Oxygen scavengers are chemicals that react with oxygen. Oxygen scavengers remove the oxygen from the boiler feedwater so it will not cause pitting corrosion.

3-2.6.2.1 **Oxygen Scavengers for Boilers up to 6205 Kilopascals.** Oxygen scavengers for boilers up to 6205 kilopascals (900 pounds per square inch gauge) include catalyzed sodium sulfite and uncatalyzed sodium sulfite, both of which are oxygen scavengers and sources of sulfite. When a deaerator is used, any uncatalyzed oxygen scavenger will suffice and can be fed into the storage area of the deaerator. Use catalyzed sodium sulfite in systems without a deaerator. A cobalt sulfate salt, which is present in the catalyzed sodium sulfite material, is used as the catalyst. Catalyzed sulfite reacts more quickly with oxygen than does uncatalyzed sulfite. Both the sodium sulfite and the catalyst must be fed into the feedwater upstream from the boiler so oxygen can be scavenged before the feedwater enters the boiler. This addition scheme

also serves to protect feedwater piping from corrosion. A sufficient amount of the oxygen scavenger must be fed to meet the demand for the oxygen initially present and provide an excess residual (reserve amount) for occasions when the oxygen level may increase unexpectedly, so that water testing will always indicate that an excess amount is present. (See Table 3-3 for typical sulfite levels in the boiler water.)

Table 3-3. Levels of Sulfite to be Carried in Boiler Water

Boiler Pressure KPa (psig)	Sulfite Residual (as ppm SO ₃)
0-103 (0-15)	20-40
110-1020 (16-149)	20-40
1030-2060 (150-299)	20-40
2070-3100 (300-449)	20-40
3100-4130 (450-599)	20-40
4140-5160 (600-749)	15-30
> 5170 (> 750)	15-30

3-2.6.2.2 **Oxygen Scavengers for Boilers Over 6205 Kilopascals.** For boilers over 6205 kilopascals (900 pounds per square inch gauge), the list of oxygen scavengers includes specialty volatile treatments such as hydroxylamine, hydroquinone, carbohydrazide, hydrazine sulfate, and erythorbic acid. Hydrazine can no longer be used because it is a suspected carcinogen. Like hydrazine, these specialty volatile treatments not only scavenge oxygen but also passivate metal surfaces. These chemicals are normally maintained in the boiler water in the parts-per-billion (ppb) range. Sulfite-type oxygen scavengers are not used in boilers over 6205 kilopascals (900 pounds per square inch gauge) because of the potential for thermal decomposition producing sulfur dioxide and hydrogen sulfide, both of which can cause corrosion. The thermal decomposition reactions are:

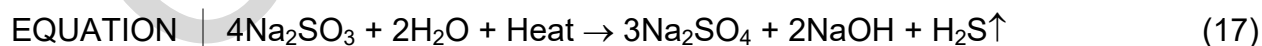

These reactions have been shown to occur at boiler pressures as low as 4140 kilopascals (600 pounds per square inch gauge), although they do not usually create a serious problem until pressures exceed 6205 kilopascals (900 pounds per square inch gauge).

3-2.7 Condensate Corrosion and Control

3-2.7.1 **Causes of Condensate Corrosion.** Oxygen and carbon dioxide are common steam condensate impurities that promote condensate corrosion. Less common are process contaminants, each of which has corrosive properties dependent upon the nature of the contaminant and on the materials that may be corroded. The piping found in steam condensate systems is commonly constructed of mild steel, whereas heat exchangers are usually copper or mild steel.

3-2.7.1.1 **Air.** Air is the source of oxygen in a condensate system. Condensate lines that are used intermittently are particularly susceptible to condensate corrosion because the cooling of a heated condensate line creates a vacuum that can draw air into the system piping through valve seals or condensate sumps. Additionally, any dissolved oxygen in the feedwater that is not completely removed, either chemically or mechanically, can enter the boiler and pass with the steam into the condensate lines where it is consumed in a pitting corrosion attack on the metal surfaces. Oxygen corrosion in a condensate system is evidenced by pitting and by the presence of corrosion product deposits called “tubercles.”

3-2.7.1.2 **Carbon Dioxide.** Carbon dioxide (CO_2) can enter the boiler system if it is dissolved in the feedwater. However, CO_2 can be removed effectively through the deaerator. The most common source of carbon dioxide in steam condensate is the carbonate (CO_3^{2-}) and bicarbonate (HCO_3^-) ions (alkalinity) in the feedwater. Under the influence of heat and pressure in the boiler, the carbonate (CO_3^{2-}) and bicarbonate (HCO_3^-) ions (alkalinity) break down into hydroxyl (OH^-) ions (alkalinity) and CO_2 gas. This free CO_2 is volatile and leaves the boiler with the steam. When the steam subsequently condenses, the CO_2 dissolves in the condensate and forms carbonic acid (H_2CO_3), which lowers the pH of the condensate and is corrosive to most metals, particularly to mild steel (see Figure 3-13). You can recognize carbon dioxide corrosion by the thinning of condensate line walls, particularly at the condensate liquid level within the pipe and at pipe threads where the condensate flows. Prevent corrosion in steam boiler systems by neutralizing the CO_2 with volatile amines.

Figure 3-13. Effect of pH on Mild Steel and Copper Corrosion

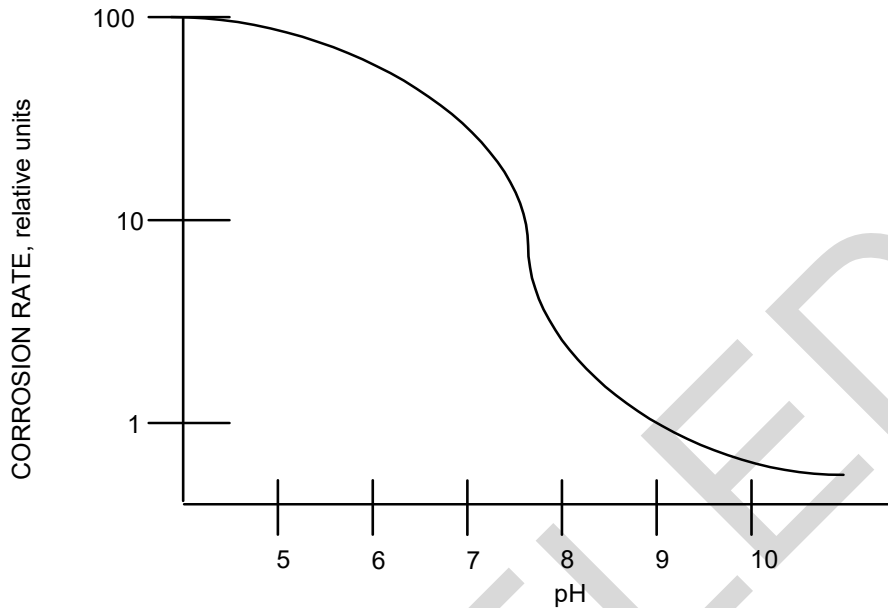

3-2.7.2 **Estimating Carbon Dioxide in Steam.** Corrosion engineers find it useful to know the amount of carbon dioxide (CO₂) in steam when assessing the return on investment (i.e., cost savings from removing the CO₂ versus the cost for use of internal chemical treatment to remove the CO₂). Engineers and water treatment service companies need to estimate the amount of CO₂ to properly estimate the amount of neutralizing amine water treatment chemical that must be used. Example 3-5 illustrates this estimation:

CO₂ levels in the steam can be estimated from the amount of bicarbonate and the carbonate alkalinity present in the feedwater as follows, where the “P” and “M” alkalinity measure these compounds. (See paragraph 6-6.1 for test methods.)

$$\begin{aligned} \text{EQUATION} \quad & \text{CO}_2 = [\text{bicarbonate} \times 0.79] + [\text{carbonate} \times 0.35] \\ & \text{CO}_2 = [(M - 2P) \times 0.79] + [2P \times 0.35] \end{aligned} \quad (18)$$

where:

- CO₂ = carbon dioxide estimate, ppm as CO₂
- M = total (methyl orange) alkalinity, ppm as CaCO₃
- P = phenolphthalein alkalinity, ppm as CaCO₃

EXAMPLE 3-5:

- a) Measured P = 2 ppm, M = 60 ppm
- b) Bicarbonate CO₂ contribution $[60 - (2 \times 2)] \times 0.79 = 44.2$

c) Carbonate CO₂ contribution (2 x 2) x 0.35 = 1.4

d) Carbon dioxide estimate CO₂ = 44.2 + 1.4 = 45.6 ppm CO₂ in the steam

NOTE: This is a significant amount of CO₂ in steam due to the amounts of P and M alkalinity in the feedwater. There is some requirement to reduce alkalinity in this quality of feedwater.

3-2.7.3 Control of Carbon Dioxide by Neutralizing Amines. Amines are organic compounds containing a nitrogen group similar to ammonia. They are referred to as “neutralizing amines” in boiler applications because they neutralize acidic (carbonic acid) conditions by raising the pH of the condensate. These amine compounds are volatile and escape the boiler with the steam and eventually dissolve in the steam condensate.

3-2.7.3.1 Control Limits. Amines are added to maintain the pH between 7.5 to 9.0, ideally 7.5 to 8.5, in all parts of the condensate return system. The condensate pH level should not be allowed to fall below 7.5 anywhere within the entire condensate return system or corrosion will occur. For shore-to-ship steam, the Navy requires 8.0 to 9.5 pH (see Table 3-17). These amines are fed separately from other chemicals and are fed directly into the boiler steam drum where they vaporize and travel with the steam into the steam lines. Use continuous amine feed to maintain a constant, effective pH in the steam condensate.

3-2.7.3.2 Vapor-Liquid Distribution Ratios. Morpholine, diethylamino-ethanol (DEAE), and cyclohexylamine are the three neutralizing amines approved for use in military boilers. Limitations of their use are described in paragraph 3-2.7.6. Physical and chemical properties of these amines are shown in Table 3-4. When steam condenses in a condensate return system that services multiple heat exchangers in different locations along the steam distribution system, some amines tend to “fall out” into condensate in legs close to the boiler while some amines tend to stay in the steam and come out in condensate toward the end of the steam distribution system. The degree to which this occurs is called the “vapor-liquid distribution ratio” and is expressed:

$$\text{Vapor-Liquid Distribution Ratio} = \frac{\text{Amine in steam phase}}{\text{Amine in condensate phase}}$$

Table 3-4. Physical and Chemical Properties of Neutralizing Amines

Property	Morpholine	DEAE	Cyclohexylamine
Boiling point (100% amine)	129 °C (264 °F)	163 °C (325 °F)	134 °C (273 °F)
Boiling point (amines/water azeotrope)	--	99 °C (210 °F)	96 °C (205 °F)
Decomposition temperature	340 °C (644 °F)	423 °C (794 °F)	330 °C (626 °F)
Vapor-liquid distribution ratio	0.4	1.7	4.7
Specific gravity (100% amine)	1.002	0.88	0.86
pH, 100 ppm solution	9.7	10.3	10.7
Amount of amine required to maintain pH of 8.0 in water containing 10 ppm CO ₂	37 ppm	22 ppm	15 ppm

Amines have different vapor-liquid distribution ratios and will not work equally well in all systems. Depending on the particular amine, it can be effective in short-, medium-, or long-distance condensate lines. In complex condensate return systems, optimum results are obtained by choosing the appropriate amine or combination of amines on a system-by-system basis. A neutralizing amine selection chart is provided in Table 3-5. Often blends of different amines are used.

Table 3-5. Neutralizing Amine Selection Chart

Amine	Low Pressure (below 103 KPa [15 psig])	High-Pressure Systems (above 103 KPa [15 psig])		
		Short System < 243 m (< 800 ft) ⁽²⁾	Medium System < 1.61 km (< 1 mile) ⁽²⁾	Long System > 1.61 km (> 1 mile) ⁽²⁾
Morpholine		X		
DEAE	X		X	X
Cyclohexylamine ⁽¹⁾	X			
Cyclohexylamine/ morpholine mixture			X	X

NOTES:

1. Cyclohexylamine is not for use in systems having a feedwater alkalinity more than 75 ppm.
2. These system lengths are for classification only and are not absolute. For example, a medium-length system may have more of the characteristics of a long system if lines are poorly insulated or because of poor design. The characteristics of a condensate return system are best determined by a condensate pH survey.

3-2.7.3.3 **Morpholine.** Morpholine has a low vapor-liquid distribution ratio and will drop out of steam quickly, making it suitable for protecting condensate return systems of short to moderate length. Morpholine is best suited for use in high-pressure systems (103 to 6205 kilopascals [15 to 900 pounds per square inch gauge]) because of its high boiling point. Very little morpholine is lost in deaerators from returning condensate.

3-2.7.3.4 **DEAE.** DEAE has a vapor-liquid distribution ratio between that of morpholine and cyclohexylamine. This makes DEAE a good choice for protecting systems of moderate length where either morpholine or cyclohexylamine, if used separately, would not provide complete protection. The low boiling point of a mixture of DEAE and water makes DEAE suitable for use in both low-pressure boilers and high-pressure boilers.

3-2.7.3.5 **Cyclohexylamine.** Cyclohexylamine has a high vapor-liquid distribution ratio and consequently is best suited for protecting extremely long systems. Cyclohexylamine can also be used in low-pressure systems. Cyclohexylamine is not used in systems when the feedwater alkalinity exceeds 75 ppm because of the low solubility of cyclohexylamine bicarbonate, which can be produced and form deposits. The likely areas for formation of these deposits are low-flow areas at the far end of the condensate return system. This deposition problem can be avoided by reducing feedwater alkalinity or by using DEAE. It is also necessary to treat long systems with morpholine to protect the early part of the system where steam is first condensed.

3-2.7.3.6 **Amine Blends.** A mixture of morpholine, DEAE, or cyclohexylamine can be used to provide full protection in medium and large systems. The optimum blend of these amines is determined by measuring the actual pH of the condensate at various locations in the condensate return system. If samples from far sections have a lower pH than other samples, the cyclohexylamine in the mixture can be increased and vice versa. Another pH survey should be done when the blending ratio is changed. An initial blend of 1 part cyclohexylamine and 3 parts morpholine is a good starting point.

3-2.7.4 **Control of Carbon Dioxide and Oxygen by Filming Amines.** Carbon dioxide corrosion can be controlled with 0.7 to 1.0 ppm of a filming amine such as octadecylamine. This chemical will coat the condensate pipe and prevent the carbon dioxide in the water from coming into contact with the pipe wall. Filming amines may also be appropriate for use if there is a high degree of air leakage (oxygen) because

they coat the metal; however, you should not use them in condensate systems that have had corrosion problems in the past. Excess adsorption of the filming amine on the rust will occur and the amine can dislodge the rust and cause it to be returned to the deaerator or to the boiler. Adding filming amines continuously during operation and directly into the steam header through a quill, instead of into the steam drum, is essential. Addition of inadequate dosages can result in accelerated pitting-type corrosion due to incomplete surface coverage. You may need written authorization from the appropriate source before using filming amines in military boilers.

3-2.7.5 Control of Carbon Dioxide and Oxygen by Specialty Volatile Amines.

Some of the specialty oxygen scavengers described in paragraph 3-2.6.2.2 for boilers over 6205 kilopascals (900 pounds per square inch gauge) can be used for the purpose of control of both carbon dioxide and oxygen. The specialty volatile amines include hydroxylamine, hydroquinone, carbonylhydrazide, hydrazine sulfate, and erythorbic acid. They work by both raising the pH of condensate and by scavenging oxygen. They also passivate metal surfaces. Their use may not be appropriate and is restricted by the Food and Drug Administration (FDA). Note that these chemicals may not be needed for good operation of military boiler plants.

3-2.7.6 Amine Limitations and Indoor Air and Steam Quality Issues.

21 CFR Part 173.310 restricts using common neutralizing amines and filming amines to the limitations summarized in Table 3-6. Note that the limits shown in Table 3-6 are maximum allowable concentrations. Using amines may not always be advisable. If amine addition is not continuous, or if the boiler operation is cyclic (e.g., shutting down the boiler for several hours each day), the maximum amine concentration may vary widely and exceed limits, even though the average concentration is within the limits.

Table 3-6. Amine Limits

Amine	Limitation
Cyclohexylamine	Not to exceed 10 ppm in steam, and excluding steam in contact with milk and milk products.
DEAE	Not to exceed 15 ppm in steam, and excluding steam in contact with milk and milk products
Hydrazine	Zero in steam.
Morpholine	Not to exceed 10 ppm in steam, and excluding steam in contact with milk and milk products.
Octadecylamine	Not to exceed 3 ppm in steam, and excluding steam in contact with milk and milk products.

3-2.7.6.1 Steam Used for Sterilization. Some facilities, hospitals in particular, use steam in autoclaves for the purpose of sterilizing equipment such as surgical instruments. There is often concern that neutralizing amines may leave an amine

contaminant on the equipment. Installing a dealkalizer to process the makeup water and thereby reduce the levels of bicarbonate and carbonate alkalinity is an alternative to using neutralizing amines. Using a dealkalizer effectively reduces, and may even eliminate, the need for neutralizing amines to reduce carbon dioxide corrosion. Steam-to-steam heat exchangers may be used to raise sterile steam.

3-2.7.6.2 Food Preparation. The use of neutralizing amines or filming amines is prohibited if the steam contacts milk or milk products. In addition, to provide a margin of safety, the military prohibits any amines in steam used directly for cooking. This may be a sufficient reason to prevent using building steam in food preparation kitchens. In some cases, kitchens use steam to heat jacketed kettles in which food is heated. This application of steam as a heat source does not involve direct contact of the steam with foodstuffs. In other cases, direct contact between the steam and the foodstuffs is the method used to provide heating. There may be concerns that the amines will impart an amine taste or odor to the food. To alleviate this concern, use package steam generators to provide a source of steam that is independent of the building steam system. Another alternative is to use a steam-to-steam heat exchanger.

3-2.7.6.3 Humidification. Steam is often used to humidify the air in buildings. The use of amines may raise a concern of contamination of the air in the building. To provide a margin of safety, the military prohibits using amines in steam that is used directly for humidification. Normally, the quantity of an amine in the air of a steam-humidified building is quite small, usually in the low ppb range; however, packaged steam generators can eliminate this concern.

3-2.8 Water Carryover in Steam. The steam that is produced from boiler water should not contain any liquid water. Common causes of water droplets or impurities being carried into the steam are misting, foaming, priming, and silica carryover.

3-2.8.1. Mist Carryover. The term “misting” refers to a process in which a fine mist is produced as water boils. This 3-stage process is illustrated in Figure 3-14. In stage 1, a bubble of steam vapor reaches the water surface. In stage 2, the bubble bursts, leaving a dent in the water. In stage 3, the water rises to fill the dent. The center of the dent fills at a faster rate than the edges resulting in a small droplet of boiler water that is thrown off as a fine mist. Most, if not all, of the mist is removed in the mist eliminator section of the steam drum; however, any mist that is not removed will be entrained in the steam. These fine droplets will have the same level of dissolved solids as the boiler water and will contaminate the steam and the condensate.

Figure 3-14. Water Boiler Mist Formation

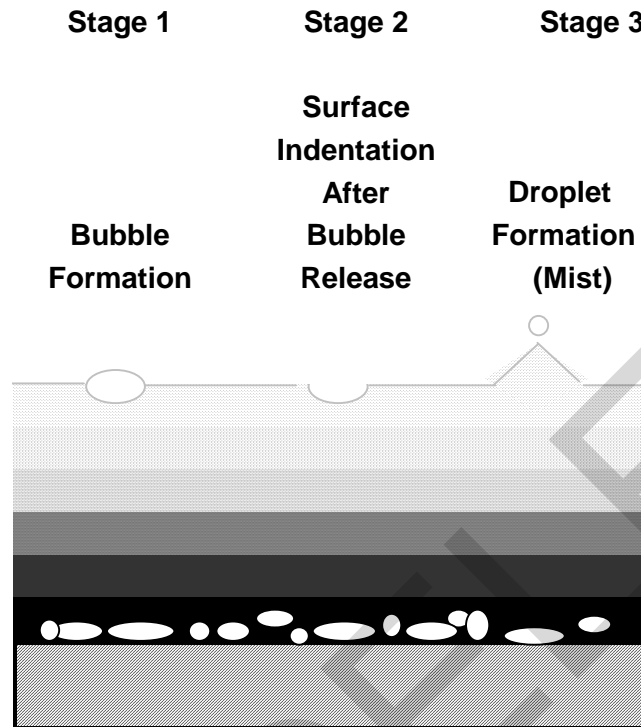

3-2.8.2 **Foaming Carryover.** The term “foaming carryover” refers to boiler water foam and the carryover of foam into the steam. A variety of conditions can cause foam. Excessive levels of alkalinity, TDS, SS, and at times water treatment chemicals can interact to create foam in the boiler. Normally, maintaining the total alkalinity at less than 20% of the TDS and the total suspended solids (TSS) at less than 8% of the TDS can control foaming to a reasonable level. In addition, adding antifoam agents to the boiler water can control foaming. Polyamides and polyglycols are examples of antifoam agents.

3-2.8.3 **Priming Carryover.** The term “priming” refers to boiler water in the steam when, due to liquid level variations and surges in the steam drum, water is mixed with the steam and is subsequently carried into the steam header. A mechanical problem or mechanical properties, such as oversensitive feedwater controls, large steam demands, or incorrect blowdown procedures, always cause priming. There is no chemical control method available, although the addition of antifoam chemicals may help reduce the extent of this occurrence. Boiler operations should be reviewed and modified if priming carryover is occurring.

3-2.8.4 **Silica Carryover.** The term “silica carryover” refers to a situation that occurs when silica in the boiler water volatilizes and enters the steam independently of water carryover. The silica can then form a deposit in the condensate lines and in process equipment when the silica condenses from the steam. When steam turbines are used, silica deposition can be very serious, resulting in unbalancing of the steam

turbine blades. Maintaining a low silica level in the boiler water can control silica carryover. The acceptable level is dependent upon the boiler operating pressure; Table 3-7 shows suggested limits.

Table 3-7. Silica Levels Allowed in Boiler Water

Boiler Pressure KPa (psig)	Allowable Silica ppm (as SiO ₂)
0-103 (0-15)	150
110-1027 (16-149)	150
1034-2062 (150-299)	150
2068-3096 (300-449)	90
3103-4130 (450-599)	40
4137-5164 (600-749)	30
5171 (750)	20

3-2.8.5 Determining Water Carryover in Steam. The best way to determine if any water carryover is occurring is to measure the conductivity of the steam or of the steam condensate. If you detect less than 25 micromhos conductivity in the condensate, then carryover is probably insignificant. If conductivity is greater than 25 micromhos, you should investigate to identify the cause.

3-2.8.5.1 Conductivity Measurement Implications. A conductivity measurement above 25 micromhos in the steam condensate indicates that there is either carryover or leakage into the steam or condensate system. Accordingly, a test for hardness in the condensate must also be performed. If you find hardness, contamination of the condensate is likely due to raw water or leakage into the condensate system rather than boiler water carryover. If boiler water is at a very low hardness, then raw water may be the cause.

3-2.8.5.2 Deposit Analysis. Any deposits found in the steam or condensate systems should be analyzed to determine the source. Deposits that are mostly magnetic iron oxide are due to corrosion of mild steel in the condensate system. Using neutralizing amines (as described in paragraphs 3-2.7.3 and 3-2.7.4) can control these deposits. If the deposits are mostly silica, increasing the blowdown or removing silica from the makeup water can reduce them. If the deposits are mostly sodium salts (sodium hydroxide, sodium carbonate, sodium chloride, sodium sulfate, and sodium phosphate), the cause is probably boiler water carryover from misting, priming, or foaming.

3-3 **DEVELOPING A STEAM BOILER SYSTEM WATER TREATMENT PROGRAM.** A complete boiler water treatment program takes into account industry-developed guidelines for feedwater quality limits and boiler water quality limits. The water treatment industry recognizes the suggested water limits developed by the American Society of Mechanical Engineers (ASME), the American Boiler Manufacturers Association (ABMA), and USACE. The limits developed by these three organizations are not always identical; furthermore, the limits are actually only guidelines. In some cases these limits have been exceeded by boiler operations without unacceptable impacts; however, these limits should be considered as prudent, safe, and practical guidelines (see Tables 3-8 through 3-20).

3-3.1 **Organizing a Treatment Program.** Once you have defined water treatment requirements, organize personnel to implement the program. The organization process consists of identifying a staff, training them to execute the program, and integrating the program into overall installation management.

3-3.2 **Operator Training.** Operator training is essential to a water treatment program. Operators should understand the operation of their specific plant and reasons for specified procedures, including requirements of CFR Title 29, Part 1910.1200, *Hazard Communication*. An understanding of reasons for, and results of, chemical treatment is essential. Knowledge of thermodynamic and mechanical interactions of plant equipment is important. The operator should be particularly aware of safe operating procedures. Since internal chemical treatment of boiler water is a significant factor in achieving reliable and efficient plant operation, operators should have an understanding of the subject. Training should include the specifics of water treatment and related costs.

3-3.2.1 **Pretreatment Training.** Pretreatment is necessary to ensure the quality of the water to be treated for industrial use and to prevent or reduce associated problems such as deposits and corrosion. Training might address these methods of pretreatment (depending on the type of plant):

- Chemical addition.
- Ion exchange.
- RO.
- Distillation.

3-3.2.2 **Treatment Training.** Steam boilers, high-temperature water systems, and cooling water systems all require treatment of feedwater to prevent or reduce deposits, scale, corrosion, and microorganisms.

3-3.2.2.1 **Boiler Water Treatment.** The training related to boiler water treatment should address:

- Necessity for internal boiler water treatment.
- Deaeration and oxygen scavenging.
- Maintenance of concentration levels.
- Causes and effects of deposits, scale, and corrosion.
- Chemical treatment programs, such as phosphate, polymers, sulfite, hydrazine, and others.
- Where to feed chemicals.
- Effects of carryover and silica on steam purity.
- Prevailing ASME and internal standards.
- Corrosion in condensate returns from oxides of iron and copper.
- Effects of filming and neutralizing amines and hydrazine.
- Boiler layup procedures.

3-3.2.2.2 **Cooling Systems Treatment.** Training for treatment of cooling systems feedwater should address:

- Once-through cooling water systems.
- Recirculating cooling water systems.
- Need for and means of maintaining clean condensers.
- Chemicals and methods of treatment.
- COC.

3-3.2.2.3 **Blowdown.** Blowdown is used in both cooling and steam systems to regulate COC of solids through dilution with makeup water. Training associated with blowdown procedures should include:

- Surface versus bottom.
- Internal provisions.

- Estimating blowdown.
- Continuous and intermittent.
- Controllers and COC.
- Heat recovery through flash tanks and heat exchangers for boilers.

3-3.2.3 **Program Content.** Training should be provided in steps that are geared to operators' capabilities. Weekly sessions, with handouts, periodic reviews, and testing should be planned to assess trainees' retention and understanding of material and effectiveness of teaching methods. Assistance in establishing a training program should be obtained from the regional Engineering Field Division (EFD) before going to other sources. In addition, a videotaped training course, *Power Principles*, is available. The course contains 80 tapes on various subjects related to power plant operations, and includes student texts and instructor guides. Four 1-hour videotapes address basic water chemistry, and four 1-hour tapes address water treatment equipment. Each tape is divided into six 10-minute sections. The tapes cover:

- Basic water chemistry.
- Chemistry concepts.
- Water chemistry fundamentals.
- Elementary water treatment.
- Water chemistry applications.
- Water treatment equipment.
- Boiler water treatment.
- Raw water treatment.
- Ion exchange.
- Cooling water treatment.

Your geographical EFD can provide additional information about this program.

3-3.3 **Equipment and Procedures.** Chapter 7 contains a description of water quality instrumentation and treatment equipment for various applications. Paragraph 7-3 describes procedures. The subject is also covered in Appendix E.

3-3.4 **Feedwater Quality Limits.** Tables 3-8 through 3-12 show feedwater limits. The limits are specific for the type of boiler, operating pressure, and steam application. Since feedwater is the combination of makeup water and condensate return, recovering as much uncontaminated condensate as possible is advisable, considering the cost of boiler water treatment and the benefits derived from both energy and water conservation. The high purity of uncontaminated condensate minimizes the requirement for treatment of makeup water and boiler water. The feedwater parameters shown in Tables 3-8 through 3-12 do not specify levels for alkalinity and silica because it is assumed that these levels in the boiler water will be limited through blowdown. In higher pressure boilers using demineralized makeup water, alkalinity and silica will be very low or even absent. Although not specified, it can make sense to reduce feedwater alkalinity and silica in boilers less than 6205 kilopascals (900 pounds per square inch gauge) to allow for an increase in COC and, consequently, to reduce chemical demand. The tables show limits for hardness, iron, and copper. Hardness and iron can be removed by softening the makeup water. Iron and copper may still be present in the feedwater if they are present in the condensate due to corrosion. In many instances, these limits cannot be met for small heating boilers (e.g., oxygen content in feedwater for boilers that lack a deaerator, or hardness levels in feedwater for boilers that lack softeners). The only alternative is to chemically treat boiler water and control COC, as required.

**Table 3-8. Suggested Feedwater Limits for Industrial Water Tube Boiler
0–2068 KPa (0–300 psig)**

Feedwater Property	ASME	ABMA	USACE
Dissolved oxygen ppm O ₂ before chemical oxygen scavenger addition	< 0.007	Note 6	NS
Total iron ppm Fe (as Fe)	< 0.1	Note 6	NS
Total copper ppm Cu (as Cu)	< 0.05	Note 6	NS
Total hardness ppm (as CaCO ₃)	< 0.5	Note 6	softened
pH at 25 °C (77 °F)	8.3-10.5	Note 6	NS
Non-volatile TOC ppm (as O ₂)	< 1	Note 6	NS
Oily matter ppm	< 1	Note 6	NS

NOTES:

1. Makeup water percentage: Up to 100% of feedwater.
2. Assumes existence of deaerator.
3. Conditions: no superheater, turbine drives, or process restriction on steam purity.
4. Steam purity: 1.0 ppm TDS maximum.
5. NS = not specified.
6. See ABMA Standard – Boiler 401

**Table 3-9. Suggested Feedwater Limits for Industrial Water Tube Boiler
2075-4137 KPa (301-600 psig)**

Feedwater Property	ASME	ABMA	USACE
Dissolved oxygen ppm O ₂ before chemical oxygen scavenger addition	< 0.007	Note 6	NS
Total iron ppm Fe (as Fe)	< 0.05	Note 6	NS
Total copper ppm Cu (as Cu)	< 0.025	Note 6	NS
Total Hardness ppm (as CaCO ₃)	< 0.3	Note 6	NS
pH at 25 °C (77 °F)	8.3-10.5	Note 6	NS
Non-volatile TOC ppm (as O ₂)	< 1	Note 6	NS
Oily matter ppm	< 1	Note 6	NS

NOTES:

1. Makeup water percentage: Up to 100% of feedwater.
2. Assumes existence of deaerator.
3. Conditions: no superheater, turbine drives, or process restriction on steam purity.
4. Steam purity: 1.0 ppm TDS maximum.
5. NS = not specified.
6. See ABMA Standard – Boiler 401

**Table 3-10. Suggested Feedwater Limits for Industrial Fire Tube Boiler
0-2068 KPa (0-300 psig)**

Feedwater Property	Limit
Dissolved oxygen (ppm O ₂) before chemical oxygen scavenger addition	< 0.007
Total iron ppm Fe (as Fe)	< 0.1
Total copper ppm Cu (as Cu)	< 0.05
Total Hardness ppm (as CaCO ₃)	< 1.0
PH at 25 °C (77 °F)	8.3-10.5
Non-volatile TOC ppm (as O ₂)	< 10
Oily matter ppm	< 1

NOTES:

1. Makeup water percentage: up to 100% of feedwater.
2. Assumes existence of deaerator.
3. Conditions: no superheater, turbine drives, or process restriction on steam purity.
4. Steam purity: 1.0 ppm TDS maximum.

Table 3-11. ASME Feedwater Limits for Industrial Water Tube Boilers

Feedwater Property	0 - 2068 KPa (0 - 300 psig)	2075-3103 KPa (301-450 psig)	3110 - 4137 KPa (451 - 600 psig)	4144 - 5171 KPa (601 - 750 psig)	5178 - 6205 KPa (751 - 900 psig)	6212 - 6895 KPa (901 - 1000 psig)	6902-10,342 KPa (1001 - 1500 psig)	10,349-13,790 KPa (1501 - 2000 psig)
Dissolved oxygen (ppm O ₂) before adding chemical oxygen scavenger	< 0.007	< 0.007	< 0.007	< 0.007	< 0.007	< 0.007	< 0.007	< 0.007
Total iron ppm Fe (as Fe)	≤ 0.1	≤ 0.05	≤ 0.03	≤ 0.025	≤ 0.02	≤ 0.02	≤ 0.01	≤ 0.01
Total copper ppm Cu (as Cu)	≤ 0.05	≤ 0.025	≤ 0.02	≤ 0.02	≤ 0.015	≤ 0.01	≤ 0.001	≤ 0.001
Total Hardness ppm (as CaCO ₃)	≤ 0.03	≤ 0.03	≤ 0.02	≤ 0.02	≤ 0.1	≤ 0.05	ND	ND
pH at 25 °C (77 °F)	8.3-10.0	8.3-10.0	8.3-10.0	8.3-10.0	8.3-10.0	8.3-9.6	8.3-9.6	8.3-9.6
Chemicals for pre-boiler system	NS	NS	NS	NS	NS	VAM	VAM	VAM
Non-volatile TOC ppm (as O ₂)	< 1	< 1	< 0.5	< 0.5	< 0.5	< 0.2	< 0.2	< 0.2
Oily matter ppm	< 1	< 1	< 0.5	< 0.5	< 0.5	< 0.2	< 0.2	< 0.2

NOTES:

1. Makeup water percentage: Up to 100% of feedwater.
2. Assumes existence of deaerator.
3. Conditions: Includes superheater, turbine drives, or process restriction on steam purity.
4. Saturated steam purity target as shown.
5. NS = not specified.
6. ND = not detectable.
7. VAM = Use only volatile alkaline materials upstream of a temporary water source.

Table 3-12. ASME Suggested Feedwater Limits for Marine Propulsion Water Tube Boiler

Feedwater Property	3103-5861 KPa (450-850 psig)	5867-8618 KPa (851-1250 psig)
Dissolved oxygen (ppm O ₂) before chemical oxygen scavenger addition	< 0.007	< 0.007
Total iron ppm Fe (as Fe)	< 0.02	< 0.01
Total copper ppm Cu (as Cu)	< 0.01	< 0.005
Total hardness ppm (as CaCO ₃)	< 0.1	< 0.05
pH at 25 °C (77 °F)	8.3–9.0	8.3–9.0
Chemicals for pre-boiler system	VAM	VAM
Oily matter ppm	< 0.05	< 0.05

NOTES:

1. Makeup water percentage: Up to 5% of feedwater.
2. External treatment: at sea, evaporator condensate; in port, evaporator condensate or water from shore facilities meeting feedwater quality guidelines.
3. Assumes existence of deaerator.
4. Saturated steam purity: 30 ppb TDS maximum, 10 ppb Na maximum, 20 ppb SiO₂ maximum.
5. VAM = Use only volatile alkaline materials.

3-3.5 Boiler Water Chemistry Limits. Tables 3-13 through 3-16 show boiler water chemistry limits. The limits are specific for the type of boiler, operating pressure, and steam application. There are two types of limits to recognize. The first comes from the presence of natural constituents in the feedwater (i.e., TDS or conductivity, silica, and alkalinity). These constituents can be the controlling factor for COC. Blowdown is ultimately required to keep their levels within limits. SS is the result of precipitation of minerals. These are kept within limits through bottom blowdown. The second type is treatment limits for chemicals added into the boiler (see Tables 3-17 and 3-18).

Table 3-13. ASME Suggested Boiler Water Limits for Industrial Water Tube Boiler

Boiler Water Property	0-2068 KPa (0-300 psig)	2075-4137 KPa (301-600 psig)
Silica (ppm SiO ₂)	< 150	< 90
Total alkalinity	< 1000	< 850
Free OH alkalinity	NS	NS
Specific conductance (μmhos/cm) without neutralization	< 7000	< 5500

NOTES:

1. Makeup water percentage: Up to 100% of feedwater.
2. Assumes existence of deaerator.
3. Conditions: no superheater, turbine drives, or process restriction on steam purity.
4. Steam purity: 1.0 ppm TDS maximum.
5. NS = not specified.

Table 3-14. ASME Boiler Water Limits for Industrial Water Tube Boilers

Boiler Water Property	0 - 2068 KPa (0 - 300 psig)	2075 - 3103 KPa (301-450 psig)	3110 - 4137 KPa (451 - 600 psig)	4144 - 5171 KPa (601 - 750 psig)	5178 - 6205 KPa (751 - 900 psig)	6212 - 6895 KPa (901 - 1000 psig)	6902 - 10342 KPa (1001 - 1500 psig)	10349 - 13790 KPa (1501 -2000 psig)
Silica (ppm SiO ₂)	≤ 150	≤ 90	≤ 40	≤ 30	≤ 20	≤ 8	≤ 2	≤ 1
Total alkalinity	< 350	< 300	< 250	< 200	< 150	< 100	NS	NS
Free OH alkalinity	NS	NS	NS	NS	NS	NS	ND	ND
Specific conductance (μmhos/cm) without neutralization	5400-1100	4600-900	3800-800	1500-300	1200-200	1000-200	≤150	≤80
TDS (maximum) ppm	1.0-0.2	1.0-0.2	1.0-0.2	0.5-0.1	0.5-0.1	0.5-0.1	0.1	0.1

NOTES:

1. Makeup water percentage: Up to 100% of feedwater.
2. Assumes existence of deaerator.
3. Conditions: Includes superheater, turbine drives, or process restriction on steam purity.
4. Saturated steam purity target as shown.
5. NS = Not specified.
6. ND = Not detectable.

**Table 3-15. ASME Boiler Water Limits for Industrial Fire Tube Boilers
0-2068 KPa (0-300 psig)**

Boiler Water Property	Limit
Silica (ppm SiO ₂)	< 150
Total alkalinity	< 700
Free OH alkalinity	NS
Specific conductance (μmhos/cm) without neutralization	< 7000

NOTES:

1. Makeup water percentage: Up to 100% of feedwater.
2. Assumes existence of deaerator.
3. Conditions: no superheater, turbine drives, or process restriction on steam purity.
4. Steam purity: 1.0 ppm TDS maximum.
5. NS = not specified.

**Table 3-16. ASME Suggested Boiler Water Limits for
Marine Propulsion Water Tube Boiler**

Boiler Water Property	3103-5861 KPa (450-850 psig)	5867-8618 KPa (851-1250 psig)
Silica (ppm SiO ₂)	< 30	< 5
Total alkalinity	NS	NS
Free OH alkalinity	< 200	ND
Specific conductance (μmhos/cm) without neutralization	< 700	< 150

NOTES:

1. Makeup water percentage: Up to 5% of feedwater.
2. External treatment: at sea, evaporator condensate. In port, evaporator condensate or water from shore facilities meeting feedwater quality guidelines.
3. Assumes existence of deaerator.
4. Saturated steam purity: 30 ppb TDS maximum, 10 ppb Na maximum, 20 ppb SiO₂ maximum.
5. NS = not specified.
6. ND = non detectable.
7. VAM = Use only volatile alkaline materials.

3-3.6 **Shore-to-Ship Steam Quality.** NAVSEASYS COM shore-to-ship steam purity is specified in NAVSEA S9086-GX-STM-020, Section 220, Volume 2, *Boiler Water/Feedwater Test and Treatment*, and PACNAVFACENGCOM P200, *Shore-to-Ship Steam and Feedwater Manual for Naval Facilities*.

Table 3-17. NAVSEASYSKOM Shore-To-Ship Steam Purity Requirements

PH	8.0–9.5
Conductivity	< 25 micromhos/cm
Dissolved silica	< 0.2
Hardness	< 0.10 ppm
Dissolved oxygen	< 15 ppb

3-3.7 **Treatment Guidelines for Low-Pressure Steam.** Treatment guidelines for boilers operating at less than 103 kilopascals (15 pounds per square inch gauge) are determined by size and type, as described in Table 3-18. Cast iron boilers and boilers less than 334 watts (10 horsepower) are not treated. Boilers with greater than 95% condensate return can either be treated the same as a closed hot water boiler (see Chapter 5), or treated the same as boilers with less than 95% condensate return. The latter uses external treatment, usually softening, and internal chemical treatment that includes a scale inhibitor (precipitating type – i.e., phosphate) or solubilizing type (i.e., phosphonates and polymers) sulfite to control pitting due to oxygen, and a neutralizing amine to control pH in the condensate system. Sometimes raising pH in the boiler water requires a supplemental source of alkalinity. Usually this supplemental source is caustic soda, but it can also be sodium carbonate (soda ash).

Table 3-18. Treatment Guidelines for Low-Pressure Steam

Boiler	Guidelines
Cast iron	Not treated
Less than 334 W (10 hp)	Not treated
Boiler with 95% condensate return	1. External treatment: softening. 2. Internal treatment: precipitating or solubilizing scale inhibitor, sulfite, tannin derivatives, filming surfactant, caustic supplement if necessary, neutralizing amine. 3. See Tables 3-19 through 3-20. Or 4. Treat same as closed hot water (see Chapter 5).
Boilers with less than 95% condensate return	1. External treatment: softening. 2. Internal treatment: precipitating or solubilizing scale inhibitor, sulfite, tannin derivatives, filming surfactant, caustic supplement if necessary, neutralizing amine. 3. See Tables 3-19 and 3-20.

3-3.8 Treatment Guidelines for Medium- and High-Pressure Steam.

Treatment of medium- (110 to 2062 kilopascals [16 to 299 pounds per square inch gauge]) and high-pressure (2068 to 6205 kilopascals [300 to 900 pounds per square inch gauge]) boilers is similar and is described in Table 3-19. Treatment can include either a precipitating (i.e., phosphate) or a solubilizing (i.e., phosphonate or polymers) approach to scale control. Sulfite is used to control pitting due to oxygen, and a neutralizing amine is used to control pH in the condensate system. Sometimes raising pH in the boiler water requires a supplemental source of alkalinity. Usually this source is caustic soda, but it can also be sodium carbonate (soda ash). Boilers operating between 4137 to 6205 kilopascals (600 to 900 pounds per square inch gauge) will sometimes use erythorbic acid or specialty volatile oxygen scavengers or amines (i.e., hydrazine, DEHA, carbonylhydrazide, hydroquinone or methylethylketoxime) as oxygen scavengers in boiler water. The volatile compounds can also scavenge oxygen in a condensate system. Refer to paragraph 3-2.7 for a description of condensate corrosion control.

Table 3-19. Treatment Guidelines for Medium- and High-Pressure Steam

Parameter	Boiler Water Treatment Control
COC	Maximum of 100, per ASME
General corrosion	Maximum total alkalinity, per ASME guidelines, pH of 10.3–12.0. May require alkalinity builder.
Pitting corrosion	20-40 ppm sulfite for boilers up to 6205 KPa (900 psig). Specialty volatile oxygen scavengers optional for boilers 4137-6205 KPa (600-900 psig). Also, tannin derivatives and other organic-based oxygen scavengers
Condensate corrosion	Maintain pH of 7.5-9.3 using neutralizing amines or follow guidelines for filming surfactant chemistry. Specialty volatile oxygen scavengers optional.
Deposition control	1. Precipitating program using phosphate or carbonate with a polymer sludge conditioner. Or 2. Solubilizing program using chelants, phosphonates, or polymers. Or 3. Tannin and lignin derivatives and phosphonates and/or polymers (including acrylate-styrenesulfonate co-polymers and polymethacrylates)
Carryover control due to foaming	Limit total alkalinity, per ASME guidelines, and treat with antifoam as required.

3-3.9 **Condensate Corrosion and Control.** Oxygen and carbon dioxide are common steam condensate impurities that promote condensate corrosion. Less common are process contaminants, each of which has corrosive properties dependent upon the nature of the contaminant and the materials that may be corroded. The piping found in steam condensate systems is most commonly constructed of mild steel, whereas heat exchangers are usually copper or mild steel. (For more information, see paragraph 3-2.7.)

3-3.10 **Treatment Guidelines for Very-High-Pressure Steam.** Treatment of very-high-pressure (greater than 6205 kilopascals [900 pounds per square inch gauge]) boilers is different than for those of lower pressure. Because temperatures and pressures are much more extreme, the boilers can tolerate little in the way of boiler water impurities. Table 3-20 provides treatment guidelines.

Table 3-20. Treatment Guidelines for Very-High-Pressure Steam

Parameter	Boiler Water Treatment Control
COC	Maximum of 100, per ASME.
General corrosion control	Maintain pH, per ASME guidelines, using coordinated, congruent, or equilibrium phosphate, or with all volatile treatment.
Pitting corrosion control	Volatile hydrazine substitutes: hydroxylamine, hydroquinone, carbohydrazide, hydrazine sulfate, tannin derivatives, or erythorbic acid.
Condensate corrosion control	Maintain pH of 7.5-9.3 using specialty volatile oxygen scavengers listed for pitting control above.
Deposition control	External treatment to remove scaling agents. Example: RO with demineralization
Carryover control due to foaming	External treatment to remove alkalinity and other minerals. Example: RO with demineralization

3-3.11 **Boiler Operator Duties.** Operators should keep feedwater quality, COC, and treatment levels within program control limits at all times. Operators must perform recordkeeping and assess trends in the results of system performance tests routinely (see paragraph 1-1.8). When changes in feedwater quality, TDS, or chemical treatment levels occur, the operator must investigate and resolve the reasons for these changes. Boiler operators need to understand their equipment and how it operates. Does it operate seasonally? Does it operate intermittently? Does the amount of condensate return vary? These conditions may require adjustments in chemical treatment. Paragraphs 3-4 and 3-5 present some common problems.

3-4 **Chemical Requirements for Boiler Start-up.** Start-up of a new or repaired boiler requires special water treatment procedures. The start-up of a boiler after a wet or dry layup period also requires special water treatment procedures.

3-4.1 **Common Problems During Start-up of New Boilers.** A common problem that can occur during start-up of new boilers is corrosion of the boiler tubes due to improper initial conditioning of the water and boiler metal. Carryover of boiler water due to improper start-up can also occur, particularly with new boilers.

3-4.2 **Start-up of New Boilers and Condensate Systems or Repaired Boilers.** As a result of the fabrication process, a new or repaired boiler that is erected in the field or shipped as a package unit will likely contain oils and greasy films, and perhaps rust, on the metal surfaces. The oils, grease, and rust can contribute to carryover and contaminate the steam and initiate corrosion of the boiler components. A pre-operational alkaline boil-out procedure is required to remove these materials. This pre-operational process is usually part of a new construction project and therefore may not be in the direct control of boiler operations personnel. Often, the contracting officer involved with the project can provide verification of the completion of this important step.

The following example of an alkaline boil-out procedure consists of four steps:

1. Inspect the inside of the boiler and remove all debris.
2. Add an alkaline boil-out chemical formulation to the boiler water. This should be roughly equivalent to the following formulation: 10.4 kilograms (24 pounds) of caustic soda, 10.4 kilograms (24 pounds) of disodium phosphate, 3.5 kilograms (8 pounds) of sodium nitrate, 0.2 kilogram (0.5 pound) non-ionic wetting agent (a low-foaming detergent) per each 3785 liters (1000 gallons) of boiler capacity.
3. Fill the boiler to the steam header and maintain at low fire for 1 to 2 days. For condensate systems, this formulation should be circulated for 3 to 4 days, drained completely, and the system dried completely by purging with dry air.
4. Drain and flush. Proceed immediately to operational treatment levels or to a layup status. Untreated water should never be allowed to remain in the boiler.

Table 3-21. Troubleshooting Boiler System Water

Problem	Recommended Solution/Possible Cause
Hardness in feedwater	1. Check softener 2. Possible leak into condensate system
Change in overall treatment levels	1. Change in amount of condensate return 2. Change in blowdown control 3. Change in overall chemical feed rate
Loss of alkalinity	1. Hardness incursion 2. Loss of caustic feed 3. Excessive blowdown
Loss of scale prohibitor	1. Hardness incursion 2. Loss of chemical feed 3. Excessive blowdown
Loss of sulfite	1. Loss of sulfite feed 2. Poor deaerator operation or influx of oxygen 3. Excessive makeup and loss of condensate
High conductivity (>25 μ mhos) in steam	Carryover due to misting, foaming, or priming
Foaming carryover	Excessively high TDS, alkalinity, or chemical treatment
Priming carryover	Operational problem with excessive load demands, feedwater and level control problem, uneven firing patterns
Misting carryover	Defective mist eliminators

3-4.2.1 Start-up of Boiler from Wet Layup. Boilers that have been properly laid up wet will already have adequate excess levels of sulfite and alkalinity (see paragraph 3-5.4). Upon adjusting the water level and firing up the boiler, feed all chemical treatments as normally added, except for sulfite and alkalinity supplement. There is no need to feed these treatments until blowdown results in reducing their levels. Then add chemicals in the amounts required to reach normal maintenance levels.

3-4.2.2 Start-up of Boiler from Dry Layup. Boilers that have been properly laid up dry (see paragraph 3-5.3) can be filled with feedwater to their normal operating boiler water level. The start-up dosage of sulfite and alkalinity supplement (caustic or soda ash) can be fed along with the standard chemical treatment feed rates to obtain normal levels of water treatment chemicals. It is necessary to achieve proper sulfite and alkalinity levels in the boiler water to control corrosion while the COC is increased to normal operating levels. The sulfite concentration should be at least 20 ppm (SO_3), and the alkalinity level should result in a pH of about 11.0.

3-5 **CHEMICAL REQUIREMENTS FOR BOILER LAYUP.** Boiler layup also requires special water treatment. Boilers that will be out of service for more than 4 calendar days require special water treatment to prevent internal corrosion. Boiler layup can be either dry or wet. The advantages of wet layup are that it often provides better corrosion protection and the boiler can be brought on-line much faster than when dry layup procedures are used.

3-5.1 **Operational Considerations.** Operational considerations are important to consider when determining the proper boiler status. The terms “lead” and “lag” are used commonly for boilers that need to meet varying load demands. The lead boiler satisfies the base steam load. The lag boiler meets any extra steam demand that might be needed during hours of the evening or mornings or when (additional) process loads are required. Lag status does not apply to a cold boiler that is not required for duty for a few days. Such a boiler should be considered in layup condition and should be prepared accordingly.

3-5.2 **Common Problems that Occur During Layup.** Common problems that occur during layup are: oxygen pitting of tubes and condensate piping, sometimes to the point of failure; general corrosion of tubes and condensate piping; and corrosion product contaminating feedwater via the condensate system.

3-5.3 **Dry Layup of Boilers.** Boilers with manholes may be laid up in one of two ways, depending on the length of storage and conditions in the boiler room: open dry layup, or quicklime or silica gel layup.

3-5.3.1 **Open Dry Layup Method.** The open dry layup method is recommended for short-term storage (30 to 150 days) where the boiler room is dry, has low humidity, and is well ventilated. It is important to keep the boiler dry. The recommended procedure consists of six basic steps:

1. Take the boiler out of service and drain it completely while still warm. Make sure the water walls and gauge columns are not overlooked.
2. Lock and tag out boiler in accordance with written procedures.
3. Break the feedwater and steam connections to the boiler and blank off connections if other boilers in the plant are operating.
4. The boiler may be opened and the inside washed of all loose scale and sediment by flushing with high-pressure water.
5. Use a stiff brush to clean all internal surfaces that can be reached.
6. Leave boiler open to the atmosphere. Should a humid atmosphere exist, the boiler must be closed up and the procedure specified in paragraph 3-5.3.2 used.

3-5.3.2 **Quicklime or Silica Gel Layup Method.** This procedure is recommended for storage over 150 days or for less than 150 days when the boiler room and atmosphere is quite humid and not well ventilated. The recommended procedure consists of eight basic steps:

1. Take the boiler out of service and drain completely while still warm. Make sure that water walls and gauge columns are not overlooked.
2. Lock and tag out the boiler in accordance with written procedures.
3. Break the feedwater and steam connections to the boiler and blank off connections if other boilers in the plant are operating.
4. The boiler may be opened and the water-contacted inside surface washed to remove all loose scale and sediment by flushing thoroughly with high-pressure water.
5. Use a stiff brush to clean all internal surfaces that can be reached.
5. Start a very light fire in the furnace to dry out the boiler water-contacted surfaces. Maintain this fire for at least 2 hours or until inspection shows no moisture on internal sections of the boiler.
6. Place quicklime (not hydrated lime) or new, unused silica gel in one or more metal or fiber trays in the boiler. Place the trays on wood blocks so air can circulate under them. The amount of lime or silica gel required is about 22 kilograms (50 pounds) per 0.36 kilogram of steam per second (3000 pounds per hour) boiler capacity.
7. Seal the boiler to prevent any moist air from entering the boiler.
8. Open and inspect the boiler every 2 months. Replace any moist quicklime or silica gel with new material.
9. Carefully reseal immediately after the inspection and after the addition of new chemicals.

3-5.4 **Wet Layup of Boilers.** This method means that the boiler is kept completely full of treated water. This method is easier to check and the boiler can be put back in service more quickly. This method should not be used if the boiler is subject to freezing temperatures.

3-5.4.1 **Wet Layup without Draining (Operational Boilers).** This method is used most commonly when a boiler is to be shut down for 4 to 30 calendar days. Often the boiler must be maintained in a standby condition. Corrosion will most likely occur in the boiler unless both the water level in the steam drum and the chemicals in the boiler are

increased. These procedures are recommended for wet layup of a boiler without draining or cleaning:

1. Approximately 4 hours before the boiler is to be shut down, add sufficient sodium hydroxide (caustic) to increase the hydroxyl alkalinity (causticity) to 10 to 20% higher than the upper limit given in Tables 3-19 and 3-20 for the pressure of the boiler to be laid up.
2. Add sufficient sodium sulfite to increase the sulfite residual to 200 ppm (as SO₃).
3. Extinguish the fire to the boiler.
4. Add water to completely fill the entire boiler until the water runs out of the vent (safety) valve or air cock.
5. When the boiler is completely cool, add more water to ensure it is full.
6. Maintain a pressure of 35 to 69 kilopascals (5 to 10 pounds per square inch gauge) during layup and maintain the levels of alkalinity and sulfite.
7. Check the boiler frequently to make sure no water has leaked out.
8. Analyze the boiler water at least once per month to make sure the chemical residuals are being maintained.

3-5.4.2 **Wet Layup of Drained Boilers.** These procedures are recommended for boilers that have been emptied for cleaning or repair before wet layup:

1. Drain the boiler completely and remove scale or deposits.
2. Remove connections to other active boilers, feedwater, and steam systems.
3. Fill the boiler with water (deaerated water if available) and add enough sodium hydroxide (caustic) to give a hydroxyl level of about 200 ppm (as OH).
4. Add sodium sulfite to give a sulfite residual of 200 ppm (as SO₃).
5. Circulate chemicals in the boiler by careful boiling for 2 hours. Be sure to fill the boiler to replace any losses during this treatment.
6. Extinguish the fire to the boiler.
7. Add water to completely fill the entire boiler until the water runs out of the vent (safety) valve or air cock.

8. When the boiler is completely cool, add more water to ensure it is full. Maintain a pressure of 35 to 69 kilopascals during layup and maintain the levels of alkalinity and sulfite.
9. Inspect the boiler on a regular basis and replace any water losses. To facilitate inspections, a small steel tank equipped with a gauge glass can be installed above the top of the boiler, as shown in Figure 3-15. Fill the tank with treated water and connect to a steam takeoff tap, vent, or safety valve connection. A glance at the water level in the small drum will quickly tell whether or not the boiler is completely filled.

Figure 3-15. Inspection Gauge for Wet Boiler Layup

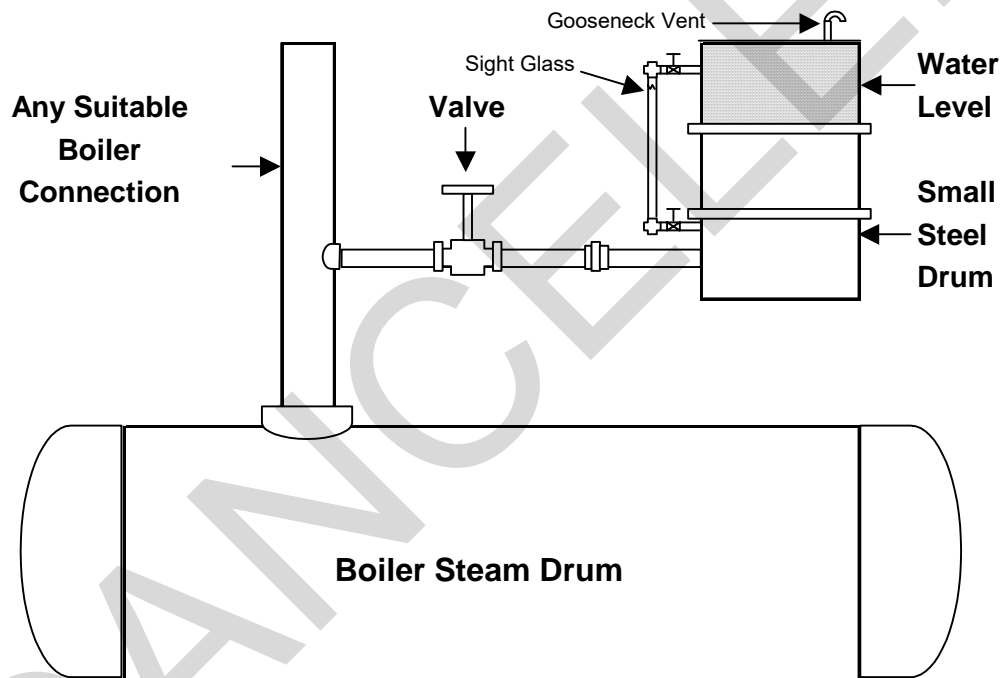

3-5.5 Layup of Condensate Systems. Layup of condensate systems is much more difficult than layup of boilers. As the system cools, oxygen will be drawn in, resulting in a situation that leads to corrosion. Purging the system with dry, inert gas can be effective, but the logistics can be nearly impossible and the hazards include the potential for suffocating people if the system is located in an unvented area. Application of a high dosage of a filming amine prior to shut down can be effective, but its use is restricted for many applications and is prohibited in military operations. Application of a high dosage of neutralizing amines (see paragraph 3-2.7.3) or of a specialty volatile oxygen scavenger (see paragraph 3-2.7.5) can be helpful. The application of any amine or specialty volatile oxygen scavenger can be limited where steam purity or FDA restrictions exist.

3-6 **COMMONLY ASKED QUESTIONS AND ANSWERS ON BOILER
WATER TREATMENT**

- Q1. What is meant by neutralized conductivity?
A1. Boiler water most often contains hydroxyl (OH⁻) alkalinity. The OH⁻ contribution to conductivity is disproportionately large compared to other ion species. Furthermore, the OH⁻ contribution towards conductivity is not used in calculating TDS. The OH⁻ conductivity is therefore neutralized using an organic acid (i.e., gallic acid). Organic acids are used because they do not contribute to conductivity.
- Q2. What is the relationship between conductivity and TDS?
A2. Conductivity is a measurement of electrical conductance of ionized species dissolved in water and is reported in units of micromhos or microsiemens per centimeter. TDS is the actual amount of mineral in solution measured in ppm. In boiler water, neutralized conductivity times 0.7 yields a good approximation to TDS. When tannin is used as a dispersant, the factor increases proportionally to the amount of tannin present.
- Q3. Why are there different types of alkalinity to be concerned with?
A3. Alkalinity can exist as bicarbonate (HCO₃⁻), a carbonate (CO₃²⁻), or as hydroxyl (OH⁻). Natural waters usually contain bicarbonate or carbonate alkalinity. Hydroxyl alkalinity is required in steam boilers below 6205 kilopascals (900 pounds per square inch gauge) and is either provided by addition of caustic or by the breakdown of bicarbonate and carbonate alkalinity in the boiler. The breakdown of bicarbonate and carbonate alkalinity also produces carbon dioxide, which forms carbonic acid in the condensate system.
- Q4. How often should bottom blowdown be done?
A4. There is no absolute rule for frequency of bottom blowdown. It can vary between once per shift to once or twice a week. The required frequency depends on the boiler, the feedwater quality and the type of chemical treatment program. A precipitating treatment program reacts with hardness in the feedwater to form a sludge that must be removed through bottom blowdown. A solubilizing treatment program keeps hardness in solution and creates little in the way of sludge.
- Q5. Where is the best location to feed sulfite?
A5. Sulfite, like any oxygen scavenger, should be fed into the storage section of a deaerator. This ensures the removal of oxygen before the feedwater enters the boiler.
- Q6. What is the difference between makeup water and feedwater?
A6. Makeup water is water that comes from a source outside of the boiler system. Feedwater is a combination of makeup water and condensate return.

- Q7. How does one balance chemical treatment levels and COC?
A7. COC is controlled through blowdown. Blowdown is often measured by maintaining conductivity or TDS within a specific control range. Chemical treatment levels are controlled by the chemical feed rate into the boiler and by blowdown. It is best to maintain consistent control of COC first, followed by proper adjustment of chemical feed rates. If there is a sudden change in chemical treatment levels without any changes in blowdown or chemical feed rates, then there is likely to be a change in feedwater quality (e.g., change in condensate return rate, hardness excursion, poor deaerator operation).
- Q8. Are boiler water treatment chemicals safe to work with?
A8. Yes, provided the directions on the MSDS sheets are followed. The highest hazard is due to chemical burns from highly caustic substances.
- Q9. Why is it impossible to get all the parameters (e.g., alkalinity, TDS) in the control range?
A9. It is not impossible as long as the control ranges are proper for a given boiler operation. The first parameter to control is COC. Maximum cycles are limited by some parameter (i.e., alkalinity, TDS, silica, carryover). Any one of these can be the limiting factor for COC. Once proper cycles are established, chemical treatment feed rates should be adjusted to keep levels within control ranges.
- Q10. The softeners need to be regenerated more often than before. What could be the problem?
A10. The problem could be one of many things. It usually is due to higher demands for makeup water. It could, however, be due to an increase in makeup water hardness levels or a deficiency in regeneration. Deficiencies in regeneration can be due to insufficient brine strength, insufficient brine time, inadequate backwash resulting in channeling, lost or cracked resin, and heavily fouled resin due to iron.

CHAPTER 4

COOLING WATER SYSTEMS

4-1 **TYPES OF COOLING WATER SYSTEMS.** Cooling water systems remove heat generated from a variety of industrial processes. There are three basic types of cooling water systems: once-through, open recirculating, and closed recirculating cooling water systems. This Chapter describes once-through and open recirculating systems. Chapter 5 describes the closed recirculating system.

4-1.1 **Once-Through Cooling Water Systems.** Once-through cooling water systems use cool water that circulates only once through the entire system before being discharged. This type of system is commonly found along rivers or coastlines where abundant water is available for use. The system contains heat exchange equipment and transfer piping, as shown in Figure 4-1. Power utility services often use this type of system.

Figure 4-1. Once-Through Cooling Water System Diagram

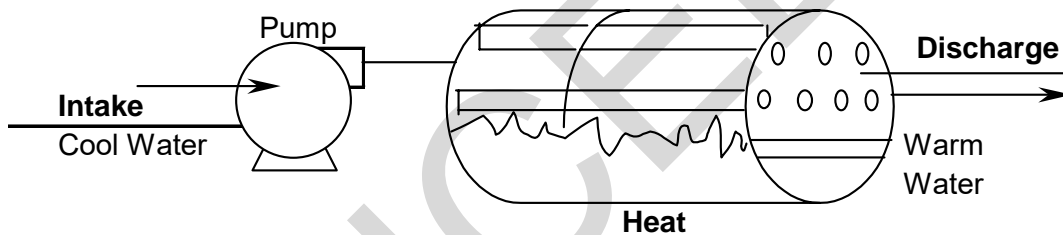

4-1.2 **Open Recirculating Cooling Water Systems.** Open recirculating cooling water systems are open to the atmosphere and continuously recycle and reuse the cooling water. These systems are composed of an evaporator unit, a cooling tower, or an evaporative condenser. These units mix air and water and allow some of the water to evaporate, cooling the balance of the water volume. The cooled water is then circulated to heat exchangers or chillers, where heat is added to the cooling water thereby removing heat from the process flow stream. The warmed water is then circulated to the cooling tower, where the cycle is repeated. Water is lost from the system primarily through evaporation; however, a portion of the cooling water must be discharged as waste (i.e., blowdown) to maintain a suitable water quality within the system. All water lost from the system is replaced by makeup water. Recirculating cooling water systems are found in most air conditioning chiller operations, as well as many heat exchange operations. Evaporative fluid coolers and evaporative condensers are terms defining open recirculating cooling water systems that use evaporators, which are slightly different than a cooling tower and do not send the cooled water out of the evaporative unit itself. An evaporative cooler cools a circulating fluid that does not change phase (e.g., does not condense from a gas to a liquid). An evaporative condenser cools a circulating fluid from a gas into a liquid, such as a refrigerant. The hot fluid that is to be cooled is brought to the unit. Figure 4-2 shows a typical evaporative cooler and evaporative condenser diagram; Figure 4-3 shows a typical open recirculating cooling

water system; and Figure 4-4 shows a typical cooling tower system.

Figure 4-2. Evaporative Fluid Cooler and Evaporative Condenser Diagram

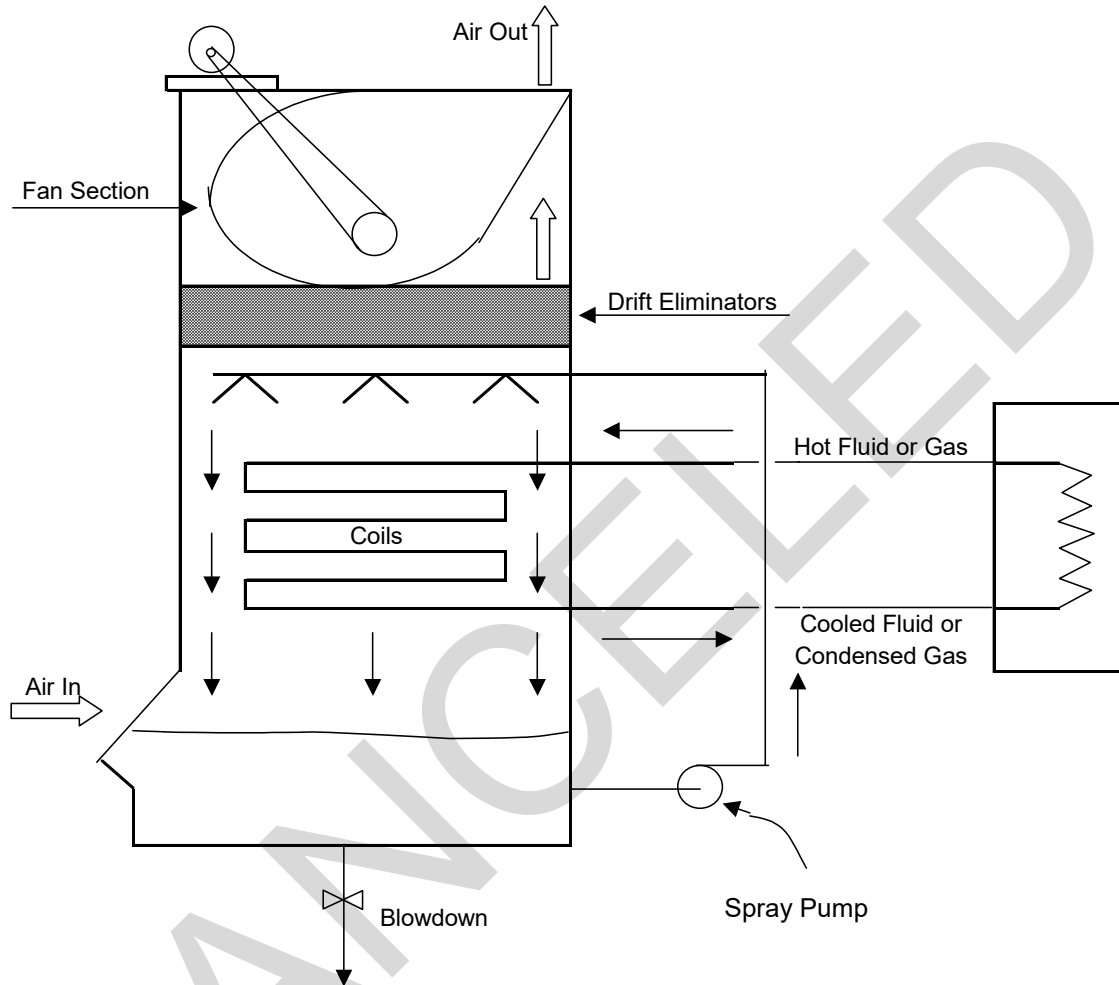

Figure 4-3. Open Recirculating Cooling Tower Water System Diagram

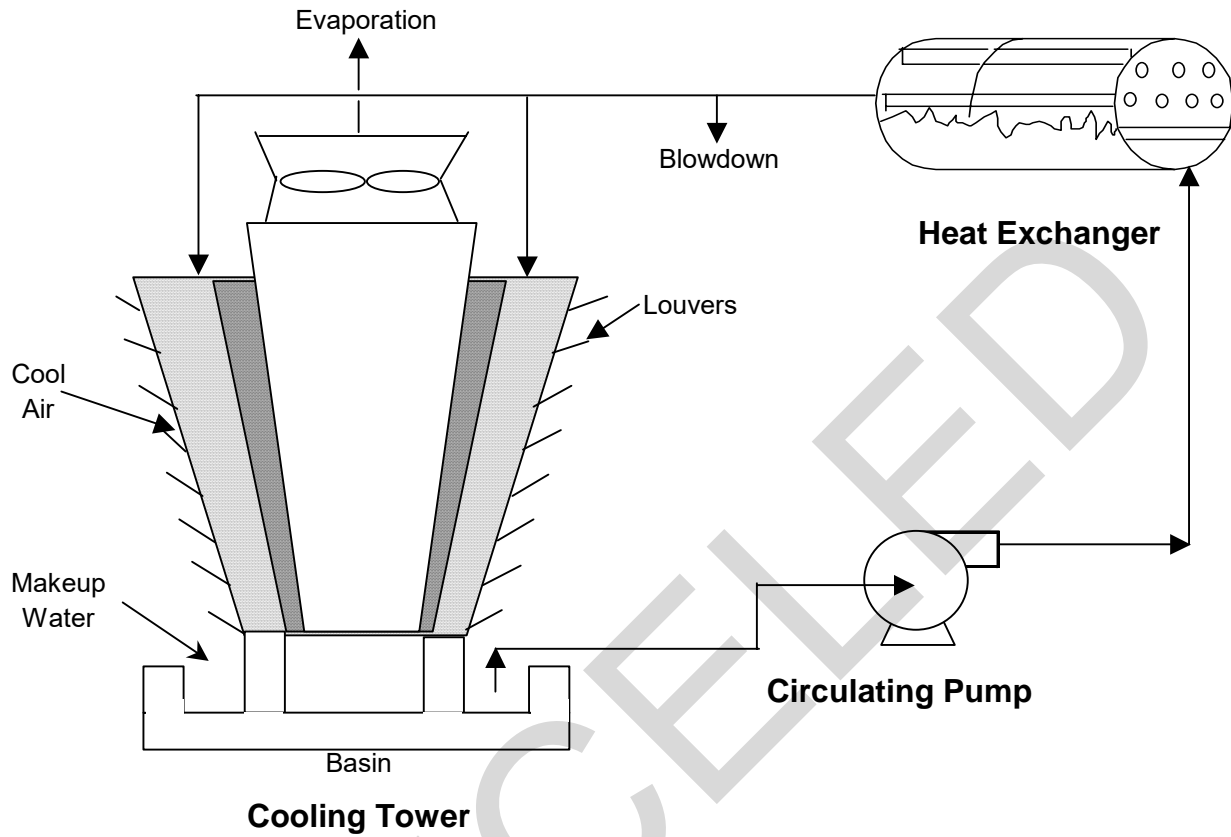
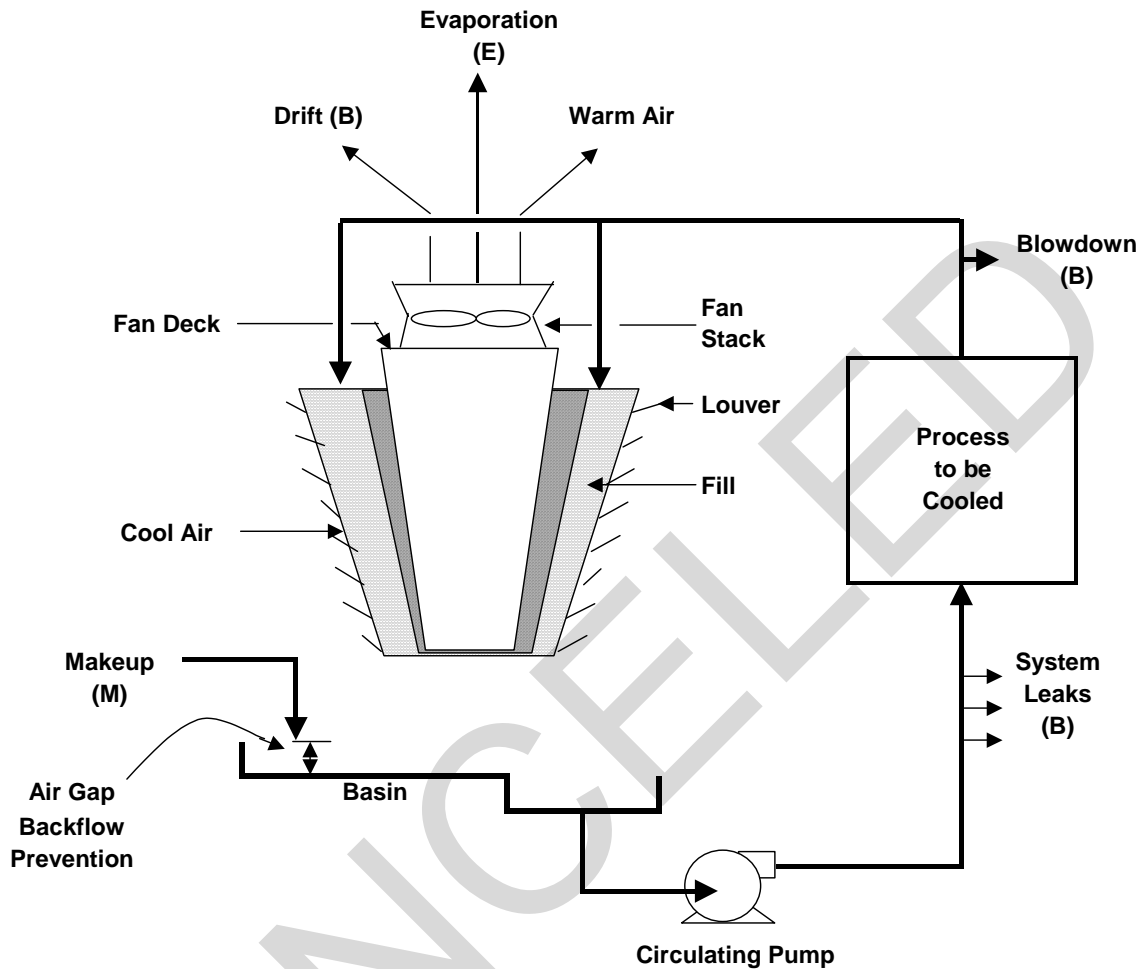

Figure 4-4. Cooling Tower Water System



4-1.3 **Types of Cooling Towers.** Types of cooling towers include natural draft , induced draft, and forced draft.

4-1.3.1 **Natural-Draft Towers.** In natural-draft towers, airflow through the tower is achieved naturally (i.e., without any mechanical means such as fans). Air flows across the falling water and up through the cooling tower as a result of the differential density between the lighter, heated and humidified, air within the tower and the cooler and dryer outside air. Fitting the tower with spray nozzles, which create more mixing of air and water droplets and improve the evaporation efficiency, produces increased water-cooling rates. Large utility power plants use these large natural-draft cooling towers, which are called hyperbolic cooling towers due to their hyperbolic shape (see Figure 4-5).

Figure 4-5. Hyperbolic Natural-Draft Cooling Towers



4-1.3.2 **Forced-Draft Towers.** The term “forced draft” denotes that air is forced or blown by fans into the cooling tower and up through the flow of falling water in the cooling tower. Drift eliminators are installed to prevent water entrained in the air from leaving the system.

4-1.3.3 **Induced-Draft Towers.** The term “induced draft” denotes that air is drawn by fans through the flow of falling water and up and out of the cooling tower. The airflow can be drawn either cross-flow or counter-flow with respect to the orientation of the falling water, resulting in either a cross-flow tower or a counter-flow tower. Drift eliminators are also present. (See Figures 4-6, 4-7, 4-8, and 4-9 for diagrams and photos of cross-flow and counter-flow cooling towers.)

Figure 4-6. Cross-Flow Cooling Tower

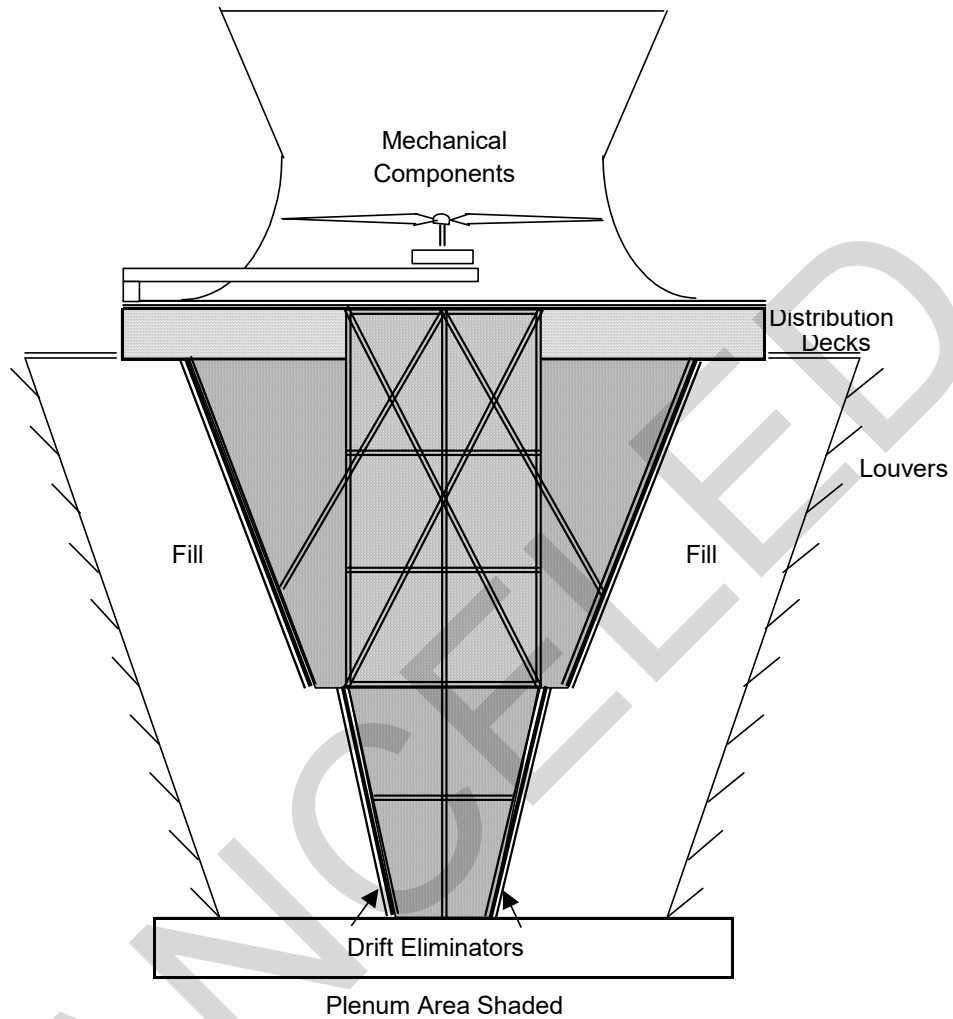

Figure 4-7. Cross-Flow Cooling Tower



Figure 4-8. Counter-Flow Cooling Tower Diagram

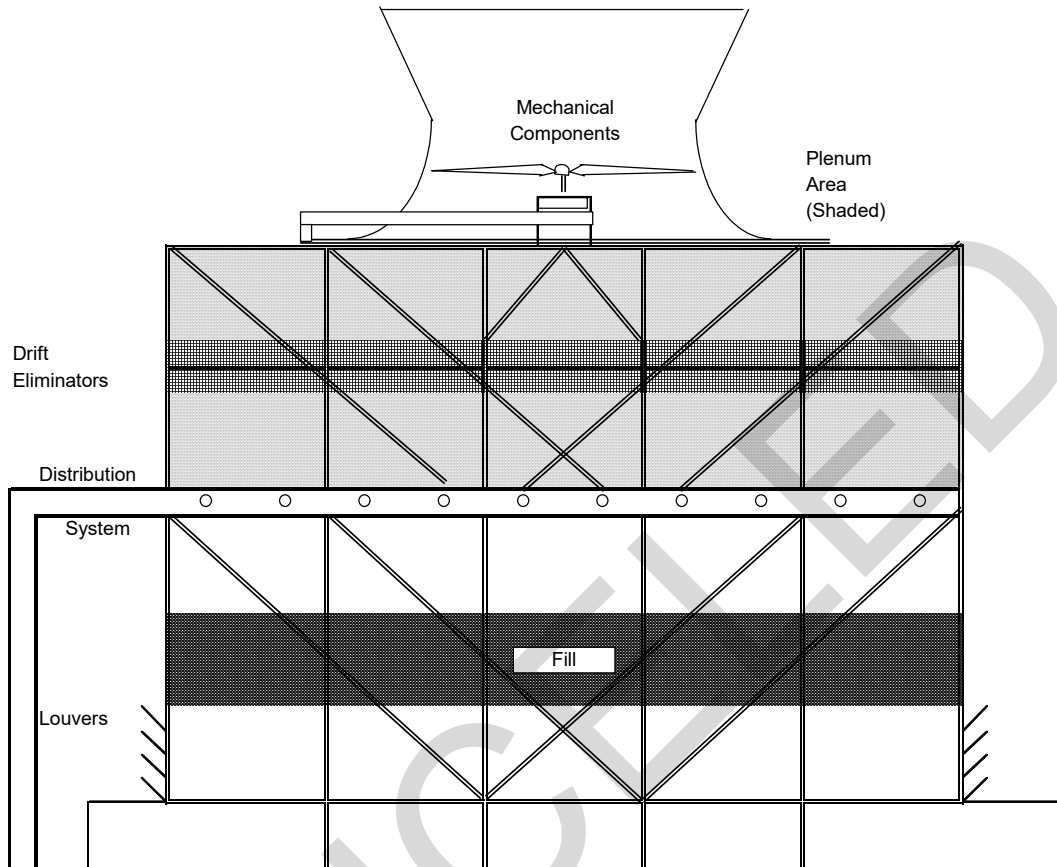

Figure 4-9. Counter-Flow Cooling Tower



4-1.3.4 **Typical Cooling Towers at Government Installations.** Cooling towers at military installations are commonly of the induced-draft, cross-flow variety, although counter-flow and forced-draft cooling towers are also represented. The cooling towers

range in size from small to large capacity.

4-1.4 **Components of a Cooling Tower.** Figure 4-10 shows a simple diagram of a 1-fan, induced-draft, cross-flow cooling tower. The major parts of the tower include the basin and cold well, louvers, fill, water distribution (and fan) deck, drift eliminators, fan and fan discharge, and the endwall casings.

Figure 4-10. Induced-Draft Cross-Flow Cooling Tower Components

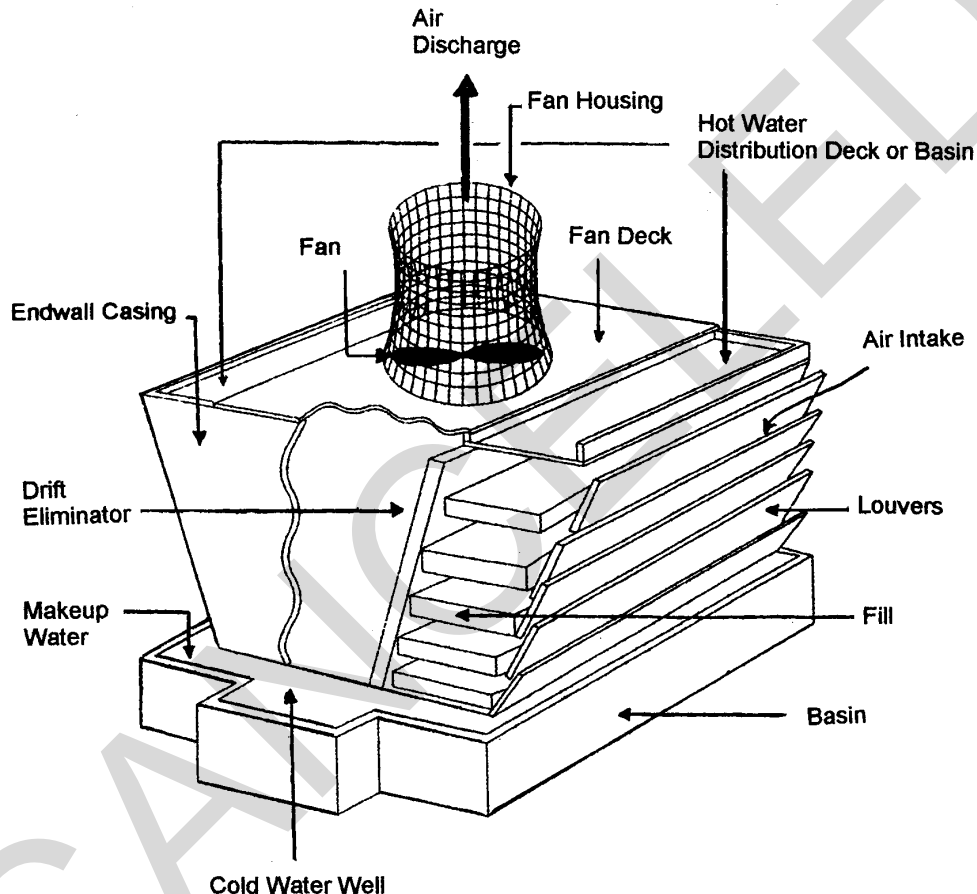

4-1.4.1 **Basin and Cold Well.** The basin is that portion of the cooling tower structure located under the tower that is used for collecting cooled water and which can be used as a location for adding makeup water. The cold well is a deepened portion of the basin that contains submerged water circulation pumps. The basin may be constructed of concrete, wood, metal, or fiberglass.

4-1.4.2 **Louvers.** Louvers are flat or corrugated members constructed of wood, plastic, cement board, or fiberglass, and installed across (horizontally) the open side of a tower. The main function of louvers is to prevent water from splashing out of the cooling tower through the openings where air enters the tower. Louvers are usually set at an angle to the direction of airflow.

4-1.4.3 **Fill.** Fill is the internal part of a tower where air and water are mixed. The fill intercepts the downward fall of water. The water is mixed with the air contained in the fill material and water is evaporated and cooled. There are two types of fill: splash fill and film fill. The falling water hits the splash fill, splashes, and breaks up into smaller water droplets, resulting in an increased rate of evaporation. The splash fill is made of wooden slats or bars, plastic, or ceramic tile. Film fill is a compact plastic material, similar to a honeycomb, that causes water to flow over the fill material, creating a large wet surface that maximizes evaporation as air travels past the film surface (see Figure 4-11).

Figure 4-11. High-Efficiency Cooling Tower Film Fill



4-1.4.4 **Drift Eliminators.** The drift eliminators efficiently remove water droplets from the air and return the recovered water to the cooling tower, thereby minimizing the loss of cooling tower water. They are located in areas that are situated after the fill and water sprays and just before the area where the air exits the cooling tower (see Figures 4-6 and 4-8). Drift eliminators are also known as “mist eliminators.”

4-1.4.5 **Water Distribution and Fan Deck.** In a cross-flow cooling tower, the hot water basin is used to distribute the warm return water flow uniformly over the tower fill (see Figure 4-6). In a counter-flow cooling tower, water sprays are used to distribute the warm water (see Figure 4-8). The fan deck supports the motor and fan of the water spray system. The stack is the structure (typically a cylinder) that encloses the fan and directs warm, humid discharge air upward and out of the cooling tower.

4-1.4.6 **Cell.** This is the smallest subdivision of a large cooling tower in which the fan can operate as an independent unit. A midwall casing must separate each end of the cell from the adjacent cells to ensure all air flow induced by the cell fan is drawn only through the cell fill and mist eliminator air path. Figure 4-7 illustrates a typical three-cell cross-flow cooling tower. Figure 4-9 illustrates a typical four-cell counter-flow cooling tower.

4-1.5 **Common Cooling Water System Problems.** Water-related problems can cause system downtime, loss of equipment efficiency, the need for capital replacement of equipment, and can increase the risk of disease from pathogenic microorganisms. An open recirculating cooling tower system has a greater potential for these problems than does a once-through cooling water system, due to the air- and water-mixing design of the open recirculating system. These problems are associated with water-caused deposits, corrosion, or microbiological organisms, and occur for various reasons:

- The cooling tower is essentially a huge air scrubber that can introduce materials such as microorganisms, gases, dust, and dirt into the circulating water, which provides an excellent growth environment for pathogenic microorganisms. These materials can contribute to the formation of deposits and cause corrosion.
- If the water is not properly treated and its quality maintained, corrosion and scale and solids deposition can occur. The potential for these problems results from the nature of the cooling system design and the operating conditions, including water evaporation, mineral concentration, and water temperatures of up to 54 °C (130 °F).
- The constant addition of makeup water results in increased quantities of mineral constituents that can form scale, deposits, and corrosion. Blowdown control and proper water treatment can minimize these problems.
- The film fill contains small water and air passages that can become plugged, thereby causing a reduction in cooling tower operational efficiency due to reduced water evaporation (see paragraph 4-1.4.3).
- Current designs for heat exchangers and cooling towers provide for more efficient operation than in the past, but unexpected water problems may occur. Some of the more prevalent potential problems are described in paragraphs 4-1.5.1 through 4-1.5.4.

4-1.5.1 **Enhanced and Super-Enhanced Chiller Condenser Tubing.** Recent air conditioning chiller equipment designs incorporate enhanced and super-enhanced chiller condenser tubes. Previous designs have used smooth-bored waterside condenser tubing. The enhanced tube is machined with rifled grooves that provide an increased surface area and a resultant increase in heat transfer; however, the rifled grooves and ridges tend to entrap SS (i.e., dirt, silt, sand, and old corrosion products), which are deposited from the cooling water as it passes through the tube. This deposition of material on metal surfaces can create a type of localized corrosion called “under-deposit corrosion.” This situation has resulted in numerous cases of tube failure. The super-enhanced chiller tubes have even finer grooves and ridges, making this type of tubing even more susceptible to under-deposit corrosion. (See Figures 4-12 and 4-13, which show photos of super-enhanced copper tubes.)

Figure 4-12. Super-Enhanced Copper Tubes

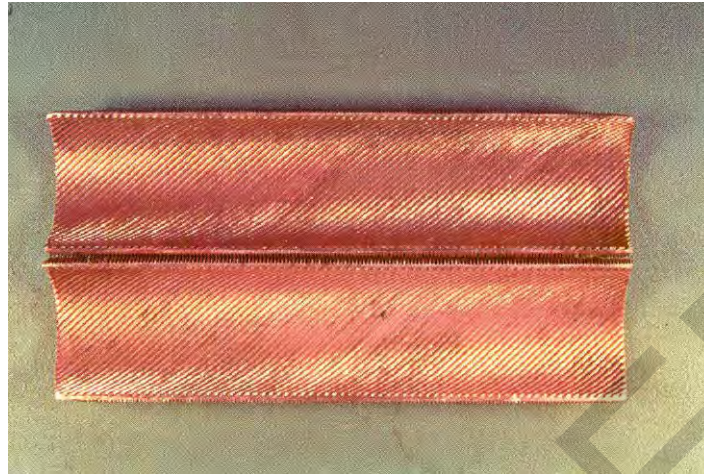
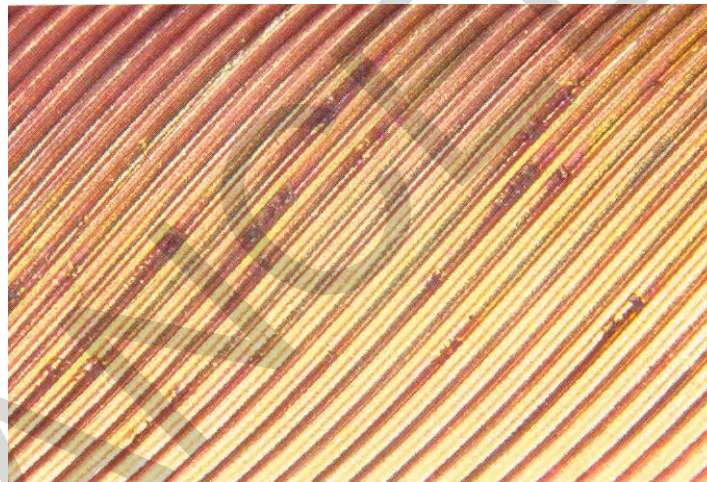

Figure 4-13. Close-Up of Corrosion Pitting on Super-Enhanced Copper Tube



4-1.5.2 **White Rust.** Some cooling towers are constructed with galvanized steel components and must not be exposed to conditions of high pH (high alkalinity). The galvanizing process deposits a protective zinc coating on a mild steel metal surface, resulting in increased resistance to corrosion. Failure to avoid such exposure can result in production of “white rust” due to the corrosion of the galvanizing coating. Eventually, this corrosion process exposes the mild steel underneath, which then starts to corrode. White rust failures have been a common occurrence throughout the country, mainly with newer cooling towers. Proper protection of the galvanizing material is necessary both during startup of a new cooling tower and during normal operations. Specific water treatment chemicals are needed to provide this protection. Examples include pretreatment with a high level of orthophosphate.

4-1.5.3 **Cooling Tower Film Fill.** Small- and medium-sized cooling towers use film fill, which is a tightly packed media as compared to the splash-type fill used

prevalently in the past (see paragraph 4-1.4.3 and Figure 4-11). Film fill has a higher potential for fouling (plugging) due to adherence and entrapment of biomass and of SS (i.e., dirt, silt, and sand). The cooling capacity of a cooling tower can be reduced if the film fill is extensively fouled (see Figure 4-14). Instances of severe fouling have resulted in the collapse of fill into the cooling tower basin. In addition, fouling deposits in the fill can harbor pathogenic microbiological organisms such as Legionnaires' Disease.

Figure 4-14. Heavily Fouled Cooling Tower Film Fill



4-1.5.4 **Legionella Bacteria.** This type of bacteria is the cause of Legionnaires' Disease. It can grow in cooling water systems even when a proper microbiological control program has been maintained. This bacterium can be discharged in the drift produced from all types of cooling tower systems. If a susceptible person inhales the bacteria, the disease could possibly develop. Due to increased awareness by cooling tower operators and the water treatment industry in general, the risk of being infected by *Legionella Pneumophila* or other pathogenic microorganism from a cooling tower system is probably not much greater today than it was a few years ago. Still, a number of outbreaks of Legionnaires' Disease are reported each year throughout the country. See paragraph 4-4.7 for more information on controlling Legionella.

4-2 Cooling Tower Water Calculations

4-2.1 Principles of Cooling Tower System Operations. The function of a cooling tower is to dissipate heat from water-cooled refrigeration, air-conditioning and industrial process systems. Water is typically the heat transfer medium used to dissipate the heat. A cooling tower uses a combination of heat and mass transfer (evaporation) to cool the water flowing through the tower. Conductive heat transfer accounts for 20 to 30% of the total heat dissipated. The remaining 70 to 80% of total cooling is the result of evaporative cooling of about 1 to 2% of the recirculating water, depending on the decrease in temperature across the tower. It takes approximately 2,326,000 joules to evaporate 1 kilogram of water (1000 BTU per 1 pound of water). If this amount of heat is extracted from 454 kilograms (1000 pounds) of water, approximately 0.45 kilogram (1 pound) of water will be evaporated and the temperature will drop 0.55 °C (1 °F). If 4.5 kilograms (10 pounds) of water are evaporated, the water temperature will drop 5.5 °C (10 °F). The water lost by evaporation is replaced with makeup water. Water is also added to replace water lost through tower drift (loss of water from the tower as a fine mist), leaks in the system (unintentional blowdown), and water discharged as intentional blowdown. Water that is added to the cooling tower to replace all of these losses is known as cooling tower makeup water.

4-2.1.1 Relationship Between Evaporation, Blowdown, and Makeup. The operation of cooling towers can be described by the relationship between evaporation, blowdown, and makeup. Makeup water must equal blowdown water plus water evaporation to maintain a constant operating water level in the system:

$$\text{EQUATION} \quad | \quad M = B + E \quad (19)$$

where

M = makeup water, liters/sec (gpm)
B = blowdown, liters/sec (gpm) (all sources)
E = evaporation, liters/sec (gpm)

NOTE: Blowdown (B) includes discharge to sewer, drift loss, and any leaks from the system.

EXAMPLE: M = 6.3 liters/sec (100 gpm)
B = 0.63 liters/sec (10 gpm)
E = 5.67 liters/sec (90 gpm)

4-2.1.2 Cycles of Concentration (COC). One of the common terms used in describing the water use efficiency of cooling tower water systems is COC. COC represents the relationship between the makeup water quantity and blowdown quantity. COC is a measure of the total amount of minerals that is concentrated in the cooling tower water relative to the amount of minerals in the makeup water or to the volume of each type of water. The higher the COC, the greater the water use efficiency. Most cooling tower systems operate with a COC of 3 to 10, where 3 represents acceptable

efficiency and 10 represents very good efficiency. It has been found that the range of 5 to 7 COC represents the most cost-effective situation.

4-2.1.2.1 **Calculating COC by Volume.** If both makeup and blowdown water volumes are known, COC by volume can be calculated. The term is defined as:

$$\text{EQUATION} \quad | \quad C = M \div B \quad (20)$$

where

C = COC, no units
M = makeup water, kg/hr (gpm)
B = blowdown losses, kg/hr (gpm)

EXAMPLE: M = 6.3 liters/sec (100 gpm)
B = 0.63 liters/sec (10 gpm)
C = M ÷ B = 10

4-2.1.2.2 **Determining COC by Water Analyses.** To determine COC, you must know the mineral content of both makeup and blowdown water. For example, you must determine both the conductivity of the recirculating cooling tower water and the conductivity of the makeup water. (Note that the blowdown water will have the same conductivity as the recirculating water.) Conductivity is commonly measured in micromhos (μmhos). You can also estimate COC by using other water quality parameters such as chlorides, silica, or sulfates. The relationship is represented by this equation:

$$\text{EQUATION} \quad | \quad C = \frac{B_{\mu\text{mhos}}}{M_{\mu\text{mhos}}} \quad \text{or} \quad \frac{B_{\text{Cl}}}{M_{\text{Cl}}} \quad (21)$$

where

C = COC, no units
 $B_{\mu\text{mhos}}$ = conductivity of blowdown (recirculating water), micromhos (μmhos)
 $M_{\mu\text{mhos}}$ = conductivity of makeup water, μmhos
Cl = chlorides in blowdown, ppm
Cl = chlorides in makeup water, ppm

EXAMPLE 4-1:

The measured conductivity of the blowdown (recirculating water) is 800 micromhos and the makeup is 300 micromhos.

The COC is:

$$C = \frac{\mu\text{mhos}}{\mu\text{mhos}}$$

$$C = 800 \div 300 = 2.67$$

NOTE: The parameters of conductivity or chloride concentration are used commonly for such measurements. Other water quality parameters can be used, but sometimes with inaccurate results (i.e., calcium, magnesium, alkalinity, and silica can form deposits, meaning they drop out of solution). COC based on these parameters could be considerably less than that based on conductivity or chlorides. Similarly, chemical additions of sulfuric acid can yield higher sulfate levels than those species cycled up naturally.

4-2.1.2.3 **Controlling COC.** A simple, sometimes overlooked rule: To increase COC, decrease blowdown; to decrease COC, increase blowdown.

4-2.1.2.4 **Relationship Between COC and Makeup.** COC and makeup requirements are related to the temperature drop across a cooling tower and to the recirculating rate of the tower. As shown in Figure 4-15, for a recirculating tower with water temperature drops of 5.5 °C (10 °F), 11 °C (20 °F), and 16.5 °C (30 °F), the makeup water requirement decreases rapidly as COC is increased to about 4 or 5, with lower incremental reductions at higher COC; therefore, COC can be adjusted (increased) to allow for reductions in water use (water conservation) and for reductions in the amount of water treatment chemicals used.

Figure 4-15. Effect of COC on Makeup Requirement

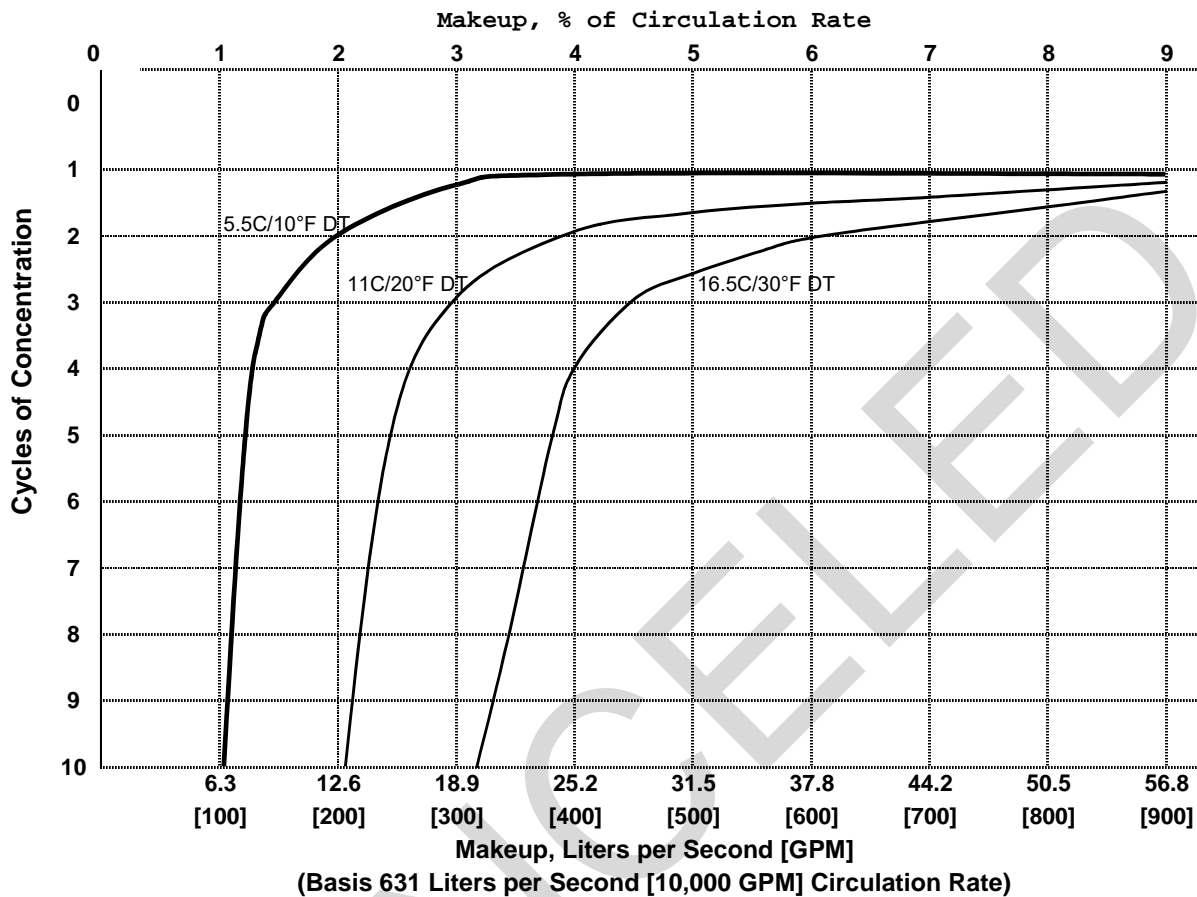

4-2.1.3 **Relationship Between Blowdown, Evaporation, and COC.** You can use the cooling water evaporation loss to calculate the blowdown rate that must be maintained to operate at a selected COC. The relationship between blowdown, evaporation, and COC is represented with this equation:

$$\text{EQUATION} \quad | \quad B = E \div (C - 1) \quad (22)$$

where

- B = blowdown, liters per day or liters per second (gpd or gpm)
- E = evaporation, liters per day or liters per second (gpd or gpm)
- C = COC, no units

EXAMPLE: A cooling tower evaporates 37.8 liters per second (600 gallons per minute) and operates at 4 COC:

$$\text{EQUATION} \quad | \quad B = 37.8 \text{ l/sec (600 gpm)} \div (4-1) = 12.6 \text{ l/sec (200 gpm)} \quad (23)$$

a) This formula is derived using data from previously presented equations:

(1)	M	=	B + E	from paragraph 4-2.1.1 (19)
(2)	C	=	M ÷ B	from paragraph 4-2.1.2.1 (20)
(3)	C	=	(B + E) ÷ B	from equation (2) and (1) above
(4)	C	=	1 + (E ÷ B)	rearranging equation (3)
(5)	(C - 1)	=	E ÷ B	rearranging equation (4)
(6)	B	=	E ÷ (C - 1)	rearranging equation (5)

b) If you know the quantity of evaporation, you can calculate the blowdown required for a given value of COC. You can estimate the evaporation using simple "rule of thumb" estimates:

b.1) For a typical recirculating cooling tower water system, approximately 1% of the recirculating rate (R) of the cooling water is evaporated for every 5.5 °C (10 °F) temperature drop in the cooling water as it passes through the tower; therefore, you may calculate the evaporation rate (E) this way:

$$\text{EQUATION} \quad | \quad E(\text{l/sec}) = 0.01 \times R(\text{l/sec}) \times \Delta T \text{ drop in } ^\circ\text{C} \div 5.5 \text{ } ^\circ\text{C} \quad (24)$$

Since $0.01 \div 5.5 = 0.0018$, this can be condensed to:

$$\text{EQUATION} \quad | \quad E = R \times \Delta T \times 0.0018 \quad (25)$$

or

$$\text{EQUATION} \quad | \quad E = R \times \Delta T \div 550 \quad (26)$$

NOTE: Newer cooling towers can have 0.75% of the recirculation rate evaporated for every 5.5 °C (10 °F) drop.

EXAMPLE 4-2:

b.2) A cooling system operates at 315 liters per second (5000 gallons per minute). The temperature drop through the tower is 7.8 °C (14 °F). The evaporation estimate is represented by this equation:

$$\text{EQUATION} \quad | \quad E = 0.01 \times 315 \text{ l/sec (5000 gpm)} \times 7.8 \text{ } ^\circ\text{C (14 } ^\circ\text{F)} \div 5.5 \text{ } ^\circ\text{C (10 } ^\circ\text{F)} = 4.5 \text{ l/sec (70 gpm)} \quad (27)$$

or

$$\text{EQUATION} \quad | \quad E = 315 \times 7.8 \div 550 = 4.5 \text{ l/sec (70 gpm)} \quad (28)$$

b.3) For a cooling tower system serving air conditioner and chiller operations, the evaporation rate used depends on the type of chiller:

- Approximately 20 liters per hour per kilowatt (1.5 gallons per hour per ton) for centrifugal, reciprocating, and screw-type chillers.
- Approximately 40 liters per hour per kilowatt (3 gallons per hour per ton) for absorption-type chillers.

4-3 **OBJECTIVES OF COOLING WATER TREATMENT.** The primary objectives of cooling water treatment are to maintain the operating efficiency of the cooling water system and to protect the equipment that contacts the cooling water. These objectives are accomplished by controlling or minimizing deposition, corrosion, and microbiological growth on the cooling water equipment. Treatment programs must also address requirements for environmental compliance, safety, water conservation, and limitation of chemical costs. This paragraph reviews the requirements for, and elements of, a water treatment program for cooling water systems.

4-3.1 **Deposit Formation and Control.** Deposits that occur in cooling water systems are usually divided into two categories: scale and fouling. The presence of either type of deposit in the heat exchangers or in the film fill can interfere with heat transfer, thereby reducing the efficiency of operation. Deposits can also promote under-deposit corrosion. Scale and non-biological fouling are described in this paragraph. Biological fouling is described in paragraph 4-4.

4-3.2 **Scale.** Scale is formed from minerals, formerly dissolved in water, that were deposited from the water onto heat transfer surfaces or in-flow water lines. As water is evaporated in a cooling tower, the concentration of dissolved solids becomes greater until the solubility of a particular scale-causing mineral salt is exceeded. When this situation occurs in an untreated cooling water system, the scale will form on any surface in contact with the water, especially on heat transfer surfaces. The most common scaling minerals are calcium carbonate, calcium phosphate, calcium sulfate, and silica, usually in that order. Formation of magnesium silicate scale is also possible under certain conditions. Most other salts, including silica, are more soluble in hot water than in cold water; however, most calcium and magnesium salts, including calcium phosphate and calcium carbonate, are more soluble in cold water than in hot water. This is called "reverse solubility." The water temperature will increase as recirculating water passes through the cooling system. As a result, calcium and magnesium scales may form anywhere in the system, but most likely on heated surfaces such as heat exchangers or surface condensers. Silica will form in areas having the lowest water temperature, such as in the cooling tower fill.

4-3.2.1 **Determining Scaling Potential.** The maximum solubility limit for specific dissolved minerals will determine the types of scale that can form under a given set of conditions. To minimize water blowdown, the amount of dissolved materials in the cooling water should be maintained as close as possible to the maximum solubility level. This water quality parameter, TDS, is controlled by maintaining COC in the system at a

level that is equal to the lowest COC allowable for whichever salt has the lowest solubility. The salt of concern is often calcium carbonate or calcium phosphate, but it may be silica. The operating COC can be increased substantially with use of the cooling water treatment chemicals described in this paragraph.

4-3.2.2 **Calcium Carbonate Scale.** Calcium carbonate scale results from the breakdown of calcium bicarbonate, a naturally occurring salt. The degree of scaling depends primarily on the calcium levels, bicarbonate alkalinity levels, and water temperature in the cooling water system. The most accurate prediction of scale can be developed using the Practical (Puckorius) Scaling Index (PSI) (see paragraph 4-3.4.2). A rough prediction of calcium carbonate scale potential can be developed using this formula:

$$\text{EQUATION} \quad \left| \quad C \equiv \sqrt{\frac{110000}{TA \times M_{ca}}} \quad (29) \right.$$

where

C = COC
TA = total (M) alkalinity (as CaCO₃) in makeup, ppm
M_{ca} = calcium hardness (as CaCO₃) in makeup, ppm

4-3.2.3 **Calcium Phosphate Scale.** Calcium phosphate scale results when calcium hardness reacts with phosphate. This will occur when more than 10 ppm of orthophosphate are present in the circulating water and when the calcium hardness is sufficiently high. The following formula can provide a very rough prediction of the potential for calcium phosphate scale:

$$\text{EQUATION} \quad \left| \quad C \equiv \frac{(105) \times (9.8 - B_{pH})}{M_{ca}} \quad (30) \right.$$

where

C = COC, no units
B_{pH} = measured pH in blowdown, pH units
M_{Ca} = calcium hardness (as CaCO₃) in makeup water, ppm

4-3.2.4 **Calcium Sulfate Scale.** Calcium sulfate scale results when the calcium hardness reacts with the sulfate. The potential for calcium sulfate scale can be predicted using this formula:

$$\text{EQUATION} \quad \left| \quad C \equiv \sqrt{\frac{1250000}{M_{ca} \times M_{su}}} \quad (31) \right.$$

where

C = COC, no units
 M_{Ca} = calcium hardness (as $CaCO_3$) in makeup, ppm
 M_{Su} = sulfate (as SO_4) in makeup, ppm

4-3.2.5 **Silica Scale.** Silica scale can occur when the concentration of silica exceeds its maximum solubility limit in water. A safe, very conservative value to assume for the solubility limit is 150 ppm (as SiO_2); thus, the maximum COC can be calculated with this formula. However, silica solubility depends on pH and temperature and is in the range of approximately 150 to 180 ppm (as SiO_2) at the temperature range encountered in most cooling towers (26 °C to 54 °C [80 °F to 130 °F]). As the pH increases in the cooling tower water, silica becomes more soluble; thus, if cooling tower water pH is 9.0, approximately 250 ppm silica (as SiO_2) is the maximum. Using 150 ppm as the upper limit, the allowable COC is represented by this equation:

$$\text{EQUATION} \quad \left| \quad \equiv \quad \frac{150}{M_{si}} \quad \right. \quad (32)$$

where

C = COC, no units
 150 = assumed maximum solubility of silica, ppm
 M_{si} = silica (as SiO_2) in the makeup, ppm

4-3.3 **Determining COC to Control Operations.** In cooling water systems, the lowest calculated COC allowable, as determined by the relationships for these salts, is the controlling factor for operations. This is because as the system operates, the material that has the lowest calculated COC will be the first to come out of solution (precipitate) and the most likely to form a scale deposit in the system. To prevent these materials from forming a deposit on cooling water equipment, you must keep the COC in the system at a level that is lower than the lowest COC calculated for calcium carbonate, calcium phosphate, calcium sulfate, and silica. Using appropriate water treatment chemicals will allow higher COC, depending on which chemical is used.

EXAMPLE 4-3:

a) A cooling tower makeup has the following composition:

Calcium hardness	100 ppm as $CaCO_3$
Total (M) alkalinity	60 ppm as $CaCO_3$
Phosphate	3 ppm as PO_4
Sulfate	60 ppm as SO_4
Silica	14 ppm as SiO_2
pH	7.2

At what COC can the system operate scale free without water treatment?
(Assume that the estimated pH in the blowdown water is 8.5.)

b) Based on calcium carbonate:

$$\text{EQUATION} \quad \left| \quad \equiv \sqrt{\frac{110000}{60 \times 100}} \equiv 4.3 \quad (33)$$

c) Based on calcium sulfate:

$$\text{EQUATION} \quad \left| \quad \equiv \sqrt{\frac{1250000}{100 \times 60}} \equiv 14.4 \quad (34)$$

d) Based on silica:

$$\text{EQUATION} \quad | \quad \text{COC} \quad \equiv \quad 150 \div 14 = 10.7 \quad (35)$$

The COC determined for calcium carbonate is lowest at 4.3, and this controls the system operation. If the system is operated without water treatment, scaling should not occur if the system is operated at less than 4.3 COC. Use of scale control treatment will allow the number of allowable COC (for calcium carbonate) to be increased; you can then determine the COC and blowdown by using a calculated scaling index.

4-3.4 Calcium Carbonate Scaling Indices. The scale found most commonly in cooling tower water systems is calcium carbonate, present in the form of calcite (CaCO_3) (i.e., limestone). The solubility of calcium carbonate, which decreases with an increase in temperature, is a complex function of temperature, TDS, calcium hardness, total alkalinity, and pH. To predict if scale would form in the hotter sections of a cooling water system, researchers have developed several scaling indices. Paragraphs 4-3.4.1 and 4-3.4.2 describe the predictive indexes that are used most commonly for cooling water.

4-3.4.1 Langelier and Ryznar Indices. W.F. Langelier derived a method to calculate the calcium carbonate scale-forming and scale-dissolving tendencies of drinking water. The method is based on determining the saturation pH (pH_s) at which calcium carbonate scale will start to precipitate out of solution. If the measured pH ($\text{pH}_{\text{actual}}$) of the water is greater than its pH_s , thus a positive value, the water has a scale-forming tendency. If the measured pH ($\text{pH}_{\text{actual}}$) of the water is less than its pH_s , thus a negative value, the water will have a scale-dissolving tendency. The $\text{pH}_{\text{actual}}$ minus pH_s is known as the Langelier Index or Langelier Saturation Index (LSI) ($\text{LSI} = \text{pH}_{\text{actual}} - \text{pH}_s$). This index was originally designed to predict calcium carbonate scale in potable water. There are serious deficiencies in the accuracy of this index; consequently, it has lost its practical application for cooling water systems.

J.W. Ryznar later devised a more sensitive formula for predicting calcium carbonate scale. This formula is known as the Ryznar Index or Ryznar Stability Index (RSI). The formula is: $2\text{pH}_s - \text{pH}_{\text{actual}}$. A value of 6 indicates “stable” water, a value less than 6 indicates a scale-forming tendency, and a value greater than 6 indicates a scale-dissolving tendency. The indices have also been used to try to estimate the degree to which calcium carbonate scale will form in drinking water and in cooling water. The more positive the LSI value, the greater the scale formation; however, for the RSI, the smaller the index, the greater the scale formation. The LSI and RSI can give conflicting predictions based on the same water quality information.

4-3.4.2 **Practical (Puckorius) Scaling Index (PSI).** Paul R. Puckorius and J. Maxey Brooke developed a modified version of the RSI that gives a more accurate and consistent indication of the calcium carbonate scaling potential of cooling water. Known as the Practical Scaling Index (PSI), and also known as the Puckorius Scaling Index, it takes into consideration the effect of the type of total alkalinity of the cooling water on the measured pH ($\text{pH}_{\text{actual}}$) value. The measured pH does not always relate correctly to bicarbonate alkalinity because of the buffering effect of other ions. Rather than using the measured pH in calculating the PSI, an adjusted or equilibrium pH (pH_{eq}) is used: $\text{PSI} = 2\text{pH}_s - \text{pH}_{\text{eq}}$. As with the RSI, a PSI value of 6 indicates stable water and a value lower than 6 indicates a scale-forming tendency. Without scale-control treatment, a cooling tower with a PSI of 6 to 7 should operate scale free. However, a PSI of greater than 6 indicates that scaling may occur. Information on calculating the PSI is provided in Appendix B. Use of the PSI is most applicable when cooling water pH is above 7.5.

4-3.5 **Scale-Control Methods.** Three basic methods are used to prevent the formation of scale in cooling water systems:

- a) Remove the water scaling ingredients from the water before use. This includes softening, RO, and other technologies described in Chapter 2.
- b) Keep the scale-forming ingredients in solution. This is the most common scale-control method used for cooling water, and it can be achieved by use of either or both of the following two methods: adding acid, which lowers the pH of the recirculating water, or adding a scale inhibitor (phosphonate or specific polymer), which allows higher COC to be maintained without scaling. Acid neutralizes (destroys) mineral alkalinity, one of the constituents forming calcium carbonate scale; however, because of the hazards associated with handling strong acids and the potential damage from an acid spill, the use of acid in cooling towers is not recommended.
- c) Allow the water-scaling ingredient to precipitate as sludge. Modern chemical treatment can distort or modify scale crystals such that they cannot adhere to each other to form a hard deposit; instead, they become a sludge that can be removed through filtration or blowdown.

All three methods are authorized for use on military installations and can be used in combination with one another.

4-3.5.1 **Calcium Carbonate Scale Control Using Solubilizing Chemicals.**

Acids and phosphonates are chemicals that keep scale from forming. The use of acid in cooling towers may not be appropriate for use at military installations due to the associated risk of corrosion.

4-3.5.1.1 **Acids.** The acid most commonly used is sulfuric acid used as a diluted solution (e.g., 40% sulfuric acid in water). The use of acids requires adequate pH control.

4-3.5.1.2 **Phosphonates.** The phosphonates used most frequently for calcium carbonate scale control in recirculating cooling water systems are AMP (amino-tri [methylene] phosphonic acid); HEDP (1-hydroxyethylidene 1,1-diphosphonic acid); and PBTC (2-phosphonobutane-1,2,4-tricarboxylic acid).

The chemical reaction of all phosphonates is similar; however, their stability varies greatly. The presence of chlorine or other oxidants in treated cooling water favors the use of PBTC, which is very resistant to decomposition, followed by HEDP, and finally AMP. An active dosage of 3 to 5 ppm of either AMP or HEDP, or 1.5 to 2.5 ppm PBTC, will increase the solubility of calcium carbonate by a factor of 3 or more relative to using no chemical treatment. Rather than operating at a PSI of 6.0 (stable water, no scale) in an untreated system, the cooling tower water can be used at a PSI of 4.0 without the occurrence of scale (see paragraph 4-3.4.2 and Appendix B); however, in the absence of calcium scaling conditions, phosphonates can increase the corrosion of both mild steel and copper.

4-3.5.2 **Calcium Carbonate Scale Control Using Solubilizing Polymers.** Many different polymers are used in water treatment. For the most part, they have multi-faceted performance capability; they can inhibit various types of scale formation as well as disperse SS. Often water treatment products will include more than one type of polymer in the product formulation. For control of calcium carbonate, homopolymers such as polyacrylate, polymethacrylate, and polymaleate are used to keep calcium carbonate in solution. Dosages of 3 to 5 ppm of active polymer in the cooling tower water can control calcium carbonate scale formation to a PSI value as low as 4.5.

4-3.5.3 **Calcium Carbonate Scale Control Using Sludge-Forming Polymers.** Certain homopolymers and copolymers act as crystal modifiers by distorting calcium carbonate crystals such that they do not attach themselves to heat exchange surfaces, but instead the crystals become SS that can be removed through filtration or blowdown. Usually dosages of 1 to 3 ppm of active polymer in the cooling tower water will control calcium carbonate scale. Due to formation of sludge, rather than the stabilization of carbonate in solution, the PSI is not meaningful under these conditions.

4-3.5.4 **Calcium Phosphate Scale Control Using Solubilizing Inhibitors.** Often calcium phosphate scale is formed in cooling water systems treated with a phosphate-

based corrosion inhibitor program or when phosphate is present in the makeup water (i.e., potable or recycled water). Calcium phosphate is much less soluble in water than is calcium carbonate. If the calcium hardness is 500 ppm and the pH is above 7.0, without any polymer treatment calcium phosphate scale will likely form, even at the low level of 10 ppm phosphate (as PO_4) in the cooling water (see paragraph 4-3.3). Calcium phosphate solubility can be increased by a factor of a little less than 3 by the addition of 4-ppm phosphonate (HEDP/PBTC) or by the use of 6 to 8 ppm of a copolymer or terpolymer specific for calcium phosphate inhibition.

4-3.5.5 Calcium Sulfate Scale Control Using Solubilizing Polymers. Calcium sulfate formation can result from high concentrations of calcium ions and sulfate ions in the recirculating water; however, calcium sulfate is the most soluble of the scale-forming calcium salts found in cooling tower waters having pH levels of greater than 8.0. This means that calcium sulfate scale will not form unless some calcium ions (hardness) remain in solution after the calcium reacts with all the carbonate and phosphate in the water. Calcium sulfate scale may occur when the recirculating water contains calcium hardness in the range of 500 to 700 ppm as CaCO_3 and sulfate in the range of 500 to 700 ppm SO_4 . (See the predictive index in paragraph 4-3.4) The addition of 3 to 5 ppm of a copolymer of acrylate and acrylamide will allow calcium sulfate to remain in solution at a level almost 3 times the level allowed when using no treatment. Calcium sulfate scale rarely forms at pH levels above 8.0 in the cooling water.

4-3.5.6 Magnesium Silicate Scale Control. Formation of magnesium silicate is possible in cooling systems, but only under certain rare conditions. Magnesium ions (hardness) first react with hydroxyl ions (OH^-) to form magnesium hydroxide, which then reacts with (absorbs) dissolved or colloidal silica. A deposit analysis often reports this material as magnesium silicate. Since magnesium hydroxide solubility decreases at pH levels above 9.0, this scale will usually occur only at a pH level above 9.0 and when the magnesium hardness concentration is greater than 100 ppm.

4-3.5.7 Silica Scale Control. Silica solubility is dependent upon temperature and pH. At pH levels greater than 8.5, silica remains soluble (no scale) at a concentration of 250 ppm as SiO_2 . At pH levels of 7.5 or below, maximum silica solubility is 150 ppm as SiO_2 . At maximum silica levels, silica will first deposit on the cooling tower slats rather than in the heat exchanger because silica is more soluble in hot water than in cold water. The slats will become coated with a white, sometimes sparkling, deposit. If this occurs, blowdown should be increased to decrease COC by at least 1 unit. This procedure should stop additional scale formation. If the concentration of silica in the makeup water is above 30 ppm, it will usually be the parameter that controls the adjustment of cooling water system COC. If the silica concentration is high, external treatment can reduce the level of silica in the makeup water (see Chapter 2). The introduction of water treatment chemicals based on new polymer technology may allow the solubility of silica to be increased above the old recognized limit of 150 ppm.

Table 4-1. Summary of Scale Control Methods

Scale	Control Method
Calcium carbonate	<ol style="list-style-type: none"> 1. Solubilize using phosphonates. 2. Solubilize using polymers (polyacrylate, polymethacrylate, polymaleate). 3. Form sludge using specialty polymers.
Calcium phosphate	<ol style="list-style-type: none"> 1. Solubilize using phosphonates. 2. Solubilize using specialty copolymers or terpolymers.
Calcium sulfate	Solubilize using copolymers of acrylate and acrylamide.
Magnesium silicate	Maintain water chemistry of: pH < 9.0, magnesium hardness < 500 ppm, and silica < 100 ppm.
Silica	<ol style="list-style-type: none"> 1. Maintain water chemistry with silica < 150 ppm. 2. Solubilize with silica-specific polymer.

4-3.6 **Cooling Water Fouling.** The term “fouling” refers to the deposition of materials that are normally held in suspension in the cooling water: mud, silt, and other SS brought into the system with the makeup water; dust, dirt, and debris scrubbed out of the air passing through the tower; product leakage such as oils; corrosion products from the system; and biological organisms, both living and dead. Combinations of any or all of these materials can be present in the cooling water.

4-3.7 **Fouling Control.** Fouling from mud, dirt, and corrosion products can be controlled by the addition of a water-soluble polymer dispersant, such as a polyacrylate. The addition of about 4 to 5 ppm of active polymer, together with sufficient water velocity (e.g., 1 meter per second [3.28 feet per second]), can keep foulants in suspension and prevent them from being deposited on heat transfer surfaces. Higher dosages (5 to 20 ppm) of active polymer can be required for heavily fouled systems. It is best to reduce the loading of SS by mechanically removing them from the system through blowdown, filtration, and physical sump cleaning. Removing oil or oily materials requires a non-foaming surfactant. Paragraph 4-4 describes prevention of fouling by biological organisms. Table 4-2 summarizes foulant control methods.

Table 4-2. Summary of Foulant Control Methods

Foulant	Control Method
Mud, dirt, corrosion products	<ol style="list-style-type: none"> 1. Disperse using polymers and maintain adequate flow. 2. Form sludge using specialty polymers.
Oily matter	Disperse using a non-foaming surfactant.

4-4 **MICROBIOLOGICAL DEPOSITS AND CONTROL.** Microbiological organisms are composed of three classes: algae, bacteria, and fungus. Large biological

organisms such as clams, snails, mussels, or similar species are referred to as microbiological organisms. The presence of any biological growth can be detrimental to cooling tower operations. Problems include fouling, corrosion, and loss of efficiency. These problems can lead to downtime, higher operating cost, and even premature replacement of equipment. Additionally, some bacteria are pathogenic and can pose a risk to human life.

4-4.1 **Algae.** The term “algae” refers to algal, microbiological, tiny, stringy blue and blue-green plants, which are usually found growing in masses on top of and on sides of cooling towers. Algae grow only in sunlit areas. They will slough off and become part of the suspended matter in the circulating water, a situation which may cause fouling and plugging of water sprays. Algae also provide a breeding place, and are a nutrient, for bacteria.

4-4.2 **Bacteria.** The term “bacteria” refers to a large group of one-celled microorganisms. Bacteria can grow in either the absence or presence of sunlight. There are several ways to classify bacteria, including “aerobic,” meaning those living in the presence of oxygen, and “anaerobic,” meaning those living in the absence of oxygen. In a cooling water system, one can categorize bacteria as either “planktonic” or “sessile,” which are terms that describe whether the bacteria are, respectively, either free floating or found growing on surfaces (stickers). Categories of bacteria are described below. Table 4-3 shows types of bacteria and their growth conditions.

4-4.2.1 **Planktonic Bacteria.** Planktonic bacteria are suspended in the water, sometimes referred to as “free floaters” or “swimmers,” and are aerobic bacteria that thrive in an oxygenated environment. They are not harmful to the cooling system since they do not cause deposits or corrosion, but they can provide nutrients for other microorganisms; in addition, some planktonic bacteria such as *Legionella Pneumophila* are pathogenic and can present a significant human health risk.

4-4.2.2 **Sessile Bacteria.** Sessile bacteria are stickers, or non-swimming bacteria, and can cause deposits and corrosion. Sessile bacteria types include slime-formers and anaerobic (corrosive) bacteria. Slime-formers can grow and form gelatinous deposits on almost any surface in contact with the cooling water. These deposits can grow so large that they restrict water flow and interfere with heat transfer; they also may promote under-deposit corrosion. Feeling the sides of the cooling tower basin just below the water level is one way to detect the presence of slime-formers. Usually if there are slime formers in the system, you can feel deposits. Anaerobic bacteria thrive in oxygen-deprived environments and often establish colonies beneath slime deposits or under other types of deposits. One type of anaerobe is sulfate-reducing bacteria (SRB), which produce hydrogen sulfide, a chemical that is very corrosive to metals. This type of corrosion attack is very localized and can result in pipe and tube failures. The presence of SRB should be suspected in a water system if the underside of a slime layer is black or if you detect the odor of rotten eggs. Any type of microbiological corrosion is referred to as microbiologically influenced corrosion (MIC). Bacteria cause most of the MIC found in cooling water systems. Use surface microbiological measurements to monitor sessile bacteria.

Table 4-3. Bacterial Types and Problems Created

Bacteria Type	Technical Names and Examples	Conditions for Growth		Problems Created
		Temperature	pH	
Aerobic - capsulated	<ul style="list-style-type: none"> • Aerobacter aerogenes • Flavobacterium • Proteus vulgaris • Pseudomonas aeruginosa • Serratia • Alcaligenes 	20-40 °C (68-104 °F)	4-8 (7.4 optimum)	Severe bacterial slimes are formed; these are gelatinous deposits
Aerobic - spore forming	<ul style="list-style-type: none"> • Bacillus myocoides • Bacillus subtilis 	20-40 °C (68-104 °F)	5-8	Bacterial slimes; spores produced are difficult to destroy
Aerobic -sulfur	<ul style="list-style-type: none"> • Thiobacillus thiooxidans 	20-40 °C (68-104 °F)	0.6-6	Sulfur or sulfides are oxidized to sulfuric acid
Anaerobic –sulfate reducing	<ul style="list-style-type: none"> • Desulfovibrio desulfuricans • Clostridium 	20-40 °C (68-104 °F)	4-8	Grows under deposits causing corrosion; converts sulfates to hydrogen sulfide (rotten egg smell)
Iron depositing	<ul style="list-style-type: none"> • Crenothrix • Leptothrix • Gallionella 	20-40 °C (68–104 °F)	7.4-9.5	Converts soluble iron salts to iron oxide; can form voluminous deposits

4-4.3 **Fungi.** The term “fungi” refers to classes of organisms made up of molds and yeasts, some of which attack and cause wood decay in cooling towers. The control of fungi requires special preservative treatment of wood. Fungi also produce deposits in cooling water equipment.

4-4.4 **Microbiological Control.** The term “microbiological control” refers to techniques used to minimize the presence of microbiological organisms in cooling water. Chemical biocide treatment is the method used on government installations for microbiological control in cooling water. Biocides that are used to control microbiological growth fall into one of two broad categories: oxidizing and non-oxidizing microbiocides. A cost-effective approach for control involves the regular use of oxidizers as a primary biocide, augmented by selective use of non-oxidizing biocides. Important factors for the effectiveness of any biocide include using a proper dosage and allowing adequate contact time with the microbiological organisms. All microbiocides are toxic and must be handled safely and with caution; use the MSDS for safety instructions.

4-4.4.1 **Oxidizing Biocides.** “Oxidizing biocides” is a term describing microbiocides that oxidize or irreversibly “burn up” the bio-organisms. Oxidizing biocides also destroy nutrients that the microorganisms require for growth. Avoid addition of excess amounts (over-feeding) of oxidizing biocides because they are corrosive to metal and wood in the cooling system and have the potential to destroy some scale and corrosion inhibitors. The various oxidizing biocides are described below. Table 4-6 provides guidelines for selecting oxidizing microbiocides.

4-4.4.1.1 **Chlorine and Chlorine Release Agents.** Chlorine (Cl_2) compounds are the most effective industrial oxidizing biocides and the most widely used. Chlorine is available as a chlorine gas, dry calcium hypochlorite (HTH), liquid sodium hypochlorite (bleach), plus several other dry products that release chlorine. When chlorine is introduced into water, it hydrolyzes to form hypochlorite ion (OCl^-) and hypochlorous acid (HOCl); it is the latter chemical that is the stronger oxidizing biocide. The presence of hypochlorous acid is greater, proportionate to hypochlorite ion, at low pH levels. At a pH of 5.0, hypochlorous acid exists almost exclusively. At a pH of 7.5, there are approximately equal amounts of hypochlorous acid and hypochlorite ion. Figure 4-16 shows this relationship. Chlorine is effective, but to a lesser degree, as a biocide at a pH of 7.5 or greater because the hypochlorite ion has about one-tenth the biocidal efficacy of hypochlorous acid. A pH range of 6.5 to 7.5 is considered optimal for chlorine or chlorine-based microbiological control programs. Above pH 7.5, relatively higher levels of chlorine are required to be effective. Military installations seldom use gaseous chlorine for treating cooling towers because of safety concerns, difficulty with controlling the feed of the gas, and increasing concern for the environmental effects of escaping residual chlorine gas. The most commonly used chlorine-based products are bleach and HTH.

Figure 4-16. Halogen Species vs. pH in Water

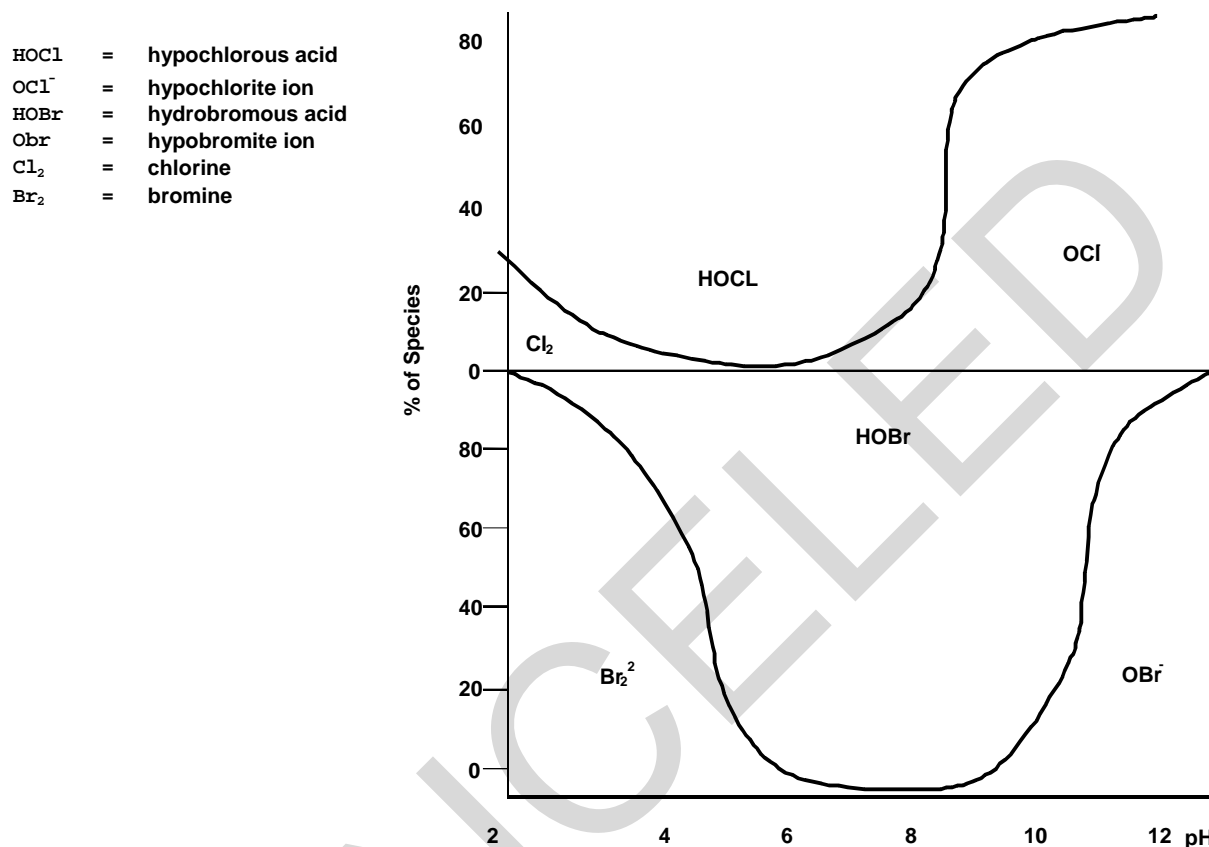

Table 4-4. Chlorine Release Agents

Release Agents	Comments
Sodium hypochlorite 12%	Concentrated liquid bleach
Calcium hypochlorite (HTH)	Dry product; releases chlorine
Chlorine gas	Gaseous chlorine
Chloroisocyanurates	Dry organic chlorine compound; releases chlorine and cyanuric acid

4-4.4.1.2 **Bromine Release Agents.** Bromine (Br₂) compounds are very similar to chlorine compounds. Although more expensive than chlorine compounds, their main advantage is that bromine is more effective at higher pH ranges (7.5 or greater) than chlorine. Bromine has a lower vapor pressure than chlorine and is 6 times as soluble in water, making it less subject to vaporization loss from a cooling tower. When bromine is introduced to water, it hydrolyzes to form hypobromite ion (OBr⁻) and hypobromous acid (HOBr); Figure 4-16 shows this relationship. A pH range of 7.5 to 10.0 is considered

optimal for the use of bromine. Bromine release agents include dry chemicals called hydantoins and bromine salts, such as sodium bromide. When a salt solution is mixed with an oxidizing agent, such as bleach, and a reaction occurs, bromine is produced. In water, bromine degrades more rapidly than chlorine. Recent developments in bromine chemistry have resulted in the production of a bromine solution (liquid). Table 4-5 shows examples of some bromine release agents. The most popular sources of bromine are the dry bromine release products.

Table 4-5. Bromine Release Agents

Release Agent	Comments
Bromo-chloro-dimethyl hydantoin	Dry product – releases bromine
Bromo-chloro-methyl-ethyl hydantoin	Dry product – releases bromine
Isocyanuric acid plus sodium bromide	Dry product – releases bromine
Chlorine plus sodium bromide	Produces bromine liquid
Peroxide plus sodium bromide	Produces bromine liquid
Ozone plus sodium bromide	Produces bromine liquid
Stabilized bromine	Hydrobromite liquid

4-4.4.1.3 **Ozone.** Ozone (O₃) is a gas produced by passing dry air either through a strong electric field or near an ultraviolet light. If ozone is dissolved in water, the resulting solution can be added to cooling water. Ozone is a very strong oxidizing biocide that, if properly applied, can provide effective control of microorganisms in cooling tower systems; however, because of safety and operational problems associated with its manufacture and use, and the resulting high capital and operating costs, it is neither the most economical method nor the preferred method for microbiological control in cooling towers under normal operations. Ozone can increase metal corrosion and does not prevent scale (see paragraph 8-2.9.1).

4-4.4.1.4 **Chlorine Dioxide.** Chlorine dioxide (ClO₂) is a gas generated by mixing several chemicals. The chlorine dioxide gas produced in this manner is subsequently dissolved in water, with the water containing the chlorine dioxide then added to the cooling water. Chlorine dioxide must be produced in close proximity to the point of use. It is not recommended for use on military installations due to the complexity of its production and safety concerns associated with its production and handling.

4-4.4.1.5 **Hydrogen Peroxide.** Hydrogen peroxide (H₂O₂) is a liquid that is usually used at a concentration of 30% in water. Hydrogen peroxide is considered one of the most environmentally friendly oxidizing biocides because it degrades to water; however, concentrated hydrogen peroxide will react in a violent manner when it comes into contact with organic chemicals and materials.

Table 4-6. Guidelines for Oxidizing Microbiocide Effectiveness

Microbiocide	Bacteria Types				Fungi	Algae	Comments
	Slime Forming		Iron Depositing	Corrosive			
	Spore Formers	Non-spore Formers					
Chlorine	P	E	E	N	P	F	Dangerous to handle; corrosive to metal; available as dry, gas, or liquid; less effective higher pH (> 7.5)
Bromine	F	E	E	N	P	F	Can be produced from bromides; very effective at pH 6.0-10.0; very effective with ammonia; less volatile than chlorine
Ozone	E	E	E	F	G	P	Very volatile; can attack wood, PVC, copper, and gaskets
Chlorine dioxide	G	E	E	N	P	F	Must be produced onsite; very volatile; not sensitive to pH; does not react with ammonia and many organics
Peroxide	G	G	G	F	P	F	Does not add TDS; degrades to water

E = Excellent G = Good F = Fair P = Poor N = Not effective

4-4.4.2 **Non-Oxidizing Biocides.** Non-oxidizing biocides are microbiocides that act as “poisons;” they disrupt the metabolic or reproductive processes of micro- and macro-organisms and are therefore toxic. Non-oxidizing biocides are organic compounds that are very toxic to organisms, including human beings and animals. They are usually liquids, but some are available as dry products (e.g., pellets, solids). A major consideration for their use is their persistence with respect to the discharge limitations for water (effluent) containing these toxic substances. Also, when choosing and applying a non-oxidizing biocide, you must consider the cooling tower system’s operating parameters, such as pH and retention time. The applied dosages of microbiocides should never exceed EPA maximum limits, which are always printed on the container labels. The labels will also identify the active microbiocide ingredient, the percentage of each chemical that is present in the formulation, and the EPA registration number. Control programs often combine both oxidizing and non-oxidizing biocides. The most important aspect of bio-fouling control is to match the non-oxidizing biocide to the problem organism. Table 4-7 provides guidelines for non-oxidizing biocide effectiveness.

CANCELLED

Table 4-7. Guidelines for Non-Oxidizing Microbiocide Selection

Microbiocide	Bacteria				Fungi	Algae	Comments
	Slime Forming		Iron Depositing	Corrosive			
	Spore Formers	Non-Spore Formers					
Quaternary ammonium salts	E	E	E	G	P	G	Effective pH 6.5-9.2; foaming potential; reacts with anionics
Organo tin plus quaternaries	E	E	E	G	P	G	Effective pH 6.5-9.2; foaming potential; reacts with anionics; tin compounds often restricted
Dibromo-nitrilo-propionamide	E	E	E	G	N	P	Effective pH 6.5-7.5; degrades quickly; uses glycol solvent
Methylene bis thiocynate	E	E	G	E	P	P	Effective pH < 7.5; deactivated with high pH
Isothiazolone	E	E	G	G	G	G	Effective pH 4.5-9.3; dangerous to humans
Dodecylguanidine	E	E	G	G	G	G	Effective pH 6.5-9.5
Glutaraldehyde	E	E	G	E	G	G	Effective pH 6-10
Terbutylazine	N	N	N	N	N	E	Very effective algaecide; blocks photosynthesis
Carbamates	E	E	G	G	G	F	Eff. pH 7-9; corrodes copper

E = Excellent G = Good F = Fair P = Poor N = Not effective

4-4.5 **Algae Control.** Algae can be controlled by two techniques: chemical methods and physical methods. Since algae require sunlight to survive and grow, covering the upper hot water decks of cooling towers with plywood can often control algae deposits. Chemical methods consist of using oxidizing and non-oxidizing biocides, which can control algae to various degrees (see Tables 4-6 and 4-7). The effectiveness of oxidizers is considered only fair while that of several non-oxidizers is in the range of very good to excellent. One of the more effective biocides for algae is terbutylazine, a triazine product (see Table 4-7).

4-4.6 **Bacterial Control.** Accepted industry practice for bacterial control is the use of oxidizing and non-oxidizing biocides that are specific for the type of bacteria. The most cost-effective microbiocide programs for medium and large cooling towers use an oxidizer as a primary biocide and one or more non-oxidizers selectively as a secondary biocide (see Tables 4-6 and 4-7). Smaller cooling systems often use one or more non-oxidizing biocides, although dry oxidizing biocides are also used commonly. The most overlooked aspect of bacterial control is maintaining a system kept clean of deposits and SS (i.e., dirt, silt, sand, corrosion products) through the use of filters and periodic wash-down procedures. **Clean systems reduce the demand for chemical and microbiological control.** Table 4-8 shows accepted industry guidelines for a bacterial control program with the use of a test kit.

Table 4-8. Guidelines for Bacterial Control in Cooling Towers

Bacterium Type	Colony-Forming Units/ml
Total aerobic bacteria	< 10 ⁴
Sulfate-reducing bacteria	Undetectable
Surface microbiological	< 10 ⁶ – Undetectable

4-4.6.1 **Bacterial Control with Oxidizing Biocides.** Bacterial control with oxidizing biocides can be accomplished by either continuous feed or slug feed of the oxidant. A continuous-feed process typically maintains 0.1 to 0.3 ppm of free halogen in the return water to the cooling tower. A typical slug-feed process adds treatment chemicals periodically to give 0.5 to 1.0 ppm of free halogen in the return water to the cooling tower for a period of 2 to 4 hours, 3 times per week. Halogen refers to the group of elements including chlorine and bromine. “Free” halogen refers to the measured residual of halogen available for disinfection. Stabilized Halogen technology is generally controlled on a total halogen residual. For continuous feed, control at 0.5 to 1 ppm total, and for slug feed control at 2.4 ppm for a period 2-4 hours, 3 times per week.

4-4.6.2 **Bacterial Control with Non-Oxidizing Biocides.** Bacterial control with non-oxidizing biocides uses one or more biocides as shown in Table 4-7. Usually different non-oxidizers are added on an alternating schedule; they are slug-fed every other week for optimum effectiveness. Each time you use a non-oxidizing biocide, it is

important to maintain an adequate dosage for 24 hours to enable sufficient contact time for maximum effectiveness.

4-4.7 **Legionnaires' Disease.** Legionnaires' Disease (Legionellosis) is a respiratory disease (atypical pneumonia) that is caused by infection of susceptible individuals who have inhaled a fine water mist containing the bacterium known as *Legionella Pneumophila*. Water in a cooling tower can become infected with the bacterium if an inadequate microbiological control situation occurs. The presence and density of *Legionella Pneumophila* bacteria cannot be detected by standard microbiological testing methodologies. Instead, cooling water samples must be sent to a laboratory that has been certified to conduct the required tests. If the presence of the bacteria in cooling water is established, proper disinfection steps are required. A procedure known as the Wisconsin Protocol, developed by the Wisconsin State Health Department, has proven effective. This protocol requires the addition of high dosages of chlorine (10 ppm free residual) at a pH of less than 7.5 for 24 hours, flushing the system, then repeating. Additional testing for Legionella is required to determine the effectiveness of the procedure. Maintaining a clean, microbiologically free cooling water system and using effective water treatment is preferable to dealing with remedial efforts. The Cooling Technology Institute (CTI) and the American Society of Heating, Refrigerating, and Air Conditioning Engineers (ASHRAE) have published position papers on the prevention of Legionella; these can be downloaded from their respective websites: <http://www.cti.org/> and <http://www.ashrae.org/>.

4-4.8 **Macrobiological Control.** The term "macrobiological control" refers to control of larger biological organisms such as mussels, clams, and snails. They can exist in cooling systems that use seawater or river water as makeup. The first line of defense is using mechanical prevention with strainers and filters on the intake water to prevent infiltration into the cooling water system. Control methods within the cooling system include thermal shock and chemical treatment with oxidizing and non-oxidizing biocides.

4-5 **CORROSION IN COOLING SYSTEMS.** The term "corrosion" (in a cooling water system) is defined as the electrochemical deterioration of a metal that is in contact with cooling water. Corrosion occurs when an electric current flows from one part of the metal (anode) through the water (electrolyte) to another part of the metal (cathode). Corrosion takes place at the anode only. The cathode is the driving force of the corrosion action. Forms of corrosion associated with industrial water systems are illustrated in Figure 4-17.

Figure 4-17. Forms of Corrosion

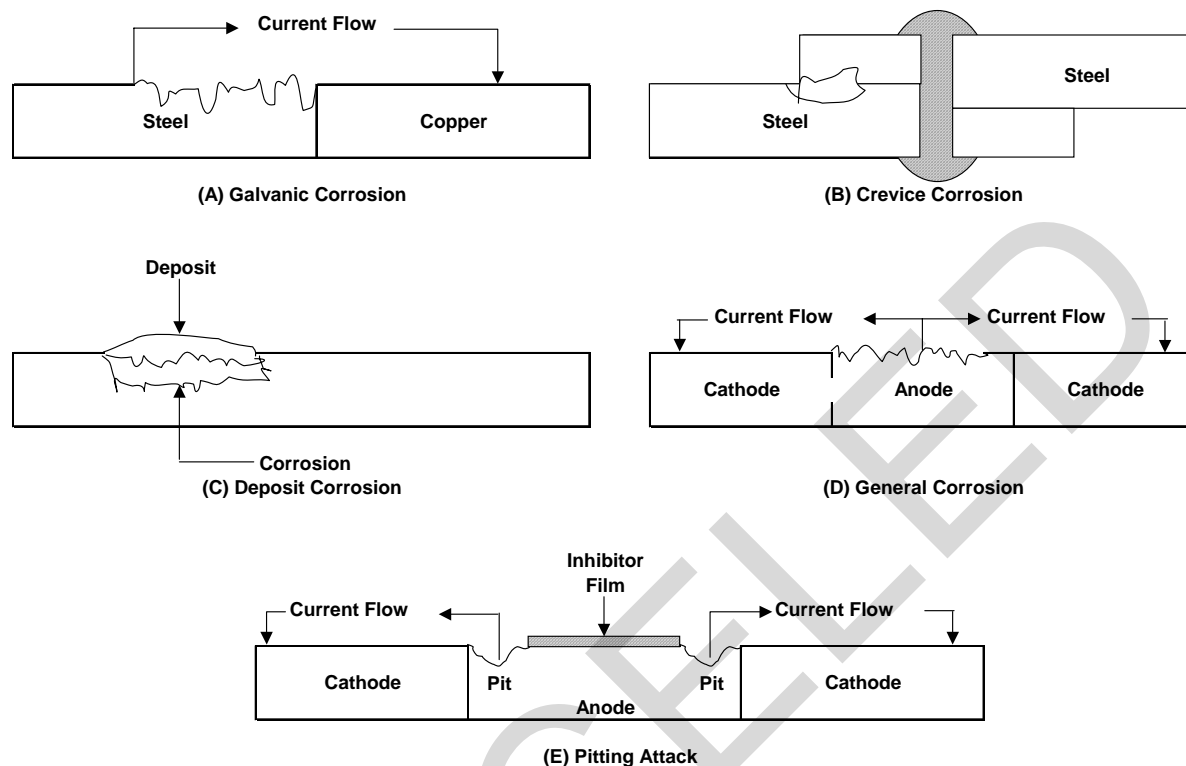

4-5.1 **Galvanic Corrosion.** See Figure 4-17 (A). This term refers to corrosion that occurs when two different metals are coupled together. The metal with the least resistance becomes the anode and will corrode due to the electrochemical reaction produced. One of the most common instances of galvanic corrosion occurring in cooling water systems results when mild steel and copper alloy metals are brought into contact with one another (e.g., copper tubing attached to a mild steel tube sheet or brass valves connected to mild steel or galvanized piping). As a result of the electrochemical reaction, the copper is dissolved in the water and corrosion of copper alloy results. The copper can also plate out (stick) on mild steel surfaces, setting up additional galvanic cells. Another example is the electrochemical reaction that occurs when mild steel and zinc (galvanizing) are coupled together at temperatures normally found in cooling tower systems. The zinc becomes the anode and is corroded. Figure 4-18 shows the galvanic series. Any coupling of a metal that is higher in the galvanic series with a metal or alloy that is lower in the galvanic series results in electrochemical reaction in which the “higher” metal functions as the anode or active metal.

**Figure 4-18. Galvanic Series of Common Metals and Alloys
Found in Cooling Water Systems**

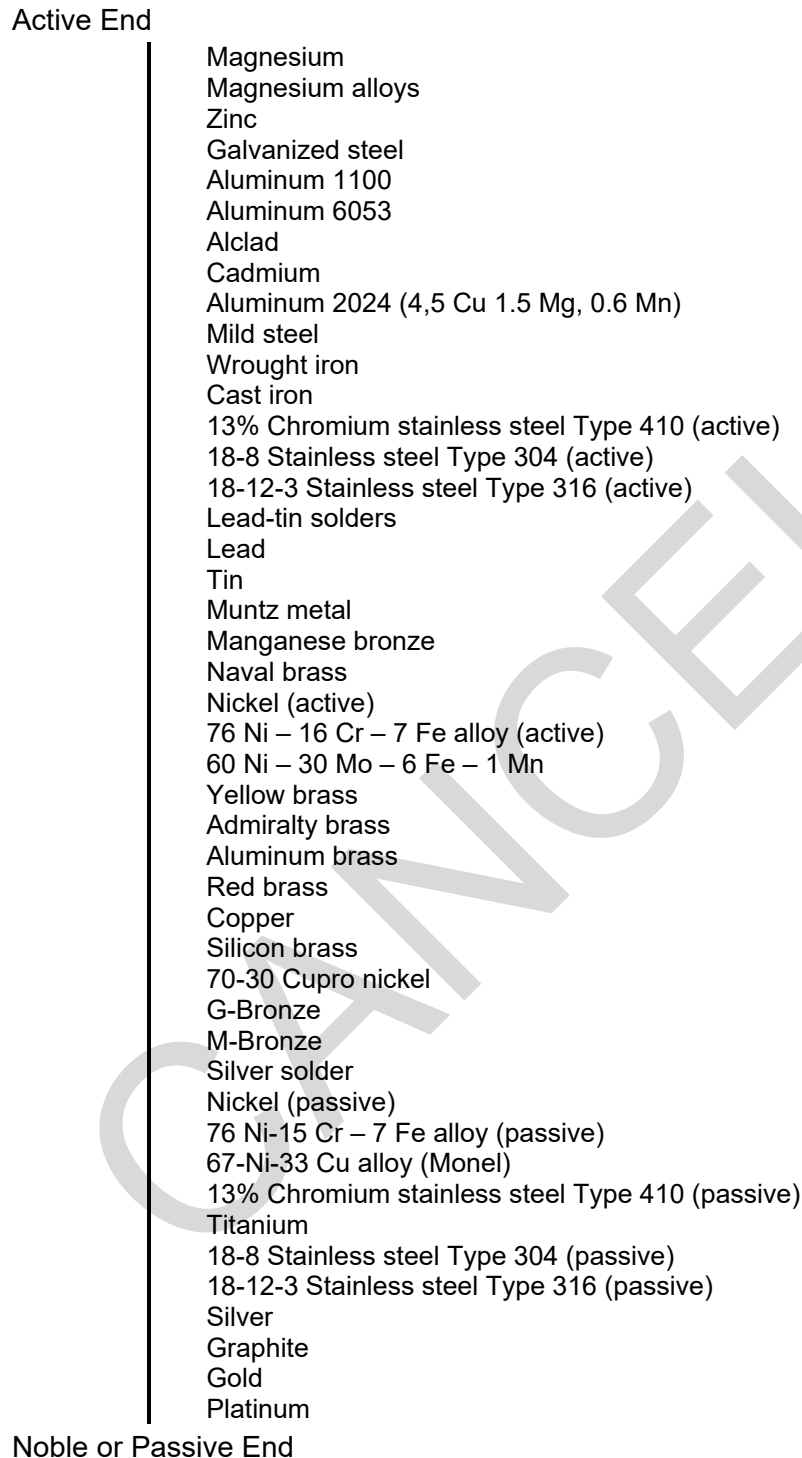

4-5.2 **General Corrosion.** See Figure 4-17 (D). The term “general corrosion” refers to uniform corrosion of metal surfaces. A single piece of metal will have cathodic and anodic areas due to differences in impurities and stresses. These areas will change periodically, causing the metal to corrode over the entire surface at a more or less uniform rate.

4-5.3 **Concentration Cell Corrosion.** When two pieces of the same metal are in a solution capable of acting as an electrolyte, and the electrolyte contains different substances or the same substance in different amounts, such as a salt or a mixture of salts, or oxygen, an electrical potential difference will develop between them.

4-5.3.1 **Crevice Corrosion.** See Figure 4-17 (B). The term “crevice corrosion” refers to corrosion that occurs in a slight separation between two pieces of metal, such as at the contact point of two mild or stainless steel plates that have been bolted together. Water flow is restricted in a crevice and, as a result, oxygen is consumed faster than it can be replenished. The metal in the crevice functions as an anode and corrodes. This is a form of concentration cell corrosion, also called “differential oxygen cell” corrosion. Stainless steel is particularly susceptible to this type of corrosion, which results in localized or pitting attack.

4-5.3.2 **Under-Deposit Corrosion.** See Figure 4-17 (C). The term “under-deposit corrosion” refers to corrosion occurring under any type of deposit. The underside of a deposit that has been caused by fouling, bacterial slime, or debris acts in much the same way as the inside of a crevice. The metal under the deposit becomes anodic and corrodes. This process is considered another form of concentration cell corrosion because oxygen cannot easily get under the deposit. All metals are susceptible to this type of corrosion, which results in localized or pitting attack.

4-5.3.2.1 **Microbiologically Influenced Corrosion (MIC).** See Figure 4-17 (E). This term refers to metal corrosion associated with microbiological organisms whose presence contributes to the creation of, or maintenance of, a corrosive environment. MIC can be either eliminated or prevented to a large degree by the proper use of biocides.

4-5.4 **Corrosion Rate.** The term “corrosion rate” refers to the rate at which the corrosion action proceeds. The rate is measured in units of mils per year (mpy). A mil is 0.0254 millimeter (one-thousandth of an inch). The rate measurement is performed using corrosion coupons that have been exposed to cooling water for a short period of time (i.e., 30 to 90 days). The weight of the coupon is measured before and after exposure to the water. The thickness of the metal lost due to corrosion over the testing period is then calculated using a measurement of the weight loss. This weight loss is extrapolated to give a rate for 1 year and a calculation of the thickness loss is then performed and the value is reported. Alternatively, this measurement can be taken using specialized instruments that rapidly measure corrosion rates. Table 4-9 shows the corrosion rates for corrosion coupons of different metals. Paragraph 6-5.2 provides detailed information on corrosion testing.

**Table 4-9. Assessing Corrosion Rates in Cooling Water Systems:
90-Day Corrosion Coupon Test**

Metal	mpy	Comment
Mild steel piping	< 1	Excellent
	> 1 to 3	Good
	> 3 to 5	Fair
	> 5 to 10	Poor
	> 10	Unacceptable
Mild steel Hx tubing	< 0.2	Excellent
	> 0.2 to 0.5	Good
	> 0.5 to 1.0	Fair
	> 1.0 to 1.5	Poor
	> 1.5	Unacceptable
Copper and copper alloys	< 0.1	Excellent
	> 0.1 to 0.2	Good
	> 0.2 to 0.3	Fair
	> 0.3 to 0.5	Poor
	> 0.5	Unacceptable
Galvanized steel	< 2	Excellent
	> 2 to 4	Good
	> 4 to 8	Fair
	> 8 to 10	Poor
	> 10	Unacceptable
Stainless steel	< 0.1	Acceptable
	> 0.1	Unacceptable

NOTE: Determine pitting on coupons by visual observation; any pitting is unacceptable.

4-5.5 Corrosion Control Methods. In cooling water systems, two basic techniques are used to provide corrosion protection to the metals that the water contacts: use of chemical corrosion inhibitors, and raising the pH of the cooling water. Figure 4-19 illustrates the effect of pH on the corrosion rate of mild steel. Most military cooling water systems contain components fabricated primarily of copper alloy and mild steel. Galvanized steel is present in galvanized cooling towers and stainless steel may be present in piping. As the cooling water pH is increased (ideally to within the range of 8.0 to 9.5), copper and mild steel corrosion rates will decrease as shown in Figure 4-19, although very high pH levels are corrosive to copper. The increase in pH alone cannot

always protect metals adequately, especially since cooling water is highly aerated (oxygen saturated). Chemical corrosion inhibitors are used to provide protection from corrosion of the metal components of cooling water systems. Table 4-10 shows criteria for the selection of corrosion inhibitors. The principal strategy for a cooling system corrosion protection program is to ensure protection of the metal in the heat exchanger (metal that is the thinnest metal in the system). The secondary goal is to provide protection from corrosion of the mild steel piping. When galvanized steel cooling towers are part of the cooling system, specialized corrosion inhibitors are the best control method. Galvanized steel is corroded at pH levels above 9.0 and below 6.0.

Figure 4-19. Effect of pH on Corrosion Rate of Unprotected Mild Steel in Water

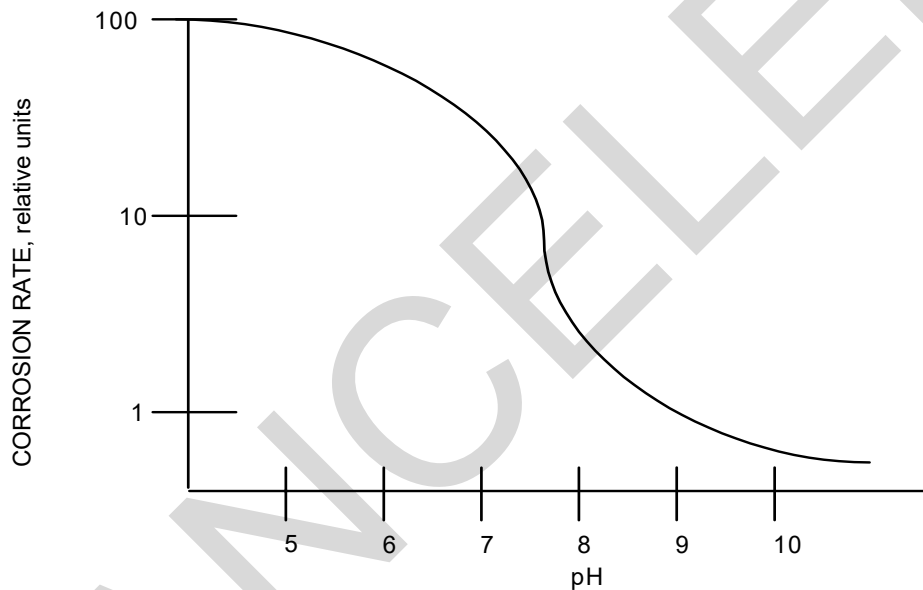

Table 4-10. Criteria for Corrosion Inhibitor Selection

Corrosion Inhibitor	Metal			pH Range (ideal)
	Steel	Copper	Aluminum	
Cathodic Inhibitor				
Polyphosphate ¹	Excellent	Attacks	Attacks	6.5-8.5
Zinc salts ²	Excellent	None	None	6.5-8.5
Polysilicate ³	Excellent	Excellent	Excellent	7.5-10.0
Molybdate	Good	Fair	Fair	7.5-10.0
Anodic Inhibitor				
Orthophosphate ¹	Good	Attacks	Attacks	6.5-8.5
Orthosilicate ³	Good	Good	Good	7.5-10.0
Copper Corrosion Inhibitor				
Azoles	Fair	Excellent	Fair	6.0-10.0

NOTES:

1. May require polymeric calcium phosphate dispersant.
2. Rarely used alone. Requires zinc solubilizer above pH 7.8.
3. Do not use if natural silica is 150 ppm or greater.

4-5.5.1 **Effective Corrosion Control.** Effective corrosion control requires maintaining appropriate pH levels, plus adding maintenance dosages of chemical corrosion inhibitors. Chemical corrosion inhibitors form a protective film or barrier on the cooling system metal surfaces that have been cleaned prior to adding an initial high dosage of inhibitor. The initial high dosage of inhibitor passivates (protects) the metal. The appropriate dosage of corrosion inhibitor must be maintained continuously in the cooling water to ensure continuing protection. Table 4-11 shows examples of various passivation and maintenance dosage levels of corrosion inhibitors. Corrosion inhibitors are divided into three classes: cathodic, anodic, and general filmers. Corrosion inhibitors form a protective film on either the anode, the cathode, or over the entire metal surface. The types of corrosion inhibitors are described below.

4-5.5.1.1 **Anodic Inhibitors.** Anodic inhibitors form a protective film coating on the anodic metal (where the metal is lost) and thus directly control corrosion by preventing the reaction that results in corrosion. Any unprotected areas will corrode at a much faster rate than the protected areas, a factor that could result in pitting or localized attack of the unprotected areas. Examples of anodic inhibitors include orthophosphate, nitrite, and orthosilicates. Under certain conditions, molybdate can function as an anodic inhibitor.

4-5.5.1.2 **Cathodic Inhibitors.** Cathodic inhibitors form a protective film coating of the cathodic metal (where metal is not lost) and thus indirectly prevent corrosion by interfering with the current flow required for the electrochemical reaction to proceed

between the cathodic and anodic metals. The corrosion reaction rate is governed by the size and type of the cathode relative to the anode. Even when cathodic areas are not completely covered by the protective film, corrosion will occur, but usually more slowly and uniformly than when using anodic inhibitors alone. The occurrence of localized corrosion or pitting attack is greatly reduced. Examples of cathodic inhibitors include zinc salts, polyphosphates, and polysilicates. Under most conditions, molybdate will function as a cathodic inhibitor.

4-5.5.1.3 **General Inhibitors.** General inhibitors produce a protective film on the surfaces of all metals. These corrosion inhibitors are organic compounds, such as certain phosphonates, amines, and other nitrogen chemicals. They may be used in cooling water systems.

4-5.5.1.4 **Corrosion Inhibitors for Specific Metals.** Some corrosion inhibitors provide corrosion control for specific metals. The protection of copper and copper alloys requires the use of azoles, such as tolyltriazole (TTA), benzotriazole (BZT), and butylbenzo-thiazole, which can be added to the system separately from, or as part of a blend of, other treatment chemicals.

4-5.5.1.5 **Galvanic or Crevice Corrosion.** Control of galvanic or crevice corrosion is achieved primarily by engineering and mechanical design. These types of corrosion can also be partially controlled by physical and chemical considerations. A dielectric coupling (insulator), used to separate two different metallurgies, can help to prevent galvanic corrosion. From a chemical perspective, adjusting pH and using proper corrosion inhibitors will reduce corrosion.

4-5.5.1.6 **Deposit Corrosion.** Control of deposit corrosion requires maintaining deposit-free metal surfaces. This applies to any form of deposit, such as scale, biomass, corrosion products, or foulants. The occurrence of most types of deposits is prevented by dispersants, scale inhibitors, or biocides, along with the maintenance of adequate flow velocities. Routine, adequate cleaning of filters and tower sumps will help reduce deposits.

4-5.5.1.7 **MIC.** MIC is best prevented by stopping conditions that foster biological growth and by using an effective microbiological control program. A MIC prevention program includes adequate control (prevention) of deposits and fouling, avoidance of low-flow and dead-leg conditions, and implementation of a consistently effective microbiological program (see paragraph 4-4.4).

Table 4-11. Guidelines for Passivation Film Formation and Subsequent Maintenance

Corrosion Inhibitor	Dosage (ppm)		Film-Formation Time (Days)
	Initial	Maintenance	
Cathodic Inhibitor			
Polyphosphate ¹	40-60 as PO ₄	10-20 as PO ₄	5-6
Zinc salts ²	10-20 as Zn	3-5 as Zn	5-6
Polysilicate ³	40-60 as SiO ₂	10-20 as SiO ₂	10-12
Molybdate	40-60 as Mo	5-20 as Mo	10-12
Anodic Inhibitor			
Orthophosphate ¹	40-60 as PO ₄	15-20 as PO ₄	5-6
Orthosilicate ³	40-60 as SiO ₂	10-15 as SiO ₂	10-12
Copper Corrosion Inhibitor			
Tolyltriazole	10-20 as TTA	1-2 as TTA	5-6

NOTES: General: Maintenance dosage shifts to lower part of range as pH rises.

1. May require polymeric calcium phosphate dispersant.
2. Rarely used alone. Requires zinc solubilizer above pH 7.8.
3. Do not use if natural silica is 150 ppm or greater.

4-6 DEVELOPING AN EFFECTIVE COOLING WATER TREATMENT PROGRAM.

An effective and complete cooling water treatment program addresses many factors, including those associated with compliance and safety, protection of equipment, and cost. Compliance and safety considerations are mandatory components of the program. Achieving or exceeding minimally acceptable equipment protection at the lowest possible cost is an advisable outcome for a well-designed program. The overall cost of the treatment program includes not only the cost of chemical treatment, but also the costs of water, disposal, manpower, and equipment. Development of an appropriate cooling water treatment program is dependent upon knowledge of both the specific equipment to be protected and the quality of the water to be used (source water and system water).

4-6.1 Equipment. Corrosion inhibitors are selected based on the metallurgy of individual pieces of cooling system equipment. Typical systems include equipment components of different metals. For example, systems may include smooth and enhanced copper tube bundles, mild steel transfer piping, and galvanized cooling tower components; therefore, to select the proper corrosion inhibitor, it is important to identify all metals contacted by the cooling water. (See Table 4-10 for corrosion inhibitor selection criteria.)

4-6.2 Operational Features and Parameters. Operational features and parameters of the cooling water system must be known to select the proper scale and

deposit inhibitors. This requirement refers to operational parameters such as maximum temperature, minimum velocities, usage patterns, and whether or not layup periods occur. The best chemical treatment programs cannot overcome the stresses of poorly operated systems. A good example of system stress is intermittent chiller operation that allows for SS accumulation (deposits) in chiller tube surfaces due to low flow or lack of flow. This situation creates a strong potential for under-deposit corrosion and for MIC that the chemical treatment may not be able to overcome completely. Stagnant water can also cause deposits and corrosion. High water temperatures can cause scale. The maximum water temperature should be known so that the proper scale-control method can be used.

4-6.3 **Water Quality.** Water quality within the cooling water system is a critical consideration. The source may be potable or reuse or recycled water. The various water constituents must be known so appropriate water treatment chemicals can be selected for controlling specific water quality parameters.

4-6.4 **Cooling Water Treatment Programs**

4-6.4.1 **Categories.** For the purpose of developing a water treatment program, cooling tower recirculating water systems can be divided into three basic categories:

- Small-sized towers – capacity less than 88 kilowatts (25 tons)
- Medium-sized towers – 88 to 352 kilowatts (25 to 100 tons)
- Large-sized towers - greater than 352 kilowatts (100 tons)

The water treatment program selected for cooling tower systems will vary depending on the size of the tower (among other factors). Treatment program considerations are described in paragraphs 4-6.5 and 4-6.6 for small-, medium-, and large-sized towers, respectively.

4-6.4.2 **Cycles of Concentration (COC).** The COC of small, medium, and large cooling towers may be controlled by blowdown, either automatic or manual, to avoid the high levels of silica and calcium salts that can lead to scale. If the cooling tower is not chemically treated, the COC should be adjusted to be slightly less than the lowest allowable COC value based on all scale-forming water ingredients (see paragraph 4-3.3). The use of chemical treatment permits a higher COC, which is usually limited by either the chemical effectiveness or the water treatment control.

EXAMPLE: An untreated cooling tower system can operate at 10 COC based on the level of silica without scale forming, but can operate at only 2 COC based on the level of calcium carbonate. Accordingly, the tower system should be operated at a maximum of 2 COC. The system can likely be operated at 5 to 6 COC when an effective chemical treatment is applied and maintained to control calcium carbonate.

4-6.5 **Treatment Program for Small Cooling Towers.** Typically a small cooling tower will have a rating of less than 88 kilowatts (25 tons). The treatment program used for small towers should be designed to be simple to control and easy to apply, with very

little operator attention required. This does not mean that no attention is required, only less than that required for medium-sized systems. The treatment program for small systems is shown in Table 4-12.

Table 4-12. Small Cooling Tower Treatment Program

Parameter	Method
COC	Do not exceed COC limits for untreated water
Scale and corrosion program	Dry slowly soluble phosphate compound
Microbiological program	Dry slowly soluble oxidizing biocide
SS	Filtration and periodic washdowns, as required

4-6.5.1 **Treatment.** Small systems can be treated with a low dosage (5 to 10 ppm) of a slowly soluble phosphate chemical (sodium/calcium polyphosphate) by placing a nylon mesh bag containing the product into the cooling tower. The product, if applied in this manner, will usually provide adequate scale and corrosion control. Microbiological control can be obtained by use of a dry, pelletized, oxidizing biocide, such as bromochlorohydrantoin or isocyanuric acid plus sodium bromide (see paragraph 4-4.4.1). Either of these biocides can be fed continuously via a feeder or suspended in a mesh bag in the cooling tower water. The cooling tower sump should be kept clean of SS and other debris by use of a filter and periodic washdowns.

4-6.5.2 **Testing.** Testing is usually limited to assurance that the optimum COC value is being maintained and that the chemical treatment agents are present in the water. The bag with the chemical treatment should not be allowed to become less than one-half full. The frequency for refilling the bag will vary; once every 1 to 2 months is typical. Initially, the treatment level should be checked to assure that adequate, but not excessive, levels of both phosphate and the biocide are present in the cooling water.

4-6.6 **Treatment Program for Medium and Large Cooling Towers.** The chemical treatment program for these cooling tower systems (typically greater than 88 kilowatts [25 tons]) requires sufficient, regular testing as well as water and chemical control to protect the equipment in contact with the cooling water. Usually treatment includes control of scale, fouling, microbiological growth, and corrosion. The composition of an optimum chemical treatment program for cooling towers on a military installation depends on the quality of water available, the operating conditions of the cooling system, and the environmental constraints placed on treatment chemicals in the blowdown water (effluent discharge limitations). Conditions at a particular installation may require variation of the quantity or mix of the chemicals suggested in Table 4-13.

Table 4-13. Treatment Programs for Medium and Large Cooling Towers

Parameter	Approach
COC	Target a minimum of 3 COC (ideally 5 COC) that the chemical treatment will allow.
Corrosion control	<ol style="list-style-type: none"> 1. Use of cathodic corrosion, possibly supplemented with anodic inhibitors for mild steel. If a galvanized cooling tower is present, use a polysilicate or low-level phosphate while keeping pH in the range of 8 to 9. 2. Copper corrosion inhibitor should be used for all copper tubes and especially for enhanced and super-enhanced copper tubing.
Scale control	Phosphonate/polymer program, augmented by a phosphate dispersant if phosphate corrosion inhibitor is used.
SS	Polymer dispersant coupled with adequate flow. Avoid no-flow conditions in heat exchangers as much as possible. Mechanical filtration and routine physical sump cleaning recommended.
Microbiological control	<ol style="list-style-type: none"> 1. Primary biocide: oxidizing biocide using continuous feed or slug feed as an alternate. 2. Secondary biocide: non-oxidizing biocide using slug feed, as required.

4-6.6.1 **Treatment.** Medium and large cooling towers are usually, but not always, treated with a liquid formulation containing both scale inhibitors and corrosion inhibitors. These are often simply referred to as an "inhibitor." Inhibitor products are usually fed on a continuous basis using automated control and feed equipment. The concentration of these formulated products varies greatly from vendor to vendor. Biocides are usually, but not always, liquid products. It is common to use an oxidizing biocide as a primary biocide and a non-oxidizing biocide as a secondary biocide, used as needed to control bacteria and other biological growth. Oxidizing biocides can either be fed continuously at a low level or dosed periodically at a higher level. Non-oxidizers are dosed as needed and only when oxidizing biocides are either ineffective or not used at all.

4-6.6.2 **Testing.** Testing should be done regularly to insure that COC, chemical levels, and bacteria levels are within the targeted control range. This requirement could demand a testing frequency of 3 times per week, or even daily.

4-6.7 **Cooling Tower Operator Duties.** If detected early, problems associated with scaling, corrosion and fouling in a cooling tower system can be minimized by corrective action. Some of the things the operator should look for when on-site are described below.

4-6.7.1 **Cooling Tower Distribution Deck.** It is important to look for the presence of algae, debris, or anything that has plugged water distribution holes causing an uneven water flow through the tower, thus lowering tower efficiency. Clean plugged holes and replace damaged water distribution spray nozzles.

In addition, look for the presence of algae deposits. If algae deposits are present, increase the level or frequency of biocide or algaecide treatment, and cover the deck if uncovered.

4-6.7.2 **Cooling Tower Fill, Air Intake Slats, and Basin**

4-6.7.2.1 **Scale Deposits on Cooling Tower Fill.** The presence of deposits, particularly on cooling tower fill, can be established by removing some fill to determine if partial plugging has occurred. Scale can range in color from white to gray or reddish depending on the scale composition. Scale formation on the cooling tower fill usually indicates a severe scaling situation. If possible, obtain a sample of the scale for analysis and, based on the result, select a scale inhibitor for that specific scale.

4-6.7.2.2 **Scale Deposits on Air Intake Slats.** Scale can form on the air intake slats of a cooling tower. This buildup is due mostly to water splashing and evaporating, causing deposition of soluble salts or minerals. This situation does not indicate a serious problem. These deposits can be, and should be, washed off periodically, but ideally not into the cooling tower basin. Chemical treatment can provide some reduction in the occurrence deposits.

4-6.7.2.3 **Slime Deposits.** Slime deposits (microbiological) can sometimes be detected by feeling below the water level on the distribution deck and on the walls of the cooling tower basin. Most microbiological growth will have a slimy feel. If slime deposits are present, increase biocide frequency or increase the dosage.

4-6.7.2.4 **Suspended Solids.** The purpose of a dispersant is to keep particulate solids in suspension and to prevent them from settling or from adhering to heat transfer surfaces. Adequate water flow is required to prevent them from settling. Particulate solids in suspension are removed with the blowdown water. The tower water should be turbid if the dispersant is doing its job. Keep the cooling tower sump clean of SS by cleaning periodically and using a filter.

4-6.7.3 **Corrosion Test Coupons.** When removing corrosion coupons, always note and record the visual appearance with regard to the presence of scale, rust, or biomass. Take photographs of the corrosion coupons. Submit (or evaluate) coupons for corrosion rate and for the type of corrosion that is occurring.

4-6.7.4 **Inside Surface of Heat Exchanger Tubes.** To effectively examine the inside (water-contacted) surfaces of heat exchanger tubes, a boroscope is needed because only a few inches of the interior can be seen visually using a flashlight. Scale deposits, typically hard and tightly adhered to the tube surface, range in color from white

to gray or reddish, depending on the composition of the scale. No scale should be present. It is important to inspect heat exchanger tubes at least once per year.

Fouling-type deposits may look similar to scale deposits. Unlike scale, these deposits usually adhere loosely to the tube surface. Biomass will appear slimy and feel slippery, and will usually adhere loosely.

4-6.7.5 Chiller Performance. Degradation of chiller performance or chiller efficiency may be a strong indication of scale or fouling problems in the chiller. If a reduction in chiller capacity occurs while cooling water is being cooled efficiently and within design parameters, then the chiller condenser section should be opened and examined. The chiller evaporator section may not contain water material scale but may be fouled with corrosion products. You should open and examine the chiller evaporator if chilled water could possibly be inadequately treated.

4-6.7.6 Cooling Tower Surfaces. Cooling towers made of galvanized steel should be examined for white rust or possible rusty surfaces that may indicate that the galvanizing is no longer present on the metal surfaces and the steel is rusting. Cooling towers constructed of wood should be examined for wood deterioration or decay.

4-7 COOLING WATER SYSTEM START-UP AND LAYUP

REQUIREMENTS. The startup of a new cooling water system requires special consideration. Proper cooling water system layup is also important, especially for chiller tube bundles or other heat exchange equipment. For a new cooling tower system, it is important to make sure that the equipment that contacts the cooling water is clean and properly protected from initial corrosion. Also, disinfection is needed to eliminate the presence of microbiological organisms that can cause corrosion, deposits, and growth of pathogenic organisms such as Legionella bacteria. Implementation of a proper layup process is critical to prevent corrosion and microbiological growth during stagnant water conditions.

4-7.1 Stand-by Conditions. The term “stand-by” is often applied to a chiller that is in rotation with other chillers on-line. This stand-by period could be of varying duration, from a few days to a few weeks. Rotating chillers frequently is important for minimizing stagnant conditions that lead to under-deposit and MIC corrosion. It is good practice to run the recirculation pumps through a stand-by chiller for at least 15 minutes each day to minimize corrosion. A chiller that must be left on stand-by for an extended period of weeks without recirculation should be laid up wet or dry according to procedures described in paragraph 4-7.4.

4-7.2 Common Problems During Layup or Due to Improper Initial Start-up. Common problems that occur during layup or due to improper initial start-up include corrosion of tubes and transfer piping (sometimes to the point of failure), microbiological growth with potential for MIC corrosion, and growth of pathogenic microorganisms.

4-7.3 Start-up of New Cooling Water Tower Systems

4-7.3.1 **Initial Cleaning.** A new cooling water tower system will contain dirt, oils, greasy films, and rust located on the metal surfaces as a result of system fabrication. A pre-operational alkaline cleaning process is required to remove the dirt, oil, grease, and rust, and to prepare metal surfaces for initial corrosion control. When galvanized steel is involved, special care must be taken so that the pH does not exceed 8.5 during the cleaning and passivation process to avoid conditions that promote white rust. The cleaning and passivating procedure for a new cooling tower system is usually part of a new system construction project and, as such, is not in the direct control of the cooling system operations personnel. Verification of the completion of these important steps is obtained from the contracting officer involved with the project. A cleaning and passivation procedure for cooling tower systems with galvanized steel is provided below. The procedure is similar for systems that do not contain galvanized steel, except that the pH restriction does not apply.

4-7.3.2 **Cleaning and Passivation Procedures.** In the startup of new cooling tower systems containing complex metallurgies that include galvanized steel, follow the cleaning and passivation procedures for cooling tower systems containing galvanized steel, stainless steel, mild steel, or copper. These procedures should not be used for cleaning and passivating aluminum. Conventional chemical cleaners and typical heating, ventilation, and air conditioning (HVAC) water treatment programs use highly alkaline, high-pH water, which can initiate white rust formation on galvanized surfaces and copper tubes. Galvanized steel can simply be passivated by exposure to highly aerated water and a phosphate or polysilicate treatment. This treatment forms a zinc corrosion inhibition layer, which is a natural, dense, adherent, and protective corrosion product film. High pH (above 8.5) produces unwanted white rust that is fragile and not protective against corrosion. The following procedures are recommended.

4-7.3.2.1 **Hydrostatic Testing.** Perform hydrostatic testing:

- a) Inspect and remove all debris.
- b) Fill the system with treated water and circulate. This should include orthophosphate or hexametaphosphate (as PO_4) at 40 to 60 ppm, and tolyltriazole (active) at 10 to 20 ppm.

4-7.3.2.2 **Pre-operational Cleaning Procedure.** If the system passes hydrostatic testing, proceed immediately to this pre-operational cleaning and passivation procedure. Do not allow untreated water to be added to the system.

- a) Drain and flush any debris from hydrostatic testing.
- b) Dose and circulate (for 24 hours) a sufficient amount of a cleaning formula based on the volume of the system. A formulation is provided below.
- c) Drain and flush the system, and clean all strainers.

- d) Fill the system with makeup water and circulate for 30 minutes.
- e) Take a sample of system water while it is circulating. The sample should match the makeup water supply for clarity and SS; conductivity $\pm 10\%$; and pH ± 0.3 pH units from 7.5 to 8.5.

If necessary, repeat steps a) through e) until the system water matches this description. The system should now be clean and passivated.

4-7.3.2.3 Chemical Cleaning and Passivation Formulation. Apply this chemical cleaning and passivation formulation when the water system pH is 7.5 to 8.5; adjust pH as required. Formulation limitations may require adding separate components to keep things in solution. Other formulations may be used.

- Orthophosphate (or) hexametaphosphate (as PO_4): 60 ppm
- Polyacrylate (active): 20 ppm
- Tolytriazole (active): 10 ppm
- Sodium gluconate: 50 ppm
- Pluronic L-61 (active) (non-ionic surfactant with antifoam): 400 ppm
- Phosphate scale inhibitor: 50 ppm

4-7.3.2.4 Passivation of the System. Supplemental corrosion inhibitors may be used in conjunction with the phosphate but are not required. Maintain and circulate the levels for the time required. After passivation, proceed to operational readiness or layup as required. Tables 4-14 and 4-15 show chemical technology used for passivation.

4-7.3.2.5 Operational Readiness. If system operation is not required for a period of a week or more, proceed to layup. For normal operation, allow corrosion inhibitor levels to subside to maintenance levels through normal blowdown. Proceed to maintenance water treatment program.

Table 4-14. Required Chemical Technology

Inhibitor	Dosage	pH	Film Formation
Polyphosphate	40-60 ppm as PO_4	6.5-7.9	14-21 days
Orthophosphate	20-30 days as PO_4	6.5-7.9	14-21 days
Tolytriazole	10-20 days as TTA	6.5-7.9	14-21 days

Table 4-15. Supplemental Chemical Technology

Inhibitor	Dosage	pH	Film Formation
Zinc	10-20 ppm as Zn	6.5-7.5	14-21 days
Polysilicate	40-50 ppm as SiO ₂	7.5-8.5	14-21 days
Molybdate	40-60 ppm as Mo	7.5-8.5	14-21 days

4-7.4 Layup of Cooling Tower Systems

4-7.4.1 Wet Layup of Cooling Water Systems and Equipment. Systems and system equipment such as heat exchangers, chiller tube bundles and the like can be laid up wet, but first they require a physical cleaning to remove all suspended materials. Apply corrosion inhibitors at increased dosages, usually at a level of about 4 to 5 times the normal maintenance dosage. Apply an increased dosage (within EPA limits) of a non-oxidizing biocide that has a long half-life, such as glutaraldehyde or isothiazolone.

4-7.4.2 Dry Layup of Cooling Water Systems and Equipment. Systems and equipment can be laid up dry, although dry layup is more appropriate for a single piece of equipment, such as a chiller's condenser tube bundle or other heat exchanger. All metal surfaces must be completely dry; residual moisture is not acceptable. In humid climates you should use a desiccant such as a quicklime gel or an equivalent. Place the desiccant in as many locations as necessary and replace as required.

CHAPTER 5

CLOSED INDUSTRIAL WATER SYSTEMS

5-1 **DEFINITION.** The term “closed water system” refers to a water system that is used to provide heating, cooling, or both for industrial processes or facilities. The system is sealed (closed), sometimes under pressure, and is not open to the atmosphere. No evaporation takes place and, with good operation, water is lost only minimally from the system. In general, water treatment for closed systems is much easier than for open systems. Makeup water is needed only to replace seal leakage and other incidental leakage. Because of the small makeup water requirements of these systems, they require little chemical treatment, which can be added intermittently as needed. Once properly treated, the system water does not form scale and has little or no corrosion potential. Two main types of closed water systems are used at military installations: hot water closed heating systems and chilled water closed cooling systems.

5-1.1 **Hot Water Heating Systems.** Hot water heating systems are designed to produce hot water, and although they are often referred to as hot water boilers, they are actually hot water heaters rather than boilers. For new construction, hot water heating systems are preferred over steam systems. Hot water heating systems, also known as hydronic heating systems, recirculate water to distribute heat in facilities. They operate at three temperature ranges:

- High-temperature water systems (pressurized systems with water temperatures higher than 177 °C [350 °F]) – no steam, only very hot water.
- Medium-temperature water systems (pressurized systems with water temperatures from 121 to 177 °C (250 to 350 °F)) – no steam, only quite hot water.
- Low-temperature water systems (water temperatures lower than 121 °C [250 °F])– no steam, only hot water.

5-1.1.1 **Hot Water Boilers.** Hot water boilers can be either direct-fired (heated by combustion of gas, oil, or coal) or unfired (heat supplied by steam from a steam boiler, heated by hot water from a higher-temperature hot water system, or heated by a solar energy system). For many applications, hot water boilers are preferred over steam boilers because there are essentially no makeup water requirements and chemical treatment programs are less complex and easier to maintain. They require less manpower for operation, less maintenance, and have fewer water-related problems than steam boiler systems. Figure 5-1 shows a hot water boiler.

Figure 5-1. Hot Water Boiler

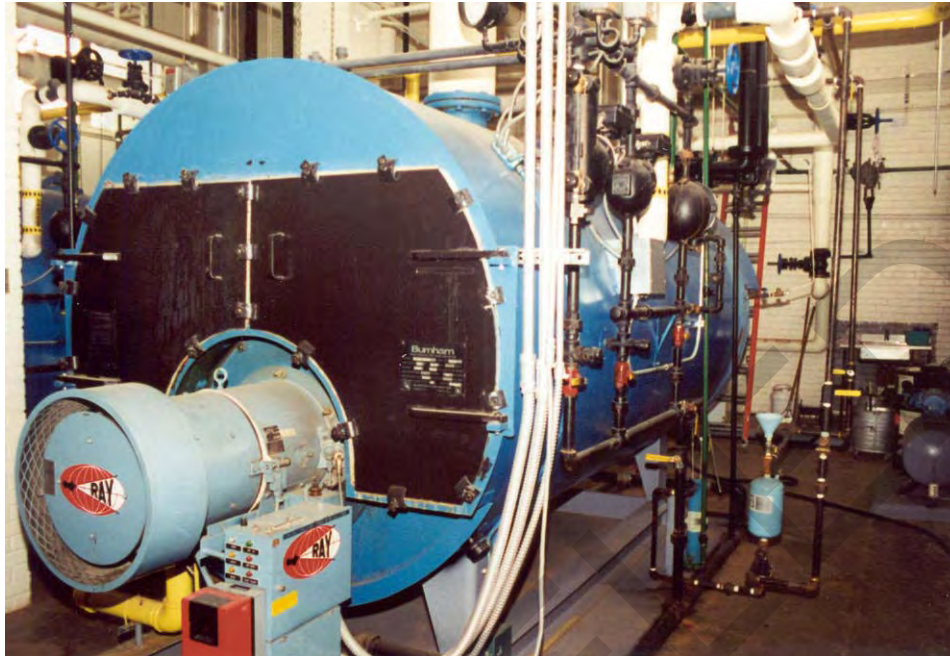

5-1.1.2 **Description of Hot Water Systems.** A typical hot water (hydronic) heating system is similar in composition to the closed cooling water system shown in Figure 5-2, except that a fired or non-fired heat exchanger is used rather than a chiller. Hot water boilers (fired and unfired) differ from steam boilers described in Chapter 3 because hot water boilers:

- Provide heated water but do not generate steam.
- Do not have deaerating heaters. (These are not required because there is essentially no makeup water requirement and thus very little air enters the system.)
- Require recirculating pumps to distribute the heated water to the processing equipment.
- Require expansion tanks that contain a cushion of steam or nitrogen.
- Do not contain a condensate return because there is no steam generated, but there is a return system.
- Do not require blowdown.
- Are fabricated with mild steel components, but also may contain copper heat exchanger tubes, particularly in unfired systems.

5-1.2 **Closed Chilled Water Systems, Brine Systems, and Glycol Systems.** Closed chilled water systems, brine systems, and glycol systems supply cold or chilled water for cooling processes and air conditioning. They are water systems designed for minimal loss of water. These systems contain mild steel piping, copper heat exchangers and, in some systems, aluminum piping, stainless steel piping, cold rolled steel piping, and potentially other metals.

5-1.2.1 **Closed Chilled Water Systems.** Closed chilled water systems circulate water that is cooled by refrigeration equipment. Water temperature ranges typically vary between 4 to 13 °C (40 to 55 °F). A typical chilled water system is depicted in Figure 5-2. Chilled water systems can have large storage capacity (3785 cubic meters [1,000,000 gallons] or higher). Chillers are shown in Figure 5-3.

Figure 5-2. Typical Closed Chilled Water System Schematic

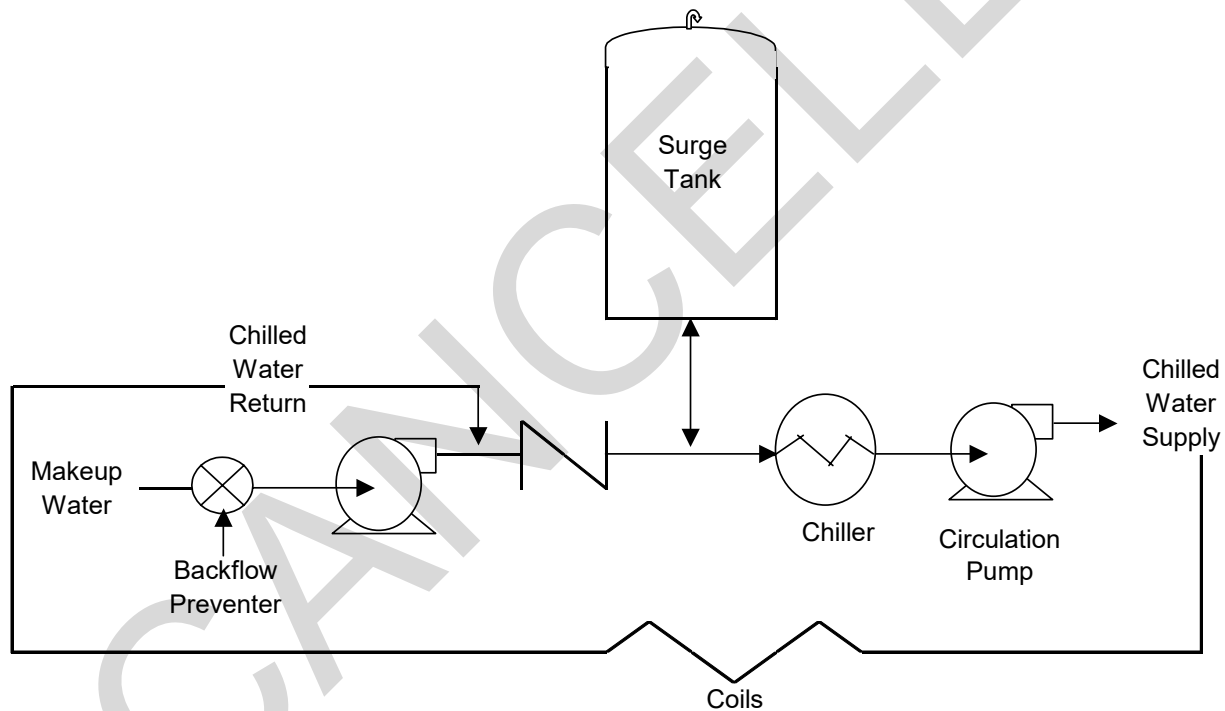

Figure 5-3. Chillers



5-1.2.2 **Closed Brine Systems.** Closed brine systems are chilled water systems in which calcium chloride, sodium chloride, or a mixture of sodium chloride and calcium chloride has been added to the water to lower its freezing point sufficiently to maintain it as a liquid (ice-free) at temperatures of -1 to 10 °C (30 to 50 °F). Brine systems have been largely replaced by glycol systems.

5-1.2.3 **Closed Glycol Systems.** Closed glycol systems are chilled water systems that contain a mixture of water and glycol (ethylene or propylene) that will not freeze at the system operating temperature of -7 to 2 °C (20 to 35 °F).

5-1.3 **Combined Hot and Chilled Water Systems.** Some closed systems serve the dual purpose of producing circulating hot water during the cold season and chilled water during the hot season.

5-1.4 **Diesel Engine Jacket Cooling Systems.** Diesel engine cooling systems are considered closed systems, even when surge tanks are open to the atmosphere. The heat transfer from the circulating water is usually accomplished using a heat exchanger, not by evaporation. These systems have low water losses. Several of the metals used in these systems require good corrosion control. The three basic types of diesel engine cooling systems are described below.

5-1.4.1 **Air-Cooled Diesel Cooling Systems.** Air-cooled diesel cooling systems are used on most small engines as well as some large engines. The jacket water is circulated through an air-cooled radiator. Antifreeze must be used in these systems when radiators are exposed to low-temperature atmospheric air or when the water temperature exceeds the boiling point (100 °C [212 °F]).

5-1.4.2 **Water-Cooled Diesel Engine Cooling Systems.** Water-cooled diesel engine cooling systems are used mainly on large engines. The jacket cooling water passes through a heat exchanger, rather than a radiator, where a separate cooling water loop removes the heat from the jacket cooling water. These systems commonly use antifreeze.

5-1.4.3 **Vapor-Phase Diesel Engine Cooling Systems.** Vapor-phase diesel engine cooling systems, also called ebullient systems, use water that is heated to a temperature at the boiling point or above the boiling point for pressurized systems. Steam is formed from the cooling water as it removes heat from the system. The steam produced in this way can be recovered and used for space heating. This type of system requires significant amounts of makeup water and chemical treatment.

5-2 **WATER TREATMENT FOR CLOSED SYSTEMS.** Water treatment programs for both closed hot water and closed chilled water systems are developed primarily to control corrosion, although the programs may also control deposition and microbiological organisms. If needed, scale deposition can be prevented by external treatment (i.e., ion exchange softening) or can be controlled with inhibitors as described in Chapter 4. Corrosion must be completely controlled by water treatment programs. If corrosion occurs, corrosion products will eventually plug the system, resulting in decreased operational efficiency and the need for cleaning. Microbiological growth is not a concern in hot water systems, but can occur in chilled water systems and should be controlled (see paragraph 5-2.3).

5-2.1 **Makeup Water Requirements.** Makeup water requirements for closed systems are very small unless there are leaks in the system (see paragraph 5-2.4). Closed systems should not be drained or purged unless there is evidence that indicates the need to remove dirty water or sludge. For proper operation, makeup water in high-temperature and medium-temperature water systems is deaerated (de-oxygenated) using both mechanical and chemical methods and is also softened. Oxygen can be removed from low-temperature water systems either chemically or mechanically to prevent oxygen-induced corrosion. Chilled water systems can require partial softening if the makeup water exceeds 250 ppm total hardness (as CaCO_3). The makeup water requirements are monitored carefully in systems of all types (see Table 5-1). If there is an increase in the quantity of makeup water required, the leak should be found and repaired quickly. After the repair, water treatment chemicals should be replenished immediately.

Table 5-1. Makeup Water Requirements for Closed Systems

System Type	Requirement
High-temperature hot water	Softened and deaerated
Medium-temperature hot water	Softened and deaerated
Low-temperature hot water	Less than 100 ppm total hardness as CaCO ₃
Chilled, brine, glycol	Less than 250 ppm total hardness as CaCO ₃
Diesel engine jacket	1. Less than 50 ppm hardness as CaCO ₃ 2. Demineralization when brackish water is used

5-2.2 **Corrosion Control Programs.** Five basic water treatment programs are used in closed systems:

- Sulfite-caustic soda.
- Nitrite-azole.
- Molybdate-azole.
- Nitrite-molybdate-azole blend.
- Polysilicate-azole.

The choice of which chemical treatment system to use should be based primarily on the water temperature and the metals in the system as well as the relative cost of the treatment program at the specific installation. The various water treatment programs are listed in Table 5-2 for each type of closed water system. Table 5-3 provides microbiological control monitoring guidelines for closed water systems.

Table 5-2. Selection Guidelines for Closed System Treatment

System Type	Treatment Program
High-temperature hot water	Sulfite-caustic (1)
Medium-temperature hot water	Sulfite-caustic (1)
Low-temperature hot water	1. Sulfite-caustic (1) 2. Nitrite-azole 3. Molybdate-azole 4. Nitrite-molybdate-azole
Chilled, brine, glycol	1. Nitrite-azole 2. Molybdate-azole 3. Nitrite-molybdate-azole
Diesel engine jacket	Polysilicate-azole

NOTES: (1) Or other oxygen scavenger-caustic.

Table 5-3. Microbiological Control Guidelines for Closed Water Systems

Bacterium Type	Colony-Forming Units/ml
Total aerobic bacteria	< 10 ³
Sulfate-reducing bacteria	Undetectable
Surface microbiological	< 10 ⁶ - Undetectable

5-2.2.1 Sulfite-Caustic (or other Oxygen Scavenger-Caustic) Treatment

Program. This program is required for high- and medium-temperature closed hot water systems. It is optional for low-temperature water systems. The water is treated with sodium hydroxide (caustic soda) and with sodium sulfite. This program is suitable for water systems having temperatures up to 288 °C (550 °F). This chemical program is not compatible with ethylene glycol nor propylene glycol. A recommended procedure for maintenance is described below.

1. Soften makeup water unless the total hardness in the makeup water supply is less than 10 ppm. The makeup water should be dealcalized if the makeup's total alkalinity is more than 200 ppm, as CaCO₃.
2. Add sodium sulfite to maintain 50 to 100 ppm sulfite (as SO₃).
3. Add the appropriate chemical to maintain a pH of 9.0 to 10.0. A pH lower than 9.0 can be raised by adding sodium hydroxide (caustic soda). A pH higher than 10.0 can be lowered by adding sodium bisulfite.

4. Test daily to maintain pH and sulfite levels within range.
5. Deaerator can be used to help reduce incoming oxygen in high make-up systems.

5-2.2.2. **Nitrite-Azole Treatment Program.** This program is not recommended for systems having water temperatures exceeding 121 °C (250 °F), or for (CL + SO₄) concentrations > 800ppm. Also, avoid nitrate-based programs if (CL + SO₄) concentrations is > 800ppm. It can be used in low-temperature water and chilled water systems. Water is treated with a nitrite-borax compound to a nitrite level of 1000 ppm (as NO₂). This level will require about 0.77 to 0.81 kilogram (1.7 to 1.8 pounds) nitrite-borax per 0.38 cubic meters (100 gallons) of water in the system. Most water treatment service companies offer this treatment as a formulated product. There is also a generic nitrite-borax compound product that is a premixed blend containing approximately 68% sodium nitrite, 10% borax, 17% sodium carbonate (soda ash) and 5% copper corrosion inhibitor. Adjust to a pH of 9.0 to 9.5 with sodium carbonate (soda ash), if necessary. This chemical treatment program is compatible with ethylene glycol water mixtures used for freeze protection. A recommended procedure for maintenance is described below.

1. Soften makeup water if the hardness is over 250 ppm as CaCO₃.
2. Add sodium nitrite-borax-azole blend to maintain a nitrite level of 600 to 1000 ppm (as NO₂) in the system.
3. Add sodium carbonate, if necessary, to maintain a pH range of 8.5 to 9.5.
4. If copper is present, maintain a minimum of 10 ppm of tolyltriazole.
5. Test after chemical addition and then monthly for pH and nitrite levels.

5-2.2.3 **Molybdate-Azole Treatment Program.** This program is not recommended for systems where water temperatures exceed 121 °C (250 °F). Most water treatment service companies offer this as a formulated product. There is also a generic molybdate-azole compound product that is a pre-mixed liquid containing approximately 10% sodium molybdate, 3% caustic soda, and 3% azole (copper corrosion inhibitor). Maintain a molybdate level of 125 ppm (as Mo) and adjust pH to the range of 8.5 to 9.5 with sodium hydroxide (caustic soda). NOTE: Some restrictions may pertain to discharge of water containing molybdate. This chemical treatment program is compatible with ethylene glycol or propylene glycol. A recommended procedure for maintenance of the system consists of five steps:

1. Soften makeup water if hardness is over 250 ppm as CaCO₃ (calcium carbonate).
2. Control the molybdate-azole compound to maintain a molybdate level of 100 to 125 ppm (as Mo).

3. Add sodium hydroxide (caustic soda) to maintain a pH of 8.5 to 9.5. It is likely that a buffer will be needed for pH control in this range.
4. If copper is present, maintain a minimum of 10 ppm of tolyltriazole.
5. Test monthly for proper pH and molybdate levels.

5-2.2.4 Molybdate-Nitrite-Azole Treatment Program. This program is not recommended for use in systems in which water temperatures exceed 121 °C (250 °F). An effective approach for corrosion control in these systems involves a program that combines elements of the molybdate program and the nitrite program. The targeted maintenance level for the combined addition of molybdate and nitrite is about half of what either would be for individual addition. Most water treatment service companies offer this chemical combination as a formulated product. This chemical treatment program is also compatible with ethylene glycol or propylene glycol. A recommended procedure for maintenance of the system consists of five steps:

1. Soften makeup water if hardness is over 250 ppm as CaCO₃ (calcium carbonate).
2. Control the nitrite-molybdate-azole compound to maintain a nitrite level of 300 to 400 ppm (as NO₂), a molybdate level of 50 to 75 ppm (as Mo). Avoid this program if (CL + S O₄) concentration exceeds [(NO₂ + MO)-100]ppm.
3. Add sodium hydroxide (caustic soda) to maintain a pH of 8.5 to 9.5. It is likely that a buffer will be needed for pH control in this range.
4. If copper is present, maintain a minimum of 10 ppm of tolyltriazole.
5. Test monthly for proper pH and treatment levels.

5-2.2.5 Polysilicate-Azole Treatment Program. This program is not recommended for systems where water temperatures exceed 121 °C. This program is especially beneficial when aluminum metal is present. Aluminum is rarely found in comfort heating and cooling systems, but is sometimes found in closed process cooling water loops or diesel engine jacket systems. Aluminum will corrode at high pH, so the pH of the system water must be closely monitored if aluminum is present. This chemical treatment program is also compatible with ethylene glycol or propylene glycol. A recommended procedure for maintenance of the system consists of five steps:

1. Soften makeup water if hardness is over 250 ppm as CaCO₃ (calcium carbonate).
2. Control the treatment to maintain a polysilicate level of 80 to 100 ppm (as SiO₂).

3. Maintain a pH of 7.5 to 8.9. Adjust with dilute hydrochloric or caustic as necessary.
4. If copper is present, maintain a minimum of 10 ppm of tolyltriazole.
5. Test monthly for proper pH and treatment levels.

5-2.3 Treatment and Control of Microbiological Growth. Treatment and control of microbiological growth is a concern in chilled or closed cooling water systems. It is a particular concern if a nitrite-based corrosion inhibitor is used. Nitrite can serve as a nutrient for some bacteria. Microbiocide selection must be compatible with the corrosion inhibitor program and the pH levels in the system water. Glutaraldehyde and isothiazolone are commonly used in chilled water systems. Oxidizing biocides should not be used since they are not compatible with nitrite water treatment.

5-2.4 Identifying Water Leaks. The best way to check for leaks in a closed water system is to periodically read and record the water usage displayed by a totalizing water meter installed in the makeup water line or to use an inert, fluorescent material indicate a leak. The florescent material can also be used to help pinpoint leaks or do leak studies. If the system does not have a water meter, the existence of leaks can be checked by testing the inhibitor concentration in the circulating water. The inhibitor concentration should be measured once per month using molybdate, polysilicate, or azole, but not nitrite. Do not depend upon the nitrite test; nitrite can be lost due to bacteria action. If nitrite is measured and its concentration has decreased while the conductivity has remained constant, biological contamination is present. If the measured values for both parameters decrease, there is a leak in the system. Borate concentration would be the best indicator of leak detection. When the inhibitor concentration has dropped to 98% of the original value, about 2% of the system water will have been lost. If the lapsed time for this 2% loss is less than 4 months, the system's loss of water is excessive and any leaks should be found and eliminated. Another convenient indication of water loss is the measurement over time of a drop in conductivity. If the system water conductivity equals that of the makeup, the treatment chemical is totally absent. Inert florescent material can be added to the system and used to help pinpoint leaks, or do leak studies. Loss of the fluorescent material can be monitored in real time; such loss indicates a leak.

NOTE: A 2% loss over 4 months equals 0.5% loss per month. The accuracy of this test is limited, so if the loss for any month exceeds 1%, the test should be repeated. If retesting confirms the water loss, the leaks should be found and eliminated.

EXAMPLE 5-1:

- a) The initial recommended molybdate concentration in chilled water systems is 125 ppm. After 4 months, the concentration is 123 ppm. Is the water loss excessive?

EQUATION | $\text{Loss} = \left(\frac{\text{initial} - \text{final}}{\text{initial}} \right) \times 100$ (36)

$$| = ([125 - 123]/125) \times 100 = 1.6\% \text{ after 4 months}$$

b) The monthly loss based on the 4-month result is calculated:

EQUATION | $1.6\% \text{ over 4 months} = 0.4\% \text{ per month}$ (37)

This loss is less than 1% per month and not excessive.

c) If the concentration had dropped to 123 ppm after 1 month, the loss would be:

EQUATION | $\text{Loss} = ([125 - 123]/125) \times 100$
 $= 1.6\% \text{ after 1 month}$ (38)

d) The monthly loss is calculated:

EQUATION | $1.6\% \text{ over 1 month} = 1.6\% \text{ per month}$ (39)

This loss is greater than 1% per month, and the system should be inspected for leaks.

5-2.5 **Procedures for Layup of Hot and Chilled Water Systems.** Follow the procedure for wet layup of operational boilers described in paragraph 3-5.4. Note these additional recommendations:

- For hot water systems, completely fill the hot water generator and expansion tank. Where nitrogen pressurization is used for the system, the expansion tank should not be filled.
- For all steel systems using the sulfite-caustic soda program, increase the pH to 11.7 with sodium hydroxide (caustic soda). Add sodium sulfite to a level of 100 ppm (as SO₃).
- Treat chilled water systems using the nitrite-borax or molybdate-caustic soda treatments with appropriate chemicals to maintain levels required for normal operation.
- Test monthly for treatment chemicals and check water levels.

CHAPTER 6

WATER SAMPLING AND TESTING OF WATER SYSTEMS

6-1 **WATER SAMPLING AND TESTING.** Water sampling and testing procedures provide information that can be used for the following purposes: to ensure the protection of the water system equipment; to prevent unexpected system failure; to provide information used to control water quality; and to verify that water treatment chemicals are maintained at the proper concentration within the system or, if not, to allow for adjustment of their concentration. Adequate chemical treatment of water systems requires that specific levels of specific chemicals be maintained in the water to provide the system with protection from corrosion and deposits. This requirement applies to both cooling and boiler water systems. The purpose of a sampling and analysis program for industrial water is to ensure and verify that the required levels of treatment chemicals are being maintained and that the water quality parameters are within the specified control ranges. The sampling and analysis program incorporates two levels of testing: in-plant routine testing used for operational purposes, and periodic independent (third-party) QA testing used for verification and oversight. When an analytical test indicates that the concentration of a given chemical is not within the limits required, the testing process must be evaluated to determine that the sampling and testing were performed properly and that the test result is valid. As part of an adequate QA/QC program, test methods, including the chemical reagents, must be checked on a routine basis. A properly applied industrial water treatment program incorporates procedures that ensure that representative samples, which are samples that are representative of actual water system conditions, have been collected and analyzed. Safety considerations must be a priority when sampling any industrial water system (particularly boilers) and when conducting laboratory tests.

6-1.1 **In-Plant Testing.** In-plant testing is used by water system operators to monitor and ensure both the proper operation of system equipment and the proper quality of the water in the equipment. Routine, appropriate, in-plant operational testing of the system waters is an essential component of a water treatment program. Routine testing of specific operational parameters and water quality criteria allows the operator to verify the adequacy of the water treatment program and to make necessary adjustments to avoid and prevent operational problems. When an analytical test indicates that the concentration of a given chemical is not within the limits required, the testing process must be evaluated to determine that the sampling and testing were performed properly and that the test result is valid. If testing data for the water quality analyses are inconsistent with that expected for the treatment method being used, the reasons must be determined. This determination can involve reanalysis and checking of the test reagents, as well as checking the accuracy of the in-plant testing results through independent QA analysis. Military installations are required to obtain water testing chemicals and equipment from commercial sources. Test procedures will be furnished with the test kits.

6-1.2 **Independent QA Analysis.** To verify the accuracy of the in-plant testing, as well as to provide supplemental or additional analyses, independent (third-party) QA analytical services are incorporated as part of the plant's QA program. These services can be more complete than routine in-plant testing and can provide a more detailed analysis of the system conditions. Independent QA analysis is a useful tool for plant managers and operators to verify that their systems are being maintained properly, and is an especially important tool for government managers at sites where plant operations have been contracted out (outsourced).

6-2 COOLING TOWER WATER SAMPLING AND TESTING

6-2.1 **Cooling Water Testing Requirements.** Water samples from the recirculating cooling water systems should be tested for pH, conductivity, and inhibitor content. Calcium hardness and methyl orange (M) alkalinity may also be tested. In addition, follow the water testing requirements established by the supplier of the water treatment chemicals where appropriate. Testing parameters for the makeup water include, as a minimum, M alkalinity, conductivity, and calcium hardness. Appropriate water testing requirements and sampling frequency are summarized in Table 6-1. Periodic testing for chlorides in the recirculating water and makeup water may be required to calculate the most accurate COC in an operating system.

Table 6-1. Recommended Water Sample Frequency and Testing Requirements for Cooling Tower Systems

Water Tested	pH	M Alkalinity	Conductivity (or TDS)	Calcium Hardness	Inhibitor
Makeup water	--	1/W	1/W	1/W	--
Small CT < 88 kW (25 tons) water*	1/W	1/W	1/W	1/W	1/W
Medium CT 88-352 kW (25-100 tons) water*	2/W	2/W	2/W	2/W	2/W
Large CT > 352 kW (100 tons) water	1/D	1/D	1/D	1/D	1/D

NOTES:

- C = Cooling tower.
- W = Week (for example, 1/W = once per week).
- D = Day (for example, 1/D = once per day).
- * = Slowly soluble polyphosphate chemicals used in treatment of small and medium cooling towers should be checked at least weekly and replaced as necessary.

6-2.2 Frequency of Cooling Water Sampling and Testing. Water samples of the recirculating water in small towers (less than 88 kilowatts [25 tons]) be sampled and tested at least once per week, those of medium-sized towers (88 to 352 kilowatts [25 to 100 tons]) at least 2 times per week, and those of large towers (more than 352 kilowatts [100 tons]) daily. You can establish a routine schedule that is designed to meet these goals for sampling and testing. For many cooling towers, the makeup water quality is quite consistent over time. Collection and analysis of 1 sample per week of the makeup source is usually an adequate frequency. If makeup water quality varies, increase the frequency to allow for sampling of makeup water at the same time as cooling water sampling. Always flush the water sample line prior to sampling.

6-2.3 Cooling Water Sampling. Cooling tower water samples are collected in clean, 1-liter (1-quart) glass or plastic bottles. The bottle is capped (sealed) immediately and tested without delay (i.e., within 1 hour since some water quality will gradually change). The sample is not collected immediately after the addition of treatment chemicals but is collected after the chemicals have been allowed to mix thoroughly with the system water. Samples of the recirculating cooling water can be collected by dipping from the cold well, or can be collected from the recirculating pump discharge after the line has been flushed for 10 seconds or until no sediment remains. If these locations are inaccessible, another location may be used. Typical sampling points for an open recirculating system are shown in Figure 6-1. It is best to always collect the sample for each system in the same manner and from the same location for consistent results.

Figure 6-1. Typical Water Sampling Points for an Open Recirculating Cooling Water System

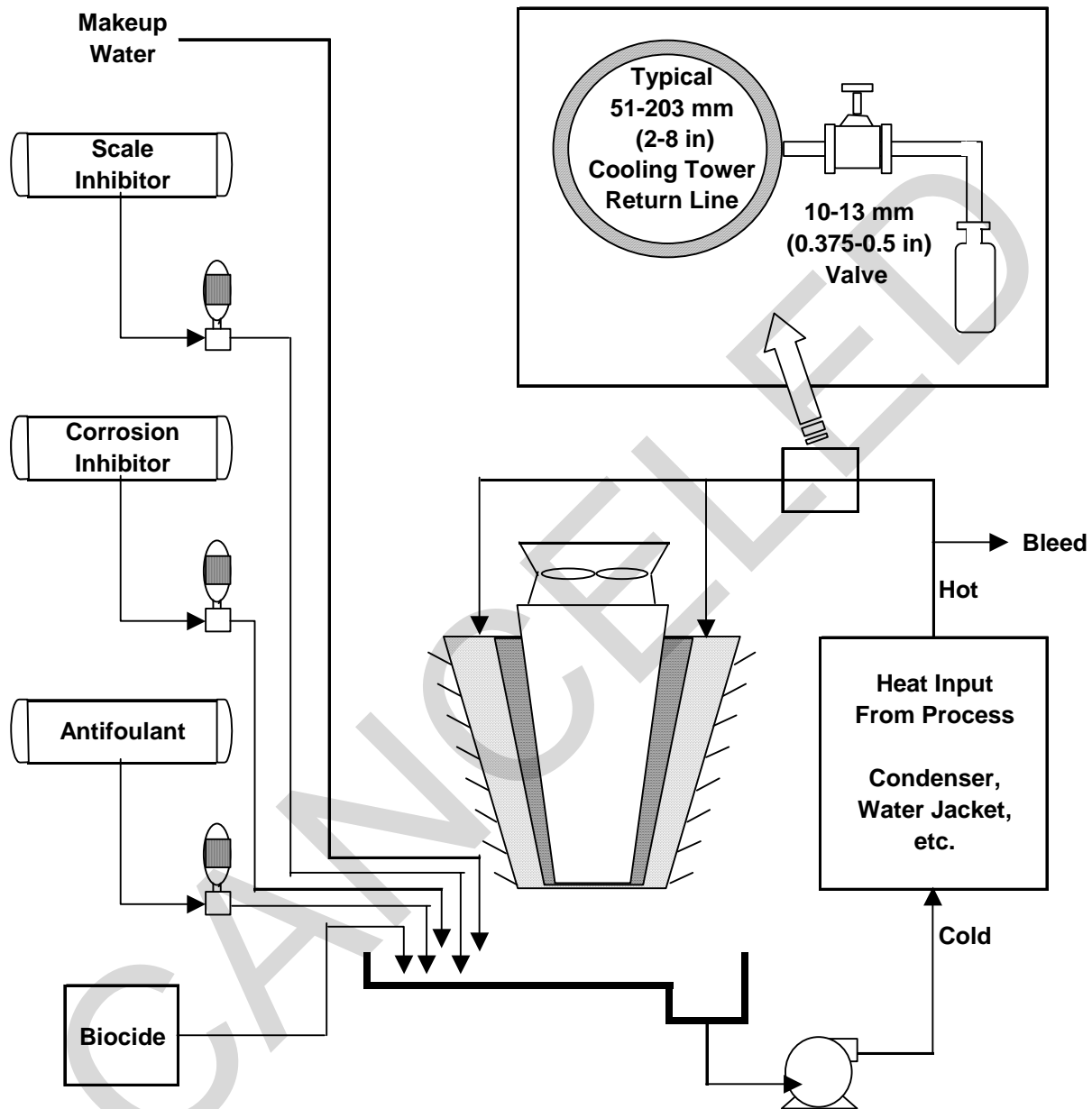

6-3 **ROUTINE BOILER WATER SAMPLING AND TESTING.** Boiler water is very hot and under pressure. Caution should be exercised and appropriate safety procedures followed when collecting samples. If the boiler water is not cooled as it is sampled, part of the water will flash off as steam during the sampling process and the remaining sample will not be truly representative of the boiler water. The sample could contain a lower level of oxygen or carbon dioxide than the actual levels in the boiler water. Values of other sample constituents would be higher because less water would be present in the test sample due to the release of the steam. Use of the sample cooler

described in paragraph 6-3.1 will greatly reduce the chance of the operator getting burned, and will allow a representative boiler water sample to be collected.

6-3.1 **Boiler Water Sampling Cooler.** A commercially available boiler water sample cooler can be used when collecting a boiler water sample. If one is not available, then a 4.6- to 6.1-meter long (15- to 20-foot) coil of copper or stainless steel tubing (60 millimeters [0.25 inch]) may be used to cool the sample. The coil can be immersed in a permanent cooling jacket as shown in Figure 6-2, or it may be immersed in a bucket of cold water, if this does not interfere with operation of the system or create a hazard. The flow of the boiler water sample through the coil must be slow enough so that the cooled boiler water sample is no more than just warm to the hand (approximately 38 °C [100 °F]).

Figure 6-2. Boiler or Condensate Water Sample Cooling Coil

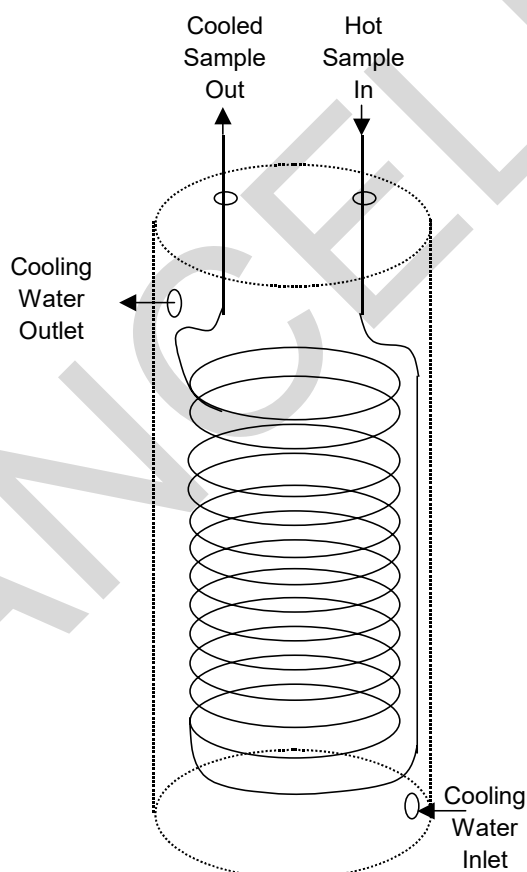

6-3.2 **Boiler Water Sampling Procedures.** The cooling water to the jacket cooling coil is turned on before taking the boiler water sample and turned off after the sample has been collected. The coil with boiler water is flushed with several times its volume before collecting the sample to be tested. The cooled end of the boiler water sample coil is then extended to the bottom of the sample bottle and at least 1 volume of the bottle is allowed to overflow the container during the collection process. The sample collection bottle can be plastic or glass. Glass bottles are not used if the boiler is silica

limited or if high silica is suspected.

6-3.3 Sampling Locations. Typical locations for water sampling points in a steam boiler system are shown in Figure 6-3. Each sampling point has a separate cooling coil. Two or more sampling points are not connected by a single manifold to the same cooling coil because it is almost impossible to determine if one of the valves has a leak that might contaminate the sample being taken. Guidelines for sample collection are provided below.

- The makeup water sample does not have to be cooled. The sample location typically will be the output of an ion exchange unit or some other water-softening unit.
- The boiler feedwater sample is a combination of makeup and condensate return. An appropriate location for sample collection is from the discharge of the boiler feed pump. This will be a hot sample, so a cooling coil is used. Alternatively, sample collection for feedwater can be from the low-pressure deaerator outlet.
- The boiler water is very hot. Collect this sample from the continuous blowdown line between the boiler and the regulating valve if possible. You may collect it from a gauge-glass connection, if necessary. Use of a cooling coil is recommended.
- The steam condensate is hot. For small systems, collect this sample from a line that enters the deaerating heater if possible. For medium and large systems, you may need to collect condensate samples at two or more locations in the system to obtain sufficient data for calculation of the proper treatment level. When attempting to find a leak, you may need to collect condensate samples from various locations in the system. Use of a cooling coil is recommended.
- Steam is collected regularly for systems with high-quality steam requirements like those with turbines and those meeting NAVSEA steam quality requirements. Otherwise, steam samples are rarely collected. Refer to the ASME Performance Test Code (ASME PTC 19.11, *Steam and Water Sampling, Conditioning and Analysis in the Power Cycle*, for sampling procedures.

Figure 6-3. Typical Locations for Water Sampling in a Steam Boiler Water System

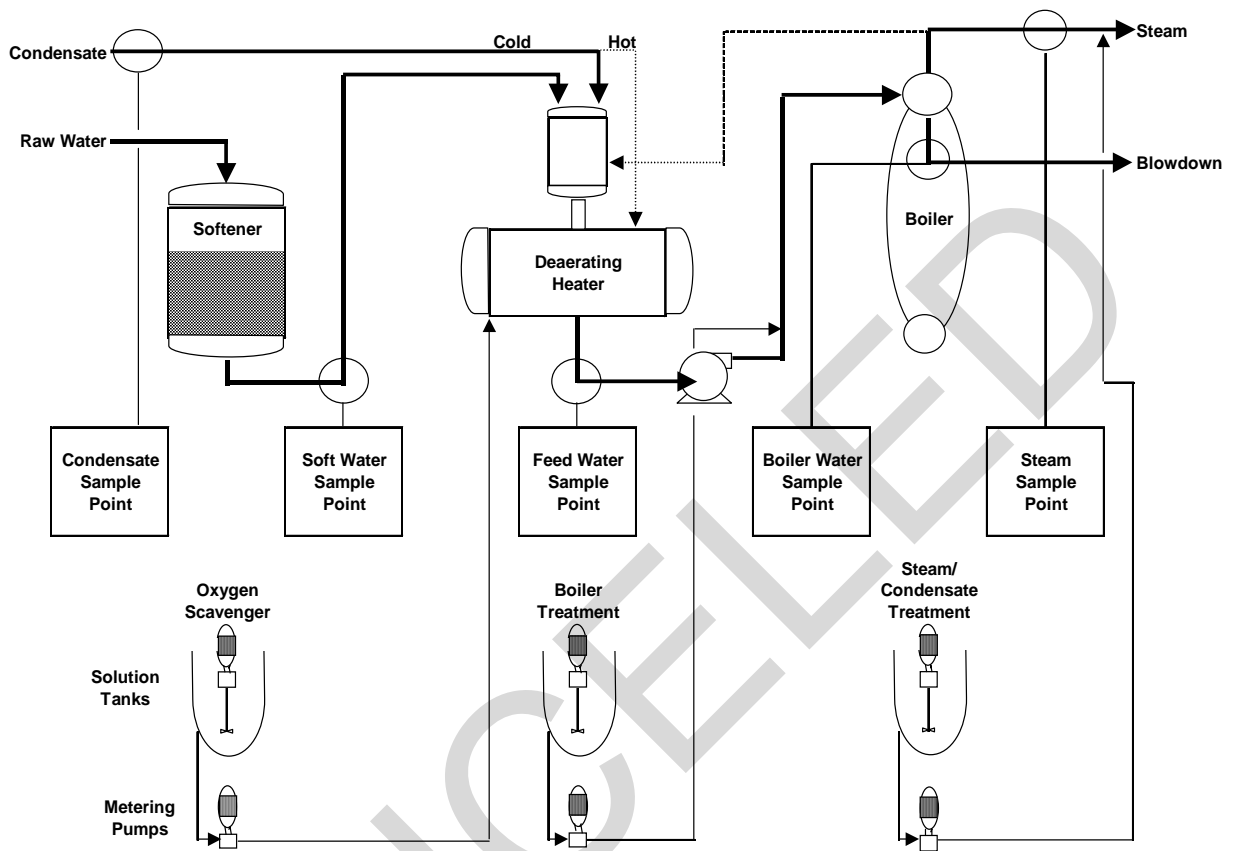

6-3.4 **Frequency of Sampling and Testing.** The recommended sampling and testing frequency for steam boiler systems is summarized in Table 6-2.

**Table 6-2. Water Sampling Frequency and Testing Requirements
for Boiler Water Systems**

Source of Sample	pH	Total Alkalinity* (M)	Hydroxyl Alkalinity (Causticity)	Calcium Hardness	TDS	Copper and Iron	Ortho-phosphate	Sulfite
Makeup water	--	1/W	--	1/W	1/W	--	--	--
Feedwater, small boilers (< 245 kW [25 hp])	--	1/W	--	1/W	1/W	--	--	--
Feedwater, medium boilers (245–1470 kW [25-150 hp])	--	2/W	--	2/W	2/W	--	--	--
Feedwater, large boilers (> 1470 kW [150 hp])	--	1/D	--	1/D	1/D	--	--	--
Boiler water, small boilers	1/W	--	1/W	--	1/W	--	1/W	1/W
Boiler water, medium boilers	2/W	--	2/W	--	2/W	--	2/W	2/W
Boiler water, large boilers	1/D	--	1/D	--	1/D	--	1/D	1/D
Condensate return (small boilers)	1/W	--	--	As needed	1/W	1/Q	--	--
Condensate return (medium boilers)	2/W	--	--	As needed	2/W	1/Q	--	--
Condensate return (large boilers)	1/D	--	--	As needed	1/D	1/Q	--	--

NOTES:

W = Week (for example, 1/W = once per week).
D = Day (for example, 1/D = once per day).

Q = Quarter (for example, 1/Q - once per 3 months).
* = Feedwater alkalinity only for boilers that use dealkalizers.

6-3.5 **Boiler Feedwater Sample.** Boiler feedwater samples should be collected once per week for small boilers (less than 245 kilowatts [25 horsepower]), at least 2 times per week for medium boilers (245 to 1470 kilowatts [25 to 150 horsepower]), and daily for large boilers (greater than 1470 kilowatts [150 horsepower]). The samples should be tested for M alkalinity, conductivity, and calcium hardness.

6-3.6 **Condensate Water Sample.** Condensate water samples should be collected once per week for small boilers (less than 245 kilowatts [25 horsepower]), at least 2 times a week for medium boilers (245 to 1470 kilowatts [25 to 150 horsepower]), and daily for large boilers (greater than 1470 kilowatts [150 horsepower]). The samples should be tested for pH and conductivity. If the conductivity is greater than 35 micromhos, the sample should be tested for calcium hardness. If applicable based on the metallurgy of the system, the condensate samples should be tested for iron and copper on a quarterly basis.

6-3.7 **Boiler Blowdown Water Sample.** Boiler blowdown water samples should be collected for small boilers (less than 245 kilowatts [25 horsepower]) once per week, for medium boilers (245 to 1470 kilowatts [25 to 150 horsepower]) at least 2 times per week, and for large boilers (greater than 1470 kilowatts [150 horsepower]) daily. The samples should be tested for hydroxyl (OH) alkalinity (causticity), neutralized conductivity, scale treatment chemicals (e.g., orthophosphate), and sulfite.

6-3.8 **Boiler Water QA Analysis.** The components of a boiler water QA program are described in paragraph 1-1.10.1. Appropriate boiler water sampling requirements are described below.

- Each operating boiler plant equipped with hot water or steam boilers and having one or more boilers of 980 kilowatts (3.3 million BTU per hour or 100 horsepower) or greater capacity may submit a boiler water sample for QA once per month to an independent QA laboratory or to the contractor providing the service to the military. These QA contractors are independent experts in the field of boiler and cooling water treatment and interpretation of sample analysis data.
- Each operating boiler plant equipped with hot water or steam boilers of less than 980 kilowatts (100 horsepower) capacity submits a boiler water sample for QA once every 3 months to an independent QA laboratory or to the contractor providing the service to the military.
- For all high-pressure (greater than 103 kilopascals [15 pounds per square inch gauge]) boilers and for low-pressure boilers treated with caustic, phosphate, tannin, and sodium sulfite, the boiler water sample size is a 1-liter plastic bottle, or as required by the QA laboratory.
- For low-pressure boilers (less than 103 kilopascals [15 pounds per square inch gauge]) treated only with

caustic, the boiler water sample size is a 0.12-liter (4-ounce) plastic bottle, although a 1-liter plastic bottle may be used.

- For hot water boilers, the boiler water sample size is a 1-liter plastic bottle, or as required by the contract laboratory.
- Boiler water sample shipping containers and bottles used for submitting boiler water check samples can be obtained by request to the contract laboratory. Shipping containers for high-pressure boiler water samples are designed for shipping a 1-liter plastic bottle. Shipping containers for water samples from low-pressure boilers treated with caustic soda are designed for shipping a 0.12-liter plastic bottle. Pack the bottle carefully so it will not leak during shipping. A completed information data sheet must be enclosed in each sample shipping container shipped to the laboratory.

6-4 **WATER SAMPLING AND TESTING FOR CLOSED HOT AND CHILLED CIRCULATING WATER SYSTEMS.** The recommended testing frequency for these systems is summarized in Table 6-3, with additional information provided below.

Table 6-3. Water Sampling and Testing Requirements for Closed Hot and Chilled Circulating Water Systems

System	pH	Sulfite	Nitrite	Molybdate	Total Hardness	Total Alkalinity
HTW with caustic-sulfite treatment	1/day	1/day	--	--	--	--
Closed MTW & LTW hot water w/nitrite-borax treatment	1/mo	--	1/mo	--	--	--
Closed MTW & LTW hot water w/molybdate treatment	1/mo	--	--	1/mo	--	--
Chilled water & brine; w/molybdate treatment	1/mo	--	--	1/mo	--	--
Chilled water & brine w/nitrite-borax treatment	1/mo	--	1/mo	--	--	--
Diesel jackets w/molybdate treatment	1/mo	--	--	1/mo	--	--
Diesel jackets nitrite-borax	1/mo	--	1/mo	--	--	--
Ion exchange feedwater	--	--	--	--	1/week	--
Ion exchange outlet	--	--	--	--	3x/day	--
Dealkalizer feedwater	--	--	--	--	--	1/week
Dealkalizer outlet	--	--	--	--	--	3x/day

6-4.1 **Sampling and Testing of Makeup Water.** The makeup water for boiler systems, chilled water systems, and diesel engine jacket water systems usually comes from an ion exchange unit or a dealkalizer.

The recirculating water from high-temperature water systems and from systems that use the sulfite-caustic soda treatment program is tested once per day for pH and sulfite (see paragraph 5-2.2.1).

Recirculating chilled water and hot water treated with the nitrite-borax or molybdate programs is tested once per month for either molybdate or nitrite, depending upon the chemical in use (see paragraph 5-2.2.2, 5-2.2.3 and 5-2.2.4). The system pH is tested once per month and on the day following chemical additions.

6-4.2 **Ion Exchangers and Dealkalizer Water.** The recommended water testing frequencies for these systems are summarized in Table 6-3, with additional information provided below.

6-4.2.1 **Influent Water Testing.** Ion exchange influent water is tested once per week for total hardness. Dealkalizer influent water is tested once per week for total (M) alkalinity.

6-4.2.2 **Effluent Water Testing.** Effluent water from these systems is tested for total hardness either once per day or once per shift (3 times a day) depending on the frequency of regeneration; more frequently if the frequency of regeneration is excessive. The appropriate frequency (cycle length) will depend upon feedwater hardness, bed size, resin type, strength of regenerant, and flow rate.

6-4.2.3 **Sampling Location.** The location of the water sample point is an important consideration for ensuring that a representative water sample is obtained. Care must be taken to avoid collecting a sample that is a mixture of influent and effluent water on ion exchange units that use automatic regeneration and multi-port valves.

6-4.2.4 **Brine Testing.** The brine used for regeneration is sampled periodically and tested with a hydrometer to measure its strength. The sodium chloride brine should be as near 100% saturation as possible (approximately 28% by weight) for efficient softener regeneration.

6-5 **WATER TESTING.** Routine and appropriate testing of the system water is an essential component of a water treatment program. Water testing provides information that can be used: to ensure the protection of the water system equipment; to prevent unexpected system failure; to provide information used to control water quality; and to verify that water treatment chemicals are maintained at the proper concentrations within the system or, if not, to allow for adjustment of their concentrations. An adequate testing program requires proper recordkeeping of the data that are used for assessing the effectiveness of the water treatment program. If testing data for the water quality analyses are inconsistent with that expected for the treatment method being used, determine the reasons. This determination can involve reanalysis and checking of the

test reagents. If the test results are correct, the water quality and water treatment program must be re-evaluated and modified, if necessary. Paragraph 6-6 describes interpretation of water test results.

6-5.1 **Water Sample Testing Methods.** Water tests are usually performed with test kits obtained from commercial sources. Test kits can be used to test for: alkalinity-phenolphthalein (P); alkalinity-methyl orange (M or total); alkalinity-hydroxyl (OH) or “causticity”; conductivity; tannin; pH; hardness (total and calcium, magnesium by difference); phosphate (ortho and total); sulfite; nitrite; chloride; molybdate; phosphonate; chlorine or bromine (total and free); total iron; and total copper.

6-5.2 **Corrosion Testing.** Corrosion test specimens or corrosion testing instruments can be used to monitor the rate of corrosion. Corrosion test information can also be used to evaluate how well equipment is being protected from corrosion by the water treatment program. The degree of corrosion (if any) that is occurring in large or critical heating and cooling systems should be determined at all military installations. Consider the following information when developing a program of corrosion testing:

6-5.2.1 **Corrosion Test Coupons.** Corrosion test coupons are usually used as corrosion test specimens for open and closed cooling systems, closed hot water systems, and domestic water systems (see Appendix C).

6-5.2.2 **Corrosion Pipe Inserts.** Corrosion pipe inserts are often used as corrosion test specimens in steam condensate return systems (see Appendix D).

6-5.2.3 **Commercial Resources for Testing.** Corrosion test coupons and testing analysis services can be obtained from commercial sources. Corrosion pipe insert assemblies for steam condensate systems and analytical evaluation of the test inserts should be obtained from a QA laboratory or contractor under contract with the military. Guidance for corrosion testing is provided in Appendices C and D.

6-5.2.4 **Corrosion Test Results.** Corrosion test results are usually determined as a rate of corrosion penetration into the metal and reported in mils metal loss per year (mpy). A mil is 2.5-thousandths of a centimeter (one-thousandth [0.001] of an inch); thus, the corrosion rate of 10 mpy means that the thickness of a piece of metal is reduced by $10 \times 0.0025 = 0.025$ centimeter per year (0.01 inch per year). If the metal coupon being studied is 0.1588 centimeter (0.0625 inch) thick, this means that it will be completely dissolved or corroded in just over 6 years. Corrosion rates may also be expressed in millimeters per year (mmpy) corrosion. The relationship between mpy and mmpy is: 1 mpy = 0.0254 mmpy; 1 mmpy = 39.4 mpy. Corrosion also may be given as a weight loss in milligrams per square decimeter per day (mdd). For mild steel, the relationship is: 1 mdd = 0.2 mpy or 1 mpy = 5 mdd.

6-5.2.5 **Testing Instruments.** A variety of electronic instruments are available to monitor and record corrosion rates. These instruments are installed and maintained by individuals who have been adequately trained for these activities. The most commonly

used instrument of this type is a linear polarization corrosion instrument that provides instantaneous corrosion measurement and is often used for troubleshooting.

6-5.2.6 **Heat Transfer Corrosion Test Equipment.** Heat transfer corrosion test equipment is used to determine the corrosion rate under heat transfer conditions. This type of equipment can more accurately determine corrosion in chillers.

6-6 **INTERPRETATION OF RESULTS FROM WATER TESTS.** Adequate chemical treatment of water systems requires that specific levels of specific chemicals be maintained in the water to provide the system with protection from corrosion and deposits. This requirement applies to both cooling and boiler water systems. When an analytical test indicates that the concentration of a given chemical is not within the required limits, the testing process must be evaluated to determine whether sampling and testing were performed properly and the test result is valid. As part of an adequate QA/QC program, test methods, including the chemical reagents, must be checked on a routine basis. Consider these guidelines when evaluating test results:

- When the (valid) test results indicate a treatment level that is too low, the chemical addition program should be evaluated and the appropriate adjustment made; this normally means increasing the chemical feed rate by 10% or less. If adjustments to the treatment program do not correct the situation, then the entire water system may need to be evaluated to determine the nature of the problem. You can obtain assistance through the military offices suggested in paragraph 1-1.10.2.
- When the (valid) test results indicate that a given level of treatment chemical is too high, the chemical addition program should be evaluated. Exercise caution when reducing chemical feed rates to adjust the level of a treatment chemical that exceeds the required limits. The chemical feed rate should not be reduced more than 5 to 10% at any one time.
- When the test results indicate that the level of hardness in the water is higher than the required level, the makeup water treatment system should be investigated and problems identified, including other possible incoming sources of water hardness into the system.

6-6.1 **Alkalinity Test Relationships**

6-6.1.1 **Sources of Alkalinity.** The three basic sources of alkalinity in water result from the bicarbonate ion (HCO_3^-), the carbonate ion (CO_3^-), and the hydroxyl ion (OH^-). The amount of each of these ions in water can be determined by titration with an acid to specific pH levels (end points) using phenolphthalein (P alkalinity) or methyl orange (M alkalinity) indicators to their particular titration end-points. The relationship between pH and the various types of alkalinity is shown in Figure 6-4.

Figure 6-4. Acidity, Alkalinity, and pH Ranges

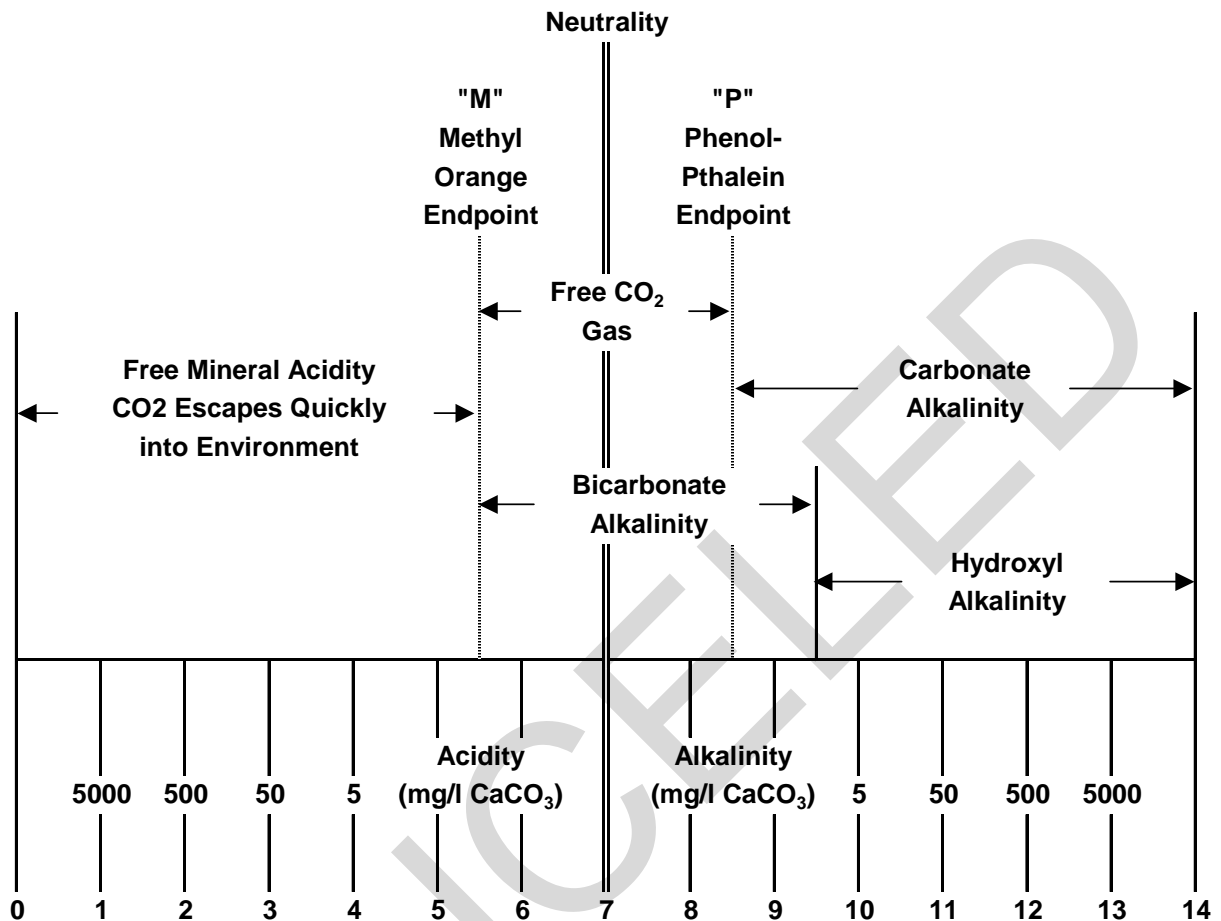

6-6.1.2 **Relationship of P, M, and OH Alkalinities.** Test procedures for determining P and M alkalinities are included in commercially available test kits. The OH⁻ alkalinity can be determined by a specific test or it can be estimated by knowing the P and M alkalinity values. The OH⁻ alkalinity is contributed by the hydroxyl ions (OH⁻) in the water, and is also known as "caustic alkalinity" or "causticity." The relationship between the measured P and M alkalinity values and the level of hydroxyl, carbonate, and bicarbonate forms of alkalinity are shown in Table 6-4 and described below.

Table 6-4. Alkalinity Relationship Based on P and M Tests

Situation	Hydroxyl	Level of Alkalinity Contributed by Carbonate	Bicarbonate
$P = M$	M	0	0
$P > \frac{1}{2}M$	$2P - M$	$2(M - P)$	0
$P = \frac{1}{2}M$	0	M	0
$P < \frac{1}{2}M$	0	$2P$	$M - 2P$
$P = 0$	0	0	M

EXAMPLE 6-1:

If $P = 86$ ppm as CaCO_3 , and if $M = 118$ ppm as CaCO_3
Then, situation 2 (from Table 6-4) exists ($P > \frac{1}{2}M$)
or P is greater than $\frac{1}{2}$ of M);

Hydroxyl = $2P - M = (2 \times 86) - 118 = 54$ ppm as CaCO_3
Causticity = hydroxyl alkalinity as $\text{CaCO}_3 \div 3$
= $54 \div 3 = 18$ ppm as OH^-

Carbonate = $2(M - P) = 2 \times (118 - 86)$
= 64 ppm as CaCO_3

Bicarbonate = 0 ppm as CaCO_3

Check: Total = $54 + 64 + 0 = 118$ ppm M alkalinity as CaCO_3

Review of each situation in Table 6-4 provides this information, with situation:

1. The tests for P alkalinity and M alkalinity are equal. This means that all of the alkalinity is due to hydroxyl ions. There is no carbonate or bicarbonate present. (This is rare but occurs when a caustic solution is not exposed to air.)
2. The P alkalinity is greater than one-half of the M alkalinity. This indicates that there is hydroxyl and carbonate alkalinity, but no bicarbonate alkalinity.
3. The P alkalinity is equal to one-half of the M alkalinity. This indicates that all the alkalinity is due to carbonate. There is no bicarbonate alkalinity, and the hydroxyl alkalinity is insignificant.
4. The P alkalinity is less than one-half of the M alkalinity. This indicates that carbonates and bicarbonates are present.

5. The P alkalinity is zero. The M alkalinity is due to bicarbonates only. No hydroxyl or carbonate alkalinity are present.

6-6.2 pH (Hydrogen Ion Concentration)

6-6.2.1 **Meaning of pH.** The pH (value) is a measure of the acidity or alkalinity of water. The test specifically measures the concentration of hydrogen ions in the water. Neutral water will have a pH of 7. Water with a value of less than pH 7 is considered acidic, while water with a value greater than pH 7 is considered alkaline. Examples are shown below.

- Common pH values for materials on the acid side include: spinach with a pH of approximately 5.5; orange juice and most soft drinks with a pH of approximately 3.5; lemon juice with a pH of approximately 2.2; and 0.1 normality (N) sulfuric acid with a pH of 1.2.
- Common pH values of materials on the alkaline side include: sodium bicarbonate with a pH of approximately 8.4; milk of magnesia with a pH of approximately 10.5; household ammonia with a pH of approximately 11.5; and 0.1 N sodium hydroxide with a pH of 13.0.

The pH scale is logarithmic. A pH of 4 is 10 times as acidic as a pH of 5 and 100 times as acidic as a pH of 6. This is important to consider when adding a strong acid to a system, because 0.1 N sulfuric acid will have more than 1 million times the acidity of neutral water.

6-6.2.2 **Relationship to Causticity.** When the pH of water exceeds a value of 9.6 to 9.8, a measurable concentration of hydroxyl ions (OH^-) is present in the water. As the hydroxyl alkalinity (causticity) increases, the pH of the solution also increases. The relationship between causticity and pH is shown in Table 6-5.

Table 6-5. Relationship Between Causticity and pH

pH	Hydroxyl Alkalinity (ppm)	
	as CaCO ₃	as OH
9.0	0.5	0.17
9.5	1.6	0.54
10.0	5	1.70
10.2	8	2.72
10.5	16	5.44
10.6	20	6.80
10.7	25	8.50
10.8	33	11.2
10.9	40	13.6
11.0	50	17.0
11.1	63	21.4
11.2	79	26.9
11.3	100	34.0
11.4	126	42.8
11.5	158	53.7
11.6	199	67.7
11.7	250	85.0
11.8	315	107
11.9	397	135
12.0	500	170

6-6.3 **Conductivity and TDS.** Each of these water quality parameters is a measure of the amount of soluble minerals present in the water. Conductivity is measured with an electronic instrument based on the flow of an electrical current through the water sample. The measurement of TDS requires evaporation of a fixed amount of water to determine the weight of the remaining minerals (i.e., the TDS in the water). The conductivity instrument may report the mineral content as micromhos or as dissolved solids. In neutral or alkaline waters, there is no consistent relationship between conductivity and TDS since each ion has its own specific conductivity. The hydroxyl ion has the highest conductivity of all the common ions found in boiler water. If alkaline boiler water is acidified to the phenolphthalein end-point with an organic acid, such as gallic acid, which neutralizes causticity but does not contribute to conductivity, the TDS is approximately equal to two-thirds of the neutralized conductivity in micromhos. This is known as "neutralized conductivity." In boiler water, a factor of 0.7 can be used for water treated with synthetic polymers as a sludge dispersant, and from

0.7 to 1.0 for water treated with Quebracho tannin, depending on the amount of tannin in the water. Conductivity and TDS are used to determine the COC and the potential for scale formation (see Chapter 3).

6-7 **IN-PLANT LABORATORY WATER TESTING REQUIREMENTS.** The water tester should be provided with a separate working space to perform the required routine water control tests. This space can be a separate room having a suitable work bench, a sink and cabinet, a distilled or deionized water source, and adequate ventilation, heating, and cooling. Standard white fluorescent lighting at reading intensity can be provided. A record file for test results and references can be located in the test area.

6-7.1 **Recommended Laboratory Equipment.** At each location, laboratory equipment should be selected so that all routine water tests can be performed. The equipment list can include standard glassware such as beakers, test tubes, graduated cylinders, and casseroles so the tests can be performed efficiently. The equipment required for each test can be included with the appropriate test kit.

6-7.2 **Chemical Reagents.** A master list of chemical reagents can be maintained. The list includes testing reagents that are stocked, their reference number, the quantity of stock, and the test for which the reagent is used. The minimum stock level should be defined and the reagent ordered when that level is reached. The chemical reagents required for field tests will be included with the appropriate test kit. The supplier provides an MSDS for each of the chemical reagents, and it should be kept in the vicinity of the test area in case of an emergency.

CHAPTER 7

WATER TREATMENT CHEMICAL FEED AND CONTROL

7-1 **CHEMICAL FEED AND CONTROL SYSTEMS.** Chemical feed and control systems are designed primarily for dynamic industrial water systems that require regular use of chemicals and control of makeup water and blowdown. These systems consist of integrated components, including sensors, automatic valves, and chemical pumps. Some of the ancillary components include drum level sensors, alarms, and telecommunications for remote monitoring. Normally, a mechanical design engineer will develop the specifications for a chemical control and feed system.

7-1.1 **Controller Types.** Water quality controllers are of two types. For cooling towers or boilers, a stand-alone type controller is the most commonly used and can be obtained from the manufacturer or from a water treatment service company. The other type of controller is an integrated component of a building management system. In many instances both types of controllers will be used for a given system, with one controller being used to augment the monitoring of the water system performance. This Chapter focuses on the stand-alone type controllers.

7-1.1.1 **Cooling Tower Water Controllers.** Cooling tower water controllers control blowdown and chemical inhibitor feed, as a minimum. Inhibitor feed can be tied into blowdown; however, it is preferable to have inhibitor feed independent of blowdown to allow for adequate feed in cases in which excessive drift (uncontrolled blowdown) results in no requirement for controlled blowdown. Remote monitoring can also control biocide feed and pH control. The most desirable cooling water inhibitor feed control strategy incorporates real-time, continuous measurement of the inhibitor concentration in the recirculating system water. The controller should then make precise chemical feed adjustments based on the real-time measurement, so that treatment levels can be reliably maintained. The typical controllers used in cooling systems are listed in Table 7-1.

Table 7-1. Cooling System Controller Functions

Function	Type
Blowdown control	1. Conductivity 2. Timer
Chemical inhibitor feed	1. Water meter initiated 2. Function of blowdown 3. Continuous percent time 4. Calendar 5. Based on real-time, continuous measurement of the inhibitor concentration in the recirculating system water.
Biocide feed	1. Calendar 2. ORP (oxidation-reduction potential for oxidizing biocides)
pH control	pH electrode
Remote monitoring	1. Alarms 2. Telecommunications (wired, wireless, or internet)

7-1.1.2 **Boiler Water Controllers.** Boiler water controllers control blowdown and chemical inhibitor feed, as a minimum. Chemical feed can be accomplished through any of several modes (e.g., continuous, water meter-initiated, blowdown, pH), depending on the requirement. Remote monitoring can also be established. The most desirable boiler water chemical feed control strategy incorporates real-time, continuous measurement of the chemical concentration in the water. The controller should then make precise chemical feed adjustments based on the real-time measurement, so that treatment levels can be reliably maintained. Typical controllers used in boiler water systems are listed in Table 7-2.

Table 7-2. Steam Boiler System Controller Functions

Function	Type
Blowdown control	1. Conductivity 2. Timer 3. Percent flow
Chemical inhibitor feed	1. Water meter initiated 2. Function of blowdown 3. Continuous percent time 4. Calendar

	5. Based on real-time, continuous measurement of chemical concentration in the water
pH control	pH electrode
Remote monitoring	1. Alarms 2. Telecommunications (wired, wireless, or internet)

7-1.2 **Chemical Pumps.** Chemical pumps are selected by the specific application for which they will be used, considering materials of construction, head pressure capacity, and volume capacity.

7-1.2.1 **Feed Pumps.** Feed pumps tied to pulsing makeup meters or some other type of proportional feed system are recommended for most systems, especially large steam and cooling water systems and unmanned small systems. The most desirable feed method is to turn on the feed pumps when the continuous real-time measurement of the inhibitor indicator indicates that the inhibitor level is below the desired treatment level. Pumps that turn on in response to continuous real-time measurement can provide control to within 3 ppm of the desired treatment level.

7-1.2.2 **Pumps of Various Types.** Pumps of various types can take suction from chemical solution tanks and inject a solution of a chemical into a line, a boiler drum, or a cooling tower basin. Pump types include piston pumps, spring-loaded diaphragm pumps, hydraulically actuated diaphragm pumps, peristaltic pumps, and gear pumps. Piston pumps and, to a lesser degree, diaphragm pumps, have trouble with valves sticking or plugging if there are solids in the stream being pumped. Peristaltic pumps do not have this problem since they have no valves. They are especially recommended for feeding sulfuric acid, but they cannot pump against much pressure. Pumps configured for flooded suction produce a more reliable delivery than pumps that must hold a suction prime via a foot valve.

7-1.3 **Water Meters, Automatic Valves, and Timers**

7-1.3.1 **Water Meters.** Water meters are selected by the specific application for which they will be used, considering materials of construction, temperature rating, pressure rating, and volume capacity. Water meters fitted with an electrical contact head are used to send low-voltage signals to timers and pumps.

7-1.3.2 **Automatic Valves.** Automatic valves are selected by the specific application for which they will be used, considering materials of construction, temperature rating, pressure rating, and volume capacity. Cooling towers normally use solenoid-actuated diaphragm valves. Boiler surface blowdown normally uses a motorized ball valve.

7-1.3.3 **Timers.** Timers are selected by the specific application for which they will be used. The duty could be any of the following: signal timer, limit timer, percentage timer, or calendar program timer. They are often an integral piece of controller equipment but can also be stand-alone units.

7-1.4 **Other Feed Devices**

7-1.4.1 **Bypass Feeders.** The typical bypass pot feeder is used to feed a solid or dry product to a water stream. A bypass feeder will operate across an orifice plate, a partly closed valve, or any other restriction in the line. Bypass feeders are not recommended for steam boiler systems, cooling tower systems, or systems that require much makeup water.

7-1.4.2 **Slowly Dissolving Dry Chemical Packages.** Nylon mesh bags containing slowly dissolving dry chemicals can be hung in the cold well of a cooling tower. This method of chemical addition is useful for small, remote cooling towers that require little attention.

7-1.4.3 **Eductor Chemical Addition Systems.** The regenerant agent used for ion exchanger softeners is usually fed by an eductor, which is an enclosed unit having a feed rate set by the manufacturer. The sales representative should be contacted in case of an equipment malfunction.

7-1.4.4 **Chemical Drip Pots.** Chemical drip pots are containers that contain treatment chemicals; they are mounted or hung in a cooling tower to feed chemical treatment, which drips into the cooling tower sump. These systems are not recommended for use, including those with a constant head.

7-2 **CHEMICAL FEED METHODS.** For safety and manpower reasons, water treatment chemical feed should be accomplished using automated equipment when possible. In some situations manual feed is the most practical, or only, means available. Other situations require a combination of manual and automated chemical feed. Finally, some chemical feed systems are fully automated, thereby minimizing any direct handling of chemical treatment. The most desirable feed method is to feed product from pumps directly connected to base tanks. The base tanks are refilled by the water treatment supplier, thereby eliminating the handling of the products by the user. Pumps that turn on in response to continuous real-time measurement can provide control to within 3 ppm of the desired treatment level.

7-2.1 **Manual Water Treatment Chemical Feed.** Manual water treatment chemical feed is commonly performed on closed systems, small cooling towers, and small steam boilers.

7-2.1.1 **Chemical Pot Feeders.** Closed systems, such as chilled water, low-temperature hot water boilers, and even small steam boilers that return over 99% condensate, are usually fed manually via a chemical pot feeder (see Figure 7-1). Chemical pot feeders (also known as shot feeders) are plumbed into a system as a

sidestream using a three-valve bypass configuration. Feeders may have funnels or screw caps. The overall volume of a water treatment system should be considered when determining the proper size of a pot feeder. A 3.78-liter (1-gallon) pot feeder on a 75,700-liter (20,000-gallon) closed system can work, but is not practical. A larger 18.9-liter (5-gallon) pot feeder is more practical. Some pot feeders are designed to serve a dual purpose as a filter.

Figure 7-1. Chemical Pot Feeder



7-2.1.2 **Dry Chemical Feeders.** Small cooling towers often require a dry, granular, or pelletized product for control of scale, corrosion, or microbiological organisms. The dry chemical can be placed in a plastic mesh bag and hung in the cooling tower sump or put into a plastic container having small holes through which a stream of water can pass. Small cooling towers can be shock-fed with a liquid chemical agent, such as a biocide. This practice is not efficient and may be ineffective. The manual handling of biocides also raises safety concerns. A liquid chemical feed system may be more effective.

7-2.2 **Automatic Chemical Feed with Manual Preparation.** This type of feed system is commonly found on steam boilers for which an operator must physically prepare a chemical mixture specific for that boiler operation. After preparation, the chemical mixture is automatically fed on demand using a chemical pump that is

controlled by an external device or by tying into a feedwater or blowdown circuit. This type of setup can also be found on small cooling towers (see Figures 7-2 and 7-3).

Figure 7-2. Manual Chemical Feed System



Figure 7-3. Automatic Chemical Feed System

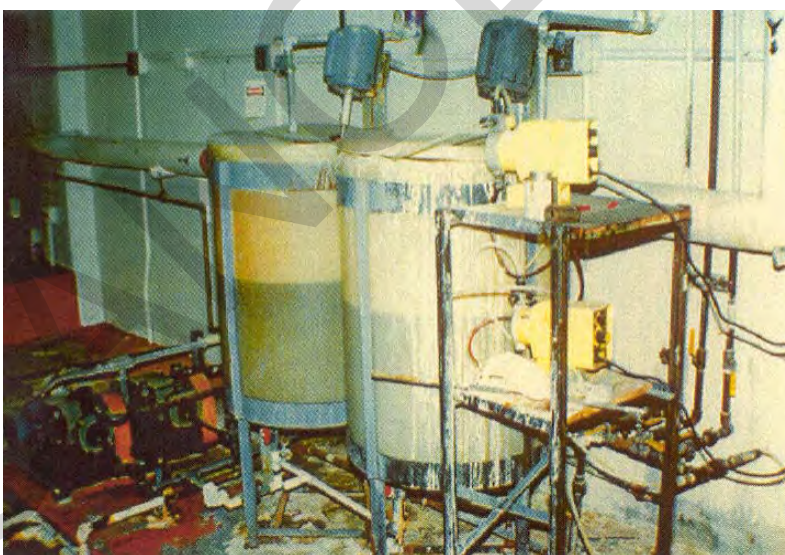

7-2.3 Automatic Neat Chemical Feed. The term “neat” refers to a concentrated chemical as received, with no dilution or mixing. An automatic chemical feed system must deliver the chemical proportionally (see Figure 7-4). Chemical pumps must be sized appropriately, and the system must have control equipment, which can consist of sensors, automatic valves, water meters, and timers. Once a system is properly connected to the chemical containers and adjusted, the only contact between the operator and the chemical containers results from maintenance of the chemical pumps, valves, and transfer lines. The most desirable chemical feed method is to feed product

from pumps directly connected to base tanks. The base tanks are refilled by the water treatment supplier, thereby eliminating the handling of products by the user. The product is fed directly from pumps into the cooling or boiler water system.

Figure 7-4. Automatic Neat Chemical Feed

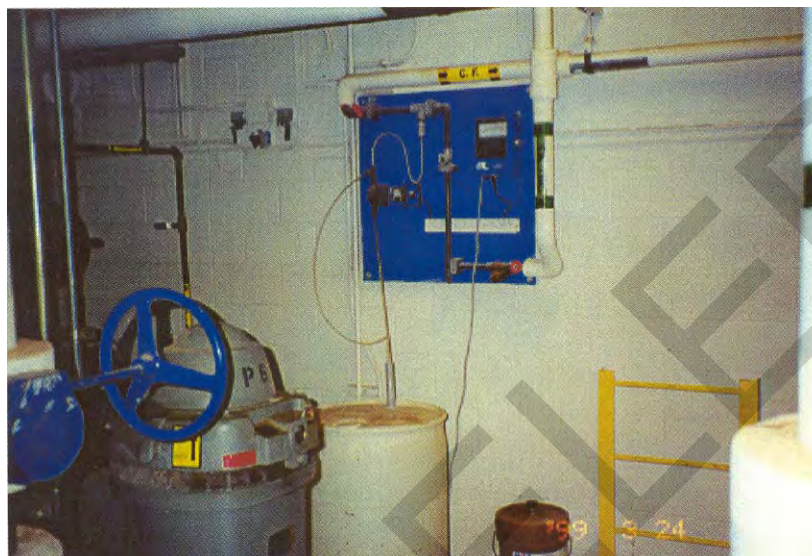

7-3 **CHEMICAL CONTROL VERIFICATION.** To ensure that systems are being maintained within water treatment program control limits, it is necessary to verify that the proper water treatment chemical dosages are being used in treated water systems. Verification involves one or more of the various methods described below.

7-3.1 **Continuous Testing.** Continuous water testing can be used in large systems where the service requirement justifies continuous control or the cost of the chemical feed warrants close control. This technique requires monitoring devices that are external to the system, which is equipped with probes and transmitters that send signals to the monitoring device. These systems are often linked directly to the chemical feed system to provide automatic control of the chemical feed.

7-3.2 **Manual Testing.** Manual testing of the levels and dosages of water treatment chemicals is the most common method of testing. This technique is effective in systems in which the treatment chemical levels are not expected to vary widely in short periods of time, or in which the treatment chemical feed can be linked to the makeup water flow rate. Normally, the results of the manual testing are used to manually adjust the chemical feed rates. The testing frequency varies depending on the type and size of the water system. Critical systems require the most attention.

7-3.3 **Little or No Testing.** Testing is necessary except in instances in which a chemical feed system does not require daily control monitoring or in which there is no treatment. This technique is used, for example, at remote cooling towers where a slowly soluble chemical is suspended in the cold well. Even for such systems an occasional test for treatment chemical level is recommended.

7-3.4 **Calibrated Mass Balance.** Accurate chemical feed (rate and dosage) can be measured precisely and adjusted according to mass water balance. Some chemical delivery systems (pumps) use a calibration column to assure that chemicals are being fed. A measured volume of chemical is fed relative to makeup water or feedwater, then balanced by maintaining COC.

7-3.5 **Automated Sensor Control.** This is a relatively advanced technology that automatically senses treatment level via an ion-specific electrode, such as might be used for pH control or spectro-analysis that senses chemical tracers. Chemical feed is adjusted automatically. The technology is effective as long as the sensing devices are calibrated and properly maintained. The technology for spectro-analysis control is relatively expensive. Another automated type of control is based on continuous monitoring and control of the inhibitor based on fluorescence technology. Chemical feed pumps are turned on when the continuous real-time measurement of the inhibitor indicates that the level is below the desired treatment level. Control can be reliably maintained within 3 ppm of the desired treatment levels in response to continuous real-time measurement. This type of control can be justified based on the reliability of proper treatment levels.

7-4 **SAFETY AND GENERAL INFORMATION.** A water treatment program includes procedures for the feeding, handling, monitoring, storage, and disposal of treatment chemicals. General trends within the water treatment industry have been: to minimize or eliminate the physical handling of chemicals for reasons of safety and manpower; to provide container management systems to eliminate drum disposal problems; and to reduce or eliminate the need to store stockpiles of treatment chemicals.

7-4.1 **Safety.** Chemicals used in water treatment, and in related maintenance activities, range from being highly toxic to mildly irritating to the persons handling them. All water treatment and testing chemicals are handled with caution, following any special instructions prescribed by the manufacturer. Areas where chemicals are handled or stored are kept clean and free of debris to minimize the chance of accidents. People who handle these chemicals can attend safety education classes, refer to the MSDS for additional information, and use proper equipment for respiration and protection as recommended by the installation environmental or safety engineer.

7-4.1.1 **Handling Acid.** When handling acid, avoid splashing the liquid. If acid does contact the eyes, skin, or even clothing, the affected area must be immediately flushed with water for 15 minutes. All cases of acid burns, especially to the eyes, are referred to a doctor. When acid is being diluted, water must never be added to acid because this may cause a violent reaction or splattering. NOTE: Acid is always poured into water; water is never poured into acid. When handling acid, goggles, face shield, rubber gloves, and a rubber apron must be worn. Safety equipment must be of a type approved by OSHA.

7-4.1.2 **Handling Caustic Soda (Sodium Hydroxide).** Caustic soda is a strong alkali that can cause severe burns when contacted in either the liquid or solid form. If caustic soda does contact the eyes, skin, or clothing, immediately flush the affected area with water for at least 15 minutes. When water is added to caustic soda, a great deal of heat may be generated, which can cause the solution to splatter or boil. If inhaled, the dust or mist from dry caustic soda may cause injury to the upper respiratory tract. When handling caustic soda, wear close-fitting, OSHA-approved industrial goggles, rubber aprons and gloves, and coveralls that fit snugly at the neck and wrist.

7-4.1.3 **Handling Other Chemicals.** Many of the other chemicals used in water treatment, including amines, soda ash, lime, sodium aluminate, sulfite, biocides, and algacides may cause some irritation on contact with the skin. Handle all chemicals with caution, following the manufacturer's recommendations. For any contact of a chemical with skin, flush the skin immediately with water. Review the MSDS that are available for the chemicals being handled for any special precautions that you should be take. Biocides and algacides are toxic, and you should handle them only when observing special caution/precautions.

7-4.1.4 **Chemical Spill Kits.** Each area where acids, caustic soda, or other hazardous materials are used or stored can be equipped with appropriate chemical spill kits. Kits for cleaning up acids, bases, and solvents are commercially available.

7-4.1.5 **First Aid Information.** First aid information concerning a given chemical is listed on the MSDS for that chemical.

7-4.1.6 **Eyewash Fountain.** An eyewash fountain or a ready source of running tap water (a bubbler drinking fountain or hose with a soft flow of water) should be made readily available to wash out or flush the eyes. If even minute quantities of acid or caustic soda enter the eyes, immediately flush the eyes with large amounts of water for at least 15 minutes.

7-4.1.7 **Safety Shower.** A readily accessible, well-marked, rapid-action safety shower should be located in the area where acid or caustic soda is being handled.

7-4.1.8 **Safety Inspection.** All safety equipment should be regularly inspected to ensure it is in proper working condition. To prevent the accumulation of rust, the safety shower and eyewash equipment should be operated (checked) weekly. Clearly marked signs containing concise instructions on the use of the safety equipment should be placed near the emergency eyewash fountain and the safety shower.

7-4.2 **Container Management.** The policy for container management is stated in paragraph 1-2.3 and is restated here. The military does not accept responsibility for disposal of chemical containers from water treatment suppliers or service companies. Any such company that has been contracted to provide chemicals must provide them in containers that are either reusable or returnable at the company's cost. The containers remain the property of the contractor. All container systems should provide for secondary containment of the contents.

7-4.3 **Chemical Storage.** Chemical storage procedures are required to follow OSHA directives, manufacturer's recommendations, and the MSDS. Identify products in storage areas by classifications of flammable, corrosive, oxidizers, reducers, and poisonous. Physically separate (store separately) the various classes of products as required by local codes. Because of the potential for chemical spills, storage areas for each class of products should have containment dikes. An alternate for container management is to use base tanks that are refilled by the water treatment service company, thereby eliminating the handling of the containers or products by the user.

CANCELLED

CHAPTER 8

NON-CHEMICAL/NON-TRADITIONAL WATER TREATMENT DEVICES

8-1 **POLICY.** Most non-chemical water treatment devices or equipment are not currently authorized for use on military installations, as stated in paragraph 1-1.5. The Air Force will allow their use only under an Energy Saving Performance Contract (ESPC) in which the contractor assumes all performance-based risk. The performance standards for system component protection must meet or exceed those that are achievable with chemical treatment. For the Navy's policy see NAVFACINST 11300.37A, "Energy and Utilities Policy Manual."

8-1.1 **Function.** Non-chemical devices for use in industrial water systems are designed to require little or no chemical treatment to solve or prevent one or more types of water-related problems, including scale, corrosion, slime, and odor. Some of the technologies are represented as non-chemical, when in fact they produce chemicals (e.g., ozone, and copper and silver ions). These technologies could be better described as non-traditional water treatment chemical devices. The various types of non-chemical devices are described in paragraph 8-2.

8-1.2 **Acceptance.** To date, there has not been a general acceptance of most non-chemical devices. Manufacturer's representations as to their effectiveness and adequacy in performing the intended functions may not be supported by adequate performance data. Non-biased, independent verification of performance conducted by a third-party entity is an important component of the process that should be used to establish performance criteria of new technologies and equipment. This verification step has not always been performed for a given technology. Recognition of the adequacy of a non-chemical technology and acceptance of its use by professional societies such as ASHRAE, the National Association of Corrosion Engineers (NACE International), and CTI could provide an increased level of confidence that the technology does in fact work, at least on some basis and to some extent.

8-1.3 **Performance Standards.** Traditional water treatment evaluation techniques and performance results provide the standard by which non-chemical devices should be measured. A complete water treatment program must address deposit control, corrosion control, microbiological control, and water conservation. These standards are described in Chapter 10. If a non-chemical water treatment device addresses only deposit control, but not corrosion or microbiological control, then it cannot make a claim to eliminate the need for all chemicals. The water treatment program would still require chemicals to control the problems that the non-chemical device cannot control.

8-2 **TYPES OF NON-CHEMICAL WATER TREATMENT DEVICES.** Non-chemical devices for water treatment are hardware devices that do not use chemicals for the purpose of controlling or preventing corrosion, deposition, and biological growth in industrial water systems. This Chapter discusses the various types of non-chemical devices on the market. It is not intended to endorse or validate any of these

technologies, nor to describe all types offered; however, the known effectiveness of these devices will be stated where performance results have been verified.

8-2.1 Electrical Impressed Current Devices. Electrical impressed current devices are a proven corrosion control technology, known as cathodic protection that is used to protect lengths of underground outside surfaces of steel piping and mild steel heat exchanger water boxes. An electrical current is applied to offset the natural potential difference between an anode and a cathode. This technology does not prevent scale deposition or microbiological concerns and is mainly used to protect mild steel.

8-2.2 Grounded Wire Devices. Grounded wire devices use a wire to ground a pipe or structure to prevent corrosion. This device is useful when stray currents (electrical) are causing corrosion. These devices have been touted as being able to prevent and remove scale. The principle of operation is uncertain, but it may be based on the fact that water impurities are charged ions and grounding affects the ions from forming scale. The scale control properties of this technology have not been conclusively and unambiguously verified.

8-2.3 Sacrificial Anodes. The use of sacrificial anodes is a proven technology that uses blocks of metal that corrode (sacrifice) to protect the metal to which they are attached. A sacrificial anode is more anodic than the metal to which it is attached (see paragraph 4-5.1). This technology is actually a form of chemical corrosion protection. As an example, a zinc or magnesium metal sacrificial anode, when attached to a mild steel surface, becomes the anode in a corrosion reaction. The sacrificial anode is corroded preferentially while the mild steel is provided some localized corrosion protection. The action of sacrificial anodes is limited by the distance over which they can be effective; usually about 0.18 to 0.56 square meters (2 to 6 square feet) around the anode is protected, depending upon the water quality.

8-2.4 Filters. Filters are a proven non-chemical method for removing SS in water. The removal of SS (dirt, silt, sand, corrosion products, and microbiological organisms) serves to minimize both the formation of deposits and the potential for under-deposit corrosion. Filtration affects biological control by reducing the presence of macro- and microbiological organisms in water. Removal of SS via filtration can improve the performance of all chemical control agents. This is comparable to a person washing a wound before applying a disinfectant. Filters do not address deposition due to scale nor do they control corrosion.

8-2.5 Magnetic Filters. Magnetic filters are a proven method for removing magnetic iron oxides from a water stream. The most common application is the use of magnetic filters to remove iron oxide before the condensate is returned to the boiler in steam condensate systems. Magnetic filters usually are high capital costs.

8-2.6 Ultraviolet Light Generators. Ultraviolet light generators are a proven method for microbiological disinfection of water. However, their effectiveness is limited to the distance through which the ultraviolet light can penetrate a water stream. This technology would not be effective for controlling (destroying) sessile bacteria that are

already attached to a surface that the light cannot reach or for controlling (destroying) anaerobic bacteria that live underneath deposits that the light cannot penetrate. This technology has limited effectiveness with highly turbid water.

8-2.7 **Magnetic and Electromagnetic Devices.** Magnetic and electromagnetic devices use an unproven technology based on the theory that magnetic fields change the physics of water and the water impurities. Water is a polar molecule. Most water impurities are positively or negatively charged ions. These are the physical properties that the magnetic fields are supposed to act on and to alter. The magnetic device is installed at a point where the water passes by, usually at a point where the water enters the system. A claim made commonly by the manufacturer of the device is that calcium carbonate scale, and possibly other scales, can be conditioned and often prevented. Most of the literature fails to provide a performance envelope of various water qualities. Most manufacturers also fail to mention how corrosion or microbiological control is achieved or even addressed. Magnetic filters used to remove magnetic iron oxide have been shown to work, as described in paragraph 8-2.5.

8-2.8 **Electrostatic Devices.** Electrostatic devices use an unproven technology based on the theory that an electric field changes the physics of water or the water impurities. Some manufacturers market their devices for scale control only. Other manufacturers state, without providing adequate verification data, that these devices address corrosion and microbiological concerns. Performance results are not included in the marketing literature.

8-2.9 **Non-Traditional Water Treatment Chemical Devices**

8-2.9.1 **Ozone.** Ozone (O_3) is a chemical gas consisting of three atoms of oxygen. It has been used in cooling tower water systems. Ozone is a very effective disinfectant for the control of aerobic bacteria and is somewhat effective for sessile bacteria. Ozone has been shown to have a limited and unpredictable effect on calcium carbonate scale. The scale that may form does not adhere to heat exchange equipment, but rather forms SS that can be removed with filtration. The performance envelope for prevention of calcium carbonate scale on heat exchange equipment is very limited and is much less than what is possible when using traditional chemical treatment. Ozone does not prevent corrosion of most metals. It provides some reduction of mild steel corrosion, but will increase the corrosion of copper at rates up to 10 times versus traditional chemical treatment. Ozone also attacks galvanized steel. Increasing the level of ozone in water increases the corrosiveness of the water. Levels of 0.1 mg/l or less are acceptable. Ozone has a short half-life and must be generated on-site. Ozone-generating equipment can have high capital costs. It is difficult to maintain an effective residual of ozone throughout the entire cooling water system because of the extreme reactivity of ozone. It is also very volatile and can be lost from the system as the water passes through the cooling water system, resulting in biomass within the tower fill.

8-2.9.2 **Copper and Silver Ionizing Devices.** Copper and silver ionizing devices use copper and silver metal rods that are electrically corroded and thus put copper and silver ions in the cooling water. Copper and silver ions are known microbiocides. Both

copper and silver ions are toxic to bacteria and algae. Performance envelopes are ambiguous. There is also a potential for the copper and silver ions to plate out on mild steel pipe, galvanized steel, and other metal surfaces, creating a galvanic corrosion cell and resulting in pitting corrosion.

CANCELLED

CHAPTER 9

CHEMICAL CLEANING OF WATER SYSTEMS

9-1 **GENERAL GUIDANCE.** Chemical cleaning of water systems can be divided into two classifications: pre-operational and remedial. Pre-operational cleaning is performed to prepare the water-contacted metal surfaces to receive chemical treatment, which provides protection from scale, corrosion, and microbiological growth. Remedial cleaning is performed to restore water systems that have been fouled with scale, corrosion products, and microbiological growth due to inadequate or ineffective water treatment. Cleaning, particularly remedial cleaning, is often performed by outside contractors familiar with cleaning procedures, techniques, and safety. It should be noted that if the water system is significantly scaled, the chemical treatment program was obviously inadequate and was not properly designed, set-up, controlled, or applied. After cleaning has been completed, the chemical treatment program and QC program must be improved so the same problem does not recur. Use of a well-designed QA program would have produced identification and notification of potential and developing problems before they became serious. Pre-operational cleaning is often performed by contractors responsible for the fabrication of the water system before turning it over to the military installation. Water system operations personnel must assess the effectiveness of any cleaning process that has been performed.

9-1.1 **Pre-Operational Cleaning.** Pre-operational cleaning can be performed on all new systems or pieces of equipment installed in any existing system, including new boiler tubes or new chiller copper tube bundles. New piping and coils will usually be contaminated with materials such as mill scale, rust, oil, and grease resulting from the fabrication, storage, and installation of the equipment. Pre-operational cleaning is performed to remove these materials and prepare metal surfaces to receive corrosion protection from chemical treatment. Pre-operational cleaning agents that are used include detergents, wetting agents, rust removers, and dispersants. These cleaning agents have a pH in the range of 9 to 11. Water systems containing piping or components constructed of galvanized steel and aluminum should not be subjected to procedures that require high pH (greater than 8.5) because this would contribute to initiating corrosion of these surfaces.

The requirement for performing a pre-operational cleaning process is usually written into the specification for new construction of a water system that must be performed by a mechanical contractor. The mechanical contractor is required to perform the work as directed in the specifications; however, if the specifications are not appropriate for the specific system, including consideration of all system metallurgy, the cleaning process may contribute to corrosion to mild steel, galvanized steel, copper, or aluminum, or it may result in incomplete cleaning of dirty and corroded metal surfaces. The specifications should be reviewed by a qualified base inspector or qualified independent consultant to ensure that cleaning agents and procedures have been specified appropriately. A contracting officer or other individual responsible for QA should inspect the equipment after cleaning and document the effectiveness of the cleaning process.

9-1.2 **Remedial Cleaning.** Remedial cleaning is performed to restore a water system that is fouled with scale, corrosion products, or microbiological biomass due to inadequate or ineffective water treatment. The problem could have resulted from using improper chemical technology, failure to maintain treatment levels within control parameters, or the failure of pre-treatment equipment. The cleaning agents used for remedial cleaning usually include acids, chelants, neutralizing agents, and specialty cleaning chemicals.

9-1.2.1 **Safety and Environmental Issues.** Remedial cleaning may pose safety issues for personnel handling acids, caustics, and various chemicals. There could also be environmental concerns associated with chemical disposal. Inexperienced personnel should not perform the chemical cleaning of an industrial water system.

9-1.2.2 **Contracting Cleaning Services.** For some cleaning jobs, such as large boilers and cooling towers, it may be advisable to engage a service company specializing in chemical cleaning. If the cleaning service is contracted, it is vital that adequate lines of communication be established, and that safety procedures employed by the service company comply with military regulations. An orientation meeting should be scheduled between military installation personnel and the service company representatives. At that time, the scope of the work can be defined, proper procedures initiated, and the nature of the hazards described thoroughly. The use of proprietary cleaning chemicals or chemical formulations may be involved; disclosure of the use and nature of these chemicals should be made at the orientation meeting. Military policies and restrictions can also be explained. The inspection of equipment after cleaning is usually the final step in the overall cleaning process.

9-1.3 **Reasons for Cleaning.** Maintenance of an effective water treatment program is essential to minimize scale and corrosion problems in industrial water systems; however, scale and deposits that form will require remedial cleaning (descaling). If not removed, these scale and water-caused deposits may impact the safety of operations personnel, interfere with heat transfer, and cause excessive damage to, or destruction of, the water-using equipment. Cleaning is not appropriate for the removal of deposits when corrosion of the system has advanced to the point where a large number of leaks may result from the removal of the deposits.

9-1.4 **Types of Deposits.** The deposits that occur in water systems can be inorganic mineral salts and corrosion products or organic (oily) or biological in nature. Deposits range in composition from very dense crystalline structures, to very porous and loosely bound materials, to gelatinous slimes. Most of the deposits formed from water constituents consist of corrosion products such as iron and copper oxides, mineral scales, or mixtures of these materials.

9-1.4.1 **Waterside Deposits Located in Heat Exchangers.** Water deposits located in heat exchangers are usually carbonate-based scales, while steamside deposits may be a mixture of metallic oxides and organic residuals from lubricating oil, particularly where reciprocating-type engines are used. In steam systems, the oxides

are usually iron and copper, resulting from aggressive condensate. Microbiological deposits may form in cooling systems from bacterial or algae growths, or from decomposition products of various microorganisms.

9-1.4.2 **Boiler Deposits.** Boiler deposits may take various forms. In low-pressure boilers using a relatively hard feedwater, deposits are essentially calcium and magnesium, silicates, sulfates, carbonates, phosphates and hydroxides, plus some organics. Deposits may also contain considerable amounts of silica, iron, and copper. These deposits can be spongy or porous or relatively hard and glass-like. Deposits of the latter characteristic occur where silica is present in appreciable quantities in the boiler water. Deposits in medium-pressure to high-pressure boiler systems usually are mixtures of iron and copper oxides and phosphates. Dense deposits may tend to form in high-heat transfer areas. Considerable quantities of sludge-type accumulations may be found in downcomers, mud drums, waterwall headers, crossover tubes, and areas of low water circulation in the boiler.

9-2 **REMEDIAL CLEANING PROCEDURES.** Cleaning procedure information and procedures presented in this Chapter are general in nature and must be modified to fit specific applications. Because contractors perform most cleanings, these procedures are provided only for general information (see paragraphs 9-1.1 and 9-1.2).

9-2.1 **Cleaning Methods**

9-2.1.1 **Mechanical Methods.** Mechanical methods are the oldest techniques used for removing deposits. To perform an adequate mechanical-type cleaning, the equipment to be cleaned may need to be partially or entirely dismantled. Even when equipment is dismantled, some areas may be extremely difficult to reach and clean. Chemical cleaning has largely replaced mechanical process equipment cleaning as the most satisfactory method of removing deposits; however, mechanical methods such as wire brushing, tumbling, scraping, and abrasive blasting with sand and grit are still employed in special applications.

9-2.1.2 **Cleaning Agents.** Cleaning agents may be broadly classified as being acid, alkaline, organic, or solvent cleaners. There is no general or universal cleaner that removes all deposits. The selection of a solvent or cleaning agent is based on the material's ability to remove or dissolve the deposit, as well as on cost considerations, safety hazards, and the effect of the cleaning material on the metals involved.

9-2.1.3 **General Guidance and Procedures for Preparing Cleaning Solutions.** General guidance and procedures for preparing cleaning solutions of inhibited hydrochloric (muriatic) acid and inhibited sulfamic acid are provided in paragraphs 9-2.2 and 9-2.3. Inhibited acid contains special chemical inhibitors that prevent the acid cleaner from attacking the base metal while allowing the acid to remove the unwanted corrosion product or scale deposit.

9-2.2 **Hydrochloric (Muriatic) Acid.** Inhibited hydrochloric (muriatic) acid in strengths of 5 to 20% is very effective for removing calcium scale and iron oxide;

however, for most applications, a 10% solution is adequate. The following formulation is for a 10% hydrochloric acid solution. It can be used for removing scale consisting primarily of carbonates with lesser amounts of phosphates, sulfates, and silicates. This type of scale is typically found in a steam boiler system containing copper alloys that has been treated with a phosphate-based program. Depending on the specific descaling application, some of these ingredients can be omitted from the formulation. For example, diethylthiourea is not needed if there is no copper in the system. It should be noted that if diethylthiourea is used, the waste material should be treated as a hazardous waste. Where there is only carbonate scale to be removed, ammonium bifluoride, which is used to remove silica-based scales, may be omitted. The addition of a wetting agent is preferable but not absolutely necessary.

9-2.2.1 **Example Procedure for 10% Solution.** The following is an example procedure that can be used to make 3785 liters (1000 gallons) of a 10% solution:

1. Add 1079 liters (285 gallons) concentrated (36% strength) hydrochloric acid, American Society for Testing and Materials (ASTM) E 1146, *Specification for Muriatic Acid (Technical Grade Hydrochloric Acid)*, to approximately 2271 liters (600 gallons) of water.
2. Add the proper amount of a corrosion inhibitor, Military Specification MIL-I-17433, *Inhibitor, Hydrochloric Acid, Descaling and Pickling*, recommended by the manufacturer to the diluted acid solution. The inhibitor must be compatible with hydrochloric acid and must not precipitate under any condition during the cleaning operation.
3. In a separate tank containing about 284 liters (75 gallons) of water:
 - a) Add 39 kilograms (85 pounds) of the chemical (1,3) diethylthiourea to complex any copper and keep it from depositing. Do not use the diethylthiourea as the corrosion inhibitor required in paragraph 9-2.2.1(step 2) above.
 - b) Add 55 kilograms (120 pounds) of ammonium bifluoride, technical grade, to help dissolve certain iron and silica scales.
 - c) Add 3.79 liters (1 gallon) of wetting agent, Military Specification MIL-D-16791, *Detergents, General Purpose (Liquid, Nonionic)*.
 - d) Add the dissolved diethylthiourea, ammonium bifluoride, and wetting agent to the diluted acid solution. Add sufficient water to obtain 3785 liters (1000 gallons).

9-2.2.2 **Carbonate Deposits.** Carbonate deposits dissolve rapidly in hydrochloric acid, with evolution of free carbon dioxide. The escaping carbon dioxide tends to create some circulation or agitation of the acid, which ensures the continual contact of fresh acid with the scale. Once the carbonate has been dissolved from a mixed deposit, a

loose, porous structure may be left behind. This residual material can be effectively removed from the equipment either mechanically or by washing with high-pressure water.

9-2.2.3 **Phosphate Deposits.** The removal of phosphate deposits can usually be accomplished by using hydrochloric acid; however, phosphate deposits have a tendency to dissolve rather slowly. To minimize the total cleaning time, a temperature of 49 to 60 °C (120 to 140 °F) is usually necessary to remove a predominantly phosphate scale.

9-2.2.4 **Metallic Oxides.** Most metallic oxides found in deposits can be removed with hydrochloric acid. The rate of dissolution is a function of temperature and solution velocity. If copper oxides are present on steel surfaces, special precautions are needed to prevent copper metal plate-out on the steel.

9-2.2.5 **Silica and Sulfate Scale.** Heavy silica and sulfate scale is almost impossible to remove with hydrochloric acid. Special chemicals and procedures are required to remove this scale.

9-2.2.6 **Hydrochloric Acid Limitations.** Hydrochloric acid is not used to clean stainless steel because the chloride ion in the acid solution may cause pitting or stress corrosion cracking. Hydrochloric acid is not used for removing scale from galvanized steel surfaces since the galvanizing will corrode. Aluminum is not cleaned using hydrochloric acid.

9-2.3 **Sulfamic Acid.** Sulfamic acid is an odorless, white, crystalline solid organic acid that is readily soluble in water. An inhibited sulfamic acid compound, in a dry powder form, is available under Military Specification MIL-B-24155, *Boiler Scale Removing Compound*. A 5 to 20% solution (2 to 9 kilograms to approximately 38 liters of water [5 to 20 pounds to approximately 10 gallons of water]) is used for removing scale from metal surfaces. The following information pertaining to sulfamic acid should be considered:

- Carbonate deposits are dissolved in sulfamic acid in a similar manner as in hydrochloric acid. All the common sulfamate salts (including calcium) are very soluble in water.
- The dry powder form of sulfamic acid is safer to handle than a liquid solution of hydrochloric acid; however, aqueous solutions of sulfamic acid are much slower in action and require heating to remove scale. The sulfamic acid solution is heated to a temperature in the range of 54 to 71 °C (130 to 160 °F) to obtain the same fast cleaning time that is achieved by using hydrochloric acid at room temperature. Sulfamic acid is more effective on sulfate scale than hydrochloric acid.
- Inhibited sulfamic acid, used at temperatures up to 43 °C (110 °F), will not corrode galvanized steel. Its use is recommended for removing scale in

cooling towers, evaporative condensers, and other equipment containing galvanized steel. In general, sulfamic acid can be applied to equipment while it is operating but should be drained from the system after a few hours, and the concentration of the normally used corrosion inhibitor should be increased several-fold to protect the metal surfaces.

- Commercially prepared descaling compounds consisting of concentrated or diluted inhibited acid (containing 7 to 28% of the acid and inhibitor) may be purchased under various trade names at prices 4 to 30 times the cost of the ingredients themselves if purchased as generic chemicals.
- Advertisements of some of these products may contain claims that cotton clothing and skin are not attacked by the acid. These claims are usually based on a very dilute solution of the acid that causes a minimal attack on clothes and skin; however, the cost of the cleaning process may be increased because a higher quantity of dilute product may be needed. Be aware that handling acid in any strength must be performed with considerable care, caution, and adherence to safety procedures.
- The cost of diluted acid is expensive; therefore, concentrated acid of government specifications should be purchased and diluted to usable strengths. The necessary corrosion inhibitors can be added to the dilute acid solution. Users of small quantities of acid cleaners (possibly less than 38 liters [10 gallons] of diluted acid per year) may not be able to justify purchasing undiluted acid and spending the time, cost, and effort to prepare the cleaning solution; therefore, consider the specific requirements before ordering.

9-2.4 **Cleaning Preparation.** The unit to be cleaned must be isolated from other parts of the system. For systems that cannot be isolated by the closing of valves, isolation may be accomplished using rubber blankets, wooden bulkheads with seals, inflatable nylon or rubber bags, rubber sponge-covered plugs, or blind flanges and steel plates with rubber seals. Long lines may require auxiliary connections for chemical cleaning. The following information should be considered before the cleaning process is started:

- Decide whether to clean using a soaking process or by circulating the cleaning solution (see paragraph 9-2.5). In either case, temporary piping or hose lines will be required to connect the cleaning solution mixing tanks or trucks to the unit, with return lines to tanks or drains. Proper precautions and adequate provisions must be made to protect equipment, isolate control lines, replace liquid level sight glasses with expendable materials, and provide suitable points for checking temperatures. It may be necessary to remove selected system components if the cleaning process might damage them.

- The entire cleaning procedure/process must be developed in detail before starting chemical cleaning operations. Factors to be considered include: the methods for controlling temperatures; the means of mixing, heating, and circulating the chemical solution; proper venting of dangerous gases from equipment to a safe area; and means for draining, filling, and flushing under inert atmospheres. Sampling points, test procedures, and control limits should also be established.

9-2.5 **Methods for Removing Scale.** Removing scale may be accomplished by circulating the inhibited acid solution through the equipment or by soaking the equipment in a tank of inhibited acid. Before starting any descaling process, check the acid to make sure it is properly inhibited. You may check the acid by placing a mild steel coupon into a beaker containing the prepared, diluted acid. You should notice no reaction around the coupon. If you observe a reaction generating hydrogen gas bubbles around the coupon, add more inhibitor.

9-2.5.1 **Recirculating Cleaning Process for Boilers.** The following example is an appropriate procedure for cleaning small boilers or other systems using a hot recirculating inhibited acid solution:

1. Fill the boiler or system with preheated (71 to 77 °C [160 to 170 °F]) dilute inhibited acid solution.
2. Allow the dilute inhibited acid solution to remain in place for 8 hours. Circulate the acid solution for approximately 15 minutes each hour at a rate of about 3.15 liters per second (50 gallons per minute) to ensure good mixing.
3. Keep the temperature of the acid solution preheated at 71 to 77 °C (160 to 170 °F). Measure and record the temperature at least once every 30 minutes.
4. Check and record the acid strength at least every hour (see paragraph 9-2.6).
5. Drain the system by forcing the acid solution out using 276 to 345 kilopascals (40 to 50 pounds per square inch gauge) nitrogen; follow Federal Specification A-A-59503, *Nitrogen, Technical, Class 1*. If leaks develop when the system is under nitrogen pressure, you must use an alternate method for removing the acid, such as pumping.
6. Fill the boiler with preheated (65 to 71 °C [150 to 160 °F]) water and soak at this temperature for 15 minutes.
7. Drain under nitrogen pressure of 276 to 345 kilopascals (40 to 50 pounds per square inch gauge).

8. Prepare this mild, acid-rinse solution: Add 7.57 liters (2 gallons) of hydrochloric acid (ASTM E 1146) for each 3785 liters (1000 gallons) of water. Also add corrosion inhibitor, Military Specification MIL-1-17433, in the amount recommended by the manufacturer.
9. Fill the boiler with the preheated (71 to 77 °C [160 to 170 °F]) mild acid-rinse solution and soak for 30 minutes.
10. Drain the mild acid-rinse solution under nitrogen pressure at 276 to 345 kilopascals (40 to 50 pounds per square inch gauge). Maintain a positive pressure of nitrogen in the boiler to prevent outside air from leaking inside.
11. Prepare this passivating solution: To each 3785 liters (1000 gallons) of distilled water (or other water with less than 50 ppm total hardness [as CaCO₃]), add 36 kilograms (80 pounds) of passivation compound 0.5% by weight sodium nitrite and 0.25% by weight monosodium phosphate.
12. Fill the boiler with the passivating solution preheated to 65 to 71 °C (150 to 160 °F), circulate for 10 minutes, and hold in the boiler at 65 to 71 °C for an additional 30 minutes.
13. Drain and rinse boiler until the pH of the rinse water is pH 8 to 10.

9-2.5.2 **Circulating Method Without Heat.** The steps below describe a typical process for descaling smaller equipment, such as enclosed vessels or hot water heater coils, without heating the inhibited acid solution:

1. Note that an acid cleaning assembly may consist of a small cart on which is mounted a pump and an 18.9- to 189-liter (5- to 50-gallon) steel or polyethylene tank with a bottom outlet to the pump.
2. Install sill cocks at the bottom of the water inlet of the heat exchanger and the top of the water outlet so that a return line can be connected directly from the acid pump and from the heat exchanger to the acid tank.
3. Prepare an inhibited acid cleaning solution (see paragraphs 9-2.2 and 9-2.3).
4. Pump the acid solution into the heat exchanger through the hose connection. Continue circulation until the reaction is complete, as indicated by foam subsidence or acid depletion.
5. If the scale is not completely removed, check the acid strength in the system (see paragraph 9-2.6). If the acid strength is less than 3%, add fresh acid solution and continue circulation until the remaining scale is removed. Usually an hour of circulation is adequate.

6. Drain the heat exchanger.
7. Neutralize remaining acid by circulating a 1% sodium carbonate (soda ash) solution (about 3.6 kilograms per 38 liters [8 pounds per 100 gallons]) for about 10 minutes.
8. Rinse thoroughly with water until the pH of the rinse water is pH 8 to 10.

9-2.5.3 **Fill and Soak Method**

1. Prepare an inhibited dilute acid solution (see paragraphs 9-2.2 and 9-2.3) in a container of suitable size.
2. Depending on the item to be cleaned and the types of scale involved, you may want to place an agitator (mixer) in the tank or install a pump outside the tank to circulate the acid solution. A method to heat the acid may be required, such as a steam coil. All equipment must be explosion-proof and acid-resistant.
3. Immerse the item to be cleaned in the dilute acid solution. Continue soaking until the reaction is complete as indicated by foam subsidence or acid depletion.
4. If the scale is not completely removed, check the acid strength (see paragraph 9-2.6). If it is less than 3%, add additional acid and continue soaking the items until the remaining scale is dissolved. Usually 1 to 2 hours of soaking is adequate.
5. Remove item from tank.
6. To neutralize remaining acid, immerse the item in a 1% sodium carbonate (soda ash) solution (about 3.6 kilograms per 38 liters [8 pounds per 100 gallons]) for 2 to 3 minutes.
7. Rinse the item thoroughly with water.

9-2.6 **Checking Acid Solution Strength.** The initial strength of the dilute inhibited acid will vary from 5 to 20%, although 10% is typical. As the acid is consumed by dissolving the scale, the strength of the acid decreases. The strength of the acid solution should be measured periodically during a cleaning operation. When the acid strength falls below 3%, the solution may be discarded since most of its scale-dissolving capability will have been used. Use the following procedure to check the acid strength:

Apparatus:

Burette, 25 milliliters (0.8 ounce) automatic (for sodium hydroxide solution)

Bottle, with dropper, 50 milliliters (2 ounces) (for phenolphthalein indicator solution)

Graduated cylinder, 10 milliliters (0.3 ounce)

Casserole, porcelain, heavy duty, 210-milliliter (7.1-ounce) capacity

Stirring rod

Reagents:

Sodium hydroxide solution, 1.0 normality (N)

Phenolphthalein indicator solution, 0.5%

Method:

1. Measure 10 milliliters of acid solution accurately in the graduated cylinder.
2. Pour into the casserole.
3. Add 2 to 4 drops of phenolphthalein indicator solution to the casserole and stir.
4. Fill the automatic burette with the 1.0 N sodium hydroxide solution; allow the excess to drain back into the bottle.
5. While stirring the acid solution constantly, add sodium hydroxide solution from the burette to the casserole until color changes to a permanent faint pink. This is the endpoint. Read the burette to the nearest 0.1 milliliter (0.003 ounce).

Results:

1. For hydrochloric acid:
Percent hydrochloric acid = milliliter of 1.0 N sodium hydroxide x 0.36
2. For sulfamic acid:
Percent sulfamic acid = milliliter of 1.0 N sodium hydroxide x 0.97

CHAPTER 10

DEVELOPING A WATER TREATMENT PROGRAM

10-1 **GENERAL INFORMATION.** Although each water treatment program may contain unique aspects, the strategic goals of every program are regulatory compliance and safety, protection of water-contacted equipment, and acceptable costs. Achieving these goals requires the cooperative efforts of personnel from several areas, including environmental protection, engineering, contracting, operations, and outside resources. Outside resources include water treatment services companies, equipment suppliers, and mechanical contractors. In some cases, military facilities may use outsourcing for procurement of all industrial water treatment chemicals and associated services. This Chapter addresses some of the options for developing both a water treatment program and performance standards that apply to implementation of a program.

Problems can occur when water treatment programs are not developed properly. Each water treatment program is designed to address regulatory compliance and safety requirements as well as water quality and equipment protection. A potential consequence of inadequate planning and design of a water treatment program is preparing inadequate scopes of work for use in procuring (contracting) for services. If equipment protection is not adequate, the cost attributed to this failure often far outweighs the cost of the water treatment chemical program. The most obvious problem is damage to, or the need for premature replacement of, the water-contacted equipment. Loss of operational efficiency is also a problem but is not always as apparent because it is rarely measured accurately; however, the additional operational costs due to operational inefficiency can be substantial. Specific types of equipment and system failures are described in Chapters 3, 4, and 5. When developing a water treatment program, you must give adequate effort and consideration to defining goals, devoting adequate resources to accomplish goals, and assessing performance.

10-2 **OPTIONS FOR SETTING UP A WATER TREATMENT PROGRAM.**

There are four methods for developing and implementing a water treatment program:

- a) **Generic Programs.** In a generic water treatment program, facility operations personnel identify and use generic or commodity chemicals as part of the water treatment program that has been developed by facility personnel. Facility operations provide all services for chemical feed and control as well as monitoring and performance assessment. Facility personnel may be required to handle and mix generic chemicals. Alternatively, a contractor can develop the program for using generic chemicals, with services being provided by facility personnel.
- b) **Outsource Proprietary Chemicals Only.** Procurement of proprietary water treatment chemicals is outsourced from a qualified water treatment contractor. Facility operations provide all services for chemical feed and control, and monitoring and performance assessment.

- c) **Outsource Proprietary Chemicals and Some Basic Periodic Services.** Proprietary water treatment chemicals, control and feed equipment, and periodic services are outsourced from a qualified water treatment contractor. Facility operations provide daily services for chemical feed and control, and monitoring and performance assessment.
- d) **Complete Outsourcing.** All chemicals and services are outsourced to a contractor. The facility provides only maintenance of operating equipment (no water-treatment-related services).

10-2.1 **Generic Chemical Water Treatment Programs.** Generic chemical water treatment programs have been implemented at military installations. The advantage of using this type of program is the cost savings generated by the use of generic chemicals relative to formulated products obtained from water treatment service companies. Generic chemicals are identified in Chapters 3 through 5. Generic chemical programs can be successful, but adequate planning and resources (including technical expertise) must be devoted to the implementation of the program. Generic chemicals and specifications are listed in Appendix F.

10-2.2 **Outsourcing Chemicals and Services.** The General Services Administration (GSA) has developed standardized procedures and contracting arrangements for the outsourcing of: procurement of proprietary chemicals; procurement of proprietary chemicals with some periodic services; and procurement of total program services. The standard contracts have been designed to develop the most favorable pricing of water services received from contractors. GSA-listed proprietary products should not be purchased solely on a "price-per-pound" or "price-per-volume-of-product" basis. For purchases above \$2500, make a "best value" determination after reviewing schedule price lists from at least 3 vendors. The "best value" determination must consider the price of products and the quality of services included with the products. It is usually necessary to obtain proposals from water treatment service companies and consider the details of the services to be provided as proposed, and the "cost per 3785 liters (1000 gallons) of makeup." Proprietary products cost 5 to 20 times more than generic chemicals. These contracts only apply to GSA-listed products. Not all products on these GSA lists may be appropriate or approved for use in military industrial water systems. The contract-specified service requirements that are to be included with the GSA-listed products must be well defined; if not, a poorly monitored and poorly implemented program may result.

10-2.3 **Contracts Based on Cost Per Unit of Water.** A practical approach for obtaining cost-effective water treatment can be developed based on the bid price to treat a unit of water (e.g., 3785 liters [1000 gallons] of water). Optimally, the contract scope of work will specify minimally acceptable performance standards as well as service requirements to be met by the contractor. Service requirements can vary from periodic consulting service to complete outsourcing.

10-3 **DEVELOPING A SCOPE OF WORK (SOW) FOR INDUSTRIAL WATER TREATMENT.** This paragraph applies only to paragraph 10-2.1.3. A SOW (sometimes

called a “statement of work” or a “statement of services to be provided”) is developed for inclusion in the required procurement documents (i.e., request for proposal/bid [RFP/RFB] and contract). The SOW will identify the specific services, chemicals, and equipment that a contractor is to provide under the terms of the contract. The SOW will, at a minimum, specify or identify the following: SOW to be performed; qualifications of supplier; water characteristics of each system to be treated; description of industrial water systems and their operation; performance specification (results required); service requirements; equipment requirements for control, feed, monitoring, and sampling; requirements for chemicals and test equipment; and quotation for total chemical cost and usage. These issues are described below.

10-3.1 **Qualifications.** The SOW specifies the minimum qualification requirements for contractors and contractor representatives. These requirements are developed to allow the participation of qualified contractors (water treatment chemical companies) having national, regional, and local operations. The SOW can specify the minimum number of years that the company has been in business and the minimum number of years and type of experience of contractor representatives, as well as required technical service capabilities.

10-3.2 **Submittal Requirements and Format.** The SOW clearly specifies the type of response (submittal) that is required from an RFP or RFB. This is necessary to avoid receiving bid responses that are so different in their presentation that they cannot be easily or objectively compared. The evaluation process can be simplified by requiring bidders to provide a comprehensive acknowledgement that they understand and accept all requirements for compliance, qualifications, service requirements, and performance standards. The RFP/RFB should require a simple, generic, technical summary that lists the proposed chemical technology and treatment ranges for each type of system to be serviced under the procurement.

10-3.3 **Water Quality.** The water supplied as makeup to industrial water systems is characterized in terms of its source, treatment, and quality, including seasonal and temporal variances. If external treatment is used on individual systems such as a steam boiler, this treatment is identified.

10-3.4 **Description of Systems and Operations.** A description of the number, capacity, and types of systems to be serviced under the contract is a critically important element of a SOW. The metallurgy of all water-contacted surfaces is identified. Without this information, performance standards cannot be adequately defined. The condition of equipment is documented. Operational parameters, such as the equipment duty, load, and usage, are described so that water usage (preferably total water usage for each system) and chemical restrictions can be considered in developing the proposal.

10-3.5 **Performance Specification.** Performance criteria are specified for protecting equipment against deposition, corrosion, and biological growths. Certain minimally acceptable standards for performance must be met. Recommended or example performance standards are listed in Chapters 3, 4, and 5 for the respective types of industrial water systems. Allowances are made for problems that cannot be

totally controlled by chemical treatment alone. One example is SS accumulation in a cooling tower system. Chemical dispersants can aid in keeping SS from settling on metal surfaces, but it may require adequate flow and physical removal to maintain good control.

10-3.6 **Service Requirements.** The SOW accurately describes the services to be provided by the contractor. Service includes the frequency of on-site visits, the duties to be performed, and the methods of reporting. The duties to be performed can include these activities: water testing; making log entries; training; maintaining automated chemical control and feed equipment; manual addition of chemicals to industrial water systems; inventory control; corrosion coupon studies; microbiological population determination; equipment inspections; laboratory support; quarterly reviews; and annual reviews.

10-3.7 **Control, Feed, Monitoring and Sampling Equipment Requirements.** The SOW specifies what equipment, if any, is required to achieve consistent control of the makeup water treatment chemical program. Automated control and feed equipment is required on most medium and large cooling towers and on most steam boilers. Automated control and feed equipment helps limit the demand for service maintenance. To provide for the preparation of an appropriate SOW, engineering and facility maintenance personnel carefully evaluate their capabilities in the area of water treatment and water systems. Inadequate water treatment equipment can result in higher service requirements or inconsistent control of the chemical program. Descriptions of chemical applications can be found in Chapter 7.

10-3.8 **Chemicals and Test Equipment.** The SOW specifies any restrictions on the use or discharge of chemicals. Examples of restrictions can include limitations on the use of acid, shipping container size limits, microbiocide selection criteria, and limitation on use of dry chemicals.

10-3.9 **Quotation for Cost and Usage.** The SOW specifies how the cost of chemicals and services is being calculated and quoted. For example, quotations for chemical treatment can be based on the cost to treat 3.785 cubic meters of water. Cost for services in the SOW can be required to be included in the cost of chemical treatment or quoted separately as line items, time, and materials. Contracts that require a "not-to-exceed" quotation supply bidders with a not-to-exceed water usage estimate.

10-4 **REPORTS AND AUDITS.** Reports and audits are tools for documenting performance and cost effectiveness of any industrial water treatment program. Audits serve to verify results from the water treatment service company. Audits also serve to verify the cost-effectiveness of product being supplied by the water treatment service company. Audits are performed by qualified agencies within the military branch in question or by independent consultants contracted to perform such duties.

GLOSSARY

ABMA — American Boiler Manufacturer's Association
AFCESA — Air Force Civil Engineer Support Agency
AFI — Air Force Instruction
AFP — Air Force Pamphlet
AFR — Air Force Regulation
AMP — Amino-tri(methylene) phosphonic acid
ASHRAE — American Society of Heating, Refrigeration, and Air-Conditioning Engineers
ASME — American Society for Mechanical Engineers
Bé — Baumé
Br₂ — Bromine
BTU — British thermal unit
BTUH — British thermal units per hour
BZT — Benzotriazole
C — Celsius
CaCO₃ — Calcium carbonate
CERCLA — Comprehensive Environmental Response, Compensation, and Liability Act
CFR — Code of Federal Regulations
Cl₂ — Chlorine
ClO₂ — Chlorine dioxide
CO₂ — Carbon dioxide
COC — Cycles of concentration
CTI — Cooling Technology Institute
CWA — Clean Water Act
D.R. — Distribution ratio
DEAE — Diethylaminoethanol
EDTA — Ethylene diamine tetra-acetic acid
EFD — Engineering Field Division
EPA — Environmental Protection Agency
ESPC — Energy Saving Performance Contract
F — Fahrenheit
FDA — Food and Drug Administration
FMA — Free mineral acids
ft — Foot
ft³ — Cubic foot

g — Grams
gal — Gallon
gpm — Gallon per minute
gr — Grain
GSA — General Services Administration
H₂O — Water
H₂O₂ — Hydrogen peroxide
HEDP — 1-hydroxyethylidene-1,1-diphosphonic acid
HMP — Sodium hexametaphosphate
HOBr — Hypobromous acid
HOCl — Hypochlorous acid
hp — Horsepower
HTH — Dry calcium hypochlorite
HTHW — High-temperature hot water
HTW — High-temperature water
HVAC — Heating, ventilation, and air conditioning
IUPAC — International Union of Pure and Applied Chemistry
kg — Kilogram
km — Kilometer
KPa — Kilopascals
kW — Kilowatt
lb — Pound
l/sec — Liters per second
LSI — Langelier Saturation Index
LTW — Low-temperature water
m/s — Meter per second
m³ — Cubic meter
m³/d — Cubic meter per day
m³/hr — Cubic meter per hour
mg — Milligrams
MgSO₄ — Magnesium sulfate
MIC — Microbiologically influenced corrosion
MIL-HDBK — Military handbook
ml — Milliliter
mm — Millimeter
mmpy — Millimeters per year

mpy — Mils per year
MSDS — Material safety data sheet
MTW — Medium-temperature water
N — Normality
NACE — National Association of Corrosion Engineers
NaCl — Sodium chloride
NAVFAC — Naval Facilities Engineering Command
NAVFACINST — Naval Facilities Instruction
NAVSEASYS COM — Naval Sea Systems Command
NSN — National Stock Number
NTA — Nitrilo-triacetic acid
O₃ — Ozone
OC1 — Hypochlorite ion
ORP — Oxidation-reduction potential
OSHA — Occupational Safety and Health Administration
oz — Ounce
PACDIV — Pacific Division
PBTC — 2-phosphonobutane-1,2,4-tricarboxylic acid
PH_{actual} — Actual measured pH
pH_{eq} — pH of equilibrium
pH_s — pH of saturation
ppb — Parts per billion
ppm — Parts per million
PSI — Practical (Puckorius) Scaling Index
psig — Pounds per square inch gauge
PVC — Polyvinyl chloride
PWTB — Public Works Technical Bulletin
QA — Quality assurance
QC — Quality control
RCRA — Resource Conservation and Recovery Act
RFB — Request for bid
RFP — Request for proposal
RO — Reverse osmosis
RSI — Ryznar Stability Index
SDI — Silt density index
SO₃ — Sulfite

SOW — Statement of work
SRB — Sulfate-reducing bacteria
SS — Suspended solids
TA — Total alkalinity
TDS — Total dissolved solids
TSCA — Toxic Substances Control Act
TSP — Trisodium phosphate
TSS — Total suspended solids
TTA — Tolytriazole
UFC — Unified Facilities Criteria
USACE — U.S. Army Corps of Engineers
W — Watt

Acid — A compound, usually having a sour taste, which can neutralize an alkali or base; a substance that dissolves in water with a formation of hydrogen ions.

Aeration — Intimate contact between air and liquid by one of the following methods: spraying the liquid in the air; bubbling air through the liquid; or agitating the liquid to promote surface absorption of air.

Algae — Tiny plant life, usually microscopic, existing in water. They are mostly green, blue-green, or yellow-green, and are the cause of most tastes and odors in water. They create suspended solids (SS) when they grow in an industrial water system.

Alkalinity — (a) A term used to represent the content of carbonates, bicarbonates, hydroxides, and occasionally borates, silicates, and phosphates in water. (b) The capacity of water to react with hydrogen ions.

Alkalinity, total or mixed indicator (M) — A measure of the total alkalinity of water. Measured by the quantity of 0.02 normality (N) sulfuric acid required to bring water to pH of 4.4, as indicated by the change in color of methyl orange or a mixed indicator. Results are expressed in parts per million (ppm) as calcium carbonate.

Alkalinity, Phenolphthalein (P) — A measure of hydroxide ions (OH) plus one-half of the normal carbonates in water. Measured by the quantity of 0.02 normality (N) sulfuric acid required to bring the water to pH 8.2, as indicated by the de-colorization of phenolphthalein indicator. Results are expressed in parts per million (ppm) as calcium carbonate.

Alkalinity, Hydroxyl — A measure of hydroxyl ion (OH⁻) contribution to the alkalinity. This is related to the system pH and also may be referred to as “causticity.”

Backwash — The reversal of flow through a filter or an ion exchanger to wash clogging material out of the filtering medium and reduce conditions causing loss of head.

Backflow preventer — A device for a water supply pipe to prevent the backflow of water into the water supply system from the system which it supplies.

Bacteria — Simple single-cell microscopic organisms generally free of pigment. They do not require light for their life processes.

Base — An alkali or hydroxide of alkali metals and ammonia. They can neutralize acids to form salts and water. A base will ionize to form hydroxyl ions (OH^-).

Biocides — Material typically used to destroy microorganisms (also called “microbiocides”).

Biological Deposits — Water-formed deposits of organisms or the products of their life processes. Biological deposits may be composed of microscopic organisms, as in slimes, or of macroscopic organisms such as barnacles or mussels.

Blowdown — Draining a portion of water from a system to reduce the concentration of dissolved solids or to discharge accumulations of materials carried by the water.

British Thermal Unit (BTU) — The amount of heat necessary to raise the temperature of one pound of water one degree Fahrenheit ($^{\circ}\text{F}$).

Brine — A saturated solution for ion exchange regeneration, refrigeration, or cooling processes. It is usually a sodium chloride water solution for ion exchange regeneration. It may be sodium chloride water solution or calcium chloride water solution for refrigeration.

Causticity — A common term that describes hydroxyl alkalinity or the alkalinity resulting from the presence of the hydroxyl ion (OH^-).

Concentration — A measure of the amount of dissolved substances contained per unit volume of solution. This may be expressed as grains per gallon, pounds per million gallons, milligrams per liter, ppm, or percent.

Condensate — The material formed when vapor returns to the liquid state. In steam heating systems, the water condensed from steam. In air conditioning, water extracted from air by condensation on the cooling coil of a refrigeration machine.

Conductivity, Specific Conductance — The reciprocal of the resistance in ohms measured between opposite faces of a centimeter cube of an aqueous solution at a specified temperature. Electrical conductivity is expressed in micromhos (μmhos), the reciprocal of megohms. This is used as a measure of total dissolved solids (TDS).

Corrosion — The destruction of a substance, usually a metal, or its properties because

of a reaction with its (environmental) surroundings.

Cycles of Concentration (COC) — In a system in which water lost through evaporation and blowdown is replaced with makeup water, COC is the ratio of the makeup quantity to the blowdown quantity ($COC = M/B$). It is the number of times the makeup water is concentrated in the system. The COC can also be calculated by dividing either the conductivity or the chloride content of the blowdown by the conductivity or chloride content of the makeup ($COC = Cond_{bd}/Cond_{mw}$).

Deaerator — Device for removing non-condensable gases from the boiler. It may operate on the principle of either heat or vacuum.

Dealkalization — Exchange of bicarbonate for chlorides in an ion exchange process.

Deionization — Complete removal of ions from water.

Demineralization — Reduction of the mineral content of water by a physical or chemical process; removal of salts.

Disinfection — The process of killing most (but not necessarily all) of the harmful and objectionable microorganisms in a fluid by various agents such as chemicals, heat, ultraviolet light, ultrasonic waves, or radiation.

Dissolved solids — (a) Solids, usually minerals, which are present in solution. (b) The dried residue from evaporation of the filtrate after separation of suspended solids (SS).

Distribution Ratio (D.R.) — This is a measure of the vapor/liquid ratio for a given material. Extremely high and low values are generally inadvisable. A high D.R. results in either high amine losses at any vents or little availability of amine at points of initial condensation, or both. A low D.R. results in high amine losses in the blowdown.

Evaporation — The process by which water passes from a liquid state to a vapor. It is the main process by which heat is removed from a cooling tower and steam is produced in a boiler.

Feedwater — Water being applied to the feedwater heater or to the boiler, consisting of both makeup and condensate return.

Filming Amines — Chemicals that form an impervious barrier between metal and the steam condensate to prevent corrosion.

Foulants — Deposition of materials normally in suspension. This includes silt, air-scrubbed dust, microbiological residuals, reaction products from treatment, and corrosion products.

Generic Chemicals — A chemical identified and purchased by the recognized chemical name, such as the International Union of Pure and Applied Chemistry (IUPAC)

designation. These generic chemicals may be blended or used separately. They are usually much less expensive than special chemical blends developed by manufacturers under a trade name.

Hardness — (a) A characteristic of water, chiefly due to the existence of carbonate and sulfate (and occasionally the nitrite and chloride) salts of calcium, iron, and magnesium. (b) Commonly computed from the amount of calcium and magnesium in the water and expressed as equivalent calcium carbonate. (c) Causes "curding" of water when soap is used, increased consumption of soap, deposition of scale in boilers, injurious effects in some industrial processes, and sometimes objectionable taste in the water.

Hardness, Carbonate — Hardness caused by the presence of carbonates and bicarbonates of calcium and magnesium in water. Such hardness may be removed to the limit of solubility by boiling the water. This is also called temporary hardness.

Hardness, Non-Carbonate — Hardness caused by calcium and magnesium sulfates and chlorides and compounds other than carbonates which cannot be reduced materially by boiling the water. (Also called "permanent hardness".)

Hardness, Total — The sum of carbonate and non-carbonate hardness.

Hydrogen Ion Concentration — Commonly expressed as the pH value that represents the logarithm of the reciprocal of the hydrogen ion concentration.

Inhibitor (applied to corrosion) — A chemical substance or mixture that effectively decreases corrosion when added to a liquid (usually in small concentrations).

Ion — A particle, atom, or group of atoms, carrying either a positive or negative electrical charge, formed when an electrolyte is dissolved in water.

Ion Exchange — A process where water is passed through a granular material wherein ions on the granular material are replaced by ions contained in the water. For example, in the zeolite softening process, the sodium ions (Na^+) of the granular zeolite are replaced by the calcium ions (Ca^{++}) in the water to leave the water free of calcium (the cause of hardness), but with an increased amount of sodium.

Langelier Index (saturation index) — An index based on the calcium hardness, total alkalinity, total dissolved solids (TDS), temperature, and pH. It is used to classify waters by their ability to either dissolve or deposit calcium carbonate. It is the algebraic difference between the actual pH and the calculated pH of saturation (pH_s) ($\text{LI} = \text{pH} - \text{pH}_s$). A positive value indicates a scale-forming tendency, a negative value indicates a scale-dissolving tendency. It was one of the first indices developed for this purpose and was designed specifically for municipal water flowing in distribution lines.

Makeup Water — Water supplied to replace the loss in a system due to leaks, evaporation, wind drift, bleed-off, blowdown, or withdrawal.

Microbiocide — A material added to cooling tower water and chilled water to control the growth of microorganisms such as algae, bacteria, and fungi.

Micromho — An electrical unit of conductance (one-millionth of a mho), which is the reciprocal of electrical resistance.

Microorganism — A minute plant or animal in water or earth that is visible only through a microscope.

Milligrams Per Liter (mg/l) — A unit of the concentration of water or wastewater constituent. It is 0.001 gram of the constituent in 1000 milliliters (ml) of water.

Neutralizing Amines — Chemicals used to neutralize carbon dioxide in steam condensate to prevent corrosion.

Normality (N) — The concentration of a solution in relation to a normal solution. Normality is a measure of the “strength” of a given solution. The normal solution contains a specific weight of a substance per liter based on the characteristics of the substance. Thus, a half-normal solution would be expressed as 0.5 N or N/2.

Oxygen Scavenger — A chemical used to remove final traces (trace amounts) of oxygen from boiler feedwater.

pH — Logarithmic measure of hydrogen ion concentration indicating degree of acidity or alkalinity of a solution. The pH range varies from 1 to 14. Values below 7.0 indicate acidity and above 7.0 indicate alkalinity (basicity).

pH_{eq} — The pH of equilibrium. The adjusted pH value of a water based on the empirical relationship between total alkalinity and pH developed from studies of hundreds of cooling systems. Development of an empirical relationship was necessary because pH in cooling waters is often buffered, a factor which affects the relationship between pH and bicarbonate alkalinity.

pH_s — The pH of saturation. It is the pH value below which a material will go into solution (dissolve) and above which it will precipitate. It is applied to calcium carbonate in the Langelier, Ryznar, and Practical Scaling Indices. It is a function of the calcium hardness, the total alkalinity, the total dissolved solids (TDS) and the temperature. It is determined with graphs, tables, or special slide rules. This equation is useful:
$$\text{pH}_s = 12.27 - 0.00915T - \log \text{CaH} - \log \text{TA} + (\log \text{TDS})/10.$$

Phosphates — Chemicals used for corrosion control in cooling towers and deposit control in boilers. Commonly, these occur as orthophosphates or polyphosphates. The level of the active phosphate chemical is reported either as percent P₂O₅ (phosphorus pentoxide) or as PO₄ (phosphate), with these two oxides of phosphate being related by factor as follows: PO₄ = 1.34 x P₂O₅.

ppm — Parts per million; one pound of material dissolved in one million pounds of water.

Precipitate — (a) To separate a dissolved substance in the solid form by its removal from a solution. (b) The substance in solid form that has been separated from solution.

Practical Scaling Index (PSI) — A modified scaling index developed by P.R. Puckorius and J.M. Brooke to provide a better and more consistent indication of scaling conditions of cooling water. It is based on using the pH of equilibrium (pH_{eq}) rather than the actual pH, and is calculated as follows:

$$\text{PSI} = 2 \text{pH}_s - \text{pH}_{\text{eq}}$$

As with the RSI, a value less than 6.0 in natural water indicates a scale-forming tendency. A value greater than 6.0 in natural water indicates a scale-dissolving tendency.

Regeneration — That part of the operating cycle of an ion exchange process in which a specific chemical solution is passed through the ion exchange bed to prepare it for a service run (i.e., return the ion exchange bed to its original composition).

Ryznar Index (stability index) — An index classifying water as to its ability to dissolve or deposit calcium carbonate scale. It is calculated as twice the pH of saturation minus the actual pH ($\text{RI} = 2 \text{pH}_s - \text{pH}$). Although in theory an RI of 7.0 should be neutral, experiments indicate that 6.0 is a better value. A value less than 6.0 in natural water indicates a scale-forming tendency. A value greater than 6.0 in natural water indicates a scale-dissolving tendency.

Scale — Deposition on a heat transfer surface of normally soluble salts. Scale is usually crystalline and dense, frequently laminated, and occasionally columnar in structure.

Shock Feed — The process of adding one or more water treatment chemicals in one application rather than gradually.

Slime — Biological growths that may accumulate to the extent that they foul equipment.

Sludge — A water-formed deposit that will settle, and may include all suspended solids (SS) carried by water. Sludge is commonly formed in boilers where it may be baked into place and become hard and adherent.

Softening Water — The process of removing from water the mineral substances that produce a condition called hardness. There are two softening processes in general use: chemical precipitation (lime and lime/soda softening) and the zeolite ion exchange process.

Solids, Suspended (SS) — All matter in water that is not dissolved and can be removed with filtration.

Solids, Dissolved — The total concentration of all substances in a filtered solution which exist as solids after the liquid is completely evaporated from the solution.

Solids, Total — The sum of the suspended and dissolved matter (solids).

Zeolite — Natural minerals as well as synthetic resins used for ion exchange.

CANCELLED

APPENDIX A

REFERENCES

GOVERNMENT PUBLICATIONS:

1. Code of Federal Regulations (CFR)
Title 21 CFR Part 173.310Boiler Water Additives
Title 29 CFR Part 1910.1200Hazard Communication
2. Department of the Army

AR 420-49 Army Regulation (AR): Utility Service, 28 Apr 1997
TM 5-650 Technical Manual (TM): Central Boiler Plant, Oct 1989
TM 5-660 Maintenance and Operation of Water Supply, Treatment, and
Distribution Systems.
PWTB 420-49-23 Public Works Technical Bulletin (PWTB): Scope of Work, A
Contracting Guide for Writing
PWTB 420-49-5 Public Works Technical Bulletin: Industrial Water Treatment
Procedures, 2 Feb 1998
3. Department of the Air Force

AFR 91-40 Industrial Water Treatment
AFP 91-41 Industrial Water Treatment Procedures
AFI 32-1054 Corrosion Control
4. Department of the Navy

Navy Facilities Engineering Command Maintenance and Operation Manuals
NAVFAC MO-225Industrial Water Treatment
NAVFACINST 11300.37Energy and Utilities Policy Manual
NAVSEA S9086-GX-STM-020, Section 220, Volume 2, Boiler Water/Feedwater Test
and Treatment
PACNAVFACENGCOM P200, Shore-to-Ship Steam and Feedwater Manual for Naval
Facilities
5. Department of Defense

MIL-HDBK-1164 Military Handbook:
Operations and Maintenance of Water Supply Systems, 3 March
1997

6. Federal Specifications

A-A-694, Sodium Chloride, Technical (Water Conditioning Grade)
A-A-12624, Antifreeze, Multi-Engine Type
A-A-55821, Calcium Hydroxide, Technical
A-A-59503, Nitrogen, Technical
O-C-114, Calcium Hypochlorite, Technical
O-C-940, Cyclohexylamine, Technical
O-M-575, Morpholine, Technical
O-S-571, Sodium Carbonate, Anhydrous, Technical
O-S-602, Sodium Hypochlorite Solution
O-S-605, Sodium Silicate Solution
O-S-634, Sodium Nitrate, Technical (Nitrate of Soda)
O-S-635, Sodium Polyphosphates, Technical
O-S-639, Sodium Phosphate, Dibasic, Anhydrous, Technical
O-S-642, Sodium Phosphate, Tribasic, Anhydrous; Dodecahydrate; and Monohydrate; Technical
O-S-650, Sodium Sulfite, Anhydrous, Technical
MIL-B-24155, Boiler Scale Removing Compound
MIL-D-16791, Detergents, General Purpose (Liquid, Nonionic)
MIL-I-17433, Inhibitor, Hydrochloric Acid, Descaling and Pickling Solutions

NONGOVERNMENT PUBLICATIONS:

1. National Association of Corrosion Engineers (NACE)
TPC Publication 1; Cooling Water Treatment Manual, 1990,
ISBN 0-915567-69-5
2. American Society for Testing and Materials (ASTM) - Performance Test Codes
Annual Book of Standards, May 1999, Water & Environmental Technologies, Volume
11.01, Water (1)
3. ASTM E 1146, Specification for Muriatic Acid (Technical Grade Hydrochloric Acid)
4. ASTM Standard Test Method: Corrosivity of Water in the Absence of Heat Transfer
(Weight Loss Methods), D2688-94(1999)e1.
5. American Society of Mechanical Engineers (ASME)
ASME Consensus on Operating Practices for the Control of Feedwater and Boiler
Water Chemistry in Modern Industrial Boilers, 1994, CRTD-Vol.34, ISBN 0-791812-04-9
6. ASME PTC 19.11, Steam and Water Sampling, Conditioning, and Analysis in the
Power Cycle
7. American Boiler Manufacturers Association (ABMA) – Boiler Water Limits and
Achievable Steam Purity for Watertube Boilers, Publication No. 401

APPENDIX B

PRACTICAL (PUCKORIUS) SCALING INDEX (PSI)

B-1 DEVELOPMENT OF PSI

1- have been used to predict the tendency of water to form or dissolve scale. Both the LSI and the RSI are based on the pH of saturation (pH_s) for calcium carbonate under a specific water condition. Both indices use the measured pH of the cooling water.

1. $LSI = (\text{measured pH}) - (pH_s)$. A positive value indicates scale; a negative value indicates no scale.

2. $RSI = (2 pH_s) - (\text{measured pH})$. A value below 6 means scale; above 6 means no scale.

B-1.2 **PSI.** Use of LSI and RSI sometimes gave inconsistent or even conflicting results. Based on a long-term study relative to calcium carbonate scale formation when applying both the LSI and RSI, P.R. Puckorius and J.M. Brooke developed a new index that gives much better and more consistent indication of cooling water-scaling conditions. The new index, the Practical Scaling Index (PSI), sometimes called the Puckorius Scaling Index, is based on correcting the system pH to match the total alkalinity of the water being evaluated. This is necessary because the pH is often buffered, causing the pH to relate incorrectly to the bicarbonate alkalinity, one of the factors in the pH_s calculation.

B-2 **CALCULATING PSI.** To calculate the PSI, the pH_s is determined in the same manner as for the LSI and RSI. An adjusted or equilibrium pH (pH_{eq}) is obtained from a total alkalinity/pH chart (Table B-7). The value of pH_{eq} rather than measured pH is used in the following formula:

$$PSI = (2 pH_s) - (pH_{eq})$$

A value below 6 means scale; above 6 means no scale.

B-2.1 **Calculating pH_s .** The pH_s can be determined from the relationship between various characteristics of water. The following factors and formula are used in determining the pH_s :

a. Factors needed to calculate pH_s :

A = TDS (ppm) (Table B-1)

B = Temperature ($^{\circ}F$) (Table B-2)

C = Calcium hardness (ppm as $CaCO_3$) (Table B-3)

D = Total alkalinity (ppm as $CaCO_3$) (Tables B-5 and B-6)

Table B-1. Factor "A" for TDS

TDS (ppm)	Value of "A"
50	0.07
75	0.08
100	0.10
150	0.11
200	0.13
300	0.14
400	0.16
600	0.18
800	0.19
1000	0.20
1500	0.21
2000	0.22
2500	0.23
3000	0.24
4000	0.25
5000	0.26

Table B-2. Factor "B" for Temperature*

°F Tens	°F, Units				
	0	2	4	6	8
30	--	2.60	2.57	2.54	2.51
40	2.48	2.45	2.43	2.40	2.37
50	2.34	2.31	2.28	2.25	2.22
60	2.20	2.17	2.14	2.11	2.09
70	2.06	2.04	2.03	2.00	1.97
80	1.95	1.92	1.90	1.88	1.86
90	1.84	1.82	1.80	1.78	1.76
100	1.74	1.72	1.71	1.69	1.67
110	1.65	1.64	1.62	1.60	1.58
120	1.57	1.55	1.53	1.51	1.50
130	1.48	1.46	1.44	1.43	1.41
140	1.40	1.38	1.37	1.35	1.34
150	1.32	1.31	1.29	1.28	1.27
160	1.26	1.24	1.23	1.22	1.21
170	1.19	1.18	1.17	1.16	--

Find value of "B" in appropriate units column. Example: For water at 86 °F, B = 1.88

b. $pH_s = 9.30 + A + B - (C + D)$

c. EXAMPLE B-1:

Water from a cooling tower has a TDS of 1000 ppm, calcium hardness of 500 ppm (as CaCO₃), total alkalinity of 100 ppm (as CaCO₃) and measured pH of 8.2. The hottest temperature on the waterside of the heat exchanger is 120 °F.

$$pH_s = 9.30 + A + B - (C + D)$$

$$pH_s = 9.30 + 0.20 + 1.57 - (2.30 + 2.00) = 6.77$$

B-2.2 Calculating pH_{eq}

- a. Puckorius and Brooke developed the improved relationship between total alkalinity and pH after studying hundreds of cooling systems over some 20 years. The pH_{eq} values shown in Table B-7 for the total alkalinity measured in cooling water are used for calculating the PSI.

**Table B-3. Factor "C" for Calcium Hardness (as ppm CaCO₃)
Zero to 200 ppm**

ppm Tens	ppm, Units									
	0	1	2	3	4	5	6	7	8	9
0	--	--	--	0.08	0.20	0.30	0.38	0.45	0.51	0.56
10	0.60	0.64	0.68	0.72	0.75	0.78	0.81	0.83	0.86	0.88
20	0.90	0.92	0.94	0.95	0.98	1.01	1.02	1.03	1.05	1.06
30	1.06	1.09	1.11	1.12	1.13	1.15	1.16	1.17	1.18	1.19
40	1.20	1.21	1.23	1.25	1.25	1.25	1.26	1.27	1.28	1.29
50	1.30	1.31	1.32	1.33	1.34	1.34	1.35	1.36	1.37	1.37
60	1.38	1.39	1.39	1.40	1.41	1.42	1.42	1.43	1.43	1.44
70	1.45	1.45	1.46	1.47	1.47	1.48	1.48	1.49	1.49	1.50
80	1.51	1.51	1.52	1.53	1.53	1.53	1.54	1.54	1.55	1.55
90	1.56	1.56	1.57	1.57	1.58	1.58	1.58	1.59	1.59	1.60
100	1.60	1.61	1.61	1.61	1.62	1.62	1.63	1.63	1.64	1.64
110	1.64	1.65	1.65	1.65	1.65	1.66	1.67	1.67	1.67	1.68
120	1.68	1.68	1.69	1.70	1.70	1.70	1.70	1.71	1.71	1.71
130	1.72	1.72	1.72	1.73	1.73	1.73	1.74	1.74	1.74	1.75
140	1.75	1.75	1.75	1.76	1.76	1.77	1.77	1.77	1.77	1.78
150	1.78	1.78	1.78	1.80	1.80	1.80	1.80	1.80	1.80	1.80
160	1.81	1.81	1.81	1.81	1.82	1.82	1.82	1.82	1.83	1.83
170	1.83	1.84	1.84	1.84	1.84	1.85	1.85	1.85	1.85	1.85
180	1.86	1.86	1.86	1.86	1.87	1.87	1.87	1.87	1.88	1.88
190	1.88	1.88	1.89	1.89	1.89	1.89	1.89	1.90	1.90	1.90
200	1.90	1.91	1.91	1.91	1.91	1.91	1.92	1.92	1.92	1.92

**Table B-4. Factor "C" For Calcium Hardness (as ppm CaCO₃)
200 to 990 ppm**

ppm Hundreds	ppm, Units									
	0	10	20	30	40	50	60	70	80	90
200	--	1.92	1.94	1.96	1.98	2.00	2.02	2.03	2.05	2.06
300	2.08	2.09	2.11	2.12	2.13	2.15	2.16	2.17	2.18	2.19
400	2.20	2.21	2.23	2.25	2.25	2.26	2.26	2.27	2.28	2.29
500	2.30	2.31	2.32	2.33	2.34	2.34	2.35	2.36	2.37	2.37
600	2.38	2.39	2.39	2.40	2.41	2.42	2.42	2.43	2.43	2.44
700	2.45	2.45	2.45	2.47	2.47	2.48	2.48	2.49	2.49	2.50
800	2.51	2.51	2.52	2.52	2.53	2.53	2.54	2.54	2.55	2.55
900	2.56	2.56	2.56	2.57	2.57	2.58	2.58	2.59	2.59	2.60

Use Table B-3 to find values of "C" for 3 to 209 ppm calcium hardness, and Table B-4 for 210 to 990 ppm. Example: For 144 ppm calcium hardness (as CaCO₃), C = 1.76

**Table B-5. Factor "D" for Alkalinity (as ppm CaCO₃)
Zero to 200 ppm**

ppm Tens	ppm, Units									
	0	1	2	3	4	5	6	7	8	9
0	--	0.00	0.30	0.48	0.60	0.70	0.78	0.85	0.90	0.95
10	1.00	1.04	1.08	1.11	1.15	1.18	1.20	1.23	1.26	1.29
20	1.30	1.32	1.34	1.36	1.38	1.40	1.42	1.43	1.45	1.46
30	1.48	1.49	1.51	1.52	1.53	1.54	1.56	1.57	1.58	1.59
40	1.60	1.61	1.62	1.63	1.64	1.65	1.67	1.67	1.68	1.69
50	1.70	1.71	1.72	1.72	1.73	1.74	1.75	1.76	1.76	1.77
60	1.78	1.79	1.80	1.81	1.81	1.82	1.83	1.83	1.83	1.84
70	1.85	1.85	1.86	1.86	1.87	1.88	1.88	1.89	1.89	1.90
80	1.90	1.91	1.91	1.92	1.92	1.93	1.93	1.94	1.94	1.95
90	1.95	1.96	1.96	1.97	1.97	1.98	1.98	1.99	1.99	2.00
100	2.00	2.00	2.01	2.01	2.02	2.02	2.03	2.03	2.03	2.04
110	2.04	2.05	2.05	2.05	2.05	2.06	2.06	2.07	2.07	2.08
120	2.08	2.08	2.09	2.09	2.09	2.10	2.10	2.10	2.11	2.11
130	2.11	2.12	2.12	2.12	2.13	2.13	2.13	2.14	2.14	2.14
140	2.14	2.15	2.15	2.16	2.16	2.16	2.16	2.17	2.17	2.17
150	2.18	2.18	2.18	2.18	2.19	2.19	2.19	2.20	2.20	2.20
160	2.20	2.21	2.21	2.21	2.21	2.22	2.22	2.23	2.23	2.23
170	2.23	2.23	2.23	2.24	2.24	2.24	2.24	2.25	2.25	2.26
180	2.26	2.26	2.26	2.26	2.26	2.27	2.27	2.27	2.27	2.28
190	2.28	2.28	2.28	2.29	2.29	2.29	2.29	2.29	2.30	2.30
200	2.30	2.30	2.30	2.31	2.31	2.31	2.31	2.32	2.32	2.32

**Table B-6. Factor "D" for Alkalinity (as ppm CaCO₃)
200 to 890 ppm**

ppm 100s	ppm, Units									
	0	10	20	30	40	50	60	70	80	90
200	--	2.32	2.34	2.36	2.38	2.40	2.42	2.43	2.45	2.45
300	2.48	2.49	2.51	2.52	2.53	2.54	2.56	2.57	2.58	2.59
400	2.60	2.61	2.62	2.63	2.64	2.65	2.66	2.67	2.68	2.69
500	2.70	2.71	2.72	2.72	2.73	2.74	2.75	2.76	2.76	2.77
600	2.78	2.79	2.80	2.81	2.81	2.81	2.82	2.83	2.83	2.84
700	2.85	2.85	2.86	2.86	2.87	2.88	2.88	2.89	2.89	2.90
800	2.90	2.91	2.91	2.92	2.92	2.93	2.93	2.94	2.94	2.95

Use Table B-5 for values of "D" for 1 to 209 ppm, and use Table B-6 for 210 to 990 ppm.

Table B-7. pH_{eq} Determined from Total Alkalinity

Alkalinity ppm Hundreds	Alkalinity ppm CaCO ₃ , Tens									
	0	10	20	30	40	50	60	70	80	90
0	--	6.00	6.45	6.70	6.89	7.03	7.14	7.24	7.33	7.40
100	7.47	7.53	7.59	7.64	7.68	7.73	7.77	7.81	7.84	7.88
200	7.91	7.94	7.97	8.00	8.03	8.05	8.08	8.10	8.15	8.15
300	8.17	8.19	8.21	8.23	8.25	8.27	8.29	8.30	8.32	8.34
400	8.35	8.37	8.38	8.40	8.41	8.43	8.44	8.46	8.47	8.48
500	8.49	8.51	8.52	8.53	8.54	8.56	8.57	8.58	8.59	8.60
600	8.61	8.62	8.63	8.64	8.65	8.66	8.67	8.67	8.68	8.70
700	8.71	8.72	8.73	8.74	8.74	8.75	8.76	8.77	8.78	8.79
800	8.79	8.80	8.81	8.82	8.82	8.83	8.84	8.85	8.85	8.86
900	8.87	8.88	8.88	8.89	8.90	8.90	8.91	8.92	8.92	8.93

b. EXAMPLE B-2:

Water from a cooling tower has a total alkalinity of 100 ppm (as CaCO₃) and a measured pH of 8.2 (same as example B-1). From Table B-7, the pH_{eq} is 7.47.

$$\begin{aligned} \text{PSI} &= (2\text{pH}_s) - (\text{pH}_{\text{eq}}) = 2(6.77) - 7.47 \\ &= 13.54 - 7.47 = 6.07 \end{aligned}$$

$$\begin{aligned} \text{RSI} &= (2\text{pH}_s) - (\text{measured pH}) = 13.54 - 8.2 \\ &= 5.34 \end{aligned}$$

$$\begin{aligned} \text{LSI} &= (\text{measured pH}) - (\text{pH}_s) = 8.2 - 6.77 \\ &= +1.43 \end{aligned}$$

c. The pH_{eq} may also be calculated as follows:

$$\text{pH}_{\text{eq}} = 1.485 \log \text{TA} + 4.54$$

where TA denotes total alkalinity.

B-2.3 Scaling Severity Keyed to Indices

- a. Commonly accepted interpretation of the previously described indices is shown in Table B-8.
- b. In Example B-2, the LSI predicted that the water would exhibit a severe to very severe scaling tendency. The RSI predicted that the water would exhibit a moderate to severe scaling tendency. The PSI predicted that the water is stable with no tendency to form or dissolve scale.

Table B-8. Scaling Indices vs. Condition

LSI	PSI/RSI	Condition
3.0	3.0	Extremely severe scaling
2.0	4.0	Very severe scaling
1.0	5.0	Severe scaling
0.5	5.5	Moderate scaling
0.2	5.8	Slight scaling
0.0	6.0	Stable water, no scaling, no tendency to dissolve scale
-0.2	6.5	No scaling, very slight tendency to dissolve scale
-0.5	7.0	No scaling, slight tendency to dissolve scale
-1.0	8.0	No scaling, moderate tendency to dissolve scale
-2.0	9.0	No scaling, strong tendency to dissolve scale
-3.0	10.0	No scaling, very strong tendency to dissolve scale

CANCELLED

APPENDIX C

CORROSION TESTING WITH COUPON-TYPE TEST SPECIMENS

C-1 **PURPOSE.** Corrosion tests with metal coupon test specimens are used to determine how corrosive water is to a specific metal. Coupon test specimens are particularly useful in monitoring the effectiveness of chemical corrosion control programs. The extent of both general and localized corrosion can be determined. Also, examination of the specimens as they are removed from the system can provide information regarding deposit accumulation or microbiological slime growth. Corrosion test coupons are usually used as corrosion test specimens for open and closed cooling systems, closed hot water systems, and domestic water systems. See ASTM Standard Test Method: Corrosivity of Water in the Absence of Heat Transfer (Weight Loss Methods), D2688-94(1999)e1.

C-2 **APPLICATION**

C-2.1 **Description of Coupons.** The coupons are metal tags of various sizes. Generally, low-carbon steel specimens are used as the most susceptible metal to corrosion; however, copper, stainless steel, brass, and other metals are available for special studies. The specimens are prepared and cleaned to ensure uniformity and weighed. The general corrosion rate is determined after exposure. Coupons are cleaned and re-weighed. Corrosion rates are calculated based on the weight loss, time of exposure, and the area and specific gravity of the coupon, and are expressed in mils per year (mpy).

C-2.2 **Test Conditions.** Since the goal of the corrosion testing program is to provide information regarding conditions within the system, the corrosion coupons should be exposed to conditions that reflect those in the system as a whole. Water velocity and temperature will significantly affect the corrosion rate. Corrosion rates can be significantly increased when velocity is either too low or too high. For best results, water velocity flowing by the test specimen should be 0.90 to 1.5 meters per second (3 to 5 feet per second), and both adjustable and measurable. Temperature also affects the rate of corrosion, with higher temperatures usually increasing corrosion; therefore, in cooling water systems both the cold supply water and the hot return water should be evaluated with corrosion coupons. When only one test rack can be installed, the warm water return at the tower should be used to provide an average hot water temperature.

C-2.3 **Test Length.** Expose corrosion coupons for a minimum of 30 calendar days and a maximum of 90 calendar days, except for special tests. Although spot checks are useful, a regular schedule will determine trends and recognize changes within the system. When corrosion test specimens of different metals are installed in the same corrosion test rack, the more noble or resistant metal should be downstream of less resistant metals.

C-2.4 **Receipt of Specimens.** Specimens are shipped in vapor-inhibited bags. Do not remove them from the bags until the specimen is to be installed. The vapor-

inhibited bags should be saved for returning exposed specimens. Do not handle specimens directly with fingers since fingerprints can initiate corrosion sites. Record on the appropriate form the exact location and date of installation.

C-2.5 Return of Specimens. After the specimens have been exposed for the selected time (30, 60, or 90 calendar days), carefully remove, air dry without disturbing any deposits, and return them to the original vapor-inhibited bag. Record date of removal on the appropriate form. Then send the exposed specimens and completed forms to the supplier for evaluation. After evaluation, the results are presented and interpreted in a written report.

C-3 INSTALLATION OF COUPON-TYPE TEST SPECIMENS

C-3.1 Method of Installation. Coupons are usually installed in pipe "tees" by means of corrosion test racks which include a 25-millimeter (1-inch) pipe plug, drilled and tapped to accept a plastic or phenolic rod with a nylon nut and bolt for attaching the coupon to the rod. A bypass arrangement with 25-millimeter piping, as shown in Figure C-1, will facilitate installation and removal as well as allow the use of multiple specimens. Polyvinyl chloride (PVC) will eliminate electrical effects but cannot be used for hot condensate. A corrosion test rack may be purchased or constructed on site.

C-3.2 Placement of Coupons. For steam and condensate return lines, install coupons in any convenient location where there are tees. When using a bypass arrangement, condensate from the outlet is piped back into the system. Bypasses should be constructed of iron pipe and fittings and installed only where there is sufficient pressure differential to ensure a continuous flow through the bypass. Direction of flow should be as shown in Figure C-1 to minimize turbulence around the corrosion test specimen and ensure that the test rack remains full of water.

**FIGURE C-1. Bypass Piping for Corrosion Testing
Cooling Water and Condensate Systems**

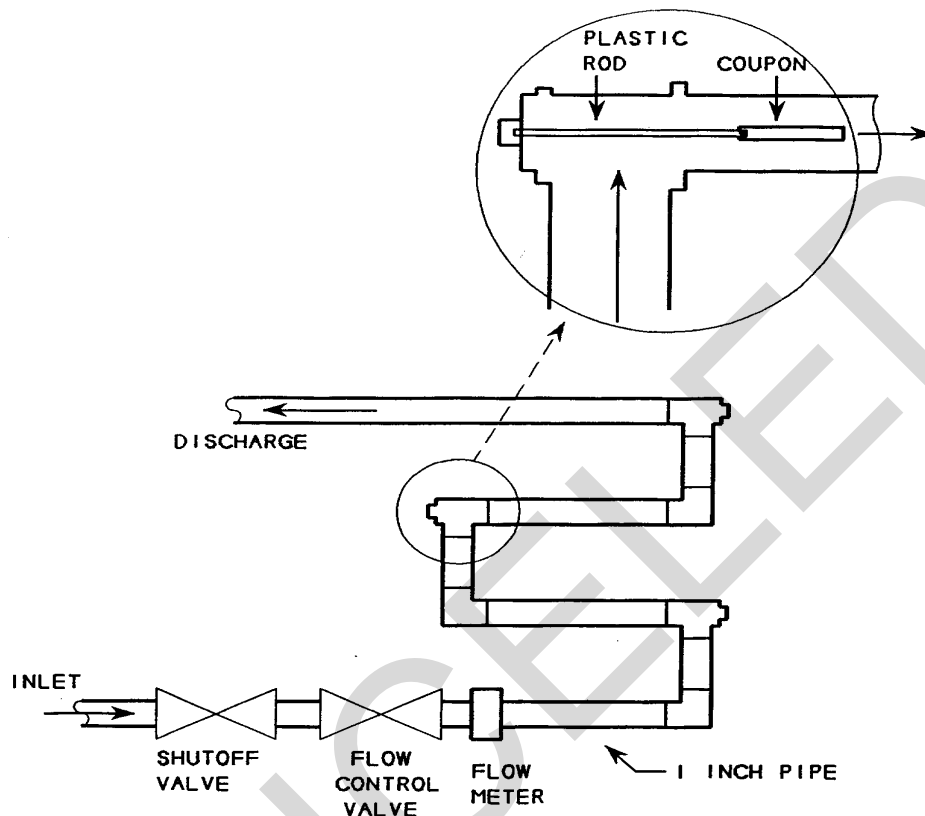

C-3.3
checked:

Test Methods. To ensure proper results, the following points should be

1. Flow through the corrosion test rack must be continuous and measurable. Use flow meters for all installations. When a flow meter does not exist, flow must be measured by timing how long it takes to fill a container of known volume such as a 20-liter (5-gallon) pail.
2. Normally, water velocity through the corrosion test rack should be 0.90 to 1.5 meters per second (3 to 5 feet per second). The velocities in meters per second (feet per second) for given liters per second (gallons-per-minute) flows for various pipe sizes are shown in Table C-1.

Table C-1. Flow Rate

Velocity m/s (ft/sec)	Line Size		
	25 mm (1 in)	32 mm (1.25 in)	38 mm (1.5 in)
0.91 (3)	0.5 l/sec (8 gpm)	0.9 l/sec (14 gpm)	1.2 l/sec (19 gpm)
1.5 (5)	0.8 l/sec (13 gpm)	1.5 l/sec (23 gpm)	1.9 l/sec (30 gpm)

NOTE: Corrosion coupons and coupon racks can be obtained from the following suppliers, among others:

1. Water treatment service companies.
2. Water treatment equipment companies.
3. Metals Samples Company
152 Metals Samples Road
P.O. Box 8, Munford
Alabama 36268
(205)358-4202
4. Advantage Controls, Inc.
4700 Harold Arbitz Drive
Muskogee, Oklahoma 74403
(800)743-7431

APPENDIX D

CORROSION TESTING WITH TEST NIPPLE ASSEMBLY

D-1 **PURPOSE.** Corrosion tests with metal test specimens are used to determine how corrosive water is toward a specific metal. Although test nipple assemblies (referred to as "tester") can be used in many applications, they are used on military installations to evaluate corrosion problems in steam condensate return systems. See ASTM Standard Test Method: Corrosivity of Water in the Absence of Heat Transfer, D2688-94(1999)e1.

D-2 **APPLICATION**

D-2.1 **Tester Specifications.** The tester consists of three 76-millimeter by 19-millimeter (3-inch by 0.75-inch) National Pipe Thread (NPT) nipples, connected by two couplings (see Figure D-1). The center nipple contains short inserts machined from steel tubing similar to the steel pipe in the condensate system. The outside diameter of the inserts is approximately the same as the inside diameter of the center 19-millimeter machined coupling. The two end nipples of the tester are installed between two unions in such a manner that condensate will constantly flow through the tester. See paragraph D-3 for detailed installation instructions.

D-2.2 **Likelihood of Corrosion.** Serious corrosion is more likely in large-area heating systems that have long return lines. More concentrated systems, such as laundries and low-pressure closed systems in which there is very little feedwater makeup, generally experience much less condensate return line corrosion.

D-2.3 **Scale of Testing.** If the test points are well chosen, information obtained from one or two condensate return systems on an installation or base is generally sufficient to serve as a survey of the entire facility. One or more testers would be installed in the largest area heating system and another in a smaller system. The testers should be installed at points where maintenance work has been required due to corrosion.

D-2.4 **Receipt of Tester.** The supplier provides the tester complete and ready for installation. An appropriate data form is also provided with the tester. This form must be completed by the user for correct interpretation of corrosion that may occur on the tester inserts. The user is required to draw a picture to show how and where the tester was installed.

D-2.5 **Removal of Tester.** At the end of the test period, the tester is removed. The tester is rinsed internally for several seconds with very hot water, drained, and immediately capped on both ends with the plastic caps that had been supplied with the tester.

D-2.6 **Condensate Sample.** A condensate sample is collected from the area where the tester was installed and returned to the supplier at the same time as the tester.

D-2.7 **Return of Tester.** The tester is packed in any convenient package, enclosing the completed data sheet, and returned to the supplier.

D-3 **INSTALLATION OF TESTER**

D-3.1 **Location of Tester.** Install the tester in a horizontal return line. If morpholine treatment is being used, install the tester in a building near the end of the steam main where the treatment would be expected to be least effective. If a mixture of morpholine and cyclohexylamine is used, install a tester at each end of the system.

D-3.2 **Test Conditions.** Ensure representative sampling of the condensate by the tester. Do not install the tester to receive drips from steam mains. Drips may be less corrosive (less acidic) than the average condensate.

D-3.3 **Placement of Tester.** Place the tester horizontally to receive the condensate from a hot water generator or space heater that is drained by a 19-millimeter trap. Do not install the tester downstream from a pump in the condensate line. Avoid bypasses and do not overload the tester with condensate from several traps. Enough condensate should flow to the tester to fill it at least halfway.

D-3.4 **Method of Installation.** To install the tester, remove a section of the pipe from the condensate return system. Replace the section of pipe with the tester, unions, and any additional pipe needed to complete the installation.

D-3.5 **Length of Test.** Leave the tester in place for about 90 days. Record the dates the tester was installed and removed.

Figure D-1. Condensate Corrosion Tester



CANCELLED

APPENDIX E

TESTING INDUSTRIAL WATER SYSTEM SAMPLES

E-1 **PURPOSE.** Testing of industrial water is performed to determine the amount of treatment chemicals so dosage levels can be properly regulated. These tests are a means by which reliable water system operations are ensured, with respect to the impact of water quality on system equipment and operation. Testing may be conducted in a permanent field laboratory or at the plant or site location using portable test kits.

E-2 **USE OF PORTABLE TEST KITS.** Portable test kits are primarily for use at the site location where the sample is taken when an immediate test result is needed. They can also be used in the permanent field laboratory. Test procedures are provided with the test kit. For tests that can be conducted either in the field laboratory or with a portable test kit, use field laboratory test procedures for best results. The water analyst should periodically check the results of the portable test kit against the field laboratory test on the same water sample (i.e., perform a check sample analysis). Portable test kits are available from a number of commercial sources.

E-3 **LABORATORY PROCEDURES AND TESTING TECHNIQUES.** The achievement of accurate test results is dependent on the use of proper reagents and on following good, basic laboratory procedures and techniques.

E-3.1 **Management of Reagents**

E-3.1.1 **Supply.** The chemical reagents stored at each field laboratory should be specific for the tests that are performed. The amount on hand should be adjusted to ensure the supply is fresh. Reagent containers must be kept tightly closed when not in use and stored in a cool place. Except for reagents with a specified shorter shelf-life, liquid reagents should be consumed within one year and dry reagents consumed within 2 years. All reagents should be properly marked with appropriate warning labels, batch control numbers, and date packaged or discard date clearly marked.

E-3.1.2 **Storage.** It is necessary to keep everything in good order at all times. Have a place for everything and keep everything in its place. Be sure all bottles are properly labeled and avoid mixing bottles. All bottles should be kept tightly closed. Keep any reserve stock of solutions and reagents in a cool, dark place.

E-3.2 **Apparatus.** The apparatus are precision instruments capable of very fine measurements. Measure carefully, as the results will be "off" if improper sample amounts are taken, incorrect volumes of solution are added, the burette is not read correctly, or if the methods prescribed are not performed exactly as written.

Each water analysis requires specific chemical apparatus. These are scientific instruments and are to be treated as such. The apparatus will last indefinitely if given proper care. All equipment and apparatus, especially glassware, should be kept clean. Unless this is done, the tests will not be reliable and errors will be introduced. Thoroughly rinse and air-dry all glassware immediately after use. If color apparatus is employed, do not expose to heat or direct sunlight. If any liquid is spilled on any of the equipment or apparatus, wipe off at once and dry.

E-3.3 Testing Procedures. The suspended matter or sludge will generally settle to the bottom if the sample is allowed to stand before testing. The clear water can then be used for the tests, making it unnecessary to filter (except for specific tests). Theoretically, all water analyses should be made at 25 °C (77 °F); however, no appreciable error will be introduced if the test is made between 20 to 30 °C (68 and 86 °F). In general, the shorter the time between the collection and analysis of the sample, the more reliable the results will be.

When the water sample color interferes with the analysis, it may be necessary to filter the sample through activated charcoal. NOTE: This does not apply to the sulfite and nitrite tests.

APPENDIX F

NONPROPRIETARY INDUSTRIAL WATER TREATMENT CHEMICALS

1. ANTIFOAM, polyamide or polyhydric alcohol
Use: Prevent foaming carryover in steam boilers
Federal Specification: None
Package/ National Stock Number (NSN): 5-gal can, NSN:
6850-01-181-0160
2. ANTIFREEZE, inhibited, 87.6% ethylene glycol, 149 °C (300 °F) minimum boiling point, nonflammable, protection to -51 °C (-60 °F)
Use: Closed hot and chilled water systems
Federal Specification: A-A-52624, *Antifreeze, Multi-Engine Type*
Package/NSN: 1-gal can, NSN: 6850-00-181-7929
 5-gal can, NSN: 6850-00-181-7933
 55-gal drum, NSN: 6850-00-181-7940
3. BIOCIDES, active ingredient, methylenebis (thiocyanate), 10% in water solution.
Use: Cooling towers with pH less than 7.5
Federal Specification: None
Package/NSN: 5-gal, NSN: 6850-01-191-5033
4. BIOCIDES, active ingredient 20%
2,2-Dibromo-3-nitripropionamide, 80% inert ingredients
Use: Cooling towers with pH less than 7.5
Federal Specification: None
Package/NSN: 5-gal can, NSN: 6850-01-191-5034
5. BIOCIDES, active ingredients 10% dodecylguanidine hydrochloride, 4% bis(tri-n-butyltin)oxide
Use: Cooling towers with and pH less than 7.5
Federal Specification: None
Package/NSN: 5-gal can, NSN: 6850-01-194-8306
6. BIOCIDES, active ingredients 20%
n-alkyldimethylbenzylammonium chloride, and 3 to 4%
bis(tri-n-butyltin)oxide, pH greater than 10.5
Use: Cooling towers with pH greater than 7.5
Federal Specification: None
Package/NSN: 5-gal can, NSN: 6840-01-189-8139

7. BIOCIDES, active ingredient 60% poly[oxyethylene(dimethyliminio)ethylene-(dimethyliminio)ethylene dichloride]
Use: Cooling towers with pH greater than 7.5
Federal Specification: None
Package/NSN: 5-gal can, NSN: 6840-01-190-2551
8. BIOCIDES, active ingredients 60% consisting of 14 to 15% disodium cyanodithioimidocarbonate and 20 to 21% potassium n-methyldithiocarbamate
Use: Cooling towers with pH greater than 7.5
Federal Specification: None
Package/NSN: 5-gal can, NSN: 6840-01-198-7945
9. BIOCIDES, active ingredient 96 to 98%
1-bromo-3-chloro-5,5-dimethylhydantoin, granular
Use: Remote cooling towers with any pH
Federal Specification: None
Package/NSN: 35-lb can, NSN: 6840-01-185-7455
10. BORAX (see sodium nitrite-borax blend, item 49)
11. CALCIUM HYDROXIDE (slaked lime) ($\text{Ca}[\text{OH}]_2$) technical, powder, 90% minimum by weight
Use: Lime-soda ash water softening
Federal Specification: A-A-55821, *Calcium Hydroxide, Technical*
Package/NSN: 50-lb bag, NSN: 6810-00-656-1091
12. CALCIUM HYPOCHLORITE, ($\text{Ca}[\text{OCl}]_2$) technical, granular, 65% chlorine by weight
Use: Algae control in cooling towers and disinfectant in treatment for Legionnaire's Disease
Federal Specification: O-C-114, *Calcium Hypochlorite, Technical*
Package/NSN: 5-lb can, NSN: 6810-00-238-8115
 100-lb drum, NSN: 6810-00-255-0472
13. CAUSTIC SODA (see sodium hydroxide, item 43)

14. CYCLOHEXYLAMINE, boiler feedwater compound, neutralizing amine, all drums to bear adequate caution labels to protect against fire, poison and caustic burn hazards
Use: Control corrosion by CO₂ in steam condensate lines
Federal Specification: O-C-940, *Cyclohexylamine, Technical*
Package/NSN:
60%, 400-lb drum, NSN: 6810-01-074-5201
60%, 15-gal drum, NSN: 6810-00-515-2235
98%, 15-gal drum, NSN: 6810-00-530-4695
98%, 55-gal drum, NSN: 6810-00-805-9798
15. DIETHYLAMINOETHANOL (DEAE), 100% solution
Use: Control corrosion by CO₂ in steam condensate lines
Federal Specification: None
Package/NSN: 55-gal drum, NSN: 6810-949-8331
16. DIPHOSPHONIC ACID (HEDP), 1-hydroxyethylidene 1,1-diphosphonic acid, active ingredient 58 to 62%, specific gravity 1.45 at 20 °C/15 °C (68 °F/59 °F), pH of 1% solution less than 2.0
Use: Inhibitor to prevent formation of calcium and magnesium scale in cooling water applications
Federal Specification: None
Package/NSN: 5-gal can, NSN: 6850-01-190-5509
55-gal drum, NSN: 6850-01-206-4601
17. ETHYLENE GLYCOL (see antifreeze, item 2)
18. HEDP (see diphosphonic acid, item 16)
19. HYDROCHLORIC ACID (muriatic), (HCl), technical, 31.45% minimum by weight, 20° Baumé (Bé)
Use: Iron-fouled ion exchange material regeneration applications
Federal Specification: ASTM E 1146, *Specification for Muriatic Acid (Technical Grade Hydrochloric Acid)*
Package/NSN: 96-oz, NSN: 6810-00-222-9641
5-gal can, NSN: 6810-00-236-5665
15-gal carboy, NSN: 6810-00-823-8010

20. MORPHOLINE, boiler feedwater compound, all drums to bear adequate caution labels to protect against fire, poison, and caustic burn hazards
Use: Control corrosion by CO₂ in steam condensate lines
Federal Specification: O-M-575, *Morpholine, Technical*
Package/NSN:
40% 5-gal can, NSN: 6810-00-419-4298
40% 55-gal drum, NSN: 6810-00-559-9889
91% 55-gal drum, NSN: 6810-00-616-9437
98% 55-gal drum, NSN: 6810-00-559-9888
21. OCTADECYLAMINE, nontoxic, creamy white dispersion of octadecylamine, chemical formula C₁₈H₃₇NH₂, melting point of 45 °C (114 °F), boiling point of 369 °C (697 °F), filming amine
Use: Control corrosion by CO₂ in steam condensate lines
Federal Specification: None
Package/NSN: 55-gal drum, NSN: None
22. PHOSPHATE COMPOUNDS (see items 23 through 32)
23. DISODIUM PHOSPHATE, anhydrous (Na₂HPO₄), 49% P₂O₅ minimum
Use: Remove hardness in boiler water
Federal Specification: O-S-639, *Sodium Phosphate, Dibasic, Anhydrous, Technical*
Package/NSN: 100-lb bag, NSN: 6810-00-264-6630
24. DISODIUM PHOSPHATE, dodecahydrate (Na₂HPO₄•2H₂O), 19% P₂O₅ minimum
Use: Remove hardness in boiler water
Federal Specification: None
Package/NSN: 100-lb bag, NSN: None
25. POLYPHOSPHATE GLASS, slowly soluble, minimum P₂O₅ content 67%, solubility: 10 to 20% per month
Use: Treatment of cooling water in smaller cooling towers
Federal Specification: None
Package/NSN: 100-lb drum, NSN: 6850-00-014-3442

26. SODIUM HEXAMETAPHOSPHATE (NaPO_3)₆ technical, type II, 66.5% P_2O_5 , glassy form, beads or plates.
Use: Cathodic corrosion inhibitor in cooling towers and to remove hardness in boiler water
Federal Specification: O-S-635, *Sodium Polyphosphates, Technical, Type II*
Package/NSN: 100-lb bag, NSN: 6810-00-531-7805
27. SODIUM TRIPOLYPHOSPHATE, anhydrous ($\text{Na}_5\text{P}_3\text{O}_{10}$), white granular, 56% P_2O_5
Use: Remove hardness in boiler water
Federal Specification: O-S-635, *Sodium Polyphosphates, Technical, Type III*
Package/NSN: 100-lb bag, NSN: 6810-00-753-5053
100-lb bag, NSN: 6810-00-926-4836
28. SODIUM TRIPOLYPHOSPHATE, hexahydrate, ($\text{Na}_5\text{P}_3\text{O}_{10}\cdot 6\text{H}_2\text{O}$), granular or powder, 43% P_2O_5 minimum
Use: Remove hardness in boiler water
Federal Specification: None
Package/NSN: 100-lb bag, NSN: None
29. TETRASODIUM PYROPHOSPHATE, anhydrous, ($\text{Na}_4\text{P}_2\text{O}_7$), granular, 53% P_2O_5 , minimum
Use: Corrosion inhibitor in cooling towers and to remove hardness in boiler water
Federal Specification: None
Package/NSN: 100-lb bag, NSN: 6810-00-249-8038
30. TETRASODIUM PYROPHOSPHATE, decahydrate, ($\text{Na}_4\text{P}_2\text{O}_7\cdot 10\text{H}_2\text{O}$), 31% P_2O_5 minimum
Use: Corrosion inhibitor in cooling towers and to remove hardness in boiler water
Federal Specification: None
Package/NSN: 100-lb bag, NSN: None
31. TRISODIUM PHOSPHATE (TSP), monohydrate ($\text{Na}_3\text{PO}_4\cdot \text{H}_2\text{O}$) technical, powder or granular, 36% P_2O_5 minimum
Use: Remove hardness in boiler water
Federal Specification: O-S-642, *Sodium Phosphate, Tribasic, Anhydrous; Dodecahydrate; and Monohydrate; Technical, Type III*
Package/NSN: 100-lb bag, NSN: None

32. TRISODIUM PHOSPHATE (TSP), dodecahydrate ($\text{Na}_3\text{PO}_4 \cdot 12\text{H}_2\text{O}$) granular flake or crystalline, 16% P_2O_5 minimum
Use: Remove hardness in boiler water
Federal Specification: O-S-642, *Sodium Phosphate, Tribasic, Anhydrous; Dodecahydrate; and Monohydrate; Technical, Type II*
Package/NSN: 100-lb drum, NSN: None
33. POLYACRYLATE, low molecular weight, water white to light amber color, total solids 45 to 65%, pH of 2.2 to 7.5, approximate molecular weight 2000 to 5000, specific gravity 1.1 to 1.23 at 25 °C (77 °F), viscosity 400 to 1400 at 25 °C
Use: Sludge dispersant in boilers
Federal Specification: None
Package/NSN: None
34. POLYACRYLIC ACID, low molecular weight, water white to light amber color, total solids 45 to 65 ±2%, approximate molecular weight 1000 to 4000, specific gravity 1.1 to 1.3 at 25 °C, viscosity 200-1000 cps at 25 °C
Use: Dispersant in cooling towers to prevent fouling by nonliving matter
Federal Specification: None
Package/NSN: 55-gal drum, NSN: 6850-01-194-6613
35. POLYMETHACRYLATE, low molecular weight, clear amber liquid, total solids 29 to 41%, pH of 6.0 to 10.5, approximate molecular weight 3800 to 10000, specific gravity 1.18 to 1.27 at 25 °C, viscosity 50 to 700 at 25 °C
Use: Sludge dispersant in boilers
Federal Specification: None
Package/NSN: None
36. QUEBRACHO TANNIN EXTRACT, Type I, powder
Use: Sludge dispersant in boilers
Federal Specification: None
Package/NSN: 50-lb bag, NSN: 6810-00-891-5741
37. SALT (see sodium chloride, item 41)
38. SLAKED LIME (see calcium hydroxide, item 11)
39. SODA ASH (see sodium carbonate, item 40)

40. SODIUM CARBONATE (soda ash) (Na_2CO_3), anhydrous technical, granular or powder form, 99.2% minimum by weight
Use: Remove calcium sulfate from water, increase alkalinity in boilers
Federal Specification: O-S-571, *Sodium Carbonate, Anhydrous, Technical*
Package/NSN: 25-lb bag, NSN: 6810-00-262-0951
100-lb drum, NSN: 6810-00-233-1715
41. SODIUM CHLORIDE (salt) (NaCl), technical mineral type, crude-sized form, type I, water soluble salt, 98.5% NaCl by weight
Use: Regenerate ion exchange resins
Federal Specification: A-A-694, *Sodium Chloride, Technical (Water Conditioning Grade)*
Package/NSN: 50-lb bag, NSN: 6810-01-026-0951
80-lb bag, NSN: 6810-00-227-0437
42. SODIUM HYDROSULFIDE ($\text{NaSH}\cdot 2\text{H}_2\text{O}$), technical grade, flake, 70 to 72% NaSH by weight
Use: Regenerate iron fouled ion exchange materials
Federal Specification: None
Package/NSN: 50-lb bag, NSN: None
43. SODIUM HYDROXIDE (caustic soda) (NaOH), technical, type I, flake form particle size gradation A/A, 96% minimum assay as NaOH
Use: Regenerate ion exchange material, increase alkalinity in boilers and adjust pH in water
Federal Specification: None
Package/NSN: 100-lb drum, NSN: 6810-00-174-6581
44. SODIUM HYPOCHLORITE SOLUTION (NaOCl), clear, light-yellow liquid containing not less than 10% available chlorine by volume
Use: Disinfectant and treatment of Legionnaires' Disease in cooling towers
Federal Specification: O-S-602, *Sodium Hypochlorite Solution*
Package/NSN: 5-gal can, NSN: 6810-00-169-5163
55-gal drum, NSN: 6810-00-214-8743

45. SODIUM MOLYBDATE, dihydrate ($\text{Na}_2\text{MoO}_4 \cdot 2\text{H}_2\text{O}$), white, free flowing odorless powder, soluble in water, commercial grade
Use: Corrosion inhibitor for open cooling systems
Federal Specification: None
Package/NSN: 200-lb lined fiber drum, NSN: None
46. SODIUM MOLYBDATE, solution, 35% as Na_2MoO_4 , clear liquid, soluble in water
Use: Corrosion inhibitor for open cooling systems
Federal Specification: None
Package/NSN: 55-gal drum, NSN: None
47. SODIUM MOLYBDATE BLEND, liquid, mixture of 10 to 12% sodium molybdate (Na_2MoO_4), 3 to 5% sodium hydroxide (NaOH), and 3 to 4% copper corrosion inhibitor
Use: Corrosion control in hot water systems, chilled and brine systems, combined hot and chilled water systems, and diesel engine jacket cooling systems; compatible with ethylene glycol antifreeze
Federal Specification: None
Package/NSN: 55-gal drum, NSN: 6850-01-185-1188
48. SODIUM NITRITE (NaNO_2), granular, 97% NO_2 by weight, technical grade
Use: Corrosion control in hot water systems
Federal Specification: O-S-634, *Sodium Nitrate, Technical (Nitrate of Soda)*
Package/NSN: 100-lb drum, NSN: None
49. SODIUM NITRITE-BORAX BLEND, powdered or granular, a mixture of 65 to 70% sodium nitrite, 8 to 12% borax (sodium tetraborate), 4 to 5% copper corrosion inhibitor, and 15 to 20% sodium carbonate, free of excess foreign matter
Use: Corrosion control in closed hot water systems. Compatible with ethylene glycol antifreeze.
Federal Specification: None
Package/NSN: 30-gal can, NSN: 6850-01-185-1187
50. SODIUM SILICATE, relatively low alkalinity, 41 °Bé, approximately 28.8% SiO_2 , 6 to 7% Na_2O , not more than 0.5% suspended matter
Use: Cathodic corrosion inhibitor in cooling towers
Federal Specification: O-S-605, *Sodium Silicate Solution*
Package/NSN: 5-gal can, NSN: 6810-00-247-0607
55-gal drum, NSN: 6810-00-247-0609
51. SODIUM SULFITE (Na_2SO_3), anhydrous, granular, 96% by weight minimum
Use: Remove oxygen from boiler feedwater and closed hot water systems (oxygen scavenger)
Federal Specification: O-S-650, *Sodium Sulfite, Anhydrous, Technical*
Package/NSN: 100-lb bag, NSN: 6810-00-782-2677

52. SODIUM SULFITE, catalyzed with cobalt, granular, 95% by weight minimum
Use: Remove oxygen from boiler feedwater (oxygen scavenger)
Federal Specification: None
Package/NSN: 50-lb bag, NSN: 6850-01-109-5604
53. SULFONATED STYRENE COPOLYMER, low molecular weight, clear amber color, total solids, 23 to 27%, pH of 6.8, molecular weight 5000 to 10,000, specific gravity 1.2 at 25 °C, viscosity 10 to 40 at 25 °C
Use: Sludge dispersant in boilers
Federal Specification: None
Package/NSN: None
54. SULFURIC ACID (H₂SO₄), technical, class A, grade 2, 93% sulfuric acid concentration, 66 °Bé
Use: Regenerate ion exchange resins, adjust pH in cooling towers
Federal Specification: None
Package/NSN: 13-gal carboy, NSN: 6810-00-975-0707
Bulk, NSN: 6810-00-251-8007
55. TOLYLTRIAZOLE (TTA), active ingredient 50% sodium tolyltriazole (43% TT)
Use: Corrosion inhibitor for copper alloys in cooling water systems
Federal Specification: None
Package/NSN: 5-gal can, NSN: 6850-01-189-9949
56. ZINC SULFATE, monohydrate (ZnSO₄•H₂O), white, free-flowing powder, soluble in water
Use: Cathodic corrosion inhibitor in cooling towers
Federal Specification: None
Package/NSN: 50-lb bag, NSN: 6810-01-198-3832

INDEX

Aeration.....	12, 15	chemistry limits	72
After-boiler	36	routine sampling and testing.....	153
Air-cooled diesel cooling systems.....	142	sampling cooler.....	154
Algae.....	2, 111,113	sampling locations	155
control	121	sampling procedures	154
Alkalinity		treatment.....	86
relationship of P, M, and OH alkalinities		treatment and control.....	45
.....	163	Boiler water sampling and testing	
sources	163	boiler blowdown water sample.....	158
test relationships	163	boiler feedwater sample.....	158
Amines		boiler water QA analysis.....	158
blends	61	condensate water sample.....	158
filming.....	61	frequency	156
food preparation.....	63	routine.....	153
humidification	63	Boiler water treatment	
indoor air and steam quality issues.....	62	commonly asked questions	86
limitations	62	Boilers	
specialty volatile.....	62	chemical requirements for layup.....	82
steam used for sterilization	63	common problems during layup.....	82
Backflow		dry layup	82
prevention devices	4	open dry layup method	82
Backwash.....	20, 21	proper pH.....	52
Bacteria.....	113	quicklime or silica gel layup method ...	83
control	121	recirculating cleaning process	188
planktonic.....	113	start-up from dry layup.....	81
sessile	113	start-up from wet layup	81
Bacterial control		wet layup.....	83
with non-oxidizing biocides	121	wet layup of drained boilers	84
with oxidizing biocides	121	wet layup without draining	84
Biological fouling.....	31	Bottom blowdown	
Boiler		frequency of.....	86
calculations	40	Brining	20
capacity rating.....	34	Bromine release agents	
components	36	bromine salts	117
deposit formation	46	hydantoins	117
operator duties	79	Calculating blowdown rates.....	42
start-up chemical requirements.....	79	Calculation of feedwater and blowdown	
Boiler and cooling water quality assurance		water.....	42
program.....	6	Carbon dioxide	
Boiler start-up		control by neutralizing amines	59
chemical requirements.....	79	Carbon dioxide in steam	
common problems.....	79	estimating	58
Boiler system efficiency		carbonic acid	86
evaluating.....	45	Cartridge and bag filters	16
Boiler systems		Centrifuge separators	16
relationship between feedwater,		Chemical cleaning of water systems	
blowdown, steam generation, and COC		checking acid solution strength	190
.....	42	circulating method without heat	189
Boiler water		cleaning agents	184

cleaning preparation	187	sampling and testing.....	159
fill and soak method	190	Closed system corrosion control	
general guidance	182	molybdate-azole treatment program.	146
guidance and procedures for preparing		molybdate-nitrite-azole treatment	
cleaning solutions.....	184	program	147
mechanical methods	184	nitrite-azole treatment program.....	146
methods for removing scale	188	polysilicate-azole treatment program	147
pre-operational cleaning	182	sulfite-caustic treatment program	145
reasons for cleaning.....	183	Closed systems	
recirculating cleaning process for boilers		corrosion control programs	144
.....	188	identifying water leaks	148
remedial cleaning.....	183	makeup water requirements	143
remedial cleaning procedures.....	184	treatment and control of microbiological	
types of deposits	183	growth	148
Chemical cleaning solutions		Closed water systems	1
hydrochloric (muriatic) acid	184	closed chilled water systems	1,141
sulfamic acid	186	diesel jacket systems.....	1,10
Chemical control verification	174	hot water systems.....	1,140
automated sensor control	175	Coke tray aerators	15
calibrated mass balance	175	Combined hot and chilled water systems	142
continuous testing	174	Common boiler problems	37
little or no testing.....	174	carryover.....	40
manual testing.....	174	corrosion	37
Chemical feed and control systems	168	deposition	37
automatic chemical feed with manual		Condensate corrosion and control.....	57
preparation.....	172	causes	57
automatic neat chemical feed	173	Condensate return rate.....	43,44
automatic valves	170	Condensate systems	
boiler water controllers.....	169	layout	85
bypass feeders.....	171	Conductivity and TDS.....	166
chemical control verification.....	174	Container management policy	8
chemical drip pots	171	Control charts	4
chemical feed methods	171	Cooling tower systems	
chemical pumps	170	calculating COC by volume	101
cooling tower water controllers	168	controlling COC	102
eductor chemical addition systems ..	171	cycles of concentration	100
feed pumps	170	determining COC by water analyses	101
manual water treatment chemical feed		relationship between blowdown,	
.....	171	evaporation, and COC	103
safety and general information.....	175	relationship between COC and makeup	
slowly dissolving dry chemical packages		102
.....	171	Cooling tower water sampling and testing	
timers	171	151
water meters	170	Cooling towers	
water quality controller types	168	cells	96
Chemical pumps	170	components	95
Chemical requirements for boiler layout ..	82	drift eliminators	96
Clean Water Act.....	7	fan deck	96
Closed brine systems.....	142	film fill.....	99
Closed chilled water systems.....	141	forced-draft towers.....	92
Closed glycol systems	142	induced-draft towers	92
Closed hot and chilled circulating water		natural-draft towers.....	91

operations logs for	5	scale control methods.....	109
relationship between evaporation, blowdown, and makeup	100	silica scale	107
types	88	silica scale control	111
water distribution.....	96	types	91
white rust.....	98	wet layup of system and equipment .	138
Cooling water		Cooling water tower systems	
testing requirements	151	common problems during layup or due to improper initial start-up	135
treatment		start-up.....	136
objectives	105	Cooling water treatment program	
Cooling water fouling	111	categories of	131
fouling control.....	111	chiller performance	135
Cooling water sampling		corrosion test coupons	134
frequency	152	developing	130
procedures	152	equipment.....	130
Cooling water systems.....	1	medium and large towers	132
calcium carbonate scale	106	operational features and parameters	130
calcium carbonate scale control using sludge-forming polymers.....	110	operator duties.....	133
calcium carbonate scale control using solubilizing chemicals.....	110	small cooling towers	131
calcium carbonate scale control using solubilizing polymers.....	110	water quality.....	131
calcium carbonate scaling indices	108	Corrosion	2
calcium phosphate scale.....	106	boiler.....	51
calcium phosphate scale control using solubilizing inhibitors	110	control methods	128
calcium sulfate scale control using solubilizing polymers.....	111	crevice corrosion.....	125
chemical cleaning and passivation		effective corrosion control.....	128
formulation	137	galvanic corrosion.....	123
common problems.....	97	general.....	51, 124
cooling towers	1	microbiologically influenced corrosion	125
corrosion	122	under-deposit corrosion	125
deposit formation and control.....	105	Corrosion control	
determining COC to control operations	107	anodic inhibitors.....	128
determining scaling potential	105	cathodic inhibitors	128
dry layup of system and equipment ..	138	for copper and copper alloys	129
evaporative condensers.....	1,88	for deposit corrosion	129
evaporative coolers.....	1	for galvanic or crevice corrosion.....	129
hydrostatic testing	136	for MIC	129
Legionella bacteria.....	99	general inhibitors	129
magnesium silicate scale control	111	Corrosion testing	161
objectives of treatment.....	105	Cycles of concentration	40
once-through systems.....	1, 88	Cyclohexylamine	61
open recirculating systems	88	DEAE	61
operational readiness.....	137	Deaerator operation.....	53
passivation	137	Dealkalization	12, 25
pre-operational cleaning procedure ..	136	Decarbonization.....	28
principles of operation.....	100	Definitions	
scale.....	105	algae.....	113
		basin	95
		biological.....	2
		brining.....	20
		cell	96
		closed water system	143
		cold well.....	95

conductivity	86	restrictions on	4
cooling water systems	88	Dissolved solid materials	46
corrosion	2	Effects of treatment on raw water	13
corrosion rate	125	Electrodialysis	12, 32
crevice corrosion	125	Enhanced and super-enhanced chiller condenser tubing	97
cross-connection	4	Environmental regulations	7
deposits	2	Evaporators	29
evaporative condensers	88	External boiler water treatment	48
evaporative fluid coolers	88	high-pressure boilers	48
feedwater	86	low-pressure boilers	48
fill	96	Federal Insecticide, Fungicide and Rodenticide Act	8
foaming carryover	64	Feed pumps	170
free halogen	121	Feedwater	
fungi	2, 115	chemical removal of free oxygen	55
general corrosion	51, 124	quality limits	68
groundwater	9	removing oxygen	52
halogen	121	Figures	
industrial wastewater	6	Acidity, Alkalinity, and pH Ranges ...	163
industrial water	1	Anion Dealkalization Process	26
lag boiler	82	Assessing Corrosion Rates in Cooling Water Systems	124
lead boiler	82	Automatic Chemical Feed System ...	173
louvers	95	Automatic Neat Chemical Feed	174
makeup water	86	Boiler or Condensate Water Sample	
microbiologically influenced corrosion	125	Cooling Coil	154
misting	63	Chemical Pot Feeder	172
oxidizing biocides	115	Chillers	142
pitting corrosion	52	Close-Up of Corrosion Pitting on Super- Enhanced Copper Tube	98
priming	64	Components of a Simple Steam Boiler System	35
reuse water	9	Cooling Tower Water System	91
scale	2	Counter-Flow Cooling Tower	94
silica carryover	64	Counter-Flow Cooling Tower Diagram	94
slimes	2	Cross-Flow Cooling Tower	93
steam boiler system	33	Demineralization Process	24
surface water	9	Duplex Softener	18
suspended solids	2	Effect of COC on Makeup Requirement	103
TDS	86	Effect of pH on Corrosion Rate of Unprotected Mild Steel in Water ...	127
under-deposit corrosion	97, 125	Effect of pH on Mild Steel and Copper Corrosion	58
water discharge pretreatment	6	Effects of Treatment on Raw Water ...	13
Degasifying	12	Evaporative Fluid Cooler and Evaporative Condenser Diagram	89
Deionization	12	Failed Boiler Tube	40
Demineralization	12, 23	Fire Tube Boiler	33
Deposits	2	Forms of Corrosion	123
Determining chemical treatment feed rates	50		
Determining feedwater rates	42		
Determining makeup water and condensate return rates	43		
Determining water carryover in steam ...	65		
Developing a water treatment program.	194		
concerns	194		
Diesel engine jacket cooling systems ...	142		
Direct steam use			

Galvanic Series of Common Metals and Alloys in Cooling Water Systems ..	124	Groundwater	9
Halogen Species vs pH in Water	116	Historical records	5
Heavily Fouled Cooling Tower Film Fill	99	Hot and chilled water systems	
High-Efficiency Cooling Tower Film Fill	96	procedures for layup	149
Hot Water Boiler.....	140	Hot water boilers.....	139
Hyperbolic Natural-Draft Cooling Towers	92	Hot water heating systems	139
Impact of scale on heat transfer.....	39	Hot water systems	
Induced-Draft Cross-Flow Cooling Tower Components.....	95	description	140
Inspection Gauge for Wet Boiler Layup	84	Hydrogen ion exchange.....	12, 22
Localized Scale Formation Process....	46	Industrial wastewater	
Manual Chemical Feed System	173	disposal procedures	6
Mechanical Deaerator Schematic (Spray Type).....	54	Industrial water	
Mechanical Deaerator Schematic (Tray Type).....	55	definition	1
Metal Fatigue on Boiler Tube	39	source selection factors.....	9
Once-Through Cooling Water System Diagram.....	88	Industrial water systems	
Open Recirculating Cooling Tower Water System Diagram.....	90	problems	2
RO Schematic.....	29	Industrial water treatment	
RO Unit	30	objectives.....	2
Scaled Boiler Tube.....	38	In-plant laboratory water testing	
Simplified Boiler System Water Balance	43	requirements.....	167
Split-Stream Dealkalizer	27	chemical reagents.....	167
Super-Enhanced Copper Tubes	98	recommended equipment.....	167
Typical Closed Chilled Water System Schematic	141	Internal boiler water treatment.....	48
Typical Ion Exchange Unit	17	scale prevention.....	48
Typical locations for water sampling in a steam boiler system	156	Interpretation of water test results	162
Typical Water Sampling Points for an Open Recirculating Cooling Water System	153	Ion exchange	11
Water Boiler Mist Formation.....	64	Ion exchange process	17
Water Tube Boiler	34	Langelier Saturation Index.....	108
Filming amines.....	61	Large boilers	
Filters	15	operations logs for	5
cartridge and bag	16	Layup of condensate systems	85
sand	16	Legionella Pneumophila	99, 122
Fire protection water systems	1	Wisconsin Protocol	122
Fire tube boilers	33	Legionnaires' Disease	122
Foaming carryover	64	Lime-soda process cold & hot	17
Fouling		Lime-soda softening	12, 16
due to iron	21	Low-pressure steam	
Frequency of bottom blowdown	86	treatment guidelines	76
Fungi	2, 115	Macrobiological control	122
gallic acid	86	Makeup water	9
		criteria for treating.....	10
		external treatment.....	11
		measurement of use rates	10
		reasons for treating.....	10
		sources	9
		split-stream treatment.....	11
		treatment methods.....	11, 12
		Makeup water rate	44
		Meaning of pH	165
		Mechanical oxygen removal	53
		deaerator operation	53
		Medium- and high-pressure steam	

treatment guidelines.....	77	bromine release agents	116
Membrane configuration	31	chlorine and chlorine release agents	115
hollow fiber	31	chlorine dioxide.....	117
spiral	31	hydrogen peroxide	117
tubular	31	ozone	117
Methods for removing scale		Phosphonates	
checking acid solution strength.....	190	stability.....	110
circulating method without heat	189	Pitting corrosion.....	52
fill and soak method	190	Potable water.....	1
recirculating cleaning process for boilers		protection of.....	4
.....	188	Practical (Puckorius) Scaling Index	109
Microbiological control	115	Pre-boiler	35
Microbiological deposits and control	112	Priming carryover	64
Mist carryover	63	QA/QC program.....	6
Morpholine	61	Record-keeping requirements	4
Nanofiltration.....	32	Regeneration cycle.....	19
Neutralizing amines	59	Relationship of pH to causticity	165
blends	61	Removing oxygen from feedwater	52
physical and chemical properties	60	Residues.....	2
selection chart.....	60	Resin fouling	21
New boiler start-up		Resin replacement.....	22
common problems.....	79	Resource Conservation and Recovery Act.8	
New cooling water tower systems		Reuse water	9
cleaning and passivation procedures	136	Reverse osmosis	29
start-up.....	136	RO pretreatment.....	30
Non-chemical treatment devices.....	3	Ryznar Stability Index.....	108
Non-chemical water treatment devices		Safe Drinking Water Act	8
electrical impressed current devices.	179	Sampling.....	4
electrostatic devices.....	180	Sampling and testing	
filters	179	boiler blowdown water	158
grounded wire devices	179	boiler condensate water.....	158
magnetic and electromagnetic devices		boiler feedwater	158
.....	180	boiler water	153
magnetic filters.....	179	boiler water sampling locations.....	155
sacrificial anodes	179	closed hot and chilled circulating water	
types	178	159
ultraviolet light generators.....	179	corrosion testing	161
Non-chemical/non-traditional water		frequency of boiler water testing.....	156
treatment devices.....	178	in-plant laboratory water testing	
acceptance.....	178	requirements.....	167
function	178	interpretation of results	162
performance standards	178	ion exchangers and dealkalizer water	160
Non-oxidizing biocides	119	makeup water	160
Non-traditional water treatment chemical		methods.....	161
devices		purpose of testing	161
copper and silver ionizing devices	180	Sand filters.....	16
ozone	180	filter cycle.....	16
Occupational Safety and Health Act	8	Sand filtration rates.....	16
octadecylamine	61	Scale.....	2, 46
OH ⁻ conductivity	86	calcium carbonate.....	47
Operations logs.....	5	calcium phosphate.....	47
Oxidizing biocides	115	calcium sulfate	47

common types in boilers	47	medium- and high-pressure steam.....	77
iron oxide and iron hydroxide	48	very-high-pressure steam	78
magnesium phosphate.....	47	Troubleshooting boiler system water.....	81
magnesium silicate	47	Types of deposits	183
Scale prevention		boiler deposits	184
high-pressure boilers	48	waterside deposits in heat exchangers	
low-pressure boilers	48	183
Sea water	31	Ultrafiltration	31
Service cycle	18	Vapor-phase diesel engine cooling systems	
Shore-to-ship steam.....	1	143
purity standards	1	Very-high-pressure steam	
quality	75	treatment guidelines	78
Silica carryover	64	Water balance	41
Slimes	2	Water carryover in steam	63
Sludge deposits	46	Water conservation.....	3
preventing	51	Water discharge pretreatment.....	6
Sodium ion exchange	12, 18	Water discharge restrictions	7
Sodium zeolite softening.....	11	Water quality controllers	
Softener operation problems.....	21	boiler water controllers.....	169
Solubilizing chemicals		cooling tower water controllers	168
acids.....	110	types	168
phosphonates	110	Water sample testing methods	161
Specialty volatile amines.....	62	Water sampling and testing	150
Split-stream dealkalization	26	independent QA analysis.....	151
Split-stream treatment.....	11	in-plant testing	150
Start-up of boiler from dry layup.....	81	meaning of pH	165
Start-up of boiler from wet layup	81	relationship of P, M, and OH alkalinities	
Start-up of new boilers and condensate		163
systems	79	relationship of pH to causticity	165
Start-up of repaired boilers	79	Water system specifications	4
Steam boiler makeup water		Water treatment program	
external treatment equipment selection		concerns in developing a program....	192
guide	11	cooling systems treatment.....	67
Steam boiler systems.....	1, 33	developing	192
components of	34	developing a scope of work for industrial	
measuring equipment	36	water treatment.....	194
water treatment program.....	65	for closed systems	143
Steam boilers		generic chemical water treatment	
fire tube boilers	33	programs.....	193
pressure classification.....	33	operator training.....	66
types	33	options for setting up	192
water tube boilers.....	34	organizing	66
Steam drum	36	outsourcing chemicals and services. 193	
Steam header	36	pretreatment training.....	66
Sulfite		reports and audits	195
best location to feed	86	steam boiler systems	65
Surface water	9	training program content.....	66
Suspended solids.....	2	treatment training.....	66
Testing and record keeping	21	Water treatment program safety	
Toxic Substances Control Act.....	7	chemical spill kits.....	176
Treatment guidelines		chemical storage.....	177
low-pressure steam.....	76	container management.....	176

eyewash fountain	176	precipitating program	49
first aid information.....	176	solubilizing program.....	50
handling acid	175	Water tube boilers	34
handling caustic soda (sodium hydroxide)	176	Water-cooled diesel engine cooling systems	142
safety inspection	176	Wet layup of drained boilers	84
safety shower	176	Wet layup without draining	83
Water treatment programs		Wisconsin Protocol	122
boiler-specific program.....	50	Wood slat aerators	15
high-pressure boilers	49		

CANCELLED