

UFC 3-230-02  
10 July 2001



---

# UNIFIED FACILITIES CRITERIA (UFC)

## OPERATION AND MAINTENANCE: WATER SUPPLY SYSTEMS

U.S. ARMY CORPS OF ENGINEERS

NAVAL FACILITIES ENGINEERING COMMAND (Preparing Activity)

AIR FORCE CIVIL ENGINEER SUPPORT AGENCY

**APPROVED FOR PUBLIC RELEASE: DISTRIBUTION UNLIMITED**

## UNIFIED FACILITIES CRITERIA (UFC)

### OPERATIONS AND MAINTENANCE: WATER SUPPLY SYSTEMS

Any copyrighted material included in this UFC is identified at its point of use. Use of the copyrighted material apart from this UFC must have the permission of the copyright holder.

Record of Changes (changes indicated by \1\ ... /1/ )

<u>Change No.</u>	<u>Date</u>	<u>Location</u>
-------------------	-------------	-----------------

CANCELLED

---

This UFC supersedes MIL-HDBK-1164, DATED 31 October 1997. The format of this document does not conform to UFC 1-300-01, however it will be reformatted at the next revision.

## FOREWORD

The Unified Facilities Criteria (UFC) system is prescribed by MIL-STD 3007 and provides planning, design, construction, sustainment, restoration, and modernization criteria, and applies to the Military Departments, the Defense Agencies, and the DoD Field Activities in accordance with [USD\(AT&L\) Memorandum](#) dated 29 May 2002. UFC will be used for all DoD projects and work for other customers where appropriate. All construction outside of the United States is also governed by Status of forces Agreements (SOFA), Host Nation Funded Construction Agreements (HNFA), and in some instances, Bilateral Infrastructure Agreements (BIA.) Therefore, the acquisition team must ensure compliance with the more stringent of the UFC, the SOFA, the HNFA, and the BIA, as applicable.

UFC are living documents and will be periodically reviewed, updated, and made available to users as part of the Services' responsibility for providing technical criteria for military construction. Headquarters, U.S. Army Corps of Engineers (HQUSACE), Naval Facilities Engineering Command (NAVFAC), and Air Force Civil Engineer Support Agency (AFCEA) are responsible for administration of the UFC system. Defense agencies should contact the preparing service for document interpretation and improvements. Technical content of UFC is the responsibility of the cognizant DoD working group. Recommended changes with supporting rationale should be sent to the respective service proponent office by the following electronic form: [Criteria Change Request \(CCR\)](#). The form is also accessible from the Internet sites listed below.

UFC are effective upon issuance and are distributed only in electronic media from the following source:

- Whole Building Design Guide web site <http://dod.wbdg.org/>.

Hard copies of UFC printed from electronic media should be checked against the current electronic version prior to use to ensure that they are current.

### AUTHORIZED BY:



DONALD L. BASHAM, P.E.  
Chief, Engineering and Construction  
U.S. Army Corps of Engineers



DR. JAMES W. WRIGHT, P.E.  
Chief Engineer  
Naval Facilities Engineering Command



KATHLEEN I. FERGUSON, P.E.  
The Deputy Civil Engineer  
DCS/Installations & Logistics  
Department of the Air Force



Dr. GET W. MOY, P.E.  
Director, Installations Requirements and  
Management  
Office of the Deputy Under Secretary of Defense  
(Installations and Environment)

## ABSTRACT

This handbook provides technical guidance for operating and maintaining water supplies, treatment plants, storage facilities, and distribution systems at military installations and applies to all personnel responsible for operating and maintaining fixed-base water systems. Topics covered include water sources, unit processes of water treatment, pumping, distribution and storage, valves and hydrants, meters, instrumentation and control, cross-connection control and backflow prevention, general maintenance, swimming pool operation, and safety and health. Administrative issues, new technology, and current water supply regulations, as well as information and details not directly related to operation and maintenance of water systems, are included by reference to the latest edition of industry standards, handbooks, and manuals of practice. MIL-HDBK-1164 replaces AFR 91-26, TM 5-660, and NAVFAC MO-210.

## OPERATIONS AND MAINTENANCE OF WATER SUPPLY SYSTEMS

## CONTENTS

		<u>Page</u>
<b>Section</b>	<b>1</b>	<b>INTRODUCTION</b>
	1.1	Scope of Handbook .....1
	1.2	Organization of Handbook.....1
<b>Section</b>	<b>2</b>	<b>APPLICABLE DOCUMENTS</b>
	2.1	Basic List .....3
	2.2	Supplemental List .....3
	2.3	Optional List .....7
	2.4	Military Publications.....8
<b>Section</b>	<b>3</b>	<b>UTILITY MANAGEMENT</b>
	3.1	Scope of This Section.....10
	3.2	References .....10
	3.3	Elements of a Water Supply System .....11
	3.3.1	Water Supply Sources.....11
	3.3.2	Water Treatment.....11
	3.3.3	Water Distribution.....12
	3.3.4	Pumping.....12
	3.3.4.1	Well Pumps .....12
	3.3.4.2	Low-Lift Pump Stations.....12
	3.3.4.3	High-Service Pump Stations.....12
	3.3.4.4	Pressure Regulating Stations .....13
	3.4	Water Utility Staffing.....13
	3.4.1	Personnel Requirements .....13
	3.4.2	Scheduling Personnel.....14
	3.4.3	Certification .....14
	3.4.4	Training .....14
	3.5	Information Management.....14
	3.5.1	Operating Records .....15
	3.5.2	Daily Logs.....15
	3.5.3	MORs.....15

	<u>Page</u>
3.5.4	Annual Reports.....16
3.5.5	Distribution System Maps and Records.....16
3.5.6	Well Records.....16
3.5.7	Laboratory Reports.....16
3.5.8	Maintenance.....16
3.5.9	Cost Accounting.....17
3.6	Emergency Planning.....17
3.6.1	Fire Protection.....17
3.6.2	Natural Disasters.....17
3.6.3	Man-Made Disasters.....17
3.6.4	Vulnerability Assessment.....17
3.7	Regulations Affecting Water Systems.....18
3.7.1	EPA Regulations.....18
3.7.2	Federal Regulatory Information.....18
3.8	Water Conservation.....18
<b>Section 4</b>	<b>WATER SUPPLY</b>
4.1	Section Overview.....19
4.2	References.....19
4.3	Water Supply Hydrology.....20
4.4	Water Use.....20
4.5	Groundwater Supplies.....20
4.5.1	Aquifer Performance.....20
4.5.2	Well Operation.....20
4.5.2.1	Balancing the Pumping Schedule.....20
4.5.2.2	Operating Well Pumps.....22
4.5.2.3	Measuring Water Levels and Drawdown.....22
4.5.2.4	Checking for Safe Pumping Yield.....24
4.5.2.5	Disinfecting Wells.....24
4.5.3	Well Maintenance and Rehabilitation.....27
4.5.3.1	Cleaning Well Screens.....27
4.5.3.2	Repairing Well Screens.....37
4.5.3.3	Maintaining Specific Well Types.....37

	<u>Page</u>
4.5.3.4	Maintaining Springs.....40
4.5.3.5	Maintaining Infiltration Galleries.....40
4.5.3.6	Maintaining Radial Wells.....40
4.5.4	Protection of Groundwater Supplies.....40
4.5.4.1	Protection against Contamination through Improper Operation .....40
4.5.5	Well Records.....41
4.5.6	Abandonment of Wells .....41
4.6	Surface Water Supplies.....41
4.6.1	Dams and Spillways .....43
4.6.1.1	Concrete and Masonry Dams .....43
4.6.1.2	Earth and Rockfill Dams .....43
4.6.1.3	Spillways.....44
4.6.2	Reservoirs .....44
4.6.2.1	Water Quality Control.....44
4.6.2.2	Silt Removal .....44
4.6.2.3	Control of Nuisance Organisms.....45
4.6.3	Intakes .....45
4.6.3.1	Operation.....45
4.6.3.2	Maintenance .....45
4.6.4	Low-Lift Pumps .....46
4.7	Water Quality.....46
4.7.1	Physical Characteristics .....46
4.7.2	Chemical Characteristics.....46
4.7.3	Biological Characteristics .....46
4.7.4	Radiological Characteristics .....46
<b>Section 5</b>	<b>WATER TREATMENT</b>
5.1	Water Treatment.....48
5.2	References .....48
5.3	Treating Water at the Source .....49
5.4	Unit Treatment Processes .....50
5.4.1	Preliminary Treatment .....50

	<u>Page</u>
5.4.2	Coagulation and Flocculation.....50
5.4.3	Sedimentation Basins and Clarifiers.....50
5.4.4	Filtration.....51
5.4.5	Disinfection.....51
5.4.6	Fluoridation.....51
5.4.7	Control of Corrosion and Scaling.....52
5.4.8	Iron and Manganese Control.....52
5.4.9	Lime Softening.....52
5.4.10	Ion Exchange Processes.....53
5.4.11	Adsorption.....53
5.4.12	Aeration.....53
5.4.13	Membrane Processes.....53
5.5	Taste and Odor Control.....53
5.6	Controlling Organic Chemicals.....54
5.6.1	Pesticides Group—Treatment.....54
5.6.2	VOCs Group.....55
5.6.2.1	Sources of VOCs.....55
5.6.2.2	Treatment.....55
5.6.3	DBPs Group.....55
5.6.3.1	Sources of DBPs.....55
5.6.3.2	Treatment.....56
5.6.3.3	State Approval of Treatment.....57
5.7	Treatment Plant Instrumentation and Control (I&C).....57
5.8	Chemicals and Chemical Application.....58
5.9	Water Treatment Plant Residues.....58
5.9.1	Disposal Methods.....58
5.9.2	Recovery Processes.....70
5.9.3	Ultimate Disposal.....70
5.9.3.1	Discharge to Sanitary Sewer.....70
5.9.3.2	Landfill.....71
5.9.3.3	Lagoons.....71
5.9.3.4	Land Spreading of Lime Sludge.....71
5.9.4	Laboratory Control Tests.....71



	<u>Page</u>
5.9.5	Maintaining Records.....72
5.10	Desalination.....72
5.11	Water Sampling and Analysis .....72
<b>Section 6</b>	<b>PUMPS AND DRIVERS</b>
6.1	Section Overview.....73
6.2	References .....73
6.3	Pumps.....73
6.4	Operation of Pumps.....74
6.4.1	General Operating Instructions for Centrifugal Pumps.....75
6.4.2	Troubleshooting Centrifugal Pumps.....75
6.4.2.1	Cavitation Problems .....75
6.4.2.2	Causes of Cavitation .....75
6.4.3	Operating Instructions for Ejector (Jet) Pumps .....85
6.4.4	Operating Instructions for Progressive Cavity Pumps.....86
6.4.5	Operating Instructions for Rotary- and Reciprocating-Displacement Pumps.....86
6.4.5.1	Prestart .....87
6.4.5.2	Starting and Operating .....87
6.4.5.3	Operating Precautions.....87
6.5	Pump Maintenance.....87
6.5.1	Maintenance Procedures for Centrifugal Pumps.....87
6.5.1.1	Lubrication .....87
6.5.1.2	Packing.....88
6.5.1.3	Sealing Water Systems .....91
6.5.1.4	Rotary Seals.....91
6.5.1.5	Shafts and Shaft Sleeves .....91
6.5.1.6	Wearing or Sealing Rings .....95
6.5.1.7	Impeller.....95
6.5.1.8	Casing Maintenance.....99

	<u>Page</u>
6.5.1.9	Pump Shutdown.....99
6.5.1.10	Overhaul Procedures.....99
6.5.2	Rotary-Displacement Pumps .....100
6.5.2.1	Clearances .....100
6.5.2.2	Packing.....100
6.5.2.3	Bearings and Alignment .....100
6.5.2.4	Checklist Items .....100
6.5.2.5	Painting.....100
6.5.3	Reciprocating-Displacement Pumps.....100
6.5.3.1	Calculations .....100
6.5.3.2	Pump Inspection .....101
6.5.4	Sludge Pumps .....101
6.5.4.1	Packing Procedures for Reciprocating Sludge Pumps .....101
6.5.4.2	Bearings and Gear Transmission for Reciprocating Sludge Pumps .....102
6.5.4.3	Shear Pins in Reciprocating Sludge Pumps .....102
6.5.4.4	Ball Valves in Reciprocating Sludge Pumps .....103
6.5.4.5	Eccentrics in Reciprocating Sludge Pumps .....103
6.5.4.6	Progressive-Cavity Sludge Pumps .....103
6.5.5	Well Pumps .....103
6.5.5.1	Centrifugal Well Pumps.....103
6.5.5.2	Reciprocating Well Pumps .....106
6.5.5.3	Ejector Pumps.....106
6.5.5.4	Starting a New Well Pump.....107
6.6	Pump Drivers .....107
6.6.1	Electric Motors.....107
6.6.1.1	Maintenance .....107
6.6.1.2	Gasoline and Diesel Engines .....107
6.7	Accessories .....116
6.7.1	Belt Drives .....116

	<u>Page</u>
6.7.1.1	Installing Belts ..... 116
6.7.1.2	Checking Tension..... 117
6.7.2	Right-Angle Gear Drives..... 117
6.7.3	O&M for Variable-Speed Drives ..... 117
6.7.4	Couplings..... 118
6.7.4.1	Checking Coupling Alignment ..... 119
6.7.4.2	Lubrication ..... 119
6.8	Recordkeeping ..... 119
6.9	Pump Safety ..... 119
6.9.1	Motor and Engine Safety ..... 120
6.9.2	Electrical Devices ..... 120
<b>Section 7</b>	<b>DISTRIBUTION AND STORAGE</b>
7.1	Section Overview..... 121
7.2	References ..... 121
7.3	Distribution ..... 122
7.3.1	Distribution System Design and Installation ..... 122
7.3.2	O&M..... 122
7.3.2.1	Main Breaks and Repairs ..... 122
7.3.2.2	Flushing..... 123
7.3.2.3	Cleaning ..... 126
7.3.2.4	Valve Maintenance ..... 126
7.3.2.5	Operational Changes..... 126
7.3.2.6	Pipe Replacement ..... 126
7.3.2.7	Leak Location and Repair..... 127
7.3.2.8	Thawing Frozen Systems ..... 127
7.3.3	Water Main Tapping Procedures..... 129
7.3.4	Instrumentation, Control, and Information Management..... 130
7.4	Storage ..... 130
7.4.1	Operation of Water Storage Facilities..... 130
7.4.1.1	Ground Storage Reservoirs..... 130

		<u>Page</u>
7.4.1.2	Underground Reservoirs .....	130
7.4.1.3	Elevated Storage .....	131
7.4.1.4	Pneumatic Tanks .....	131
7.4.2	Maintaining Storage Facilities .....	131
7.4.3	Water Storage Facility Safety .....	132
<b>Section 8</b>	<b>VALVES AND HYDRANTS</b>	
8.1	Section Overview .....	133
8.2	References .....	133
8.3	Valves and Valve Operation .....	133
8.3.1	Valve Operation .....	133
8.3.1.1	Manual Operation .....	133
8.3.1.2	Power Operation .....	134
8.3.2	General Maintenance of Valves, Valve Boxes, and Accessories .....	134
8.3.3	Distribution System Valves .....	134
8.3.3.1	Lost Valves .....	134
8.3.3.2	Maintenance Procedures .....	140
8.4	Hydrants .....	141
8.4.1	Hydrant O&M .....	141
8.4.1.1	Hydrant Inspection .....	141
8.4.1.2	Hydrant-Flow Tests .....	143
8.4.1.3	Hydrant Flushing .....	143
8.4.1.4	Hydrant Safety .....	143
<b>Section 9</b>	<b>I&amp;C AND WATER METERS</b>	
9.1	Overview of Section .....	145
9.2	References .....	145
9.3	I&C .....	145
9.3.1	Water Meters .....	146
9.3.2	Meter Reading .....	146
9.4	Instrument Maintenance and Repair .....	147
9.4.1	Maintenance Schedules .....	147
9.4.2	Inspection and Maintenance Records .....	147

	<u>Page</u>
9.4.3	Sensor Maintenance.....147
9.4.4	Transmission System Maintenance.....150
9.4.5	Indicator, Register, and Recorder Maintenance .....150
9.4.5.1	Recorders .....150
9.4.5.2	Totalizers or Registers .....150
9.4.5.3	Combination Totalizer Indicator-Recorder.....154
9.4.6	Water Meter Maintenance .....154
9.4.7	Weir and Flume Maintenance .....154
9.5	Safety .....154
<b>Section 10</b>	<b>CROSS-CONNECTION CONTROL AND BACKFLOW PREVENTION</b>
10.1	Cross-Connections and Backflow.....157
10.2	References .....157
10.3	Classes of Backflow Hazards .....157
10.3.1	Class I—Low Degree of Hazard .....157
10.3.2	Class II—Moderate Degree of Hazard.....158
10.3.3	Class III—High Degree of Hazard .....158
10.4	Approved Backflow Prevention Devices .....158
10.4.1	Air Gap .....158
10.4.2	Vacuum Breakers .....159
10.4.3	Reduced Pressure Principle Device.....159
10.4.4	Double Check Valve Assembly.....159
10.5	Selection and Installation of Backflow Preventers .....159
10.6	Inspection and Testing Schedule .....160
10.6.1	Inspection .....160
10.6.2	Testing.....161
10.7	Maintenance of Backflow Preventers .....161
10.8	Administrative Issues.....161
10.9	Records of Inspection.....161
10.10	Location Records.....161

	<u>Page</u>
<b>Section 11</b>	<b>GENERAL MAINTENANCE OPERATIONS</b>
11.1	Scope of This Section.....162
11.2	References .....162
11.3	Maintenance Inspections.....163
11.3.1	Types of Inspection and Repair.....163
11.3.1.1	Operator's Inspection .....163
11.3.1.2	Preventive Maintenance Inspection.....163
11.3.1.3	Control Inspection.....163
11.3.1.4	Major Overhaul and Repairs.....164
11.3.2	Personnel. ....164
11.3.3	Maintenance Information. ....164
11.3.4	Maintenance Management System .....164
11.3.4.1	Goals .....165
11.3.4.2	Components .....165
11.3.4.3	Maintenance Personnel.....166
11.3.5	Spare Parts and Stock Control. ....166
11.3.5.1	Expendable Stock.....166
11.3.5.2	Standby Items.....166
11.3.5.3	Supply of Material.....167
11.3.6	Removing Equipment from Service .....167
11.3.6.1	Short Period.....167
11.3.6.2	Protracted Period.....167
11.3.7	Operating under Winter Conditions.....167
11.4	Electrical Equipment.....168
11.4.1	General.....168
11.4.2	Routine Inspections.....168
11.4.3	Switch Gear .....168
11.4.4	Electric Motors.....169
11.4.5	Standby Power Generators .....170
11.4.6	Instrumentation and Controls .....170
11.4.6.1	Regular Maintenance .....170
11.4.6.2	Calibration .....170

	<u>Page</u>
11.4.7	Tools and Equipment.....171
11.5	Mechanical Equipment. ....171
11.5.1	Aerators .....171
11.5.2	Rapid-Mix Basins and Equipment.....171
11.5.3	Flocculators .....171
11.5.4	Sedimentation Basins and Clarifiers.....171
11.5.4.1	Nonmechanically Cleaned Sedimentation Basins.....171
11.5.4.2	Lubrication Requirements.....175
11.5.4.3	Overload Alarm.....176
11.5.4.4	Upflow Clarifiers and Solids Contact Unit .....176
11.5.5	Gravity Filters. ....176
11.5.5.1	Filter Media.....180
11.5.5.2	Loss of Filter Media. ....185
11.5.5.3	Gravel Inspection.....186
11.5.5.4	Filter Underdrain System.....186
11.5.5.5	Wash Water Troughs .....187
11.5.5.6	Operating Console.....187
11.5.5.7	Rate Controllers.....188
11.5.5.8	Gages.....189
11.5.5.9	Piping and Valves.....191
11.5.5.10	Maintenance Schedule .....191
11.5.6	Pressure Filters .....191
11.5.7	Precoat Filters .....192
11.5.8	Ion-Exchange Equipment .....193
11.5.8.1	Operating Conditions.....193
11.5.8.2	Demineralization Equipment.....196
11.5.9	Recarbonation Equipment .....196
11.5.9.1	Combustion Units .....196
11.5.9.2	Carbon Dioxide Gas Feeders and Evaporator Units.....197
11.5.10	Distillation Equipment.....197
11.5.10.1	Multiple-Effect Evaporators .....197

	<u>Page</u>
11.5.10.2	Vapor-Compression Distillation Units.....198
11.5.10.3	Maintenance Procedure Schedule .....199
11.5.11	Electrodialysis Equipment .....199
11.5.12	Reverse Osmosis Equipment .....199
11.5.13	Backflow Preventers .....199
11.5.14	Valves.....201
11.5.15	Pumps.....201
11.5.16	Compressors .....201
11.6	Lubrication .....201
11.6.1	General Information.....201
11.6.2	Types of Lubricants .....205
11.6.3	Lubricant Uses.....205
11.6.4	Lubricating Precautions .....211
11.6.5	Grease Fittings. ....212
11.6.6	Identifying Lubricant Items.....213
11.7	Combustion Engines.....213
11.8	Chemical Storage and Feeders .....213
11.8.1	General.....213
11.8.2	Lime Slakers.....213
11.8.3	Gas Chlorinators.....214
11.8.4	Liquid Chlorine Evaporators .....218
11.8.5	Hypochlorite Solution Feeders .....219
11.8.6	Dry Chemical Feeders.....219
11.8.6.1	Test Calibration .....221
11.8.7	Solution Feeders. ....221
11.9	Tanks and Reservoirs.....221
11.9.1	Paint Systems for Steel Storage Tanks .....221
11.9.1.1	Surface Preparation.....221
11.9.1.2	Paint Application Methods .....232
11.9.1.3	Paint Selection.....232
11.9.2	Cathodic Protection for Steel Tanks .....233
11.9.2.1	Limitations .....233
11.10	Pipelines.....233
11.10.1	Protective Coatings. ....233



	<u>Page</u>
11.10.2	General Information.....233
11.10.3	Paint Protection. ....234
11.10.4	Paint Application.....234
11.10.4.1	Surface Preparation.....234
11.10.4.2	Preparation of Paint.....234
11.10.5	Corrosion-Preventive Compounds.....234
11.11	Chain Drive.....234
11.12	Tools and Equipment.....237
11.12.1	Tool Inventory.....237
11.12.1.1	Tool Care and Usage .....237
11.12.1.2	Tool Storage.....237
11.12.1.3	Tool Inspection .....237
11.12.1.4	Caution and Usage.....237
11.12.2	Equipment and Supplies.....237
<b>Section 12</b>	<b>SWIMMING POOL OPERATIONS</b>
12.1	Responsibilities .....246
12.2	References .....246
12.3	Operations.....247
<b>Section 13</b>	<b>SAFETY AND HEALTH</b>
13.1	Pertinent Regulations .....251
13.2	General Safety Guidelines .....251
<b>APPENDIX</b>	
<b>Appendix A</b>	<b>Sample Calculations.....252</b>

## FIGURES

Figure	1	Effects of Overlapping Fields of Influence—Pumped Wells .....	21
	2	Using Air Line to Find Depth of Water Level .....	23
	3	Jetting Tool for Well Screening .....	32
	4	Piping Arrangement for Backwashing and Backblowing.....	36
	5	Types of Wearing (Sealing) Ring.....	98
	6	Typical Well Pumping and Recovery Test.....	110
	7	Backwash Rate for Media Cleaning.....	183
	8	Multiple Hook Gage .....	184

## TABLES

Table	1	Gallons (Liters) of Water Per Foot (Meters) of Depth for Various Well Diameters.....	26
	2	Materials Required for 100 Gallons (400 Liters) of Chlorine Solution .....	29
	3	Jetting Nozzle Discharge .....	31
	4	Eductor Submergence Required for Various Well Depths.....	35
	5	Air Requirements for Backwashing Well Screen with Air-Lift .....	37
	6	Maintenance Checklist for Groundwater Supplies .....	38
	7	Maintenance Checklist for Surface Water Supplies.....	42
	8	Chemicals Used in Water Treatment.....	59
	9	Water Treatment Plant Residue Disposal Summary .....	67
	10	Comparison of Pump Discharge and Head.....	74
	11	Routine Operations Checklist for Centrifugal Pumps .....	76

	<u>Page</u>
12	Troubleshooting Checklist for Centrifugal Pumps .....79
13	Troubleshooting Checklist for Progressive-Cavity Pumps .....86
14	Lubrication Schedule for Centrifugal-Type Pumps .....89
15	Hand Oiler Adjustment .....91
16	Guide for Stuffing Box Inspection .....92
17	Maintenance Checklist for Bearings .....96
18	Startup Checklist for Vertical Turbine Well Pumps.....108
19	Troubleshooting Checklist for Vertical Turbine Well Pumps .....111
20	Routine Operations Checklist for Electric Motors .....114
21	Operations Checklist for Gasoline and Diesel Engines.....115
22	Checklist for Repairing Water Main Breaks and Leaks .....124
23	Flow Rate and Number of Hydrant Outlets Required to Flush Water Mains with 40 psi (280 kPa) of Pressure .....125
24	Current and Voltage Required to Thaw Wrought-Iron and Cast-Iron Pipe .....128
25	Maintenance Checklist for Valves and Accessories.....135
26	Maintenance Checklist for Fire Hydrants .....142
27	Maintenance Checklist for Flow, Pressure, and Level Sensors.....148
28	Maintenance Checklist for Transmission Systems .....151
29	Maintenance Checklist for Indicators, Registers, and Recorders .....153

	<u>Page</u>
30	Maintenance Checklist for Water Meters .....155
31	Maintenance Checklist for Weirs and Flumes.....156
32	Approved Backflow Devices .....158
33	Suggested Intervals for Inspecting Backflow Devices.....160
34	Maintenance Checklist for Aeration Equipment .....172
35	Maintenance Checklist for Rapid Mix, Flocculation, and Sedimentation Basins .....174
36	Maintenance Checklist for Gravity Filtration Equipment .....177
37	Maintenance Checklist for Ion-Exchange Softening Units .....194
38	Maintenance Checklist for Distillation Equipment .....200
39	Maintenance Checklist for Compressors .....202
40	Lubricating Oils, Greases, and Preservatives .....206
41	Lubricating Oil and Grease Uses.....208
42	Troubleshooting Checklist for Solution-Feed, Vacuum-Operated Gas Chlorinators.....215
43	Maintenance Checklist for Chlorination Equipment .....217
44	Maintenance Checklist for Dry Chemical Feeders .....220
45	Calibration Tests for Dry Chemical Feeders.....222
46	Maintenance Checklist for Solution Chemical Feeders.....225
47	Maintenance Checklist for Storage Facilities .....227

	<u>Page</u>
48	Troubleshooting Checklist for Chain Drives .....236
49	Suggested Tools for Water Treatment Plants .....238
50	Suggested Equipment for Water Treatment Plants .....242
51	Suggested Materials and Supplies for Water Treatment Plants .....244
52	Monthly Operating Checklist for Swimming Pools .....247
53	Troubleshooting Checklist for Swimming Pools .....248
REFERENCES	.....257
COPYRIGHT NOTIFICATION	.....264
GLOSSARY	.....265

## Section 1: INTRODUCTION

1.1 Scope of Handbook. MIL-HDBK-1164 provides general technical guidance for operating and maintaining potable water systems at fixed military installations. Since no two installations are exactly alike, this handbook is supplemental to site-specific operations and maintenance (O&M) manuals provided for each installation. The handbook applies to all personnel responsible for operating and maintaining fixed-base water systems, including supervisors as well as operators. To provide military personnel with the most up-to-date information available the handbook guides the reader to industry standards, manuals of practice, training guides, handbooks, and miscellaneous documents published by the American Water Works Association (AWWA) and other authorities in the water supply and treatment field. This manual is not intended to be read in its entirety. Rather, the reader is expected to refer to individual parts as the need arises.

1.2 Organization of Handbook. It is suggested that the reader become familiar with the organization, content, and intended use of this handbook by first looking at the Table of Contents. Next, the reader may page through the manual to get an overall idea of the organization. For most topics, the reader will be guided to published references for detailed information. References provided for each topic will generally be listed in order of increasing technical complexity. The handbook does contain tables, charts, and at-a-glance checklists for quick how-to reference by operators and maintenance personnel.

The remainder of the handbook is organized as follows:

- a) Section 2: Applicable Documents
- b) Section 3: Utility Management
- c) Section 4: Water Supply
- d) Section 5: Water Treatment
- e) Section 6: Pumps and Drivers
- f) Section 7: Distribution and Storage
- g) Section 8: Valves and Hydrants
- h) Section 9: I&C and Water Meters

- i) Section 10: Cross-Connection Control and Backflow Prevention
- j) Section 11: General Maintenance Operations
- k) Section 12: Swimming Pool Operations
- l) Section 13: Safety and Health

CANCELLED

## Section 2: APPLICABLE DOCUMENTS

2.1 Basic List. Publications included in the basic list provide general information that is fundamental to the successful operation of all potable water systems. Publications on this list are updated periodically by the publisher; the latest edition of each is recommended for inclusion in the library of all fixed-base water systems.

2.1.1 Principles and Practices of Water Supply Operations Series: Basic Science Concepts and Applications (AWWA)

2.1.2 Principles and Practices of Water Supply Operations Series: Water Quality (AWWA)

2.1.3 Principles and Practices of Water Supply Operations Series: Water Sources (AWWA)

2.1.4 Principles and Practices of Water Supply Operations Series: Water Transmission and Distribution (AWWA)

2.1.5 Principles and Practices of Water Supply Operations Series: Water Treatment (AWWA)

2.2 Supplemental List. The supplemental list of references contains information on topics that do not apply to every installation. To the extent that the listed references do apply to an installation's water system, the latest editions of those selected publications are recommended for inclusion in the water utility's library. The single-topic references included in the supplemental list generally contain more detailed information than is found in references in the basic list.

2.2.1 Manual of Water Supply Practices: Automation and Instrumentation (AWWA M2)

2.2.2 Manual of Water Supply Practices: Safety Practices for Water Utilities (AWWA M3)

2.2.3 Manual of Water Supply Practices: Water Fluoridation Principles and Practices (AWWA M4)

2.2.4 Manual of Water Supply Practices: Water Utility Management Practices (AWWA M5)

2.2.5 Manual of Water Supply Practices: Water Meters— Selection, Installation, Testing and Maintenance (AWWA M6)



- 2.2.6 Manual of Water Supply Practices: Problem Organisms in Water—Identification and Treatment (AWWA M7)
- 2.2.7 Manual of Water Supply Practices: Concrete Pressure Pipe (AWWA M9)
- 2.2.8 Manual of Water Supply Practices: Steel Pipe—A Guide for Design and Installation (AWWA M11)
- 2.2.9 Manual of Water Supply Practices: Simplified Procedures for Water Examination (AWWA M12)
- 2.2.10 Manual of Water Supply Practices: Recommended Practice for Backflow Prevention and Cross-Connection Control (AWWA M14)
- 2.2.11 Manual of Water Supply Practices: Installation, Field Testing, and Maintenance of Fire Hydrants (AWWA M17)
- 2.2.12 Manual of Water Supply Practices: Emergency Planning for Water Utility Management (AWWA M19)
- 2.2.13 Manual of Water Supply Practices: Chlorination Principles and Practices (AWWA M20)
- 2.2.14 Manual of Water Supply Practices: Groundwater (AWWA M21)
- 2.2.15 Manual of Water Supply Practices: Sizing Water Service Lines and Meters (AWWA M22)
- 2.2.16 Manual of Water Supply Practices: PVC Pipe Design and Installation (AWWA M23)
- 2.2.17 Manual of Water Supply Practices: Dual Water Systems (AWWA M24)
- 2.2.18 Manual of Water Supply Practices: Flexible-Membrane Covers and Linings for Potable Water Reservoirs (AWWA M25)
- 2.2.19 Manual of Water Supply Practices: External Corrosion—Introduction to Chemistry and Control (AWWA M27)
- 2.2.20 Manual of Water Supply Practices: Cleaning and Lining Water Mains (AWWA M28)
- 2.2.21 Manual of Water Supply Practices: Precoat Filtration (AWWA M30)

- 2.2.22 Manual of Water Supply Practices: Distribution System Requirements for Fire Protection (AWWA M31)
- 2.2.23 Manual of Water Supply Practices: Distribution Network Analysis for Water Utilities (AWWA M32)
- 2.2.24 Manual of Water Supply Practices: Flow Meters in Water Supply (AWWA M33)
- 2.2.25 Manual of Water Supply Practices: Water Audits and Leak Detection (AWWA M36)
- 2.2.26 Manual of Water Supply Practices: Operational Control of Coagulation and Filtration Processes (AWWA M37)
- 2.2.27 Manual of Water Supply Practices: Electrolydialysis and Electrolydialysis Reversal (AWWA M38)
- 2.2.28 Manual of Water Supply Practices: Reverse Osmosis and Nanofiltration (AWWA M40)
- 2.2.29 Manual of Water Supply Practices: Ductile-Iron Pipe Fittings (AWWA M41)
- 2.2.30 Manual of Water Supply Practices: Distribution Valves— Selection Installation, Field Testing, and Maintenance (AWWA M44)
- 2.2.31 Small Water System Operation and Maintenance (California State University, Sacramento Foundation)
- 2.2.32 Water Distribution System Operation and Maintenance (California State University, Sacramento Foundation)
- 2.2.33 Water Treatment Plant Operation, Volume 1 (California State University, Sacramento Foundation)
- 2.2.34 Water Treatment Plant Operation, Volume 2 (California State University, Sacramento Foundation)
- 2.2.35 AWWA Standard for Vertical Turbine Pumps: Line Shaft and Submersible Types (AWWA E101)
- 2.2.36 AWWA Standard for Water Wells (ANSI/AWWA A100)
- 2.2.37 Centrifugal Pumps and Motors: Operation and Maintenance (AWWA)

- 2.2.38 The Complete Swimming Pool Reference (Mosby—Year Book, Inc.)
- 2.2.39 Cross-Connection and Backflow Prevention (AWWA)
- 2.2.40 Disinfecting Water Mains (AWWA Standard C651-92)
- 2.2.41 Distribution System Maintenance Techniques (AWWA)
- 2.2.42 Drinking Water Handbook for Public Officials (AWWA)
- 2.2.43 Drought Management Planning (AWWA)
- 2.2.44 EO 12902, Energy Efficiency and Water Conservation in Federal Facilities
- 2.2.45 Evaluation and Restoration of Water Supply Wells (American Water Works Association Research Foundation [AWWARF])
- 2.2.46 Guidance Manual for Compliance with the Filtration and Disinfection Requirements for Public Water Systems Using Surface Water Sources (AWWA)
- 2.2.47 International Fire Service Training Association Manual 205 (International Fire Service Training Association [IFSTA])
- 2.2.48 Lead and Copper Rule Guidance Manual—Vol. I: Monitoring, NTIS PB92 112 101 (U.S. Environmental Protection Agency [USEPA])
- 2.2.49 Lead and Copper Rule Guidance Manual—Vol. II: Corrosion Control Treatment, EPA 811-B-92-002 (USEPA)
- 2.2.50 Lead Control Strategies (AWWARF)
- 2.2.51 Maintaining Distribution System Water Quality (AWWA)
- 2.2.52 Maintenance Management (AWWA)
- 2.2.53 Manual of Cross-Connection Control (Foundation for Cross-Connection Control and Hydraulic Research, University of Southern California)
- 2.2.54 Painting and Repainting Steel Tanks, Standpipes, Reservoirs, and Elevated Tanks for Water Storage (AWWA Standard D102)
- 2.2.55 Plant Engineering Magazine's Exclusive Guide to Interchangeable Industrial Lubricants (Cahners Publishing)

- 2.2.56 Plant Engineering Magazine's Exclusive Guide to Synthetic Lubricants (Cahners Publishing)
- 2.2.57 Pool-Spa Operators Handbook (National Swimming Pool Foundation)
- 2.2.58 Procedures Manual for Polymer Selection in Water Treatment (AWWARF)
- 2.2.59 Procedures Manual for Selection of Coagulant, Filtration, and Sludge Conditioning Aids in Water Treatment, (AWWA)
- 2.2.60 Recommended Practice for Fire Flow Testing and Marking of Hydrants (National Fire Protection Association [NFPA] 291)
- 2.2.61 SDWA Advisor: Regulatory Update Service (AWWA)
- 2.2.62 Standard Methods for the Examination of Water and Wastewater (American Public Health Association [APHA], AWWA, Water Environment Federation [WEF])
- 2.2.63 Surface Water Treatment: The New Rules (AWWA)
- 2.2.64 The U.S.A.I.D. Desalination Manual (Office of Engineering, U.S. Agency for International Development)
- 2.2.65 Water Conservation (AWWA)
- 2.2.66 Water Conservation Managers Guide to Residential Retrofit (AWWA)
- 2.2.67 Work Practices for Asbestos-Cement Pipe (AWWA)
- 2.2.68 Corrosion Control for Operators (AWWA)
- 2.3 Optional List. The optional list contains publications written for professionals in the water supply field—engineers, chemists, and advanced operators—who desire a greater understanding of the theory and application of water works practices.
- 2.3.1 Advances in Taste-and-Odor Treatment and Control (AWWA)
- 2.3.2 Assessment of Existing and Developing Water Main Rehabilitation Practices (AWWARF)
- 2.3.3 Case Studies of Modified Disinfection Practices for Trihalomethane Control (AWWARF)

- 2.3.4 Emergency Water Supply Planning for Fixed Army Installations, Technical Report N-86/11 (USA-CERL)
- 2.3.5 Filtration Strategies to Meet the Surface Water Treatment Rule (AWWA)
- 2.3.6 Identification and Treatment of Tastes and Odors in Drinking Water (AWWA & Lyonnaise des Eaux)
- 2.3.7 Internal Corrosion of Water Distribution Systems (AWWARF)
- 2.3.8 Lime Handling, Application and Storage, Bulletin 213 (National Lime Association)
- 2.3.9 Management of Water Treatment Plant Residuals (American Society of Civil Engineers [ASCE]/AWWA)
- 2.3.10 Minimizing Earthquake Damage (AWWA)
- 2.3.11 An Operator's Guide to Bacteriological Testing (AWWA)
- 2.3.12 Ozone in Water Treatment: Application and Engineering. (Lewis Publishers)
- 2.3.13 Preliminary Report: Field Test of Trash Rack Heating to Prevent Frazil Ice Blockage (U.S. Army CRREL)
- 2.3.14 Reservoir Management for Water Quality and THM Precursor Control (AWWARF)
- 2.3.15 Reverse Osmosis: A Practical Guide for Industrial Users (Tall Oaks Publishing Co.)
- 2.3.16 Sludge Handling and Disposal (AWWA)
- 2.3.17 Water Quality and Treatment (AWWA)
- 2.3.18 NACE RP0169-92, Control of External Corrosion on Underground or Submerged Metallic Piping Systems (National Association of Corrosion Engineers [NACE])
- 2.3.19 NACE RP0196-96, Galvanic Anode Cathodic Protection of Internal Submerged Surfaces of Steel Water Storage Tanks (NACE)
- 2.3.20 NACE RP0388-95, Impressed Current Cathodic Protection of Internal Submerged Surfaces of Steel Water Tanks (NACE)

- 2.4 Military Publications
- 2.4.1 Air Force Publications
- 2.4.1.1 AFI 32-1066, Plumbing Systems
- 2.4.1.2 AFM 85-31, Industrial Water Treatment
- 2.4.1.3 AFM 88-45, Civil Engineering Corrosion Control-Cathodic Protection Design
- 2.4.1.4 AFOOSH Standard 48-14, Swimming Pools, Spas, Hot Tubs, and Bathing Areas
- 2.4.1.5 AFI 32-1067, Water Systems
- 2.4.1.6 AFI 32-7047, Compliance Tracking and Reporting
- 2.4.1.7 AL-TR-1991-0049, Water Vulnerability Assessments
- 2.4.1.8 AFOOSH Standard 91-25, Confined Spaces
- 2.4.2 Army Publications
- 2.4.2.1 AR 40-5, Health and Environment
- 2.4.2.2 AR 420-49, Utility Services
- 2.4.2.3 TB MED 576, Sanitary Control and Surveillance of Water Supplies at Fixed Installations (Army Technical Bulletin, Medical)
- 2.4.2.4 TM 5-662, Repair and Utilities: Swimming Pool Operation and Maintenance
- 2.4.2.5 TM 5-813 Series, Water Supply: Source, Treatment, and Distribution Systems
- 2.4.2.6 TB MED 575, Swimming Pools and Bathing Facilities
- 2.4.3 Navy Publications
- 2.4.3.1 BUMEDINST 6240.10, Standards for Drinking Water
- 2.4.3.2 NAVFAC MO-2109, Inspection of Elevated Water Tanks

2.4.3.3 NAVFACENGCOM Guide Specification, Section 02090, Removal and Disposal of Lead-Containing Paint (Lead/Federal)

2.4.3.4 OPNAVINST 5090.1B, Environmental and Natural Resource Program Manual, Chapter 8: "Drinking Water Systems and Water Conservation"

2.4.4 Tri-Service (DOD) Publications

2.4.4.1 MIL-HDBK-1110, Paints and Protective Coatings

2.4.4.2 MIL-HDBK-1136, Cathodic Protection Operation and Maintenance

2.4.4.3 MIL-HDBK-1165, Water Conservation

2.4.4.4 MIL-HDBK-1167, Swimming Pool Operation and Maintenance

CANCELLED

## Section 3: UTILITY MANAGEMENT

3.1 Scope of This Section. Section 3 is intended to provide general information on water system operation and management, including:

- a) General information about water systems
- b) Personnel and staffing
- c) Reports and recordkeeping
- d) Emergency planning
- e) Regulations affecting water systems
- f) Water conservation

3.2 References. Several publications are referred to in this section as including necessary or supplementary information on utility management. These publications are listed below, along with the paragraph number used for the document in Section 2, Applicable Documents. For brevity, subsequent references to each of these documents use only the Section 2 paragraph number. The following publications are mentioned in Section 3:

- a) AL-TR-1991-0049, Water Vulnerability Assessments (par. 2.4.1.7)
- b) BUMEDINST 6240.10, Standards for Drinking Water, (BUMED Instruction dated 3 February 1993) (par. 2.4.3.1)
- c) Distribution System Requirements for Fire Protection (par. 2.2.22)
- d) Drinking Water Handbook for Public Officials (par. 2.2.42)
- e) Emergency Water Supply Planning for Fixed Army Installations, Technical Report N-86/11 (par. 2.3.4)
- f) EO 12902, Energy Efficiency and Water Conservation in Federal Facilities (par. 2.2.44)
- g) Manual of Water Supply Practices: Emergency Planning for Water Utility Management (par. 2.2.12)



- h) Manual of Water Supply Practices: Water Utility Management Practices (par. 2.2.4)
- i) Minimizing Earthquake Damage (par. 2.3.10)
- j) MIL-HDBK-1165, Water Conservation (par. 2.4.4.3)
- k) Principles and Practices of Water Supply Operations Series: Water Quality (par. 2.1.2)
- l) Principles and Practices of Water Supply Operations Series: Water Sources (par. 2.1.3)
- m) Principles and Practices of Water Supply Operations Series: Water Transmission and Distribution (par. 2.1.4)
- n) Principles and Practices of Water Supply Operations Series: Water Treatment (par. 2.1.5)
- o) TB MED 576, Sanitary Control and Surveillance of Water Supplies at Fixed Installations (par. 2.4.2.3)

3.3 Elements of a Water Supply System. All fixed-base water systems have a source of supply and facilities for distributing water to the point of use. At some installations, treatment facilities and pumping are also required. Paragraphs 3.3.1 through 3.3.4.4 provide an overview of the basics of water system operation.

3.3.1 Water Supply Sources. The most common way to provide potable water at fixed military installations is to buy it from a nearby municipality or private water company. At installations where purchased water is not an option, the most common sources of water include wells, rivers, lakes, and reservoirs. Other potential sources include rain catchment and desalination, but these are normally used only when fresh water is scarce. Basic information on water supply sources may be found in pars. 2.2.42 and 2.1.3.

More detailed information on water supply is provided in Section 4 of this handbook.

3.3.2 Water Treatment. Water treatment facilities vary from providing basic disinfection of groundwater supplies to very sophisticated treatment plants using one or more of the following processes: coagulation, sedimentation, filtration, carbon

treatment, lime-soda softening, fluoridation, and disinfection. A general introduction to water treatment processes and their applications is provided in par. 2.2.42.

More detailed information on water treatment is provided in Section 5 of this handbook.

3.3.3 Water Distribution. A distribution system is a network of pipes, including necessary valves, hydrants, and storage reservoirs, that carry potable water to the point of use. Even military installations that purchase potable water usually install and maintain their own distribution and storage systems. A general introduction to water distribution system operation and maintenance is provided in par. 2.2.42.

More detailed information on water distribution is provided in Section 7 of this handbook.

3.3.4 Pumping. Pumping and gravity flow are the two essential methods used to move water from place to place. Pumps and pumping facilities vary depending on their specific use. General-use categories include:

- a) Well pumps
- b) Low-lift pump stations
- c) High-lift (or high-service) pump stations
- d) Booster pump stations

3.3.4.1 Well Pumps. Well pumps are used to lift water from wells and may discharge directly to a distribution system, to storage, or to a treatment plant. For more detailed information on water well pumps, see pars. 4.5.2 and 4.5.3.

3.3.4.2 Low-Lift Pump Stations. The usual application for low-lift pump stations is pumping water from a surface supply to the intake of a non-pressure treatment plant. Low-lift pumps may also be used for transferring water from one unit process to another within a treatment facility. For more detailed information on low-lift pump stations, see par. 4.6.4.

3.3.4.3 High-Service Pump Stations. High-service pumps transfer potable water from non-pressurized sources such as storage reservoirs directly to the distribution system. In general, system pressures for high-service pumps should fall between 50 and 75 pounds per square inch (psi) (3.5 to 5 kilograms per square centimeter [kg/sq cm]) for residential service. System pressure should not drop below 20 psi (1.4

kg/sq cm). For fire hydrants, the recommended minimum static pressure is 35 psi (2.5 kg/sq cm).

For more detailed information on high-service pumps, see Section 6 of this handbook.

3.3.4.4 Pressure Regulating Stations. Booster pumps are occasionally installed to increase the pressure in a pipeline or in a specific zone of a distribution system to help meet peak demands such as fire flow and to supply water to elevated storage tanks. Booster pump stations are particularly suited for a distribution system located in hilly country where there are two or more pressure zones, or on the periphery of an overextended or overloaded distribution system. Booster pumping stations are usually automatically or remotely controlled from the main pumping station and are normally equipped with electrically driven centrifugal pumps. Sometimes it is necessary to take water from a higher pressure zone and reduce the pressure for use in a lower pressure zone. Pressure reducing valves are used to automatically throttle flow and maintain the desired pressure in the lower distribution system zone.

3.4 Water Utility Staffing. Effective use of manpower in water treatment facilities is important at all times for efficiency and economy, and is essential during national emergencies.

3.4.1 Personnel Requirements. Military water supply systems vary so greatly in design, arrangement, and complexity that the number of personnel needed cannot be determined solely by installation population or water usage. The best approach is to prepare a list of tasks that need to be performed, indicating how much time each task will take and the knowledge and skills required to perform it. Analyzing this information will help determine the qualifications and size of staff needed to operate and maintain the facility.

Installations that do not provide treatment other than disinfection can usually get by with 1 shift per day, 5 or 7 days per week. Nights, weekends, and holidays can be covered by having key personnel on call. Treatment plants, however, can require more attention depending on size, complexity, and production schedules. Most states have specific staffing criteria based on size and complexity of the treatment facility.

An estimate of O&M labor needs can be obtained by applying the 5/3 Rule. That is, for an effort of 7 days per week, 3 shifts per day, 1 position equals 5/3 staff members. The concept can be adjusted for other work periods (such as 1 shift

per 5 days or 2 shifts per 7 days). Appendix A contains a sample computation illustrating the 5/3 Rule.

3.4.2 Scheduling Personnel. Work schedules for treatment plant operators are a matter of local preference for length of shift (8 or 12 hours) and for fixed or rotating shifts. Studies have shown that constantly rotating shifts can be harmful to employees' physical and mental well-being. Rotating shifts on a 6- to 8-week cycle is better.

Except in emergency situations, maintenance crews typically do not work around the clock. A 10-hour shift for maintenance personnel has been shown to offer the most productivity as well as provide the most efficient use of equipment.

3.4.3 Certification. Virtually all regulatory jurisdictions require that a certified operator be in charge of an installation's water supply and treatment facilities. The numbers and grade level of certified operators required at a given installation are determined by the size and complexity of the treatment facilities. To qualify for higher levels of certification, greater combinations of education and experience are required. To become certified at any level, the operator must pass an examination based on what he or she needs to know to work at a plant. Higher certification entails more extensive examination. For more information on certification, contact the Association of Boards of Certification for Operating Personnel in Water Utilities and Pollution Control Systems (ABC):

Executive Director, ABC  
P.O. Box 786  
Ames, Iowa 50010-0786  
Phone (515) 232-3623

3.4.4 Training. Training may be obtained by attending technical schools, community colleges, short courses, workshops, and by successfully completing home study courses. After an operator is certified, continual training is essential to maintain high standards of service, ensure safe, efficient operation, and keep personnel informed of all current technical developments. Additional information on training can be obtained either from ABC (par. 3.4.3) or from par. 2.2.42.

3.5 Information Management. In general, good records promote efficient operation of the water system. Specifically, records are essential to an effective maintenance program, are required to comply with certain water quality regulations, and are necessary for planning purposes. The information management system is most efficient when tailored to the particular needs of the installation. Only those records known to be useful should be kept, and records should be readily accessible to

all personnel concerned with the water system's O&M. Many records will be kept for a long time and should be protected from damage. Some records, such as maps, will require occasional updating. A computerized information management system can effectively meet all of these criteria. File hard copies of all records according to military procedures. Guidance on the water system records that are commonly maintained can be found under subsequent headings in this section. There is no substitute for good records.

3.5.1 Operating Records. Suggested records for the following unit processes can be found in par. 2.1.5: activated carbon, aeration, chlorination, corrosion/scale control, filtration, fluoridation, ion-exchange, iron and manganese control, presedimentation, reverse osmosis, screening, sedimentation, water softening, and water weed control.

3.5.2 Daily Logs. Enter each day's operating data in the daily operating log and then in the monthly operating report (MOR) to provide a record of daily and average monthly operations. The data recorded cover all aspects of operations including a diary of routine operational duties, unusual conditions (operational and maintenance), accidents, complaints, and visitors.

3.5.3 MORs. Each installation's water treatment facility prepares a monthly report compiled from daily operation data reports. Monthly reports permit technical review of current performance and comparison of performance over a long period. Accumulated monthly reports show variations caused by changes of seasons, methods of operation, and installation population.

These forms are used for preparing the MOR:

- a) AF Form 1461, Water Utility Operating Log
- b) NAVFAC Form 11340/2, Potable Water Treatment Plant Operating Record
- c) DA Form 4141, Water General

The following forms are used with those mentioned above at installations that have treatment in addition to disinfection, fluoridation, or treatment for scale and corrosion control.

- a) AF Form 1460, Water Utility Operating Log (Supplemental)

b) NAVFAC Form 11330/6, Potable Water Treatment Supply and Distribution Operating Record

c) DA Form 4374, Water Supplementary

3.5.4 Annual Reports. Annual reports generally include a description of facilities, gallons of water pumped/treated, quantity of chemicals consumed, capital costs, operating costs, and personnel status. Effective annual reports are clear, concise, and informative. It is generally recommended that the format be consistent from year to year to facilitate comparison with past performance.

3.5.5 Distribution System Maps and Records. For information, see par. 2.1.4.

3.5.6 Well Records. Well records show decreases in yield or increases in drawdown, and help to show the cause. Well records should be completed when the well is built and the records brought up to date when the well is tested. All well data are kept on file and used for reference when well repairs are made or when other wells are constructed in the area. Use prescribed forms for recording general well data, as well as pumping test results. Air Force personnel use AF Form 996, Well Data, to record this information.

3.5.7 Laboratory Reports. State and local requirements for reporting the results of water analysis must be at least as stringent as federal requirements, but specific requirements vary from state to state. General information recommended for inclusion in every report is covered in par. 2.1.2.

3.5.8 Maintenance. Maintenance records include manufacturer's catalogs, brochures, and instruction manuals for all installed equipment. Shop drawings and as-built drawings provide additional, specific information about equipment and facilities and are used with maintenance manuals to achieve efficient O&M of mechanical systems. At a minimum, maintenance records need to document, for each piece of equipment, when service was last performed and when it will be required again. A good record system also includes a complete repair and cost history for all installed equipment.

3.5.9 Cost Accounting. Although accounting personnel maintain cost and budget records, it is recommended that the waterworks supervisor keep records of operating costs as well. These records provide up-to-the-minute information on expenditures and can be used to predict yearly costs and forecast budgets.

3.6 Emergency Planning. Health and fire protection depend so much on a safe, adequate water supply that measures for protecting the system and plans for emergency operation are basic responsibilities of those in charge of the water supply facilities. Basic information on emergency planning is contained in par. 2.2.42.

For more information on emergency planning, see the publications listed in pars. 2.2.4, 2.2.12, 2.3.4, and 2.3.10.

3.6.1 Fire Protection. Fire protection falls into two broad categories: general protection of installation facilities and equipment, and protection of the water supply and treatment facilities. For more information on fire protection planning and procedures, see the publications listed in pars. 2.1.4, 2.2.4, and 2.2.22.

3.6.2 Natural Disasters. Natural disasters include earthquakes, hurricanes, tornadoes, and floods. Discussions of the effects of natural disasters, as well as measures to mitigate them, can be found in the publications listed in pars. 2.2.12, 2.3.4, and 2.3.10.

3.6.3 Man-Made Disasters. Disasters caused by people include events such as accidents, riots, strikes, hazardous material spills, vandalism, terrorism, and bomb blasts. Discussions of the effects of man-made disasters, as well as measures to mitigate them, can be found in pars. 2.2.12 and 2.3.4.

3.6.4 Vulnerability Assessment. A vulnerability assessment is a four-step process that identifies system components most likely to fail in a given situation. For a list of common water system components and how each component may be vulnerable to typical hazards, as well as an example of a vulnerability assessment, see par. 2.2.12.

Additional information can be found in pars. 2.3.4 and 2.4.1.7.

3.7 Regulations Affecting Water Systems. Congress passed the original Safe Drinking Water Act (SDWA) in 1974 to ensure that the public drinking water system serving the U.S. population would meet established SDWA standards. These standards, known as the Primary Drinking Water Regulations and Secondary Drinking Water Regulations, set the numeric limits for drinking water quality. These regulations apply to all public water systems. Most of the military installation water supplies are considered public water systems and are required to comply with the local, state, and federal drinking water regulations including public notification requirements.

3.7.1 EPA Regulations. The SDWA and the 1986 and 1996 amendments to SDWA direct the EPA to promulgate regulations and guidance on maintaining drinking water quality to protect the public health. The 1996 amendments waived the sovereign immunity. Most of the states have the primacy for the implementation SDWA provisions, however, individual states can establish additional compliance requirements. Installations should check with the Bio-environmental engineer and base environmental coordinator to assure compliance with the applicable regulations. For guidance in complying with the EPA regulations, see military regulations listed in pars. 2.4.2.3 and 2.4.3.1.

Installations in foreign countries are required to meet Final Governing Standards (FGS) of the host nation or the Standards established under the Overseas Environmental Baseline Guidance Document (OEBGD).

3.8 Water Conservation. Water conservation practices at military installations are fully covered in the publications listed in pars. 2.4.4.3 and 2.2.44.

CANCELLED



## Section 4: WATER SUPPLY

4.1 Section Overview. This section provides general information pertaining to water supply sources. Section 4 also presents specific information on the operation and maintenance of water wells, dams and reservoirs, and intake structures.

4.2 References. Publications containing additional information on water supply issues are listed below. Subsequent references to these sources within Section 4 use only the paragraph number shown in parentheses after the title. This number corresponds to the paragraph number of the document in Section 2, Applicable Documents.

Pertinent water supply information can be found in the following published sources:

- a) AWWA Standard for Water Wells (par. 2.2.36)
- b) Manual of Water Supply Practices: Groundwater (par. 2.2.14)
- c) Manual of Water Supply Practices: Problem Organisms in Water—Identification and Treatment (par.2.2.6)
- d) Preliminary Report: Field Test of Trash Rack Heating to Prevent Frazil Ice Blockage (par. 2.3.13)
- e) Principles and Practices of Water Supply Operations Series: Basic Science Concepts and Applications (par. 2.1.1)
- f) Principles and Practices of Water Supply Operations Series: Water Quality (par. 2.1.2)
- g) Principles and Practices of Water Supply Operations Series: Water Sources (par. 2.1.3)
- h) Principles and Practices of Water Supply Operations Series: Water Transmission and Distribution (par. 2.1.4)
- i) Principles and Practices of Water Supply Operations Series: Water Treatment (par. 2.1.5)
- j) Small Water System Operation and Maintenance (par. 2.2.31)

4.3 Water Supply Hydrology. The publications listed in pars. 2.1.1, 2.1.3, and 2.2.1 include information on the hydrologic cycle—that is, the natural distribution and circulation of water in the earth's atmosphere, on the earth's surface, and below the earth's surface. These resources present the basic distinctions between surface waters and ground waters and introduce the principles of hydraulics (volume and flow).

4.4 Water Use. Water usage at medium to large military installations is similar to usage in a modern city. Water is used for residential, commercial, and industrial purposes, as well as for fire protection. The most important reason for maintaining continuity of service is to protect public health. To adequately supply all water requirements, water system operators need to know the magnitude and occurrence of peak flows.

A discussion of water use issues, as well as emergency and alternative water sources, can be found in par. 2.1.3.

4.5 Groundwater Supplies. Detailed and specific information on groundwater sources, water well terminology, well location and construction practices, and well types can be found in the publications listed in pars. 2.1.3, 2.2.1, and 2.2.36.

4.5.1 Aquifer Performance. The three basic calculations related to water well performance are well yield, drawdown, and specific capacity. These calculations provide information for selecting appropriate pumping equipment and identifying any changes in the productive capacity of the well. Paragraph 2.1.1 defines these parameters and provides sample calculations. Paragraph 4.5.2.3 provides a method for computing drawdown.

4.5.2 Well Operation

4.5.2.1 Balancing the Pumping Schedule. When water is pumped from a well, a depression is produced in the water table as drawdown occurs. When pumping stops, the water again rises to the static water level. The depth and lateral extent of the cone of depression depends on the pumping rate of the well. If two or more wells are located so closely together that their cones of depression overlap, the wells compete with each other for the groundwater. Then, each produces less water than if operated alone (Figure 1). Place operating wells as far apart as possible to minimize the effect of overlapping cones of depression. Operate wells in rotation to equalize wear on pumping equipment.

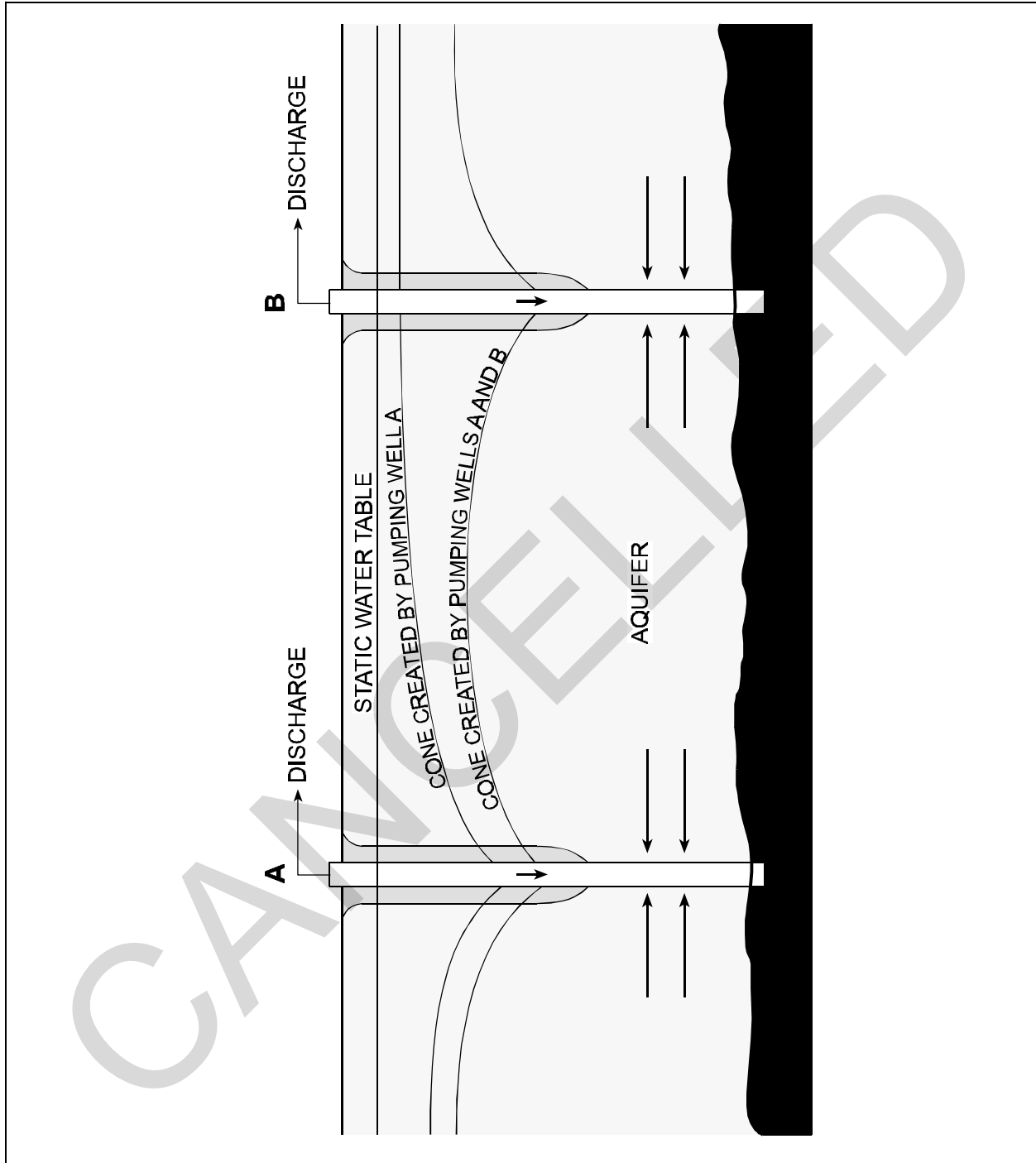

Figure 1  
Effects of Overlapping Field of Influence - Pumped Wells

4.5.2.2 Operating Well Pumps. Pump wells carefully and keep pumping rates within the specified design range. Continuous operation is generally preferable to frequent starting and stopping, but varying water demand and storage capacity usually require some combination of on and off time. Both over-pumping and frequent starting and stopping can damage the aquifer, resulting in reduced yield. In coastal areas, over-pumping may also cause saltwater intrusion. Frequent start/stop operation also shortens equipment life and consumes more energy. It is usually preferable to limit pump starts to less than once per hour. Additional information on well pump information is included in pars. 2.2.14 and 2.2.31.

4.5.2.3 Measuring Water Levels and Drawdown. Well tests are necessary to evaluate the performance of a well. These tests include measuring the static water level, the pumping rate, the pumping levels at various times after pumping has started, and the increasing water levels after pumping has stopped. Measure the static level, pumping level, and drawdown on each well as often as practical. If a daily measurement cannot be made owing to a large number of wells or difficulty in taking the measurements, measure the level in each well at least twice a month at as near the same time as possible. A sample calculation for static level, pumping level, and drawdown is included in Appendix A.

a) Orifices, meters, and pitot tubes used to measure flow rates are described in pars. 2.1.2 and 2.1.4.

b) Measure water levels using the air line method, electric sounders, wetted tape, or electrical depth gages. The most common method of depth measurement is the air line method, which is explained below and depicted on Figure 2.

(1) Place an air line of known length in a well (unless one has been permanently attached) to a depth below the expected pumping level. Connect the surface end of the line to an air pump and connect a pressure gage to the line so that air pressure in the line can be read. Make all joints airtight.

(2) With the well pump shut down, apply air pressure through the air pump until the gage needle no longer registers any increase in pressure. The gage reading then shows the amount of pressure that was necessary to force the standing water out of the air line. This is directly proportional to the height of the water standing in the well above the bottom of the air line. Multiply the gage pressure in psi by 2.31 to determine the height in feet; multiply kiloPascals (kPa) by 10.1973 to obtain centimeter (cm) of water.

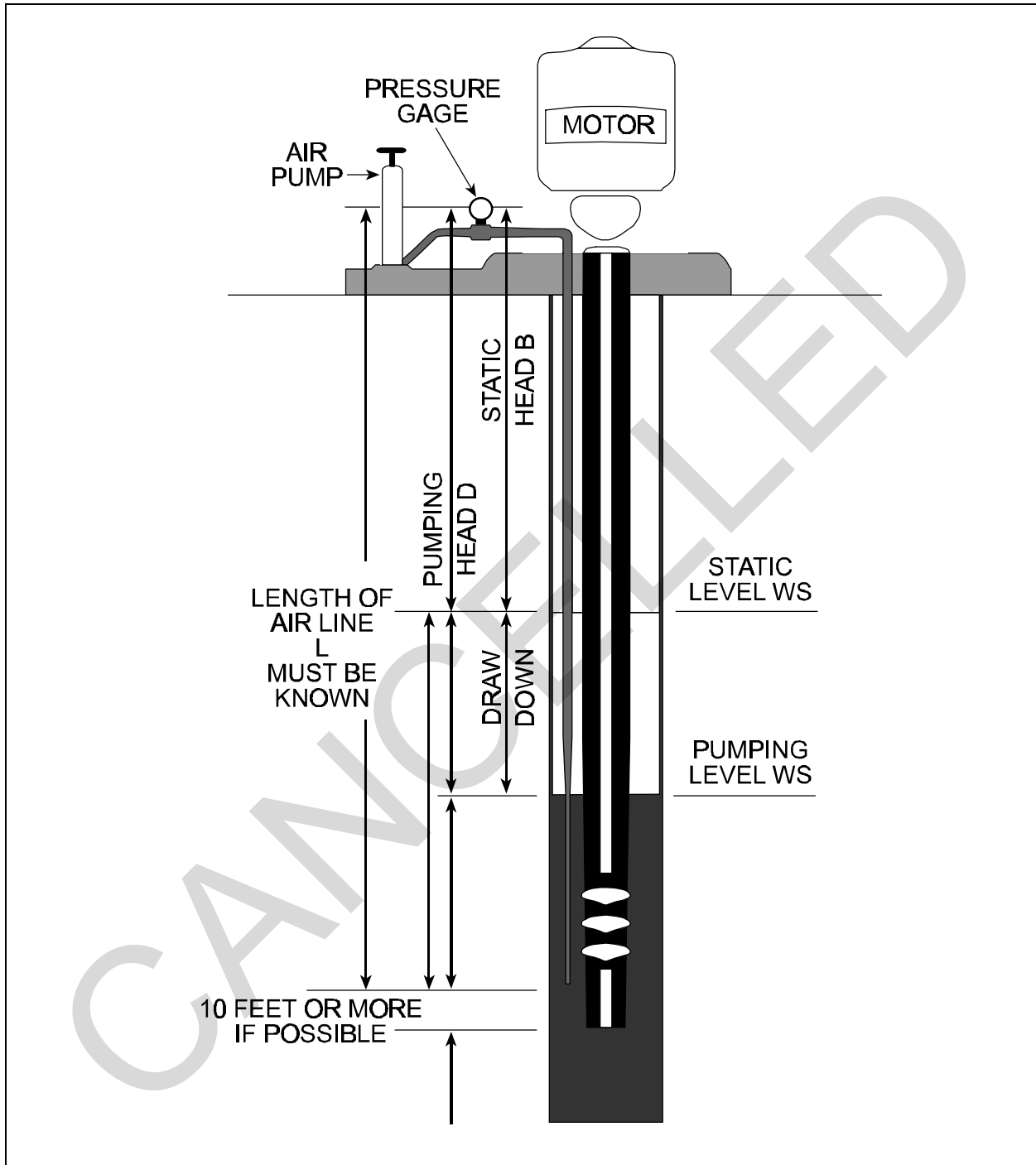

Figure 2  
Using Air Line to Find Depth of Water Level

(3) Some gages measure feet of water in addition to air pressure; if available, use a gage that indicates feet of water. To determine the distance below the air gage at which the water stands in the well, subtract the calculated height of water above the bottom of the air line from the known length of the air line below the well top. This value is the static level.

(4) Start the well pump and observe the air gage until the reading no longer changes, pumping in additional air to make up for any leakage. Convert this pressure reading to feet. This measurement is the height at which water stands in the well above the bottom of the air line during pumping. Deduct this value from the length of the air pipe below the well top to get the pumping level. The drawdown is the difference between the static level and the pumping level.

c) Maintain careful records of static level and drawdown correlated with the capacity or pumping rate. This information can help you anticipate difficulties and provide data for proper maintenance measures:

(1) A falling static level indicates gradual lowering of the water table or interference by other wells.

(2) An increased drawdown may indicate receding groundwater level, well interference, or leaky casing or delivery pipes. Increased drawdown may also suggest a clogged, scaled, or corroded well screen; a sand- or silt-packed gravel area and adjacent stratum; or a cave-in of the water-bearing stratum.

d) Take measurements periodically to develop a well chart like the one shown in Figure 6 (Section 6). The pumping rate can be kept constant using a valve in the discharge line. Start the test with the valve one-half to three-fourths open at the desired flow rate. Compare well charts with prior test results to detect changes that require attention.

4.5.2.4 Checking for Safe Pumping Yield. Typically, the measured drawdown is compared to the depth of the top of the well screen or artesian aquifer. To prolong the life of the well, especially a gravel-packed well, and to decrease maintenance, operate the well at a pumping rate that achieves 50 percent of the maximum drawdown. If the desired yield cannot be obtained at this pumping rate, you may need to perform maintenance on the well to restore well yield.

4.5.2.5 Disinfecting Wells. Major pollution of aquifers may take years to overcome. Minor pollution may be overcome by chlorinating the water. Disinfect wells, springs, infiltration galleries, and radial collectors as a normal maintenance procedure. Disinfect deep wells after original development, each time the pump is removed, each

time the screen is cleaned using surging methods, and whenever regular bacteriological analyses indicate contamination is present.

a) Preparing the Disinfectant. The best method of disinfection involves preparing a stock chlorine solution that, when mixed with 100 gallons (400 liters [L]) of water in the well, provides a dosage of 100 milligrams per liter (mg/L). The stock chlorine solutions described below have a volume of 2 quarts (2 L), the amount required for each 100 gallons (400 L) of water in the well. Use calcium hypochlorite (65 percent available chlorine) or sodium hypochlorite (liquid household bleach containing 5.25 percent available chlorine) to make the solution. Prepare the solutions in clean crockery, glass, or rubber-lined containers. Metal containers will be corroded by the strong chlorine solution.

(1) Calcium Hypochlorite. Add 2 ounces (66 grams [g]) of granular high-test calcium hypochlorite to a small quantity of water and stir to a smooth watery paste free of lumps. Add this mixture to enough water to make 2 quarts (2 L). Stir the solution for 10 to 15 minutes before allowing the inert ingredients to settle. Use the clear liquid with the chlorine and discard the inert ingredients. Use 2 quarts (2 L) for every 100 gallons (400 L) of well water.

(2) Sodium Hypochlorite. Dilute 1 quart (1 L) of common liquid household bleach with 1 quart (1 L) of water. Use 2 quarts (2 L) for every 100 gallons (400 L) of well water.

b) Disinfecting Drilled, Driven, and Bored Wells. Calculate the quantity of water in the well based on the depth of water and the contents of the well in gallons per foot or liters per meter (Lpm) (Table 1). Introduce 2 quarts (2 L) of stock solution for each 100 gallons (400 L) of water in the well. Pour the stock solution directly into the well through a clean hose that is alternately raised and lowered in the well water. Operate the pump until a distinct odor of chlorine can be detected in the water discharged. Allow the well to stand for 24 hours, then pump water to waste until the chlorine residual drops to an acceptable level. Surging during chlorine treatment is helpful (see par. 4.5.3.1[g]). Obtain samples for bacteriological analysis and determine potability before putting well into service.

Table 1  
Gallons (Liters) of Water Per Foot (Meters)  
of Depth for Various Well Diameters

Well Diameter		Gallons of Water Per Foot of Depth		Well Diameter		Gallons of Water Per Foot of Depth	
inches	(mm)		(Lpm)	inches	(mm)		(Lpm)
4	(100)	0.65	(3.1)	20	(500)	16.32	(15.7)
6	(150)	1.47	(4.7)	22	(550)	19.75	(17.3)
8	(200)	2.61	(6.3)	24	(600)	23.50	(18.8)
10	(250)	4.08	(7.9)	27	(700)	29.74	(22.0)
12	(300)	5.88	(9.4)	30	(800)	36.72	(25.1)
14	(350)	8.00	(11.0)	36	(900)	52.88	(28.3)
15	--	9.18	--	42	(1,000)	71.97	(31.4)
16	(400)	10.44	(12.6)	48	(1,200)	94.00	(37.7)
18	(450)	13.22	(14.1)	60	(1,500)	148.88	(47.1)

c) **Disinfecting Dug Wells.** After the casing or lining has been completed, use a stiff brush or broom to wash the interior casing or lining wall with a strong solution (100 mg/L) of chlorine. Calculate the quantity of water in the well and follow the procedure for disinfection described above for drilled, driven, and bored wells.

d) **Disinfecting Springs.** Disinfect spring encasements using a procedure similar to the one used for dug wells. If the water pressure is not sufficient to raise the water to the top of the encasement, try shutting off the flow from the spring and keeping the chlorine solution in the spring for 24 hours. If the flow cannot be shut off completely, continue disinfecting the spring for as long as practical. Stock chlorine solution can be used as the disinfecting agent. Conduct bacteriological testing before returning the spring to use.

e) **Disinfecting Infiltration Galleries and Radial Collectors.** Add sufficient hypochlorite compounds to ensure a free residual chlorine concentration in the gallery of 50 to 100 mg/L. Allow water to stand for 24 hours. Then pump the water



to the storm sewer system until the residual chlorine content drops to an acceptable level.

#### 4.5.3 Well Maintenance and Rehabilitation

4.5.3.1 Cleaning Well Screens. A clogged well screen or a clogged aquifer near the well bore are the most common causes of decreasing yield. If the specific capacity has dropped to 60 percent of the new well value, then cleaning the well screen can improve the yield. If the specific capacity has dropped to 40 percent of the new well value, it is usually necessary to redevelop the well. Well screens on deep wells can be cleaned in place using one of the methods described below. Well screens can also be pulled for cleaning or for reuse.

Several well screen cleaning methods are listed below. Also listed are the paragraph numbers corresponding to a full discussion of the cleaning processes.

Treatment	Par. No.
Acid Treatment	4.5.3.1 (a)
Chlorine Treatment	4.5.3.1 (b)
Phosphate Treatment	4.5.3.1 (c)
Dry Ice Cleaning	4.5.3.1 (d)
Jet Cleaning	4.5.3.1 (e)
Sonic Process Cleaning	4.5.3.1 (f)
Surging	4.5.3.1 (g)
Backwashing and Surging	4.5.3.1 (h)
Backwashing and Backblowing	4.5.3.1 (i)

a) Acid Treatment. Encrustation of screens is caused principally by calcium carbonate deposits and occasionally by iron oxide and calcium sulfate deposits. Corrosion may also cause encrustation. Acidizing with properly inhibited muriatic acid or sulfamic acid cleans encrusted screens. Do not use uninhibited acids. The following procedures apply:

(1) Estimate the severity of encrustation from the records of changes in yield, specific capacity, drawdown, etc.

(2) Use an experienced and qualified contractor. Unless otherwise directed by the utility manager, base personnel do not typically perform acidizing operations. Be sure all people working on an acidizing project wear proper protective clothing.

Caution: Before proceeding with the treatment, disconnect the well from the distribution system.

(3) Use an inhibited acid. Wells are most often acidized using muriatic acid (commercial hydrochloric acid, 27 percent concentration) purchased with, or to which has been added, an inhibitor. These inhibitors are proprietary compounds: they keep the attack on the metal to a minimum but do not affect the reaction with calcium carbonate. Select the inhibitor or inhibited acid to obtain the maximum protection for the particular metal in the screen.

(4) Add the acid carefully through a hose placed in the case with its discharge end at the level of the screen. This procedure prevents dilution of the acid and gives a concentration of about 15 percent at the screen.

(5) In typical situations, leave the acid in the well for at least 5 hours. For quicker action, the acid may be heated, particularly if there is a flow of water past the well screen.

(6) After the acid treatment, pump the well to waste until the pH of the water returns to normal.

Caution: Provide for neutralization of this wastewater or other safe disposal until the water returns to normal.

(7) Sulfamic acid (do not confuse with sulfuric acid) may be used in place of muriatic acid. Sulfamic acid is a granular solid that is safe and easy to store and handle. It may be dissolved in water at the job site to provide a strong acid solution that will do the same cleaning job as muriatic acid. Although sulfamic acid does not attack metals as rapidly as muriatic acid, inhibitors should still be used to protect the casing. To dissolve iron oxide deposits on the screens, add 50 pounds (22.5 kilograms [kg]) of salt (sodium chloride) for every 100 pounds (45 kg) of granular sulfamic acid.

(8) Reaction of the acid in the well produces carbon dioxide and hydrogen. If iron sulfide is present in the well screen, hydrogen sulfide gas is also produced. Hydrogen sulfide is a toxic gas. Provide adequate ventilation in pump houses or other confined areas when acidizing the screens. It is recommended that

personnel avoid standing in pits or depressions adjacent to the well being treated. Carbon dioxide and hydrogen sulfide are heavier than air and settle in low areas.

(9) Do not pump nearby wells when acid treatment is in progress.

(10) In addition to cleaning the well screen in place, the acidizing treatment described above can be used to dissolve encrustations before pulling the well screen. This treatment helps loosen the well screen in the well and makes it much easier to pull.

b) Chlorine Treatment. Chlorine solutions may also be used to clean well screens. Chlorine added to a clogged well functions primarily by destroying bacterial slime growths. Follow steps (1) through (3) below:

(1) Prepare solutions of chlorine that produce 100 to 200 mg/L of chlorine when mixed with the water in the well (Table 2). Introduce the solution into the well using the procedure described for acid treatment (par. 4.5.3.1[a][4]).

Table 2  
Materials Required for 100 Gallons (400 Liters)  
of Chlorine Solution

Desired Chlorine Strength	Chlorine pounds (g)	Dry Calcium Hypochlorite 70% pounds (g)	Quarts (L) of Bleach Per 100 Gallons (400 L) of Water		
			5%	7%	10%
50 ppm	0.05 (23)	0.07 (32)	0.4	0.3	0.2
100 ppm	0.10 (45)	0.14 (65)	0.8	0.6	0.4
150 ppm	0.15 (68)	0.20 (97)	1.2	0.9	0.6
200 ppm	0.20 (91)	0.30 (130)	1.6	1.2	0.8
300 ppm	0.25 (113)	0.40 (162)	2.4	1.7	1.2
400 ppm	0.35 (159)	0.50 (227)	3.2	2.3	1.6

(2) Allow the well to stand for 24 hours. Then pump water to waste until the chlorine residual reaches 0.1 mg/L. Surging during chlorine treatment is helpful (par. 4.5.3.1[g]).

(3) Perform three or four successive treatments with chlorine. Alternating acid treatment with chlorine treatment can be very effective. Complete the acid treatment first, followed by chlorine treatment after most of the acid has been pumped to waste. A second series of acid and chlorine treatments can be undertaken after the initial acid and chlorine treatments have been completed.

c) Phosphate Treatment. The glassy phosphates (sodium hexametaphosphates) act as dispersing agents on such screen-plugging materials as amorphous silica, hydrated ferric oxide, iron carbonate, and calcium carbonate. Follow these treatment steps:

(1) Dissolve 15 to 30 pounds (7 to 14 kg) of glassy phosphate in a minimum amount of water and add 1 pound (450 g) of calcium hypochlorite for each 100 gallons (400 L) of water in the well casing (under static conditions). To dissolve the phosphate, suspend the chemical in a wire basket or burlap bag. Do not simply dump the phosphate in the dissolving tank or barrel. Add the solution to the well through a hose using the procedure described for acid treatment (par. 4.5.3.1[a][4]).

(2) Allow the solution to remain in the well for 24 to 48 hours and surge approximately every 2 hours. If surging is not possible, allow the solution to stand in the well for 1 week.

Caution: Treatment with glassy phosphate for more than 1 week may cause the well yield to decrease.

(3) After treatment, pump the well to waste for 8 hours and test the output. Repeat the treatment until the output no longer improves. Analyze the phosphate content of the well water after final treatment and pumping to make sure it has been reduced to normal background levels.

d) Dry Ice Cleaning. Compressed carbon dioxide gas, or "dry ice," has been used for well cleaning with mixed results. This treatment works best in deep wells with high static levels. Follow these steps:

(1) For wells measuring 6 to 10 inches (150 to 250 millimeters [mm]) in diameter, use 10 to 15 pounds (4.5 to 7 kg) of dry ice for light surging and 25 to 50 pounds (11 to 23 kg) for heavy surging. Drop pieces of broken dry ice of about 2 inches (5 centimeters [cm]) in diameter into the well casing until enough has

been added to blow the water through the screen. The water will not freeze if there are 11 pounds (5 kg) or approximately 1.5 gallons (5 L) of water in the well casing for each pound (450 g) of dry ice added.

(2) Provide a pressure gage on the well casing and seal the well to prevent loss of carbon dioxide. When the gas is released, it expands and creates a surging action that produces backpressure and backwashing of the screens. The escape of gas through the water-bearing strata will be evident from irregular movement of the pressure gage needle. The particular conditions involved are different in practically all cases, and the exact procedure depends largely on the operator's judgment.

Caution: Dry ice may cause "burns" if handled with bare hands. Use heavy gloves or tongs. Also, since high pressure may develop during dry ice treatment, provide for control and release of excessive pressure (150 psi or 1,030 kPa). The gas is suffocating. Provide ample ventilation.

e) Jet Cleaning. Horizontal jet cleaning of wells is performed from inside the well screen. The process requires only a relatively simple jetting tool, along with a high-pressure pump, a hose, a string of 2-inch (50-mm) pipe, and an adequate water supply. The jetting tool itself is shown on Figure 3. It consists of an attachment fitted with one to four horizontal nozzles (3/16-, 1/4-, or 3/8-inch [5-, 6-, 10-mm]) orifices. The bottom of the tool is closed. The upper end is threaded so that the tool can be screwed into the lower end of the string of 2-inch (50-mm) pipe. Follow these steps to jet clean a well screen:

(1) Select a nozzle to match the output of the high-pressure pump used and the well pump (Table 3).

Table 3  
Jetting Nozzle Discharge(1)

Orifice inches (mm)	150 psi		200 psi		250 psi	
	1 Nozzle gpm (Lps)	2 Nozzles gpm (Lps)	1 Nozzle gpm (Lps)	2 Nozzles gpm (Lps)	1 Nozzle gpm (Lps)	2 Nozzles gpm (Lps)
3/16 (5)	13 (0.8)	25 (1.6)	15 (0.9)	29 (1.8)	17 (1.1)	33 (2.1)
1/4 (6)	23 (1.5)	45 (2.8)	26 (1.6)	52 (3.3)	52 (3.3)	37 (2.3)
3/8 (10)	49 (3.1)	97 (6.1)	56 (3.5)	110 (6.9)	61 (3.8)	120 (7.6)

(1) Nozzle discharge rates in Lps are approximate.

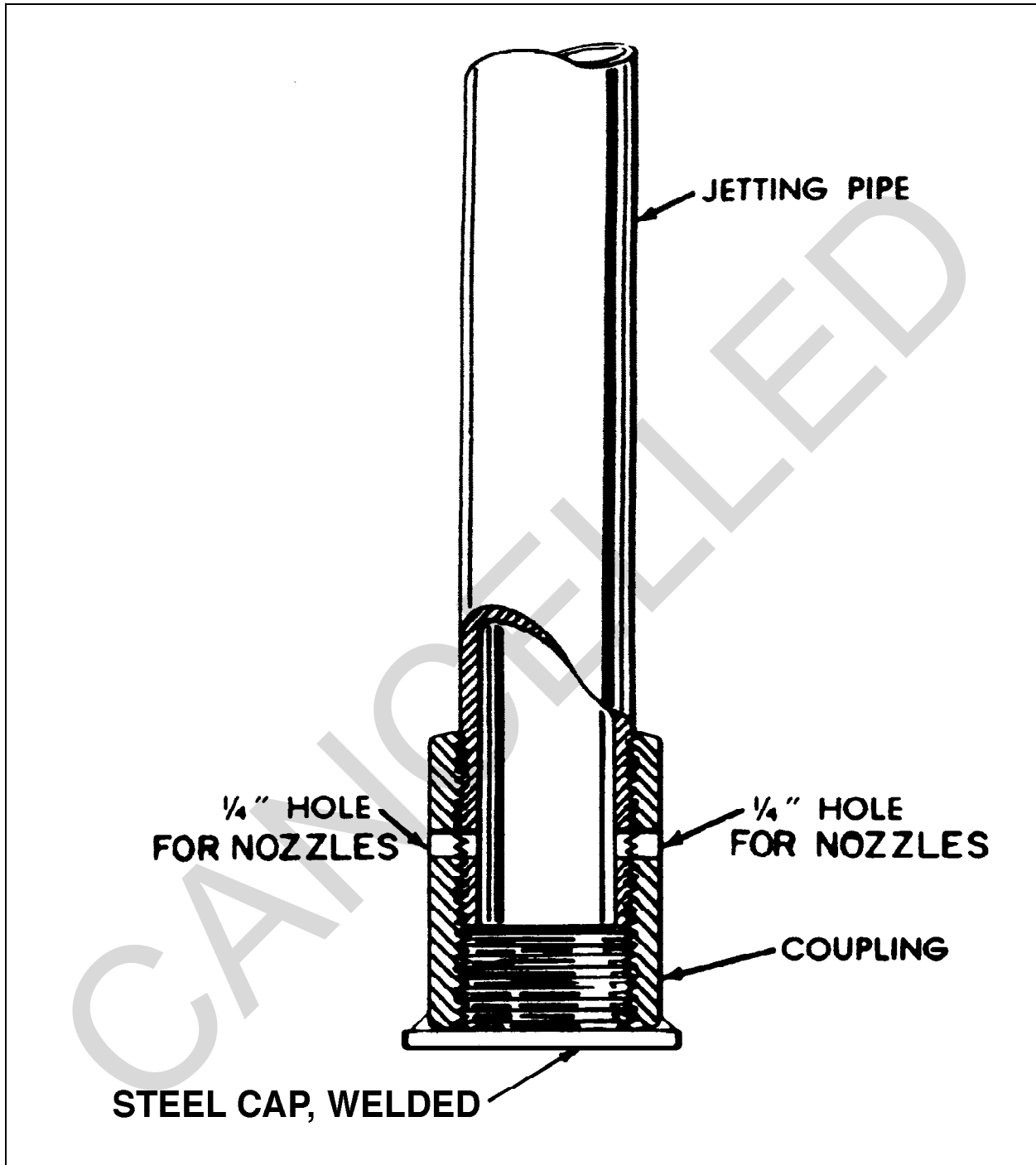

Figure 3  
Jetting Tool for Well Screening

(2) Attach the string of 2-inch (50-mm) pipe to a hose with a swivel connection at the top.

(3) Lower the jetting tool into the screen. Turn on the high-pressure pump and slowly rotate the jetting tool while raising and lowering it. The forceful action of the high-velocity jets, working the water through the screen openings, breaks up the clog.

(4) Pump the well lightly while the jetting is under way in order to remove the dislodged material. The well pump should pump out approximately 15 percent more water than is being added to the well by the jetting tool.

f) Sonic Process Cleaning. Normally, this method is performed by outside contractors. It consists of lowering a series of small, explosive charges on a wire into the well and detonating them by means of an electrical charge at the surface. The size of each charge depends on pipe size, thickness, grade, type, and condition. The charges are placed on a connecting wire at calculated distances and are detonated in a special time-delay sequence. Each charge, lasting only a fraction of a second, creates an expanded gas bubble that produces a shock wave at its leading edge as it rushes down the well column. As the wave strikes the well casing, it causes strong vibrations that help loosen the clog. The expanding bubble also produces a surging action that helps clean the screen. This action is repeated with the detonation of each charge. Sonic processes are most effective in sandstone aquifers where clogging may only extend 1 to 2 inches into the aquifer.

Caution: Do not use any other method of blasting for cleaning screens.

g) Surging. Cleaning a well screen by surging is accomplished by a method different from that used for surging a new well being developed. (See par. 2.1.3 for a discussion of surging new wells.) This operation can be accomplished by utility personnel, without pulling the pump and without expert help. Follow these steps:

(1) Disconnect the discharge of the pump and alternately start and stop the pump. This operation raises the water in the pump casing and allows it to fall again. The greater the distance to the static water level, the more effective the operation. If the water level in the well stands at a high elevation, a surge pipe may be attached to the discharge of the pump.



(2) Repeat the process of starting and stopping the pump at 3- to 5-minute intervals until the discharge runs clear. Water running back down the pump column just after the pump is stopped may cause the motor and impeller to turn in a reverse direction. Do not attempt to start pump during this reverse rotation.

h) Backwashing and Surging. When surging alone is not sufficient, backwashing may be used. This procedure consists of allowing a large volume of water to rush down the casing. Follow these steps:

(1) Where bypass pump connections or wash-water lines are not included in the installation, remove the flap in the check valve.

(2) Open the pump discharge valve and allow a full head of water from the storage tank to rush down the well casing. If the casing fills rapidly, it is because the screen is badly clogged.

Caution: Before starting the backwash operation, be sure the pump and motor turn freely. Otherwise, the downrush of water may rotate the pump in the wrong direction and unscrew the pump shaft.

(3) Allow the backwashing to continue for approximately 5 minutes. Then close the backwash valve, open the pump discharge valve, and start the pump. Run the discharge to waste until the water is clear. Repeat the operation. Check the results by measuring the water level and yield.

i) Backwashing and Backblowing. A combination of backwashing with water and backblowing with air may be used, if the well pump has been pulled. The compressed air increases the surging action and provides air-lift pumping that removes dislodged sand. Use experienced personnel for this operation, and follow this procedure:

(1) Remove the well pump and insert a 4-inch eductor pipe to a depth according to Table 4. The arrangement of eductor pipe and air line is shown in Figure 4.

Table 4  
Eductor Submergence Required for Various Well Depths

Depth of Well		Submergence of Eductor
(feet)	(m)	(percent of well depth)
10-50	(3.0-15.2)	70-66
51-100	(15.5-30.5)	65-55
101-200	(30.8-61.0)	54-50
201-300	(61.3-91.4)	49-43
301-400	(91.7-121.9)	42-40
401-500	(122.2-152.4)	39-33

(2) Cap the 4-inch (100-mm) eduction line with a tapped pipe plug through which the air line runs. Connect the air pipe by means of an air hose (or non-rigid system) to an air compressor having a minimum capacity of 110 cubic feet per minute (cfm) or 50 liters per second (Lps).

(3) With the eduction valve open, build up the air pressure until the water is discharged and pressure reaches a constant value. Pump the water until it runs clear.

(4) Release the air pressure, close the 4-inch discharge valve, and apply air until static pressure is reached. At this point, air escapes from the bottom of the 4-inch eduction pipe and causes both air and water to surge through the screen and create movement in the sand and gravel.

(5) Open the 4-inch (100-mm) valve and allow the air-lift to pump out the loosened sand and silt.

(6) When the water is clear, repeat steps (4) and (5) above. Faster results can be obtained if water can be pumped into the well casing while the air is being added (step (4) above).

(7) Check results after each series of operations. An increase in pumping pressure on the gage indicates increasing inflow into the well and less drawdown.

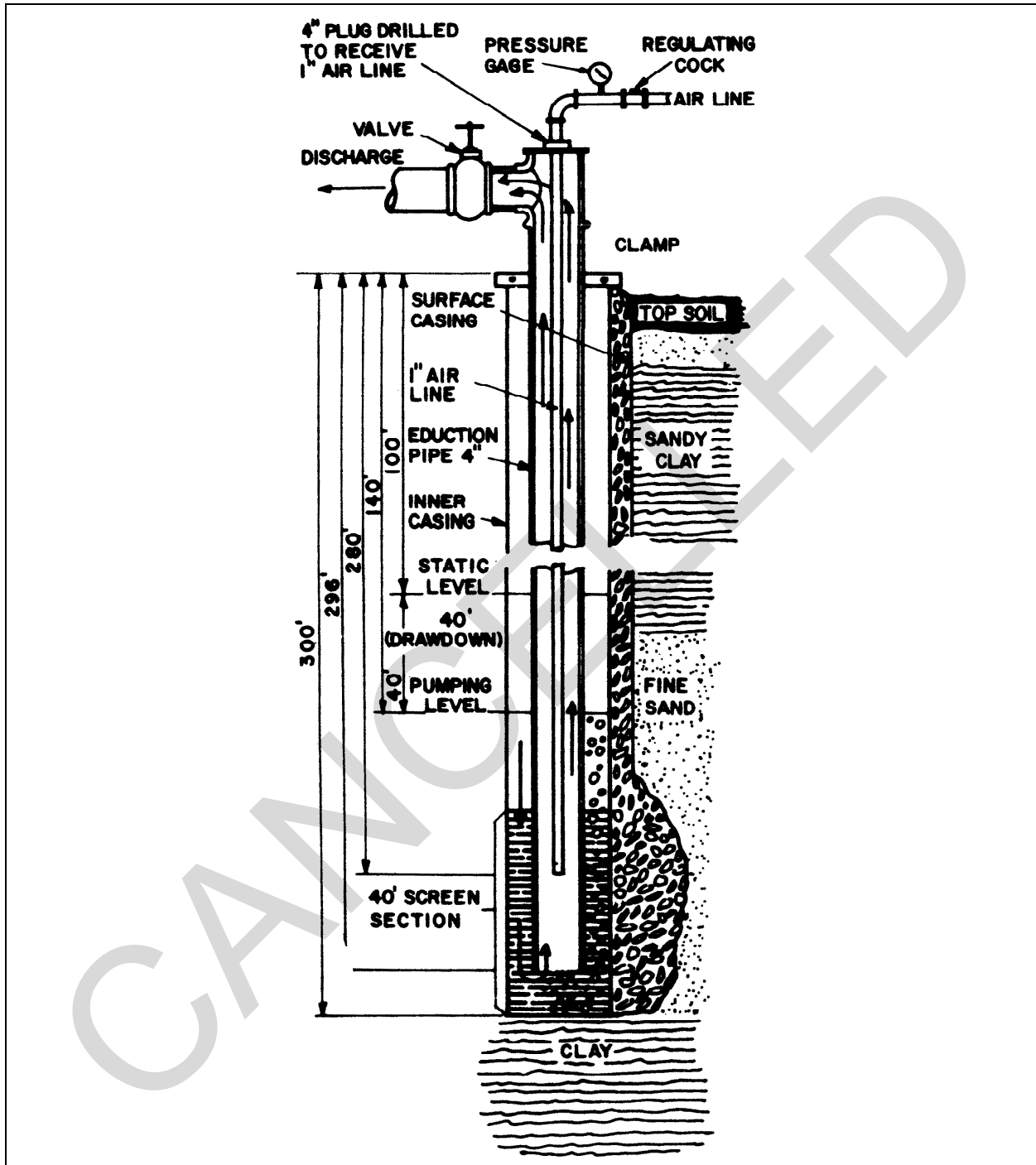

Figure 4  
Piping Arrangement for Backwashing and Backblowing

Caution: When starting backblowing operations, do not start at maximum rates. Keep the gravel chamber full at all times to replace sand loss.

(8) For this operation, provide excess air. The desirable amounts of excess air, with 50 percent submergence, are shown in Table 5.

Table 5  
Air Requirements for Backwashing Well Screen with Air-Lift

feet	Lift		Air Required	
	(m)		cfm/gallon pumped	(Lps)
100	(30)		0.5	(0.2)
200	(60)		0.7	(0.3)
400	(120)		1.0	(0.5)
500	(150)		1.5	(0.7)

4.5.3.2 Repairing Well Screens. It is sometimes desirable to pull a heavily encrusted screen for cleaning. Likewise, a screen suspected of being damaged by corrosion can be pulled and inspected. On screens that have been pulled for any reason, check the wire windings, bail plug, and packer. If the screen has corroded away or been damaged, replace it with a new screen or return it to the factory for repair. Generally, field repair of well screens is neither practical nor effective.

4.5.3.3 Maintaining Specific Well Types. In addition to the general maintenance items common to all wells, different types of wells require special care because of their particular construction or operation. Groundwater supply maintenance procedures are summarized in Table 6.

a) **Bored Wells.** Casing failures and screen clogging are the primary causes of failure in bored wells. High turbidity in the water may indicate that the screen needs cleaning or replacement.

b) **Dug Wells.** The masonry or concrete casings are subject to cracks and joint failure that can allow surface water into the well. Well bottoms can fill with silt and sand, which will require periodic removal.

c) Driven Wells. Driving the well point may damage the screen or seal it off. If water yield decreases, suspect screen clogging and try backwashing. If this fails, pull the point and clean it or replace it with a new one.

Table 6  
Maintenance Checklist for Groundwater Supplies

Inspection	Action	Frequency (1),(2)
Operating record review	Ascertain changes in conditions since previous inspection and take necessary action.	SA
Sanitary conditions	Dig ditches to carry away standing water within 50 feet (15 m) of well, spring, or infiltration gallery.	SA
Pollution sources	Fence area to keep livestock at least 50 feet (15 m) from well, spring, etc.	SA
	Remove cesspools, privies, septic tanks, etc.; cover area with hypochlorite; fill any open excavations resulting from removal.	SA
Wells, springs, infiltration galleries, silt, etc.	Remove accumulations of more than 1 foot (30 cm).	V
Concrete; cracks in housing; other watertight structures in wells, springs, infiltration galleries, and radial wells	Repair as necessary by making surface structure watertight.	Q
	Shore up infiltration gallery wall structures.	Q
Operating records and evidence of contamination	Disinfect wells, springs, infiltration galleries, etc., when indicated.	V
Well output loss and condition of well screen	Clean well screen by approved method.	V
Well equipment (well apron, top of casing, well pits); cracks and	Repair as necessary to make all items watertight.	SA

possible leakage

Table 6 (Continued)

Inspection	Action	Frequency (1),(2)
Well vents	Clean, repair, or replace if torn or clogged.	M
Water use for equipment operation	Make certain water for bearing lubrication and pump priming are from a safe supply and that cooling water for engines and compressors is not returned to water system.	SA
Air intakes on compressors	Screen air intake if necessary; clean and replace air filters; blow down air storage tanks to remove accumulated oil.	M
Bored wells: casing failure	If water is turbid, the screen is defective; remove and replace.	V
Dug wells: silt accumulation; wall failure	Clean as necessary; repair cracked walls; increase capacity if necessary by driving horizontal collector pipes.	Q
Driven well: decrease in water yield; screen clogging	Try backwashing, or pull the point and clean or replace.	M
Gravel-packed wells: silt clogging of screen and gravel pack; gravel level	Clean as necessary; add new gravel as required to keep the level at proper elevation.	M

(1) M = Monthly; Q = Quarterly; SA = Semiannually; V = Variable, as conditions may indicate.

(2) The frequencies shown are suggested frequencies that may be modified by local command, as individual installation conditions warrant.

d) **Drilled Wells.** Drilled wells require little maintenance on casings. Screens can become clogged and will require periodic cleaning. Inspecting or removing the screen requires a major effort. Cleaning the screen in place is the preferred method (see par. 4.5.3.1). Alternatively, remove, clean, and replace the screen.

e) **Gravel-Packed Wells.** Both the gravel and screen may become clogged in a gravel-packed well. Add gravel periodically to keep the gravel level above the well screen.

4.5.3.4 **Maintaining Springs.** Springs are subject to surface contamination. Inspect the area around the spring regularly to detect contamination and guide preventive measures for contamination control. If contamination is detected, thoroughly disinfect the spring before returning it to service.

4.5.3.5 **Maintaining Infiltration Galleries.** In addition to silt accumulation, undermining of walls and failure of the wall structures may occur. Operating records on static level and drawdown will indicate whether the yield is being maintained. Maintenance functions that can increase the life of the structure include cross bracing, adding sheet piles, and adding gravel. Yield can sometimes be increased by driving wells in the bottoms of the galleries.

4.5.3.6 **Maintaining Radial Wells.** Shallow radial water collectors may be subject to contamination from overlying ground pollution. In some locations, silt or sand may accumulate in the caisson and require removal. Dewater the collector well and gunit the surface if spalling of concrete walls is severe.

4.5.4 **Protection of Groundwater Supplies.** A number of state and national laws protect aquifers. Wellhead protection programs (WHPP) are local mandates. The publications in pars. 2.1.3 and 2.2.1 discuss these and other aspects of groundwater protection.

4.5.4.1 **Protection against Contamination through Improper Operation.** Guard against pollution through improper operation of well supplies by following these steps:

- a) Always prime the pump with potable water.
- b) Disinfect the pump and drop pipe before installation and after any repair. Disinfect the equipment as it is lowered into the well.

Note: Give particular attention to the disinfection of the pump packing. Ridding this particular area of bacteria can be difficult.

c) Keep the drain from the pump base open and free so that any leakage will be carried away from the source.

4.5.5 Well Records. Maintain these well records:

- a) The log of the original wellhole
- b) Pump design details
- c) Maintenance records
- d) Water quality analyses
- e) Well discharge meter readings
- f) Schedule of well use (include duration of use)
- g) Pumping and static levels of well capacity tests
- h) Discharge pressure at various pumping rates

Long-term records of rainfall and departures from normal rainfall amounts help show whether changes in the level of the water table and artesian pressure surface are caused by variations in long-term rainfall patterns. Air Force personnel use AF Form 996, Well Data, and AF Form 997, Daily Well Activity Record, to record this information.

4.5.6 Abandonment of Wells. Wells may be abandoned because of lowered water table, plugged screens, corroded casings that allow soil to enter the well, or objectionable sand pumping. The following procedures apply:

- a) For deep wells and driven wells, pull the casing and fill the hole with concrete. Securely cap the top of the well to prevent people or animals from falling into the well. The well cap also helps prevent contamination of the aquifer.
- b) Fill abandoned dug wells and springs as a safety measure.

4.6 Surface Water Supplies. Almost all large population centers and large military installations are served from surface water sources. General information on surface water supplies, water storage, intake structures, and low-lift pumping can be



found in par. 2.1.3. This text also addresses the special problems encountered in operating surface supplies.

Specific O&M practices are described in the following subsections and summarized in Table 7.

Table 7  
Maintenance Checklist for Surface Water Supplies

Inspection	Action	Frequency (1),(2)
Watershed area	Ensure that facilities are in working order for sewage disposal and garbage and trash removal; repair facilities as necessary; remove debris.	Q
Recreational facilities on watershed	Clean and repair facilities as necessary.	M
Reservoir mosquito control	Remove vegetation in shallow water; vary water level a few inches.	Every 10 days (summer only)
Reservoir algae	Report algae blooms to operating staff.	W (summer only)
Reservoir capacity loss	Dredge when necessary.	A
Reservoir sides and bottom	Remove extraneous debris and vegetation from sides and bottom, if exposed; grade sides to prevent erosion.	W
Dams (leakage and exposed surface conditions)	Concrete and masonry dams: repair upstream face first, then downstream face.	M
	Earth and rockfill dams: sod or gravel slopes; keep riprap on upstream face even and in good condition; repair leaks by excavating and backfilling.	W
Ice conditions on concrete dam	Where ice formations exist, break ice to a few feet upstream.	D (winter)
Dam spillway conditions	If blocked, remove trash, debris, or ice.	D
Dam gates	Lubricate gates and appurtenances.	M
Intake structures (cracks and silt deposits; ice conditions)	Repair cracks; remove silt deposits; take action to prevent ice clogging.	W
Intake screens	Remove any material not removable by regular operation procedures.	W

- 
- (1) D= Daily; W = Weekly; M= Monthly; Q = Quarterly;  
A = Annually, as conditions may indicate.
- (2) The frequencies shown are suggested frequencies that may be modified by local command, as individual installation conditions warrant.

#### 4.6.1 Dams and Spillways

4.6.1.1 Concrete and Masonry Dams. Inspect dams periodically. At each inspection, lubricate gates and appurtenance equipment as necessary. Leaks or seepage indicate cracks that can be repaired with cement mortar or grout. Seal the upstream side first so that water is not trapped in the dam.

In winter, break the ice several feet upstream to protect the dam against ice thrust.

4.6.1.2 Earth and Rockfill Dams. Properly constructed earth dams keep water from entering the earth beneath or around the sides of the dam. They also allow any water that is not retained behind the dam to travel to the downstream face of the dam without building up internal pressure. Inspect earthfill and rockfill dams and maintain a proper appearance with all slopes sodded or graveled. Keep riprap on the upstream face even and in good condition.

If leaks or seepage are evident from inspection, the turbidity of the seeping water indicates the importance of the condition. Clear water indicates no loss of soil and no increase in the size of the leak. Turbid water indicates a worsening of conditions: the more turbid the water, the more urgent the need for repair. Seepage at or under the toe of the dam indicates a dangerous condition. Such seepage can result in dam failure. If seepage is observed, report this to a higher authority at once.

Repair minor leaks immediately by excavating or drilling to a moderate depth on the upstream face and sealing with puddled clay rammed into place. In the case of serious leaks, cut down the damn from the tip and fill with good material. It is recommended that new fill be bonded into the original material and compacted. When seepage is detected at the toe of the dam, add new layers of earth to the downstream face.

4.6.1.3 Spillways. Keep spillways free of trash and debris, since blocked spillways may cause overtopping of the dam and possible failure by erosion. Earthfill dams invariably fail if they are overtopped. A log boom stretched across the reservoir about 30 feet ahead of the spillway helps keep it clear. Spillway flashboards are not used if the dam is subject to flash flooding.

Inspect and lubricate gates and any similar apparatus as required.

4.6.2 Reservoirs. Maintenance of reservoirs usually involves one or more of the following tasks: watershed sanitation, surveillance, and control; silt removal; and control of nuisance organisms.

4.6.2.1 Water Quality Control. The quality of water in the reservoir depends on the quality of water in the feeding stream. Various sources of pollution are possible. Operating functions consist of surveying the watershed to locate possible contamination sources and controlling those sources as much as practical. Total ownership of the watershed is seldom possible, so agreements with others may be necessary to ensure a high-quality water source.

4.6.2.2 Silt Removal. Silt will eventually fill all reservoirs. Reservoirs are designed with a siltation basin that may account for half or more of the total reservoir volume. The extent of silting can be determined by comparing the reservoir volume with the initial reservoir contour or prior sounding surveys. This information can be used to calculate the storage capacities available for various water levels in the reservoir. When necessary to extend the life of the reservoir, silt can be removed by dredging.

4.6.2.3 Control of Nuisance Organisms. Control strategies for a number of nuisance organisms commonly found in water supplies can be found in par. 2.2.6. This publication covers the most common organisms, including algae, bloodworms, zebra mussels, actinomycetes, nematodes, rotifers, *Giardia*, and *Cryptosporidium*.

4.6.3 Intakes. The intake is an important part of the water supply system. Unless it is properly designed, maintained, and operated, it can readily be the cause of a partial or complete shutdown of the entire system, often causing difficult and expensive repair.

4.6.3.1 Operation. Many intakes are fitted with gates at various depths. Others have an adjustable suction pipe attached to a floating raft to draw water from the reservoir or lake at different levels. Water may be drawn at or near the surface when the deeper water has a bad taste or odor from decomposing organic matter. Water at an intermediate depth is used when microorganisms are prevalent near the surface. The lower depth can provide cooler water in the summer. Experience will tell the operator which water intake depth yields the best water.

Intake stoppage may, in most cases, be cleared by backflushing the intake conduit or pipeline. When danger of intake stoppage exists, keep backflushing equipment readily available. Damage by surface ice can be prevented by locating an

intake below the ice level and by placing lake intakes beyond the ice line of the lake. The intake structure, however, must be designed to withstand the pressure of the ice. If ice around an intake cannot be removed by scraping or other manual means, remove it by pumping water out of the intake (reverse flushing). If necessary, steam can be piped into the water to raise the temperature.

4.6.3.2 Maintenance. Maintenance operations on intakes in rivers, lakes, and impounded reservoirs involve the structures and their appurtenances.

- a) Inspect all structures periodically for cracks or structural defects.
- b) Measure the depth of the suction well to determine the accumulation of silt and sand. Dredge these accumulations as necessary.
- c) When ice conditions endanger the structure or clog the intake opening, take protective measures. Install log booms or bubble compressed air into the water at critical points to prevent freezing. Frazil ice can form in supercooled water and may cause complete blockage of intakes. Additional information on frazil ice can be found in pars. 2.1.3 and 2.3.13.
- d) Remove any material on screens that is not removable by ordinary operations. Lubricate and repair any accessory equipment to movable screens.

4.6.4 Low-Lift Pumps. The term “low-lift” describes pumps that are capable of pumping large quantities of water against a very low head, usually less than 50 feet (15 meters [m]). A typical application for such pumps is transferring surface water to treatment where gravity flow is not practical. Detailed guidance on pump O&M is found in Section 6 of this handbook.

4.7 Water Quality. Most materials are water soluble to some degree. Water supplies come in contact with many materials, both natural and man-made. As a consequence, all waters—groundwater, surface water, and rainwater—contain a variety of impurities. We now commonly refer to impurities as contaminants, but not all contaminants are harmful to humans. Most contaminants cause no significant problems. Some are a nuisance or impart undesirable esthetic qualities to water, while others like calcium and fluoride are beneficial in moderate concentrations. However, certain chemicals, both inorganic and organic, pose a threat to humans. This section focuses on contaminants found in raw water supplies. Information on treatment techniques for removal of contaminants can be found in Section 5 of this handbook. Regulations governing finished water quality are addressed in pars. 2.1.2 and 3.7.

4.7.1 Physical Characteristics. The pertinent physical characteristics of water supplies include temperature, turbidity, color, taste, and odor. Of these, only turbidity is regulated. Information on the physical properties of water can be found in pars. 2.1.2 and 2.1.3.

4.7.2 Chemical Characteristics. Chemical contaminants in water fall into two broad categories: organic and inorganic. In general, organic chemicals have a carbon-based structure while inorganic chemicals do not. More than 1,000 organic chemicals have been found in drinking water, and the list is growing. The more common inorganic characteristics include pH, alkalinity, hardness, calcium, stability, iron, manganese, dissolved oxygen, and fluoride. More information on chemical characteristics, including the regulatory standards for drinking water, can be found in pars. 2.1.2 and 2.1.3.

4.7.3 Biological Characteristics. Plants and animals, both living and dead, contribute to the biological characteristics of water. Included in this category are algae, bacteria, viruses, and protozoa such as *Giardia* and *Cryptosporidium*. However, not all forms are microscopic. Some large aquatic plants (macrophytes) found in lakes and reservoirs can be of concern as well. More information on the biological characteristics of water, including common control measures, can be found in pars. 2.1.2, 2.1.3, 2.1.5, and 2.2.6.

4.7.4 Radiological Characteristics. Radiation is considered detrimental to humans. Some water supplies have relatively high levels of natural radioactivity. Other potential sources of radionuclide contamination are industrial and medical processes. More information on radiological contaminants, including radiological standards, can be found in pars. 2.1.2 and 2.1.3.

## Section 5: WATER TREATMENT

5.1 Water Treatment. Treatment consists of adding and/or removing substances from water so as to bring about a desired change in quality. In general, treatment is provided to protect public health or to improve the acceptability (aesthetic quality) of the finished product. This section is a guide to basic information on most of the common water treatment processes.

5.2 References. Publications containing additional information on water treatment are listed below. Subsequent references to these sources within Section 5 use only the paragraph number shown in parentheses after the title. This number corresponds to the paragraph number of the document in Section 2, Applicable Documents.

Pertinent water treatment information can be found in the following published sources:

- a) Guidance Manual for Compliance with the Filtration and Disinfection Requirements for Public Water Systems Using Surface Water Sources (par. 2.2.46)
- b) Identification and Treatment of Tastes and Odors in Drinking Water (par. 2.3.6)
- c) Lead and Copper Rule Guidance Manual-Vol. I: Monitoring (par. 2.2.48)
- d) Lead and Copper Rule Guidance Manual-Vol. II: Corrosion Control Treatment (par. 2.2.49)
- e) Lead Control Strategies (par. 2.2.50)
- f) Manual of Water Supply Practices: Automation and Instrumentation (par. 2.2.1)
- g) Manual of Water Supply Practices: Chlorination Principles and Practices (par. 2.2.13)
- h) Manual of Water Supply Practices: Flow Meters in Water Supply (par. 2.2.24)
- i) Manual of Water Supply Practices: Groundwater (par. 2.2.14)

- j) Manual of Water Supply Practices: Operational Control of Coagulation and Filtration Processes (par. 2.2.26)
- k) Manual of Water Supply Practices: Precoat Filtration (par. 2.2.21)
- l) Manual of Water Supply Practices: Problem Organisms in Water—Identification and Treatment (par. 2.2.6)
- m) Manual of Water Supply Practices: Reverse Osmosis and Nanofiltration (par. 2.2.28)
- n) Manual of Water Supply Practices: Water Fluoridation Principles and Practices (par. 2.2.3)
- o) Ozone in Water Treatment: Application and Engineering (par. 2.3.12)
- p) Principles and Practices of Water Supply Operations Series: Basic Science Concepts and Applications (par. 2.1.1)
- q) Principles and Practices of Water Supply Operations Series: Water Quality (par. 2.1.2)
- r) Principles and Practices of Water Supply Operations Series: Water Sources (par. 2.1.3)
- s) Principles and Practices of Water Supply Operations Series: Water Treatment (par. 2.1.5)
- t) Procedures Manual for Polymer Selection in Water Treatment (par. 2.2.58)
- u) Procedures Manual for Selection of Coagulant, Filtration, and Sludge Conditioning Aids in Water Treatment (par. 2.2.59)
- v) Reverse Osmosis: A Practical Guide for Industrial Users (par. 2.3.15)
- w) Standard Methods for the Examination of Water and Wastewater (par. 2.2.62)
- x) The U.S.A.I.D. Desalination Manual (par. 2.2.64)

5.3 Treating Water at the Source. Treatment of water supplies is generally done at a treatment plant where positive monitoring and control is possible. Sometimes, however, providing treatment at the source (in situ treatment) is more economical or practical. Treating reservoirs for algae or zebra mussel control is an example of in situ treatment. For detailed information on specific in situ treatment techniques, see pars. 2.1.3, 2.1.5, 2.2.6, and 2.2.14).

5.4 Unit Treatment Processes. For each process, guidance and information is provided on fundamentals of how water treatment facilities and related equipment operate, common operating problems, process control tests, applicable regulations, recordkeeping, and safety precautions. General maintenance routines and procedures for mechanical equipment can be found in Section 11 of this handbook.

5.4.1 Preliminary Treatment. Preliminary treatment (pretreatment) is used to remove objects or grit that could clog or damage downstream equipment. Pretreatment includes several processes that may be used alone or together. For information on the most common processes, screening, presedimentation, and microstraining, see par. 2.1.5.

5.4.2 Coagulation and Flocculation. Suspended material that is too fine to be removed by plain sedimentation can be clustered into settleable particles through the process of coagulation and flocculation. Coagulation and flocculation, along with filtration, are sometimes referred to as “conventional” treatment. Consult par. 2.1.5 for general information on coagulation and flocculation.

Specific information on chemical reactions, selection of coagulants, conducting jar tests, and help with calculating chemical dosages can be found in pars. 2.1.1, 2.1.2, 2.2.26, 2.2.58, and 2.2.59.

Maintenance of rapid mix and flocculation facilities is included in par. 11.5.2.

5.4.3 Sedimentation Basins and Clarifiers. In conventional water treatment, sedimentation is the step between flocculation and filtration. Sedimentation (or “clarification,” as it is sometimes called), is also used to remove the large quantities of chemical precipitates formed during lime softening.

Refer to par. 2.1.5 for a general description of the sedimentation process. This reference also gives specific information on basin types (conventional rectangular basins, center-feed basins, peripheral-feed basins, spiral-flow basins, and shallow basins), as well as plate and tube settlers. Information on other clarification processes found in this reference include solids-contact basins, dissolved-air flotation, and



contact clarifiers. In addition to the basic topics, information is provided on waste disposal and equipment maintenance. Table 35 (Section 11) presents a summary of maintenance procedures for rapid-mix basins, flocculators, and clarifiers.

5.4.4 Filtration. In conventional water treatment, filtration is used to remove floc, suspended matter, and microorganisms carried over from the preceding unit processes. When groundwater is treated to remove hardness, iron and manganese filtration removes chemical precipitates. Basic information on filter operation can be found in par. 2.1.5. Topics include conventional filtration, direct filtration, slow sand filtration, diatomaceous earth filtration, filter media, underdrain systems, surface agitators, filter control equipment, backwashing procedures, and optimizing filter effluent quality.

Detailed filter maintenance procedures are included in pars. 11.5.5 through 11.5.7. Additional, related information is contained in the publications listed in pars. 2.2.21, 2.2.26, and 2.2.46.

5.4.5 Disinfection. In water treatment, disinfection is usually the last barrier to prevent disease-causing organisms from reaching the consumer. Disinfection does not sterilize water—that is, completely destroy all living organisms. However, experience has shown that disinfection, in combination with effective filtration, can protect humans from most waterborne pathogens (disease-causing agents). This section focuses on chlorine and hypochlorite compounds, but information on other disinfectant/oxidants such as ozone, permanganate, and chlorine dioxide is provided. General topics include chlorine chemistry, application points, chlorine handling and storage, chlorine equipment, and regulations including trihalomethanes (THMs) and other disinfection byproducts (DBPs), as well as concentration and contact time (CT). Applicable references are listed in pars. 2.1.2, 2.1.5, 2.2.13, 2.2.46, and 2.3.12.

Maintenance procedures for chlorination equipment are described in pars. 11.8.3, 11.8.4, and 11.8.5.

5.4.6 Fluoridation. Fluoride ion is added to public water supplies to reduce tooth decay in children. Where fluoridation is practiced, it is strictly regulated by state and local health departments. Although there are no federal regulations requiring fluoridation, EPA endorses the practice. This section provides information on chemicals, chemical feed equipment, dosage requirements, and testing. For specific guidance on these and related topics, see pars. 2.1.2, 2.1.5, and 2.2.3.

General guidance on maintenance of fluoridation equipment can be found in pars. 11.8.6 and 11.8.7.

5.4.7 Control of Corrosion and Scaling. A primary goal of water treatment is to produce stable water—that is, water that is neither corrosive nor scale-forming. Meeting this goal is not always easy. The focus of this section is on the characteristics and control of scale and internal corrosion of pipes. Control measures for external corrosion of pipes, tanks, equipment, and structures is covered in Section 11. For information on the chemistry of corrosion and scale formation, control methods, and chemical handling and storage, as well as guidance in selecting a control process, see pars. 2.1.5 and 2.2.68.

In 1991, the USEPA enacted a regulation called the Lead and Copper Rule. This rule is designed to reduce exposure to excessive lead and copper in drinking water. Detailed information on the Lead and Copper Rule, including monitoring and testing, can be found in pars. 2.2.48, 2.2.49, and 2.2.50. These sources also provide guidance on developing control strategies.

5.4.8 Iron and Manganese Control. Iron and manganese are natural contaminants found in many groundwater supplies and in stratified lakes and reservoirs. These elements are not normally harmful to human health, but relatively small amounts of iron and manganese can give water an undesirable taste, discolor plumbing fixtures, and stain laundry. Paragraph 2.1.5 describes control measures for naturally occurring iron and manganese in raw water supplies. Controlling iron that results from corrosion of distribution systems is covered in par. 5.4.7.

5.4.9 Lime Softening. Certain dissolved minerals, mainly calcium and magnesium, give water the property known as “hardness.” Hardness is a folk term inherited from when it was difficult or “hard” to wash with highly mineralized waters. While hardness minerals are not at all harmful to human health, they can cause scaling and adversely affect aesthetics. Reducing minerals that cause hardness is called “softening.” The focus of this paragraph is on lime and lime-soda softening. Other processes used for softening are ion exchange and membrane treatment. Ion exchange softening is covered in par. 5.4.10; membrane technology is covered in par. 5.4.13. Besides the general topics, subjects covered include basic chemistry of the lime-soda process and recarbonation, as well as description of treatment facilities. Refer to pars. 2.1.2 and 2.1.5 for further discussion of these topics. Maintenance of lime slakers is discussed in par. 11.8.2.

5.4.10 Ion Exchange Processes. Ion exchange is a common alternative for lime-soda softening, especially for small water systems or for systems with dispersed water sources, such as supply wells. Ion exchange can also be used to demineralize water completely, but the focus of this paragraph is on softening. Paragraph 2.1.5 includes a description of the process and facilities, process chemistry, health concerns,

regulations, operation of the ion exchange process, process control tests, and common operating problems. Recordkeeping and safety precautions are also discussed. Maintenance of ion exchange equipment is discussed in par. 11.5.8.

5.4.11 Adsorption. Carbon adsorption has historically been used to improve the appearance and flavor of water. Today, the adsorption process is gaining wider use in the water works industry to remove a broad range of organic contaminants. Paragraph 2.1.5 includes information on the principles of adsorption plus the facilities for applying powdered activated carbon (PAC) and granular activated carbon (GAC).

5.4.12 Aeration. Aeration is used to reduce the concentration of certain objectionable dissolved gases such as hydrogen sulfide, carbon dioxide, and volatile organic chemicals (VOCs) and to oxidize dissolved metals. Aeration is often the first process used in a water treatment plant. At other installations, aeration and disinfection may be the only treatment provided. Information on various types of aerators can be found in par. 2.1.5. Maintenance of aeration equipment is discussed in par. 11.5.1.

5.4.13 Membrane Processes. In this process, water is forced through a porous membrane while contaminants are held back or rejected. The references listed in pars. 2.1.5, 2.2.28, and 2.3.15 provide information on the types of membrane processes, operating principles, membrane types, feedwater concerns, post-treatment, membrane cleaning, and reject water disposal.

5.5 Taste and Odor Control. Controlling tastes and odors is one of the most troublesome problems in water treatment. Tastes and odors appear in both ground and surface water supplies. The main means of control are aeration (par. 5.4.12), adsorption (par. 5.4.11), and oxidation (par. 5.4.5). Additional information on taste and odor can be found in par. 2.3.6.

5.6 Controlling Organic Chemicals. The SDWA regulates four categories of organic contaminants: pesticides, volatile organic compounds (VOCs), synthetic organic chemicals (SOCs), and DBPs. Effectively removing organic chemicals requires special treatment techniques. See par. 3.7 for monitoring and reporting requirements.

5.6.1 Pesticides Group—Treatment. Activated carbon adsorption is the most effective method available for removing pesticides. Some pesticide removal occurs during conventional treatment by coagulation, sedimentation, and filtration. However, removals are very small, usually less than 10 percent. Chemical oxidation with chlorine, ozone, or potassium permanganate also removes pesticides, also generally less than 10 percent.

a) Conventional water treatment followed by activated carbon adsorption effectively removes pesticides from drinking water. Using activated carbon adsorption in water treatment is discussed in par. 5.4.11. PAC or GAC can be used for pesticide removal. The effectiveness of carbon adsorption depends on the concentrations of adsorbent and adsorbate, contact or residence time, and the competition for available adsorption sites, as well as the temperature and pH of the water. Because of these variabilities, no general rule can be given for carbon dosage or design criteria for activated carbon treatment. Dosage and design requirements are generally determined by laboratory methods or pilot plant operations.

b) Because pesticides and their carrier solvents have odors, water treatment for removing these odors can somewhat reduce pesticide levels. However, where a few milligrams per liter of PAC may be adequate for odor control, several more milligrams per liter are generally required to remove organics. Relying on odors to signal pesticide contamination or relying on intermittent odor control by PAC to ensure a safe pesticide level is risky and considered poor practice. Where PAC is used, multiple points of injection should be considered for maximum efficiency of the adsorbant (to maximize pesticide removal). A disadvantage of PAC is that the sludge formed after application is sometimes troublesome and difficult to manage.

c) The uncertainties involved in pesticide occurrence in water supplies make GAC beds that are continuously online the best protection against pesticide contamination. Organic pesticides have been demonstrated to be very strongly adsorbed both on virgin GAC and on exhausted GAC used for odor control. The life of a GAC bed for pesticide removal is not indefinite. However, if a GAC bed's usefulness has been exhausted from adsorbing odors, that means it is generally time to replace it for pesticide control, too.

## 5.6.2 VOCs Group

5.6.2.1 Sources of VOCs. Water supplies derived from groundwaters, as well as from surface waters, may contain VOCs. Contamination is most common in urban or industrial areas, and is generally believed to be from improper disposal of hazardous wastes and industrial discharges.

Many of the regulated VOCs are suspected carcinogens, and the others may damage the kidneys, liver, or nervous system. The presence of one of these compounds, even at a low level, is a concern since these are manufactured chemicals (not naturally occurring in the environment), and their presence indicates the potential for further contamination of that source water.

Groundwater is of particular concern in that these waters move very slowly and do not have a rapid natural cleansing mechanism. Thus, once groundwaters are contaminated, they will generally remain so for many years or decades.

5.6.2.2 Treatment. Methods for removing VOCs include aeration and GAC. PAC treatment or conventional drinking water treatment (coagulation, sedimentation, and filtration) have not proven effective. Methods such as reverse osmosis and macromolecular resins may eventually prove useful in removing VOCs. Before implementing a VOC control strategy, check local environmental regulations and permit requirements. Aeration could cause violation of air quality standards. Spent carbon from GAC adsorbers could be considered a hazardous waste.

### 5.6.3 DBPs Group

5.6.3.1 Sources of DBPs. Chlorine, when used for bacterial and viral disinfection of water supplies, interacts with organic precursors present in natural waters to form a variety of chlorinated organic compounds collectively called disinfection byproducts. DBPs are associated with a number of chronic health problems, including cancer. Because the natural organic precursors are more commonly found in surface waters, water taken from a surface source is more likely than groundwater (with some exceptions) to have high DBP levels after chlorination. A number of DBPs have been targeted for regulation, including THMs and haloacetic acids (HAAs). Other oxidants used for disinfection, i.e., ozone and chlorine dioxide, can also form DBPs (although not to the same extent as chlorine).

5.6.3.2 Treatment. Treatment options available to meet DBP standards are to substitute new disinfectants for chlorine that do not generate DBPs or that produce fewer DBPs; to reduce organic precursor concentrations before chlorination; and to remove DBPs after formation.

a) Ozone, chlorine dioxide, and chloramine are possible alternate disinfectants. Use of these chemicals for disinfection purposes is discussed in par. 5.4.5. It is good practice to monitor carefully the microbiological quality of the treated and distributed water during the transition period to an alternate disinfectant.

b) Treatment processes to reduce or control precursor levels include offline raw water storage, aeration, improved coagulation, ion exchange resins, adsorption on PAC and GAC, ozone-enhanced biological activated carbon (BAC), and adjustment of the chlorine application point. Bench- and pilot-plant studies should be performed to determine which treatment process will most effectively reduce precursor

levels. Carbon adsorption is considered effective in removing high levels of precursors.

(1) The air-water ratio required for aeration to effectively remove volatile organic precursors is higher than the air-water ratios needed for taste and odor control or iron and manganese removal. The high air-to-water ratio promotes the growth of aerobic organisms (such as algae) and can be a significant problem. Aeration is discussed in par. 5.4.12.

(2) Some organic precursors are removed during coagulation. These organics often adhere to the particulate matter that settles. Coagulation is discussed in par. 5.4.2.

(3) High doses of PAC removes only a portion of the precursors. High costs and sludge problems limit the use of PAC for precursor control.

(4) GAC can adsorb a wide spectrum of organics. Frequently, GAC adsorbs enough precursor material so that chlorine disinfection can be practiced following GAC treatment without forming excessive DBPs. Carbon adsorption is discussed in par. 5.4.11.

(5) One of the quickest and least expensive ways of maintaining low DBP levels in chlorine-treated water is to chlorinate the highest quality of water (water with the lowest possible organic content). If water is filtered, the highest quality of water is filter effluent. However, unless additional contact tanks are constructed, the contact time is not usually long enough for adequate disinfection. Chlorinating coagulated and settled water reduces (but does not eliminate) DBP levels in finished water. DBPs continue to form during distribution. Disinfection before filtration limits bacterial growth in the filters. The absence of a disinfectant at the beginning of treatment may cause problems because of the growth of algae, slime, and higher forms in the early part of water treatment plants.

c) Technology available for DBP reduction includes PAC, ozonation, GAC, and aeration.

(1) Very high doses of PAC and ozone are required to get substantial (but not complete) DBP removal. These processes would be too expensive in light of the removals obtained.

(2) GAC filters can effectively remove DBPs (as well as other organics) below contaminant levels.

(3) Locating the aeration process after chlorination will remove volatile DBPs from the finished water. However, organic precursors not removed in the water treatment process continue to react with the remaining chlorine residual after aeration to raise DBP levels in the distribution system. Therefore, removing volatile DBPs from finished water by aeration is not considered a viable control method.

5.6.3.3 State Approval of Treatment. A facility must obtain state approval before significantly modifying its treatment process to comply with DBP requirements. The facility is required to submit a detailed plan of proposed modifications and safeguards it will implement to ensure that the bacteriological quality of the drinking water serviced is not decreased by such changes. Each system must comply with the provisions set forth in the state-approved plan.

5.7 Treatment Plant Instrumentation and Control (I&C). The references below include information on meters, recorders, alarms, and automatic control systems. Specific information is provided on flow, pressure, and level measurement in pars. 2.1.5, 2.2.1, and 2.2.24.

5.8 Chemicals and Chemical Application. Information about chemicals commonly used in the water works industry are listed in Table 8. For additional information on specific chemicals used in given unit processes—including application, storage, handling, and chemical safety—refer to the appropriate unit process heading in this section. Maintenance of mechanical equipment is covered in Section 11.

5.9 Water Treatment Plant Residues. The most common residues from water treatment processes are designated as either “slurries” or “sludges.” Slurry solids are usually spent activated carbon or waste diatomaceous earth from diatomaceous filters. Sludges may be mud-like, natural sediments; gelatinous aluminum, magnesium, or iron oxides and hydroxides; or calcium carbonate (lime sludge). Water treatment processes that produce these sludges are presedimentation of raw water; chemical coagulation, flocculation, and sedimentation; lime-soda ash softening; iron and manganese removal; and filter backwashing.

Other residues are surface water intake screenings; aqueous solutions of sodium, calcium, and magnesium chlorides that result from regeneration of cation exchange water softening resins; and reject stream from membrane processes.

Refer to the applicable paragraphs in this section for a discussion of the residue characteristics and appropriate solids concentration and dewatering techniques for the various water treatment processes.

Table 8  
Chemicals Used in Water Treatment

Chemical Name and Formula	Common or Trade Name	Shipping Containers	Suitable Handling Materials	Available Forms	Weight, lb/ft <sup>3</sup>	Solubility, lb/gal	Commercial Strength	Characteristics	AWW A Standard
Coagulation									
Aluminum sulfate, $Al_2(SO_4)_3 \cdot 14H_2O$	Alum, filter alum, sulfate of alumina	100-, 200-lb bags; 300-, 400-lb bbls.; bulk (carloads)	Dry—iron, steel; solution—lead-lined rubber, silicon, asphalt, 316 stainless steel	Ivory-colored: powder granule lump	38-45 60-63 62-67	4.2 (60°F)	15-22% $Al_2O_3$	pH of 1% solution, 3.4	B 403
	Liquid alum	Bulk; tank trucks, tank cars		Pale green liquid				8.3% $Al_2O_3$ liquid	
Ammonium aluminum sulfate, $Al_2(SO_4)_3(NH_4)_2SO_4 \cdot 24H_2O$	Ammonia alum, crystal alum	Bags; bbls.; bulk	Duriron, lead, rubber, silicon, iron, stoneware	Lump Nut Pea Powdered	64-68 62 65 60	0.3 (32°F), 8.3 (212°F)	11% $Al_2O_3$	pH of 1% solution, 3.5	
Bentonite	Colloidal clay, volclay, wilkinite	100-lb bags; bulk	Iron, steel	Powder, pellet, mixed sizes	60	(Insol-uble colloidal suspen-sion used)			
Ferric chloride, (a) $FeCl_3$ (35-45% solution)  (b) $FeCl_3 \cdot 6H_2O$	"Ferri-chlor," chloride of iron	5-, 13-gal carboys; trucks; tank cars	Glass, rubber, stoneware, synthetic resins	Dark brown syrupy liquid		Complete	37-47% $FeCl_3$ , 20-21% Fe	Hygroscopic (store lumps and powder in tight containers); no dry feed; optimum pH, 4.0-11.0	
	Crystal ferric chloride	300-lb bbls.		Yellow-brown lump					

59

MIL-HDBK-1164



Table 8 (Continued)

Chemical Name and Formula	Common or Trade Name	Shipping Containers	Suitable Handling Materials	Available Forms	Weight, lb/ft <sup>3</sup>	Solubility, lb/gal	Commercial Strength	Characteristics	AWW A Standard
(c) FeCl <sub>3</sub>	Anhydrous ferric chloride	500-lb casks; 100-, 300-, 400-lb kegs		Green-black power			98% FeCl <sub>3</sub> , 34% Fe		
Ferric sulfate Fe <sub>2</sub> (SO <sub>4</sub> ) <sub>3</sub> •9H <sub>2</sub> O	"Ferri-floc," Ferrisul	100-, 175-lb bags; 400-, 425-lb drums	Ceramics, lead, plastic, rubber, 18-8 stainless steel	Red-brown powder 70 or granule 72		Soluble in 2-4 parts cold water	90-94% Fe <sub>2</sub> (SO <sub>4</sub> ) <sub>3</sub> , 25-26% Fe	Mildly hygroscopic; coagulant at pH 3.5-11.0	B 406
Ferrous sulfate, FeSO <sub>4</sub> •7H <sub>2</sub> O	Copperas, green vitriol	Bags; bbls.; bulk	Asphalt, concrete, lead, tin, wood	Green crystal granule, lump	63-66	0.5 (32°F), 1.0 (68°F), 1.4 (86°F)	55% FeSO <sub>4</sub> , 20% Fe	Hygroscopic; cakes in storage; optimum pH, 8.5-11.0	B 402
Potassium aluminum sulfate, K <sub>2</sub> SO <sub>4</sub> Al <sub>2</sub> (SO <sub>4</sub> ) <sub>3</sub> •24H <sub>2</sub> O	Potash alum	Bags, lead-lined; bulk (carloads)	Lead, lead-lined, rubber, stoneware	Lump Granule Powder	62-67 60-65 60	3.0 (68°F), 3.3 (86°F)	10-11% Al <sub>2</sub> O <sub>3</sub>	Low, even solubility; pH of 1% solution, 3.5	
Sodium aluminate, Na <sub>2</sub> OAl <sub>2</sub> O <sub>3</sub>	Soda alum	100-, 150-lb bags; 250-, 440-lb drums; solution	Iron, plastics, rubber, steel	Brown powder, liquid (27°Be)	50-60	Complete	70-80% Na <sub>2</sub> Al <sub>2</sub> O <sub>4</sub> , min. 32% Na <sub>2</sub> A1 <sub>2</sub> O <sub>4</sub>	Hopper agitation required for dry feed	B 405
Sodium silicate, Na <sub>2</sub> OSiO <sub>2</sub>	Water glass	Drums; bulk (tank trucks, tank cars)	Cast iron, rubber, steel	Opaque, viscous liquid			38-42 Bé	Variable ratio of Na <sub>2</sub> O to SiO <sub>2</sub> ; pH of 1% solution, 12.3	B 404
Disinfection and Dechlorinating Agents									
Ammonium aluminum sulfate, Al <sub>2</sub> (SO <sub>4</sub> ) <sub>3</sub> (NH <sub>4</sub> ) <sub>2</sub> SO <sub>4</sub> •24H <sub>2</sub> O	Ammonia alum, crystal alum	Bags; bbls.; bulk	Duriron, lead, rubber, silicon, iron, stoneware	Lump Nut Pea Powdered	64-68 62 65 60	0.3 (32°F), 8.3 (212°F)	11% Al <sub>2</sub> O <sub>3</sub>	pH of 1% solution, 3.5	

90

MIL-HDBK-1164

Table 8 (Continued)

Chemical Name and Formula	Common or Trade Name	Shipping Containers	Suitable Handling Materials	Available Forms	Weight, lb/ft <sup>3</sup>	Solubility, lb/gal	Commercial Strength	Characteristics	AWW A Standard
Ammonium sulfate, (NH <sub>4</sub> ) <sub>2</sub> SO <sub>4</sub>	Sulfate of ammonia	100-lb bags	Ceramics, plastics, rubber, iron (dry)	White or brown crystal		42.5	6.3 (68°F)	Cakes in dry feed; add CaSO <sub>4</sub> for free flow	B 302
Anhydrous ammonia, NH <sub>3</sub>	Ammonia	50-, 100-, 150-lb cylinders; in bulk (tank cars and trucks)	Glass, iron, monel metal, nickel, steel	Colorless gas		3.9 (32°F) 3.1 (60°F) 1.8 (125°F)	99-100% NH <sub>3</sub>		
Aqua ammonia, NH <sub>4</sub> OH	Ammonia water, ammonium hydrate, ammonium hydroxide	Carboys; 750-lb drums; 8,000-gal tank cars or trucks	Glass, iron, monel metal, nickel, steel	Colorless liquid		Complete	29.4% NH <sub>2</sub> (26° Bé)		
Calcium hypochlorite, CaOCl <sub>2</sub> •4H <sub>2</sub> O	"HTH," Perchloron, "Pitt-chlor"	5-lb cans; 100-, 300-, 800-lb drums	Glass, rubber, stoneware, wood	White granule, powder	52.5		70% available Cl <sub>2</sub>	1-3% available Cl <sub>2</sub> , solution used	B 300
Chlorinated lime, CaO 2CaOCl <sub>2</sub> •3H <sub>2</sub> O	Bleaching power, chloride of lime	100-, 300-, 800-lb drums	Glass, rubber, stoneware, wood	White powder	48		25-37% available Cl <sub>2</sub>	Deteriorates	
Chlorine, Cl <sub>2</sub>	Chlorine gas, liquid chlorine	100-, 150-lb cylinders; 1-ton containers; 16-, 30-, 55-, 85-, and 90-ton tank cars; tank trucks (about 15-16 tons)	Dry-black iron, copper, steel; wet gas-glass, hard rubber, silver	Liquefied gas under pressure	91.7	0.07 (60°F), 0.04 (100°F)	99.8% Cl <sub>2</sub>		B 301
Chlorine dioxide, ClO <sub>2</sub>	Chlorine dioxide	Generated as used	Plastics, soft rubber (avoid hard rubber)	Yellow-red gas		0.02 (30 mm)	26.3% available Cl <sub>2</sub>		

Table 8 (Continued)

Chemical Name and Formula	Common or Trade Name	Shipping Containers	Suitable Handling Materials	Available Forms	Weight, lb/ft <sup>3</sup>	Solubility, lb/gal	Commercial Strength	Characteristics	AWW A Standard
Ozone, O <sub>3</sub>	Ozone	Generated at site of application	Aluminum, ceramics, iron, steel, wood	Colorless gas					
Pyrosodium sulfite Na <sub>2</sub> O <sub>5</sub> S <sub>2</sub>	Sodium metabisulfite	Bags; drums; bbls.	Iron, steel, wood	White crystalline powder		Complete in water	Dry, 67% SO <sub>2</sub> ; sol. 33.3% SO <sub>2</sub>	Sulfurous odor	
Sodium chlorite, NaClO <sub>2</sub>	Technical sodium chlorite	100-lb drums	Metals (avoid cellulose materials)	Light orange powder, flake			82% NaClO <sub>2</sub> , 30% available Cl <sub>2</sub>	Generates ClO <sub>2</sub> at pH 3.0	B 303
Sodium hypochlorite, NaOCl	Sodium hypochlorite	5-, 13-gal carboy; 1,300-2,000-gal tank trucks	Ceramics, glass, plastics, rubber	Light yellow liquid			12-15% available Cl <sub>2</sub>		B 300
Sodium sulfite, Na <sub>2</sub> SO <sub>3</sub>	Sulfite	Bags; drums; bbls.	Iron, steel, wood	White crystalline powder		Complete in water	23% SO <sub>3</sub>	Sulfurous taste and odor	
Sulfur dioxide, SO <sub>2</sub>	Sulfurous acid anhydride	Steel cylinders; ton containers; tank cars or trucks	Aluminum, brass, Durco D-10, stainless steel 316	Colorless gas		20% at 32°F, complete in water	99% SO <sub>2</sub>	Irritating gas	
Fluoridation and Fluoride Adjustment									
Ammonium silico fluoride, (NH <sub>4</sub> ) <sub>2</sub> SiF <sub>6</sub>	Ammonium fluor-silicate	100- and 400-lb drums	Steel, iron, lead	White crystals		1.7 (63°F)	100%	White, free-flowing solid	
Calcium fluoride, CaF <sub>2</sub>	Fluorspar	Bags; drums; bbls.; hopper cars; trucks	Steel, iron, lead	Powder		Very slight	85% CaF <sub>2</sub> , less than 5% SiO <sub>2</sub>		

Table 8 (Continued)

Chemical Name and Formula	Common or Trade Name	Shipping Containers	Suitable Handling Materials	Available Forms	Weight, lb/ft <sup>3</sup>	Solubility, lb/gal	Commercial Strength	Characteristics	AWW A Standard
Hydro-fluosilicic acid, H <sub>2</sub> SiF <sub>6</sub>	Fluo-silicic acid	Rubber-lined drums; trucks; or R.R. tank cars	Rubber-lined steel, PVC	Liquid		Approx. 1.2 (68°F)	Approx. 35%		B 703
Hydrogen fluoride, HF	Hydro-fluoric acid	Steel drums; tank cars	Steel	Liquid			70%	Below 60%, steel cannot be used	
Sodium fluoride NaF <sub>6</sub>	Fluoride	Bags; bbls.; fiber; drums; kegs	Iron, lead, steel	Nile blue or white powder; light dense	50 75	0.35 (most temps.)	90-95% NaF	pH of 4% solution, 6.6	B 701
Sodium silicofluoride, Na <sub>2</sub> SiF <sub>6</sub>	Sodium silico-fluoride	Bags; bbls.; fiber; drums	Iron, lead, steel	Nile blue or yellowish-white powder	75	0.03 (2°F), 0.06 (72°F), 0.12 (140°F)	99% Na <sub>2</sub> SiF <sub>6</sub>	pH of 1% solution, 5.3	B 702
Fluoride Adjustment									
Aluminum oxide, Al <sub>2</sub> O <sub>3</sub>	Activated alumina	Bags; drums	Iron, lead, steel	Powder, granules (up to 1-1/2-in. diam)	Vari-able	Insol-uble	100%		
Bone charcoal C	"Fluo-Carb"	Bags; drums; bulk	Wood, iron, steel	Granules	Vari-able			Black; best used in beds for presolution	
Tricalcium phosphate Ca <sub>3</sub> O <sub>8</sub> P <sub>2</sub>	"Fluorex"	Bags; drums; bulk; bbls.	Iron, steel	Granular technical	50-63	Insol-uble		Also available as white powder	
High-magnesium lime CaMgO <sub>2</sub>	Dolomitic lime	Bags; bbls; bulk	Wood, iron, steel	Lump, pebble, ground		Slakes slowly	58% CaO <sub>2</sub> 40% MgO <sub>2</sub>		

Table 8 (Continued)

Chemical Name and Formula	Common or Trade Name	Shipping Containers	Suitable Handling Materials	Available Forms	Weight, lb/ft <sup>3</sup>	Solubility, lb/gal	Commercial Strength	Characteristics	AWW A Standard
Stabilization and Corrosion Control									
Carbon dioxide, CO <sub>2</sub>	Carbon dioxide gas, liquid carbon dioxide	20-, 50-lb cylinders. Bulk; tank trucks, tank cars			47.4 @ 70°F				
Disodium phosphate, Na <sub>2</sub> HPO <sub>4</sub> •12H <sub>2</sub> O	Basic sodium phosphate, DSP, secondary sodium phosphate	125-lb kegs; 200-lb bags; 325-lb bbls.	Cast iron, steel	Crystal	60-64	0.4 (32°F), 6.4 (86°F)	19.5% P <sub>2</sub> O <sub>5</sub>	Precipitates Ca, Mg; pH of 1% solution, 9.1	
Sodium hexametaphosphate, (NaPO <sub>3</sub> ) <sub>6</sub>	"Calgon," glassy phosphate, vitreous phosphate	100-lb bags	Hard rubber, plastics, stainless steel	Crystal, flake, powder	47	1-4.2	66% P <sub>2</sub> O <sub>5</sub> (unadjusted)	pH of 0.25% solution, 6.0-8.3	
Sodium hydroxide, NaOH	Caustic soda, soda lye	100-, 700-lb drums; bulk (trucks, tank cars)	Cast iron, rubber, steel	Flake Lump Liquid		2.4 (32°F) 4.4 (68°F), 4.8 (104°F)	98.9% NaOH, 74-76% NaO <sub>2</sub>	Solid; hygroscopic; pH of 1% solution, 12.9	
Sulfuric acid, H <sub>2</sub> SO <sub>4</sub>	Oil of vitriol, vitriol	Bottles; carboys; drums; trucks, tank cars	Concentrated—iron, steel; dilute—glass, lead, porcelain, rubber	Solution (60-66° Bé)		Complete	77.7% H <sub>2</sub> SO <sub>4</sub> (60° Bé); 93.2% H <sub>2</sub> SO <sub>4</sub> (66° Bé)	Approx. pH of 0.5% solution, 1.2	
Tetrasodium pyrophosphate, Na <sub>4</sub> P <sub>2</sub> O <sub>7</sub> •10H <sub>2</sub> O	Alkaline sodium pyrophosphate, TSPP	125-lb kegs; 200-lb bags; 300-lb bbls.	Cast iron, steel	White powder	68	0.6 (80°F), 3.3 (212°F)	53% P <sub>2</sub> O <sub>5</sub>	pH of 1% solution, 10.8	

Table 8 (Continued)

Chemical Name and Formula	Common or Trade Name	Shipping Containers	Suitable Handling Materials	Available Forms	Weight, lb/ft <sup>3</sup>	Solubility, lb/gal	Commercial Strength	Characteristics	AWW A Standard
Trisodium phosphate, Na <sub>3</sub> PO <sub>4</sub> •12H <sub>2</sub> O	Normal sodium phosphate, tertiary sodium phosphate, TSP	125-lb kegs; 200-lb bags; 325-lb bbls.	Cast iron, steel	Crystal: coarse medium standard	56 58 61	0.1 (32°F), 13.0 (158°F)	19% P <sub>2</sub> O <sub>5</sub>	pH of 1% solution, 11.9	
Softening									
Calcium hydroxide, Ca(OH) <sub>2</sub>	Hydrated lime, slaked lime	0-lb bags; 100-lb bbls.; bulk (carloads) trucks	Asphalt, cement, iron, rubber, steel	White powder: light dense		0.014 (68°F) 0.012 (90°F)	85-99% Ca(OH) <sub>2</sub> 63-73% CaO	Hopper agitation required for dry feed of light form	B 202
Calcium oxide, CaO	Burnt lime, chemical lime, quicklime, unslaked lime	50-lb bags; 100-lb bbls; bulk (carloads)	Asphalt, cement, iron, rubber, steel	Lump, pebble, granule		Slakes to form hydrated lime	75-99% CaO	pH of saturated solution, 12.4; detention time, temperature, amount of water all critical for effluent slaking	B 202
Sodium carbonate, Na <sub>2</sub> CO <sub>3</sub>	Soda ash	Bags; bbls.; bulk (carloads, trucks)	Iron, rubber, steel	White powder: extra-light light dense	23 35 65	1.5 (68°F), 2.3 (86°F)	99.4% Na <sub>2</sub> CO <sub>3</sub> , 58% Na <sub>2</sub> O	Hopper agitation required for dry feed of light and extra-light forms; pH of 1% solution, 11.3	B 201
Sodium chloride, NaCl	Common salt, salt	Bags; bbls.; bulk (carloads)	Bronze, cement, rubber	Rock fine		2.9 (32°F), 3.0 (68°F), 86°F	98% NaCl		B 200

Table 8 (Continued)

Chemical Name and Formula	Common or Trade Name	Shipping Containers	Suitable Handling Materials	Available Forms	Weight, lb/ft <sup>3</sup>	Solubility, lb/gal	Commercial Strength	Characteristics	AWW A Standard
Taste and Odor Control									
Activated carbon, C	"Aqua Nuchar," "Hydro-darco," "Norite"	Bags; bulk	Dry—iron, steel; wet—rubber, silicon, iron, stainless steel	Black granules power	15	Insoluble (suspension used)			B 600 & B 604
Chlorine, Cl <sub>2</sub>	Chlorine gas, liquid chlorine	100-, 150-lb cylinders; 1-ton tanks; 16- 30-, 55-ton tank cars	Dry—black iron, copper, steel; wet gas—glass, hard rubber, silver	Liquefied gas under pressure	91.7	0.07 (60°F), 0.04 (100°F)	99.8% Cl <sub>2</sub>		B 301
Chlorine dioxide, ClO <sub>2</sub>	Chlorine dioxide	Generated as used	Plastics, soft rubber (avoid hard rubber)	Yellow-red gas		0.02 (30 mm)	26.3% available Cl <sub>2</sub>		
Copper sulfate, CuSO <sub>4</sub> •5H <sub>2</sub> O	Blue vitriol, blue stone	100-lb bags; 450-lb bbls.; drums	Asphalt, silicon, iron, stainless steel	Crystal Lump Power	75-90 73-80 60-64	1.6 (32°F), 2.2 (68°F), 2.6 (86°F)	99% CuSO <sub>4</sub>		B 602
Ozone O <sub>3</sub>	Ozone	Generated at site of appli- cation	Aluminum, ceramics, glass	Colorless gas					
Potassium permanganate, KMnO <sub>4</sub>	Purple salt	Bulk; bbls.; drums	Iron, steel, wood	Purple crystals		0.23 (32°F) 0.54 (68°F) 1.05 (104°F)	100%	Danger of explosion on contact with organic matters	B 603

Table 9  
Water Treatment Plant Residue Disposal Summary

Type of Waste	Quantities and Characteristics	Treatment Required	Disposal Possibilities
Screenings	Vary widely; evaluate particular water source; check other plants using same water source or other similar plants.	None.	Return to watercourse if quantities are small. Truck to landfill along with other plant solid waste.  Investigate disposal with wastewater treatment plant screenings.
Presedimentation sludges	Vary widely; evaluate particular water source; check other plants using same water source or other similar plants.	Dewatering in lagoon, sand drying bed, or mechanical unit may be required.	Dredging or draglining and hauling to landfill; multiple, drainage basins make cleaning easier.
Chemical clarification sludges	Composed of raw water impurities and coagulation chemicals. Solids content - 0.1% to 2%; 75-90% of total is suspended; 20-40% of total is volatile. Dry unit weight 75-95 lbs/ft <sup>3</sup> . Gelatinous.	Gravity thickening is often desirable, recycling supernatant to plant influent. (3)  Sludge concentrations of 0.5-1.0% can be obtained.  In addition to gravity thickening, dewatering processes may also be used:  Drying beds. Freeze/thaw treatment processes are effective for alum sludge dewatering but expensive except in climates where sludges can be lagooned and frozen naturally.	Send concentrated sludge or continuously withdrawn sludge to wastewater treatment plant.(1)  Haul dried sludge to landfill



Table 9 (Continued)

Type of Waste	Quantities and Characteristics	Treatment Required	Disposal Possibilities
Filter wash water (2)	<p>Normal wash generates about 150 gal/ft<sup>2</sup> filter area. Chemically-precipitated raw water impurities and coagulation chemicals. For alum plants, total solids varies with time up to 1,000 mg/L, average 400 mg/L. Plants removing iron and manganese may be 4 times higher in total solids.</p>	<p>Centrifuges and vacuum filters dewater sludges up to about 15% solids.</p> <p>Pre-coat vacuum filters dewater sludge up to 25% solids.</p> <p>Pressure filtration dewater sludge to 25-40% solids, often requiring lime as conditioner.</p> <p>Flow equalization and concentration through sedimentation and decanting.</p>	<p>Same as for coagulation sludges. Combine with coagulation sludge where applicable. Where no coagulation used, dispose as softening sludge. Gradually return entire flow to plant influent. (3)</p>
Lime softening sludges	<p>Assume 3 lb dry sludge solids per lb quicklime added.</p>	<p>Dewatering lime softening sludges is not particularly difficult. The following methods can be used following thickening:</p>	<p>Discharge to wastewater treatment plants. (1)</p>

Table 9 (Continued)

Type of Waste	Quantities and Characteristics	Treatment Required	Disposal Possibilities
Diatomaceous earth sludges	<p>Clarifier underflow.</p> <p>Solids concentration is generally approximately 5%, but may range from 2 to 30%.</p> <p>Non-gelatinous. Typically 85-95% calcium carbonate, with some magnesium hydroxide.</p> <p>See filter manufacturer's literature for quantities. Solids normally 60-70% diatomaceous earth; remainder raw water impurities; dry density about 10 lb/ft<sup>3</sup>; specific gravity 2.</p>	<p>1. Lagooning (up to 50% solids).</p> <p>2. Vacuum filtration (40-50% solids).</p> <p>3. Centrifuging (50-60% solids).</p> <p>Return to water plant influent.</p> <p>Lagooning, with supernatant recycled to plant influent.</p>	<p>Dewatered sludge hauled to landfill (agricultural applications possible).</p> <p>Recalcining generally limited to large plants (&gt;20 mgd) by economic considerations.</p> <p>Haul solids from lagoon to landfill.</p>
Carbon slurries	Quantities and characteristics variable.	Granular carbon can be regenerated and recycled. Powdered carbon cannot be regenerated; dispose of powdered carbon following dewatering.	Haul solids to landfill. Incinerate dewatered solids (high heating value).

Table 9 (Continued)

Type of Waste	Quantities and Characteristics	Treatment Required	Disposal Possibilities
Cation exchange resin regeneration brines	See manufacturer's literature for quantities. Total dissolved solids up to 45,000 mg/L. Chlorides up to 112,000+ mg/L. Almost no suspended solids.	Evaporation lagoons where concentration is desired and climate permits	Best solution is ocean disposal. Return to watercourse only if brine can be greatly diluted. Discharge to wastewater treatment plant only if greatly diluted. Disposal wells possible but suitability is site-specific.

- (1) For discharge to sanitary sewers, avoid cross connections and slug flow and always check:
  - (a) Possible damage to sewer system from residue discharge.
  - (b) Effects of residues on liquid and solids treatment processes at the wastewater treatment plant.
  - (c) Hydraulic capacity of the wastewater treatment facilities.
- (2) Sedimentation basins or solids contact reactions ahead of filters will generally remove 70-90% of total plant solids. The remainder of solids will appear in the filter wash water.
- (3) Returning filter backwash and thickener overflow streams to plant influent may be viewed with disfavor by regulators because of the possibility of recycling pathogens.

5.9.1 **Disposal Methods.** It is preferable to dispose of residues in a way that is both economically and environmentally acceptable. Recovery and disposal systems often require increasing the solids content of a residue by removing water. The required solids concentration (and the method of concentration) depends on the chemical recovery or final disposal alternatives used. Table 9 summarizes water treatment plant residue-handling systems currently in use.

Note: Do not discharge residue to a natural water course or public sewer without the approval of the applicable federal, state, and local authorities.

5.9.2 **Recovery Processes.** Alum, ferric chloride, ferrous sulfate, magnesium carbonate, and lime can be recovered from waste sludge by various methods. However, recovery is not usually economical except at the largest municipal facilities and, thus, is not considered viable for military installations. However, manufacturers of alum and ferric coagulants will sometimes agree to accept waste sludges for reprocessing.

5.9.3 **Ultimate Disposal.** Traditionally, water treatment plant wastes have been disposed of by discharge to rivers and lakes, either directly or by way of a storm sewer.

Current environmental laws do not allow this because such discharge harms the receiving body of water (cloudy water, toxicity to aquatic life, formation of sludge banks). Following are alternative methods of ultimate sludge disposal, which, in some cases, may be economical and environmentally sound solutions.

5.9.3.1 Discharge to Sanitary Sewer. In general, water treatment plant residues can be disposed of by discharge to a sanitary sewer without upsetting the wastewater treatment processes. However, problems can result if the amount of sludge is too great.

a) The sewer can be overloaded hydraulically by large batch dumps of sludge. This problem can be handled by storing the sludge in a holding tank, then bleeding the sludge slowly into the sewer during periods of low wastewater flow (such as after midnight). However, sewer flow needs to be sufficient to prevent sludge solids from accumulating in the sewer, since the solids may then clog the sewer.

b) The water treatment sludge solids increase the amount of sludge to be disposed of at the sewage treatment plant. Therefore, the dewatering and disposal problems are not eliminated, but simply shifted elsewhere. Water treatment plant sludge is not affected by sludge digestion processes at the sewage treatment plant but does take up digester volume. In some cases, water plant sludges have been reported to clog digesters.

5.9.3.2 Landfill. Modern sanitary landfills are designed and operated to keep the amount of water leaching from the filled material to a minimum. For this reason, landfill regulations often require that sludges contain at least 20 percent dry solids, and sometimes require as high as 50 to 60 percent. Wet sludges are not acceptable because they are difficult to mix well with other solid wastes before covering, and because the large amount of water could percolate through the soil and pollute water supplies.

5.9.3.3 Lagoons. Disposal lagoons are simply dewatering lagoons that are never cleaned out, thus eliminating the main operating problem of drying lagoons. The main disadvantage is that large land areas are permanently committed for use as lagoons. For plants with small sludge quantities and plentiful land, lagoons can be practical for sludge disposal.

5.9.3.4 Land Spreading of Lime Sludge. In many agricultural areas, particularly in the Midwest, farming practices require that lime or limestone be added to the fields periodically to control soil pH. Sludge from lime water softening processes can be used for this purpose if it is sufficiently dewatered to allow easy handling.

5.9.4 Laboratory Control Tests. The main control tests involved in sludge handling and disposal are the solids tests (total solids and suspended solids) used to determine the effectiveness of dewatering processes. Some recycling processes require testing for hazardous materials. Ocean disposal may require bioassay testing to determine the effect on the aquatic environment.

5.9.5 Maintaining Records. The dewatering and ultimate disposal of water plant sludges and other residues can often be expensive. To manage water treatment plant residues adequately, maintain records on residue quantities and characteristics, chemical quantities used for residue treatment processes, results of laboratory control tests, and operating notes.

5.10 Desalination. Some geographic locations, including coastal areas, islands, and some inland regions, have little or no fresh water even though unlimited supplies of saline water are available.

When it is necessary to establish and maintain military installations in such areas, the water supply is generally derived by converting saline water into fresh water. Several methods are available, but they are all quite expensive and complicated to use. These methods include distillation, ion exchange, electrodialysis, and reverse osmosis. Other methods (such as freezing, hydrate formations, solvent extractions, and solar evaporation) are not considered practical desalination methods.

For more information on desalination, see par. 2.2.64.

5.11 Water Sampling and Analysis. Sampling and analysis for plant quality control differs from testing conducted to monitor compliance with the SDWA. Process tests are generally conducted by treatment plant personnel, are used to enhance and control plant performance, and are not required by law. Applicable process control tests for each unit process are detailed in pars. 5.4.1 through 5.4.13. Compliance monitoring is covered in par. 3.7. Additional information on sampling and analysis can be found in pars. 2.1.2 and 2.2.62.

## Section 6: PUMPS AND DRIVERS

6.1 Section Overview. This section covers the operation of pumps used in water supply facilities. It also covers the motors, engines, and accessories (together called pump drivers) that provide the mechanical source of energy to pumps.

6.2 References. Several publications are referred to in this section as including necessary or supplementary information on pumps and drivers. These publications are listed below, along with the paragraph number corresponding to the publication's listing in Section 2, Applicable Documents. For brevity, subsequent references to each of these documents within Section 6 use only the Section 2 paragraph number. The following publications are mentioned in Section 6.

- a) AWWA Standard for Vertical Turbine Pumps: Line Shaft and Submersible Types (par. 2.2.35)
- b) Centrifugal Pumps and Motors: Operation and Maintenance (par. 2.2.37)
- c) Distribution System Maintenance Techniques (par. 2.2.41)
- d) MIL-HDBK-1110, Paints and Protective Coatings (par. 2.4.4.1)
- e) Principles and Practices of Water Supply Operations Series: Basic Science Concepts and Applications (par. 2.1.1)
- f) Principles and Practices of Water Supply Operations Series: Water Transmission and Distribution (par. 2.1.4)

6.3 Pumps. Velocity pumps and positive-displacement pumps are the two categories of pumps commonly used in water supply operations. Velocity pumps, which include centrifugal and vertical turbine pumps, are used for most distribution system applications. Positive-displacement pumps, which include rotary and reciprocating pumps, are most commonly used in water treatment plants for chemical metering and pumping sludge. Detailed descriptions of the pump types commonly used in water supply systems, along with applications, operating characteristics, and a listing of general advantages and disadvantages, can be found in par. 2.1.4.

Specific information on vertical turbine pumps is contained in par. 2.2.35.

Table 10 lists maximum capacity and discharge head values for several general pump types.

Table 10  
Comparison of Pump Discharge and Head

Pump Type	Maximum Capacity		Maximum Discharge Head	
	gpm	(Lps)	feet of water	(kg/sq cm)
Air lift	3,000	(190)	700	(21)
Centrifugal				
Axial flow (propeller)	200,000+	(12,600)	50	(2)
Diffuser	700	(45)	1,000	(30)
Mixed flow	250,000+	(15,800)	100	(3)
Regenerative turbine	100	(6)	600	(18)
Vertical turbine	30,000	(1,890)	>1,500	(45)
Volute	40,000	(2,500)	500	(15)
Ejector (jet)	50	(3)	150	(5)
Progressive cavity (helical rotor)	1,200	(75)	2,300	(70)
Reciprocating displacement				
Diaphragm	300	(20)	800	(25)
Piston	300	(20)	800	(25)
Plunger	300	(20)	800	(2)
Rotary displacement	55	(3)	1,000	(30)

6.4 Operation of Pumps. Operate all mechanical equipment, including pumps, in accordance with the manufacturer's instructions. General O&M information, including starting and stopping procedures, flow control, and performance monitoring, can be found in par. 2.1.4.

For assistance with calculating pumping rates, pump heads, horsepower and efficiency, and reading pump curves, see par. 2.1.1.

6.4.1 General Operating Instructions for Centrifugal Pumps. A quick reference checklist for starting and stopping centrifugal pumps is provided below (Table 11).

Procedures may vary for different pump types and pump applications. Know what to expect when the equipment starts.

6.4.2 Troubleshooting Centrifugal Pumps. Symptoms and possible causes of operating difficulties are listed in Table 12. For more troubleshooting help, see par. 2.1.4.

See also Table 19, a troubleshooting checklist for vertical turbine well pumps, which are a class of centrifugal pump.

6.4.2.1 Cavitation Problems. Cavitation is one of the most serious operational problems with centrifugal pumps. Cavitation occurs when cavities or bubbles of vapor form in the liquid. The bubbles collapse against the impeller, making a sound as though there were rocks in the pump. If left uncorrected, cavitation will seriously damage the pump.

6.4.2.2 Causes of Cavitation. Conditions that typically cause cavitation include operating the pump with too great a suction lift or an insufficiently submerged suction inlet. Cavitation develops when normal pump operating conditions have been exceeded. Noise, vibration, impeller erosion, and reduction in total head and efficiency result from cavitation. Cavitation in a centrifugal pump may be caused by any of the following:

a) The impeller vane is traveling at higher revolutions per minutes (rpm) than the liquid.

b) Suction is restricted.

Note: Do not throttle the suction of a centrifugal pump.

c) The required net positive suction head (NPSH) is equal to or greater than the available NPSH.

d) The specific pump speed is too high for the operating conditions.

e) The liquid temperature is too high for the suction conditions.



Table 11  
Routine Operations Checklist for Centrifugal Pumps

Inspection	Action
Prestart Checks Valves	<p>Open the valve in the cooling liquid supply to the bearing, if the bearings are liquid cooled.</p> <p>Open the valve in the flushing water supply to the stuffing boxes, if so equipped.</p> <p>Open the valve in the sealing liquid supply to the stuffing boxes or mechanical seals, if so equipped.</p> <p>Open or close the discharge valves according to the manufacturer's manual.</p>
Rotors	<p>Check the rotor to see that it is free. You should be able to turn the rotor shaft by hand. Do not start the pump until any difficulty is corrected.</p> <p>Prime centrifugal pumps before startup. The equipment will not pump water unless air in the pump and suction piping is replaced with water. In addition, the rotating element may seize from a lack of lubrication.</p> <p>Use one of the following methods to prime the pump, depending on operating conditions: positive suction head (1) or negative suction head (2).</p>
Starting the Pump	<p>Always start the pump according to the manufacturer's manual.</p>
Equipment area Valves	<p>Ensure that all personnel are clear of dangerous areas.</p> <p>For pumps started with discharge valves closed, open valves slowly after pump approaches operating speed. Do not operate the pump with a closed discharge valve.</p>

Table 11 (Continued)

Inspection	Action
Stuffing boxes and Packing	<p>Observe leakage from the stuffing boxes and adjust the sealing liquid valve for proper flow to ensure packing lubrication. For new packing, allow pump to run for 10 to 15 minutes before tightening the stuffing box gland. Gradually tighten the stuffing box gland until leakage slows to a constant drip.</p>
Pump and driver	<p>Check the general mechanical operation of the pump and driver. Ensure that working parts are free to move without damage.</p>
Stopping the Pump	<p>Always review instructions for disconnecting and securing drive and rotating equipment.</p>
Valves	<p>As a rule, there is a check valve in the discharge line close to the pump. In such cases, shut down the pump by stopping the driver according to the manufacturer's manual.</p> <p>Then close all valves, except the check valve, in this order: discharge, suction, pump cooling water supply, and other connections leading to the pump or system.</p> <p>In some instances, however, the use of a check valve is not feasible because the sudden closing of the valve under high discharge pressure might create pressure surges or water hammer. In such cases, close the discharge valve slowly to avoid water hammer.</p>
Monitoring Operations	<p>Unusual sounds</p> <p>Learn to recognize the normal sounds and conditions of a properly run pump. Listen to the sounds of the pump on regular inspection tours and investigate any abnormal sounds at once.</p>

Table 11 (Continued)

Inspection	Action
Bearings	Check bearing temperature and lubrication. Where petroleum-based lubricants are used, follow the manufacturer's manual and do not over lubricate.
Suction and discharge readings	Check these readings and compare with "normal" valves. Make sure valves are set as required. Check shaft packing. Check discharge rate. Check driving equipment.

- (1) Positive Suction Head. When the intake (suction) side of the pump is under pressure, use the following priming sequence:
- a. Open all suction valves to allow water to enter the suction pipe and pump casing.
  - b. Open all vents located on the highest point of the pump casing to allow trapped air to be released.
- Note: The pump is properly primed when water flows from all open vents in a steady stream.
- (2) Negative Suction Head. Two priming methods are available for a negative suction head condition—that is, when the pump lifts water to the intake (suction lift).
- a. Vacuum Pump or Ejection Method. When steam, high-pressure water, or compressed air is available, prime the pump by attaching an ejector to the highest point in the pump casing for evacuating the air from the suction piping and casing. A vacuum may be substituted for the above equipment. Start the ejector or vacuum pump to exhaust the air from the pump casing and suction pipe. When water discharges from the ejector or vacuum pump, start the centrifugal pump, but continue priming until the centrifugal pump has reached operating speed.
  - b. Priming a Pump with a Foot Valve. A foot valve is used at the lowest point on the suction pipe. The foot valve retains water in the suction pipe and pump casing after the pump has been initially primed. To prime, open the suction valve, if one is installed. Open vent valves at the highest points on the pump casing. Fill the pump and suction line from an independent water supply. Allow to fill until a steady steam flows from the vent valves.

Table 12  
 Troubleshooting Checklist for Centrifugal Pumps

Symptom	Possible Cause
Pump does not deliver water.	Pump not primed. Pump or suction pipe not completely filled with water. Suction lift too high. Air pocket in suction line. Inlet of suction pipe insufficiently submerged. Suction valve not open or partially open. Discharge valve not open. Speed too low. Wrong direction of rotation. Total head of system higher than design head of pump. Parallel operation of pumps unsuitable for existing conditions. Foreign matter in impeller.
Insufficient capacity delivered.	Pump or suction pipe not completely filled with water. Suction lift too high. Excessive amount of air or gas in water. Air pocket in suction line. Air leaks into suction line. Air leaks into pump through stuffing boxes. Foot valve too small. Foot valve partially clogged. Inlet of suction pipe insufficiently submerged.

Table 12 (Continued)

Symptom	Possible Cause
Insufficient pressure developed.	<p>Suction valve only partially open.</p> <p>Discharge valve only partially open.</p> <p>Speed too low.</p> <p>Total head of system higher than design head of pump.</p> <p>Parallel operation of pumps unsuitable for such operation.</p> <p>Foreign matter in impeller.</p> <p>Wearing rings worn.</p> <p>Impeller damaged.</p> <p>Casing gasket defective, permitting internal leakage.</p> <p>Excessive amount of air or gas in water.</p> <p>Speed too low.</p> <p>Wrong direction of rotation.</p> <p>Total head of system higher than design head of pump.</p> <p>Parallel operation of pumps unsuitable for existing conditions.</p> <p>Wearing rings worn.</p> <p>Impeller damaged.</p> <p>Casing gasket defective, permitting internal leakage.</p>
Pump loses prime after starting.	<p>Pump or suction pipe not completely filled with water.</p> <p>Suction lift too high.</p> <p>Excessive amount of air or gas in water.</p> <p>Air pocket in suction line.</p> <p>Air leaks into suction line.</p>

Table 12 (Continued)

Symptom	Possible Cause
<p>Pump requires excessive power.</p>	<p>Air leaks into pump through stuffing boxes.            Inlet of suction pipe insufficiently submerged.            Water-seal pipe plugged.            Seal cage improperly located in stuffing box, preventing sealing fluid from entering space to form the seal.            Speed too high.            Wrong direction of rotation.            Total head of system higher than design head of pump.            Total head of system lower than pump design head.            Foreign matter in impeller existing conditions.            Misalignment.            Shaft bent.            Rotating part rubbing on stationary part.            Wearing rings worn.            Packing improperly installed.            Incorrect type of packing for operating conditions.            Gland too tight resulting in no flow of liquid to lubricate packing.</p>
<p>Stuffing box leaks excessively.</p>	<p>Seal cage improperly located in stuffing box, preventing sealing fluid entering space to form the seal.            Misalignment.            Shaft bent.            Shaft or shaft sleeves worn or scored at the packing.            Packing improperly installed.</p>

Table 12 (Continued)

Symptom	Possible Cause
Packing has short life.	<p>Incorrect type of packing for operating conditions.</p> <p>Shaft running off center because of worn bearings or misalignment.</p> <p>Rotor out of balance, resulting in vibration.</p> <p>Gland too tight, resulting in no flow of liquid to lubricate packing.</p> <p>Excessive clearance at bottom of stuffing box between shaft and casing, causing packing to be forced into pump interior.</p> <p>Dirt or grit in sealing liquid, leading to scoring of shaft or shaft sleeve.</p> <p>Water-seal pipe plugged.</p> <p>Seal cage improperly located in stuffing box, preventing sealing fluid from entering space to form the seal.</p> <p>Misalignment.</p> <p>Shaft bent.</p> <p>Bearings worn.</p> <p>Shaft or shaft sleeves worn or scored at the packing.</p> <p>Packing improperly installed.</p> <p>Incorrect type of packing for operating conditions.</p> <p>Shaft running off center because of worn bearings or misalignment.</p> <p>Rotor out of balance, resulting in vibration.</p> <p>Gland too tight, resulting in no flow of liquid to lubricate packing.</p>

Table 12 (Continued)

Symptom	Possible Cause
Pump vibrates or is noisy.	<p>Failure to provide cooling liquid to water-cooled stuffing boxes.</p> <p>Excessive clearance at bottom of stuffing box between shaft and casing, causing packing to be forced into pump interior.</p> <p>Dirt or grit in sealing liquid, leading to scoring of shaft or shaft sleeve.</p> <p>Pump or suction pipe not completely filled with water.</p> <p>Suction lift too high.</p> <p>Foot valve too small.</p> <p>Foot valve partially clogged.</p> <p>Inlet of suction pipe insufficiently submerged.</p> <p>Operation at very low capacity.</p> <p>Foreign matter in impeller.</p> <p>Misalignment.</p> <p>Foundations not rigid.</p> <p>Shaft bent.</p> <p>Rotating part rubbing on stationary part.</p> <p>Bearings worn.</p> <p>Impeller damaged.</p> <p>Shaft running off center because of worn bearings or misalignment.</p> <p>Rotor out of balance, resulting in vibration.</p> <p>Dirt or grit in sealing liquid, leading to scoring of shaft or shaft sleeve.</p>



Table 12 (Continued)

Symptom	Possible Cause
Bearings have short life.	<p>Excessive grease or oil in antifriction-bearing housing, or lack of cooling, causing excessive bearing temperature.</p> <p>Lack of lubrication.</p> <p>Improper installation of antifriction bearings (damage during assembly, incorrect assembly of stacked bearings, use of unmatched bearings as a pair, etc.).</p> <p>Dirt getting into bearings.</p> <p>Rusting of bearings because of water getting into housing.</p> <p>Excessive cooling of water-cooled bearing resulting in condensation in the bearing housing of moisture from the atmosphere.</p> <p>Misalignment.</p> <p>Shaft bent.</p> <p>Rotating part rubbing on stationary part.</p> <p>Bearings worn.</p> <p>Shaft running off center because of worn bearings or misalignment.</p> <p>Rotor out of balance, resulting in vibration.</p> <p>Excessive thrust caused by a mechanical failure inside the pump or by the failure of the hydraulic balancing device, if any.</p> <p>Excessive grease or oil in antifriction-bearing housing or lack of cooling, causing excessive bearing temperature.</p> <p>Lack of lubrication.</p>

Table 12 (Continued)

Symptom	Possible Cause
Pump overheats and seizes.	<p>Improper installation of antifriction bearings (damage during assembly, incorrect assembly of stacked bearings, use of unmatched bearings as a pair, etc.).</p> <p>Dirt getting into bearings.</p> <p>Rusting of bearings because of water getting into housing.</p> <p>Excessive cooling of water-cooled bearing, resulting in condensation in the bearing housing of moisture from the temperature.</p> <p>Pump not primed.</p> <p>Operation at very low capacity.</p> <p>Parallel operation of pumps unsuitable for existing conditions.</p> <p>Misalignment.</p> <p>Rotating part rubbing on stationary part.</p> <p>Bearings worn.</p> <p>Shaft running off center because of worn bearings or misalignment.</p> <p>Rotor out of balance, resulting in vibration.</p> <p>Excessive thrust caused by a mechanical failure inside the pump or by the failure of the hydraulic balancing device, if any.</p> <p>Lack of lubrication.</p>

6.4.3 Operating Instructions for Ejector (Jet) Pumps. Jet pumps are a type of centrifugal pump. Because of their relatively low efficiency, they are rarely used for public water systems. However, jet pumps are inexpensive and require little maintenance and may be used on wells supplying very small, low-demand systems. The operating principle of these pumps is described in par. 2.1.4.

Note: All operating rules and troubleshooting checks that apply to centrifugal pumps apply to ejector pumps.

Start the pump and adjust the manual back pressure valve until the correct operating cycle is achieved. Do not change the adjustment after the pump is operating. If pump discharge decreases, check troubleshooting guides for centrifugal pumps. Also inspect the ejector nozzle and throat for deposits, and check nozzle submergence.

6.4.4 Operating Instructions for Progressive Cavity Pumps. Progressive or helical-rotor pumps are positive displacement pumps and not subject to the same problems as centrifugal pumps. Operate according to the manufacturer's instructions.

Caution: Do not run dry.

Common operating problems encountered with progressive cavity pumps and possible causes are given in Table 13.

6.4.5 Operating Instructions for Rotary- and Reciprocating-Displacement Pumps. A general description of positive displacement pumps is provided in par. 2.1.4.

6.4.5.1 Prestart. Rotary- and reciprocating-displacement pumps do not usually require priming. However, when priming is necessary, follow priming procedures for centrifugal pumps.

6.4.5.2 Starting and Operating. Always start and operate rotary- and reciprocating-displacement pumps with both suction and discharge valves open to prevent motor overload and pump damage.

Table 13  
 Troubleshooting Checklist for Progressive-Cavity Pumps

Symptom	Possible Cause
No water is delivered.	Broken or disconnected shaft. Excessive discharge head. Plugged or nonsubmerged suction.
Pump does not deliver rated capacity.	Speed too low. Suction lift excessive. Suction partially plugged. Mechanical defect.
Pressure is too low.	Discharge head too high. Speed too low. Pressure relief valve set too low. Mechanical defect.
Pump stops after starting to operate.	Bent column shaft. Clogged suction.

#### 6.4.5.3 Operating Precautions

a) Rotary- and reciprocating-displacement pumps depend on clearances for efficiency. Keep grit or other abrasive material out of the liquid being pumped to prevent excessive wear and rapid loss of efficiency and self-priming ability.

b) A pressure-relief valve that discharges back to the suction side of the pump is usually provided on the outlet piping. Adjust this valve for a relief pressure that does not overload the motor. Make sure the check valves seat properly at normal pressures. Otherwise, loss of efficiency and priming ability result.

c) Use the manufacturer's manuals to develop a checklist for the particular rotary- or reciprocating-displacement pump being used.

6.5 Pump Maintenance. Information contained in the following paragraphs is general and is not intended to replace maintenance procedures provided by the equipment manufacturer. Additional information on pump maintenance can be found in the publications listed in pars. 2.1.4, 2.2.37, and 2.2.41.

6.5.1 Maintenance Procedures for Centrifugal Pumps. The following paragraphs describe general maintenance procedures for all types of horizontal and vertical centrifugal pumps. For details of procedures that apply specifically to volute, diffuser, regenerative-turbine, split-case, and multistage design, consult the manufacturer's manuals.

6.5.1.1 Lubrication. General lubrication instructions are provided in par. 11.6. Manufacturer's manuals cover lubrication frequency for special cases, but the following generally applies.

Caution: Do not lubricate totally enclosed equipment or insufficiently guarded equipment while it is moving.

- a) To avoid errors, establish a marking system to make sure that the proper lubricant is used. Make sure the same product symbol and identifying color are marked on lubricant containers, lubricant applicators, and locations near lubrication points.
- b) Never over lubricate. Over lubrication causes antifriction bearings to overheat and may damage the grease seals. Over lubrication may also damage electric motor windings.
- c) For simplified operation, provide the same type of grease gun fitting (zerk) at all points using the same type of grease. The fewer the types of grease used, the fewer grease guns required and the less likelihood of improper grease being used.
- d) Table 14 provides a general lubrication schedule for centrifugal-type pumps. When hand oilers are used to lubricate the shaft bearings, check the settings daily and adjust them according to Table 15.

6.5.1.2 Packing. Selection of packing is usually done in accordance with the manufacturer's recommendations or assistance. For pumping water, packing types include non-reinforced woven or braided cotton asbestos, semi-metallic plastic, or a combination of the two. If you require the manufacturer's assistance to select packing, supply detailed information to the manufacturer on the following items:

- a) Description of liquid handled, including percentage concentration, temperature, and impurities
- b) Amount of abrasive present

- c) Stuffing box dimensions (depth of box, outside diameter, and shaft or sleeve diameter); also, stuffing box pressure and temperature
- d) Shaft speeds
- e) Sealing cage (lantern gland) location and width
- f) Shaft or seal material and hardness

Table 14  
Lubrication Schedule for Centrifugal-Type Pumps

Lubrication Point	Action Required	Frequency (1)
Antifriction bearing	Check temperature (with thermometer); if running hot, bearing is probably over lubricated; remove excess lubricant.	M
	Drain lubricant; flush lubricant wells and bearings with kerosene; add clean fresh lubricant.	Q
Ball-thrust bearing	Add fresh grease to grease cups, but do not attempt to keep grease from coming out around the collar seal.	M
	Change the grease in the grease cup if the pump operates more than 50 times a day; otherwise, change yearly.	Q
Bearing housing	Check oil level in oil housing; do not add oil with pump running; remove oil vent plug when adding oil.	D
	Open housing; flush with kerosene; add clean fresh lubricant.	Q
Enclosed shaft-type bearing	Check oil cup; add lubricant as necessary.	W

Table 14  
Lubrication Schedule for Centrifugal-Type Pumps

Lubrication Point	Action Required	Frequency (1)
Grease-sealed packing gland	Check spring-loaded grease cup; refill as necessary; adjust spring tension to maintain grease discharge through packing at approximately 1 ounce per day.	D
Guide bearing	Add grease through fittings provided.	M
Sealing water system	Check packing gland assembly; adjust packing if excessive seal-water leakage is noticed, allow 60 drops per minute with pump running.	D
	Check stuffing box for free movement of gland.	SA
Hand oiler	According to Table 15.	Each shift
Solenoid oiler	Check that leads are connected; check needle valve for clogging; adjust for 2 to 4 drops per minute; refill container as necessary.	D
Sleeve bearing	Check bearing temperature; if too hot, add lubricant.	M
	Drain lubricant; wash wells and bearing with kerosene.	Q
Universal joint coupling	Lubricate couplings and slip splines with fresh grease.	SA

(1) D-Daily; W-Weekly; M-Monthly; Q-Quarterly;  
SA-Semiannually.

Table 15  
Hand Oiler Adjustment

Pump Operation Schedule (times per day)	Pump Running Time (minutes)	Oiler Rate
Maximum of 2	Not over 5 (a)	1 drop/15 min
3 to 12	Not over 5 (a)	1 drop/4 min
12 to 50	Not over 5 (a)	1 drop/2 min
More than 50		2 to 4 drops/min

(a) Pump running times in excess of 5 minutes will require increased oiling rates.

A guide for stuffing box inspection is provided in Table 16.

6.5.1.3 Sealing Water Systems. Make the daily checks for the sealing water system that are listed in Table 14. If the leakage cannot be adjusted properly, repack the stuffing box according to par. 6.5.1.2 and Table 16. Each year, disassemble the sealing water lines and valves to make sure that the water passages are open.

6.5.1.4 Rotary Seals. If a pump has seals that do not have the conventional follower and pliable, replaceable packing, consult the manufacturer's manual.

6.5.1.5 Shafts and Shaft Sleeves. Each year, when the pump is dismantled, examine the shaft carefully at the impeller hub, under the shaft sleeves, and at the bearings.

a) Shafts. The shaft may be damaged by rusting or pitting caused by leakage along the shaft at the impeller or shaft sleeves. If antifriction bearings are improperly fitted to the pump shaft, the inner race rotates on the pump shaft and damages the shaft. Excessive thermal stresses or corrosion may loosen the impeller on the shaft and subject the keyway to shock. Replace any shaft that is bent or distorted. After the shaft has been replaced, check it for possible runout. The maximum allowable is 0.002 inches (51 microns [ $\mu$ ]).



Table 16  
Guide for Stuffing Box Inspection

Inspection/ Procedure	Action	Frequency (1),(2)
Inspect stuffing box	Ensure that stuffing box glands are moving freely and that gland bolts and nuts are oiled.	SA
Remove old packing	<p>Check for excessive leakage that cannot be reduced by gland adjustment; if found, proceed according to the steps below:</p> <p>a) Remove old packing and clean box. If the box has a seal cage, make sure it is located opposite the sealing liquid inlet.</p> <p>b) Use packing recommended by manufacturer.</p> <p>c) Measure the depth of box and sealing liquid inlet tap. Place enough rings of packing in the bottom of the box that seal cage is in proper position once packing is compressed. Do not try to pack a pump by renewing only the last three or four rings.</p>	V
Check packing ring joints	a) Make sure the packing ring joints are staggered.	V
Add new packing	<p>a) Cut the packing so that the joints are square after the packing is bent around the shaft. Packing should be cut about 1/16 inch longer than measured to be sure that the outside diameter of the ring hugs the stuffing box wall rather than the sleeve. Use care in cutting the rings.</p> <p>b) Except as detailed below, use the follower gland and a few convenient equal-length spacers to compress each ring firmly into place before inserting the next ring.</p>	V

Table 16 (Continued)

Inspection/ Procedure	Action	Frequency (1),(2)
Woven or braided packing	<p>c) Stagger the joints, and make sure that the lantern ring is centered under the water supply connection.</p> <p>d) After the last piece of packing has been placed, tighten the follower gland nuts until finger tight.</p> <p>a) Dip each ring of packing in oil before adding it to the stuffing box.</p> <p>b) Woven or braided packing does not have to be added one ring at a time. Fill the box half full. Then draw the rings up snug by taking up on the packing sleeves and gland. Release the follower, add the remainder of the packing, and draw up snug. Then back off the gland until finger tight.</p>	
Plastic or metal packing	<p>a) Plastic and metallic packing must be compressed individually. Dip each ring in oil, insert in the stuffing box, and draw up tight by split-packing rings and gland. Hand turn the shaft a few times to gloss the packing.</p> <p>b) Always use metallic or jacketed rings next to the bottom of the box, bushings, seal cages, or glands because non-jacketed plastic rings will squeeze into the clearances provided at these locations.</p>	
Combustion-type packing	<p>a) Follow instructions supplied by the manufacturer when using combustion-type packing.</p>	

Table 16 (Continued)

Inspection/ Procedure	Action	Frequency (1),(2)
Position lantern rings	a) If a lantern ring is used, be sure it is positioned correctly; if grease sealing is used, be sure the lantern ring is filled with grease before the remaining rings are put in place.	V
Run-in new packing	<p>a) New packing has to be run-in.</p> <p>b) Start the pump with the stuffing box gland quite loose. Allow the pump to run 10 to 15 minutes.</p> <p>c) Gradually tighten the stuffing box gland until leakage is reduced to a constant drip. Packing that is too tight in the box causes undue friction, creates heat, glazes the packing, and may score the shaft sleeves. Packing must remain soft and pliable.</p> <p>d) Use drip leakage to ensure proper lubrication throughout the packing box.</p>	V
Inspect packing gland	If the stuffing box leaks too much, tighten the gland. If this does not help, remove the packing and inspect the shaft sleeve	W

(1) W-Weekly; SA-Semiannually; V-Variable, as conditions may indicate.

(2) The frequencies shown are suggested frequencies that may be modified by local command, as individual installation conditions warrant.

b) **Shaft Sleeves.** Inspect shaft sleeves each year. They are subject to wear and may require replacement, depending on the severity of service. When the sleeve has become appreciably worn, the packing cannot be adjusted to prevent leakage and the sleeve should be replaced. Otherwise, excessively grooved or scored sleeves will pare and score new packing as soon as it is inserted into the stuffing box.

c) **Bearings.** Inspect the bearings and add lubricant according to the procedures described in Table 17.

6.5.1.6 **Wearing or Sealing Rings.** Each year, inspect the wearing or sealing rings that seal the discharge water from suction water in rotating pumps. These are not perfect seals and do allow some leakage. Do not allow this leakage to become excessive because of worn rings, or the pump efficiency will be impaired. Three types of wearing rings are shown in Figure 5.

a) Proper wearing ring clearance is very important. In the straight-type wearing ring, the most common type, the diametrical clearance need not be less than 0.025 inch (0.64 mm) and should not be greater than 0.050 inch (1.25 mm).

b) In the L-shaped type, clearance in the space parallel to the shaft should be the same as for the straight-type. The clearance of the space at the right angle to the shaft is governed by the end-play tolerances in the bearing.

c) For specification information on the L-shape and labyrinth-type rings, consult the manufacturer's manual.

6.5.1.7 **Impeller.** Each year, remove the rotating element and inspect it thoroughly for wear (see par. 6.5.1.10 for dismantling procedures).

a) Remove any deposits or scaling.

b) Check for erosion and cavitation effects. Cavitation causes severe pitting and a spongy appearance in the metal.

c) If cavitation effects are severe, some changes in pump design or use may be necessary. Report the matter to the supervisor.

Table 17  
Maintenance Checklist for Bearings

Inspection	Action	Frequency (1),(2)
Antifriction bearings Check bearing temperature	Check with a standard thermometer. Antifriction bearings that are running too hot probably have too much lubricant.	M
Change lubricant	Change lubricant according to Table 14). If lubricant change does not prevent overheating, disassemble and inspect the bearing. If nothing appears to be wrong, check the pump and motor alignment.	Q
Check clearances	During the quarterly lubrication change, check the clearances. Recommended clearance is 0.002 inch (51 $\mu$ ), plus 0.001 inch (25 $\mu$ ) for each inch (25 mm) of the shaft-journal diameter.	Q
Check bearing condition	<p>Each year, when the pump is dismantled, check the condition of the bearings and the bearing race; replace as necessary.</p> <p>The preferred method in general use for mounting a bearing on a pump shaft is to heat the bearing to expand the inner race and shrink it on the shaft. The bearing is heated in an oil bath or electric oven to a uniform temperature of 200° to 250°F (93° to 121°C). When heated, it should be quickly mounted on the shaft.</p> <p>An alternate method uses force exerted by an arbor press or hammer blows. In forcing a bearing onto a shaft, be sure that the race is never cocked during the operation. The bearing position on the shaft should be pressed firmly against the shaft shoulder. Check with a feeler gage.</p>	A

Table 17 (Continued)

Inspection	Action	Frequency (1),(2)
Sleeve bearings	Check with a standard thermometer. Sleeve bearings that are running too hot probably have too much lubricant.	M
Change lubricant	Change lubricant according to Table 14). If lubricant change does not solve the overheating problem, disassemble and inspect the bearing. If the bearing is in good condition, check the pump and motor alignment.	Q
Check clearances	During the quarterly lubrication change, check the clearances. Normal clearance is 0.002 inch (51 $\mu$ ), plus 0.001 inch (25 $\mu$ ) for each inch (25 mm) of the shaft-journal diameter.  Make sure that the oil rings are free to turn with the shaft. Repair or replace oil rings when necessary.	Q
Check bearing condition	Each year, when the pump is dismantled, check the condition of the bearings and the bearing race; replace as necessary. Sleeve bearings are usually split-type and can be easily removed and installed. Rotation of the bearing is prevented by a pin in the top half of the bearing housing.	A

(1) M-Monthly; Q-Quarterly; A-Annually.

(2) The frequencies shown are suggested frequencies that may be modified by local command, as individual installation conditions warrant.

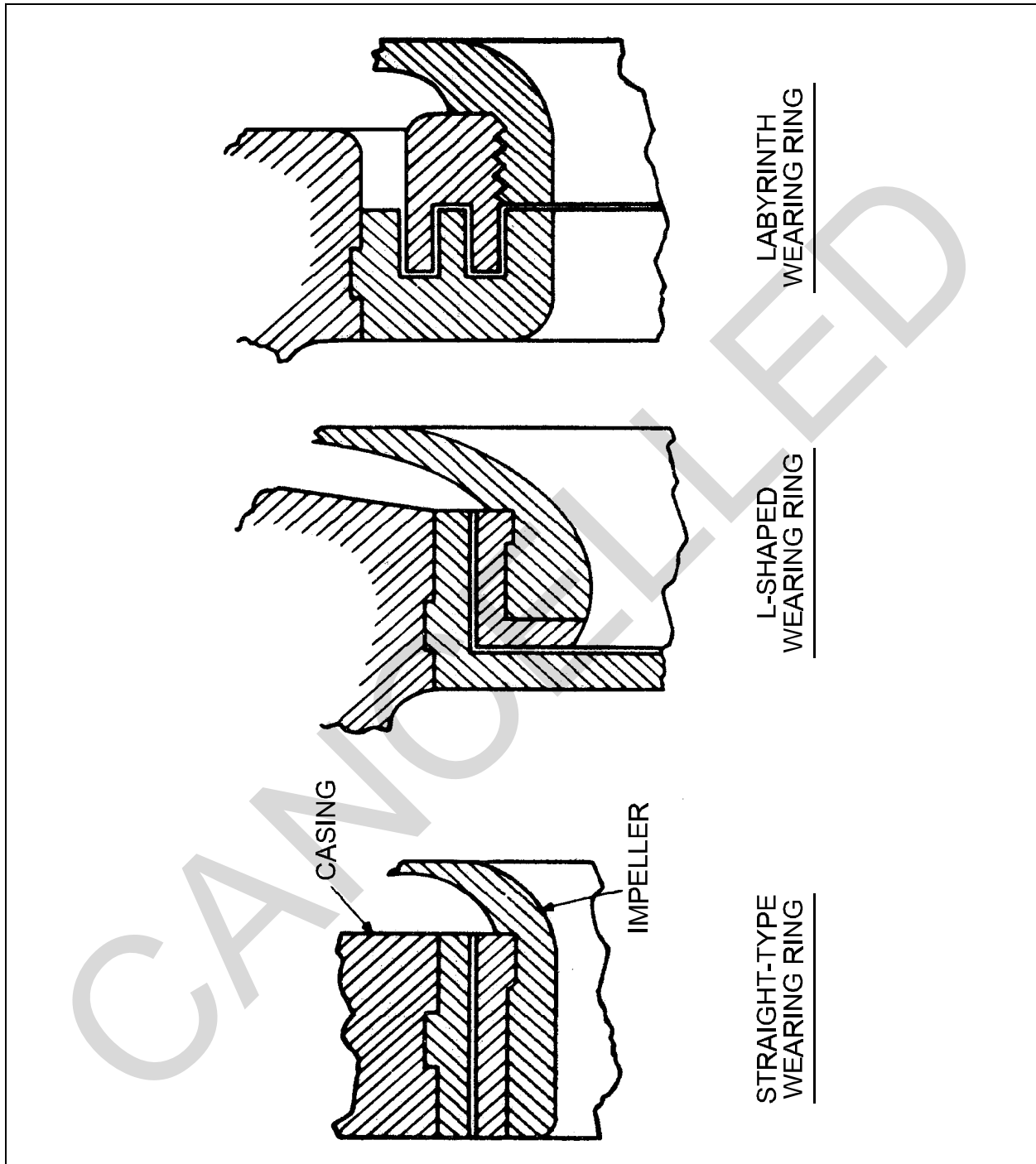

Figure 5  
Types of Wearing (Sealing) Ring

6.5.1.8 Casing Maintenance. Keep the waterways clean and clear of rust. When the unit is dismantled, clean and paint the waterway with a suitable paint that will adhere firmly to the metal. A routine program of cleaning and repainting helps prevent complete erosion of the protective coat before replacement.

6.5.1.9 Pump Shutdown. When a pump is shut down for an extended period, or for overhaul inspection and maintenance, the following procedures apply:

- a) Shut off all valves on suction discharge, waterseal, and priming lines. Drain the pump completely by removing vent and drain plugs until the water has run off. This operation protects against corrosion, sedimentation, and freezing.
- b) Disconnect the switch to the motor and remove the fuses.
- c) Drain the bearing housing. If the shutdown is to be followed by an inactive period, purge all the old grease. Otherwise, refill with fresh grease. If an overhaul is scheduled, do not refill the oil or grease receptacles until the pump is reassembled.

6.5.1.10 Overhaul Procedures. The frequency of complete overhaul depends on the hours of pump operation, the severity of service conditions, the construction material of the pump, and the care the pump receives during its operation. If the pump is not operated continuously, opening the pump for inspection is not necessary unless there is definite evidence that the capacity has fallen off excessively, or if there is an indication of trouble inside the pump or in the bearings. In general, it is good practice to dismantle pumps in relatively continuous operation once a year. Because pump designs and construction vary from model to model, and from one manufacturer to another, there is no set of specific procedures for dismantling and reassembling. Rules (a) through (d) below are basic. For detailed procedures, consult the manufacturer's manual.

- a) Use extreme care in dismantling the pump to avoid damaging internal parts. For convenience in reassembly, lay out all parts in the order they are removed. Protect all machined faces against metal-to-metal contact and corrosion. Do not remove ball bearings unless absolutely necessary.
- b) While the pump is dismantled, examine the foot valve and check valve to make sure they are seating and functioning properly.
- c) To assemble the pump, reverse the dismantling procedure. Follow the manufacturer's manual explicitly.



- d) Check the pump and motor alignment after reassembly.

6.5.2 Rotary-Displacement Pumps. There are numerous types of rotary displacement pumps and, therefore, it is not possible to set up detailed maintenance procedures that apply to all types. Establish individual maintenance procedures according to the manufacturer's manual. Using the manual, set up procedures similar to those presented for a centrifugal-type pump. At annual intervals, disassemble the pumps and clean both exterior and interior surfaces.

6.5.2.1 Clearances. Check clearances for tolerances listed in the manufacturer's manual.

6.5.2.2 Packing. Check the packing assembly, and repack as needed.

6.5.2.3 Bearings and Alignment. Check the bearings and the alignment of the pump and motor.

6.5.2.4 Checklist Items. Check all items included in the checklist previously determined from the manufacturer's manual and the listings for centrifugal-type pumps.

6.5.2.5 Painting. Paint exterior surfaces and interior surfaces subject to rust with a suitable underwater paint or effective protective coating.

6.5.3 Reciprocating-Displacement Pumps. There are three types of reciprocating pumps: plunger, piston, and diaphragm. Consult the manufacturer's manual for each individual pump.

6.5.3.1 Calculations. Calculate the delivery of piston and plunger pumps every year. The decrease in percent delivery from the volumetric displacement per pump stroke is termed "slippage." Excessive slippages indicate the need for maintenance and possible repair.

a) Volumetric Displacement. Compute the volumetric displacement by multiplying the piston or plunger area by the length of stroke. Make proper allowance for double-action pumps.

b) Delivery. Calculate the percent delivery from a comparison of the measured delivery per stroke and the computed volumetric displacement per stroke. If delivery is less than 90 percent of the volumetric displacement, check the valves, pistons, and packing for leakage. Make any necessary replacements to maintain the desired efficiency.

6.5.3.2 Pump Inspection. Dismantle the pump and inspect thoroughly each year according to the following schedule:

- a) Remove and examine all valves, valves seats, and springs. Reface valves and valve seats as necessary and replace worn or defective parts.
- b) Remove all old packing and repack.
- c) Check the pump and driver alignment.
- d) Check the plunger or rod for scoring or grooving.
- e) Clean the interior and exterior surfaces. Paint the interior with suitable underwater paint or protective coating. Paint the exterior.

6.5.4 Sludge Pumps. Two types of sludge pumps, reciprocating and progressive cavity, are discussed here. Maintain centrifugal-type sludge pumps according to the procedures previously presented for centrifugal-type pumps. Modify the procedures listed to conform to manufacturers' manuals. For lubrication requirements of all sludge pumps, consult the manufacturer's manual.

#### 6.5.4.1 Packing Procedures for Reciprocating Sludge Pumps

- a) Daily, or more frequently if necessary, check the sight-feed oil cup, if one is provided for lubrication between the plunger and the stuffing box. Add a squirt of oil around the plunger as often as necessary.
- b) At varying intervals, renew the packing when no takeup is left on the packing-gland bolts.
  - (1) Remove the old packing, and clean the cylinder and piston walls. Place new packing in the cylinder and tamp each ring into place. Be sure that the packing ring joints are staggered.
  - (2) To break the packing, run the pump for a few minutes with the sludge line closed and the valve covers open.
  - (3) Turn down the gland nuts, no more than is necessary, to keep sludge from getting past the packing. Be sure all packing-gland nuts are tightened uniformly. When chevron-type packing is used, make sure that the nuts holding the packing gland are only finger tight to prevent ruining the packing and scoring the plunger.

c) Check the packing-gland adjustment each week to make sure that the gland is just tight enough to keep sludge from leaking through the gland, making sure that the piston walls are not being scored. Before operating a pump, especially after it has been standing idle, loosen all nuts on the packing gland.

#### 6.5.4.2 Bearings and Gear Transmission for Reciprocating Sludge Pumps

- a) Daily (or once per shift), lubricate the bearings and the gear transmissions with a grease gun. If the pump runs continuously, grease more often than once a shift.
- b) Check the gear transmission each month and keep it filled to the proper level with the proper oil. Open the drain to eliminate accumulated moisture.
- c) Change the oil every 3 months to prevent excessive emulsification.

#### 6.5.4.3 Shear Pins in Reciprocating Sludge Pumps

- a) Check the shear-pin adjustment each week. Set the eccentric by placing a shear pin through the proper hole in eccentric flanges to give the required stroke. Tighten the hexagonal nuts on the eccentric flanges just enough to take the spring out of the lock washers.
- b) If shear pins fail, check for a solid object lodged under the piston, a clogged discharge line, or a stuck or wedged valve.
- c) When a shear pin fails, the eccentric moves to the neutral position and prevents damage to the pump. Remove the cause of failure and insert a new shear pin.

6.5.4.4 Ball Valves in Reciprocating Sludge Pumps. Every 3 months, replace all valve balls that are worn small enough to jam into the valve chamber. A decrease in diameter of 1/2 inch (13 mm) is sufficient to cause this difficulty. Check the valve chamber gaskets and replace them when necessary.

6.5.4.5 Eccentrics in Reciprocating Sludge Pumps. Each year, remove the brass shims from the eccentric strap to take up the babbitt bearing. After removing the shims, operate the pump for 1 hour and check the eccentric to be sure it is not running hot.

6.5.4.6 Progressive-Cavity Sludge Pumps. Follow these maintenance procedures for screw-type sludge pumps:

a) Seals. When grease seals are used instead of water seals, check the grease pressure in the seals daily.

b) Bearings. Lubricate the sludge pump through the grease connections on the bearing housing each week. Flush out the bearing housing each year. Then refill with new grease.

c) Packing Glands. Check the packing glands for leakage each week.

(1) For water seals, allow about 60 drops of leakage per minute when the pump is running.

(2) If leakage is high, tighten the two gland nuts evenly a few turns, but do not draw the glands too tight. After adjusting the gland, turn the shaft by hand to make sure that it turns freely.

6.5.5 Well Pumps. Well-pump types are centrifugal pumps, reciprocating (piston or plunger) pumps, and jet (ejector) pumps.

6.5.5.1 Centrifugal Well Pumps. The turbine well pump is the most widely used type of well pump. Use the maintenance items listed for centrifugal-type pumps (par. 6.5.1) and the manufacturer's manual to develop maintenance charts for turbine well pumps. In addition, check the following items:

a) Types of Lubrication

(1) Oil-Lubricated Pump and Bearings. Make sure that the oil tubing and lubricators are filled each day. Check the solenoid oilers for proper operation and see that they are filled. Check the oil level in the sight gage lubricator for underwater bearings. Make sure that the oil feed is at an average rate of 3 to 4 drops per minute.

(2) Water-Lubricated Pump and Bearings. This type of design requires lubrication with clear water. Daily, make sure that the prelubrication tank is full when the pump is in use.

a. When filling the tank by pump, be sure to close the tank-filling valve when the tank is full. Open the lubrication valve to allow water to reach the bearings before the pump is started.

b. If the bearings are lubricated from main pressure, close the lubricating valve after the pump is started.

c. If the pump operates automatically and has a lubrication-delayed solenoid valve, wait 1 minute before checking the lubricating valve for proper operation. Check operation of the solenoid valve and check the packing for excessive leakage.

d. Check the pre-lubrication control on pumps that have safety controls to prevent starting before lubrication water is turned on. Make sure that this water flows to the bearings when the equipment is supposed to function.

e. Check the time-delay relay for proper functioning, and compare with the manufacturer's recommendation.

f. Clean and lubricate the guides and linkages.

b) Impeller Adjustment. Every 3 months, check the impeller for maximum efficiency setting and adjust if necessary. On hollow-shaft motors, the adjustment nut is on the top of the motor. Consult the manufacturer's manual for the detailed adjustment procedure.

c) Impeller Fitting. When the pump is pulled for inspection, note signs of pitting or wear on the impellers.

(1) Cavitation. Pitting in the lower stages may be from cavitation.

(2) Sand Erosion. Sand in the water erodes the impellers. If sand is the cause of difficulty, check the well screen and replace if necessary. Where the erosion effect is appreciable, repair or replace impellers that are not likely to last until the next inspection.

(3) Clearances. Repair or replace impellers, as necessary, to maintain the close clearance required for pump efficiency. See the manufacturer's manual regarding pump clearances and efficiencies.

d) Bowls and Waterways. When the pump is pulled for inspection, inspect the bowls and water passage for pitting, wear, and corrosion.

e) Overhaul Procedures

(1) Frequency. As with the centrifugal pumps, the frequency of complete overhaul depends on the hours of operation, severity of operation, etc. Generally, however, a pump in continuous operation should be pulled for inspection and overhaul annually. Perform the overhaul under experienced supervision and in strict accordance with the manufacturer's manual. Overhaul the pump if any of the following conditions exist, regardless of scheduled frequency of maintenance:

- a. The pump shaft does not turn freely because parts below the pump head are binding.
- b. The pump shows excessive vibration.
- c. A performance test shows a decrease of 25 percent in capacity under normal head and speed conditions.

(2) Clearances. When a pump is pulled, check the diametrical clearance of each bearing ring to make sure it is between 0.025 and 0.050 inch (0.64 and 1.25 mm). Allow a maximum diametrical clearance of 0.025 inch (0.64 mm) on oil-lubricated bearings. Maximum allowable clearances for water-lubricated cutless rubber bearings are 0.040 inch (1.0 mm) for shaft diameters up to 1.5 inches (40 mm) and 0.070 inch (1.8 mm) for shaft diameters 1.5 to 4 inches (40 to 100 mm).

(3) Dismantling and Reassembly. Follow the same procedures listed for centrifugal-type pumps.

(4) Alignment. Check the pump and motor alignment each year.

(5) Painting. Annually, or when the pump is pulled, paint all iron parts with a good grade of underwater paint or effective protective coating on the exterior of the pump and, if possible, on the interior parts subject to rust. Apply the paint only to surfaces that are clean and dry. Do not paint the data plate.

#### 6.5.5.2 Reciprocating Well Pumps

a) General Information. Use the manufacturer's manual to develop checklists for each reciprocating well pump.

b) Delivery. Measure the pump output twice a year for a known number of strokes. Delivery per stroke should be at least 90 percent of the volumetric displacement of the pump (plunger area times stroke length). When the pump delivery drops to 50 percent or less, or when the pump delivery is between 50 and 90 percent but less than the installed water requirements, remove the pump from the well and

check the valves and cup leathers. Before removing the pump, consult the manufacturer's method for picking up the foot valve and for additional maintenance procedures.

c) **Overhaul Procedures.** Inspect the pump jack for wear each year. Replace worn bearings and parts. Check the packing assembly and repack as necessary. If the pump delivery is satisfactory, do not overhaul the pump parts in the well. Paint the exterior of the pump as necessary.

#### 6.5.5.3 Ejector Pumps

a) **Centrifugal Pump.** Maintain the centrifugal pump portion of the system according to the maintenance items listed for centrifugal pumps in par. 6.5.1.

b) **Ejector Assembly.** Each year, or as directed by the utilities manager, remove the ejector, the foot valve, and the screen from the well. Examine all parts for wear and corrosion and repair or replace any defective parts. Paint the exterior of the pump in accordance with par. 2.4.4.1. If practical, paint interior iron with a good grade of underwater paint or effective protective coating meeting ANSI/NSF Standard 61.

6.5.5.4 Starting a New Well Pump. Table 18 lists startup procedures for vertical turbine well pumps. While plant operators will not generally be responsible for performing these startup procedures, they may be charged with overseeing the contractors performing installation and it is preferable that they are familiar with the startup tasks. Figure 6 shows the necessary water-level checks. If problems occur, refer to the troubleshooting checklist provided in Table 19.

6.6 Pump Drivers. Pump drivers provide the mechanical source of energy to pumps. The driver is usually an electric motor, gasoline or diesel engine. More detailed information on pump drivers is provided in par. 2.1.4.

6.6.1 Electric Motors. Electric motors are the most common drive used in military water systems. Proper operation of an electric motor requires that the operator be able to recognize the normal sounds and conditions of a properly running motor. In general, investigate any change in the sound or operating condition detected during the regular inspection. Table 20 includes a list of routine operating checks for electric motors.

6.6.1.1 Maintenance. As a rule, the electrical shop is responsible for routine maintenance of electrical motors. Under some circumstances, the responsibility for

cleaning and servicing antifriction bearings may be delegated to the operator. General guidance for routine maintenance of electrical equipment is provided in par. 11.4 and in par. 2.1.4.

6.6.1.2 Gasoline and Diesel Engines. Gasoline and diesel engines are commonly used for emergency, standby, and portable pumping units. The operator is usually responsible for performing operating checks. Table 21 lists items to check before, during, and after starting gasoline and diesel engines. Use this checklist as a general guide only. Obtain specific details from the manufacturer's manual for each unit, and perform any additional services specified in the manual.

In addition to the checks listed in Table 21, perform the following tasks:

- a) Unit Readiness Checks. Operate all emergency and standby units at full load for the time specified by the equipment manufacturer. One hour each week is often recommended to ensure unit readiness.
- b) Routine Maintenance. Operators are generally responsible for operating checks and routine maintenance.



Table 18  
Startup Checklist for Vertical Turbine Well Pumps

Inspection	Action
Prestart Inspection Well Pump equipment Valve and piping system Bearings Electrical connections Instrumentation	Disinfect according to par. 4.5.2.5. Check alignment. Check for proper operation. Check for leaks. Set valves so water pumped at startup does not feed into distribution system until bacteriological quality has been tested and clearance received. Pre-lubricate bearings on water-lubricated, line-shaft pumps with settings of more than 50 feet. Make sure that all electrical connections are correct and that terminals are tight. Make sure all instrumentation is hooked up according to the manufacturer's instructions.
Startup Inspection Pump Motor Instrumentation Bearings	Start pump. Check immediately for evidence of malfunction or excessive heat or vibration. Check operating power input. Check for malfunction or excessive heat or vibration. Check rotation direction of motor. Check water or oil lubrication system Observe how quickly motor comes up to operating speed; check final operation speed. Check for excessive heat or vibration.

Table 18  
Startup Checklist for Vertical Turbine Well Pumps

Inspection	Action
Post-Startup Inspection	
Well	Check for abrasive material (sand pumping) or the presence of gas within the well.
Water level	Make immediate check of water level and record data for future reference. Perform pumping and recovery water-level checks as shown in Figure 6.
Pressure tests	Check pump pressure and flow output. Determine the corresponding pumping level in the well. Compute the field head (1) and compare it to the pump curve supplied by the manufacturer (2).
Water quality	After pumping for 24 hours, collect a water sample for microbiological analysis to ensure water is free from disease-causing organisms.

- (1) Field head is computed as follows: calculate the static and dynamic head losses being overcome by the pump. The total field head equals (a) the friction losses in the pump column and through the pump discharge elbow to the location of the pressure gage on the pump plus (b) the vertical distance from the pumping level in the well to the pressure gage plus (c) the pressure gage reading converted to feet of head.
- (2) The manufacturer's pump curve should be a combined curve showing a composite assembly rating for multistage pumps, not a single-bowl-assembly curve used for a single-stage pump.

For additional help reading pump curves or calculating head losses, consult par. 2.1.1. A sample field head calculation is provided in Appendix A.

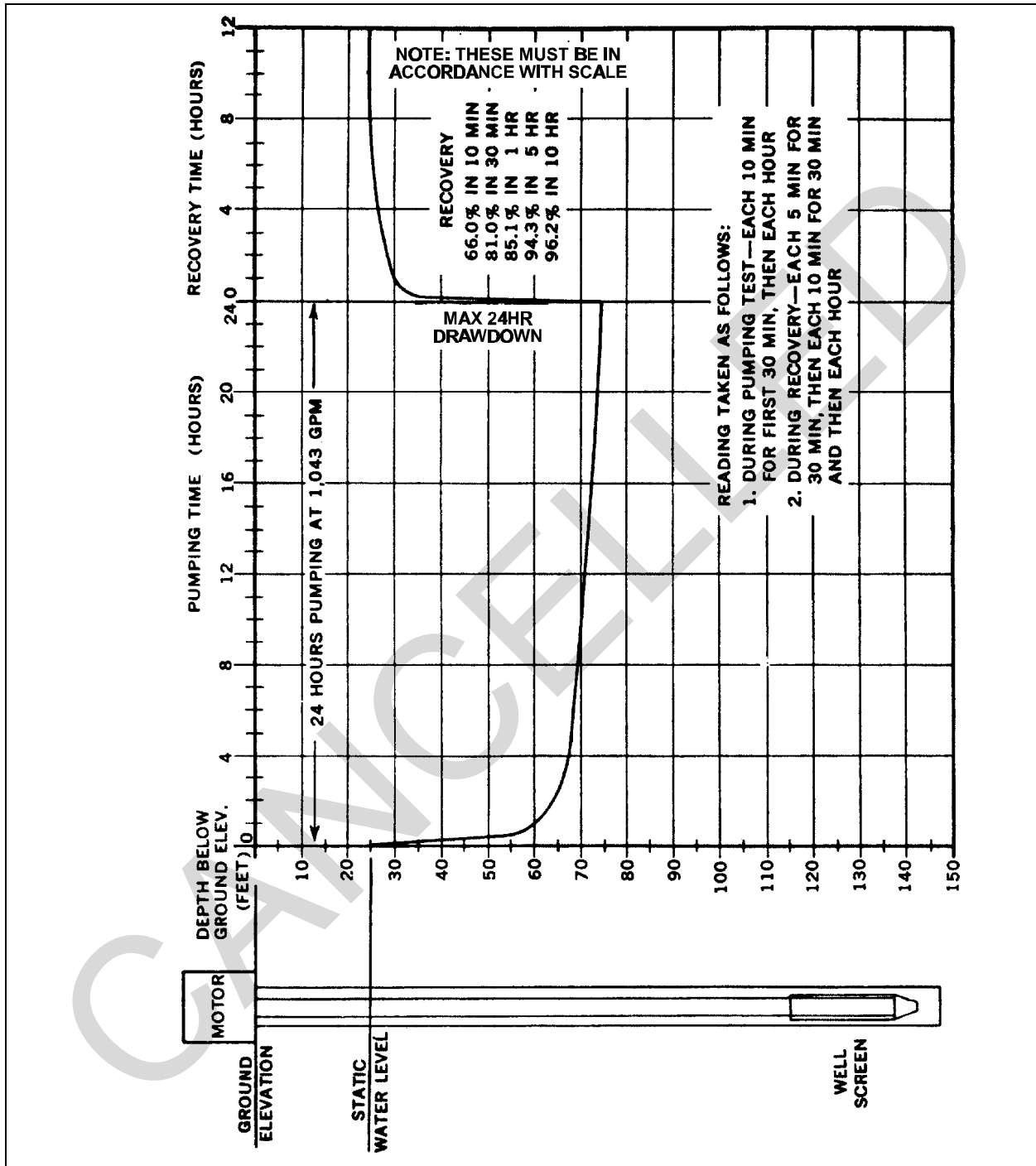

Figure 6  
 Typical Well Pumping and Recovery Test

Table 19  
 Troubleshooting Checklist for Vertical Turbine Well Pumps

Symptom	Cause of Trouble	Remedy
Pump fails to start.	Bearing friction	Check tube tension nut for tightness; check for bent shaft and proper anchoring; check oil.
	Corrosion products or biological growth	Check, particularly on out-of-service pumps. Where necessary, flush with acid, chlorine, and/or hexametaphosphate.
	Fuses burned out	Check voltages at each phase of motor terminals.
	Impeller locked	Check for sand; raise or lower impeller; backwash. Pull pump if necessary. Also check impeller adjustment; raise impeller to allow shaft to stretch for hydraulic thrust.
	Faulty driver	Disconnect from pump and check starting.
	Power not available	Check circuit breaker, fuse, and starter.
	Overload relay trip	Reset.
	Trash in casing	Check. If necessary, pull pump and clean.
	Low voltage	Check.
	Well cave-in	Check; pull pump; repair well.
Pump does not deliver water.	Pump not primed	Check for proper pump submergence. Vent well to atmosphere to eliminate vacuum at pump suction.
	Discharge head too high	Check for closed discharge valves or stuck check valves.

Table 19 (Continued)

Symptom	Cause of Trouble	Remedy
Pump requires excessive power.	Pump parts failure	Check for broken shaft, broken bowl assembly, loose impellers, and loose column-pipe joints.
	Wrong direction of rotation	Check for switched power leads.
	Speed too low	Check power supply voltage and frequency. Check for bearing friction and impeller corrosion or obstruction.
	Suction clogged	Backwash or use chemical treatment to clean.
	Operating water level low	Check static level and drawdown. Lower pump, clean screen, and decrease pumping rate.
	Low speed	Check power supply voltage and frequency; check for excessive bearing friction and impeller corrosion or obstruction.
	Low water level in well	Check well vent. Check pump inlet for turbulence, vortexing, or eddies. Check well screen for sand, rust, or biological growth.
	Faulty instruments	Correct instrument readings.
	Impeller rub	Check adjustment of impeller height.
Wrong lubricant	Compare manufacturer's instructions with lubricant being used.	
Misalignment	Check for tight bearings; check for pump and casing vibration.	

Table 19 (Continued)

Symptom	Cause of Trouble	Remedy
Pump vibrates excessively.	Packing too tight	Check for proper leakage to provide shaft lubrication.
	Pump selection wrong	Check capacity rating, etc.
	Wrong direction of rotation	Check power leads.
	Excessive speed	Check power frequency and voltage; check gear ratios.
	Air entering pump	Check on over-pumping and water level drawdown; check leaks in well vent.
	Bearing trouble	Check for sand in water. Check lubricant (oil and grease) for proper grade.
	Rough operation	Check disconnected motor. Check for sand in impeller or bowl. Check for wear in rotating parts.

Table 20  
Routine Operations Checklist for Electric Motors

Inspection	Action
<p>Motor</p> <p>Unusual Conditions</p> <p>Unusual noises in operation</p> <p>Motor fails to start or to come up to speed normally</p> <p>Motor or bearings feel or smell hot</p> <p>Continuous or excessive sparking at commutator</p> <p>Hot commutator</p> <p>Blackened commutator</p> <p>Sparking at brushes</p> <p>Fine dust under couplings with rubber buffers or pins</p> <p>Smoke, charred insulation, or solder whiskers extending from armature</p> <p>Excessive hum</p> <p>Regular clicking</p> <p>Rapid knocking</p> <p>Chattering brush</p> <p>Vibration</p>	<p>Keep the motor free from dirt or moisture.</p> <p>Keep the operating space free from articles that may obstruct air circulation.</p> <p>Check the bearings for oil leakage.</p> <p>Check regularly for these unusual conditions. Report any irregularities to the plant superintendent for correction by the electrical shop.</p>

Table 21  
Operations Checklist for Gasoline and Diesel Engines

Inspection	Action
<p>Prestart Checks</p> <ul style="list-style-type: none"> <li>Motor</li> <li>Fire extinguisher</li> <li>Gages</li> <li>Accessories and drives</li> <li>Battery</li> <li>Air breather</li> </ul>	<ul style="list-style-type: none"> <li>Check equipment for signs of tampering or leaks.</li> <li>Ensure extinguisher is in working order.</li> <li>Check all fuel, oil, and water levels.</li> <li>Inspect according to manufacturer's instructions.</li> <li>Check for cracks and leaks.</li> <li>Make sure breather is free of obstruction.</li> </ul>
<p>Startup/Warmup Checks</p> <ul style="list-style-type: none"> <li>Choke or primer</li> <li>Engine</li> <li>Indicator lights</li> <li>Other instruments</li> </ul>	<ul style="list-style-type: none"> <li>Check for proper operation.</li> <li>Test warmup time and efficiency.</li> <li>Ensure oil gage or indicator lights are in working order.</li> <li>Check that ammeter, tachometer, fuel gage, voltmeter, and temperature gage are working.</li> </ul>
<p>Operating Checks</p> <ul style="list-style-type: none"> <li>Clutch</li> <li>Transmission and engine/controls</li> <li>Instruments</li> </ul>	<ul style="list-style-type: none"> <li>Ensure clutch is working properly.</li> <li>Check for unusual sounds, vibration, overheating, etc.</li> <li>Check that all instruments are registering readings.</li> </ul>
<p>Post-Shutdown Checks</p> <ul style="list-style-type: none"> <li>Gages</li> </ul>	<ul style="list-style-type: none"> <li>Check fuel, oil, and water levels.</li> </ul>



Table 21 (Continued)

Inspection	Action
Instruments	Check indicators. Indicators should return to zero when engine is not running.
Battery and voltmeter	Check that battery has not run down and retains sufficient charge.
Accessories and belts	Check for signs of wear.
Electrical Wiring	Inspect wire integrity (no frayed or charred wires; no loose wires).
Air cleaner and breather caps	Look for obstructions or clogs.
Fuel filters	Be sure filters are not clogged or dirty. Change or clean as required or at regular intervals.
Engine controls	Controls should move freely. Check for binding, sticking, etc.
Leakage	Look for oil and coolant leaks.
Gear oil levels	Check level.

Additional O&M information for internal combustion engines is provided in par. 2.1.4. Overhaul and tune-up type maintenance is the motor pool's responsibility.

6.7 Accessories. Accessories include belt drives, gear drives, variable speed drives, and couplings that connect the driver to the pump.

6.7.1 Belt Drives. Two types of belts are used for belt drivers: V-belts and flat belts. Maintaining proper tension and alignment of belt drives ensures long life of belts and sheaves. Incorrect alignment causes poor operation and excessive belt wear. Inadequate tension reduces the belt grip and causes high belt loads, snapping, and unusual wear. Keep belts and sheaves clean and free of oil, which deteriorates belts. Replace belts as soon as they become frayed, worn, or cracked.

6.7.1.1 Installing Belts. Before installing belts, replace worn or damaged sheaves. Check alignment with a straight edge or string, and make the necessary corrections to keep the pulleys in line. Loosen the belt tensioning adjustment enough

to remove and install belts without the use of force. Never use a screwdriver or other lever to force belts onto sheaves. Check multiple belts for matching size and length. It is not good practice to replace only one V-belt on a multiple belt assembly. Instead, replace the complete set with a set of matching belts. After belts are installed, adjust the tension. Recheck the tension after 8 hours of operation.

6.7.1.2 Checking Tension. Check belt tension each week and adjust, as required, to prevent slipping or excessive wear on the belts.

6.7.2 Right-Angle Gear Drives. O&M procedures for right-angle gear drives should follow manufacturer's recommendations. Immediately after starting a right-angle gear drive, remove the inspection plate and check for proper flow of lubricant. If there is no flow, stop the motion and check for mechanical defects. If no mechanical defect is found, it may be necessary to change the lubricant or drain and warm the old lubricant. Temperature or service conditions may require changing the lubricant type. To avoid detrimental effects of possible water-oil emulsion, drain old oil and refill with fresh recommended lubricant quarterly or about every 500 hours of operation, whichever is more frequent. The choice of lubricant depends on prevailing air temperatures and the manufacturer's recommendations.

6.7.3 O&M for Variable-Speed Drives. Variable-speed drives are commonly used in water systems. Designs vary considerably from manufacturer to manufacturer. Therefore, consult the manufacturer's manual to determine O&M requirements. Items common to most variable-speed drives are listed below.

- a) Check for Normal Operation. Observe the drive each shift and note any abnormal conditions.
- b) Clean Discs. Remove grease, acid, and water from the disc face and thoroughly dry it. Use clear solvents that leave no residue.
- c) Check Speed-Change Mechanisms. Shift drive through the entire speed range to make sure that shafts and bearings are lubricated and discs move freely in a lateral direction on shafts.
- d) Check V-Belt. Make sure the belt runs level and true. If one side rides high, a disc is sticking on the shaft because of insufficient lubrication or the wrong lubricant. In that case, stop the drive, remove the V-belt, and clean the disc and shaft thoroughly with kerosene until the disc moves freely.

e) Check Lubrication. Be sure to apply lubricant at all force-feed lubrication fittings and grease cup fittings. Refer to the manufacturer's manual for proper lubricants.

(1) Once every 10 to 14 days, add two or three strokes of grease through the force-feed fittings at the end of the shifting screw and variable shaft to lubricate the bearings of movable discs. Shift the drive from one extreme speed to the other to thoroughly distribute the lubricant over the disc-hub bearings.

(2) Every 60 days, add two or three shots of grease through the force-feed fittings that lubricate the frame bearings on the variable-speed shaft.

(3) Every 60 days, add grease to grease the cup that lubricates the thrust bearings on the constant-speed shaft.

(4) Every 60 days, add two or three strokes of grease through the force-feed fittings on motor-frame bearings. Do not use hard grease or grease that contains graphite.

(5) Check the reducer oil level every 30 days and add oil when necessary. Drain and replace the oil according to the manufacturer's recommendations.

f) Remove Unit from Service. If the drive will not be operated for 30 days or more, shift the unit to minimum speed. This places the springs on the variable-speed shaft on minimum tension and relieves the belt of excessive pressure and tension.

6.7.4 Couplings. Unless couplings between the driving and driven elements of a pump or any other piece of equipment are kept properly aligned, breaking or excessive wear occurs in the coupling, the driving machinery, or the driver. Worn or broken couplings, burned out bearings, sprung or broken shafts, and excessively worn or ruined gears are some of the damages caused by misalignment. To prevent outages and the expense of installing replacement parts, check the alignment of the equipment before damage occurs.

6.7.4.1 Checking Coupling Alignment. Excessive bearing and motor temperatures caused by overload, noticeable vibration, or unusual noises may all be warnings of misalignment. Realign when necessary, using a straight edge and thickness gage or wedge. To ensure satisfactory operation, level up to within 0.005 inch ( $127 \times 10^{-3}$  mm), as follows:

- a) Remove coupling pins.
- b) Rigidly tighten any driven equipment to its base. Slightly tighten the bolts holding the driver to its base.
- c) To correct horizontal and vertical alignment, shift or shim the driver to bring coupling halves into position so no light can be seen under a straight edge laid across them. Lay the straight edge in at quarter points of the circumference, holding a light in back of the straight edge to help ensure accuracy.
- d) Check for angular misalignment with a thickness or feeler gage inserted at the same four places to make sure that the space between coupling halves is equal at all points.
- e) If the equipment is properly aligned, coupling pins can be put in place easily (using only finger pressure). Do not hammer pins into place.
- f) If the equipment is still misaligned, repeat the procedure.

6.7.4.2 Lubrication. Use lubrication procedures and lubricants recommended by the manufacturer and in par. 11.6.

6.8 Recordkeeping. Keep equipment and maintenance records for each pump and drive assembly. The method used is prescribed by local command. In general, records will contain entries for routine maintenance (lubrication, equipment checks, etc.), as well as scheduled overhauls and nonscheduled repairs. A description of the work done, the date, and the name of the person doing the work are minimum entries. Since a pump's condition is best evaluated by comparing its current performance to its original performance, a record of flow, pressure, pump speed, amperage, and other test data determined immediately following installation is recommended.

6.9 Pump Safety. Specific hazards related to operating and servicing pumps include rotating equipment, lifting heavy machinery, using hand tools, working with electrical devices, and fires.

Always stop machinery before it is cleaned, oiled, or adjusted. Lock out the controlling switchgear before any work begins, so that the machinery cannot be started by another person. Post a conspicuous tag on or over the control panel, giving notice that the equipment is under repair and should not be restarted. Also note the name of the person who locked out the equipment.

Caution: Remove guards for maintenance only when the machinery is not in operation.

6.9.1 Motor and Engine Safety. Follow special safety precautions when dealing with motors and engines. In addition to all the other safety concerns associated with water distribution (as discussed in other sections), be cautious around electrical devices and be aware of fire safety guidelines.

6.9.2 Electrical Devices

a) No safety tool can protect absolutely against electrical shock. Use plastic hard hats, rubber gloves, rubber floor mats, and insulated tools when working around electrical equipment. These insulating devices cannot guarantee protection, however, and no one using them should be lulled into a false sense of security.

b) Electrical shocks from sensors are possible in many facilities, such as pumping stations, because many instruments do not have a power switch disconnect. It is important to tag such an instrument with the number of its circuit breaker so that the breaker can be identified quickly. After the circuit breaker has been shut off, tag or lock the breaker so other personnel will not re-energize the circuit while repairs are being performed. Even after a circuit is disconnected, it is good practice to check the circuit with a voltmeter to be certain that all electrical power has been removed. Make sure switches are locked open and properly tagged when personnel are working on equipment. Use fully enclosed, shockproof panels when possible. Such equipment should be provided with interlocks so that it cannot be opened while the power is on.

c) Use extreme care in working around transformer installations.

## Section 7: DISTRIBUTION AND STORAGE

7.1 Section Overview. The distribution system is a network of pipes, storage reservoirs, valves and hydrants, water meters, and backflow preventers. This section covers pipes and storage facilities. The remaining distribution system components are covered in Sections 8, 9, and 10.

7.2 References. Publications containing additional information on water distribution and storage are listed below. Subsequent references within Section 7 use only the number shown in parentheses after the title. This number corresponds to the document's paragraph number in Section 2, Applicable Documents.

Useful water distribution and storage publications include the following:

- a) AFOSH Standard 91-25, Confined Spaces (par. 2.4.1.8)
- b) Distribution System Maintenance Techniques (par. 2.2.41)
- c) Disinfecting Water Mains AWWA Standard C651-92 (par. 2.2.40)
- d) Manual of Water Supply Practices: Automation and Instrumentation (par. 2.2.1)
- e) Manual of Water Supply Practices: Cleaning and Lining Water Mains (par. 2.2.20)
- f) Manual of Water Supply Practices: Concrete Pressure Pipe (par. 2.2.7)
- g) Manual of Water Supply Practices: Distribution Network Analysis for Water Utilities (par. 2.2.23)
- h) Manual of Water Supply Practices: Distribution System Requirements for Fire Protection (par. 2.2.22)
- i) Manual of Water Supply Practices: Ductile-Iron Pipe Fittings (par. 2.2.29)
- j) Manual of Water Supply Practices: PVC Pipe Design and Installation (par. 2.2.16)
- k) Manual of Water Supply Practices: Safety Practices for Water Utilities (par. 2.2.2)

l) Manual of Water Supply Practices: Steel Pipe—A Guide for Design and Installation (par. 2.2.8)

m) Manual of Water Supply Practices: Water Audits and Leak Detection (par. 2.2.25)

n) Principles and Practices of Water Supply Operations Series: Water Transmission and Distribution (par. 2.1.4)

### 7.3 Distribution

7.3.1 Distribution System Design and Installation. Design and installation of distribution systems are normally engineering functions. Basic information, including planning and layout, sizing mains, pipe materials and selection, pipe handling, excavation, laying pipe, backfilling, pressure and leak testing, flushing and disinfection, final inspection, site restoration, and site safety, can be found in the publications listed in the following paragraphs: 2.1.4, 2.2.22, 2.2.23, 2.2.29, 2.2.16, 2.2.8, and 2.2.7.

7.3.2 O&M. Factors essential to maintaining a dependable water distribution system include ensuring water quality, providing adequate flows for protection against fire (fire flow), and maintaining adequate pressure. The operation of a distribution system consists essentially of setting and operating valves, keeping records of water flows and levels, and correctly balancing the system flow to maintain the desired pressure in all parts of the system. General information on system O&M can be found in the publications listed in pars. 2.1.4 and 2.2.41.

7.3.2.1 Main Breaks and Repairs. Since water main breaks need to be repaired as rapidly as possible, it is recommended that personnel be trained and repair plans made in advance. Perform the following tasks to eliminate delay in beginning repairs:

a) Post telephone numbers of key personnel conspicuously in the water plant.

b) Keep the following items available and ready for use at all times: valve keys, hand tools, digging tools, pavement breakers, trench-shoring material, a portable centrifugal pump, floodlights, an emergency chlorinator, and calcium hypochlorite.

c) Keep a stock of split-sleeve and mechanical-joint repair fittings in sizes that fit critical mains.

d) Make advance arrangements with a municipal utility, a public works department, or an outside contractor for the use of large construction equipment (for example, power shovels, cranes, etc.) that may be needed but are not normally stocked by the installation.

Leak repair techniques depend on the type of leak. Understanding the methods of installation and the most advantageous use of each technique will help you make the proper selection for any particular repair. Table 22 covers various leak repair procedures.

7.3.2.2 Flushing. Matter deposited in the distribution system over time can often be removed by periodically flushing the system. The frequency varies for different waters and pipe materials, but annual flushing is usually enough. Dead-end pipes should be flushed and disinfected at least once a year. Flushing and disinfection are required whenever mains are opened for repair.

Flushing water mains near a nuisance, particularly at dead ends, may remove or reduce problems with taste, odor, color, or turbidity. Flushing may permanently resolve problems caused by foreign material left in new or repaired mains. If complaints about quality are received, investigate the possibility that stagnant water in dead-end lines may be the cause and take remedial action. Find and eliminate conditions that make repeated flushing necessary: a dead end or a low point in the main may allow sediment to accumulate, or growth of slime organisms may be caused by insufficient chlorination. Flushing is also helpful in clearing the non-potable part of the water system.

a) Flushing Procedure. Start flushing at the supply source and continue to the ends of the distribution system. Do not start flushing at the ends of the system because accumulated debris must then be drawn through the entire length of the system. For maximum scouring velocity, flush each section of pipe independently by closing off intersecting pipelines. This process directs the full flow through the section to be flushed. A velocity of 2.5 feet per second (0.76 meters per second [mps]) is recommended for flushing. With a main pressure of 40 psi (280 kiloPascals [kPa]), a 2.5-inch (65-mm) hydrant outlet will discharge approximately 1,000 gpm (60 Lps); a 4.5-inch (115-mm) hydrant outlet will discharge approximately 2,500 gpm (160 Lps). Table 23 gives the number of hydrant outlets required to flush various size water mains.



Table 22  
Checklist for Repairing Water Main Breaks and Leaks

Problem Type	Repair Procedure
Small holes	Use wood plugs to stop small holes temporarily. (Replace wood plugs with permanent metal plugs at a later date.) Temporary wood plugs can be used to plug ends of pipes up to 8 inches in diameter. Brace the plugs to withstand the pressure in the main.
Joint leaks	Repair joint leaks by recaulking the joint, if caulking has been used in the joint.
Cracks in mains	Cracks in mains usually require that the valves be shut off in the affected area, especially in severe main breaks. Notify the fire fighting authorities in case of main shutoff.
Shut off valves	
Repair leak	Repair leaks in mains using split sleeves or mechanical couplings. Split-sleeve and mechanical-joint repair fittings offer the best method for quick, effective repairs. Several companies manufacture split-sleeve and mechanical-joint repair fittings.
Split-sleeve repair method	Insert a split sleeve. Split-sleeve fittings can be installed underwater if necessary.
Mechanical-joint repair method	Cut out a section of the cracked pipe and replace it with a piece of pipe and mechanical couplings. Mechanical couplings are manufactured by several companies for various types of repair jobs. Consult the manufacturer's instructions for installation methods to make the proper selection and installation. If the break is too long for a short insertion piece, insert a whole length of pipe.
Flush and disinfect main	When a water main is opened for repair, flush and disinfect it according to procedures presented in par. 2.2.40 before returning it to service.

**Table 23**  
**Flow Rate and Number of Hydrant Outlets Required to Flush Water Mains with 40 psi**  
**(280 kPa) of Pressure**

Pipe Diameter		Flow		Number of 2.5-in. (65-mm)
inches	(mm)	gpm	(Lps)	Hydrant Outlets
4	(100)	100	(6)	1
6	(150)	200	(13)	1
8	(200)	400	(25)	1
10	(250)	600	(38)	1
12	(300)	900	(57)	2
16	(400)	1,600	(100)	2

b) Flushing Plan. Draw up a flushing plan to ensure complete cleaning of the system:

- (1) Using distribution maps, prepare a list of hydrants and blowoffs to be opened in an order that will flush the system from source to ends.
- (2) List, in correct order, valves to be closed and opened for each flushing point.
- (3) If service in any section will be disrupted by the plan, arrange to flush it at night. Notify heating plant and fire fighting personnel in such sections.

c) Operating Guides

- (1) Remove service meters from the section being flushed.
- (2) Flush each pipe section until water is reasonably clear.
- (3) Take care not to damage unpaved roads, walks, or improved grounds. If necessary, use a section of lightweight pipe to direct flows so that damage does not occur.
- (4) Place all valves in normal operating position before proceeding to the next flushing point.

(5) To permit flushing dead ends, install a blowoff at the end of each end main. Paint the blowoff hydrants a different color from fire hydrants and prominently mark them as blowoff hydrants. Dead ends may need flushing more often than other sections of the system.

For additional information on hydrant flushing, see par. 8.4.1.3.

7.3.2.3 Cleaning. Corrosion, scale, and deposited matter cannot normally be removed with simple flushing. When increased system head loss reduces system capacity below fire flow requirements, mechanical cleaning is necessary. Clean water mains in place using cable-attached devices or fluid-propelled devices (pigs). As a rule, this work is done on a contract basis by firms specializing in main cleaning. After cleaning, the mains may be relined to restore original smoothness of the interior. If this is properly done, 95 percent or more of the original capacity can be restored. If the mains are not lined with a corrosion-resistant material after cleaning, start chemical treatment to prevent accelerated corrosion and red water. Additional information on cleaning water mains can be found in the publications listed in pars. 2.1.4, 2.2.41, and 2.2.20.

7.3.2.4 Valve Maintenance. See par. 8.3.2.

7.3.2.5 Operational Changes. Some of the conditions causing loss in carrying capacity may be remedied by making changes in operating procedures:

a) If the water supply is corrosive, or lacks buffering capacity as it enters the distribution system, it will aggravate tuberculation. To offset this condition, institute a change in treatment to stabilize the water and increase its pH. See par. 5.4.7 for more information about controlling corrosion.

b) If carrying-capacity loss is caused by slime growth, special chlorination procedures may be adopted to remedy the condition.

c) Where accumulation of sediment is the cause of carrying-capacity loss, periodic flushing of the entire system, through hydrants and blowoffs, is normally necessary.

7.3.2.6 Pipe Replacement. Eventually, most water mains will have to be replaced. Consider lining existing water mains as an alternative where high-cost digging is required, such as under pavements and in industrial areas. Lining a pipe can eliminate the need for frequent or continuous flushing. Linings can be installed to reduce or eliminate leaks through corroded areas of the pipe or through bad joints. A smooth lining in a corroding pipe maximizes hydraulic carrying capacity and minimizes

pumping costs. Additionally, linings can correct the structural failures, bridge breaks, and missing sections in corroded pipe, thus restoring service through a continuous pipeline. Line water mains in place using one or more of the following general methods: cement-mortar lining, slip-lining, and in situ formed-tube lining. As a rule, this work is done on a contract basis by firms specializing in main cleaning and relining. More information on cleaning and lining may be found in pars. 2.1.4 and 2.2.20.

7.3.2.7 Leak Location and Repair. Leaking pipes reduce the capacity of the system, waste water, reduce water pressure, and potentially create public safety hazards. Conduct leak detection surveys at the time of minimum water use. Shut off all valves, except those that will direct the water flow through the section under study.

Caution: Good practice requires that the fire fighting authorities be notified before closing any section of the system.

Specific directions for leak detection and repair may be found in the publications listed in pars. 2.1.4, 2.2.25, and 2.2.41.

7.3.2.8 Thawing Frozen Systems. Pipes may freeze in temperate as well as frigid zones. In frigid climates, freezing presents a major problem to a water distribution system, and pipes are normally insulated and heated. In areas where the ground is permanently frozen, water pipes are placed in heated conduits. In temperate climates, where freezing is only a seasonal problem, pipes are typically buried below frost penetration depth. It is also necessary to heat stored water in cold areas. Even with proper protection against freezing, pipes may freeze. When this happens, operators should be prepared to thaw the pipes.

a) Electrical Thawing. Electrical thawing is quick and relatively inexpensive. The electrical circuit for the thawing operation consists of a source of current (a DC generator, such as a welding unit, or a transformer connected to an AC outlet), a length of the frozen pipe, and two insulated wires connecting the current source and the pipe. As current flows through the pipe, heat is generated and the ice within the pipe begins to melt. As the water starts to flow, the rest of the ice is progressively melted by contact with the flowing water. The wires from the current source may be connected to nearby hydrants, valves, or exposed points at the ends of the frozen section.

(1) Current and Voltage. Data concerning the current and voltage required to thaw various sizes of wrought-iron and cast-iron pipe are given in Table 24.

(2) Required Time. The time required for electrical thawing varies from 5 minutes to over 2 hours, depending on the pipe size and length, the intensity of freezing, and several other factors. The best practice is to supply current until the water flows freely.

(3) Precautions to Take

a. In general, do not use a current higher than the one listed in Table 24 for a particular pipe size. When in doubt, use a lower current for a longer period.

Table 24  
Current and Voltage Required to Thaw Wrought-Iron  
and Cast-Iron Pipe

	Pipe Size		Pipe Length		Approx. Volts	Approx. Amps
	inches	(mm)	feet	(m)		
Wrought Iron	3/4	(20)	600	(180)	60	250
	1	(25)	600	(180)	60	300
	1-1/2	(40)	600	(180)	60	350
	2	(50)	500	(150)	55	400
	3	(75)	400	(120)	50	450
Cast Iron	4	(100)	400	(120)	50	500
	6	(150)	400	(120)	50	600
	8	(200)	300	(90)	40	600

b. Select contact points on the pipe as close as possible to the frozen section.

c. Make sure contact points are free of rust, grease, or scale.

d. Remove meters, electrical ground connections, and couplings to building plumbing from the line to be thawed.

e. If pipe joints have gaskets or other insulation, thaw the pipe in sections between the joints or use copper jumpers to pass the current around the insulated joints.

#### (4) Thawing Procedures

a. DC Generator. To thaw pipe with a welding generator or similar DC source, set the generator to the correct amperage for the pipe to be thawed and connect leads to the pipe.

b. AC Circuit. Transformers are required to adjust the amperage of an AC circuit to the pipe being thawed. Consult the installation electrical engineer for the best transformer arrangement. This arrangement depends on line voltage, available transformers, and required amperage. To keep hazards to a minimum, a competent electrician generally sets and connects transformers, makes the connections, and assist in the thawing procedure. Where frequent thawing is necessary at different points, the transformers may be mounted on a trailer for ready use.

b) Steam Thawing. Steam thawing is slower than electrical thawing and is used only when insulating material in pipe joints or couplings makes the use of electricity impractical. In steam thawing, a hose connected to a boiler is inserted through a disconnected fitting and gradually advanced as the steam melts the ice. Steam thawing is commonly used on fire hydrants.

Additional methods for thawing frozen pipes can be found in par. 2.1.4.

7.3.3 Water Main Tapping Procedures. Water main connections may be made when the pipe is empty or filled with flow (wet tapping). Use wet tapping to make a connection without turning off the water or interrupting service to existing customers. More detailed information on tapping procedures may be obtained from the pipe manufacturer or from the publication listed in par. 2.1.4.

7.3.4 Instrumentation, Control, and Information Management. Information on these topics can be found in the publication listed in pars. 2.1.4 and 2.2.1.

7.4 Storage. Water storage serves to equalize supply and demand, increase operating convenience, level out pumping requirements, decrease power costs, provide water during power source or pump failures, provide large quantities of water to meet fire demands, provide surge relief, increase detention times, and blend water sources. General information describing water storage requirements, types of storage structures, and associated equipment can be found in par. 2.1.4.

7.4.1 Operation of Water Storage Facilities. General information on O&M of water storage facilities can be found in par. 2.1.4.

#### 7.4.1.1 Ground Storage Reservoirs

a) Covered reservoirs or tanks should be vented to allow the passage of air to and from the reservoir as the water level changes. Use fine screens on the vents to prevent entrance of animals and insects, and keep the screens in good repair. Keep access manhole covers in place to prevent accidents and contamination. Slope the ground away from the reservoir in all directions so no surface water can flow towards it. Leaks in the cover or walls that permit the entrance of surface water or shallow groundwater are dangerous. Repair leaks at once.

b) In freezing areas, inspect vent screens frequently to keep them clear of ice and frost. Where ground storage tanks are used only for fire protection, operate fire pumps and recirculate tank contents as frequently as required to prevent or reduce ice formation. The construction of earth banks around storage tanks will help insulate the tanks and prevent freezing. Where these measures do not stop freezing, install steam or hot water coils or paint the tanks a dark, energy-absorbent color.

7.4.1.2 Underground Reservoirs. If storage tanks are constructed below ground level, or are surrounded by an earthen embankment, the inspection and repair includes only the interior walls, roofs, appurtenances, and embankment. If the earthen embankment, surrounding soil, or interior of the tank shows evidence of tank leakage, the earth may need to be excavated and repairs made on the walls. Signs of leakage include the following:

- a) Water streams
- b) Wet, soggy earth that does not dry
- c) Sinkholes
- d) Erosion

#### 7.4.1.3 Elevated Storage

a) Freezing Prevention. Cover the elevated-tank riser pipe with insulating material to guard against frozen water. In climates where insulation alone may not give adequate protection, install steam coils in the riser and pipe stream into the coils from a nearby boiler plant. Alternatively, connect a circulating hot-water heater to the rise to take water about 15 to 20 feet (5 to 6 m) above the riser base and return it near the base. In the latter case, adding a small recirculating pump is desirable because it provides a large amount of recirculation with limited heat rise. Inspect vent screens frequently throughout the winter and keep them clear of frost. An

ice ring several inches thick may form inside elevated tanks, especially if water circulation is slow. In the spring, the ring melts loose from the tank sides and floats to the top of the water. The top of the ice ring is then considerably higher than the water surface. To keep the ring from damaging the top of a closed tank or projecting above the top of an open tank, set altitude valves to maintain a freeboard of at least 14 percent of the tank depth during the winter.

b) **Corrosion Prevention.** For methods of preventing corrosion in tanks and standpipes, see par. 11.9.2. Even though cathodic protection prevents corrosion below the water surface, when it is used, the complete interior of the tank roof and exterior need other protection, such as periodic painting.

7.4.1.4 **Pneumatic Tanks.** While the operation of these units is usually automatic, the operator is responsible for operating pressure equipment effectively. It is important to see that the air cushion is maintained at all times. Air may be depleted by leaks and by dissolving in the water. Consult the manufacturer's instructions for methods of starting, stopping, and operating this pressure equipment.

7.4.2 **Maintaining Storage Facilities.** Guidance on specific maintenance procedures and paint systems applicable to water storage facilities can be found in par. 11.9.

#### 7.4.3 **Water Storage Facility Safety**

a) In general, only trained and experienced operators should be allowed to work on elevated and ground-level storage tanks and standpipes. This work is hazardous and dangerous for untrained workers. Special precautions are also needed for work on or in tanks. In these confined working areas, workers need to guard against slipping or falling from dangerous heights. Refer to Occupational Health and Safety Act (OSHA) Part 1910.146, Permit-Required Confined Space, and to par. 2.4.1.8.

b) The following guidelines apply to working in and around storage facilities.

(1) Read, understand, and follow all applicable safety directives, including those pertaining to confined-space entry.

(2) Check the security of ladders frequently. Provide required safety cages or safety cable equipment.



(3) Provide workers with boots and clothing for working in wet and slippery conditions.

(4) Provide workers performing disinfection with special protective goggles and gloves.

(5) Install special fans or other ventilation equipment inside tanks while work is being done there.

(6) Provide adequate light inside tanks so that personnel can perform their work properly and safely. Take special care to use waterproof wiring and light units to prevent shocks in a wet environment.

For further information, see par. 2.2.2.

CANCELLED

## Section 8: VALVES AND HYDRANTS

8.1 Section Overview. This section covers the operation and maintenance of various types of valves. It also addresses hydrant O&M, safety, and testing.

8.2 References. Pertinent information about valves and hydrants can be found in the published sources listed below. Subsequent references to these sources within Section 8 use only the number shown in parentheses after the title. This number corresponds to the paragraph number of the document in Section 2, Applicable Documents.

- a) Distribution System Maintenance Techniques (par 2.2.41)
- b) International Fire Service Training Association Manual 205 (par. 2.2.47)
- c) Manual of Water Supply Practices: Installation, Field Testing, and Maintenance of Fire Hydrants (par. 2.2.11)
- d) Manual of Water Supply Practices: Safety Practices for Water Utilities (par. 2.2.2)
- e) Principles and Practices of Water Supply Operations Series: Water Transmission and Distribution (par. 2.1.4)
- f) Recommended Practice for Fire Flow Testing and Marking of Hydrants (par. 2.2.60)

8.3 Valves and Valve Operation. Valves are used in water supply systems to start and stop flow, to throttle or control the quantity of water, to regulate pressures within the system, and to prevent backflow. Valves are typically operated using manual, electrical, hydraulic, or pneumatic operators. Most valves used in water systems fall into one of the following general valve classifications: gate, globe, needle, pressure relief, air/vacuum relief, diaphragm, punch, and rotary. The type of valve and the method used to operate it depends on the use of the valve, its function in the water system, and the source of energy available.

### 8.3.1 Valve Operation

8.3.1.1 Manual Operation. Small valves or valves that are used infrequently are generally operated manually. Valves operated manually should be opened all the way, then closed one-quarter turn of the handwheel. This prevents the valve from sticking in

the open position. Open and close the valve slowly and at an even rate to reduce the hazard of a hammer. Unless otherwise indicated, valves are opened by turning the handwheel or key counterclockwise. Always consult the manufacturer's instructions for operating a specific type of valve. It is good practice to operate (exercise) valves periodically.

8.3.1.2 Power Operation. Only minimal attention is required for operating power-operated valves, except in the case of power failure. In this event, consult the manufacturer's instructions for emergency manual operation. Most power-operated valves are equipped with safety devices to allow for emergency manual operation.

8.3.2 General Maintenance of Valves, Valve Boxes, and Accessories. A general valve maintenance schedule is presented in Table 25. Specific maintenance procedures for various valve types and valve accessories are provided in literature supplied by the valve manufacturer. Valve boxes should be maintained on the same basis as the valve maintenance schedule shown in Table 25.

8.3.3 Distribution System Valves. Gate valves are normally used in the distribution system. These valves are usually equipped with a 2-inch-square (50-mm-sq) operating nut that requires a valve key for operation. Most distribution system valves are buried and the operating nut is accessible through a valve box. Common difficulties with distribution system valves are "lost" valves, inoperable valves, and valve boxes that have been covered by road work or filled with foreign matter.

8.3.3.1 Lost Valves. The lost valve problem can be avoided by using an indexed valve record book in which all pertinent data is recorded, including all valve locations. The location should be referenced with respect to fixed, permanent markers. If a valve is lost, use a dip needle, miner's compass, or metal detector to locate the valve box. A good valve record includes information on maintenance operations performed, tells whether the valve was opened or closed at the time of inspection, and lists any errors in location. Keep one copy of the valve record book with the maintenance crew, and keep one on file.

Table 25  
Maintenance Checklist for Valves and Accessories

Inspection	Action	Frequency (1), (2)
Manually operated valves		
Gate valves Distribution system valves	Locate, check operation, lubricate stem packing; if packing leaks, dig up valve and tighten packing gland or replace packing; check stem alignment; check for broken stem or stripped stem or chewed nut.	SA
Valve bypass	Check for position, inspect, and lubricate.	SA
Gears	Check and lubricate; correct any deficiencies.	SA
Vault	Check condition, clean, check masonry; make repairs as necessary.	SA
Treatment plant valves	Operate inactive valves. Lubricate as required (including gears). Replace or resurface leaking valve seats. Lubricate chain wheels.	Q A V
Butterfly valves	Check valve stem for watertightness, and adjust, if necessary. Check operation and inspect for tight closure.	Q SA A
Rotary valves Cone valves (and ball valves)	Operate; lubricate metal-to-metal contacts in pilot mechanism; lubricate packing glands; lubricate all parts of seating and rotating mechanisms. Dismantle, remove corrosion products, wire brush plug and valve body; paint valves with corrosion-resistant paints.	M A

Table 25 (Continued)

Inspection	Action	Frequency (1), (2)
Plug valves	Lubricate with lubricant stick. Operate all valves; check for corrosion and foreign matter between plug and seat; lubricate gearing. Inspect; dismantle if necessary; clean, wire brush, re-machine plug and body or replace if condition is beyond re-machining.	M or Q Q A
Curb stops	Remove and replace whenever necessary.	V
Multiport valves	Lubricate with grease.	SA
Globe valves	Operate valve to prevent sticking; check for leakage, adjust packing nut, and replace packing if necessary.	Q
Diaphragm valves	Check valve closure for tight shutoff; if valve does not hold, remove valve stem and disk and regrind seat and disk.	SA
Diaphragm valves	Operate valve; check valve stem and lubricate as necessary; check for tight closing.	Q
Sluice gates	Check diaphragm for cracks; renew as necessary.	A
Sluice gates	Operate inactive gates; lubricate stem screws and gears.	M
Sluice gates	Clean valve with wire brush and paint with corrosion-protective paint.	A
Sluice gates	Check seating wedges on valves seating against pressure.	A
Backflow preventers Reduced pressure Power-operated valves	Test tightness of unit.	M

Table 25 (Continued)

Inspection	Action	Frequency (1), (2)
Hydraulic-cylinder operators		
Hydraulic cylinder	Check through one valve operation cycle.	M
Piston rod and tell-tale rod	Oil packing; tighten packing gland if leakage exists; replace packing if necessary.	M
Waste line discharge	Check for water flow when valve is wide open and shut; if leakage occurs, disassemble valve and piston, check leathers for wear and replace as necessary.	M
Cylinder and piston	Disassemble; inspect for scoring and corrosion; check cup leathers; polish any scored areas; remove corrosion products from piston surfaces and cylinder heads.	A
Pneumatic valve operators	Check packing and air hose; lubricate as necessary.	M
	Check piston, cylinder, and leathers; clean and maintain similar to hydraulic valve operators.	A
Motorized valve operators	Operate valve and check for tight closing.	Q
	Change gear drive lubricant.	Quarterly or after 500 hours of operation, whichever is more frequent
	Maintain electric motors as described in par. 11.4.4.	

Table 25 (Continued)

Inspection	Action	Frequency (1), (2)
Valve operator pilot controls	<p>Check control through one full cycle of operation.</p> <p>Lubricate pins, linkage, packing glands, and adjustment rod threads as necessary; remove corrosion products; check for leakage and repair.</p> <p>Disassemble; inspect unit and clean strainers; examine diaphragm for failure; regrind or replace worn valve seats.</p>	<p>M</p> <p>M</p> <p>A</p>
Automatic valves Air-release valves, valve unit.	Remove valve from service; inspect float for leaks, and pins and linkage for corrosion; remove corrosion products; clean orifices.	A
Vault	Inspect for condition of masonry, steps, and manhole covers; repair as necessary.	A
Altitude valves Pilot controls	Inspect and lubricate.	M
Valve unit and operator	Disassemble; inspect hydraulic cylinder and repair; inspect valve, repair, and paint, as necessary.	A
Check valves	<p>Inspect the closure control mechanism (if any); clean and adjust as necessary; check pin wear if balanced disk type; check seating on ball type.</p> <p>Disassemble; clean, reseal, and repair as necessary.</p>	<p>A</p> <p>V</p>
Float valves	<p>Inspect float; repair as necessary.</p> <p>Inspect valve and valve operating mechanism.</p>	<p>M</p> <p>A</p>

Table 25 (Continued)

Inspection	Action	Frequency (1), (2)
Pressure-regulating valves	Inspect, clean, adjust, disassemble, and repair as necessary (see manufacturer's instructions).	A
Valve accessories Gear boxes	Lubricate gears (see manufacturer's instructions)	M or Q
	Check gear operation through full operating cycle; listen for undue noise, etc.	SA
	Check housing for corrosion; paint as necessary.	A
Valve boxes	Clean debris out of box; inspect for corrosion; check alignment and adjust as necessary.	SA
Floor stands	Lubricate stem and indicator collars.	Q
	Inspect condition; clean and paint.	A
Valve position indicator		
Post indicators	Lubricate.	Q
Electric position indicators	Check contact points, wiring, etc.	A

(1) W-Weekly; M-Monthly; Q-Quarterly; SA-Semiannually; A-Annually; V-Variable, as conditions may indicate.

(2) The frequencies shown are suggested frequencies that may be modified by local command, as individual installation conditions warrant.



8.3.3.2 Maintenance Procedures. Distribution system valves are usually left open and operated only during emergencies. To make sure that distribution valves operate when needed, each valve in the system should be operated twice a year and any indicated maintenance carried out. To check the operation of the valve, first close the valve completely and then open it completely. Back off on the valve about one turn to avoid locking the valve in an open position. If the valve does not operate properly, perform necessary maintenance and repair at once.

a) **Valve Seating.** The usual cause for a valve not seating properly in the closed position is foreign matter lodged on the valve seat. Open the valve slightly to give a high-velocity flow across the valve seat. If necessary, open a hydrant to increase flow enough to flush foreign matter from the valve seat.

b) **Valve-Stem Sealing**

(1) **Packing.** Check and lubricate the valve-stem packing. Dry packing will impede valve closure at all points of the stem movement. Lubricate dry packing by pouring a mixture of half kerosene and half lubricating oil down a 1/2-inch (13-mm) pipe to discharge the mixture onto the stem below the operating nut. If the packing leaks, dig up the valve, tighten the packing gland, or replace the packing as necessary. To reduce leakage while replacing packing, open the valve as wide as possible.

(2) **O-Ring Seals.** Most modern valves use O-ring seals rather than packing. If water is leaking around the stem, replace the O-rings.

c) **Valve Stem.** Valve stems may be out of alignment or broken, or may have stripped threads. If the valve stem is out of alignment, the valve operates easily near open or closed positions, but not when the valve is partially closed. A broken or stripped stem permits unlimited turning of the stem without closing the valve. All of the above conditions require replacing the valve stem. Follow the manufacturer's instructions for removing and inserting the stem. If the valve-stem nut is missing or damaged, replace it.

d) **Valve Seat Refacing.** When a gate-valve seat leaks, remove the valve and reface the valve seat. The procedure to follow should be detailed in the manufacturer's instructions and includes these general terms:

- (1) Remove the bonnet. Inspect and clean all working parts.
- (2) Check all working parts for signs of wear or deterioration.

- (3) Remove old packing or O-rings.
- (4) Refinish the working parts by grinding, sanding or polishing, and lapping. Replace all parts beyond repair.
- (5) Replace the valve parts; repack and test the valve for proper operation.

8.4 Hydrants. Fire hydrants are mainly used for fire protection. Other uses include flushing water mains and sewers, and filling tank trucks for street washing and tree spraying. Hydrants may also be used as a temporary water source for construction jobs. General information related to types of hydrants, component parts, O&M, common operating problems, records, and hydrant safety is included in pars. 2.1.4 and 2.2.41.

8.4.1 Hydrant O&M. Maintenance procedures for specific types of hydrants are provided in Table 26. Additional details are provided below.

8.4.1.1 Hydrant Inspection. Hydrants are inspected and tested by water utility personnel accompanied by a fire department representative, according to command and field engineering office directives. Hydrants can usually be maintained by replacing all worn parts and seats through the top of the hydrant. The operator is generally responsible for ensuring that the proper tools are used. Each year, test the hydrant for tightness of joints and fittings in the following manner:

- a) Remove one hydrant cap and replace it with a cap fitted with a pressure gage. Open the valve slowly until it is wide open. Record the pressure.
- b) Check for leakage at the following points:
  - (1) Hydrant Top. If a leak is found, remove the cover plate and tighten or repack the seal.
  - (2) Nozzles Entering Barrel. For leaks here, caulk the connection with lead.
  - (3) Nozzle Caps. If the nozzle caps are leaking, replace any defective gaskets.
  - (4) Cracks in Barrel. For leaks from cracks in the barrel, install a new barrel or a new hydrant.

Table 26  
Maintenance Checklist for Fire Hydrants

Inspection	Action	Frequency (1)(2)
Dry-barrel hydrants	Check drain valve to be sure it opens.	A
	Where ground water level rises into barrel, plug drain valve and dewater barrel by a pump.	A
Wet-barrel hydrants	Check packing glands and valve seats; repair as necessary.	A
Pit-type hydrants	Check for water accumulation; dewater as necessary.	A
All hydrants		
On dead ends	Flush; check barrel after flushing.	A
Not on dead ends	Flush; check barrel after flushing.	A
	Check water flow.	A
	Repair as necessary; if main shut down is required, notify fire department.	V
In winter	Check for freezing; thaw if necessary.	W (3) M (4)
Leakage tests	Inspect all places where leaks might occur; repair as necessary.	A
Valve parts		
Operating nut	Check for rounded corners; replace as necessary; lubricate.	A
Nozzle threads	Check for damage; replace as necessary.	A
Chains	Check for paint fouling; clean.	A
Flow tests	Determine hydrant flow.	A

(1) W-Weekly; M-Monthly; A-Annually; V-Variable, as conditions may indicate.

(2) The frequencies shown are suggested frequencies that may be modified by local command, as individual installation conditions warrant.

(3) Weekly near important structures.

(4) Monthly elsewhere.

(5) **Drain Valve.** Close this valve when the hydrant is open. If water comes out of the drain or saturates the ground around the hydrant when the hydrant valve is open, replace the drain valve facing or gasket.

c) Close the hydrant valve, open the second nozzle, open the hydrant valve, and flush the hydrant. Record the pressure with the hydrant valve open.

d) Close the hydrant valve slowly and note the lowering of the water level in the hydrant after the valve is closed. If the water level does not drop, the main valve is leaking or the drain valve is plugged.

8.4.1.2 **Hydrant-Flow Tests.** Conduct hydrant-flow testing in accordance with the latest edition of the publications listed in pars. 2.2.47 and 2.2.60.

During flow tests, the hydrant nozzle needs to be unobstructed, so the only way of protecting property is to choose the nozzle that will do the least damage. Provide barricades to divert traffic and take any other precautions necessary to minimize property damage and prevent personal injury.

Additional references include those listed in pars. 2.1.4, 2.2.11, and 2.2.41.

8.4.1.3 **Hydrant Flushing.** Water flow rates required for flushing water mains is given in par. 2.1.4. Before beginning the flushing, plan to divert flushing flow to prevent property damage. Use flow diffusers or a length of fire hose where necessary to direct the flow into a gutter or drainage ditch. A rigid pipe connected to a hydrant outlet and turned at an angle to divert flow down a gutter is not considered a good idea. The torque produced by the angular flow could be enough to twist or otherwise damage the hydrant.

8.4.2 **Hydrant Safety.** In addition to the general safety precautions detailed in par. 2.2.2, special precautions must be taken to prevent injury and damage to private property during hydrant flushing. Following are several special safety concerns:

a) Besides getting people wet, the force and volume of water from a full hydrant stream are sufficient to seriously injure workers or pedestrians.

b) If traffic is not adequately controlled, drivers trying to avoid a hydrant stream might stop quickly or swerve. An accident might result.

c) If the temperature is below freezing, water that is allowed to flow onto pavement may freeze and cause accidents.

d) If flow is diverted with a hose to a sewer, care must be taken not to create a cross-connection.

e) If flow is diverted with a hose, the end of the hose must be securely anchored. A loose hose end can swing unpredictably and could cause serious injury.

CANCELLED

## Section 9: I&amp;C AND WATER METERS

9.1 Overview of Section. This section contains information on primary instrumentation (sensors), secondary instrumentation (transmitters and recorders), and control systems as well as supervisory control and data acquisition (SCADA) systems, which are relatively new tools for controlling and monitoring water treatment systems. Special attention is given to O&M of water meters and other flow measuring devices such as weirs and flumes.

9.2 References. Detailed information on instrumentation and control (I&C) and water meters is presented in several publications. The list below identifies useful publications, along with the paragraph number corresponding to each document's listing in Section 2, Applicable Documents. Subsequent references to these publications are given by paragraph number alone.

- a) Distribution System Maintenance Techniques (par. 2.2.41)
- b) Manual of Water Supply Practices: Automation and Instrumentation (par. 2.2.1)
- c) Manual of Water Supply Practices: Flow Meters in Water Supply (par. 2.2.24)
- d) Manual of Water Supply Practices: Safety Practices for Water Utilities (par. 2.2.2)
- e) Manual of Water Supply Practices: Water Meters—Selection, Installation, Testing and Maintenance (par. 2.2.5)
- f) Principles and Practices of Water Supply Operations Series: Basic Science Concepts and Applications (par. 2.1.1)
- g) Principles and Practices of Water Supply Operations Series: Water Transmission and Distribution (par. 2.1.4)
- h) Principles and Practices of Water Supply Operations Series: Water Treatment (par. 2.1.5)

9.3 I&C. The term “instrumentation,” as used in the water works industry, refers to a very wide range of equipment used for observation, measurement, and control. Equipment types range from simple, mechanical, direct-reading meters and gages to complex electronic, automatic monitoring/control systems. All I&C systems

have some type of sensing device. More complex systems will include one or more of the following elements: transmitter, indicator, and recorder. Modern I&C equipment allows an operator to monitor and control equipment, flow rates, pressures, levels, and processes not only at the water treatment plant, but for all parts of the distribution network as well.

9.3.1 Water Meters. The primary function of water meters is to measure and record the volume of water flowing in a line. Flow is the most important measurement made at water supply facilities. Flow data is used to account for the water treated and pumped to distribution, chemical flow pacing, long-range planning, etc. Various types of meters and flow measuring devices, including flumes and weirs, are described in the references cited in par. 9.2 above. Additional topics such as installation, testing procedures and test equipment, recordkeeping, general maintenance, and repair of meters may also be found in these references. Help calculating flow rates is provided in par. 2.1.1.

9.3.2 Meter Reading. Meters are generally furnished with registers that measure water flow in terms of flow rate or total volume. Water meter registers are typically of two general types: the straight-reading type and the circular-reading type. The straight-reading type is read like the odometer on a car. The meter register reports the number indicated by the counting wheels. Fixed zeroes to the right of the counting wheel window should be included in the meter reading. The circular reading dial is somewhat difficult to read and has been gradually replaced by straight registers on new meters. When a hand on any scale is between two numbers of a circular reading dial, the lower number is read. If the hand seems exactly on any figure, check the hand on the next lower scale. If that hand is on the left side of zero, read the figure on which the hand lies. Otherwise, read the next lower figure.

Because the registers are never reset while the meters are in service, the amounts recorded for any given period are determined by subtraction. To obtain the volume of water that passed through the meter since the previous reading, subtract the previously recorded reading from the present reading. The maximum amount that can be indicated on the usual line meter before it turns to all zeros and starts over again is 99,999 cubic feet, or 999,999 gallons. Thus, to get a current measurement when the reading is lower than the last previous one, add 100,000 to the present reading on a cubic feet meter, or 1,000,000 to the present reading on a gallon meter. The small denomination scale giving fractions of 1 cubic foot or 10 gallons is used for testing purposes only and is disregarded in the regular reading.

Additional information regarding direct meter readout and remote reading may be found in pars. 2.1.4 and 2.2.5.

9.4 Instrument Maintenance and Repair. The success of water instrument maintenance procedures is based on knowledge of the construction, operation, and adjustment of the equipment; availability of the necessary special tools; and stored spare parts and special instructions from manufacturers. For the special knowledge necessary, maintenance personnel are advised to consult the manufacturer's instructions. Additional information on maintaining water meters can be found in several publications (see pars. 2.1.4, 2.1.5, 2.2.1, 2.2.5, 2.2.24, and 2.2.41).

9.4.1 Maintenance Schedules. The design and intricacy of meters, instrumentation, and automatic control systems depend on the function to be performed and the manufacturer's particular equipment. Because there are many manufacturers of meters, instruments, and automatic controls, listing specific maintenance procedures that apply to all units is not possible. The procedures here are basic and the minimum required for the most common types of units. When developing maintenance schedules, personnel may adapt the procedures given here to specific directions issued by the manufacturers.

9.4.2 Inspection and Maintenance Records. It is a good idea to keep a log of all inspection and maintenance actions. A particularly useful record system is a card file for each piece of equipment. This card shows the type of equipment, the manufacturer's serial number, the date installed, the location, and the frequency of scheduled maintenance. If these cards are arranged chronologically, each card will come to the attention of maintenance personnel at the proper time for the inspection to be made. Many water suppliers are now using computers in their operation. Information commonly kept on a service or meter history card is entered into a computer to establish a permanent record. A control number is associated with each service or meter. Any future information concerning work on a customer service line or meter testing and repairs can be entered for the appropriate control number. More information management can be found in pars. 2.1.4 and 2.2.1.

9.4.3 Sensor Maintenance. Maintenance procedures for flow, pressure and level-sensing devices are given in Table 27.



Table 27  
Maintenance Checklist for Flow, Pressure, and Level Sensors

Inspection	Action	Frequency (1),(2)
Flow sensors		
Venturi-type devices		
Annular chamber	Flush and clean annular chamber, throat and inlet; purge trapped air from chamber and connecting piping; flush piezometer pressure taps.	Q
Exterior	Clean and paint as necessary.	A
Interior	Check interior for corrosion; dismantle, clean, and restore smoothness of interior surfaces as necessary; for flanged joints, check possible intrusion of gasket into interior; replace if necessary.	A
Orifice plates	Remove plate, dress off roughness; flush sediment traps.	A
Pitot tube	On permanent installations, check tips and clean.	Q
Flow tube	Check instrument taps; flush if necessary.	Q
Pressure sensors		
Diaphragm	Disassemble and check for condition and leaks; also clean, adjust, repair, or renew as necessary; check calibration.	A
Bourdon tube	Check calibration, clean and adjust as necessary.	A

Table 27 (Continued)

Inspection	Action	Frequency (1),(2)
Manometer	Clean tubes and gage unit as necessary. Check mercury level and add mercury if necessary; clean or replace mercury if necessary.	SA A or V
Level sensors		
Floats	Check for bent rod, binding, or other damage; correct undesirable conditions; apply light oil to moving parts; check alarm system.	M
Bubble pipe	Check air discharge pipe for freeness; check air compressor system; clean, repair, or renew worn parts as necessary.	Q
Probes	Check contacts, wiring, and electrical connections; repair as necessary.	Q
	Check probe surface; check calibration; clean, repair, or renew as necessary.	SA

(1) W-Weekly; M-Monthly; Q-Quarterly; SA-Semiannually;  
A-Annually; V-Variable, as conditions may indicate.

(2) The frequencies shown are suggested frequencies that may be modified by local command, as individual installation conditions warrant.

9.4.4 Transmission System Maintenance. Information needs to be transmitted from the sensing device, which measures the variable, to the instruments that indicate, record, or total it. The transmission system may be mechanical, hydraulic, pneumatic, or electrical. Each system consists of two components—the transmitter and the transmission link. Maintenance procedures for transmission systems are summarized in Table 28.

9.4.5 Indicator, Register, and Recorder Maintenance. Besides transmission devices, secondary instruments include indicators or gages (momentary indication of discrete information), recorders (chart record of information by time), and registers or totalizers (also termed “integrators”). The latter category expresses the total quantity of measured variable from start to current time. There are many styles and designs of each basic type, and various combinations of these types. Therefore, no detailed maintenance procedure can cover all types, designs, and combinations. Maintenance procedures depend not only on the type of receiver (indicator, recorder, or register), but also on the type of transmission system used. It is recommended that maintenance personnel study the manufacturer’s instructions for detailed procedures, in addition to following the basic maintenance procedures for indicators, registers, and recorders summarized in Table 29.

9.4.5.1 Recorders. Recording instruments have all of the fundamental elements of an indicator unit and, in addition, contain a clock mechanism (spring or electrical), a chart, and a marking pen. Charts may be either circular or strip and are changed on schedule by operating personnel. Maintenance procedures depend on the type of transmission system employed, as well as on the design and other factors. Consult the manufacturer’s instructions for detailed procedures. General maintenance procedures are included in Table 29.

9.4.5.2 Totalizers or Registers. This type of receiver has internal components similar to those in recorders. In addition, it contains an integrator mechanism that converts transmitted signals into a sum of the total quantity of material that has moved past the point of measurement from the beginning of the measured period to the time of observation. This total appears on a numerical register similar to an automobile odometer. Clean, service, and adjust registers according to the manufacturer’s instructions on the same general schedule as recorders.

Table 28  
Maintenance Checklist for Transmission Systems

Inspection	Action	Frequency (1), (2)
Mechanical	Direct links—make certain pulley, drums, cable, etc., work freely and are not corroded; clean, lubricate, and adjust.	Q
Hydraulic	Pressure links-blow down pressure lines, make certain there are no restrictions; correct adverse conditions.	SA
Pneumatic		
Transmitter	Flush liquid side of air-relay units; clean; if necessary check diaphragm; check air-input orifice, clean, blow out moisture traps.	D
	Disassemble, repair, or renew as necessary.	V
Link	Check connecting tubing for condition; check nozzle system for leaks.	SA
Electrical		
Transmitter	Service transmitter; check signal interval length over instrument range.	M
	Check mercury switch and magnet; adjust as necessary.	Q
	Remove old lubricant, add new.	SA
Link	Check wires whenever necessary.	V
Indicators	Clean cover and glass of gages.	SA
	Check zero setting and calibration	A
Mechanical transmission	Inspect and service as for transmitter.	Q
Hydraulic transmission	Vent air from mercury wells; check pulley shaft, chain, cam, stuffing box, and other parts.	W
	Check mercury wells; add new mercury if necessary; clean or replace mercury if necessary.	A

Table 28 (Continued)

Inspection	Action	Frequency (1), (2)
Pneumatic transmission	Service on same schedule and in same manner as transmitter.	
Electrical transmission	Service generally on same schedule as transmitter.	
Recorders	Clean unit, especially dials.	SA
	Check operation, adjust and repair as necessary.	A
	Clean pen; check ink flow; check cam cycle and pulley freedom.	2W
	Check zero position; adjust and lubricate.	Q
Totalizers	Check contact points, armature, clutch, clutch cups, etc.; clean, adjust, repair, or renew parts.	SA
	Renew modular unit if necessary.	V
	Renew illumination lamp as necessary.	V
Combination	Inspect, clean, adjust or repair on same schedule as recorders.	
Combination	Check, clean, adjust or repair on same schedule as individual components.	

(1) D-Daily; W-Weekly; M-Monthly; Q-Quarterly; SA-Semiannually; as conditions may indicate.

V-Variable,

(2) The frequencies shown are suggested frequencies that may be modified by local command, as individual installation conditions warrant.

Table 29  
Maintenance Checklist for Indicators, Registers, and Recorders

Inspection	Action	Frequency (1), (2)
Indicators	Clean cover and glass of gages. Check zero setting and calibration.	SA A
Mechanical transmission	Inspect and service as for transmitter.	Q
Hydraulic transmission	Vent air from mercury wells; check pulley shaft, chain, cam, stuffing box, and other parts.  Check mercury wells; add new mercury if necessary; clean or replace mercury if necessary. (3)	W  A
Pneumatic transmission	Service on same schedule and in same manner as transmitter.	
Electrical transmission	Service generally on same schedule as transmitter.  Clean unit, especially dials.	SA  A
Recorders	Clean pen; check ink flow; check cam cycle and pulley freedom.  Check zero position; adjust and lubricate.  Check contact points, armature, clutch, clutch cups, etc.; clean, adjust, repair, or renew parts.  Renew modular unit if necessary.  Renew illumination lamp as necessary.	2W  Q SA V V
Totalizers	Inspect, clean, adjust or repair on same schedule as recorders.	

Table 29 (Continued)

Inspection	Action	Frequency (1), (2)
Combination	Check, clean, adjust or repair on same schedule as individual components.	

- (1) W-Weekly; Q-Quarterly; SA-Semiannually; A-Annually; V-Variable, as conditions may indicate.
- (2) The frequencies shown are suggested frequencies that may be modified by local command, as individual installation conditions warrant.
- (3) Caution: Mercury fumes are poisonous. Use caution when handling mercury and avoid spills.

9.4.5.3 Combination Totalizer Indicator-Recorder. There are various combinations, designs, and styles of instruments in this classification. There are also devices that sum totals from various individual totalizers, or show ratios of one flow to another. In general, the maintenance procedures and schedules for this category are a combination of the procedures for the individual units above. Develop a maintenance schedule according to the manufacturer's instructions.

9.4.6 Water Meter Maintenance. Maintenance procedures for water meters are summarized in Table 30.

9.4.7 Weir and Flume Maintenance. All types of head-area meters are used for open-flow measurement, and their proper operation depends on the absence of any kind of interference at the discharge opening. Maintenance procedures for weirs and flumes are summarized in Table 31.

9.5 Safety. General hazards connected with servicing I&C systems include use of hand tools, working in confined spaces, and electric shocks. Special attention should be given to prevent electrical shock that may be caused by improper grounding of building electrical systems onto the plumbing system. If residential water meters are not mounted on a yoke, or if a permanent jumper wire is not provided across the meter connections, use a separate wire with large alligator clips as a temporary bridge between the pipes when meters are removed or installed. Additional safety information is provided in the references cited in par. 9.2.

Table 30  
Maintenance Checklist for Water Meters

Inspection	Action	Frequency (1),(2)
Volume meters	Check operation; check for noise. Check mounting and alignment.	M A
Velocity-type meters	Check operation; check for noise.	M
Meter pit	Clean, remove water before freezing season.	SA
Exterior	Paint as necessary.	A
Interior	Check for worn parts; repair or replace as necessary.	V
Proportional meters	Check on same program as velocity meters.	V
Compound meters	Check large-flow component on same schedule as velocity-type meters.	M
Magnetic flow meters	Check electrical connections.	A
Meter pit	Check, clean, remove water to protect against freezing.	A (Fall)
Measuring unit	Check for possible hot water damage.	A
Unit parts	Check for worn parts, repair or replace as necessary; clean and brighten.	V

(1) A-Annually; M-Monthly; SA-Semiannually; V-Variable, as conditions may indicate.

(2) The frequencies shown are suggested frequencies that may be modified by local command, as individual installation conditions warrant.



Table 31  
Maintenance Checklist for Weirs and Flumes

Inspection	Action	Frequency (1), (2)
Weirs	Check weir edge to make certain it is clean. Check and open breather pipe, if any. Drain weir to check evenness of water break-over; check for tuberculation or corrosion; dress-off rough spots.	D M A
Parshall flume	Check throat section to be sure it is clean and free of growths. Clean stilling well and connecting pipes.	M Q

(1) A-Annually; D-Daily; M-Monthly; Q-Quarterly, as conditions may indicate.

(2) The frequencies shown are suggested frequencies that may be modified by local command, as individual installation conditions warrant.

## Section 10: CROSS-CONNECTION CONTROL AND BACKFLOW PREVENTION

10.1 Cross-Connections and Backflow. Cross-connections are the physical links through which contaminated materials can enter a potable water supply. The contaminant enters the potable water supply when the pressure of the polluted source exceeds the pressure of the potable source. The flow of contaminated water to the potable system is called “backflow.” Backflow of contaminated water through cross-connections can occur in all water systems and does occur in most water systems. Backflow results from either back pressure or back siphonage. Backflow due to back pressure occurs when the user’s water system is under higher pressure than the public water supply system. Back siphonage is caused by the development of negative or sub-atmospheric pressures in the water supply piping. This condition occurs when system pressure is lowered by pump malfunction or high fire flow.

10.2 References. Information on types of cross-connections, where cross-connections occur, public health significance, methods of control, and details of setting up a cross-connection control program can be found in the publications listed below:

- a) AFI 32-1066, Plumbing Systems (par. 2.4.1.1)
- b) Cross-Connection and Backflow Prevention (par. 2.2.39)
- c) Manual of Cross-Connection Control (par. 2.2.53)
- d) Manual of Water Supply Practices: Recommended Practice for Backflow Prevention and Cross-Connection Control (par. 2.2.10)
- e) Principles and Practices of Water Supply Operations Series: Water Transmission and Distribution (par. 2.1.4)

Subsequent references to these publications use only the Section 2, Applicable Documents, paragraph number noted above (in parentheses after the document title).

10.3 Classes of Backflow Hazards. Backflow hazards have been divided into the three classes—low, moderate, and high—as defined below. The Uniform Plumbing Code recognizes two levels of hazard—low and high.

10.3.1 Class I—Low Degree of Hazard. If a backflow were to occur, the resulting health significance would be limited to minor changes in the esthetic quality, such as taste, odor, or color. The foreign substance must be nontoxic and nonbacterial in nature, with no significant health effect.

10.3.2 Class II—Moderate Degree of Hazard. If a backflow were to occur, the esthetic qualities of the water supply would change significantly. The foreign substance must be nontoxic to humans.

10.3.3 Class III—High Degree of Hazard. If a backflow were to occur, the effect on the water supply could cause illness or death if the water were consumed by humans. The foreign substance may be toxic to humans either from a chemical, bacteriological, or radiological standpoint. Effects of these contaminants may result from short- or long-term exposure.

10.4 Approved Backflow Prevention Devices. Devices that protect the potable water supply from these backflow hazards are listed in Table 32 and discussed below. Additional descriptions of approved backflow prevention devices can be found in the references listed in par. 11.2.

Table 32  
Approved Backflow Devices

Degree of Hazard	Allowed Approved Devices
Class I	Air gap Atmospheric type vacuum breaker Pressure type vacuum breaker Double check valve assembly Reduced pressure principle device
Class II	Air gap Double check valve assembly Reduced pressure principle device
Class III	Air gap Reduced pressure principle device

10.4.1 Air Gap. An approved air gap may be used under any and all conditions of hazard and pressure conditions.

10.4.2 Vacuum Breakers. Pressure and atmospheric vacuum breakers are primarily in-plant or end-of-service line solutions to cross-connection. They are not used in water service connections. They are placed at the end of a line, and at fixtures or equipment that discharge to atmospheric pressure. These do not protect against

back pressure, only against back siphonage. Valves should not be located downstream from an atmospheric type vacuum breaker.

Note: Vacuum breakers are permitted on irrigation systems regardless of hazard class for protection from back siphonage only.

10.4.3 Reduced Pressure Principle Device. The reduced pressure (RP) principle device protects against both back pressure and back siphonage and can be used for any degree of hazard.

10.4.4 Double Check Valve Assembly. This device works in a back pressure or back siphonage mode. This device neither discharges water nor provides a visual sign of backflow or unit malfunction. Therefore, it does not offer the degree of protection provided by the reduced pressure principle device.

10.5 Selection and Installation of Backflow Preventers. Selecting proper devices is very important. However, having the proper device on the connection is not sufficient; the device also needs to be installed correctly. Guidance on selecting and installing backflow prevention devices is provided in par. 2.2.10. Critical potable water supplies should have parallel installation of the proper approved backflow prevention device. This avoids interruption to water service when maintenance or testing is required. This type of installation also provides higher flow capacity than is provided by one backflow preventer. Methods and devices occasionally promoted for backflow prevention include the single check valve, the swivel connection, the removable section or spool, and the barometric loop. None of these methods is approved for use in military water systems. Reasons for their unacceptability are discussed below:

a) A single check valve offers no visual or mechanical means of determining malfunctioning. Since all such mechanical devices are subject to wear and interference resulting from deposits and other factors, the single check valve is not considered an adequate backflow preventer.

b) The swivel connection and removal section or spool are too easily allowed to remain in place to be considered an acceptable means of backflow prevention.

c) A barometric loop consists of a vertical section of pipe, extending at least 35 feet (11 m) above the highest fixture. The principle is that a complete vacuum cannot raise water to an elevation greater than 33.9 feet (10.3 m). The device does not protect against backflow because of back pressure, and installing a pipe loop of this height is usually costly and impractical.

10.6 Inspection and Testing Schedule. Each installation should create a schedule for inspecting and testing all backflow protection devices, including air gaps.

Determine the intervals between inspecting, testing, and overhauling each device according to the age, condition of each device, and degree of hazard. It is important to inspect all devices installed on Class III (high degree of hazard) cross-connections at least once every 6 months (Table 33). In general, follow the overhaul intervals recommended by the manufacturer. Ideally, overhaul intervals will not exceed 5 years. Keep the inspection and testing schedule in the recurring work program.

Table 33  
Suggested Intervals for Inspecting Backflow Devices

Degree of Hazard	6 Months	12 Months
Class I		X
Class II		X
Class III	X	
Class III (Air Gap)		X

10.6.1 Inspection. A certified backflow inspector must inspect all cross-connections and backflow prevention devices to ensure that:

- a) An approval air gap is maintained.
- b) Backflow prevention devices are in good condition.
- c) New devices are properly installed and debris from the installation does not interfere with functioning of the device. (This inspection is to be completed within 1 week after acceptance and 3 months after installation.)

10.6.2 Testing. Complete all testing according to the manufacturer's service instructions. Repair and retest any device found to be defective until it is in satisfactory condition.

10.7 Maintenance of Backflow Preventers. Maintenance is necessary for any mechanical equipment to keep it operational. Therefore, it is generally best to install any mechanical protective device in a location where it is accessible for routine inspection, testing, and required maintenance. These devices are mechanical and subject to breakdown, and they will need to be isolated during inspection and repair. If there is only one service line from the potable system and if water service is required

100 percent of the time, a bypass and a second RP principle backflow preventer will be required to provide an uninterrupted protected supply from the potable system.

10.8 Administrative Issues. Administrative issues, including legislation, education, and licensing, are discussed in the publication listed in par. 2.2.10. Additional Air Force requirements are listed in par. 2.4.1.1.

10.9 Records of Inspection. Use an appropriate form approved by the military service to record data on all cross-connections. Provide the location, degree of hazard, description of air gap or protective device installed, and a sketch of the installation on the form. After each inspection is completed, record the date of inspection, test results, observations, corrective action taken, and name of the inspector on the appropriate form. For an air gap, the test consists of a visual inspection, with "OK" recorded. Testing for other backflow devices is more involved.

10.10 Location Records. In general, records of all cross-connection control or backflow prevention devices should be prepared and properly maintained. These records are to include an inventory listing of all locations and an individual record on each location.

## Section 11: GENERAL MAINTENANCE

11.1 Scope of This Section. This section deals with maintenance inspections and general maintenance services required at military water supply systems that are not addressed elsewhere in the handbook. In addition, this section contains tables specifying tools and equipment, lubricants, and materials and supplies required to perform general and specific equipment maintenance tasks.

11.2 References. Several publications are referred to in this section as including necessary or supplementary maintenance information. These publications are listed below, along with the paragraph number corresponding to the publication's listing in Section 2, Applicable Documents. For brevity, subsequent references to each document within Section 11 use the Section 2 paragraph number alone.

- a) Distribution System Maintenance Techniques (par. 2.2.41)
- b) Manual of Water Supply Practices: Electrodialysis and Electrodialysis Reversal (par. 2.2.27)
- c) Manual of Water Supply Practices: External Corrosion—Introduction to Chemistry and Control (par. 2.2.19)
- d) Manual of Water Supply Practices: Reverse Osmosis and Nanofiltration (par. 2.2.28)
- e) MIL-HDBK-1110, Paints and Protective Coatings (par. 2.4.4.1)
- f) MIL-HDBK-1136, Cathodic Protection Operation and Maintenance (par. 2.4.4.2)
- g) NACE RPO169-92, Control of External Corrosion on Underground or Submerged Metallic Piping Systems (par. 2.3.18)
- h) NACE RPO196-96, Galvanic Anode Cathodic Protection of Internal Submerged Surfaces of Steel Water Storage Tanks (par. 2.3.19)
- i) NACE RPO388-95, Impressed Current Cathodic Protection of Internal Submerged Surfaces of Steel Water Tanks (par. 2.3.20)
- j) NAVFACENGCOM Guide Specification, Section 02090: Removal and Disposal of Lead-Containing Paint (par. 2.4.3.3)

k) Painting and Repainting Steel Tanks, Standpipes, Reservoirs, and Elevated Tanks for Water Storage (par. 2.2.54)

l) Plant Engineering Magazine's Exclusive Guide to Interchangeable Industrial Lubricants (par. 2.2.55)

m) Plant Engineering Magazine's Exclusive Guide to Synthetic Lubricants (par. 2.2.56)

n) Principles and Practices of Water Supply Operations Series: Water Transmission and Distribution (par. 2.1.4)

o) Reverse Osmosis: A Practical Guide for Industrial Users (par. 2.3.15)

### 11.3 Maintenance Inspections

11.3.1 Types of Inspection and Repair. Water supply system personnel are concerned with three categories of inspection and, to some degree, with overhaul and repair.

11.3.1.1 Operator's Inspection. Regular inspection of equipment is part of an operator's routine duties to ensure proper functioning of the system. Such inspection includes lubrication, minor adjustments, and renewal of parts that do not require major overhaul or repairs. The operator's inspection also entails detecting and reporting (to the proper authority) any abnormal conditions (appearance, leaks, unusual noises, etc.).

11.3.1.2 Preventive Maintenance Inspection. Cleaning, lubricating, adjusting, and renewing parts that do not require major overhaul and repairs, plus detecting and reporting (to the proper authority) any abnormal conditions (appearance, leaks, unusual noises, etc.) also comprise preventive maintenance inspection. Such inspections may be conducted by personnel who have been assigned specific areas of inspection responsibility or by personnel operating a particular piece of equipment or system.

11.3.1.3 Control Inspection. Scheduled examinations or tests of public works and public utilities are made to determine their physical conditions. These examinations are termed control inspections and are performed jointly by engineering and operating personnel. Control inspection includes electrical, mechanical, and structural inspection.



11.3.1.4 Major Overhaul and Repairs. As a rule, major overhaul and repairs are not made by operating personnel. This work is usually performed under contract.

11.3.2 Personnel. It is generally best if well-trained personnel perform inspections, repairs, and preventive maintenance tasks. Personnel assigned to these tasks should possess a thorough knowledge of the functions and operations of the equipment and the procedures for servicing it safely.

11.3.3 Maintenance Information. Water supply system personnel need ready access to equipment O&M information. Keep this information on file and update it as necessary. The best sources of maintenance information are the manufacturers' instruction manuals provided with each piece of equipment. This material should be bound and organized according to equipment type and be kept in good order for quick reference. The following information is typically included in these manuals: descriptive literature (catalog cuts and data sheets); parts lists; instructions for installation, operation, maintenance, and repair; performance data (i.e., pump performance curves); electrical diagrams; and schedules of required lubricants and chemicals. It is normally recommended that operating personnel be familiar with each piece of equipment through careful examination of these instruction manuals.

The material contained in this handbook is designed as a general overview of maintenance requirements and may not contain answers for specific maintenance questions. Consult the manufacturers' instruction manuals for specific maintenance information. The specifications, shop drawings, and as-built drawings, which should also be kept on file, show dimensions of each piece of equipment and provide information on pipe sizes and materials, valve types, equipment types, etc. They are available to plant personnel if the schematic drawings and valve and equipment schedules in this manual do not provide sufficient information.

11.3.4 Maintenance Management System. Regularly scheduled preventive maintenance is essential for keeping equipment in good running order. Daily tasks may be incorporated into the sampling and laboratory testing routine to make the most efficient use of the operator's time. If possible, perform routine tasks on the same day of the week or month to avoid confusion about when they were last performed. For example, each Monday can be set aside for performing weekly tasks, and the first Tuesday of the month can be set aside for monthly tasks. Annual lubrication can be performed during January.

Since operating personnel cannot be expected to remember the service requirements for every piece of equipment, a system of preventive maintenance is essential. To ensure the system is successfully implemented and maintained, it should

be relatively simple to operate, producing maximum output for minimum input. The following paragraphs describe the components of a good maintenance system. Additional information on maintenance management systems can be found in par. 2.1.4.

11.3.4.1 Goals. An effective maintenance management system is designed to achieve the following goals:

- a) Provide periodic, timely, standardized, and complete equipment maintenance
- b) Prevent excessive maintenance, such as over greasing bearings
- c) Increase system reliability by preventing or providing early detection of equipment malfunction
- d) Improve the efficiency of equipment operation
- e) Extend equipment life
- f) Improve safety by reducing unexpected breakdowns and by providing safety precautions along with maintenance and service procedures
- g) Reduce overall maintenance costs
- h) Provide a complete record system covering equipment history, maintenance costs, and work loads.

11.3.4.2 Components. The following components are necessary for a maintenance management system:

- a) Complete equipment records and maintenance history
- b) Preventive maintenance scheduling
- c) Corrective maintenance cost reporting
- d) Standardized preventive maintenance procedures
- e) Management reports on maintenance costs, overdue tasks, and employee utilization.

11.3.4.3 Maintenance Personnel. Another component of an effective maintenance management system is efficient organization of maintenance personnel. This includes providing adequate staffing, developing job descriptions and an organizational chart, providing maintenance training programs, and holding periodic staff meetings.

Job descriptions are often developed for use in assessing the skill level required to perform particular tasks in a maintenance program. Depending on the size of the facility, complexity of equipment, and size of the maintenance department, various skill levels may be required (for example, Operator I and II, Mechanic, Electrician, etc.). In many facilities, specialized equipment maintenance may require the use of outside contractors.

11.3.5 Spare Parts and Stock Control. Keep sufficient types and quantities of materials and stock on hand to ensure practical, economical, and continuous service. A review of the equipment and the manufacturers' recommendations will aid in determining which spare parts and miscellaneous supplies should be included in the inventory.

11.3.5.1 Expendable Stock. Stock levels for expendable items used at a fairly uniform rate (such as pump packing, treatment chemicals, and laboratory reagents) are based on maintenance experience and operating reports. However, levels may be modified for reasons of economy. Thus, savings can sometimes result if treatment chemicals are bought in large quantities.

11.3.5.2 Standby Items. Seldom-used materials needed to safeguard health, ensure uninterrupted operation of installation facilities, or prevent destruction of property are classed as standby items. Typical examples are chlorinator parts, such as a spare flowmeter, auxiliary chlorine valves, and cylinder connections. Hold materials to be stocked as standby items to a minimum, based on a detailed study of the water supply system. Consider these issues in setting up stocks of standby items:

- a) Non-critical parts immediately available from nearby installations, municipalities, or supply houses are not stocked. Critical parts are stocked.
- b) Much repair work at pumping stations and treatment plants can be anticipated, and parts for these repairs can be secured when needed.
- c) Only major sizes of pipe and fittings are stocked in large amounts.
- d) If the plant has several similar units, parts that are interchangeable need not be stocked for each unit.

e) As soon as an item is drawn from standby stock, a replacement is ordered.

11.3.5.3 Supply of Material. Watch stock levels closely and order essential materials far enough in advance to ensure continuous service. It is recommended that supervisors be familiar with normal and alternate sources of supply and the time each source usually needs to make delivery. Supervisors generally will follow up orders and help supply personnel find alternate supply sources if delivery is delayed. Supplies will be obtained according to normal supply procedures.

#### 11.3.6 Removing Equipment from Service

11.3.6.1 Short Period. Take precautions to prevent damage to equipment removed from service for a short time. Factors to be considered and precautions to be taken depend on the type of equipment and outside conditions. If the outage is likely to last more than a week, test operate the equipment once a week during that time.

11.3.6.2 Protracted Period. Special precautions are necessary for equipment that is to be out of service for long periods. Failure to retire or adequately protect equipment may cause serious damage during idleness or on resumption of operation. When it is known that the outage will be protracted, dismantle the equipment, if practical, and protect it against corrosion and other damage with suitable greases, oils, and rust-preventative compounds or coverings.

11.3.7 Operating under Winter Conditions. Protecting operating and standby equipment against damage is especially important in cold climates. Make sure lubricants are changed to winter grades. Drain equipment that is temporarily out of use or on standby service, or provide proper antifreeze coolant to prevent units (such as the housings of pumps, radiators, piping and similar items) from freezing or bursting.

Additional information on operating equipment under winter conditions can be found in par. 2.1.4.

11.4 Electrical Equipment. The following maintenance instructions are general. Perform maintenance of individual pieces of equipment according to the recommendations of the manufacturer. Operating procedures and ambient conditions, such as dirt and vibration, may dictate maintenance schedules different from those recommended here.

11.4.1 General. Major electrical equipment is best maintained by qualified, experienced electricians and in accordance with the manufacturer's recommendations.

Water system personnel may perform some inspections, lubrication, and simple routine maintenance. In general, do not open an electrical control panel unless the job requires it. De-energize electrical equipment at the motor control center and at the equipment itself before working on it. Always tag the open breaker and, if possible, lock it in the "open" position.

11.4.2 Routine Inspections. Visually inspect electrical equipment every day. Keep area clean. Look for the source of any leaks or unusual heat, noise, or odors. On rotating equipment with sleeve bearings, check the oil level and see that oil rings turn with the shaft. On rotating equipment with slip rings or commutators, check for excessive sparking.

Inspect motors on rotating equipment weekly. Be sure that the shaft is free of oil and/or grease from the bearings and start the motor to make sure it comes up to speed in normal time. Check the bearings for excessive heat or noise. Check slip rings and commutators for excessive sparking during starting.

Lubricate bearings according to the manufacturer's recommendations. Do not lubricate excessively; lubrication on insulating surfaces will deteriorate the insulation and gather dirt, which decreases the effectiveness of the insulation.

11.4.3 Switch Gear. Perform the following work items in accordance with the manufacturer's instructions, but not less than once per year. Perform the work more often if the equipment is exposed to excessive dirt or vibration.

These maintenance procedures apply to all electrical equipment that has contact-making devices (circuit breakers, contactors, switches, relays, etc.), electrical coils (transformers, reactors, solenoids, etc.), electrical terminations, insulators, or accessible electrical wiring or busses. Additional information on motor control equipment can be found in par. 2.1.4.

- a) Open equipment panel and wipe insulators and busses with clean, soft, lint-free rags. Clean interior with soft brushes or a vacuum cleaner.
- b) Check all accessible electrical terminations and connections, including terminations of power and control cables, bolted bus connections, and all accessible ground connections. Taped connections need not be checked. Check visually and tighten loose connections with a screwdriver or wrench.
- c) Record the voltage at the secondary terminal of each power and distribution transformer, both loaded and unloaded. Compare this reading with

previous readings. Change taps or contact the power company if the voltage is more than 5 percent high or low.

d) Inspect contacts on switches, contactors, circuit breakers, disconnects, and relays if the contacts are accessible. Dress or replace contacts if they are pitted or burned. Replace contacts in pairs, not singly.

11.4.4 Electric Motors. Perform the following work items in accordance with the manufacturer's instructions, but not less than once per year. Perform the work more often if the equipment is exposed to excessive dirt or vibration. Additional information on motor control equipment can be found in par. 2.1.4.

a) Blow dirt from the windings. Clean out magnetic particles that may be hanging on poles.

b) Drain, wash, and renew oil in sleeve bearings. Clean and renew grease in ball-and-roller bearings. Check air gaps. Inspect bearings for excessive wear.

c) Check end play. Under load, machines without thrust bearings should have the rotor within the end play. That is, the rotor should not be riding against the thrust collar of either bearing. This condition can cause heating and failure of the bearing; it can be corrected by shifting the rotor on the shaft or by shifting the laminations. Consult the manufacturer.

d) On rotating equipment with commutators or slip rings, check brush tension and brush wear. Make sure brushes are free in the brush holder. Replace brushes as required. Sand-in new brushes. Check commutators and slip rings for wear, scratches, or pitting. Dress as required.

e) Megger low-voltage rotating equipment using a 500-volt megger. Megger reading should be 1 megohm at minimum, but readings should be compared with previous readings, since a decreasing megger reading indicates deteriorating insulation or excessive dirt or moisture.

f) Check foot bolts, end shield bolts, pulleys, couplings, gear and journal set screws, and keys. Ensure that all covers and guards for pulleys and couplings are in good condition and securely fastened. Observe operation during starting and running.

11.4.5 Standby Power Generators. Operate emergency generators once a week, if possible, to ensure they will work properly when needed. Operate the

generators in accordance with the manufacturer's instruction (operation at full load for at least 1 hour is commonly recommended). Normal power sources must be disconnected to operate standby power at full load. Engine generators should comply with all applicable regulations regarding exhaust emissions.

11.4.6 Instrumentation and Controls. The following paragraphs address maintenance and calibration issues. Additional information on instrumentation and controls, including general troubleshooting guidelines, can be found in Section 9 and in par. 2.1.4.

11.4.6.1 Regular Maintenance. If kept in the proper environment, modern electronic equipment requires only periodic cleanings. Every 3 months, instruments should be opened or withdrawn from their cases, inspected, and cleaned with a soft brush. Instruments with moving parts should be lightly lubricated in accordance with the manufacturers' instructions. Do not over-lubricate. Check for interferences between moving parts. Fill ink wells on recorders as needed. Look for source of unusual heat, sound, or odors.

11.4.6.2 Calibration. Check calibration annually on instruments, gages, and pressure switches. If possible, calibrate equipment in place using the piping, wiring, and fluids of the processes and calibrate a whole subsystem at once. Since this method does not require removing the instrument, it avoids errors such as bad connections and leaks on reinstallation. The disadvantages are that in-place calibration may disrupt the process, and it may be difficult to get sufficient accuracy and range. Calibrate pressure gages and pressure switches by connecting them to a pressure header with a bleed valve and a pressure valve connected to an air tank. Use a gage of known accuracy and recent calibration for a reference. Check set points of pressure switches on increasing or decreasing pressure. Gages and pressure switches should be checked annually.

11.4.7 Tools and Equipment. In order to maintain, repair, and troubleshoot electrical equipment and circuits, the proper tools are required. In addition to a normal complement of small hand tools (see par. 11.12), a voltage tester with sufficient range to measure the highest voltage expected, a clamp-on type ammeter, a megger (a device for checking the insulation resistance), and an ohmmeter or circuit tester are required.

11.5 Mechanical Equipment. The following maintenance instructions are general. Maintain individual pieces of equipment according to the recommendations of the manufacturer. Operating procedures and ambient conditions, such as dirt and vibration, may dictate maintenance schedules different from those recommended here.

11.5.1 Aerators. Maintenance frequencies for aeration equipment are summarized in Table 34.

11.5.2 Rapid-Mix Basins and Equipment. Because rapid-mix devices revolve at great speed, do not attempt to check the rotation of the mixer paddles during operation, except by visual observation. When the mixing basin is empty, check the condition of the paddles, bearings, drive shaft, and motor. Then clean, lubricate, and paint as necessary. Table 35 presents a summary of maintenance procedures for rapid-mix basins.

11.5.3 Flocculators. Table 35 covers flocculator maintenance.

11.5.4 Sedimentation Basins and Clarifiers. All types of settling basins require the same basic maintenance (lubrication, cleaning, flushing, and painting). Maintain basins that incorporate proprietary mechanisms or devices according to the manufacturer's instructions. Table 35 presents a summary of maintenance procedures for sedimentation basins.

11.5.4.1 Non-mechanically Cleaned Sedimentation Basins. Clean these sedimentation basins at about 3-month intervals, or when development of an odor or rising floc particles indicates development of septic sludge conditions. Basins with mechanical equipment for removing settled sludge usually clean themselves satisfactorily during normal operations. However, it may be necessary at times to drain them and to clean the tank and mechanism with a high-pressure water hose.



Table 34  
Maintenance Checklist for Aeration Equipment

Inspection	Action	Frequency (1), (2)
Waterfall type aerators (cascade)	Inspect aerator surfaces; remove algae; clean.	D
Waterfall type aerators (tray)	Clean and repair trays; clean coke or replace.	SA
Waterfall type aerators (cascade)	Repair or replace surfaces as necessary.	A
Packed tower aerators (strippers)	Inspect packing for scale buildup.	W
Packed tower aerators (strippers)	Clean with acid. (3)	Biweekly or as required
Diffuser type aerators		
Porous ceramic plate or tube	Check discharge pressure. If clogging is evident, dewater tank and clean diffusers.	V
Porous ceramic plate or tube	Drain aeration tank. Check for joint leaks, broken diffusers, and clogging. (4)	SA
Water side of ceramic diffusers	Clean with acid in place or remove and soak in acid. (3)	SA
Air side of ceramic diffusers	If plates are clogged with iron oxide, treat with 30% HCl; if clogged with dust, soot, oil, etc., remove diffusers and burn off extraneous material in a furnace following the manufacturer's instructions.	SA
Porous saran-wound tube diffusers	Inspect and clean as required. (5)	SA
Injection nozzles	Inspect and clean.	SA

Table 34 (Continued)

Inspection	Action	Frequency (1), (2)
Spray nozzle aerators		
Nozzles	Check for clogging. Clean, removing nozzles if necessary. (6)	W
Manifolds	Remove caps and clean out sediment. Check pipe supports and repair as necessary. Paint as necessary.	Q
Spray fence	Paint.	A
Blowers and accessory equipment		
Compressor or blower	Lubricate. Check output pressure for indications of clogging.	D
Air filters	Clean, repair, or replace.	W
Compressor or blower	Open, inspect, clean, repair, and paint exterior surfaces.	A

- (1) D-Daily; W-Weekly; Q-Quarterly; SA-Semiannually; A-Annually; V-Variable, as conditions may indicate.
- (2) The frequencies shown are suggested frequencies that may be modified by local command, as individual installation conditions warrant.
- (3) Caution: Handle acids very carefully. Particularly, do not pour water into sulfuric or chromic acid, as it will boil violently and splatter the acid over you. Such acid will cause severe burns to the skin and clothes. Perform acid treatment only on the approval of the plant superintendent and under the supervision of a chemist or other qualified personnel.
- (4) Note: Chlorine gas introduced into the air line at intervals between inspections helps hold down organic growths. Removable plates should be soaked in 50 percent nitric acid. Plates grouted in place cannot be treated with nitric acid; use chromic acid (made by adding 1 g of sodium dichromate to 50 mL of sulfuric acid). Pour approximately 2 fluid ounces on each plate on 2 succeeding days.
- (5) As the component materials cannot be subjected to strong acid or heat, scrub the diffusers with a brush and detergent.
- (6) Do not use a pipe wrench for this purpose.

Table 35  
Maintenance Checklist for Rapid Mix,  
Flocculation, and Sedimentation Basins

Inspection	Action	Frequency (1), (2)
Rapid-mix basins	Drain, wash down walls, flush sediment to waste line. (3) Repair spalled spots on walls and bottom. Check valves or sluice gates, lubricate, and paint as necessary.	SA
Baffled mixing chambers	Clean baffles and repair as necessary.	SA
Flocculator basins	Check paddle rotation to ascertain whether any flocculators are inoperative. Clean and lubricate drive, bearings, gears, and other mechanical parts. Check underwater bearings for silt penetration. Replace scored bearings.	M SA
Rapid (or flash) mixers	Check paddles. Clean bearings and drive shaft. Lubricate and paint as necessary.	SA
Revolving-sludge-collector basins	Drain tank. Check submerged parts.	SA
Operating parts	Lubricate.	D or W
Speed reducers and oil baths	Remove water and grit. Replace oil as necessary.	W
Drive head	Lubricate (but do not over lubricate).	D
Worm gear	Check oil level. Drain water from housing.	W M
Turntable bearings	Lubricate. Change oil.	M SA

Table 35 (Continued)

Inspection	Action	Frequency (1), (2)
Chains	Drain off water, add oil as necessary. Change oil.	M SA
Annular ball bearings	Lubricate. Inspect condition.	D M
Center bearings, shaft bearings, bushings, etc.	See manufacturer's instructions.	V
Tank equipment	Tighten bolts and nuts. Check for excessive wear. Flush and backblow sludge line. Check motors, couplings, and shear pins. Check rakes. Clean and paint equipment.	A
Conveyor-type-collector basins	See above, and consult manufacturer's instructions.	V
Upflow or solids-contact clarifier	See manufacturer's instructions.	V

(1) D-Daily; W-Weekly; Q-Quarterly; SA-Semiannually; A-Annually; V-Variable, as conditions may indicate.

(2) The frequencies shown are suggested frequencies that may be modified by local command, as individual installation conditions warrant.

(3) Caution: Do not allow cross-connections to the drinking water supply system.

11.5.4.2 Lubrication Requirements. Regular lubrication is required when the basin is in continuous operation. Intermittent operation may allow an increase in the lubrication interval. If operating periods are intermittent and infrequent, operate the mechanism briefly between operating periods and lubricate accordingly. Devices subject to wide seasonal temperature variations will require seasonal changes in lubricant grades, especially when summer grade oils thicken at lower temperatures and reduce the flow capability. Daily or weekly lubrication of operating units is part of the operator's inspection. The choice of lubricant and its frequency of application are

established by the manufacturer or by local command. Inspect the speed reducer each week to make sure that the oil is at the proper level, is free of water and grit, and is of a suitable viscosity. If a reducer runs hot during its operation, the oil level may be too high or too low. When the reducer is out of service for extended periods, make sure that it is filled completely to prevent seals from drying out. Replace oil when necessary.

11.5.4.3 Overload Alarm. If the equipment has an overload alarm, check it for operation. If the alarm sounds at any time, shut off the equipment, locate the source of trouble, and rectify the situation. Disabling the alarm switch is not recommended. It is important that the alarm provide continuous operation under overload (high-torque) conditions. If the overload is caused by a sludge buildup leading to cut-out of the starter switch or pin shearing, drain the tank and flush out the sludge.

11.5.4.4 Upflow Clarifiers and Solids Contact Units. These are all proprietary items; maintain them according to the manufacturer's instructions. Devices that use rotating parts have motors and gears that require maintenance.

a) Operator's Inspection. Check for leaks in valves and piping each month. Make sure that sludge valves function properly. Also check time clock and other accessories that control sludge valve operation.

b) Cleaning Maintenance. Drain unit, clean, and inspect wearing parts twice a year. Remove encrustation where it may interfere with operating parts; follow the manufacturer's instructions in this operation. Check chemical feed lines to make sure that they are not clogged and are in good condition.

11.5.5 Gravity Filters. This paragraph deals with maintenance of conventional or rapid filters, formerly known as "rapid sand filters." Media commonly used in rapid filters include graded sand, crushed anthracite, GAC, and garnet or ilmenite. Media types may be used alone, as in traditional sand filters and deep-bed monomedia filters, or in combination, as in dual and tri- or mixed-media filters. The following maintenance procedures supplement (but do not substitute for) requirements established by the equipment manufacturers. A quick reference guide to maintenance of gravity filters appears in Table 36.

Table 36  
Maintenance Checklist for Gravity Filtration Equipment

Inspection	Action	Frequency (1), (2)
Filter media	<p>Inspect surface for unevenness, sink holes, cracks, algae, mud balls or slime.</p> <p>Dig out sand and gravel at craters of appreciable size.</p> <p>Locate and repair underdrain system breaks.</p> <p>Chlorinate to kill algae growths.</p> <p>Probe for hard spots and uneven gravel layers; if present, treat filter with acid.</p> <p>Check wash water rise rate and sand expansion during backwashing.</p> <p>Check sand condition for grain size growth; sample sand, determine weight loss on acid digestion, and run sieve test; acid-treat if necessary, or replace sand, if necessary.</p>	<p>M</p> <p>V</p> <p>V</p> <p>Q</p> <p>SA</p> <p>SA</p> <p>A</p>
Gravel	<p>Check elevation of gravel surface.</p> <p>Examine gravel for encrustation, cementation, alum penetration, or mud balls; if necessary, remove, clean, and re-lay gravel.</p>	<p>M</p> <p>SA</p>
Underdrain system	<p>Remove sand from an area 10 feet square (1 sq m) and inspect an area of gravel 2 feet square (0.2 sq m) or larger. If underdrains are deteriorated, remove all sand and gravel, repair underdrains, and replace gravel and sand.</p>	<p>A</p>

Table 36 (Continued)

Inspection	Action	Frequency (1), (2)
Underdrain system (continued)	If underdrain is porous and clogged by alum floc, treat with 2 percent NaOH solution for 12 to 16 hours.	V
Wash water troughs	Check level and elevation; adjust. Check for corrosion; if present, dry troughs, wire brush, and paint.	Q SA
Operating tables	Clean table (console or panel) inside and out.	W
Cables	Adjust tension.	V
Hydraulic lines (or pneumatic)	Check for leakage; repair as required.	V
4-way transfer valves	Adjust; tighten packing glands or add new packing. Lubricate with grease. Adjust valve position indicator, if necessary. Disassemble, clean, lubricate, and replace worn parts.	M M M A
Table	Paint inside.	A
Rate controllers		
Direct-acting		
General	Clean exterior, check diaphragm leakage, tighten packing, and check freedom of movement and zero differential.	W
Diaphragm pot	Disassemble, clean, and replace.	A or V

Table 36 (Continued)

Inspection	Action	Frequency (1), (2)
Controller mechanism	Disassemble and service; clean venturi; paint surfaces needing protection.	Every 3 years
Indirect-acting General	Clean outside; adjust packing; lubricate and tighten fittings; check knife edges; check piston travel; repack as necessary.	W
Pilot valves	Disassemble, clean, and lubricate; check piston travel; clean piping and strainers; check for leaks in diaphragm.	A
Controller mechanism	Disassemble and service; clean venturi; clean hydraulic cylinders; paint as necessary.	Every 3 years
Mechanically operated loss-of-head gages	Check zero setting; adjust stop collars or cable; release air from float chamber.	M
Mud leg	Flush out sediment.	M
Float chamber	Remove float and clean; replace mercury if necessary; check pressure pipelines; paint interior and exterior.	A
Diaphragm- pendulum loss-of-head unit	Check zero setting; purge diaphragm cases of air; check cable at segment; remove dirt from knife edges; tighten cam hubs on shafts; drain mud from mud leg.	M
Pipelines to diaphragm	Check for free flow and absence of encrustation.	SA



Table 36 (Continued)

Inspection	Action	Frequency (1), (2)
Diaphragm- pendulum unit	Check for leakage; disassemble unit, clean, and lubricate; check working parts and cables; repack stuffing box; check knife edges.	A
Mercury-float-type rate-of-flow gages	Check at zero differential; adjust indicator arm and recording pens; check stop collars on cables.	M
	Check accuracy and percent error; if greater than $\pm 3$ percent, adjust.	SA
Pressure lines	Check and clean as necessary.	SA
Float chamber	Clean float and check mercury; paint all parts requiring protection.	A
Piping and valves	Check for joint leaks; check pipe hangers and replace, if necessary; paint as necessary.	M

(1) W-Weekly; M-Monthly; Q-Quarterly; SA-Semiannually; A-Annually; V-Variable, as conditions may indicate.

(2) The frequencies shown are suggested frequencies that may be modified by local command, as individual installation conditions warrant.

#### 11.5.5.1 Filter Media

a) Each month, drain the filter to the surface of the filter medium. Inspect the surface for unevenness, sinkholes, cracks, and evidence of algae, mud balls, or slime.

(1) If depressions or craters on the surface area are of appreciable size, dig out the sand and gravel, and locate and repair any break in the underdrain system.

(2) Remove mud balls manually or break them up with high-pressure sprays.

(3) If severe algae growths exist on media or walls, remove the filter from service and treat it with a strong hypochlorite solution. Add enough hypochlorite to produce 2 to 4 mg/L of free residual chlorine in a volume of water 6 inches deep above the filter surface. Draw down the filter until the water level is just above the bed surface. Allow the filter to stand 6 to 8 hours, then backwash the surface. Follow this procedure with a complete backwashing. Repeat if necessary.

b) On a quarterly basis, probe the filter for hard spots and uneven gravel. Examine the sand below the surface by digging to gravel with the water drawn down to the gravel level. Clogs may appear because sand grains have cemented with mud balls or because grains have increased in size due to calcium carbonate deposit encrustation (for example, in softening plants or where lime and ferrous sulfate are used for coagulation). If so, clean the sand by treating the idle filter with inhibited muriatic acid (hydrochloric acid to which a chemical has been added to reduce corrosion of metal) or sulfurous acid. It is good practice to notify the utility managers before these chemicals are used.

(1) Add the inhibited muriatic acid at the surface and allow it to pass downward through the bed and out the filter drain or "rewash" line. Alternatively, add it to an empty filter through a small tap on the bed side of the wash water supply line.

(2) Use sulfurous acid as follows. Allow the sulfur dioxide gas from a cylinder to discharge into the filter wash water supply line while slowly filling the filter bed with wash water. Use one 150-pound cylinder with 6,000 gallons of water to produce a 0.3 percent solution. Allow solution to stand for 6 hours.

c) Twice a year, usually when seasonal water temperature changes occur, determine any change in the rate of wash water rinse and check sand expansion as follows:

(1) The flow rate of backwash water should be sufficient for cleaning the media but should not provide so much pressure that loss of media results. In general, the backwash flow rate should be at least 15 gallons per minute per square foot (10 liters per second per square meter [Lps/sq m]), which is equivalent to a rise rate of 2 feet per minute (600 mm/min) as measured by a hook gage. Higher rates may be required for some types of filter media, but rapid sand filters typically backwash at a rise rate of about 2.0 to 2.5 feet per minute (600 to 750 mm/min). The highest rate for

each filter should be determined by actual experience at the plant. The rise rate is related to the backwash rate, as illustrated in the following calculation:

$$\frac{15 \text{ gallons}}{\text{minute} \times \text{square foot}} \times \frac{1 \text{ cubic foot}}{7.48 \text{ gallons}} = \frac{2 \text{ feet}}{\text{minute}}$$

$$\frac{10 \text{ liters}}{\text{second} \times \text{square meter}} \times \frac{1 \text{ cubic meter}}{1,000 \text{ liters}} = \frac{0.01 \text{ meter}}{\text{second}}$$

$$\frac{0.01 \text{ meter}}{\text{second}} \times \frac{60 \text{ seconds}}{\text{minute}} = \frac{1,000 \text{ mm}}{\text{meter}} = \frac{600 \text{ mm}}{\text{minute}}$$

a. **Media Expansion.** Filter media should be expanded at least 20 to 25 percent for good cleaning action, although a greater expansion may be optimum in some cases. Higher expansions risk washing out some filter media along with the accumulated solids. The degree of expansion is affected by many variables associated with the filter media and the water. Filter media variables include size and gradation as well as shape and density. Water variables include viscosity and density which, in turn, vary with water temperature. Figure 7 relates media size and specific gravity to backwash rate and gives approximate temperature correction factors. Media cleaning is also affected by interparticle abrasion, although the bulk of the cleaning action is due to the force of the rising backwash water. Expansion can be measured by attaching cups to a pole at suitable intervals, then dipping the pole into the backwashing filter bed; the highest cup that contains sand indicates the height of bed expansion. A waterproof flashlight attached to a pole works well to show the top of the sand, but only after the backwash water becomes relatively clear.

b. **Hook Gage.** A multiple hook gage (Figure 8) is a series of vertical, sharp, pointed rods held in a frame that may be hung on the side of the filter. The tips of the sharp, pointed rods are set accurately at 2- or 3-inch (50- to 75-mm) spacings. The hook can be used to check the rate of filtration or backwashing, although its primary use is for measuring backwash flow rate. Hang the frame on the side of the filter and accurately record the time required for the water level to fall or rise between the points. The volume of water in the filter box between the gage points can easily be calculated. From the recorded time, the flow rate can accurately be determined.

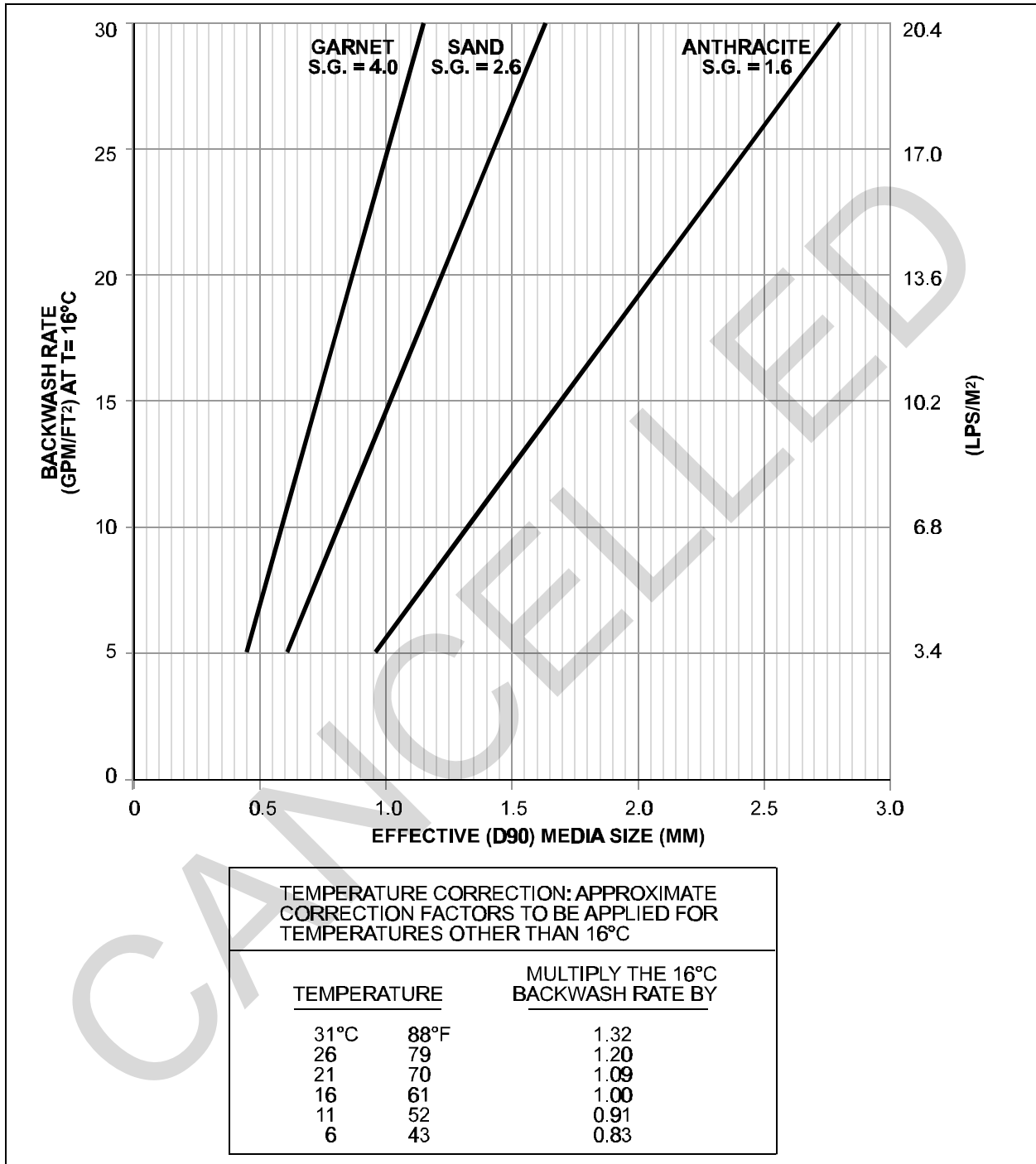

Figure 7  
Backwash Rate for Media Cleaning

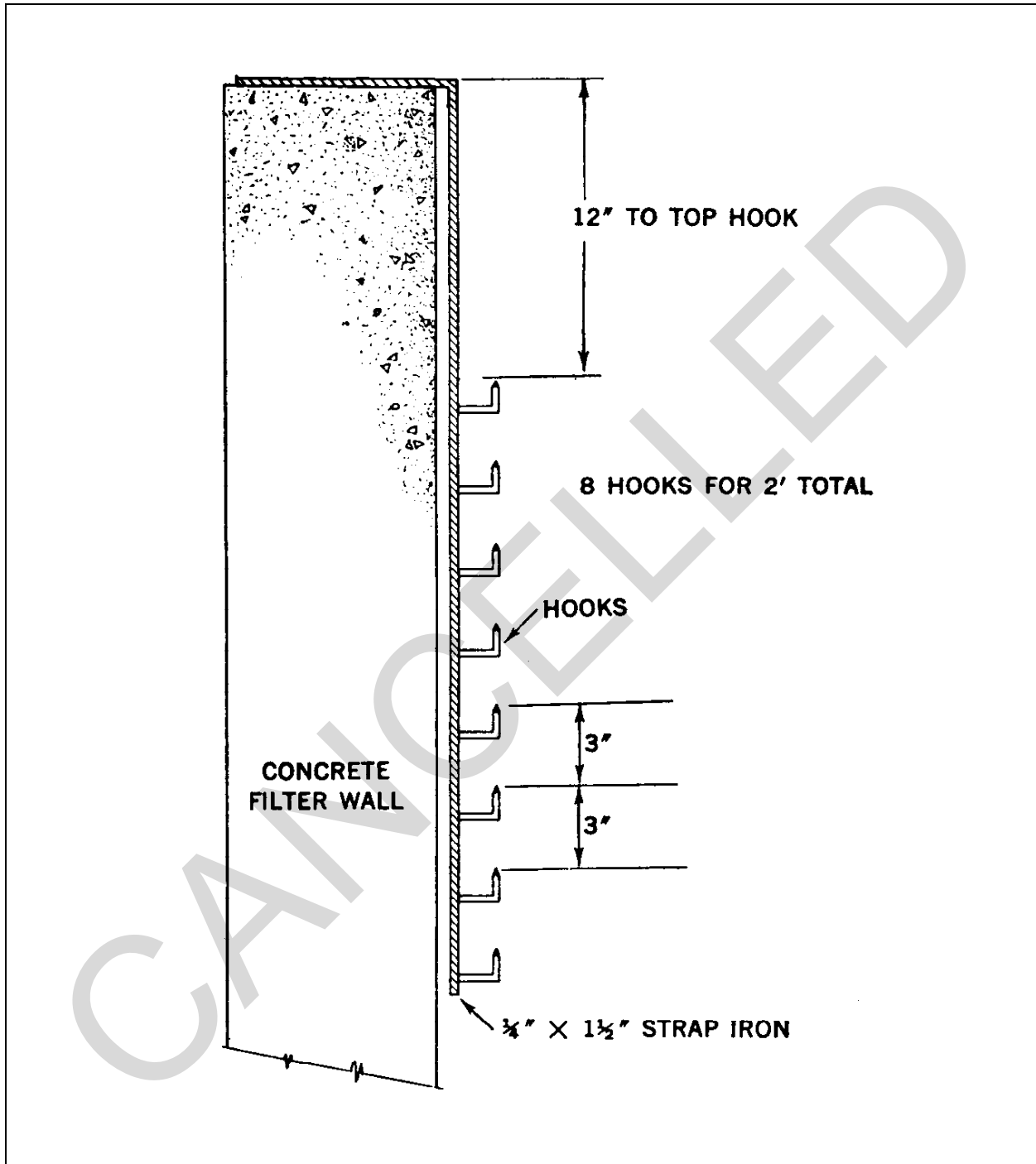

Figure 8  
Multiple Hook Gage

d) Inspect the media twice a year. If visual inspection does not reveal the condition of the media, locate the elevation of the top of the bed to determine if the bed has “grown” in depth. Also, remove a media sample and analyze it as follows:

(1) Make a sampling tube 12 inches (300 mm) square by 36 inches (1 m) deep. Force a tube into the gravel and drain the bed. Remove the sand from the tube. Collect several such samples from well-scattered locations on the filter bed, mix thoroughly, and reduce sample size by quartering until about 2 pounds (1 kg) remain. Dry this sample and mix, quarter, and reduce it to a usable sample size.

(2) Determine the loss of weight of a 10-gram sample during acid treatment. Treat the sample with 10 percent hydrochloric acid in a Pyrex evaporating dish on a water bath for 24 hours. Replace acid loss during treatment period. Wash, dry, and weigh the sand. Determine the weight loss and compare it to the previous analysis.

(3) From the rest of the sand sample, remove 100 grams and run a sieve test. Pass the sand through several standard sieve sizes, weighing the sand grains retained on each sieve. Compare the results to a previous test. Retention of greater amounts of sand on the larger sieve sizes indicates growth of the filter media.

(4) If visual inspection, weight loss, or sieve analysis shows growth of sand grains to a point that filtration efficiency is impaired, treat the sand as outlined in par. 11.5.5.1(b) above and adjust the water treatment process as necessary. If treatment is not effective, remove and replace the filter media.

**11.5.5.2 Loss of Filter Media.** Media can be washed from the filter along with the backwash water or can filter through the gravel layer along with the product water. Losses of media in the backwash water can be kept to a minimum by controlling the backwash flow rate, maintaining level backwash troughs at the proper elevation above the media surface, and controlling hydraulic short circuiting as a result of clogged media or gravel. Losses through the filter gravel can be controlled by placing a layer of coarse garnet or ilmenite between the media and the gravel and by controlling mounding of the filter gravel. Leakage of media can be detected by a small trap located in the effluent line from each filter. Many new filters leak sand for a period and then stop. Such leakage poses no real problem. However, if sand leakage increases over a period, it is probably an indication of mounded gravel.

**11.5.5.3 Gravel Inspection.** Gravel inspection includes the procedures described in (a) through (c) below.

a) At monthly intervals, use a probe to check the gravel bed surface for unevenness. If ridges or sinkholes are indicated, the filter may need overhauling.

(1) Probing a Filter During Backwash. This method uses a metal rod long enough that the operator can reach the gravel layer while standing on the top of the filter. The rod has a heavy grade screen attached to the end so that it can penetrate the expanded filter media bed (the rod is stopped by the gravel layer). By probing every few feet along the filter, mounds or holes in the gravel layer can be discovered. A variation in the gravel level of over 2 inches (50 mm) indicates serious problems.

(2) Probing a Filter at Rest. The filter can be probed at rest using a metal rod of about 1/4-inch (6-mm) diameter that penetrates the sand layer but not the underlying gravel.

b) Remove media from an area of about 3 square feet (0.3 sq m) twice a year, taking care not to disturb the gravel. Examine the gravel by hand to determine whether it is cemented with encrustation or mud balls and whether it is layered improperly.

c) If any undesirable conditions exist to a marked degree, remove the media and re-lay the filter gravel. If unevenness or layer mixing is caused by a faulty underdrain system, repair it; if it is caused by faulty backwashing, correct the backwashing procedure.

11.5.5.4 Filter Underdrain System. Inspect the filter bottom as needed. Sand boils (during backwashing), sand craters on the surface, or marked unevenness of the gravel layers indicate trouble in the underdrain system. Inspection and treatment procedures are as follows:

a) To inspect the bottom, remove the media over an area of about 10 square feet (1 sq m). Select an area where sand boils or other indications of trouble have been noticed. Place planking over the gravel to stand on and remove gravel from areas about 2 feet square (0.2 sq m). Check underdrains for deterioration of any nature. If underdrains need repair, remove all sand and gravel, make repairs, and replace gravel and sand in proper layers.

b) Where underdrains are of the porous-plate type and are clogged with alum floc penetration, flood the underdrain system with a 2 percent sodium hydroxide (caustic soda) solution for 12 to 16 hours.

11.5.5.5 Wash Water Troughs. At quarterly intervals, check the level and elevation of troughs. Draw water below the trough weirs, crack the wash water valve and observe any low points where water spills over the weir before the weir is covered completely.

- a) Adjust the troughs as necessary to produce an even flow throughout their lengths on both sides.
- b) Twice a year, inspect the metal troughs for corrosion. If corrosion exists, allow the troughs to dry, clean by wire brushing, and paint with an appropriate protective paint or coating.

11.5.5.6 Operating Console. Operating controls for filter valves may be mounted on a console, panel, or table. The controls actuate filter valves that may be powered either by hydraulic or pneumatic means. The controls may be connected to the valve mechanism either by cable or chain and operated through electrical, hydraulic, or pneumatic connections.

- a) Perform these maintenance operations each week:
  - (1) Clean the table, console, or panel inside and out, using soap and water if necessary.
  - (2) If the console is cable-operated, inspect it for leaks and stop any leakage; if it is pneumatically operated, check tubing for possible leakage.
- b) Perform transfer-valve maintenance as follows:
  - (1) Adjust 4-way transfer valves and handles each month to make sure that all filter valves open at the same rate. Tighten packing glands or add new packing as necessary.
  - (2) Lubricate transfer valves with grease each month. Do not over lubricate the valves; one-half turn of the grease screw is generally sufficient.
  - (3) Inspect the valve position indicator each month and adjust it to read correctly in all positions.
  - (4) Disassemble the 4-way transfer valves in the table each year. Clean or replace any worn parts, seats, or washers.



c) Paint the inside of the table, console, or panel each year to protect against corrosion.

11.5.5.7 Rate Controllers. Rate-of-flow controllers may be either direct-acting or indirect-acting. Maintenance procedures for both types follow:

a) Direct-Acting Controllers

(1) Each week, clean exterior, check for leakage through diaphragm pot, and lubricate or tighten packing to stop any existing leakage. Also, make sure that both the diaphragm and the control gate move freely between zero differential and the open and closed positions.

(2) At regular intervals, remove and disassemble the diaphragm pot, including the rubber diaphragm. If the water does not cause tubercles, this operation may only need to be performed once every 3 to 5 years.

(3) Every 3 years, disassemble and service the controller gate and mechanism. Inspect the venturi throat. Paint or apply protective coating, as necessary.

b) Indirect-Acting Controllers

(1) Each week, clean the outside of the controller, adjust the packing, and lubricate or tighten the fittings as necessary to stop any leakage from the hydraulic cylinder, the controller valve, the piping, or the pilot valve. Make sure that the knife edges seat correctly and are free of paint and other foreign matter. Also, be sure that the piston has free vertical travel and does not bind. Replace the packing if necessary.

(2) Each year, disassemble, clean, and lubricate the pilot valve. Remove foreign matter from the piston with a cloth. Do not use an abrasive to clean the piston. Make sure that the piston is moving freely. Disconnect and clean the pilot valve piping and strainers; make sure that no foreign matter enters the pilot valve during the cleaning operation. Check for leaks or cracks in the diaphragm.

11.5.5.8 Gages. Indicating and recording instruments mounted on the operating table or control panel may include a filter rate controller, loss-of-head gage, flow-rate gage, water level, backwash flow rate meter, wash water rise indicator, and summation gage for total filter output.

a) Mechanically Operated Loss-of-Head Gage. The equipment that operates the indicator, or indicator recorder instrument, requires the maintenance operations described in the following paragraphs. The inspector should follow these instructions in general and consult the manufacturer's instructions for detailed adjustments.

(1) Each month, check the zero setting in the following way. Open the equalizing valve on mercury float-type head gages and make certain that the indicator arm and the recording pen return to zero. Note the reason for any incorrect reading, and adjust the stop collar or wire cable, if necessary, to bring the indicator to the proper zero reading. On floats and float chambers that are so equipped, release the air. (On some models it is possible to release the air by jerking the wire cable lightly.)

(2) Each month, remove the float from the float chamber, wash the float, and remove encrustations. Use care not to mar the float. Replace the mercury, if necessary, avoiding any spillage. When replacing the mercury, be sure that the amount is correct. Also, paint the interior and exterior of the float chamber and other parts each year to prevent corrosion. In addition, check the pressure pipelines to the float chamber and remove any encrustation.

Caution: Mercury fumes are poisonous. Handle mercury carefully since a spill creates a continuing health hazard and is difficult to clean up.

b) Diaphragm-Pendulum Unit Loss-of-Head Gage. When the actuating mechanism is of this type, the following general maintenance procedures apply. For a more detailed discussion of the procedures, consult the manufacturer's instruction.

(1) Each month, purge the diaphragm cases of air and check the cable to be sure that it leaves the segment at a tangent to the lower end when the unit reads zero. Remove dirt from the knife edges; if necessary, tighten the cam hubs on their shafts. Drain mud from the mud leg as described in par. 11.5.5.8(a)(2) above.

(2) Check the pipelines to the diaphragm twice a year to make sure that they are open and free of encrustation.

(3) Inspect the diaphragms each year for leakage. Replace if necessary.

Note: Spare diaphragms should be kept underwater.

(4) Disassemble the unit in order to clean and lubricate it when necessary. Check the working parts and the cables (they should be free of knots, splices, or fraying). Repack the stuffing box if it is leaking. Make sure that the knife edges rest solely on their edges when the pendulum is hung vertically and be sure that all cable ends are knotted tightly.

c) Mercury-Float-Type Rate-of-Flow Gages. General maintenance procedures are outlined below. For more detailed procedures, consult the manufacturer's instructions.

(1) Once a month, check the unit by opening the equalizing valve to eliminate the differential pressure in the gage. Adjust the indicator, the recording pens, and the register to zero. Check the position of the stop collars on the cables. Also, inspect and clean the stops on the indicator and recording pen.

(2) Every 6 months, check the accuracy of the rate-of-flow gages in the following way. Determine the exact time for the water to drop 1 foot (30 cm), using hook gages. Determine the amount of water in this 1-foot (30-cm) depth (calculate, allowing for inlets, gullets, structural members, etc., or measure the input, if possible, from the wash water rinse or the drop in the level of the wash water tank). During the period timed for the drop in the water level of 1 foot (30 cm), note and record the reading of the flow rate. Calculate the rate of flow and percent error, according to the following equations:

$$\text{Gallons per minute} = \frac{V \times 60}{T}$$

Where:

V = volume in 1 foot depth of water (gallons or liters)

T = drop time (seconds)

$$\text{Percent} = \frac{F_1 - F_2}{F_2} \times 100$$

Where:

Percent = percent of error

F1 = indicated flow rate (gpm  
or liters per minute [L/min])

F2 = measured flow rate (gpm or L/min)

Note: If the error is greater than  $\pm 3$  percent, make the necessary adjustments.

(3) Twice a year, check the pressure pipelines to the float chamber and clean and remove encrustation to allow for free flow.

(4) Once a year, clean the float and check the mercury for replacement. If necessary, paint the interior and the exterior of the float chamber and other parts to protect against corrosion.

11.5.5.9 Piping and Valves. Each month, check for leaks at the joints. Also check the pipe hangers and replace any that have deteriorated. Paint piping, valves, and hangers if necessary to prevent corrosion. Maintenance procedures for valves appear in Section 8.

11.5.5.10 Maintenance Schedule. The maintenance operation frequency and schedule of inspections for filtration are presented in Table 36.

11.5.6 Pressure Filters. Pressure filters need the same care and attention as gravity filters. Open these filters regularly and inspect them carefully. The following maintenance procedures apply:

a) Inspect piping and valves for leaks each week. Lubricate and repack valves if necessary.

b) Open the pressure shell and inspect the filter bed surface each month. Follow procedures described in (1) through (6).

(1) Use a garden rake or probe during backwashing (while the manhole is open) to test for mud balls in the lower part of the filter bed and for evenness of the gravel layer surface.

(2) Determine whether the sand bed level has changed since the last inspection by comparing the bed surface elevation with some reference point.

(3) If the filter does not have a surface wash system and shows evidence of mud balls, backwash it at the highest rate possible while jetting the surface with a stream of water from a high-pressure hose. Install a permanent surface wash system.

(4) Open the filter each year and remove the sand from an area large enough to allow inspection of the gravel. If the sand or gravel distribution indicates non-uniform distribution of backwash water, the filter media and gravel may need to be removed and the underdrain system checked.

(5) Clean and paint the exterior of the shell each year.

(6) Every 3 years (or more often if necessary), remove the filter medium and gravel and check the underdrain system for wash water distribution. Repair if necessary. Clean the underdrain system, and paint it or apply a protective coating to all parts subject to corrosion, including the inside of the shell. Replace the gravel and the filter media.

11.5.7 Precoat Filters. In general, the maintenance procedures for cleaning the filter element are the same for both pressure- or vacuum-filter types. The following procedures apply:

a) Each month, or as often as operating conditions require, check the filter elements. The need for cleaning is evident when the precoat shows bare spots on the elements. Iron oxide deposits, manganese dioxide deposits, and algae growths cause element clogging.

(1) For iron oxide removal, treat the elements with a 0.5 percent solution of oxalic acid. Information is available from the manufacturer on the amount of oxalic acid to use for units of different sizes. The following procedures are used:

- a. Start with an empty filter after a regular washing.
- b. Close the drain valve and the main outlet valve; open the recirculation valve.
- c. Fill the tank to a level covering the top of the elements.
- d. Add the proper quantity of oxalic acid and recirculate for 1 hour.
- e. Drain and hose down the elements and the tank interior.
- f. Close the drain valve; refill, circulate a few minutes, and then drain again. If the cleaning is not completely effective, repeat the procedure.

(2) The procedure for manganese dioxide removal is the same as the procedure for iron oxide removal, except that anhydrous sodium bisulfite is added to the solution rather than oxalic acid (see the manufacturer's instructions for the correct amount).

(3) To remove algae growths, add a 12.5 percent hypochlorite solution to the tank volume after filling the tank to the proper level (see the manufacturer's instructions for the proper amounts to use for units of different sizes).

b) Check the piping and valves and appurtenant equipment twice a year, including the body-feed equipment. Make any adjustments the manufacturer's instructions indicate are necessary.

c) Clean and paint all exterior surfaces, if necessary.

11.5.8 Ion-Exchange Equipment. Ion-exchange maintenance schedule is summarized in Table 37.

11.5.8.1 Operating Conditions. Determine the operating condition of the softener each quarter. Refer to operating records and make such tests and meter readings as are necessary to determine the following information:

a) Flow Rate. Natural ion exchangers can operate satisfactorily at a flow rate of 5 gpm per square foot (3.5 Lps/sq m); synthetic resins operate at a rate of 6 to 7 gpm per square foot (4 to 5 Lps/sq m). Rates higher than these cause undesirable head loss through the bed and bed packing. Adjust the controls of the flow rate each quarter.

b) Backwash Rate. The rate of backwash should be 6 to 8 gpm per square foot (4 to 6 Lps/sq m) of bed surface. Rates below this value do not clean the bed properly. Rates too high wash some of the resin out of the softener and reduce its softening capacity. Adjust the flow rate control to produce the best backwash rate each quarter.

c) Pressure. Each quarter, check operating records for any change in the difference between inlet and outlet pressure. Any change in head loss through the softener indicates a problem. A decrease in pressure drop may indicate improper valve closure or a channelized bed. An increase in pressure drop may indicate a valve not completely opened, a dirty bed, clogged gravel, or a clogged underdrain system.

d) Softening Efficiency. Each quarter, check the records to determine the softening capacity between the regeneration periods. Compare the current amount

of hardness removal with that recorded when the ion-exchange resin bed was new, and calculate the efficiency based on the original capacity as 100 percent. A decrease in efficiency may be caused by a dirty bed, coated resin grains, loss of ion-exchange bed, or improper regeneration (either by weak brine solution or under-regeneration or over-regeneration). Replace resin bed if the efficiency has decreased by 25 percent and it cannot be almost completely restored by cleaning and using special procedures recommended by the manufacturer.

CANCELLED

Table 37  
Maintenance Checklist for Ion-Exchange Softening Units

Inspection	Action	Frequency (1), (2)
Softener unit		
Shell	Clean and wire brush; paint.	A
Valves and fittings	Check for obstructions, corrosion, and fastness.	Q
	Check for leaks; repack if necessary.	SA
Ion-exchange medium	Check bed surface for dirt, fines, and organic growths; remove foreign matter and add resin to desired level.	Q
Gravel	Probe through resin to determine gravel surface; level gravel surface with rake during backwash flow; replace gravel when caked or if resin is being lost to effluent; wash and grade gravel and place in four separate layers; use new lime-free gravel at discretion of inspector.	Q
Underdrains	Check pressure drop through underdrains; if necessary, remove manifold or plate underdrains; clean and replace.	A or V
Regeneration equipment		
Salt-storage unit	Clean tank as necessary to remove dirt.	V
Brine tank	Clean out dirt and insolubles; allow to dry; paint both exterior and interior surface.	SA
Ejector	Clean, disassemble, check erosion and corrosion; clear clogged pipes; assemble and replace.	A



Table 37 (Continued)

Inspection	Action	Frequency (1), (2)
Operating conditions		
Flow rates	Check rate of flow through bed; adjust controls to optimum rate, depending on type of resin.	Q
Backwash rates	Check rate and adjust controls to optimum rate.	Q
Pressure	Check difference between inlet and outlet pressures; if undesirable changes in pressure drop have occurred, seek cause and remedy.	Q
Efficiency	Compare total softening capacity with previous inspection; determine cause of decrease, if any, and remedy situation.	Q
Out-of-service softeners	Drain; keep synthetic resins damp; do not regenerate before draining.	V
Demineralization equipment	Maintain according to manufacturer's instructions.	V

(1) Q-Quarterly; SA-Semiannually; A-Annually; V-Variable, as conditions may indicate.

(2) The frequencies shown are suggested frequencies that may be modified by local command, as individual installation conditions warrant.

11.5.8.2 Demineralization Equipment. Ion-exchange equipment used for demineralization is highly specialized. Maintain it according to the manufacturer's instructions.

#### 11.5.9 Recarbonation Equipment

11.5.9.1 Combustion Units. Maintenance of combustion units depends on the equipment used, fuel impurities, the effectiveness of the scrubber and drier, and the materials of construction. Consult the manufacturer's instructions for maintenance of the compressor or blower.

- a) Operator's Inspection. Each day, check burners, compressor, gages, and traps. Adjust the equipment to ensure top-level operation.
- b) Drier, Scrubber, and Traps. Each month, check material in the drier and replace as necessary. Adjust the spray and clean out connecting piping; clean the gas traps.
- c) Corrosion Inspection. Every 6 months, inspect all equipment for internal and external corrosion. Repair the equipment if necessary, and paint it or use protective coatings.

11.5.9.2 Carbon Dioxide Gas Feeders and Evaporator Units. Maintenance of carbon dioxide gas feeders and evaporator units will generally follow the procedures outlined in par. 11.8 for vacuum operated gas feed chlorinators and liquid chlorine evaporators. Consult the manufacturer's instruction for specific maintenance requirements.

#### 11.5.10 Distillation Equipment

11.5.10.1 Multiple-Effect Evaporators. These evaporators may be of two types:

a) Submerged-Tube Evaporators. As a general practice, remove scale from the evaporator tubes as soon as it becomes 1/16-inch thick, regardless of the model or manufacturer.

(1) Thermal Cracking of Scale. In the tube model, the scale may be cracked by suddenly flooding the shell with cold water after the tubes have been preheated with steam at the first effect coil steam pressure. This method of cracking is the most satisfactory when the scale is less than 1/16 inch thick.

(2) Mechanical Cracking of Scale. Where thermal cracking is not effective, mechanical cracking may be used.

a. Tube Model. Crack the scale by inserting a bar between the lines of tubes.

b. Coil Model. Manually crack the scale by bouncing the coils on a hardwood block in order to crack the heavier coating, then wire brush the coils. Consult the manufacturer's instructions for specific instructions.

Caution: Using a chipping hammer to remove the scale may seriously damage the coils.

(3) Acid Cleaning. In the coil model, scale generally may be dissolved quickly by immersing the coil in a 20 percent solution of inhibited muriatic acid (commercial hydrochloric acid). Wash the coils thoroughly in water before reinstalling them in the evaporator.

(4) Zinc Plate Replacement. Replace the zinc plates when they have been reduced to about one-quarter of their original size.

(5) Condenser and Cooler Tube Cleaning. Clean these tubes (if used) by flushing, wire brushing or scraping, and flushing again before reinstalling them.

(6) Shutdown Protection. If the plant is to be shut down for an indefinite period and is subject to freezing conditions, remove all water from all parts of the evaporator.

b) Flash-Type Evaporators. Specific maintenance instructions are provided by the manufacturer. The following procedures are the recommended minimum:

(1) Check the evaporator stages for corrosion or encrustation each quarter; clean and repair the evaporator as necessary.

(2) Check the steam tube side of the evaporator twice a year and repair it if necessary.

(3) Each year, inspect all parts of the unit (both interior and exterior) for signs of deterioration, and inspect the piping and valves. Repair or renew parts as necessary; paint interiors.

11.5.10.2 Vapor-Compression Distillation Units. Detailed maintenance procedures are found in the manufacturer's instructions. The following procedures are the minimum required:

a) After 200 to 400 hours of operation, check the evaporator for corrosion or encrustation. If the tubes are encrusted, use either chemical or mechanical means for scale removal. Mechanical cleaning is used for hard scale that cannot be removed by chemical treatment.

(1) For chemical treatment, add sodium bisulfate directly, or in solution, to the evaporator. Sulfuric acid and inhibited muriatic acid are better than sodium bisulfate; however, in general they should be used only if approved by the utility

managers. The amount of acid to be added varies depending on the size and type of the unit. Consult the manufacturer's instructions. Generally, the acid cleaning is continued during a 2-hour recirculation period; methyl orange is used as the indicator to show when the acid is spent. After treatment, drain the unit, flush well, rinse with alkaline solution to neutralize any remaining acid, and return to service.

(2) The equipment needed to remove scale formation mechanically includes an electric drill with bit and wire brush attachments that fit the evaporator tubes. The tubes must be wet before the drilling is started. Water is fed through the drill bit during operation. Drill each tube and then wire brush. Remove scale from the evaporator shell or head by scraping; remove all dislodged particles of scale from the evaporator. Reassemble the evaporator and return it to service.

Note: For safety, ground the electric drill used for removing scale, and protect the operator from electrical shock resulting from using an electric drill in a wet environment.

b) Check all mechanical controls, fuel lines, electrical connections, lubrication points, and valves each quarter.

c) Check the engine, vapor compressors, vent condensers, heat exchanger, cooler system, and instrumentation twice a year. Clean, adjust, and repair this equipment as necessary.

d) Check the entire system. Clean, repair each year, and paint as necessary.

11.5.10.3 Maintenance Procedure Schedule. Maintenance operation frequencies and the schedule of inspection for distillation equipment are summarized in Table 38.

11.5.11 Electrodialysis Equipment. When establishing maintenance procedures, follow the detailed instructions provided by the equipment manufacturer. General maintenance procedures for electrodialysis equipment can be found in par. 2.2.27.

11.5.12 Reverse Osmosis Equipment. Membrane equipment is very specialized. Maintain it in accordance with the manufacturer's instructions. General information on reverse osmosis equipment maintenance—including daily, weekly and monthly monitoring, membrane cleaning, and troubleshooting procedures for a variety of operating problems—can be found in pars. 2.2.28 and 2.3.15.

11.5.13 Backflow Preventers. See par. 10.7.

Table 38  
Maintenance Checklist for Distillation Equipment

Inspection	Action	Frequency (1), (2)
Distillation equipment		
Multiple-effect evaporators		
Submerged tube		
Tubes or coils	Remove scale by cracking or acid wash (see manufacturer's instructions).	V
Zinc plates	Remove and replace when reduced to one-quarter of their original size.	V
Condenser or cooler tubes	Clean, as necessary, by wire brushing and flushing.	V
Flash-type evaporators		
Evaporator stages	Check for corrosion or encrustation; clean and repair as necessary.	Q
Stream side of evaporator	Clean and repair.	SA
Entire unit	Check for signs of deterioration; repair or renew parts as necessary; paint exterior.	A
Vapor-compression distillation units		
Tubes in evaporator	Clean.	Every 200 to 400 hours
	Chemically.	V
	Mechanically.	V

Table 38 (Continued)

Inspection	Action	Frequency (1), (2)
Mechanical and electrical controls	Inspect, clean, and repair or replace worn parts.	Q
Engine, vapor compressors, vent condenser, heat exchanger, cooler system, etc.	Inspect, clean, repair, and adjust.	SA
Entire unit	Check, clean, repair, and paint as necessary.	A

- (1) Q-Quarterly; SA-Semiannually; A-Annually; V-Variable, as conditions may indicate.
- (2) The frequencies shown are suggested frequencies that may be modified by local command, as individual installation conditions warrant.

11.5.14 Valves. See par. 8.3.2.

11.5.15 Pumps. See par. 6.5.

11.5.16 Compressors. Table 39 is a checklist of the procedures for maintaining compressors. Note that these procedures are general. Always read and follow the manufacturer's instructions for mechanical equipment.

## 11.6 Lubrication

11.6.1 General Information. Proper lubrication prevents damage to wearing surfaces, reduces the maintenance required, and cuts power costs and equipment outages. The instructions that follow list the recommended lubricants for various uses. Directions for lubricating specific equipment are presented in tabular form and, where desirable, are repeated in the text that applies to the specific equipment items. These instructions may be modified by the operator to meet individual situations, but in general such modifications require the approval of the utility manager.

Table 39  
Maintenance Checklist for Compressors

Inspection	Action	Frequency (1), (2)
Intake Filters	Inspect the compressor filter. Inspect more frequently (daily) in areas with severe dust. (3) Clean or replace as indicated for each filter type.	M SA
Impregnated paper filter	Replace when dirty.	
Cloth filter	Wash with soap and water, dry, and reinstall. Keep spare filter on hand for use when main filter is being washed.	
Wire mesh and oil-bath filter	Clean with a standard solvent; reoil or drain and refill oil bath; reuse.	
Bearings	Inspect bearings and lubricate if necessary. Most compressors have bearings that require oiling.	D
Crankcase reservoir	Examine the reservoir dipstick or sight glass for oil level. Keep reservoir full but do not overfill as excess oil can lock up or damage compressor. (4) Change compressor oil when necessary. If there are filters in the oil system, change these regularly as well.	D Q
Drip-feed oiler	Check drip rate.	D
Force-feed oiler	Check pressure.	D
Grease fittings	Ensure fittings are greased.	Q
Cylinder or casing fins	Clean with compressed air or vacuum to ensure proper cooling of the compressor.	W

Table 39 (Continued)

Inspection	Action	Frequency (1), (2)
Unloader	Check that compressor comes up to speed and that the unloader changes at start of the compression cycle. Listen for a change in sound. When the compressor stops, you will hear a small pop and the air bleeding off the cylinders. If the unloader is not functioning properly, the compressor will stall when starting, fail to start, or (if belt driven) burn off the belts.	D
Safety Valves	Test weekly. Do not change pre-set cutoff settings in high-pressure cutoff switches, low oil pressure switches, and high temperature cutoff switches. If any of these safety switches are not functioning properly, correct the problem before starting the compressor again. Record the safety switch settings and maintain record in the equipment file.	W
Air receiver	Drain the condensate from the air receiver using the valve located at the bottom of the tank. If the air receiver is equipped with automatic drain valves, inspect periodically for proper functioning.	D
Belts	Inspect the belt tension by pressing the belt down approximately 3/4 inch between the two pulleys. Make sure the compressor is locked off before performing this test. Do not over tighten belts.	SA



Table 39 (Continued)

Inspection	Action	Frequency (1), (2)
Operating Controls	<p>Examine regularly. Make sure compressor is stopping and starting at the proper settings.</p> <p>For dual installations, make sure compressors are alternating (if so designed); inspect gage for accuracy. Compare readings with recorded startup values or other known, accurate readings.</p>	Q
Tool oilers	<p>If your compressor has a tool oiler on the receiver, check the reservoir and fill with rock drill oil when necessary.</p>	W
Entire unit	<p>Clean all compressors thoroughly at least once a month. Dirt, oil, grease, and other materials should be cleaned off the compressor and surrounding area. Compressors have a tendency to lose oil around piping, fittings, and shafts; therefore, diligent cleaning is required by the maintenance operator to ensure proper and safe operation.</p>	M

- (1) D-Daily; W-Weekly; M-Monthly; Q-Quarterly; SA-Semiannually; A-Annually; V-Variable, as conditions may indicate.
- (2) Service frequencies shown are suggested. Always follow the manufacturer's service schedule if known. Service frequencies may be modified by local command, as individual installation conditions warrant.
- (3) Note: Never operate a compressor without the suction filter because dirt and foreign materials will collect on the rotors, pistons, or blades and cause excessive wear.
- (4) Heat from the compressor tends to break down oil quickly. Thus, most compressor manufacturers specify particular oils for their equipment and frequent

Table 39 (Continued)

Inspection	Action	Frequency (1), (2)
------------	--------	-----------------------

oil changes are recommended.

11.6.2 Types of Lubricants. Oils, greases, and preservatives for waterworks are listed in Table 40. This list does not contain all the lubricants available under military specifications, but it has been developed in an effort to establish good lubrication practice for normal operating conditions with as small a number of good lubricants as is feasible. Following Table 40 and Table 41 (a list of uses for oils and greases) does not relieve the operator from using lubricants that meet the requirements of the equipment manufacturer's recommendations. The information in Table 40 should be familiar to all maintenance and operating personnel. This list is subject to modification at the judgment of maintenance personnel, providing the modification is approved by the utility manager.

11.6.3 Lubricant Uses

a) Different authorities may make conflicting lube recommendations for essentially the same item; however, general reference material is available to help select the correct lubricant for a specific application.

b) Grease is graded on a number scale, or viscosity index, by the National Lubricating Grease Institute. For example, No. 0 is very soft; No. 6 is quite stiff. A typical grease for most treatment plant applications might be a No. 2 lithium or sodium compound grease, which is used for operating temperatures up to 250°F (120°C).

c) A list of uses for lubricants that are generally satisfactory when used on equipment operating under normal ranges of temperature, pressure, and corrosion is contained in Table 41. However, in view of the wide variation in characteristics of equipment and conditions of operation, the manufacturer's instructions for lubrication should be checked to make sure that listed lubricants meet the requirements of the manufacturer's recommended lubricants.

Table 40  
Lubricating Oils, Greases, and Preservatives

Product	Military Specification Number	Symbol	Approximate SAE Grade(a)	National Stock Number(b)	Temperature Range
Lubricating oil, general purpose	MIL-L-15016A	2075	20W	--	Above
		2110(c)	10W-75W	9150-00-223-4137	-10°F (-23°C)
		2135	20W-75W	9150-00-231-6664	0°F (-18°C)
		2190	30W	9150-00-231-6639	0°F (-18°C)
		2250	40W	--	35°F (2°C)
		3050(c)	20W	9150-00-223-4138	35°F (2°C)
		3065	30W-80W	--	0°F (-18°C)
		3080	40W-90W	9150-00-223-8890	5°F (-15°C)
		3150	140W	9150-00-240-2258	15°F (-9°C)
Lubricating oil, compounded	MIL-L-15019B	4065	40W	9150-00-243-3196	35°F (2°C)
		6135	140W	9150-00-231-6645	60°F (16°C)
		8190	30W	9150-00-231-9033	35°F (2°C)
Lubricating oil, mineral, cylinder	MIL-L-15018B	5190	140W	9150-00-240-2260	60°F (16°C)
Lubricating oil, stream turbine (noncorrosive)	MIL-L-17331B	2190TEP	30W	9150-00-235-9061	60°F (16°C)
Lubricating oil, internal combustion engine, subzero	MIL-L-10295A	OES	--	9150-00-242-7603	-65° to 0°F (-54 to -18°C)
Lubricating oil, instrument jewel-bearing, nonspreading low temperature	MIL-L-3918	OCW	--	9150-00-270-0063	-40°F (-40°C)
Lubricants; chain, exposed-gear and wire rope	VV-L-751A	CW-11B	--	9150-00-246-3276	All
Lubricating oil, internal combustion engine	MIL-L-2104A	OE-10	10W	9150-00-265-9425	-20°F (-29°C)
		OE-30	30W	9150-00-265-9433	0°F (-18°C)
		OE-50	50W	9150-00-265-9440	15°F (-9°C)
Grease, automotive and artillery	MIL-G-10924A	GAA	--	9150-00-190-0907	-65° to 125°F (-54 to 52°C)
Grease, ball and	MIL-G-18709	BR	--	9150-00-249-0908	125° to 200°F

**Table 40**  
**Lubricating Oils, Greases, and Preservatives**

Product	Military Specification Number	Symbol	Approximate SAE Grade(a)	National Stock Number(b)	Temperature Range
roller bearing40 Grease, graphite	VV-G-671C	GG-1	--	9150-00-272-7652	(52 to 93°C) 125°F max. (52°C)
Lubricating oil, internal combustion, preservative	MIL-L-21260	PE-1	--	9150-00-111-0208	
Lubricating oil, preservative, medium	--	PL-MED	--	9150-00-231-2356	
Corrosion preventive, petroleum, hot application	MIL-G-11796A	CL-3	--	8030-00-231-2353	
Corrosion preventive, compound, solvent cutback, cold application	MIL-C-16173B	CT-1	--	8030-00-231-2362	

- (a) SAE numbers 10W through 50W are for crankcase lubrication. SAE numbers 75W through 140W are for transmission lubrication.
- (b) National stock numbers are for 5-gallon containers for lubricating oils and 35-pound containers for grease, except 1/2-ounce can for MIL-L-3918. For other containers see Federal Supply Catalog.
- (c) Quenched.

Table 41  
Lubricating Oil and Grease Uses

Equipment	Oil or Grease Symbol
Air compressors	
Vertical with splash lubrication	
Gage pressure less than 100 psi	2110, 3050
Gage pressure greater than 100 psi	2135, 2190, 3050
Horizontal	2135, 2190, 3050
External lubrication, sight feed, wick feed, hand oiling.	2135, 2190, 3050
External lubrication, circulating system or splash type crankcase	2110, 2135, 3050
Cylinders:	
Wet conditions	8190
Dry conditions	2190, 2250, 3065
Bearings:	
Ball, all temperatures to 200°F (93°C)	BR
Ball, low-pitch line speed	
Operating temperature below 32°F (0°C)	2075
Operating temperature 32° to 150°F (0 to 66°C)	2190, 2250, 3065
Ball, medium-pitch line speed	
Operating temperature below 32°F (0°C)	2075
Operating temperature 32° to 150°F (0 to 66°C)	2135, 3050
Ball, high-pitch line speed	
Operating temperature below 32°F (0°C)	2075
Operating temperature 32° to 150°F (0 to 66°C)	2110, 3050

Table 41  
Lubricating Oil and Grease Uses

Equipment	Oil or Grease Symbol
Ring-oiled, small, miscellaneous	2110
Kingsbury thrust bearing	2190TEP
Thrust (other than Kingsbury, subject to water)	4065
Thrust (other than Kingsbury, not subject to water)	2135, 2190
Bronze guide	GAA
Countershaft	CG 1
Differential (enclosed)	3150, 5190, 6135
Eccentric	3065
Guide	GAA, CG 1
Oilite bronze bushings	OE10, OE30
Pillow block	GAA
Underwater-babbitted	GAA, CG 1
Universal joint, slip splines	BR
Chain Drives	
Roller	3080; GAA, CG1
Roller (enclosed)	Winter, 2075; Summer, 3065
Roller (semi-enclosed)	Winter, 3080; Summer, 6135
Slow-speed	CW-IIB
Medium-speed	5190
Chemical feeders	See manufacturer's instructions

Table 41  
Lubricating Oil and Grease Uses

Equipment	Oil or Grease Symbol
Clarifier equipment	Do
Couplings	6135
Drive jaw clutch	OE50
Gear case or gear head	Low temperature, 3080; High temperature, 5190
Gears	
Herringbone	Winter, 2075; Summer, 3065
Helical	Do
Motor reducers	Winter, 3050; Summer, 2135
Open	5190
Planetary	Winter, 2075, 2110; Summer, 2135
Worm and pump transmission	Winter, 3080; Summer, 6135
Instruments	OCW
Motors	See manufacturer's instructions
Packing, sludge pumps	4065, 6135
Pumps	See manufacturer's instructions
Seal packings	GAA
Shafting	

Table 41  
Lubricating Oil and Grease Uses

Equipment	Oil or Grease Symbol
Large	2190, 3065
Small	2110, 2135, 3050
Shear pins	WB
Sheaves	CG 1, GAA
Solenoid oilers	3050
Valve stems	GAA

11.6.4 Lubricating Precautions. In order to avoid plant failures due to improper lubrication, take the following precautions:

- a) Do not over lubricate. Over lubrication causes antifriction bearings to heat and may damage grease seals; it may also cause damage to the windings in electric motors.
- b) Do not lubricate totally enclosed or insufficiently guarded equipment while the equipment is in motion.
- c) Lubricate greased bearings as follows:
  - (1) Shut off, lock out, tag and block the unit if moving parts that might be a safety hazard are close to the grease fitting or drain plugs.
  - (2) Remove the drain plug from the bearing housing.
  - (3) Remove the grease fitting protective cap and wipe off the grease fitting. Be sure that you do not force dirt into the bearing housing along with the clean grease.
  - (4) Pump in clean grease until the grease coming out of the drain hole is clean. Don't pump grease into a bearing with the drain plug in place. This could easily build up enough pressure to blow out the seals.



(5) Put the protective cap back on the grease fitting.

(6) With the drain plug still removed, put the unit back in service. As the bearing warms up, excess grease will be expelled from the drain hole. After the unit has been running for a few hours, the drain plug may be put back in place. Special drain plugs with spring-loaded check valves are recommended because they will protect against further buildup.

d) Generally, the time between flushing and repacking for greased bearings should be divided by 2 for every 25°F (14°C) above 150°F (65°C) operating temperature. Also, generally, the time between lubrications should not be allowed to exceed 48 months, since lube component separation and oxidation can become significant after this period of time, regardless of amount of use.

e) Another point worth noting is that grease is normally not suitable for moving elements with speeds exceeding 12,000 inches per minute (5 mps). Usually, oil lubricating systems are used for higher speeds. Lighter viscosity oils are recommended for high speeds, and, within the same speed and temperature range, a roller bearing will normally require one grade heavier viscosity than a ball bearing.

f) Keep lubricant containers tightly closed, except when in use, to prevent contamination of the lubricant by the entrance of dust, grit, and abrasives. Store lubricants in dust-free areas. Before using lubricant containers, wipe the spouts and lips; before using grease guns, wipe the gun and fitting to ensure the absence of foreign matter.

g) A good rule of thumb is to change and flush oil completely at the end of 600 hours of operation or 3 months, whichever occurs first. More specific procedures for flushing and changing lubricants are outlined by most equipment manufacturers.

h) Every operator should be aware of the dangers of overfilling with either grease or oil. Overfilling can result in high pressures and temperatures, and ruined seals or other components. It has been observed that more antifriction bearings are ruined by over greasing than by neglect.

i) A thermometer can tell a great deal about the condition of a bearing. Ball bearings are generally in trouble above 180°F (82°C). Grease-packed bearings typically run 10 to 50°F (5 to 30°C) above ambient temperature.

j) For clarifier drive units, which are almost always located outdoors, condensation presents a dangerous problem for the lubrication system. Most units of current design have a condensate bailing system to remove water from the gear housing by displacement. These units should be checked often for proper operation, particularly during seasons of wide air temperature fluctuation.

k) Pumps incorporate many types of seals and gaskets constructed of combinations of elastomers and metals. As for lubricants, conflicting advice can be obtained. A file containing data on general properties of materials used can help in the choice of lubricant.

11.6.5 Grease Fittings. The same grease gun fitting should be provided on all lubrication points requiring the same grease. This practice reduces the number of grease guns required, keeps the use of improper lubricants to a minimum, and simplifies operation.

11.6.6 Identifying Lubricant Items. The product symbol and identifying color should be marked on lubricant containers and grease guns, and at or near all oil cups and grease fittings, to assure the choice of the proper lubricant for that location.

Additional information on lubricants can be found in the publications listed in pars. 2.2.55 and 2.2.56.

11.7 Combustion Engines. Very few water system operators actually repair gasoline- or diesel-powered engines. However, a number of inspections and routine procedures are needed to ensure that these engines are well maintained. A checklist of these procedures can be found in par. 2.1.4.

## 11.8 Chemical Storage and Feeders

11.8.1 General. Different chemical feeders work on very different principles. Each water treatment facility will require several chemical feeders to accurately control chemical application to the process. Some general information is provided in this section and in Section 5 under process headings that require use of chemical feeders. Always read and follow the manufacturer's instructions for mechanical equipment.

### 11.8.2 Lime Slakers

a) Clean the dust-removal and the vapor-removal equipment during every shift. Make sure that dust and moisture do not reach the chemical feeding mechanism and cause caking or corrosion. Remove clinkers or grit not removed by regular operations.

b) While the slaker is out of service each week, clean grit out of each compartment. Wipe off the outside of the slaker with an oily rag. (The thin film of oil prevents the adherence of moisture or lime solution and thus protects paint.) Clean the vapor-removal system and check the mechanism for proper functioning. Clean all appurtenances.

c) Each month, check agitators, stirrers, and heat exchangers; replace any impellers on baffles in front of the heat exchanger that show appreciable wear. Inspect and repair, or replace as necessary, all wiring defects or metal deteriorations. Tighten bolts, eliminate vibration, tighten belts, and paint the equipment where necessary. Every 1,000 to 1,500 hours, lubricate the support bearing-drive with grease (do not use oil).

d) Overhaul lime slakers each year. Drain and clean the slaker and dust-removal system. Check the slaker bottom and sides for wear and repair them as necessary. Paint the exterior and inside top edges of the slaker lids to protect them from corrosion. Check the for leaks and scale in the heat exchanger. Clean the thermometers and check their accuracy. Clean and lubricate all bearings. Repair controls, floats, piping, screens, valves, and vapor-removal equipment. Paint all equipment where necessary.

11.8.3 Gas Chlorinators. The operator should be familiar with the equipment to be maintained. An instruction book is furnished with every chlorinator; consult it for specific steps to follow in servicing. Should the book be lost, the manufacturer can supply a duplicate (as long as the model and serial numbers are included with the request for replacement). Follow the manufacturer's suggestions for O&M. This paragraph offers general maintenance procedures that apply to all gas chlorinators. A troubleshooting chart for solution-feed, vacuum-operated gas chlorinators is included as Table 42. General maintenance procedures for chlorination equipment are summarized in Table 43.

a) Inspect Chlorinator for Leaks. Examine the chlorinator and all piping for chlorine or water leaks each day. All chlorine leaks are serious because they increase rapidly in size and cause extensive corrosion and damage. Red discoloration at gas header connections means that a leak is corroding the fittings. Use an ammonia-water bottle to locate the chlorine gas leak. Do not pour ammonia water on the suspected leak. Rather, waft the open bottle near the suspected leak. If chlorine vapor is present, a dense white cloud will appear. Use litharge and glycerine cement or Teflon tape in making all metal-threaded pipe connections. Do not use grease or oil.

b) Operate the Chlorine Valves. Open and close all chlorine valves each day to ensure proper and complete operation. Do not use force in closing a valve. Repair or replace any faulty valves at once.

c) Check the Water System. Each month, clean the water strainers and check the pressure reducing valve for proper operation. Clean the injector nozzle and throat once a year. (Insufficient injector vacuum usually indicates that cleaning is required.) Muriatic acid may be used for cleaning mineral deposits from the injector nozzle and throat.

Table 42  
 Troubleshooting Checklist for Solution-Feed, Vacuum-Operated Gas Chlorinators

Symptom	Possible Cause
Flowmeter fails to indicate gas flow.	Gas supply valve closed. Gas supply cylinder(s) empty. Insufficient ejector vacuum. Filter in gas-inlet connection block dirty. Dirty flowmeter. Rate valve closed. Rate valve dirty. Air leakage in regulator stack. Vacuum regulator valve plug stuck in closed position.
Ejector vacuum is insufficient.	Ejector water supply valve closed. Solution line valve closed. Dirty strainer. Dirty ejector. Partially or fully blocked solution line. Ejector throat not full of water (applies only when ejector is mounted in horizontal position and back pressure is zero or less). Insufficient water supply flow rate and

Table 42  
 Troubleshooting Checklist for Solution-Feed, Vacuum-Operated Gas Chlorinators

Symptom	Possible Cause
	pressure for existing back pressure conditions. Drain valve leaking air. Insufficient booster pump discharge pressure.

Table 42 (Continued)

Symptom	Possible Cause
Gas flow rate cannot be controlled.  Maximum gas flow rate produces too low a residual in the treated process liquid.  Minimum gas flow rate produces too high a residual in the treated process liquid.  Flowmeter continues to indicate flow when ejector water supply valve is closed.  Water leaks from ejector into gas line.	Condensed gas vapor (liquid chlorine) in chlorinator.  Dirty vacuum regulator valve. Air leakage in regulator stack. Insufficient ejector vacuum.  Chlorinator capacity too low. Air leakage caused by dirty sealing surfaces.  Chlorinator capacity range too high.  Condensed gas vapors (liquid chemicals) in chlorinator. Vacuum regulator valve stuck in the open position. Solution line draining due to a back pressure of zero or less. Ball stuck in flowmeter.  Diaphragm backflow check valve not seating properly.

CANCELLED

Table 43  
Maintenance Checklist for Chlorination Equipment

Inspection	Action	Frequency (1), (2)
Operation maintenance	Insert a new lead gasket in the chlorine valves or tubes to cylinders or equipment.	V
Condensation on chlorine cylinders	Ventilate.	V
Chlorine leak detection	Use an unstopped bottle of aqua-ammonia to detect leaks; repair immediately.	D
Gas system	Disassemble, clean, and replace faulty parts in piping, meters, valves, and tubing.	D
Chlorine valves	Open and close valves to assure that all are operable; check stuffing boxes and repair or replace faulty valves or packing.	D
Chlorine solution tubes	Look for location of potential leaks, and for iron and manganese deposits; if iron or manganese are present, treat with a solution of hexametaphosphate in makeup water.	A
Chlorine feeder water supply	Clean water strainers and pressure reducing valves; adjust float valves and ejector capacity.	M
Hard-rubber threads, valves and parts	Disassemble or operate; use graphite grease to prevent freezing; hand tighten only—do not use tools.	Q
Vacuum relief	Clean out any obstruction.	D
Cabinet and working parts	Clean all parts where accumulation may interfere with proper operation.	W

Table 43 (Continued)

Inspection	Action	Frequency (1), (2)
Overhaul  Direct-feed chlorinators	Disassemble and clean all parts thoroughly; paint cabinet inside and out; examine parts and repair or replace as needed; use care in choice of cleaning agents and lubricants.  Use same procedures as for solution-feed machine where they apply.	A

- (1) D-Daily; W-Weekly; M-Monthly; Q-Quarterly; A-Annually; V-Variable, as conditions may indicate.
- (2) The frequencies shown are suggested frequencies that may be modified by local command, as individual installation conditions warrant.

d) Check the Gas System. Check all piping and parts carrying chlorine gas to verify that they are operating properly. Check flexible connectors at the gas-supply containers. (To maintain a gas-tight seal, use a new lead gasket each time a valve or tube is connected, including each time an empty chlorine cylinder is replaced.) Remove and clean gas filters periodically. Check the heater each day to make sure it is warm. See that metering devices, pressure reducing and shutoff valves, hose lines, etc., work properly. Disassemble and clean when necessary, to determine the cause of the fault. At the first sign of weakening, replace any faulty parts.

e) Clean the Cabinet and Critical Working Parts. Thoroughly clean the chlorinator cabinet, glass parts, flowmeter, rate valve, vacuum regulator valve, and other parts in which dirt may interfere with operations or make equipment unsightly. Clean and cover unpainted metal that is subject to corrosion with a proper protective coating.

11.8.4 Liquid Chlorine Evaporators. The chlorine vessel on the inside of the evaporator and the water bath mechanism are the primary components requiring maintenance. The chlorine vessel is subject to internal corrosion from chlorine and external corrosion from the water bath. The chlorine vessel and the water bath are normally cleaned and inspected every 2 years or after evaporating 250 tons of chlorine, whichever occurs first. The sacrificial anodes in the cathodic protection system in the



evaporator should be replaced when the evaporator is taken apart for cleaning and inspection. Follow these steps to clean the evaporator:

- a) Dismantle and remove the chlorine vessel from the evaporator.
- b) Flush the chlorine vessel with cold water to remove corrosion products from the inside.
- c) Visually inspect the interior for pitting. If pitting is severe, replace the chlorine vessel.
- d) Remove all flushing water and reassemble the evaporator.
- e) Fill the water bath and heat it to 180°F (82°C). Attach an aspirator so that a vacuum can be exerted on the inside of the chlorine vessel. The vacuum should be about 25 inches (635 mm) of mercury, and should be held for 24 hours with the water bath at 180°F (82°C), to make sure that all moisture is removed from the inside of the chlorine vessel.

#### 11.8.5 Hypochlorite Solution Feeders

- a) Hypochlorite solutions are highly alkaline. The reaction of this alkaline material with the hardness in the makeup water results in carbonate scale deposits in the pump head and tubing, and in the solution diffuser at the point of application. Dilute (5 percent) hydrochloric (muriatic) acid solution can be pumped through the hypochlorinator to remove this scale. Be sure to flush out the hypochlorite solution with water first.
- b) The diaphragm continually flexes. Inspect it to make sure it operates properly.
- c) Check valves and seats for corrosion, hardening, swelling, scale, or foreign material that might prevent proper seating. Refer to solution-feeder maintenance information in par. 11.8.7 for additional maintenance procedures.

11.8.6 Dry Chemical Feeders. Maintenance procedures for dry chemical feeders are summarized in Table 44.

#### 11.8.7

Table 44  
Maintenance Checklist for Dry Chemical Feeders

Inspection	Action	Frequency (1), (2)
Dry feeders	Remove chemical dust accumulations; check feeder performance; check for loose bolts; clean solution tank of accumulated sediment; lubricate moving parts.	D
Drive mechanisms and moving parts	Service and lubricate.	Q
Calibration	Check feed-rate accuracy and adjust, as necessary	M
Overhaul feeders	Thoroughly clean feeder and feeding mechanism; paint; service and lubricate drive mechanisms and bearings; clean and paint solution tanks.	A
Feeders out of service	Clean; remove all chemicals from hopper and feeder mechanisms.	V
Disc feeders	Clean rotating disc and plow.	V
Oscillating feeders	Check and adjust mechanism and adjustable stroke rod.	M
Rotary gate feeders	Clean pockets of star feeder and scraper.	M
Belt-type feeders	Check vibratory mechanism, tare-balance, feeding gate, belt drive and belt; calibrate delivery.	M
Loss-in-weight feeders	Check feeder scale sensitivity, tare-weight, and null balance.	M
Screw feeders	Clean screw, check ratchet drive or variable speed drive.	M
Dust collectors		
Motors	Lubricate motors	V
Filter bags	Check condition and attachment. Securely attach sound bags; replace damaged or torn bags.	V

(1) D-Daily; M-Monthly; Q-Quarterly; A-Annually; V-Variable, as conditions may indicate.

(2) The frequencies shown are suggested frequencies that may be modified by local command, as individual installation conditions warrant.

11.8.7.1 Test Calibration. Make monthly calibrations to check the accuracy of feed-rate and control mechanisms. Indicate or record feed rates and amounts. The test procedures in Table 45 apply to various feeders.

11.8.8 Solution Feeders. Maintenance procedures for solution feeders are summarized in Table 46.

11.9 Tanks and Reservoirs. Water storage facilities are maintained according to the procedures listed in Table 47. The following paragraphs cover the activities involved in painting tanks: surface preparation, paint application methods, and paint selection. Additional information on tank inspection, painting, and maintenance can be found in pars. 2.1.4 and 2.2.41.

11.9.1 Paint Systems for Steel Storage Tanks

11.9.1.1 Surface Preparation. Good surface preparation is required to ensure adequate bonding of the paint to the metal to be protected. See par. 11.10.4.1.

a) If the original surface preparation was poor and the mill scale was not removed when the tank was originally painted, blast cleaning is required before repainting. If the original surface preparation was adequate, but the old paint has completely broken down, blast cleaning of areas with loose or failing paint is usually warranted. If the old paint is still in good condition, only those areas with loose paint need to be removed by wire brushing or sanding.

b) All areas that have been cleaned of loose paint down to the bare metal need to be primed before rust has a chance to form. Follow Steel Structures Painting Council specifications.

Table 45  
Calibration Tests for Dry Chemical Feeders

Inspection	Action	Frequency (1),(2)
<p>Volumetric dry feeders</p> <p>Test calibration and adjust feeder</p>	<p>Perform the test described below for your type of volumetric dry feeder (with or without scale) and repeat several times.</p> <p>Average the data from several tests to compare with the rate setting, rate indicator, and recorder (if one is used). Take particular care in the timing and weighing operations.</p> <p>Make any adjustments necessary to bring the feed rate within <math>\pm 5</math> percent by weight of the rate setting.</p>	W
<p>Feeders not on a scale</p>	<p>Make at least three tests within the normal operating range of the feeder.</p> <p>Use a pan or other container of known weight to catch the discharge of the feeder for a definite period. Weigh the discharged material, calculate the rate of feed per hour, and compare the results with the rate setting, rate indicator, and recorder (if one is used).</p>	W
<p>Feeders on a platform scale</p>	<p>Balance the scale or record initial reading while the feeder is stopped; start the feeder and run for a definite period; rebalance the scale (i.e., record weight loss).</p>	W

Table 45 (Continued)

Inspection	Action	Frequency (1),(2)
	From the difference in the two scale readings, calculate the amount fed in the measured time and then calculate the feeding rate in pounds per hour.	
Belt-type gravimetric feeders	Calibrate weekly or whenever the feeder is used for a different chemical.	W or V
Clean belt and feeder	Clean according to manufacturer's instructions	W or V
Set initial balance	<p>Balance the scale and operate the feeder until the feeder scale beam is in full balance and indicates a proper load on the belt. If the feeder is proportionally paced, set the proportioning equipment on "manual control." Set the rate-of-feed at maximum and proceed with the following calibration test.</p> <p>Stop the feeder and make sure the scale moves freely and is in exact balance.</p> <p>Adjust the amount of chemical on the belts by adding or removing chemical at the rear of the belt, until an exact balance is obtained.</p> <p>Zero the belt revolution counter or weight integrator, start the feeder, and run it until a definite weight of chemical has been discharged (about two-thirds of a belt load). Then stop the feeder.</p>	W or V
Determine weight of material discharged	<p>Rebalance the scale precisely.</p> <p>The difference between this scale reading and the one taken during the test is the weight of material discharged.</p>	W or V

Table 45 (Continued)

Inspection	Action	Frequency (1),(2)
Compare balance and revolution counter; adjust poise if necessary	<p>Check the calculated amount of material discharged against the number of pounds fed as indicated by the revolution counter. If the weight of the chemical delivered differs from that indicated by more than <math>\pm 1</math> percent, adjust the poise on the scale beam and repeat the test. (Moving the poise to a lower value reduces the loading on the belt and vice versa.)</p> <p>Repeat testing and adjustment until a belt loading is found that agrees with the amount fed, as indicated by the totalizer counter.</p> <p>Note: Some belt type gravimetric feeders may be made to discharge into a container of known weight, in which the feed rate may be checked by actually weighing the amount discharged at a definite time.</p>	W or V
Loss-in-weight gravimetric feeder	<p>Test calibration of this feeder is similar to the test calibration method used for the belt-type gravimetric feeder.</p> <p>When the feeder is empty, check the tare weight to make sure that the scale shows 0 weight. All other determinations and adjustments are similar to the belt-type gravimetric feeder described above.</p>	W or V

- (1) W-Weekly; V-Variable, whenever new chemical is used in feeder.
- (2) The frequencies shown are suggested frequencies that may be modified by local command, as individual installation conditions warrant.

Table 46  
Maintenance Checklist for Solution Chemical Feeders

Inspection	Action	Frequency (1), (2)
Pot feeders		
Flow through pot	Determine amount of chemical fed to ascertain if flow through pot is effective.	D
Sediment trap	Clean trap and check needle valve.	M
Chemical pot	Clean pot and orifice.	SA
Overhaul	Clean and paint pot feeder and appurtenances.	A
Differential solution feeders		
Chemical storage tank	Inspect and clean.	SA
Oil volume	Check and replenish.	SA
Pitot tubes and needle valve	Check and replace as necessary.	A
All equipment	Paint as necessary.	V
Decanter feeders		
Swing-pipe	Check to make sure it does not bind.	M
Motor ratchet, pawl, reducing gears	Check and lubricate.	SA
Overhaul	Inspect, clean, repair, and paint all parts as necessary.	A or V
Rotating dipper feeders		
Motor	Follow manufacturer's instructions	V

Table 46 (Continued)

Inspection	Action	Frequency (1), (2)
Transmission	Change oil after 100 hours of operation.	Every 100 hours
	Drain and flush, clean interior, and refill.	SA
Shaft bearings	Lubricate.	W
Drive chain	Clean, check alignment; check sprocket teeth; lubricate chain and sprockets.	M
Agitator	If used, clean and lubricate according to manufacturer's instructions.	V
Belt drives	Check alignment, tension, and inner cords of belt drives.	M
Dipper and float valve	Check dipper clearance and adjust float valve setting.	SA
Proportioning pumps		
Operator's inspection	Inspect sight feeders, rate of flow, piping, joints.	D
Feeder	Clean feeder.	W
Solution tank	Clean.	M
Linings	If cracks occur, special linings should be repaired.	A
Overhaul	Disassemble, clean, and overhaul.	A

- (1) D-Daily; W-Weekly; M-Monthly; SA-Semiannually; A-Annually; V-Variable, as conditions may indicate.
- (2) The frequencies shown are suggested frequencies that may be modified by local command, as individual installation conditions warrant.



Table 47  
Maintenance Checklist for Storage Facilities

Inspection	Action	Frequency (1), (2)
Complete inspection	Drain, clean, and examine interior surfaces. Repair as required. Disinfect before returning to service.	Every 3 to 5 years
Foundations, wood	Check for settlement, cracks, spalling, and exposed reinforcing; repair as necessary with 1 part cement to 1 part sand.	SA
Foundations, concrete	Check wood foundations and pads for checked, split, rotted or termite-infested members; also check for direct contact of untreated wood with soil. Repair or eliminate undesirable conditions as necessary.	SA
Concrete tanks (ground-level storage)		
Walls	<p>Check exterior for seepage; mark spots.</p> <p>Check exterior and interior for cracks, leaks, spalling, etc.</p> <p>Remove loose, scaly, or crumbly concrete; patch with rich cement grout; paint grout with iron waterproofing compound.</p> <p>Chip out cracks and repair with cement slurry.</p> <p>For cracks in prestressed tanks, consult designing and/or erecting company.</p>	<p>SA</p> <p>A (Spring)</p> <p>A</p> <p>A</p> <p>A</p>
Expansion joints	Check for leakage; check for missing filler; clean and repair as necessary.	SA

Table 47 (Continued)

Inspection	Action	Frequency (1), (2)
Roofs	Check condition; check hatches; check screens on openings. Clean as necessary.	SA
Earth embankments	Check for erosion, burrowing animals, improper drainage, and leakage through embankment. Repair as necessary. If leakage through the embankment exists, drain tank and look for cracks in tank walls or bottom.	SA
Concrete tanks (underground storage)	Check interior walls, roof, appurtenances and embankment; if leakage is evident, excavate and repair walls.	SA
Concrete tanks (elevated storage)	Check and repair.	SA or A
Steel tanks (ground-level storage)	Check for ice damage in spring; repair as necessary.	A
Walls and bottom	Examine exterior and interior for rust, corrosion products, loose scale, leaky seams, and rivets and for condition of paint.	SA
	Replace rivets or patch leaking areas, as necessary.	V
	Check painted surfaces for deterioration; paint as necessary.	SA
Roofs	Check condition, hatches, screens, manholes and paint; lock hatches; remove spider rods if corroded; repair, replace, or paint, as necessary.	SA

Table 47 (Continued)

Inspection	Action	Frequency (1), (2)
Steel tanks (standpipes)	If problem is noted during inspection, arrange for an outside contractor to repair the steel tank.	SA
Steel tanks (underground storage)	Check tank interior, roof, and appurtenances.	SA
Steel tanks (elevated storage)	If problem is noted during inspection, arrange for an outside contractor to repair the steel tank.	SA
Tanks	Use contractor.	SA
Tower structures	Check for corrosion and for loose, missing, bowed, bent, or broken members; loose sway bracing; misalignment of tower legs; or evidence of instability. Repair as necessary.	SA
Roofs	Check obstruction and navigation lights, hoods, shields, receptacle, and fittings for missing or damaged parts or inoperation; also check lightning rods, terminals, cables, and ground connections; repair, replace, or renew; paint as necessary.	SA
Risers and heating systems	Two months before freezing weather, check riser pipe insulation and repair as necessary; also check heating system operation.	A
	One month before freezing weather, operate heating system for 8 hours; repair or adjust defective parts.	A

Table 47 (Continued)

Inspection	Action	Frequency (1), (2)
Cathodic protection	<p>Check flow of current; if absent, check fuses, anodes, ground wire connections and immersion of electrodes; adjust or repair as necessary. If current flow or amperage is above desired level, adjust as necessary; make certain that connections to rectifier are not reversed.</p> <p>Check anode condition; replace as necessary.</p>	<p>V</p> <p>V</p>
Wooden tanks Towers	<p>Check for loose, missing, twisted, bowed, cracked or split pieces; also check for termite infestation, misalignment of legs, and evidence of loose sway bracing; repair and eliminate undesirable conditions; paint as necessary.</p>	SA
Tanks	<p>Check operating records to make certain tank is kept filled; also check structural condition of tank for soundness, evidence of leakage, and corrosion of steel bands. Check all appurtenances, ladders, roofs, screens, etc.; make any repairs or adjustments necessary.</p>	SA
Pneumatic tanks	<p>Paint metal parts; paint timber only if necessary for appearance.</p>	A
Pneumatic tanks	<p>Inspect air pump and motor; check operating record of time cycle; check for air leaks, if time cycle is too short; check valve operations, particularly pressure relief valves.</p>	Q

Table 47 (Continued)

Inspection	Action	Frequency (1), (2)
Appurtenances   Miscellaneous appurtenances  Grounds	Check tank for signs of corrosion; take steps necessary to eliminate corrosion or protect against it.	A
	Check ladders, walkways, guardrails, handrails, stairways, and risers for rust, corrosion, poor anchorage, missing pieces, general deterioration or damage; replace or repair parts as necessary.	SA
	Check all electrical connections and conduits leading to tanks; make any repairs or adjustments necessary.	SA
	Check for accumulations of debris, trash, and foliage; clean the area.	SA

- (1) Q-Quarterly; SA-Semiannually; A-Annually; V-Variable, as conditions may indicate.
- (2) The frequencies shown are suggested frequencies that may be modified by local command, as individual installation conditions warrant.

### 11.9.1.2 Paint Application Methods

a) Paint may be applied by a number of methods:

- (1) Brushing
- (2) Air spraying
- (3) Airless spraying
- (4) Roller application
- (5) Special methods for applying heavy coatings.

b) The method best suited for application depends on the type of paint, degree of complexity of the surface being painted, paint viscosity, and other considerations, such as the amount of spray carryover with spray-painting techniques. The paint manufacturer and a professional painting contractor can advise installation personnel of the best application method for the tank being painted. Apply paint according to the instructions in par. 2.4.4.1.

### 11.9.1.3 Paint Selection

a) Select protective coatings in accordance with par. 2.4.4.1. It is normally recommended that only paints meeting ANSI/NSF Standard 61 be used on surfaces in contact with potable water. Environmental conditions affecting the exterior of the tank and water characteristics within the tank result in varying painting system requirements. A reputable paint manufacturer can provide valuable guidance in paint selection, based on laboratory testing results and experience with painting systems on similar tasks.

b) Paint testing may be required on tanks for which a particular paint system has proven unsatisfactory. Various painting systems can be used on different areas of the tank to determine which system performs the best.

c) The thickness of the dried paint film should be specified and measured after the painting has been completed. Various paints require varying dry-film thickness for optimum life.

d) In general, it is best to use paints that require similar surface preparation procedures for both the interior and exterior of the tank, since these procedures are usually conducted in a single operation.

e) Paragraph 2.2.54 includes standards for several outside and inside paint systems. The standard gives general information on the suitability of the paint systems under varying conditions, as well as information about surface preparation, paint-film thickness, and procedures for applying paint. Paint systems used for painting tanks on military installations should meet or exceed the requirements established in this standard.

11.9.2 Cathodic Protection for Steel Tanks. Design standards and specifications for cathodic and impressed current protection of steel water tanks may be found in pars. 2.3.19 and 2.3.20. For general information on corrosion of exposed and buried metals, refer to par. 2.2.19. The primary reference for cathodic protection is MIL-HDBK-1136 (par. 2.4.4.2).

11.9.2.1 Limitations. Cathodic protection is limited to structures in contact with an electrolyte, such as soil or water. In steel elevated water storage tanks, only the inside surfaces of the riser and the submerged bowl can be protected. Protect the outside of the tank from atmospheric corrosion by some other means.

11.10 Pipelines. Because pipes are normally buried and out of sight, pipeline maintenance is often neglected. Components of a pipeline maintenance program include inspection, leak detection and repair, flushing, pigging, slip-lining, cement-mortar lining, wrapping, and cathodic protection. These and other aspects of pipeline maintenance are covered in pars. 2.1.4, 2.2.41, and 2.3.18.

11.10.1 Protective Coatings. To supplement the information provided above about corrosion protection for specific equipment, this paragraph offers general information about corrosion-inhibiting coatings.

11.10.2 General Information. The prevention of corrosion and surface deterioration is standard maintenance practice in waterworks. Protect all exposed surfaces, whether external or internal. Protective coatings and linings may be nonmetallic or metallic. The former includes paint, enamel, bitumen, cement, plastic, and rubber. Metallic coatings include zinc, aluminum, and lead. Other corrosion-control treatments are used on metal equipment surfaces that cannot be painted. Cathodic protection is used where electrolytic corrosion occurs.

11.10.3 Paint Protection. Surface coating with paint is the most general method of corrosion prevention. Try to select paint to meet the existing conditions; the choice depends on whether or not the equipment or structure is indoors or outdoors.

11.10.4 Paint Application. Prepare and apply surface paints according to the procedures detailed in par. 2.4.4.1.

11.10.4.1 Surface Preparation. Before applying the paint, prepare all surfaces. Foreign substances on the surface interfere with the protective action of the coating. Therefore, remove loose scale, rust, dust, oil, or grease completely. For best results, paint only clean surfaces. Sandblast metal surfaces if required. Use sandpaper on a wire brush where required. Wipe off dust and clean greasy or oily surfaces with solvent cleaners. Take special precautions when removing lead-based paints. See par. 2.4.4.1.

11.10.4.2 Preparation of Paint. Paint should be mixed properly and screened, if necessary, to remove grit and film. Cover paint containers when not in use. Clean brushes, rollers, and spray applicators before and after use. For damp surfaces, where drying temperatures are less than 40°F (4°C), specially prepared paints are normally used.

11.10.5 Corrosion-Preventive Compounds. Corrosion-preventive compounds are used in pits, pump dry-wells, and damp areas. Paint does not serve this purpose. Two corrosion-preventive compounds commonly used in waterworks are shown in Table 40.

11.11 Chain Drive. Chain drives may be designed for slow, medium, or high speeds. Follow these steps to maintain chain drives:

- a) Check Operation. Check general operating conditions during regular tours of duty.
- b) Check Chain Slack. The correct amount of slack is essential for proper chain drive operation. Unlike belts, chains should not be tight around the sprocket. When chains are tight, working parts carry a much heavier load than necessary. Too much slack is also harmful. A properly installed chain has a slight sag or looseness on the return run. All drive chains should have a tightener.
- c) Check Alignment. If sprockets are not in line or if shafts are not parallel, excessive sprocket and chain wear results. To check alignment, remove the chain and place a straight edge against sides of the sprocket where no wear has occurred. Replace sprockets and chain if they are excessively worn.
- d) Lubricate. Lubrication depends on the drive speeds. Refer to the manufacturer's manual and par. 11.6.2 for lubricant types.



(1) **Slow-Speed Drives.** Because slow-speed drives are not usually enclosed, adequate lubrication is difficult. Heavy oil applied to the outside of the chain seldom reaches the working parts; in addition, the oil catches dirt and grit and becomes abrasive. Soak exposed-type chains in a recommended lubricant to restore lubricating film. Remove excess lubricant by hanging the chains up to drain. Do not lubricate chains on elevators, conveyers, or feeders that handle dirty, gritty material. Dust and grit combine with lubricants to form a cutting compound that reduces chain life. Do not lubricate underwater chains that operate in contact with considerable grit. If the water is clean, lubricate the chain with the recommended lubricant with a brush while the chain is running.

(2) **Medium-Speed Drives.** Continuously lubricate medium-speed drives with a drip- or sight-feed oiler. The lubricant type depends on temperature conditions.

(3) **High-Speed Drives.** High-speed drives should be completely enclosed in an oil-type case and the oil maintained at proper level. Oil type depends on temperature conditions. Drain the oil and refill the case to the proper level according to the manufacturer's recommendations.

e) **Clean and Inspect**

(1) On enclosed types, flush the chain and enclosure with kerosene. On exposed types, remove the chain. Soak and wash it in kerosene. Clean the sprockets, install the chain, and adjust the tension.

(2) Note and correct abnormal conditions before serious damage results. Do not put a new chain on old sprockets. Always replace old sprockets when replacing a chain. Old, out-of-pitch sprockets cause as much chain wear in a few hours as years of normal operation.

f) **Troubleshooting.** A troubleshooting checklist for chain drives is included as Table 48.

Table 48  
Troubleshooting Checklist for Chain Drives

Symptom	Cause of Trouble	Remedy
Broken pins or rollers.	Shock loads or chain speed too high for pitch.	If speed-pitch relation is cause, use chain of shorter pitch.
Chain climbs sprockets.	Poor fit or severe overload.	If sprockets fit poorly, renew; make sure tightener is installed in drive chain.
Chain clings to sprockets.	Possibly incorrect or worn sprockets or heavy tacky lubricants.	Renew or reverse sprockets, or change to proper lubricant.
Chain gets stiff.	Poor alignment or excessive overload.	Correct alignment and eliminate overload.
Chain whips.	Too long centers; or high pulsating loads.	Correct either condition.
Noise.	Misalignment; improper slack, loose bolts.	Correct alignment; adjust slack; tighten bolts; reverse or renew worn chain.
Wear on chain side walls or sides of teeth.	Misalignment.	Remove chain and correct alignment.

## 11.12 Tools and Equipment

11.12.1 Tool Inventory. Effective maintenance requires that the tools needed to service the facility properly be readily available. Table 49 provides a list of suggested tools to keep at the facility for general maintenance use. Specific tools may be required for specialized equipment. Special test equipment may also be needed. Consult the manufacturer's instructions for such equipment needs.

11.12.1.1 Tool Care and Usage. Tools have specific uses and in general should not be used for other purposes. When the proper tool is not available, try to obtain it.

11.12.1.2 Tool Storage. For easy retrieval, keep tools on a tool board or in a toolbox. Keep the board or box clean and, if appropriate, paint it once a year. In general, tools not in their proper places should be in use; if not, find them and return them to their proper places.

11.12.1.3 Tool Inspection. It is a good practice to inspect tools every month. Damaged or worn tools can be replaced and edged tools (chisels, planes) kept sharp if they are regularly checked. Clean and lubricate tools before returning them to storage.

11.12.1.4 Caution and Usage. Do not use a screwdriver as a chisel, pliers as a wrench, or a wrench as a hammer. Do not use toothed-jaw (stillson-type) wrenches on hard rubber pipe, bolts, or nuts.

11.12.2 Equipment and Supplies. In addition to proper tools, a water treatment plant should be adequately supplied with the equipment, implements, and supplies that are essential to proper maintenance. Good housekeeping is a part of maintaining buildings and grounds and a part of operating equipment. Thus, in-house equipment and materials usually include housekeeping and gardening tools, equipment, and supplies. Table 50 lists the suggested implements. Table 51 lists materials and supplies to keep at the facility.

Table 49  
Suggested Tools for Water Treatment Plants (1)

Axes, spare ax handles	"C" clamps, assorted
Awls	Cotter pin puller
Bars	Countersink, assorted for wood or metal
Crow	Cutters, wire
Wrecking	Cutters, 1/2-inch (10-mm) bolt
Bit brace and assortment of bits for wood and metal	Dies, assorted for bolt and pipe threading stocks
Blacksmith's anvil, tools, forge, and hand blower	Drills, assorted
Bolt stock and dies	1/2-inch (13-mm) electric, portable with drill press stand mount
Breast drill and assortment of drills	3/8-inch (10-mm) electric, cordless, 12-volt
Calipers	Drills, assorted (continued)
Inside and outside	1/4-inch hand drill, heavy duty
Micrometer	1/4-inch hand drill, heavy duty
Caulking tools, water main type (assorted sizes and types)	Drill bits
Chisels	Twist drills, high speed fractional set 1/16-inch to 1/2-inch x 64ths
Assorted	Twist drills, high speed metric set 1.0-mm to 13 mm x 0.5 mm
Bull point	Spade bits 1/4-inch to 1-1/2-inch by 1/8ths (6-mm to 40-mm)
Cape	Masonry bits, carbide tip, for rotary drills 1/4-inch x 4-inch, 5/16-inch x 4-inch, 3/8-inch x 4-inch, 1/2-inch x 6-inch (6-mm x 100-mm, 8-mm x 100-mm, 10-mm x 100-mm, 13-mm x 150-mm)
Cold	
Diamond point	
Round nose	
Assorted, wood	
Assorted, for air hammer	

Table 49  
Suggested Tools for Water Treatment Plants (1)

Hand	Hammers
Press, bench type	Ball peen, assorted sizes
Star drills of various sizes	Blacksmith's type
Extractors, screw, various sizes	Claw
Files	Mason's
Assorted sizes	Caulking
Flat	Sledge-type, various sizes
Half round	Hatchet
Round	Jacks, screw or hydraulic, various sizes
Taper (triangular)	Joint runner, asbestos, for use with lead joints
Wood rasp	Lathe
Fire pot, including metal foot and wrought steel ladle for use with B and S cast iron pipe	Metal, 12-inch (300-mm) swing, 24-inch (600-mm) centers
Flanging tools, for use with copper pipe	Tools and appurtenances
Flaring tools, for use with copper pipe	Lead pot and ladles
Fuse puller	Levels
Gages	Line
Set of shims	Spirit, metal frame, 18-inch (500-mm)
Test for pressure and vacuum	Line, Mason
Glass cutter	Manhole-cover lifting hooks
Grinder	Mattock
Electric or hand, bench type	Nail sets, various sizes
Wheels, coarse, fine, and wire brush	Oil cans, several types and sizes as required
Hacksaw, adjustable frame with extra blade	

Table 49  
Suggested Tools for Water Treatment Plants (1)

Packing hooks	Saws, rip, crosscut, compass and keyhole
Packing tools, assorted	Screwdrivers, various sizes
Pipe Cutter	Saw set
Pipe Cutter, wheels (spare)	Saw vise
Pipe taps	Scale platform
Pipe thread taps (combination), 1/4- to 2-inch (6- to 50-mm)	Screw pitch gage
Pipe threading stock with assorted dies	Scribers
Pipe tripod	Sharpening stone
Plane, smooth, bench, 7-inch (180-mm)	Shovels
Pliers	Square point, long and short handle
Assorted sizes	Round point, long and short handle
Diagonal cutting	Snake, 25-foot (8-m) spiral
Gas	Soldering iron and appurtenances
Combination slip joint	Specific tools for specialized equipment
Needlenose	Square, steel, large and small
Wrench	Stamping tools, steel, letters and numerals
Plumb bob	Straight edge, steel
Puller, gear set	Tampers
Punches, assorted sizes, center, drift	Tape, 50-foot (15-m) steel
Putty knives	Tar pot
Reamers, hand, taper, pipe expansion	Torch, blow and gasoline
Rules, 6-foot folding	

Table 49  
Suggested Tools for Water Treatment Plants (1)

Trowels	Wrenches
Floats, steel, and cork assorted	Adjustable, various sizes
Pointing	Allen set screw
Valve resetting tool	Box wrench set
Vises, bench and pipe, portable chain vise and stand	Hydrant
Voltage tester	Monkey
Wall scrapers	Open end, various sizes
Washer or gasket cutter for making own washers	Ratchet, socket set
Welding outfit with appurtenances, goggles and gloves	Socket, set of various sizes
Wire stripper	Spanner
	Stillson, various sizes
	Torque
	Valve

(1)Authorization (Table of Allowances) for specific tools is issued by individual services.

Table 50  
Suggested Equipment for Water Treatment Plants

Equipment	
Alemite or zerk grease guns for plant equipment	Paint sprayer
Block and tackle for 1/2-inch and 3/4-inch rope (10- to 20-mm)	Pick
Boots, rubber	Rope, 1/2-inch, 3/4-inch, 1-inch, 10-, 20-, 25-mm) and sash cord.
Brooms, street, ordinary, industrial	Safety equipment:
Brushes, flue, paint and whitewash, scrubbing, wire	Barricades
Caulking gun for windows	Electric blankets
Chain hoist, 1-ton (1,000-kg) capacity	First aid equipment
Electric drop light, explosion-proof with 200-foot (60-m) extension cord	Gas detector
Electric torch light, 1-1/2 or 3-volt	Gas mask (chlorine)
Flashlights, hand	Harness (safety belt) with 25 feet (8 m) x of 3/4-inch (20-mm) rope
Gloves, rubber and canvas work	Respirator for paint spraying, dust, etc.
Hydrometers, battery and alcohol	Warning signals
Ladders, step, extension (20-foot)	Squeegees, floor and window
Lanterns, red and white globe	Torches, bomb-type
Leak detectors	Two-wheel hand trucks
Manhole lifter	Vacuum cleaner
Mop and handle	Valve key
	Waste cans
	Wheel barrow, rubber-tired
	Wringer buckets



Table 50 (Continued)

Garden Implements	
Brush hooks	Lawn mower (hand or motor)
Garden trowel	Pruning shears
Hedge clippers	Rakes, wood, steel
Hoe	Scythe
Hose: Garden type (300-foot)	Sickle
Nozzle (Shut-off type)	Spade
Insect sprayer	Sprinklers
Lawn roller	

Table 51  
Suggested Materials and Supplies for Water Treatment Plants

Materials	
Alcohol or antifreeze	Chain, assorted sizes and lengths
Assortment of bolts, nuts, washers, screws, cotterpins, rivets, lock washers, cap screws, stud bolt, etc., stored in jars or cans	Chamois skins
Bricks, common	Cleaning powders, assorted
Calcium chloride (for icy pavements)	Cleaning solvents (kerosene, dry-cleaning solvent, wood alcohol)
Caulking compound	Cups, drinking
Caulking compounds, Duro-lite or equal, for glass house windows	Cutter wheels, spare
Caulking yarn	Disinfectants
Cement	Emery cloth, assorted grades
Cement, asbestos	Fittings, brass or iron, assorted sizes
	Flashlight batteries
	Fuses, assorted Glass

Table 51  
Suggested Materials and Supplies for Water Treatment Plants

Graphite	Polish, brass
Grease, for lubrication	Putty
Hose, nipples, and clamps for garden hose, extra	Rags, clean and sterilized
Iron and boiler cement	Sand, stone or gravel
Kerosene	Sandpaper, assorted grades
Lead and lead wool	Soap
Light bulbs	Solder
Measures, oil, 1-quart and 1-pint	Soldering paste
Mops	Spare handles for hammers, hatchets and axes
Nails, assorted sizes	Spare parts for all machines and apparatus
Oakum	Sponges
Oil for lubrication	Steel wool
Oil, rust removing, penetrating	Tape, friction and electrician's
Packing for pumps	Thermometers, assorted
Paint remover	Toilet paper
Painter's drop cloths	Towels
Paints, turpentine, linseed oil, thinners, etc.	Valve grinding compound
Pipe joint compound	Waste, wiping
Pipe stock, depending on system	Wicks, for torches and lanterns
Plugs, rubber expansion	Wire, annealed No. 10 and No. 16

## Section 12: SWIMMING POOL OPERATIONS

12.1 Responsibilities. Water system operators are responsible for the operation, purification, and sanitation of swimming pools and spas at military installations. Responsibilities generally include monitoring water chemistry and maintaining pool equipment, including filters, pumps, and valves. In addition, operators may oversee emergency and accident procedures, administrative practices, and safety measures.

12.2 References. Refer to service-specific policy statements for guidance and direction regarding the responsibilities of operating personnel in providing O&M services at swimming pools and spas:

- a) AFOSH Standard 48-14, Swimming Pools, Spas, Hot Tubs, and Bathing Areas (par. 2.4.1.4) (Air Force)
- b) AR 420-29, Utility Services (par. 2.4.2.2) (Army)
- c) TM 5-662, Repair and Utilities: Swimming Pool Operation and Maintenance (par. 2.4.2.4) (Navy)

When complete, MIL-HDBK-1167, Swimming Pool Operation and Maintenance (par. 2.4.4.4), will be used by all service branches.

Detailed information about pool equipment and management can be found in The Pool-Spa Operators Handbook (par. 2.2.57), a publication of the National Swimming Pool Foundation (NSPF). This reference guide covers the following topics:

- a) Types of pools
- b) Filters and filtration
- c) Pool circulation and recirculation equipment
- d) Pool water sanitizing, chemical balance, water testing, management, and maintenance
- e) Operational problems and chemical adjustments
- f) Care of seasonal pools
- g) Disease and accident prevention

12.3 Operations. Table 52 provides a monthly operating checklist for swimming pool management. If problems occur, refer to the troubleshooting checklist provided in Table 53.

Table 52  
Monthly Operating Checklist for Swimming Pools(1)

Monthly Inspection	Specific Procedure/Requirement
Clean chemical feeders	Follow manufacturer's recommendations for cleaning feeders. Alternatively, follow the steps outlined below: <ol style="list-style-type: none"> <li>a) Turn off the feeder.</li> <li>b) Remove the foot valve and strainer from the chemical solution being pumped.</li> <li>c) Place the assembly in fresh water and pump for 5 minutes to remove all chemicals.</li> <li>d) Place the foot and strainer in a 10 percent solution of muriatic acid. Turn on the pump. Run at least a pint of the acid through the unit.</li> <li>e) Remove the assembly from the acid solution and submerge in fresh water to remove all acid from the unit. Pump fresh water for at least 5 minutes to remove all acid before returning the unit to its original chemical solution.</li> </ol>
Check gas chlorinators	See par. 11.8.3.
Check filter media	For sand filters: check for mud balls, channeling, or abnormalities; rake sand clean; add or replace sand if necessary. For D.E. filters: check filter septa for tears or holes; repair if necessary. For cartridge filters: soak in a cleaner to remove excess oils.
Check safety equipment and barriers	Inspect light fixtures, electronic surveillance equipment, GFIs, and fire extinguishers. Check integrity of all barriers, doors, locks and latches.

(1) This checklist was created using information from The Complete Swimming Pool Reference (par. 2.2.38).

Table 53  
 Troubleshooting Checklist for Swimming Pools

Symptom	Possible Cause of Trouble	Remedy
Cloudy water	Poor coagulation and filtration	Establish correct alum dosage; backwash filters and apply fresh floc to filters; maintain proper chlorine residual.
Cloudy water: greenish	Algae: chlorine too low	Maintain proper chlorine residual.
	Copper corrosion: pH low	Adjust pH by adding soda ash; maintain Langelier saturation index within recommended range.
Cloudy water: milky	pH low	Adjust pH by adding soda ash.
	PH high in hard waters	Adjust pH by adding sodium bisulfate or dilute hydrochloric acid. (Note: Use of these chemicals is for special cases only and requires permission of base medical officer.)
	Too much alum	Reduce alum dosage.
	Defective diatomaceous earth filter element	Repair or replace.
Cloudy water: rusty	Iron corrosion: pH low	Adjust by adding soda ash; maintain Langelier saturation index within recommended range.
	Iron in makeup: poor filtration	Establish correct alum dosage; backwash filters and apply fresh floc to filters; maintain proper chlorine residual. Ensure filters are in proper operational order by conducting required inspection and maintenance.

Table 53 (Continued)

Symptom	Possible Cause of Trouble	Remedy
Discolored side walls or bottom: green	Algae: chlorine too low	Maintain proper chlorine residual. If adjustment of chlorine residual does not adequately remove the problem, drain pool and scrub walls and bottom with 5 mg/L chlorine solution. Rinse well before refilling pool.
	Copper corrosion: pH low	Adjust pH by adding soda ash; maintain Langelier saturation index within recommended range.
Discolored side walls or bottom: rusty	Iron corrosion: pH low	Adjust pH by adding soda ash; maintain Langelier saturation index within recommended range. If problem is severe, drain pool and scrub walls with strong soap solution. If soap fails to remove stain, scrub with 2 to 5 percent solution of muriatic acid. Rinse well and refill pool.
	Iron in makeup: poor filtration	Establish correct alum dosage; backwash filters and apply fresh floc to filters; maintain proper chlorine residual. Ensure filters are in proper operational order by conducting required inspection and maintenance. If problem is severe, drain pool and scrub with strong soap solution. If soap fails to remove stain, scrub with 2 to 5 percent solution of muriatic acid. Rinse well and refill pool.
Eye irritation	pH low Chlorine high	Adjust pH by adding soda ash. Adjust chlorinator to maintain proper chlorine residual.

Table 53 (Continued)

Symptom	Possible Cause of Trouble	Remedy
Inlet flow low	Chlorine low Pumps not operating	Adjust chlorinator to maintain proper chlorine residual. Look for clogged suction or discharge lines or air leaks in suction line. Check pump switches, valves, stuffing box, and internal parts. See pump maintenance procedures in par. 6.5.
Filter runs short Skin irritation	Hair catcher needs cleaning Too much alum pH high	Clean. Reduce alum dosage. Adjust pH by adding sodium bisulfate or dilute hydrochloric acid. (Note: Use of these chemicals is for special cases only and requires permission of base medical officer.)
Slime on sides or bottom	Chlorine too low	Drain pool and scrub walls and bottom with 5 mg/L chlorine solution. Rinse well before refilling pool. Maintain proper chlorine residual.
Water feels slippery	pH high	Adjust pH by adding sodium bisulfate or dilute hydrochloric acid. (Note: Use of these chemicals is for special cases only and requires permission of base medical officer.)

## Section 13: SAFETY AND HEALTH

13.1 Pertinent Regulations. All military agencies are subject to the provisions of OSHA. Portions of the act that apply to O&M of water treatment plants fall under Part 1910, Occupational Safety and Health Standards, and its subparts.

OSHA standards are implemented at military installations by way of specific service regulations. The service regulations are available through the installation's safety, occupational health, and fire department officers. Keep these regulations in the workplace and make them available to all personnel. Appropriate safety precautions are included throughout this handbook and in applicable references. Specific instructions are included in the appropriate service regulations. Instruction manuals and other training aids are available through the library or training office.

13.2 General Safety Guidelines. General guidelines for safe work practices and techniques for a variety of water utility work situations can be found in:

- a) Manual of Water Supply Practices: Safety Practices for Water Utilities (par. 2.2.2)
- b) Principles and Practices of Water Supply Operation Series (pars. 2.1.1 through 2.1.5)
- c) Work Practices for Asbestos-Cement Pipe (par. 2.2.67)



APPENDIX A  
SAMPLE CALCULATIONS

5/3 Rule Sample Computation

1. Working hours required per position per year. A work position entails a commitment of 8 work hours per work position per day.

$$(8 \text{ hours/day}) \times (365 \text{ days/year}) = 2,920 \text{ hours/year}$$

2. Paid hours per work year:

$$(40 \text{ hours/week}) \times (52 \text{ weeks/year}) = 2,080 \text{ hours/year}$$

3. Nonproductive hours, typically vacation (160 hours), sick leave (40 hours), holiday (80 hours), training (48 hours):

Say 328 hours per year.

4. Hours actually worked per work year:

$$(2,080 \text{ hours/year}) - (328 \text{ hours per year}) = 1,752 \text{ hours/year}$$

5. Number of employees required to staff 1 position per shift:

$$(2,920 \text{ hours/year}) / (1,752 \text{ hours/year}) = 1.667 \text{ employees/position/shift}$$

6. Number of employees required to staff 1 position for 3 shifts.

$$(1.667 \text{ employees/position/shift}) \times 3 \text{ shifts} = 5 \text{ employees/position}$$

7. Labor rate (actual cost to agency).

Say \$20.66 /hour

8. Agency cost to staff 1 position:

$$(1.667 \text{ employees/position}) \times (2,080 \text{ hours/year}) \times (\$20.66 \text{ /hour}) = \$71,636/\text{position}$$

## APPENDIX A (Continued)

## Static Level, Pumping Level, and Drawdown Calculation

1. Assume a length of air line (L) of 150 feet (ft). Assume that the pressure gage reading ( $P_1$ ) before starting the pump is 25 pounds per square inch (psi).
2. Convert pressure to feet of water (A) to determine the height of water above the bottom of the air line:  $(A) = 25 \times 2.31 = 57.7$  ft.
3. Calculate the static water level (B) by subtracting the calculated height from the known air line length:  
 $(B) = L - A = 150 - 57.7 = 92.3$  ft.
4. Assume that the gage reading ( $P_2$ ) during pumping is 18 psi. Convert this pressure to feet (C) to determine the height at which water stands in the well above the bottom of the air line during pumping:  $(C) = 18 \times 2.31 = 41.6$  ft.
5. Calculate the pumping level (D) by subtracting (C) from the known length of air line:  
 $(D) = L - C = 150 - 41.6 = 108.4$  ft.
6. Determine the drawdown using any of the following methods:

$$D - B = 108.4 - 92.3 = 16.1 \text{ ft}$$

$$A - C = 57.7 - 41.6 = 16.1 \text{ ft}$$

$$P_1 - P_2 = 25 - 18 = 7 \text{ psi}; 7 \text{ psi} \times 2.31 = 16.1 \text{ ft}$$

## APPENDIX A (Continued)

## Metric Static Level, Pumping Level, and Drawdown Calculation

1. Assume a length of air line (L) of 45.7 meters (m). Assume that the pressure gage reading ( $P_1$ ) before starting the pump is 172 kiloPascals (kPa).
2. Convert pressure to meters of water (A) to determine the height of water above the bottom of the air line:

$$(A) = 172 \text{ kPa} \times \frac{4.0147 \text{ inch H}_2\text{O}}{\text{kPa}} \times \frac{0.0254 \text{ m}}{\text{inch}} = 17.5 \text{ m}$$

3. Calculate the static water level (B) by subtracting the calculated height from the known air line length:  
(B) = L - A = 45.5 - 17.5 = 28.2 m.
4. Assume that the gage reading ( $P_2$ ) during pumping is 124 kPa. Convert this pressure to meters (C) to determine the height at which water stands in the well above the bottom of the air line during pumping: (C) = 124 x 0.102 = 12.6 m.
5. Calculate the pumping level (D) by subtracting (C) from the known length of air line:  
(D) = L - C = 45.7 - 12.6 = 33.1 m.
6. Determine the drawdown using any of the following methods:

$$D - B = 33.1 - 28.7 = 4.9 \text{ m}$$

$$A - C = 17.5 - 12.6 = 4.9 \text{ m}$$

$$P_1 - P_2 = (172 - 124) \times 0.102 = 4.9 \text{ m}$$

## APPENDIX A (Continued)

## Field Head Calculation

1. Assume that a pressure gage located on the discharge of a well pump indicates a pressure of 35 pounds psi for a discharge of 500 gallons per minute (gpm). The corresponding pumping level in the well is 60 ft below the elevation of the pressure gage. The pump column is 8 inches in diameter and extends into the well 100 ft below the pump discharge.
2. The friction loss for 500 gpm of water through an 8-inch pipe, with a friction coefficient (C) of 100, is 8.1 ft divided by 1,000 ft. The equivalent length of an 8-inch long sweep elbow is 13 ft. Thus, the friction loss through the column and discharge elbow can be calculated as follows:

$$113 \text{ ft} \times \frac{8.1 \text{ ft}}{1,000 \text{ ft}} = 0.9 \text{ ft}$$

For help with head loss calculations, refer to par. 2.1.1.

3. The vertical distance from the well pumping level to the pressure gage was given as 60 ft.
4. The pressure at the pressure gage expressed as ft of head equals:

$$35 \text{ psi} \times \frac{2.31 \text{ ft}}{\text{psi}} = 80.9 \text{ ft}$$

5. Total field head is the sum of the friction loss, vertical distance, and pressure in ft of head:

$$0.9 \text{ ft} + 60 \text{ ft} + 80.9 \text{ ft} = 141.8 \text{ ft}$$

## APPENDIX A (Continued)

## Metric Field Head Calculation

1. Assume that a pressure gage located on the discharge of a well pump indicates a pressure of 240 kPa for a discharge of 30 liters per second (Lps). The corresponding pumping level in the well is 18 m below the elevation of the pressure gage. The pump column is 200 millimeters (mm) in diameter and extends into the well 30 m below the pump discharge.
2. The friction loss for 30 Lps of water through a 200-mm pipe, with a friction coefficient (C) of 100, is 2.5 m divided by 300 m. The equivalent length of a 200-mm long sweep elbow is 4 m. Thus, the friction loss through the column and discharge elbow can be calculated as follows:

$$34 \text{ m} \times \frac{2.5 \text{ m}}{300 \text{ m}} = 0.28 \text{ m}$$

For help with head loss calculations, refer to par. 2.1.1.

3. The vertical distance from the well pumping level to the pressure gage was given as 18 m.
4. The pressure at the pressure gage expressed as meters of head equals:

$$240 \text{ kPa} \times \frac{0.1020 \text{ m}}{\text{kPa}} = 24.5 \text{ m}$$

5. Total field head is the sum of the friction loss, vertical distance, and pressure in ft of head:

$$0.28 \text{ m} + 18 \text{ m} + 24.5 \text{ m} = 42.8 \text{ m}$$

## REFERENCES

NOTE: THE FOLLOWING REFERENCED DOCUMENTS FORM A PART OF THIS HANDBOOK TO THE EXTENT SPECIFIED HEREIN. USERS OF THIS HANDBOOK SHOULD REFER TO THE LATEST REVISIONS OF CITED DOCUMENTS UNLESS OTHERWISE DIRECTED.

FEDERAL/MILITARY SPECIFICATIONS, STANDARDS, BULLETINS, HANDBOOKS, AND NAVFAC GUIDE SPECIFICATIONS:

Unless otherwise indicated, copies are available from the Naval Publishing and Printing Service Office (NPPSO), Standardization Document Order Desk, Building 4D, 700 Robbins Avenue, Philadelphia, PA 19111-5094.

AFR 91-26/ TM 5-660/ NAVFAC MO-210	Maintenance and Operation of Water Supply, Treatment, and Distribution Systems (30 August 1984)
MIL-HDBK-1110	Paints and Protective Coatings
MIL-HDBK-1136	Cathodic Protection Operation and Maintenance
MIL-HDBK-1165	Water Conservation
MIL-HDBK-1167	Swimming Pool Operation and Maintenance

AIR FORCE REGULATIONS, MANUALS, INSTRUCTIONS, AND GUIDES:

Unless otherwise indicated, copies are available from the Air Force Publications Distribution Center, 2800 Eastern Boulevard, Baltimore, MD 21220-2896.

AFI 32-1066	Plumbing Systems
AFI 32-1067	Water Systems
AFI 32-7047	Compliance Tracking and Reporting
AFM 85-31	Industrial Water Treatment

AFM 88-45	Civil Engineering Corrosion Control-Cathodic Protection Design
AFOSH Standard 48-14	Swimming Pools, Spas, Hot Tubs, and Bathing Areas
AFOSH Standard 91-25	Confined Spaces
AL-TR-1991-0049	Water Vulnerability Assessments

ARMY REGULATIONS, MANUALS, INSTRUCTIONS, AND GUIDES:

AR 40-5	Health and Environment
AR 420-49	Utility Services
TB MED 575	Swimming Pools and Bathing Facilities
TB MED 576	Sanitary Control and Surveillance of Water Supplies at Fixed Installations
TM 5-662	Repair and Utilities; Swimming Pool Operation and Maintenance
TM 5-813	Water Supply: Source, Treatment, and Distribution Systems

NAVY REGULATIONS, MANUALS, INSTRUCTIONS, AND GUIDES:

BUMEDINST 6240.10	Standards for Drinking Water
NAVFAC MO-2109	Inspection of Elevated Water Tanks
OPNAVINST 5090.aB	Environmental and Natural Resource Program Manual, Chapter 8: "Drinking Water Systems and Water Conservation"

NAVFACENGCOM Guide Specification,  
Section 02090, Removal and Disposal of Lead-  
Containing Paint (Lead/Federal)

OTHER GOVERNMENT DOCUMENTS AND PUBLICATIONS:

EO 12902	Energy Efficiency and Water Conservation in Federal Facilities
U.S. Army CRREL	Preliminary Report: Field Test of Trash Rack Heating to Prevent Frazil Ice Blockage (F. Donald Haynes, et al., Hanover, New Hampshire: U.S. Army CRREL, 1991.
U.S.A.I.D.	U.S.A.I.D. Desalination Manual (Office of Engineering, U.S. Agency for International Development (out of print)
Technical Report N-86/11	Emergency Water Supply Planning for Fixed Army Installations (USA-CERL)
NTIS PB92 112 101	Lead and Copper Rule Guidance Manual — Vol I: Monitoring (USEPA)
EPA 811-B-92-002	Lead and Copper Rule Guidance Manual — Vol. II: Corrosion Control Treatment



NONGOVERNMENT PUBLICATIONS:

## AMERICAN WATER WORKS ASSOCIATION (AWWA)

AWWA Standard D102	Painting and Repainting Steel Tanks, Standpipes, Reservoirs, and Elevated Tanks for Water Storage
AWWA E101	AWWA Standard for Vertical Turbine Pumps: Line Shaft and Submersible Types
ANSI/AWWA A100	AWWA Standard for Water Wells
AWWA Standard C651-92	Disinfecting Water Mains
AWWA M2	Manual of Water Supply Practices: Automation and Instrumentation
AWWA M3	Manual of Water Supply Practices: Safety Practices for Water Utilities
AWWA M4	Manual of Water Supply Practices: Water Fluoridation Principles and Practices
AWWA M5	Manual of Water Supply Practices: Water Utility Management Practices
AWWA M6	Manual of Water Supply Practices: Water Meters-Selection, Installation, Testing and Maintenance
AWWA M7	Manual of Water Supply Practices: Problem Organisms in Water—Identification and Treatment
AWWA M9	Manual of Water Supply Practices: Concrete Pressure Pipe
AWWA M11	Manual of Water Supply Practices: Steel Pipe—A Guide for Design and Installation
AWWA M12	Manual of Water Supply Practices: Simplified Procedures for Water Examination
AWWA M14	Manual of Water Supply Practices: Recommended Practice for Backflow

	Prevention and Cross-Connection Control
AWWA M17	Manual of Water Supply Practices: Installation, Field Testing, and Maintenance of Fire Hydrants
AWWA M19	Manual of Water Supply Practices: Emergency Planning for Water Utility Management
AWWA M20	Manual of Water Supply Practices: Chlorination Principles and Practices
AWWA M21	Manual of Water Supply Practices: Groundwater
AWWA M22	Manual of Water Supply Practices: Sizing Water Service Lines and Meters
AWWA M23	Manual of Water Supply Practices: PVC Pipe Design and Installation
AWWA M24	Manual of Water Supply Practices: Dual Water Systems
AWWA M25	Manual of Water Supply Practices: Flexible-Membrane Covers and Linings for Potable Water Reservoirs
AWWA M27	Manual of Water Supply Practices: External Corrosion—Introduction to Chemistry and Control
AWWA M28	Manual of Water Supply Practices: Cleaning and Lining Water Mains
AWWA M30	Manual of Water Supply Practices: Precoat Filtration
AWWA M31	Manual of Water Supply Practices: Distribution System Requirements for Fire Protection
AWWA M32	Manual of Water Supply Practices: Distribution Network Analysis for Water Utilities
AWWA M33	Manual of Water Supply Practices: Flow

## Meters in Water Supply

AWWA M36	Manual of Water Supply Practices: Water Audits and Leak Detection
AWWA M37	Manual of Water Supply Practices: Operational Control of Coagulation and Filtration Processes
AWWA M38	Manual of Water Supply Practices: Electrolydialysis and Electrodialysis Reversal
AWWA M40	Manual of Water Supply Practices: Reverse Osmosis and Nanofiltration
AWWA M41	Manual of Water Supply Practices: Ductile-Iron Pipe Fittings
AWWA M44	Manual of Water Supply Practices: Distribution Valves-Selection Installation, Field Testing, and Maintenance

Advances in Taste-and-Odor Treatment and Control

Assessment of Existing and Developing Water Main Rehabilitation Practices (AWWARF)

Case Studies of Modified Disinfection Practices for Trihalomethane Control (AWWARF)

Centrifugal Pumps and Motors: Operation and Maintenance

Corrosion Control for Operators

Cross-Connection and Backflow Prevention

Distribution System Maintenance Techniques

Drinking Water Handbook for Public Officials

Evaluation and Restoration of Water Supply Wells (AWWARF)

Filtration Strategies to Meet the Surface Water Treatment Rule

Guidance Manual for Compliance with the Filtration and Disinfection Requirements for Public Water Systems Using Surface Water Sources

Identification and Treatment of Tastes and Odors in Drinking Water (with Lyonnaise des Eaux)

Internal Corrosion of Water Distribution Systems (AWWARF)

Lead Control Strategies (AWWARF)

Maintaining Distribution System Water Quality

Maintenance Management

Management of Water Treatment Plant Residuals

Minimizing Earthquake Damage

Principles and Practices of Water Supply Operations Series: Basic Science Concepts and Applications

Principles and Practices of Water Supply Operations Series: Water Quality

Principles and Practices of Water Supply Operations Series: Water Sources

Principles and Practices of Water Supply Operations Series: Water Transmission and Distribution

Principles and Practices of Water Supply Operations Series: Water Treatment

Procedures Manual for Polymer Selection in Water Treatment (AWWA Research Foundation)

Procedures Manual for Selection of Coagulant, Filtration, and Sludge Conditioning Aids in Water Treatment,

Reservoir Management for Water Quality and THM Precursor Control (AWWARF)

SDWA Advisor: Regulatory Update Service

Sludge Handling and Disposal

Standard Methods for the Examination of Water and Wastewater (with the American Public Health Association [APHA] and the Water Environment Federation [WEF])

Surface Water Treatment: The New Rules

Water Conservation

Water Conservation Managers Guide to Residential Retrofit

Water Quality and Treatment

Work Practices for Asbestos-Cement Pipe

(Unless otherwise indicated, copies are available from AWWA, 6666 W. Quincy Avenue, Denver, Colorado 80235.)

CALIFORNIA STATE UNIVERSITY, SACRAMENTO FOUNDATION

Small Water System Operation and Maintenance

Water Distribution System Operation and Maintenance

Water Treatment Plant Operation, Volume 1

Water Treatment Plant Operation, Volume 2

(Available from California State University, Sacramento Foundation, 6000 J Street, Sacramento, California 95819-6025.)

INTERNATIONAL FIRE SERVICE TRAINING ASSOCIATION

International Fire Service Training Association Manual 205

(Available from IFSTA, Fire Protection Publications, Oklahoma State University, Stillwater, Oklahoma 74078-0118.)

NATIONAL ASSOCIATION OF CORROSION ENGINEERS (NACE)

Control of External Corrosion on Underground or Submerged Metallic Piping Systems (NACE RP0169-92)

Galvanic Anode Cathodic Protection of Internal Submerged Surfaces of Steel Water Storage Tanks (NACE RPO196-96)

Impressed Current Cathodic Protection of Internal Submerged Surfaces of Steel Water Tanks (NACE RPO388-95)

(Available from NACE, Post Office Box 218340, Houston, Texas 77218)

#### NATIONAL FIRE PROTECTION ASSOCIATION (NFPA)

Recommended Practice for Fire Flow Testing and Marking of Hydrants (NFPA 291)

(Available from NFPA, 1 Batterymarch Park, P.O. Box 1901, Quincy, Massachusetts 02269-9101.)

#### NATIONAL LIME ASSOCIATION

Lime Handling, Application and Storage, Bulletin 213

(Available from National Lime Assoc. 3601 N. Fairfax Dr., Alexandria, VA 22201)

#### NATIONAL SWIMMING POOL FOUNDATION (NSPF)

Pool-Spa Operators Handbook (T. Kowalsky, ed.)

(Available from NSPF, 10803 Gulfdale, Suite 300, San Antonio, Texas 78216.)

#### AUTHORED PUBLICATIONS:

Bryne, Wes. Reverse Osmosis: A Practical Guide for Industrial Users. Littleton, Colorado: Tall Oaks Publishing, Inc. 1995.

Griffiths, Tom, EdD. The Complete Swimming Pool Reference. St. Louis, Missouri: Mosby-Year Book, Inc. 1994.

Holzhauer, Ron. "Plant Engineering Magazine's Exclusive Guide to Interchangeable Industrial Lubricants." *Plant Engineering*. Vol. 49, No. 13. October 9, 1995.

Holzhauer, Ron. "Plant Engineering Magazine's Exclusive Guide to Synthetic Lubricants." *Plant Engineering*. Vol. 48, No. 16. December 1994.

Langlais, Bruno, David A. Recknow, and Deborah R. Brink, eds. Ozone in Water Treatment: Application and Engineering. Lewis Publishers and AWWARF. 1991.

Manual of Cross-Connection Control. 8th ed. Los Angeles, California: Foundation for Cross-Connection Control and Hydraulic Research, University of Southern California. 1988.

CANCELLED

## COPYRIGHT NOTIFICATION

Portions of this document are excerpted from copyrighted sources. The following list identifies copyrighted material and gives permissions information.

Paragraph 7.3.2.6 is reprinted in part from Water Supply Practices (M28): Cleaning and Lining Water Mains, by permission. Copyright © 1987, American Water Works Association.

Paragraph 6.9 is reprinted from Principles and Practices of Water Supply Operations: Water Transmission and Distribution, by permission. Copyright © 1996, American Water Works Association.

Paragraphs 6.9.1 and 6.9.2 are reprinted from Principles and Practices of Water Supply Operations: Water Transmission and Distribution, by permission. Copyright © 1996, American Water Works Association.

Paragraph 7.4.3 is reprinted from Principles and Practices of Water Supply Operations: Water Transmission and Distribution, by permission. Copyright © 1996, American Water Works Association.

Paragraph 8.4.2 is reprinted from Principles and Practices of Water Supply Operations: Water Transmission and Distribution, by permission. Copyright © 1996, American Water Works Association.

Paragraph 9.5 is reprinted from Principles and Practices of Water Supply Operations: Water Transmission and Distribution, by permission. Copyright © 1996, American Water Works Association.

Table 52 contains information originally published in T. Griffiths, The Complete Swimming Pool Reference, St. Louis, MO: Mosby-Year Book, Inc. Copyright © 1994.



## GLOSSARY

<u>Abbreviation or Acronym</u>	<u>Definition</u>
ABC	Association of Boards of Certification for Operating Personnel in Water Utilities and Pollution Control Systems
AC	alternating current
AF	alkalinity factor
AFB	Air Force Base
AFCESA	Air Force Civil Engineer Support Agency
AFI	Air Force Instruction
AFM	Air Force Manual
AFOOSH	Air Force Occupational Safety and Health
AFR	Air Force Regulation
APHA	American Public Health Association
ANSI	American National Standards Institute
AR	Army Regulation
ASCE	American Society of Civil Engineers
AWWA	American Water Works Association
AWWARF	American Water Works Association Research Foundation
BAC	biological activated carbon
Btu	British thermal unit
BUMEDINST	Bureau of Medicine Instruction
C	Centigrade; also Hazen and Williams pipe friction coefficient
CAC	combined available chlorine
cal	calorie
CEESC	Technical Support Civil Engineering

CECPW-ES	Civil Engineering Center for Public Works - Engineering Services
CF	calcium factor
cm	centimeter
CT	contact time
cu	cubic
cfm	cubic feet per minute
cfs	cubic feet per second
CT	contact time
CYA	cyanuric acid
DA	Department of the Army
DBP	disinfection byproduct
DC	direct current
DO	dissolved oxygen
DoD	Department of Defense
DPD	n,n,-diethyl-p-phenylenediamine
EO	Executive Order
EPA	Environmental Protection Agency
F	Fahrenheit
FAC	free-available chlorine
FGS	Final Governing Standard
FPA	Flavor Profile Analysis
fpm	feet per minute
fps	feet per second
ft	feet
g	gram

GAC	granular activated carbon
gal	gallon
gpd	gallons per day
gpcd	gallons per capita per day
gpg	grains per gallon
gpm	gallons per minute
gps	gallons per second
h	head
ha	hectare
HAA	haloacetic acid
hp	horsepower
HQ	headquarters
I&C	Instrumentation & Control
IFSTA	International Fire Service Training Association
in.	inch
jet	ejector
kg	kilogram
km	kilometer
kPa	kiloPascals
kg/sq cm	kilograms per square centimeter
kg/sq m	kilograms per square meter
kw	kilowatt
kwh	kilowatt-hour
L	liter
L/min	liters per minute
LANTNAVFACENGCOM	Atlantic Division, Naval Facilities Engineering Command

lb	pound
Lpm	liters per meter
Lps	liters per second
Lps/sq m	liters per second per square meter
m	meter
mg	milligram
mgd	million gallons per day
mg/L	milligrams per liter
mil	million
MIL-HDBK	Military Handbook
mL	milliliter
mm	millimeter
MO	Maintenance and Operations
MOR	Monthly Operating Report
MPN	most probable number
mps	meters per second
mrem	millirem
NACE	National Association of Corrosion Engineers
NAVFAC	Naval Facilities Engineering Command
NAVFACENGCOM	Naval Facilities Engineering Command
NFPA	National Fire Protection Association
NIPDWR	National Interim Primary Drinking Water Regulations
NOM	natural organic matter
NSF	National Sanitation Foundation
NSPF	National Swimming Pool Foundation
NPSH	net positive suction head

O&M	Operations and Maintenance
OEBGD	Overseas Environmental Baseline Guidance Document
OPNAVINST	Operations Naval Instruction
ORP	oxidation-reduction potential
OSHA	Occupational Safety and Health Act
PAC	powdered activated carbon
par(s).	paragraph(s)
pcf	pound per cubic foot
pCi	picocurie
pH	hydrogen-ion concentration
ppm	parts per million
psf	pounds per square foot
psi	pounds per square inch
Q	rate of flow (quantity)
RP	reduced pressure
rpm	revolutions per minute
s	slope (hydraulic)
SCADA	supervisory control and data acquisition
SDWA	Safe Drinking Water Act
sec	second
sq	square
SOC	synthetic organic chemical
TAC	total available chlorine
TB-MED	Technical Bulletin-Medical
TDS	total dissolved solids
TF	temperature factor

THM	trihalomethanes
TM	Technical Manual
TOC	total organic carbon
TON	threshold odor number
TU	turbidity units
USEPA	U.S. Environmental Protection Agency (also EPA)
WEF	Water Environment Federation
WHPP	wellhead protection programs
v	velocity
VOC	volatile organic compound (also volatile synthetic organic chemical compounds)
vol	volume

CANCELLED

This glossary is intended to serve as a general water supply systems usage guide. As such, it contains some terms not used in the body of this document; however, these terms are important for water treatment plant operators to know.

Absorption. The process of taking in or soaking up liquids; not to be confused with adsorption.

Acid. A compound, usually having a sour taste, which is able to neutralize an alkali or base; a substance that dissolves in water with a formation of hydrogen ions.

Acidity. A quantitative measurement of the total acid constituents of a water, both in the ionized and unionized states expressed as pH.

Acre-Foot. A measurement used for reservoirs of water storage that is equivalent to one acre (43,560 square feet) one foot deep, or 43,560 cubic feet or 325,830 gallons.

Adsorption. The adherence of dissolved, colloidal, and finely divided matter on the surfaces of solid bodies with which they are brought in contact, not to be confused with absorption.

Aeration. The bringing about of intimate contact between air and a liquid by one of the following methods: spraying the liquid in the air; bubbling air through the liquid; or by agitation of the liquid to promote surface absorption of air.

Aerobic. Requiring the presence of free oxygen.

Agglomeration. The gathering together of dispersed suspended matter into larger flocs of particles which settle rapidly.

Air Binding. The condition whereby entrained air clogs or otherwise interferes with proper operation of a sand filter, pump, or pipe.

Algae. Tiny plant life, usually microscopic, existing in water. They are mostly green, blue-green, or yellow-green, and are the cause of most tastes and odors in water.

Alkalinity. A term used to represent the content of carbonates, bicarbonates, hydroxides, and occasionally borates, silicates, and phosphates in water.

Anaerobic. Requiring the absence of free oxygen.

Anion. A negatively charged ion in an electrolyte solution, attracted to the anode under the influence of electric potential.

Appurtenances. Structures, devices and appliances, other than pipe and conduit, which are used in connection with a water distribution system, for example, valves, hydrants, corporation cocks, services, etc.

Aquiclude. A geologic formation which, although porous and capable of absorbing water slowly, will not transmit it rapidly enough to furnish an appreciable supply for a well or spring. The permeability is so low that, for all practical purposes, water movement is precluded or severely restricted.

Aquifer. A water-bearing formation or stratum beneath the earth's surface which transmits water from one point to another.

Artesian. An adjective applied to groundwater, or items connected with groundwater, for example, a well, under ground basin, etc., where water is under pressure and will rise to a higher elevation if afforded an opportunity to do so.

Backblowing. Reversal of the flow of water under pressure in a well to free the screen or strainer and the aquifer of clogging material.

Backflow. The backing-up of water through a conduit or channel in the direction opposite to normal flow.

Backflow Preventer. A device for a water supply pipe to prevent the backflow of water into the water supply system from the connections on its outlet end.

Backsiphonage. The flowing back of contaminated or polluted water from plumbing fixture or cross-connection, into a water supply line, because of a lowering of the pressure in the line. Also termed "backflow."

Backwash. The reversal of flow through a filter to wash clogging material out of the filtering medium and reduce conditions causing loss of head. Also called filter wash.

Bacteria. Primitive microscopic plants, generally free of pigment, which reproduce by dividing in one, two, three plants. Do not require light for their life processes.

Bacteria Count. An estimate of the total number of bacteria of all kinds in 1-ml sample which will grow at the stated temperature, usually 37°C. Also standard plate count.

Base. An alkali or hydroxide of the alkali metals, and of ammonia, which neutralizes acids to form salts and water. Ionizes to form (OH<sup>-</sup>) ions. A hydroxide. An alkali.

Basin. A natural or artificially created space or structure, surface or underground, which by reason of its shape and the character of its confining material, is capable of holding water. The term is sometimes used for a receptacle midway in size between a reservoir and a tank.

Blowoff. A controlled outlet on a pipeline, tank, or conduit used to discharge water or accumulations of material carried by the water.



Boom. A floating structure, usually of timber or logs, used to protect the face of a dam or other structure from damage by wave action, by floating material being dashed against it by the waves, or to defect floating material away from such a structure.

Brackish Water. Water rendered unfit for drinking because of salty or unpleasant tastes caused by the presence of excessive amounts of dissolved chemicals, chlorides, sulfates, and alkalis.

Capillarity. The degree to which a material or object containing minute openings or passages, when immersed in a liquid, will draw the surface of the liquid above the hydrostatic level.

Cathodic Protection. Reduction or elimination of corrosion by making the metal a cathode by means of an impressed direct current (DC) or attachment to a sacrificial anode (usually Mg, Al, or Zn).

Centigrade. Pertaining to the Centigrade thermometer scale; water freezes as 0°C, and boils at 100°C.

Centrifugal. Moving or directed outward from the center.

Chemical Feeder. A device for feeding chemicals to water at a know, controlled rate.

Chloramines. Compounds of organic amines or ammonia with chlorine.

Chlorination. Treatment of water the addition of chlorine either as a gas or liquid, or in the form of hypochlorite, usually for the purpose of disinfection, oxidation, etc.

Chlorination, Breakpoint. The application of chlorine to water containing free ammonia to provide a free available chlorine residual.

Chlorination, Post-. The application of chlorine to water subsequent to any treatment. The term refers only to the point of application.

Chlorination, Pre-. The application of chlorine to water prior to any treatment.

Chlorinator. A device to apply chlorine to water at a known, controlled rate.

Chlorine, Combined, Available Residual. That portion of the total residual chlorine remaining in water at the end of a specified contact period, which will react chemically and biologically as chloramines, or organic chloramines.

Chlorine Demand. The difference between the amount of chlorine added to water and the amount of residual chlorine remaining at the end of a specified contact period.

Chlorine, Free Available Residual. That portion of the total residual chlorine remaining in water at the end of a specified contact period, which will react chemically and biologically as hypochlorous acid, HOCl, or hypochlorite ion, (OCI-).

Chlorine Ice. A solid hydrate of chlorine sometimes formed at the diffuser or in the bell jar of a chlorinator, where the gas comes in contact with the cold water.

Chlorine Residual. The total amount of chlorine (combined and free available chlorine) remaining in water at the end of a specified contact period following chlorination.

Clarification. Process of subsidence and deposition by gravity of suspended matter carried by water or other liquids. Also called settling, it is usually accomplished by reducing the velocity of flow of the liquid below the point where it can transport the suspended material.

Coagulant. A chemical or material which when added to water will combine with added or naturally present chemicals to form a precipitate, called a floc, which will settle and aid in the removal of suspended matter in the liquid.

Coagulation. The destabilization and initial aggregation of colloidal and finely divided suspended matter by the addition of a floc-forming chemical.

Coagulation Basin. A basin employed for the coagulation of suspended or colloidal matter, with or without addition of a coagulant, in which the liquor is mixed gently to induce coagulation, flocculation, and agglomeration, in preparation for subsequent sedimentation.

Coefficient. A numerical quantity or factor, determined by experimental methods, put into a formula, which expresses the relationship between two or more variables, commonly used to adjust the theoretical relation to that found in actual practice.

Coefficient, Discharge. The factor or number by which the theoretical discharge of fluids through orifices, nozzles, tubes, weirs, etc., must be multiplied to obtain the actual discharge.

Coefficient, Roughness. A factor, in the Kutter, Manning, and other formulas for computing the average velocity of the flow of water in a conduit. It represents the effect of roughness of the confining material of the channel or conduit upon the energy losses in the flowing water.

Coefficient, Uniformity. The degree of variation in the size of the grains that constitute a granular material. It is the ratio of: (1) the diameter of a grain of a size that is too large to pass through a sieve which allows 60 percent of the material (by weight) to pass through, to (2) the diameter of a grain of a size that is too large to pass through a sieve which allows 10 percent of the material (by weight) to pass through. The

coefficient is unity for any material whose grains are all the same size, and it increases above unity with variation in the size of the grains.

Coliform Organisms. A group of bacteria, predominantly inhabitants of the intestine of humans, but also found on vegetation, including all aerobic and facultative anaerobic bacilli, that ferment lactose to produce a gas as one of the byproducts.

Colloids. Finely divided solids which will not settle, but may be removed by coagulation or biochemical action.

Color, Apparent. Pigmentation due to the presence of suspended solids in a water supply.

Color, True. Pigmentation due to the presence of finely divided particles or droplets either dispersed, or in solution, in a water supply.

Community Water System. A public water system which serves at least 15 service connections used by year-round residents or regularly serves at least 25 year-round residents.

Compound. A substance containing molecules or two or more different elements which have entered into chemical combination with each other to form another substance unlike any of the constituent elements.

Concentration. A measure of the amount of dissolved substances contained per unit volume of solution. May be expressed as grains per gallon, pounds per million gallons, milligrams per liter.

Contaminant. As referred to in the Safe Drinking Water Act, means any physical chemical, biological, or radiological substance or matter in water.

Contamination. A general term signifying the introduction into water of microorganisms, chemicals, wastes, or sewage, which renders the water unfit for its intended use. Usually considered to imply the presence, or possible presence, of disease-producing bacteria. A specific type of pollution.

Corrosion. The destruction of a substance; usually a metal, or its properties because of a reaction with its (environment) surroundings.

Crenothrix. A genus of bacteria characterized by unbranched, attached filaments having a gelatinous sheath in which iron is deposited. They precipitate metallic oxide deposits in pipes, etc., which sometimes color the water. Also, after death, they cause disagreeable taste and odors in water.

Cross-Connection. In plumbing, a physical connection through which a supply of potable water could be contaminated, polluted, or infected. A physical connection between water supplies from different systems.

Dam. A barrier constructed across a watercourse for the purpose of (1) creating a reservoir, (2) diverting water from the reservoir into a conduit or channel, (3) creating a head which can be used to generate power, and (4) improving river navigability.

Dechlorination. The partial or complete reduction of residual chlorine in a liquid by any chemical or physical process.

Demanganization. In water treatment, the removal of compounds of manganese from water.

Demineralization. Reduction of the mineral content of water by a physical or chemical process; removal of salts.

Deoxygenation. Depletion of the dissolved oxygen content in a liquid.

Detention Time. The theoretical length of time for water to pass through a basin or tank, of all the water moves through with the same uniform velocity; mathematically equal to the volume of basin divided by the rate of flow.

Diffuser. A porous plate, tube, or other device through which air is forced and divided into minute bubbles for diffusion in liquids. Commonly made of Carborundum, Alundum, metal, or plastic materials.

Discharge. (1) As applied to a stream, the rate of flow or volume of water flowing at a given place within a period of time. (2) The process of water or other liquid passing through an opening or along a conduit or channel. (3) The water or other liquid which emerges from an opening or passes along a conduit or channel.

Disinfectant. Any oxidant, including but not limited to chlorine, chlorine dioxide, chloramines, and ozone added to water in any part of the treatment or distribution processes, that is intended to kill or inactivate pathogenic microorganisms.

Disinfection. The process of killing or inactivating most (but not necessarily all) of the harmful and objectionable microorganisms in a fluid by various agents such as chemicals, heat, ultraviolet light, ultrasonic waves, radiation, etc.

Dissociation. The dissolving of molecules of a substance in water into positive and negative ions. Also called ionization.

Dissolved Solids. Solids that are present in solution.

Distillation. The process of converting a liquid to a gaseous or vaporous state and condensing the resulting vapor to liquid under the influence of heat (and possibly reduced pressure or partial vacuum), followed by cooling. Used to remove impurities from a liquid in order to improve its purity.

Dose Equivalent. The product of the absorbed dose from ionizing radiation and such factors as account for differences in biological effectiveness due to the type of radiation and its distribution in the body as specified by the International Commission on Radiological Units and Measurements.

Drawdown. The lowering of the water surface in a well, and of the water table or piezometric surface adjacent to the well, resulting from the withdrawal of water from the well by pumping. Drawdown is the difference between static level and pumping level.

Dry Feeder. A feeder for dispensing a chemical or other fine material in the solid state to water or wastewater at a rate controlled manually or automatically by the rate of flow. The constant rate may be either volumetric or gravimetric.

E. Coli. See Escherichia coli.

Effective Size. The size of sieve which will permit 10 percent (by weight) of the sand sample to pass but will retain the remaining 90 percent. A measure of the relative ability of a filtering material to permit the passage of water.

Effluent. (1) A liquid which flows out of a containing space. (2) Water, or other liquid, partially or completely treated or in its natural state, which flows out of a reservoir, basin, treatment plant, or part thereof.

Electrolysis. Chemical changes in an electrolyte caused by an electrical current. The use of this term to mean corrosion by stray currents should be discouraged.

Element. A substance which cannot be subdivided into simpler substances by ordinary chemical changes.

Elevated Storage. In any distribution system, storage of water in a tank supported on a tower.

Escherichia Coli (E. Coli). One of the species of bacteria in the coliform group. Its presence is considered indicative of fresh fecal contamination.

Eutrophic Lake. Lake or other contained water body rich in nutrients. Characterized by a large quantity of planktonic algae, low water transparency with high dissolved oxygen in upper layer, zero dissolved oxygen in deep layers during summer months, and brown- or black-colored organic deposits.

Evaporation. (1) The process by which water passes from a liquid state, at temperatures below the boiling point, to vapor. It is the principal process by which surface or subsurface water is converted to atmospheric vapor. (2) The quantity of water that is evaporated; the rate is expressed in depth of water, measured as liquid water, removed from a specified surface per unit of time—generally in inches or centimeters per day, month, or year.

Evapotranspiration. Water withdrawn from soil by evaporation and/or plant transpiration. Considered synonymous with consumptive use.

Facultative Bacteria. Bacteria which can adapt themselves to growth in the presence, as well as in the absence, of oxygen.

Fahrenheit. Pertaining to the Fahrenheit thermometer scale. Water freezes at 32°F and boils at 212°F.

Filter. A device or structure for removing solid or colloidal matter (which usually cannot be removed by sedimentation) from water, or other liquids or semiliquids, by a straining process whereby the solids are held on a medium of some kind (granular, diatomaceous earth, woven, porous, etc.) while the liquid passes through.

Filter Bottom. The underdrainage system for collecting the water that has passed through a filter and for distributing the wash water that cleans the filter medium.

Filter, Diatomite. A filter employing diatomaceous earth as the filtering material.

Filter, Gravity. An open filter, the operating level of which is placed near the hydraulic grade line of the influent and through which the water flows by gravity.

Filter, Pressure. A filter of the closed type, having a vertical or horizontal cylinder of iron, steel, wood, or other material inserted in a pressure line.

Filter, Rapid Sand. A filter used in the purification of water. Water which has been previously treated usually by coagulation and sedimentation is passed downward through a filtering medium, consisting of a layer of relatively coarse sand, or prepared anthracite coal, or other suitable material; usually from 24 to 30 inches thick, resting on a supporting bed of gravel or porous medium such as Carborundum. The filtered water is removed by an underdrainage system which also distributes the wash water during backwashing. Filter rates commonly range from 2 to 3 gallons per minute per square foot of filter area. Also called mechanical filter.

Filter Rate. The rate of application of material to some process involving filtration; for example, waterflow to a rapid sand filter.

Filter Rate Controller. An automatic device inserted in the effluent pipe of a filter to maintain the rate of flow constant throughout the filter run.

Filter, Slow Sand. A filter used in the purification of water where water without previous treatment is passed downward through a filtering medium consisting of a layer of sand or other suitable material; usually finer media than for a rapid sand filter, and from 24 to 40 inches thick. The filtered water is removed by an underdrainage system and the filter is cleaned by scraping off and replacing the clogged layer. It is characterized by a low rate of filtration, usually from 3 to 6 million gallons per day per acre of filter area.

Fines. The finer grained particles of a mass of soil, sand, or gravel.

Finished Water. Treated water.

Fire Demand. The quantity of water and rate of flow required for firefighting purposes; based on the types and sizes of structures to be protected and the duration of the fire.

Fixed Installation. An installation which, through extended use, has gained those structures and facilities not initially found or intended for use at a "temporary" standard facility.

Flashboard. A temporary barrier, of relatively low height and usually constructed of wood, placed along the crest of the spillway of a dam to allow the water surface in the reservoir to be raised above the spillway level to increase storage capacity. Construction is such that it can be readily removed or lowered, or carried away by high flow or floods.

Floc. Small gelatinous masses which are accumulations of microparticles, bacteria, and other organisms; formed in a liquid by the addition of chemical coagulants, or by the gathering together of particles by mixing.

Flocculation. The formation of flocs subsequent to the process of coagulation.

Flume. An open conduit, constructed of wood, masonry, metal, and constructed on a grade; sometimes elevated.

Flume, Control. A flume arranged for measuring the flow of water or other liquids; generally including a constricted section wherein a minimum energy head exists at all stages.

Flume, Parshall. A device for measuring the flow of liquid in an open conduit.

Fluoridation. The addition of a chemical to increase the concentration of fluoride ions to a predetermined limit causing a reduction in the incidence of dental cavities.

Foot Valve. A valve placed in the bottom of the suction pipe of a pump, which opens to allow water to enter the suction pipe but closes to prevent water from passing out of it at the bottom end.

Friction, Hydraulic. The resistance to flow exerted on the perimeter or contact surface of a body of water moving in a stream of conduit, caused by the roughness that is characteristic of the confining surface and which induces turbulence and consequent loss of energy. Energy losses arising from excessive turbulence, impact at obstructions, curves, eddies, and pronounced channel changes are not ordinarily ascribed to hydraulic friction.

Friction Loss. Pressure lost in overcoming friction of pipe material on flowing water.

Gage. (1) A device for indicating magnitude or position in specific units, when such magnitude or position undergoes change, for example: the elevation of a water surface, the velocity of flowing water, the pressure of water, the amount or intensity of precipitation, the depth of snowfall, etc. (2) The act or operation of registering or measuring magnitude or position when characteristics are undergoing change. (3) The operation, including both field and office work, of measuring the discharge of a stream of water in a waterway.

Gage, Loss of Head. A gage on a filter which indicates the loss of head involved in the filtering operation whereby the operator is able to ascertain the need for filter washing.

Gage, Pressure. A device for registering the pressure of solids, liquids, or gases. It may be graduated to register pressure in any units desired.

Gage, Recording. A gage which makes a continuous record. Also called a register.

Gage, Water-Level. A gage, recording or otherwise, which indicates the water level in a reservoir, still well, or other receptacle.

Gaging, Stream. Measuring the (1) velocity of a stream of water in a channel or open conduit and the (2) area of the water cross section, for the purpose of determining the discharge.

Gallery. (1) An underground structure designed and installed for the purpose of collecting subsurface water. (2) A passageway in a structure, such as a dam water treatment plant, etc., used for obtaining access to interior parts, or to carry pipes, or to house machinery.

Galvanic Series. A list of metals arranged according to their relative corrosion potentials in some specific environment; sea water is often used.



Grade, Hydraulic. In closed circuit under pressure, a line joining the elevations to which water would rise in pipes freely vented and under atmospheric pressure.

Gram. A metric unit of mass defined as one thousandth of a kilogram. Practically equal to the weight of a cubic centimeter of water.

Greensand. A common name for glauconite, a natural zeolite, used in water softening.

Gross Alpha Particle Activity. The total radioactivity due to alpha particle emission as inferred from measurements on a dry sample.

Gross Beta Particle Activity. The total radioactivity due to beta particle emission as inferred from measurements on a dry sample.

Groundwater. Water occurring in a stratum (aquifer) below the surface of the ground. The term is not applied to water which is percolating or held in the top layers of the soil, but to that below the water table.

Groundwater Recharge. Water descending to the zone of saturation under natural conditions or as added through the activities of man.

Halogen. One of the chemical elements fluorine, chlorine, bromine iodine.

Hardness. A folk term inherited from the past with origins in the household use of waters for washing. Some waters were hard to use in doing the family laundry. More soap was needed to produce suds in these waters. Thus, tradition defines hardness in terms of soap-consuming capacity. However, for practical purposes, hardness is currently defined as the calcium and magnesium content of water expressed in terms of calcium carbonate. In addition to increased consumption of soap, hardness minerals are responsible for deposition of scale in boilers, detrimental effects in some industrial processes, and sometimes objectionable taste in the water.

Head, Friction. The head lost of water flowing in a stream or conduit as the result of the disturbances set up by the contact between the moving water and its containing conduit, and by intermolecular friction. In laminar flow the head lost is approximately proportional to the first power of the velocity; in turbulent flow it is approximately proportional to the square of the velocity. While strictly speaking, head losses due to bends, expansions, obstructions, impact, etc., are not included in this term, the usual practice is to include all such head losses under this term.

Head, Loss of. The decrease in the head between two points.

Head, Negative. The loss of head in excess of the static head (a partial vacuum) produced by clogging of rapid sand filters near the end of a filter run.

Head, Pressure. The head represented by the expression,  $p/w$ , where  $p$  is pressure and  $w$  is weight. When  $p$  is in pounds per square foot and  $w$  is the weight of the liquid per cubic foot,  $h$  become head in feet.

Head, Static. The vertical distance between the free level of the source of supply, and the level of the free discharge surface.

Head, Static Suction. The vertical distance from the free surface level of the source of supply to the center line of the pump.

Head, Total. The difference in elevation between the surface of water at the source of supply and the elevation of the water at the outlet at the source of supply and the elevation of the water at the outlet (static head), plus velocity head, and friction head.

Head, Velocity. The theoretical vertical height through which a liquid body may be raised due to its kinetic energy. It is equal to the square of the velocity divided by twice the acceleration due to gravity.

Hydraulic Grade. A line connecting all points representing the head in any system. Frequently, it is mistakenly called hydraulic gradient, but it is simply a curve representing line pressures at various points along a line or throughout a water system.

Hydraulic Radius. The right cross-sectional area of a stream of water divided by the length of that part of its periphery in contact with its containing conduit; the ratio of area to wetted perimeter.

Hydrogen-ion Concentration (pH). A measure of the acidity or alkalinity of a solution. A value of seven is neutral; low numbers are acid, large numbers are alkaline. Strictly speaking, pH is the negative logarithm of the hydrogen-ion concentration.

Hydrologic Cycle. The complete cycle of phenomena through which water passes, beginning as atmospheric water vapor, passing into liquid or solid form as precipitation, thence along or into the ground surface, and finally again return to the form of atmospheric water vapor.

Impeller. A rotating set of vanes designed to produce the rotation of a mass of fluid. The peripheral speed of the vane tips determines the head produced and the working pressure of a pump. The rotating unit in a centrifugal pump.

Infiltration. (1) The flow or movement of water through the pores of a soil or other porous medium. (2) The absorption of liquid water by the soil, either as it falls as precipitation, or from a stream flowing over the surface. Also called seepage.

Infiltration Gallery. A sizable gallery with openings in its sides and bottom, extending generally horizontally into a waterbearing formation, for the purpose of collecting the water contained therein.

Influent. Water flowing into a reservoir, basin, treatment plant, or a part thereof

Inorganic Matter. Chemical substances of mineral origin; not of basically carbon structure.

Intermittent Stream. A stream or portion of a stream that flows only in direct response to precipitation. It receives little or no water from springs and no long-continued supply from melting snow or other sources.

Interstice. A pore or open space in rock or granular material, not occupied by solid matter. Also called void or void space.

Ion. An electrically charged atom ( $N^+$ ,  $Al^{+3}$ ,  $Cl^-$ ,  $S^{2-}$  or group of atoms known as "radicals" ( $NH_4^+$ ,  $SO_4^{2-}$ ,  $PO_4^{3-}$ ).

Ion Exchange. A process whereby water is passed through a granular material and ions of the granular material are replaced by ions contained in the water. For example, in the zeolite softening process the sodium ions ( $Na^+$ ) of the granular zeolite are replaced by the calcium ions ( $Ca^{++}$ ) in the water to leave the water free of calcium, the cause of hardness, but containing an equivalent amount of sodium.

Ionization. The process of the formation of ions by the splitting of molecules of electrolytes in solution.

Jar Test. A laboratory test used to determine the optimum amounts of coagulant to be added or most efficient coagulation.

Jetting. (1) A method of well sinking wherein the casing is sunk by driving while the material inside is washed out by a water jet, and carried to the top of the casing. (2) A method of sinking piles by means of a water jet. (3) A method of inserting well points by means of water jet.

Kilopascals. A unit of pressure equal to 0.01 atmosphere or 0.14501 psi.

Lagooning. The placement of solid or liquid material in a basin, reservoir, or artificial impoundment for purposes of storage, treatment, or disposal.

Langelier Index. An expression to indicate the hydrogen-ion concentration that a water should have to be in equilibrium with its content of calcium carbonate.

Lateral. The smaller pipes of a filter underdrainage system which are connected to the main pipe, or manifold, and which contain orifices through which the filtered water flows.

Level, Hydrostatic. The level of elevation to which the top of a column of water would rise, if afforded opportunity to do so, from an artesian aquifer, or basin, or from a conduit under pressure.

Level, Pumping. The elevation at which water stands in a well when the well is being pumped at a given rate.

Level, Static. The elevation of water table or pressure surface when it is not influenced by pumping or other form of extraction from the groundwater body. It is the level of groundwater in a well before pumping.

Lime-Soda Ash Softening. A process of softening water by adding lime to precipitate carbonate hardness and soda ash to precipitate noncarbonate hardness, with subsequent removal of precipitate by sedimentation and filtration.

Liter. 1,000 milliliters; practically 1,000 cubic centimeters.

Main. A pipeline on the discharge side of a water pumping station.

Maintenance. The upkeep necessary for efficient operation of physical properties. It involves labor and materials, but is not to be confused with replacement or retirement.

Man-Made Beta Particle and Photon Emitters. All radio-nuclides emitting beta particles and/or photons listed in Maximum Permissible Body Burdens and Maximum Permissible Concentration of Radionuclides in Air or Water for Occupational Exposure, NBS Handbook 69, except the daughter products of Thorium-232, Uranium-235, and Uranium-238.

Manometer. Single or double (U-tube) glass tube containing a liquid; and indicating instrument used for measuring flow pressure or liquid level.

Maximum Contaminant Level. The maximum permissible level of a contaminant in water which is delivered to the free flowing outlet of the ultimate user of a public water system, except in the case of turbidity where the maximum permissible level is measured at the point of entry to the distribution system. Contaminants added to the water under circumstances controlled by the user, except those resulting from corrosion of piping and plumbing caused by water quality, are excluded from this definition.

Maximum Total Trihalomethane Potential (MTP). The maximum concentration of total trihalomethanes produced in a given water containing a disinfectant residual after 7 days at a temperature of 25°C or above.

Membrane Filtration. A method of quantitative or qualitative analysis of bacterial or particulate matter in a water sample by filtration through a membrane capable of retaining bacteria.

Meter. A unit of length; 100 centimeters; 1,000 millimeters; a device for measuring the flow of fluid.

Microorganism. A minute plant or animal in water or earth that is visible only through a microscope.

Milligrams Per Liter. A unit of the concentration of water or wastewater constituent. It is 0.001 g of the constituent in 1,000 ml of water. It has replaced the parts per million unit, to which it is approximately equivalent, in reporting the results of water and wastewater analyses.

Mineral. (1) Any of a class of substances occurring in nature, usually comprising inorganic substances (such as quartz and feldspar) of definite chemical composition and usually of definite crystal structure, but sometimes also including rocks formed by these substances as well as certain natural products of organic origin, such as asphalt and coal. (2) Any substance that is neither animal or vegetable.

Mixer, Flash. A device for quickly dispersing chemicals uniformly throughout a liquid.

Mole. Molecular weight of a substance expressed in grams.

Most Probable Number (MPN). The best estimate, according to statistical theory, of the number of coliform (intestinal) organisms present in 100 ml of a water sample.

Mud Balls. The end results of the cementing together of sand grains in a filter bed by gelatinous material, such as a coagulant. They may vary in size from a pea to 1 to 2 inches in diameter.

Nitrogen Cycle. The unending cycle in nature through which the nitrogen passed from plant and animal proteins, to organic nitrogenous material, to ammonia, to nitrites, to nitrates, and then to plant and animal proteins again.

Noncommunity Water System. A public water system that is not a community water system.

Nonpotable Water. Water that has not been examined, properly treated and approved by appropriate authorities as being safe for domestic consumption. All waters are considered nonpotable until declared potable.

Operating Log. Daily detailed records of operation.

Organic. (1) Characteristics of, pertaining to, or derived from living organisms. (2) Pertaining to a class of chemical compounds containing carbon.

Orifice. (1) An opening with closed perimeter, usually sharp edged, and of regular form in a plate, wall, or partition through which water may flow; generally used for the purpose of measurement or control of water. (2) The open end of a small tube, such as a pitot tube, piezometer, etc.

Oxidation. Loss of electrons; as when a metal goes from the metallic state to the corroded state (opposite of Reduction). Thus, when a metal reacts with oxygen, sulfur, etc., to form a compound as oxide, sulfide, etc., it is oxidized.

Packer. In well drilling, a device lowered in the lining tubes which swells automatically or can be expanded by manipulation from the surface at the correct time to produce a watertight joint against the sides of the borehole or the casing, thus entirely excluding water from higher horizons.

Pathogenic. Disease producing.

Peak Demand. The maximum monetary load placed on a water plant or pumping station. This is usually the maximum average load over a period of time such as peak hourly demand, peak day demand, or instantaneous peak demand.

Perched Groundwater. Groundwater that is separated from the main body of groundwater by an aquiclude.

Percolation. (1) The movement of flow of water through the interstices or pores of a soil or other medium. (2) The flow or trickling of a liquid downward through a contact or filtering medium. The liquid may or may not fill the pores of the medium.

Permeability. The property of a material which permits appreciable movement of water through it when saturated and actuated by hydrostatic pressure of the magnitude normally encountered in natural subsurface water. Perviousness is sometimes used in the same sense as permeability. The rate of permeability is measured by the quantity of water passing through a unit cross section in a unit time when the gradient of the energy head is unity.

Person. An individual, corporation, company, association, partnership, state, municipality, or Federal Agency.

Perviousness. The property of a material that permits appreciable movement of water through it when it is saturated and the movement is actuated by hydrostatic pressure of the magnitude normally encountered in natural subsurface water. More properly called permeability.

pH. A measure of the acidity or alkalinity of a solution. A value of seven is neutral; low numbers are acid, large numbers are alkaline. Strictly speaking, pH is the negative logarithm of the hydrogen-ion concentration.

Photometer. An instrument that measures the intensity of light or the degree of light absorption.

Photosynthesis. The synthesis of complex organic materials, especially carbohydrates, from carbon dioxide, water, and inorganic salts with sunlight as the source of energy and with the aid of a catalyst such as chlorophyll.

Picocurie (pCi). That quantify of radioactive material producing 2.22 nuclear transformations per minute.

Piezometer. An instrument for measuring pressure head in a conduit, tank, soil, etc. It usually consists of a small pipe or the tube tapped into the side of the container, connected with a manometer pressure gage, mercury or water column, or other device for indicating pressure head.

Piezometric Surface. An imaginary surface that everywhere coincides with the static level of the water in an aquifer. If at any given place the water from different depths in the aquifer rises to different levels, the aquifer has more than one piezometric surface.

Pitometer. A device that uses the principle of the pitot tube for determining the velocity of flowing water in closed conduits, usually flowing under pressure.

Pitot Tube. A device for measuring the velocity of flowing water, using the velocity head of the stream as an index of velocity. It consists essentially of an orifice held to point upstream, connected with a tube in which the rise of water due to velocity head may be observed and measured. It may also consist of two orifices or openings, one facing upstream, one downstream, each connected to tubes (or water columns), in which case the difference in height, or the water differential, in the two columns is an index of velocity.

Pollution. The addition of sewage, industrial wastes, or other harmful or objectionable material to water. A general term that does not necessarily signify the presence of disease-producing bacteria.

Potable. Water which does not contain any objectionable substances or pollution, and is satisfactory for human consumption.

Precipitate. To separate a substance, in the solid form, from a solution. The substance in solid form which has been separated out.

Precipitation. (1) The total measurable supply of water received directly from clouds, as rain, snow, hail, and sleet; usually expressed as depth in a day, month, or year, and designated as daily, monthly, or annual precipitation. (2) The process by which atmospheric moisture is discharged onto a land or water surface. (3) The phenomenon which occurs when a substance held in solution in a liquid passes out of solution into solid form.

Pressure. (1) The total load or force acting upon a surface. (2) In hydraulics the term when used without qualifications usually means pressure per unit area (pounds per square inch, or kilograms per square centimeter) above local atmospheric pressure.

Pressure, Atmospheric. The pressure exerted by the atmosphere at any point. Such pressure decreases as the elevation of the point above sea level increases. One atmosphere is equal to 14.7 pounds per square inch, 29.92 inches or 760 millimeters of mercury column or 33.90 feet of water column at average sea level under standard conditions. Also called standard atmospheric pressure and standard pressure.

Pressure, Hydrostatic. The pressure, expressed as a total quantity or per unit of area, exerted by a body of water at rest.

Pressure, Negative. A pressure less than the local atmospheric pressure at a given point.

Pressure Tank. A tank used in connection with a water distribution system, either for a single household or for several houses, which is airtight and holds both air and water, and in which the air is compressed, the pressure so created being transmitted to the water.

Primacy. A state government has primary enforcement authority under the Safe Drinking Water Act. Primacy is delegated to the state by the Environmental Protection Agency (EPA) Administrator. Before assuming primacy, the state must establish drinking water regulations no less stringent than the present National Interim Primary Drinking Water Regulations (NIPDWR).

Primary Regulations. Regulations governing constituents that affect the health of consumers are applicable to all public water systems and are enforceable by Environmental Protection Agency (EPA) or states with primary enforcement authority.

Priming. (1) The action of starting the flow in a pump or siphon. (2) The first coat applied to a surface to prevent corrosion or to protect the surface.

Public Water System. A system for the provision to the public of piped water for human consumption, if such a system has at least fifteen service connections or regularly serves an average of at least 25 individuals daily at least 60 days out of the year. Such



term includes any collection, treatment, storage, and distribution facilities under control of the operator of such system and used primarily in connection with such system, and any collection or pretreatment storage facilities not under such control which are used primarily in connection with such system.

Pump. A mechanical device for causing flow, or for raising or lifting water or other fluid, or for applying pressure to fluids.

Pump, Air-Lift. A pump, used largely in lifting water from wells, where air under pressure is discharged into the water at the bottom of the well in fine bubbles, which mix with the water and reduce the apparent specific gravity of the air-water mixture. The surrounding water causes the resulting mixtures of water and air to rise in the discharge pipe to the outlet.

Pump, Booster. A pump installed on a pipeline to raise the pressure of the water on the discharge side of the pump.

Pump, Centrifugal. A pump consisting of an impeller fixed on a rotating shaft and enclosed in a casing, having an inlet and a discharge connection. The rotating impeller creates pressure in the liquid by the velocity derived from centrifugal force.

Pump, Displacement. A type of pump in which the water is induced to flow from the source of supply through an inlet valve and into the pump chamber by a vacuum created by the withdrawal of some physical device which on its return displaces a certain volume of the water contained in the chamber and forces it to flow through the discharge valves and discharge pipes.

Pump, Piston. A reciprocating pump; wherein the cylinder is tightly fitted with a reciprocating piston.

Pump, Plunger. A reciprocating pump which has a plunger that does not come in contact with the cylinder walls, but enters and withdraws from it through packing glands. Such packing may be inside, outside, or outside the center; according to the design of the pump.

Pump, Regenerative Turbine. A centrifugal pump where the velocity energy of the water is partially converted into pressure head as it leaves the impeller, by fixed guide vanes.

Pump, Reciprocating. A type of displacement pump consisting essentially of a closed cylinder containing a piston or plunger, as the displacing mechanism, drawing liquid into the cylinder through an inlet valve, and forcing it out through an outlet valve. When the piston acts on the liquid in one end of the cylinder, the pump is termed single-action and when it acts in both ends, it is termed double-action.

Pump, Rotary. A type of displacement pump consisting essentially of elements rotating in a pump case which they closely fit. The rotation of these elements alternately draws in and discharges the water being pumped. Such pumps act with neither suction nor discharge valves, operate at almost any speed, and do not depend on centrifugal forces to lift the water.

Pump, Vertical Turbine Well. A centrifugal pump adapted for deep well use, consisting of a series of stages, each stage comprising a set of vanes in a case or bowl. The number of stages increases with the operating head.

Radius of Influence. The distance from a well, or group of wells, during pumping, within which the water table or other piezometric surface is lowered by withdrawal of the water. The area varies in extent with the rate and duration of pumping.

Rate of Flow. The volume of water per unit of time which is passing a certain observation point at a particular instant. Common expressions are cubic feet per second (cfs), gallons per minute (gpm), gallons per day (gpd), million gallons per day (mgd).

Raw Water. Untreated water; usually the water entering the first treatment unit of a water treatment plant. Water used as a source of water supply taken from a natural or impounded body of water, such as a stream, lake, pond, or groundwater aquifer.

Recarbonation. The diffusion of carbon-dioxide gas through water to restore the carbon dioxide removed by adding lime to water in water softening.

Recharge Basin. A basin excavated in the earth to receive the discharge from streams or storm drains for the purpose of replenishing groundwater supply

Rem. The unit of dose equivalent from ionizing radiation to the total body or any internal organ or organ system. A "millirem" (mrem) is 1/1000 of a rem.

Reservoir. A pond, lake, tank, basin, or other facility, either natural in its origin, or created in whole or in part by the building of engineering structures, which is used for the storage, regulation, and/or control of water.

Runoff. (1) In the general sense, that portion of the precipitation which is not absorbed by the deep strata, but finds its way into the streams after meeting the persistent demands of evapotranspiration. (2) That part of the precipitation which runs off the surface of a drainage area and reaches a stream or other body of water or a drain or sewer.

Sanitary Survey. Study of environmental conditions of a water source or system which might affect its potability or safety.

Saturation. The condition of a liquid when it has taken into solution the maximum possible quantity of a given substance at a given temperature and pressure.

Scale. An accumulation of solid material, precipitated out of waters containing certain mineral salts in solution, and formed on the interior surfaces of pipelines, tanks, boilers, etc., under certain physical conditions.

Secondary Maximum Contaminant Level. The advisable maximum level of a contaminant in water that is delivered to the free-flowing outlet of the ultimate user of a public water system. Contaminants added to the water under circumstances controlled by the user, except those resulting from corrosion of piping and plumbing caused by water quality, are excluded from this definition.

Secondary Regulations. Standards dealing with the esthetic quality of drinking water, which are not federally enforceable and are intended as guidelines for the states.

Sedimentation. Process of subsidence and deposition by gravity of suspended matter carried by water or other liquids. Also called settling, it is usually accomplished by reducing the velocity of flow of the liquid below the point where it can transport the suspended material.

Sedimentation Basin. A structure designed to hold water in a quiescent state or at a reduced velocity for a sufficient interval of time to permit the gravitational depositing of suspended matter, with or without the aid of previous flocculation or coagulation.  
Settling basin. Settling tank.

Self-Purification. The natural process of purification in a moving or still body of water whereby the bacterial content is reduced, the organic content is stabilized, and the dissolved oxygen returned to normal.

Sequestering Agent. A chemical that causes the complexing of certain phosphates with metallic ions in solution so that the ions may no longer be precipitated.  
Hexametaphosphates are an example.

Service Connection. Any pipeline, with its appurtenances, which branches off or connects with a water main and carries water from the main to a consumer.

Silting, Reservoir. The reduction of storage capacity in reservoirs due to the deposition of silt.

Slake. To mix with water. For example, when calcium oxide (unslaked lime) is mixed with water, calcium hydroxide (slaked lime) is formed.

Sludge Dewatering. The process of removing a part of the water in sludge by any method such as draining, evaporation, pressing, vacuum filtration, centrifuging,

exhausting, passing between rollers, acid flotation, or dissolved-air flotation with or without heat. It involves reducing from a liquid to a semi-dry condition capable of being shoveled other than merely changing the density of the liquid (concentration) on the one hand or drying (as in a kiln) on the other.

Sluice Gate. A gate, used for sluicing, constructed to slide vertically and fastened into or against the masonry of dams, tanks, or other structures.

Slurry. A suspension of small undissolved particles in a very high concentration.

Softening, Water. The process of removing from water certain mineral substances which produce a condition called hardness. There are two softening processes in general use: chemical precipitation and the zeolite ion-exchange process.

Solids-Contact Process. The name given to the process of chemical mixing, coagulation, flocculation, and sedimentation when carried on in a single tank in such a manner that the mixed chemicals are introduced into a zone already precipitated floc which serve as nuclei for further floc formation.

Solution. A gas, liquid, or solid dispersed homogeneously in a gas, liquid, or solid.

Solution Feeder. A feeder for dispensing a chemical or other material in the liquid or dissolved state to water at a rate controlled manually or automatically the quantity of flow. The constant rate is usually volumetric.

Sparger. An air diffuser designed to give large bubbles, used singly or in combination with mechanical aeration devices.

Specific Capacity. The rate at which water may be drawn from a formation through a well, to cause a drawdown of a stipulated depth. The usually units of measurement are gallons per minute per foot and liters per minute per meter.

Specific Gravity. Ratio of weight of a unit volume of a substance to an equal volume of water under standard conditions.

Spillway. A waterway in or about a dam or other hydraulic structure, for the escape of excess water.

Spring. A surface feature where water issues from a rock or soil onto the land or into a body of water, the place of issuance being relatively restricted in size. Springs are classified in accordance with many criteria, including character of water, geologic formation, geographical location, etc.

Stabilization. (1) In lime-soda water softening, any process that will minimize or eliminate scale-forming tendencies. (2) In corrosion control, pH adjustment of water to maintain carbonate equilibrium at the saturation point.

Standpipe. (1) A pipe or tank connected to a closed conduit and extending above the hydraulic grade of the conduit, installed to afford relief from surges in pressure in pipelines. (2) A tank resting on ground, with its height greater than its diameter, used to store water in distribution systems. (3) A fixed vertical pipe for furnishing water to the upper part of buildings in case of fire.

State. The agency of the state government which has jurisdiction over public waster systems. During any period when a state does not have primary enforcement responsibility pursuant to section 1413 of the Safe Drinking Water Act (Public Law 95-523), the term "state" means the Regional Administrator, US Environmental Protection Agency.

Sterilization. Destruction of all living organisms, usually by a chemical compound or heat.

Stratum. A geological term used to designate a single bed or layer of rock which is more or less homogeneous in character.

Streamflow. The water that is flowing in a stream channel. Commonly used interchangeably with stream discharge to designate the rate of flow.

Superchlorination. The application of chlorine to water to provide free residual chlorination, in which the residual is usually so large as to require dechlorination.

Supplier of Water. Any person who owns or operates a public system.

Surge. A monetary increase in flow (in an open conduit) or pressure (in a closed conduit) which passes longitudinally along the conduit, due usually to sudden changes in velocity.

Survey, Hydrographic. An instrumental survey to measure and determine characteristics of streams and other bodies of water within an area, including such things as location, area extent, and depth of water in lakes or the ocean; the width, depth, and course of streams; position and elevation of high water marks; location and depth of well, etc.

Suspended Solids. All visible material in water which at the time of sampling is not dissolved, and which can be removed by filtration.

Suspension. A system consisting of small particles kept dispersed by agitation or by molecular motion in the surrounding water. The permanency of suspension is

dependent on the degree of agitation and the size of particles. A colloid is a special kind of suspension.

Temperature. (1) The thermal state of a substance with respect to its ability to communicate heat to its environment. (2) The measure of the thermal state on the arbitrarily chosen numerical scale, usually Centigrade or Fahrenheit.

Threshold Odor. The point at which, after successive dilutions with odorless water, the odor of the water sample can just be detected. The threshold odor is expressed quantitatively by the number of times the sample is diluted with equal quantities of odorless water.

Threshold Treatment. The prevention of the deposition of calcium carbonate in water after the softening treatment by the addition of a small quantity of sodium hexametaphosphate.

Total Trihalomethanes (TTHM). The sum of the concentration in milligrams per liter of the trihalomethane compounds (trichloromethane (chloroform)), dibromochloromethane, bromodichloromethane, and tribromomethane (bromoform)), rounded to two significant figures.

Transpiration. The process by which plants dissipate water into the atmosphere through their leaves and other surfaces.

Treated Water. Water that has undergone processing such as sedimentation, filtration, softening, disinfection, etc., and is ready for consumption. Included is purchased potable water which is retreated (chlorinated, fluoridated, etc.).

Tributary. A stream or other body of water, surface, or underground, which contributes its water, even though intermittently and in small quantities, to another and larger stream or body of water.

Trihalomethanes (THM). One of the family of organic compounds, named as derivatives of methane, wherein three of the four hydrogen atoms in methane are each substituted by a halogen atom in the molecular structure. Technically, THM belong to the group of chemicals classified as volatile synthetic organic chemical (VOC) compounds. The EPA, however, has addressed THMs and VOCs separately.

Tuberculation. Localized corrosion at scattered locations resulting in knoblike mounds.

Turbidity. (1) A condition in water caused by the presence of suspended matter, resulting in the scattering and absorption of light rays. (2) A measure of fine suspended matter in liquids. (3) An analytical quantity usually reported in arbitrary turbidity units determined by measurements of light diffraction.

Unit Weight. The weight of a unit volume of material, such as pounds per cubic foot or per cubic inch.

Vacuum. Condition existing in a closed space from which all gas, vapor, or other matter has been removed. Commonly applied to a closed space in which pressure is much lower than surrounding atmospheric pressure; any space where negative pressure exists.

Vacuum Breaker. A device for relieving a vacuum or partial vacuum formed in a pipeline, thereby preventing back-siphonage.

Vacuum Filter. A filter consisting of a cylindrical drum mounted on a horizontal axis, covered with a filter cloth, and revolving with a partial submergence in liquid slurry. A vacuum is maintained under the cloth for the larger part of a revolution to extract moisture. The cake is scraped off continuously.

Valve. A device installed in a pipeline for the purpose of controlling the magnitude and direction of the flow. It consists essentially of a shell and a disc or plug fitted to the shell.

Valve, Altitude Control. A valve which automatically shuts off the flow when the water reaches a predetermined elevation in an elevated tank, and opens when the pressure on the pump side is less than that on the tank side of the valve.

Valve, Check. A valve provided with a disc hinged on one edge, a spherical ball, or other device so arranged that it opens in the direction of normal flow, and closes with reversal of flow.

Valve, Gate. A valve where the closing element consists of a disc which slides over the opening or cross-sectional area through which water passes, and fits tightly against it.

Valve, Needle. A valve with a circular outlet through which the flow is controlled by means of a tapered needle which extends through the outlet, reducing the area of the outlet as it extrudes, and enlarging the area as it retreats.

Valve, Pressure-Regulating. A valve placed at either end of a pressure-regulating apparatus inserted in a water main to regulate the pressure in a waterline either upstream or downstream from the valve.

Valve, Four-Way. A valve constructed with four waterways and with a movable element operated by a quarter turn to provide passage between either pair of adjacent waterways.

Vaporization. The process by which water changes from the liquid or sublimation to the gaseous state.

Velocity, Mean. The average velocity of a stream flowing in a channel or conduit at a given cross section or in a given reach. It is equal to the discharge divided by the cross-sectional area of the section, or the average cross-sectional area of the reach. Also called average velocity.

Venturi Meter. A meter for measuring the rate of flow of a liquid through closed conduits or pipes, consisting of a venturi tube and one of several proprietary forms of flow registering devices.

Virus. The smallest (10 to 300 millimicrons in diameter) form capable of producing infection and disease in humans or other large species. The true viruses are insensitive to antibiotics. They multiply only in living cells where they are assembled as complex macromolecules utilizing the cells' biochemical systems. They do not multiply by division as do intracellular bacteria.

Volatile. Passing off readily in the form of a vapor.

Volatile Synthetic Organic Chemicals (VOCs). A general class of organic chemicals which are relatively volatile. The primary VOCs identified by the EPA as affecting safety of drinking water are trichloroethylene, tetrachloroethylene, carbon tetrachloride, trichlorethane, dichloroethane, methylene chloride, and vinyl chloride. These chemicals in water supplies result from industrial contamination.

Water. A chemical compound consisting of two parts of hydrogen and one part of oxygen by volume and usually having other solid, gaseous, or liquid materials in solution or suspension.

Water-Bearing Formation. A term, more or less relative, used to designate a geological formation that contains considerable groundwater. It is usually applied to formations from which the groundwater may be extracted by pumping, drainage, etc.

Watercourse. A channel in which a flow of water occurs, either continuously or intermittently, and if the latter, with some degree of regularity. Such flow must be in a definite direction. Watercourses may be either natural or artificial, and the former may occur either on the surface or underground. A different set of legal principles may apply to rights to use water from different classes of watercourses.

Water Hammer. The phenomenon of oscillations in the pressure of water in a closed conduit, flowing full, which results from a too rapid acceleration or retardation of flow. From this phenomenon, momentary pressures greatly in excess of the normal static pressure may be produced in a closed conduit.

Water Meter. A device installed in a pipe under pressure for measuring and registering the quantity of water passing through it.



Water Quality. The chemical, physical, and biological characteristics of water with respect to its suitability for a particular purpose. The same water may be of good quality for one purpose or use, and bad for another, depending on its characteristics and the requirements for the particular use.

Watershed. (1) The area contained within a divide above a specified point on a stream. In water supply engineering, it is called a watershed or a catchment area. (2) The divide between drainage basins.

Water Supply. In general, the sources of water for public or private uses.

Water Table. The upper surface of a zone of saturation (in groundwater) where the aquifer is not confined by an overlying impermeable formation.

Weir. An obstruction placed across a stream or other flowing water so as to cause the water to pass through an opening or notch, thus allowing the quantity of water to be measured.

Well. An artificial excavation that derives water from the interstices of the rocks or soil which it penetrates.

Well, Artesian. A well tapping a confined or artesian aquifer in which the static water level stands above the bottom of the confining bed and the top of the aquifer. The term is used to include all wells tapping such basins or aquifers. Those in which the head is insufficient to raise the water to or above the land surface are called subartesian wells.

Well, Bored. A well that is excavated by means of an auger (hand or power) as distinguished from one which is dug or drilled.

Well Casing. Metal pipe used to line the borehole of a well.

Well, Drilled. A well that is excavated wholly or in part by means of a drill (either percussion or rotary) which operates by cutting or by abrasion; the materials are brought to the surface by means of a bailer, sand pump hollow drill tool, or by a hydraulic or self-cleaning method.

Well, Driven. A well that is constructed by driving a casing, at the end of which there is a drive point, without the use of any drilling, boring, or jetting device.

Well, Dug. A well that is excavated by means of picks, shovels, or other hand tools, or by means of a power shovel or other dredging or trenching machinery, as distinguished from one put down by a drill or auger.

Well Field. A tract of land containing a number of wells.

Well, Flowing. A well that discharges water at the surface without the aid or application of a pump or other lifting device.

Well, Gravel-Packed. A type of well in which the sand adjacent to the well screen has been removed and replaced by gravel.

Well Log. A chronological record of the soil and rock formations encountered in the operation of sinking a well, with either their thickness or the elevation of the top and bottom of each formation given. It also usually includes statements about the lithologic composition and water-bearing characteristics of each formation, static and pumping water levels, and well yield.

Well Point. A device, consisting of a perforated metal tube or screen attached to a jetting or driving head end, to permit passage of water.

Well Screen. A special form of slotted or perforated well casing that admits water from an aquifer consisting of unconsolidated granular material, while preventing the granular material from entering the well.

Well, Subartesian. A nonflowing well in which the water rises by hydrostatic pressure above the saturation zone, but not to the land surface.

Yield, Safe. The maximum dependable draft which can be made continuously upon a source of water supply (surface or groundwater) during a period of years in which the probable driest period or greatest deficiency in water supply is likely to occur.

Zeolite Process. The process of softening water by passing it through a substance known in general as a zeolite, which exchanges sodium ions for hardness constituents in the water.

CUSTODIANS  
NAVY - YD2  
AF - 50  
ARMY - CE

PREPARING ACTIVITY  
NAVY - YD2

PROJECT NO.  
FACR-1177

**STANDARDIZATION DOCUMENT IMPROVEMENT PROPOSAL**

INSTRUCTIONS

1. The preparing activity must complete blocks 1, 2, 3, and 8. In block 1, both the document number and revision letter should be given.
2. The submitter of this form must complete blocks 4, 5, 6, and 7.
3. The preparing activity must provide a reply within 30 days from receipt of the form.

NOTE: This form may not be used to request copies of documents, nor to request waivers, or clarification of requirements on current contracts. Comments submitted on this form do not constitute or imply authorization to waive any portion of the referenced document(s) or to amend contractual requirements.

<b>I RECOMMEND A CHANGE:</b>	1. DOCUMENT NUMBER MIL-HDBK-1164	2. DOCUMENT DATE (YYMMDD) 970303
3. DOCUMENT TITLE  OPERATIONS AND MAINTENANCE OF WATER SUPPLY SYSTEMS		
4. NATURE OF CHANGE (Identify paragraph number and include proposed rewrite, if possible. Attach extra sheets as needed.)		
5. REASON FOR RECOMMENDATION		
<b>6. SUBMITTER</b>		
a. NAME (Last, First, Middle Initial)	b. ORGANIZATION	
c. ADDRESS (Include Zip Code)	d. TELEPHONE (Include Area Code) (1) Commercial (2) DSN (If applicable)	7. DATE SUBMITTED: (YYMMDD)
<b>8. PREPARING ACTIVITY</b>		
a. NAME COMMANDER, NAVFACENCOM ATTN CRITERIA OFFICE	b. TELEPHONE (Include Area Code) (1) Commercial (2) DSN (757) 322-4200 262-4200	
c. ADDRESS (Include Zip Code) 1510 GILBERT STREET NORFOLK VA 23511-2699	<b>IF YOU DO NOT RECEIVE A REPLY WITHIN 45 DAYS, CONTACT:</b> Defense Quality and Standardization Office 5203 Leesburg Pike, Suite 1403, Falls Church, VA 22041-3466 Telephone (703) 756-2340 DSN 289-2340	