

# **UNIFIED FACILITIES CRITERIA (UFC)**

---

## **FOUNDATIONS IN EXPANSIVE SOILS**



**APPROVED FOR PUBLIC RELEASE; DISTRIBUTION UNLIMITED**

**UNIFIED FACILITIES CRITERIA (UFC)**  
**FOUNDATIONS IN EXPANSIVE SOILS**

Any copyrighted material included in this UFC is identified at its point of use. Use of the copyrighted material apart from this UFC must have the permission of the copyright holder.

U.S. ARMY CORPS OF ENGINEERS (Preparing Activity)

NAVAL FACILITIES ENGINEERING COMMAND

AIR FORCE CIVIL ENGINEER SUPPORT AGENCY

Record of Changes (changes are indicated by \1\ ... /1/)

<b>Change No.</b>	<b>Date</b>	<b>Location</b>

---

This UFC supersedes TM 5-818-7, dated 1 September 1983. The format of this UFC does not conform to UFC 1-300-01; however, the format will be adjusted to conform at the next revision. The body of this UFC is the previous TM 5-818-7, dated 1 September 1983.

## FOREWORD

\1\

The Unified Facilities Criteria (UFC) system is prescribed by MIL-STD 3007 and provides planning, design, construction, sustainment, restoration, and modernization criteria, and applies to the Military Departments, the Defense Agencies, and the DoD Field Activities in accordance with [USD\(AT&L\) Memorandum](#) dated 29 May 2002. UFC will be used for all DoD projects and work for other customers where appropriate. All construction outside of the United States is also governed by Status of forces Agreements (SOFA), Host Nation Funded Construction Agreements (HNFA), and in some instances, Bilateral Infrastructure Agreements (BIA.) Therefore, the acquisition team must ensure compliance with the more stringent of the UFC, the SOFA, the HNFA, and the BIA, as applicable.

UFC are living documents and will be periodically reviewed, updated, and made available to users as part of the Services' responsibility for providing technical criteria for military construction. Headquarters, U.S. Army Corps of Engineers (HQUSACE), Naval Facilities Engineering Command (NAVFAC), and Air Force Civil Engineer Support Agency (AFCEA) are responsible for administration of the UFC system. Defense agencies should contact the preparing service for document interpretation and improvements. Technical content of UFC is the responsibility of the cognizant DoD working group. Recommended changes with supporting rationale should be sent to the respective service proponent office by the following electronic form: [Criteria Change Request \(CCR\)](#). The form is also accessible from the Internet sites listed below.

UFC are effective upon issuance and are distributed only in electronic media from the following source:

- Whole Building Design Guide web site <http://dod.wbdg.org/>.

Hard copies of UFC printed from electronic media should be checked against the current electronic version prior to use to ensure that they are current.

AUTHORIZED BY:

  
DONALD L. BASHAM, P.E.  
Chief, Engineering and Construction  
U.S. Army Corps of Engineers

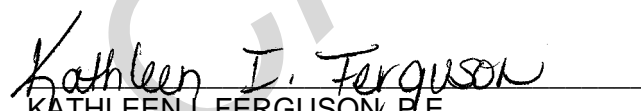
  
KATHLEEN I. FERGUSON, P.E.  
The Deputy Civil Engineer  
DCS/Installations & Logistics  
Department of the Air Force

  
DR. JAMES W. WRIGHT, P.E.  
Chief Engineer  
Naval Facilities Engineering Command

  
Dr. GET W. MOY, P.E.  
Director, Installations Requirements and  
Management  
Office of the Deputy Under Secretary of Defense  
(Installations and Environment)

TM 5-818-7

---

TECHNICAL MANUAL

FOUNDATIONS  
IN  
EXPANSIVE SOILS

CANCELLED

---

HEADQUARTERS, DEPARTMENT OF THE ARMY  
SEPTEMBER 1983

## REPRODUCTION AUTHORIZATION/RESTRICTIONS

This manual has been prepared by or for the Government and, except to the extent indicated below, is public property and not subject to copyright.

Copyrighted material included in the manual has been used with the knowledge and permission of the proprietors and is acknowledged as such at point of use. Anyone wishing to make further use of any copyrighted material, *by itself and apart from this text*, should seek necessary permission directly from the proprietors.

Reprints or republications of this manual should include a credit substantially as follows: "Department of the Army USA, Technical Manual TM 5-818-7, Foundations in Expansive Soils, 1 September 1983."

If the reprint or republication includes *copyrighted* material, the credit should also state: "Anyone wishing to make further use of copyrighted material, *by itself and apart from this text*, should seek necessary permission directly from the proprietors."

CANCELLED

Change }  
No. 1 }

HEADQUARTERS  
DEPARTMENT OF THE ARMY  
Washington, DC, 20 March 1985

### FOUNDATIONS IN EXPANSIVE SOILS

Changes have been made to correct dates and titles of referenced publications. TM 5-818-7, 1 September 1983, is changed as follows:

1. New or changed material is indicated by a star.
2. Remove old pages and insert new pages as indicated below:

	<i>Remove pages</i>	<i>Insert pages</i>
A-1.....		A-1

3. File this change sheet in front of the publication for reference purposes.

**The proponent agency of this manual is the Office of the Chief of Engineers, United States Army. Users are invited to send comments and suggested improvements on DA Form 2028 (Recommended Changes to Publications and Blank Forms) directly to HQDA (DAEN-ECE-G), WASH DC 20314-1000.**

By Order of the Secretary of the Army:

JOHN A. WICKHAM, JR.  
*General, United States Army*  
*Chief of Staff*

Official:  
DONALD J. DELANDRO  
*Brigadier General, United States Army*  
*The Adjutant General*

Distribution:  
To be distributed in accordance with DA Form 12-34B requirements for TM 5-800 Series: Engineering and Design for Real Property Facilities.

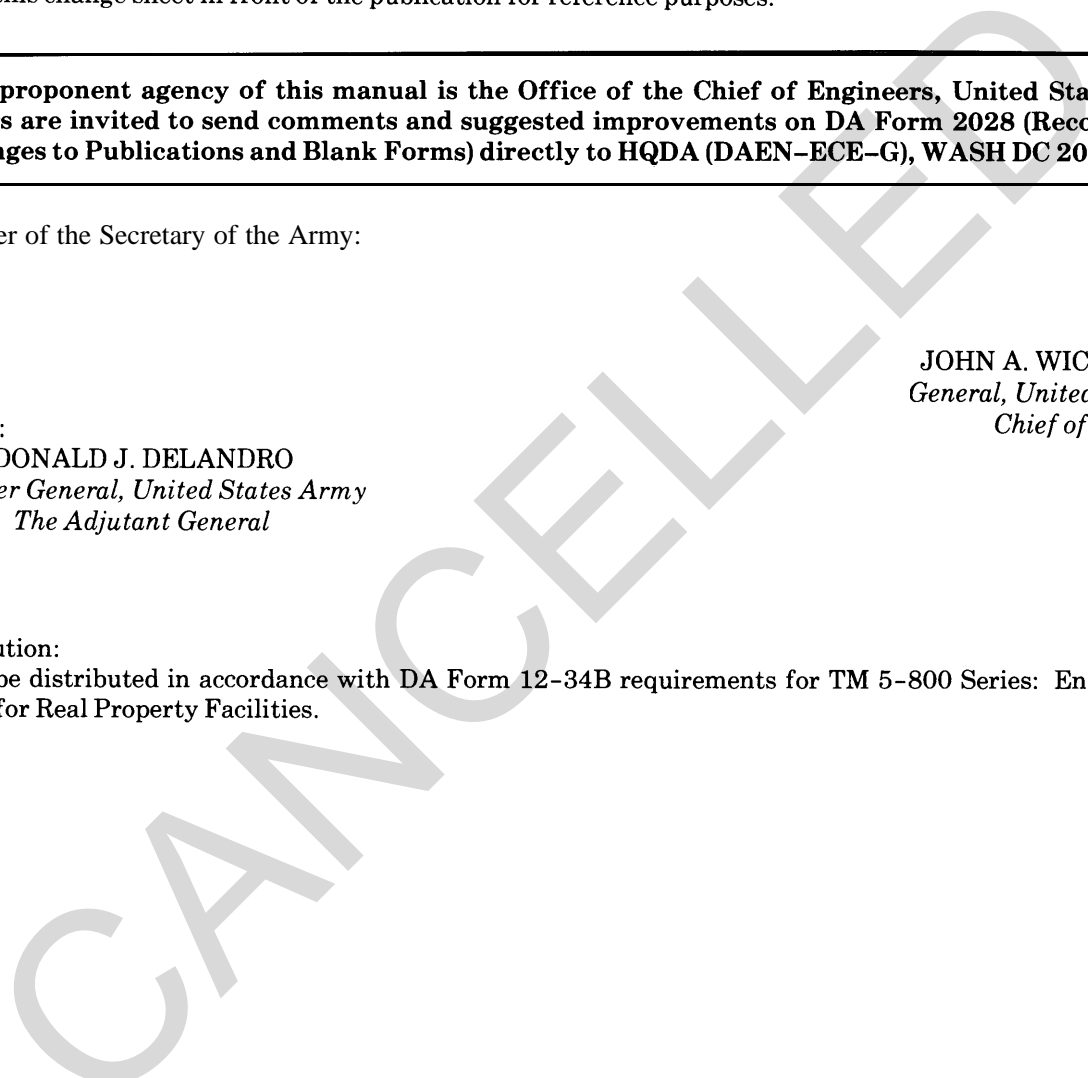

FOUNDATIONS IN EXPANSIVE SOILS

	<i>Paragraph</i>	<i>Page</i>
CHAPTER 1. INTRODUCTION		
Purpose, . . . . .	1-1	1-1
Scope . . . . .	1-2	1-1
Background, . . . . .	1-3	1-1
Causes and patterns of heave . . . . .	1-4	1-2
Elements of design. . . . .	1-5	1-4
2. RECOGNITION OF PROBLEM AREAS		
Site selection, . . . . .	2-1	2-1
Hazard maps, . . . . .	2-2	2-1
3. FIELD EXPLORATION		
Scope, . . . . .	3-1	3-1
Surface examination... . . . .	3-2	3-1
Subsurface exploration . . . . .	3-3	3-1
Groundwater . . . . .	3-4	3-5
4. LABORATORY INVESTIGATIONS		
Identification of swelling soils... . . . .	4-1	4-1
Testing procedures . . . . .	4-2	4-3
5. METHODOLOGY FOR PREDICTION OF VOLUME CHANGES		
Application of heave predictions . . . . .	5-1	5-1
Factors influencing heave . . . . .	5-2	5-1
Direction of soil movement . . . . .	5-3	5-2
Potential total vertical heave... . . . .	5-4	5-2
Potential differential heave... . . . .	5-5	5-5
Heave with time, . . . . .	5-6	5-5
6. DESIGN OF FOUNDATIONS		
Basic considerations . . . . .	6-1	6-1
Shallow individual or continuous footings . . . . .	6-2	6-4
Reinforced slab-on-grade foundations . . . . .	6-3	6-5
Deep foundations . . . . .	6-4	6-10
7. MINIMIZATION OF FOUNDATION MOVEMENT		
Preparation for construction. . . . .	7-1	7-1
Drainage techniques, . . . . .	7-2	7-1
Stabilization techniques, . . . . .	7-3	7-2
8. CONSTRUCTION TECHNIQUES AND INSPECTION		
Minimization of foundation problems from construction . . . . .	8-1	8-1
Stiffened slab foundations . . . . .	8-2	8-1
Drilled shaft foundations . . . . .	8-3	8-1
9. REMEDIAL PROCEDURES		
Basic considerations . . . . .	9-1	9-1
Evaluation of information . . . . .	9-2	9-1
Stiffened slab foundations,.... . . . .	9-3	9-2
Drilled shaft foundations. . . . .	9-4	9-2
APPENDIX A REFERENCES. . . . .		A-1
B CHARACTERIZATION OF SWELL BEHAVIOR FROM SOIL SUCTION . . . . .		B-1
C FRAME AND WALL CONSTRUCTION DETAILS . . . . .		C-1
D BIBLIOGRAPHY . . . . .		D-1

**LIST OF FIGURES**

<i>Figure</i>	<i>Title</i>	<i>Page</i>
1-1	Examples of cracks in an exterior wall . . . . .	1-3
1-2	Examples of wall fractures from doming heave of swelling and shrinking foundation soils . . . . .	1-5
1-3	Examples of fractures from dish-shaped lift on swelling foundation soils . . . . .	1-5
1-4	Decision process of design . . . . .	1-6
2-1	Occurrence and distribution of potentially expansive materials in the United States, 1977, with boundaries of physiographic provinces . . . . .	2-3

<i>Figure</i>	<i>Title</i>	<i>Page</i>
4-1	Relationship used to determine the potential expansiveness for Van Der Merwe's empirical method . . . . .	4-2
4-2	Simple swell test. . . . .	4-4
5-1	Assumed equilibrium pore water pressure profiles beneath foundation slabs. . . . .	5-3
5-2	Example application of equilibrium pore water pressure profile for a site near Hayes, Kansas . . . . .	5-4
5-3	Soil-slab displacements on heaving soil. . . . .	5-6
5-4	Approximate method for computing foundation swell . . . . .	5-7
6-1	Effective plasticity index (PI) or average PI in the top 15 feet of soil beneath the slab. . . . .	6-3
6-2	Footings on nonexpansive stratum . . . . .	6-5
6-3	Interior joint detail for slab-on-grade . . . . .	6-5
6-4	Basement walls with slab-on-grade. . . . .	6-6
6-5	Typical conventional rebar slab in Little Rock, Arkansas, for single-family, single-story, minimally loaded frame residence with 11- to 12-foot wall spacing. . . . .	6-7
6-6	Post-Tensioned slab in Lubbock, Texas, for single-family, single-story, minimally loaded frame residence . . . . .	6-8
6-7	Approximate relationship between the Thornthwaite Moisture Index and the edge lift-off distance. . . . .	6-8
6-8	Approximate distribution of the Thornwaite Moisture Index (MI) in the United States . . . . .	6-9
6-9	Settlement and deflection of a mat foundation. . . . .	6-10
6-10	Drilled shaft details . . . . .	6-14
6-11	Distribution of load from uplift of swelling soil . . . . .	6-15
6-12	Typical grade beam void details . . . . .	6-17
6-13	Typical exterior and interior grade beams . . . . .	6-18
7-1	Drainage trench around outside of structure . . . . .	7-2
7-2	Application of a horizontal membrane . . . . .	7-4
7-3	Vertical and horizontal moisture barriers. . . . .	7-5
B-1	Thermocouple psychrometer monitoring apparatus. . . . .	B-3
B-2	Electrical circuit for the thermocouple psychrometer. . . . .	B-4
B-3	Calibration of filter paper. . . . .	B-5
B-4	Soil suction and water content relationship for Fort Carson overburden at 1 to 3 feet of depth . . . . .	B-7
B-5	Illustration of the compressibility factor . . . . .	B-9
C-1	Wall ties to concrete beams . . . . .	C-1
C-2	Wall ties to concrete column. . . . .	C-2
C-3	Wall ties to steel column. . . . .	C-3
C-4	Wall ties to steel beams . . . . .	C-5
C-5	Wall connections with control joints. . . . .	C-6
C-6	Typical details of interior partitions. . . . .	C-7
C-7	Typical bar joist first floor framing . . . . .	C-8
C-8	Typical cast-in-place or precast concrete grade beam with steel bar joist floor framing . . . . .	C-9
C-9	Typical ribbed mat foundation . . . . .	C-10
C-10	Optional construction details of exterior beams (interior beam similar) for ribbed mat construction. . . . .	C-11

LIST OF TABLES

<i>Table</i>	<i>Title</i>	<i>Page</i>
1-1	Examples of Causes of Foundation Heave from Changes in Soil Moisture . .	1-4
2-1	Premises for Categorization of Soils by the WES Hazard Map . . . . .	2-2
2-2	Tabulation of Potentially Expansive Materials in the United States . . . . .	2-4
3-1	Field Reconnaissance . . . . .	3-2
3-2	Soil Sampling Methods. . . . .	3-4
4-1	WES Classification of Potential Swell . . . . .	4-1
4-2	Other Empirical Methods for Prediction of Potential Heave . . . . .	4-3
5-1	Factors Influencing Magnitude and Rate of Volume Change . . . . .	5-1
6-1	Foundation Systems . . . . .	6-2
6-2	Superstructure Systems . . . . .	6-4
6-3	Classification of Piles . . . . .	6-11



<i>Table</i>	<i>Title</i>	<i>Page</i>
6-4	Applications of Drilled Shafts .....	6-12
6-5	Defects Associated with Drilled Shafts. ....	6-13
7-1	pH Test Procedure for the Lime Modification Optimum Content .....	7-6
8-1	Considerations for Inspection. ....	8-3
8-2	Inspection of Reinforced Slab Foundations .....	8-3
8-3	Inspection of Drilled Shafts .....	8-4
9-1	Remedial Measures. ....	9-2
B-1	Calibration Salt Solutions. ....	B-2

CANCELLED

# CHAPTER 1

## INTRODUCTION

---

### 1-1. Purpose

This manual presents guidance and information for the geotechnical investigation necessary for the selection and design of foundations for heavy and light military-type buildings constructed in expansive clay soil areas. The information in this manual is generally applicable to many types of structures such as residences, warehouses, and multistory buildings. Emphasis is given to the maintenance of an environment that encourages constant moisture conditions in the foundation soils during and following construction. Special attention must always be given to specific requirements of the structure such as limitations on allowable differential movement.

*a.* The guidance and information provided in this manual can significantly reduce the risk of undesirable and severe damages to many structures for numerous expansive soil conditions. However, complete solutions for some expansive soil problems are not yet available; e.g., the depth and amount of future soil moisture changes may be difficult to predict.

*b.* This manual presents guidance for selecting economical foundations on expansive soil to minimize structural distress to within tolerable levels and guidance for minimizing problems that may occur in structures on expansive soils.

### 1-2. Scope

*a.* Guidelines of the geotechnical investigation and analysis necessary for selection and design of military-type buildings constructed in expansive clay soil areas, as outlined in chapters 2 to 5, consist of methods for the recognition of the relative magnitude of the swelling soil problem at the construction site, field exploration, laboratory investigations, and application of methodology for prediction of volume changes in swelling foundation soils. Chapter 6 presents guidance for selection of the type of foundation with structural details of design procedures provided for reference. Chapters 7 to 9 discuss methods of minimizing foundation movement, construction techniques and inspection, and considerations for remedial repair of damaged structures.

*b.* Guidance is not specifically provided for design of highways, canal or reservoir linings, retaining walls, and hydraulic structures. However, much of the

basic information presented is broadly applicable to the investigation and analysis of volume changes in soils supporting these structures and methods for minimizing potential soil volume changes. Guidance is also not specifically provided for the design of structures in areas susceptible to soil volume changes from frost heave and chemical reactions in the soil (e.g., oxidation of iron pyrite), although much of the information presented can be useful toward these designs.

### 1-3. Background

This manual is concerned with heave or settlement caused by change in soil moisture in nonfrozen soils. Foundation materials that exhibit volume change from change in soil moisture are referred to as expansive or swelling clay soils. Characteristic expansive or swelling materials are highly plastic clays and clay shales that often contain colloidal clay minerals such as the montmorillonites. Expansive soils as used in this manual also include marls, clayey siltstones, sandstones, and saprolites.

*a. Damages from differential movement.* The differential movement caused by swell or shrinkage of expansive soils can increase the probability of damage to the foundation and superstructure. Differential rather than total movements of the foundation soils are generally responsible for the major structural damage. Differential movements redistribute the structural loads causing concentration of loads on portions of the foundation and large changes in moments and shear forces in the structure not previously accounted for in standard design practice.

*b. Occurrence of damages.* Damages can occur within a few months following construction, may develop slowly over a period of about 5 years, or may not appear for many years until some activity occurs to disturb the soil moisture. The probability of damages increases for structures on swelling foundation soils if the climate and other field environment, effects of construction, and effects of occupancy tend to promote moisture changes in the soil.

*c. Structures susceptible to damages.* Types of structures most often damaged from swelling soil include foundations and walls of residential and light (one- or two-story) buildings, highways, canal and reservoir linings, and retaining walls. Lightly loaded

one- or two-story buildings, warehouses, residences, and pavements are especially vulnerable to damage because these structures are less able to suppress the differential heave of the swelling foundation soil than heavy, multistory structures.

(1) *Type of damages.* Damages sustained by these structures include: distortion and cracking of pavements and on-grade floor slabs; cracks in grade beams, walls, and drilled shafts; jammed or misaligned doors and windows; and failure of steel or concrete plinths (or blocks) supporting grade beams. Lateral forces may lead to buckling of basement and retaining walls, particularly in overconsolidated and nonfissured soils. The magnitude of damages to structures can be extensive, impair the usefulness of the structure, and detract aesthetically from the environment. Maintenance and repair requirements can be extensive, and the expenses can grossly exceed the original cost of the foundation.

(2) *Example of damages.* Figure 1-1 illustrates damages to a building constructed on expansive soil with a deep water table in the wet, humid climate of Clinton, Mississippi. These damages are typical of buildings on expansive soils. The foundation consists of grade beams on deep drilled shafts. Voids were not provided beneath the grade beams above the expansive foundation soil, and joints were not made in the walls and grade beams. The floor slab was poured on-grade with no provision to accommodate differential movement between the slab and grade beams. The heave of the floor slab exceeded 6 inches. The differential soil movement and lack of construction joints in the structure aggravated cracking.

#### 14. Causes and patterns of heave

*a. Causes.* The leading cause of foundation heave or settlement in susceptible soils is change in soil moisture, which is attributed to changes in the field environment from natural conditions, changes related to construction, and usage effects on the moisture under the structure (table 1-1). Differential heave may be caused by nonuniform changes in soil moisture, variations in thickness and composition of the expansive foundation soil, nonuniform structural loads, and the geometry of the structure. Nonuniform moisture changes occur from most of the items given in table 1-1.

##### *b. Patterns of heave.*

(1) *Doming heave.* Heave of foundations, although often erratic, can occur with an upward, long-term, dome-shaped movement that develops over many years. Movement that follows a reduction of natural evapotranspiration is commonly associated with a doming pattern of greatest heave toward the center of the structure. Evapotranspiration refers to the evaporation of moisture from the ground surface and trans-

piration of moisture from heavy vegetation into the atmosphere. Figure 1-2 schematically illustrates some commonly observed exterior cracks in brick walls from doming or edgedown patterns of heave. The pattern of heave generally causes the external walls in the superstructure to lean outward, resulting in horizontal, vertical, and diagonal fractures with larger cracks near the top. The roof tends to restrain the rotation from vertical differential movements leading to additional horizontal fractures near the roofline at the top of the wall. Semiarid, hot, and dry climates and deep water tables can be more conducive to severe and progressive foundation soil heaves if water become available.

(2) *Cyclic heave.* A cyclic expansion-contraction related to drainage and the frequency and amount of rainfall and evapotranspiration may be superimposed on long-term heave near the perimeter of the structure. Localized heaving may occur near water leaks or ponded areas. Downwarping from soil shrinkage (fig. 1-2) may develop beneath the perimeter during hot, dry periods or from the desiccating influence of trees and vegetation located adjacent to the structure. These edge effects may extend inward as much as 8 to 10 feet. They become less significant on well-drained land. Heavy rain periods may cause ponding adjacent to the structure with edge lift (fig. 1-3) and reversal of the downwarping.

(3) *Edge heave.* Damaging edge or dish-shaped heaving (fig. 1-3) of portions of the perimeter maybe observed relatively soon after construction, particularly in semiarid climates on construction sites with preconstruction vegetation and lack of topographic relief. The removal of vegetation leads to an increase in soil moisture, while the absence of topographic relief leads to ponding (table 1-1). A dish-shaped pattern can also occur beneath foundations because of consolidation, drying out of surface soil from heat sources, or sometimes lowering of the water table. Changes in the water table level in uniform soils beneath uniformly loaded structures may not contribute to differential heave. However, structures on a deep foundation, such as drilled shafts with a slab-on-grade, can be adversely affected by a changing water table or changes in soil moisture if the slab is not isolated from the perimeter grade beams and if internal walls and equipment are not designed to accommodate the slab movement.

(4) *Lateral movement.* Lateral movement may affect the integrity of the structure.

(a) Lateral thrust of expansive soil with a horizontal force up to the passive earth pressure can cause bulging and fracture of basement walls. Basement walls and walls supporting buildings usually cannot tolerate the same amount of movement as free-standing retaining walls. Consequently, such walls must be designed to a higher degree of stability.



a. Vertical cracks



b. Diagonal and vertical cracks

U. S. Army Corps of Engineers

*Figure 1-1. Examples of cracks in an exterior wall.*

(b) The walls and foundations of structures constructed on slopes greater than 5 degrees (9 percent) may experience damage from downhill soil creep of cohesive expansive soils. Downhill creep can also shear

shaft foundations. The mechanism of creep may be such that the soil alternately expands and contracts aided by gravity. The depth of creeping soil varies from a few inches to several feet.

Table 1-1. Examples of Causes of Foundation Heave from Changes in Soil Moisture

Changes in field environment from natural conditions	1.	Significant variations in climate, such as long droughts and heavy rains, cause cyclic moisture changes resulting in edge movement of structures.
	2.	Changes in depth to the water table lead to changes in soil moisture.
	3.	Frost heave and chemical reactions in the soil, such as oxidation of iron pyrite, noted.
Changes related to construction	1.	Covered areas reduce natural evaporation of moisture from the ground increasing soil moisture.
	2.	Covered areas reduce transpiration of moisture from vegetation increasing soil moisture.
	3.	Construction on a site where large trees were removed may lead to an increase of moisture because of prior depletion of soil moisture by the extensive root system.
	4.	Inadequate drainage of surface water from the structure leads to ponding and localized increases in soil moisture. Defective rain gutters and downspouts contribute to localized increases in soil moisture.
	5.	Seepage into foundation subsoils at soil/foundation interfaces and through excavations made for basements or shaft foundations leads to increased soil moisture beneath the foundation.
	6.	Drying of exposed foundation soils in excavations and reduction in soil surcharge weight increase the potential for heave.
	7.	Aquifers tapped.
Usage effects	1.	Watering of lawns leads to increased soil moisture.
	2.	Planting and growth of heavy vegetation, such as trees, at distances from the structure less than 1 to 1.5 times the height of mature trees aggravate cyclic edge heave.
	3.	Drying of soil beneath heated areas of the foundation, such as furnace rooms, leads to soil shrinkage.
	4.	Leaking underground water and sewer lines can cause foundation heave and differential movement.

### 1-5. Elements of design

The foundation should be constructed or taken to a depth to protect the structure against damage by swelling or shrinking soil. Furthermore, the foundation should transmit the combined dead and imposed loads to the ground without causing settlements or other movements that are large enough to impair or damage the structure or reduce its overall usefulness. Finally, the foundation should provide protection from the freeze-thaw cycle of soil in cold climates and adequately resist any chemical or deleterious attack such as sulfates and other harmful material in the soil.

#### a. Decision process of design.

(1) Figure 1-4 shows steps in the decision process, during the predesign and design phases, to properly select the foundation and superstructure. These steps include: site and soil investigations; a study of topography, drainage, and soil stabilization; and the selec-

tion of the foundation and superstructure.

(2) A foundation report for future reference should be made after construction.

b. *Economics of the foundation.* A thorough geotechnical study and an investigation of the foundation system during the predesign and preliminary design phases are normally essential.

(1) The features of the design should be kept simple to minimize costs and future maintenance expenses. Irregular geometries should be avoided. Construction of independently supported rectangular sections of the structure separated by joints, for example, may be appropriate if differential movement and separation between the independent sections does not significantly detract from the aesthetics or present a safety hazard. External parts of the structure, such as porches, terraces, breezeways, and garages, should be supported by part of the engineered foundation or isolated from the main structure. If the external parts of

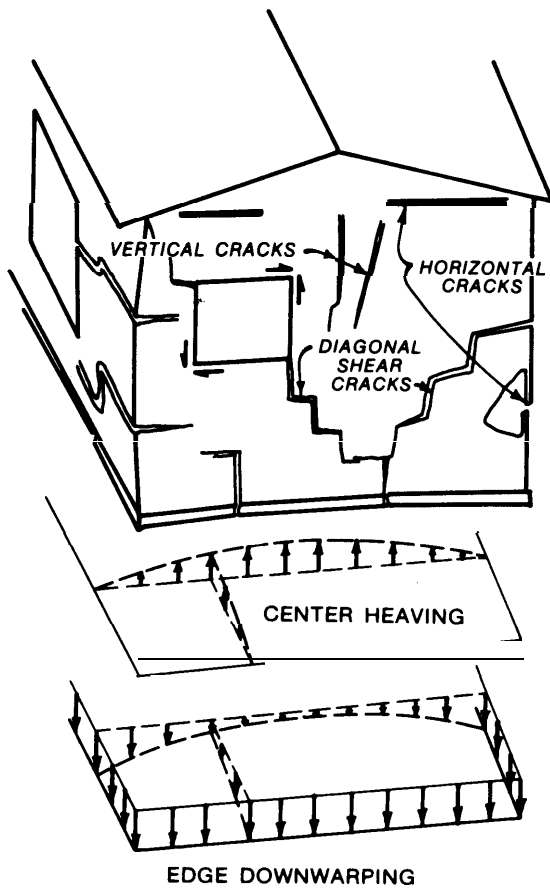

U. S. Army Corps of Engineers

Figure 1-2. Examples of wall fractures from doming heave of swelling and shrinking foundation soils.

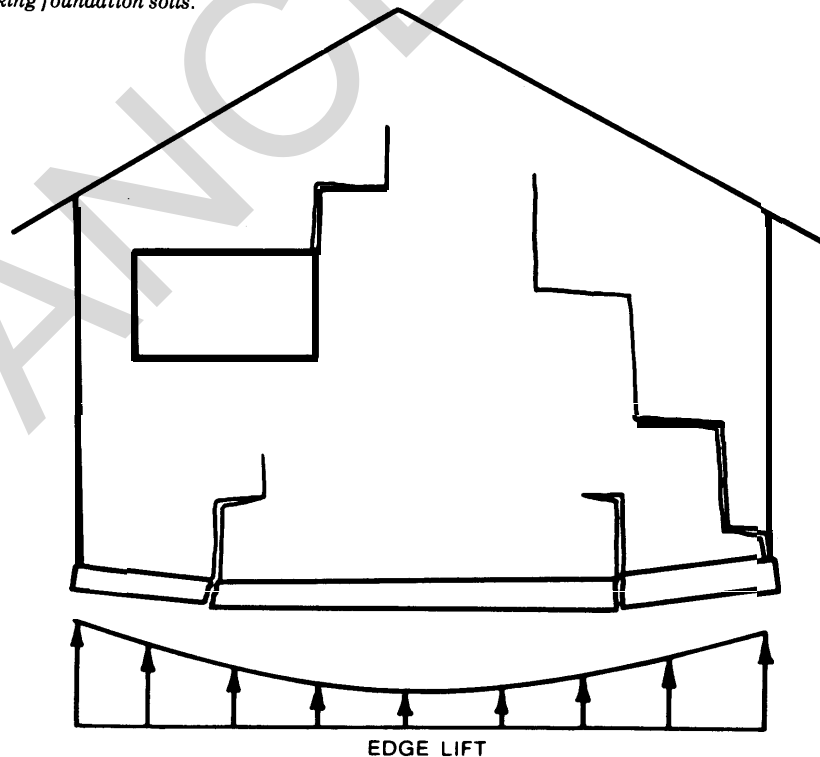

U. S. Army Corps of Engineers

Figure 1-3. Examples of fractures from dish-shaped lift on swelling foundation soils.

the structure are simply supported on-grade or attached to the structure, they can contribute to future maintenance problems.

(2) Potential problems that could eventually affect the performance of the structure are best determined during the predesign and preliminary design phases when compromises can be made between the structural, architectural, mechanical, and other aspects of the design without disrupting the design process. Changes during the detailed design phase or during construction will probably delay construction and pose economic disadvantages.



## CHAPTER 2

## RECOGNITION OF PROBLEM AREAS

## 2-1. Site selection

The choice of the construction site is often limited. It is important to recognize the existence of swelling soils on potential sites and to understand the problems that can occur with these soils as early as possible. A surface examination of the potential site as discussed in paragraph 3-2 should be conducted and available soil data studied during the site selection.

*a. Avoidance of potential problems.* If practical, the foundation should be located on uniform soils subject to the least swelling or volume change. Discontinuities or significant lateral variations in the soil strata should be avoided. Swampy areas, backfilled ponds, and areas near trees and other heavy vegetation should be avoided. Special attention should be given to adequate compaction of filled areas, types of fill, and leveling of sloped sites (para 7-1).

(1) *Undeveloped sites.* Undeveloped sites generally have little or no subsurface soil information available and require subsurface exploration (para 3-3).

(a) Substantial differential heave may occur beneath structures constructed on previously undeveloped sites where trees and other heavy vegetation had been removed prior to construction. Soil moisture will tend to increase since loss of heavy vegetation reduces the transpiration of moisture. Construction of the foundation over the soil will tend to further increase soil moisture because of reduced evaporation of moisture from the ground surface.

(b) Swampy or ponded areas may contain greater quantities of plastic fine particles with a greater tendency to swell than other areas on the site.

(c) Future irrigation of landscaped areas and leakage from future sewer and other water utility lines following development of the site may substantially increase soil moisture and cause a water table to rise or to develop if one had not previously existed. Filled areas may also settle if not properly compacted.

(2) *Developed sites.* Subsurface exploration should be conducted if sufficient soil data from earlier borings are not available for the site selection and/or problems had occurred with previous structures. Some subsurface exploration is always necessary for site selection of any structure of economic significance, particularly multistory buildings and structures with special requirements of limited differential distortion.

(a) An advantage of construction on developed

sites is the experience gained from previous construction and observation of successful or unsuccessful past performance. Local builders should be consulted to obtain their experience in areas near the site. Existing structures should be observed to provide hints of problem soil areas.

(b) The soil moisture may tend to be much closer to an equilibrium profile than that of an undeveloped site. Differential movement may not be a problem because previous irrigation, leaking underground water lines, and previous foundations on the site may have stabilized the soil moisture toward an equilibrium profile. Significant differential movement, however, is still possible if new construction leads to changes in soil moisture. For example, trees or shrubs planted too close to the structure or trees removed from the site, change in the previous irrigation pattern following construction, lack of adequate drainage from the structure, and improper maintenance of drainage provisions may lead to localized changes in soil moisture and differential heave. Edge movement of slab-on-grade foundations from seasonal changes in climate may continue to be a problem and should be minimized as discussed in chapter 7.

(3) *Sidehill or sloped sites.* Structures constructed on sites in which the topography relief is greater than 5 degrees (9 percent gradient) may sustain damage from downhill creep of expansive clay surface soil. Sidehill sites and sites requiring split-level construction can, therefore, be expected to complicate the design. See chapter 7 for details on minimization of foundation soil movement.

*b. Soil surveys.* Among the best methods available for qualitatively recognizing the extent of the swelling soil problem for the selected site is a careful examination of all available documented evidence on soil conditions near the vicinity of the site. Local geological records and publications and federal, state, and institutional surveys provide good sources of information on subsurface soil features. Hazard maps described in paragraph 2-2 document surveys available for estimating the extent of swelling soil problem areas.

## 2-2. Hazard maps

Hazard maps provide a useful first-order approximation of and guide to the distribution and relative expansiveness of problem soils. These maps should be



used in conjunction with local experience and locally available soil surveys and boring data. The maps discussed in a and b below are generally consistent with each other and tend to delineate similar areas of moderately or highly expansive soil.

a. *Waterways Experiment Station (WES) Map.* This map, which was prepared for the Federal Highway Administration (FHWA), summarizes the areas of the United States, except Alaska and Hawaii, where swelling soil problems are likely to occur (fig. 2-1). The basis for classification depends primarily on the estimated volume change of argillaceous or clayey materials within the geologic unit, the presence of montmorillonite, the geologic age, and reported problems

due to expansive materials. The stratigraphy and mineralogy are key elements in the classification.

(1) *Classification.* The soils are classified into categories of High, Medium, Low, and Nonexpansive as shown in figure 2-1. The distribution of expansive materials is categorized by the geologic unit on the basis of the degree of expansiveness that relates to the expected presence of montmorillonite and the frequency of occurrence that relates to the amount of clay or shale. The amount refers most significantly to the vertical thickness of the geologic unit, but the areal extent was also considered in the classification. The premises in table 2-1 guide the categorization of soils.

Table 2-1. Premises for Categorization of Soils by the WES Hazard Map

---

1. Any area underlain by argillaceous rocks, sediments, or soils will exhibit some degree of expansiveness.
2. The degree of expansiveness is a function of the amount of expandable clay minerals present.
3. Generally, the Mesozoic and Cenozoic rocks and sediments contain significantly more montmorillonite than the Paleozoic (or older) rocks. (Damage to structures founded on Permian (Upper Paleozoic) has also been observed.)
4. Areas underlain by rocks or sediments of mixed textural compositions (e.g., sandy shales or sandy clays) or shales or clays interbedded with other rock types or sediments are considered on the basis of geologic age and the amount of argillaceous material present.
5. Generally, those areas lying north of the glacial boundary are nonexpansive due to glacial drift cover.
6. Soils derived from weathering of igneous and metamorphic rocks are generally nonexpansive.
7. Climate or other environmental aspects are not considered.
8. Argillaceous rocks or sediments originally composed of expandable clay minerals do not exhibit significant volume change when subjected to tectonic folding, deep burial, or metamorphism.
9. Volcanic areas consisting mainly of extruded basalts and kindred rocks may also contain tuffs and volcanic ash deposits that have devitrified and altered to montmorillonite.
10. Areas along the glaciated boundary may have such a thin cover of drift that the expansive character of the materials under the drift may predominate.

---

(2) *Physiographic provinces.* Table 2-2 summarizes the potentially expansive geologic units on the basis of the 20 first-order physiographic provinces. Figure 2-1 shows the locations of the physiographic provinces.

b. *Other maps.*

(1) *Area map of susceptible soil expansion problems.* A hazard map was developed by M. W. Wiczak (Transportation Research Board, Report 132) on the basis of the occurrence and distribution of expansive soils and expansive geologic units, the pedologic analysis, and climatic data to delineate areas susceptible to expansion problems. Some geologic units for which engineering experiences were not available may have been omitted, and the significance of pedological soil on expansion was not shown on the map.

(2) *Assessment map of expansive soils within the United States.* The major categories for classification of the severity of the swelling soil problem presented by J. P. Krohn and J. E. Slosson (American Society of Civil Engineers, *Proceedings of the Fourth International Conference on Expansive Soils*, Volume 1 (see app. A) correspond to the following modified shrink-swell categories of the Soil Conservation Service (SCS) of the U. S. Department of Agriculture:

High:	Soils containing large amounts of montmorillonite and clay (COLE >6 percent)
Moderate:	Soils containing moderate amounts of clay with some montmorillonitic minerals (3 percent ≤ COLE ≤ 6 percent)
Low:	Soils containing some clay with the clay consisting mostly of kaolinite and/or other low swelling clay minerals (COLE <3 percent).

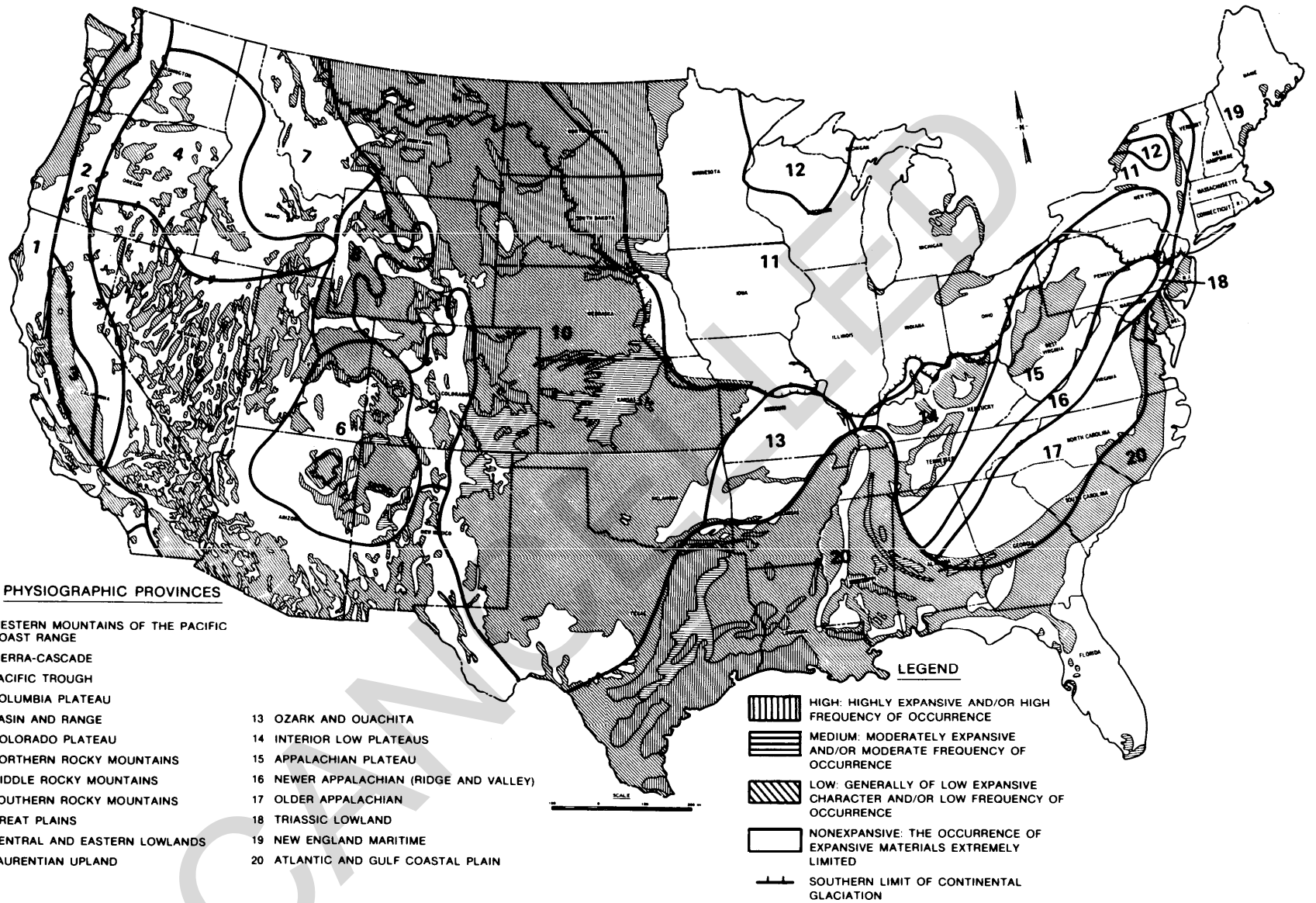

U. S. Army Corps of Engineers

Figure 2-1. Occurrence and distribution of potentially expansive materials in the United States, 1977, with boundaries of physiographic provinces.

Table 2-2. Tabulation of Potentially Expansive Materials in the United States

Physiographic Province		Predominant Geologic Unit	Geologic Age	Location of Unit	Map <sup>b</sup> Category	Remarks
No. <sup>a</sup>	Name					
1	Western Mountains of the Pacific Coast Range	Reefridge	Miocene	CA	1	The Tertiary section generally consists of interbedded sand- stone, shale, chert, and volcanics
		Monterey	Miocene	CA	1	
		Rincon	Miocene	CA	1	
		Tembler	Miocene	CA	1	
		Umpqua	Paleocene-Eocene	OR	3	
		Puget Gp	Miocene	WA	3	
		Chico Fm	Cretaceous	CA	1	
2	Sierra Cascade	Cascade Gp	Pliocene	OR	4	Predominate material is volcanic Interbedded sandstones and shales may occur throughout, particu- larly in western foot hills
		Columbia Gp	Miocene	WA	4	
		Volcanics	Paleozoic to Cenozoic	NV	4	
		Volcanics	Paleozoic to Cenozoic	CA	4	
3	Pacific Trough	Troutdale	Pliocene	WA	3	Great Valley materials charac- terized by local areas of low- swell potential derived from bordering mountains. Some scattered deposits of bentonite
		Santa Clara	Pleistocene	CA	3	
		Riverbank	Pleistocene	CA	3	
4	Columbia Plateau	Volcanics	Cenozoic	WA, OR, ID, NV	4	Some scattered bentonites and tuffs
5	Basin and Range	Valley fill materials Volcanics	Pleistocene Tertiary	OR, CA, NV, UT, AZ, NM, TX OR, CA, NV, UT, AZ, NM, TX	3	Playa deposits may exhibit limited swell potential. Some scattered bentonites and tuffs
6	Colorado Plateau	Greenriver	Eocene	CO, UT, NM	3	Interbedded sandstones and shales
		Wasatch	Eocene	CO, UT, NM	3	
		Kirkland shale	Upper Cretaceous	CO, UT, NM, AZ	2	
		Lewis shale	Upper Cretaceous	CO, UT, NM, AZ	2	
		Mancos	Upper Cretaceous	CO, UT, NM, AZ	1	
		Mowry	Upper Cretaceous	CO, UT, NM, AZ	1	
		Dakota	Jurassic- Cretaceous	CO, UT, NM, AZ	3	
		Chinle	Triassic	NM, AZ	1	

(Continued)

<sup>a</sup> Refer to map of physiographic provinces, Figure 2-1.<sup>b</sup> Numerical map categories correspond as follows: 1 - high expansion, 2 - medium expansion, 3 - low expansion, and 4 - nonexpansive.

Table 2-2. (Continued)

Physiographic Province		Predominant Geologic Unit	Geologic Age	Location of Unit	Map Category	Remarks
No.	Name					
7	Northern Rocky Mountains	Montana Gp	Cretaceous	MT	1	Locally some sandstone and siltstone
		Colorado Gp	Cretaceous	MT	2	Locally some siltstone
		Morrison	Jurassic	MT	3	Shales, sandstones, and
		Sawtooth	Jurassic	MT	3	limestones
8	Middle Rocky Mountains	Windriver	Eocene	WY, MT	3	
		Fort Union	Eocene	WY, MT	3	
		Lance	Cretaceous	WY, MT	1	
		Montana Gp	Cretaceous	WY, MT	1	
		Colorado Gp	Cretaceous	WY, MT	2	
		Morrison	Jurassic-Cretaceous	WY, MT	3	
9	Southern Rocky Mountains	Metamorphic and granitic rocks	Precambrian	WY	4	Montana and Colorado Gps may be present locally with some
		Metamorphic and granitic rocks	Precambrian	CO	4	Tertiary volcanic and minor amounts of Pennsylvania lime-
		Metamorphic and granitic rocks	Precambrian to Cenozoic	NM	4	stone (sandy or shaly).
10	Great Plains	Fort Union	Paleocene	WY, MT	3	
		Thermopolis	Cretaceous	WY, MT	1	
		Montana Gp	Cretaceous	WY, MT, CO, NM	1	
		Colorado Gp	Cretaceous	WY, MT, CO, NM	2	
		Mowry	Cretaceous	WY, MT, CO, NM	1	
		Morrison	Jurassic-Cretaceous	WY, MT, CO, NM	3	
		Ogallala	Pliocene	WY, MT, CO, NM, SD, NE, KS, OK, TX	3	Generally nonexpansive but bentonite layers are locally present
		Wasatch	Eocene	MT, SD	3	
		Dockum	Triassic	CO, NM, TX	3	
		Permian Red Beds	Permian	KS, OK, TX	3	
		Virgillian Series	Pennsylvanian	NE, KS, OK, TX, MO	3	
		Missourian Series	Pennsylvanian	KS, OK, TX, MO	3	
Desmonian Series	Pennsylvanian	KS, OK, TX, MO	3			
11	Central and Eastern Lowlands	Glacial lake deposits	Pleistocene	ND, SD, NM, IL, IN, OH, MI, NY, VT, MA, NE, IA, KS, MO, WI	3	Some Paleozoic shales locally present which may exhibit low swell

(Sheet 2 of 4)

Table 2-2. (Continued)

<u>Physiographic Province</u>		<u>Predominant Geologic Unit</u>	<u>Geologic Age</u>	<u>Location of Unit</u>	<u>Map Category</u>	<u>Remarks</u>
<u>No.</u>	<u>Name</u>					
12	Laurentian Uplands	Keweenaw	Precambrian	NY, WI, MI	4	Abundance of glacial material of varying thickness
		Huronian	Precambrian	NY, WI, MI	4	
		Laurentian	Precambrian	NY, WI, MI	4	
13	Ozark and Ouachita	Fayetteville	Mississippian	AR, OK, MO	3	May contain some montmorillonite in mixed layer form
		Chickasaw Creek	Mississippian	AR, OK, MO	3	
14	Interior Low Plains	Meramac Series	Mississippian	KY	3	Interbedded shale, sandstone, and limestone
		Osage	Mississippian	KY, TN	3	
		Kinderhook	Mississippian	KY, TN	3	
		Chester Series	Mississippian	KY, IN	3	
		Richmond	Upper Ordovician	KY, IN	3	
		Maysville	Upper Ordovician	KY, IN	3	
		Eden	Upper Ordovician	KY, IN	3	
15	Appalachian Plateau	Dunkard Gp	Pennsylvanian-Permian	WV, PA, OH	3	Interbedded shale, sandstone, limestone, and coal
16	Newer Appalachian	See Remarks	See Remarks	AL, GA, TN, NC, VA, WV, MD, PA	4	A complex of nonexpansive Precambrian and Lower Paleozoic meta-sedimentary and sedimentary rocks
17	Older Appalachian	See Remarks	Paleozoic	AL, GA, NC, SC, VA, MD	4	A complex of nonexpansive metamorphic and intrusive igneous rocks
18	Triassic Lowland	Newark Gp	Triassic	PA, MD, VA	4	
19	New England Maritime	Glacio-marine deposits	Pleistocene	ME	3	Pleistocene marine deposits underlain by nonexpansive rocks. Local areas of clay could cause some swell potential
20	Atlantic and Gulf Coastal Plain	Talbot and Wicomico Gps	Pleistocene	NC, SC, GA, VA, MD, DE, NJ	4	Interbedded gravels, sands, silts, and clays
		Lumbee Gp	Upper Cretaceous	NC, SC	3	Sand with intermixed sandy shale
		Potomac Gp	Lower Cretaceous	DC	3	Sand with definite shale zones
		Arundel Fm	Lower Cretaceous	DC	1	
		Continental and marine coastal deposits	Pleistocene to Eocene	FL	4	Sands underlain by limestone, local deposits may show low swell potential

(Sheet 3 of 4)

Table 2-2. (Continued)

Physiographic Province		Predominant Geologic Unit	Geologic Age	Location of Unit	Map Category	Remarks
No.	Name					
20	Atlantic and Gulf Coastal Plain (Cont'd)	Yazoo Clay	Eocene	MS, LA	1	A complex interfacing of gravel, sand, silt, and clay. Clays show varying swell potential A mantle of uniform silt with essentially no swell potential Interbedded stringers and lenses of sands, silts, clays, marl, and chalk
		Porters Creek Clay	Paleocene	MS, AI, GA	1-3	
		Selma Gp	Cretaceous	MS, AI, GA	2-3	
		Loess	Pleistocene	LA, MS, TN, KY	4	
		Mississippi alluvium	Recent	LA, MS, AR, MO	3	
		Beaumont-Prairie Terraces	Pleistocene	LA, MS, TX	1	
		Jackson, Claiborne, Midway	Paleocene-Oligocene	LA, MS	1-3	
		Navarre, Taylor, Austin	Upper Cretaceous	TX	1-2	
		Eagle Ford, Woodbine	Upper Cretaceous	TX	1-3	
		Washita	Lower Cretaceous	TX, OK	1-3	
		Fredricksburg	Lower Cretaceous	TX	3	
		Trinity	Lower Cretaceous	TX	4	

(Sheet 4 of 4)

These categories of classification use the coefficient of linear extensibility (COLE), which is a measure of the change in linear dimension from the dry to a moist state, and it is related to the cube root of the volume change. Premises guiding the categorization of the Krohn and Slosson map include: degree of expansion as a function of the amount of expandable clay; cover of nonexpansive glacial deposits; and low-rated areas with nonexpansive and small quantities of expansive soils. Environmental factors, such as climatic effects, vegetation, drainage, and effects of man, were not considered.

(3) *Soil Conservation Service county soil surveys.* Survey maps by SCS provide the most detailed surficial soil maps available, but not all of the United States is mapped. Soil surveys completed during the 1970's contain engineering test data, estimates of soil engineering properties, and interpretations of properties for each of the major soil series within the given county. The maps usually treat only the upper 30 to 60 inches of soil and, therefore, may not fully define the foundation soil problem.

(4) *U.S. and State Geological Survey maps.* The U.S. Geological Survey is currently preparing hazard maps that will include expansive soils.

*c. Application of hazard maps.* Hazard maps provide basic information indicative of the probable degree of expansiveness and/or frequency of occurrence of swelling soils. These data lead to initial estimates for the location and relative magnitude of the swelling problem to be expected from the foundation soils. The SCS

county survey maps prepared after 1970, if available, provide more detail on surface soils than do the other maps discussed in *b* above. The other maps used in conjunction with the SCS maps provide a better basis for election of the construction site.

(1) Recognition of the problem area at the construction site provides an aid for the planning of field exploration that will lead to the determination of the areal extent of the swelling soil formations and samples for the positive identification and evaluation of potential swell of the foundation soils and probable soil movements beneath the structure.

(2) Problem areas that rate highly or moderately expansive on any of the hazard maps should be explored to investigate the extent and nature of the swelling soils. Structures in even low-rated areas of potential swell may also be susceptible to damages from heaving soil depending on the ability of the structure to tolerate differential foundation movement. These low-rated areas can exhibit significant differential soil heave if construction leads to sufficiently large changes in soil moisture and uneven distribution of loads. Also, low-rated areas on hazard maps may include some highly swelling soil that had been neglected.

(3) Figure 2-1 indicates that most problems with swelling soils can be expected in the northern central, central, and southern states of the continental United States. The Aliamanu crater region of Fort Shafter, Hawaii, is another example of a problem area.

## CHAPTER 3

### FIELD EXPLORATION

---

#### 3-1. Scope

The field study is used to determine the presence, extent, and nature of expansive soil and groundwater conditions. The two major phases of field exploration are surface examination and subsurface exploration. The surface examination is conducted first since the results help to determine the extent of the subsurface exploration. In situ tests may also be helpful, particularly if a deep foundation, such as drilled shafts, is to be used.

#### 3-2. Surface examination

*a. Site history.* A study of the site history may reveal considerable qualitative data on the probable future behavior of the foundation soils. Maps of the proposed construction site should be examined to obtain information on wooded areas, ponds and depressions, water-courses, and existence of earlier buildings. Surface features, such as wooded areas, bushes, and other deep-rooted vegetation in expansive soil areas, indicate potential heave from accumulation of moisture following elimination of these sources of evapotranspiration. The growth of mesquite trees, such as found in Texas, and other small trees may indicate subsurface soil with a high affinity for moisture, a characteristic of expansive soil. Ponds and depressions are often filled with clayey, expansive sediments accumulated from runoff. The existence of earlier structures on or near the construction site has probably modified the soil moisture profile and will influence the potential for future heave beneath new structures.

*b. Field reconnaissance.* A thorough visual examination of the site by the geotechnical engineer is necessary (table 3-1). More extensive subsurface exploration is indicated if a potential for swelling soil is evident from damages observed in nearby structures. The extent of desiccation cracks, plasticity, slickensides, and textures of the surface soil can provide a relative indication of the potential for damaging swell.

(1) *Cracking in nearby structures.* The appearance of cracking in nearby structures should be especially noted. The condition of on-site stucco facing, joints of brick and stone structures, and interior plaster walls can be a fair indication of the possible degree of swelling that has occurred. The differential heave that may occur in the foundation soil beneath the proposed structure, however, is not necessarily equal to the dif-

ferential heave of earlier or nearby structures. Differential heave depends on conditions such as variation of soils beneath the structure, load distribution on the foundation, foundation depth, and changes in groundwater since construction of the earlier structures.

(2) *Soil gilgai.* The surface soil at the site should also be examined for gilgai. Soil gilgai are surface mounds that form at locations where the subsurface soil has a greater percentage of plastic fines and is thus more expansive than the surface soil. Gilgai begin to form at locations where vertical cracks penetrate into the subsurface soil. Surface water enters and swelling takes place around the cracks leaving fractured zones where plastic flow occurs. These mounds usually have a higher pH than the adjacent low areas or depressions and may indicate subsurface soil that had extruded up the fractures.

(3) *Site access and mobility.* Indicators of site access and mobility (table 3-1) may also influence behavior of the completed structure. For example, nearby water and sewer lines may alter the natural moisture environment. Flat land with poor surface drainage, as indicated by ponded water, may aggravate differential heave of the completed structure if drainage is not corrected during construction. Construction on land with slopes greater than 5 degrees may lead to structural damage from creep of expansive clay surface soils. Trees located within a distance of the proposed structure of 1 to 1.5 times the height of mature trees may lead to shrinkage beneath the structure, particularly during droughts.

*c. Local design and construction experience.* Local experience is very helpful in indicating possible design and construction problems and soil and groundwater conditions at the site. Past successful methods of design and construction and recent innovations should be examined to evaluate their usefulness for the proposed structure.

#### 3-3. Subsurface exploration

Subsurface exploration provides representative samples for visual classification and laboratory tests. Classification tests are used to determine the lateral and vertical distribution and types of foundation soils. Soil swell, consolidation, and strength tests are needed to evaluate the load/displacement behavior and bearing capacity of the foundation in swelling soil. The struc-



Table 3-1. Field Reconnaissance

Indicators of swelling soil	1.	Desiccation cracks	Cracks appear in the ground surface during dry periods. Larger and more frequent polygon arrangements of cracks indicate greater potential swell. Dry strength of exposed surfaces is high.
	2.	Plasticity	Relative ease to roll into a small thread indicates greater potential swell.
	3.	Slickensides	Slickensides and fissures are abundant in freshly exposed surfaces of many swelling soils.
	4.	Texture	Slick, cohesive soil tending to adhere to shoes or tires of vehicles when wet indicates swelling soil.
	5.	Structure distortion	Relative size and frequency of cracks and distortion in nearby structures indicates the relative potential swell. Potential swell is approximately the sum of the crack widths. Appearance of power lines, fences, or trees often gives an indication of creep behavior.
	6.	Gilgai	Surface mounds of rounded or long, narrow shape.
Indicators of site access and mobility	1.	Restrictions on access.	
	2.	Locations of utilities and restrictions concerning removal or relocation.	
	3.	Locations of existing structures on site and adjacent to the site. Description of foundation types. Obtain photographs if it can be reasonably expected that existing structures may be affected by construction operations.	
	4.	Locations of trees and other major surface vegetation and restrictions concerning removal or disposition.	
	5.	Surface drainage including presence of ponded water.	
	6.	Examination of contour maps of the site: fill areas, slopes, rock outcrops, or other topographic features.	
	7.	Possible condition of ground at time of construction in relation to trafficability of equipment.	

ture interaction effects in swelling soil are complicated by the foundation differential movement caused by soil heave. Sufficient samples should be available to allow determination of the representative mean of the swell and strength parameters of each distinctive soil stratum. The lower limit of the scatter in strength parameters should also be noted.

*a. Sampling requirements.* The design of lightly loaded structures and residences can often be made with minimal additional subsurface investigations and soil testing if the site is developed, if subsurface features are generally known, and if the local practice has consistently provided successful and economical designs of comparable structures. Additional subsurface investigation is required for new undeveloped sites, multistory or heavy buildings, structures with previously untested or new types of foundations, and special structures that require unusually limited differential movements of the foundation such as deflection/length ratios less than 1/1000. Where the local practice has not consistently provided satisfactory designs, a careful review of the local practice is neces-

sary. Corrections to improve performance compared with earlier structures may prove difficult to devise and implement and may require evaluation of the behavior of the subsurface foundation soils and groundwater conditions.

*b. Distribution and depth of borings.* The distribution and depth of borings are chosen to determine the soil profile and to obtain undisturbed samples required to evaluate the potential total and differential heave of the foundation soils from laboratory swell tests, as well as to determine the bearing capacity and settlement. Consequently, greater quantities of undisturbed samples may be required in swelling soils than normally needed for strength tests.

(1) Borings should be spaced to define the geology and soil nonconformities. Spacings of 50 or 25 feet and occasionally to even less distance may be required when erratic subsurface conditions (e.g., soils of different swelling potential, bearing capacity, or settlement) are encountered. Initial borings should be located close to the corners of the foundation, and the number should not be less than three unless subsurface condi-

tions are known to be uniform. Additional borings should be made as required by the extent of the area, the location of deep foundations such as drilled shafts, and the encountered soil conditions.

(2) The depth of sampling should be at least as deep as the probable depth to which moisture changes and heave may occur. This depth is called the depth of the active zone  $X_a$ . The active depth usually extends down about 10 to 20 feet below the base of the foundation or to the depth of shallow water tables, but it may be deeper (para 5-4c). A shallow water table is defined as less than 20 feet below the ground surface or below the base of the proposed foundation. The entire thickness of intensely jointed or fissured clays and shales should be sampled until the groundwater level is encountered because the entire zone could swell, provided swelling pressures are sufficiently high, when given access to moisture. Continuous sampling is required for the depth range within the active zone for heave.

(3) Sampling should extend well below the anticipated base of the foundation and into strata of adequate bearing capacity. In general, sampling should continue down to depths of 1.5 times the minimum width of slab foundations to a maximum of 100 feet and a minimum of three base diameters beneath the base of shaft foundations. The presence of a weak, compressible, or expansive stratum within the stress field exerted by the entire foundation should be detected and analyzed to avoid unexpected differential movement caused by long-term volume changes in this stratum. Sampling should continue at least 20 feet beneath the base of the proposed foundation. Determination of the shear strength and stress/strain behavior of each soil stratum down to depths of approximately 100 feet below the foundation is useful if numerical analysis by the finite element method is considered.

*c. Time of sampling.* Sampling may be done when soil moisture is expected to be similar to that during construction. However, a design that must be adequate for severe changes in climate, such as exposure to periods of drought and heavy rainfall, should be based on maximum levels of potential soil heave. Maximum potential heaves are determined from swell tests using soils sampled near the end of the dry season, which often occurs toward the end of summer or early fall. Heave of the foundation soil tends to be less if samples are taken or the foundation is placed following the wet season, which often occurs during spring.

*d. Sampling techniques.* The disturbed samples and the relatively undisturbed samples that provide minimal disturbance suitable for certain laboratory soil tests may be obtained by the methods described in table 3-2. Drilling equipment should be well maintained during sampling to avoid equipment failures, which cause delays and can contribute to sample disturbance.

Personnel should be well trained to expedite proper sampling, sealing, and storage in sample containers.

(1) *Disturbed sampling.* Disturbed auger, pit, or split spoon samplers may be useful to roughly identify the soil for qualitative estimates of the potential for soil volume change (para 4-1). The water content of these samples should not be altered artificially during boring, for example, by pouring water down the hole during augering.

(2) *Undisturbed sampling.* Minimization of sample disturbance during and after drilling is important to the usefulness of undisturbed samples. This fact is particularly true for expansive soils since small changes in water content or soil structure will significantly affect the measured swelling properties.

(a) The sample should be taken as soon as possible, after advancing the hole to the proper depth and cleaning out the hole, to minimize swelling or plastic deformation of the soil to be sampled.

(b) The samples should be obtained using a push tube sampler without drilling fluid, if possible, to minimize changes in the sample water content. Drilling fluids tend to increase the natural water content near the perimeter of the soil sample, particularly for fissured soil.

(c) A piston Denisen or other sampler with a cutting edge that precedes the rotating outer tube into the formation is preferred, if drilling fluid is necessary, to minimize contamination of the soil sample by the fluid.

*e. Storage of samples.* Samples should be immediately processed and sealed following removal from the boring hole to minimize changes in water content. Each container should be clearly labeled and stored under conditions that minimize large temperature and humidity variations. A humid room with relative humidity greater than 95 percent is recommended for storage since the relative humidity of most natural soils exceeds 95 percent.

(1) *Disturbed samples.* Auger, pit, or other disturbed samples should be thoroughly sealed in waterproof containers so that the natural water content can be accurately measured.

(2) *Undisturbed samples.* Undisturbed samples may be stored in the sampling tubes or extruded and preserved, then stored. Storage in the sampling tube is not recommended for swelling soils even though stress relief may be minimal. The influence of rust and penetration of drilling fluid or free water into the sample during sampling may adversely influence the laboratory test results and reduce the indicated potential heave. Iron diffusing from steel tubes into the soil sample will combine with oxygen and water to form rust. Slight changes in Atterberg limits, erosion resistance, water content, and other physical properties may occur. In addition, the outer perimeter of a soil sample

Table 3-2. Soil Sampling Methods

Type of Sample	Purpose	Sampler	Description	Application
Disturbed	Profile classification: Specific gravity Grain-size distribution Atterberg limits  Water content Physicochemical <sup>a</sup> Lime treatment <sup>b</sup>	Auger	Bucket	All soils where wall can be maintained without caving. Continuous flight augers not recommended as the location in the profile cannot be approximated.  Capable of providing large quantities of soil for special tests such as compaction or chemical stabilization.
		Split spoon	Tube sampler split lengthwise	
		Pit	Shallow trench or large borehole	
Undis- turbed	In situ classification:  Swell behavior Shear strength	Pit	Shallow trench or large borehole	Capable of providing large quantities of soil for special tests such as compaction or chemical stabilization.
		Push tube	<u>Pistonless</u> : driving head fixed to sampling tube with ball pressure release valve to bleed off compressed air and form vacuum during sampler withdrawal	Medium to stiff clays free of gravel or small rocks that could damage the leading edge of the tube sampler.
			<u>Free piston</u> : piston locked at lower end of sampler during insertion into hole and resting on top of sample during push. Vacuum assisted sampler withdrawal	Medium to stiff clays free of gravel or small rocks that could damage the leading edge of the tube sampler.
			<u>Fixed piston</u> : piston fixed to drill rig during the push causing vacuum to assist during the push and sampler withdrawal	Medium to stiff clays free of gravel or small rocks that could damage the leading edge of the tube sampler.
		Rotary core barrel	<u>Double-barrel or Denison Sampler</u> : outer barrel with cutter shoe to advance the sampler and inner barrel with cutter edge to fine trim and contain the sample	Hard soils and soils containing gravel.
<u>Single barrel</u> : with cutter shoe, usually diamond head, to advance and contain the sample	Rock.			

<sup>a</sup> Discussed in paragraph 4-1d.<sup>b</sup> Discussed in paragraph 7-3d.

stored in the sampling tube cannot be scraped to remove soil contaminated by water that may have penetrated into the perimeter of the sample during sampling. The sample may also later adhere to the tube wall because of rust. If samples are stored in tubes, the tubes should be brass or lacquered inside to inhibit corrosion. An expanding packer with a rubber O-ring in both ends of the tube should be used to minimize moisture loss. The following procedures should be followed in the care and storage of extruded samples.

(a) Expansive soil samples that are to be extruded and stored should be removed from the sampling tubes immediately after sampling and thoroughly sealed to minimize further stress relief and moisture loss. The sample should be extruded from the sampling tube in the same direction when sampled to minimize further sample disturbance.

(b) Samples extruded from tubes that were obtained with slurry drilling techniques should be wiped clean to remove drilling fluid adhering to the surface of the sample prior to sealing in the storage containers. An outer layer of 1/8 to 1/4 inch should be trimmed from the cylindrical surface of the samples so that moisture from the slurry will not penetrate into the sample and alter the soil swelling potential and strength. Trimming will also remove some disturbance at the perimeter due to sidewall friction. The outer perimeter of the soil sample should also be trimmed away during preparation of specimens for laboratory tests.

(c) Containers for storage of extruded samples may be either cardboard or metal and should be approximately 1 inch greater in diameter and 1.5 to 2 inches greater in length than the sample to be encased. Three-ply, wax-coated cardboard tubes with metal bottoms are available in various diameters and lengths and may be cut to desired lengths.

(d) Soil samples preserved in cardboard tubes should be completely sealed in wax. The wax and cardboard containers provide an excellent seal against moisture loss and give sufficient confinement to minimize stress relief and particle reorientation. A good wax for sealing expansive soils consists of a 1 to 1 mixture of paraffin and microcrystalline wax or 100 percent beeswax. These mixtures adequately seal the sample and do not become brittle when cold. The temperature of the wax should be approximately 20 degrees Fahrenheit above the melting point when applied to the soil sample, since wax that is too hot will penetrate pores and cracks in the sample and render it useless, as well as dry the sample. Aluminum foil or plastic wrap may be placed around the sample to prevent penetration of molten wax into open fissures. A small amount of wax (about 0.5-inch thickness) should be placed in the bottom of the tube and allowed to partly congeal. The sample should subsequently be placed in the tube,

completely immersed and covered with the molten wax, and then allowed to cool before moving.

(e) When the samples are being transported, they should be protected from rough rides and bumps to minimize further sample disturbance.

*f. Inspection.* A competent inspector or engineer should accurately and visually classify materials as they are recovered from the boring. Adequate classification ensures the proper selection of samples for laboratory tests. A qualified engineering geologist or foundation engineer should closely monitor the drill crew so that timely adjustments can be made during drilling to obtain the best and most representative samples. The inspector should also see that all open boreholes are filled and sealed with a proper grout, such as a mixture of 12 percent bentonite and 88 percent cement, to minimize penetration of surface water or water from a perched water table into deeper strata that might include moisture deficient expansive clays.

### 3-4. Groundwater

Meaningful groundwater conditions and engineering properties of subsurface materials can often best be determined from in situ tests. In situ tests, however, are not always amenable to simple interpretation. The pore water conditions at the time of the test may differ appreciably from those existing at the time of construction. A knowledge of groundwater and the negative pore water pressure are important in evaluating the behavior of a foundation, particularly in expansive soil. Every effort should be made to determine the position of the groundwater level, its seasonal variation, and the effect of tides, adjacent rivers, or canals on it.

*a. Measurement of groundwater level.* The most reliable and frequently the only satisfactory method for determining groundwater levels and positive pore water pressures is by piezometers with tips installed at different depths. Ceramic porous tube piezometers with small diameters (3/8-inch) risers are usually adequate, and they are relatively simple, inexpensive, and sufficient for soils of low permeability.

*b. Measurement of in situ negative pore water pressure.* Successful in situ measurements of negative pore water pressure and soil suction have been performed by such devices as tensiometers, negative pore pressure piezometers, gypsum blocks, and thermocouple psychrometer. However, each of these devices has certain limitations. The range of tensiometers and negative pore pressure piezometers has been limited to the cavitation stress of water under normal conditions, which is near one atmosphere of negative pressure. The fluid-filled tensiometer is restricted to shallow soils less than 6 feet in depth. The useable range of the tensiometer is reduced in proportion to the pressure exerted by the column of fluid in the tensiometer. Gyp-

sum blocks require tedious calibration of electrical resistivity for each soil and dissolved salts greatly influence the results. Thermocouple psychrometer cannot measure soil suctions reliably at negative pressures that are less than one atmosphere and require a constant temperature environment. Psychrometer also measure the total suction that includes an osmotic component caused by soluble salts in the pore water, as well as the matrix suction that is comparable with the

negative pore water pressure. Tensiometers require constant maintenance, while gypsum blocks and psychrometer tend to deteriorate with time and may become inoperable within one year. A routine field measurement of soil suction is not presently recommended because of the limitations associated with these devices. Alternatively, laboratory measurements of soil suction can be easily performed (para 4-2a).

CANCELLED

CHAPTER 4

LABORATORY INVESTIGATIONS

4-1. Identification of swelling soils

Soils susceptible to swelling can be identified by classification tests. These identification procedures were developed by correlations of classification test results with results of one-dimensional swell tests performed in consolidometers on undisturbed and compacted soil specimens. Classification data most useful for identifying the relative swell potential include the liquid limit (LL), the plasticity index (PI), the COLE (para 2-2b(2)), the natural total soil suction  $\tau_{nat}^o$ , and physico-chemical tests. Several of the more simple and successful methods recommended for identifying swelling soil from classification tests described below were developed from selected soils and locations combined with the results of limited field observations of heave. These procedures assume certain environmental conditions for surcharge pressure (e.g., 1 pound per square inch) and changes in moisture from the initial water content (e.g., to saturation or zero final pore water pressure),

a. *WES classification.* Consolidometer swell tests

Table 4-1. WES Classification of Potential Swell

Classification of potential swell	Potential swell $S_p$ percent	Liquid limit LL percent	Plasticity index PI percent	Natural soil suction $\tau_{nat}^o$ tsf
Low	<0.5	<50	<25	<1.5
Marginal	0.5-1.5	50-60	25-35	1.5-4.0
High	>1.5	>60	>35	>4.0

b. *Texas Department of Highways and Public Transportation (TDHPT) method.* This procedure, which is known as Tex-124-E of the TDHPT Manual of Testing Procedures, is based on the swell test results of compacted soils from Texas. Field heaves of each soil stratum in the profile are estimated from a family of curves using the LL, PI, surcharge pressure on the soil stratum, and initial water content. The initial water content is compared with maximum (0.47 LL + 2) and minimum (0.2 LL + 9) water contents to evaluate the percent volumetric change. The potential vertical rise (PVR) of each stratum is found from a chart using the percent volumetric change and the unit load bearing on the stratum. These PVRs for depths of as much as 30 feet or more are summed to evaluate the total PVR. This method may overestimate the heave of low plasticity soils and underestimate the heave of high plasticity soils.

were performed on 20 undisturbed clays and clay shales from the states of Mississippi, Louisiana, Texas, Oklahoma, Arizona, Utah, Kansas, Colorado, Wyoming, Montana, and South Dakota. Results of these tests for a change in moisture from natural water content to saturation at the estimated in situ overburden pressure (pressures corresponding to depths from 1 to 8 feet) indicated the degrees of expansion and potential percent swell  $S_p$  shown in table 4-1. The  $S_p$  represents the percent increase in the vertical dimension or the percent potential vertical heave. The classification may be used without knowing the natural soil suction, but the accuracy and conservatism of the system are reduced. Soils that rate low may not require further swell tests, particularly if the LL is less than 40 percent and the PI is less than 15 percent. Soils with these Atterberg limits or less are essentially nonexpansive. However, swell tests may be required for soils of low swelling potential if the foundation of the structure is required to maintain small differential movements less than 1 inch (para 4-2c).

c. *Van Der Merwe method.* This method evolved from empirical relationships between the degree of expansion, the PI, the percent clay fraction, and the surcharge pressure. The total heave at the ground surface is found from

$$\Delta H = \sum_{D=1}^{\bar{D}=n} F \cdot PE \quad (4-1)$$

where

- AH = total heave, inches
- D = depth of soil layer in increments of 1 foot = increment at the deepest level
- F = reduction factor for surcharge pressure,  $F = 10^{-D/20}$
- PE = potential expansiveness in inch/foot of depth (fig. 4-1)

The PE is found by assumed values of PE = 0, 1/4, 1/2, and 1 inch/foot for low, medium, high, and very high

levels, respectively, of potential expansiveness, defined in figure 4-1 as functions of the PI and the minus 2 $\mu$  fraction. The PE values are based on consolidometer swell test results and field observations. This method does not consider variations in initial moisture conditions.

*d. Physiochemical tests.* These tests include identification of the clay minerals, such as montmorillonite, illite, attapulgite, and kaolinite, with kaolinite being relatively nonexpansive, cation exchange capacity (CEC), and dissolved salts in the pore water. The CEC is a measure of the property of a clay mineral to exchange ions for other anions or cations by treatment in an aqueous solution. The relatively expansive montmorillonite minerals tend to have large CEC exceeding 80 milliequivalents per 100 grams of clay, whereas the CEC of nonexpansive kaolinite is usually less than 15 milliequivalents. The presence of dissolved salts in the pore water produces an osmotic component of soil suction that can influence soil heave if the concentration of dissolved salts is altered. In most cases, the osmotic suction will remain constant and not normally influence heave unless, for example, significant leaching of the soil occurs.

*e. Other methods.* Other methods that have been successful are presented in table 4-2. These methods lead to estimates of the percent swell  $S_p$  or vertical heave assuming that all swell is confined to the verti-

cal direction, and they require an estimate of the depth of the active zone  $X_a$  (para 5-4c). Both the TDHPT and Van Der Merwe methods do not require estimates of  $X_a$  since computations extend down to depths where the computed heaves become negligible. The Van Der Merwe, McKeen-Lytton, and Johnson methods tend to give maximum values or may overestimate heave, whereas the remaining methods tend to give minimum values or may underestimate heave when compared with the results of field observations at three WES test sections.

*f. Application.* These identification tests along with the surface examination of paragraph 3-2 can indicate problem soils that should be tested further and can provide a helpful first estimate of the expected in situ heave.

(1) More than one identification test should be used to provide rough estimates of the potential heave because limits of applicability of these tests are not known. In general, estimates of potential heave at the ground surface of more than 1/2 inch may require further laboratory tests, particularly if local experience suggests swelling soil problems. Soil strata in which the degree of expansion is medium or high should also be considered for further swell tests (para 2-2c).

(2) The McKeen-Lytton method of table 4-2 has been applied to the prediction of potential differential heave for average changes in moisture conditions by the Post-Tensioning Institute (PTI) for design and con-

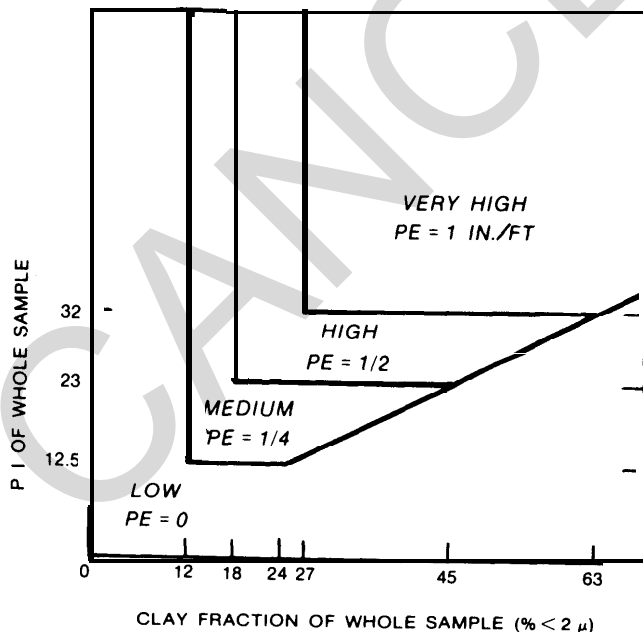

(Based on data from Van Der Merwe, 1964, published in The Civil Engineer with permission granted by the S. A. Institute of Civil Engineers, Johannesburg, South Africa)

Figure 4-1. Relationship used to determine the potential expansiveness for Van Der Merwe's empirical method.

Table 4-2. Other Empirical Methods for Prediction of Potential Heave.

Method	Description <sup>a</sup>
Vijayvergiya and Ghazzaly	$\text{Log } S_p = 1/12(0.44LL - w_o + 5.5)$ from initial water content to saturation for 0.1- <i>tsf</i> surcharge pressure.
Schneider and Poor	$\text{Log } S_p = 0.9(\text{PI}/w_o) - 1.19$ for no fill or weight on the swelling soil to saturation.
McKeen-Lytton by McKeen	$S_p = -100\gamma_h \log_{10} \frac{\bar{\tau}_f}{\bar{\tau}_o}$ <p>where</p> <ul style="list-style-type: none"> <li><math>\gamma_h</math> = suction compression index</li> <li><math>\tau_f</math> = final weighted in situ suction</li> <li><math>\tau_o</math> = initial in situ weighted suction</li> </ul> <p>The <math>\gamma_h</math> is found from a chart using the CEC, PI, and percent clay. The weighted suction is given by <math>\bar{\tau} = 0.5\tau_1 + 0.3\tau_2 + 0.2\tau_3</math> where <math>\tau_1</math>, <math>\tau_2</math>, and <math>\tau_3</math> are in situ suctions measured in the top, middle, and bottom third of the active zone.</p>
Johnson	$\text{PI} \geq 40 \quad S_p = 23.82 + 0.7346\text{PI} - 0.1458H - 1.7w_o + 0.0025\text{PI}w_o - 0.00884\text{PI}H$ $\text{PI} < 40 \quad S_p = -9.18 + 1.5546\text{PI} + 0.08424H + 0.1w_o - 0.0432\text{PI}w_o - 0.01215\text{PI}H$ <p>for 1 psi surcharge pressure to saturation.</p>

<sup>a</sup>  $S_p$  = percent swell; LL = liquid limit in percent; PI = plasticity index in percent;  $w_o$  = initial water content in percent; H = depth of soil in feet.

struction of stiffened slabs-on-grade in expansive soils. The PTI structural design procedure is described in paragraph 6-3b.

#### 4-2. Testing procedures

Quantitative characterization of the expansive soil from swell tests is necessary to predict the anticipated

potential soil heave devaluation of swell behavior and predictions of total and differential heave are determined from the results of tests on undisturbed specimens. Strength tests may be performed to estimate the bearing capacity of the foundation soil at the final or equilibrium water content. A measure of shear strength with depth is also needed to evaluate soil sup-



port from adhesion along the perimeter of shaft foundations or the uplift that develops on the shaft when swelling occurs.

a. *Swell tests.* Laboratory methods recommended for prediction of the anticipated volume change or potential in situ heave of foundation soils are consolidometer swell and soil suction tests. The WES expansive soil studies show that consolidometer swell tests may underestimate heave, whereas soil suction tests may overestimate heave compared with heaves measured in the field if a saturated final moisture profile is assumed (chap 5). The economy and simplicity of soil suction tests permit these tests to be performed at frequent intervals of depth from 1 to 2 feet.

(1) *Consolidometer.* Recommended consolidometer swell tests include swell and swell pressure tests described in Appendix VIII of EM 1110-2-1906. The swell test may be performed to predict vertical heave  $\Delta H$  of soil thickness  $H$  when the vertical overburden and structural pressures on thickness  $H$  are known prior to the test. The total vertical heave at the ground surface is the sum of the  $\Delta H$  for each thickness  $H$  in the soil profile. Figure 5-4 illustrates the application of swell test data. The swell pressure test is performed to evaluate the swell pressure  $\delta_s$  and swell index  $C_s$  required for prediction of vertical heave by equation

(5-8) discussed in paragraph 5-4e. The confining pressure required to restrain heave is defined as  $\delta_s$ . When little is known about swell behavior or groundwater conditions, an appropriate swell test is given in (a) and (b) below.

(a) An initial loading pressure, simulating field initial (preconstruction) vertical pressure  $\sigma_v$ , should be applied to determine the initial void ratio  $e_0$ , point 1 of figure 4-2, then removed to the seating pressure  $\delta_{se}$  (i.e., the lowest possible load) prior to adding distilled water, point 2. The specimen is allowed to expand at the seating pressure until primary swell is complete, point 3, before applying the consolidation pressures.

(b) The swell test of figure 4-2 can eliminate the need for additional tests when behavior is different than that anticipated (e.g., the specimen consolidates rather than swells following addition of water at loading pressures greater than the seating pressure). The void ratio-log pressure curve for final effective pressures, varying from the seating to the maximum applied pressure, can be used to determine heave or settlement with respect to the initial void ratio  $e_0$ . Net settlements will occur for final effective pressures exceeding the swell pressure  $\delta_s$ . Figure 4-2 illustrates how the percent swell  $S_p$  or heave  $\Delta H$  may be found with respect to the initial vertical pressure  $\sigma_v$ .

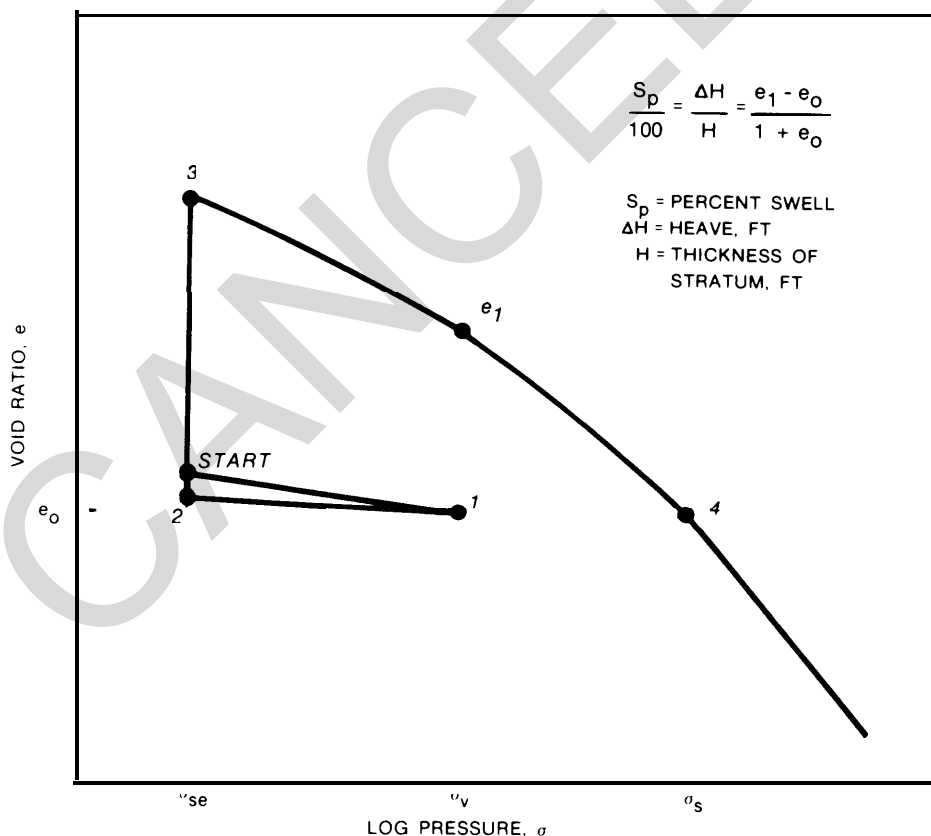

U. S. Army Corps of Engineers

Figure 4-2. Simple swell test.

(c) The  $\sigma_c$  in figure 4-2 is defined as confining pressure that must be applied to the soil to reduce the volume expansion down to the (approximated) in situ  $e_0$  in the presence of free water. Consolidometer tests in appendix VIII of EM 1110-2-1906 tend to provide lower limits of the in situ swell pressure, while the simple swell test, figure 4-2, tends to provide upper limits. The maximum past pressure is often a useful estimate of the in situ swell pressure at  $e_0$ .

(2) *Soil suction.* Soil suction is a quantity that also can be used to characterize the effect of moisture on volume changes and, therefore, to determine the anticipated foundation soil heave. The suction is a tensile stress exerted on the soil water by the soil mass that pulls the mass together and thus contributes to the apparent cohesion and undrained shear strength of the soil. The thermocouple psychrometer and filter paper methods, two of the simplest approaches for evaluation of soil suction and characterization of swelling behavior, are described in appendix B. The suction procedure, which is analogous to the procedure for characterization of swell from consolidometer swell tests, is relatively fast, and the results can increase confidence in characterization of swell behavior.

*b. Strength tests.* The results of strength tests are used to estimate the soil bearing capacity and load/deflection behavior of shaft or other foundations. The critical time for bearing capacity in many cases is immediately after completion of construction (first loading) and prior to any significant soil consolidation under the loads carried by the foundation. The long-term bearing capacity may also be critical in expansive foundation soils because of reductions in strength from wetting of the soil.

*c. Application.* Sufficient numbers of swell and

strength tests should be performed to characterize the soil profiles. Swell tests may not be necessary on specimens taken at depths below permanent deep groundwater levels.

(1) The representative mean of the swell and strength parameters (and lower limit of the scatter in strength parameters) of each distinctive soil stratum should be determined down to depths of 1.5 times the minimum width of mat slabs to a maximum of 100 feet and to at least three base diameters beneath the base of shaft foundations.

(2) One consolidometer swell and one strength test should be performed on specimens from at least five undisturbed samples at different depths within the depth of the anticipated active zone (e.g., within 10 to 20 feet beneath the base of the foundation). Suction tests may also be performed at relatively frequent depth intervals (e.g., 1-foot increments) to better characterize swell behavior and thereby increase confidence in prediction of potential heave discussed in chapter 5.

(3) One consolidometer swell and one strength test should be performed on specimens from each undisturbed sample (or at intervals of 2.5 feet for continuous sampling) at depths above the base of deep shaft foundations to permit evaluation of the adjacent soil heave and uplift forces exerted on the shaft/soil interface. Suction tests may also be performed to further characterize swell behavior and increase confidence in prediction of potential heave.

(4) Suction test results can characterize the pore pressure profile by indicating depths of desiccation and wetting, which are useful for minimizing potential foundation problems from soil movement and for evaluating remedial measures to correct problems.

## CHAPTER 5

### METHODOLOGY FOR PREDICTION OF VOLUME CHANGES

#### 5-1. Application of heave predictions

Reasonable estimates of the anticipated vertical and horizontal heave and the differential heave are necessary for the following applications.

*a.* Determination of adequate designs of structures that will accommodate the differential soil movement without undue distress (chap 6). These predictions are also needed to estimate upward drag from swelling soils on portions of deep foundations such as drilled shafts within the active zone of moisture change and heave. Estimates of upward drag help determine an optimum design of the deep foundation.

*b.* Determination of techniques to stabilize the foundation and to reduce the anticipated heave (chap 7).

#### 5-2. Factors influencing heave

Table 5-1 describes factors that significantly influence the magnitude and rate of foundation movement. The difficulty of predicting potential heave is complicated beyond these factors by the effect of the type and geometry of foundation, depth of footing, and distribution of load exerted by the footing on the magnitude of the swelling of expansive foundation soil. Additional problems include estimating the exact location that swelling soils will heave or the point source of water seeping into the swelling soil and the final or equilibrium moisture profile in the areas of heaving soil.

*Table 5-1. Factors Influencing Magnitude and Rate of Volume Change*

Factor	Description
<i>Soil Properties</i>	
Composition of solids	A high percentage of active clay minerals include montmorillonites and mixed layer combinations of montmorillonites and other clay minerals that promote volume change.
Concentration of pore fluid salts	High concentrations of cations in the pore fluid tend to reduce the magnitude of volume change; swell from osmosis can be significant over long periods of time.
Composition of pore fluid	Prevalence of monovalent cations increase shrink-swell; divalent and trivalent cations inhibit shrink-swell.
Dry density	High initial dry densities result in closer particle spacings and larger swells.
Structure	Flocculated particles tend to swell more than dispersed particles; cemented particles tend to reduce swell; fabrics that slake readily may promote swell.
<i>Environmental Conditions</i>	
Climate	Arid climates promote desiccation, while humid climates promote wet soil profiles.
Groundwater	Fluctuating and shallow water tables (less than 20 ft from the ground surface) provide a source of moisture for heave.
Drainage	Poor surface drainage leads to moisture accumulations or ponding.
Vegetative cover	Trees, shrubs, and grasses are conducive to moisture depletion by transpiration; moisture tends to accumulate beneath areas denuded of vegetation.
Confinement	Larger confining pressures reduce swell; cut areas are more likely to swell than filled areas; lateral pressures may not equal vertical overburden pressures.
Field permeability	Fissures can significantly increase permeability and promote faster rates of swell.

5-3. Direction of soil movement

The foundation soil may expand both vertically and laterally. The vertical movement is usually of primary interest, for it is the differential vertical movement that causes most damages to overlying structures.

a. *Vertical movement.* Methodology for prediction of the potential total vertical heave requires an assumption of the amount of volume change that occurs in the vertical direction. The fraction of volumetric swell  $N$  that occurs as heave in the vertical direction depends on the soil fabric and anisotropy. Vertical heave of intact soil with few fissures may account for all of the volumetric swell such that  $N = 1$ , while vertical heave of heavily fissured and isotropic soil may be as low as  $N = 1/3$  of the volumetric swell.

b. *Lateral movement.* Lateral movement is very important in the design of basements and retaining walls. The problem of lateral expansion against basement walls is best managed by minimizing soil volume change using procedures described in chapter 7. Otherwise, the basement wall should be designed to resist lateral earth pressures that approach those given by

$$\delta_h = K_o \delta_v \leq K_p \delta_v \quad (5-1)$$

where

- $\delta_h$  = horizontal earth pressure, tons per square root
- $K_o$  = lateral coefficient of earth pressure at rest
- $\delta_v$  = soil vertical or overburden pressure, tons per square foot
- $K_p$  = coefficient of passive earth pressure

The  $K_o$  that should be used to calculate  $\delta_h$  is on the order of 1 to 2 in expansive soils and often no greater than 1.3 to 1.6.

5-4. potential total vertical heave

Although considerable effort has been made to develop methodology for reliable predictions within 20 percent of the maximum in situ heave, this degree of accuracy will probably not be consistently demonstrated, particularly in previously undeveloped and untested areas. A desirable reliability is that the predicted potential total vertical heave should not be less than 80 percent of the maximum in situ heave that will eventually occur but should not exceed the maximum in situ heave by more than 20 to 50 percent. Useful predictions of heave of this reliability can often be approached and can bound the in situ maximum levels of heave using the results of both consolidometer swell and soil suction tests described in paragraph 4-2a. The fraction  $N$  (para 5-3a) should be 1 for consolidometer swell test results and a minimum of  $1/3$  for soil suction test results. The soil suction tests tend to provide an upper estimate of the maximum in situ heave ( $N = 1$ ) in part because the soil suction tests are performed

without the horizontal restraint on soil swell that exists in the field and during one-dimensional consolidometer swell tests.

a. *Basis of calculation.* The potential total vertical heave at the bottom of the foundation, as shown in figure 5-1, is determined by

$$\begin{aligned} AH &= N \cdot DX \sum_{i=N BX}^{i=N EL} DELTA(i) \\ &= N \cdot DX \sum_{i=N BX}^{i=N EL} \frac{e_f(i) - e_o(i)}{1 + e_o(i)} \quad (5-2) \end{aligned}$$

where

- $AH$  = potential vertical heave at the bottom of the foundation, feet
- $N$  = fraction of volumetric swell that occurs as heave in the vertical direction
- $DX$  = increment of depth, feet
- $NEL$  = total number of elements
- $NBX$  = number of nodal point at bottom of the foundation
- $DELTA(i)$  = potential volumetric swell of soil element  $i$ , fraction
- $e_f(i)$  = final void ratio of element  $i$
- $e_o(i)$  = initial void ratio of element  $i$

The  $AH$  is the potential vertical heave beneath a flexible, unrestrained foundation. The bottom nodal point  $NNP = NEL + 1$ , and it is often set at the active depth of heave  $X_a$ .

(1) The initial void ratio, which depends on geologic and stress history (e.g., maximum past pressure), the soil properties, and environmental conditions shown in table 5-1 may be measured on undisturbed specimens using standard laboratory test procedures. It may also be measured during the laboratory swell tests as described in EM 1110-2-1906. The final void ratio depends on changes in the foundation conditions caused by construction of the structure.

(2) The effects of the field conditions listed in table 5-1 may be roughly simulated by a confinement pressure due to soil and structural loads and an assumption of a particular final or equilibrium pore water pressure profile within an active depth of heave  $X_a$ . The effects of confinement and the equilibrium pore water pressure profiles are related to the final void ratio by physical models. Two models based on results of consolidometer swell and soil suction tests are used in this manual (para 4-2a).

b. *Pore water pressure profiles.* The magnitude of swelling in expansive clay foundation soils depends on the magnitude of change from the initial to the equilibrium or final pore water pressure profile that will be observed to take place in a foundation soil because of

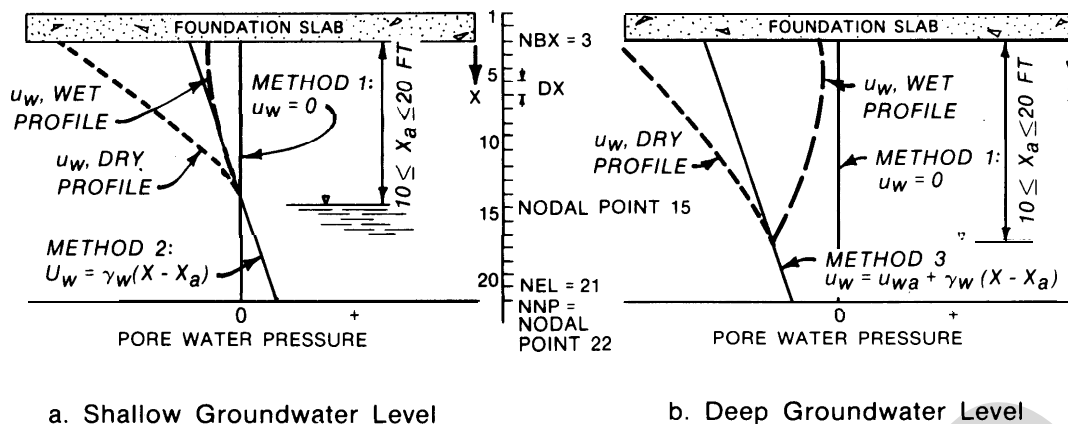

a. Shallow Groundwater Level

b. Deep Groundwater Level

U. S. Army Corps of Engineers

Figure 5-1. Assumed equilibrium pore water pressure profiles beneath foundation slabs.

the construction of the foundation.

(1) *Initial profile.* Figure 5-1 illustrates relative initial dry and wet profiles. The wet initial profile is probably appropriate following the wet season, which tends to occur by spring, while the dry initial profile tends to occur during late summer or early fall. The initial pore water pressure profile does not need to be known if the consolidometer swell model is used because the heave prediction is determined by the difference between the measured initial  $e_0$  and final  $e_1$  void ratios (fig. 4-2). The initial void ratio is a function of the initial pore water pressure in the soil. The initial pore water pressure profile, which must be known if the soil suction model is used, may be found by the method described in appendix B.

(2) *Equilibrium profile.* The accuracy of the prediction of the potential total vertical heave in simulating the maximum in situ heave depends heavily on the ability to properly estimate the equilibrium pore water pressure profile. This profile is assumed to ultimately occur beneath the central portion of the foundation. The pore water pressure profile beneath the foundation perimeter will tend to cycle between dry and wet extremes depending on the field environment and availability of water. The three following assumptions are proposed to estimate the equilibrium profile. A fourth possibility, the assumption that the groundwater level rises to the ground surface, is most conservative and not normally recommended as being realistic. The equilibrium profile may also be estimated by a moisture diffusion analysis for steady-state flow, which was used to predict differential heave as part of the procedure developed by the Post-Tensioning Institute (PTI) for design and construction of slabs-on-grade (para 6-3b). The results, which should be roughly compatible with the hydrostatic profiles discussed in (b) and (c) below, lead to predictions of heave smaller than the saturated profile.

(a) *Saturated.* The saturated profile, Method 1

in figure 5-1, assumes that the in situ pore water pressure is zero within the active zone  $X_a$  of moisture change and heave

$$u_w = 0 \quad (5-3)$$

where  $u_w$  is the pore water pressure in tons per square foot at any depth  $X$  in feet within the active zone. Although a pore water pressure profile of zero is not in equilibrium, this profile is considered realistic for most practical cases and includes residences and buildings exposed to watering of perimeter vegetation and possible leaking underground water and sewer lines. Water may also condense in a layer of permeable subgrade soil beneath foundation slabs by transfer of water vapor from air flowing through the cooler subgrade. The accumulated water may penetrate into underlying expansive soil unless drained or protected by a moisture barrier. This profile should be used if other information on the equilibrium pore water pressure profile is not available.

(b) *Hydrostatic I.* The hydrostatic I profile, Method 2 in figure 5-1a, assumes that the pore water pressure becomes more negative with increasing vertical distance above the groundwater level in proportion to the unit weight of water

$$u_w = \gamma_w(X - X_a) \quad (5-4)$$

where  $\gamma_w$  is the unit weight of water (0.0312 ton per cubic foot).

This profile is believed to be more realistic beneath highways and pavements where drainage is good, ponding of surface water is avoided, and leaking underground water lines are not present. This assumption will lead to smaller predictions of heave than the saturated profile of Method 1.

(c) *Hydrostatic II.* This profile, Method 3 in figure 5-1b, is similar to the hydrostatic I profile except that a shallow water table does not exist. The negative pore water pressure of this profile also becomes more negative with increasing vertical distance above the

bottom of the active zone  $X_a$  in proportion to the unit weight of water

$$u_w = u_{wa} + \gamma_w(X - X_a) \quad (5-5)$$

where  $u_{wa}$  is the negative pore water pressure in tons per square foot at depth  $X_a$  in feet.

(d) *Example application.* Figure 5-2 illustrates how the saturated (Method 1) and hydrostatic II (Method 3) profiles appear for a suction profile without a shallow water table at a sampling site near Hayes, Kansas. The initial in situ soil suction or negative pore water pressure was calculated from the given natural soil suction without confining pressure  $\tau_0$  by

$$\tau = \tau^0 - \alpha \delta_m \quad (5-6)$$

where

- $\tau$  = in situ soil suction, tons per square foot
- = compressibility factor (defined in app B)
- $\delta_m$  = mean normal confining pressure, tons per square foot

The mean normal confining pressure  $\delta_m$  is given by

$$\delta_m = \frac{\delta_v (1 + 2K_T)}{3} \quad (5-7)$$

where  $\delta_v$  is the overburden or vertical confining pressure. The ratio of horizontal to vertical total stress  $K_T$  was assumed to be unity. The initial in situ soil suction  $\tau$  was assumed to be essentially the matrix suction  $\tau_m$  or negative pore water pressure  $u_w$  (i.e., the osmotic component of soil suction  $\tau_s$  was negligible). The sign convention of the soil suction  $\tau$  is positive, whereas that of the corresponding negative pore water pressure

$u_w$  is negative (i.e.,  $\tau_m = -u_w$ ). Figure 5-2 shows that the hydrostatic equilibrium profile is nearly vertical with respect to the large magnitude of soil suction observed at this site. Heave will be predicted if the saturated profile occurs (Method 1 as in fig. 5-1), while shrinkage will likely be predicted if the hydrostatic II (Method 3) profile occurs. The availability of water to the foundation soil is noted to have an enormous impact on the volume change behavior of the soils. Therefore, the methods of chapter 7 should be used as much as practical to promote and maintain a constant moisture environment in the soil.

c. *Depth of the active zone.* The active zone depth  $X_a$  is defined as the least soil depth above which changes in water content and heave occur because of climate and environmental changes after construction of the foundation.

(1) *Shallow groundwater levels.* The depth  $X_a$  may be assumed equal to the depth of the water table for groundwater levels less than 20 feet in clay soil (fig. 5-1a). The  $u_{wa}$  term shown in figure 5-1b becomes zero for the hydrostatic I equilibrium profile in the presence of such a shallow water table.

(2) *Deep groundwater levels.* The depth  $X_a$  for deep groundwater levels may often be determined by evaluating the initial pore water pressure or suction with depth profile as described in appendix B. The magnitude of  $u_w$  is then determined after the depth  $X_a$  is established.

(a) If depths to groundwater exceed 20 feet beneath the foundation and if no other information is available, the depth  $X_a$  can be assumed to be between 10 feet (for moist profiles or soil suctions less than 4 tons per square foot) and 20 feet (for dry profiles or soil suctions greater than 4 tons per square foot) below the base of the foundation (fig. 5-1b). However, the depth  $X_a$  should not be estimated less than three times the base diameter of a shaft foundation. Sources of moisture that can cause this active zone include the seepage of surface water down the soil-foundation interface, leaking underground water lines, and seepage from nearby new construction.

(b) The pore water pressure or soil suction is often approximately constant with increasing depth below  $X_a$ . Sometimes  $X_a$  can be estimated as the depth below which the water content/plastic limit ratio or soil suction is constant.

(c) If the soil suction is not approximately constant with increasing depth below depths of 10 to 20 feet,  $X_a$  may be approximated by being set to a depth 1 to 2 feet below the first major change in the magnitude of the soil suction, as shown in figure 5-2.

d. *Edge effects.* Predictions of seasonal variations in vertical heave from changes in moisture between extreme wet and dry moisture conditions (fig. 5-1) are for perimeter regions of shallow foundations. These

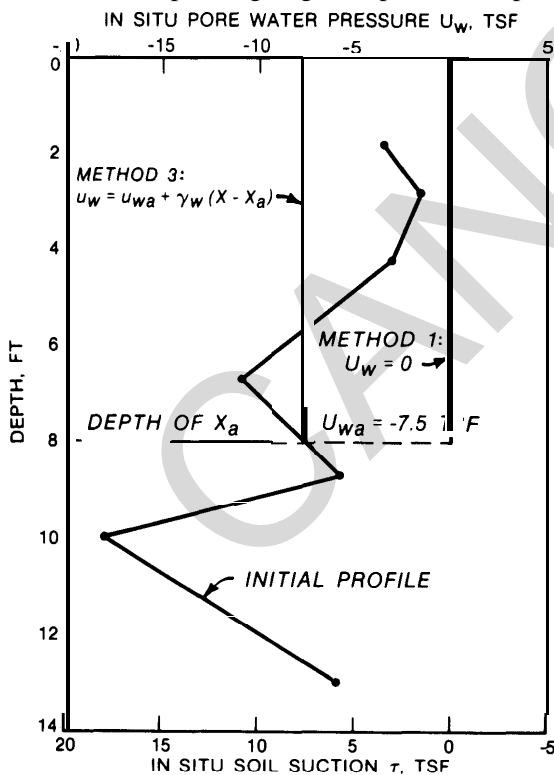

U. S. Army Corps of Engineers

Figure 5-2. Example application of equilibrium pore water pressure profile for a site near Hayes, Kansas.

calculations require a measure or estimate of both seasonal wet and dry pore water pressure or suction profiles. It should be noted from figure 5-1b that perimeter cyclic movement from extremes in climatic changes can exceed the long-term heave beneath the center of a structure.

(1) *Soil-slab displacements.* A slab constructed on the ground surface of a wet site may in time lead to downwarping at the edges after a long drought or growth of a large tree near the structure (fig. 5-3a). Edge uplift may occur following construction on an initially dry site (fig. 5-3b). The AH in figure 5-3 is representative of the maximum differential vertical heave beneath the slab, excluding effects of restraint from the slab stiffness, but does consider the slab weight.

(2) *Edge distance.* The edge lift-off distance  $e$  of lightly loaded thin slabs at the ground surface often varies from 2 to 6 feet but can reach 8 to 10 feet.

(3) *Deflection/length ratio.* The deflection/length ratio of the slab is  $A/L$ , where  $A$  is the slab deflection and  $L$  is the slab length. The angular deflection/span length  $\Delta/l$  (para 6-1d) is twice  $\Delta/L$  of the slab (fig. 5-3).

*e. Methods of predicting vertical heave.*

(1) *Hand (manual) applications.* The heave  $\Delta H$  from a consolidometer test may be found by

$$\frac{\Delta H}{H} = \frac{c_s}{1 + e_o} \log \frac{\delta_s}{\delta'_v} \quad (5-8)$$

where

$H$  = thickness of expansive soil layer, feet

$c_s$  = swell index, slope of the curve between points 3 and 4, figure 4-2

$\delta_s$  = swell pressure, tons per square foot

$\delta'_v$  = final vertical effective pressure, tons per square foot

The final effective pressure is given by

$$\delta'_v = \delta_v - u_w \quad (5-9)$$

where  $\delta_v$  is the total vertical overburden pressure and  $u_w$  is the equilibrium pore water pressure in tons per square foot. If  $u_w$  is zero for a saturated profile, equation (5-3), then  $\delta'_v$  is equal to  $\delta_v$  and heave will be the same as that given by the equation for  $S_p$  in figure 4-2. A simple hand method and an example of predicting potential total vertical heave from consolidometer swell tests assuming a saturated equilibrium profile, equation (5-3), are given in TM 5-818-1 and in figure 5-4. However, hand calculations of potential heave can become laborious, particularly in heterogeneous profiles in which a variety of loading conditions need to be evaluated for several different designs,

(2) *Computer applications.* Predictions of potential total heave or settlement can be made quickly with the assistance of the computer program HEAVE available at the U. S. Army Corps of Engineers Waterways

Experiment Station. The program HEAVE is applicable to slab, long continuous, and circular shaft foundations. This program considers effects of loading and soil overburden pressures on volume changes, heterogeneous soils, and saturated or hydrostatic equilibrium moisture profiles (equations (5-3) to (5-5)). Results of HEAVE using the saturated profile, equation (5-3), are comparable with results of manual computations described in figure 5-4.

## 5-5. Potential differential heave

Differential heave results from edge effects beneath a finite covered area, drainage patterns, lateral variations in thickness of the expansive foundation soil, and effects of occupancy. The shape and geometry of the structure also result in differential heave. Examples of effects of occupancy include broken or leaking water and sewer lines, watering of vegetation, and ponding adjacent to the structure. Other causes of differential heave include differences in the distribution of load and the size of footings.

*a. Unpredictability of variables.* Reliable predictions of future potential differential heave are often not possible because of many unpredictable variables that include: future availability of moisture from rainfall and other sources, uncertainty of the exact locations of heaving areas, and effects of human occupancy.

*b. Magnitude of differential heave.*

(1) Potential differential heave can vary from zero to as much as the total heave. Differential heave is often equal to the estimated total heave for structures supported on isolated spot footings or drilled shafts because some footings or portions of slab foundations often experience no movement. Eventually, differential heave will approach the total heave for most practical cases and should, therefore, be assumed equal to the total potential heave, unless local experience or other information dictates otherwise.

(2) The maximum differential heave beneath a lightly loaded foundation slab may also be estimated by the procedure based on the moisture diffusion theory and soil classification data developed by the PTI. Heave predictions by this method will tend to be less than by assuming that the differential heave is the total potential heave.

## 5-6. Heave with time

Predictions of heave with time are rarely reliable because the location and time when water is available to the soil cannot be readily foreseen. Local experience has shown that most heave (and the associated structural distress) occurs within 5 to 8 years following construction, but the effects of heave may also not be observed for many years until some change occurs in the

HEAVE BENEATH FLEXIBLE,  
WEIGHTLESS SLAB

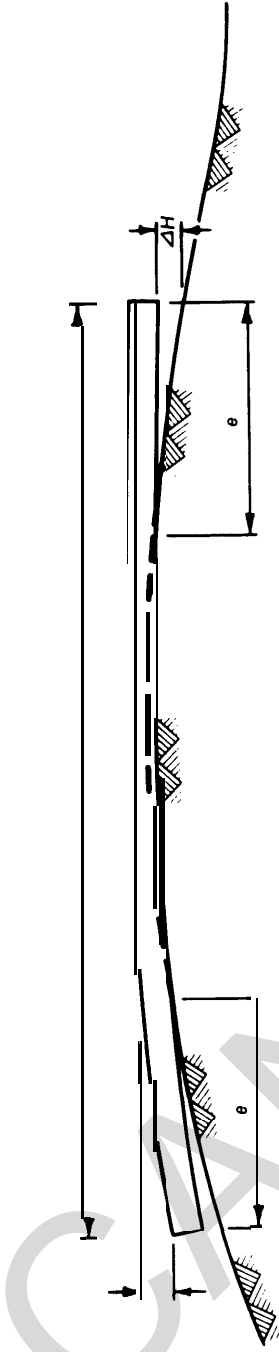

a. Center Lift or Downwarping

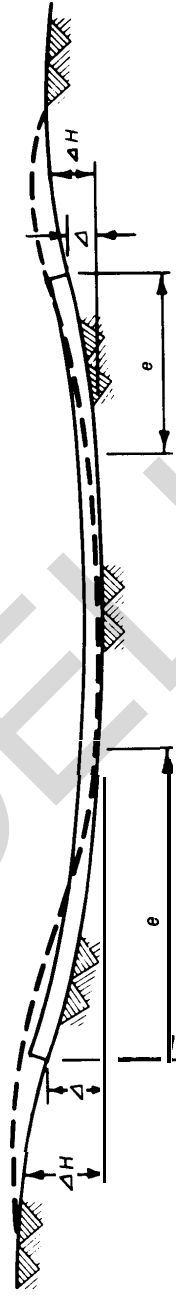

b. Edge Uplift

U. S. Army Corps of Engineers

Figure 5-3. Soil-slab displacements on heaving soil.



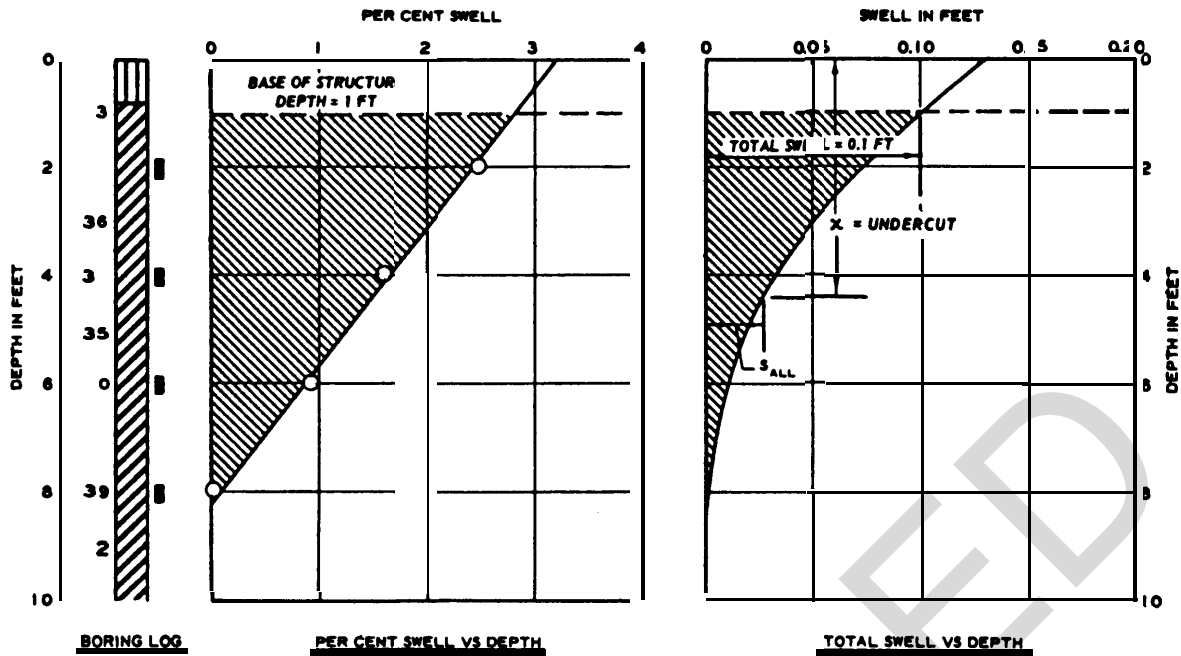

NOTE: FIGURES TO LEFT OF BORING LOG ARE NATURAL WATER CONTENTS.  
 ■ DENOTES LOCATION OF SAMPLE FOR SWELL TESTS.

**(A) PROCEDURE FOR ESTIMATING TOTAL SWELL**

1. ON BASIS OF BORING LOG PROFILE SELECT SAMPLES AT INTERVALS FOR SWELL TESTS.
2. LOAD SPECIMENS IN CONSOLIDOMETER TO OVERBURDEN PRESSURE PLUS WEIGHT OF STRUCTURE; ADD WATER AND OBSERVE SWELL.
3. COMPUTE SWELL IN TERMS OF PER CENT OF ORIGINAL SPECIMEN HEIGHT AND PLOT VS DEPTH.
4. COMPUTE TOTAL SWELL WHICH IS EQUAL TO AREA ENCOMPASSED BY PER CENT SWELL VS DEPTH CURVE. FOR EXAMPLE, USING CURVES SHOWN ABOVE:

$$\text{TOTAL SWELL} = 1/2 \times (3.2 - 1.0) \times 2.8/100 = 0.10 \text{ FT}$$

**(B) PROCEDURE FOR ESTIMATING AMOUNT OF UNDERCUT (x) NECESSARY TO REDUCE TOTAL SWELL TO AN ALLOWABLE VALUE (S<sub>ALL</sub>)**

1. FROM PER CENT SWELL VS DEPTH RELATIONSHIP, COMPUTE AND PLOT TOTAL SWELL VS DEPTH RELATIONSHIP.
2. FOR A GIVEN VALUE OF S<sub>ALL</sub>, THE AMOUNT OF UNDERCUT IS READ DIRECTLY OFF THE TOTAL SWELL-DEPTH CURVE.

NOTE: UNDERCUT MATERIAL SHOULD BE REPLACED BY INERT MATERIAL OR ELSE THE BASE OF THE STRUCTURE SHOULD BE LOWERED TO THE DEPTH OF THE REQUIRED UNDERCUT.

U. S. Army Corps of Engineers

Figure 5-4. Approximate method for computing foundation swell.

foundation conditions to disrupt the moisture regime. Predictions of when heave occurs are of little engineering significance for permanent structures. The impor-

tant engineering problems are the determination of the magnitude of heave and the development of ways to minimize distress of the structure.

## CHAPTER 6

### DESIGN OF FOUNDATIONS

#### 6-1. Basic considerations

*a. Planning.* Swelling of expansive foundation soils should be considered during the preliminary design phase and the level of structural cracking that will be acceptable to the user should be determined at this time.

(1) The foundation of the structure should be designed to eliminate unacceptable foundation and structural distress. The selected foundation should also be compatible with available building materials, construction skills, and construction equipment.

(2) The foundation should be designed and constructed to maintain or promote constant moisture in the foundation soils. For example, the foundation should be constructed following the wet season if possible. Drainage should be provided to eliminate ponded water. Excavations should be protected from drying. Chapter 7 describes the methods of minimizing soil movement.

*b. Bearing capacity.* Foundation loading pressures should exceed the soil swell pressures, if practical, but should be sufficiently less than the bearing capacity to maintain foundation displacements within tolerable amounts. Present theoretical concepts and empirical correlations permit reasonably reliable predictions of ultimate capacity, but not differential movement of the foundation. Factors of safety (FS) are therefore applied to the ultimate bearing capacity to determine safe or allowable working loads consistent with tolerable settlements. Further details on bearing capacity are presented in TM 5-818-1.

*c. Foundation systems.* An appropriate foundation should economically contribute to satisfying the functional requirements of the structure and minimize differential movement of the various parts of the structure that could cause damages. The foundation should be designed to transmit no more than the maximum tolerable distortion to the superstructure. The amount of distortion that can be tolerated depends on the design and purpose of the structure. Table 6-1 illustrates foundation systems for different ranges of differential movement or effective plasticity index ( $\overline{PI}$ ) for proper selection of the foundation. Figure 6-1 explains the term  $\overline{PI}$ . The use of  $\Delta H$  is preferred to  $\overline{PI}$  because  $\Delta H$  is a more reliable indicator of in situ heave. Also,  $\overline{PI}$  is not a satisfactory basis of design in situations such as a 5-foot layer of highly swelling soil overlying nonswell-

ing soil, rock, or sand. Pervious sand strata may provide a path for moisture flow into nearby swelling soil.

(1) *Shallow individual or continuous footings.* Shallow individual or long continuous footings are often used in low swelling soil areas where the predicted footing angular deflection/span length ratios are on the order of 1/600 to 1/1000 or 0.5 inch or less of movement.

(2) *Stiffened mats (slabs).* Stiffened mat foundations are applicable in swelling soil areas where predicted differential movement  $\Delta H$  may reach 4 inches. The stiffening beams of these mats significantly reduce differential distortion. The range provided in table 6-1 for beam dimensions and spacings of stiffened slabs for light structures normally provides an adequate design.

(3) *Deep foundations.* A pile or beam on a drilled shaft foundation is applicable to a large range of foundation soil conditions and tends to eliminate effects of heaving soil if properly designed and constructed (para 6-4). The type of superstructure and the differential soil movement are usually not limited with properly designed deep foundations. These foundations should lead to shaft deflection/spacing ratios of less than 1/600.

*d. Superstructure systems.* The superstructure should flex or deform compatibly with the foundation such that the structure continues to perform its functions, contributes aesthetically to the environment, and requires only minor maintenance. Frame construction, open floor plans, and truss roofs tend to minimize damage from differential movement. Load bearing walls tend to be more susceptible to damage from shear than the relatively flexible frame construction. Wood overhead beams of truss roof systems provide structural tension members and minimize lateral thrust on walls. Table 6-2 illustrates the relative flexibility provided by various superstructure systems.

(1) *Tolerable angular deflection/length ratios.* The ability of a structure to tolerate deformation depends on the brittleness of the building materials, length to height ratio, relative stiffness of the structure in shear and bending, and mode of deformation whether heave (dome-shaped, fig. 1-2) or settlement (dish-shaped, fig. 1-3). The vertical angular deflection/span length ( $\Delta/l$ ) that can be tolerated, therefore, varies considerably between structures. The  $\Delta/l$  is the differential displacement  $\Delta$  over the length  $l$  between columns as

Table 6-1. Foundation Systems

<u>Predicted Differential Movement, inches</u>	<u>Effective Plasticity Index, PI</u>	<u>Foundation System</u>	<u>Remarks</u>		
1/2	<15	Shallow individual Continuous wall Strip	Lightly loaded buildings and residences.		
		Reinforced and stiffened thin mat	Residences and lightly loaded structures; on-grade 4- to 5-in. reinforced concrete slab with stiffening beams; maximum free area between beams 400 ft <sup>2</sup> ; 1/2 percent reinforcing steel; 10- to 12-in.-thick beams; external beams thickened or deepened, and extra steel stirrups added to tolerate high edge forces as needed; dimensions adjusted to resist loading. Beams posi- tioned beneath corners to reduce slab distortion.		
			<u>Type of Mat</u>	<u>Beam Depth, in.</u>	<u>Beam Spacing, ft</u>
1/2 to 1	15 to 25		Light	16 to 20	20 to 15
1 to 2	26 to 40		Medium	20 to 25	15 to 12
2 to 4	>41		Heavy	25 to 30	15 to 12
No limit		Thick, reinforced mat	Large, heavy structures; mats usually 2 ft or more in thickness.		
No limit		Deep foundations, pile or drilled shaft	Foundations for any light or heavy structure; grade beams span between piles or shafts 6 to 12 in. above ground level; suspended floors or on-grade slabs iso- lated from grade beams and walls. Concrete drilled shafts may be underreamed or straight, reinforced, and cast in place with 3000-psi concrete of 6-in. slump.		

SOIL LAYER	DEPTH D, FEET	WEIGHT FACTOR, F	F · ΔD	PLASTICITY INDEX PI	F · ΔD · PI
PI = 25	0 - 3	F = 3	3 · 3 = 9	25	225
PI = 50	3 - 5		3 · 2 = 6	50	300
	5 - 8	F = 2	2 · 3 = 6	50	300
PI = 40	8 - 10		2 · 2 = 4	40	160
	10 - 15	F = 1	1 · 5 = 5	40	200
			30	TOTALS	1185

$$\bar{PI} = 1185/30 = 39.4 \text{ or } 40$$

**Assumptions:**

- (1) The PI in the top and middle third is given 3 and 2 times as much weight (weight factor F), respectively, as the bottom one third to determine PI.
- (2) A minimum PI of 15 should be used for any layer with PI less than 15.
- (3) The PI should be increased by a slope factor  $F_s$ , in which  $\log F_s = 0.01S$ ; S = percent gradient in the slope of the ground surface.

*(Based on data from Publication No. 1571, by the Building Research Advisory Council, 1968)*

Figure 6-1. Effective plasticity index ( $\bar{PI}$ ) or average PI in the top 15 feet of soil beneath the slab.

footings or about twice the A/L ratio of the slab (fig. 5-3). Only rough guidance of the range of tolerable  $\Delta/l$  ratios can be offered, such as in table 6-2, for different framing systems.

(a) Propagation of cracks depends on the degree of tensile restraint built into the structure and its foundation. Thus, frame buildings with panel walls are able to sustain larger relative deflections without severe damage than unreinforced load-bearing walls. Structural damage is generally less where the dish-shaped pattern develops than in the case of center heaving or edge downwarping because the foundation is usually better able to resist or respond to tension forces than the walls.

(b) A  $\Delta/l$  ratio of 1/500 is a common limit to avoid cracking in single and multistory structures. Plaster, masonry or precast concrete blocks, and brick walls will often show cracks for  $\Delta/l$  ratios between 1/600 to 1/1000. However, cracks may not appear in these walls if the rate of distortion is sufficiently slow to allow the foundation and frame to adjust to the new

distortions. The use of soft bricks and lean mortar also tend to reduce cracking. Reinforced masonry, reinforced concrete walls and beams, and steel frames can tolerate  $\Delta/l$  ratios of 1/250 to 1/600 before cracks appear in the structure. Deflection ratios exceeding 1/250 are likely to be noticed in the structure and should usually be avoided. The  $\Delta/l$  ratios exceeding 1/150 usually lead to structural damage.

(2) Provisions for flexibility. The flexibility required to avoid undesirable distress may be provided by joints and flexible connections. Joints should be provided in walls as necessary, and walls should not be tied into the ceiling. Slabs-on-grade should not be tied into foundation walls and columns but isolated using expansion joints or gaps filled with a flexible, impervious compound. Construction items, such as reinforced concrete walls, stud frames, paneling, and gypsum board, are better able to resist distortions and should be used instead of brick, masonry blocks, or plaster walls. The foundation may be further reinforced by making the walls structural members capa-

Table 6-2. Superstructure Systems.

Superstructure system	Tolerable vertical angular deflection/ span length ratios, $\Delta/l$	Description
Rigid	1/600 to 1/1000	Precast concrete block, unreinforced brick, masonry or plaster walls, slab-on-grade.
Semirigid	1/360 to 1/600	Reinforced masonry or brick reinforced with horizontal and vertical tie bars or bands made of steel bars or reinforced concrete beams vertical reinforcement located on sides of doors and windows; slab-on-grade isolated from walls.
Flexible*	1/150 to 1/360	Steel, wood framing; brick veneer with articulated joints; metal, vinyl, or wood panels; gypsum board on metal or wood studs; vertically oriented construction joints; strip windows or metal panels separating rigid wall sections with 25-ft spacing or less to allow differential movement; all water pipes and drains into structure with flexible joints; suspended floor or slab-on-grade isolated from walls (heaving and cracking of slab-on-grade probable and accounted for in design).
Split construction*	1/150 to 1/360	Walls or rectangular sections heave as a unit (modular construction); joints at 25-ft spacing or less between units and in walls; suspended floor or slab-on-grade isolated from walls (probable cracking of slab-on-grade); all water pipes and drains equipped with flexible joints; construction joints in reinforced and stiffened slabs at 150-ft spacing or less and cold joints at 65-ft spacing or less.

\* A  $\Delta/l$  value exceeding 1/250 is not recommended for normal practice, and a  $\Delta/l$  exceeding 1/150 often leads to structural damage.

ble of resisting bending such as reinforced concrete shear walls. Several examples of frame and wall construction are provided in appendix C.

## 6-2. Shallow individual or continuous footings

*a. Susceptibility to damage.* Structures supported by shallow individual or continuous wall footings are susceptible to damages from lateral and vertical movement of foundation soil if provisions are not made to accommodate possible movement. Dishing or substantial settlement may occur in clays, especially in initially wet soil where a well-ventilated crawl space is constructed under the floor. The crawl space prevents rainfall from entering the soil, but the evaporation of moisture from the soil continues. Center heave or edge downwarping (fig. 1-2) can occur if the top layer of soil is permeable and site drainage is poor. Fractures may appear in walls not designed for differential movement after  $\Delta/l$  ratios exceed 1/600 or differential movement exceeds about 0.5 inch.

*b. Applications.* Shallow footings may be used where expansive strata are sufficiently thin to allow location of the footing in a nonexpansive or low-swelling stratum (fig. 6-2).

(1) A structural floor slab should be suspended on top of the footing (fig. 6-2a) or the slab-on-grade should be isolated from the walls (fig. 6-2b). The slab-on-grade should be expected to crack.

(2) Figure 6-3 illustrates examples of interior construction for a slab-on-grade. Interior walls may be suspended from the ceiling or supported on the floor. A flexible joint should be provided in the plenum between the furnace and the ceiling. Sewer lines and other utilities through the floor slab should be permitted to slip freely.

(3) Swelling of deep expansive soil beneath a non-expansive stratum may cause differential movement of shallow footings if the moisture regime is altered in the deep soil following construction (e.g., change in groundwater level, or penetration of surface water into deep desiccated soil). Excavations for crawl spaces

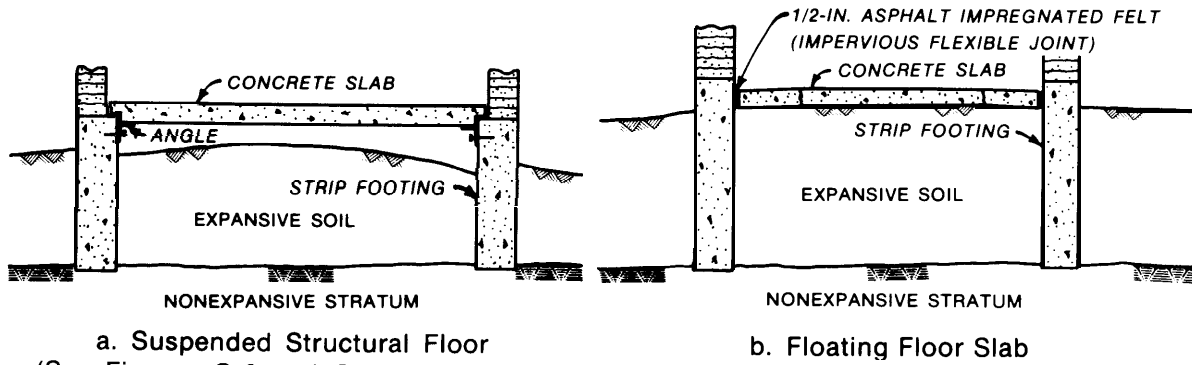

a. Suspended Structural Floor  
(See Figures C-8 and C-9 for Details)

b. Floating Floor Slab

U. S. Army Corps of Engineers

Figure 6-2. Footings on nonexpansive stratum.

or basements decrease the vertical confining pressure and pore water pressure, which can cause the underlying expansive foundation soil to heave from adjustment of the moisture regime back to the natural pore water pressures.

c. *Basements.* Basements and long continuous footings constructed in excavations are subject to swell pressures from underlying and adjacent expansive soil.

(1) *Walls.* Basement walls of reinforced concrete can be constructed directly on the foundation soil without footings provided foundation pressures are less than the allowable bearing capacity (fig. 6-4a). However, placing heavy loads on shallow footings may not be effective in countering high swell pressures because of the relative small width of the footings. The stress imposed on the soil is very low below a depth of about twice the width of the footing and contributes little to counter the swell pressure unless the expansive soil layer is thin.

(2) *Voids.* Voids can also be spaced at intervals beneath the walls to increase loading pressures on the foundation soil and to minimize flexing or bowing of the walls (fig. 6-4b). The voids may be made with removable wood forms, commercially available card-

board, or other retaining forms that deteriorate and collapse (para 6-4d).

(3) *Joints.* Joints should be provided in interior walls and other interior construction if slab-on-ground is used (fig. 6-3). The slab should be isolated from the walls with a flexible impervious compound.

(4) *Lateral earth pressure on wall.* The coefficient of lateral earth pressure can exceed one if the backfill is heavily compacted and expansive, or the natural soil adjacent to the wall is expansive. Controlled backfills are recommended to minimize lateral pressures and increase the economy of the foundation (para 7-3a). Steel reinforcement can provide the necessary restraint to horizontal earth pressures. Unreinforced masonry brick and concrete blocks should not be used to construct basement walls.

d. *Design.* Standard design procedures for foundations of buildings and other structures are presented in TM5-818-1.

### 6-3. Reinforced slab-on-grade foundations

a. *Application.* The reinforced mat is often suitable for small and lightly loaded structures, particularly if

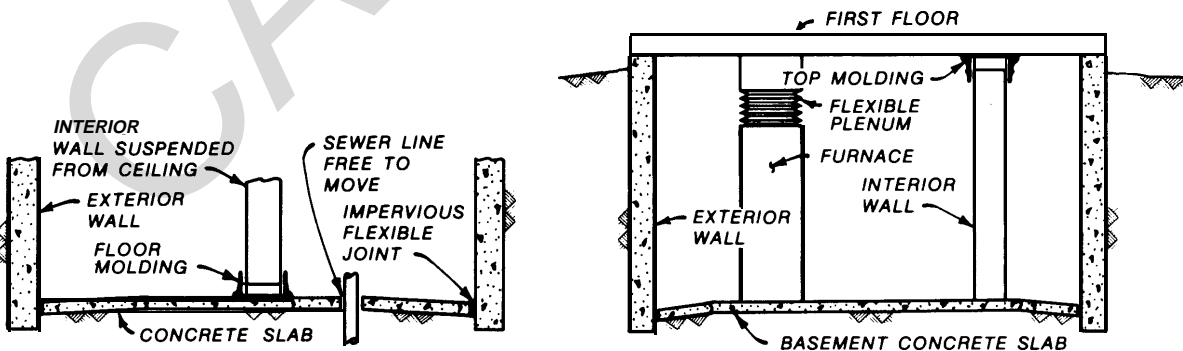

a. Wall Suspended from Ceiling

b. Furnace and Interior Wall Supported on Floor

U. S. Army Corps of Engineers

Figure 6-3. Interior joint details for slab-on-grade.

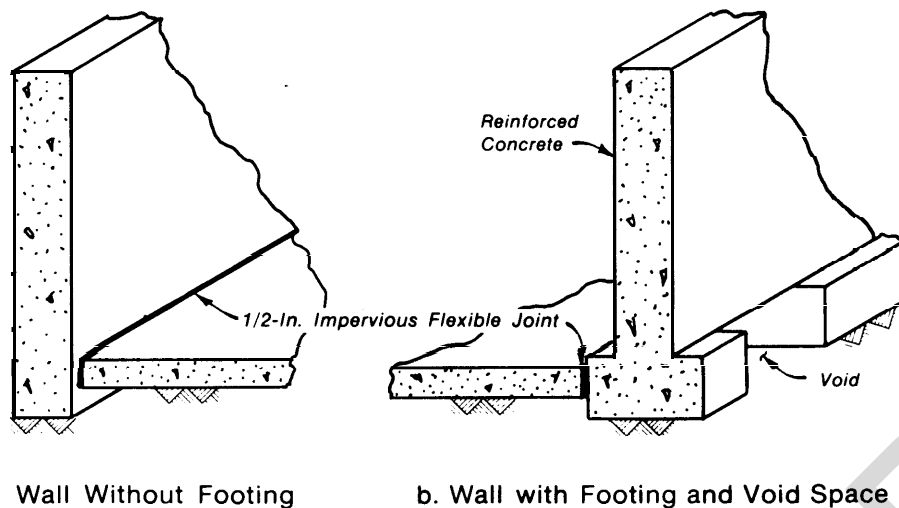

a. Wall Without Footing

b. Wall with Footing and Void Space

U. S. Army Corps of Engineers

Figure 6-4. Basement walls with slab-on-grade.

the expansive or unstable soil extends nearly continuously from the ground surface to depths that exclude economical drilled shaft foundations. This mat is suitable for resisting subsoil heave from the wetting of deep desiccated soil, a changing water table, laterally discontinuous soil profiles, and downhill creep, which results from the combination of swelling soils and the presence of slopes greater than 5 degrees. A thick, reinforced mat is suitable for large, heavy structures. The rigidity of thick mats minimizes distortion of the superstructure from both horizontal and vertical movements of the foundation soil.

(1) *Effects of stiffening beams.* Concrete slabs without internal stiffening beams are much more susceptible to distortion or doming from heaving soil. Stiffening beams and the action of the attached superstructure with the mat as an indeterminate structure increase foundation stiffness and reduce differential movement. Edge stiffening beams beneath reinforced concrete slabs can also lessen soil moisture loss and reduce differential movement beneath the slab. However, the actual vertical soil pressures acting on stiffened slabs can become very nonuniform and cause localized consolidation of the foundation soil.

(2) *Placement of nonswelling layer.* Placement of a nonswelling, 6-inch-(or more) thick layer of (preferably) impervious soil on top of the original ground surface before construction of lightly loaded slabs is recommended to increase the surcharge load on the foundation soil, slightly reduce differential heave, and permit the grading of a slope around the structure leading down and away from it. This grading improves drainage and minimizes the possibility that the layer (if pervious) could be a conduit for moisture flow into desiccated foundation expansive soils. The layer should have some apparent cohesion to facilitate trench construction for the stiffening beams.

*b. Design of thin slabs for light structures.* Stiffened slabs may be either conventionally reinforced or posttensioned. The mat may be inverted (stiffening beams on top of the slab) in cases where bearing capacity of the surface soil is inadequate or a supported first floor is required. The Department of Housing and Urban Development, Region IV, San Antonio Area Office, has documented a series of successful conventionally reinforced and posttensioned slabs for the southern central states. Successful local practice should be consulted to help determine suitable designs.

(1) *Conventionally reinforced.* The conventional reinforced concrete waffle type mat (table 6-1), which is used for light structures, consists of 4- to 5-inch-thick concrete slab. This slab contains temperature steel and is stiffened with doubly reinforced concrete crossbeams. Figure 6-5 illustrates an engineered rebar slab built in Little Rock, Arkansas. Appendix C provides details of drawings of reinforced and stiffened thin mats. The 4-inch slab transmits the self-weight and first floor loading forces to the beams, which resist the moments and shears caused by differential heave of the expansive soil. Exterior walls, roof, and internal concentrated loads bear directly on the stiffening beams. Clearance between beams should be limited to 400 square feet or less. Beam spacings may be varied between the limits shown in table 6-1 to allow for concentrated and wall loads. Beam widths vary from 8 to 12 or 13 inches but are often limited to a minimum of 10 inches.

(a) *Concrete and reinforcement.* Concrete compressive strength  $f'_c$  should be at least 2500 psi and preferably 3000 psi. Construction joints should be placed at intervals of less than 150 ft and cold joints less than 65 ft. About 0.5 percent reinforcing steel should be used in the mat to resist shrinkage and temperature effects.

**FOUNDATION:**

Type: Rebar (Typical)  
 P.I.: 20  
 Concrete: 2500 psi  
 Slab Steel: 6" x 6" No. 6 WWF  
 Beam Steel: For 24" beams, 2-#5 top, 2-#5 bottom  
 Stirrups: #2 @ 48" on Center  
 Fill: 4" inert material  
 Membrane: 6-mil polyethylene

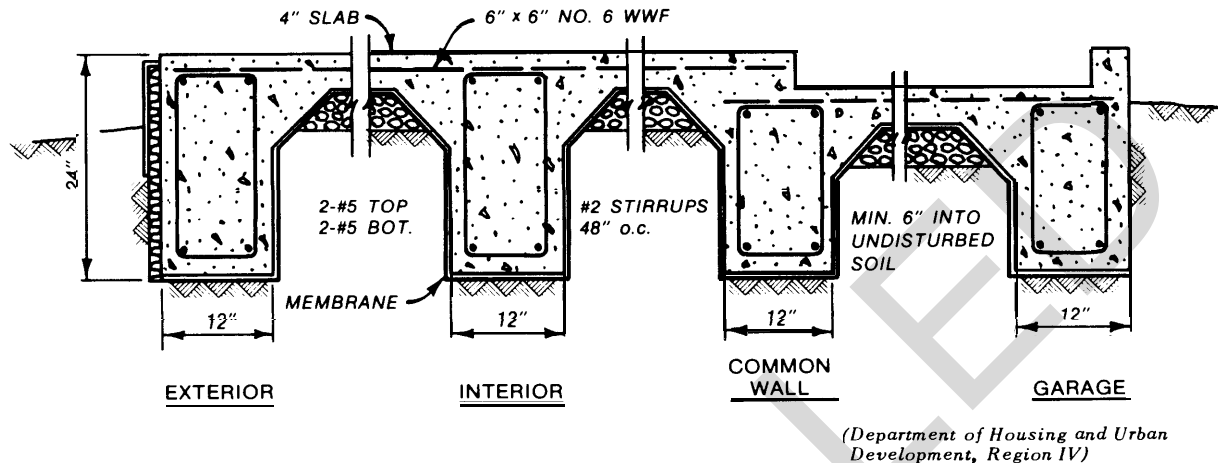

Figure 6-5. Typical conventional rebar slab in Little Rock, Arkansas, for single-family, single-story, minimally loaded frame residence with 11- to 12-foot wall spacing.

(b) *Preliminary design.* The three designs for reinforced and stiffened thin mats presented in table 6-1 differ in the beam depth and spacing depending on the predicted  $\Delta H$  or  $\overline{PI}$ . The beam depths and spacings for each of the light, medium, and heavy slabs are designed for  $\Delta/l$  ratios of 1/500 and tend to be conservative in view of still undetermined fully acceptable design criteria and relatively high repair cost of reinforced and stiffened slabs. Stirrups may be added, particularly in the perimeter beams, to account for concentrated and exterior wall loads.

(2) *Post-tensioned.* Figure 6-6 illustrates an example of a posttensioned slab. Properly designed and constructed posttensioned mats are more resistant to fracture than an equivalent section of a conventional rebar slab and use less steel. However, post-tensioned slabs should still be designed with adequate stiffening beams to resist flexure or distortion from differential heave of the foundation soil. Experienced personnel are necessary to properly implement the posttensioning.

(3) *Assumptions of design parameters.* Design parameters include effects of climate, center and edge modes of differential swelling, perimeter and uniform loads, and structural dimensions.

(a) The effects of climate and differential swelling are accounted for by predictions of the maximum differential heave  $\Delta H$  and the maximum edge lift-off

distance  $e_m$ . Procedures for prediction of  $\Delta H$  are provided in chapter 5. Reasonable values of the  $e_m$  are correlated with the Thornthwaite Moisture Index (TMI) in figure 6-7. The TMI, a climate related parameter roughly estimated from figure 6-8, represents the overall availability of water in the soil. The TMI can vary 10 to 20 or more (dimensionless) units from year to year. The  $e_m$  should be picked toward the top of the range in figure 6-7 for fissured soils. Since the  $e_m$  may exceed the range given in figure 6-7, depending on the activity of the soil or extreme changes in climatic conditions (e.g., long droughts and heavy rainfall), the value of  $e_m$  in feet may also be approximated by  $2.5\Delta H$  with  $\Delta H$  in inches for  $\Delta H \leq 4$  inches.

(b) The loading distribution depends on the architectural arrangement of the building and often cannot be significantly altered. Perimeter and concentrated loads should be supported directly on the stiffening beams.

(c) The length and width of the slab are usually fixed by the functional requirement. Beam spacing depends on the slab geometry and varies between 10 and 20 feet. The depth of stiffening beams is controlled by the moment and shear capacity. The beam depth is adjusted as needed to remain within the allowable limits. The width of the stiffening beam is usually controlled by the excavation equipment and soil bearing capacity.

(4) *Structural design procedure.* The design procedure



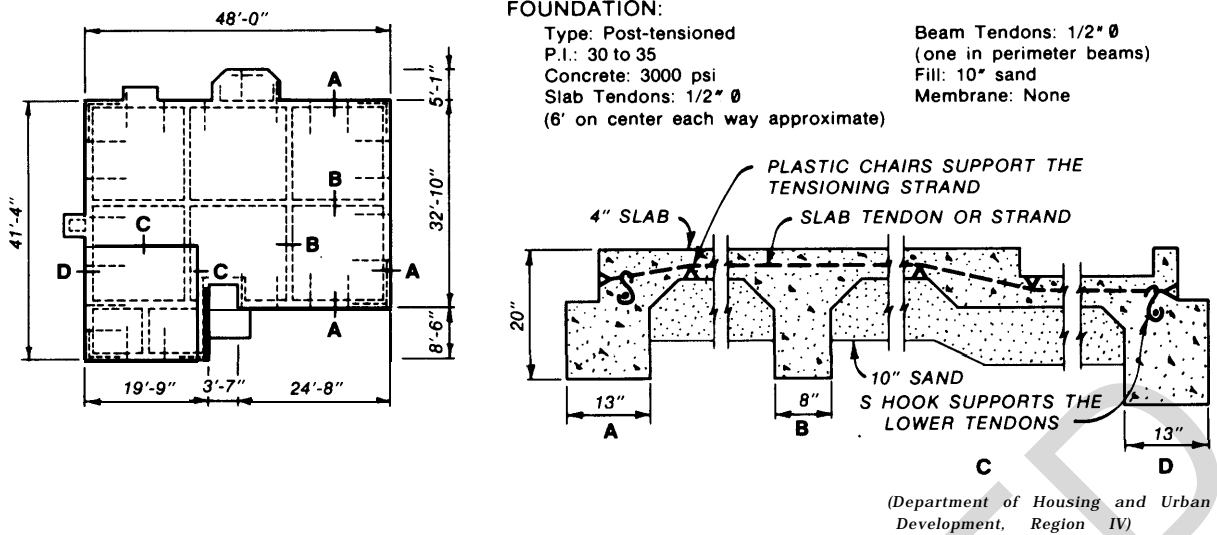

Figure 6-6. Post-tensioned slab in Lubbock, Texas, for single-family, single-story, minimally loaded frame residence.

...ure should provide adequate resistance to shear, moment, and deflections from the structural loading forces, while overdesign is minimized. An economically competitive procedure that builds on the early work of the Building Research Advisory Board of the National Academy of Sciences is that developed for the Post-Tensioning Institute (PTI).

(a) The PTI procedure is applicable to both con-

ventionally reinforced and posttensioned slabs up to 18 inches thick. It considers the previously discussed assumptions of the design parameters.

(b) The  $e_m$  and maximum differential heave  $y_m$  of the unloaded soil determined by the PTI procedure reflect average moisture conditions and may be exceeded if extreme changes in climate occur.

(c) Material parameters required by the PTI pro-

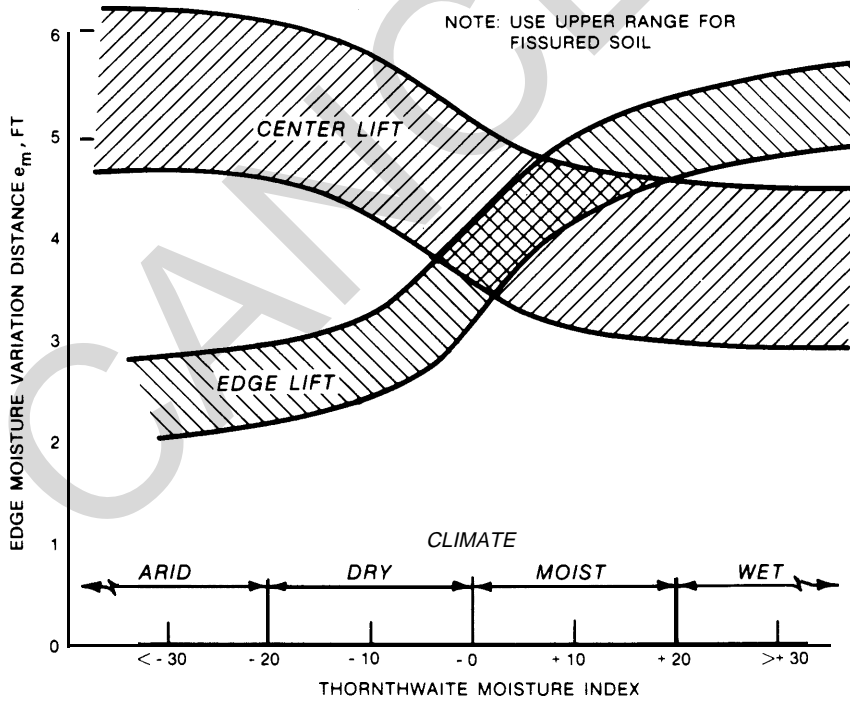

(Based on data from W. K. Wray, 1980, published in Proceedings, Fourth International Conference on Expansive Soils, Vol I, with permission of the American Society of Civil Engineers)

Figure 6-7. Approximate relationship between the Thornthwaite Moisture Index and the edge lift-off distance.

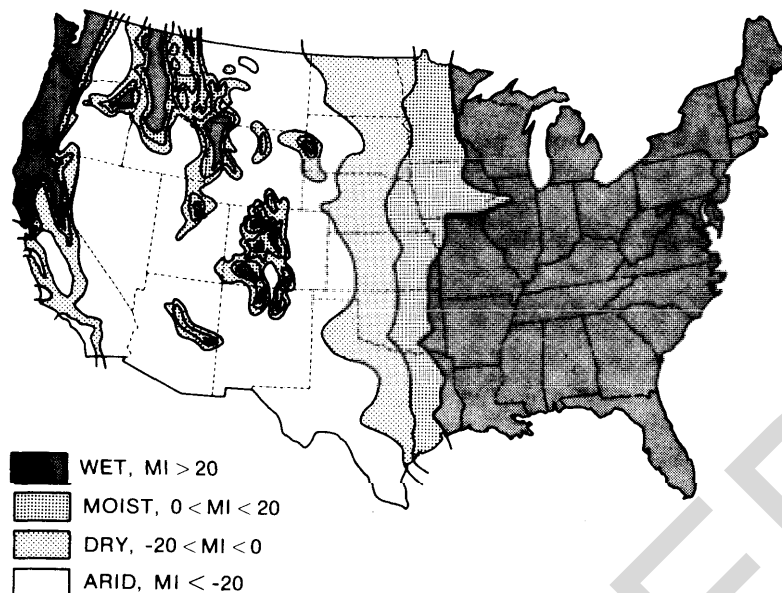

U. S. Army Corps of Engineers

Figure 6-8. Approximate distribution of the Thornthwaite Moisture Index (MI) in the United States.

cedure are the compressive strength of concrete; allowable tensile and compressive stresses in concrete; type, grade, and strength of the prestressing steel; grade and strength of the mild steel reinforcement; and slab subgrade friction coefficient. The amount of reinforcing steel recommended by this procedure should be considered a minimum. The slab-subgrade coefficient of friction should be 0.75 for concrete cast on polyethylene membranes and 1.00 if cast on-grade.

(d) **The allowable  $\Delta/l$  ratio must be estimated.** This ratio may be as large as 1/360 for center heave and 1/800 for edge heave. The smaller edge  $\Delta/l$  ratio criterion is recommended by the PTI because edge lift is usually much less than center lift deflections and the stems of the beams resisting the positive bending moment may be unreinforced.

c. **Design of thick mats.** The state of the art for estimating spatial variations in soil pressures on thick mats is often not adequate. These mats tend to be heavily overdesigned because of the uncertainty in the loading and the relatively small extra investment of some overdesign.

(1) **Description.** Concrete mats for heavy structures tend to be 3 feet or more in thickness with a continuous two-way reinforcement top and bottom. An 8-foot-thick mat supporting a 52-story structure in Houston, Texas, contains about 0.5 percent steel, while the 3-foot-thick mat of the Wilford Hall Hospital complex at Lackland Air Force Base in Texas also contains about 0.5 percent steel. The area of steel is 0.5 percent of the total area of the concrete distributed equally each way both top and bottom. The steel is overlapped near the concentrated loads, and a 3-inch

cover is provided over the steel. The depth of the excavation that the mats are placed in to achieve bearing capacity and tolerable settlements eliminates seasonal edge effects such that the edge lift-off distance is not applicable.

(2) **Procedure.** The thick mat is designed to determine the shear, moment, and deflection behavior using conventional practice, then modified to accommodate swell pressures and differential heave caused by swelling soils. The analyses are usually performed by the structural engineer with input on allowable soil bearing pressures, uplift pressures (hydrostatic and swell pressures from expansive soils) and estimates of potential edge heave/shrinkage and center heave from the foundation engineer. Computer programs are commonly used to determine the shear, moments, and deflections of the thick mat.

(a) **Structural solutions.** The structural solution may be initiated with an estimate of the thickness of a spread footing that resists punching shear and bending moments for a given column load, concrete compressive strength, and soil bearing capacity. Following an estimation of the initial thickness, hand solutions of mat foundations for limited application based on theory of beams on elastic foundations are available from NAVFAC DM-7. More versatile solutions are available from computer programs based on theory of beams on elastic foundations such as BMCOL 2, which is available at the U.S. Army Corps of Engineer Waterways Experiment Station, and finite element analysis.

(b) **Foundation soil/structure solutions.** The BMCOL 2 soil-structure interaction program permits nonlinear soil behavior. Finite element programs are

also available, but they are often burdened with hard to explain local discontinuities in results, time-consuming programming of input data, and need of experienced personnel to operate the program. The finite element program originally developed for analysis of Port Allen and Old River Locks was applied to the analysis of the Wilford Hall Hospital mat foundation at Lackland Air Force Base in Texas. Figure 6-9 compares predicted with observed movement of the 3.5-foot-thick mat at Wilford Hall. Foundation soils include the fissured, expansive Navarro and upper Midway clay shales. These computer programs help refine the design of the mat and can lead to further cost reductions in the foundation.

6-4. Deep foundations

The deep foundation provides an economical method for transfer of structural loads beyond (or below) unstable (weak, compressible, and expansive) to deeper stable (firm, incompressible, and nonswelling) strata. Usually, the deep foundation is a form of a pile foundation. Numerous types of pile foundations exist of which the most common forms are given in table 6-3. Occasionally when the firm-bearing stratum is too deep for the pile to bear directly on a stable stratum, the foundation is designed as friction or floating piles and supported entirely from adhesion with the surrounding soil and/or end bearing on underreamed footings.

a. *General applications.* Each of the types of piling is appropriate depending on the location and type of structure, ground conditions (see table 3-1 for examples), and durability. The displacement pile is usually appropriate for marine structures. Any of the piles in table 6-3 may be considered for land applications. Of these types the bored and cast in situ concrete drilled shaft is generally more economical to construct than driven piles.

b. *Application of drilled shafts.* Table 6-4 describes detailed applications of drilled shaft foundations including advantages and disadvantages. Detailed discussion of drilled shaft foundations is presented below because these have been most applicable to the solution of foundation design and construction on expansive clay soils.

(1) A drilled shaft foundation maybe preferred to a mat foundation if excavating toward an adequate bearing stratum is difficult or the excavation causes settlement or loss of ground of adjacent property.

(2) A drilled shaft foundation 20 to 25 feet deep tends to be economically competitive with a ribbed mat foundation,

(3) Drilled shafts may be preferred to mat foundations if differential heave  $\Delta H$  exceeds 4 inches or  $\Delta/l$  ratios exceed 1/250, Mat foundations under such conditions may tilt excessively leading to intolerable distortion or cracking.

(4) The shaft foundation may be economical com-

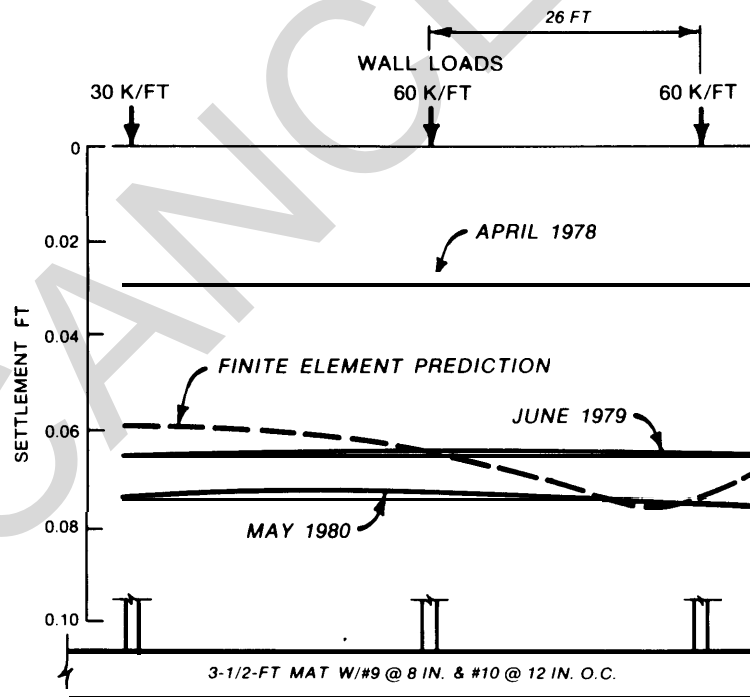

NOTE: APPROXIMATELY 100% STRUCTURAL LOADS IN PLACE; APRIL 1978.

U. S. Army Corps of Engineers

Figure 6-9. Settlement and deflection of a mat foundation.

Table 6-3. Classification of Piles

Classification	Type	Description
Displacement	Timber Precast concrete Steel circular or rectangular Tapered timber or steel	Driven piles with solid circular or rectangular cross section or hollow section with closed bottom end. Piles hammered or jacked down into place.
Small displacement	Precast concrete Prestressed concrete Steel H section Steel circular or rectangular Screw	Small cross-section pile consisting of open-end cylinder, rectangular, H section, or screw configuration.
Nondisplacement	Drilled shaft Tubes filled with concrete Precast concrete Injected cement mortar Steel section	Piles placed in open boreholes. Usually concrete placed in holes drilled by rotary auger, baling, grabbing, airlift, or reverse circulation methods.
Combination	Steel-driven tube replaced by concrete Precast shell filled with concrete Jointed pile of different materials	Combination of different forms of piles.

pared with traditional strip footings, particularly in open construction areas and with shaft lengths less than 10 to 13 feet, or if the active zone is deep, such as within areas influenced by tree roots.

*c. General considerations.*

(1) *Causes of distress.* The design and construction of drilled shaft foundations must be closely controlled to avoid distress and damage. Most problems have been caused by defects in construction and by inadequate design considerations for effects of swelling soil (table 6-5). The defects attributed to construction techniques are discontinuities in the shaft, which may occur from the segregation of concrete, failure to complete concreting before the concrete sets, and early set of concrete, caving of soils, and distortion of the steel reinforcement. The distress resulting from inadequate design considerations are usually caused by wetting of subsoil beneath the base, uplift forces, lack of an air gap beneath grade beams, and lateral movement from downhill creep of expansive clay.

(2) *Location of base.* The base of shafts should be located below the depth of the active zone, such as below the groundwater level and within nonexpansive soil. The base should not normally be located within three base diameters of an underlying unstable stratum.

(a) Slabs-on-grade isolated from grade beams and walls are often used in light structures, such as residences and warehouses, rather than the more costly structural slabs supported by grade beams and shafts. These slabs-on-grade will move with the expansive soil and should be expected to crack.

(b) To avoid "fall-in" of material from the granu-

lar stratum during underreaming of a bell, the base may be placed beneath swelling soil near the top of a granular stratum.

(3) *Underreams.* Underreams are often used to increase anchorage to resist uplift forces (fig. 6-10). The belled diameter is usually 2 to 2.5 times the shaft diameter  $D_s$  and should not exceed 3 times  $D_s$ . Either 45- or 60-degree bells may be used, but the 45-degree bell is often preferred because concrete and construction time requirements are less. Although the 45-degree bell may be slightly weaker than the 60-degree bell, no difference has been observed in practice. The following considerations are necessary in comparing underreamed shafts with straight shafts.

(a) Straight shafts may be more economical than underreams if the bearing stratum is hard or if subsoils are fissured and friable. Soil above the underream may be loose and increase the upward movement needed to develop the bell resistance.

(b) The shaft can often be lengthened to eliminate the need for an underream, particularly in soils where underreams are very difficult to construct. Friction resistance increases rapidly in comparison with end bearing resistance as a function of the relative shaft-soil vertical movement.

(c) Underreams reduce the contact bearing pressure on potentially expansive soil and restrict the minimum diameter that may be used.

(4) *Uplift forces.* If bells or underreams are not feasible, uplift forces (table 6-5) may be controlled by the following methods:

(a) The shaft diameter should be the minimum required for downloads and construction procedures and control.

Table 6-4. Applications of Drilled Shafts

Applications	Advantages	Disadvantages
<p>Absence of a shallow, stable founding stratum; support of structures with shafts drilled through swelling soils into zones unaffected by moisture changes.</p>	<p>Personnel, equipment, and materials for construction usually readily available; rapid construction due to mobile equipment; careful inspection of excavated hole usually possible; noise level of equipment less than some other construction methods; low headroom needed.</p>	<p>Accurate predictions of load and settlement behavior not always possible.</p>
<p>Support of moderate-to-high column loads; high column loads with shafts drilled into hard bedrock; moderate column loads with unreamed shafts bottomed on sand and gravel.</p>	<p>Excavated soil examined to check the projected soil conditions and profile; excavation possible for a wide variety of soil conditions.</p>	<p>Careful design and construction required to avoid defective foundations; careful inspection necessary during construction; inspection of concrete after placement difficult.</p>
<p>Support of light structures on friction shafts.</p>	<p>Heave and settlement at the ground surface normally small for properly designed shafts.</p>	<p>Inadequate knowledge of design methods and construction problems leading to improper design; strict requirements for investigations.</p>
<p>Rigid limitations on allowed structure deformations at site where differential heave or settlement is predicted to exceed 3 to 4 in.; large lateral variations in soil conditions.</p>	<p>Disturbance of soil minimized by drilling, thus reducing consolidation and dragdown due to remolding compared to other methods of placing deep foundations such as driving.</p>	<p>Construction techniques sometimes very sensitive to subsurface conditions: susceptible to "necking" in squeezing ground; difficult to concrete requiring tremie if hole filled with slurry or water; cement washing out if water is under artesian pressure; pulling casing disrupting continuity of concrete in the shaft or displacing/distorting the reinforcing cage.</p>
<p>Structural configurations and functional requirements or economics precluding a mat or other foundation; resisting uplift forces from swelling soils; and providing anchorage to pulling, lateral, or overturning forces.</p>	<p>A single shaft carrying very large loads.</p> <p>Pile caps eliminated.</p> <p>Changes in geometry (diameter, penetration, underream) made during construction if required by subsurface conditions.</p>	<p>Heave beneath base of shaft aggravating movement beneath slab-on-grade.</p> <p>Failures difficult and expensive to correct.</p>

Table 6-5. Defects Associated with Drilled Shafts

Defects from Construction Techniques	
Defect	Remarks
Discontinuities in the shaft	Do not leave cuttings in the borehole prior to concreting. Too rapid pulling of casing can cause voids in the concrete. Avoid groundwater pressure greater than concrete pressure, inadequate spacing in steel reinforcement, and inadequate concrete slump and workability.
Reduced diameter from caving soil	Caving or squeezing occurs along the shaft in cohesionless silt, rock flour, sand or gravel, and soft soils, especially below the water table. Coarse sands and gravels cave extensively during drilling and tend to freeze casing in place. Soft soils tend to close open boreholes. Raising the auger in soft soils may "suck" the borehole to almost complete closure.
Distortion of reinforcement	Distortion of steel reinforcement cages can occur while the casing is pulled. Horizontal bands or ties should be placed around reinforcing steel.
Defects Attributed to Swelling Soil	
Mode of Defect	Remarks
Subsoil wetting below base of shaft	Moisture may migrate down the concrete of the shaft from the surface or from perched water tables into deeper desiccated zones, causing the entire shaft to rise. Shafts may also heave from a rising deep water table. Rise is sometimes avoided by increasing the shaft length or placing the base in nonswelling soil or within a water table.
Uplift	Heave of surrounding desiccated swelling clays can cause friction forces, which in time cause the shaft to rise and even fracture from excessive tensile stress. Rise can be reduced by placing an underreamed base in nonswelling soil, increasing steel reinforcement along the entire shaft length and underreamed base to resist the tensile stress, and providing sleeving to reduce adhesion between the shaft and soil.
Grade beams on swelling soil	Lack of an air gap between the surface of swelling soil and the grade beam can cause the grade beam to rise.
Lateral swell	Shaft foundations have low resistance to damage from lateral swell. Downhill creep of expansive clays contributes to damaged foundations.

(b) The shaft length may be extended further into stable, nonswelling soil to depths of twice the depth of the active zone  $X_a$ .

(c) Widely spaced shafts may be constructed with small diameters and a total loading force  $Q_w$  that exceeds the maximum uplift thrust (fig. 6-11) expressed as

$$Q_u = \pi D_s \int_0^{L_n} f_s dL < Q_w \quad (6-1)$$

where

$Q_u$  = maximum uplift thrust on perimeter of shaft, tons

$D_s$  = diameter of shaft, feet

$L_n$  = thickness of the swelling layer moving up relative to the shaft, feet

$f_s$  = skin resistance, tons per square foot

$dL$  = differential increment of shaft length  $L$ , feet

The point  $n$  in figure 6-11 is the neutral point. The value of  $L_n$  should be approximately equal to the depth  $X_a$ . The maximum skin resistance  $f_s$  is evaluated in  $d$  below. The loading force  $Q_w$  should also be less than or equal to the soil allowable bearing capacity. Wide spans between shafts also reduce angular rotation of the structural members. The minimum spacing of shafts should be 12 feet or 8 times the shaft diameter (whichever is smaller) to minimize effects of adjacent shafts.

(d) The upper portion of the shaft should be kept vertically plumb (maximum variation of 1 inch in 6 feet shown in fig. 6-10) and smooth to reduce adhesion between the swelling soil and the shaft. Friction reducing material, such as roofing felt, bitumen slip layers, polyvinyl chloride (PVC), or polyethylene sleeves, may be placed around the upper shaft to re-

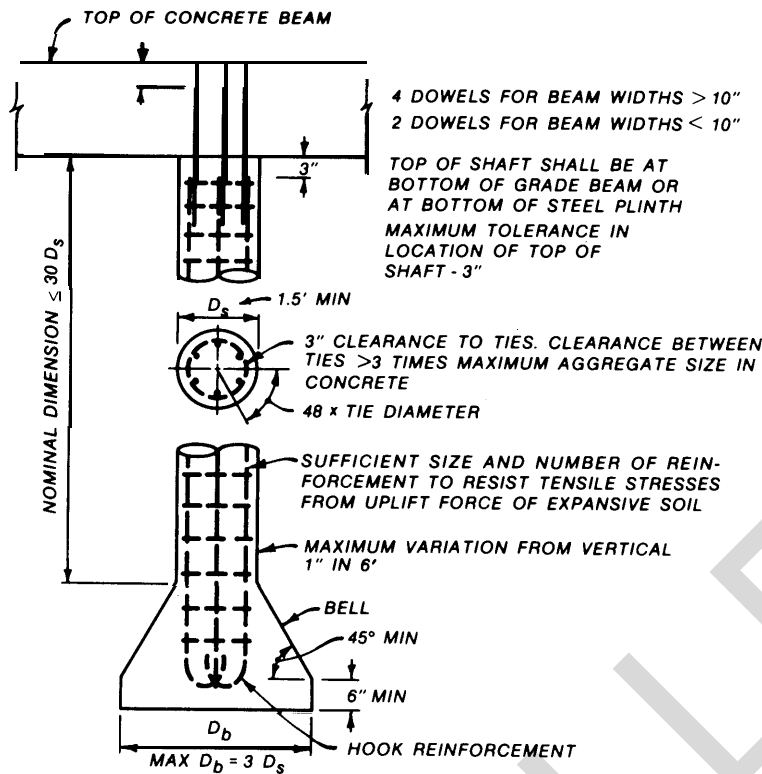

**DESIGN**

1. USE 3000-PSI CONCRETE
2. ASSUME SHAFT AS A SHORT TIED COLUMN
3. MINIMUM  $A_s = 0.01A_c$ ; MORE MAY BE REQUIRED
4. KEEP BELL SIZES IN INCREMENTS OF 6" (e.g., 3'-0", 3'-6", etc.)
5. VERTICAL REINFORCEMENT ASTM A 615 GRADE 60 STEEL

(Based on data from U. S. Army Construction Engineering Research Laboratory TR M-81 by W. P. Jobs and W. R. Stroman)

Figure 6-10. Drilled shaft details.

duce both uplift and downdrag forces. Vermiculite, pea gravel, or other pervious materials that will allow access of water to the expansive material should be avoided.

*d. Design.* The heave or settlement of the foundation usually controls the design and should not exceed specified limits set by usage requirements and tolerances of the structure. The design of drilled shafts, in addition to bearing capacity, should consider the method of construction, skin resistance, and uplift forces. The computer program HEAVE (WES Miscellaneous Paper GL-82-7) may be used to help determine the movement of drilled shafts for different lengths and diameters of the shaft, and the diameter of the underream for different loading forces.

(1) *Skin resistance.* Skin resistance develops from small relative displacements between the shaft and the adjacent soil. Positive (upward directed) skin friction, which helps support structural loads, develops when the shaft moves down relative to the soil. Uplift of adjacent swelling soils also transfers load to the shaft

foundation by positive skin friction and can cause large tensile stresses to develop in the shaft. Negative skin friction, which adds to the structural loads and increases the end bearing force, develops when the surrounding soil moves down relative to the shaft. Negative skin friction is associated with the settling of the adjacent fill, loading of surrounding compressible soils, or lowering of the groundwater level.

(a) The maximum skin friction  $f_s$  may be evaluated by the equation

$$f_s = c_a + K\delta'_v \tan \phi_a \tag{6-2}$$

where

- $c_a$  = adhesion, tons per square foot
- $K$  = ratio of horizontal to vertical effective stress
- $\delta'_v$  = vertical effective stress, tons per square foot
- $\phi_a$  = angle of friction between the soil and shaft, degrees

The angle  $\phi_a$  is close to, although less than, the effective angle of internal friction  $\phi'$  for remolded cohesive

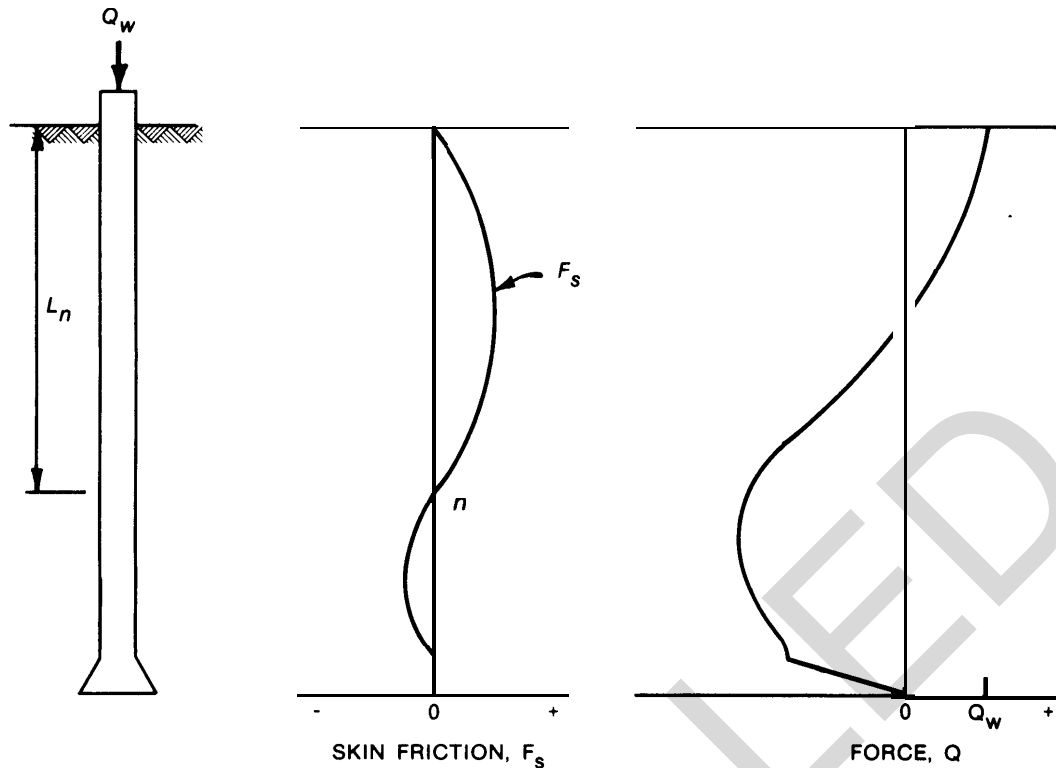

U. S. Army Corps of Engineers

Figure 6-11. Distribution of load from uplift of swelling soil.

soil against concrete. The skin resistance, which is a function of the type of soil (sand, clay, and silt), is usually fully mobilized with a downward displacement of 1/2 inch or less or about 1 to 3 percent of the shaft diameter. These displacements are much less than those required to fully mobilize end bearing resistance.

(b) The fully mobilized skin resistance has been compared with the undrained, undisturbed shear strength  $c_u$  for all clays by

$$f_s = c_u = \alpha_f c_u \quad (6-3)$$

in which  $\alpha_f$  is a reduction coefficient that has been found to vary between 0.25 and 1.25 depending on the type of shaft and soil conditions. The reduction factor is the ratio of mobilized shearing resistance to the undrained, undisturbed shear strength. The  $\alpha_f$  appears to be independent of soil strength. Also, the in situ reduction factor may appear greater than one depending on the mechanism of load transfer. For example, the shaft load may be transferred over some thickness of soil such that the effective diameter of the shaft is greater than the shaft diameter  $D$ . The reduction factor concept, although commonly used, is not fully satisfactory because  $\alpha_f$  is empirical and should be evaluated for each shaft foundation. The average  $\alpha_f$  for use in stiff overconsolidated clays is about 0.5 to 0.6. An  $\alpha_f$  of 0.25 is recommended if little is known about the soil or if slurry construction is used.

The reduction factor approaches zero near the top and

bottom of the shafts in cohesive soils, reaching a maximum near the center. The reduction of  $\alpha_f$  at the top is attributed to soil shrinkage during droughts and low lateral pressure, while the reduction at the bottom is attributed to interaction of stress between end bearing and skin resistance.

(c) Skin resistance may also be evaluated in terms of effective stress from results of drained direct shear tests

$$f_s = c' + K\sigma'_v \tan \phi' = \beta\sigma'_v \quad (6-4)$$

where  $c'$  is the effective cohesion and  $\phi'$  is the effective angle of internal friction. The effective cohesion is assumed zero in practical applications and eliminated from equation (6-4). Most of the available field data show that  $K \tan \phi'$  or  $\beta$  varies from 0.25 to 0.4 for normally consolidated soils, while it is about 0.8 for overconsolidated soils. Reasonable estimates of  $\beta$  can also be calculated for normally consolidated soils by

$$\beta = (1 - \sin \phi') \tan \phi' \quad (6-5a)$$

and in overconsolidated soils by

$$\beta = (1 + 2K_0) \frac{\cos \phi' \sin \phi'}{3 - \sin \phi'} \quad (6-5b)$$

where  $K_0$  is the lateral coefficient of earth pressure at rest. If  $K_0$  is not known, a reasonable minimum estimate of  $\beta$  is given by assuming  $K_0 = 1$ . The effective cohesion is often assumed to be zero.

(2) *Uplift forces.* Uplift forces, which are a direct function of swell pressures, will develop against sur-



faces of shaft foundations when wetting of surrounding expansive soil occurs. Side friction resulting in uplift forces should be assumed to act along the entire depth of the active zone since wetting of swelling soil causes volumetric expansion and increased pressure against the shaft. As the shaft tends to be pulled upward, tensile stresses and possible fracture of concrete in the shaft are induced, as well as possible upward displacement of the entire shaft.

(a) The tension force  $T$  (a negative quantity) may be estimated by

$$T = Q_w - Q_u \quad (6-6)$$

where  $Q_w$  is the loading force from the structure and includes the weight of the shaft. Limited observations show that the value of  $K$  required to evaluate  $Q_u$  (equation (6-1)) from the skin resistance  $f_s$  (equations (6-3) and (6-4)) varies between 1 and 2 in cohesive soils for shafts subject to uplift forces. The same swelling responsible for uplift also increases the lateral earth pressure on the shaft. Larger  $K$  values increase the computed tension force.

(b) The shaft should be of proper diameter, length, and underreaming, adequately loaded, and contain sufficient reinforcing steel to avoid both tensile fractures and upward displacement of the shaft. ASTM A 615 Grade 60 reinforcing steel with a minimum yield strength  $f_s$  of 60,000 psi should be used. The minimum percent steel required if ASTM A 615 Grade 60 steel is used is given approximately by

$$\text{Percent } A_s \cong -0.03 \frac{T}{D_s^2} \quad (6-7)$$

where  $T$  is the tension force in tons and the shaft diameter  $D_s$  is in feet. The minimum percent steel  $A_s$  should be 1 percent of the concrete area  $A_c$  (fig. 6-10), but more may be required. The reinforcing steel should be hooked into any existing bell as shown in figure 6-10, and it may also be hooked into a concrete grade beam.

Maximum concrete aggregate size should be one third of the openings in the reinforcement cage.

*d. Grade beams.* Grade beams spanning between shafts are designed to support wall loads imposed vertically downward. These grade beams should be isolated from the underlying swelling soil with a void space beneath the beams of 6 to 12 inches or 2 times the predicted total heave of soil located above the base of the shaft foundation (whichever is larger). Steel is recommended in only the bottom of the grade beam if grade beams are supported by drilled shafts above the void space. Grade beams resting on the soil without void spaces are subject to distortion from uplift pressure of swelling foundation soil and are not recommended.

(1) *Preparation of void space.* Construction of grade beams with void spaces beneath the beams may require overexcavation of soil in the bottom of the grade beam trench between shafts. The void space may be constructed by use of sand that must later be blown away at least 7 days after concrete placement, or by use of commercially available cardboard or other retainer forms that will support the concrete. The cardboard forms should deteriorate and collapse before swell pressures in underlying soil can deflect or damage the grade beams. The resulting voids should be protected by soil retainer planks and spacer blocks. Figure 6-12 illustrates some void details.

(2) *Loading.* Interior and exterior walls and concentrated loads should be mounted on grade beams. Floors may be suspended from grade beams at least 6 inches above the ground surface, or they may be placed directly on the ground if the floor slab is isolated from the walls. Support of grade beams, walls, and suspended floors from supports other than the shaft foundation should be avoided. Figure 6-13 illustrates typical exterior and interior grade beams.

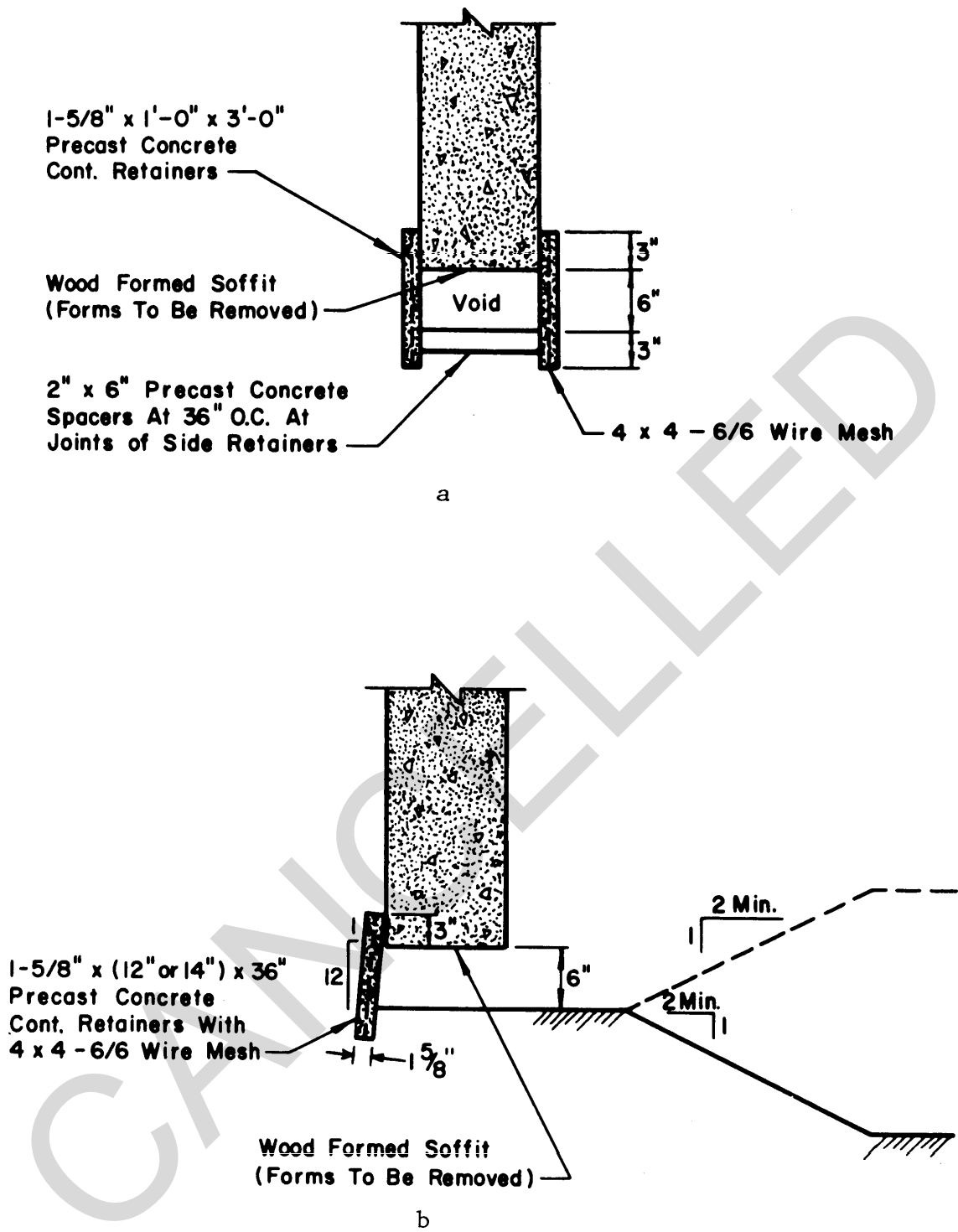

(Based on data from U. S. Army Construction Engineering Research Laboratory TR M-81 by W. P. Jobes and W. R. Stroman)

Figure 6-12. Typical grade beam void details.

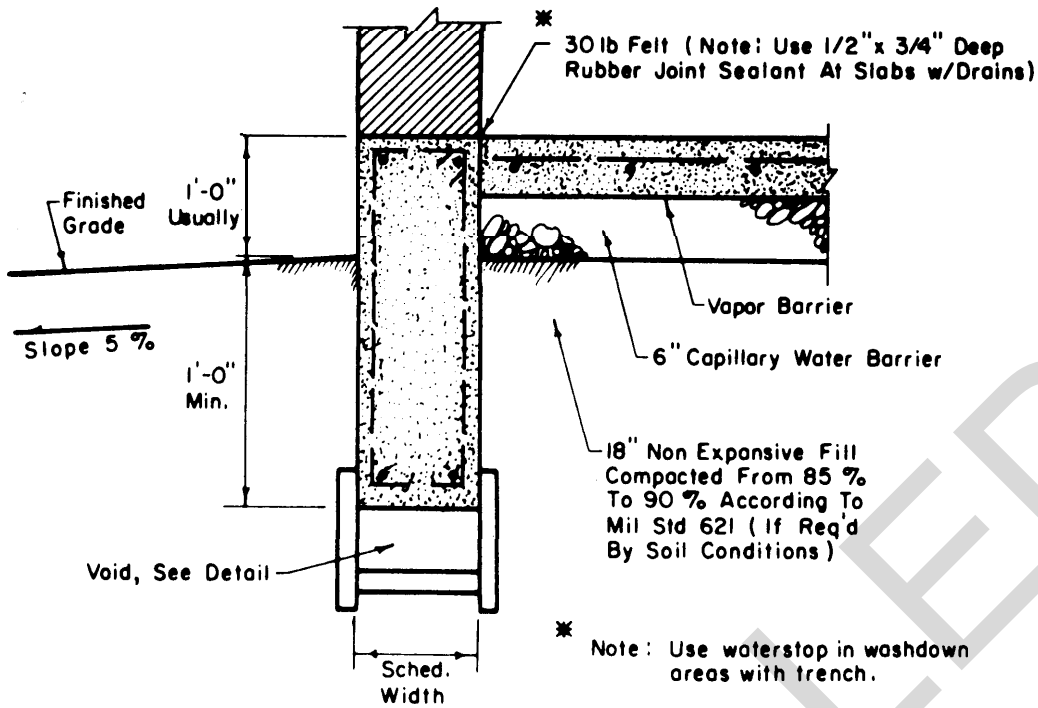

a

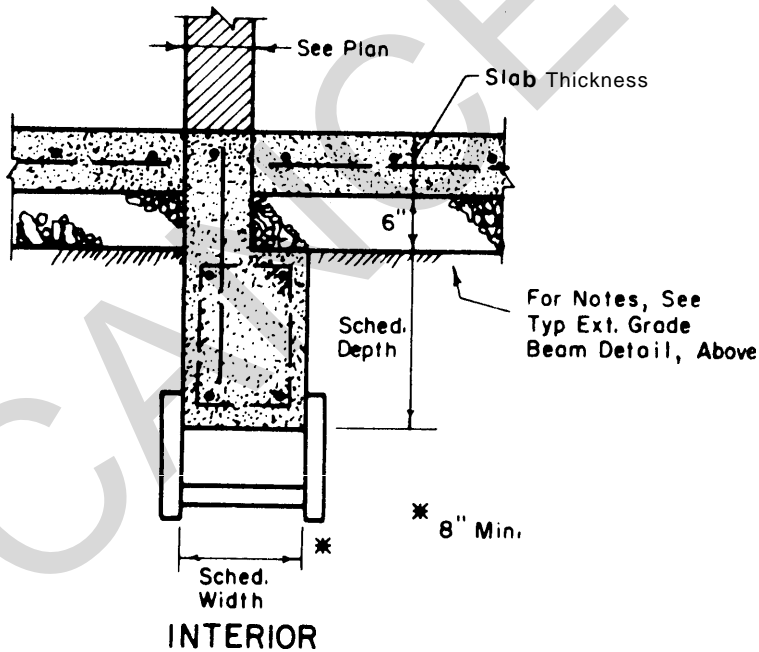

b

(Based on data from U. S. Army Construction Engineering Research Laboratory TR M-81 by W. P. Jobes and W. R. Stroman)

Figure 6-13. Typical exterior and interior grade beams.

## CHAPTER 7

## MINIMIZATION OF FOUNDATION MOVEMENT

## 7-1. Preparation for construction

The foundation should always be provided with adequate drainage, and the soil properly prepared to minimize changes in soil moisture and differential movement.

*a. Removal of vegetation.* Existing trees and other heavy vegetation should be removed. New plantings of like items installed during postconstruction landscaping should not be located within a distance away from the structure ranging from 1 to 1.5 times the height of the mature tree.

*b. Leveling of site.* Natural soil fills compacted at the natural water content and the natural density of the in situ adjacent soil minimize differential movement between cut and fill areas of sloping ground, trenches, or holes caused by removal of vegetation. The volume of cut portions should be kept to a minimum. Cut areas reduce the overburden pressure on underlying swelling soil and lead to time-dependent heave.

*c. Excavation.*

(1) Construction in new excavations (within a few years of excavating) without replacement of a surcharge pressure equal to the original soil overburden pressure should be avoided where possible because the reduction in effective stress leads to an instantaneous elastic rebound plus a time-dependent heave. The reduction in overburden pressure results in a reduction of the pore water pressure in soil beneath the excavation. These pore pressures tend to increase with time toward the original or equilibrium pore pressure profile consistent with that of the surrounding soil and can cause heave.

(2) Ground surfaces of new excavations, such as for basements and thick mat foundations, should be immediately coated with sprayed asphalt or other sealing compounds to prevent drying of or the seepage of ponded water into the foundation soil during construction (fig. 7-1). Rapid-cure RC 70 or medium-cure MC 30 cutback asphalts are often used as sealing compounds, which penetrate into the soil following compaction of the surface soil and cure relatively quickly.

## 7-2. Drainage techniques

Drainage is provided by surface grading and subsurface drains.

*a. Grading.* The most commonly used technique is grading of a positive slope away from the structure. The slope should be adequate to promote rapid runoff and to avoid collecting, near the structure, ponded water, which could migrate down the foundation/soil interface. These slopes should be, greater than 1 percent and preferably 5 percent within 10 feet of the foundation.

(1) Depressions or water catch basin areas should be filled with compacted soil (para 7-3a) to have a positive slope from the structure, or drains should be provided to promote runoff from the water catch basin areas. Six to twelve inches of compacted, impervious, nonswelling soil placed on the site prior to construction of the foundation can ensure the necessary grade and contribute additional uniform surcharge pressure to reduce uneven swelling of underlying expansive soil.

(2) Grading and drainage should be provided for structures constructed on slopes, particularly for slopes greater than 9 percent, to rapidly drain off water from the cut areas and to avoid ponding of water in cuts or on the uphill side of the structure. This drainage will also minimize seepage through backfills into adjacent basement walls.

*b. Subsurface drains.* Subsurface drains (fig. 7-1) may be used to control a rising water table, groundwater and underground streams, and surface water penetrating through pervious or fissured and highly permeable soil. Drains can help control the water table before it rises but may not be successful in lowering the water table in expansive soil. Furthermore, since drains cannot stop the migration of moisture through expansive soil beneath foundations, they will not prevent all of the long-term swelling.

(1) *Location of subsurface drains.* These drains are usually 4- to 6-inch-diameter perforated pipes placed adjacent to and slightly below the baseline of the external wall to catch free water (fig. 7-1).

(a) An impervious membrane should be placed beneath the drain in the trench to prevent migration of surface moisture into deeper soil. The membrane adjacent to the foundation wall should be cemented to the wall with a compatible joint sealant to prevent seepage through the joint between the membrane and the foundation.

(b) If a 6- to 12-inch layer of granular material

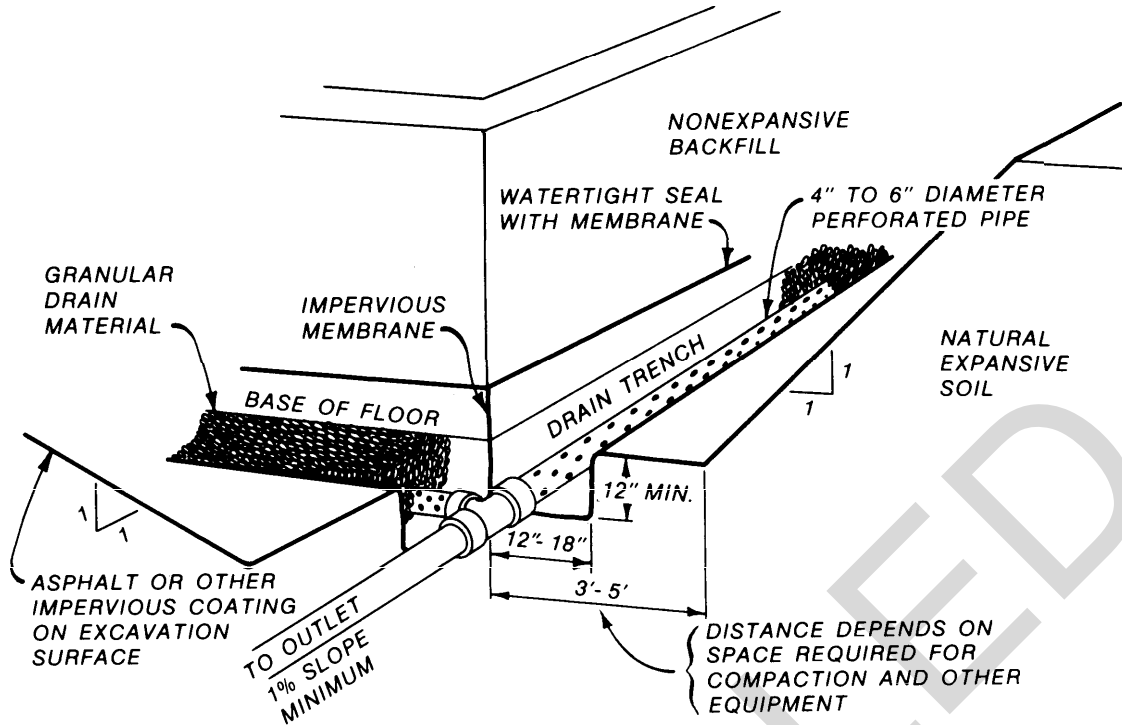

U. S. Army Corps of Engineers

Figure 7-1. Drainage trench around outside of structure.

was provided beneath a slab-on-grade, the granular material in the drain trench should be continuous with the granular material beneath the floor slab. The perforated pipe should be placed at least 12 inches deeper than the bottom of the granular layer. An impervious membrane should also be placed on the bottom and sides of the drain trench but should not inhibit flow of moisture into the drain from beneath the floor slab. Granular fills of high permeability should be avoided where possible.

(c) Deep subsurface drains constructed to control arising water table should be located at least 5 feet below a slab-on-grade. An impervious membrane should not be placed in the drain trench. These drains are only partially effective in controlling soil heave above the drain trench, and they are relatively expensive. A more economical solution may be to place a temporary (or easily removable slab-on-grade) with a permanent slab after the groundwater table has reached equilibrium.

(2) *Outlets.* Drains should be provided with outlets or sumps to collect water and pumps to expel water if gravity drainage away from the foundation is not feasible. Sumps should be located well away from the structure. Drainage should be adequate to prevent any water from remaining in the drain (i.e., a slope of at least 1/8 inch per foot of drain or 1 percent should be provided).

(3) *Drain trench material.* The intrusion of fines

in drains may be minimized by setting the pipe in filter fabric and pea gravel/sand.

### 7-3. Stabilization techniques

Two effective and most commonly used soil stabilization techniques are controlled backfilling and continuous maintenance involving drainage control and limited watering of surface soil adjacent to the structure during droughts. Other techniques, such as moisture barriers and lime treatment, are not widely used in minimizing differential heave of single and multistory buildings. Presetting or pending for periods of a few months to a year prior to construction is often effective but normally is not used because of time requirements. Prewetting should not be used on fissured clay shales because swelling from water seeping into fissures may not appear until a much later date and delayed problems may result.

a. *Controlled backfills.* Removal of about 4 to 8 feet of surface swelling soil and replacement with nonexpansive, low permeable backfill will reduce heave at the ground surface. Backfills adjacent to foundation walls should also be nonswelling, low permeable material. Nonswelling material minimizes the forces exerted on walls, while low permeable backfill minimizes infiltration of surface water through the backfill into the foundation soil. If only pervious, nonexpansive (granular) backfill is available, a subsurface drain at the bottom of the backfill is necessary to carry off in-

filtrated water (fig. 7-1) and to minimize seepage of water into deeper desiccated foundation expansive soils.

(1) *Backfill of natural soil.* Backfill using natural soil and compaction control has been satisfactory in some cases if nonswelling backfill is not available. However, this use of backfill should be a last resort,

(a) In general, the natural soil should be compacted to 90 percent of standard maximum density and should be wet of optimum water content. Foundation loads on fills should be consistent with the allowable bearing capacity of the fill. Overcompaction should be avoided to prevent aggravating potentially swelling soil problems such as differential heave of the fill. Compaction control of naturally swelling soil is usually difficult to accomplish in practice. Some soils become more susceptible to expansion following remolding, and addition of water to achieve water contents necessary to control further swell may cause the soil to be too wet to work in the field.

(b) As an alternative, backfills of lime-treated natural soil compacted to 95 percent standard maximum density at optimum water content may be satisfactory if the soil is sufficiently reactive to the lime (*d* below), Lime treatment may also increase soil strength and trafficability on the construction site.

(2) *Backfill adjacent to walls.* A IV on IH slope cut into the natural soil should dissipate lateral swell pressures against basement or retaining walls exerted by the natural swelling material. The nonswelling backfill should be a weak material (sand fill with friction angle of 30 degrees or lessor cohesive fill with cohesion less than about 0.5 tons per square foot) to allow the fill to move upward when the expansive natural soil swells laterally. Restraining loads should not be placed on the surface of the fill. A friction reducing medium may be applied on the wall to minimize friction between the wall and the backfill, TM 5-818-4 discusses details on optimum slopes of the excavation and other design criteria.

*b. Maintenance.* Maintenance programs are directed toward promoting uniform soil moisture beneath the foundation. A good program consists of the following:

(1) Maintenance of a positive slope of about 5 percent around the structure for drainage and elimination of water catch areas.

(2) Maintenance of original drainage channels and installation of new channels as necessary.

(3) Maintenance of gutters around the roof and diversion of runoff away from the structure.

(4) Avoidance of curbs or other water traps around flower beds.

(5) Elimination of heavy vegetation within 10 to 15 feet of the foundation or 1 to 1.5 times the height of mature trees.

(6) Uniform limited watering around the structure during droughts to replace lost moisture.

*c. Moisture barriers.* The purpose of moisture barriers is to promote uniform soil moisture beneath the foundation by minimizing the loss or gain of moisture through the membrane and thus reducing cyclic edge movement, Moisture may still increase beneath or within areas surrounded by the moisture barriers leading to a steady but uniform heave of the foundation or slab-on-grade.

(1) *Types of barriers.* These barriers consist of horizontal and vertical plastic and asphalt membranes and granular materials. Concrete is an ineffective moisture barrier. Longlasting membranes include chlorinated polyethylene sheets, preferably placed over a layer of catalytically blown or sprayed asphalt. All joints, seams, and punctures should be sealed by plastic cements or concrete/asphalt joint sealants. ASTM D 2521 (Part 15) describes use of asphalt in canal, ditch, and pond linings (app A).

(2) *Horizontal.*

(a) An impervious membrane on the ground surface in a crawl space where rainfall does not enter may help reduce shrinkage in clayey foundation soils with deep groundwater levels by minimizing evaporation from the soil. A vapor barrier should not be placed in ventilated crawl spaces if there is a shallow water table or if site drainage is poor because heave maybe aggravated in these cases. Figure 7-2 illustrates a useful application of horizontal membranes,

(b) Other applications include the use of horizontal moisture barriers around the perimeter of structures to reduce lateral variations in moisture changes and differential heave in the foundation soil. Plastic or other thin membranes around the perimeter should be protected from the environment by a 6- to 12-inch-thick layer of earth.

(c) A disadvantage of these barriers is that they are not necessarily reliable and may be detrimental in some cases. For example, most fabrics and plastic membranes tend to deteriorate with time. Undetected (and hence unrepaired) punctures that allow water to get in, but not to get out, commonly occur in handling on placement. Punctures may also occur during planting of vegetation. If the barrier is a concrete slab, the concrete may act as a wick and pull water out of the soil.

(3) *Vertical.*

(a) Plumbing or utility trenches passing through the barrier may contribute to soil moisture beneath the foundation.

(b) The vertical barrier (fig. 7-3) should extend to the depth of the active zone and should be placed a minimum of 3 feet from the foundation to simplify construction and to avoid disturbance of the foundation soil. The barrier may not be practical in prevent-

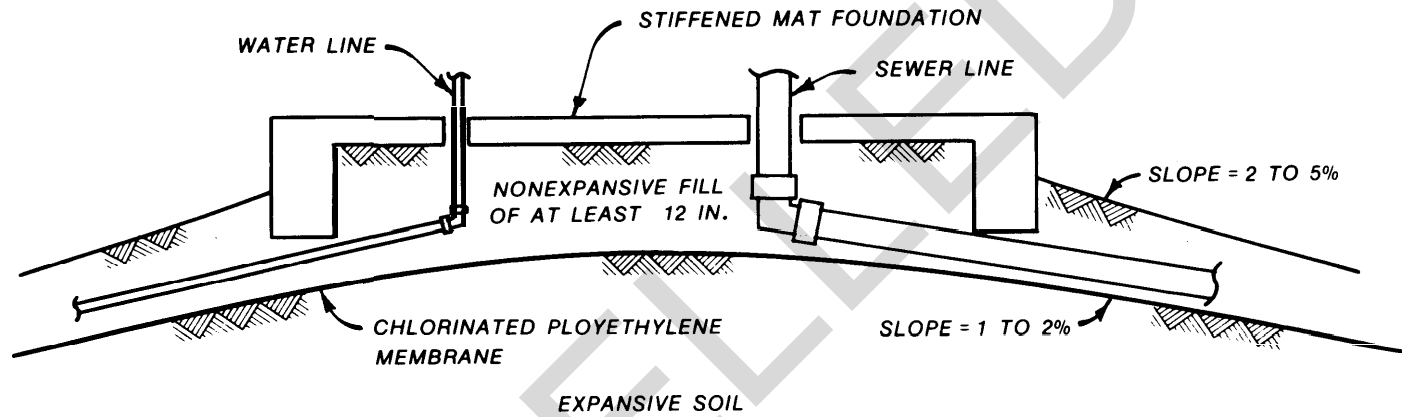

NOTE: POTENTIAL SOURCES OF WATER SHOULD BE LOCATED ABOVE THE MEMBRANE.

U. S. Army Corps of Engineers

Figure 7-2. Application of a horizontal membrane.

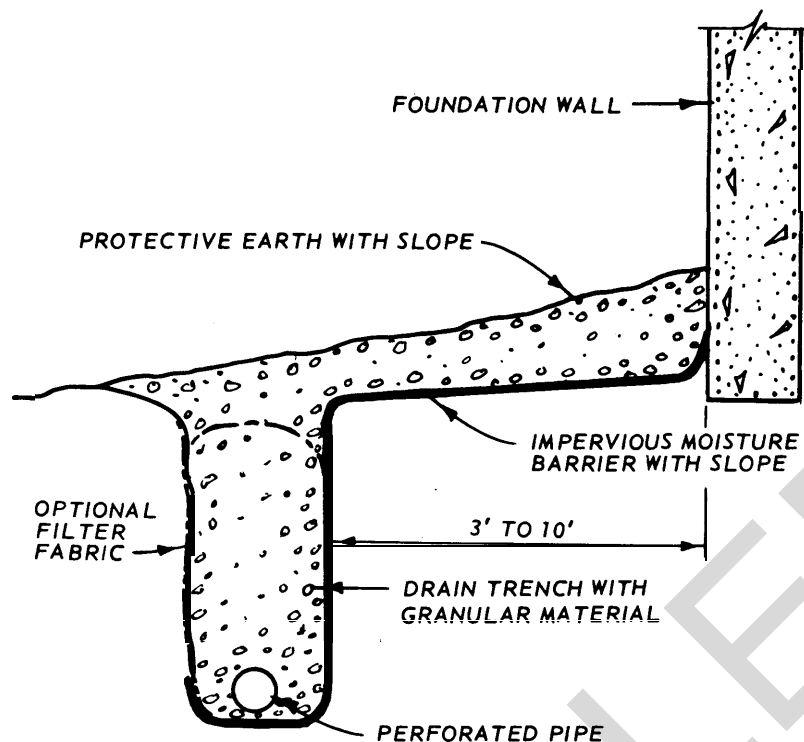

U. S. Army Corps of Engineers

Figure 7-3. Vertical and horizontal moisture barriers.

ing migration of moisture beneath the bottom edge for active zones deeper than 8 to 10 feet. The granular barrier may also help reduce moisture changes during droughts by providing a reservoir of moisture. The placement of a filter fabric around the trench to keep fine particles from entering the perforated pipe will permit use of an open coarse aggregate instead of a graded granular filter. In some cases, the perforated pipe could be eliminated from the drain trench.

*d. Lime treatment.* This treatment is the most widely used and most effective technique of chemical alteration to minimize volume changes and to increase the shear strength of foundation expansive soils.

(1) *Applications.* Lime treatment is applied to the strengthening and minimization of volume change of soil in railroad beds, pavement subgrades, and slopes. When this treatment is applied to foundation soils of single and multistory structures, it is not always successful because the usefulness depends on the reactivity of the soil to lime treatment and the thoroughness of dispersion of lime mixed into the soil.

(a) Lime treatment is effective in the minimization of volume changes of natural soil for backfill. However, this treatment increases the soil permeability and the soil strength. The soil permeability should be kept low to restrict seepage of surface water through the backfill. The backfill strength should be as low as possible compatible with economical design to minimize the transfer of lateral swell pressures from

the natural in situ soil through the backfill to the basement and retaining walls.

(b) Lime treatment may be used to stabilize a 6- to 12-inch layer of natural expansive soil compacted on the surface of the construction site to provide a positive slope for runoff of water from the structure and a layer to reduce differential heave beneath the floor slab.

(c) Lime treatment may be applied to minimize downhill soil creep of slopes greater than 5 degrees (9 percent) by increasing the stiffness and strength of the soil mass through filling fractures in the surface soils. If lime slurry pressure injection (LPSI) can cause a lime slurry to penetrate the fissures in the soil mass to a sufficient depth (usually 8 to 10 feet), then the lime-filled seams will help control the soil water content, reduce volumetric changes, and increase the soil strength. However, LPSI will probably not be satisfactory in an expansive clay soil that does not contain an extensive network of fissures because the lime will not penetrate into the relatively impervious soil to any appreciable distance from the injection hole to form a continuous lime seam moisture barrier.

(d) LPSI may be useful for minimization of movement of fissured foundation expansive soils down to the depth of the active zone for heave or at least 10 ft. The lime slurry is pressure injected on 3- to 5-foot center to depths of 10 to 16 feet around the perimeter of the structure 3 to 5 feet from the structure.



(2) *Soil mixture preparation.* Lime should be thoroughly and intimately mixed into the soil to a sufficient depth to be effective. For stabilization of expansive clay soils for foundations of structures, mixing should be done down to depths of active zone for heave. In practice, mixing with lime is rarely done deeper than 1 to 2 feet. Therefore, lime treatment is normally not useful for foundations on expansive soil except in the above applications. Moreover, poor mixing may cause the soil to break up into clods from normal exposure to the seasonal wetting/drying cycles. The overall soil permeability is increased and provides paths for moisture flow that require rapid drainage from this soil. Lime treatment should be performed by experienced personnel.

(3) *Lime modification optimum content (LMO).* The LMO corresponds to the percent of lime that maximizes the reduction in the soil plasticity or the PI. The reduction in plasticity also effectively minimizes the volume change behavior from changes in water content and increases the soil shear strength.

(a) A decision to use lime should depend on the degree of soil stabilization caused by the lime. Lime

treatment is recommended if a 50 percent reduction in the PI is obtained at the LMO content (table 7- 1). The PI should be determined for the natural soil, LMO, LMO+ 2, and LMO - 2 percent content.

(b) The increase in strength of the lime-treated soil should be similar for soil allowed to cure at least 2 or more days following mixing and prior to compaction to similar densities.

(c) The amount of lime needed to cause the optimum reduction in the PI usually varies from 2 to 8 percent of the dry soil weight.

e. *Cement treatment.* Cement may be added to the soil to minimize volume changes and to increase the shear strength of the foundation expansive soil if the degree of soil stabilization achieved by lime alone is not sufficient. The amount of cement required will probably range between 10 to 20 percent of the dry soil weight. A combination of lime-cement or lime-cement-fly ash may be the best overall additive, but the best combination can only be determined by a laboratory study. TM 5-822-4 presents details on soil stabilization with cement and cement-lime combinations.

Table 7-1. pH Test Procedure for the Lime Modification Optimum Content

---

**Materials:**

1. Lime to be used for soil stabilization.
2. Air-dried soil.

**Apparatus:**

1. pH meter (the pH meter must be equipped with an electrode having a pH range of 14).
2. 150-ml (or larger) plastic bottles with screw-top lids.
3. 50-ml plastic beakers.
4. CO<sub>2</sub>-free distilled water.
5. Balance.
6. Oven.
7. Moisture cans.

**Procedure:**

1. Standardize the pH meter with a buffer solution having a pH of 12.45.
2. Weigh to the nearest 0.01 g representative samples of air-dried soil, passing the No. 40 sieve and equal to 20.0 g of oven-dried soil.
3. Pour the soil samples into 150-ml plastic bottles with screw-top lids.
4. Add varying percentages of lime, weighed to the nearest 0.01 g, to the soils. (Lime percentages of 0, 1, 2, 3, 4, 5, 6, and 8, based on the dry soil weight, may be used.)
5. Thoroughly mix soil and dry lime.
6. Add 100 ml of CO<sub>2</sub>-free distilled water to the soil-lime mixtures.
7. Shake the soil-lime and water for a minimum of 30 sec or until there is no evidence of dry material on the bottom of the bottle.
8. Shake the bottles for 30 sec every 10 min.
9. After 1 hr, transfer parts of the slurry to a plastic beaker and measure the pH.
10. Record the pH for each of the soil-lime mixtures. The lowest percent of lime giving a pH of 12.40 is the percent required to stabilize the soil. If the pH does not reach 12.40, the minimum lime content giving the highest pH is that required to stabilize the soil.

---

## CHAPTER 8

## CONSTRUCTION TECHNIQUES AND INSPECTION

## 8-1. Minimization of foundation problems from construction

Many problems and substandard performance of foundations observed in structures on expansive soils occur from poor quality control and faulty construction practice. Much of the construction equipment and procedures that are used depends on the foundation soil characteristics and soil profiles. Careful inspection during construction is necessary to ensure that the structure is built according to the specifications.

*a. Important elements of construction techniques.* Construction techniques should be used that promote a constant moisture regime in the foundation soils during and following construction. The following elements of construction are important in obtaining adequate foundation performance in expansive soils.

(1) *Excavations.* The excavation should be completed as quickly as possible to the design depth and protected from drying. An impervious moisture barrier should be applied on the newly exposed surfaces of the excavation to prevent drying of the foundation soils immediately after excavating to the design depth. Sides of the excavation should be constructed on a 1V on 1H slope or an appropriate angle that will not transmit intolerable swelling pressures from the expansive soil to the foundation. The foundation should be constructed in the excavation as quickly as practical.

(2) *Selection of materials.* Selected materials should conform to design requirements.

(a) Backfills should be nonswelling materials.

(b) Concrete should be of adequate strength and workability.

(c) Reinforcing steel should be of adequate size and strength.

(d) Moisture barriers should be durable and impervious.

(3) *Placement of materials.* All structural materials should be positioned in the proper location of the foundation.

(4) *Compaction of backfills.* Backfills of natural expansive soil should be compacted to minimize effects of volume changes in the fill on performance of the foundation. Backfills should not transmit intolerable swell pressures from the natural expansive foundation soil to basement or retaining walls.

(5) *Drainage during construction.* The site should be prepared to avoid ponding of water in low areas. Consideration should be given to compaction of 6 to 12

inches or more of impervious nonswelling soil on the site prior to construction of the foundation to promote drainage and trafficability on the site. Dehydrated lime may also be sprinkled on the surface of expansive soil to promote trafficability. Sumps and pumps should be provided at the bottom of excavations if necessary to remove rainwater or subsurface drainage entering the excavation. Provision for after normal duty operation of the pumps should also be made.

(6) *Permanent drainage.* Grades of at least 1 percent and preferably 5 percent, to promote drainage of water away from the structure, should be provided around the perimeter of the structure. Low areas should be filled with compacted backfill. Runoff from roofs should be directed away from the structure by surface channels or drains. Subsurface drains should be constructed to collect seepage of water through pervious backfills placed adjacent to the foundation.

*b. Considerations of construction inspection.* Table 8-1 lists major considerations of construction inspection. Inspections related to concrete reinforced slab and drilled shaft foundations, the two most commonly used foundations in expansive soil areas, are discussed below.

## 8-2. Stiffened slab foundations

Items in table 8-2 should be checked to minimize defective slab foundations.

*a.* The inspector should check for proper site preparation and placement of the moisture barrier, steel, and concrete. All drainage systems should be inspected for proper grade and connections to an outlet.

*b.* Posttensioned slabs require trained personnel and careful inspection to properly apply the posttensioning procedure. For example, anchors for the steel tendons should be placed at the specified depth (lower than the depth of the tensioning rods) to avoid pullout during tensioning. Tendons should be stressed 3 to 18 days following the concrete placement (to eliminate much of the shrinkage cracking) such that the minimum compressive stress in the concrete exceeds 50 pounds per square inch. Stressing should be completed before structural loads are applied to the slabs.

## 8-3. Drilled shaft foundations

Items in table 8-3 should be checked to minimize defective shaft foundations. The foundation engineer

should visit the construction site during boring of the first shaft holes to verify the assumptions regarding the subsurface soil profile, e.g., the nature and location of the subsoils. Periodically, he or she should also check the need for the designer to consider modifications in the design.

*a. Location of shaft base.* The base of the shaft is located in the foundation soils to maintain shaft movements within tolerable limits. This depth depends on the location and thickness of the expansive, compressible or other unstable soil, sand lenses or thin permeable zones, depth to groundwater, and depth to foundation soil of adequate bearing capacity. The design depth may require modification to relocate the base in the proper soil formation of adequate bearing capacity and below the active zone of heave. The purpose of locating the base of the shaft in the proper soil formation should be emphasized to the inspector during the first boring of the drilled shaft foundation. Underreams may be bored in at least 1.5-foot-diameter (preferably 2.5-foot) dry or cases holes where inspections are possible to ensure cleanliness of the bottom.

*b. Minimization of problems.* Long experience has shown that drilled shaft foundations are reliable and economical. Nevertheless, many problems are associated with these foundations and can occur from inadequate understanding of the actual soil profile and groundwater conditions, mistakes made while drilling, inadequate flow of concrete, and improper reinforcement.

*(1) Inadequate information.*

*(a)* Site conditions should be known to permit optimum selection of equipment with the required mobility.

*(b)* Subsurface conditions should be known to permit selection of equipment with adequate boring capacity.

*(c)* Type of soil (e.g., caving and pervious strata) may require slurry drilling. Specifications should permit sufficient flexibility to use slurry for those soil conditions where it may be needed.

*(d)* Previously unnoticed sand lenses or thin permeable zones in otherwise impervious clay may cause problems during construction of drilled shafts. Seepage through permeable zones may require casing or slurry and may render construction of an underream nearly impossible.

*(e)* Overbreak or the loss of material outside of the nominal diameter of the shaft due to caving soil is a serious problem that can cause local cavities or defects in the shaft. The construction procedure (boring dry, with casing, or using slurry) should be chosen to minimize overbreak.

*(2) Problems with the dry method.* Caving, squeezing soil, and seepage are the most common prob-

lems of this method. Stiff or very stiff cohesive soils with no joints or slickensides are usually needed. Underreams are vulnerable to caving and should be constructed as quickly as possible.

*(3) Problems with the casing method.* Slurry should be used while drilling through caving soil prior to placement of the casing and sealing of the casing in an impervious layer. An impervious layer is necessary to install the bottom end of the casing.

*(a)* Casing should not be pulled until the head of concrete is sufficient to balance the water head external to the casing; otherwise, groundwater may mix with the concrete.

*(b)* Squeezing or localized reduction in the borehole diameter on removal of the casing can be minimized by using a relatively high slump concrete with a sufficient pressure head.

*(c)* Casing sometimes tends to stick in place during concrete placement. If the concrete appears to be setting up, attempts to shake the casing loose should be abandoned and the casing left in place to avoid the formation of voids in the shaft when the casing is pulled.

*(d)* Steel reinforcement should be full length to avoid problems in downdrag of the reinforcement while the casing is pulled. The reinforcement cage should also be full length if uplift forces are expected on the drilled shaft from swelling soil.

*(4) Problems with the slurry method.* Slurry of sufficient viscosity is used to avoid problems with caving soils. A rough guide to appropriate slurry viscosities is given by a Marsh cone funnel test time of about 30 seconds for sandy silts and sandy clays to 50 seconds for sands and gravels. The Marsh cone test time is the time in seconds required to pour 1 quart of slurry through the funnel. The workability of the slurry should also be adequate to allow complete displacement of the slurry by the concrete from the perimeter of the borehole and steel of the rebar cage.

*(a)* Slurries should be of sufficient viscosity to eliminate settling of cuttings. Loose cuttings adhering to the perimeter of the hole can cause inclusions and a defective shaft.

*(b)* The tremie sometimes becomes plugged, stopping the flow of concrete into the borehole. The tremie should not be pulled above the concrete level in the shaft before the concrete placement is completed, otherwise inclusions may occur in the shaft following reinsertion of the tremie into the concrete.

*(c)* The reinforcement cage may move up if the tremie is too deep in the concrete or the concrete is placed too rapidly.

*c. Placement of concrete.* Concrete strength of at least 3,000 pounds per square inch should be used and placed as soon as possible on the same day as drilling the hole. Concrete slumps of 4 to 6 inches and limited

**aggregate size** of one third of the rebar spacing are recommended to facilitate flow of concrete through the reinforcement cage and to eliminate cavities in the shaft. Care should be exercised while placing the concrete to ensure the following:

- (1) Continuity while pulling the casing.

- (2) Tip of tremie always below the column of freshly placed concrete in wet construction; no segregation in a dry hole.

- (3) Adequate strength of the rebar cage to minimize distortion and buckling.

*Table 8-1. Considerations for Inspection*

	<u>Construction</u>
Excavation	<ol style="list-style-type: none"> <li>1. Bracing system.</li> <li>2. Tie backs.</li> <li>3. Dewatering.</li> <li>4. Retaining structures.</li> <li>5. Protection from drying of temporarily exposed surfaces of expansive clay.</li> </ol>
Effects on surrounding structures	<ol style="list-style-type: none"> <li>1. Retaining walls and lost ground.</li> <li>2. Slope stability, erosion, and soil stabilization.</li> <li>3. Surface and subsurface drainage.</li> <li>4. Foundation movement and fracture of adjacent (nearby older structures).</li> </ol>
Maintenance	<ol style="list-style-type: none"> <li>1. Broken or leaking water, sewer, and other utility lines.</li> <li>2. Surface drainage system.</li> <li>3. Vibration effects from adjacent (nearby) structures.</li> <li>4. Changes in groundwater.</li> </ol>
	<u>Postconstruction</u>
	<ol style="list-style-type: none"> <li>1. Broken or leaking water, sewer, and other utility lines.</li> <li>2. Surface drainage system.</li> <li>3. Foundation movement and fractures in the new structure.</li> <li>4. Vibration effects from adjacent (nearby) structures.</li> <li>5. Changes in groundwater.</li> <li>6. Heavy vegetation near the structure.</li> </ol>

*Table 8-2. Inspection of Reinforced Slab Foundations*

Site preparation	<ol style="list-style-type: none"> <li>1. Proper selection of materials.</li> <li>2. Proper compaction of fill.</li> <li>3. Proper backfill of plumbing trenches and holes due to removal of trees.</li> <li>4. Proper cleanout of trenches for reinforcing beams.</li> <li>5. Proper slope of trenches.</li> <li>6. New excavations coated with sprayed asphalt or sealing surface to prevent drying of the exposed excavation surface.</li> <li>7. Proper beam size and spacing.</li> <li>8. Proper slab thickness.</li> </ol>
Membrane placement	<ol style="list-style-type: none"> <li>1. Moisture barrier contoured to the shape of the trench to eliminate voids between the trench and bottom of the membrane.</li> <li>2. Elimination of punctures, holes, and leaks in the membrane.</li> </ol>
Steel placement	<ol style="list-style-type: none"> <li>1. Proper location of steel reinforcing bars and wire mesh.</li> <li>2. Proper placement of tensioning rods and anchors.</li> <li>3. Proper reinforcement size.</li> <li>4. Adequate forming and means to hold post-tensioning anchorage assemblies in place.</li> </ol>
Concrete placement	<ol style="list-style-type: none"> <li>1. Mixture as specified (e.g., approved components in mixture, desired slump of concrete, no extra water added to mixture, proper conveying, placing and vibrating of concrete, and finishing).</li> <li>2. Reinforcement not displaced by concrete.</li> <li>3. Provide adequate curing for slab.</li> <li>4. Obtain desired early age strength of concrete before form removal and before allowing traffic on the slab.</li> </ol>

Table 8-2. Inspection of Reinforced Slab Foundations—Continued

Post-tensioning	<ol style="list-style-type: none"> <li>1. Verify all tendons stressed according to specification and within 3 to 10 days of the concrete placement.</li> <li>2. Ends of properly stressed tendons cut off, pockets grouted, and any necessary repairs made. Improperly stressed tendons must not be cut off.</li> </ol>
-----------------	---

Table 8-3. Inspection of Drilled Shafts

Drilling	<ol style="list-style-type: none"> <li>1. Proper shaft dimensions.</li> <li>2. Collapse of hole.</li> <li>3. Proper cleanout of hole of loose cuttings and weak soil.</li> </ol>
Dry method	<ol style="list-style-type: none"> <li>1. Loose cuttings in the hole.</li> <li>2. No more than 2 to 3 inches of water at the bottom if end bearing.</li> <li>3. Concrete not strike the shaft perimeter if free fall (ACI 304-73 recommends that concrete should be deposited at or near its final position such that the tendency to segregate is eliminated when flowing laterally into place).</li> <li>4. Adequate vibration provided to consolidate concrete around reinforcement.</li> </ol>
Casing method	<ol style="list-style-type: none"> <li>1. Clean and undeformed casing before concrete placement.</li> <li>2. Sufficient concrete placed to balance the external pressure head before the casing is pulled.</li> </ol>
Slurry method	<ol style="list-style-type: none"> <li>1. Viscosity of slurry adequate to be displaced from the perimeter of the hole and the reinforcing steel by the concrete.</li> <li>2. Clean-out bucket used to clean the bottom prior to concreting.</li> <li>3. Bottom of the tremie pipe maintained in fresh concrete at all times after placement has begun. The deeper the embedment in concrete the flatter the finished slope will be.</li> </ol>
Underreams	<ol style="list-style-type: none"> <li>1. Minimal cuttings in the bottom (at least 75 to 80 percent of the bottom free of cuttings).</li> <li>2. Adequate bell diameter (check travel of the kelly on the ground surface when the reamer is extended to the proper bell diameter).</li> </ol>
Concrete placement	<ol style="list-style-type: none"> <li>1. No segregation during placement.</li> <li>2. Concrete never to be poured through water.</li> <li>3. Adequate slump (avoid hot concrete).</li> <li>4. Maximum aggregate size not too large for reinforcement.</li> </ol>
Reinforcement cage	<ol style="list-style-type: none"> <li>1. Resistance to buckling during the concrete placement.</li> <li>2. Full length if casing used.</li> <li>3. Restriction to flow of concrete through the cage.</li> <li>4. Restrained from movement during concrete placement.</li> <li>5. Proper position of the cage.</li> </ol>

## CHAPTER 9

## REMEDIAL PROCEDURES

## 9-1. Basic considerations

Remedial work for damaged structures is usually difficult to determine because the cause of the problem (e.g., location of source or loss of soil moisture, and swelling or settling/shrinking soil) may not be readily apparent. A plan to fix the problem is often difficult to execute, and the work may have to be repeated because of failure to isolate the cause of the moisture changes in the foundation soil. An effective remedial procedure may not be found until several attempts have been made to eliminate the differential movement. Requirements for minimizing moisture changes (chap. 7) are therefore essential. The foundation should have sufficient capacity to maintain all distortion within tolerable limits acceptable to the superstructure. This distortion occurs from differential heave for the most severe climates and changes in the field environment.

*a. Specialized effort.* Investigation and repair are therefore specialized procedures that usually require much expertise and experience. Cost of repair work can easily exceed the original cost of the foundation. The amount of damage that requires repair also depends on the attitudes of the owner and occupants to tolerate distortion as well as damage that actually impairs the usefulness and safety of the structure.

*b. Minimization of repairs.* Most damage from effects of swelling soil tends to be cosmetic rather than structural, and repairs are usually more economical than rebuilding as long as the structure remains sound. At-early signs of distress, remedial action to minimize future distortion should be undertaken and should be given a greater priority than the cosmetic repairs as this action will minimize maintenance work over the long term. Maintenance expenses and frequency of repairs tend to be greatest in lightly loaded structures and residences about 3 to 4 years following the original construction. Overall maintenance can be minimized by taking remedial action to minimize future distortion before extensive repairs are required (e.g., breaking out and replacing sections of walls).

*c. Examples of remedial procedures.* The choice of remedial measures is influenced by the results of site and soil investigations as well as by the type of original construction. Table 9-1 illustrates common remedial measures that can be taken. Only one remedial procedure should be attempted at a time so as to determine its effect on the structure. The structure should

be allowed to adjust, following completion of remedial measures, for at least a year before cosmetic work is done. The structure is seldom rebuilt to its original condition, and in some instances, remedial measures have not been successful.

## 9-2. Evaluation of information

All existing information on the foundation soils and design of the foundation and superstructure should be studied before proceeding with new soil investigations.

*a. Foundation conditions.* The initial soil moisture at time of construction, types of soil, soil swell potentials, depth to groundwater, type of foundation and superstructure, and drainage system should be determined. The current soil moisture profile should also be determined. Details of the foundation, such as actual bearing pressures, size and length of footings, and slab and shaft reinforcing, should also be collected. Drilling logs made during construction of shaft foundations may be used to establish soil and groundwater conditions and details of shaft foundations. Actual construction should be checked against the plans to identify any variances.

*b. Damages.* The types and locations of damage, as well as the time movements first became noticeable, should be determined. Most cracks caused by differential heave are wider at the top than at the bottom. Nearly all lateral separation results from differential heave. Diagonal cracks can indicate footing or drilled shaft movement, or lateral thrust from the doming pattern of heaving concrete slabs. Fractures in slabs-on-grade a few feet from and parallel with the perimeter walls also indicate heaving of underlying soils. Level surveys can be used to determine the trend of movement when prior survey records and reliable benchmarks are available. Excavations may be necessary to study damage to deep foundations, such as cracks in shafts from uplift forces.

*c. Sources of moisture.* The source of soil moisture that led to the differential heave should be determined to evaluate the cause of damage. Location of deeprooted vegetation, such as shrubs and trees, location and frequency of watering, inadequate slopes and pending, seepage into foundation soil from surface or perched water, and defects in drain, water, and sewer lines can

make important changes in soil moisture and can lead to differential heave.

9-3. Stiffened slab foundations

Most slab foundations that experience some distress are not damaged sufficiently to warrant repairs. Damage is often localized by settlement or heave of one side of the slab. The cause of the soil movement, whether settlement or heave, should first be determined and then corrected.

*a. Stabilization of soil moisture.* Drainage improvements and a program to control soil moisture at the perimeter of the slab are recommended (chap 7) for all damaged slab foundations.

*b. Remedial procedures.* Remedial work on slabs depends on the type of movement. Repair of a settled area requires raising of that area, while repair of a heaved area often requires raising the entire unheaved portion of the slab up to the level of the heaved portion. Repair **costs are** consequently usually greater for heaving than settling cases.

(1) Repair of a damaged slab consists of a combination of underpinning and mudjacking using a cement grout. Mudjacking using a cement grout is required simultaneously with underpinning to fill voids during leveling of the slab. Fractured slabs are usually easier to repair than unfractured slabs that have been distorted by differential movement because usually only the fractured portion of the slab requires treatment. The distortion of unfractured slabs can also cause considerable damage to the superstructure and inconvenience to the occupants.

(2) Underpinning and mudjacking are applied simultaneously and usually clockwise around the slab

until all parts of the foundation are at the same elevation. If a heaved area is lowered to the same elevation as the rest of the foundation, such as to repair a mushroomed or dome-shaped heave pattern, the slab is first supported before digging out the soil to prevent the slab from creeping down on the work crew during the digging. Attempts at leveling dome-shaped distortion by raising the perimeter may be unsuccessful because mudjacking usually causes the entire slab to rise.

9-4. Drilled shaft foundations

Most damage to structures with shaft foundations consists of fractured slabs-on-grade. The shaft may contribute to the damage caused by migration of moisture down the shaft/soil interface into swelling soil beneath the shaft footing. The fracture pattern of open cracks in the floor slab parallel to and several feet from the wall often shows that the slab had not been free to move near the walls. Damage to drilled shafts is often caused by upward movement of the shaft from swelling soil beneath its base and by uplift forces on the shaft perimeter from adjacent swelling soil.

*a. Stabilization of soil moisture.* Drainage improvements and a program to control soil moisture around the perimeter of the foundation are recommended (chap 7).

*b. Remedial procedures.* Repair often requires total removal of the slab and underlying wet soil, replacement with nonswelling soil, and placement of a new slab isolated from the perimeter walls. Repair of drilled shafts consists of cutting down the top of the shaft and releveling the foundation. The tops of the drilled shafts are cut to the elevation of the top of the lowest shaft where possible.

Table 9-1. Remedial Measures

Measure	Description
Drainage	Slope ground surface (positive drainage) from structure; add drains for downspouts and outdoor faucets in areas of poor drainage, and discharge away from foundation soil; provide subdrains if perched water tables or free flow of subsurface water are problems; provide flexible, watertight utility connections.
Moisture stabilization (maintenance of constant moisture whether at high or low levels)	Remove natural swelling soil and recompact with impervious, non-swelling backfill; install vertical and/or horizontal membranes around the perimeter; locate deep-rooted vegetation outside of moisture barriers; avoid automatic sprinkling systems in areas protected with moisture barriers; provide a constant source of moisture if a combination of swelling/shrinking soils is occurring; thoroughly mix 4 to 8 percent lime into soil to reduce potential for swell or pressure-inject line slurry around the perimeter of the structure.
Superstructure adjustments	Free slabs from foundation by cutting along foundation walls; provide slip joints in interior walls and door frames; reinforce masonry and concrete block walls with horizontal and vertical tie bars or reinforced concrete beams; provide fanlights over doors extended to the ceiling.

Table 9-1. Remedial Measures—Continued

Measure	Description
Spread footings and deep foundation adjustments	Decrease footing size; underpin with deep shafts; mudjack using a cement grout; reconstruct void beneath grade beams; eliminate mushrooms at top of shafts; adjust elevation by cutting the top of the shaft or by adding shims; increase footing or shaft spacing to concentrate loading forces and to reduce angular distortion from differential heave between adjacent footings and shafts.
Continuous wall foundation adjustments	Provide voids beneath portions of wall foundation; posttension; reinforce with horizontal and vertical tie bars or reinforced concrete beams.
Reinforced and stiffened slab-on-grade adjustments	Mudjack using a cement grout; underpin with spread footings or shafts to jack up the edge of slabs,

CANCELLED



## APPENDIX A

## REFERENCES

*Government Publications**Department of the Army*

## Technical Manuals

- |            |  |
|------------|--|
| TM 5-818-1 | Procedures for Foundation Design of Buildings and Other Structures (Except Hydraulic Structures) |
| TM5-818-4  | Backfill for Subsurface Structures   |
| TM5-822-4  | Soil Stabilization for Roads and Streets   |

## Department of the Army, Corps of Engineers

- \* U.S. Army Construction Engineering Research Laboratory (CERL), P.O. Box 4005, Champaign, IL 61820
- \* TR M-81 Structures on Expansive Soils
- USACE Publications Depot, 2803 52nd Avenue, Hyattsville, MD 20781
- EM 1110-2-1906 Laboratory Soils Testing
- Waterways Experiment Station, P.O. Box 631, Vicksburg, MS 39180
- Miscellaneous Paper User's Guide for Computer Program, HEAVE
- GL-82-7

## Department of the Navy

Naval Publications and Forms Center, 5801 Tabor Ave., Philadelphia, PA 19120

- \* NAVFAC DM-7.2 Foundations and Earth Structures Design Manual

## Non-Government Publications

- \* American Concrete Institute (ACI), P.O. Box 19150, Detroit, MI 48219
- \* 304-73 Measuring, Mixing, Transporting, and Placing Concrete
- \* (R 1978)
- American Society of Civil Engineers (ASCE), 345 East 47th St., New York, N.Y. 10017
- Assessment of Expansive Soils in the United States, Proceedings of the Fourth International Conference on Expansive Soil, (Volume 1, pp. 596-608, 1980)
- American Society of Testing and Materials (ASTM), 1916 Race Street, Philadelphia, PA 19103
- \* A 615-82 Deformed and Plain Billet-Steel Bars for Concrete Reinforcement
- \* D 2521-76 Asphalt Used in Canal, Ditch, and Pond Lining
- \* (R 1981)
- Post-Tensioning Institute, 301 Osborn, Suite 3500, Phoenix, AZ 85013
- \* Design and Construction of Post-Tensioned Slabs-on-Ground, (First Edition, 1980)
- Texas Department of Highways and Public Transportation, Austin, Texas 78703
- Manual of Testing Procedures, 100-E Series, Department D-9, 1978
- Transportation Research Board, 2101 Constitution Ave., N.W., Washington, D.C. 20418
- "Relationship Between Physiographic Units and Highway Design Factors," National Cooperative Highway Research Program, Report 132, 1977

## APPENDIX B

## CHARACTERIZATION OF SWELL BEHAVIOR FROM SOIL SUCTION

## B-1. Introduction

Soil suction is a quantity that can be used to characterize the effect of moisture on volume, and it is a measure of the energy or stress that holds the soil water in the pores or a measure of the pulling stress exerted on the pore water by the soil mass. The total soil suction is expressed as a positive quantity and is defined as the sum of matrix  $\tau_m^\circ$  and osmotic  $\tau_s$  suctions.

*a. Matrix suction.* The matrix suction  $\tau_m^\circ$  is related to the geometrical configuration of the soil and structure, capillary tension in the pore water, and water sorption forces of the clay particles. This suction is also pressure-dependent and assumed to be related to the in situ pore water pressure  $u_w$  by

$$\tau_m^\circ = -u_w + \alpha \delta_m \quad (\text{B-1})$$

$$\delta_m = \frac{1 + 2K_T}{3} \delta_v \quad (\text{B-2})$$

where

- $\tau_m^\circ$  = matrix soil suction, tons per square foot
- $\alpha$  = compressibility factor, dimensionless
- $\delta_m$  = total mean normal confining pressure, tons per square foot
- $K_T$  = ratio of total horizontal to vertical stress in situ
- $\delta_v$  = total vertical pressure, tons per square foot

The exponent “ $\circ$ ” means that the  $\tau_m^\circ$  is measured without confining pressure except atmospheric pressure. Experimental results show that the in situ matrix suction  $\tau_m$  is equivalent to  $-u_w$  for soils. The compressibility factor is determined by the procedure in paragraph B-3d.

*b. Osmotic suction.* The osmotic suction  $\tau_s$  is caused by the concentration of soluble salts in the pore water, and it is pressure-independent. The effect of the osmotic suction on swell is not well known, but an osmotic effect may be observed if the concentration of soluble salts in the pore water differs from that of the externally available water. For example, swell may occur in the specimen if the external water contains less soluble salts than the pore water. The effect of the osmotic suction on swell behavior is assumed small compared with the effect of the matrix suction. The osmotic suction should not significantly affect heave if the salt concentration is not altered.

## B-2. Methods of measurement

Two methods are recommended for determining the total soil suction: thermocouple psychrometer and filter paper. The suction range of thermocouple psychrometers usually is from 1 to 80 tons per square foot while the range of filter paper is from 0.1 to more than 1,000 tons per square foot. Two to seven days are required to reach moisture equilibrium for thermocouple psychrometer, while 7 days are required for filter paper. The thermocouple psychrometer method is simple and can be more accurate than filter paper after the equipment has been calibrated and the operating procedure established. The principal disadvantage is that the suction range is much more limited than the filter paper method. The filter paper method is technically less complicated than the thermocouple psychrometer method; however, the weighing procedure required for filter paper is critical and vulnerable to large error.

*a. Calibration.* The total soil suction is given on the basis of thermodynamics by the equation

$$\tau^\circ = -\frac{RT}{v_w} \ln \frac{p}{p_0} \quad (\text{B-3})$$

where

- $\tau^\circ$  = total suction free of external pressure except atmospheric pressure, tons per square foot
- $R$  = universal gas constant, 86.81 cubic centimetres-tons per square foot/mole-Kelvin
- $T$  = absolute temperature, Kelvin
- $v_w$  = volume of a mole of liquid water, 18.02 cubic centimetres/mole
- $p/p_0$  = relative humidity
- $p$  = pressure of water vapor, tons per square foot
- $p_0$  = pressure of saturated water vapor, tons per square foot

Equation (B-3) shows that the soil suction is related to the relative humidity in the soil. Both thermocouple psychrometer and filter paper techniques require calibration curves to evaluate the soil relative humidity from which the soil suction may be calculated using equation (B-3). Calibration is usually performed with salt solutions of various known molality (moles of salt per 1,000 grams of water) that produce a given relative humidity. Table B-1 shows the modalities re-

Table B-1. Calibration Salt Solutions

Measured temperature $t$ , °C	Suction, tsf for cited molality of sodium chloride solution						
	0.053	0.100	0.157	0.273	0.411	0.550	1.000
15	3.05	4.67	7.27	12.56	18.88	25.29	46.55
20	3.10	4.74	7.39	12.75	19.22	25.76	47.50
25	3.15	4.82	7.52	13.01	19.55	26.23	48.44
30	3.22	4.91	7.64	13.22	19.90	26.71	49.37

quired for sodium chloride salt solutions to provide the soil suctions given as a function of temperature.

*b. Thermocouple psychrometer technique.* The thermocouple psychrometer measures relative humidity in soil by a technique called Peltier cooling. By causing a current to flow through a single thermocouple junction in the proper direction, that particular junction will cool, then water will condense on it when the dew-point temperature is reached. Condensation of this water inhibits further cooling of the junction. Evaporation of condensed water from the junction after the cooling current is removed tends to maintain a difference in temperature between the thermocouple and the reference junctions. The microvoltage developed between the thermocouple and the reference junctions is measured by the proper readout equipment and related to the soil suction by a calibration curve.

(1) *Apparatus.* Laboratory measurements to evaluate total soil suction may be made with the apparatus illustrated in figure B-1. The monitoring system includes a cooling circuit with the capability of immediate switching to the voltage readout circuit on termination of the current (fig. B-2). The microvoltmeter (item 1, fig. B-2) should have a maximum range of at least 30 microvolt and allow readings to within 0.01 microvolt. The 12-position rotary selector switch (item 2) allows up to 12 simultaneous psychrometer connections. The 0-25 millimeter (item 3), two 1.5-volt dry cell batteries (item 4), and the variable potentiometer (item 5) form the cooling circuit. Equipment is available commercially to perform these measurements of soil suction.

(2) *Procedure.*

(a) Thermocouple psychrometer are inserted into 1-pint-capacity metal containers with the soil specimens, and the assembly is sealed with No. 13-1/2 rubber stoppers. The assembly is inserted into a 1- by 1- by 1.25-foot chest capable of holding six 1-pint containers and insulated with 1.5 inches of foamed polystyrene. Cables from the psychrometer are passed through a 0.5-inch-diameter hole centered in the chest cover. The insides of the metal containers are coated with melted wax to inhibit corrosion of the containers.

(b) The apparatus is left alone until equilibrium is attained. Temperature equilibrium is attained within a few hours after placing the chest cover. Time to reach equilibrium of the relative humidity in the air

measured by the psychrometer and the relative humidity in the soil specimen depends on the volume and initial relative humidity in the container. Equilibrium time may require up to 7 days, but may be reduced to 2 or 3 days by repeated testing of soils with similar suctions.

(c) After equilibrium is attained, the microvoltmeter is set on the 10- or 30-microvolt range and zeroed by using a zeroing suppression or offset control. The cooling current of approximately 8 milliamperes is applied for 15 seconds and then switched to the microvoltmeter circuit using the switch of item 6 in figure B-2. The maximum reading on the microvoltmeter is recorded. The cooling currents and times should be identical to those used to determine the calibration curves.

(d) The readings can be taken at room temperature, preferably from 20 to 25 degrees Centigrade, and corrected to a temperature of 25 degrees Centigrade by the equation

$$E_{25} = \frac{E_t}{0.325 + 0.027t} \quad (\text{B-4})$$

where

$E_{25}$  = microvolt at 25 degrees Centigrade

$E_t$  = microvolt at  $t$  degrees Centigrade

Placement of the apparatus in a constant temperature room will increase the accuracy of the readings.

(3) *Calibration.* The psychrometer are calibrated by placing approximately 50 millilitres of the salt solutions of known molality (table B-1) in the metal containers and following the procedure in b(2) above to determine the microvolt output. Equilibration time may be reduced to 2 or 3 days by surrounding the psychrometer with filter paper soaked with solution. The suctions given for the known modalities are plotted versus the microvolt output for a temperature of 25 degrees Centigrade. The calibration curves of 12 commercial psychrometer using the equipment of figure B-1 were within 5 percent and could be expressed by the equation

$$T_0 = 2.65E_{25} - 1.6 \quad (\text{B-5})$$

where  $T_0$  is the total soil suction in tons per square foot. The calibration curves using other equipment may be somewhat different.

*c. Filter paper technique.* This method involves enclosing filter paper with a soil specimen in an airtight container until complete moisture equilibrium is

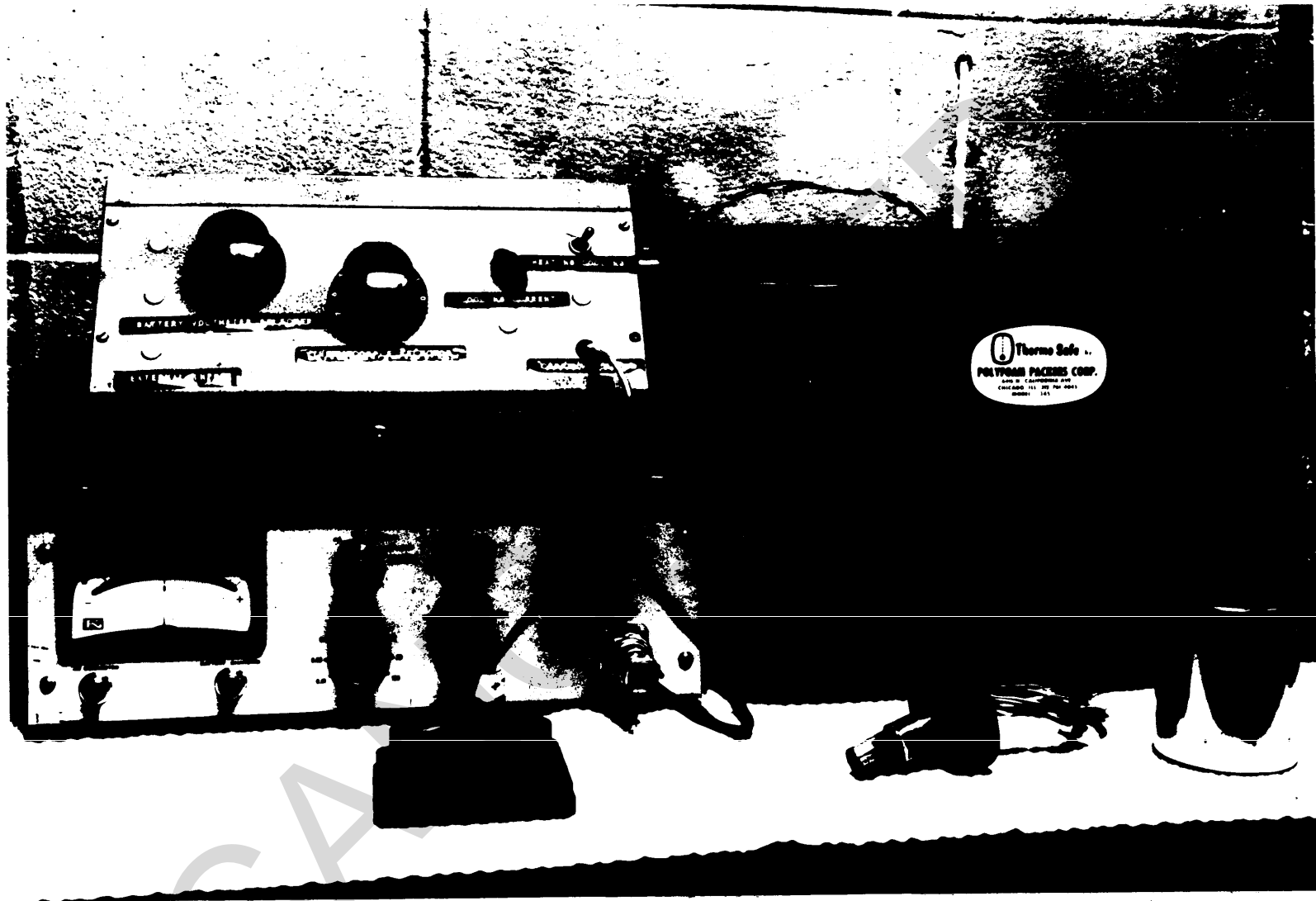

U. S. Army Corps of Engineers

*Figure B-1. Thermocouple psychrometer monitoring apparatus.*

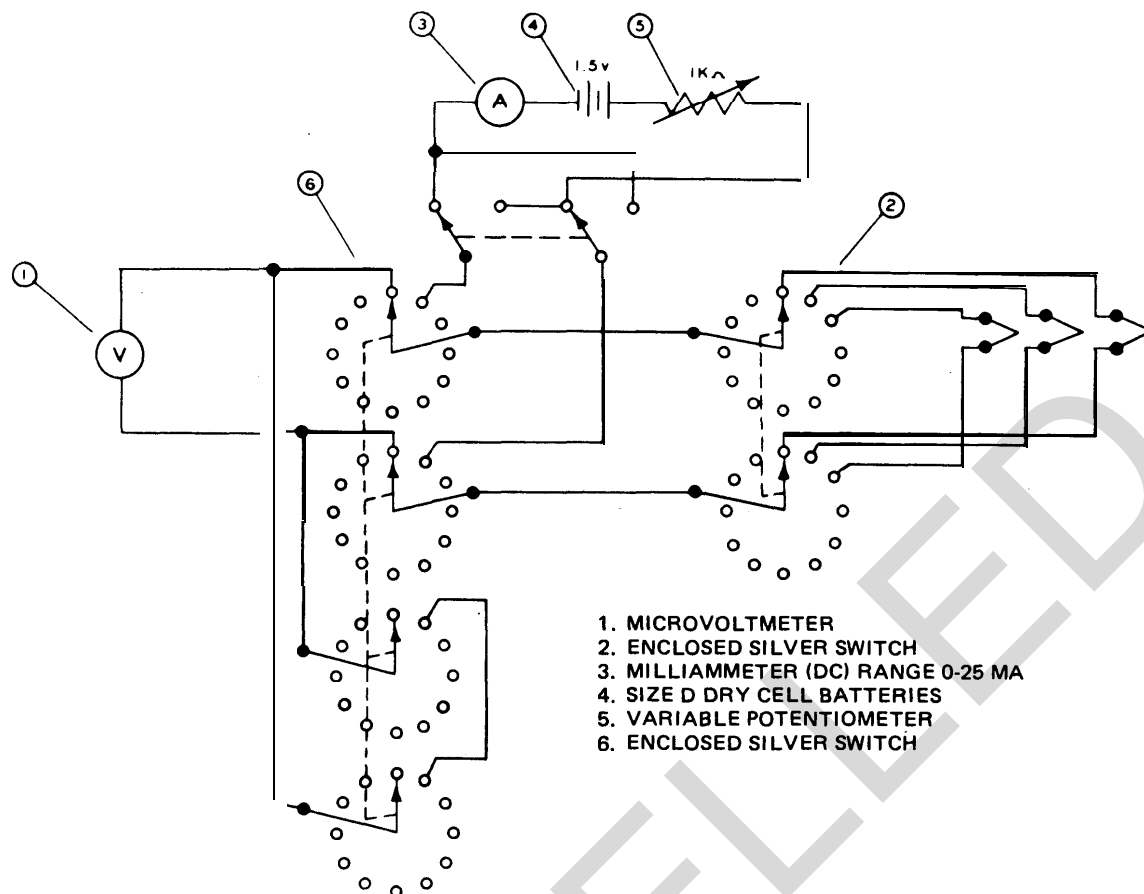

U. S. Army Corps of Engineers

Figure B-2. Electrical circuit for the thermocouple psychrometer.

reached. The water content in percent of the dry weight is subsequently determined, and the soil suction is found from a calibration curve.

(1) *Apparatus.* Materials consist of 2-inch-diameter filter paper, 2-inch-diameter tares, and a gravimetric scale accurate to 0.001 g. A filter paper is enclosed in an airtight container with the soil specimen.

(2) *Procedure.*

(a) The filter paper disc is pretreated with 3 percent reagent grade pentachlorophenol in ethanol (to inhibit bacteria and deterioration) and allowed to air dry. Reagent grade pentachlorophenol is required because impurities in the treatment solution influence the calibration curve. Care is required to keep the filter paper from becoming contaminated with soil from the specimen, free water, or other contaminant (e.g., the filter paper should not touch the soil specimen, particularly wetted specimens).

(b) Seven days are required to reach moisture equilibrium in the airtight container. At the end of 7 days, the filter paper is transferred to a 2-inch-diameter covered tare and weighed immediately on a gravimetric scale accurate to 0.001 g. The number of

filter papers and tares weighed at one time should be kept small (nine or less) to minimize error caused by water evaporating from the filter paper.

(c) The tare is opened and placed in an oven for **at least 4 hours or overnight at a temperature of  $110 \pm 5$  degrees Centigrade.** The oven-dry weight of the filter paper is then determined, and the water content as a percent of the dry weight is compared with a calibration curve to determine the soil suction.

(3) *Calibration.* The oven-dry water content of the filter paper is dependent on the time lapse following removal from the drying oven before weighing.

(a) The calibration curves shown in figure B-3 were determined for various elapsed times following removal from the oven. The calibrations are given for Fisherbrand filter paper, Catalog Number 9-790A, enclosed with salt solutions of various molality for 7 days. Calibration curve No. 1 resulted from weighing the filter paper 5 seconds following removal from the oven. Time lapses of 15 minutes and 4 hours lead to a similar calibration curve (No. 3) of significantly smaller water contents than the 5-second curve for identical suctions. Calibration curve No. 2 was determined

by removing 12 specimens from the oven, waiting 30 seconds to cool, then weighing as soon as possible and within 15 minutes.

(b) Calibration curves based on the method used to determine curve No. 3 with a waiting time between 15 and 30 minutes are recommended if the suctions of

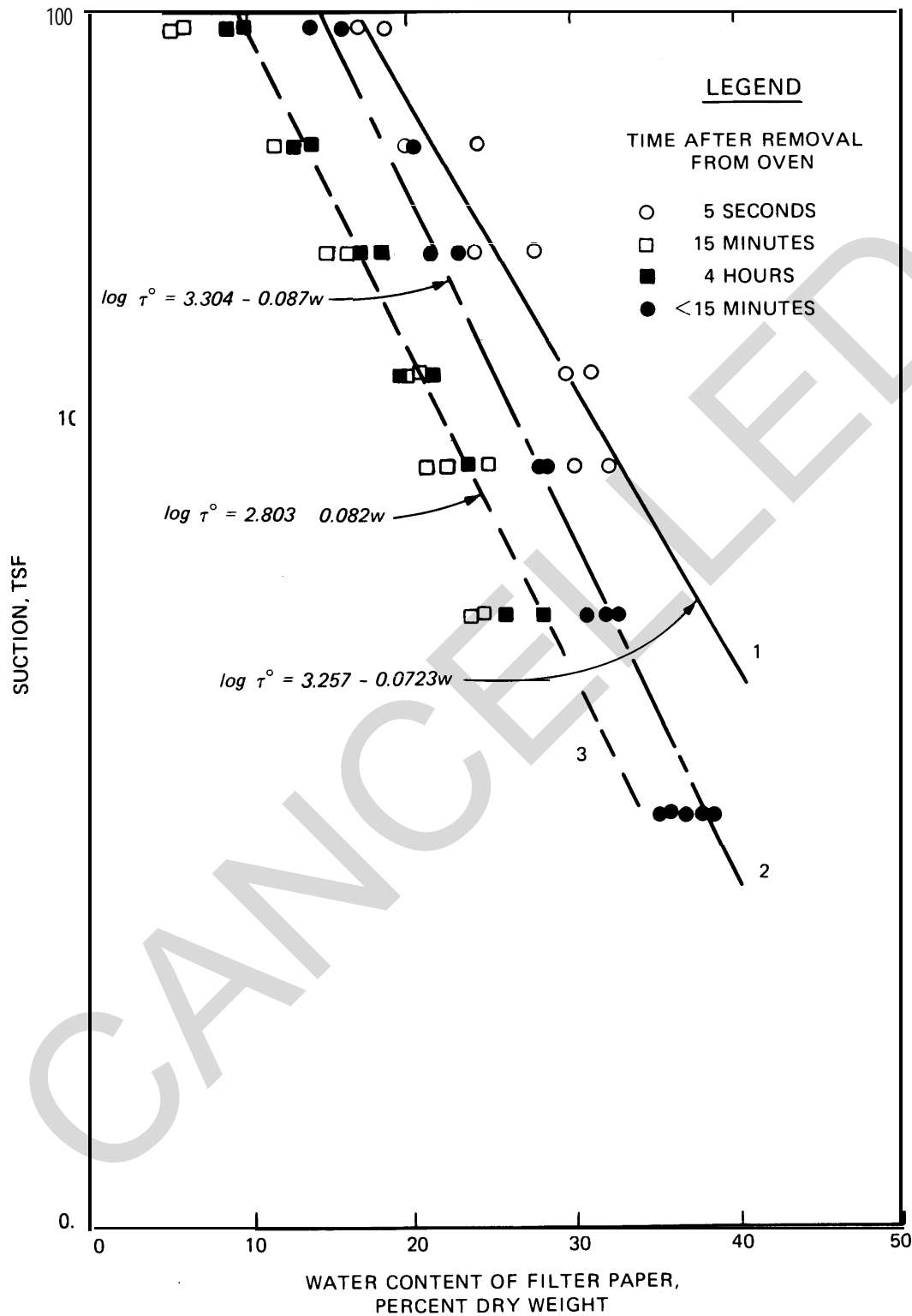

Figure B-3. Calibration of filter paper.

large numbers of specimens are to be evaluated. However, the accuracy will be less than if curve No. 1 and its procedure are used because curve No. 3 can be influenced by changes in the relative humidity of the testing room. The gravimetric scale should be located near the drying oven for the 5-second calibration curve (No. 1) to be practical. Changes in filter paper weights are normally small (e.g., less than 0.1 g) and require accurate calibration of the gravimetric scale and adherence to a single standardized procedure.

**B-3. Characterization of swell behavior**

The swell behavior of a particular soil may be characterized from the matrix suction-water content relationship and the compressibility factor  $\alpha$  to calculate heave by the equation

$$\frac{\Delta H}{H} = \frac{e_1 - e_0}{1 + e_0} = \frac{C_\tau}{1 + e_0} \log \frac{\tau_{mo}^o}{\tau_{mf}^o} \quad (B-6)$$

where

- $\Delta H$  = potential vertical heave at the bottom of the foundation, feet
- $H$  = thickness of the swelling soil
- $e_1$  = final void ratio following swell
- $e_0$  = initial void ratio
- $C_\tau$  =  $\alpha G_s / 100B$ , suction index
- $\alpha$  = compressibility factor
- $G_s$  = specific gravity
- $B$  = slope soil suction parameter
- $\tau_{mo}^o$  = initial matrix suction without surcharge pressure, tons per square foot
- $\tau_{mf}^o$  = final matrix suction without surcharge pressure, tons per square foot

The suction index  $C_\tau$  is similar to  $\gamma_h(1 + e_0)$  where  $\gamma_h$  is the suction compression index of the McKeen-Lytton method in table 4-2. Equation (B-6) is similar to equation (5-2) of paragraph 5-4a and equation (5-8) of paragraph 5-4a from which the total potential heave is calculated. Equation (B-6) will also lead to the same or similar predictions of heave for identical changes in suction. The suction index, a measure of the swelling capability, is analogous to the swell index  $c_s$  of consolidometer swell tests, except that the suction index is evaluated with respect to the change in matrix suction without surcharge pressure rather than the change in effective pressure.

*a. Matrix suction and water content relationship.*

This relationship is evaluated from the total soil suction and water content relationship. The total soil suction as a function of water content is found from multiple 1-inch pieces of the undisturbed sample. The pore water may be evaporated at room temperature, for various periods of time up to about 48 hours, from several undisturbed specimens; various amounts of distilled water may also be added to several other undisturbed specimens of each sample to obtain a multi-point water content distribution. Each specimen may

be inserted into a 1-pint metal container with a thermocouple psychrometer or with filter paper to evaluate the total soil suction as previously described. The dry density and void ratio of each undisturbed specimen from which the compressibility factor  $\alpha$  is determined may be evaluated by the water displacement method. Using thermocouple psychrometers, collect soil suction data on DA Form 5182-R (Soil Suction, Water Content and Specific Volume). DA Form 5182-R will be reproduced locally on 11- by 8½-inch paper. A copy of DA Form 5182-R for local reproduction purposes can be found at the back of this manual.

(1) The multipoint total soil suction and water content relationship may be plotted as shown in figure B-4 for each undisturbed sample. The open circles in the figure represent natural water content  $w_0$ , and the closed circles symbolize water being added to or evaporated from the undisturbed specimens at room temperature. An osmotic suction  $\tau_s$  is sometimes indicated by a horizontally inclined slope at high water contents, and the magnitude may be estimated by noting the total soil suction at high water contents. Large osmotic suctions appreciably flatten the slope as shown in figure B-4. The matrix suction and water content relationship can be approximated by subtracting the osmotic suction from the total soil suctions and expressing the result as

$$\log \tau_m^o = A - Bw \quad (B-7)$$

where

- $\tau_m^o$  = matrix suction without surcharge pressure, tons per square foot
- $A$  = ordinate intercept soil suction parameter, tons per square foot
- $B$  = slope soil suction parameter
- $w$  = water content, percent dry weight

Information on piezometric pore water pressures is used in approximating the matrix suction and water content relationship in the presence of appreciable osmotic suctions.

(2) The matrix suction and water content relationship of figure B-4 was approximated by noting that the groundwater elevation, at which  $u_w = 0$ , was 1.5 feet. Hence, the matrix suction at the natural water content of 27 percent was the total mean confining pressure  $\sigma_m$  of approximately 0.1 ton per square foot from equation (B-1). The value  $\sigma_m$  may be estimated from equation (B-2) if  $K_T$  can be approximated. The remainder of the curve was approximated by subtracting 26 tons per square foot, which was the total average suction at the natural water content of 27 percent less 0.1 ton per square foot, from the total soil suction observed at smaller water contents. The osmotic suction should be subtracted from the total suction; otherwise heave predictions will be overestimated since the osmotic suction does not appear to cause much heave and

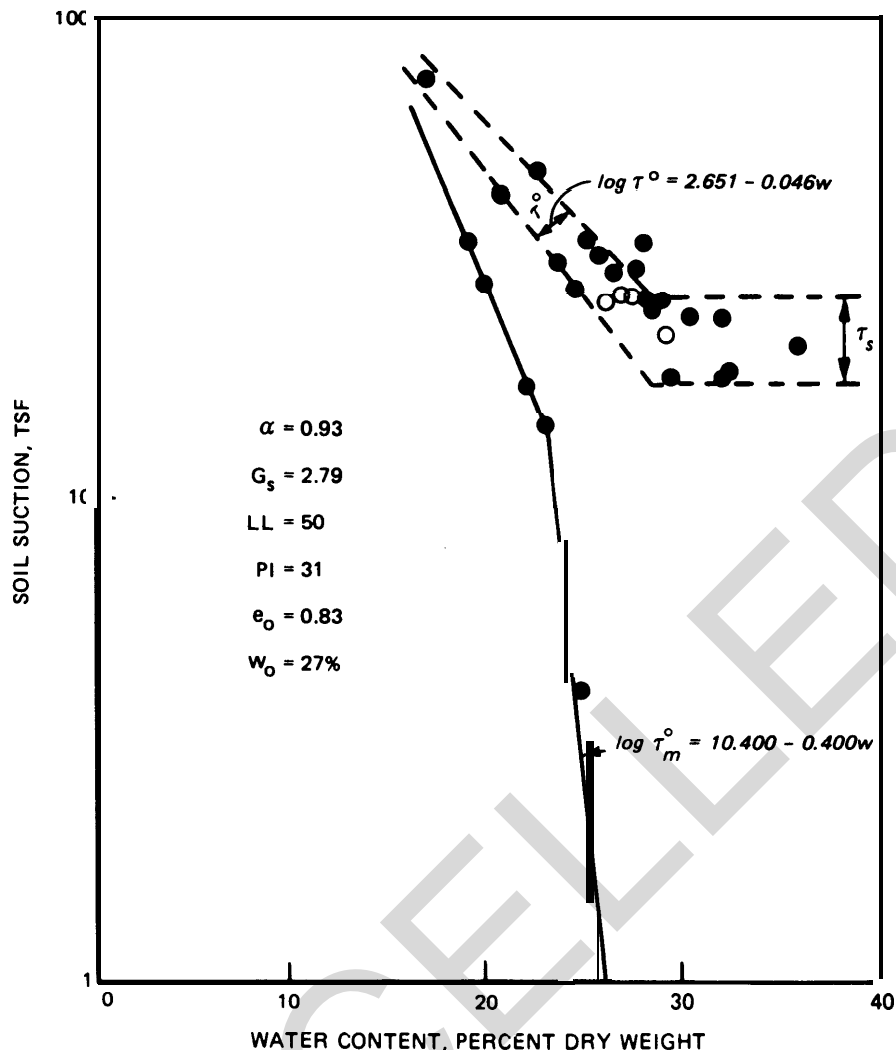

U. S. Army Corps of Engineers

Figure B-4. Soil suction and water content relationship for Fort Carson overburden at 1 to 3 feet of depth.

if the equilibrium moisture profiles of figure 5-1 (para 5-4b) are used.

b. *Initial matrix suction.* The initial matrix suction  $\tau_m^o$  without surcharge pressure may be evaluated using the soil suction test procedure on undisturbed specimens or may be calculated from equation (B-7) and the natural (initial) water content.

c. *Final matrix suction.* The final matrix suction  $\tau_{mf}^o$  without surcharge pressure may be calculated from the assumption

$$\tau_{mf}^o = \left( \frac{1 + 2K}{3} \right) \delta'_v \quad (B-8)$$

$K$  = coefficient of effective lateral earth pressure

$\delta'_v$  = final vertical effective pressure, tons per square foot or from equation (B-1) setting  $a = 1$  and if  $K_T$  can be approximated.

The final vertical effective pressure may be found from

$$\delta'_v = \delta_v - u_w \quad (B-9)$$

where  $\delta_v$  is the final total vertical pressure. The pore water pressure  $u_w$  (fig. 5-1) is found from equations (5-3), (5-4), or (5-5).

d. *Compressibility factor.* The compressibility factor  $a$  is the ratio of the change in volume for a corresponding change in water content, i.e., the slope of the curve  $\gamma_w/\gamma_d$  plotted as a function of the water content where  $\gamma_w$  is the unit weight of water and  $\gamma_d$  is the dry density. The value of  $a$  for highly plastic soils is close to 1, and much less than 1 for sandy and low plasticity soils. High compressibility  $a$  factors can indicate highly swelling soils; however, soils with all voids filled with water also have a equal to 1.

(1) Figure B-5 illustrates the compressibility factor calculated from laboratory data for a silty clay taken from a field test section near Clinton, Mississippi. Extrapolating the line to zero water content, as shown in the figure, provides an estimate of  $1/R$  with



$$R = \frac{W_s}{V_o} \quad (B-10)$$

where

R = shrinkage ratio

$W_s$  = mass of a specimen of oven-dried soil, grams

$V_o$  = volume of a specimen of oven-dried soil, cubic centimetres

(2) The shrinkage limit SL of the clay shown in figure B-5 may be taken as the abrupt change in slope of the curve, which is 23.3 percent. The SL is calculated by the following equation:

$$SL = w - \frac{V - V_o}{W_s} \times 100 \quad (B-11)$$

where  $w$  is the water content and  $V$  is the volume of the wet soil specimen in cubic centimetres. Equation (B-11) assumes that  $\alpha = 1$ . For soils with  $\alpha$  less than 1, the SL varies depending on the initial water content of the specimen. For example, if the initial water content is at the natural water content of 25.7 percent, then equation (B-11) will give

$$SL = 25.7 - (0.658 - 0.588) 100 = 18.7 \quad (B-12)$$

as shown in figure B-5. Other shrinkage limits may be evaluated by drawing straight lines with slope  $\alpha = 1$  through other water content points. Soils with the PI less than 40 are more likely to indicate compressibility factors less than 1 than higher plasticity soils. Equation (B-11) is not applicable to soils with  $\alpha$  much less than 1.

*e. Examples.*

(1) The potential heave of the soil characterized by figure B-4 may be calculated from equation (B-6). The final in situ pore water pressure  $u_w$  is equal to 0 at the groundwater level of 1.5 feet. If the depth  $H$  is 1.5 feet, then  $\sigma_v = 0.09$  ton per square foot. From these variables and the parameters in DA Form 5182-R.

$$C_\tau = \frac{\alpha G_s}{100B} = \frac{(0.93)(2.79)}{(100)(0.400)} = 0.065$$

$$\tau_{mo}^\circ = 10^{10.400 - 0.400w_o} = 0.398 \text{ ton per square foot}$$

$$\tau_{mf}^\circ = u_w + \alpha \sigma_v = 0 + 0.93(0.09) = 0.084 \text{ ton per square foot}$$

Therefore,

$$\begin{aligned} \frac{\Delta H}{H} &= \frac{C_\tau}{1 + e_o} \log \frac{\tau_{mo}^\circ}{\tau_{mf}^\circ} \\ &= \frac{0.065}{1 + 0.83} \log \frac{0.398}{0.084} = 0.024 \end{aligned}$$

The potential heave  $\Delta H$  will be 0.036 foot or 0.4 inch for the 1.5-foot layer of soil overburden. Practically, the computation indicates that 1/2 inch of heave is expected.

(2) If the osmotic component of suction is not known, then the potential heave may still be roughly approximated by noting that the mean minimum total suction at high water content is 22 tons per square foot in the example of figure B-4. This value may be taken as the final total soil suction  $\tau_f^\circ$ . The initial value of total soil suction  $\tau_o^\circ$  is found by noting that the mean total soil suction at natural water content is 26 tons per square foot in figure B-4. The slope B of the total soil suction and water content curve is subsequently used to evaluate the suction index  $C_\tau$ . The potential heave for this case will be

$$C_T = \frac{(0.93)(2.79)}{(100)(0.046)} = 0.564$$

$$\begin{aligned} \frac{\Delta H}{H} &= \frac{C_\tau}{1 + e_o} \log \frac{\tau_o^\circ}{\tau_f^\circ} \\ &= \frac{0.564}{1 + 0.83} \log \frac{26}{22} = 0.022 \end{aligned}$$

The potential heave  $\Delta H$  will be 0.033 foot or 0.4 inch for the 1.5-foot layer of soil overburden. The disadvantage of this latter approach is that the equilibrium matrix suction or pore water pressure profile is not known, except that the final matrix suction will be small and probably close to the saturated profile (equation (5-3)). The program HEAVE will compute the potential heave for this case as well as those shown in figure 5-1.

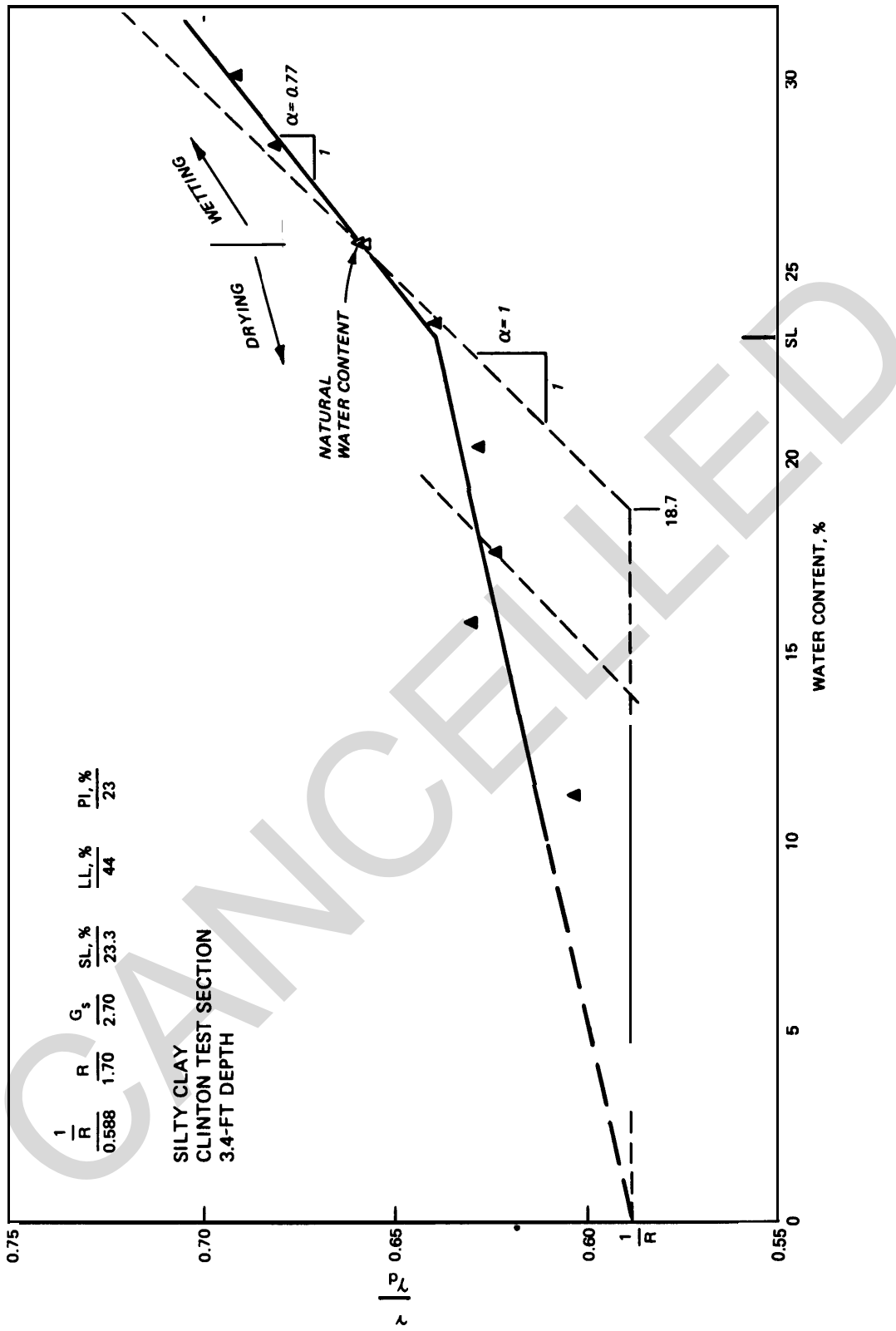
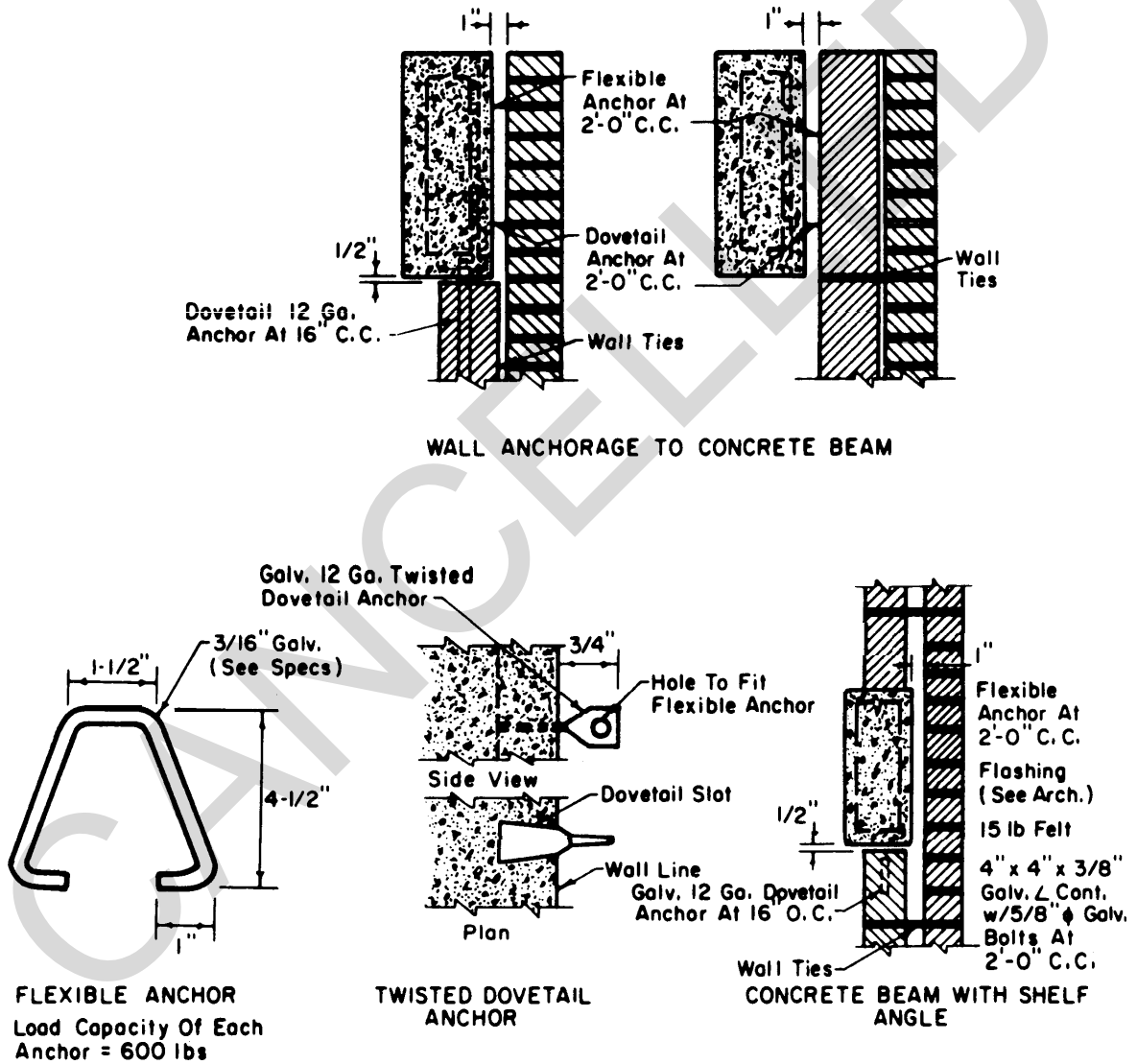

Figure B-5. Illustration of the compressibility factor.

APPENDIX C

FRAME AND WALL CONSTRUCTION DETAILS

Figures C-1 through C-10 illustrate types of construction for expansive foundation soils. These figures were taken from U.S. Army Corps of Engineers Construction Engineering and Research Laboratory Technical Report M-81. The figures show practical wall ties to concrete and steel beams, wall connections with control joints, details of interior partitions, bar joist first floor framing with grade beams, and stiffened mat foundations.



Note:  
Ties to beam are required when column ties are omitted.

Figure C-1. Wall ties to concrete beams.

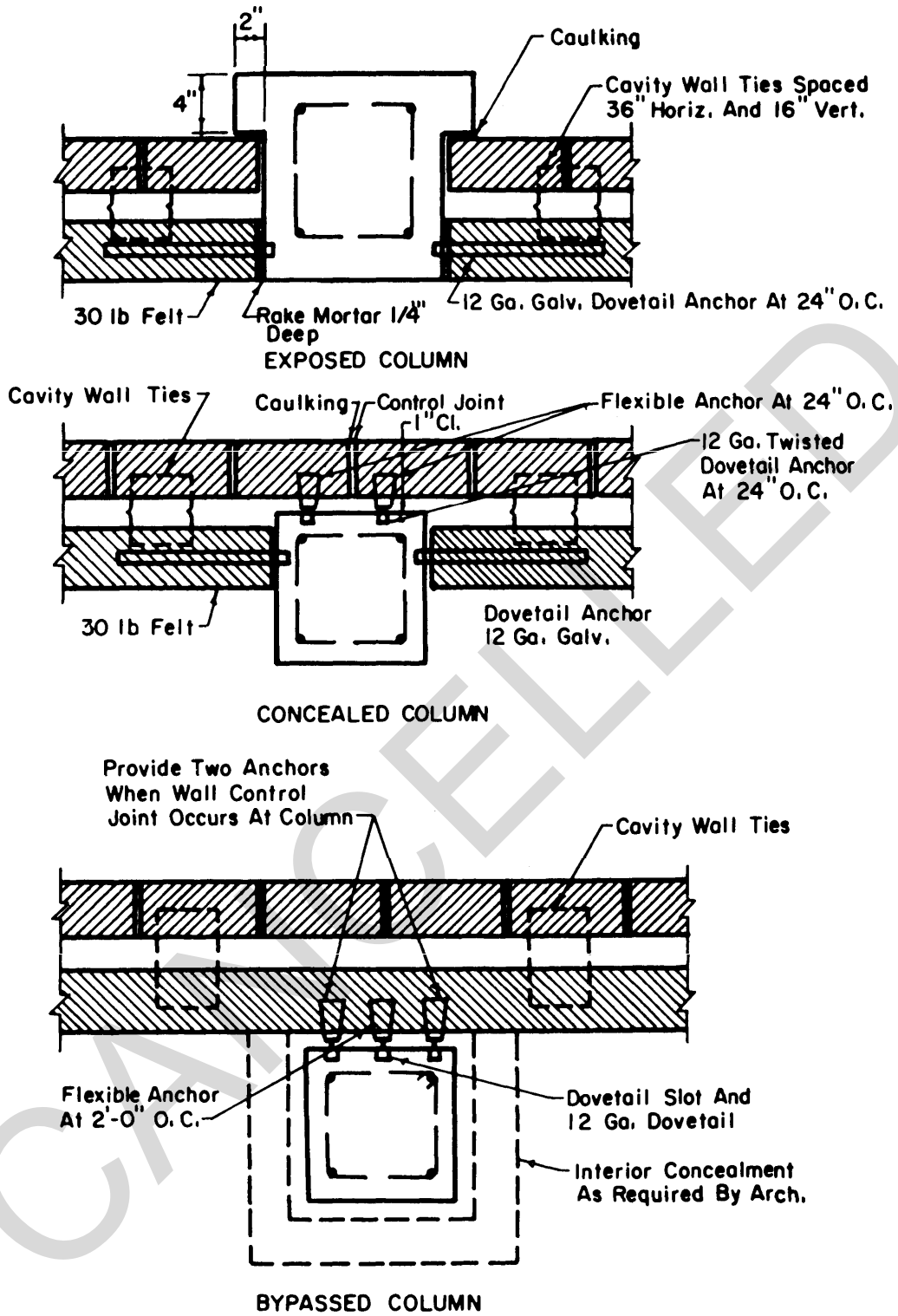

Note: Ties to column are required only when ties to beam are omitted.

Figure C-2. Wall ties to concrete column.

U. S. Army Corps of Engineers

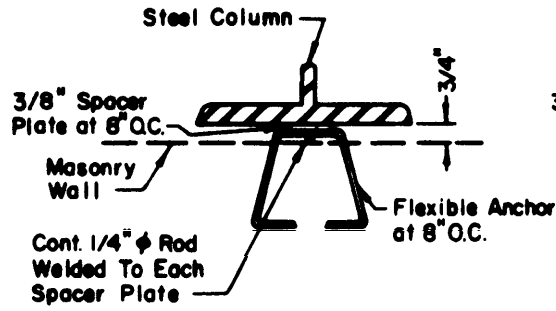

FLEXIBLE ANCHOR

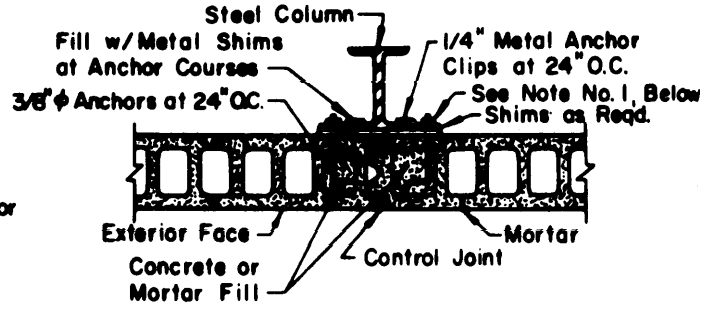

OPTIONAL WALL AND COLUMN CONNECTION

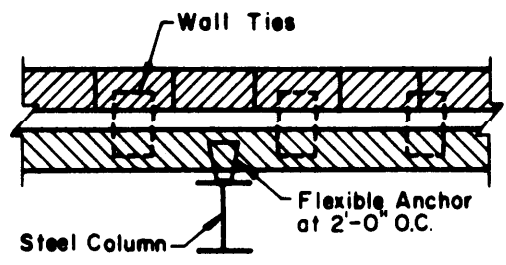

STEEL COLUMN-NO CONTROL JOINT

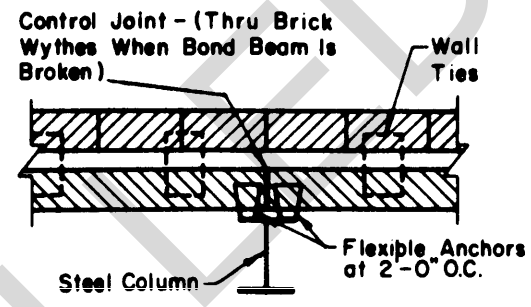

STEEL COLUMN-WITH CONTROL JOINT

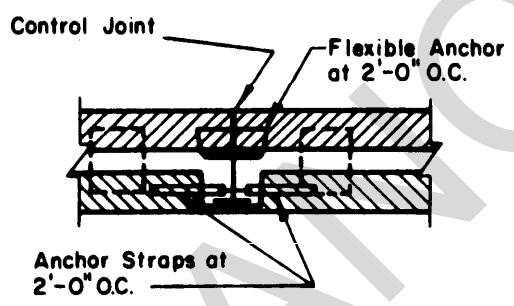

Masonry Shall Be 3/4" Clear All Around Steel Column

STEEL COLUMN IN EXTERIOR WALL

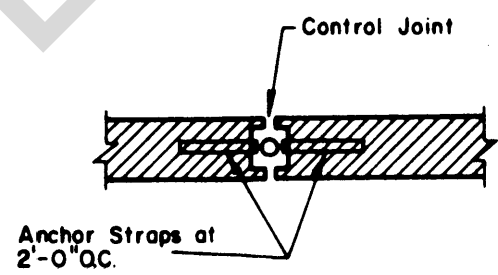

Masonry Shall Be 3/4" Clear All Around Steel Column

STEEL COLUMN IN INTERIOR WALL

Ties To Columns Are Required Only When Ties To Beam Above Are Omitted.  
Do Not Connect Column To Wall At Corners of Buildings

Note:  
1. Nuts Should Not Be Tightened Excessively, Horizontal Movement of Wall Is Necessary.

Figure C-3. Wall ties to steel column (Sheet 1 of 2).

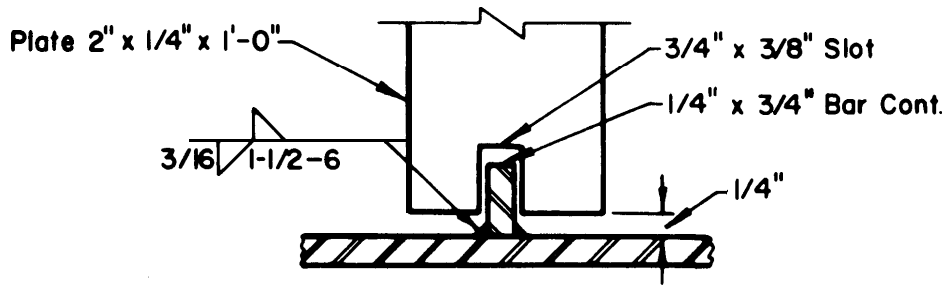

DETAIL "A"

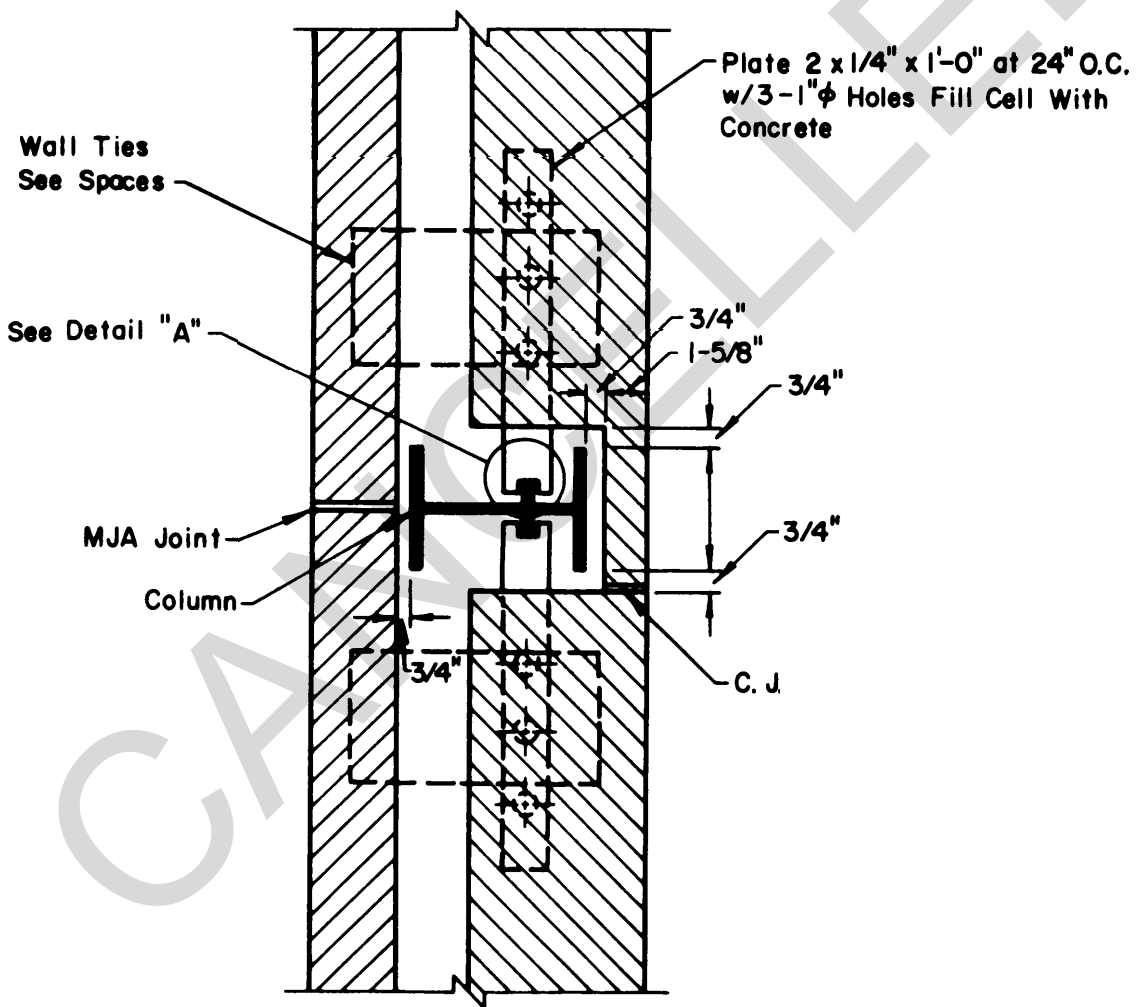
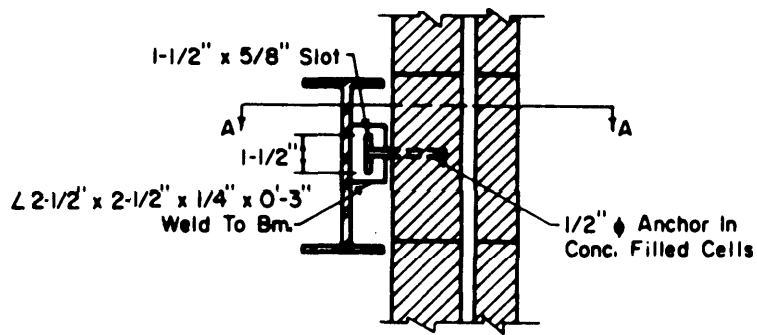
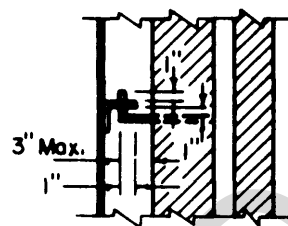

Figure C-3. (Sheet 2 of 2).

U. S. Army Corps of Engineers



ALTERNATE WALL ANCHOR TO STEEL BEAM \*



SECTION A-A

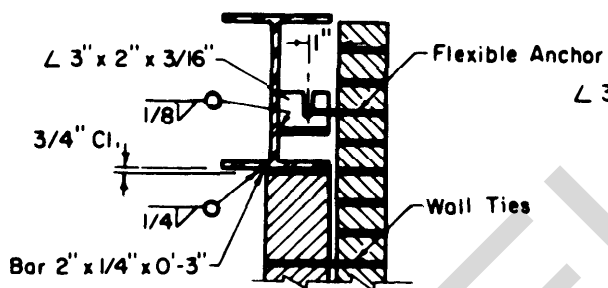

WALL ANCHORAGE TO STEEL BEAM \*

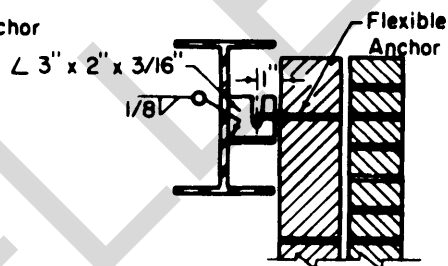

WALL ANCHORAGE TO STEEL BEAM \*

Note:

Ties to beam required only when ties to column are omitted.

- \* 2'-0" Spacing for Exterior Walls
- 4'-0" Spacing for Interior Walls

Figure C-4. Wall ties to steel beam.

U. S. Army Corps of Engineers

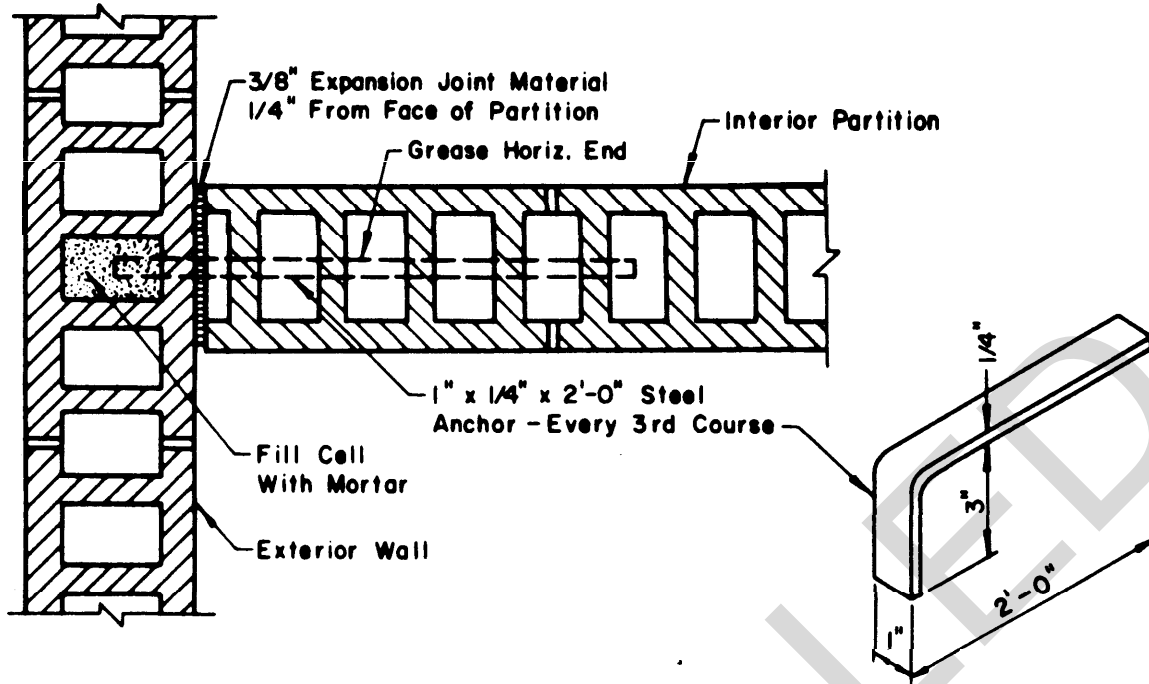

FOR PARTITIONS 6" WIDE OR WIDER

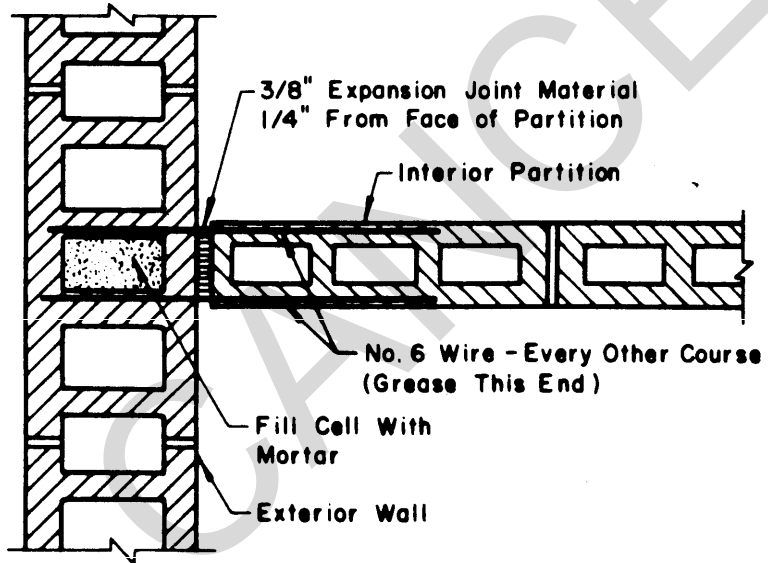

FOR 4" WIDE PARTITIONS

Figure C-5. Wall connections with control joints.

U. S. Army Corps of Engineers



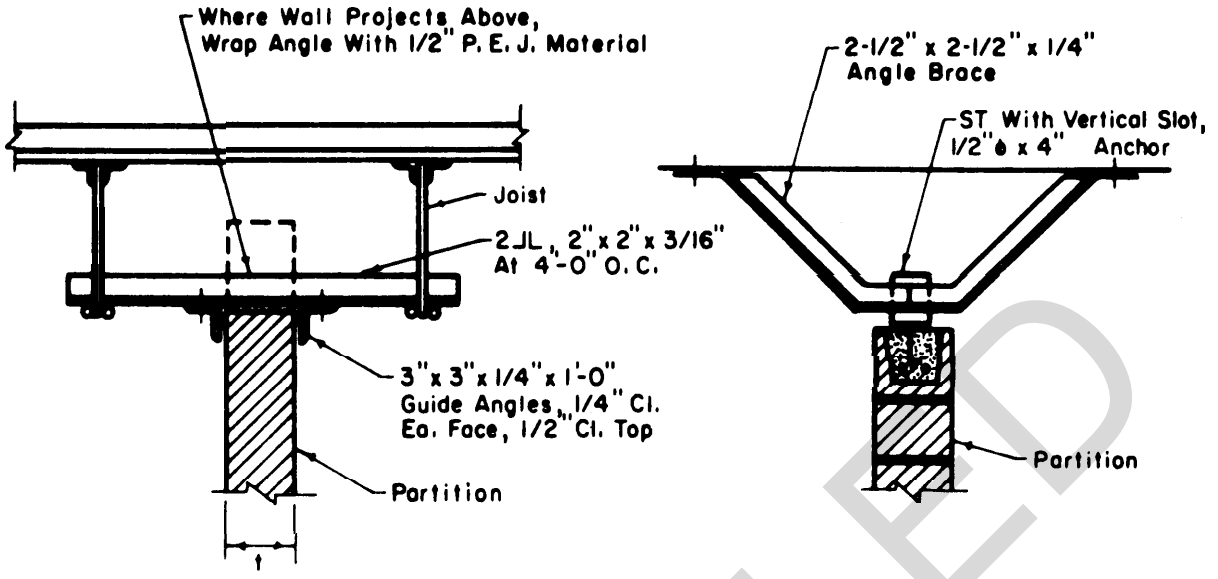

WITH STRUCTURAL STEEL JOIST

ALTERNATE SUPPORT

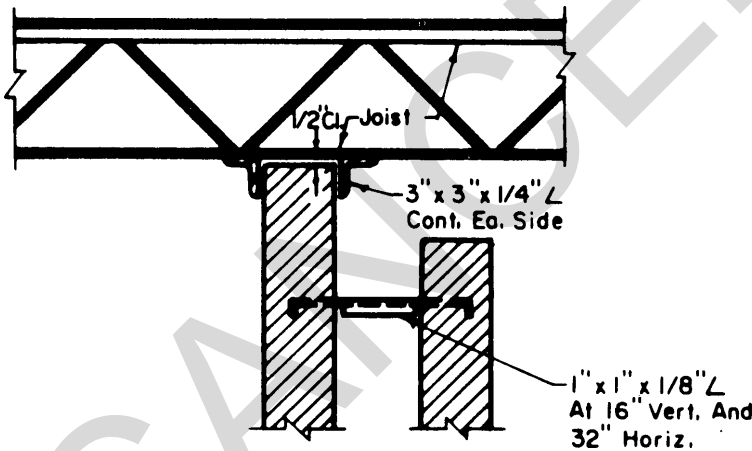

CHASE PARTITION

Figure C-6. Typical details of interior partitions.

U. S. Army Corps of Engineers

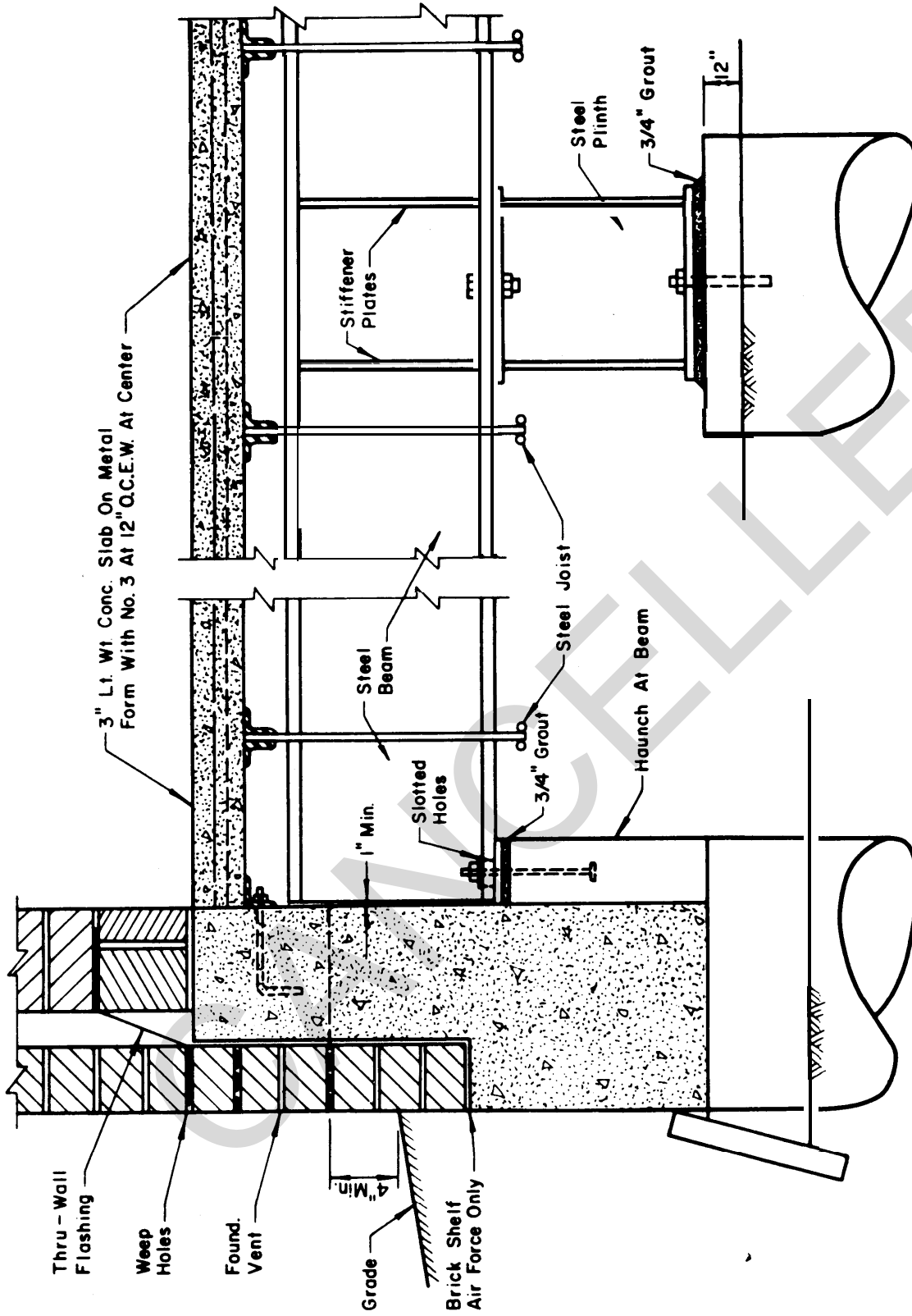

Figure C-7. Typical bar joist first floor framing.

U. S. Army Corps of Engineers

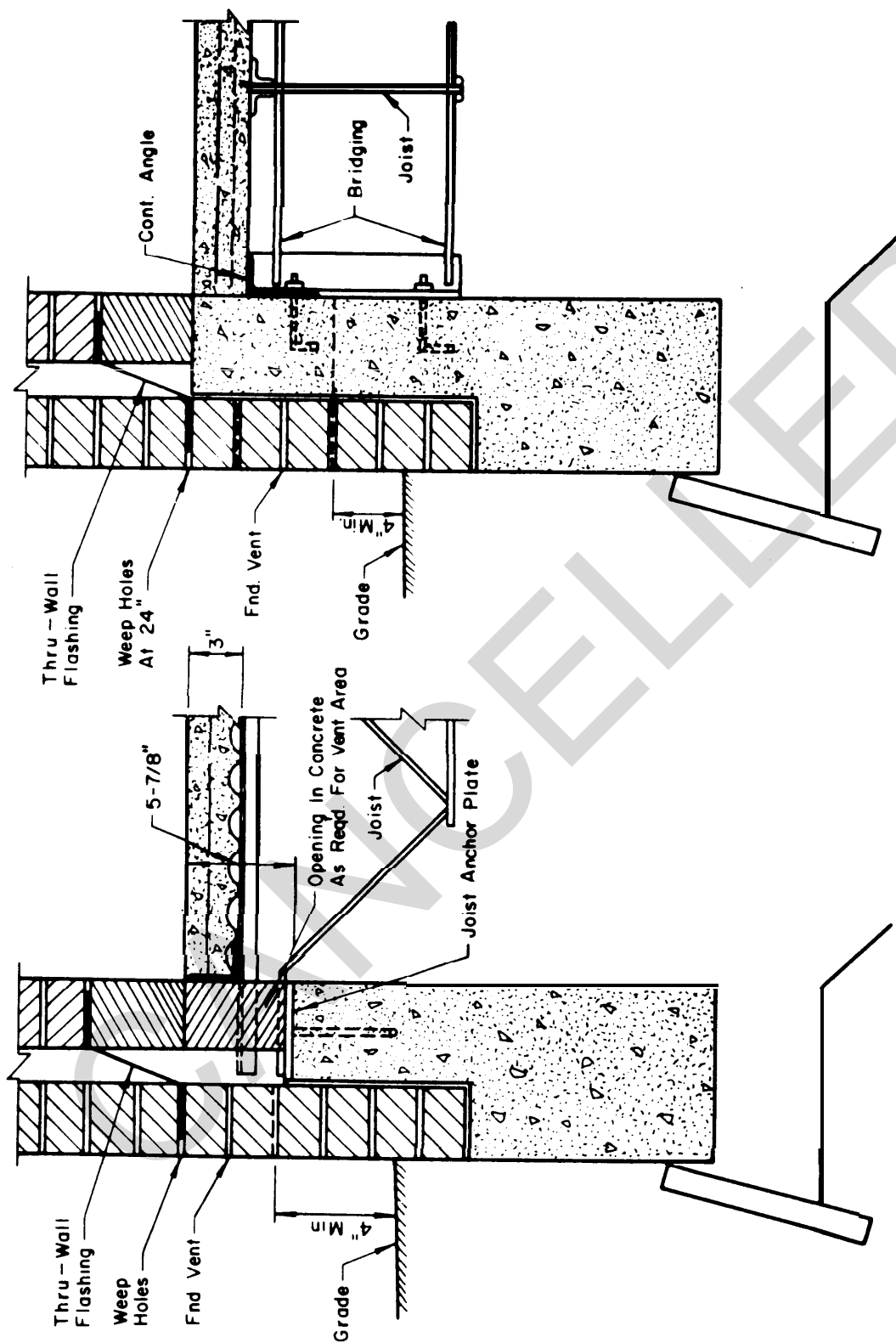

Fig C-8. Typical cast-in-place or precast concrete grade beam with steel bar joist floor framing.

U. S. Army Corps of Engineers

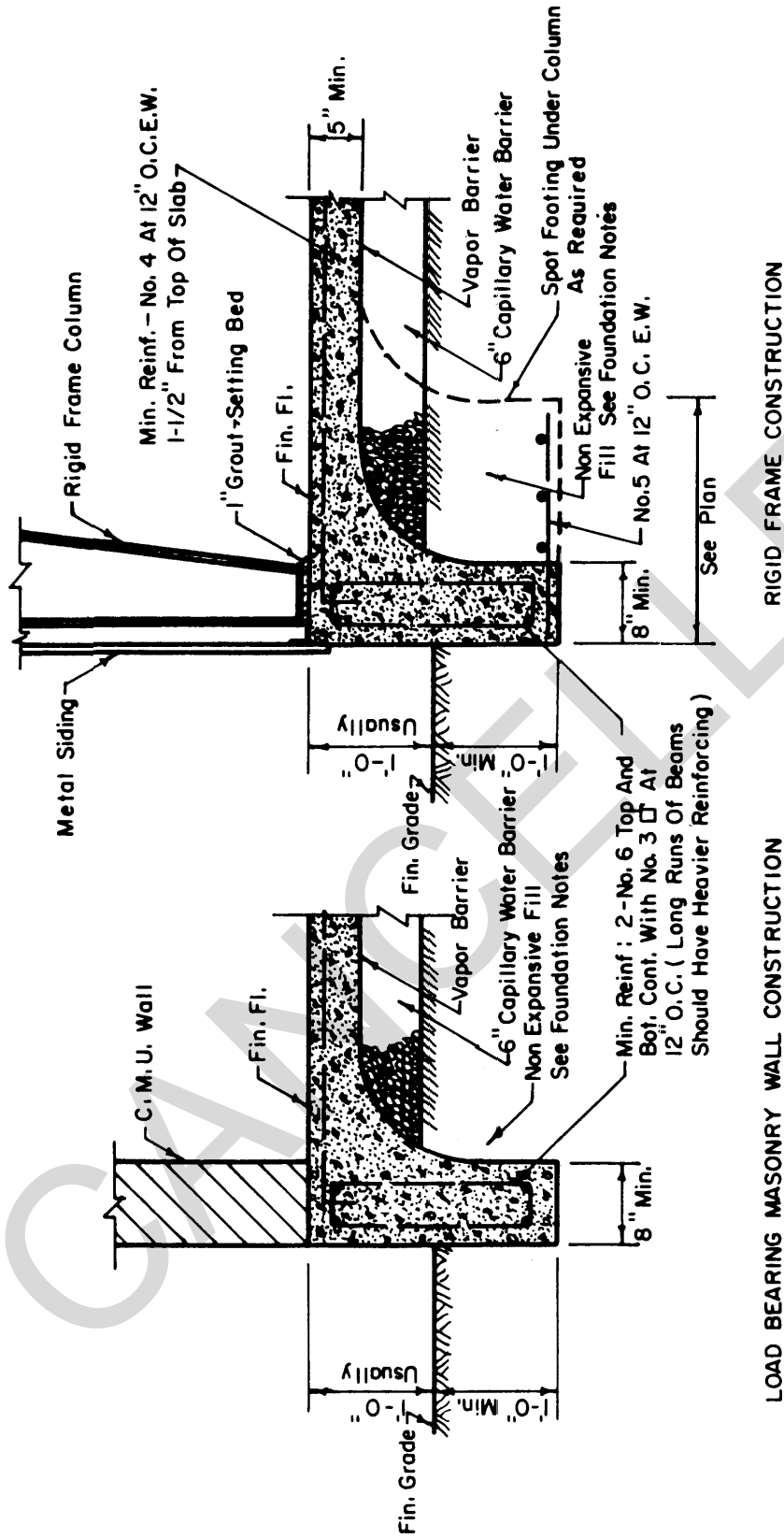

Figure C-9. Typical ribbed mat foundations.

U. S. Army Corps of Engineers

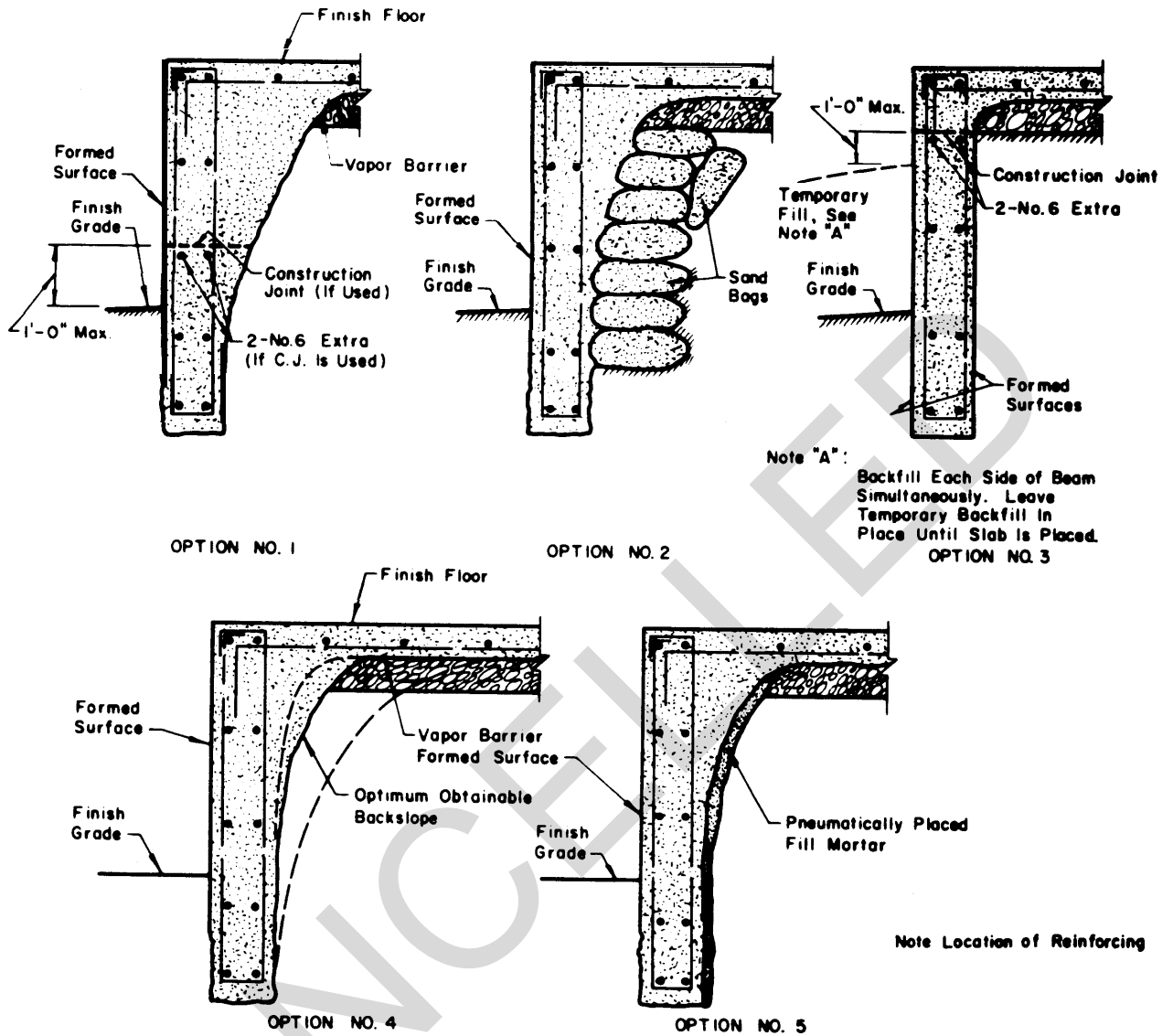

Figure C-10. Optional construction details of exterior beams (interior beam similar) for ribbed mat construction.

U. S. Army Corps of Engineers

## APPENDIX D

**BIBLIOGRAPHY**

- American Concrete Institute, *Manual of Concrete Practice*. Detroit, Michigan (1980).
- Atwood, W. W., *The Physiographic Provinces of North America*. Ginn and Company, Buffalo, New York (1940).
- Blacklock, J. R. and Lawson, C. H., "Handbook for Railroad Track Stabilization Using Lime Slurry Pressure Injection". Report No. FRA/ORD-77/30, U.S. Department of Transportation, Washington, D.C. (1977).
- Boussinesq, J., "Application des Potentials a L'Etude de L'Equilibre et du Mouvement des Solides Elastiques". Gaithier-Villars, Paris, France (1885).
- Bowles, J. E., "Foundations for Family Housing". Technical Report D-20, Construction Engineering Research Laboratory, Champaign, Illinois (1974).
- Bowles, J. E., *Foundation Analysis and Design*. McGraw-Hill Book Company, New York, (1977).
- Building Research Advisory Board (BRAB), "Criteria for Selection and Design of Residential Slab-on-Ground". Publication No. 1571, National Academy of Sciences-National Research Council, Washington, D.C. (1968).
- Burland, J. B., "Shaft Friction of Piles in Clay—A Simple Fundamental Approach". *Ground Engineering*, Volume 6, No 3 (1973).
- Burland, J. B., Broms, B. B., and DeMello, V. F. B., "Behavior of Foundations and Structures". *Ninth International Conference on Soil Mechanics and Foundation Engineering*, Volume 2, Tokyo, Japan (1977).
- Chen, F. H., *Foundations on Expansive Soils*. Elsevier Scientific Publishing Company, New York (1975).
- Clough, G. W. and Duncan, J. M., "Finite Element Analyses of Port Allen and Old River Locks". Contract Report S-69-6, U.S. Army Engineer Waterways Experiment Station, Vicksburg, Mississippi (1969).
- Eades, J. L. and Grim, P. E., "A Quick Test to Determine Lime Requirements for Lime Stabilization". *Highway Research Record 139*, Highway Research Board, Washington, D.C. (1966).
- Esrig, M. I. et al., "Initial Development of a General Effective Stress Method for the Prediction of Axial Capacity for Driven Piles in Clay". *Geotechnical/Environmental Publication*, Volume XI, No. 2, Woodward-Clyde Consultants, San Francisco, California (1978).
- Feld, J., "Tolerance of Structures to Settlement". *Journal of Soil Mechanics and Foundations Division*, Volume 91, No. SM3 (1965).
- Focht, J. A., Khan, F. R., and Gemeinhardt, J. P., "Performance of One Shell Plaza Deep Mat Foundation". *Journal of the Geotechnical Engineering Division, Proceedings of the American Society of Civil Engineers*, Volume 104, No. GT5 (1978).
- Frazer, J. C. W., Taylor, R. K., and Grollman, A., "Two-Phase Liquid Vapor Isothermal Systems, Vapor Pressure Lowering". *International Critical Tables*, Volume 3 (1928).
- Haliburton, T. A., "Soil-Structure Interaction: Numerical Analysis of Beams and Beam Columns". Technical Publication No. 14, School of Civil Engineering, Oklahoma State University, Oklahoma (1971).
- Holland, J. E. and Lawrence, C., "Seasonal Heave of Australian Clay Soils". *Proceedings of the Fourth International Conference on Expansive Soils, American Society of Civil Engineers*, Denver, Colorado (1980).
- Holland, J. E. et al., "The Behavior and Design of Housing Slabs on Expansive Clays". *Proceedings of the Fourth International Conference on Expansive Soils, American Society of Civil Engineers*, Denver, Colorado (1980).
- Holtz, W. G., "Public Awareness of Homes Built on Shrink-Swell Soils". *Proceedings of the Fourth International Conference on Expansive Soils, American Society of Civil Engineers*, Denver, Colorado (1980).
- Jobes, W. P. and Stroman, W. R., "Structures on Expansive Soils". Technical Report M-81, Construction Engineering Research Laboratory, Champaign, Illinois (1974).
- Johnson, L. D., 1978., "Predicting Potential Heave and Heave With Time in Swelling Foundation Soils". Technical Reports S-78-7, U.S. Army Engineer Waterways Experiment Station, CE, Vicksburg, Mississippi (1978).
- Johnson, L. D., "Overview for Design of Foundations on Expansive Soils". Miscellaneous Paper GL-79-21, U.S. Army Engineer Waterways Experiment Station, Vicksburg, Mississippi (1979).
- Johnson, L. D., "Field Test Sections on Expansive Soils". *Proceedings of the Fourth International Conference on Expansive Soils, American Society of Civil Engineers*, Volume I, Denver, Colorado (1980).
- Johnson, L. D. and Snethen, D. R., "Prediction of Potential Heave of Swelling Soil". *Geotechnical Testing Journal*, Volume 1, No. 3 (1978).

- Lambe, T. W. and Whitman, R. V., *Soil Mechanics*, John Wiley and Sons, New York (1969).
- Lytton, R. L., "Theory of Moisture Movement in Expansive Clays". Research Report 118-1, Center for Highway Research, University of Texas, Austin, Texas (1969).
- Lytton, R. L., "Expansive Clay Roughness in the Highway Design System". *Proceedings of Workshop on Expansive Clays And Shales in Highway Design and Construction*, Denver, Colorado, prepared for the Federal Highway Administration, Washington, D.C. (1973).
- Lytton, R. L., "Foundations in Expansive Soils". *Numerical Methods in Geotechnical Engineering*, Chapter 13, McGraw-Hill Book Company, New York (1977).
- Lytton, R. L., Dyke, L. D., and Mathewson, C. C., "Creep Damage to Structures on Expansive Clay Slopes". Report No. RF 4079, prepared for the U.S. Army Engineer Waterways Experiment Station by the Department of Civil Engineering, Texas A&M University, College Station, Texas, and published in the *Proceedings of the Fourth International Conference on Expansive Soils, American Society of Civil Engineers*, Denver, Colorado (1980).
- Mathewson, C. C., Castleberry, J. P., II, and Lytton, R. L., "Analysis and Modeling of the Performance of Home Foundations on Expansive Soils in Central Texas". *Bulletin of the Association of Engineering Geologists*, Volume 12, No. 4 (1975).
- McKeen, R. G., "Field Studies of Airport Pavements on Expansive Clay". *Proceedings of the Fourth International Conference on Expansive Soils, American Society of Civil Engineers*, Volume 1, Denver, Colorado (1980).
- McQueen, I. S. and Miller, R. S., "Calibration and Evaluation of a Wide Range Gravimetric Method for Measuring Moisture Stress". *Soil Science*, Volume 106, No. 3 (1968).
- Palmer, W. C. and Vaughn Havens, A., "A Graphical Technique for Determining Evapotranspiration by the Thornthwaite Method". *Monthly Weather Review*, Volume 86, No. 4 (1958).
- Parry, R. H. G., "Classification Test for Shrinking and Swelling Soils". *Civil Engineering and Public Works Review*, London, England, Volume 61, No. 719 (1966).
- Patrick, D. M. and Snethen, D. R., "An Occurrence and Distribution Survey of Expansive Materials in the United States by Physiographic Areas". Report No. FHWA-RD-76-82, Prepared for the Federal Highway Administration by the U.S. Army Engineer Waterways Experiment Station, CE, Vicksburg, Mississippi (1976).
- Potyondy, J. G. et al., "Skin Friction Between Various Soils and Construction Materials." *Geotechnique*, Volume 11, No. 4 (1961).
- Prendergast, J. D. et al., "Concept Development for Structures on Expansive Soils by the Pattern Language Design Methodology". Technical Report M-151, Construction Engineering Research Laboratory, Champaign, Illinois (1975).
- Reese, L. C. and Wright, S. J., "Construction of Drilled Shafts and Design for Axial Loading". *Drilled Shaft Design and Construction Guidelines Manual*, Volume I, Implementation Package 77-21, U.S. Department of Transportation, Washington, D.C. (1977).
- Richards, B. G., "Moisture Flow and Equilibria in Unsaturated Soils for Shallow Foundations". *Permeability and Capillarity of Soils*, ASTM Special Technical Publication No. 417, Philadelphia, Pennsylvania (1966).
- Russam, K. and Coleman, J. D., "The Effect of Climatic Factors on Subgrade Moisture Conditions". *Geotechnique*, Volume 11, No. 1 (1961).
- Schneider, G. L. and Poor, A. R., "The Prediction of Soil Heave and Swell Pressures Developed by an Expansive Clay". Research Report TR 9-74, Construction Research Center, University of Texas, Arlington, Texas (1974).
- Seely, C. O., "The Current Practice of Building Lightly Loaded Structures on Expansive Soils in the Denver Metropolitan Areas". *Proceedings of the Workshop on Expansive Clays and Shales in Highway Design and Construction*, Volume 1, prepared for the Federal Highway Administration, Washington, D.C. (1973).
- Seelye, E. E., *Foundations-Design and Practice*. John Wiley and Sons, New York (1956).
- Snethen, D. R., "Technical Guidelines for Expansive Soils in Highway Subgrades". Report No. FHWA-RD-79-51, prepared for the Federal Highway Administration by the U.S. Army Engineer Waterways Experiment Station, CE, Vicksburg, Mississippi (1979).
- Snethen, D. R. and Johnson, L. D., "Evaluation of Soil Suction From Filter Paper". Miscellaneous Paper GL-80-4, U.S. Army Engineer Waterways Experiment Station, CE, Vicksburg, Mississippi (1980).
- Statement of the Review Panel, "Engineering Concepts". *Moisture Equilibria and Moisture Changes in Soils Beneath Covered Areas*, Butterworths and Company, Australia (1965).
- Thornthwaite, C. W., "An Approach Toward a Rational Classification of Climate". *Geographical Review*, Volume 38, No. 1 (1948).
- Tomlinson, J. J., *Pile Design and Construction Practice*. Viewpoint Publications, London, England (1977).

- Townsend, F. C., "Use of Lime in Levee Restorations". Technical Report GL-79-12, U.S. Army Engineer Waterways Experiment Station, CE, Vicksburg, Mississippi (1979).
- U.S. Army Engineer District, Fort Worth, "Investigations for Building Foundations in Expansive Clays". Volumes 1 and 2, Fort Worth, Texas (1968).
- Van Der Merwe, D. H., "The Prediction of Heave from the Plasticity Index and Percentage Fraction of Soils". *Civil Engineer in South Africa*, Volume 6, No. 6 (1964).
- Vesic, A. S., "Design of Pile Foundations". *National Cooperative Highway Research Program Synthesis of Highway Practice*, No. 42, Transportation Research Board, National Research Council, Washington, D.C. (1977).
- Vijayvergiya, V. N. and Ghazzaly, O. I., "Prediction of Swelling Potential for Natural Clays". *Proceedings of the Third International Conference on Expansive Clay Soils*, Volume I, Haifa, Israel (1973).
- Wahls, H. E., "Tolerable Settlement of Buildings," *Journal, Geotechnical Engineering Division, Proceedings of the American Society of Civil Engineers*, Volume 107, No. GT11 (1981).
- Webb, D. L., "Foundations and Structural Treatment of Buildings on Expansive Clay in South Africa". *Proceedings of the Second International Research and Engineering Conference on Expansive Clay Soils*, Texas A&M University, College Station, Texas (1969).
- White, E. E., "Foundation Difficulties, Methods of Control and Prevention". *Analysis and Design of Building Foundations*, Chapter 23, Envo Publishing Company, Leigh Valley, Pennsylvania (1976).
- Woodward, R. J., Gardner, W. S., and Greer, D. M., *Drilled Pier Foundations*, McGraw-Hill Book Company, New York (1972).
- Wray, W. K., "Analysis of Stiffened Slabs-On-Ground Over Expansive Soil". *Proceedings of the Fourth International Conference on Expansive Soils, American Society of Civil Engineers*, Volume 1, Denver, Colorado (1980).
- Wright, S. J. and Reese, L. C., "Design of Large Diameter Bored Piles". *Ground Engineering*, England, Volume 12, No. 8, (1979).



The proponent agency of this publication is the Office of the Chief of Engineers, United States Army. Users are invited to send comments and suggested improvements on DA Form 2028 (Recommended Changes to Publications and Blank Forms) direct to HQDA (DAEN-ECE-G), WASH DC 20314.

By Order of the Secretary of the Army:

JOHN A. WICKHAM, JR.  
*General, United States Army*  
*Chief of Staff*

Official:

ROBERT M. JOYCE  
*Major General, United States Army*  
*The Adjutant General*

DISTRIBUTION:

To be distributed in accordance with DA Form 12-34B, requirements for TM 5-800 Series: Engineering and Design for Real Property Facilities,

CANCELLED

# SOIL SUCTION, WATER CONTENT, AND SPECIFIC VOLUME

For use of this form, see TM 5-818-7; proponent agency is US Army Corps of Engineers.

PROJECT	BORING/SAMPLE/DEPTH	DATE																																																																										
<table border="1" style="width: 100%; border-collapse: collapse;"> <tr> <td style="width: 15%;">PSYCHROMETER NO.</td> <td></td> </tr> <tr> <td>SAMPLE CONTAINER NO.</td> <td></td> </tr> <tr> <td>WATER CONTENT INCREMENT (0, +, -)</td> <td></td> </tr> <tr> <td> <table border="1" style="width: 100%; border-collapse: collapse;"> <tr> <td style="width: 50%;">THERMOCOUPLE OUTPUT</td> <td style="width: 50%;">L. MILLIVOLTS</td> </tr> <tr> <td></td> <td>T. °C</td> </tr> </table> </td> <td></td> </tr> <tr> <td> <table border="1" style="width: 100%; border-collapse: collapse;"> <tr> <td style="width: 50%;">PSYCHROMETER OUTPUT</td> <td style="width: 50%;">ET. MICROVOLTS</td> </tr> <tr> <td></td> <td>E. °C</td> </tr> </table> </td> <td></td> </tr> <tr> <td>SOIL SUCTION †, TONS/FT<sup>2</sup></td> <td>T</td> </tr> <tr> <td>TARE NO.</td> <td></td> </tr> <tr> <td>TARE PLUS WET SOIL</td> <td></td> </tr> <tr> <td>TARE PLUS DRY SOIL</td> <td></td> </tr> <tr> <td> <table border="1" style="width: 100%; border-collapse: collapse;"> <tr> <td style="width: 50%;">WEIGHT IN GRAMS</td> <td style="width: 50%;">W<sub>w</sub></td> </tr> <tr> <td>TARE</td> <td></td> </tr> <tr> <td>DRY SOIL</td> <td>W<sub>s</sub></td> </tr> </table> </td> <td></td> </tr> <tr> <td>WATER CONTENT, PERCENT</td> <td>w</td> </tr> <tr> <td colspan="2">TEST TEMPERATURE OF WATER, °C</td> </tr> <tr> <td>WET SOIL AND WAX IN AIR</td> <td></td> </tr> <tr> <td> <table border="1" style="width: 100%; border-collapse: collapse;"> <tr> <td style="width: 50%;">WEIGHT IN GRAMS</td> <td style="width: 50%;">W</td> </tr> <tr> <td>WAX</td> <td></td> </tr> </table> </td> <td></td> </tr> <tr> <td>WET SOIL AND WAX IN WATER</td> <td></td> </tr> <tr> <td> <table border="1" style="width: 100%; border-collapse: collapse;"> <tr> <td style="width: 50%;">DRY SOIL ††</td> <td style="width: 50%;">W<sub>s</sub></td> </tr> <tr> <td>SPECIFIC GRAVITY OF SOIL</td> <td>G<sub>s</sub></td> </tr> </table> </td> <td></td> </tr> <tr> <td>WET SOIL AND WAX ‡</td> <td></td> </tr> <tr> <td>WAX</td> <td></td> </tr> <tr> <td>WET SOIL</td> <td>V</td> </tr> <tr> <td>DRY SOIL = W<sub>s</sub>/G<sub>s</sub></td> <td>V<sub>s</sub></td> </tr> <tr> <td>WET DENSITY = (W/V) 62.4</td> <td>γ<sub>m</sub></td> </tr> <tr> <td>DRY DENSITY = (W<sub>s</sub>/V) 62.4</td> <td>γ<sub>d</sub></td> </tr> <tr> <td>VOID RATIO = (V - V<sub>s</sub>)/V<sub>s</sub></td> <td>e</td> </tr> <tr> <td>POROSITY, % = [(V - V<sub>s</sub>)/V] X 100</td> <td>n</td> </tr> <tr> <td>DEGREE OF SATURATION, % = [V<sub>w</sub>/(V - V<sub>s</sub>)] X 100</td> <td>S</td> </tr> <tr> <td>SPECIFIC VOLUME = 1/γ<sub>d</sub></td> <td>V<sub>T</sub></td> </tr> </table>			PSYCHROMETER NO.		SAMPLE CONTAINER NO.		WATER CONTENT INCREMENT (0, +, -)		<table border="1" style="width: 100%; border-collapse: collapse;"> <tr> <td style="width: 50%;">THERMOCOUPLE OUTPUT</td> <td style="width: 50%;">L. MILLIVOLTS</td> </tr> <tr> <td></td> <td>T. °C</td> </tr> </table>	THERMOCOUPLE OUTPUT	L. MILLIVOLTS		T. °C		<table border="1" style="width: 100%; border-collapse: collapse;"> <tr> <td style="width: 50%;">PSYCHROMETER OUTPUT</td> <td style="width: 50%;">ET. MICROVOLTS</td> </tr> <tr> <td></td> <td>E. °C</td> </tr> </table>	PSYCHROMETER OUTPUT	ET. MICROVOLTS		E. °C		SOIL SUCTION †, TONS/FT <sup>2</sup>	T	TARE NO.		TARE PLUS WET SOIL		TARE PLUS DRY SOIL		<table border="1" style="width: 100%; border-collapse: collapse;"> <tr> <td style="width: 50%;">WEIGHT IN GRAMS</td> <td style="width: 50%;">W<sub>w</sub></td> </tr> <tr> <td>TARE</td> <td></td> </tr> <tr> <td>DRY SOIL</td> <td>W<sub>s</sub></td> </tr> </table>	WEIGHT IN GRAMS	W <sub>w</sub>	TARE		DRY SOIL	W <sub>s</sub>		WATER CONTENT, PERCENT	w	TEST TEMPERATURE OF WATER, °C		WET SOIL AND WAX IN AIR		<table border="1" style="width: 100%; border-collapse: collapse;"> <tr> <td style="width: 50%;">WEIGHT IN GRAMS</td> <td style="width: 50%;">W</td> </tr> <tr> <td>WAX</td> <td></td> </tr> </table>	WEIGHT IN GRAMS	W	WAX			WET SOIL AND WAX IN WATER		<table border="1" style="width: 100%; border-collapse: collapse;"> <tr> <td style="width: 50%;">DRY SOIL ††</td> <td style="width: 50%;">W<sub>s</sub></td> </tr> <tr> <td>SPECIFIC GRAVITY OF SOIL</td> <td>G<sub>s</sub></td> </tr> </table>	DRY SOIL ††	W <sub>s</sub>	SPECIFIC GRAVITY OF SOIL	G <sub>s</sub>		WET SOIL AND WAX ‡		WAX		WET SOIL	V	DRY SOIL = W <sub>s</sub> /G <sub>s</sub>	V <sub>s</sub>	WET DENSITY = (W/V) 62.4	γ <sub>m</sub>	DRY DENSITY = (W <sub>s</sub> /V) 62.4	γ <sub>d</sub>	VOID RATIO = (V - V <sub>s</sub> )/V <sub>s</sub>	e	POROSITY, % = [(V - V <sub>s</sub> )/V] X 100	n	DEGREE OF SATURATION, % = [V <sub>w</sub> /(V - V <sub>s</sub> )] X 100	S	SPECIFIC VOLUME = 1/γ <sub>d</sub>	V <sub>T</sub>
PSYCHROMETER NO.																																																																												
SAMPLE CONTAINER NO.																																																																												
WATER CONTENT INCREMENT (0, +, -)																																																																												
<table border="1" style="width: 100%; border-collapse: collapse;"> <tr> <td style="width: 50%;">THERMOCOUPLE OUTPUT</td> <td style="width: 50%;">L. MILLIVOLTS</td> </tr> <tr> <td></td> <td>T. °C</td> </tr> </table>	THERMOCOUPLE OUTPUT	L. MILLIVOLTS		T. °C																																																																								
THERMOCOUPLE OUTPUT	L. MILLIVOLTS																																																																											
	T. °C																																																																											
<table border="1" style="width: 100%; border-collapse: collapse;"> <tr> <td style="width: 50%;">PSYCHROMETER OUTPUT</td> <td style="width: 50%;">ET. MICROVOLTS</td> </tr> <tr> <td></td> <td>E. °C</td> </tr> </table>	PSYCHROMETER OUTPUT	ET. MICROVOLTS		E. °C																																																																								
PSYCHROMETER OUTPUT	ET. MICROVOLTS																																																																											
	E. °C																																																																											
SOIL SUCTION †, TONS/FT <sup>2</sup>	T																																																																											
TARE NO.																																																																												
TARE PLUS WET SOIL																																																																												
TARE PLUS DRY SOIL																																																																												
<table border="1" style="width: 100%; border-collapse: collapse;"> <tr> <td style="width: 50%;">WEIGHT IN GRAMS</td> <td style="width: 50%;">W<sub>w</sub></td> </tr> <tr> <td>TARE</td> <td></td> </tr> <tr> <td>DRY SOIL</td> <td>W<sub>s</sub></td> </tr> </table>	WEIGHT IN GRAMS	W <sub>w</sub>	TARE		DRY SOIL	W <sub>s</sub>																																																																						
WEIGHT IN GRAMS	W <sub>w</sub>																																																																											
TARE																																																																												
DRY SOIL	W <sub>s</sub>																																																																											
WATER CONTENT, PERCENT	w																																																																											
TEST TEMPERATURE OF WATER, °C																																																																												
WET SOIL AND WAX IN AIR																																																																												
<table border="1" style="width: 100%; border-collapse: collapse;"> <tr> <td style="width: 50%;">WEIGHT IN GRAMS</td> <td style="width: 50%;">W</td> </tr> <tr> <td>WAX</td> <td></td> </tr> </table>	WEIGHT IN GRAMS	W	WAX																																																																									
WEIGHT IN GRAMS	W																																																																											
WAX																																																																												
WET SOIL AND WAX IN WATER																																																																												
<table border="1" style="width: 100%; border-collapse: collapse;"> <tr> <td style="width: 50%;">DRY SOIL ††</td> <td style="width: 50%;">W<sub>s</sub></td> </tr> <tr> <td>SPECIFIC GRAVITY OF SOIL</td> <td>G<sub>s</sub></td> </tr> </table>	DRY SOIL ††	W <sub>s</sub>	SPECIFIC GRAVITY OF SOIL	G <sub>s</sub>																																																																								
DRY SOIL ††	W <sub>s</sub>																																																																											
SPECIFIC GRAVITY OF SOIL	G <sub>s</sub>																																																																											
WET SOIL AND WAX ‡																																																																												
WAX																																																																												
WET SOIL	V																																																																											
DRY SOIL = W <sub>s</sub> /G <sub>s</sub>	V <sub>s</sub>																																																																											
WET DENSITY = (W/V) 62.4	γ <sub>m</sub>																																																																											
DRY DENSITY = (W <sub>s</sub> /V) 62.4	γ <sub>d</sub>																																																																											
VOID RATIO = (V - V <sub>s</sub> )/V <sub>s</sub>	e																																																																											
POROSITY, % = [(V - V <sub>s</sub> )/V] X 100	n																																																																											
DEGREE OF SATURATION, % = [V <sub>w</sub> /(V - V <sub>s</sub> )] X 100	S																																																																											
SPECIFIC VOLUME = 1/γ <sub>d</sub>	V <sub>T</sub>																																																																											

| WEIGHT-VOLUME RELATIONS | | |
| $$\# \text{ VOLUME OF WET SOIL AND WAX} = \frac{\text{WEIGHT OF WET SOIL AND WAX}}{\text{DENSITY OF WET SOIL AND WAX}}$$  $$\# \text{ VOLUME OF WAX} = \frac{\text{WEIGHT OF WAX}}{\text{SPECIFIC GRAVITY AT WAX}}$$ | | |

\* T °C = 1/0.0395  
 \*\* E<sub>25</sub> = E<sub>T</sub>/0.325 + 0.0271  
 † SEE INDIVIDUAL PSYCHROMETER CALIBRATION LINE  
 †† IF NOT MEASURED DIRECTLY, MAY BE COMPUTED AS FOLLOWS: W<sub>s</sub> =  $\frac{W}{1 + 0.01 W}$