

UNIFIED FACILITIES CRITERIA (UFC)

GEOTECHNICAL ENGINEERING PROCEDURES FOR FOUNDATION DESIGN OF BUILDINGS AND STRUCTURES



APPROVED FOR PUBLIC RELEASE; DISTRIBUTION UNLIMITED

UNIFIED FACILITIES CRITERIA (UFC)

**GEOTECHNICAL ENGINEERING PROCEDURES FOR FOUNDATION DESIGN OF
BUILDINGS AND STRUCTURES**

Any copyrighted material included in this UFC is identified at its point of use.
Use of the copyrighted material apart from this UFC must have the permission of the
copyright holder.

U.S. ARMY CORPS OF ENGINEERS

NAVAL FACILITIES ENGINEERING COMMAND (Preparing Activity)

AIR FORCE CIVIL ENGINEER SUPPORT AGENCY

Record of Changes (changes are indicated by \1\ ... /1/)

Change No.	Date	Location

This UFC supersedes DM 7.01, DM 7.02, and DM-38.4.

FOREWORD

The Unified Facilities Criteria (UFC) system is prescribed by MIL-STD 3007 and provides planning, design, construction, sustainment, restoration, and modernization criteria, and applies to the Military Departments, the Defense Agencies, and the DoD Field Activities in accordance with [USD\(AT&L\) Memorandum](#) dated 29 May 2002. UFC will be used for all DoD projects and work for other customers where appropriate. All construction outside of the United States is also governed by Status of forces Agreements (SOFA), Host Nation Funded Construction Agreements (HNFA), and in some instances, Bilateral Infrastructure Agreements (BIA.) Therefore, the acquisition team must ensure compliance with the more stringent of the UFC, the SOFA, the HNFA, and the BIA, as applicable.

UFC are living documents and will be periodically reviewed, updated, and made available to users as part of the Services' responsibility for providing technical criteria for military construction. Headquarters, U.S. Army Corps of Engineers (HQUSACE), Naval Facilities Engineering Command (NAVFAC), and Air Force Civil Engineer Support Agency (AFCESA) are responsible for administration of the UFC system. Defense agencies should contact the preparing service for document interpretation and improvements. Technical content of UFC is the responsibility of the cognizant DoD working group. Recommended changes with supporting rationale should be sent to the respective service proponent office by the following electronic form: [Criteria Change Request \(CCR\)](#). The form is also accessible from the Internet sites listed below.

UFC are effective upon issuance and are distributed only in electronic media from the following source:

- Whole Building Design Guide web site <http://dod.wbdg.org/>.

Hard copies of UFC printed from electronic media should be checked against the current electronic version prior to use to ensure that they are current.

AUTHORIZED BY:



DONALD L. BASHAM, P.E.
Chief, Engineering and Construction
U.S. Army Corps of Engineers



KATHLEEN I. FERGUSON, P.E.
The Deputy Civil Engineer
DCS/Installations & Logistics
Department of the Air Force



DR. JAMES W. WRIGHT, P.E.
Chief Engineer
Naval Facilities Engineering Command

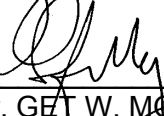

Dr. G. W. MOY, P.E.
Director, Installations Requirements and
Management
Office of the Deputy Under Secretary of Defense
(Installations and Environment)

CONTENTS

	<u>Page</u>
CHAPTER 1 INTRODUCTION	
Paragraph 1-1	PURPOSE.....1-1
1-2	SCOPE.....1-1
1-3	REFERENCES.....1-1
1-4	GENERAL GUIDANCE.....1-1
1-4.1	Content Guidance.....1-1
CHAPTER 2 SOILS AND GEOLOGY	
Paragraph 2-1	INTRODUCTION.....2-1
2-1.1	Purpose.....2-1
2-1.2	Scope.....2-1
2-1.3	References.....2-1
CHAPTER 3 SELECTION OF FOUNDATION TYPES	
Paragraph 3-1	SELECTION OF FOUNDATION TYPE.....3-1
3-1.1	Foundation Selection Consideration.....3-1
3-1.2	Adverse Subsurface Conditions.....3-2
3-1.3	Cost Estimates and Final Selection.....3-2
CHAPTER 4 SHALLOW FOUNDATIONS	
Paragraph 4-1	INTRODUCTION.....4-1
4-1.1	Purpose.....4-1
4-1.2	Scope.....4-1
4-1.3	Related Criteria.....4-1
4-1.4	References.....4-1
4-1.5	Secondary References.....4-1
CHAPTER 5 DEEP FOUNDATIONS	
Paragraph 5-1	INTRODUCTION.....5-1
5-1.1	Purpose.....5-1
5-1.2	Scope.....5-1
5-1.3	Related Criteria.....5-1
5-1.4	References.....5-1
5-1.5	Secondary References.....5-2
CHAPTER 6 RETAINING WALLS AND CELLULAR COFFERDAMS	
Paragraph 6-1	INTRODUCTION.....6-1
6-1.1	Purpose.....6-1
6-1.2	Scope.....6-1

	6-1.3 Related Criteria	6-1
	6-1.4 Cellular Cofferdams.....	6-1
	6-1.5 References	6-7

CHAPTER 7 SLOPE STABILITY ANALYSIS

Paragraph	7-1 INTRODUCTION.....	7-1
	7-1.1 Purpose	7-1
	7-1.2 Scope	7-1
	7-1.3 Related Criteria	7-1
	7-1.4 References	7-1
	7-1.5 Secondary References.....	7-1

CHAPTER 8 EXCAVATION, FILL, BACKFILL, AND SOIL STABILITIZATION FOR STRUCTURES

Paragraph	8-1 EXCAVATIONS.....	8-1
	8-1.1 Introduction and Scope	8-1
	8-1.2 Open Cuts	8-1
	8-1.3 Trenching	8-2
	8-1.4 Rock Excavation.....	8-11
	8-1.5 Excavation Stabilization, Monitoring, and Safety.....	8-17
	8-1.6 Embankment Cross-Section Design.....	8-18
	8-1.7 BORROW EXCAVATON.....	8-30
	8-2 FILL	8-31
	8-2.1 Types of Fill.....	8-31
	8-2.2 Foundations on Compacted Fill.....	8-32
	8-2.3 Compaction Requirements	8-33
	8-2.4 Placing and Control of Backfill.....	8-34
	8-2.5 Fill Settlements.....	8-34
	8-2.6 Hydraulic Fills	8-35
	8-3 BACKFILL	8-39
	8-3.1 Introduction	8-39
	8-3.2 Planning and Design of Structures and Excavations to Accommodate Backfill Operations.....	8-39
	8-3.3 Evaluation, Design, and Processing of Backfill Materials	8-51
	8-3.4 Selection of Backfill Materials.....	8-60
	8-3.5 Processing of Backfill Materials.....	8-63
	8-4 EARTHWORK: EXCAVATION AND PREPARATION FOR FOUNDATIONS	8-64
	8-4.1 Excavation.....	8-64
	8-4.2 Foundation Preparation.....	8-67
	8-5 BACKFILL OPERATIONS	8-68
	8-5.1 Placement of Backfill	8-69
	8-5.2 Good Construction Practices, and Problems.....	8-69
	8-5.3 Special Problems	8-75
	8-5.4 Installation of Instruments	8-76
	8-5.5 Post Construction Distress	8-76

	8-6 SPECIFICATION PROVISIONS.....	8-77
8-6.1	General	8-77
8-6.2	Preparation of Specifications.....	8-77
8-6.3	Foundation Preparation.....	8-79
8-6.4	Backfill Operations	8-79
8-7	STABILIZATION OF SUBGRADE SOILS	8-81
8-7.1	General	8-81
8-7.2	Vibrocompaction.....	8-81
8-7.3	Vibrodisplacement Compaction.....	8-82
8-7.4	Grouting and Injection	8-98
8-7.5	Precompression	8-99
8-7.6	Reinforcement.....	8-102
8-7.7	Miscellaneous Methods.....	8-104

CHAPTER 9 DEWATERING AND GROUNDWATER CONTROL

Paragraph	9-1 INTRODUCTION.....	9-1
	9-1.1 Purpose	9-1
	9-1.2 Scope	9-1
	9-1.3 References	9-1
	9-1.4 Secondary References.....	9-1

CHAPTER 10 FOUNDATIONS IN EXPANSIVE SOILS

Paragraph	10-1 INTRODUCTION.....	10-1
	10-1.1 Purpose	10-1
	10-1.2 Scope	10-1
	10-1.3 References	10-1

CHAPTER 11 FOUNDATIONS IN AREAS OF SIGNIFICANT FRONT PENETRATION

Paragraph	11-1 INTRODUCTION.....	11-1
	11-1.1 Types of Areas	11-1
	11-1.2 General Nature of Design Problems.....	11-2
	11-2 FACTORS AFFECTING DESIGN OF FOUNDATIONS	11-4
	11-2.1 Physiography and Geology	11-4
	11-2.2 Temperature.....	11-4
	11-2.3 Foundation Materials.....	11-5
	11-2.4 Water Conditions.....	11-7
	11-2.5 Frost Heave and Effect of Surcharge	11-7
	11-2.6 Type of Structure.....	11-7
	11-3 SITE INVESTIGATIONS	11-7
	11-3.1 General.....	11-7
	11-3.2 Remote Sensing and Geophysical Investigations	11-8
	11-3.3 Direct Site Investigations	11-8
	11-4 FOUNDATION DESIGN.....	11-9
	11-4.1 Selection of Foundation Type.....	11-9
	11-4.2 Foundation Freeze and Thaw and Techniques for Control..	11-11

11-4.3	Control of Movement and Distortion	11-14
11-4.4	Vibration Problems and Seismic Effects.....	11-15
11-4.5	Design Criteria for Various Specific Features.....	11-16

CHAPTER 12 FOUNDATIONS FOR VIBRATING EQUIPEMENT AND SEISMIC LOADINGS

Paragraph	12-1	INTRODUCTION.....	12-1
	12-1.1	Introduction.....	12-1
	12-1.2	Single Degree of Freedom, Damped Force Systems	12-1
	12-1.3	Foundations on Elastic Soils	12-3
	12-1.4	Wave Transmission, Attenuation and Isolation.....	12-12
	12-1.5	Evaluation of S-wave Velocity in Soils.....	12-14
	12-1.6	Settlement and Liquefaction	12-22
	12-1.7	Seismic Effects on Foundations	12-25

CHAPTER 13 PILE DRIVING EQUIPMENT

Paragraph	13-1	INTRODUCTION.....	13-1
	13-1.1	Purpose	13-1
	13-1.2	Scope	13-1
	13-1.3	References	13-1

CHAPTER 14 GROUTING METHODS AND EQUIPMENT

Paragraph	14-1	INTRODUCTION.....	14-1
	14-1.1	Purpose	14-1
	14-1.2	Scope	14-1
	14-1.3	References	14-1

APPENDIX A	REFERENCES.....	A-1
------------	-----------------	-----

FIGURES

<u>Figure</u>	<u>Title</u>	
6-1	Design Criteria for Cellular Cofferdams.....	6-3
8-1.1	Sliding Trench Shield	8-7
8-1.2	Skeleton Shoring.....	8-9
8-1.3	Close (Tight) Sheet piling	8-9
8-1.4	Box Shoring.....	8-10
8-1.5	Telescopic Shoring.....	8-10
8-1.6	General Guidance for Underpinning.....	8-11
8-1.7	Rippability of Subsurface Materials Related to Longitudinal Seismic Velocity for a Heavy Duty Ripper (Tractor-Mounted).....	8-14
8-1.8	Suggested Guide for Ease of Excavation.....	8-14
8-1.9	Cube Root Scaling Versus Maximum Particle Velocity	8-15
8-1.10	Guideline for Assessing Potential for Damage Induced by Blasting Vibration to Residential Structure Founded on Dense Soil or Rock	8-16
8-1.11	Guide for Predicting Human Response to Vibrations and Blast Effects	8-16
8-1.12	Resistance of Earth Dam, Embankment Materials To Piping and Cracking.....	8-27
8-3.1	Open Backfill Zones	8-42
8-3.2	Confined Backfill Zones	8-43
8-3.3	Complex Structures.....	8-44
8-3.4	Excavation Subject to Bottom Heave	8-46
8-3.5	Excess Lateral Pressure Against Vertical Walls Induced by Compaction .	8-47
8-7.1	Applicable Grain-size Ranges for Different Stabilization Methods	8-95
8-7.2	Range of Particle-size Distributions Suitable for Densification by Vibrocompaction	8-96
8-7.3	Sand Densification Using Vibratory Rollers.....	8-97
8-7.4	Relative Density as a Function of Vibroflot Hole Spacings.....	8-98
8-7.5	Allowable Bearing Pressure on Cohesionless Soil Layer Stabilized by Vibroflotation	8-101
8-7.6	Soil Particle Sizes Suitable for Different Grout Types and Several Concentrations and Viscosities Shown.	8-102
11-1	Frost and Permafrost in North America	11-3
11-2	Ground Temperatures During Freezing Season in Limestone, Maine	11-5
11-3	Ground Temperatures During Freezing Season in Fairbanks, Alaska	11-6
11-4	Design Alternatives	11-12
11-5	Heave Force Tests.....	11-16
12-1	Response Spectra for Vibration Limits.....	12-3
12-2	Response Curves for the Single-degree-of-Freedom System with Viscous Damping.....	12-5
12-3	Six Modes of Vibration for a Foundation	12-5
12-4	Equivalent Damping Ratio for Oscillation of Rigid Circular Footing on Elastic Half-space	12-6
12-5	Examples of Computations for Vertical and Rocking Motions.....	12-9
12-6	Coupled Rocking and Sliding Motion of Foundation.....	12-12

12-7	Distribution of Displacement Waves from a Circular Footing on the Elastic Half-space	12-15
12-8	Theoretical Relation Between Shear Velocity Ratio V_p/V_p and Poisson's Ratio.....	12-17
12-9	Idealized Cyclic Stress-Strain Loop for Soil.....	12-19
12-10	Variation of Shear Modulus with Cyclic Strain Amplitude; $G_{max} = G_0 \epsilon = 1$ to 3×10^{-4} Percent; Scatter in Data up to about ± 0.1 On the Vertical Scale	12-24
12-11	Variation of Viscous Damping with Cyclic Strain Amplitude; Data Scatter up to About ± 50 Percent of Average Damping Values Shown for any Strain.....	12-24

TABLES

<u>Table</u>	<u>Title</u>	
3-1	Foundation Possibilities for Different Subsoil Conditions	3-3
3-2	Checklist for Influence of Site Characteristics on Foundation Selection for Family Housing	3-4
8-1.1	Factors Controlling Stability of Sloped Cut in Some Problem Soils.....	8-3
8-1.2	Factors Controlling Excavation Stability	8-4
8-1.3	OSHA Requirements (Minimum) for Trench Shoring	8-8
8-1.4	Typical Properties of Compacted Soils	8-20
8-1.5	Relative Desirability of Soils as Compacted Fill	8-24
8-1.6	Clay Dispersion Potential	8-29
8-2.1	A Summary of Densification Methods for Building Foundations.....	8-37
8-2.2	Compaction Density as a Percent of ASTM 1557 Laboratory Density	8-39
8-3.1	Typical Engineering Properties of Compacted Materials.....	8-55
8-5.1	Summary of Compaction Criteria	8-73
8-7.1	Stabilization of Soils for Foundations of Structures	8-85
8-7.2	Applicability of Foundation Soil Improvement for Different Structures And Soil types (for Efficient Use of Shallow Foundations)	8-94
8-7.3	Vibroflotation Patterns for Isolated Footings for an Allowable Bearing Pressure.....	8-101
12-1	Mass Ratio, Damping Ratio, and Spring Constant for Rigid Circular Footing on the Semi-Infinite Elastic Body.....	12-6
12-2	Values of k_f/L for Elastic Layer (k from Table 12-1).....	12-11
12-3	Attenuation Coefficients for Earth Materials	12-15
12-4	Values of Constant η Used with Equation (12-23)	12-21
12-5	Values of Constant K_2 Used with Equation (12-24) to Estimate cyclic Shear Modulus at Low Strains for Sands	12-22
12-6	Criteria for Excluding Need for Detailed Liquefaction Analyses	12-25

CHAPTER 1

INTRODUCTION

1-1 **PURPOSE.** This UFC presents guidance for selecting and designing foundations for buildings and facilities of all types and associated features for buildings such as earth embankments and slopes, retaining structures, and machinery foundations. Foundations for hydraulic structures are not included; however, foundations design methods for piers, wharves and waterfront structures are covered. Foundation design differs considerably from design of other elements of a structure because of the interaction between the structure and the supporting medium (soil and rock). The soil and rock medium are highly variable as compared to steel and concrete products above the soil; therefore, much attention is given to presenting subsurface investigation methods to better determine the properties of the soil and rock. The seismic aspects of foundation design are presented in detail.

1-2 **SCOPE.** Information contained in this UFC is directed toward construction usually undertaken on military reservations, although it is sufficiently general to permit its use on a wide variety of construction projects. Some of the references are directed toward highway construction, but are also general enough to be applied to any construction foundation items. Effort has been made to refer the user to as many non-government standards as possible, when they appear to cover the topics as well as the former manuals or provide new and innovative methods for the design of foundations on soil and rock. Where there are no non-government criteria or insufficient coverage of the topic in the non-government criteria, the existing government criteria from either the U.S. Army Corps of Engineers or Naval Facilities Engineering Command publications are either referenced or have been inserted totally in the document.

1-3 **REFERENCES.** Appendix A contains a list of references used in this UFC. References are denoted as primary or secondary when mentioned in the chapters. Primary references will cover the subject of the chapter in detail without the aid of additional references. Secondary references may cover a portion of the subject matter of a chapter in detail, but will need additional references to complete a design or investigation. The non-government criteria primary references present both load factor, used in the International Building Code, and safety factor design methods, whereas the U.S Army Corps of Engineers Technical Manuals and Naval Facilities Engineering Design Manuals present the classic design procedures using the traditional safety factor design approaches.

1-4 **GENERAL GUIDIANCE.** These Geotechnical criteria are intended for a graduate civil engineer who has had some Geotechnical engineering exposure in the classroom and in the field of construction and engineering design for approximately three years. The engineer should have access to a textbook in Geotechnical engineering from the college attended and have access to the Internet to obtain the references mentioned in the text.

1-4.1 **Content Guidance.** These Geotechnical engineering criteria have been organized starting with a referenced textbook for background on shallow foundations,

deep foundations, retaining structures, and slopes with settlement analysis covered in each section. Specialty areas follow for excavation and stabilization for structures, dewatering, and foundations in expansive soils, frost areas and seismic or vibration environments.

CANCELLED

CHAPTER 2

SOILS AND GEOLOGY

2-1 INTRODUCTION

2-1.1 **Purpose.** The criteria presented in this UFC are the basic building blocks of Geotechnical engineering. .

2-1.2 **Scope.** Apply criteria to all projects for the military services. Issues concerning foundation investigations, and physical and strength properties and classification of soils and rocks, and reporting on these are covered in the referenced publications.

2-1.3 References.

- UFC 3-220-10N, *Soil Mechanics*
- ASTM D2487, D 2488, and D 5878
- *Soil Sampling*, Technical Engineering and Design Guides
- *Geophysical Exploration for Engineering and Environmental Investigations*, Technical Engineering and Design
- *Fundamentals of Geotechnical Engineering*

CHAPTER 3

SELECTION OF FOUNDATION TYPES

3-1 SELECTION OF FOUNDATION TYPE

3-1.1 **Foundation Selection Considerations.** Selection of an appropriate foundation depends upon the structure's function, existing soil and groundwater conditions, construction schedules, construction economy, the value of basement area, and other factors. On the basis of preliminary information concerning the purpose of the structure, foundation loads, and subsurface soil conditions, alternative types of foundations for the bearing capacity and total and differential settlements should be evaluated. Some foundation alternatives for different subsoil conditions are summarized in table 3-1. When making foundation selections consider the following:

3-1.1.1 Some foundation alternatives may not be initially obvious. For example, preliminary plans may not provide for a basement, but when cost studies show that a basement permits a floating foundation that reduces consolidation settlements at little or no increase in construction cost, or even at a cost reduction, the value of a basement may be substantial. Benefits of basement areas include needed garage space, office or storage space, and space for air conditioning and other equipment. The last item otherwise may require valuable building space or disfigure a roofline.

3-1.1.2 While mat foundations are more expensive to design than individual spread footings, they usually result in considerable cost reduction, provided the total area of spread footings is a large percentage of the basement area. Mat foundations may decrease the required excavation area, compared with spread footings.

3-1.1.3 The most promising foundation types should be designed, in a preliminary manner, for detailed cost comparisons. Carry these designs far enough to determine the approximate size of footings, length and number of piles required, etc. Estimate the magnitude of differential and total foundation movements and the effect on structure. The behavior of similar foundation types in the area should be ascertained.

3-1.1.4 Final foundation design should not be started until alternative types have been evaluated. Also, the effect of subsurface conditions (bearing capacity and settlement) on each alternative should be at least qualitatively evaluated.

3-1.1.5 A checklist of factors that could influence foundation selection for family housing is shown in table 3-2.

3-1.2 **Adverse Subsurface Conditions.** If poor soil conditions are encountered, procedures that may be used to ensure satisfactory foundation performance include the following:

3-1.2.1 Bypass the poor soil by means of deep foundations extending to or into a suitable bearing material (chap. 11).

3-1.2.2 Design the structure foundations to accommodate expected differential settlements. Distinguish between settlements during construction that affect a structure and those that occur during construction before a structure is affected by differential settlements.

3-1.2.3 Remove the poor material, and either treat and replace it, or substitute good compacted fill material.

3-1.2.4 Treat the soil in place prior to construction to improve its properties. This procedure generally requires considerable time. The latter two procedures are carried out using various techniques of soil stabilization described in Chapter 16.

3-1.3 **Cost Estimates and Final Selection**

3-1.3.1 On the basis of tentative designs, the cost of each promising alternative should be estimated. Estimate sheets should show orderly entries of items, dimensions, quantities, unit material and labor cost, and cost extensions. Use local labor and material costs.

3-1.3.2 The preliminary foundation designs that are compared must be sufficiently completed to include all relevant aspects. For example, the increased cost of piling may be partially offset by pile caps that are smaller and less costly than spread footings. Similarly, mat or pile foundations may require less excavation. Foundation dewatering during construction may be a large item that is significantly different for some foundation alternatives.

3-1.3.3 The most appropriate type of foundation generally represents a compromise between performance, construction cost, design cost, and time. Of these, design cost is generally the least important and should not be permitted to be a controlling factor. If a lower construction cost can be achieved by an alternative that is more expensive to design, construction cost should generally govern.

3-1.3.4 Foundation soils pretreatment by precompression under temporary surcharge fill, regardless of whether vertical drains are provided to accelerate consolidation, requires a surcharge loading period of about 6 months to a year. The time required may not be available unless early planning studies recognized the possible foundation cost reduction that may be achieved. Precompression is frequently advantageous for warehouses and one-story structures. Precompression design should be covered as a separate design feature and not considered inherent in structure design.

Table 3-1 Foundation Possibilities for Different Subsoil Conditions

Foundation Possibilities		
Subsoil Conditions	Light, Flexible Structure	Heavy, Rigid Structure
Deep Compact or Stiff Deposit	Footing Foundations	Footing Foundations or Shallow Mat
Deep Compressible Strata	Footing Foundations on Compacted Granular Zone ^a , or Shallow Mat ^a , or Friction Piles	Deep Mat with Possible Rigid Construction in Basement ^a , or Long Piles or Caissons to Bypass, or Friction Piles
Soft or Loose Strata Overlying Firm Strata	Bearing Piles or Piers, or Footing Foundations on Compacted Granular Zone ^a , or Shallow Mat ^a	Bearing Piles or Piers, or Deep Mat
Compact or Stiff Layer Overlying Soft Deposit	Footing Foundations ^a , or Shallow Mat ^a	Deep Mat (Floating), or Long Piles or Caissons to Bypass Soft Deposit
Alternating Soft and Stiff Layers	Footing Foundations ^a , or Shallow Mat ^a	Deep Mat, or Piles or Caissons to Underlying Firm Stratum to provide Satisfactory Foundation

^aConsider possible advantages of site pre-loading, with or without vertical drains, to accelerate consolidation.

(Courtesy L.J. Goodman and R.H. Kerol, *Theory and Practice of Foundation Engineering*, 1968, P.312 Reprinted by permission MacMillan Company, Inc., New York)

Table 3-2 Checklist for Influence of Site Characteristics on Foundation Selection for Family Housing

Site Characteristics		Foundations			
		Post	Spread	Slab-on-Grade (all)	Basement
Natural Ground	Grading				
Level	None	--	--	--	1, 2, 3, 4, 5
Rolling	None	--	--	Requires Grading	1, 2, 3, 4, 5
Rolling	Cut and Fill	--	1, 2, 3, 4, 5	1, 2, 3, 4, 5	1, 2, 3, 4, 5
Hilly	None	--	--	Requires Grading	1, 2, 3, 4, 5
Hilly	Cut and Fill	--	1, 2, 3, 4, 5	1, 2, 3, 4, 5	1, 2, 3, 4, 5
Groundwater					
Surface		--	Requires Temporary Lowering	--	Do Not Use
Footing Level Below Water Level		--	--	--	Use Perimeter Drainage
Soil type					
GW, GP, GM, GC, SW, SP, SM, SC		1, 2	1, 2	1, 2	1, 2
ML, CL, OL, MH, CH, OH		3, 4, 5, 6	3, 4, 5, 6	3, 4, 5, 6	3, 4, 5, 6

1. Compaction control – increase density if required, use compaction control in fills.
2. Check relative density of cohesionless (GW, GP, SW, SP) soils, generally based on standard penetration resistance.
3. Use undrained shear strength to estimate stress and bearing capacity ratio for slab design.
4. Check if settlement is a problem.
5. Check liquidity index as indication of normally or pre-consolidated clay.
6. Check expansive properties.

CHAPTER 4

SHALLOW FOUNDATIONS

4-1 INTRODUCTION

4-1.1 **Purpose.** This chapter presents guidance for selecting and designing shallow foundations for buildings and structures. Shallow foundations are those that bear at a Depth of bearing/Base (D/B) width of footing equal to less than 5. The referenced criteria are to be used by the engineer to develop the bearing capacity, settlement potential and size of shallow foundations for buildings or structures.

4-1.2 **Scope.** Apply criteria to all projects for the military services. The methods for determining the ability to use a shallow foundation, settlement potential (the most important factor in shallow foundation design) allowable soil bearing capacity as limited by shear strength, and the size of the foundation are presented in referenced criteria. The allowable settlement tolerances for structures are covered in the primary references.

4-1.3 **Related Criteria.** Reference Chapters 8, "Excavation, Fill, Backfill, and Soil Stabilization For Structures," Chapter 10, "Foundations in Expansive Soils," and Chapter 11 "Foundations in Areas of Significant Frost Penetration" and Chapter 12 "Foundations for Vibrating Equipment and Seismic Loadings" when designing shallow foundations when any of the factors, excavations, soil stabilization, expansive soils, seismic situations, vibration or significant frost penetration are present for a particular site.

4-1.4 **References.** These present load factor and safety factor design methods and should be used as a unit. Last reference presents safety factor design and the classic design procedures.

- *Engineering Manual for Shallow Foundations, Driven Piles, Drilled Shafts, Retaining Walls and Abutments*
- *Engineering Manual for Settlement Studies*
- *Shear Strength Correlation for Geotechnical Engineering*
- UFC 3-220-10N, *Soil Mechanics*

4-1.5 Secondary References

- American Society of Civil Engineers, *Settlement Analysis*, Technical Engineering and Design Guides
- American Society of Civil Engineers, *Design of Shallow Foundations*

- American Society of Civil Engineers, *Bearing Capacity of Soils, Technical Engineering and Design*
- *Fundamentals of Geotechnical Engineering*

CANCELLED

CHAPTER 5

DEEP FOUNDATIONS

5-1 INTRODUCTION

5-1.1 **Purpose.** The criteria presented in this UFC are to be used by the engineer to develop the types, lengths, diameters or horizontal dimensions, materials and installation methods of deep foundations. Deep foundations are those that receive some or all of their support from soil strata at a depth where the Depth of bearing/Base width of footing ratio is greater than 5. The materials for deep foundations may be concrete, steel, timber, aggregates, soils and combinations of these materials including mixed in placed soils with Portland cement, limes and fly ashes. There are many installation methods, and some examples are driving with hammers or rams, screw type installations, drilled installations, deep mixing, deep compaction and grout injection. There are new developments in this field everyday. It is important to seek the latest guidance from the references and from the geotechnical engineering community. ASCE Geotechnical Institute and the Deep Foundations Institute are the main sources of information for developments in deep foundations.

5-1.2 **Scope.** Apply criteria to all projects for the military services. The methods of determining the most economical deep foundation, settlement potential, bearing capacity and size of the deep foundations is presented in detail.

5-1.3 **Related Criteria.** Reference Chapter 10, "Foundations in Expansive Soils" and Chapter 11, "Foundations in Areas of Significant Frost Penetration" when designing deep foundations when either of these factors, expansive soil or significant frost penetration, are present for a particular site.

5-1.4 **References.** These present load factor and safety factor type designs and should be used as a unit.

- *Engineering Manual for Shallow Foundations, Driven Piles, Drilled Shafts, Retaining Walls and Abutments*
- *Engineering Manual for Settlement Studies*
- *Shear Strength Correlation for Geotechnical Engineering*
- *Design of Pile Foundations, Technical Engineering and Design Guides*
- UFC 3-220-10N, *Soil Mechanics*

5-1.5 Secondary References

- [American Society Of Civil Engineers/Geo-Institute](#), 20-96, *Standard*

Guidelines for the Design and Installation of Pile Foundation

- 2000 International Building Code (IBC 2000)
Chapter 18, <http://www.icbo.org/>
- *Design of Sheet Pile Walls*, Technical Engineering and Design Guides
- [Deep Foundations Institute](#),
Auger CIP Piles Manual
Inspectors Guide to Augered CIP Piles
Drilled Shaft Inspector's Manual
Lexicon of Foundation Terms in Five Languages
Driven Foundation Piling (Catalog 1998)
Dynamic Monitoring and Analysis
Interpretation & Analysis fo the Static Loading Test
Guidelines for Static Design
Testing of Pile Driving Cushion Material
Soil Nailing Design & Applications
Inspector's Manual for Pile Foundations
- *Fundamentals of Geotechnical Engineering*
- Pile Buck, Inc. <http://www.pilebuck.com/>
3800 SW Boat Ramp Road, Palm City, Florida 34990
- [ADSC](#): The International Association of Foundation Drilling, Drilled Shafts
 - Drilled Shafts - Axial Loads
 - Drilled Shafts - Clay
 - Drilled Shafts – Concrete
 - Drilled Shafts - Design
 - Drilled Shafts – Design, General
 - Drilled Shafts – General
 - Drilled Shafts – Non-Destructive Testing
 - Drilled Shafts – Rock
 - Drilled Shafts - Sand
 - Drilled Shafts – Shale, Slurry
 - Drilled Shafts – Slurry
 - Drilled Shafts – Soils
 - Drilled Shafts – Specifications
 - Drilled Shafts – Testing
 - Drilled Shafts – Testing, Uplift
 - Drilled Shafts – Uplift
 - Earth Retention
 - Drilled Shafts – Testing, Uplift

CHAPTER 6

RETAINING WALLS AND CELLULAR COFFERDAMS

6-1 INTRODUCTION

6-1.1 **Purpose.** The criteria presented in this UFC are to be used by the engineer to develop the type, dimensions, and materials for building retaining walls under waterfront conditions to mountainous terrain. The materials may be concrete, metals, timber, soils, geotextiles and/or combinations of these materials. A special reference and paragraphs are added here for cellular cofferdams. Cellular cofferdams are very similar to retaining walls but require special design attention.

6-1.2 **Scope.** Apply the Geotechnical criteria to all projects for the military services. The methods of determining settlement potential, bearing capacity, earth pressures, and the size of the retaining walls is presented in detail. The criteria for designing retaining structures or walls that include gravity, concrete, steel, tied and braced bulkheads and cofferdams is presented in easily understood formats with real life examples to guide the engineer.

6-1.3 **Related Criteria.** Chapters 7, Slope Stability Analysis, Chapter 8, Excavation, Fill, Backfill, and Soil Stabilization for Structures, Chapter 9, De-watering and Groundwater Control, Chapter 10, Foundation in Expansive Soils, Chapter 11, Foundations in Areas of Significant Frost Penetration and Chapter 12, and Foundations for Vibrating Equipment and seismic loadings should be consulted for conditions that may effect the design of the retaining wall systems.

6-1.4 **Cellular Cofferdams.** Double-walled or cellular cofferdams consist of a line of circular cells connected by smaller arcs, parallel semi-circular walls connected by straight diaphragms or a succession of cloverleaf cells (see Figure 6-1). For analysis, these configurations are transformed into equivalent parallel wall cofferdams of width B.

6-1.4.1 **Analysis.** Stability depends on the ratio of width to height, the resistance of an inboard berm, if any, and type and drainage of cell fill materials.

6-1.4.1.1 **Exterior Pressures.** Usually active and passive pressures act on exterior faces of the sheeting. However, there are exceptions. These are illustrated in Figure 6.1.

6-1.4.1.2 **Stability Requirements.** A cell must be stable against sliding on its base, shear failure between sheeting and cell fill, and shear failure on the centerline of the cell. It must also resist bursting pressures through interlock tension. These failures are influenced by foundation type. See Figure 6-1 for design criteria for cofferdams with, and without, berms, on rock, and on fine-grained or coarse-grained soil.

- Sand base. For cell walls on sand, penetration of sheeting must be sufficient to avoid piping at the interior toe of the wall and to prevent pullout of outboard sheeting.
- Clay base. For cofferdams on clay, penetration of the outboard sheeting is usually controlled by the pullout requirement; piping is not critical.
- Bearing capacity. For cofferdams in either clay or sand, check the bearing capacity at the inboard toe by methods for shallow foundations.

6-1.4.1.3 **Cell Deformations.** The maximum bulging of cells occurs at approximately $\frac{1}{4}$ the height above the cofferdam base. The cells tilt 0.02 to 0.03 radians due to the difference in lateral loads on the outboard and inboard faces. Deflections under the lateral overturning loads are a function of the dimensions, the foundations support, and the properties of the cell fill.

6-1.4.2 **Cell Fill.** Clean, coarse-grained, free-draining soils are preferred for cell fill. They may be placed hydraulically or dumped through water without any requirement for compaction or special drainage.

- Materials. Clean, granular fill materials should be used in large and critical cells. Every alternative should be studied before accepting fine-grained backfill as fine-grained soils produce high bursting pressures and minimal cell rigidity. Their use may require the addition of interior berms, increased cell width, or consolidation (by sand drains or pumping). All soft material trapped within the cells must be removed before filling.
- Drainage. Install weep holes on inboard sheeting to the cell fill. For critical cells, and/ or those with marginal fill material, wellpoints, or wells between cells have been used to increase cell stability.
- Corrosion retardation. When cofferdams are used in permanent structures, especially in locations exposed to brackish water or seawater, severe corrosion occurs from the top of the splash zone to a point just below mean low-water level. Use a protective coating, corrosion resistant steel and/ or cathodic protection in those areas.

Figure 6-1 Design Criteria for Cellular Cofferdams

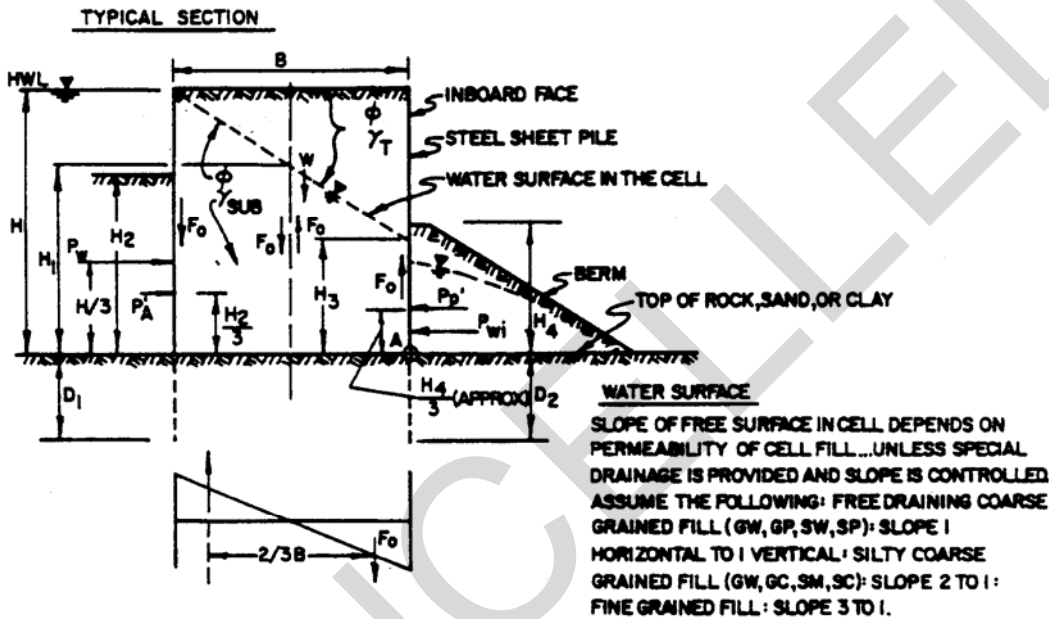
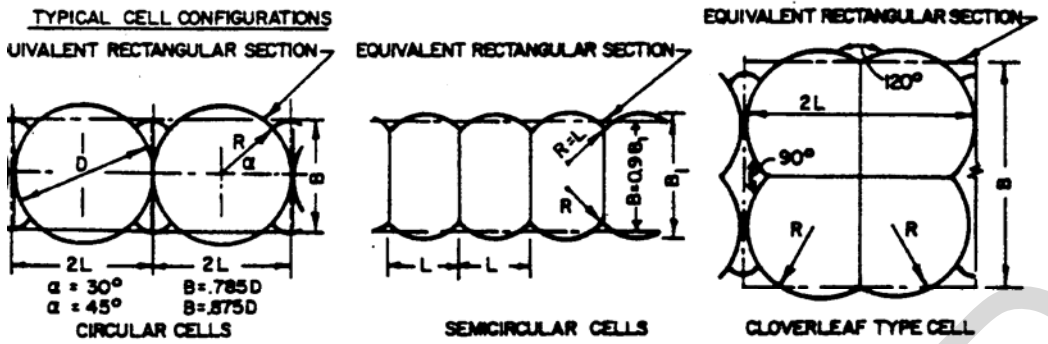

HORIZONTAL STRESS DIAGRAMS IN CELL FILL

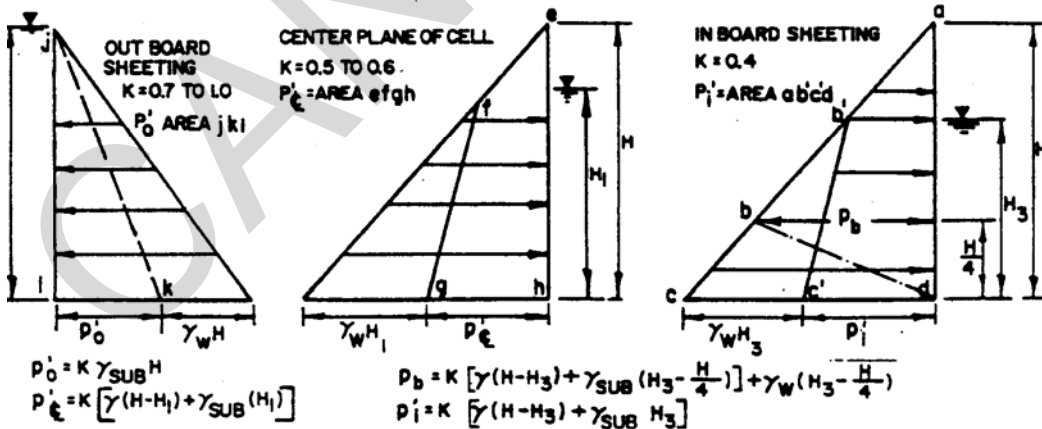

Figure 6-1 Design Criteria for Cellular Cofferdams

PARAMETERS FOR ANALYSIS

1. Equivalent width of cofferdam.	Assume $B = 0.85H$ for first trial.
2. Effective weight of cell fill.	$W = [B(H-H_1)\gamma_T + B(H_1)\gamma_{sub}]$
3. Average distance between cross walls.	L
4. Horizontal active force on outboard side - compute using $K_A = \tan^2(45 - \phi/2)$.	$P'_A = K_A \frac{\gamma_{sub}(H_2)^2}{2}$
5. Coefficient of horizontal earth pressure.	K (varies - see horizontal pressure - diagram)
6. Water force on outboard side.	$P_w = \gamma_w \frac{(H)^2}{2}$
7. Horizontal passive force due to berm plus water force.	$P_p = P'_p + P_{w1}$ (include wall friction between sheet pile and soil)
8. Net overturning moment due to total horizontal force.	$M_O = (P_w \times \frac{H}{3}) + (P'_A \times \frac{H_2}{3}) - (P_p \times \frac{H_4}{3})$ (point of application of P_p is approximated as $H_4/3$, see References in text for further guidance)
9. Resisting moment due to cell fill.	$M_R = W(B/2)$
10. Radius of cell wall.	R
11. Interlock tension.	$T = P_b L$ where P_b = total horizontal stress at point b Zone at maximum interlock tension located at $H/4$ above base. See stress diagram, Inboard Sheeting and references cited in text
12. Ultimate interlock strength.	$T_u = 16$ kip/in for ordinary U.S. steel sheet piles and 28 kips/in for high interlock U.S. sheet piles
13. Effective unit weight.	γ_E = weighted average of cell fill γ_T and γ_{sub} (above and below water in the cell)
14. Friction angle of soil and steel.	$\delta = 2/3 \phi'$
15. Coefficient of friction between cell fill and rock.	λ = use 0.5 for smooth rock, for all other use $\tan\phi$
16. Drained angle of shearing resistance of soil.	ϕ'
17. Coefficient of interlock friction.	$f = 0.3$
18. Horizontal effect <u>stress</u> on a vertical plane.	p' = (see pressure diagram for subscript)
19. Horizontal effect <u>force</u> on a vertical plane.	P' = (see pressure diagram for subscript)

Figure 6-1 Design Criteria for Cellular Cofferdams

DESIGN METHODS

COFFERDAM ON ROCK - WITH BERM

1. Factor of safety against sliding on Base

$$F_S = \frac{W \lambda}{P_{WO} + P_A - P_P} \geq 1.25 \text{ (TEMPORARY) TO } 1.5 \text{ (PERMANENT)}$$

2. Factor of safety against overturning, F_O

$$F_O = \frac{M_R}{M_O} \geq 3 \text{ TO } 3.5 \quad \begin{array}{l} 3 \text{ (TEMPORARY WALL)} \\ 3.5 \text{ (PERMANENT WALL)} \end{array}$$

3. Factor of safety against excessive interlock tension

$$F_i = \frac{T_u}{T} \geq 1.5 \text{ TO } 2.0 \quad \begin{array}{l} 1.5 \text{ (TEMPORARY WALL)} \\ 2.0 \text{ (PERMANENT WALL)} \end{array}$$

4. Factor of safety against vertical shear on centerline, F_{VS} (Terzaghi)

$$F_{VS} = 2/3 \frac{B}{M_o} [P'_e \tan \phi + (P'_i - P_p) f] \geq \begin{array}{l} 1.25 \text{ (TEMPORARY WALL)} \\ 1.50 \text{ (PERMANENT WALL)} \end{array}$$

Where P'_e is calculated using the effective stress diagram for the Center Plane of cell, and equals the area efgh with $K = 0.5$ to 0.6 ; and P'_i is calculated using the effective stress diagram of Inboard Sheeting, and equals area ab'c'd with $K = 0.4$.

5. Factor of safety against tilting, F_t

$$F_t = \frac{1}{M_o} \frac{1}{6} \gamma_E B^2 H \left(3 \tan^2 \phi - \frac{B}{H} \tan^3 \phi + \frac{3KfH}{B} \right) \geq \begin{array}{l} 1.25 \text{ (TEMPORARY)} \\ 1.50 \text{ (PERMANENT)} \end{array}$$

FOR $K = \tan^2(45 - \phi/2)$

6. Factor of safety against shear at cell fill, sheet pile interface, F_{sf}

$$F_{sf} = \frac{B}{M_o} \left[(P'_o + P'_A + \frac{P'_e}{L}) \tan \delta + P'_e f \frac{B}{L} \right] \geq \begin{array}{l} 1.25 \text{ (TEMPORARY)} \\ 1.50 \text{ (PERMANENT)} \end{array}$$

Where P'_o is calculated using the effective stress diagram for Outboard Sheeting, and is equivalent to area jkl with $K = 0.7$ to 1.0 .

7. Select value of B which satisfies all requirements.

COFFERDAM ON ROCK - WITHOUT BERM

Follow design Steps 1 through 7 as above for cofferdam with berm.

8. Put $P_P = 0$ in all equations to compute M_o and factor of safety.

9. In computing F_{VS} , P'_i is calculated using the stress diagram for Inboard Sheeting, and equals area ab'c'd with $K = 0.4$.

Figure 6-1 Design Criteria for Cellular Cofferdams

COFFERDAM ON DEEP SAND FOUNDATION - WITHOUT BERM

10. Penetration of sheet piling may depend on underseepage requirements which are evaluated with flow net. In general, this is to avoid piping at inboard toe.

$$D_1 = D_2 = \frac{2H}{3}$$

or $D_1 = D_2 = \frac{H}{2}$ if water level is lowered at least $\frac{H}{6}$ below inboard ground surface.

11. Check factors of safety for Steps 2, 3, 4, 5, and 6 above for cofferdams on rock.
12. Factor of safety for stability against bearing capacity failure, F_{bc}

$$F_{bc} = \frac{Q_{ult}}{\frac{W}{B} + \frac{GM_o}{B^2}} \geq 2 \quad (\text{NOTE: } P_p = 0)$$

Q_{ult} = ULTIMATE BEARING CAPACITY FOR CONTINUOUS FOOTING OF WIDTH B (SEE CHAPTER 4)

13. Penetration to avoid pull-out of outboard sheeting.

$$\frac{Q_{ult}}{Q_p} \geq 1.5, \text{ WHERE } Q_{ult} = \text{ULTIMATE PULLOUT CAPACITY PER LINEAR FOOT OF WALL} = 1/2 K_o \gamma_E D_1^2 \tan \delta \times \text{PERIMETER (NOTE: } P_p = 0), \text{ AND } Q_p = \frac{M_o}{3B(1 + \frac{B}{4L})}$$

COFFERDAM ON DEEP SAND FOUNDATION - WITH BERM

14. Design as per steps for cofferdam on deep sand foundation without berm, except that passive resultant P_p is included in resisting overturning moment.
15. Stability against bearing capacity failure is not as critical with presence of berm.
16. Penetration of sheeting required to avoid piping is evaluated with flow net.
17. Penetration of Outboard Sheeting to avoid pull-out is the same as for cofferdam on deep sand without berm except include P_p in calculation of M_o .

COFFERDAM ON STIFF TO HARD CLAY

18. Design procedures same as for cofferdams on sand. Stability against bearing capacity failure of inboard toe $F_{bc} \geq 2.5$. Penetration of sheeting to avoid piping is usually not important.
19. Penetration to avoid pull-out of Outboard Sheeting

$$\frac{Q_{ult}}{Q_p} \geq 1.5; Q_p \text{ SAME AS STEP 13}$$

$$Q_{ult} = C_o D_1 \times \text{PERIMETER (} C_o \text{ FROM TABLE 1)}$$

Figure 6-1 Design Criteria for Cellular Cofferdams

COFFERDAM ON SOFT TO MEDIUM STIFF CLAY

20. Design procedures same as for cofferdams on deep sand, with modifications as per following steps. Penetration to avoid piping is usually not important.
21. Factor of Safety for stability against bearing capacity failure, F_{bc}
$$F_{bc} \text{ from Step 12} \geq 3$$
22. Because of internal instability due to settlement of compressible foundation, factor of safety against vertical stress on centerline F_{vs} from Step 4 should be
$$F_{vs} = \frac{P_c}{M_0} \times \frac{RfB}{L} \times \frac{(L+Q25B)}{(L+Q5B)} \geq \begin{cases} 1.25 \text{ (TEMPORARY)} \\ 1.50 \text{ (PERMANENT)} \end{cases}$$

Investigate overall stability of cofferdam with respect to sliding along a curved surface below the bottom of the sheeting by slope stability analysis from DM-7.1 CHAPTER 7.
23. Investigate and evaluate seams of pervious sand within the clay deposit which could develop excessive uplift pressure below the base of the cofferdam.
24. Evaluate penetration of outboard sheeting to avoid pull-out as per Step 19.

6-1.5 **References.** Present load factor and safety factor type designs and should be used a unit.

- *Engineering Manual for Shallow Foundations, Driven Piles, Drilled Shafts, Retaining Walls and Abutments*
- *Engineering Manual for Settlement Studies*
- *Shear Strength Correlation for Geotechnical Engineering*
- *Retaining and Flood Walls, Technical Engineering and Design guides*
- UFC 3-220-10N, *Soil Mechanics*
- *Design of Sheet Pile Walls, Technical Engineering and Design Guides*
- *Fundamentals of Geotechnical Engineering*
- "Sheet Pile Tensions in Cellular Structures"
- *Foundations, Design and Practice*
- "Design, Construction and Performance of Cellular Cofferdams"
- "Field Study of Cellular Cofferdams"

CHAPTER 7

SLOPE STABILITY ANALYSIS

7-1 INTRODUCTION

7-1.1 **Purpose.** The criteria presented in this UFC are to be used by the engineer to develop dimensions and details for existing or new slopes, and for predicting their safety and reliability.

7-1.2 **Scope.** Apply criteria to all projects for the military services. The methods to analyze the stability and reliability, dimensions, and safety of natural slopes and constructed earth embankments are present in the references cited. Slope failures can be rapid and progressive when overstressed by external loads or a reduction of shear strength of the soil material within the slope. The factor of safety is simply the ratio of the force resisting failure to the sum of the forces causing rupture along the defined slip surface. The criteria give the engineer methods of determining these forces.

7-1.3 **Related Criteria.** See Chapter 4, "Shallow Foundations", and Chapter 8, "Excavation, Fill, Backfill, and Soil Stabilization for Structures" for additional criteria that may apply to slope stability.

7-1.4 **References.** These present the load factor and safety factor methods of design.

- UFC 3-220-10N,
- *Engineering Manual for Settlement Studies*
- *Engineering Manual for Slope Stability Studies.*
- *Shear Strength Correlation for Geotechnical Engineering*

7-1.5 Secondary References

- *2000 International Building Code (IBC 2000)*
Chapter 18, <http://www.icbo.org/>
- *Fundamentals of Geotechnical Engineering*

CHAPTER 8

EXCAVATIONS, FILL, BACKFILL, AND SOIL STABILIZATION FOR STRUCTURES

8-1 EXCAVATIONS

8-1.1 Introduction and Scope

This chapter covers the methods of evaluating the stability of shallow and deep excavations. There are two basic types of excavations:

- “open excavations” where stability is achieved by providing stable side slopes
- “braced excavations” where vertical or sloped sides are maintained with protective structural systems that can be restrained laterally by internal or external structural elements. Guidance on performance monitoring is given in *Logging the Mechanical Character of Rocks*, Chapter 2.

8-1.1.1 **Methodology.** In selecting and designing the excavation system, the primary controlling factors will include:

- soil type and soil strength parameters
- groundwater conditions
- slope protection
- side and bottom stability
- vertical and lateral movements of adjacent areas, and effects on existing structures

8-1.1.2 **Related Criteria.** For additional criteria on excavations, see UFC 3-220-05, *Dewatering and Groundwater Control*.

8-1.2 Open Cuts

8-1.2.1 **Sloped Cuts.** Depth and slope of an excavation, and groundwater conditions control the overall stability and movements of open excavations. In granular soils, instability usually does not extend significantly below the excavation, provided seepage forces are controlled. In rock, depths and slopes of excavation, particular joint patterns, in situ stresses, and groundwater conditions control stability. In cohesive soils, instability typically involves side slopes but may also include materials well below the base of the excavation. Instability below the base of excavation, often referred to as bottom heave, is affected by soil type and strength, depth of cut, side slope and/or berm geometry, groundwater conditions, and construction procedures. Methods for controlling bottom heave are given in UFC 3-220-10N.

Methods described in UFC 3-220-10N may be used to evaluate the stability of open excavations in soils where behavior of such soils can be reasonably determined by field investigation, laboratory testing, and analysis. In certain geologic formations (stiff clays, shales, sensitive clays, clay tills, etc.) stability is controlled by construction procedures, side effects during and after excavation and inherent geologic planes of weaknesses - Table 8-1.1 (modified from *Effects of Construction on Geotechnical Engineering*, by Clough and Davidson) presents a summary of the primary factors controlling excavation slopes in some problem soils. Table 8-1.2 (modified from UFC 3-220-10N) summarizes measures that can be used for excavation protection for both conventional and problem soils.

8-1.2.2 **Vertical Cuts.** Many cuts in clays will stand with vertical slopes for a period of time before failure occurs. However, changes in the shear strength of the clay with time and stress release resulting from the excavation can lead to progressive deterioration in stability. This process can be rapid in stiff, highly fissured clays, but relatively slow in softer clays. (See UFC 3-220-10N for critical heights for vertical cuts in cohesive soils.) For cuts in hard unweathered rock, stability is mostly controlled by strength along bedding planes, groundwater condition, and other factors (see UFC 3-220-10N, and *Stability of Steep Slopes on Hard Unweathered Rock*, by Terzaghi for detailed discussion on the effects of rock discontinuities). Cuts in rock can stand vertical without bolting or anchoring depending on rock quality and joint pattern.

8-1.3 **Trenching**

8-1.3.1 **Site Exploration.** Individual trenching projects frequently extend over long distances. An exploration program should be performed to define the soil and groundwater conditions over the full extent of the project, so that the design of the shoring system can be adjusted to satisfy the varying site conditions.

8-1.3.2 **Trench Stability.** Principal factors influencing trench stability are the lateral earth pressures on the wall support system, bottom heave, and the pressure and erosive effects of infiltrating groundwater (see Chapter 6 and UFC 3-220-10N). External factors that influence trench stability include:

- **Surface Surcharge.** The application of any additional load between the edge of the excavation and the intersection of the ground surface with the possible failure plane must be considered in the stability analyses for the excavation.
- The effects of vibrating machinery, blasting or other dynamic loads in the vicinity of the excavation must be considered. The effects of vibrations are cumulative over periods of time and can be particularly dangerous in brittle materials such as clayey sand or gravel.
- **Ground Water Seepage.** Improperly dewatered trenches in granular soils can result in quick conditions and a complete loss of soil strength or bottom heave. (See UFC 3-220-10N.)
- **Surface Water Flow.** This can result in increased loads on the wall support system and reduction of the shear strength of the soil. Site

drainage should be designed to divert water away from trenches.

TABLE 8-1.1
Factors Controlling Stability of Sloped Cut in Some Problem Soils

SOIL TYPE	PRIMARY CONSIDERATIONS FOR SLOPE DESIGN
Stiff-fissured Clays and Shales	Field shear resistance may be less than suggested by laboratory tests. Slope failures may occur progressively and shear strengths reduced to residual values compatible with relatively large deformations. Some case histories suggest that the long-term performance is controlled by the residual friction angle which for some shales may be as low as 12 degrees. The most reliable design procedure would involve the use of local experience and recorded observations.
Loess and Other Collapsible Soils	Strong potential for collapse and erosion of relatively dry material upon wetting. Slopes in loess are frequently more stable when cut vertical to prevent infiltration. Benches at intervals can be used to reduce effective slope angles. Evaluate potential for collapse as described in UFC 3-220-10N.
Residual Soils	Significant local variations in properties can be expected depending on the weathering profile from parent rock. Guidance based on recorded observation provides prudent basis for design.
Sensitive Clays	Considerable loss of strength upon remolding generated by natural or man-made disturbance. Use analyses based on unconsolidated undrained tests or field vane tests.
Talus	Talus is characterized by loose aggregation of rock that accumulates at the foot of rock cliffs. Stable slopes are commonly between 1-1/4 to 1-3/4 horizontal to 1 vertical. Instability is associated with abundance of water, mostly when snow is melting.
Loose Sands	May settle under blasting vibration, or liquify, settle, and lose strength if saturated. Also prone to erosion and piping.

TABLE 8-1.2
Factors Controlling Excavation Stability

Construction Activity	Objectives	Comments
Dewatering	To prevent boiling, softening, or heave in excavation bottom, reduce lateral pressures on sheeting, reduce seepage pressures on face of open cut, and eliminate piping of fines through sheeting.	Investigate soil compressibility and effect of dewatering on settlement of nearby structures; consider recharging or slurry wall cutoff. Examine for presence of lower aquifer and need to dewater. Install piezometer if needed. Consider effects of dewatering in cavity-laden limestone. Dewater in advance of excavation.
Excavation and Grading	Pipe trenching, basement excavation, site grading.	Analyze safe slopes (see UFC 3-220-10N) or bracing requirement (see Chapter 3), effects of stress reduction on over-consolidated, soft or swelling soils and shales. Consider horizontal and vertical movements in adjacent areas due to excavation and effect on nearby structures. Keep equipment and stockpiles a safe distance from top of excavation.
Excavation Wall Construction	To support vertical excavation walls, to stabilize trenching in limited space.	See Chapter 6 for wall design. Reduce earth movements and bracing stresses, where necessary, by installing lagging on front flange of soldier pile. Consider effect of vibrations due to driving sheet piles or soldier piles. Consider dewatering requirements as well as wall stability in calculating sheeting depth. Movement monitoring may be warranted.
Dewatering	To prevent boiling, softening, or heave in excavation bottom, reduce lateral pressures on sheeting, reduce seepage pressures on face of open cut, and eliminate piping of fines through sheeting.	Investigate soil compressibility and effect of dewatering on settlement of nearby structures; consider recharging or slurry wall cutoff. Examine for presence of lower aquifer and need to dewater. Install piezometer if needed. Consider effects of dewatering in cavity-laden limestone. Dewater in advance of excavation.

TABLE 8-1.2
Factors Controlling Excavation Stability

Construction Activity	Objectives	Comments
Excavation and Grading	Pipe trenching, basement excavation, site grading.	Analyze safe slopes (see UFC3-220-10N) or bracing requirement (see Chapter 8-1.3), effects of stress reduction on over consolidated, soft or swelling soils and shales. Consider horizontal and vertical movements in adjacent areas due to excavation and effect on nearby structures. Keep equipment and stockpiles a safe distance from top of excavation.
Excavation Wall Construction	To support vertical excavation walls, to stabilize trenching in limited space.	See Chapter 6 for wall design. Reduce earth movements and bracing stresses, where necessary, by installing lagging on front flange of soldier pile. Consider effect of vibrations due to driving sheet piles or soldier piles. Consider dewatering requirements as well as wall stability in calculating sheeting depth. Movement monitoring may be warranted.
Blasting	To remove or to facilitate the removal of rock in the excavation.	Consider effect of vibrations on settlement or damage to adjacent areas. Design and monitor or require the contractor to design and monitor blasting in critical areas; require a pre construction survey of nearby structures.
Anchor or Strut Installation, Wedging of Struts, Pre-stressing Ties	To obtain support system stiffness and interaction.	Major excavations require careful installation and monitoring, e.g., case anchor holes in collapsible soils; measure stress in ties and struts; wedging, etc.

8-1.3.3
follows:

Support Systems. Excavation support systems commonly used are as

- Trench Shield. A rigid prefabricated steel unit used in lieu of shoring, which extends from the bottom of the excavation to within a few feet of the top of the cut. Pipes are laid within the shield, which is pulled ahead, as trenching proceeds, as illustrated in Figure 8-1.1 (from “Cave-In!” by Petersen). Typically, this system is useful in loose granular or soft cohesive soils where excavation depth does not exceed 3.5 m (12 ft). Special shields have been used to depths of 9 m (30 ft).
- Trench Timber Shoring. Table 8-1.3 illustrates the Occupational Safety and Health Act's minimum requirements for trench shoring. Braces and shoring of trench are carried along with the excavation. Braces and diagonal shores of timber should not be subjected to compressive stresses in excess of:
$$S = 1300 - 20 L/D$$

where:
L = unsupported length (mm or inches)
D = least side of the timber (mm or inches)
S = allowable compressive stress in kilograms per square cm (pounds per square inch) of cross section
Maximum Ratio L/D = 50
* Note: L/D units need to be consistent
- Skeleton Shoring. Used in soils where cave-ins are expected. Applicable to most soils to depth up to 9.1 m (20 ft). See Figure 8-1.2 (from “Cave-In”) for illustration and guidance for skeleton shoring. Structural components should be designed to safely withstand earth pressures.
- Close (Tight) Sheet piling. Used in granular or other running soils, compared to skeleton shoring, it is applicable to greater depths. See illustration in Figure 8-1.3 (from “Cave-In”)
- Box Shoring. Applicable to trenching in any soil. Depth limited by structural strength and size of timber. Usually limited to 18.2 m (40 ft). See illustration in Figure 8-1.4 (from “Cave-In”)
- Telescopic Shoring. Used for excessively deep trenches. See illustration in Figure 8-1.5 (“Cave-In”).
- Steel Sheet piling and Bracing. Steel sheet piling and bracing can be used in lieu of timber shoring. Structural members should safely withstand water

**Table 8-1.3
OSHA Requirements (Minimum) for Trench Shoring**

Size and Spacing of Members												
Depth of Trench	Kind or Condition of Earth	Uprights		Stringers		Cross Braces ¹					Maximum Spacing	
		Minimum Dimension	Maximum Spacing	Minimum Dimension	Maximum Spacing	Width of Trench (feet)					Vertical	Horizontal
						Up to 3	4 to 6	7 to 9	10 to 12	13 to 15		
Feet		Inches	Feet	Inches	Feet	Inches	Inches	Inches	Inches	Inches	Feet	Feet
5 to 10	Hard, compact	3 x 4 or 2 x 6	6	--	--	2 x 6	4 x 4	4 x 6	6 x 5	6 x 8	4	6
	Likely to crack	3 x 4 or 2 x 6	3	4 x 6	4	2 x 6	4 x 4	4 x 6	6 x 6	6 x 8	4	6
	Soft, sandy, or filled	3 x 4 or 2 x 6	Close Sheeting	4 x 6	4	4 x 4	4 x 6	6 x 6	6 x 8	8 x 8	4	6
	Hydrostatic Pressure	3 x 4 or 2 x 6	Close Sheeting	6 x 8	4	4 x 4	4 x 6	6 x 6	6 x 8	8 x 8	4	6
11 to 15	Hard	3 x 4 or 2 x 6	4	4 x 6	4	4 x 4	4 x 6	6 x 6	6 x 8	8 x 8	4	6
	Likely to crack	3 x 4 or 2 x 6	2	4 x 6	4	4 x 4	4 x 6	6 x 6	6 x 8	8 x 8		6
	Soft, sandy or Filled	3 x 4 or 2 x 6	Close Sheeting	4 x 6	4	4 x 6	6 x 6	6 x 8	8 x 8	8 x 10	4	6
	Hydrostatic Pressure	3 x 6	Close Sheeting	8 x 10	4	4 x 6	6 x 6	6 x 8	8 x 8	8 x 10	4	6
16 to 20	All kinds or Conditions	3 x 6	Close Sheeting	4 x 12	4	4 x 12	6 x 8	8 x 8	8 x 10	10 x 10	4	6
Over 20	All kinds or Conditions	3 x 6	Close Sheeting	6 x 8	4	4 x 12	8 x 8	8 x 10	10 x 10	10 x 12	4	

¹ Trench jacks may be used in lieu of, or in combination with, cross braces. Where desirable, steel sheet piling and bracing of equal strength may be substituted for wood.

Figure 8-1.2
Skeleton Shoring

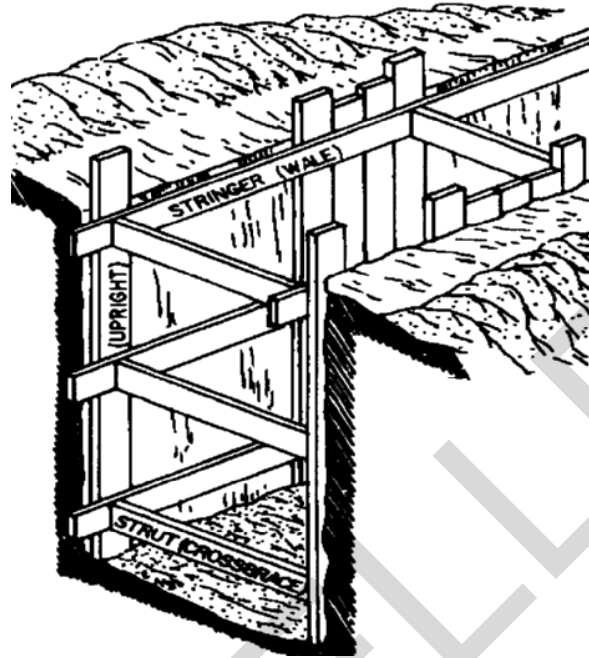

Figure 8-1.3
Close (Tight) Sheeting

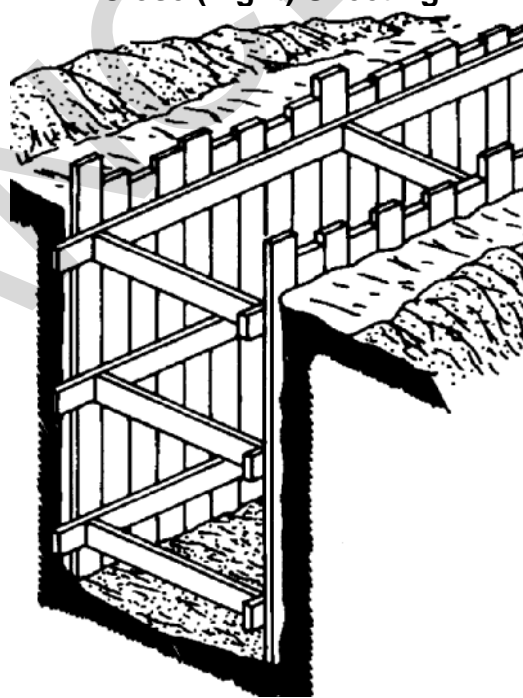

Figure 8-1.4
Box Shoring

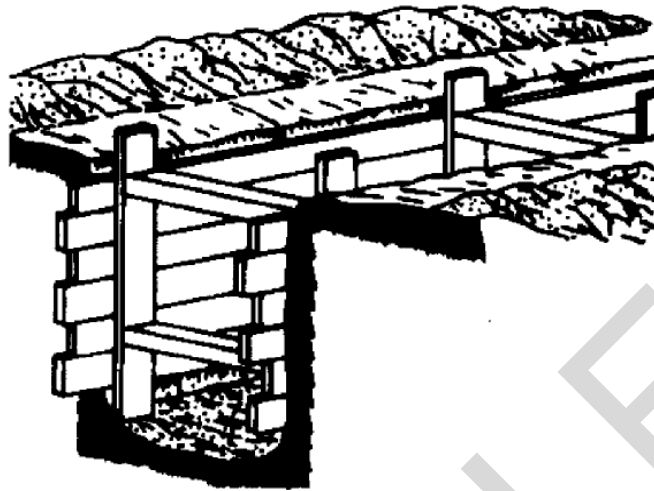
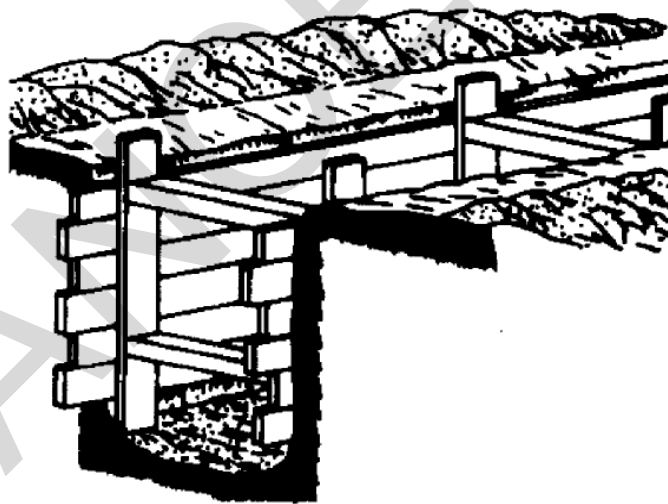

Figure 8-1.5
Telescopic Shoring



8-1.4 ROCK EXCAVATION

8-1.4.1 **Preliminary Considerations.** The primary objective is to conduct work in such a manner that a stable excavation will be maintained and that rock outside the excavation prism will not be adversely disturbed. Rock excavation planning must be based on detailed geological data at the site. To the extent possible, structures to be constructed in rock should be oriented favorably with the geological setting. For example, tunnels should be aligned with axis perpendicular to the strike of faults or major fractures. Downslope dip of discontinuities into an open cut should be avoided.

In general, factors that must be considered in planning, designing and constructing a rock excavation are as follows:

- Presence of strike, dip of faults, folds, fractures, and other discontinuities
- In situ stresses
- Groundwater conditions
- Nature of material filling joints
- Depth and slope of cut
- Stresses and direction of potential sliding; surfaces
- Dynamic loading, if any
- Design life of cut as compared to weathering or deterioration rate of rock face
- Rippability and/or the need for blasting
- Effect of excavation and/or blasting on adjacent structures

The influence of most of these factors on excavations in rock is similar to that of excavations in soil; see UFC 3-220-10N.

FIGURE 8-1.6
General Guidance for Underpinning

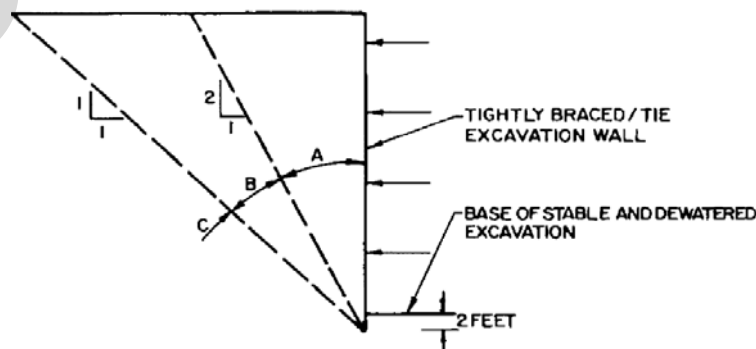

8-1.4.2 **Rippability.** Excavation ease or rippability can be assessed approximately from field observation in similar materials or by using seismic velocity, fracture spacing, or point load strength index. Figure 8-1.7 (from *Handbook of Ripping*, by Caterpillar Tractor Co.) shows an example of charts for heavy-duty ripper performance (ripper mounted on tracked bulldozer) as related to seismic wave velocity. Charts similar to Figure 8-1.8 are available from various equipment manufacturers. Figure 8-1.8 is for guidance and restricted in applicability to large tractors heavier than 50 tons with engine horsepower greater than 350 Hp. Ripper performance is also related to configuration of ripper teeth, equipment condition and size, and fracture orientation.

Another technique of relating physical properties of rock to excavation ease is shown in Figure 8-1.9, (from *Logging the Mechanical Character of Rock*, by Franklin, et al.) Where fracture frequency (or spacing) is plotted against the point load strength index corrected to a reference diameter of 50 mm (see *The Point-Load Strength Test*, by Broch and Franklin).

A third and useful technique is exploration trenching in which the depth of unrippable rock can be established by digging test trenches in rock using rippers (or other excavation equipment) anticipated to be used for the project. The size and shape of the area to be excavated is a significant factor in determining the need for blasting, or the equipment needed to remove the rock.

8-1.4.3 **Blasting.** Of major concern is the influence of the blasting on adjacent structures. The maximum particle velocity (the longitudinal velocity of a particle in the direction of the wave that is generated by the blast) is accepted as a criterion for evaluating the potential for structural damage induced by blasting vibration. The critical level of the particle velocity depends on the frequency characteristics of the structure, frequency of ground and rock motion, nature of the overburden and capability of the structure to withstand dynamic stress. Figure 8-1.9 can be used for estimating the maximum particle velocity, which can then be used in Figure 8-1.10 (from *Blasting Vibrations and Their Effects on Structures*, by Bureau of Mines) to estimate potential damage to residential structures. Guidance for human response to blasting vibrations is given in Figure 8-1.11 (from *Engineering of Rock Blasting on Civil Protects*, by Hendron).

Once it has been determined that blasting is required, a pre-blasting survey should be performed. At a minimum, this should include:

- Examination of the site
- Detailed examination and, perhaps, photographic records of adjacent structures
- Establishment of horizontal and vertical survey control points

- Consideration of vibration monitoring, and monitoring stations and schedules established

During construction, detailed records should be kept of:

- Charge weight
- Location of blast point(s) and distance(s) from existing structures
- Delays
- Response as indicated by vibration monitoring (for safety, small charges should be used initially to establish a site-specific relationship between charge weight, distance, and response)

CANCELLED

FIGURE 8-1.7
Rippability of Subsurface Materials Related to Longitudinal Seismic Velocity for a Heavy Duty Ripper (Tractor-Mounted)

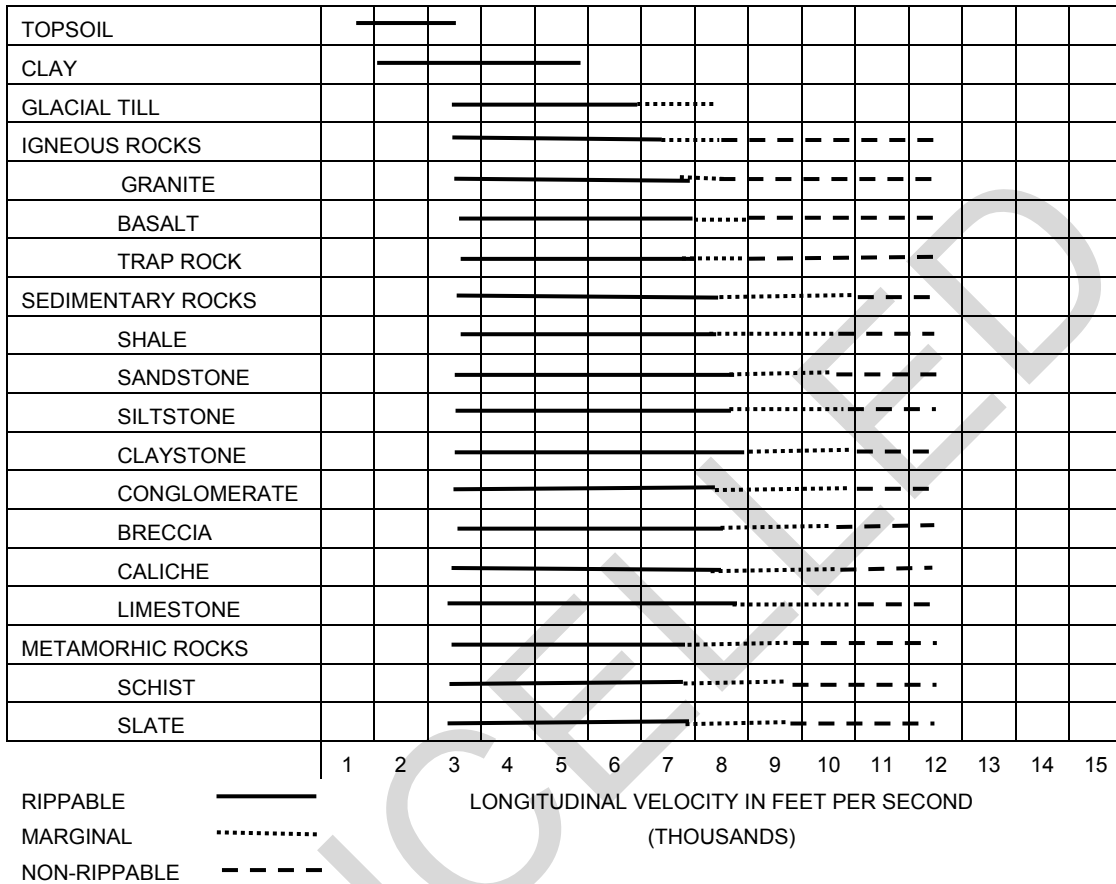

FIGURE 8-1.8
Suggested Guide for Ease of Excavation

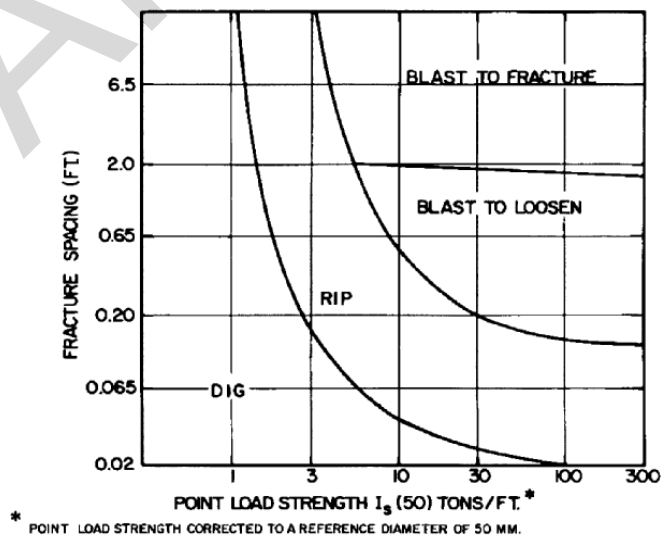
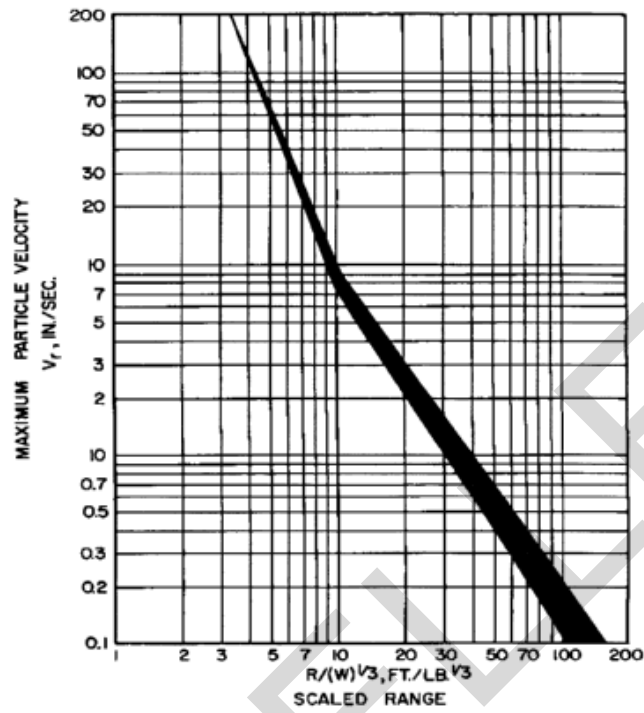

FIGURE 8-1.9
Cube Root Scaling Versus Maximum Particle Velocity



Example: Weight of Explosive Charge: 8 Lbs. = W ; Distance from Blast Point: 100 feet = R
 $R/(W)^{1/3} = 50$; Peak $V_r = 0.5$ in/sec (from chart)

FIGURE 8-1.10
Guideline for Assessing Potential for Damage Induced by Blasting Vibration to Residential Structure Founded on Dense Soil or Rock

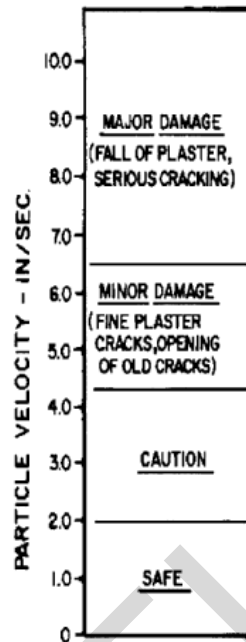
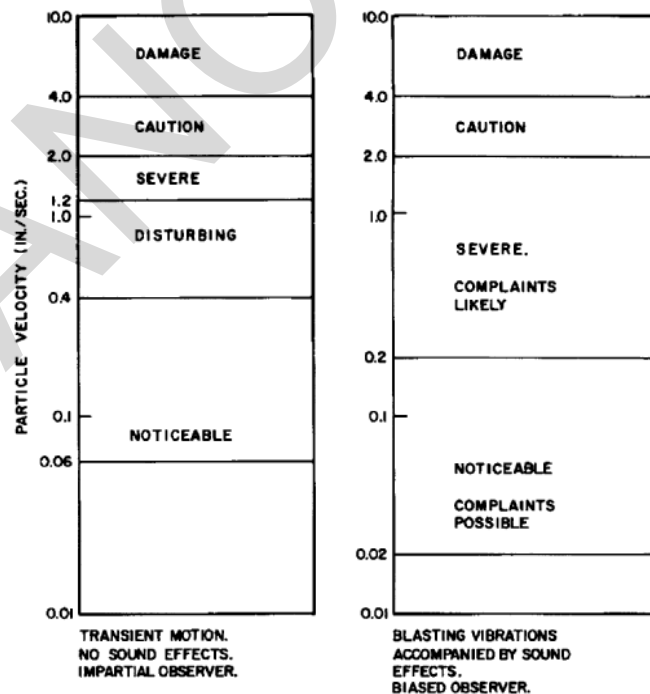

FIGURE 8-1.11
Guide for Predicting Human Response to Vibrations and Blasting Effects



8-1.5 Excavation Stabilization, Monitoring, and Safety

8-1.5.1 **Stabilization.** During the planning and design stage, if analyses indicate potential slope instability, means for slope stabilization or retention should be considered. Some methods for consideration are given in Chapter 6.

On occasion, the complexity of a situation may dictate using very specialized stabilization methods. These may include grouting and injection, ground freezing, deep drainage and stabilization, such as vacuum wells or electro-osmosis, and diaphragm walls.

8-1.5.2 **Monitoring.** During excavation, potential bottom heave, lateral wall or slope movement, and settlement of areas behind the wall or slope should be inspected carefully and monitored if critical. Monitoring can be accomplished by conventional survey techniques, or by more sophisticated means such as heave points, settlement plates, extensometers or inclinometers, and a variety of other devices. See UFC 3-220-10N.

8-1.5.3 **Safety.** Detailed safety requirements vary from project to project. As a guide, safety requirements are specified by OSHA, see Public Law 91-596. A summary of the 1980 requirements follows:

- Banks more than 1.2 m (4 ft) high shall be shored or sloped to the angle of repose where a danger of slides or cave-ins exists as a result of excavation.
- Sides of trenches in unstable or soft material, 1.2 m (4 ft) or more in depth, shall be shored, sheeted, braced, sloped, or otherwise supported by means of sufficient strength to protect the employee working within them.
- Sides of trenches in hard or compact soil, including embankments, shall be shored or otherwise supported when the trench is more than 1.2 m (4 ft) in depth and 2.4 m (8 ft) or more in length. In lieu of shoring, the sides of the trench above the 1.2 m (4 ft) level may be sloped to preclude collapse, but shall not be steeper than a 305 mm (1 ft) rise to each 152 mm (6 in) horizontal. When the outside diameter of a pipe is greater than 1.8 m (6 ft), a bench of 1.2 m (4 ft) minimum shall be provided at the toe of the sloped portion.
- Materials used for sheeting and sheet piling, bracing, shoring, and underpinning shall be in good serviceable condition. Timbers used shall be sound and free from large or loose knots, and shall be designed and installed so as to be effective to the bottom of the excavation.
- Additional precautions by way of shoring and bracing shall be taken to prevent slides or cave-ins when:
 - Excavations or trenches are made in locations adjacent to backfilled excavations; or

- Where excavations are subjected to vibrations from railroad or highway traffic, operation of machinery, or any other source.
- Employees entering bell-bottom pier holes shall be protected by the installation of a removable-type casing of sufficient strength to resist shifting of the surrounding earth. Such temporary protection shall be provided for the full depth of that part of each pier hole that is above the bell. A lifeline, suitable for instant rescue and securely fastened to the shafts, shall be provided. This lifeline shall be individually manned and separate from any line used to remove materials excavated from the bell footing.
- Minimum requirements for trench timbering shall be in accordance with Table 8-1.3.
- Where employees are required to be in trenches 3 ft deep or more, ladders shall be provided which extend from the floor of the trench excavation to at least 3 feet above the top of the excavation. They shall be located to provide means of exit without more than 25 ft of lateral travel.
- Bracing or shoring of trenches shall be carried along with the excavation.
- Cross braces or trench jacks shall be placed in true horizontal position, spaced vertically, and secured to prevent sliding, falling, or kickouts.
- Portable trench boxes or sliding trench shields may be used for the protection of employees only. Trench boxes or shields shall be designed, constructed, and maintained to meet acceptable engineering standards.
- Backfilling and removal of trench supports shall progress together from the bottom of the trench. Jacks or braces shall be released slowly, and in unstable soil, ropes shall be used to pull out the jacks or braces from above after employees have cleared the trench.

8-1.6 Embankment Cross-Section Design

8-1.6.1 **Influence of Material Type.** Table 8-1.4 lists some typical properties of compacted soils that may be used for preliminary analysis. For final analysis engineering property tests are necessary. See Table 8-1.5 for relative desirability of various soil types in earth fill dams, canals, roadways and foundations. Although practically any non-organic insoluble soil may be incorporated in an embankment when modern compaction equipment and control standards are employed, the following soils may be difficult to use economically:

- Fine-grained soils may have insufficient shear strength or excessive compressibility.
- Clays of medium to high plasticity may expand if placed under low confining pressures and/or at low moisture contents. See UFC3-220-10N, for identification of soils susceptible to volume expansion.

- Plastic soils with high natural moisture are difficult to process for proper moisture for compaction
- Stratified soils may require extensive mixing of borrow.

8-1.6.2 **Embankments on Stable Foundation.** The side slopes of fills not subjected to seepage forces ordinarily vary between 1 on 1-1/2 and 1 on 3. The geometry of the slope and berms are governed by requirements for erosion control and maintenance. See *Engineering Manual for Slope Stability Studies* for procedures to calculate stability of embankments.

8-1.6.3 **Embankments on Weak Foundations.** Weak foundation soils may require partial or complete removal, flattening of embankment slopes, or densification. Analyze cross-section stability by methods of UFC 3-220-10N.

8-1.6.4 **Embankment Settlement.** Settlement of an embankment is caused by foundation consolidation, consolidation of the embankment material itself, and secondary compression in the embankment after its completion.

- See UFC 3-220-10N for procedures to decrease foundation settlement or to accelerate consolidation.
- Significant excess pore pressures can develop during construction of fills exceeding about 80 ft in height or for lower fills of plastic materials placed wet of optimum moisture. Dissipation of these excess pore pressures after construction results in settlement. For earth dams and other high fills where settlement is critical, construction pore pressures should be monitored by the methods of UFC 3-220-10N.
- Even for well-compacted embankments, secondary compression and shear strain can cause slight settlements after completion. Normally this is only of significance in high embankments, and can amount to between 0.1 and 0.2 percent of fill height in three to four years or between 0.3 and 0.6 percent in 15 to 20 years. The larger values are for fine-grained plastic soils.

**Table 8-1.4
Typical Properties of Compacted Soils**

Group Symbol	Soil Type	Range of Maximum Dry Unit Weight, gm/cm ³ (lbs/ft ³)	Range of Optimum Moisture, Percent	Typical Value of Compression		Typical Strength Characteristics				Typical Coefficient of Permeability cm/min (ft/min)	Range of CBR Values	Range of Subgrade Modulus k gm/cm ³ (lbs/ft ³)
				At 134 kPa (1.4 tsf)	At 345 kPa (3.6 tsf)	Cohesion (as Compacted) kPa (lb/ft ²)	Cohesion (Saturated) kPa (lb/ft ²)	Effective Stress Envelope Deg	Tan			
GW	Well graded, clean gravel – sand mixtures	2.002 – 2.162 (125 – 135)	11 – 8	0.3	0.6	0	0	>38	>0.79	9 x 10 ⁻² (3 x 10 ⁻²)	40 – 80	8,300 – 13,800 (300 – 500)
GF	Poorly graded, clean gravel – sand mixtures	1.842 – 2.002 (115 – 125)	14 – 11	0.4	0.9	0	0	>37	>0.74	3.0 (10 ⁻¹)	30 – 60	6,900 11,100 (250 – 400)
GM	Silty gravels, poorly graded gravel-sand-silt	1.922 – 2.162 (120 – 135)	12 – 8	0.5	1.1	---	---	>34	>0.67	3 x 10 ⁻⁴ (>10 ⁻⁵)	20 – 60	2,800 – 11,100 (100 – 400)
GC	Clayey gravels, poorly graded gravel-sand-silt	1.842 – 2.082 (115 – 130)	14 – 9	0.7	1.6	---	---	>31	>0.60	3 x 10 ⁻⁶ (>10 ⁻⁷)	20 – 40	2,800 – 8,300 (100 – 300)

**Table 8-1.4
Typical Properties of Compacted Soils**

Group Symbol	Soil Type	Range of Maximum Dry Unit Weight, gm/cm ³ (lbs/ft ³)	Range of Optimum Moisture, Percent	Typical Value of Compression		Typical Strength Characteristics				Typical Coefficient of Permeability cm/min (ft/min)	Range of CBR Values	Range of Subgrade Modulus k gm/cm ³ (lbs/ft ³)
				At 134 kPa (1.4 tsf)	At 345 kPa (3.6 tsf)	Cohesion (as Compacted) kPa (lb/ft ²)	Cohesion (Saturated) kPa (lb/ft ²)	Effective Stress Envelope Deg	Tan			
ML	Well graded clean sands, gravelly sands	1.762 – 2.082 (110 – 130)	16 – 9	0.6	1.2	0	0	38	0.39	3 x 10 ⁻² (>10 ⁻³)	20 – 40	5,500 – 8,300 (200 – 300)
ML - CL	Poorly graded clean sands, sand gravel mix	1.602 – 1.922 (100 – 120)	21 – 12	1.0	2.2	65 (1350)	22 (460)	32	0.52	1.5 x 10 ⁻⁵ (>5 x 10 ⁻⁷)	***	***

**Table 8-1.4
Typical Properties of Compacted Soils**

Group Symbol	Soil Type	Range of Maximum Dry Unit Weight, gm/cm ³ (lbs/ft ³)	Range of Optimum Moisture, Percent	Typical Value of Compression		Typical Strength Characteristics				Typical Coefficient of Permeability cm/min (ft/min)	Range of CBR Values	Range of Subgrade Modulus k gm/cm ³ (lbs/ft ³)
				At 134 kPa (1.4 tsf)	At 345 kPa (3.6 tsf)	Cohesion (as Compacted) kPa (lb/ft ²)	Cohesion (Saturated) kPa (lb/ft ²)	Effective Stress Envelope Deg	Tan			
SW	Well graded clean sands, gravelly sands	1.762 – 2.082 (110 – 130)	16 – 9	0.6	1.2	0	0	38	0.79	3 x 10 ⁻² (>10 ⁻³)	20 – 40	5,500 – 8,300 (200 – 300)
SP	Poorly graded clean sands, sand gravel mix	1.602 – 1.922 (100 – 120)	21 – 12	0.8	1.4	0	0	37	0.74	3 x 10 ⁻² (>10 ⁻³)	10 – 40	5,500 – 8,300 (200 – 300)
SM	Silty soils, poorly graded sand-silt mix	1.762 – 2.002 (110 – 125)	16 – 11	0.8	1.6	50 (1050)	20 (420)	34	0.67	1.5 x 10 ⁻³ (>5 x 10 ⁻⁵)	10 – 40	5,500 – 8,300 (200 – 300)
SM – SC	Sand-silt clay mix with slightly plastic fines	1.762 – 2.082 (110-130)	15 – 11	0.8	1.4	50 (1050)	14 (300)	33	0.68	>6 x 10 ⁻⁵ (>2 x 10 ⁻⁶)	5-30	2,800 – 8,300 (100-300)

**Table 8-1.4
Typical Properties of Compacted Soils**

Group Symbol	Soil Type	Range of Maximum Dry Unit Weight, gm/cm ³ (lbs/ft ³)	Range of Optimum Moisture, Percent	Typical Value of Compression		Typical Strength Characteristics				Typical Coefficient of Permeability cm/min (ft/min)	Range of CBR Values	Range of Subgrade Modulus k gm/cm ³ (lbs/ft ³)
				At 134 kPa (1.4 tsf)	At 345 kPa (3.6 tsf)	Cohesion (as Compacted) kPa (lb/ft ²)	Cohesion (Saturated) kPa (lb/ft ²)	Effective Stress Envelope Deg	Tan			
SC	Clay like sands, poorly graded sand/ clay mix.	-2.002 (105-125)	19-11	1.1	2.2	74 (1550)	11 (230)	31	0.60	>2 x 10 ⁻⁷ (>2 x 10 ⁻⁷)	5-20	2,800 – 8,300 (100-300)
CL	Inorganic clays of low to medium plasticity	1.922 (95-120)	24-12	1.3	2.5	86 (1800)	13 (270)	28	0.54	>3 x 10 ⁻⁶ (>10 ⁻⁷)	15 or less	1,400 – 5,500 (50-200)
OL	Organic silts and silt clays low plasticity	80-100	33-21	***	***	****	*****	***	***	***	5 or less	1,400 – 2,800 (50-100)

**Table 8-1.4
Typical Properties of Compacted Soils**

Group Symbol	Soil Type	Range of Maximum Dry Unit Weight, gm/cm ³ (lbs/ft ³)	Range of Optimum Moisture, Percent	Typical Value of Compression		Typical Strength Characteristics				Typical Coefficient of Permeability cm/min (ft/min)	Range of CBR Values	Range of Subgrade Modulus k gm/cm ³ (lbs/ft ³)
				At 134 kPa (1.4 tsf)	At 345 kPa (3.6 tsf)	Cohesion (as Compacted) kPa (lb/ft ²)	Cohesion (Saturated) kPa (lb/ft ²)	Effective Stress Envelope Deg	Tan			
MH	Inorganic clay silts/el-astic silt	1.121 - 1.522 (70-95)	40-24	2.0	3.8	73 (1500)	20 (420)	25	0.47	>1.5 x 10 ⁻⁵ (>5 x 10 ⁻⁷)	10 or less	1,400 – 2,800 (50-100)
CH	Inorganic clays of high plasticity	1.201 – 1.682 (75-105)	36-19	2.6	3.9	342 (7150)	11 (230)	19	0.35	>3 x 10 ⁻⁶ (>10 ⁻⁷)	15 or less	700 – 3,500 (50-150)
OH	Organic & silty clays	1.041 – 1.602 (65-100)	45-21	***	***	*****	*****	****	****	****	5 or less	350 – 2800 (25-100)

Notes:

1. All properties are for conditions of "Standard Proctor" maximum density, except volume of "k" and CBR which are for "Modified Proctor" maximum density.
2. Typical strength characteristics are for effective envelopes and are obtained USBR data.
3. Compression values are for vertical loading with complete lateral containment.
4. (>) indicates that typical property is greater than the value shown. Asterisks (*) indicate insufficient data available for an estimate.

Table 8-1.5
Relative Desirability of Soils as Compacted Fill

Group Symbol	Soil Type	Relative Desirability for Various Uses									
		Rolled Earth Fill Dams			Canal Sections		Foundations		Roadways		
		Homogeneous Embankment	Core	Shell	Erosion Resistance	Compacted Earth Lining	Seepage Important	Seepage Not Important	Fills		Surfacing
								Frost Heave Not Possible	Frost Heave Possible		
GW	Well graded gravels, gravel-sand mixture, little or fines	-	-	1	1	-	-	1	1	1	3
GF	Poorly graded gravels, gravel-sand mixture, little or no fines	-	-	2	2	-	-	3	3	3	-
GM	Silty gravels, poorly graded gravel-sand-silt mixtures	2	4	-	4	4	1	4	4	9	5
GC	Clayey gravels, poorly graded gravel-sand-clay mixtures	1	1	-	3	1	2	6	5	5	1
SW	Well graded sands, gravel like sands, little or no fines	-	-	3 if gravelly	6	-	-	2	2	2	4
SP	Poorly graded sands, gravel like sands, little or no fines	-	-	4 if gravelly	7 if gravelly	-	-	5	6	4	-
SM	Silty sands, poorly graded sand-silt mixtures	4	5	-	8 if gravelly	5 erosion critical	3	7	6	10	6
SC	Clay like sands, poorly graded sand-clay mixtures	3	2	-	5	2	4	8	7	6	2

**Table 8-1.5
Relative Desirability of Soils as Compacted Fill**

Group Symbol	Soil Type	Relative Desirability for Various Uses									
		Rolled Earth Fill Dams			Canal Sections		Foundations		Roadways		
		Homogeneous Embankment	Core	Shell	Erosion Resistance	Compacted Earth Lining	Seepage Important	Seepage Not Important	Fills		Surfacing
Frost Heave Not Possible	Frost Heave Possible										
ML	Inorganic silts and very fine sands. Rock flour, silty or clayey fine sands with slight plasticity.	6	6	-	-	6 Erosion critical	6	9	10	11	-
CL	Inorganic clays of low to medium plasticity, gravelly clays, sandy clays, silty clays, lean clays.	5	3	-	9	3	5	10	9	7	7
OL	Organic silts and organic silts-clays of low plasticity	8	8	-	-	7 Erosion critical	7	11	11	12	-
MH	Inorganic silts, micaceous or diatomaceous fine sandy or silty soils, elastic silts.	9	9	-	-	-	8	12	12	13	-
CH	Inorganic clays of high plasticity, fat clays	7	7	-	10	8 volume change critical	9	13	13	8	-
OH	Organic clays of medium high plasticity	10	10	-	-	-	10	14	14	14	-

(-) indicates not appropriate for this type of use.

8-1.6.5 **Earth Dam Embankments.** Evaluate stability at three critical stages: the end of construction stage, steady state seepage stage, and rapid drawdown stage. See UFC 3-220-10N for pore pressure distribution at these stages. Seismic forces must be included in the evaluation. Requirements for seepage cutoff and stability dictate design of cross section and utilization of borrow materials.

8-1.6.5.1 **Seepage Control.** Normally the earthwork of an earth dam is zoned with the least pervious, fine-grained soils in the central zone and coarsest, most stable material in the shell. Analyze seepage by the methods of UFC 3-220-10N.

- Consider the practicability of a positive cutoff trench extending to impervious strata beneath the embankment and into the abutments.
- For a properly designed and constructed zoned earth dam, there is little danger from seepage through the embankment. Drainage design generally is dictated by necessity for intercepting seepage through the foundation or abutments. Downstream seepage conditions are more critical for homogeneous fills. See UFC 3-220-10N for drainage and filter requirements.

8-1.6.5.2 **Piping and Cracking.** A great danger to earth dams, particularly those of zoned construction, is the threat of cracking and piping. Serious cracking may result from tension zones caused by differences in stress-strain properties of zoned material. See Figure 1 (*Influence of Soil Properties and Construction Methods on the Performance of Homogeneous Earth Dams*) for classification of materials according to resistance to piping or cracking. Analyze the embankment section for potential tension zone development. Place an internal drainage layer immediately downstream of the core to control seepage from possible cracking if foundation settlements are expected to be high.

8-1.6.5.3 **Dispersive soil.** Dispersive clays should not be used in dam embankments. Determine the dispersion potential using Table 8-1.6. A hole through a dispersive clay will increase in size as water flows through (due to the breakdown of the soil structure), whereas the size of a hole in a non-dispersive clay would remain essentially constant. Therefore, dams constructed with dispersive clays are extremely susceptible to piping.

FIGURE 8-1.12
Resistance of Earth Dam. Embankment Materials To Piping and Cracking

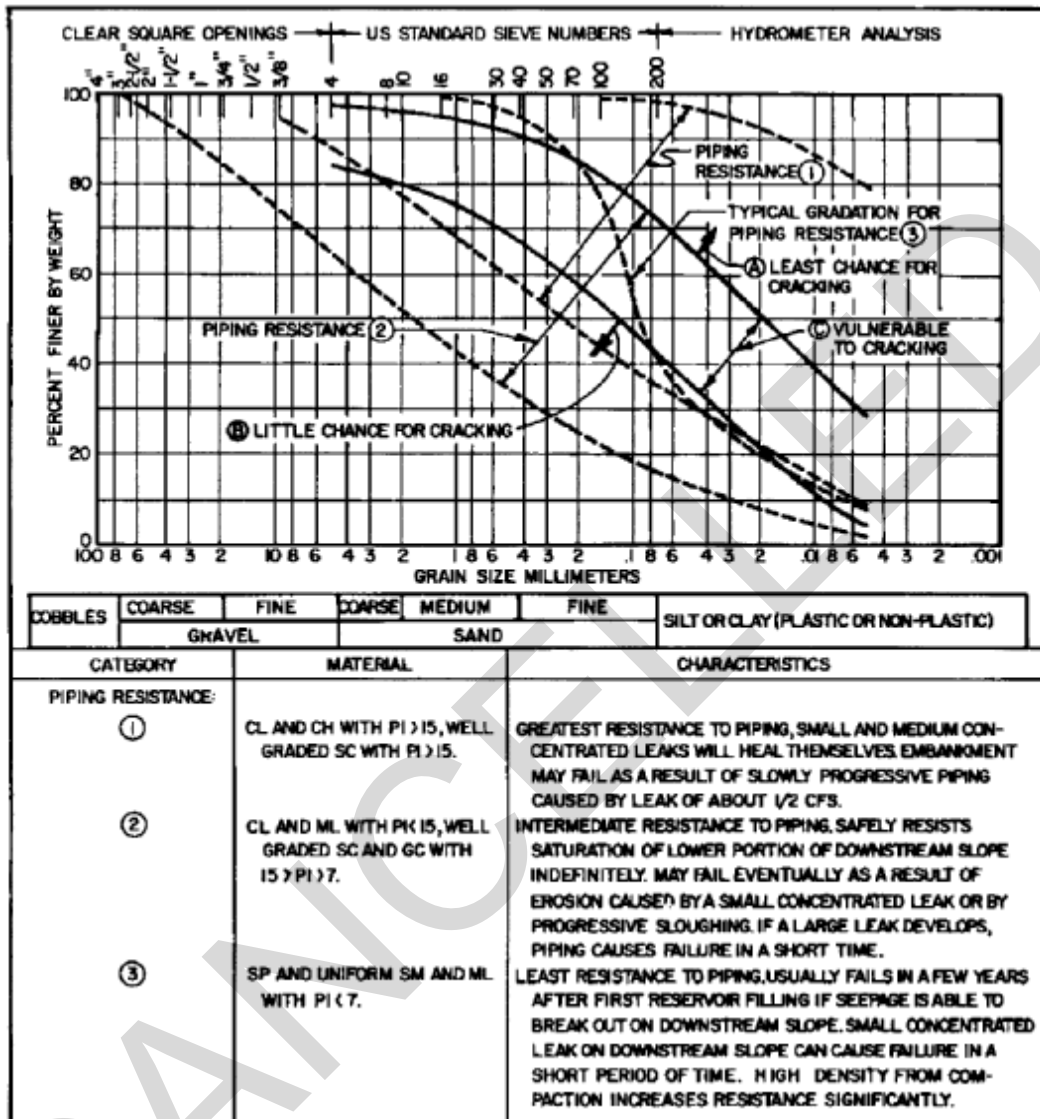

FIGURE 8-1.12 (continued)
Resistance of Earth Dam Embankment Materials To Piping and Cracking

CATEGORY	MATERIAL	CHARACTERISTICS
CRACKING RESISTANCE		
(A)	CH WITH $D_{50} < 0.02$ MM AND $P_1 > 20$	HIGH POSTCONSTRUCTION SETTLEMENT, PARTICULARLY IF COMPACTED DRY. HAS SUFFICIENT DEFORMABILITY TO UNDERGO LARGE SHEAR STRAINS FROM DIFFERENTIAL SETTLEMENT WITHOUT CRACKING.
(B)	GC, SC, SM, SP WITH $D_{50} > 0.15$ MM	SMALL POSTCONSTRUCTION SETTLEMENT. LITTLE CHANCE FOR CRACKING UNLESS POORLY COMPACTED AND LARGE SETTLEMENT IS IMPOSED ON EMBANKMENT BY CONSOLIDATION OF THE FOUNDATION.
(C)	CL, ML AND SM WITH $P_1 < 20$, 0.15 MM $> D_{50} > 0.02$ MM.	MEDIUM TO HIGH POSTCONSTRUCTION SETTLEMENT AND VULNERABLE TO CRACKING. SHOULD BE COMPACTED AS WET AS POSSIBLE CONSISTENT WITH STRENGTH REQUIREMENTS.

CANCELLED

Table 8-1.6
Clay Dispersion Potential

*Percent Dispersion	Dispersive Tendency
Over 40	Highly Dispersive (do not use)
15 to 40	Moderately Dispersive
0 to 15	Resistant to Dispersion

*The ratio between the fraction finer than 0.005 mm in a soil-water suspension that has been subjected to a minimum of mechanical agitation, and the total fraction finer than 0.005 mm determined from a regular hydrometer test x 100.

CANCELLED

8-1.7 **Borrow Excavation**

8-1.7.1 **Borrow Pit Exploration.** Make exploratory investigations to determine the suitable sources of borrow material. Laboratory tests to determine the suitability of available materials include natural water contents, compaction characteristics, grain-size distribution, Atterberg limits, shear strength, and consolidation. Typical properties of compacted materials for use in preliminary analyses are given in Table 8-1.4. The susceptibility to frost action also should be considered in analyzing the potential behavior of fill material. The scope of laboratory testing on compacted samples depends on the size and cost of the structure, thickness and extent of the fill, and also strength and compressibility of underlying soils. Coarse-grained soils are preferred for fill; however, most fine-grained soils can be used advantageously if attention is given to drainage, compaction requirements, compaction moisture, and density control.

The number and spacing of borings or test pits for borrow exploration must be sufficient to determine the approximate quantity and quality of construction materials within an economical haul distance from the project. For mass earthwork, initial exploration should be on a 61 meters (200 foot) grid. If variable conditions are found during the initial explorations, perform intermediate borings or test pits. Explorations should develop the following information:

- A reasonably accurate subsurface profile to the anticipated depth of excavation
- Engineering properties of each material considered for use
- Approximate volume of each material considered for use
- Water level
- Presence of salts, gypsums, or undesirable minerals
- Extent of organic or contaminated soils, if encountered

8-1.7.2 **Excavation Methods.** Consider the following when determining excavation methods:

- Design and efficiency of excavation equipment improves each year. Check various construction industry publications for specifications.
- Determine rippability of soil or rock by borings (RQD and core recovery, see UFC 3-220-10N), geophysical exploration, and/or trial excavation.

8-1.7.3 **Utilization of Excavated Materials.** In the process of earthmoving there may be a reduction of the volume ("shrinkage") because of waste and densification, or an increase of volume ("swell") in the case of rock or dense soils, because the final density is less than its original density.

Determine total borrow volume, V_B , required for compacted fill as follows:

$$V_B = \left(\frac{\gamma_F}{\gamma_B} \cdot V_F \right) + \frac{W_L}{\gamma_B}$$

where: γ_F = dry unit weight of fill

γ_B = dry unit weight of borrow

V_F = required fill volume

W_L = weight lost in stripping, waste, oversize and transportation

The volume of borrow soil required should be increased according to the volume change indicated above. A "shrinkage" factor of 10 to 15 percent may be used for estimating purposes. Note that a large percentage of cobble size material will increase the waste, because sizes larger than 3 inches are generally excluded from compacted fill.

Note the following for Rock Fill:

- Maximum expansion ("swell") from in-situ conditions occurs in dense, hard rock with fine fracture systems that breaks into uniform sizes. Unit volume in a quarry will produce approximately 1.5 volumes in fill.
- Minimum expansion occurs in porous, friable rock that breaks into broadly graded sizes with numerous spalls and fines. Unit volume in quarry will produce approximately 1.1 volumes in fill.

8-2 FILL

8-2.1 **Types of Fill.** Fills include conventional compacted fills; hydraulic fills; and uncontrolled fills of soils or industrial and domestic wastes, such as ashes, slag, chemical wastes, building rubble, and refuse. Properly placed compacted fill will be more rigid and uniform and have greater strength than most natural soils. Hydraulic fills may be compacted or uncompacted and are an economical means of providing fill over large areas. Except when cohesionless materials, i.e., clean sands and gravels, are placed under controlled conditions so silty pockets are avoided and are compacted as they are placed, hydraulic fills will generally require some type of stabilization to ensure adequate foundations.

Uncontrolled fills are likely to provide a variable bearing capacity and result in a non-uniform settlement. They may contain injurious chemicals and, in some instances, may be chemically active and generate gases that must be conducted away from the structure. Subject foundations on fills of the second and third groups (and the first group if not adequately compacted) to detailed investigations to determine their

suitability for supporting a structure, or else they should be avoided. Unsuitable fills often can be adequately stabilized.

8-2.2 Foundations on Compacted Fills

8-2.2.1 Compacted Fill Beneath Foundations. Compacted fills are used beneath foundations where it is necessary to raise the grade of the structure above existing ground or to replace unsatisfactory surface soils. Fills constructed above the natural ground surface increase the load on underlying soils, causing larger settlements unless construction of the structure is postponed until fill induced settlements have taken place. Settlements beneath a proposed fill can be computed using methods outlined in Chapter 4. If computed settlements are excessive, consider surcharging and postponing construction until the expected settlement under the permanent fill loading has occurred. Extend the fill well beyond the loading area, except where the fill is placed against a cut slope. Where the fill is relatively thick and is underlain by soft materials, check its stability with respect to deep sliding. If the fill is underlain by weaker materials, found the footings on the fill unless settlement is excessive. If the fill is underlain by a stronger material, the footings may be founded on the fill or on the stronger material.

8-2.2.2 Foundations Partially on Fill. Where a sloping ground surface or variable foundation depths would result in supporting a foundation partially on a natural soil, or rock, and partially on compacted fill, settlement analyses are required to estimate differential settlements. In general, a vertical joint in the structure should be provided, with suitable architectural treatment, at the juncture between the different segments of foundations. The subgrade beneath the portions of foundations to be supported on natural soils or rock should be undercut about 1 meters (3 feet) and replaced by compacted fill that is placed at the same time as the fill for the portions to be supported on thicker compacted fill.

8-2.2.3 Design of Foundations on Fill. Foundations can be designed on the basis of bearing capacity and settlement calculations described in Chapter 10. The settlement and bearing capacity of underlying foundation soils also should be evaluated. Practically all types of construction can be founded on compacted fills, provided the structure is designed to tolerate anticipated settlements and the fill is properly placed and compacted. Good and continuous field inspection is essential.

8-2.2.4 Site Preparation. The site should be prepared by clearing and grubbing all grass, trees, shrubs, etc. Save as many trees as possible for environmental considerations. Strip and stockpile the topsoil for later landscaping of fill and borrow areas. Placing and compacting fills should preferably be done when the area is still unobstructed by footings or other construction. The adequacy of compacted fills for supporting structures is dependent chiefly on the uniformity of the compaction effort. Compaction equipment generally can be used economically and efficiently only on large areas. Adverse weather conditions may have a pronounced effect on the cost of compacted fills that are sensitive to placement moisture content, e.g., on materials

having more than 10 to 20 percent finer than the No. 200 sieve, depending on gradation.

8-2.2.5 Site Problems. Small building areas or congested areas where many small buildings or utility lines surround the site present difficulties in regard to maneuvering large compaction equipment. Backfilling adjacent to structures also presents difficulties, and power handtamping equipment must be employed, with considerable care necessary to secure uniform compaction. Procedures for backfilling around structures are discussed in this Chapter.

8-2.3 Compaction Requirements

8-2.3.1 General. Guidelines for selecting compaction equipment and for establishing compaction requirements for various soil types are given in table 8-2.1. When fill materials have been thoroughly investigated and there is ample local experience in compacting them, it is preferable to specify details of compaction procedures, such as placement water content, lift thickness, type of equipment, and number of passes. When the source of the fill or the type of compaction equipment is not known beforehand, specifications should be based on the desired compaction result, with a specified minimum number of coverage of suitable equipment to assure uniformity of compacted densities.

8-2.3.2 Compaction Specifications. For most projects, the placement water content of soils sensitive to compaction moisture should be within the range of - 1 to + 2 percent of optimum water content for the field compaction effort applied. Each layer is compacted to not less than the percentage of maximum density specified in Table 8-2.2. It is generally important to specify a high degree of compaction in fills under structures to minimize settlement and to ensure stability of a structure. In addition to criteria set forth in Chapter 8, consider the following factors in establishing specific requirements:

- The sensitivity of the structure to total and differential settlement as related to structural design is particularly characteristic of structures to be founded partly on fill and partly on natural ground.
- If the ability of normal compaction equipment to produce desired densities in existing or locally available materials within a reasonable range of placement water content is considered essential, special equipment should be specified.
- The compaction requirements for clean, cohesionless, granular materials will be generally higher than those for cohesive materials, because cohesionless materials readily consolidate, or liquefy, when subjected to vibration. For structures with unusual stability requirements and settlement limitations, the minimum density requirements indicated in table 15-2 should be increased. For coarse-grained, well-graded, cohesionless soils with less than 4 percent passing the 0.075 Micron (No. 200) sieve, or for poorly graded cohesionless soils with less than 10 percent, the material should be compacted at the highest practical water content, preferably saturated. Compaction by vibratory rollers generally is the most

effective procedure. Experience indicates that pervious materials can be compacted to an average relative density of 85 ± 5 percent with no practical difficulty. For cohesionless materials, stipulate that the fill be compacted to either a minimum density of 85 percent relative density or 95 percent of compaction effort, whichever gives the greater density.

- If it is necessary to use fill material having a tendency to swell, the material should be compacted at water contents somewhat higher than optimum and to no greater density than required for stability under proposed loadings (Table 8-2.1). The bearing capacity and settlement characteristics of the fill under these conditions should be checked by laboratory tests and analysis. Swelling clays can, in some instances, be permanently transformed into soils of lower plasticity and swelling potential by adding a small percentage of hydrated lime (Chapter 16).

8-2.3.3 Compacted Rock. Compacted crushed rock provides an excellent foundation fill. Vibratory rollers are preferable for compacting rock. Settlement of fill under the action of the roller provides the most useful information for determining the proper loose lift thickness, number of passes, roller type, and material gradation. Compaction with an 89 kN (10-ton) vibratory roller is generally preferable. The rock should be kept watered at all times during compaction to obviate collapse settlement on loading and first wetting. As general criteria for construction and control testing of rock fill are not available, test fills should be employed where previous experience is inadequate and for large important rock fills.

8-2.4 Placing And Control Of Backfill. Backfill should be placed in lifts no greater than shown in Table 8-2.1, preferably 200 mm (8 inches) or less and depending on the soil and type of equipment available. No backfill should be placed that contains frozen lumps of soil, as later thawing will produce local soft spots. Do not place backfill on muddy, frozen, or frost-covered ground. Methods of compaction control during construction are described in paragraph 8-3.

8-2.5 Fill Settlements. A fill thickness of even 1 m (3 ft) is a considerable soil load, which will increase stresses to a substantial depth (approximately $2B$, where B = smallest lateral dimension of the fill). Stress increases from the fill may be larger than those from structure footings placed on the fill. Use procedures outlined in chapter 10 to obtain expected settlements caused by fill loading. Many fills are of variable thickness, especially where an area is landscaped via both cutting and filling to obtain a construction site. In similar cases, attention should be given to building locations with respect to crossing cut and fill lines so that the proper type of building settlement can be designed (building may act as a cantilever, or one end tends to break off, or as a beam where the interior sags). Proper placing of reinforcing steel in the wall footings (top for cantilever action or bottom for simple beam action) may help control building cracks where settlement is inevitable; building joints can be provided at critical locations if necessary. The combined effect of structure (one- and two-story residences) and fill loading for fills up to 3 m (10 ft) in thickness on sound soil and using compaction control

should not produce a differential settlement of either a smooth curved hump or sag of 25 mm in 15 m (1 inch in 50 f) or a uniform slope of 50 mm in 15 m (2 inches in 50 ft).

8-2.6 Hydraulic Fills. Hydraulic fills are placed on land or underwater by pumping material through a pipeline from a dredge or by bottom dumping from barges. Dredge materials vary from sands to silts and fine-grained silty clays and clays. Extensive maintenance dredging in the United States has resulted in disposal areas for dredge materials, which are especially attractive from an economic standpoint for development purposes. Dikes are usually required to retain hydraulic fills on land and may be feasible for underwater fills. Underwater dikes may be constructed of large stones and gravel.

8-2.6.1 Pervious Fills. Hydraulically placed pervious fills with less than 10 percent fines will generally be at a relative density of 50 to 60 percent but locally may be lower. Controlled placement is necessary to avoid silt concentrations. Compaction can be used to produce relative densities sufficient for foundation support (Table 8-2.1). Existing uncompacted hydraulic fills of pervious materials in seismic areas are subject to liquefaction, and densification will be required if important structures are to be founded on such deposits. Rough estimates of relative density may be obtained using standard penetration resistance. Undisturbed borings will be required to obtain more precise evaluation of in situ density and to obtain undisturbed samples for cyclic triaxial testing, if required. For new fills, the coarsest materials economically available should be used. Unless special provisions are made for removal of fines, borrow containing more than 10 percent fines passing the 0.075 Micron (No. 200) sieve should be avoided, and even then controlled placement is necessary to avoid local silt concentrations.

8-2.6.2 Fine-Grained Fills. Hydraulically placed overconsolidated clays excavated by suction dredges produce a fill of clay balls if fines in the wash water are permitted to run off. The slope of such fills will be extremely flat ranging from about 12 to 16H on 1V. These fills will undergo large immediate consolidation for about the first 6 months until the clay balls distort to close void spaces. Additional settlements for a one-year period after this time will total about 3 to 5 percent of the fill height.

Maintenance dredgings and hydraulically placed normally consolidated clays will initially be at water contents between 4 and 5 times the liquid limit. Depending on measures taken to induce surface drainage, it will take approximately 2 years before a crust is formed sufficient to support light equipment and the water content of the underlying materials approaches the liquid limit. Placing 305 mm to 1 m (1 to 3 ft) of additional cohesionless borrow can be used to improve these areas rapidly so that they can support surcharge fills, with or without vertical sand drains to accelerate consolidation. After consolidation, substantial one- or two-story buildings and spread foundations can be used without objectionable settlement. Use considerable care in applying the surcharge so that the shear strength of the soil is not exceeded (e.g., use light equipment).

8-2.6.3 **Settlements of Hydraulic Fills.** If the coefficient of permeability of a hydraulic fill is less than 0.0616 mm/minute (0.0002 ft/minute), the consolidation time for the fill will be long and prediction of the behavior of the completed fill will be difficult. For coarse-grained materials with a larger coefficient of permeability, fill consolidation and strength buildup will be relatively rapid and reasonable strength estimates can be made. Where fill and foundation soils are fine-grained with a low coefficient of permeability, piezometers should be placed both in the fill and in the underlying soil to monitor pore pressure dissipation. It may also be necessary to place settlement plates to monitor the settlement. Depending on the thickness of the fill, settlement plates may be placed both on the underlying soil and within the fill to observe settlement rates and amounts.

8-2.6.4 **Compaction of Hydraulic Fills.** Dike-land hydraulic fills can be compacted as they are placed by use of the following:

- Driving track-type tractors back and forth across the saturated fill. (Relative densities of 70 to 80 percent can be obtained in this manner for cohesionless materials.)
- Other methods such as vibratory rollers, vibro-flotation, terraprobings, and compaction piles. Below water, hydraulic fills can be compacted by use of terraprobings, compaction piles, and blasting.

8-2.6.5 **Underwater Hydraulic Fills.** For structural fill placed on a dredged bottom, remove the fines dispersed in dredging by a final sweeping operation, preferably with suction dredges, before placing the fill. To prevent extremely flat slopes at the edge of a fill, avoid excessive turbulence during dumping of the fill material by placing with clamshell or by shoving off the sides of deck barges. To obtain relatively steep slopes in underwater fill, use mixed sand and gravel. With borrow containing about equal amounts of sand and gravel, underwater slopes as steep as 1V on 2H may be achieved by careful placement. Uncontrolled bottom dumping from barges through great depths of water will spread the fill over a wide area. To confine such fill, provide berms or dikes of the coarsest available material or stone on the fill perimeter.

**Table 8-2.1
A Summary of Densification Methods for Building Foundations**

Soil Group	Soil Types	Degree of Compaction		Fill and Backfill				Deep Foundation Deposits		
				Typical Equipment and Procedures for Compaction				Field Control	Compaction Methods	Field Control
				Equipment	No. of Phases or Coverages	Comp. Lift Thick., mm (in)	Placement Water Content			
Pervious (Free Draining)	GW GP SW SP	Compacted	90 to 95% ASTM D 1557 maximum density 75 to 85% of relative density	Vibratory rollers and compactors	Indefinite	Indefinite	Saturate by flooding	Control samples at intervals to determine degree of compaction or relative density	None available except for near surface (down to approximate depth of five feet) Compaction by equipment and procedure shown at left	
				Rubber tired rollers ^a	2-5 coverages	300 (12)				
				Crawler type tractor ^c	2-5 coverages	130 (5)				
				Power hand tamper ^c	Indefinite	150 (6)				
	Semi compacted	85 to 90% ASTM D 1557 maximum density 65 to 75% of relative density	Rubber tired roller ^a	2-5 coverages	360 (14)	Saturate by flooding	Control samples per above, if needed	Vibroflotation, compaction piles, sand piles, explosives Surface compaction as per above	Undisturbed samples from borings or test pits to determine degree of compaction or relative density	
			Crawler type tractor	1-2 coverages	250 (10)					
			Power hand tamper	Indefinite	200 (8)					
			Controlled routing of construction equipment	Indefinite	200 – 250 (8-10)					

**Table 8-2.1
A Summary of Densification Methods for Building Foundations**

Soil Group	Soil Types	Degree of Compaction		Fill and Backfill				Deep Foundation Deposits		
				Typical Equipment and Procedures for Compaction				Field Control	Compaction Methods	Field Control
				Equipment	No. of Phases or Coverages	Lift Thick., mm (in)	Placement Water Content			
Semi-Impervius and Impervius	GM	Compacted	90 – 95% ASTM D 1557 maximum density	Rubber tired roller (a)	2-5 coverages	200 (8)	Optimum water content based on ASTM D 1557	Control samples at intervals to determine degree of compaction	(A) Surface compaction by equipment and procedures shown @ left is feasible only if material is at proper water content. (B) Densification of soils is controlled by consolidation process: Preload fills* Lowering of groundwater table Drying * Consolidation may be accelerated by means of vertical drains. Field control exercised by observation of pore pressures and surface settlements.	
	GC			Sharpefoot roller (d)	4-8 passes	150 (6)				
	SM			Power hand tamper (c)	Indefinite	100 (4)				
	SC	Semicompacted	85-90% ASTM D 1557 maximum density	Rubber tired roller (a)	2-4 coverages	250 (10)	(A) Optimum water content based on ASTM D 1557.	(A) Control samples as noted above, if needed. (B) Field control exercised by visual inspection of action of compaction equipment.		
	ML			Sharpefoot roller (d)	4-8 passes	200 (8)	(B) Wet side maximum water content at which one material can satisfactorily operate, minimum water content required to bond particles (and not result in voids or honey-combed materials.)			
	CL			Crawler type tractor (b)	3 coverages	150 (6)				
	OL			Power hand tamper (d)	Indefinite	150 (6)				
	OH			Control of construction equipment	Indefinite	150 – 200 (6-8)				
	MH									
	CH									

Note: The above requirements will be adequate in relation to most construction. In special cases where tolerable settlements are unusually small, it may be necessary to employ additional compaction equivalent to 95-100% of CE55 compaction effort. A coverage consists of one application of the wheel of a rubber tired roller of the treads of a crawler type tractor over each point in the area being compacted. For a sharpefoot roller drum over the area being compacted.

- a. Rubber tired rollers having a wheel load between 18,000 and 25,000 lbs. and a tire pressure between 80 and 100 psi.
- b. Crawler type tractors weighing not less than 20,000 lbs and exerting a foot pressure not less than 6 ½ psi.
- c. Power hand tamper weighing more than 100 lbs: pneumatic or operated by gasoline engine.
- d. Sharpefoot rollers having a foot pressure between 250 and 500 psi and tamping 7-10 tamp lengths with a face area between 7 and 16 sq. inches.

Table 8-2.2
Compaction Density as a Percent of ASTM D 1557 Laboratory Test Density

	<u>ASTM D 1557 Maximum Density, in Percentage</u>	
	Cohesive Soils	Cohesionless Soils
<u>Fill/Embankment/Backfill</u>		
Under proposed structures, building Slabs, steps, paved areas	90	95 ^a
Under sidewalks and grassed areas	85	90
<u>Sub-grade</u>		
Under building slabs, steps and Paved areas / top 300 mm (12inches)	90	95
Under sidewalks, top 150 mm (6 inches)	85	90

^a Maybe 85% relative density / whichever is higher

8-3 BACKFILL

8-3.1 **Introduction.** The greatest deficiencies in earthwork operations around deep-seated or subsurface structures occur because of improper backfilling procedures and inadequate construction control during this phase of the work. Therefore, primary emphasis in this section is on backfilling procedures. Design and planning considerations, evaluation and selection of materials, and other phases of earthwork construction are discussed where pertinent to successful backfill operations. Although the information in this section is primarily applicable to backfilling around large and important deep-seated or buried structures, it is also applicable in varying degrees to backfilling operations around all structures, including conduits.

8-3.2 **Planning and Design of Structures and Excavations to Accommodate Backfill Operations.** Many earthwork construction problems can be eliminated or minimized through proper design, thorough planning, and recognition of problem areas effecting backfill operations. Recognition and consideration must be given in planning to design features that will make backfilling operations less difficult to accomplish. Examples of problem areas and how forethought in design and planning can help to eliminate backfill deficiencies are presented in the following paragraphs.

8-3.2.1 **Effect of Excavation And Structural Configuration On Backfill Operations.** Some of the problems encountered in earthwork construction are related to the excavation and the configuration of the structures around which backfill is to be placed. It is the designer's

responsibility to recognize these problems and to take the necessary measures to minimize their impact on the backfill operations.

8-3.2.1.1 **Open Zones.** An open zone is defined as a backfill area of sufficient dimensions to permit the operation of heavy compaction equipment without endangering the integrity of adjacent structures around which compacted backfill operations are conducted. Figure 8-3.1 shows examples of open zones. In these zones where large compaction equipment, can operate, it is generally not too difficult to obtain the desired density if appropriate materials and proper backfill procedures are used. For areas that can be economically compacted by heavy equipment, the designer can avoid problems by including in the design provisions sufficient working space between structures or between excavation slopes and structures to permit access by the heavy compaction equipment. Generally, a working space of at least 3.6 m (12 ft) between structure walls and excavation slope and at least 4.5 m (15 ft) between structures is necessary for heavy equipment to maneuver. In addition to maneuvering room, the designer must also consider any adverse loading caused by the operation of heavy equipment too close to structure walls, as discussed in paragraph 2-3d.

8-3.2.1.2 **Confined zones.** Confined zones are defined as areas where backfill operations are restricted to the use of small mechanical compaction equipment (Fig 8-3.2) either because the working room is limited or because heavy equipment (Fig. 8-3.1) would impose excessive soil pressures that could damage the structure. Most deficiencies in compacted backfill around subsurface structures have occurred in confined zones where required densities are difficult to achieve because of restricted working room and relatively low compaction effort of equipment that is too lightweight. The use of small equipment to achieve required compaction is also more expensive than heavy equipment since thinner lifts are required. However, because small compaction equipment can operate in spaces as narrow as 0.6 m (2 ft) in width, such equipment is necessary to achieve the required densities in some areas of most backfill projects. Therefore, the designer should plan structure and excavation areas to minimize the use of small compaction equipment.

8-3.2.2 **Structure Configuration.** The designer familiar with backfilling operations can avoid many problems associated with difficult to reach confined zones, which are created by structural shapes obstructing the placement and compaction of backfill, by considering the impact of structural shape on backfill operations. In most cases, structural shapes and configurations that facilitate backfill operations can be used without significantly affecting the intended use of the structure.

8-3.2.2.1 **Curved Bottom and Wall Structures.** Areas below the spring line of circular, elliptical, and similar shaped structures are difficult to compact backfill against because compaction equipment cannot get under the spring line. If possible, structures should be designed with continuously curved walls and flat floors such as in an igloo-shaped structure. For structures where a curved bottom is required to satisfy the intended function, it may be advisable for the designer to specify that a template shaped like the bottom of the structure be used to guide the excavation below the spring line so that uniform foundation support will be provided.

8-3.2.2.2 **Complex Structures.** Complex structures have variable shaped walls and complex configurations in plan and number of levels. These structures can also be simple structures interconnected by access shafts, tunnels, and utility conduits. Because of their irregular shapes and configurations the different types of structures significantly increase excavation and backfill problems.

Typical examples of complex structures are stepped multilevel structures and multichambered structures with interconnecting corridors (Figure 8-3.3). Complex structures are generally more difficult to compact backfill around and are more likely to have settlement problems (paragraph 8-3.2.3.1). Although the multilevel step structure (Figure 8-3.3(a)) is not particularly difficult to compact backfill around, at least for the first level, the compaction of backfill over the offset structure will generally require the use small equipment. Small equipment will also be required for compaction of backfill around and over the access corridor and between the two chambers (Figure 8-3.3 (b)). Where possible, the design should accommodate intended functions into structures with uniformly shaped walls and a simple configuration.

Where structures of complex configurations are necessary, construction of a three-dimensional model during the design and planning phases will be extremely beneficial. From the model, designers can more easily foresee and eliminate areas in which it would be difficult to place and compact backfill.

8-3.2.2.3 **Service Conduits.** Since compaction of backfill is difficult around pipes and conduits, group utility lines together or place in a single large conduit where feasible, rather than allow to form a haphazard maze of pipes and conduits in the backfill. Run utility lines either horizontally or vertically wherever possible. Coordinate plans for horizontally run appurtenances, such as utility lines, access tunnels, and blast-delay tubing, with the excavation plans so that wherever feasible these appurtenances can be supported by undisturbed soils rather than by compacted backfill.

Figure 8-3.1 Open Backfill Zone

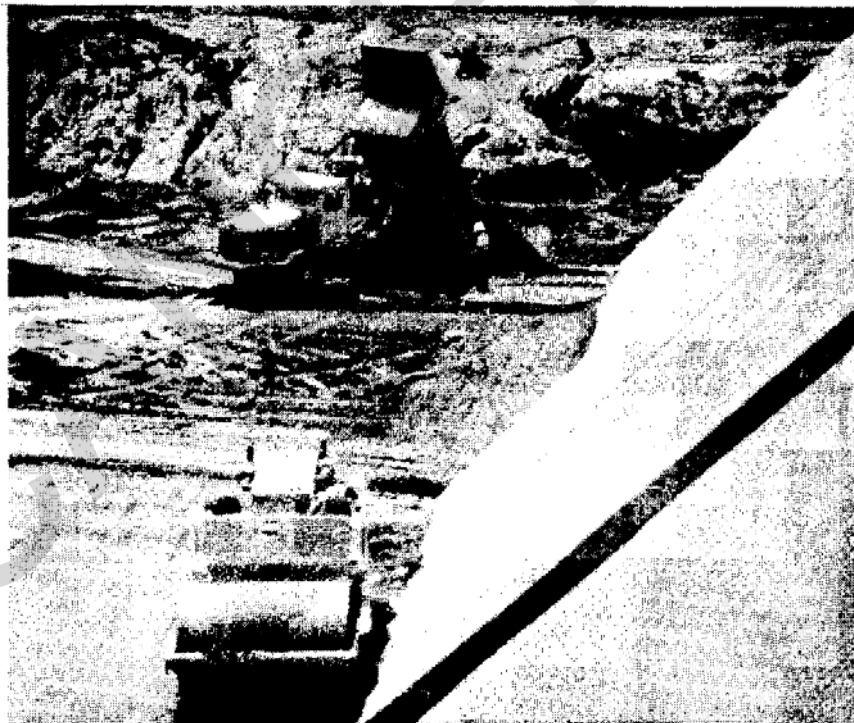
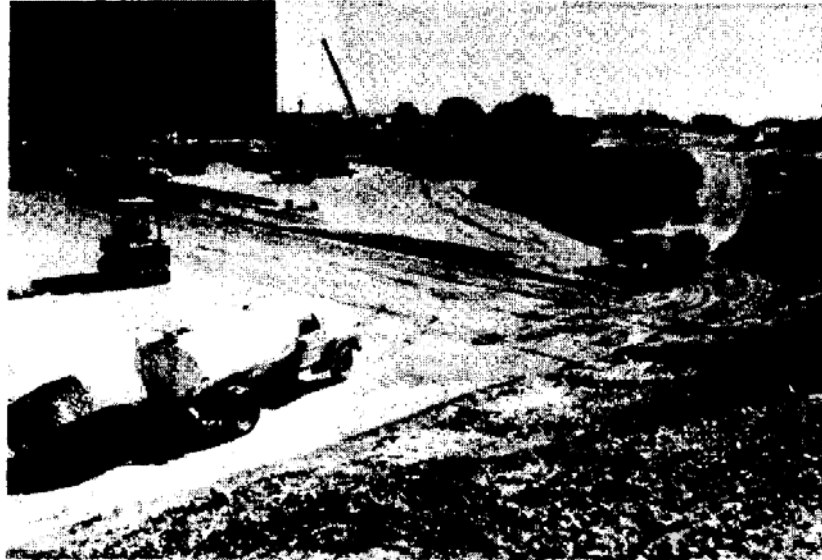

8-3.2.2.4 **Excavation Plans.** Develop excavation plans with the backfill operations and the structure configurations in mind. The excavation and all completed structures within the excavation should be conducive to good backfill construction procedures, and access should be provided to all areas so that compaction equipment best suited to the size of the area can be used. The plans for excavation should also provide for adequate haul roads and ramps. Positive excavation slopes should be required in all types of soil deposits to facilitate compaction of backfill against the slope and to ensure good bond between the backfill and the excavation slopes. Remove loose material from the excavation slopes; in some case, benches may be required to provide a firm surface to compact backfill against.

Figure 8-3.2 Confined Backfill Zones



Figure 8-3.3 Complex Structures

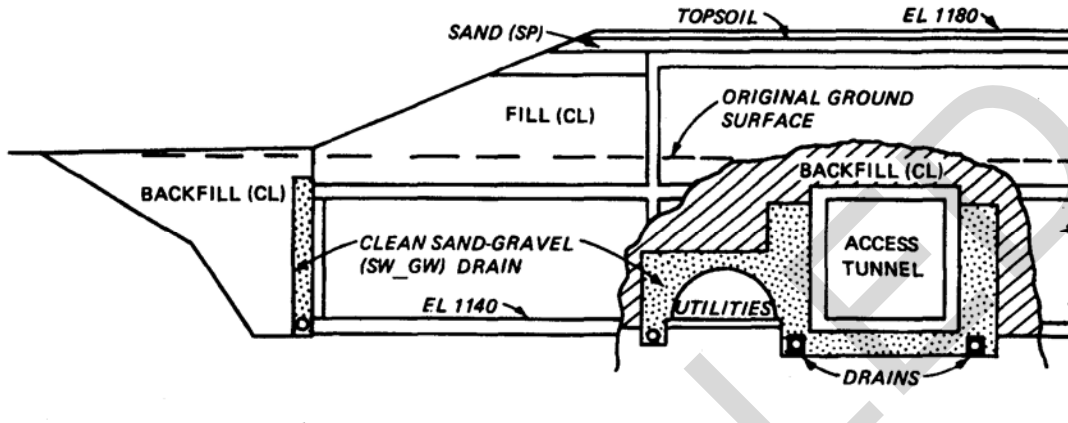

(a) TWO-STORY STRUCTURE

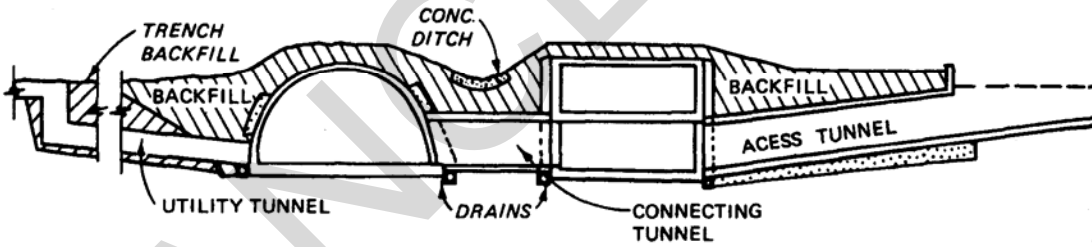

(b) CONNECTING STRUCTURES

8-3.2.2.5 **Lines and Grades.** Exercise care in planning lines and grades for excavation to ensure that uniform, adequate support is provided at the foundation level of important structures. Generally, foundations consisting of part backfill and part undisturbed materials do not provide uniform bearing and should be avoided wherever possible. The foundation should be overexcavated where necessary and backfilled with compacted select material to provide uniform support for the depth required for the particular structure. Where compacted backfill is required beneath a structure, the minimum depth specified should be at least 450 mm (18 inches).

8-3.2.2.6 **Thin-walled Metal Structures.** Thin-walled, corrugated metal structures are susceptible to deflections of structural walls when subjected to backfill loads. Minimize adverse deflections by planning backfill operations so that compacted backfill is brought up evenly on both sides of the structure to ensure uniform stress distribution. Temporary surcharge loads applied to the structure crown may also be required to prevent vertical distortions and inward deflection at the sides.

8-3.2.3 **Backfill Problem Areas.** Other features that have the potential to become problem areas are discussed in the following paragraphs. These potential problem areas must be considered during the planning and design phases to minimize deficiencies in structure performance associated with backfill placement and to make backfilling operations less difficult.

8-3.2.3.1 **Settlement and Downdrag.** In the construction of underground structures and particularly missile launch site facilities, tolerances to movement are often considerably less than those in normal construction. The design engineer must determine and specify allowable tolerances in differential settlement and ensure that differential settlement is minimized and/or accommodated. Settlement analysis procedures are outlined in Chapter 4.

8-3.2.3.2 **Critical Zones.** Critical backfill zones are those immediately beneath most structures. Consolidation and swelling characteristics of backfill materials should be thoroughly investigated so that materials having unfavorable characteristics will not be used in those zones. Some settlement can be expected to take place, but it can be minimized by requiring a higher than normal compacted density for the backfill. Cohesive backfill compacted at water content as little as 3 to 4 percentage points below optimum may result in large settlements caused by collapse of non-swelling soil material or heave of swelling materials upon saturation after construction. Compacting cohesive backfill material at optimum water content or slightly on the wet side of optimum generally will reduce the amount of settlement and swelling that would occur. Confirm the reduction by consolidation and swell tests on compacted specimens.

8-3.2.3.3 **Service Conduits.** Settlement within the backfill around structures will also occur. A proper design will allow for the estimated settlement as determined from studies of consolidation characteristics of the compacted backfill. Where service conduits, access corridors, and similar facilities connect to the structure oversize sleeves, flexible connections and other protective measures, as appropriate, may be used to prevent damage within the

structure.

8-3.2.3.4 Differential Settlement. Complex structures are more susceptible to differential settlement because of the potential for large variations in loads carried by each component foundation. In the multilevel stepped structure (Figure 8-3.3 (a)), the foundation supporting the lower level offset component must also support the volume of backfill over that part of the structure. Measures must be taken to ensure that the proper functioning of all elements is not hampered by differential settlement. The increased cost of proper design and construction where unusual or difficult construction procedures are required is insignificant when compared with the cost of the structure. The cost of remedial measures to correct deficiencies caused by improper design and construction usually will be greater than the initial cost required to prevent the deficiencies.

8-3.2.3.5 Downdrag. In addition to conventional service loads, cut and cover subsurface structures are susceptible to downdrag frictional forces between the structure and the backfill that are caused by settlement of the backfill material adjacent to and around the structure. Downdrag loads can be a significant proportion of the total vertical load acting on the structure and must be considered in the structure settlement analysis. Structure-backfill friction forces may also generate significant shear forces along the outer surface of structures with curve-shaped roofs and walls. The magnitude of the friction forces depends upon the type of backfill, roughness of the structure's surface, and magnitude of earth pressures acting against the structure. Techniques for minimizing downdrag friction forces generally include methods that reduce the structure surface roughness such as coating the structure's outer surface with asphalt or sandwiching a layer of polyethylene sheeting between the structure's outer surface and fiberboard (blackboard) panels. Backfill settlement and associated downdrag can also be minimized by requiring higher backfill densities adjacent to the structure.

Figure 8-3.4 Excavation Subject to Bottom Heave

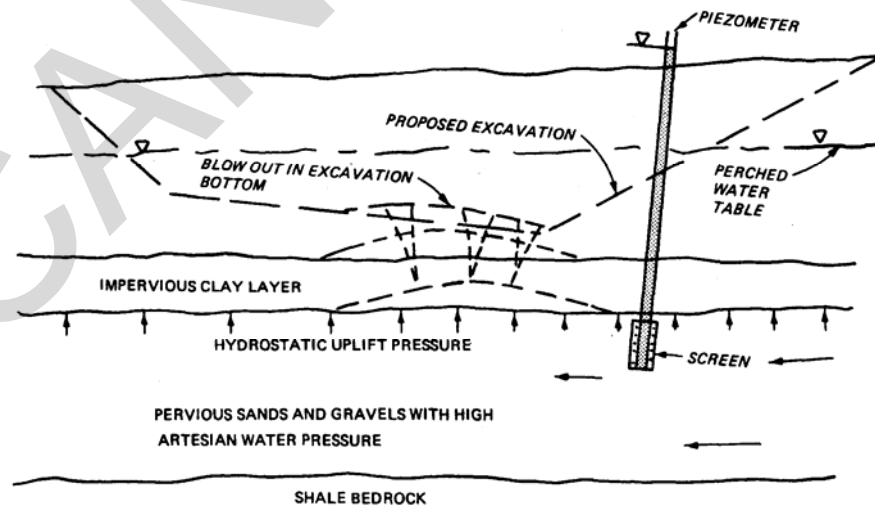
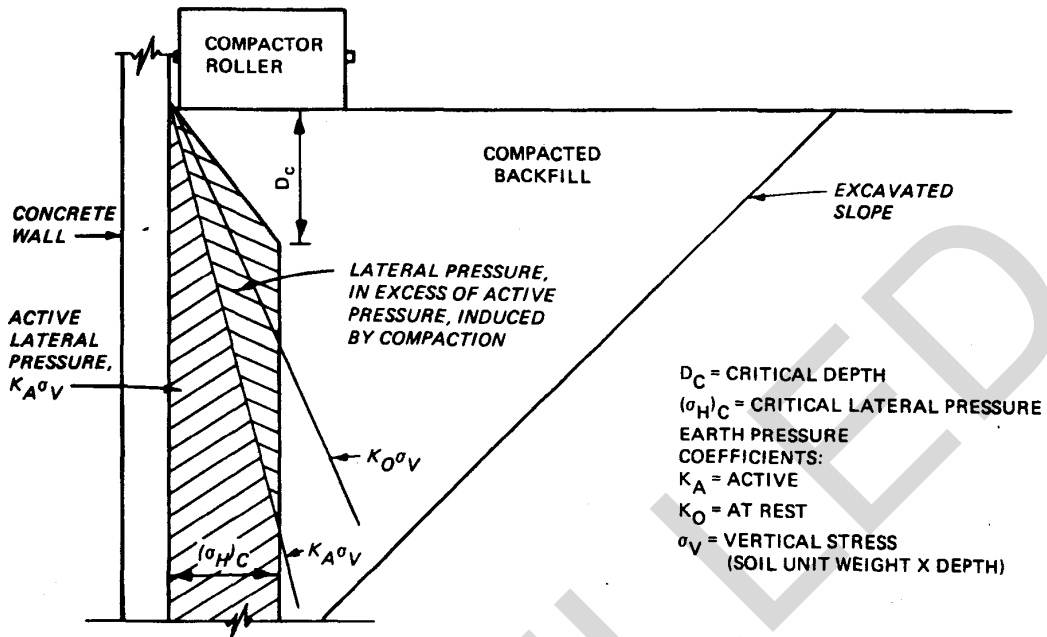
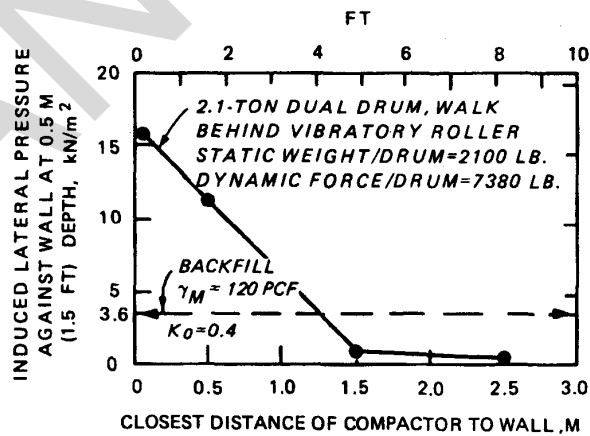

Figure 8-3.5 Excess Lateral Pressure Against Vertical Walls Induced by Compaction



COMPACTION EQUIPMENT	CRITICAL DEPTH D_c , FT	$(\sigma_H)_c$ psf
10-TON SMOOTH WHEEL ROLLER	1.9	420
3.2-TON VIBRATORY ROLLER	1.7	400
1.4-TON VIBRATORY ROLLER	1.2	260
400-KG VIBRATORY PLATE	1.5	340
120-KG VIBRATORY PLATE	1.0	240

a. MAXIMUM INDUCED LATERAL PRESSURES



b. EFFECT OF DISTANCE FROM WALL

8-3.2.3.6 **Groundwater.** Groundwater is an important consideration in planning for

construction of subsurface structures. If seepage of groundwater into the excavation is not adequately controlled, backfilling operations will be extremely difficult. The groundwater level must be lowered sufficiently (at least 0.6 – 0.9 m (2 to 3 ft) for granular soils and as much as 1.6 - 3 m (5 to 10 ft) for fine-grained soils below the lowest level of backfilling) so that a firm foundation for backfill can be established. If the level is not lowered, the movement of hauling or compaction equipment may pump seepage water through the backfill, or the initial backfill layers may be difficult to compact because of an unstable foundation. Since the proper water content of the backfill is essential for achieving proper compaction, prevention of groundwater seepage into the excavation during backfilling operations is mandatory.

- The contractor is generally responsible for the design, installation, and operation of dewatering equipment. Inadequate dewatering efforts can be minimized by adequate planning and implementation of groundwater investigations
- The possibility of hydraulic heave in cohesive material must also be investigated to ensure stability of the excavation floor. Hydraulic heave may occur where an excavation overlies a confined permeable stratum below the groundwater table 8-3.3a. If the upward hydrostatic pressure acting at the bottom of the confining layer exceeds the weight of overburden between the bottom of the excavation and the confining layer, the bottom of the excavation will rise bodily even though the design of the dewatering system is adequate for control of groundwater into the excavation. To prevent heave, the hydrostatic pressure beneath the confined stratum must be relieved
- Subsurface structures located in part or wholly below the groundwater table require permanent protection against groundwater seepage. The type of protection may range from simple impermeable barriers to complex permanent dewatering systems
- Dewatering and groundwater control procedures are described in Chapter 9

8-3.2.3.7 **Gradation and Filter Criteria for Drainage Materials.** Groundwater control is often accomplished by ditches positioned to intercept the flow of groundwater and filled with permeable granular material. The water is generally collected in perforated pipes located at the bottom of the ditch and pumped to a suitable discharge area. Such drainage systems are referred to as filter drains. The gradation of the granular filter material is critical for the functioning of the system. Selection of the proper gradation for the filter material is dependent upon the gradation of the material that is being drained. Drainage of silts and clays usually requires a graded filter made up of several layers of granular material with each layer having specific requirements for maximum grain size and gradation. Details on the design of filter drains are presented in Chapter 9.

8-3.2.3.7.1 **Selected Material.** If materials at the jobsite do not meet the designed filter requirements, select material must be purchased from commercial sources and shipped to the

jobsite. Filter material must be stockpiled according to gradation. For graded filter systems, the materials must be placed with care to minimize mixing of individual components.

8-3.2.3.7.2 Filter Cloths. Both woven and non-woven filter cloths, which have been found satisfactory for use as a filter media for subsurface drains, are available. When granular filter materials are not economically available, a single wrap of filter cloth around a pipe may be used in lieu of a coarser backfill. When available granular filter material is too coarse to satisfy filter criteria for the protected soil, a single layer of filter cloth may be used adjacent to the protected soil. To reduce the chance of clogging, no filter cloth should be specified with an open area less than 4 percent and or equivalent opening size (EOS) of less than the No. 100 sieve (0.15 mm (0.0059 inch)). A cloth with openings as large as allowable should be specified to permit drainage and prevent clogging. Additional information on air-field drainage is contained in TM 5-820-2/AFM 88-5.

Filter cloth can also provide protection for excavated slopes and serve as a filter to prevent piping of fine-grained soils. In one project, sand was not available for backfill behind a wall and coarse gravel had to be used to collect seepage. The filter cloth used to protect the excavated slope served as a filter against piping of the natural silty clay under seepage gradients out of the excavated slope after the coarse gravel backfill was placed.

8-3.2.3.8 Earth Pressures. The rationale design of any structure requires the designer to consider all loads acting on the structure. In addition to normal earth pressures associated with the effective pressure distribution of the backfill materials, subsurface cut-and-cover structures may also be subjected to surcharge loads caused by heavy equipment operating close to the structure and by increased permanent lateral earth pressures caused by compaction of backfill material with heavy equipment. Procedures for predicting normal earth pressures associated with the effective pressure of backfill materials are discussed in Chapter 6.

8-3.2.3.8.1 Surcharge Earth Pressures. Exact solutions for surcharge earth pressures generated by heavy equipment (or other surcharge loads) do not exist. However, approximations can be made using appropriate theories of elasticity such as Boussinesq's equations for load areas of regular shape or Newmark's charts for irregular shaped load areas as given in UFC 3-220-10N. As a conservative guide, heavy-equipment surcharge earth pressures may be minimized by specifying that heavy compaction equipment maintain a horizontal distance from the structure equivalent to the height of the backfill above the structure's foundation.

8-3.2.3.8.2 Compaction Induced Pressures. Compaction-induced earth pressures can cause a significant increase in the permanent lateral earth pressures acting on a vertical wall of a structure (fig. 8-3.5). This diagram is based on the assumption that the equipment can operate to within 150 mm (6 in) of the wall. Significant reductions in lateral pressures occur as the closest allowable distance to the wall is increased (Fig 8-3.5). For an operating distance 1.5 m (5 ft) from the wall, the induced horizontal earth pressure is much less than that caused by the backfill. The magnitude of the increase in lateral pressure is dependent, among other

factors, on the effective weight of the compaction equipment and the weight, earth pressure coefficient, and Poisson's ratio of the backfill material. Compaction-induced earth pressures against walls are also described in Chapter 6.

The designer must evaluate the economics of the extra cost of structures designed to withstand very close-in operation of heavy compaction equipment versus the extra cost associated with obtaining required compaction of backfill in thin lifts with smaller compaction equipment. A more economical alternative might be to specify how close to the walls different weights of compaction equipment can be operated.

One method of reducing lateral earth pressures behind walls has been to use about 1.2 m (4 ft) of uncompacted granular (sand or gravel) backfill above the base of the wall. Soil backfill can then be compacted in layers above the granular backfill. Compression of the granular material prevents the buildup of excessive lateral pressures against the wall.

8-3.3 Evaluation, Design, and Processing of Backfill Materials. The evaluation, design, and proper processing of backfill materials are extremely important phases of the pre-construction operations. The purpose of the evaluation phase is to determine the engineering characteristics of potential backfill materials. The design phase must take into account the engineering characteristics required of the backfill and specify materials that, when compacted properly, will have these characteristics. Proper processing of the backfill material will ensure that desirable engineering characteristics will be obtained as the material is placed.

8-3.3.2 Evaluation of Backfill Materials. Evaluation of backfill materials consists of exploration, sampling, and laboratory testing to determine the engineering characteristics of potential backfill materials. Detailed instructions for exploration, sampling, laboratory testing, and foundation design are presented in Chapters 2 and 3. However, to emphasize the need for an adequate investigation, some aspects of planning and investigation that should be considered are discussed in the following paragraphs.

8-3.3.2.1 Field Exploration and Sampling. Field exploration and sampling are extremely important to the design of foundations, selection of backfill, and planning for construction. A great amount of material will be available from required excavations, and the investigation for foundation conditions should include the sampling and evaluation of these materials for possible use as backfill. Where an adequate volume of suitable backfill cannot be obtained from the construction excavation, the exploration and sampling program must be expanded to find other sources of suitable material whether from nearby borrow areas or commercial sources.

The purpose of the investigation is to delineate critical conditions and provide detailed information on the subsurface deposits so that proper design and construction, including backfilling operations, can be accomplished with minimum difficulty. Thus careful planning is required prior to the field exploration and sampling phase of the investigation. Available geologic and soil data should be studied, and if possible, preliminary borings should be made. Once a site has been tentatively selected, orientation of the structure to the site

should be established. The engineer who plans the detailed field exploration program must have knowledge of the structure, e.g., its configuration and foundation requirements for design loads and settlement tolerances. The planning engineer should also know the type and quantity of backfill required. The importance of employing qualified field exploration personnel cannot be overemphasized. The exploration crews should be supervised in the field by a soils engineer or geologist familiar with the foundation and backfill requirements so that changes can be made in the exploration program where necessary to provide adequate information on subsurface conditions. The field engineer should also know the location of significant features of the structure so that sampling can be concentrated at these locations. In addition, he should have an understanding of the engineering characteristics of subsurface soil and rock deposits that are important to the design of the structure and a general knowledge of the testing program so that the proper type and quantity of samples will be obtained for testing.

- From the samples, the subsurface deposits can be classified and boring logs prepared. The more continuous the sampling operation, the more accurate will be the boring logs. All borings should be logged with the description of the various strata encountered as discussed in ASTM D 1586 and ASTM D 2487. Accurate logging and correct evaluation of all pertinent information are essential for a true concept of subsurface conditions.
- When the exploratory borings at the construction site have been completed, the samples and logs of borings should be examined to determine if the material to be excavated will be satisfactory and in sufficient quantity to meet backfill requirements. Every effort should be made to use the excavated materials; however, if the excavated materials are not satisfactory or are of insufficient quantity, additional exploration should be initiated to locate suitable borrow areas. If borrow areas are not available, convenient commercial sources of suitable material should be found. Backfill sources, whether excavation, borrow, or commercial, should contain several times the required volume of compacted backfill.
- Groundwater studies prior to construction of subsurface structures are of the utmost importance, since groundwater control is necessary to provide a dry excavation in which construction and backfilling operations can be properly conducted. Data on groundwater conditions are also essential for forecasting construction dewatering requirements and stability problems. Groundwater studies must consist of investigations to determine: groundwater levels to include any seasonal variations and artesian conditions; the location of any water-bearing strata; and the permeability and flow characteristics of water-bearing strata. Methods for investigating groundwater conditions are described in Chapter 9.

8-3.3.2.2 **Laboratory Testing.** The design of any foundation is dependent on the engineering characteristics of the supporting media, which may be soil or rock in either its natural state or as compacted backfill. The laboratory-testing program will furnish the engineer information for planning, designing, and constructing subsurface structures. Laboratory testing

programs usually follow a general pattern and to some extent can be standardized, but they should be adapted to particular problems and soil conditions. Special tests and research should be utilized when necessary to develop needed information. The testing program should be well planned with the engineering features of the structure and backfill in mind; testing should be concentrated on samples from areas where significant features will be located but should still present a complete picture of the soil and rock properties. The laboratory test procedures and equipment are described in ASTM D 2487 and its references.

8-3.3.2.2.1 Identification and Classification of Soils. The Unified Soil Classification System used for classifying soils for military projects (ASTM D 2487) is a means of identifying a soil and placing it in a category of distinctive engineering properties. Table 8-3.1 shows the properties of soil groups pertinent to backfill and foundations. Using these characteristics, the engineer can prepare preliminary designs based on classification and plan the laboratory testing program intelligently and economically.

The Unified Soil Classification System classifies soils according to their grain-size distribution and plasticity characteristics and groups them with respect to their engineering behavior. With experience, the plasticity and gradation properties can be estimated using simple, expedient tests (See ASTM D 2487) and these estimates can be confirmed using simple laboratory tests. The principal laboratory tests performed for classification are grain-size analyses and Atterberg limits.

The engineering properties in table 8-3.1 are based on "Standard Proctor" (ASTM D 2487) maximum density except that the California Bearing Ratio (ASTM D 1883) and the subgrade modulus are based on ASTM D 1557 maximum density. This information can be used for initial design studies. However, for final design of important structures, laboratory tests are required to determine actual performance characteristics, such as ASTM D 1557 compaction properties, shear strength, permeability, compressibility, swelling characteristics, and frost susceptibility where applicable, under expected construction conditions.

The Unified Soil Classification System is particularly useful in evaluating, by visual examination, the suitability of potential borrow materials for use as compacted backfill. Proficiency in visual classification can be developed through practice by comparing estimated soil properties with results of laboratory classification tests.

8-3.3.2.2.2 Compaction Testing. Compaction test procedures are described in detail in ASTM D 1557 (app. A.) It is important that the designer and field inspection personnel understand the basic principles and fundamentals of soil compaction. The principles of soil compaction are discussed in appendix B of this manual.

The purpose of the laboratory compaction tests is to determine the compaction characteristics of available backfill materials. Also, anticipated field density and water content can be approximated in laboratory compacted samples in order that other engineering properties, such as shear strength, compressibility, consolidation, and swelling, can be studied. For most soils there is an optimum water content at which a maximum density is

obtained with a particular compaction effort. A standard five-point compaction curve relating density and water content can be developed by the procedures outlined in ASTM D 1557.

The impact compaction test results normally constitute the basis on which field compaction control criteria are developed for inclusion in the specifications. However, for some cohesionless soils, higher densities can be obtained by the vibratory compaction method (commonly referred to as maximum relative density), described in EM 1110-21906. The required field compaction is generally specified as a percentage of laboratory maximum dry density and referred to as percent ASTM D 1557 maximum density. Water content is an important controlling factor in obtaining proper compaction. The required percentage of maximum dry density and the compaction water content should be selected on the basis of the engineering characteristics, such as compression moduli, settlement, and shear strength, desired in the compacted backfill. It should be noted that these characteristics could be adversely affected by subsequent increases in water content after placement. This situation could result from an increase in the groundwater level after construction.

Density control of placed backfill in the field can be facilitated by the use of rapid compaction check tests (ASTM D 5080). A direct rapid test is the one-point impact compaction test. Rapid indirect tests, such as the Proctor needle penetration for cohesive soils or the cone resistance load for cohesionless soils, can also be used when correlations with ASTM D 1557 maximum density have been established.

Table 8-3.1 Typical Engineering Properties of Compacted Materials^a

Group Symbol	Soil Type	Range of Maximum Dry Unit Weight, gm/cm ³ (pcf)	Range of Optimum Water, Content Percent	Typical Value of Compression (Percent of Original Height)		Typical Strength Characteristics			Typical Coefficient of Permeability cm/sec (ft/min)	Range of CBR Values	Range of Subgrade Modulus k kPa/mm (lb/cu in)
				At 138 kPa (20 psi)	At 345 kPa (50 psi)	Cohesion (as compacted) psf	Cohesion (saturated) psf	Effective Stress Envelope deg			
GW	Well graded, clean gravels, gravel-sand mixtures	2.00-2.16 (125-135)	11-8	0.3	0.6	0	0	>38	2.5×10^{-2} (5×10^{-2})	40-80	81-136 (300-500)
GP	Poorly graded clean gravel-sand mix	1.84-2.00 (115-125)	14-11	0.4	0.9	0	0	>37	5×10^{-2} (10^{-1})	30-60	68-108 (250-400)
GM	Silty gravels, poorly graded gravel-sand-silt	1.92-2.16 (120-135)	12-8	0.5	1.1	----	----	>34	$>5 \times 10^{-7}$ ($>10^{-6}$)	20-60	27-108 (100-400)
GC	Clayey gravels, poorly graded gravel-sand-clay	1.84-2.08 (115-130)	14-9	0.7	1.6	----	----	>31	$>5 \times 10^{-8}$ ($>10^{-7}$)	20-40	27-81 (100-300)
SW	Well graded clean sands, gravelly sands	1.76-2.08 (110-130)	16-9	0.6	1.2	0	0	38	5×10^{-4} ($>10^{-3}$)	20-40	54-81 (200-300)

Table 8-3.1 Typical Engineering Properties of Compacted Materials^a

Group Symbol	Soil Type	Range of Maximum Dry Unit Weight, gm/cm ³ (pcf)	Range of Optimum Water, Content Percent	Typical Value of Compression (Percent of Original Height)		Typical Strength Characteristics			Typical Coefficient of Permeability cm/sec (ft/min)	Range of CBR Values	Range of Subgrade Modulus k kPa/mm (lb/cu in)
				At 138 kPa (20 psi)	At 345 kPa (50 psi)	Cohesion (as compacted) kPa (psf)	Cohesion (saturated) kPa (psf)	Effective Stress Envelope deg			
SM	Silty sands, poorly graded sand-salt mix	1.76-2.00 (110-125)	16-11	0.8	1.6	50 (1050)	20 (420)	34	2.5×10^{-5} (5×10^{-5})	10-40	21-81 (100-300)
SM-SC	Sand-silt clay mix with slightly plastic fines	1.76-2.08 (110-130)	15-11	0.8	1.4	50 (1050)	14 (300)	33	1×10^{-6} (2×10^{-6})	-----	-----
SC	Clayey sands, poorly graded sand-clay-mix	1.68-2.00 (105-125)	19-11	1.1	2.2	74 (1550)	11 (230)	31	2.5×10^{-7} (5×10^{-7})	5-20	21-81 (100-300)
ML	Inorganic silts and clayey silts	1.52-1.92 (95-120)	24-12	0.9	1.7	67 (1400)	9 (190)	32	5×10^{-6} (10^{-5})	15 or <	21-54 (100-200)
ML-CL	Mixture of inorganic silt and clay	1.60-1.92 (100-200)	22-12	1.0	2.2	65 (1350)	22 (460)	32	2.5×10^{-5} (5×10^{-5})	-----	21-54 (100-200)

Table 8-3.1 Typical Engineering Properties of Compacted Materials^a

Group Symbol	Soil Type	Range of Maximum Dry Unit Weight, gm/cm ³ (pcf)	Range of Optimum Water, Content Percent	Typical Value of Compression (Percent of Original Height)		Typical Strength Characteristics			Typical Coefficient of Permeability cm/sec (ft/min)	Range of CBR Values	Range of Subgrade Modulus k kPa/mm (lb/cu in)
				At 138 kPa (20 psi)	At 345 kPa (50 psi)	Cohesion (as compacted) kPa (psf)	Cohesion (saturated) kPa (psf)	Effective Stress Envelope deg			
CL	Inorganic clays of low to medium plasticity	1.52-1.92 (95-120)	34-12	1.3	2.5	86 (1800)	13 (270)	28	5×10^{-8} (10^{-7})	15 or <	14-54 (50-200)
OL	Organic silts and silt-clays of low plasticity	1.28-1.60 (80-100)	33-21	----	----	----	----	----	----	5 or <	14-27 (50-100)
MH	Inorganic clayey silts, elastic silts	1.20-1.52 (75-95)	40-24	2.0	3.8	72 (1500)	20 (420)	25	2.5×10^{-7} (5×10^{-7})	10 or <	14-27 (50-100)
CH	Inorganic clays of high plasticity	1.28-1.68 (80-105)	36-19	2.6	3.9	103 (2150)	11 (230)	19	5×10^{-8} (10^{-7})	15 or <	14-34 (50-150)
OH	Organic and silty clays	1.20-1.60 (75-100)	45-21	----	----	----	----	----	----	5 or <	7-27 (25-100)

- Notes: 1. All properties are for condition of Standard Proctor maximum density except values of k and CBR, which are for CE55 maximum density.
 2. Typical strength characteristics are for effective strength envelopes and are obtained from USBR data.
 3. Compression values are for vertical loading with complete lateral reinforcement.
 4. (>) Indicates that typical property is greater than the value shown. (.....) Indicates insufficient data available for an estimate.

8-3.3.2.2.3 **Shear Strength Testing.** When backfill is to be placed behind structure walls or bulkheads or as foundation support for a structure, and when fills are to be placed with unrestrained slopes, shear tests should be performed on representative samples of the backfill materials compacted to expected field densities and water contents to estimate as constructed shear strengths. The appropriate type of test required for the conditions to be analyzed is presented in ASTM D 3080, 6528 and 4767. Procedures for shear strength testing are described in EM 1110-2-1906.

8-3.3.2.2.4 **Consolidation and Swell Testing.** The rate and magnitude of consolidation under a given load are influenced primarily by the density and type of soil and the conditions of saturation and drainage. Fine-grained soils generally consolidate more and at a slower rate than coarse-grained soils. However, poorly graded, granular soils and granular soils composed of rounded particles will often consolidate significantly under load but usually at a relatively fast rate.

The procedure for the consolidation test is outlined in ASTM D 2435 and D 4546. The information obtained in this test can be used in settlement analyses to determine the total settlement, the time rate of settlement, and the differential settlement under varying loading conditions. Consolidation characteristics are important considerations in selection of backfill materials. The results of consolidation tests performed on laboratory compacted specimens of backfill material can be used in determining the percent compaction to be required in the specifications.

Swelling characteristics can be determined by a modified consolidation test procedure. The degree of swelling and swelling pressure should be determined on all backfill and foundation materials suspected of having swelling characteristics. This fact is particularly important when a considerable overburden load is removed by excavation or when the compacted backfill with swelling tendencies may become saturated upon removal of the dewatering system and subsequent rise of the groundwater level. The results of swelling tests can be used to determine the suitability of material as backfill. When it is necessary to use backfill materials that have a tendency to swell upon saturation because more suitable materials are unavailable, the placement water content and density that will minimize swelling can be determined from a series of tests. FHWA-RD-79-51 provides further information applicable to compacted backfills.

8-3.3.2.2.5 **Permeability Tests.** Permeability tests to determine the rate of flow of water through a material can be conducted in the laboratory by procedures described in ASTM D 2434, D 2335 and D 3152. Permeability characteristics of fine-grained materials at various densities can also be determined from consolidation tests.

Permeability characteristics for the design D3 of permanent drainage systems for structures founded below the groundwater level must be obtained from laboratory tests. The tests should be performed on representative specimens of backfill materials compacted in the laboratory to densities expected in the field.

In situ material permeability characteristics for the design of construction excavation dewatering systems can also be approximated from laboratory tests on representative undisturbed samples. Laboratory permeability tests on undisturbed samples are less expensive than in situ pumping tests performed in the field; however, laboratory tests are less accurate in predicting flow characteristics.

8-3.3.2.2.6 Slake Durability of Shales. Some clay shales tend to slake when exposed to air and water and must be protected immediately after they are exposed. The extent of slaking also governs the manner in which they are treated as a backfill material (paragraph 8-3.3.3.3). Slaking characteristics can be evaluated by laboratory jar-slake tests or slake-durability tests.

The jar-slake test is qualitative with six descriptive degrees of slaking determined from visual observation of oven dried samples soaked in tap water for as long as 24 hours. The jar-slake test is not a standardized test. One version of the jar-slake test is discussed in FHWA-RD-78-141. Six suggested values of the jar-slake index I_J are listed below:

I_J	Behavior
1	Degrades into pile of flakes or mud
2	Breaks rapidly and forms many chips
3	Breaks rapidly and forms few chips
4	Breaks slowly and forms several fractures
5	Breaks slowly and develops few fractures
6	No change

Shales with I_J values of 1 to 3 should be protected when occurring in excavated slopes and compacted as soil if used for backfill.

The slake-durability test is a standardized test that gives a quantitative description in percent by weight of material remaining intact at the conclusion of the test. Details of the test are presented in FHWA-RD-78-141.

8-3.3.2.2.7 Dynamic Tests for Special Projects. Dynamic tests for special projects The dynamic analysis of projects subject to seismic or blast induced loading conditions requires special dynamic tests on both in situ and backfill materials. Tests required for dynamic analysis include: cyclic triaxial tests; in situ density measurements; and tests to determine shear wave velocities, shear modulus, and damping (ER 1110-2-1806).

8-3.3.2.2.8 In-situ Water Content. The in situ water content, including any seasonal variation, must be determined prior to construction for materials selected for use as backfill. Natural in situ water contents will determine the need for wetting or drying the backfill material before placement to obtain near optimum water contents for placement and compaction. ASTM D 2216 discusses the test method for determining water content.

8-3.4 **Selection of Backfill Materials.** Selection of backfill materials should be based upon the engineering properties and compaction characteristics of the materials available. The results of the field exploration and laboratory test programs should provide adequate information for this purpose. The materials may come from required excavation, adjacent borrow pits, or commercial sources. In selecting materials to be used, first consideration should be given to the maximum use of materials from required excavation. If the excavated materials are deficient in quality or quantity, other sources should be considered. Common backfill having the desired properties may be found in borrow areas convenient to the site, but it may be necessary to obtain select backfill materials having particular gradation requirements, such as filter sands and gravels and pipe or conduit bedding materials from commercial sources.

8-3.4.1 **Primary Considerations.** Primary considerations for borrow material sources are suitability and quantity. Accessibility and proximity of the borrow area to the jobsite should also be considered. The water contents of the borrow area material should be determined seasonally, and a source of water should be located if the natural water contents are considerably less than the required placement water content. If several sources of suitable backfill are available, other factors to be considered in selecting the borrow materials are ease of loading and spreading and the means for adding or reducing water. The need for separating or mixing soil strata from excavation or borrow sources should be considered if necessary to provide reasonably uniform engineering properties throughout the compacted backfill.

8-3.4.2 **Compaction Characteristics.** If compaction characteristics of the major portion of the backfill are relatively uniform, problems of controlling placement of backfill will be significantly reduced since the inspector will be able to develop more rapidly the ability to recognize the adequacy of the compaction procedures. In addition, the frequency of testing for compaction control could be reduced. When available backfill materials are unusual, test sections of compacted backfill are sometimes justified to develop placement procedures and to determine the engineering characteristics to be expected in field-compacted materials.

8-3.4.3 **Workability.** An important factor in choosing backfill materials is the workability or ease with which the soil can be placed and compacted. Material characteristics that effect workability include: the ease of adjusting water contents in the field by wetting or aeration; the sensitivity to the compaction water content with respect to optimum; and the amount of compaction effort required to achieve specified densities.

8-3.4.4 **Types of Backfill Material.** A discussion of the many types of backfill and their compaction characteristics is beyond the scope of this manual since soil types will vary on each project. However, the compaction characteristics of several rather broad categories of backfill (Table 8-3.1) are discussed briefly.

8-3.4.4.1 **Coarse-Grained Soils.** Coarse-grained soils include gravelly and sandy soils and range from clayey sands (SC) through the well-graded gravels of gravelsand mixtures (GW) with little or no fines (table 8-3.1). They will exhibit slight to no plasticity. All of the well-

graded soils falling in this category have fairly good compaction characteristics and when adequately compacted provide good backfill and foundation support.

One difficulty that might arise with soils in this category would be in obtaining good compaction of the poorly graded sands and gravels. These poorly graded materials may require saturation with downward drainage and compaction with greater compaction effort to achieve sufficiently high densities. Also, close control of water content is required where silt is present in substantial amounts. Coarse-grained materials compacted to a low relative density are susceptible upon saturation to liquefaction under dynamic loads.

For sands and gravelly sands with little or no fines, good compaction can be achieved in either the air-dried or saturated condition. Downward drainage is required to maintain seepage forces in a downward direction if saturation is used to aid in compaction. Consideration may be given to the economy of adding cement to stabilize moist clean sands that are particularly difficult to compact in narrow confined areas. However, the addition of cement may produce zones with greater rigidity than untreated adjacent backfill and form "hard spots" resulting in non-uniform stresses and deformations in the structure.

Cohesionless materials are well suited for placement in confined areas adjacent to and around structures where heavy equipment is not permitted and beneath and around irregularly shaped structures, such as tunnels, culverts, utilities, and tanks. Clean, granular, well-graded materials having a maximum size of 1 inch with 95 percent passing the 4.75 mm (No. 4) sieve and 5 percent or less passing the 75 Micron (No. 200) sieve are excellent for use in these zones. However, a danger exists of creating zones where seepage water may accumulate and saturate adjacent cohesive soils resulting in undesirable consolidation or swelling. In such cases, provisions for draining the granular backfill, sealing the surface, and draining surface water away from the structure are necessary.

8-3.4.4.2 Fine-Grained Soils of Low to Medium Plasticity. Inorganic clays (CL) of low to medium plasticity (gravelly, sandy, or silty clays and lean clays) and inorganic silts and very fine sands (ML) of low plasticity (silty or clayey fine sands and clayey silts) are included in this category. The inorganic clays are relatively impervious and can be compacted fairly easily with heavy compaction equipment to provide a good stable backfill. Soils in the CL group can be compacted in confined areas to a fairly high degree of compaction with proper water content and lift thickness control. The clayey sands of the SC group and clayey silts of the ML group can be compacted to fairly high densities, but close control of water content is essential and sometimes critical, particularly on the wet side of optimum water content. Some ML soils, if compacted on the dry side of optimum, may lose considerable strength upon saturation after compaction. Considerable settlement may occur. Caution must therefore be exercised in the use of such soils as backfill, particularly below the groundwater level. Also, saturated ML soils are likely to be highly susceptible to liquefaction when dynamically loaded. Where such soils are used as backfill in seismic prone areas, laboratory tests should be conducted to determine their liquefaction potential.

8-3.4.4.3 **Rock.** The suitability of rock as backfill material is highly dependent upon the gradation and hardness of the rock particles. The quantity of hard rock excavated at most subsurface structure sites is relatively small, but select cohesionless materials may be difficult to find or may be expensive. Therefore, excavated hard rock may be specified for crusher processing and used as select cohesionless material.

8-3.4.4.4 **Shale.** Although shale is commonly referred to as rock, the tendency of some shales to breakdown under heavy compaction equipment and slake when exposed to air or water after placement warrants special consideration.

Some soft shales break down under heavy compaction equipment causing the material to have entirely different properties after compaction than it had before compaction. This fact should be recognized before this type of material is used for backfill. Establishing the proper compaction criteria may require that the contractor construct a test fill and vary the water content, lift thickness, and number of coverages with the equipment proposed for use in the backfill operation. This type of backfill can be used only in unrestricted open zones where heavy towed or self-propelled equipment can operate.

Some shales have a tendency to break down or slake when exposed to air. Other shales that appear rock-like when excavated will soften or slake and deteriorate upon wetting after placement as rockfill. Alternate cycles of wetting and drying increases the slaking process. The extent of material breakdown determines the manner in which it is treated as a backfill material. If the material completely degrades into constituent particles or small chips and flakes, it must be treated as a soil-like material with property characteristics similar to ML, CL, or CH materials, depending upon the intact composition of the parent material. Complete degradation can be facilitated by alternately wetting, drying, and disking the material before compaction. A detailed discussion on the treatment of shales as a fill material is given in FHWA-RD-78-141.

8-3.4.4.5 **Marginal Materials.** Marginal materials are those materials that, because of either poor compaction, consolidation, or swelling characteristics, would not normally be used as backfill if sources of suitable material were available. Material considered to be marginal include fine-grained soils of high plasticity and expansive clays. The decision to use marginal materials should be based on economical and energy conservation considerations to include the cost of obtaining suitable material whether from a distant borrow area or commercial sources, possible distress repair costs caused by use of marginal material, and the extra costs involved in processing, placing, and adequately compacting marginal material.

The fine-grained, highly plastic materials make poor backfill because of the difficulty in handling, exercising water-content control, and compacting. The water content of highly plastic finegrained soils is critical to proper compaction and is very difficult to control in the field by aeration or wetting. Furthermore, such soils are much more compressible than less-plastic and coarse-grained soils; shear strength and thus earth pressures may fluctuate between wide limits with changes in water content; and in cold climates, frost action will occur in fine-grained soils that are not properly drained. The only soil type in this category that might

be considered suitable as backfill is inorganic clay (CH). Use of CH soils should be avoided in confined areas if a high degree of compaction is needed to minimize backfill settlement or to provide a high compression modulus.

The swelling (and shrinking) characteristics of expansive clay vary with the type of clay mineral present in the soil, the percentage of that clay mineral, and the change in water content. The active clay minerals include montmorillonite, mixed-layer combinations of montmorillonite and other clay minerals, and under some conditions chlorites and vermiculites. Problems may occur from the rise of groundwater, seepage, leakage, or elimination of surface evaporation that may increase or decrease the water content of compacted soil and lead to the tendency to expand or shrink. If the swelling pressure developed is greater than the restraining pressure, heave will occur and may cause structural distress. Compaction on the wet side of optimum moisture content will produce lower magnitudes of swelling and swell pressure. Expansive clays that exhibit significant volume increases should not be used as backfill where the potential for structural damage might exist. Suitability should be based upon laboratory swell tests.

Additives, such as hydrated lime, quicklime, and fly ash, can be mixed with some highly plastic clays to improve their engineering characteristics and permit the use of some materials that would otherwise be unacceptable. Hydrated lime can also be mixed with some expansive clays to reduce their swelling characteristics. Laboratory tests should be performed to determine the amount of the additive that should be used and the characteristics of the backfill material as a result of using the additive. Because of the complexity of soil additive systems and the almost completely empirical nature of the current state of the art, trial mixes must be verified in the field by test fills.

8-3.4.4.6 **Commercial By-Products.** The use of commercial by-products, such as furnace slag or fly ash as backfill material, may be advantageous where such products are locally available and where suitable natural materials cannot be found. Fly ash has been used as a lightweight backfill behind a 7.6 m (25 ft) high wall and as an additive to highly plastic clay. The suitability of these materials will depend upon the desirable characteristics of the backfill and the engineering characteristics of the products.

8-3.5 **Processing of Backfill Materials.** The construction of subsurface structures often requires the construction of elements of the structure within or upon large masses of backfill. The proper functioning of these elements is often critically affected by adverse behavioral characteristics of the backfill. Behavioral characteristics are related to material type, water content during compaction, gradation, and compaction effort. While compaction effort may be easily controlled during compaction, it is difficult to control material type, water content, and gradation of the material as it is being placed in the backfill; control criteria must be established prior to placement.

8-3.5.1 **Material Type.** Backfill material should consist of a homogeneous material of consistent and desirable characteristics. The field engineer must ensure that only the approved backfill material is used and that the material is uniform in nature and free of any

anomalous material such as organic matter or clay pockets. Stratified material should be mixed prior to placing to obtain a uniform blend. Stockpile excavated material to be used as backfill according to class or type of material.

8-3.3.5.2 **Water Content.** While water content can be adjusted to some extent after placing (but before compacting), it is generally more advantageous to adjust the water content to optimum compaction conditions before placing. Adjustment of water content can be accomplished by aeration (disking or turning) or sprinkling the material in 305 mm to 450 mm (12 to 18 in) layers prior to placing or stockpiling. If the material is stockpiled, provisions should be made to maintain constant moisture content during wet or dry seasons.

8-3.3.5.3 **Ensuring Gradation.** Some backfill materials consisting of crushed rock, gravel, or sand require limitations on maximum and minimum particle-size or gradation distributions. Where materials cannot be located that meet gradation criteria, it may be advantageous to require processing of available material by sieving to obtain the desired gradation.

8-4 **EARTHWORK: EXCAVATION AND PREPARATION FOR FOUNDATIONS**

8-4.1 **Excavation**

8-4.1.1 **General.** In general, excavation for subsurface structures will consist of open excavation and shaft and tunnel excavation. Where excavation to great depths is required, a variety of soils and rock may be encountered at a single site. Soils may range through a wide spectrum of textures and water contents. Rock encountered may vary from soft rock, very similar to a firm soil in its excavation requirements, to extremely hard rock requiring extensive blasting operations for removal. Groundwater may or may not be present. The groundwater conditions and the adequacy of groundwater control measures are important factors in excavation, in maintaining a stable foundation, and in backfilling operations. The extent to which groundwater can be controlled also influences the slopes to which the open excavation can be cut, the bracing required to support shaft and tunnel excavation, and the handling of the excavated material.

8-4.1.2 **Good Construction Practices, and Problems.** A majority of the problems encountered during excavation are related to groundwater conditions, slope stability, and adverse weather conditions. Many of the problems can be anticipated and avoided by preconstruction planning and by following sound construction practices.

8-4.1.2.1 **Groundwater.** Probably the greatest source of problems in excavation operations is groundwater. If the seepage of groundwater into an excavation is adequately controlled, other problems will generally be minor and can be easily handled. Several points should be recognized that, if kept in mind, will help to reduce problems attributable to groundwater. In some instances, groundwater conditions can be more severe than indicated by the original field exploration investigation since field explorations provide information only for selected locations and may not provide a true picture of the overall conditions.

If groundwater seepage begins to exceed the capacity of the dewatering system, conditions should not be expected to improve unless the increased flow is known to be caused by a short-term condition such as heavy rain in the area. If seepage into the excavation becomes excessive, excavation operations should be halted until the necessary corrective measures are determined and affected. The design and evaluation of dewatering systems require considerable experience that the contractor or the contracting office often do not possess, and the assistance of specialists in this field should be obtained.

Groundwater without significant seepage flow can also be a problem since excess hydrostatic pressures can develop below relatively impervious strata and cause uplift and subsequent foundation or slope instability. Excess hydrostatic pressures can also occur behind sheet pile retaining walls and shoring and bracing in shaft and tunnel excavations. Visual observations should be made for indications of trouble, such as uncontrolled seepage flow, piping of material from the foundation or slope, development of soft wet areas, uplift of ground surface, or lateral movements.

Accurate daily records should be kept of the quantity of water removed by the dewatering system and of the piezometric levels in the foundation and beneath excavation slopes. Separate records should be kept of the flow pumped by any sump-pump system required to augment the regular dewatering system to note any increase of flow into the excavation. Flowmeters or other measuring devices should be installed on the discharge of these systems for measurement purposes. These records can be invaluable in evaluating "Changed Condition" claims submitted by the contractor. The contractor should be required to have "standby" equipment in case the original equipment breaks down.

8-4.1.2.2 **Surface Water.** Sources of water problems other than groundwater are surface runoff into the excavation and snow drifting into the excavation. A peripheral, surface-drainage system, such as a ditch and berm, should be required to collect surface water and divert it from the excavation. In good weather there is a tendency for the contractor to become lax in maintaining this system and for the inspection personnel to become lax in enforcing maintenance. The result can be a sudden filling of the excavation with water during a heavy rain and consequent delay in construction. The surface drainage system must be constantly maintained until the backfill is complete. Drifting snow is a seasonal and regional problem, which can best be controlled by snow fences placed at strategic locations around the excavation.

8-4.1.2.3 **Slope Integrity.** Another area of concern during excavation is the integrity of the excavation slopes. The slopes may be either unsupported or supported by shoring and bracing. The lines and grades indicated in the plans should be strictly adhered to. The contractor may attempt to gain additional working room in the bottom of the excavation by steepening the slopes; this change in the plans must not be allowed.

- Where shoring and bracing are necessary to provide a stable excavation, and the plans and specifications do not provide details of these requirements, the contractor should be required to submit the plans in sufficient detail so that they

can be easily followed and their adequacy checked. The first principle of excavation stabilization, using shoring and bracing, is that the placing of supports should proceed with excavation. The excavation cut should not be allowed to yield prior to placing of shoring and bracing since the lateral pressures to be supported would generally be considerably greater after yield of the unshored cut face than if no movement had occurred prior to placement of the shoring. Excavation support systems are discussed in paragraph 8-1. All safety requirements for shoring and bracing as contained therein and should be strictly enforced.

- The inspector must be familiar with stockpiling requirements regarding the distance from the crest of the excavation at which stockpiles can be established and heavy equipment operated without endangering the stability of the excavation slopes. He must also know the maximum height of stockpile or weight of equipment that can be allowed at this distance.
- Excessive erosion of the excavation slopes must not be permitted. In areas subject to heavy rainfall, it may be necessary to protect excavation slopes with polyethylene sheeting, straw, silt fences, or by other means to prevent erosion. Excavation slopes for large projects that will be exposed for several seasons should be vegetated and maintained to prevent erosion.

8-4.1.2.4 **Stockpiling Excavated Material.** Generally, procedures for stockpiling are left to the discretion of the contractor. Prior to construction, the contractor must submit his plans for stockpiling to the contracting officer for approval. In certain cases, such as where there are different contractors for the excavation and the backfill phases, it may be necessary to include the details for stockpiling operations in the specifications. In either case, it is important that the stockpiling procedures be conducive to the most advantageous use of the excavated materials.

As the materials are excavated, they should be separated into classes of backfill and stockpiled accordingly. Thus the inspection personnel controlling the excavation should be qualified to classify the material and should be thoroughly familiar with backfill requirements. Also, as the materials are placed in stockpiles, water should be added or the materials should be aerated as required to approximate optimum water content for compaction. Field laboratory personnel can assist in determining the extent to which this is necessary. The requirements of shaping the stockpile to drain and sealing it against the entrance of undesirable water by rolling with spreading equipment or covering with polyethylene sheeting should be enforced. This step is particularly important for cohesive soils that exhibit poor draining characteristics and tend to remain wet if once saturated by rains. Stockpiles must be located over an area that is large enough to permit processing and where they will not interfere with peripheral drainage around the excavation and will not overload the slopes of the excavation.

In cases where significant energy and cost saving can be realized, special stockpiling requirements should be implemented. An example would be a large project

consisting of a number of excavation and backfilling operations. The excavation material from the first excavation could be stockpiled for use as backfill in the last excavation. The material from the intermediate excavations could in turn be immediately used as backfill for the first, second, etc., phases of the project and thereby eliminate double handling of excavated backfill for all but the first-phase excavation.

8-4.1.2.5 **Protection of Exposed Material.** If materials that are exposed in areas, such as walls of a silo shaft, foundation support, or any other area against which concrete will be placed, are susceptible to deterioration or swell when exposed to the weather, they should be properly protected as soon after exposure as possible. Depending on the material and protection requirements, this protection may be pneumatic concrete, asphalt spray, or plastic membrane. In the case of a foundation area, the contractor is required to underexcavate leaving a cover for protection, as required, until immediately prior to placement of the structure foundation. Any frost-susceptible materials encountered during excavation should be protected if the excavation is to be left open during an extended period of freezing weather.

8-4.1.2.6 **Excavation Record.** As the excavation progresses, the project engineer should keep a daily record of the type of material excavated and the progress made.

8-4.2 **Foundation Preparation**

8-4.2.1 **Good Construction Practices, and Problems.** As mentioned previously, the problems associated with foundation preparation are greatly reduced by following such proper excavation procedures as maintaining a dry excavation and planning ahead. The principles of good foundation preparation are simple, but enforcing the provisions of the specifications concerning the work is more difficult. Inspection personnel must recognize the importance of this phase of the work since, if not properly controlled, problems can result.

8-4.2.1.1 **Stable Foundations.** It is most important that a stable foundation be provided. Thus it may be necessary, particularly in the case of sensitive fine-grained materials, to require that the final excavation for footings be carefully done with hand tools and that no equipment be allowed to operate on the final cut surface. To provide a working platform on which to begin backfill placement on these sensitive materials, it may be necessary to place an initial layer of granular material.

8-4.2.1.2 **Foundations Supported on Rock.** If the foundation is to be supported on rock, the soundness of the exposed rock should be checked by a slaking test (soaking a piece of the rock in water to determine the resulting degree of deterioration (see paragraph 8-3.2.2), and visual observation to determine if the rock is in a solid and unshattered condition. If removal of rock below the foundation level is required, the space should be filled with concrete. A qualified geological or soils engineer should inspect the area if it is suspected that the material will deteriorate or swell when exposed to the weather. If necessary, the materials must be protected from exposure using the methods previously discussed in paragraph 8-4.1.2.

- Before placement of any structure foundation is begun, the plans should be rechecked to ensure that all required utilities and conduits under or adjacent to the foundation have been placed, so that excavating under or undermining the foundation to place utilities and conduits will not become necessary later.
- Occasionally, it may be found upon completion of the excavation that if a structure were placed as shown on the plans, it would be supported on two materials with drastically different consolidation characteristics, such as rock and soil, rock and backfill, or undisturbed soil and backfill. This situation could occur because the pre-design subsurface information was inadequate, because the structure was relocated or reoriented by a subsequent change in the plans, because of an oversight of the design engineer, or because of the excavation procedures followed by the contractor. Regardless of the reason, measures such as over-excavation and placement of subsequent backfill should be taken, where possible, and in coordination with the design office to provide a foundation of uniform material. Otherwise, the design office should evaluate the differences in foundation conditions for possible changes to the structural foundation elements.
- Preparing the area to receive the backfill consists of cleaning, leveling, and compacting the bottom of the excavation if the foundation is in soil. All debris and foreign material, such as trash, broken concrete and rock, boulders, and forming lumber, should be removed from the excavation. All holes, depressions, and trenches should be filled with the same material as that specified to be placed immediately above such a depression, unless otherwise designated, and compacted to the density specified for the particular material used. If the depression is large enough to accommodate heavy compacting equipment, the sides of the depression should have a positive slope and be flat enough for proper operation of compaction equipment. After the area is brought to a generally level condition by compacting in lifts in accordance with specifications, the entire area to receive backfill should be sacrificed to the depth specified, the water content adjusted if necessary, and the area compacted as specified. If the foundation is in rock, the area should be leveled as much as possible and all loose material removed.
- All work in the excavation should be accomplished in the dry; therefore, the dewatering system should be operated for the duration of this work. Under no circumstances should the contractor be allowed to dry an area by dumping a thick layer of dry material over it to blot the excess water. If soil exists at the foundation level and becomes saturated, it cannot be compacted. The saturated soil will have to be removed and replaced or drained sufficiently so that it can be compacted. Any frozen material in the foundation should be removed before placement of concrete footings or compacted backfill.

8-5.1 **Placement of Backfill.** Backfill construction is the refilling of previously excavated space with properly compacted material. The areas may be quite large, in which case the backfilling operation will be similar to embankment construction. On the other hand, the areas may be quite limited, such as confined areas around or between and beneath concrete or steel structures and areas in trenches excavated for utility lines. Prior to construction of the backfill, the inspection personnel should become thoroughly familiar with the various classes of backfill to be used. They should be able to readily identify the materials on sight, know where the various types of material should be placed, and be familiar with the compaction characteristics of the soil types.

8-5.2 **Good Construction Practices, and Problems.** Problems with placement of backfill will vary from one construction project to another. The magnitude of the problems will depend on the type of materials available such as backfill, density requirements, and the configuration of the areas in which compaction is to be accomplished. Problems should be expected during the initial stages of backfill compaction unless the contractor is familiar with compaction characteristics of backfill materials. The inspector can be of great assistance to the contractor during this period by performing frequent water content and density checks. The information from these checks will show the contractor the effects of the compaction procedures being used and point out any changes that should be made.

8-5.2.1 **Backfilling Procedures.** Problems associated with the compaction of backfill can be minimized by following good backfilling procedures. Good backfilling procedures include: processing the material (paragraph 8-3.4) before it is placed in the excavation; placing the material in a uniformly spread loose lift of the proper thickness suited to the compaction equipment and the type of material to be used; applying the necessary compaction effort to obtain the required densities; and ensuring that these operations are not performed during adverse weather. Proper bond should be provided between each lift and also between the backfill and the sides of the excavation.

8-5.2.2 **Compaction Equipment, Backfill Material, and Zones.** The type of compaction equipment used to achieve the required densities will usually depend upon the type of backfill material being compacted and the type of zone in which the material is placed.

- In open zones, coarse-grained soils that exhibit slight plasticity (clayey sands, silty sands, clayey gravels, and silty gravels) should be compacted with either sheepsfoot or rubber-tired rollers; close control of water content is required where silt is present in substantial amounts. For sands and gravelly sands with little or no fines, good compaction results are obtained with tractor compaction. Good compaction can also be achieved in gravels and gravel-sand mixtures with either a crawler tractor or rubber-tired and steel-wheeled rollers. The addition of vibration to any of the means of compaction mentioned above will usually improve the compaction of soils in this category. In confined zones, adequate compaction of cohesionless soils in either the air-dried or saturated condition can be achieved by vibratory-plate compactors with a static weight of at least 100 pounds. If the material is compacted in the saturated condition, good compaction

can be achieved by internal vibration (for example, by using concrete vibrators). Downward drainage is required to maintain seepage forces in a downward direction if the placed material is saturated to aid in compaction.

- Inorganic clays, inorganic silts, and very fine sands of low to medium plasticity are fairly easily compacted in open zones with sheepsfoot or rubber-tired rollers in the 67 kN (15,000 pound) and above wheel-load class. Some inorganic clays can be adequately compacted in confined zones using rammer or impact compactors with a static weight of at least 0.445 kN (100 pounds) provided close control of lift thickness and water content is maintained.
- Fine-grained, highly plastic materials, though not good backfill materials, can best be compacted in open zones with sheepsfoot rollers. Sheepsfoot rollers leave the surface of the backfill in a rough condition, which provides an excellent bond between lifts. In confined areas the best results, which are not considered good, are obtained with rammer or impact compactors.

8-5.2.3 Lift Thickness. The loose-lift thickness will depend on the type of backfill material and the compaction equipment to be used.

- As a general rule, a loose-lift thickness that will result in a 0.15 m (6 in) lift when compacted can be allowed for most sheepsfoot and pneumatic-tired rollers. Cohesive soils placed in approximately 0.25 m (10 in) loose lifts will compact to approximately 0.15 m (6 in), and cohesionless soils placed in approximately 0.20 m (8 in) base lifts will compact to 0.15 m (6 in). Adequate compaction can be achieved in cohesionless materials of about 0.300 to 0.381 m (12 to 15 in) loose-lift thickness if heavy vibratory equipment is used. The addition of vibration to rolling equipment used for compacting cohesive soils generally has little effect on the lift thickness that can be compacted, although compaction to the desired density can sometimes be obtained by fewer coverages of the equipment.
- In confined zones where clean cohesionless backfill material is used, a loose-lift thickness of 0.100 to 0.150 m (4 to 6 in) and a vibratory plate or walk-behind, dual-drum vibratory roller for compaction is recommended. Where cohesive soils are used as backfill in confined zones, use of rammer compactors and a loose-lift thickness of not more than 100 mm (4 in) should be specified. Experience has shown that "two-by-four" wood rammers, or single air tampers (commonly referred to as powder puffs" or "pogo sticks") do not produce sufficient compaction.

8-5.2.4 Density Requirements. In open areas of backfill where structures will not be constructed, compaction can be less than that required in more critical zones. Compaction to 90 percent of ASTM D 1557 maximum dry density should be adequate in these areas. If structures are to be constructed on or within the backfill, compaction of cohesionless soils to within 95 to 100 percent of ASTM D 1557 maximum dry density and of cohesive soils to at least 95 percent of ASTM D 1557 should be required for the full depth of backfill beneath these

structures. The specified degree of compaction should be commensurate with the tolerable amount of settlement, and the compaction equipment used should be commensurate with the allowable lateral pressure on the structure. Drainage blankets and filters having special gradation requirements should be compacted to within 95 to 100 percent of ASTM D 1557 maximum dry density. Table 8-5.1 gives a summary of type of compaction equipment, coverage, and lift thickness for the specified degree of compaction of various soil types.

8-5.2.5 **Cold Weather.** In areas where freezing temperatures either hamper or halt construction during the winter, certain precautions can, and should, be taken to prevent damage from frost penetration and subsequent thaw. Some of these precautions are presented below.

- Placement of permanent backfill should be deferred until favorable weather conditions prevail. However, if placement is an absolute necessity during freezing temperatures, either dry, cohesionless, non frost-susceptible materials or material containing additives, such as calcium chloride, to lower the freezing temperature of the soil water should be used. Each lift should be checked for frozen material after compaction and before construction of the next lift is begun. If frozen material is found, it should be removed; it should not be disked in place. Additives should not be used indiscriminately since they will ordinarily change compaction and water content requirements. Prior laboratory investigation should be conducted to determine additive requirements and the effect on the compaction characteristics of the backfill material.
- Under no circumstances should frozen material, from stockpile or borrow pit, be placed in backfill that is to be compacted to a specified density.
- Prior to halting construction during the winter, the peripheral surface drainage system should be checked and reworked where necessary to provide positive drainage of surface water away from the excavation.
- Foundations beneath structures and backfill around structures should not be allowed to freeze, because structural damage will invariably develop. Structures should be enclosed as much as possible and heated if necessary. Construction should be scheduled so as to minimize the amount of reinforcing steel protruding from a partially completed structure since steel will conduct freezing temperatures into the foundation.
- Permanent backfill should be protected from freezing. Records should be made of all temporary coverings that must be removed before backfilling operations are resumed. A checklist should be maintained to ensure that all temporary coverings are removed at the beginning of the next construction season.
- During freezing weather, records should be kept of the elevation of all critical structures to which there is the remotest possibility of damage or movement due to frost heave and subsequent thaw. It is important that frost-free benchmarks be established to which movement of any structure can be referenced. Benchmarks also should be established on the structures at strategic locations

prior to freezing weather.

- At the beginning of the following construction season and after the temporary insulating coverings are removed, the backfill should be checked for frozen material and ice lenses, and the density of the compacted material should be checked carefully before backfilling operations are resumed. If any backfill has lost its specified density because of freezing, it should be removed.

8-5.2.6 **Zones Having Particular Gradation Requirements.** Zones that have particular gradation requirements include those needed to conduct and control seepage, such as drainage blankets, filters, and zones susceptible to frost penetration. Drainage zones are often extremely important to the satisfactory construction and subsequent performance of the structure. To maintain the proper functioning of these zones, care must be taken to ensure that the material placed has the correct gradation and is compacted according to specifications.

CANCELLED

Table 8-5.1 Summary of Compaction Criteria^a

Soil Group	Soil Types	Degree of Compaction		Fill and Backfill				
				Typical Equipment and Procedures for Compaction				
				Equipment	No. of Passes or Coverages	Comp. Lift Thickness mm (in)	Placement Water Content	Field Control
Pervious (Free Draining)	GW GP SW SP	Compacted	90 – 95% of CE 55 maximum density	Vibratory Rollers	Indefinite	Indefinite	Saturate by Flooding	Control tests at intervals to determine degree of compaction or relative density
			75 – 85% of relative density	Rubber Tired Roller ^b	2-5 Coverages	300 (12)		
		Semi-Compacted	85 to 90% of CE 55 maximum density	Crawler Type Tractor ^c	2-5 Coverages	200 (8)		
			65 to 75% of relative density	Power Hand Tamper ^d	Indefinite	150 (6)		
				Rubber Tired Roller ^b	2-5 Coverages	360 (14)	Saturate by Flooding	Control tests at intervals to determine degree of compaction or relative density, if needed
				Crawler Type Tractor ^c	1-2 Coverages	250 (10)		
				Power Hand Tamper ^d	Indefinite	200 (8)		
				Controlled routing of construction equipment	Indefinite	200–250 (8-10)		

Note: The above requirements will be adequate in most construction venues. In special cases where tolerable settlements are unusually small, it may be necessary to employ additional compaction equivalents to 95-100% of compaction effort. A coverage consists of one application of the wheel of a rubber tired roller or the treads of a crawler type tractor over each point in the area being compacted. For a sheepsfoot roller, one pass consists of one movement of a sheepsfoot roller drum over the area being compacted.

- a) From TM 5-818-1
- b) Rubber – tired rollers having a wheel load between 80 and 111 kN (18,000 and 25,000 lb) with a tire pressure between 552-689 kPa (80-100 psi).
- c) Crawler type tractors weighing not < 89 kN (20,000 lbs) / exerting a foot pressure not < 4.5 kPa (6.5psi).
- d) Power hand tampers weighing more than 0.44 kN (100 lbs) / pneumatic or gasoline powered.
- e) Sheepsfoot roller with a foot pressure between 1724-3448 kPa (250-500 psi)/ tamping feet 180-250 mm (7-10 in) long/ face area between 4500-10300 mm² (7-16 sq. in.)

Table 8-5.1 Summary of Compaction Criteria^a

Soil Group	Soil Types	Degree of Compaction		Fill and Backfill				
				Typical Equipment and Procedures for Compaction				
				Equipment	No. of Passes or Coverages	Comp. Lift Thickness mm (in)	Placement Water Content	Field Control
Semi-Pervious and Impervious	CM	Compacted	90 to 95% of CE55 maximum density	Rubber tired Roller ^b	2-5 Coverages	200 (8)	Optimum water content	Control tests at intervals to determine degrees of compaction
	CC			Sheepsfoot Roller ^e	4-8 Passes	150 (6)		
	SM			Power hand Tamper ^d	Indefinite	100 (4)		
	SC	Semi-Compacted	85 to 90% of CE55 maximum density	Rubber tired rollers ^b	2-4 coverages	250 (10)	(A) Optimum water content (B) Observation: wet side maximum water content at which material can satisfactorily operate; dry side minimum water content required to bond particles; must not result in voids or honey-combed materials.	(A) Control tests as shown (B) Field control via visual inspection of process
	ML			Sheepsfoot Roller ^e	4-8 passes	200 (8)		
	CL			Crawler-type Tractor ^c	3 coverages	150 (6)		
	OL			Power hand tamper ^d	Indefinite	150 (6)		
	OH			Controlled routing of construction equipment ^f	Indefinite	150-200 (6-8)		
	MH							
	CH							

Note: The above requirements will be adequate in most construction venues. In special cases where tolerable settlements are unusually small, it may be necessary to employ additional compaction equivalents to 95-100% of compaction effort. A coverage consists of one application of the wheel of a rubber tired roller or the treads of a crawler type tractor over each point in the area being compacted. For a sheepsfoot roller, one pass consists of one movement of a sheepsfoot roller drum over the area being compacted.

- e) From TM 5-818-1
- f) Rubber – tired rollers having a wheel load between 80 and 111 kN (18,000 and 25,000 lb) with a tire pressure between 552-689 kPa (80-100 psi).
- g) Crawler type tractors weighing not < 89 kN (20,000 lbs) / exerting a foot pressure not < 4.5 kPa (6.5psi).
- h) Power hand tampers weighing more than 0.44 kN (100 lbs) / pneumatic or gasoline powered.
- e) Sheepsfoot roller with a foot pressure between 1724-3448 kPa (250-500 psi)/ tamping feet 180-250 mm (7-10 in) long/ face area between 4500-10300 mm² (7-16 sq. in.)

8-5.3 **Special Problems.** In open zones, compaction of backfill will not generally present any particular problems if proper compaction procedures normally associated with the compaction of soils are exercised and the materials available for use, such as backfill, are not unusually difficult to compact. The majority of the problems associated with backfill will occur in confined zones where only small compaction equipment producing a low compaction effort can be used or where because of the confined nature of the backfill zone even small compaction equipment cannot be operated effectively.

Considerable latitude exists in the various types of small compaction equipment available. Unfortunately, very little reliable information is available on the capabilities of the various pieces of equipment. Depending upon the soil type and working room, it may be necessary to establish lift thickness and compaction effort based essentially on trial and error in the field. For this reason, close control must be maintained particularly during the initial stages of the backfill until adequate compaction procedures are established.

8-5.3.1 **Difficult Structures.** Circular, elliptical and arched walled structures are particularly difficult to adequately compact backfill beneath the under side of haunches because of limited working space. Generally, the smaller the structure the more difficult it is to achieve required densities. Rock, where encountered, must be removed to a depth of at least 0.15 m (6 in) below the bottom of the structure and the overdepth backfilled with suitable material before foundation bedding for the structure is placed. Some alternate bedding and backfill placement methods are discussed below.

- One method is to bring the backfill to the planned elevation of the spring line using conventional heavy compaction equipment and methods. A template in the shape of the structure to be bedded is then used to reexcavate to conform to the bottom contours of the structure. If the structure is made of corrugated metal, allowance should be made in the grade for penetration of the corrugation crests into the backfill upon application of load. Success of this method of bedding is highly dependent on rigid control of grade during reexcavation using the template. This procedure is probably the most applicable where it is necessary to use a cohesive backfill.
- Another method of bedding placement is to sluice a clean granular backfill material into the bed after the structure is in place. This method is particularly adapted to areas containing a maze of pipes or conduits. Adequate downward drainage, generally essential to the success of this method, can be provided by sump pumps or, if necessary, by pumping from well points. Sluicing should be accompanied by vibrating to ensure adequate soil density. Concrete vibrators have been used successfully for this purpose. This method should be restricted to areas where conduits or pipes have been placed by trenching or in an excavation that provides confining sides. Also, this method should not be used below the groundwater table in seismic zones, since achieving densities high enough to assure stability in a seismic zone is difficult.

- Another method is to place clean, granular bedding material with pneumatic concrete equipment under the haunches of pipes, tunnels, and tanks. The material is placed wet and should have an in-place water content of approximately 15 to 18 percent. A nozzle pressure of 40 pounds per square inch is required to obtain proper density. Considerable rebound of material (as much as 25 percent by volume when placed with the hose nozzle pointed vertically downward and 50 percent with the nozzle pointed horizontally) occurs at this pressure. Rebound is the material that bounces off the surface and falls back in a loose state. However, the method is very satisfactory if all rebound material is removed. The material can be effectively removed from the backfill by dragging the surface in the area where material is being placed with a flat-end shovel. Two or three men will be needed for each gunite hose operated.
- For structures and pipes that can tolerate little or no settlement, lean grouts containing granular material and various cementing agents, such as portland cement or fly ash, can be used. This grout may be placed by either method discussed above. However, grouts may develop hard spots (particularly where the sluice method is used that could cause segregation of the granular material and the cementing agent), which could generate stress concentrations in rigid structures such as concrete pipes. Stress concentrations may be severe enough to cause structural distress. If lean grouts are used as backfill around a rigid structure, the structure must be designed to withstand any additional stress generated by possible hard spots.

8-5.4 Installation of Instruments. Installation of instrumentation devices should be supervised, if not actually done, by experienced personnel from Contracting Officer's Organization or by firms that specialize in instrumentation installation. The resident engineer staff must be familiar with the planned locations of all instruments and necessary apparatus or structures (such as trenches and terminal houses) so that necessary arrangements and a schedule for installation can be made with the contractor and with the office or firm that will install the devices. Inspectors should inspect any instrumentation furnished and installed by the contractor. Records must be made of the exact locations and procedures used for installation and initial observations. Inspectors should ensure that necessary extensions are added for the apparatus (such as lead lines and piezometer tubes) installed within the backfill as the backfill is constructed to higher elevations. Care must be used in placing and compacting backfill around instruments that are installed within or through backfill. Where necessary to prevent damage to instruments, backfill must be placed manually and compacted with small compaction equipment such as rammers or vibratory plates.

8-5.5 Post-construction Distress. Good backfill construction practices and control will minimize the potential for postconstruction distress. Nevertheless, the possibility of distress occurring is real, and measures must be taken to correct any problems before they become so critical as to cause functional problems with the facility. Therefore, early detection of distress is essential. Some early signs of possible

distress include: settlement or swelling of the backfill around the structure; sudden or gradual change of instrumentation data; development of cracks in structural walls; and adverse seepage problems. Detailed construction records are important for defining potential distress areas and assessing the mechanisms causing the distress.

8-6 SPECIFICATION PROVISIONS

8-6.1 **General.** The plans and specifications define the project in detail and show how it is to be constructed. They are the basis of the contractor's estimate and of the construction contract itself. The drawings show the physical characteristics of the structure, and the specifications cover the quality of materials, workmanship, and technical requirements. Together they form the guide and standard of performance that will be required in the construction of the project. Once the contract is let, the plans and specifications are binding on both the Contracting Officer and the contractor and are changed only by written agreement. For this reason, it is essential that the contractor and the Contracting Officer's representative anticipate and resolve differences that may arise in interpreting the intent and requirements of the specifications. The ease with which this can be accomplished will depend on the clarity of the specifications and the background and experience of the individuals concerned. Understanding of requirements and working coordination can be improved if unusual requirements are brought to the attention of prospective bidders and meetings for discussion are held prior to construction. Situations will undoubtedly arise that are not covered by the specifications, or conditions may occur that are different from those anticipated. Close cooperation is required between the contractor and the inspection personnel in resolving situations of this nature; if necessary, to be fair to both parties a change order should be issued.

8-6.2 **Preparation of Contract Specifications.** Preparation of contract specifications is easier if an outline of general requirements is available to the specification writer. However, it would be virtually impossible to prepare a guide specification that anticipates all problems that may occur on all projects. Therefore, contract specifications must be written to satisfy the specific requirement of each project. Some alternate specification requirements that might be considered for some projects are discussed below.

8-6.2.1 **Excavation.** The section of the specifications dealing with excavation contains information on drainage, shoring and bracing, removal and stockpiling, and other items, and refers to the plans for grade requirements and slope lines to be followed in excavating overburden soils and rock.

8-6.2.2 **Drainage.** For some projects the specifications will require the contractor to submit a plan of his excavation operations to the Contracting Officer for review. The plans and specifications will require that the excavation and subsequent construction and backfill be carried out in the dry. To meet this requirement, a dewatering system based on the results of groundwater studies may be included in the plans. Also, for some projects the specifications may require the contractor to submit his plan for controlling groundwater conditions. The specifications should likewise indicate the possibility of groundwater conditions being different from those shown in the subsurface

investigation report due to seasonal or unusual variations or insufficient information, since the contractor will be held responsible for controlling the groundwater flow into the excavation regardless of the amount. To this end, the specifications should provide for requiring the contractor to submit a revised dewatering plan for review where the original dewatering plan is found to be inadequate.

8-6.2.3 **Shoring and Bracing.** The specifications either will require the contractor to submit for review his plans for the shoring and bracing required for excavation or will specify shoring and bracing required by subsurface and groundwater conditions and details of the lines and grades of the excavation. In the latter case, the contractor may be given the option to submit alternate plans for shoring and bracing for review by the Contracting Officer. The plans will present the necessary information for the design of such a system if the contractor is allowed this option.

8-6.2.4 **Stockpiling.** Provisions for stockpiling materials from required excavation according to type of backfill may or may not be included in the specifications. Generally, procedures for stockpiling are left to the discretion of the contractor, and a thorough study should be made to substantiate the need for stockpiling before such procedures are specified. There are several conditions under which inclusion of stockpiling procedures in the specifications would be desirable and justified. Two such conditions are discussed in the following paragraphs.

- Under certain conditions, such as those that existed in the early stages of missile base construction where time was an important factor, it may be necessary or desirable to award contracts for the work in phases. As a result, one contractor may do the excavating and another place the backfill. It is probable that the excavation contractor will have little or no interest in stockpiling the excavated materials in a manner conducive to good backfilling procedures. When such a situation can be foreseen, the specifications should set forth stockpiling procedures. The justification for such requirements would be economy and optimum use of materials available from required excavation as backfill.
- The specifications will contain provisions for removing, segregating, and stockpiling or disposing of material from the excavation and will refer to the plans for locations of the stockpiles. The subsoil conditions and engineering characteristics requirements may state that the specifications must be quite definite concerning segregation and stockpiling procedures so that the excavated materials can be used most advantageously in the backfill. The specification may require that water be added to the material or the material be aerated as it is stockpiled to approximate optimum water content, that the stockpile be shaped to drain and be sealed from accumulation of excess water, and that the end dumping of material on the stockpile be prohibited to prevent segregation of material size or type along the length of the stockpile.

An alternative to this latter action would be to specify the various classes of backfill required and leave the procedure for stockpiling the materials by type to the discretion of the contractor. In this case, the contractor should be required to submit a

detailed plan for excavating and stockpiling the material. The plan should indicate the location of stockpiles for various classes of backfill so that the material can be tested for compliance with the specifications. The contractor may elect to obtain backfill material from borrow or commercial sources rather than to separate and process excavated materials. Then the specifications should require that stockpiles of the various classes of needed backfill be established at the construction site in sufficient quantity and far enough in advance of their use to allow for the necessary testing for approval unless conditions are such that approval of the supplier's stockpile or borrow source can be given.

8-6.3 Foundation Preparation. The provisions for preparation for structures will generally not be grouped together in the specifications but will appear throughout the earthwork section of the specifications under paragraphs on excavation, protection of foundation materials, backfill construction, and concrete placement. When a structure is to be founded on rock, the specifications will require that the rock be firm, unshattered by blasting operations, and not deteriorated from exposure to the weather. The contractor will be required to remove shattered or weathered rock and to fill the space with concrete.

8-6.3.1 Structures on Soil. Specifications for structures founded on soil require the removal of all loose material and all unsuitable material, such as organic clay or silt, below the foundation grade. When doubt exists as to the suitability of the foundation materials, a soils engineer should inspect the area and his recommendations should be followed. When removal of rock material below the planned foundation level is required, the over-excavation will usually require filling with concrete. The specifications also require dewatering to the extent that no backfill or structural foundation is placed in the wet.

Specifications for preparation of the soil foundation to receive backfill require removing all debris and foreign matter, making the area generally level, and scarifying, moistening, and compacting the foundation to a specified depth, generally 305 mm (12 in). Specific provisions may or may not be given with respect to leveling procedures.

8-6.4 Backfill Operations. The specifications define the type or types of material to be used for backfill construction and provide specific instructions as to where these materials will be used in the backfill. The percentage of ASTM D 1557 maximum dry density to be obtained, determined-by a designated standard laboratory compaction procedure, will be specified for the various zones of backfill. The maximum loose-lift thickness for placement will also be specified. Because of the shape of the compaction curve, the degree of compaction specified can be achieved only within a certain range of water contents for a particular compaction effort. Though not generally specified in military construction, the range of water contents is an important factor affecting compaction.

8-6.4.1 Compacting. The specifications sometimes stipulate the characteristics and general type of compaction equipment to be used for each of the various types of backfill. Sheepsfoot or rubber-tired rollers, rammer or impact compactors, or other suitable equipment are specified for fine-grained, plastic materials. Non-cohesive, free

draining materials are compacted by saturating the material and operating crawler-type tractor, surface or internal vibrators, vibratory compactors, or other similar suitable equipment. The specifications generally will prohibit the use of rock or rock-soil mixtures as backfill in this type of construction. However, when the use of backfill containing rock is permitted, the maximum size of the rock is given in the specifications along with maximum lift thickness, loading, hauling, dumping, and spreading procedures, type of compaction equipment, and method of equipment operation. The specifications should prohibit the use of rock or rock-soil mixtures as backfill in areas where heavy equipment cannot operate. Rock / soil mixtures having greater than 8 to 10 percent binder should be prohibited in all areas. In the case of backfill containing rock, the density is not generally specified. Obtaining adequate density is usually achieved by specifying the compaction procedures. The specifications may require that these procedures be developed in field test sections.

Specifications may also require specific equipment and procedures to ensure adequate bedding for round-bottom structures such as tunnels, culverts, conduits, and tanks. Procedures normally specified for placement of bedding for these types of structure are discussed in paragraph 1.3.

8-6.4.2 Backfill Against Structures. The specifications will state when backfill may be placed against permanent concrete construction with respect to the time after completion; this time period is usually from 7 to 14 days. To provide adequate protection of the structures during backfill construction, the specifications require that the backfill be built up symmetrically on all sides and that the area of operation of heavy equipment adjacent to a structure be limited. Also, the minimum thickness of compacted materials to be placed over the structures by small compaction equipment, such as vibratory plate or rammer type, will be specified before heavy equipment is allowed to operate over the structure. The specifications require that the surface of the backfill be sloped to drain at all times when necessary to prevent ponding of water on the fill. The specifications also provide for groundwater control, so that all compacted backfill will be constructed in the dry. Where select, freedraining, cohesionless soils of high permeability are required in areas where compaction is critical, the specifications list gradation requirements. Gradation requirements are also specified for materials used for drains and filters.

Unusually severe specification requirements may be necessary for backfill operations in confined areas. The requirements may include strict backfill material type limitation, placement procedures, and compaction equipment.

8-6.4.3 Protection from Freezing. It is not the policy of the Government to inform the contractor of ways to accomplish the necessary protection from freezing temperatures. However, to ensure that adequate protection is provided, it may be necessary to specify that the contractor submit detailed plans for approval for such protection.

8-7 STABILIZATION OF SUBGRADE SOILS

8-7.1 **General** . The applicability and essential features of foundation soil treatments are summarized in Tables 8-7.1 and 8-7.2 and in Figure 8-7.1. The depth of stabilization generally must be sufficient to absorb most of the foundation pressure bulb.

The relative benefits of vibrocompaction, vibrodisplacement compaction, and precompression increase as load intensity decreases and size of loaded area increases, soft, cohesive soils treated in place are generally suitable only for low-intensity loadings. Soil stabilization of wet, soft soils may be accomplished by addition of lime; grout to control water flow into excavations to reduce lateral support requirements or to reduce liquefaction or settlement caused by adjacent pile driving; seepage control by electro osmosis; and temporary stabilization by freezing. The range of soil grain sizes for which each stabilization method is most applicable is shown in figure 8-7.1.

8-7.2 **Vibrocompaction**. Vibrocompaction methods (blasting, terraprobe, and vibratory rollers) can be used for rapid densification of saturated cohesionless soils (Figure 8-7.1.) The ranges of grain-size distributions suitable for treatment by vibrocompaction, as well as vibroflotation, are shown in Figure 8-7.2. The effectiveness of these methods is greatly reduced if the percent finer than the 0.075 Micron (No. 200) sieve exceeds about 20 percent or if more than about 5 percent is finer than 0.002 millimeter, primarily because the hydraulic conductivity of such materials is too low to prevent rapid drainage following liquefaction. The usefulness of these methods in partly saturated sands is limited, because the lack of an increase of pore water pressure impedes liquefaction. Lack of complete saturation is less of a restriction to use of blasting because the high-intensity shock wave accompanying detonation displaces soil, leaving depressions that later can be backfilled.

8-7.2.1 **Blasting**. Theoretical design procedures for densification by blasting are not available and continuous onsite supervision by experienced engineers having authority to modify procedures as required is essential if this treatment method is used. A surface heave of about 150 mm (6 in) will be observed for proper charge sizes and placement depths. Surface cratering should be avoided. Charge sizes of less than 1.8 to more than 27 kg (4 to more than 60 lb) have been used. The effective radius of influence for charges using (meters = lb) 60 percent dynamite is as follows:

$$R = 3M^{1/3} \text{ (feet)}$$

8-7.2.1.1 **Charge Spacings**. Charge spacings of 3 to 7.62 m (10 to 25 ft) are typical. The center of charges should be located at a depth of about two thirds the thickness of the layer to be densified, and three to five successive detonations of several spaced charges each are likely to be more effective than a single large blast. Little densification is likely to result above about a 1 m (3 ft) depth, and loosened material may remain around blast points. Firing patterns should be established to avoid the "boxing in" of pore water. Free-water escape on at least two sides is desirable.

8-7.2.1.2 **Pre-Flooding**. If blasting is used in partly saturated sands or loess, pre-flooding of the site is desirable. In one technique, blast holes about 76 to 88 mm (3 to 3 ½ in) in diameter are drilled to the desired depth of treatment, then small charges

connected by prima cord, or simply the prima cord alone, are strung the full depth of the hole. Each hole is detonated in succession, and the resulting large diameter holes formed by lateral displacement are backfilled. A sluiced-in cohesionless backfill will densify under the action of vibrations from subsequent blasts. Finer grained backfills can be densified by tamping.

8-7.2.2 Vibrating Probe (Terraprobe). A 30-in-outside-diameter, open-ended pipe pile with 9.5 mm (3/8-in) wall thickness is suspended from a vibratory pile driver operating at 15 Hz. A probe length from 3.05 to 4.57 m (10 to 15 ft) greater than the soil depth to be stabilized is used. Vibrations of 9.5 mm to 25.4 mm (3/8 to 1 in) amplitude are applied in a vertical mode. Probes are made at a spacing of between 0.91 and 3.05 m (3 to 10 ft). After the soil sinks to the desired depth, the probe is held for 30 to 60 seconds before extraction. The total time required per probe is typically 2 ½, to 4 minutes. Effective treatment has been accomplished at depths of 3.66 to 18.29 m (12 to 60 ft). Areas in the range of 376 to 585 m² (450 to 700 sq yd) may be treated per machine per 8 hour shift.

Test sections about 9.1 to 18.3 m (30 to 60 ft) on a side are desirable to evaluate the effectiveness and required probe spacing. The grain-size range of treated soil should fall within limits shown in Figure 16-2. A square pattern is often used, with a fifth probe at the center of each square giving more effective increased densification than a reduced spacing. Saturated soil conditions are necessary as underlying soft clay layers may dampen vibrations.

8-7.2.3 Vibratory Rollers. Where cohesionless deposits are of limited thickness, e.g., less than 2 m (6 ft), or where cohesionless fills are being placed, vibratory rollers are likely to be the best and most economical means for achieving high density and strength. Use with flooding where a source of water is available. The effective depth of densification may be 2 m (6 ft) or more for heaviest vibratory rollers or a fill placed in successive lifts, a density-depth distribution similar to that in Figure 8-7.3 results. It is essential that the lift thickness, soil type, and roller type be matched. Properly matched systems can yield compacted layers at a relative density of 85 to 90 percent or more.

8-7.3 Vibrodisplacement Compaction. The methods in this group are similar to those described in the preceding section except that the vibrations are supplemented by active displacement of the soil and, in the case of vibroflotation and compaction piles, by backfilling the zones from which the soil has been displaced.

8-7.3.1 Compaction Piles. Partly saturated or freely draining soils can be effectively densified and strengthened by this method, which involves driving displacement piles at close spacings, usually 1 to 2 m (3 to 6 ft) on centers. One effective procedure is to cap temporarily the end of a pipe pile (e.g., by a detachable plate) and drive it to the desired depth, which may be up to 18 m (60 ft). Either an impact hammer or a vibratory driver can be used. Sand or other backfill material is introduced in lifts with each lift compacted concurrently with withdrawal of the pipe pile. In this way, not only is the backfill compacted, but the compacted column has also expanded laterally below the pipe tip forming a caisson pile.

8-7.3.2 Heavy Tamping (Dynamic Consolidation). Repeated impacts of a very

heavy weight (up to 356 kN (80 kips)) dropped from a height of 15 to 40 m (50 to 130 ft) are applied to points spaced 4.5 to 9.0 m (15 to 30 ft) apart over the area to be densified. In the case of cohesionless soils, the impact energy causes liquefaction followed by settlement as water drains. Radial fissures that form around the impact points, in some soils, facilitate drainage. The method has been used successfully to treat soils both above and below the water table.

The product of tamper mass and height of fall should exceed the square of the thickness of layer to be densified. A total tamping energy of 2 to 3 blows per square meter or square yard is used. Increased efficiency is obtained if the impact velocity exceeds the wave velocity in the liquefying soil. One crane and tamper can treat from 293 to 627 m² (350 to 750 sq yd) per day. Economical use of the method in sands requires a minimum treatment area of 2671 m² (7500 sq yd). Relative densities of 70 to 90 percent are obtained. Bearing capacity increases of 200 to 400 percent are usual for sands and marls, with a corresponding increase in deformation modulus. The cost is reported as low as one-fourth to one-third that of vibroflotation.

Because of the high-amplitude, low-frequency vibrations (2-12 Rz), minimum distances should be maintained from adjacent facilities as follows:

Piles or bridge abutment	4.6 – 6.1 m	(15 – 20 ft)
Liquid storage tanks	9.1 m	(30 ft)
Reinforced concrete buildings	15.2 m	(50 ft)
Dwellings	30.5 m	(100 ft)
Computers (not isolated)	91.4 m	(300 ft)

8-7.3.3 Vibroflotation. A cylindrical penetrator about 381 mm (15 in) in diameter and 1.8 m (6 ft) long, called a vibroflot, is attached to an adapter section containing lead wires and hoses. A crane handles the whole assembly. A rotating eccentric weight inside the vibroflot develops a horizontal centrifugal force of about 89 kN (10 tons) at 1800 revolutions per minute. Total weight is about 18 kN (2 tons).

To sink the vibroflot to the desired treatment depth, a water jet at the tip is opened and sets in conjunction with the vibrations so that a hole can be advanced at a rate of about 1.2 m (3.6 ft) per minute; then the bottom jet is closed, and the vibroflot is withdrawn at a rate of about 30 mm (0.1 ft) per minute. Newer, heavier vibroflots operating at 100 horsepower can be withdrawn at twice this rate and have a greater effective penetration depth. Concurrently, a cohesionless sand or gravel backfill is dumped in from the ground surface and densified. Backfill consumption is at a rate of about .62 to 1.77 m³ per m² (0.7 to 2 cubic yards per square yard) of surface. In partly saturated sands, water jets at the top of the vibroflot can be opened to facilitate liquefaction and densification of the surrounding ground. Liquefaction occurs to a radial distance of 305 mm to 610 mm (1 to 2 ft) from the surface of the vibroflot. Most vibroflotation applications have been to depths less than 18 m (60 ft), although depths of 27 m (90 ft) have been attained successfully.

A relationship between probable relative density and vibroflot hold spacings is given in Figure 8-7.4. Newer vibroflots result in greater relative densities. Figure 8-7.5 shows relationships between allowable bearing pressure to limit

settlements to 25.4 mm (1 in) and vibroflot spacing. Allowable pressures for "essentially cohesionless fills" are less than for clean sand deposits, because such fills invariably contain some fines and are harder to densify.

Continuous square or triangular patterns are often used over a building site. Alternatively, it may be desired to improve the soil only at the locations of individual spread footings. Patterns and spacings required for an allowable pressure of 287 kPa (3 tons per sq ft) and square footings are given in Table 8-7.3.

CANCELLED

Table 8-7.1 Stabilization of Soils for the Foundations of Structures

	Method	Principle	Most Suitable Soil Condition/ Type	Maximum Effective Treatment Depth meters (ft)	Economical Size of Treated Area	Special Materials Required	Special Equipment Required	Properties of Treated Material	Special Advantages and Limitations	Relative Costs (1976)
Vibro-Compaction	Blasting	Shock waves and vibrations causes liquefaction, displacement	Saturated, clean sands, partially saturated sands and silts after flooding`	18 M (60 ft)	Small areas can be treated economically	Explosives; backfill to plug drill holes	Jetting or drilling machinery	Can obtain relative densities to 70-80%; may get variable density	Rapid, inexpensive; can treat small areas, variable properties; no improvement near surface dangerous	Low \$0.50 to \$1.00 per cubic meter (cubic yard)
	Terraprobe	Densification by vibrations, liquefaction induced settlement under overburden	Saturated or clean dry sand	18 M (60 ft) (ineffective 3.6 M (12 ft) depth and above)	1000M ² >1200yd ²	None	Vibratory pile driver and 75mm diameter open steel pipe	Can obtain relative densities of 80% or more	Rapid, simple; good underwater and w/ soft underlayers; difficult to penetrate stiff upper layers; not good in poorly saturated soils.	Moderate; \$1.50-. \$3.25/cubic meter (cubic yd) \$2.00 cubic meter (cubic yd) average
	Vibratory Rollers	Densification by vibration, liquefaction induced settlement under roller weight	Cohesion-less soils	1.8-3 M (6-10 ft)	Any size	None	Vibratory roller	Can obtain very high relative densities	Best method for thin layers and lifts	Low

Table 8-7.1 Stabilization of Soils for the Foundations of Structures

	Method	Principle	Most Suitable Soil Condition/ Type	Maximum Effective Treatment Depth (feet)	Economical Size of Treated Area	Special Materials Required	Special Equipment Required	Properties of Treated Material	Special Advantages and Limitations	Relative Costs (1976)
Vibro-Displacement Compaction	Compaction piles	Densification by displacement of pile volume and vibration during drilling	Loose sandy soils, partly saturated clay like soils; loess	1.8 M (60ft)	Small to moderate	Pile material (often sand or soil + cement)	Pile driver	Can obtain high densities; good uniformity	Useful in soils w/ fines, uniform compaction easy to check results, slow, limited improvement in upper 300 – 600 mm (1-2 ft)	High
	Heavy Tamping (Dynamic consolidation)	Repeated application of high intensity impacts @ surface.	Cohesionless best; other types can also be improved	15- 18 M (50-60 ft)	>3344 M ² (4000 yd ²)	None	Tamper of 10-40 tons; high capacity crane	Can obtain high relative densities; reasonable uniformity	Simple, rapid; suitable for some soils w/ fines; usable above and below water; requires control; must be away from existing structures.	Less than vibro-floatation.
	Vibrofloatation	Densification by vibration and compaction of backfill material	Cohesionless soils with less than 20%	90ft	>1000 M ² (1200 yd ²)	Granular backfill	Vibroflot; crane	Can obtain high relative densities; good uniformity	Useful in saturated and partially saturated soils; uniformity	\$10.00-\$25.00/m ² (yd ²); \$1.00/m ² (yd ²); may cost about half of compaction or concrete piles.

Table 8-7.1 Stabilization of Soils for the Foundations of Structures

	Method	Principle	Most Suitable Soil Condition/ Type	Maximum Effective Treatment Depth (feet)	Economical Size of Treated Area	Special Materials Required	Special Equipment Required	Properties of Treated Materials	Special Advantages and Limitations	Relative Costs (1976)
Grouting and Injection	Particulate Grouting	Penetration grouting; fill soil pores w/ cement and/or clay	Medium to coarse sand and gravel	Unlimited	Small	Grout, water	Mirrors, tanks, pumps, hoses	Impervious, high strength with cement grout; eliminates liquefaction danger	Low cost grouts, high strength: limited to coarse grained soils hard to evaluate	Lowest of the grout systems
	Chemical grouting	Solutions of two or more chemicals react in soil pores to form a gel or a solid precipitate	Medium silts and coarser	Unlimited	Small	Grout, water	Mirrors, tanks, pumps, hoses	Impervious, low to high strength; eliminate liquefaction danger	Low viscosity, controllable gel time, good water shut-off; high cost, hard to evaluate	High to very high \$30/m ² - \$80/m ² typical
	Pressure Injected Lime	Lime slurry injected to shallow depths under high pressure	Expansive clays	Unlimited; but 2-3 m usual	Small	Lime, water, surfactant	Slurry tanks, agitators, injectors	Lime encapsulated zones formed by chemicals resulting from cracks, root holes, hydraulic fracture.	Rapid and economical treatment for foundation soils under light structures.	\$2.50- \$3.00/m of ground surface area.

Table 8-7.1 Stabilization of Soils for the Foundations of Structures

Grouting and Injection (Continued)	Method	Principle	Most Suitable Soil Condition/ Type	Maximum Effective Treatment Depth (feet)	Economical Size of Treated Area	Special Materials Required	Special Equipment Required	Properties of Treated Materials	Special Advantages and Limitations	Relative Costs (1976)
	Displacement Grout	Highly viscous grout acts as radial hydraulic jack when pumped in under high pressure	Soft, fine grained soils; foundation soils with large voids or cavaties	Unlimited, but a few, as usual	Small	Soil, cement, water	Batching equipment, high pressure pumps and hoses	Grout bulbs within compressed soil matrix	Good for correction of differential settlements, filling large voids; careful control required	Low for materials; high for injection process.

Table 8-7.1 Stabilization of Soils for the Foundations of Structures

	Method	Principle	Most Suitable Soil Condition/ Type	Maximum Effective Treatment Depth (feet)	Economical Size of Treated Area	Special Materials Required	Special Equipment Required	Properties of Treated Material	Special Advantages and Limitations	Relative Costs (1976)
Precompression	Preloading	Load is applied sufficiently in advance of construction so that compression of soft soils is completed prior to site development	Normally consolidated soft clays, silts, organic deposits, completed sanitary landfills	-----	>1000m ²	Earth fill or other material for loading the site; sand or gravel for drainage blanket.	Earth moving equipment; large H ₂ O tanks or vacuum drainage systems may be used; settlement markers; piezometers	Reduced water content and void ratio/ increased strength	Easy, theory well developed, consistent and uniform; requires long time (sand drains or wicks can be used to reduce consolidation time	Low / moderate if vertical drains are required.
	Surcharge fills	Fill in excess of that required permanently is applied to achieve a given amt of settlement in a shorter time; excess fill then removed	Normally consolidated soft clays, silts, organic deposits: completed sanitary landfills	-----	>1000m ²	Earth fill / other material for loading/ sand or gravel as drainage blanket	Earth moving equipment; settlement markers; piezometers	Reduced H ₂ O content, void ratios and compressibility: increased strength	Faster than preloading w/o surcharge; theory well developed; extra material handling; use sand drains/ wicks	Moderate/ Sand drains moderate cost

Table 8-7.1 Stabilization of Soils for the Foundations of Structures

	Method	Principle	Most Suitable Soil Condition/ Type	Maximum Effective Treatment Depth (feet)	Economical Size of Treated Area	Special Materials Required	Special Equipment Required	Properties of Treated Material	Special Advantages and Limitations	Relative Costs (1976)
Precompression (Continued)	Dynamic Consolidation	High energy impacts compress and dissolve gas in pores to give immediate settlement; increased pore pressure gives subsequent drainage.	Partly saturated fine grained soils; quarternary clays w/ 1-4 gas in micro – bubbles	30 m	>15000-30000 m ²	>15000-30000 m ²	Tamper of 10-40 tons, high capacity cranes	Reduced water content, void ratio and compressability; Increased strength	Faster than preloading, economical on large areas; uncertain mechanism in clays; less uniformity than preloading	< preload fills w/ sand drains
	Electro-osmosis	DC current causes H ₂ O to flow from anode to cathode where it is then removed	Normally consolidated silts and silty clays	10-20m	Small	Anodes (rebar or aluminum) Cathodes (well points or rebar)	D/C power supply, wiring, metering system	Reduced water content and compressibility; increased strength, electrochemical hardening	No fill loading required, can use in confined areas, relatively fast, non-uniform properties between electrodes; useless in highly conductive soils	High

Table 8-7.1 Stabilization of Soils for the Foundations of Structures

	Method	Principle	Most Suitable Soil Condition/ Type	Maximum Effective Treatment Depth (feet)	Economical Size of Treated Area	Special Materials Required	Special Equipment Required	Properties of Treated Material	Special Advantages and Limitations	Relative Costs (1976)
Reinforcement	Mix in Place Piles and Walls	Lime, cement or asphalt introduced through rotating auger or special in-place mixer	All soft or loose inorganic soils	>20m	Small	Cement, lime, or chemical stabilization.	Drill rig, rotating cutting and mixing head, additive proportioning equipment	Modified soil piles or walls of relatively high strength.	Does native soil, reduced lateral support requirements during excavation; difficult to exert quality control.	Moderate to high
	Strips and Membranes	Horizontal toenails or membranes buried in soil under footings	All	A few meters	Small	Metal or plastic strips, polyethylene, polypropylene, or polyester fabrics	Excavation, earth handling and compaction equipment.	Increased bearing capacity, reduced deformations.	Increased allowable bearing pressures, requires over-excavation for footings.	Low to moderate
	Vibro-replacement stone columns	Hole jetted into soft fine grain soils / backfilled w/ dense, compacted gravel	Soft clays and alluvial deposits	20 m	>1500 m ²	Gravel or crushed rock backfill	Vibroflot. crane or vibro-cat, water	Increased bearing capacity; reduced settlements	Faster than pre-compression. No dewatering; limited bearing capacity	Moderate to high, relative to depth penetration.

Table 8-7.1 Stabilization of Soils for the Foundations of Structures

	Method	Principle	Most Suitable Soil Condition/ Type	Maximum Effective Treatment Depth (feet)	Economical Size of Treated Area	Special Materials Required	Special Equipment Required	Properties of Treated Material	Special Advantages and Limitations	Relative Costs (1976)
Thermal	Heating	Drying at low temperatures; alteration of clays of intermediate temps (400 – 600 ° C): Fusion @ high temps (> 1000° C)	Fine grained soils; especially partially saturated silts and clays: loess	15 m	Small	Selected fuels	Fuel tanks, burners, blowers	Reduced water control, plasticity, water sensitivity; increased strength	Can obtain irreversible improvements in properties; introduces stabilization w/ hot gases. Experimental @ this writing (1976)	High
	Freezing	Freezes soft, wet ground to increase strength, reduce pliability	All soils	Several m	Small	Refrigerant	Refrigeration system	Increased strength, reduced pliability	Cannot be used with flowing ground water; temporary.	High

Table 8-7.1 Stabilization of Soils for the Foundations of Structures

	Method	Principle	Most Suitable Soil Condition/ Type	Maximum Effective Treatment Depth (feet)	Economical Size of Treated Area	Special Materials Required	Special Equipment Required	Properties of Treated Material	Special Advantages and Limitations	Relative Costs (1976)
Miscellaneous	Remove and replace, with / without admixtures	Foundation soil excavated; improved by drying or admixtures	Inorganic soils	10 m	Small	Only if admixtures are needed	Excavation and compaction equipment; dehydrating system	Increased strength and stiffness; reduced compressibility	Uniform, controlled foundation soils when replaced; may require large area of de-watering.	High
	Moisture barriers	Excess water in foundation soils is prevented	Expansive soils	5 m	Small	Membranes, gravel, lime or asphalt	Excavating, trenching, and compaction equipment	Original natural or as compacted properties retained	Best used with small structures/ may not be 100% effective.	Low to moderate
	Pre-wetting	Soil is brought to final estimated water content prior to construction	Expansive soils	2-3 m	Small	Water	Water tanks	Decreased swelling potential	Low cost, best used for small light constructions; shrinking and swelling may sill occur	Low
	Structural Fills (with or without admixtures)	Fill distributes loads to underlying soils	Use over soft clays or organic soils, marsh lands	-----	Small	Sand, gravel, fly/bottom ash, clam/oyster shell , incinerator ash	Compaction equipment	Soft subgrade protected by structural load-bearing fill	High strength, good load distribution to underlying soft soils.	Moderate to high.

**Table 8-7.2 Applicability of Foundation Soil Improvement for Different Structures and Soil Types
(for Efficient Use of Shallow Foundations)**

Category of Structure	Structure	Permissible Settlement	Load Intensity/ Usual Bearing Pressure Required kPa (tsf)	Probability of Advantageous Use of Soil Improvement Techniques		
				Loose Cohesionless Soils	Soft Alluvial Deposits	Old, Inorganic Soils
Office/Apartment Frame or load bearing construction	High rise/ more than six stories	Small<25-50mm	High 287-96 (3-1)	High	Unlikely	Low
	Medium rise 3-6 stories	Small<25-50mm	Moderate 192 (2)	High	Low	Good
	Low rise 1-3 stories	Small<25-50mm	Low 96-192 (1-2)	High	Good	High
Industrial	Large span w/heavy machines, cranes;process and power plants	Small<25-50mm Differential Settlement Critical	Variable/ high local concentrations to >383 (4)	High	Unlikely	Low
	Framed warehouses & factories	Moderate	Low 96-192 (1-2)	High	Good	High
	Covered storage, storage rack systems, production areas	Low to moderate	Low <192 (2)	High	Good	High
Others	Water /waste water treatment plants	Moderate Differential settlement important	Low <14364 (150) <144 (1.5)	High, if needed at all	High	High
	Storage tanks	Moderate to high, Diff. maybe critical	High/up to 28728 (300)	High, if needed at all	High	High
	Open storage Areas	High	High/up to 28728 (300)	High, if needed at all	High	High
	Embankments/ Abutments	Moderate to high	High/up to 28728 (300)	High, if needed at all	High	High

Figure 8-7.1 Applicable Grain-size Ranges for Different Stabilization Methods

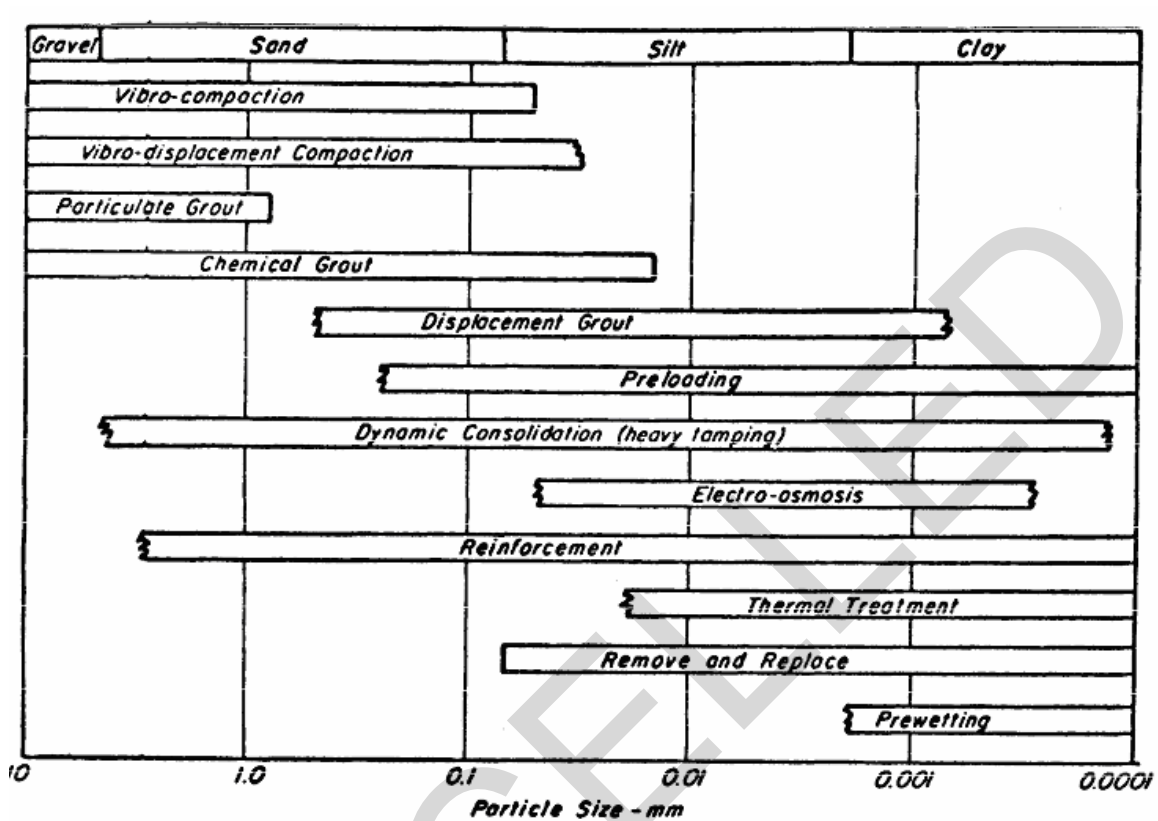

(Courtesy of J. K. Mitchell, "Innovations in Ground Stabilization," Chicago Soil Mechanics Lecture Series, Innovations in Foundation Construction, Illinois Section, 1972. Reprinted by permission of The American Society of Civil Engineers, New York.)

Figure 8-7.2 Range of Particle-size Distributions Suitable for Densification by Vibrocompaction

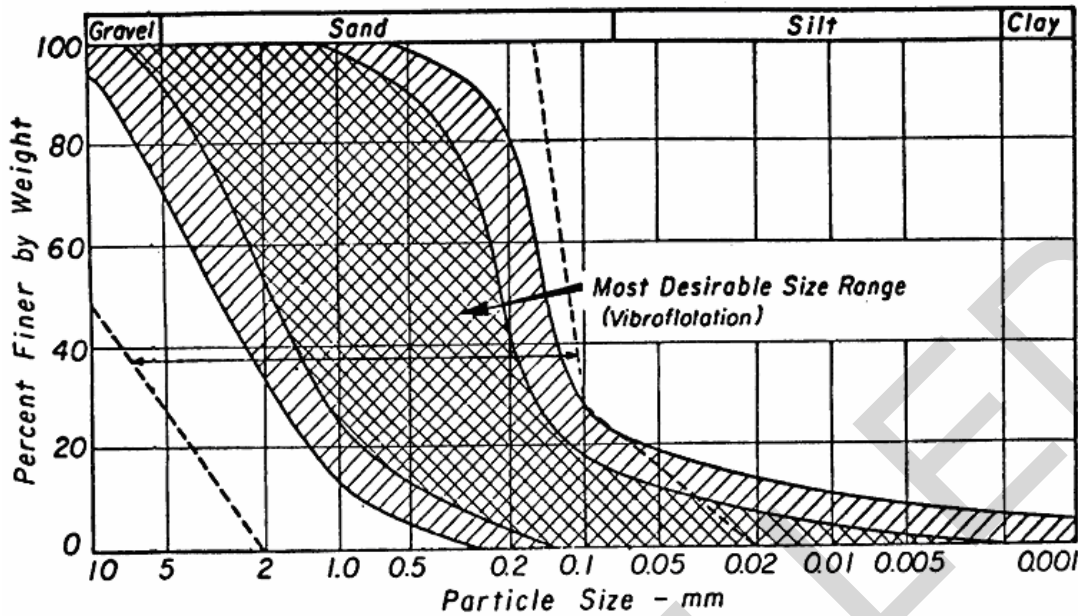

(Courtesy of J. K. Mitchell, "Innovations in Ground Stabilization," Chicago Soil Mechanics Lecture Series, Innovations in Foundation Construction, Illinois Section, 1972. Reprinted by permission of The American Society of Civil Engineers, New York.)

Figure 8-7.3 Sand Densification Using Vibratory Rollers

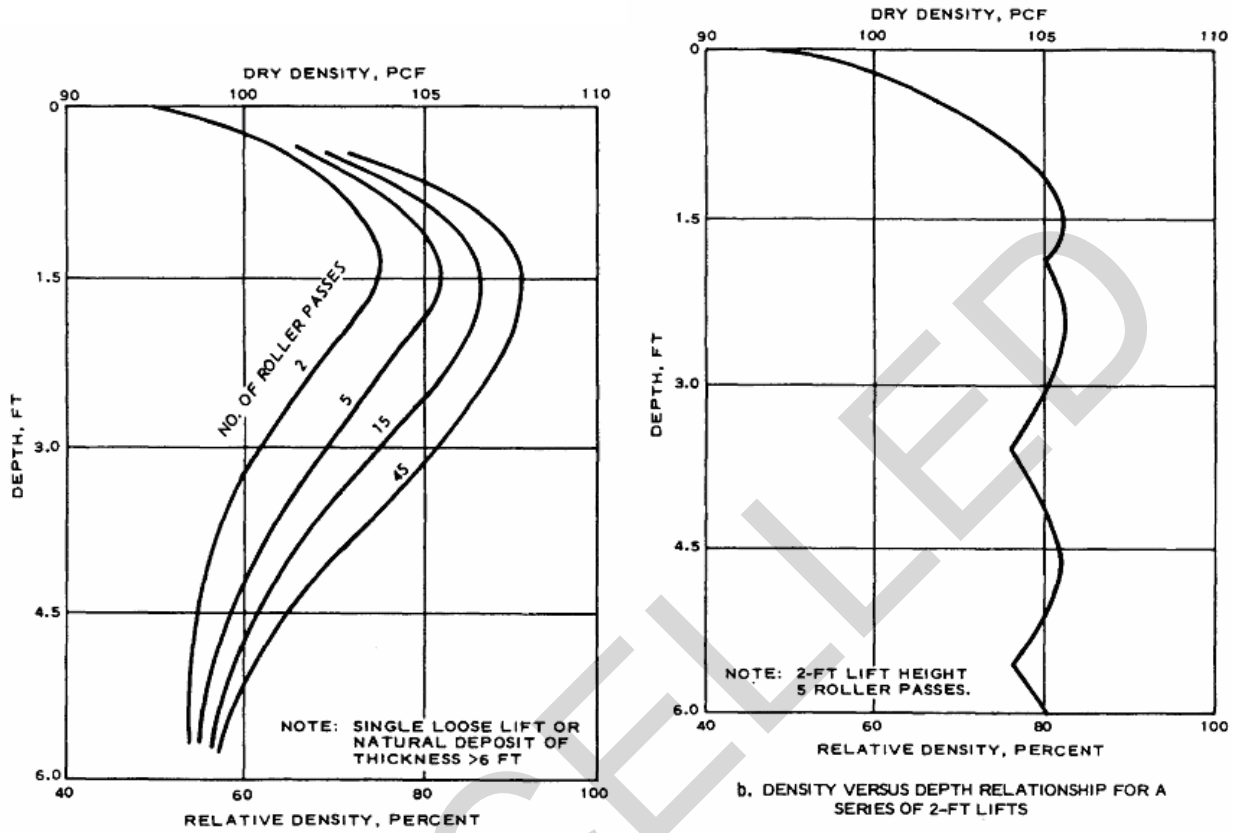
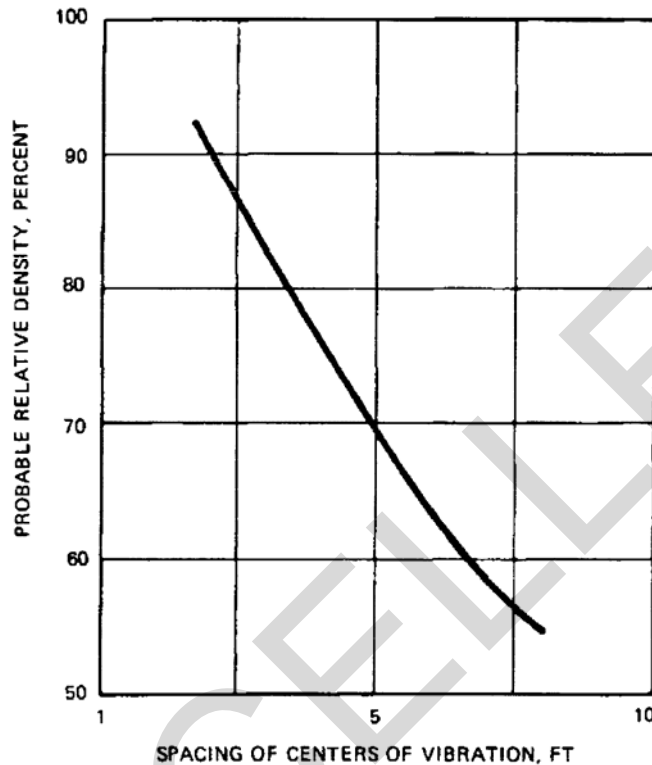

Figure 8-7.4 Relative Density as a Function of Vibrofloat Hole Spacings



8-7.4 **Grouting and Injection.** Grouting is a high-cost soil stabilization method that can be used where there is sufficient confinement to permit required injection pressures. It is usually limited to zones of relatively small volume and to special problems. Some of the more important applications are control of groundwater during construction; void filling to prevent excessive settlement; strengthening adjacent foundation soils to protect against damage during excavation, pile driving, etc.; soil strengthening to reduce lateral support requirements; stabilization of loose sands against liquefaction; foundation underpinning; reduction of machine foundation vibrations; and filling solution voids in calcareous materials,

8-7.4.1 **Grout Types and Groutability.** Grouts can be classified as particulate or chemical. Portland cement is the most widely used particulate grouting material. Grouts composed of cement and clay are also widely used, and lime-slurry injection is finding increasing application. Because of the silt-size particles in these materials, they cannot be injected into the pores of soils finer than medium to coarse sand. For successful grouting of soils, use the following guide

$$\frac{(D_{15})_{\text{soil}}}{(D_{85})_{\text{grout}}} > 25$$

Type 1 portland cement, Type III portland cement, and processed bentonite cannot be used to penetrate soils finer than 30, 40, and 60 mesh sieve sizes, respectively. Different types of grouts may be combined to both coarse- and fine-grained soils.

8-7.4.2 **Cement and Soil-Cement Grouting.** See the American Society of Civil Engineers Grouting Publications for cement and soil-cement grouting.

8-7.4.3 **Chemical Grouting.** To penetrate the voids of finer soils, chemical grout must be used. The most common classes of chemical grouts in current use are silicates, resins, lignins, and acrylamides. The viscosity of the chemical-water solution is the major factor controlling groutability. The particle-size ranges over which each of these grout types is effective is shown in Figure 8-7.6.

8-7.5 **Precompression.**

8-7.5.1 **Preloading.** Earth fill or other material is placed over the site to be stabilized in amounts sufficient to produce a stress in the soft soil equal to that anticipated from the final structures. As the time required for consolidation of the soft soil may be long (months to years) and varies directly as the square of the layer thickness and inversely as the hydraulic conductivity, preloading alone is likely to be suitable only for stabilizing thin layers and with a long period of time available prior to final development of the site.

8-7.5.1.1 **Surcharge Fills.** If the thickness of the fill placed for pre-loading is greater than that required to induce stresses corresponding to structure-induced stresses, the excess fill is termed a surcharge fill. Although the rate of consolidation is essentially independent of stress increase, the amount of consolidation varies approximately in proportion to the stress increase. It follows, therefore, that the preloading fill plus surcharge can cause a given amount of settlement in shorter time than can the preloading fill alone. Thus, through the use of surcharge fills, the time required for preloading can be reduced significantly.

The required surcharge and loading period can be determined using conventional theories of consolidation. Both primary consolidation and most of the secondary compression settlements can be taken out in advance by surcharge fills. Secondary compression settlements may be the major part of the total settlement of highly organic deposits or old sanitary landfill sites.

Because the degree of consolidation and applied stress vary with depth, it is necessary to determine if excess pore pressures will remain at any depth after surcharge removal. If so, further primary consolidation settlement under permanent loadings would occur. To avoid this occurrence, determine the duration of the surcharge loading required for points most distant from drainage boundaries.

The rate and amount of preload may be controlled by the strength of the underlying soft soil. Use berms to maintain foundation stability and place fill in stages to permit the soil to gain strength from consolidation. Predictions of the rates of

consolidation strength and strength gain should be checked during fill placement by means of piezometers, borings, laboratory tests, and in-situ strength tests.

8-7.5.2 **Vertical Drains.** The required preloading time for most soft clay deposits more than about 1.5 to 3 m (5 to 10 ft) thick will be large. Providing a shorter drainage path by installing vertical sand drains may reduce the consolidation time. Sand drains are typically 254 to 370 mm (10 to 15 in) in diameter and are installed at spacings of 1.5 to 4.5 m (5 to 15 ft). A sand blanket or a collector drain system is placed over the surface to facilitate drainage. Other types of drains available are special cardboard or combination plastic-cardboard drains. Provisions should be made to monitor pore pressures and settlements with time to determine when the desired degree of pre-compression has been obtained.

Both displacement and non-displacement methods have been used for installing sand drains. Although driven, displacement drains are less expensive than augured or "bored" non-displacement drains; they should not be used in sensitive deposits or in stratified soils that have higher hydraulic conductivity in the horizontal than in the vertical direction. Vertical drains are not needed in fibrous organic deposits because the hydraulic conductivity of these materials is high, but they may be required in underlying soft clays.

8-7.5.3 **Dynamic Consolidation (Heavy Tamping).** Densification by heavy tamping has also been reported as an effective means for improving silts and clays, with preconstruction settlements obtained about 2 to 3 times the predicted construction settlement. The time required for treatment is less than for surcharge loading with sand drains. The method is essentially the same as that used for cohesionless soils, except that more time is required. Several blows are applied at each location followed by a 1- to 4-week rest period, then the process is repeated. Several cycles may be required. In each cycle the settlement is immediate, followed by drainage of pore water. Drainage is facilitated by the radial fissures that form around impact points and by the use of horizontal and peripheral drains. Because of the necessity for a time lapse between successive cycles of heavy tamping when treating silts and clays, a minimum treatment area of 15,000 to 30,000 m² (18,000 to 35,000 sq yd) is necessary for economical use of the method. This method is presently considered experimental in saturated clays.

8-7.5.4 **Electro osmosis.** Soil stabilization by electro osmosis may be effective and economical under the following conditions: (1) a saturated silt or silty clay soil, (2) a normally consolidated soil, and (3) a low pore water electrolyte concentration. Gas generation and drying and fissuring at the electrodes can impair the efficiency of the method and limit the magnitude of consolidation pressures that develop. Treatment results in non-uniform changes in properties between electrodes because the induced consolidation depends on the voltage, and the voltage varies between anode and cathode. Thus, reversal of electrode polarity may be desirable to achieve a more uniform stress condition. Electro osmosis may also be used to accelerate the consolidation under a preload or surcharge fill. The method is relatively expensive.

Figure 8-7.5 Allowable bearing pressure on cohesionless soil layers stabilized by vibroflotation

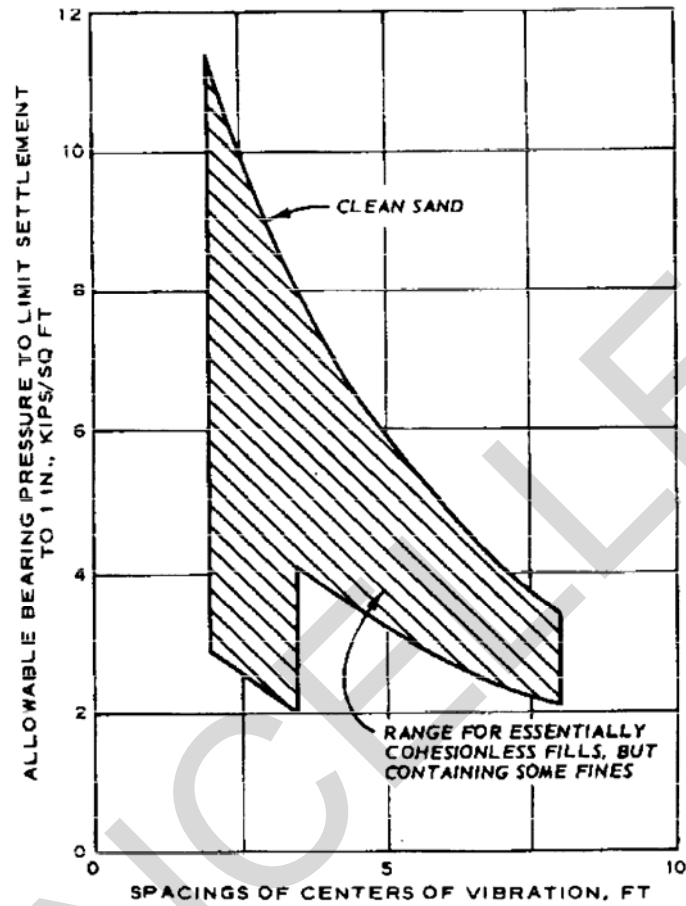
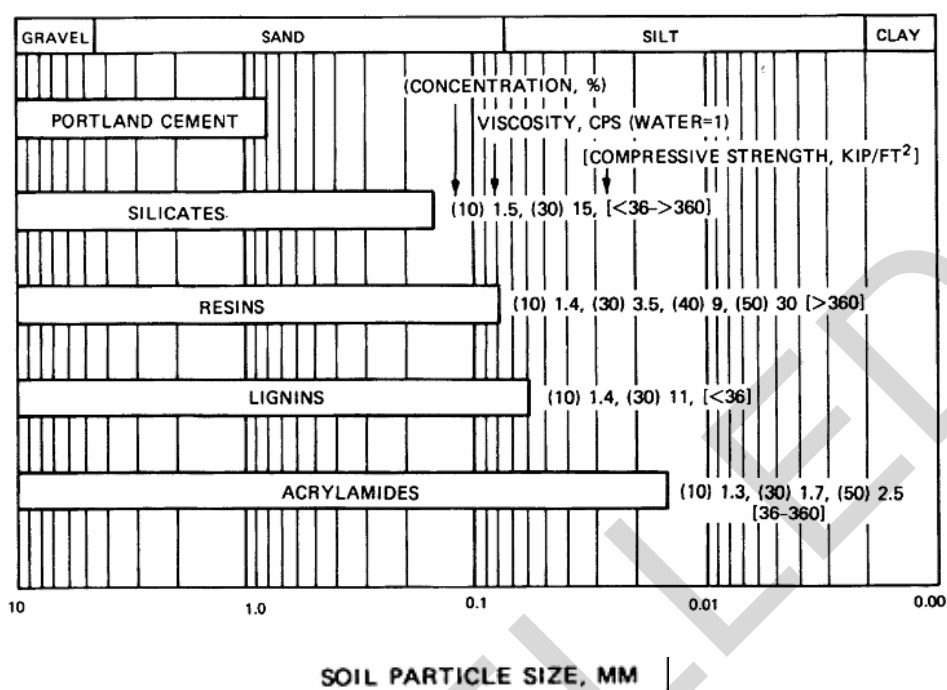

Table 8-7.3 Vibroflotation Patterns for Isolated Footings for an Allowable Bearing Pressure

Square Footing Size in meters (feet)	Vibroflotation Points	Center to Center Spacing in meters (feet)	Pattern
1.2 (4.0)	1	---	---
1.4 – 1.7 (4.5 – 5.5)	2	1.8 (6.0)	Line
1.8 – 2.1 (6 - 7)	3	2.3 (7.5)	Triangle
2.3 – 2.9 (7.5 - 9.5)	4	1.8 (6.0)	Square
3.0 – 3.7 (10 – 12)	5	2.3 (7.5)	Square +1 @ center

Figure 8-7.6 Soil Particle Sizes Suitable for Different Grout Types and Several Concentrations and Viscosities Shown



8-7.6 **Reinforcement.** The supporting capacity of soft, compressible ground may be increased and settlement reduced through use of compression reinforcement in the direction parallel to the applied stress or tensile reinforcement in planes normal to the direction of applied stress. Commonly used compression reinforcement elements include mix-in-place piles and walls. Strips and membranes are used for tensile reinforcement, with the latter sometimes used to form a moisture barrier as well.

8-7.6.1 **Mix-in-Place Piles and Walls.** Several procedures are available, most of them patented or proprietary, which enable construction of soil-cement or soil-lime in situ. A special hollow rod with rotating vanes is augered into the ground to the desired depth. Simultaneously, the stabilizing admixture is introduced. The result is a pile of up to 0.6 meters (2 feet) in diameter. Cement, in amounts of 5 to 10 percent of the dry soil weight, is best for use in sandy soils. Compressive strengths in excess of 9.6 mPa (200 kips) per sq ft can be obtained in these materials. Lime is effective in both expansive plastic clays and in saturated soft clay. Compressive strengths of about 0.96 – 1.92 kPa (20 to 40 kips) per square foot are to be expected in these materials. If overlapping piles are formed, a mix-in-place wall results.

8-7.6.2 **Vibroreplacement Stone Columns.** A vibroflot is used to make a cylindrical, vertical hole under its own weight by jetting to the desired depth. Then, up to 1 m² (cubic yard) coarse granular backfill, usually gravel or crushed rock of 19 to 25 mm (¾ to 1 in) diameter is dumped in, and the vibroflot is used to compact the gravel vertically and radially into the surrounding soft soil. This process of backfilling and compaction by vibration is continued until the densified stone column reaches the surface.

8-7.6.3 **Strips and Membranes.** Low-cost, durable waterproof membranes, such as polyethylene, polypropylene asphalt, and polyester fabric asphalt, have had application as moisture barriers. At the same time, these materials have sufficient tensile strength that when used in envelope construction, such as surrounding a well-compacted, fine-grained soil, the composite structure has a greater resistance to applied loads than conventional construction with granular materials. The reason is that any deformation of the enveloped soil layer causes tension in the membrane, which in turn produces additional confinement on the soil and thus increases its resistance to further deformation.

In the case of a granular soil where moisture infiltration is not likely to be detrimental to strength, horizontally bedded thin, flat metal or plastic strips can act as tensile reinforcing elements. Reinforced earth has been used mainly for earth retaining structures; however, the feasibility of using reinforced earth slabs to improve the bearing capacity of granular soil has been demonstrated.

Model tests have shown that the ultimate bearing capacity can be increased by a factor of 2 to 4 for the same soil unreinforced. For these tests, the spacing between reinforcing layers was 0.3 times the footing width. Aggregate strip width was 42 percent of the length of strip footing.

8-7.6.4 **Thermal Methods.** Thermal methods of foundation soil stabilization, freezing or heating, are complex and their costs are high.

8-7.6.4.1 **Artificial Ground Freezing.** Frozen soil is far stronger and less pervious than unfrozen ground. Hence, artificial ground freezing has had application for temporary underpinning and excavation stabilization. More recent applications have been made to back-freezing soil around pile foundations in permafrost and maintenance of frozen soil under heated buildings on permafrost. Design involves two classes of problems; namely, the structural properties of the frozen ground to include the strength and the stress-strain-time behavior, and thermal considerations to include heat flow, transfer of water to ice, and design of the refrigeration system.

8-7.6.4.2 **Heating.** Heating fine-grained soils to moderate temperatures, e.g., 100°C +, can cause drying and accompanying strength increase if subsequent rewetting is prevented. Heating to higher temperatures can result in significant permanent property improvements, including decreases in water sensitivity, swelling, and compressibility; and increases in strength. Burning of liquid or gas fuels in boreholes or injection of hot air into 15 to 23 mm (6 to 9 in) diameter boreholes can produce 1.22 meters to 2.13 m (4 to 7 ft) diameter strengthened zones, after continuous treatment for about 10 days. Dry or partly saturated weak clayey soils and loess are well suited for this type of treatment, which is presently regarded as experimental.

8-7.7 **Miscellaneous Methods.**

8-7.7.1 **Remove and Replace.** Removal of poor soil and replacement with the same soil treated by compaction, with or without admixtures, or by a higher quality material offer an excellent opportunity for producing high-strength, relatively incompressible, uniform foundation conditions. The cost of removal and replacement of thick deposits is high because of the need for excavation and materials handling, processing, and recompaction. Occasionally, an expensive dewatering system also may be required. Excluding highly organic soils, peats, and sanitary landfills, virtually any inorganic soil can be processed and treated so as to form an acceptable structural fill material.

8-7.7.2 **Lime Treatment.** This treatment of plastic fine-grained soils can produce high-strength, durable materials. Lime treatment levels of 3 to 8 percent by weight of dry soil are typical.

8-7.7.3 **Portland Cement.** With treatment levels of 3 to 10 percent by dry weight, portland cement is particularly well suited for low-plasticity soils and sand soils.

8-7.7.4 **Stabilization Using Fills.** At sites underlain by soft, compressible soils and where filling is required or possible to establish the final ground elevation, load-bearing structural fills can be used to distribute the stresses from light structures. Compacted sands and gravels are well suited for this application as are also fly ash, bottom ash, slag, and various lightweight aggregates, such as expanded shale, clam and oyster shell, and incinerator ash. Admixture stabilizers may be incorporated in these materials to increase their strength and stiffness.

Clam and oyster shells as a structural fill material over soft marsh deposits represent a new development. The large deposits of clam and oyster or reef shells that are available in the Gulf States coastal areas can be mined and transported short distances economically. Clamshells are 19 to 38 mm ($\frac{3}{4}$, to 1 $\frac{1}{2}$ in) in diameter, whereas, oyster shells, which are coarser and more elongated, are 50 to 100 mm (2 to 4 in) in size. When dumped over soft ground, the shells interlock; if there are fines and water present, some cementation develops owing to the high calcium carbonate (>90 percent) content. In the loose state, the shell unit weight is about 3 kPa (63 lbs per sq ft); after construction, it is about 4.5 kPa (95 lbs per sq ft). Shell embankments "float" over very soft ground; whereas, conventional fills would sink out of sight. An approximately 1.5 m (5 ft) thick layer is required to be placed in a single lift. The only compaction used is from the top of the lift, so the upper several inches are more tightly knit and denser than the rest of the layer.

CHAPTER 9

DEWATERING AND GROUNDWATER CONTROL

9-1 INTRODUCTION

9-1.1 **Purpose.** The criteria presented in this UFC are to be used by the engineer to develop methods and details to dewater or control groundwater during construction of excavations, walls, slopes and foundations. Methods of erosion control in open excavations, control of groundwater during construction and control of groundwater in completed structures are presented.

9-1.2 **Scope.** Apply these Geotechnical criteria to all projects for the military services. Methods of calculating the amount of ground water runoff, how to control groundwater by several methods are presented, and the safety aspects can be determined. The following topics are discussed in the reference.

- Excavations requiring drainage
- Seepage control
- Seepage cutoffs
- Control of surface waters
- Sheet-pile cofferdams
- Foundation underdrainage and waterproofing.

9-1.3 **References.**

- UFC 3-220-05, *Dewatering and Groundwater Control*

9-1.4 **Secondary.**

- UFC 3-220-10N, *Soil Mechanics*

CHAPTER 10

FOUNDATIONS IN EXPANSIVE SOILS

10-1 INTRODUCTION

10-1.1 **Purpose.** The criteria presented in this UFC are to be used by the engineer to develop methods and details for repairing existing foundations or design details for new foundations that are to be constructed in expansive soils.

10-1.2 **Scope.** Apply criteria to all projects for the military services. The methods of design for new construction, soil treatments and construction methods for foundations in expansive soils are presented in detail in the primary references. Give particular attention if there is any indication of expansive properties since retro-repairs are severely expensive. The methods for repair of foundations constructed in expansive soils are explained in detail. This is a very important aspect of expansive soils since so many existing small buildings, from homes to small apartment complexes, are effected by expansive soils; therefore, the retrofit methods of repair that have been used to substantially repair the structures are extremely important to the designer and are presented in the primary references. Check every project that is earth related for soils that have properties that potentially, or are, expansive. **More damage to roads and structures is attributed to not addressing this potentially devastating problem than any other single soil related problem.**

10-1.3 References.

- See Expansive Soils Publications, ASCE in Appendix A
- *2000 International Building Code* (IBC 2000) Chapter 18

CHAPTER 11

FOUNDATIONS IN AREAS OF SIGNIFICANT FROST PENETRATION

11-1 INTRODUCTION

11-1.1 **Types of Areas.** For purposes of this UFC, areas of significant frost penetration may be defined as those in which freezing temperatures occur in the ground to sufficient depth to be a significant factor in foundation design. Detailed requirements of engineering design in such areas are given in the UFC series, Arctic and Subarctic Construction (UFC 3-130-01 through 3-130-07.) Areas of significant frost penetration may be subdivided as follows.

11-1.1.1 **Seasonal Frost Areas.** Significant ground freezing occurs in these areas during the winter season, but without development of permafrost. In northern Texas, significant seasonal frost occurs about 1 year in 10. A little farther north it is experienced every year. Depth of seasonal freezing increases northward with decreasing mean annual and winter air temperatures until permafrost is encountered. With still further decrease of air temperatures, the depth of annual freezing and thawing becomes progressively thinner.

The layer extending through both seasonal frost and permafrost areas in which annual freeze-thaw cycles occur is called the annual frost zone. In permafrost areas, it is also called the active layer. It is usually not more than 3 m (10 ft) thick, but it may exceed 6 m (20 ft). Under conditions of natural cover in very cold permafrost areas, it may be as little as 305 mm (1 ft) thick. Its thickness may vary over a wide range even within a small area. Seasonal changes in soil properties in this layer are caused principally by the freezing and thawing of water contained in the soil. The water may be permanently in the annual frost zone or may be drawn into it during the freezing process and released during thawing. Seasonal changes are also produced by shrinkage and expansion caused by temperature changes.

11-1.1.2 **Permafrost Areas.** In these areas, perennially frozen ground is found below the annual frost zone. In North America, permafrost is found principally north of latitudes 55 to 65 degrees, although patches of permafrost are found much farther south on mountains where the temperature conditions are sufficiently low, including some mountains in the contiguous 48 States. In areas of continuous permafrost, perennially frozen ground is absent only at a few widely scattered locations, as at the bottoms of rivers and lakes. In areas of discontinuous permafrost, permafrost is found intermittently in various degrees. There may be discontinuities in both horizontal and vertical extent. Sporadic permafrost is permafrost occurring in the form of scattered permafrost islands. In the coldest parts of the Arctic, the ground may be frozen as deep as 610 m (2000 ft).

The geographical boundaries between zones of continuous permafrost, discontinuous permafrost, and seasonal frost without permafrost are poorly defined but are represented approximately in Figure 11-1

11-1.2 **General Nature Of Design Problems.** Generally, the design of foundations in areas of only seasonal frost follows the same procedure as where frost is insignificant or absent, except that precautions are taken to avoid winter damage from frost heave or thrust. In the spring, thaw and settlement of frost-heaved material in the annual frost zone may occur differentially, and a very wet, poorly drained ground condition with temporary but substantial loss of shear strength is typical.

11-1.2.1 **Permafrost Areas.** In permafrost areas, the same annual frost zone phenomena occur, but the presence of the underlying permafrost introduces additional potentially complex problems. In permafrost areas, heat flow from buildings is a fundamental consideration, complicating the design of all but the simplest buildings. Any change from natural conditions that results in a warming of the ground beneath a structure can result in progressive lowering of the permafrost table over a period of years that is known as degradation. If the permafrost contains ice in excess of the natural void or fissure space of the material when unfrozen, progressive downward thaw may result in extreme settlements or overlying soil and structures. This condition can be very serious because such subsidence is almost invariably differential and hence very damaging to a structure. Degradation may occur not only from building heat but also from solar heating, as under pavements, from surface water and groundwater flow, and from underground utility lines. Proper insulation will prevent degradation in some situations, but where a continuous, source of heat is available, thaw will in most cases eventually occur.

11-1.2.2 **Seasonal Frost Areas.** The more intense the winter cooling of the frozen layer in the annual frost zone and the more rapid the rate of frost heave, the greater the intensity of uplift forces in piles and foundation walls. The lower the temperature of permafrost, the higher the bearing capacity and adfreeze strength that can be developed, the lower the creep deformation rate under footings and in tunnels and shafts, and the faster the freeze-back of slurried piles. Dynamic response characteristics of foundations are also a function of temperature. Both natural and manufactured construction materials experience significant linear and volumetric changes and may fracture with changes in temperature. Shrinkage cracking of flexible pavements is experienced in all cold regions. In arctic areas, patterned ground is widespread, with vertical ice wedges formed in the polygon boundaries. When underground pipes, power cables, or foundation elements cross shrinkage cracks, rupture may occur during winter contraction. During summer and fall, expansion of the warming ground may cause substantial horizontal forces if the cracks have become filled with soil or ice.

Figure 11-1 Frost and permafrost in North America

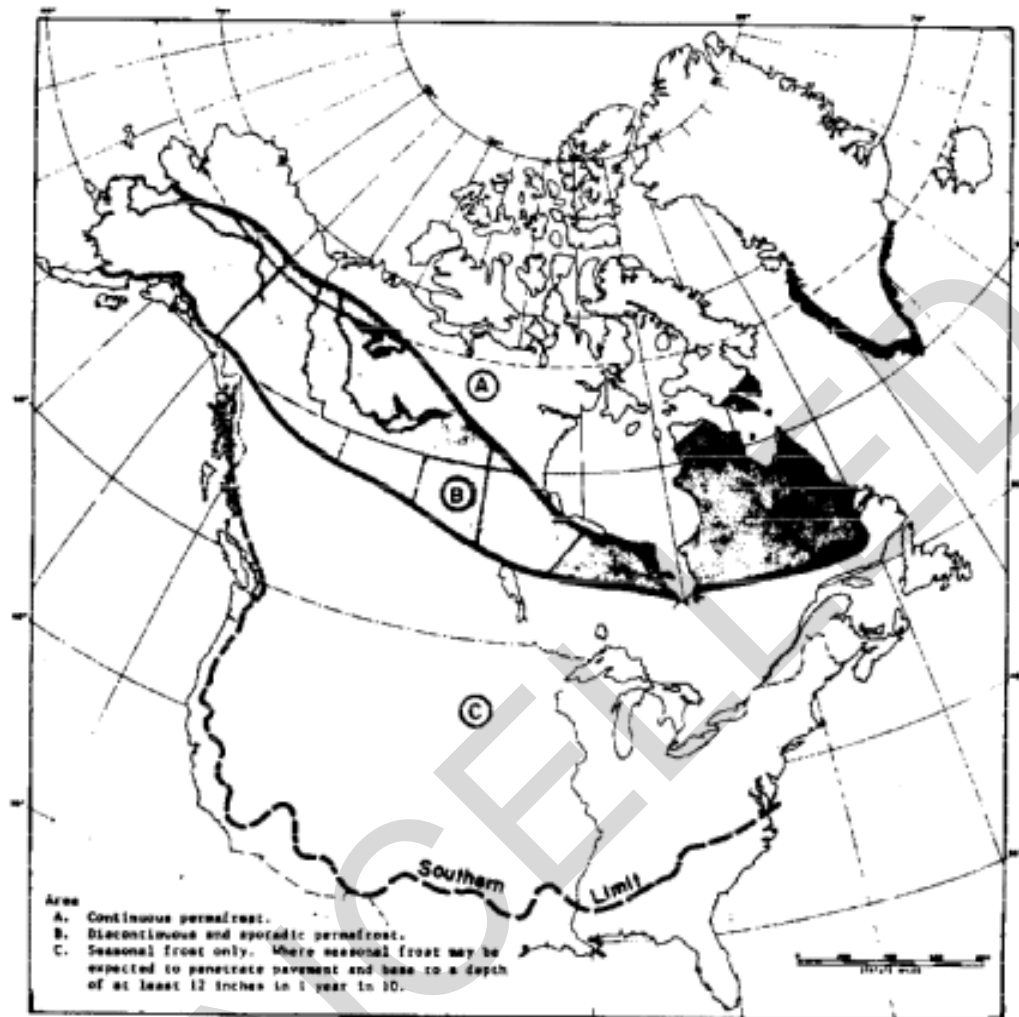

Engineering problems may also arise from such factors as the difficulty of excavating and handling ground when it is frozen; soft and wet ground conditions during thaw periods; surface and subsurface drainage problems; special behavior and handling requirements for natural and manufactured materials at low temperatures and under freeze-thaw action; possible ice uplift and thrust action on foundations; condensation on cold floors; adverse conditions of weather, cost, and sometimes accessibility; in the more remote locations, limited local availability of materials, support facilities, and labor; and reduced labor efficiency at low temperatures.

Progressive freezing and frost heave of foundations may also develop under refrigerated warehouses and other facilities where sustained interior below-freezing temperatures are maintained. The design procedures and technical guidance outlined in this chapter may be adapted to the solution of these design problems.

11-2 FACTORS AFFECTING DESIGN OF FOUNDATION

11-2.1 **Physiography and Geology.** Physiographic and geology details in the area of the proposed construction are a major factor determining the degree of difficulty

that may be encountered in achieving a stable foundation. For example, pervious layers in fine-grained alluvial deposits in combination with copious groundwater supplies from adjacent higher terra-in may produce very high frost-heave potential, but clean, free-draining sand and gravel terrace formations of great depth, free of excess ice, can provide virtually trouble-free foundation conditions.

11-2.2 Temperature. The most important factors contributing to the existence of adverse foundation conditions in seasonal frost and permafrost regions are cold air temperatures and the continual changes of temperature between summer and winter. Mean annual air temperatures usually have to be -17° to -13° C (2° to 8° F) below freezing for permafrost to be present, although exceptions may be encountered both above and below this range. Ground temperatures, depths of freeze and thaw, and thickness of permafrost are the product of many variables including weather, radiation, surface conditions, exposure, snow and vegetative cover, and insulating or other special courses. The properties of earth materials that determine the depths to which freezing-and-thawing temperatures will penetrate below the ground surface under given temperature differentials over a given time are the thermal conductivity, the volumetric specific heat capacity, and the volumetric latent heat of fusion. These factors in turn vary with the type of material, density, and moisture content. Figure 11-2 shows how ground temperatures vary during the freezing season in an area of substantial seasonal freezing having a mean annual temperature of 3° C (37° F) (Limestone, Maine), and Figure 11-3 shows similar data for a permafrost area having a mean annual temperature of -3° C (26° F) (Fairbanks, Alaska).

For the computation of seasonal freeze or thaw penetration, freezing-and-thawing indexes are used based upon degree-days relative to 0° C (32° F). For the average permanent structure, the design indexes should be those for the coldest winter and the warmest summer in 30 years of record. This criterion is more conservative than that used for pavements because buildings and other structures are less tolerant of movement than pavements. It is important to note that indexes found from weather records are for air about 4.5 ft above the ground; the values at ground surface, which determine freeze-and-thaw effects, are usually different, being generally smaller for freezer conditions and larger for thawing where surfaces are exposed to the sun. The surface index, which is the index determined for temperature immediately below the surface, is n times the air index, where n is the correction factor. Turf, moss, other vegetative cover, and snow will reduce the n value for temperatures at the soil surface in relation to air temperatures and hence give less freeze or thaw penetration for the same air freezing or thawing index. Values of n for a variety of conditions are given in UFC 3-130-01.

More detailed information on indexes and their computation, including maps showing distribution of index values, is presented in UFC 3-130-01.

11-2.3 Foundation Materials. The foundation design decisions may be critically affected by the foundation soil, ice, and rock conditions.

11-2.3.1 Soils. The most important properties of soils affecting the performance of engineering structures under seasonal freeze-thaw action are their frost-heaving

characteristics and their shear strengths on thawing. Criteria for frost susceptibility based on percentage by weight finer than 0.02 mm are presented in Reference 20. These criteria have also been developed for pavements. Heave potential at the lower limits of frost susceptibility determined by these criteria is not zero, although it is generally low to negligible from the point of view of pavement applications. Applicability of these criteria to foundation design will vary, depending upon the nature and requirements of the particular construction. Relative frost-heaving qualities of various soils are shown in UFC 3-220-10N.

11-2.3.1.1 **Permafrost Soils.** Permafrost soils cover the entire range of types from very coarse, boulder strewn glacial drift to clays and organic soils. Strength properties of frozen soils are dependent on such variables as gradation, density, degree of saturation, ice content, unfrozen moisture content, temperature, dissolved soils, and rate of loading. Frozen soils characteristically exhibit creep at stresses as low as 5 to 10 percent of the rupture strength in rapid loading. Typical strength and creep relationships are described in UFC 3-130-01.

Figure 11-2 Ground Temperatures During Freezing Season in Limestone, Maine

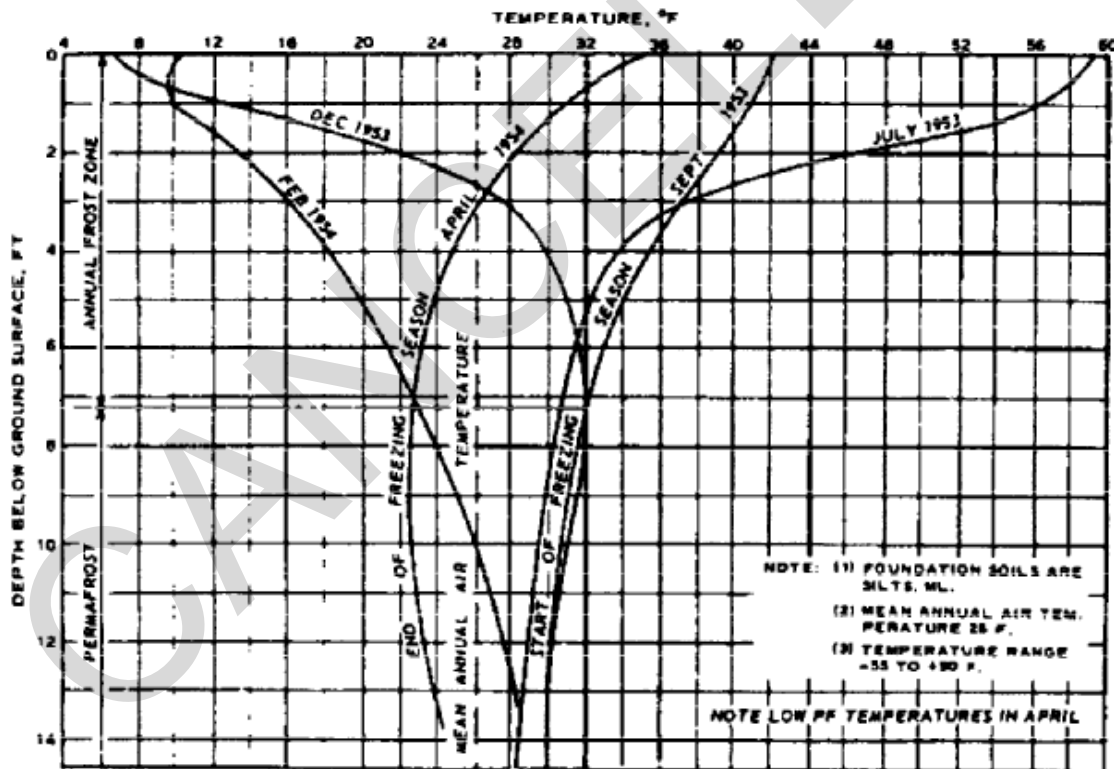
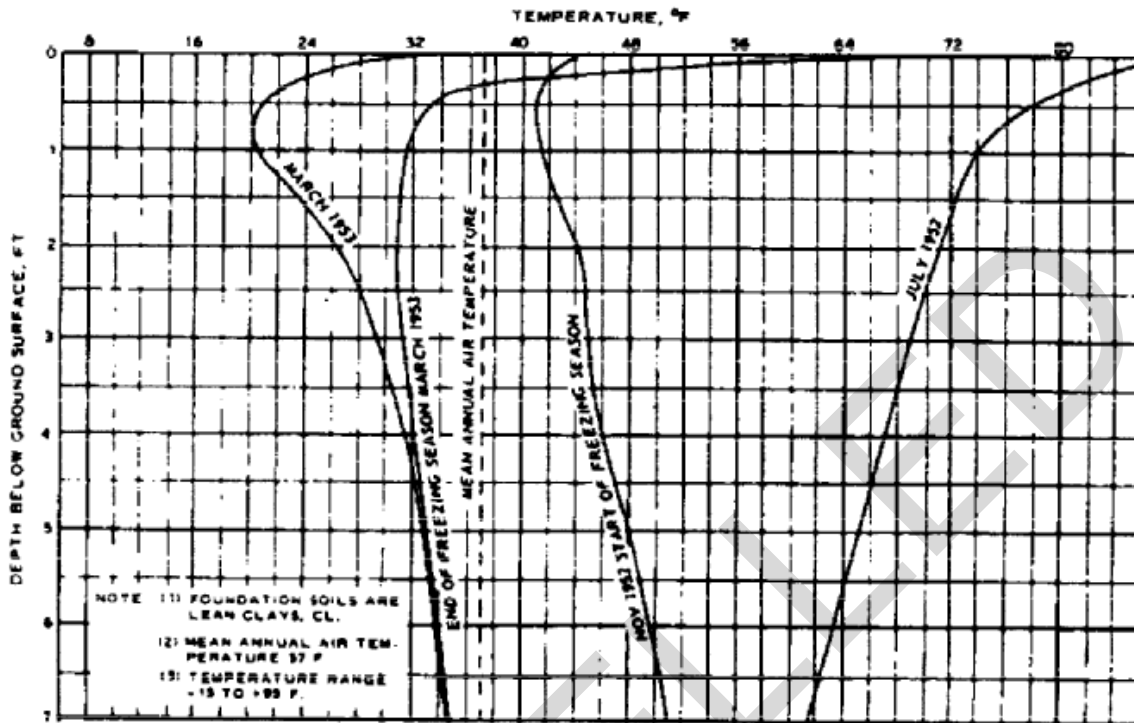

Figure 11-3 Ground Temperatures During Freezing Season in Fairbanks, Alaska



11-2.3.2 **Ice.** Ice that is present in the ground in excess of the normal void space is most obvious as more or less clear lenses, veins or masses easily visible in cores, and test pits or excavations, but it may also be so uniformly distributed that it is not readily apparent to the unaided eye. In the annual frost zone, excess ice is formed by the common ice segregation process, although small amounts of ice may also originate from filling of shrinkage cracks; ice formations in this zone disappear each summer. Below the annual frost zone, excess ice in permafrost may form by the same type of ice segregation process as above, may occur as vertical ice wedges formed by a horizontal contraction-expansion process, or may be "fossil ice" buried by land slides or other events. Although most common in fine-grained soils, substantial bodies of excess ice are not uncommon in permanently frozen clean, granular deposits. The possible adverse effects of excess ice are discussed in paragraph 11-4.1.1.

11-2.3.3 **Rock.** Bedrock subject to freezing temperatures should never be assumed problem-free in absence of positive subsurface information. In seasonal frost areas, mud seams in bedrock or concentrations of fines at or near the rock surface, in combination with the ability of fissures in the rock to supply large quantities of water for ice segregation, frequently cause severe frost heave. In permafrost areas, very substantial quantities of ice are often found in bedrock, occurring in fissures and cracks and along bedding planes.

11-2.4 Water Conditions

11-2.4.1 **Free Water.** If free water drawn to developing ice segregation can be easily replenished from an aquifer layer or from a water table within a few feet of the plane of freezing, heave can be large. However, if a freezing soil has no access to free water beyond that contained in voids of the soil immediately at or below the plane of freezing, frost heave will necessarily be limited.

11-2.4.2 **Free Water in Permafrost Areas.** In permafrost areas, the supply of water available to feed growing ice lenses tends to be limited because of the presence of the underlying impermeable permafrost layer, usually at relatively shallow depths, and maximum heave may thus be less than under otherwise similar conditions in seasonal frost areas. However, uplift forces on structures may be higher because of lower soil temperatures and consequent higher effective tangential adfreeze strength values.

11-2.4.3 **Soil Water Content.** The water content of soil exerts a substantial effect upon the depth of freeze or thaw penetration that will occur with a given surface freezing or thawing index. Higher moisture contents tend to reduce penetration by increasing the volumetric latent heat of fusion as well as the volumetric specific heat capacity. While an increase in moisture also increases thermal conductivity, the affect of latent heat of fusion tends to be predominant, UFC 3-130-01 contains charts showing thermal conductivity relationships.

11-2.5 **Frost-Heave Forces and Effect Of Surcharge.** Frost-heave forces on structures may be quite large. For some engineering construction, complete prevention of frost heave is unnecessary and uneconomical, but for most permanent structures, complete prevention is essential. Under favorable soil and foundation loading conditions, it may be possible to take advantage of the effect of surcharge to control heave. It has been demonstrated in laboratory and field experiments that the rate of frost heaving is decreased by an increase of loading on the freezing plane and that frost heaving can be completely restrained if sufficient pressure is applied. However, heave forces normal to the freezing plane may reach more than 958 kPa (10 tons per sq ft). Detailed information on frost-heaving pressures and on the effect of surcharge is presented in UFC 3-130-01.

11-2.6 **Type of Structure.** The type and uses of a structure affect the foundation design in frost areas as in other places. Applicable considerations are discussed in UFC 3-130-01.

11-3 **SITE INVESTIGATIONS**

11-3.1 **General.** In addition to the needed site investigations and data described in the manuals for non-frost conditions, design of foundations in areas of significant frost penetration requires special studies and data because of factors introduced by the special frost-related site conditions. Detailed site investigation procedures applicable for arctic and subarctic areas are described in UFC 3-130-02, Chapter 2, and UFC 3-130-04, Chapter 4, and may be adapted or reduced in scope, as appropriate, in areas of less severe winter freezing. Methods of terrain evaluation in arctic and subarctic regions are given in UFC 3-130-01.

11-3.2 **Remote Sensing and Geophysical Investigations.** These techniques are particularly valuable in selection of the specific site location, when a choice is possible. They can give clues to subsurface frozen ground conditions because of effects of ground freezing upon such factors as vegetation, land wastage, and soil and rock electrical and acoustical properties.

11-3.3 **Direct Site Investigations.** The number and extent of direct site explorations should be sufficient to reveal in detail the occurrence and extent of frozen strata, permafrost and excess ice including ice wedges, moisture contents and groundwater, temperature conditions in the ground, and the characteristics and properties of frozen materials and unfrozen soil and rock.

11-3.3.1 **Bedrock.** The need for investigation of bedrock requires special emphasis because of the possibilities of frost heave or ice inclusions. Bedrock in permafrost areas should be drilled to obtain undisturbed frozen cores whenever ice inclusions could affect the foundation design or performance.

11-3.3.2 **Discontinuous Permafrost.** In areas of discontinuous permafrost, sites require especially careful exploration and many problems can be avoided by proper site selection. As an example, the moving of a site 15 to 30 m (50 to 100 ft) from its planned position may place a structure entirely on or entirely off permafrost, in either case simplifying foundation design. A location that is partly on, and partly off, permafrost might involve an exceptionally difficult or costly design.

11.3.3.3 **Frozen Soils.** Because frozen soils may have compressive strengths as great as that of a lean concrete and because ice in the ground may be melted by conventional drilling methods, special techniques are frequently required for subsurface exploration in frozen materials. Core drilling using refrigerated drilling fluid or air to prevent melting of ice in the cores provides specimens that are nearly completely undisturbed and can be subjected to the widest range of laboratory tests. By this procedure, soils containing particles up to boulder size and bedrock can be sampled, and ice formations can be inspected and measured. Drive sampling is feasible in frozen fine-grained soils above about -4°C (25°F) and is often considerably simpler, cheaper, and faster. Samples obtained by this procedure are somewhat disturbed, but they still permit ice and moisture content determinations. Test pits are very useful in many situations. For frozen soils that do not contain very many cobbles and boulders, truck-mounted power augers using tungsten carbide cutting teeth will provide excellent service where classification, gradation, and rough ice-content information will be sufficient. In both seasonal frost and permafrost areas, a saturated soil condition is common in the upper layers of soil during the thaw season, so long as there is frozen, impervious soil still underlying. Explorations attempted during the thaw season are handicapped and normally require eased boring through the thawed layer. In permafrost areas, it is frequently desirable to carry out explorations during the colder part of the year, when the annual frost zone is frozen, than during the summer.

In subsurface explorations that encounter frozen soil, it is important that the boundaries of frozen and thawed zones and the amount and mode of ice

occurrence be recorded. Materials encountered should be identified in accordance with the Unified Soil Classification System (ASTM D 2487), including the frozen soil classification system, as presented in UFC 3-130-01.

11-3.3.4 **Seasonal Frost Areas.** In seasonal frost areas, the most essential site data beyond those needed for nonfrost foundation design is the design freezing index and the soil frost-susceptibility characteristics. In permafrost areas, as described in UFC 3-130-01, the data requirements are considerably more complex; determination of the susceptibility of the foundation materials to settlement on thaw and of the subsurface temperatures and thermal regime will usually be the most critical special requirements. Ground temperatures are measured most commonly with copper-constantan thermocouples or with thermistors.

11-3.3.5 **Special Site Investigations.** Special site investigations, such as installation and testing of test piles, or thaw-settlement tests may be required. Assessment of the excavation characteristics of frozen materials may also be a key factor in planning and design.

11-4 FOUNDATION DESIGN

11-4.1 **Selection of Foundation Type.** Only sufficient discussion of the relationships between foundation conditions and design decisions is given below to indicate the general nature of the problems and solutions. Greater detail is given in UFC 3-220-10N.

11-4.1.1 **Foundations in Seasonal Frost Areas.** When foundation materials within the maximum depth of seasonal frost penetration consist of clean sands and gravels or other non-frost-susceptible materials that do not develop frost heave, thrust, or thaw weakening, design in seasonal frost areas may be the same as for non-frost regions, using conventional foundations, as indicated in Figure 11-4. Effect of the frost penetration on related engineering aspects, such as surface and subsurface drainage systems or underground utilities, may need special consideration. Thorough investigations should be made to confirm the non-frost susceptibility of subgrade soils prior to design for this condition.

When foundation materials within the annual frost zone are frost-susceptible, seasonal frost heave and settlement of these materials may occur. In order for ice segregation and frost heave to develop, freezing temperatures must penetrate into the ground, soil must be frost-susceptible, and adequate moisture must be available. The magnitude of seasonal heaving is dependent on such factors as rate and duration of frost penetration, soil type and effective pore size, surcharge, and degree of moisture availability. Frost heave in a freezing season may reach a foot or more in silts and some clays if there is an unlimited supply of moisture available. The frost heave may lift or tilt foundations and structures, commonly differentially, with a variety of possible consequences. When thaw occurs, the ice within the frost-heaved soil is changed to water and escapes to the ground surface or into surrounding soil, allowing overlying materials and structures to settle. If the water is released by thaw more rapidly than it can be drained away or redistributed, substantial loss in soil

strength occurs. In seasonal frost areas, a heaved foundation may or may not return to its before-heave elevation. Friction on lateral surface or intrusion of softened soil into the void space below the heaved foundation members may prevent full return. Successive winter seasons may produce progressive upward movement. Therefore, when the soils within the maximum depth of seasonal frost penetration are frost-susceptible, foundations in seasonal frost areas should be supported below the annual frost zone, using conventional foundation elements protected against uplift caused by adfreeze grip and against frost overturning or sliding forces, or the structure should be placed on compacted non-frost-susceptible fill designed to control frost effects (Figure 11-4).

11-4.1.2 Foundations in Permafrost Areas. Design on permafrost areas must cope with both the annual frost zone phenomena described in paragraph 11-4.1 and those peculiar to permafrost.

11-4.1.2.1 Permafrost Foundations not Adversely Affected by Thaw. Whenever possible, structures in permafrost areas should be located on clean, non-frost-susceptible sand or gravel deposits or rock that is free of ground ice or of excess interstitial ice, which would make the foundation susceptible to settlement on thaw. Such sites are ideal and should be sought whenever possible. Foundation design under these conditions can be basically identical with temperate zone practices, even though the materials are frozen below the foundation support level, as has been demonstrated in Corps of Engineers construction in interior Alaska. When conventional foundation designs are used for such materials, heat from the structure will gradually thaw the foundation to progressively greater depths over an indefinite period of years. In 5 years, for example, thaw may reach a depth of 40 ft. However, if the foundation materials are not susceptible to settlement on thaw, there will be no effects on the structure from such thaw. The possible effect of earthquakes or other dynamic forces after thawing should be considered.

11-4.1.2.2 Permafrost Foundations Adversely Affected by Thaw. When permafrost foundation materials containing excess ice are thawed, the consequences may include differential settlement, slope instability, development of water-filled surface depressions that serve to intensify thaw, loss of strength of frost loosened foundation materials under excess moisture conditions, development of underground uncontrolled drainage channels in permafrost materials susceptible to bridging or piping, and other detrimental effects. Often, the results may be catastrophic. For permafrost soils and rock containing excess ice, design should consider three alternatives, as indicated in Figure 11-4: (1) maintenance of stable thermal regime, (2) acceptance of thermal regime changes and (3) modification of foundation conditions prior to construction. These approaches are discussed in UFC 3-130-01. Choice of the specific foundation type from among those indicated in Figure 11-4 can be made on the basis of cost and performance requirements after the development of details to the degree needed for resolution.

11-4.2 Foundation Freeze and Thaw and Techniques for Control. Detailed guidance for foundation thermal computations and for methods of controlling freeze-and-thaw penetration is presented in UFC 3-130-01.

11-4.2.1 **Design Depth of Ordinary Frost Penetration.** For average permanent structures, the depth of frost penetration assumed for design in situations not affected by heat from a structure, should be that which will occur in the coldest year in 30 years. For a structure of a temporary nature or otherwise tolerant of some foundation movement, the depth of frost penetration in the coldest year in 10 years or even that in the mean winter may be used, as may be most applicable. The design depth should preferably be based on actual measurements or on computations if measurements are not available. When measurements are available, they will almost always need to be adjusted by computations to the equivalent of the freezing index selected as the basis for design, as measurements will seldom be available for a winter having a severity equivalent to that value.

CANCELLED

Figure 11-4 Design Alternatives

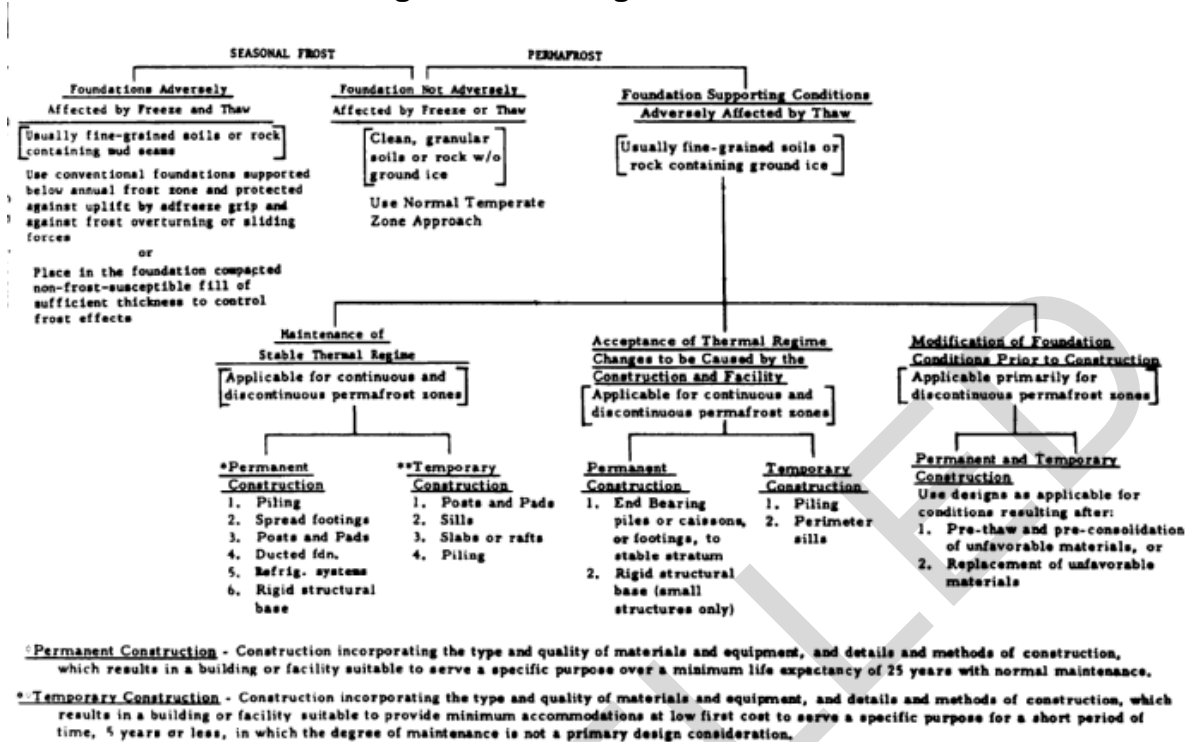

The frost penetration can be computed using the design freezing index and the detailed guidance given in UFC 3-130-01. For paved areas kept free of snow, approximate depths of frost penetration may be estimated from UFC 3-130-01, by entering the appropriate chart with the air freezing index. A chart is also presented in UFC 3-130-01, from which approximate depths of frost penetration may be obtained for a variety of surface conditions, using the air freezing index in combination with the appropriate surface index/air correction factor (n-factor).

In the more developed parts of the cold regions, the building codes of most cities specify minimum footing depths, based on many years of local experience; these depths are invariably less than the maximum observed frost penetrations. The code values should not be assumed to represent actual frost penetration depths. Such local code values have been selected to give generally suitable results for the types of construction, soil moisture, density, and surface cover conditions, severity of freezing conditions, and building heating conditions that are common in the area. Unfortunately, the code values may be inadequate or inapplicable under conditions that differ from those assumed in formulating the code, especially for unheated facilities, insulated foundations, or especially cold winters. Building codes in the Middle and North Atlantic States and Canada frequently specify minimum footing depths that range from 1 to 1.5 m (3 to 5 ft). If frost penetrations of this order of magnitude occur with fine silt and clay-type soils, 30 to 100 percent greater frost penetration may occur in well-drained gravels under the same conditions. With good soil data and knowledge of local conditions, computed values for ordinary frost penetration, unaffected by building heat, may be expected to be adequately reliable, even though the freezing index may have to

be estimated from weather data from nearby stations. In remote areas, measured frost depths may be entirely unavailable.

11-4.2.2 Design Depth of Ordinary Thaw Penetration. Estimates of seasonal thaw penetration in permafrost areas should be established on the same statistical measurement bases as outlined in paragraph 11-4.2.1 above for seasonal frost penetration. The air thawing index can be converted to a surface thawing index by multiplying it by the appropriate thawing conditions n-factor from UFC 3-130-01 and the thaw penetration can then be computed using the detailed guidance given in that criteria. Approximate values of thaw penetration may also be estimated from a chart of the air thawing index versus the depth of thaw in UFC 3-130-01. Degradation of permafrost will result if the average annual depth of thaw penetration exceeds the average annual depth of frost penetration.

11-4.2.3 Thaw or Freeze Beneath Structures. Any change from natural conditions, which results in a warming of the ground beneath a structure, can result in progressive lowering of the permafrost table over a period of years. Heat flow from a structure into underlying ground containing permafrost can only be ignored as a factor in the long-term structural stability when the nature of the permafrost is such that no settlement or other adverse effects will result. The source of heat may be not only the building heat but also the solar radiation, underground utilities, surface water, and groundwater flow. UFC 3-130-01 provides guidance on procedures for estimating the depth of thaw under a heated building with time.

The most widely-employed, effective and economical, means of maintaining a stable thermal regime under a heated structure, without degradation of permafrost, is by use of a ventilated foundation. Under this scheme, provision is made for the circulation of cold air between the insulated floor and the underlying ground. The same scheme can be used for the converse situation of a refrigerated facility supported on unfrozen ground. The simplest way of providing foundation ventilation is by providing an open space under the entire building, with the structure supported on footings or piling. For heavier floor loadings, ventilation ducts below the insulated floor may be used. Experience has shown that ventilated foundations should be so elevated, sloped, oriented, and configured as to minimize possibilities for accumulation of water, snow, ice, or soil in the ducts. Guidance in the thermal analysis of ventilated foundations, including the estimation of depths of summer thaw in supporting materials and design to assure winter refreezing, is given UFC 3-130-01.

Natural or forced circulation thermal piles or refrigeration points may also be used for overall foundation cooling and control of permafrost degradation.

11-4.2.4 Foundation Insulation. Thermal insulation may be used in foundation construction in both seasonal frost and permafrost areas to control frost penetration, frost heave, and condensation, and to conserve energy, provide comfort, and enhance the effectiveness of foundation ventilation. Unanticipated loss of effectiveness by moisture absorption must be avoided. Cellular glass should not be used where it will be subject to cyclic freezing and thawing in the presence of moisture. Insulation thickness and placement may be determined by the guidance given in UFC 3-130-01.

11-4.2.5 **Granular Mats.** In areas of significant seasonal frost and permafrost, a mat of non-frost-susceptible granular material may be used to moderate and control seasonal freeze-and-thaw effects in the foundation, to provide drainage under floor slabs, to provide stable foundation support, and to provide a dry, stable working platform for construction equipment and personnel. Seasonal freezing-and-thawing effects may be totally or partially contained within the mat. When seasonal effects are only partially contained, the magnitude of seasonal frost heave is reduced through both the surcharge effect of the mat and the reduction of frost penetration into underlying frost-susceptible soils. UFC 3-130-01 provides guidance in the design of mats.

11-4.2.6 **Solar Radiation Thermal Effects.** The control of summer heat input from solar radiation is very important in foundation design in permafrost areas. Corrective measures that may be employed include shading, reflective paint or other surface material, and sometimes live vegetative covering. In seasonal frost areas, it may sometimes be advantageous to color critical surfaces black to gain maximum effect of solar heat in reducing winter frost problems. UFC 3-130-01 provides guidance on the control of solar radiation thermal effects.

11-4.3 **Control of Movement and Distortion.** The amount of movement and distortion that may be tolerated in the support structure must be established and the foundation must be designed to meet these criteria. Movement and distortion of the foundation may arise from seasonal upward, downward, and lateral displacements, from progressive settlement arising from degradation of permafrost or creep deflections under load, from horizontal seasonal shrinkage and expansion caused by temperature changes, and from creep flow, or slide of material on slopes. Heave may also occur on a non-seasonal basis if there is progressive freezing in the foundation, as under a refrigerated building or storage tank. If the subsurface conditions, moisture availability, frost penetration, imposed loading, or other factors vary in the foundation area, the movements will be non-uniform. Effects on the foundation and structure may include various kinds of structural damage, jamming of doors and windows, shearing of utilities, and problems with installed equipment.

11-4.3.1 **Frost-Heave and Thaw-Settlement Deformations.** Frost heave acts in the same direction as the heat flow or perpendicular to the freezing plane. Thus, a slab on a horizontal surface will be lifted directly upward, but a vertical retaining wall may experience horizontal thrust. Foundation members, such as footings, walls, piles, and anchors, may also be gripped on their lateral surfaces and heaved by frost forces acting in tangential shear. Figure 11-5 shows an example of frost-heave forces developed in tangential shear on timber and steel pipe piles restrained against upward movement.

In rivers, lakes, or coastal water bodies, foundation members, to which floating ice may adhere, may also be subject to important vertical forces as water levels fluctuate.

11-4.3.2 **Controlling Frost Heave.** Among methods that can be used to control detrimental frost action effects are placing non-frost-susceptible soils in the depth subject to freezing to avoid frost heave or thrust; providing sufficient embedment or

other anchorage to resist movement under the lifting forces; providing sufficient loading on the foundation to counterbalance upward forces: isolating foundation members from heave forces; battering tapering members within the annual frost zone to duce effectiveness of heave grip; modifying soil frost susceptibility; in seasonal frost areas only, taking advantage of natural heat losses from the facility to minimize adfreeze and frost heave; or cantilevering building attachments, e.g., porches and stairs, to its main foundation.

11-4.3.3 **Permafrost.** In permafrost areas, movement and distortion caused by thaw of permafrost can be extreme and should be avoided by designing for full and positive thermal stability whenever the foundation would be adversely affected by thaw. If damaging thaw settlement should start, a mechanical refrigeration system may have to be installed in the foundation or a program of continual jacking may have to be adopted for leveling of the structure. Discontinuance or reduction of building heat can also be effective. Detailed guidance is given in UFC 3-130-01.

11-4.3.4 **Creep Deformation.** Only very small loads can be carried on the unconfined surface of ice-saturated frozen soil without progressive deformation. The allowable long-term loading increases greatly with depth but may be limited by unacceptable creep deformation well short of the allowable stress level determined from conventional short-term test. Present practice is to use large footings with low unit loadings; support footings on mats of well-drained non-frost-susceptible granular materials, which reduce stresses on underlying frozen materials to conservatively low values; or place foundations at sufficient depth in the ground so that creep is effectively minimized. Pile foundations are designed to not exceed sustainable adfreeze bond strengths. In all cases, analysis is based on permafrost temperature at the warmest time of the year.

11-4.4 **Vibration Problems and Seismic Effects.** Foundations supported on frozen ground may be affected by high stress-type dynamic loadings, such as shock loadings from high-yield explosions, by lower stress pulse-type loadings as from earthquakes or impacts, or by relatively low-stress, relatively low-frequency, steady-state vibrations. In general, the same procedures used for non-frozen soil conditions are applicable to frozen soils. Design criteria are given in UFC 3-220-03A and UFC 3-220-09. These criteria also contain references to sources of data on the general behavior and properties of non-frozen soils under dynamic load and discuss types of laboratory and field tests available. However, design criteria, test techniques, and methods of analysis are not yet firmly established for engineering problems of dynamic loading of foundations. Therefore, the senior engineer of the organization should be notified upon initiation of design and should participate in establishing criteria and approach and in planning field and laboratory tests.

All design approaches require knowledge of the response characteristics of the foundation materials, frozen or non-frozen, under the particular load involved. As dynamic loadings occur in a range of stresses, frequencies, and types (shock, pulse, steady-state vibrations, etc.), and the response of the soil varies depending upon the load characteristics, the required data must be obtained from tests that produce the same responses as the actual load. Different design criteria are used for the different

types of dynamic loading, and different parameters are required. Such properties as moduli, damping ability, and velocity of propagation vary significantly with such factors as dynamic stress, strain, frequency, temperature, and soil type and condition. UFC 3-130-01 discusses these properties for frozen ground.

11-4.5 **Design Criteria for Various Specific Engineering Features.** In addition to the basic considerations outlined in the preceding paragraphs of this chapter, the design of foundations for frost and permafrost conditions requires application of detailed criteria for specific engineering situations. Guidance for the design of various specific features, construction consideration, and monitoring of performance of foundation is presented in UFC 3-130-01.

Figure 11-5 Heave Force Test

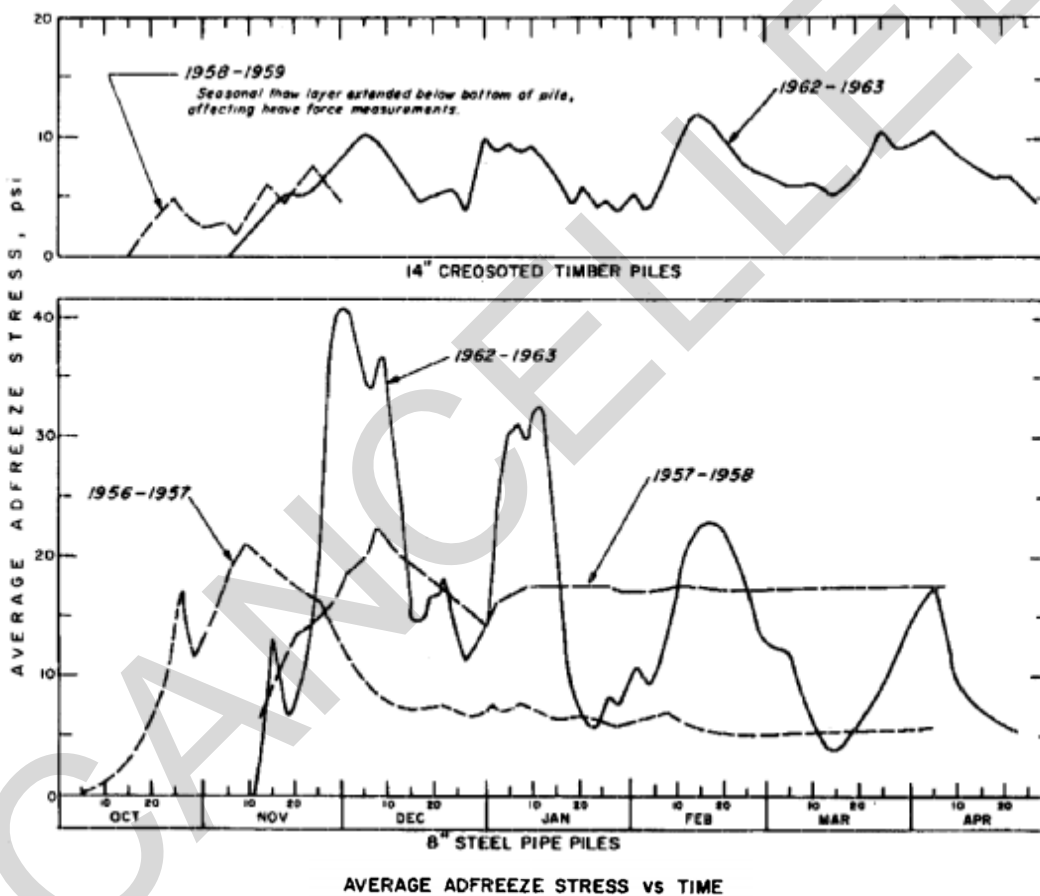

(Average tangential Adfreeze bond stress versus time, and timber and steel pipe piles with silt-water slurry in dry excavated holes. Piles were installed within annual frost zone only, over permafrost, to depths from ground surface of 1.1 to 2 meters (3.6 to 6.5 feet).)

CHAPTER 12

DESIGN FOR EQUIPMENT VIBRATIONS AND SEISMIC LOADINGS

12-1 INTRODUCTION

12-1.1 **Introduction.** Vibrations caused by steady state or transient loads may cause settlement of soils, excessive motions of foundations or structures, or discomfort or distress to personnel. Some basic design factors for dynamic loading retreated in this action. Design of a foundation system incorporates the equipment lading, subsurface material properties, and geometrical proportions in some analytical procedure.

12-1.1.1 **Vibration Criteria.** Figure 12-1 shows some limiting values of vibration criteria for machines, structures, and personnel. On this diagram, vibration characteristic: are described in terms of frequency and peak amplitudes of acceleration, velocity, or displacement. Values of frequency constitute the abscissa of the diagram and peak velocity is the ordinate. Values of peak displacement are read along one set of diagonal lines and labeled in displacement (inches), and peak acceleration values are read along the other set of diagonal lines and labeled in various amounts of g, the acceleration of gravity. The shaded zones in the upper right-hand corner indicate possible structural damage to walls by steady-state vibrations. For structural safety during blasting, limit peak velocity to 50 mm (2 in) per second and peak acceleration to 0.10g for frequencies exceeding 3 cycles per second. These limits may occasionally have to be lowered to avoid being excessively annoying to people.

12-1.1.2 **Equipment Vibration Criteria.** For equipment vibration, limiting criteria consist of a maximum velocity of 1.0 inch per second up to a frequency of about 30 cycles per second and a peak acceleration of 0.15 g alive this frequency, however, this upper limit is for safety only, and specific criteria must be established for each installation. Usually, operating limits of equipment are based on velocity criteria; greater than 0.5 inch per second indicates extremely rough operation and machinery should be shut down; up to 0.25 mm (0.1 in) per second occurs for smooth, well-balanced equipment; and less than 0.025 mm (0.01 in) per second represents very smooth operation.

12-1.1.3 **Vibration Affect on Personnel.** Figure 12-1 also includes peak velocity criteria for reaction of personnel to steady-state abrasions. Peak velocities greater than 0.25 mm (0.1 in) per second are “troublesome to persons,” and peak velocities of 0.025 mm (0.01 in) per second are just “barely noticeable to persons.” It is significant that persons and machines respond to equivalent levels of vibration. Furthermore, persons may notice vibrations that are about 1/100 of the value related to safety of structure.

12-1.2 **Single Degree of Freedom, Damped Forced Systems.** Vibrations of foundation-soil systems can adequately be represented by simple mass-spring-dashpot systems. The model for this simple system consists of a concentrated mass, m , supported by a linear elastic spring with a spring constant, k , and a viscous damping unit (dashpot) having a damping constant, c . The system is excited by an external

force, e.g., $Q = Q_0 \sin(\omega t)$, in which Q_0 is the amplitude of the exciting force, $\omega = 2\pi f_0$ is the angular frequency (radians per second) with f_0 the exciting frequency (cycles per second), and t is time in seconds.

If the model is oriented as shown in the insert in figure 12-2(a), motions will occur in the vertical or z direction only, and the system has one degree of freedom (one coordinate direction (z) is needed to describe the motion). The magnitude of dynamic vertical motion, A_z , depends upon the magnitude of the external excitation, Q , the nature of Q_0 , the frequency, f_0 , and the system parameter m , c , and k . These parameters are customarily combined to describe the "natural frequency" as follows:

$$f_n = 1/(2\pi)\sqrt{k/m} \quad (12-1)$$

and the "damping ratio" as

$$D = c/2\sqrt{k/m} \quad (12-2)$$

Figure 12-2(a) shows the dynamic response of the system when the amplitude of the exciting force, Q_0 , is constant. The abscissa of the diagram is the dimensionless ratio of exciting frequency, f_0 , divided by the natural frequency, f_n , in equation (12-1). The ordinate is the dynamic magnification factor, M_z which is the ratio of A_z to the static displacement, $A_z = (Q_0/k)$. Different response curves correspond to different values of D .

Figure 12-2(b) is the dynamic response of the system when the exciting force is general by a rotating mass, which develops:

$$Q_0 = m_e(\bar{e})4\pi^2 f_0^2 \quad (12-3)$$

where

m_e = the total rotating mass

\bar{e} = the eccentricity

f_0 = the frequency of oscillation, cycles per second

The ordinate M_z (fig 12-2(b)) relates the dynamic displacement, A_z , to $m_e \bar{e}/m$. The peak value of the response curve is a function of the damping ratio and is given by the following expression:

$$M_{e(\max)} \text{ or } M_z = \frac{1}{2D} \sqrt{1 - D^2} \quad (12-4)$$

For small values of D , this expression becomes $1/2D$. These peak values occur at frequency ratios of

$$\frac{f_0}{f_n} = \sqrt{1 - D^2} \quad (12-5)$$

or

$$\frac{f_o}{f_n} = \frac{1}{w \sqrt{1 - 2D^2}} \quad (12-6)$$

Figure 12-1 Response Spectra for Vibration Limits

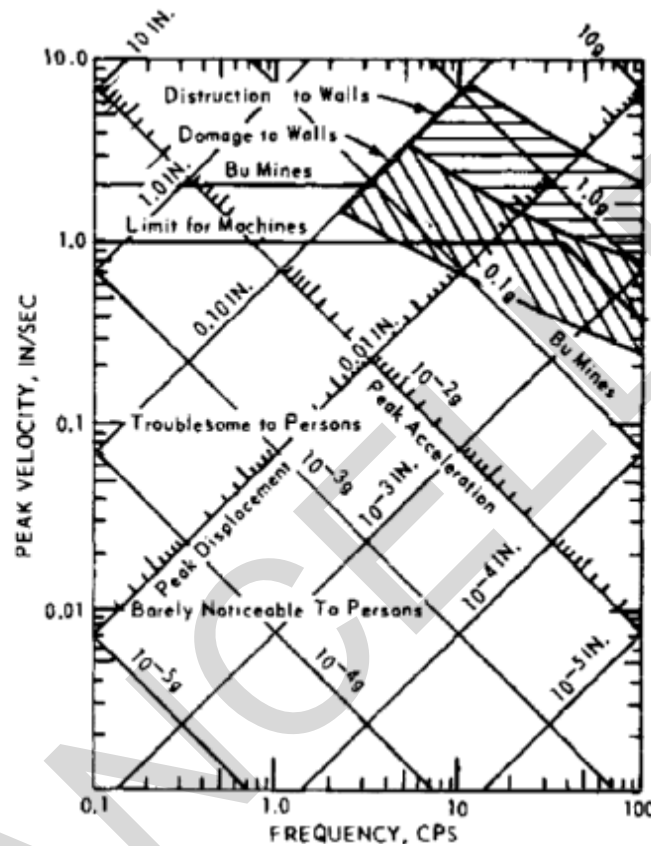

(Courtesy of F. E. Richart, Jr., J. R. Hall, Jr. and R. D. Woods, *Vibrations of Soils and Foundations*, 1970. p 316. Reprinted by permission of Prentice-Hall, Inc., Englewood Cliffs, N. J.)

12-1.3 Foundations on Elastic Soils

12-1.3.1 **Foundations on Elastic Half-Space.** For very small deformations, assume soils to be elastic materials with properties as noted in UFC 3-220-09. Therefore, theories describing the behavior of rigid foundations resting on the surface of a semi-infinite, homogeneous, isotropic elastic body have been found useful for study of the response of real footings on soils. The theoretical treatment involves a circular foundation of radius, r_o , on the surface of the ideal half-space. This foundation has six degrees of freedom: (1-3) translation in the vertical (z) or in either of two horizontal (x and y) directions; (4) torsional (yawing) rotation about the vertical (z) axis; or (5-6)

rocking (pitching) rotation about either of the two horizontal (x and y) axes. These vibratory motions are illustrated in figure 12-3.

A significant parameter in evaluating the dynamic response in each type of motion is the inertia reaction of the foundation. For translation, this is simply the mass, $m = (W/g)$, whereas in the rotational modes of vibration, it is represented by the mass moment of inertia about the axis of rotation. For torsional oscillation about the vertical axis, it is designated as I_o , whereas for rocking oscillation, it is I_ψ (for rotation about the axis through a diameter of the base of the foundation). If the foundation is considered to be a right circular cylinder of radius, r_o , height, h , and unit weight, γ , expressions for the mass and mass moments of inertia are as follows:

$$m = \frac{\pi r_o^2 h \gamma}{g} \quad (12-7)$$

$$I_o = \frac{\pi r_o^4 h \gamma}{2g} \quad (12-8)$$

$$I_\psi = \frac{\pi r_o^2 h \gamma}{g} \left(\frac{r_o^2}{4} + \frac{h^2}{3} \right) \rho \quad (12-9)$$

Theoretical solutions describe the motion magnification factors M_z or M_ψ , for example, in terms of a "mass ratio" B_z and a dimensionless frequency factor a_o . Table 12-1 lists the mass ratios, damping ratios, and spring constants corresponding to vibrations of the rigid circular footing resting on the surface of an elastic semi-infinite body for each of the modes of vibration. Introduce these quantities into equations given in paragraph 12-1.2 to compute resonant frequencies and amplitudes of dynamic motions. The dimensionless frequency, a_o , for all modes of vibration is given as follows:

$$a_o = \frac{2\pi f_o r_o}{V_s} = \omega r_o \sqrt{\rho/G} \quad (12-10)$$

The shear velocity, V_s , in the soil is discussed in paragraph 17-5.

Figure 12-4 shows the variation of the damping ratio, D , with the mass ratio, B , for the four modes of vibration. Note that D is significantly lower for the rocking mode than for the vertical or horizontal translational modes. Using the expression $meters = 1/(2D)$ for the amplitude magnification factor and the appropriate D_ψ from figure 12-4, it is obvious that $meters_\psi$ can become large. For example, if $B_\psi = 3$, the $D_\psi = 0.02$ and $meters_\psi = 1/(2 \times 0.02) = 25$.

Figure 12-2 Response Curves for the Single-Degree-of-Freedom System with Viscous Damping

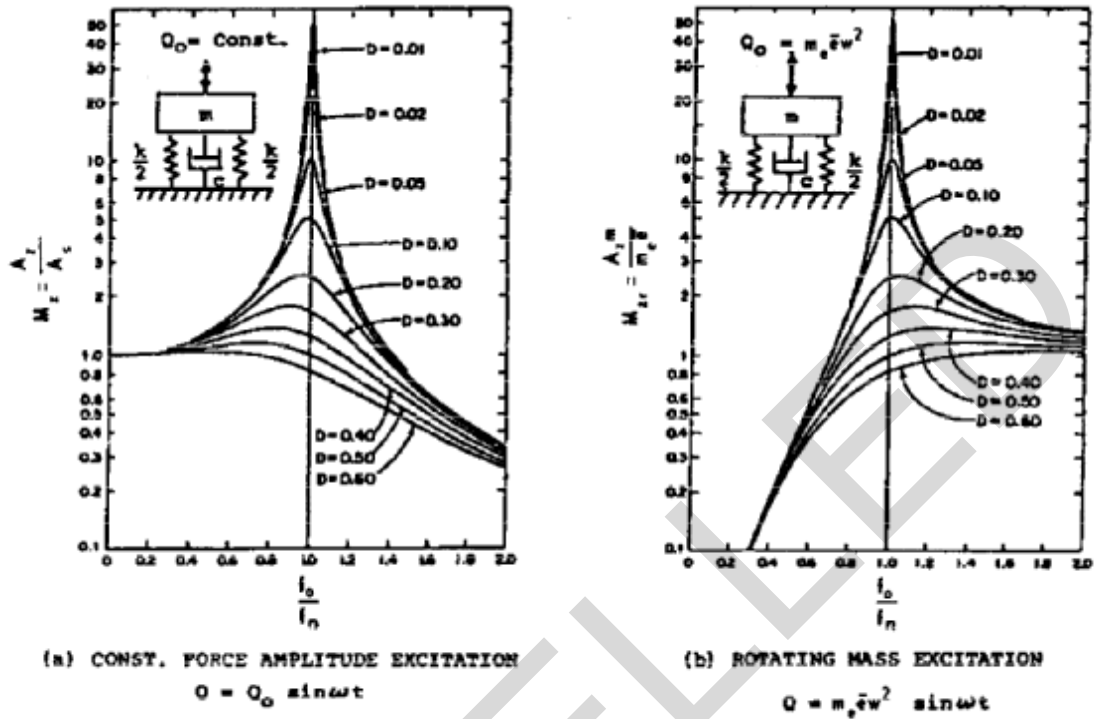

(Courtesy of F. E. Richart, Jr., J. R. Hall, Jr., and R. D. Woods, *Vibrations of Soils and Foundations*, 1970, pp 383-384. Reprinted by permission of Prentice-Hall, Inc., Englewood Cliffs, N. J.)

Figure 12-3 Six Modes of Vibration for a Foundation

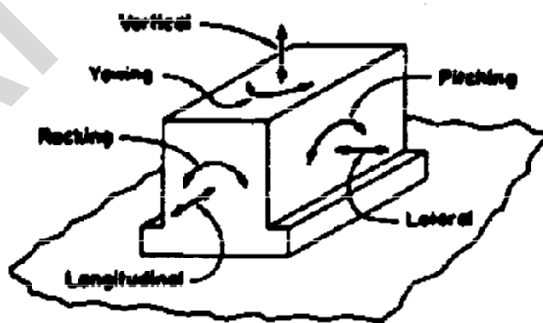
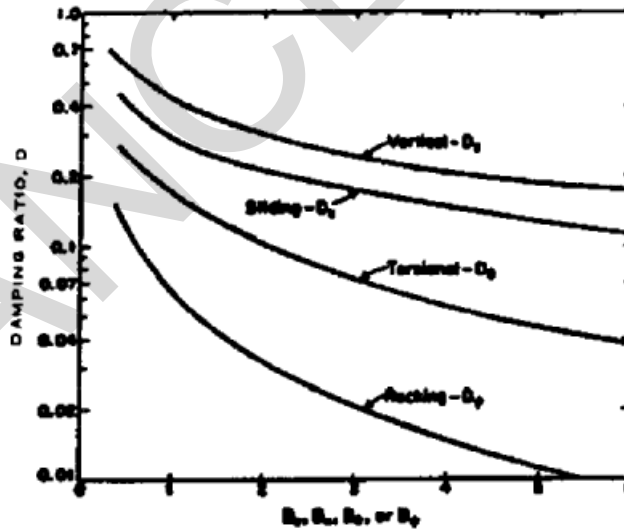

Table 12-1 Mass Ratio, Damping Ratio, and Spring Constant for Rigid Circular Footing on the Semi-Infinite Elastic Body

Mode of Vibration	Mass (or Inertia) Ratio, B_i	Damping Ratio D_i	Spring Constant k_i
Vertical	$B_z = \frac{(1 - \nu)}{4} \frac{m}{\rho r_o^3}$	$D_z = \frac{0.425}{\sqrt{B_z}}$	$k_z = \frac{4Gr_o}{1 - \nu}$
Sliding	$B_x = \frac{(7 - 8\nu)m}{32(1 - \nu)\rho r_o^3}$	$D_x = \frac{0.288}{\sqrt{B_x}}$	$k_x = \frac{32(1 - \nu)}{7 - 8\nu} Gr_o$
Rocking	$B_\psi = \frac{3(1 - \nu)}{8} \frac{I_\psi}{\rho r_o^5}$	$D_\psi = \frac{0.15}{(1 + B_\psi)\sqrt{B_\psi}}$	$k_\psi = \frac{8 Gr_o^3}{3(1 - \nu)}$
Torsional	$B_\theta = \frac{I_\theta}{\rho r_o^5}$	$D_\theta = \frac{0.50}{1 + 2B_\theta}$	$k_\theta = \frac{16}{3} Gr_o^3$

Figure 12-5 Equivalent Damping Ratio for Oscillation of Rigid Circular Footing on Elastic Half-Space



(Courtesy of F. E. Richart, Jr., J. R. Hall, Jr., and R. D. Woods, *Vibrations of Soils and Foundations*, 1970, p 226. Reprinted by permission of Prentice-Hall, Inc., Englewood Cliffs, N. J.)

12-1.3.2 **Effects of Shape Foundation.** The theoretical solutions described above treated a rigid foundation with a circular contact surface bearing against the elastic half-space. However, foundations are usually rectangular in plan. Rectangular footings may

be converted into an equivalent circular footing having a radius, r_o , determined by the following expressions:

For translation in z- or x-directions:

$$r_o = \sqrt{\frac{4cd}{\pi}} \quad (12-10)$$

For rocking:

$$r_o = \sqrt[4]{\frac{16cd^3}{3\pi}} \quad (12-11)$$

For torsion:

$$r_o = \sqrt[4]{\frac{16cd(c^2 + d^2)}{6\pi}} \quad (12-12)$$

In equations (12-10), (12-11), and (12-12), $2c$ is the width of the rectangular foundation (along the axis of rotation for rocking), and $2d$ is the length of the foundation (in the plane of rotation for rocking). Two values of r_o are obtained for rocking about both x and y axes.

12-1.3.3 **Computations.** Figure 12-5 presents examples of computations for vertical motions (Example 1) and rocking motions (Example 2).

12-1.3.4 **Effect of Embedment.** Embedment of foundations a distance d below the soil surface may modify the dynamic response, depending upon the soil-foundation contact and the magnitude of d . If the soil shrinks away from the vertical faces of the embedded foundation, no beneficial effects of embedment may occur. If the basic evaluation of foundation response is based on a rigid circular footing (of radius r_o) at the surface, the effects of embedment will cause an increase in resonant frequency and a decrease in amplitude of motion and the embedment ratio d/r_o .

For vertical vibrations, both analytical and experimental results indicate an increase in the static spring constant with an increase in the static spring constant with an increase in embedment depth. Embedment of the circular footing a distance $d/r_o \leq 1.0$ produces an increase in the embedded spring constant k_{zd} which is greater than k_z , (table 12-1) by $k_{zd}/k_z \cong (1+0.6 d/r_o)$. An increase in damping also occurs, e.g., $D_{zd}/D_z \cong (1+0.6 d/r_o)$. These two approximate relations lead to an estimate of the reduction in amplitude of motion because of embedment from $A_{zd}/A_z = 1/D_{zd}/D_z \times k_{zd}/k_z$. This amount of amplitude reduction requires complete soil adhesion at the vertical face, and test data have often indicated less effect of embedment. Test data indicate that the resonant frequency may be increased by a factor up to $(1 + 0.25 d/r_o)$ because of embedment.

The influence of embedment on coupled rocking and sliding vibrations depends on the ratio B_y/B_x (table 12-1). For $B_y/B_x \approx 3.0$, the increase in natural frequency due to embedment may be as much as $(1+0.5 d/r_o)$. The decrease in amplitude is strongly dependent upon the soil contact along the vertical face of the foundation, and each case should be evaluated on the basis of local soil and construction conditions.

12-1.3.5 **Effect of Finite Thickness Of Elastic Layer.** Deposits of real soils are seldom homogeneous to significant depths; thus theoretical results based on the response of a semi-infinite elastic media must be used with caution. When soil layers are relatively thin, with respect to foundation dimensions, modifications to the theoretical half-space analyses must be included.

Generally, the effect of a rigid layer underlying a single elastic layer of thickness, H , is to reduce the effective damping for a foundation vibrating at the upper surface of the elastic layer. This condition results from the reflection of wave energy from the rigid base back to the foundation and to the elastic medium surrounding the foundation. For vertical or torsional vibrations on a rigid circular foundation resting on the surface of the elastic layer, it has been established that a very large amplitude of resonant vibrations can occur if

$$\frac{V_s}{f_0} > 4H$$

In equation (12-13), V_s is the shear wave velocity in the elastic layer and f_0 is the frequency of footing vibrations. When the conditions of equation (12-4) occur, the natural frequency (equation (12-1)) becomes the important design criterion because at that frequency excessive dynamic motion will occur. To restrict the dynamic oscillation to slightly larger than the static displacement, the operating frequency should be maintained at one half, or less, of the natural frequency (figure 12-2).

The relative thickness (expressed by H/r_0) also exerts an important influence on foundation response. If H/r_0 is greater than about 8, the foundation on the elastic layer will have a dynamic response comparable to that for a foundation on the elastic half-space. For $H/r_0 < 8$, geometrical damping is reduced, and the effective spring constant is increased. The values of spring constant, k , in table 12-1 are taken as reference values, and table 12-2 indicates the increase in spring constant associated with a decrease in thickness of the elastic layer. Values of the increase in spring constant for sliding and for rocking modes of vibration will tend to fall between those given for vertical and torsion for comparable H/r_0 conditions.

Figure 12-5 Examples of Computations for Vertical and Rocking Motions

EXAMPLE 1

**A. FOUNDATION FOR SINGLE - CYLINDER
VERTICAL COMPRESSOR**

14" BORE , 9" STROKE
450 RPM OPERATING SPEED
UNBALANCED FORCES:
VERTICAL PRIMARY = 7720 LB.
VERTICAL SECONDARY = 1985 LB.
HORIZ. PRIMARY = 104 LB.
HORIZ. SECONDARY = 0 LB.

WT. MACHINE AND
MOTOR = 10900 LB.

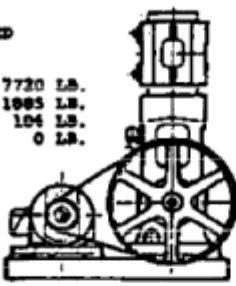

DESIGN CRITERION : SMOOTH OPERATION
(LESS THAN 0.10 IN / SEC VELOCITY)
AT 450 RPM THIS REQUIRES $A_{zs} = 0.002$ IN.

SOIL PROPERTIES: $v_s = 680$ FT / SEC
 $G = 11,000$ LB / IN²
 $\rho = 110$ LB / FT³
 $\mu = 0.33$

SOLUTION :

FOR FIRST ESTIMATE OF FOUNDATION SIZE,
DETERMINE STATIC SIZE FOR $A_{zs} = 0.002$ IN.

$$A_{zs} = \frac{Q_0}{k_x} = 0.002 = \frac{(1-\mu)Q_0}{4 G r_0} = \frac{0.667(7720+1985)}{4(11000)r_0}$$

$r_0 = 72.8" = 6.07$ FT FOR CIRCULAR FOUNDATION
THEN REQUIRED AREA = $\pi r_0^2 = 115.6$ FT²
TRY 15'x8'x3' THICK FOUNDATION BLOCK
THEN A = 120 FT², and $r_0 = 6.18$ FT.
WT. FOUNDATION BLOCK = 54,000 LB.
WT. TOTAL = W = 64,900 LB.

FROM TABLE 17-11

$$k_x = \frac{(1-\mu)W}{4 \rho r_0^2} = \frac{0.67 \times 64900}{4 \times 110 (6.18)^2} = 0.42$$

$$D_x = \frac{0.425}{\sqrt{k_x}} = 0.56$$

$M_x \approx 1.0$. THUS $A_x = A_{zs}$

$$A_{zs} = \frac{(1-\mu) Q_0}{4 G r_0} = 0.00197" , \text{ FOR } r_0 = 6.18 \text{ FT.}$$

THEREFORE, THE 15'x 8'x 3' THICK CONCRETE
BLOCK FOUNDATION IS SATISFACTORY

EXAMPLE 2

**B. MACHINE FOUNDATION SUBJECTED TO
ROCKING VIBRATIONS**

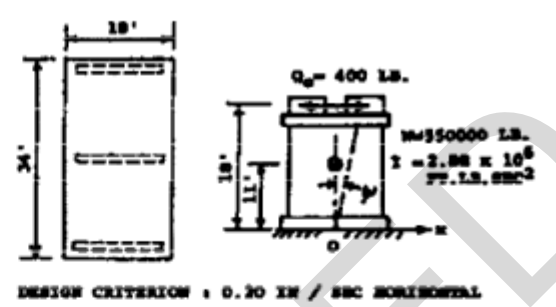

DESIGN CRITERION : 0.20 IN / SEC HORIZONTAL
MOTION AT MACHINE CENTERLINE
AT 1300 RPM THIS LIMITS A_{zs} TO 0.0015 IN
FROM COMBINED ROCKING AND SLIDING.
(AT SLOWER SPEEDS THE ALLOWABLE A_{zs}
IS LARGER)

SOIL PROPERTIES: $v_s = 770$ FT / SEC
 $G = 14,000$ LB / IN²
 $\rho = 110$ LB / FT³
 $\mu = 0.33$

HORIZONTAL TRANSLATION ONLY:

$$\text{EQUIVALENT } r_0 = \sqrt{\frac{4cd}{\pi}} = \sqrt{\frac{18 \times 34}{\pi}} = 13.96 \text{ FT}$$

$$k_x = \frac{(1-\mu)W}{32(1-\mu)\rho r_0^2} = 0.37 \therefore M_x = 1.0$$

$$A_{zs} = \frac{Q_0}{k_x} = \frac{Q_0(1-\mu)}{32(1-\mu)G r_0} = 0.0003 \text{ IN.}$$

HORIZONTAL TRANSLATION IS NEGLIGIBLE

ROCKING ABOUT POINT O

$$\text{EQUIVALENT } r_0 = \sqrt{\frac{16cd^3}{3\pi}} = \sqrt{\frac{34(18)^3}{3\pi}} = 12.04 \text{ FT}$$

$$k_y = \frac{3(1-\mu)I}{8\rho r_0^2} = \frac{3(0.67)2.88 \times 10^6}{8 \times 110(12.04)^2} = 0.83$$

THEN $D_y = \frac{0.15}{(1+k_y)\sqrt{k_y}} = 0.09$, AND FROM
EQ.17-4, $M_y = 5.6$

THE STATIC MOMENT ABOUT O IS
 $T_s = 400 \times 18 = 7200$ FT.LB. , AND THE
STATIC ANGULAR DEFLECTION IS

$$\theta_s = \frac{T_s}{k_y} = \frac{7200 \times 3(0.67)}{8(14000)[44(12.04)^2]} = \frac{0.51}{10^6} \text{ RAD}$$

THIS ROTATION WOULD PRODUCE A HORIZONTAL
MOTION AT THE MACHINE CENTERLINE OF

$$A_{zs} = \theta_s h = \frac{0.51}{10^6} (18 \times 12) = 1.10 \times 10^{-4} \text{ IN.}$$

OR, THE DYNAMIC AMPLITUDE AT RESONANCE IS

$$A_z = M_y A_{zs} = 6.17 \times 10^{-4} \text{ IN.} < 0.0015 \text{ IN.}$$

12-1.3.6 **Coupled Modes of Vibration.** In general, vertical and torsional vibrations can occur independently without causing rocking or sliding motions of the foundation. To accomplish these uncoupled vibrations, the line of action of the vertical force must pass through the center of gravity of the mass and the resultant soil reaction, and the

exciting torque and soil reaction torque must be symmetrical about the vertical axis of rotation. Also, the center of gravity of the foundation must lie on the vertical axis of torsion.

When horizontal or overturning moments act on a block foundation, both horizontal (sliding) and rocking vibrations occur. The coupling between these motions depends on the height of the center of gravity of the machine-foundation about the resultant soil reaction. Details of a coupled rocking and sliding analysis are given in the example in figure 12-6.

A “lower bound” estimate of the first mode of coupled rocking and sliding vibrations can be obtained from the following:

$$\frac{1}{f_0^2} = \frac{1}{f_1^2} + \frac{1}{f_2^2} \quad (12-14)$$

In equation (12-14), the resonant frequencies in the sliding x and rocking w motions can be determined by introducing values from table 12-1 into equations (12-1) and (12-5). (Note that equation (12-14) becomes less useful when D_z is greater than about 0.15). The first mode resonant frequency is usually most important from a design standpoint.

12-1.3.7 **Examples.** Figure 12-5, Example 1, illustrates a procedure for design of a foundation to support machine-producing vertical excitations. Figure 12-5, Example 2, describes the analysis of uncouple horizontal and rocking motion for a particular foundation subjected to horizontal excitations. The design procedure of Example 1 is essentially an iterative analysis after approximate dimensions of the foundation have been established to restrict the static deflection to a value comparable to the design criterion.

- Figure 12-5, Example 1, shows that relatively high values of damping ratio D are developed for the vertical motion of the foundation, and Example 2 illustrates that the high damping restricts dynamic motions to values slightly larger than static displacement caused by the same force. For Example 2, establishing the static displacement at about the design limit value leads to satisfactory geometry of the foundation.
- Example 2 (Figure 12-5) gives the foundation geometry, as well as the analysis needed to ascertain whether the design criterion is met. It is assumed that the 400-pound horizontal force is constant at all frequencies and that a simple superposition of the single-degree-of-freedom solutions for horizontal translation and rocking will be satisfactory. Because the horizontal displacement is negligible, the rocking motion dominates, with the angular rotation at resonance amounting to $(\text{meters}_v \times \psi_s)$ or $A_\psi = 5.6 \times 0.51 \times 10^{-6} = 2/85 \times 10^{-6}$ radians. By converting this motion to horizontal displacement at the machine centerline, it is found that the design conditions are met.
- Figure 12-6, the foundation of Example 2 (figure 12-5), is analyzed as a coupled system including both rocking and sliding. The response curve for angular rotation shows a peak motion of $A_\psi = 2.67 \times 10^{-6}$ radians, which is comparable to the value found by considering rocking alone. The coupled dynamic response of

any rigid foundation, e.g., a radar tower, can be evaluated by the procedure illustrated in Figure 12-6.

Table 12-2 Values of k_L/L for Elastic Layer (k from Table 12-1)

meters/ r_o	0.5	1.0	2.0	4.0	8.0	∞
Vertical	5.0	2.2	1.47	1.23	1.10	1.0
Torsion	---	1.07	1.02	1.009	---	1.0

CANCELLED

Figure 12-6 Coupled Rocking and Sliding Motion of Foundation

IN THE SKETCH REPRESENTING THE DYNAMIC MOTION OF THE FOUNDATION OF FIGURE 17-5, EXAMPLE 2, THE SUBSCRIPT "g" REFERS TO THE CENTER OF GRAVITY, AND "b" REFERS TO THE CENTER OF THE BASE.

$$x_b = x_g - h_0 \psi \quad I_b = I_g + m h_0^2$$

m = TOTAL MASS, AND I = MASS MOMENT OF INERTIA

$$c_x = D_x 2\sqrt{k_x} = \frac{18.4 (1-\nu)}{(1-\nu) - 8\nu} r_0^2 \sqrt{\rho G}$$

$$c_\psi = D_\psi 2\sqrt{k_\psi I} = \frac{0.80 r_0^4 \sqrt{\rho G}}{(1-\nu)(1+\nu)}$$

$$F_x = -c_x \dot{x}_b - k_x x_b \quad ; \quad F_\psi = -c_\psi \dot{\psi} - k_\psi \psi$$

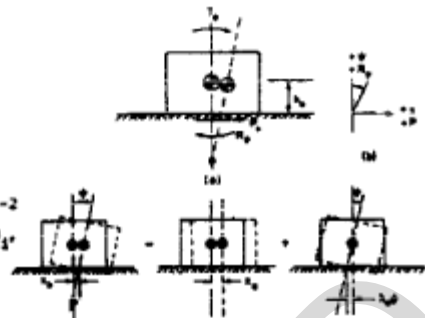

THE EQUATION OF EQUILIBRIUM FOR HORIZONTAL TRANSLATION IS

$$m \ddot{x}_g + c_x \dot{x}_b + k_x x_b = Q_x = m \ddot{x}_b + m h_0 \ddot{\psi} + c_x \dot{x}_b + k_x x_b \quad (a)$$

AND FOR ROTATION ABOUT THE CENTER OF GRAVITY IT IS

$$I_g \ddot{\psi} + c_\psi \dot{\psi} + k_\psi \psi - c_x h_0 \dot{x}_b - k_x h_0 x_b = T_\psi \quad \text{OR}$$

$$I_b \ddot{\psi} - m h_0 \ddot{x}_g + c_\psi \dot{\psi} + k_\psi \psi - c_x \dot{x}_b h_0 - k_x x_b h_0 = T_\psi \quad (b)$$

$$\text{LET } x_b = A_{x1} \sin \omega t + A_{x2} \cos \omega t = A_x \sin (\omega t - \theta_x) \quad (c)$$

$$\psi = A_{\psi 1} \sin \omega t + A_{\psi 2} \cos \omega t = A_\psi \sin (\omega t - \theta_\psi)$$

$$Q_x = Q_0 \sin \omega t$$

$$T_\psi = Q_0 h \sin \omega t$$

NOTE: $A_x = \sqrt{A_{x1}^2 + A_{x2}^2} ; \tan \theta_x = \frac{-A_{x2}}{A_{x1}}$
 $A_\psi = \sqrt{A_{\psi 1}^2 + A_{\psi 2}^2} ; \tan \theta_\psi = \frac{-A_{\psi 2}}{A_{\psi 1}}$

INTRODUCING THE EXPRESSIONS (c) INTO EQUATIONS (a) AND (b) GIVE FOUR EQUATIONS WITH FOUR UNKNOWN (A_{x1}, A_{x2}, A_{ψ1}, A_{ψ2}), FOR EACH CHOSEN VALUE OF ω (ω = 2π-FREQUENCY). THUS A COMPUTER SOLUTION IS NEEDED. THE GRAPH BELOW SHOWS THE ROCKING RESPONSE CURVE FOR THE FOUNDATION (SEE SKETCH ABOVE AND FIGURE 17-5). THE PARAMETERS NEEDED FOR THE SOLUTION ARE NOTED BELOW.

Q₀ = 400 LB. (FREQUENCY INDEPENDENT)*
 h = 18 FT. , h₀ = 11 FT.
 $m = \frac{550,000}{32.2} = 17,080 \text{ LB SEC}^2 / \text{FT.}$

I_b = 2.88 × 10⁶ FT LB SEC²
 r₀ = 13.96 FT (SLIDING)
 r₀ = 12.04 FT (ROCKING)
 k_x = 1.39 × 10⁸ LB / FT
 k_ψ = 1.41 × 10¹⁰ FT LB / RAD
 c_x = 1.45 × 10⁶ LB SEC / FT
 c_ψ = 3.62 × 10⁷ FT LB SEC/RAD

* FOR ROTATING MASS MACHINE TYPE EXCITATION, WE WOULD INTRODUCE

$$Q_0 = m_e \bar{g} \omega^k$$

m_e = eccentric mass
 ḡ = eccentric radius

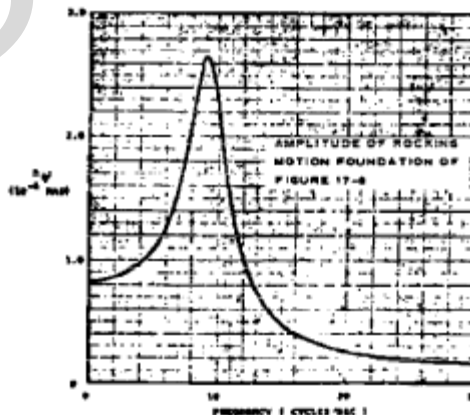

12-1.4 **Wave Transmission, Attenuation, and Isolation.** Vibrations are transmitted through soils by stress waves. For most engineering analyses, the soil may be treated as an ideal homogeneous, isotropic elastic material to determine the characteristics of the stress waves.

12-1.4.1 **Half-Space.** Two types of body waves may be transmitted in an ideal half-space, compression (P-) waves and shear (S-) waves; at the surface of the half-space, a third wave known as the Rayleigh (R-) wave or surface wave will be

transmitted. The characteristics that distinguish these three waves are velocity, wave front geometry, radiation damping, and particle motion. Figure 12-7 shows the characteristics of these waves as they are generated by a circular footing undergoing vertical vibration on the surface of an ideal half-space with $\mu = 0.25$. The distance from the footing to each wave in figure 12-7 is drawn in proportion to the velocity of each wave. The wave velocities can be computed from the following:

$$\begin{aligned} \text{P-wave velocity:} & & (12-17) \\ v_c &= \sqrt{\frac{\lambda + 2G}{\rho}} \\ \text{S-wave velocity:} & & \\ v_s &= \sqrt{\frac{G}{\rho}} \\ \text{R-wave velocity:} & & \\ v_R &= K v_s \end{aligned}$$

where

$$\begin{aligned} \lambda &= \frac{2\mu G}{1 - 2\mu} \quad \text{and } G \text{ are Lamé's constants; } & G &= \frac{E}{2(1 + \mu)} \\ \rho &= \frac{\gamma}{g} = \text{mass density of soil} \\ \gamma &= \text{moist or saturated unit weight} \\ K &= \text{constant, depending on Poisson's ratio} \\ &0.87 \leq K \leq 0.98 \text{ for } 0 \leq \mu \leq 0.5 \end{aligned}$$

The P- and S-waves propagate radially outward from the source along hemispherical wave fronts, while the R-wave propagates outward along a cylindrical wave front. All waves encounter an increasingly larger volume of material as they travel outward, thus decreasing in energy density with distance. This decrease in energy density and its accompanying decrease in displacement amplitude are called geometrical damping or radiation damping.

The particle motions are as follows: for the P- wave, a push-pull motion in the radial direction; for the S-wave, a transverse motion normal to the radial direction; and for the R-wave, a complex motion, that varies with depth and occurs in a vertical plane containing a radius. At the surface, R-wave particle motion describes a retrograde ellipse. The shaded zones along the wave fronts in figure 12-7 represent the relative particle amplitude as a function of inclination from vertical.

12-1.4.2 Layered Media. In a layered medium, the energy transmitted by a body wave splits into four waves at the interface between layers. Two waves are reflected back into the first medium, and two waves are transmitted or refracted into the second medium. The amplitudes and directions of all waves can be evaluated if the properties

of both media and the incident angle are known. If a layer containing a lower modulus overlies a layer with a higher modulus within the half-space, another surface wave, known as a Love wave, will occur. This wave is a horizontally oriented S-wave whose velocity is between the S-wave velocity of the layer and of the underlying medium.

The decay or attenuation of stress waves occurs for two reasons: geometric or radiation damping, and material or hysteretic damping. An equation including both types of damping is the following:

(12-18)

$$A_2 = A_1 \frac{r_1}{r_2} C \exp [-\alpha(r_2 - r_1)]$$

where

A_2 = desired amplitude at distance r_2

A_1 = known or measured amplitude at radial distance r_1 from vibration source

C = constant, which describes geometrical damping

= 1 for body (P- or S-) waves

= 0.5 for surface or R-waves

α = coefficient of attenuation, which describes material damping

12-1.4.3 **Isolation.** The isolation of certain structures or zones from the effects of vibration may sometimes be necessary. In some instances, isolation can be accomplished by locating the site at a large distance from the vibration source. The required distance, r_2 , is calculated from equation (12-18). In other situations, isolation may be accomplished by wave barriers. The most effective barriers are open or void zones like trenches or rows of cylindrical holes. Somewhat less effective barriers are solid or fluid-filled trenches or holes. An effective barrier must be proportioned so that its depth is at least two-thirds the wavelength of the incoming wave. The thickness of the barrier in the direction of wave travel can be as thin as practical for construction considerations. The length of the barrier perpendicular to the direction of wave travel will depend upon the size of the zone to be isolated but should be no shorter than two times the maximum plan dimension of the structure or one wavelength, whichever is greater.

12-1.5 **Evaluation of S-Wave Velocity in Soils.** The key parameter in a dynamic analysis of a soil-foundation system is the shear modulus, G . The shear modulus can be determined in the laboratory or estimated by empirical equations. The value of G can also be computed by the field-measured S-wave velocity and equation (12-16).

12-1.5.1 **Modulus at Low Strain Levels.** The shear modulus and damping for machine vibration problems correspond to low shear-strain amplitudes of the order of 1 to 3×10^{-4} percent. These properties may be determined from field measurements of the seismic wave velocity through soil or from special cyclic laboratory tests.

Figure 12-7 Distribution of Displacement Waves from a Circular Footing on the Elastic Half-Space

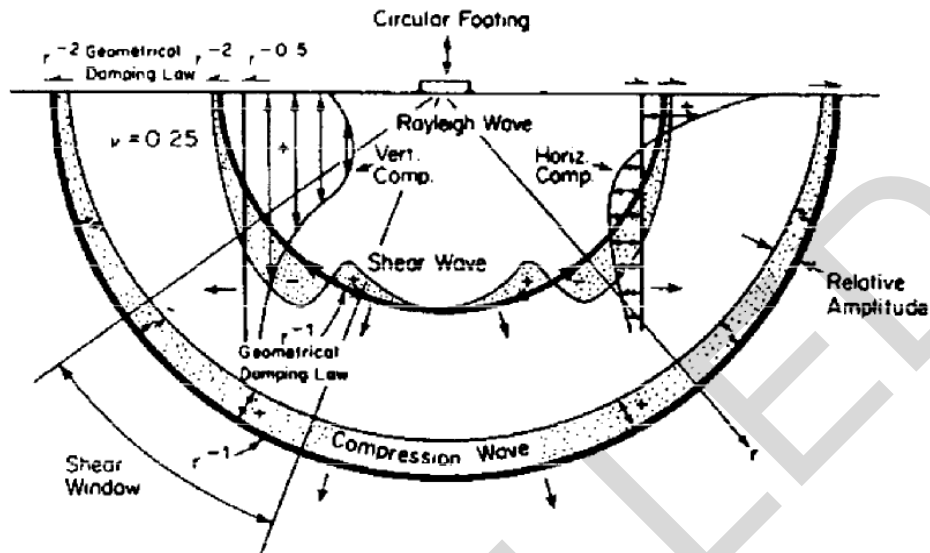

(Courtesy of F. E. Richart, Jr., J. R. Hall, Jr., and R. D. Woods, *Vibrations of Soils and Foundations*, 1970, p 91. Reprinted by permission of Prentice-Hall, Inc., Englewood Cliffs, N. J.)

Table 12-3 Attenuation Coefficients for Earth Materials

Materials		α (1/ft) @ 50 Hz ^a
Sand	Loose, fine	0.06
	Dense, fine	0.02
Clay	Silty (loess)	0.06
	Dense, dry	0.003
Rock	Weathered volcanic	0.02
	Competent marble	0.00004

^a α is a function of frequency. For other frequencies, f , compute $\alpha_f = (f/50) \times \alpha_{50}$

Source: U.S. Army Corps of Engineers

12-1.5.2 **Field Wave Velocity Tests.** S-wave velocity tests are preferable made in the field. Measurements are obtained by inducing a low-level seismic excitation at one location and measuring directly, the time required for the induced S-wave to travel between the excitation and pickup unit. Common tests, such as uphole, downhole or crosshole propagation, are described in geotechnical engineering literature.

A problem in using seismic methods to obtain elastic properties is, that any induce elastic pulse (blast, impact, etc.) develops three wave types previously discussed, i.e., P-, S-, and R-waves. Because the velocity of all seismic waves is hundreds of feet per second and the pickup unit detects all three wave pulses plus any random noise, considerable expertise is required to differentiate between the time of arrival of the wave of interest and the other waves. The R-wave is usually easier to

identify (being slower, it arrives last; traveling near the surface, it contains more relative energy). Because R- and S-wave velocities are relatively close, the velocity of the R-wave is frequently used in computations for elastic properties.

- Because amplitudes in seismic survey are very small, the computed shear and Young's moduli are considerably larger than those obtained from conventional laboratory compression tests.
- The shear modulus, G , may be calculated from the S- (approximately the R-wave) wave velocity as follows:

$$G = \rho V_s^2 \quad (12-19)$$

where

$\rho = \gamma/32.2$ = mass density of soil using wet or total unit weight

V_s = S-wave velocity (or R-wave), feet per second

This equation is independent of Poisson's ratio. The V_s value is taken as representative to a depth of approximately one-half wavelength. Alternatively, the shear modulus can be computed from the P-wave velocity and Poisson's ratio from:

$$G = \frac{\rho(1 - 2\mu)}{2(1 - \mu)} V_p^2 \quad (12-20)$$

The use of this equation is somewhat limited because the velocity of a P-wave is approximately 5000 feet per second (approximately the velocity in many soils) and Poisson's ratio must be estimated. For saturated or near saturated soils, $\mu \rightarrow 0.5$. The theoretical variation of the ratio V_s/V_p with μ is shown in figure 12-8.

Figure 12-8 Theoretical Relation Between Shear Velocity Ratio V_p/V_s and Poisson's Ratio

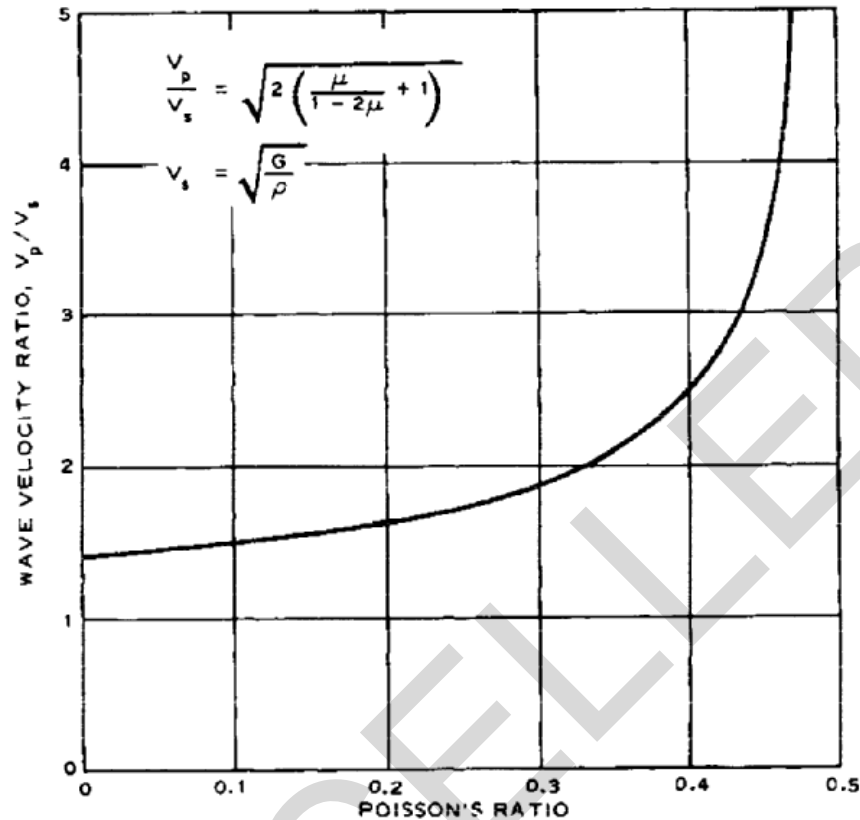

12-1.5.3 **Laboratory Measurement of Dynamic Stress-Strain Properties.** Low shear-strain amplitude, e.g., less than 10-2 percent, shear modulus data may be obtained from laboratory tests and usually involves applying some type of high-frequency forced vibration to a cylindrical sample of soil and measuring an appropriate response. Some types of tests allow the intensity level of the forced vibration to be varied, thus yielding moduli at different shear strains.

High strain-level excitation, e.g., 0.01 to 1.0 percent, may be achieved by low-frequency, cyclic loading triaxial compression tests on soil samples. The modulus, damping and strain level for a particular test are calculated directly from the sample response data. The usual assumption for calculating the modulus and damping from forced cyclic loading tests on laboratory samples is that at any cyclic strain amplitude the soil behaves as a linear elastic, viscous, damped material. A typical set of results may take the form of a hysteresis loop as shown in Figure 12-9. Either shear or normal stress cyclic excitation may be used. The shear modulus is calculated from the slope of the peak-to-peak secant line. The damping is computed from the area of the hysteresis loop, and the strain level is taken as the single-amplitude (one-half the peak-to-peak amplitude or origin to peak value) cyclic strain for the condition during that cycle of the test. Note that the equations for modulus and damping shown in Figure 12-9 assume the soil behaves as an equivalent elastic viscous, dampened material, which is linear

within the range of strain amplitude specified. This assumption is usually made in most soil dynamics analyses because of the low-vibration amplitudes involved. If the cyclic hysteresis loops are obtained from triaxial test specimens, the resulting modulus will be the stress-strain modulus, E . If the tests involve simple shear or torsion shear such that modulus will be the shear modulus, G . In either case, the same equations apply.

The shear modulus, G , can be computed from the stress strain modulus and Poisson's ratio as follows:

(12-21)

$$G = \frac{E}{2(1 + \mu)}$$

The shear strain amplitude, A_e , may be computed from the axial strain amplitude, e , and Poisson's ratio as follows:

(12-22)

$$A_e = \varepsilon(1 + \mu)$$

For the special case of saturated soils, Poisson's ratio is 0.5, which leads to the following:

$$G = E/3$$

$$A_e = 1.5\varepsilon$$

Figure 12-9 Idealized Cyclic Stress-Strain Loop for Soil

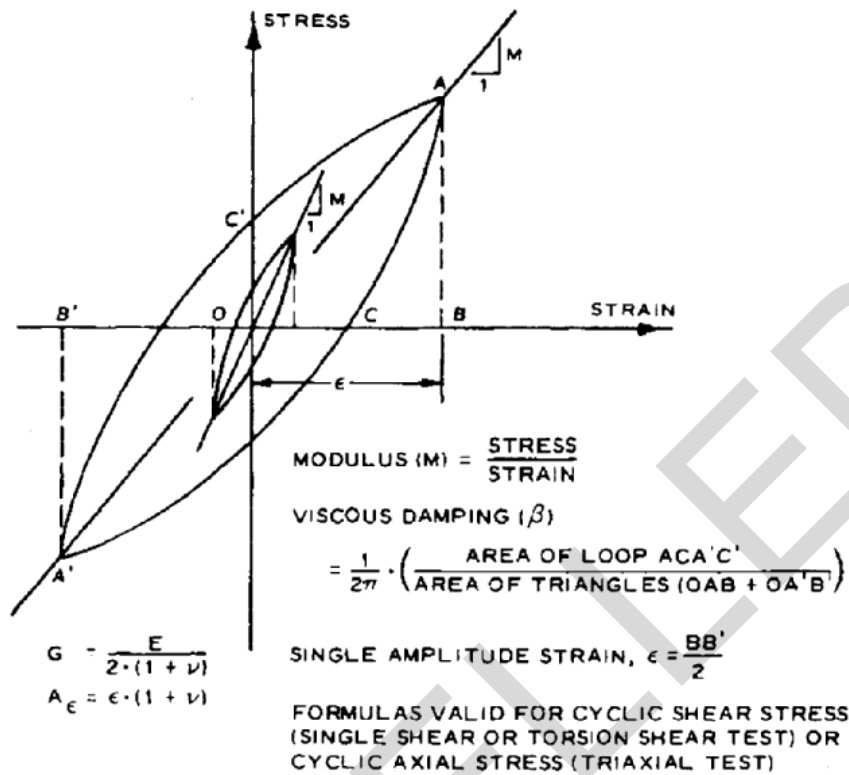

12-1.5.4 Correlations. Empirical correlations from many sets of data have provided several approximate methods for estimating the S-wave velocity and shear modulus for soils corresponding to low-strain excitation. For many undisturbed cohesive soils and sands: (12-23)

$$G = \frac{1230(21973 - e)^2}{1 + e} (\text{OCR})^\eta (\dot{\sigma}_0)^{0.5} \text{ (pounds per square inch)}$$

where

e = void ratio

η = empirical constant, which depends on the PI of cohesive soils (table

12-4); For sands, PI = 0

and $\eta = 0$, so OCR term reduces to 1.0. For clays, the maximum

value is $\eta = 0.5$ for PI ≥ 100 .

$\dot{\sigma}_0 = 1/3 (\dot{\sigma}_1 + \dot{\sigma}_2 + \dot{\sigma}_s) =$ mean normal effective stress, pounds per square inch

(1) For sands and gravels, calculate the low-strain shear modulus as follows:

$$G = 1000(K_s)(\dot{\sigma}_0)^{0.5} \text{ (pounds per square foot)} \quad (12-24)$$

where

K_2 = empirical constant (table 12-5)
= 90 to 190 for dense sand, gravel, and cobbles with little clay
 $\dot{\sigma}_0$ = mean normal effective stress as in equation (12-23) (but in units of pounds per square foot)

(2) For cohesive soils as clays and peat, the shear modulus is related to S_u as follows:

$$G = K_2 S_u \quad (12-25)$$

For clays, K_2 ranges from 1500 to 3000. For peats, K_2 ranges from 150 to 160 (limited data base).

(3) In the laboratory, the shear modulus of soil increases with time even when all other variables are held constant. The rate of increase in the shear modulus is approximately linear as a function of the log of time after an initial period of about 1000 minutes. The change in shear modulus, ΔG , divided by the shear modulus at 1000 minutes, G_{1000} , is called the normalized secondary increase. The normalized secondary increases ranges from nearly zero percent per log for sensitive clays. For good correlation between laboratory and field measurements of shear modulus, the age of the in situ deposit must be considered, and a secondary time correction applies to the laboratory data.

12-1.5.5 **Damping in Low Strain Levels.** Critical damping is defined as

$$c_c = 2\sqrt{km} \quad (12-26)$$

Where k is the spring of vibrating mass and m represents mass undergoing vibration (W/g). Viscous damping of all soils at low strain-level excitation is generally less than about 0.01 percent of critical damping for most soils or:

$$D = c/c_c \leq 0.05 \quad (12-27)$$

It is important to note that this equation refers only to material damping, and not to energy loss by radiation away from a vibrating foundation, which may also be conveniently expressed in terms of equivalent viscous damping. Radiation damping in

machine vibration problems is a function of the geometry of the problem rather than of the physical properties of the soil.

**Table 12-4 Values of Constant η Used with Equation (12-23) to Estimate
Cyclic Shear Modulus at Low Strains**

Plasticity Index	K
0	0
20	0.18
40	0.30
60	0.41
80	0.48
≥ 100	0.50

(Courtesy of O. Hardin and P. Drnevich, "Shear Modulus and Damping in Soils: Design Equations and Curves," Journal Soil Mechanics and Foundations Division, Vol 98, No. SM7, 1972, pp 667-692. Reprinted by permission of American Society of Civil Engineers, New York.)

Table 12-5 Values of Constant K_2 Used with Equation (12-24) to Estimate Cyclic Shear Modulus at Low Strains for Sands

e	K_2	D_r (%)
0.4	70	90
0.5	60	75
0.6	51	60
0.7	45	45
0.8	39	40
0.9	33	30

(Courtesy of H.B. Seed and I. meters. Idriss, "Simplified Procedures for Evaluating Liquefaction Potential" Journal Soil Mechanics and Foundations Division, Vol 97, NoSM(, 1971, pp1249-1273. Reprinted by permission of American Society of Civil Engineers, New York.)

12-1.5.6 Modulus and Damping at High Strain Levels. The effect of increasingly higher strain levels is to reduce the modulus (Figure 12-10) and increase the damping of the soil (Figure 12-11). Shear modulus and damping values at high strains are used mainly in computer programs for analyzing the seismic response of soil under earthquake loading conditions. The various empirical relations for modulus and damping pertain to sands and soft, normally consolidated clays at low-to-medium effective confining pressures, in the range of about 30 meters (100 feet) or overburden. Stiff over-consolidated clays and all soils at high effective confining pressure exhibit lower values of damping and higher values of modulus, especially at high strain levels. As a maximum, the modulus and damping values for stiff or strong soils at very high effective confining pressures correspond to values pertaining to crystalline or shale-type rock.

12-1.6 Settlement and Liquefaction.

12-1.6.1 Settlement. Repeated shearing strains of cohesionless soils cause particle rearrangements. When the particles move into a more compact position, settlement occurs. The amount of settlement depends on the initial density of the soil, the thickness of the stratum, and the intensity and number of repetitions of the shearing strains. Generally, cohesionless soils with relative densities (D_r) greater than about 75 percent should not develop settlements. However, under 10^8 or 10^7 repetitions of dynamic loading, even dense sands may develop settlements amounting to 1 to 2 percent of the layer thickness. To minimize settlements that might occur under sustained dynamic loadings, the soil beneath and around the foundation may be pre-compacted during the construction process by vibroflotation, multiple blasting, or vibrating rollers acting at the surface. The idea is to subject the soil to a more severe dynamic loading condition during construction than it will sustain throughout the design operation.

12-1.6.2 **Liquefaction of Sands.** The shearing strength of saturated cohesionless soils depends upon the effective stress acting between particles. When external forces cause the pore volume of a cohesionless soil to reduce the amount V , pore water pressures are increased during the time required to drain a volume V of water from the soil element. Consequently, pore pressure increases depend upon the time rate of change in pore volume and the drainage conditions (permeability and available drainage paths). When conditions permit the pore pressure, u , to build up to a value equal to the total stress, σ_n , on the failure plane, the shear strength is reduced to near zero and the mixture of soil grains and water behaves as a liquid. This condition is true liquefaction, in which the soil has little or no shearing strength and will flow as a liquid. Liquefaction or flow failure of sands involves a substantial loss of shearing strength for a sufficient length of time that large deformations of soil masses occur by flow as a heavy liquid.

12-1.6.3 **Liquefaction Due to Seismic Activity.** Soil deposits that have a history of serious liquefaction problems during earthquakes include alluvial sand, Aeolian sands and silts, beach sands, reclaimed land, and hydraulic fills. During initial field investigations, observations that suggest possible liquefaction problems in seismic areas include low penetration resistance; artesian heads or excess pore pressures; persistent inability to retain granular soils in sampling tubes; and any clean, fine, uniform sand below the groundwater table. The liquefaction potential of such soils for structures in seismic areas should be addressed unless they meet one of the criteria in Table 12-6. In the event that none of the criteria is met and a more favorable site cannot be located, the material in question should be removed, remedial treatment applied, or a detailed study and analysis should be conducted to determine if liquefaction will occur.

Figure 12-10 Variation of Shear Modulus with Cyclic Strain Amplitude; $G_{max} = G$ at $\epsilon = 1$ To $3 \cdot 10^{-4}$ Percent; Scatter in Data up to About ± 0.1 on Vertical Scale

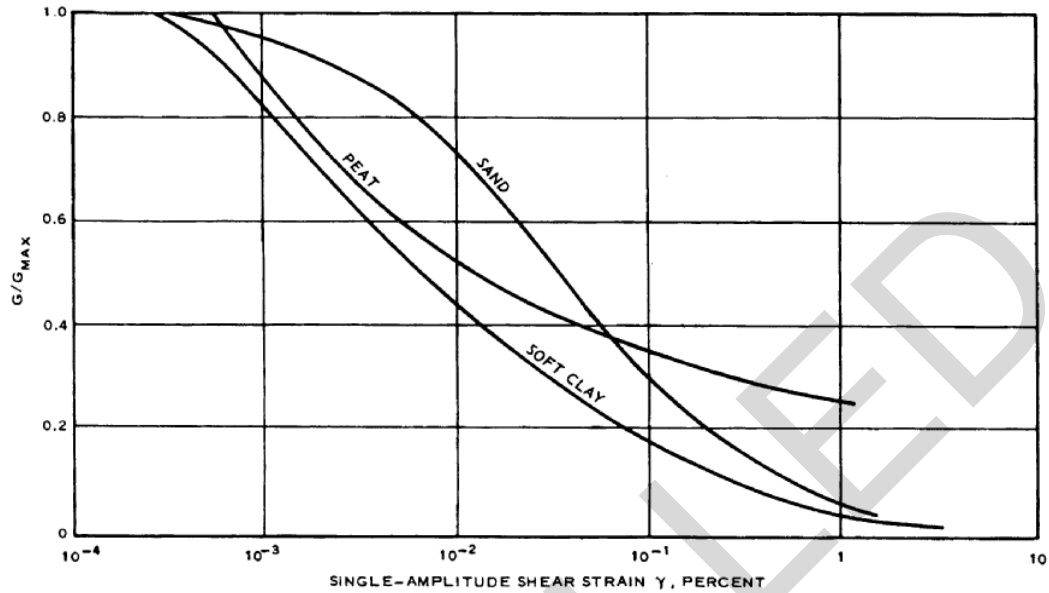

(Courtesy of H. B. Seed and I. M. Idriss, "Simplified Procedure for Evaluating Soil Liquefaction Potential," *Journal, Soil Mechanics and Foundations Division*, Vol 97, No. SM9, 1971, pp. 1249-1273. Reprinted by permission of the American Society of Civil Engineers, New York.)

Figure 12-11 Variation of Viscous Damping with Cyclic Strain Amplitude; Data Scatter up to About ± 50 of Average Damping Values Shown for Any Strain

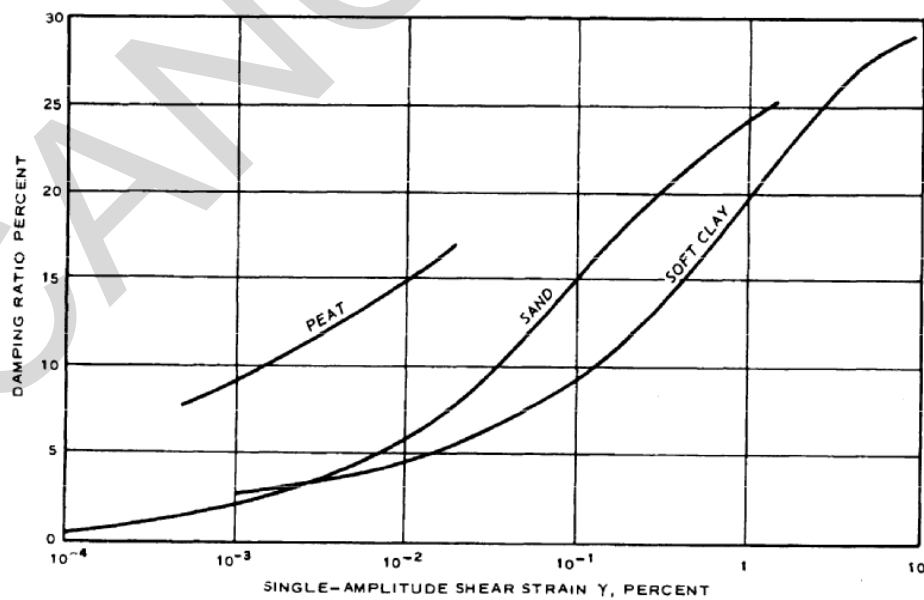

(Courtesy of H. B. Seed and I. M. Idriss, "Simplified Procedure for Evaluating Soil Liquefaction Potential," *Journal, Soil Mechanics and Foundations Division*, Vol 97, No. SM9, 1971, pp. 1249-1273. Reprinted by permission of the American Society of Civil Engineers, New York.)

Table 12-6 Criteria for Excluding Need for Detailed Liquefaction Analyses

<ol style="list-style-type: none">1. CL, CH, SC or GC Soils2. GW or GP soils or materials consisting of cobbles, boulders, uniform rock fill, which have a free-draining boundaries that are large enough to preclude the development of excess pore properties3. SP, SW or SM soils that have an average density equal to or greater than 85 percent, provided that the minimum relative density is not less than 80 percent4. ML or SM soils in which the dry density is equal to or greater than 95 percent of the modified Proctor (ASTM D 1557) density5. Soils of pre-Holocene age, with natural over consolidation ratio equal to or greater than 16 and with relative density greater than 70 percent6. Soils located above the highest potential groundwater table7. Sands in which the N value is greater than three times the depth in feet, or greater than 75; provided that 75 percent of the values meet this criterion, the minimum N value is not less than one times the depth in feet, that there are no consistent patterns of low values in definable zones or layers, and that the maximum particle size is not greater than one inch. Large gravel particles may affect N values so that the results of the SPT are not reliable8. Soils in which the shear wave velocity is equal to or greater than 2000 fps. Geophysical survey data and site geology should be reviewed in detail to verify that the possibility of included zones of low velocity is precluded9. Soils that, in undrained cycle triaxial tests, under isotropically consolidated, stress controlled conditions, and with cyclic stress ratios equal to or greater than 0.45, reach 50 or more with peak-to-peak strains not greater than 5 percent; provided that methods of specimen preparation and testing conform to specified guidelines
<p>Note: The criteria given above do not include a provision for exclusion of soils on the basis of grain size distribution, and, in general, grain size distribution alone cannot be used to conclude that soils will not liquefy. Under adverse conditions non-plastic soils with a very wide range grain sizes may be subject to liquefaction.</p>

12-1.7 Seismic Effects on Foundations. Ground motions from earthquakes cause motions of foundations by introducing forces at the foundation-soil contact zone. Methods for estimating ground motions and their effects on the design of foundation elements are discussed in UFC 3-220-10N.

CHAPTER 13

PILE DRIVING EQUIPMENT

13-1 INTRODUCTION

13-1.1 **Purpose.** The criteria presented in this UFC are to be used by the engineer and the construction representative to develop methods and details for driving and installing pile foundations. The data referenced can aid the engineer in driving, testing and evaluating the capacity and condition of the piling before, during and after installation.

13-1.2 **Scope.** Apply the Geotechnical criteria to all projects for the military services. The descriptions of pile driving and installation equipment including the weight, stroke, capacity of hammer, ram weight, helmet, swinging and fixed leads, cushions, cushion blocks and other hammer criteria and physical properties are presented in the referenced material.

13-1.3 References.

- UFC 3-220-10N, *Soil Mechanics*
- Pile Buck, Inc.

CHAPTER 14

GROUTING METHODS AND EQUIPMENT

14-1 INTRODUCTION

14-1.1 **Purpose.** The criteria presented in this UFC are to be used by the engineer and the construction representative to develop methods and details for different types of grouting to be used in underground construction. The data referenced can aid the engineer in selecting methods, equipment and type of grouting to obtain the desired results.

14-1.2 **Scope.** Apply the Geotechnical criteria to all projects for the military services. The types of grout and equipment, where to grout and how to grout, and the physical properties of the grouts are covered in the referenced materials. New methods and equipment are being developed everyday; therefore, it is imperative to use the reference often to stay abreast of the current knowledge and methods of grouting and equipment.

14-1.3 Reference.

- See Grouting Publications, ASCE in Appendix A.

APPENDIX A

REFERENCES

GOVERNMENT PUBLICATIONS:

1. Department of Defense
Unified Facilities Criteria
<http://dod.wbdg.org>
UFC 3-220-10N, *Soil Mechanics*
UFC 3-130-01 *Arctic and Subarctic Construction - General Provisions*
UFC 3-130-02, *Arctic and Subarctic Construction - Site Selection and Development*
UFC 3-130-03, *Arctic and Subarctic Construction - Runway and Road Design*
UFC 3-130-04, *Arctic and Subarctic Construction - Foundations and Structures*
UFC 3-130-05, *Arctic and Subarctic Construction - Utilities*
UFC 3-130-06, *Arctic and Subarctic Construction - Calculation Methods for Determination of Depth of Freeze and Thaw in Soils*
UFC 3-130-07, *Arctic and Subarctic Construction - Buildings*
UFC 3-220-05, *Dewatering And Groundwater Control*

NON-GOVERNMENT PUBLICATIONS:

1. Transportation Research Board
Lockbox 289
Washington, D.C. 20055
Or FAX 202-334-2519
NCHRP VOL. 343, *Engineering Manual for Shallow Foundations, Driven Piles, Drilled Shafts, Retaining Walls, and Abbutments*, R.L. Allen, J.M. Duncan, R.T. Sancio, Virginia Tech, Dec 1991
2. Virginia Tech
Engineering Manual for Settlement

Blacksburg, Virginia 24061
<http://cgpr.ce.vt.edu>

Studies, J.M. Duncan, A.L. Buchignani,
1987

Engineering Manual Sheet Pile Walls, R.L.
Allen, J.M. Duncan, R.T. Sancio, 1987

*Engineering Manual for Slope Stability
Studies*, J.M. Duncan, A.L. Buchignani,
Marios De Wet

*Shear Strength Correlation for
Geotechnical Engineering*, J.M. Duncan,
R.C. Horz, T.L. Yang, 1989,

3. American Society of Civil Engineers

American Society of Civil Engineers
1801 Alexander Bell Drive
Reston, VA 20191
Tel: 800-548-2723
<http://www.asce.org>

Retaining and Flood Walls, Technical
Engineering and Design Guides as
Adapted from the U.S. Army Corps of
Engineers, No. 4

Soil Sampling, Technical Engineering and
Design Guides as Adapted from the U.S.
Army Corps of Engineers, No. 30, ,

Settlement Analysis, Technical
Engineering and Design Guides as
Adapted from the U.S. Army Corps of
Engineers, No. 9

Design of Shallow Foundations, Samuel E.
French

Bearing Capacity of Soils, Technical
Engineering and Design Guides as
Adapted from the U.S. Army Corps of
Engineers, No. 7

Design of Pile Foundations, Technical
Engineering and Design Guides as
Adapted from the U.S. Army Corps of
Engineers, No. 1

Design of Sheet Pile Walls, Technical
Engineering and Design Guides as
Adapted from the U.S. Army Corps of

Engineers, No. 15

Chemical Grouting, Technical Engineering and Design Guides as Adapted from the U.S. Army Corps of Engineers, No. 24

Geophysical Exploration for Engineering and Environmental Investigations, Technical Engineering and Design Guides as Adapted from the U.S. Army Corps of Engineers, No. 23

20-96, Standard Guidelines for the Design and Installation of Pile Foundations

EXPANSIVE SOILS PUBLICATIONS

Expansive Soils and the Geomembrane Remedy

Impact of Climatic Variation on Design Parameters for Slab on Ground

Foundations in Expansive Soils

Mineralogy-Swelling Potential

Relationships for Expansive Shales

Prediction of Heave Using "Effective" Stress

Suction-Swelling Relations

Using Soil Diffusion to Design Raft

Foundation on Expansive Soils

Evaluation Protocol for Repair of

Residences Damaged by Expansive Soils

Suction Compression Index Based on

CLOD Test Results

Using Soil Suction to Estimate Differential Soil Shrink or Heave

Piled Rafts in Swelling or Consolidating Soils

Irrigation, Drainage, and Landscaping for Expansive Soil

Limitations of Residential Structures on Expansive Soils

Treating Expansive Soils

Assessment of Expansive Soils in the United States

Characterization of Expansive Soils Using Soil Suction Data

A Foundation Code for Expansive Soil

Conditions

*A Model for Slab Foundations on
Expansive Soils*

Pile Foundations in Swelling Soils

Proceedings of the Fourth International

Conference on Expansive Soils

*The Structural Analysis of Footings on
Expansive Soil*

Review of Expansive Soils

GROUTING PUBLICATIONS

*Advances in Grouting and Ground
Modification*

*An Alternate Compaction Grouting
Technique*

*An Approach to the Design of Limited
Mobility Displacement (LMD) Grouting*

*Compensation Grouting: Concept, Theory
and Practice*

*A Critical Look at Use of "Rules of Thumb"
for Selection of Grout Injection Pressures*

Design Verification into the Grouting Pgm

*Effects of Grout Composition, Depth and
Injection Rate on Compaction Grouting*

*Effects of Jet Grouting on Adjacent Ground
and Structures*

*Equipment for Cement Grouting: An
Overview*

*Geotechnical Investigations for Grouting in
Soil*

*Prediction and Validation of Compaction
Grout Effectiveness*

*Verification of Jet Grouting for Structure
Rehabilitation*

Jet Grouting in Cohesive Soils

Abutment Stabilization with Jet Grouting

Jet Grouting: New Directions

Chemical Grouting

*Compaction Grouting: From Practice to
Theory*

*"Compaction Grouting" State of the
Practice 1997*

*Grouting: Compaction, Remediation and
Testing*

Grouting in a Karst Environment

Grouting to Great Depths

Influence of Fines Content on the Behavior of Compaction Grout
Limited Mobility Displacement Grouting: When "Compaction Grout" is Not Compaction Grout
Monitoring Systems for Control of Compensation Grouting

4. Deep Foundations Institute

Deep Foundations Institute
326 Lafayette Avenue
Hawthorne, NJ 07506
Tel: 973-423-4030
FAX: 973-423-4031
Email: dfihq@dfi.org

<http://www.dfi.org/>

Auger CIP Piles Manual
Inspectors Guide to Augered CIP Piles
Drilled Shaft Inspector's Manual
Lexicon of Foundation Terms in Five Languages
Driven Foundation Piling (Catalog 1998)
Dynamic Monitoring and Analysis
Interpretation & Analysis fo the Static Loading Test
Guidelines for Static Design
Testing of Pile Driving Cushion Material
Soil Nailing Design & Applications
Inspectors Manual for Pile Foundations

5. ADSC: THE INTERNATIONAL ASSOCIATION OF FOUNDATION DRILLING
P.O. Box 550399
Dallas, Texas 75355-0339
Tel: 214-343-2091
FAX: 214-343-2384
Email: adsc@adsc-iafd.com

<http://www.adsc-iafd.com/>

Drilled Shafts
Drilled Shafts - Axial Loads
Drilled Shafts - Clay
Drilled Shafts – Concrete
Drilled Shafts - Design
Drilled Shafts – Design, General
Drilled Shafts – General
Drilled Shafts – Non-Destructive Testing
Drilled Shafts – Rock
Drilled Shafts - Sand
Drilled Shafts – Shale, Slurry
Drilled Shafts – Slurry
Drilled Shafts – Soils
Drilled Shafts – Specifications
Drilled Shafts – Testing
Drilled Shafts – Testing, Uplift
Drilled Shafts – Uplift
Earth Retention

6. Pile Buck[®], Inc.
P.O Box 64-3929
Vero Beach, Florida 32964
Tel: (772) 231-5200
FAX: (772) 231-8400

Soil Mechanics
Foundations
Earth Support Systems and Retaining Structures
Mooring Systems

email pilebuck@pilebuck.com

<http://www.pilebuck.com>

7. ASTM International
100 Barr Harbor Drive
P.O. Box C700
West Conshohocken
Pennsylvania, USA 19428-2959
Tel: 610-832-9585
FAX 610-832-9555

<http://www.astm.org/>

8. International Code Council
5203 Leesburg Pike
Suite 600
Falls Church, VA 22041
Tel: 703-9311-44533
FAX 703-379-1546
Email: webmaster@icc-safe.org

<http://www.iccsafe.org>

9. Braja Das

10. The Geotechnical and
Geoenvironmental Software Directory

<http://www.ggsd.com/>

11. The Geotechnical Directory

*Breakwaters, Jetties, Bulkheads and
Seawalls
Coastal Protection
Cellular Cofferdams
Steel Sheet Piling Design Manual
Pile Hammer Specifications*

*ASTM D2487, Standard Classification of
soils for Engineering Purposes (Unified
Soil Classification System*

*D 2488, Standard Practice for Description
and Identification of Soils (Visual-Manual
Procedure)*

*D 5578, Standard Guide for Using Rock
Mass Classification Systems for
Engineering Purposes*

*2000 International Building Code (IBC
2000) Chapter 18*

*FEMA 273.4, 274.4, 302, 303
Accompany IBC 2000,*

*Fundamentals of Geotechnical
Engineering, 2000*

Catalogues 1306 programs in the fields of
Geotechnical Engineering, Soil Mechanics,
Rock Mechanics, Engineering Geology,
Foundation Engineering, Hydrogeology,
Geoenvironmental Engineering,
Environmental Engineering, Data Analysis
and Data Visualisation and lists 778
worldwide suppliers and publishers of
these programs.

A good resource for making University
contacts, books, publications, software

<http://www.geotechnicaldirectory.com/>

listings, meetings, contractors and professional contacts.

12. Clough, G.W. and Davidson, R.R. *Effects of Constuction on Geotechnical Engineering*, Specilty Session No. 3, Relationship Between Design and Construction in Soil Engineering, Ninth International Conference on Soil Mechanics and Foundation Engineering, Tokyo, 1977.
13. Terzaghi, K. *Stability of Steep Slopes on Hard Unweathered Rock*, Norwegian Geotechnical Institute, Publications No. 50, 1963
14. Petersen E.V. *Cave-In*, Roads and Engineering Construction, November 1963, December 1963, and January 1964.
15. Goldberg, D.T., Jaworksi, W.E. and Gordon, M.D. *Lateral Support Systems and Underpinning*, Vol. II, Design Fundamentals, Vol. III, Construction Methods, Federal Highway Administration, Report Nos. FHWA-RD-75-129, 130, 1976.
16. Bherrum L., Clausen, J.F. and Duncan, J.M. *Stability of Flexible Structures*, General Report, Proceedings, Fifth-International European Conference on Soil Mechanics and Foundation Engineering, Vol. 11, 1977
17. Lambe, T.W. *Braced Excavation*, 1970 Specialty Conference, Lateral Stresses in the Ground an Design of Earth Retaining Structures, June 22-24, Cornell University, ASE, 1971
18. Peck, R.B. *Deep Excavation and Tunneling in Soft Ground*, Proceedings, Seventh International Conference on Soil Mechanics and Foundation Engineering, State-of-the-Art Vol. 1, 1969
19. Caterpillar Tractor Company *Handbook of Ripping*, Fifth Edition, Peoria, Ill., 1975

20. Franklin, J.A., Broch, E and Walton, G. *Logging the Mechanical Character of Rock*, Transactions, Institution of Mining and Metallurgy, January 1971.
21. Broch, E. and Franklin, J.A. *The Point-Load Strength Test*, International Journal Rock Mechanics and Mining Science, Vol. 9, 1972.
22. U.S. Department of Interior, Bureau Of Mines, 1971 *Blasting Vibrations and Their Effect on Structures*
23. Hendron, A.J. *Engineering of Rock Blasting on Civil Projects*, Rock Excavation Seminar Lectures, ASCE, New York, 1976

CANCELLED