

UNIFIED FACILITIES CRITERIA (UFC)

AIR FORCE SIGN STANDARD



APPROVED FOR PUBLIC RELEASE; DISTRIBUTION UNLIMITED

UNIFIED FACILITIES CRITERIA (UFC)

AIR FORCE SIGN STANDARD

Any copyrighted material included in this UFC is identified at its point of use. Use of the copyrighted material apart from this UFC must have the permission of the copyright holder.

U.S. ARMY CORPS OF ENGINEERS

NAVAL FACILITIES ENGINEERING COMMAND

AIR FORCE CENTER FOR ENVIRONMENTAL EXCELLENCE (Preparing Activity)

Record of Changes (changes are indicated by \1\ ... /1/)

Change No.	Date	Location

The format of this document does not conform to UFC 1-300-1.
It will be formatted at the next revision.

This UFC supersedes AFPAM 32-1097, dated 1 November 1997.

FOREWORD

The Unified Facilities Criteria (UFC) system is prescribed by MIL-STD 3007 and provides planning, design, construction, sustainment, restoration, and modernization criteria, and applies to the Military Departments, the Defense Agencies, and the DoD Field Activities in accordance with [USD\(AT&L\) Memorandum](#) dated 29 May 2002. UFC will be used for all DoD projects and work for other customers where appropriate. All construction outside of the United States is also governed by Status of forces Agreements (SOFA), Host Nation Funded Construction Agreements (HNFA), and in some instances, Bilateral Infrastructure Agreements (BIA.) Therefore, the acquisition team must ensure compliance with the more stringent of the UFC, the SOFA, the HNFA, and the BIA, as applicable.

UFC are living documents and will be periodically reviewed, updated, and made available to users as part of the Services' responsibility for providing technical criteria for military construction. Headquarters, U.S. Army Corps of Engineers (HQUSACE), Naval Facilities Engineering Command (NAVFAC), and Air Force Civil Engineer Support Agency (AFCESA) are responsible for administration of the UFC system. Defense agencies should contact the preparing service for document interpretation and improvements. Technical content of UFC is the responsibility of the cognizant DoD working group. Recommended changes with supporting rationale should be sent to the respective service proponent office by the following electronic form: [Criteria Change Request \(CCR\)](#). The form is also accessible from the Internet sites listed below.

UFC are effective upon issuance and are distributed only in electronic media from the following source:

- Whole Building Design Guide web site <http://dod.wbdg.org/>.

Hard copies of UFC printed from electronic media should be checked against the current electronic version prior to use to ensure that they are current.

AUTHORIZED BY:



DONALD L. BASHAM, P.E.
Chief, Engineering and Construction
U.S. Army Corps of Engineers



DR. JAMES W. WRIGHT, P.E.
Chief Engineer
Naval Facilities Engineering Command

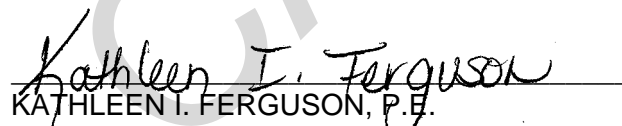

KATHLEEN I. FERGUSON, P.E.
The Deputy Civil Engineer
DCS/Installations & Logistics
Department of the Air Force

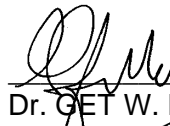

Dr. GET W. MOY, P.E.
Director, Installations Requirements and
Management
Office of the Deputy Under Secretary of Defense
(Installations and Environment)

AIR FORCE SIGN STANDARD

OPR: HQ AFCEE/DCD
(Mr. David M. Duncan)

Certified by: HQ USAF/ILEC
(Col Andrew Scafford)

Supersedes AFPAM 32-1097, 1 November 1997.

The intent of this document is to standardize the design, construction and placement of Air Force signs. This document sets standards for identification, direction, regulation, motivation and information signs; street address signs; base destination signs; parking regulation signs; and interior signs.

The criteria introduced in this document are intended for implementation at all Air Force installations. Implementation is subject to funding priorities, mission objectives and MAJCOM coordination. MAJCOMs are encouraged to adopt these standards, but do have the authority to adjust them to meet their own objectives for design and compatibility, using the standard colors listed in paragraph 2.18. This authority does not, however, apply to the portion of these criteria which are based on such national standards as the Manual on Uniform Traffic Control Devices (MUTCD), the Americans with Disabilities Act Accessibility Guidelines (ADAAG), and the Uniform Federal Accessibility Standards (UFAS).

The ADAAG, UFAS, and the Federal Highway Administration's MUTCD are national standards for sign design and placement. The MUTCD is the authority for all traffic control devices on Air Force installations.

SUMMARY OF REVISIONS

This document supersedes and completely revises AFP 88-40, Sign Standards. This document incorporates the Americans with Disabilities Act Accessibility Guidelines (ADAAG) and the Uniform Federal Accessibility Standards (UFAS) applicable to Air Force signs and is composed in the latest Air Force Instruction (AFI) format.

TABLE OF CONTENTS

Chapter 1—Document Overview

Section 1A—Purpose

1.1. Benefits of Guidelines	15
1.2. Need for Guidelines	15
1.3. Document Description	15
1.4. General Guidelines for Signs	15
1.5. Limitations	16

Section 1—Objective-A Sign System

1.6. Sign Control Group.....	17
1.7. Master Sign Plan.....	17

Section 1C—Overview of Sign Types

1.8.	Exterior Signs	18
1.9.	Interior Signs.....	19

Chapter 2--Typography, Graphics & Sign Placement

Section 2A—Typography

2.1.	Introduction to Typography	20
2.2.	Alternative Typefaces	20
2.3.	Tile Systems.....	20
2.4.	Helvetica Medium.....	20
2.5.	Helvetica Regular	20
2.6.	Letter Spacing Standards	22
2.7.	Arrow Tile.....	22
2.8.	Tile System Application	22
2.9.	Standard Letter Heights	23
2.10.	Sign Assembly Sequence.....	23
2.11.	Sign Layout Guidelines	31

Section 2B—Graphics

2.12.	Graphic Emblems.....	33
2.13.	Air Force Seal and Coat of Arms	33
2.14.	Air Force Shields and Emblems	35
2.15.	Service Symbols.....	37
2.16.	Sports and Recreation Symbols	39
2.17.	The Community Symbol	40
2.18.	Color Standards	42

Section 2C—Sign Placement

2.19.	Freestanding Exterior Signs	43
2.20.	Base Identification Signs Types A1, A2	45
2.21.	Military Facility Signs Types B1, B2 and B3.....	46
2.22.	Military Building Entry Sign Type B4	47
2.23.	Building Number Sign Type B5	48
2.24.	Centralized Facilities Sign Type C1	49
2.25.	Community Facility Signs Types C2 and C3	49
2.26.	Community Building Entry Sign Type C4	50
2.27.	Recreational Facility Sign Type C5.....	51
2.28.	Bus Route Sign Type C6.....	51
2.29.	Destination Signs Types D1 and D2	51
2.30.	Warning Sign Types E1 and A3	54
2.31.	Warning Sign Type E2	54
2.32.	Parking Regulation Sign Type E3	57
2.33.	Parking Regulation Sign Type E4	57
2.34.	Base Morale Signs Types F1a and F1b	57
2.35.	Standard Morale Sign Type F2.....	59
2.36.	Unit Morale Sign Type F3.....	60
2.37.	Information Signs Types G1 and G2	60
2.38.	Pedestrian Information Sign Type G3	60

2.39. Wall Mounted Exterior Signs 62

Chapter 3—The Americans with Disabilities Act

Section 3A—Introduction

3.1. Background and Purpose 63
3.2. Compliance 63
3.3. Scope..... 63
3.4. Accessibility..... 63
3.5. Exterior Signs 63
3.6. Sign Design 63

Section 3B—Characters

3.7. Character Legibility 63
3.8. Character Proportion 63
3.9. Width to Height Ratio 64
3.10. Range of Stroke 64
3.11. Character Height 64
3.12. Raised and Brailled Characters 64
3.13. Finish and Contrast with Background 64

Section 3C—Mounting and Illumination

3.14. Mounting Guidelines 65
3.15. Recommended Illumination 65

Section 3D—Symbols of Accessibility

3.16. Facilities 65
3.17. Telephones and Listening Systems..... 65

Chapter 4—Exterior Identification Signs

Section 4A—Introduction

4.1. Types of Signs 66
4.2. Sides of Signs 66
4.3. Criteria for Signs 66
4.4. Further Information 66

Section 4B—Base Identification Signs

4.5. Introduction 66
4.6. Types of Signs 66
4.7. Placement of Graphics 66
4.8. Main Entrance Sign Type A1 68
4.9. Secondary Entrance Sign Type A2 70
4.10. Entry Gate Sign Type A3 71

Section 4C—Military Identification Signs

4.11. Introduction 75
4.12. Information 75
4.13. Types of Signs 75
4.14. Graphics and Placement 76
4.15. Military Identification Sign Type B1..... 78

4.16. Military Identification Sign Type B2.....	79
4.17. Military Identification Sign Type B3.....	81
4.18. Military Building Entry Sign Type B4	83
4.19. Building Number Sign Type B5	86
4.20. Military Construction Sign Type B6	87
4.21. Building Accessibility Sign Type B7	87

Section 4D—Community Identification Signs

4.22. Introduction.....	93
4.23. General Description	93
4.24. Types of Signs	93
4.25. Standards for Commercial Firms	96
4.26. Symbols and Logotypes on Community Signs.....	96
4.27. Centralized Facilities Sign Type C1	97
4.28. Community Facilities Sign Type C2.....	103
4.29. Community Facilities Sign Type C3.....	106
4.30. Community Building Entry Sign Type C4	110
4.31. Recreational Facility Sign Type C5	112
4.32. Bus Route Sign Type C6.....	116

Section 4E—Water Tower Graphics

4.33. General Description	119
4.34. Information	119
4.35. Other Graphics and Lettering	119
4.36. Colors	119
4.37. Proportions/Shapes	119
4.38. Visibility	119

Chapter 5—Direction Signs

Section 5A—Introduction

5.1. Importance	121
5.2. Priorities (Master Sign Plan)	121
5.3. Common Destinations.....	121
5.4. Maps and Signs	121
5.5. Message Limitations	121
5.6. Visibility	121
5.7. Criteria	121
5.8. Further Information	121

Section 5B—Direction Signs Typography

5.9. Tile System and Arrow	121
5.10. Placement	122
5.11. Rules	122

Section 5C—Types of Direction Signs

5.12. General Information	123
5.13. Usage of Sign Type D1	123
5.14. Usage of Sign Type D2	123
5.15. Usage of Sign Type D3	123

5.16.	Usage of Sign Type D4	123
5.17.	Placement Standards	123
5.18.	Direction Sign Type D1	125
5.19.	Direction Sign Type D2	126
5.20.	Direction Sign Type D3	131
5.21.	Direction Sign Type D4	132

Chapter 6—Regulatory Signs

Section 6A—Introduction

6.1.	General Guidelines	134
6.2.	Criteria	134
6.3.	Safety Signs	134
6.4.	Further Information	134

Section 6B—Highway Standards

6.5.	Introduction	134
6.6.	Importance of Standards	134
6.7.	References	134

Section 6C—Base Warning Signs

6.8.	Introduction	137
6.9.	Requirements and Guidance	137
6.10.	Mounting.....	137
6.11.	Layouts.....	137
6.12.	Base Warning Sign Type E1	137
6.13.	Base Warning Sign Type E2	141

Section 6D—Parking Regulation Signs

6.14.	Introduction	146
6.15.	Parking Regulation Sign Type E1	146
6.16.	Parking Regulation Sign Type E2	146

Chapter 7—Motivation Signs

Section 7A—Introduction

7.1.	Importance	151
7.2.	Challenges	151
7.3.	Master Sign Plan	151
7.4.	Types of Signs	151
7.5.	Materials, Structures and Illumination	151
7.6.	Further Information	151

Section 7B—Base Morale Signs

7.7.	Base Morale Sign Type F1a	153
7.1.	Base Changeable Letter Sign Type F1b	154
7.1.	Standard Morale Sign Type F2a	155
7.1.	Standard Changeable Letter Sign Type F2b.....	159
7.1.	Unit Morale Sign Type F3.....	161

Chapter 8—Information Signs and Base Maps

Section 8A—Introduction

8.1. General Information	163
8.2. Types of Signs	163
8.3. Base Map	163
8.4. Further Information	163

Section 8B—Information Signs

8.5. Information Sign Type G1	164
8.6. Information Sign Type G2	164
8.7. Pedestrian Information Sign Type G3	167

Section 8C—Base Map

8.8. Need	170
8.9. Consistency	170
8.10. Clarity	170
8.11. Information	170
8.12. Design	170
8.13. One Point Perspective	171

Chapter 9—Signs for Historic Buildings

Section 9A—Introduction

9.1. General Information	173
9.2. Usage.....	173
9.3. Further Information	173

Section 9B—Typography and Spacing

9.4. Recommended Typeface.....	173
9.5. Other Typefaces.....	173
9.6. Spacing.....	173

Section 9C—Building Identification Signs

9.7. Information	174
9.8. Layout and Structure	174
9.9. Placement and Visibility	175
9.10. Usage.....	175
9.11. Mounting	175
9.12. Layouts.....	175
9.13. Building Identification Sign Type H1 Three Line Message Layouts.....	175
9.14. Building Identification Sign Type H1 Organizational Emblem Standard Layout	176
9.15. Building Identification Sign Type H1 Expanded Layout	177
9.16. Building Entry Sign and Building Number Sign Types H3 and H4	177
9.17. Building Entry Sign Type H3 Layouts	178
9.18. Building Number Sign Type H4 Layout	178

Chapter 10—Wall Mounted Signs

Section 10A—Introduction

10.1. General Information	186
10.2. Usage.....	186
10.3. Description	186
10.4. Colors/Finishes	186
10.5. Materials	186
10.6. Size.....	186
10.7. Placement	186
Section 10B—Typography	
10.8. Typeface.....	187
10.9. Templates	187
10.10. Size.....	187
Section 10C—Message Placement	
10.11. Message Placement Single Story Buildings	188
10.12. Message Placement Multi-Story Buildings	191
Section 10D—Fascia Mounted Signs	
10.13. Letters	193
10.14. Minimum Depth	193
10.15. Placement of Message.....	194
10.16. Long Messages	194
Section 10E—Wall Mounted Organizational Emblems	
10.17. Usage.....	195
10.18. Prioritization of Emblems	195
10.19. Panels	195
Section 10F—Large Scale Buildings	
10.20. Style	197
10.21. Size of Letters	197
10.22. Placement of Message.....	197
10.23. Primary and Secondary Messages	197
10.24. Caveat	197
Section 10G—Hangars	
10.25. General Information.....	199
10.26. Size and Placement	200

Chapter 11—Interior Signs

Section 11A—Introduction

11.1. General Information.....	201
11.2. Color	201
11.3. Design Parameters	201
11.4. Standards	201
11.5. Mounting.....	201
11.6. Sources	201

Section 11B—Interior Sign Types

11.7. Main Categories.....	201
11.8. Other Information	202
11.9. Building Directory Sign Types AA1 and AA1a	202

11.10. Building Directory Sign Type AA2 and Floor Directory Sign Type AA3.....	206
11.11. Building Directory Sign Type AA2 Layout	206
11.12. Floor Directory Sign Type AA3 Layout.....	209
11.13. Office Identification Signs Types BB1, BB2, BB3 and BB4.....	210
11.14. Office Identification Signs Types BB5, BB6 and BB7	211
11.15. Direction Signs Types CC1 and CC2	218
11.16. Regulation Signs Types DD1 and DD2	221
11.17. Bulletin Boards Sign Types EE1	221

Chapter 12—Specifications and Details

Section 12A—Introduction and Bid Package

12.1. Introduction	227
12.2. Purchase	227
12.3. Preparation of Bid Package	227

Section 12B—Freestanding Exterior Signs Options

12.4. Material Selection	228
12.5. Minimum Standards	228
12.6. Finishes	228
12.7. Materials	230
12.8. Foundations	231
12.9. Breakaway or Yielding Sign Supports	231

Section 12C—Freestanding Exterior Signs Specifications

12.10. Finishes	232
12.11. Materials	233
12.12. Foundations	235
12.13. Reproduction Processes	235

Section 12D—Freestanding Exterior Signs

12.14. Freestanding Exterior Signs Structural Details	236
---	-----

Section 12E—Wall Mounted Signs

12.15. Wall Mounted Exterior Sign Options	246
12.16. Wall Mounted Exterior Sign Specifications	246

Section 12F—Interior Signs Options

12.17. Colors and Finish	246
12.18. Graphics	246
12.19. Interior Signs Permanent Graphics	246
12.20. Interior Signs Changeable Graphics	247

Section 12G—Interior Signs Specifications

12.21. Materials and Finishes	249
12.22. Reproduction Processes	250

Section 12H—Interior Signs

12.23. Interior Signs Details	251
-------------------------------------	-----

Section 12I—Military Construction Signs

12.24. Military Construction Sign Requirements	260
12.25. Materials	261

Figures

2.1.	Helvetica Medium Tile System	21
2.2.	Helvetica Regular Tile System	22
2.3.	Correct Letter Spacing	23
2.4.	Correct Arrow Alignment	25
2.5.	Arrow Grids	25
2.6.	Letter Tiles	26
2.7.	Sign Grid	26
2.8.	Standard Letter Heights (12.5 mm - 50 mm CAP Height)	27
2.9.	Standard Letter Heights (75 mm - 100 mm CAP Height)	28
2.10.	Standard Letter Height (150 mm CAP Height)	29
2.11.	Sign Assembly Sequence	30
2.12.	Building Signs	31
2.13.	Secondary Information	31
2.14.	Major Tenant	31
2.15.	High Priority Component Units	31
2.16.	Coequal Units	31
2.17.	Three or More Coequal Units	32
2.18.	Military and Community Tenants	32
2.19.	Line Breaks	32
2.20.	Abbreviations	32
2.21.	Numbers	32
2.22.	Balance	33
2.23.	Correct Layout	34
2.24.	Incorrect Layouts	34
2.25.	Air Force Coat of Arms	35
2.26.	Air Force Shield	36
2.27.	Air Force Squadron Emblem	37
2.28.	Service Symbols	38
2.29.	Concession Symbols	38
2.30.	Regulation Symbols	39
2.31.	Sports and Recreation Symbols	40
2.32.	The Community Symbol	41
2.33.	Community Symbol Signs	42
2.34.	Rural Sign Placement	45
2.35.	Urban Sign Placement	45
2.36.	Base Identification Sign Placement	46
2.37.	Military Facility Sign Placement	47
2.38.	Military Facility Sign Visibility	47
2.39.	Military Building Entry Sign Placement	48
2.40.	Military Building Entry Sign Visibility	48
2.41.	Building Number Sign – Alternate Locations for Visibility by Security Police and Fire Personnel	49
2.42.	Centralized Facilities Sign Placement	49
2.43.	Community Facilities Sign Placement	50

2.44.	Community Facilities Sign Visibility	51
2.45.	Community Building Sign Placement	52
2.46.	Community Building Sign Visibility	52
2.47.	Recreational Facility Sign	53
2.48.	Bus Route Sign	53
2.49.	Destination Sign	54
2.50.	Separation Distance Criteria	55
2.51.	Warning and Base Identification Signs on Same Structure	55
2.52.	Warning and Base Identification Signs on Different Structures	56
2.53.	Warning Sign on Area Boundary	56
2.54.	Warning Sign on Building	57
2.55.	Wall-Mounted Parking Signs	58
2.56.	Freestanding Parking Signs	58
2.57.	Base Morale Sign Inside Gate Placement	59
2.58.	Base Morale Sign Central Location Placement	59
2.59.	Standard Morale Sign	60
2.60.	Unit Morale Sign and Building Identification Sign	61
2.61.	Unit Morale Sign Near Entrance	61
2.62.	Pedestrian Information Sign Placement and Separation Distance Criteria	62
3.1.	Width to Height Ratio	64
3.2.	International Symbols of Accessibility	65
4.1.	Main Entrance Type A1	67
4.2.	Secondary Entrance Type A2	67
4.3.	Entry Gate Type A3	68
4.4.	Main Entrance Sign Type A1 Dimensions	69
4.5.	Main Entrance Sign Type A1 Layouts	70
4.6.	Secondary Entrance Sign Type A2 Dimensions	72
4.7.	Secondary Entrance Sign Type A2 Layouts	73
4.8.	Entry Gate Sign Type A3 Dimensions	74
4.9.	Entry Gate Type A3 Standard Layout	75
4.10.	Entry Gate Type A3 Expanded Layout	75
4.11.	Military Facility Type B1	76
4.12.	Military Facility Type B2	77
4.13.	Military Facility Type B3	77
4.14.	Military Facility Type B4	78
4.15.	Military Identification Sign Type B1	80
4.16.	Military Identification Sign Type B1 Layouts	82
4.17.	Military Identification Sign Type B2	83
4.18.	Military Identification Sign Type B2 Layouts	85
4.19.	Military Identification Sign Type B3	86
4.20.	Military Identification Sign Type B3 Layouts	88
4.21.	Military Building Entry Sign Type B4	89
4.22.	Military Building Entry Sign Type B4 Standard Layouts	90
4.23.	Military Building Entry Sign Type B4 Expanded Layout	91
4.24.	Building Number Sign Type B5	91
4.25.	Proportions	92

4.26.	Display Conditions	92
4.27.	Mounting Conditions	93
4.28.	Centralized Facilities Type C1	94
4.29.	Community Facilities Type C2.....	95
4.30.	Community Facilities Type C3.....	95
4.31.	Community Building Entry Type C4.....	96
4.32.	The Community Symbol	98
4.33.	Placement of Community Symbol.....	99
4.34.	Centralized Facilities Sign Type C1	100
4.35.	Centralized Facilities Sign Type C1 Layout A.....	101
4.36.	Centralized Facilities Sign Type C1 Layout B	102
4.37.	Community Facilities Sign Type C2.....	104
4.38.	Community Facilities Sign Type C2 Layouts.....	105
4.39.	Community Facilities Sign Type C2 Layouts.....	106
4.40.	Community Facilities Sign Type C3.....	108
4.41.	Community Facilities Sign Type C3 Layouts.....	109
4.42.	Community Facilities Sign Type C3 Layouts.....	110
4.43.	Community Building Entry Type C4.....	112
4.44.	Community Building Sign Type C4 Layouts	114
4.45.	Recreational Facility Sign Type C5	115
4.46.	Recreational Facility Sign Type C5 Panels A, B, C and D	116
4.47.	Bus Route Sign Type C6 Placement	118
4.48.	Bus Route Sign Type C6 Layouts.....	119
4.49.	Template for Air Force Symbol on Water Tower Tanks.....	120
5.1.	Diagrammatic Sign Type D1	122
5.2.	Directional Sign Type D2	123
5.3.	MUTCD Arrow Properties	124
5.4.	Arrow and Letter Titles.....	124
5.5.	Sign Assembly Sequence.....	125
5.6.	Direction Sign Type D1	127
5.7.	Direction Sign Type D1 Layout 1.....	128
5.8.	Direction Sign Type D1 Layout 2.....	129
5.9.	Direction Sign Type D2	130
5.10.	Direction Sign Type D2 Layout.....	132
5.11.	Direction Sign Type D3 Typical Panel	132
5.12.	Typical Sign Configurations	133
6.1.	Highway Standards	135
6.2.	Highway Standard Stop Sign.....	136
6.3.	Base Warning Sign	138
6.4.	Base Warning Signs.....	139
6.5.	Base Warning Sign Type E1 Panel A	140
6.6.	Base Warning Sign Type E1 Panel B	141
6.7.	Base Warning Sign Type E1 Panel C	142
6.8.	Base Warning Sign Type E1 Panels D, E, F and G	143
6.9.	Base Warning Sign Type E2 Panels A and C	145
6.10.	Base Warning Sign Type E2 Panel B	146

6.11.	Parking Regulation Signs	148
6.12.	Parking Regulation Sign Type E1 Layouts	149
6.13.	Parking Regulation Sign Type E2 Panels A and B	150
6.14.	Parking Regulation Sign Type E2	150
7.1.	Base Morale Sign Type F1	152
7.2.	Standard Morale Sign Type F2	152
7.3.	Unit Morale Sign Type F3	153
7.4.	Base Morale Sign Type F1a	154
7.5.	Base Changeable Letter Sign Type F1b	155
7.6.	Changeable Letter Tile Dimensions	155
7.7.	Base Changeable Letter Sign Type F1b Layouts.....	157
7.8.	Sign Panel Type F2a	158
7.9.	Sign Elevation Type F2a	158
7.10.	Sign Elevations Type F2a	159
7.11.	Sign Panel Tiles	160
7.12.	Sign Grid	160
7.13.	Sign Panel Layout	161
7.14.	Organizational Emblem on Unit Morale Sign Type F3	162
8.1.	Information Sign Type G1	163
8.2.	Information Sign Type G2	164
8.3.	Pedestrian Information Sign Type G3	164
8.4.	Information Sign Type G1 Panel Layout	165
8.5.	Information Sign Type G2 Panel Layout	167
8.6.	Pedestrian Information Sign Type G3	169
8.7.	Pedestrian Information Sign Type G3 Layout.....	170
8.8.	Base Site Plan	171
8.9.	Base Map Derived from Simplified Base Site Plan	172
8.10.	Aerial View Map	172
9.1.	Clarendon Medium	174
9.2.	Spacing.....	174
9.3.	Building Identification Signs Installation	176
9.4.	Building Identification Sign Type H1 Three Line Message Layout	179
9.5.	Building Identification Sign Type H1 Organizational Emblem Standard Layout	180
9.6.	Building Identification Sign Type H1 Expanded Layout	181
9.7.	Building Identification Sign Type H2 One or Two Line Message Layout	182
9.8.	Building Entry Sign and Building Number Sign Types H3 and H4	183
9.9.	Building Entry Sign Type H3 Layouts	184
9.10.	Building Number Sign Type H4 Layout	185
10.1.	Wall Mounted Signs	187
10.2.	Typography and Standard Letter Heights	188
10.3.	Message Placement Single Story Buildings Below Fascia.....	190
10.4.	Message Placement Single Story Buildings on Façade	190
10.5.	Message Placement Single Story Buildings on Façade	191
10.6.	Message Placement Multi-Story Buildings, Examples A and B	192
10.7.	Message Placement Multi-Story Buildings, Examples C, D, E and F	193
10.8.	Fascia Mounted Signs	194

10.9.	Fascia Mounted Signs Elevation	195
10.10.	Organizational Emblems	196
10.11.	Wall Mounted Emblems	196
10.12.	Large Scale Building Signs	198
10.13.	Primary and Secondary Messages	199
10.14.	Hangar Signs	200
11.1.	Interior Sign Types	203
11.2.	Placement of Building Directory Sign Types AA1 and AA1a	204
11.3.	Building Directory Type AA1 Layout.....	205
11.4.	Building Directory Sign Type AA1a Layout.....	206
11.5.	Placement of Building Directory Sign Type AA2 and Floor Directory Sign Type AA3.....	208
11.6.	Building Directory Sign Type AA2 Layout	209
11.7.	Floor Directory Sign Type AA3 Layouts	210
11.8.	Office Identification Signs Types BB1, BB2 and BB3	213
11.9.	Office Identification Sign Types BB1 Layout.....	214
11.10.	Office Identification Signs Types BB2, BB3 and BB4 Layouts	215
11.11.	Placement of Identification Signs Types BB5, BB6 and BB7.....	216
11.12.	Office Partition Sign Identification Type BB5 Layout.....	217
11.13.	Office Identification Sign Type BB6 Layout	217
11.14.	Service Identification Sign Type BB7 Layout.....	218
11.15.	Placement of Direction Sign Types CC1 and CC2	219
11.16.	Direction Sign Type CC1 Layout	220
11.17.	Direction Sign Type CC2 Layout	221
11.18.	Placement of Regulation Sign Types DD1 and DD2.....	223
11.19.	Regulation Signs Types DD1 and DD2 Layouts	224
11.20.	Placement of Bulletin Board Type EE1	225
11.21.	Bulletin Boards Sign Type EE1	226
12.1.	Sign Details A1, A2 and F1	236
12.2.	Sign Details B1, B2, B3, C2, C3, G1, H1 and H2	237
12.3.	Sign Details C1	238
12.4.	Sign Details D1	239
12.5.	Sign Details D2	240
12.6.	Sign Details G3	241
12.7.	Sign Details E1 and A3	242
12.8.	Sign Details F2 and F3.....	243
12.9.	Sign Details, B4, C4-C6, E2-E4 and G2	244
12.10.	Sign Details	245
12.11.	Wall Mounted Exterior Signs Details	248
12.12.	Sign Details AA1, AA2, AA3	252
12.13.	Sign Details AA1, AA2, AA3	253
12.14.	Sign Details BB1, BB2, BB3, BB4, BB5	254
12.15.	Sign Details BB1, BB2, BB3, BB4 and BB5	255
12.16.	Sign Details BB6, BB7, DD1 and DD2	256
12.17.	Sign Details BB6, BB7, DD1 and DD2	257
12.18.	Sign Details CC1 and CC2	258

12.19. Sign Details CC1 and CC2259
12.20. Sign Details EE1260

Tables

2.1. Spacing Table24
2.2. Separation Distance Criteria54

CANCELLED

Chapter 1

DOCUMENT OVERVIEW

Section 1A--Purpose

1.1. Benefits of Guidelines. Air Force bases are used by large numbers of people, including active duty personnel, families and friends, civilian employees, retired personnel and others on official and personal business. Bases function as communities as well as military installations. A well conceived sign system effectively guides base users and makes Air Force installations more attractive, inviting and easy to use.

1.2. Need for Guidelines. This document presents a total orientation system that integrates interior and exterior signs with base maps and the information provided by gate guards in order to clarify base circulation. It also establishes guidelines for non-Air Force entities whose registered trademark signage has a recognized place in the community. Additionally, it provides guidance for standardizing sign material, color, style and placement throughout an installation. An effective sign program will reduce the number of signs on each installation to the absolute minimum required for directions, identification and customer service. This eliminates visual clutter and results in an efficient, cost effective and attractive system that enhances the quality of life and creates a unified professional appearance for all Air Force installations. The applicability of this document is limited to the United States Air Force.

1.3. Document Description. The document begins with an explanation of the Base Master Sign Plan. The following chapters cover typography, graphics, sign placement, the Americans with Disabilities Act, identification signs, direction signs, regulatory signs, motivation signs, information signs, wall mounted signs, signs for historic buildings and interior signs. The last chapter gives specifications and details for sign construction.

1.4. General Guidelines for Signs. Signs are most effective when they function as part of a total orientation system that includes base maps, street signs, building signs and guidance from gate personnel. An effective orientation system is logical, easy to follow and leads the visitor from the point of entry to the desired destination with no confusion. In order to design an effective orientation system, the following points should be considered.

1.4.1. Identify each decision point with a sign that clearly indicates the options.

1.4.2. Keep names of destinations consistent throughout the system, including the names on maps and the names used by security police when they are directing visitors to points on base. A direction sign pointing the way to the Personnel Center should lead to a building that is called the Personnel Center and not something else.

1.4.3. Do not omit a destination from a series of direction signs until that destination is reached. A sign series leading a visitor to a particular building should culminate in the building identification or street address sign.

1.4.4. Minimize the number of signs on base. A primary objective of this system is to reduce the number of signs and to eliminate the visual clutter that results from over signage. Locate signs only where they are absolutely needed to provide orientation. As a general rule, provide one sign for each building. The number of direction signs can be minimized if the streets are properly identified in accordance with the Federal Highway Administration's Manual on Uniform Traffic Control Devices (MUTCD) and if good base maps are made available to visitors at entry points. The MUTCD is available from the U.S. Department of Transportation, Federal Highway Administration, Washington D.C. 20590.

1.4.5. Signs are an important part of the impression made by a base. Use signs of high quality design and construction in order to present a professional image for the Air Force. Chapter 12 gives sample specification and details for sign construction.

1.4.6. Building-mounted regulatory signs used to denote hazardous materials, paint lockers, etc. should be kept to the minimum number and size required to meet safety regulations.

1.5. Limitations.

1.5.1. There are several standards and references which are relevant to sign design and placement. These include the Americans with Disabilities Act Accessibility Guidelines, the National Fire Protection Association Code for Safety to Life, the Federal Highway Administration's Manual on Uniform Traffic Control Devices and the U.S. Department of Transportation's Standard Highway Signs publication and Traffic Control Devices Handbook. This document is intended to supplement, not replace these references, which continue to be the authority for the issues to which they apply. Part VI of the MUTCD, Traffic Controls for Street and Highway Construction, Maintenance, Utility and Emergency Operations is currently available on the Construction Criteria Base (CCB) in the Documents Library under FHA Criteria. Parts I through V and VII through IX will be added in the future. For the interim, the entire manual can be ordered from the Superintendent of Documents. Use stock number 050-001-00308-2 and write to the following address:

Superintendent of Documents
U.S. Government Printing Office
Washington D.C. 20402

1.5.2. Commercial equivalent activities such as Air Force Services activities, Army and Air Force Exchange Service activities and the Defense Commissary Agency, which typically have standard, recognizable image signs and symbols, may deviate from the standards for facility identification signs defined in this document. These activities are permitted to use the standard image sign and symbols appropriate to their function which provide an attractive, identifiable image and/or wording that is easily recognizable to potential users as long as they are set in a framework that is consistent with the installation's architectural guidelines. The signs should be tastefully done and complement the architectural character of the installation. The size, placement and material composition of these signs will be consistent with MAJCOM standards, coordinated with the installation Sign Control Group as defined below, and approved by the installation commander. Signs for facilities on the National Historic Register, or within a

historic district, will also be coordinated and approved through the State Historic Preservation Office. Some Air Force installations have design guidelines which dictate colors, font styles, mounting, etc. which further clarify the guidance in this Sign Standard.

1.5.3. This document is not intended to address all possible signage options in Military Family Housing. For example, housing area entrance signs should follow MAJCOM guidance and specific base Housing Community Plans.

1.5.4. This document does not apply to Visual Air Navigation Facility signs placed in and around the airfield environment for the purpose of providing information for operating aircraft. Such signs must comply with the requirements of AFI 32-1044, Visual Air Navigation Systems.

1.5.5. Some situations will require signs not discussed in this document. This sign system is expected to evolve as the needs of the Air Force change, and additions or modifications will be made as necessary. All questions and suggestions relating to signs and sign standards should be sent to HQ AFCEE/DCD.

Section 1B--Objective-A Sign System

1.6. Sign Control Group. Each base should establish a sign control group to review and approve sign needs, designs and placement. The group should include representatives from the civil engineering office, security police and wing safety.

1.7. Master Sign Plan. The first step in implementing an effective sign system on base is the development of a Master Sign Plan that shows the location and content of every proposed exterior sign. The components of a Master Sign Plan include a Site Plan, a Sign Schedule and a Sign Inventory.

1.7.1. Importance of Master Sign Plan. It is the key to an efficient, attractive and cost effective system. The plan should be developed before any new signs are procured, since it will enable construction and placement of new signs to be prioritized, coordinated and streamlined.

1.7.2. Sign Site Plan. The engineer preparing the plan should become familiar with all the Air Force sign types and their functions. A copy of the current base site plan should be used as the base drawing for the signage site plan. The engineer should tour the base, marking the location of each required sign on the site plan, and assigning a number to each sign. A sign master plan should not be prepared without touring the base, since vegetation or other obstacles may actually hide a location that looks clear on a base plan.

1.7.3. Sign Schedule. Using the information gathered on the base tour, the engineer should prepare the sign schedule. The sign schedule will show the sign number, sign type and exact message and will reference the appropriate structural details.

1.7.4. Sign Inventory. As the signs are manufactured and installed, the information in the master plan should be transferred to base sign inventory sheets in accordance with AFR 75-88, Highways for National Defense in the Continental US. This information will be used as the basis

for maintaining and updating signs in the future. Several sign inventory software packages are available to automate the process. Additional information on these programs and their applicability may be obtained from:

McTrans Center
University of Florida
512 Weil Hall
P.O. Box 116585
Gainesville, FL 32611-6585
(352) 392-0378

Section 1C--Overview of Sign Types

1.8. Exterior Signs. There are five basic categories of exterior signs, plus two variations. Sign dimensions are shown in millimeters (mm) and site related dimensions are shown in meters (m).

1.8.1. Identification Signs. The three basic types identification signs are covered in detail in Chapter 4.

1.8.1.1. Base Identification Signs. These are placed at base entrances to identify and introduce the installation to visitors.

1.8.1.2. Military Identification Signs. These identify military activities and facilities and carry unit name information and street address.

1.8.1.3. Community Identification Signs. These identify activities and facilities used for non-military purposes. The standards for community signs also apply to signs for private firms operating on base. AAFES facilities and nationally recognized food chain franchises operated by AAFES may utilize their individual registered trademark signage in general compliance with these standards.

1.8.2. Direction Signs. These direct vehicular traffic on base and are very important for meeting the information needs of visitors and other base users. They are covered in Chapter 5.

1.8.3. Regulatory Signs. These regulate vehicular traffic and parking, warn of safety hazards and maintain security. They are covered in Chapter 6.

1.8.4. Motivation Signs. These serve various morale objectives and are covered in Chapter 7.

1.8.5. Information Signs and Base Maps. These are covered in Chapter 8.

1.8.6. Historic Building Signs. These are freestanding and wall-mounted exterior signs that use a special typeface in order to complement the character of historic buildings. These are covered in Chapter 9.

1.8.7. Wall Mounted Signs. These may be used instead of freestanding exterior signs at the

discretion of the base commander. These are covered in Chapter 10.

1.9. Interior Signs. These form an orientation system within a building, guiding visitors from the entry to the desk of the person they are seeking. They are discussed in Chapter 11; there are a number of types:

1.9.1. Building Directories.

1.9.2. Office Identification Signs.

1.9.3. Direction Signs.

1.9.4. Regulation Signs.

1.9.5. Bulletin Boards.

CANCELLED

Chapter 2

TYPOGRAPHY, GRAPHICS & SIGN PLACEMENT

Section 2A--Typography

2.1. Introduction to Typography. The term typography describes the style, size, and spacing of letters. Different styles of letters are referred to as fonts or typefaces. Each font is typically available in a range of sizes. Helvetica medium and Helvetica regular are the principle approved fonts used on Air Force signs. Helvetica medium is used for primary information on most signs. Helvetica regular is used for secondary information on identification signs and for certain regulatory signs. Letterforms used in association with the AF Symbol will be based on the “Arial Black” font (see Chapter 4).

2.2. Alternative Typefaces. Use of alternative typefaces may be approved for signs for historic buildings or bases with unique architectural character such as Randolph Air Force Base. See Chapter 9 - Signs for Historic Buildings. Note: Selected typeface must be in compliance with ADAAG.

2.3. Tile Systems. Proper letter spacing on signs is achieved through use of a tile system. Letter manufacturers supply letters on proportionately sized paperboard tiles. These tiles have notches which are used with layout lines drawn on the sign face to align the words and to insure proper vertical matching. See paragraph 2.10. Sign Assembly Sequence.

2.4. Helvetica Medium. The tile system for Helvetica medium is illustrated on this page. Compare any tile system purchased for use on Air Force signs with Figure 2.1 to insure conformity in letter form design and spacing.

2.5. Helvetica Regular. The Helvetica regular tile system is illustrated on this page as a guide for comparison with alphabets supplied by manufacturers. Arrows are not included in this alphabet, since all directional signs use Helvetica medium.

Figure 2.1. Helvetica Medium Tile System.

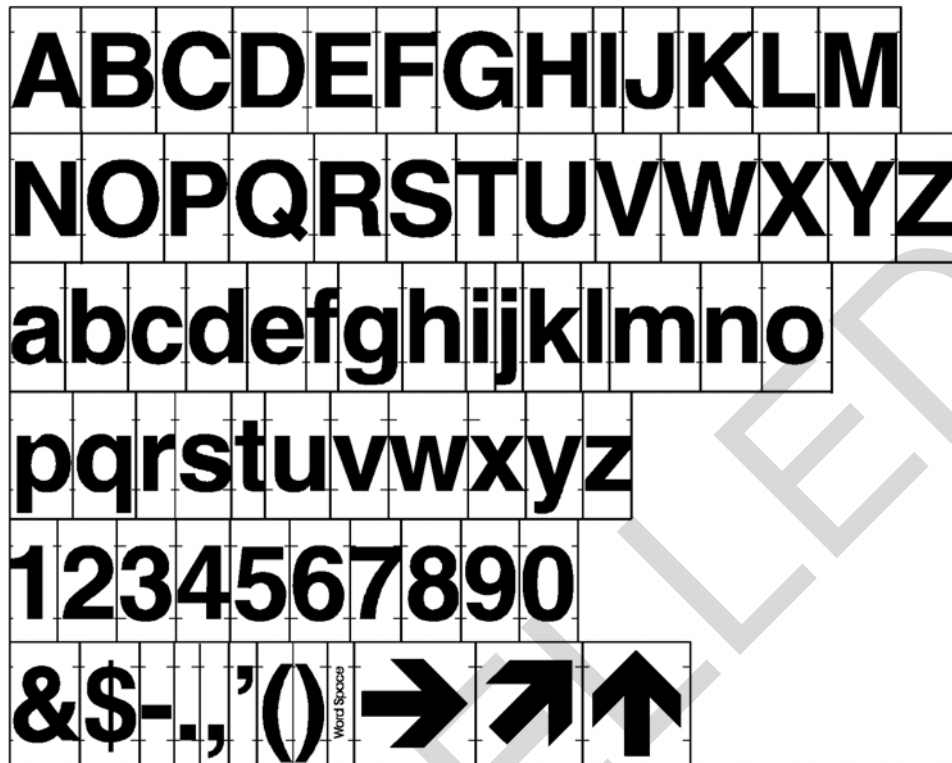
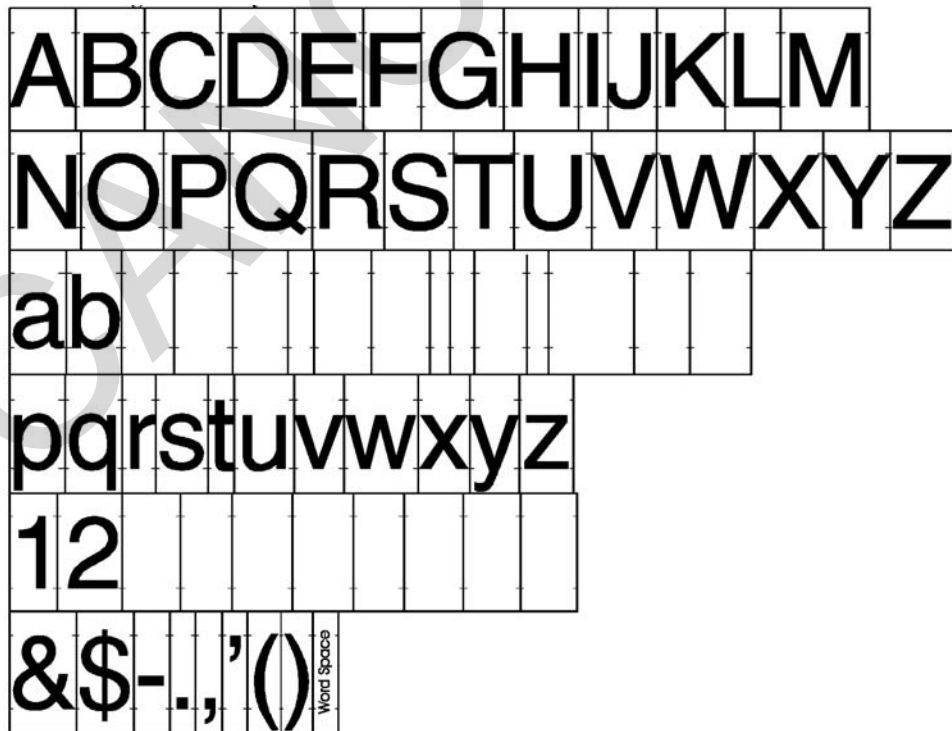

Figure 2.2. Helvetica Regular Tile System.



2.6. Letter Spacing Standards. Tile systems are easy to obtain, but there may be times when tiles are not available. In those situations, use the letter spacing specifications given here for both the Helvetica medium and the Helvetica regular typefaces. Letter spacing is based on a unit system in which each unit is equivalent to 1/50th of the capital letter height. Table 2.1 shows the numbers of spacing units required between characters. Use 20 units between words and 6 units before a punctuation mark such as a comma, period, semi colon, colon, parentheses, apostrophe, or dash. , . ; : () ' -. No units are used before or after a diagonal slash (/). An example of correct letter spacing is seen in Figure 2.3.

2.7. Arrow Tile. Figures 2.4 and 2.5 show the correct proportion and stroke width for arrows and their proper placement in relation to letters. The dimensions of the arrow tile and letter spacing are based on the system described in paragraph 2.6, where one unit is 1/50th the height of a capital letter. Use the standard arrow tile for the Type G3 Pedestrian Information sign and all interior directional signs. Use the standard Manual on Uniform Traffic Control Devices arrow on all traffic and directional signs.

2.8. Tile System Application. Air Force signs are laid out by arranging letter and spacing tiles on a layout grid drawn on the sign face. (A dimensioned layout for each type of sign is given in Chapters 3 through 10.) Tiles are applied to the sign by placing them next to each other and lining up the alignment notches with the layout lines drawn on the sign face. The sizes of the different signs in the system are based on multiples of the capital letter height (cap height) of the alphabet to be used in each sign. All of the layout elements relate to the capital letter height. (See Figure 2.6.) The maximum tile count given in Figure 2.7 and on the sign layouts in the following chapters indicates the maximum number of tiles or characters, based on average character widths for upper and lower case letters and including spaces and punctuation, that can fit on each line of the sign panel.

2.9. Standard Letter Heights. A standard letter height, based on the height of the capital letters (cap height) of the alphabet used, has been specified for each type of sign. Examples of standard letter heights used on Air Force signs are illustrated in Figures 2.8 through 2.10. Compare each alphabet purchased with these standards to make sure that it is correct.

2.10. Sign Assembly Sequence. Signs should be assembled using the sequence shown in Figure 2.11.

Figure 2.3. Correct Letter Spacing.

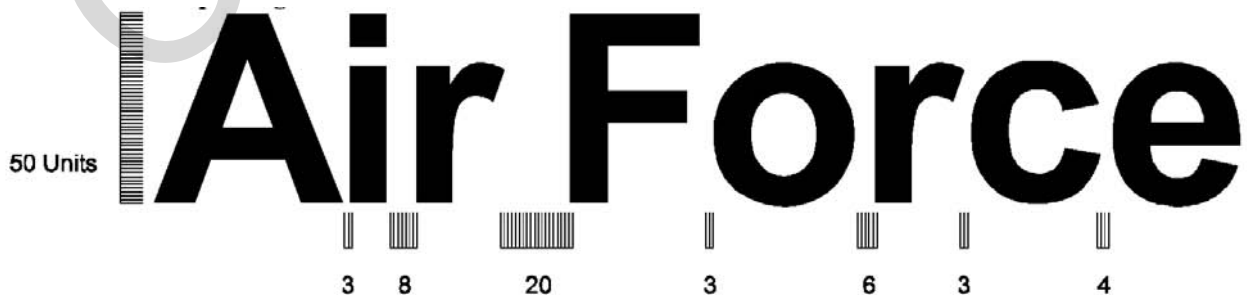

Table 2.1. Spacing Table.

	vwxyz	ftz	acdeg oqs	mnpru	bhijkl
T	-3	1	-1	0	4
AKVWY	-1	0	1	2	3
F	0	1	2	3	4
XZ	1	2	3	4	5
CLP	1	2	3	5	5
DOQS	2	3	5	6	7
BEGR	3	5	6	7	8
HIJMNU	4	5	6	8	8
kvwxy	0	1	2	3	4
rz	1	2	3	5	5
cft	2	3	4	5	6
beops	2	3	5	6	7
ahmnu	3	5	6	7	7
dgijlq	4	5	7	8	8

	147	2	3	0	5689
7	2	3	3	4	5
24	3	3	4	5	5
0	4	5	5	6	7
569	5	5	6	7	7
38	5	6	7	7	8
1	6	7	7	8	8

Figure 2.4. Correct Arrow Alignment.

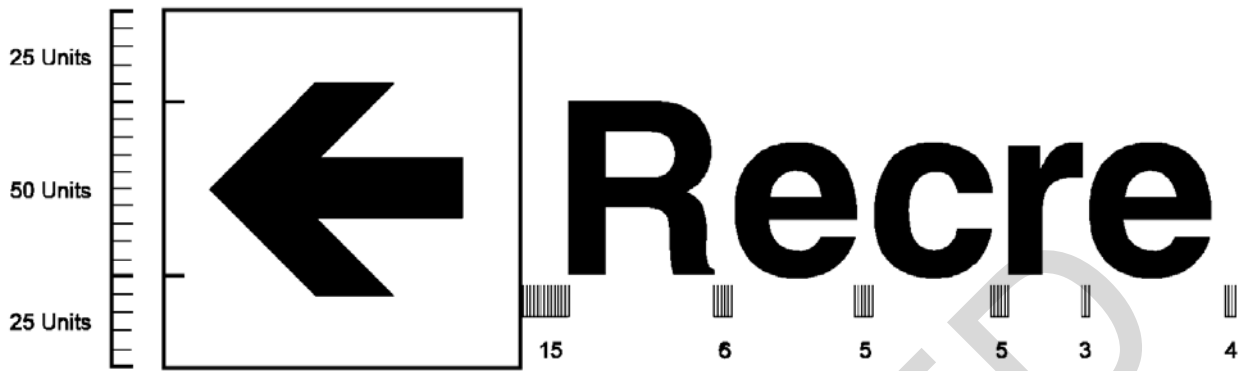

Figure 2.5. Arrow Grids.

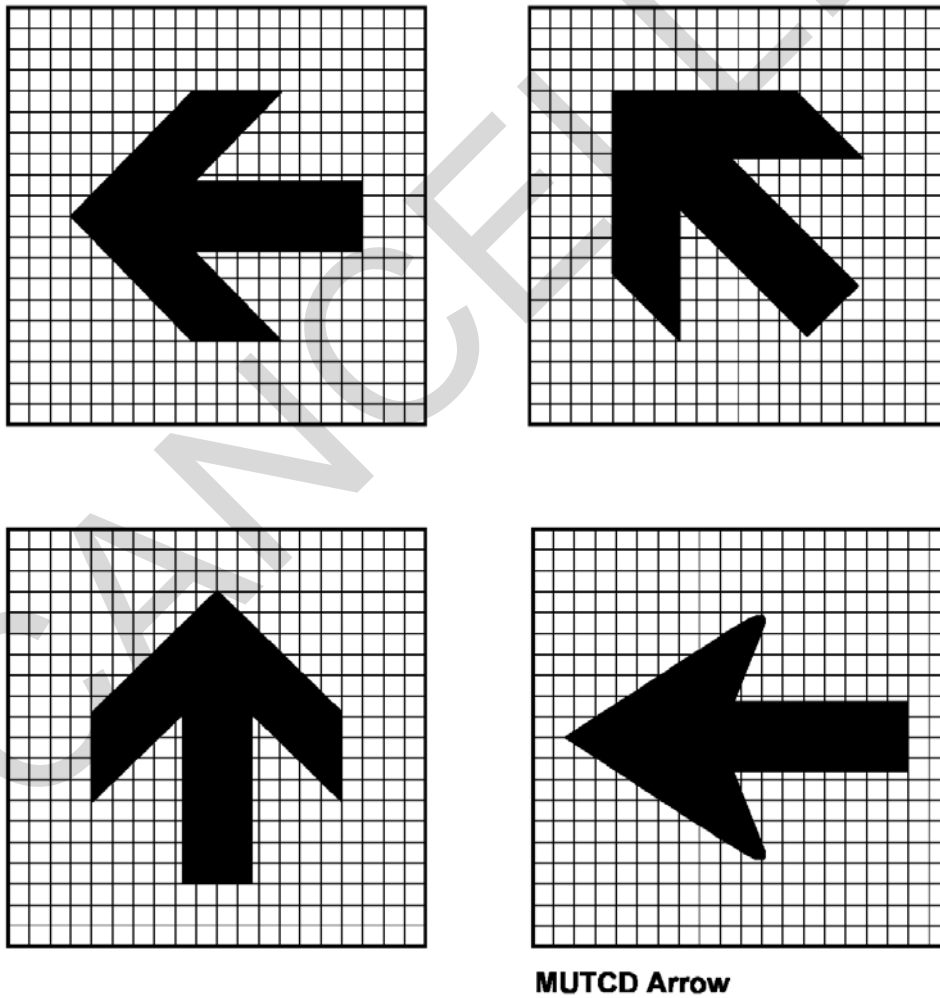

Figure 2.6. Letter Tiles.

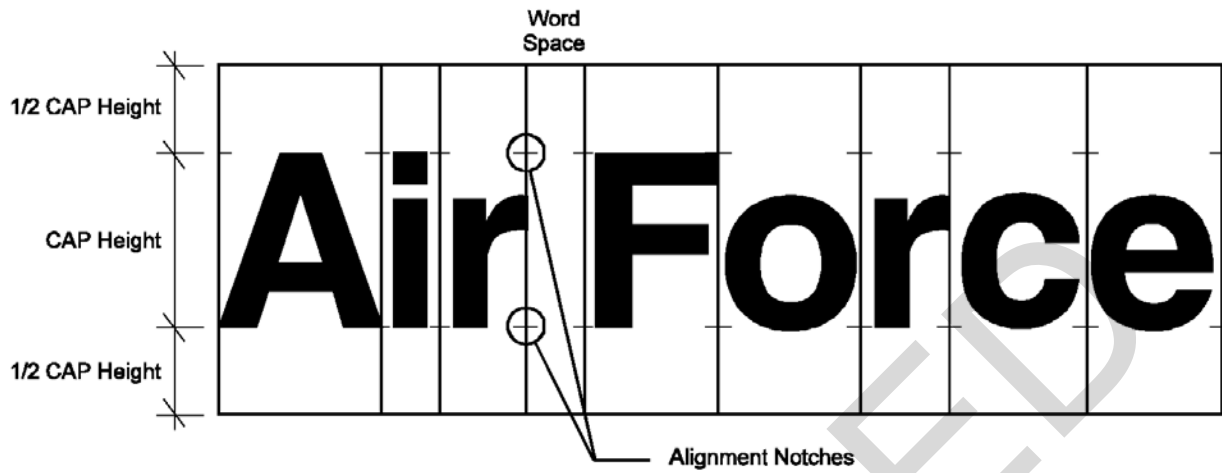

Figure 2.7. Sign Grid.

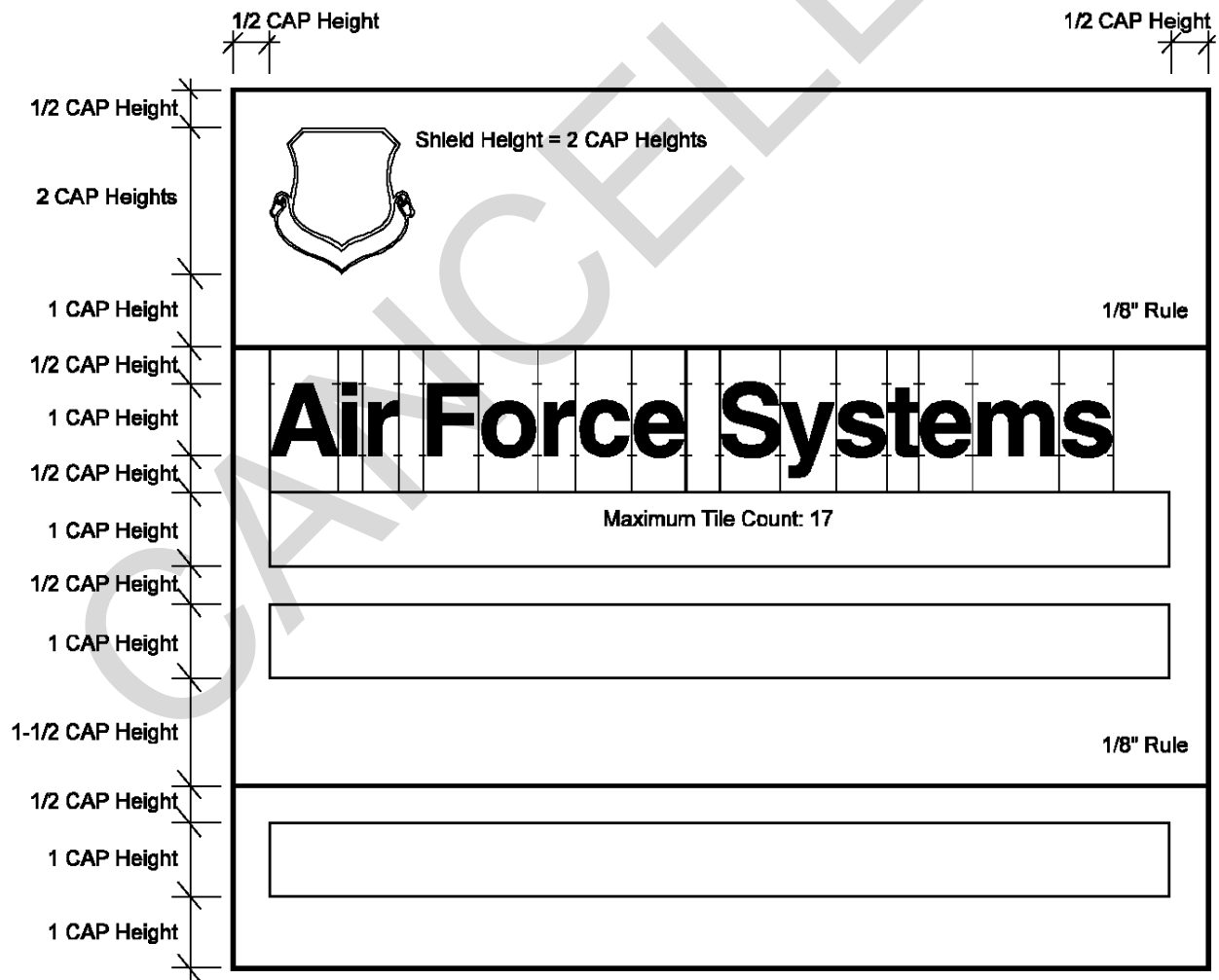

Figure 2.8. Standard Letter Heights (12.5 mm - 50 mm CAP Height).

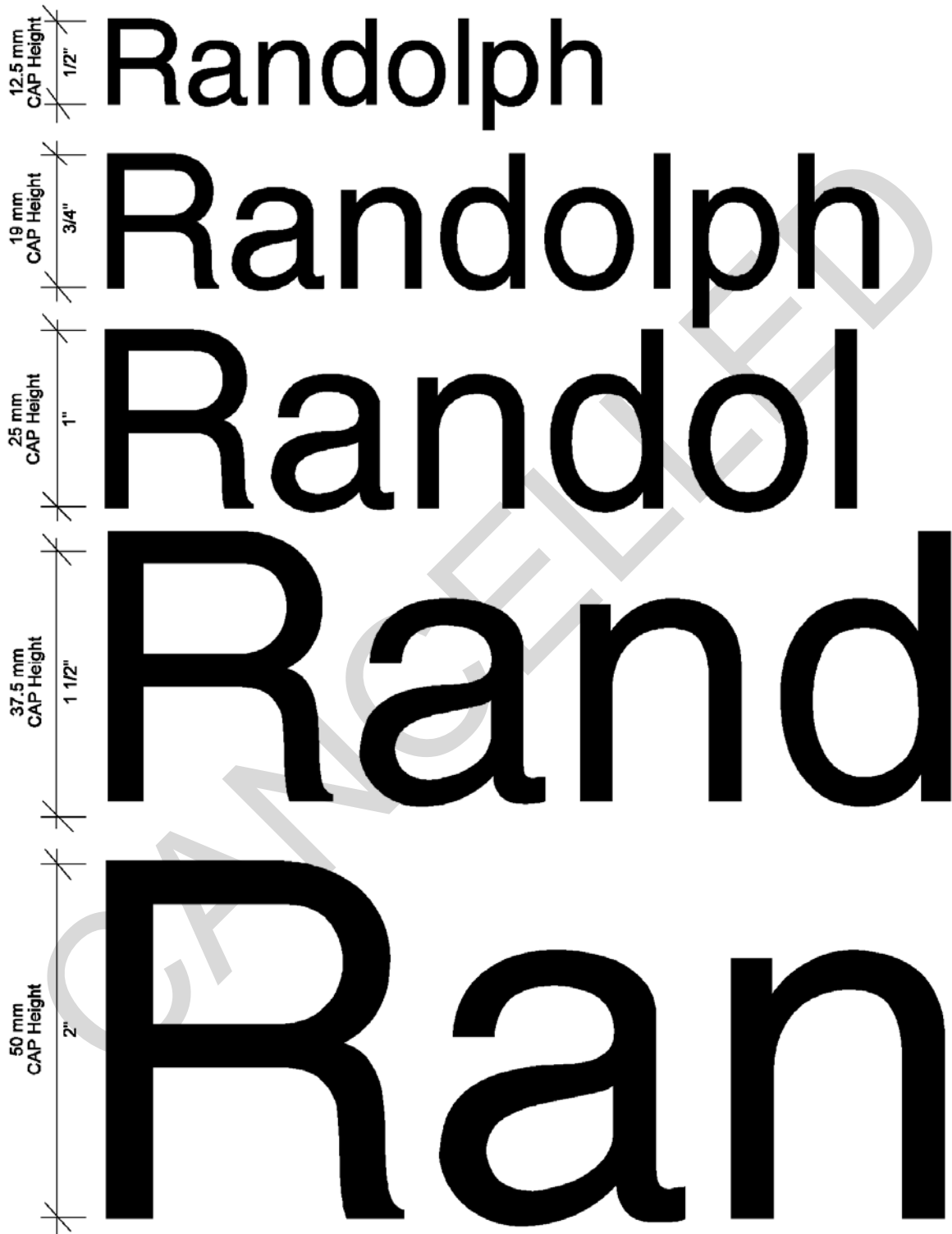

Figure 2.9. Standard Letter Height (75 mm - 100 mm CAP Height).

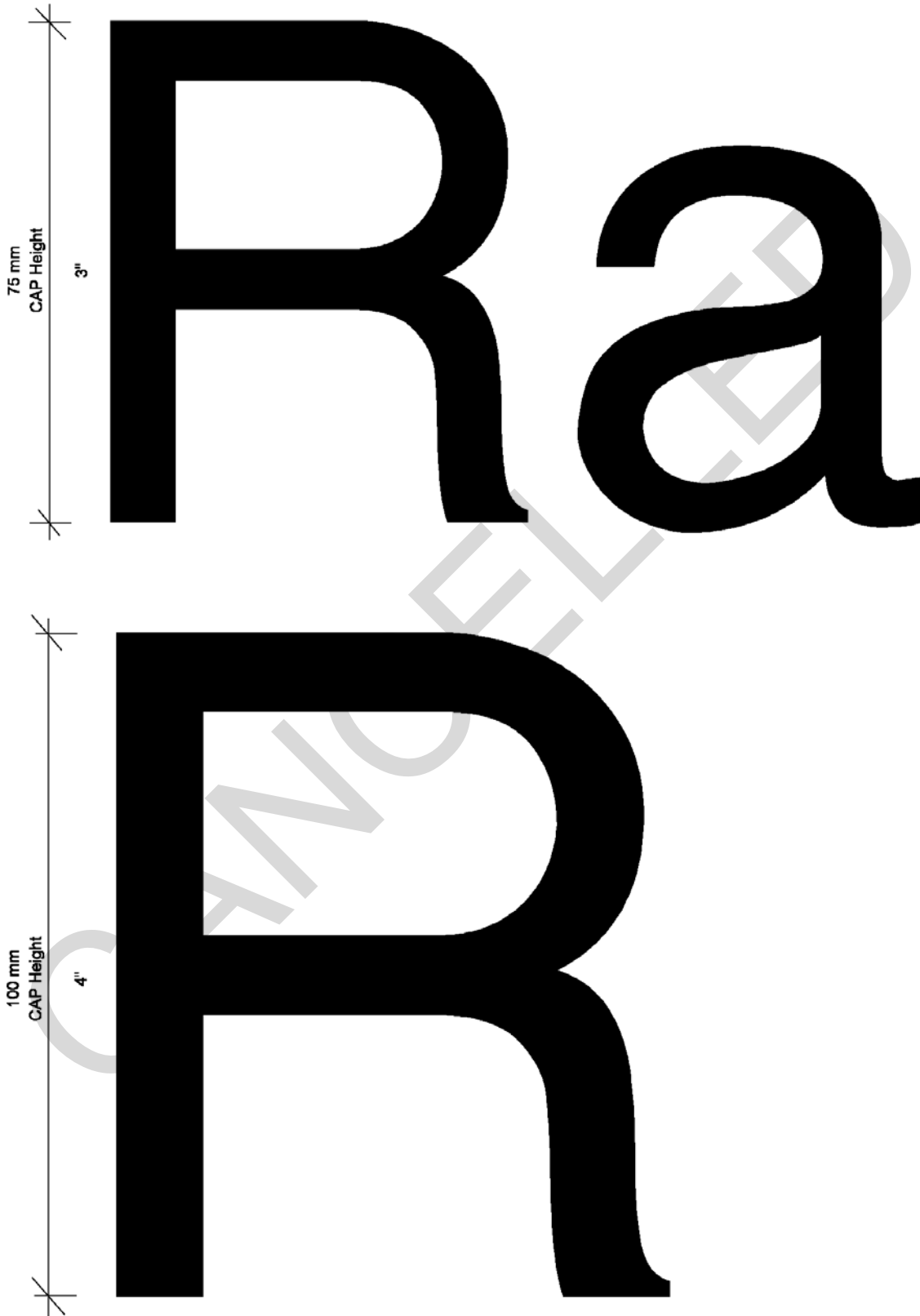

Figure 2.10. Standard Letter Height (150 mm CAP Height).

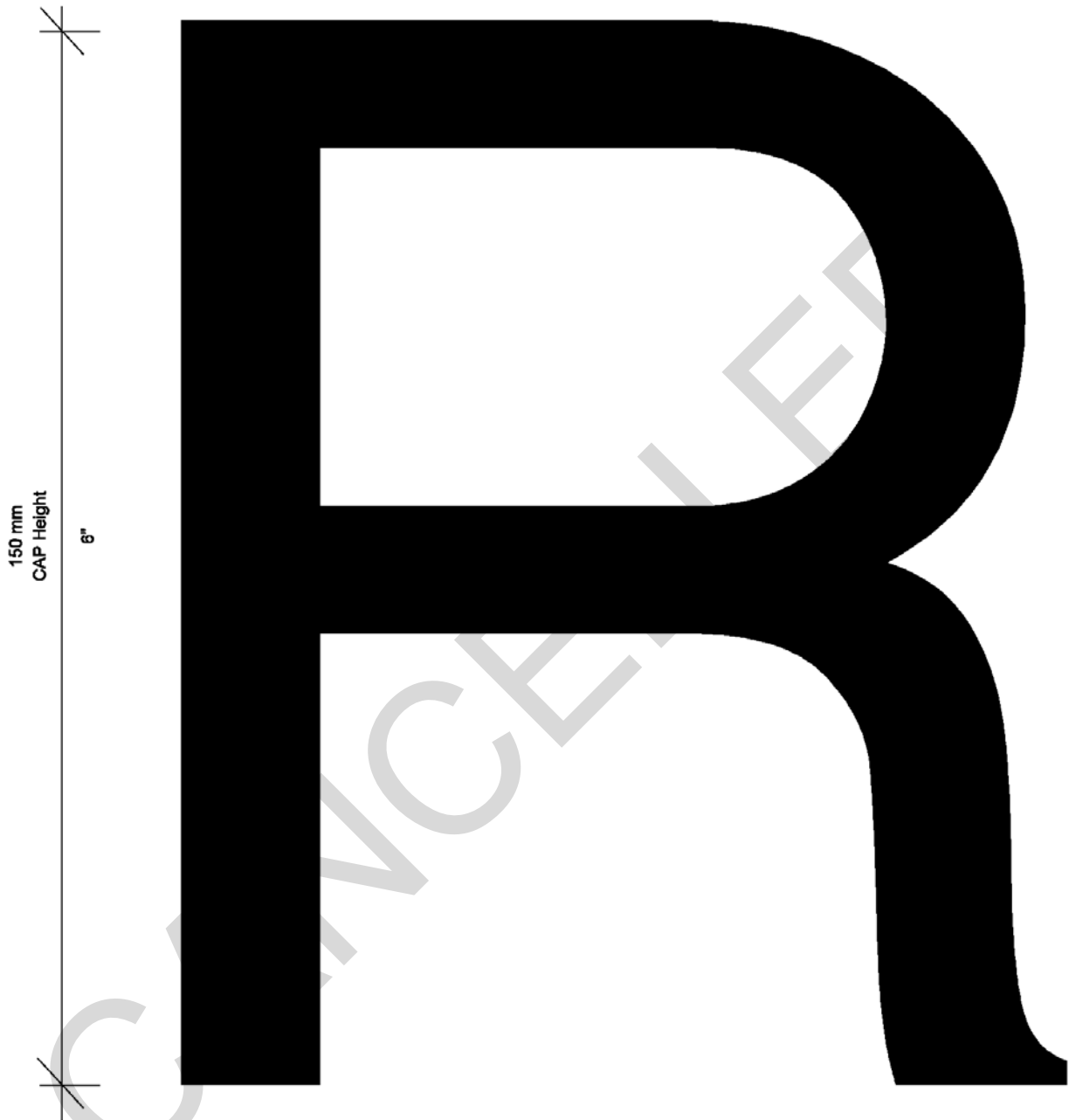
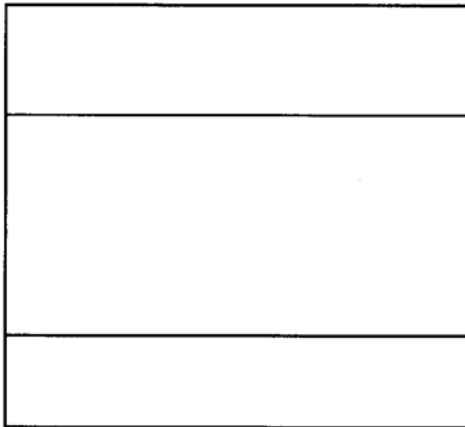
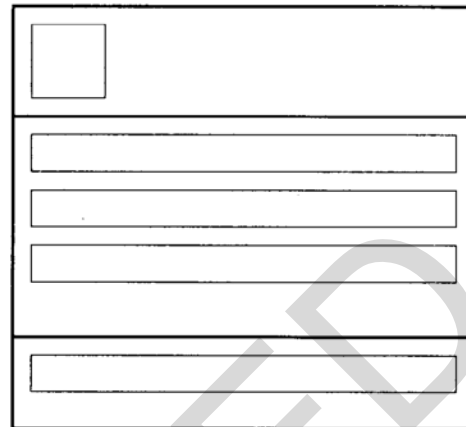

Figure 2.11. Sign Assembly Sequence.



Layout Sign Face



Layout Tile Grid



Apply Letter Tiles

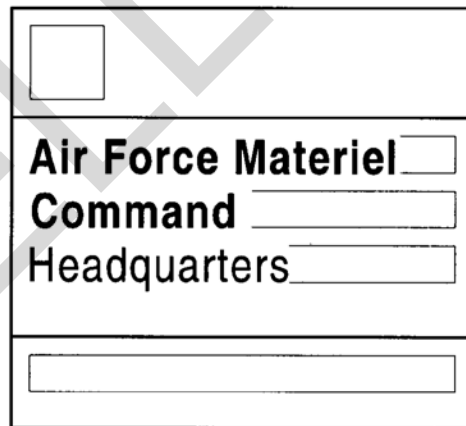

Apply Remaining Letter Tiles



Apply Authorized Emblem and Number Tiles



Completed Sign

2.11. Sign Layout Guidelines. Sign layouts should follow the formats outlined in Figures 2.12 - 2.22.

2.11.1. Building Signs. Building identification signs generally carry only one unit name, which is displayed in the Helvetica medium typeface.

Figure 2.12. Building Signs.

509th Bomb Wing

2.11.2. Secondary Information. Secondary information to identify a component of a unit may be added in the Helvetica regular typeface.

Figure 2.13. Secondary Information.

**509th Bomb Wing
Headquarters**

2.11.3. Major Tenant. If a building houses more than one organization, the identification sign usually indicates only the major tenant.

Figure 2.14. Major Tenant.

**Deputy Commander
for Resource
Management**

2.11.4. High Priority Component Units. If, however, the major tenant includes high priority component units (the destinations most often sought by people who are new to the base), those names should also be shown on the sign. The title of the major tenant is shortened to accommodate the component unit in this example.

Figure 2.15. High Priority Component Units.

**DCR
Base Finance**

2.11.5. Coequal Units. In cases where there is no clear major tenant, two or three coequal units may be shown on the sign.

Figure 2.16. Coequal Units.

**Base Operations
26th Weather Sq.**

**Family Services
Red Cross
Thrift Shop**

2.11.6. Three or More Coequal Units. If more than three coequal units wish to be identified, and the order of preference cannot be agreed to, use a general designation, such as Base

Administration, the building name, the building number, or the street address.

Figure 2.17. Three or More Coequal Units.

Rickenbacker Building **Building 5010**

2.11.7. Military and Community Tenants. There are two categories of building identification signs: military identification signs and community identification signs. If a building houses both a military and a community facility, place the major tenant first on the sign face, and use the design rules that apply to the major tenant's sign category.

Figure 2.18. Military and Community Tenants.

**Post Office
Area Defense
Council**

2.11.8. Line Breaks. Sensible line breaks in a sign message are basically a matter of good judgment. As a rule, single ideas or names should appear on the same line.

Figure 2.19. Line Breaks.

Pacific Air Forces **Air Force
Materiel Command**

2.11.9. Abbreviations. Spell out names in full whenever possible. If abbreviations are required, they should be consistent for all signs within a base.

Figure 2.20. Abbreviations.

**25th Tactical
Air Support Sq**

2.11.10. Numbers. The numbers ten (10) and under should be spelled out and numbers over ten (10) should be written as numerals unless otherwise specified in the authorized unit name.

Figure 2.21. Numbers.

Eighth Air Force 19th Air Division

2.11.11. Balance. Balance the lines so that the sign does not look awkward. Additional examples of unit names with proper line breaks are shown below.

Figure 2.22. Balance.

Aerospace Defense Command First Strategic Aerospace Division	11th Air Refueling Squadron Air Force Office of Special Investigations
---	---

2.11.12. Correct and Incorrect Layout. Figure 2.23 is an example of correct word placement, line sequence, type style and letter spacing. Figure 2.24 gives several incorrect examples.

Section 2B - - Graphics

2.12. Graphic Emblems. There are four different graphic emblems which may be used on Air Force military identification signs. These are the Air Force Symbol, the Air Force Coat of Arms, the Air Force Shield, and the squadron emblem disk.

2.13. Air Force Symbol and Coat of Arms. These may only be used in specific applications.

2.13.1. Use of Symbol. Use the Air Force Symbol only on base identification signs (See paragraphs 4.8 and 4.9) and water towers (See paragraph 4.33), never on any other type of sign or structure.

2.13.2. Use of Coat of Arms. The Air Force Coat of Arms may be used on signs identifying components of headquarters level. It is always rendered in full color with no design variations.

2.13.3. Contrast to Background. The Air Force Coat of Arms is outlined with a thin black line and is edged with golden yellow piping to contrast with the sign background (See Figure 2.25). Refer to AFPAM 36-2801 for further information.

Figure 2.23. Correct Layout.

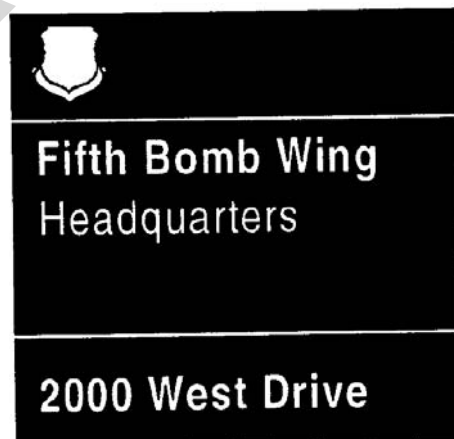

Correct Word Placement

Figure 2.24. Incorrect Layouts.

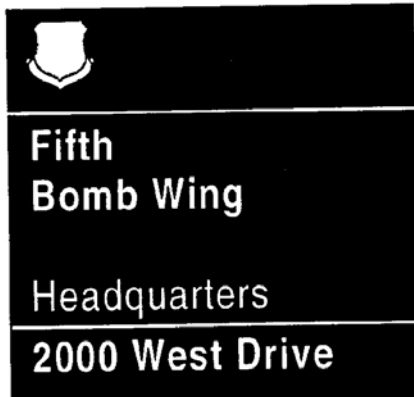

Incorrect Word Placement

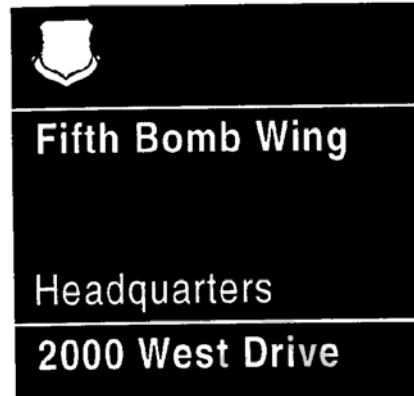

Incorrect Line Sequence and Letter Spacing



Incorrect Emblem, Type and Number Size

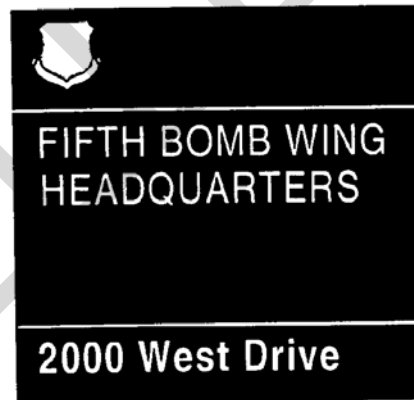

Incorrect Type Style

Figure 2.25. Air Force Coat of Arms.

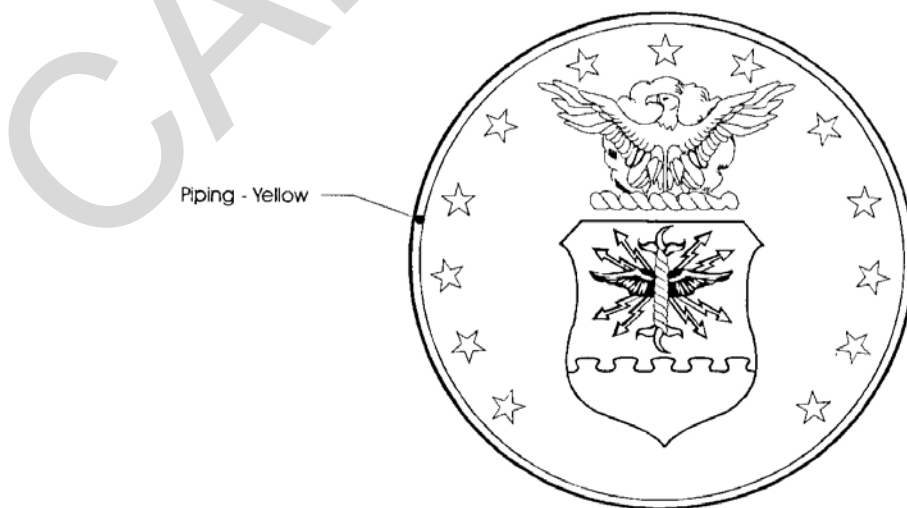

2.14. Air Force Shields and Emblems. Use the Air Force shield to display unit emblems. The unit emblem is an important part of the Air Force's tradition of military heraldry. Emblems express unit pride and identity, and depict distinctive history or special functions.

2.14.1. Overuse of Emblems. The overuse of organizational emblems on signs, however, is a problem common to many bases. Overuse dilutes the impact of emblems and gives an impression of sameness and repetition, rather than distinctiveness. It is strongly recommended that authorized organizational emblems be used only where they apply directly to unit identification. (See AFPAM 36-2801 for the rules of authorization of emblems.)

2.14.2. Emblem Use by Tenant Units. The use of emblems graphically highlights the military organization of the base, since each flag bearing and squadron level unit is identified with its authorized emblem. A tenant unit authorized to display an emblem under AFPAM 36-2801 may use either the emblem of its parent organization or its own unit emblem.

2.14.3. Use of Multiple Emblems. The use of multiple emblems on most signs is discouraged since they are redundant – a unit has only one authorized emblem. The Air Force Symbol is the only emblem to be displayed on the Main Entrance Sign, Type A-1, and the Secondary Entrance Sign, Type A-2. Multiple emblems may be displayed on the Base Morale Sign, Type F1a, to introduce the visitor to the major mission related units on the base.

2.14.4. Use of Shield. A flag bearing unit such as a command, division, wing, group, or its equivalent unit may display its emblem in the format of the Air Force shield on building identification signs. See Chapter 4, Section 4C – Military Identification Signs.

2.14.5. Design for Shield Decal. The shape of the Air Force shield is shown in Figure 2.26. Before a unit emblem is converted to a decal, the design must be simplified and clarified for reproduction in a professional manner. The design of the shield face should be simple in order to permit clear reproduction. Colors should be solid with no half tone screens. The shield must be outlined with a thin black line, and the entire design must be edged with golden yellow, white, or silver gray piping to contrast with the standard brown sign background. The lettering of the unit designation must be sharp and legible. For further information relating to these shields, refer to AFPAM 36-2801.

Figure 2.26. Air Force Shield.

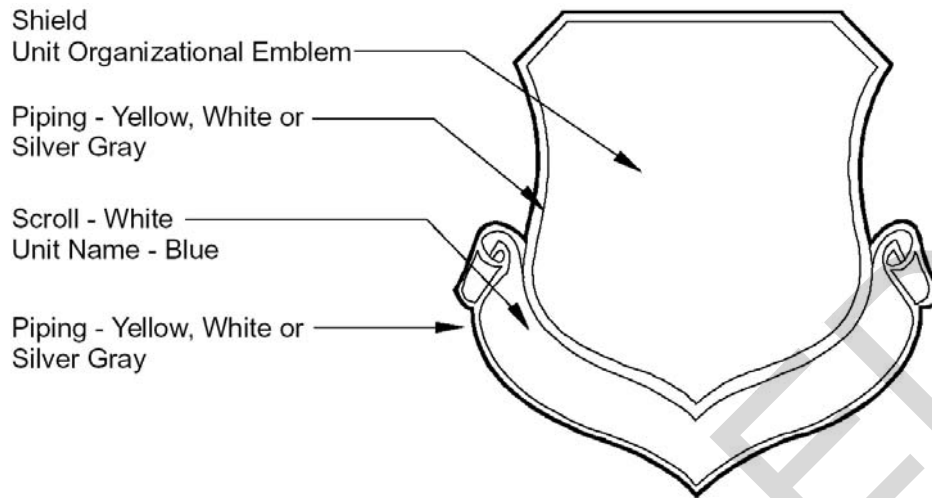

2.14.6. Squadron Emblems. A squadron may use its authorized emblem on building identification signs and on unit morale signs. (See paragraphs 4.13 and 7.11 for information on these sign types). A disk is used for squadron insignia. All elements of the design must fit within the disk. The unit designation should appear on the scroll below the disk, and the unit motto, if used, on the scroll above the disk.

2.14.7. Ordering Emblem Decals. Decals of authorized squadron emblems may be ordered from UNICOR (Federal Prison Industries), federal corrections institutions approved by the Joint Commission on Printing, or commercial manufacturers.

2.14.8. Design for Emblem Decal. As with the Air Force shield, the design of a squadron emblem should be simplified and clarified before the emblem is converted to a decal. Colors should be solid, with no half tone screens. The disk should be outlined with a thin black line, and the entire design edged with golden yellow, white, or silver gray piping to contrast with the standard brown sign background. The lettering of the unit designation must be sharp and legible. For further information relating to these emblems, refer to AFPAM 36-2801.

Figure 2.27. Air Force Squadron Emblem.

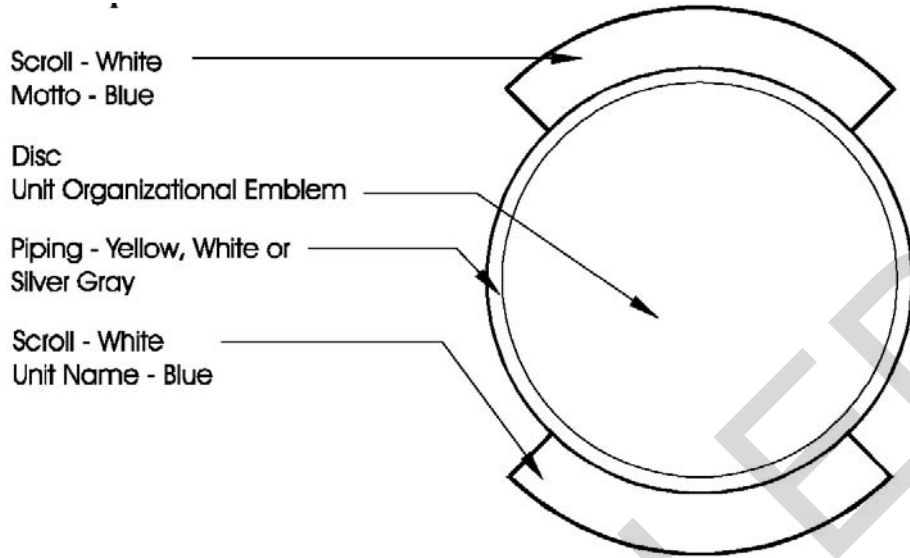

2.15. Service Symbols. Use service symbols on Air Force signs because of their strong visual impact and because graphics are easier to understand and follow than words. For this reason, it is recommended that service symbols be used in lieu of word messages whenever possible. However, restroom signs must have compliant text and Braille accompanying the gender symbols.

2.15.1. Authorized Symbols. The symbols shown below and on the following pages are authorized along with the standard symbols approved by the Manual on Uniform Traffic Control Devices for use on exterior and interior Air Force signs. The Department of Transportation symbols shown below were developed as passenger/pedestrian oriented symbols for use in transportation related facilities.

2.15.2. Background. The symbols should be used as shown with black or dark brown pictographs against a white background. The one exception is the handicapped accessibility symbol which should have a white pictograph against a dark background.

2.15.3. Border. The symbol background border should always be square with rounded corners as indicated. The line weight of the border must be consistent for all symbols.

2.15.4. Limitations on Usage. These symbols are not intended for use on traffic control devices except for the "Parking" and "No Parking" signs described in paragraph 6.15, or according to the Manual on Uniform Traffic Control Devices.

Figure 2.28. Service Symbols.



Figure 2.29. Concession Symbols.

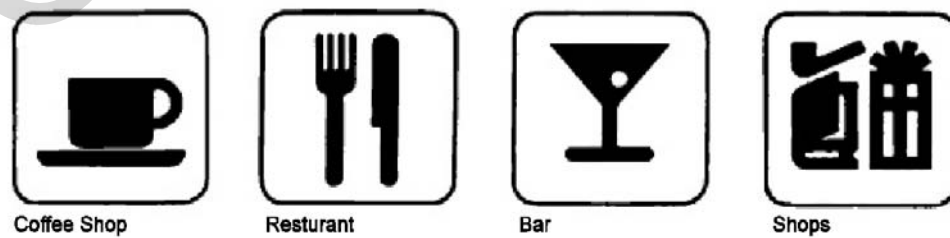

Figure 2.30. Regulation Symbols.



2.16. Sports and Recreation Symbols. The sports and recreation symbols shown in Figure 2.31 are based on designs developed for the 1972 Olympic Games. These symbols are authorized for use on signs that identify recreational facilities. Use National Park Service recreation symbols for those activities that are not covered by the Olympic symbols. Some typical National Park Service recreation symbols are included below.

2.16.1. Description. The symbols should be used as shown with black or dark brown pictographs against a white background. See the description of the Type C5 Recreational Facility Sign in paragraph 4.31 for more information.

2.16.2. Border. The border should always be square with rounded corners as shown. The line weight of the border should be consistent for all symbols.

Figure 2.31. Sports and Recreation Symbols.



2.17. The Community Symbol. The symbol is based on the letter “C” (for community), placed at three different angles and interlocked to form the outline of a person. Reproduce the design exactly as shown in Figure 2.32 maintaining the relative sizes of the elements and the spatial relationships. The gridded drawing shown may be used as a guide for enlargement of the symbol. The symbol should always be rendered in a solid tone. No shadings or patterns of any kind are permitted, and the symbol must never be hidden in any way.

Figure 2.32. The Community Symbol.

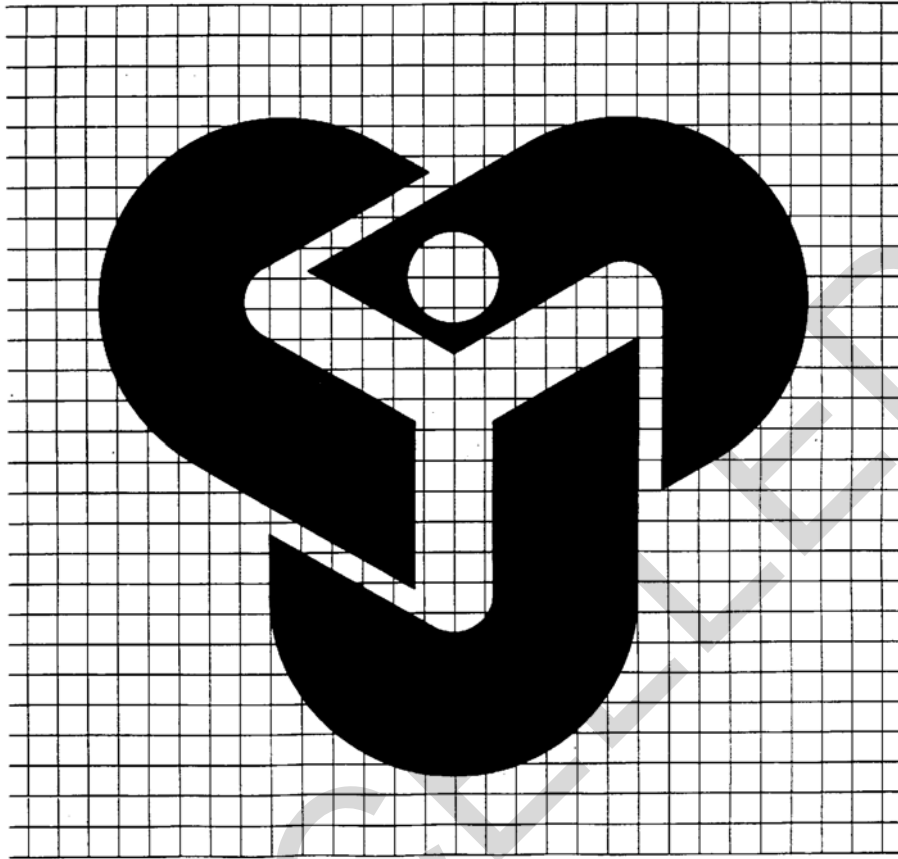

2.17.1. Usage. The community symbol is an optional graphic device which may be used on any sign or printed item dealing with a community, recreational, or other non-military activity.

2.17.2. Placement. Place the symbol in the upper left hand corner of signs identifying community facilities. It should be white against the standard brown background. Unlike the other pictographs and symbols shown in this pamphlet, the community symbol does not appear within a square. See Figures 4.33, 4.32 and 4.35.

Figure 2.33. Community Symbol Signs.



2.18. Color Standards. The colors used on the signs in this program conform to the color standards developed by the Federal Highway Administration. These are the only colors that are permitted in the production of Air Force signs, with the exception of motivation signs. Semi-gloss paint must fall within the glossimeter readings for eggshell in matte finishes (11 to 19 degree gloss on 60 degree glossimeter). These color standards also apply to safety signs.

2.18.1. Standard Blue.

Reflective Sheeting: Federal Highway Administration PR Color #3, Highway Blue

Paint: Federal Standard 595a, Color #15090 (Gloss)

Ink: PMS 294

2.18.2. Standard Brown.

Reflective Sheeting: Federal Highway Administration PR Color #5, Highway Brown

Paint: ISCC-NBS, Color Designation 56 String Brown

National Park Service Brown

Ink: PMS 469

2.18.3. Standard Yellow.

Reflective Sheeting: Federal Highway Administration PR Color #1, Highway Yellow

Paint: Federal Standard 595a, Color #13538 (Gloss), Color #23538 (Semigloss)

Ink: PMS 116

2.18.4. Standard Red.

Reflective Sheeting: Federal Highway Administration PR Color #2, Highway Red
Paint: Federal standard 595a, Color #11105 (Gloss), Color #21105 (Semigloss)
Ink: PMS 187

2.18.5. Standard Green.

Reflective Sheeting: Federal Highway Administration PR Color #4, Highway Green
Paint: Federal Standard 595a, Color #14109 (Gloss), Color #24108 (Semigloss)
Ink: PMS 342

2.18.6. Standard Orange.

Reflective Sheeting: Federal Highway Administration
PR Color #6, Highway Orange
Paint: ISCC-NBS Color Designation 48 Vivid Orange
Ink: PMS 152

2.18.7. Standard Black.

Non-Reflective Sheeting: Black
Paint: Federal Standard 595a, Color #17038 (Gloss). Color #27038 Semigloss)
Ink: PMS Process Black

2.18.8. Standard White.

Reflective Sheeting: Federal Highway Administration White or Silver White
Paint: Federal Standard 595a, Color #17875 (gloss), Color #27875 (Semigloss)
Ink: PMS White

2.18.9 “Air Force” Blue (for use on water tower)

Pantone #287

2.18.10 Pantone Cool Gray #4 (for use on water tower)

2.18.11 Pantone Cool Gray #9 (for use on water tower)

Section 2C--Sign Placement

2.19. Freestanding Exterior Signs.

2.19.1. General Information. Good judgment is very important in determining sign placement. Signs should be placed far enough from the edge of the roadway to minimize traffic hazards but close enough to be clearly visible to the user.

2.19.2. Placement. All traffic control signs, including the Type C6 Bus Route Sign, Type D Destination Signs and Type E Parking Regulation Signs, must conform to the placement standards shown in the Manual on Uniform Traffic Control Devices. Placement of all other

signs covered in this pamphlet should conform to the standards in this section, which meet or exceed the Manual on Uniform Traffic Control Devices guidelines. Whenever practical, a minimum lateral clearance of (12') from the roadway is recommended for these signs. All signs less than (12') from the edge of the roadway should have breakaway or yielding sign supports that comply with state standards and/or are approved by the Federal Highway Administration.

2.19.3. **Visibility.** Signs should be placed where they can be clearly seen by the user. Check sight lines before signs are erected to ensure that traffic control devices, roadway entrances, and exits are not hidden. Ensure the signs do not block sight distance for drivers at intersections. Place signs to take advantage of indirect light from existing light sources for good night visibility.

2.19.4. **Relationships to Site.** Signs should relate well to their sites, that is, they should look good in relation to the nearby landscape and structures.

2.19.5. **Series of Signs.** Series of signs requiring driver or pedestrian decisions should be placed far enough apart to allow enough time for the user to make the required decisions.

2.19.6. **Visual Clutter.** Take care to avoid visual clutter. No sign should be erected unless the information it provides is absolutely necessary for directions, identification or customer service.

2.19.7. **Lateral Clearance - Rural Signs.** In rural or outlying areas, a minimum lateral clearance of 4.0 m (12') from the edge of the traveled way (Figure 2.34) or 1.8 m (6') from the edge of the paved shoulder or curb (Figure 2.34) is preferred, wherever possible, for all Identification, Warning, Motivation and Information Signs.

2.19.8. **Lateral Clearance - Urban Signs.** In urban areas, signs should be placed with minimum lateral clearances of 1.8 m (6') from the edge of the roadway or paved shoulder and 0.6 m (2') from the face of any curb (Figure 2.35). A clearance of 0.3 m (1') from the face of the curb is permissible in urban areas where sidewalk width is limited or where existing poles are close to the curbs (Figure 2.35).

Figure 2.34. Rural Sign Placement

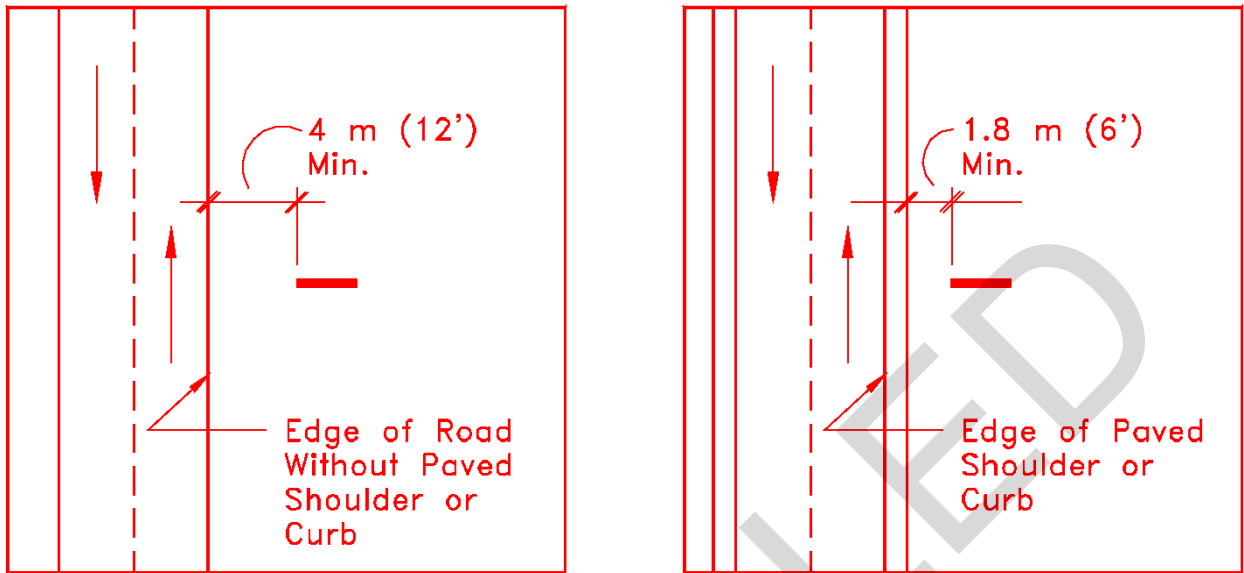
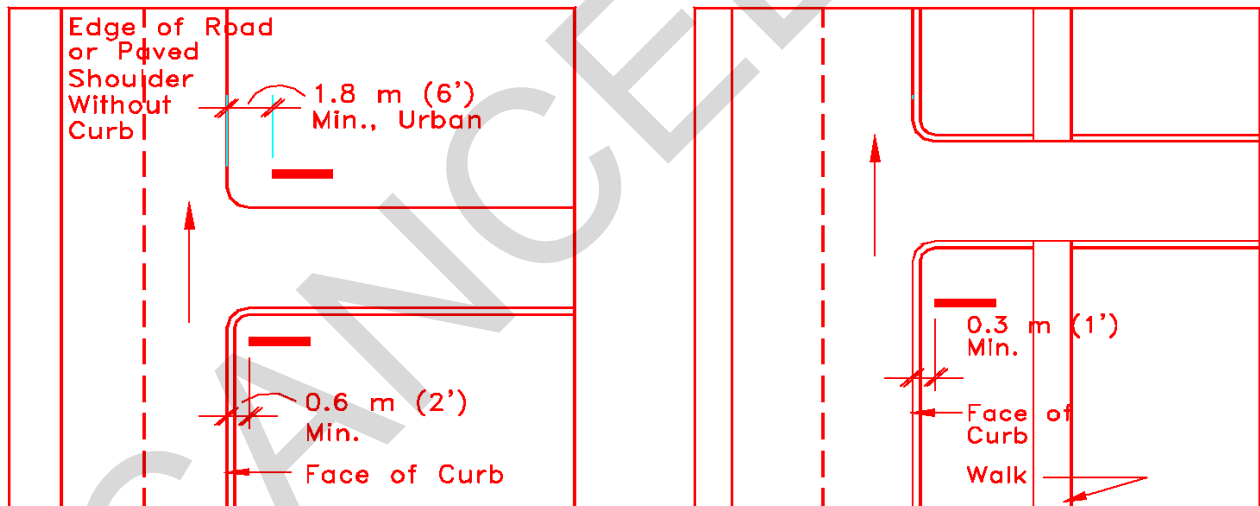
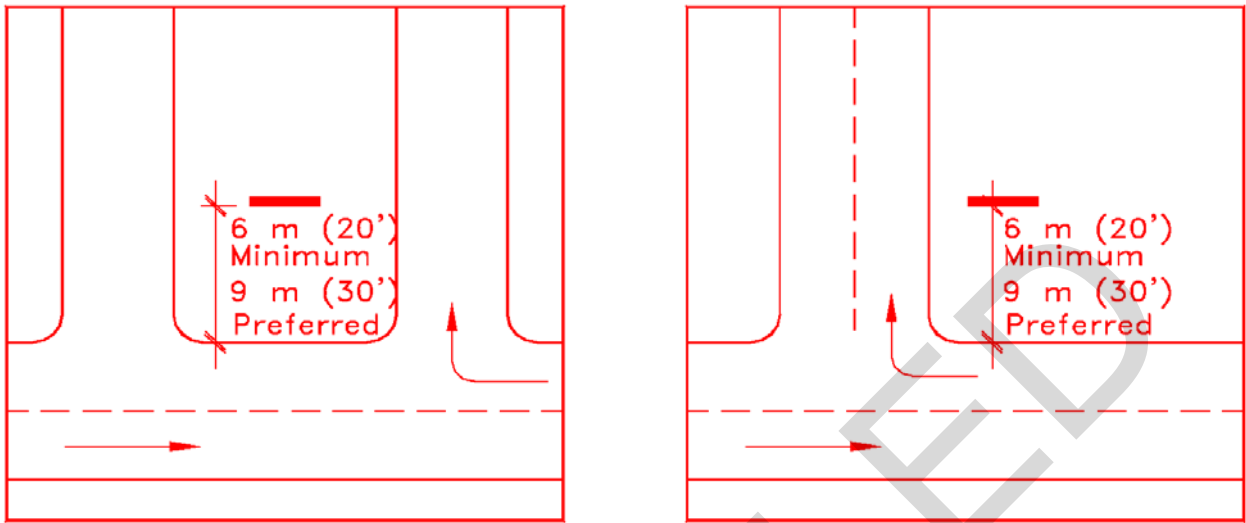

Figure 2.35. Urban Sign Placement.



2.20. Base Identification Signs Types A1, A2. Base identification signs, Types A1 and A2, are located at high volume entrance points. Place the sign parallel to the traffic flow, and set it back a minimum of 6 m (20') from the edge of the roadway. A 9 m (30') setback is preferred when practical.

Figure 2.36. Base Identification Sign Placement.



2.21. Military Facility Signs Types B1, B2 and B3.

2.21.1. Placement. Place the military facility signs, Types B1, B2 and B3, as close as possible to the building entrance and perpendicular to the roadway to permit viewing by traffic moving in both directions (Figure 2.37).

2.21.2. Visibility. If the building is set back from the roadway and is not visible or is only partially visible from the roadway, place the sign next to the entrance driveway and on the side of the driveway closest to the building (Figure 2.38).

2.21.3. Relationship to Parking. Place the sign no less than 2.4 m (8') from the entrance to the parking area.

Figure 2.37. Military Facility Sign Placement.

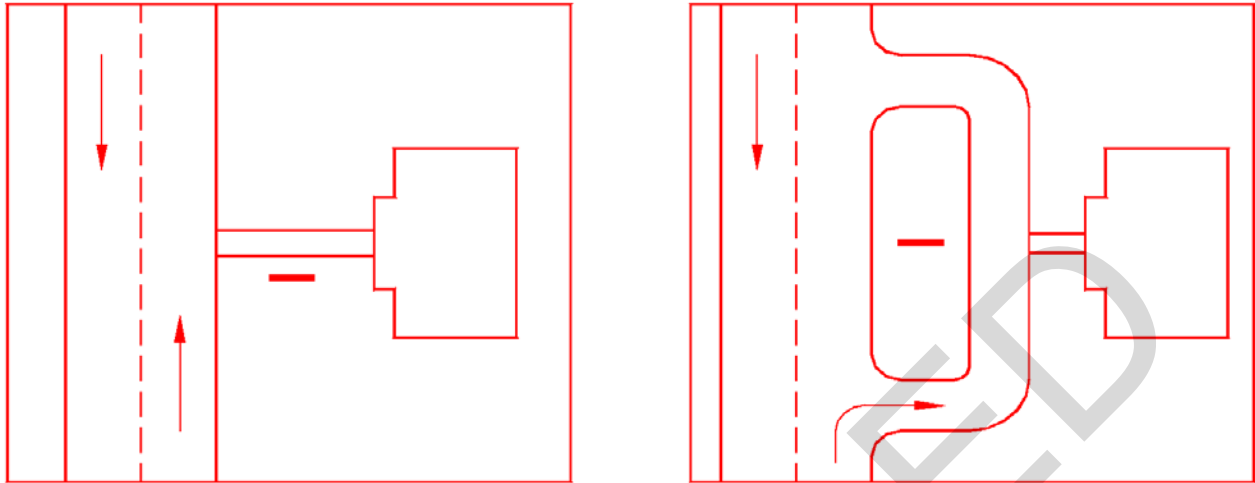
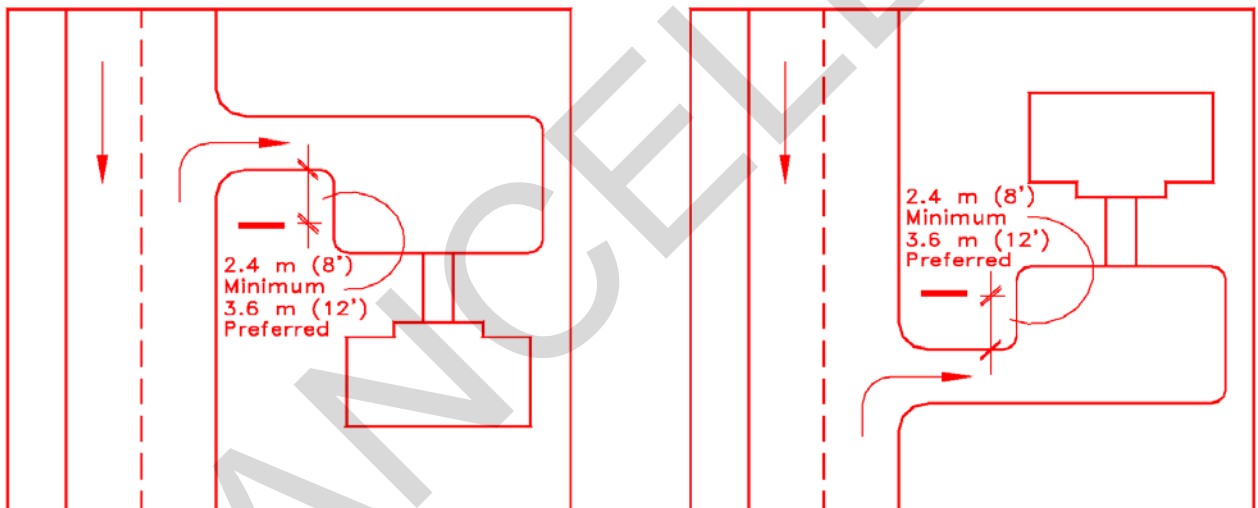

Figure 2.38. Military Facility Sign Visibility.



2.22. Military Building Entry Sign Type B4.

2.22.1. Placement. Place the Military Building Entry sign, Type B4, directly on the wall next to the secondary entry point. (Figure 2.39).

2.22.2. Visibility. If the building is set back from the roadway and is not visible or only partially visible from the roadway, place the sign next to the main entrance of the building to confirm the information shown on the Type B1, B2 or B3 sign placed at the entrance driveway (Figure 2.40).

Figure 2.39. Military Building Entry Sign Placement.

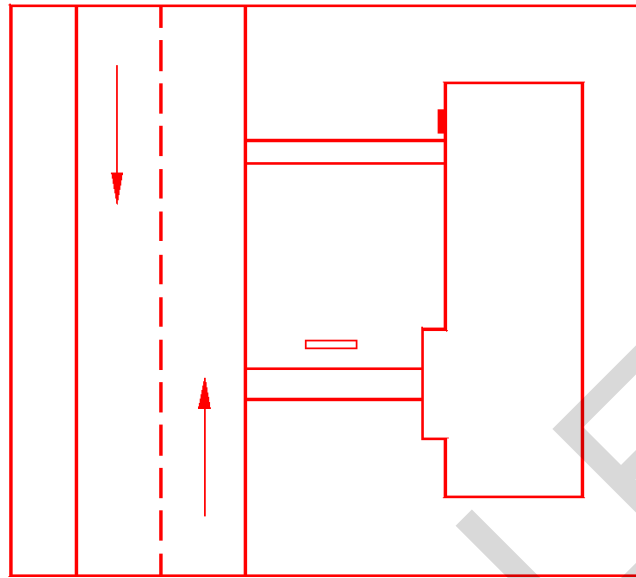
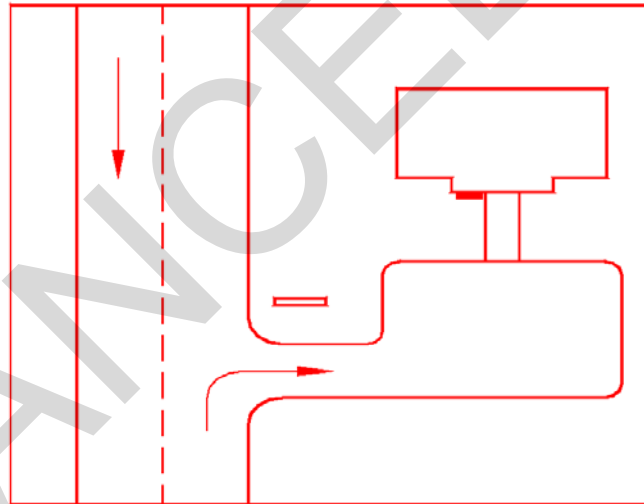
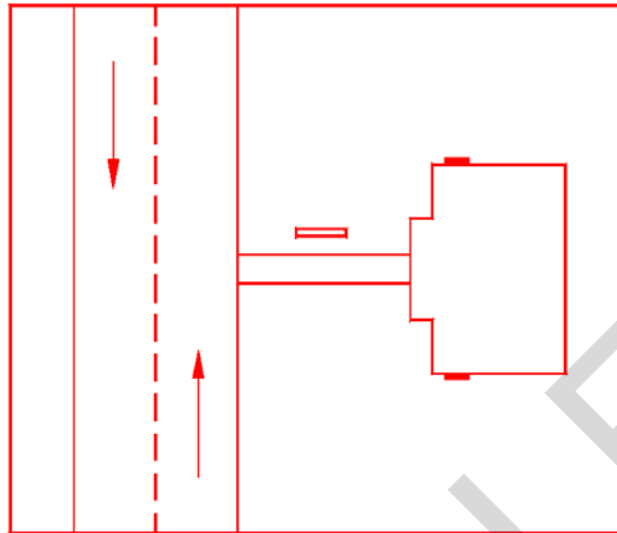

Figure 2.40. Military Building Entry Sign Visibility.



2.23. Building Number Sign Type B5. The Type B5 Building Number Sign may be used in addition to the Type B4 sign if building number identification is needed to accommodate emergency response or real property requirements. In the absence of installation-specific mounting requirements for visibility by security police and fire personnel, the Type B5 sign is mounted directly below the Building Entry Sign.

Figure 2.41. Building Number Sign - Alternate Locations for Visibility by Security Police and Fire Personnel.



2.24. Centralized Facilities Sign Type C1.

2.24.1. Placement. Place the Centralized Facilities Sign, Type C1, on the side of the roadway next to the entrance to the parking area (Figure 2.42).

2.24.2. Visibility. Place the sign no less than 1.8 m (8') from the entrance to the parking area. Set the sign perpendicular to the roadway to permit viewing by traffic moving in both directions.

Figure 2.42. Centralized Facilities Sign Placement.

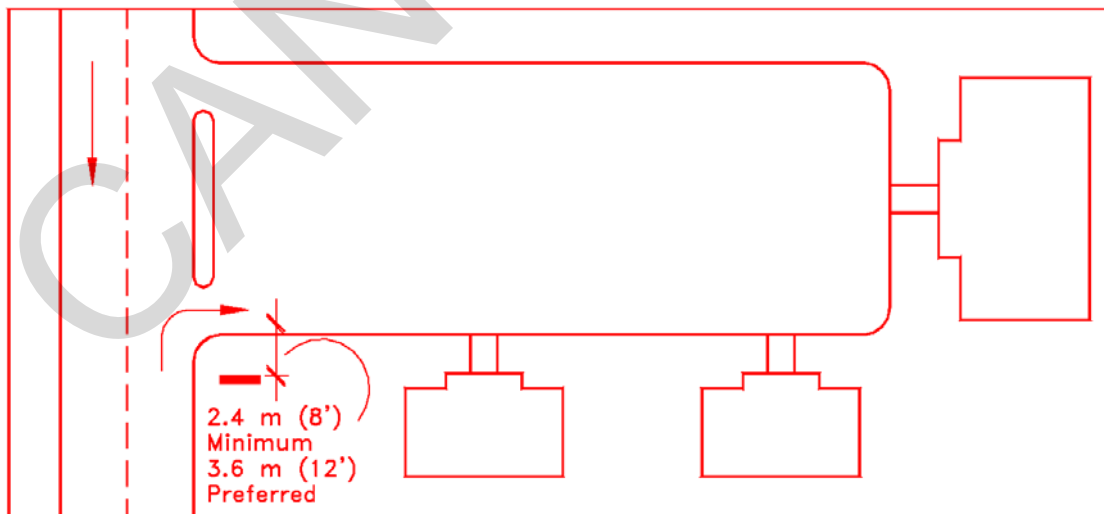

2.25. Community Facility Signs Types C2 and C3.

2.25.1. Placement. Place the Community Facility Signs, Types C2 and C3, as close as possible to the building entrance, and perpendicular to the roadway to permit viewing by traffic moving in both directions (Figure 2.43). Avoid placing freestanding community signs where other wall-mounted signs exist that are easily readable from the street, such as exchanges and commissaries.

2.25.2. Visibility. If the facility is set back from the roadway and is not visible or only partially visible from the roadway, place the sign next to the entrance driveway (Figure 2.43).

2.25.3. Relationship to Parking. Place the sign no less than 2.4 m (8') from the entrance to the parking area.

2.26. Community Building Entry Sign Type C4.

2.26.1. Placement. Place the Community Building Entry sign, Type C4, directly on the wall next to the secondary entry point (Figure 2.45).

2.26.2. Visibility. If the building is set back from the roadway and is not visible or only partially visible from the roadway, place the sign next to the main entrance of the building to confirm the information shown on the sign at the entrance driveway (Figure 2.46).

Figure 2.43. Community Facilities Sign Placement.

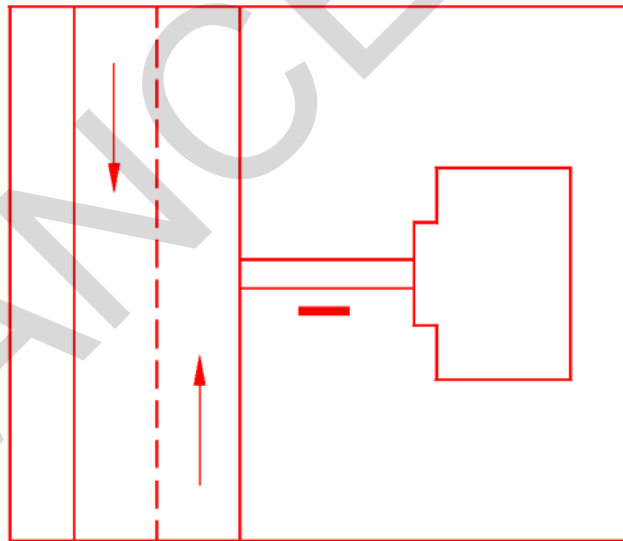
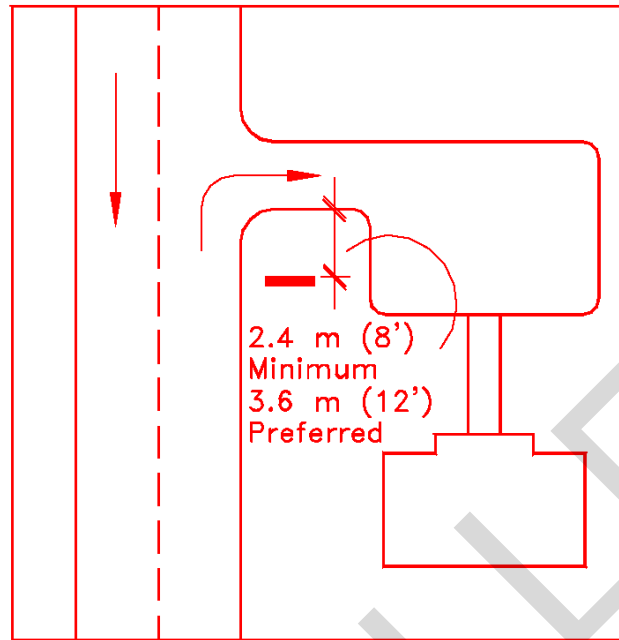

Figure 2.44. Community Facilities Sign Visibility.



2.27. Recreational Facility Sign Type C5. Place the Type C5 sign directly on a wall or fence next to the entrance to a recreational facility (Figure 2.47).

2.28. Bus Route Sign Type C6. Place the type C6 sign at the side of the roadway to indicate a bus stop in accordance with the Manual on Uniform Traffic Control Devices 2B-32 (Figure 2.48).

2.29. Destination Signs Types D1 and D2.

2.29.1. Placement. The Manual on Uniform Traffic Control Devices states that destination signs should be placed 60 m (200') or more in front of an intersection in rural or outlying areas. Shorter distances may be justified in urban or built-up areas.

2.29.2. Visibility. Set the sign perpendicular to the roadway. Graphics usually occur on only one side of the sign since most destination signs are placed in advance of an intersection on the right-hand side of the road where the driver is accustomed to looking (Figure 2.49).

2.29.3. Separation Distance. If two destination signs are used before an intersection, place the signs in accordance with the separation distance criteria in Table 2.2. See Figure 2.50 for example.

Figure 2.45. Community Building Sign Placement.

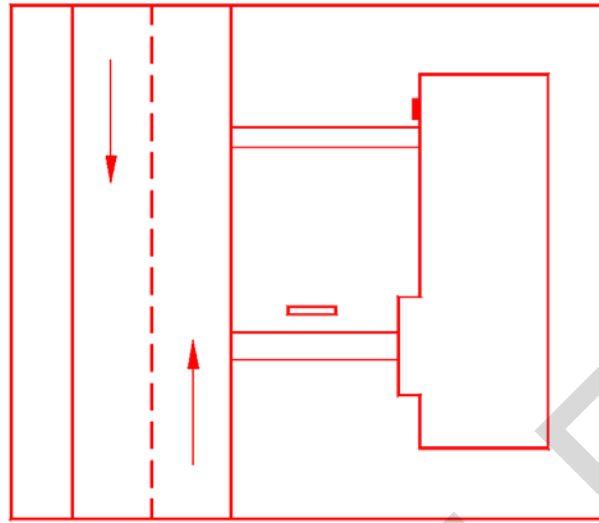

Figure 2.46. Community Building Sign Visibility.

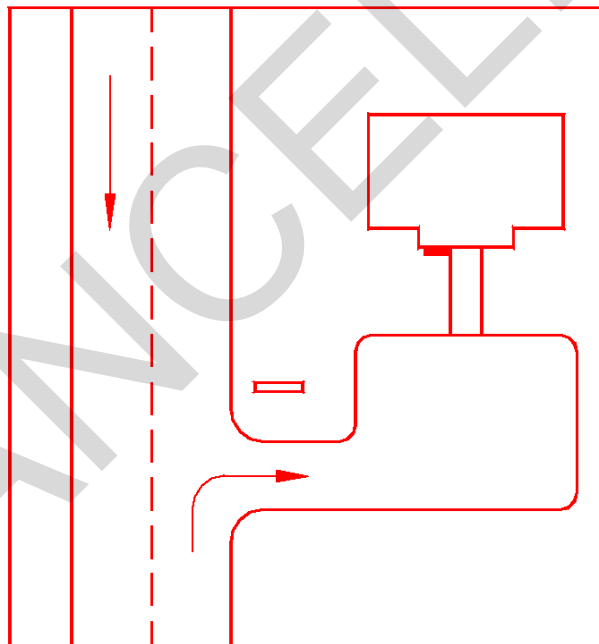

Figure 2.47. Recreational Facility Sign.

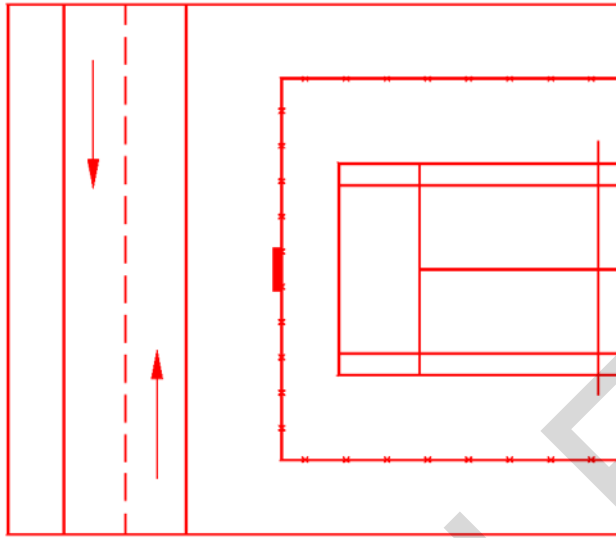

Figure 2.48. Bus Route Sign.

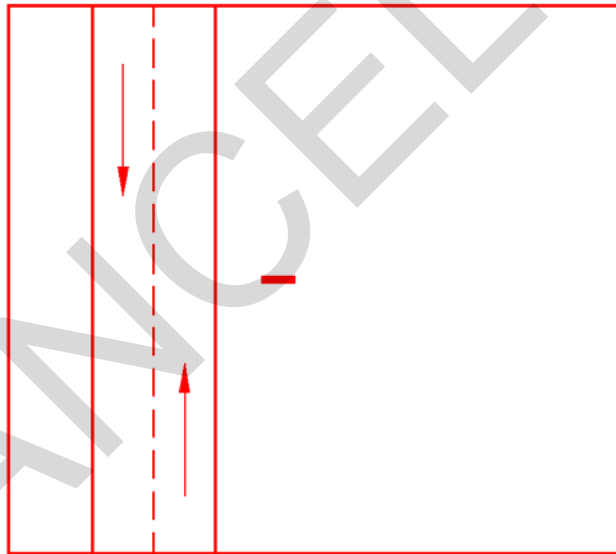

Figure 2.49. Destination Sign.

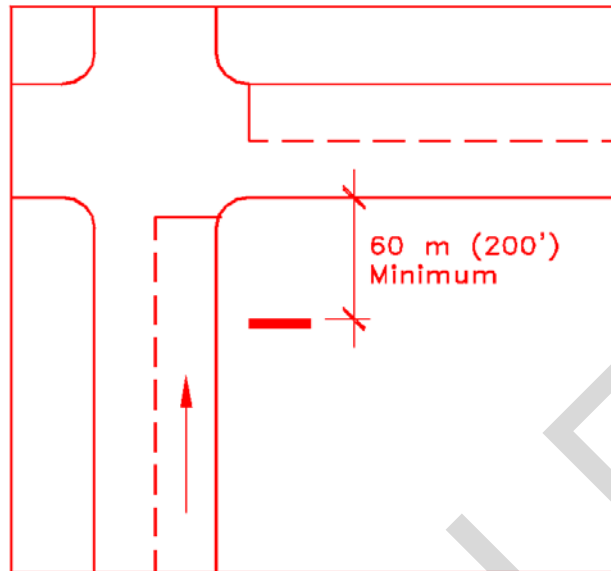

Table 2.2. Separation Distance Criteria.

Design Speed		Separation Distance	
Kilometers per Hour	Miles per Hour	Meters	Feet
40 or less	25 or less	45	150'
48	30	60	200'
56	35	75	250'
64	40	100	325'
72	45 or more	120	400'

2.30. Warning Signs Types E1 and A3.

2.30.1. Placement. Place the Type E1 Warning sign approximately 15 m (50') in advance of all vehicle entry gates. The Type A3 Base Identification sign may be combined with the type E1 sign on the same sign structure (Figure 2.51).

2.30.2. Separation of Signs. If more than two sign structures are used, place the signs at least 15 m (50') apart (Figure 2.52).

2.31. Warning Sign Type E2.

2.31.1. Area Boundaries. Place the Type E2 Base Warning signs directly on fences or walls which define area boundaries as directed by AFI 31-209 and AFI 31-101 (Figure 2.53).

2.31.2. Buildings. Place the warning signs for buildings on the entrance doorways (Figure 2.54).

Figure 2.50. Separation Distance Criteria.

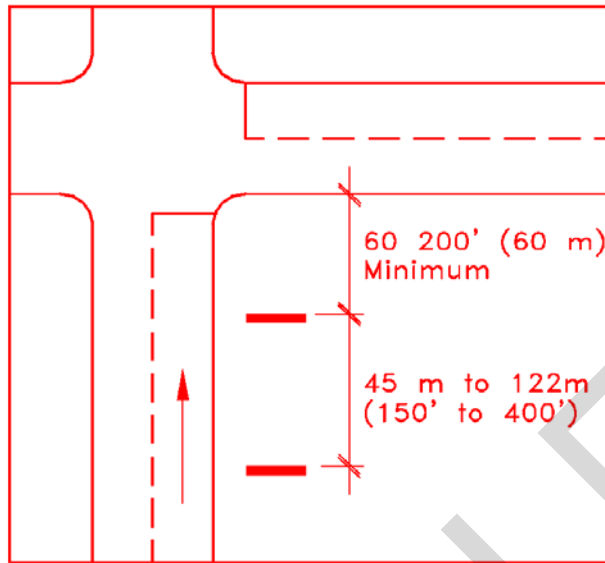

Figure 2.51. Warning and Base Identification Signs on Same Structure.

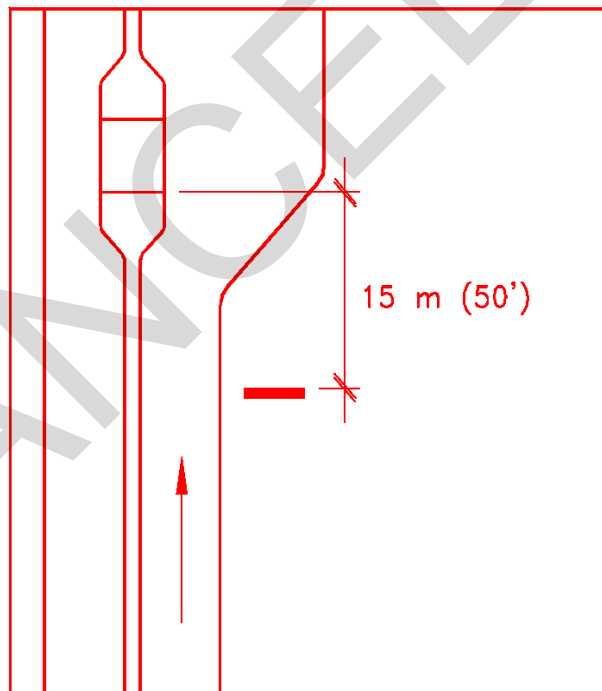

Figure 2.52. Warning and Base Identification Signs on Different Structures.

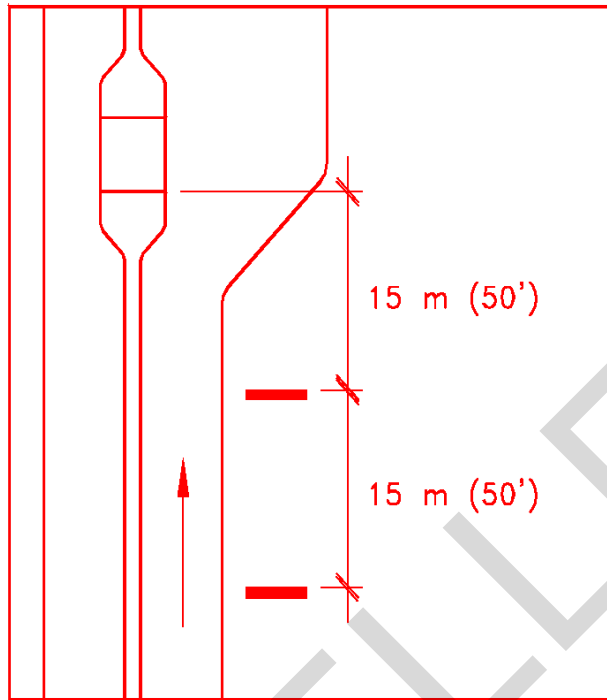

Figure 2.53. Warning Sign on Area Boundary.

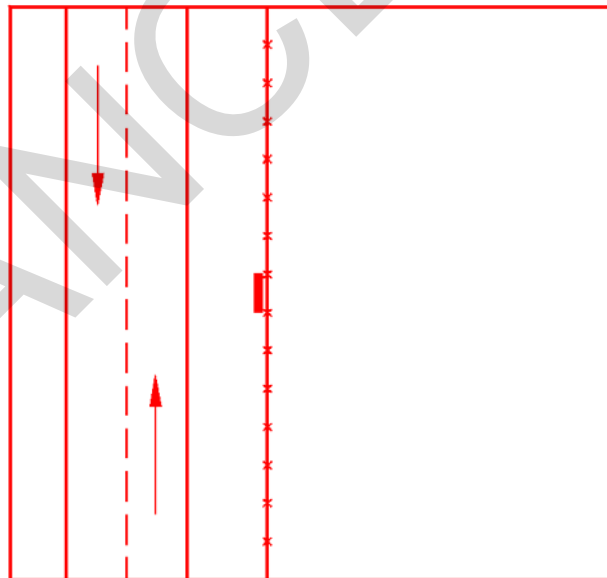
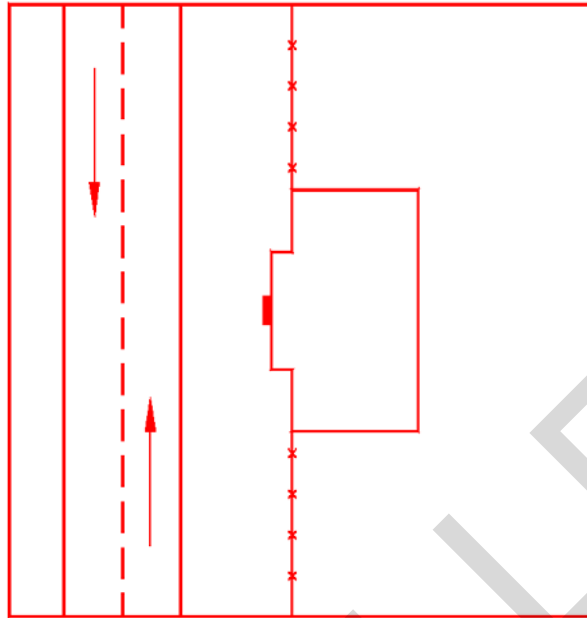

Figure 2.54. Warning Sign on Building.



2.32. Parking Regulation Sign Type E3. Placement Standards for Parking Regulation Signs are shown in the Manual on Uniform Traffic Control Devices 2B-31 to 2B-34.

2.33. Parking Regulation Sign Type E4.

2.33.1. Placement. Type E4 Reserved Parking Signs may be wall-mounted if the parking stall is close enough to an existing wall to permit clear identification (See Figure 2.55). Otherwise, place freestanding signs as shown in Figure 2.56.

2.33.2. Area Designation. Where possible, reserved parking should be designated by areas, not individual spaces, as designations change frequently and numerous signs add to visual clutter. Reserved parking should be kept to a minimum.

2.33.3. Curb Markings. Apply curb markings for reserved parking directly to the curb only when no other method of designation is possible, as determined by the Sign Control Group or designated representative from the civil engineering office.

2.34. Base Morale Signs Types F1a & F1b.

2.34.1. Placement of F1a. Place the Base Morale sign, Type F1a, inside the main gate and perpendicular to the roadway, to permit viewing by traffic entering the base (Figure 2.57). As an alternative, place the sign at a central location on base, in an open area free from other signs or obstructions. Place the sign parallel to the traffic flow, and set it back a minimum distance of 3.6 m (12') from the edge of the roadway (Figure 2.58).

2.34.2. Placement of F1b. Sign Type F1b should be placed parallel to the flight line at the

principal arrival point.

Figure 2.55. Wall-Mounted Parking Signs.

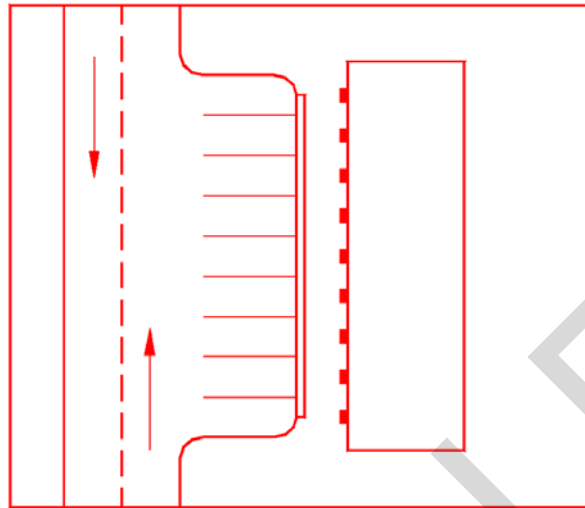

Figure 2.56. Freestanding Parking Signs.

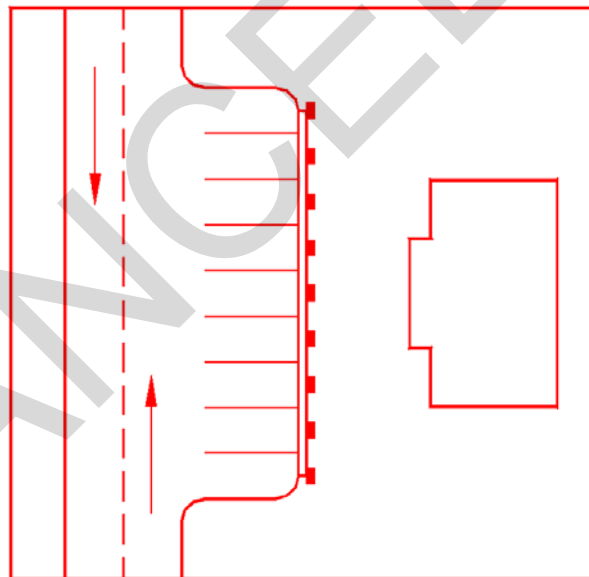

Figure 2.57. Base Morale Sign Inside Gate Placement.

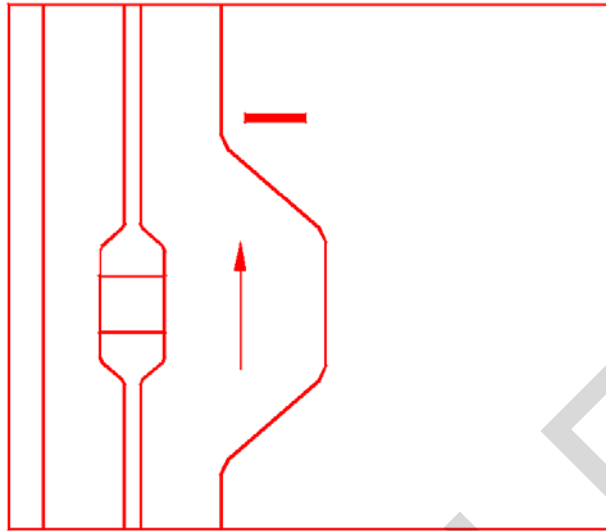
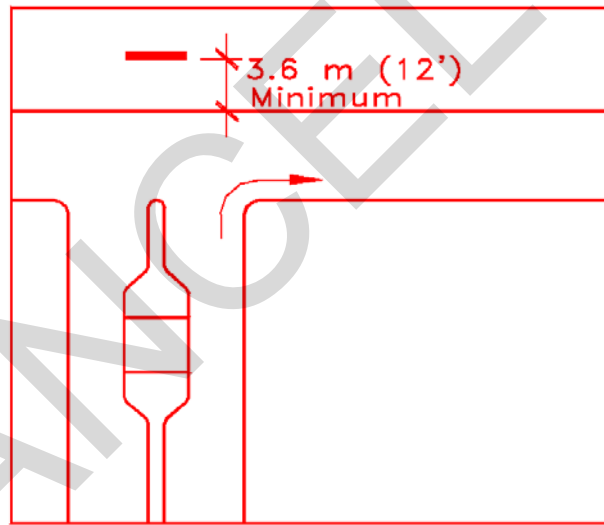
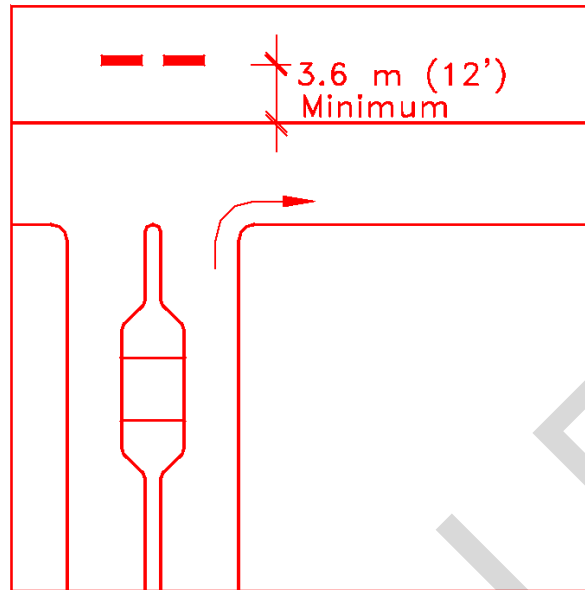

Figure 2.58. Base Morale Sign Central Location Placement.



2.35. Standard Morale Sign Type F2. The Standard Morale sign, Type F2, may be placed at three or four locations on base in open areas free from other signs or obstructions. Place the sign parallel to the traffic flow, and set it back a minimum distance of 3.6 m (12') from the edge of the roadway (Figure 2.59).

Figure 2.59. Standard Morale Sign.



2.36. Unit Morale Sign Type F3.

2.36.1. Placement. Locate the Unit Morale sign, Type F3, so that it does not conflict with the building identification sign (Figure 2.60).

2.36.2. Visibility. If the building is set back from the roadway and is not visible or is only partially visible from the roadway, place the sign near the entrance to the building (Figure 2.61).

2.37. Information Signs Types G1 and G2. Place the Information signs, Types G1 and G2, in the vicinity of the exhibit they describe, oriented to the roadway or to the principal direction from which a visitor will approach.

2.38. Pedestrian Information Sign Type G3.

2.38.1. Placement. This sign provides directional guidance for pedestrians and should be placed a minimum of 0.3 m (1') back from the sidewalk or edge of the normal pedestrian pathway (Figure 2.62).

2.38.2. Description. The sign is set perpendicular to the pathway and has graphics on both sides for viewing by people moving in both directions.

2.38.3. Separation Distance. A minimum lateral separation distance of 3.6 m (12') from the edge of the vehicular roadway or the face of the curb is recommended (Figure 2.62).

Figure 2.60. Unit Morale Sign and Building Identification Sign.

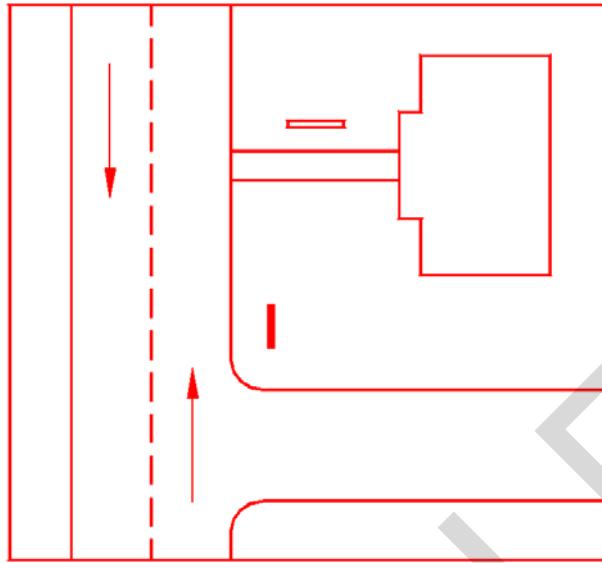

Figure 2.61. Unit Morale Sign Near Entrance.

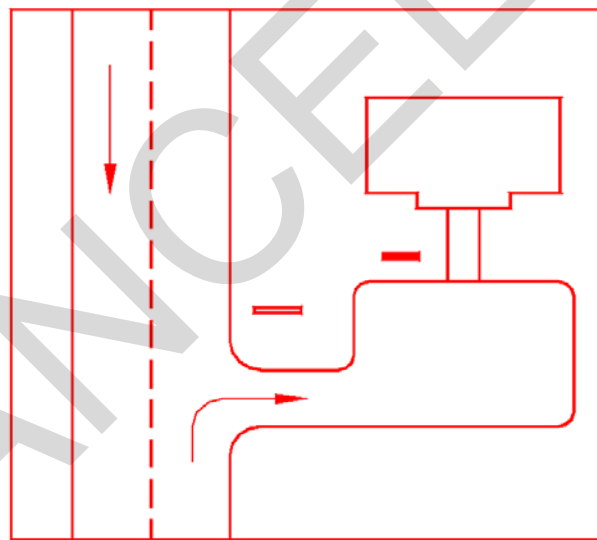
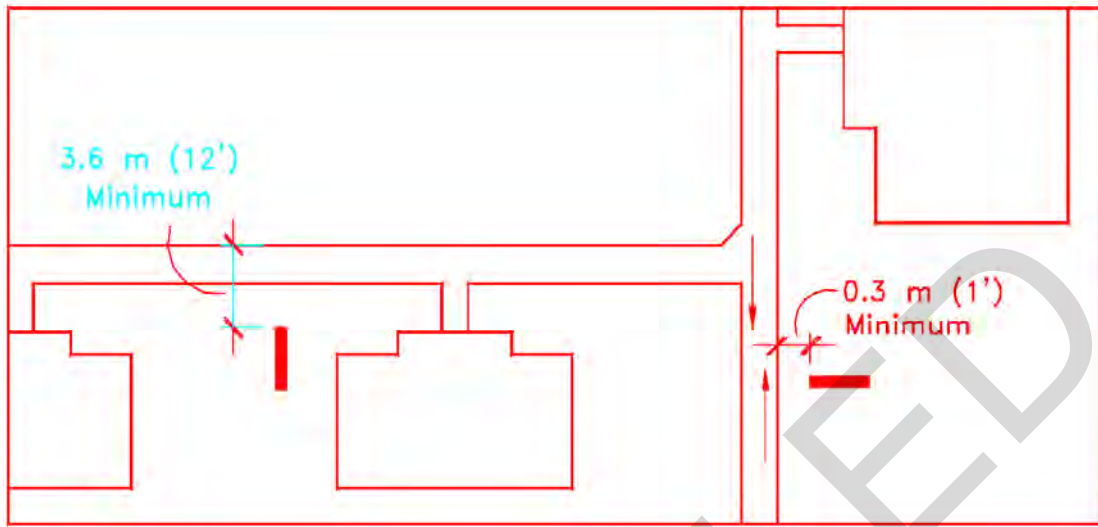

Figure 2.62. Pedestrian Information Sign Placement and Separation Distance Criteria.



2.39. Wall Mounted Exterior Signs.

2.39.1. Style. Wall mounted signs should complement the architectural style and siting of each building. The message should be placed where it can be clearly seen by visitors.

2.39.2. Placement. Place the message over the main entrance to the building whenever possible. See Chapter 10 for further placement criteria.

2.39.3. Visibility. Use the manufacturer's template to check the final positioning of the message on the wall prior to installation. Check the sight lines to ensure that the message is not blocked by foliage or other obstructions.

2.39.4. Coequal Organizations. If the building houses two coequal organizations, place the messages flush to opposite sides of the building facade.

2.39.5. Non-frontal Entrance. If the main entrance does not front on the roadway, place the message on the side of the building that faces the roadway and flush to the entrance side of the building. Mount the organizational emblem adjacent to the entrance.

2.39.6. Set Back Entrances. If the building is set back from the roadway and is not visible or only partially visible from the roadway, place a freestanding identification sign next to the entrance driveway to the building on the side of the driveway closest to the building. Place the wall-mounted sign over the main entrance to the building.

Chapter 3

THE AMERICANS WITH DISABILITIES ACT

Section 3A—Introduction

3.1. Background and Purpose. The Americans with Disabilities Act (ADA) was passed by Congress in 1990 and was fully implemented in 1992. It is intended to extend civil rights protection and provide equal accommodations and access for the disabled.

3.2. Compliance. On military installations, any area or building that is used by civilians or the general public must comply with the Americans with Disabilities Act Accessibility Guidelines (ADAAG) or the Uniform Federal Accessibility Standards (UFAS), whichever is more stringent.

3.3. Scope. This pamphlet is not intended to be a complete guide to the ADA, nor is it a comprehensive ADA signage document. Base civil engineers and other personnel involved in the design or construction of the built environment, including signs, are urged to consult the ADAAG and UFAS for information on all aspects of accessibility. Complete information on sign design is included in the ADAAG and UFAS. Designers should work with manufacturers and contractors to ensure that the affected signs comply.

3.4. Accessibility. The general idea of the ADAAG and UFAS is to provide *accessible routes* to all accessible spaces within a site or building. Ensure that all new construction and additions or alterations to existing buildings are accessible. Additions or alterations must never *decrease* the accessibility of a facility. In general, any change should be towards greater accessibility.

3.5. Exterior Signs. Although the ADAAG and UFAS apply mostly to interior signs, there are several types of exterior signs that must also be considered. Accessible routes should be provided from parking areas, public transportation stops, and public streets or sidewalks to building entrances. In general, exterior signs that are intended to be read from vehicles are not affected by ADAAG and UFAS requirements (except for parking signs), while signs that are used by pedestrians are affected.

3.6. Sign Design. The ADAAG and UFAS impact sign design in five ways: character proportion, character height, the use of characters and pictorial symbols, finish and contrast, and mounting location and height. There are also requirements governing the use of symbols denoting accessibility.

Section 3B—Characters

3.7. Character Legibility. Character legibility results from the relationship of many factors, including viewing distance, character height and width, stroke height and width, font style, the contrast with the background, and surface glare. The ADA requirements are intended to address all of these concerns so that signs are legible to the widest possible range of people.

3.8. Character Proportion. There are two aspects of character proportion: the width to height ratio of the letter and the width to height ratio of the strokes that form the letter. Both are important for

ADA compliance.

3.9. Width to Height Ratio. The acceptable range of width to height ratios for letters and numbers on signs is from 1:1 to 3:5. That is, letters can vary from having the width equal to the height (1:1) to having 3 units of width for every 5 units of height. Text that uses the 3:5 ratio is closer in appearance to standard text.

3.10. Range of Stroke. The acceptable range of stroke width to height is from 1:5 to 1:10.

3.11. Character Height. Text on signs is sized according to the distance from which it is to be read. The minimum height required is measured using an upper case 'X'. Signs suspended or projected overhead for an accessible route are mounted with their bottoms a minimum of 2 000 mm (80") above the finished floor. Letters on these signs have a minimum height of 75 mm (3").

3.12. Raised and Brailled Characters. Raised and Brailled characters and symbols are only required on signs that designate permanent rooms or spaces, including restrooms and room numbers. They are not required for informational or way-finding signs. Raised letters and numerals on signs must protrude a minimum of 0.8 mm (1/32") from the surface of the sign. All letterforms must be all upper case with typeface of san serif or simple serif. Character height must be between 16 mm (5/8") and 50 mm (2"). Raised letters must be accompanied by Grade 2 Braille. Pictograms must have a minimum clear border of 150 mm (6") and must be accompanied by a verbal description directly below the pictogram.

Figure 3.1. Width to Height Ratio.

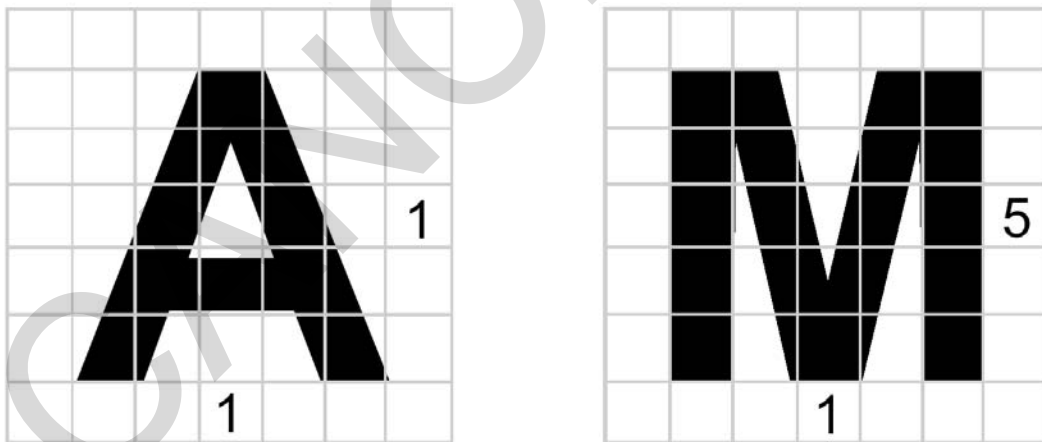

LETTER WIDTH TO HEIGHT RATIO: 1:1

LETTER STROKE WIDTH TO HEIGHT RATIO: 1:5

3.13. Finish and Contrast with Background. Finish and contrast are an important factor in legibility. Both the characters and background of ADA compliant signs must have a matte, eggshell, or other non-glare finish. An eggshell finish is defined as 11 to 19 degrees of gloss on a 60 degree glossimeter. Characters and symbols must contrast with the sign background; that is, light characters must be on a dark background and dark characters must be on a light background. Light characters on a dark background are generally considered to provide the greater readability.

Section 3C--Mounting and Illumination

3.14. Mounting Guidelines. Permanent signs should comply with the following mounting guidelines:

3.14.1. Install interior signs that identify rooms or spaces on the wall adjacent to the latch side of a door. If there is no wall space at the latch side of the door, place the sign on the nearest adjacent wall.

3.14.2. The mounting height of interior signs that identify rooms or spaces is 1 525 mm (60" A.F.F.) to the centerline of the sign.

3.14.3. The mounting location of interior signs should be arranged so that a person can approach within 75 mm (3") of the sign without encountering protruding objects or a door swing.

3.15. Recommended Illumination. Recommended illumination levels are uniform over a sign surface and should be between 107 and 3 23 lux (10 and 30 foot-candles).

Section 3D--Symbols of Accessibility

3.16. Facilities. Facilities and portions of facilities required to be identified as accessible must display the international symbol of accessibility. This includes accessible passenger loading zones, accessible entrances when not all entrances are accessible, accessible toilet and bathing facilities when not all are accessible, and accessible parking spaces.

3.17. Telephones and Listening Systems. Text telephones must display the international TDD symbol, and listening systems must display the international symbol of hearing loss. Consult the ADAAG and UFAS for further information.

Figure 3.2. International Symbols of Accessibility.

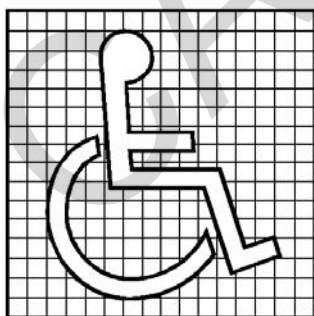

Accessibility



Access for Hearing Loss



TDD Symbol

Chapter 4

EXTERIOR IDENTIFICATION SIGNS

Section 4A—Introduction

4.1. Types of Signs. There are three types of exterior identification signs. These are Base Identification Signs, Military Identification Signs, and Community Identification Signs. Signs may be finished with enamel or covered with reflective sheeting, depending on the type of sign and the intended placement. Signs that are placed in a well-lit area or are illuminated by flood lights are usually covered with reflective sheeting to facilitate night visibility.

4.2. Sides of Signs. Graphics may appear on one or both sides of a sign, depending on sign type and sign placement. Free standing identification signs mounted perpendicular to the roadway are usually two-sided, while most other signs are one-sided.

4.3. Criteria for Signs. The criteria for standard free-standing building identification signs should be used for the buildings on most bases. On some bases, the base commander may choose to use wall mounted building identification signs. Information on these signs can be found in Chapter 10. Buildings with historic character should be identified with the signs for historic buildings described in Chapter 9.

4.4. Further Information. Refer to Chapter 2 for information on typography and sign placement. Chapter 12 gives the specifications and structural criteria for sign construction.

Section 4B--Base Identification Signs

4.5. Introduction. The base identification sign forms a significant part of a visitor's first impression of the base. It introduces the installation and influences visitors' reactions. Good design, organization, and maintenance are crucial.

4.6. Types of Signs. There are three types of base identification signs. The Main Entrance Sign, Type A1, is used to identify the principal visitor entrance to the base (Figure 4.1). The Secondary Entrance Sign, Type A2, is used to identify secondary entrances that receive high volumes of visitor traffic (Figure 4.2). The Entry Gate Sign, Type A3, is used to identify secondary entrances with limited public access (Figure 4.3). It may also be used in conjunction with Type A1 and A2 signs if the entry gate is located at a distance from the main access road. The Type A3 sign is mounted on the same sign structure as the Base Warning Sign. (See Chapter 6 for information on the Base Warning Sign.)

4.7. Placement of Graphics. Graphics should appear on only one side of base identification signs since they are either viewed by incoming traffic or placed parallel to the roadway.

Figure 4.1. Main Entrance Type A1.

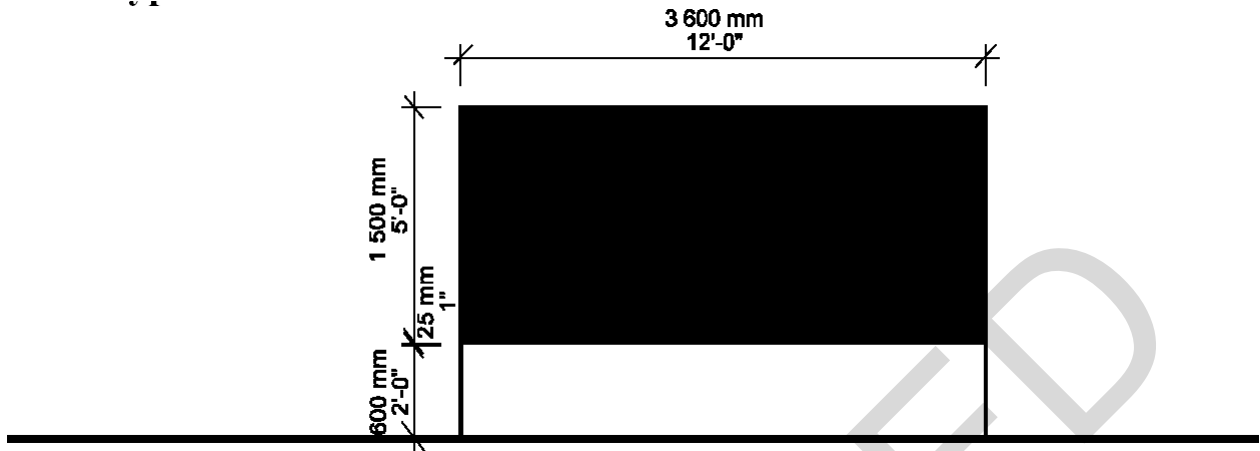

See Figure 4.5.

Figure 4.2. Secondary Entrance Type A2.

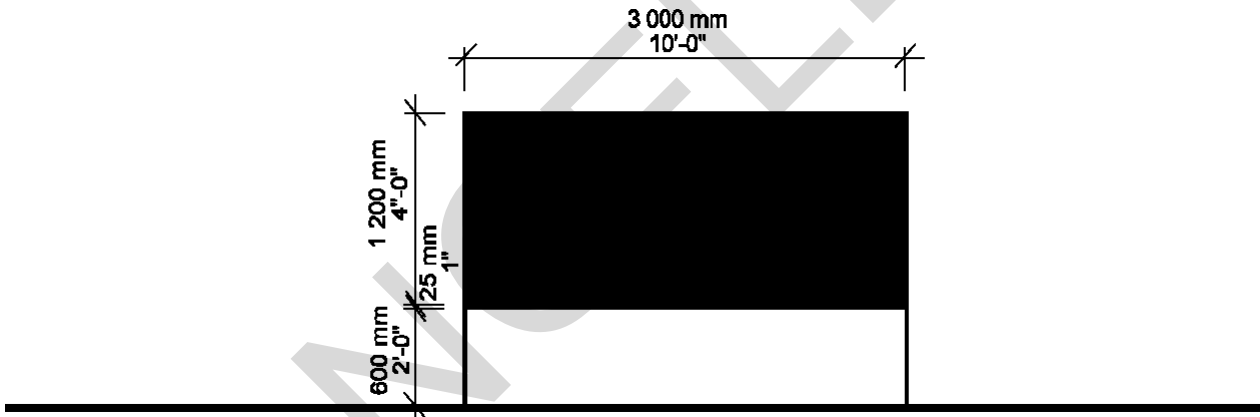

See Figures 4.6 and 4.7.

Figure 4.3. Entry Gate Type A3.

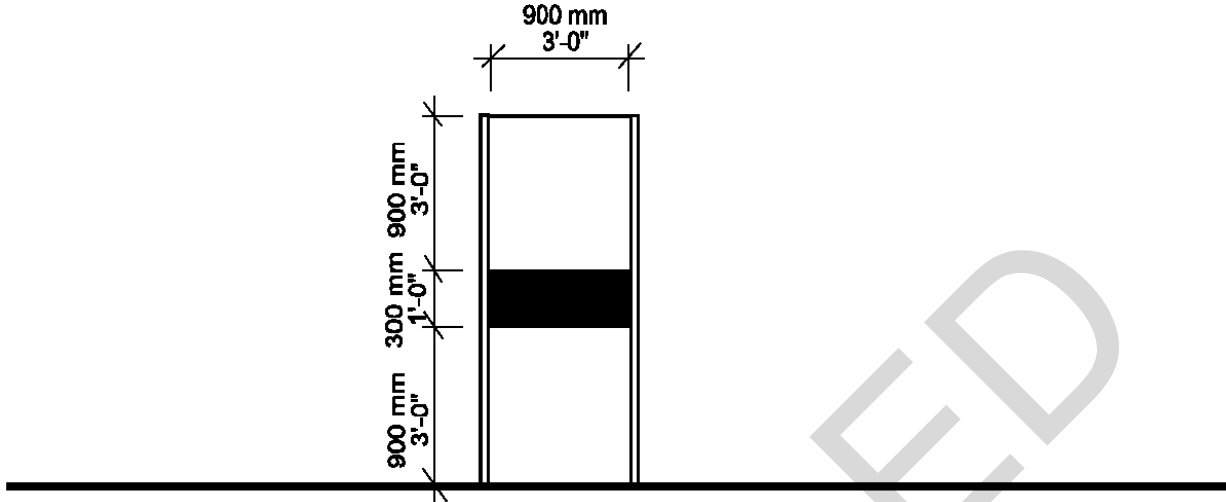

See Figure 4.8.

4.8. Main Entrance Sign Type A1.

4.8.1. General Description. Air Force installations can create a consistent professional image by developing greater uniformity in the design of entrance signs. The structure supporting the sign may vary to complement the predominant architectural style of the base, but the design of the sign itself should conform to the following standards (Figure 4.4).

4.8.2. Information. The sign face shall contain only the following information:

- The title "U.S. AIR FORCE" in upper case letters.
- The installation name in upper and lower case letters.
- The Air Force Symbol.

4.8.3. Other Graphics and Lettering. No additional graphics or lettering are to be applied.

4.8.4. Materials. The symbol and letterforms will be constructed of stainless steel or aluminum, approximately 1/2" in depth. The symbol and letterforms are to be mounted in such a way as to provide a minimum 1/2" clearance from the background surface. The background material should be durable and require minimal maintenance.

4.8.5. Colors. No color will be applied (factory or field applied) to the symbol or letterforms. The visible metallic surfaces may have either a brushed or polished finish. Background material requiring either a factory or field applied color will be either Standard Blue (see paragraph 2.18.1.) or Standard Brown (see paragraph 2.18.2.). Backgrounds composed of masonry units, such as brick, concrete or stone, will use a mortar color that closely matches the unit color to optimize visibility of the symbol and letterforms. Entrance signs with backgrounds composed of light-colored stucco and consistent with a base-wide architectural theme are acceptable.

4.8.6. Proportions/Shapes. Due to the diversity of some existing entrance signs, the application of the symbol and letterforms composition may vary in overall size, but must maintain the composition and proportions as shown (see Figure 4.5.). The shape of the letterforms are to be based on “Arial Black” font. The shapes of neither the symbol nor the letterforms are to be altered in any way.

4.8.7. Visibility. Position and orient the symbol and letterforms in a way that provides the best visibility from public ways. Size the symbol and letterforms proportional composition as large as is practical so as to be easily read from a reasonable distance. Avoid a cluttered appearance by having no more than one application of the symbol and letterforms at an entrance, unless the entrance sign is oriented to be viewed from either side.

4.8.8. Layout. See Figure 4.5 for sign layout options. Dimensions shown are based on application to the standard Sign Type A1. When conditions require a larger or smaller application of the symbol and letterforms, all dimensional proportions are to be maintained.

Figure 4.4. Main Entrance Sign Type A1 Dimensions.



Figure 4.5. Main Entrance Sign Type A1 Layouts.

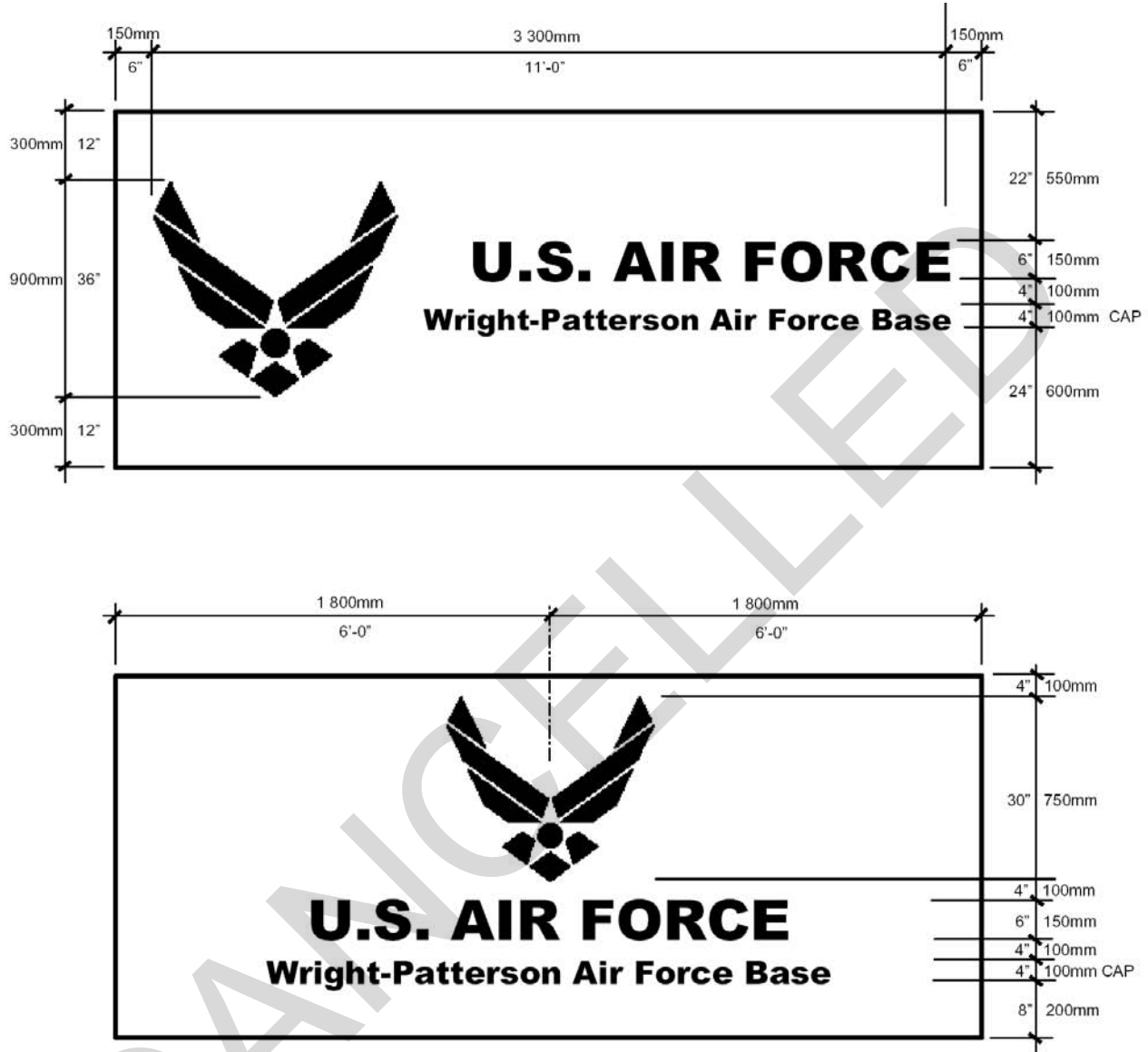

4.9. Secondary Entrance Sign Type A2.

4.9.1. Placement. Many bases have one or more secondary entrances in addition to the main gate. Place sign Type A2 at secondary entrances that receive high volumes of visitor traffic.

4.9.2. Information. The sign face is slightly smaller than the main entrance sign (see Figure 4.6.) and shall contain only the following information:

- The title "U.S. AIR FORCE" in upper case letters.
- The installation name in upper and lower case letters.
- The Air Force Symbol.

4.9.3. Other Graphics and Lettering. No additional graphics or lettering are to be applied.

4.9.4. Materials. The symbol and letterforms will be constructed of stainless steel or aluminum, approximately 1/2" in depth. The symbol and letterforms are to be mounted in such a way as to provide a minimum 1/2" clearance from the background surface. The background material should be durable and require minimal maintenance.

4.9.5. Colors. No color will be applied (factory or field applied) to the symbol or letterforms. The visible metallic surfaces may have either a brushed or polished finish. Background material requiring either a factory or field applied color will be either Standard Blue (see paragraph 2.18.1.) or Standard Brown (see paragraph 2.18.2.). Backgrounds composed of masonry units, such as brick, concrete or stone, will use a mortar color that closely matches the unit color to optimize visibility of the symbol and letterforms. Entrance signs with backgrounds composed of light-colored stucco and consistent with a base-wide architectural theme are acceptable.

4.9.6. Proportions/Shapes. Due to the diversity of some existing entrance signs, the application of the symbol and letterforms composition may vary in overall size, but must maintain the composition and proportions as shown (see Figure 4.7.). The shape of the letterforms are to be based on "Arial Black" font. The shapes of neither the symbol nor the letterforms are to be altered in any way.

4.9.7. Visibility. Position and orient the symbol and letterforms in a way that provides the best visibility from public ways. Size the symbol and letterforms proportional composition as large as is practical so as to be easily read from a reasonable distance. Avoid a cluttered appearance by having no more than one application of the symbol and letterforms at an entrance, unless the entrance sign is oriented to be viewed from either side.

4.9.8. Layout. See Figure 4.7 for sign layout options. Dimensions shown are based on application to the standard Sign Type A2. When conditions require a larger or smaller application of the symbol and letterforms, all dimensional proportions are to be maintained.

4.10. Entry Gate Sign Type A3.

4.10.1. Placement. Certain secondary entrances are used primarily by personnel employed on the base, rather than by visitors. These entrances do not require major identification signs such as the Type A1 and A2, and may be identified with the Type A3 sign at the entry gate.

4.10.2. General Description. The Type A3 sign can be used in combination with Type A1 and A2 signs when the repetition of the gate name is helpful to the visitor, such as when the entry is a long distance from the entrance. The Type A3 sign is mounted with the Type E1 Base Warning Sign. (See paragraph 6.12.2 for additional guidelines.)

4.10.3 Colors. White letters on standard brown background.

4.10.4. Dimensions. 300 mm x 900 mm (1' - 0" x 3' - 0").

4.10.5. Emblem. Seals and emblems are not permitted on Type A3 signs.

4.10.6. Layouts. There are two layouts available, the standard layout and the expanded layout, based on the length of message required. If the base name is too long to fit on the standard layout, use of the expanded layout may be used. The expanded layout has smaller lettering than the standard one and can therefore accommodate a longer message.

4.10.7. Standard Layout/Typography.

- Base Name: upper and lower case Helvetica medium, 75 mm (3") capital letter height, flush left. The message line will accommodate a maximum of 15 tiles or characters. Use the abbreviation AFB.
- Gate Name: upper and lower case Helvetica medium, 50 mm (2") capital letter height, flush left. See Figures 4.9 and 4.10 for the sign layouts.

4.10.8. Expanded Layout Typography.

- Unit Name: upper and lower case Helvetica medium, 50 mm (2") capital letter height, flush left. The message line will accommodate a maximum of 25 tiles or characters. Use the abbreviation AFB.
- Gate Name: upper and lower case Helvetica medium, 50 mm (2") capital letter height, flush left.

Figure 4.6. Secondary Entrance Sign Type A2 Dimensions.



Figure 4.7. Secondary Entrance Sign Type A2 Layouts.

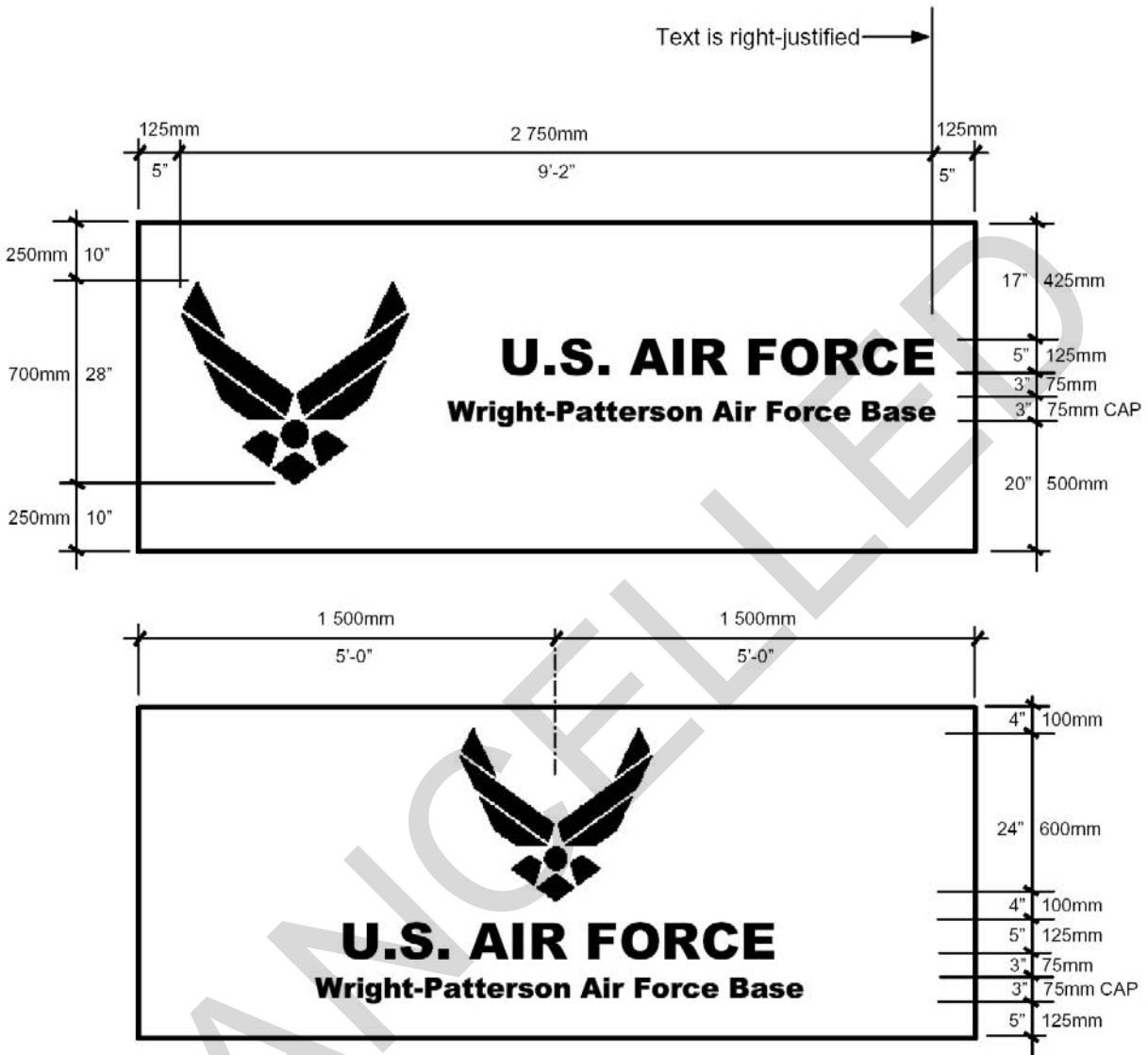

Figure 4.8. Entry Gate Sign Type A3 Dimensions.

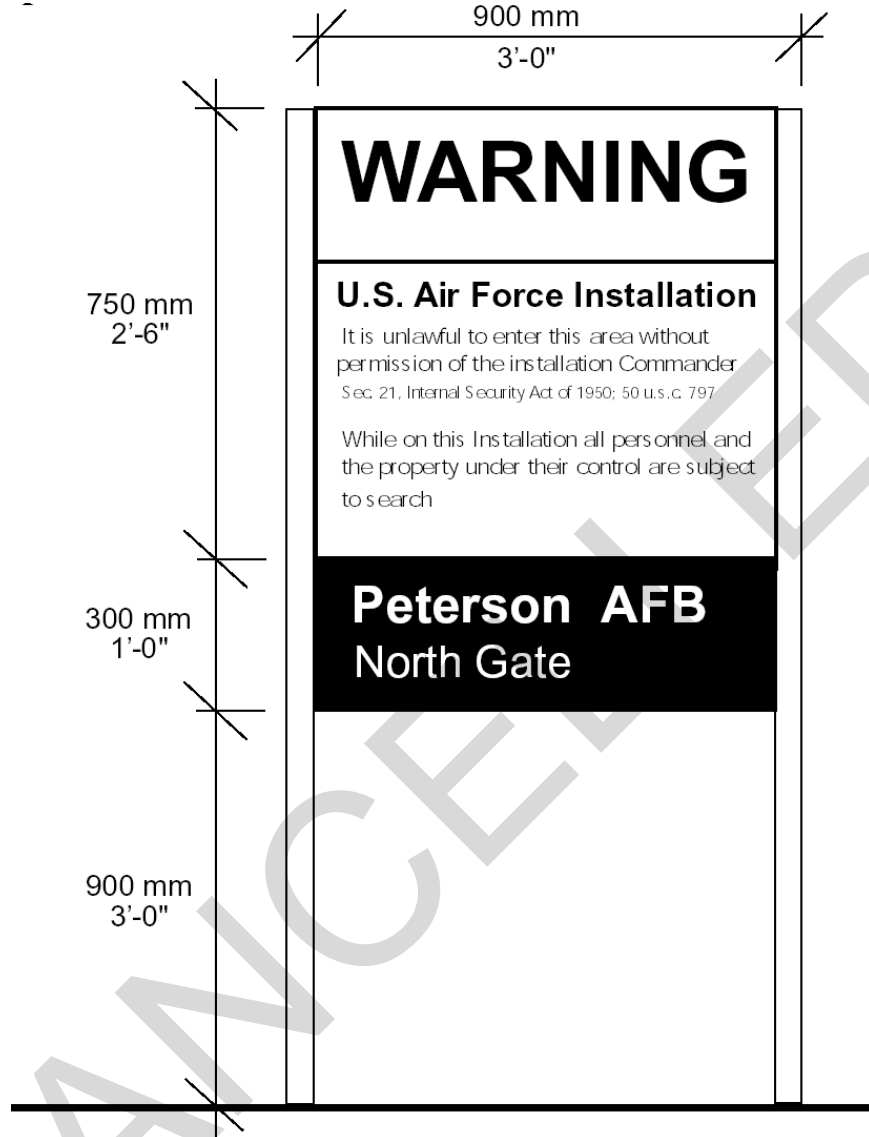

Figure 4.9. Entry Gate Type A3 Standard Layout.

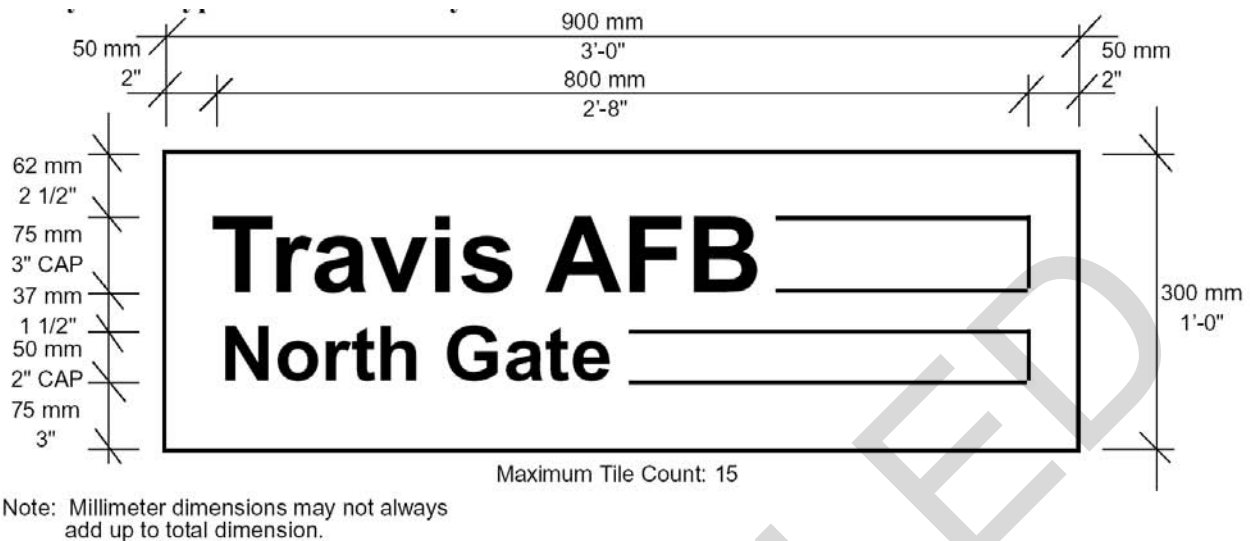

Figure 4.10. Entry Gate Type A3 Expanded Layout.



Section 4C--Military Identification Signs.

4.11. Introduction. There are six types of signs used to identify military activities and facilities. Different sizes and design elements are used to identify the different organizational levels.

4.12. Information. The signs should carry one unit name and any secondary information required to identify the unit component (such as headquarters). No unit mottoes or names or titles of individuals are permitted.

4.13. Types of Signs. Use the Type B1 Military Identification Sign to identify the highest level flag bearing organizations on base (Figure 4.11). The Type B2 Military Identification Sign is used to identify lower echelon flag bearing units (Figure 4.12). Tenant squadrons and squadron headquarters with authorized organizational emblems may also use this sign at the discretion of the base commander. Use the Type B3 Military Identification Sign to identify squadron level units and

squadron components (Figure 4.13). The Type B4 Military Building Entry Sign is used in addition to these signs to identify a unit that has an entry point other than the main entrance to a building (Figure 4.14). The Type B5 Building Number Sign is used to display the building number on the side or front of a building for rapid identification, while the Type B6 Military Construction Sign identifies Air Force construction projects.

4.14. Graphics and Placement. Graphics may appear on both sides of types B1, B2 and B3, since they are placed perpendicular to the roadway and can be viewed by traffic moving in both directions. The Types B4 and B5 signs are wall mounted.

Figure 4.11. Military Facility Type B1.

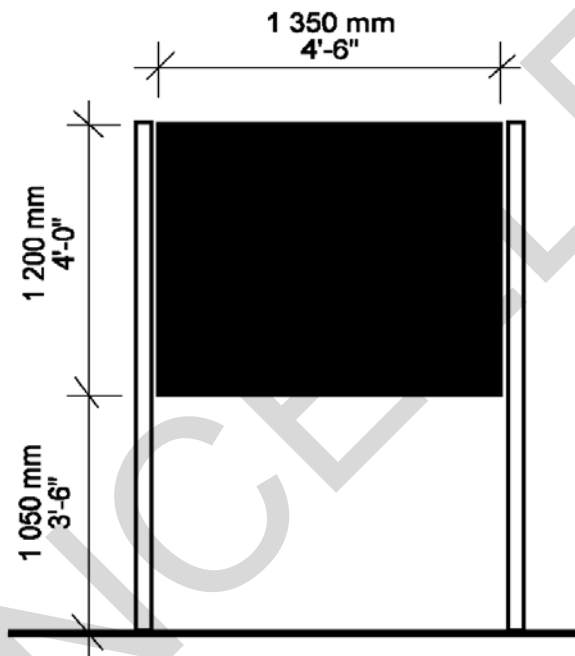

Figure 4.12. Military Facility Type B2.

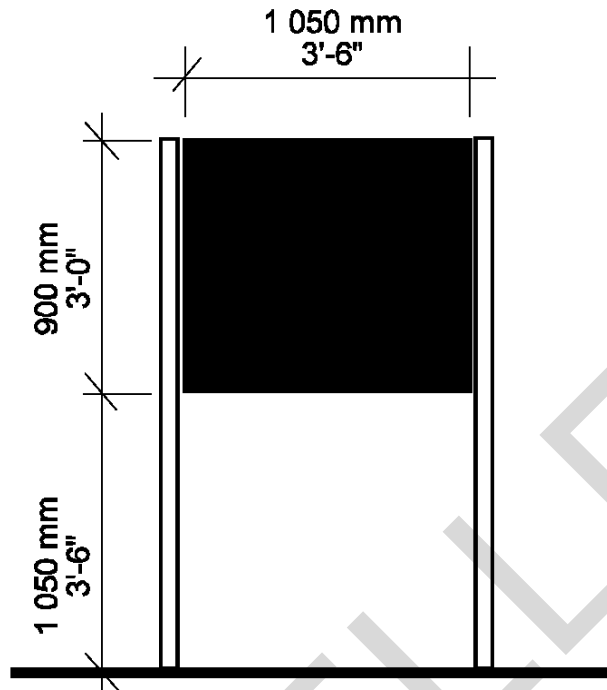

Figure 4.13. Military Facility Type B3.

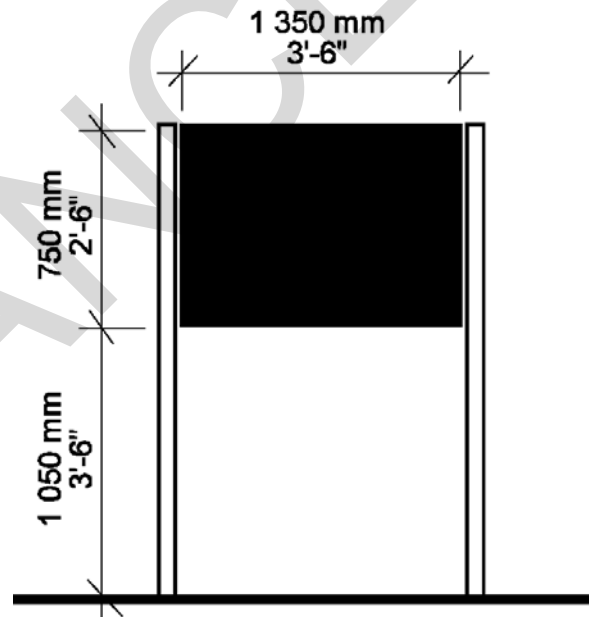
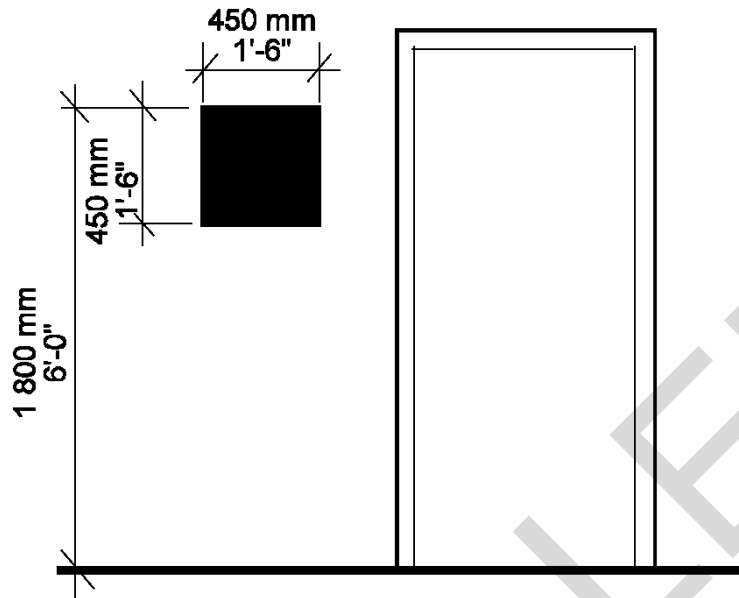

Figure 4.14. Military Facility Type B4.



4.15. Military Identification Sign Type B1.

4.15.1. General Description. Use Type B1 signs to identify major flag bearing organizations. They are intended for command level organizations, but if there are no command level organizations, Type B1 signs identify the highest level units on the base.

4.15.2. Colors. White letters and numbers on standard brown background; full-color shield.

4.15.3. Dimensions. 1 200 mm x 1 350 mm (4'- 0" x 4'- 6")

4.15.4. Typography (See Figure 4.16).

- Unit Name: upper and lower case Helvetica medium, 100 mm (4") capital letter height, flush left.
- Secondary Information: upper and lower case Helvetica regular, 100 mm (4") capital letter height, flush left. The message area accommodates three lines, with a maximum line length of 17 tiles or characters per line.
- Street Address: street address number and street name, upper and lower case Helvetica medium, 100 mm (4") numbers, flush left.

4.15.5. Shield. Authorized organizational emblem, 200 mm x 200 mm (8" x 8"), upper left corner.

4.15.6. Rules. 3 mm (1/8") wide, white tape.

4.15.7. Layouts. See Figure 4.16 for the sign layouts.

4.16. Military Identification Sign Type B2.

4.16.1. General Description. Use Type B2 signs to identify flag bearing units other than the highest level units on base. Tenant squadrons and squadron headquarters with authorized organizational emblems may also use the Type B2 sign at the discretion of the base commander.

4.16.2. Colors. White letters and numbers on standard brown background; full-color shield.

4.16.3. Dimensions. 900 mm x 1 050 mm (3'- 0" x 3'- 6").

CANCELLED

Figure 4.15. Military Identification Sign Type B1.

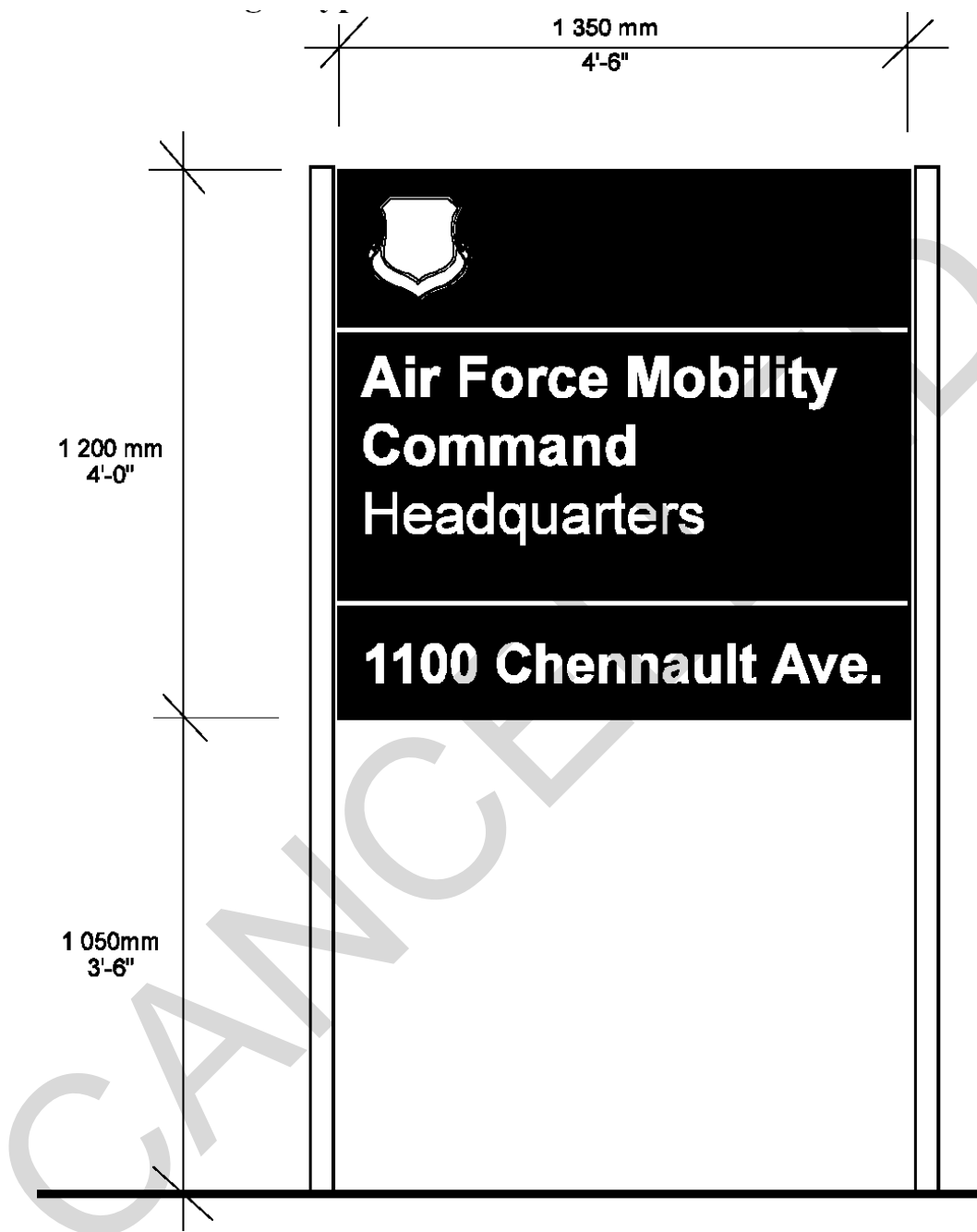

4.16.4. Typography (Figure 4.18).

- Unit Name: upper and lower case Helvetica medium, 75 mm (3") capital letter height, flush left.
- Secondary Information: upper and lower case Helvetica regular, 75 mm (3") capital letter height, flush left.
- The message area will accommodate three lines, with a maximum line length of 17 tiles or characters per line.

- Street Address: street address number and street name, upper and lower case Helvetica medium, 75 mm (3") numbers, flush left.

4.16.5. Emblem. Authorized organizational emblem, 150 mm x 150 mm (6" x 6"), upper left corner.

4.16.6. Rules. 3 mm (1/8") wide, white tape.

4.16.7. Layouts. See Figure 4.18 for the sign layouts.

4.17. Military Identification Sign Type B3.

4.17.1. General Description. Use Type B3 signs to identify squadron level units and squadron components or their equivalents. Tenant squadrons and squadron headquarters may use either the Type B3 sign or the Type B2 sign at the discretion of the base commander.

4.17.2. Placement of Graphics (Figure 4.19). Do not use organizational emblems on the Type B3 sign. Position the building number in the upper left corner of the sign, in place of an emblem, for better visual balance.

4.17.3. Colors. White letters and numbers on standard brown background.

4.17.4. Dimensions. 750 mm x 1 050 mm (2'-6" x 3'-6")

4.17.5. Typography (Figure 4.19).

- Unit Name: upper and lower case Helvetica medium, 75 mm (3") capital letter height, flush left.
- Secondary Information: upper and lower case Helvetica regular, 75 mm (3") capital letter height, flush left.
- The message area accommodates three lines, with a maximum line length of 17 tiles or characters per line.
- Street Address: street address number and street name, upper and lower case Helvetica medium, 100 mm (4") numbers, flush left.

4.17.6. Emblem. Organizational emblems are not permitted on Type B3 signs.

4.17.7. Rules. 3 mm (1/8") wide white tape.

4.17.8. Layouts. See Figure 4.20 for the sign layouts.

Figure 4.16. Military Identification Sign Type B1 Layouts.



Figure 4.17. Military Identification Sign Type B2.

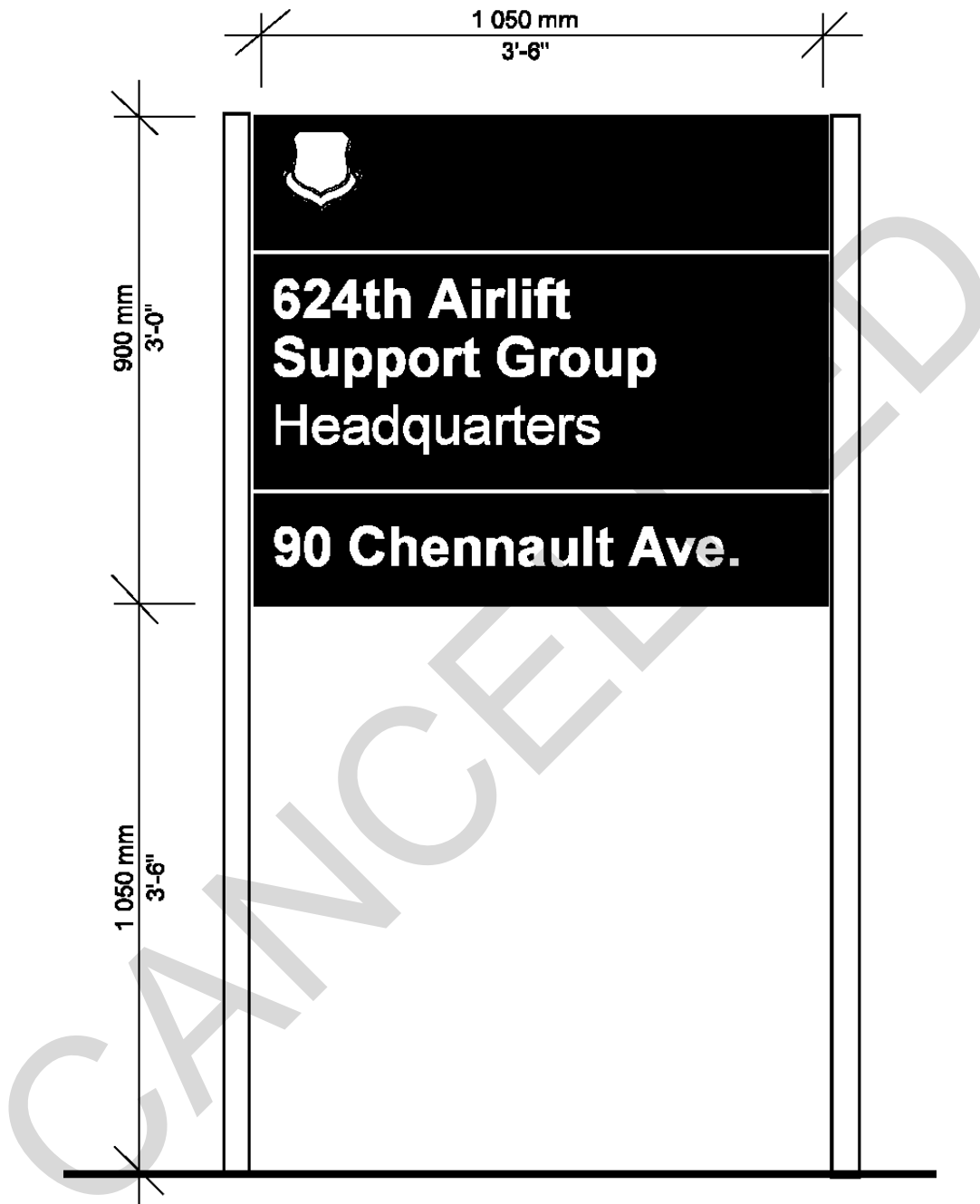

4.18. Military Building Entry Sign Type B4.

4.18.1. General Description and Usage. Some buildings such as converted hangars, have more than one primary entrance. Use Type B4 Building Entry signs to identify organizations that are reached through the alternate entries of this type of building. These organizations are usually squadron level units, squadron components, or their equivalents.

4.18.2. Graphics and Placement. The Type B4 sign is always wall-mounted. An organizational emblem may appear in the upper left corner with the unit name, or it may appear alone, centered in the sign panel as shown in Figure 4.22. These two variations may not be used together. Only one sign is permitted at each building entrance.

4.18.3. Colors. White letters and numbers on standard brown background, full color shield.

4.18.4. Dimensions. 450 mm x 450 mm (1'- 6" x 1'- 6")

4.18.5. Emblem (if used). Authorized organizational emblem, 100 mm x 100 mm (4" x 4") if used in upper left corner or 300 mm x 300 mm (12" x 12") if centered on sign (See Figure 4.22).

4.18.6. Rules. 3 mm (1/8") wide, white tape.

4.18.7. Layouts. Either the standard layout or the expanded layout may be used, based on the length of message required. If the required message on a building entry sign is too long to fit on the standard layout shown below, use the expanded layout. The expanded layout has smaller lettering than the standard layout and can therefore accommodate more lines and more characters per line. See Figures 4.22 and 4.23 for sign layouts.

4.18.8. Standard Layout Typography.

- Unit Name: upper and lower case Helvetica medium, 50 mm (2") capital letter height, flush left.
- Secondary Information: upper and lower case Helvetica regular, 50 mm (2") capital letter height, flush left.
- The message area will accommodate three lines, with a maximum line length of 10 tiles or characters per line.
- Number: Street address number, Helvetica medium, 75 mm (3") numbers, flush left.

Figure 4.18. Military Identification Sign Type B2 Layouts.

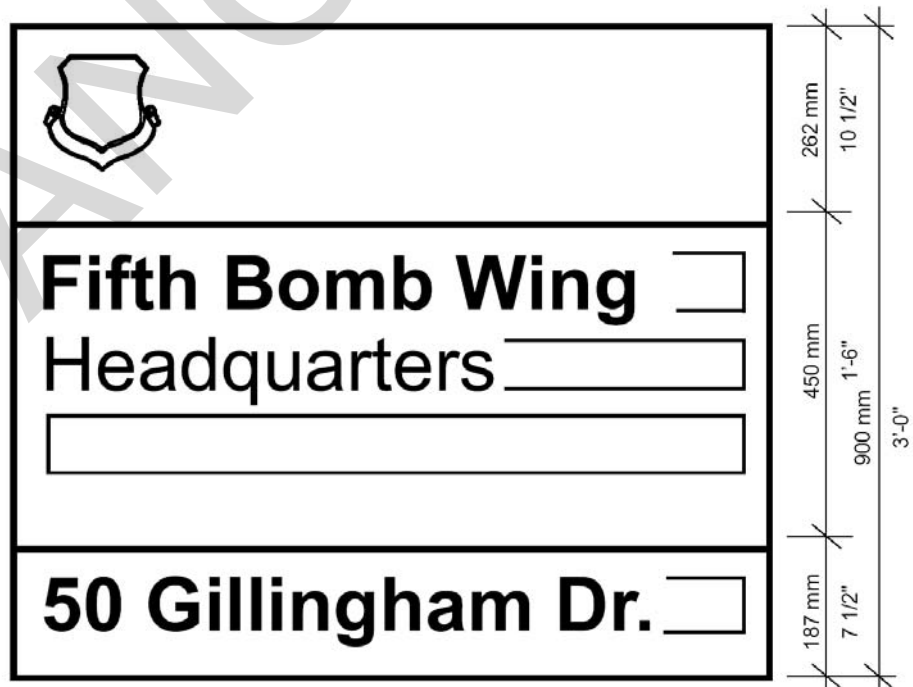
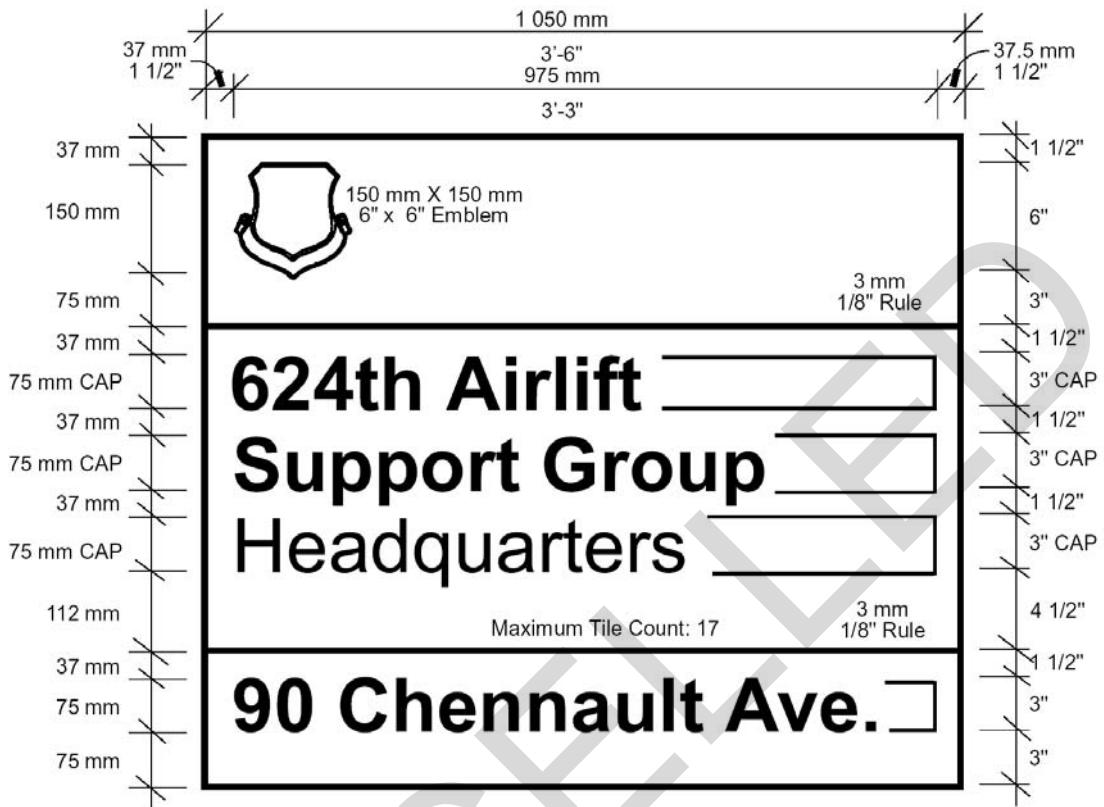
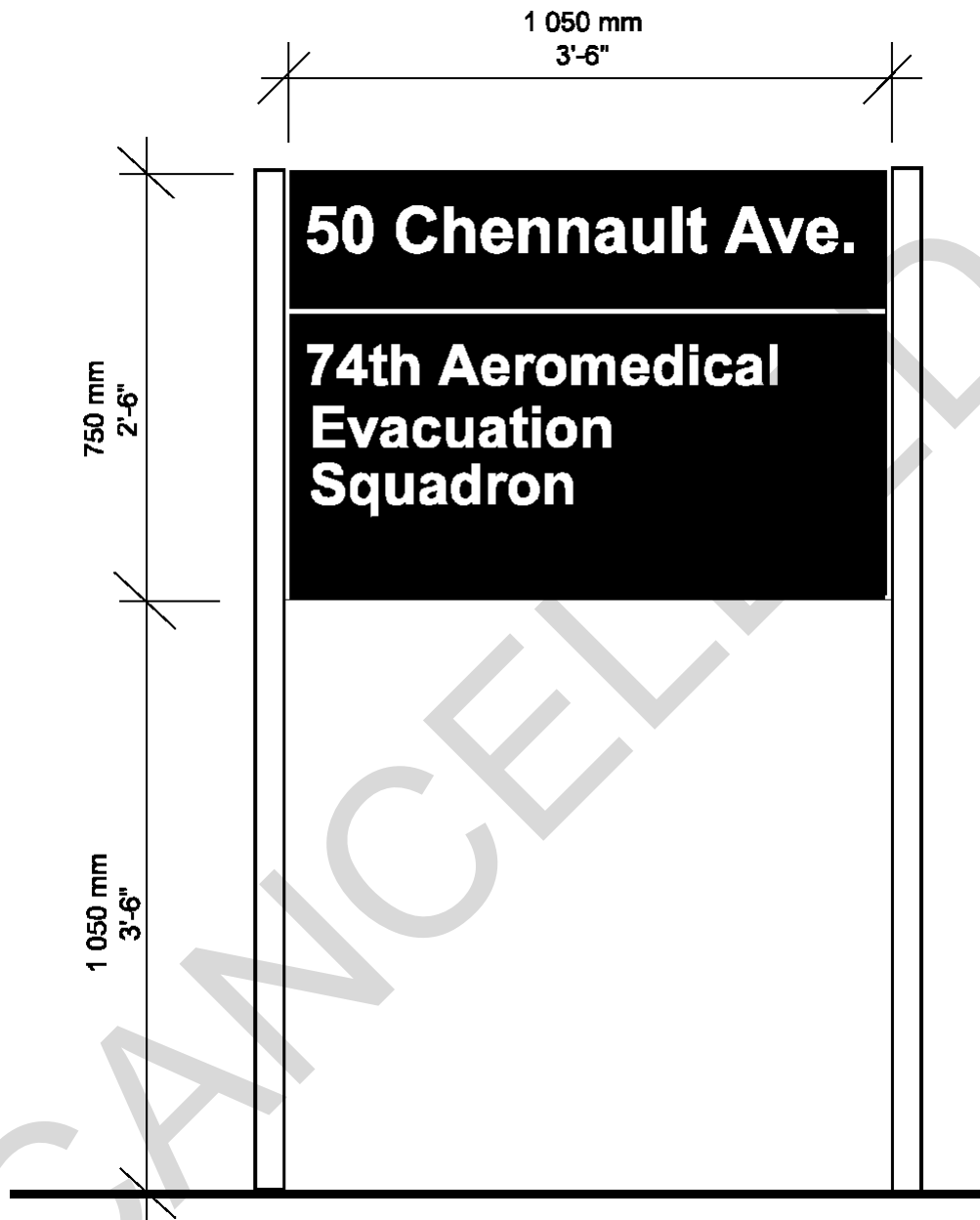

Figure 4.19. Military Identification Sign Type B3.



4.18.9. Expanded Layout Typography.

- Unit Name: upper and lower case Helvetica medium, 37 mm (1 ½ ") capital letter height, flush left.
- Secondary Information: upper and lower case Helvetica regular, 37 mm(1 ½ ") capital letter height, flush left.
- The message area will accommodate four lines, with a maximum line length of 15 tiles or characters per line.

4.19. Building Number Sign Type B5.

4.19.1. Mounting. Bases may choose to provide the Type B5 Building Number Sign in addition to the Type B4 Military Building Entry Sign. In the absence of installation-specific mounting requirements for visibility by security police and fire personnel, mount the Type B5 sign directly below the Type B4 Military Building Entry Sign or the Type C4 Community Building Entry Sign. (See Figure 4.24).

4.19.2. Colors. White letters and numbers on standard brown background.

4.19.3. Dimensions. 200 mm x 450 mm (8" x 1'-6").

4.19.4. Typography. Helvetica medium, 2" (50 mm) numbers, centered.

4.20. Military Construction Sign Type B6. Required for all Military Construction Projects. Exceptions may be made for security reasons or to meet the restrictions of host nations. In addition, host MAJCOMs may require the Military Construction Sign on non-Military Construction Projects. Specific requirements for sign graphics and construction are provided in Engineering Technical Letter (ETL) 93-1, Construction Signs dated 11 Mar 93.

4.21. Building Accessibility Sign Type B7. When not all entrances to a building are accessible, accessible building entrances must be identified with the international symbol of accessibility. The symbol shall be displayed as shown in Figures 4.25, 4.26 and 4.27.

4.21.1. Colors. White symbol on standard dark contrasting background.

4.21.2. Dimensions. 150 mm x 150 mm (6"x 6").

Figure 4.20. Military Identification Sign Type B3 Sign Layouts.

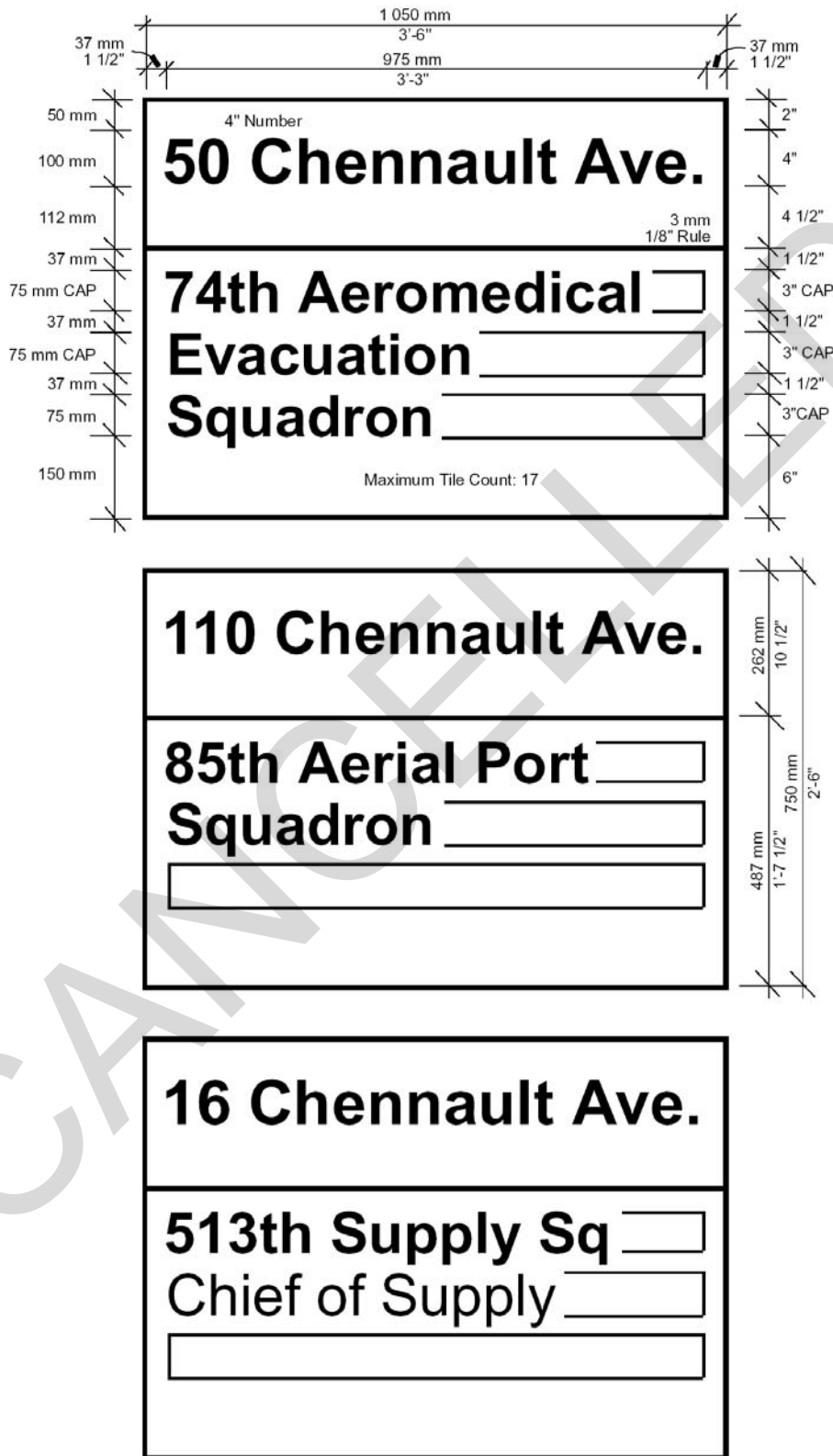
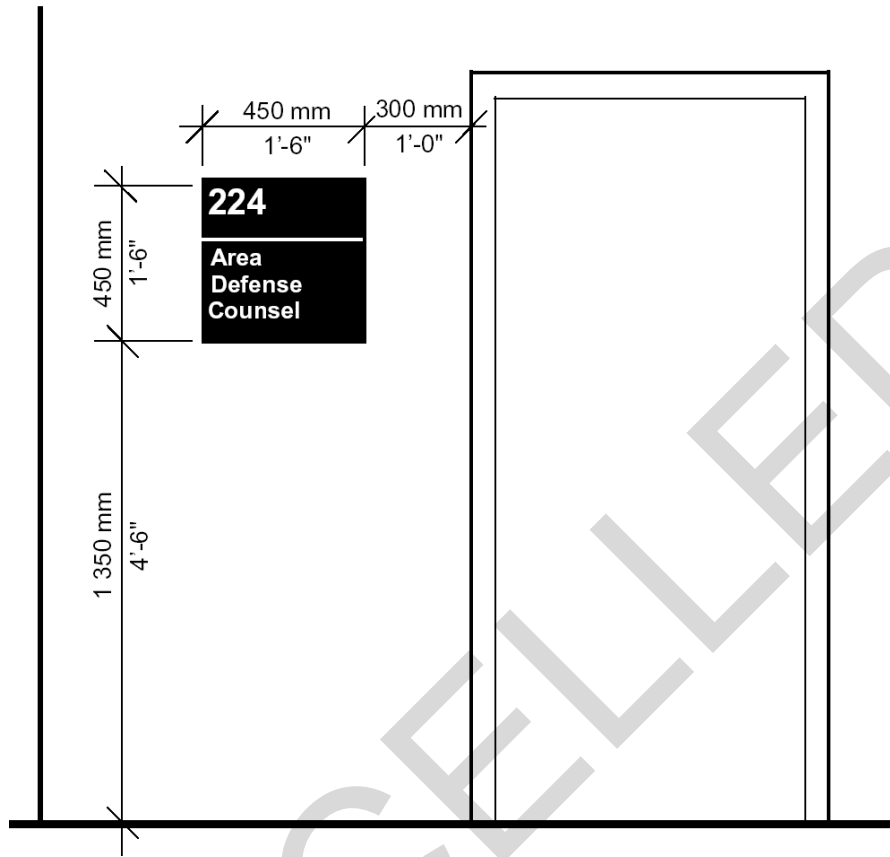

Figure 4.21. Military Building Entry Sign Type B4.



CANCELLED

Figure 4.22. Military Building Entry Sign Type B4 Standard Layouts.

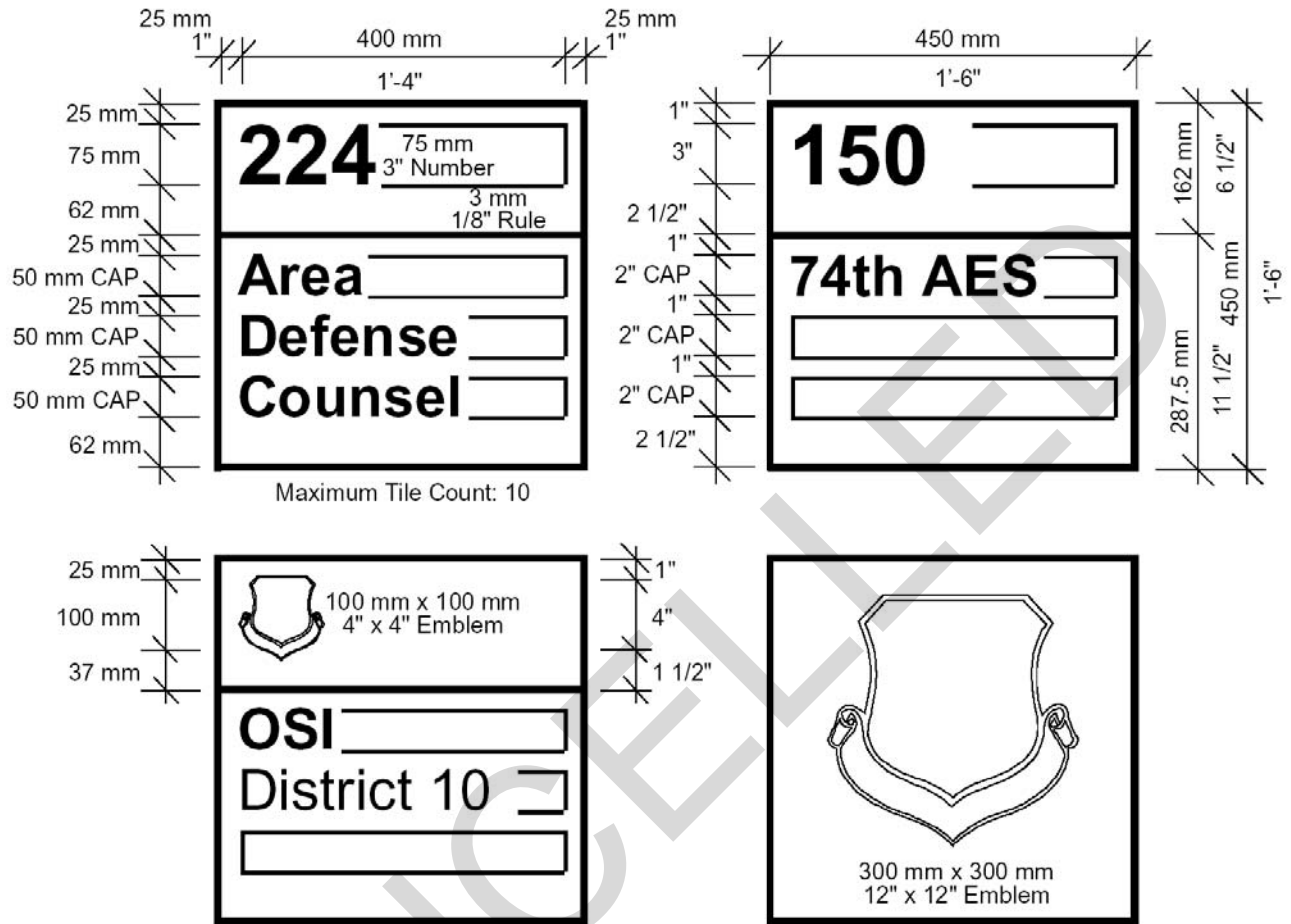

Figure 4.23. Military Building Entry Sign Type B4 Expanded Layout.

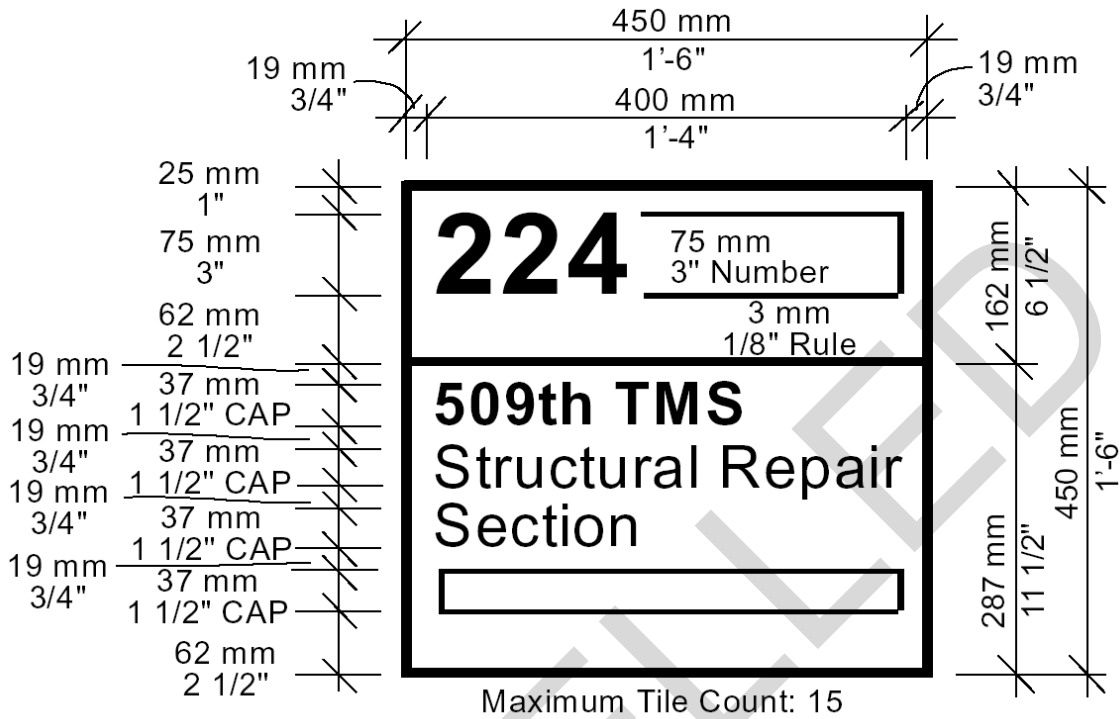

Figure 4.24. Building Number Sign Type B5.

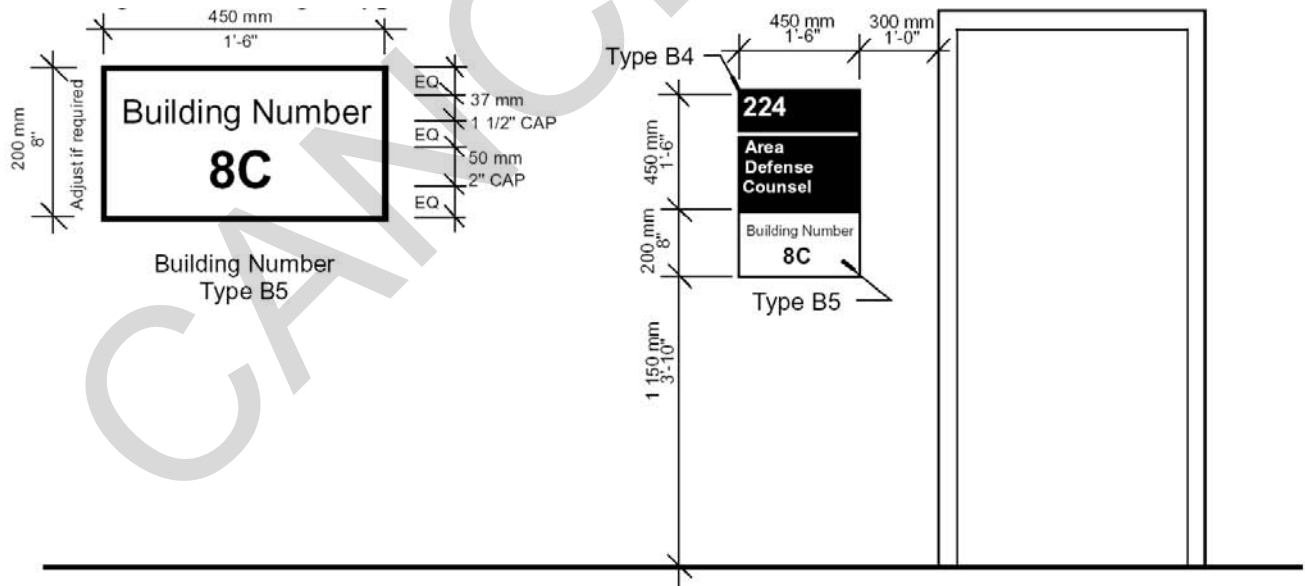

Figure 4.25. Proportions.

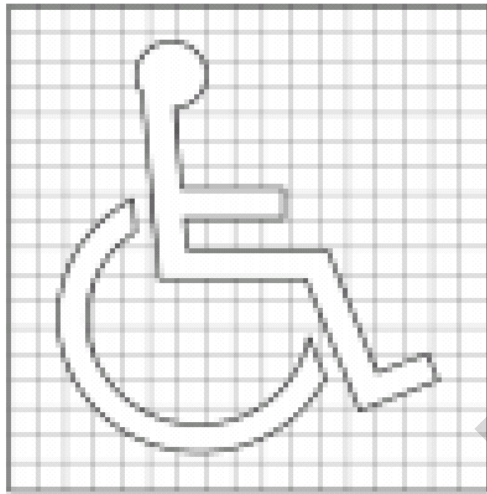

Figure 4.26. Display Conditions.

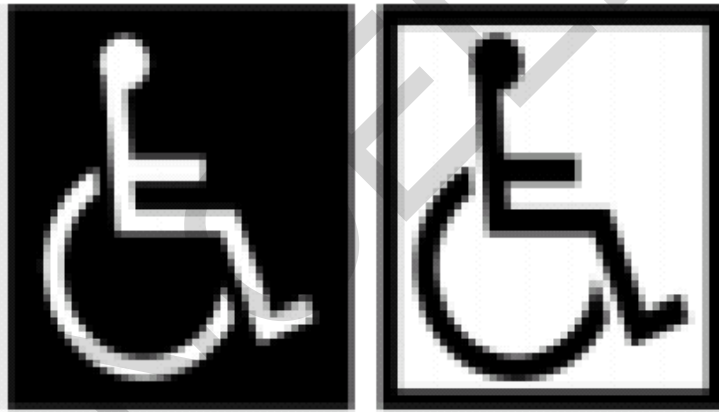
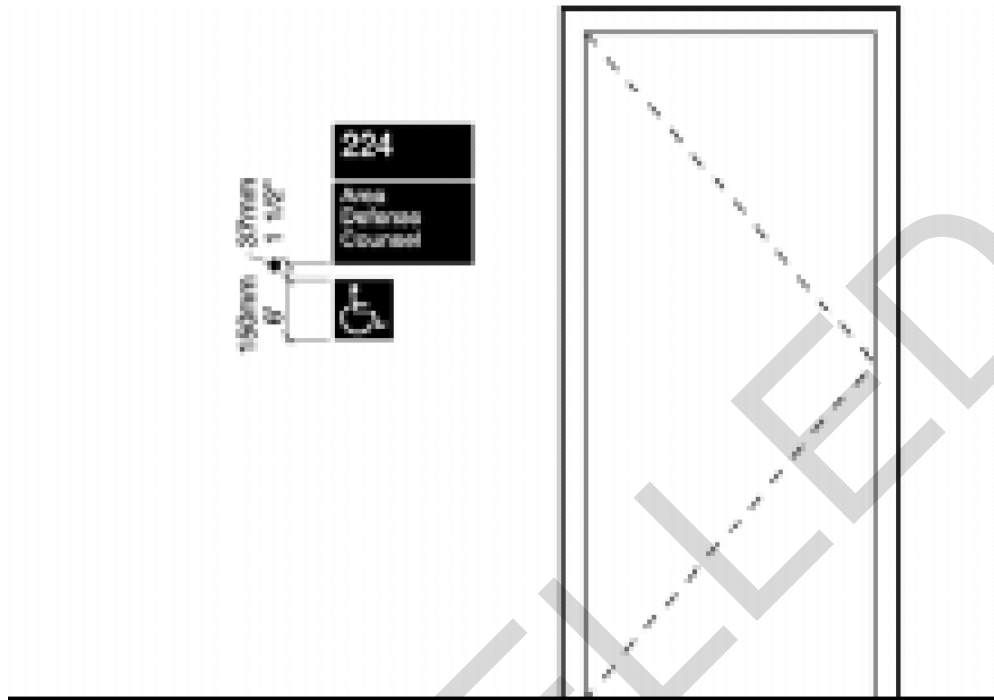

Figure 4.27. Mounting Conditions.



Section 4D--Community Identification Signs

4.22. Introduction. Community identification signs are used to identify activities and facilities used for community, recreational, and other non military purposes. These activities are identified with signs that are different from those used for purely military facilities.

4.23. General Description. While the general character of these signs is the same as the military identification signs, the background color is different, they do not carry military emblems and they seldom carry building numbers. The use of commercial and community-related symbols and logotypes is encouraged to add color and visual interest.

4.24. Types of Signs. There are four types of community signs. The Centralized Facilities Sign, Type C1, is used to identify large groups of community facilities such as those in the Community Center or Recreation Center (Figure 4.28). The Community Facilities Sign, Type C2 (Figure 4.29) is used to identify major facilities such as the Commissary or Base Exchange. The Community Facilities Sign, Type C3 (Figure 4.30) is used to identify smaller facilities such as the Child Care Center, Youth Center, or Barber Shop. The Community Building Entry Sign, Type C4 (Figure 4.31) is used to identify activities that have a specific entry point other than the main entrance of a building.

Figure 4.28. Centralized Facilities Type C1.

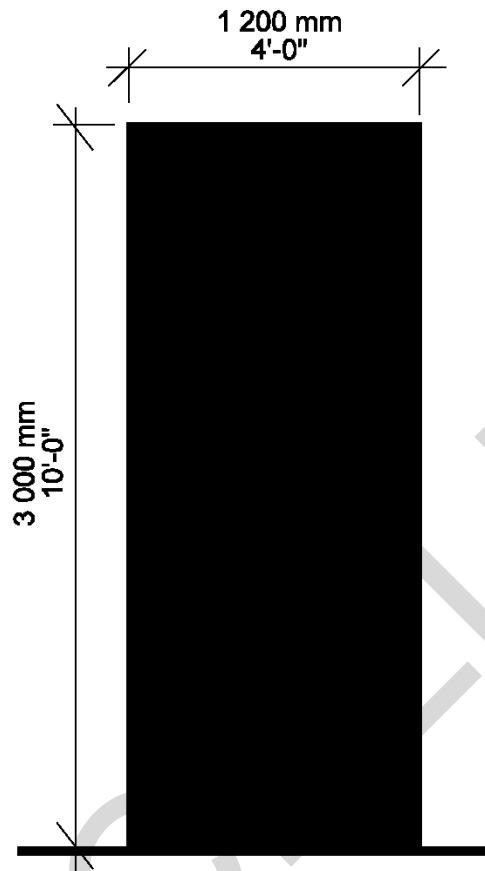

Figure 4.29. Community Facilities Type C2.

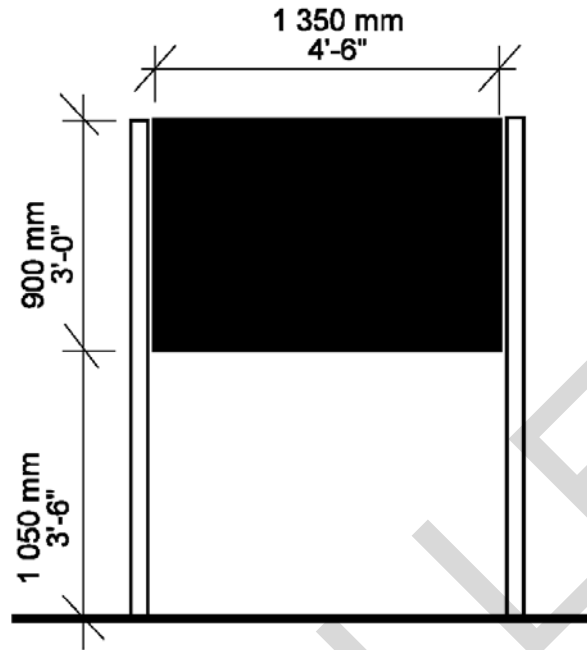

Figure 4.30. Community Facilities Type C3.

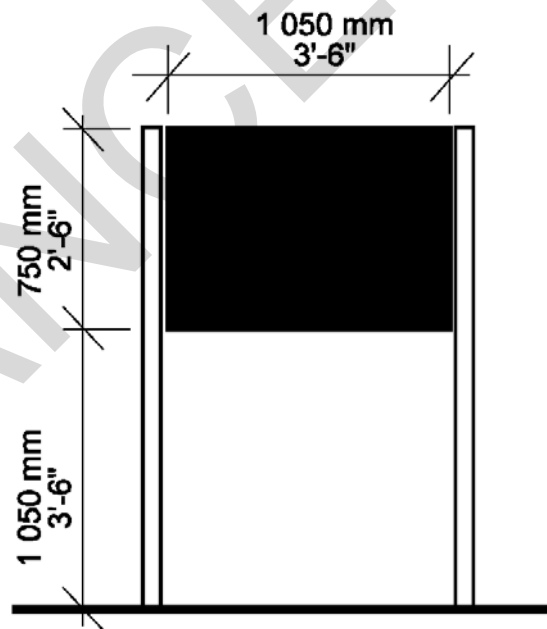
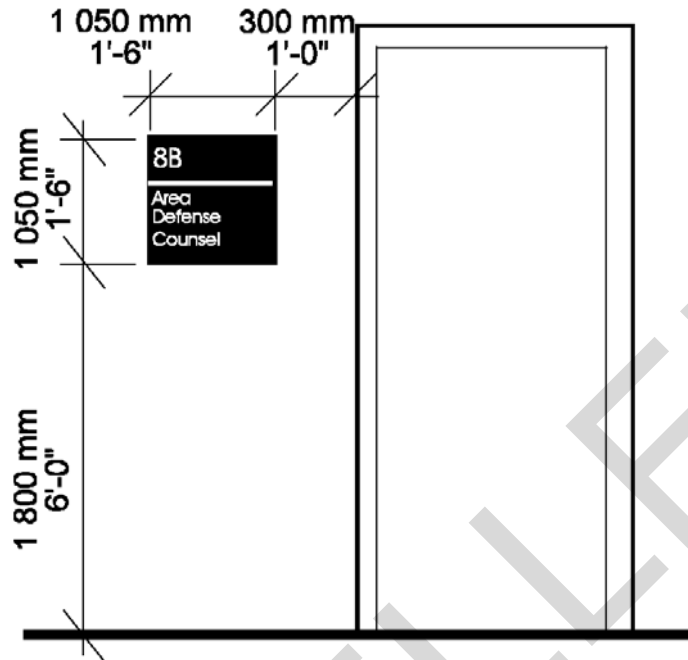

Figure 4.31. Community Building Entry Type C4.



4.25. Standards for Commercial Firms. These standards also apply to signs for commercial firms that operate on base. Private signs which do not meet these standards are not permitted.

4.26. Symbols and Logotypes on Community Signs.

4.26.1. Description and Usage. The use of symbols and logotypes on signs identifying community facilities assists in identification and adds visual interest. (These symbols should appear in the upper left corner of the sign as shown in Figure 4.32 and in Figure 4.33.) If the base commander approves the community symbol for use on base, it should be used on the majority of community signs in order to strengthen the association between the symbol and the activities and facilities that it identifies. The symbol will have little meaning if it is used on only one or two signs.

4.26.2. Placement & Colors. They should be placed within a circle as illustrated in Figure 4.32 and should always be black or dark colored on a white or light colored background. The light colored background should have a Munsell value notation of 5.0 to 10.0. Note that the community symbol appears directly on the sign face. It is the only symbol that is not placed within a square.

4.26.3. AAFES Facilities. Facilities run by AAFES will display the registered trademark AAFES logo as specified in the approved AAFES Graphics Standards Manual .

4.26.4. Independent Organizations. Independent organizations such as the Credit Union, the Post Office and the Red Cross may display their own symbols. Base-operated facilities such as the

Youth Center, the Child Care Center, the Library and Hobby Shops may use the community symbol at the discretion of the base commander.

4.26.5 DeCA Facilities. Facilities operated by the Defense Commissary Agency (DeCA) will display their standard image sign as approved by their Commissary Operating Board, the MAJCOM, the installation Sign Control Group, and the installation Commander.

4.27. Centralized Facilities Sign Type C1.

4.27.1. Usage. Use the Type C1 Centralized Facilities Sign when several community or recreational activities are located in a common area (usually with shared parking).

4.27.2. Placement of Graphics. If the community symbol is used, it should be placed in the upper left corner of the sign. (See Figures 4.32 and also Figure 4.33.). Note that the community symbol appears directly on the sign face. It is the only symbol that is not placed within a square.

4.27.3. Restrictions on Usage. If the community symbol has not been approved for use on the base, follow Sign Layout B, paragraph 4.28.2.

4.27.4. Colors.

- White letters on standard brown background.
- Community symbol: white on standard brown background.

4.27.5. Dimensions. 3 000 x 1 200 mm (10' x 4'- 0").

4.27.6. Typography.

- Center Name: upper and lower case Helvetica medium, 4" (100 mm) capital letter height, flush left. This message area will accommodate up to two lines, with a maximum tile length of 15 tiles or characters per line.
- Facilities List: upper and lower case Helvetica regular, 75 mm (3") capital letter height, flush left. This message area will accommodate up to six lines, with a maximum line length of 20 tiles or characters per line. Abbreviate names exceeding this length.

4.27.7. Symbol. Community symbol: 200 mm x 200 mm (8" X 8"), upper left corner. This symbol is used at the discretion of the base commander.

4.27.8. Rules. 3 mm (1/8") wide, white tape.

4.27.9. Layouts. See Figures 4.35 and 4.36 for the sign layouts.

Figure 4.32. The Community Symbol.



CANCELLED

Figure 4.33. Placement of Community Symbol.

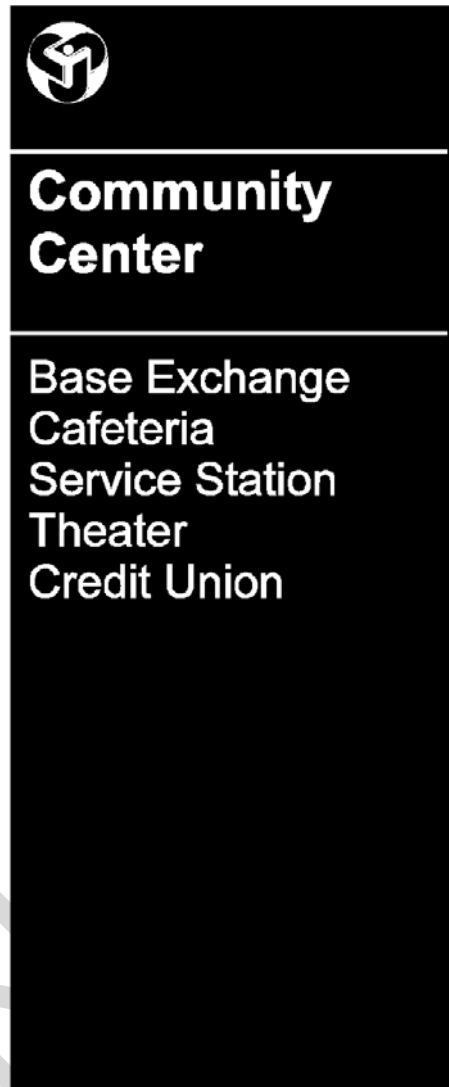

Figure 4.34. Centralized Facilities Sign Type C1.

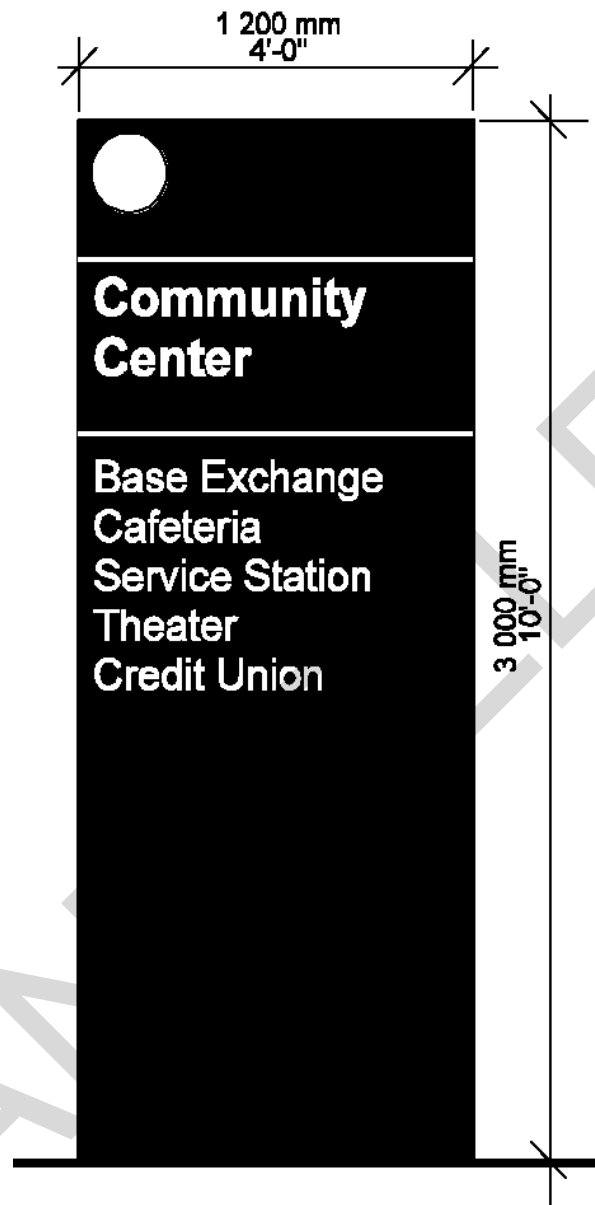

Figure 4.35. Centralized Facilities Type C1 Layout A.

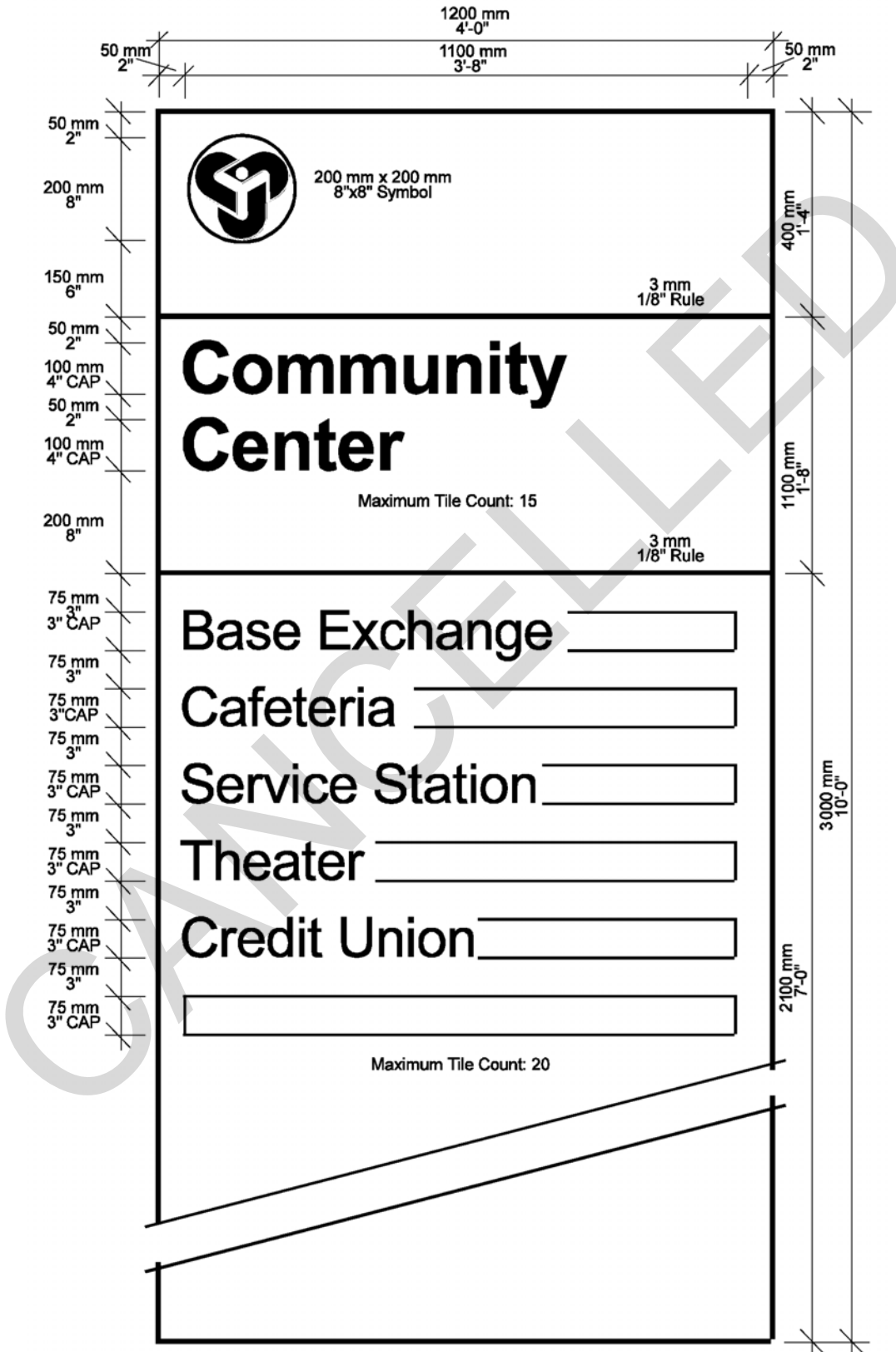
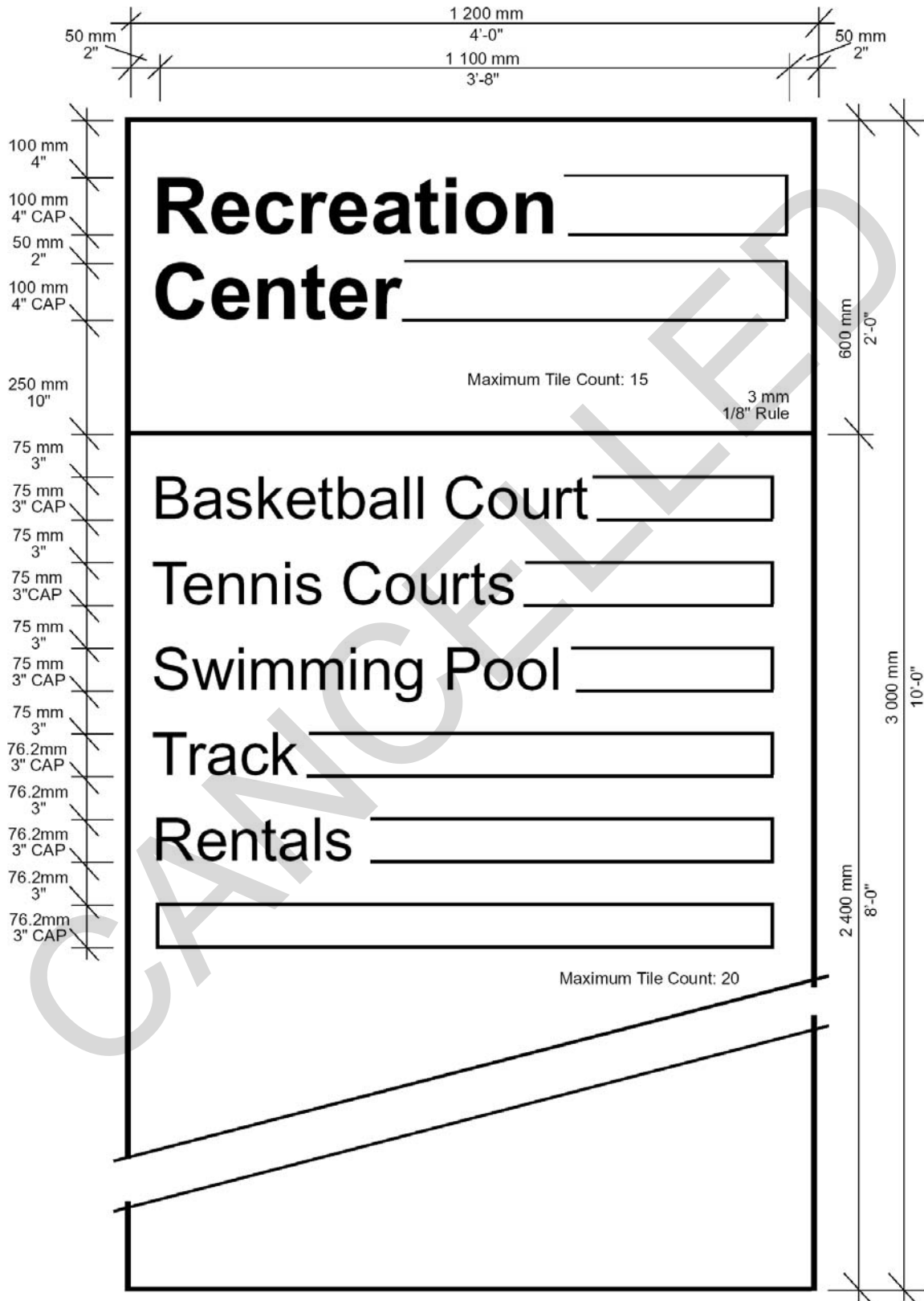

Figure 4.36. Centralized Facilities Sign Type C1 Layout B.



4.28. Community Facilities Sign Type C2.

4.28.1. Usage. Use Type C2 signs to identify major community facilities such as the Commissary and Base Exchange. The base civil engineer will determine which facilities may use a Type C2 sign based on scale, importance, and frequency of use.

4.28.2. Placement of Graphics. A symbol or logotype should be placed in the upper left corner of the sign. If an appropriate symbol or logotype is unavailable and if the community symbol has not been approved for use on the base, use the street address number (Figure 4.39).

4.28.3. Colors. White letters on standard brown background; symbol in full color.

4.28.4. Dimensions. 900 mm x 1 350 mm (3'- 0" X 4'- 6").

4.28.5. Typography.

- Facility Name: upper and lower case Helvetica medium, 100 mm (4") capital letter height, flush left.
- Secondary Information: upper and lower case Helvetica regular, 100 mm (4") capital letter height, flush left.
- The message area will accommodate three lines, with a maximum line length of 17 tiles or characters per line.

4.28.6. Symbol or Number. 200 mm x 200 mm (8" X 8") square, upper left corner. Street address Number (if used instead of a symbol): Helvetica medium, 100 mm (4") numbers, flush left.

4.28.7. Rules. 3 mm (1/8") wide white tape.

4.28.8. Layouts. See Figures 4.38 and 4.39 for the sign layouts.

Figure 4.37. Community Facilities Sign Type C2.

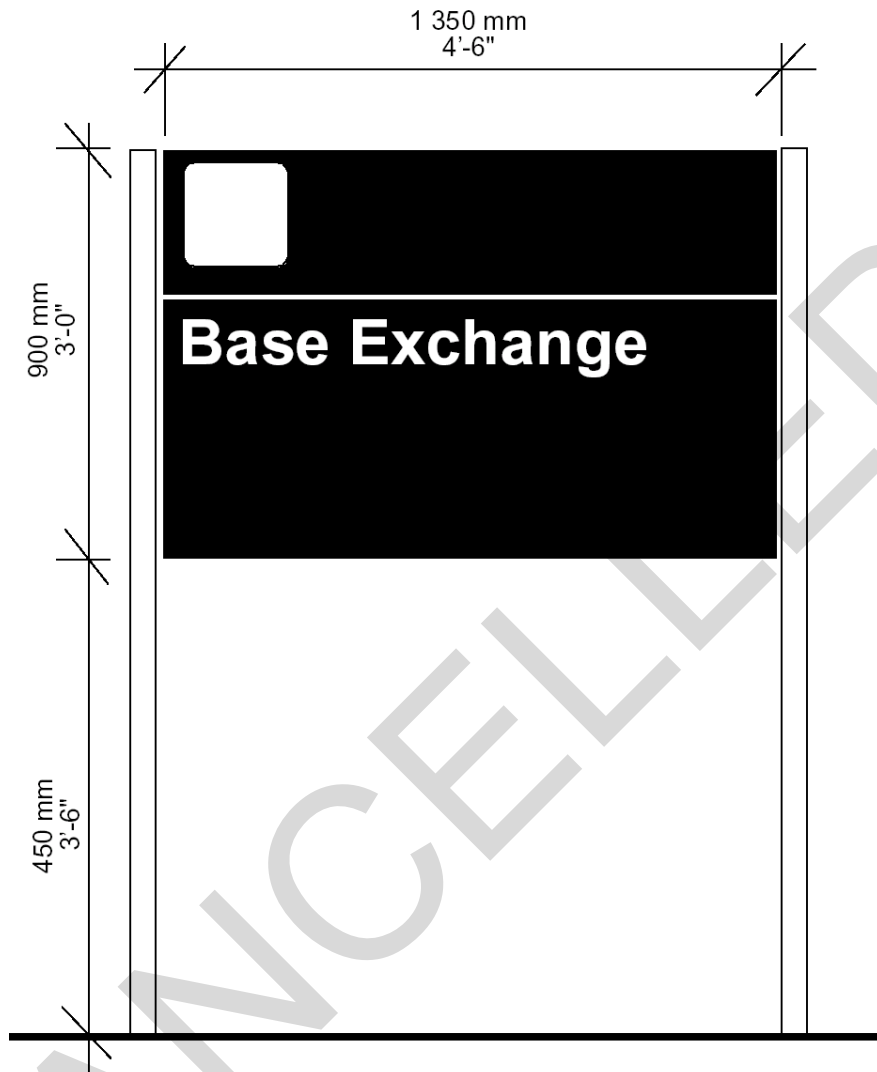

Figure 4.38. Community Facilities Sign Type C2 Layouts.

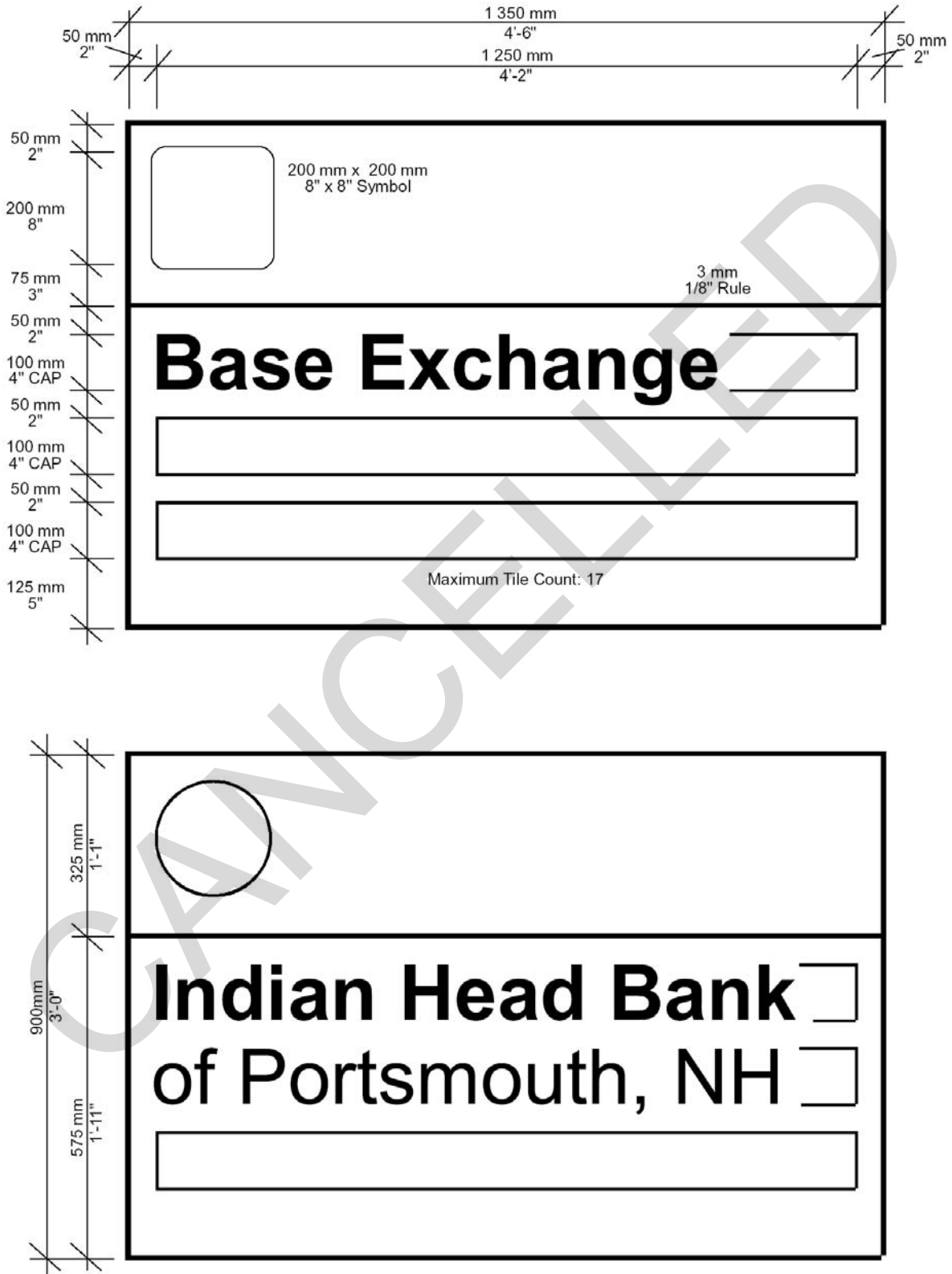
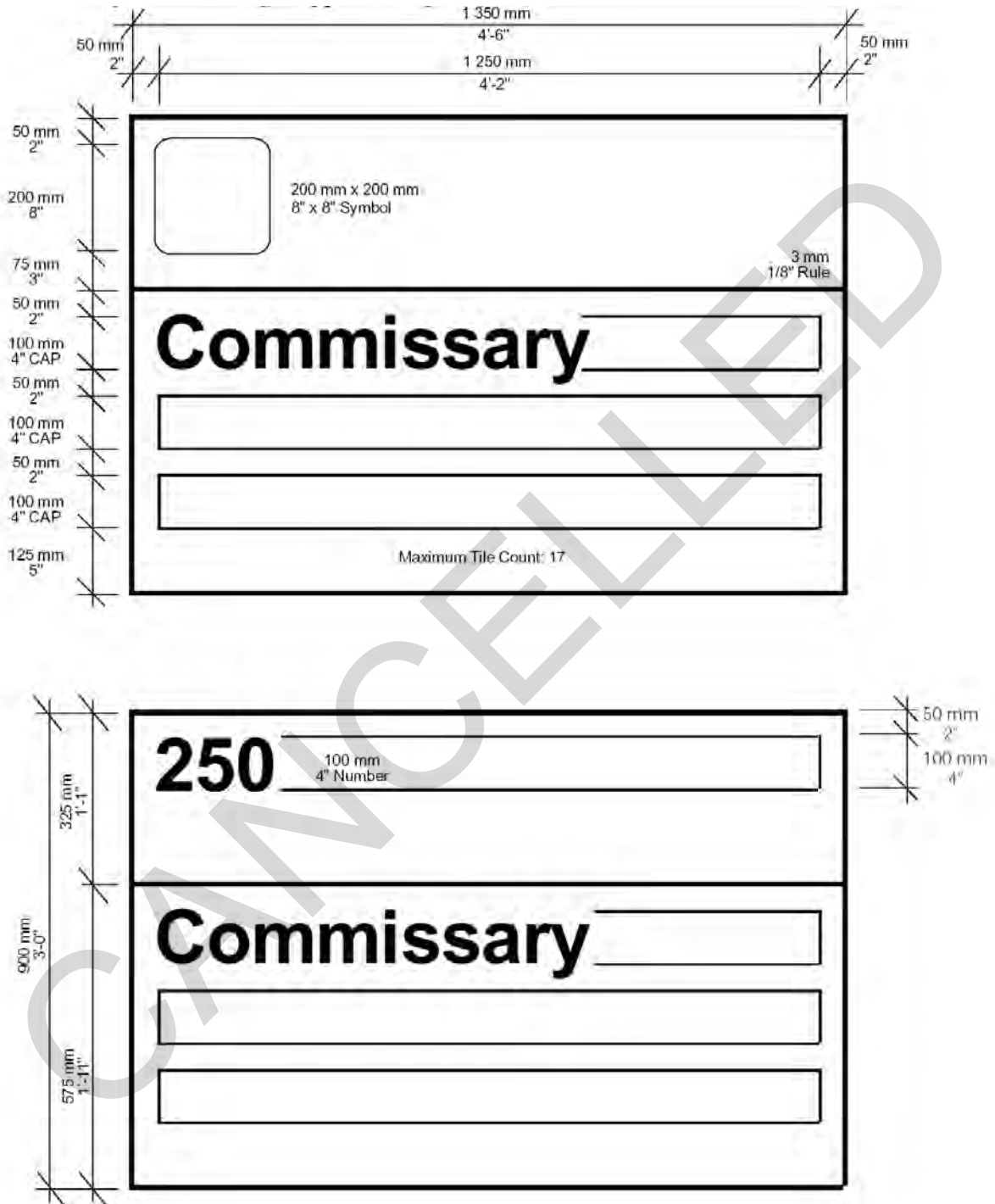

Figure 4.39. Community Facilities Sign Type C2 Layouts.



4.29. Community Facilities Sign Type C3.

4.29.1. Usage. Use Type C3 signs to identify small scale community facilities such as the Child Care Center, the Youth Center, and the Credit Union.

4.29.2. Placement of Graphics. Use a symbol or logotype in the upper left corner of the sign (Figure 4.41) If an appropriate symbol or logotype is unavailable and if the community symbol has not been approved for use on the base, use the street address number (Figure 4.42).

4.29.3. Colors. White letters on standard brown background; symbol in full color.

4.29.4. Dimensions. 750 mm x 1 050 mm (2'- 6" x 3'- 6").

4.29.5. Typography.

- Facility Name: upper and lower case Helvetica medium, 75 mm (3") capital letter height, flush left.
- Secondary Information: upper and lower case Helvetica regular, 75 mm (3") capital letter height, flush left.
- The message area will accommodate three lines, with a maximum line length of 17 tiles or characters per line.

4.29.6. Symbol or Number. Symbol: 150 mm x 150 mm (6" x 6") square, upper left corner. Street address Number (if used instead of a symbol): Helvetica medium, 100 mm (4") numbers, flush left.

4.29.7. Rules. 3 mm (1/8") wide white tape.

4.29.8. Layouts. See Figures 4.41 and 4.42 for the sign layouts.

Figure 4.40. Community Facilities Sign Type C3.

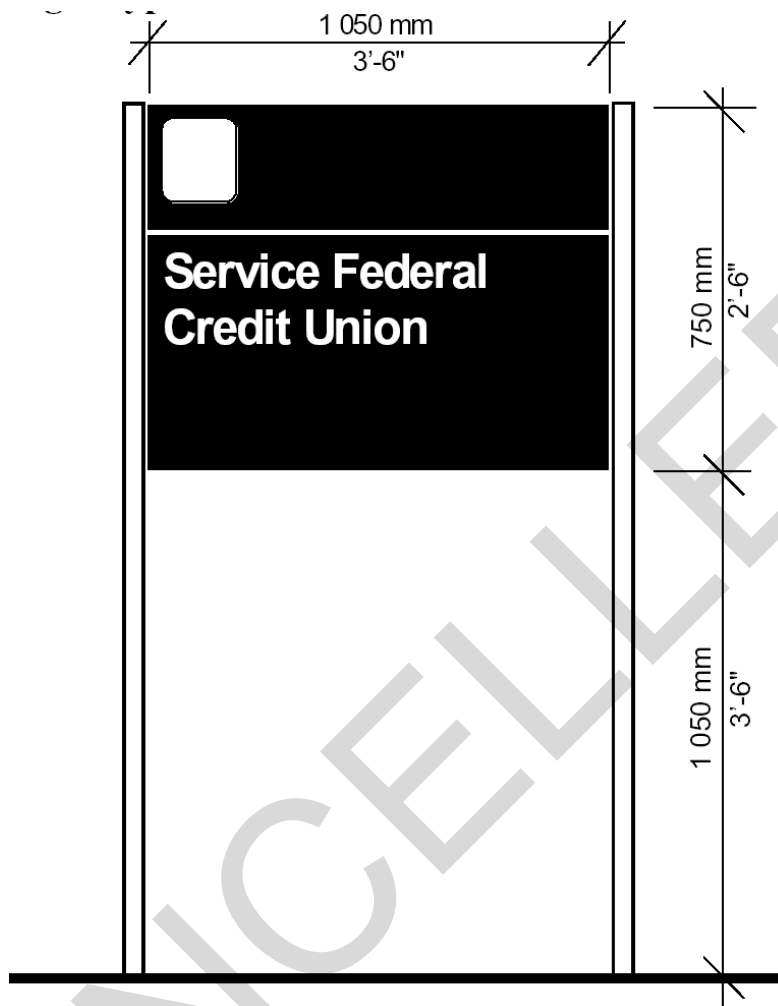

Figure 4.41. Community Facilities Sign Type C3 Layouts.

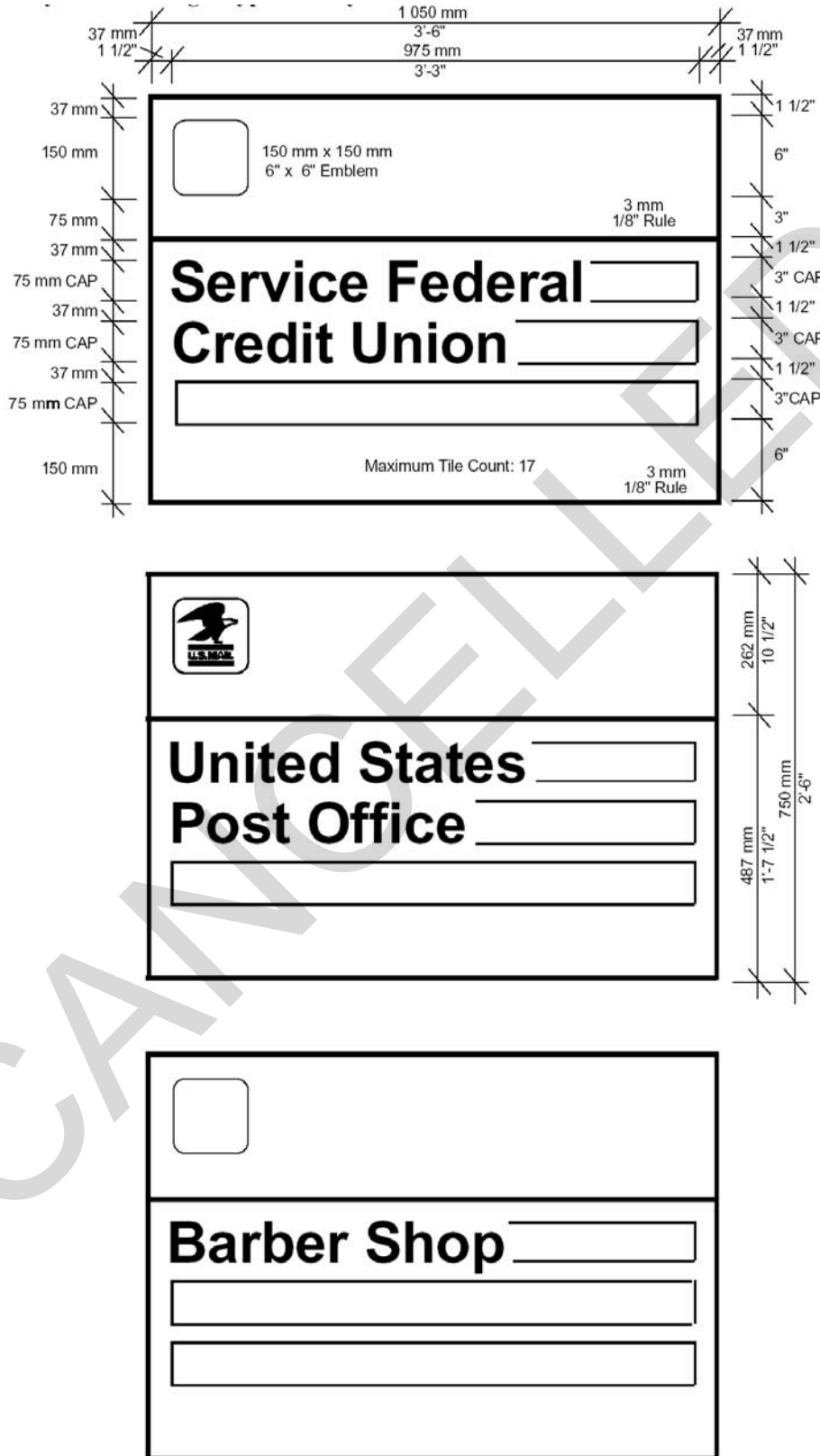
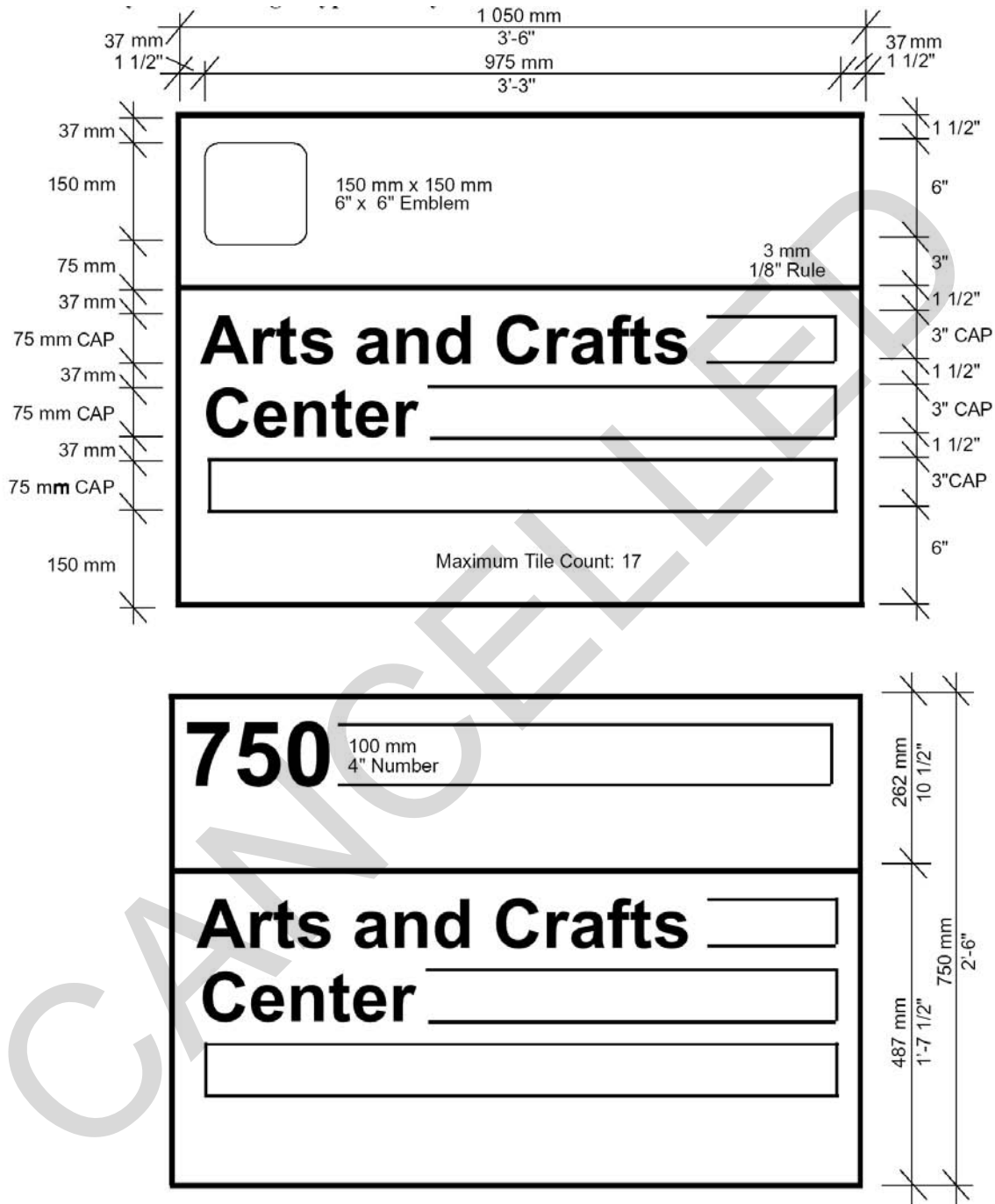

Figure 4.42. Community Facilities Sign Type C3 Layouts.



4.30. Community Building Entry Sign Type C4.

4.30.1. Usage and Placement. Use the community building entry sign to identify those activities that are reached through a separate entry point in cases where the building has more than one primary entrance. This sign is always wall-mounted.

4.30.2. Placement of Graphics. Place a symbol or logotype in the upper left corner of the sign. If an appropriate symbol or logotype is unavailable and if the community symbol has not been approved for use on the base, use the street address number (Figure 4.44).

4.30.3. Colors. White letters on standard brown background; symbol in full color.

4.30.4. Dimensions. 450 mm x 450 mm (1'- 6" x 1'- 6").

4.30.5. Typography.

- Facility Name: upper and lower case Helvetica medium, 50 mm (2") capital letter height, flush left.
- The message area will accommodate three lines, with a maximum line length of 10 tiles or characters per line.

4.30.6. Symbol. 100 mm x 100 mm (4" x 4") square, upper left corner.

4.30.7. Rules. 3 mm (1/8") wide white tape.

4.30.8. Layouts. See Figure 4.44 for the sign layouts.

CANCELLED

Figure 4.43. Community Building Entry Type C4.

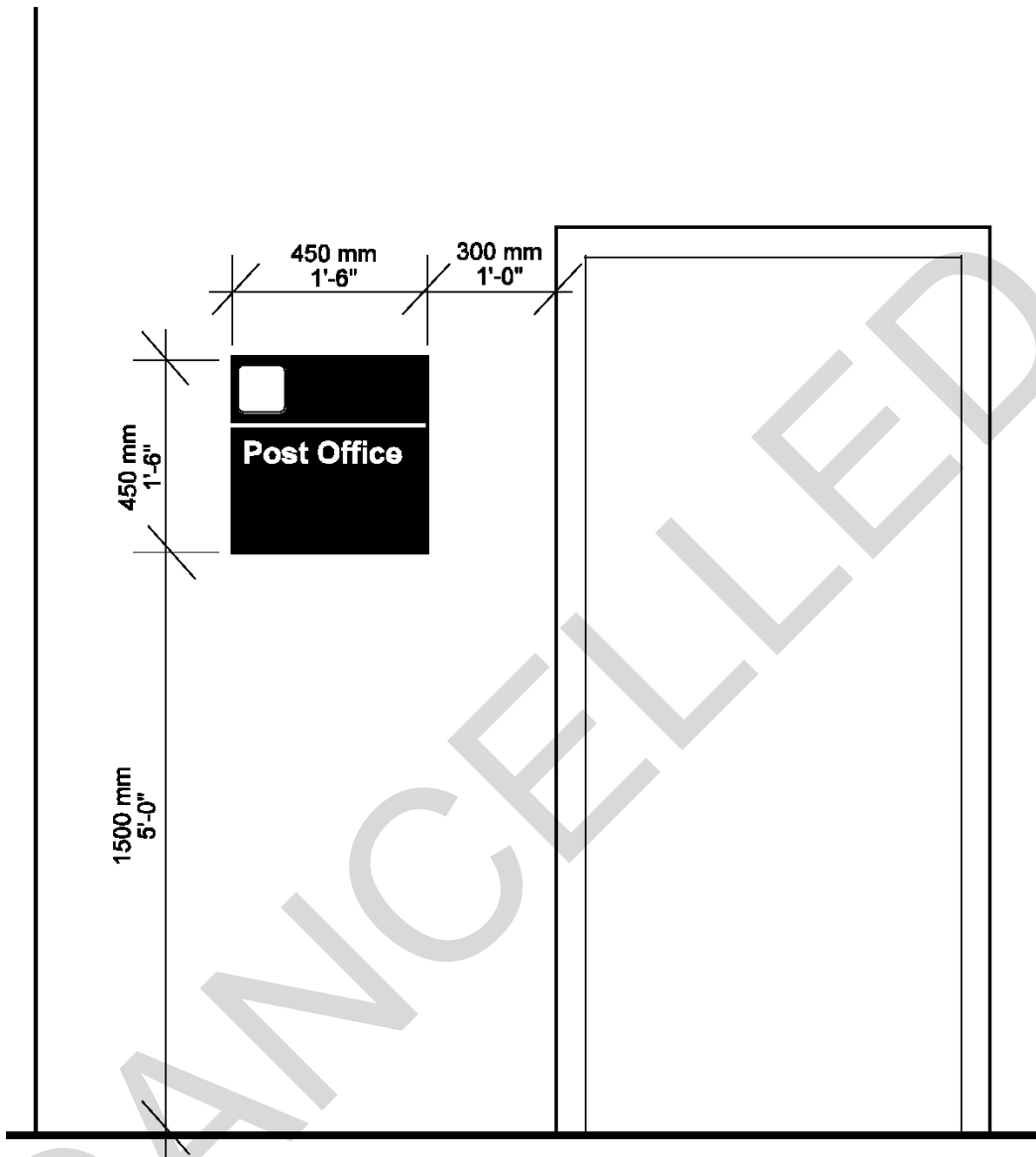

4.31. Recreational Facility Sign Type C5. The sports and recreation pictographs are based on designs developed for the 1972 and 1976 Olympic Games (Figure 2.32).

4.31.1. Usage. Use this type of sign to identify recreational facilities such as tennis courts and playing fields.

4.31.2. Graphics. The basic sign panel shows a symbol and facility name, or it may show the symbol alone if the meaning is clear.

4.31.3. Mounting. An additional sign panel may be placed below the main sign panel to provide further information. Mount both panels on the same backing sheet during fabrication. The sign

backing sheet should have rounded corners.

4.31.4. Colors.

- Typography: White letters on standard brown background;
- Symbol: black or dark brown on white.

4.31.5. Layouts. See Figure 4.46 for sign layouts and layouts for panels C and D.

4.31.6. Sign Panel A.

4.31.6.1. Dimensions. 1' - 6" X 1' - 0" (450 mm x 300 mm).

4.31.6.2. Typography.

- Facility name - upper and lower case Helvetica medium, 37 mm (1 1/2") capital letter height, flush left.
- The message area will accommodate two lines with a maximum line length of 9 tiles or characters per line.

4.31.6.3. Symbol. 250 mm x 250 mm (10" x 10") square.

4.31.7. Sign Panel B.

4.31.7.1. Dimensions. 300 mm x 300 mm (1' - 0" x 1' - 0").

4.31.7.2. Symbol. 250 mm x 250 mm (10" x 10") square.

4.31.8. Sign Panel C.

4.31.8.1. Dimensions. 300 mm x 300 mm (1' - 0" x 1' - 0").

4.31.8.2. Typography.

- Upper and lower case Helvetica medium, 12 mm (1/2") capital letter height, flush left.
- The message area will accommodate 10 lines with a maximum line length of 26 tiles or characters per line.

4.31.9. Sign Panel D.

4.31.9.1. Dimensions. 150 mm x 300 mm (6" x 1' - 0").

4.31.9.2. Arrow. 70 mm x 250 mm (2 3/4" x 10") arrow with 25 mm (1") arrow shaft width.

Figure 4.44. Community Building Entry Sign Type C4 Layouts.

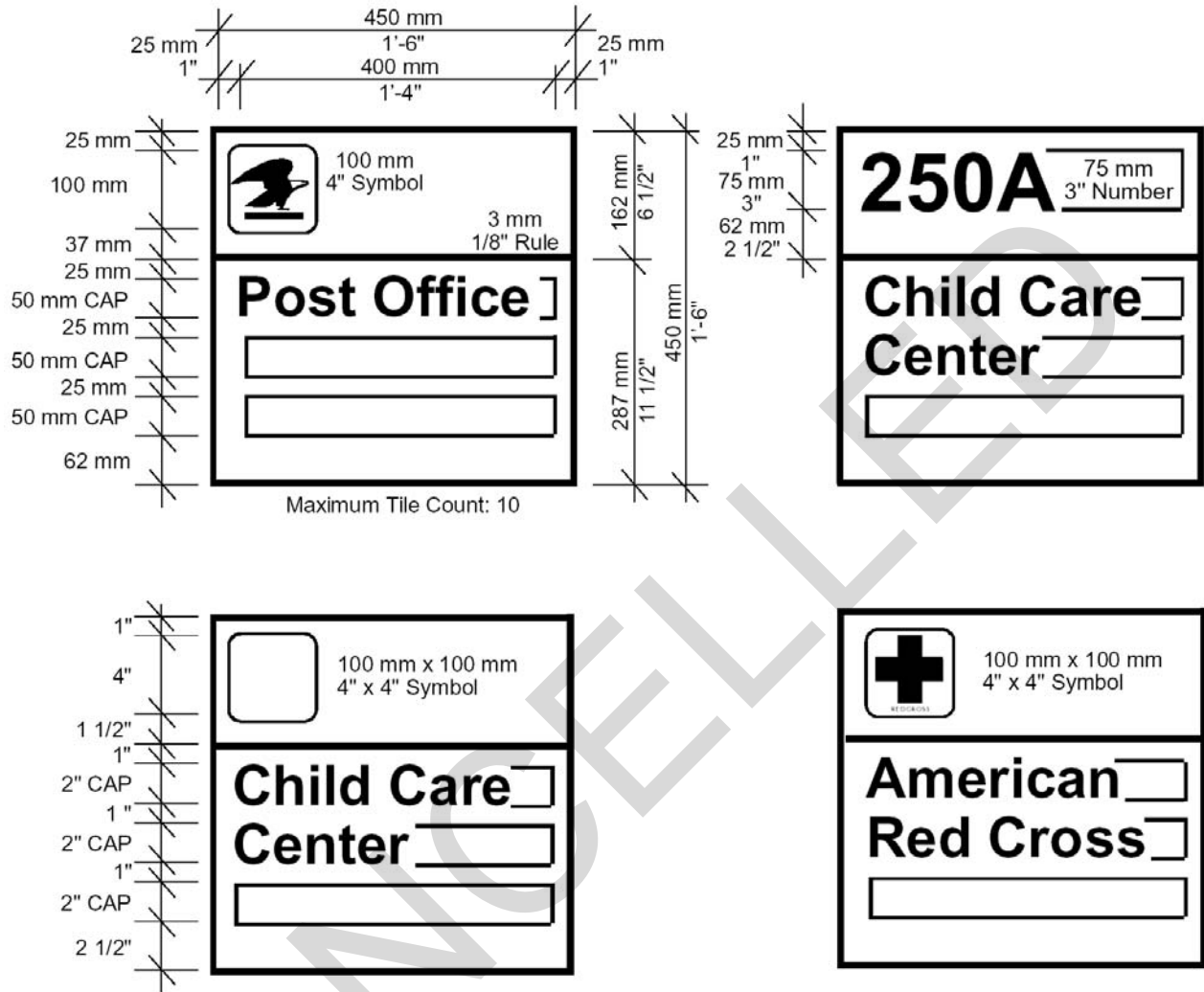

Figure 4.45. Recreational Facility Sign Type C5.

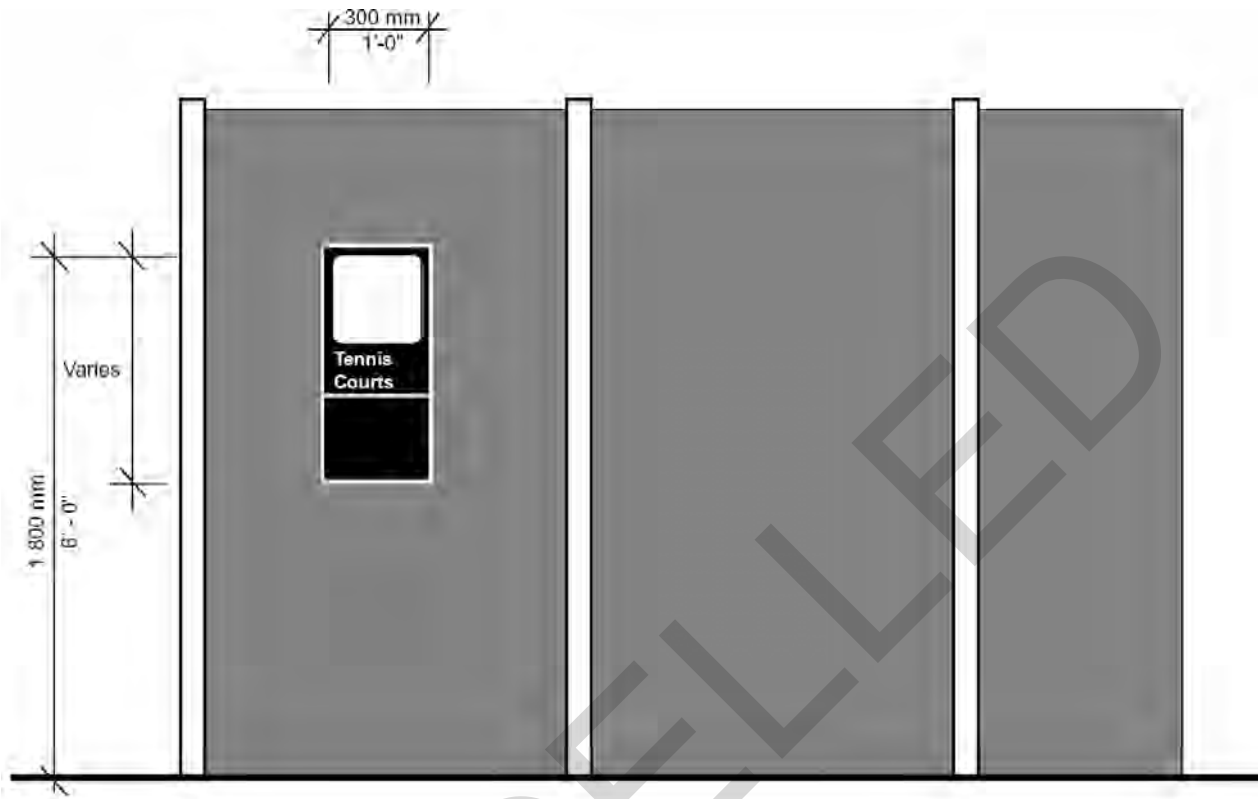
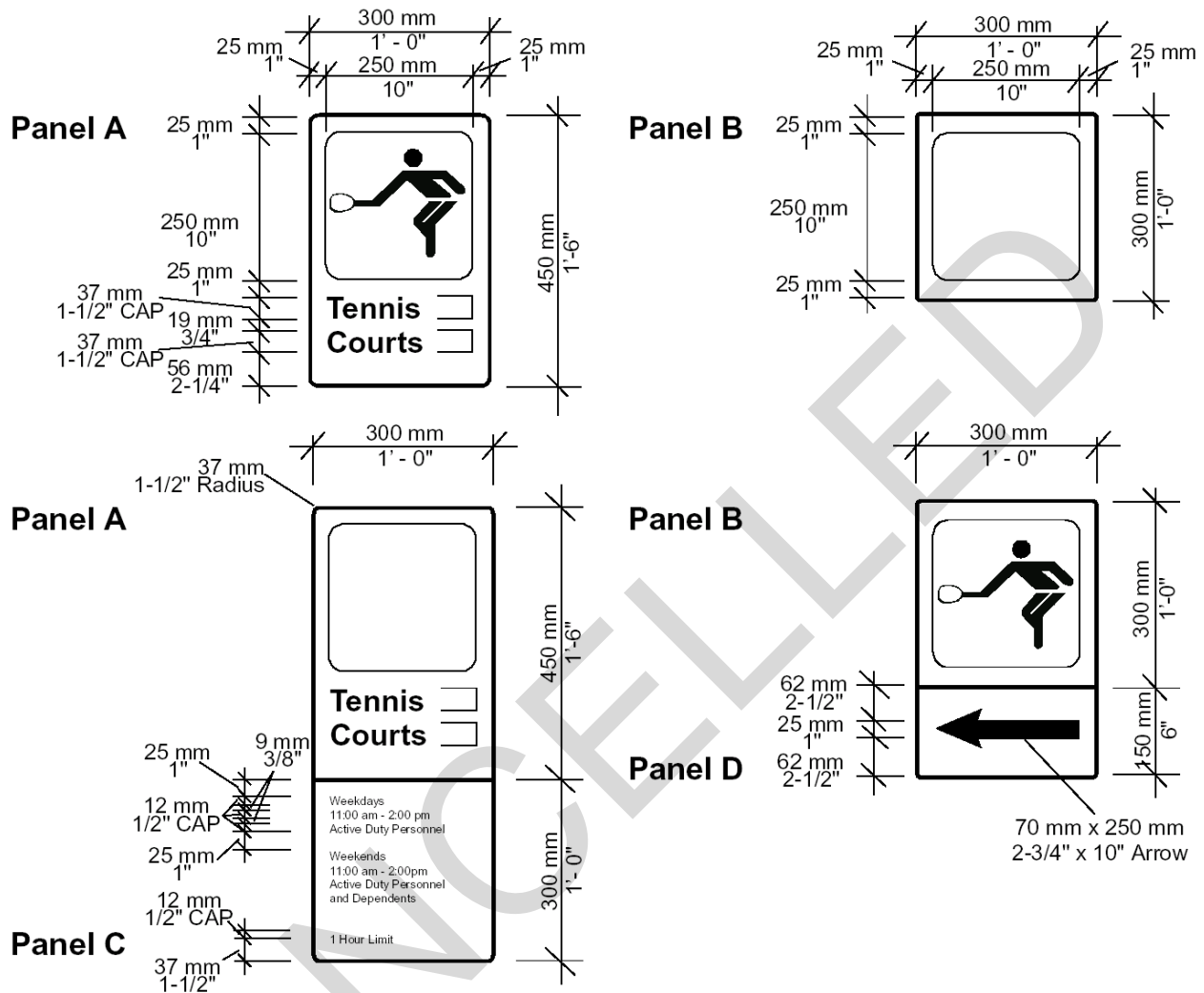

Figure 4.46. Recreational Facility Sign Type C5 Panels, A, B, C and D.



4.32. Bus Route Sign Type C6.

4.32.1. Introduction. Most Air Force bases have buses operating on prescribed routes to move people to destinations on and off base. These routes are sometimes an extension of local public transportation, and sometimes special services. Clear and consistent identification of bus routes, stops, and schedules will make transportation more convenient. Note: Sign Type C6 does not have to comply with the ADAAG.

4.32.2. Usage. Use the Type C6 Bus Route Sign to identify bus stops and bus routes. Graphics may appear on one or both sides of the sign, depending on sign placement. (See Chapter 2 for sign placement standards.) The basic sign panel consists of the standard bus symbol or a local transit company logo and the words "Bus Stop." See panels in Figure 4.48

4.32.3. Mounting. An additional sign panel may be placed below the basic sign panel to provide

further information. Mount both panels on the same type of backing sheet during fabrication. The backing sheet should have rounded corners. See panels C and D in Figure 4.48 and the sign layouts.

4.32.4. Sign Panels A and B.

4.32.4.1. Color.

- White letters on standard brown background.
- Bus symbol: black on white background.
- Local transit symbol: dark color on light colored background.

4.32.4.2. Dimensions. 450 mm x 300 mm (1' - 6" x 1' - 0").

4.32.4.3. Typography.

- Bus Stop: upper and lower case Helvetica medium, 75 mm (3") capital letter height, flush left.

4.32.4.4. Symbol. 250 mm x 250 mm (10" x 10") square.

4.32.5. Sign Panel C.

4.32.5.1. Colors. White letters on standard brown background.

4.32.5.2. Dimensions. 300 mm x 300 mm (1' - 0" x 1' - 0").

4.32.5.3. Typography.

- Bus Schedule: upper and lower case Helvetica medium, 12 mm (½ ") capital letter height, flush left.
- The message area will accommodate 10 lines with a maximum line length of 26 tiles or characters per line.

4.32.6. Sign Panel D.

4.32.6.1. Colors. White letters on standard brown background.

4.32.6.2. Dimensions. 150 mm x 300 mm (6" x 1' - 0").

Figure 4.47. Bus Route Sign Type C6 Placement.

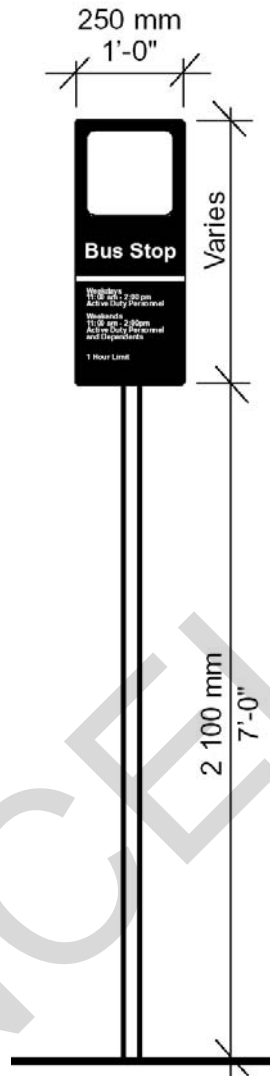

4.32.6.3. Typography.

- Route Name: upper and lower case Helvetica medium, 37 mm (1 ½ ") capital letter height, flush left.
- The message area will accommodate a maximum line length of 9 tiles or characters.

4.32.7. Sign Panel E.

4.32.7.1. Colors. White letters on standard brown background.

4.32.7.2. Dimensions. 150 mm x 300 mm (6" x 1'- 0").

4.32.7.3. Typography.

- Route Letter: upper case Helvetica medium, 50 mm (2") capital letter height.
- Route: upper and lower case Helvetica medium, 37 mm (1 ½ ") capital letter height,

flush left.

Figure 4.48. Bus Route Sign Type C6 Layouts.

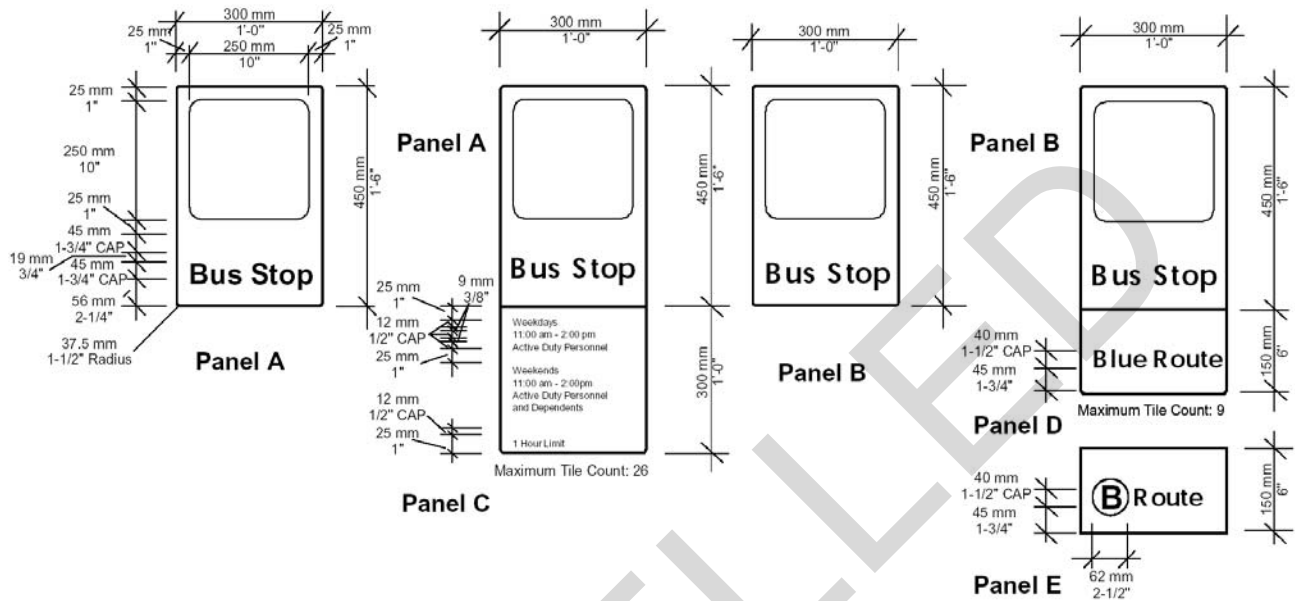

Section 4E – Water Tower Graphics

4.33. General Description. The size and visual prominence of water towers provide an excellent opportunity to exhibit a consistent, professional and recognizable image to the surrounding community. In order to ensure that these image qualities are achieved and maintained, all water tower tanks located on Air Force installations are to be painted in conformance with the following standards.

4.34. Information. The face of the water tower tank shall contain only the following information:
The Air Force Symbol.
The title “AIR FORCE” in upper case letters.

4.35. Other Graphics and Lettering. No additional graphics or lettering are to be applied.

4.36. Colors. The paint scheme for the AF Symbol and letterforms will consist of four (4) colors as indicated in Figure 4.49. The background color for the body of the tank will be a uniform light tone consistent with installation standards.

4.37. Proportions/Shapes. The application of the symbol and letterforms template may vary in overall size, but must maintain the composition and proportions as shown (see Figure 4.49.). The shape of the letterforms are based on “Arial Black” font. The shapes of neither the symbol nor the letterforms are to be altered in any way.

4.38. Visibility. Due to the diversity of water tower tank shapes, configurations and orientations, the

following guidelines are provided in order to facilitate consistent and effective implementation.

4.38.1. Number of Applications. Avoid a cluttered appearance by having no more than two (2) applications of the symbol and letterforms on one tank.

4.38.2. Orientation. Orient the symbol and letterforms on the side(s) of the tank that provide the best visibility from public ways.

4.38.3. Size. Size the symbol and letterforms as large as is practical so as to be easily read from a reasonable distance.

4.38.4. Position. Position the symbol and letterforms in a manner that minimizes visual interference by railings or other structural elements, and minimizes distortion due to any vertical curvature of the tank surface.

Figure 4.49. Template for Air Force Symbol on Water Tower Tanks



Specify paint to match the following colors:

- Color #1: Pantone 287
- Color #2: Black
- Color #3: Pantone Cool Gray 9 (metallic)
- Color #4: Pantone Cool Gray 4 (metallic)

Note: Unit proportions are measured to the edges of the Color #1 portion of the image .

Chapter 5

DIRECTION SIGNS

Section 5A—Introduction

5.1. Importance. There are too many potential destinations on any Air Force base to list on direction signs, but effective direction signs help visitors find their destinations more easily. Direction signs, proper street identification, and effective base maps form the basic keys to visitor orientation.

5.2. Priorities (Master Sign Plan). Coordinate the content and location of all direction signs in the base Master Sign Plan. These signs should form part of a logical system which directs each visitor from the point of entry through every intersection to a final destination. Prioritize destinations to be listed. Give the highest priority to the destinations that are most often sought by people new to the base or that serve as highly visible landmarks on base. Those who live or work on base or who visit frequently do not need the degree of help required by a first time or infrequent visitor.

5.3. Common Destinations. Facilities that are likely to have a great deal of first time traffic include the Commissary, Base Exchange, Hospital, Community Center, clubs, in-processing points, billeting, and major military activities.

5.4. Maps and Signs. Use the same names on base maps as on direction signs, and direct the security police to use the sign and map terminology when giving directions.

5.5. Message Limitations. Area designations such as East Base or West Base should be used only if they are meaningful. No more than four destinations should appear on one direction sign. If it is necessary to show more than four destinations, add a second sign, but do not use more than two direction signs in any situation. See Chapter 2 for sign placement standards

5.6. Visibility. Fabricate all graphics from white reflective materials to facilitate nighttime visibility. Green reflective sheeting is preferred to paint for the sign background.

5.7. Criteria. All traffic control signs on base streets should comply with the Manual on Uniform Traffic Control Devices (MUTCD), as the streets are considered public roads.

5.8. Further Information. This chapter gives the criteria for exterior direction signs, including information on sizes, appearance, message, permitted graphics, and layout. Recommended specifications and structural details are given in Chapter 12. See Figure 12.6 for the Type G3 Pedestrian Information Signs.

Section 5B--Direction Signs Typography

5.9. Tile System and Arrow. The type of letter tile system used on direction signs is the same as the type used on identification signs. (See Chapter 2 for specific information on sign typography.) The standard Manual on Uniform Traffic Control Devices arrow is used to indicate direction.

5.10. Placement. As the layouts indicate, messages are placed flush left or flush right in relation to the arrow. Arrows pointing left or up will have flush left messages, and arrows pointing to the right will have flush right messages. The arrow is centered in the space between the message and the edge of the sign.

5.11. Rules. The letters are always Helvetica medium. The message area accommodates a maximum of 17 tiles or characters. Spell names out in full whenever possible. If abbreviations are required, conform to AFDD1-2, Air Force Glossary.

Figure 5.1. Diagrammatic Sign Type D1.

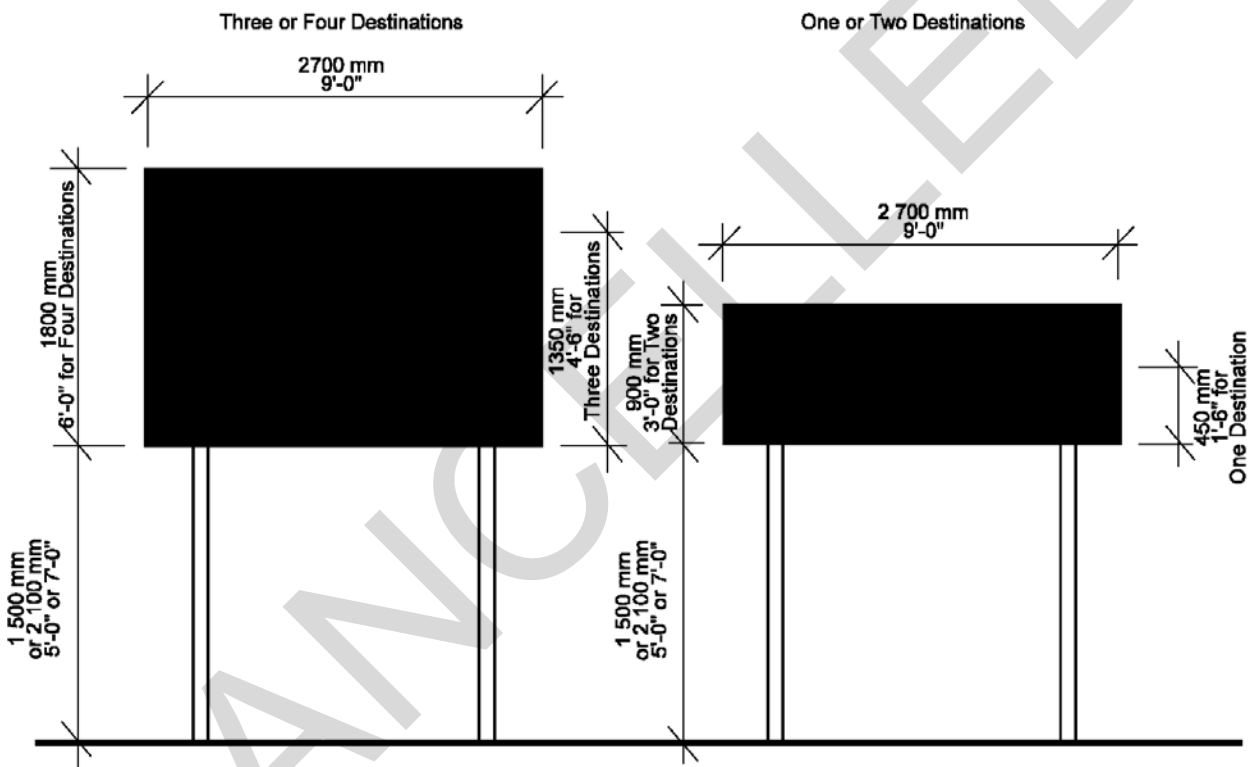
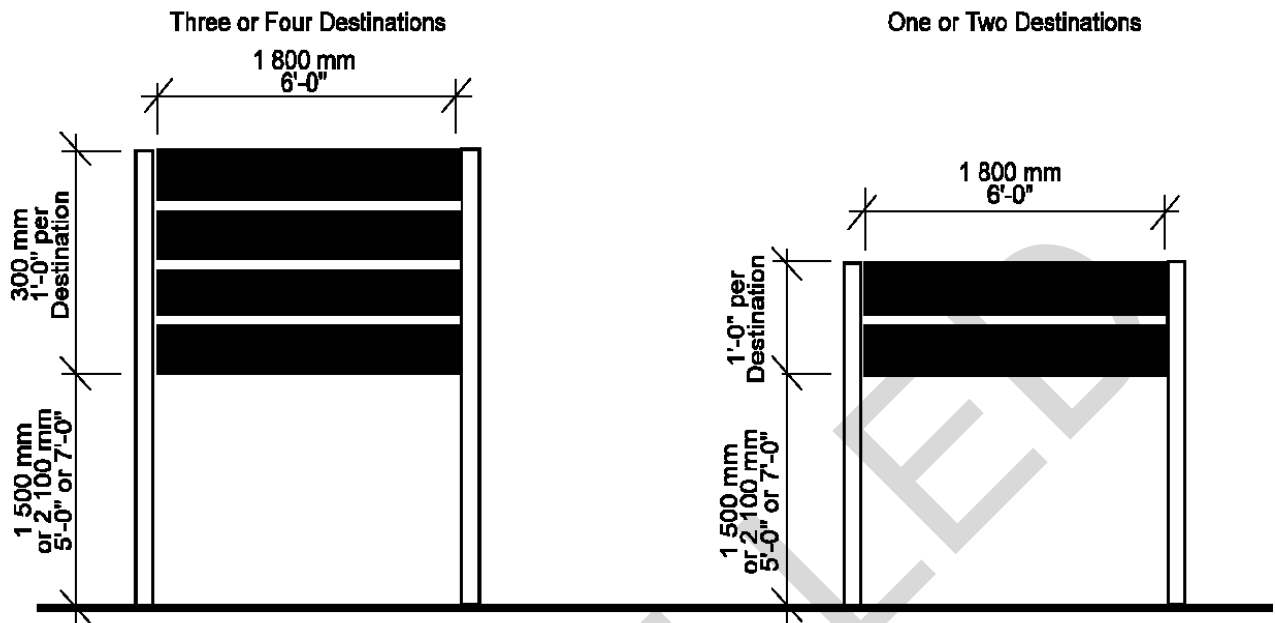

Figure 5.2. Directional Sign Type D2.



Section 5C--Types of Direction Signs

5.12. General Information. There are four types of direction signs: D1, D2, D3 and D4. Both the Type D1 and D2 Direction Signs use the standard Manual on Uniform Traffic Control Devices arrow rather than the standard arrow tile used on information signs.

5.13. Usage of Sign Type D1. The Type D1 sign is used on roadways with a posted speed limit of 40-72 km/hr (25-45 miles per hour). Roadways with higher posted speed limits require larger letter and sign sizes.

5.14. Usage of Sign Type D2. The Type D2 Direction Sign is used on roadways with speed limits of 40 km/hr (25 miles per hour) or less.

5.15. Usage of Sign Type D3. The Type D3 Sign is the standard street name sign.

5.16. Usage of Sign Type D4. The Type D4 Sign is used to direct users to accessible building entrances.

5.17. Placement Standards. See Chapter 2 for sign placement standards.

Figure 5.3. MUTCD Arrow Proportions.

MUTCD Arrow Proportions					
Sign	A	B	C	D	E
Type D1	65mm 2 5/8"	75mm 3"	131mm 5 1/4"	9mm 3/8"	12mm 1/2"
Type D2	44mm 1 3/4"	50mm 2"	87mm 3 1/2"	6mm 1/4"	8mm 5/16"

Figure 5.4. Arrow and Letter Titles.

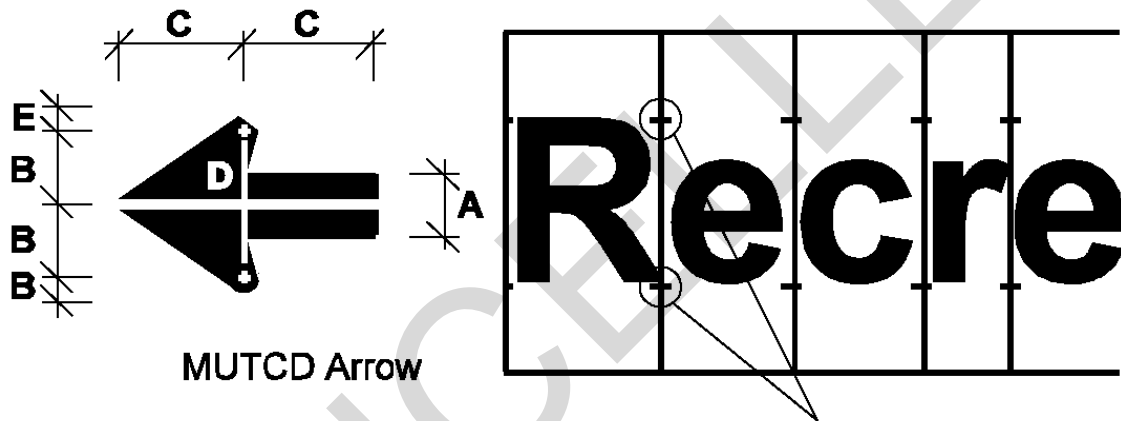
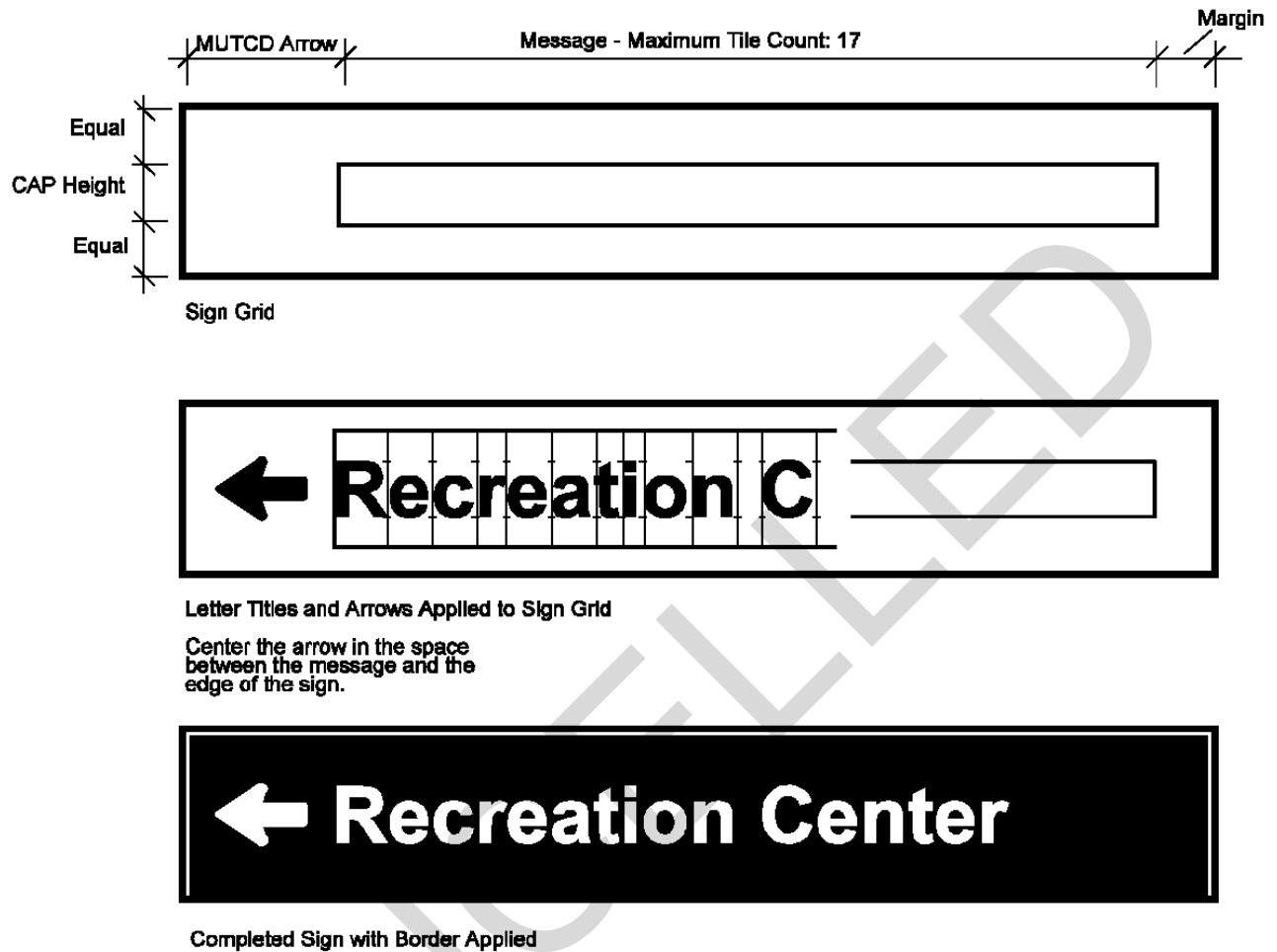

Figure 5.5. Sign Assembly Sequence.



5.18. Direction Sign Type D1.

5.18.1. Information and Sizes. No more than four destination messages are permitted on a sign. The sign panel is normally 2 700 mm (9'- 0") wide, but if the messages are short, the width of the sign may be reduced by 150 mm (6") increments, as appropriate. A typical sign with shorter messages is shown in Figure 5.8. In this case the width of the sign has been reduced to 2 400 mm (8'- 0").

5.18.2. Visibility. Use a white border on the sign panel and rules between the destinations to increase night time visibility.

5.18.3. Graphics. Graphics should appear on only one side of the sign since the sign will be placed in advance of an intersection and will be viewed by traffic moving in one direction only.

5.18.4. Colors. White letters, arrows, rules and borders (reflectivity mandatory) on standard green background (reflectivity desirable). Most Air Force installations currently use standard brown as the background color. To maintain visual consistency, individual sign replacements or

additions should continue with the established base standard. Since green is the background color that the MUTCD has established for this sign type, every effort should be made to comply if a basewide direction sign replacement project is undertaken.

5.18.5. Dimensions. 450 mm x 2 700 mm (1'- 6" x 9'- 0") to 1 800 mm x 2 700 mm (6'- 0" x 9'- 0"). If the sign is placed where parking and/or pedestrian movement is likely to occur, or if there are other obstructions to view, a clear height of 2 100 mm (7'- 0") to the bottom of the sign panel should be maintained. Maintain a clear height of 1 500 mm (5' 0") if no such hazards exist.

5.18.6. Typography.

- Upper and lower case Helvetica medium, 150 mm (6") capital letter height, flush left or right to arrow.
- The message area will accommodate four lines with a maximum line length of 17 tiles or characters per line.

5.18.7. Arrow. Manual on Uniform Traffic Control Devices standard 175 mm x 270 mm (7" x 10 ½ ") placed left or right as appropriate.

5.18.8. Rules. 6 mm (1/4") wide white tape.

5.18.9. Border. 25 mm (1") wide white tape.

5.18.10. Layouts. See Figures 5.7 and 5.8 for the sign layouts.

5.19. Direction Sign Type D2.

5.19.1. Usage. The Type D2 sign is used on roadways with a posted speed limit of 40 km/hr (25 miles per hour) or less.

5.19.2. Information. Use separate slat for each destination so that messages can be changed without remaking the entire sign face. No more than four destinations are permitted on a sign. If the sign shows four destinations and those destinations are not likely to change, the sign may be fabricated as a single panel. Separate each destination with a white rule.

5.19.3. Placement. If the sign is placed where parking and/or pedestrian movement is likely to occur, or if there are other obstructions to view, a clear height of 2 100 mm (7'- 0") to the bottom of the sign panel should be maintained. Maintain a clear height of 1 500 mm (5'- 0") if no such hazards exist.

5.19.4. Visibility. Use white border on the sign panel to increase nighttime visibility.

5.19.5. Graphics. Graphics appear on only one side since the sign is placed in advance of an intersection and will be viewed by traffic moving in one direction only.

5.19.6. Layout. See Figure 5.10 for sign layout.

Figure 5.6. Direction Sign Type D1.

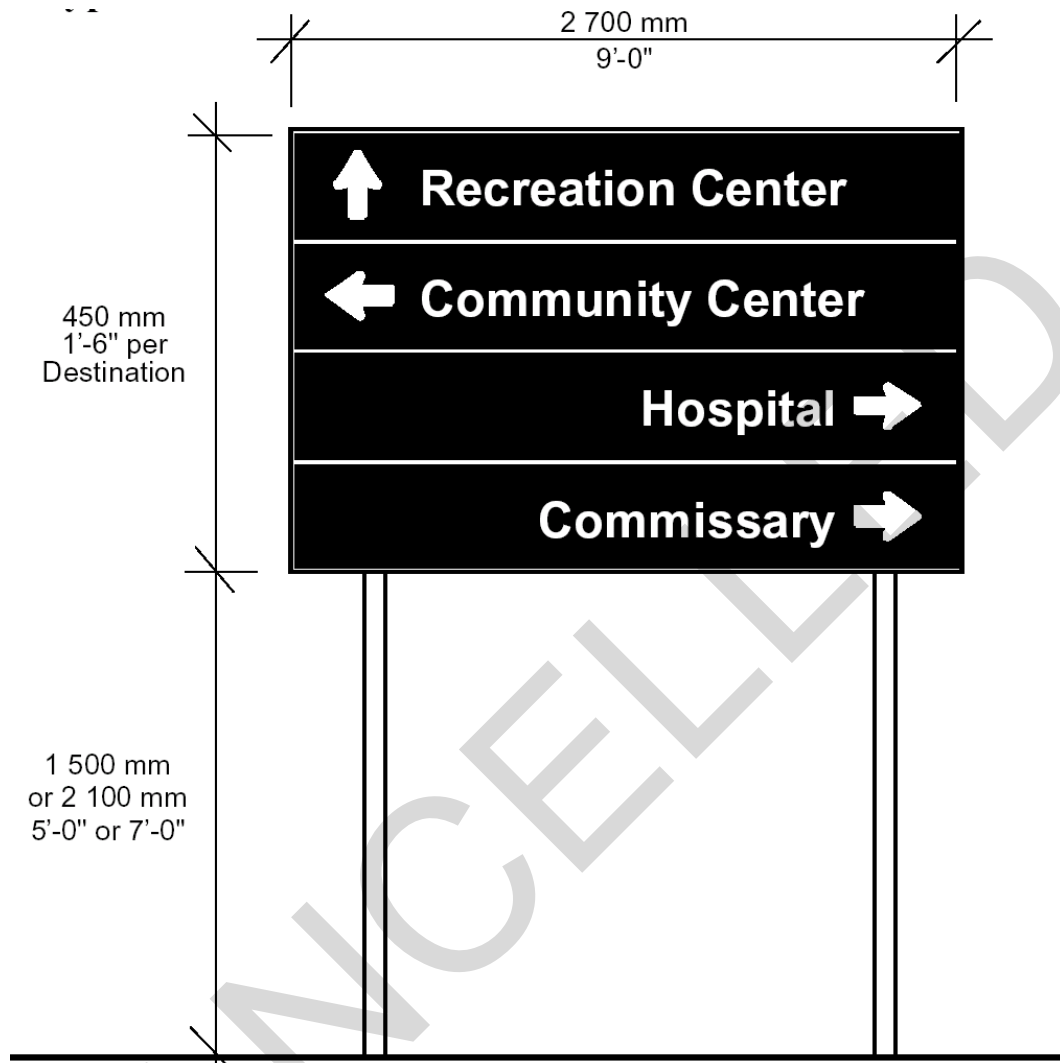

Figure 5.7. Direction Sign Type D1 Layout 1.

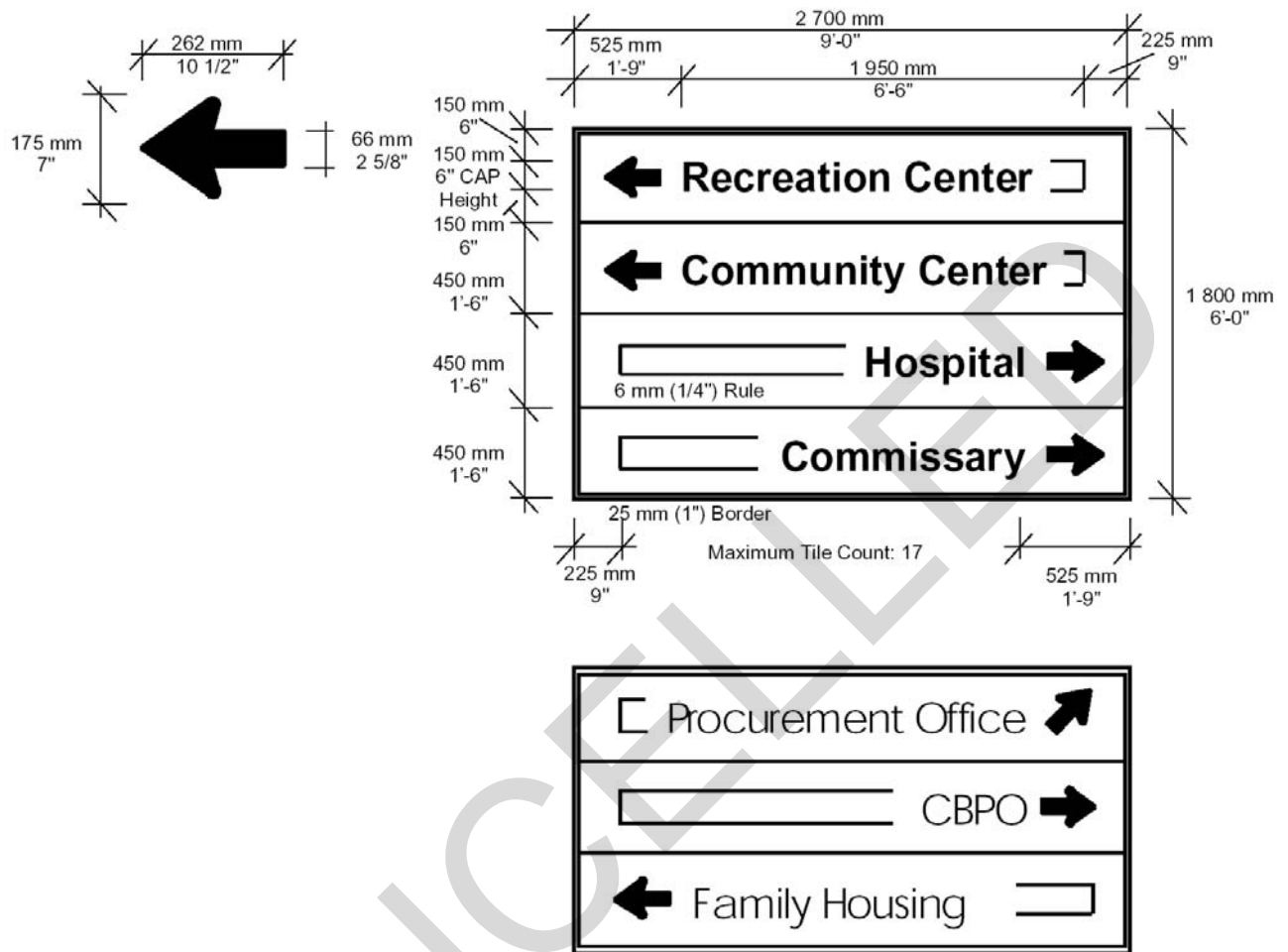

Figure 5.8. Direction Sign Type D1 Layout 2.

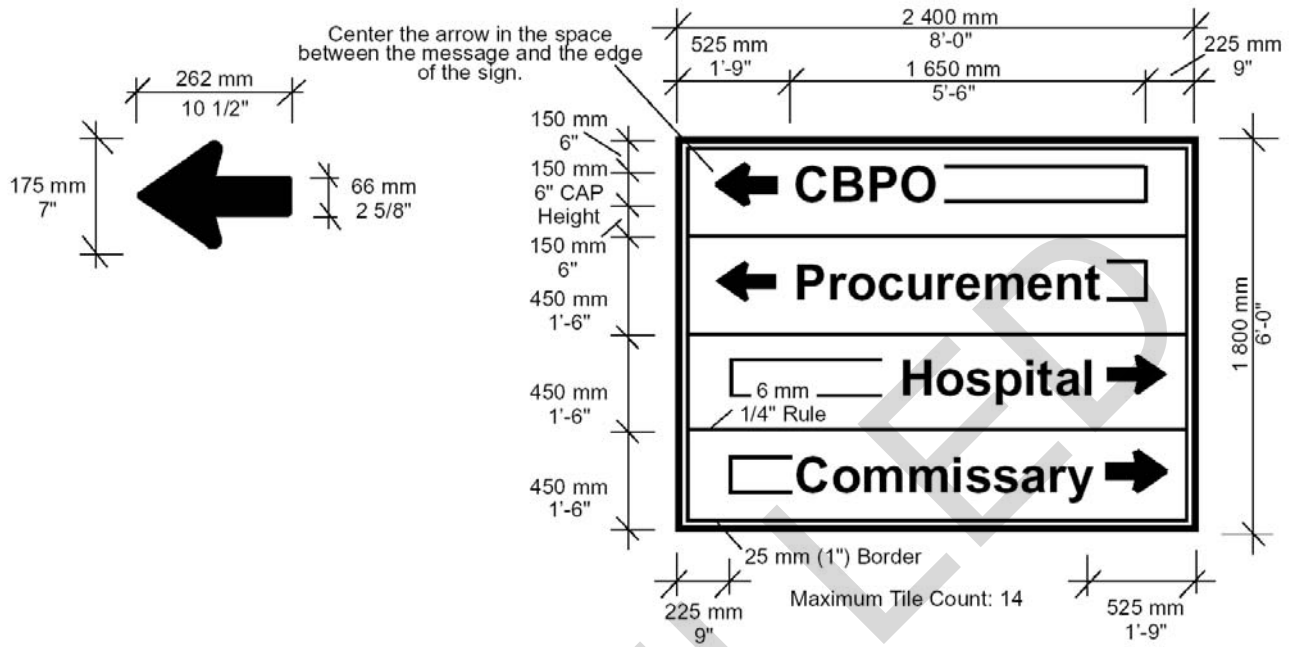
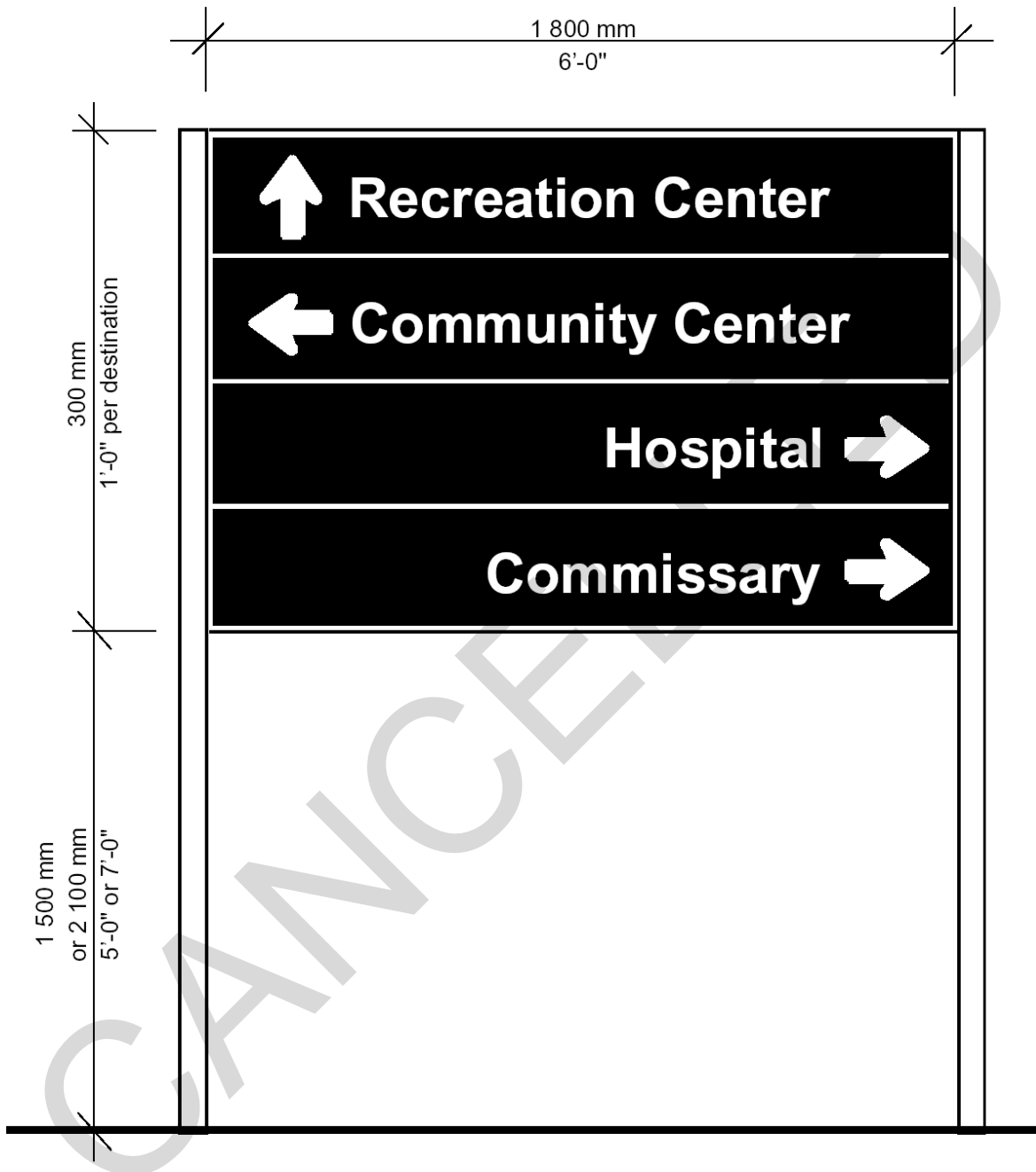

Figure 5.9. Direction Sign Type D2.



5.19.7. Colors. White letters, arrows, rules and borders (reflectivity mandatory) on standard green background (reflectivity desirable). To maintain visual consistency, individual sign replacements or additions should continue with the established base standard. Since green is the background color that the MUTCD has established for this sign type, every effort should be made to comply if a base-wide direction sign replacement project is undertaken.

5.19.8. Dimensions. Slats - 300 mm x 1 800 mm (1'- 0" x 6'- 0").

5.19.9. Typography:

- Upper and lower case Helvetica medium, 100 mm (4") capital letter height, flush left or right to arrow.
- The message area of each slat will accommodate a maximum of 17 tiles or characters.

5.19.10. Arrow. Manual on Uniform Traffic Control Devices standard 116 mm x 175 mm (4 5/8" x 7") placed left or right as appropriate.

5.19.11. Rules. 6 mm (1/4") thick white tape.

5.19.12. Border. 19 mm (3/4") thick white tape.

5.20. Direction Sign Type D3.

5.20.1. Street Name Sign. The Type D3 sign is the standard street name sign.

5.20.2. Colors. White letters, arrows, rules and borders (reflectivity mandatory) on standard brown background (reflectivity desirable).

5.20.3. Dimensions. Slats - 150 mm (6") minimum x 300 mm (1'-0") minimum. Sign width will vary in 150 mm (6") increments as required to accommodate longer street names.

5.20.4. Typography.

- Street Name: Upper case Helvetica medium, 100 mm (4") capital letter height, centered.
- Secondary Information: Upper case Helvetica medium, 65 mm (2 1/2") capital letter height, left or right justified as required.

5.20.5. Border. 13 mm (1/2") thick white tape.

Figure 5.10. Direction Sign Type D2 Layout.

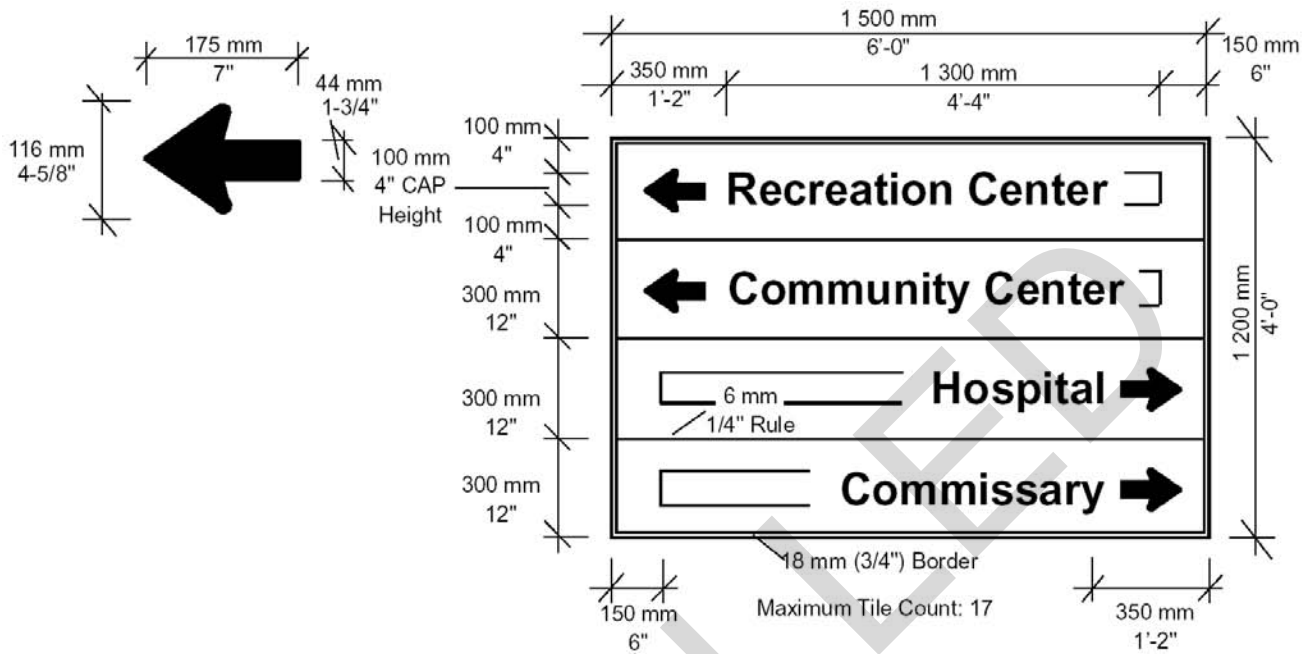
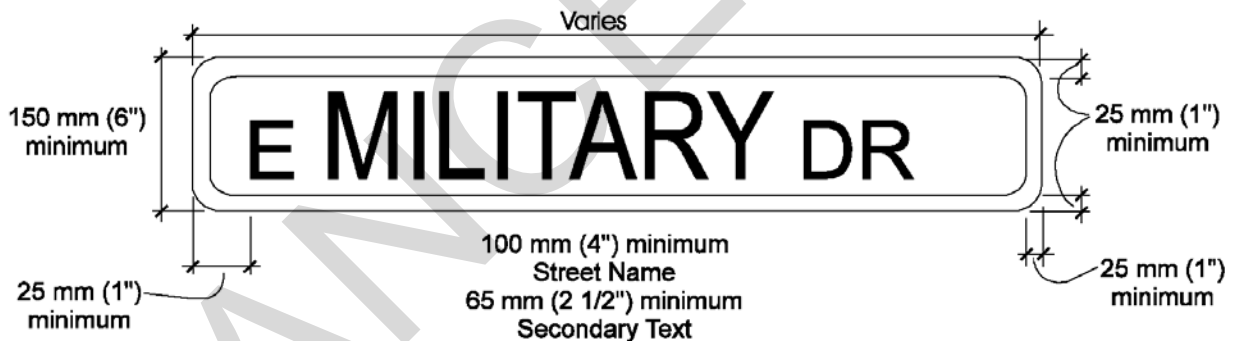

Figure 5.11. Direction Sign Type D3 Typical Panel.



5.21. Direction Sign Type D4.

5.21.1. Building Accessibility. When not all entrances to a building are accessible, inaccessible entrances shall have directional signage to indicate the route to the nearest accessible entrance. Directional signage may take the form of directional arrows or in the case of complex instructions, written directional information.

5.21.2. Depending on site conditions the sign may either be wall or post mounted.

5.21.3. See Chapter 4, Sign Type B7 (paragraph 4.21) for International Symbol of Accessibility specifications.

5.21.4. Colors. White symbol, arrow or text on standard brown background.

5.21.5. Dimensions. Symbol sign 150 mm x 150 mm (6"x6"). Directional information sign 150 mm x 150 mm (6" x 6").

Figure 5.12. Direction Sign Type D3, Typical Configurations.



CANCELLED

Chapter 6

REGULATORY SIGNS

Section 6A--Introduction

6.1. General Guidelines. Regulatory signs should be approached in a systematic fashion. Establish and follow the Master Sign Plan to ensure that the base does not become cluttered. Post no more regulatory signs than are necessary for safety and security.

6.2. Criteria. There are several categories of regulatory signs: Highway standards, Base Warning Signs and Parking Regulation Signs. This chapter gives the criteria for exterior regulatory and base warning signs, including information on sizes, appearance, message, permitted graphics and layout.

6.3. Safety Signs. Safety signs warn personnel of physical hazards and unsafe practices. Air Force standards for safety signs are contained in AFOSH 9166, General Industrial Operations, and are updated by the Air Force Safety Center (AFSC/SEGS).

6.4. Further Information. Information on typography, graphics, and sign placement can be found in Chapter 2. Recommended specifications and structural details are given in Chapter 12.

Section 6B--Highway Standards

6.5. Introduction. Highway Standards regulate vehicular traffic on base. Refer to the Manual on Uniform Traffic Control Devices (MUTCD) published by the Federal Highway Administration for highway standards in the United States. Similar standards exist for foreign countries.

6.6. Importance of Standards. Any deviation from the accepted highway safety signs could create serious safety hazards. It is important to continue the use of familiar highway signs on base, so highway warnings and other regulatory signs and traffic control devices should follow the standard shapes, designs, and colors of the nation where the base is located.

6.7. References. In the United States, these standards are described in the Manual on Uniform Traffic Control Devices and must be followed for all traffic control signs. The parking regulation signs discussed in paragraph 6.14 utilize standard symbols and are intended to supplement the Manual on Uniform Traffic Control Devices.

Figure 6.1. Highway Standards.

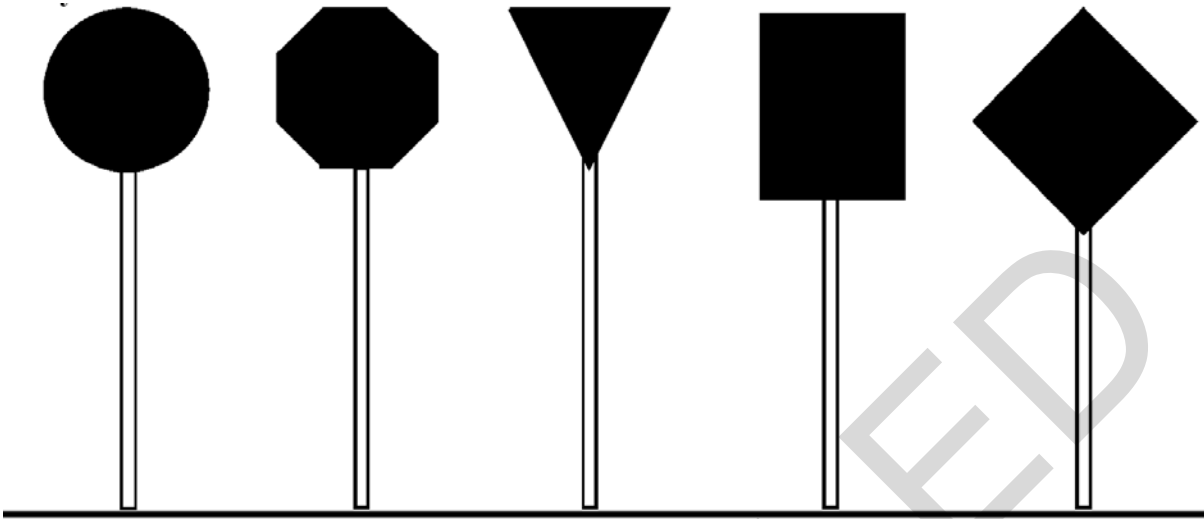
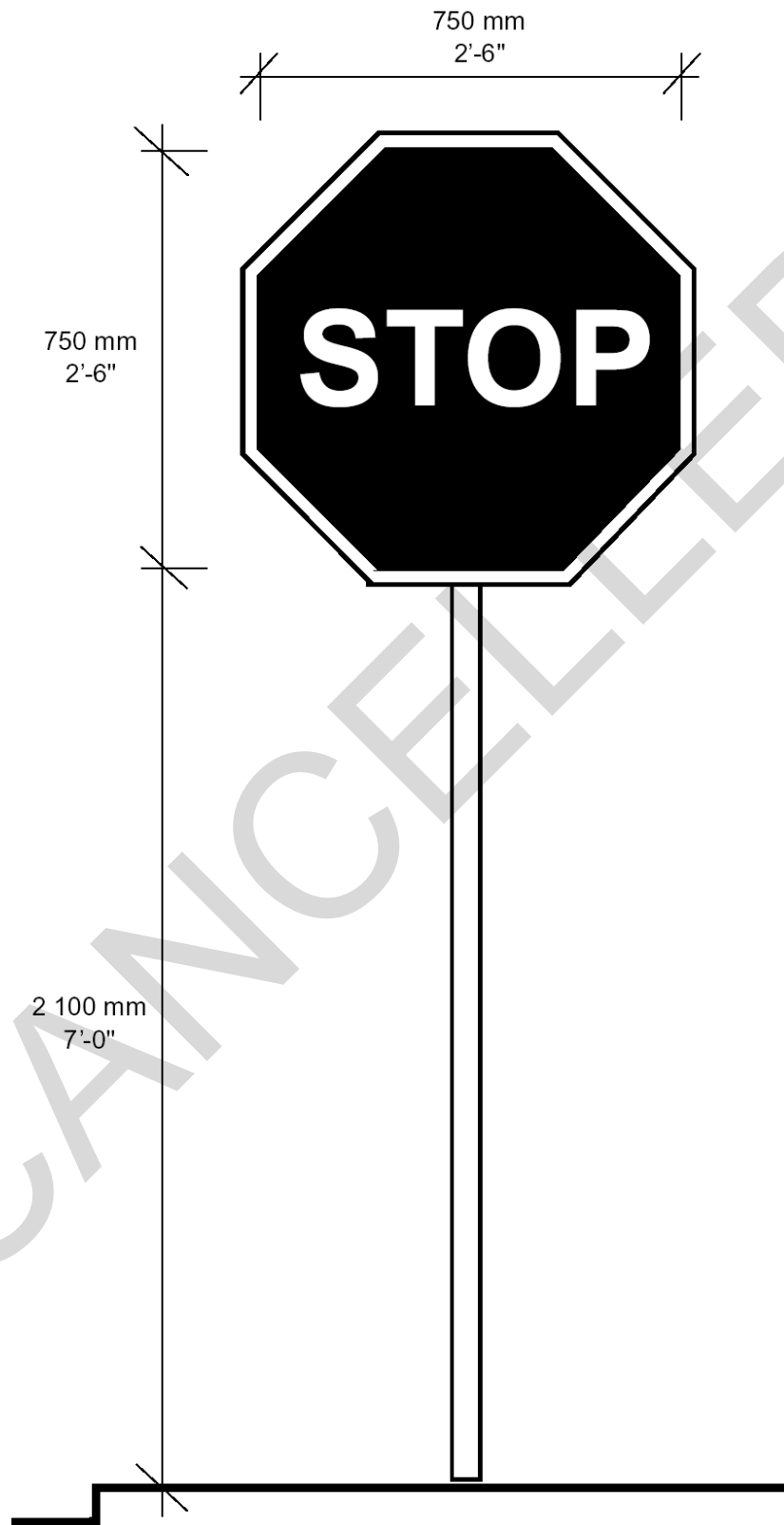

Figure 6.2. Highway Standard Stop Sign.



Section 6C--Base Warning Signs

6.8. Introduction. Several types of signs are used to define areas of restricted access in order to maintain proper levels of security. Warning signs are displayed at the installation perimeter, at controlled areas or facilities, restricted areas or facilities and facilities protected by Intrusion Detection Equipment (IDE).

6.9. Requirements and Guidance. The requirements and guidance for the proper use of warning signs are contained in AFI 31-101, The Air Force Installation Security Program.

6.10. Mounting. Warning signs may be mounted directly on fences or walls. Locations and frequency are to be in accordance with AFI 31-101. The structural support for free-standing warning signs will be in compliance with established base standards. Warning signs are not to be mounted to the face, or supporting structure, of any other sign type.

6.11. Layouts. See Figures 6.6 through 6.11 for the sign layouts.

6.12. Base Warning Sign Type E1.

6.12.1. Usage. Use the Type E1 Base Warning Sign Layout for the Air Force Installation Warning Sign, the Controlled Area Sign, and the Restricted Area Sign at all personnel and vehicle entry points. If working dog teams are used inside or around a posted area, place the military working dog team notice directly below the sign panel.

6.12.2. Mounting. Combinations of additional notices, such as a solicitation warning or photography prohibition, may be required at base entry points. Place these notices directly below the installation warning sign or combine them on a separate sign structure placed below Warning Sign Panel E. The Type A3 Entry Gate sign may also be shown on this structure. (See paragraph 4.10.2.) Mount all the panels on the same backing sheet during fabrication. If two sign structures are required, the height of the two structures should be equal (not to exceed 7' - 0" or 2 100 mm) and the signs should be distributed evenly between them.

6.12.3. Visibility. Both the background panel and the message on all base warning signs must be reflective.

Figure 6.3. Base Warning Sign.

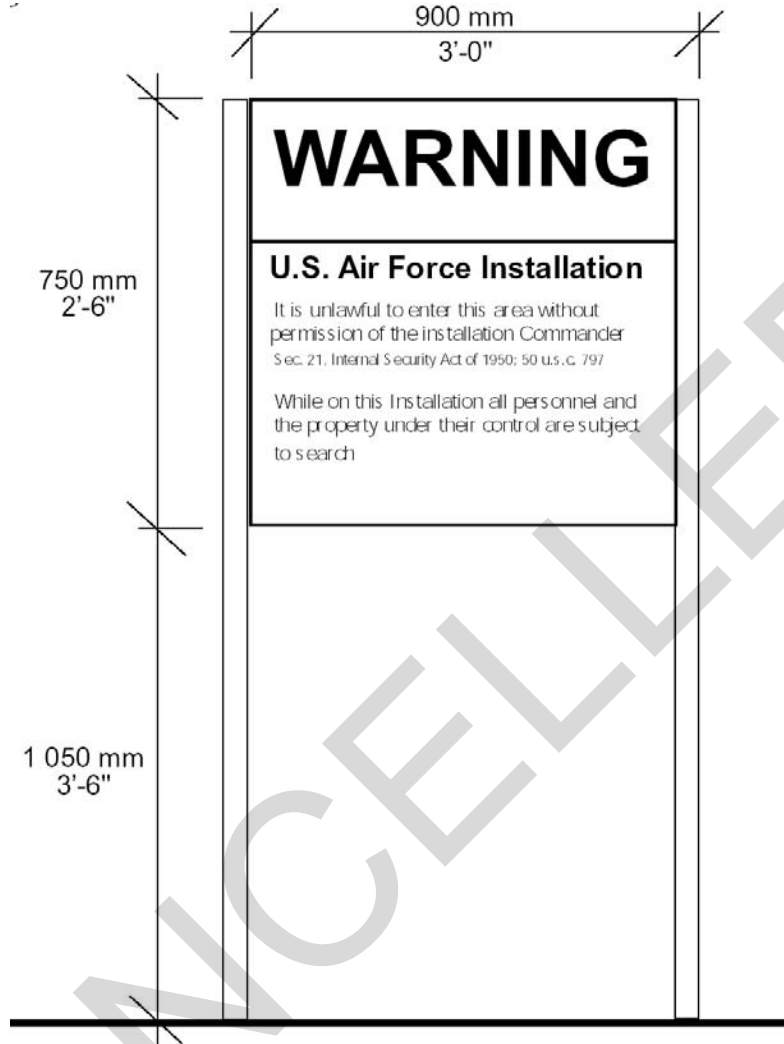

6.12.4. Sign Panel A.

6.12.4.1. Colors.

- **WARNING:** standard red letters on white background.
- **Heading, text and citation** - black letters on white background.

6.12.4.2. Dimensions. 750 mm x 900 mm (2'- 6" x 3'- 0").

6.12.4.3. Typography.

- **WARNING:** upper case Helvetica medium, 125 mm (5") capital letter height, centered.
- **Heading:** upper and lower case Helvetica medium, 50 mm (2") capital letter height, flush left. The heading line will accommodate a maximum of 25 tiles or characters.
- **Text:** upper and lower case Helvetica medium, 25 mm (1") capital letter height, flush

left. The text area will accommodate eight lines, with a maximum of 44 tiles or characters per line.

- Citation: upper and lower case Helvetica medium 19 mm (3/4") capital letter height, flush left.

6.12.5. Sign Panel B.

6.12.5.1. Colors.

- WARNING: Black letters on white background.
- Heading, text and citation: Black letters on white background.

6.12.5.2. Dimensions. 750 mm x 900 mm (2' - 6" x 3' - 0").

6.12.5.3. Typography.

- WARNING: upper case Helvetica medium, 125 mm (5") capital letter height, centered.
- Heading: upper and lower case Helvetica medium, 50 mm (2") capital letter height, flush left. The heading line will accommodate a maximum of 25 tiles or characters.
- Text: upper and lower case Helvetica medium, 25 mm (1") capital letter height, flush left. The text area will accommodate eight lines, with a maximum of 44 tiles or characters per line.
- Citation: upper and lower case Helvetica medium 19 mm (3/4") capital letter height, flush left.

Figure 6.4. Base Warning Signs.

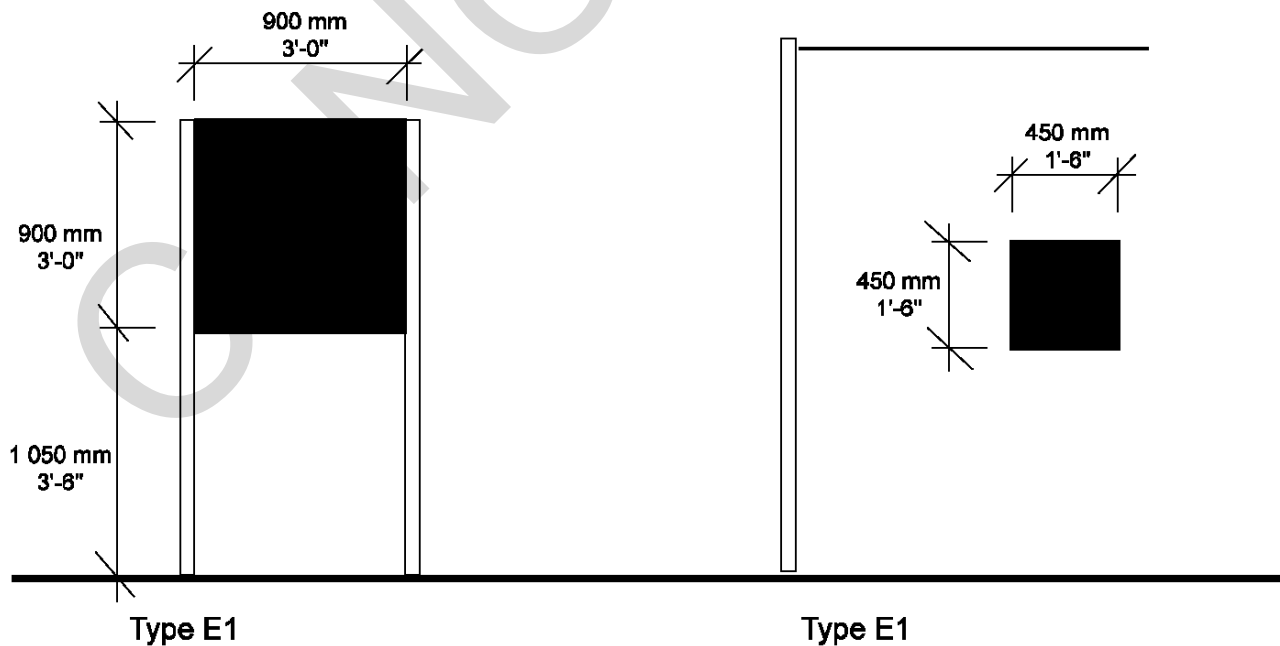

Figure 6.5. Base Warning Sign Type E1 Panel A.



Figure 6.6. Base Warning Sign Type E1 Panel B.



6.12.6. Sign Panel C.

6.12.6.1. Color. Black letters on white background.

6.12.6.2. Dimensions. 150 mm x 900 mm (6' x 3' - 0").

6.12.6.3. Typography.

- Upper and lower case Helvetica medium, 25 mm (1") capital letter height, flush left.

6.12.7. Sign Panels D, E, F and G.

6.12.7.1. Typical Layouts. Panel E and Panel F show layouts for typical additional notice messages. A 44 mm (1 3/4") space should be placed between paragraphs.

6.12.7.2. Colors.

- WARNING: standard red letters on white background.
- Heading and text: black letters on white background.

6.12.7.3. Typography. Panel dimensions and message specifications are indicated in Figure 6.9. All typography should be upper and lower case Helvetica medium, flush left.

6.13. Base Warning Sign Type E2.

6.13.1. Usage. The Type E2 warning sign is similar to the Type E1 warning sign, but smaller. Use the Type E2 Air Force Installation Warning Sign to post area boundaries. Use the Type E2 Controlled Area and Restricted Area signs to post area boundaries and the interior and exterior

doors of buildings.

6.13.2. Mounting. If working dog teams are used inside or around a posted area, place the military working dog team notice panel directly below the warning sign panel. Mount the two panels on the same backing sheet during fabrication.

6.13.3. Sign Panel A.

6.13.3.1. Colors.

- WARNING and “Use of deadly force authorized”: standard red letters on white background.
- Heading, text and U. S. Code citation: black letters on white background.

6.13.3.2. Dimensions. 375 mm x 450 mm (1'- 3" x 1'- 6").

6.13.3.3. Typography.

- WARNING: upper case Helvetica medium, 62 mm (2½") capital letter height, centered.
- Heading: upper and lower case Helvetica medium, 25 mm (1") capital letter height, flush left. The heading line will accommodate a maximum of 25 tiles or characters. Text: upper and lower case Helvetica medium, 12 mm (½") capital letter height, flush left. The text will accommodate eight lines, with a maximum of 44 tiles or characters per line.
- Citation: upper and lower case Helvetica medium 9 mm (3/8") capital letter height, flush left.

Figure 6.7. Base Warning Sign Type E1 Panel C.



Figure 6.8. Base Warning Sign Type E1 Panels D, E, F and G.

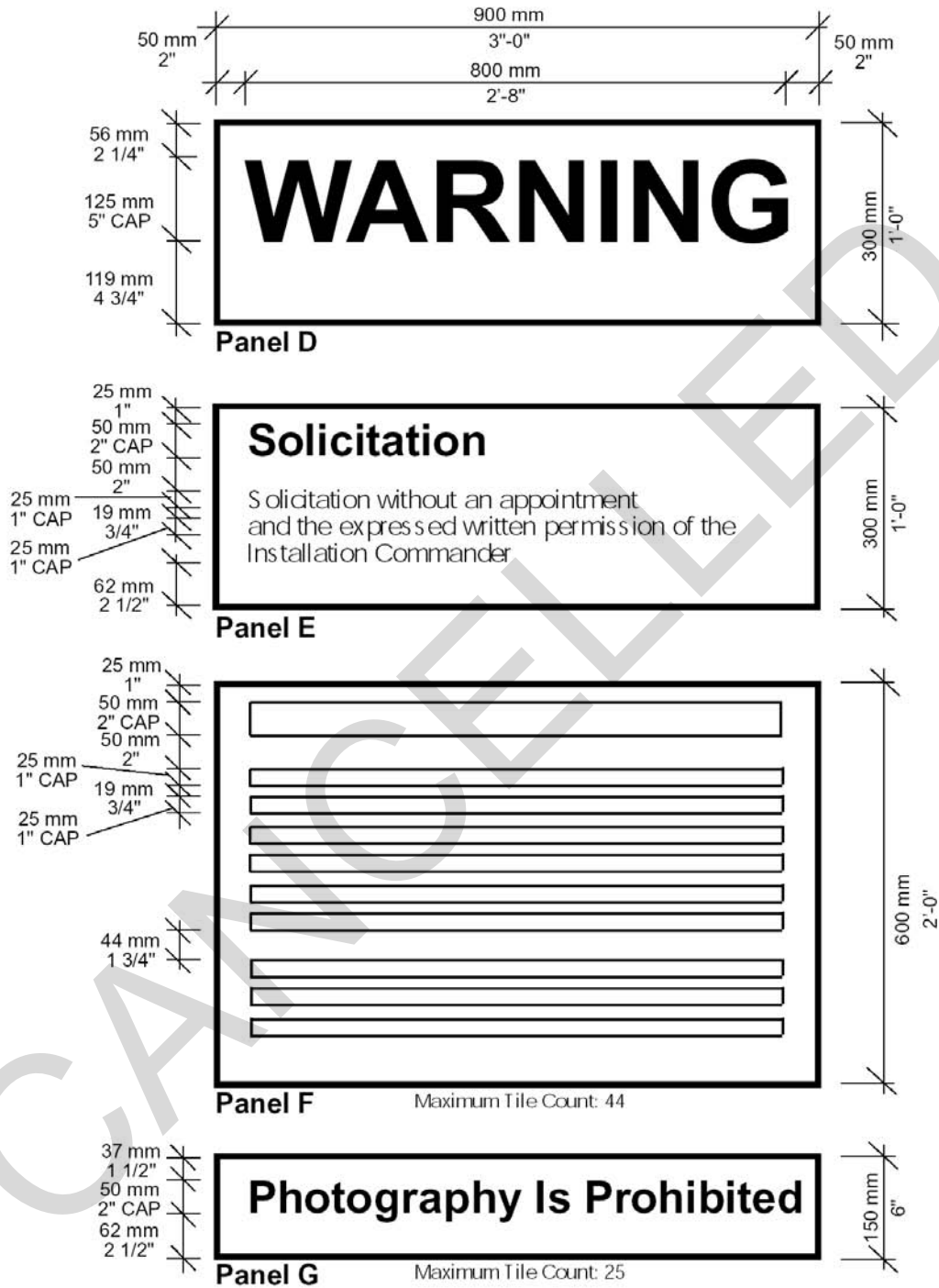

6.13.4. Sign Panel C.

6.13.4.1. Color. Black letters on white background.

6.13.4.2. Dimensions. 75 mm x 450 mm (3" x 1'- 6")

6.13.4.3. Typography.

- Upper and lower case Helvetica medium, 12 mm (½”) capital letter height, flush left.

6.13.5. Sign Panel B.

6.13.5.1. Colors.

- WARNING and “Use of deadly force authorized”: standard red letters on white background.
- Heading, text and U. S. Code citation: black letters on white background.

6.13.5.2. Dimensions. 375 mm x 450 mm (1’ - 3” x 1’ - 6”).

6.13.5.3. Typography.

- WARNING: upper case Helvetica medium, 62 mm (2 ½”) capital letter height, centered.
- Heading - upper and lower case Helvetica medium, 25 mm (1”) capital letter height, flush left. The heading line will accommodate a maximum of 25 tiles or characters.
- Text - upper and lower case Helvetica medium, 12 mm (½”) capital letter height, flush left. The text will accommodate eight lines, with a maximum of 44 tiles or characters per line.
- Citation - upper and lower case Helvetica medium 9 mm (3/8”) capital letter height, flush left.

Figure 6.9. Base Warning Sign Type E2 Panels A and C.

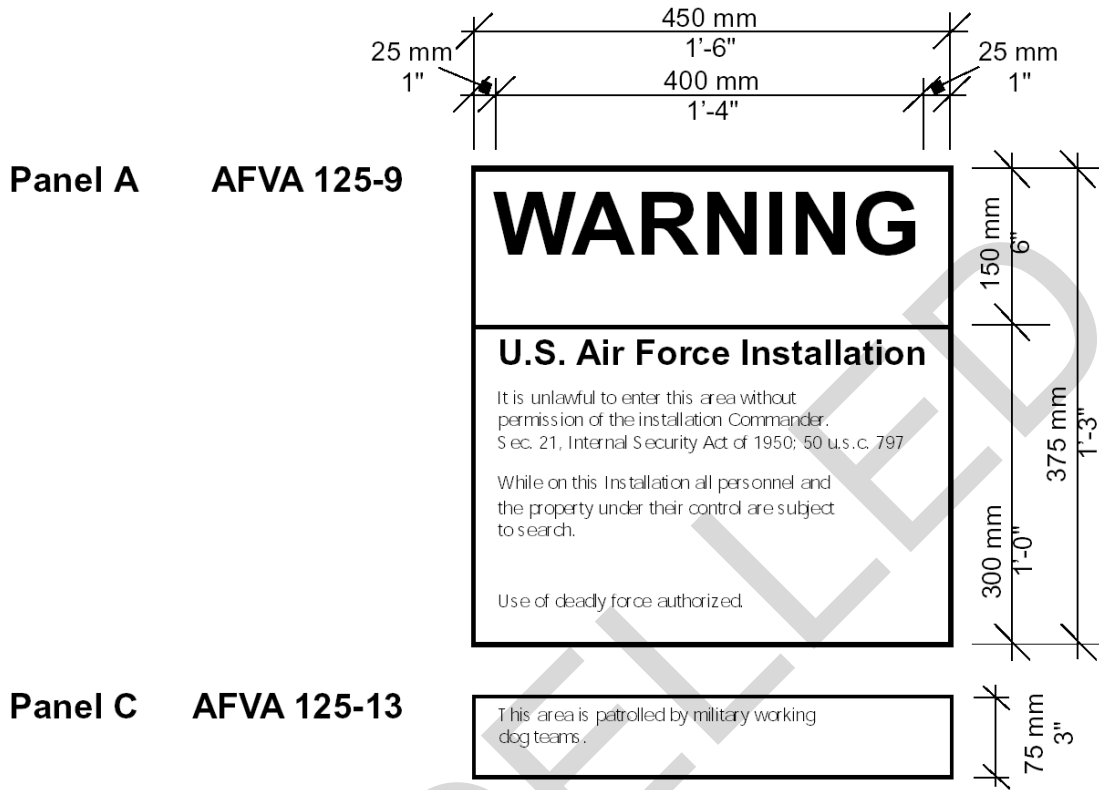
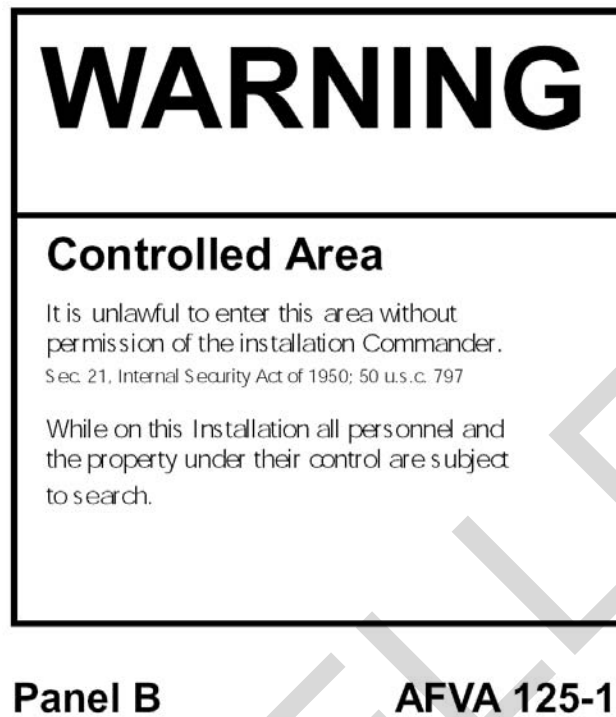

Figure 6.10. Base Warning Sign Type E2 Panel B.



Section 6D--Parking Regulation Signs

6.14. Introduction. Parking Regulation Signs, Type E1 and E2, identify general and restricted parking areas. They are designed to meet the specific needs of the Air Force and to supplement the national standards noted in 6.5. The large number of reserved parking signs at most bases adds visual clutter and leads to maintenance problems. This problem can be solved by reconsidering the reserved parking policy and by changing the way reserved parking spaces are identified.

6.14.1. Limiting Reserved Spaces. Limit the number of parking spaces reserved for individuals such as the base commander or senior NCO, or groups such as general officers. Reserve parking areas for unit personnel only if it is necessary to ensure that parking is available in the immediate area. Assign numbered parking spaces to personnel or post the entire reserved area with a sign at each entrance.

6.14.2. References. These parking signs are intended to supplement the Manual on Uniform Traffic Control Devices and include freestanding signs, wall mounted signs and curb markings.

6.15. Parking Regulation Sign Type E1.

6.15.1. Usage. Use Type E1 sign panels to identify general and restricted parking areas and to define specific parking regulations (such as the hours and days of regulation), including handicapped accessible parking places. Maintain a clear height of 1 500 - 2100 mm (5'- 0" to 7' - 0") to the bottom of the Type E1 sign panel.

6.15.2. Pictographs. Type E1 sign panels use pictographs such as the “P” symbol for parking, the no parking symbol, or the international symbol of access for the handicapped as the primary graphic element. (Figure 2.31 for the regulation symbols.)

6.15.3. Verbal Message. A verbal message should be included to confirm the pictographic message or to add special information such as “Visitor Parking.”

6.15.4. Information and Mounting. To provide additional information, use another sign panel below the main sign panel. Both panels should be mounted on the same backing sheet during fabrication. All sign panels should have rounded corners.

6.15.5. Colors.

- Panels A, B, E, F, G and H: standard green “P” symbol and border on white background. Colors may be reversed if desired.
- Panels C and D: black “P” symbol and standard red circle with slash, border, and letters on white background.
- Panel J: white symbol, letters, and border on standard dark contrasting background. If there is an established color scheme for this sign type in the surrounding community, it is highly recommended that the same scheme be used on-base for easy recognition by visitors.

6.15.6. Dimensions and Typography. Dimensions and message specifications are indicated in Figure 6.12. All typography is upper and lower case Helvetica medium, centered.

6.16. Parking Regulation Sign Type E2.

6.16.1. Introductions. Use type E2 sign panels or curb markings to identify reserved parking stalls. Wherever possible, reserved parking should be designated by area, rather than by individual spaces, as the designations change frequently and numerous signs add to visual clutter.

6.16.2. Curb Markings. Apply curb markings directly to curb only when no other method of designating spaces is possible.

6.16.3. Sign Panel A and B.

6.16.3.1. Colors. Standard green letters and border on white background.

6.16.3.2. Typography.

- Upper and lower case Helvetica medium, 25 mm (1”) or 37 mm (1½”) capital letter height centered.
- The message line will accommodate a maximum of 13 titles or characters for the 25 mm (1”) capital letter height message and 9 characters for the 37 mm (1½”) capital letter height message.

6.16.4. Curb Markings.

6.16.4.1. Colors. Black letters or numbers on white or standard yellow background.

6.16.4.2. Typography. Upper case Helvetica medium 50 mm (2") capital letter height, centered.

Figure 6.11. Parking Regulation Signs.

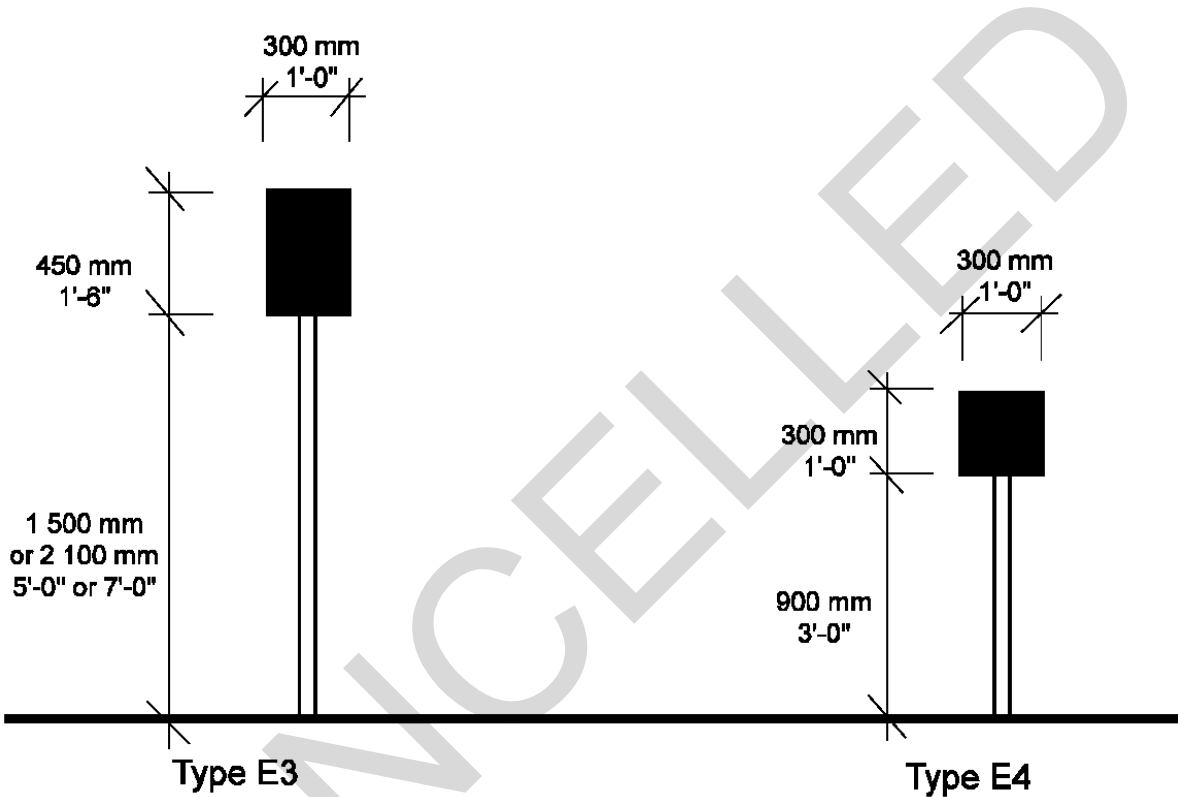

Figure 6.12. Parking Regulation Sign Type E1 Layouts.

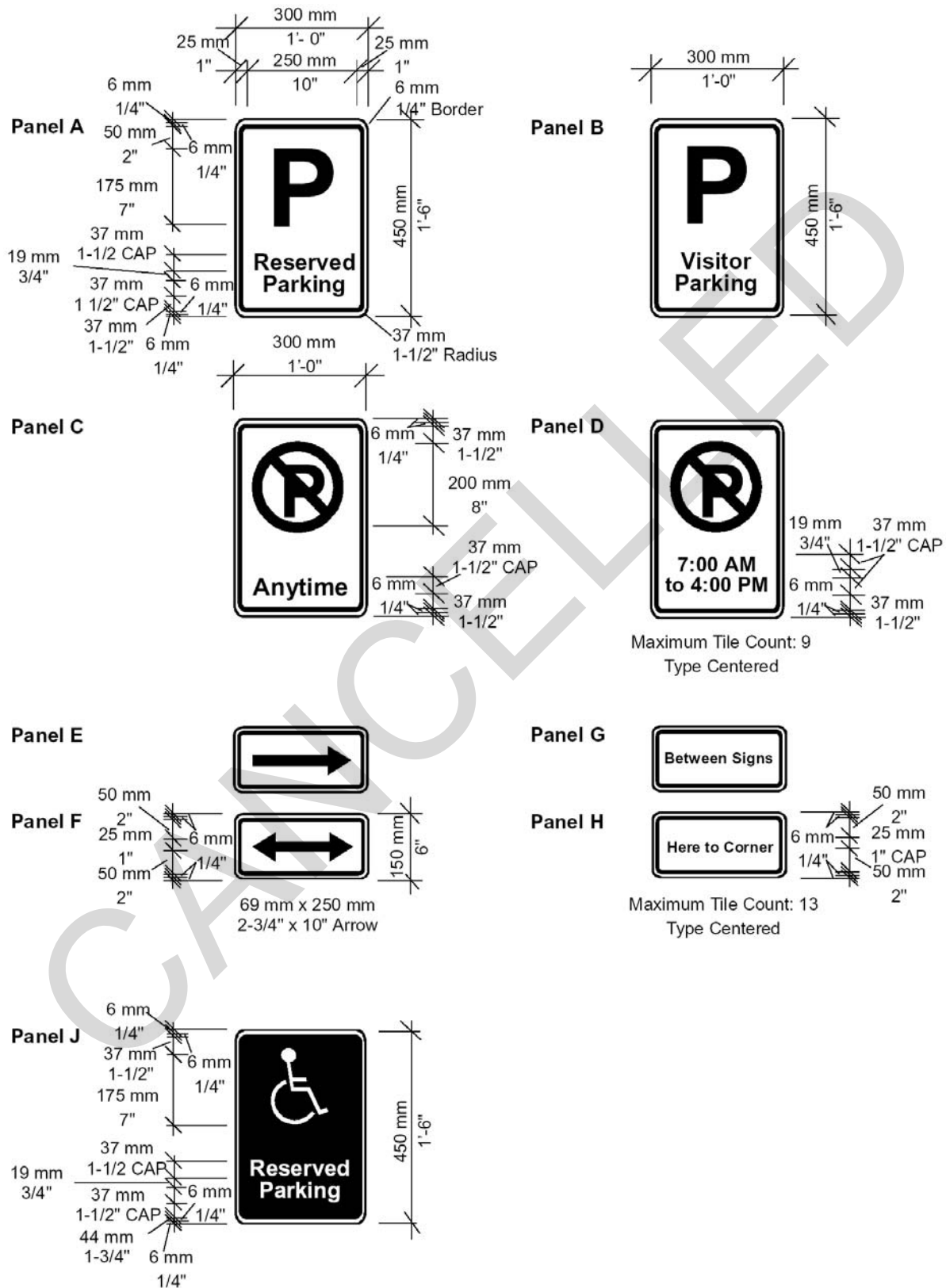

Figure 6.13. Parking Regulation Sign Type E2 Panels A and B.

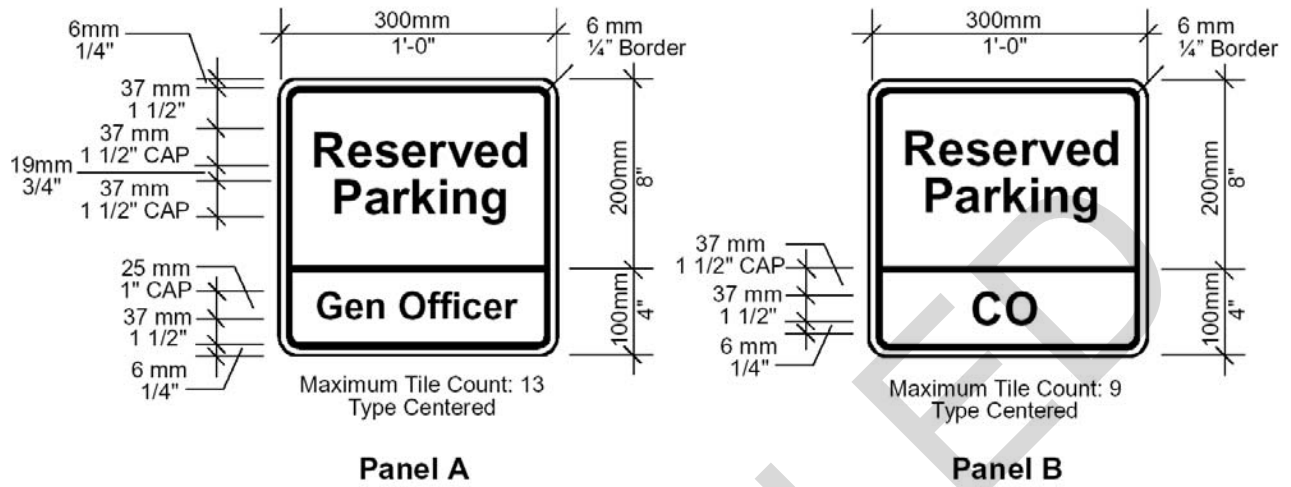
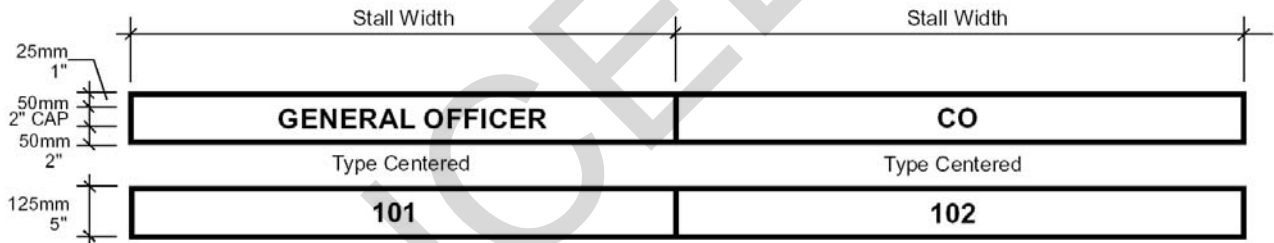

Figure 6.14. Parking Regulation Sign Type E2.

Curb Markings



Chapter 7

MOTIVATION SIGNS

Section 7A—Introduction

7.1. Importance. Air Force bases have many signs designed to motivate. They are important elements of campaigns to boost morale, improve safety, aid in recruiting, and other objectives.

7.2. Challenges. The quality of these signs varies a great deal. Although some are professionally made, many are produced by people who have limited experience in design or communication. The standards described here are not intended to eliminate motivation signs or to regiment them unnecessarily. Many motivation signs have a vitality that should be maintained. Haphazard placement and odd sizes, however, often create unattractive clutter.

7.3. Master Sign Plan. The base civil engineer is responsible for controlling the quality, content and placement of motivation signs. Include motivation signs in the base Master Sign Plan, and minimize the number in order to avoid a cluttered appearance.

7.4. Types of Signs. There are three types of morale signs F1, F2 and F3.

7.4.1. Type F1. The Type F1 Base Morale Sign is used to identify the principal organization or organizations on base.

7.4.2. Type F2. The Type F2 Standard Morale Sign is used to support safety campaigns, fund raising drives and special events.

7.4.3. Type F3. The Type F3 Unit Morale Sign is used to display organization emblems and mottoes and to express unit pride.

7.4.4. Electronic Messaging. Electronic messaging can be an effective method of conveying a wide variety of information and may be considered for incorporation into motivation signs. Overall dimensions and proportions for the selected sign type are to be maintained if possible. It is recommended to limit electronic messaging to a single sign located in the vicinity of the main entrance or at a central location in the community area. Electronic messaging may also be effectively used at a VIP entry point along the flight line. Added attention should be given to placement of signs incorporating electronic messaging to maximize readability while minimizing any adverse impact on traffic flow and safety.

7.5. Materials, Structures and Illumination. Sign faces may be finished in a variety of materials, but sign structures should conform to those shown in Chapter 12. Signs that will be viewed at night may be illuminated by flood lights.

7.6. Further Information. Information on typography, graphics and sign placement can be found in Chapter 2. Recommended specifications and structural details are in Chapter 12.

Figure 7.1. Base Morale Sign Type F1.

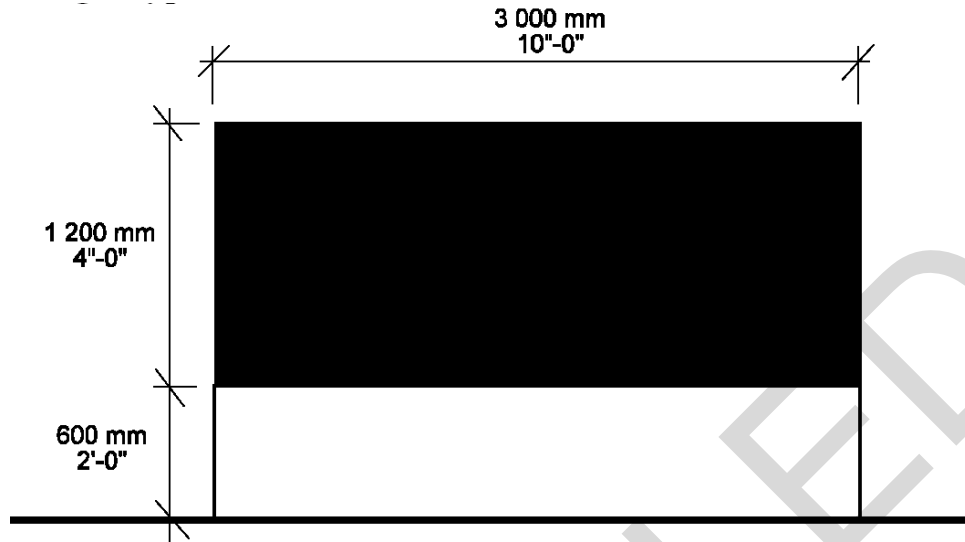

Figure 7.2. Standard Morale Sign Type F2.

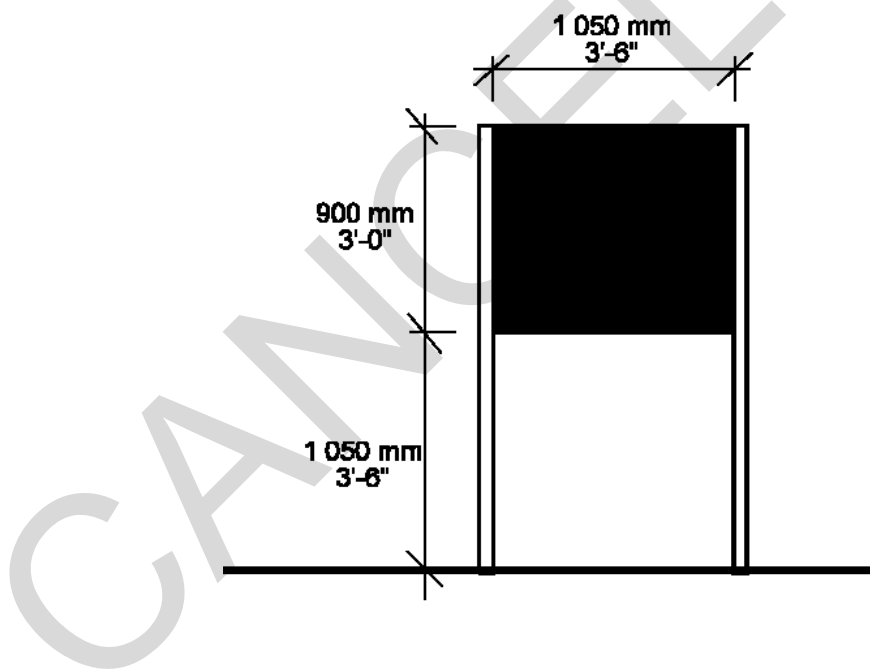
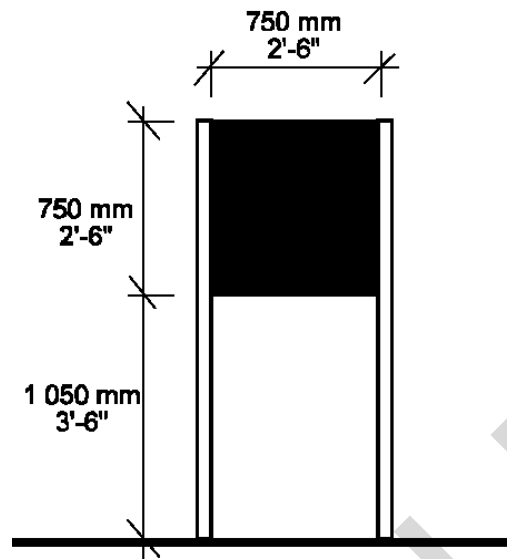

Figure 7.3. Unit Morale Sign Type F3.



Section 7B--Base Morale Signs

7.7. Base Morale Sign Type F1a.

7.7.1. General Introduction. The Base Morale Sign, Type F1a, identifies the principal organizations on base or displays the command hierarchy for the base.

7.7.2. Placement and Information. This sign is placed inside the main gate or at a central location on base, and may show the command shield, organizational emblems, mottoes, awards and other elements related to base morale.

7.7.3. Design Parameters. The design of the sign may vary. The sign shown below is for illustration only. There are no restrictions on the use of color or the character of the specific design, but the sign should be professionally designed and fabricated.

7.7.4. Dimensions. The dimensions should not exceed 1 200 mm x 3 000 mm (4'-0" x 10'-0").

Figure 7.4. Base Morale Sign Type F1a.



7.8. Base Changeable Letter Sign Type F1b.

7.8.1. General Information. The Base Changeable Letter Sign, Type F1b, identifies the base and the principal organizations on base and welcomes important visitors.

7.8.2. Placement. The sign should be placed parallel to the flight line at the principal arrival point.

7.8.3. Information (Message). The base name is placed on the upper part of the sign, and the changeable message is placed on the lower part of the sign. This message is made up of changeable letter tiles with magnetic backing which are placed on the steel sign panel.

7.8.4. Structure. Use sign structure as the sign structure for the Type F1a Base Morale Sign.

7.8.5. Changeable Letter Tile Dimensions. Changeable Letter Tile: 150 mm (6") upper case letter centered on a 225 mm (9") tile. The width of the tile varies with the letter width.

7.8.6. Tile Supply. Multiple alphabets, including punctuation marks, should be prepared on tiles.

7.8.7. Layouts. See Figure 7.7 for the sign layouts.

Figure 7.5. Base Changeable Letter Sign Type F1b.



1 200 mm x 3 000 mm
4'-0" X 10'-0" Sign Panel

Figure 7.6. Changeable Letter Tile Dimensions.



Changeable Letter Tile: 6" upper case letter centered on a 9" tile. The width of the tile varies with the letter width. Multiple alphabets, including punctuation marks, should be prepared on tiles.

7.8.8. Colors. White letters on standard color background.

7.8.9. Dimensions. 1 200 mm x 3 000 mm (4'- 0" x 10'- 0").

7.8.10. Typography.

- Base Name: upper and lower case Helvetica medium, 150 mm (6") capital letter height, centered.
- The message line will accommodate a maximum of 25 tiles or characters.
- Changeable Message: upper case Helvetica medium, 150 mm (6") capital letter height, centered.
- The message area will accommodate three lines with a maximum of 18 tiles per line.

7.8.11. Rules. 6 mm (1/4 ") wide white tape.

7.9. Standard Morale Sign Type F2a.

7.9.1. Usage. Use standard Morale Sign, Type F2a, to support and promote safety campaigns, fund raising drives, special events and other worthwhile programs.

7.9.2. Responsible Person. The base civil engineer is responsible for approving, installing and monitoring the use of these signs.

7.9.3. Design. As with the other motivation signs, the design and fabrication should reflect well on Air Force professionalism. The design may vary.

7.9.4. Color. There are no restrictions on the use of color.

7.9.5. Dimensions. 900 mm x 1 050 mm (3'- 0" x 3'- 6").

7.9.6. Combinations. Signs may be used in combinations as shown in Figure 7.10.

CANCELLED

Figure 7.7. Base Changeable Letter Sign Type F1b Layouts.

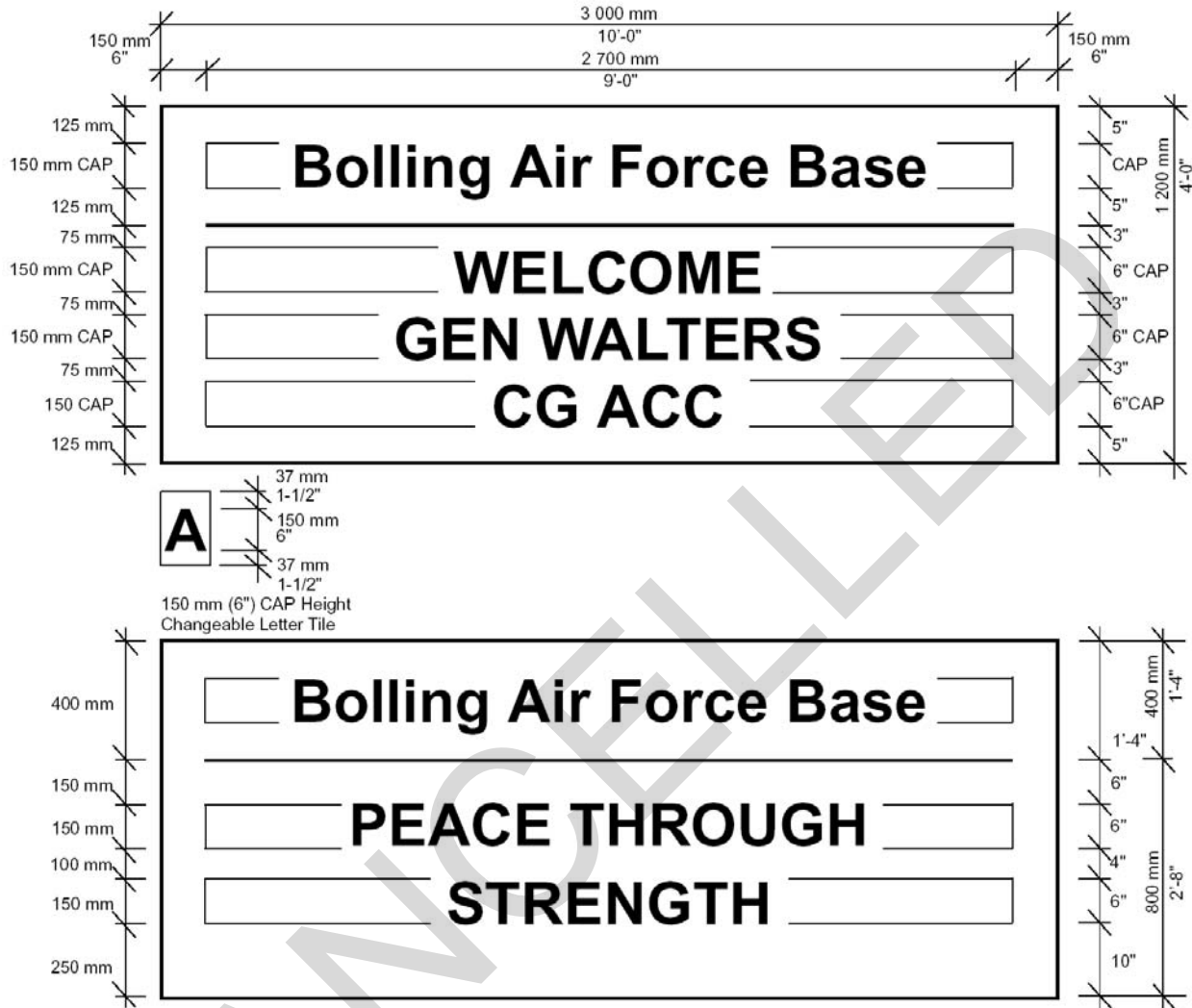

Figure 7.8. Sign Panel Type F2a.



900 x 1 050 mm
3'-0" x 3'-6" Sign Panel

Figure 7.9. Sign Elevation Type F2a.

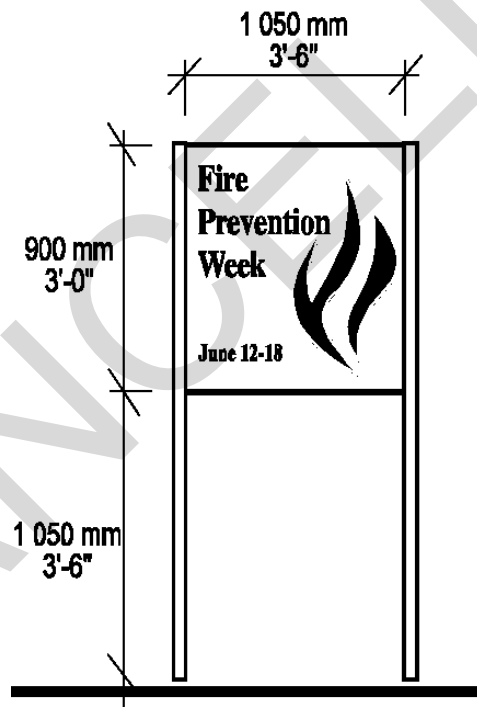
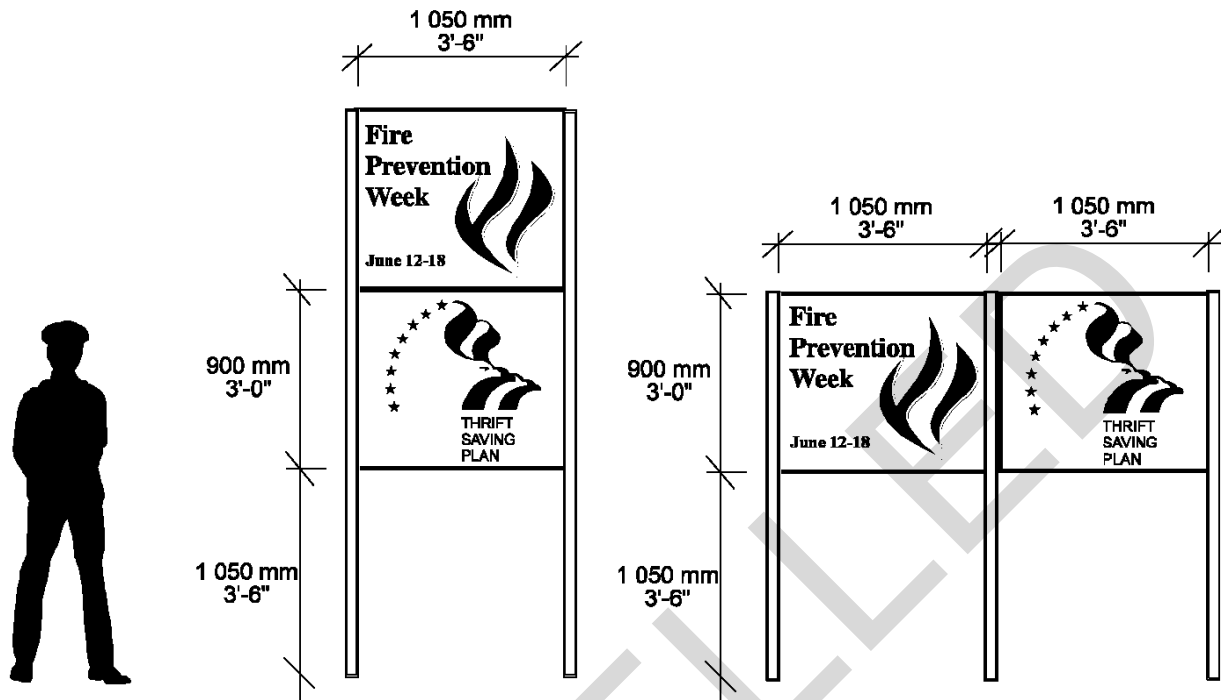

Figure 7.10. Sign Elevation Type F2a.



7.10. Standard Changeable Letter Sign Type F2b.

7.10.1. Usage. The Standard Changeable Letter Sign, Type F2b, complements the standard morale signs shown in Figures 7.8, 7.9 and 7.10. It may be used alone or in combination with these signs.

7.10.2. Tiles. The sign message is made up of changeable letter tiles with magnetic backing which are placed on the steel sign panel. Multiple alphabets, including punctuation marks, should be prepared on tiles. Rules, which help to structure the message, can also be mounted on changeable tiles.

7.10.3. Colors. White letters on standard color background.

7.10.4. Dimensions. 900 mm x 1 050 mm (3'- 0" x 3'- 6").

7.10.5. Typography.

- Changeable Message: upper case Helvetica medium, 3" (75 mm) capital letter height, centered.
- The message area will accommodate four lines with a maximum of 12 tiles per line.

7.10.6. Rules. 3 mm (1/8") thick white tape.

Figure 7.11. Sign Panel Tiles.



Changeable Letter Tile: 75 mm (3")
upper case letter centered on a
112 mm(4-1/2") tile. The width
of the tile varies with the letter
width.

Figure 7.12. Sign Grid.

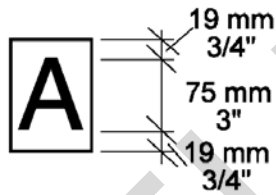

CANCELLED

Figure 7.13. Sign Panel Layout.



7.11. Unit Morale Sign Type F3.

7.11.1. Usage and Message. The Unit Morale Sign is used to express unit pride and spirit. This sign may show the unit emblem, mottoes, awards, and other elements related to unit morale.

7.11.2. Design and Color. As with other motivation signs, the design of the signs may vary. The only restriction on the use of color is that organizational emblems should appear on a standard color background.

7.11.3. Emblem. An organizational emblem placed on a Type B4 sign panel may identify the entrance to a building, as shown in Figure 4.22. If the organizational emblem is used on a unit identification sign (Figure 4.17) or a building entry sign (Figure 4.22), it should not be repeated on a morale sign placed in the same area.

7.11.4. Dimensions. 750 mm x 750 mm (2'- 6" x 2'- 6").

Figure 7.14. Organizational Emblem on Unit Morale Sign Type F3.

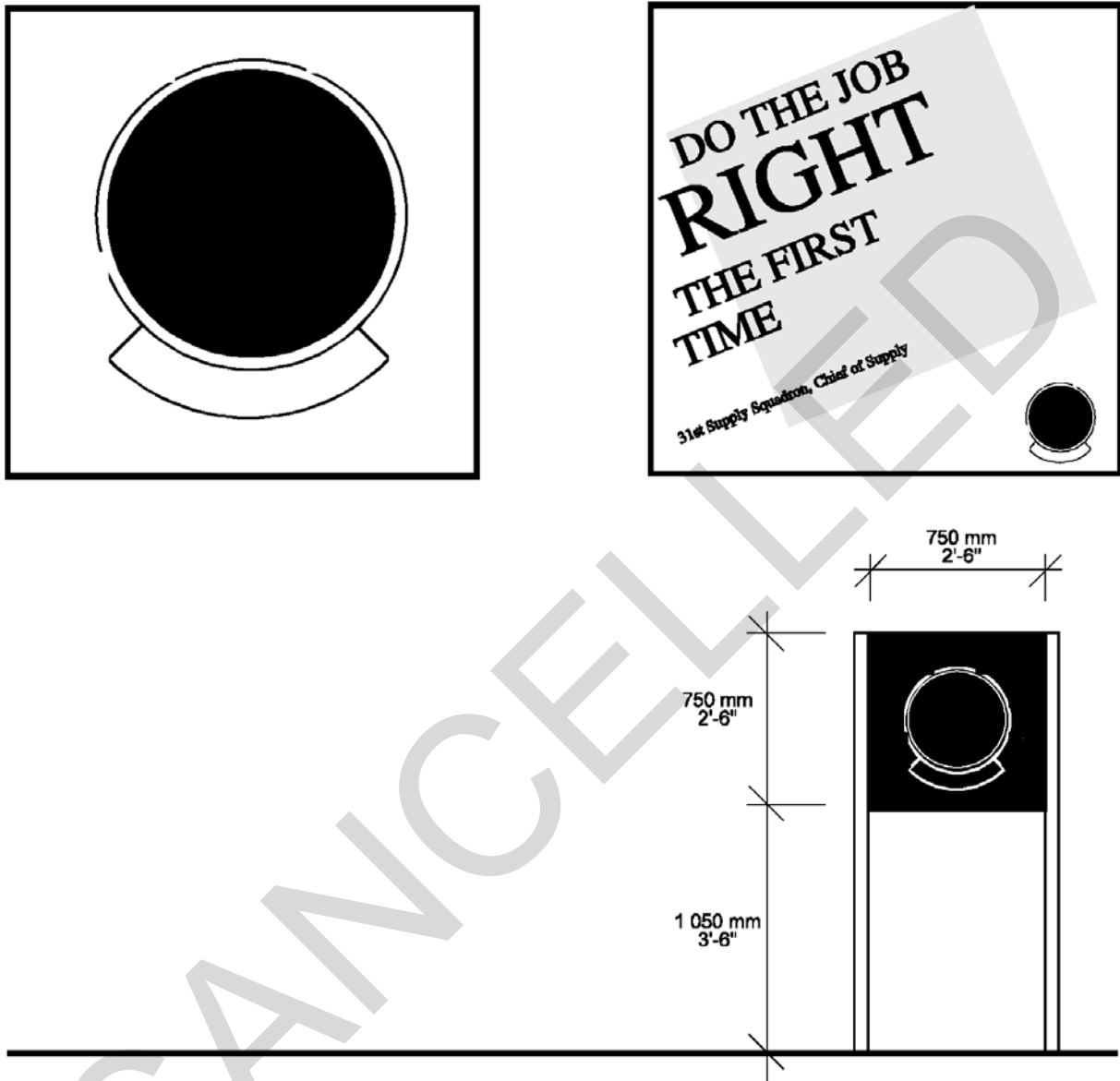

Chapter 8

INFORMATION SIGNS AND BASE MAPS

Section 8A--Introduction

8.1. General Information. This chapter gives the criteria for information signs and base maps, including standards for sizes, appearance, messages, permitted graphics, and layout. Information signs provide educational information and directional guidance for visitors.

8.2. Types of Signs. There are three types of information signs: G1, G2 and G3. The Type G1 Information Sign is used for large-scale exhibits. The Type G2 Information Sign is used for small-scale exhibits. The Type G3 Pedestrian Information Sign provides directional guidance.

8.3. Base Map. The base map is intended for distribution to visitors.

8.4. Further Information. See Chapter 2 for information on typography, graphics and sign placement. Structural sign details and recommended specifications can be found in Chapter 12.

Figure 8.1. Information Sign Type G1

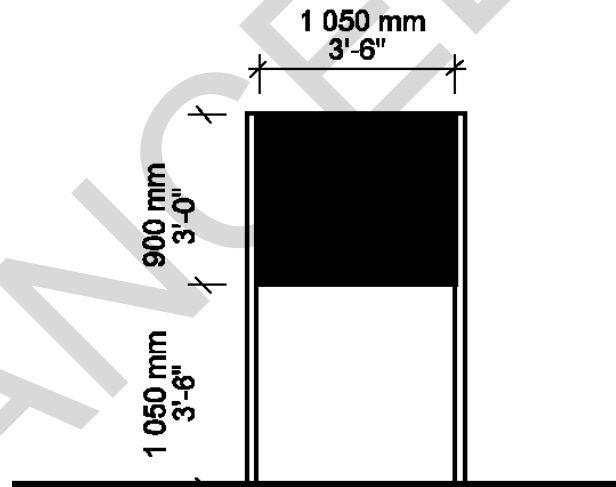

Figure 8.2. Information Sign Type G2.

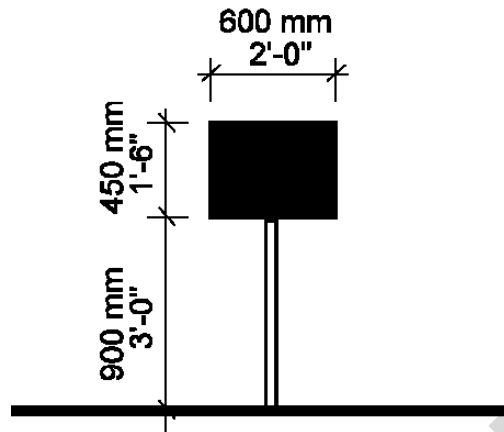

Figure 8.3. Pedestrian Information Sign Type G3.



Section 8B--Information Signs

8.5. Information Sign Type G1.

8.5.1. Usage and Graphics. Use the Type G1 sign to display information relating to large scale exhibits, such as aircraft and missiles. Graphics should appear on only one side of the sign.

8.5.2. Colors.

- Title band: white letters on standard color background.
- Text: black letters and graphics on white background.

8.5.3. Dimensions. 900 mm x 1 050 mm (3'- 0" x 3'- 6").

8.5.4. Typography.

- Title: upper and lower case Helvetica medium, 75 mm (3") capital letter height, flush left.
- The message line will accommodate a maximum of 17 tiles or characters.
- Text: upper and lower case Helvetica medium, 19 mm (3/4") capital letter height, flush left.
- The text area will accommodate up to 18 lines with a maximum of 42 tiles or characters per line. Leave a 50 mm (2") space between paragraphs.

Figure 8.4. Information Sign Type G1 Panel Layout.

Sign Panel

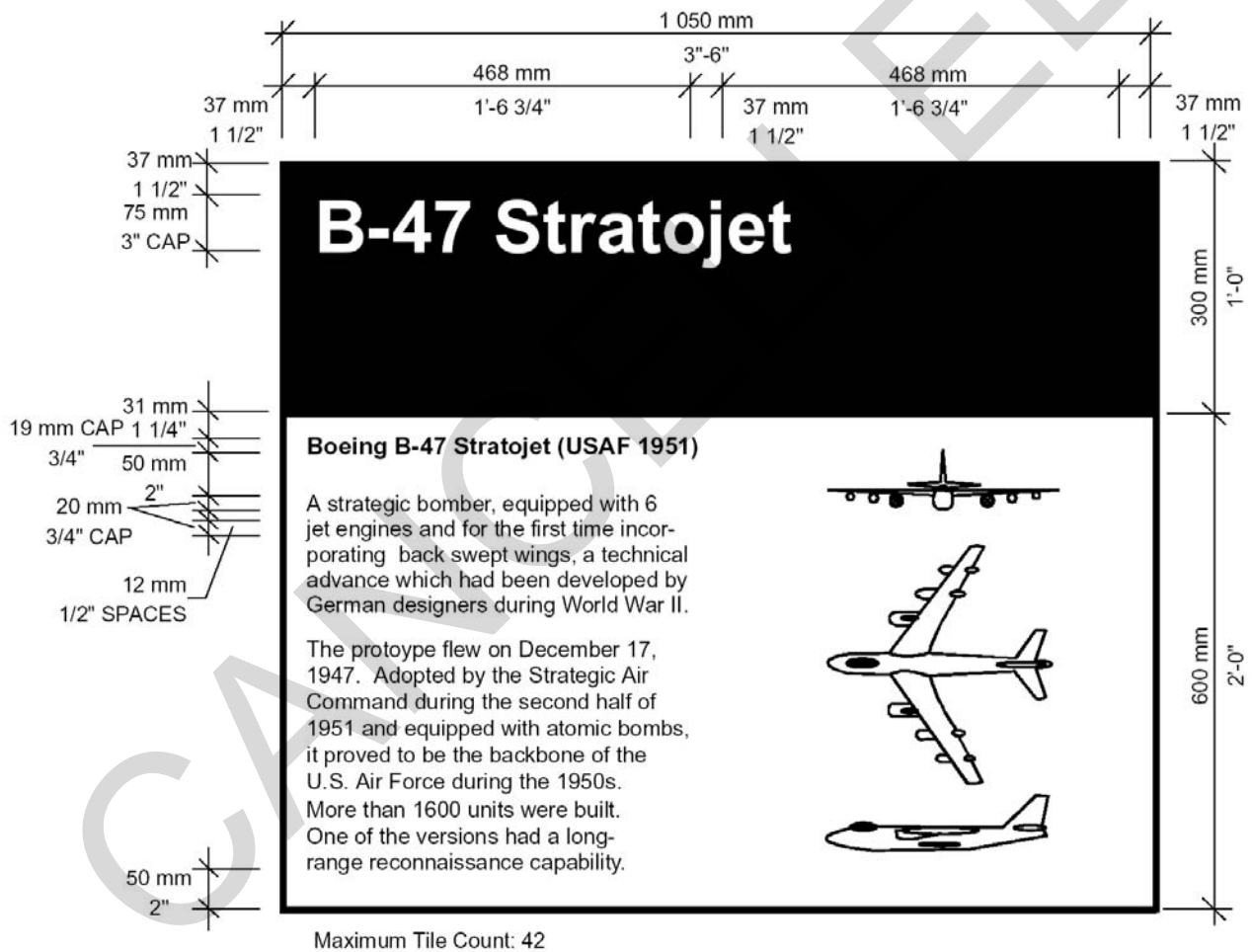

8.6. Information Sign Type G2.

8.6.1. Usage. Use the Type G2 sign to display information relating to small scale exhibits or in situations where a large sign would be obtrusive.

8.6.2. Shape and Graphics. All sign panels should have rounded corners. Graphics appear on

only one side of the sign.

8.6.3. Colors.

- Title band: white letters on standard color background.
- Text: black letters and graphics on white background.

8.6.4. Dimensions. 450 mm x 600 mm (1'- 6" x 2'- 0").

8.6.5. Typography.

- Title: upper and lower case Helvetica medium, 37 mm (1½") capital letter height, flush left.
- The message line accommodates a maximum of 20 tiles or characters.
- Text: upper and lower case Helvetica medium, 9 mm (3/8") capital letter height, flush left.
- The text area accommodates a maximum of 38 tiles or characters per line.
- Leave a 25 mm (1") space between paragraphs.

CANCELLED

Figure 8.5. Information Sign Type G2 Panel Layout.

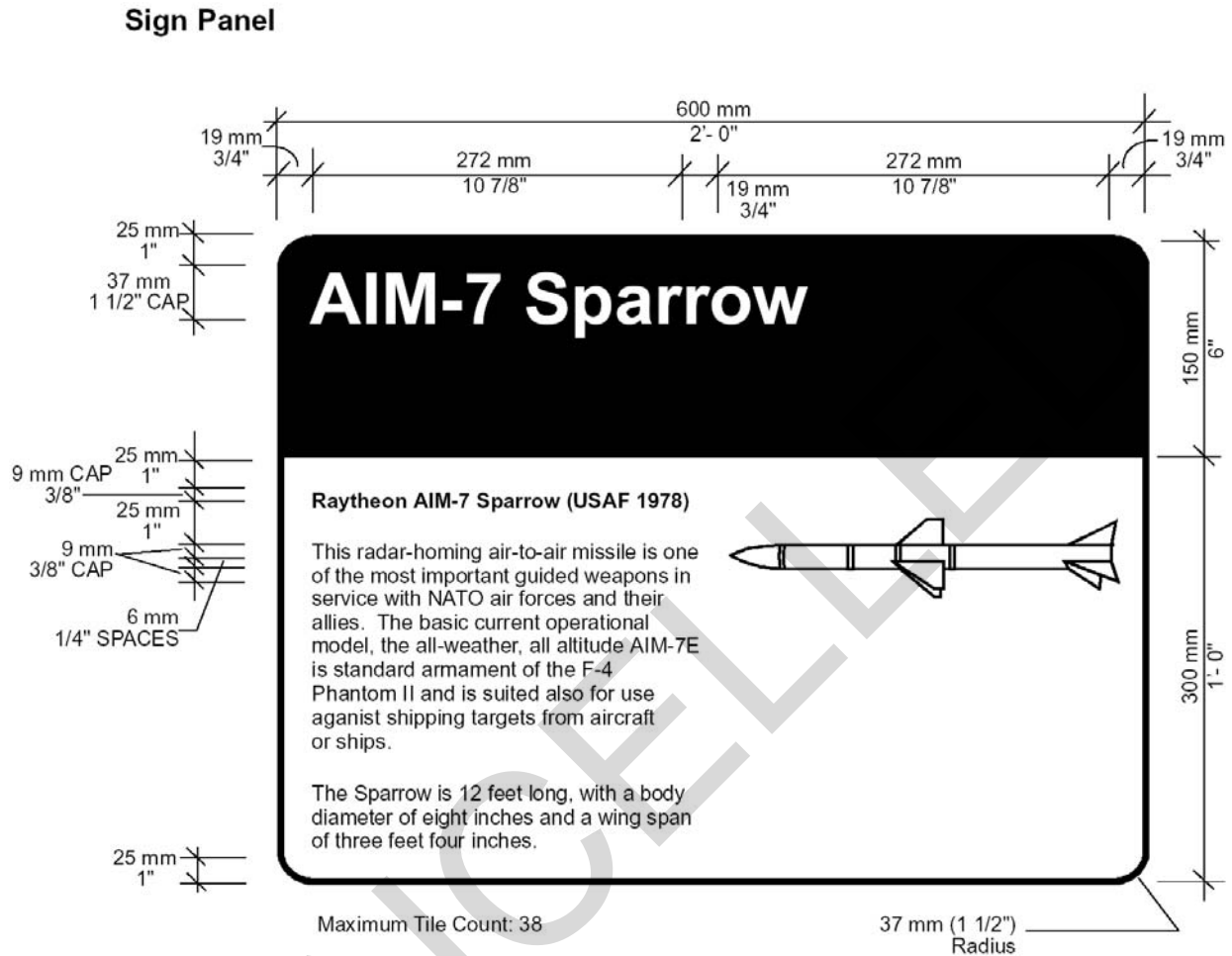

8.7. Pedestrian Information Sign Type G3.

8.7.1. General Information. The Type G3 Pedestrian Information Sign provides directional guidance for pedestrians. On training bases and on bases with campus plans, pedestrian circulation is often separate from vehicular circulation and requires its own guidance system. This sign type is also useful in large parking areas at facilities such as community centers and office complexes.

8.7.2. Design Parameters. Use a separate sign slat for each destination so that messages can be changed without remaking the entire sign face. In cases where the sign shows six destinations which are not likely to change, the sign may be fabricated as a single panel. Separate the destinations with white rules. As shown in Figure 8.3, two different post heights are used with Type G3 signs. Use the 1 800 mm (6'-0") posts for signs with four to six destinations and the 1 500 mm (5'-0") posts for signs with two to three destinations. Place no more than six and no fewer than two destinations on a Type G3 sign.

8.7.3. Graphics/Messages. Graphics/messages should appear on both sides of the sign to permit viewing by people moving in both directions.

8.7.4. Visibility. No border is used on the sign panel since nighttime visibility at high speeds is usually not required for pedestrian signs.

8.7.5. Colors. White letters, rules and arrows on standard brown background.

8.7.6. Dimensions. Slats - 150 mm x 900 mm (6" x 3'-0").

8.7.7. Typography.

- Upper and lower case Helvetica medium, 50 mm (2") capital letter height, flush left or right to arrow.
- The message line will accommodate a maximum of 17 tiles or characters.

8.7.8. Rules. 3 mm (1/8") wide white tape.

8.7.9. Arrow. Standard tile, 75 mm (3") high, placed left or right as appropriate.

CANCELLED

Figure 8.6. Pedestrian Information Sign Type G3.

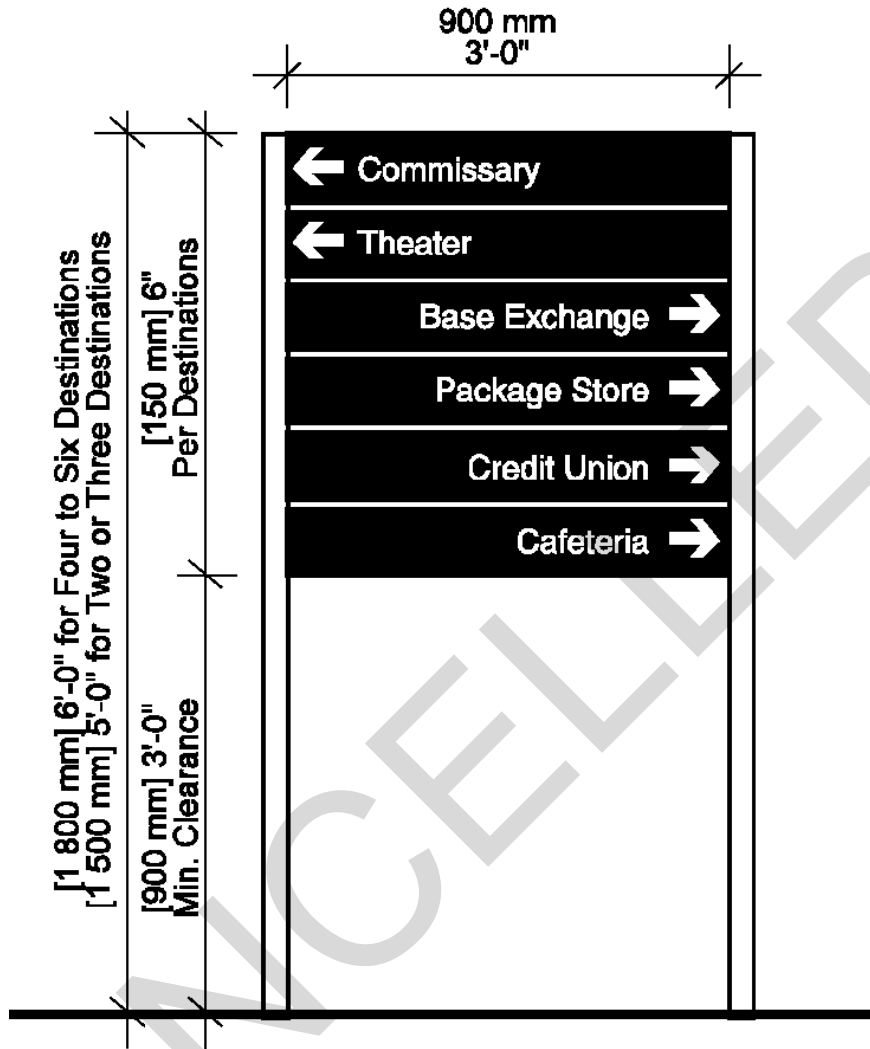
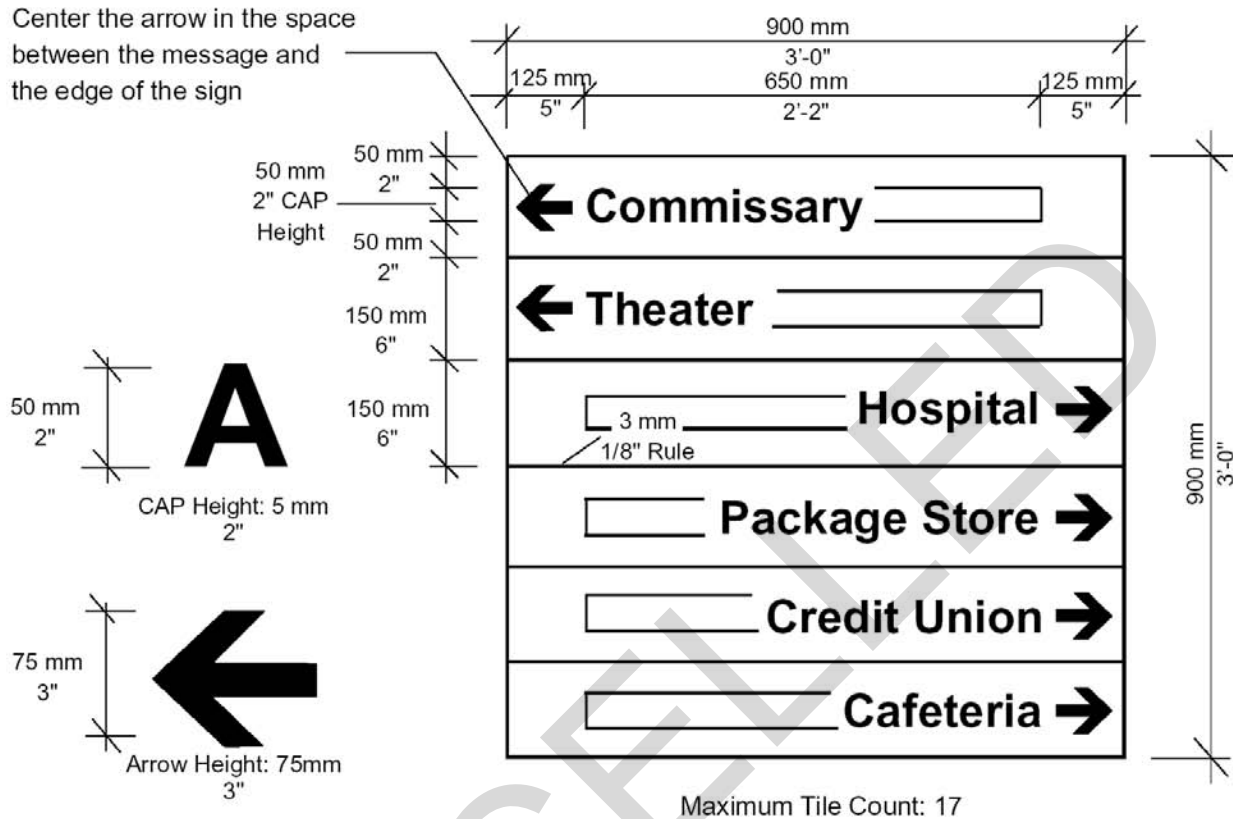

Figure 8.7. Pedestrian Information Sign Type G3 Layout.



Section 8C--Base Map

8.8. Need. Most first time visitors to an Air Force base receive information at the entry gate. Providing a base map at the time of arrival orients visitors and helps them find their destinations.

8.9. Consistency. The base map, direction signs and building and street identification signs comprise the total orientation system outlined in this pamphlet. It is essential to use consistent nomenclature throughout the system. The Community Center, for example, should be indicated by the same name on the map, the direction signs, and the building identification signs.

8.10. Clarity. Design the map for clarity and ease of use. Maps created by merely reducing the base site plan are usually too difficult to read, so the site plan must be simplified in order to emphasize major circulation routes and destinations.

8.11. Information. The destinations most often sought by people new to the base should be clearly named on the map. Other major destinations should be listed in a map legend keyed to building address numbers. Housing areas may be indicated with a general designation such as "Wherry Housing". It is not necessary to draw each housing unit.

8.12. Design. Use a halftone screen to indicate roadways. Emphasize important buildings by increasing the scale of the buildings in relation to other buildings or by adding color. See the

example maps in Figures 8.8 through 8.10.

8.13. One Point Perspective. A map drawn in one-point perspective is shown below. Although it is more difficult to render than a two-dimensional map, it is often easier for the visitor to read as it shows the buildings in elevation as well as plan. This map should be drawn from the perspective of the main entrance in order to aid in visitor orientation.

Figure 8.8. Base Site Plan.

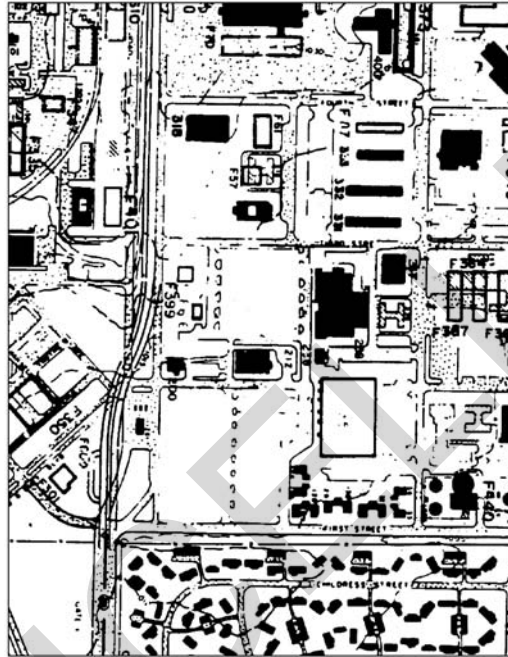
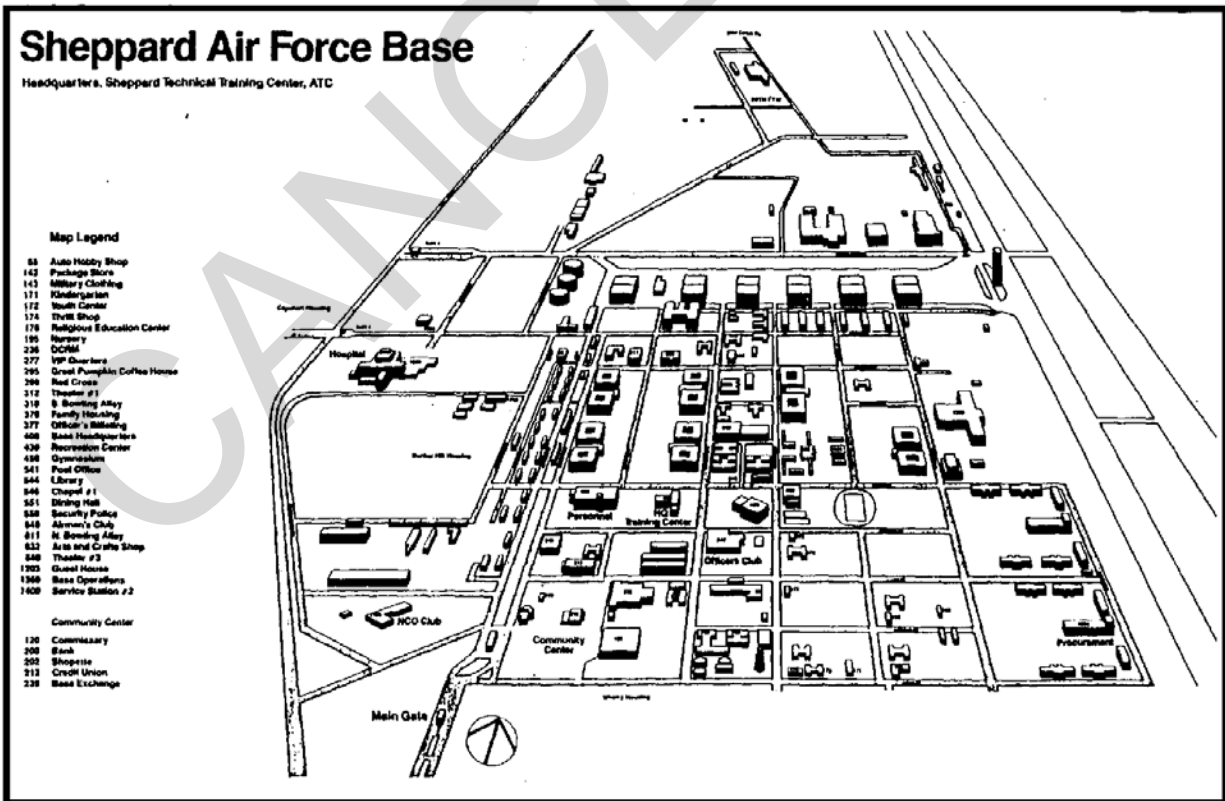

Figure 8.9. Base Map Derived from Simplified Base Site Plan.



Figure 8.10. Aerial View Map.



Chapter 9

SIGNS FOR HISTORIC BUILDINGS

Section 9A--Introduction

9.1. General Information. The signs in this pamphlet were designed to relate to the architectural style of most Air Force Bases, but historic buildings may need special identification signs that complement their distinctive character. Signs intended for use with historic buildings use special typography and color.

9.2. Usage. The base commander should decide if these signs are appropriate to any areas of the base. If historic signs are used, they must be used consistently. A Master Sign Plan ensures that all signs, whether conventional or historic, are installed in a systematic fashion.

9.3. Further Information. Information on sign placement is in Chapter 2. Recommended specifications and structural details are in Chapter 12.

Section 9B--Typography and Spacing

9.4. Recommended Typeface. Use Clarendon medium, the typeface used by the National Park Service, for historic building signs. It is a square serif typeface designed in the late nineteenth century. The letter forms have a strong historic character and good legibility.

9.5. Other Typefaces. There are many versions of Clarendon commercially available. The Clarendon medium style shown in Figure 9.1 is recommended. Other acceptable typefaces are Craw Clarendon, a slightly heavier version, and the National Park Service typeface called NPS Modified Clarendon. Compare all purchased letters with the illustration in Figure 9.1 to ensure conformity.

9.6. Spacing. Unlike the Helvetica typeface described in Chapter 2, Clarendon medium may not be available in a tile system, in which cases letter spacing must be determined visually. The “normal” spacing shown in Figure 9.2 is the most legible and attractive positioning of the letters.

Figure 9.1. Clarendon Medium.

**ABCDEFGHIJKLM
MNOPQRSTUVWXYZ
XYZ
abcdefghijklmno
pqrstuvwxyz
1234567890**

Figure 9.2. Spacing.

Too Tight

Contracting

Normal

Contracting

Too Wide

Contracting

Section 9C--Building Identification Signs

9.7. Information. Use the Type H signs to identify military and community facilities of historic value. The sign displays the building address number and the organization or building name. The unit emblem may appear on the sign in place of the building address number as shown in Figure 9.5. As with the conventional military identification signs shown in this pamphlet, no unit mottoes, names or titles of individuals are permitted.

9.8. Layout and Structure. Clarendon medium numbers and letters are centered on the sign panel.

Follow the sign structure specifications for the Type B2 or Type B3 sign, as appropriate.

9.9. Placement and Visibility. The sign is usually placed perpendicular to the roadway. Graphics should appear on both sides of the sign so the message can be seen by traffic moving in both directions.

9.10. Usage. The Type H3 sign is used in addition to other Type H signs to identify a unit that has an entry point other than the main entrance to a building. The Type H4 Building Number Sign is used to display the building address number on the side or front of a building for rapid identification.

9.11. Mounting. In the absence of installation-specific mounting requirements for visibility by security police and fire personnel, mount the Type H4 sign directly below the Type H3 sign.

9.12. Layouts. See Figures 9.4 through 9.7 for the sign layouts.

9.13. Building Identification Sign Type H1 Three line Message Layouts.

9.13.1. Colors. White letters and numbers on standard brown background.

9.13.2. Dimensions.

- Three line message: 900 mm x 1 050 mm (3'- 0" x 3'- 6").
- One or two line message : 750 mm x 1 050 mm (2'- 6" x 3'- 6").

9.13.3. Typography.

- Message: upper and lower case Clarendon medium, 75 mm (3") capital letter height, centered.
- The message area will accommodate three lines with a maximum line length of 15 characters per line.
- Building Address Number: Clarendon medium, 100 mm (4") numbers centered.

9.13.4. Rules. 3 mm (1/8") wide white tape.

9.13.5. Other Layouts. See Figure 9.5 for the layout for signs with a one or two line message. See Figures 9.5 and 9.6 for the layouts for signs with an organizational emblem and the expanded sign layout.

Figure 9.3. Building Identification Signs Installation.

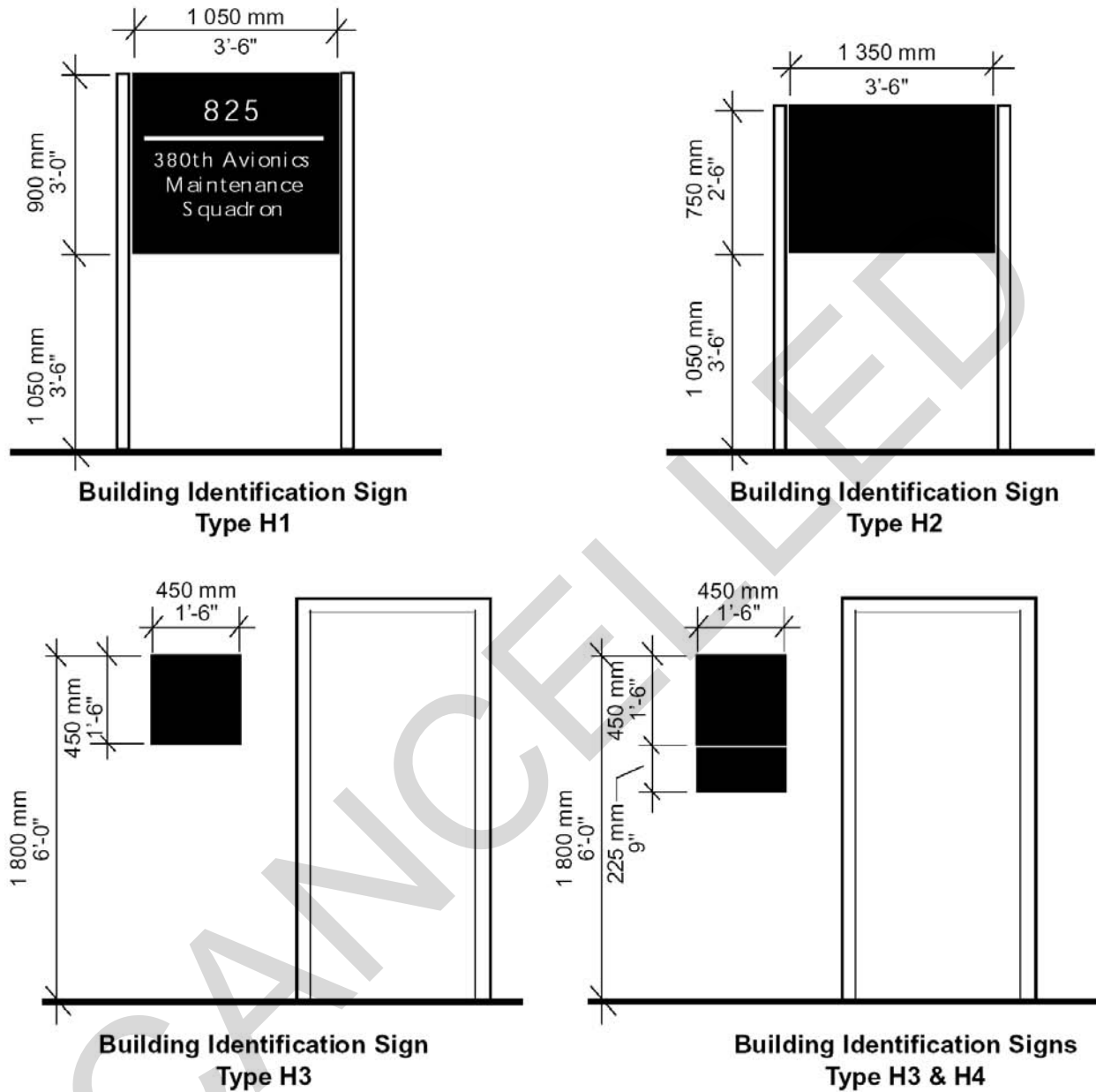

9.14. Building Identification Sign Type H1 Organizational Emblem Standard Layout.

9.14.1. Usage. Type H1 Sign with Organizational Emblem: Flag bearing units, tenant squadrons, and squadron headquarters units may request that their organizational emblem appear on the building identification sign instead of the building address number.

9.14.2. Colors. White letters on standard brown background; full-color emblem.

9.14.3. Dimensions. 900 mm x 1 050 mm (3'- 0" x 3'- 6").

9.14.4. Typography.

- Upper and lower case Clarendon medium, 75 mm (3") capital letter height, centered.
- The message area will accommodate three lines with a maximum line length of 15 characters per line.

9.14.5. Emblem. Authorized organizational emblem, 200 mm x 200 mm (8" x 8"), centered.

9.14.6. Rules. 3 mm (1/8") wide white tape.

9.14.7. Layouts. Use the sign layout shown below in Figure 9.5.

9.15. Building Identification Sign Type H1 Expanded Layout.

9.15.1. Usage. If the required message on a Type H1 sign is too long to fit on the standard layout shown in Figure 9.5 the expanded layout may be used. The expanded layout has smaller lettering than the standard layout and can accommodate more information.

9.15.2. Colors. White letters and numbers on standard brown background.

9.15.3. Dimensions. 900 mm x 1 050 mm (3'-0" x 3'-6").

9.15.4. Typography.

- Message: upper and lower case Clarendon medium, 62 mm (2½") capital letter height, centered.
- The message area will accommodate four lines with a maximum line length of 18 characters per line.
- Building Address Number: Clarendon medium, 4" (100 mm) numbers, centered.

9.15.5. Rules. 3 mm (1/8") wide white tape.

9.16. Building Entry Sign and Building Number Sign Types H3 and H4.

9.16.1. Usage. When buildings have more than one primary entrance, use Type H3 Building Entry Signs to identify organizations that have their own entry. These are usually squadron level units, squadron components, or their equivalents.

9.16.2. Mounting. The Type H3 sign is always wall mounted. The Type H4 Building Number Bases may choose to provide the Type H4 Building Number Sign in addition to the Type H3 Building Entry Sign. In the absence of installation-specific mounting requirements for visibility by security police and fire personnel, the Building Number Sign is mounted directly below the Building Entry Sign.

9.16.3. Structure and Layouts. Follow the sign structure specifications for the Type B4 sign, and see Figures 9.9 and 9.10 for the sign layouts.

9.17. Building Entry Sign Type H3 Layouts.

9.17.1. Colors. White letters and numbers on standard brown background.

9.17.2. Dimensions. 1'- 6" x 1'- 6" (450 mm x 450 mm).

9.17.3. Typography.

- Message: Upper and lower case Clarendon medium, 37 mm (1½") capital letter height, centered.
- The message area will accommodate three lines with a maximum line length of 12 characters per line.
- Building Address Number: Clarendon medium, 50 mm (2") numbers, centered.

9.17.4. Rules. 3 mm (1/8") wide white tape.

9.18. Building Number Sign Type H4 Layout.

9.18.1. Colors. White letters and numbers on standard brown background.

9.18.2. Dimensions. 450 mm x 225 mm (1'- 6" x 9").

9.18.3. Typography.

- Message: "Building Number" Upper and lower case Clarendon medium, 37 mm (1½") capital letter height, centered. The message area will accommodate the two lines required to fit the words "Building Address Number".
- Building Number: Clarendon medium, 50 mm (2") numbers, centered.

Figure 9.4. Building Identification Sign Type H1 Three Line Message Layout.

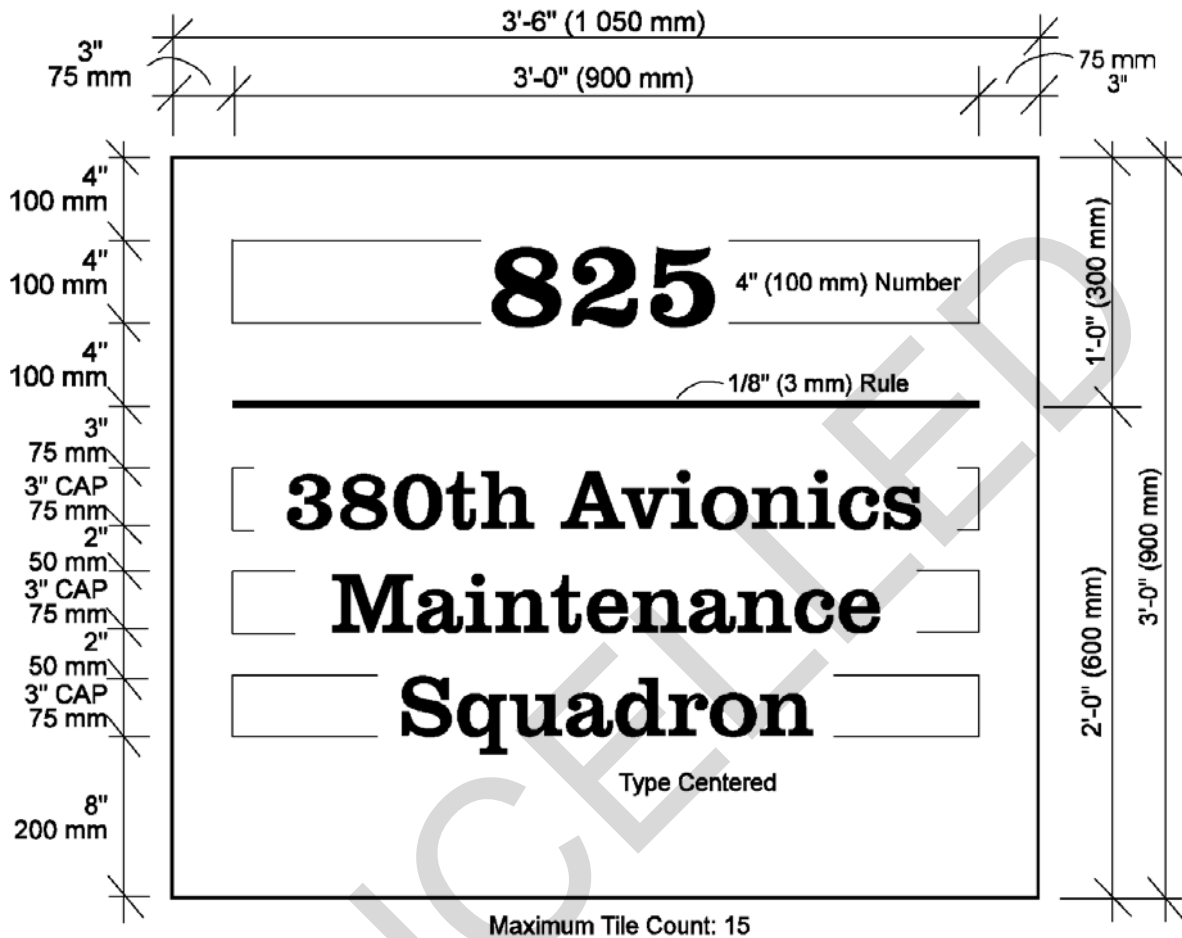

Figure 9.5. Building Identification Type H1 Organizational Emblem Standard Layout.

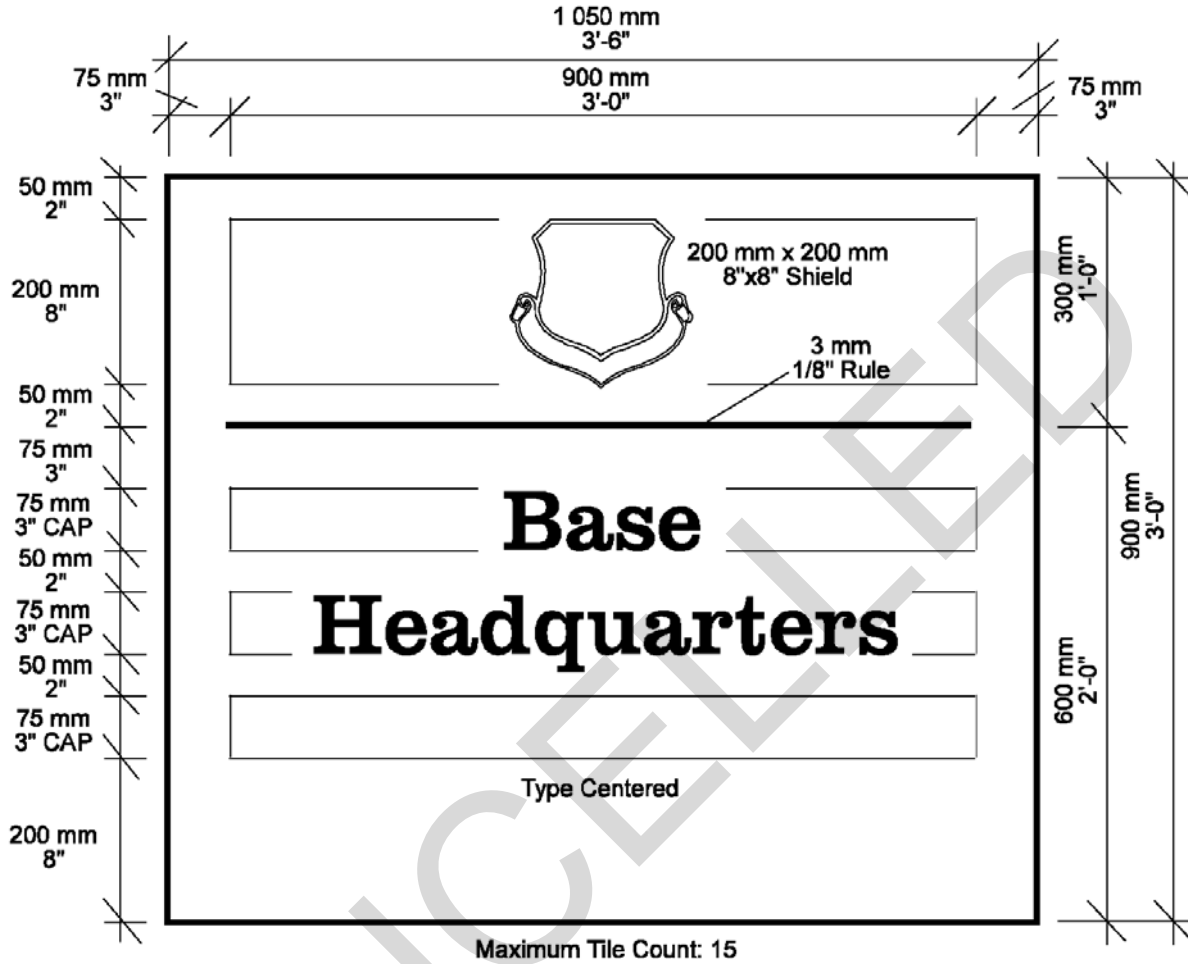

Figure 9.6. Building Identification Sign Type H1 Expanded Layout.

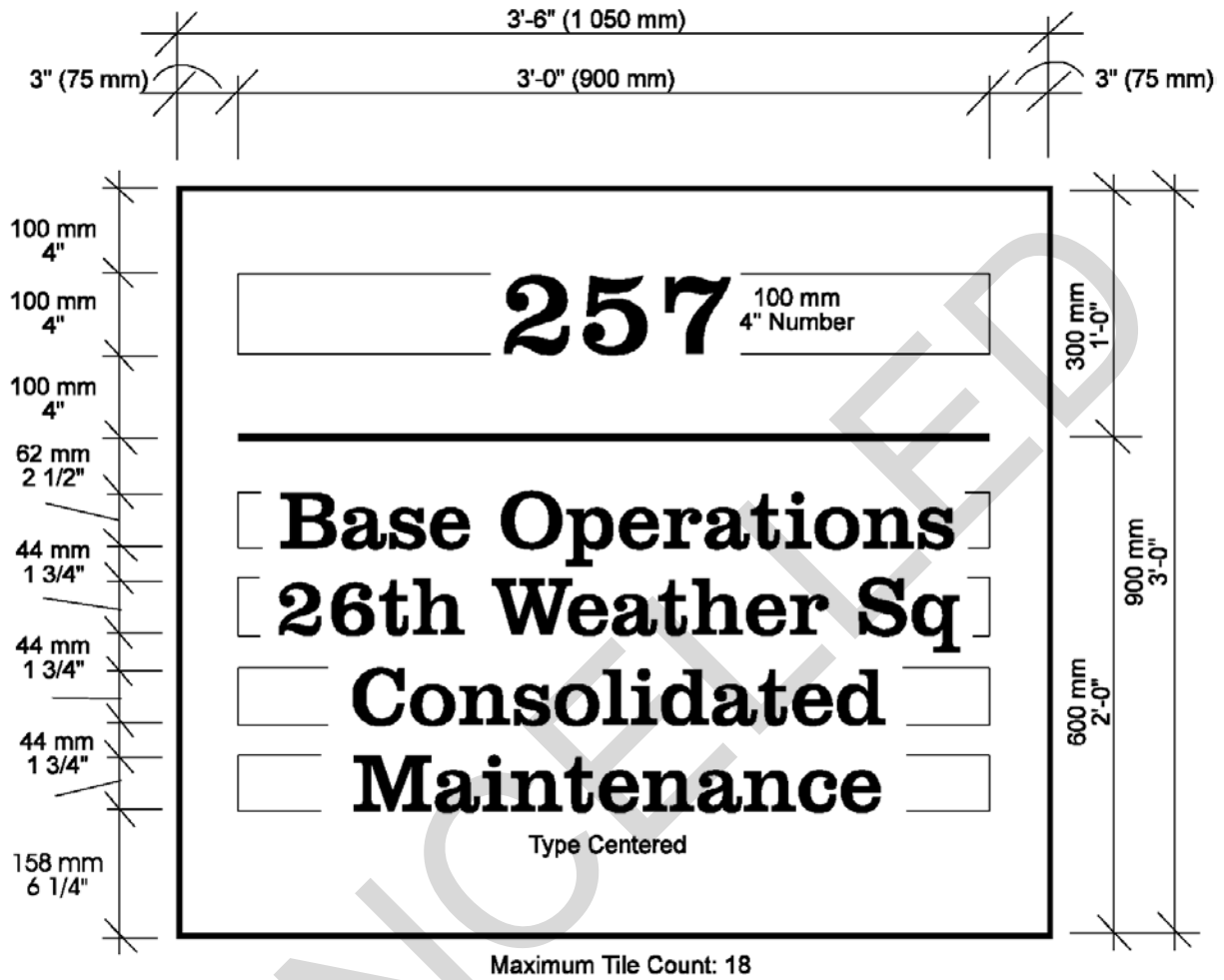

Figure 9.7. Building Identification Sign Type H2 One or Two Line Message Layout.

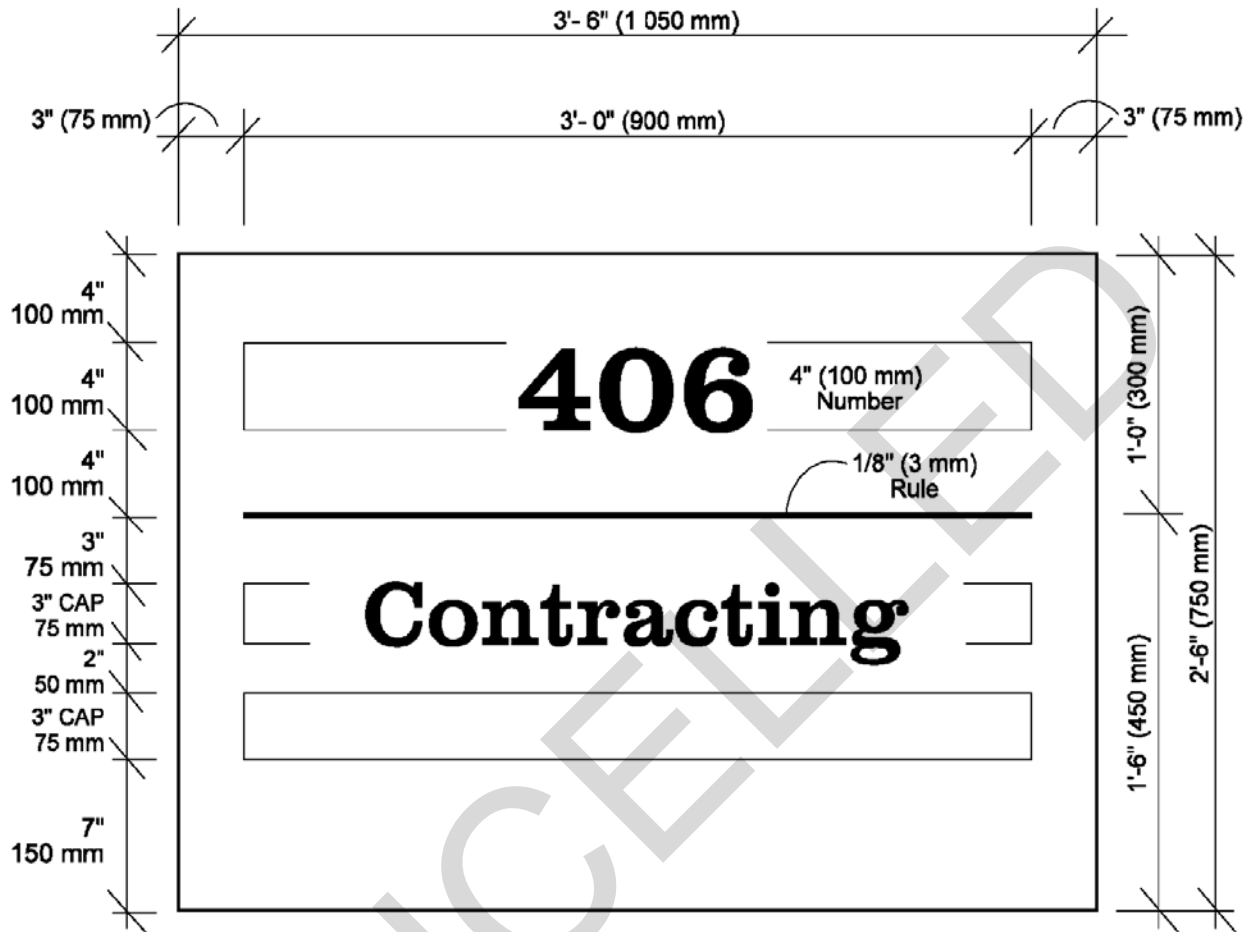

Figure 9.8. Building Entry Sign and Building Number Sign Types H3 and H4.

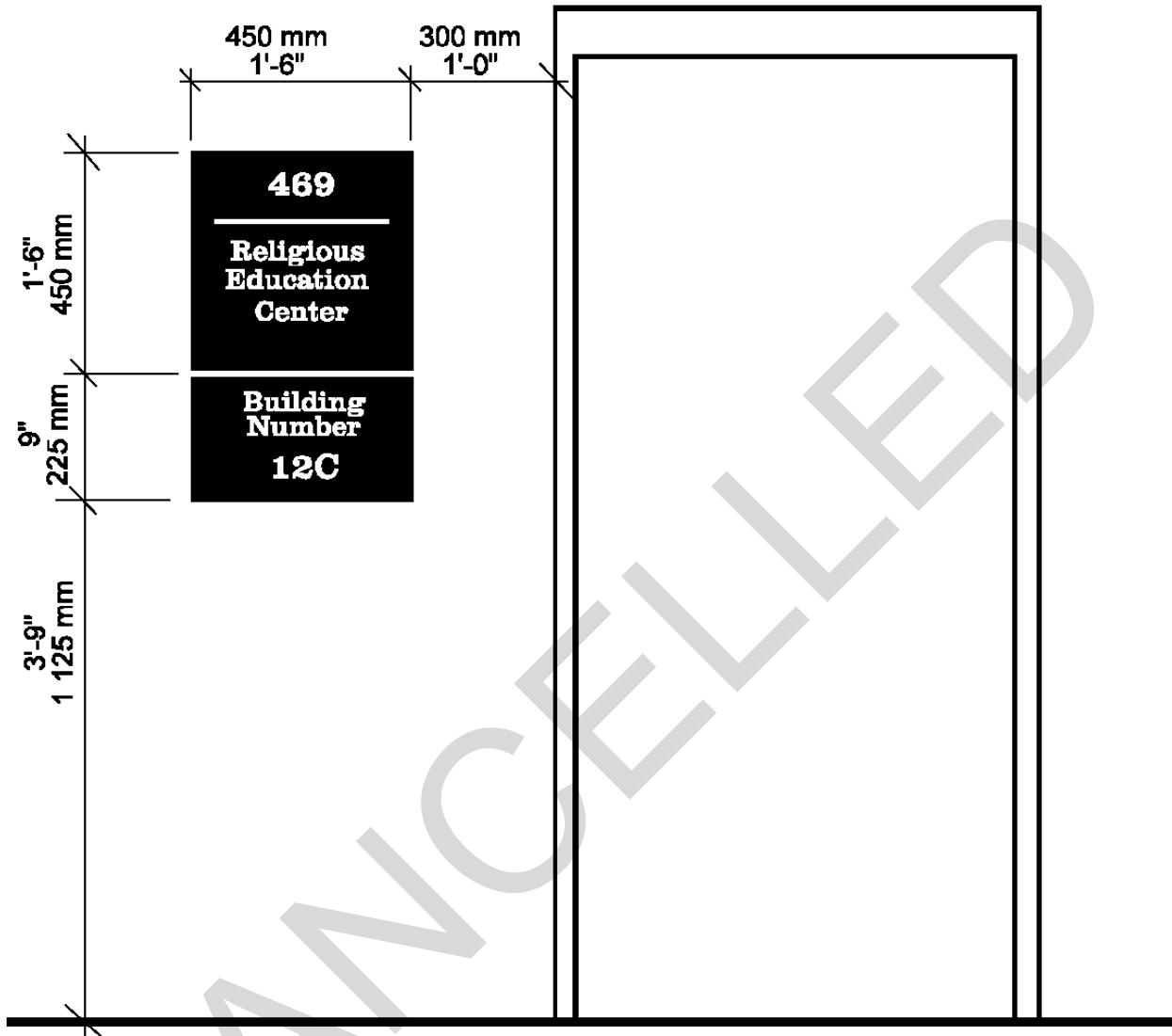

Figure 9.9. Building Entry Sign Type H3 Layouts.

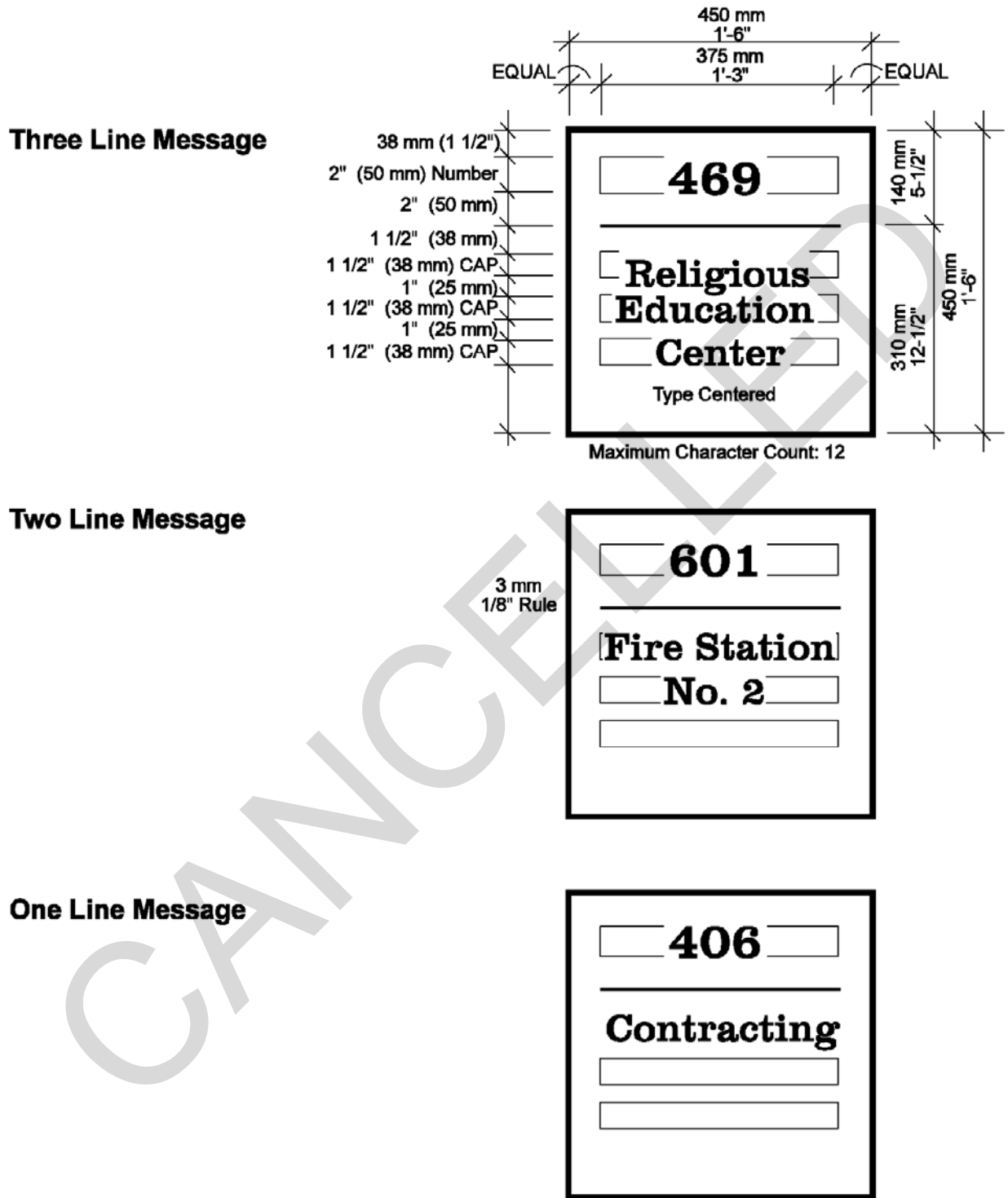
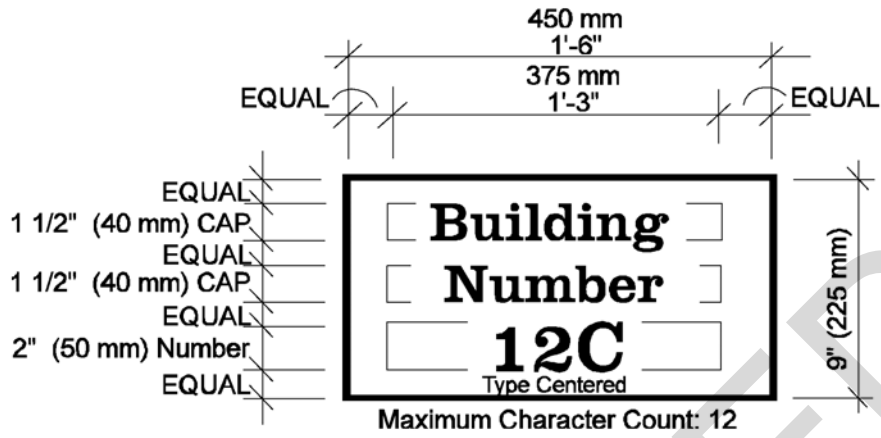

Figure 9.10. Building Number Sign Type H4 Layout.



CANCELLED

Chapter 10

WALL MOUNTED SIGNS

Section 10A—Introduction

10.1. General Information. Wall mounted identification signs supplement the freestanding identification signs described elsewhere in this pamphlet. In some situations, wall mounted signs better complement base architecture and reduce maintenance problems.

10.2. Usage. The base commander will decide if wall mounted signs are appropriate to the base. If wall mounted signs are chosen, use them throughout the base. A sign master plan ensures that all signs, whether freestanding or wall mounted, are installed in a systematic fashion.

10.3. Description. Wall mounted signs are made up of individual dimensional letters applied directly to the surface of the wall. Letters are 12 mm to 25 mm (½" to 1") deep, Helvetica medium typeface. The depth separates them from the plane of the wall and gives them a crisp appearance, while the Helvetica medium typeface relates to other Air Force signs.

10.4. Colors/Finishes. The color or finish of the letters should compliment the predominant color of the building while providing enough contrast with the background for visibility. Use a light-color or bright metallic finish for the lettering on dark buildings and a standard brown or dark bronze finish for the lettering on light colored buildings.

10.5. Materials. Several letter materials are available through sign manufacturers, such as rigid foam with aluminum facing, PVC, etc. Letter materials should be selected based on durability, architectural compatibility, cost effectiveness and ultimately, approval by the Sign Control Group.

10.6. Size. Since the letters are applied directly to the surface of the wall rather than to a background panel, they must be of sufficient size to stand out against the architectural detail of the building. A minimum 300 mm (12") capital letter height is specified for one and two story buildings, while larger letters are used for larger buildings. Messages for wall mounted signs are limited to a maximum of four words.

10.7. Placement. Placement of the message on the building wall is a matter of good judgment. The following pages show several approaches. The base civil engineer should select the most appropriate solutions for the architectural style of the buildings, and apply them consistently.

Figure 10.1. Wall Mounted Signs.

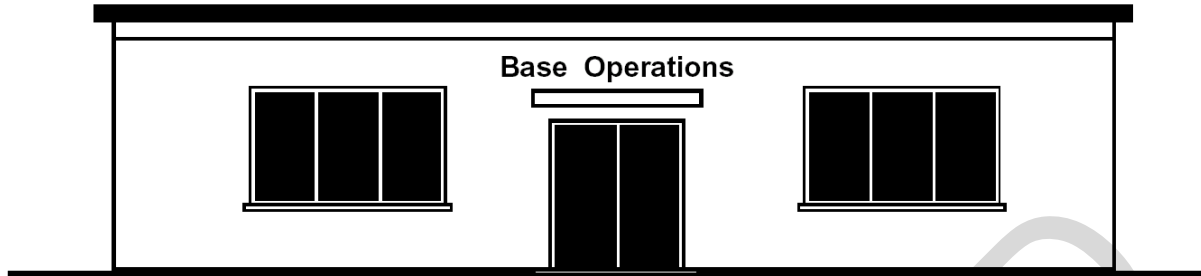

Section 10B—Typography

10.8. Typeface. Helvetica medium is the principal typeface for all wall mounted identification signs. Compare all purchased letters with the illustrations shown in Figure 10.2 and in Figure 2.1 to assure conformity.

10.9. Templates. Many manufacturers will provide a full-scale template for each message at little or no additional cost. The template is an outline of each letter in the message drawn on a long paper strip. It provides proper alignment and letter spacing and serves as a visual aid in positioning the message on the building wall. In those rare situations where templates are not available, use the letter spacing specifications shown in Table 2.1.

10.10. Size. The height of the letters shown is based on the capital letters (cap height) of the alphabet. Three principal sizes are used: 300 mm (12") cap height, 450 mm (18") cap height and 600 mm (24") cap height. Each letter should have a minimum depth of 19 mm (3/4") to 25 mm (1"). 150 mm (6") cap height letters with a minimum depth of 12 mm (1/2") may be used on fascia mounted signs. Use both upper and lower case letters to increase the visual impact and legibility of the message.

Figure 10.2. Typography and Standard Letter Heights.

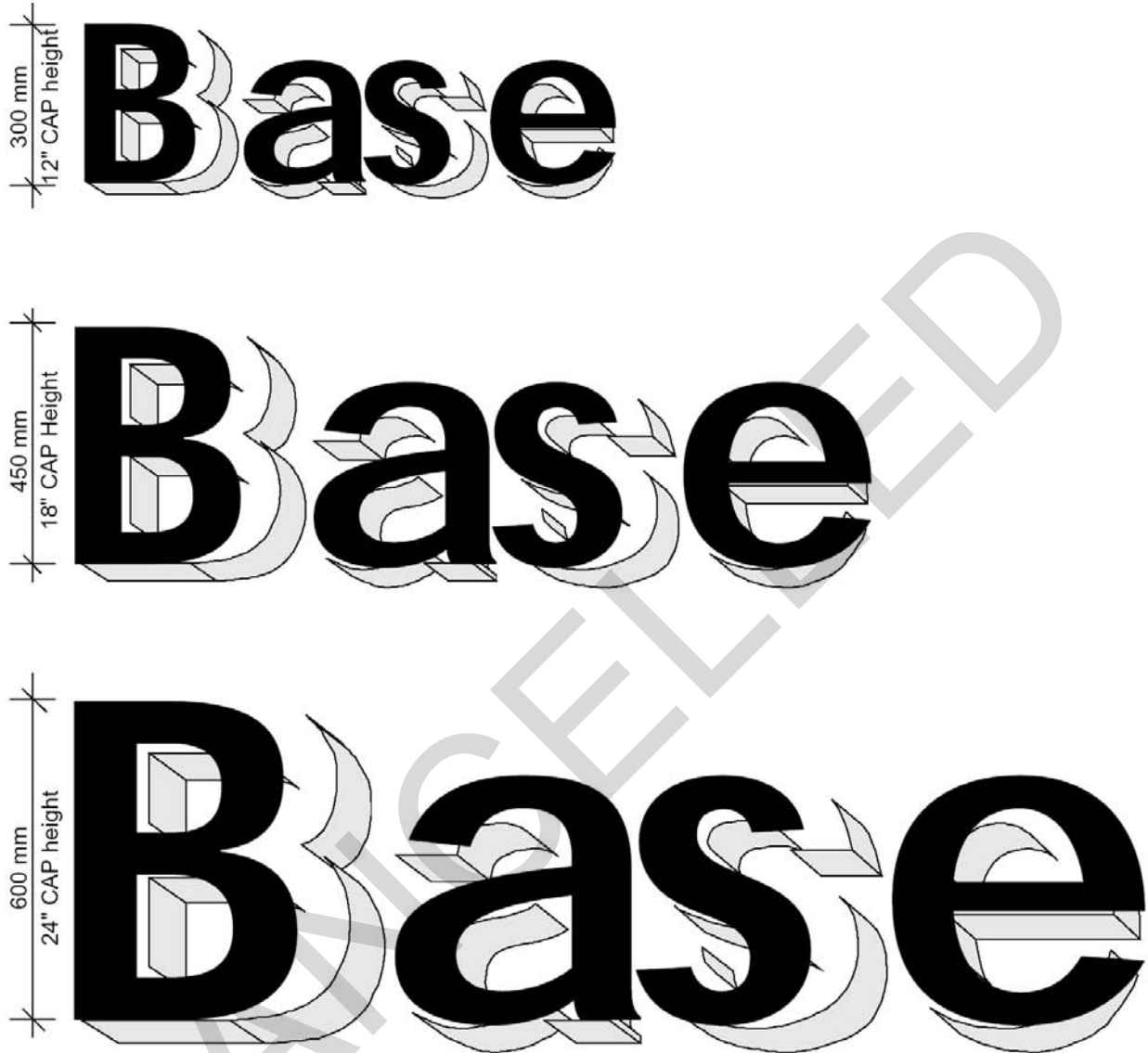

Section 10C--Message Placement

10.11. Message Placement Single Story Buildings.

10.11.1. Below Fascia. On many single story buildings the area that forms a band above the door and window heads and below the fascia contains no architectural detailing, and is therefore ideal for an identification sign. Letters with a 300 mm (12") capital letter height as shown in Figure 10.3 require an area a minimum of 2 ½ caps or 750 mm (2' - 6") high. If the band is less than 750 mm (2' - 6") high, follow the guidelines in paragraph 10.11.4.

10.11.2. Placement of Letters. To correctly place the message, draw a horizontal line halfway up the band. Position the letters so that one-third of the capital letter height lies below this

centerline and two-thirds lies above it. For a 300 mm (12") high capital, 100 mm (4") of the letter will be below the centerline and 200 mm (8") will be above it.

10.11.3. Placement of Message. Center the message above the main entrance to the building. (See Examples A and C in Figure 10.3). If the message cannot be centered above the entrance, due to length, architectural details, or other reasons, place the message flush to the edge of the window as shown in Example B.

10.11.4. Facade Area. On single story buildings where the band above the doors and window is less than 750 mm (2' - 6") high, the message is placed lower on the building facade. Align the message with the top of the windows and door canopy. (See Examples A and B in Figure 10.4.) Place the message as close to the main entrance as possible, but take care to leave enough space that it does not appear to crowd the facade.

10.11.5. Other Options. Buildings that do not have adequate space for a wall mounted message should be identified with a freestanding sign (paragraph 4.13), or with a fascia mounted sign (Figure 10.9).

CANCELLED

Figure 10.3. Message Placement Single Story Buildings Below Fascia.

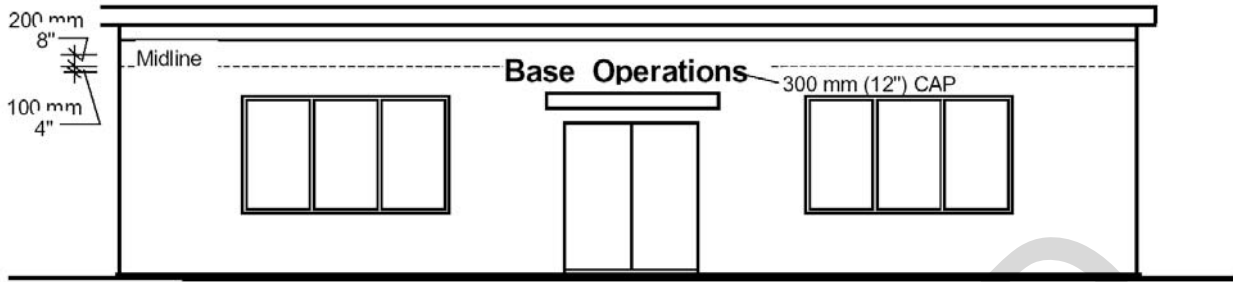

Example A

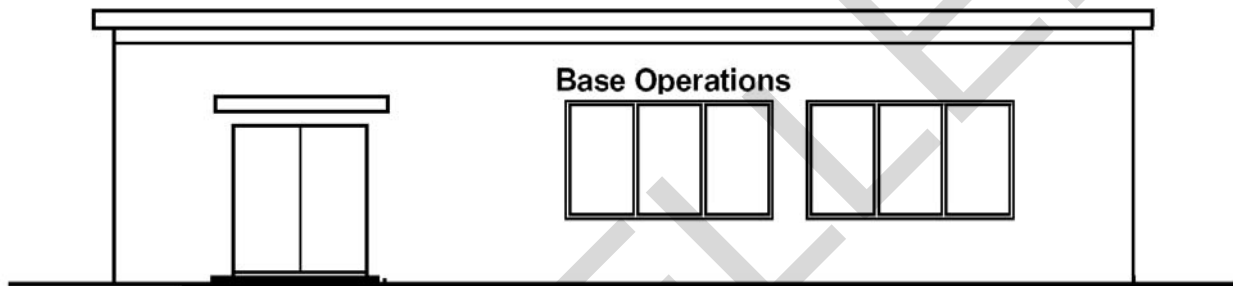

Example B

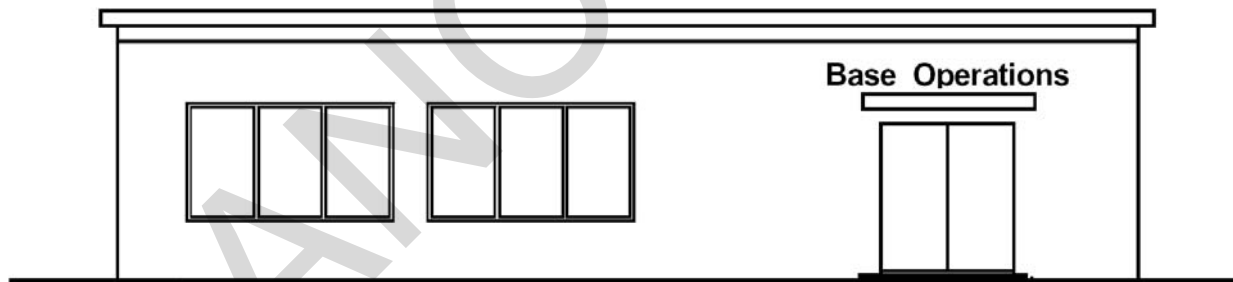

Example C

Figure 10.4. Message Placement Single Story Buildings on Facade.

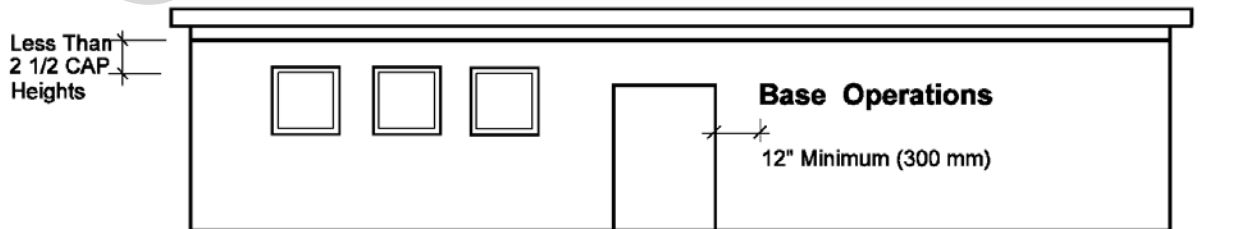

Example A

Figure 10.5. Message Placement Single Story Buildings on Façade.

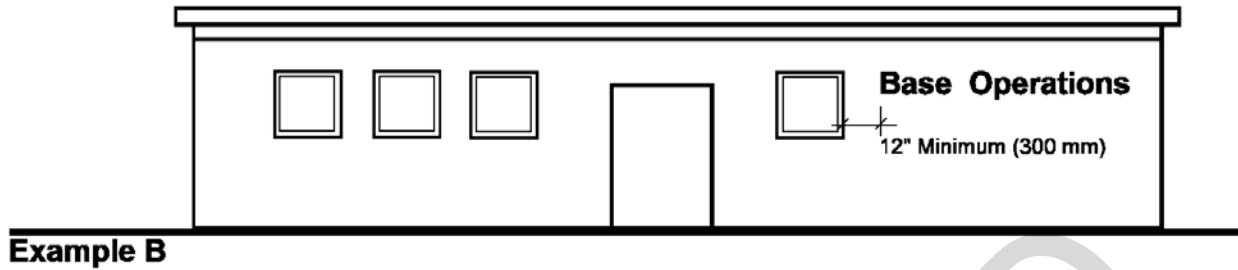

10.12. Message Placement Multi-Story Buildings.

10.12.1. On Spandrel Band. Many multi-story buildings have a spandrel band running above the first floor windows and below the second floor windows. This is an ideal location for an identification sign. Letters with a 300 mm (12") capital letter height as shown in Figure 10.6., Example A, require an area that is a minimum of 2 ½ caps or 750 mm (2' - 6") high. If the band is less than 750 mm (2' - 6") high, follow the guidelines in Figure 10.4, Example A.

10.12.2. Placement of Letters. Draw a horizontal line halfway up the spandrel band between the first and second story windows. Position the letters so that one-third of the capital letter height lies below this centerline and two-thirds is above the centerline.

10.12.3. Placement of Message. Center the message above the main entrance to the building. If the message cannot be centered above the entrance due to length, architectural details, or other reasons, place the message flush to the edge of the window as shown below. See Example B in Figure 10.6.

10.12.4. Additional Criteria. Additional message placement criteria for multi-story buildings are summarized below.

10.12.4.1. Spandrel Area to 4 Caps. Message placement on 750 mm to 1 200 mm (2' - 6" to 4' - 0") spandrel area. See Example C in Figure 10.7.

10.12.4.2. Spandrel Area Over 4 Caps. Message placement for a spandrel area over 4 caps or 1 200 mm (4' - 0") high. Position the letters so that the full capital letter height sits on the centerline. The full 300 mm (12") of the capital letter in the example is above the centerline. See Example D in Figure 10.7.

Figure 10.6. Message Placement Multi-Story Buildings, Examples A and B.

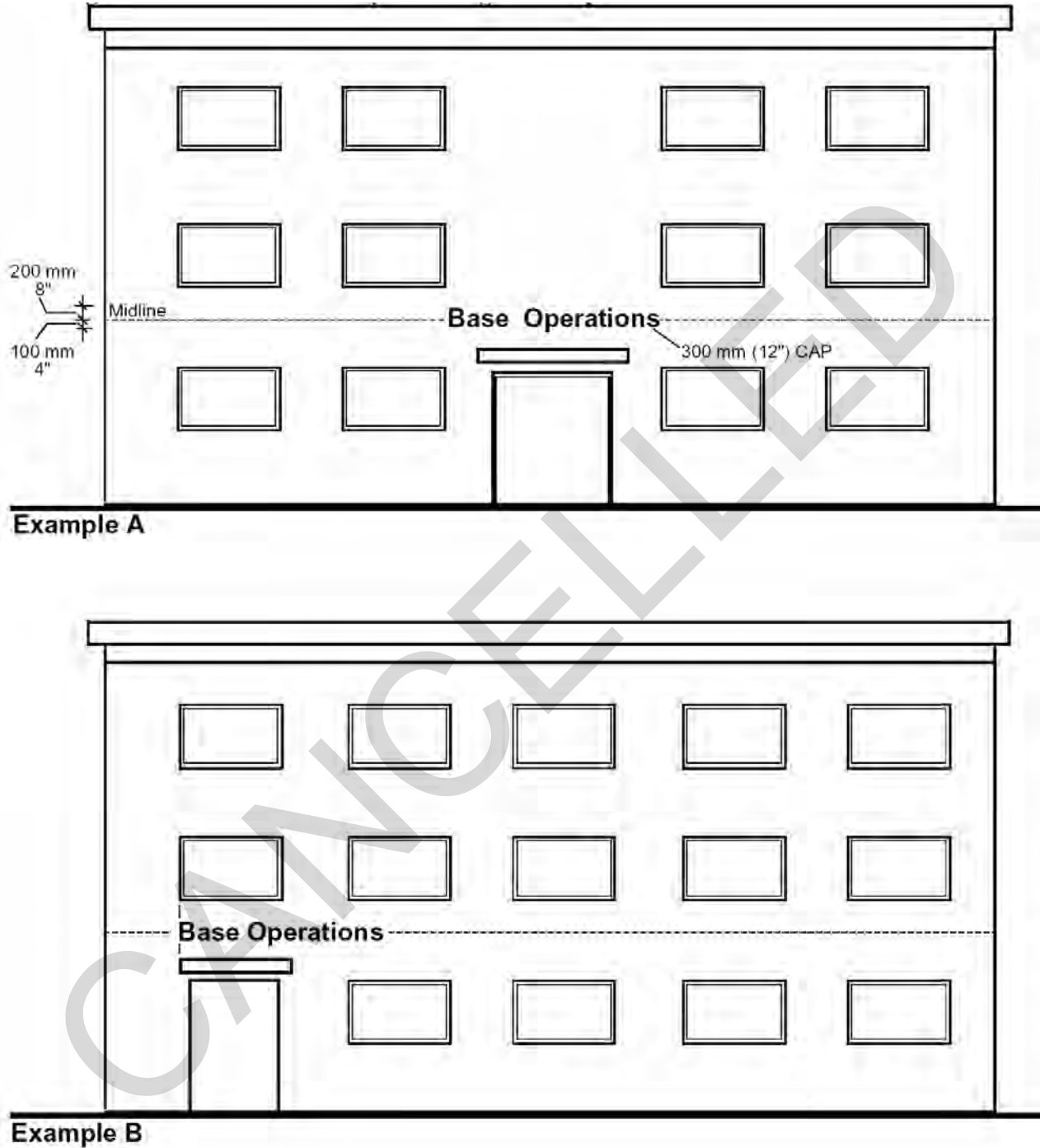

10.12.4.3. Below Second Store Windows. Message placement below second story windows. Position the letter on a line $2\frac{1}{2}$ cap heights or 750 mm (2'- 6") below the window. See Example E in Figure 10.7.

10.12.4.4. On Blank Wall. Message placement on a blank, windowless wall. Position the

letters on a line 2 ½ cap heights below the eaves. The scale of the wall may require that larger letters be used. The example shows a message with an 450 mm (18”) capital letter height placed on a line 1 125 mm (3’ - 9”) below the eaves. See Example F in Figure 10.7.

Figure 10.7. Message Placement Multi-Story Building, Examples C, D, E and F.

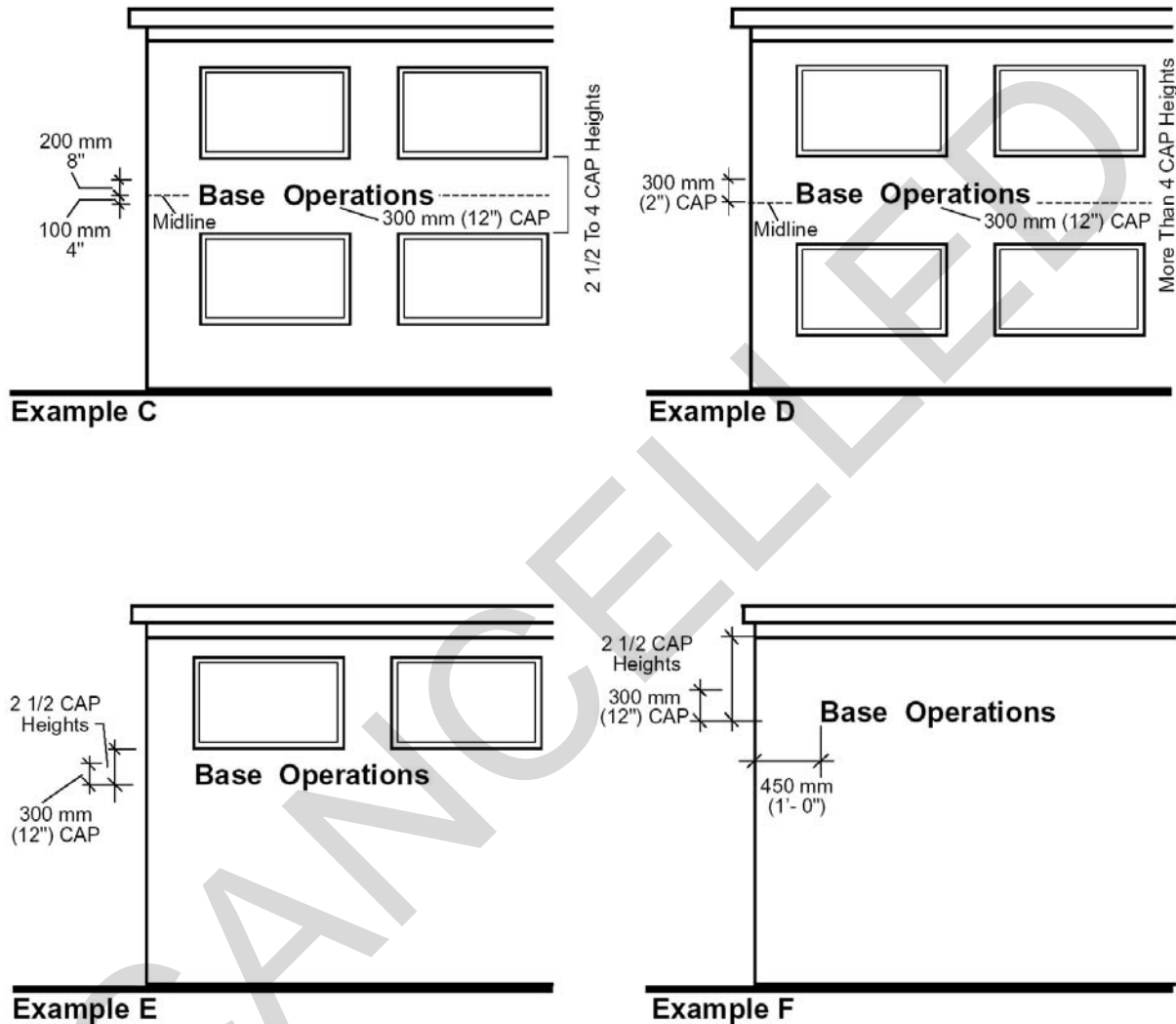

Section 10D--Fascia Mounted Signs

10.13. Letters. The letters on fascia mounted signs can be smaller than the letters on wall mounted signs. The door canopy projects from the plane of the wall and the canopy fascia provides a distinct background panel which calls attention to the message. A 150 mm (6”) capital letter height is specified for these signs. Each letter should be a minimum of 12 mm ½” deep.

10.14. Minimum Depth. The minimum depth fascia suitable for a sign is 2 ½ caps or 375 mm (1’ - 3”) high.

10.15. Placement of Message. To position the message vertically, draw a horizontal line at the midpoint of the fascia. Place the letters so that one-third of the capital letter height lies below the line and two-thirds lies above it. In Example A, in Figure 10.8, 50 mm (2") of the capital letter shown is below the centerline and 4" (100 mm) is above the centerline.

10.16. Long Messages. Long messages may require two lines. See Example B in Figure 10.8. The fascia must be a minimum of 4 caps or 600 mm (2' - 0") high to accommodate two 150 mm (6") cap height message lines. Separate the message lines with one-half the cap height or 75 mm (3"). Position the upper message line one-third of the capital letter height or 50 mm (2") above the centerline of the fascia.

Figure 10.8. Fascia Mounted Signs.

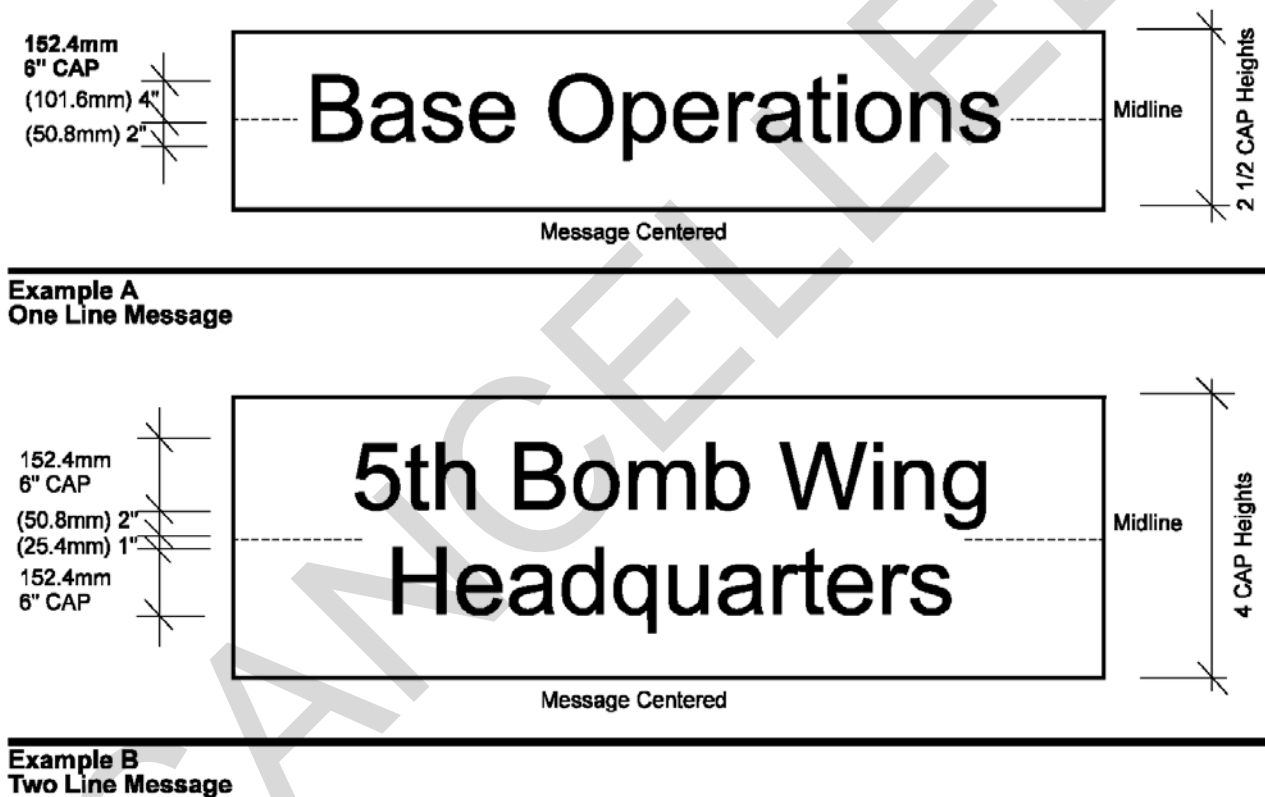
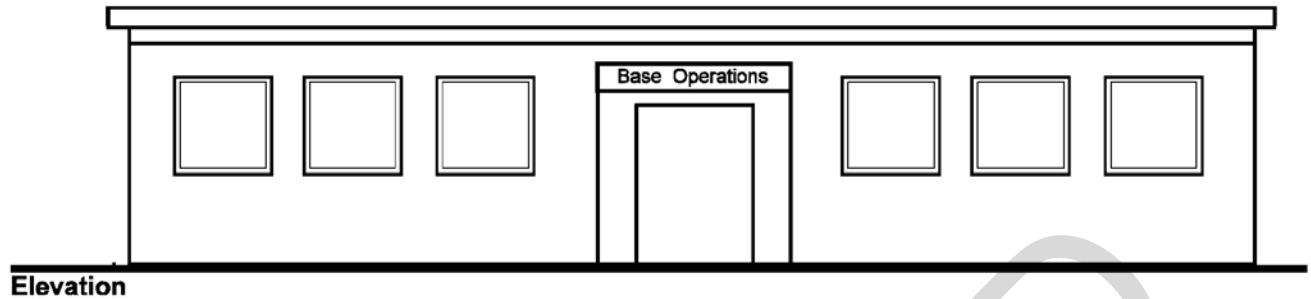

Figure 10.9. Fascia Mounted Signs Elevation.



Section 10E--Wall Mounted Organizational Emblems

10.17. Usage. The organizational emblem is an important part of a unit's identity and should be placed next to the main entrance of the building. The emblem helps to indicate the main entrance when the building identification sign is not located in the vicinity of the entrance.

10.18. Prioritization of Emblems. If the building houses more than one organization, only the emblem of the major tenant should be shown. In cases where there is no clear major tenant, two emblems may be shown.

10.19. Panels. The emblem is applied on either a 450 mm x 450 mm (1'- 6" x 1'- 6") panel (see Figure 4.22) or a silhouetted aluminum panel. Like the wall mounted dimensional letters, these panels are 19 mm (3/4") to 25 mm (1") deep to separate them from the plane of the wall. The background color of the panels is standard brown.

Figure 10.10. Organizational Emblems.

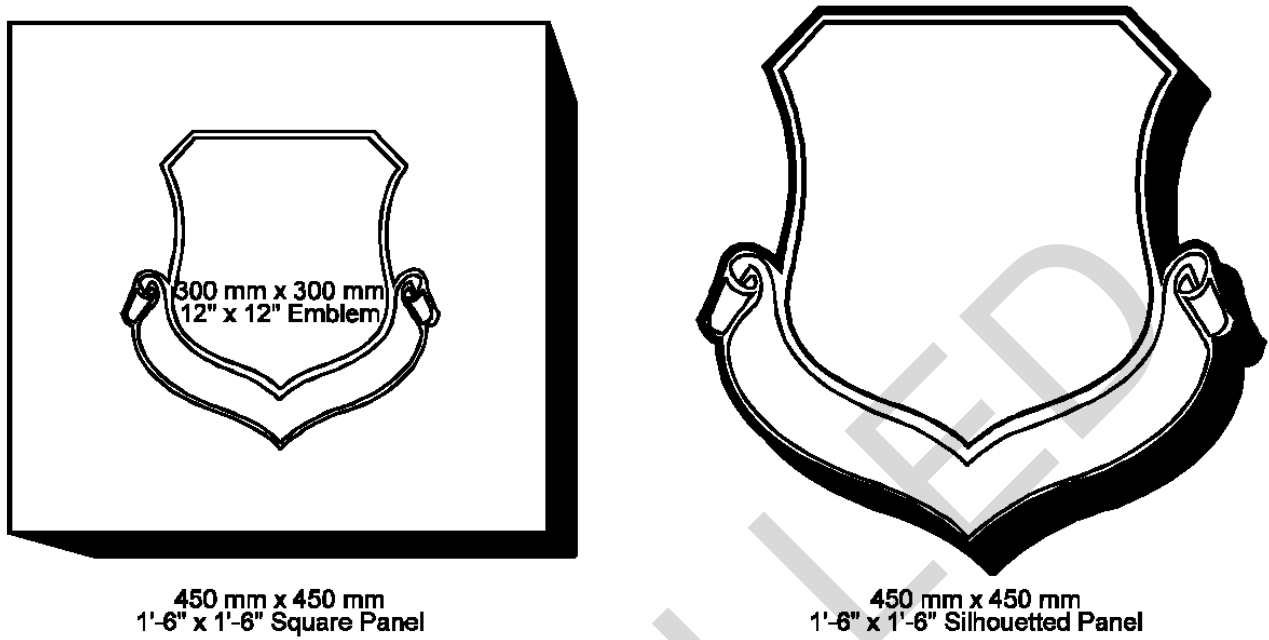
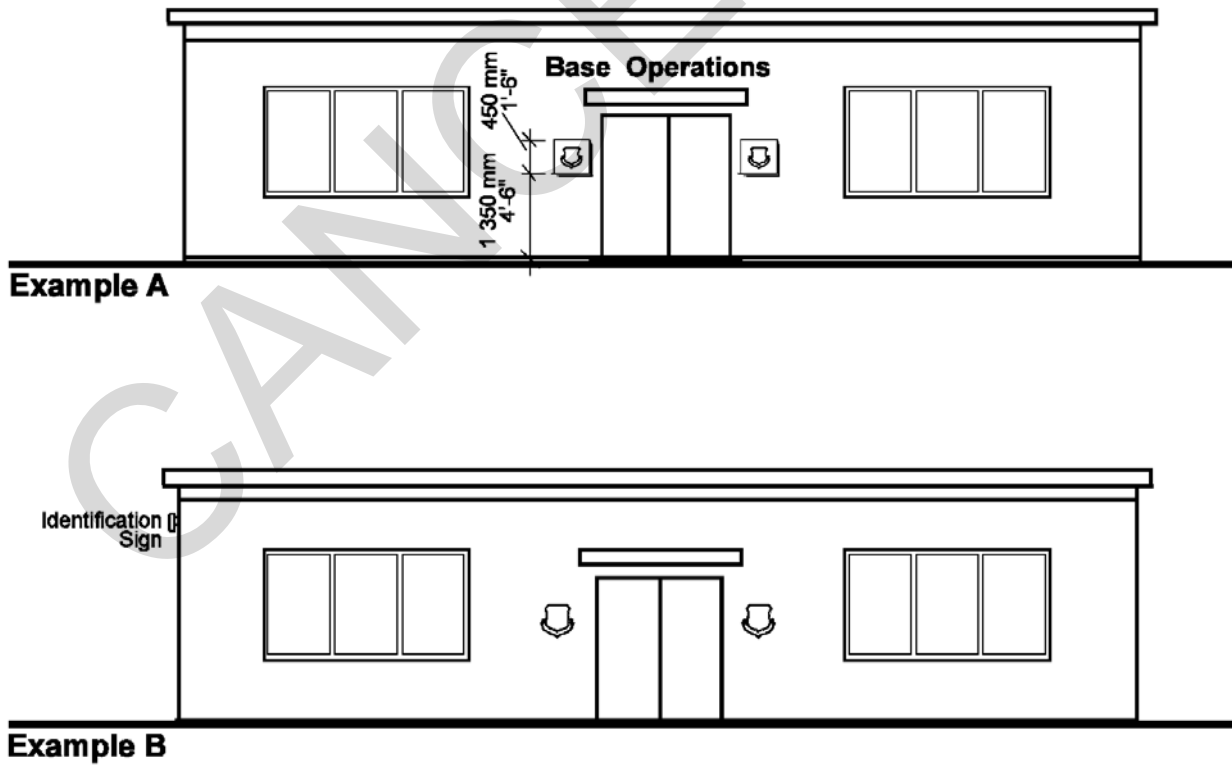

Figure 10.11. Wall Mounted Emblems.



Section 10F--Large Scale Buildings

10.20. Style. Wall mounted signs for large scale buildings should complement the architectural style of the buildings.

10.21. Size of Letters. Horizontal courses, lintels and fascias provide excellent references for the alignment of the message. If the message cannot be placed on a distinctive background (such as the lintel in Example A, Figure 10.12), it should be big enough to stand on its own in relation to the other architectural elements of the building. Compare the size of the letters in Example B, Figure 10.12 with those in Example A.

10.22. Placement of Message. If possible, the message should be centered over the main entrance to the building. Use the vertical alignment standards given in paragraph 10.11.2.

10.23. Primary and Secondary Messages. Some large scale buildings may require two messages. The primary message is placed high on the building facade to identify the building from a distance, while the secondary message is placed over the main entrance to the building.

10.24. Caveat. The signs should relate to the architectural style of the building, and the placement of the messages should be considered on a case by case basis. The solutions shown in Figure 10.13 are examples only.

CANCELLED

Figure 10.12. Large Scale Building Signs.

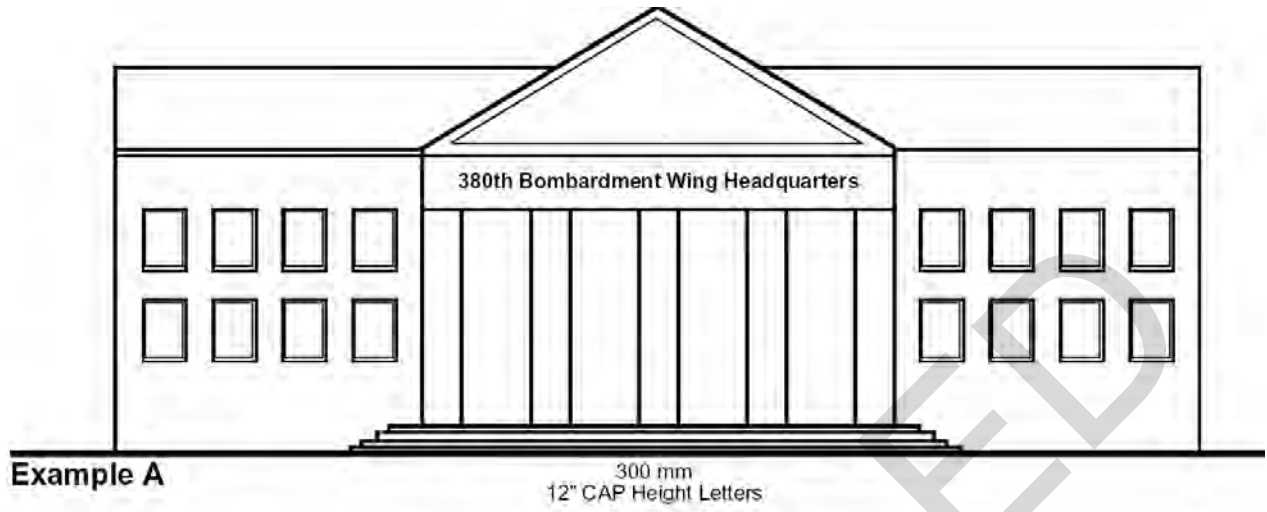
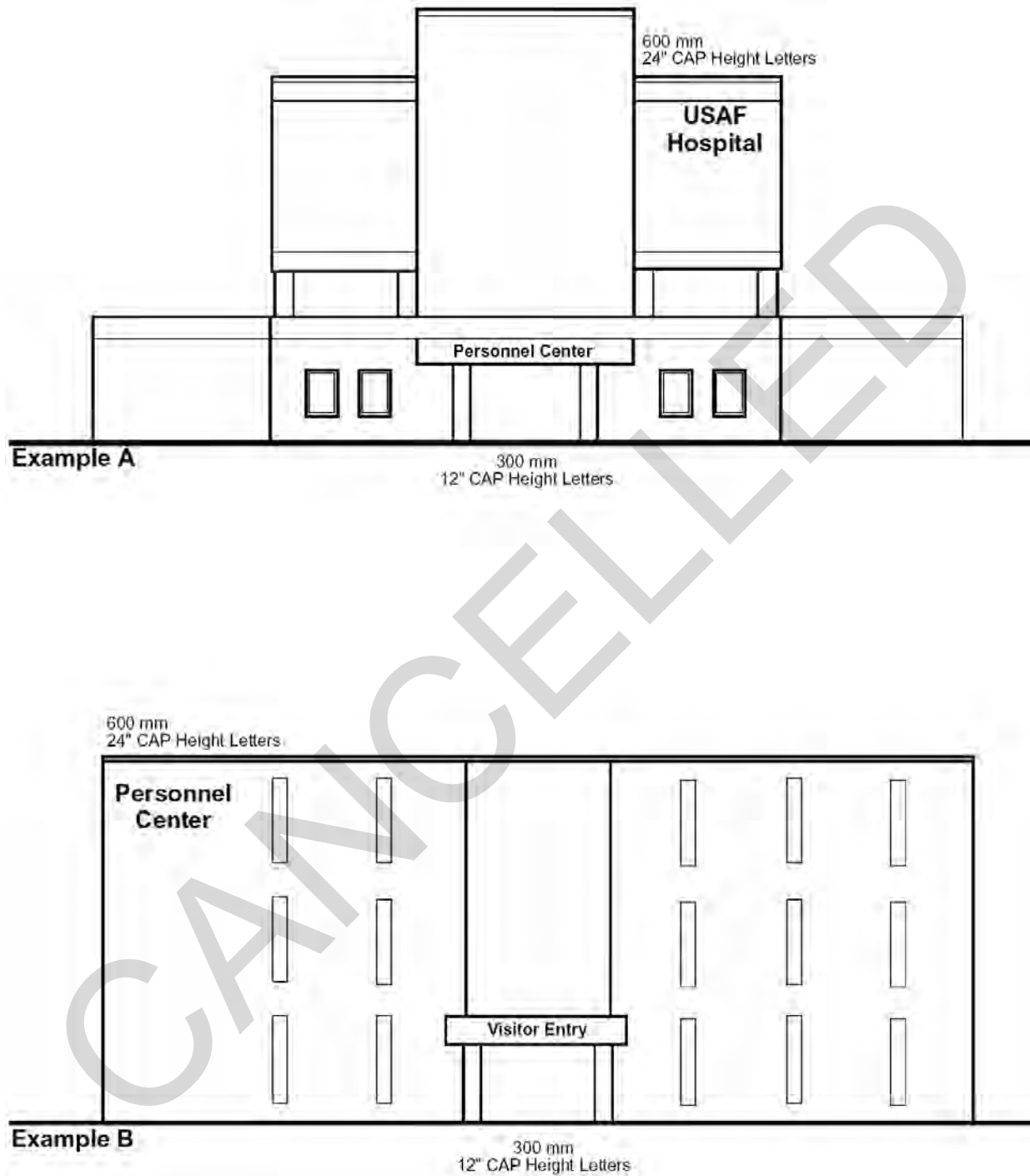

Figure 10.13. Primary and Secondary Messages.



Section 10G--Hangars

10.25. General Information. Hangars are often referred to simply by number. Large numbers placed consistently at the gable ends of hangars or at the sides along the flight line can help identify the hangars and give them a sense of uniformity.

10.26. Size and Placement. Use numbers 1 500 mm (5'- 0") to 1 800 mm (6'- 0") high. The specific size and placement of the numbers will depend on the architectural style of the hangar. As with the wall mounted letters, the numbers should be individually applied to the surface of the wall and not mounted on a background panel.

Figure 10.14. Hangar Signs.

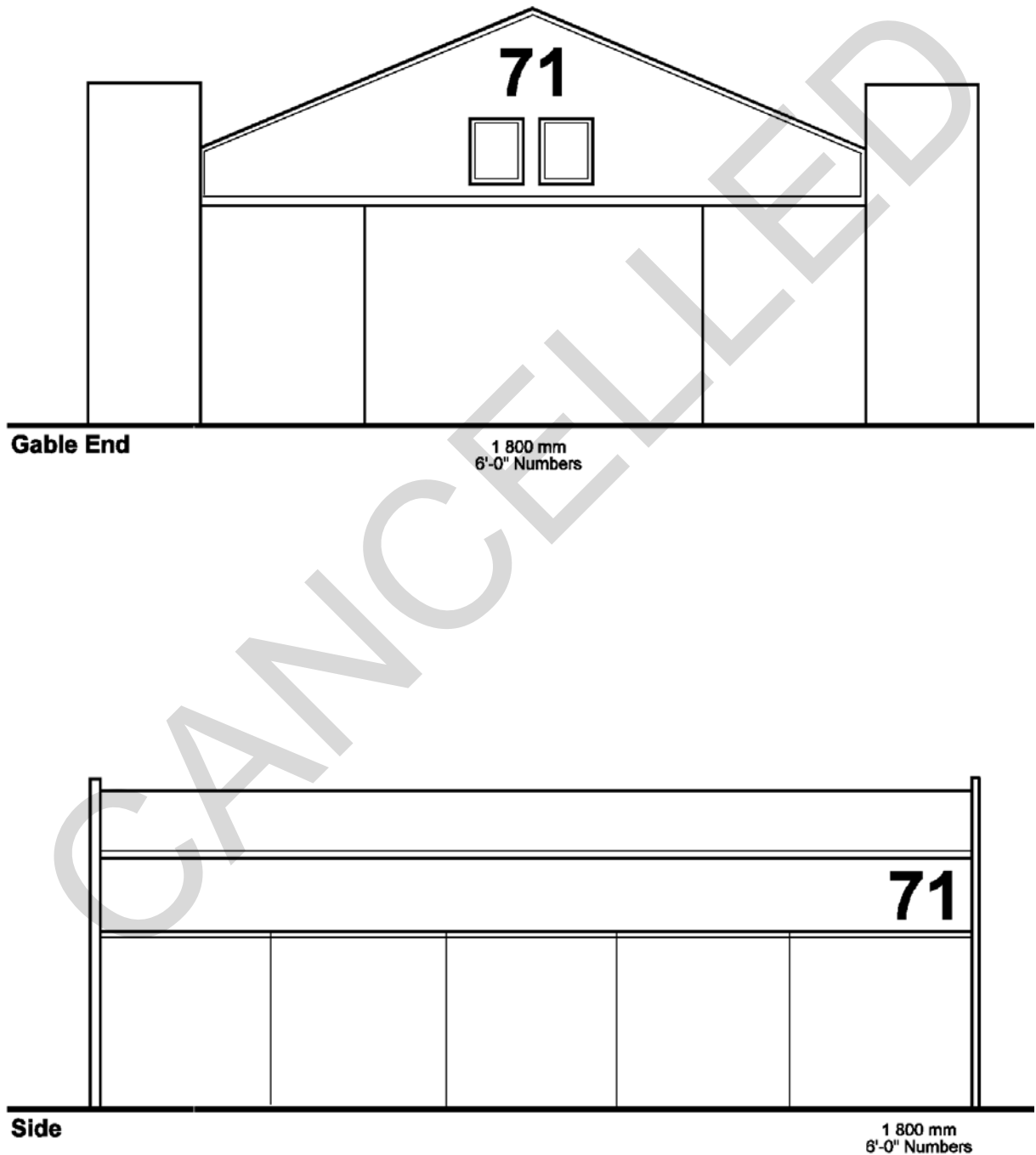

Chapter 11

INTERIOR SIGNS

Section 11A--Introduction

11.1. General Information. Interior signs should complement interior architecture and color schemes if at all possible. Since buildings vary a great deal, interior signs will also vary. The standards discussed here apply to buildings that do not have custom designed interior signs and are also intended to serve as a guide for the design of all interior signs. This chapter gives the standards for interior signs, including information on size, appearance, message, permitted graphics and layout.

11.2. Color. Standard brown or any dark color appropriate to the interior environment of the specific building may be used.

11.3. Design Parameters. All interior signs should be designed so that they require the minimum possible maintenance. The sign system should be flexible enough to adapt to frequent personnel changes and office relocations. The system shown here is designed to guide visitors through a building from the entrance point to the correct floor, the correct area of a floor, the correct office and (if appropriate) the correct desk.

11.4. Standards. All interior signs should follow these standards for system organization, sign types, and sizes. Variations in types of hardware and colors are permitted. These signs are designed to be compatible with the signs shown in the GSA Manual on the Design of Sign/Symbol Systems for Federal Facilities.

11.5. Mounting. Mounting options will vary with each system. For facilities or functional areas that require frequent removal and replacement of interior signs, consider the use of hook and loop fasteners, such as Velcro . A hook and loop attachment system allows for easy sign removal and replacement when frequent sign changes are required, does not require skilled labor and minimizes damage to wall surfaces.

11.6. Sources. There are many commercial sign systems available. There are usually national and local manufacturers of interior signs in most metropolitan areas. There are also many sign-making machines available.

11.6.1. References. Refer to the most recent version of the National Fire Protection Association (NFPA) NFPA 101 Life Safety Code and the NFPA Life Safety Code Handbook for the design and placement of all signs relating to means of egress and other life safety issues. Refer to Chapter 3 for the design and placement of all signs relating to the Americans with Disabilities Act.

Section 11B--Interior Sign Types

11.7. Main Categories. Like exterior signs, interior signs are standardized by function. The four

main sign categories are Information, Direction, Identification and Regulation.

11.8. Other Information. Bulletin boards display materials that relate to information, regulation, and motivation and are covered at the end of this chapter. The size, recommended design and layout for each type of sign are provided on the following pages. Information on typography and graphics can be found in Chapter 2. See Chapter 12 for information on sign structure and details.

11.9. Building Directory Sign Types AA1 and AA1a.

11.9.1. Usage, Location and Visibility. Types AA1 and AA1a building directories are used for major buildings. They are located in the main entrance lobby and should be clearly visible to visitors as they enter the building. For purposes of the ADAAG, these are considered to be temporary signs and need not comply.

11.9.2. Components of Type AA1. The Type AA1 building directory has two components. The permanent header panel gives the name of the building or the major organization, and may also show the unit organization emblem. The directory section is a changeable letter board with molded plastic letters that have tabs to align the letters in the slots of the letter board. It lists the name of each tenant in the building.

11.9.3. Components of Type AA1a. The Type AA1a building directory is similar to the Type AA1 directory, with the addition of a schematic building floor plan to assist in visitor orientation.

11.9.4. Building Directory Sign type AA1 Layout.

11.9.4.1. Colors. Colors should coordinate with the building interior design scheme.

11.9.4.2. Dimensions. 900 mm x 1 800 mm (3'- 0" x 6'- 0").

11.9.4.3. Typography.

- Heading: upper and lower case Helvetica medium, 50 mm (2") capital letter height, flush left.
- Secondary Heading: upper and lower case Helvetica regular, 50 mm (2") capital letter height, flush left.
- The heading area will accommodate two lines with a maximum line length of 30 tiles or characters per line.
- Text: upper and lower case Helvetica medium, 12 mm (½ ") capital letter height, flush left.
- The text area will accommodate three columns of 19 lines each, with a maximum line length of 45 tiles or characters per line.

11.9.4.4. Emblem: Authorized organizational emblem, 100 mm x 100 mm (4" x 4"), upper left corner.

Figure 11.1. Interior Sign Types.

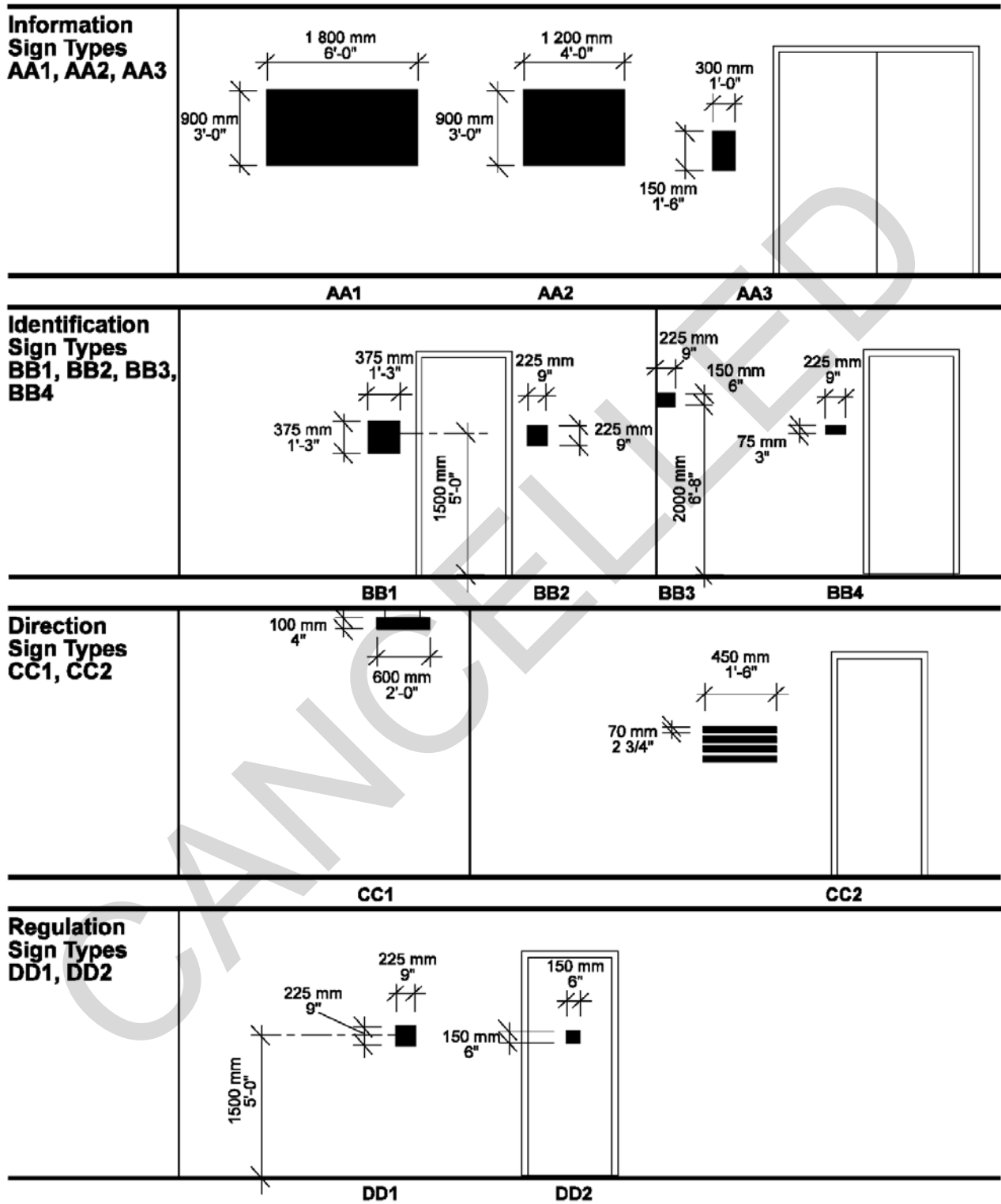

Figure 11.2. Placement of Building Directory Signs Types AA1 and AA1a.

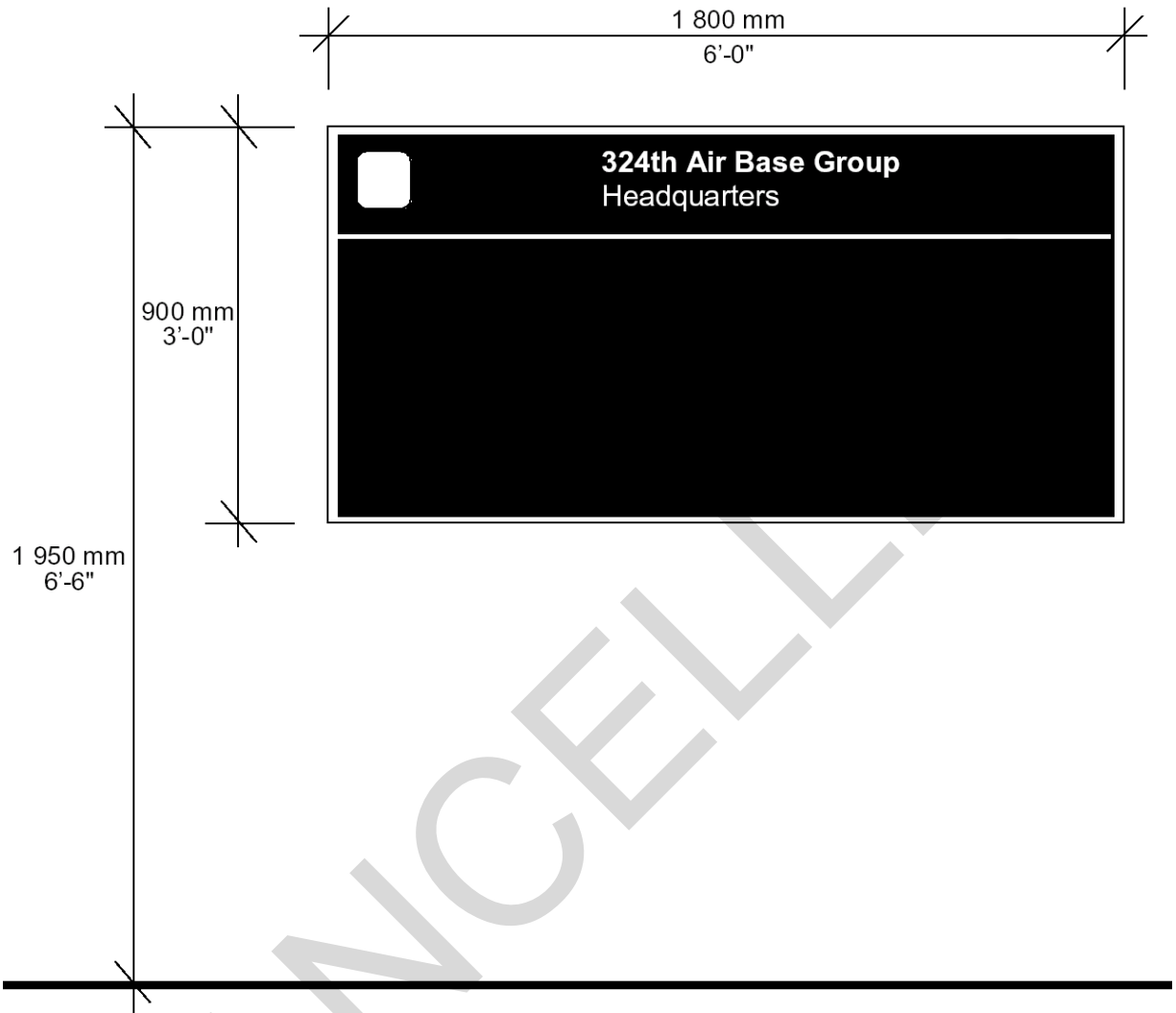
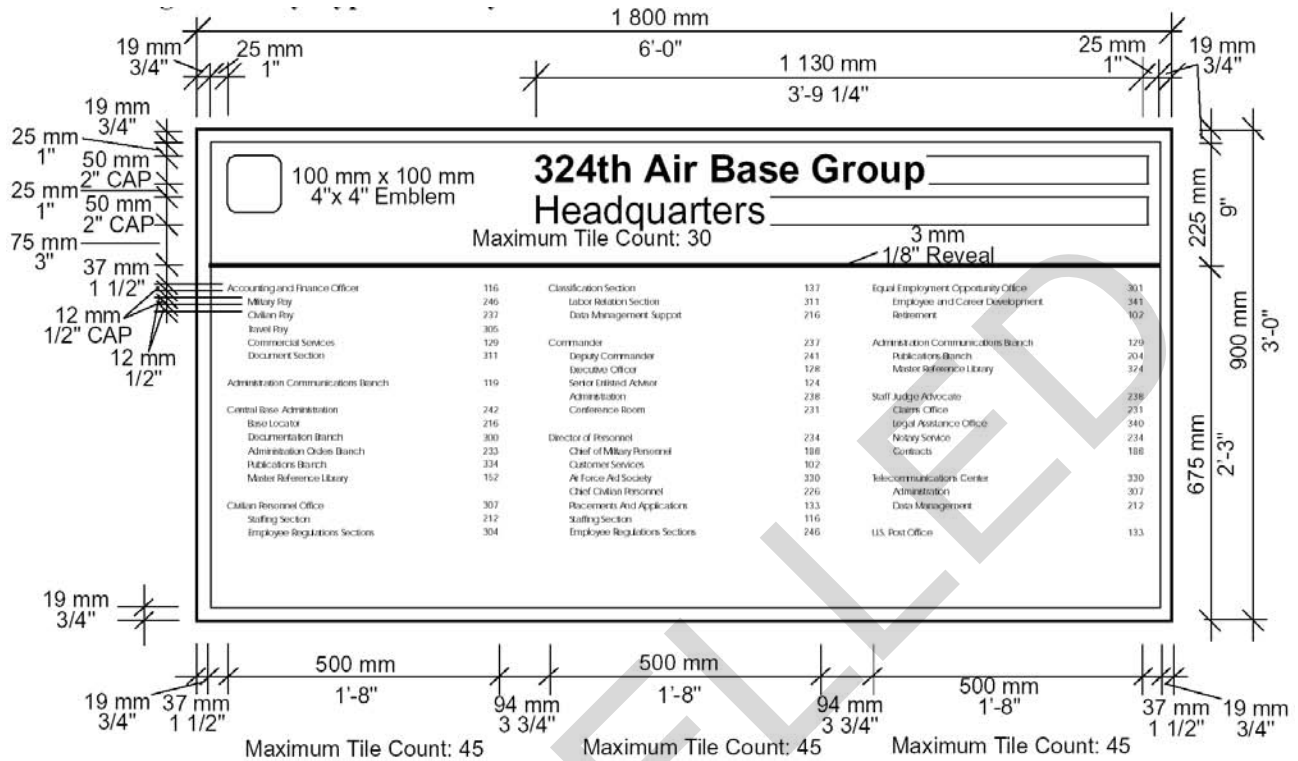

Figure 11.3. Building Directory Type AA1 Layout.



11.9.5. Building Directory Sign Type AA1a Layout.

11.9.5.1. Colors. Colors should coordinate with the building interior design scheme.

11.9.5.2. Dimensions. Height is 900 mm (3'-0"). Width may vary from 1 800 mm (6'-0") to 2 700 mm (9'-0").

11.9.5.3. Typography.

- Heading: upper and lower case Helvetica medium, 50 mm (2") capital letter height, centered over building floor plan.
- Secondary Heading: upper and lower case Helvetica regular, 50 mm (2") capital letter height, centered over building floor plan.
- The heading area will accommodate two lines with a maximum line length of 30 tiles or characters per line.
- Text: upper and lower case Helvetica medium, 12 mm 1/2" capital letter height, flush left.
- The text area will accommodate three columns of 19 lines each, with a maximum line length of 45 tiles or characters per line.

11.9.5.4. Emblem. Authorized organizational emblem, 100 mm x 100 mm (4" x 4"), upper left corner.

11.9.5.5. Building Floor Plan. Aligned and centered with directory text. This should be a professional quality schematic graphic.

Figure 11.4. Building Directory Sign Type AA1a Layout.

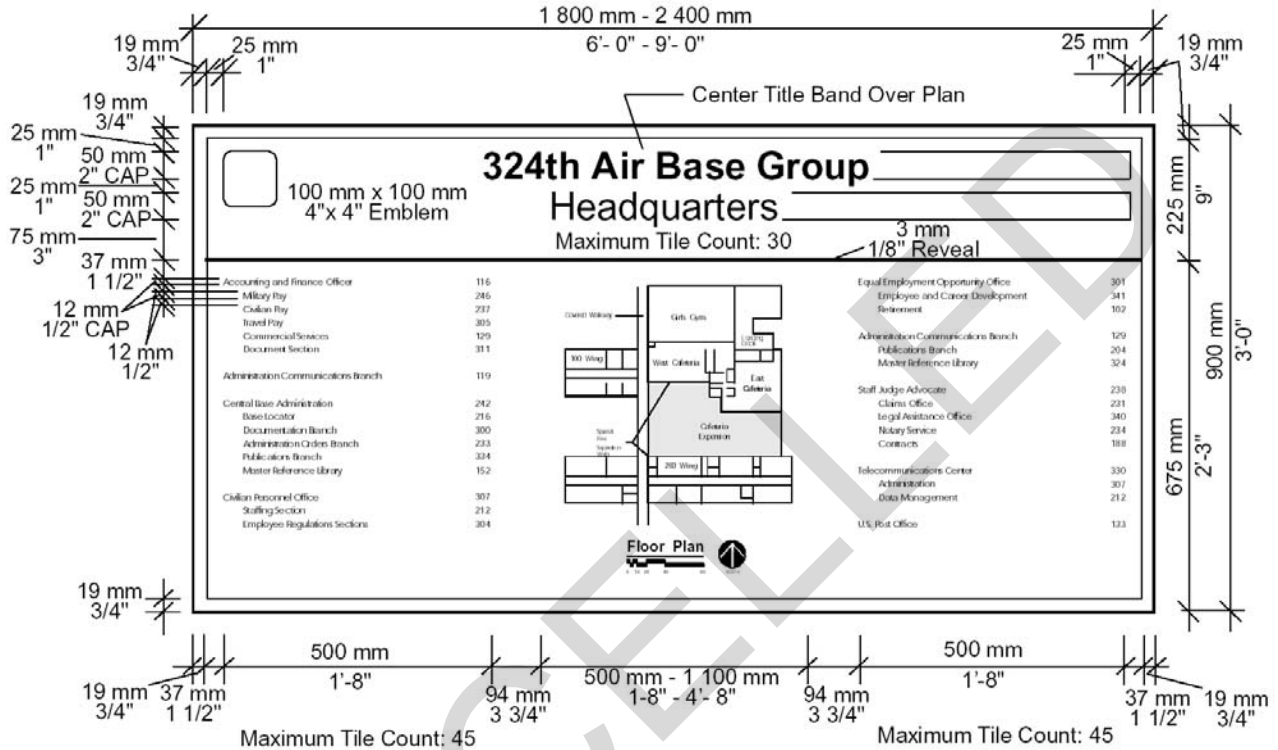

11.10. Building Directory Sign Type AA2 and Floor Directory Sign Type AA3.

11.10.1 Usage, Location and Visibility of AA2. The Type AA2 building directory is similar to the Type AA1 directory but lists fewer tenants. It should be located in the main entrance lobby and should be clearly visible to visitors as they enter the building. For purposes of the ADAAG, these are considered to be temporary signs and need not comply.

11.10.2. Locations and Visibility of AA3. The Type AA3 floor directory should be located in the elevator lobby of each floor, clearly visible to traffic entering the lobby from elevators or corridors. If the floor is not serviced by elevators, the floor directory should be located in the major stairway landings. For purposes of the ADAAG, these are considered to be temporary signs and need not comply.

11.11. Building Directory Sign Type AA2 Layout.

11.11.1. General Information. The Type AA2 building directory consists of a permanent header panel showing the name of the building or the major organization and a changeable directory that lists each tenant. An organizational emblem is not used on the header panel of the Type AA2 directory. The directory section is a board with changeable copy inserts or tiles.

Changeable letter boards with molded plastic changeable letters are a less favored option.

11.11.2. Colors. Colors should coordinate with the building interior design scheme.

11.11.3. Dimensions. 900 mm x 1 200 mm (3'- 0" x 4'- 0")

11.11.4. Typography.

- Heading: upper and lower case Helvetica medium, 50 mm (2") capital letter height, flush left.
- Secondary Heading: upper and lower case Helvetica regular, 50 mm (2") capital letter height, flush left.
- The heading area will accommodate two lines with a maximum line length of 30 tiles or characters per line.
- Text: upper and lower case Helvetica medium, 12 mm (1/2") capital letter height, flush left.
- The text area will accommodate two columns of 19 lines each, with a maximum line length of 45 tiles or characters per line.

CANCELLED

Figure 11.5. Placement of Building Directory Sign Type AA2 and Floor Directory Sign Type AA3.

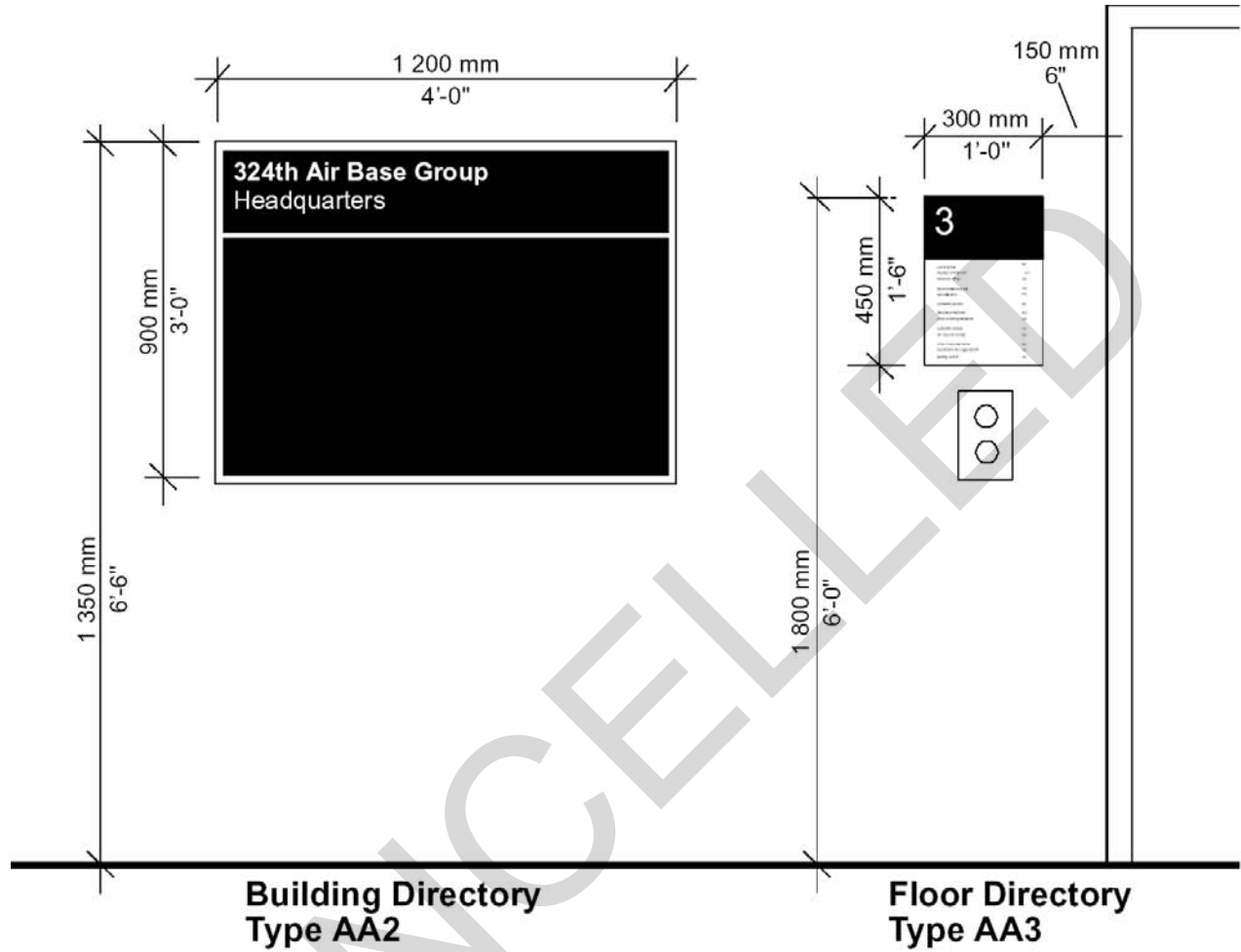
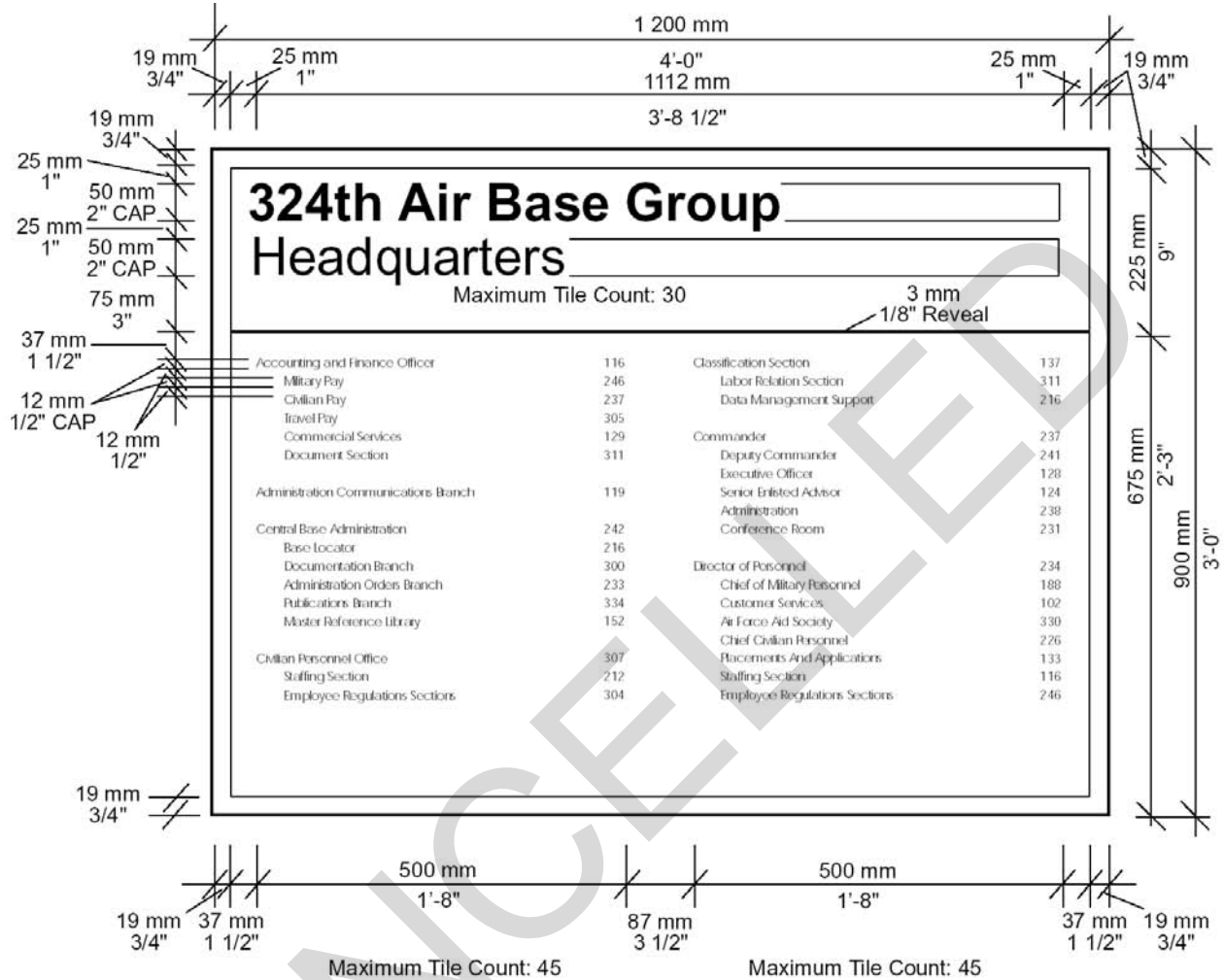

Figure 11.6. Building Directory Sign Type AA2 Layout.



11.12. Floor Directory Sign Type AA3 Layout.

11.12.1. General Information. The Type AA3 floor directory consists of a permanent header panel with the floor number, plus an insert panel that lists each tenant on the floor. The insert panel is a clear sleeve which will accept a paper or plastic insert listing the names of the tenants. A laser printed card stock sheet may be used as an insert, as shown in Figure 11.7.

11.12.2. Colors. Colors should coordinate with the building interior design scheme.

11.12.3. Dimensions. 450 mm x 300 mm (1'- 6" x 1'- 0").

11.12.4. Typography.

- Floor number: Helvetica medium, 75 mm (3") number, flush left.
- Insert, headings: upper and lower case Helvetica medium, 9 mm (3/8") capital letter height, flush left.

- Insert, text: upper and lower case Helvetica regular, 9 mm (3/8") capital letter height, flush left.
- The insert message area will accommodate 15 lines with a maximum length of 35 tiles or characters per line.

Figure 11.7. Floor Directory Sign Type AA3 Layouts.

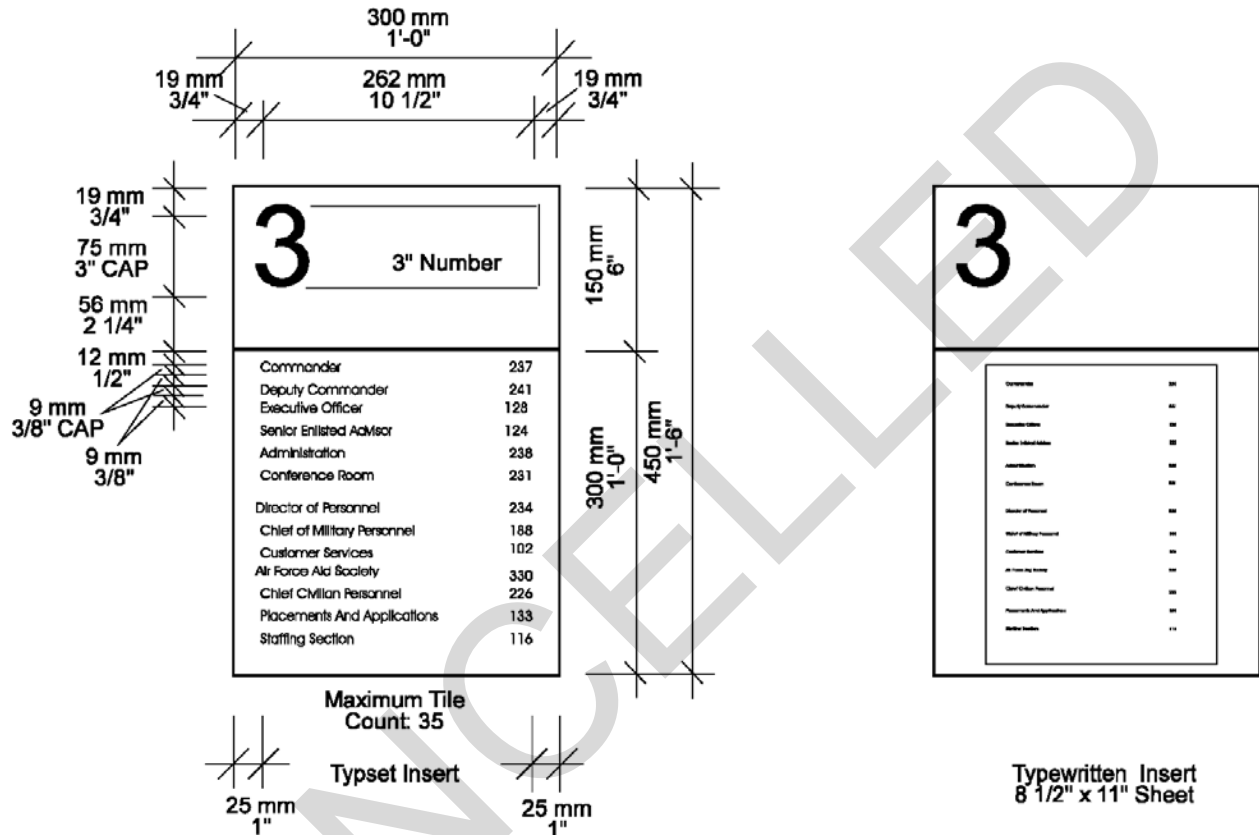

11.13. Office Identification Signs Types BB1, BB2, BB3 and BB4.

11.13.1. Usage. There are four types of office identification signs. The Type BB1 sign is used to identify a major office or area in a building (such as a wing or annex). The Type BB2 and Type BB3 signs are used for all other designated offices. The room number sign, Type BB4, is used to identify a secondary office entrance or a room with no designated function. 11.13.2. Description. The Type BB2 sign is a wall mounted sign, and is preferred to the Type BB3 projecting sign because it is easier to fabricate and maintain, but both types may be used. Each sign consists of a permanent header panel with the room number, wing, or annex designation plus an insert panel which identifies the occupant. The insert panel is a clear sleeve which will accept a paper or plastic insert with the name of the occupant. The Type BB4 sign consists of a header panel only, with no insert panel. It should be positioned at the same height from the floor as the Type BB2 sign. (See Figure 11.8)

11.13.3. Office Identification Sign Type BB1 Layout.

11.13.3.1. Colors. Colors should coordinate with the building interior design scheme

11.13.3.2. Dimensions. 375 mm x 375 mm (1'-3" x 1'-3").

11.13.3.3. Typography.

- Heading: upper case Helvetica medium 37 mm (1 ½ ") capital letter height, flush left.
- The heading area will accommodate two lines with a maximum of 10 tiles or characters per line and accompanying Grade Two Braille.
- Tenant name: upper and lower case Helvetica medium, 19 mm (¾ ") capital letter height, flush left.
- Secondary information: upper and lower case Helvetica regular, 19 mm (¾ ") capital letter height, flush left.
- The insert area will accommodate four lines with a maximum of 24 tiles or characters per line.

11.13.4. Office Identification Signs Type BB2, BB3 and BB4 Layouts.

11.13.4.1. Colors. Colors should coordinate with the building interior design scheme.

11.13.4.2. Dimensions. BB2 - 225 mm x 225 mm (9" x 9"), BB3 - 150 mm x 300 mm (6" x 12"),
BB4 - 75 mm x 225 mm (3" x 9").

11.13.4.3. Typography.

- Room number BB2, BB4: Helvetica medium, 37 mm (1 ½ ") numbers, flush left and accompanying Grade Two Braille.
- Room number BB3: Helvetica medium 75 mm (3") numbers, flush left.
- Tenant name: upper and lower case Helvetica medium, 12 mm (½ ") capital letter height, flush left.
- Secondary information: upper and lower case Helvetica regular, 12 mm (½ ") capital letter height, flush left.
- The insert area for the Type BB2 sign will accommodate four lines with a maximum of 21 tiles or characters per line.
- The insert area for the Type BB3 sign will accommodate one line with a maximum of 21 tiles or characters per line.

11.14. Office Identification Signs Type BB5, BB6 and BB7.

11.14.1. Usage, Placement and Description of BB5. The office partition identification sign Type BB5 is used to identify offices in open office areas. Place sign on the corner of the partition closest to traffic circulation. The sign consists of a permanent header panel showing the office workstation number and an insert panel which identifies the occupant. The insert panel has a clear sleeve which accepts a paper or plastic insert with the name of the occupant.

11.14.2. Usage and Placement of BB6. Use the Type BB6 desk plaque to identify individuals. If the base is removed, it may also be mounted on the office partition instead of the Type BB5 sign.

11.14.3. Usage of BB7. The service identification sign, Type BB7, is used to identify restrooms, telephones, and other services. The symbols for these services are shown in Figures 2.29, 2.30 and 2.31.

11.14.4. Sign Type BB5 - Office Partition Identification Sign.

11.14.4.1. Colors. Colors should coordinate with the building interior design scheme

11.14.4.2. Dimensions 150 mm x 150 mm (6" x 6").

11.14.4.3. Typography.

- Office identification: upper case Helvetica medium letters and numbers, 25 mm (1") high, flush left.
- Tenant Name: typewritten on a 75 mm x 150 mm (3" x 6") card, flush left, as shown in Figure 11.12.

Figure 11.8. Office Identification Signs Types BB1, BB2 and BB3.

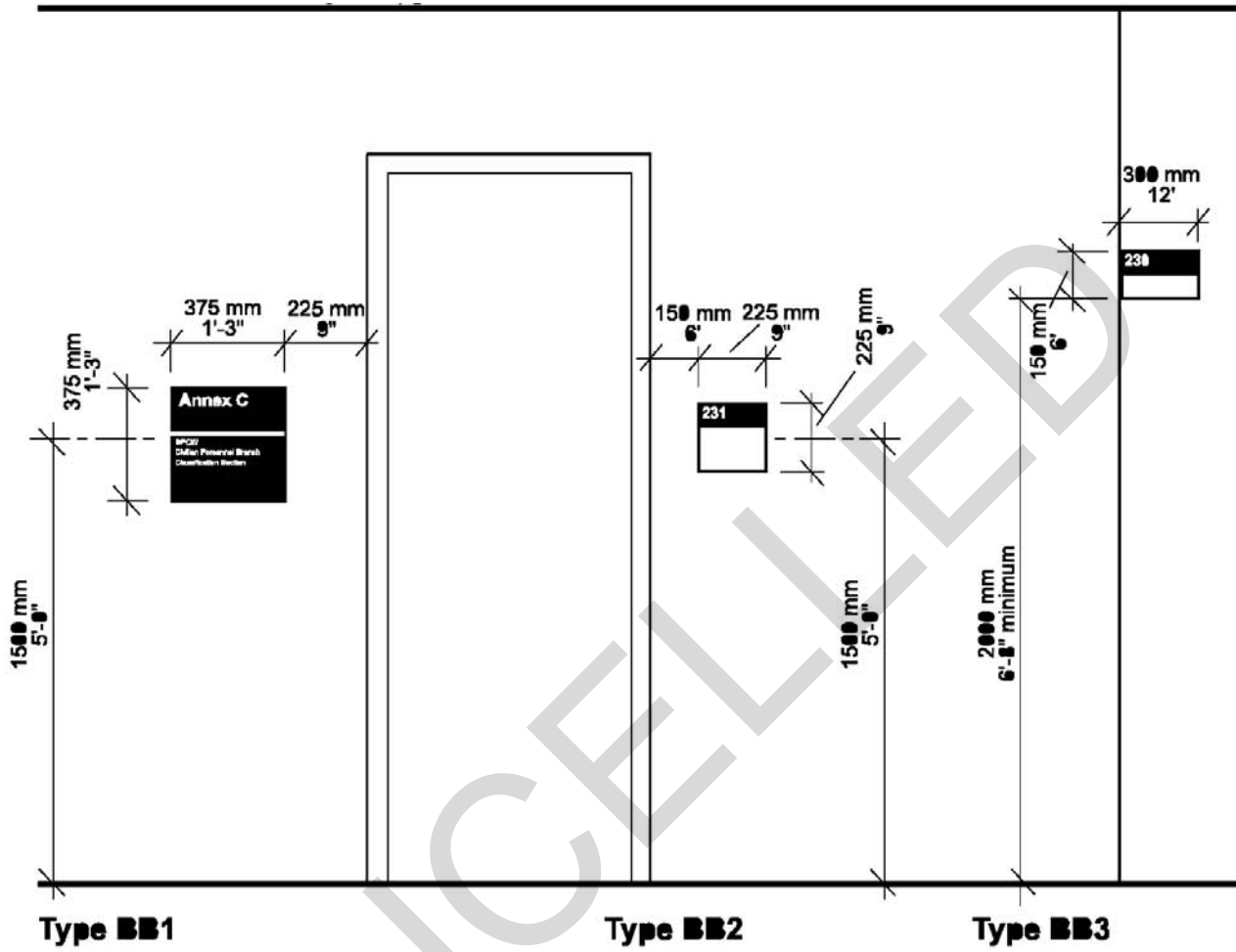

Figure 11.9. Office Identification Sign Type BB1 Layout.

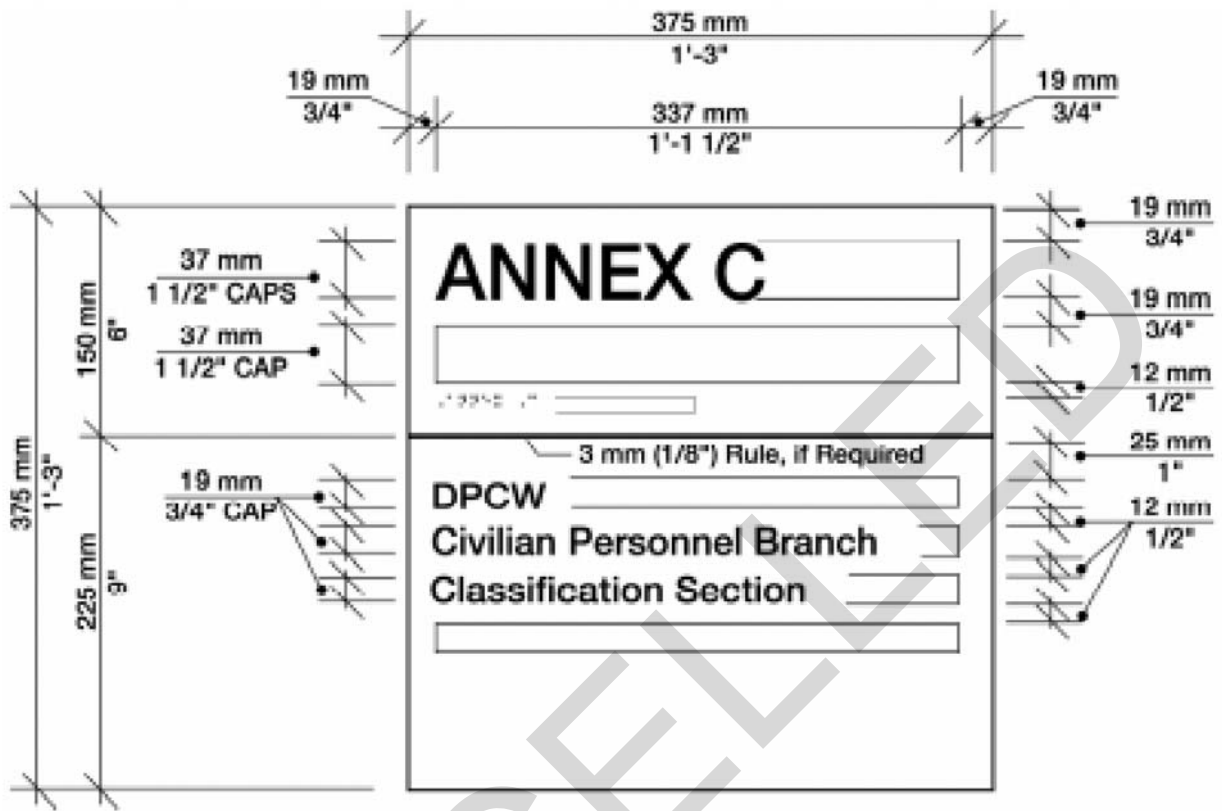

Figure 11.10. Office Identification Types BB2, BB3 and BB4 Layouts.

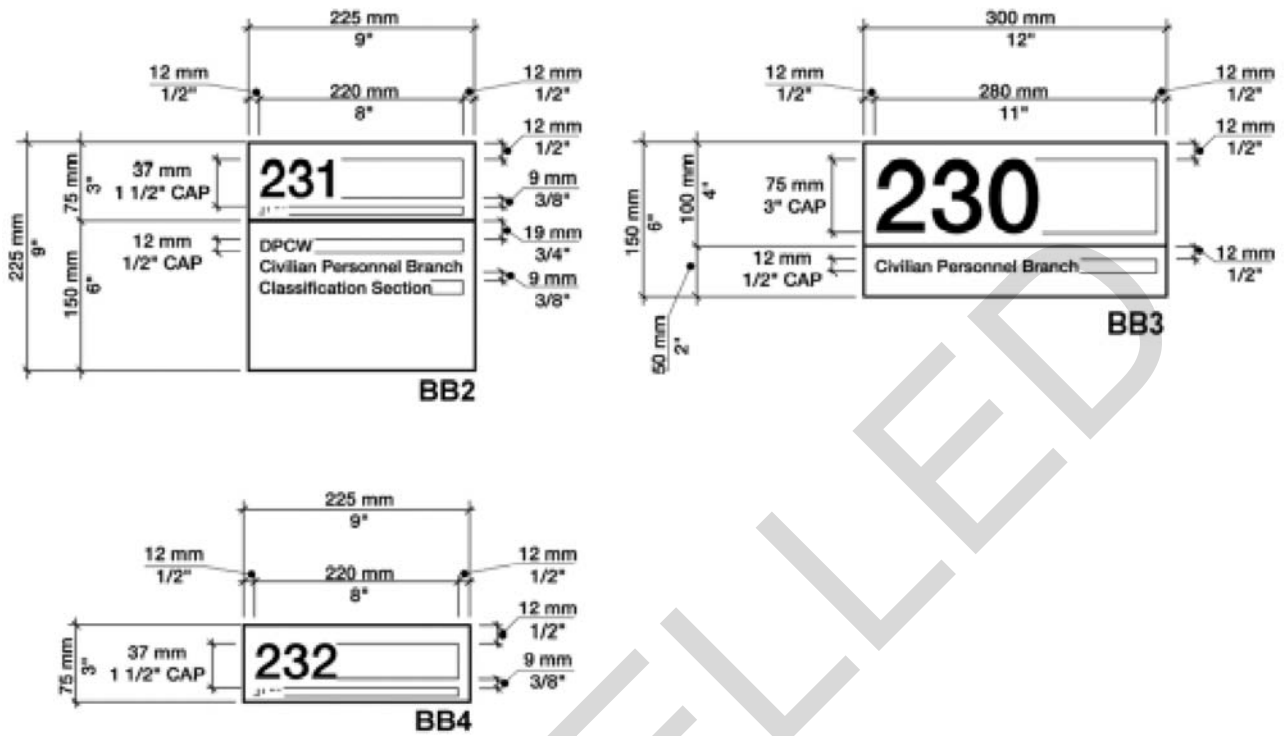

Figure 11.11. Placement of Identification Signs Types BB5, BB6 and BB7.

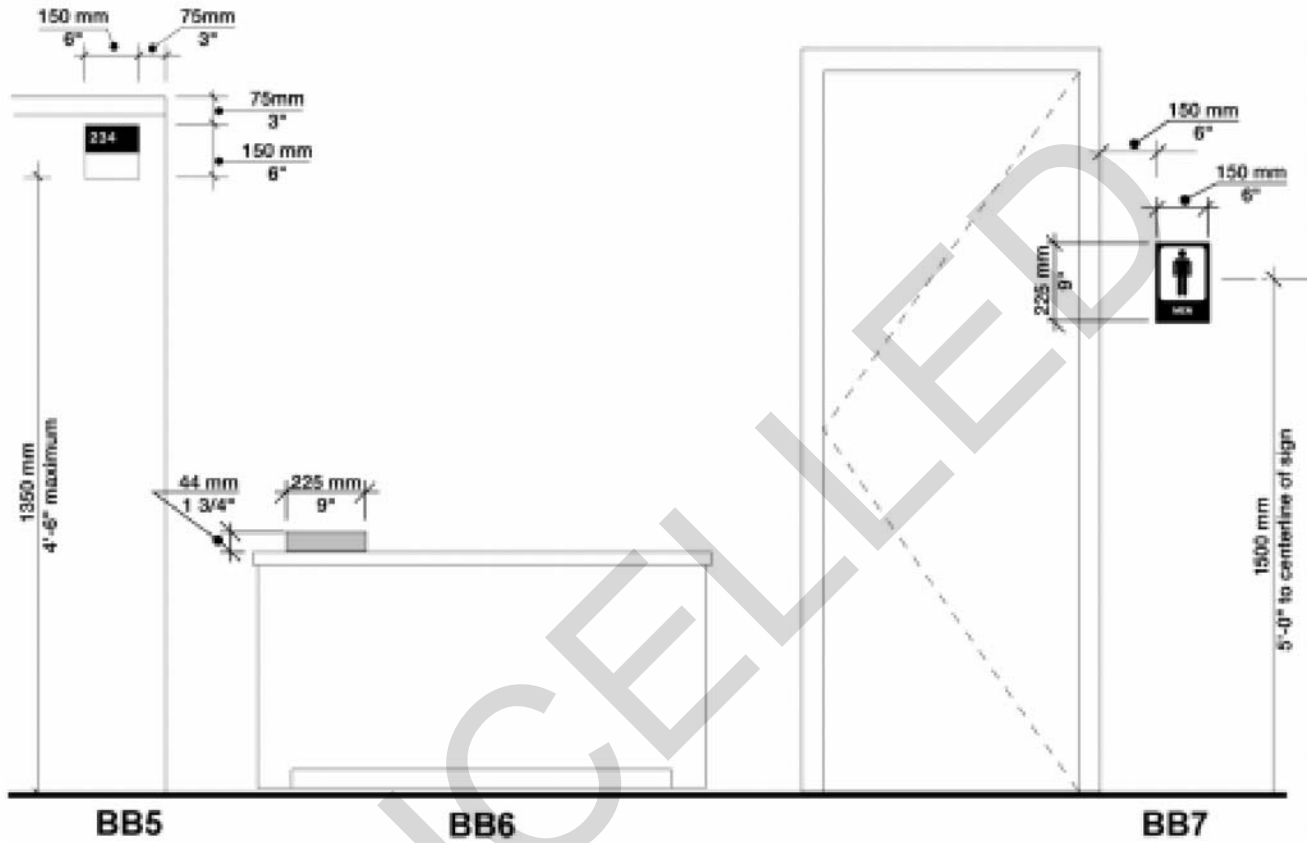
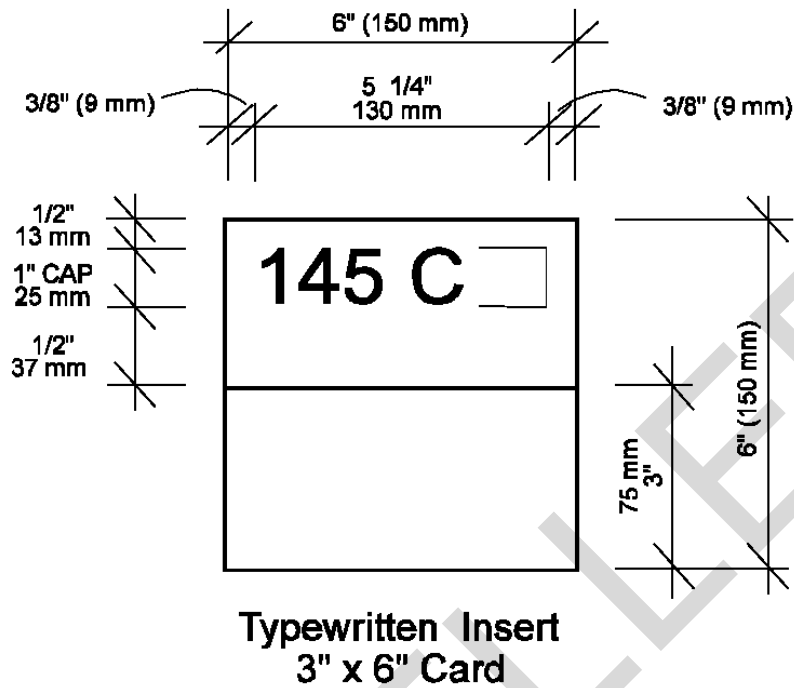

Figure 11.12. Office Partition Sign Identification Type BB5 Layout.



11.14.5. Office Identification Sign Type BB6 Layout - Desk Plaque.

11.14.5.1. Colors. Colors should coordinate with the building interior design scheme.

11.14.5.2. Dimensions. 44 mm x 225 mm (1 3/4" x 9") and 50 mm x 225 mm (2" x 9").

11.14.5.3. Typography.

- Name: upper and lower case Helvetica medium, 12 mm (1/2") capital letter height, flush left. The name line will accommodate a maximum of 21 tiles or characters.
- Title: upper and lower case Helvetica medium, 9 mm (3/8") capital letter height, flush left. The title line will accommodate a maximum of 30 tiles or characters.

Figure 11.13. Office Identification Sign Type BB6 Layout.

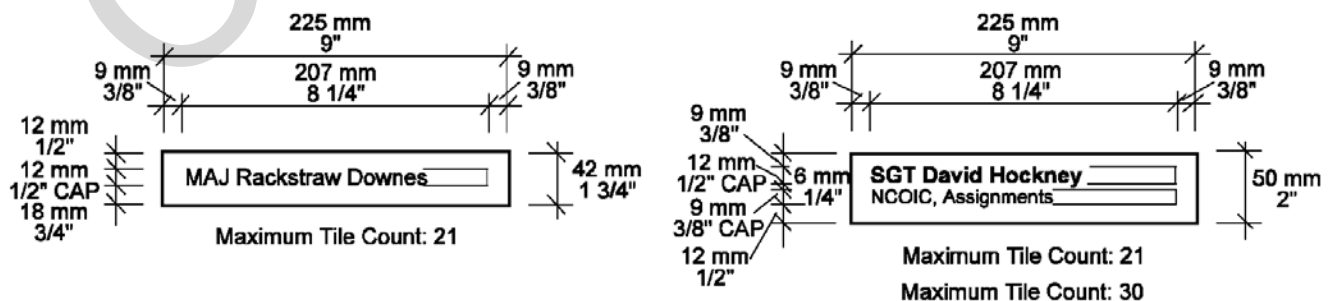

11.14.6. Office Identification Sign Type BB7 Layout - Service Identification.

11.14.6.1. Colors. Colors to coordinate with building interior design scheme.

11.14.6.2. Symbols. Black symbol or red symbol (where appropriate) on white background.

11.14.6.3. Dimensions. 225 mm x 150 mm (9" x 6").

11.14.6.4. Typography.

- Service name (Option 1): upper case Helvetica medium, 16 mm (5/8") capital letter height, centered with accompanying Grade Two Braille. The message line will accommodate a maximum of 7 tiles.
- Service name (Option 2): upper and lower case Helvetica medium, 19 mm (3/4") capital letter height, centered. The message line will accommodate a maximum of 9 tiles.

Figure 11.14. Service Identification Sign Type BB7 Layout.

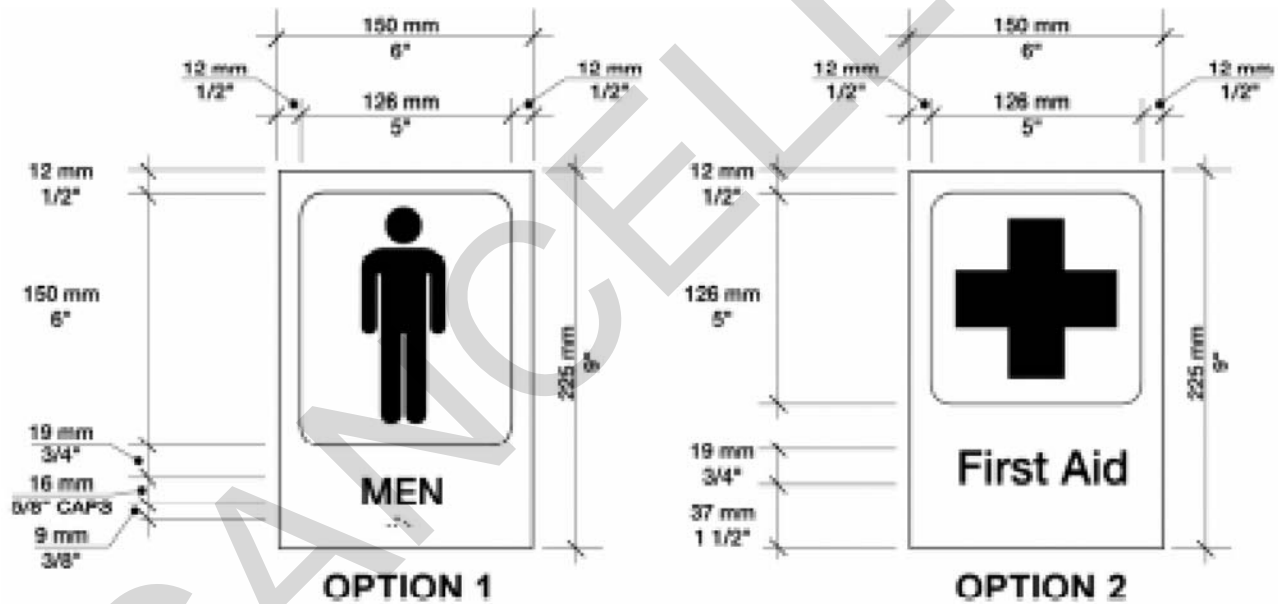

11.15. Direction Signs Types CC1 and CC2.

11.15.1. Types and Locations. There are two types of direction signs: the ceiling mounted Type CC1 sign and the wall mounted Type CC2 sign. A direction sign should be located at each decision point in the path of travel, for example, opposite elevators or stairways, and at each corridor intersection.

11.15.2. Information. Direction signs should indicate room numbers. The destinations most often sought by people entering the building for the first time (such as Finance, Pass and ID, or Vehicle Registration) should be listed by name. All others should be identified by room number alone. This greatly simplifies both initial fabrication and maintenance.

11.15.3. Signage System. Direction signs should tie into the interior signage system. Every building should have a directory (Sign Type AA2) at each entrance and a floor directory (Sign Type AA3) at each elevator or stairway landing. The directories should include room numbers in order to give continuity of directional information from entry through arrival on the floor and location of the room. Room numbers placed on or beside office doors complete the system.

11.15.4. Placement of Messages. Messages are placed flush left or flush right to the arrow. Arrows pointing to the left, up, or down, have flush left messages, and arrows pointing to the right have flush right messages. The arrow is centered in the space between the message and the edge of the sign.

Figure 11.15. Placement of Direction Signs Types CC1 and CC2.

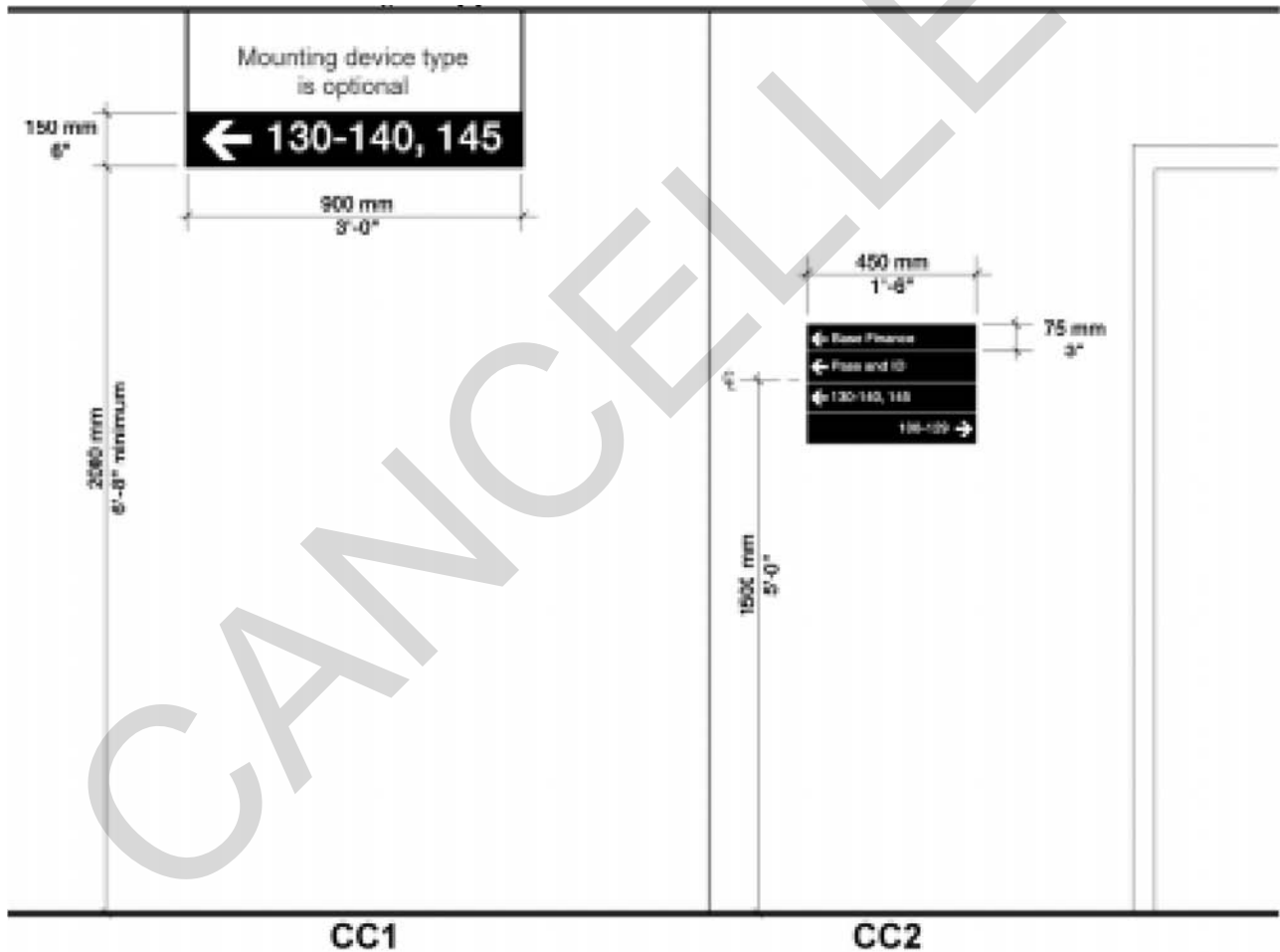

11.15.5. Direction Signs Type CC1 Layouts.

11.15.5.1. Colors. Colors should coordinate with the building interior design scheme.

11.15.5.2. Dimensions. Slats - 150 mm x 900 mm (6" x 3' - 0").

11.15.5.3. Typography. Upper and lower case Helvetica medium, 75 mm (3") capital letter height, flush left or right (to arrow). The message area of each slat will accommodate a maximum of 11 tiles or characters.

11.15.5.4. Arrow. Standard tile, 113 mm (4 1/2") high, placed left or right as appropriate.

11.15.6. Direction Sign Type CC2 Layout.

11.15.6.1. Dimensions. Slats - 75 mm x 450 mm (3" x 1' - 6").

11.15.6.2. Typography. Upper and lower case Helvetica medium, 25 mm (1") capital letter height, flush left or right (to arrow). The message area of each slat will accommodate a maximum of 16 tiles or characters.

11.15.6.3. Arrow. Standard tile, 37 mm (1 1/2") high, placed left or right as appropriate.

Figure 11.16. Direction Sign Type CC1 Layout.

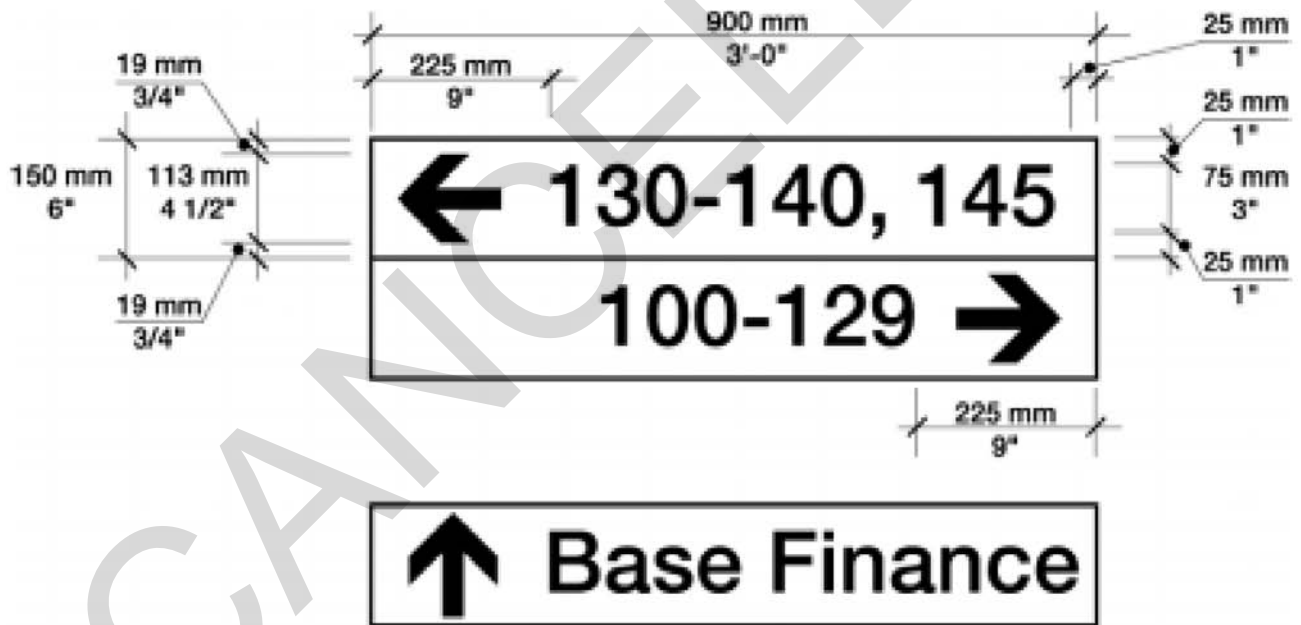
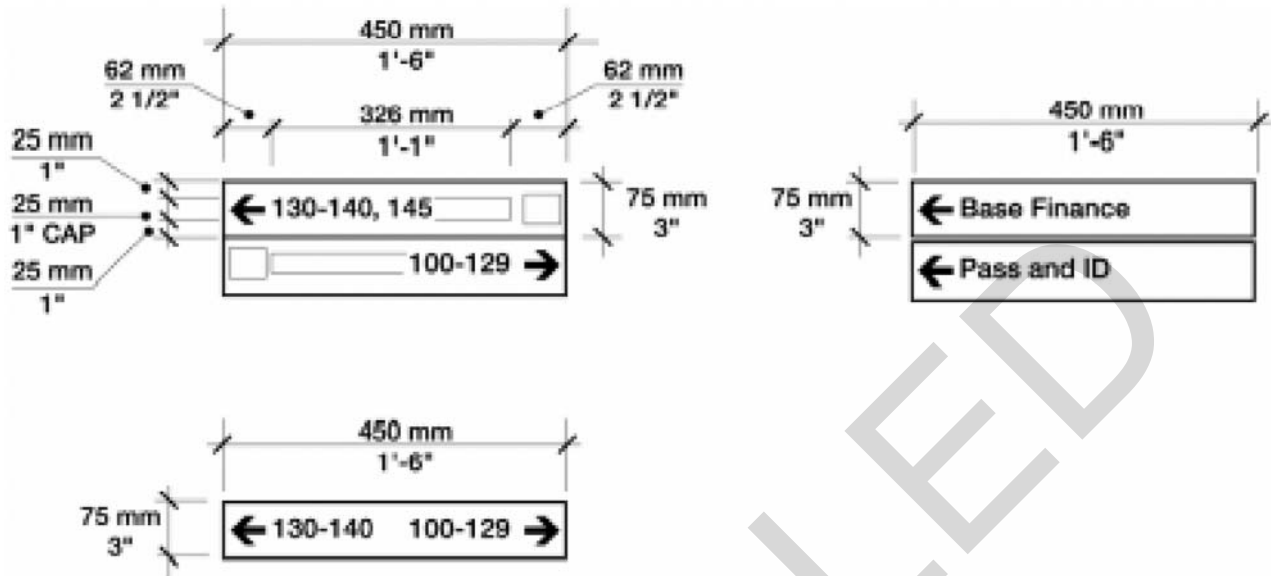

Figure 11.17. Direction Sign Type CC2 Layout.



11.16. Regulation Signs Types DD1 and DD2.

11.16.1. Standards. There are many regulation signs required for use in Air Force buildings. Air Force standards for safety signs are contained in AFOSH 9166, General Industrial Operations, and are updated by the Air Force Safety Center (AFSC/SEGS).

11.16.2. Locations. These signs should be located where specific warning or prohibitive information is required. The Type DD1 sign should be located in open areas (such as hangars or workshops), and the Type DD2 sign should be located in offices, labs and corridors.

11.16.3. Message. If the symbol on the Type DD2 sign needs reinforcement by a word message for clarity, use the sign layout for the Type BB7 sign. See Figure 11.14.

11.16.4. Regulation Signs Types DD1 and DD2 Layouts.

11.16.4.1. Colors. Symbols - black symbol and standard red circle with bar on white background.

11.16.4.2. Type DD1 Sign Dimensions. 225 mm x 225 mm (9" x 9").

11.16.4.3. Type DD1 Sign Symbol. 187 mm x 187 mm square (7 1/2" x 7 1/2").

11.16.4.4. Type DD2 Sign Dimensions. 150 mm x 150 mm (6" x 6").

11.16.4.5. Type DD2 Sign Symbol. 125 mm x 125 mm square (5" x 5").

11.17. Bulletin Boards Sign Type EE1.

11.17.1. Usage. Bulletin boards are used to display many kinds of information, including notices, regulations, memoranda, and posters to promote worthwhile causes and advertise special events.

11.17.2. Appearance. The appearance of a bulletin board is completely dependent on the visual quality and organization of the materials mounted on it. The unit commander or the person in charge of maintaining the bulletin board must insist that materials are kept current and neatly arranged.

11.17.3. Description. The Type EE1 bulletin board consists of a permanent header panel with a general title, such as "Notices" or "Information", and a cork panel for bulletins and announcements.

11.17.4. Colors. Colors to coordinate with building interior color scheme.

- Header panel - white letters on dark background.
- Cork panel - muted tone to coordinate with building interior color scheme.

11.17.5. Dimensions. 900 mm x 1 800 mm (3' - 0" x 6' - 0").

11.17.6. Typography. Heading - upper and lower case Helvetica medium, 50 mm (2") capital letter height, flush left.

Figure 11.18. Placement of Regulation Signs Types DD1 and DD2.

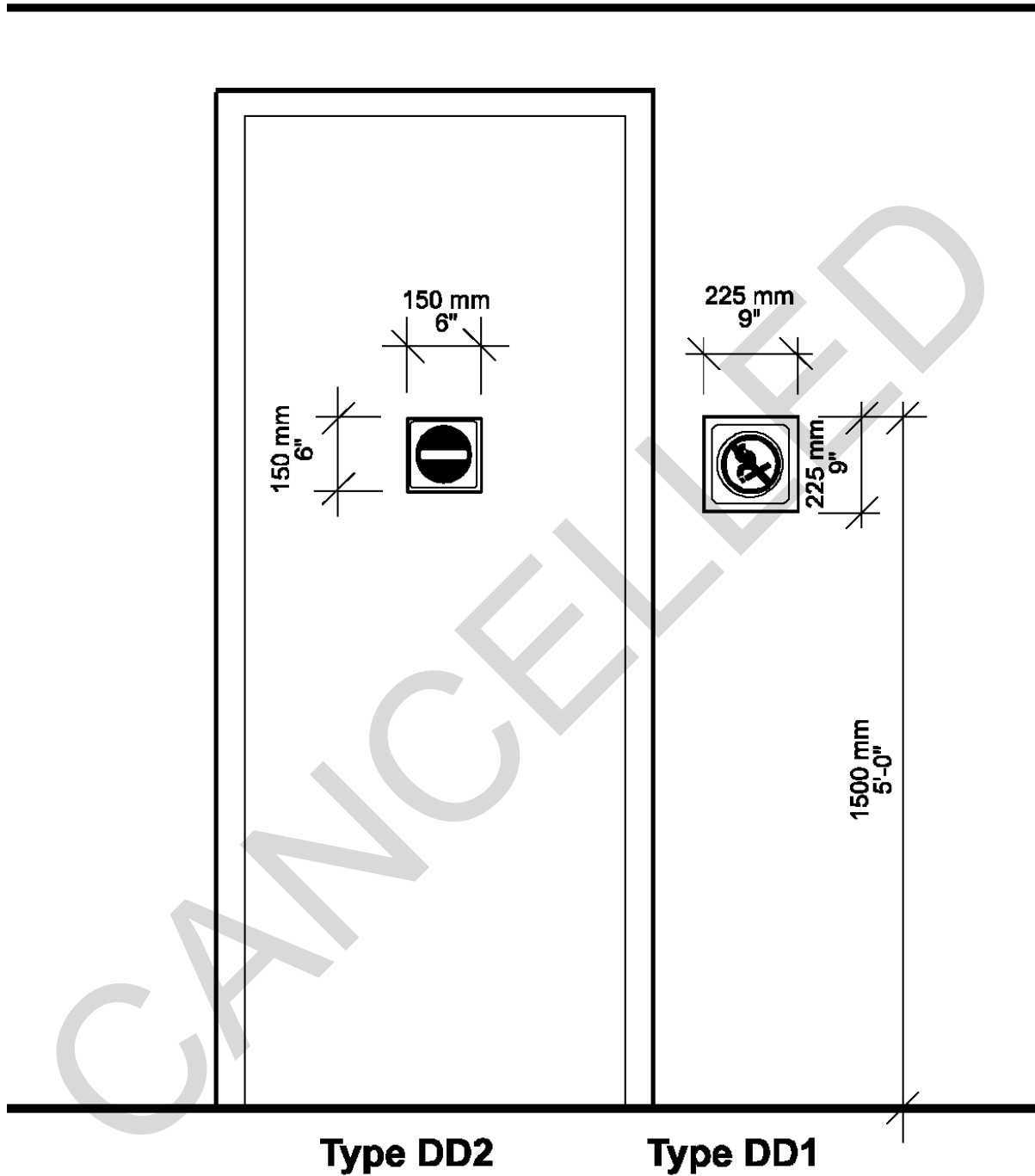
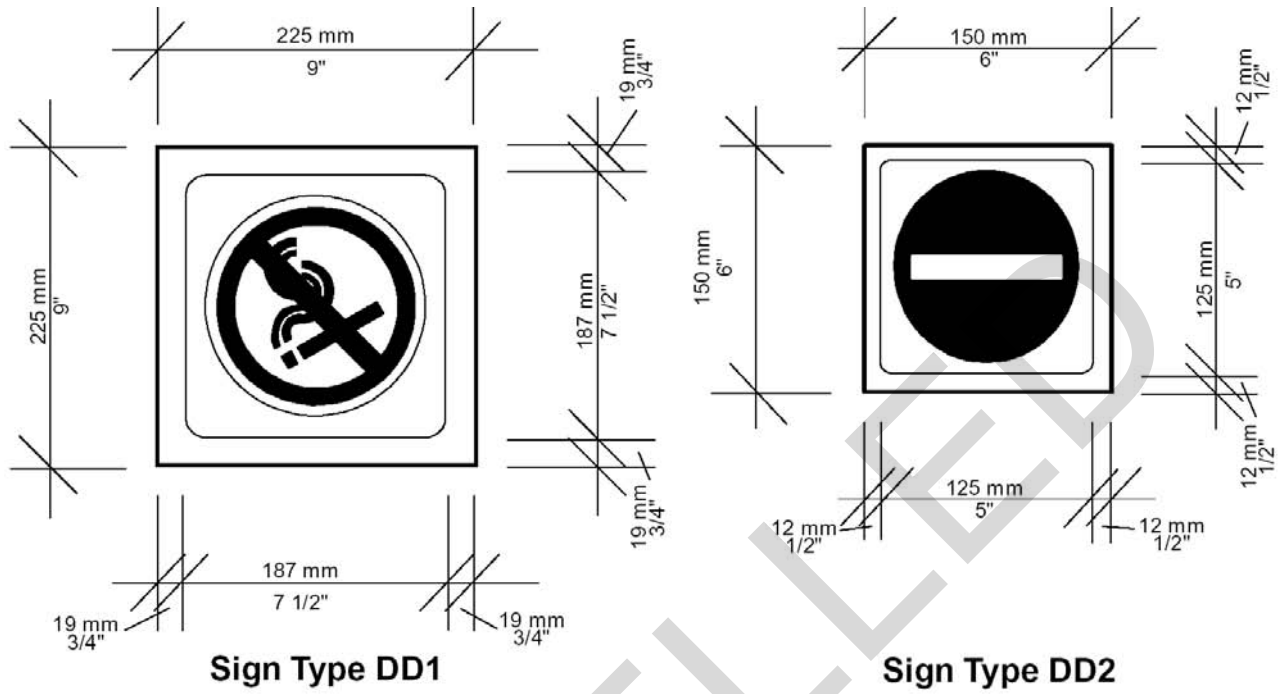

Figure 11.19. Regulation Signs Types DD1 and DD2 Layouts.



CANCELLED

Figure 11.20. Placement of Bulletin Board Type EE1.

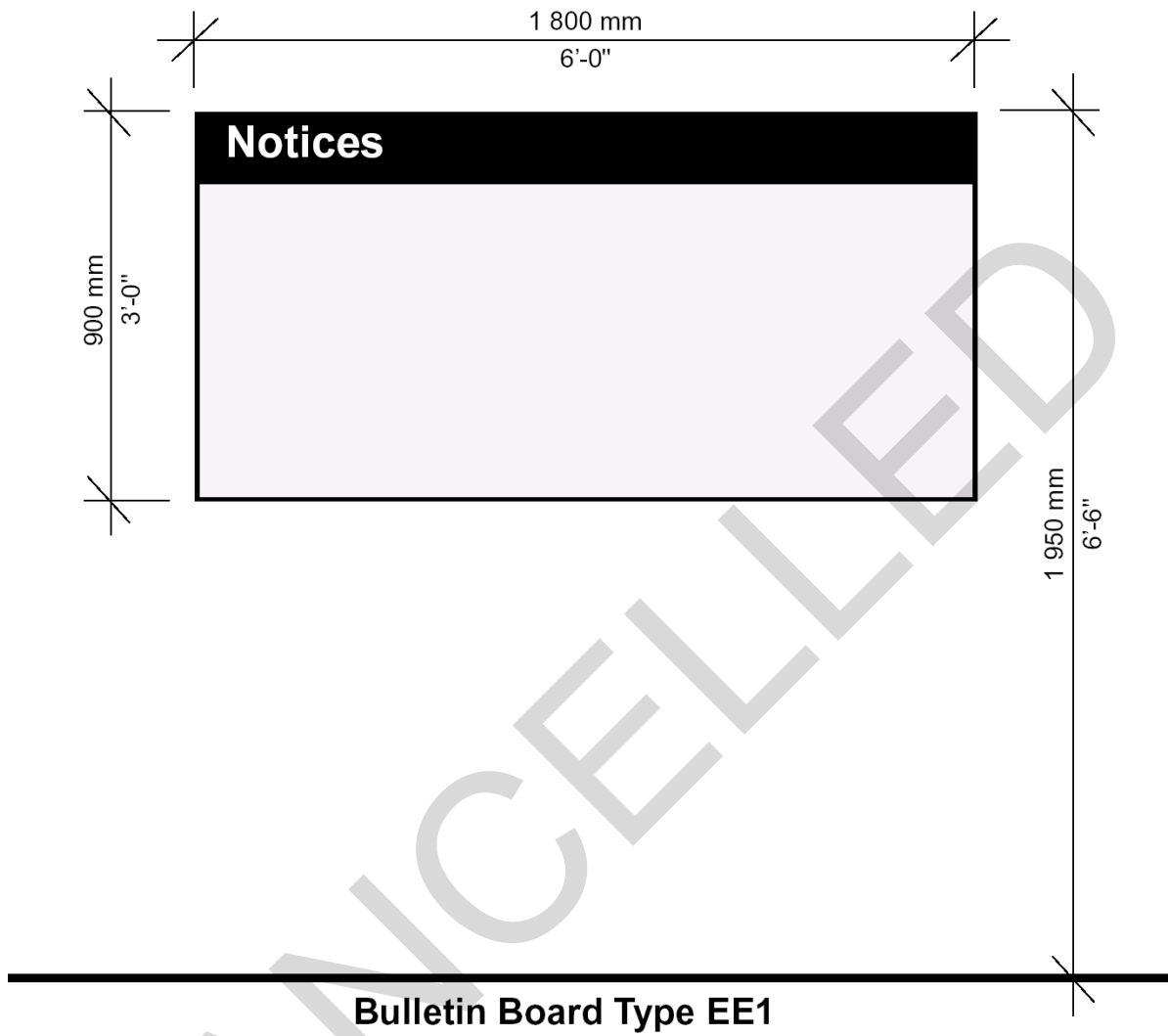
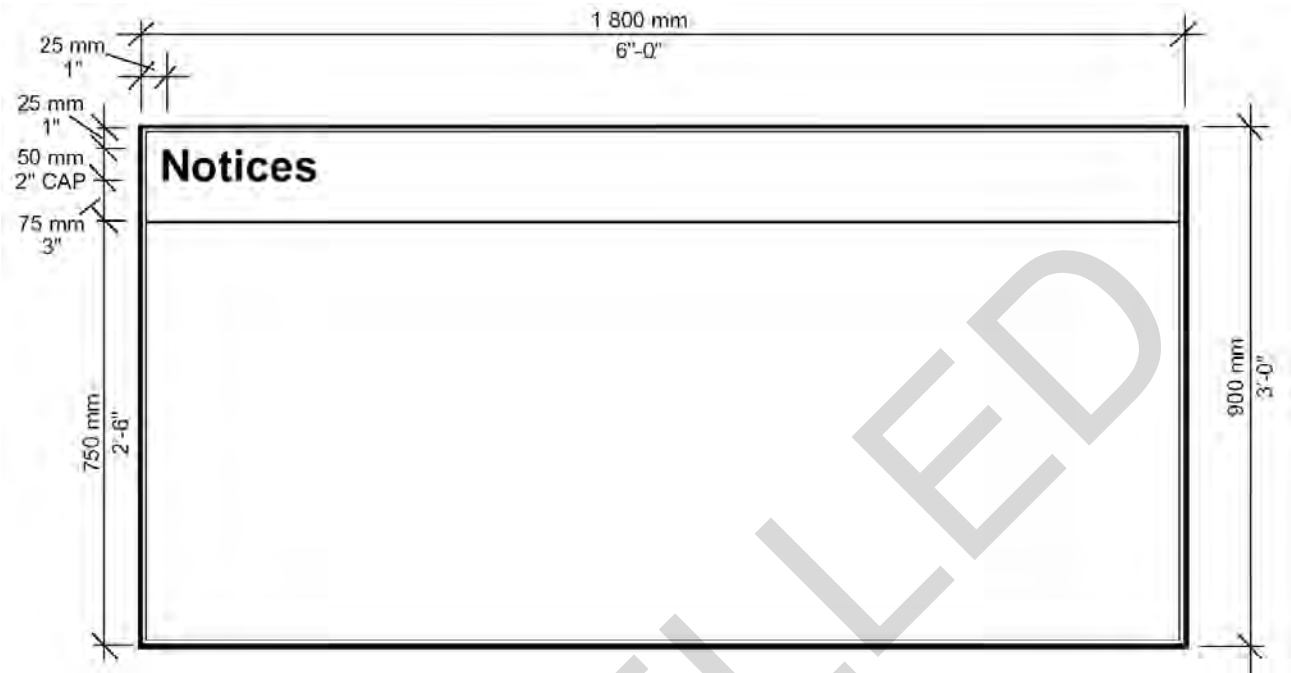

Figure 11.21. Bulletin Boards Sign Type EE1.



Chapter 12

SPECIFICATIONS AND DETAILS

Section 12A--Introduction and Bid Package

12.1. Introduction. This chapter gives complete specifications and structural details for Air Force signs and includes instructions on putting together a bid package. It must be emphasized that the intent of this chapter is not to provide "standard" specifications and details, but to furnish users with a starting point for the development of project-specific specifications and details. Although reasonable efforts have been made to verify that the enclosed details are technically correct and meet existing, generally available building code requirements, there is no expressed or implied warranty of correctness and compliance. It is the final responsibility of the user/designer to ensure the accuracy, completeness, applicability, workability, code compliance, and cost effectiveness of all specifications and details, whether used in whole or in part.

12.2. Purchase. In accordance with Title 18, U.S.C., Sec. 4124(a) and Federal Acquisition Regulations (FAR) subpart 8.6, Federal Prison Industries, Inc. (UNICOR) has a mandatory preference for items listed in its "Schedule of Products". For items not listed, refer to FAR 8.001 for available sources listed in descending order of priority. Questions regarding the availability of products or waiver request procedures may be directed to:

Federal Prison Industries, Inc. (UNICOR)
Customer Service Center
P.O. Box 13640
Lexington, KY 40583-3640
(800) 827-3168

FAX: (606) 254-9692

E-mail: custserv@central.unicor.gov

12.3. Preparation of Bid Package. In order to solicit bids from manufacturers, assemble the following items into a bid package:

- Sign Plan. The base Sign Plan, which consists of the sign site plan and the sign schedule. (See Chapter 1.)
- Illustrations. Illustrations of each sign type needed, which can be reproduced from this pamphlet. For example, if Type B2 signs are used in the program, include copies of Figures 4.17 and 4.18 in the bid package.
- Structural Drawings. Structural drawings of each sign used, reproduced from this chapter.
- Specifications. Complete specifications for each sign type and sign structure, reproduced from this chapter.
- Standard Bid Forms. Standard bid forms, prepared by the base Contracting Office.

Section 12B--Freestanding Exterior Sign Options

12.4. Material Selection. Every project has individual requirements based on the project budget, the

location and architectural style of the base, and other factors. In addition, the availability and cost of materials vary with location and over time. For this reason some flexibility is allowed in material selection. Options for material selection are described in paragraphs 12.5 and 12.6, followed immediately by detailed specifications.

12.5. Minimum Standards. These specifications represent the minimum standards for sign materials and construction. Products which meet or exceed the performance of the materials specified may be substituted as appropriate. The final material selection and fabrication decisions should be based on the sign shop capabilities and the long term needs of each base.

12.6. Finishes.

12.6.1. Sign Panel Finish Options.

12.6.1.1. Baked Enamel. Factory-finished baked enamel provides the most durable and cost effective finish available. Alkyd, acrylic, epoxy or urethane enamels may be used. Factory-finished alkyd baked enamel is widely available.

12.6.1.2. Reflective Sheeting. Reflective sheeting provides good nighttime visibility, but is susceptible to deterioration under conditions of intense heat exposure. Nighttime visibility can also be achieved by mounting reflective graphics on a baked enamel sign panel.

12.6.1.3. Plastic, Cast Acrylic, Duralite or Polycarbonate Panels. Panels with an integral finish may be used if a correct color match for all sign types is maintained. See paragraph 2.18 for the standard Air Force colors.

12.6.1.4. Vinyl Sheeting. Non-reflective vinyl sheeting may also be used as a sign panel finish if a correct color match for all sign types is maintained. See paragraph 2.18 for the standard Air Force colors.

12.6.2. Sign Post Finish Options.

12.6.2.1. Baked Enamels. Factory finished baked enamel is the most durable and cost effective finish available.

12.6.2.2. Alkyd and Acrylic Enamels. Alkyd and acrylic enamels can be quickly touched up in the field.

12.6.2.3. Epoxy or Urethane Enamels. Epoxy or urethane enamels, while more durable than alkyd and acrylic enamels, are more difficult to touch up because of the short shelf-life of the product. It is also difficult to obtain these products with the semi-gloss finish which is specified for all Air Force signs.

12.6.2.4. Electrodeposition Process. This is a viable option.

12.6.3. Graphics Options. Messages, emblems, arrows, rules and borders.

12.6.3.1. One-of-a-Kind Signs. Die-cut vinyl or reflective sheeting with adhesive backing is used for unique signs such as building identification or destination signs. Use die-cut reflective sheeting when nighttime visibility is required.

12.6.3.2. Multiple Signs. Graphics for mass produced signs such as bus route signs and regulation signs are silk-screened. The graphics for non-reflective signs may be silk-screened directly onto the painted sign face or screened onto adhesive backed vinyl sheeting and then applied to the sign face. The graphics for reflective signs shall be silk-screened onto white reflective sheeting.

12.6.3.3. Decals. Decals for shields, emblems and symbols shall be silk screened onto adhesive backed vinyl sheeting or reflective sheeting, as appropriate, and die-cut for later applications to the sign face.

12.6.4. Nighttime Visibility (Reflectivity).

12.6.4.1. Reflective Graphics on Non-reflective Background. Graphics die-cut from reflective sheeting and applied to a non-reflective background such as a baked enamel finish or vinyl sheeting are the most cost effective way to achieve good nighttime visibility.

12.6.4.2. Reflective Graphics on Reflective Background. Graphics die-cut from reflective sheeting and applied to a reflective background (reflective sheeting) provide the best visibility. The base sign shop's level of experience with reflective sheeting should be considered in the final selection of the background material.

12.6.5. Nighttime Visibility (Illumination). While the use of reflective materials is the most cost-effective way to achieve night visibility, it is sometimes appropriate to illuminate major signs such as Type A1 and A2 Base Identification signs and the Type F1b Base Changeable Letter signs.

12.6.5.1. External Illumination.

12.6.5.1.1. Large base-mounted signs, such as Sign Types A1, A2 and F1b, can be illuminated with two 150W PAR floodlights placed in front of the sign face at the quarter points. Freestanding signs, such as Sign Types F2 and G1, can be illuminated by a 75W PAR spotlight. The lights are placed at ground level at a distance from the sign equal to the sign's height. (For example: the light source for a Type G1 sign, which is 1 980 mm (6' - 6") tall, should be placed at a distance of 1 980 mm (6' - 6") from the sign).

12.6.5.1.2. The sign face should be evenly illuminated, with no hot spots. Glare should be controlled so that the illumination is confined to the sign face only. The light fixture should be unobtrusive and should have a neat daytime appearance.

12.6.5.1.3. Use weatherproof, commercial grade fixtures and fittings, code approved for exposed locations. A cylindrical shield is recommended to control glare. The fixture

should be set in a complete enclosure, (such as a 300 mm x 300 mm (1'- 0" x 1'- 0") five-sided box) or in plantings or foliage in order to achieve a neat daytime appearance.

12.6.5.2. Internal Illumination. Internal illumination may be used, but it can be costly and subject to vandalism. Internally illuminated signs should have a metal housing. The graphics should be routed or punched out of the metal sign face and white acrylic plastic should be inset in the opening. The appearance of the sign face should duplicate the examples shown in this pamphlet.

12.7. Materials.

12.7.1. Sign Panel Material Options.

12.7.1.1. Aluminum. Aluminum sheeting is generally recommended because of its light weight, ease of handling and corrosion resistance. Most base sign shops have extensive experience with aluminum sheeting for traffic control signage.

12.7.1.2. Steel. Steel sheeting should be used for the Type F1b and F2b changeable letter (magnetic) signs and may be used on the larger base identification signs should it prove cost effective. Galvanize all steel sheeting prior to finishing.

12.7.1.3. Plastic, Cast Acrylic, Duralite or Polycarbonate Sheets. Provide ultraviolet-light-resistant, surface treated opaque sheets in sizes and thicknesses indicated. These materials may be appropriate where there is high incidence of pilferage of aluminum signs.

12.7.1.4. Fiberglass Backing Panels. Provide molded seamless thermosetting glass fiber reinforced polyester panels in sizes and thicknesses indicated. If fiberglass is used, have the material manufacturer submit a written warranty agreeing to repair or replace fiberglass panels that fail due to coating degradation, chalking, fading, or fiberglass delamination or cracking.

12.7.1.5. Other. Materials such as exterior plywood or exterior masonite may be used on non-permanent base morale signs in order to reduce costs.

12.7.2. Sign Post Material Options.

12.7.2.1. Aluminum. Aluminum posts are generally recommended because of their high strength to weight ratio, ease of handling and corrosion resistance. These features justify the additional cost for aluminum. Provide bituminous coating for post imbedded in concrete and acidic soil. Soil embedded aluminum posts qualify as yielding sign supports under federal regulations, eliminating the need for breakaway or yielding connectors. (See Breakaway or Yielding Sign Supports in paragraph 12.8.)

12.7.2.2. Steel. Steel posts are specified for the Type D1 destination sign and may be used for other signs as well, should they prove cost effective. Steel posts have high strength and are less expensive than aluminum posts. However, steel posts are susceptible to rusting and

corrosion and require breakaway connectors such as slip base connectors or load concentrating couplers to meet federal regulations. All steel posts should be galvanized prior to finishing. Provide bituminous coating for post imbedded in concrete and acidic soil.

12.7.2.3. Wood. Wood posts are considerably less expensive than metal posts, but have problems with maintenance, durability and general appearance. Soil embedded wood posts do qualify as yielding sign supports under federal regulations. (See Breakaway or Yielding Sign Supports, paragraph 12.8.)

12.8. Foundations.

12.8.1. Foundation Options.

12.8.1.1. Concrete Footings. The use of concrete footings for all signage is strongly recommended. The post and panel structures shown in this pamphlet are designed with low lateral stability in order to reduce material cost. The vertical stability of the sign posts is therefore critical to the appearance and durability of the signs. This degree of stability can be achieved only with the use of strong and secure footings.

12.8.1.2. Soil Embedment. Soil mounted sign posts (without concrete foundation collars, soil bearing plates or anchors) may be used on bases located in areas with minimal frost penetration, if soil conditions provide strong and secure support for the sign posts. Soil embedment saves on initial installation costs, but may not be cost effective in the long term due to maintenance problems.

12.8.1.3. Base Plates. Post sleeves or base plate mounts should be considered for non-permanent signs such as base morale signs. The posts can be removed or replaced as required. Temporary covers or inserts should be provided to protect the post sleeves when not in use. Signs which are likely to sustain frequent damage should also be equipped with these mounts or with breakaway connectors.

12.8.2. Maintenance. The sign foundation should have a neat appearance. Maintenance of the area around the base of the sign can be simplified by the use of a gravel trough running the full width of the base or by the use of low-level planting.

12.9. Breakaway or Yielding Sign Supports.

12.9.1. Usage and Standards. Breakaway or yielding sign supports should be used for all traffic control signs (including the destination and parking signs described in this pamphlet) placed within 9 m (30') from the paved edge of the traveled way and for all other signs which are placed within 3.6 m (12') from the edge of the traveled way (unless they are protected by guard rails or other means.) The design of these supports must conform to the Standard Specifications for Structural Supports for Highway Signs, Luminaires and Traffic Signals, published by the American Association of State Highway and Transportation Officials (AASHTO).

12.9.2. Usage of Connectors. In locations where breakaway or yielding sign supports are

required it is recommended that breakaway connectors such as slip base connectors or load concentrating couplers be used for signs likely to sustain frequent damage. This will permit sign replacement without replacement of the footing.

12.9.3. Local Standards. Air Force installations may use either the breakaway or yielding sign supports specified in this pamphlet or sign supports meeting the appropriate standards of the state in which they are located.

12.9.4. Slip Base Connector. A welded breakaway connector used on steel posts. See Figure 12.10.

12.9.5. Load Concentrating Coupler. A breakaway connector used on both steel and aluminum posts. This connector is mechanically fastened to the post so that no welding is required. However, it is more expensive than the slip base connector. See Figure 12.10.

12.9.6. Soil Embedment. Soil embedment of aluminum or wooden posts to a depth no greater than 1 070 mm (3' - 6") (without concrete foundation collars, soil bearing plates, or anchors) qualifies for the signs shown in this pamphlet as a yielding sign support under federal regulations.

12.9.7. Recommendations. In summary, both slip base connectors and load concentrating couplers are effective, but expensive. Less expensive devices will be available in the future, but these designs are the best available at this time. Soil embedment is inexpensive, but can only be used in certain parts of the country and may cause maintenance and durability problems. Perforated signposts are approved by the Federal Highway Administration, but they do not have the proper appearance for the exterior signs in this pamphlet and are not recommended.

Section 12C--Freestanding Exterior Signs Specifications

12.10. Finishes.

12.10.1. Paints. Paints furnished under this specification shall be products that are included on the applicable GSA Qualified Products List. Colors shall conform to Federal Standard No. 595a as shown in paragraph 2.18 of this pamphlet.

12.10.1.1. Qualified alkyd, acrylic, epoxy or urethane enamels may be used.

12.10.1.2. Prime coats and other surface pretreatment shall be applied as recommended by the manufacturer.

12.10.1.3. Two color coats of enamel shall be applied and baked according to the manufacturer's instructions for the substrate specified. Baked enamel coatings on aluminum shall conform to the Architectural Aluminum Manufacturing Association's voluntary specification 603.8. Baked enamel coatings on steel shall conform to Military Specification MIL-E- 480A.

12.10.2. Inks. Inks furnished under this specification shall be products that are qualified for listing on the applicable GSA Qualified Products List. Colors shall conform to Federal Standard No. 595a in paragraph 2.18 of this pamphlet.

12.10.2.1. Silk-screen ink, whether transparent or opaque, shall be supplied by a manufacturer with experience in production of such inks for the materials and surfaces specified.

12.10.2.2. No ink shall be used that will fade, discolor or delaminate as a result of exposure to ultraviolet light. All inks shall be applied evenly without pinholes, scratches or application marks.

12.10.2.3. Surface pre-treatment shall be applied as recommended by the manufacturer.

12.10.3. Reflective Sheeting. Reflective sheeting shall conform to Federal Highway Administration standard FP-79 Table IV (Engineer Grade) reflective sheeting. Colors shall be as shown in paragraph 2.18 of this pamphlet. The sheeting shall include a pre-coated pressure sensitive adhesive backing (Class 1) or a tack free heat activated adhesive backing (Class 2). The sheeting shall be of such quality and type that it can be applied without additional adhesive coats on either the backing or the application surface. FP-79 Table V (High Intensity) reflective sheeting may be used on selected regulatory signs in area where the degree of hazard or potential hazard is greater than normal.

12.10.4. Vinyl Sheeting. Non-reflective vinyl sheeting shall have a .003 mil to .006 mil film thickness and shall conform to Military Specification M43719A. The colors shall be as shown in paragraph 2.18 of this pamphlet. The sheeting shall include a pre-coated pressure sensitive adhesive backing (Class 1) or a tack-free heat activated adhesive backing (Class 2). The sheeting shall be of such quality and type that it can be applied without additional adhesive coats on either the backing or the application surface.

12.11. Materials.

12.11.1. Aluminum. All aluminum for signposts shall be 6061-T6 alloy with mill finish. Aluminum for extrusions shall be 6063-T5 or 6063-T6 with mill finish in accordance with ASTM-B221. All aluminum sheeting shall be 6061-T6 with mill finish in accordance with ASTM-B209. Aluminum shall be of the best commercial quality and the various forms shall be straight and true. There shall be no scratches, scars, creases or buckles.

12.11.1.1. Prior to application of baked enamel finish, surface shall be cleaned and primed according to manufacturer's specification. Solvent cleaning followed by a wash coat of basic zinc chromate—vinyl butyral is recommended—as well as a prime coat of enamel primer in conformance with Federal Specification TT-P-636.

12.11.1.2. Prior to application of reflective sheeting, surface shall be degreased and etched according to manufacturer's specifications.

12.11.1.3. Welded joints shall be heliarc welded in conformance with the American Welding Society and the Architectural Aluminum Association's specifications.

12.11.2. Steel. Square steel signposts shall conform to ASTM-A500 or A501. All other structural steel shall conform to ASTM-A36. Steel sheeting shall conform to Federal Specification QQ-S-77C, Class D.

12.11.2.1. All steel shall be galvanized after fabrication in accordance with ASTM-A123.

12.11.2.2. Prior to application of baked enamel finish, surface shall be cleaned and primed according to the specifications of the manufacturer and the Steel Structure Painting Council. Solvent cleaning followed by a wash coat of basic zinc chromate-vinyl butyral and a prime coat of enamel primer is recommended in conformance with Federal Specification TTP- 636.

12.11.2.3. Prior to application of reflective sheeting, surface shall be cleaned and treated according to manufacturer's specifications.

12.11.3. Wood Posts. All wood for posts shall be No. 1 Structural Grade Larch, fir, hemlock, lodge pole pine or western cedar, in accordance with the Standard Grading Rules for Western Lumber published by the Western Wood Products Association, Portland, Oregon. No. 1 Structural Grade (Stress Rated) southern pine, pitch pine, Virginia pine and ponderosa pine are also acceptable. All woods shall be pressure treated with chromated copper arsenate at the factory. Prior to application of enamel finish, surfaces shall be cleaned and primed according to manufacturer's specifications.

12.11.4. Plastic, Cast Acrylic Duralite or Polycarbonate Sheets. Provide ultraviolet-light-resistant, surface treated opaque sheets in sizes and thicknesses indicated with the minimum flexural strength as recommended and tested for each material in accordance with ASTM D 790.

12.11.5. Fiberglass Backing Panels. Provide molded seamless thermosetting glass fiber reinforced polyester panels in sizes and thicknesses indicated, with a minimum tensile strength of 103 Mpa (15,000 psi) when tested in accordance with ASTM D 638 and a minimum flexural strength of 207 Mpa (30,000 psi) when tested in accordance with ASTM D 790.

12.11.6. Metal Fasteners.

12.11.6.1. Mounting hardware for aluminum signs shall be hardened aluminum ASTM-B211 6061-T6 alloy.

12.11.6.2. Mounting hardware for steel signs shall be galvanized steel in accordance with ASTM-A307 and ASTM-A153.

12.11.7. Magnetic Sheeting. Flexible magnetic sheeting for changeable letter signs shall be of best commercial quality available and shall have a minimum thickness of .030 inches.

12.12. Foundations. Concrete foundations shall withstand all wind, water, ice and similar forces.

The depth of the footings shown in the drawings may be modified to suit local conditions. Post sleeve or base plate mounts on the foundation may be used when needed.

12.12.1. Base-mounted Signs. Base-mounted signs, such as Sign Types A1, A2 and F1 shall be mounted on a "T" type footing with steel rod reinforcements as shown in Figure 12.1. All exposed concrete shall be air entrained, vibrated and finished smooth. All concrete shall be poured at 20.7 Mpa (3,000 psi) with a 28 day cure.

12.12.2. Freestanding Signs. Freestanding signs, such as the building identification sign, shall be mounted in drilled hole concrete footings as shown in the drawings. All foundations shall be flush with the ground level. All concrete shall be poured at 20.7 Mpa (3,000 psi) with a 28 day cure.

12.13. Reproduction Processes.

12.13.1. Die-cutting: Letter forms and graphics die-cut from vinyl and reflective sheeting shall be of the best commercial quality available. Die-cutting shall be executed in such a manner that edges and corners of finished letter forms and graphics are true and clean. Letter forms and graphics with rounded positive or negative corners, or nicked, cut or ragged edges shall not be used. All applied die-cut letters and graphics shall be permanently affixed to sign surfaces in such a manner that all letter surface and edge areas are tightly and evenly adhered to the sign surface.

12.13.2. Silk-screening. All silk screening specified shall be executed from photo-screens prepared from typesetters' reproductions of the copy specified. Typesetters' reproductions shall be no smaller than 50 percent of the actual size specified. The Helvetica medium and Helvetica regular letter forms shall match the samples shown in Figures 2.1. and 2.2 of this pamphlet. Graphics shall be assembled as mechanical art in a professional manner prior to preparation of photo screens. No hand-cut screens shall be used.

12.13.2.1. Graphics may be silk-screened directly onto the sign face or silk screened onto vinyl or reflective sheeting and die-cut for later application to the sign face.

12.13.2.2. All silk-screen printing shall be executed in such a manner that all edges and corners of the finished graphics are true and clean. Graphics with rounded positive or negative corners shall not be used.

Section 12D--Freestanding Exterior Signs

12.14. Freestanding Exterior Signs Structural Details. See Figures 12.1 through 12.10.

Figure 12.2. Sign Details B1, B2, B3, C2, C3, G1, H1 and H2.

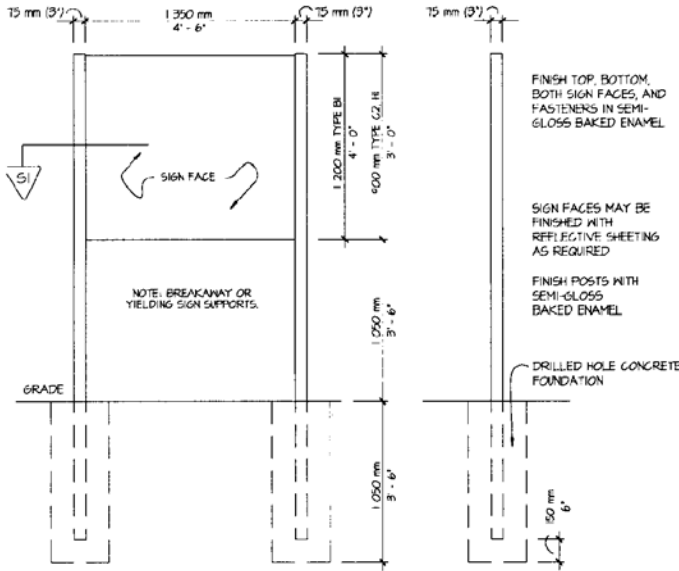

FRONT ELEVATION AND SECTION: TYPES B1, C2, H1
SCALE: 1/4"=1'-0"

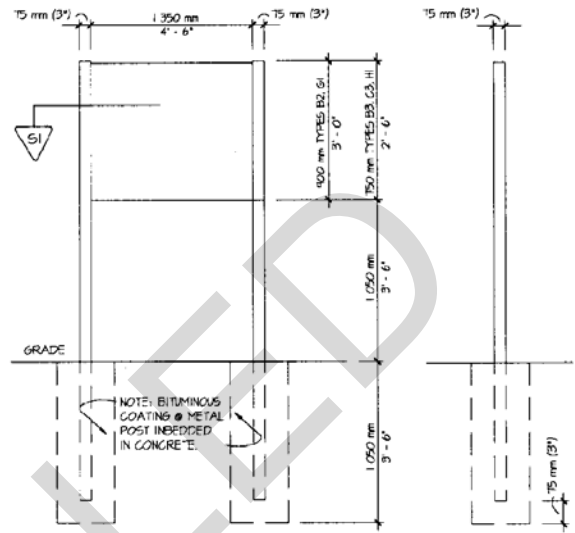

FRONT ELEVATION AND SECTION: TYPES B2, B3, C3, G1, H2
SCALE: 1/4"=1'-0"

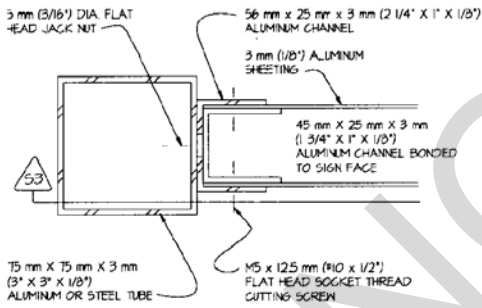

S1 HORIZONTAL SECTION
SCALE: 3"=1'-0"

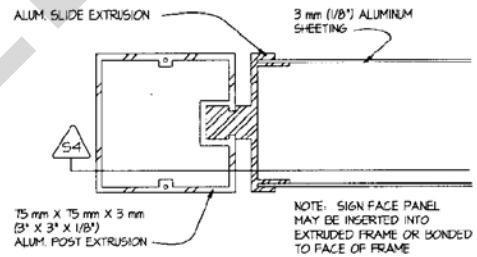

S2 ALT. HORIZONTAL SECTION (EXTRUDED POST)
SCALE: 3"=1'-0"

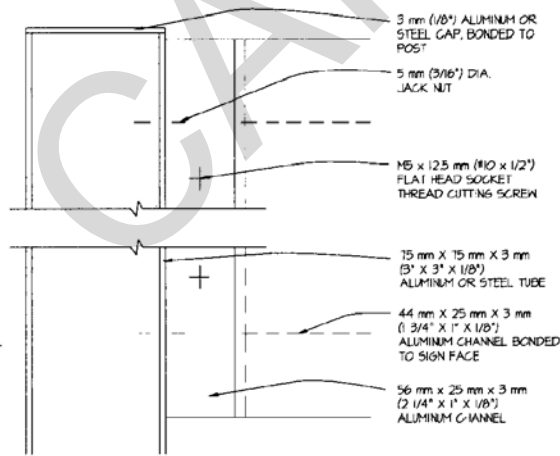

S3 VERTICAL SECTION
SCALE: 3"=1'-0"

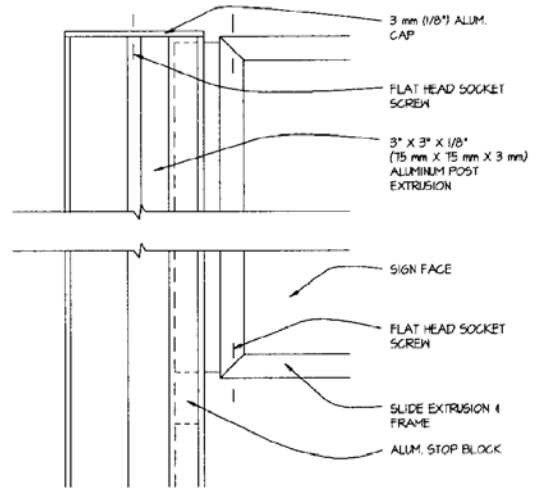

S4 ALT. VERTICAL SECTION
SCALE: 3"=1'-0"

Figure 12.3. Sign Details C1.

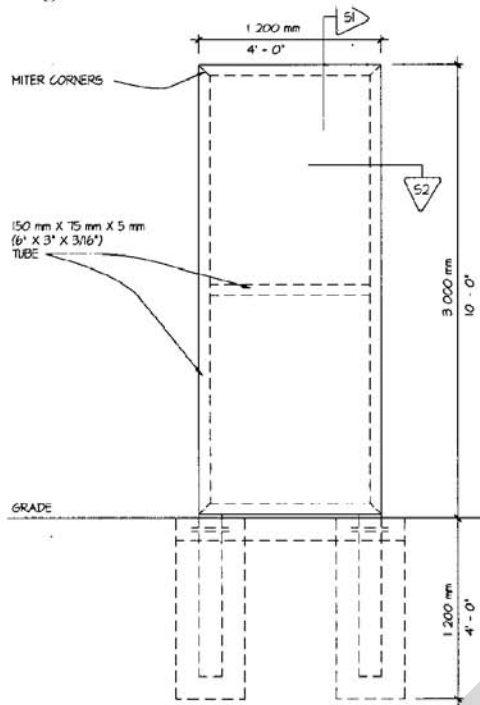

FRONT ELEVATION
SCALE: 1/4"=1'-0"

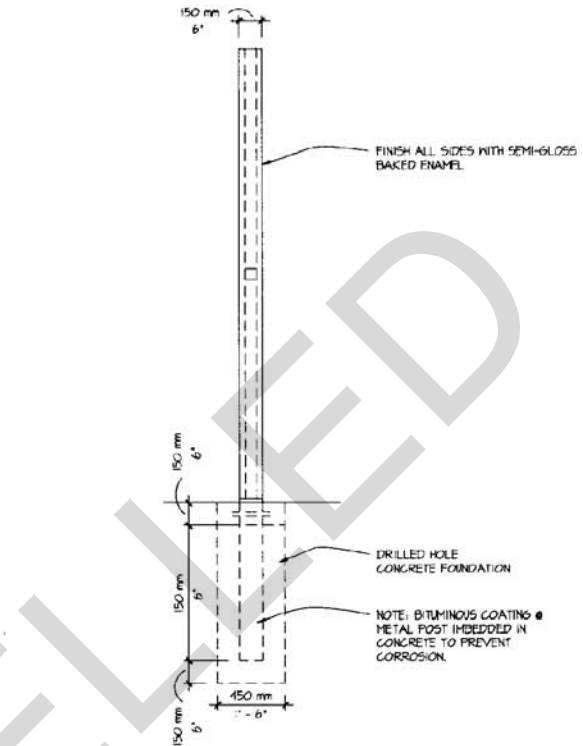

SIDE ELEVATION
SCALE: 1/4"=1'-0"

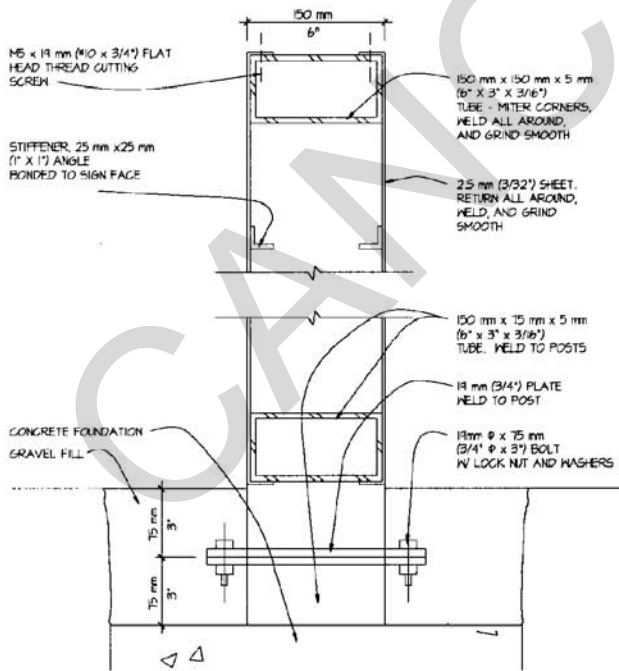

S1 VERTICAL SECTION
SCALE: 3/4"=1'-0"

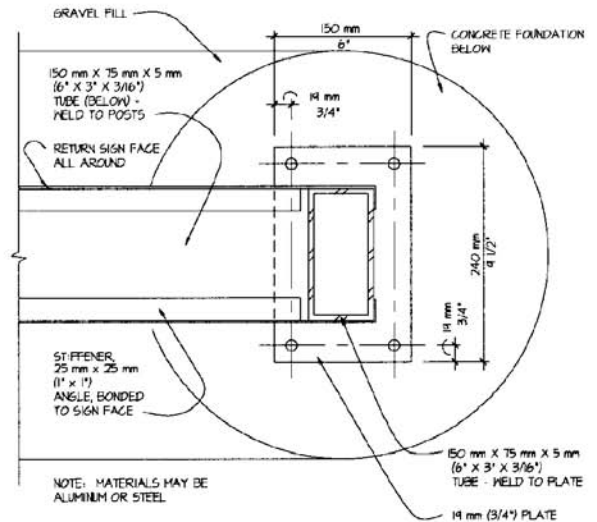

S2 HORIZONTAL SECTION
SCALE: 3/4"=1'-0"

Figure 12.4. Sign Details D1.

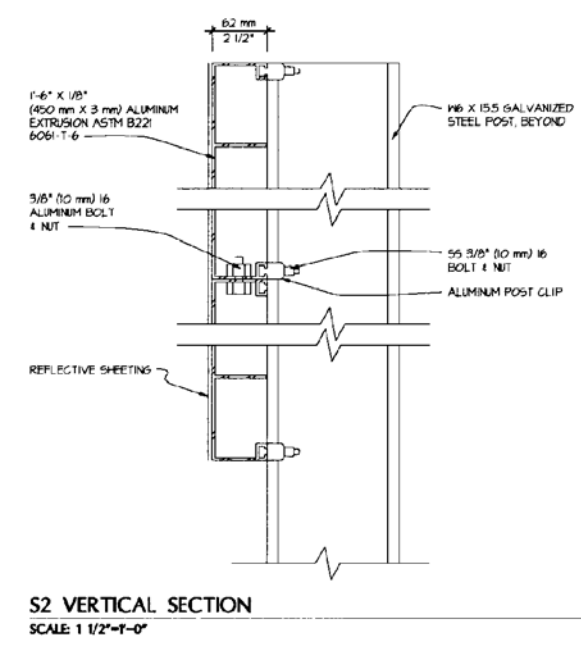
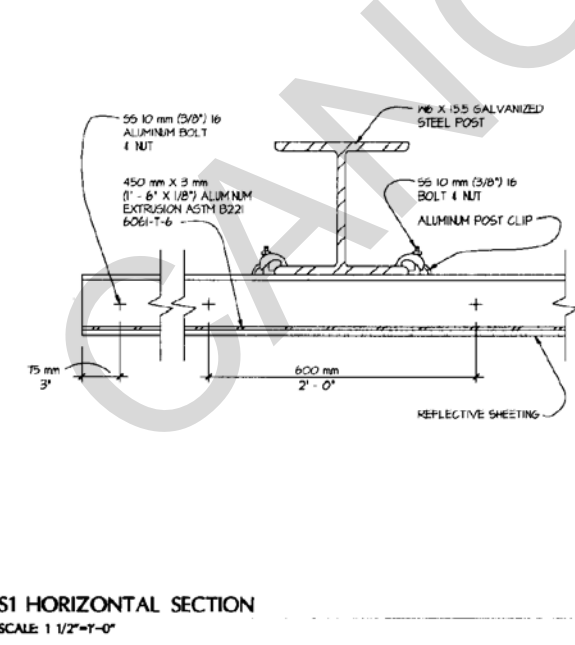
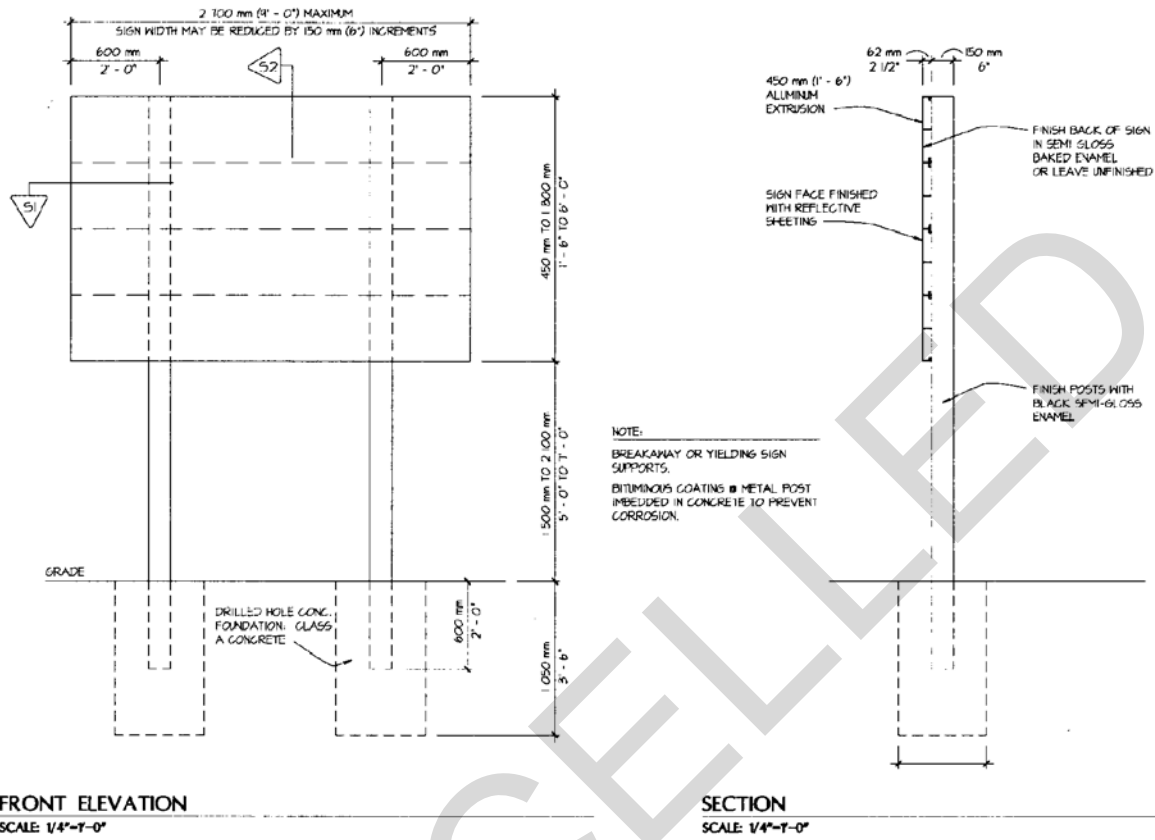
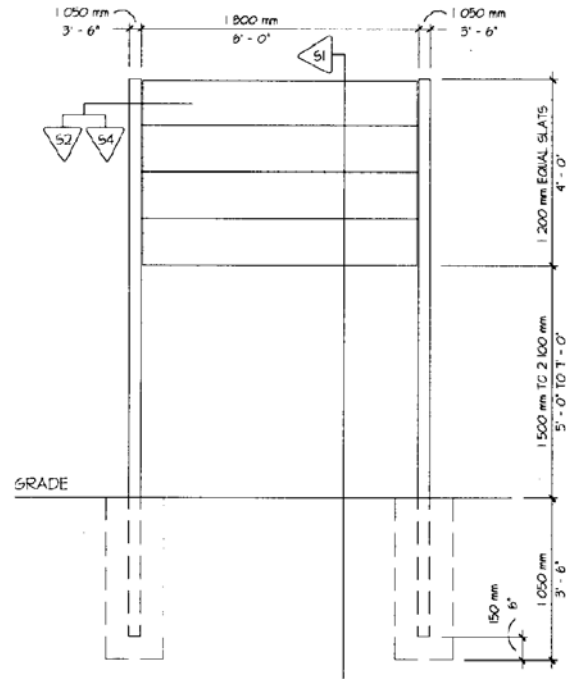
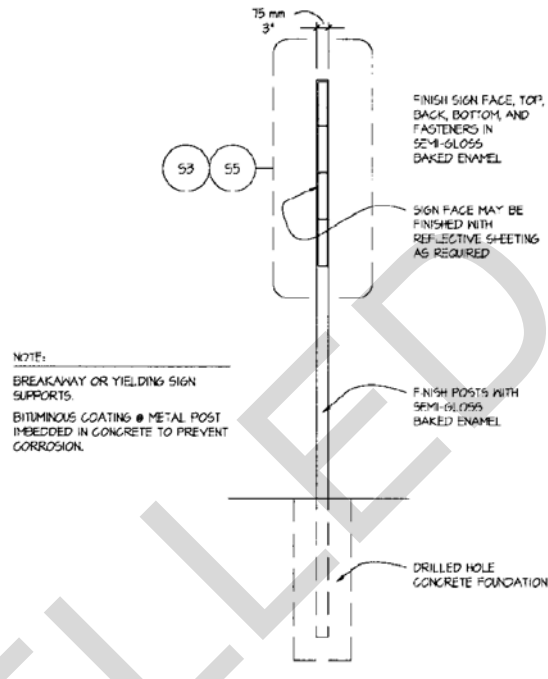

Figure 12.5. Sign Details D2.



FRONT ELEVATION

SCALE: 1/4"=1'-0"



S1 VERTICAL SECTION

SCALE: 1/4"=1'-0"

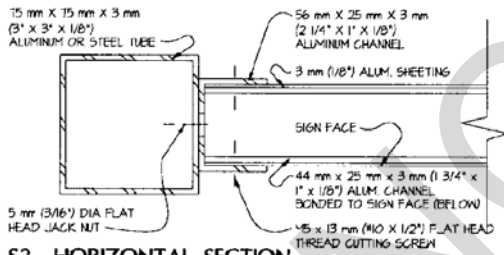

S2 HORIZONTAL SECTION

SCALE: 3/8"=1'-0"

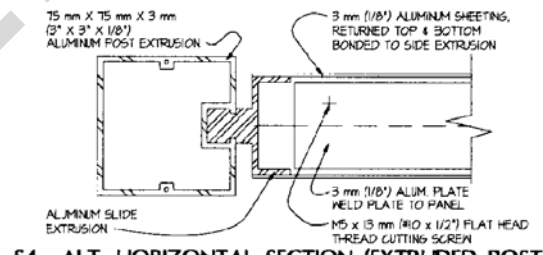

S4 ALT. HORIZONTAL SECTION (EXTRUDED POST)

SCALE: 3/8"=1'-0"

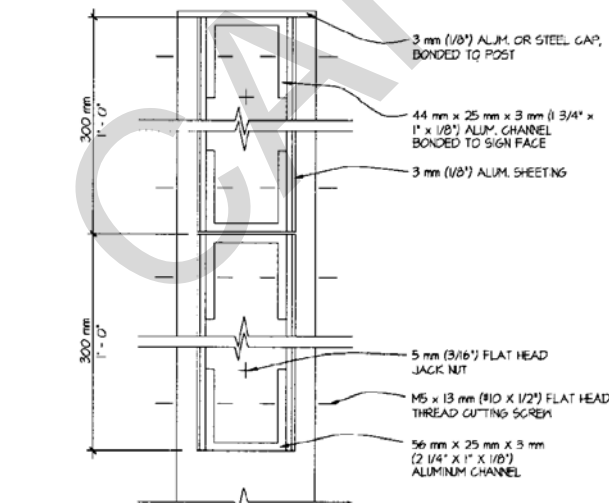

S3 VERTICAL SECTION

SCALE: 3/8"=1'-0"

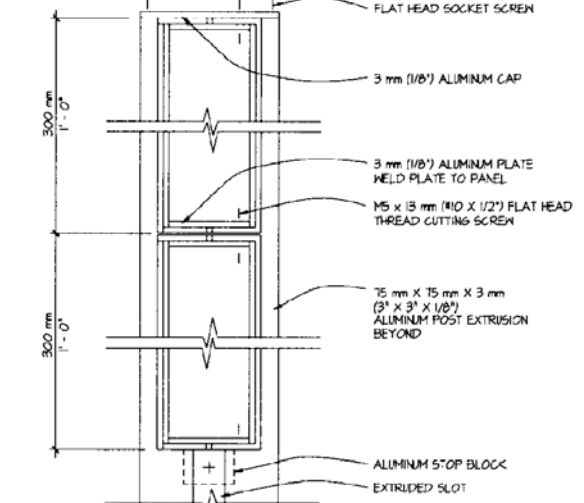

S5 ALTERNATE VERTICAL SECTION

SCALE: 3/8"=1'-0"

Figure 12.6. Sign Details G3.

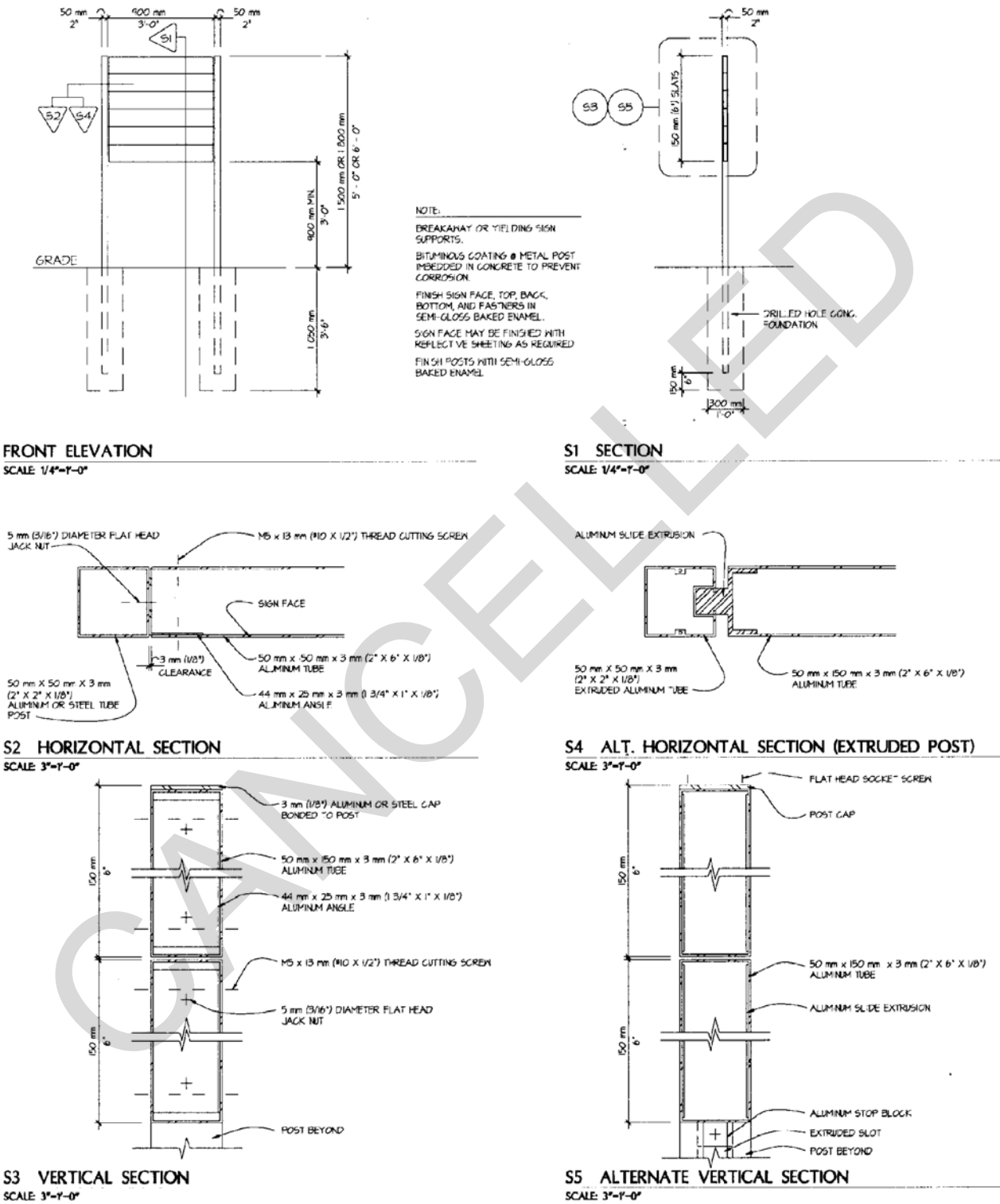

Figure 12.7. Sign Details E1 and A3.

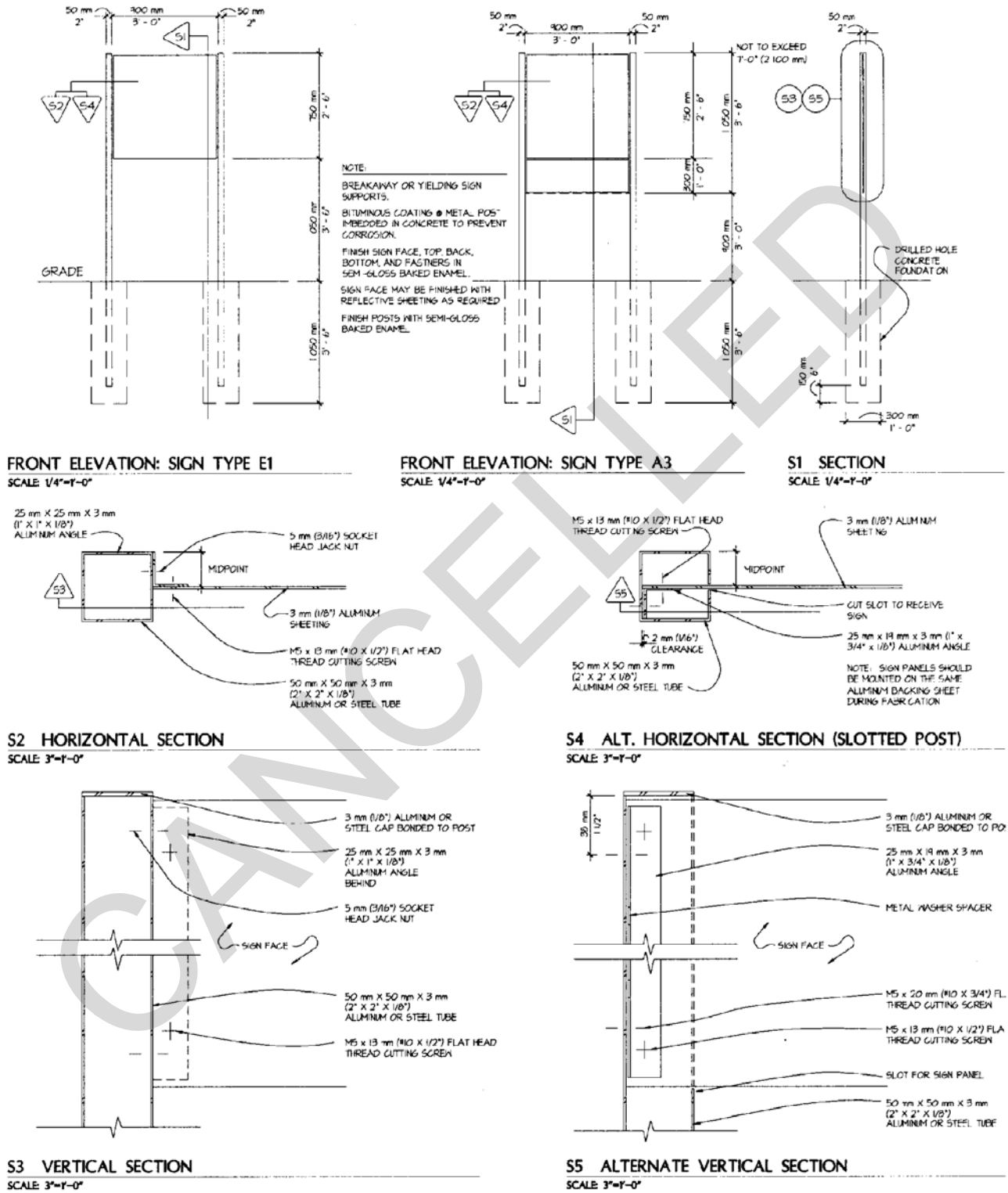
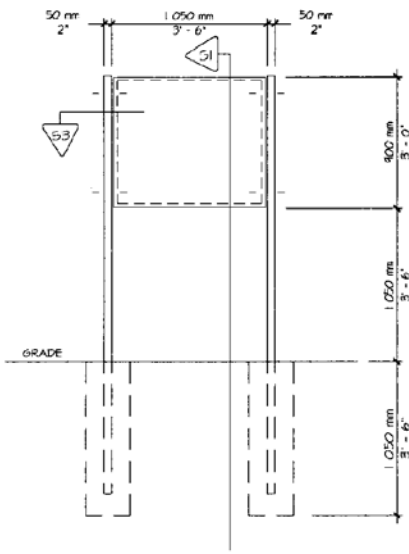
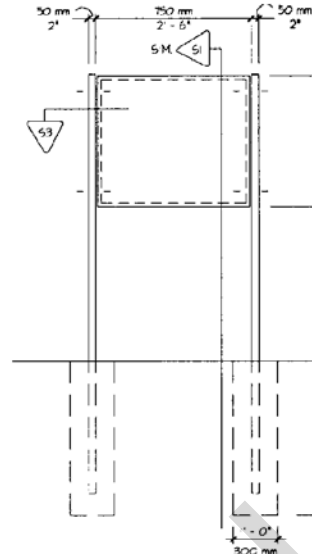

Figure 12.8. Sign Details F2 and F3.



FRONT ELEVATION: SIGN TYPE F2
1/4" = 1'-0"



FRONT ELEVATION: SIGN TYPE F2, F3
1/4" = 1'-0"

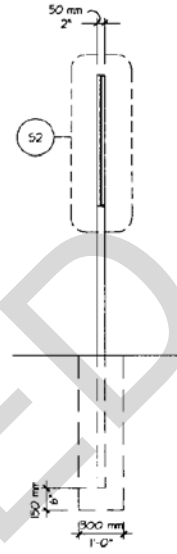

S1 SECTION
1/4" = 1'-0"

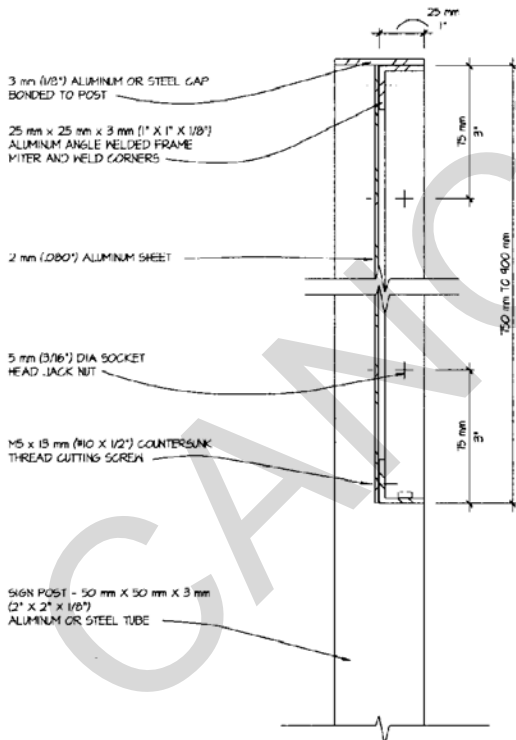

S2 VERTICAL SECTION
3/8" = 1'-0"

NOTE:
BREAKAWAY OR YIELDING SIGN SUPPORTS.
BITUMINOUS COATING & METAL POST IMBEDDED IN CONCRETE TO PREVENT CORROSION.
FINISH SIGN FACE TOP, BACK, BOTTOM, AND FASTENERS IN SEMI-GLOSS BAKED ENAMEL.
SIGN FACE MAY BE FINISHED WITH REFLECTIVE SHEETING AS REQUIRED.
FINISH POSTS WITH SEMI-GLOSS BAKED ENAMEL.

NOTE:
SIGN PANEL FOR TEMPORARY SIGNS MAY BE EXTERIOR PLYWOOD OR EXTERIOR MASONITE.
SIGN PANEL FOR TYPE F2A SIGN SHALL BE 1.6 mm (.0625") GALVANIZED STEEL.

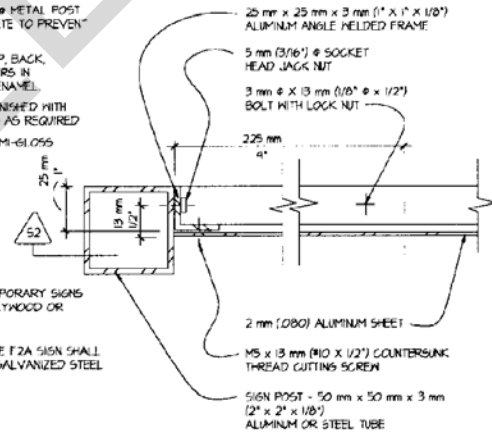

S3 HORIZONTAL SECTION
3/8" = 1'-0"

ANCHORS: WELD PIECES OF REBAR TO PIPE SLEEVE AT ALL FOUR SIDED

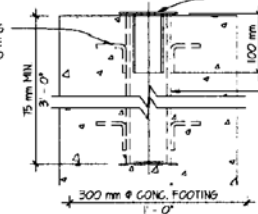

S4 PIPE SLEEVE SECTION
NOT TO SCALE

REMOVABLE CAP: WELD 100 mm x 100 mm x 3 mm (4" x 4" x 1/8") PLATE TO 100 mm (4") LONG PIECE OF TUBE STEEL.

PIPE SLEEVE: WELD 100 mm x 100 mm x 3 mm (4" x 4" x 1/8") PLATE TO BOTTOM OF 15 mm x 15 mm x 6 mm (3/8" x 3/8" x 1/4") TUBE STEEL AND ANCHOR AS NOTED.

NOTE: ALL METAL IS TO BE COATED WITH BITUMINOUS MATERIAL.

Figure 12.9. Sign Details B4, C4-C6, E2-E4 and G2.

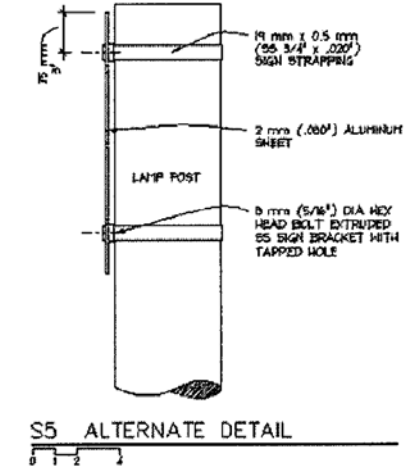
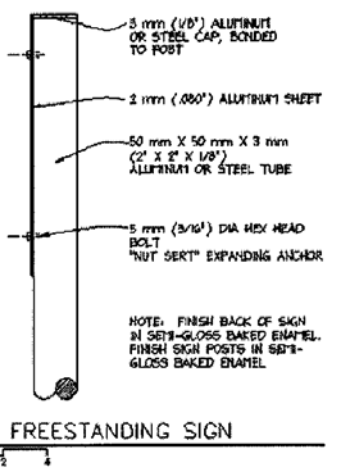
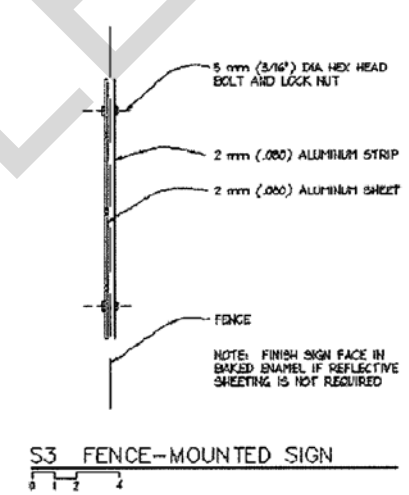
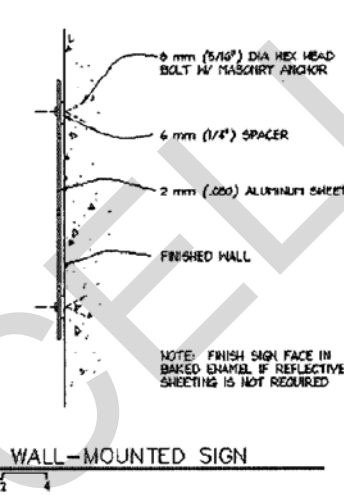
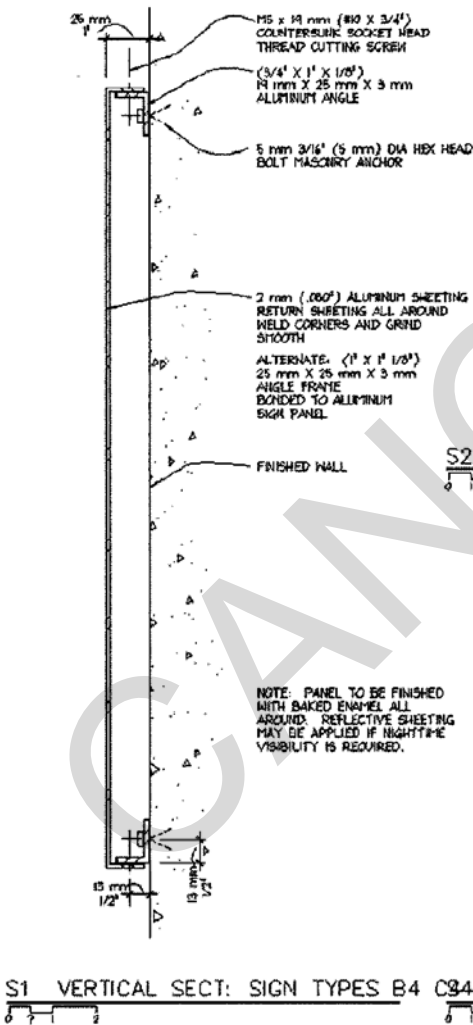
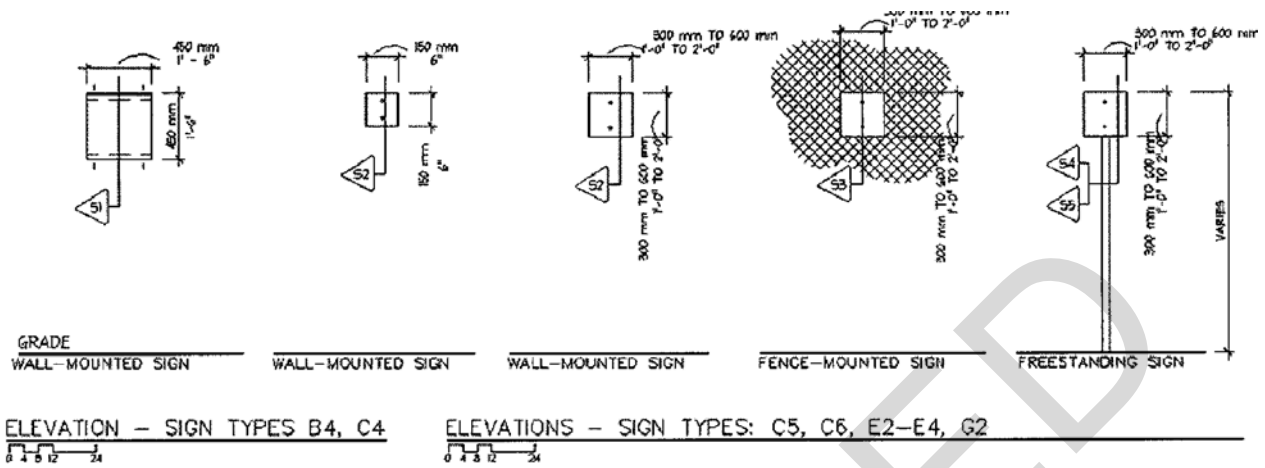
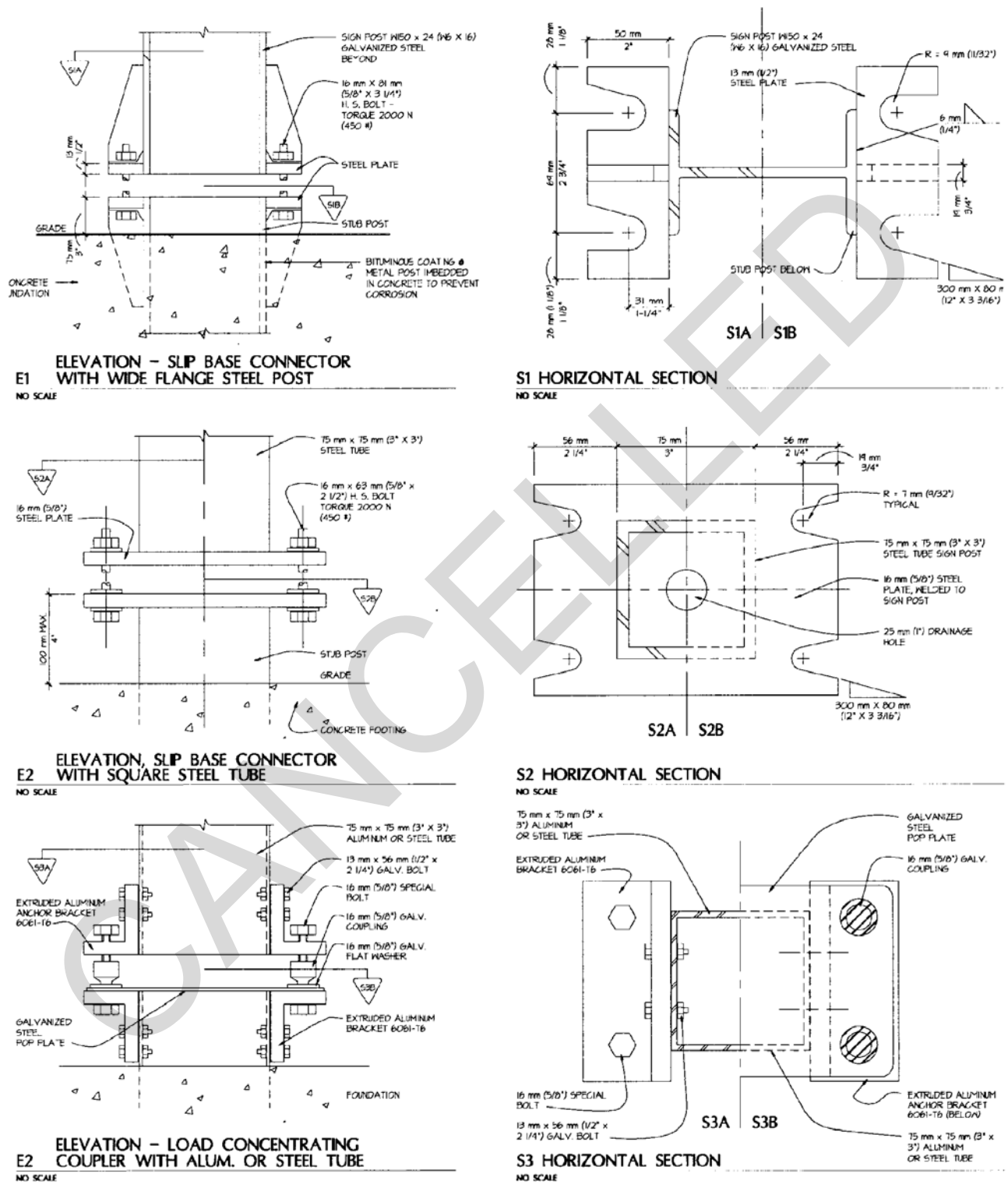

Figure 12.10. Sign Details.



Section 12E-- Wall Mounted Signs

12.15. Wall Mounted Exterior Sign Options. Wall mounted dimensional letters may be fabricated in injection molded acrylic plastic, cast aluminum, or fabricated aluminum. Plastic letters should be finished in semi-gloss acrylic enamel. Aluminum letters should be finished in semi-gloss baked enamel. Colors should match those shown in paragraph 2.18 of this pamphlet.

12.15.1. Letter Materials. Aluminum letters are attractive and durable, but expensive. Acrylic plastic letters can be purchased for half the price of aluminum letters, but are less durable, particularly in hot climates. Each base should decide which is the most cost-effective product for its needs. It is recommended that aluminum letters be used in new construction, while acrylic plastic letters may be more appropriate for a base-wide retrofit program. Styrofoam dimensional letters do not have sufficient durability for exterior applications, so their use is discouraged.

12.16. Wall Mounted Exterior Sign Specifications.

12.16.1. Letter Size. 150 mm (6") CAP height letters shall have a 13 mm (1/2") minimum depth. 300 mm (12"), 450 mm (18") and 600 mm (24") CAP height letters shall have a 19 mm (3/4") to 25 mm (1") minimum depth.

12.16.2. Letter Forms. The letters shall be channel shaped in section with sharp, not rounded, corners. The letter forms shall match those shown in Figures 2.1 and 2.2. All edges and corners shall be true and clean.

12.16.3. Letter Mounting. The letters shall be mounted to the wall according to the manufacturers' specifications. Recommended mounting techniques are shown in Figure 12.11.

12.16.4. Hangar Numbers. Large wall mounted numbers for hangars shall be individually cut from 1/4" (6 mm) aluminum plate and mounted with jack nuts, bolts or masonry anchors as required. The numbers shall be finished in semi-gloss baked enamel.

12.16.5. Emblem Mounting. Organizational emblems shall be mounted either on a sign panel or on a silhouetted panel with a 25 mm (1") return all around. See Figure 10.11.

Section 12F--Interior Signs Options

12.17. Colors and Finishes. Interior signs should relate to interior architecture and color schemes whenever possible. The colors and finishes for the interior signs shown in this pamphlet are intended only as an example. Standard brown or any dark color appropriate to the specific interior environment may be used.

12.18. Graphics. Graphics for interior signs are separated into three categories, ADA compliant permanent graphics, such as permanent room identification signs, non-compliant permanent graphics, such as header panels for directories and directional signs, and changeable graphics, such as changeable letters for building directories and name insert cards identifying tenants.

12.19. Interior Signs Permanent Graphics. ADA compliant letters, numbers and Braille may be applied to the sign face by either surface applying photo-polymer or sandblasted engraving stock.

Non-compliant letters and numbers may be applied to the sign face either by the application of die-cut material or by silk-screening. Die-cut vinyl letters and numbers with adhesive backing that are individually applied to the sign face are used for one-of-a-kind signs, such as direction signs. Graphics that are silk screened directly onto the sign face are used for mass-produced signs, such as regulation signs. If greater durability is required, the graphics may be applied to the reverse side of clear matte acrylic, back sprayed with enamel and then bonded to a backing panel. Use adhesive faced vinyl letters or numbers for one-of-a-kind signs. Use reverse silk-screening for mass produced signs.

12.20. Interior Signs Changeable Graphics.

12.20.1. Directory. The directory section of building directories is a slotted changeable letter board which accepts molded plastic letters that spell out the names of the tenants. The letters have tabs that align the letters in the slots of the letter board.

12.20.2. Insert Panel. The insert panel of the floor directories or office identification signs consists of a clear sleeve that will accept a paper or plastic insert identifying the tenant or tenants. This insert may be prepared in the following ways.

12.20.2.1. Die-cut vinyl letters applied to .015 rigid vinyl film.

12.20.2.2. Dry transfer letters applied to paper card stock.

12.20.2.3. Typeset message photographically enlarged to size and mounted on paper card stock.

12.20.2.4. Typewritten message photographically enlarged or used at actual size.

12.20.3. Method. The method most appropriate to each building should be chosen, and the same method should be used consistently throughout the building.

Figure 12.11. Wall Mounted Exterior Signs Details.

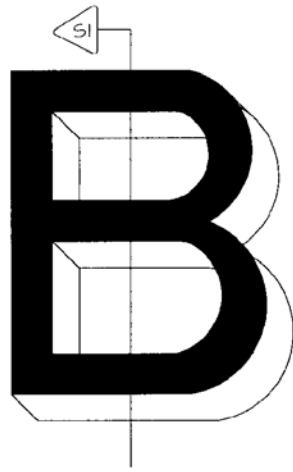

DIMENSIONAL LETTER
NOT TO SCALE

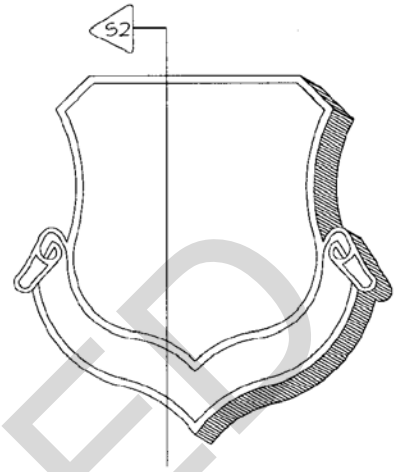

SILHOUETTED EMBLEM
NOT TO SCALE

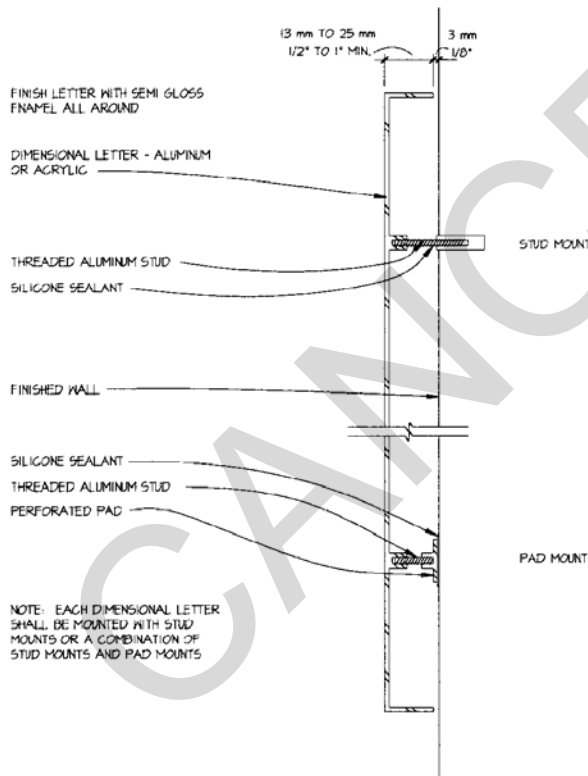

S1 SECTION, DIMENSIONAL LETTER
3\"/>

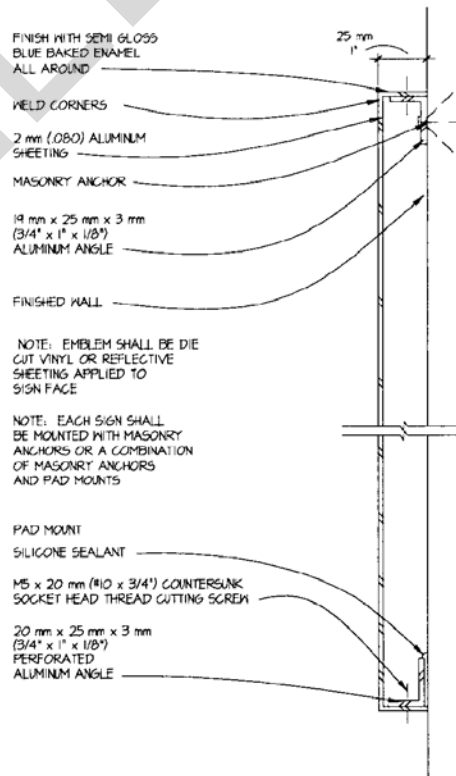

S2 SECTION, SILHOUETTED EMBLEM
3\"/>

Section 12G--Interior Signs Specifications

12.21. Materials and Finishes.

12.21.1. Aluminum. Aluminum used for concealed framing of signs shall be 6063-T5 alloy with mill finish in accordance with ASTM-B221. Aluminum used for all exposed surfaces shall have a clear or dark bronze anodized finish and shall be alloy 6063-T5 or other alloy recommended by the Aluminum Company of America, Kaiser Aluminum, Reynolds Aluminum or equivalent manufacturers to produce the required finish.

12.21.1.1. Aluminum shall be given a pre-anodic etched AA C22 treatment, followed by an anodic oxide coating in strict accordance with manufacturers' specifications for color anodized finishes. The coating shall have a minimum thickness of .007 inches.

12.21.1.2. Welded joints shall be heliarc welded in conformance with the American Welding Society and the Aluminum Association's specifications.

12.21.2. Metal Fasteners. All exposed metal fasteners shall be hardened aluminum ASTM-B211 6061-T6 alloy.

12.21.3. Vinyl. Vinyl sheeting for die-cut graphics shall have a .003 to .006 film thickness and shall conform to Military specifications M43719A. The sheeting shall include a pre-coated pressure sensitive adhesive backing (Class 3). The changeable letter boards for the building directories shall be pre-slotted, non-fading, washable vinyl, 5 mm to 6 mm 3/16" to 1/4" thick.

12.21.4. Glass. Glass shall be polished clear plate glass with clean cut edges conforming to Federal Specification DD-G- 451a. All glazing work shall be performed in accordance with applicable Standards of the Flat Glass Jobbers Association Glazing Manual.

12.21.5. Plastic. All acrylic plastics used for particular applications shown on the drawings shall be of new stock, free from defects and of the best quality available. Interior signs should complement interior architecture and color schemes. Standard blue or any dark color appropriate to the interior environment of the specific building may be used.

12.21.6. Adhesives. All adhesives and adhesive tapes required for plastics, glass and metals shall be of a type recommended for the particular usage by the manufacturer and guaranteed to meet the general and structural support criteria shown on the drawings.

12.21.7. Cork. Cork shall have a plastic impregnated surface and burlap backing. The cork shall have a smooth surface finish free from air pockets, raised cork blemishes and joint imperfections.

12.21.8. Paints and Inks. Paints and inks shall be products which are qualified for inclusion on the applicable GSA Qualified Products List. The colors should complement interior architecture and color schemes.

12.21.8.1. Qualified alkyd, acrylic, epoxy or urethane enamels may be used. Prime coats and

other surface pre-treatments shall be applied as recommended by the manufacturer.

12.21.8.2. Silk-screen inks, whether transparent or opaque shall be supplied by a manufacturer with experience in production of such inks for the purposes and surfaces involved.

12.21.8.3. No paint or ink shall be used that will fade, discolor or delaminate as a result of exposure to ultraviolet light. All paints and inks shall be evenly applied, without pinholes, scratches, peeling, or application marks.

12.21.9. Photo-polymer. Photo-polymer used for ADA compliant graphics shall be of the type that has a minimum durometer reading of 90. Tactile graphics should/must be raised 1/32 inch from first surface of plaque by photomechanical stratification processes.

12.21.10. Engraving Stock. Engraving stock used for ADA compliant graphic shall be three-ply lamination contrasting color core meeting ANSI/ASTM D-635-77 test method.

12.22. Reproduction Processes.

12.22.1. Die-cutting. Letter forms and graphics die-cut from vinyl sheeting shall be of the best commercial quality available. All die-cutting shall be executed in such a manner that all edges and corners of finished letter forms and graphics shall be true and clean. Letter forms and graphics with rounded positive or negative corners, or nicked, cut or ragged edges, shall not be used. All applied die-cut letters and graphics shall be permanently affixed to sign surfaces in such a manner that all letter surface and edge areas are tightly and evenly adhered to the sign surface.

12.22.2. Silk-screening. All silk-screening shall be executed from photo-screens prepared from typesetters' reproductions of the copy specified. Typesetters' reproductions shall be no smaller than 50% of the actual size specified. Graphics shall be assembled as mechanical art in a professional manner prior to preparation of photo screens. No hand-cut screens shall be used. All silk-screen printing shall be executed in such a manner that all edges and corners of the finished graphics shall be true and clean. Graphics with rounded positive or negative corners shall not be used.

12.22.3. Dry-transfer Letters. Dry-transfer letters shall match the quality of Instant Lettering brand by Letraset USA, Inc., Bergenfield, NJ; Normatype brand by Keuffel & Esser Co., Morristown, NJ; Transfer Lettering brand by Chartpak, Leeds, MA or equal. The Helvetica medium and Helvetica regular letter forms shall match the samples shown in Figures 2.1 and 2.2 of this pamphlet.

12.22.4. Typesetting. All typeset messages shall be prepared by photo-typesetting equipment. The Helvetica medium and Helvetica regular letter forms shall match the samples shown in Figures 2.1. and 2.2 of this pamphlet. No typesetters' proofs shall be enlarged more than three times for use as a graphic insert.

12.22.5. Photographic Enlargements. Photographic enlargements or “photostats” shall be executed on matte or semi-gloss prepared paper. The enlarged image shall be sharp, clean and free of chemical discoloration.

12.22.6. Graphic Blasting. Graphic blasted material shall be sandblasted to a uniform depth of 1/32” leaving raised text and Braille. The background shall be blasted utilizing the appropriate texture of blasting silica to achieve the proper consistent depth. Careful control of nozzle pressure, distance and angle is necessary to prevent distortion. All blasting shall be executed in such a manner that all edges and corners of finished copy are true and clean. Copy with rounded positive negative corners, edge building-up or bleeding shall not be used.

Section 12H--Interior Signs

12.23. Interior Signs Details. See Figures 12.12 through 12.20.

CANCELLED

Figure 12.12. Sign Details AA1, AA2, AA3.

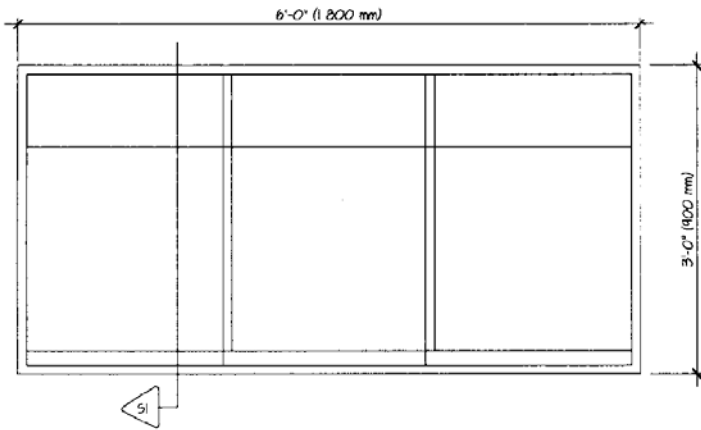

BUILDING DIRECTORY, TYPE AA1

1/2" = 1'-0"

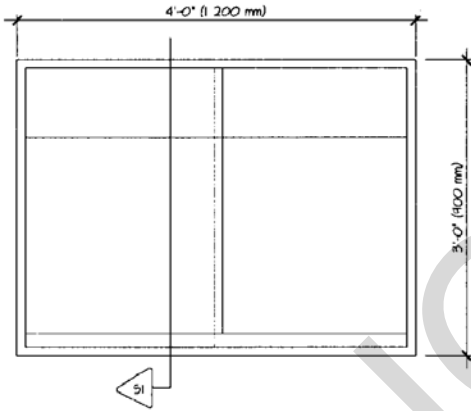

BUILDING DIRECTORY, TYPE AA2

1/2" = 1'-0"

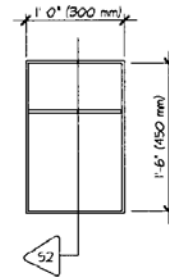

BUILDING DIRECTORY, TYPE AA3

1/2" = 1'-0"

Figure 12.13. Sign Details AA1, AA2, AA3.

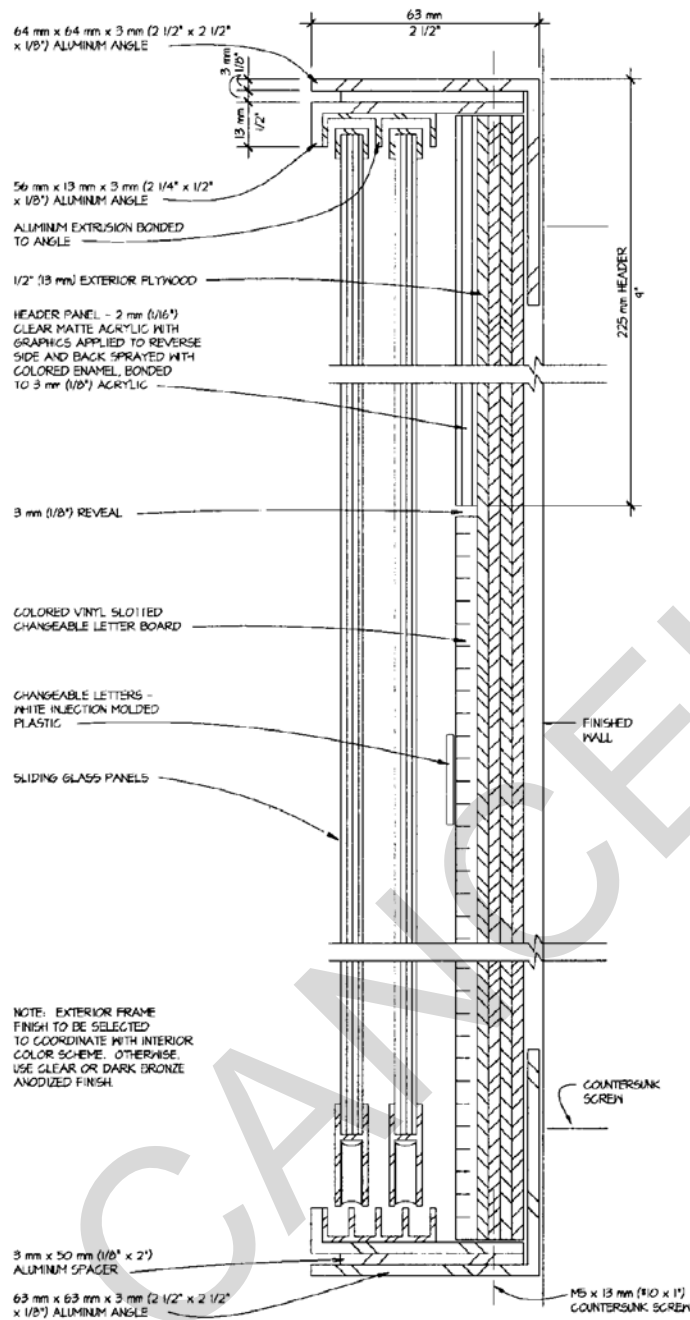

S1 VERTICAL SECTION, TYPES AA1, AA2
HALF SCALE

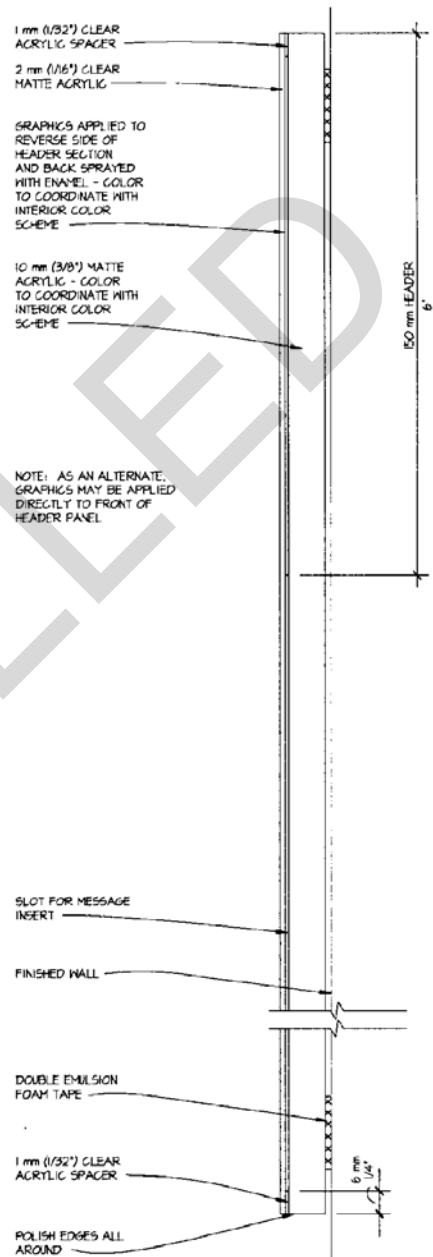

S2 VERTICAL SECTION, TYPE AA3
HALF SCALE

Figure 12.14. Sign Details BB1, BB2, BB3, BB4, BB5.

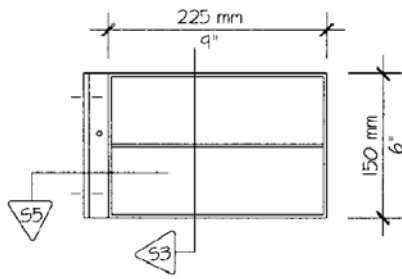

SIGN TYPE BB3

SCALE: 1 1/2" = 1'-0"

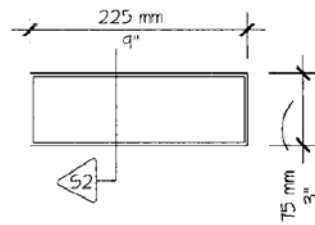

SIGN TYPE BB4

SCALE: 1 1/2" = 1'-0"

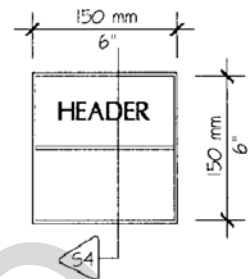

SIGN TYPE BB5

SCALE: 1 1/2" = 1'-0"

CANCELLED

Figure 12.15. Sign Details, BB1, BB2, BB3, BB4 and BB5.

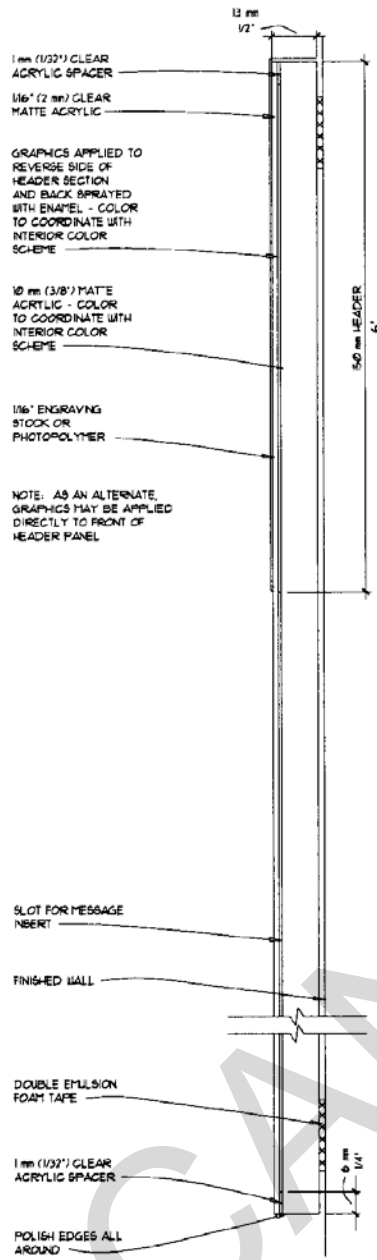

S1 VERTICAL SECTION, TYPE BB1
 HALF FULL SIZE

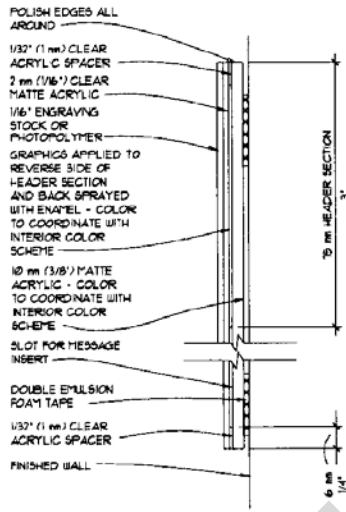

S2 VERTICAL SECTION, TYPES BB2, BB4
 HALF SCALE

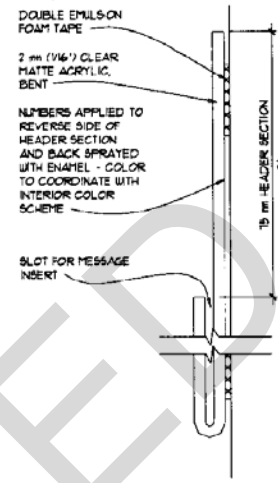

S4 VERTICAL SECTION, TYPE BB5
 HALF SCALE

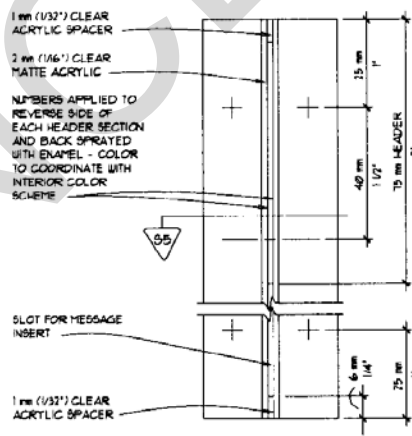

S3 VERTICAL SECTION, TYPE BB3
 HALF SCALE

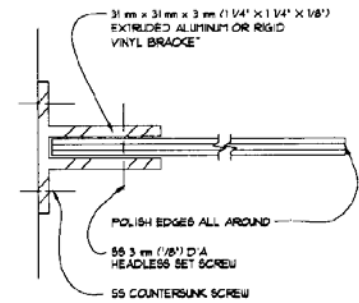

S5 HORIZ. SECTION, TYPE BB3
 HALF SCALE

Figure 12.16. Sign Details BB6, BB7, DD1 and DD2.

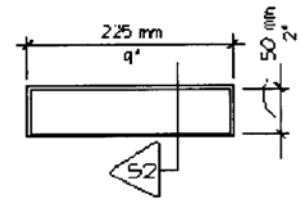
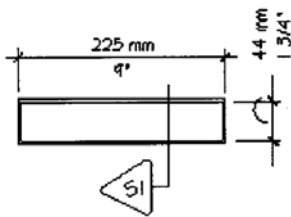

DESK PLAQUES, TYPE BB6

SCALE 1 1/2" = 1'-0"

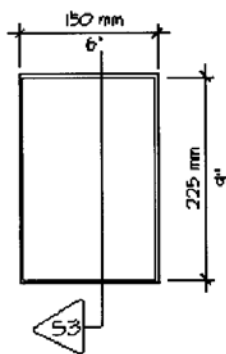

SIGN TYPE BB7

SCALE 1 1/2" = 1'-0"

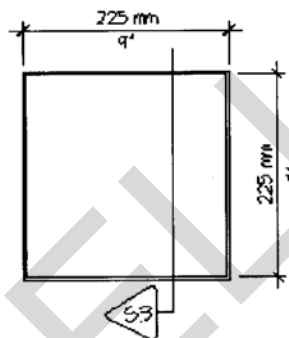

SIGN TYPE DD1

SCALE 1 1/2" = 1'-0"

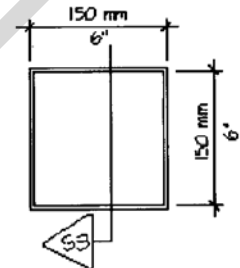

SIGN TYPE DD2

SCALE 1 1/2" = 1'-0"

Figure 12.17. Sign Details BB6, BB7, DD1 and DD2.

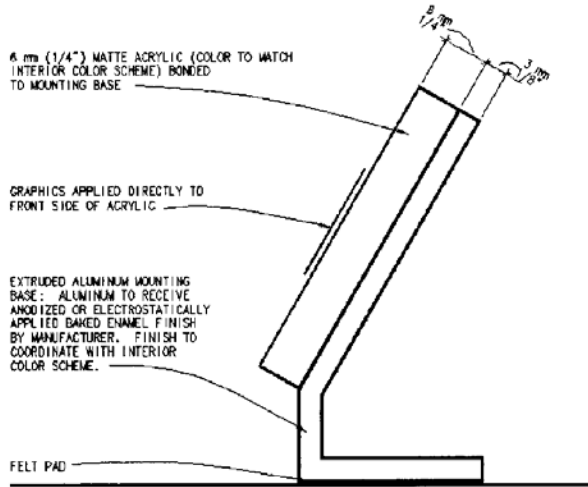

S1 VERTICAL SECTION, TYPE BB6
 FULL SCALE

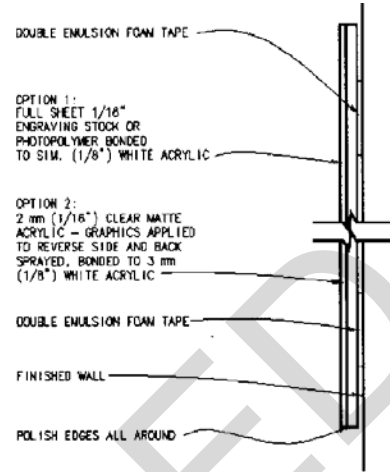

S3 VERTICAL SECTION, TYPES BB7, DD1, DD2
 FULL SCALE

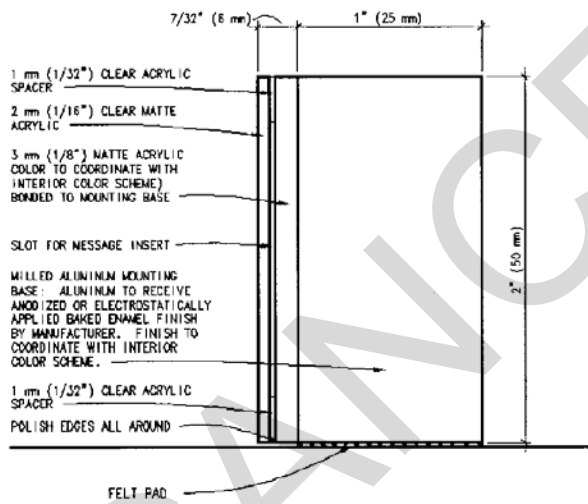

S2 VERTICAL SECTION, TYPE BB6, ALTERNATE
 FULL SCALE

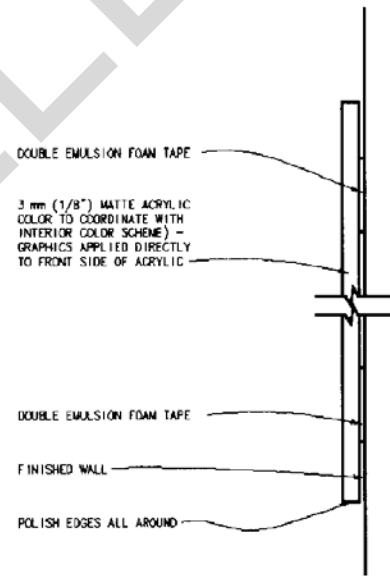

S4 ALTERNATE DETAIL, SIGN TYPES BB7, DD1, DD2
 FULL SCALE

Figure 12.18. Sign Details CC1 and CC2.

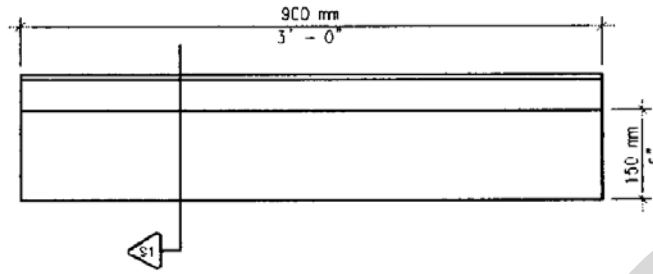

DIRECTIONAL SIGN, TYPE CC1

1 1/2" = 1'-0"

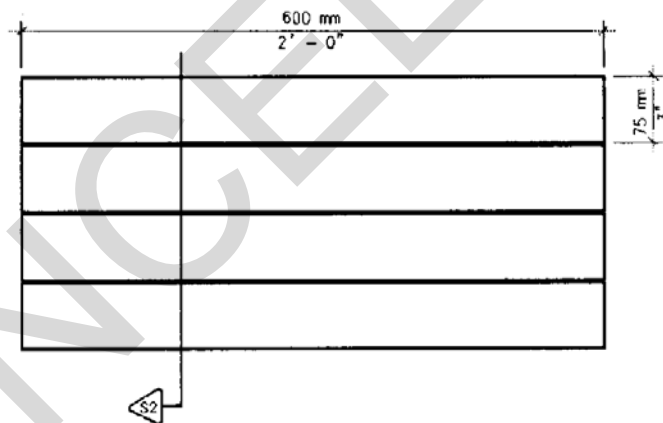

DIRECTIONAL SIGN, TYPE CC2

1 1/2" = 1'-0"

Figure 12.19. Sign Details CC1 and CC2.

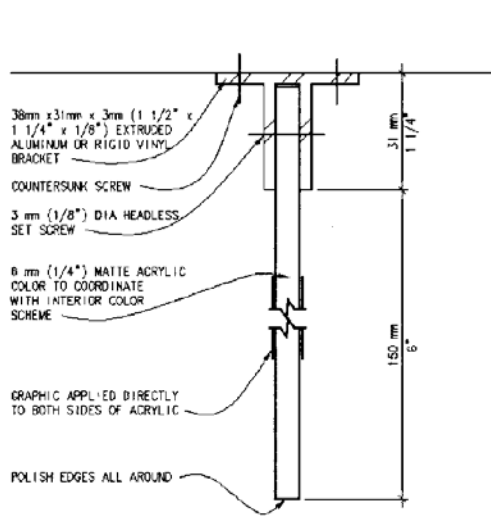

S1 VERTICAL SECTION, TYPE CC1
 HALF SCALE

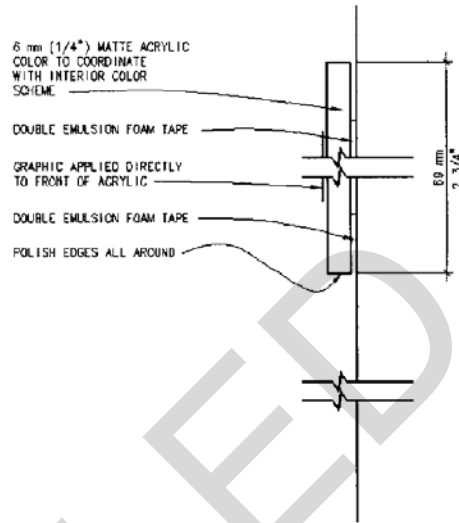

S3 VERTICAL SECTION, TYPE CC2
 HALF SCALE

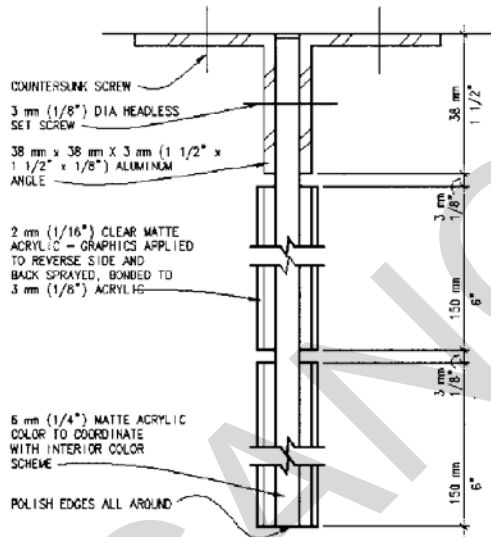

S2 ALTERNATE DETAIL, SIGN TYPE CC1, MULTIPLE
 HALF SCALE

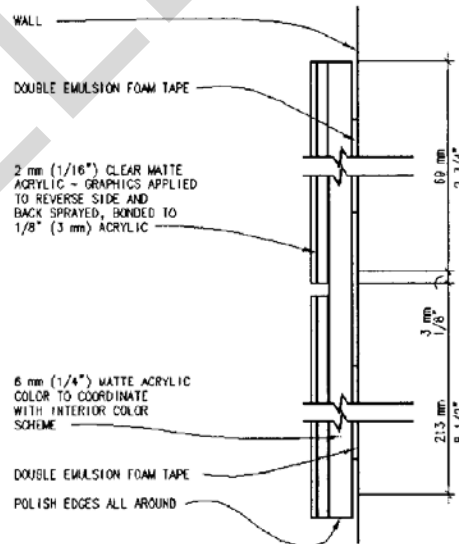

S4 ALTERNATE DETAIL, SIGN TYPE CC2, MULTIPLE
 HALF SCALE

Figure 12.20. Sign Details EE1.

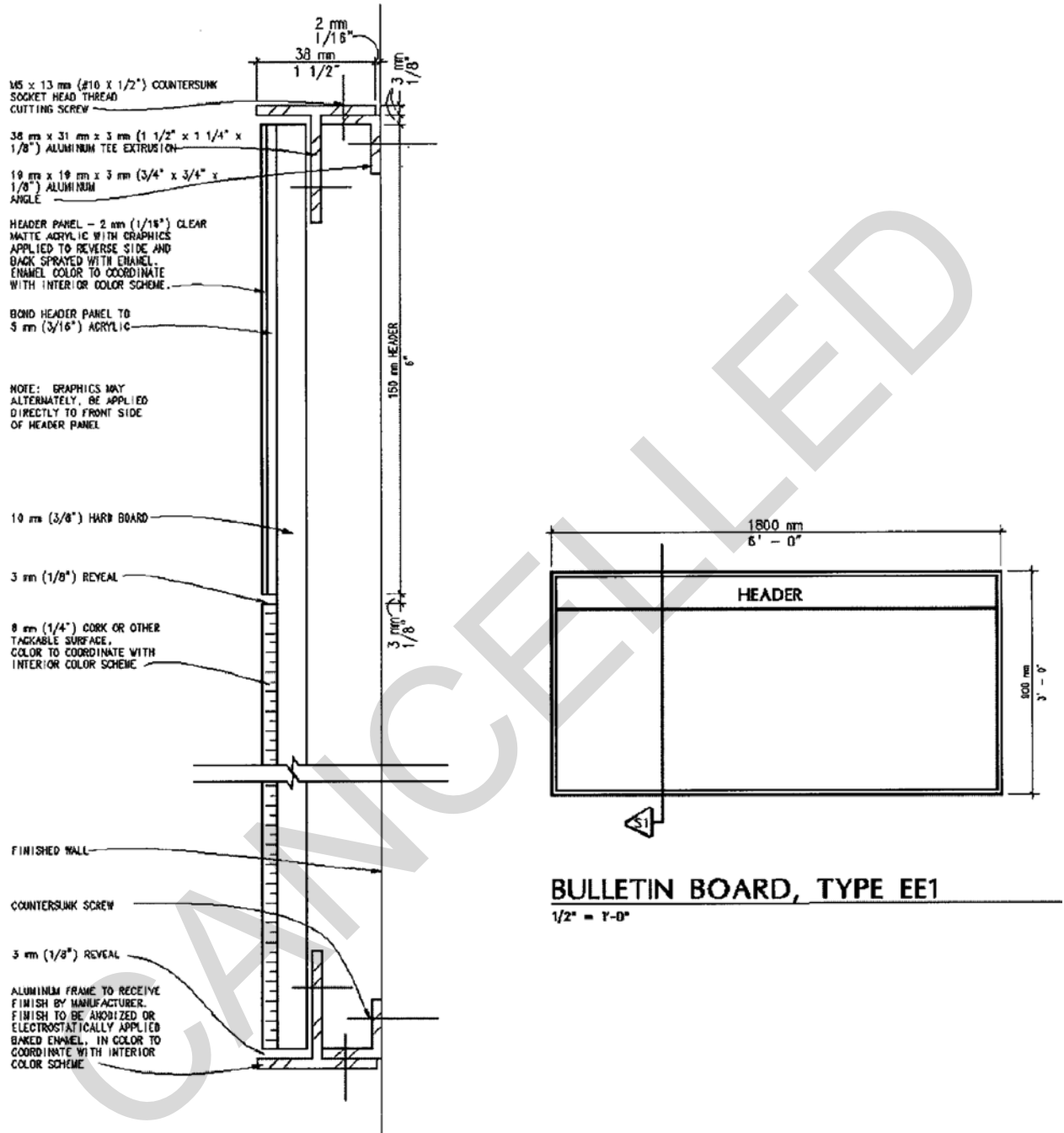

S1 VERTICAL SECTION, TYPE EE1
 HALF SCALE

Section 12I--Military Construction Signs

12.24. Military Construction Sign Requirements.

12.24.1. Exceptions. Military Construction Signs are required for all Military Construction Projects (MCP). Exceptions may be made for security reasons or for host nation restrictions. MAJCOMs have the authority to require construction signs on non-MCP projects. Refer to ETL 02-9 for more information regarding Construction Sign Requirements

12.24.2. MAJCOM, Design Manager, and A-E. The host MAJCOM provides the desired sign colors, specifications and details to the design manager in the project Requirements Document. The design manager ensures the A-E includes these specifications and details in the contract documents.

12.24.3. General Contractor. The General Contractor shall furnish and maintain the sign and shall remove the sign at the end of the project.

12.25. Materials.

12.25.1. Panel and Paint. The sign panel for a Military Construction Sign is to be a 1 200 mm x 2 400 mm (4' -0" x 8' -0") sheet of 13 mm (½") grade AC exterior plywood. Paint all sides of sign with one coat of primer paint followed by two coats of gloss exterior enamel.

12.25.2. Colors and Lettering. Colors shall conform to Federal Standard No. 595a in paragraph 2.18. Lettering shall be white gloss, exterior enamel.

12.25.3. Reference. Refer to Engineering Technical Letter (ETL) 93-1, Construction Signs, dated 11 Mar 93.

EARNEST O. ROBBINS II, Major General, USAF
The Civil Engineer
DCS/Installations & Logistics