

UNIFIED FACILITIES CRITERIA (UFC)

ARCHITECTURE



APPROVED FOR PUBLIC RELEASE; DISTRIBUTION UNLIMITED

UNIFIED FACILITIES CRITERIA (UFC)

ARCHITECTURE

Any copyrighted material included in this UFC is identified at its point of use. Use of the copyrighted material apart from this UFC must have the permission of the copyright holder.

Indicate the preparing activity beside the Service responsible for preparing the document.

U.S. ARMY CORPS OF ENGINEERS

NAVAL FACILITIES ENGINEERING SYSTEMS COMMAND (Preparing Activity)

AIR FORCE CIVIL ENGINEER CENTER

Record of Changes (changes are indicated by \1\ ... /1/)

Change No.	Date	Location
1	1/5/2021	2-4.3 1407.7.1 ccr 9099; 3-2 ccr 9208; 3-3 ccr 8235 and 8541; 3-6.2 ccr 9570
2	11/1/2022	2-4.2 renumbered per 2021 IBC; 3-6.3 ccr 12024 and 10895; A-3.3 removed semi-permanent construction; A-8 renumbered
3	10/2/2023	Revised 2018 IBC references to "2021 IBC" or "IBC" ccr 13329 & 13629; para 3-6.3 deleted second bullet and added Navy / Army note and add separate Air Force bullet ccr 9847; Chapter 3-6.3 revise 4 th bullet to "Spaces with large exterior doors . . ." ccr 11656; para 3-6.3 revise spec section from 07 05 23 to 01 91 19; Chapter 3-7.1 revise title to "Daylighting Design" ccr 11185; retitled references to UFC 4-010-05 to "SCIF/SAPF . . ."; Chapter 2-4.3 Section 1404.13.3, delete first sentence, ccr 13930



This UFC supersedes UFC 3-101-01, dated 28 November 2011, with Changes 1-5, dated 25 September 2019.

FOREWORD

The Unified Facilities Criteria (UFC) system is prescribed by MIL-STD 3007 and provides planning, design, construction, sustainment, restoration, and modernization criteria, and applies to the Military Departments, the Defense Agencies, and the DoD Field Activities in accordance with [USD \(AT&L\) Memorandum](#) dated 29 May 2002. UFC will be used for all DoD projects and work for other customers where appropriate. All construction outside of the United States is also governed by Status of Forces Agreements (SOFA), Host Nation Funded Construction Agreements (HNFA), and in some instances, Bilateral Infrastructure Agreements (BIA). Therefore, the acquisition team must ensure compliance with the most stringent of the UFC, the SOFA, the HNFA, and the BIA, as applicable.

UFC are living documents and will be periodically reviewed, updated, and made available to users as part of the Services' responsibility for providing technical criteria for military construction. Headquarters, U.S. Army Corps of Engineers (HQUSACE), Naval Facilities Engineering Systems Command (NAVFAC), and Air Force Civil Engineer Center (AFCEC) are responsible for administration of the UFC system. Defense agencies should contact the preparing service for document interpretation and improvements. Technical content of UFC is the responsibility of the cognizant DoD working group. Recommended changes with supporting rationale may be sent to the respective DoD working group by submitting a Criteria Change Request (CCR) via the Internet site listed below.

UFC are effective upon issuance and are distributed only in electronic media from the following source:

- Whole Building Design Guide website <http://www.wbdg.org/ffc/dod>.

Refer to UFC 1-200-01, *DoD Building Code*, for implementation of new issuances on projects.

AUTHORIZED BY:



CHRISTINE T. ALTENDORF, PhD,
P.E., SES
Chief, Engineering and Construction
U.S. Army Corps of Engineers



R. DAVID CURFMAN, P.E., SES
Chief Engineer
Naval Facilities Engineering Systems Command

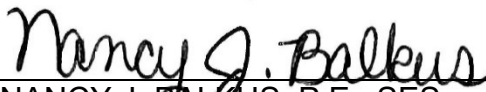

NANCY J. BALKUS, P.E., SES
Deputy Director of Civil Engineers
DCS/Logistics, Engineering &
Force Protection (HAF/A4C)
HQ United States Air Force



MICHAEL McANDREW
Deputy Assistant Secretary of Defense
(Construction) and Acting Deputy Assistant
Secretary of Defense (Housing) Office of the
Assistant Secretary of Defense (Sustainment)

**UNIFIED FACILITIES CRITERIA (UFC)
[NEW][REVISION] SUMMARY SHEET**

Document: UFC 3-101-01, *Architecture*

Superseding: UFC 3-101-01, dated 28 November 2011, with Changes 1-5, dated 25 September 2019

Description: This UFC unifies the architectural criteria for DOD. The format is updated to the standard format of the Criteria Standard Format for all UFC.

Reasons for Document:

- Required update cycle
- Approved Criteria Change Request (CCRs)
- Conform the format to the UFC 1-300-01 *Criteria Format Standard* including alignment of requirements with the International Building Code (IBC).
- Incorporate latest technologies, policies and references

Impact: Improved mission capability through:

- Reduced total ownership costs of buildings through corrosion resistant design requirements
- Use of reference model codes to greatest extent possible
- Unification of service requirements

Unification Issues

- Referenced space planning criteria is contained in service specific publications.
- Service differences in Air Barrier Testing criteria are noted in this UFC.

TABLE OF CONTENTS

CHAPTER 1	INTRODUCTION	1
1-1	PURPOSE AND SCOPE.....	1
1-2	APPLICABILITY.....	1
1-3	GENERAL BUILDING REQUIREMENTS.....	1
1-3.1	Environmental Severity and Humid Locations.....	1
1-4	BACKGROUND.....	1
1-5	OVERVIEW OF THIS UFC.....	2
1-6	CYBERSECURITY.....	3
1-7	ADDITIONAL REQUIREMENTS.....	3
CHAPTER 2	MODIFICATIONS TO THE IBC.....	5
2-1	CHAPTER 7 – FIRE AND SMOKE PROTECTION FEATURES.....	5
2-1.1	SECTION 721 - PRESCRIPTIVE FIRE RESISTANCE.....	5
2-1.2	SECTION 722 - CALCULATED FIRE RESISTANCE.....	5
2-2	CHAPTER 8 – INTERIOR FINISHES.....	5
2-2.1	SECTION 802 GENERAL.....	5
2-3	CHAPTER 12 – INTERIOR ENVIRONMENT.....	5
2-3.1	SECTION 1202 – VENTILATION.....	5
2-3.2	SECTION 1206 - SOUND TRANSMISSION.....	5
2-4	CHAPTER 14 – EXTERIOR WALLS.....	9
2-4.1	SECTION 1401 – GENERAL.....	9
2-4.2	SECTION 1404 - INSTALLATION OF WALL COVERINGS.....	9
2-4.3	SECTION 1407 - EXTERIOR INSULATION AND FINISH SYSTEMS (EIFS).....	12
2-4.4	SECTION 1410 - GYPSUM BOARD CONSTRUCTION.....	13
2-5	CHAPTER 18 – SOILS AND FOUNDATIONS.....	13
2-5.1	SECTION 1805 - DAMPPROOFING AND WATERPROOFING.....	13
2-5.2	SECTION 1808 – FOUNDATIONS.....	13
2-6	CHAPTER 20 - ALUMINUM.....	13
2-6.1	SECTION 2002 - MATERIALS.....	13
2-7	CHAPTER 21 - MASONRY.....	14
2-7.1	SECTION 2115 - MASONRY DETAILING AND MISCELLANEOUS PROVISIONS. [Addition].....	14

2-8	CHAPTER 22 - STEEL.....	15
2-8.1	SECTION 2203 - PROTECTION OF STEEL FOR STRUCTURAL PURPOSES.....	15
2-8.2	SECTION 2211 COLD-FORMED STEEL LIGHT-FRAME CONSTRUCTION.....	15
2-9	CHAPTER 23 - WOOD.....	15
2-9.1	SECTION 2304 – GENERAL CONSTRUCTION REQUIREMENTS. . .	15
2-10	CHAPTER 25 – GYPSUM BOARD, GYPSUM PANEL PRODUCTS AND PLASTER.....	16
2-10.1	SECTION 2515 - TRIM AND MOLDINGS [Addition].	16
CHAPTER 3	DESIGN	17
3-1	DESIGN QUALITY.....	17
3-1.2	Installation Exterior Architecture.....	17
3-1.3	Historic Architecture.....	17
3-1.4	Projects in the National Capital Region (NCR).	17
3-2	BUILDING ORIENTATION.....	18
3-3	HAZARD PREVENTION.....	18
3-3.1	Radon.....	18
3-3.2	Paints with Lead, Cadmium and Chromium.....	19
3-3.3	Beryllium Coatings and Compounds.....	20
3-4	MECHANICAL/ELECTRICAL/TELECOMMUNICATION ROOMS.....	21
3-5	PLUMBING.....	21
3-6	AIR BARRIER DESIGN AND TESTING.....	21
3-6.1	New Construction.....	21
3-6.2	Renovations.....	21
3-6.3	Inspections and Testing.....	21
3-6.4	Mock-Ups.....	22
3-7	FENESTRATION DESIGN.....	22
3-7.1	Daylighting Requirements.....	22
3-8	ACOUSTICS – OUTSIDE TO INSIDE NOISE CONTROL.....	22
3-8.1	Design.....	22
CHAPTER 4	PROGRAMMING, PLANNING, AND PRE-DESIGN SERVICES	25
4-1	SPACE PLANNING CRITERIA.....	25

4-2	BUILDING AREA CALCULATIONS.....	25
4-2.1	Scope Changes.....	25
4-2.2	Calculations of Gross Building Area.....	25
4-3	PRE-DESIGN SERVICES.....	29
CHAPTER 5 DESIGN AND POST-DESIGN SERVICES.....		31
5-1	GENERAL.....	31
5-2	DESIGN SERVICES.....	31
5-2.1	Design Charrettes.....	31
5-2.2	Architectural Compatibility Submittal.....	31
5-2.3	Architectural Basis of Design/Design Analysis.....	32
5-2.4	Specifications.....	35
5-2.5	Architectural Drawings.....	35
5-2.6	Color Boards and Binders.....	37
APPENDIX A BEST PRACTICES.....		39
A-1	INTRODUCTION.....	39
A-2	WHOLE BUILDING DESIGN GUIDE.....	39
A-3	PLANNING ISSUES.....	39
A-4	LOCAL CONSTRUCTION METHODS, MATERIALS AND SKILLS.....	40
A-5	BUILDING ENVELOPE.....	40
A-6	AIR BARRIER MOCK-UP TESTING.....	48
A-7	EXTERIOR INSULATION AND FINISH SYSTEM (EIFS).....	50
A-8	DAYLIGHTING.....	50
APPENDIX B GLOSSARY.....		65
B-1	ACRONYMS.....	65
B-2	DEFINITION OF TERMS.....	69
APPENDIX C REFERENCES.....		71

FIGURES

Figure 4-1	Sample Gross Building Area Calculation.....	27
Figure 4-2	Sample Block Plan.....	28
Figure A-1	Effects Of Building Massing on Daylight Availability.....	53
Figure A-2	Examples of Passive Daylighting Strategies.....	54
Figure A-3	Building Orientation Can Maximize Daylight Exposure.....	55

Figure A-4	Example of Architectural Shading Devices.....	56
Figure A-5	Diagram of Toplighting Strategies	58
Figure A-6	Examples of Toplighting Applications.....	59
Figure A-7	Example of Clerestory Application	59
Figure A-8	Examples of Sidelighting Applications.....	60
Figure A-9	Examples of Roof Shapes.....	60
Figure A-10	Example of Splayed Skylights.....	61
Figure A-11	Example of an Active Daylighting System that Tracks the Sun and Directs Daylight into the Building.....	63
Figure A-12	Example of Solar-Adaptive Shading	63

TABLES

Table 2-1	Interior Acoustic Requirements for Typical Spaces.....	7
Table 2-2	Acoustic Requirements for Typical Facilities	8
Table 3-1	Building Façade Sound Isolation	23
Table 4-1	Gross Building Area	26
Table A-1	Construction Mock-Up Guidance Matrix.....	49
Table A-2	Comparison Of Glass Types (From Alpenglass Heat Mirror).....	57

CHAPTER 1 INTRODUCTION

1-1 PURPOSE AND SCOPE.

This UFC provides technical requirements, model code modifications, and requirements for architectural design services. Architects must use the information in this document in the development of plans, specifications, calculations, construction contract documents, and Design-Build Requests for Proposals (RFP). The information in this UFC serves as the minimum architectural requirements. Project conditions and programmatic requirements may dictate the need for designs that exceed these requirements.

1-2 APPLICABILITY.

This UFC applies to agencies of the U.S. Armed Services and their contractors that are preparing construction contract documents for Department of Defense-owned facilities. These criteria are applicable in the 50 states, the District of Columbia, Puerto Rico, U.S. territories and possessions, and as far as practical, at installations in foreign countries. This UFC applies to all types of construction regardless of funding, including properties listed or eligible for listing on the National Register of Historic Places, as well as National Guard and Reserve projects constructed on military installations or non-military DoD property. Certain specialized facilities carry more stringent requirements. See UFC or other criteria that are applicable to the respective specialized facility that is being designed. This UFC is applicable to the traditional architectural services customary for Design-Bid-Build design services and for Design-Build construction contracts.

1-3 GENERAL BUILDING REQUIREMENTS.

Comply with UFC 1-200-01, DoD Building Code. UFC 1-200-01 provides applicability of model building codes and government unique criteria for design disciplines and building systems, as well as for accessibility, antiterrorism, security, high performance and sustainability requirements, and safety. Use this UFC in addition to UFC 1-200-01 and the UFCs and government criteria referenced therein.

1-3.1 Environmental Severity and Humid Locations.

The architectural design must incorporate systems and details to meet the environmental corrosivity conditions for the specific project location, as defined by its Environmental Severity Classification (ESC). See UFC 1-200-01 for determination of ESC for project locations. The humidity conditions must also be considered during design; humid locations are those in ASHRAE climate zones 0A, 1A, 2A, 3A, 3C, 4C, and 5C (as identified in ASHRAE 90.1).

1-4 BACKGROUND.

UFC 1-200-01 implements and supplements International Building Code (IBC) as the building code for DoD. Chapter 2 of this UFC further modifies the IBC for architecture-

specific design requirements and is organized by the chapter of the IBC that each section modifies. Apply any section in the IBC that is not specifically referenced as it is written in the IBC.

The IBC section modifications are one of four actions, according to the following legend:

[Addition] – Add new section, including new section number, not shown in IBC.

[Deletion] – Delete referenced IBC section or noted portion of a section.

[Replacement] – Delete referenced IBC section or noted portion and replace it with the narrative shown.

[Supplement] – Add narrative shown as a supplement to the narrative shown in the referenced section of IBC.

1-5 OVERVIEW OF THIS UFC.

Brief descriptions of the various chapters and appendices of this UFC follow.

- CHAPTER 2 – MODIFICATIONS TO IBC. Chapter 2 provides supplemental requirements for applying the IBC architectural provisions to conventional DoD building design by listing required modifications for specific IBC sections.
- CHAPTER 3 – DESIGN. Chapter 3 includes architectural design requirements, such as design quality, building orientation, and hazard prevention.
- CHAPTER 4 – PROGRAMMING AND PLANNING. Chapter 4 includes requirements for space planning and building area calculations.
- CHAPTER 5 – PRE-DESIGN, DESIGN AND POST-DESIGN SERVICES. Chapter 5 includes a detailed description of these services, including design charrettes, Architectural Compatibility Submittals, Architectural Basis of Design, Specifications, and Drawings.
- APPENDIX A – BEST PRACTICES. This chapter contains useful recommendations and guidance on a number of important topics, such as planning issues, local construction methods, building envelope considerations, air barrier testing, and daylighting data.
- APPENDIX B – GLOSSARY. This section includes acronyms and definitions of terms.
- APPENDIX C – REFERENCES. This section contains a list of references used in this document. The publication date of the code or standard is not included in this document. Unless otherwise specified, the most recent edition of the referenced publication applies.

1-6 CYBERSECURITY.

Control systems (including systems separate from an energy management control system) must be planned, designed, acquired, executed, and maintained in accordance with UFC 4-010-06, and as required by individual Service Implementation Policy.

1-7 ADDITIONAL REQUIREMENTS.

When performing work for different Activities within the U.S., additional regional or service-specific requirements apply. Confirm with the Authority Having Jurisdiction (AHJ) the applicability of any regional requirements.

CANCELLED

This Page Intentionally Left Blank

CANCELLED

CHAPTER 2 MODIFICATIONS TO THE IBC

2-1 CHAPTER 7 – FIRE AND SMOKE PROTECTION FEATURES.

2-1.1 SECTION 721 - PRESCRIPTIVE FIRE RESISTANCE.

721.1 – General [Supplement]

Use the UL Fire Rated Assemblies Directory or Nationally Recognized Testing Laboratories for design of fire-resistance-rated wall, floor, and roof assemblies in addition to this section.

2-1.2 SECTION 722 - CALCULATED FIRE RESISTANCE.

722.1 – General [Supplement]

Use the UL Fire Rated Assemblies Directory or Nationally Recognized Testing Laboratories for design of fire-resistance-rated wall, floor, and roof assemblies in addition to this section.

2-2 CHAPTER 8 – INTERIOR FINISHES.

2-2.1 SECTION 802 GENERAL.

802.8 - Paint and Coatings Selection [Addition]

Base paint selection on Master Painters Institute's (MPI's) Detailed Performance Standards for the coating materials and MPI's Architectural Painting Specification Manual for the system. Do not use MPI's "Intended Use" standards. Refer to The Society for Protective Coatings (SSPC) standards, National Association of Corrosion Engineers (NACE) standards, and UFC 3-190-06 for painting steel and concrete structures, particularly in marine and other severe environmental locations.

2-3 CHAPTER 12 – INTERIOR ENVIRONMENT.

2-3.1 SECTION 1202 – VENTILATION.

1202.2.3 - Enclosed Roof Spaces [Addition]

Ventilate enclosed roof spaces created outside the building thermal envelope. For sloped roofs, ventilation must comply with IBC Section 1202 Ventilation. Ensure that moisture transfer from ventilated attics into the building is minimized.

2-3.2 SECTION 1206 - SOUND TRANSMISSION.

1206.1 - Scope [Supplement]

Section 1206.4 applies to other occupancies.

1206.4 - Interior Acoustics for Other Occupancies [Addition]

Design so that interior acoustics coordinate with the architecture, fire protection, mechanical, and structural design. A comprehensive acoustical design must include considerations for sound isolation, building mechanical system noise and vibration control, room finishes, and space adjacencies.

There are basically two types of sound transmission; airborne and structure-borne. Structure-borne sound is transmitted through a material by vibrations and re-radiated to another point (such as upper floor foot traffic). Sound transmission requirements are performance-based. Refer to the Glossary in this guidance for added explanations and definitions of acoustical terms such as STC (Sound Transmission Class) and NIC (Noise Isolation Class). Table 2-1 provides acoustic requirements for common facility and space types.

1206.4.1 - Interior Acoustics Reference Criteria [Addition]

Spaces such as Special Access Program Facilities (SAPF) and Sensitive Compartmented Information Facilities (SCIF) must comply with specific criteria to be accredited for operation. Specialty spaces including television and radio broadcast facilities, music auditoria, large lecture halls (50 people or more), network operations centers, or other spaces will require an acoustical consultant as an integral member of the design team.

The following references include explanations, guidelines, design strategies, and prediction tools to aid in meeting the above required acoustic criteria.

- UFC 3-450-01 "Noise and Vibration Control"
- UFC 4-010-05 "SCIF/SAPF Planning, Design and Construction"
- *Sound Matters* from General Services Administration
- ANSI/ASA S12.2, *Criteria for Evaluating Room Noise*
- ASTM E1130, *Standard Test Method for Objective Measurement of Speech Privacy in Open Plan Spaces Using Articulation Index*
- ASTM E2638, *Standard Test Method for Objective Measurement of the Speech Privacy Provided by a Closed Room*

Table 2-1 Interior Acoustic Requirements for Typical Spaces

	Space Acoustic Requirements			
	Sound Isolation ⁽¹⁾		Background Noise Level ⁽³⁾	Reverberation Time
	Partitions	Doors ⁽²⁾		
Auditorium ⁽⁴⁾	STC 60 or greater	STC 50 or greater	25	< 1.0 sec
Unaccompanied Housing (UH)	STC 50	STC 25	30	n/a
Child Care	STC 50	STC 25	35	< 0.8 sec
Clinic/ Health Unit	STC 50	STC 25	35	< 1.0 sec
Conference Room	STC 50 or greater	STC 30 or greater	30	< 0.8 sec
Classroom	STC 50	STC 30	35	< 0.6 sec
Firing Range	STC 65 or greater	STC 55 or greater	n/a	n/a
Food Service	STC 55	STC 25 or greater	40	< 1.4 sec
Hearing Room	STC 55	STC 35	30	0.6-0.7 sec
Laboratory: Dry	STC 50	STC 25	45	< 1.4 sec
Library	STC 50	STC 30	40	< 1.2 sec
Open Office	n/a	STC n/a	40 ⁽⁵⁾	< 1.0 sec
Private Office ⁽⁶⁾	STC 35-50	STC 25	35	n/a
Place of Worship	STC 55	STC 35	30	0.8-1.4 sec ⁽⁷⁾

1. Sound Isolation requirements are stated in terms of Sound Transmission Class (STC), a laboratory performance metric. See also Facility-Specific UFC for more detailed requirements, which take precedence.
2. STC requirements for most doors (STC 30 and below) can be achieved by using door seals on standard doors. For higher sound isolation requirements, consider using a vestibule, sound rated door(s) or a combination of the two.
3. Background Noise Level requirements are stated in terms of Noise Criteria (NC) or RC Mark II levels. NC and RC Mark II levels are considered equivalent for design purposes; however, RC Mark II noise levels provide additional means to describe the quality of a sound for assessment purposes.
4. Assumes space is primarily used for speech functions. Multipurpose auditoria with music programming must have criteria established by the Government or project acoustical consultant in the response to a proposal.
5. Consider a sound masking system if privacy is important in open office areas. A sound masking system will not alleviate NIC project requirements in other areas of a building. Refer to ASTM E2638 for additional information regarding privacy design considerations in open office areas
6. Criteria dependent on privacy requirements of the occupants.
7. Criteria to be refined by the Government or project acoustical consultant based on specific worship type.

If a space type is not included in the above Table 2-1, the standards in Table 2-2 include interior acoustic requirements for other space/building types.

Table 2-2 Acoustic Requirements for Typical Facilities

Facility/ Space Type	Reference Standard to Meet Project Acoustic Requirements ^(1, 2)			
	Sound Isolation	Background Noise Level	Room Finishes	Mechanical System Noise & Vibration
Administrative/ Office Buildings <ul style="list-style-type: none"> • Open Offices • Private Offices • Conference Rooms • Training Rooms • Lobbies 	GSA PBS-P100 (see Section 3.5.3)	ASHRAE HVAC Applications Handbook, Ch. 49 – Noise & Vibration Control	GSA PBS-P100 (see Section 3.5.3)	ASHRAE HVAC Applications Handbook, Ch. 49 – Noise & Vibration Control
Child Facilities <ul style="list-style-type: none"> • Child Care • Day Care • Child Development • K-12 Schools 	ANSI S12.60 Parts 1 and 2	ANSI S12.60 Parts 1 and 2	ANSI S12.60 Parts 1 and 2	ASHRAE HVAC Applications Handbook, Ch. 49 – Noise & Vibration Control
Housing <ul style="list-style-type: none"> • UH • Multifamily Residences • Single Family Residences 	IBC (See Section 1206)	ASHRAE HVAC Applications Handbook, Ch. 49 – Noise & Vibration Control	UFC 3-450-01, Noise and Vibration Control	ASHRAE HVAC Applications Handbook, Ch. 49 – Noise & Vibration Control
Medical Care <ul style="list-style-type: none"> • Hospitals • Clinics 	FGI – Sound & Vibration: Design Guidelines for Health Care Facilities	FGI – Sound & Vibration: Design Guidelines for Health Care Facilities	FGI – Sound & Vibration: Design Guidelines for Health Care Facilities	FGI – Sound & Vibration: Design Guidelines for Health Care Facilities
Research Facilities <ul style="list-style-type: none"> • Laboratories • Associated Lab Support Spaces 	NIH – Design Requirements Manual	NIH – Design Requirements Manual (see Section 6.5)	NIH – Design Requirements Manual	NIH – Design Requirements Manual (Section 6.5)
SCIF and SAPF	IC Tech Spec for ICD/ICS 705	ASHRAE Applications Handbook, Ch. 49 – Noise & Vibration Control	UFC 4-010-05	ASHRAE HVAC Applications Handbook, Ch. 49 – Noise & Vibration Control
Legal Facilities <ul style="list-style-type: none"> • Courts • Associated Court Support Spaces 	U.S. Courts Design Guide (Chapter 14)	U.S. Courts Design Guide (Chapter 14)	U.S. Courts Design Guide (Chapter 14)	ASHRAE HVAC Applications Handbook, Ch. 49 – Noise & Vibration Control
<p>1. Chapters and sections referenced are intended to facilitate quick reference of the above standards and not exclude the requirements in the rest of the document.</p> <p>2. Requirements in the above referenced standards do not supersede requirements stated in Table 2-1 if there is a discrepancy.</p>				

2-4 CHAPTER 14 – EXTERIOR WALLS.

2-4.1 SECTION 1401 – GENERAL.

1401.2 - Corrosive Environments [Addition]

For corrosion prone locations as defined in UFC 1-200-01, protect steel surfaces by hot-dipped galvanizing or providing stainless steel. Use Type 316L stainless steel when using stainless steel. Protect hot-dipped galvanized metal with an industrial coating in addition to galvanizing, as galvanized metal will still corrode in these environments. Isolate dissimilar metals (for example, aluminum and steel, stainless steel and carbon steel, and zinc-coated steel and uncoated steel) by appropriate means to avoid the creation of galvanic cells which occur when dissimilar metals come in contact.

2-4.2 SECTION 1404 - INSTALLATION OF WALL COVERINGS.

1404.3.3 /2/ - Building Envelope Vapor Retarders [Addition]

For building enclosure systems or environmental conditions not covered elsewhere in IBC Article 1404, design the enclosure using simplified or transient design tools referenced in the *ASHRAE Handbook of Fundamentals*, Chapter 25, Heat, Air and Moisture Control in Building Assemblies, and the following sections. Do not provide multiple vapor retarders that trap moisture between the retarders. Select vapor retarders in accordance with ASTM C755. Based on the results of the analysis described in this section, design the assemblies for appropriate diffusion control.

1404.3.3.1 /2/ Vapor pressure differential calculation.

First determine the vapor pressure difference between indoor and outdoor climates. For exterior vapor pressure, use the mean outdoor dry bulb and dew-point temperatures for the coldest and hottest months in UFC 3-400-02. If the vapor pressure difference is less than 0.25" Hg (847 Pa), place the vapor retarder with appropriate permeance for the application on the predominantly high vapor pressure side of the assembly.

1404.3.3.2 /2/ Vapor pressure differential greater than 0.25 Hg (847 Pa).

If the vapor pressure difference between indoor and outdoor climates is greater than 0.25" Hg (847 Pa), perform a job-specific simplified or transient vapor transmission (hygrothermal) analysis for walls, roofs, and exposed floors (and floors over crawlspaces) based on project specific climate as defined by UFC 3-400-02, and the specified components and materials. Indicate the temperature and relative humidity for the inside and the outside of the building; a complete listing of building components, including the vapor retarder; their thickness, location, thermal resistance and permanence; and building location and use.

1404.3.3.2.1 /2/Simplified Hygrothermal Analysis.

Use the steady state dewpoint or Glaser methods described in the *ASHRAE Handbook of Fundamentals* (Chapter 25), using the mean outdoor dry bulb and dew point temperatures for the hottest and coldest months.

1404.3.3.2.2 /2/Transient Hygrothermal Analysis.

Use a mathematical model that simulates transient hygrothermal conditions, such as WUFI/ORNL (ASTM Manual 40 reviews these models). If the WUFI model is selected, use the climate data included in the WUFI program in lieu of UFC 3-400-02. Users of such methods must understand their limitations, and interpretation of the analysis results must be done by a trained person to reasonably extrapolate field performance approaching the design results. For the mathematical model method, use interior conditions based on a dewpoint of 53°F (12°C) in summer conditions and a dewpoint of 40°F (5°C) in winter conditions. The maximum threshold must be a surface relative humidity of 80% averaged over a period of 30 days to achieve a successful building enclosure assembly for temperatures between 40°F and 120°F (5°C and 50°C) and other criteria described in Chapter 6 of ASHRAE Standard 160. These are thresholds above which mold can grow and building assemblies deteriorate.

1404.3.4 /2/- Floor Slab Vapor Retarders. [Addition]

Floor slabs on grade must have a vapor retarder of 0.05 perms or less meeting the requirements of ASTM E1745 Class A. Under slab vapor retarders must be durable enough to withstand construction activity and must be terminated around the perimeter and penetrations detailed according to the manufacturer's instructions. Additionally, specifications must require measurement of slab relative humidity in accordance with ASTM F2170 to meet the requirements of the floor finish manufacturer or must include an application of a topical moisture mitigation material.

1404.3.5 /2/- Roof Vapor Retarders. [Addition]

Provide moisture analysis of the roof assemblies per paragraph titled, Building Envelope Vapor Retarders. Roof assemblies on concrete slabs must include a vapor retarder on top of the concrete and a vented metal deck to control moisture in the concrete from affecting roof assemblies. However, design low-slope roof assemblies using rigid insulation without a vapor retarder whenever possible. Install vapor retarder in accordance with guidance in the *NRCA Roofing and Waterproofing Manual*.

1404.4.3 - Sill Pan Flashing [Addition]

Penetrations such as windows and louvers in the exterior wall assemblies must have pan flashing installed in the rough opening sill. This pan sill flashing must have end dams at both jambs a minimum of 2 in. (50 mm) high and a rear dam of 2 in. (50 mm) high. Comply with ASTM E2112, the requirements in Chapter 4, Masonry, Brick Industry of America (BIA) Tech Notes, and the *SMACNA Architectural Sheet Metal Manual* recommendations.

1404.13.2 - Selection of Windows and Glazing. [Addition]

Based on a life cycle cost analysis (LCCA), select windows and glazing with the best possible performance from a U-factor, Solar Heat Gain Coefficient (SHGC), daylighting, and Visible Transmittance (VT) for the fenestration. Optimize the emissivity coatings to control both heat gain into the building due to solar radiation and heat loss from the building. Select frames with thermal breaks. Include flashings under fenestration in an appropriate manner. Fenestration must meet both code and UFC 4-010-01 requirements. Do not use steel, wood, or plastic-clad wood windows in locations with Environmental Severity Classifications (ESC) of C4 or C5. See UFC 1-200-01 for determination of ESC for a project location.

1404.13.3 - Aluminum Windows. [Addition]

Aluminum windows must be heavy-duty commercial quality systems; conforming to AAMA/WDMA/CSA 101. For window reinforcing purposes, concealed 316L stainless steel or aluminum reinforcing inserts are required. Internal fasteners must be 316L stainless steel. Aluminum windows must have anodized aluminum finish and color to meet the requirements in the applicable installation exterior architectural guidelines.

1404.13.4 - Operable Windows. [Addition]

Provide locks which discourage the opening of windows during HVAC system operation. Provide window guards at upper floor operable windows of housing projects in compliance with ASTM F2090.

1404.13.5 - Window Installation and Details. [Addition]

Install windows according to ASTM E2112. Provide concrete step detail that prevents water from being driven directly under window sills. Seal exterior window and door rough openings to prevent water infiltration into wall cavities including sealing exterior wall and interior side furred out walls.

1404.13.6 - Window Screens. [Addition]

Window screen must be mounted on the inside of the window frame with aluminum window frame screens matching the color of the window frame. Provide the anodized aluminum screen frames with 316L stainless steel spring clips to hold screen frame securely in window frame. Screen material must be plastic-coated fiberglass or aluminum mesh.

1404.13.7 - Weatherstripping. [Addition]

Provide nonferrous metal and UV-resistant vinyl weather stripping. Weatherstripping must be factory applied, and limit infiltration to 0.25 cubic feet/min/square foot (1.698 cubic meter/min/square meter) in accordance with ASTM E283.

1404.13.8 - Storefronts [Addition]

Exterior storefront systems must be heavy-duty commercial quality aluminum system with anodized aluminum finish and color to meet the requirements in the applicable installation exterior architectural guidelines; and conform to AAMA/WDMA/CSA 101. Storefront doors must be medium stile. Install storefronts according to ASTM E2112.

1404.13.9 - Exterior Glazing [Addition]

Exterior windows must have insulated glazing system (outer lite low E with an air space and interior lite meeting IBC requirements for wind and windborne debris protection, where applicable, and UFC requirements for Antiterrorism protection). Consider building energy efficiency, occupant comfort, daylighting, acoustic performance, and security when selecting exterior window and glazing systems. Coordinate glazing tint with applicable installation exterior architectural guidelines unless otherwise noted, sustainability recommendations and energy requirements. Unless otherwise required, unshaded glazing must be factory tinted; shaded glazing at storefront requiring see-through visibility may be clear, non-tinted.

2-4.3 SECTION 1407 - EXTERIOR INSULATION AND FINISH SYSTEMS (EIFS).

1407.7 - Exterior Insulation and Finish Systems (EIFS) Use and Detailing [Addition]

Selection of EIFS systems must be based on a LCCA that considers maintenance requirements and frequency of recoating. Use only self-draining EIFS systems. Do not install EIFS within 6 in (150 mm) of grade, or in areas where it will be subject to abuse by moving vehicles or equipment, such as a loading dock. Do not use EIFS in areas of heavy pedestrian traffic, or if such use cannot be avoided, specify high-impact resistant system. Use high-impact systems a minimum of 4 ft. (1220 mm) above grade where subject to damage from pedestrian traffic or lawn maintenance equipment.

Construction documents must provide specific design details for windows, trim, expansion joints, and drainage planes. Comply with the criteria listed in the latest version of EIFS Standards & ICC-ES Acceptance Criteria document produced by the EIFS Industry Members Association (EIMA). Where EIFS is applied to a (side) wall which has an eave from the roof, a premolded polypropylene / use PVC kickout flashing to channel the water away from the exterior wall.

1407.7.1 EIFS in High Wind Zones.

In areas with design wind loads up to 35 psf (170 Kg/m²) (118 mph or 190km/h), adhered EIFS must only be permitted provided the EIFS assembly includes a minimum 5/8-in.- (16-mm-) thick glass-fiber-faced siliconized gypsum sheathing fastened with corrosion-resistant screws that have a minimum 3/8-in- (10-mm-) diameter washer heads fastened to engineered light-gage metal framing spaced 16 in (405 mm) on center with screws spaced 4 in (100 mm) on center. In areas with higher wind speeds,

the contractor must provide \1\ wind-tested assemblies and submit test documentation establishing performance under design /1/ wind-loads in accordance with ASCE/SEI 7.

2-4.4 SECTION 1410 - GYPSUM BOARD CONSTRUCTION.

1410.1 - Prevention of Mold [Addition]

Use glass mat gypsum (paperless or non-cellulose facing) sheathing for exterior applications and use glass mat or moisture/mold resistant gypsum wall board for the interior face of exterior walls (prevents food source for mold). On exterior walls, use only interior wall finishes that allow water vapor within the wall to escape into the conditioned space. Do not use vinyl wall coverings, oil-based paint, and other vapor-resistant materials as interior finishes for exterior walls.

2-5 CHAPTER 18 – SOILS AND FOUNDATIONS.

2-5.1 SECTION 1805 - DAMPPROOFING AND WATERPROOFING.

1805.2.2 - Walls [Supplement]

If required to address hydrostatic pressure or as recommended by the geotechnical report, provide drainage planes combined with waterproofing material and a footing drain on below-grade walls.

1805.4.2 - Foundation Drain [Supplement]

Footing drains and under-slab drainage must be incorporated based on the recommendations of the geotechnical engineering report.

2-5.2 SECTION 1808 – FOUNDATIONS.

1808.6.5 - Insulation [Addition]

Where the energy model or code requires insulation for slab-on-ground floors, use high-density (40-100 psi [276-689 kPA] depending on floor loading with a safety factor of 5) extruded polystyrene under the vapor retarder. Apply requirements of ASCE 32-01 to keep soils thawed to minimize frost action in cold regions. Coordinate final assembly U-Factors with the mechanical engineer to comply with overall facility energy requirements. Protect insulation from weather, including rain, ultraviolet solar radiation, mechanical abuse, compression, or accidental or deliberate movement from its location during its service life.

2-6 CHAPTER 20 - ALUMINUM.

2-6.1 SECTION 2002 - MATERIALS.

2002.2 - Corrosion Prone Locations. [Addition]

For corrosion prone locations as defined in UFC 1-200-01, protect aluminum surfaces with an industrial coating or heavy-duty anodized coating. Isolate dissimilar metals (for example, aluminum and steel, stainless steel and carbon steel, and zinc-coated steel and uncoated steel) by appropriate means to avoid the creation of galvanic cells which occur when dissimilar metals come in contact.

2-7 CHAPTER 21 - MASONRY.

2-7.1 SECTION 2115 - MASONRY DETAILING AND MISCELLANEOUS PROVISIONS. [Addition].

2115.1 - Masonry Details [Addition]

Comply with the Brick Industry Association (BIA) Technote 7, Technote 18A, and Technote 21 for specific brick masonry recommendations and other topic specific Technotes as applicable.

2115.2 - Expansion Joint Position and Location [Addition]

No single recommendation for positioning and spacing of vertical expansion joints can be applicable to structures. Analyze each building to determine the potential horizontal and vertical movements and make provisions to relieve excessive stress that might be expected to result from such movement. Place expansion and crack control joints in accordance with BIA Technote 18A. Place expansion joints symmetrically on building elevations. Indicate expansion joints on the contract drawings.

2115.3 - Plastic and Membrane Through-Wall Flashing [Addition]

Plastic flashings and asphalt-impregnated felt flashings are prohibited.

2115.4 - Clearance Between Masonry and Back-up Construction [Addition]

Provide a 2-in. (50 mm) minimum clear dimension from the face of cavity insulation or sheathing material to the back of the exterior wythe of masonry. See American Concrete Institute, ACI 530 for additional information. See BIA Technote 21 for additional guidance.

2115.5 - Flashing at Penetrations and Projections [Addition]

Do not design structural steel frame members to be exposed inside a cavity wall. Provide flashing at penetrations exposed into the cavity such as columns or beams, and at floor slabs, wall projections and recesses, and wall bases. Projections, recesses, and caps must be flashed and sloped away from the wall to ease drainage.

2115.6 - Location of Weep Holes [Addition]

Provide open-head joint weeps at through-wall flashing for brick masonry. Locate weeps on the same course as the flashing. Space weep holes at 24 in. (610 mm) on

center for brick masonry and 32 in. (815 mm) on center for concrete masonry. Locate weeps above the level of the finished grade, including landscape mulching, to prevent the weeps from becoming clogged with foreign material. Weeps must be designed to be open-head joints with corrugated plastic inserts only. Provide masonry vents at top of walls and below continuous shelf angles. These provide better ventilation of cavity spaces to prevent buildup of warm, moist air at the tops of cavities. For single-wythe exterior CMU walls, provide a flashing/weep system for open CMU cells to drain to the exterior.

2-8 CHAPTER 22 - STEEL.

2-8.1 SECTION 2203 - PROTECTION OF STEEL FOR STRUCTURAL PURPOSES.

2203.2 - Corrosive Environments [Addition]

For corrosion prone locations as defined in UFC 1-200-01, protect steel surfaces by hot-dipped galvanizing or providing stainless steel. Use Type 316L stainless steel when using stainless steel. Protect hot-dipped galvanized metal with an industrial coating in addition to galvanizing, as galvanized metal will still corrode in these environments. Isolate dissimilar metals (for example, aluminum and steel, stainless steel and carbon steel, and zinc-coated steel and uncoated steel) by appropriate means to avoid the creation of galvanic cells which occur when dissimilar metals come in contact.

2-8.2 SECTION 2211 COLD-FORMED STEEL LIGHT-FRAME CONSTRUCTION.

2211.3 - Above-Grade Finished Floor Elevation [Addition]

Provide a minimum of 18 inches (455 mm) clear space above finished grade for light frame metal floor construction.

2-9 CHAPTER 23 - WOOD.

2-9.1 SECTION 2304 – GENERAL CONSTRUCTION REQUIREMENTS.

2304.12.1.1 - Joists, girders, and subfloor [Replacement]

Provide a minimum of 18 inches (455 mm) clear space above finish grade and crawlspaces for light-frame wood construction. Wood girders that are closer than 12 inches (305 mm) to the exposed ground in crawlspaces or unexcavated areas located within the perimeter of the building foundation must be naturally durable or preservative-treated wood.

2-10 CHAPTER 25 – GYPSUM BOARD, GYPSUM PANEL PRODUCTS AND PLASTER.

2-10.1 SECTION 2515 - TRIM AND MOLDINGS [Addition].

2515.1 - Materials.

In high humidity interior areas (for example, bathrooms, locker rooms, pools, trainers), areas open to the exterior (for example, mechanical rooms, and hangars), and spaces that are not conditioned by design or may not be conditioned during prolonged periods due to deployment, use PVC or plastic trims, casings, and accessories in lieu of metal, which may rust over time.

CANCELLED

CHAPTER 3 DESIGN

3-1 DESIGN QUALITY.

The following principles are adapted from GSA's *Guiding Principles for Federal Architecture*:

- Provide facilities in an architectural style and form that is distinguished, and which will reflect the dignity, enterprise, vigor, and stability of the Federal Government. Place emphasis on the choice of designs that embody the finest contemporary American architectural thought relative to the building's function. Pay specific attention to the possibilities of incorporating into such designs qualities that reflect the regional architectural traditions of that part of the country in which buildings are located. Designs must adhere to sound construction practice and utilize materials, methods, and equipment of proven dependability. Buildings must be economical to build, operate and maintain; resilient, sustainable, and accessible.
- The development of an official style must be avoided. Design must flow from the architectural profession to the Services and not vice versa.
- Consider the choice and development of the building site as the first step of the design process. Pay special attention to the general ensemble of streets and public places of which these buildings will form a part. Where appropriate, locate buildings to permit a generous development of landscape.

3-1.2 Installation Exterior Architecture.

Most military installations and service design agencies have published design guidelines that contain criteria relative to achieving, maintaining, and emphasizing a positive exterior visual environment. Follow the design guidance contained in these documents. In the absence of such guidelines, design facilities to harmonize with the character of existing facilities considered historically or architecturally significant to the area. Air Force projects must comply with the Air Force Corporate Facilities Standards and applicable Installation Facilities Standards.

3-1.3 Historic Architecture.

Follow the Secretary of Interior's Standards for Rehabilitation and Guidelines for Rehabilitating Historic Buildings for repair or renovation of historic facilities and new construction near historic facilities.

3-1.4 Projects in the National Capital Region (NCR).

In accordance with the National Capital Planning Act of 1952, as amended, submit all master plans and designs for proposed construction projects in the NCR to the National

Capital Planning Commission (NCPC) for appropriate reviews and approvals consistent with the timelines issued by the NCPC.

3-2 BUILDING ORIENTATION.

Establish building siting in \1\ in accordance with the Regulating Plan of the Installation Master Plan, see UFC 2-100-01, section 2-9.1.2./1/ Optimize building layout and orientation with regard to functional arrangement, access, exterior appearance, views, present and expected future site acoustic conditions, and other considerations.

Utilize the site environmental factors to orient buildings to minimize annual facility energy use and to optimize daylighting. Consider seasonal solar angles and prevailing winds to enhance energy performance of the building within the site-specific micro climate. See Appendix A Best Practices, paragraph Daylighting for additional information. See also UFC 1-200-02.

3-3 HAZARD PREVENTION.

Design facilities to comply with 29 CFR Occupational Safety and Health Act (OSHA). Pay particular attention to lead and asbestos particulates, which may be lying on top of materials to be removed, and polychlorinated biphenyls (PCBs) that are part of caulking and sealant materials that may have been absorbed into adjacent building materials and require grinding.\1\

Design fixed ladders and roof hatches in accordance with 29 CFR 1910.23 and the IBC, according to the most stringent requirements. Design handrails, guardrails, and fall arrest systems to comply with 29 CFR 1910.28, 29 CFR 1910.140, and the IBC, according to the most stringent requirements. /1/

3-3.1 Radon.

Evaluate and mitigate radon per the appropriate Service and Installation regulations.

3-3.1.1 Identification of Radon.

3-3.1.1.1 Army, Air Force and Navy.

Check the Environmental Protection Agency's (EPA's) Map of Radon Zones (by state), EPA 402-R-93-071, to determine the radon area.

3-3.1.1.2 Navy.

For Navy requirements follow OPNAV M-5090.1C Chapter 30 "Radon Assessment and Mitigation", and the Navy Radon Assessment and Mitigation Program (NAVRAMP) Guidebook for Naval Shore Installations. NAVRAMP provides for compliance with the procedural requirements of the Toxic Substances Control Act (TSCA) related to radon. For existing buildings check the results of the NAVRAMP survey by contacting the NAVFAC Facility Engineering Systems Command (FEC) Air Pollution Engineer.

3-3.1.1.3 Air Force.

Check the results of the AF Radon Assessment and Mitigation Program (RAMP) study of 1987. During that study, Air Force Installations were screened for radon in existing structures. Installations were classified as being of low, medium, or high risk. Incorporate radon reduction measures in the construction of new facilities at those installations designated as medium or high risk if installation not included in EPA Priority Areas No. 1. See AFMAN 48-148 for additional guidance on radon sampling and mitigation.

3-3.1.1.4 Lack of Radon Data.

If no data is available for the area or site to make a prediction of radon levels, then a radon survey must be done, or a passive radon mitigation system installed.

3-3.1.2 Radon Mitigation System Design.

Provide passive under-slab depressurization systems for projects located in Priority Areas No. 1 (predicted average radon level is greater than 4/pCi/L). Change the system to active, if needed, based on follow-up testing. Check the following EPA documents available from the EPA's Publications about Radon website, <https://www.epa.gov/radon/publications-about-radon>

- EPA's Model Standards and Techniques for Control of Radon in New Residences, U.S. Environmental Protection Agency, Air and Radiation (6604-J), EPA 402-R-94-009,
- Radon Prevention in the Design and Construction of Schools and Other Large Buildings, EPA/625/R-92-016,

3-3.2 Paints with Lead, Cadmium, and Chromium.

Painted surfaces containing lead, cadmium, and chromium, as well as operations involving these and other heavy metals are regulated by the Occupational Safety and Health Act (OSHA) and the Resource Conservation and Recovery Act (RCRA). Paints containing lead, cadmium, and chromium are often found as protective coatings on structural steel, tanks, piping, metal building components, exterior coatings on metal surfaces, aircraft, and ships. Paints containing lead, cadmium, chromium, and other heavy metals are used in current operational processes in various facilities, such as aircraft maintenance hangars, and ship maintenance and repair facilities. If not properly controlled and managed, dust and particulates containing lead, cadmium, chromium, and other heavy metals can be generated from operational activities resulting in contaminated dust deposits on building surfaces that must be remediated during renovation, alteration, repair, or demolition activities. For Navy and Marine Corps projects involving renovation, alteration, repair, or demolition, comply with UFC 3-810-01N.

Facilities with heavy metal paints or coatings, or facilities that operated or will operate utilizing heavy metals or chemicals in their operations, must comply with the Occupational Safety and Health Act 29 CFR 1910.141 General Environmental Controls, 29 CFR 1910.1025 Lead, 29 CFR 1910.1026 Chromium (VI), and 29 CFR 1910.1027 Cadmium. The requirements found in the CFR may affect facility design requirements, which include but are not limited to: separate toilets and washing/bathing areas, change rooms, decontamination areas, clothes washing facilities, areas for controlled disposal of contaminated waste and work clothes, high-efficiency particulate air (HEPA) systems and filters, and deluge showers. Designate areas of facilities utilizing these heavy metals or chemicals as regulated areas whenever exposure can be expected to be in excess of the permissible exposure limit(s), and demarcate from the rest of the workplace in a manner that adequately establishes and alerts building occupants of the boundaries of the regulated area. Design facilities to allow the performance of the OSHA and EPA air sampling and monitoring as required for the specific hazardous metal or chemical in use.

3-3.3 Beryllium Coatings and Compounds.

Beryllium is an essential material used in the aerospace, electronics, energy, telecommunications, information technology, defense, medical, and nuclear industries. Beryllium is classified as a strategic and critical material by the U.S. Department of Defense. Beryllium is used industrially in three forms: as a pure metal, as beryllium oxide, and most commonly as an alloy with copper, aluminum, magnesium, or nickel. Workers in industries where beryllium is present may be exposed to beryllium by inhaling or contacting beryllium in the air or on surfaces. Beryllium is a highly toxic metal and workers who inhale beryllium are at an increased risk of developing chronic beryllium disease (CBD) or lung cancer. Coatings and compounds containing beryllium are used in current operational processes in various facilities, such as aircraft maintenance hangars, and ship maintenance and repair facilities. If not properly controlled and managed, dust and particulates containing beryllium can be generated from operational activities resulting in contaminated dust deposits on building surfaces which must be remediated during renovation, alteration, repair, or demolition activities. For Navy and Marine Corps projects involving renovation, alteration, repair, or demolition, comply with UFC 3-810-01N.

Facilities that operated or will operate utilizing beryllium in their operations must comply with the Occupational Safety and Health Act 29 CFR 1910.1024 Beryllium, 29 CFR 1915.1024 Beryllium, and 29 CFR 1926.1124 Beryllium. The requirements found in the CFR may affect facility design requirements, which include but are not limited to: separate toilets and washing/bathing areas, change rooms, decontamination areas, clothes washing facilities, areas for controlled disposal of contaminated waste and work clothes, high-efficiency particulate air (HEPA) systems and filters, and deluge showers. Designate areas of facilities utilizing these heavy metals or chemicals as regulated areas whenever exposure can be expected to be in excess of the permissible exposure limit(s), and demarcate from the rest of the workplace in a manner that adequately establishes and alerts building occupants of the boundaries of the regulated area.

Design facilities in a manner to allow the performance of the OSHA and EPA air sampling and monitoring that are required for beryllium.

3-4 MECHANICAL/ELECTRICAL/TELECOMMUNICATION ROOMS.

Design adequate mechanical equipment rooms, electrical rooms, and telecommunication rooms. Provide sufficient floor-to-floor height, vertical distribution space, and mechanical equipment space to accommodate a ducted system to supply preconditioned ventilation air (when a ducted system is used). Provide an adequate volume of space for all building distribution systems and provide access for maintenance. For mechanical equipment room sizing, coordinate with the mechanical designer at the earliest stage to ensure the required clearances for maintenance, servicing, and safety are included. Provide mechanical rooms in accordance with UFC 3-410-01. For telecommunications rooms, coordinate with the electrical designer. Do not route water or sanitary piping above electrical rooms or telecommunication rooms. See UFC 3-580-01 for additional telecommunications system requirements. For noise control, refer to Chapter 2 paragraph, Sound Transmission.

3-5 PLUMBING.

Refer to UFC 3-420-01 for plumbing fixture count and requirements.

3-6 AIR BARRIER DESIGN AND TESTING.

3-6.1 New Construction.

Clearly identify air barrier components of each envelope assembly on construction documents and detail the joints, interconnections, and penetrations of the air barrier components. Clearly identify the boundary limits of the building air barriers and of the zone or zones to be tested for building air tightness on the drawings. Include the calculated six-sided area of the air barrier envelope on the drawings for each test area.

Compartmentalize spaces under negative pressure, such as boiler rooms and laundry rooms, and provide make-up air for combustion. \1\

3-6.2 Modifications.

When a building is undergoing a modification /1/ of the building envelope, see Appendix A, paragraph Air Barrier for Modifying an Existing Building, for guidance.

3-6.3 Inspections and Testing.

Continuous air barrier inspection and testing must be in accordance with the requirements of the International Green Construction Code (IgCC) with \2\ building air leakage rate not exceeding 0.25 cfm/ft² (1.25 L/s-m²) under a pressure differential of 0.3 inches of water (75 Pa) when tested. /2/

Detailed inspection and testing requirements and acceptance criteria must be included in the project specifications. Include UFGS Section \3\ 01 91 19 /3/ as part of the project specification when testing of the air barrier is required.

The following facility air barriers require inspection only:

- Those facility types outside the scope of ASHRAE 90.1
- \3\ Navy / Army: New and existing buildings and conditioned spaces under 10,000 ft² (929 m²) /3/
- \3\ Air Force: No exception for new buildings and conditioned spaces, regardless of size. /3/
- Semi-heated buildings
- \3\ Spaces with large exterior doors, such as sliding hangar doors, overhead coiling and, or sectional doors. /3/
- Building additions onto non-renovated structures if the interface cannot be adequately sealed for testing.

3-6.4 Mock-Ups.

Mockups for air barrier installation require approval by the AHJ. See Appendix A, Best Practices for guidance.

3-7 FENESTRATION DESIGN.

Develop a comprehensive design that considers both exterior shading devices, including horizontal sunscreens and vertical fins (beneficial in hot southern climates), and interior shading devices (necessary to control glare when direct solar intrusion is inevitable). Optimize the window-to-wall ratio to (1) reduce lighting energy when using daylighting controls and (2) avoid the glare and added energy consumption that can result from large window areas. Glazing areas above 7 ft. (2135 mm) high are useful in increasing daylight penetration, especially when coupled with light-reflecting shelves. Base design on life cycle cost effectiveness. Design glazing to optimize daylighting and views, which has been proven to enhance occupant well-being.

Coordinate the selection among windows, storefronts, and curtain walls with the structural design. Coordinate the final fenestration design with the mechanical and electrical engineers to comply with overall facility energy requirements.

3-7.1 Daylighting \3\ Design /3/.

Design DoD projects to optimize daylight entering occupied spaces while minimizing the effects of solar heat gain and glare. See Appendix A for daylighting best practices.

3-8 ACOUSTICS – OUTSIDE TO INSIDE NOISE CONTROL.

3-8.1 Design.

Design the facility to provide a comfortable inside acoustical environment that limits exterior noise intrusion to noise-sensitive spaces. Develop a comprehensive acoustical design for individual facilities based on the acoustic analysis that uses the tools below. Identify outside noise sources. Utilize the Air Installation Compatible Use Zones (AICUZ) map and determine the Day Night Average Sound Level (DNL) or Community Noise Equivalent Level (CNEL) of the project site. In addition to the AICUZ map noise level, determine if other noise sources are near the project site. Other noise sources include engine test facilities, vehicle traffic, rail line, small arms ranges, or any site noise source that can be identified. Determine if any of the following noise sources are within the following distances:

- Major Road within 1,000 ft. (305 m) project site
- Rapid Transit Line or Rail Line within 3,000 ft. (915 m) of project site
- Engine Test Facility within 3,000 ft. (915 m) of project site
- Firing Range within 3,000 ft. (915 m) of project site

If an AICUZ map is available, use Table 3-1 for noise mitigation measures. If the project site is within the specified distance of a noise generating element listed above, the project will require an acoustical engineer to conduct an analysis including a site noise test for a continuous 72 hours to determine the DNL or CNEL.

If an AICUZ map is unavailable, and the project site is within the specified distance of a noise generating element listed above, the project will require an acoustical engineer to conduct an analysis including a site noise test for a continuous 72 hours to determine the DNL or CNEL. The measurement period must include two weekdays and one weekend day to capture typical site activity and be conducted in accordance with ANSI S12.9 Parts 1 & 2 – Quantities and Procedures for Description and Measurement of Environmental Sound. Based on the AICUZ map and testing results, the table below summarizes the required composite Outdoor Indoor Transmission Class (OITC) values for the building envelope.

Table 3-1 Building Façade Sound Isolation

Required Composite⁽¹⁾ Isolation of Building Façade and Roof Construction Based on Interior Background Noise Levels				
Interior Background Noise Level ⁽²⁾	Exterior Sound Level at the Site (DNL or CNEL)			
	< 65 dBA	65 dBA - 70 dBA	70 dBA - 75 dBA	> 75 dBA
NC-25 or Lower	OITC 35	OITC 40	OITC 45	OITC 50
NC-30	OITC 30	OITC 35	OITC 40	OITC 45
NC-35	OITC 28	OITC 30	OITC 35	OITC 40
Above NC-35	OITC 25	OITC 28	OITC 30	OITC 35

1. Composite calculations must include all envelope elements including doors, windows, louvers, and other openings.
2. Equivalent RC Mark II noise levels may be used.

Apply the more stringent criteria when the project site has both AICUZ map information and site noise testing measurements.

CANCELLED

CHAPTER 4 PROGRAMMING, PLANNING, AND PRE-DESIGN SERVICES

4-1 SPACE PLANNING CRITERIA.

Program non-standardized facility sizes based on a functional analysis of activities to be accommodated to determine the actual amount of space required. Base facility planning on specific requirements for each project, to include all functional, technical, and economic considerations. To obtain the most economical and efficient use of space, design facilities based on the functional organization of adequately sized spaces. The following publications contain tables of allowances for general planning purposes; however, the final size of each project must be based on actual requirements:

- AFMAN 32-1084, "Facility Requirements"
- AR 405-70, Utilization of Real Property
- TM 5-803-5, "Installation Design" and model design-build RFP and standard designs, as applicable
- UFC 2-000-05N, Facility Planning Criteria for Navy/Marine Corps Shore Installations

The documents above are used to determine general facility requirements. Refer to other facility-specific UFC for more detailed requirements.

4-2 BUILDING AREA CALCULATIONS.

Include net and gross floor area calculations in the Basis of Design/Design Analysis to confirm scope and code/criteria compliance. Include a block diagram indicating the building outline and all areas that contribute to the building area. Conform to gross area calculation methods and definitions for military programming and scope validation in this UFC. For Type of Spaces and Definitions, see Table 4-1. Other area calculations and definitions may be required to establish compliance with IBC and Life Safety codes. Figures 4-1 and 4-2 illustrate a sample gross building area calculation and block diagram.

4-2.1 Scope Changes.

Changes to scope are governed by Title 10 USC 2853, as documented in project Change Management Plans included in the Project Management Plans.

4-2.2 Calculations of Gross Building Area.

Other facility-specific UFC such as those for medical facilities, family housing, and unaccompanied housing provide additional guidance regarding how to calculate the gross area for those facility types. For other facilities, calculate the gross area of a building using Table 4-1 (definitions of spaces per IBC).

Table 4-1 Gross Building Area

Type of Space	Definition
Enclosed Spaces	<p>The total area of all floors measured from the exterior face of exterior walls or from centerline of walls separating adjoined buildings including:</p> <ul style="list-style-type: none"> - mezzanines - basements - penthouses - enclosed spaces such as pre-engineered metal building's housing equipment. - enclosed stairwells, elevators, utility chases are included as part of the area of the floor that they occupy.
Unenclosed Programmed Facilities	<p>For covered outdoor facilities with no exterior walls, where the area is programmed by the space function (for example, walls are not required and only a roof is necessary to perform its designated function) the facility gross square footage is the total area measured under the roof. Refer to individual service component planning documents for programmed areas of these spaces.</p>
One-Half Spaces	<p>Include one-half of the gross area of paved or finished attached covered areas, such as:</p> <ul style="list-style-type: none"> - balconies and porches - covered but not enclosed entrances - covered raised loading platforms - covered ground level or depressed loading facilities - covered but not enclosed walks or passageways - covered and uncovered but not enclosed exterior stairs - covered ramps <p>For Army Unaccompanied Enlisted Personnel Housing (UEPH) calculate interior shared corridors as one-half space; calculate circulation spaces within the living unit as full area.</p>
Excluded Spaces	<p>Exclude the following spaces from the gross area calculations when the average ceiling height is less than 7 ft (2.1 m) measured from the underside of a structural system and with perimeter walls measuring a minimum of 59 in. (1500mm) in height:</p> <ul style="list-style-type: none"> - mezzanines - interstitial spaces - penthouses - enclosed crawl and utility spaces such as tunnels, raceways, and trenches-catwalks - equipment platforms - exterior uncovered walks, ramps, and stoops - uncovered loading platforms or facilities, either depressed, ground level, or raised

Excluded Spaces	<ul style="list-style-type: none"> - open courtyards - open paved terraces - roof overhangs - glazing shading devices, and awnings - Prefabricated enclosures provided by the equipment manufacturer which house equipment are considered equipment and are also excluded - the void areas of atria (only include the floor area of the lowest level of atria)
-----------------	--

Figure 4-1 Sample Gross Building Area Calculation

PROJECT LOCATION		
GROSS FLOOR AREA CALCULATION * (SEE BLOCK PLAN EXAMPLE)		
<u>AREA A</u>		
Area A	$124'-6" \times 52'-4" = 6515.1 \text{ sf}$	
AREA A TOTAL		6515.1 sf 605.3 sm
<u>AREAS A1 thru A5 (Exterior Covered – ½ Area)</u>		
Area A1	$17'-0" \times 7'-0" / 2 =$	59.5 sf
Area A2	$42'-3" \times 7'-0" / 2 =$	148.0 sf
Area A3	$22'-8" \times 7'-0" / 2 =$	79.0 sf
Area A4	$17'-0" \times 7'-0" / 2 =$	59.5 sf
Area A5	$10'-6" \times 9'-0" / 2 =$	47.0 sf
AREAS A1 thru A5 TOTAL		393.0 sf 36.5 sm
<u>AREA B</u>		
Area B	$9'-0" \times 32'-4" =$	291.0 sf 27.0 sm
<u>AREA B1 (Exterior Covered – ½ Area)</u>		
Area B1	$9'-0" \times 5'-3" / 2 =$	24.0 sf
AREA B1 TOTAL		24.0 sf 2.2 sm
BUILDING TOTAL GROSS		7,223.5 sf 670.9 sm
SCOPE TOTAL MAX. ALLOWABLE GROSS AREA*		7,224 sf 671 sm



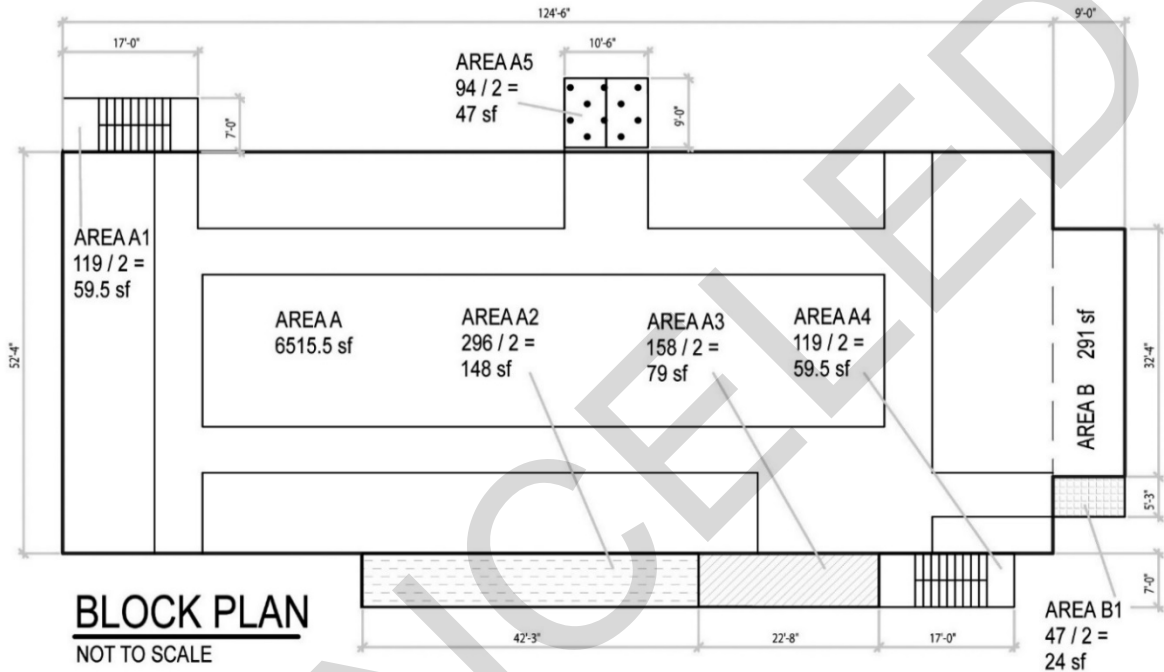

Figure 4-2 Sample Block Plan

ARCHITECTURAL BASIS OF DESIGN FOR PROJECT NUMBER ***

EXAMPLE BUILDING PROJECT NAME at the EXAMPLE MILITARY INSTALLATION LOCATION
 SERVICE BRANCH SPECIFICATION NUMBER Xxxxxx-xx-x-xxxx



LEGEND OF COVERED BUT NOT ENCLOSED SPACES

-  COVERED ENTRANCES - HALF SQUARE FOOTAGE
-  COVERED EXTERIOR STAIRS - HALF SQUARE FOOTAGE
-  COVERED RAMPS - HALF SQUARE FOOTAGE
-  COVERED PORCHES - HALF SQUARE FOOTAGE
-  COVERED LOADING FACILITIES - HALF SQUARE FOOTAGE

EXAMPLE BUILDING AREA TABULATION

BUILDING AREA A	6,515.5 sf	605.3 sm
OUTSIDE STAIR A1	59.5 sf	5.5 sm
RAMP A2	148.0 sf	13.7 sm
PORCH A3	79.0 sf	7.3 sm
OUTSIDE STAIR A4	59.5 sf	5.5 sm
LOADING AREA A5	47.0 sf	4.4 sm
BUILDING AREA B	291.0 sf	27.0 sm
COVERED ENTRANCE B1	24.0 sf	2.2 sm
TOTAL 1391 AREA	7,223.5 sf	670.9 sm
1391 ALLOWABLE AREA	7,224 sf	671 sm

4-3 PRE-DESIGN SERVICES.

This process involves meeting with the using activity to review the programmed requirements for a new project. Based on these meetings the program documents and the DD Form 1391 are updated for submission to Congress. Prepare DD Form 1391 using the Electronic Project Generator (EPG) for Navy projects. For Army and Air Force projects, use the DD Form 1391 Processor System. Government personnel normally complete this process, but often an Architect/Engineer is contracted to provide planning support for preliminary programming, studying functional adjacencies, providing sketches, and other design-related support. A planning charrette is used to define the user's requirements.

CANCELLED

This Page Intentionally Left Blank

CANCELLED

CHAPTER 5 DESIGN AND POST-DESIGN SERVICES

5-1 GENERAL.

Provide architectural design services in accordance with this chapter. For the Navy, provide architectural design services in accordance with FC 1-300-09N. For Air Force, projects comply with the Air Force Corporate Facilities Standards and applicable Installation Facility Standards.

5-2 DESIGN SERVICES.

Provide the following design services unless modified by the contract.

5-2.1 Design Charrettes.

Functional Analysis Concept Developments (FACDs) and design charrettes are cooperative efforts by the design team, user/customer representatives, Government design and contract personnel, and other interested parties. They may last a few days, or a week or more, and include on-site development of a consensus conceptual design in response to functional, aesthetic, environmental, base planning, site, budgetary, and other requirements. For Air Force projects, the final document is called a Planning Charrette Report (PCR). In addition to Charrettes, the Navy also uses FACD studies; see FC 1-300-09N for additional information on FACDs. The scope of FACDs, PCRs, and design charrettes are project specific and will be defined in the Scope of Work.

5-2.2 Architectural Compatibility Submittal.

If the project Scope or Statement of Work requires an Architectural Compatibility Submittal, it must meet the requirements herein. On high visibility projects, the designer of record may be asked to provide a presentation of this submittal. If a project does not require a separate Architectural Compatibility Submittal, address exterior building design and compatibility in the Basis of Design, as defined herein, using applicable installation exterior architectural guidelines.

When required, the Architectural Compatibility Submittal documents the exterior architectural design of a new facility or major renovation. Determine architectural compatibility at the concept stage of the project. Provide adequate documentation that indicates that the materials, colors, and design elements used on the exterior of the building are compatible with other facilities nearby and with other design guidance required by the installation or customer. Clearly show that the design meets the requirements of Chapter 3 paragraph, Design Quality.

5-2.2.1 Exterior Finish and Color Schedule.

The Architect is responsible for selection and coordination of final exterior finish and color selections using installation architectural guidelines, after obtaining input from the using activity and the Government's architectural reviewer. Indicate these selections on a comprehensive schedule located on the contract drawings.

5-2.2.2 Format.

The Architectural Compatibility Submittal consists of the following four elements:

5-2.2.2.1 Statement of Compatibility.

Provide a brief description of the design, stating concisely the architectural compatibility of the project with respect to the existing nearby permanent facilities and the applicable installation exterior architectural guidelines. Include not only building characteristics, but also a site analysis, visual environment concept, and appropriateness of construction materials and colors.

5-2.2.2.2 Drawings.

Provide the following drawings as applicable:

1. Site Plan - Indicate site boundaries, building locations (existing, proposed, and future), drives and roads, parking, pedestrian circulation, pedestrian and service entrances, \2\ dumpsters /2/ and landscaping.
2. Floor Plans - Indicate main entrances, service areas, room designations, and exterior stairs and ramps.
3. Elevations - Provide all building elevations, and indicate all exterior materials, architectural characteristics and design elements. As an option, provide concept renderings.

5-2.2.2.3 Exterior Color Boards.

Provide tangible samples of all exterior materials and colors. When matching existing materials and colors, it is not sufficient to state, "match existing."

5-2.2.2.4 Photographs.

Provide enough digital photographs to indicate the character of the existing nearby facilities that have influence on the architectural design of the project. Reference photograph locations on the Site Plan or with a key plan.

5-2.3 Architectural Basis of Design/Design Analysis.

The Basis of Design/Design Analysis is a written document that describes the project at the Preliminary Stage and is updated at each subsequent stage. The Navy uses the term Basis of Design. The Army and Air Force use the term Design Analysis. Include the following items:

1. Scope of Work – Summarize the architectural program or scope of work, listing the overall square footage, the functional requirements of the facility, and a tabulation of rooms with square footages of each space.

2. Type of Construction - Describe the type of construction selected and justify its use relative to building permanency, life cycle cost, functionality, and fire resistance. Coordinate with the Fire Protection Engineer.
3. Life Safety Code Analysis - Provide an analysis of the design to include the required number of exits, travel distances, egress capacity of exits, and fire area separations. Coordinate with the Fire Protection Engineer.
4. Gross Floor Area Calculations - Provide a tabulated breakdown of the net and gross programmed areas to confirm project scope and statutory criteria compliance. Provide a supplemental drawing keyed to the area tabulation. Indicate method of take-off based on calculation and diagram guidance in Chapter 4.
5. Accessibility - Describe accessibility features included in the project and indicate how the design meets the accessibility requirements noted in UFC 1-200-01. If a partial or full exclusion to accessibility requirements has been or is being pursued indicate proper documentation and the status of the exclusion.
6. Architectural Compatibility - Identify the design guidelines that pertain to this project and describe how the proposed design incorporates these guidelines. Discuss the approach to achieving architectural compatibility with other surrounding architecture in accordance with the installation exterior architectural guidelines. Exterior color boards are required for all projects. For Air Force projects, refer to the Air Force Corporate Facilities Standards and applicable Installation Facilities Standards.
7. Roof System Selection - Indicate the construction of the roof, roof membrane selection, substrate, roof slope, roof drainage system, and justify the use of parapets.
8. Thermal Insulation - Describe the types of insulation to be provided and indicate specific "U" values for the wall, roof, and floor construction. Provide a description of all architectural energy conserving and generating features, including any passive solar systems. Provide a moisture vapor analysis in accordance with Chapter 2 of this UFC.
9. Security Requirements - Describe the physical security or hardening requirements such as controlled access, SCIF, and Secure Room requirements that will be used in the design.
10. Antiterrorism – Per UFC 4-010-01, DoD buildings are categorized as low occupancy, inhabited, primary gathering, high-occupancy family housing, or billeting. Describe the occupancy of the facility, if progressive collapse avoidance will be included in the design, if the facility is within a controlled perimeter, and what the standoff distances will be. Include sketches as required to depict the site of the project and standoff distances. Include a summary of how the facility meets each of the applicable Standards in UFC 4-010-01 and Geographic Combatant Commander (GCC) Antiterrorism construction standards. Outline any special requirements, including any requirement for hardening of the facility. Provide the construction information necessary for the installation of all applicable Standards in UFC 4-010-01 and the Geographic

Combatant Commander (GCC) Antiterrorism construction standards. Do not include information on force protection methods, philosophy, explosive weights, and design threats, as this information is considered sensitive and Controlled Unclassified Information.

11. Architectural Acoustics – Include a statement of adherence to the applicable criteria per Chapters 2 and 3 of this UFC. This statement must include, but not be limited to:

- Identify design team members responsible for the acoustical engineering.
- Provide a detailed identification of conditions, materials, or features which will impact the acoustic design of the project.
- Describe Testing, Mock-up, Commissioning, and Quality Control processes.

Upon the completion of a project, if post-construction testing is not included in the project scope, the Government may elect to test the airborne or impact isolation sound isolation, background noise level, or other parameters established as project criteria. Additional modifications or remediation to meet the project acoustical criteria will be at the expense of Design-Build or Construction team.

12. Sustainable Design – Include the architectural description of the sustainable design in the separate chapter “Sustainable Design”. Describe the overall sustainability and energy performance of the project, with the architectural portion leading the process of compliance. Describe the sustainable design features included in the design. Provide an analysis of compliance with applicable requirements of UFC 1-200-02; the High Performance and Sustainable Building (HPSB) Checklist and description of how targets will be met, or justifications for missed targets. When applicable, include the sustainable Third Party Certification checklist and describe how applicable credits align with the HPSB Checklist requirements.

13. Doors and Windows - Indicate the types of doors and windows selected for the project and explain the basis for their selection. Use operable windows where feasible. Indicate any special door requirements such as STC ratings, cipher locks. Indicate any special window requirements such as OITC ratings.

14. Demolition or Deconstruction – Describe the extent of any architectural demolition or deconstruction and items to be salvaged.

15. Special Construction Features - Describe the special construction features built into the facility, such as barred windows, special wall/roof construction, raised flooring, radio frequency electromagnetic radiation (RF) shielding, High-Altitude Electromagnetic Pulse (HEMP) protection, and vaults.

16. Commissioning – Identify architectural systems scheduled for commissioning as required by the Commissioning Plan.

5-2.4 Specifications.

Design-Bid-Build and Design-Build projects have differing specification requirements. Specifications must be concise, definitive, and free of ambiguities and omissions that may result in controversy and contractor claims for additional compensation. For Army and Navy design-bid-build specifications, the use of SPECSINTACT and Unified Facilities Guide Specifications (UFGS) is required. These documents are available on the WBDG website. For Air Force projects, the use of UFGS or other commercial guide specifications is at the discretion of the Air Force Project Manager. For projects using UFGS, comply with UFC 1-300-02. For Navy projects, see also FC 1-300-09N. When preparing a Design-Build Request for Proposal (RFP), see the NAVFAC Design Build Master website located at <https://www.wbdg.org/ffc/navy-navfac/design-build-request-proposal>.

5-2.5 Architectural Drawings.

Confirm drawing size with the Government Project Manager prior to starting drawings. Provide architectural drawings that comply with the National CAD Standard and Spatial Data Standard (SDSFIE) for Facilities, Infrastructure, and Environment/ Computer-Aided Design and Drafting (SDS/CADD Standards). For projects accomplished using Building Information Modeling (BIM) use the National BIM Standard, along with published Service supplemental standards. Include the following requirements in the final drawings as applicable:

1. Title and General Sheets: Lists all drawings in the set, project title, project name, location map, and vicinity map.

Floor Plans: Fully dimensioned and referencing other drawings. Indicate plan orientation. Draw building plans parallel to the sheet border with north generally up or to the left or right edge if better suited. Orient floor plans consistently throughout all discipline drawings. Orient site and building plans in approximately the same orientation.
2. Building Code/Life Safety Code Analysis: Conduct a diagrammatic analysis and indicate code compliance (such as remoteness of exits, common path of travel, compartmentalization, and fire extinguisher locations) to graphically demonstrate compliance with the Life Safety Code. Coordinate with Fire Protection Engineer as required.
3. Furniture Placement Plans: Indicate furniture arrangement if separate interior design drawings are not provided in the drawing set.
4. Roof Plans: Completely dimensioned and referencing other details.

Reflected Ceiling Plans: Fully coordinated with disciplines.
5. Building Elevations: For elevations indicate location of control joints and expansion joints.
6. Building Sections and Wall Sections: For differing conditions, identify air barrier, moisture barrier, and insulation barrier systems.

7. Wall Types: Provide all interior and exterior wall and partition types. Indicate wall type locations on the floor plans.
8. Air Barrier: Indicate the boundary limits of the air barrier components (pressurization area for air barrier testing) on the plan and section. Indicate the actual area of the pressure boundary (ft.²/m²).
9. Interior Elevations: Indicate differing conditions and coordinate with other drawings.
10. Doors, Windows, and Louvers: Provide types, schedules, and details.
11. Room Finish Schedule, Legend, and Finish Notes: For all finishes.
12. Signage Plan, Schedule, Legend, and Notes if not provided on separate interior design drawings.
13. Detail all conditions. Pay particular attention to the moisture barrier system, the continuous air barrier, wall and roof penetration flashing details, surface termination and transitions, roof ridges, roof edges, and parapet and drainage details.

Provide drawing requirements suitable for the project type and scope of work.

5-2.5.1 Exterior Finishes and Colors.

Provide a comprehensive exterior finish and color schedule, indicating selections for all exterior materials. Locate this schedule on the finish schedule sheet or on the sheet with the exterior building elevations. When matching existing materials and colors, it is not sufficient to state, "match existing." Do not indicate that the Contracting Officer will make color selections.

5-2.5.2 Dimensioning.

Provide floor plans with sufficient dimensions to avoid difficulties during construction. Provide adequate dimensions on each floor plan so that it is not necessary to refer to other drawings in order to determine dimensions. Dimensioning guidelines are as follows:

5-2.5.3 Exterior Dimensions.

- Provide overall building dimensions.
- Provide dimensions to include building expansion joints.
- Provide continuous dimension strings from column centerlines to exterior building surfaces.
- Provide continuous dimension strings from column centerlines to exterior building wall line breaks.
- Provide dimensions to wall and masonry openings.
- Provide vertical dimensions for elevations and sections.

- Coordinate overall architectural dimensions with structural dimensions on the structural drawings.

5-2.5.4 Interior Dimensions.

- Dimensions must indicate design intent. For example, if a door is to be centered on a space, indicate dimensions as “equal-equal.”
- Indicate all statutory dimensions, such as accessibility requirements and egress.
- Provide continuous strings of dimensions through the building in each direction that extend through the exterior wall.
- Dimension masonry walls and stud partitions to one side of the wall. Wall thickness may be indicated with dimensions or by wall types.
- When a dimension string passes through a space that is shown elsewhere at a larger scale, this space may be provided with an overall dimension. The large-scale plan must show additional dimensions. To ensure continuity, take dimensions from the same wall face as shown on the overall plan.
- Where a wall or partition aligns with a column, wall opening, window jamb, or other feature, ensure that other dimensions to that wall or partition are to the same face. Additionally, if a dimension is to a particular wall or partition face, then other dimensions to that wall must be to that face.

5-2.5.5 Referencing.

1. Use reference symbols (section and detail cuts) liberally on the drawings to indicate which section or detail applies. Use material indications to clearly identify construction materials. Generally, provide the following:
2. Floor Plans – Indicate building and wall sections, major details, and areas of large-scale plans.
3. Building Elevations – Indicate building and major wall sections, expansion, control and seismic joints, construction materials.
4. Building Sections – Indicate wall sections, major details, such as air barrier interfaces, and construction materials.
5. Details – Indicate construction materials. Where several sections or details are provided on the same drawing, it is acceptable to reference a single section or detail for materials with additional call-outs as needed for differing conditions.

5-2.6 Color Boards and Binders.

Exterior finish material color boards or binders displaying actual samples of all proposed finishes are required during the design of a project. If binders are provided, provide in accordance with UFC 3-120-10.

This Page Intentionally Left Blank

CANCELLED

APPENDIX A BEST PRACTICES

A-1 INTRODUCTION.

This appendix identifies background information, good architectural design practices, and DoD preferences. The designer is expected to review and interpret this guidance and apply the information according to the needs of the project.

A-2 WHOLE BUILDING DESIGN GUIDE.

The Whole Building Design Guide provides additional information and discussion on architectural practice and facility design, including a holistic approach to integrated design of facilities.

The WBDG provides access to all Construction Criteria Base (CCB) criteria, standards, and codes for the DoD Military Departments, National Aeronautics and Space Administration (NASA), and others. These include Unified Facilities Criteria (UFC), Unified Facilities Guide Specifications (UFGS), Performance Technical Specifications (PTS), design manuals, and specifications. For approved Government employees, it also provides access to non-government standards.

A-3 PLANNING ISSUES.

Consider the following issues when planning a facility:

A-3.1 Building Orientation.

In general, minimize east- and west-facing glazing. The orientation for rectilinear CONUS buildings is with the long axis parallel to the east/west direction for optimum energy conservation. Typically, orient glazing north (south in the southern hemisphere) to provide daylighting while minimizing glare. South-facing glazing (north in the southern hemisphere) should be appropriately shaded on the exterior to exclude summer (winter in the southern hemisphere) sun.

A-3.2 Design for Flexibility.

Flexibility in architectural design facilitates the change or expansion of an existing structure to accommodate changing functional requirements with minimum expenditure of resources. DoD usually owns and operates its facilities from the time of construction until the end of its useful life. During this long tenure of use, functional requirements of buildings will change, often drastically. Careful planning for reconfigurable technology infrastructure and utility distribution, minimizing permanent interior walls and using systems furniture and demountable partition systems enhances flexibility. When feasible, design facilities to facilitate future expansion in response to mission requirements.

A-3.3 Design for Function and Life Cycle.

Permanent Construction. Buildings must be energy efficient, and have finishes, materials, and systems selected for low maintenance and low life cycle cost over a life cycle of more than 25 years.

- Temporary Construction. Buildings must use low cost construction, with finishes, materials, and systems selected with maintenance factors as secondary considerations to meet a life cycle of 5 years or less.
- Mobilization and Emergency Construction. Buildings must minimize design and construction time and maximize conservation of critical materials and funds. Maintenance factors and longevity are secondary considerations.
- Contingency Construction. Such structures may not be used for the purpose of satisfying requirements of a permanent nature at the conclusion of combat or contingency operations.
- Manufactured and Pre-engineered Buildings. This type of construction should be considered where it meets the quality, performance, and functional requirements of the project, when it will be architecturally compatible with adjacent structures, and when justified by life cycle cost. Also consider this building technique when there is limited time for on-site construction erection activities due to weather conditions.

A-4 LOCAL CONSTRUCTION METHODS, MATERIALS AND SKILLS.

Design to take advantage of economies resulting from the use of suitable local construction methods, materials, and skills that are consistent with the intent of these criteria. This is particularly important in overseas locations, where local materials may not be common to architects from the United States. Construction means and methods are the responsibility of the construction contractor.

A-5 BUILDING ENVELOPE.

This section provides background on the science of building envelope design and includes additional design recommendations. Review this section in conjunction with the requirements in Chapter 2. The building enclosure functions to control the transfer of the following elements: heat, air, moisture, light/radiation, and noise.

A-5.1 Heat.

Heat, which is energy, is transferred from warm to cold in one of three ways: conduction, convection, and radiation.

A-5.1.1 Conduction.

Conduction is most effectively resisted by low-conduction materials such as insulation. Highly conductive materials when inserted through the insulating layer can cause a loss

of efficiency in the overall assembly's ability to resist heat transfer in a phenomenon called thermal bridging. Examples of high-conduction materials interrupting insulation include the following:

- Steel studs
- Cantilever concrete balconies and projections
- Structural steel and aluminum that are outside the thermal envelope and connected to the building structure
- Z-furring supporting cladding interrupting the insulation
- Shelf angles attached continuously and directly to the structure.

Many of these materials can be designed to reduce thermal bridging by intermittent support through insulation and maintaining them outside the insulation layer. Others like cantilever balconies or exterior structure, can be thermally broken by specially designed structural thermal breaks. Structural steel should be within the insulated enclosure, unless thermally broken. Thermal bridges impact energy efficiency and are a likely cause of condensation.

A-5.1.2 **Convection.**

Convection is the movement of heat transported by fluids, including air. Air movement can transport heat as well as water vapor from warm to cold. Surfaces that can cool the air adjacent to them, such as slabs on grade and basement walls, and cause the air to become heavier and sink. This draws warm, moist air in to replace it in a continuous convective loop. Warm air can have a dew-point higher than the cold surface, which can cause condensation and the ensuing mold, rot and corrosion. Convection in exterior assemblies is caused by designing air spaces adjacent to cold materials. This can happen in a basement on a concrete wall insulated by glass fiber batts (fibrous insulation is mostly air), or adjacent to glass in fenestration. Eliminating air gaps or separating them from warm air by an air barrier is an effective strategy in reducing convective flow of heat and condensation.

A-5.1.3 **Radiation.**

Radiation is the flow of heat, across space or fluid or gas, from a warm body to a colder one. One example of radiational heat transfer is from the interior to a cold glass surface. Radiational heat gain is direct or reflected solar radiation coming in to a building through glazing or heating up building materials of the enclosure. Heat can be radiated from one sheet of glass to the other in insulating glass. Low emissivity coatings in glass assemblies can be effective in reducing the radiational transfer of heat from the exterior and from the interior, improving both the U-factor and Solar Heat Gain Coefficient. Heat gain from the sun can be effectively reduced by including radiant barriers, such as aluminum foil with an adjacent air gap. Radiant barriers in wall and roof assemblies will only work with an adjacent air gap (see above paragraph on air gaps and convection). Quadruple glazing using heat mirror foils, two low emissivity low-

e layers and filled with inert gas such as argon or krypton, is the state of the art for glass selection today and should be considered for extreme climates.

A-5.2 Air.

Air leakage, or unintentional air movement through the enclosure under a pressure difference between inside and out, transfers heat (energy loss), water vapor, smoke, odors, dust, and other pollutants, including chemical, biological, and radiological agents, into and out of buildings. Infiltrating air is unconditioned for temperature and moisture content and can contain pollutants. It causes discomfort and can unbalance spaces such as patient isolation rooms, protected environment rooms, or chemical storage areas that are designed for controlled pressure, thus compromising pollutant control. Mechanical systems attempt to reduce uncontrolled infiltration by introducing more air than is exhausted. This theoretically puts the building under positive pressure, reducing infiltration. The success of this strategy is dependent on how leaky the building is. (As an analogy, a balloon with a big hole in it can't be inflated.)

Air leakage can be the major source of water vapor transfer through building enclosures. Unlike the moisture transport mechanism of diffusion due to a vapor pressure difference, air pressure differentials can transport hundreds of times more water vapor through air leaks in the envelope over the same period of time ("The Difference Between a Vapor Barrier and an Air Barrier," Quirouette, 1985). This water vapor can condense within the envelope in a concentrated manner, depending on the pathway, if the enclosure includes surfaces below the dewpoint of the air, causing building deterioration and mold growth. Internal compartmentalization of a building (floors and demising partitions) is also a key to the control of the unwanted transfer of air, pollutants, noise, and smoke. See the following resources for more information and sample design details

- Building Envelope Design Guide:
<http://www.wbdg.org/design/envelope.php>
- WBDG Resource Webpage for Air Barrier Systems:
<http://www.wbdg.org/resources/airbarriers.php>
- Also see ECB 2012-16 Building Air Tightness And Air Barrier Continuity Requirements Applicability: Directive and Guidance
<https://www.wbdg.org/ffc/dod/engineering-and-construction-bulletins-ecb/usace-ecb-2012-16>.

A-5.3 Moisture.

Moisture in its different forms is the major cause of water intrusion, condensation, shortening of service life, and disruption of operations. Walls leak when three conditions exist simultaneously: (1) Rainwater is on a wall, (2) Openings exist through which the rainwater can pass, and (3) Forces are present to drive or draw the rainwater inward. If any of these three essential conditions is eliminated, rainwater will not penetrate the enclosure.

A-5.4 Walls are Porous.

It is difficult and impractical to keep wind-driven rain off the exterior walls of a building. Overhangs, cornices, and solar shading can be effective in minimizing, but will not prevent, wetting of a wall. Thus, it should be expected that exterior walls will be covered by a film of water during a rain event, and that this film thickens when rain flows down the building wall. It is virtually impossible to build an exterior wall without any unintentional openings or leakage paths. Such openings may be pores, cracks, incompletely filled or poorly adhered mortar joints, or moving joints between elements or different materials. A typical masonry wall contains multiple apertures of various types and sizes yielding many joints between dissimilar materials prone to movement and joint failure. One square foot of brick masonry contains 6.75 modular brick, 6 lineal ft. (1830 mm) of mortar joint, and 12 lineal ft. (3660 mm) of brick-mortar joint interface. For 20,000 ft² (1858 m²) of wall surface, this equates to 135,000 modular brick, 22.7 miles (36.5 km) of mortar joint, and 45.5 miles (73.2 km) of brick-mortar joint interface. Water can penetrate openings as small as 0.005 in. (.1 mm), which is just slightly more than the thickness of a sheet of bond paper.

A-5.4.1 Drainage Plane.

Even if a good seal is achieved initially, odds are that the seal will deteriorate over time under the action of temperature, water, deterioration due to ultraviolet radiation, and differential movement. For these reasons, a single 4-in. (100-mm) -wythe of masonry conventionally laid up in the field (or any cladding for that matter) should not by itself be expected to be watertight. It is also why sealants cannot be expected to keep water out of building enclosures. There needs to be an underlying drainage plane or WRB and flashings to lead water that penetrates building assemblies out again.

A-5.4.2 Forces Acting on the Wall.

Forces acting on an exterior wall during a rain event that individually or in combination can contribute to rain penetration include the following: (1) raindrop momentum or kinetic energy, (2) capillary suction; (3) external or internal air pressure; (4) gravity, and (5) surface tension. Water hits and wets the tops of buildings first, as well as projections. Water tends to travel over and flow down reveals and channels in the façade in a concentrated manner.

A-5.4.3 Rain Screen Design.

When the joints are well-pointed, brick masonry tends to absorb moisture for 4 - 6 in. (100 to 150 mm) depth after a rain event, and to dry out in dry periods. All masonry mass walls must have ventilation on the interior face of the exterior wall (and parapets) to assure proper drying. Single-wythe concrete block walls are undesirable because they do not manage moisture well. Wall design should be a rainscreen design; in other words, cladding should have a WRB in the wall assembly behind the cladding, with flashings to lead water out. This is true for claddings including EIFS; face-sealed assemblies are not acceptable.

A-5.4.4 **Tool Masonry Joints.**

Exterior masonry wall joints must be tooled. This will densify the mortar bonding. Joints must be tooled concave, vee, beaded, or weathered types.

A-5.4.5 **Coatings on Exterior Walls.**

Dependent upon the moisture migration study, it is advisable in cavity or double exterior wall construction to apply a low permeable coating to the exterior walls to help minimize the amount of moisture transfer through the wall. Apply a high permeable coating to the interior side of wall surfaces to ensure that any water vapor that passes through the exterior coating and vapor barriers enters the air-conditioned space and does not remain trapped within the insulation and wall material. Vinyl wall covering may be used in air-conditioned buildings as a vapor barrier if it is required by the moisture migration study and no other vapor barrier is used. Otherwise, vinyl wall covering should not be used on the interior surface of exterior walls as it may act as a vapor barrier.

A-5.5 **Air Barrier for Modifying an Existing Building.**

The following are five possible scenarios relating to air barriers in existing buildings:

A-5.5.1 **Major Envelope Modifications with Existing Air Barrier.**

For a renovation project that includes modifying the building envelope that has an existing air barrier: Pressure test the air barrier prior to the renovation to verify the air barrier meets its designated leakage rate goal. The result of this initial pressure test can serve as baseline for comparison to a second pressure test performed after the renovation is completed. If air leakage data for this building envelope is not available prior to design kick-off, develop a separate scope to conduct an initial pressure test with diagnostic evaluation, which may include thermographic evaluation methods. If the air barrier will be disturbed or is damaged during renovation, then repair to maintain its integrity. If, after an initial pressure test is performed, its results indicate that the air barrier failed to meet the current air leakage goal, perform a cost analysis to determine if the building should be outfitted with a new air barrier. The cost analysis evaluation should produce the lowest Life-Cycle Cost (LCC), highest Net Savings (NS), or a Savings to Investment Ratio (SIR) of at least one, or greater. Use Building Life Cycle Cost (BLCC5) to perform cost evaluation; reference the National Institute of Standards and Technology (NIST) *Handbook 135* for cost evaluation guidelines. If SIR is less than one, use best judgment within the scope of the project to determine air barrier feasibility. After construction of the air barrier has been completed, perform a second pressure test to verify that it meets the established leakage rate goal. If the air barrier fails to meet its leakage rate goal, use diagnostic methods to determine the source of leaks. After additional sealing is applied, based on the results of the diagnostic tests, determine the economic feasibility of performing another pressure test.

A-5.5.2 Minor Envelope Modifications without Existing Air Barrier.

For a building undergoing only a minor modification to the building envelope, such as removing/installing new windows or doors or replacing the roofing system: Greater challenges in easily, fully, and cost effectively accessing surfaces upon which to apply a complete air barrier may exist. For this case, sealing select building components may help reduce infiltration; however, component sealing is unlikely to achieve the same level of air tightness that would be achieved in applying a complete air barrier to the building. Install windows and doors with an air leakage rate in accordance with the Unified Facility Guide Specifications (UFGS) or the National Fenestration Rating Council (NFRC).

A-5.5.3 Major Envelope Modifications without Existing Air Barrier.

For projects that include modifying the existing building envelope that are not equipped with an air barrier: Determine if the modification to the envelope is sufficiently extensive, (generally, wherein only the building's structure remains). Perform a cost analysis to determine the cost effectiveness of installing a new air barrier. The cost analysis evaluation should produce the lowest Life-Cycle Cost (LCC), highest Net Savings (NS), or a Savings to Investment Ratio (SIR) of at least one, or greater. Use Building Life Cycle Cost (BLCC5) to perform cost evaluation; reference the National Institute of Standards and Technology (NIST) *Handbook 135* for cost evaluation guidelines. If SIR is less than one, use best judgment within the scope of the project to determine air barrier feasibility. If it is cost effective, install a new air barrier as required for a new building and pressure test it if required to ensure the air barrier meets the current air leakage goal.

A-5.5.4 New Addition to Existing Building.

For a new addition to an existing building that has no air barrier: Install an air barrier on the new addition as required for a new building. If the addition does not have an air plenum in common with the existing building, with some modifications to the testing protocol, it can likely be pressure tested in a manner similar to a freestanding new building. If the addition shares a common air plenum with the existing building, pressure testing just the addition is not possible, unless a temporary air barrier is installed to separate the two spaces.

A-5.5.5 Minor Non-Envelope Modifications without Existing Air Barrier.

For a building undergoing modifications not directly impacting the envelope: Sealing methods can be used in an effort to reduce air infiltration. However, sealing in this manner is not likely to result in achieving a level of airtightness that is nearly as tight as that of a complete air barrier. These sealing methods involve materials intended to achieve airtightness, such as applying closed-cell spray foam or sealant to the assembly, but are not limited to these materials. These materials should meet the permeance criteria of ASTM E2178. Removable ceiling tiles allow easy access to problem areas, and walls require destruction of finishes to expose gaps in the building

envelope, such as those around windows. Stuffing glass-fiber insulation in cracks is not an acceptable sealing method, because glass-fiber merely acts as a dust filter and allows air under a pressure differential to pass through it. Also, glass-fiber insulation will hold moisture, which can lead to hidden moisture and mold problems. For minor renovation and repair projects, seal air leaks in building components in the following order of priority:

1. Top of building

- Attics
- Roof/wall intersections and plenum spaces
- Mechanical penthouse doors and walls
- HVAC equipment
- Other roof penetrations

2. Bottom of Building

- Soffits and ground floor access
- Underground parking access doors
- Exhaust and air intake vents
- Pipe, duct, cable, and other service penetrations into core of building
- Sprinkler hangar penetrations, inspection hatches, and other holes
- Seal core wall to floor slab
- Crawl spaces

3. Vertical shafts

- Gasket stairwell fire doors
- Fire hose cabinets or toilet room recessed accessories connected to shafts
- Plumbing, electrical, cable, and other penetrations within service rooms
- Elevator rooms and electric rooms (reduce size of cable holes, firestop, and seal bus bar)
- Openings

4. Exterior Walls

- Weatherstrip windows, doors, including balcony/patio doors and seal window trim
- Exhaust fans and ducting
- All service penetrations
- Baseboard heaters
- Electrical receptacles
- Baseboards

5. Compartmentalize

- Garages
- Vented mechanical rooms
- Garbage compactor rooms
- Emergency generator rooms
- High voltage rooms
- Shipping dock
- Elevator rooms
- Workshops
- Compartmentalized walls are sealed at the top, bottom, and penetrations. Include weatherstripping/gasketing on doors and windows.

A-5.6 Light / Radiation.

Generally speaking, light is desirable while the accompanying heat (radiation) is not. They penetrate through the fenestration, which is the least energy-efficient component of the envelope. In addition to effective glazing design and shade structures, building orientation plays a large role in managing the light/heat gain balance. See discussions under Building Orientation and Radiation in this Appendix for more information.

A-5.7 Noise.

Noise by definition is unwanted sound. Project acoustical considerations are intended to limit noise to the building occupants so that the building function is not limited due to noise within or around a building. Best practices will be achieved by meeting the project requirements as stated in Chapters 2 and 3. Standards referenced in Chapter 2 include best practices and suggestions to provide an appropriate acoustic environment for most space types. Thoughtful consideration of the project acoustic requirements is very beneficial early in the design process.

Proper preparation of the required statement of adherence outlined in Chapter 5 to meet requirements established in Chapters 2 and 3 of this UFC is an important basis to understanding the project acoustical requirements; however, the Design or Design-Build team will still need to be mindful of implementing the requirements during the design and meeting the requirements during the construction of the project.

A-6 AIR BARRIER MOCK-UP TESTING.

A-6.1 Guidance on When to Test Mock-Ups.

See Table A-1, Construction Mock-up Guidance Matrix, for recommendations. Approximate suggested definitions of sizes to use for the matrix:

- Small: Up to 10,000 sf (929 sm)
- Medium: 10,000 to 50,000 sf (929 to 4645 sm)
- Large (Common): above 50,000 sf (4645 sm)
- Large (Unique): above 25,000 sf (2323 sm)

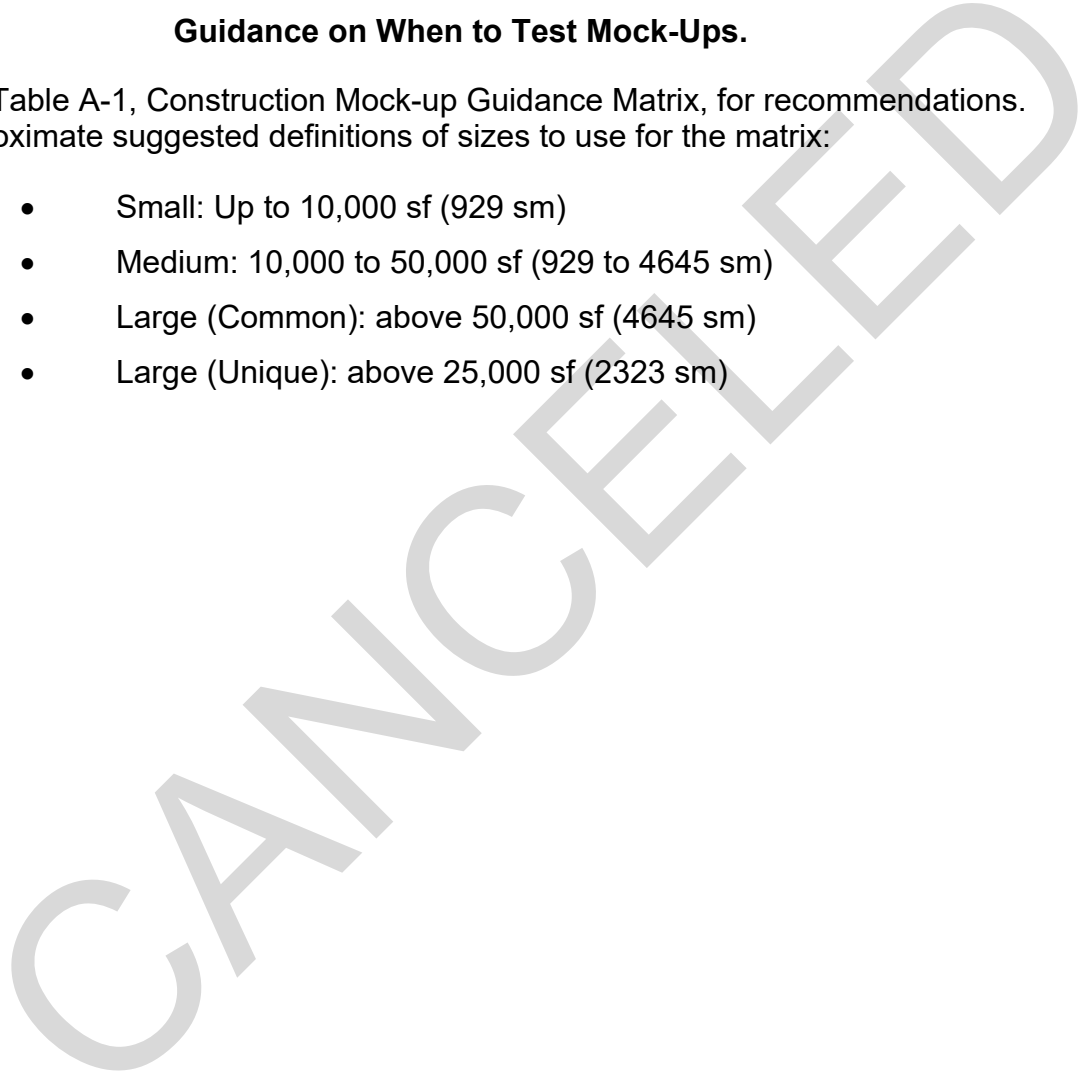

Table A-1 Construction Mock-Up Guidance Matrix

<u>Guidance:</u> The Authority Having Jurisdiction (AHJ) may give consideration to implementing construction mock-ups based upon the following decision matrix.		
FACILITY TYPE	APPLICATION	RECOMMENDED GUIDANCE
<p>Small size facility Common facility such as: mech building; pump house; small and medium warehouses. Size range: square feet</p>	<p>Small facilities that are not unique and provide support functions on an installation</p>	<p>Recommend not requiring construction mock-ups</p>
<p>Medium size facility Common facility types such as MWRs; chapels; child care centers; small and medium size administrative facilities, post offices; post exchanges. Size range: square feet</p>	<p>Medium size facilities that are not unique and utilize typical and proven construction materials, methods and processes. The application of these systems carries little to no risk of not being constructed satisfactorily.</p>	<p>Recommend not requiring construction mock-ups</p>
<p>Large size facility: Common facility types such as barracks buildings; large dining facilities; laboratories; highly visible headquarters facilities; large company operations facilities, maintenance facilities, large storage warehouses. Size range: square feet</p>	<p>Large size facilities that do not necessarily employ unique construction technology or innovative features but due to size, visibility and interest on the installation; failure of this facility would be detrimental to mission execution and would reflect poorly on the installation command.</p>	<p>Recommend consideration be given to providing construction mock-up at critical connections for windows; advanced structural systems</p>
<p>Large size facility: Unique facilities that utilize uncommon or prototype systems; advanced technology or innovative technology for structural systems or window walls. Size range: square feet</p>	<p>Large size facilities that employ unique construction technology or innovative features; maintenance problems or systems failure within this facility would be detrimental to mission execution and would reflect poorly on the installation command.</p>	<p>Strongly recommend providing construction mock-ups at critical connections for window; advanced structural systems or unique curtain wall systems that employ daylighting sensors or integral shading screens.</p>

A-6.2 On Site Mock-Ups.

When approved by the AHJ, a mockup of the wall system will include a representative wall and window constructed on site, complete with its components, and must be tested for air and water infiltration.

Each item that contributes to the moisture control and air barrier performance must be included in the mockup. The installed fenestration must be tested first using ASTM E783 to determine air tightness. ASTM E1105 can then be used to determine if fenestrations and their connections to walls are meeting liquid water leakage requirements.

A-7 EXTERIOR INSULATION AND FINISH SYSTEM (EIFS).

EIFS is not recommended for exterior wall finish, especially in regions where hurricanes and typhoons are a concern and in other regions where water penetration is a particular problem. If EIFS is used, follow the guidance provided in Chapter 2 and also consider the new generations of self-cleaning EIFS finish coatings to reduce maintenance costs.

A-8 DAYLIGHTING.

The introduction of daylight into interior spaces has a well-documented effect on the productivity of occupants and the education of students. In a study done by the Hescong Mahone Group, students who worked in daylighted classrooms progressed 26% faster on reading exams and 20% faster on math exams than students working in a classroom with less daylight. In another study completed by the Hescong Mahone Group, office workers were found to perform 10%-25% better on tests of mental function when the best daylight views were available to them.

Daylighting strategies can be divided into passive or active systems. Passive systems such as overhangs are the most common and refer to the location, profile, orientation, and shading of glazing on a building. See Figure A-2 for passive daylighting strategies. Optimizing these components result in a building that admits daylight without excessive heat gain or glare. Because the devices and components are stationary, these techniques are categorized as passive. In comparison, active daylighting systems have moving parts, typically to track the sun throughout the day. An example of an active system includes a skylight with a moving mirror that captures direct sunlight and redirects it through the skylight, into the building.

A-8.1 Benefits of Daylight.

Daylight in interior spaces has multiple benefits. Daylighted environments provide a connection to the outdoors, are healthier for occupants and have the potential to save

energy. Research has shown that children learn better¹, retail stores sell more product², and office workers are more productive³ in daylighted environments. Since daylight also helps to regulate our circadian cycle⁵, introducing daylight into interior spaces is a top priority. Daylight is a natural resource that is more efficient than electric light and should be utilized to its fullest potential. See http://www.wbdg.org/references/mou_daylight.php

A-8.1.1 **Maximize Daylight Potential.**

Building orientation, views, side and top lighting, shading devices, and selective glazing are critical to maximizing daylight potential. The following recommendations are for the northern hemisphere. In the southern hemisphere, recommendations regarding north and south orientations are reversed. Also, interior spaces should have high ceilings and light reflective surfaces to allow deep daylight penetration. Provide architectural and shading devices for daylight and view windows. In areas of high threat, light shelves tend to be discouraged because of blast mitigation. These objects can become additional projectiles during a blast. Refer to the Whole Building Design Guide, Balancing Security/Safety with Sustainability Objectives, http://www.wbdg.org/resources/balancing_objectives.php.

Over 60% of existing square footage of interior spaces (within the US) has access to roofs for top-lighting and 25% of existing national square footage has access to side-lighting.⁶

A-8.1.2 **Considerations.**

- Use the building shape to access daylight
- Maximize view windows on the north and south facades
- Provide high ceilings to allow deeper daylight penetration
- Bring daylight high into the space to maximize penetration
- Consider external light shelves to provide shading for view windows, where possible
- Consider internal light shelves to provide shading for clerestories and also a surface for reflecting light onto the ceiling, where possible

¹ The Heschong Mahone Group, “Daylighting in Schools”, <http://www.h-m-g.com/projects/daylighting/summaries%20on%20daylighting.htm>

²The Heschong Mahone Group, “Skylighting and Retail Sales,” http://www.h-m-g.com/projects/daylighting/summaries%20on%20daylighting.htm#Skylighting_and_Retail_Sales - PG&E 1999

³ California Energy Commission. (2003). Windows and Offices: A study of office worker performance and the indoor environment (Catalogue No. P500-03-082-A-9).

⁴ “Design Objectives, Productive”, Whole Building Design Guide, 22 August 2002 <http://www.wbdg.org/design/productive.php>

⁵ New Buildings Institute, Inc. “Lighting and Human Performance”, Advanced Lighting Guidelines, Chapter 2. 2001 Edition, p.2-12-13

⁶ Heschong, Lisa, “Daylighting Workshop”, Pacific Energy Center, (March 2003).

- Provide separate shading devices for daylight windows and view windows.
- Use selective glazing to maximize visible transmittance (high T_{vis}) and minimize solar radiation (low shading coefficient).
- Use high reflectance values on ceiling and wall surfaces to balance out the daylight.
- Avoid daylight barriers such as solid walls near the building perimeter.

A-8.1.3 **Building Shape.**

The building shape and massing has a significant impact on how much daylight can reach the occupied spaces and therefore, how well various daylighting strategies will work in the building. Deep floor plates create dark interior spaces that will necessitate electric lighting even during the day. Narrower plates allow daylight penetration throughout the entire building section. See Figure A-1 for the effects of building shape and massing on daylight availability.

Figure A-1 Effects Of Building Massing on Daylight Availability

These four building footprints have equal floor area but provide very different levels of daylight availability.

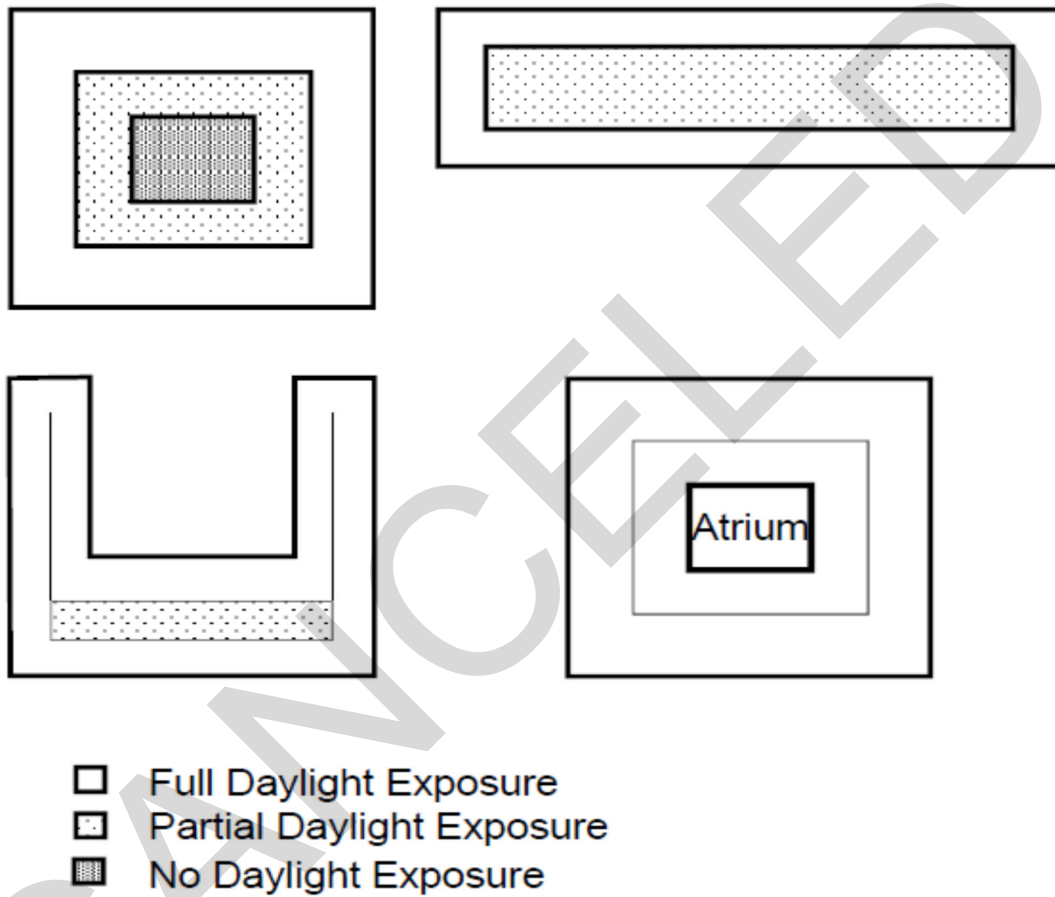
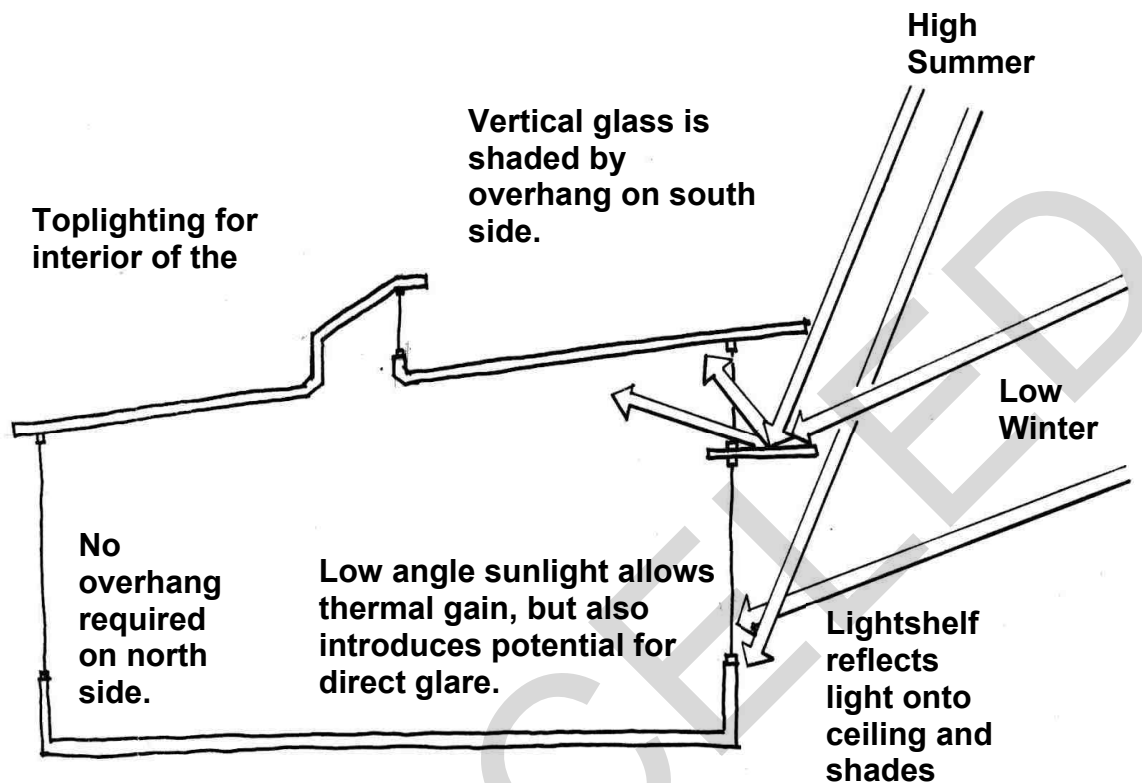

Figure A-2 Examples of Passive Daylighting Strategies



A-8.1.4 Project Types that Benefit from Daylight.

The introduction of daylight into any space has the potential to provide these benefits for the occupants as well as reduce building energy use. However, some project types are better suited than others to take advantage of daylight.

- Open spaces with high ceilings such as hangars, warehouses, recreation centers, and maintenance areas offer good opportunities for toplighting with skylights and clerestories.
- Perimeter spaces such as offices, lobbies, classrooms, cafeterias, and residential areas are all good sidelighting applications. See Figure A-8 for examples of sidelighting applications.

A-8.1.5 Economics.

The use of daylight can produce more comfortable work environments. This benefit may be difficult to quantify, but the energy saved by dimming or switching electric light in response to daylight can be quantified. The implementation of skylights and clerestories as well as lighting control equipment such as dimming ballasts and photocells all increase initial cost. Refer to UFC 4-010-01 for potential additional requirements for Antiterrorism.

A-8.2 Glazing Orientation.

Building orientation is critical to maximizing daylight potential. Building orientations that maximize north and south exposures provide the most effective orientations while East and West exposures may allow excessive heat gain and are hard to control direct sun penetration, see Figure A-3. Southern exposures have the potential of providing over 50% of the daylight for the building space. The success to daylighting on southern exposures is controlling the direct sunlight penetration with shading devices, see Figure A-4 for an example of an Architectural shading device. Northern exposures require minimal shading in the winter months. East and West orientations require manual shading devices. Vertical blinds control daylight well on this orientation.

Figure A-3 Building Orientation Can Maximize Daylight Exposure

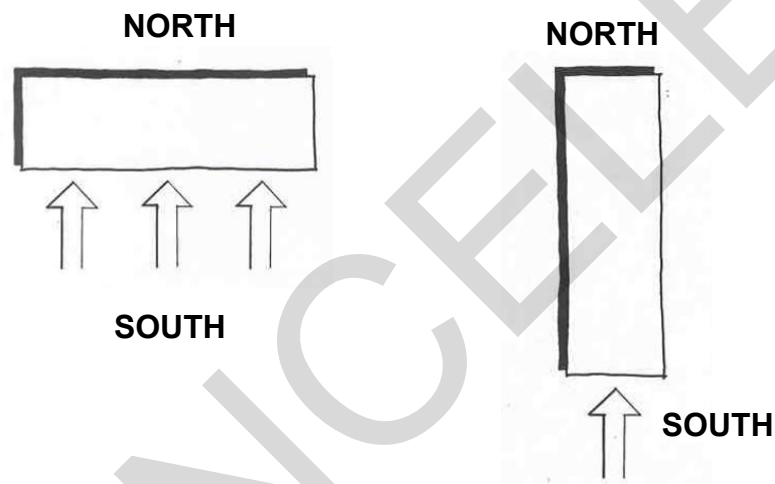

Figure A-4 Example of Architectural Shading Devices



A-8.2.2 Considerations.

- Orient building to maximize north and south exposures.
- North facing windows provide the most even illumination.
- If orientation is off-axis from north and south, provide shading devices for south-east and south-west exposures.
- Provide architectural shading devices for south orientations.
- Provide manual shading devices for south orientations. Horizontal blinds best control the high angle light on southern exposures.
- Provide manual shading devices for east and west orientations. Vertical blinds best control the low angle light on east and west exposures.
- In spaces that include daylight harvesting, provide automated shading devices to maximize the electric lighting energy savings.

A-8.3 Glazing Characteristics.

Use selective glazing to optimize and tune glass based on its purpose and use (clerestory or vision). Clerestory glass may require high visibility transmittance without color distortion while minimizing infrared penetration. See Table A-2 for comparison of glass types.

Table A-2 Comparison Of Glass Types (From Alpenglass Heat Mirror)

Sample Glass Types	Total Daylight Transmittance %	Solar Heat Gain Coefficient
Clear Double Insulating Glass (1/8" thick)	81	0.75
Laminated Glass (1/2" clear)	85	0.72
HM 88/Clear	72	0.57
HM SC75/Clear	62	0.36
HM 55/Clear	47	0.30

A-8.3.2 Considerations.

- Maximize glazing transmittance (T_{vis}) for daylight glazing (0.70 or greater) for clerestories and other daylight fenestrations.
- Although the visible transmittance selected depends on personal preference, typically, use T_{vis} values in the medium range for view windows (0.40 or greater).
- Minimize infrared transmittance by specifying a moderate to low shading coefficient (SC) or low solar heat gain coefficient (SHGC) (50% or lower).
- Use high transmittance glazing greater than 60% to maximize daylight. Glazing should also have a high thermal resistance ratio in order to minimize heat gain.
- Do not use tinted or mirrored coatings. Use clear glazing.

A-8.4 Quantity of Glazing.

Toplighting optimization varies between 3% and 9% skylight to floor area ratio. The optimal amount of toplighting area factors in daylight contribution, cooling loads, and potential energy savings. In order to calculate toplighting area optimization, use a calculation program similar to "SkyCalc". Sunny climates with a cooling load dominated environment will require less toplighting than cooler overcast climates. See Figures A-5, A-6 and A-7 for toplighting strategies and applications.

Figure A-5 Diagram of Toplighting Strategies

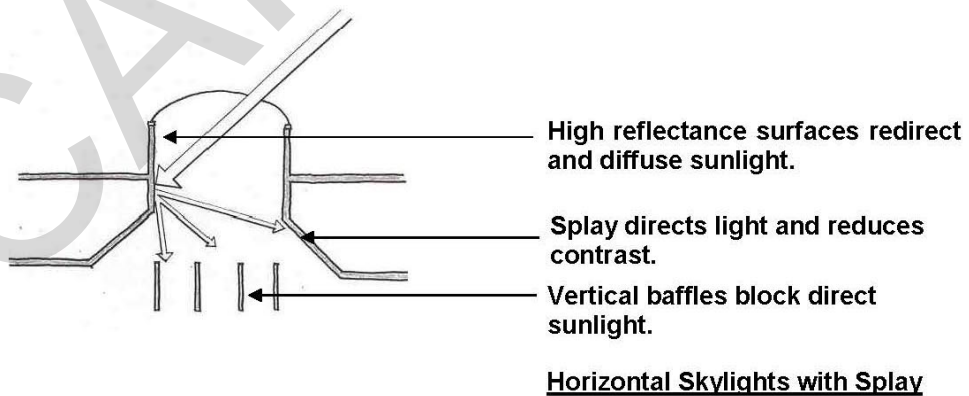
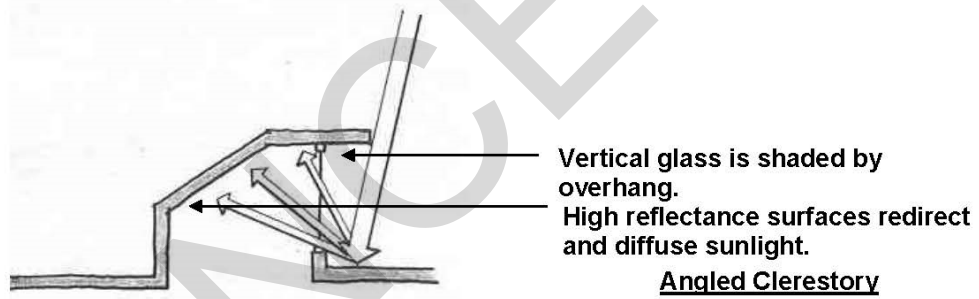
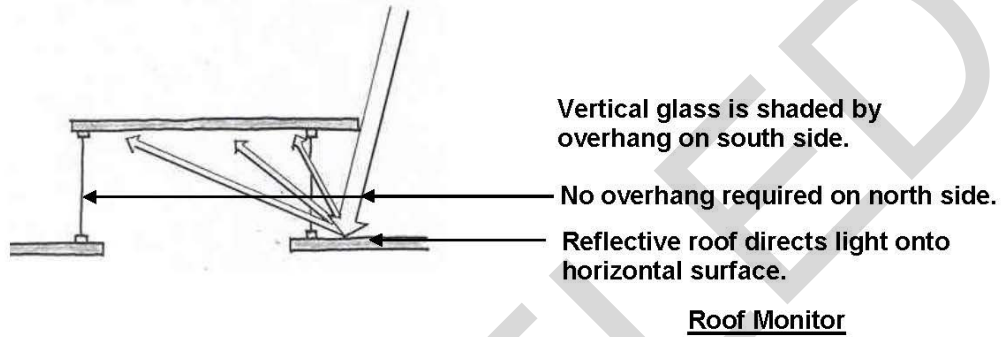

Figure A-6 Examples of Toplighting Applications

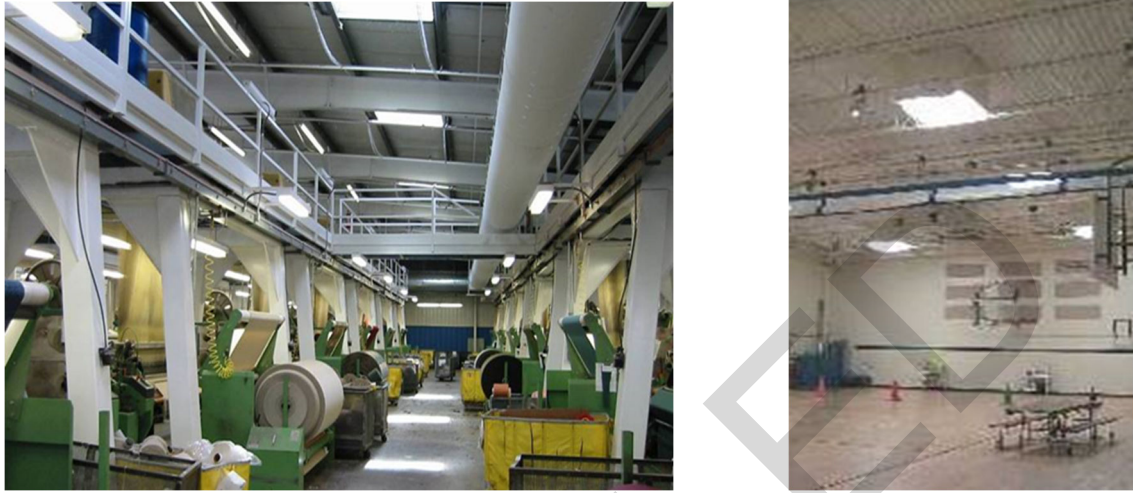
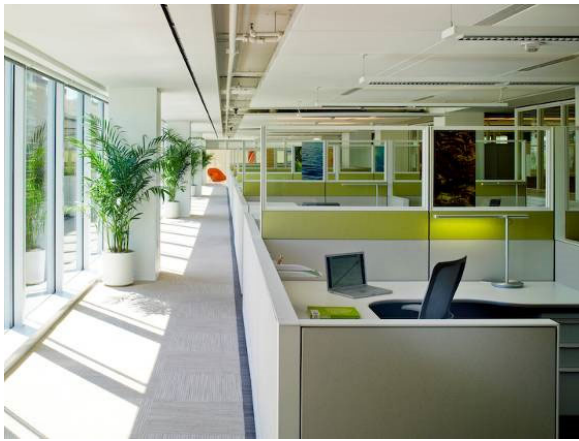

Figure A-7 Example of Clerestory Application



Figure A-8 Examples of Sidelighting Applications



Photograph: Eric Laignel



A-8.4.2 Considerations.

- Sidelighting windows should be located as high as possible since effective daylight penetration from windows is 1.5 times the height of the window .
- Use high continuous clerestories for the deepest daylight penetration and uniformity.
- Provide glazing at eye level in order to provide exterior views,
- Use view windows that have minimal wall area between windows. Avoid small windows located in large wall areas because of the uncomfortable contrast and glare that result.
- 1 sq ft (0.09 m²) of top lighting can provide illumination to about 10 times the area that sidelighting provides yet does not provide the view.
- Space top lighting apertures approximately one and a half times the ceiling height for even illumination. Recess and splay (45° to 60°) skylights to minimize glare.
- Toplighting systems located at least 1.5 times the mounting height on center can provide even daylight distribution.
- Skylight area should be between 2% to 9% of the floor area depending on the climate optimization

A-8.5 Glare and Contrast Control.

Glare and excessive contrast occur when side and top lighting devices allow direct sunlight penetration. Quality daylighting allows skylight and only reflected sunlight to reach the task. Punched openings also can cause uncomfortable contrast ratios. Figures A-9 and A-10 are examples of how the use of roof shapes and splayed skylights can be used to minimize glare and excessive contrast.

Figure A-9 Examples of Roof Shapes



Figure A-10 Example of Splayed Skylights



A-8.5.2 \2\ Considerations. /2/

- Coordinate external and internal shading with architect.
- Utilize top-lighting systems with vertical glazing to control direct radiation.
- If horizontal glazing is designed for top lighting systems, then provide splayed openings or translucent shielding below the skylight in order to minimize the contrast.
- Avoid punched windows; use continuous or mostly continuous side lighting.
- Use high reflectance surfaces for ceiling and walls (90% for ceilings and 60% for walls).
- Consider integrating use of automated window shading or dynamic glazing with the electric lighting control system to optimize the amount of daylight entering the space while minimizing the effects of solar heat gain and glare.

A-8.6 \2\ Automated Shading. /2/

Automated shading should be considered in spaces utilizing daylight harvesting to preserve the functionality of the daylight harvesting system and maximize the energy savings of the system. The shades may be controlled to reduce glare and unwanted heat gain while still allowing natural light to enter the space. When utilizing automated shading the following may be considered:

- For ease of use the automated shades will be operated by common controls with the lighting control system; the controls should have the same appearance and design.
- For maximum energy savings, the automated shading system should position the shades based on a combination of time of day, façade direction, and sky conditions.
- For maximum design flexibility and ease of installation, shade systems should have the capability to address each shade individually.
- The shading system may have a manual override that allows the occupant to temporarily adjust the shades to any desired position. The system will revert back to automatic control after a specified period of time.
- Based on the application and size of the windows or skylights, the shading system may employ drive (motor) technology that is either line-voltage or low-voltage in nature; an overall installed cost assessment of the shading system and the necessary equipment to integrate to the lighting control and building management systems may be done to determine the overall best value, installed cost solution for the project.

A-8.7 \2\ Active Daylighting. /2/

Active daylighting strategies and devices utilize a mechanical component to collect and distribute daylight. Such devices differ from the passive strategies that have previously been discussed which are stationary. The example shown in Figure A-11 turns a series of reflectors as the sun moves throughout the day. These reflectors catch the direct sunlight and redirect it through the skylight.

Such devices add extra initial cost and also pose additional maintenance issues. However, they also can make use of daylight for a longer period of time throughout the day. With tracking devices, effective daylighting can begin earlier in the morning and last later in the day than with stationary skylights.

Figure A-11 **Example of an Active Daylighting System that Tracks the Sun and Directs Daylight into the Building**



A-8.7.1 \2\ **Solar-adaptive Shading.** /2/

Another active daylight control technology is solar-adaptive window shading whereby shades automatically adjust throughout the day based on sky conditions or the sun's location. This type of shading system blocks and reflects direct sunlight during the day to reduce solar heat gain and demand on the building's air conditioning system. An example of solar-adaptive shading is shown in Figure A-12.

Figure A-12 **Example of Solar-Adaptive Shading**



A-8.8 \2\ Physical Modeling. /2/

Daylight levels depend on many factors such as window shapes, orientation, shading, and time of day. Therefore, physical models built to scale can provide information on light quality, shade, shadows, and actual light levels. By building the model with the actual proposed materials and orienting it with adjustments for latitude, season, and time of day, the light quality can be seen in the model. Such models inform the designer about quality issues including light patterns, shade, shadows, contrast, and penetration in the space. An illuminance meter inside the model will provide accurate predictions of expected light levels in the building.

A-8.9 \2\ Computer Simulation. /2/

A wide range of software programs model the sun's path and its impact on building geometry in addition to how it affects heat gain and energy use. In using any of the software, be aware of its limitations and assumptions, as well as the variables under the users' control. These tools provide a prediction of how building components will behave throughout changing conditions. They do not provide actual light levels or energy use. The following web sites detail the features of some of these programs and their applications.

- US Department of Energy – Energy Efficiency and Renewable Energy Building Energy Software Tools Directory: http://www.eere.energy.gov/buildings/tools_directory/
- Whole Building Design Guide Energy Analysis Tools: <http://www.wbdg.org/resources/energyanalysis.php>

APPENDIX B GLOSSARY

B-1

ACRONYMS

AAMA	American Architectural Manufacturer Association
ASCE	American Society of Civil Engineers
ACI	American Concrete Institute
AF	Air Force
AFCEC	Air Force Civil Engineer Center
AFMAN	Air Force Manual
AHJ	Authority Having Jurisdiction
AICUZ	Air Installation Compatible Use Zones
ANSI	American National Standards Institute
AR	Army Regulations
ASA	Acoustical Society of America
ASHRAE	American Society of Heating, Refrigeration and Air Conditioning Engineers
ASTM	American Society of Testing and Materials
AT	Antiterrorism
BIA	Brick Industry Association
BIM	Building Information Modeling
BLCC	Building Life Cycle Cost
C	Celsius
CADD	Computer-aided Design and Drafting
CBD	Chronic Beryllium Disease
CCB	Construction Criteria Base
CCR	Criteria Change Request
CFR	Code of Federal Regulations

CNEL	Community Noise Equivalent Level
CONUS	Continental United States
CSA	Canadian Standards Association
DNL	Day Night Average Sound Level
DoD	Department of Defense
ECB	Engineering and Construction Bulletins
EIFS	Exterior Insulation Finish System
EIMA	EIFS Industry Members Association
EPA	Environmental Protection Agency
EPG	Electronic Project Generator
ESC	Environmental Severity Classification
F	Fahrenheit
FACD	Functional Analysis Concept Development
FEC	Facilities Engineering Command
FGI	Facilities Guidelines Institute
ft	Foot or feet
HEMP	High-Altitude Electromagnetic Pulse
HEPA	High-Efficiency Particulate Air
Hg	Mercury
HNFA	Host Nation Funded Construction Agreements
HPSB	High Performance and Sustainable Building Requirements
HQUSACE	Headquarters, U.S. Army Corps of Engineers
GCC	Geographic Combatant Commander
GSA	General Services Administration
IBC	International Building Code

ICD	Intelligence Community Directive
ICS	Intelligence Community Standard
IESNA	Illuminating Engineering Society of North America
IFS	Installation Facilities Standards
in	Inch or inches
IP	Inch-pound
ISO	International Organization for Standardization
Kg	Kilogram
LCCA	Life Cycle Cost Analysis
m	Meters
mm	Millimeters
MPI	Master Painters Institute
MWR	Moral, Welfare and Recreation
NACE	National Association of Corrosion Engineers
NASA	National Aeronautics and Space Administration
NAVFAC	Naval Facilities Engineering Systems Command
NAVRAMP	Navy's Radon Assessment and Mitigation Program
NC	Noise Criteria
NCPC	National Capital Planning Commission
NCR	National Capital Region
NFRC	National Fenestration Rating Council
NIC	Noise Isolation Class
NIH	National Institute of Health
NIST	National Institute of Standards and Technology
NRCA	National Roofing Contractors Association

NS	Net Savings
OITC	Outdoor Indoor Transmission Class
OSHA	Occupational Safety and Health Administration
Pa	Pascal (SI unit of pressure)
PBS	Public Buildings Services
PCB	Polychlorinated Biphenyls
PCR	Planning Charrette Report
psi	Pound per square inch
PTS	Performance Technical Specifications
PVC	Polyvinyl Chloride
RAMP	Radon Assessment and Mitigation Program
RC	Room Criteria
RCRA	Resource Conservation and Recovery Act
RF	Radio Frequency
RFP	Request for Proposal
3 SAPF	Special Access Program Facility /3/
SC	Shading Coefficient
SCIF	Sensitive Compartmented Information Facility
SDSFIE	Spatial Data Standard for Facilities, Infrastructure and Environment
SEI	Structural Engineering Institute
sf	square feet
SHGC	Solar Heat Gain Coefficient
SI	International System of Units (Metric System)
SIR	Savings to Investment Ratio
sm	square meters

SMACNA	Sheet Metal and Air Conditioning Contractors' National Association
SOFA	Status of Forces Agreement
STC	Sound Transmission Coefficient
TSCA	Toxic Substances Control Act
TM	Technical Manual(s)
UEPH ARMY	Unaccompanied Enlisted Personnel Housing
UFC	Unified Facilities Criteria
UFGS	Unified Facilities Guide Specifications
USACE	U.S. Army Corps of Engineers
USGBC	U.S. Green Building Council
VT	Visible Transmittance
WBDG	Whole Building Design Guide
WDMA	Window and Door Manufacturer Association
WRB	Water Resistant Barrier

B-2 DEFINITION OF TERMS

Air Barrier. The term “air barrier” refers to the “continuous air barrier” the combination of interconnected materials, assemblies, and sealed joints and components of the building envelope that minimize air leakage into or out of the building envelope specified by ASHRAE 90.1.

Building System and Subsystems. An assembly of dimensionally and functionally pre-coordinated subsystems which, when combined, produces an essentially complete building. A subsystem is one of many building components designed and manufactured to be integrated with other subsystems to produce an entire building system.

Building Information Model (BIM). A BIM is a three-dimensional digital model of a facility. It incorporates all disciplines and facilitates coordination, calculations of relevant building parameters, and the development of construction documents.

Corrosion. Corrosion is the deterioration of a material or its properties due to a reaction of that material with its chemical environment and is inclusive of the deterioration of all

materials, which can be caused through sun exposure, mold and mildew, wind, and other environmental elements.

Environmental Severity Classification (ESC). Environmental severity is defined as the corrosivity of the local environment of a given location or region. Environmental severity contributes directly to the occurrence of corrosion. The effects of corrosion and the rate at which they occur are consequences of the corrosion system, which is comprised of a material or physical system, the environment, and operational conditions.

Noise Isolation Class (NIC). NIC is a method for field transmission ratings. The higher the number the better the noise control. NIC rates a partition's ability to block airborne noise transfer. NIC testing is preferable to STC testing as it is specified on more specific space types (such as spaces with operable walls, unaccompanied housing sleeping rooms to each other or to the adjacent corridor, and the actual work spaces in administration facilities). For a field STC test, the individual transmission loss measurements are modified based upon the reverberation time, the size of the room, and the size of the tested partition. The NIC does not include these modifications and simply measures the transmission loss between 125 and 4,000Hz. The value of this rating is that it better tests the performance of the assembly in the field, though it is highly dependent on field conditions of the tested space.

Outdoor-Indoor Transmission Class (OITC). OITC is defined as the A-weighted sound level reduction of a test specimen (or a space) in the presence of an idealized mixture of transportation noises; aircraft takeoff, freeway, and railroad pass-by. It assigns a single number rating to measure Sound Transmission Loss (TL) data obtained in accordance with ASTM E-90. The higher the number, the better the control.

Sound Transmission Class (STC). STC is a single number developed under laboratory conditions that represents the effectiveness of materials or construction to retard the transmission of air-borne sound. It is not as effective for measurement in low frequency noise sources such as mechanical equipment.

APPENDIX C REFERENCES

ACOUSTICAL SOCIETY OF AMERICA (ASA)

<https://acousticalsociety.org/>

ANSI/ASA S12.2, Criteria for Evaluating Room Noise

AIR BARRIER ASSOCIATION OF AMERICA

<http://www.airbarrier.org/>

The Difference Between a Vapor Barrier and an Air Barrier, Quirouette, 1985

AMERICAN ARCHITECTURAL MANUFACTURER ASSOCIATION (AAMA)

<http://www.aamanet.org>

AAMA/WDMA/CSA 101, Windows, Doors, and Unit Skylights

AMERICAN CONCRETE INSTITUTE (ACI) INTERNATIONAL

<http://www.aci-int.org>

ACI 530, Building Code Requirements for Masonry Structures

AMERICAN NATIONAL STANDARDS INSTITUTE (ANSI)

<http://www.ansi.org/>

ANSI S12.9 Part 1, Quantities and Procedures for Description and Measurement of Environmental Sound, Part 1, Basic Quantities and Definitions

ANSI S12.9 Part 2, Quantities and Procedures for Description and Measurement of Environmental Sound, Part 2: Measurement of Long-Term, Wide-Area Sound

ANSI S12.60 Part 1, Acoustical Performance Criteria, Design Requirements, and Guidelines for Schools, Part 1: Permanent Schools

ANSI S12.60 Part 2, Acoustical Performance Criteria, Design Requirements, and Guidelines for Schools, Part 2: Re-locatable Classroom Factors

AMERICAN SOCIETY OF CIVIL ENGINEERS (ASCE)

<http://www.asce.org>

ACSE/SEI 7, Minimum Design Loads for Buildings and Other Structures

ASCE 32-01, Design and Construction of Frost Protected Shallow Foundations

AMERICAN SOCIETY OF HEATING, REFRIGERATING AND AIR-CONDITIONING ENGINEERS (ASHRAE)

<https://www.ashrae.org/>

ANSI/ASHRAE/IESNA Standard 90.1 2013, Energy Standards for Buildings Except Low Rise Residential Buildings, 2013

ASHRAE Standard 160, Criteria for Moisture-Control Design Analysis in Buildings

ASHRAE Handbook-Fundamentals

ASHRAE HVAC Applications Handbook

ASTM INTERNATIONAL

<http://www.astm.org>

ASTM C755, Standard Practice for Selection of Vapor Retarders for Thermal Insulation

ASTM C1060, Standard Practice for Thermographic Inspection of Insulation Installations in Envelope Cavities of Frame Buildings

ASTM E283, Standard Test Method for Determining Rate of Air Leakage Through Exterior Windows, Curtain Walls, and Doors Under Specified Pressure Differences Across the Specimen

ASTM E741, Standard Test Method for Determining Air Change in a Single Zone by Means of a Tracer Gas Dilution

ASTM E783, Standard Test Method for Field Measurement of Air Leakage Through Installed Exterior Windows and Doors

ASTM E1105, Standard Test Method for Field Determination of Water Penetration of Installed Exterior Windows, Skylights, Doors, and Curtain Walls, by Uniform or Cyclic Static Air Pressure Difference

ASTM E1130, Standard Test Method for Objective Measurement of the Speech Privacy in Open Plan Spaces Using Articulation Index

ASTM E1186, Standard Practices for Air Leakage Site Detection in Building Envelopes and Air Barrier Systems

ASTM E1745, Standard Specification for Plastic Water Vapor Retarders Used in Contact with Soil or Granular Fill under Concrete Slabs

ASTM E2112, Standard Practice for Installation of Exterior Windows, Doors and Skylights

ASTM E2638, Standard Test Method for Objective Measurement of the Speech Privacy Provided by a Closed Room

ASTM F2090, Standard Specification for Window Fall Prevention Devices with Emergency Escape (Egress) Release Mechanisms

ASTM F2170, Standard Test Method for Determining Relative Humidity in Concrete Floor Slabs Using in situ Probes

ASTM Manual 40, Moisture Analysis and Condensation Control in Building Envelopes

BRICK INDUSTRY ASSOCIATION (BIA)

<http://www.gobrick.com>

BIA Technical Note 7, Water Penetration Resistance - Design and Detailing

BIA Technical Note 18A, Accommodating Expansion of Brickwork

BIA Technical Note 21, Brick Masonry Cavity Walls

EIFS INDUSTRY MEMBERS ASSOCIATION

EIFS Standards & ICC-ES Acceptance Criteria

<http://www.eima.com/>

FACILITY GUIDELINES INSTITUTE

<https://fgiguideines.org/>

FGI – Sound & Vibration: Design Guidelines for Health Care Facilities

GENERAL SERVICES ADMINISTRATION (GSA)

GSA PBS-P100, Facilities Standards for the Public Buildings Services (P-100),

<https://www.gsa.gov/real-estate/design-construction/engineering-and-architecture/facilities-standards-p100-overview>

Guiding Principles for Federal Architecture, <https://www.gsa.gov/real-estate/design-construction/design-excellence/design-excellence-program/guiding-principles-for-federal-architecture>

Sound Matters, https://wbdg.org/FFC/GSA/gsa_soundmatters.pdf

U.S. Courts Design Guide, Judicial Conference of the United States,

<https://www.wbdg.org/ffc/gsa/criteria/us-courts-design-guide>

INTERNATIONAL ORGANIZATION FOR STANDARDIZATION (ISO)

<http://www.iso.org>

ISO 6781, Thermal Insulation -- Qualitative Detection of Thermal Irregularities in
Building Envelopes -- Infrared Method

INTERNATIONAL CODE COUNCIL (ICC, IBC)

<https://www.iccsafe.org/>

International Building Code, \3\ 2021 /3/

International Green Construction Code, 2018

MASTER PAINTERS INSTITUTE (MPI)

www.mpi.net/

Master Painters Institute

NATIONAL ASSOCIATION OF CORROSION ENGINEERS (NACE)

<https://www.nace.org/home>

NACE Standards

NATIONAL CAPITAL PLANNING COMMISSION (NCPC)

National Capital Planning Act of 1952, <http://www.archives.gov/research/guide-fed-records/groups/328.htm>

NATIONAL INSTITUTE OF BUILDING SCIENCES

<https://www.nationalbimstandard.org/>

National BIM Standard

NATIONAL INSTITUTE OF HEALTH

NIH – Design Requirements Manual,
<https://www.wbdg.org/ffc/nih/criteria/nih-design-requirements>

NATIONAL INSTITUTE OF STANDARDS AND TECHNOLOGY

National Institute of Standards and Technology (NIST) Handbook 135,
<https://www.wbdg.org/ffc/nist/criteria/nist-handbook-135>

NATIONAL PARK SERVICE

Secretary of Interior's Standards for Rehabilitation and Guidelines for Rehabilitating
Historic Buildings,

<https://www.wbdg.org/ffc/nps/criteria/secretary-interior-standards-rehabilitation-illustrated-guidelines-rehabilitating-historic>

NATIONAL ROOFING CONTRACTORS ASSOCIATION (NRCA)

<http://www.nrca.net/>

NRCA Roofing and Waterproofing Manual

OFFICE OF THE DIRECTOR OF NATIONAL INTELLIGENCE

<https://www.dni.gov/index.php>

IC Tech Spec for ICD/ICS 705,

https://www.dni.gov/files/documents/ICD/ICD_705_SCIFs.pdf

SHEET METAL AND AIR CONDITIONING CONTRACTORS NATIONAL ASSOCIATION (SMACNA)

<https://www.smacna.org>

Architectural Sheet Metal Manual

SPATIAL DATA STANDARD FOR FACILITIES, INFRASTRUCTURE, AND ENVIRONMENT (SDSFIE)

<https://www.sdsfieonline.org/>

SDS/CADD Standards

UNITED STATES CODE

10 USC 2853, Authorized Cost and Scope of Work Variations

<https://www.govregs.com/uscode/10/2853>

UNITED STATES DEPARTMENT OF THE AIR FORCE

Air Force Corporate Facilities Standards, <http://afcfs.wbdg.org/>

Installation Facilities Standards. <https://www.wbdg.org/ffc/af-afcec/installation-facilities-standards-ifs>

AFMAN 48-148, Ionizing Radiation Protection, https://static.e-publishing.af.mil/production/1/af_sg/publication/afman48-148/afman48-148.pdf

AFMAN 32-1084, Facility Requirements, <https://www.wbdg.org/ffc/af-afcec/manuals-afm/afman-32-1084>

UNITED STATES DEPARTMENT OF THE ARMY

DD Form 1391 Processor System, <https://www.hnc.usace.army.mil/Media/Fact-Sheets/Fact-Sheet-Article-View/Article/482078/dd1391-processor-system/>

AR 405-70, Utilization of Real Property

Spatial Data Standard for Facilities, Infrastructure, and Environment/ Computer-Aided Design and Drafting (SDSFIE), <https://www.sdsfieonline.org/Home/Index>

TM 5-803-5, Installation Design, <https://www.wbdg.org/ffc/army-coe/technical-manuals-tm/tm-5-803-5>

USACE ECB 2012-16 Building Air Tightness And Air Barrier Continuity Requirements Applicability: Directive and Guidance, <https://www.wbdg.org/ffc/dod/engineering-and-construction-bulletins-ecb/usace-ecb-2012-16>

UNITED STATES DEPARTMENT OF DEFENSE, UNIFIED FACILITIES CRITERIA PROGRAM

<http://dod.wbdg.org>

UFC 1-200-01, DoD Building Code

UFC 1-200-02, High Performance and Sustainable Building Requirements

UFC 1-300-02, UFGS Format Standard

FC 1-300-09N, Navy and Marine Corps Design Procedures

UFC 2-000-05N, Facility Planning Criteria for Navy/Marine Corps Shore Installations

UFC 3-120-10, Interior Design

UFC 3-190-06, Protective Coatings and Paints

UFC 3-400-02, Design: Engineering Weather Data

UFC 3-410-01, Heating, Ventilating, and Air Conditioning Systems

UFC 3-420-01, Plumbing Systems

UFC 3-450-01, Noise and Vibration Control

UFC 3-580-01 Telecommunications Interior Infrastructure Planning and Design

UFC 3-810-01N Navy and Marine Corps Environmental Engineering for Facility Construction

UFC 4-010-01, DoD Minimum Antiterrorism Standards for Buildings

UFC 4-010-05, \3\ SCIF/SAPF /3/ Planning, Design, and Construction

UFC 4-010-06, Cybersecurity

UNITED STATES DEPARTMENT OF DEFENSE, UNIFIED FACILITIES GUIDE SPECIFICATIONS

<https://www.wbdg.org/ffc/dod/unified-facilities-guide-specifications-ufgs>

UFGS Section 07 05 23 Pressure Testing an Air Barrier System for Air Tightness

UNITED STATES DEPARTMENT OF LABOR, OCCUPATIONAL SAFETY AND HEALTH ADMINISTRATION

<http://www.osha.gov>

29 CFR Occupational Safety and Health Act (OSHA)

29 CFR 1910.27, Scaffolds and Rope Descent Systems

29 CFR 1910.141 General Environmental Controls

29 CFR 1910.1025 Lead

29 CFR 1910.1026 Chromium (VI)

29 CFR 1910.1027 Cadmium

29 CFR 1910.1024 Beryllium

29 CFR 1915.1024 Beryllium

29 CFR 1926.1124 Beryllium

UNITED STATES DEPARTMENT OF THE NAVY

OPNAV M-5090.1 Environmental Readiness Manual (10 Jan 2014)

<http://www.navybmr.com/study%20material/OPNAV%20M-5090.1.pdf>

Navy Radon Assessment and Mitigation Program Guidebook for Naval Shore Installations

https://www.cnrc.navy.mil/content/cnrc/cnrc_hq/regions/ndw/installations/nas_patuxent_river/om/environmental_support/radon-

[survey/jcr_content/par1/pdfdownload_0/file.res/NAVRAMP%20Nonresidential%20Guidebook%20-%20Final%206%20JUN%202015.pdf](https://www.epa.gov/radon/publications-about-radon)

UNITED STATES ENVIRONMENTAL PROTECTION AGENCY

<https://www.epa.gov/radon/publications-about-radon>

EPA 402-R-93-071, *EPA's Map of Radon Zones (by State)*

EPA 402-R-94-009, *EPA's Model Standards and Techniques for Control of Radon in New Residences*

EPA/625/R-92-016, *Radon Prevention in the Design and Construction of Schools and Other Large Buildings*

UNITED STATES NATIONAL CAD STANDARD

<https://www.nationalcadstandard.org/ncs6/index.php>

CANCELLED