

EXRG4 - INTERIOR DESIGN

Floor Finish		Wall Finish		Ceiling Finish		Room Height	Room Noise		
Preferred	Alternate	Preferred	Alternate	Preferred	Alternate	ft - in	Min NC	Max NC	SC
VT		GPT		AT1		8' - 0"	30	35	45

EXRG4 - DOOR SCHEDULE

Mark	Type	Count	Height	Width	Notes
			ft - in	ft - in	
A	Single-Flush	1	7' - 0"	3' - 0"	

Room Description: Exam, Screening

NSF: 120

EXRG4

Plate Description: Room/Equipment Isometric

Scale:

Sheet
1

of
5

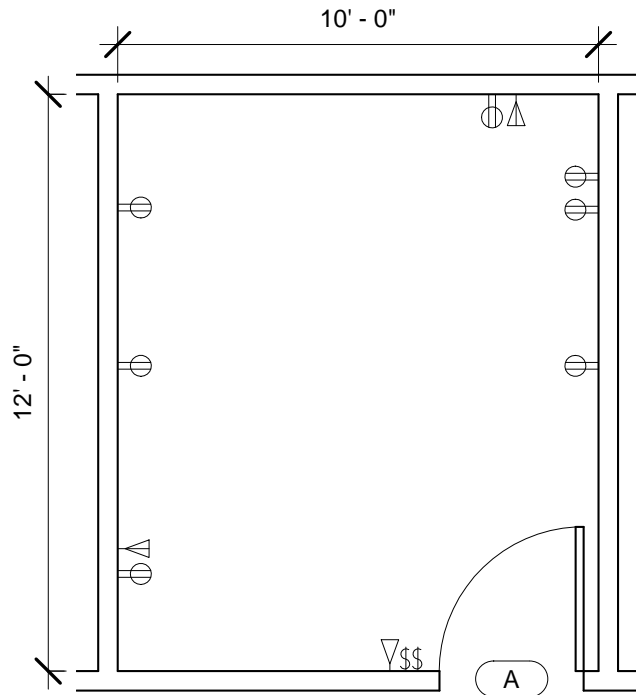

EXRG4 - FLOOR PLAN

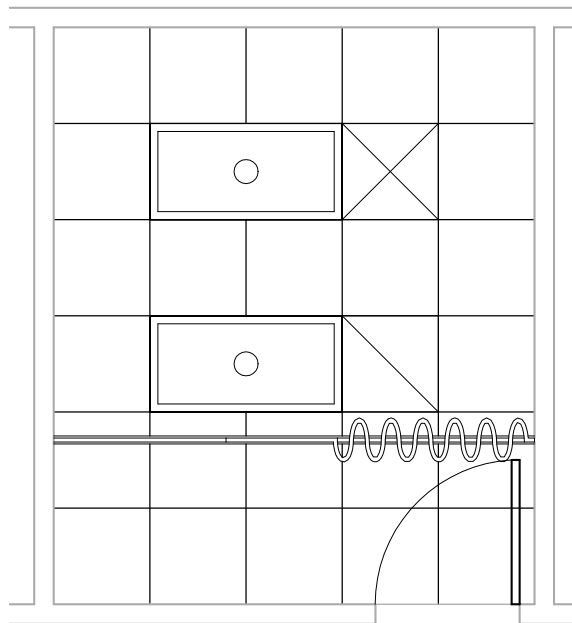

EXRG4 - CEILING PLAN

Room Description: Exam, Screening	NSF: 120	EXRG4	
Plate Description: Floor & Ceiling Plans	Scale: 1/4" = 1'-0"	Sheet 2	of 5

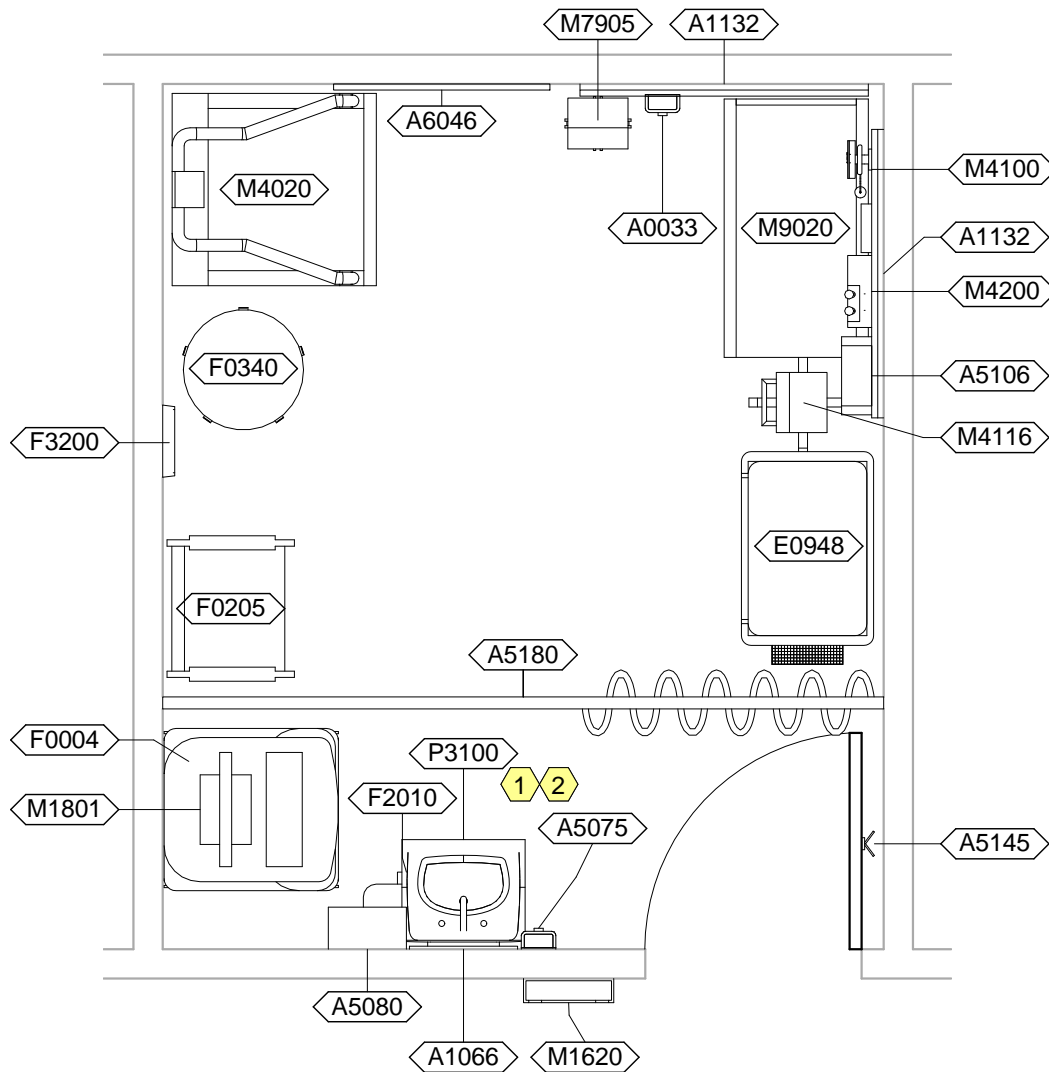

EXRG4 - NOTES

- 1 JSN P3200, Lavatory Electronic, may be used instead of JSN P3100, Lavatory. For the JSN P3200, Lavatory Electronic, provide either battery power or hard wired connection.
- 2 JSN P8710, Utility Center, shall be included in Navy projects only.

Room Description: Exam, Screening	NSF: 120	<h1>EXRG4</h1>	
Plate Description: Equipment Plan	Scale: 3/8" = 1'-0"	Sheet <h2>3</h2>	of <h2>5</h2>

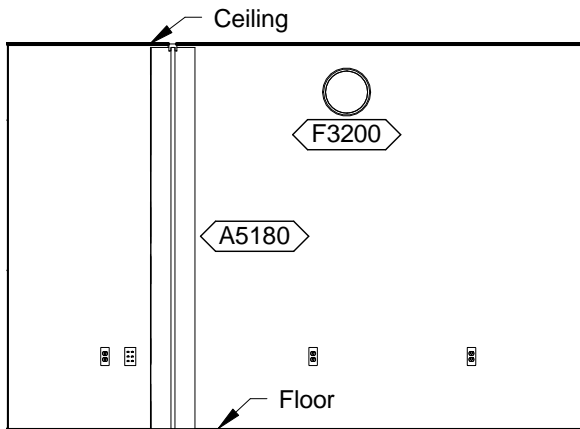

EXRG4 - PLAN WEST

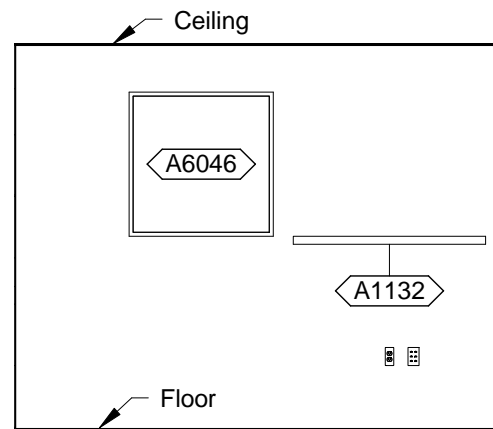

EXRG4 - PLAN NORTH

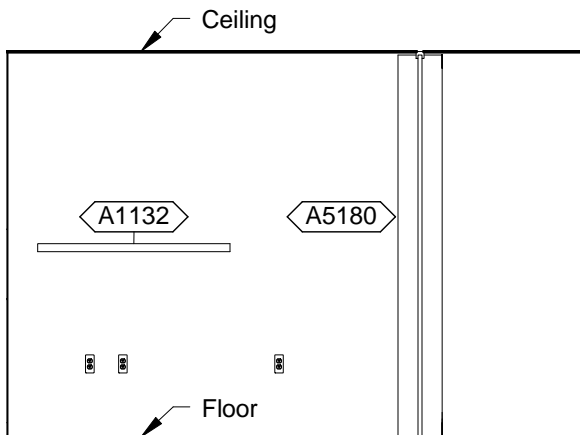

EXRG4 - PLAN EAST

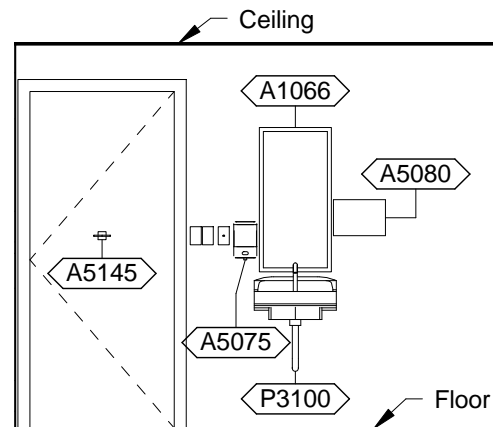

EXRG4 - PLAN SOUTH

<p>Room Description: Exam, Screening</p>	<p>NSF: 120</p>	<p>EXRG4</p>	
<p>Plate Description: Interior Room Elevations</p>	<p>Scale: 1/4" = 1'-0"</p>	<p>Sheet 4</p>	<p>of 5</p>

EXRG4 - EQUIPMENT SCHEDULE

JSN	Nomenclature	Qty	Logistics				Utilities						
			AR	NA	AF	VA	1	2	3	4	5	6	
A0033	Hand Sanitizer, Wall Mounted	1	-	-	-	-	-	-	-	-	-	-	-
A1066	Mirror, Float Glass, With SS Frame	1	A	A	A	A	-	-	-	-	-	-	-
A1132	Rail, Accessory Mounting, 48"	2	A	A	A	A	-	-	-	-	-	-	-
A5075	Dispenser, Soap, Disposable	1	C	C	C	C	-	-	-	-	-	-	-
A5080	Dispenser, Paper Towel, SS, Surface Mounted	1	A	A	A	A	-	-	-	-	-	-	-
A5106	Waste Disposal Unit, Sharps w/Glove Dispenser	1	C	A	C	C	-	-	-	-	-	-	-
A5145	Hook, Garment, Double, SS, Surface Mounted	2	A	A	A	A	-	-	-	-	-	-	-
A5180	Track, Cubicle, Surface Mounted, With Curtain	1	A	A	A	A	-	-	-	-	-	-	-
A6046	Artwork, Decorative, With Frame	1	C	C	C	C	-	-	-	-	-	-	-
E0948	Cart, General Storage, Mobile, 42"H x 32"W x 22"D	1	C	C	C	C	-	-	-	-	-	-	-
F0004	Mobile, Workstation	1	-	-	-	-	-	-	-	-	-	-	-
F0205	Chair, Side With Arms	1	C	C	C	C	-	-	-	-	-	-	-
F0340	Stool, Self Adjusting	1	C	C	C	C	-	-	-	-	-	-	-
F2010	Basket, Wastepaper, Step-On	1	C	C	C	C	-	-	-	-	-	-	-
F3200	Clock, Battery, 12" Diameter	1	C	C	C	C	-	-	-	-	-	-	-
M1620	Holder, Chart, Patient, Wall or Door Mounted	1	A	A	A	A	-	-	-	-	-	-	-
M1801	Computer, Microprocessing, w/Flat Panel Monitor	1	C	C	C	C	-	A	-	-	-	-	-
M4020	Scale, Person Weighing, High Capacity	1	C	C	C	C	-	A	-	-	-	-	-
M4100	Sphygmomanometer, Aneroid, Wall Mounted	1	C	C	C	C	-	-	-	-	-	-	-
M4116	Monitor, Vital Signs	1	C	C	C	C	-	A	-	-	-	-	-
M4200	Otoscope/Ophthalmoscope, Wall Mounted	1	C	C	-	C	-	A	-	-	-	-	-
M7905	Oximeter, Pulse	1	C	C	C	C	-	A	-	-	-	-	-
M9020	Table, Exam, Pediatric, With Scale	1	C	C	C	C	-	A	-	-	-	-	-
P3100	Lavatory, Vitreous China, Slab Type	1	A	A	A	A	D	-	-	-	-	-	-

EXRG4 - DATA/TELEPHONE EQUIPMENT

JSN	Nomenclature	Qty	Logistics			
			AR	NA	AF	VA
A1010	Telecommunication Outlet	2	A	A	A	A
A1014	Telephone, Wall Mounted, 1 Line, with Speaker	1	A	A	A	A

Room Description: Exam, Screening	NSF: 120	EXRG4	
Plate Description: Equipment Schedule	Scale:	Sheet 5	of 5