

# Earthquake-Resistant Design Concepts

An Introduction to Seismic Provisions for New Buildings

Second Edition

FEMA P-749 / September 2022



**FEMA**





# Earthquake-Resistant Design Concepts

## An Introduction to Seismic Provisions for New Buildings

Second Edition

Prepared by  
APPLIED TECHNOLOGY COUNCIL  
201 Redwood Shores Parkway, Suite 240  
Redwood City, California 94065  
[www.ATCouncil.org](http://www.ATCouncil.org)

Prepared for  
FEDERAL EMERGENCY MANAGEMENT AGENCY  
Michael Mahoney, Project Officer  
Pataya Scott, Project Monitor  
Washington, D.C.

### SECOND EDITION PROJECT TEAM

APPLIED TECHNOLOGY COUNCIL  
Jon A. Heintz (Project Executive, Program  
Manager)  
Ayse Hortacsu (Project Manager)  
Chiara McKenney (Project Manager)

PROJECT TECHNICAL COMMITTEE  
Ronald O. Hamburger (Project Technical  
Director)

PROJECT REVIEW PANEL  
David Bonneville  
Michael J. Griffin  
John Hooper

FOCUS GROUP  
Christina Aronson  
Alex Griffin  
Solmaz Jumakuliyeva  
Sung Yeob Lim  
Ginevra Rojahn  
Kayla Secrest

### FIRST EDITION PROJECT TEAM

PREPARED BY  
National Institute of Building Sciences Building  
Seismic Safety Council

LEAD AUTHOR  
Ronald O. Hamburger



## Notice

---

Any opinions, findings, conclusions, or recommendations expressed in this publication do not necessarily reflect the views of the Applied Technology Council (ATC), the Department of Homeland Security (DHS), or the Federal Emergency Management Agency (FEMA). Additionally, neither ATC, DHS, FEMA, nor any of their employees, makes any warranty, expressed or implied, nor assumes any legal liability or responsibility for the accuracy, completeness, or usefulness of any information, product, or process included in this publication. Users of information from this publication assume all liability arising from such use.

Cover photographs – Top left: flexible pipe connections at rooftop expansion joint (photo credit: M. Phipps); top right: buckling-restrained braced frame; bottom left: earthquake-resistant detailing of steel reinforcement for a reinforced concrete column; bottom right: base isolators under the Utah State Capitol Building (photo credit: M. Renlund).

---

# Preface

One of the key ways that a community protects itself from potential earthquake disasters is by adopting and enforcing a building code with appropriate seismic design and construction standards. This publication serves as a guide on current seismic design provisions in the United States and reaffirms FEMA's ongoing support of efforts to encourage design and building practices that address earthquake hazards and minimize the resulting risk of damage, injury, and societal disruption.

Building codes and standards are technical documents used primarily by engineers, architects, and code officials. Nevertheless, understanding the basis for seismic regulations in U.S. building codes and standards is important for individuals both inside and outside of technical community. This guide provides practical information for both groups. Part A is written for a general audience and provides a high-level, easy-to-read explanation of the basis and intent of U.S. seismic provisions. Part B is written for an engineering audience and provides a walkthrough of the seismic design process for new buildings.

The Applied Technology Council (ATC) is grateful to Ronald Hamburger, Project Technical Director, who prepared both this new edition of the guide and the first edition. ATC is also indebted to the Building Seismic Safety Council (BSSC) for the development of the original source materials for the report, including many of the images.

The Project Review Panel, consisting of David Bonneville, Michael Griffin, and John Hooper, provided technical review, advice, and consultation at key stages of the work. The Focus Group, consisting of Christina Aronson, Alex Griffin, Solmaz Jumakuliyeva, Sung Yeob Lim, Ginevra Rojahn, and Kayla Secrest, provided invaluable advice on the content, organization, and ease of use.

ATC gratefully acknowledges Michael Mahoney (FEMA Project Officer) and Pataya Scott (FEMA Project Monitor) for their input and guidance in the preparation of this document. Carrie Perna and Ginevra Rojahn provided report production services. Chiara McKenney managed the project.

Ayse Hortacsu  
ATC Director of Projects

Jon A. Heintz  
ATC Executive Director



---

# How to Use this Guide

This guide provides an overview of earthquake-resistant design concepts and their context within the seismic requirements of U.S. building codes. Acknowledging that interest in this subject comes from both inside and outside of the structural engineering community, this guide is divided into two parts.

Part A, intended for a general audience, provides a non-technical explanation of the intent of U.S. seismic provisions and the key principles of earthquake-resistant design. This part is written for a wide audience, including elected officials, decision-makers in insurance and finance, building and business owners, and other interested members of the public. This part is also useful to engineers, architects, and other design professionals.

Part B, intended for an engineering audience, presents the key steps in the seismic design process for new buildings. Background is provided on the major principles that serve as the foundation for the process, and special topics of interest are highlighted. The envisioned audience includes practicing engineers early in their career, practicing engineers new to seismic design, engineering graduate or undergraduate students, and architects. It is recommended that readers of Part B first read Part A.

## Part A: General Audience

The information presented across the five chapters of Part A provide the reader with an understanding of earthquake hazard fundamentals, the approach to seismic risk in current building codes, new concepts that could impact future seismic provisions, key design features for seismic resistance, and vulnerabilities of common structure types.

- Chapter 1 provides an overview of the key geological effects of earthquakes and general concepts of earthquake hazard.
- Chapter 2 describes how seismic provisions in building codes are developed and implemented.
- Chapter 3 explains how current building codes approach earthquake risk and how this approach may evolve in the future.
- Chapter 4 highlights fundamental design features that are necessary for seismic resistance in buildings.
- Chapter 5 introduces the most common structure types used in the United States and what aspects of each are most vulnerable in earthquakes.

## Part B: Engineering Audience

The five chapters of Part B teach the reader, who is assumed to have a basic knowledge of structural engineering principles, how to understand and apply the seismic design process for new buildings embodied in the ASCE/SEI 7-22 Standard, *Minimum Design Loads and Associated Criteria for Buildings and Other Structures*, published by the Structural Engineering Institute of the American Society of Civil Engineers.

- Chapter 6 introduces basic concepts of structural dynamics and outlines the overall seismic design process that is covered in more detail in Chapters 7 to 9.
- Chapters 7 to 9 cover the key steps in the seismic design process, which include determining the seismic design criteria, designing the seismic force-resisting system, and seismically protecting nonstructural components.
- Chapter 10 covers special considerations, including energy dissipation systems, seismic isolation, soil-structure interaction, performance-based design, design for tsunami, and design of nonbuilding structures.

Part B is a practical, standalone guide that does not require a concurrent reading of ASCE/SEI 7-22. However, as this guide focuses only on the most commonly applied seismic requirements, it does not touch upon every condition in ASCE/SEI 7-22, and actual structural design of any building requires careful review of the ASCE/SEI 7 Standard. To allow the reader to quickly find the relevant sections of ASCE/SEI 7-22, references are provided where relevant.

## Key Terms, Acronyms, and Symbols

Throughout the report, key terms are highlighted in **orange** (Part A) or **blue** (Part B). The full list of key terms is provided as a glossary in the back of the guide, along with lists of acronyms and symbols.

## Other Materials

References and project participants are provided at the back of the guide.

## Callout Boxes



Additional resources on topics in this guide are provided in this type of box.



Provisions that are new in ASCE/SEI 7-22 are highlighted in this type of box.



Quick references to specific sections of ASCE/SEI 7-22 appear in this type of box.



---

# Table of Contents

Preface .....	iii
How to Use this Guide.....	v
List of Figures.....	xi
List of Tables .....	xvii

## Part A: General Audience

<b>Chapter 1: How Earthquakes Affect Buildings.....</b>	<b>1-1</b>
<b>1.1 Background .....</b>	<b>1-1</b>
<b>1.2 Ground Shaking .....</b>	<b>1-6</b>
1.2.1 Strong Motion Recordings .....	1-6
1.2.2 Earthquake Hazard .....	1-7
<b>1.3 Other Geological Earthquake Effects .....</b>	<b>1-11</b>
1.3.1 Landslides.....	1-11
1.3.2 Liquefaction .....	1-12
1.3.3 Tsunami .....	1-13
1.3.4 Fault Rupture.....	1-14
<b>Chapter 2: How U.S. Seismic Provisions are Developed and Implemented .....</b>	<b>2-1</b>
<b>2.1 Building Codes .....</b>	<b>2-1</b>
<b>2.2 Consensus Standards.....</b>	<b>2-4</b>
<b>2.3 Existing Buildings .....</b>	<b>2-5</b>
<b>2.4 History of U.S. Seismic Provisions .....</b>	<b>2-6</b>
2.4.1 National Earthquake Hazards Reduction Program .....	2-7
2.4.2 Development of Provisions for New Buildings.....	2-8
2.4.3 Development of Provisions for Existing Buildings .....	2-9
<b>2.5 Implementation of the Building Code.....</b>	<b>2-10</b>

<b>Chapter 3: How U.S. Building Codes Approach Earthquake Risk .....</b>	<b>3-1</b>
<b>3.1 Approach in Current Codes.....</b>	<b>3-1</b>
3.1.1 Approach for New Buildings.....	3-2
3.1.2 Approach for Existing Buildings.....	3-2
3.1.3 Implications of Current Approach.....	3-3
<b>3.2 Performance-based Procedures.....</b>	<b>3-5</b>
<b>3.3 Future Directions.....</b>	<b>3-6</b>
<b>Chapter 4: Key Features of Earthquake-resistant Building Design .....</b>	<b>4-1</b>
<b>4.1 Earthquake-resistant Structures .....</b>	<b>4-1</b>
4.1.1 Stable Foundations .....	4-2
4.1.2 Continuous Load Path.....	4-4
4.1.3 Adequate Stiffness and Strength .....	4-6
4.1.4 Regularity .....	4-7
4.1.5 Redundancy.....	4-9
4.1.6 Ductility and Toughness.....	4-10
4.1.7 Separation from Adjacent Structures.....	4-11
<b>4.2 Earthquake-resistant Nonstructural Components .....</b>	<b>4-12</b>
<b>Chapter 5: How Common Structure Types Perform in Earthquakes.....</b>	<b>5-1</b>
<b>5.1 Structure Types .....</b>	<b>5-1</b>
5.1.1 Bearing Wall Systems.....	5-1
5.1.2 Building Frame Systems .....	5-6
5.1.3 Moment Frames .....	5-7
5.1.4 Dual Systems.....	5-9
5.1.5 Cantilever Column Systems .....	5-9
<b>5.2 Protective Systems.....</b>	<b>5-10</b>

## **Part B: Engineering Audience**

<b>Chapter 6: Overview of the Seismic Design Process.....</b>	<b>6-1</b>
<b>6.1 Seismic Design Process.....</b>	<b>6-1</b>

6.2	Background .....	6-3
<b>Chapter 7: Determine Seismic Design Criteria .....</b>		<b>7-1</b>
7.1	Identify Site Class.....	7-1
7.2	Obtain the Design Response Spectra for the Site .....	7-3
7.3	Assign Risk Category.....	7-7
7.4	Assign Seismic Design Category.....	7-8
<b>Chapter 8: Design the Structure.....</b>		<b>8-1</b>
8.1	Select Structural System .....	8-1
8.1.1	Wall Systems .....	8-2
8.1.2	Braced Frame Systems .....	8-4
8.1.3	Moment-Resisting Frame Systems .....	8-5
8.1.4	Dual Systems.....	8-6
8.1.5	Cantilever Column Systems.....	8-6
8.2	Identify Design Coefficients .....	8-6
8.3	Check for Configuration Irregularities .....	8-7
8.4	Calculate Seismic Loads.....	8-10
8.4.1	Base Shear Strength .....	8-11
8.4.2	Redundancy.....	8-14
8.4.3	Vertical Earthquake Forces.....	8-14
8.5	Analyze and Design Structural Elements .....	8-14
8.5.1	Equivalent Lateral Force Procedure .....	8-14
8.5.2	Simplified ELF .....	8-16
8.5.3	Modal Response Spectrum Analysis.....	8-17
8.5.4	Linear Response History Analysis .....	8-18
8.5.5	Nonlinear Response History Analysis.....	8-18
8.6	Check Drift and Stability .....	8-19
8.7	Design Diaphragms.....	8-21
8.8	Detail Connections and Other Elements .....	8-24
8.8.1	Concrete and Masonry Walls.....	8-24

8.8.2	Steel Braced Frames.....	8-25
8.8.3	Moment Frames.....	8-25
8.8.4	Light-Frame Systems.....	8-27
<b>Chapter 9: Anchor and Brace the Nonstructural Components .....</b>		<b>9-1</b>
9.1	Determine if Anchorage or Bracing is Required.....	9-1
9.2	Calculate Seismic Forces.....	9-2
9.3	Provide Drift Compatibility .....	9-6
9.4	Check for Seismic Qualification.....	9-6
<b>Chapter 10: Special Considerations .....</b>		<b>10-1</b>
10.1	Performance-based Design .....	10-1
10.2	Design for Tsunami.....	10-4
10.3	Soil-Structure Interaction.....	10-4
10.4	Energy Dissipation Systems.....	10-5
10.5	Seismic Isolation Systems .....	10-8
10.6	Nonbuilding Structures.....	10-10
<b>Acronyms.....</b>		<b>I-1</b>
<b>Symbols.....</b>		<b>II-1</b>
<b>Glossary.....</b>		<b>III-1</b>
<b>References.....</b>		<b>IV-1</b>
<b>Project Participants.....</b>		<b>V-1</b>

---

# List of Figures

Figure 1-1	Earthquakes in the United States detected over a one-week span .....	1-1
Figure 1-2	Tectonic plate boundaries affecting North America .....	1-2
Figure 1-3	Map of active faults around San Francisco.....	1-3
Figure 1-4	Relative amounts of energy released in different magnitude earthquakes .....	1-3
Figure 1-5	Intensity tends to diminish with distance from the zone of fault rupture .....	1-4
Figure 1-6	Intensity is amplified in loose saturated soils and lower in locations with firm soils and near-surface rock. ....	1-4
Figure 1-7	Acceleration, velocity, and displacement, 1949 El Centro Earthquake .....	1-7
Figure 1-8	Map of frequency of damaging earthquake shaking in the United States .....	1-8
Figure 1-9	MMI maps for the conterminous United States for return periods of 475 years, 975 years, and 2,475 years.....	1-10
Figure 1-10	House destroyed when the hillside beneath it gave way following the 1994 M6.7 Northridge Earthquake .....	1-11
Figure 1-11	Liquefaction-induced settlement of apartment buildings in the 1964 Niigata Earthquake in Japan .....	1-12
Figure 1-12	Lateral spreading damage to a highway in the 1959 Hegben Lake Earthquake .....	1-12
Figure 1-13	Sukuiso, Japan a week after the M9.0 Tohoku Earthquake and Tsunami .....	1-13
Figure 1-14	Horizontal offset of a fence near Point Reyes, California from fault rupture in the 1906 7.8M San Francisco Earthquake .....	1-14
Figure 1-15	Vertical fault offset of a school track from surface fault rupture in the 1999 M7.7 Chi-Chi Earthquake in Taiwan .....	1-14

Figure 3-1	Widespread damage in San Francisco following the earthquake and fire in 1906..	3-4
Figure 3-2	Christchurch, New Zealand after demolition of many buildings in the Central Business District following the 2011 Christchurch Earthquake .....	3-4
Figure 4-1	Buildings are a complex assemblage of structural and nonstructural elements .....	4-1
Figure 4-2	Types of shallow foundations.....	4-3
Figure 4-3	Deep foundation using piles .....	4-3
Figure 4-4	Effects of ground motion on a building .....	4-4
Figure 4-5	This carport, originally supported by but not firmly attached to the adjacent house, became detached from the house during ground shaking .....	4-5
Figure 4-6	Houses that fell off its foundation in the 1989 Loma Prieta Earthquake.....	4-5
Figure 4-7	Earthquake-resistant wood frame construction uses steel hardware to tie the framing elements together and provide a continuous load path .....	4-6
Figure 4-8	First story of an apartment building in San Francisco leaning to the side after the 1989 Loma Prieta Earthquake .....	4-7
Figure 4-9	Two examples of buildings with weak/soft stories .....	4-8
Figure 4-10	Building with torsional irregularity created by the lack of walls at the front of the first story, while more solid walls are present on the remaining three sides .....	4-8
Figure 4-11	Building with two reentrant corners where two wings intersect each other .....	4-9
Figure 4-12	Illustration of common causes of damage at reentrant corner irregularities .....	4-9
Figure 4-13	Comparison of redundancy between two buildings with equal overall wall length.....	4-10
Figure 4-14	Failure of an unreinforced masonry wall in the 1989 Loma Prieta Earthquake .....	4-11
Figure 4-15	Pounding damage on two buildings in Santiago, Chile, following the 2010 Chile Earthquake.....	4-12

Figure 4-16	Two views of a building showing the structure on the left and nonstructural components on the right .....	4-13
Figure 4-17	Failure of partitions, light fixtures, and ceilings in an office building damaged by the 1994 Northridge Earthquake .....	4-14
Figure 4-18	Lateral “swaying” deformation of structures during earthquake shaking can cause damage to nonstructural elements .....	4-14
Figure 5-1	Typical URM bearing wall building .....	5-2
Figure 5-2	Damaged URM building in the 2014 M6.0 South Napa Earthquake .....	5-3
Figure 5-3	Damaged URM building in the 2020 M5.7 Magna Earthquake .....	5-3
Figure 5-4	A typical reinforced concrete or reinforced masonry bearing wall building .....	5-4
Figure 5-5	Reinforced masonry wall construction .....	5-5
Figure 5-6	Diagonal cracking in a reinforced concrete building damaged by the 1989 Loma Prieta Earthquake .....	5-5
Figure 5-7	Typical wood light-frame construction .....	5-6
Figure 5-8	Steel braced frames left exposed on the exterior of a high-rise and inside a grocery store .....	5-7
Figure 5-9	A tall steel moment frame structure under construction .....	5-8
Figure 5-10	Cantilever column systems are commonly used for carports and similar structures .....	5-9
Figure 5-11	Wall damper visible during construction of a hospital .....	5-10
Figure 5-12	Seismic isolators on top of columns at an airport in Burbank, California.....	5-11
Figure 6-1	Seismic design process as outlined in this guide and ASCE/SEI 7-22 .....	6-1
Figure 6-2	Dynamic behavior of an SDOF structure .....	6-3

Figure 6-3	Ground motion effect on structure .....	6-4
Figure 6-4	SDOF structure subjected to ground motion.....	6-5
Figure 6-5	Displacement response of 1-second SDOF structure to a ground motion .....	6-5
Figure 6-6	Acceleration response spectrum for an example ground motion.....	6-6
Figure 6-7	Illustration of the effect of nonlinear response.....	6-8
Figure 7-1	Representative acceleration response spectra for a site near Los Angeles, California with different assumed soil conditions .....	7-1
Figure 7-2	Example seismic hazard curve for peak ground acceleration .....	7-3
Figure 7-3	Representative design response spectrum for site near Los Angeles, California with Site Class C conditions .....	7-5
Figure 7-4	Two-period design response spectrum.....	7-6
Figure 7-5	Seismic design category on default site class for Risk Category I and II buildings .....	7-10
Figure 8-1	Deformed shape and typical damage patterns in multi-story concrete or masonry walls.....	8-3
Figure 8-2	Common types of steel braced frame systems.....	8-4
Figure 8-3	Typical deformed shape of moment-resisting frame responding to lateral forces....	8-5
Figure 8-4	Reentrant corner irregularity.....	8-8
Figure 8-5	Diaphragm discontinuity irregularity.....	8-8
Figure 8-6	Out-of-plane offset irregularity .....	8-8
Figure 8-7	Examples of buildings with a soft first story, a common type of stiffness irregularity .....	8-9
Figure 8-8	Vertical geometric irregularity .....	8-9



Figure 8-9	Example of an in-plane discontinuity irregularity.....	8-10
Figure 8-10	Simple multi-degree of freedom (MDOF) structure in free vibration .....	8-11
Figure 8-11	Forces acting on MDOF structure in free vibration.....	8-12
Figure 8-12	Eccentric application of story forces.....	8-16
Figure 8-13	Mode shapes and inertial forces associated with free vibration of MDOF structure .....	8-17
Figure 8-14	Story drift.....	8-19
Figure 8-15	Deflection of diaphragm under lateral loading .....	8-21
Figure 8-16	Diaphragm elements .....	8-23
Figure 8-17	Typical reinforcing requirements in special reinforced concrete walls .....	8-24
Figure 8-18	Typical reinforcing for special concrete moment frame.....	8-26
Figure 8-19	Section through perimeter of two-story wood framed building.....	8-27
Figure 8-20	Use of blocking and steel straps to transfer tensile forces in the structure .....	8-28
Figure 8-21	Use of blocking to transfer shear loads and prevent joist roll-over .....	8-28
Figure 8-22	Use of holddown devices to resist overturning loads .....	8-29
Figure 9-1	Examples of nonstructural anchorage.....	9-4
Figure 9-2	Examples of nonstructural bracing.....	9-5
Figure 9-3	Pipe crossing seismic joint between two buildings.....	9-6
Figure 10-1	Standard ASCE/SEI 41 Performance levels.....	10-2
Figure 10-2	Fluid viscous damper assembly in frame.....	10-7

Figure 10-3 Elastomeric isolator ..... 10-8

Figure 10-4 Sliding-type isolation bearing ..... 10-9

Figure 10-5 Structures commonly found in petroleum refineries and chemical plants ..... 10-10

Figure 10-6 Seismic design criteria for steel storage racks of the type used in large  
warehouses and big-box retail stores are included in the building code ..... 10-11

---

# List of Tables

Table 1-1	Excerpts of the Modified Mercalli Intensity Scale.....	1-5
Table 2-1	Standards Related to Earthquake Resistance Referenced by the I-Codes.....	2-4
Table 2-1	Responsibilities of Members of a Typical Building Design Team .....	2-11
Table 7-1	Site Class and Shear Wave Velocities .....	7-2
Table 7-2	Risk Categories .....	7-7
Table 7-3	Seismic Design Categories, Risk, and Seismic Design Requirements .....	7-8



# Part A:

# General Audience

This part of the guide provides a non technical explanation of the intent of seismic provisions and the fundamental principles of earthquake resistant design. The intended audience is interested members of the public, including elected officials, decision makers in insurance and finance, building owners, and business owners. The information is also useful to engineers, architects, and other design professionals.



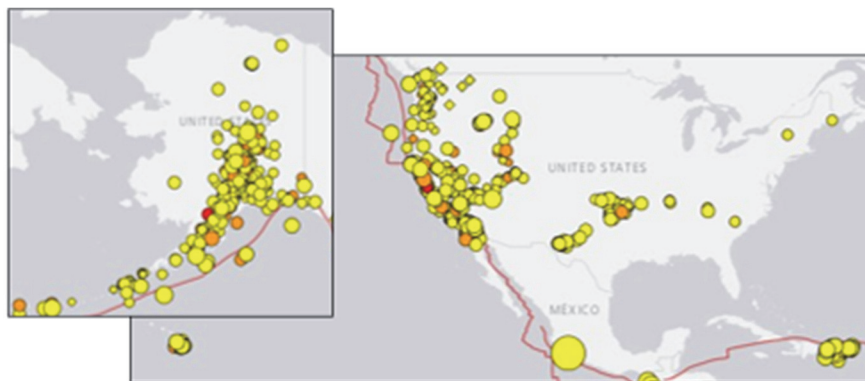
# Chapter 1: How Earthquakes Affect Buildings

Imagine that two earthquakes of the same magnitude each strike a different location. One earthquake causes large loss of life and widespread building damage, leading to economic disruption and slow recovery of local communities. The other causes some building damage but no deaths, and the impact to the local economy and communities is felt but manageable. There are many reasons that could explain how two earthquakes of similar magnitude can produce such different effects. It could in part be related to the intensity of the earthquake at the affected population centers, a factor most influenced by distance from the epicenter and soil types present. It could also be explained by the degree of exposure; the more people and buildings in the affected area, the more damaging effects there will be. There are specific site conditions that can also exacerbate damage, such as the presence of steep slopes. Often most influential on the impacts of an earthquake, however, is how many of the buildings in the affected area were constructed using earthquake-resistant design principles.

This chapter provides general background on earthquakes, an overview of geological effects caused by earthquakes, and an introduction to the concept of earthquake hazard. One of the geological effects, ground shaking, is given special attention because it is the most common cause of earthquake damage and the primary focus of earthquake-resistant building design. The remaining chapters of this guide introduce earthquake-resistant design concepts and explain how the seismic building code provisions that embody them are developed and implemented in practice.

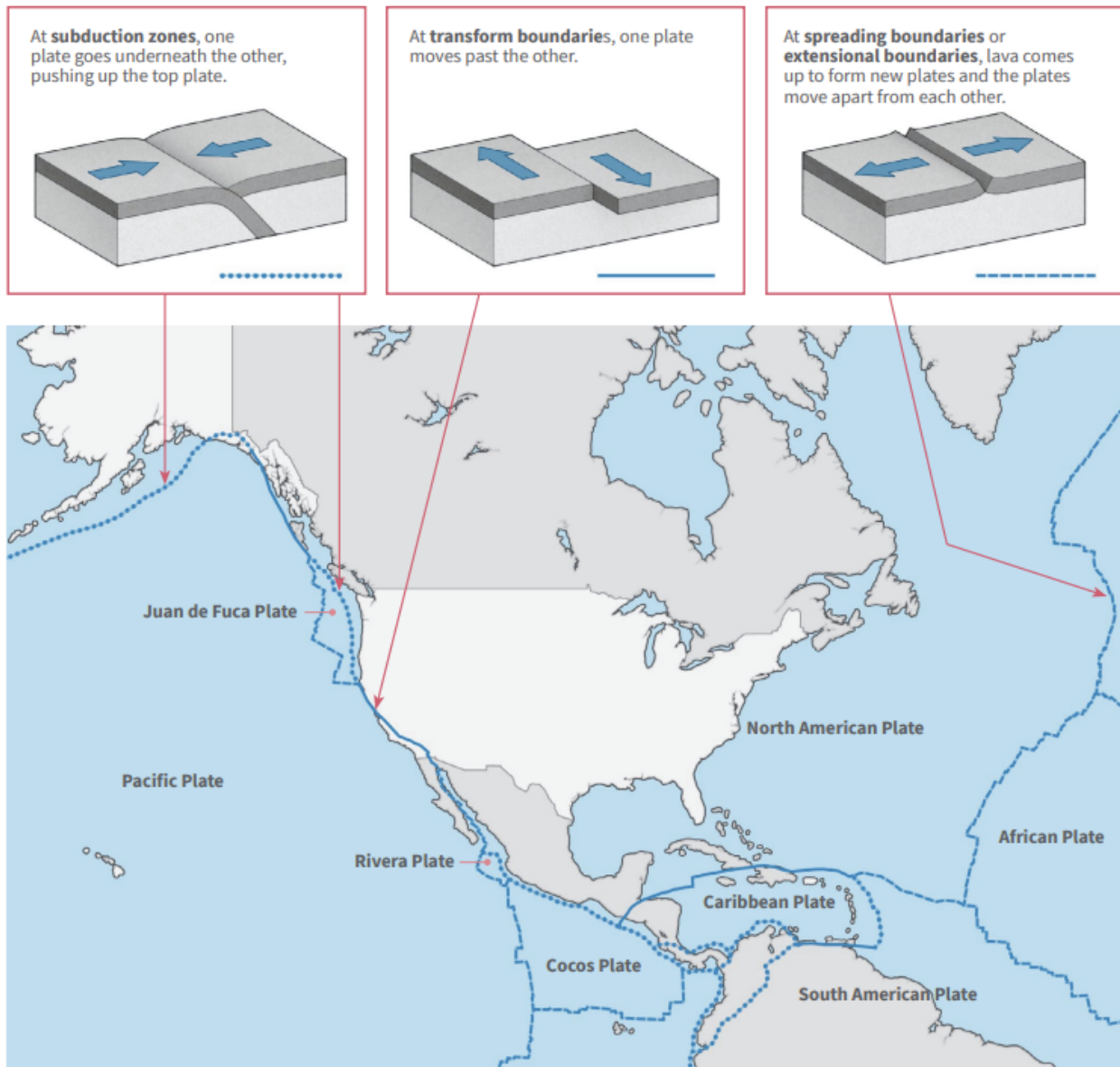
## 1.1 Background

Every year, about 500,000 detectable earthquakes occur worldwide, of which about 100,000 are felt by people (USGS, 2022a). These earthquakes range from small events felt by a few people to large earthquakes that cause widespread damage. Figure 1-1 shows an example of the earthquakes detected in the United States by the U.S. Geological Survey (USGS) over the course of a week.



**Figure 1-1** Earthquakes in the United States detected over a one-week span (USGS, 2022b).

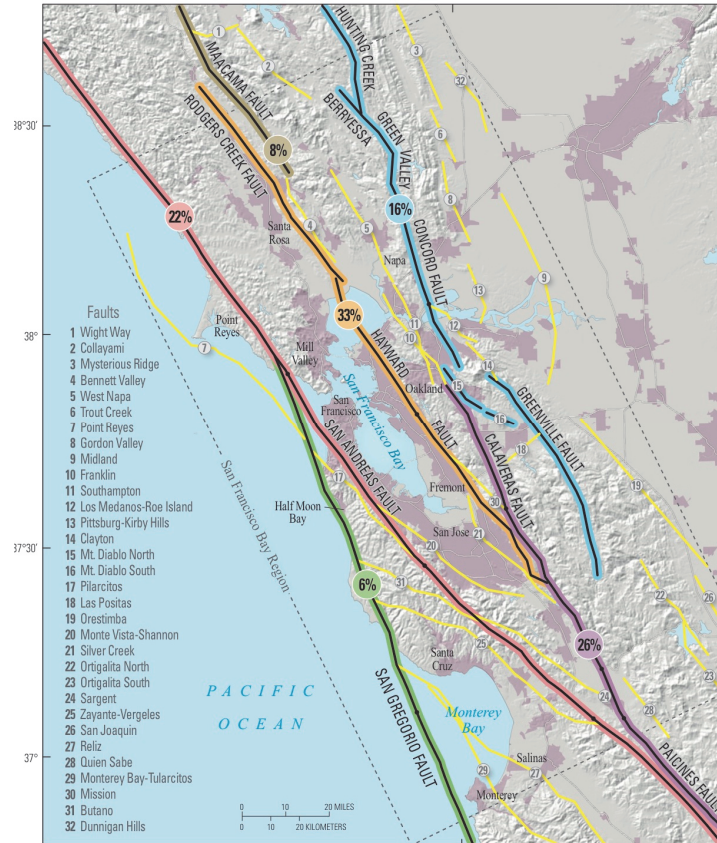
The crust of the earth is composed of tectonic plates that are constantly being pushed, pulled, and twisted by the flow of magma in the mantle. Figure 1-2 shows the major plates affecting North America and the sense of the relative plate movement across the boundaries. At these boundaries, the plates are usually locked together by friction, which prevents them from moving relative to one another. Over a period of hundreds to thousands of years, stress builds up along these boundaries. Occasionally, the stress along a plate boundary will exceed the friction locking the plates together or the stress at an internal location in a plate will exceed the strength of the rock itself.



**Figure 1-2** Tectonic plate boundaries affecting North America (from FEMA P-530). The west coast and Alaska have the most frequent earthquakes because they are adjacent to the plate boundary between the North American and Pacific plates.

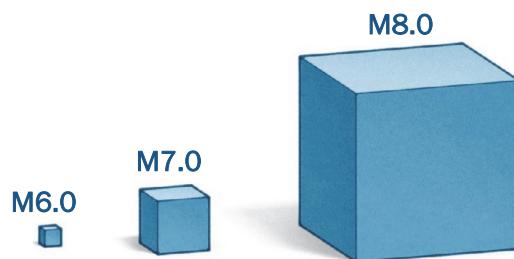


When this occurs, the rock fractures or slips, releasing stored energy and causing an earthquake. These locations of high stress, called **faults**, are typically clustered together (Figure 1-3). Most faults are near plate boundaries, but faults can also occur at the interior of a plate. The location of most faults are known, but earthquakes occasionally occur on faults that were previously unknown.



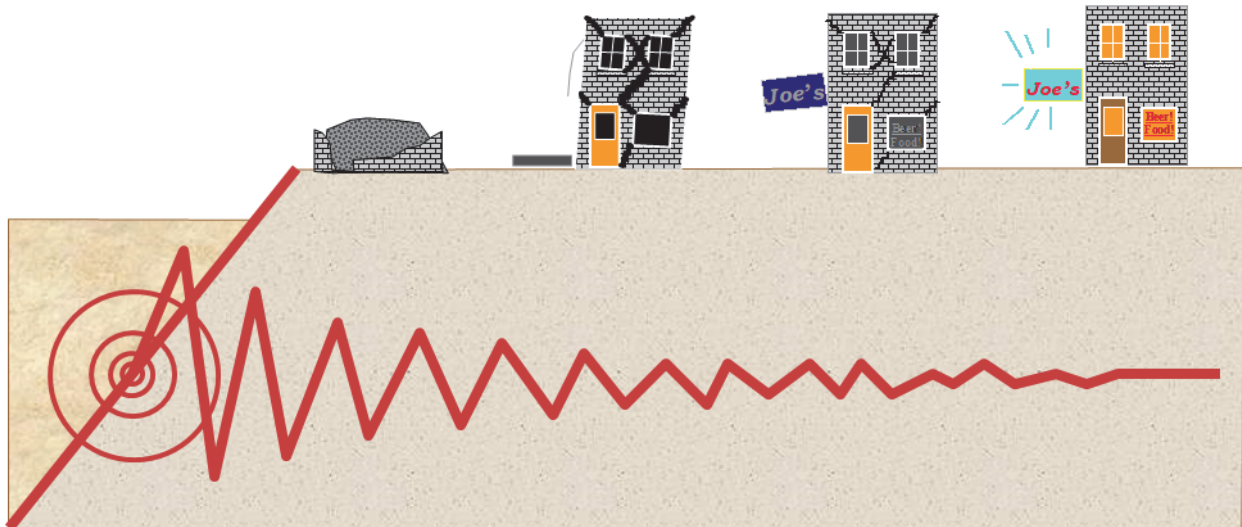
**Figure 1-3** Map of active faults around San Francisco (Aagaard et al., 2016). San Andreas, the most well-known fault, is one of several that pose a hazard. Percentage shown indicates probability of a major earthquake on the fault by 2043.

In the news, it is common to hear the severity of an earthquake communicated in terms of its **magnitude** (M), an objective measure of the amount of energy release. Magnitude is on a logarithmic scale; an M6.0 releases 32 times more energy than an M5.0, and an increase in magnitude of two, say from M6.0 to M8.0, represents a thousand time increase in energy (Figure 1-4).



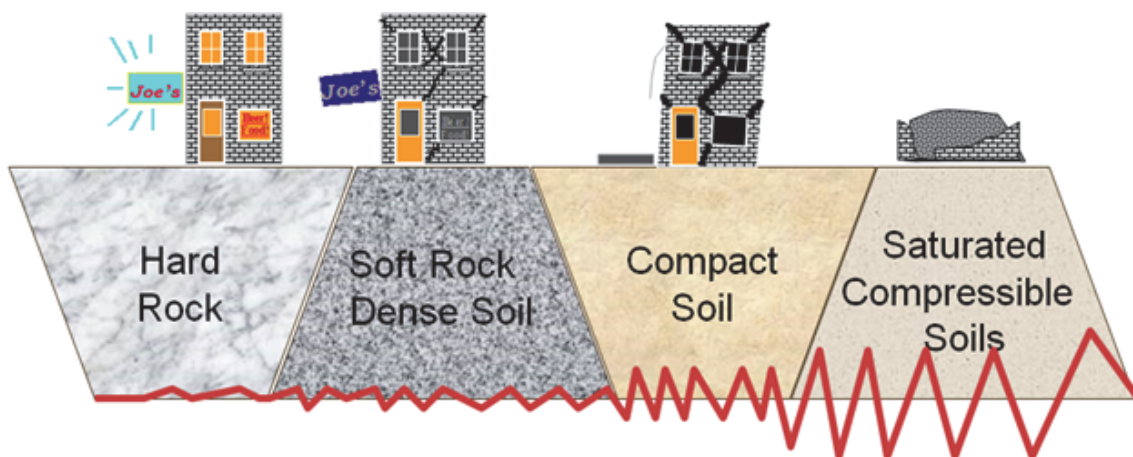
**Figure 1-4** Relative amounts of energy released in different magnitude earthquakes (from FEMA P-530). The amount of energy is represented by the volume of the box.

While magnitude represents the total destructive potential of an earthquake, it does not actually quantify the intensity of the effects at a specific location. Earthquake effects generally diminish with distance from the epicenter, just as ripples created by a stone dropped in a puddle diminish in size with distance (Figure 1-5). The most intense effects of an earthquake generally occur at sites closest to the area on the fault that produced the earthquake.



**Figure 1-5 Intensity tends to diminish with distance from the zone of fault rupture.**

The intensity of effects experienced at a site is also affected by the type of soils present. Sites with soft soils, such as those that are found in river valleys and along the edges of large lakes and bays, tend to amplify the effects. Sites with hard rock formations near the surface will experience less intense shaking than sites that have loose or soft soils or deep deposits of soils over the rock (Figure 1-6).



**Figure 1-6 Intensity is amplified in loose saturated soils and lower in locations with firm soils and near-surface rock.**

**Modified Mercalli Intensity (MMI)** is a qualitative scale used to characterize the severity of earthquake effects based on observations of people affected by the earthquake. The intensity of the earthquake is determined based on reports from people on how they reacted to the earthquake and their descriptions of the damage. Table 1-1 provides an excerpt of the MMI scale for high intensity shaking levels.

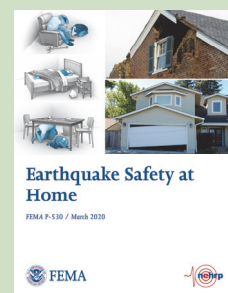
**Table 1-1 Excerpts of the Modified Mercalli Intensity (MMI) Scale (USGS, 2021c)**

Intensity	Shaking	Description
I to V	Not felt to Moderate	Not listed for brevity.
VI	Strong	Felt by all, many frightened. Some heavy furniture moved; a few instances of fallen plaster. Damage slight.
VII	Very strong	Damage negligible in buildings of good design and construction; slight to moderate in well-built ordinary structures; considerable damage in poorly built or badly designed structures; some chimneys broken.
VIII	Severe	Damage slight in specially designed structures; considerable damage in ordinary substantial buildings with partial collapse. Damage great in poorly built structures. Fall of chimneys, factory stacks, columns, monuments, walls. Heavy furniture overturned.
IX	Violent	Damage considerable in specially designed structures; well-designed frame structures thrown out of plumb. Damage great in substantial buildings, with partial collapse. Buildings shifted off foundations.
X	Extreme	Some well-built wooden structures destroyed; most masonry and frame structures destroyed with foundations. Rails bent.



### FEMA P-530: Earthquake Safety at Home

This guide to earthquake preparedness provides a well-illustrated, approachable introduction to the science behind earthquakes, an overview of regions of the United States with high risk of earthquakes, and guidance for seismic retrofitting of common home types. Published 2020. Available as a [free PDF](#).



## 1.2 Ground Shaking

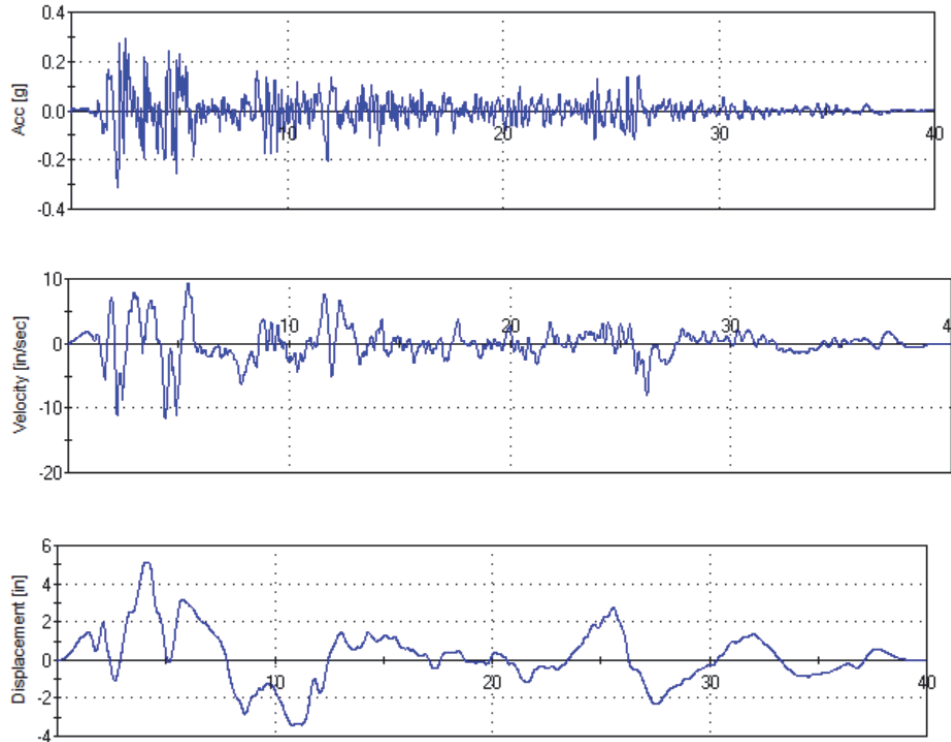
Energy released from an earthquake radiates out from the origin through the surrounding rock and soils in all directions as random vibrations, which are felt on the surface as **ground shaking**. Ground shaking is the most widespread effect of earthquakes and the most common cause of building damage. The primary focus of earthquake-resistant building design is to minimize damage from ground shaking.

Ground shaking can last from a few seconds in small earthquakes to several minutes in very large ones. People experiencing ground shaking from an earthquake may refer to it as a rolling motion or an up-and-down motion. In reality, such observer reports are based on individual sensitivity to the motion as well as where they were when the shaking occurred. All earthquakes shake the ground in random directions, both vertically and horizontally.

### 1.2.1 Strong Motion Recordings

Ground shaking effects cannot be quantified using magnitude or MMI. **Strong motion recording** instruments are used to record acceleration, velocity, and displacement, which are the key attributes used to measure shaking intensity. The U.S. Geological Survey (USGS) and other institutions have placed thousands of instruments in buildings and at ground level in areas subject to earthquakes. Measurements from the instruments are used to understand the character and intensity of ground shaking at each site, considering its distance from the fault rupture and type of soil present. This data is useful in design of buildings and other structures.

Figure 1-7 shows plots of acceleration, velocity, and displacement recorded in the 1940 M6.9 El Centro Earthquake in Southern California. The peak acceleration of the ground at the instrument site was approximately 30% of the acceleration a free-falling object would experience if dropped (i.e., acceleration of gravity). The **peak ground acceleration** (PGA) for this site would be communicated as 0.3g, where  $g$  represents gravity. This acceleration is about the same as would be experienced in a car that accelerated from zero to 60 miles per hour in ten seconds. However, in this earthquake, the peak acceleration lasted only a fraction of a second, before reversing itself. While a car accelerating in this manner would travel approximately 500 feet before reaching 60 miles per hour, the ground at this instrument moved only five inches before reversing itself and moving four inches in the opposite direction. Over the duration of about 40 seconds, the back-and-forth movement was repeated many times. The strongest earthquake ground motions ever recorded have produced accelerations as much as six or seven times stronger than that shown in the figure and have had durations of several minutes.



**Figure 1-7 Acceleration, velocity, and displacement, 1940 El Centro Earthquake (data from USGS).**

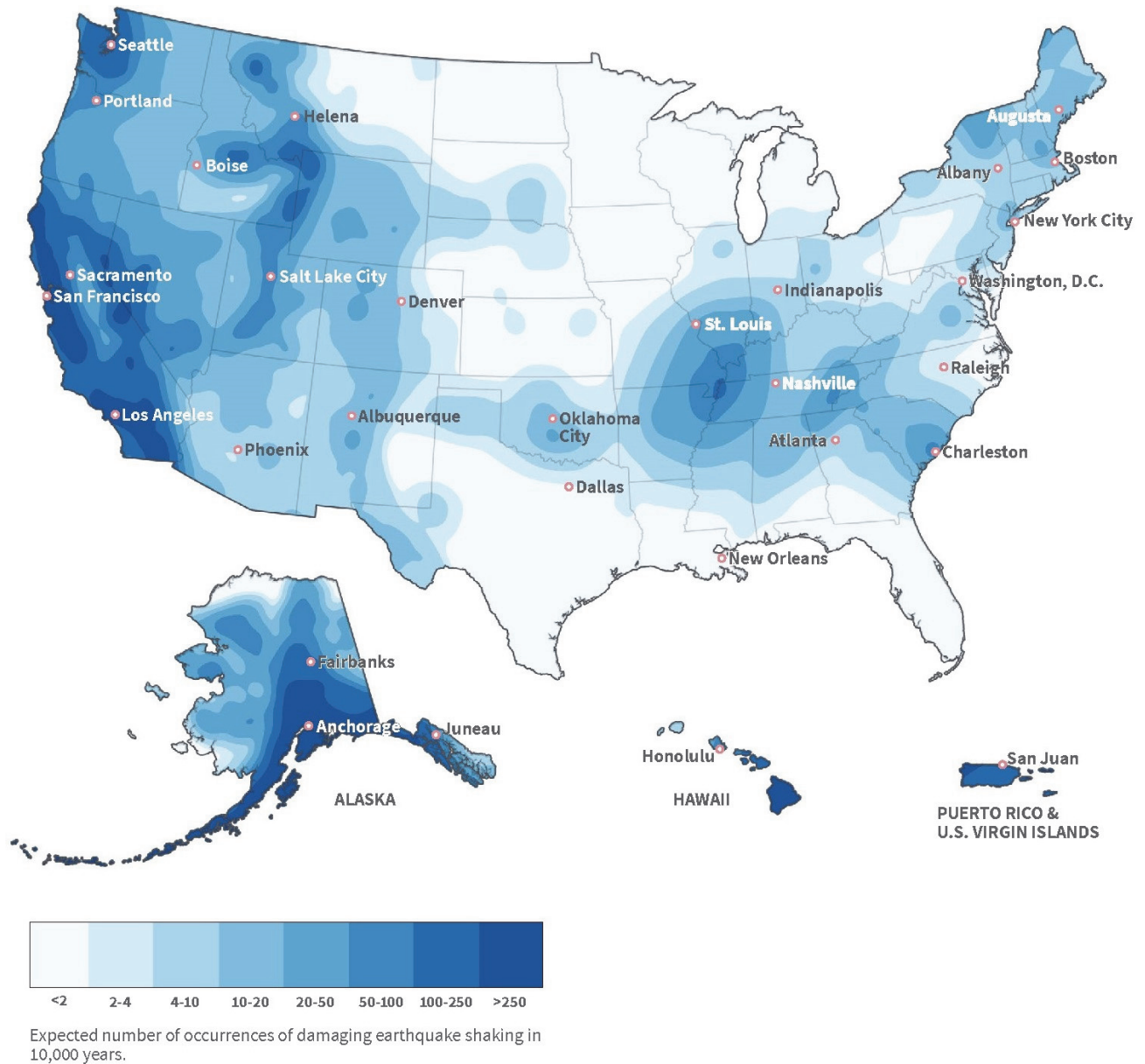
## 1.2.2 Earthquake Hazard

Earthquakes occur randomly in time but large earthquakes occur much less frequently than smaller ones. **Return period** is the number of years, on average, between events of similar size. (Similar terminology is used for other natural hazards such as flooding.) As earthquake magnitude increases, so does the intensity of the ground shaking and the size of the geographic area affected by the shaking. The risk of high-intensity earthquake ground shaking in a region is based on the frequency and intensity of earthquakes that affected the region in the past. **Earthquake hazard** is the term to describe the probability that a region or individual building location will experience the destructive effects of earthquakes and to quantify those effects.

Earthquake hazard varies across the United States, and much of the country can be subjected to severe earthquake effects. The frequency of occurrence, or return period, for such severe earthquake effects ranges from a few hundred years in the most active portions of the nation, including parts of Alaska, California, and Washington, to several thousand years in other regions. The intensity of shaking and other earthquake effects a site may experience is a function of soil types, proximity to active faults, and characteristics of those faults, including activity rate and potential earthquake magnitudes.

The risk of high-intensity earthquake ground shaking in a region is related to the frequency and intensity of earthquakes that affected the region in the past. Earthquakes have occurred in nearly

every region of the United States. Figure 1-8 is a map of the expected frequency of damaging earthquake shaking in the United States. Damaging earthquakes occur frequently in coastal California, the Pacific Northwest, and Alaska. However, some of the most intense earthquakes have actually occurred elsewhere. Other areas of frequent earthquake activity include Hawaii; Puerto Rico; the intermountain region of Utah, Idaho, Wyoming, and Montana; the Mississippi Valley area known as the New Madrid seismic zone; and a belt along the Appalachian Mountains. Isolated earthquakes have occurred in most other regions of the nation.



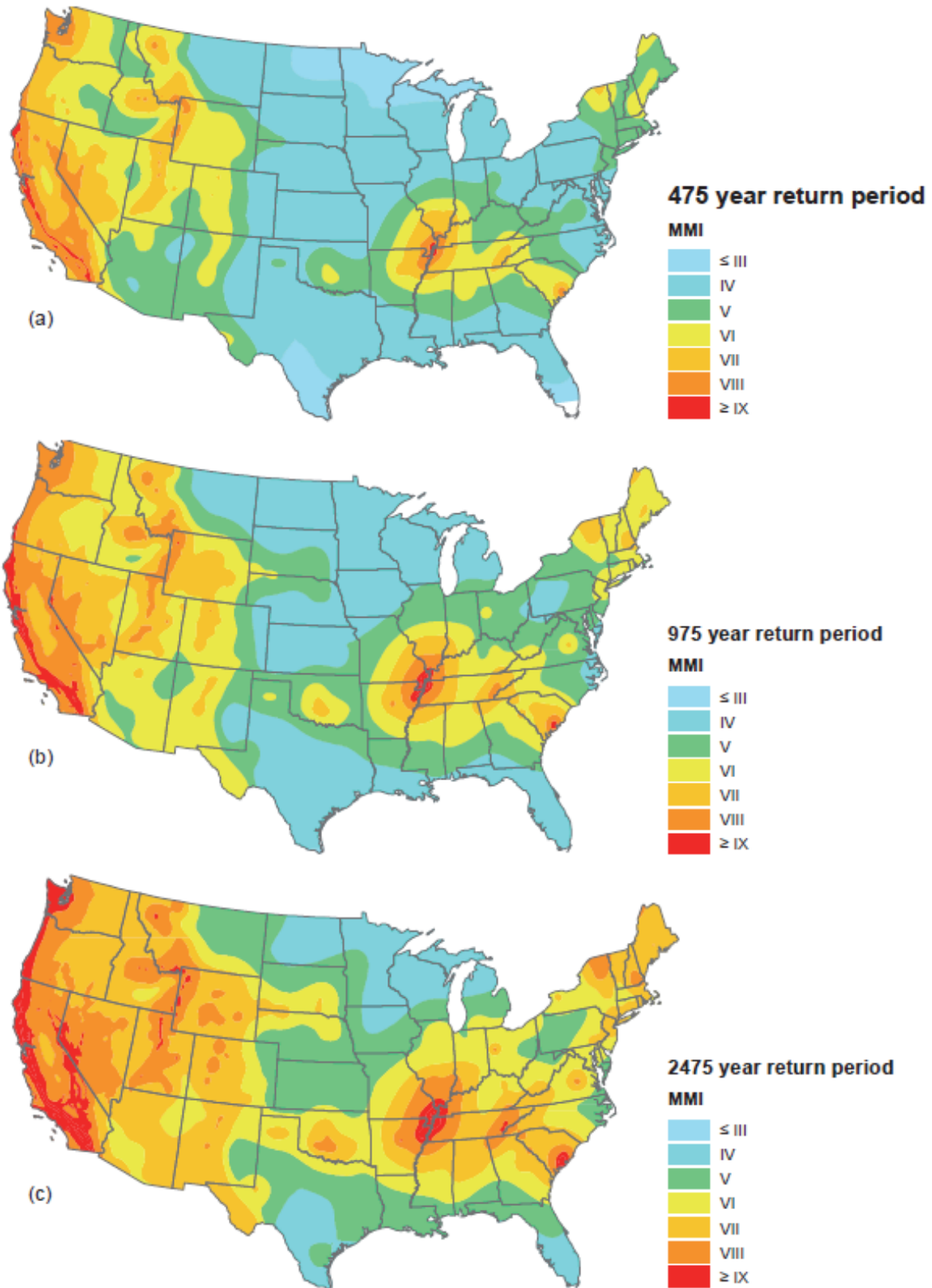
**Figure 1-8** Map of frequency of damaging earthquake shaking in the United States (from FEMA P-530).

Seismologists, geotechnical engineers, and earth scientists use a process called **seismic hazard analysis** to quantify the probability that a site will experience high-intensity ground shaking. Although it is not possible to predict the specific size, location, or time of future earthquakes with any certainty, these specialists use data on the past activity rates for known faults, as well as information on their length and how quickly stress builds up in the rock along the faults, to determine the probability that the faults will produce future earthquakes of various sizes. The mathematical relationships used to express these probabilities are called **recurrence relationships**.

In addition, earth scientists and geotechnical engineers use data from strong motion recording instruments to develop ground motion prediction models that indicate the likely intensity of motion at a site if an earthquake of a specific size and at a specific distance from the site occurs. Using the recurrence equations for individual faults and the ground motion prediction models, earth scientists and engineers develop mathematical relationships that indicate the probability of different intensities of ground shaking occurring at specific sites.

The USGS, as part of its responsibility under the National Earthquake Hazards Reduction Program (NEHRP), maintains a seismic hazard geo-database that engineers use to determine the required strength of building designs. Figure 1-9 shows a series of maps prepared by the USGS using this database, illustrating the projected MMI at different sites across the conterminous United States for return periods of 475 years, 975 years, and 2,475 years respectively, assuming sites with typical firm soils.

These maps illustrate that as earthquake return period increases, the probable intensity of motion also increases. At a return period of 2,475 years, much of the United States is at risk of experiencing ground shaking with intensities capable of causing significant structural damage (MMI VII and higher). It should be noted that sites with softer soils, commonly found adjacent to rivers and shorelines, experience more intense shaking than illustrated in the figure while those with near-surface rock or very stiff soils experience less intense motions. Similarly, sites subject to landslides, liquefaction, or lateral spreading will experience more intense effects than indicated by these maps.



**Figure 1-9** MMI maps for the conterminous United States for return periods of 475 years, 975 years, and 2,475 years (from USGS).



## 1.3 Other Geological Earthquake Effects

While ground shaking occurs over the entire affected area, other geological earthquake effects occur only where specific conditions exist. Fault rupture can only occur at locations crossed by a fault. Liquefaction can occur only at sites with saturated loose granular soils. Landslides occur on steep slopes, and tsunamis only affect coastal areas. The location specificity of these hazards, however, does not diminish their potential impact. Tsunamis and landslides have caused many deaths in recent earthquakes, and liquefaction has slowed recovery and caused substantial economic losses.

### 1.3.1 Landslides

When strong earthquake shaking occurs, **landslides** can be triggered on steep sloping sites with loose soils. Earthquake-induced landslides can be very localized, destroying individual buildings, such as that shown in Figure 1-10, or affect entire communities.



**Figure 1-10** House destroyed when the hillside beneath it gave way following the 1994 M6.7 Northridge Earthquake (from Douglas C. Pizac/Associated Press).

### 1.3.2 Liquefaction

Soil **liquefaction** occurs when loose saturated soils, typically sands and silts, are subjected to strong earthquake shaking. The strong shaking compacts or densifies the granular soils and, in the process, forces out a portion of the water that saturates them. As the water is pushed out, it flows upward creating a quicksand-like condition in which the soils lose their ability to support foundations. When soil liquefaction occurs, structures supported on the liquefied soils can sink and settle dramatically (Figure 1-11) and underground structures can float free.



**Figure 1-11** Liquefaction-induced settlement of apartment buildings in the 1964 Niigata Earthquake in Japan (from University of Washington).

Another ground instability related to liquefaction is **lateral spreading**. When liquefaction occurs on sites with even a mild slope, surface soils flow downhill like a fluid and carry with them any structures they support. Figure 1-12 shows damage to pavement on a site that experienced liquefaction and lateral spreading during an earthquake near Yellowstone National Park in 1959.



**Figure 1-12** Lateral spreading damage to a highway in the 1959 Hegben Lake Earthquake (from USGS).

### 1.3.3 Tsunami

Earthquakes along segments of faults that underly the floors of oceans and other large bodies of water can cause **tsunamis** that can result in great life and property loss in coastal regions located close to or even thousands of miles from the earthquake. For example, a 2004 tsunami that originated from an earthquake in the Indian Ocean is resulted in more than 228,000 lives lost and \$10 billion in estimated economic damage (ReliefWeb, 2022). The 2011 Tohoku Earthquake and Tsunami (Figure 1-13) resulted in more than 18,000 lives lost and \$220 billion in estimated economic damage (NOAA, 2021).

Tsunamis are caused by displacement of a seafloor, often triggered by earthquakes on underwater subduction faults. During the earthquake, a portion of the sea floor is rapidly raised in elevation, pushing a wave of water outward from the source. Most life loss related to tsunamis is a result of drownings but collapse of structures can also be a factor. Tsunami effects that damage structures include hydro-dynamic forces associated with passage of the wave, flotation of structures off their foundations, and impact by water-borne debris including large vessels, shipping containers, and vehicles.

Tsunamis can take many minutes or even hours after the generating earthquake to reach a coast, so many communities have relied on early warning systems and evacuation planning as a means of protecting against life loss. Although buildings and structures can be designed to resist forces generated by a tsunami, structures in coastal communities have not been designed to resist tsunami effects. Within the past five years, the building codes have adopted requirements for design of some structures essential to community response and recovery for tsunami effects (Section 10.2). Most structures, however, are exempt from such requirements.



**Figure 1-13** Sukuiso, Japan a week after the M9.0 Tohoku Earthquake and Tsunami (from D. McCord, NOAA).

### 1.3.4 Fault Rupture

The slippage within the rock that occurs during an earthquake, known as **fault rupture**, can initiate near and propagate up to the ground surface or occur miles beneath the surface and remain hidden. Surface fault rupture can result in abrupt lateral (Figure 1-14) or vertical (Figure 1-15) offsets, ranging from a few inches to many feet. The forces produced by the rupture can be large, so it is challenging to design structures that can resist being pulled apart by fault rupture. The best defense against damage from ground fault rupture is to not build over known **fault traces**.



**Figure 1-14** Horizontal offset of a fence near Point Reyes, California from fault rupture in the 1906 7.8M San Francisco Earthquake (from USGS).



**Figure 1-15** Vertical fault offset of a school track from surface fault rupture in the 1999 M7.7 Chi-Chi Earthquake in Taiwan (from B. Yeats).

---

# Chapter 2: How U.S. Seismic Provisions are Developed and Implemented

One of the primary ways a community protects itself and its individual citizens from potential earthquake disasters is by adopting and enforcing a building code with appropriate seismic design and construction requirements. Seismic provisions in U.S. building codes have evolved over the past century to apply knowledge gained from observation of earthquake damage and research conducted over that time. The seismic provisions of U.S. building codes are implemented during building design and construction through a regulatory process involving a wide range of individuals. This Chapter provides an overview of the role building codes play in ensuring society has adequate protection from earthquakes, how seismic provisions in building codes are developed, and how the provisions are implemented during design and construction of a building. The content focuses on new buildings, but existing buildings are briefly discussed.

## 2.1 Building Codes

**Building codes** are an extensive compendium of legally enforceable, technical regulations that establish the minimum design, construction, and maintenance requirements for new and existing buildings and structures of different occupancies and uses. In the United States, building codes are adopted and enforced at the local level (i.e., by individual cities and counties), although some states and territories mandate that all communities within the state adopt a single state-approved series of codes. Building codes are primarily written for use by architects, engineers, and building regulators. However, they are useful for various purposes by safety inspectors, environmental scientists, real estate developers, contractors and subcontractors, manufacturers of building products and materials, insurance companies, facility managers, tenants, and others.

Presently, most U.S. communities formally adopt a building code and have a system in place for building regulation, but this was and still is not always the case. In fact, some rural areas in the United States have still not adopted a building code and, in these areas, it is legal to design and construct structures using any standards considered appropriate by the designers and builders. Further, not all codes enforced at the local level will result in adequate earthquake-resistant design and construction. For example, some communities in the Central and Eastern United States that are at significant risk of experiencing damaging earthquakes have applied modifications to the nationally recommended seismic requirements to reduce the cost and impact of earthquake-resistant construction in their communities. Other communities adopt codes that are out-of-date or are slow to incorporate recent improvements in building technology. As a result, although the cost of incorporating appropriate earthquake resistance into new construction is small, many buildings continue to be constructed without adequate protection, leaving people in these communities at risk.

As some historical context, in the late 1800s and early 1900s, some major U.S. cities, including Chicago, Los Angeles, Philadelphia, and New York, developed their own building codes. Typically, the local building officials and fire marshals led the effort with voluntary assistance from local design professionals, construction industry associations, and the insurance industry. Most of the codes were developed because of frequent urban conflagrations that occurred in that era, but San Francisco developed a code in response to the earthquake there in 1906. Initially, the building codes were unique to each city, but over time cities began to collaborate on a regional level to further develop codes, and as a result the requirements became more uniform. As this practice was formalized, building officials in the Northeast and Central United States, Southeastern United States, and Western United States each formed organizations to develop **model building codes** appropriate to their regions. Most individual cities within the regions adopted the model building codes, sometimes with local amendments.

Today, most building codes adopted and enforced in the United States are based on a series of model building codes developed and published by the International Code Council (ICC), a successor to the organizations that developed the earlier region-based model codes. The ICC is a professional association mostly composed of building regulators, such as building officials and fire marshals. The I-Codes are intended to be nationally and internationally applicable, though they are mostly adopted within the United States. There are 15 total I-codes, but only three pertain to seismic provisions:

- The *International Building Code (IBC)* addresses nearly all types of buildings, including residential, commercial, institutional, governmental, and industrial buildings and structures;
- The *International Residential Code (IRC)* addresses one- and two-family dwellings and low-rise multi-unit dwellings.
- The *International Existing Buildings Code (IEBC)* addresses existing buildings.

Several other organizations, including the National Fire Protection Association (NFPA) and the International Association of Plumbing and Mechanical Officials (IAPMO), also publish model codes, which are adopted by some U.S. communities.

The ICC and other model code development organizations publish new editions of their codes on regular cycles, which are typically three years long. Each time the model codes are updated, hundreds of changes are made to reflect the use of new construction products and technologies, new research and lessons learned through observation of poor performance, and to accommodate changes to societal expectations. ICC follows a formal update process for their codes that enables any individual or organization to propose new requirements or changes to existing requirements. There is a formal member-consensus voting process used to approve or deny proposals. Professional associations representing engineers and architects, building industry trade associations, individual construction product suppliers, and individual members of the public all participate in this process.

Some communities adopt the model codes each time a new model code is issued, while other communities wait years before adopting an updated code. Some communities adopt the codes

verbatim, while others modify the provisions or adopt only portions of them. The development and widespread adoption of the I-Codes is beneficial in that it has created a more uniform regulatory environment in which design professionals and contractors need to become familiar with only a single set of requirements regardless of where they are practicing. Also, the consensus process used to update the codes generally ensures that the requirements are fundamentally sound and nationally applicable.

Once adopted by a state or local government, the building code becomes law and is typically enforced by a government official. This official is typically identified as the Chief Building Official, but sometimes another title is used, such as Fire Marshal or Clerk. Collectively, the officials empowered to enforce the requirements of a building code are identified in the codes as the **Authority Having Jurisdiction** (AHJ).



### International Building Code (IBC), International Residential Code (IRC), and International Existing Buildings Code (IEBC)

Three model building codes by ICC pertain to seismic provisions:

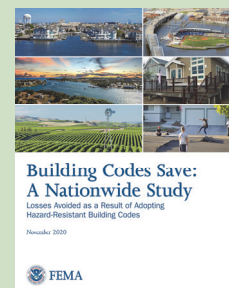
- The IBC is the model code for all buildings.
- The IRC is a model code with special provisions applicable for detached one- and two-family dwellings and townhouses up to three stories.
- The IEBC is the model code for repair, alteration, addition, and change of occupancy for existing buildings.

Published 2020. Available for free [on the web](#).



### FEMA Report: Building Codes Save: A Nationwide Study

This report presents a study about hazard losses avoided by communities that have adopted more stringent building codes. The study summarized in the report analyzed local data to generate a nationwide picture of what percentage of new building stock is built to hazard-resistant codes, the estimated long-term cost savings of adoption of these codes, and how the benefits of commercial and residential building codes differ. Published 2020. Available as a [free PDF](#).



## 2.2 Consensus Standards

Many design requirements, including ones for earthquake resistance, are not contained in the text of the I-codes. Rather, I-codes reference outside documents called **consensus standards**, which include the detailed, and often material-specific, requirements. The model codes typically adopt the most recent edition of each standard available at the time of code publication. Once adopted by a code as a reference, these standards become as effective as if they were transcribed within the codes. Important standards that include requirements for earthquake-resistant design and construction are listed in Table 2-1. There are other standards governing the design of specialty structures including bridges, storage tanks, storage racks, telecommunications towers, and electrical transmission towers, but those are not listed.

**Table 2-1 Standards Related to Earthquake Resistance Referenced by the I-Codes**

Topic Area	Standard	Publisher
New buildings	ASCE/SEI 7 <i>Minimum Design Loads and Associated Criteria for Buildings and Other Structures</i>	Structural Engineering Institute (SEI) of ASCE
Existing buildings	ASCE/SEI 41 <i>Seismic Evaluation and Retrofit of Existing Buildings</i>	Structural Engineering Institute (SEI) of ASCE
Steel	AISC 360 <i>Specification for Steel Buildings</i>	American Institute of Steel Construction (AISC)
Steel	AISC 341 <i>Seismic Provisions for Steel Buildings</i>	American Institute of Steel Construction (AISC)
Steel	AWS D.8 <i>Seismic Supplement</i>	American Welding Society (AWS)
Reinforced concrete	ACI 318 <i>Building Code Requirements for Reinforced Concrete</i>	American Concrete Institute (ACI)
Wood-frame	NDS <i>National Design Specification</i>	American Wood Council (AWC)
Wood-frame	SDPWS <i>Special Design Provisions for Wind and Seismic</i>	American Wood Council (AWC)
Cold-formed steel	AISI S100 <i>North American Specification for the Design of Cold Formed Steel Structural Members</i>	American Iron and Steel Institute (AISI)
Reinforced masonry	TMS 402/602 <i>Building Code Requirements and Specification for Masonry Structures</i>	The Masonry Society (TMS)





## Consensus Standards

Industry associations like ASCE, AISC, ACI, AWC, AISI, and TMS publish consensus standards for design and construction practice in their respective industries. If referenced by a building code, these industry standards become part of the code. Publishing dates vary by standard. Consensus standards are available through their publishers.



## 2.3 Existing Buildings

A new building becomes an existing building the moment it becomes occupied. After a few years of use, most buildings do not conform to the currently enforced building code in some way because the codes continue to evolve. As the buildings age, the lack of conformance will become more significant. For the most part, building codes do not require upgrading existing buildings to conform to current code requirements. However, recognizing that some building types are particularly hazardous in earthquakes, some communities have amended their building codes to mandate retrofit of these structures. Building types addressed by these mandates have include unreinforced masonry buildings and some older concrete and wood-frame buildings.

Chapter 5 describes common types of buildings in the existing U.S. building stock, including some that are especially vulnerable to earthquake damage.

It would be impracticable to require that each existing building be brought into conformance with the current code, each time a community adopts an updated version of the code. Most existing buildings are only required to be maintained to conform to the requirements of the code under which they were originally permitted. However, there are a few exceptions:

- When a substantive alteration or addition is made to the structure.
- When the use of the structure changes, such that the new occupancy results in greater risk to the public than did the prior occupancy.
- When extensive damage occurs, requiring substantive repair (e.g., after an earthquake or fire).
- When the community determines, through its adopted building code, that the building conforms to a class of structures that is excessively hazardous to the public safety.

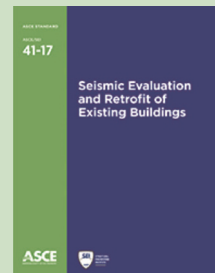
Depending on the age of an existing structure and its materials of construction, it may be impracticable to bring the building into full compliance with the code requirements for new construction. Therefore, when upgrade is required, many codes permit upgrade to reduced criteria, relative to that required of new construction.

The IEBC is the model code most commonly adopted for enforcement of building safety in existing buildings. Like the IBC, the IEBC adopts many of its provisions by reference to national standards. One such standard is the ASCE/SEI 41 Standard, *Seismic Evaluation and Retrofit of Existing Buildings*. This standard specifies evaluation procedures that can be used to determine the performance of buildings in earthquakes of different intensity. The design and analysis procedures that can be used to upgrade building performance when it is found to be unacceptable. ACI and AISC are developing companion standards that provide guidance on the capacity of archaic reinforced concrete and structural steel structures, respectively, to resist earthquake shaking with desired limiting levels of damage.



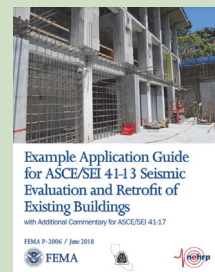
### ASCE/SEI 41 Standard: Seismic Evaluation and Retrofit of Existing Buildings

This standard provides engineering procedures to evaluate the earthquake resistance of existing buildings and design retrofits that improve their ability to withstand earthquakes. Published 2017. Available through ASCE.



### FEMA P-2006: Example Application Guide for ASCE/SEI 41-13 Seismic Evaluation and Retrofit of Existing Buildings

This report provides helpful guidance on the interpretation and use of ASCE/SEI 41, *Seismic Evaluation and Retrofit of Existing Buildings*, through a set of step-by-step design examples that cover key selected topics. Discussion of the foundational principles, performance objectives, analysis procedures, and acceptance criteria is also included. Published 2018. Available as a [free PDF](#).



## 2.4 History of U.S. Seismic Provisions

In the United States, the early development of earthquake requirements for building codes occurred primarily in the western states, notably California. These first requirements were developed by volunteers from the Structural Engineers Association of California (SEAOC), in cooperation with the International Conference of Building Officials, a predecessor to the ICC. These initial requirements appeared as a non-mandatory appendix in the 1927 edition of the *Uniform Building Code*, an early model code adopted primarily in western states. Over the years, as more earthquakes occurred in western states, SEAOC worked with its sister associations in other states, most notably Washington,

to refine and improve these regulations. Eventually they were moved into the body of the *Uniform Building Code* and became mandatory.

During the early years of seismic code provision development, the principal basis for code changes was observation of the performance of actual buildings in earthquakes. When an earthquake occurred, engineers and building officials would survey the damage and, when certain types of construction performed poorly, they would change the code to address observed problems. By 1970, many engineers and building officials practicing on the West Coast believed they had developed a building code capable of providing buildings with adequate earthquake performance. However, in 1971, the M6.6 San Fernando Earthquake near Los Angeles resulted in extensive damage to many then code-conforming structures and the collapse of some such structures. That earthquake made it clear that the building code needed significant improvement and served as a wake-up call to engineers that more work was needed.

### 2.4.1 National Earthquake Hazards Reduction Program

A few years after the 1971 San Fernando Earthquake, Congress passed the Earthquake Hazards Reduction Act of 1977 (Public Law 95-124) that established the **National Earthquake Hazards Reduction Program** (NEHRP). Under the NEHRP, four federal agencies, the Federal Emergency Management Agency (FEMA), the National Institute of Standards and Technology (NIST), the National Science Foundation (NSF), and the U.S. Geological Survey (USGS), were authorized and provided with dedicated funding to mitigate earthquake risks to life and property in the United States. Since its inception, the program has funded and supported many important initiatives involving basic research and the application of this research to foster broad-scale mitigation of earthquake risks. The NEHRP has been reauthorized periodically since that time and continues to support this work. Many NEHRP activities have contributed to improved seismic provisions. Each agency serves a specific role in the program.

**USGS** focuses on identification of the level of earthquake hazard throughout the United States. As part of this effort, USGS operates a network of strong motion instruments that record the effects of earthquakes at sites that range from a few to hundreds of miles from the geographic origin of the event. These data permit the USGS to identify the likely intensity of future earthquakes throughout the United States and to develop the national seismic hazard maps that serve as the basis for the design ground motion specified by the building codes.



**NSF** fosters technological leadership by sponsoring basic research and the development of new generations of scientists and engineers. Over the years it has sponsored a broad range of earthquake engineering research including field investigations of damage caused by earthquakes and laboratory and analytical research performed by individual students and professors. NSF also funds national research centers to conduct fundamental research focused on mitigating U.S. earthquake hazards, such as Natural Hazards Engineering



Research Infrastructure (NHERI). Much of past NSF research is reflected in requirements contained in current building codes.

**NIST** conducts research and development work, and it also supports public-private partnerships with the goal of improving the technological competitiveness of the United States. It has sponsored and participated in research that led to development of some of the earthquake-resistant technologies reflected in the current model building codes. In the 2004 reauthorization of the NEHRP program, NIST was identified as the lead NEHRP agency with responsibility for coordinating the activities of the four NEHRP agencies and for establishing an advisory committee to assess scientific and engineering trends, program effectiveness, and program management.



**FEMA** fulfills statutory and regulatory authorities to support state, local, tribal, and territorial preparation for, response to, recovery from, and mitigation of natural and manmade disasters. It provides assistance through pre- and post-disaster grants, education, risk analysis, data collection, engineering best practices, and hazard-resistant building code development. Under the NEHRP, FEMA sponsors the development of tools and practices that encourage the development of a more earthquake-resistant nation.



## 2.4.2 Development of Provisions for New Buildings

One of the early research programs sponsored by NSF under the NEHRP was development by the Applied Technology Council (ATC), an organization formed by SEAOC after the 1971 San Fernando Earthquake, of a guidance document containing recommendations for next-generation seismic building code requirements. Published in 1978, this document, *Tentative Provisions for the Development of Seismic Regulations for Buildings*, acknowledged that the new concepts and procedures presented should be evaluated in comparative designs to test workability, practicability, enforceability, and cost impact before they were considered for code adoption. FEMA later took over this initiative and funded the Building Seismic Safety Council (BSSC), a non-profit council organized under the National Institute of Building Sciences, to conduct this effort, which resulted in consensus-approved modifications to the original document published as the *NEHRP Recommended Seismic Provisions for New Buildings and Other Structures* (the **NEHRP Provisions**), a primary resource document that underlies the seismic design requirements contained in current building codes.

Since the first publication of the *NEHRP Provisions* in the early 1980s, FEMA has funded continuous update of the document so that it remains a valuable resource for the model code and national standards development organizations. These updates are developed through the voluntary efforts of engineers, architects, building officials, academics, and industry experts, working under the auspices of the BSSC. The first building code adoption of the *NEHRP Provisions* occurred in 1992.

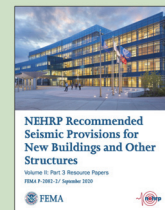
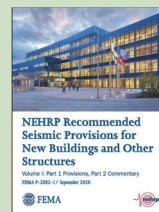
Originally, the *NEHRP Provisions* were published as a complete, self-contained set of requirements for seismic design of new buildings and structures. Once the ASCE/SEI 7 standard adopted much of

the requirements contained in the *NEHRP Provisions* almost verbatim, it became more useful to publish the document in three parts. Part 1 contains recommended updates to the ASCE/SEI 7 standard; Part 2 contains a detailed commentary; and Part 3 contains a series of white papers on potential future improvements to seismic design criteria. The most recent edition of the *NEHRP Provisions*, available as FEMA P-2082, serves as the basis for seismic requirements contained in the ASCE/SEI 7-22 standard, which will be referenced by the 2024 edition of the *International Building Code*. ASCE/SEI 7 is discussed in technical detail in Part B of this guide.



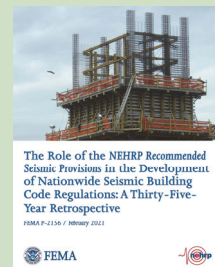
### FEMA P-2082: NEHRP Recommended Seismic Provisions for New Buildings and Other Structures

A consensus-based technical resource document, commonly referred to as the *NEHRP Provisions*, which presents guidance for the advancement of seismic design and construction practices, including recommendations for changes to ASCE/SEI 7. The *NEHRP Provisions* are used by model code and standards organizations to improve codes and standards. Published 2020. [Volume I](#) and [Volume II](#) are available as free PDFs.



### FEMA P-2156: The Role of the NEHRP Recommended Seismic Provisions in the Development of Nationwide Seismic Building Code Regulations: A Thirty-Five Year Retrospective

This retrospective describes the role of the *NEHRP Provisions* in improving seismic design practices, summarizes the major technical changes resulting from the effort, and describes future considerations. Published 2021. Available as a [free PDF](#).



## 2.4.3 Development of Provisions for Existing Buildings

Under the NEHRP, substantial funding has also been provided for the development of evaluation and upgrade criteria for existing buildings. In the mid-1980s, FEMA, under its existing buildings program, contracted with ATC to develop a series of seismic evaluation and retrofit guideline documents. This culminated with publication of the FEMA 273/274, *Guidelines and Commentary for Seismic Rehabilitation of Buildings in 1997*. Shortly after publication of this document, FEMA partnered with ASCE to update the FEMA-273/274 documents and publish the improved document as FEMA 356, *Prestandard for Seismic Rehabilitation of Buildings*. After several years of trial use and feedback by

engineers, ASCE converted this prestandard into the ASCE/SEI 41 standard, *Seismic Evaluation and Retrofit of Existing Buildings*. ASCE/SEI 41 is referenced by the IEBC and is currently the primary design criteria used by engineers to design building seismic upgrades.

Both FEMA and NIST support the continued improvement and update of the ASCE/SEI 41 standard through a series of projects, including the FEMA-funded ATC-140 project, which works directly with ASCE/SEI 41 committee members to identify and develop needed improvements to the standard.

## 2.5 Implementation of the Building Code

For a new building to be earthquake-resistant, seismic provisions must be properly incorporated into building design, and construction must be conducted per the design. This section provides context on the typical process for design and construction of a new building in the United States.

Most buildings in the United States are developed as a financial investment, either with the intent of selling the building at a profit or holding it as an asset and deriving income or benefit from its use. The persons or organizations who lead this process are known as developers, who are typically businesspersons or organizations who have expertise in marshalling the necessary resources, including land, investors, design professionals, and contractors.

Developers start with a location and at least a basic concept of the building they would like to produce. Developers rely on a large team of design professionals to bring this concept to fruition in the form of drawings and specifications that describe in detail how the project is to be constructed, collectively known as **construction documents**.

The design team typically includes an architect, a geotechnical engineer, a structural engineer, a civil engineer, an electrical engineer, a mechanical engineer, as well as a number of other specialists. In all U.S. states and territories, people acting in the role of a design professional must be licensed by the state to practice in their area of specialty. Prior to licensing individuals, most states require demonstration of competence through a process of education, experience, and examination. To obtain a license to practice, architects and engineers must possess an appropriate degree from an accredited institution, work under the guidance of a licensed design professional for several years, pass a competency examination, and maintain competency through continuing education and professional development.

Although it is possible for a developer to individually hire each of the design professionals necessary for a project, developers typically directly hire only an architect and a geotechnical engineer. The architect is typically responsible for retaining the other design professionals. Table 2-2 describes the responsibilities of the typical members of a design team for a building project.

**Table 2-2 Responsibilities of Members of a Typical Building Design Team**

Design Professional	Responsibilities
Architect	<ul style="list-style-type: none"> <li>▪ Determine the basic shape, layout, and appearance of the building</li> <li>▪ Design the building configuration for its intended occupancy (e.g., residential or office)</li> <li>▪ Ensure adequate egress (safe exit paths) out the building</li> <li>▪ Ensure fire-resistance of the building</li> <li>▪ Retain the other design professionals needed to complete the project and coordinates the efforts so that they are compatible</li> </ul>
Geotechnical engineer	<ul style="list-style-type: none"> <li>▪ Explore the soils at the site, perform laboratory testing of soil samples</li> <li>▪ Make recommendations, contained in a geotechnical report, as to the types of foundations that are appropriate to the proposed construction, the severity of potential earthquake effects at the site, and measures necessary during construction to permit safe excavation for foundations and basements</li> </ul>
Structural engineer	<ul style="list-style-type: none"> <li>▪ Design the structure to support the weight of the building and its occupants and withstand the effects of wind, rain, earthquakes, and other hazards</li> <li>▪ Provide criteria for earthquake-resistant anchorage and bracing of the nonstructural components</li> </ul>
Civil engineer	<ul style="list-style-type: none"> <li>▪ Design of the site, grading, paving, and underground utilities serving the building site</li> </ul>
Mechanical engineer; electrical engineer; plumbing engineer; (MEP)	<ul style="list-style-type: none"> <li>▪ Design of the heating, ventilating, and air conditioning systems</li> <li>▪ Design of lighting and power systems</li> <li>▪ Design of plumbing and sanitary systems</li> </ul>

Because the structure of a building provides the primary resistance to earthquake effects, structural engineers take a lead responsibility in ensuring the earthquake safety of the building. However, other design professionals also play an important role in this regard by ensuring that the designs of cladding, ceilings, lighting, HVAC, and other nonstructural components and systems have earthquake resistance that meets the minimum seismic design criteria specified by the structural engineer.

Once the design team completes the construction documents, the developer submits these to the local building department to obtain a building permit. The building department reviews the construction documents to ensure that they have been prepared and signed by appropriately licensed individuals, and that they conform to the requirements of the building code. Once the building department is satisfied that a design conforms to the applicable requirements and appropriate fees are paid, the building official, commonly referred to as the AHJ, issues a building

permit to allow construction. The contractor is required to post a copy of the building permit, sometimes called the job card, at the construction site, as evidence that an appropriate permit has been obtained.

Just as is the case with design professionals, most contractors specialize in and are licensed to work in one or more specialty areas, such as steel fabrication or erection, wood framing construction, or mechanical systems. While developers could hire individual contractors to perform each of the individual types of construction required, developers typically hire a general contractor who takes overall responsibility for construction, hires each of the other contractors (subcontractors) on behalf of the developer and coordinates all activities necessary to complete the project.

Contractors are required to build the project in accordance with the drawings and specifications and to perform quality control supervision of their work. However, in past earthquakes, some failures have occurred because of construction features that were not built in conformance with the design requirements. As a result, the building codes now require a series of independent inspections to ensure that the builder properly executes the design. These inspections may be directly performed by the AHJ, private individuals or firms with the appropriate qualifications, the design professionals themselves, or a combination of these parties.

When an inspection is performed, the conformance of the construction with the design and code requirements is documented by a series of reports and/or by the inspector's signature on the job card. If an inspector finds that the construction does not conform in some way to the code or design requirements, the builder must correct the issue before a sign-off is given. Upon completion of construction and submittal of documentation by the builder of evidence that the building has passed all required inspections, the AHJ will issue a certificate of occupancy. If a building is occupied without this permit, the AHJ can require that other law enforcement officials vacate the premises and lock it. Even after an occupancy permit has been issued for a structure, the AHJ can revoke the permit if there is reason to believe that the structure has become unsafe in some way. It is not uncommon for this to occur after a fire, earthquake, hurricane, or other event that causes extreme damage to buildings. This also can occur if the owner or occupants allow a building to deteriorate to a point at which the structure is no longer safe for use. In extreme cases, the building official can order demolition of structures deemed unsafe.



---

# Chapter 3: How U.S. Building Codes Approach Earthquake Risk

The primary objective of current U.S. building codes is to prevent buildings from causing large-scale loss of human life in earthquakes. Minimizing damage and preventing loss of function are not explicit objectives for buildings of typical occupancies, and if they are achieved it is only as a byproduct of the primary objective of life safety. Earlier codes focused on preventing building collapse, so the current approach represents substantial advances in earthquake-resistant design and a rise in societal expectations. Technology and knowledge continue to advance, making it more feasible for engineers to deliver buildings that would have minimal damage and impact to function in earthquakes. Societal expectations for building performance in disasters also continue to rise, motivated by the negative local-level impacts of recent disasters. Encouraged by these factors, a movement is currently underway to change the objective for building performance from one measured in loss of life to one measured in post-earthquake recovery time. If the movement is successful, the future of earthquake-resistant design may look quite different.

## 3.1 Approach in Current Codes

Even in the areas of highest earthquake risk in the United States, severe earthquakes occur infrequently at a particular location, often with hundreds of years between events capable of causing widespread damage. Because the average building has a useful life of about 50 years, many buildings will not ever be exposed to severe earthquake shaking. As a result, building codes are based on the concept of **acceptable risk**, which involves the establishment of minimum standards that attempt to balance the cost of earthquake-resistant construction against the chance of incurring unacceptable losses in future earthquakes.

This approach developed over a period of more than one hundred years. Initially, the intent of the building codes was simply to prevent buildings from collapsing in earthquakes. Engineers of the time did not know how to reliably accomplish this, and achievement of better performance was not a realistic goal. As engineers became more confident in their ability to minimize the risk of earthquake-induced collapse, building codes sought to reduce anticipated damage to nonstructural systems and components, as well as essential facilities, like hospitals. This happened not only because the technology to make this possible became available, but also because society began to indicate dissatisfaction with the levels of damage occurring to infrastructure in disasters.

Defining acceptable risk is difficult because the risk that is acceptable to one person may be unacceptable to others. A person's perception of an acceptable level of risk is usually dependent on whether or not the person believes they will be personally affected and to what extent, and how much the person is being asked to personally spend to avoid the risk.

U.S. building codes have adopted a life safety protection goal as representing acceptable risk for building seismic design. Under this concept, buildings are designed with the intent that they protect life safety but can experience significant damage when subjected to design earthquake shaking and potentially be damaged so severely that they cannot be repaired. In essence, developers of building code requirements reasoned that it was appropriate to require builders to incorporate sufficient safety to protect human life in earthquakes, but that most building owners would not want the added cost to provide greater protection against events there was no guarantee would happen.

### 3.1.1 Approach for New Buildings

For most new buildings, the building codes uses a design philosophy focused on life safety protection. This philosophy assumes that buildings and structures will be damaged in earthquakes representative of the local hazard, but that there will be:

- Low probability of individual life loss or injury,
- Very low probability of massive life loss (as could occur if many buildings collapsed), and
- Low probability that structures essential to post-earthquake response (e.g., police and fire stations, hospitals, emergency communications centers) will lose an ability to function.

The building codes identify two specific earthquake intensity levels for design purposes. The first of these is termed **maximum considered earthquake** (MCE) shaking. This level of shaking has return periods varying from approximately 1,000 to 3,000 years, depending on regional location and frequency of earthquakes in that region. For this earthquake level, the code seeks only to minimize the probability of structural collapse to avoid massive life loss. The second level of shaking, termed **design earthquake** shaking, has an intensity two-thirds that of the maximum considered earthquake shaking. Design earthquake shaking has return periods of several hundred years to approximately 1,500 years, depending on location. For this level of shaking, the code seeks to limit damage that could injure individual occupants or prevent function of essential services.

This philosophy accepts, for economic reasons, that some buildings affected either by design earthquake shaking or maximum considered earthquake shaking may be so severely damaged that repair could take months to years, or that it may be impractical to repair at all.

### 3.1.2 Approach for Existing Buildings

Providing seismic resistance to achieve the current definition of acceptable risk in a new building is cost effective and results in only a minor increase in the cost of construction, relative to that required without such protection. To seismically retrofit an existing building, however, is significantly more expensive than the cost would have been to build the equivalent protection into new construction. Retrofit construction is also disruptive to occupants. To minimize these impacts, ASCE/SEI 41 and IEBC permit upgrade of existing buildings using a slightly more lenient acceptable risk target than for new buildings. For most regions of the United States, this level of acceptable risk is achieved by designing for earthquake shaking that is approximately twice as likely to occur as that for new

buildings. IEBC requires such design when upgrade is triggered by occupancy change or substantial structural alterations or additions. Individual owners and design teams can, of course, elect to design upgrades for existing buildings to the same target risks required for new structures, or even lower risk (i.e., better than life safety), on a voluntary basis.

### 3.1.3 Implications of Current Approach

What the acceptable risk approach does not consider, however, is that when design-level or more severe earthquakes occur, their effects are sufficiently widespread that a substantial portion of the building inventory in entire communities can be rendered unusable for many months, threatening the viability of the community.

Several recent effects of such disasters have occurred in the past 20 years. Following the devastating effects of Hurricane Katrina on New Orleans in 2005, more than half of the population of the city fled. Many resettled in other locations, because the buildings where they used to live and work were no longer habitable and could not be repaired for months to years. Fifteen years later, New Orleans' population remained at 80% of that which existed before the hurricane (FEMA, 2021).

Earthquakes have caused similar disasters in the past and will continue to cause more in the future. The M7.8 San Francisco Earthquake of 1906 and resulting fires devastated much of San Francisco (Figure 3-1), then the ninth largest city in the United States, resulting in catastrophic economic losses and a shift in growth to regions that were less affected by the earthquake (Ager et al., 2019). The M9.2 Great Alaskan Earthquake of 1964 destroyed much of Anchorage, Alaska. More recent events, such as the M6.7 Northridge Earthquake of 1994 caused significant damage to the built environment and direct economic losses of \$42 billion (1998 dollars). Insured losses in Northridge cost more than three times the total earthquake premiums collected in the 25-year period prior to the disaster, which eventually led to an insurance availability crisis and collapse of the earthquake insurance industry in California (Petak and Elahi, 2001).

Almost half of the U.S. population, 150 million people, reside in portions of forty-two states that are at risk of experiencing a damaging earthquake within the next 50 years. Sixteen of those states, including Alaska, Arkansas, California, Hawaii, Kentucky, Missouri, Oregon, South Carolina, Tennessee, and Washington, are at very high risk, and their metropolitan regions could face unprecedented life loss and catastrophic damage to buildings, critical infrastructure, and lifeline infrastructure systems with cascading social and economic consequences (Petersen et al., 2014). A disaster in one community or state can have economic and social impacts on neighboring communities, states, and the entire nation.

Following a disastrous earthquake in Christchurch, New Zealand in 2011, which resulted in demolition of a substantial portion of the city (Figure 3-2), many engineers and government planners began to question the sustainability of our acceptable risk approach to building design.



**Figure 3-1** Widespread damage in San Francisco following the earthquake and fire in 1906 left people without places to live or work and forced a shift in economic development to Southern California (from National Archives).



**Figure 3-2** Christchurch, New Zealand after demolition of many buildings in the Central Business District following the 2011 Christchurch Earthquake (from Miyamoto International).

## 3.2 Performance-based Procedures

Even before the 2011 Christchurch Earthquake, some engineers were already questioning the wisdom of designing structures with the intent that they will be substantially damaged by design-level events. Following a series of damaging earthquakes that struck California between 1987 and 1994, SEAOC, with funds provided by FEMA and the California Office of Emergency Services, developed a framework for new design procedures that would permit design for better performance, called Vision 2000. Specifically, the goals of Vision 2000 were to enable engineers to design buildings with predictable seismic performance and to suggest enhanced performance objectives as a basis for design, relative to those underlying the contemporary building code. These new procedures were called performance-based design.

The technical requirements of the building codes are often described as **prescriptive** because they prescribe specific criteria and procedures that design and construction must conform to. Performance-based procedures differ from prescriptive procedures in several important ways.

Structural design using prescriptive procedures involves the following steps:

1. Select a structural system type (e.g., steel braced frame, or concrete shear wall)
2. Proportion the structure such that it has the strength and resistance to shaking specified by the building code
3. Detail (design) the structure to conform to material-specific requirements for earthquake resistance

When designing using prescriptive approaches, engineers do not actually evaluate the ability of the structure to perform as intended by the building code. Rather, the engineer is able to presume that because the building complies with the prescriptive requirements, this performance will be obtained.

By contrast, structural design using performance-based procedures involves the following steps:

1. Reach agreement between key stakeholders, including the developer, building official, major tenants, lenders, and insurers as to the specific performance that is to be attained
2. Perform analytical simulations to predict the performance of a building in response to design events like earthquakes
3. Demonstrate that the desired performance can be attained

When completed, the resulting design may not conform to the strength or detailing requirements of the building code, but it does provide the desired performance.

Performance-based procedures are often used to design upgrades for existing buildings, because it is often impracticable to bring these structures into full compliance with the prescriptive requirements for new structures. Performance-based procedures are also commonly used to permit the use of new technologies, materials, and systems that are not yet covered by the building code. These procedures are also used to design buildings that will be capable of superior performance to that intended by the prescriptive code requirements. Performance-based seismic design procedures

have recently become the preferred approach for design of high-rise buildings in regions of high earthquake risk.

When first presented in the Vision 2000 publication, performance objectives were stated in qualitative terms defining the level of protection desired (e.g., collapse prevention, life safety, immediate occupancy), and the earthquake intensities for which these goals were to be achieved. The performance levels themselves were only qualitatively defined. Over the nearly 30 years since the Vision 2000 Project, performance-based design technology has improved substantially. The most recent procedures, embodied in the FEMA P-58 series of publications, defines performance by quantifying the probability that losses (e.g., repair cost, downtime, casualties) may exceed certain quantitative levels. While performance-based procedures are gaining in popularity, the building codes permit, but do not yet require their use.

Section 10.1 provides more information on performance-based design.



### FEMA P-58: Development of Next Generation Performance-Based Seismic

This series, consisting of seven reports, presents the background on performance-based seismic design and guidance for application of the concepts. The methodology utilizes performance measures that can be understood by decision makers, such as the amount of damage, number of potential casualties, loss of use or occupancy, and repair costs. FEMA P-58-7, *Building the Performance You Need: A Guide to State-of-the-Art Tools for Seismic Design and Assessment*, provides a short introduction to the topic that is clear and approachable for a general audience. Second edition published 2018. Available as free PDFs.



## 3.3 Future Directions

Societal dissatisfaction with the levels of earthquake damage anticipated by the acceptable risk approach in present building code provisions and the availability of new tools that can predict earthquake performance with more precision have motivated a serious reconsideration of the life safety objective embedded in current building codes. In recent years, engineers, building officials, and other relevant parties have been exploring ways the code provisions can better support lower damage levels and an objective of community resilience, including several different efforts from the

Earthquake Engineering Research Institute (EERI), ICC, and SEAOC. The concepts behind the future direction of these codes are commonly referred to as resiliency-based or functional recovery-based.

In 2019, Congress charged NIST and FEMA with assembling a panel of experts to document the available options for developing resilient infrastructure in the United States that would be capable of surviving design-level earthquakes without jeopardizing the viability of the affected communities. This resulting FEMA P-2090 report, *Recommended Options for Improving the Built Environment for Post-Earthquake Reoccupancy and Functional Recovery Time*, which was published in 2021, recommends options for developing a more earthquake-resistant and resilient country. The FEMA P-2090 report proposes design for a **functional recovery** performance target. The difference between design for functional recovery and resiliency are that a functional recovery design approach admits, similarly to acceptable risk approach, the acceptability of some damage. Functional recovery design seeks to ensure that damage is limited such that buildings and lifeline infrastructure can be restored rapidly enough following an earthquake that the community remains viable. Current building codes seek to ensure that hospitals, police stations, fire stations, and emergency response facilities are functional immediately following an earthquake, although the effectiveness of those provisions is still under debate by some. A functional recovery-based code would seek to ensure that housing, food markets, large employers, and utilities also be restored to service, even if in an impaired but operational mode, rapidly following an earthquake. Places of business, which are essential to maintaining a vital economy, would also be designed to be restored within reasonable time.

Functional recovery concepts are presently under development, and there are several aspects that must be further developed before they would be ready for inclusion in the code.

- Specific building occupancies that must be functional at some time following the earthquake event and the target time for resumption of function of these buildings will need to be identified.
- Design criteria that can be effective in achieving this functional recovery capability will need to be identified.
- An approach for addressing the existing inventory of buildings, which comprise most of the present built environment and will for many years to come, will need to be identified.
- Design and repair standards for lifelines infrastructure that are sufficient to provide functional recovery-level performance will need be developed.
- Ways to provide sufficient redundancy and resiliency in critical lifelines including electricity, natural gas and water supply, sewer and waste processing facilities, telecommunications, and roadways and bridges, will need to be identified.

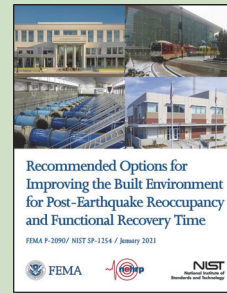
The BSSC Provisions Update Committee (PUC), which oversees update of the *NEHRP Provisions*, recently formed an issue team to bring consensus resolutions for these issues and present a set of design criteria for functional recovery design. BSSC hopes to engage representatives of other groups

working on such code requirements and present consensus procedures that could be adopted by the ASCE/SEI 7 standard and the building codes. Such adoption could occur as early as 2027.



### FEMA P-2090 / NIST SP-1254, Recommended Options for Improving the Built Environment for Post-Earthquake Reoccupancy and Functional Recovery Time

This report provides a set of options in the form of recommendations and tasks for improving the seismic performance of the built environment. It explains why reoccupancy and functional recovery concepts are needed, describes a target performance state, and identifies potential cost and benefits associated with implementing enhanced seismic design. Published 2021. Available as a [free PDF](#).



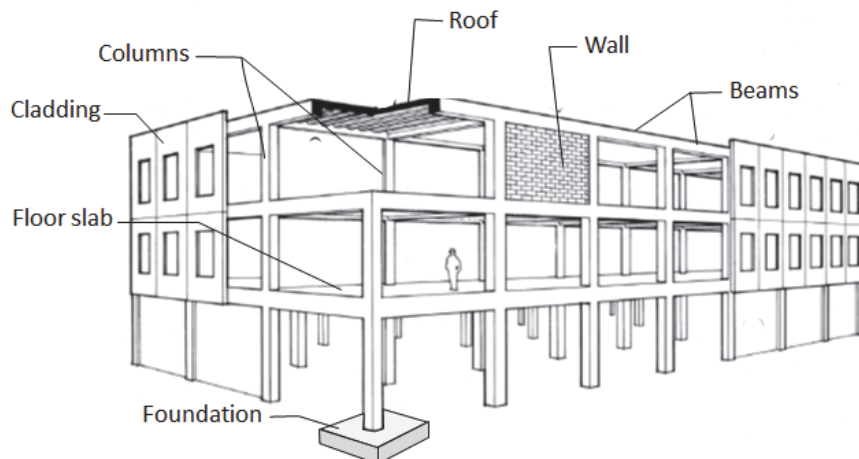


# Chapter 4: Key Features of Earthquake-Resistant Building Design

For a building to be earthquake-resistant, the design must incorporate several key features, and the design must be constructed properly. Lack of any of these features makes a building more vulnerable to earthquake damage. This chapter presents a brief overview of these important earthquake-resistant features. Most pertain to design of the structure, but protection of nonstructural components, such as ceilings, piping, cladding, and equipment, is also covered.

## 4.1 Earthquake-Resistant Structures

Buildings are a complex assemblage of many elements, as illustrated in Figure 4-1. Typical structural elements include beams, columns, floor slabs, roofs, walls, and foundations. Beams are horizontal elements that provide direct vertical support for the floors and roof. Columns are typically vertical elements that support the beams. Structural walls, which are sometimes present as infill between beams and columns, can provide vertical support for the floors and roof as well as resist horizontal forces from wind and earthquakes. Foundations, typically constructed of reinforced concrete, are typically located beneath first story (or basement) columns and walls. In many older buildings, cladding present on the outside of a building also served as a structural wall, but in many newer structures, cladding does not serve a structural purpose and is considered a nonstructural component.



**Figure 4-1** Buildings are a complex assemblage of structural and nonstructural elements (adapted from Lagorio et al., 1986).

A building can be defined as an enclosed structure intended for human occupancy. However, a building includes the structure itself and nonstructural components (e.g., cladding, roofing, interior walls and ceilings, HVAC systems, electrical systems) permanently attached to and supported by the structure. The current building codes identifies more than ninety separate structural systems associated with buildings.

Structural engineers design these structural elements to withstand the weight of the building, the weight of occupants, pressures due to wind and snow, and movements imparted by earthquakes and temperature changes; these are collectively known as **loads**. Structural design for most loads, other than earthquake, seeks to provide a very small chance that the structure will be damaged under anticipated loading. This is because most loads, such as those associated with occupant use, wind, or snow, occur frequently during the life of the structure, and it would be considered unacceptable to have to repair a structure after every such loading.

Damaging earthquakes, however, occur at a particular location only on the order of hundreds or thousands of years apart, so most structures will likely never be subjected to a damaging event. Current building codes have adopted the concept of acceptable risk (Section 3.1). Under this concept, design for earthquake resistance is conducted with the understanding that structures may be extensively damaged when they experience rare, but credible earthquake events, but the expectation is that they will not be so damaged that they are likely to collapse and endanger occupants. Under this acceptable risk approach, engineers design economical structures capable of protecting public safety, but the structures have significantly less strength than if they needed to resist earthquakes without damage.

Design of the structural system of a building must incorporate several important features:

- Stable foundations
- Continuous load paths
- Adequate stiffness and strength
- Redundancy
- Regularity
- Ductility and toughness
- Adequate separation from neighboring construction

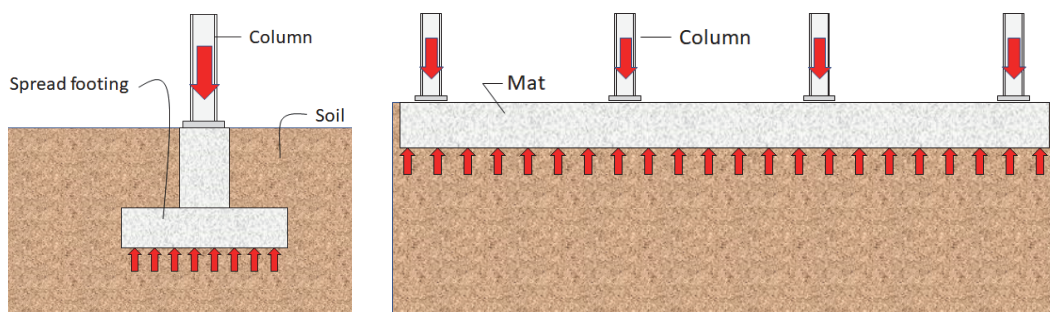
In areas of highest earthquake risk (i.e., areas colored orange and red in Figure 1-9c) the building codes require inclusion of all these features in the design and construction of structures. In areas of lower earthquake risk, where less intense ground shaking is likely to occur, the building codes permit relaxation of some of these requirements, as long as the structures are designed with additional strength.

#### **4.1.1 Stable Foundations**

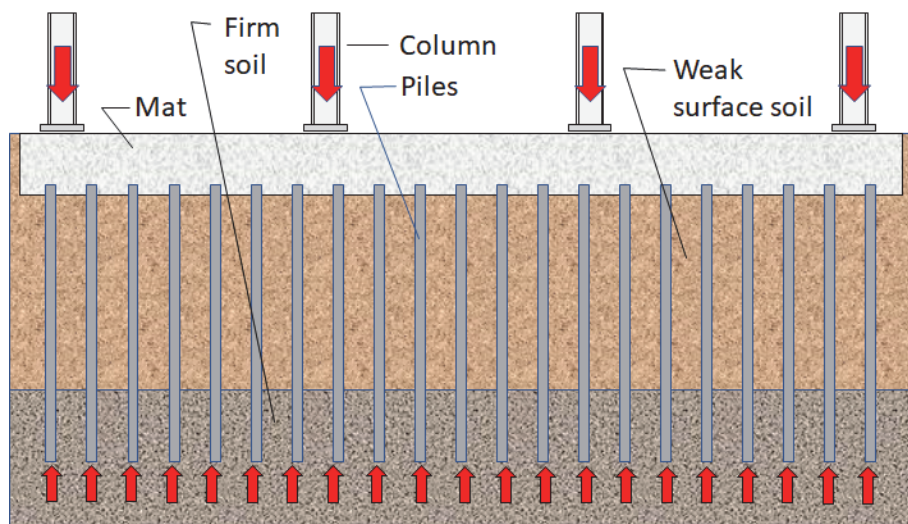
The weight of a structure is typically carried to the ground by vertical columns, walls, or a combination of these elements. Composed of reinforced concrete, masonry, structural steel, and

wood, these columns and walls are typically much stronger than the soils underlying the structure. Therefore, foundations, typically constructed of reinforced concrete, are used to spread the load from the strong structural elements above to the relatively weaker and more compressible soils below to provide safe support without excessive settlement. In an earthquake, a foundation must safely deliver forces generated by ground shaking into the soil and prevent the building from sliding or toppling.

Foundations consist of two types: shallow and deep foundations. Common types of **shallow foundations** include individual spread footings and mats, illustrated respectively in Figures 4-2a and b. On some sites, soils within a few feet of the ground surface are too weak or compressible to provide support for heavy structures. In those cases, it is necessary to use **deep foundations** with vertical elements called piles that extend through the weaker soils at the surface into the firm soils below. Piles can be made of concrete, steel, or wood. They can be driven into the ground using heavy construction equipment called pile drivers, or they can be drilled and cast into the ground. Usually, a spread footing or mat is used to transfer load from the columns or walls to the piles. Figure 4-3 illustrates a mat supported on piles.



(a) Spread footing (b) Foundation mat  
**Figure 4-2** Types of shallow foundations.

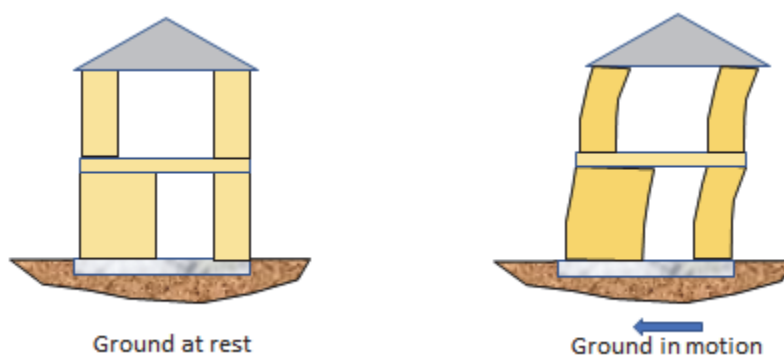


**Figure 4-3** Deep foundation using piles.

In addition to being able to support the weight of the structure without excessive settlement, the foundation system must be able to resist earthquake-induced overturning forces and be capable of transferring large horizontal forces between the structure and the ground without excessive settlement or sliding. Foundation systems also must be capable of resisting both transient and permanent ground deformations without inducing excessively large displacements in the supported structures. On sites that are subject to liquefaction or lateral spreading, it is important to provide vertical bearing support for the foundations beneath the liquefiable layers of soil or provide foundations strong enough to bridge over local areas of ground failure. This may require deep foundations with drilled shafts or driven piles. Because surface soils can undergo large lateral displacements during strong ground shaking, it is important to tie together individual foundation elements, such as spread footings, so that the structure is not torn apart by the ground moving differently under different parts of the building. A continuous mat is an effective foundation system to resist such displacements. When individual pier or spread footing foundations are used, reinforced concrete grade beams can be used to tie individual foundations so that the foundations move as an integral unit.

#### 4.1.2 Continuous Load Path

When an earthquake occurs, the ground moves back and forth violently. If a building has stable foundations, these foundations will move with the ground. However, because the building has mass, the rest of the structure will initially stay in place, causing the structure to distort, as illustrated in Figure 4-4. As the ground shaking continues, the structure itself will shake back and forth, and pieces of the structure that are not adequately attached, can pull apart and become detached, resulting in partial or total collapse. Figure 4-5 illustrates such damage to a carport which was not adequately attached to the adjacent house to hold the two structures together. Figure 4-6 illustrates a house that fell off its foundation in the 1989 Loma Prieta earthquake, because there were no anchor bolts to tie the structure and foundation together.



**Figure 4-4** Effects of ground motion on a building. As the ground moves out from under the building, the building tends to stay at rest, causing distortion throughout the structure.

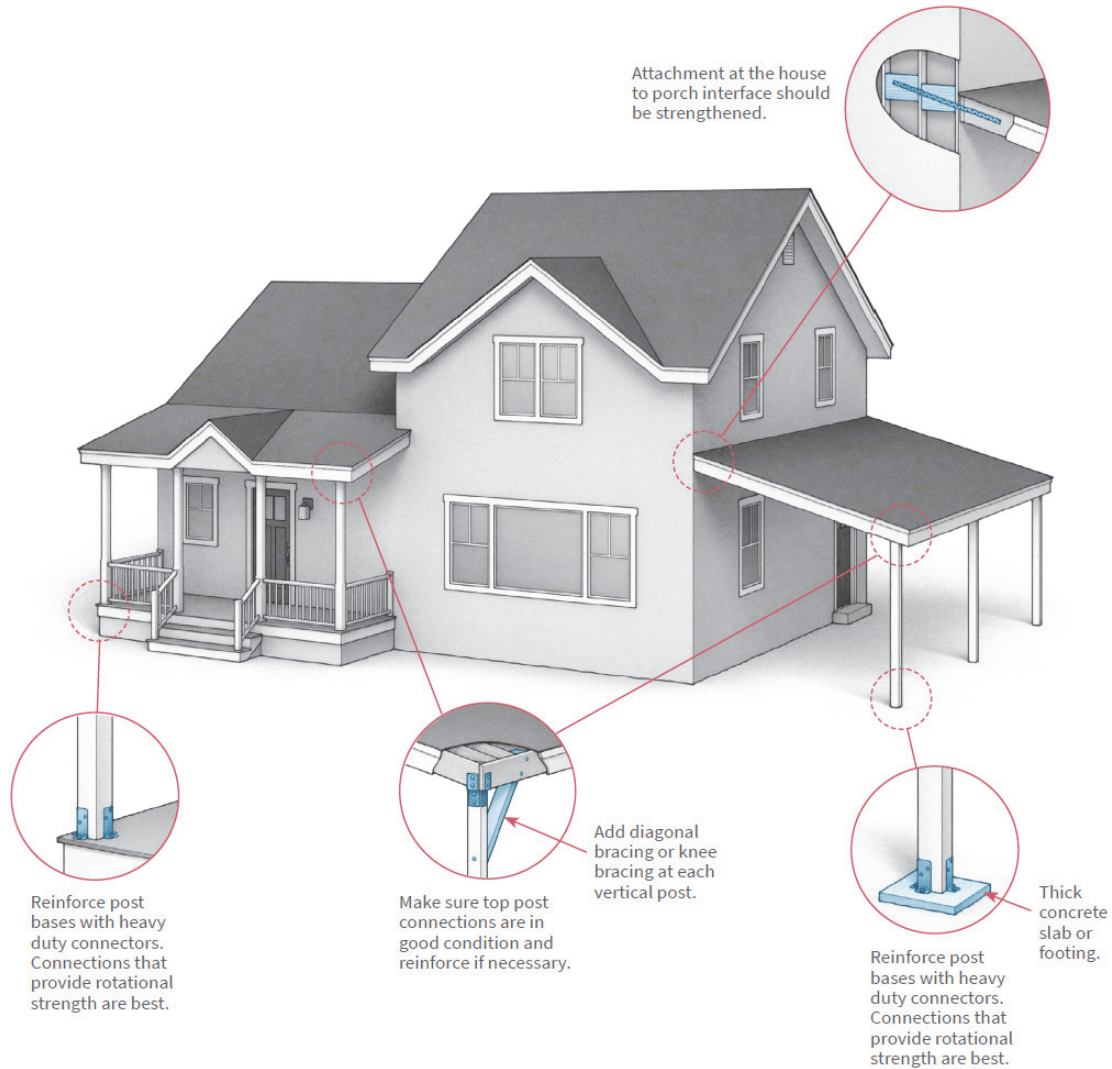


**Figure 4-5** This carport, originally supported by but not firmly attached to the adjacent house, became detached from the house during ground shaking (from FEMA P-530).



**Figure 4-6** House that fell off its foundation in the 1989 Loma Prieta Earthquake.

If structures are properly tied together to provide a continuous **load path**, damage like this can be avoided. A load path is a series of connected elements designed to deliver loads from their origin to the foundation. In steel construction, load path is achieved by bolted or welded connections between each of the framing elements. In reinforced concrete and masonry structures, continuous reinforcing bars must run throughout the structure to tie it together. In wood frame structures, like the houses illustrated in Figure 4-5 and 4-6, steel hardware is used to tie the structure together, as illustrated in Figure 4-7.



**Figure 4-7 Earthquake-resistant wood-frame construction uses steel hardware to tie the framing elements together and provide a continuous load path (from FEMA P-530).**

### 4.1.3 Adequate Stiffness and Strength

Strong earthquake shaking will induce both vertical and lateral forces in a structure. The lateral forces that tend to move structures horizontally have proven to be particularly damaging. If a structure has inadequate lateral stiffness or strength, these lateral forces can produce large horizontal displacements in the structure and potentially cause instability. Figure 4-8 shows large permanent deformation in the first story of a four-story apartment building damaged in the 1989 Loma Prieta Earthquake. The first level was designed with very few walls, to accommodate the parking of cars in the garage. The upper stories were designed with a large number of walls to support the function as apartments. This failure happened because the first story of this building was weaker and less stiff than the stories above. Greater strength and stiffness at the first story would have prevented this damage. This condition, where one story has substantially less strength and

stiffness than stories above, is known as a weak or **soft story** irregularity. Some communities, such as San Francisco and Los Angeles, have adopted laws requiring retrofit of buildings with this condition.



**Figure 4-8** First story of an apartment building in San Francisco leaning to the side after the 1989 Loma Prieta Earthquake.

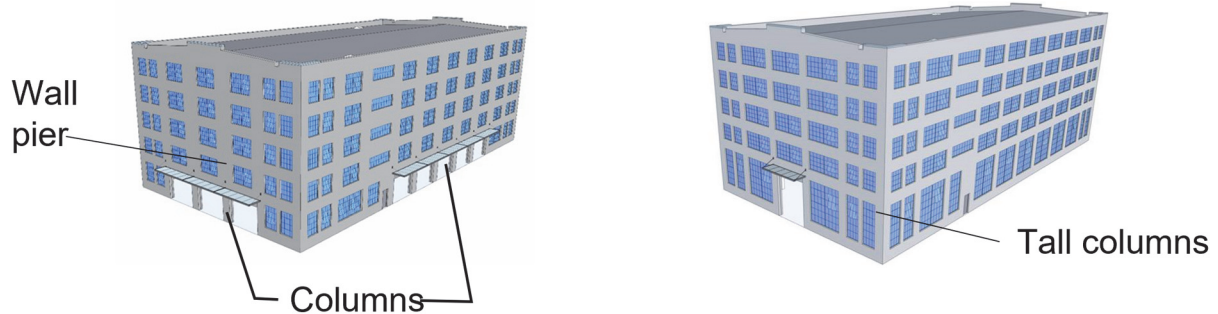
#### 4.1.4 Regularity

A structure is considered regular if the distribution of its mass, strength, and stiffness is such that it will sway in a uniform manner when subjected to ground shaking. For a regular building, lateral movement in each story and on each side of the structure will be about the same, as will the strength of the structure relative to the supported mass. Regular structures tend to dissipate the energy of the earthquake uniformly throughout the structure, resulting in light and well-distributed damage. In an irregular structure, however, the damage can be concentrated in one or a few locations, resulting in extreme local damage and the potential for collapse.

The building code defines several types of irregularities that were observed to cause undesirable concentrations of damage and poor performance in past earthquakes. To control the potential damage, structures that have irregularities in their design are required to have more strength. Some irregularities considered by the building codes include: soft and weak stories, torsional irregularities, plan irregularities, and discontinuous structural systems. As illustrated in the Figure 4-9 to 4-12 below, many irregularities are evident in the appearance of the building. However, not all buildings that appear irregular actually are, because engineers can configure the structural systems with regularity, even when the architectural form is irregular.

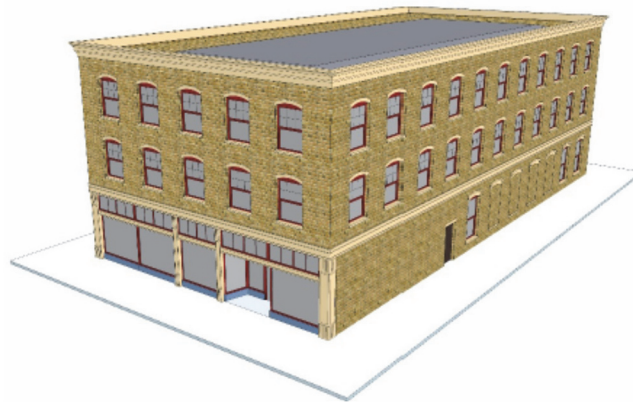
Figure 4-9 illustrates two examples of buildings that have weak/soft stories. The building on the left has a soft/weak story because the first story columns at the building entry are smaller than the wall

piers in the story above, and therefore have less stiffness and strength. The building on the right side has a soft story at the first story where the columns are taller and more flexible than in higher stories. This will tend to produce higher bending forces on the first story. If these first story columns are not designed stronger to take these larger forces, a weak story will also be present.



**Figure 4-9 Two examples of buildings with weak/soft stories (from FEMA P-154).**

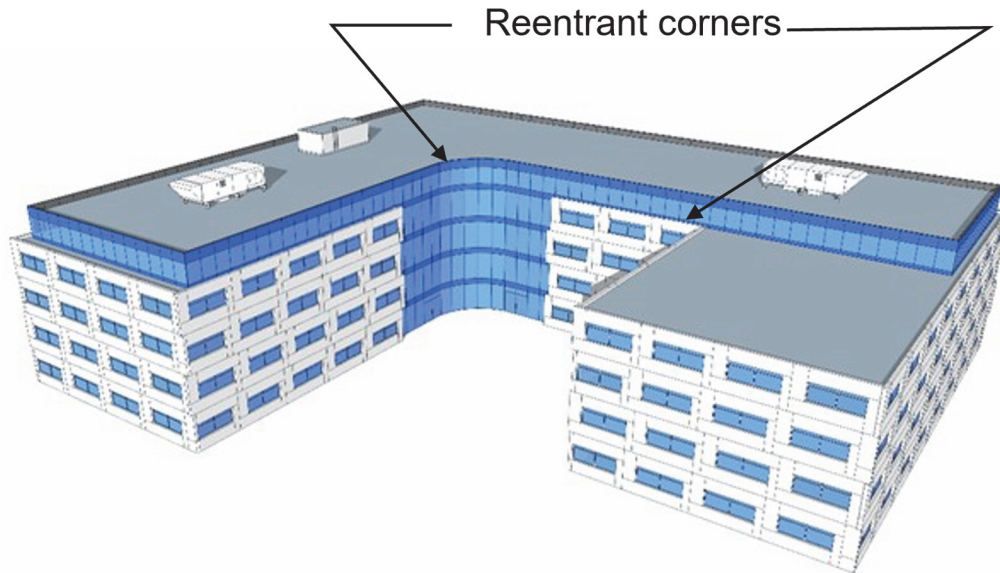
Figure 4-10 illustrates a building with a **torsional irregularity**. This irregularity is caused by the relatively open building front at the first story, while the remaining sides of the building have solid, or mostly solid walls at this level. In an earthquake, this building will twist about its vertical axis, amplifying the displacement on each side of the building resulting from swaying and making damage more likely.



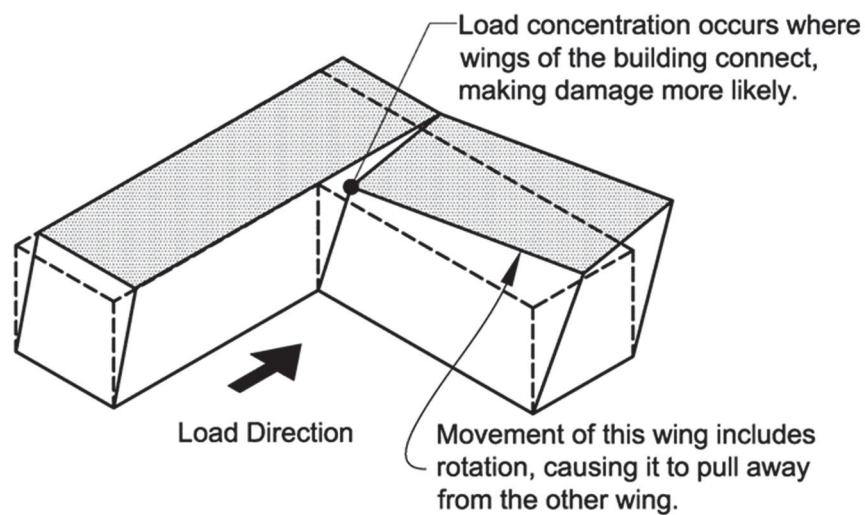
**Figure 4-10 Building with torsional irregularity created by the lack of walls at the front of the first story, while more solid walls are present on the remaining three sides (from FEMA P-154).**

Figure 4-11 illustrates a building with a plan irregularity known as a **reentrant corner**. This type of irregularity often occurs, as in the figure, where two or more wings of a building join together. Figure 4-12 illustrates how response of such a building to an earthquake can lead to the wings pulling apart at the re-entrant corner.





**Figure 4-11** Building with two reentrant corners where two wings intersect each other (from FEMA P-154).



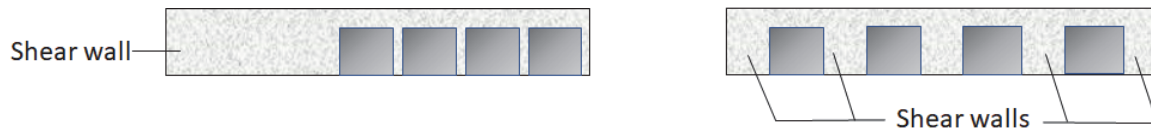
**Figure 4-12** Illustration of common causes of damage at reentrant corner irregularities (from FEMA 232).

Section 8.3 provides more information about irregularities.

### 4.1.5 Redundancy

If all the strength and earthquake resistance of a structure are concentrated in only one or a few elements, the structure will not have any residual strength if those elements are seriously damaged, and this can lead to structural collapse. If a structure has **redundancy**, a large number of elements participate in providing the strength of the structure. If only a few are badly damaged, the remaining

elements may have adequate residual strength to prevent collapse. Figure 4-13 illustrates this by showing two similar, single-story commercial buildings with four large door openings. The building on the left has these doors grouped on one side of the building, resulting in a single large wall that is used to resist horizontal earthquake forces. The building on the right has the four doors spaced out along the length of the building, such that there are five individual walls present to resist horizontal earthquake forces. The building on the right is more redundant because if one wall fails due to earthquake damage, the other walls will still be available to support the structure. Redundancy can be thought of as not putting all of your earthquake-resistant eggs in one basket.



**Figure 4-13 Comparison of redundancy between two buildings with equal overall wall length. The building at the left is not redundant because it only has one wall to resist horizontal earthquake forces. If it failed there would be no backup wall to carry the earthquake force.**

#### 4.1.6 Ductility and Toughness

**Ductility** and **toughness** are structural properties that relate to the ability of a structural element to sustain damage when overloaded while continuing to carry load without failure. These are extremely important properties for structures designed to sustain damage without collapse.

Most structural elements are designed to provide sufficient strength to support anticipated loads without failure and enough stiffness so that they will not deflect excessively under these loads. If such an element is subjected to a load larger than it was designed to carry, it may fail in an abrupt manner, losing load-carrying capacity and allowing the structure to collapse. Masonry and concrete, for example, will crush when overloaded in compression and will crack and pull apart when placed in tension or shear. Wood will crush when overloaded in compression, split when overloaded in shear, and break when overloaded in tension. Steel will buckle if overloaded in compression and will twist when loaded in bending, if not properly braced, but will yield when overloaded in tension. When steel yields, it stretches a great deal while continuing to carry load, and this property allows it to be used in structures of all types to provide them with ductility and toughness. Figure 4-14 shows the failure of an unreinforced masonry wall in the 1989 Loma Prieta Earthquake. Unreinforced masonry buildings have no steel reinforcement in the masonry, which makes them not ductile or tough, and frequently collapse in earthquakes. As a result, this construction type has been prohibited for many years in regions likely to experience strong earthquake shaking.

In reinforced masonry and concrete structures, steel is used in the form of reinforcing bars that are placed integrally with the masonry and concrete. When reinforced masonry and concrete elements are loaded in bending or shear, the steel reinforcing bars will yield in tension and continue to carry load, thus protecting the masonry and concrete from failure. In wood structures, steel fasteners (typically nails, bolts, and straps) bind the pieces of wood together. When the wood is loaded in shear

or bending, these steel connectors yield and protect the wood from splitting and crushing. In steel structures, ductility is achieved by proportioning the structural members with sufficient thickness to prevent local buckling, by bracing the members to prevent them from twisting, and by joining the members together using connections that are stronger than the members so the structure does not pull apart. In structures of all types, ductility and toughness are achieved by proportioning the structure so that some members can yield to protect the rest of the structure from damage.

The measures used to achieve ductility and toughness in structural elements are unique to each construction material and to each type of structural system. The building codes specify the measures to use to provide ductility and toughness through reference to the various materials industry design standards each of which contain detailed requirements for obtaining structural ductility.



**Figure 4-14** Failure of an unreinforced masonry wall in the 1989 Loma Prieta Earthquake (from USGS).

#### 4.1.7 Separation from Adjacent Structures

When buildings are affected by ground shaking, they sway from side to side. If adjacent buildings are not adequately separated and move out of phase with each other, they can slam into each other in an effect known as **pounding**. Pounding can cause local damage, as illustrated in Figure 4-15, and in more severe cases, lead to partial or total collapse. To avoid such damage, the building code requires that structures be set back from their property lines so that they will not intrude on the neighboring airspace and potentially become a pounding hazard for adjacent structures. Many

existing buildings in urban centers were constructed prior to this requirement and can be subject to pounding damage in future earthquakes.

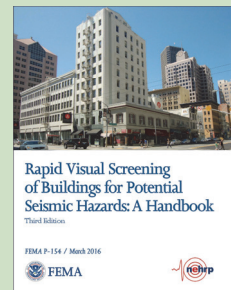


**Figure 4-15** Pounding damage on two buildings in Santiago, Chile, following the 2010 Chile Earthquake.



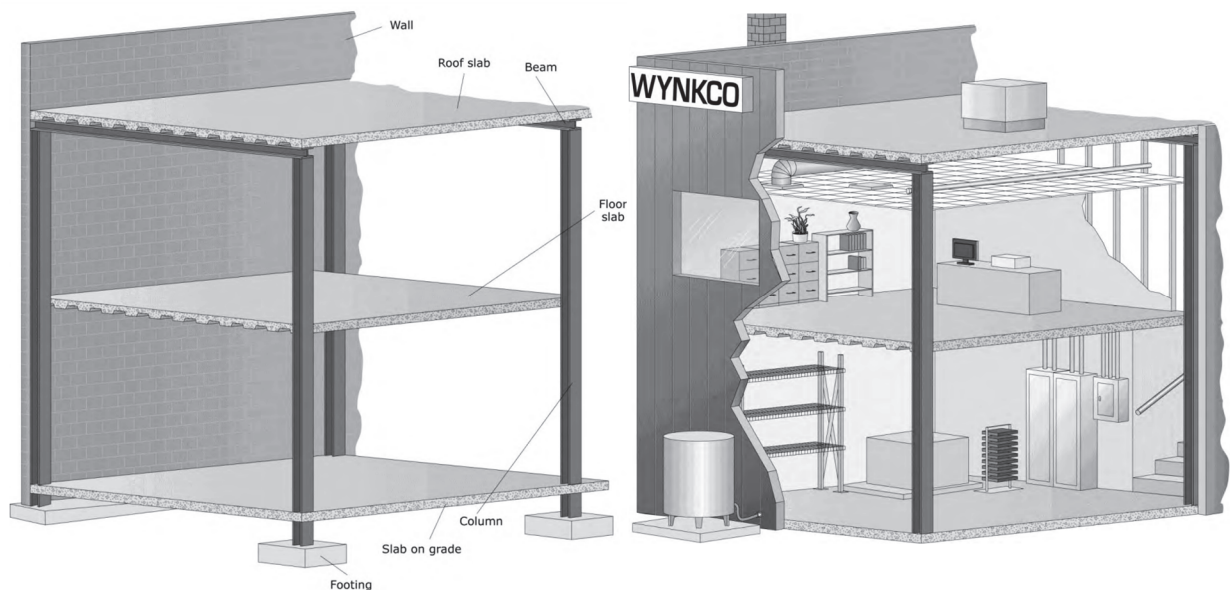
**FEMA P-154: Rapid Visual Screening of Buildings for Potential Seismic Hazards: A Handbook**

This report presents a procedure to rapidly screen existing buildings for potential seismic hazards. Many of the seismic hazards in the screening are closely related to the earthquake-resistant structural features described in this chapter. Published 2015. Available as a [free PDF](#).



## 4.2 Earthquake-Resistant Nonstructural Components

Although adequately resistant structural systems are essential to good earthquake performance, the cost of the structure represents less than 25% of the total cost of most buildings (FEMA, 2011), and buildings typically rely on **nonstructural components** and systems to support the occupancy and function of the building. Nonstructural components include cladding, ceilings, HVAC, plumbing, electrical power supply and distribution, fire protection, stairs, and elevators. Industrial facilities have other important systems essential to their purpose and function. Figure 4-16 illustrates nonstructural components using two cutaway views of a building. The view on the left shows only the structural system, while the view on the right shows some of the many nonstructural components and systems in typical buildings.



**Figure 4-16** Two views of a building showing the structure on the left and nonstructural components on the right (from FEMA E-74).

When earthquake shaking affects a building, this generates forces and deformations on all of the nonstructural components as the structure sways back and forth. The most common damage to nonstructural components occurs when the earthquake forces cause the component to slide or overturn. Figure 4-17 shows such damage in an office building that experienced strong shaking in the 1994 Northridge Earthquake.

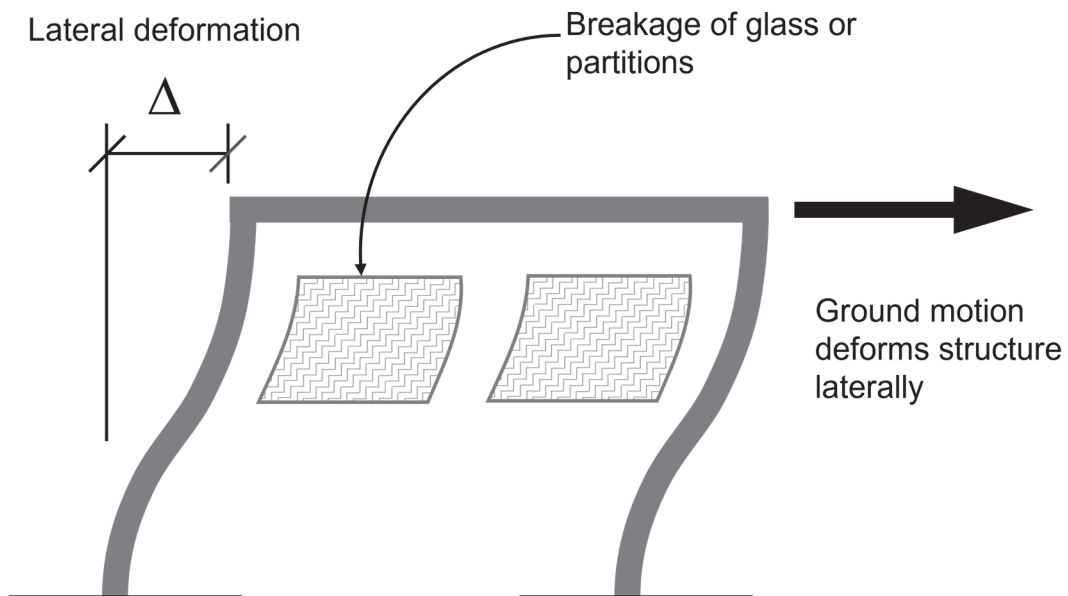
In zones of significant earthquake hazard, the building codes require, with some exceptions, that all nonstructural components be anchored and braced to the structure such that they will not experience the type of damage illustrated in Figure 4-17 and become falling hazards during earthquake shaking.

Some nonstructural components, such as cladding and piping systems, are sensitive to the swaying displacements that structures experience during earthquake shaking as illustrated in Figure 4-18.

The building codes require that such systems be designed with adequate flexibility to accommodate these displacements without creating hazards, such as falling glass from broken windows.



**Figure 4-17** Failure of partitions, light fixtures, and ceilings in an office building damaged by the 1994 Northridge Earthquake (from FEMA E-74).



**Figure 4-18** Lateral “swaying” deformation of structures during earthquake shaking can cause damage to nonstructural elements (adapted from FEMA E-74).

Some nonstructural components and systems, such as fire protection and emergency lighting systems, are essential to the safety of building occupants, while other systems such as communications equipment in police and fire stations, are essential to the disaster response functions of these facilities. The building codes identify these components as **designated seismic systems** and require design of these systems to minimize the likelihood that damage sustained during an earthquake would impair their ability to function. This often requires that prototypes of such components be subjected to laboratory testing on a shake table, to demonstrate that they are sufficiently robust to function after an earthquake.

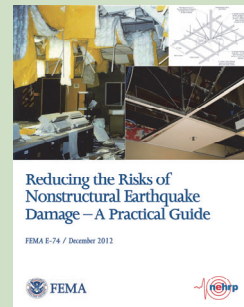
Adequate earthquake performance of nonstructural components and systems can be challenging for several reasons:

- The professionals responsible for the design of these systems are usually focused on the routine function of the systems, rather than their earthquake performance.
- Provisions necessary to ensure proper earthquake performance (e.g., anchoring) may impede their primary intended functions.
- Many nonstructural components and systems are installed by tenants, without formal design or submission to a building permit process.



### FEMA E-74: Reducing the Risks of Nonstructural Earthquake Damage - A Practical Guide

This report provides an overview of common types of damage to nonstructural components, describes proper design of seismic anchorage, and presents effective methods for reducing the seismic risk of existing vulnerable nonstructural components. Published 2012. Available as a [free PDF](#).







# Chapter 5: How Common Structure Types Perform in Earthquakes

Most buildings can be categorized using one of several common structure types. Over the years, engineers have observed that each structure type has unique earthquake vulnerabilities. For this reason, building codes classify structures by their structural system type and designate specific design requirements for each system. This chapter presents an overview of the common structure types and earthquake damage most associated with each of them. It also provides a general discussion of the structural system-specific design requirements contained in the building codes.

## 5.1 Structure Types

Structural systems are categorized based on the material of construction (e.g., concrete, masonry, steel, or wood), the way in which lateral (i.e., horizontal) forces from earthquake shaking are resisted by the structure (e.g., by walls or frames), and by the relative quality of earthquake-resistant design and detailing provided.

There are five broad categories of structural systems used in areas with earthquake hazard: bearing wall systems, building frame systems, moment frame systems, dual systems, and cantilever column systems.

Building codes categorize quality and extent of earthquake-resistant detailing using the terms special, intermediate, and ordinary. Systems that employ extensive measures to provide for superior earthquake resistance are termed **special** systems, while systems that do not have such extensive design features are called **ordinary** systems. The building codes also include design rules for structural systems intended to provide seismic resistance that is superior to that of ordinary systems but not as good as special systems; these systems are called **intermediate** systems.

Section 8.1 provides more in-depth information about structural systems. Section 8.8 provides more in-depth information about detailing.

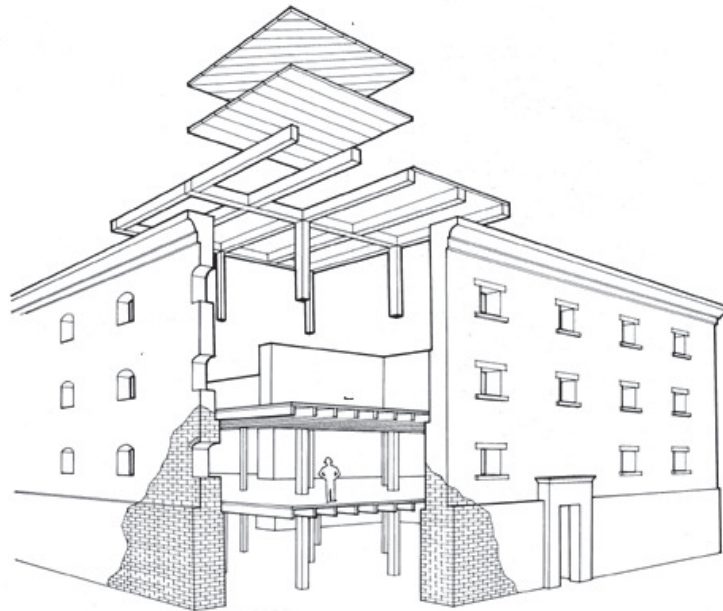
### 5.1.1 Bearing Wall Systems

**Bearing wall buildings** are the oldest form of building construction. In bearing wall systems, structural walls located throughout the structure provide the primary vertical support for the weight of the building as well as the resistance to lateral forces produced by wind and earthquakes. Bearing wall buildings are commonly used for residential construction, warehouses, and low-rise commercial buildings of concrete, masonry, and wood construction. Walls in bearing wall buildings can be of reinforced brick, concrete, or stone masonry; reinforced concrete; cold-formed steel; or wood

construction. Horizontal structural elements (i.e., floors and roofs) are most commonly of steel-framed, wood-framed, or concrete construction.

Bearing wall buildings resist earthquake forces through a mechanism sometimes called a box system, in which the horizontal elements (floors and roof) act as horizontal beams to carry earthquake forces to the end walls, which then transmit these forces vertically to the foundation.

Figure 5-1 shows the typical components of **unreinforced masonry** (URM) bearing wall buildings, which were commonly constructed in U.S. cities in the nineteenth and twentieth centuries. Walls are commonly constructed of clay brick masonry, laid up in multiple wythes (i.e., brick and mortar course thickness), with common nominal thickness of 9, 13, 17, 21 and 24 inches. Typically, the walls at each successive story are one wythe thinner than the story below. Floors are most commonly of timber construction with wood joists and beams pocketing directly into the walls.



**Figure 5-1** Typical URM bearing wall building (from Lagorio et al., 1986).

Many older URM buildings do not have adequate attachment between the walls and floors. When subjected to strong shaking, the walls can fall away from the building, resulting in collapse. This is called out-of-plane wall failure. Often, this starts at the parapet (the continuation of the wall above the roof line) and can extend through multiple stories. The resulting debris poses a considerable hazard to pedestrians and adjacent buildings (Figure 5-2 and Figure 5-3).



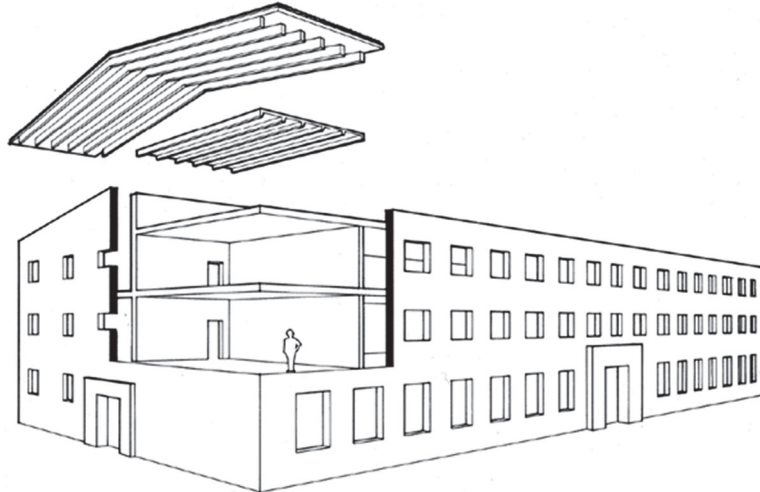
**Figure 5-2** Damaged URM building in the 2014 M6.0 South Napa Earthquake (from USGS).



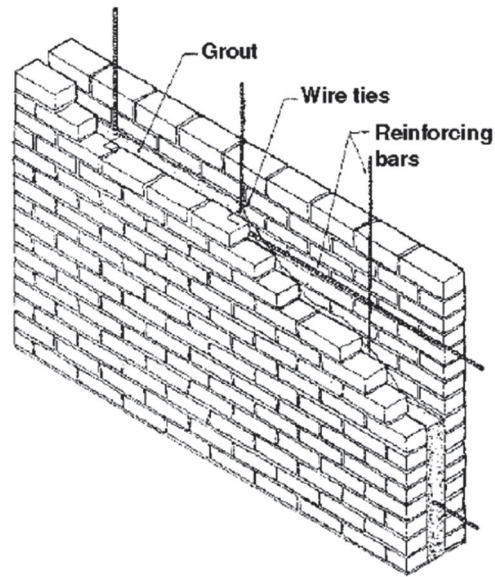
**Figure 5-3** Damaged URM building in the 2020 M5.7 Magna Earthquake (from Utah Geological Survey).

Another significant vulnerability of URM buildings is the lack of steel reinforcement in their walls. As a result, the walls have little ductility, and, if not provided with adequate strength, they will fail in a sudden manner, often leading to collapse. The performance of this building type has been consistently poor in past earthquakes. As a result, present day building codes prohibit this type of construction except in regions with very low seismicity. Some jurisdictions have even made retrofit of existing URM buildings mandatory.

Figure 5-4 depicts the construction of **reinforced masonry** or **reinforced concrete** bearing wall buildings. The construction is similar to that of unreinforced masonry buildings except that the walls, which may be composed of brick masonry, concrete block masonry, or concrete, are provided with both vertical and horizontal reinforcing steel. Floors and roofs may be of wood, concrete, or steel-framed concrete construction. Figure 5-5 illustrates the typical construction of a reinforced brick masonry wall, wherein reinforcing bars are placed in an open gap between the inner and outer wythes of brick, which is then filled with grout to bond the brick and steel together. Reinforced concrete block walls are constructed in a similar manner, except that the reinforcing is placed in open cells within the masonry unit that are then filled with grout. Depending on the amount of and types of reinforcing placed in the walls, the building codes classify these bearing wall buildings as ordinary, intermediate, or special. Special reinforced concrete bearing walls may be used even in those regions subject to the most severe seismic risk regions, with a maximum roof height of 240 feet. In most tall buildings of this type, the walls are placed in a central core, rather than at the perimeter, to allow more attractive architectural design for the exterior façade.



**Figure 5-4** A typical reinforced concrete or reinforced masonry bearing wall building (from Lagorio et al., 1986).



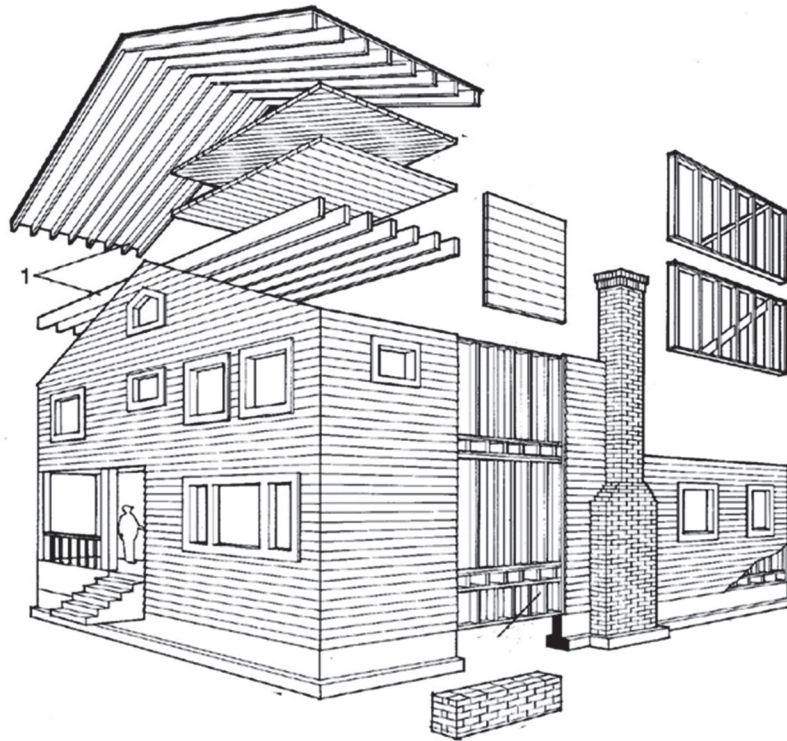
**Figure 5-5 Reinforced masonry wall construction (from Allen, 1985).**

The most common damage to reinforced bearing wall buildings consists of diagonal cracking of the concrete or masonry walls, and in extreme cases, crushing and spalling of the concrete or masonry units together with buckling of the reinforcing steel. Figure 5-6 shows typical damage of this type.



**Figure 5-6 Diagonal cracking in a reinforced concrete building damaged by the 1989 Loma Prieta Earthquake (from FEMA P-154).**

The most common form of low-rise construction in the United States is light **wood-frame** or **cold-formed steel frame** bearing wall construction. Figure 5-7 depicts the typical construction of a structure of this type. The walls are constructed of vertical studs, either sawn wood or cold-formed steel, spaced between 12 and 24 inches apart and sheathed either with gypsum board, plaster, wood panel sheathing, or a combination. Floors are repetitively framed with either wood or cold-formed steel joists supporting wood structural panel flooring, sometimes topped with light-weight gypsum concrete slabs.



**Figure 5-7 Typical wood light-frame construction (from Lagorio et al., 1986).**

Typical buildings of this type are lightweight and have many closely spaced walls to withstand seismic loading. As a result, most light-frame buildings have a high strength-to-weight ratio and high redundancy, typically resulting in outstanding seismic performance. The most common damage consists of cracking of interior gypsum board sheathing on partition walls and exterior stucco sheathing. If adequate connection between the wood frame superstructure and the foundations is not provided, these buildings can slide off their foundations (Figure 4-6).

### 5.1.2 Building Frame Systems

Building frames are a common structural system for buildings constructed of **structural steel** and reinforced concrete. In **building frame** structures, the weight of the building is typically carried by vertical elements called columns and horizontal elements called beams. Lateral resistance is provided either by diagonal steel members called **braces** that extend between the beams and columns to provide horizontal rigidity or by concrete, masonry, or timber shear walls that provide

lateral resistance but do not carry the weight of the structure. In some building frame structures, the diagonal braces or walls form an inherent and evident part of the building design as is the case for buildings shown in Figure 5-8. In most buildings, the braces or walls are hidden behind exterior cladding or interior partitions.



**Figure 5-8** Steel braced frames left exposed on the exterior of a high-rise (left) and inside a grocery store (right).

Building frame systems with concrete or masonry walls experience the same general types of damage as bearing wall buildings. However, because the walls in these buildings do not serve the dual purpose of providing vertical support for the weight of the building and resistance to earthquakes, it is acceptable for the walls to experience more damage than in bearing wall buildings. For this reason, the building codes permits design of these buildings for reduced forces, compared with the requirements for bearing wall buildings.

Damage to braced frame buildings typically consists of buckling of the bracing or failure of the connections of the braces to the frames. Since the braces typically are not required to carry the weight of the building, these buildings also may be designed with reduced seismic resistance, relative to bearing wall buildings.

### 5.1.3 Moment Frames

Moment-resisting frames, also called **moment frames**, are commonly used for both structural steel and reinforced concrete construction. In this form of construction, the horizontal beams and vertical

columns provide both support for the weight of the structure and the strength and stiffness needed to resist lateral forces. Stiffness and strength are achieved using rigid connections between the beams and columns that prevent these elements from rotating relative to one another. Although more expensive to construct than bearing wall and braced frame structural systems, moment frame systems are popular because they do not require braced frames or structural walls, therefore permitting large open spaces and facades with many unobstructed window openings. Figure 5-9 shows a steel moment frame building under construction.



**Figure 5-9 A tall steel moment frame structure under construction.**

Damage to steel moment frame buildings can take the form of permanent distortion of the beams and columns or failure of the connections between the beams and columns. Until the 1994 Northridge Earthquake, engineers believed that special steel moment frame buildings meeting code criteria for member proportions and connection configuration were highly resistant to earthquake shaking. As a result, the building codes permitted construction of these structures to any height. However, following that earthquake, engineers discovered fractures of the steel framing near the beam-to-column joints in many of these buildings. Following that, the building codes updated special requirements for the design of beam-to-column connections in these structures.

Damage to reinforced concrete moment frames is highly dependent on the type and quantity of reinforcing steel provided in the beams and columns. Special concrete moment frames must have extensive reinforcing in both beams and columns. In these structures, damage is anticipated to be limited to cracking and potentially minimal spalling of concrete in beams at connections to columns. In ordinary and intermediate moment frames, more severe damage can occur. Just as with steel



structures, the building codes permit construction of special concrete moment frames without height restrictions. Ordinary and intermediate moment frames, either of steel or concrete construction, are limited in height in regions of higher seismicity.

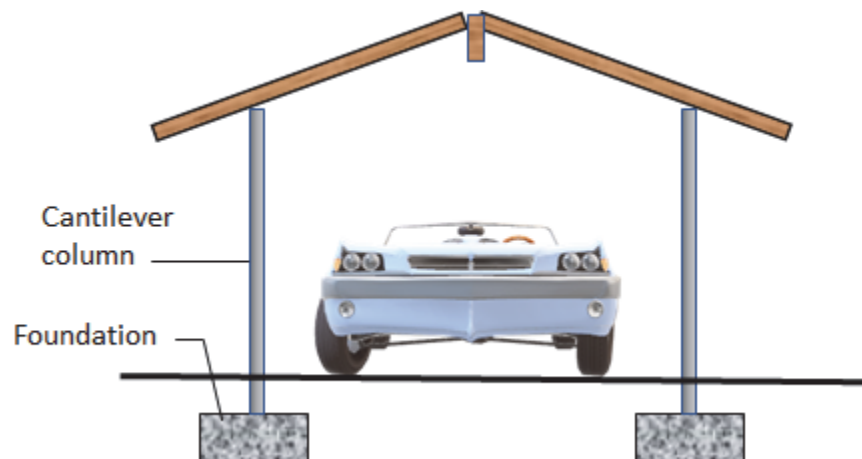
### 5.1.4 Dual Systems

**Dual systems**, an economical alternative to moment frames, are commonly used for tall buildings. Dual system structures feature a combination of moment frames and concrete, masonry, or steel walls, or steel braced frames. The moment frames provide vertical support for the weight of the structure and provide a portion of the earthquake resistance of the structure while most of the earthquake resistance is provided either by concrete, masonry, or steel walls, or by steel braced frames. Some dual systems are also called frame-shear wall interactive systems.

Damage to dual system buildings is like that experienced both by building frame structures and moment frame structures since both systems are present. Because these structures are inherently redundant, as they have multiple systems to resist earthquake forces, they are permitted to be designed for reduced seismic forces relative to bearing wall and building frame systems.

### 5.1.5 Cantilever Column Systems

**Cantilever column** systems are sometimes used for light single-story structures, such as carports (Figure 5-10) or in the top story of multi-story structures. In these structures, the columns cantilever upward from their bases, where they are restrained from rotation. The columns provide both vertical support of the weight of the building and lateral resistance to earthquake forces. Structures using this system have performed poorly in past earthquakes and severe restrictions are placed on its use in zones of high seismic activity. The building codes also require that design of these systems consider relatively large seismic forces to minimize the potential for damage.



**Figure 5-10** Cantilever column systems are commonly used for carports and similar structures. The columns cantilever upward from fixed foundations to support a roof.

## 5.2 Protective Systems

Most earthquake-resistant structural systems used in buildings are variations of systems that were traditionally used in structures not designed for earthquake resistance. Over the years, engineers and researchers improved the earthquake resistance of these traditional systems by observing their behavior in laboratory tests and actual earthquakes and incrementally refining the design criteria to achieve better performance. Nevertheless, these systems are still designed today with the understanding that they will sustain damage when subjected to design-level or more severe earthquake effects.

Beginning in the 1970s, engineers and researchers began to develop **protective systems** and technologies capable of responding to earthquake ground shaking without sustaining damage and thereby protecting the building or structure. The building codes presently include design criteria for two such technologies: seismic isolation and energy dissipation systems.

**Energy dissipation systems** are composed of structural elements capable of dissipating large amounts of earthquake energy without experiencing damage, much like the shock absorbers placed in the suspensions of automobiles. Energy dissipation systems usually are placed in a structure as part of a diagonal bracing system. Several types of energy dissipation system are available today including fluid viscous dampers, friction dampers, wall dampers (Figure 5-11), tuned mass dampers, and hysteretic dampers.



**Figure 5-11** Wall damper visible during construction of a hospital.

**Seismic isolation** systems consist of specially designed bearing elements that are typically placed between a structure and its foundation. Two types of bearing are commonly used; one is composed of layers of natural or synthetic rubber material bonded to thin steel plates in a multilevel sandwich form, and the second consists of specially shaped steel elements coated with a low-friction material. Both types of bearings can accommodate large lateral displacements while transmitting small forces into the structure above. When these isolation systems are placed in a structure, they effectively “isolate” the building from ground shaking so that, when an earthquake occurs, the building experiences only a small fraction of the forces that would affect it if it were rigidly attached to its foundations. Figure 5-12 shows seismic isolators at the tops of columns in a parking structure at the Burbank, California airport.



**Figure 5-12** Seismic isolators on top of columns at an airport in Burbank, California.

Although seismic isolation and energy dissipation systems have been available for more than thirty years, their use in new buildings has been confined primarily to very important structures that must remain functional after a strong earthquake and to buildings housing valuable contents such as museums or data centers. As their use adds to the construction cost, most owners prefer not to provide the additional protection provided by these technologies.

Sections 10.4 and 10.5 provide additional background on protective systems.



# Part B:

# Engineering Audience

This part of the guide provides an introduction to the key steps in the seismic design process for new buildings. The intended audience is practicing engineers early in their career, practicing engineers new to seismic design, and engineering students. It is assumed that the reader has a basic knowledge of structural engineering principles.

**Note:** It is recommended that readers of this part first read Part A.



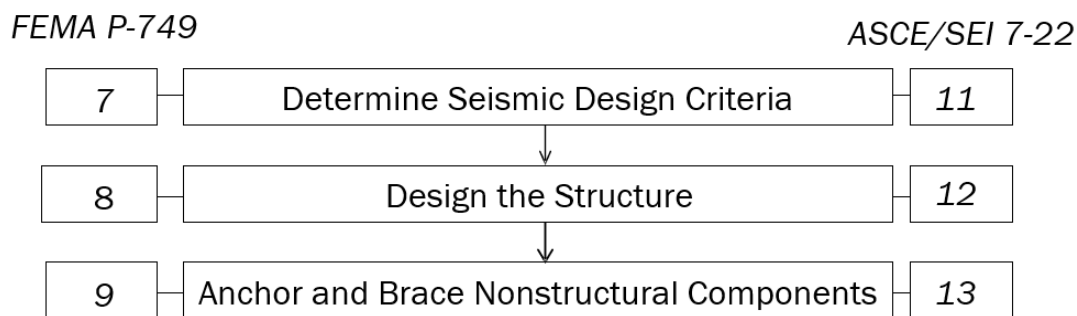
# Chapter 6: Overview of the Seismic Design Process

Current seismic requirements for prescriptive design of new buildings address all the key features of earthquake-resistant design presented in Chapter 4. This chapter provides an overview of the seismic design process for new buildings and background on structural dynamics principles that inform the process. Chapters 7 to 9 each cover a major step of the design process in detail and provide explanation of the fundamental principles associated with each step. Chapter 10 provides basic information on considerations that apply under special circumstances.

## 6.1 Seismic Design Process

Current U.S. building codes adopt prescriptive seismic design requirements through adoption of the ASCE/SEI 7 Standard, *Minimum Design Loads and Associated Criteria for Buildings and Other Structures*. ASCE-SEI revises this standard every six years. The current version is the 2022 edition, which will be adopted by the 2024 *International Building Code* (IBC), the model code for new construction used by most jurisdictions in the United States. This guide describes the criteria contained in ASCE/SEI 7-22 and notes where significant changes relative to the last edition (2016) have occurred.

Figure 6-1 is a flowchart illustrating the key steps in the building seismic design process, along with references to the chapters in this guide that provide explanation of fundamental principles associated with the step and applicable ASCE/SEI 7 chapters where the requirements are found.



**Figure 6-1** Seismic design process as outlined in chapters of this guide and ASCE/SEI 7-22.

Determining the seismic design criteria, the first step, consists of identifying the risk category, level of seismic hazard, and seismic design category. Designing the structure, the second step, involves using the criteria from the first step in selecting a structural system, developing a preliminary design, performing analysis to predict the seismic response, ensuring adequate strength and stiffness, and detailing the structure to comply with system-specific requirements. The final step is to design anchorage and bracing for nonstructural components.

ASCE/SEI 7 and this guide focus on design requirements associated with ground shaking, but consideration of other potential earthquake effects like landslide, liquefaction, tsunami, and fault rupture is also important. The existence of other hazards is location-specific, and mitigation of them in design is similarly dependent on individual site conditions, so specific design criteria is not included within ASCE/SEI 7. Rather, ASCE/SEI 7 requires a geotechnical investigation to determine if these hazards exist and that the geotechnical engineer provides recommendations for any necessary mitigation in a report.

Design for other loads (e.g., dead, live, wind) impact the structural design of a building, but are not covered by this guide. ASCE/SEI 7 covers other loading criteria, including load combinations for design.

**Performance-based design** is an alternative approach to the prescriptive design process described in Chapters 7 to 9. Although ASCE/SEI 7 and the building codes specifically permit this approach, there is currently no standard for performance-based design of new buildings. However, existing resources can be applied. Section 10.1 provides more information.

**Tsunami design** is required by ASCE/SEI 7-22 for select buildings in tsunami hazard zones. Section 10.2 provides basic information about tsunami-resistant design, but detailed background is outside the scope of this guide.

**Soil-structure interaction (SSI)** analysis is not required by ASCE/SEI 7-22, but instructions are provided in the standard, and it is becoming more common in seismic design. Section 10.3 provides basic background on using SSI.

**Energy dissipation and seismic isolation systems** improve the seismic performance of buildings when used but are rare in the United States. Sections 10.4 and 10.5 provide additional information on these systems.

**Nonbuilding structures** are addressed by ASCE/SEI 7-22 and in many cases, similar to the design of buildings. Section 10.6 explains what nonbuilding structures are and in what ways design of them is similar or not similar to buildings.





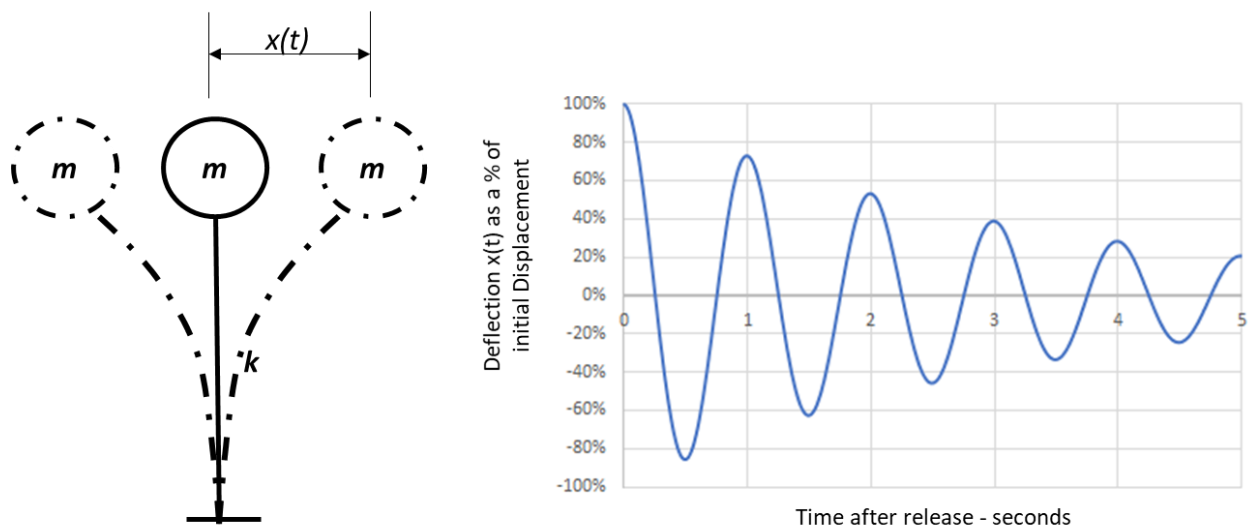
## ASCE/SEI 7-22: Minimum Design Loads and Associated Criteria for Buildings and Other Structures

This standard describes the design loads and associated criteria to be used in the general design of buildings and other structures. Loads covered include dead, live, seismic, soil, flood, tsunami, snow, rain, atmospheric ice, and wind loads. Published 2022. Available through ASCE.



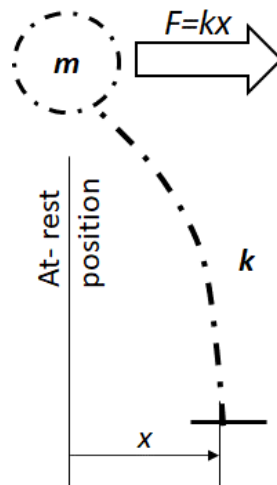
## 6.2 Background

Figure 6-2 portrays a simple, elastic structure consisting of a lumped mass,  $m$ , mounted on top a single column element, having **lateral stiffness**,  $k$ . Such structures are termed **single degree of freedom (SDOF)** systems. If pulled to the side to an initial displacement and released, as illustrated in the figure, the mass will oscillate about its zero-deflection point, slowing with time, and eventually come to rest. The amount of time it takes for the mass to make one complete oscillation, from a position of maximum displacement in one direction, back through the zero-deflection point, to maximum displacement in the reverse direction and back again, is called the **period** of the structure, Period is represented by the symbol  $T$ . For SDOF structures, like that shown in Figure 6-2, the period,  $T$ , has a value given by the expression  $2\pi\sqrt{m/k}$ , which, in the case of the structure in Figure 6-2, is one second. The amount of degradation in peak amplitude that occurs from one cycle of motion to the next is a measure of the amount of **damping**, or energy dissipation, that is occurring.



**Figure 6-2 Dynamic behavior of an SDOF structure.**

If this simple structure is subjected to earthquake ground motion, the ground will displace from underneath the structure, as illustrated in Figure 6-3, and the mass will tend to stay at rest due to its inertia. Because the column has been deformed by the moving ground and has stiffness,  $k$ , the column will impose a force,  $kx$ , on the mass, which will then accelerate towards the position of the displaced ground and then oscillate. However, in an earthquake, the ground is continuously moving, and deforming the structure, causing a time-variant force on the mass with the mass moving in an apparently chaotic manner.



**Figure 6-3 Ground motion effect on structure.**

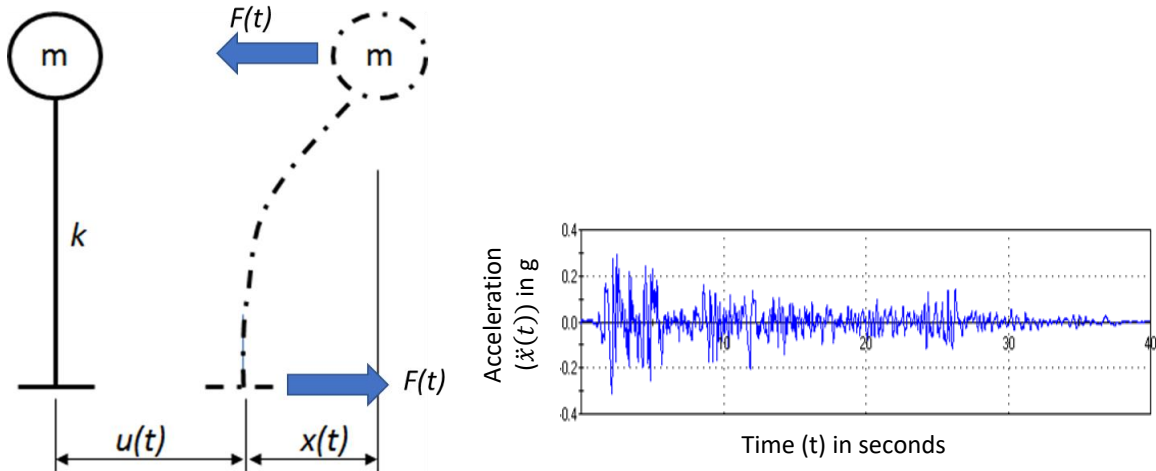
The response of this simple structure to earthquake shaking is measured in terms of the time-varying lateral deformation between the mass and its base,  $x(t)$ ; and the time-varying amount of force,  $F(t)$ , experienced by the structural element supporting the mass, both resulting from the response of the structure to the motion of the ground, represented as the time varying acceleration function  $\ddot{u}(t)$ .

The force and displacement experienced by the structure in responses to a specific ground motion (Figure 6-4) can be obtained by the stepwise numerical solution of the equation of motion for the structure:

$$m(\ddot{x}(t) + \ddot{u}(t) + c\dot{x}(t) + k(x)x(t)) = 0 \quad (6-1)$$

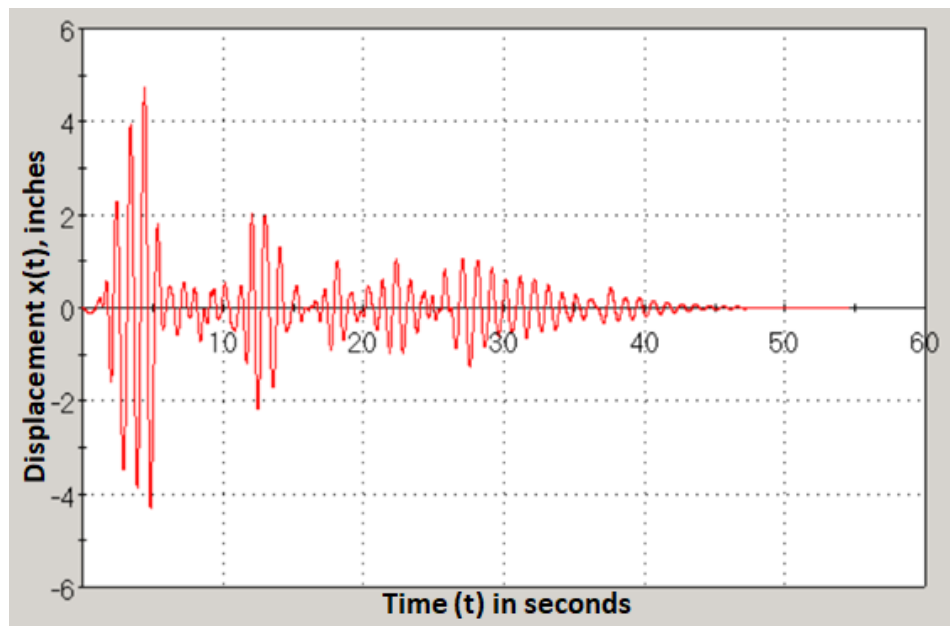
where:

- $\dot{x}(t)$  = velocity of the mass at time  $t$ , relative to its base
- $\ddot{x}(t)$  = acceleration of the mass at time  $t$ , relative to its base
- $c$  = ability of the structure to dissipate earthquake energy, known as damping



**Figure 6-4 SDOF structure subjected to ground motion.**

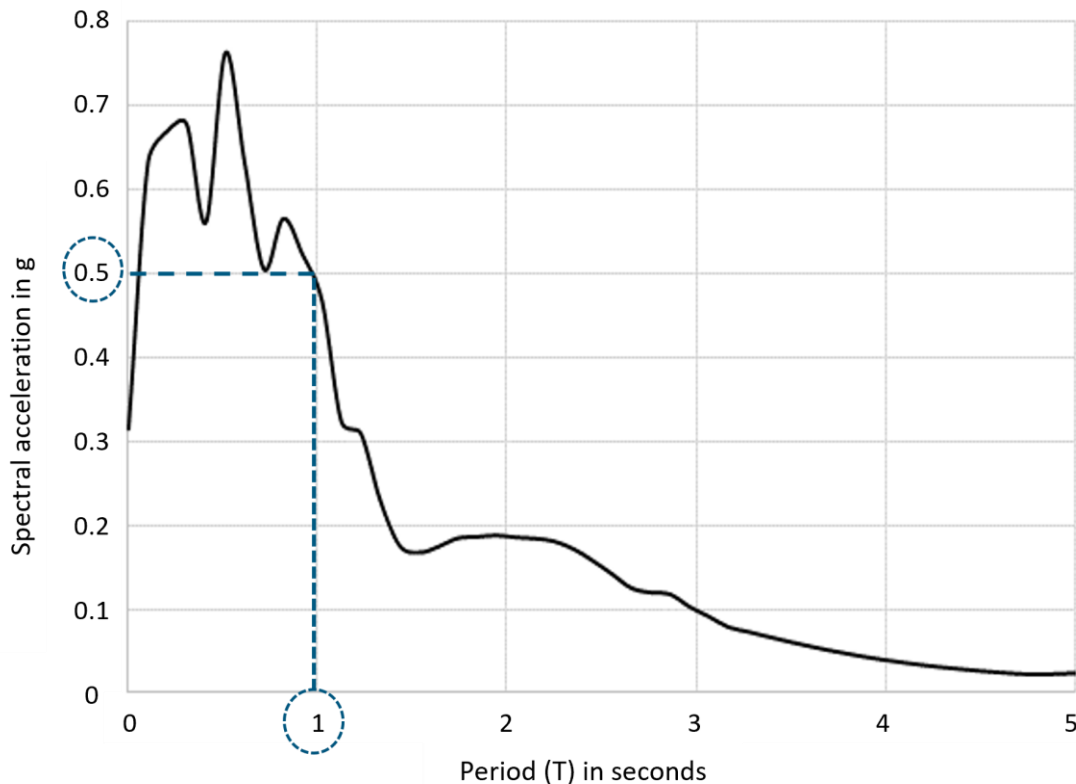
Figure 6-5 is a plot of the displacement response, which is the value of  $x$  as a function of time for the simple structure and ground motion shown in Figure 6-4. The structure exhibits a series of degrading sinusoidal responses at its fundamental period of one second each time the ground motion excites the structure significantly, which for this ground motion and structure, happens five times during the earthquake. The force in the structure at time  $t$  is simply the displacement  $x$  at time  $t$ , factored by the stiffness  $k$ . This structure displays a peak displacement to this ground motion of about five inches, and if it had a stiffness of 1,000 kips per inch, it would experience a peak force  $F$  of about 5,000 kips.



**Figure 6-5 Displacement response of 1-second SDOF structure to a ground motion.**

Observation of many plots of structural response to earthquake motions have led engineers to understand that earthquake response can be well represented by idealizing the structural response as that of a SDOF system, or series of SDOF systems, having a natural period (or periods) of vibration of the actual structure. This enables use of a simplified method of analysis, called **modal response spectrum analysis**, that allows engineers to avoid the complex mathematics associated with solving Equation 6-1, when designing structures.

An **acceleration response spectrum** is a graphical plot that shows the peak acceleration that SDOF structures having different natural periods,  $T$ , and specified damping,  $c$ , would experience if subjected to a specific earthquake motion. Figure 6-6 is the acceleration response spectrum for the ground motion used in the example shown in Figures 6-3 and 6-4. The horizontal axis is the structural period  $T$ , and the vertical axis is the peak acceleration, termed **spectral acceleration**,  $S_a(T)$ , that a structure of period  $T$  will experience when subjected to this motion.



**Figure 6-6** Acceleration response spectrum for an example ground motion.

If a response spectrum plot for an earthquake motion is available, then the engineer can simply find the spectral acceleration,  $S_a(T)$ , read off the vertical axis of the response spectra plot at the period of the structure,  $T$ . For the example SDOF structure having a period  $T$  of one second and 5% damping, the maximum acceleration that the structure will experience in response to this ground motion is approximately  $0.5g$ , where  $g$  is the acceleration due to gravity. Once this is known, it is easy to compute the maximum force the structure will experience during this motion using the formula:

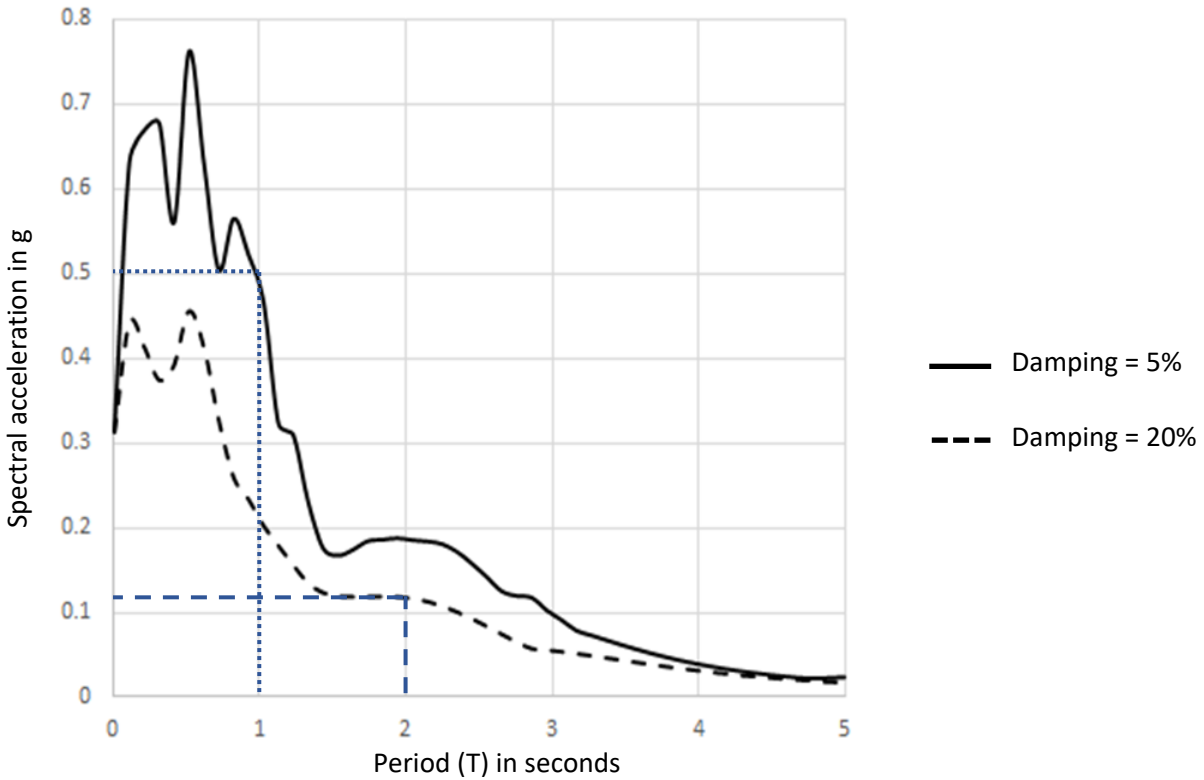
$$F = S_a(T)W \quad (6-2)$$

where  $W$  is the weight of the structure. If the example structure has a weight of 1,000 kips, the maximum force it would experience in response to this earthquake motion would be 500 kips ( $0.5 \times 1,000$  kips).

In Equation 6-1, the stiffness of the structure,  $k(x)$  is expressed as a function of the deformation of the structure,  $x$ . In the simplest form, the stiffness of the structure has a constant numerical value. Structures that respond in this manner are said to have **linear elastic** behavior. Such structures will return to their at-rest, undeformed position, once the shaking stops. Such a structure will be undamaged and in the same condition after experiencing the earthquake as it was before. This linear or elastic type of behavior is representative of structural response as long as the force  $F$  is less than a limiting value known as the **elastic limit**.

For reasons of economy and historic precedent, most structures are designed with less strength than would be required to resist design ground motion without damage (Section 3.1). Such structures have **nonlinear** behavior. Instead of having constant stiffness throughout the earthquake, these structures experience a degradation or reduction in stiffness as damage occurs, for example yielding of steel, cracking of concrete and masonry, or slippage of nails in wood structures. There are two significant effects of this damage. First, as the stiffness of the structure decreases, the natural period of the structure,  $T$ , becomes longer. The second effect is that the damage that occurs dissipates some of the energy of the earthquake, which increases the amount of damping.

Figure 6-7 illustrates the effect of nonlinear behavior for a hypothetical structure with an initial undamaged period of one second and 5% damping, which because of nonlinear behavior has an effective period of two seconds and effective damping of 20%. In the figure, the plot shown with a solid line is the same 5% damped response spectrum previously shown in Figure 6-6 and the plot shown with a broken line is the spectrum for this same motion with 20% damping. As shown in the figure, with an elastic period of 1 second, the structure would experience 0.5g of acceleration. However, with an effective (degraded) period of two seconds, and effective damping of 20%, the structure would experience only about 0.12g of acceleration, or roughly one-fifth as much. Since, per Equation 6-2, the earthquake force on the structure is proportional to the spectral acceleration, this structure would experience roughly one-fifth the force of a similar structure that was strong enough to remain elastic during this motion.



**Figure 6-7 Illustration of the effect of nonlinear response.**

In the design process, the effects of inelastic response described above is represented by the **response modification coefficient**,  $R$ . In the example above, the structure would be assigned an  $R$  value of 4, and it would be designed for one fourth of the force ( $1/R$ ) required to resist the ground motion without damage (i.e., elastically). The building code designates the value of  $R$  that can be used, depending on the type of structural system used to resist earthquake forces, the quality of seismic-resistant detailing that is incorporated in the design, and the proven ability of structures of that type to experience nonlinear behavior without collapse.

# Chapter 7: Determine Seismic Design Criteria

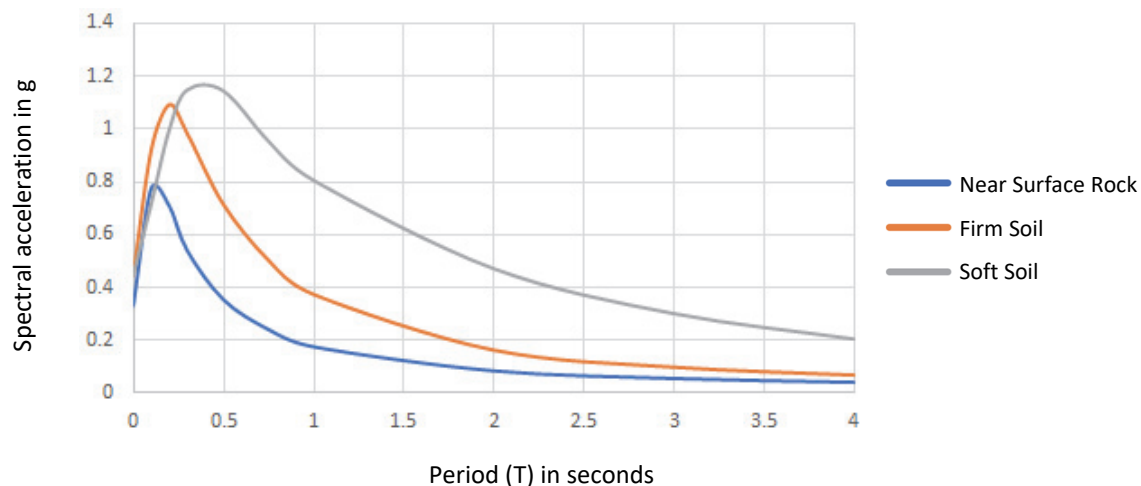
Seismic design criteria are determined based on the soil type, building location, and occupancy of the building. The process to determine the design criteria initiates with determination of a design acceleration response spectrum for the location of the building and two key spectral response acceleration parameters:  $S_{DS}$  and  $S_{D1}$ , which are derived from the response spectrum. Because the design acceleration response spectrum is dependent on the character of soils present at the site, the site class must be identified at the start of the design process. Once the site class is known, the design team can obtain the design response spectrum from the national seismic hazard database maintained by USGS. Alternatively, site-specific procedures can be used. (Site-specific procedures are technically complex and beyond the scope of this publication.) Another important part of determining seismic design criteria is the assignment of the risk category to the building. Using the response spectrum and risk category, the seismic design category can be identified.



ASCE/SEI 7-22 Chapter 11 provides the procedure for identifying seismic design criteria.


## 7.1 Identify Site Class

Site soil conditions can affect both the dynamic character and amplitude of shaking and is a key consideration in determining design ground shaking parameters. Figure 7-1 presents 500-year return period acceleration response spectra for an arbitrary site in Los Angeles, California, for three different site conditions: near-surface rock, firm soil, and soft soil.



**Figure 7-1** Representative acceleration response spectra for a site near Los Angeles, California with different assumed soil conditions (from USGS).

As illustrated in the figure, sites with near-surface rock tend to have lower amplitude shaking than sites with firm or soft soils. Also, as the soils become softer, intense shaking will occur over a broader range of structural periods and therefore strongly affect more buildings. Because of this, one of the first steps in the seismic design process is determination of the site characteristics, or site class.

 ASCE/SEI 7-22 Chapter 20 provides the procedure for determining site class.

Under ASCE/SEI 7, site class is determined based on the average **shear wave velocity**,  $\bar{v}_s$ , of the soils in the 30 meters (100 feet) immediately below ground surface. Shear wave velocity is typically determined by geotechnical engineers and/or geophysicists based on in-situ testing using any of several methods that measure the time it takes for sound waves to travel through the soil. Shear wave velocity can also be estimated using regional correlations between soil type and shear wave velocity. Once the average shear wave velocity for a site is known or estimated, this can be used directly to determine the design ground shaking spectrum, or alternatively, the shear wave velocity can be used to determine a site class, and then site class can be used to determine the design response spectrum. Table 7-1 below, extracted from ASCE/SEI 7-22 Chapter 20 shows the relationship between shear wave velocity and site class.

**Table 7-1 Site Class and Shear Wave Velocities (ASCE, 2022)**

Site Class	$\bar{v}_s$ , Calculated Using Measured or Estimated Shear Wave Velocity Profile
A. Hard rock	>5,000 ft/s
B. Medium hard rock	>3,000 to 5,000 ft/s
BC. Soft rock	>2,100 to 3,000 ft/s
C. Very dense sand or hard clay	>1,450 to 2,100 ft/s
CD. Dense sand or very stiff clay	>1,000 to 1,450 ft/s
D. Medium dense sand or stiff clay	>700 to 1,000 ft/s
DE. Loose sand or medium stiff clay	>500 to 700 ft/s
E. Very loose sand or soft clay	< 500 ft/s
F. Soils requiring site response analysis in accordance with ASCE/SEI 7-22 Section 21.1	See ASCE/SEI 7-22 Section 20.2.1

ASCE/SEI 7 permits engineers to determine design ground motions for a default site class wherein the design spectrum is based on the most severe spectral values determined using any of Site Classes, C, CD, D, DE, or E. This permits projects to proceed without the expense of determining site class but can result in a substantial penalty in the form of increased design forces.





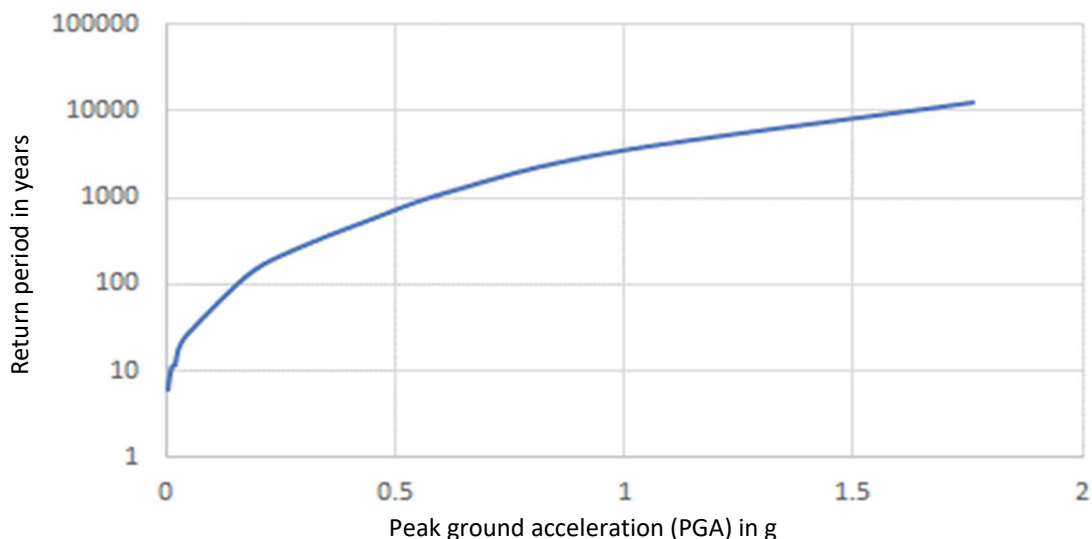
## New in ASCE/SEI 7-22: Intermediate Site Classes BC, CD, and DE

ASCE/SEI 7-16 and earlier editions identified six site classes (A, B, C, D, E, and F), with A representing typical conditions at sites with near-surface hard rock conditions, such as granite or schist, and F representing sites with very soft, saturated unstable soils, subject to liquefaction. ASCE/SEI 7-22 introduces intermediate Site Classes BC, CD, and DE to reduce the impact on design spectral parameters when moving between site classes.

## 7.2 Obtain the Design Response Spectra for the Site

At any site, minor earthquake effects will be experienced relatively frequently, while severe earthquake effects will be rare. These relationships can be expressed in the form of a seismic hazard curve that plots spectral response acceleration at a given period as a function of the average number of years between events capable of producing such effects, called **return period**. Figure 7-2 is a representative hazard curve and indicates the relationship between **peak ground acceleration** (PGA) and earthquake return period for a site near Los Angeles, California having Site Class C conditions. PGA is the spectral acceleration at zero period.

The figure shows that as the return period for reoccurrence of earthquakes producing PGA increases, so too does the ground motion intensity. For the sample site depicted, earthquakes having return periods of 100 years will produce ground shaking with a peak ground acceleration of approximately 0.20g; earthquakes with return periods of 1,000 years about 0.50g and 10,000 years of about 1.5g. Any specific return period defines a seismic hazard level.



**Figure 7-2** Example seismic hazard curve for peak ground acceleration.

If subjected to strong enough ground shaking, any structure would collapse. The primary goal of present building codes is to provide assurance that the risk of structural collapse is acceptably small, while considering that there are costs associated with designing and constructing structures to be collapse-resistant. The building codes define a reference earthquake shaking level, termed **risk-targeted maximum considered earthquake** ( $MCE_R$ ) shaking and seeks to provide a small probability (on the order of 10 percent or less) that structures with ordinary occupancies would collapse when subjected to such shaking.

Throughout most of the twentieth century, building codes required earthquake-resistant design only in the Western United States. These codes specified design earthquake shaking with a 475-year return period, based on the seismic hazard present in the Western United States. In the 1990s, the public became aware that some of the most severe U.S. earthquakes had occurred in the Central and Eastern United States, so building codes were updated to better address the longer return periods prevalent in those regions. To address the variability across the United States of return period, ASCE/SEI 7 now specifies design ground motions with different return periods, based on the seismicity of each region. This approach is sometimes called **uniform risk** because it provides uniform risk against earthquake effects, regardless of the region in which a structure is located.

For historic reasons, associated with the practice in earlier building codes, ASCE/SEI 7 specifies required seismic design forces for structures and nonstructural components using a reduced level of shaking termed **design earthquake** (DE) shaking. DE shaking intensity is two-thirds that of  $MCE_R$  shaking. The return periods for both  $MCE_R$  and DE shaking vary around the nation. Generally,  $MCE_R$  shaking has return periods ranging from approximately 1,000 years to 3,000 years, determined with the intent of producing a uniform risk of earthquake-induced collapse. DE shaking has return periods ranging from about 300 to 1,000 years, depending on location. For structures of ordinary occupancy, not located within a few kilometers of a major active fault, this results in a risk of earthquake-induced collapse of about 1% in 50 years. For near fault site, the risk can be higher.

Once the site class for a project is known, the next step in the seismic design process is to determine the **design response spectrum**. Section 6.2 introduces the concept of acceleration response spectra, and how they can be used to determine the amount of acceleration and force a structure will experience as a result of earthquake shaking. ASCE/SEI 7-22 references a seismic hazard database developed by USGS that contains the values of design spectral response acceleration at 22 different periods, ranging from zero seconds to ten seconds, on a 2-kilometer by 2-kilometer grid around the United States and its territories, for each of the site classes described in Section 7.1 (USGS, 2022d).



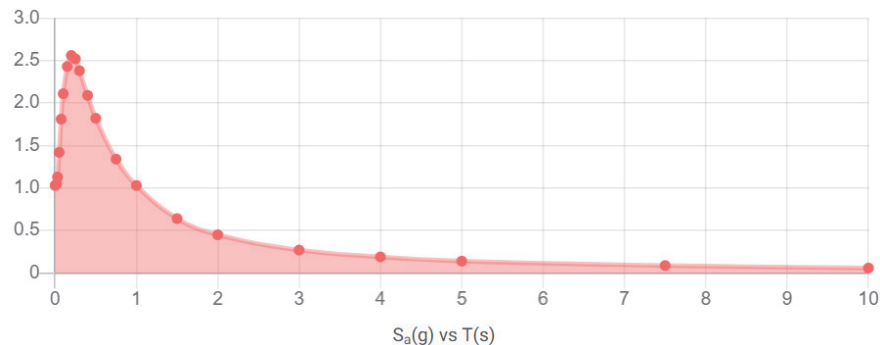
ASCE/SEI 7-22 Chapters 11, 20, and 21 contain procedures for finding design ground motion.



## New in ASCE/SEI 7-22: Removal of Site Class-dependent Coefficients

ASCE/SEI 7-16 and earlier editions of the standard included maps of spectral response parameters for Site Class BC conditions derived from the USGS database. Engineers would use site class-dependent coefficients,  $F_a$  and  $F_u$ , to convert the mapped values to values appropriate to their site class. This approach was abandoned in ASCE/SEI 7-22 because it was found that the site class coefficients were not sufficiently accurate, particularly for softer soil sites subject to ground shaking from large magnitude earthquakes.

In order to obtain the design response spectrum, it is necessary to use an online database interface like the ASCE 7 Hazards Tool to look up the value of the spectral response acceleration parameters based on input of the latitude, longitude, and site class for the project. Figure 7-3 presents a design response spectrum for a site near Los Angeles, California, having Site Class C conditions. In the figure, the red dots indicate the periods and spectral values obtained from the USGS database. Unlike the response spectrum shown in Figure 6-6, which was obtained for one earthquake motion, the design spectrum shown in Figure 7-3 is smoothed so it does not have the irregular peaks and valleys seen in Figure 6-6. This is because each ground motion will produce differently shaped spectra. The design spectra are intended to envelope the many different earthquake spectra that can occur at a site.

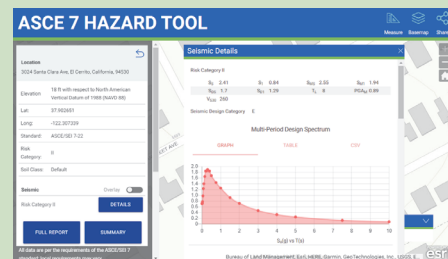


**Figure 7-3** Representative design response spectrum for site near Los Angeles, California with Site Class C conditions.



## ASCE 7 Hazard Tool

This online tool allows users to easily retrieve key design parameters for a specific location. Data is available for seismic, tsunami, wind, tornado, flood, ice, snow, and rain load parameters. Seismic data is pulled from the USGS database. Available for free [online](#).



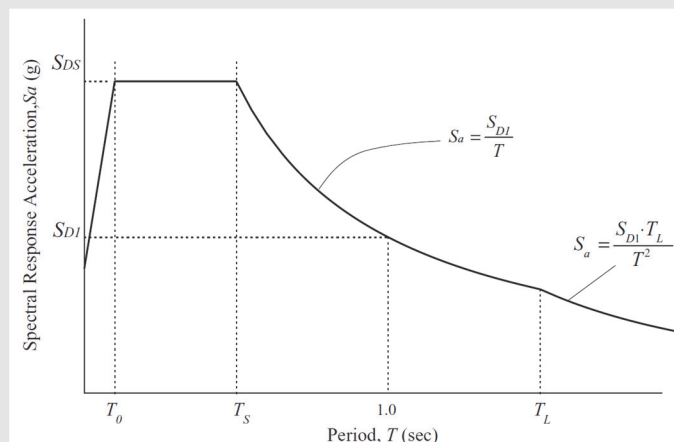
ASCE/SEI 7 permits project teams to perform their own seismic hazard and site response analyses and derive **site-specific spectra** in lieu of using the design spectra obtained from the USGS database. This is necessary for sites outside the United States and its territories that are not included in the USGS database and may also be appropriate for project sites where more recent data on important site parameters are available than those used by the USGS in developing their database. ASCE/SEI 7 Chapter 21 provides the criteria for performing such site-specific analyses and requires that site specific spectra values not be taken less than 80% of the values obtained from the database. This latter requirement is to assure that projects not be designed using excessively aggressive assumptions.



### New in ASCE/SEI 7-22: Multi-Period Response Spectrum

ASCE/SEI 7-16 and earlier editions of the standard used the standard spectral shape shown in Figure 7-4. In this simple spectral shape,  $S_{DS}$  and  $S_{D1}$  were the spectral response acceleration at periods of 0.2 seconds and 1 second, respectively, and the spectrum was divided into three domains: the plateau (constant response acceleration), the hyperbola (constant response velocity), and the parabola (constant response displacement). ASCE/SEI 7-22 replaced the simple response spectrum shown below with the multi-period response spectrum obtained from the USGS database and discussed in this section. The procedures for calculating  $S_{DS}$  and  $S_{D1}$  from the multi-period spectrum ensure that the simple spectrum shown in Figure 7-4 reasonably envelopes the multi-period spectrum.

Prior to the publication of ASCE/SEI 7-22, it was common for major projects to use site-specific spectra. This is because the ergodic, three-domain design response spectrum contained in earlier editions of the standard could be quite inaccurate on some sites. With the adoption of multi-period spectra and broadening of the number of site classes, the ergodic spectra have become much more accurate, lessening the need for site-specific spectra in most cases.



**Figure 7-4 Two-period design response spectrum that served as the standard spectrum in ASCE/SEI 7-16 and earlier editions. The multi-period response spectrum supersedes this two-period design response spectrum in ASCE/SEI 7-22.**

Once the design spectrum for a site has been obtained, the design procedures rely on a series of parameters directly derived from the spectrum. These parameters include:

- Design spectral response acceleration at short periods,  $S_{DS}$ ,
- Design spectral response acceleration at 1-second period,  $S_{D1}$ , and
- Long-period transition period,  $T_L$ .

These parameters are used to determine the seismic design category (SDC) for the structure and are used directly in the Equivalent Lateral Force (ELF) analysis method.

### 7.3 Assign Risk Category

Section 3.1 describes the concept of acceptable risk and the fact that in U.S. building codes the level of risk deemed acceptable is in part dependent on the intended use of the structure. The use of the structure is represented by the **risk category**, which represents the consequences to society of its failure. Risk categories, associated uses and occupancies, and example buildings per ASCE/SEI 7 are provided in Table 7-2. The structure descriptions in ASCE/SEI 7 are intentionally general to allow local building codes to exercise latitude in risk category assignment, dependent on their community needs. Designers should check the requirements of the governing building code when making Risk Category assignments.

**Table 7-2 Risk Categories (ASCE, 2022)**

Risk Category	Intended Use and Occupancy	Examples
I	Buildings and other structures that represent low risk to human life in the event of failure	Barns and other normally unoccupied structures
II	Buildings and structures not assigned to other risk categories	Most commercial, industrial, and residential structures
III	Buildings and structures that could pose a substantial risk to human life; that could cause a substantial economic impact or mass disruption to life and not assigned to Risk Category IV; or contain substantive quantities of hazardous materials that would pose a public threat if released	Buildings with several thousand occupants, such as high-rise office buildings, as well as public schools, manufacturing facilities with toxic materials, and some public utility structures such as electrical generating stations and water treatment plants
IV	Buildings and structures designated as essential facilities, or which could pose a substantial hazard to the community, or which are essential to the operation of other Risk Category IV structures	Hospitals, police and fire stations, and emergency communications facilities



ASCE/SEI 7-22 Section 1.5 addresses risk category assignment. Table 1.5-1 designates the risk category based on intended use and occupancy.

## 7.4 Assign Seismic Design Category

The level of seismic design required by U.S. building codes considers both the level of acceptable risk, based on risk category, and the severity of shaking and other earthquake effects, the structure is likely to experience, given its location. ASCE/SEI 7 uses the **seismic design category** (SDC) concept to determine the required level of design.



ASCE/SEI 7-22 Section 11.6 contains the procedures for determining SDC.

There are six SDCs ranging from A to F. Structures in regions anticipated to have earthquakes of only minimal intensity and having ordinary occupancies are assigned to SDC A. Structures located in the most seismically active regions that have sensitive occupancies, for which minimal risk of damage is considered acceptable, are assigned to SDC F. As seismic design category increases, ASCE/SEI 7 specifies progressively more rigorous seismic design and construction as a means of ensuring that all buildings meet the requirements for acceptable risk (Section 3.1). Thus, as the SDC for a structure increases, so too do the strength and detailing requirements and the cost of providing seismic resistance. Table 7-3 summarizes the types of buildings assigned to each seismic design category and the primary design requirements associated with these categories. Note that although Table 7-3 refers to MMI (Section 1.2) as a means to identify which seismic design category a structure is assigned to, ASCE/SEI 7 actually designates this based on the values of the spectral response acceleration parameters  $S_{DS}$  and  $S_{D1}$ , described in the previous chapter.

**Table 7-3 Seismic Design Categories, Risk, and Seismic Design Requirements**

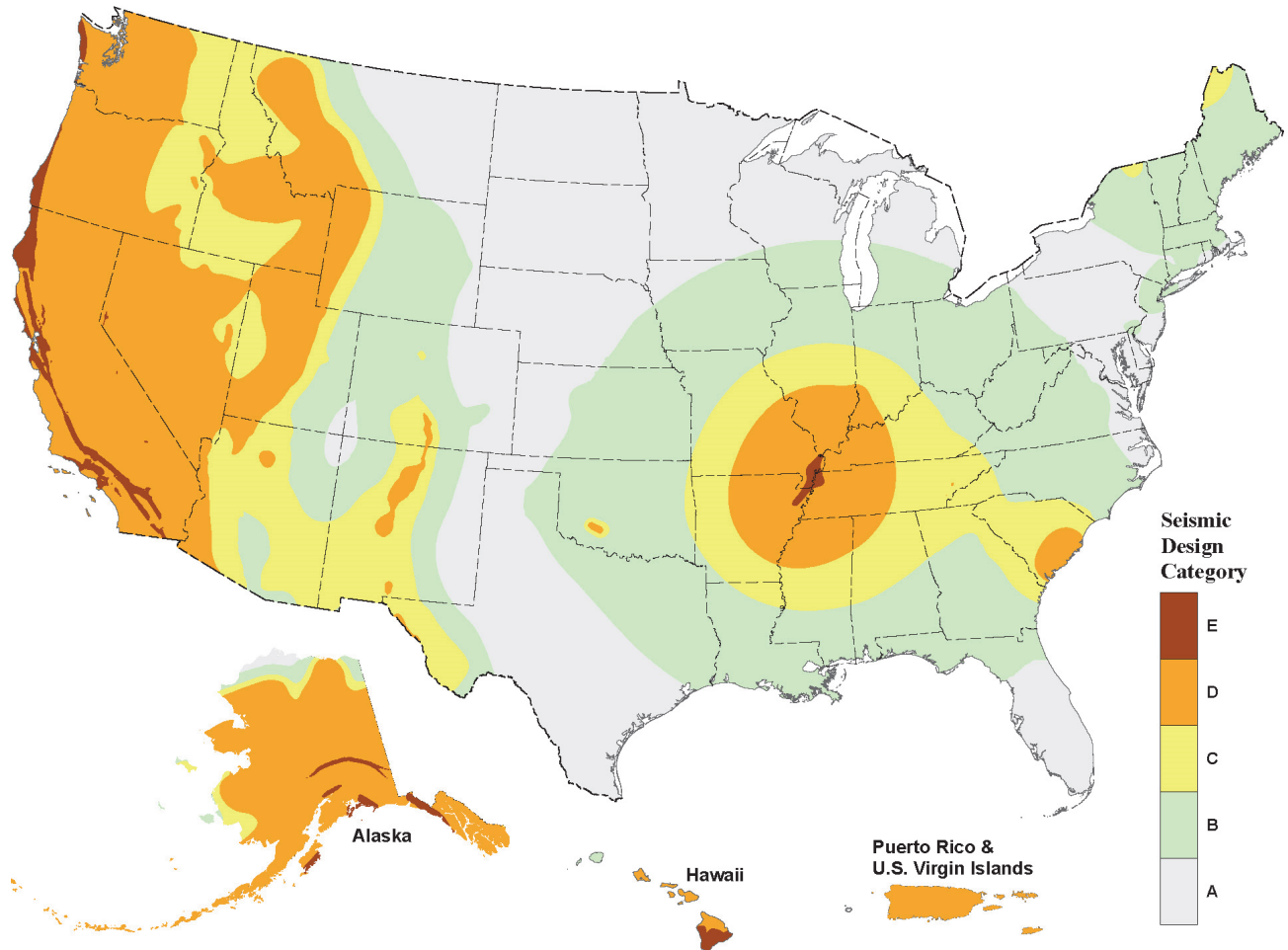
SDC	Building Type and Expected MMI	Seismic Criteria
A	Buildings located in regions having a very small probability of experiencing damaging earthquake effects	<ul style="list-style-type: none"> <li>No specific seismic design requirements but structures are required to have complete lateral force-resisting systems and to meet basic structural integrity criteria.</li> </ul>
B	Risk Category I, II, and III structures that could experience moderate (MMI VI) intensity shaking	<ul style="list-style-type: none"> <li>Structures must be designed to resist seismic forces.</li> </ul>
C	Risk Category I, II, and III structures that could experience strong (MMI VII) shaking and Risk Category IV structures that could experience moderate (MMI VI) shaking	<ul style="list-style-type: none"> <li>Structures must be designed to resist seismic forces.</li> <li>Some types of structural systems are prohibited.</li> <li>Critical nonstructural components must be provided with seismic restraint.</li> </ul>

**Table 7-3 Seismic Design Categories, Risk, and Seismic Design Requirements (continued)**

SDC	Building Type and Expected MMI	Seismic Criteria
D	Risk Category I, II, and III structures that could experience very strong shaking (MMI VIII or greater) and Risk Category IV structures that could experience strong (MMI VII) or greater shaking.	<ul style="list-style-type: none"> <li>▪ Structures must be designed to resist seismic forces.</li> <li>▪ Only structural systems capable of providing good performance are permitted.</li> <li>▪ Nonstructural components that could cause injury must be provided with seismic restraint.</li> <li>▪ Nonstructural systems required for life safety protection must be demonstrated to be capable of post-earthquake functionality.</li> <li>▪ Special construction quality assurance measures are required.</li> </ul>
E	Risk Category I, II, and III structures located within a few kilometers of major active faults capable of producing MMI IX or more intense shaking	<ul style="list-style-type: none"> <li>▪ Structures must be designed to resist seismic forces.</li> <li>▪ Only structural systems that are capable of providing superior performance permitted.</li> <li>▪ Some types of irregularities are prohibited.</li> <li>▪ Nonstructural components that could cause injury must be provided with seismic restraint.</li> <li>▪ Nonstructural systems required for life safety protection must be demonstrated to be capable of post-earthquake functionality.</li> <li>▪ Special construction quality assurance measures are required.</li> </ul>
F	Risk Category IV structures located within a few kilometers of major active faults capable of producing MMI IX or more intense shaking	<ul style="list-style-type: none"> <li>▪ Structures must be designed to resist seismic forces.</li> <li>▪ Only structural systems capable of providing superior performance are permitted.</li> <li>▪ Some types of irregularities are prohibited.</li> <li>▪ Nonstructural components that could cause injury must be provided with seismic restraint.</li> <li>▪ Nonstructural systems required for facility function must be demonstrated to be capable of postearthquake functionality.</li> <li>▪ Special construction quality assurance measures are required.</li> </ul>

In communities where soil conditions vary, similar buildings constructed on different sites may be assigned to different seismic design categories and this can result in very different seismic design requirements for similar buildings in the same city. Figure 7-5 shows the seismic design category for low-rise, Risk Category I and II structures located on sites with average alluvial soil conditions. Structures of a higher risk category would be assigned to a higher SDC. Tall structures and structures

on sites with other than average alluvial soils also may be assigned to different SDCs. Note that for structures not covered by the IRC, SDC D<sub>0</sub>, D<sub>1</sub>, and D<sub>2</sub> are grouped into one seismic design category: SDC D.



**Figure 7-5** Seismic design category on default site class for Risk Category I and II buildings (from USGS).



# Chapter 8: Design the Structure

This chapter describes the ASCE/SEI 7 procedures for determining the required seismic strength, stiffness, and detailing of structures in Seismic Design Category (SDC) B through SDC F. The list below indicates these steps and identifies the section in which these steps are discussed.

- Select structural system (Section 8.1)
- Identify system design coefficients (Section 8.2)
- Check for configuration irregularities (Section 8.3)
- Calculate seismic loads (Section 8.4)
- Analyze and design structural elements (Section 8.5)
- Check drift and stability (Section 8.6)
- Design diaphragms (Section 8.7)
- Detail connections and other elements (Section 8.8)

Nonbuilding structures are addressed by ASCE/SEI 7-22 and in many cases, similar to the design of buildings. Section 10.6 explains what nonbuilding structures are and in what ways design of them is similar to or not similar to buildings.



ASCE/SEI 7 Chapter 12 provides design requirements for building structures.

## 8.1 Select Structural System

Over many years, engineers have observed that some structural systems perform better in earthquakes than others. Based on these observations, selection of a structural system type is a key and early step in the seismic design criteria for buildings. Structural systems are categorized based on three characteristics:

- Material of construction (e.g., concrete, masonry, steel, or wood)
- How lateral forces induced by earthquake shaking are resisted by the structure
- Relative quality of earthquake-resistant design and detailing

Ductility is the ability of some structural systems to experience deformations beyond those that cause them to develop their peak strength while continuing to carry load. Brittle structural systems have no ductility. They will deform elastically until the applied load is equal to their ultimate strength, then fail suddenly and lose load-carrying ability. Structures with limited ductility may be able to retain load-carrying capability up to deformation 50% larger than the deformation at which they develop peak strength. Highly ductile structures may be able to withstand deformations up to 4 or 5 times those at which peak strength is achieved without loss of load-carrying capability. In reality, most structural systems have some ductility. ASCE/SEI 7 categorizes systems with superior ductility as **special**, systems with limited ductility as **ordinary**, and systems with intermediate levels of ductility as

**intermediate.** ASCE/SEI 7 permits design of intermediate and special systems with less strength than ordinary systems. However, to qualify as an intermediate or special system, the design must follow rigorous detailed requirements that can result in greater construction cost. Section 8.8 describes these requirements in more detail.



ASCE/SEI 7 Table 12.2-1 defines the applicable structural systems for seismic resistance, associated height restrictions, applicability to different SDCs, and applicable design coefficients ( $R$ ,  $C_d$  and  $\Omega_0$ ).

Based on past historic performance, some structural systems that have little ductility are prohibited from use in seismic design categories associated with intense earthquake shaking or immediate post-earthquake occupancy. Still other systems are only permitted for use for buildings of limited height or weight.

The portion of the structure that is specifically designed to provide the required earthquake resistance is called the **seismic force-resisting system** (SFRS). Structures assigned to SDC A can use any type of SFRS if the system is complete and provides minimum specified strength. Buildings assigned to SDC B or higher must utilize one of the specific SFRSs or combinations of these systems listed in Table 12.2-1 of the ASCE/SEI 7-22 and comply with all of the design rules applicable to the selected system. The SFRS of a building resists other lateral loads (e.g., wind), but this chapter focuses on seismic considerations.

ASCE/SEI 7-22 Table 12.2-1 lists more than 90 structural systems, providing designers with a wide range of choices and classifies structural systems for buildings into one of six broad categories:

- Bearing wall systems,
- Building frame systems,
- Moment-resisting frame systems,
- Dual systems and shear wall frame interactive systems,
- Cantilever column systems, and
- Systems not specifically designed for seismic resistance.

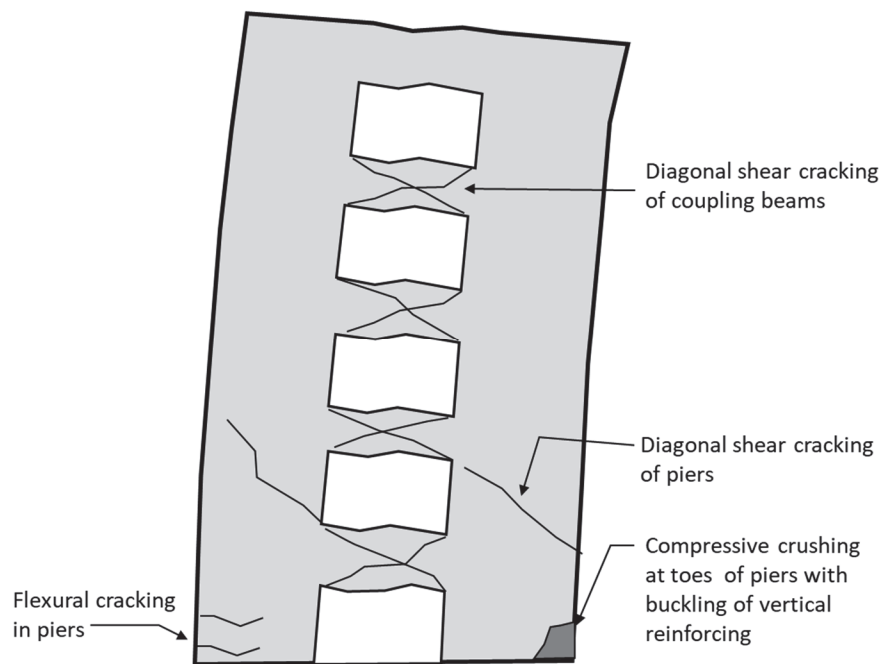
The sections below describe key structural requirements for these systems.

### 8.1.1 Wall Systems

**Wall systems** include structures in which masonry, concrete, wood-frame, structural steel, composite steel and concrete, or cold-formed steel walls provide lateral resistance to wind and earthquake forces. Wall systems can be classified as **bearing wall systems** or **building frame systems**, depending on whether the walls carry a substantial portion of the gravity loading of the building or they rely on them only to resist lateral loads. The building code requires that wall systems that carry substantial portions of the vertical load of a building be designed with higher strength than those that do not so that they will experience less damage in response to strong shaking.

The primary factor affecting the classification of a structural system of concrete or masonry walls as plain, detailed, ordinary, intermediate, or special is the quantity and detailing of reinforcing steel contained in the wall. Figure 8-1 shows an exaggerated, deformed shape for a typical concrete or masonry wall subjected to lateral forces from an earthquake illustrating the types of damage that may occur. Typical damage includes diagonal cracking due to shear in coupling beams and piers, flexural cracking at the bases of vertical piers and compressive crushing and spalling at the corners of piers, accompanied by buckling and potentially fracturing of vertical reinforcing steel.

**Plain masonry** (unreinforced) and concrete walls are not provided with reinforcing to resist seismic forces and the types of damage indicated in the figure and can rapidly lose strength in earthquake shaking. Detailed plain walls are provided with nominal reinforcing at openings, such as those for doors and windows. This reinforcing is primarily intended to prevent cracking originating at the corners of the opening but is not effective in resisting repeated straining of the wall into the inelastic range.



**Figure 8-1** Deformed shape and typical damage patterns in multi-story concrete or masonry walls.



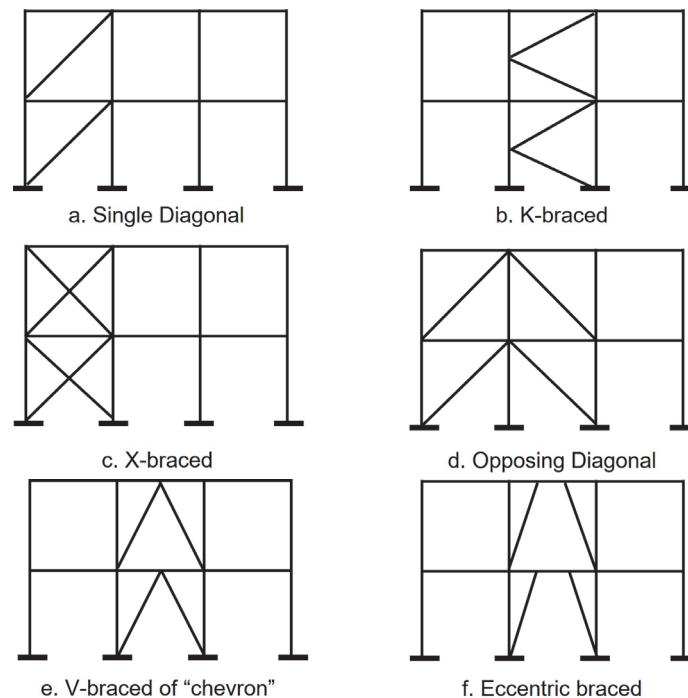
#### New in ASCE/SEI 7-22: Ductile Coupled Wall System

ASCE/SEI 7-22 and ACI 318-19 introduced a new class of special concrete shear wall system, called the **ductile coupled wall system**. The coupled wall system is required to incorporate coupling beams, meeting specific dimensional criteria, over openings. These coupling beams serve as a benign means of dissipating earthquake energy and permit use of reduced design forces relative to other concrete wall systems.

Walls of **light-frame construction**, including both wood and cold-formed steel, are categorized with regard to their ability to resist inelastic response, primarily, based on the type of sheathing used to provide lateral resistance. Traditional systems of plaster and gypsum board sheathing have limited ability to provide repeated resistance to lateral deformation, once the plaster or gypsum product cracks. Walls with these sheathing materials are limited to SDC B, C and D, and in SDC D are only permitted for low-rise structures. Walls incorporating plywood or structural panel sheathing attached with appropriate fasteners can resist many cycles of large lateral displacement and are permitted in all SDCs and are permitted to be designed for reduced forces, relative to walls with ordinary sheathing materials.

### 8.1.2 Braced Frame Systems

The most common braced frame systems are constructed from steel. **Steel braced frames** are a common type of structural steel building frame system. Figure 8-2 shows common types of steel braced frame systems. Braced frame systems that are specifically detailed for seismic resistance must meet the criteria of AISC 341, *Seismic Provisions for Steel Structures*. This is required for braced frames in SDC D, E, or F and permitted for other SDCs. AISC 341 does not permit single diagonal braced frames with more than 50% of the braces in a story and in a frame line aligned in one direction because if the braces are overloaded, and buckle, the frame will lose lateral resistance. Similarly, K-braced frames are prohibited by AISC 341 because under lateral loads, the compression braces can buckle, and the tensile braces will then place large, concentrated loads on the columns at mid-height, potentially resulting in column buckling and collapse.

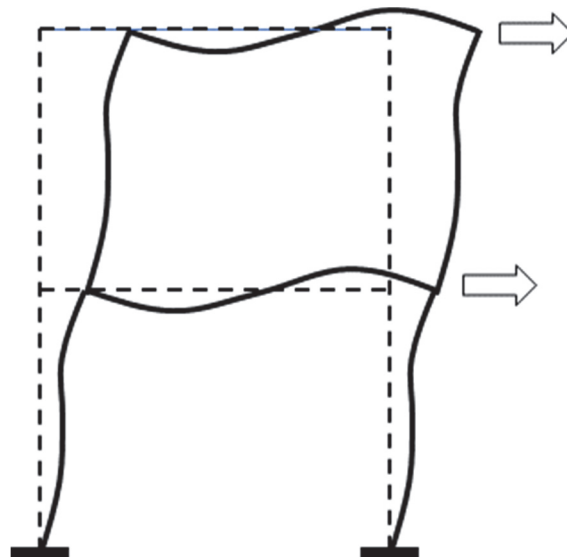


**Figure 8-2** Common types of steel braced frame systems.

**Concentrically braced frames** are configured such that the beams, columns and braces intersect at common points. **Eccentrically braced frames** (Figure 8-2(f)) are configured such that brace-to-beam connections are offset from each other, or offset from beam-column intersections, such that nonlinear behavior is accommodated through ductile flexural or shear yielding of the beams, rather than the braces themselves. **Buckling-restrained braced frames** use braces consisting of a central steel core that can yield in tension or compression, braced by an outer sleeve. This newer system is highly tolerant of repeated nonlinear cyclic loading, and, like the eccentrically braced frame, is permitted to be designed for reduced strength relative to other concentrically braced frame types.

### 8.1.3 Moment-resisting Frame Systems

Moment-resisting frame systems (also called **moment frames**) can be constructed of structural steel, reinforced concrete, or a combination of steel and reinforced concrete called composite construction. Moment frames derive their lateral resistance through the rigid or semi-rigid connection of their beams and columns. This results in the lateral deformation pattern illustrated in Figure 8-3. This deformation pattern occurs simultaneously with the development of shearing forces and bending moments in the beams and columns, and axial forces associated with overturning in the columns. ACI 318 and AISC 341 respectively describe the detailing required of special, intermediate, and ordinary moment frames of reinforced concrete, steel, and composite construction.



**Figure 8-3** Typical deformed shape of moment-resisting frame responding to lateral forces.

Special moment frames detailed in accordance with ACI 318 and AISC 341 can provide large inelastic response, permitting them to be designed for low lateral forces, relative to other systems, and allowing use of these systems without height restrictions, even in SDC D, E, and F. Both ACI 318 and AISC 341 require design of beams and columns such that flexural yielding of the frame will occur mostly in the beams, rather than the columns, to minimize damage to columns. Both specifications also restrict the materials that can be used in special moment frames, and the locations of splices in members to ensure that nonlinear behavior is achievable.

Both ACI and AISC recognize intermediate and ordinary moment frame systems. These systems have relaxed detailing criteria relative to special moment-resisting frames but are required to have greater strength than special moment frames, to limit the amount of nonlinear behavior experienced in design shaking.

### 8.1.4 Dual Systems

**Dual systems** are a combination of a concrete, steel, or composite moment-resisting frame system and a concrete or masonry wall, or braced steel frame system. In SDC C, D, E and F, design of dual systems requires a structural analysis that considers the interaction between the moment frame and other elements. The moment frame must be designed to resist at least 25% of the total required seismic forces and have sufficient strength to resist the forces predicted by analysis. The intent of this requirement is that the moment frame will act as a redundant (i.e., back-up) system, that will be capable of resisting earthquake forces should the primary system (walls or braced frames) become extensively damaged. Like special moment frame systems, dual systems that incorporate a special moment-resisting frame can be constructed without height limit in SDC D, E, and F. In SDC B, ASCE/SEI 7 permits a type of dual system known as a frame-wall interactive system. In this system, it is not necessary that the moment frame be capable of resisting 25% of the total seismic design forces.

### 8.1.5 Cantilever Column Systems

**Cantilever column** systems are a special form of moment-resisting frame in which there are no beams connected to the column tops to restrain them against rotation. These systems derive their lateral resistance solely from the fixity against rotation at the column base. The simple SDOF structure described in Chapter 6 is an example of a cantilever column system. Both concrete and steel cantilever columns systems are permitted by the code. Detailing of the cantilevered columns can conform to the criteria for special, intermediate, or ordinary moment-resisting frame systems. Regardless, the limits on height are very restrictive and these structures must be designed to remain nearly elastic in response to design earthquake shaking. This is because these systems often have low redundancy, that is, formation of a single hinge, at the column base, results in formation of a plastic mechanism. In addition, these systems tend to be quite flexible, and can quickly develop large P-delta effects and instability.

## 8.2 Identify Design Coefficients

ASCE/SEI 7-22 Table 12.2-1 specifies the values of three design coefficients used to determine the required strength and stiffness for the seismic force-resisting system of a structure:

- $R$  is the **response modification coefficient** that accounts for the ability of some seismic force-resisting systems to respond to earthquake shaking in a ductile manner without loss of load-carrying capacity.  $R$  values range from 1 for systems that have no ability to provide ductile response to 8 for systems that are capable of highly ductile response. The  $R$  factor is used to reduce the required design strength for a structure.

- $C_d$  is the **deflection amplification coefficient**. It is used to adjust computed lateral displacements for the structure determined using linear analysis procedures to the anticipated inelastic lateral displacement that will occur in design earthquake shaking. The  $C_d$  factors assigned to the various structural systems are typically similar but smaller than the  $R$  coefficients, which accounts in an approximate manner for the effective damping and energy dissipation that can be mobilized during inelastic response of highly ductile systems. The more ductile a system is, the greater will be the difference between the value of  $R$  and  $C_d$ .
- $\Omega_o$  is an **overstrength coefficient** used to account for the fact that the actual seismic forces on some elements of a structure can significantly exceed those indicated by analysis using the design seismic forces. For most structural systems, the  $\Omega_o$  coefficient will have a value between 2 and 3.

### 8.3 Check for Configuration Irregularities

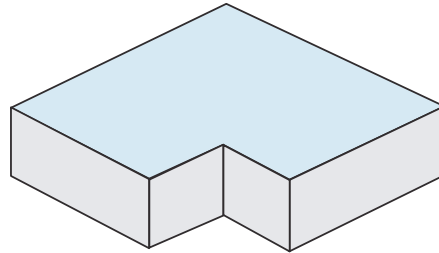
The values of the design coefficients ( $R$ ,  $C_d$ , and  $\Omega_o$ ) specified in ASCE/SEI 7 were developed for systems that have regular configuration, with deformation and nonlinear response well-distributed throughout the structure and limited torsion about the vertical axis. Also, some of the analysis procedures used to determine the required strength of structural systems are incapable of predicting response reliably when the structures are not regular. To the extent that structures have nonuniform distribution of strength or stiffness and discontinuous structural systems, the assumptions that underlie the design procedures can become invalid. These conditions are known as irregularities, and structures that have one or more of these irregularities are termed **irregular** structures (Section 4.1.4).

Some irregularities require modification of the analysis procedures used to determine required strength and story drift. Some irregularities trigger requirements for portions of the structure to be provided with greater strength to counteract the negative effects of the irregularity. Some irregularities have led to such poor performance in past earthquakes that they are prohibited from use in structures assigned to SDC E or SDC F. ASCE/SEI 7 identifies two basic categories of structural irregularity: horizontal and vertical.

**Horizontal irregularities** include the following types:

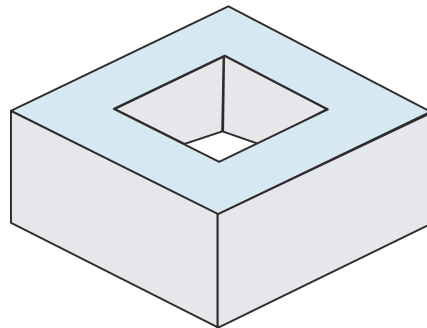
- **Torsional irregularity:** This condition exists when the distribution of vertical elements of the SFRS within a story, including braced frames, moment frames and walls, is such that when the building is pushed to the side by wind or earthquake forces, it will tend to twist as well as deflect horizontally. Torsional irregularity is deemed to exist if: 75% of the lateral strength at a story is located on one side of the center of mass or the drift in a story at the ends exceeds 120% of the average story drift. Presence of this irregularity requires explicit consideration of inherent and accidental torsion when determining required strength and story drift and strengthening of some elements of the seismic force-resisting system. It can also affect the assessed redundancy factor.

- **Reentrant corner irregularity:** This is a geometric condition that occurs when a building with a rectangular plan shape has a missing corner or when a building is formed by multiple connecting wings. Figure 8-4 illustrates this irregularity.



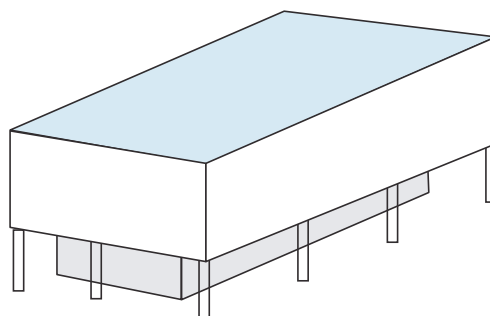
**Figure 8-4 Reentrant corner irregularity.**

- **Diaphragm discontinuity irregularity:** This occurs when a floor or roof has a large open area as can occur in buildings with large atriums. Figure 8-5 illustrates this irregularity.



**Figure 8-5 Diaphragm discontinuity irregularity.**

- **Out-of-plane offset irregularity:** This occurs when the vertical elements of the SFERS, such as braced frames or shear walls, are not aligned vertically from story to story. Figure 8-6 illustrates this irregularity.



**Figure 8-6 Out-of-plane offset irregularity.**

- **Nonparallel systems irregularity:** This occurs when the SFERS does not include a series of frames or walls that are oriented at 90-degree angles with each other.



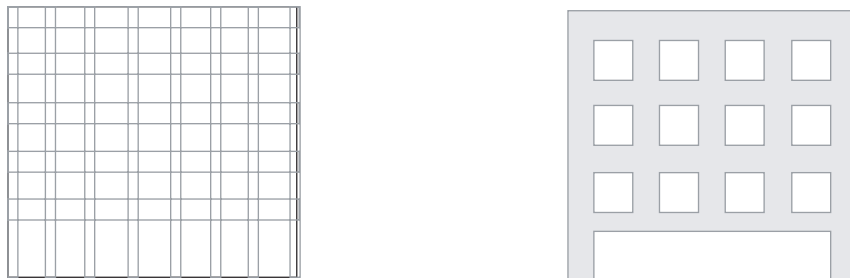


## New in ASCE/SEI 7-22: Removal of Extreme Torsional Irregularity

ASCE/SEI 7-22 removes the extreme torsional irregularity, a type of horizontal irregularity that was included in previous editions of ASCE/SEI 7.

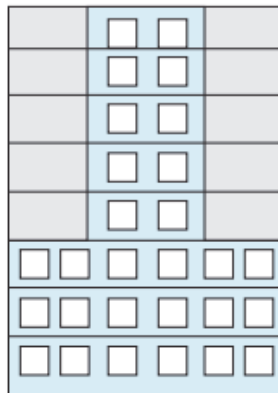
**Vertical irregularities** include the following types:

- **Soft story irregularity:** This occurs when the stiffness of one story is substantially less than that of the stories above. This commonly occurs at the first story of multi-story moment frame buildings where the architectural design calls for a tall lobby area. It also can occur in multi-story bearing wall buildings when the first story walls are punched with a number of large openings relative to the stories above, such as for a garage or glass storefront. Figure 8-7 illustrates these two conditions. An extreme soft story irregularity is deemed to exist when the stiffness of a story is less than 60% of the story above. Extreme soft story irregularity is an extreme version of the soft-story irregularity that is prohibited in SDC E and SDC F structures.



**Figure 8-7** Examples of buildings with a soft first story, a common type of stiffness irregularity.

- **Vertical geometric irregularity:** This occurs where the width in plan of the SFRS is more than 130% larger in one or more stories than it is in adjacent stories. Figure 8-8 illustrates this condition.



**Figure 8-8** Vertical geometric irregularity.

- **In-plane discontinuity irregularity:** This occurs when the vertical elements of the SFRS, such as its walls or braced frames, do not align vertically within a given line of framing or the frame or wall has a significant setback. Figure 8-9 provides an example of this irregularity.



**Figure 8-9 Example of an in-plane discontinuity irregularity.**

- **Weak story irregularity:** This occurs when the strength of the walls or frames that provide lateral resistance in one story is substantially less than that of the walls or frames in the adjacent stories. This irregularity often accompanies a soft-story irregularity but does not always. It is prohibited in SDC E and F structures, where the story stiffness of one story is less than 80% of the story above. Extreme weak story irregularity is an extreme version of the weak-story irregularity that is prohibited in SDC E and SDC F structures.

## 8.4 Calculate Seismic Loads

ASCE/SEI 7 requires that structures have adequate strength to resist specified design earthquake forces in combination with other loads. Earthquake shaking induces both horizontal and vertical forces in structures. These forces vary during an earthquake and, for brief periods ranging from a few tenths of a second to a few seconds, they can become very large. In structures assigned to SDC D, E, or F, these forces easily can exceed the forces associated with supporting the building weight and contents. In keeping with the basic design philosophy of accepting damage but attempting to avoid collapse, the design seismic forces specified by ASCE/SEI 7 are less than those which would enable a structure to remain undamaged by design earthquake shaking.

Typically, engineers design structures so that only some of the structural elements (e.g., beams, columns, walls, braces) and their connections provide the required seismic resistance. For example, the braced frame structures in Figures 8-4 a, b, c, e, and f each have three bays, but only one of the bays has bracing. The braces, beams, and columns that the braces connect to would be designed to resist seismic forces, while the other beams and columns would not. The ASCE/SEI 7 standard specifies the magnitude of earthquake design forces and the required combinations of seismic forces with other loads, including dead and live loads that must be used to design the SFRS.

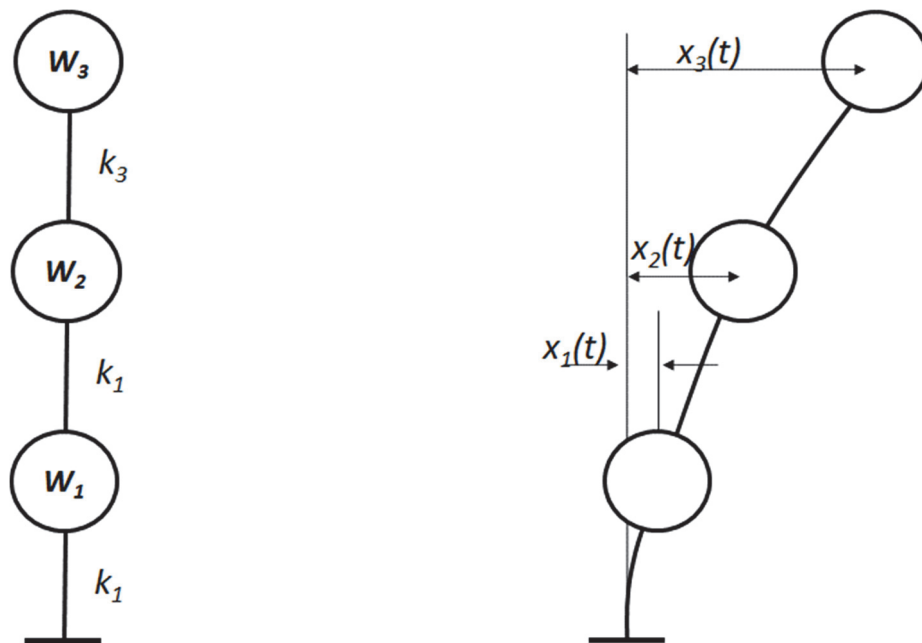
The magnitude of the specified earthquake forces and how they are calculated depends on the SDC, the type of structural system that is used, the configuration of the structure, and the type of element or connection being designed. These are described briefly below. For SDC A structures, ASCE/SEI 7 simply requires that structures be designed with adequate strength to resist 1% of the weight of the structure, applied as a lateral force in each direction, at each level.



ASCE/SEI 7-22 Chapter 2 specifies the required combinations of seismic loads with other design loadings, including dead and live.

### 8.4.1 Base Shear Strength

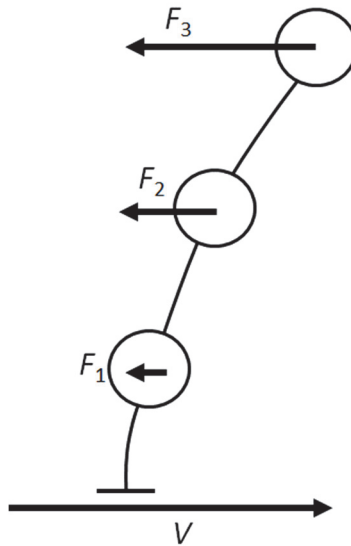
Figure 8-10(a) displays a simple, **multiple degree of freedom** structure consisting of a single cantilever column with masses, having weights  $W_1$ ,  $W_2$ , and  $W_3$ , lumped at 3 levels. Like the simple SDOF structure depicted in Figure 6-2, if the top mass of the structure is displaced to the side, as illustrated in Figure 8-10(b), then released, the structure will respond in free vibration, holding the deformed shape illustrated. This shape is termed the fundamental mode shape of the structure.



(a) Simple 3-mass structure

(b) Fundamental mode shape

**Figure 8-10** Simple multi-degree of freedom (MDOF) structure in free vibration.



**Figure 8-11 Forces acting on MDOF structure in free vibration.**

When the ground shakes, inertial force acts on each mass, at a magnitude of acceleration times the mass, as shown in Figure 8-11. Because the base of the structure is not moving relative to the ground, equilibrium must be provided by a reaction force, denoted  $V$  in the figure, that is equal in magnitude to the sum of the  $F$  forces. This reaction force,  $V$ , is termed the **base shear**.



The base shear equations shown here as Equations 8-1 through 8-6 appear in ASCE/SEI 7 as Equations 12.8-1 through 12.8-6.

ASCE/SEI 7 requires design of structures for a minimum base shear force,  $V$ , given by the equation:

$$V = C_s W \quad (8-1)$$

where:

- $C_s$  = the **seismic response coefficient**
- $W$  = the **seismic weight** of the structure

The seismic response coefficient,  $C_s$ , depends on the **fundamental period of vibration** ( $T$ ) of the structure, the risk category (Section 7.3), and the type of SFRS used (Sections 8.1 and 8.2). For structures with fundamental periods of vibration less than the mapped value of  $T_L$  at their site, the seismic response coefficient,  $C_s$ , is taken as the lesser of the value given by:

$$C_s = \frac{S_{DS}}{(R/I_e)} \quad (8-2)$$

$$C_s = \frac{S_{D1}}{(R/I_e)T} \quad (8-3)$$

where:

$S_{DS}$  = the spectral response acceleration parameter obtained from the USGS online database, as described in Chapter 7,

$S_{D1}$  = the spectral response acceleration parameter obtained from the USGS online database, as described in Chapter 7,

$R$  = the response modification coefficient discussed in Section 8.2,

$I_e$  = an **importance factor**, the value of which depends on the risk category previously described in Section 7.3, and

$T$  = the fundamental period of vibration of the structure.

The seismic weight is equal to the weight of the structure and all permanently attached nonstructural components and systems including cladding, roofing, partitions, ceilings, and MEP equipment. In storage and warehouse occupancies,  $W$  also includes 25 percent of the design storage load. For buildings with a flat roof in areas susceptible to a ground snow load of 30 pounds per square foot (psf) or more, the seismic weight also includes 20 percent of the uniform design snow load.

The quantity  $R/I_e$  in Equations 8-2 and 8-3 is an expression of the permissible amount of inelastic structural response or ductility. The value of  $R$  is determined from the ASCE/SEI 7 standard Table 12.2-1 based on the selected seismic force-resisting system. For buildings in Risk Category I or II, the importance factor,  $I_e$ , has a value of 1.0. For structures in Risk Categories III and IV, the importance factors are 1.25 and 1.5, respectively. Thus, for structures in higher risk categories, less inelastic behavior is permitted, which is consistent with the desired reduced risk of damage.

For structures with a fundamental period of vibration greater than  $T_L$ , the value of  $C_s$  is determined using the equation:

$$C_s = \frac{S_{D1}T_L}{(R/I_e)T^2} \quad (8-4)$$

Regardless of fundamental period, the value of the base shear coefficient for any structure, cannot be taken as less than the value obtained from the following equation:

$$C_s = 0.044S_{DS}I_e \quad (8-5)$$

On sites close to major active faults, where ground motions can have large impulsive components, the base shear coefficient cannot be taken less than:

$$C_s = 0.5 \frac{S_1}{(R/I_e)} \quad (8-6)$$

In Equation 8-6, the parameter  $S_1$  is the value of the 1-second  $MCE_R$  spectral response acceleration at the site assuming conditions corresponding to Site Class BC.

### 8.4.2 Redundancy

The strength design of structures assigned to SDC D, E, and F is subject to consideration of **redundancy** (Section 4.1.5). A structure is sufficiently redundant if the notional removal of any single element in the SFRS (e.g., a shear wall or brace) does not reduce the lateral strength of the structure by more than one third and does not create an extreme torsional irregularity. If the configuration of an SFRS meets certain prescriptive requirements, a rigorous check of the redundancy is not required. If a structure does not meet these prescriptive requirements or the minimum strength and irregularity criteria described above, the redundancy factor,  $\rho$ , applies, and required strength of all elements and their connections comprising the SFRS, except diaphragms, must be increased by 30 percent.

### 8.4.3 Vertical Earthquake Forces

Structures in SDC C, D, E, and F must also be designed for the effects of vertical shaking. All members in these SDCs must be designed for vertical seismic forces, whether or not they are part of the designated SFRS. Vertical seismic load effect,  $E_v$ , can be determined from either of two equations:

$$E_v = 0.2S_{DS}D \quad (8-7)$$

$$E_v = 0.3S_{av}D \quad (8-8)$$

In the equation,  $S_{DS}$  is the horizontal design spectral acceleration at short periods and  $S_{av}$  is the vertical spectral response acceleration at short period, derived in accordance with Section 11.9.2 of ASCE/SEI 7.  $D$  is dead load.

## 8.5 Analyze and Design Structural Elements

ASCE/SEI 7 requires structural analysis to determine the strength required of each beam, brace, column, and wall of the SFRS. The code permits use of several different approaches. These include equivalent lateral force procedure, simplified equivalent lateral force procedure, modal response spectral analysis, linear response history analysis, and nonlinear response history analysis.

### 8.5.1 Equivalent Lateral Force Procedure

The most used approach is known as **Equivalent Lateral Force** (ELF) procedure, in which the required seismic base shear force  $V$ , is applied as a series of vertically distributed static forces to a mathematical model of the structure and the individual seismic demand,  $E$ , on each element is determined and ultimately combined with dead, live and other prescribed forces for determination of required strength.

The static seismic design force applied at each story is given by the equation:

$$F_i = \frac{w_i h_i^k}{\sum_{j=1}^n w_j h_j^k} V \quad (8-9)$$



Equation 8-9 discussed here appears in two parts in ASCE/SEI 7-22. ASCE/SEI 7 Equation 12.8-11 computes the seismic design force at each level,  $F_x$ , as the product of a vertical force distribution factor,  $C_{vx}$  and the base shear  $V$ . ASCE/SEI 7 Equation 12.8-11 defines the value of  $C_{vx}$  and takes the form of Equation 8-9.

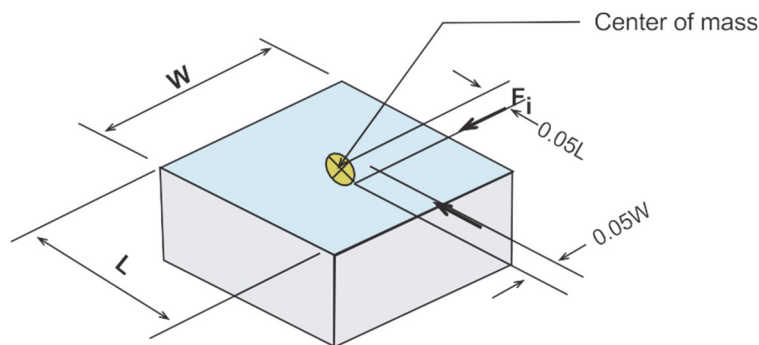
In Equation 8-9, the superscript “ $k$ ” has a value of unity for structures with a fundamental period,  $T$ , less than or equal to 0.5 second, has a value of two for structures with a fundamental period greater than or equal to 2.5 seconds, and has a value that is linearly interpolated from these values for structures with a fundamental period that falls between these values. The value of the period can be determined using either a series of approximate formula that depend on the type of SFRS used or methods of structural dynamics that directly consider the distribution of the structural mass and stiffness. Equation 8-9 is intended to represent the distribution of inertial forces associated with free vibration in the natural modes of the structure with the term  $(w_i h_i^k / \sum_{i=1}^n w_i h_i^k)$  approximating the relative amplitude and contribution of each dominant mode shapes at each level.

The fundamental period,  $T$ , seismic base shear force,  $V$ , and individual story forces,  $F_i$ , must be computed and applied independently in the two primary orthogonal directions of response. The major vertical elements of the SFRS (i.e., frames or walls) will be aligned in these two orthogonal directions in most structures. However, when this is not the case, any two orthogonal axes may be used. The story forces,  $F_i$ , are applied as static loads, and an elastic analysis is performed to determine the distribution of seismic forces in the various beams, columns, braces, and walls that form the vertical elements of the SFRS.

In SDC C, D, E, and F, structures with vertical seismic force-resisting elements (e.g., shear walls, braced frames, moment frames, or combinations of these systems) located in plan such that they can experience significant seismic forces as a result of shaking in either of the major orthogonal building axes must be designed considering this behavior. An example of such a structure is one with columns common to intersecting braced frames or moment frames aligned in different directions. Another example is a structure with vertical elements aligned in two or more directions that are not orthogonal to each other. Design of these structures requires considering that forces can be incident in any direction. This requirement can be satisfied by considering 100 percent of the specified design forces applied along one primary axis simultaneously with 30 percent of the specified design forces in an orthogonal direction. When this approach is used, at least two load cases must be considered consisting of 100 percent of the specified forces in direction A taken with 30 percent of the specified forces in direction B and 30 percent of the specified forces in direction A taken with 100 percent of the forces in direction B where directions A and B are, respectively, orthogonally oriented to each other.

Structures can experience torsional excitation of their seismic force-resisting systems due to imbalance in the placement of live loads, nominal differences in strength and stiffness in lateral elements on each side of the structure, difference in arrival times of ground motion at different sides of the structure, and other effects. Consideration of **accidental torsion** is intended to ensure that all structures are configured with minimum torsional resistance.

The analysis of torsionally irregular structures in SDC B and all structures in SDC C, D, E, and F that do not have flexible diaphragms, typically composed of wood sheathing or untopped metal deck, must consider the effects of accidental torsion. In the ELF method, accidental eccentricity is accounted for by applying the lateral forces ( $F_i$ ) at each level at a location that is displaced from the center of mass of the level by a distance equal to 5 percent of the width of the level perpendicular to the direction of application of the force. Figure 8-12 illustrates this concept. If the structure is not symmetrical, the 5 percent displacement of the point of application of the forces must be taken to both sides of the center of mass, and the design seismic forces on the elements must be taken as the highest forces obtained from either point of application. The purpose of this eccentric application of the forces is to account for any potential unbalanced loading that may occur if, for example, one side of a building is occupied during earthquake shaking while the other side is vacant. This requirement also is intended to ensure that all structures have a minimum amount of resistance to torsional effects.



**Figure 8-12 Eccentric application of story forces.**

The design seismic forces on some elements in irregular structures must be amplified by the  $\Omega_0$  overstrength coefficient described in Section 8.2. The purpose of design using these amplified forces is to avoid damage to elements whose failure could result in widespread damage and collapse of the structure. An example of such an element is the column beneath a discontinuous shear wall.

### 8.5.2 Simplified ELF

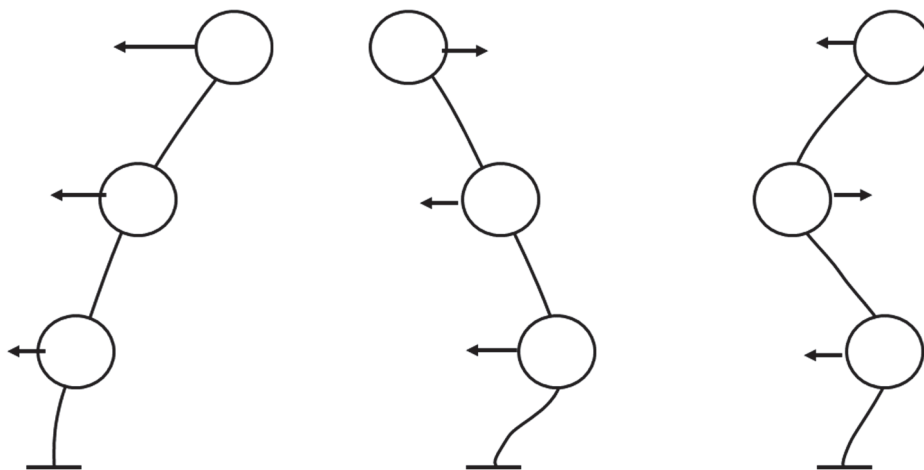
The simplified ELF method is applicable to low-rise structures that have stiff seismic force-resisting systems using walls or braced frames. The base shear force equations are simplified relative to those in the standard ELF method, as is the vertical force distribution formula. Further, it is not required to compute story drift (Section 8.6). However, the simplified method requires design for larger forces to ensure that assumptions used to create the simple procedure do not compromise safety.



### 8.5.3 Modal Response Spectrum Analysis

Modal response spectrum analysis is a hybrid between ELF and dynamic methods. MDOF structures like that illustrated in Figure 8-11 will have as many natural modes of vibration as they have individual dynamic degrees of freedom. For this purpose, a dynamic degree of freedom can be thought of as a unique direction of motion associated with an individual mass. The simple two-dimensional MDOF structure illustrated in Figure 8-11 has three dynamic degrees of freedom consisting of independent lateral translation of each of the three masses. If that structure were three-dimensional, rather than two dimensional, it would have nine dynamic degrees of freedom consisting of two orthogonal directions of lateral displacement and one of twisting about a vertical axis for each mass.

Figure 8-13 illustrates the three mode shapes for the three independent natural modes of vibration for the two-dimensional structure previously illustrated in Figure 8-11. When subjected to earthquake ground motions, each of these modes will be excited, resulting in inertial forces on the masses, in each mode, as also illustrated in the figure. In modal response spectrum analysis, the engineer creates a mathematical model of the structure that includes representation of the structural geometry, stiffness, and mass. This model is used to determine the natural periods of vibration for each mode and the mode shapes. These data are then used, together with the design response spectrum for the site to determine the modal forces on the structure. The structure is then analyzed for these modal forces to determine the force in each member and connection due to each mode of response. Finally, these forces are added, typically using a square root sum of squares approach, to estimate the likely maximum combined forces, considering that the maximum forces in each mode are unlikely to occur simultaneously. Finally, the forces are scaled up such that the base shear,  $V$ , obtained from the analyses is not less than the base shear obtained from ELF analysis. While modal response spectrum analysis has the advantage that it can result in less conservative design forces for some structures, the root sum of squares combination of force results in a loss of sign for forces and displacements, which some engineers find to be disadvantageous.



**Figure 8-13** Mode shapes and inertial forces associated with free vibration of MDOF structure.



### New in ASCE/SEI 7-22: Removal of Required Design Strength Reduction for Modal Response Spectrum Analysis

Modal response spectrum analysis was once thought to be superior to ELF in its ability to predict structural response. Under earlier editions of ASCE/SEI 7, a reduction in the required design strength was permitted with this technique. However, reliability studies indicated that this strength reduction resulted in structures that could not perform as well as structures designed using the ELF method, so the reduction was removed in ASCE/SEI 7-22.



ASCE/SEI 7-22 Section 12.9.1 covers the requirements for modal response spectrum analysis.

## 8.5.4 Linear Response History Analysis

Linear response history analysis is another technique permitted by ASCE/SEI 7. In this approach, a mathematical model of the structure is constructed and subjected to a suite of ground motions that have been scaled or matched to the design response spectrum for the site. The computer software used for this analysis does a numerical integration of the equation of motion for the structure (Equation 6-1), and the maximum forces in each member and connection for each ground motion are determined. These are averaged, then scaled such that the total base shear force,  $V$ , is equal to that obtained from the ELF method. Finally, as with the ELF methods, these forces are combined with the forces from dead, live, and other loads. Linear response history analysis is advantageous, relative to modal response spectrum analysis because it preserves the sign of earthquake forces and displacements, which some engineers find advantageous for connection design. Also, it can eliminate some conservatism associated with the root sum of squares summation approach used in modal response spectrum analysis. However, it is computationally complex and requires manipulation of the results from a suite of ground motions, requiring more effort.



ASCE/SEI 7-2 Section 12.9.2 covers the requirements for linear response history analysis.

## 8.5.5 Nonlinear Response History Analysis

Nonlinear response history analysis (NLRHA) is the fourth method of analysis permitted by ASCE/SEI 7. NLRHA is like linear response history analysis except that the stiffness of members and connections is modified throughout the analysis to simulate the occurrence of cracking, yielding, buckling and other damage. NLRHA is a complex technique that calculates the forces and deformations induced in a structure in response to a suite of earthquake records and accounts explicitly for the dynamic properties of the structure, as well as the damage caused by earthquake response. Members and connections are evaluated in two groups. Members and connections that have inherent ductility and an ability to yield while continuing to carry load are evaluated based on the level of nonlinear deformation predicted by the analysis. Elements that have limited or no

ductility are evaluated based on the amount of force predicted by the ground motions. It is commonly used in performance-based design approaches (Section 10.1), high-rise buildings, and structures with energy dissipation systems (Section 10.4) or seismic isolation (Section 10.5).



### NEHRP Technical Brief No. 4: Nonlinear Structural Analysis for Seismic Design

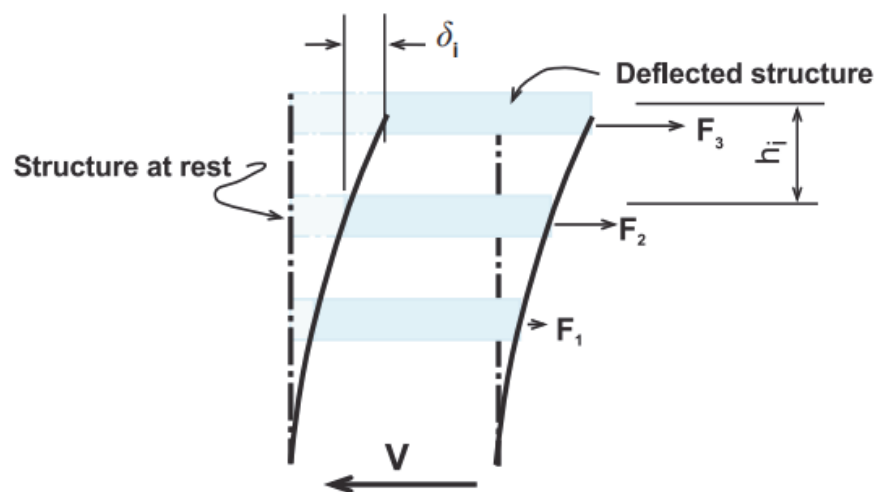
This report addresses provides clear and concise guidance for conducting nonlinear structural analysis for seismic design of buildings. Published 2010. Available as a [free PDF](#).



## 8.6 Check Drift and Stability

Unless the simplified ELF analysis procedure is used, structures must be evaluated to ensure that their anticipated lateral deflection in response to earthquake shaking does not exceed acceptable levels or result in P-delta instability. Two evaluations are required: the first is an evaluation of the adequacy of the story drift of the structure at each level, and the second is an evaluation of stability.

**Story drift** is a measure of how much one floor or roof level displaces under load relative to the floor level immediately below. It is typically expressed as a ratio of the difference in deflection between two adjacent floors divided by the height of the story that separates the floors. Figure 8-14 illustrates the concept of story drift, showing this as the quantity  $\delta_i$ , the drift that occurs under the application of the design seismic forces.



**Figure 8-14** Story drift.

ASCE/SEI 7 sets maximum permissible story drift limits based on risk category and construction type. The adequacy of a structure in this respect is determined by calculating the design story drift,  $\Delta$  using the equation:

$$\Delta = \frac{C_d \delta_i}{I_e} \leq \Delta_a h_i \quad (8-10)$$

where:

- $\delta_i$  = the computed story drift under the influence of the design seismic forces,
- $C_d$  = the deflection amplification coefficient described in Section 8.4, and
- $I_e$  = the occupancy importance factor.

The acceptable drift ratio,  $\Delta_a$ , varies from 0.007 to 0.025 depending on risk category of the building and construction type.

Drift is also an important consideration for structures constructed near one another. In response to strong ground shaking, structures located close together can hit one another, an effect known as **pounding** (Section 4.1.7). Pounding can induce forces in a structure at the area of impact and has been known to cause the collapse of some structures. Therefore, ASCE/SEI 7 requires sufficient separation of adjacent structures and from property lines so that pounding will not occur if the structure experiences the design drifts determined using Equation 8-10.

In addition, ASCE/SEI 7 requires evaluation of a structural stability under the anticipated lateral deflection by calculating the quantity  $\theta$  for each story:

$$\theta = \frac{P_x \Delta}{V_x h_x C_d} \quad (8-11)$$

where:

- $P_x$  = the weight of the structure above the story being evaluated,
- $\Delta$  = the design story drift determined using Equation 8-10,
- $V_x$  = the sum of the lateral seismic design forces above the story,
- $h_x$  = the story height, and
- $C_d$  = the deflection amplification coefficient described earlier.

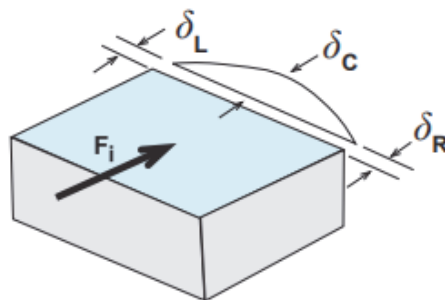
If the calculated value of  $\theta$  at each story is less than or equal to 0.1, the structure is considered to have adequate stiffness and strength to provide stability. If the value of  $\theta$  exceeds 0.1, the lateral force analysis must include explicit consideration of **P-delta effects**. These effects are an amplification of forces that occurs in structures when they undergo large lateral deflection. The limiting value for  $\theta$  ( $\theta_{max}$ ) is calculated as:

$$\theta_{max} = \frac{0.5}{\beta C_d} \leq 0.25 \quad (8-12)$$

If the structure exceeds this limiting value, it is considered potentially unstable and must be redesigned unless NLRHA is used to demonstrate that the structure is adequate. In the equation for  $\theta_{max}$ ,  $\beta$  is calculated as the ratio of the story shear demand under the design seismic forces to the story shear strength. It can conservatively be assumed to have a value of 1.0. This requirement can become a controlling factor in areas of moderate seismicity for flexible structures like steel moment frames.

## 8.7 Design Diaphragms

In addition to determining the seismic forces ( $E$ ) on the vertical elements of the SFRS, the building code requires determination of the seismic forces on the horizontal elements, typically called **diaphragms**. In most structures, the diaphragms consist of the floors and roofs acting as large horizontal beams that distribute the seismic forces to the various vertical elements. Diaphragms are categorized as being rigid, flexible, or of intermediate stiffness depending on the relative amounts of deflection that occur in the structure when it is subjected to lateral loading. Figure 8-15 shows the deflected shape of a simple single-story rectangular building under the influence of lateral forces in one direction. The roof diaphragm has deflection  $\delta_L$  at the left side,  $\delta_R$  at the right side and  $\delta_C$  at its center. If the deflection at the center of the diaphragm,  $\delta_C$ , exceeds twice the average of deflections  $\delta_L$  and  $\delta_R$  at the ends, the diaphragm must be considered **flexible**. ASCE/SEI 7 permits diaphragms of untopped wood sheathing or steel deck to be considered flexible regardless of the computed deflection. Diaphragms consisting of reinforced concrete slabs or concrete-filled metal deck that meet certain length-to-width limitations can be considered perfectly **rigid**. Other diaphragms must be considered to be of **intermediate** stiffness.



**Figure 8-15** Deflection of diaphragm under lateral loading.

A flexible diaphragm is considered to distribute forces to the supporting vertical elements of the SFRS using so-called tributary mass assumptions, much in the same way as a simple beam spanning between the vertical elements. For other diaphragms, the distribution of forces to the vertical elements of the SFRS must be considered based on the relative rigidity of the vertical elements and the diaphragms using methods of structural analysis.

Diaphragms that are not flexible must be designed for two types of forces. The first type are the inertial forces associated with the weight of the diaphragm itself and the acceleration the building transmits to the diaphragm as the building responds to shaking. The second type are transfer forces, associated with redistribution of forces in vertical elements of the SFRS above and below the diaphragm, based on the relative stiffness of these elements. Regardless of whether diaphragms are classified as flexible, rigid or of intermediate stiffness, there are three procedures available to determine the required diaphragm inertial forces. The first of these has been in ASCE/SEI 7 for many years and uses the equation:

$$F_{px_i} = \frac{\sum_{j=i}^n F_j}{\sum_{j=i}^n W_j} W_{px_i} \quad (8-13)$$

In this equation,  $F_{px}$  is the total force to be applied to the diaphragm at level  $i$ ,  $F_j$  is the seismic design force at each level  $j$  determined from Equation 8-9,  $w_{px}$  is the seismic weight of the structure tributary to the diaphragm at level  $i$ , and  $w_j$  is the seismic weight at each level  $j$  of the structure.

The second approach was introduced in ASCE/SEI 7-16 and more accurately accounts for both the ability of some diaphragms to exhibit ductile behavior and the differences in shaking experienced by horizontal levels supported by different structural systems. This procedure is required for precast concrete diaphragm systems in SDC C, D, E, and F and is permitted for wood sheathed and bare metal deck diaphragms. In this procedure, design diaphragm inertial forces are determined using the equation:

$$F_{px} = \frac{C_{px}}{R_s} W_{px} \quad (8-14)$$

In Equation 8-14,  $C_{px}$  is computed using approximate modal mass participation factors determined using a series of equations associated with different structural system types, the number of stories, the design peak ground acceleration, and the occupancy importance factor.  $R_s$ , termed the diaphragm force reduction factor, is determined from a table of values for different diaphragm types and is intended to account for the ability of some diaphragms to exhibit ductility and nonlinear deformation.

The third approach for determining inertial diaphragm forces is applicable only to single story buildings with rigid vertical seismic force-resisting elements, including steel braced frames and masonry or concrete walls, and having either wood or steel deck diaphragms without concrete topping. For these buildings, it is permitted to compute the design inertial diaphragm forces as the lesser of that obtained from Equations 8-15 and 8-16:

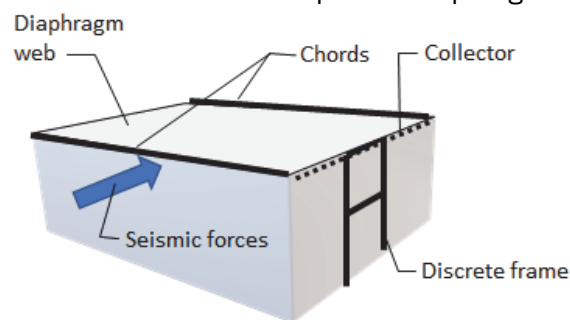
$$F_{px} = \frac{S_{DS}}{R_{diaph}/I_e} W_{px} \quad (8-15)$$

$$F_{px} = \frac{S_{D1}}{(R_{diaph}/I_e)T_{diaph}} W_{px} \quad (8-16)$$

In the equation,  $R_{diaph}$  is a measure of the available diaphragm ductility, taken as 4.5 for wood diaphragms and specially detailed steel deck diaphragms and 1.5 for ordinary steel deck diaphragms;  $T_{diaph}$  is an estimate of the fundamental period of the diaphragm, computed based on the diaphragm span length; and other factors are as previously defined.

Regardless of the procedure used to compute diaphragm design forces, diaphragms must be designed for shear and flexure. It is common to use the analogy of a beam when designing diaphragms, where the diaphragm web is assumed to carry the shear forces and boundary elements at the diaphragm edges are assumed to resist flexure in the form of concentrated tension and compression forces, commonly called **chord forces**. Beams located near the edges of the diaphragms can be designed and connected to carry these chord forces, in combination with other loads, or other continuous elements, such as a band of reinforcing steel can be used for this purpose.

Another important diaphragm element is the **collector**, sometimes also called a drag strut. These elements are used to “drag” load from the diaphragm web into discrete vertical elements of the SFRS, such as isolated walls or frames. As with chords, it is common to use floor or roof support beams as collectors. Figure 8-16 illustrates these important diaphragm elements.



**Figure 8-16 Diaphragm elements.**



## NEHRP Technical Briefs: Diaphragms

The following guides provide guidance on analysis, design, and detailing:

- Concrete Diaphragms, Chords, Collectors ([NIST GCR 16-917-42](#))
- Composite Diaphragms ([NIST GCR 11-917-10](#))
- Wood Light-Frame Diaphragm ([NIST GCR 14-917-32](#))
- Precast Concrete Diaphragms ([NIST GCR 17-917-47](#))



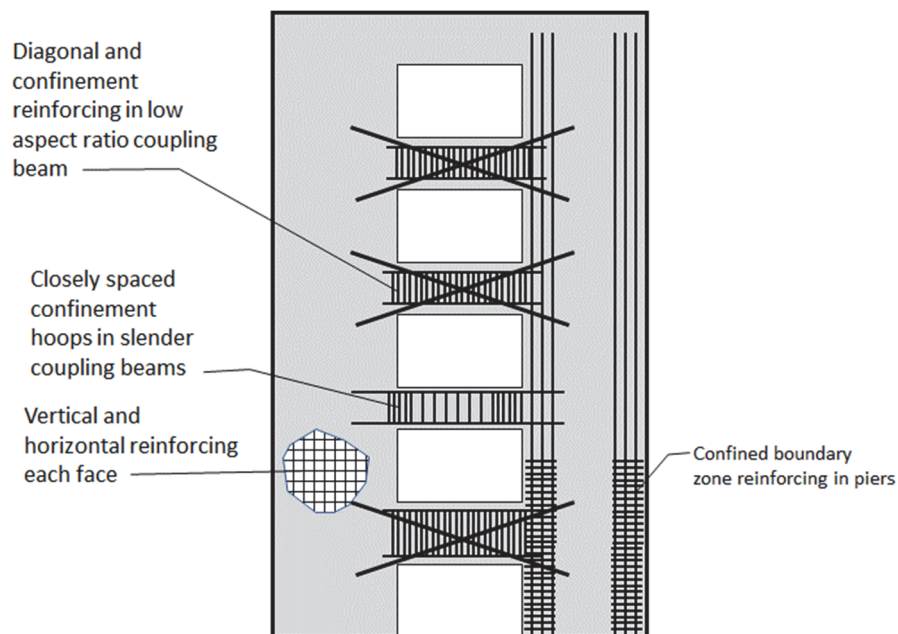
## 8.8 Detail Connections and Other Elements

The final step in the design process, once the SFRS has been designed, is to detail the structure.

**Detailing** refers to ensuring that the details, including connections of elements, bends and spacing of reinforcing, and similar items, conform with all applicable building code requirements. Table 2-1 contains material-specific standards that contain the applicable requirements, as referenced by ASCE/SEI 7-22 Table 12.2-1, such as ACI 318, TMS 502, AISC Specifications, and the National Design Specification.

### 8.8.1 Concrete and Masonry Walls

Figure 8-17 illustrates some of the special reinforcement required to conform to the criteria for special reinforced concrete walls, as specified in ACI 318. These include: two curtains of vertical and horizontal reinforcement throughout the wall; closely spaced, closed stirrups or hoops in beams over the openings of walls (called coupling beams); provision of special diagonal tension reinforcement capable of carrying 100% of the seismic shear forces in coupling beams with low aspect ratios; and provision of closely spaced hoops around vertical reinforcing in those portions of concrete walls and piers that are anticipated to experience high strains during earthquake shaking (called boundary zones). TMS 503 specifies different requirements for special reinforced masonry walls because it is not possible to place the same types of reinforcing in masonry walls. To compensate for this, ASCE/SEI 7 specifies higher design forces for special masonry walls as opposed to special concrete walls.



**Figure 8-17** Typical reinforcing requirements in special reinforced concrete walls.





## NEHRP Technical Briefs: Concrete and Masonry Systems

The following guides provide specific recommendations on analysis, design, and detailing of concrete and masonry walls.

- Cast-in-Place Concrete Special Structural Walls and Coupling Beams ([NIST GCR 11-917-11](#))
- Steel Special Concentrically Braced Frames ([NIST GCR 13-917-24](#))
- Special Reinforced Masonry Walls ([NIST GCR 14-917-31](#))



### 8.8.2 Steel Braced Frames

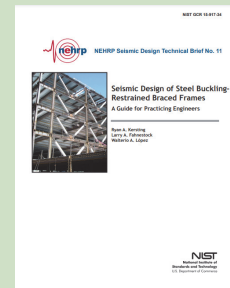
Steel braced frames in SDC D, E, and F must conform to the detailing requirements of AISC 341. Depending on the classification of the braced frame as ordinary, intermediate, or special, AISC 341 requires that columns, braces, and beams meet member compactness criteria, to avoid premature buckling and fracture and requires that connections of braces to beams and columns be designed sufficiently strong to develop the full expected strength of the brace in compression and tension. This ensures that the braces can buckle and yield, modes of behavior that permit inelastic deformation of the structure, while maintaining a substantial portion of its lateral resistance. In addition, gusset plate brace connections of special concentrically braced frames must be designed to accommodate the out-of-plane rotations resulting from brace buckling.



## NEHRP Technical Briefs: Braced Frames

The following guides provide specific recommendations on analysis, design, and detailing of steel braced frames.

- Steel Special Concentrically Braced Frames ([NIST GCR 13-917-24](#))
- Buckling Restrained Steel Braced Frames ([NIST GCR 15-917-34](#))

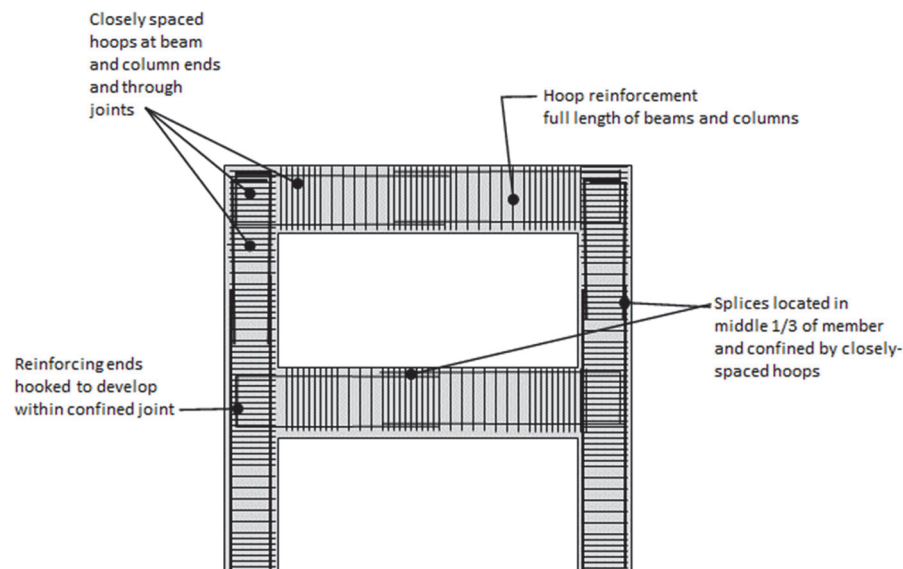


### 8.8.3 Moment Frames

AISC 341 requires special compactness criteria (i.e., control of the slenderness of webs and flanges) in steel beams and columns, so that local buckling and strength degradation can be minimized. Further, AISC 341 requires the use of beam-column connection details that have been proven by testing and analysis to be capable of developing the required nonlinear behavior. AISC 358, *Prequalified Connections for Special and Intermediate Steel Moment Frames* provide criteria for

design and construction of prequalified connection details demonstrated to have the necessary robustness.

ACI 318 requires provision of closely spaced hoop lateral reinforcement in beams, columns, and beam-column joints of special moment frames. As illustrated in Figure 8-18 these are required at the end zones of beams and columns, throughout the height of beam-column joints, and at locations where reinforcing splices occur. Hoops must have sufficient cross ties and area of reinforcement to effectively confine the concrete and prevent its crushing under large compressive strains, as well as brace the longitudinal steel against compression buckling. The shear capacity of beams must exceed the shear associated with development of flexural plastic hinges at both ends together with gravity shears. This ensures that nonlinear behavior will occur primarily through flexural, rather than shear yielding, and that concrete is sufficiently confined that during the formation of plastic flexural hinges, the concrete will retain its strength.



**Figure 8-18** Typical reinforcing for special concrete moment frame.

In addition to detailing the SFRS, it is also necessary to design and detail the gravity load-carrying system to ensure that the gravity load-bearing elements have **deformation compatibility** with the SFRS. Particularly for special and intermediate systems, elements of the SFRS are specifically detailed to ensure that they have superior deformation capacity. In structures having these systems, the gravity system must “go along for the ride.” That is, although the elements of the gravity system are not relied on to carry lateral forces, they will deflect to the same extent that the lateral system does, and as a result they will inevitably carry some lateral forces.

The same industry specifications that govern the design and detailing criteria for elements of the lateral force-resisting system also have criteria for detailing the gravity system elements for deformation compatibility. ACI 318, for example, requires that gravity load-carrying columns have sufficient ties to ensure that they can develop the shear strength associated with the seismic story drifts. Similarly, AISC 341 requires that column splices be designed with sufficient shear capacity. In

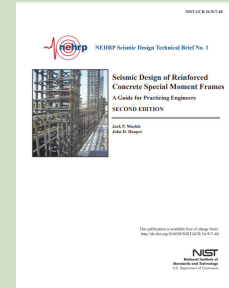
some cases, it may be more economical to stiffen the SFRS to protect the gravity load-bearing elements than it is to detail the gravity elements for compatibility.



### NEHRP Technical Briefs: Moment Frames

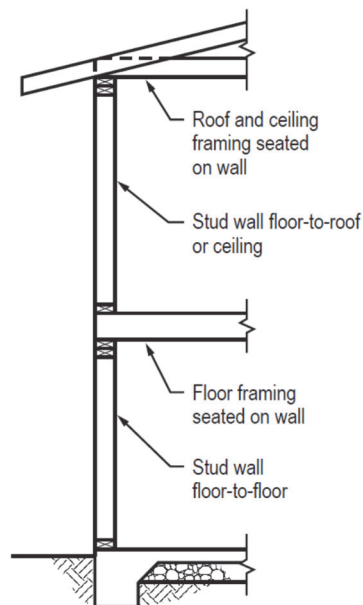
The following guides provide specific recommendations on analysis, design, and detailing of moment frames.

- Reinforced Concrete Special Moment Frames ([NIST GCR 16-917-40](#))
- Reinforced Steel Special Moment Frames ([NIST GCR 16-917-41](#))



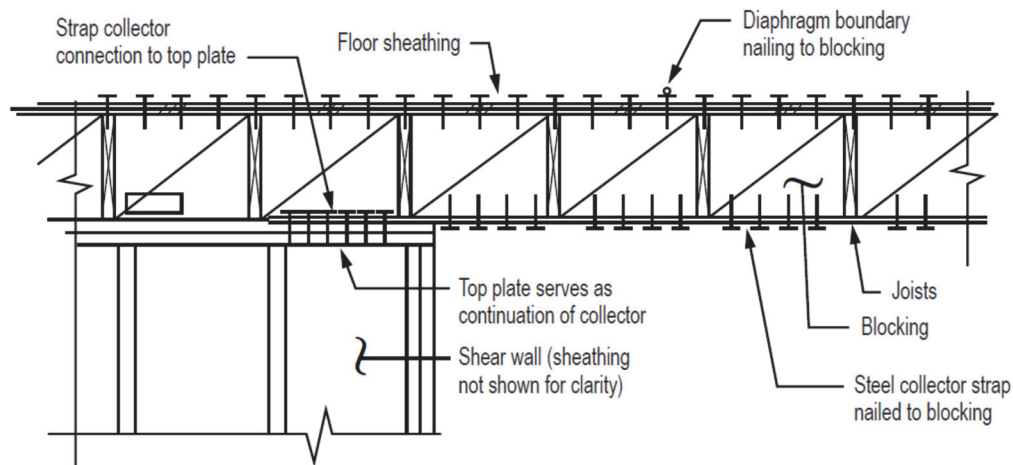
## 8.8.4 Light-Frame Systems

Traditional light-frame construction, comprised either of wood or cold-formed steel, relies on repetitively framed horizontal members (i.e., joists or rafters) to span between load-bearing walls framed by closely spaced studs. These members transfer gravity loads between them by direct compressive bearing. For example, in Figure 8-19, which shows a typical section through the exterior wall of a two-story wood structure, the roof rafters and floor joists bear on the top plates of the stud walls, and the plates transfer load by bearing on the ends of the vertical studs. Detailing of such structures for seismic resistance typically requires assuring a continuous load path for shear and tensile forces, in addition to the compressive forces by which gravity loads are traditionally transferred in bearing.

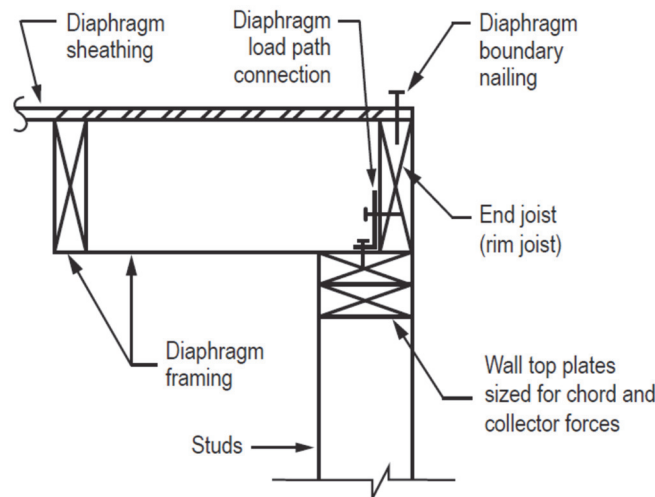


**Figure 8-19** Section through perimeter of two-story wood framed building (NIST, 2014).

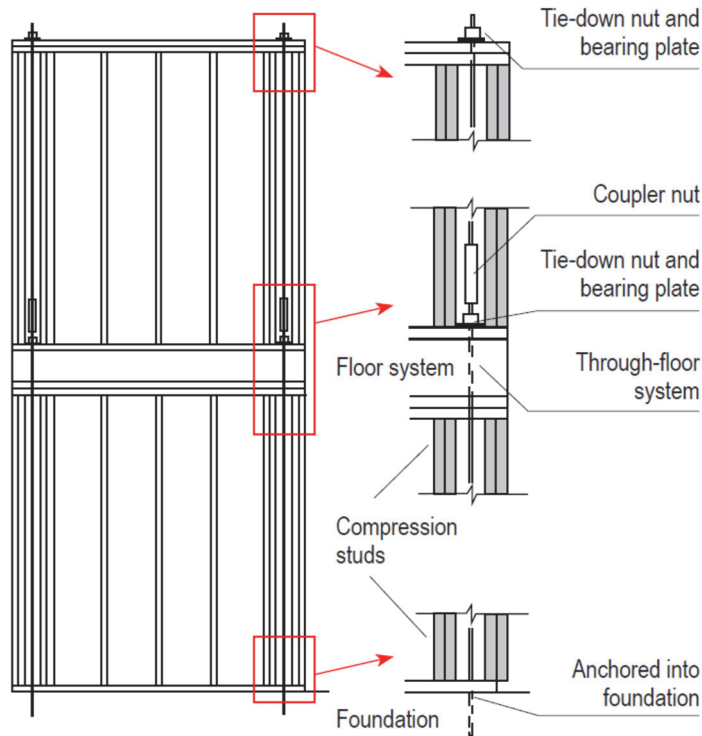
Important seismic detailing includes the use of blocking between joists on top of walls to prevent rolling of the joists and transfer shear forces from the diaphragm or walls above to walls below (Figure 8-21), the use of hold-down-type devices at the ends of walls to resist tensile forces associated with overturning (Figure 8-22) and the use of blocking, together with metal straps to transfer tensile forces from one point in the structure to another (Figure 8-20). In addition, the applicable industry standards including the *Special Design Provisions for Wind and Seismic* published by the AWC and the *North American Standard for Seismic Design of Cold Formed Steel*, published by AISI specify other detailing requirements including minimum framing sizes, permissible fastener types and spacing limits, and requirements for bracing and blocking of members.



**Figure 8-20 Use of blocking and steel straps to transfer tensile forces in the structure (from NIST, 2014).**



**Figure 8-21 Use of blocking (or rim joist) to transfer shear loads and prevent joist roll-over (from NIST, 2014).**



**Figure 8-22 Use of holddown devices to resist overturning loads (from NIST, 2014).**



### NEHRP Technical Briefs: Light-frame Systems

The following guides provide specific recommendations on analysis, design, and detailing of light frames.

- Wood Light-Frame Diaphragm Systems ([NIST GCR 14-917-32](#))
- Cold-Formed Steel Lateral-Load Resisting Systems ([NIST GCR 16-917-38](#))





# Chapter 9: Anchor and Brace the Nonstructural Components

Ground shaking also affects **nonstructural components** and systems. Common nonstructural components in buildings include exterior cladding and glazing, ceilings, lighting systems, plumbing systems, HVAC systems, and occupant furnishings, such as shelving and refrigerators. Accelerations produced by ground shaking induce horizontal and vertical forces on these components. Unless the components are adequately anchored or braced to the supporting structure or ground, these forces can cause the components to slide or overturn. This can pose a falling hazard to occupants, damage the components, or render the building non-functional. In addition, the displacements that a building undergoes in response to shaking can damage nonstructural components that are attached to the structure at one or more levels, such as vertical risers in plumbing systems, interior partitions, and exterior cladding. Finally, the inertial forces that mechanical and electrical components experience can damage these components and prevent their functioning, even if the components are adequately anchored and braced. This chapter provides an overview of the seismic requirements in ASCE/SEI 7-22 for seismic protection of nonstructural components. In addition to requirements for anchorage and bracing, those components attached at more than one point in a structure, or attached to multiple structures, must be capable of withstanding the anticipated design earthquake displacement of the structure(s) without creating a hazard, such as falling glass. Also, certain designated nonstructural components required for post-earthquake function and life safety protection must be certified capable of resisting design seismic shaking and remaining functional.



ASCE/SEI 7 Chapter 13 provides design requirements for nonstructural components.

## 9.1 Determine if Anchorage or Bracing is Required

ASCE/SEI 7 requires anchorage and/or bracing of all permanent nonstructural components in structures assigned to SDC D, E, and F, with some exceptions. These exceptions are limited to items that do not pose a life safety threat, are not required for post-earthquake functionality, or which have been observed to perform adequately in past earthquakes, regardless of whether they are braced. Specifically, the exceptions are:

- Components that weigh less than 400 pounds and have a center of mass less than four feet above the supporting floor level,
- Components that weigh less than 20 pounds, and
- Certain piping and electrical conduit systems that are suspended within a few inches of the supporting floor system.

In SDC C, mechanical and electrical system components are exempt from anchorage/bracing requirements provided they weigh less than 20 pounds and are not required for post-earthquake

function of life safety systems. In SDC B, bracing and anchorage is only required for parapets and for architectural components required for post-earthquake function or life safety protection.

## 9.2 Calculate Seismic Forces

In SDC C and higher, most nonstructural components and systems must be designed with adequate attachment to their supporting structures or the ground to prevent sliding or overturning in design earthquake shaking.

The first step in calculating the seismic design force is determining the **component importance factor**,  $I_p$ . Nonstructural components and systems that satisfy any of the following criteria are assigned an  $I_p$  of 1.5:

- The component is required for life safety purposes following an earthquake. Fire sprinkler systems, emergency egress lighting and similar components are included in this category.
- The component contains hazardous material that, if released, could pose a threat to life safety. This would include piping carrying potentially toxic gases, tanks containing corrosive materials, laboratory equipment containing potentially harmful bacteria, and similar components.
- The component is attached to a Risk Category IV structure and is required for continued operation of the structure (e.g., a communication system in a police station or an emergency generator in a hospital).

Components that are not exempt must be installed in structures using anchorage and bracing that have adequate strength to resist specified seismic forces.

The required strength of component attachments is determined from the formula:

$$F_p = 0.4 S_{DS} I_p W_p \frac{H_f C_{AR}}{R_\mu R_{PO}} \quad (9-1)$$

where:

$F_p$  = the required attachment force,

$I_p$  = the component importance factor,

$W_p$  = the weight of the component,

$S_{DS}$  = the design short-period response acceleration obtained from the USGS online database,

$H_f$  = is a factor that accounts for the increase in shaking intensity with height within the structure,

$R_\mu$  = a factor that accounts for the ability of the structure to undergo inelastic response and thereby reduce the intensity of shaking experienced by components mounted in the structure;



$C_{AR}$  = is a factor to account for resonance between the component and structure it is mounted on, and

$R_{PO}$  = a factor that accounts for the ability of a component to respond inelastically.

The height amplification factor,  $H_f$  is determined from the formula:

$$H_f = 1 + 2.5 \left( \frac{z}{h} \right) \quad (9-2)$$

where,  $z$  is the height within the structure where the component is attached and  $h$  is the height of the structure. Alternatively, when the fundamental natural period of the structure,  $T_a$ , is known,  $H_f$  can be computed from the formula:

$$H_f = 1 + a_1 \left( \frac{z}{h} \right) + a_2 \left( \frac{z}{h} \right)^{10} \quad (9-3)$$

where:

$$a_1 = \frac{1}{T_a} \leq 2.5 \quad (9-4)$$

$$a_2 = \left( 1 - \left( \frac{0.4}{T_a} \right)^2 \right) \quad (9-5)$$

$T_a$  can be determined based on the structural system type using procedures contained in ASCE/SEI 7 Chapter 12.

$R_\mu$  is determined from the formula:

$$R_\mu = \sqrt{1.1 \left( \frac{R}{\Omega_o} \right)} \quad (9-6)$$

where  $R$  and  $\Omega_o$  are the structural response modification and overstrength factors obtained from ASCE/SEI 7-22 Tables 12.2-1 depending on the SFRS. The values of  $C_{AR}$ ,  $R_{PO}$ , and  $\Omega_{op}$  are determined from ASCE/SEI 7-22 Table 13.5-1.



### New in ASCE/SEI 7-22: Revised Equation for Nonstructural Component Forces

ASCE/SEI 7-22 introduces a new procedure for calculating the required anchorage forces, replacing a procedure that had been in use for more than 20 years.

In addition to these general strength and deformation requirements, ASCE/SEI 7 identifies design requirements for some architectural components including exterior glazing and ceiling systems. The requirements for exterior glazing are intended to ensure that large quantities of exterior glazing do not break during earthquakes and fall onto occupied street and sidewalk areas.

Figure 9-1 shows examples of nonstructural component anchorage. Figure 9-2 shows examples of nonstructural component bracing.



**Figure 9-1** Examples of nonstructural anchorage. Left: Rooftop air handler anchored to a housekeeping pad. Right: Shelving unit mounted to a wall (from FEMA E-74).



**Figure 9-2** Examples of nonstructural bracing. Top left: Ceiling-mounted medical device. Top right: Above-ceiling air handling unit (from FEMA E-74). Bottom left: Conduit (from FEMA E-74). Bottom right: Partial-height partition wall. Red arrows point to braces.

## 9.3 Provide Drift Compatibility

In SDC C and higher, ASCE/SEI 7 requires demonstration that nonstructural components that attach at multiple levels in a structure can accommodate the differential drift,  $D_p$ , between the two points of attachment, as given by the formula:

$$D_p = \Delta_{xa} - \Delta_{ya} \quad (9-7)$$

where  $\Delta_{xa}$  and  $\Delta_{ya}$  are respectively the design story drifts computed per Equation 8-10 at the two points of attachment.

Nonstructural components that are supported by two different structures, for example a pipe that crosses from one structure to another (Figure 9-3), must be capable of accommodating the algebraic sum of the design displacements of the two structures at the points of attachment.



**Figure 9-3** Pipe crossing seismic joint between two buildings (from M. Phipps). The loops in the pipe have been designed to provide flexibility to accommodate movement across the joint.

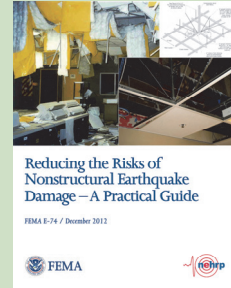
## 9.4 Check for Seismic Qualification

ASCE/SEI 7 requires qualification of designated mechanical and electrical equipment to demonstrate that it is capable of remaining functional following design earthquake shaking. Two methods are permitted for demonstrating **seismic qualification**. One of these is to subject a prototype of the equipment to testing on a shaking table using a prescribed ground motion input, and demonstrating that the equipment functions after the test. The second method comprises use of experience data, consisting of documentation that similar equipment has been exposed to earthquake shaking of design intensity or greater and remained functional. Regardless of the technique used, equipment manufacturers are required to submit certification that designated units are seismically qualified.



## FEMA E-74: Reducing the Risks of Nonstructural Earthquake Damage – A Practical Guide

This report provides an overview of common types of damage to nonstructural components, describes proper design of seismic anchorage, and presents effective methods for reducing the seismic risk of existing vulnerable nonstructural components. Published 2012. Available as a [free PDF](#).





# Chapter 10: Special Considerations

This chapter provides summary discussion of important considerations that are limited to special circumstances in seismic design. The topics covered include performance-based design, design for tsunami, soil-structure interaction, energy dissipation systems, seismic isolation systems, and design of nonbuilding structures.

## 10.1 Performance-based Design

**Performance-based design** provides engineers an alternative method of seismic design that can result in better performing buildings and allow code-intended performance to be achieved more economically. It can also facilitate the use of features not presently recognized or permitted by the building codes.

For many years, building codes have permitted the use of design procedures and building construction that do not conform to the prescriptive requirements of the building code, provided that the project team can demonstrate to the satisfaction of the AHJ that the resulting construction will provide equivalent protection of public safety and welfare. These permissive procedures are called alternative means and methods. Historically, the alternative means and methods approach has been used to introduce new design and construction technologies by demonstrating their use on real projects prior to their adoption by the code in later editions.

The design process under the alternative means and methods approach is as follows:

1. Define and reach agreement as to what performance is appropriate or acceptable
2. Perform a design
3. Test the design under design loadings, either in the laboratory or analytically
4. Determine whether the desired performance can be attained

Performance-based design is an alternative to prescriptive design requirements described in Chapters 6 to 9 of this guide. It is called performance-based because the design process focuses on defining and verifying the performance that can be obtained. Performance-based designs may or may not actually conform to the prescriptive code requirements but should be capable of providing equivalent or better performance than conforming designs. Today, performance-based design approaches are commonly used for fire/life safety, blast protection, and seismic design.

Performance-based seismic design practices initiated in the 1990s, with the development of FEMA 273/274, *Guidelines and Commentary for Seismic Rehabilitation of Buildings*, which later evolved into the ASCE/SEI 41 Standard, *Seismic Evaluation and Retrofit of Existing Buildings*. FEMA 273/274 established a series of standard structural performance levels, as shown in Figure 10-1, and identified a series of standard performance objectives for existing buildings that paralleled the performance objectives described in commentary to ASCE/SEI 7 for new buildings. In ASCE/SEI 41

vernacular, a performance objective is a statement of a particular performance level to be achieved for a given ground motion hazard level. The recommended performance objectives for new buildings are Collapse Prevention Performance for  $MCE_R$  shaking and Life Safety Performance for DE shaking.



**Figure 10-1 Standard ASCE/SEI 41 performance levels.**

Because the procedures for alternative means and methods in the building code allow for demonstration of equivalent or superior performance, performance-based design has become the preferred approach for design of buildings to achieve better performance than required by the building code. As an example of this, a corporation may decide that the appropriate performance objectives for a critical data center are Operational Performance for design earthquake shaking and Life Safety Performance for  $MCE_R$  shaking. Formulation of other performance objectives is also possible.

One of the principal advantages of performance-based design approaches is that because all project participants, including the owner/developer, design team, and AHJ, must agree to the performance objectives used as the basis for design, everyone should be clear as to the expected building performance in future earthquakes. This can also become a disadvantage. It is very difficult to precisely predict future earthquake performance of a building which has not yet been constructed. This is because each earthquake produces unique ground motions and each ground motion has different effects on buildings; our methods of analyzing buildings are approximate; the strengths of construction materials are highly variable; contractors are allowed tolerances in their construction; and the building condition may deteriorate over time. Given these uncertainties, there is significant potential that a building designed to a particular objective will perform worse than implied by the objective, leading to post-earthquake litigation and disputes.

Another significant disadvantage to the ASCE/SEI 41 methodology is that when selecting performance objectives, many owners desire information on the repair costs, repair times, and other consequences associated with their performance objective selection. The ASCE 41 performance levels relate only qualitatively to these important consequences.

In response to these issues, FEMA funded the development by ATC of the FEMA P-58 series, *Next Generation Performance-based Seismic Design Methodology*. FEMA P-58 expresses performance as the probability of incurring earthquake-induced casualties, repair costs, repair times, and other



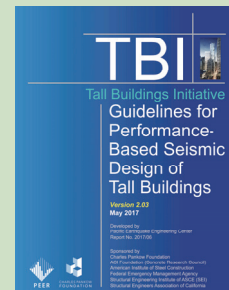
consequences. First published in 2010, FEMA P-58 is seeing expanded use in building design. It is also being used to explore potential improvements to the building code design requirements.

As the FEMA P-58 methodology was being evaluated, the Pacific Earthquake Engineering Research (PEER) Center, one of three NSF-funded national earthquake engineering research centers, developed its *TBI Guidelines for Performance-based Seismic Design of Tall Buildings* to provide engineers an alternative means of designing more reliable high-rise structures. The *PEER TBI Guidelines* offer a hybrid approach between the ASCE/SEI 41 and FEMA P-58 methodologies. Specifically, the *PEER TBI Guidelines* provide a methodology that enables engineers to design for the ASCE/SEI 41 performance objective of Collapse Prevention Performance for  $MCE_R$  shaking with 90% confidence. The procedures embedded in the *PEER TBI Guidelines* have become the preferred approach for seismic design of buildings in the Western United States and have also influenced the development of ASCE/SEI 7 Chapter 16, *Nonlinear Response History Analysis*. More recently still, ASCE published a prestandard for performance-based wind design.



### PEER TBI Guidelines for Performance-Based Seismic Design of Tall Buildings

This document provides procedures on performance-based design for earthquake-resistant design of tall buildings, as an alternative to the prescriptive procedures of ASCE/SEI 7. Published 2017. Available as a [free PDF](#).



### FEMA P-58: Development of Next Generation Performance-Based Seismic Design Procedures for New and Existing Buildings

This series, consisting of seven reports, presents the background on performance-based seismic design and guidance for application of the concepts. The methodology utilizes performance measures that can be understood by decision makers, such as the amount of damage, number of potential casualties, loss of use or occupancy, and repair costs. FEMA P-58-7, *Building the Performance You Need: A Guide to State-of-the-Art Tools for Seismic Design and Assessment*, provides a short introduction to the topic that is clear and approachable for a general audience. Second edition published 2018. Available as [free PDFs](#).



## 10.2 Design for Tsunami

The 2016 edition of ASCE/SEI 7 introduced criteria for design for tsunami resistance. The tsunami-resistant design criteria are applicable only to Risk Category III and IV structures within a tsunami hazard zone. These criteria follow a performance-based approach like that found in the ASCE/SEI 41 Standard, *Seismic Evaluation and Retrofit of Existing Buildings*.

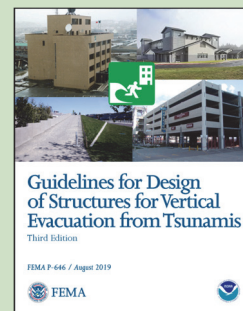


ASCE/SEI 7-22 Chapter 6 provides tsunami design criteria.



### FEMA P-646: Guidelines for Design of Structures for Vertical Evacuation from Tsunamis

This document addresses guidelines for design against extreme tsunami and earthquake forces, specifically for vulnerable communities along the coast where vertical evacuation is the only alternative. The document provides general information and guidance on determining tsunami hazard, options for vertical evacuation, determination of tsunami and earthquake loads, and the structural design criteria necessary to address these loads. Third edition published 2019. Available as a [free PDF](#).



## 10.3 Soil-Structure Interaction

Including **soil-structure interaction** (SSI) in seismic analysis can more accurately predict the behavior of a structure in response to ground shaking. It permits engineers to account for the effect of soil flexibility and energy dissipation potential on response of a structure. This can sometimes result in more economical designs as well as designs that better account for the structural deformation of foundations in response to strong shaking.

Although most seismic analysis performed in support of structural design represents the structure as fixed to the ground, this is a significant simplification. The soils that most structures are founded on are quite deformable and have only modest strength. There are several important consequences of this. First, the very presence of the structure and its foundations affects the motion of the ground, in much the same way that the presence of a boat in water affects the motion of the water immediately surrounding the boat. Pairs of strong motion instruments with one placed on a foundation of the building and the other nearby but in the free field confirm that the shaking at the building is often different and less intense than that experienced in the free field. This is significant because the ground motion prediction models used by the USGS to develop the design ground motion database are based on both free-field and in-structure instruments and accounts for these effects in only a general manner.

Another important aspect of the deformability of soils is that rather than being fixed at their bases, most structures can be more properly viewed as being mounted on a series of vertical, horizontal, and rotational nonlinear springs, and dashpots. The effect of these springs and dashpots is to increase the effective fundamental period of vibration, change the mode shapes, and add damping to the response, as the structure will radiate some of the imposed energy from the earthquake back out into the surrounding soils.

SSI is a means of accounting for these effects and is permitted under the requirements of ASCE/SEI 7 Chapter 19. SSI can take many forms. In its simplest form, the engineer models springs at the base of the structure to represent the flexibility of the soil and the effects this has on the modal properties and response of the structure. In its most complex form, engineers can represent the soils underlying a structure as nonlinear finite elements, just as the structure is modeled, and propagate earthquake energy up to the structure through the soil elements from the bedrock. It is also possible to perform such analysis in steps, first using a very detailed representation of the soil, with the mass and stiffness of the structure represented simply to account for the modification that occurs to the ground motion, and then analyzing the structure for the modified ground motions. ASCE/SEI 7 Chapter 19 also presents simpler procedures that permit closed form solution of period lengthening and damping increment effects.

Although use of SSI is not required by the code, it has been used for many years in the design and evaluation of nuclear structures and seismic evaluation and retrofit of buildings. Recently, use of SSI has become more common for design of new structures.

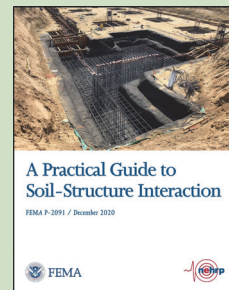


ASCE/SEI 7-22 Chapter 19 provides soil-structure interaction criteria.



FEMA P-2091: A Practical Guide to Soil-Structure Interaction

This guide walks engineers through determining when soil-structure interaction (SSI) effects are of importance and how to implement them in design. Information regarding SSI as implemented in code provisions is presented in an easy-to-follow and concise format, along with examples of applying SSI effects in design. Published 2020. Available as a [free PDF](#).



## 10.4 Energy Dissipation Systems

Energy dissipation systems can be used to modify the response of a structure to ground shaking and minimize damage. This technology was first introduced into the building codes in the 1980s and has uses in both design of new construction and retrofit of existing structures. Use of an energy dissipation system does add cost to the project, both for design and construction. As a result, its use

in the United States has been limited. Energy dissipation systems and seismic isolation (Section 10.5) have seen widespread application in Japan and some other countries.

Section 6.2 describes how damping, or energy dissipation, reduces the spectral amplitude of shaking a structure will experience in an earthquake, effectively reducing the intensity of earthquake shaking the structure experiences. Damping is classically expressed as the velocity-dependent term  $c$  in the equation of motion (Equation 6-1) and is typically expressed as the percent of critical damping present in a structure. Figure 6-2 illustrates the free vibration an SDOF structure with 5% of critical damping would experience if displaced and then released. A structure with 100% of critical damping would come to rest in one cycle of motion.

All real structures have some inherent damping present. The energy dissipation associated with this damping occurs because of minor cracking of concrete and masonry, slippage in bolted connections of steel structures, working of nails in wood structures, and similar behaviors in nonstructural elements such as cladding, interior partitions. The amount of inherent damping structures will exhibit is dependent on how much deformation the structure is undergoing, with larger damping occurring under larger amplitude motion.

Another form of damping that is important to seismic response is **hysteretic damping**. Hysteretic damping occurs when a structure undergoes inelastic response, such as yielding of beams in flexure or braces in tension. The strain energy that occurs as these elements yield dissipates energy and produces damping.

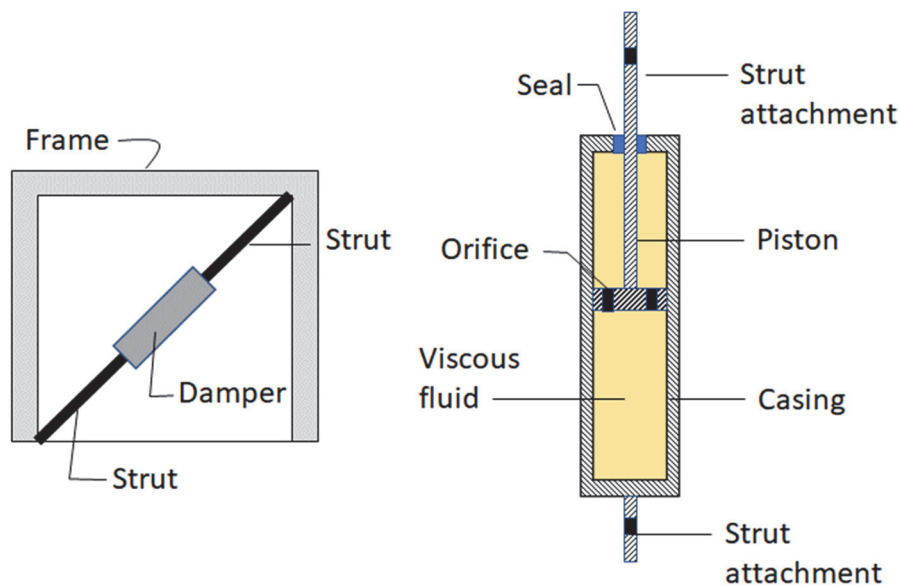
The building code assumes that structures responding to design earthquake shaking will exhibit 5% of critical damping through a combination of inherent and hysteretic damping and the design spectra used to determine required seismic design forces are 5%-damped spectra.

Several types of **dampers** are available that can enhance the effective damping of a structure.

- Fluid viscous dampers are similar to automotive shock absorbers. They consist of a double acting hydraulic cylinder that dissipates energy by moving a piston device through a viscous fluid that is contained within an enclosed cylinder.
- Friction dampers are essentially structural braces that are spliced to the structure using slotted holes and high-strength bolts with a tactile material on the mating surfaces of the connection. When the braces are subjected to tension or compression forces, they slip at the splice connection and dissipate energy through friction.
- Wall dampers are a form of viscous damper that consists of vertical plates arranged in a sandwich configuration with a highly viscous material. One set of plates is attached to one level of a structure and another set to the adjacent level. When the structure displaces laterally in response to earthquake shaking, the plates shear the viscous material and dissipate energy.
- Hysteretic dampers dissipate energy by yielding specially shaped structural elements that are placed in series with conventional wall or brace elements.

- Tuned mass dampers consist of a large mass on a spring-like device. When they are mounted on a structure, the lateral displacement of the structure excites the mass, which then begins to move and dissipate significant portions of the energy of the earthquake, protecting the structure in the process.

The most common dampers are of the fluid viscous type, illustrated in Figure 10-2. The fluid viscous damper consists of a double-acting hydraulic cylinder in which a piston, with specially machined orifices moves through a viscous fluid constrained by an outer casing. The edge of the piston is attached with a strut to one part of the structure, in the case of the illustration, a beam-column joint, and the casing is attached with a strut to another part of the structure. As the structure drifts, in response to earthquake shaking the piston is dragged through the viscous fluid, dissipating energy in the form of heat.



**Figure 10-2 Fluid viscous damper assembly in frame.**

ASCE/SEI 7 Chapter 18 specifies the criteria for design of structures with energy dissipation systems. This requires that in addition to the energy dissipation system, the structure must also have one of the seismic force-resisting systems permitted by Chapters 12 or 15 of ASCE/SEI 7 for the SDC. Analysis can use ELF, modal response spectrum analysis, or nonlinear response history analysis techniques. In the ELF and modal response spectrum approaches, the base shear force is permitted to be reduced up to 25% depending on the amount of damping provided. The chapter includes procedures to compute the amount of damping provided, based on the computed spectral response of the structure, and the characteristics of the damping devices. In nonlinear response history analysis, the damping devices are directly modeled to simulate their effect on the response of the structure.

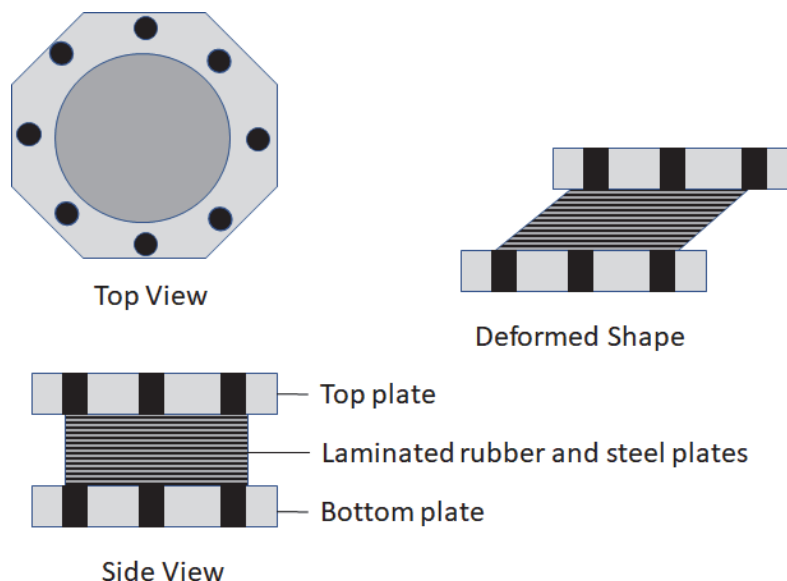
Since few engineers are familiar with how to design using damping technology, ASCE/SEI 7 requires independent design peer review when energy dissipation systems are used for seismic force resistance. ASCE/SEI 7 also requires rigorous manufacturing quality assurance procedures for the

production of energy dissipation devices to ensure that the damping properties assumed in design can be obtained and that the devices are capable of accommodating design earthquake shaking.

## 10.5 Seismic Isolation Systems

**Seismic isolation** is a method of altering the response of a structure by inserting deformable bearing elements in the vertical load-carrying system of the structure to significantly affect the structural stiffness and fundamental period of response, as well as add energy dissipation or damping. Most commonly, seismic isolation bearings are placed at the base of the structure, between the columns (or bearing walls) and the supporting foundations, or subgrade structure. For this reason, seismic isolation has often been termed **base isolation**.

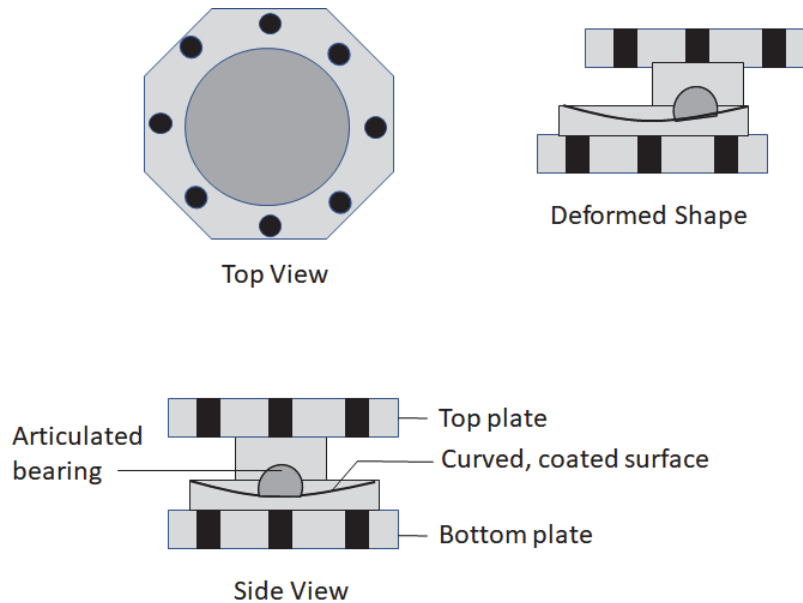
Two basic types of isolation bearings are commonly used: elastomeric and sliding. Figure 10-3 illustrates top, side, and deformed views of a typical elastomeric bearing. The bearings consist of thick steel top and bottom plates, sandwiching and bonded to a laminate consisting of multiple layers of either natural or synthetic rubber and steel plates. The rubber laminations provide the isolator flexibility and an ability to deform laterally by as much as three times the bearing height, as illustrated in the deformed view. The steel laminations provide volumetric stability for the rubber and enable it to withstand vertical loads without excessive vertical displacement. The lateral stiffness of the bearing enables it to return to its neutral position when lateral forces are released. Some elastomeric bearings have a solid lead core within the laminated steel-rubber layers to provide additional damping.



**Figure 10-3 Elastomeric isolator.**

Figure 10-4 illustrates the concept for a common sliding-type bearing, also known as a friction pendulum. In this bearing type, the bottom plate is machined with a curved surface and coated with a low friction, wear-resistant material. The top plate is attached to an articulated bearing system

consisting of a semi-spherical bearing trapped by a machined plate, with all surfaces similarly coated with friction-resistant materials. When lateral forces act on the bearing, the upper plate slides relative to the lower plate. The amount of resistance provided is a function of the curvature of the curved coated surface on the lower bearing, the friction coefficient of the surface preparation and the vertical weight on the bearing.



**Figure 10-4 Sliding-type isolation bearing.**

Essential elements of seismic isolation systems include the bearings themselves, a rigid diaphragm above the isolators to enable the structure to move as a unit on the bearings, and a robust foundation system capable of resisting the sliding and overturning forces. The structure above and below the isolation bearing must be designed to withstand the substantial P-delta effects associated with large lateral displacements of the bearings, which can be on the order of 24 inches or more. Elastomeric type bearings distribute half of the P-delta associated moments to the structure above and half to that below. Sliding-type bearings distribute all of the P-delta moments to the structure beneath the bottom plate.

Another important consideration in the design of seismically isolated structure is that all the building elements that cross the plane of isolation, including electrical lines, plumbing, cladding systems, and HVAC ducts, must be designed, and installed to accommodate the relative displacements of the structure across the isolation plane.

The design criteria are similar to that of damping systems and involves determining the effective natural period of the isolated structure, as well as the damping of the isolation system. The superstructure must be designed using small values of the response modification coefficient,  $R$ , so that inelastic behavior of the superstructure is limited and most deformation occurs in the isolators themselves.

Seismic isolation is one of the most effective methods of protecting structures from the effects of earthquakes and is ideal for use in structures that can tolerate little damage to the structure, its mechanical and electrical systems, or its contents. For these reasons, it is most used in the United States for hospitals, data centers, and museums. It is also commonly used as a means of retrofitting historically important structures constructed of archaic and fragile systems, without extensive structural modifications to the historic structure.



ASCE/SEI 7-22 Chapter 17 specifies the criteria for design and manufacture of seismic isolation systems.

## 10.6 Nonbuilding Structures

The building code also includes seismic design criteria for many types of structures that are not buildings. These structures are called **nonbuilding structures** and include:

- Storage tanks, pressure vessels, and pipe supports such as those commonly found in petroleum refineries and chemical plants (Figure 10-5),
- Water towers,
- Chimneys and smokestacks,
- Steel storage racks (Figure 10-6),
- Piers and wharves,
- Amusement structures including roller coasters, and
- Electrical transmission towers.



**Figure 10-5** Structures commonly found in petroleum refineries and chemical plants.





**Figure 10-6** Seismic design criteria for steel storage racks of the type used in large warehouses and big-box retail stores are included in the building code.

ASCE/SEI 7 identifies four different types of structures and specify somewhat different design requirements for each:

- Buildings,
- Nonbuilding structures similar to buildings,
- Nonbuilding structures not similar to buildings, and
- Nonbuilding structures supported by other structures.

The primary difference between buildings and nonbuilding structures similar to buildings is that buildings are designed with the intent that they will be occupied and provide shelter to occupants, while nonbuilding structures are not. Because most buildings are occupied, they are typically enclosed, and have uniform distribution of story heights and weight. Nonbuilding structures are often used in industrial applications and are configured to suit their industrial uses. They often are unenclosed, support large concentrations of weight (e.g., large pressure vessels, and heavy rotating equipment such as compressors or electrical generators) and must be designed to resist cyclic and thermal forces from the processes they support. These design criteria often result in structures that use much larger members and are much stronger than is typical of buildings. Over many years, engineers have observed that structural features that have resulted in poor performance in

buildings, have not been a problem in nonbuilding structures similar to buildings. Given this, and the reduced occupancy associated with most nonbuilding structures, ASCE/SEI 7 specifies similar design procedures but different criteria for the design of buildings and nonbuilding structures similar to buildings. The requirements for seismic design of building structures are contained in Chapter 12 of ASCE/SEI 7 while that for nonbuilding structures similar to buildings is contained in Chapter 15.

Most of the design requirements for nonbuilding structures similar to buildings are the same as those for buildings. However, the limitations on structural systems associated with SDC, and the required design forces are relaxed relative to the criteria for buildings. Table 15.4-1 presents the system limitations,  $R$ ,  $C_d$ , and  $\Omega_b$  coefficients applicable to such nonbuilding structures.

Nonbuilding structures not similar to buildings include mechanical and electrical equipment items with structural support systems that are integral to the function of the equipment. Examples include ground-supported tanks, elevated tanks, pressure vessels, cooling towers, electrical transmission towers, and chimneys and stacks. The design requirements for many of these highly specialized structure types are contained in design standards developed by industry associations such as the American Petroleum Institute and American Waterworks Association. Rather than transcribing the requirements contained in these standards, ASCE/SEI 7 specifies seismic design criteria for these structures through reference to the industry standards, sometimes with specification as to how ground motions are to be derived and other limits.

Nonbuilding structures supported by other structures are typified by small penthouse structures housing mechanical equipment, mounted on top of buildings or other structures. These are designed similar to nonbuilding structures similar to buildings, with the exception that the ground shaking level used to design the structure is based on the motion transmitted by the supporting structure.

Some nonbuilding structures, however, are not covered by the design recommendations contained in the building codes because they are of a highly specialized nature and industry groups that focus on the design and construction of these structures have developed specific criteria for their design. Some such structures are highway and railroad bridges, nuclear power plants, hydroelectric dams, and offshore petroleum production platforms.



ASCE/SEI 7-22 Chapter 15 provides design requirements for nonbuilding structures.

---

# Acronyms

<b>ACI</b>	American Concrete Institute
<b>AHJ</b>	Authority Having Jurisdiction
<b>AISI</b>	American Iron and Steel Institute
<b>ANSI</b>	American National Standards Institute
<b>ASCE</b>	American Society of Civil Engineers
<b>ATC</b>	Applied Technology Council
<b>AWC</b>	American Wood Council
<b>AWS</b>	American Welding Society
<b>DE</b>	Design earthquake
<b>ELF</b>	Equivalent Lateral Force
<b>FEMA</b>	Federal Emergency Management Agency
<b>IBC</b>	International Building Code
<b>ICC</b>	International Code Council
<b>IEBC</b>	International Existing Buildings Code
<b>IRC</b>	International Residential Code
<b>MCE</b>	Maximum considered earthquake
<b>MCE<sub>R</sub></b>	Risk-targeted maximum considered earthquake
<b>MDOF</b>	Multiple degrees of freedom
<b>MEP</b>	Mechanical, electrical, plumbing
<b>MMI</b>	Modified Mercalli Intensity scale
<b>NEHRP</b>	National Earthquake Hazard Reduction Program
<b>NFPA</b>	National Fire Protection Association

<b>NHERI</b>	Natural Hazards Engineering Research Infrastructure
<b>NIST</b>	National Institute of Standards and Technology
<b>NOAA</b>	National Oceanic and Atmospheric Administration
<b>NSF</b>	National Science Foundation
<b>PGA</b>	Peak ground acceleration
<b>SEI</b>	Structural Engineering Institute of ASCE
<b>SDC</b>	Seismic design category
<b>SDOF</b>	Single degree of freedom
<b>SEAOC</b>	Structural Engineers Association of California
<b>SFRS</b>	Seismic force-resisting system
<b>SSI</b>	Soil-structure interaction
<b>TMS</b>	The Masonry Society
<b>URM</b>	Unreinforced masonry
<b>USGS</b>	U.S. Geological Survey

---

# Symbols

$c$	Damping
$C_d$	Deflection amplification coefficient
$C_s$	Seismic response coefficient
$D$	Dead load
$E_v$	Vertical seismic effect
$F_p$	Horizontal seismic design force for a nonstructural component
$I_e$	Importance factor (structure)
$I_p$	Component importance factor (nonstructural component)
$g$	Gravity
$M$	Magnitude
$R$	Response modification coefficient
$S_a$	Spectral acceleration
$S_1$	MCE <sub>R</sub> response acceleration at 1-second period in site class BC
$S_{DS}$	Design spectral response acceleration at short periods
$S_{D1}$	Design spectral response acceleration at 1-second period
$T$	Fundamental period of vibration of the structure
$T_L$	Long-period transition period
$V$	Base shear
$W$	Seismic weight
$\delta$	Displacement or deflection
$\Delta$	Design story drift
$\Omega_o$	Overstrength coefficient
$\rho$	Redundancy factor



---

# Glossary

The following definitions are provided to explain the key terms used throughout this guide.

## A

**Acceleration:** Rate of change of velocity with time.

**Acceleration response spectrum:** A graphical plot of the maximum acceleration that structures, having different natural periods of vibration, will experience when subjected to a specific earthquake ground motion.

**Acceptable risk:** The risk of damage and consequential losses from future earthquakes that is deemed acceptable when developing design criteria, either for individual buildings, or in the case of building codes, all buildings.

**Accidental torsion:** In seismic analysis, application of the seismic forces at a small eccentricity from the center of mass of the structure to account for uncertainty in modeling the distribution of mass, stiffness, and strength, and to ensure torsional stability.

**Active fault:** A fault that has moved one or more times in the past 10,000 years.

**Addition:** An increase in the aggregate floor area, height, or number of stories of a structure.

**Alteration:** Any construction or renovation to an existing structure other than an addition.

**Amplification:** A relative increase in the magnitude of a quantity, such as ground motion or building shaking.

**Amplitude:** The maximum value of a time-varying quantity.

**Appendage:** An architectural component such as a canopy, marquee, ornamental balcony, or statuary.

**Architectural components:** Components such as exterior cladding, ceilings, partitions, and finishes.

**Authority Having Jurisdiction (AHJ):** The governmental agency responsible for regulation of building construction in a community.

## B

**Base:** The level at which the horizontal seismic ground motions are imparted to a structure.

**Base shear force:** A term used in linear structural analysis techniques to describe the vector sum of the lateral forces that are applied to the structure to represent the effects of earthquake shaking.

**Base isolation:** Seismic isolation system placed at the base of the building (e.g., between the columns and the foundation).

**Beam:** A horizontal structural element that typically carries load in the vertical plane (e.g., from gravity loads).

**Bearing wall system:** A structural system in which vertical structural walls serve the dual purpose of providing vertical support for a significant portion of the weight of the structure as well as resistance to lateral forces.

**Braced frame:** A structural system in which diagonally inclined members provide the primary resistance to lateral forces.

**Buckling-restrained braced frames:** A frame with braces that are designed to yield in compression, rather than buckle.

**Building:** An enclosed structure used for human occupancy.

**Building codes:** Regulations adopted by local governments that establish minimum standards for construction, maintenance, modification, and repair of buildings and other structures.

**Building frame system:** A structural system in which vertical forces associated with the weight of the structure and that of its supported contents are carried by beams and columns while lateral forces associated with wind or earthquake loading are carried by either diagonal braces or vertical walls that do not support significant portions of the weight of the structure.

**Building official:** A public official charged with the administration and enforcement of the building.

**Building response:** The way in which a building reacts to earthquake ground motion; includes, for example, rocking, sliding, distorting, and collapsing.

## C

**Cantilever column system:** A structural system in which resistance to lateral forces is provided by the bending strength of the vertical column elements, which are fixed against rotation at their bases and free to translate and rotate at their tops.

**Center of mass:** Point on the building plan about which the weight of the building is evenly distributed.

**Chord:** A structural element at the edge of a diaphragm that resists tensile and compressive forces associated with bending of the diaphragm.



**Coefficient of variation:** A measure of the amount of scatter between the average value in a normally distributed group or population and the value that is exceeded by only 84 percent of the members of the population divided by the average value.

**Cold-formed steel frame:** A structural framework consisting of repetitive, closely spaced, vertical (studs) and horizontal (joists) elements all composed of light gauge steel, typically formed in a C shape.

**Collector:** An element within a diaphragm that transfers horizontal forces carried by the diaphragm from or to vertical elements of the seismic force-resisting system such as frames or walls.

**Column:** A slender vertical structural element.

**Component:** Part of an architectural, structural, electrical, or mechanical system.

**Concentrically braced frame:** A braced frame system in which the beams, columns, and braces intersect at common points.

**Concrete:** A mixture of Portland cement, sand, rock, water, and other materials that is placed into forms and allowed to harden into a structural element.

**Concrete tilt-up building:** A type of reinforced concrete structure in which the exterior concrete walls are constructed lying flat against the ground and then tilted vertically into position.

**Configuration:** The size, shape, and geometrical proportions of a building.

**Connection:** A method by which different structural elements are joined to one another to transfer forces.

**Consensus standard:** A publication presenting design and/or construction criteria developed with the participation of a broad group of stakeholders following a process conforming to American National Standards Institute (ANSI) criteria.

**Construction documents:** Drawings and specifications prepared by architects and engineers to portray the technical requirements under a contract for construction.

**Cycle of motion:** For a shaking object, the motion that occurs as the object moves from an initial position to a maximum displacement in one direction, back through the initial position to a maximum displacement in the opposite direction, and then back to the initial position.

## D

**Damper:** A structural element that dissipates energy associated with shaking of a structure.

**Damping:** The natural dissipation of energy that occurs in a vibrating structure as a result of friction, cracking, and other behaviors and that eventually brings a vibrating structure to rest.

**Dead load:** The weight of a structure and all its permanently attached appurtenances including cladding and mechanical, plumbing, and electrical equipment.

**Deep foundation:** A type of foundation that transfers the loads from a structure to competent soils located at depth beneath the ground surface.

**Deflection:** The state of being displaced from an initial at-rest position.

**Deflection amplification coefficient:** A numerical factor used to approximate the deflection a structure will experience in responses to design shaking.

**Deformation:** Load-induced distortion of structural or nonstructural elements or components .

**Deformation compatibility:** The ability of properly designed elements to withstand the deformations associated with the response of a structure to earthquake shaking without failure.

**Design earthquake:** The earthquake shaking that is two-thirds of maximum considered earthquake shaking.

**Design seismic map:** A map contained in building codes and referenced standards that specifies the geographic distribution of the value of ground shaking parameters specified as minimum values to be used in design.

**Designated seismic system:** A nonstructural component or system of components that must remain functional to protect life safety or to support the operation of an essential facility.

**Detailing:** Design of the connections of elements, bends and spacing of reinforcing and similar items conform to conform to applicable building code requirements.

**Diaphragm:** A horizontal or nearly horizontal assembly of structural elements used to tie a structure together, typically at a floor or roof level and transfer inertial seismic forces to the vertical elements of the seismic force-resisting system.

**Diaphragm discontinuity irregularity:** A type of horizontal irregularity that occurs when a floor or roof has a large open area.

**Displacement:** Movement of a structure due to applied forces.

**Drift:** Deflection of a building or structure caused by lateral forces.

**Dual system:** A structural system in which a combination of moment-resisting frames and braced frames or walls are provided to resist lateral forces.

**Ductile coupled wall system:** A new class of special concrete shear wall system in which walls are interconnected by beams, meeting specific dimensional criteria, over openings.

**Ductility:** The ability of some structural systems to experience extensive deformation and damage without loss of load-carrying capability.

## E

**Earthquake:** A sudden motion or vibration in the earth caused by the abrupt release of energy in the earth's lithosphere.

**Earthquake hazard:** Quantification of the probability that a region or individual building site may experience the destructive effects of earthquakes of different intensity.

**Eccentricity:** Non-coincidence between the center of mass and center of resistance of a building or characteristic of a braced frame design in which the center lines of the braces and the structural members to which they are connected do not meet at a point.

**Eccentrically braced frame:** A type of braced frames in which the intersections of the braces with beams occurs at distance away from the intersection of beams and columns, or beams and other braces.

**Elastic:** Capable of recovering size and shape after deformation.

**Elastic analysis:** See *linear analysis*.

**Elastic limit:** The force and deformation amplitudes beyond which a structural element will become damaged.

**Energy dissipation systems:** Structural elements capable of dissipating large amounts of earthquake energy without experiencing damage.

**Equivalent Lateral Force:** An approximate method of structural analysis that represents the effects of earthquake shaking as a series of lateral static forces applied to the structure.

**Essential facility:** A building or structure intended for use during post-earthquake recovery operations including police and fire stations, hospitals, and emergency communications centers.

**Exceedance probability:** The probability that a specified level of ground motion will be exceeded at a site or in a region during a specified exposure time.

**Extreme stiffness irregularity:** A type of vertical structural irregularity sometimes referred to as extreme soft story irregularity.

**Extreme weak story irregularity:** A type of vertical structural irregularity wherein one story of a structure has significantly less strength than the story immediately above.

## F

**Fault:** A fracture in the earth's crust along which relative displacement can occur.

**Fault trace:** The path along the earth's surface that overlies a zone of fracture in the earth's crust along which past earthquake movement has occurred.

**Flexible diaphragm:** A floor, roof, or horizontal bracing system that experiences lateral deformations equal to or greater than those experienced by the vertical frames or walls it connects.

**Footing:** The enlarged base of a foundation designed to spread the load of the structure so that it does not exceed the soil bearing capacity.

**Force:** In physics, the influence that causes a free body to undergo an acceleration. Force also can be described by intuitive concepts such as a push or pull that can cause an object with mass to change its velocity (which includes to begin moving from a state of rest) or that can cause a flexible object to deform.

**Force distribution:** Portion of the total forces applied to a structure that is resisted by each structural element.

**Frame-shear wall interactive system:** A type of structural system in which resistance to lateral forces is provided by a combination of moment-resisting frames and shear walls without limitation on the relative strength or stiffness of each.

**Frequency:** For a vibrating structure, the number of times per second that the structure will undergo one complete cycle of motion.

**Functional recovery:** A building performance state in which building damage, if any, has been repaired to a level that permits use of the building for its intended purpose, albeit possibly in an impaired mode.

**Fundamental period:** In structures with multiple modes of vibration, the longest of the natural periods.

## G

**g:** The acceleration due to the earth's gravity or 32 feet per second per second.

**Ground failure:** Physical changes to the ground surface produced by an earthquake; these include fault rupture, landslides, lateral spreading, and liquefaction.

**Ground shaking:** Broad spectrum, random vibrations of the ground in all directions caused by the release of energy from an earthquake fault rupture.

**Grout:** A mixture of sand, Portland cement, water, and other elements used to fill voids in masonry construction, bond the masonry units together, and bond reinforcing steel to the masonry.

## H

**Hysteretic damping:** A form of energy dissipation that results from inelastic deformation of structural elements, such as yielding of beams in flexure, or yielding of braces in tension.

**Hysteretic properties:** For a structural element or member, the variation of stress in the element as a function of imposed deformation considering the prior loading history.

## I

**Inelastic structural response:** The force and deformation behavior of a structure after the onset of damage.

**In-plane discontinuity irregularity:** A type of vertical structural irregularity that occurs when the vertical elements of a seismic force-resisting system, such as its walls or braced frames, do not align vertically within a given line of framing or the frame or wall has a significant setback.

**Intensity:** The destructive potential that an earthquake produces at a given location; in the United States, intensity generally is measured by the Modified Mercalli Intensity (MMI) scale.

**Intermediate system:** A structural system that has been designed to provide more ductility and toughness than that required for an *ordinary* system but less than that for a *special* system.

**Intermediate diaphragm:** A type of diaphragm with in-plane stiffness intermediate to that of flexible and rigid diaphragms.

**International Building Code (IBC):** A model building code published by the International Code Council, adopted by most U.S. communities as the basis for local building regulation.

**International Existing Buildings Code (IEBC):** A model building code published by the International Code Council and adopted by some U.S. communities as the basis for regulating existing buildings and structures.

**International Residential Code (IRC):** A model building code published by the International Code Council and adopted by some U.S. communities intended for use in regulating the construction of low-rise residential buildings.

**Irregular structure:** A structure that has one or more specified irregularities.

**Irregularity:** A condition relating to the shape of a structure or the distribution of its weight, stiffness, or strength that could lead to atypical behavior when subjected to earthquake shaking.

## L

**Landslide:** Disturbance in hillside ground, sometimes caused by earthquake ground motion, in which one land mass slides down and over another.

**Lateral force:** A force that acts on an element or portion of a structure so as to produce horizontal motion.

**Lateral spreading:** A ground instability whereby soils that have experienced liquefaction or overlie liquefied soils, flow downhill, often creating fissures and uneven terrain.

**Lateral stiffness:** The resistance of a structure or structural element to being displaced by a force.

**Linear analysis:** Any method of structural analysis that ignores the effects of both structural damage and large displacements on internal forces and displacements.

**Linear elastic behavior:** Behavior that a structural or structural element will exhibit when loading is less than its elastic limit, characterized by returning to an at-rest position when a disturbing force is removed.

**Linear dynamic analysis:** An approximate method of structural analysis that predicts the forces and deformations induced in a structure by ground shaking without consideration of the effects of structural damage that may occur.

**Liquefaction:** A phenomenon that occurs in loose, saturated sandy and silty soils resulting in loss of bearing and shear capacity.

**Load path:** The continuous chain of structural elements and their connections that transmit a force from one point in a structure to another.

**Loads:** Forces that result from the weight of all building materials, occupants and their possessions, environmental effects, differential movement, and restrained dimensional changes.

**Live load:** The weight of objects supported by a structure but not permanently attached to it (e.g., furniture, occupants, vehicles).

**Loss:** Any adverse economic or social consequences caused by earthquakes.

## M

**Masonry:** Built-up construction combining of building units of fired clay (bricks), stone, concrete, glass, gypsum, stone, typically bonded together with mortar and grout.

**Magnitude (M):** An objective measure of the amount of energy released by an earthquake fault rupture, expressed on a logarithmic scale.

**Mass:** The inertia or sluggishness that an object, when frictionlessly mounted, exhibits in response to any effort made to start it or stop it or to change in any way its state of motion.

**Mat foundation:** A form of foundation in which a monolithic reinforced concrete slab underlying a large portion of a structure (or the entire structure) is used to transfer the weight of the structure to the underlying soil.

**Maximum considered earthquake (MCE):** The most severe level of earthquake shaking considered by the U.S. building codes, typically having a mean recurrence interval of from 1,000 to several thousand years.

**Mitigation:** Any action taken to reduce or eliminate the risk to life and property from natural hazards.

**Model building codes:** A publication of recommended building regulations put forward as a guide for development and adoption of locally enforced building codes.

**Modified Mercalli Intensity:** A scale for earthquake intensity ranging from I (not felt) to X (total destruction).

**Moment:** The force effect associated with the application of a force at a distance from the point under consideration, tending to cause a rotation about that point.

**Moment frame:** See *moment-resisting frame system*.

**Moment-resisting frame system:** A structural frame that derives resistance to lateral displacement through the rigid or nearly rigid interconnection of beams and columns.

**Monolithic:** In reinforced concrete construction, a term used to describe elements that are cast in one continuous placement of concrete without joints.

**Mortar:** A mixture of sand, cement, lime, and water used to bond bricks or concrete blocks together to form an integral structural element.

**Multiple degree of freedom (MDOF):** A structure having discrete multiple or distributed masses supported by multiple structural elements.

## N

**Natural period:** The time, in seconds or fractions of a second, that a structure in free vibration will take to undergo one complete cycle of motion, in any of its natural deflected shapes.

**National Earthquake Hazards Reduction Program (NEHRP):** An act of U.S. Congress authorizing funding and establishing priorities for the National Institute of Standards and Technology, the Federal Emergency Management Agency, and U.S. Geological Survey to perform earthquake loss reduction activities.

**NEHRP Provisions:** A resource publication on appropriate building code requirements for seismic resistance developed by the Building Seismic Safety Council, under FEMA's guidance, using NEHRP funding, and referenced extensively by the ASCE/SEI 7 Committee in developing earthquake loading provisions for the building codes.

**Nonbuilding structure:** Generally, a self-supporting structure other than a building that carries gravity loads and that may be required to resist the effects of earthquakes.

**Nonstructural component:** A portion of a building or structure that is provided for purposes other than acting as a structural element including doors, windows, some types of walls, and mechanical and electrical equipment.

**Nonstructural wall:** A wall intended to separate occupied spaces from each other and/or the building exterior and which is not designed to resist structural loads.

**Non-detailed structural system:** A structural system, permitted in regions of low seismic risk, which does not have specific seismic detailing requirements.

**Nonlinear analysis:** Any of several types of structural analysis that consider the effects of structural damage and large displacements on structural behavior.

**Nonlinear behavior:** The response of a structure to motions and or forces that exceed its elastic limit.

**Nonlinear response history analysis (NLRHA):** A method of structural analysis that uses numerical integration of the equation of motion to simulate the forces and deformations that occur in a structure in response to earthquake shaking considering the effects of structural damage that may occur.

**Nonparallel systems irregularity:** A type of horizontal irregularity that occurs when the seismic force-resisting system does not include a series of frames or walls that are oriented at 90-degree angles with each other.

## O

**Ordinary system:** A structural system that has been designed and detailed to provide only limited ductility and toughness.

**Out-of-plane offset irregularity:** A type of horizontal irregularity that occurs when the vertical elements of the seismic force-resisting system, such as braced frames or shear walls, are not aligned vertically from story to story.



**Overstrength coefficient:** A design coefficient used to approximate the effect of structural overstrength and nonlinear behavior on elements sensitive to overload.

**Overturning:** The effect of lateral forces acting on a structure which tend to cause the structure to overturn about its base.

## P

**P-delta effects (P- $\Delta$ ):** A tendency of vertical loads placed on a laterally displaced structure to increase the lateral displacements, potentially causing instability.

**Peak ground acceleration (PGA):** Spectral acceleration at zero period.

**Performance-based design:** A design procedure intended to produce specific structural performance rather than meet prescriptive building code criteria.

**Period:** The elapsed time of a single cycle of a vibratory motion or oscillation; the inverse of frequency.

**Permanent deformation:** A change in the permanent shape and geometry of the ground or of a structure that occurs as a result of damage sustained during an earthquake.

**Pier foundation:** A type of cast-in-place concrete pile that has a large diameter, usually greater than 18 inches and sometimes as large as five or six feet.

**Pile foundation:** A type of foundation in which a vertical or nearly vertical element (the pile) is embedded directly into the ground to transfer the weight of a structure into the ground either through friction between the sides of the pile and the surrounding soil or end bearing of the pile against stiff soils and rock beneath it.

**Plain concrete:** A structural element of concrete construction that does not include sufficient steel reinforcement or prestressing to be classified as reinforced or prestressed concrete.

**Plain masonry:** A structural element of masonry construction that does not include sufficient steel reinforcement to be classified as reinforced masonry. Also called *unreinforced masonry*.

**Pounding:** The behavior that occurs when closely spaced structures collide into each other in response to ground shaking.

**Prescriptive:** Requirements in building codes that specify precisely how a structure is to be configured or designed.

**Prestressed concrete:** A form of concrete construction in which reinforcement is provided by steel cables or rods that have been embedded in the concrete and then stressed in tension to place the concrete in compression.

**Protective system** : A structural system that is designed to dissipate earthquake energy and reduce structural response without causing damage in the structure.

## R

**Recurrence interval:** See *return period*.

**Redundancy:** A property of some structures in which multiple elements are used to provide support for the structure so that if one or some of these elements are damaged, other elements are available to continue to support the structure.

**Reentrant corner irregularity:** A type of horizontal irregularity that occurs where two or more wings of a building join.

**Regular structure:** A structure that does not have any specified irregularities.

**Reinforced concrete:** A type of structural element formed of concrete with embedded steel rod reinforcement.

**Reinforced masonry:** A type of structural element formed of masonry units with embedded steel rod reinforcement.

**Reinforcing steel:** Round steel bars that have been deformed to provide bond with concrete and/or grout.

**Resilience:** A property of a community having sufficiently robust construction and infrastructure that it is capable of recovering quickly following a major earthquake or other natural disaster.

**Resonance:** The amplification of a vibratory motion occurring when the period of an impulse or periodic stimulus coincides with the period of the oscillating body.

**Response modification coefficient (R):** A factor specified in the building code to approximate the effects of nonlinear structural response.

**Response spectrum analysis:** An approximate method of linear dynamic analysis that computes the forces and deformations induced in a structure by earthquake shaking using a response spectrum as the representation of the ground motion.

**Retrofit:** Any modification to an existing structure intended to reduce the potential damage from flooding, erosion, high winds, earthquakes, or other hazards.

**Return period:** The average time interval, in years, that can be expected between repeat occurrences of similar extreme events such as earthquakes, floods, snow, and ice accumulations.

**Rigid diaphragm:** A floor, roof, or horizontal bracing system that deflects substantially less than the vertical frames or walls it connects when subjected to lateral forces.

**Risk category:** A categorization of buildings and other structures based on their intended use and the risk that structural failure would pose to the public.

**Risk-targeted maximum considered earthquake (MCE<sub>R</sub>):** The most severe earthquake shaking level considered by the building code and adjusted to produce a minimum acceptable risk of collapse for structures meeting the building code requirements.

## S

**Seismic design category (SDC):** A categorization of buildings and other structures based on consideration of the intended use and the seismicity of the site.

**Seismic force-resisting system (SFRS):** The part of a structural system designed to provide required resistance to prescribed seismic forces.

**Seismic hazard analysis:** A mathematical analysis used to determine the probability of exceedance for a ground motion parameter as a function of the amplitude of the parameter.

**Seismic hazard map:** A map showing contours of the ground motion acceleration parameters expected across a geographic region within a defined return period or probability of exceedance; in the United States, these maps are produced by the U.S. Geological Survey.

**Seismic isolation:** A protective system that reduces a structures response with the use of specially designed bearings, often placed at the base of a structure, that lengthen the period of the structure and increase its damping.

**Seismic qualification:** A process of certifying the adequacy of certain nonstructural components to resist specified levels of shaking and remain functional.

**Seismic risk:** A measure of the severity of the possible losses associated with the behavior of a building or structure in likely earthquakes.

**Single degree of freedom structure (SDOF):** A type of idealized, simple planar structure consisting of a single, concentrated mass and single supporting structural element.

**Shallow foundations:** Individual spread footings or mats.

**Shear:** A force that acts by attempting to cause the fibers or planes of an object to slide over one another.

**Shear wave velocity:** The speed with which shear waves will travel through an elastic or inelastic medium, such as the soils underlying a site.

**Site class:** A designation of the earthquake response of a site related to its shear wave velocity.

**Site-specific spectra:** A characterization of maximum considered earthquake or design earthquake shaking derived using either seismic hazard analysis, site response analysis, or a combination of these.

**Soft story:** A story in a structure with a soft-story irregularity that has substantially less stiffness than adjacent stories.

**Static load:** A force that remains constant with time.

**Stiffness:** A quantitative measure of the amount of force required to produce a unit amount of deflection or displacement in a structure.

**Stiffness-soft story irregularity:** A type of vertical irregularity in which one story of a structure has substantially less stiffness than adjacent stories.

**Story drift:** The difference in peak lateral displacement from the at-rest position of the center of mass of the diaphragm levels immediately above and below a story.

**Story drift ratio:** The ratio of drift in a story to the story height.

**Strain:** Deformation of a material per unit of the original dimension.

**Strength:** The capability of a material or structural member to resist or withstand applied forces.

**Stress:** Applied load per unit area or the internal resistance of a material to deformation forces.

**Strong motion recording:** A record of the acceleration, velocity, or displacement experienced by an instrument subjected to ground shaking, or the response of a structure to such shaking.

**Soft story irregularity:** A type of vertical structural irregularity.

**Special system:** A structural system that is designed to provide high levels of ductility and toughness.

**Spectral acceleration:** The maximum acceleration that a structure having a specific natural period of vibration would experience when subjected to a particular earthquake.

**Spread footing:** A type of foundation in which individual reinforced concrete slabs are placed beneath individual building columns (or sometimes closely spaced groups of columns) to transfer the weight supported by the column(s) to the underlying soil.

**Structural element:** A piece of a structure that is used to both support the weight of the structure and that of its supported contents and attachments and resist various types of environmental loads including earthquakes and wind.

**Structural steel:** An alloy of iron, carbon, and other elements that has been formed by a hot rolling process into either flat plates or shaped elements for use in construction.

**System:** An assembly of components or elements designed to perform a specific function (e.g., a structural system or a force-resisting system).

## T

**Tilt-up:** See *concrete tilt-up building*.

**Torsion:** Structural behavior associated with twisting about a vertical axis for structures or a longitudinal axis for individual structural elements.

**Torsional irregularity:** A type of horizontal irregularity caused by an arrangement of vertical elements of the seismic force-resisting system that is not placed symmetrically with respect to the center of mass of the structure.

**Toughness:** A structural property that relates to the ability of a structural element to sustain damage when overloaded while continuing to carry load without failure.

**Transient deformation:** Deformation (movement) of the ground or a structure supported on the ground that occurs during an earthquake event.

**Tsunami:** A naturally occurring, series of very long period ocean waves, sometimes having amplitudes of 10 or more feet, resulting from a rapid, large-scale disturbance in a body of water, caused by earthquakes, landslides, volcanic eruptions, or meteorite impacts.

## U

**Unreinforced masonry (URM):** Masonry construction that does not include sufficient steel reinforcement to be classified as reinforced masonry; also referred to as *plain masonry*.

## V

**Vertical bearing support:** The mechanism by which the weight of a structure and its supported contents is transferred to and resisted by the ground.

**Vertical force:** A force that acts vertically; vertical earthquake forces represent the effects of vertical accelerations experienced in an earthquake.

**Vertical geometric irregularity:** This occurs where the width, in plan, of the seismic force-resisting system is more than 130% larger in one or more stories than it is in adjacent stories.

## W

**Wall system:** A structural system in which masonry, concrete, light wood frame or cold formed steel frame walls provide lateral resistance to wind and earthquake forces.

**Weak story irregularity:** A type of vertical structural irregularity that occurs when the strength of the walls or frames that provide lateral resistance in one story is substantially less than that of the walls or frames in the adjacent stories.

**Wood frame:** A form of construction in which repetitive, closely spaced wood members are used to carry structural loads.

---

# References

- Aagaard, B.T., Blair, J.L., Boatwright, J., Garcia, S.H., Harris, R.A., Michael, A.J., Schwartz, D.P., and DiLeo, J.S., 2016, "Earthquake outlook for the San Francisco Bay region 2014–2043", U.S. *Geological Survey Fact Sheet 2016–3020*.
- Ager, P., Eriksson, K., Hansen, C.W., and Lønstrup, L., 2019, *How the 1906 San Francisco Earthquake Shaped Economic Activity in the American West*, NBER Working Paper No. 25727, National Bureau of Economic Research, Cambridge, Massachusetts.
- Allen, E., 1985, *Fundamentals of Building Construction and Methods*, John Wiley and Sons, New York.
- ASCE, 2017, *Seismic Evaluation and Retrofit of Existing Buildings*, ASCE/SEI 41-17, American Society of Civil Engineers, Structural Engineering Institute, Reston, Virginia.
- ASCE, 2022, *Minimum Design Loads for Buildings and Other Structures*, ASCE/SEI 7-22, American Society of Civil Engineers, Structural Engineering Institute, Reston, Virginia.
- FEMA, 2006, *Homebuilders' Guide to Earthquake Resistant Design and Construction*, FEMA 232, prepared by National Institute of Building Sciences Building Seismic Safety Council for the Federal Emergency Management Agency, Washington, D.C.
- FEMA, 2010, *Earthquake-Resistant Design Concepts: An Introduction to the NEHRP Recommended Seismic Provisions for New Buildings and Other Structures*, prepared by the National Institute of Building Sciences Building Seismic Safety Council for the Federal Emergency Management Agency, Washington, D.C.
- FEMA, 2011, *Reducing the Risks of Nonstructural Earthquake Damage – A Practical Guide*, FEMA E-74, prepared by the Applied Technology Council for the Federal Emergency Management Agency, Washington, D.C.
- FEMA, 2015, *Rapid Visual Screening of Buildings for Potential Seismic Hazards: A Handbook, Third Edition*, FEMA P-154, prepared by the Applied Technology Council for the Federal Emergency Management Agency, Washington, D.C.
- FEMA, 2018a, *Example Application Guide for ASCE/SEI 41-13 Seismic Evaluation and Retrofit of Existing Buildings*, FEMA P-2006, prepared by the Applied Technology Council for the Federal Emergency Management Agency, Washington, D.C.
- FEMA, 2018b, *Seismic Performance Assessment of Buildings, Methodology and Implementation*, FEMA P-58 Series, prepared by the Applied Technology Council for the Federal Emergency Management Agency, Washington, D.C, <https://femap58.atcouncil.org/>.

FEMA, 2019, *Guidelines for Design of Structures for Vertical Evacuation from Tsunamis*, FEMA P-646, prepared by the Applied Technology Council for the Federal Emergency Management Agency, Washington, D.C.

FEMA, 2020a, *Earthquake Safety at Home*, FEMA P-530, prepared by the Applied Technology Council for the Federal Emergency Management Agency, Washington, D.C.

FEMA, 2020b, *Building Codes Save: A Nationwide Study*, prepared by Compass PTS JV for the Federal Emergency Management Agency, Washington, D.C.

FEMA, 2020c, *NEHRP Recommended Seismic Provisions for New Buildings and Other Structures, Volume I: Part 1 Provisions, Part 2 Commentary*, FEMA-2082-1, prepared by National Institute of Building Sciences Building Seismic Safety Council for the Federal Emergency Management Agency, Washington, D.C.

FEMA, 2020d, *NEHRP Recommended Seismic Provisions for New Buildings and Other Structures, Volume II: Part 3 Resource Papers*, FEMA-2082-2, prepared by National Institute of Building Sciences Building Seismic Safety Council for the Federal Emergency Management Agency, Washington, D.C.

FEMA, 2020e, *A Practical Guide to Soil-Structure Interaction*, FEMA P-2091, prepared by National Institute of Building Sciences Building Seismic Safety Council for the Federal Emergency Management Agency, Washington, D.C.

FEMA, 2021a, *Recommended Options for Improving the Built Environment for Post-Earthquake Reoccupancy and Functional Recovery Time*, FEMA P-2090/NIST SP-1254, prepared by the Applied Technology Council for the Federal Emergency Management Agency, Washington, D.C.

FEMA, 2021b, *The Role of the NEHRP Recommended Seismic Provisions in the Development of Nationwide Seismic Building Code Regulations: A Thirty-Five Year Retrospective*, FEMA P-2156, prepared by the National Institute of Building Sciences Building Seismic Safety Council for the Federal Emergency Management Agency, Washington, D.C.

ICC, 2020, *2021 International Building Code*, International Code Council, Inc., Country Club Hills, Illinois, <https://codes.iccsafe.org/content/IBC2021P2>.

ICC, 2020, *2021 International Existing Buildings Code*, International Code Council, Inc., Country Club Hills, Illinois, <https://codes.iccsafe.org/content/IEBC2021P2>.

ICC, 2020, *2021 International Residential Code*, International Code Council, Inc., Country Club Hills, Illinois, <https://codes.iccsafe.org/content/IRC2021P2>.



- Jones, D., "20 years after Northridge, are homeowners ready for a quake?" *Los Angeles Times*, Los Angeles, California, <https://www.latimes.com/opinion/la-xpm-2014-jan-17-la-oe-ones-northridge-quake-insurance-20140117-story.html>, accessed September 24, 2022.
- Lagorio, H., Friedman, H., and Wong, K., 1986, *Issues for Seismic Strengthening of Existing Buildings: A Practical Guide for Architects*, Center for Environmental Design, University of California at Berkeley, California.
- National Archives, 1906, *Photograph of St. Francis Hotel Showing the Clean Sweep of Fire in the Business Section of All Except Class A Steel Frame Buildings After the 1906 San Francisco Earthquake*, National Archives and Records Administration, College Park, Maryland, <https://catalog.archives.gov/id/2127289>, accessed September 24, 2022.
- NIST, 2014, *Seismic Design of Wood Light-Frame Structural Diaphragm Systems: A Guide for Practicing Engineers*, NIST GCR 14-917-32, prepared by the NEHRP Consultants Joint Venture, a partnership of the Applied Technology Council and the Consortium of Universities for Research in Earthquake Engineering for the National Institute of Standards and Technology, Gaithersburg, Maryland.
- NOAA, 2021, *On this Day: 2011 Tohoku Earthquake and Tsunami*, National Oceanic and Atmospheric Administration, Washington, D.C., <https://www.ncei.noaa.gov/news/day-2011-japan-earthquake-and-tsunami>, published March 11, 2021.
- NOAA, 2022, *Aerial of Sukuiso, Japan*, Natural Hazards Image Database, National Oceanic and Atmospheric Administration, Washington, D.C., <https://www.ngdc.noaa.gov/hazardimages/#/all/256/image/1482>, accessed September 24, 2022.
- PEER/ATC, 2010, *Modeling and Acceptance Criteria for Seismic Design and Analysis of Tall Buildings*, PEER/ATC 72-1, prepared by the Applied Technology Council for the Pacific Earthquake Engineering Research Center, Berkeley, California.
- Petak, W., and Elahi, S., 2001, *The Northridge Earthquake, USA, and its Economic and Social Impacts*, <http://resilience.abag.ca.gov/wp-content/documents/resilience/toolkit/The%20Northridge%20Earthquake%20and%20its%20Economic%20and%20Social%20Impacts.pdf>, accessed April 5, 2020.
- Petersen, M.D., Moschetti, M.P., Powers, P.M., Mueller, C.S., Haller, K.M., Frankel, A.D., Zeng, Y., Rezaeian, S., Harmsen, S.C., Boyd, O.S., Field, E.H., Chen, R., Rukstales, K.S., Luco, N., Wheeler, R.L., Williams, R.A., and Olsen, A.H., 2014, *Documentation for the 2014 Update of the United States National Seismic Hazard Maps*, U.S. Geological Survey Open-File Report 2014-1091, <https://dx.doi.org/10.3133/ofr20141091>.
- ReliefWeb, 2022, *South Asia: Earthquake and Tsunami - Dec 2004*, <https://reliefweb.int/disaster/ts-2004-000147-idn>, accessed September 24, 2022.

Renlund, M., 2008, *Base Isolators under the Utah State Capitol*, used under CC BY 2.0.

UGS, 2020, *2020 Magna Earthquake*, Utah Geological Survey, Salt Lake City, Utah, <https://earthquakes.utah.gov/magna-quake/>, accessed September 24, 2022.

USGS, 2014, "2014 South Napa CA M6 Earthquake - August 24," U.S. Geological Survey, Reston, Virginia, <https://www.usgs.gov/media/images/2014-south-napa-ca-m6-earthquake-august-24-5>, published August 23, 2014.

USGS, 2022a, *Cool Earthquake Facts*, U.S. Geological Survey, Reston, Virginia, from <https://www.usgs.gov/natural-hazards/earthquake-hazards/science/cool-earthquake-facts>, accessed September 24, 2022.

USGS, 2022b, *Latest Earthquakes*, U.S. Geological Survey, Reston, Virginia, <https://earthquake.usgs.gov/earthquakes/map>, accessed September 24, 2022.

USGS, 2022c, *The Modified Mercalli Intensity Scale*, U.S. Geological Survey, Reston, Virginia, <https://www.usgs.gov/programs/earthquake-hazards/modified-mercalli-intensity-scale>, accessed September 24, 2022.

USGS, 2022d, *Seismic Design Ground Motions*, U.S. Geological Survey, Reston, Virginia, <https://doi.org/10.5066/f7nk3c76>, accessed September 24, 2022.

Yeats, B., 2012, *High School Running Track in Taiwan Crossed by the Chelungpu Fault in an Earthquake in September 1999*, used under CC BY 2.0.

---

# Project Participants

## Second Edition Project Team

### Federal Emergency Management Agency

Mike Mahoney (Project Officer)  
Federal Emergency Management Agency  
400 C Street, SW  
Washington, D.C. 20472

Pataya Scott (Project Monitor)  
Federal Emergency Management Agency  
400 C Street, SW  
Washington, D.C. 20472

### Applied Technology Council

Jon A. Heintz (Project Executive, Program  
Manager)  
Applied Technology Council  
201 Redwood Shores Parkway, Suite 240  
Redwood City, California 94065

Chiara McKenney (Project Manager)  
Applied Technology Council  
201 Redwood Shores Parkway, Suite 240  
Redwood City, California 94065

Ayse Hortacsu (Project Manager)  
Applied Technology Council  
201 Redwood Shores Parkway, Suite 240  
Redwood City, California 94065

### Project Technical Committee

Ronald O. Hamburger (Project Technical Director)  
Simpson Gumpertz & Heger, Inc.  
999 Harrison St, Suite 2400  
Oakland, CA 94612

### Project Review Panel

David Bonneville  
Degenkolb Engineers  
375 Beale St #500  
San Francisco, California 94105

John Hooper  
Magnusson Klemencic Associates  
1301 Fifth Avenue, Suite 3200  
Seattle, Washington 98101

Michael J. Griffin  
CCS Group, Inc.  
1415 Elbridge Payne Rd, Suite 265  
Chesterfield, Missouri 63017

## Focus Group

Christina Aronson  
Federal Emergency Management Agency  
400 C Street, SW  
Washington, D.C. 20472

Sung Yeob Lim  
Uzun+Case, LLC  
1230 Peachtree Street NE, Suite 2500  
Atlanta, Georgia 30309

Alex Griffin  
Burns & McDonnell  
425 S Woods Mill Rd #300  
Chesterfield, Missouri 63017

Ginevra Rojahn  
Applied Technology Council  
201 Redwood Shores Parkway, Suite 240  
Redwood City, California 94065

Solmaz Jumakuliyeva  
Estructure  
1144 65th St, Suite A  
Oakland, California 94608

Kayla Secrest  
Wallace Design Collective  
123 North Martin Luther King Jr. Boulevard  
Tulsa, Oklahoma 74103

## First Edition Project Team

### Federal Emergency Management Agency

Mike Mahoney (Project Officer)  
Federal Emergency Management Agency

### National Institute of Building Sciences Building Seismic Safety Council

Ronald O. Hamburger (Project Technical Director)  
Simpson Gumpertz & Heger, Inc.





**FEMA**

FEMA P-749